

73[®]

Amateur Radio's Technical Journal

A Wayne Green Publication

**Home-Brew
Contest Winner:
"Smart" Squelch**
Page 44

**Poor Man's
Spectrum
Analyzer**
Page 10

The Ultimate Fuse
Page 52

Trek to Tibet
Page 32

**\$100 TVRO
Receiver**
Page 60

**Confessions
of a Counter
Evolutionary**
Page 100

**Poor Man's
Spectrum Analyzer**
—another 73 breakthrough
..... WB5IPM 10

The AC4YN Story
—a Tibetan adventure,
circa 1936-1937..... G5YN 32

"Smart" Squelch for SSB
..... W9MKV, W9YAN 44

The Ultimate Fuse
—ac overload protection
..... W2OLU 52

**Multi-Purpose
Peak Adapter**
—don't settle for being
average..... K9EUI 54



TVRO Receiver—60

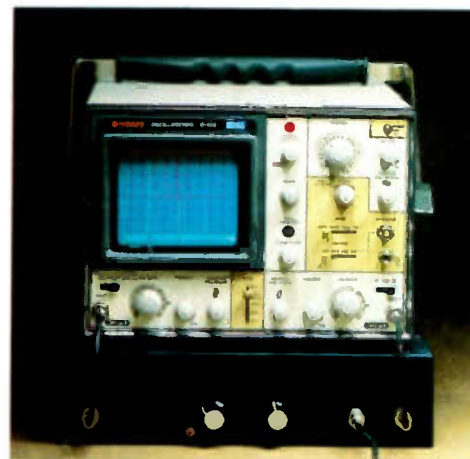

Spectrum Analyzer—10

The \$100 TVRO Receiver
 —Satellite Central,
part VIII..... Gibson 60

**VUM:
Volume Units Meter**
—makes measuring decibels
easy..... W4MLE 72

Analog Isn't Dead
—don't be LED astray by the
digital revolution... WB6AFN/9 76

Line Voltage at a Glance
—at last, a useful gadget
..... W4RNL 84

**Confessions of a
Counter Evolutionary**
—the best circuit yet?
..... WA2FPT 100

Never Say Die—6
Social Events—92
Ham Help—97, 122, 139
Reader Service—114
Fun!—116
Letters—117
Contests—119
New Products—126
DX—128
Review—130
Awards—133
Corrections—135
Satellites—138
Dealer
Directory—162
Propagation—162



0

ICOM Handhelds

2 Meter, 220 or 440 MHz

ICOM's reliable, field proven, handhelds have been the most popular handheld on the market. Here's a few reasons why:

THE TRANSCIVERS. The IC-2AT features full coverage of the 2 meter ham band. The IC-3AT covers 220 to 224.99 MHz, and the IC-4AT has 440 to 449.995 MHz. Each radio is only 2.6in x 1.4in x 6.5in in size. Excellent audio quality is provided by a quality speaker and an electret condenser microphone. All have battery saving 0.15 watt low power. Touchtone® pad is included.*

STANDARD EQUIPMENT. Each transceiver comes complete — ready to use — with BP3 rechargeable battery, AC wall charger, flexible antenna, earphone, wrist strap, and belt clip...all standard.

THE SYSTEM. Accessories for the handheld series are interchangeable among transceivers. Slide on removable battery packs allow quick changing of batteries. Batteries may be charged while removed from the transceiver.

Service manuals for IC-2AT now available. 3AT and 4AT available soon.

IC-3AT
220 MHz

IC-4AT
440 MHz

IC-2AT
2 meter

Leather Case
Available with or without cut out for Touchtone® pad.

IC-HM9
Speaker Mic

IC-BC30
Battery Charger
117 VAC (Battery Determines Charge Rate)

IC-BP5**
Battery Pack
10.8 VDC, 425 mA
1.5 hr charge

IC-ML1 12 VDC
144 MHz Booster
10W out/12 VDC
(comes with 5ft coax, BNC to PL-259)

IC-BP4** ††
Battery Case

IC-BP3†
Battery Pack
8.4VDC 250 mA
15 hr. charge

IC-CPI
Cigarette Lighter
Cord w/ Fuse
(charges BP3/ powers DC1)

IC-BP2**
Battery Pack
7.2 VDC 425 mA
1.5 hr charge

IC-BC25U
AC Wall Charger
117 VAC in
(for charging BP3 only)



ICOM

The World System

Battery Pack	Nominal Transceiver Power (watts)
BP2	1.0
BP3	1.5
BP5	2.3

IC-DC1
DC Regulator
12 VDC in/
9.6 VDC out
(comes with DC cord — will not get power from BC30)

* Also available without Touchtone® Pad
** Requires BC 30 Charger
† Will charge from BC30, BC25U, CPI, or 12 VDC Direct (pack is internally regulated)
†† Accepts 6 AA size batteries - Alkaline or NiCd (Do not attempt to charge Alkaline batteries)

5-STORE BUYING POWER *in action!*

YAESU HAND HELD's



2 METER
FM

CALL FOR
SPECIAL
PRICES

70CM
FM

FT-208R

FT-708R

ETD ALPHA



ALL ALPHA AMPLIFIERS ARE
IN STOCK FOR FAST DELIVERY
CALL FOR SPECIAL PRICES

MIRAGE B-1016 2 METER AMPLIFIER



160W OUTPUT,
SSB, FM, CW.

Freq. range: 14.4-14.8MHz • RF out: 160W nom.
(10W in) • RF power in: 5-15W • DC operating
pwr: 13.8VDC @ 20-25A • Intermittent duty
cycle • Built-in receiver pre-amp. Auto-
matic internal or external relay keying.

REGULAR
\$279.95 **\$249.95**

KLM/TRI-EX

KLM KT-34A

4 element tri-bander

Regular \$389.95 *Sale* **\$309**

KLM KT-34XA

6 element tri-bander

Regular \$569.95 *Sale* **\$469**

KLM 7.2-1 40M rotatable dipole.
Regular \$199.95 Special \$159.00

KLM 7.2-2 40M, 2 element beam.
Regular \$349.95 Special \$299.00

KLM 7.2-3 40M, 3 element beam.
Regular \$529.95 Special \$449.00

KLM 7.0-7.3 4A 40M, 4 element beam.
Regular \$749.95 Special \$629.00

144-148-13LB. 2M, 13 el. long boom.
Regular \$89.95 Special \$77.95

432-16LB 432MHz, 16 el. long boom.
Regular \$74.95 Special \$60.70

144-150-16C. 2M, 16 el. Cir pol.
Regular \$116.95 Special \$93.55

420-450-18C 435 MHz 18 el. Cir pol.
Regular \$69.95 Special \$58.70

TRI-EX W51, 51 foot tower.
Regular \$999.95 Special \$829.95

COMBO DEALS

W51 TOWER w/ KT-34A
\$1099

W51 TOWER w/ KT-34XA
\$1239

PRICES ARE FOB CALIFORNIA.
FREIGHT IS NORMALLY EXTRA
ON ANTENNAS & TOWERS
except for certain combinations. Please inquire.

KENWOOD BIG FIVE

Cash in on our 5-store buying
power. Most items in stock
for fast delivery.

CALL NOW!



TS-930S



TS-130S



TR-2500

TR-7730



TS-830S

ALL LISTED ANTENNAS/TOWERS IN STOCK...no wait.

WE'LL MATCH OR BEAT ANY LEGITIMATE KLM/TRI-EX PRICE!

SERVING HAMS
BETTER.

North...south...east...west.

Bob Ferrero, W6RJ/K6AHV,
Jim Rafferty, N6RJ
other well known hams
give you courteous,
personalized
service.



FREE
PHONE **800 854-6046**

9:30AM to 5:30PM PACIFIC TIME.

OVER-THE-COUNTER, 10AM to 5:30PM.

MONDAY THROUGH SATURDAY

CALIFORNIA CUSTOMERS PLEASE PHONE OR VISIT LISTED STORES

FREE SHIPMENT (U.P.S. Brown)
CONTINENTAL U.S.A.

ANAHEIM, CA 92801

2620 W. La Palma,
(714) 761-3033 (213) 860-2040
Between Disneyland & Knott's Berry Farm

BURLINGAME, CA 94010

999 Howard Ave., (415) 342-5757
5 miles south on 101 from S.F. Airport.

OAKLAND, CA 94609

2811 Telegraph Ave., (415) 451-5757
Hwy 24 Downtown. Left 27th off-ramp.

SAN DIEGO, CA 92123

5375 Kearny Villa Road (714) 560-4900
Hwy 163 & Clairemont Mesa Blvd.

VAN NUYS, CA 91401

6265/ Sepulveda Blvd., (213) 988-2212
San Diego Fwy at Victory Blvd.

AEA • ALLIANCE • ALPHA • AMECO • AMPHENOL • ARRL • ASTRON
• AVANTI • BENCHER • BERK • TEK • BIRO • B&W • CALLBOOK • CDE
• COLLINS • CUBIC • CURTIS • CUSCRAFT • DAIWA • DATONG

• DENTRON • DRAKE • DX ENGINEERING • EIMAC • MUSTLER
• HY-GAIN • ICOM • J.W. MILLER • KENWOOD • KLM • LARSEN
• LUNAR • METZ • MFJ • MICRO • LOG • MINI • PRODUCTS

• MIRAGE • NYE • PALOMAR • ROBOT • ROHN • SHURE • SWAN
• TELEX • TELREX • TEMPO • TEN-TEC • TRISTAO
• YAESU and many more!

Prices, specifications, descriptions subject to change without notice. Calif. residents please add sales tax.



INFO

Manuscripts

Contributions in the form of manuscripts with drawings and/or photographs are welcome and will be considered for possible publication. We can assume no responsibility for loss or damage to any material. Please enclose a stamped, self-addressed envelope with each submission. Payment for the use of any unsolicited material will be made upon acceptance. All contributions should be directed to the 73 editorial offices. "How to Write for 73" guidelines are available upon request.

Editorial Offices:

Pine Street
Peterborough NH 03458
Phone: 603-924-9471

Advertising Offices:

Elm Street
Peterborough NH 03458
Phone: 603-924-7138

Circulation Offices:

Elm Street
Peterborough NH 03458
Phone: 603-924-9471

Subscription Rates

In the United States and Possessions:
One Year (12 Issues) \$25.00
Two Years (24 Issues) \$38.00
Three Years (36 Issues) \$53.00

Elsewhere:

Canada—\$27.97/1 year only, U.S. funds. Foreign surface mail—\$44.97/1 year only, U.S. funds drawn on U.S. bank. Foreign air mail—please inquire.

To subscribe, renew or change an address:

Write to 73 Magazine, Subscription Department, PO Box 931, Farmingdale NY 11737. For renewals and changes of address, include the address label from your most recent issue of 73. For gift subscriptions, include your name and address as well as those of gift recipients. Postmaster: Send form #3579 to 73 Magazine, Subscription Services, P.O. Box 931, Farmingdale, NY 11737.

Subscription problem or question:

Write to 73 Magazine, Subscription Department, PO Box 931, Farmingdale NY 11737. Please include an address label.

73 Magazine (ISSN 0098-9010) is published monthly by 73, Inc., a subsidiary of Wayne Green, Inc., 80 Pine Street, Peterborough NH 03458. Second class postage paid at Peterborough NH 03458 and at additional mailing offices. Entire contents copyright 1982, Wayne Green, Inc. All rights reserved. No part of this publication may be reprinted or otherwise reproduced without written permission from the publisher. Microfilm Edition—University Microfilm, Ann Arbor MI 48106.

look here

1-713-658-0268

SANTEC ST 144 μ p	\$299.00
New AEA MBARC	399.00
AEA MBA-RO	269.00
MBA-RC	399.00
MM 2	125.00
CK 2	89.00
Demo Kenwood TS530S	600.00
New FT1012D/3	749.00
JWL 2 meter square horizontal mobile antenna	29.95
ICOM IC260A	379.00
IC290	429.00
IC720A/AC	1298.00
IC25A	309.00
IC251A	589.00
IC3AT/IC4AT	269.00 ea.
IC 22U	250.00
FT208R/FT708R	289.00 ea.
FRG7700	449.00
FT707	649.00
Robot 800A	749.00
Robot 400	675.00
Belden 8214 RG8 foam	36¢/ft.
8267 RG213	43¢/ft.
9405 heavyduty rotor cable	45¢/ft.
9258 RG8X	19¢/ft.
Drake TR5	699.00
TR7A	1450.00
R7A	1400.00
KLM KT34XA	469.00
KT34A	309.00
Kantronics Minireader	249.00
Microrrty	249.00
Butternut HF6V	125.00
Saxton 450ohm openwire ladderline	20¢/ft.
high s/n ALPHA PA78	2795.00
Kenwood TS 660	599.00
RG214 nonmil copperbraided	70¢/ft.
Dowkey coaxrelay	99.95
RCA 40673	1.95
Hal interface	159.00
CT 2100	699.00
KB2100	169.00
Hamssoft	Call
Astro 103	1095.00
Astro 150A	849.00
Mallory 2.5A/1000PIV	19¢ ea.
W6TOG Kits	STOCK
Bird (Stock)	STOCK
Collins Accessories	Stock
all items guaranteed	
Used Clean Corner	
Round Emblem Collins	Call
KWM2	800.00
75S3B	600.00
75S3C	700.00
32S3	600.00
516F2	200.00

Complete Mechanical/Electrical
Checkout Before Shipment

MASTERCARD VISA

All prices for Houston except where indicated. Prices subject to change without notice, all items guaranteed. Some items subject prior sale. Texas residents add 6% tax. Please add sufficient postage, balance collect.

MADISON

Electronics Supply

1508 McKinney \checkmark 45
Houston, Texas 77010

Loop Antenna

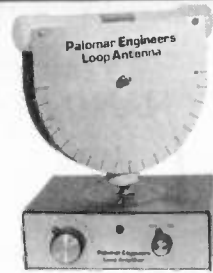

Here is an exciting new device to improve your reception on 160, 80, the broadcast band, and on VLF.

It is well known that loops pick up far less noise than most other antennas. And they can null out interference. Now Palomar Engineers brings you these features and more in a compact, carefully engineered, attractive desktop package.

Unlike ordinary direction-finder loops, it tilts to match the incoming wave front. The result: Deep nulls up to 70 db. You have to listen to believe it!

Does local noise on 160 give you a headache? The loop practically eliminates it. Broadcast station 2nd harmonic ruining your DX? Turn and tilt the loop and it's gone. Does your friend in the next block with his kilowatt block those weak ones? Use the loop and hear him fade out.

Loop nulls are very sharp on local and ground wave signals but usually are broad or nonexistent on distant skywave signals. This allows local interference to be eliminated while DX stations can still be heard from all directions.

The loops are Litz-wire wound on RF ferrite rods. They plug into the Loop Amplifier which boosts the loop signal 20 db and isolates and preserves the high Q of the loop. The tuning control peaks the loop and gives extra preselection to your receiver.

Plug-in loops are available for these bands:

- 10-40 KHz (Omega)
- 40-150 KHz (WWVB, Loran)
- 150-550 KHz (VLF)
- 540-1600 KHz (Broadcast)
- 1600-5000 KHz (160 & 80 meters)
- 5-15 MHz (HF-1)

Free catalog on request.



Loop Amplifier \$77.50; Plug-in Loop Antennas \$59.95 each (specify frequency band). To order add \$3 packing/shipping. California residents add sales tax.

Palomar Engineers

1924-F W. Mission Rd., Escondido, CA 92025
Phone: (714) 747-3343

The Memory Keyer that started a revolution in CW

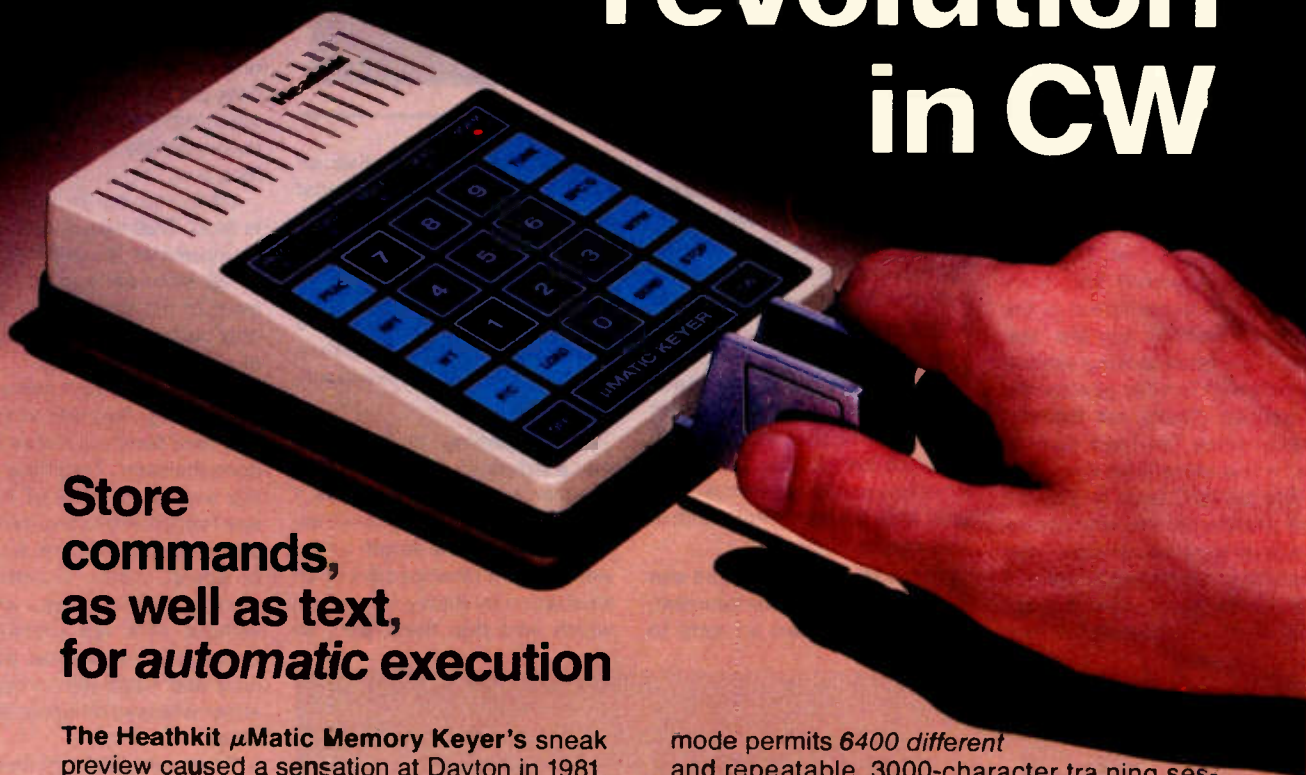

**Store
commands,
as well as text,
for automatic execution**

The Heathkit μ Matic Memory Keyer's sneak preview caused a sensation at Dayton in 1981, and the excitement is still running high. Ask about it on the air. Those who own one will tell you it revolutionized their operating practices, eased their hand fatigue, multiplied QSOs – and increased the number of incoming QSLs. In contest, you can prove it's the best every time.

Inside, a custom microprocessor stores up to 240 characters of text or commands. Variable-length buffers eliminate wasted memory space. Command strings let you sequence speed, weight and repetition alterations or text in any order you desire. Choose the speed (1-99), any of 11 weight settings, plus spacing and message repeat count, then sit back and collect contacts...

Capacitive-touch iambic paddles unplug and store inside the keyer when not in use. Left handed? A two-key function will reverse the paddles! Or a socket will connect to your favorite keyer. To boost copy, a 4-level random 'practice'

mode permits 6400 different and repeatable, 3000-character training sessions at any speed you like.

Other features include a built-in sidetone oscillator and speaker with volume/tone controls, phone jack and earphone, message editing, entry error alarm, self-diagnostics, battery backup and a unique auto-shutoff should you forget. Complete details on the revolutionary μ Matic Memory Keyer are in the new Heathkit Catalog and at your nearby Heathkit Electronic Center.*



Send for a free catalog! Write:
Heath Company, Dept. 011-924
Benton Harbor, MI 49022

In Canada, contact Heath Company,
1480 Dundas Street E., Mississauga, ONT L4X 2R7

Visit your Heathkit Store



Where Heathkit products are displayed, sold and serviced.

See your telephone white pages for locations.

*Units of Veritechnology Electronics Corporation in the U.S.

Heathkit®

W2NSD/1 NEVER SAY DIE

editorial by Wayne Green



THE WORLD'S FAIR— KNOXVILLE

Yes, there is a ham exhibit at the new World's Fair. The local hams got together and managed to get some space in the Knoxville exhibit for the station. It's a good looking exhibit, packed with Ten-Tec gear for the most part. That's not too surprising since Ten-Tec's plant is just a few miles from Knoxville.

The fair isn't large by World's Fair standards. I've only seen a few such fairs, so perhaps I was expecting too much. I am old enough to have spent a good deal of time wandering the New

York fair in 1938, watching the early television programs being produced. They had iconoscope cameras in those days, so the lights had to be fierce compared with the later developed image orthocons, which were far more sensitive (and expensive).

They had a lot of entertainment exhibits at that fair. I didn't see much of that at Knoxville. Here the exhibits are almost entirely international and national, with little from our major industrial corporations.

At the Montreal fair, there was a good deal of entertainment, but the lines were so long to

watch it that many were discouraged. I know I had to miss most of the highly touted shows because I didn't have a day apiece to devote to line standing. Fortunately, most of the ones that I had to miss at Montreal turned up when San Antonio had their World's Fair, so I eventually saw them.

I'm beginning to recognize that a successful fair means hot weather and long, long lines. I think the line for the Chinese exhibit is almost the length of the whole fair! It reminded me of an illustration by Ripley for an item which said that there were so

many Chinese that a column of them four wide could parade by night and day forever, with the newly born keeping up with the pace of the line. The line at the fair seemed endless. Most of the more interesting exhibits had lines, but none compared with the Chinese.

It appears that Knoxville has gotten a bum rap from some of the media. I was there in late May and found little problem in getting hotel accommodations. Even when I went on Sunday to the fair, I was able to park within one block of the fair gate. They have parking lots all around the outskirts of town where you can leave your car and be commuted by a bus.

Of course, my favorite subject is food. That was one of my big memories of the New York fair of '38. Montreal was a bust, with most of the food stands selling only buffalo burgers—which are okay, but not exciting.

At San Antonio, I had a great time eating. They had all sorts of fast food services. Knoxville has done the same. They have one of the widest varieties of food of any fair yet. Have you ever seen a cobbler stand? Yep, a choice of apple, cherry, blueberry, or mixed fruit cobbler, with or without soft ice cream. You could also get Belgian waffles, nice and fresh and crisp, with either whipped cream or soft ice cream.

There are plenty of repeaters around Knoxville, so if you decide to drive to the fair you won't have any problem getting talked in. I called in on 146.73 and got route instructions—first to the Knoxville hamfest, then to the fair. No problem getting help.

If you're within driving distance of Knoxville, I'd say it's worth your while to plan on getting down there (or up) this summer. Be sure to check in at the ham exhibit and log in. If you flash your ham license, they'll let you sit down and do some contest-type operating. It seems that World's Fair stations are reasonably rare, so there are pileups for everyone. It's a lot easier than getting down to Swaziland or something. And you can get a taste of quite a bunch of foreign countries by visiting their exhibits.

Speaking of the Knoxville hamfest, while I didn't see anyone there from *Ham Radio* magazine, I did catch a glimpse



Three of the landmark structures of The 1982 World's Fair in Knoxville, Tennessee, form around the three-acre Waters of the World Lake. At left is the Sunsphere, 266 feet high and the "theme structure" of the exposition. The five-level sphere, encased in glass made of 24-karat gold dust, houses a restaurant and two cocktail lounges and observation areas. In the right foreground is the 1,500-seat Tennessee State Amphitheatre. The United States pavilion (at far right) features "talk-back computers," a "national energy debate" utilizing television screens and a new IMAX film, to be shown on a screen seven stories high and 90 feet wide. Downtown Knoxville forms the background at left. (Photo by Mike DuBose)

Power up.



40 W, 15 memories/offset recall, scan, priority, DTMF touch-pad

TR-7850

Kenwood's remarkable TR-7850 2-meter FM mobile transceiver provides all the features you could desire, including a powerful 40 watts RF output. Frequency selection is easier than ever, and the rig incorporates new memory developments for repeater shift, priority, and scan, and includes a built-in autopatch touch-pad (DTMF) encoder. A 25-watt output version, the TR-7800, is also available.

TR-7850 FEATURES:

- **Powerful 40 watts power output**
Selectable high or low power operation. High 40-watt output provides reliable signal for wide area coverage.
- **15 multifunction memory channels, easily selectable with a rotary control**
M1-M13... memorize frequency and offset (± 600 kHz or simplex). M14... memorize transmit and receive frequencies independently for nonstandard offset. M0... priority channel, with simplex, ± 600 kHz, or nonstandard offset operation.
- **Internal battery backup for all memories**
All memory channels (including transmit offset) are retained when four AA NiCd batteries (not Kenwood supplied) are installed in battery holder inside TR-7850. Batteries are automatically charged while transceiver is connected to 12-VDC source.
- **Extended frequency coverage**
143.900-148.995 MHz, in switchable 5-kHz or 10-kHz steps.

- **Priority alert**
M0 memory is priority channel. "Beep" alerts operator when signal appears on priority channel. Operation can be switched immediately to priority channel with the push of a switch.
- **Built-in autopatch touch-pad (DTMF) encoder**
Front-panel touch pad generates all 12 telephone-compatible dual tones in transmit mode, plus four additional DTMF signaling tones (with simultaneous push of REV switch).
- **Front-panel keyboard**
For frequency selection, transmit offset selection, memory programming, scan control, and selection of autopatch encoder tones.
- **Autoscan**
Entire band (5-kHz or 10-kHz steps) and memories. Automatically locks on busy channel; scan resumes automatically after several seconds, unless CLEAR or mic PTT button is pressed to cancel scan.
- **Up/down manual scan**
Entire band (5-kHz or 10-kHz steps) and memories, with UP/DOWN microphone (standard).

- **Repeater reverse switch**
Handy for checking signals on the input of a repeater or for determining if a repeater is "upside down."
- **Separate digital readouts**
To display frequency (both receive and transmit) and memory channel.
- **LED bar meter**
For monitoring received signal level and RF output.
- **LED indicators**
To show: +600 kHz, simplex, or -600 kHz transmitter offset; BUSY channel; ON AIR.
- **TONE switch**
To actuate subaudible tone module (not Kenwood-supplied).
- **Compact size**
Depth is reduced substantially.
- **Mobile mounting bracket**
With quick-release levers.

More information on the TR-7850 is available from all authorized dealers of Trio-Kenwood Communications, 1111 West Walnut Street, Compton, California 90220.

 **KENWOOD**
...pacesetter in amateur radio

Matching accessory for fixed-station operation:

- KPS-12 fixed-station power supply for TR-7850
- **Other accessories not shown:**
- KPS-7 fixed-station power supply for TR-7800
- SP-40 compact mobile speaker



Specifications and prices are subject to change without notice or obligation.

STAFF

PUBLISHER/EDITOR

Wayne Green W2NSD/1

EXECUTIVE VICE PRESIDENT

Sherry Smythe

ASSISTANT PUBLISHER/EDITOR

Jeff DeTray WB88TH

MANAGING EDITOR

John Burnett

ASST. MANAGING EDITOR

Susan Philbrick

EDITORIAL ASSISTANTS

Nancy Noyd
Richard Phenix
Steve Jewett

TECHNICAL EDITOR

Tim Danlel N8RK

ASSISTANT

TO THE PRESIDENT

Matthew Smith KA1IEI

ASSOCIATES

Robert Baker WB2GFE
John Edwards KI2U
Bill Gosney KE7C
Sanger Green
Chod Harris VP2ML
Dr. Marc Leavey WA3AJR
J. H. Nelson
Bill Pasternak WA6ITF
Peter Stark K2OAW

**PRODUCTION MANAGER/
PUBLICATIONS**

Nancy Salmon

**ASST. PRODUCTION
MANAGER/PUBLICATIONS**

Michael Murphy

**ADVERTISING GRAPHICS
MANAGERS**

Steve Baldwin
Bruce Hedlin
Jane Preston

PRODUCTION

Frances Benton
Betty Butler
Flona Davies
Linda Drew
Sandra Dukette
Denzel Dyer
Dianne Riltson
Theresa Ostebo
Scott Philbrick
Mary Seaver
Deborah Stone
Irene Vail
Judi Wimberly
David Wozmak

PHOTOGRAPHY

Bryan Hastings
John R. Schwelgert
Robert M. Villeneuve
Thomas Villeneuve

TYPESSETTING

Sara Bedell
Melody Bedell
Marie Barker
Debbie Davidson
Michele DesRochers
Jennifer Fay
Anne Rocchio
Ellen Schwartz
Karen Stewart
Lisa Steiner

GENERAL MANAGER

Debra Wetherbee

CONTROLLER

Roger J. Murphy

EXECUTIVE ASSISTANT

Leatrice O'Neill

ACCOUNTING MANAGER

Knud Keller KV4GG/1

CIRCULATION MANAGER

Patricia Ferrante
603-924-9471

BULK SALES MANAGER

Ginnie Boudrieau
1-(800)-343-0728

ADVERTISING

603-924-7138

Jim Gray W1XU, Mgr.
Nancy Ciampa, Asst. Mgr.
Ross Kenyon KA1GAV
Cornelia Taylor

of one of the CQ chaps. Funny thing, even though this was an official ARRL hamfest, I didn't see any of their officials. Hmmm. Maybe I missed 'em.

The people at Ten-Tec, in addition to supporting the ham exhibit at the World's Fair, also had the most elaborate exhibit at the hamfest. I don't know how they get any work done!

The ham station at the fair was not of enough importance for the FCC to manage a special events call, but the Knoxville chaps were very resourceful. A local club had the call WA4KFS, so they "borrowed" the call for the fair... it representing the Knoxville Fair Station.

I sat down for a few minutes to see how the station was working. Aiming the beam at Europe, I found a relatively clear spot (not bad for Sunday afternoon on 20m) and called CQ. Wouldn't you know that the chap who came back to my call lives a few

miles from Peterborough and, when he found out who was operating, mentioned that he drives past my place every day going to work!

Having been on the ham tour to China a year ago, I wasn't ready to face the three-hour or more line to see their exhibit. Then I found out that our press passes not only got us in the fair free, but were also useful for going to the head of lines. Hmmm. It makes good sense since one of the things the fair needs most desperately is some good press. So Sherry and I ambled down to the China exhibit, flashed our press passes, and got right in.

Sherry was disappointed, I think. Sure enough, China had all their stuff there on exhibit... with a lot of the items for sale. But it was pretty much the same as we'd seen at the Canton Trade Fair. We did come close to buying one of their gorgeous rugs. Only the problems of ship-

ping it home slowed us down in Canton... now we had no such excuse. The rugs are spectacular and quite reasonable in price. They're not as inexpensive as in China, of course, but they're still a bargain.

The exhibit was interesting, but would have been a bummer if we'd had to invest much line time. That's probably one of the drawbacks to being into travel.

The worst days as far as lines are concerned are Friday and Saturday. Thursday is the lightest attendance day, with Sunday being second. That's Baptist country, remember, and Sunday is for church. The lines for food were small, if any. Sure, if you really *had* to have a hamburger and wanted it at 12:30, there was a line. But right next to that stand you could get something more interesting with no wait. The Hungarian ex-

Continued on page 139

Well... I Can Dream, Can't I?

by Bandel Linn K4PP



"While we were digging you a deeper ground, we struck oil!"

At Last.

A microthin, synthesized, programmable, sub-audible tone encoder that fits inside the ICOM IC-2AT.

Need we say more?

\$29.95



**COMMUNICATIONS
SPECIALISTS**

426 West Taft Avenue, Orange, CA 92667
800/854-0547 California: 714/998-3021

Poor Man's Spectrum Analyzer

— another 73 breakthrough

Frank H. Perkins WBS1PM
Box 13642
Arlington TX 76013

Hams enjoy making all types of electrical measurements. In fact, it's one of our favorite pastimes and topics of conversation. Fortunately, good, low-cost oscilloscopes, DVMs, and other instruments are available to us for measuring voltage, current, power, swr, frequency, and so on.

There is one instrument, however, that has been beyond the reach of most of our budgets—the spectrum

analyzer. Commercial versions of this useful rf instrument start at \$2500, which is a little steep for most of us. It is possible for you to build a simple spectrum analyzer for about \$150 that works with a low-cost oscilloscope. The analyzer can be used to check HF transmitting equipment, among other applications. Its use, theory of operation, and construction are discussed in this article.

Spectrum Analyzer Operation

A spectrum analyzer is a special receiver that allows

you to view the frequency components of its input signal on an oscilloscope CRT. The spectrum analyzer repeatedly tunes across the frequency band you have chosen with its center-frequency and frequency-span controls. For example, if you set the center-frequency control for 20 MHz and adjust the frequency-span control for a tuning range from 10 MHz below to 10 MHz above the center frequency, the analyzer will repeatedly tune the 10-MHz-to-30-MHz band.

As the analyzer tunes from the low end to the high end of the band, it moves the CRT trace from left to right. The S-meter output from the analyzer moves the CRT trace upward from the bottom of the CRT screen according to signal strength. A spectrum analyzer display usually looks like a number of spikes. The farther to the right a signal (spike) appears on the CRT, the higher its frequency; the strength of the signal is indicated by its height. There usually appears to be some "grass" along the bottom of the CRT display. This is due to noise. You probably have seen spectrum analyzer displays in ham gear sales liter-

ature and some magazine articles.

To appreciate how useful a spectrum analyzer can be, let's first look at Photo B, an rf signal on a normal oscilloscope. To me it looks like a clean sine wave. What do you think?

Now let's look at Photo C, the same rf signal on our spectrum analyzer. The half-spike on the left is our zero-frequency reference. The next signal to the right, which is the tallest, is the fundamental component of our rf signal. The three signals to the right of the fundamental are the 2nd, 3rd, and 4th harmonics.

If the spectrum of our transceiver or linear amplifier output looked the same as this photo, we would not be complying with FCC Regulation 97.73, even though our fundamental signal was properly within an HF amateur band.

To understand what's wrong, compare the height of the 2nd harmonic signal to the fundamental. The second harmonic is about 2.6 CRT divisions shorter than the fundamental. With a 10-dB-per-division vertical calibration, the second harmonic is 26 dB below the fundamental.

FCC Regulation 97.73 re-



Photo A. High frequency spectrum analyzer covers 0 to 60 MHz.

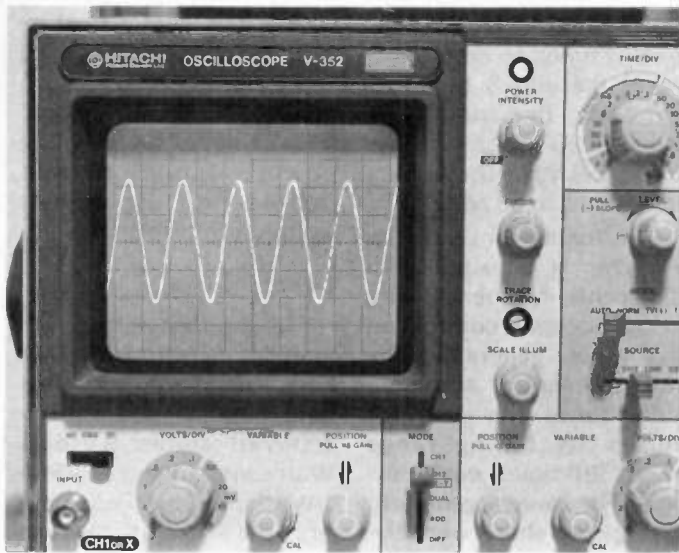

Photo B. Rf signal as viewed on an ordinary oscilloscope. Is this a clean signal?

quires low-power transmitters up to 5 Watts to suppress all signal frequency components (spurs) outside the HF band of operation at least 30 dB below the fundamental. For a transmitter from 5 to 500 Watts, this figure is 40 dB. For a 1000-Watt transmitter or linear amplifier, the figure is 43 dB. Checking our photo again, we notice that the 3rd harmonic signal is about 39 dB below the fundamental. We're also going to have a problem with the 3rd harmonic if we are running 5 Watts or more power. The 4th harmonic is no problem since it's about 55 dB below the fundamental.

We can correct the problem by adding a filter between our transceiver or linear and the antenna. However, unless we are able to check the output spectrum of our transmitting equipment, we may never know we have a problem—until our neighbors start complaining or we get a "friendly advisory" from the local FCC monitoring station.

There are many uses for a spectrum analyzer besides monitoring transmitter outputs, but this use alone can make an HF spectrum analyzer construction project worthwhile. If you build one, you'll probably be the first on your block (or in

your favorite net or club) to have one of your own!

Spectrum Analyzer Hookup

Fig. 1 shows how to hook up the high frequency spectrum analyzer for monitoring the output spectrum of a transmitter or linear amplifier. Remember, the analyzer is a receiver. It requires a very small sample of power for operation. This is done with an L-pad sampler. The sampler will not interfere with normal transmitting or transceiving operation. The output from the L-pad is further reduced with a step attenuator to match the full-scale input-power requirements of the analyzer (1/4 to 1/10 of a milliwatt). The spectrum is displayed on the oscilloscope being used with the spectrum analyzer.

It is important to observe good safety practices when using the L-pad, attenuator, and spectrum analyzer. Be sure all station equipment, the L-pad, attenuator, analyzer, and oscilloscope cases are properly grounded. Use the proper L-pad for your power range. Double-check your hookup before applying power. If the output of a transmitter was directly connected to the analyzer by accident, it would instantly be damaged when the transmitter was keyed.

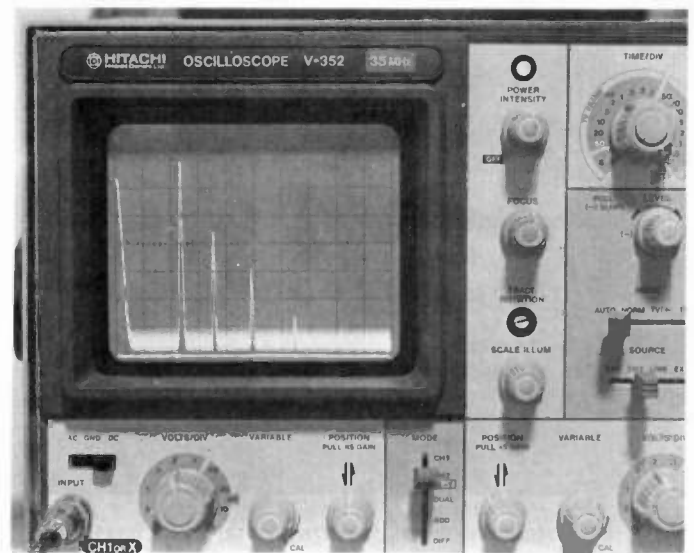

Photo C. Same rf signal on the spectrum analyzer. Second harmonic is only 26 dB below the fundamental. Don't put this signal on the air!

Overall Circuit Operation

Let's first discuss Fig. 2, the spectrum analyzer block diagram. We will then look at the circuits in each block in detail. Notice that the analyzer block diagram looks similar to that of a single-conversion superheterodyne receiver. The i-f frequency of the spectrum analyzer is 90 MHz.

The sampled input signal from the L-pad is adjusted to the proper power level with the step attenuator, as we discussed before. The signal is then taken through a low-pass filter with a 60-MHz cutoff frequency. The low-pass filter prevents 90-MHz signals from leaking into the analyzer and "confusing" it. The input is

next mixed with the 90-MHz to 150-MHz voltage-controlled oscillator (vco) in the double-balanced mixer. The difference output from the mixer, which is the desired i-f signal, is then filtered by the 90-MHz bandpass filter. The bandpass filter provides the necessary selectivity for the spectrum analyzer. The 90-MHz signal from the bandpass filter is preamplified and applied to the log amplifier. The output of the log amplifier is logarithmic signal strength video for the oscilloscope vertical (Y) axis.

The voltage-controlled oscillator frequency is controlled by the sweep generator, which simultaneously controls the horizontal (or X axis) of the oscilloscope. Note that when the vco is

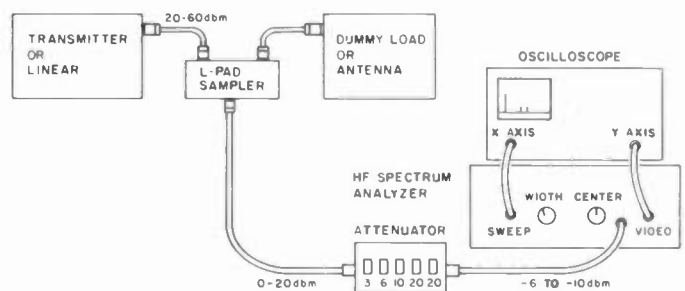

Note 1. Never hook transmitter or linear directly to step attenuator or analyzer. Always use L-pad sampler of the proper power rating.

Note 2. Be sure transmitter, linear, L-pad, attenuator, analyzer, and scope are grounded.

Fig. 1. Typical HF spectrum analyzer hookup.

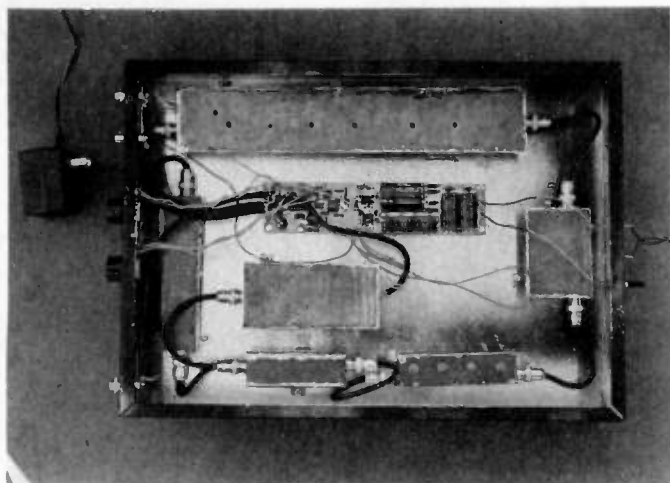

Photo D. Bottom view of spectrum analyzer chassis. Log amplifier is at the top. Power supply and sweep generator board is directly below the log amplifier. Vco is next. The mixer is directly below the vco. The mixer connects to the low-pass filter at the left. The bandpass filter is at the lower right. Preamplifier is on the middle right.

tuned to 90 MHz, the analyzer is tuned to zero MHz. When the vco is tuned to 120 MHz, the analyzer is tuned to 30 MHz. With the vco at 150 MHz, the analyzer is tuned to 60 MHz.

The tuning range of the analyzer is adjusted with the center-frequency and frequency-span controls on the sweep generator. The sweep generator automatically tunes the analyzer across its tuning range about 10 times each second. The sweep generator clamps or "shorts out" the video during the retrace between each sweep to avoid a confusing oscilloscope display. This eliminates the need for an oscilloscope

with a Z-axis (blanking) input. The power supply provides +24 V dc, +12 V dc, and -6 V dc for the spectrum analyzer circuitry. The power supply operates from 12 V ac supplied by a wallplug transformer.

L-Pad

Fig. 3 shows the schematic of a 100-to-1000-Watt L-pad sampler, with alternate circuitry for a 10-to-100-Watt sampler, a 1-to-10-Watt sampler, and a 0.25-to-1-Watt sampler. Four pairs of 4.7k, 1-Watt resistors form the series element of the 100-to-1000-Watt sampler. A 51-Ohm, 1/2-Watt resistor forms the shunt element. The L-pad resistors are rated for continuous operation. A single hair-thin strand from an old "zip" cord provides some fusing protection in the event of a component failure or circuit fault. The series elements for the other power ratings are shown in Fig. 3.

0-to-59-dB Step Attenuator

Fig. 4 shows the step attenuator schematic. Five pi-style resistive attenuators are switched in or out as necessary to achieve the proper attenuation. Switches are double-pole, double-throw. Resistors may be 1/2 Watt or 1/4 Watt, although 1/4-Watt resistors are easier to work with. Note the shielding between sections. Resistors must be 5% tolerance. (The resistor values for each attenuator came from Reference 1.)

Low-Pass Filter, Mixer, and Vco

Fig. 5 shows the details of these circuits. The low-pass filter consists of three pi-sections, separated by shielding. The cutoff frequency of the filter is about 60 MHz. Three sections are used to give a high attenuation at the 90-MHz i-f frequency and above.

Each port of the double-balanced mixer is padded with 50-Ohm attenuators to

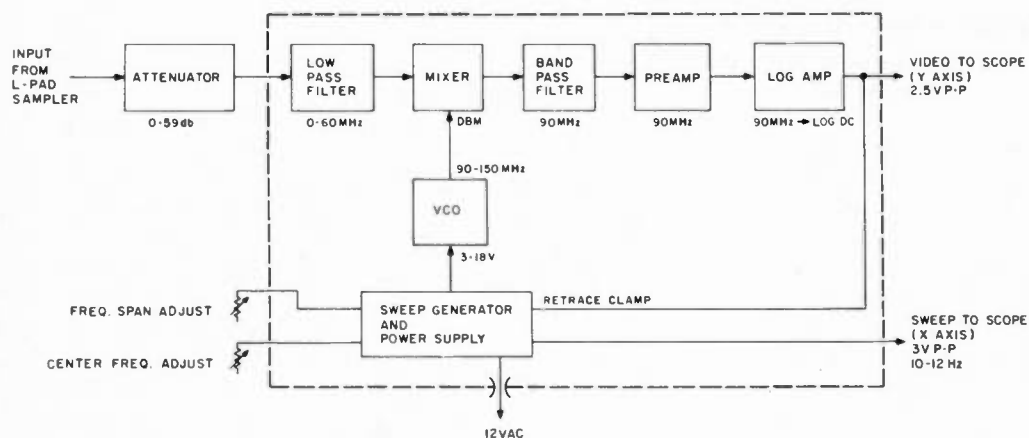
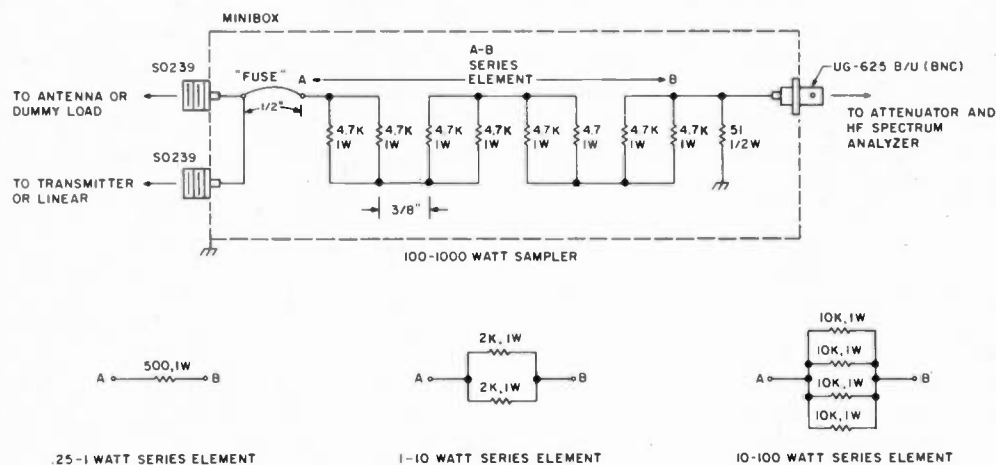

Fig. 2. Block diagram.



- Note 1. Carbon composition (noninductive) resistors.
- Note 2. "Fuse" is single, hair-thin copper strand from ac "zip" cord.
- Note 3. Connect SO-239 connectors with RG-8 center conductor wire.
- Note 4. Test-run sampler before connecting to attenuator.
- Note 5. Keep BNC connector 3" away from SO-239s; space resistor sets 3/8" minimum; "fuse" is 1/2" to 3/4" long.

Fig. 3. L-pad power samplers.

ICOM HF

Three Choices—Three Great Radios

IC-720A

Listen to signals from around the world with a 100 KHz — 30 MHz receiver. Talk with a 160 — 10 meter transceiver — ready to go WARC 79 bands, dual VFO's — split operation. ICOM's DFM (Direct Feed Mixer), passband



tuning, speech compressor, 100 watts, SSB, CW, AM, RTTY (FSK), computer compatible tuning, 12 volt operation, all features standard except CW & AM narrow filters. ICOM system* accessories are available for a complete station.

IC-740

Versatility plus! ICOM's newest addition to HF offers features most asked for by ham operators. 160 — 10 meters, variable noise blanker and AGC with off position, IF shift and passband tuning, automatic SSB mode



selection, notch filter, switchable CW filter, 8 memories, SWR meter, XIT, speech compressor, 100 watts and 12 volt operation. Options are FM, automatic keyer, internal AC power supply and 5 IF filters. ICOM system* compatible

IC-730

Go portable/mobile with ICOM's small HF. ICOM system* compatible. 100dB dynamic range, +19.5dBm intercept point receiver utilizing ICOM's DFM, SSB, CW, AM, dual VFO's — split operation, one memory per band, CW/SSB filter



options, 100 watts, 12 volt operation.

**ICOM system. The same accessories work with all three HF transceivers — IC-2K1 autohandsitching in-salbandwidth linear amplifier, AT-500 or AT-100 autohandsitching, autotuning antenna tuner, IC-18P5 power supply, IC-10A memory backup, IC-18P3 external speaker, IC-11-1 headphones, IC-111 autohandsitching mobile antenna, IC-18B5 mobile mount and IC-18M5 desk microphone (condenser type)*

ICOM
The World System

encourage good mixer performance (low mixer spurs) at the expense of extra conversion loss. Mini-Circuits SRA-1 and SBL-1 are good commercial mixers. It is quite possible to build a suitable double-balanced mixer from small ferrite toroids and hot carrier diodes, if you have trouble finding these commercial units. (Consult Reference 1 for details.)

The vco consists of an MRF901 Colpitts oscillator coupled to a wideband 2N5179 amplifier. The MRF901 was eventually chosen for the oscillator transistor because of its well-behaved phase-shift characteristics between 90 MHz and 150 MHz. The two MV109 hyper-abrupt Epicap diodes act as tuning capacitors and account for the oscillator's wide tuning range. A small pick-up loop near the oscillator coil provides an output for checking frequency and doing other tests. The oscillator is also lightly coupled to the

2N5179 vco amplifier. The output of this amplifier drives the local oscillator port of the mixer. A diode-capacitor rf detector provides a dc output for checking amplifier output power. The wideband amplifier design is based on data from Reference 1. The oscillator design is based on third-attempt desperation! Note the use of the feedthrough capacitors and shielding. These are as much a part of the circuit as the MRF901.

Bandpass Filter

The bandpass filter is detailed in Fig. 6. It consists of four relatively small helical

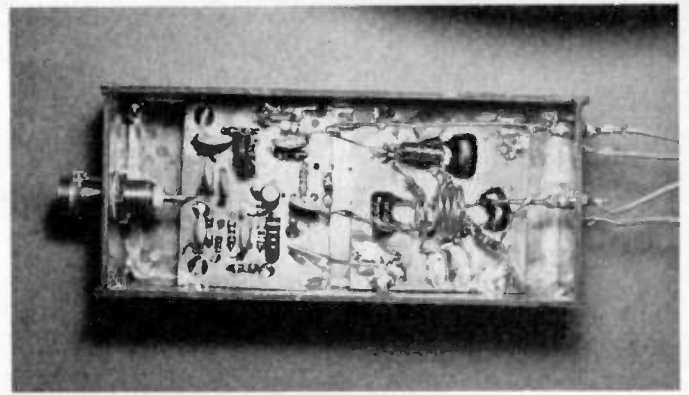
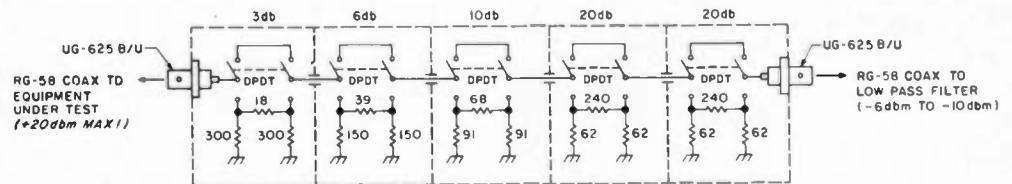

Photo E. Vco layout. Oscillator is near the feedthroughs.

resonators. The input and output resonators are tap-coupled to the input and output connectors. The four resonators are aper-

ture-coupled to each other. The two center resonators are slightly stagger-tuned to give the filter bandpass a sharp "nose." The 3-dB



Note 1. DPDT toggle switch—Radio Shack 275-1546 or equivalent.

Note 2. BNC receptacle—Radio Shack 278-105 or Amphenol 31-236.

Note 3. Resistors 1/2 or 1/4 W, 5% noninductive.

Note 4. Attenuator box made from single- and double-sided G-10 circuit board plus copper shim stock.

Fig. 4. 0-59-dB step attenuator.

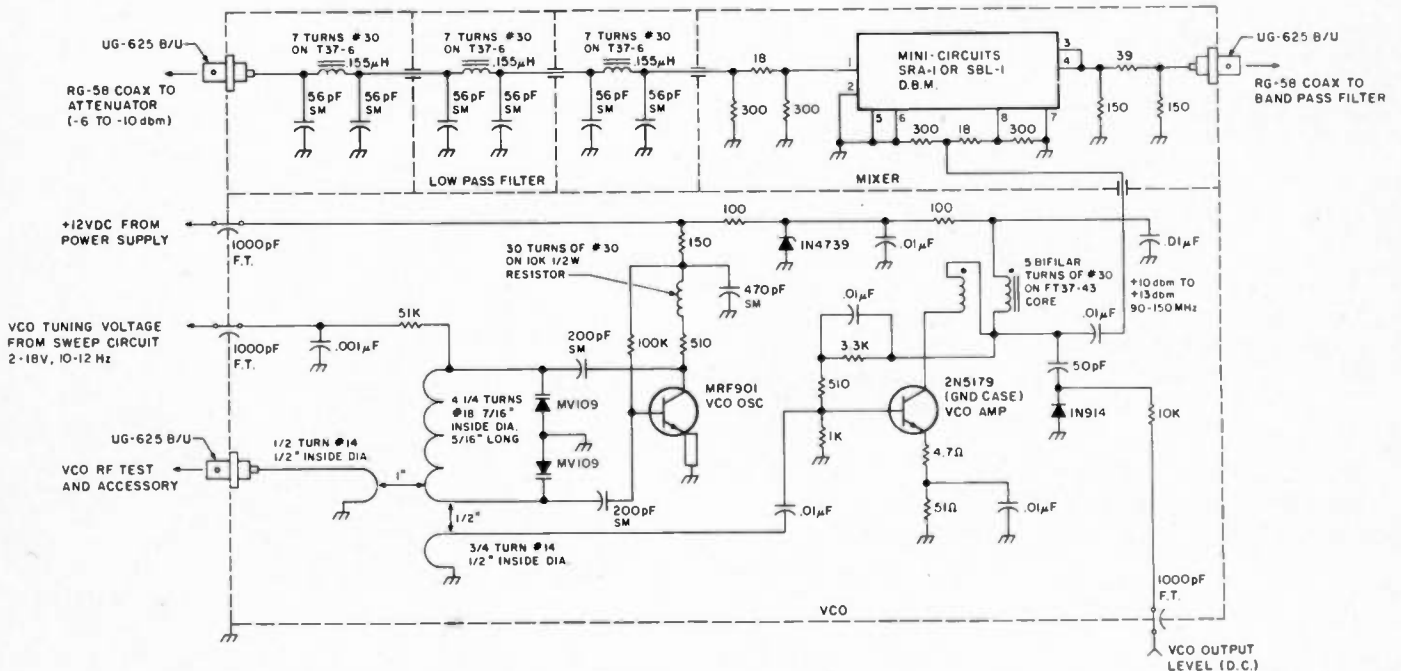

Note 1. Resistors are 1/4 W, 5%; unspecified capacitors are 50-V ceramic.

Note 2. Capacitors marked "SM" are $\pm 5\%$ silver mica.

Note 3. 1000-pF feedthrough capacitors available from Alaska Microwave.

Note 4. MV-209s or MV-309s may be substituted for MV-109s (contact Motorola distributor).

Note 5. Box built from single- and double-sided G-10 circuit board plus copper shim stock.

Fig. 5. Low-pass filter, mixer, and vco.

SELECT YOUR FAVORITE FEATURE



Yes, the **CT2100** has the features you want – and built-in, too! The **CT2100** has been designed by the RTTY people at HAL for optimum operator convenience. No “hidden” keyboard controls to remember – it’s all on the front panel, arranged for serious operators. Why settle for a compromise or imitation when you can have the **CT2100**? Compare feature for feature; you’ll find that the **CT2100** offers the most performance and flexibility for your dollar.

- Send or receive ASCII, Baudot, or Morse code
- RTTY and Morse demodulators are built-in
- RTTY speeds of 45, 50, 74, 100, 110, 300, 600, and 1200 baud – ASCII or Baudot
- Four RTTY modems: “high tones”, “low tones”, “103 Modem tones”, and “202 Modem tones”
- Three shifts for high and low tones (170, 425, and 850 Hz)
- Crystal-synthesized transmit tones
- Send and receive Morse code at 1 to 100 wpm
- Characters displayed on 24 line screen
- Choose either 36 or 72 characters per line
- 2 pages of 72 character lines or 4 pages of 36 character lines
- Split-screen for pretyping transmit text
- Audio, current loop, or RS232 data I/O
- Printers available for hard-copy of all 3 codes
- On-screen RTTY tuning bar plus LED indicators
- ALL ASCII control characters; half or full duplex
- Brag-tape storage of 8-256 character messages in MSG2100 EPROM option
- Two programmable HERE IS messages

Write or call for more details. See the CT2100, KB2100, Printer, and Video Monitor at your favorite HAL dealer.



HAL COMMUNICATIONS CORP.

BOX 365

URBANA, ILLINOIS 61801

217-367-7373

345

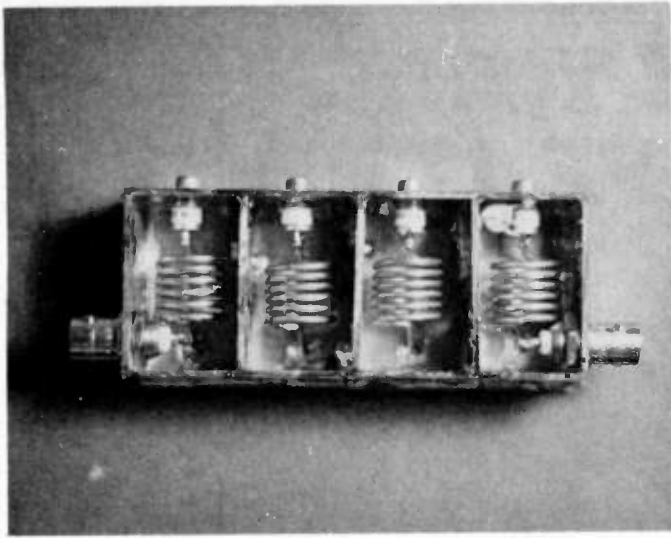

Photo F. Bandpass filter layout.

bandwidth of the filter is about 220 kHz. Insertion loss is somewhat high, but is acceptable for this application.

Preamplifier and Log Amplifier

The schematics of the preamplifier and log amplifier are shown in Fig. 7. The preamplifier consists of two wideband 2N5179 amplifiers. The log amplifier consists of six tuned 90-MHz i-f stages. Each stage uses the friendly 40673 dual-gate FET. The input stage acts as a buffer amplifier. The next five stages form the logarithmic signal-strength video detector. The log amplifier may remind you of an i-f strip in an FM receiver. In fact, it uses the limiter principle in its operation.

Notice that each stage in the log amplifier has an rf detector across its output consisting of a 50-pF capacitor, a 1N914 diode, and a 10k resistor. The rf detector on the buffer stage is just a tuning aid. The outputs of the rf detectors on the 1st through 5th log amp stages are tied to a common 1k resistor (in parallel with a 150-pF capacitor). Because of its relatively low value, the detector outputs are more or less summed across the 1k resistor.

A small input signal is amplified by all five log amp stages. Only the 5th stage will develop enough signal to provide an output from its detector. As the input signal is made larger, the 4th stage detector also

will begin contributing to the output. As the output is made still larger, the 5th stage will saturate or limit. From this point it will contribute no additional voltage across the 1k output resistor. At about this same signal level, the 3rd log amp stage will begin to contribute some output, and so on. Each log amp stage provides a gain of about 12 dB until it saturates. The gain of the i-f strip, from the 1k resistor's point of view, then drops 12 dB. It is this successive limiting and dropping off of i-f stages that creates the logarithmic video output characteristic. Note that when the 1st log amp stage saturates, the log amplifier reaches its full-scale output.

I was surprised how accurately the logarithmic amplifier does track a logarithmic curve. Using my commercial step attenuator as a reference, the calibration of my logarithmic amplifier was within 1 dB. The sensitive i-f system must be shielded to prevent interference from commercial FM stations.

Power Supply and Sweep Generator Circuits

These circuits are shown in Fig. 8. The power supply is straightforward, providing +12 V dc, +24 V dc, and -6 V dc. Note the feedthrough capacitors used to filter out any rf

picked up by the 12-V-ac power leads.

The heart of the sweep generator is the 555 IC timer. The two 2N2907s act as current sources. Each generates linear ramp voltages across 10-uF tantalum capacitors. The 555 synchronizes the ramps. The ramps are set at a 10-Hz-to-12-Hz repetition rate. One ramp is fed through a dc-restoring capacitor-diode clamp to the output connector for the oscilloscope horizontal (X) axis. The second ramp is fed to the 5k frequency-span potentiometer through an inverting operational amplifier buffer. The output from the frequency-span pot is summed with the output of the 5k center-frequency pot in the vco-tuning voltage amplifier. The output of this amplifier is fed to the vco-tuning voltage input.

When the ramps are reset by the 555, pin 3 of the 555 also trips the retrace VMOS clamp transistor through the retrace comparator amplifier. This shorts the logarithmic amplifier video output to ground during retrace. Otherwise, the video is fed to the output connector for the oscilloscope vertical (Y) axis. The 4th amplifier in the TL084C quad-operational-amplifier IC is used simply as a 6-V-dc reference by the other three amplifiers.

Shielded Enclosure Construction

All circuits in the high frequency spectrum analyzer except the sweep generator and the power supply must be installed in shielded enclosures. I built each enclosure for my analyzer using 1/16-inch, G-10 epoxy circuit board stock. Enclosure base plates are made from single-sided or double-sided stock. Double-sided stock must be used for the enclosure sides, ends, and partitions. (See Fig. 9 for construction details.)

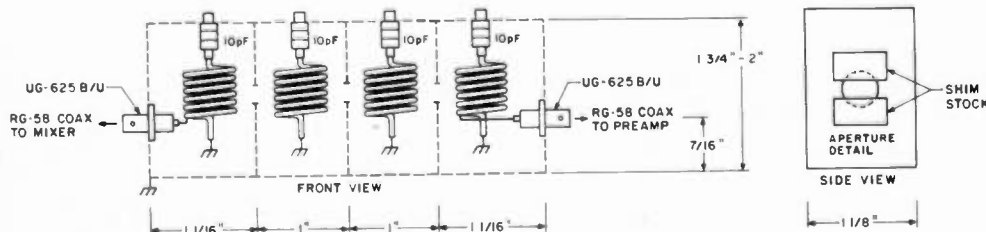

Note 1. Coils are 6 turns of #12, 1/2" inside diameter, 5/8" long, taps at 1/4 turn.

Note 2. 10-pF piston trimmer, Sprague-Goodman GGP8R500 or equivalent; alternate, air-variable, Johnson 189-564-1.

Note 3. Filter box made from single- and double-sided G-10 circuit board plus copper shim stock.

Note 4. Filter box is 1-1/8" deep.

Note 5. Mount BNC connectors near front side.

Note 6. Coupling apertures are 3/8" x 3/16". Drill 3/8"-diameter holes in compartment wall pieces and then solder copper shim strips across tops and bottoms to narrow apertures.

Fig. 6. Bandpass filter.



Stuck with a problem?

Our TE-12P Encoder might be just the solution to pull you out of a sticky situation. Need a different CTCSS tone for each channel in a multi-channel Public Safety System? How about customer access to multiple repeater sites on the same channel? Or use it to generate any of the twelve tones for EMS use. Also, it can be used to access Amateur repeaters or just as a piece of versatile test equipment. Any of the CTCSS tones may be accessed with the TE-12PA, any of the audible frequencies with the TE-12PB. Just set a dip switch, no test equipment is required. As usual, we're a stickler for 1day delivery with a full 1 year warranty.

- Output level flat to within 1.5db over entire range selected.
- Immune to RF.
- Powered by 6-30vdc, unregulated at 8 ma.
- Low impedance, low distortion, adjustable sinewave output, 5v peak-to-peak.
- Instant start-up.

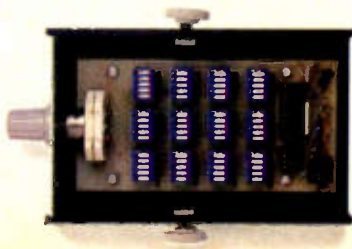

TE-12PA

67.0 XZ	85.4 YA	103.5 1A	127.3 3A	156.7 5A	192.8 7A
71.9 XA	88.5 YB	107.2 1B	131.8 3B	162.2 5B	203.5 M1
74.4 WA	91.5 ZZ	110.9 2Z	136.5 4Z	167.9 6Z	
77.0 XB	94.8 ZA	114.8 2A	141.3 4A	173.8 6A	
79.7 SP	97.4 ZB	118.8 2B	146.2 4B	179.9 6B	
82.5 YZ	100.0 1Z	123.0 3Z	151.4 5Z	186.2 7Z	

- Frequency accuracy, ± 1 Hz maximum -40°C to $+85^{\circ}\text{C}$
- Frequencies to 250 Hz available on special order.
- Continuous tone

TE-12PB

TEST-TONES:	TOUCH-TONES:	BURST TONES:
600	697 1209	1600 1850 2150 2400
1000	770 1336	1650 1900 2200 2450
1500	852 1477	1700 1950 2250 2500
2175	941 1633	1750 2000 2300 2550
2805		1800 2100 2350

- Frequency accuracy, ± 1 Hz maximum -40°C to $+85^{\circ}\text{C}$
- Tone length approximately 300 ms. May be lengthened, shortened or eliminated by changing value of resistor

\$89.95

 **COMMUNICATIONS SPECIALISTS**

426 West Taft Avenue, Orange, California 92667
(800) 854-0547/California: (714) 998-3021



Note the brass "cap strips." These provide a base for soldering on the thin copper (shim stock) enclosure tops. I use this method for mounting the tops so that they can be peeled back easily when I need to modify or repair circuitry. Use a 40-Watt soldering iron for soldering the enclosures together. Solder the tops on with a 25-Watt iron. Be sure the solder seams have no gaps.

Don't let the need for shielded enclosures discourage you. There are several easy, accurate ways to cut circuit board material. Beg, borrow, or buy a copy of *Printed Circuits Handbook* (Reference 4). This book does a good job of showing how to cut circuit board stock. Alternatively, make friends with a ham who owns or works at a commercial circuit board shop! Anyway, making shielded enclosures is easier than it first appears.

My original analyzer used quite a few BNC connectors. The number of connectors can be reduced by building the low-pass filter, mixer, and vco enclosures together on one base plate. Look at the schematic, Fig. 5, for shield partitioning details. Likewise, the preamplifier and log amplifier enclosures can be built together (Fig. 7). The bandpass filter should be built by itself, as should the attenuator. This arrangement allows the analyzer to be tuned up with very little test equipment.

Circuit Board Layout and Construction

There are a lot of possible component substitutions for the spectrum analyzer. Some of the components you use in your analyzer will no doubt be different from the ones I used—at least in physical size. This makes standard circuit boards impractical. It is easy to lay out your circuit-

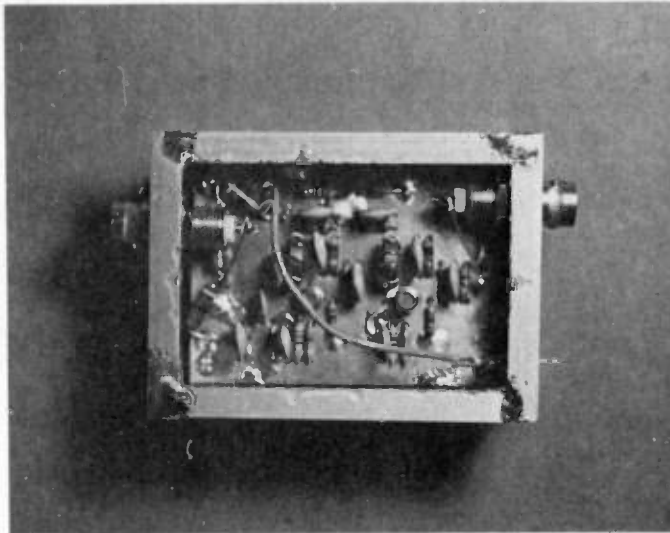

Photo G. Preamplifier layout. Note that the brass "cap strips" have been installed.

ry for construction on single-sided circuit board stock. The copper is on the top side. It acts as a ground plane and helps stabilize the circuitry. All analyzer circuitry built in this manner was built on 1.8-inch-wide circuit board strips—lengths as needed. The low-pass filter, bandpass filter, and attenuator are built "in the air" inside their shielded enclosures. They don't need a circuit board.

Get some drafting vellum with a light blue, 1/10-inch grid on it. After you have all the parts for a circuit, you can begin developing its circuit board layout. After mulling over the schematic, lay the actual components on the grid paper and think through their interconnections. Juggle them as needed into a neat arrangement. Remember that all ground connections are going to be made on the top.

After you have the layout and interconnections visualized in an area, pick up each component and sketch in its outline on the vellum. Show its connection to other components (under the board) with dotted lines. You will be surprised how fast this goes. Remember to keep the input and output components of each rf stage sepa-

rated. This is aided by using circuit board strips. Check the photos of my layout for ideas (minor circuit changes were made after some of the photos).

Once the layout is complete, tape it to your circuit board blank. Drill through the layout into the circuit board each place where a component or wire lead goes through the board. Use a #55 drill bit. After all holes are drilled, lightly countersink with a 1/8-inch drill bit all holes that are not going to be a ground connection. This keeps the leads going through these holes from shorting to the ground plane. Drill 1/8-inch holes in each corner of the board. 4-40 × 1/2-inch screws are put in these holes to act as legs for the board. Begin installing components. They are interconnected under the board by their leads and/or bus wire. Remember to keep connections as short as possible.

The vco oscillator circuit is built totally on top of the circuit board ground plane so that leads can be very short. Follow the layout in the photo carefully. The vco amplifier is built in the normal way.

I used brass tubes (bought at a hobby shop) for coil-winding mandrels. Where wiring goes through

a partition on the schematics, use a 1/8-inch hole drilled in the partition wall.

After you double-check your wiring, install the circuit boards in their shielded enclosures. Tack-solder the ground plane of the circuit to one side of the enclosure. Do not install the tops of the enclosures yet—we have testing to do!

Because of the power involved, build the L-pad sampler carefully. The circuit board used to mount the resistors has no copper on either side except at the corner on the far side of the SO-239 connectors. This small piece of ground plane is covered with masking tape before the copper is etched with ferric chloride. The 51-Ohm resistor is grounded here. A ground wire is then taken from here to a lug at the BNC connector (make the lug from copper shim stock).

Mount the board using 4-40 × 3/4-inch screws. Use 5/16-inch-diameter × 1/2-inch-long aluminum tubing slipped over each 4-40 screw to stand the circuit board off. Be sure the resistor pairs are separated from each other by 3/8 of an inch. The physical layout of the resistors should look like the schematic in Fig. 3. The "fuse" wire, which is a single, hair-thin strand of copper wire from an old "zip" cord, must be at least 1/2 inch long. The L-pad is built in a medium-size minibox.

I mounted the shielded enclosures and the sweep generator/power-supply board in a 3-inch-high × 12-inch-wide × 18-inch-deep aluminum chassis. (Refer to Photo D for typical mounting.) Individual circuits are tested before final mounting and installation of the enclosure tops.

Testing and Alignment

The minimum test equipment needed to align and test the HF spectrum ana-

AT LAST!

This service will be available nationally. Lab tested & time proven modifications professionally installed in your amateur Handy-Talkie 2M, 220, 440, MH2 transceiver by Henry Radios warranty technicians (KNOWN AS "A&W PRODUCTIONS")



HAVE ALL PL TONES AVAILABLE AT YOUR FINGER TIPS

Outboard the dip switch! Have it neatly inlayed into the back cover of your Handy-Talkie making all 32 PL Tones Selectable at a moment's notice.

\$25 Got your own PL? Send it to us with your Handy-Talkie unit and we do the professional installation for you.

\$55 We will install a new PL and inlay the dip switch into the back cover of your Handy-Talkie ready to operate.

Send us your Handy-Talkie unit and a check or money order plus \$3.50 for shipping and handling payable to **A&W PRODUCTIONS, INC.**

For **TEMPO** units the dip switch is inlayed into the Push-to-Talk bar. The **TEMPO S-15** will have the dip switch inlayed into the back cover.

\$45 We will install a **NEW BATTERY BEATER** in your **TEMPO S-1, S-2, S-4, S-5** **READY** to operate. Your New Battery Beater will use the same jack as the charger with no new holes and regulation circuits built into unit. Comes with Cigar Lighter Adapter with internal fuse.

CONTACT A&W PRODUCTIONS FOR SPECIAL MODIFICATIONS YOU MAY WANT TO HAVE DONE. WE SPECIALIZE IN THE TEMPO HANDY-TALKIES.

WE ARE AN OFFICIAL "TEMPO" REPAIR STATION
ALL WORK GUARANTEED FOR 30 DAYS. SEND YOUR HANDY-TALKIE AND A CHECK OR MONEY ORDER TO:

AW PRODUCTIONS
3305 Pico Blvd., Santa Monica
California 90405 (213) 828-9310

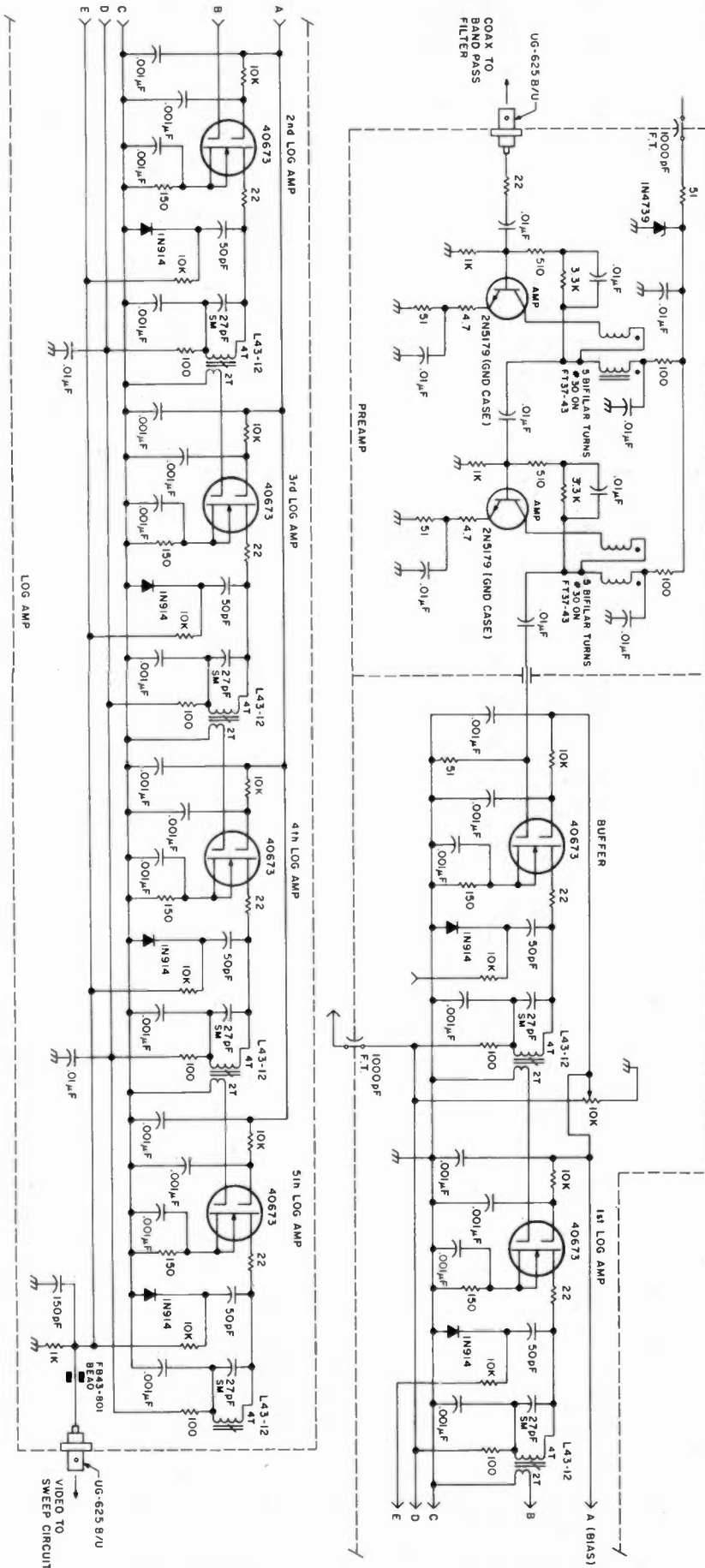

Fig. 7. Preamp and log amp.

alyzer includes a high-impedance volt ohmmeter, a 350-MHz frequency counter, and a 5-MHz bandwidth, single-channel, dc-coupled oscilloscope with a triggered sweep. A grid-dip oscillator also is useful. You should make up several 2-foot RG-58 cables with BNC connectors. These will be used during testing. For best results, testing and alignment should be done in the order listed below.

Power Supply Testing. Check the resistance between the primary and secondary of the wallplug transformer before use. It should show an open circuit. Check the secondary ac voltage. It should be 12 V ac to 15 V ac with no load. Hook the 12 V ac to the power supply and check the 12 V dc, 24 V dc, and -6 V dc outputs. They should be within 1/2 volt.

Sweep Generator Testing. Connect the power supply to the sweep generator and turn the power supply on. Check pin 2 of the 555 IC with your oscilloscope. You should find a 10-Hz-to-12-Hz ramp waveform. The bottom of the waveform should be at 4 volts and the top of the waveform at 8 volts. The front of the ramp (long slope) should appear straight. You should find a similar ramp at the X-axis output connector. This ramp will be between -0.6 volts and 3.4 volts.

Check pin 8 of the TL084C op amp. You should find a pulse train with a 10-Hz-to-12-Hz repetition rate. The pulse train should

Note 1. Resistors are 1/4 W, 5%; unspecified capacitors are 50-V ceramic.

Note 2. Capacitors marked "SM" are $\pm 5\%$ silver mica.

Note 3. L43-12 rf transformers and FT37-43 toroids are available from Amidon.

Note 4. Shielded box made from single- and double-sided G-10 circuit board plus copper shim stock.

ege, inc.

✓453

2% Bonus for Prepaid Orders
(Cashier's Check or Money Order)

AUGUST SPECIALS

1-800-336-4799

(Orders Only, Please)



ORDER TOLL FREE

ORDER HOURS: 11 am - 7 pm (Eastern Time) M-F
9 am - 3 pm (Eastern Time) Saturday
Closed Tuesdays

TEN-TEC SALE

OMNI-C 160-10M Transceiver	968.00
255 Deluxe Power Supply/Speaker	169.95
229 2KW Antenna Tuner	228.95
243 Remote VFO for Omni-C	168.95
ARGOSY 80-10m Transceiver	439.95
225 Power Supply	114.95

COMPLETE LINE OF FILTERS AND ACCESSORIES IN STOCK
— CALL FOR QUOTES —



HF TRANSCEIVERS

720A - The Top of the Line	2m and UHF	IC 2A/2AT-2m handheld
730 - A Great Mobile		IC 3AT-220MHz handheld
740 - New Model		IC 4AT-440-450MHz handheld
		IC 25A-2m 25 watt XCVR
		IC 290A-2m all mode XCVR

COMPLETE LINE OF FILTERS AND ACCESSORIES IN STOCK
— CALL FOR QUOTES —
— Shipping not included in prices —

ANTENNA/ROTOR SPECIALS

MOSELEY - THE NEW LINE!

TA 33 3-element 10-15-20 Meter Beam	199.95
CL 33 3-element 10-15-20 Meter Beam	226.95
CL 36 6-element 10-15-20 Meter Beam	303.95

CUSHCRAFT

A3 10-15-20m 3-element Beam	172.95
A4 10-15-20m 4-element Beam	224.95

HY-GAIN

TH3MK3 10-15-20M 3-elem. Beam w/stainless hdwr.	194.95
TH7 DX New Broad Band 7-element Beam	329.95

KLM

KT34A 10-15-20m 4-element Beam	310.95
KT34XA 10-15-20m 6-element Beam	459.95

HUSTLER 3TBA 10-15-20m 3-element Beam 188.95

ROTORS - Package prices when purchased with any 1 of the antennas above.

ALLIANCE HD73	89.95
CDE/HY-GAIN Ham IV	165.95

— Shipping not included in prices —

MJF PRODUCTS (Call for other MJF items)

989 New 3KW Tuner	279.95
962 1.5KW Tuner mtr/switch	189.95
9498 300 watt deluxe tuner	119.95
941C 300 watt tuner switch/mtr.	76.95
940 300 watt tuner switch/mtr.	67.95
484 Grandmaster mem. keyer 12 msg.	113.95
482 4 msg memory keyer	81.95
422 Pacesetter Keyer w/Bencher BY1	87.15
408 Deluxe Keyer with speed mtr	67.95
496 Keyboard II	289.95
752B Dual tunable filter	76.95
102 24-hour clock	29.95

TELEX HEADSETS-HEADPHONES

C1210/C1320 Headphones	22.95/32.95
PROCOM 200 Headset/dual Imp.MIC	77.50
PROCOM 300 lt/wt. Headset	
Dual Imp. microphone	69.95

KLM ANTENNAS (other antennas in stock)

144-148 13L82m 13-elem. w/balun	77.95
144-148 16C 2m 16-element for oscar	93.55
420-450-14 420-450 MHz 14-element beam	37.54
420-450-18C 420-450 MHz 18-element oscar	58.70
432-16L8 16 element 430-434 MHz beam/balun	60.70

HUSTLER 5BTV 10-80m Vertical 99.95
48TV 10-40m Vertical 78.95

HF Mobile Resonators

	Standard	Super
10 and 15 meter	8.95	13.50
20 meters	11.95	15.95
40 meters	13.95	18.50
75 meters	14.50	28.95

AVANTI AP 151.3G2m on glass ant 27.95

BUTTERNUT HF6V 10-80m vertical 109.95

BENCHER PADDLES Black 34.95
Chrome 42.95

AEA Keyers, Code Readers CALL
Isopole 144 (Limited Qty.) 29.95

HY-GAIN ANTENNAS

18 AVT/W8 10-80m vertical	CALL
14 AVQ/WB 10-40m vertical	CALL
TH3MK2 10-15-20m 2-element beam	CALL
TH3JR 10-15-20m beam	CALL

(Most antennas now with stainless hardware)

CUSHCRAFT (Call for other Cushcraft items)

AV3 10-15-20m vertical	44.50
AV5 10-80m vertical	88.75
ARX-2B Ringo Ranger II, 2m vertical	34.00
A3219 2m 800m DX Beam	81.95
2148 SSB 144-146 MHz boomer	68.20
214FB 144.5-148 MHz FM boomer	68.20
220B 220 MHz SSB boomer	74.95
A147-11 11-element 2m FM beam	37.50
A147-20T 20-element 2m SSB/FM beam	61.50
AMS 147 2m Magnet Mount	27.50

ASTRON POWER SUPPLIES (13.8 VDC)

RS7 A5 amps continuous, 7 amp ICS	48.60
RS12 A9 amps cont., 12 amps ICS	66.35
RS20A 16 amps cont., 20 amps ICS	87.20
RS20M same as RS20A + meters	105.50
RS35A 25 amps cont., 35 amp ICS	131.95
RS35M same as RS35A + meters	151.95
VS35M 25 amp cont. adjustable	171.00
VS20M 16 amp cont. adjustable	124.00

MINIQUAD HQ-1 127.95

VoCOM ANTENNAS/2m Amps

5/8 wave 2m hand held Ant	15.95
2 watts in, 25 watts out 2m Amp	69.95
200 mw in, 25 watts out 2m Amp	82.95
2 watts in, 50 watts out 2m Amp	105.95
2 watts in, 100 watts out, 2m Amp	159.95
Power Pack for I-COM 2A/2AT	185.95

MIRAGE AMPS & WATT METERS

MP1/MP2 HF or VHF Watt Meters	99.95
B23 2 in-30 out. All Mode 2m Amp	CALL
B108 10 in-80 out. All Mode 2m Amp	CALL
B1016 10 in-160 out. All Mode 2m Amp	CALL
B3016 30 in-160 out. All Mode 2m Amp	CALL
D1010N UHF Amp, All Mode	CALL
C106 220 MHz Amp	CALL

SANTAC

Handhelds

144up 2m Synthesized handheld	295.00
440up MHz Synthesized handheld	CALL
ST7-T MHz Synthesized handheld	229.00

Amplifiers - Tokyo High Power

HL-32V 2m 30 watt out	75.00
HL-82V 2m 80 watt out, recv. preamp	149.95
HL-160V 2m 160 w out, recv. preamp	299.95
HL-20U 440-450 MHz	CALL

★ SUPER SPECIALS ★

A2DEN PCS 300 2m Handheld	284.00
PCS 3000 2m XCVR	284.00
KDK FM 2030 25 watt 2m XCVR	CALL

KENWOOD, YAESU, DENTRON
— CALL FOR QUOTES —

CABLE BY SAXTON

RG 213 Mil Spec	25c/ft.
RG 8/m 95% shield foam	24c/ft.
Mini-8	11c/ft.
RG 58	9c/ft.
RG 59	9c/ft.
8-wire Rotor 2 #18, 6 #22	15c/ft.

CLOCKS BY BMI

173B 24-hour clock	26.95
173 DM dual desk clock	54.95

DAIWA/MCM

CN520/CN540 watt meters	59.95/69.95
CNW418/CNW518 Antenna Tuners	169.95/279.95
CNA 2002 Auto 2.5W Tuner	399.95

ORDER INFORMATION

Orders or Quotes Only 1-800-336-4799

Information and Virginia orders: (703) 643-1063

Store Hours: M-W-F: 12 noon-8 pm
Thursday: 10 am-4 pm
Saturday: 9 am-3 pm

Mailing Address: 2410 Drexel St.
Woodbridge, VA 22192

Store Location: 13646 Jefferson Davis Hwy.
(New Location) Woodbridge, VA 22191

— DEALER INQUIRIES INVITED —

— CALL FOR QUOTES —

Partial product listing — send stamp for a flyer or call for quotes. Terms: Prices do not include shipping. VISA and Master Charge accepted. 2% discount for prepaid orders (cashier's check or money order). COD fee \$2.00 per order. Prices subject to change without notice or obligation. No personal checks accepted.

be high (20 volts) about 20% of the time and low (-3 volts) about 80% of the time.

Turn the frequency-span pot fully clockwise (no ramp) and set the center-frequency pot mid-range. You should find 6 V dc to 12 V dc on pin seven of the TL084C op amp (vco-tuning voltage). Vary the setting of the center-frequency pot. The vco-tuning voltage should vary from -3 volts to 21 volts. Set the center-frequency pot for a 10-volt output. Turn the frequency-span pot counterclockwise until you have a ramp waveform from 2 volts to 20 volts (readjust the center-frequency pot as needed). This completes preliminary sweep generator testing.

If your sweep generator fails to act as above, recheck component values and circuit hookup for problems. Refer to the theory of operation for additional hints.

Vco Testing. Connect the vco-tuning voltage from the sweep generator to the vco. Ground the RG-58 shield at the vco enclosure. Connect 12 V dc from the power supply to the vco power input. Disconnect one side of the oscillator coil for a moment. Power up and check the MRF901 collector voltage. It should be about 6 V dc to 8 V dc. If it is too high, reduce the value of the 100k bias resistor. If it is too low, increase the value of the bias resistor. You can't use a pot here! Once the collector voltage is verified, power down and reconnect the coil.

Power up and connect your counter to the vco rf test jack. Turn the frequency-span pot fully clockwise (no ramp) and adjust the center-frequency pot for a 3-volt output. Your counter should read about 90 MHz. Adjust the vco coil spacing to get the vco in the 89.5-MHz-to-90.5-MHz range. Check the dc output from the rf detector of the vco

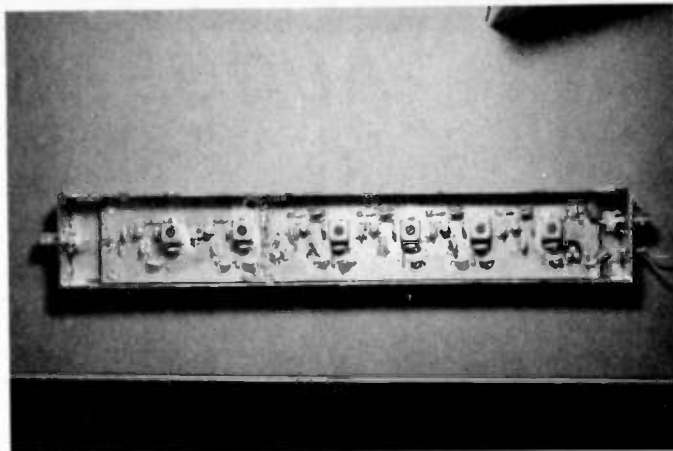

Photo H. Log amplifier layout. Note strip design.

amplifier output for a 0.8-V-dc-to-1.3-V-dc level. Adjust the spacing between the vco coil and the amplifier pick-up loop, if necessary, to obtain the proper detector output.

Set the center-frequency pot for a 150-MHz oscillator output. You should have a tuning voltage of about 18 V dc. Check the rf-detector output voltage again to be sure it's still between 0.8 V dc and 1.3 V dc. Monitoring the dc voltage from the rf detector with your scope, tune the center-frequency pot back and forth between 3 volts and 18 volts. The detector output voltage may smoothly vary some but should not "jump." An abrupt voltage change indicates a parasitic oscillation. If this should occur, work with your oscillator layout (very short leads) to get rid of it.

A tuning voltage of less than 1 V dc may cause the oscillator output to be erratic in frequency and amplitude. This is not a problem. Once the vco oscillator and amplifier are operating properly, install the vco enclosure top.

Preamplifier and Log Amplifier Testing. Connect 12 V dc to the preamplifier and log amplifier circuits and power up. Turn the frequency-span pot fully clockwise (ramp off) and adjust the center-frequency pot for 90 MHz at the vco rf test jack. Disconnect the frequency

counter. Hook the attenuator box to the vco rf test jack with a two-foot RG-58 cable. Hook the output of the attenuator to the input of the preamplifier with another two-foot cable.

Set the bias pot on the log amplifier about mid-range. Monitor the dc output of the rf detector on the log amplifier buffer. Tune the buffer transformer slug for peak output. Use the attenuator to set the detector output to 0.2 V dc. Now adjust the bias pot of the log amplifier for peak output. Adjust the attenuator for a just-detectable output at the log amplifier buffer. If all seems well with the preamplifier, install the top on its enclosure. Prepare the top for the log amplifier section. Drill 1/8-inch-diameter holes in the top over each i-f transformer location and over the bias pot. (Use drafting vellum as a template.)

Hook the oscilloscope to the video output of the log amplifier. Adjust the slugs in each log amplifier stage for peak video output. The tuning of each stage should be smooth, and the tuning of the bias pot should also be smooth. If the video output from the log amplifier jumps suddenly while tuning, you may have a self-oscillation in the log amplifier. If this happens, carefully work with your layout. Ferrite beads, extra bypass capacitors, and small copper

shim stock shields can be used to eliminate the problem. My i-f strip was quite stable, so I do not think you will have a problem.

If you live near a commercial FM station, it may interfere with your tuning efforts. Tape the shield top on the log amplifier during initial tuning to help eliminate this problem. As soon as it appears that the log amplifier is working, solder on the top. Once the top is soldered on, it will totally eliminate the interference.

Bandpass Filter Tuning

Set the vco to 90 MHz. Hook the attenuator between the vco rf test jack and the bandpass filter input. Hook the bandpass filter output to the preamplifier and log amplifier. Monitor the video output of the log amplifier on your oscilloscope. With the tops off the bandpass sections, you should get some signal. If not, temporarily bridge the input and output sections with a 1-pF capacitor tacksoldered at the input and output tap points. Tune the input and output stages for peak response. Remove the 1-pF capacitor if used. Now peak the two middle stages. You probably will get an overcoupled response (double-hump). Just center the tuning between the humps.

Now install the shield tops, one at a time. Tune all bandpass stages after each top is installed. Tuning will become very sharp, especially if you are using air-variable tuning capacitors instead of piston trimmers. When the last top is installed, carefully peak all stages.

Set up your oscilloscope for X-Y operation, using the X-axis output of the sweep generator for the oscilloscope horizontal input and the log amplifier video output for the vertical input. Gradually turn the frequency-span control counterclockwise until you get a sweep display of the filter

7+11 SWD PARTS KITS

MITSUMI VARACTOR UHF TUNER Model UES-A56F **\$34.95**

Freq. Range UHF470 - 889MHz
Antenna Input 75 ohms
Channels 14-83 Output Channel 3

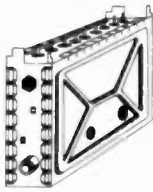

KIT NO.	PART NO.	DESCRIPTION	PRICE
1	VT1-SW	Varactor UHF Tuner, Model UES-A56F	\$34.95
2	CB1-SW	Printed Circuit Board, Pre-Drilled	18.95
3	TP7-SW	P.C.B. Potentiometers, 1-20K, 1-1K, and 5-10K ohms, 7-pieces	5.95
4	FR35-SW	Resistor Kit, 1/4 Watt, 5% Carbon Film, 32-pieces	4.95
5	PT1-SW	Power Transformer, PRI-117VAC, SEC-24VAC, 250ma	6.95
6	PP2-SW	Panel Mount Potentiometers and Knobs, 1-1KBT and 1-5KAT w/Switch	5.95
7	SS14-SW	IC's 7-pcs, Diodes 4-pcs, Regulators 2-pcs Heat Sink 1-piece	29.95
8	CE9-SW	Electrolytic Capacitor Kit, 9-pieces	5.95
9	CC33-SW	Ceramic Disk Capacitor Kit, 50 W.V., 33-pieces	7.95
10	CT-SW	Variable Ceramic Trimmer Capacitor Kit, 5-65pfd, 8-pieces	5.95
11	L4-SW	Coil Kit, 18mhs 2-pieces, 22µhs 1-piece (prewound inductors) and 1 T37-12 Ferrite Torroid Core with 3 ft. of #26 wire	5.00
12	ICS-SW	IC Sockets, Tin inlay, 8-pin 5-pieces and 14-pin 2-pieces	1.95
13	SR-SW	Speaker, 4x6" Oval and Prepunched Wood Enclosure	14.95
14	MISC-SW	Misc. Parts Kit Includes Hardware, (6/32, 8/32 Nuts, 6 Bolts), Hookup Wire, Ant Terms, DPDT Ant. Switch, Fuse, Fuseholder, etc	9.95
When Ordering All Items, (1 thru 14), Total Price			139.95

UHF ANTENNAS and ACCESSORIES

MDS-AMATEUR-ETV 32 ELEMENT YAGI ANTENNA



- NOT A KIT
- 1.9-2.5 GHz
- 23 dB AVERAGE GAIN
- 38 1/2" LENGTH
- DIE CAST WATERPROOF HOUSING WITH 4 1/4" x 2 1/4" AREA FOR ELECTRONICS
- COMMERCIAL GRADE
- INCLUDES MOUNTING HARDWARE

MAE-1 32 Element YAGI Antenna \$19.95

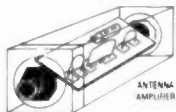

ZYZZX VHF-UHF WIDEBAND ANTENNA AMPLIFIER

MODEL ALL-1
50 MHz — 900 MHz
12 dB GAIN ± 0.5dB

A Revolutionary New One Stage HYBRID IC Broadband Amplifier

This unit is not available anywhere else in the world. One unit serves many purposes and is available in Kit or Assembled form. Ideal for outdoor or indoor use. I/O impedance is 75 ohms. Amplifier includes separate coax feed power supply. Easily assembled in 25 minutes. No coils, capacitors etc. to tune or adjust.

ALL-1 Complete Kit with power supply \$24.95
ALL-1 Wired and Tested with power supply \$34.95

Our New STVA 14.5 dB GAIN, 14 ELEMENT CORNER REFLECTOR YAGI ANTENNA



STVA-3 Yagi Antenna
14.5 dB, 75 ohm, Chan 60-68 \$16.95

STVA-4 Yagi Antenna
14.5 dB, 75 ohm, Chan 44-52 \$16.95

STVA-1 Yagi Antenna, 11.5 dB, 75 ohm, Chan 42-54 \$9.95

RG-59/U 75 ohm Low Loss Coax Cable \$.12 p/ft
F-59 Coaxial Connectors, ea. .39
MT-1 Special UHF 75-300 ohm Matching Transformer, ea. 1.45

Switch to Bambi!

Electronically

Bambi Electronic Video Switch ... makes switching of your VCR/VTR, Pay TV Decoders, Cable TV, Video Discs, Video Games, Closed Circuit TV, Antennae and Microcomputer as easy as pushing buttons.

The Bambi Electronic Video Switch is an electronic switching network which can accept up to six different sources of video signals and provide the flexibility of directing the inputs to any or all of the three outputs.

Now you can eliminate ... the drudgery of disconnecting and reconnecting your video equipment each time you use it ... the tangled mess of cables which are impossible to trace out ... not being able to use more than one function at a time.

Bambi lets you enjoy your video equipment the way it should be ... electronically and on line at the push of a button.

Model
BEVS-1 Wired

\$129.95

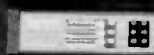

Bambi's front panel was designed with the user in mind. Computer styled construction, with soft-touch keyboard (rated for over 10 million operations), arranged in matrix form allows easy input/output selection without referring to charts. Functions selected through the keyboard are immediately displayed on the 18 LED status indicators.

Check the quality of Bambi against that of much higher priced competition. All solid state electronic switching provides low attenuation (3dB), wide frequency response (40-890 MHz), and excellent isolation between signal sources (each I/O section individually shielded for 65dB min. isolation).

Bambi's Specifications:

- Input/Output Impedance 75 ohm
- Signal Loss 3dB ±1dB
- Noise 45dB ±1dB
- Input Return Loss 12dB min.
- Isolation 65dB min.
- Power Req. 117VAC 60 Hz, 2W
- Dimensions 10" W x 6" D x 3 1/4" H
- Weight 4 1/2 lbs

SWD-1 VIDEO CONVERTER

FOR CABLE TV

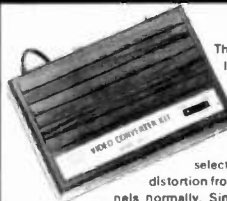

The SWD-1 Video Converter is utilized on cable TV systems to remove the KHz's signal from a distorted video (channel 3 in/out) and also pass thru the normal undistorted/detected audio signal. Rocker switch selects operating mode to remove KHz's distortion from the video or pass all other channels normally. Simple to assemble—less than 30 minutes. Pre-tuned. Input/output Channel 3. Impedance 75 ohms, 117VAC.

SWD-1 Video Converter Kit \$69.95

VTR ACCESSORIES

SIMPLE SIMON VIDEO STABILIZER



Simple Simon Video Stabilizer, Model VS-125, eliminates the vertical roll and jitter from "copy guard" video tapes when playing through large screen projectors or on another VTR. Simple to use. Just adjust the lock control for a stable picture. Once the control is set, the tape will play all the way through without further adjustments. Includes 12V power supply.

VS-125 Video Stabilizer, wired \$54.95

SIMPLE SIMON VIDEO SWITCHING BOX



The Affordable Video Control Center

Excellent in isolation and no loss routing system. Simple Simons VSB-300 Video Switching Box enables you to bring a variety of video components together for easy viewing/dubbing. Also you gain the ability to record one channel while viewing another. Unit includes two F-type quick connector ended cables.

VSB-300 Video Switching Box, wired \$19.95

7+11 PWD PARTS KITS

INTRODUCING OUR 7+11 PWD PARTS KITS



KIT NO.	PART NO.	DESCRIPTION	PRICE
1	1VT1-PWD	Varactor UHF Tuner, Model UES-A56F	\$34.95
2	2CB1-PWD	Printed Circuit Board, Pre-drilled	18.95
3	3TP11-PWD	PCB Potentiometers 4-20K, 1-5K, 2-10K, 2-5K, 1-1K, and 1-50k (11 pieces)	8.95
4	4FR-31-PWD	Resistor Kit, 1/4W, 5% 29-pcs, 1/2 W 2-pcs	4.95
5	5PT1-PWD	Power Transformer, PRI-117VAC, SEC-24VAC at 500ma	9.95
6	6PP2-PWD	Panel Mount Potentiometers and Knobs, 1-1KBT and 1-5KAT with switch	5.95
7	7SS17-PWD	IC's 7-pcs, Diodes 4-pcs, Regulators 2-pcs Transistors 2-pcs, Heat Sinks 2-pcs	29.95
8	8CE14-PWD	Electrolytic Capacitor Kit, 14-pieces	8.95
9	9CC20-PWD	Ceramic Disk Capacitor Kit, 50 WV, 20-pcs	7.95
10	10CT5-PWD	Variable Ceramic Trimmer Capacitor, 5-65pfd, 5-pieces	4.95
11	11L5-PWD	Coil Kit, 18mhs 3-pcs, 22µhs 1-piece (prewound inductors) and 2 T37-12 Ferrite Toroid cores with 6 ft. #26 wire	6.00
12	12ICS-PWD	IC Sockets, Tin inlay, 8 pin 4-pcs, 14 pin 1-pc and 18 pin 2-pcs	2.95
13	13SR-PWD	Enclosure with PM Speaker and Pre-drilled Backpanel for mounting PCB and Ant. Terms	14.95
14	14MISC-PWD	Misc. Parts Kit, Includes Hardware, (8/32, 8/32 Nuts & Bolts), Hookup Wire, Solder, Ant. Terms DPDT Ant. Switch, Fuse, Fuseholder, etc.	9.95
15	15MC16-PWD	Mylar Capacitors, 14-pcs and Silver Mica Capacitors 2-pieces	7.95
When Ordering All Items, (1-15), Total Price			159.95

SIMPLE SIMON ELECTRONIC KITS, Inc.

3871 S. Valley View, Suite 12, Dept. 7, Las Vegas, NV 89103

In Nevada Call: 702-871-2892
1-800-782-3716

Outside Nevada Call:

Available by Mail Order Only
Send Check* or Money Order. Minimum Order: \$16.95. Add 10% Shipping and Handling on orders under \$40.00. For orders over \$40.00, add 5%. Minimum Shipping and Handling \$2.00. Cat. \$1.00 — VISA and Mastercard Acceptable — *Check orders will be held 30 days before shipping.

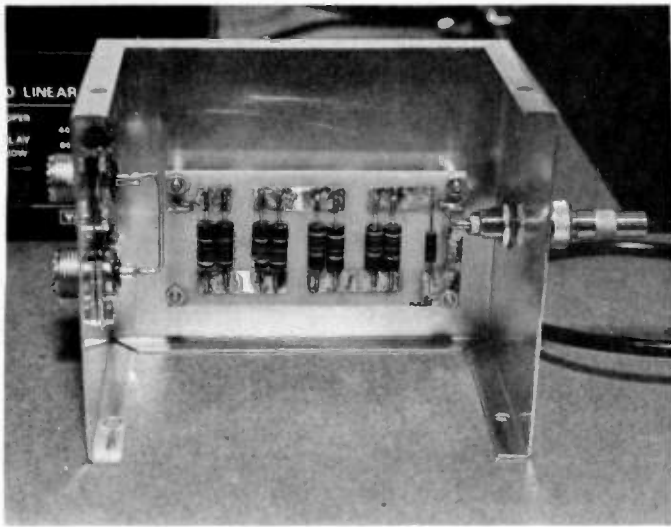

Photo 1. L-pad sampler.

bandpass. Make fine adjustments for a smooth bandpass shape. Stagger-tune the two middle bandpass filter sections just a bit to sharpen the nose of the filter. Be sure to put in enough attenuation to keep the video output from the log amplifier under two volts during the bandpass filter tuning procedure.

If it seems that you have an over-coupled response in your filter, narrow the aperture between the two middle bandpass filter sections. If the filter tunes sharply but exhibits high loss, then widen the aperture between the two middle sections.

Final Setup

Install all circuitry in your chassis and complete all wiring and coaxial cable hookup. Set the analyzer upside down in front of your scope. Connect your oscilloscope to the analyzer X- and Y-axis outputs. Set up the oscilloscope again for X-Y operation. Turn the analyzer on (no signal). Turn the frequency-span pot fully clockwise (no ramp). Using your frequency counter at the vco rf test jack, set the vco for 90 MHz operation with the center-frequency pot. You should see two horizontal lines about 2 volts apart. Rotate the frequency-span pot counterclockwise a little. You should see the bandpass-filter response again. This is due to mixer leak-through and is normal.

Set the retrace line (lower straight line) under the bandpass response curve at the bottom of the CRT

screen. Widen the trace with the oscilloscope controls to reach across the screen. Turn the frequency-span pot fully clockwise again. Set the vco frequency to 120 MHz. Now turn the span pot counterclockwise until the zero-frequency half-spike appears on the left side of the screen. There should also be some grass above the retrace line along the bottom of the screen. The analyzer should now be scanning 0 to 60 MHz.

Feed a small 30-MHz signal from a grid-dip oscillator (use a pick-up loop as shown in Photo 1) or a low-power-signal generator to the analyzer through the attenuator. You should now see the 30-MHz signal spike about mid-screen. You may also see the 2nd harmonic of the 30-MHz signal on the right edge of the screen. Adjust the attenuator so that the 30-MHz signal is about

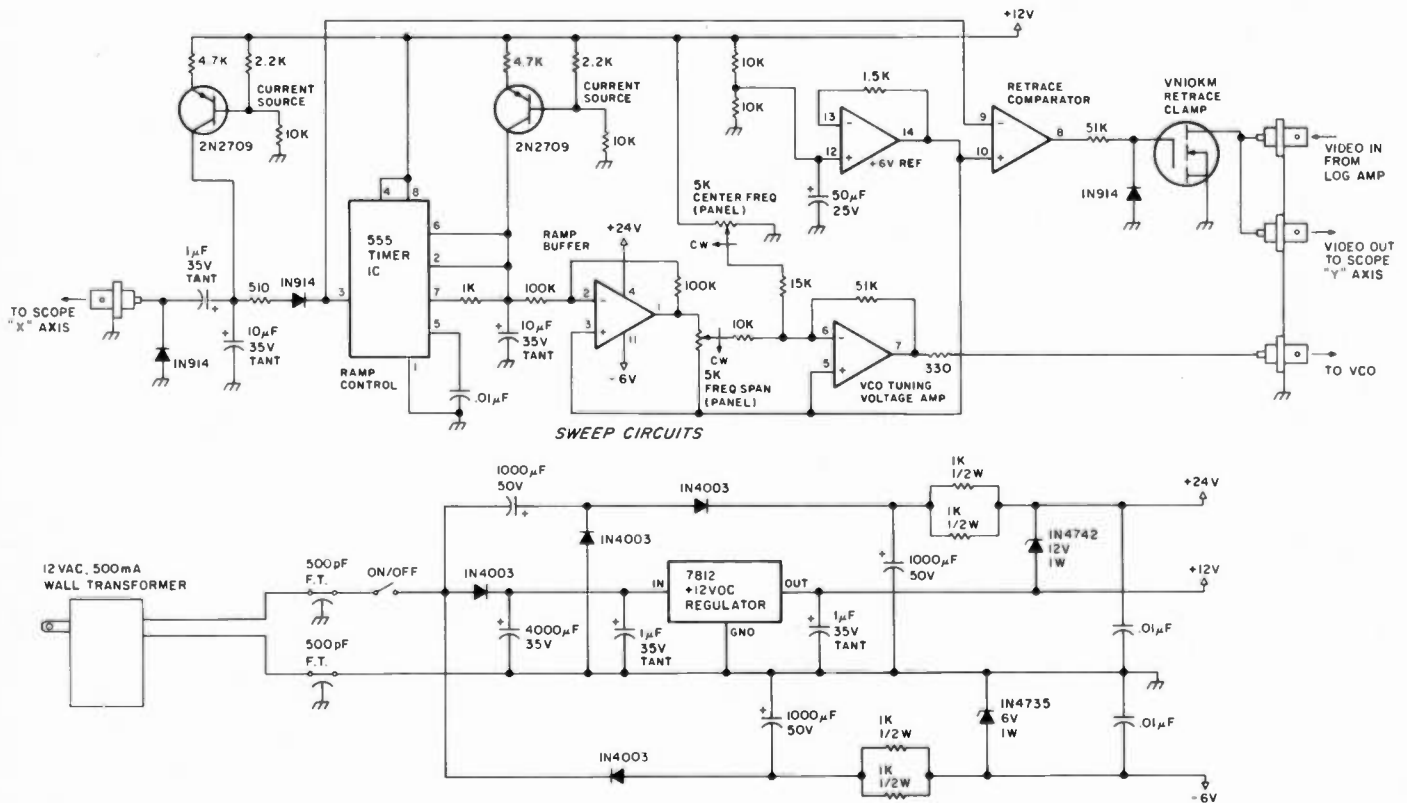

- Note 1. Wall transformer available from Jameco.
- Note 2. Other devices available from Radio Shack.
- Note 3. TL084C is quad op amp.
- Note 4. 500-pF threaded feedthroughs available from Alaska Microwave.

Fig. 8. Power supply and sweep circuits.



MICROLOG

INNOVATORS IN DIGITAL COMMUNICATION

AMATEUR RADIO COMMUNICATION AT ITS FINEST



Both Systems Provide

You won't find as much well thought out programming, circuitry, and features anywhere, at any price! The ATR-6800 combines the best of both worlds, an easy to use video system for CW/RTTY/SSTV with automatic station control and a stand-alone computer with expandable memory & full instruction set in Motorola assembly language. Add the BASIC language option package and you'll have the unique combination of an RFI proof computer and ultimate RTTY/CW HAM station. And don't forget "easy to use." All of us at Microlog are RADIO ACTIVE on RTTY, so there's a lot of personal attention to detail and ease of operation. "Stick-on" command listing and video status display will get you on the air quick and sounding like a pro.

- SIMPLE DIRECT CONNECTION to your Transceiver.
- COMPLETE SYSTEM, built-in Demodulator & AFSK Modulator with keyboard programmable tone pairs.
- SPLIT-SCREEN operation with keyboard selectable line location.
- LARGE, TYPE AHEAD text buffer.
- TEN, programmable message memories, plus ID's WRU & SELCALs.
- RANDOM CODE generator & hand key input for practice.
- Baudot 60 to 132 WPM.
- ASCII 110 & 300 baud.
- SYNC-LOCK MODE for improved ASCII operation.
- RECORDER INTERFACE FOR "BRAG-TAPE" or recording off-the-air.
- CODE CONVERTED Printer output in Baudot or ASCII.
- SSTV/GRAPHICS transmit.
- FULL 63 KEY Computer grade keyboard.

There's a certain thrill to using efficient, reliable digital communications equipment on the air. That's the fun of RTTY. Spice up your Amateur Radio operation with the silent video system that does it all, the Microlog ACT-1. Even if you own a home computer and are considering an out-board interface/program, remember, we've put it all in one RFI tight enclosure that's ready to go as soon as you power up. And, with the "Battery-backed" mem-

ory option, you won't even lose your pre-programmed messages if there's a "blink" in the A.C. The ACT-1 has features that the competition doesn't even have on the drawing board! Check for yourself, you could spend a lot more and still come up short.

ATR-6800 vs ACT-1 The most often asked question we hear is "What's the difference between the ATR & the ACT-1?" The ACT-1 is a dedicated system for RTTY/CW/SSTV. It provides all the functions and features you need for a multi-mode station. Along with this superior "ON-the-AIR" performance, the ATR-6800 extends your operation into the realm of automatic station control and computer programming. Plug-in applications modules expand the ATR's memory to add new HAM oriented programs which are enabled by simple keyboard commands. By adding the BASIC option package, you'll have pre-programmed full community mailbox, contest dupe sheet, personal station log, message editor, BASIC computer language and 16k of battery-backed (non-volatile) memory. We also provide a subroutine list so that you can write programs to directly control the ATR-6800 in easy to use BASIC language. The ATR-6800 then is the expandable, "do everything" system where your imagination is the only limit! The ACT-1 is designed for the HAM who needs the essentials of a complete video system for digital communications.

TECHNICAL SPECIFICATIONS ATR-6800 & ACT-1

INPUTS
Speaker Audio 100mv min.
Digital TTL Keyer, Hand Key
RS232 ± 12V, 330 Ohm Source

OUTPUT TO TRANSMITTER FOR CW/RTTY/SSTV
+ Voltage Keying +40VDC @ 300ma Max.
- Voltage Keying -150VDC @ 50ma Max.
Mercury Relay 200VDC or 2 amp (20VA Max.) N.O. & N.C.
T/R Change Over ATR — Relay ± 30V @ 2 amp N.O. & N.C.
ACT-1 — Transistor + 12VDC @ 300 ma. GND on XMT

AFSK Tones, Range Keyboard Programmable 500 Hz to 3000 Hz
AFSK Tones, Level Mic Compatible 30-50mv Audio
Slow Scan Mic Compatible Audio. Sync 1200 Hz, Black-1500 Hz, White 2300 Hz

MISCELLANEOUS CONNECTIONS
RS 232 ± 12VDC, 330 Ohm Source Impedance, Negative Mark
Printer Driver ATR — Hi-speed RS-232 upto 2400 Baud
• 50-speed Baudot & ASCII Floating Relay for Current Loop Switching
ACT-1 — Hi-speed Baudot & ASCII Transistor Switch + 40VDC @ 100 ma.
• Optional Hi-speed ASCII RS232 @ 2400 Baud.

Tape Recorder Mike + 100 mv Audio
"Brag Tape" Speaker + 200 mv Audio
Scope Horizontal and Vertical Outputs to Scope for RTTY Tuning Aid
Automatic or Speed Lock

Morse Speed Tracking Automatic or Speed Lock

VIDEO OUTPUT
1 Volt Peak to Peak, Negative Sync Composite Video (American Standard)
European standard available upon request.

VIDEO FORMAT
Normal 24 lines, 40 characters per line
Zoom 12 lines, 20 characters per line
Black on White or Keyboard selectable
White on Black Any location Line 0 (Off) to Line 20, Keyboard selectable
Display Split Screen Keyboard selectable

SSTV 3 lines, 6 characters per line + graphics

TEST MESSAGES: Quick Brown Fox and RYRY's in Baudot, U-U in ASCII, VVV in Morse.

SYNC: Transmits "Blank-Fill" in RTTY and BT in Morse when Text Buffer is empty and unit is in transmit. Keyboard command on/off.

UN-SHIFT on Space: Automatically shifts back to "LETTERS" upon receipt or transmission of space. Keyboard command on/off.

REAL-TIME CLOCK: Keyboard set, always on screen display, hours, minutes, seconds. Can also be inserted in transmit text buffer by keyboard command.

WORD WRAP AROUND: Prevents spilling words at the end of a line. Works in receive as well as transmit.

CODE PRACTICE: Random 5 char generator sends at any speed you set via the keyboard. Hand-Key input allows use in code practice oscillator that will also read your sending!

STATUS DISPLAY can be called up to show the condition and control commands for 20 programmable parameters, such as AFSK tone freqs, UNOS, printer, etc. Useful as a "HELP" command in case you misplace the manual. There's also a constant "TOP-LINE" display of Time, Mode, Speed, & Code in use.

DETECTION MODES
Direct Phase correlation detector with AGC controlled bandpass filter (100 Hz nominal width — 800 Hz center frequency)
Demodulator Computer program enhanced dual tone demod. Primary tones fixed @ 2125/2295 Hz. Secondary tones variable @ 500 — 3000 Hz.
RS232 compatible half duplex or full duplex up to 9600 Baud.

DATA RATES
Morse 5-199 WPM Keyboard selectable in 1 WPM steps. Auto speed tracking or speed on receive
All standard 45, 50, 57, 74, 100 Baud (60, 66, 75, 100 and 132 WPM)
Baudot 110 & 300 Baud normal & synclock using Internal Modern. ATR adds speeds up to 9600 Baud.
ASCII 8 seconds per frame

Slow Scan

OUTPUT OPERATING MODES
Symbol Character outputs when typed
Word Words sent after "Space Bar"
Line Line sent after "Return"
Buffer Send entire contents of text buffer

TUNING INDICATORS
Audio Ref. Tone 800 Hz Keyed Regenerated
Visual LED on Mark (Keydown)
Scope Tuning ellipse for RTTY

PROGRAMMABLE MEMORIES
Here is:
ID: 10-40 character messages (400 total) or *10-80 character messages (800 total) battery backed
WRU: 15 characters maximum in standard ID and 17 in RTTY ID
Up to 15 characters
Selective Call: ATR — 4 memories, up to 15 characters each
ACT-1 — 2 memories for printer on and printer off

COMPUTER CAPABILITY
Memory Standard unit has 4000 bytes of RAM for user program. Basic package adds 16K.
Language Basic or Motorola M6800
Commands Input, Output, Load, Go with Break Point, or Normal Basic
Tape Interface Store Programs on Audio Cassette

POWER
115 VAC, 60 Hz 60 VA Max. ACT-1, 30 VA Max (230 VAC, 50 Hz optional)
12 volt version available
External input for charging expanded battery backed memory. 6-15VDC @ 10 ma max

MECHANICAL
ATR-6800: 14 1/4" W x 12 1/4" D x 4 1/4" H
Size 15 lb.
ACT-1: 17.8 W x 3H x 9.5D
Size 7 lb.
Weight
ATR-6800 & ACT-1: Beige Top, Black Base
Color AL5052 Aluminum Alloy
Material

* Standard on ATR, Optional on ACT-1
** Standard on ATR, Not available on ACT-1

51 MICROLOG CORPORATION — 18713 Mooney Drive — Gaithersburg, MD 20879 (301)258-8400

the same height as the zero-frequency half-spike. If things have gone well so far, you are getting a signal through the low-pass filter and mixer, so you can now install their enclosure tops.

Set the frequency-span control so that the 30-MHz signal spike is about two scope divisions wide. Now fine-tune the bandpass filter again and re-peak the log amplifier. Switch the 10-dB attenuator section in and out while adjusting the vertical gain of the oscilloscope so that the signal height changes one CRT division. Now switch a 20-dB section in and out. Signal height should change two CRT divisions. Readjust the frequency span control for a 0-to-60-MHz analyzer tuning range.

Increase signal strength until the first small spike pops out of the grass between the 0- and 30-MHz signals. This is slightly above the overload point of the analyzer. The 30-MHz signal spike should be near the top of the CRT screen (8th vertical division). Full-scale inputs should be the next (7th) CRT division down. Touch up the oscilloscope controls if necessary. The zero-frequency half-spike will be about six divisions tall. Switch all attenuation out and reduce the signal generator output so that the 30-MHz test signal is seven divisions tall. Check the vertical calibration of the analyzer over the attenuator's 59-dB range.

Using your signal generator and frequency counter, take notes on the horizontal calibration of your analyzer. This is done by centering a signal from your signal generator on each CRT horizontal division (vertical line) and recording its frequency. Your analyzer is now ready for use. But first, test the L-pad carefully!

Hook up your L-pad to your transmitting equip-

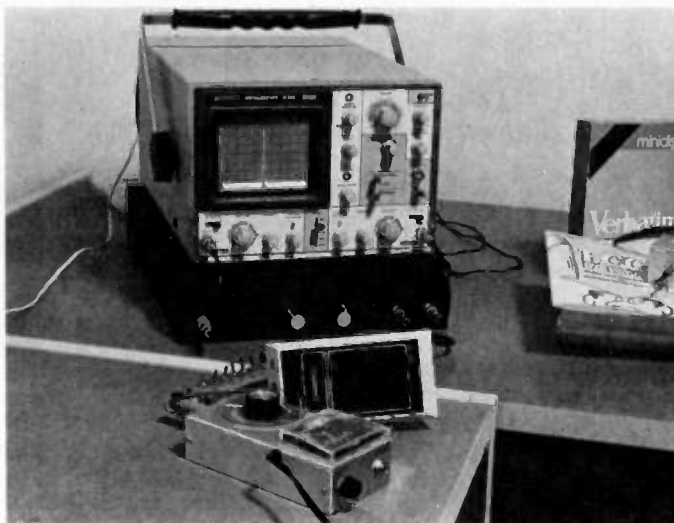
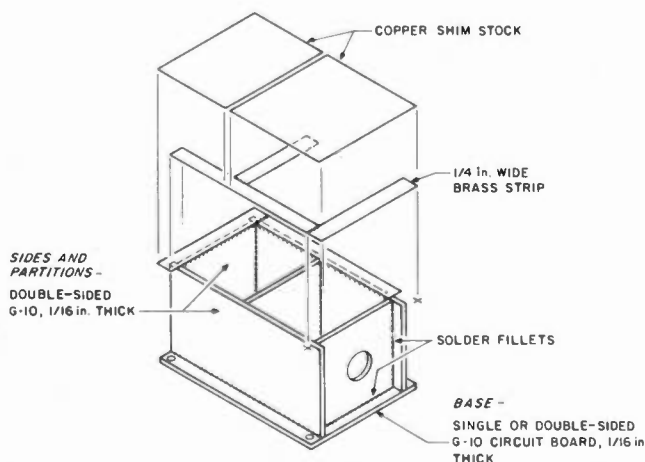

Photo 1. The spectrum analyzer can easily be tuned up with simple test equipment.

ment. Be sure everything is grounded properly. I suggest mounting the L-pad and attenuator on an aluminum plate which is in turn wall-mounted. Ground the plate! Do not connect the attenuator to the L-pad yet. Connect your transmitter to an swr meter, the swr meter to the L-pad, and the L-pad to your dummy load. The L-pad should introduce little, if any, swr. Starting with low power (100 Watts or less), key down for 30 seconds. Power down your transmitter completely and quickly inspect the inside of your L-pad. The "fuse" should be OK and nothing should be hot. Continue testing to full station power.

If everything has gone well, then power down your transmitter completely and connect the attenuator to the L-pad. Switch in all attenuation and connect the attenuator to the spectrum analyzer. Remember that the analyzer and oscilloscope cases should be solidly grounded. Starting again with low power, key down and adjust the attenuator for a full-scale spectrum analyzer display. How does your spectrum look?! Always switch in full attenuation before increasing power. Remember, do not go over one kilowatt continuous output (2 kW p-p). Do not attempt to use the spectrum analyzer system where your swr is greater



Note 1. Solder G-10 circuit board and brass strips with 40-W iron.
Note 2. Solder copper shim stock with 25-W iron.

Fig. 9. Shielded box construction detail.

than 2:1. Always be sure you are using an L-sampler with a high enough power rating!

Component Sources and Substitutions

It often is lamented that home-brewing projects is difficult these days because of poor component availability. I started seriously experimenting with electronics 20 years ago in the good old days of component availability. The difference between now and then is that we have about a thousand times more components to experiment with!

It's simply a matter of motivation and tenacity. You can get any component that you need. True, Mom and Pop's local TV component place doesn't carry everything, but they may be able to order it for you. Don't be afraid to contact a manufacturer or a big distributor like Hall-Mark, Arrow, Allied, etc. They are usually glad to work with you (although order minimums can be an occasional problem). Best of all, look at the ads in this magazine. There are several dozen mail-order distributors which market primarily to the experimenter.

On specifics: You can get circuit board stock, chemicals, drill and router bits, etc., from Kepro in Fenton, Missouri. You can get MRF901s, 40673s, 500-pF and 1000-pF feedthrough capacitors from Alaska Microwave Labs in Anchorage, Alaska. You can get ferrite beads, toroids, and i-f transformers from Amidon Associates in N. Hollywood, California. Small air-variable capacitors for the bandpass filter are available from Radiokit in Greenville, New Hampshire. You can get resistors, capacitors, 555 ICs, TL084C quad op amps, VMOS transistors, and many of the parts discussed above from Radio Shack. You can get

50 db GAIN

OVER A 1/4 WAVE WET NOODLE!

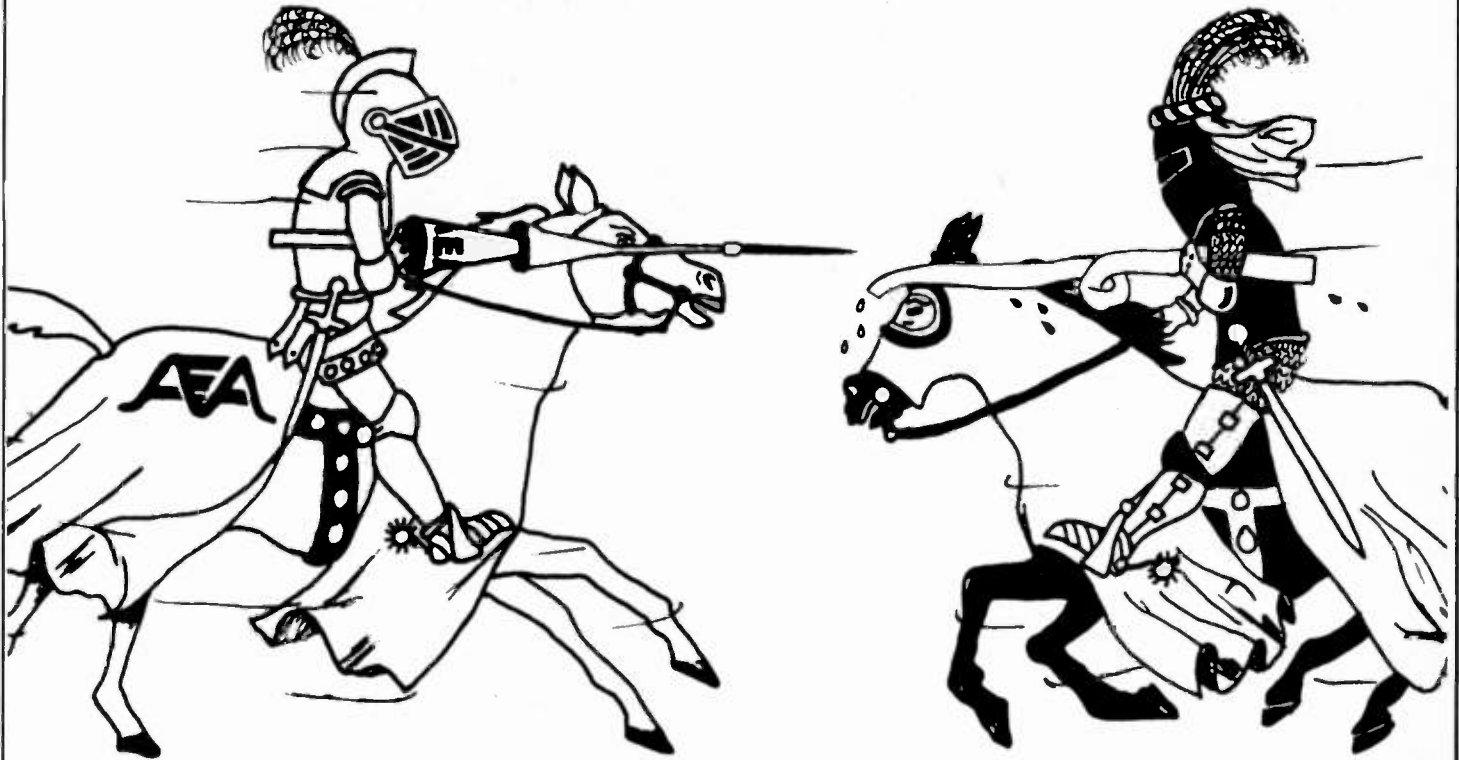

It sounds ridiculous, doesn't it? Amateur Radio advertising is not exempt from exaggeration. When facts are distorted by fabrication you may be induced to buy a product that ultimately is incapable of meeting the performance claimed by the manufacturer. Caveat Emptor (buyer beware)!

The AEA IsoPole™ antenna has 3 db gain over a dipole in free space. This is an honest and supportable claim. Yet other manufacturers claim as much as a 7 db gain for their antennas using no reference standard or a 1/4 wave antenna as reference. The 1/4 wave is not a recognized reference used by reputable antenna engineers because it is most difficult to properly decouple in a repeatable fashion.

The IsoPole antennas offer the maximum gain attainable for the length of antenna. This is a bold statement and one we know we can stand behind!

For any linear array antenna to outperform the IsoPole by 3 db or more on-the-horizon gain, it would have to be at least 20 feet long! Anything less and you can bet that advertising deception is being used.

Before you buy a VHF or UHF base station antenna, get some good honest facts about VHF antenna design. Send for your FREE

copy of "Facts About Proper VHF Vertical Antenna Design" by Professor D.K. Reynolds, K7DBA. You'll be glad you did.

In the meantime, we would like to expose you to some of the comments we have received from customers that are using the IsoPole.

Seattle, WA — Compact & easy to install, quality & keeps XYL happy -looks good!!

Half Moon Bay, CA — Found repeaters I only heard about before from my QTH — Excellent. Amazed at light weight and low cost...

Sturgis, SD — The IsoPole Antenna has exceeded my expectations.

Lumberton, NC — You really do what you say! The best 2 mtr. antenna I have ever owned!

La Habra, CA — Hooked up today, and it was a perfect match throughout the entire band. For the money, you can not go wrong.

Tok, AK — Truly a fine antenna, working better than the five element yagi it replaced.

Sacramento, CA — Assembly was remarkably easy. I needed an efficient, low profile antenna & your product fit the bill to a "T".

Warsaw, IND — AMAZED!!! Antenna ground mounted on required mast & outperforming a (R.R.) at 55' on top of tower.

Loris, SC — I'm a commercial radio salesman, and the IsoPole is THE antenna I recommend.

Seattle, WA — Works well — excellent. Had (R.R.) at 80'. With the IsoPole at 20 ft. I now hear repeaters and simplex I never heard with (R.R.) The IsoPole will soon be at 80'.

Freehold, NJ — It is everything your ad says and more.

Great Neck, NY — Amazing difference between (R.R.) 10 db or better, raise rept. never heard before — SUPER, 73 and thanks.

Richfield, OH — Works extremely well, broke a repeater at 100 mi using 150 mw!

Vernon, TX — (The dealer) said the antenna WAS THE BEST ON MARKET and I AGREE! It IS AN EXCELLENT antenna & works to specs -Thanks.

Prices and Specifications subject to change without notice or obligation.

AEA

Brings you the Breakthrough!

-2

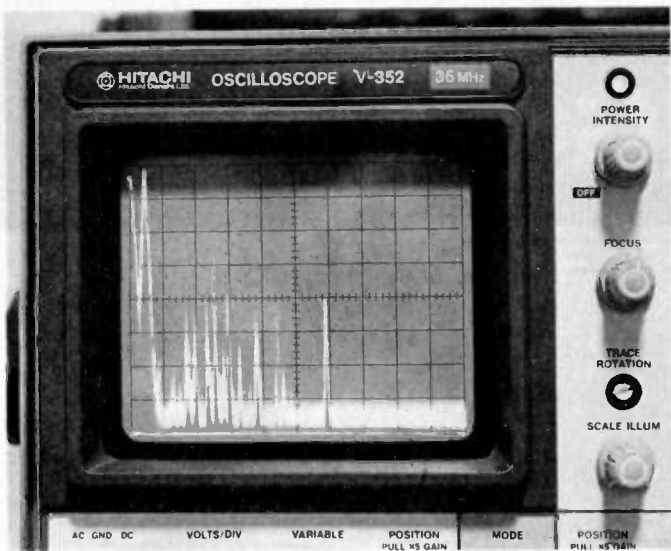

Photo K. 0-to-60-MHz spectrum on longwire antenna, using accessory preamplifier.

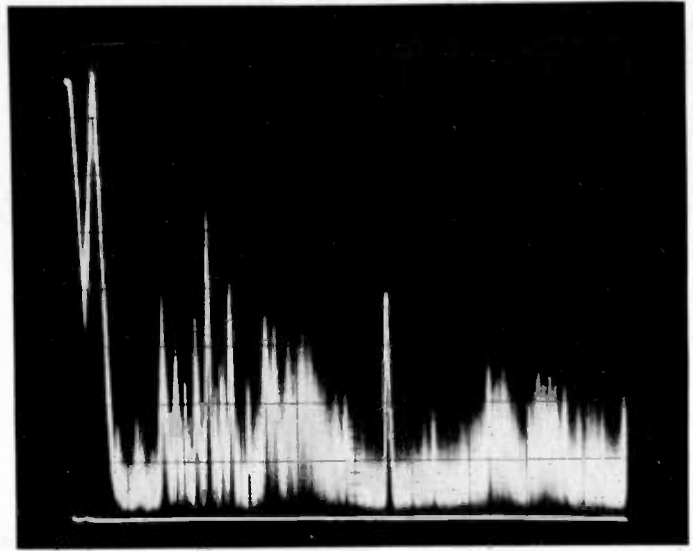

Photo L. 0-to-60-MHz spectrum on longwire antenna with my trusty but noisy computer on.

wall transformers and tantalum capacitors from Jameco in Belmont, California. 2N5179s are carried by most TV parts houses. The double-balanced mixers can be ordered directly from Mini-Circuits in Brooklyn, New York. See, you have no excuse!

OK, the MV109s might be a slight problem. An MV209 or MV309 should also work. I got my stock from Hall-Mark. If you run into a problem getting these diodes, pick up the phone and call Motorola Semiconductor in Phoenix, Arizona, for help.

The high frequency spectrum analyzer should be fairly tolerant of component substitutions except in the vco oscillator circuit and the L-pad. For example,

the "hotter" 3N211 could substitute for the 40673 if you crank its gain down a bit with the log amplifier bias pot. You could use MRF901s in place of the 2N5179s (don't try to go the other way!). Solid copper conductors (#12) stripped from house wiring can be used for coil stock in the vco and bandpass filter. Any decent electrolytics of the proper capacitance and voltage rating can be used in the power supply and sweep generator circuits. Electrolytics could also be used in place of the tantalum capacitors in a pinch. Try to get close-tolerance parts in this case.

Useful Accessories

You can duplicate the 2-stage wideband-preampli-

fier circuit to use as an accessory ahead of the attenuator. This will allow you to view the 0-to-60-MHz radio spectrum on a longwire antenna and quickly judge the band conditions through six meters. Vco frequency-tuning is somewhat nonlinear, which is typical of simple wideband oscillators. A 6-MHz crystal oscillator driving a TTL Schmitt trigger makes a useful calibrator. The output of the TTL gate contains every harmonic through 60 MHz. Lightly couple the TTL gate to the spectrum analyzer input with an insulated wire antenna placed near the analyzer input connector. A momentary-on push-button can be used to activate the calibrator.

Analyzer Applications

We have talked about using the HF spectrum analyzer to monitor transmitting equipment. This was the primary application I had in mind when I designed the analyzer. It is especially useful to hams who are home-brewing their own HF transmitters or linears. It is also useful for checking low-pass filter performance and band conditions. I'm sure you will find other applications.

The analyzer has a 50-Ohm input impedance and

is dc-coupled. Be sure to add a blocking capacitor ahead of the attenuator if you are going to look at an rf signal that is riding on a dc level. Stay away from high-voltage dc circuits. The bandpass of this analyzer is too wide for looking at SSB modulation linearity. However, this can be judged adequately from a two-tone pattern on a normal oscilloscope.

From Here

This project demonstrates that a useful spectrum analyzer can easily be built from relatively common and inexpensive components. Avid experimenters should treat this design as a starting-off point. Meanwhile, let's get those transmitter spectrums cleaned up! If you would like to ask me a question about the analyzer project, please send an SASE. 73! ■

References

1. *Solid State Design for the Radio Amateur*, by Wes Hayward and Doug DeMaw, ARRL Publications.
2. *Hewlett-Packard Electronic Instruments and Systems*, by Hewlett-Packard, Palo Alto, California, 1981.
3. "High Performance Spectrum Analyzer," Wayne Ryder, *Ham Radio*, June, 1977.
4. *Printed Circuits Handbook*, 2nd Edition, by Clyde F. Coombs, McGraw-Hill.

Specifications for HF Spectrum Analyzer

Frequency range	0 to 60 MHz
3-dB bandwidth	220 kHz
30-dB bandwidth	1,100 kHz
3:30-dB shape factor	1:5
Dynamic range	60 dB
Spurious responses	60 dB below full-scale
Noise floor	65 dB below full-scale
Full-scale input	-8 dBm \pm 2 dBm
Y-axis output	0 to 2.5 volts
X-axis output	-0.5 to +3.5 volts
Y-axis calibration	10 dB/division
X-axis calibration	6 MHz/division (approximate)
0 to 8 MHz	4 MHz \pm 0.75 MHz/division
8 to 24 MHz	8 MHz \pm 1 MHz/division
24 to 60 MHz	6 MHz \pm 1 MHz/division

HAZER™

TOO OLD-TOO SCARED-
TOO TIRED TO CLIMB?

HAZE YOUR TOWER

- Hazer follows parallel to tower
- Raise or lower Antenna to ground
- Works best on self standing towers
- Guy wire lugs provided on Hazer
- Midway tower guy wires must temporarily be removed during operation
- Simple & easy to install and use
- Complete with winch, 100 ft of cable, hardware & instructions

MARTIN ENGINEERING
P.O. BOX 253 ✓134
BOONVILLE, MO 65233
816-882-2734



HAZER II Heavy duty, aluminum,
for Rohn 20 & 25 tower \$279.95

HAZER III Standard duty, aluminum,
for Rohn 20 & 25 tower \$199.95

HAZER IV Heavy duty, steel, for
Rohn 20 & 25 \$249.95
Tower, Rotator, Ant. not included

BASE RINGO RANGER II

- 7dB GAIN
- HIGHEST GAIN
- 2 METER OMNI
- OUTPERFORMS
- CONE AND
- DOUBLE ZEPP
- WORK MORE STATIONS
- ELIMINATE NOISE
- LIGHTNING PROTECTED
- ACCESS MORE REPEATERS
- ASSEMBLE EASILY
- INSTALL QUICKLY
- A COMPLETE ANTENNA
- ALL PARTS INCLUDED
- 600,000 HAPPY USERS
- BECOME ONE TODAY
- ARX-2B 134-164MHz
- ARX-220B 220-225MHz
- ARX-450B 435-450MHz

TERRIFIC 2 METER RANGERS

MOBILE RANGERS

- MORE RANGE
- 3 dB GAIN
- 5/8" STAINLESS WHIP
- GRIP TIGHT 90LB
- MAGNET
- CHROME PLATED BASE
- NEAT APPEARANCE
- THUMB LOCK ADJUSTMENT
- NO WHIP CUTTING
- LOW PRICE
- MAGNETIC MOUNTS
- AMS-147 146-148 MHz
- AMS-220 220-225 MHz
- TRUNK LIP MOUNTS
- ATS-147 146-148 MHz
- ATS-220 220-225 MHz

MOBILE

BUY FROM YOUR DEALER



THE ANTENNA COMPANY

48 Perimeter Road, P.O. Box 4680
Manchester, NH 03108
Telex - 953050 ✓106

Introducing our Latest Model — NOVAX II

SIMPLEX / DUPLEX
AUTOPATCH



NOVAX I

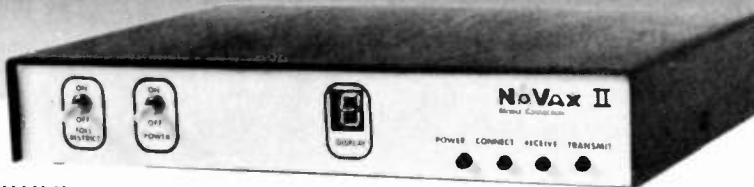

NOVAX II

NOW TWO MODELS TO
SERVE YOU BETTER
YOUR OWN PRIVATE AUTOPATCH



NOVAX interfaces your standard 2 meter; 220; 450; etc. Base station and telephone, using a high speed scan switching technique so that you can direct dial from your automobile or with your HT from the backyard or poolside — Automatically ... Easy installation transceivers, featuring solid state switching, offer best results ... Available interfaced with an ICOM 22U.

FEATURES	NOVAX I	NOVAX II
• 3 min. Call duration timer	YES	YES
• Up to 45 sec. activity timer	YES	YES
• Single digit Access Control	YES	NO
• DTMF (Touch Tone)* phone connection	YES	YES
• 4 digit Access Control	NO	YES
• Toll Restrict	NO	YES
• LED Digital Display	NO	YES
• Vinyl covered alum. case size	5" x 6" x 2"	10" x 8" x 1 3/4"
• Directly Interfaces with Repeater	NO	YES
• Rotary Dial System (incl. Last digit dial)	NO	YES—"Option"—\$49.95
• Ring Back (reverse autopatch) "Option"	YES—\$39.95; Kit \$29.95	YES—Wired—\$39.95
• Price	Kit; \$169.95/wired \$219.95	Wired only \$279.95
N.Y.S. Res. add approx. Sales Tax		SHIPPING ADD \$3.50 in U.S.A.

To order, send
check, money
order to:
MASTER CHARGE
AND VISA ACCEPTED



Box 162 - Tudman Rd.
Westmoreland, N.Y. 13490
or Phone 315-829-2785 ✓21

* Trademark ITT

DISCOVER VAST



DISCOVER THE NEW DENTRON LINE OF VALUE ENGINEERED PRODUCTS.

Every Dentron unit is the result of an intensive engineering effort focused on your specific needs. You get the gear you want, with the features you want, the performance you want, at a price you'll love. Value engineering...it means you don't have to pay for more than you want, or settle for less than you need.

GALION Linear Amplifier: 1200 PEP watts input on SSB; 1000 watts input on CW; 160-80-40-30-20-17-15 Meter amateur boards; modifications for 12 and 10 meter amateur bands and associated MARS frequencies; rugged reliable 3-500Z grounded grid triode; high volume forced air cooling-2 speed blower; full function metering; internal in-out switching. 3-500Z tube included. 15½" W x 7¼" H x 15¼" D; 47 lbs.

CM-U TUNED INPUT ACCESSORY: Tuned Input accessory for amateur band amplifiers which have no tuned input stage. The circuitry is symmetrical on all bands. No tuning necessary. 4" W x 2¼" H x 4¼" D; 3 lbs.

MLX Mini Transceiver: 25 Watt PEP SSB/CW Transceiver for any one Amateur Band, 160 to 6 Meters. Digital Readout, 12 Volt Operation. NI-CAD Portapack available. 5" W x 2¼" H x 7" D; 4 lbs.

GLA-1000B Linear Amplifier: 80-15m w/some MARS; 1200w PEP SSB, 700w CW; (4) D-50A's w/tuned input for Solid-State rigs; 125w drive, 117/234v; 11" W x 5-3/8" H x 11" D; 30 lbs.

GALION "II" Linear Amplifier: 160-80-40-30-20-17-15 Meter amateur bands; 12 and 10 meters for export only; 2000 watts PEP SSB, 1000 watts CW, RTTY, SSTV, AM; 100% in Amateur Service; 2-type 3-500Z EIMAC Power Grid Triodes; 2, 3-500Z tubes included. 15½" W x 7¼" H x 15" D; 49 lbs.

NEW HORIZONS



STATION ONE CW Radio Station: A complete 3-band, 25 watt, CW transceiver and accessories station for new and experienced hams. This kit comes complete with transceiver, code key, 3 band dipole, headset, logbook, ARRL License Manual, radio and code course on cassette. 5" W x 4" H x 5" D; 7 lbs.

GLT-1000 Antenna Tuner: 1.8-30 MHz continuous; Tunes wire, coax, balanced line; 1.2 KW PEP; 1 KW CW Input; 11" W x 4 1/2" H x 12" D; 13 lbs.

MLT-2500 2KW Antenna Tuner: 1.8-30 MHz continuous; Tunes coax, wires and balanced line. Wattmeter accuracy $\pm 10\%$ of full scale, 14" W x 5.5" H x 14" D; 28 lbs.

MLA-2500 C Linear Amplifier: A full 2 KW PEP, 1 KW CW amplifier. Uses two type 8122 output tubes with a total plate dissipation of 800 watts; The new MLA-2500 C is up to date with full coverage of all amateur bands, including the new W.A.R.C. 30, 17, and 12 meter bands, and 160 meters. 14" W x 5.3" H x 14" D; 49 lbs.

Jr. Monitor Tuner: 1.8-30 MHz, 300w, batun; for coax, wire and balanced line. Base or mobile (bracket incl.). 6" W x 3" H x 8" D; 4 lbs.

NDT-300 Tuner: 1.8-30 MHz; built in directional wattmeter with dual meters; wide matching range, built-in 4:1 balance. 14" W x 2" H x 14" D; 8 lbs.

MLX-2500 Transceiver: (NDT Tuner Optional) 160-80-40-30-20-17-15-12-10 Meter amateur bands; USB, LSB, CW; 500 watts PEP SSB, 400 watts CW; 0.5uV for 10 db S/N, 120/240VAC 50/60 Hz Supply built in; All Silicon Solid State Receiver; 2-6MJ6 tubes in transmitter output; 14 1/2" W x 5 1/4" H x 14" D; 29 lbs.

MLA-2500 VHF 2 Meter Amplifier: 50-54 MHz, 142-150 MHz; 1800 Watts PEP, 1000 watts F.M. or C.W., 875 watts A.M. Linear; 8122 Ceramic/Metal Tetrodes; 120/240 VAC, 50/60 Hz; 14" W x 5" H x 14" D; 49 lbs.

Clipperton-L Linear Amplifier: 160-15m w/some MARS; 2KW PEP SSB, 1KW DC CW, RTTY/SSTV; (4) 572B's, 65-150w drive; Size: 14 1/2" W x 8" H x 14 1/2" D; 42 lbs.

GLA-500 VHF Amplifier: 144-150 MHz; 500 Watts Input PEP SSB; SSB 50%; CW, FM-35%; 115-120 or 230-240 VAC 50/60 Hz.; 1-4CX250B Metal/Ceramic Tetrode; 11" W x 5 1/2" H x 11" D; 31 lbs.

Clipperton T Antenna Tuner: 2 KW Tuner; 1.8-30 MHz Continuous; Tunes coax, wires or balanced line, 14 1/2" W x 6" H x 14 1/2" D; 22 lbs.

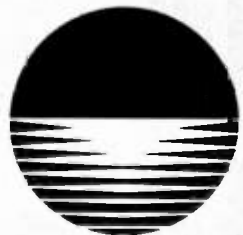

DENTRON
DISCOVERING VAST NEW HORIZONS

1605 Commerce Drive 167
Stow, Ohio 44224 U.S.A.
216-688-4973 Telex: 241-633

Lt. Col. (Ret.) Sir Evan Nepean Bt. G5YN
Goldens, Teffont
Nr. Salisbury
Wiltshire, England

The AC4YN Story

— a Tibetan adventure, circa 1936-1937

In 1936, it was decided to send a political mission to Lhasa in Tibet. I was then a subaltern in Peshawar District Signals on the north-west frontier of India.

At that time, Tibet was in a politically weak position. The Dalai Lama had died and his reincarnation had not yet been found. The Tashi Lama was on a visit to China, and the Chinese, who had always considered Tibet to be a province of

China, wished to bring him back to Tibet with an escort of their army. A regent had been appointed to cover this period.

The Tibetan government, therefore, invited the mission to Lhasa with two objectives. The primary one was to persuade the Tashi Lama to return to Lhasa, to march out beyond Lhasa, meet him, and bring him back to Lhasa in triumph without an escort of the

Chinese army. The second objective was for us to review the Tibetan army and advise on its improvement with a view to making Tibet a more effective buffer state between the northeast frontier of India and China.

The political side of the mission was handled by the leader, the late Sir Basil Gould, who, at that time, was B. J. Gould, Esq., political officer, Sikkim, and by H. E. Richardson, Esq., British trade agent, Gyantse, the late Col. Freddy Spencer Chapman, personal assistant to Gould, and Rai Bahardur Norbhu, a high-ranking English-speaking Tibetan.

The health of the mission was in the hands of Captain W. S. Morgan of the Indian Medical Service. While the mission was in Lhasa, he also did a great deal of work for the Tibetans. He held many clinics and carried out many successful operations for cataracts under what, by modern standards, would have been considered very primitive conditions.

Military matters were in the hands of Brigadier Philip Neame VC DSO, and communications were looked after by Lieut. Sidney Dagg and myself.

Communications in Tibet were rudimentary. The Indian Posts and Telegraphs operated as far as Gyantse, where the British trade agent had his post supported

ed by a squadron of Indian mounted infantry. Beyond Gyantse, the mail was carried by mounted runners. A telegraph line operated as far as Lhasa. It was a single strand of galvanized iron wire supported on light wooden poles with no special insulation. It operated single-current simplex earth return. One could tap in not only at Gyantse, but also at each rest house along the route. Mounted linemen patrolled the route re-erecting any poles that were blown down and repairing breaks in the line.

If we went beyond Lhasa, we would no longer have access to this circuit. It would therefore be necessary for us to take transportable wireless with which we could send back our diplomatic traffic. Another important reason for taking wireless on the mission was to outface the Chinese. They had a transmitter at Lhasa although I never heard it. As it happened, we never went beyond Lhasa. The Tashi Lama died before we succeeded in persuading the Chinese not to send an escort of their army.

The responsibility for producing radio equipment was given to Northern Command Signals; Lieut. Sidney Dagg of that regiment was given the task. As no suitable service equipment was available, he had a transmitter and receiver built in the regimental workshops

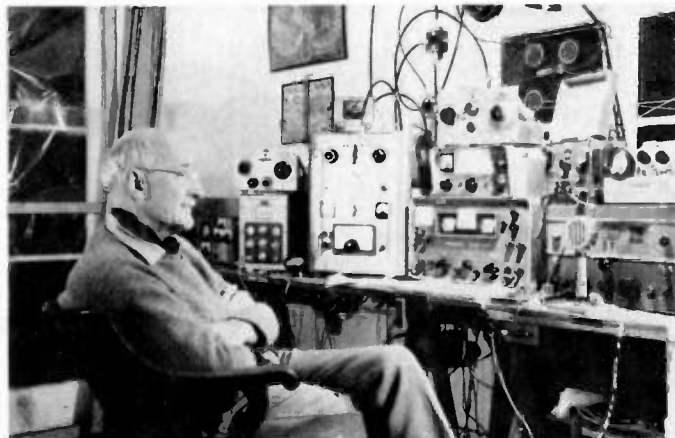
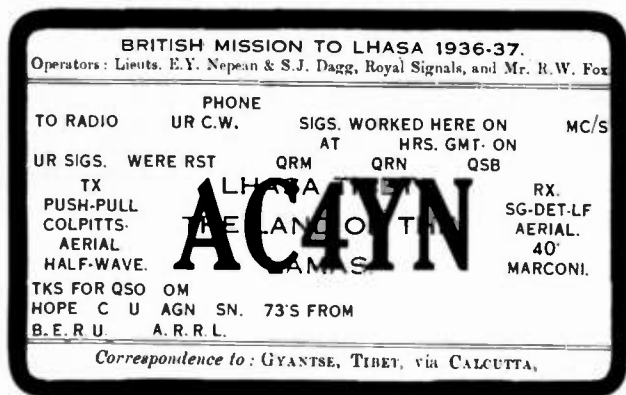

G5YN (ex-AC4YN, VUQ, VU2YN, LA9YC, VS1YN, DL2YN) at home.

at Rawalpindi. It must be remembered that everything was carried on pack animals—ponies or yaks—in panniers two to an animal, each one not weighing more than one maud (80 lbs.).

Dagg produced the following equipment:

- The main transmitter, consisting of a self-excited push-pull Colpitts oscillator using two AT-50 triodes with an input of 100 Watts.

- A balanced Collins coupler to couple the transmitter to the open-wire aerial feeders.

- An Eddystone "All World Four" (1-V-2) battery receiver.

- A rotary transformer to convert 12 volts dc to 1000 volts dc at up to 100 milliamps.

- A Phillips record player—turntable, pick-up, and amplifier—operating on 230 volts ac.

- Two twelve-inch moving-coil loudspeakers. (We had baffles made locally on arrival.)

- One transverse-current carbon microphone.

- One 12-volt dc to 230-volt ac rotary converter.

- One 550-Watt Stuart Turner charging engine.

- Four six-volt, 120-Ampere-hour batteries.

- Two 36-foot steel sectional masts.

- Lots of aerial wire, insulators, and Eddystone 4-inch feeder separators.

I brought a few things of my own from Peshawar:

- A 1-V-1 receiver which I had built myself. This covered 10 to 550 meters using Eddystone plug-in coils. The tuning control was a Utility 100:1 slow-motion dial. The receiver proved much more efficient than the All World Four. The tuning and reaction controls were much smoother and the signal/noise ratio very much better. Much to my sorrow, I was made to leave it behind when I left the mission.

- A simple audio amplifier ending in two PX-4 triodes in push-pull to enable my receiver to operate a loudspeaker for broadcast reception.

- 45 feet of duralumin tubular mast in 5-foot sections, the property of Peshawar District Signals. I had to leave this behind also, much to the fury of my commanding officer.

- My own key, a pair of headphones, and a small box of bits and pieces. Unfortunately, I no longer have this key as the Post Of-

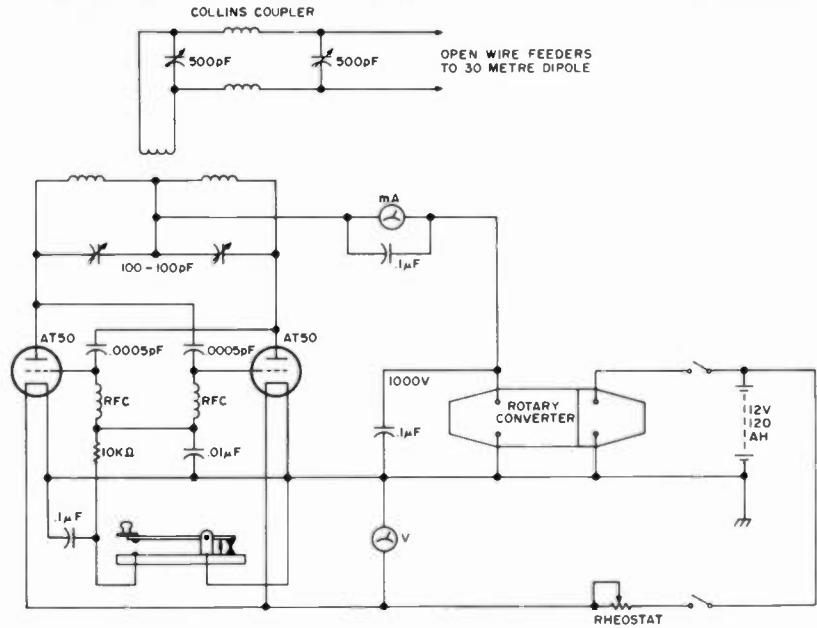

Fig. 1. AC4YN transmitter.

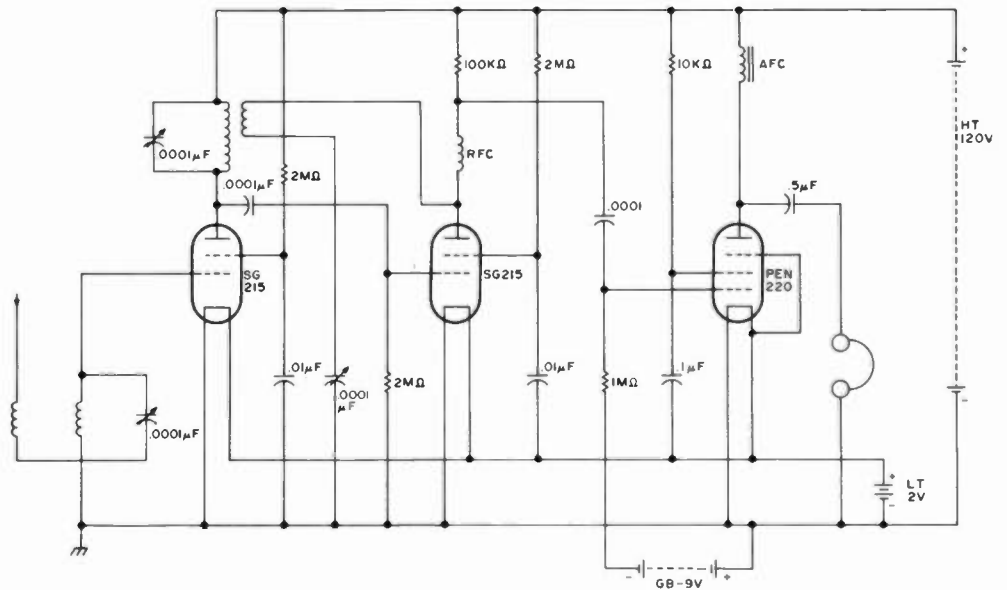
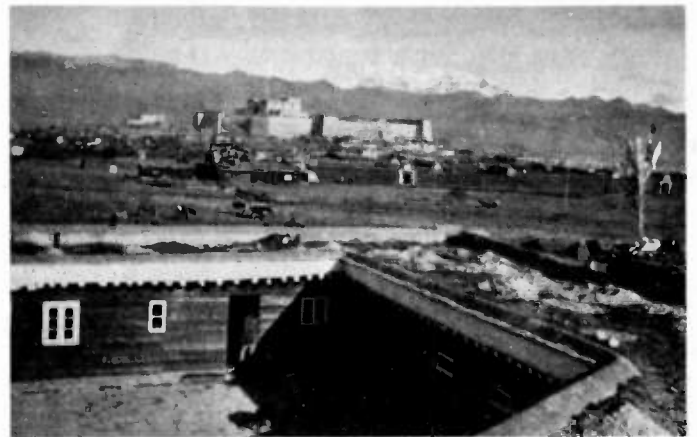

Fig. 2. AC4YN receiver.



View from roof of rest house at Phari Village and jong in middle distance. Himalayas in background.

fice "lost" it when they had my equipment in custody during the last war.

Before joining the mission, I was sent to Simla, the summer hill station of army headquarters. There I gained experience in operating the control station of the army group with which we would be communicating from Lhasa. It was known as the VV group as all stations had a three-letter callsign, of which the first two were VV. The mission call was VUQ. I also was briefed to check the accuracy of *The Army Route Book of Tibet* and look out for any possible landing grounds.

From Simla, I travelled across India to Calcutta where I joined Dagg. We did some shopping and then went on to join the rest of the mission. We first traveled by train across the Plain of Bengal to Siliguri, the railhead in the foothills of the Himalayas. I chiefly remember the flatness of the country and the paddy fields.

At Siliguri, we transferred to a taxi and had a hair-raising and spectacular drive up the beautiful valley of the river Teesta. At one point, we crossed the river by a bridge which spanned a gorge in one magnificent arch, with the river racing far below. The Teesta is a tributary of the Brahmaputra.

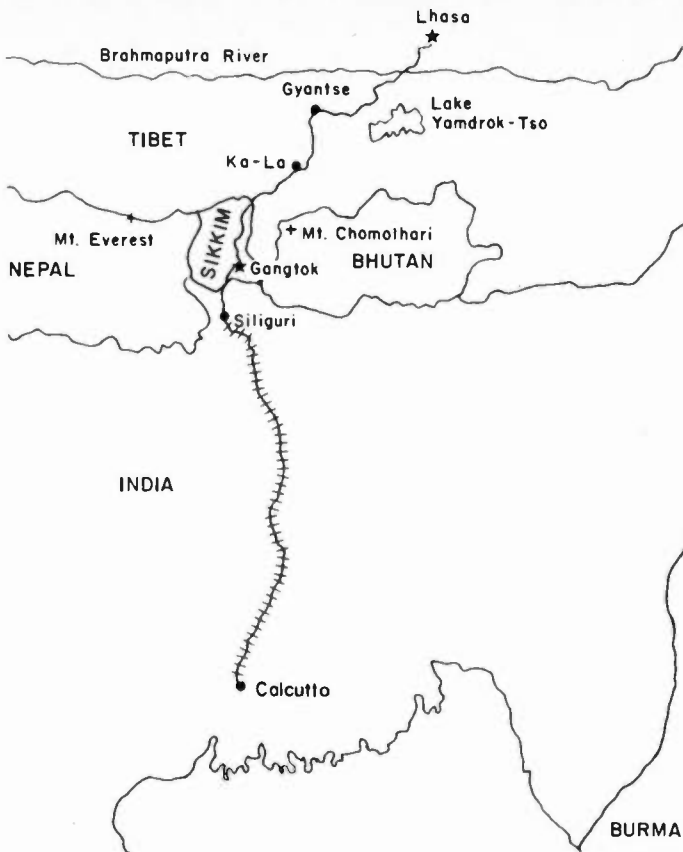

The route from Calcutta to Lhasa. (Map from 1930s sources by Alan R. Phenix.)

We arrived safely at Gangtok, the capital of Sikkim, where Sir Basil Gould had his residency. Already at Gangtok were Freddy Chapman and Brigadier Philip Neame. Chapman not only acted as PA [personal assistant] to Sir Basil but was also in charge of cinematography, botany, ornithology, and zoology. Here, Dagg and I took the opportunity to check our

radio equipment. The transmitter worked well, and we called in on the VV group. We also checked that the receivers would bring in the BBC overseas service for news, etc. We did not have time to try out the amateur bands at that time.

We then divided the equipment into 80-pound loads for back transport. The most awkward load was the charging engine, which weighed 120 lbs. In

the Army, this was carried as a top load on a Class 1 mule. However, we had no proper pack saddles and the ponies would not have been strong enough. Finally, it was lashed to two stout bamboo poles and carried by four coolies.

When we set off, our entourage down to the last servant and sweeper was 50 strong, including 25 pack animals and their drivers. These were ponies at first and yaks later. In those days, the motor road ended at Gangtok, so from then on we either walked or rode.

As far as the halfway point, Gyantse, there were good rest houses at each stage in which we could spend the night in comfort. The first day's journey was through rain forest, where rhododendrons grew in thirty-foot trees and leeches abounded. The first halt was at Karponang at 9,500 feet, just short of the Tibetan border. I remember suffering from mountain sickness here, but it passed off in about half an hour.

Next day, we crossed into Tibet by the Natu La Pass at 14,600 feet and dropped down into the Chumbi Valley. Over the pass it was much dryer as the monsoon drops most of its moisture on the southern slopes of the Himalayas, leaving Tibet a comparatively dry country with only a few inches of snow despite a very hard winter.



Lieut. Dagg unpacks and tests record player at an intermediate halt. Freddy Chapman at right.



How the charging engine traveled to Lhasa.

AZDEN ★ NEW! ★ AZDEN ★ NEW! ★ AZDEN ★ NEW! ★ AZDEN

THE GIANT **AZDEN**® COMPANY
 REVOLUTIONIZES THE STATE OF THE ART
 AWE AND AZDEN. INTRODUCE THE BRILLIANT NEW PCS-2800
 MICROCOMPUTER CONTROLLED
 SUPERIOR COMMERCIAL GRADE
10 METER
 FM TRANSCEIVER

\$299⁰⁰



COMPARE THESE FEATURES
 WITH ANY UNIT AT ANY PRICE

- **FREQUENCY RANGE:** Receive and transmit: 28.000 to 29.995 MHz, 10KHz steps with built-in -10C KHz repeater offset.
- **ALL SOLID STATE-CMOS PL DIGITAL SYNTHESIZED.**
- **SIZE: UNBELIEVABLE! ONLY 6 3/4" x 2 3/8" x 9 3/4". COMPARE!**
- **MICROCOMPUTER CONTROLLED:** All scanning and frequency-control functions are performed by microcomputer.
- **DETACHABLE HEAD:** The control head may be separated from the radio for use in limited spaces and for security purposes.
- **SIX-CHANNEL MEMORY:** Each memory is re-programmable. Memory is retained even when the unit is turned off.
- **MEMORY SCAN:** The six channels may be scanned in either the "busy" or "vacant" modes for quick, easy location of an occupied or unoccupied frequency. **AUTO RESUME. COMPARE!**
- **FULL-BAND SCAN:** All channels may be scanned in either "busy" or "vacant" mode. This is especially useful for locating repeater frequencies in an unfamiliar area. **AUTO RESUME. COMPARE!**
- **INSTANT MEMORY-1 RECALL:** By pressing a button on the microphone or front panel, memory channel 1 may be recalled for immediate use.
- **MIC-CONTROLLED VOLUME AND SQUELCH:** Volume and squelch can be adjusted from the microphone for convenience in mobile operation.
- **DIRECT FREQUENCY READOUT:** LED display shows operating frequency, NOT channel number. **COMPARE!**
- **TEN (10) WATTS OUTPUT:** Also 1 watt low power for shorter distance communications. LED readout displays power selection when transmitting.
- **DIGITAL S/R/F METER:** LEDs indicate signal strength and power output. No more mechanical meter movements to fall apart!
- **LARGE 1/2-INCH LED DISPLAY:** Easy-to-read frequency display minimizes "eyes-off-the-road" time.
- **PUSHBUTTON FREQUENCY CONTROL FROM MIC OR FRONT PANEL:** Any frequency may be selected by pressing a microphone or front-panel switch.
- **SUPERIOR RECEIVER SENSITIVITY:** 0.28 μ V for 20-cB quieting. The squelch sensitivity is superb, requiring less than 0.1 μ V to open. The receiver audio circuits are designed and built to exacting specifications, resulting in unsurpassed received-signal intelligibility.
- **TRUE FM, NOT PHASE MODULATION:** Transmitted audio quality is optimized by the same high standard of design and construction as is found in the receiver. The microphone amplifier and compression circuits offer intelligibility second to none.
- **OTHER FEATURES:** Dynamic Microphone, built in speaker, mobile mounting bracket, external remote speaker jack (head and radio) and much, much more. All cords, plugs, fuses, microphone hanger, etc. Included. Weight 6 lbs.
- **ACCESSORIES:** 15' REMOTE CABLE...\$29.95. FMPS-4R A/C POWER SUPPLY...\$39.95. TOUCHTONE MIC. KIT...\$39.95. EXTERNAL SPEAKER...\$18.00.

AMATEUR-WHOLESALE ELECTRONICS ORDER NOW TOLL FREE

8817 S.W. 129th Terrace, Miami, Florida 33176
 Telephone (305) 233-3631 • Telex: 80-3356
 U.S. DISTRIBUTOR DEALER
 INQUIRIES INVITED

1-800-327-3102

CREDIT CARD HOLDERS MAY USE OUR TOLL FREE ORDERING NUMBER.

In the valley, we spent three nights, one at Champitung, 13,350 feet, another at Yatung, 9,950 feet, and a third at Gautsa, 12,600 feet. At Yatung there was a detachment of Indian mounted infantry. The next day we climbed up out of the valley on to the main Tibetan plain at 14,300 feet. We stopped the night at Phari, which was a small town with a fort, or jong, and a good rest house.

At each of these halts, Dagg and I set up a receiver to check on the VV group and take down news broadcasts from the BBC. It was a year after sunspot maxima, so HF propagation was good and there was nothing unexpected about what we heard. The only embarrassment was the charging engine. Dagg had been given no chance to test it at high altitude, and as we gained height, it developed less and less power due to shortage of oxygen. At 6,000 feet it would just work. At 10,000 feet it would start and run when cold. As soon as it warmed up it stalled, and that was that.

We sent a signal home to Stuart Turners who, in due course, sent out a pair of variable-jet carburetors. They did not arrive until after I had left the mission, but I was told that when they were fitted the engine ran very well, developing more than its rated power.



Tibetans working the hand charger.



The transmitter, receiver, and Collins coupler installed in the barracks at Gyantse.

While Dagg and I were dealing with radio matters, Chapman was studying the local fauna and flora. In due course, he sent back a magnificent collection of seeds and pressed flowers to Kew Gardens.

There were six more night halts before reaching our major intermediate halt at

Gyantse: Tuna, 15,000 feet, Dochen, 14,900 feet, Kala, 14,850 feet, Samada, 14,100 feet, Kangmar, 13,900 feet, and Saugang at 13,000 feet. Gyantse itself was at 13,100 feet. The way was mainly over a stony plain with mountains rising to 20,000 feet in the distance. Sometimes we passed through

rocky gorges and occasionally by streams. We passed close under Mt. Chomolhari, a beautiful snow-covered cone rising to 24,000 feet.

Gyantse is a fair-sized town with monasteries, a jong, the headquarters of the British trade agent, and barracks for a company of Indian mounted infantry, at that time the 2/7 Rajputana Rifles. Here several official receptions took place. For instance, we had to time our arrival carefully so as to be three miles from the town at 11:00 am. We were met here by Raja Tering, a cousin of the Maharajah of Sikkim. Half a mile further on, we were met by Mr. Richardson (the British trade agent), Capt. Salomons, an escort of mounted infantry, and Capts. Guthrie and Morgan of the IMS, the Army surgeons. Captain Morgan accompanied us for the rest of the mission. A mile further on, the eastern and western jongpens met us, and finally the Tibetan trade agent and the Abbot of Gyantse Gomba. This order of precedence is very strict. The most senior official meets you nearest your destination and the most junior farthest out. On each occasion, ceremonial scarves of white natural silk are exchanged.

Here, Dagg and I were able to have a thorough sort-out of our gear. We cut



View of my tent, home of AC4YN, in the garden of the Dekyi Langka at Lhasa.

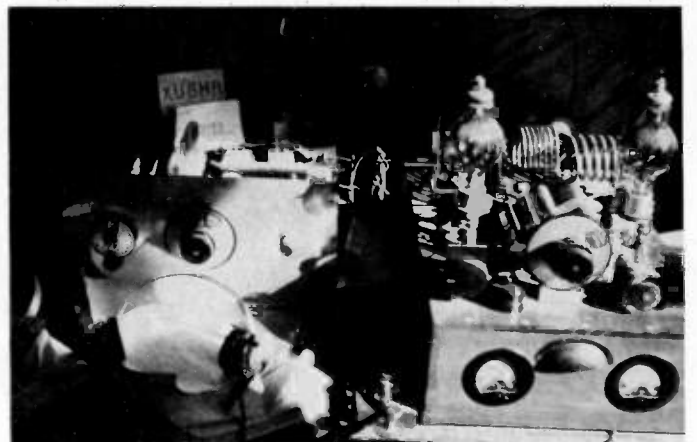

The transmitter and receiver, VUQ/AC4YN, in my tent at Lhasa.

MFJ Super Keyboards



5 MODES: CW, Baudot, ASCII, memory keyer, Morse code practice. **TWO MODELS:** MFJ-496, \$339.95. 256 character buffer, 256 character message memory, automatic messages, serial numbering, repeat/delay. MFJ-494, \$279.95. 50 character buffer, 30 character memory, automatic messages.

MFJ brings you a pair of 5 Mode Super Keyboards that gives you more features per dollar than any other keyboard available. You can send CW, Baudot, ASCII. Use it as a memory keyer and for MORSE code practice.

You get text buffer, programmable and automatic message memories, error deletion, buffer preload, buffer hold, plus much more.

MODE 1: CW

The 256 character (50 for 494) text buffer makes sending perfect CW effortless even if you "hunt and peck."

You can preload a message into the buffer and transmit when ready. For break-in, you can stop the buffer, send comments on key paddles and then resume sending the buffer content.

Delete errors by backspacing.

A meter gives buffer remaining or speed. Two characters before buffer full the meter lights up red and the sidetone changes pitch.

Four programmable message memories (2 for 494) give a total of 256 characters (30 for 494). Each message starts after one ends for no wasted memory. Delete errors by backspacing.

To use the automatic messages, type your call into message A. Then by pressing the CQ button you send CQ CQ DE (message A).

The other automatic messages work the same way: CQ TEST DE, DE, QRZ.

Special keys for KN, SK, BT, AS, AA and AR. A lot of thought has gone into human engineering these MFJ Super Keyboards.

For example, you press only a one or two key sequence to execute any command.

All controls and keys are positioned logically and labeled clearly for instant recognition.

Pots are used for speed, volume, tone, and

weight because they are more human oriented than keystroke sequences and they remember your settings when power is off.

Weight control makes your signal distinctive to penetrate QRM.

MODE 2 & 3 (RTTY): BAUDOT & ASCII

5 level Baudot is transmitted at 60 WPM. Both RTTY and CW ID are provided.

Carriage return, line feed, and "LTRS" are sent automatically on the first space after 63 characters on a line. This gives unbroken words at the receiving end and frees you from sending the carriage return. After 70 characters the function is initiated without a space.

All up and down shift is done automatically. A downshift occurs on every space to quickly clear garbled reception.

The buffer, programmable and automatic messages, backspace delete and PTT control (keys your rig) are included.

The ASCII mode includes all the features of Baudot. Transmission speed is 110 baud. Both upper and lower case are generated.

MODE 4: MEMORY KEYSER

Plug in a paddle to use it as a deluxe full feature memory keyer with automatic and programmable memories, iambic operation, dot-dash memories, and all the features of the CW mode.

MODE 5: MORSE CODE PRACTICE

There are two Morse code practice modes. Mode 1: random length groups of random characters. Mode 2: pseudo random 5 character groups in 8 separate repeatable lists (with answers).

Insert space between characters and groups to form high speed characters at slower speed for easy character recognition.

Select alphabetic or alphanumeric plus punctuation. You can even pause and then resume.

MORE FEATURES

Automatic incrementing serial number from 0 to 999 can be inserted into buffer or message memory for contests.

Repeat function allows repetition of any message memory with 1 to 99 seconds delay. Lets you call CQ and repeat until answered.

Two key lockout operation prevents lost characters during typing speed bursts.

Clock option (496 only) send time in CW, Baudot, ASCII. 24 hour format.

Set CW sending speed before or while sending.

Tune switch with LED keys transmitter for tuning. Tune key provides continuous dots to save finals. Built-in sidetone and speaker.

PTT (push-to-talk) output keys transmitter for Baudot and ASCII modes.

Reliable solid state keying for CW: grid block, cathode, solid state transmitters (-300V, 10 ma Max, +300V, 100 ma Max). TTL and open collector outputs for RTTY and ASCII.

Fully shielded. RF proof. All aluminum cabinet. Black bottom, eggshell white top. 12"Ox7"Wx1 1/4"H (front) x3 1/2"H (back). Red LED indicates on.

9-12 VDC or 110 VAC with optional adapter.

MFJ-494 is like MFJ-496 less sequential numbering, repeat/delay functions. Has 50 character buffer, 30 character message memory. Clock option not available for MFJ-494.

Every single unit is tested for performance and inspected for quality. Solid American construction.

OPTIONS

MFJ-53 AFSK PLUG-IN MODULE. 170 and 850 Hz shift. Output plugs into mic or phone patch jack for FSK with SSB rigs and AFSK with FM or AM rigs. \$39.95 (+ \$3).

MFJ-54 LOOP KEYING PLUG-IN MODULE. 300V, 60 ma loop keying circuit drives your RTTY printer. Opto-isolated. TTL input for your computer to drive your printer. \$29.95 (+ \$3).

MFJ-61 CLOCK MODULE (MFJ-496 only). Press key to send time in CW, Baudot or ASCII. 24 hour format. \$29.95 (+ \$3).

110 VAC ADAPTER. \$7.95 (+ \$3).

BENCHER IAMBIC PADDLE. \$42.95 (+ \$4).

A PERSONAL TEST

Give the MFJ-496 or MFJ-494 Super Keyboard a personal test right in your own ham shack.

Order one from MFJ and try it — no obligation. See how easy it is to operate and how much more enjoyable CW and RTTY can be. If not delighted, return it within 30 days for refund (less shipping). One year unconditional guarantee.

To order, call toll free 800-647-1800. Charge VISA, MC, or mail check or money order for \$339.95 for MFJ-496, \$279.95 for MFJ-494, \$39.95 for MFJ-53 AFSK module, \$29.95 for MFJ-54 Loop Keying module, \$29.95 for MFJ-61 Clock module, \$7.95 for the 110 VAC adapter and \$42.95 for Bencher Paddle. Include \$5.00 shipping and handling per order or as indicated in parentheses if items are ordered separately.

Why not really enjoy CW and RTTY? Order your MFJ Super Keyboard at no obligation today.

**TO ORDER OR FOR YOUR NEAREST DEALER
CALL TOLL FREE 800-647-1800**

Call 601-323-5869 for technical information, order/repair status. Also call 601-323-5869 outside continental USA and in Mississippi.

Write for FREE catalog, over 80 products

**MFJ ENTERPRISES,
INCORPORATED**

Box 494, Mississippi State, MS 39762



Using the PA equipment. The monk who enjoyed singing.



The Regent inspects the record player/PA equipment.

a dipole for the Army HQ group wavelength of 30 meters. Each half of the dipole was 25 feet long, and the open-wire feeders were 40 feet long. We set up the transmitter and receiver in a room in the barracks. We were lucky enough to find here a home-made charging machine which had been built to charge the battery of a broadcast receiver. It was built around a six-volt car dynamo driven by a wondrous contrivance of wooden pulleys and flapping leather belts. Cranked by coolies, it managed to produce enough charge to enable us to maintain short schedules with the VV group, but not enough to spare to enable us to make any transmission on the amateur bands.

It was now decided that Dagg should go back to Cal-

cutta and have a new hand-charger built. It had been hoped that a charging engine used by a recent Everest expedition might still be available at Katmandu, but enquiries showed that it had been disposed of. Dagg eventually rejoined us in Lhasa with a most efficient gear-driven device. It used a Ford 12-volt dynamo and had two large crank handles. Four coolies managed to produce 6 Amps through 12 volts of batteries. This rate of work is only about 1/10th HP, so they can't have been working very hard!

The political part of the mission went ahead to Lhasa, leaving me behind with the radio gear and the Bell and Howell 35mm projector. There was no point in taking these on up to Lhasa until power was available.



Ringang.

In due course, I was summoned to join the main party.

Now, Lhasa had an electric light plant. It worked on the dc three-wire system with 440 volts of batteries having the center tap earthed. The supply was, therefore, 220 volts. Those on one wire had positive earth, those on the other had negative earth. The cells were charged by a motor generator. The motor ran at 3 kV ac. The ac was generated by a small hydroelectric plant in the foothills of the 20,000-foot mountains which rose from the 12,000-foot Lhasa plain about three miles away.

The insulation of the transmission line was a bit rudimentary, and on damp evenings there were impressive brush discharges. The stream driving the turbine froze at night during the winter so that charging could be carried out only by day.

You will realize that this was a considerable engineering achievement when you remember that every item had to be carried up from the road head by coolies and pack animals. Great credit also is due to the Tibetan official who assembled and commissioned it with only unskilled labor at his disposal and who was responsible for running it. His name was Ringang. He was one of the four Tibetans who, as boys, were sent

to England and educated at Rugby. He was also responsible for the official ciphers. He arranged for our batteries to be charged by connecting them in parallel with the end cells of the 440-volt battery.

The mission was accommodated in a nice villa in a garden called the Dekiy Langka. There were not enough rooms for us all to sleep inside, so I had a tent in the garden in which I also set up the transmitter and receiver. The aerial was supported at one end on a forty-foot mast consisting of five of the eight-foot sections of duralumin. The other end was supported on one section set up on the flat roof of the house. Regular contact was kept with the control station of the VV group at Army headquarters, Simla, in the summer, and with New Delhi in the winter. All the outstations at various army stations in India and the one in Hong Kong were worked on the 30-meter wave.

Once this was organized, I looked around for the 20-meter amateur band. This was soon found and the transmitter tuned to the band by netting on to the receiver. You will remember that each half of the dipole was 25 feet and the feeders were 40 feet, making the overall length of each half 65 feet, so there was no problem in loading it up via the Collins coupler.

N&G

WATTS 800-327-3364

DISTRIBUTING

7201 N.W. 12th ST.
MIAMI, FLORIDA 33126
1-305-592-9685 • 1-305-763-8170

WE ALSO CARRY MANY
MARINE & AIRCRAFT RADIOS

THE LEADER IN COMMUNICATIONS

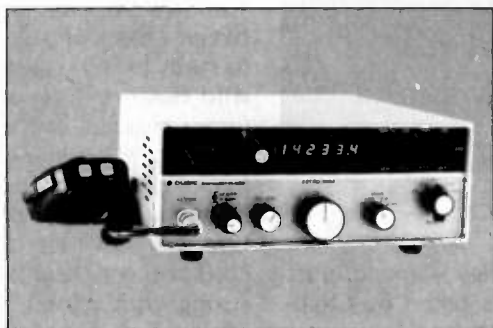

ASTRO 150 \$975.00
MATCHING POWER SUPPLY 179.95
MATCHING ANTENNA TUNER 189.95

General Frequency Range

- 160 Meter Band - 1.8-2.4 MHz†
- 80 Meter Band - 3.0-4.5 MHz
- 40 Meter Band - 6.0-8.3 MHz
- 20 Meter Band - 13.8-16.0 MHz
- 15 Meter Band - 20.8-23.0 MHz
- 10 Meter Band - 28.0-30.0 MHz††

†† Model 150 only

† Model 151 only

**HF/SSB
PORTABLE
RADIO STATION
100 WATT
115/230V
50/60 Hz AC
OR 12V DC
IS AVAILABLE**

CUBIC



DIPLOMAT 150



BATTERY PACK CHARGER

BIRD WATT METERS & ACCESSORIES LARGEST SELECTION IN THE EAST

G.S.C. REGULATED Power Supplies

Model	List	Sale
IV	24.00	18.00
6-R	71.00	55.00
10-R	92.00	67.00
20-R	116.00	87.00
35-R	227.00	161.00

**U.S. DISTRIBUTOR
FOR 9FT
TONNA ANTENNAS
CALL US**

Prices Or Specifications
Are Subject To Change
Without Notice



HAL Communications Corp

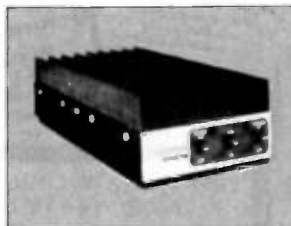

MIRAGE AMPLIFIERS

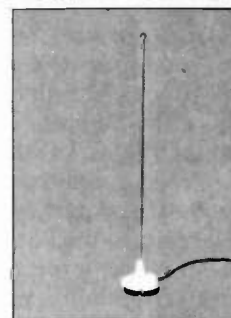

1/4 WAVE MAG
LIST 24.95
N&G PRICE 15.00

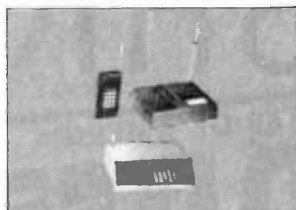

FREEDOM PHONE
BEARCAT SCANNERS

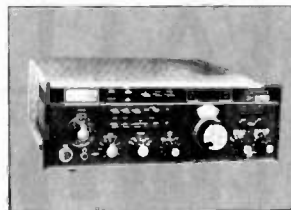

THE DRAKE LINE

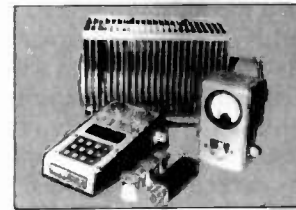

BIRD 43 152.00
All Bird Prod. in Stock

ALL PRICES ARE SUGGESTED RETAIL PRICES • PLEASE CALL FOR QUOTES.

The first people to respond to that historical call, "CQ de AC4YN," were VU2 amateurs. Before the Chinese invasion, the intermediate for Tibet was AC4. There was no licensing authority, so I created the call by adding the two letters of my own callsign to the intermediate. Unfortunately, I did not make a copy of the log for my own records, so I have no recollection of individual callsigns worked.

The first DX to be worked was VK and ZL. They were so reliable that we regarded them as locals. This was very useful, as the political officer had relations in New Zealand. We were able to pass Christmas greetings between the two parties via amateur radio, earning considerable kudos both for amateur radio and Royal Signals.

As the year progressed, our signals seemed to reach further and further west until, in December, I raised my first G station. In my excitement, I asked him if he would relay messages to my family. However, I must have scared him off as he did not come back to me again.

I was not able to spend much time on the air as I had to join in a great number of the business and social activities of the mission. We attended and gave many official parties. There were visits to the Potala, the three huge monasteries (Sera, Drepung, and Kundun), the cathedral, and various temples. Although the Tibetans are Buddhists, there were still traces of ancestor and devil worship. It was always considered wise to placate any gods, spirits, or devils that may be around. One such temple was dedicated to snakes.

Besides these places, we also visited the mint, the arsenal, and the Norbu Lingha, the Dalai Lama's summer palace and gardens. Some of my time also was



The Potala.

taken up helping Freddy Chapman with cipher work and photography. On some evenings, we gave cinema performances. These were always packed, not only with our own staff and friends, but also by as many locals as could squeeze into the room. Some of the films were old comics we had rented from a film library and brought with us. Of these, the most popular were those starring Rin Tin Tin, since they reminded locals of their own shepherd dogs.

What they enjoyed most were films taken by Chapman which had been sent down to Calcutta for processing and returned to us. The appearances of themselves and their friends on the screen were greeted with loud applause. Another thing which amused them was talking into the microphone and hearing their own voices, amplified by the record player amplifier, booming out over the loudspeakers.

All too soon, the time came when I had to leave

Lhasa, the mission, and all the good friends I had made up there. A frontier war had started and my commanding officer demanded my return to the regiment. So, about mid-December, I set off back with my Pathan bearer and a couple of pack ponies. Traveling light, I did double stages. Chapman came with me as far as the Yamdrok So, a vast lake between Lhasa and Gyantse, to study bird life and gather wild flowers. I crossed the upper reaches of the Brahmaputra in coracles, came back over the 16,600-foot Karo La, and went down to Gyantse. In winter, it is very cold at these heights, and a strong wind blows all day raising dust storms. If Tibetans have to travel in the winter, they do so at night when the wind drops.

I continued these double stages back to Gangtok, and then went by taxi to Siliguri and by train to Calcutta. I had to call in at New Delhi for debriefing before returning to my regiment in Peshawar.

In order to keep the radio in operation after my departure, Reg Fox, who was ex-Royal Signals, was sent up from Calcutta. He did not arrive until after I left, so I did not have the pleasure of meeting him. When the mission closed in the spring, he stayed on in Lhasa and married a Tibetan girl. He remained until the Chinese invasion, when he escaped to India where he died. Whether any of his records, logs, or equipment have survived, I do not know.

To those who are interested in reading about the mission, I recommend F. Spencer Chapman's book *Lhasa, The Holy City*, published by Chatto and Windus, London, 1938. The political officer in Sikkim's letter no. 4(7)-P.37 to the Foreign Office (dated 30th April 1937) and his diary of events are probably available from the Public Record Office, London. ■

ZDPX

British Experimental Artificial Aerial Transmitting Station

To RADIO **AC4** via **C.C.P.** 21-19

Experimental Radio Station **VK6JE** To Radio **AC4YN**

QRA - MR. Z. Y. CHEN, Y. M. C. A., HANGCHOW, CHINA.
 TO RADIO **AC4YN** - UR CW SIGS WKD HR AT 2.35⁰⁰ CCT 1.5⁰⁰ GMT
 ON Sep 24 1936 QRG 14 MC R5 S & T 9 FB
 QRM am QRN am WX fine

C. **XU8HR** I. A. R. A. C.

UNITED STATES OF AMERICA

W3DDM

Radio **AC4YN** Date 1-1-38 Time 8AM EST DST
 Sfr: I am ...

new

In Repeaters

*Some people want the finest,
Others want the lowest price....*

Now you can have Both!

**Introducing the New Low Cost Spectrum
SCR 77 Repeaters—2M, 220 & 440 MHz!**

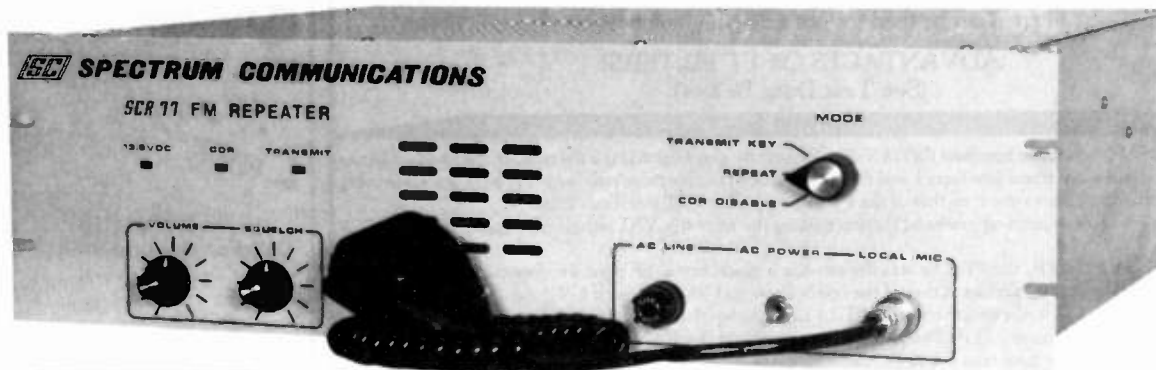

15 or 30 Wt. Xmtrs.

- Includes:**
- 0.35 μ V Rcvr. 8 Pole IF Filter
 - Crystals — high stability .0005%
 - Local Mic
 - Your Call programmed into IDer
 - Provision for Auto-Switchover to Btry. Pwr.
 - Built-in 115/230V AC Supply; basic Panel Controls, Spkr., LED Indicators

If you're looking for a new Repeater, but you really don't need (or can't afford) all the features and options on our world famous, 'super deluxe' SCR1000/4000, then our new economy line of SCR77 Repeaters is ideal for you!

These new Repeaters maintain the quality of design, components and construction which made Spectrum gear famous. However, all of the "bells & whistles" which you may not need or want have been eliminated — *at a large cost savings to you!* The SCR77 is a real "workhorse" basic machine designed for those who want excellent, super-reliable performance year after year — *but no frills!* ('PL', 12 Pole IF Filter, Front End Preselector, and a 30Wt. Transmitter are the only "built-in" options available; but Autopatch, Remote Control, and other equipment can be connected via the rear panel jack.)

*A complete line
of duplexers, antennas, cabinets,
cable, etc., is also available.*

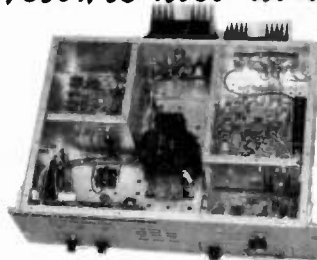

Of course, if you do want a full featured/super deluxe repeater, with higher power and a full list of available 'built-in' options, then you want our SCR1000 or 4000 "Dream Machine". These units will continue to be available for those who want 'The Ultimate in Repeaters'.

SCR77 Pricing (15Wt.): 2M or 220MHz, \$995.00 Amateur Net. 440MHz, \$1150.00. For no 'plug-in' ID board (Export), deduct \$40.00. *Call or write today for a data sheet, or to place your order!* Sold Factory Direct or through Export Sales Reps only.

**10M FM RX/TX Boards, Repeaters & Remote Bases NOW
AVAILABLE! Call or Write for Full Info.**

¡Se habla Español!



SPECTRUM COMMUNICATIONS

GET A NEW TS830S FOR \$150!

(But only if you have one already.)

IT'S EASY—HERE'S HOW

Supplant or supplement your original 2.7kHz BW (bandwidth) monolithic and ceramic filters with a **MATCHED PAIR** of high-performance **FOX TANGO** 2.1kHz BW discrete-crystal filters. Can be used for both RX/TX or for RX only; your choice.

ADVANTAGES OF FT FILTERS? (See Test Data Below)

- * With the FT 2.1's the basic bandpass (BP) in SSB is significantly narrower and the shape factor (SF) is much better than that of the stock filters (see Tests 1 and 2). But the differences are more striking when VBT is used to bring the BP of the stock filters down to that of the FT filters without VBT (see Tests 2 and 3).
- * FT 2.1's have more squared-off passband corners making the narrower VBT settings particularly useful for CW operation.
- * With VBT set at 500Hz, the FT 2.1's actually provide a much better SF than the optional Kenwood 500Hz 8.83MHz CW filter; they approach that of the costly Kenwood 500Hz 455kHz CW filter.
- * With VBT set for 300Hz, the selectivity of the FT 2.1's approaches that of the optional Kenwood 250Hz 8.83MHz filter. However, the original 2.7kHz filters are not very useable at this BW due to the large insertion loss and very peaked passband. (Compare tests 6 and 7).
- * With VBT in use, the FT 2.1's significantly reduce the "shoulder" effect. The "high side" data shows their greater ultimate attenuation of close-in signals.

TEST DATA (Courtesy of KA2R)

Test No.	--1--	--2--	--3--	--4--	--5--	--6--	--7--
St'k Ftrs	2 x 2.7	—	2 x 2.7	2 x 2.7	—	2 x 2.7	—
FT Ftrs	—	2 x 2.1	—	—	2 x 2.1	—	2 x 2.1
VBT BW	out	out	1990 ¹	500	500	300	300
Shape F.	1.34	1.19	1.45	2.74	2.38	3.32	2.91
- 6dB BW	2440	1990	1995	478	481	318	341
- 60dB BW	3270	2370	2900	1270	1140	1110	990
- 80dB BW	3410	2480	3090	1540	1290	1395	1133
Hi Side ²	740	440	1320	2820	1720	2995	2000
VBT Ins Loss	0	0	0	5dB	0	10dB	1dB

¹ VBT set to provide about same BW as 2x2.1 filters without VBT.

² Distance (Hz) from USB upper -6dB point to point where audio from S9+10dB signal becomes inaudible.

Careful tests are fine, but the final proof of filters is in the using. Here are a few quotes from users: "... Spectacular improvement in SSB RX... VBT now works as it really should... I saved money--I don't need a CW filters... excellent installation instructions--many new options... Fox Tango filters make a new rig out of my old '830..." Why hesitate? Get your filters now while the special introductory offer lasts. And don't worry about obsolescence--If you decide to trade up to the TS930, your FOX TANGO filters will match it and make a really new rig out of the new rig.

Regular price: \$55+\$125=\$180+shipping
INTRODUCTORY PRICE (Complete kit)... \$150

Includes Matched Pair of Fox-Tango Filters, All needed cables, parts, instructions.

10% quantity discount applies

ONE YEAR GUARANTEE!

Order by mail or phone. Pay by VISA/MC, Check, M.O., or C.O.D.

Ask about our filters and cascading kits for Yaesu, Kenwood, Drake, Heath, etc.

AUTHORIZED EUROPEAN AGENTS

Scandinavia: MICROTEC, Makedien 26, Other: INGOIMPEX, Postfach 24 49

3200: Sandefjord, NORWAY D-8070, Ingolstadt, W. GERMANY



FOX-TANGO CORPORATION

Box 15944S, West Palm Beach, Florida 33406

Phone: (305) 683-9587



JULY 4TH
CELEBRATION



ICOM



IC-740
Call For Quote

HF Trans., Digital, Dual VFOs

ICOM



IC-505
\$449 SALE \$399

6M Multimode FM Option, 3W/10W



YAESU



FT-102
Call For Quote

HF Digital Transceiver
Inc. FM, 240W DC

YAESU



FT-230R
\$359.95 SALE \$319

2M, FM, Mobile
LCD Dual VFOs Memory 25W

HAND-HELDS

	w/TTP	w/o TTP
IC 2A/2AT	\$242.00	\$216.00
IC 3A/3AT 220	\$269.00	\$242.00
IC 4A/4AT 440	\$269.00	\$242.00
FT-208R 2M	\$319.00	
FT 708R 440	\$319.00	



HAL COMMUNICATIONS
ON DISPLAY AT EEB

CT-2100 Communications Terminal
KB-2100 Keyboard
DS-3100 Terminal
CWR-6850 Telereader

Full Line Available

Sanyo & Zenith Monitors
in Stock at Special Prices

Shipping Charges Not Included.
Prices Subject to Change Without Notice

Electronic
Equipment Bank

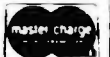

516 Mill St., N.E., Vienna, VA 22180

703-938-3350



Tues. Wed. Fri. 10AM-5PM
Thurs. 10AM-9PM Sat. 10AM-4PM
Closed Sun & Mon

Plan a visit next time you're in
Washington, D.C.

SORRY: NO CODs

WORLD TIME WATCH

the first microprocessor watch made especially for hams



24 hr. timer
microprocessor
water resistant
solar assist

New Low Price
-\$59.95

The HAM-1 functions include local time, world time, (G.M.T. too) count-up and count down chronometer, day, month, date, alarm and hourly chime. It's ideal for log-keeping, DX time conversion and 10 minute I.D. timing. The HAM-1 features a high contrast Seiko display and solar cell battery assist. Battery life is better than 4 years. The HAM-1 is water resistant to 20 meters, the case is 100% solid stainless steel and the crystal is scratch resistant mineral glass. The HAM-1 is rugged and durable and has a 1 year warranty.

2 METER AMPLIFIER
\$39.95



• 2 Watts In, 10 Watts Out • V.S.W.R. Protected • Can be Used for F.M. & S.S. B. • Led Status Indicators • Low Loss SO-239 Connectors • Current Drain Less Than 2.5A at 13.6 V.D.C. • Massive Heatsink • Built In T/R Switch

TEMPO S-1 UPGRADE KITS
\$39.95

Upgrade your early Tempo S-1 to current Production Specifications, kits include: • 450 M.A.H. Battery Pack • New Case Assembly • All New Escutcheons • Spkr./Mic. Jack w/Dust Cap • New Earphone & Jack • P.C.B. and Parts for Easy Installation • Detailed Instruction Manual • For Radios With & Without T.T. Pad.

Other Accessories Available:

Spkr./Mic. Designed for S-1's. . . \$24.95
Heavy Duty Belt Clip. 7.50
Flex Antenna 6.00

To Order Call or Write to:

ADVANCED COMMUNICATIONS
INTERNATIONAL
2411 Lincoln Avenue ✓ 448
Belmont, CA. 94002 U.S.A.
(415) 595-3949

Add \$3.00 per order for shipping & handling. California residents add 6% sales tax. Visa, Master Charge accepted.

QUALITY parts at DISCOUNT PRICES

STEREO 8 TRACK HOME UNIT



BRAND NEW UNITS...
ASSEMBLY INCLUDES;
TAPE HEAD, MOTOR BELT,
110VAC MOTOR, PRE-AMP,
LIGHTS, SWITCHES,
SOLENOID AND OTHER
USEFUL PARTS...
AN EXCEPTIONAL BUY!
\$7.25 PER ASSEMBLY

MINI BSR AUTOMATIC RECORD CHANGER



\$17.50 each

* B.S.R. MODEL C136R/C/3
* PLAYS 33/45/78 RECORDS
* MINI SIZE: 8 1/4" X 12"
INCLUDES DUST COVER AND
PLASTIC CASE (NOT PICTURED)
WITH FRONT CUT OUT TO FIT
STEREO UNIT (NOT INCLUDED).

JOYSTICK



PRECISION
DEVICE...
CONTAINS 4
50K CENTER
TAPPED ALPS
POTS. \$4.75 ea

BLACK PLASTIC CASE



PAC-TEC
SERIES C
BLACK PLASTIC ENCLOSURE
ADJUSTABLE HEIGHT FROM
1.63" TO 2.93"; WIDTH
6.85"; DEPTH 8". BUILT-
IN STAND OFFS FOR P.C.
BOARDS. FRONT AND BACK
PANELS NOT INCLUDED...
\$.25 PER CASE

VARACTOR DIODES

BB-103 3 FOR \$1.00
100 FOR \$30.00
MV2205 3 FOR \$1.00
100 FOR \$30.00

MITSUMI MODEL UES-555F VARACTOR UHF TUNER



FREQ. RANGE
470 - 889 MHz
ANTENNA INPUT
300 OHMS
\$25.00 each
10 FOR \$220.00

MINI SIZE BUZZERS

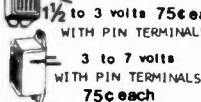

1/2 to 3 volts 75c ea
WITH WIRE LEADS
1/2 to 3 volts 75c ea
WITH PIN TERMINALS
3 to 7 volts
WITH PIN TERMINALS
75c each

PHOTO FLASH CAPACITORS



170 MFD 330 VOLT
1 1/2" X 7/8"
2 FOR \$1.50
10 FOR \$7.00
600 MFD 360 VOLT
3 3/4" HIGH X 1" DIA.
\$1.00 EA. 10 FOR \$9.00

750 MFD 330 VOLT

2" HIGH X 1 3/4"
\$1.25 EACH 10 FOR \$11.00
SLIDE POTS
500K
linear taper
2 7/8" LG.-
1 3/4" TRAVEL 75c EACH

COMPUTER GRADE CAPACITOR

1700 mfd. 150VDC \$2.00
2 1/2" DIA X 4 3/4" HIGH
3,600 mfd.
40VDC \$1.00
1 3/8" DIA. X 3" HI
6,400 mfd.
60VDC \$2.50
1 3/8" DIA X 4 1/4"

12,000 mfd. 40 VDC \$3.00
2" DIA X 4 1/4" HIGH
18,000 mfd. 75 VDC \$4.00
2 1/2" DIA X 4 1/2" HIGH
22,000 mfd. 15 VDC
2" DIA X 2 1/2" HIGH \$2.00

22,000 mfd. 40VDC
2" DIA. X 6" HIGH \$3.00
25,000 mfd. 75 VDC \$4.50
3" DIA X 4 3/8" HIGH
45,000 mfd. 25 VDC
2" DIA. X 4" HIGH \$3.50
72,000 mfd. 15 VDC
2" DIA. X 4" HIGH \$3.50

CLAMPS TO FIT CAPACITORS 50c ea
L-PAD
STANDARD 8 OHM
50 DB L-PAD...
\$1.50 EACH

8' LINE CORD

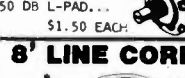

18 - 3 SUT M/E
ROUND GRAY
\$2.00 EACH 10 FOR \$18.50

TRANSFORMERS

120 volt
primaries

5.6 VOLTS at 750 MA \$3.00
6 VOLTS at 150 mA \$1.25
12 V.C.T. at 500 MA \$2.50
16.5 V. at 3 AMPS \$8.50
18 VOLTS at 350 MA \$2.00
18 VOLTS at 1 AMP \$4.50
18 V.C.T. at 2 AMP \$5.50
25.2 V.C.T. at 2.8 AMP \$5.50
35 V.C.T. at 1 AMP \$3.50
42 V.C.T. at 1.2 AMP \$4.50
65 V.C.T. at 2 AMP \$5.50

L.E.D.'s STANDARD JUMBO DIFFUSED

RED 10 FOR \$1.50
GREEN 10 FOR \$2.00
YELLOW 10 FOR \$2.00
FLASHER LED
5 VOLT OPERATION
JUMBO SIZE
2 FOR \$1.70

BI POLAR LED SUB MINI LED

.079" X .098"
20mA at 1.75v
10 FOR \$1.00
200 FOR \$18.00
QUANTITY PRICES AVAILABLE

BLACK LIGHT (ULTRAVIOLET)

1-E. # F6T58L \$2.50 each

FREE! SEND FOR OUR NEW 40 PAGE CATALOG FREE!

CONNECTORS WEATHERPROOF 2 CONDUCTOR



POLARIZED SET, 18 GA.
WIRE. \$1.00 / SET
4 CONDUCTOR
\$1.50 PER SET
WEATHER-PROOF SOCKET
AND CONNECTOR SET...

EDGE CONNECTOR

ALL ARE .156" SPACING
15/30 GOLD
SOLDER EYELET \$2.00 EACH
18/36 GOLD
SOLDER EYELET \$2.00 EACH
22/44 GOLD
SOLDERTAIL (P.C. STYLE)
\$2.50 EA 10 FOR \$22.50
22/44 TIN
SOLDERTAIL (P.C. STYLE)
\$1.35 EA 10 FOR \$12.50
42/84 GOLD
SOLDER EYELET \$4.00 EACH

4PDT RELAY



14 pin style
3 amp contacts
24 volt d.c. or
120 volt a.c. coil
Used but fully tested
\$1.70 EACH
specify coil voltage
LARGE QUANTITIES AVAILABLE
SOCKETS FOR RELAY 50c each

6 VDC RELAY

MINIATURE
D.P.D.T.
3 AMP CONTACTS
FUJITSU # FBR3210006
\$1.75 EA 10 / 16.00

KEY SWITCH

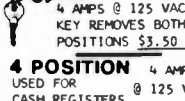

S.P.S.T.
4 AMPS @ 125 VAC
KEY REMOVES BOTH
POSITIONS \$3.50 EA
4 POSITION 4 AMPS
USED FOR
CASH REGISTERS @ 125 VAC

8-TRACK AND CASSETTE TAPE PLAYER / RECORDER



COMPLETE CHASSIS
READY TO INSTALL
INTO YOUR CABINET
\$20.00 PER UNIT.

BRAND NEW, COMPLETELY FUNCTIONAL TAPE DECKS
* RECORD AND PLAY 8 TRACK OR CASSETTE TAPES
* L.E.D. FUNCTION INDICATORS
* COMPLETE SCHEMATIC AND HOOK UP DIAGRAM
* REQUIRES 12.6 - 15 VDC POWER SUPPLY

MICROWAVE TRANSISTORS

75 ohm CO-AX
12 FOOT
R.C.A. PLUGS BOTH
ENDS...USED FOR VIDED
GAMES, ETC \$1.25 EA

0-10 MINUTE TIMER

ADJ. TIMING
MOTOR FROM
0 - 10 MIN.
RATED 10 AMPS.
125 VAC MOUNTS
ON 1" CENTERS...
\$4.75 EACH

CANNON XLRA-3-13 CONNECTOR

3 PRONG
CHASSIS MOUNT
CONNECTOR
\$2.00 EACH
10 FOR \$18.00

2" ALLIGATOR CLIPS

7 clips for \$1.00
100 clips for \$12.00
500 clips for \$50.00

6volt 9amp/hr RECHARGEABLE

ELPOWER # EP690
SOLID GEL CELL
5 1/2" X 4 1/4"
X 2 3/4".....
\$15.00 EACH

CRYSTAL

CASE STYLE
HC33/U \$3.50 EACH

ALL ELECTRONICS CORP.

905 S. Vermont Ave.
P.O. BOX 20406
Los Angeles, Calif. 90006
(213) 380-8000

Mon. - Fri. Saturday
9 AM - 5 PM 10 AM - 3 PM

TERMS
* Quantities Limited
* Min. Order \$10.00
* Add \$2.50
Shipping USA
* Calif. Res. Add 6%
* Prompt Shipping
NO COD

MANUFACTURERS - WE WILL
PURCHASE YOUR EXCESS
INVENTORY (213) 380-8000

"Smart" Squelch for SSB

Editor's Note: W9MKV and W9YAN's "Smart Squelch" overwhelmed the competition to win the first 73 Magazine Home-Brew Contest. The authors received a \$250 prize in addition to the normal article payment. You can build this trend-setting project; W9MKV offers a PC board for \$7.00 and a complete parts kit is available from Radiokit, Box 411, Greenville NH 03048, for \$49.95. Congratulations to W9MKV and W9YAN for a job well done.

Frank S. Reid W9MKV
PO Box 5283
Bloomington IN 47402

David A. Link W9YAN
213 Western Drive
Bloomington IN 47401

This circuit detects the human voice but ignores noise, steady tones, and the Russian woodpecker HF radar pulses. It requires no receiver modification and works even when voice signals are below the noise level.

A squelch turns off receiver audio to eliminate annoying background noise when there is no signal. Squelch circuits in AM and FM receivers are carrier-operated. On single sideband, which has no carrier, squelching is more difficult. Most SSB rigs with squelch, e.g., the popular 2-meter multimode transceivers, use agc (S-meter) voltage to open squelch in SSB mode. Agc-operated squelch is adequate for strong signals on relatively quiet channels. Agc and VOX-type squelch-

es open for any noise or heterodyne that exceeds a preset level. Weak signals often are missed because the threshold must be set above the noise level.

White noise sometimes can make you imagine tiny voices in the noise, but it won't fool the Smart Squelch. Detecting unreadably-weak signals is worthwhile if a change of antenna direction or receiver control settings will make them usable.

The audio-operated squelch circuit described

here is similar in principle to Motorola's "Constant Sinad" squelch, a discrete-component circuit with 22 transistors.

Discriminating the Human Voice

People normally speak about three syllables per second. The squelch works by detecting voice-band energy (500-3000 Hz) which is varying in frequency at a rate of 0.5 to 3.25 Hz.

The circuit is a type of FM detector. It is insensitive to amplitude variations throughout the range where the input stage is not driven to saturation but background noise is strong enough to saturate the limiter. The squelch works properly with most speaker-level signals. You can connect it directly to the receiver's detector output, adjusting gain of input buffer amplifier U1A as necessary.

Performance

A receiver tuned to WWV provides a good demonstration of the circuit's capabilities. Squelch opens for voice announcements and ignores the rest of the transmissions.

The squelch can turn on well within the first spoken syllable. Speed of response depends mostly upon the rise-time of active low-pass filter U3A. The receiver is muted one second after the last voice detection. The beginning of a steady tone



Photo A. Squelch unit is attached to the right side of the HF SSB transceiver. Rectangular LEDs above the control knob indicate circuit status. (Photo by KA9FJS)

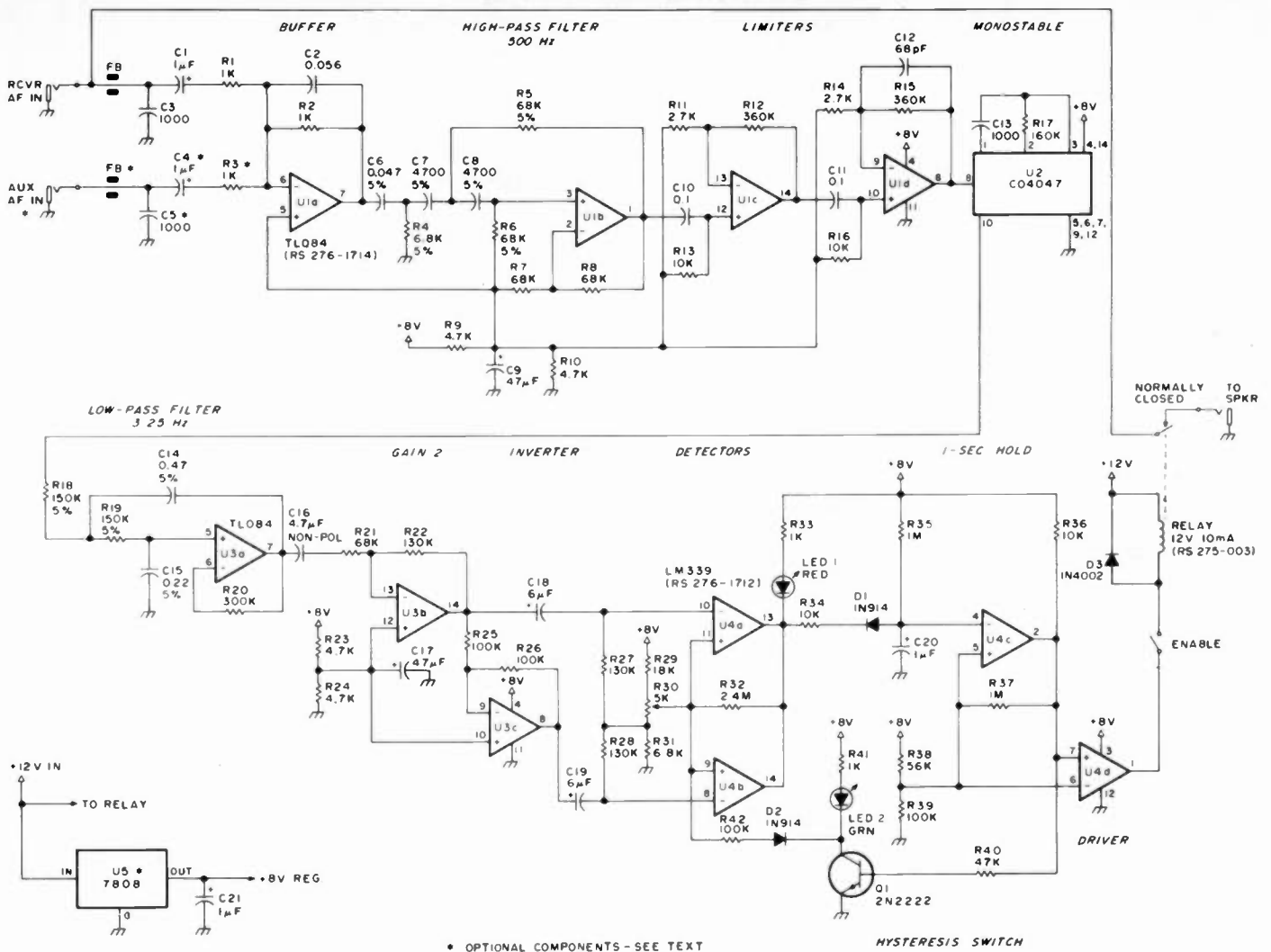

Fig. 1. Schematic diagram.

opens the squelch only momentarily. It opens intermittently on music. Response to CW depends on code speed and tone.

A single squelch circuit can control multiple receivers, unsquelching them all when any receiver detects a voice signal. (We like to monitor HF aircraft and marine frequencies plus 144.2 MHz—the 2-meter SSB calling frequency.)

The squelch is useful when rf radiation from computer systems overwhelms the normal squelch in a VHF FM receiver. It's also good for monitoring VHF/UHF mobile-telephone channels in systems where a constant idle tone is transmitted while no call is in progress. The circuit has other applications as a

"smart" VOX (voice-operated switch) for transmitters, recorders, intercoms, security systems, remote-base systems, and repeater equipment.

Circuit Description

U1A is a unity-gain summing amplifier, input buffer, and low-pass filter with 3-kHz cutoff. U1A drives U1B, a third-order high-pass active filter with 3-dB cutoff at 500 Hz. We chose high-performance FET-input operational amplifiers so that active filters could use high resistances and small capacitors. The TL084 quad op-amp chip is equivalent to the National LF357.

U1C and U1D are limiter amplifiers with a combined gain of 85 dB. U1D's output is voice-band audio turned into constant-amplitude

square waves. The square waves trigger CMOS monostable U2. U2 and the following low-pass filter form a frequency-to-voltage converter, i.e., FM detector, somewhat similar to an automobile tachometer circuit.

Active low-pass filter U3A cuts off at 3.25 Hz, the best compromise between noise-falsing and the rate at which people speak syllables.² Note that U3A has no bias network even though the amplifier uses a single-polarity power supply. U2's averaged pulses keep the output of U3A at 5 to 6

volts with normal noise input from the receiver. R17, which sets U2's period, can be varied to keep U3A's quiescent output voltage near the center of its range.

On very quiet channels there may not be enough pulses from U2 to keep U3A properly biased. False detects may occur as U3A's output goes in and out of its linear range. You can inject extra noise or low-level tone into the squelch circuit's auxiliary input to achieve the desired results for your particular application.

U3A's output is ac-coupled to U3B, which amplifies with a gain of 2, and thence to U3C, a unity-gain inverter. U3B and U3C together form a phase splitter with a gain of 2. The phase

M² ENGINEERING'S VHF H.T. CONVERTERS

• DOUBLE BAND HC-V, HC-U2 • SINGLE BAND HC-V220

• BI-LATERAL PROTECTION AGAINST
ACCIDENTAL TRANSMISSION
FOR UP TO 5 WATTS

• STANDARD BNC
CONNECTORS

• HC-V
154-158
159-163

• HC-U2
460-464
480-484

• HC-V220
221-225

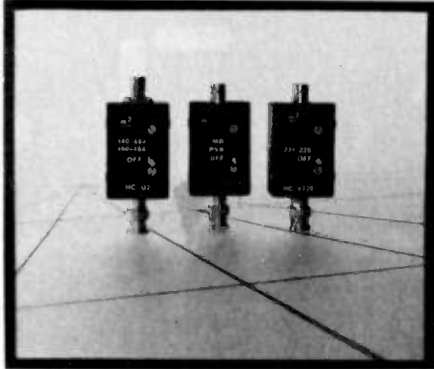

HC-U2
\$72.45

HC-V
\$47.45

HC-V220
\$62.45

M-SQUARED
ENGINEERING, INC.
1446 LANSING AVE.
SAN JOSE, CA. 95118
14081266-9214

DEALERS
WELCOME

Shipping included
Calif. residents add
6.5% sales tax

HI-Q BALUN

- For dipoles, yagis, inverted vees & doublets
- Replaces center insulator
- Puts power in antenna
- Broadbanded 3-40 MHz
- Small, lightweight and weatherproof
- 1:1 Impedance ratio
- For full legal power and more
- Helps eliminate TVI
- With SO 239 connector



only \$12.95

HI-Q ANTENNA CENTER INSULATOR



Small, rugged, lightweight, weatherproof. Replaces center insulator. Handles full legal power and more. With SO 239 connector

\$6.95

HI-Q ANTENNA END INSULATORS



Rugged, lightweight, injection molded of top quality material, with high dielectric qualities and excellent weatherability. End insulators are constructed in a spiral unending fashion to permit winding of loading coils or partial winding for tuned traps. May be used for:

- Guy wire strain insulators
- End or center insulators for antennas
- Construction of antenna loading coils or multiband traps

\$4.95

DIPOLES

MODEL	BANDS	LENGTH	PRICE WITH HI-Q BALUN	WITH HI-Q CENTER INSULATOR
Dipoles				
D-80	80,75	130	\$31.95	\$27.95
D-40	40,15	66	28.95	24.95
D-20	20	33	27.95	23.95
D-15	15	22	26.95	22.95
D-10	10	16	25.95	21.95

Shortened dipoles

SD-80	80,75	90	35.95	31.95
SD-40	40	45	32.95	28.95

Parallel dipoles

PD-8010	80,40,20,10,15	130	43.95	39.95
PD-4010	40,20,10,15	66	37.95	33.95
PD-8040	80,40,15	130	39.95	35.95
PD-4020	40,20,15	66	33.95	29.95

Dipole shorteners - only, same as included in SD models

S-80	80,75	\$11.95 pr
S-40	40	\$10.95 pr

All antennas are complete with a HI-Q Balun or HI-Q Antenna Center insulator, No. 14 antenna wire, ceramic insulators, 100 nylon antenna support rope (SD models only 50) rated for full legal power. Antennas may be used as an inverted V and may also be used by MARS or SWLs.

Antenna accessories—available with antenna orders
Nylon guy rope 450# test 100 feet \$4.49
Ceramic (Dogbone Type) antenna insulators \$1.50 pr
SO-239 coax connectors .55

All prices are postpaid USA 48
Available at your favorite dealer or order direct from

Dealer Inquiries Invited
Van Gorden Engineering

BOX 21305 B, SOUTH EUCLID, OHIO 44121

REMEMBER THE FUN AT PLAYBOY'S GREAT GORGE RESORT IN 1976 & 1978?

**THE ARRL
HUDSON DIVISION
CONVENTION
MOVES BACK TO
GREAT GORGE
FOR 1982!**

If you attended the ARRL Hudson Division Convention in '76 or '78, then you know what a great time we'll be having on the weekend of October 30-31, 1982, at the same fantastic location in Great Gorge, New Jersey. If you missed either of these years, ask someone who was there. You'll hear about all the super activities, seminars, forums, fleamarket and exhibits covering everything from 160 meters to microwave; all modes, all facets of our great hobby... plus, new for '82, even more on computers and TVRO earth stations! As in the past, we also have a full women's program for non-ham XYL's, and the Great Gorge resort has everything in sports and leisure activities you could ever want.



**DON'T MISS OUT. RESERVE NOW AND SAVE—TICKETS
ARE \$9.00 AT THE DOOR. USE COUPON BELOW.**

HARC CONVENTION, POST OFFICE BOX 528, ENGLEWOOD, NJ 07631

Please send me the following 1982 Hudson Division Convention Tickets:

____ (Quantity) REGISTRATION TICKETS @ \$ 7.50 \$ _____
____ BANQUET TICKETS** @ \$24.00 \$ _____

TOTAL ENCLOSED (Make check payable to "HARC") \$ _____

• PLEASE ENCLOSE A STAMPED—SELF-ADDRESSED ENVELOPE •

NAME _____ CALL _____

ADDRESS _____

CITY, STATE, AND ZIP CODE _____

FLEAMARKET SELLERS ONLY—CHECK HERE FOR INFO

**INDICATE BELOW
ANY SPECIAL RE-
QUESTS FOR BANQUET
FOR SEATING (Club
table or group seating)

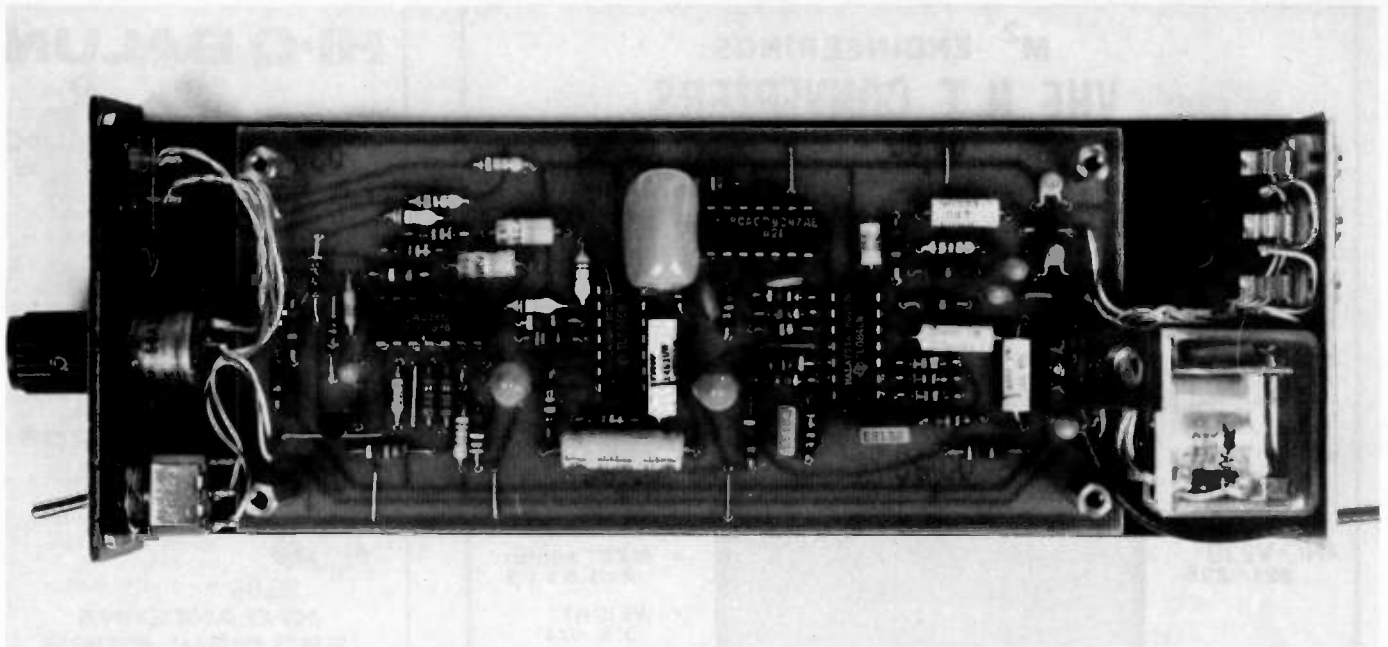

Photo B. Circuit board and chassis detail. The only external connections required are receiver audio, speaker, and 12 volts dc. (Photo by KA9FJS)

detect. Q1 conducts while squelch is open, further reducing the threshold voltage via R42 and D2. R42 determines the amount of hysteresis. The 100k value shown for R42 provides smooth squelch operation.

The circuit uses 25-30 mA plus relay current. The eight-volt-regulator IC, U5,

should be used for mobile operation. Otherwise, the entire circuit can run from a well-regulated 12-volt supply. (Omit U5 and add a jumper between input and output pins of U5 on the PC board.)

Adjustment

LED1 lights whenever the

detector is active. Listen to a voice signal and adjust the threshold control until LED1 blinks for every spoken syllable, then make fine adjustments as necessary for noise conditions. The enable switch allows you to adjust the squelch before activating the relay and allows you to unsquelch with-

out disturbing the threshold setting. Scale markings around the control knob make it easier to reset an often-used level.

Construction

All-new parts cost about \$40, using referenced items from Radio Shack and ECG. Resourceful hams can build

		Parts List				
Semiconductors						
U1, U3	TL084C quad BIFET op amp	2	\$ 5.98	R11, R14	2.7k	2
U2	CD4047 CMOS multivibrator (ECG 4047)	1	1.49	R9, R10, R23, R24	4.7k	4
U4	LM339 quad comparator	1	1.50	R4*, R31	6.8k	2
U5	7808 8-volt regulator (optional—see text)	1	.99	R30	5k, linear pot	1
Q1	2N2222 or equiv. silicon NPN transistor	1	.15	R13, R16, R34, R36	10k	4
D1, D2	1N914 or equiv. silicon diode	2	.20	R29	18k	1
D3	1N4002 or equiv. silicon diode	1	.10	R40	47k	1
LED1	Red LED (rectangular)	1	.49	R38	56k	1
LED2	Green LED (rectangular)	1	.49	R5*, R6*, R7, R8, R21	68k	5
Capacitors (All 20 V or more)						
C12	68 pF	1	.12	R25, R26, R39, R42	100k	4
C3, C5, C13	1000 pF	3	.45	R22, R27, R28	130k	3
C7, C8	4700 pF, 5%	2	.60	R18*, R19*	150k	2
C6	0.047 uF, 5%	1	.30	R17	160k (see text)	1
C2	0.056 uF	1	.30	R20	300k	1
C10, C11	0.1 uF	2	.30	R12, R15	360k	2
C15	0.22 uF, 5%	1	.40	R35, R37	1M	2
C14	0.47 uF, 5%	1	.40	R32	2.4M	1
C1, C4, C20,						
C21	1 uF, electrolytic	4	1.60			
C16	4.7 uF, non-polarized (RS 272-998)	1	.99			
C18, C19	6 uF, electrolytic	2	2.36			
C9, C17	47 uF, electrolytic	2	2.00			
Resistors (All 1/4 Watt; * = 5%)						
R1, R2, R3, R33, R41	1k	5				
Other						
	Ferrite beads	2	.10			
	Miniature earphone jacks	3	1.29			
	Relay, 12-volt SPDT (RS 275-003)	1	2.99			
	Switch, miniature toggle SPST	1	1.49			
	Control knob	1	.49			
	Hardware, PC board, chassis					10.00
	Parts Total					\$40.85
42 @ \$.08 ea. = \$3.28						

Free UPS shipping on orders over \$100.00
 2 locations open Mon-Sat 10 am 'til 6 pm
 Thurs & Friday 'til 9 pm



Mich. res. add 4%

KENWOOD
R. L. DRAKE

ICOM

TEN-TEC

YAESU

MFJ AND MORE!

CALL FOR QUOTES

Summer Special
 HD73 ALLIANCE ROTOR
 \$89.95

RSE HAM SHACK

2 locations
 1207 W. 14 Mile Road, Clawson MI 48017
 313-435-5660
 31155 Plymouth Road, Livonia MI 48150
 313-522-4232 ✓ 117

RTTY/CW
 For the TRS-80*

* A Trademark of the Tandy Corp.

ROM-116
 Now includes:
 • TEXT EDITING
 • RTTY PICTURES
 • SAVE TEXT TO DISK *Detailed brochure available on request.*

Featuring:

1200 BAUD OPERATION. Not limited to 110 baud because of timing loops. 60, 66, 75 & 100 W.P.M. Plus 110, 150, 300, 600 & 1200 baud operations possible.

FLEXIBILITY OF OPERATION. Instantly change: Baud Rates; Program Mode (ASCII/Baudot); Program Status.

SPLIT SCREEN VIDEO. Transmit & receive data displayed separately.

REAL TIME. Automatic CW/ID without user intervention. Automatically updates at end of month or year.

Other features include:

- Two Serial Ports
- Fourteen Buffers
- Automatic CW/ID
- Transmit Control
- Selective Call Feature
- Error Correction & Editing
- Word Wrapping
- Easy to Interface
- 30 Day Unconditional Guarantee
- Hardware Requirements: TRS-80 Model I or III 16K EXTERNAL TERMINAL UNIT REQUIRED

CROWN MicroProducts

606 State Street, P.O. Box 892-R • Marysville, WA 98270 • (206) 659-4279

"No-Stretch"
 Phillystran® HPTG

the only flexible FIELD PROVEN electrically transparent tower-guy system

1. eliminates EMI and RFI at broadcast sites
2. simplifies installation of AM, FM, AM directional and TV towers. Made with DuPont's Kelvar®. Lightweight, flexible, yet as strong as extra-high-strength galvanized steel* . . . negligible creep, negligible elongation with new HPTG* for tension-once and walk-away installations.
3. maintenance free. Non-conducting, non-corroding, nonmetallic. No internal corrosion. No white-noise arcing across insulators. No insulators required.
4. no more expensive re-guying.

*Comparative stress-strain data and information about other physical properties available on request.

**Call/write for:
 10 REASONS WHY
 YOUR BEST BUY IS
 PHILLYSTRAN®
 and the new
 PHILLYSTRAN® HPTG**

PHILADELPHIA RESINS CORP.

20 Commerce Drive
 Montgomeryville, PA 18936
 (215) 855-8450

*an uncommon organization
 doing big things worldwide
 in a quiet way.*

Your Ham Tube Headquarters!

TOLL 800-221-0860 FREE TUBES

3-400Z	\$85.00	6883B	\$6.75
3-500Z	\$85.00	7360	\$9.15
4-400A	\$80.00	7735A	\$29.50
4CX250B	\$50.00	8122	\$98.00
572B	\$39.50	8156	\$10.95
811A	\$12.00	8844	\$29.50
813	\$35.00	8873	\$175.00
6146B	\$6.50	8874	\$180.00
6360	\$4.25	8877	\$450.00
		8908	\$10.50

E.F. JOHNSON Sockets for 4CX250B & 4-400A @ \$9.95

SEMICONDUCTORS		RF CONNECTORS	
MRF 245/SD1416	\$30.00	PL 259	10/\$4.95
MRF 454	\$18.95	PL 258	10/\$8.95
MRF 455	\$12.50	UG 175/176	10/\$1.60
		UG 255/U	\$2.50 ea.
MRF 644/SD1088	\$19.95	UG 273/U	\$2.25 ea.
2N3055	\$.95	M 358	\$2.50 ea.
2N6084	\$12.50	M 359	\$1.75 ea.
		Type "N" twist on (RGR/U)	\$4.75

TOP BRAND Popular Receiving Tube Types
FACTORY BOXED 75/80% OFF LIST
FREE LIST Available
Includes full line of RF Power Transistors.
Minimum Order \$25.
Allow \$3.00 Minimum for UPS Charges
Write or phone for free catalog.
TUBES—BOUGHT, SOLD AND TRADED

CeCo
Since 1922

Premium Prices Paid
For EIMAC Tubes

COMMUNICATIONS, Inc.
2115 Avenue X
Brooklyn, NY 11235
Phone (212) 646-6300 ✓92

"BEEPER III"

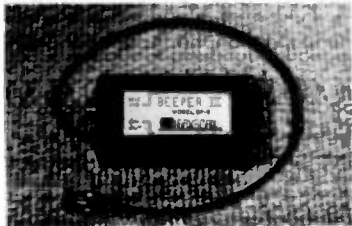

"THE PROFESSIONAL TOUCH COMES TO AMATEUR RADIO!"

"BP-3 automatically provides a gentle high frequency beep at the beginning of each transmission and a low beep at the end. Virtually eliminates "talk-over"! Operates for up to one year on a single 9-V battery (not supplied). Can be directly interfaced to any transceiver which is keyed by grounding the PTT line (the PTT line voltage must be positive, not greater than 24 VDC, nor the current greater than 100 ma.) Works with virtually all modern gear. You've heard it; now you can have it!"

"ADD THE BEEP!"

- BP-3A Complete with case, cable, Standard 4-pin connectors. . . . **\$9.95 pp**
 - BP-3B As above except without connectors. Add your own. . . . **\$6.95 pp**
 - BP-3C Circuit-board version for custom installation. . . . **\$9.95 pp**
- All units assembled/tested. OH residents add 6% Sales Tax"

FAXSCAN INC. ✓85
3148 Dori Drive • Dayton, Ohio 45418 TM

H.T.-Power!

Limited Offer...
SUPER STICK II

2 METER 5/8 WAVE TELESCOPIC ANTENNA

PLUS

A DUCK FOR UNDER A BUCK

\$19⁹⁹ + 1¢

FOR THE DUCK

	PRICE	GAIN *	BASE CONNECTOR **	FULLY COLLAPSED
SUPER STICK II	\$19. ⁹⁵	6-9 DB	BNC-Tempo 5/15-32 TNC-F—50239	Collapsed is a matched 1/4 Wave Antenna
BRAND C	\$26. ⁹⁵	6-9 DB	BNC ONLY	NA Will not transmit in collapsed position.
BRAND V	\$24. ⁹⁵	5-8 DB	BNC ONLY	NA Will not transmit in collapsed position.

* Measured Field Strength Over Rubber Duck

** Specify Base Type BNC, Tempo, Ect.

RD2S Stubby

The Tuned Antenna Company brings you the Super Stick II for those long hauls with your H.T., plus our 5/8 Wave Antenna may be operated collapsed with the same operating characteristic of a Rubber Duck Antenna. The Super Stick II is available with Tempo S-1, BNC-TNC-F-PL-259 Bases at a price that is several bucks under other 5/8 Wave Antennas, making the Super Stick II the best buy around. See your local dealer for stock. Settle for nothing less than a Super Stick II.

Terms: C.O.D., check or money order. Please add \$2.00 for first antenna and \$1.00 for each additional antenna to cover shipping and handling. California residents add 6% sales tax.

FOR DEALER LOCATION OR TO ORDER CALL:
(714) 268-0720

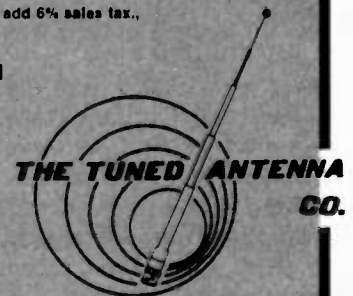

9520 Chesapeake Dr. #606
San Diego, California 92123

The Ultimate Fuse

— ac overload protection

Neil Johnson W2OLU
PO Box 585
South Orleans MA 02662

Recently, while working on the design for a new power supply, I managed to blow over a dozen fuses. My regular ham buddy was on a weekend fishing trip, so I kept making the same, simple error. After the trouble was located and cor-

rected, it somehow struck me: There's got to be a better way!

In the past, hams who built their own power supplies could depend on manufacturers to offer several different types of relays, some with manual reset capabilities and some with electrical reset features, but such items are no longer available to the amateur builder. In view of this deficiency, a few years ago I offered a homely solution to the dc overload-relay problem: how to homebrew what you can no longer purchase.¹

It is common practice for commercial and military installations to provide circuitry to protect their power supplies, both as to input and output. Dc overload relays are properly installed in the output of the rectifier or filter circuits, and ac overload relays are installed in the primary circuits of the various power supplies, and so on. But I had yet to see how an amateur experimenter might put together a suitable substitute for an ac overload relay.

In an earnest effort to devise some sort of simple

circuitry for such a need, it came to mind that several factors had to be taken into consideration. The system had to be simple, foolproof, and, above all else, inexpensive. There is no logic in providing an expensive method for the sort of thing which a typical amateur might wish to protect. The setup to be described satisfies all of the foregoing.

The heart of the protective circuit lies in the utilization of a surplus 24-volt dc relay. These are widely available at low cost. If such a relay can be incorporated into a simple circuit, then we should end up with a satisfactory combination for taking care of ac overloads.

Refer to Fig. 1. Note that we have incorporated a surplus 2.5-volt filament transformer of 10-Ampere rating. Since silicon diodes came into play as substitutes for mercury-vapor tubes, such transformers have become a drug on the market. But a suitable transformer of similar ratings should serve; that is, a low-voltage secondary and rather high current rating.

Preliminary experiments

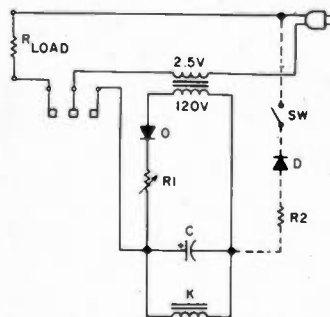

Fig. 1. The early circuitry was fairly simple, but half-wave rectification from the 120-volt winding caused the setup to be less sensitive than desired. Added components shown connected with dotted lines are needed to keep the relay locked up after an overload has caused the circuit to be broken. (Note: Relay shown at rest, i.e., non-energized.)

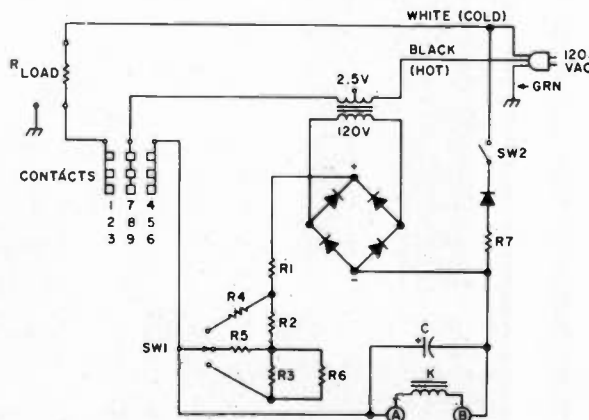

Fig. 2. Final version of overload relay. SW1 selects 2.5-, 5-, or 10-Amp kickout points.

led me to develop the most elementary circuitry to fulfill the concept. When current is passed through the 2.5-volt winding a current will be induced into the 120-volt winding (now the secondary). After rectifying and filtering, the dc voltage is used to actuate the 24-volt dc relay. The variable resistor, R, can be adjusted to allow various ac currents to pass before the relay will trip and open the ac circuit.

This will not completely suffice, however, since the relay will buzz back and forth between on and off unless some form of lock-up is provided. The added components, shown by dotted lines, attend to this function. Lock-up is obtained with lower current than is required for pull-in, and simple half-wave rectification will serve. Reset is furnished by opening the switch, which is normally closed.

The system that finally evolved is shown in Fig. 2. The full-wave bridge rectifier furnished more voltage than the original half-wave circuit and allows the relay to trip out at a lower current. In a thorough search for a relay of better suitabilities, over a dozen relays were checked out experimentally. Finally, it was decided to opt for a relatively sensitive unit which has the added advantage of having three sets of contacts, all rated at 10 Amperes. To be on the safe side, these are wired in parallel.

My thoughts then were directed to the feasibility of obtaining a suitable variable resistor, in order to enable the relay to actuate at various current settings. Easier said than done!

The three principal calibrating resistors are used in place of a "nice to have" 3000-Ohm, 10-Watt wirewound potentiometer. The 5-Watt, 1000-Ohm size is a

fairly common item in all stores which cater to radio and TV servicemen. Additional resistors were added to cause the setup to kick out at 2.5, 5, and 10 Amperes. This 4-to-1 range is in line with what the commercial makers of such relays—Westinghouse for example—design into their products.

Other design factors worth mentioning are:

(a) The 100- μ F electrolytic capacitor seems to be about right in this setup. A lower value may cause the dc relay to buzz, and a higher value can cause a time delay to take place—definitely undesirable in any form of protective circuitry where high power is involved; and (b) Avoid carbon resistors in the 1000-Ohm positions. Careful checks show that a 1000-Ohm, 2-Watt carbon resistor will be dissipating 1.6 Watts or 80% of its full value. This will cause upward change in the resistance, and, indirectly, "calibration creep" in the finished instrument.

Random thoughts at this juncture: Others have asked me whether simpler devices, such as the thermal overload units commonly found on the back of TV sets, would suffice. These have been tried and their use cannot be justified since the time delay is intolerable where an expensive unit requires protection. Personally, I almost lost a very nice Powerstat® while attempting to live with such protection.

Perhaps solid-state devices might be designed to furnish the same function? I would be disinclined to depend upon such a setup in view of the relatively high-voltage spikes which are encountered when a highly inductive component—such as the power transformer in a large amateur rig—needs to have its primary circuit interrupted. For that rea-

Parts List

T— 2.5-volt, 10-A filament transformer
 D— all diodes type 1N4007
 C— 100 μ F, 35 volts
 S1— Rotary switch with 3 positions
 S2— Momentary-contact switch, wired for normally-closed operation (Radio Shack 275-619)
 K— Potter & Brumfield type KUP 14D15 (Fair Radio Sales, Lima, Ohio, \$2.50)
 R1-R3— 1000 Ohms, 5-Watt, wirewound
 R4, R5— 330 Ohms, 1-Watt
 R6— 15k Ohms, 1-Watt
 R7— 2700 Ohms, 2-Watt
 Small cabinet or chassis, 3-wire ac cord, and 5-way output terminals

son, I chose 1000-volt silicon diodes, type 1N4007, for service in this unit.

So we have an ac overload relay which is simple, inexpensive, and dependable. Furthermore, it can be calibrated to kick out at several different amperages at the flick of a switch. I have yet to see such a simple item described in print, and I thought it would be nice to share this knowledge with other members of the amateur fraternity. So, why not try this out and

experiment at ease, without blowing box after box of fuses?

All of the foregoing calibrations were obtained with ac loads consisting of non-inductive heater coils. If your circuit to be protected is highly reactive, you may find the relay kickout points to be slightly different. ■

Reference

1. "Son of the Overload Relay," *73 Magazine*, January, 1977, p. 140.



ANNOUNCING



RF PRODUCTS announces production of 5/8 wavelength VHF telescoping antennas for 144-148 MHz (2M), 152-174 MHz and 220-225 MHz (1 1/4 M). These new antennas are intended for use on hand-held and base station transceivers. They are available with BNC connector, 5/16-32 stud, or PL-259 connector. A telescoping brass nickel-plated nine section radiator is used for lighter weight and less RF junctions than previously available 5/8 wavelength antennas. Maximum gain is achieved by the combination of a base spring for whip protection and a tuned matching network for minimum VSWR. Minimum 2-meter bandwidth for 1.5:1 VSWR is 3.5 MHz. Overall length with BNC connector is 45 1/4 inches (1162mm). The BNC connector and 5/16-32 stud models are intended for hand-held transceiver (HTs) use and the PL-259 model which includes a type M359 right angle adaptor is intended for direct rear mounting on base station transceivers. Suggested list price for all models is \$19.95 the most popular of which are listed below.

P/N	DESCRIPTION	P/N	DESCRIPTION
191-200	2 M, 5/16-32 stud	191-800	1 1/4 M, 5/16-32 stud
191-214	2 M, BNC connector	191-814	1 1/4 M, BNC connector
191-219	2 M, PL-259 connector	191-819	1 1/4 M, PL-259 connector

ELECTRICAL SPECIFICATIONS

Gain (re 1/4 wave helical) 6db min.
 Bandwidth(2M), 1.5:1 VSWR 3.5MHz min.
 Bandwidth(1 1/4 M), 1.5:1 VSWR 5MHz min.
 Maximum power(HT models) 10 watts
 Maximum power(PL-259 model) 30 watts

MECHANICAL SPECIFICATIONS (with BNC)

Length extended(2M) 45 3/4"/1162mm
 Length extended(1 1/4 M) 32 1/8"/815mm
 Length collapsed(2M) 8 1/16"/207mm
 Length collapsed(1 1/4 M) 7 7/8"/200mm
 Weight 2.2oz/80g

SPECIALIZING IN PORTABLE, FIXED STATION AND TEST EQUIPMENT ANTENNAS
 Check or M.O. only, postage prepaid in continental U.S.
 Florida residents add 5% sales tax
 DEALER INQUIRES INVITED

RF PRODUCTS

P.O. BOX 33, ROCKLEDGE, FL. 32955 (305) 631-0775

Multi-Purpose Peak Adapter

— don't settle for being average

This adapter was originally designed to be used with a Bird 43 watt-meter, using the standard plug-in elements; however, this same unit can be modified for use with almost any rf detector or swr bridge. Circuits can be easily added to provide an adjustable peak output indicator

and/or an alc output for transmitter control. The peak adapter circuit also can be used with an FM receiver as a peak-deviation meter. Easily-obtainable parts are used and while I built mine in a separate box, you might be able to build it into your meter enclosure. The ICs must be

kept away from high rf levels, however. The peak adapter circuit is shown in Fig. 1.

The unit must be powered from a bipolar supply of ± 6 to ± 15 volts or from a pair of 9-volt batteries. If extended use of the adapter is anticipated, the ac supply shown in Fig. 2 should be used. Regulation is not totally necessary, but does ensure minimum offsets and prevents transients from entering critical circuits.

The main purpose of the peak detector circuit is to overcome the main fault of a meter when trying to indicate peaks: the mass of the movement damps the response time such that variations of the applied current are averaged out. The more sensitive the movement, the worse the damping effect. The Bird 43 uses a 30- μ A movement and most swr bridges use a 50- to 200- μ A meter.

Even with the peak detector, the meter will still

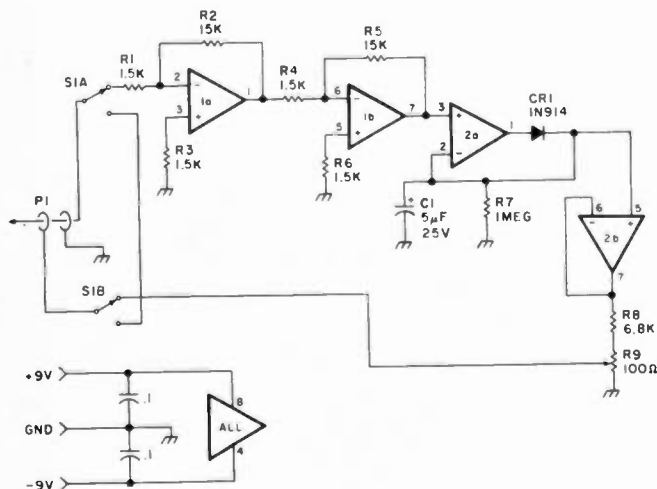

Fig. 1. Peak adapter. All ICs are MC1458 dual op amps (Radio Shack 276-038); resistors are 1/4-Watt; S1 is a DPDT miniature toggle; P1 is a Radio Shack 274-139.

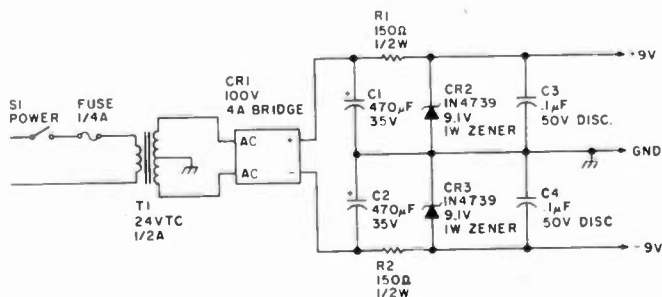
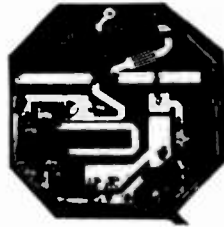

Fig. 2. Power supply schematic. CR1 = Radio Shack 276-1171; CR2,3 = RS 276-562; C1,2 = RS 272-1018; C3,4 = RS 272-135.

2300 MHZ QUALITY KITS THAT PERFORM !

- UCC-1 DOWNCONVERTER KIT** \$35.00
Includes quality PC board, NE02137 xstrs, matched diodes, molded coils, all PC board parts, .141 semi-rigid coax, and 12 page instruction book. 22 db gain; 5.5 db NF.
- UCC-2 DOWNCONVERTER KIT** \$42.00
The UCC-1 with NE64535 high gain RF transistor.
- SMC-1 DELUXE DOWN CONVERTER KIT** \$43.00
The UCC-1 kit with extras. Includes thermal drift stabilization, low-temp solder, F-61 and F-59 connectors, TV matching xtmr, plans for many types of antennas, and very detailed 26 page instruction manual. Recommended for the first time builder.
- SMC-2 DELUXE DOWNCONVERTER KIT** \$50.00
The SMC-1 with NE64535 high gain RF transistor.



RFA-1 2-STAGE SELECTIVE PREAMP \$39.95
"Stopsign" shape mates with downconverter board. Selective filter reduces image noise. 16 db net gain.

TU-8 DELUXE POWER SUPPLY KIT \$39.95
Quality case and smooth tuning MIL spec. pot. Complete with 2 ft. cable & matching xlmr. Other power supply kits from \$27.95.

ANT-4 DISK YAGI ANTENNA KIT \$30.00
32 element disk yagi with 12 inch weatherproof housing. Now includes adjustable mounting bracket! (Threaded rod not included).

SEND SASE FOR CATALOG.

**WE PAY ALL SHIPPING CHARGES
DISCOUNTS ON ORDERS OVER \$100.**

SMP

Superior Microwave Products, Inc.
P.O. Box 1241
Vienna, Virginia 22180

**ORDERS ONLY
800-368-3028**

Information & Orders ✓ 376
From VA. & Wash. Metro
Area Call 703-255-2918



MFJ SHORTWAVE ACCESSORIES

NEW Indoor Tuned Active Antenna. Rivals, can even exceed reception of outside long wire.

Rivals long wires

\$79⁹⁵



MFJ-1020 NEW INDOOR ACTIVE ANTENNA sits on your desk ready to listen to the world. Rivals, can often exceed, reception of outside long wire. Unique **Tuned Active Antenna** minimizes intermod, provides RF selectivity, reduces noise outside tuned band. Also use as preselector for external antenna. Covers 300 KHz to 30 MHz in five bands. Adjustable telescoping antenna. Controls: Tune, Band Selector, Gain, On-Off/Bypass. LED. FET, bipolar circuitry. Phono jack for external ant. 6x2x6 inches. 9-12 VDC or 9 V battery for portable use. 110 VAC with optional AC adapter, \$9.95.



\$99⁹⁵

MFJ-1040 RECEIVER PRESELECTOR. Improves weak signal reception, rejects out-of-band signals, reduces image response, 1.8 to 54 MHz. Up to 20 db gain. Low noise MOSFET. Gain control. Bandswitch. Can use 2 ant., 2 rcvrs. ON-OFF/Bypass. 20 db attenuator. LED. Coax, phono jacks. 8x2x6 in. Also for XCVRS to 350 watts input. Auto bypass. Delay control. PTT jack. **MFJ-1045, \$69.95.** Same as MFJ-1040, less attenuator. xcvr auto bypass. delay control, PTT. Use 1 ant., 1 rcvr. 5x2x6 in. 9V bat. Both requires 9-18 VDC or 110 VAC with optional AC adapter, \$9.95.

\$89⁹⁵



MOBILE SWL CONVERTERS to hear the short-wave world while you drive. **MFJ-304 (\$69.95)** covers 19, 25, 31, 49 meter bands. **MFJ-308 (\$89.95)** adds 13, 16, 41, 60 meters. Two dual-gate MOSFETS give excellent sensitivity, selectivity with car receiver. Push button band selector. Tune with car radio. Plugs between antenna and radio. 12 VDC. **304** is 5 1/4 x 1 1/4 x 4". **308** is 6 1/4 x 1 1/4 x 5". **Free catalog.**

MFJ-10, 3 foot coax with connectors, \$4.95.

Order from MFJ and try it. If not delighted, return within 30 days for refund (less shipping).

One year unconditional guarantee.

Order yours today. Call toll free 800-647-1800. Charge VISA, MC. Or mail check, money order. Add \$4.00 each for shipping and handling.

CALL TOLL FREE ... 800-647-1800

Call 601-323-5869 for technical information, or der/repair status. Also call 601-323-5869 outside continental USA and in Mississippi. ✓ 47

MFJ ENTERPRISES, INCORPORATED

Box 494, Mississippi State, MS 39762

THE LAST WORD IN READERS

THE NEW



MBA-RO

FEATURES:

- 32 CHARACTERS FOR EASY HIGH SPEED COPY OF MORSE
- ASCII and BAUDOT RTTY
- NO RECEIVER MODIFICATION NECESSARY
- INSTANT SPEED TRACKING FOR MORSE CODE OVER WIDE SPEED RANGE FROM 2 TO 99 WPM
- OPERATES FROM 12 V.D.C.



For AEA Readers or other AEA Products, call or visit:

AEA

Brings you the Breakthrough!

Radios Unlimited

1760 Easton Avenue
Somerset, N.J. 08873
(201) 469-4599

✓ 105

take the same amount of time to respond to its highest level, but the circuit has a long enough time constant to ensure that the pointer will remain at the peak level long enough to be observed. The Bird 43 elements contain a half-wave detector (+ output) and a small capacitor to bypass the rf. Internal resistance of the 30- μ A meter is 1500 Ohms, so to ensure proper linearity, the input of the peak adapter presents a 1500-Ohm load to the element.

Circuit Description

The first two stages are standard inverting dc amplifiers. Each stage has a gain of 10 for a total of 100. Thus, a full-scale input level of 45 mV results in an output of 4.5 V dc. IC2A is a unity-gain half-wave detector. The diode's placement in the feedback loop eliminates the error due to its 600-mV drop. The input impedance of IC2A is high, so the discharge time constant is essentially determined by R7. The output impedance of IC2A is less than 100 Ohms, so the charge time of C1 is almost instantaneous. IC2B is a unity-gain follower configuration used to isolate the load from C1. Amplifying the input signal by 100 ensures overcoming any low-level non-linearity in CR1. R8 and R9 divide the output back down to a level required to feed the meter.

Fig. 3(a) shows the original circuit in the Bird 43. The meter connects directly to the output of the directional coupler through a length of coax cable. The length is not critical and is supplied as a convenience to permit remote mounting of the directional coupler.

Fig. 3(b) shows the jack added to the Bird meter to permit connecting the peak adapter. I mounted the jack on the right side of the case. (Remove the meter move-

ment before drilling the 3/8" hole!) The jack is a 3-conductor, 1/4"-type with shorting contacts (Radio Shack part number 274-139). The shorting contacts connect the meter to the coupler when the remote plug is removed, so no switch is necessary. Use the "ring" connection for the meter and the "tip" for the coupler output. Break the connection at the positive lug of the meter. Even though the jack is grounded to the case, it is a good idea to run a wire from the negative meter terminal to the "sleeve" connection of the jack.

Calibration is easily accomplished by connecting the meter between the transmitter and a 50-Ohm load. Measure the power output with a steady carrier (preferably at least half-scale). Switch on the peak detector circuit and adjust R9 for a reading of 1.4 times the first reading. The meter now is calibrated to read peak power output (with a load impedance of 50 Ohms).

PEP output is defined as the peak-to-peak level of the output signal. It is not practical to have the meter read this since it would be necessary to change to the next higher element. R9 could be adjusted so the PEP would be read on the next higher scale using the same element; however, damage to the element could occur since it would be used outside its normal range.

When observing a voice-produced SSB signal, you will have to talk for several seconds to allow time for the meter movement to respond. A longer "hang" time can be obtained by increasing the value of C1.

The output of an swr bridge is similar to the Bird elements but the load impedance is usually higher. To use the peak detector with an swr bridge, or a

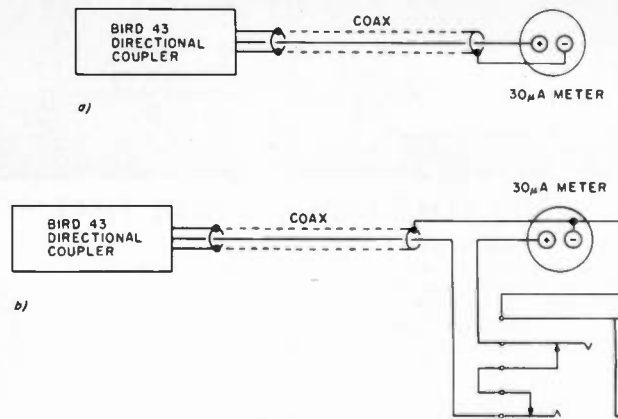

Fig. 3. (a) Original Bird 43 hookup. (b) Modified hookup using Radio Shack 274-277 for J1.

detector like the one in the Heath Antenna[®], change the circuit of IC1A to that shown in Fig. 4. You will have to calibrate the meter at several different power levels. The dc output voltage of a bridge detector, and the detector in the Antenna, drops with a decrease in frequency, so calibration at several frequencies in each band is desired. Calibration must be done with the aid of a borrowed wattmeter, an rf ammeter or voltmeter, or a wideband scope that has a vertical amplifier response flat to at least 30 MHz.

When using the peak adapter with a device like the Antenna, you will have to furnish a meter for the adapter. Any movement up to 5 mA can be used or a VOM on the 2.5- or 3-volt dc range. Just be sure that the VOM you use will not detect rf by itself. If you use a 1-mA meter, you can eliminate R9 and use a 3.9k resistor for R8. Calibration can be done with R19. A typical swr bridge circuit is shown in Fig. 5.

At a power of 100 Watts rms into the Antenna, I obtained the following read-

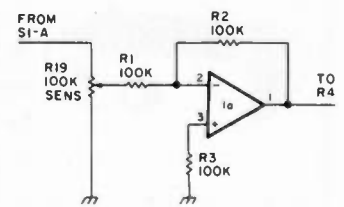

Fig. 4. High-impedance peak adapter.

ings from the Antenna's detector:

Band	Dc Volts
160	0.8
80	1.0
40	1.4
20	2.0
15	2.5
10	3.0

The circuit of Fig. 6 is a peak-indicator driver with adjustable threshold control. R10 is adjusted with a steady carrier to light the LED at the desired power level.

Alc voltage can be applied to most mixers or intermediate stages in a transmitter to reduce the rf level before the output stage is driven into the non-linear region. The alc voltage can be developed by adding the circuit in Fig. 7. It even can be useful for transmitters that already have alc because gain reduction can be

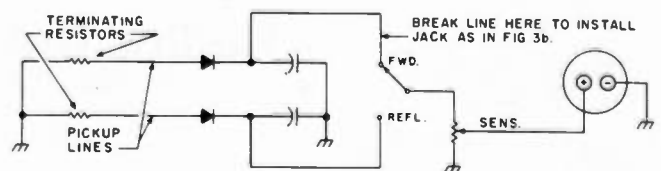

Fig. 5. Typical swr bridge.



The HAM SHACK

808 N. Main • Evansville, IN 47711

TEN-TEC

546 Omni-C Xcvr	\$969
580 Delta	679
525 Argosy	439

Call for Accessories & Package Prices

KANTRONICS

Computer Interface	\$169
--------------------	-------

AEA MBA RO Reader	\$269
AZDEN PCS-3000/300	289
BUTTERNUT HF6V Vertical	99
CUSHCRAFT A3 3 Element	169
DRAKE TR7A	call
HAL CT 2100	695
HY-GAIN TH7 DX	339
ICOM 740	call
KLM KT34A	309
MFJ 496 Keyboard	289
MIRAGE B1016	239
ROHN Tower	call
SANTEC ST-144/uP	295

812-422-0231 ✓449

MON-FRI 9AM-6PM • SAT 9AM-3PM

Write for our new and used equipment list!

NEW MFJ-102 SOLID STATE 24 HOUR DIGITAL CLOCK

Switchable to 24 hour GMT or 12 hour format. ID timer. Seconds readout. Bright BLUE .6" digits. Alarm, snooze, lock functions. Power out, alarm on indicators. Assembled.



Switch to 24 hour GMT or 12 hour format!
ID timer. Seconds readout.
Bright BLUE .6 inch digits.

\$32.95

Now you can switch to either 24 hour GMT time or 12 hour format! Double usefulness.

Switchable "Seconds" readout for accuracy. ID timer. Alerts every 9 minutes after you tap the button. Also use as snooze alarm.

"Observed" timer. Just start clock from zero and note end time of event up to 24 hours.

Alarm. For skeds reminder or wake-up use. Synchronizable with WWV.

Fast/Slow set buttons for easy setting. Big, bright, blue digits (vacuum fluorescent) are 0.6" for easy-on-the-eyes, across-the-room viewing.

Lock function prevents missetting. Operates on 110 VAC, 60 Hz (50 Hz with simple modification). UL approved.

Handsome styling with rugged black plastic case with brushed aluminum top and front.

Sloping front for easy viewing. 6x2x3".

Order from MFJ and try it — no obligation. If not delighted, return it within 30 days for refund (less shipping). One year limited warranty by MFJ.

Order today. Call toll free 800-647-1800. Charge VISA, MC or mail check, money order for \$32.95 plus \$4.00 shipping/handling for MFJ-102.

Put this new improved MFJ digital clock to work in your shack. Order today.

CALL TOLL FREE ... 800-647-1800

Call 601-323-5869 for technical information, order/repair status. Also call 601-323-5869 outside continental USA and in Mississippi. ✓47

MFJ ENTERPRISES, INCORPORATED

Box 494, Mississippi State, MS 39762

COAX SWITCHES

from Barker & Williamson, Inc.

Model 593

- **Single Pole 3 Position** with grounding of all unused positions
- **Crosstalk** (measured at 30 MHz) is -45db between adjacent outlets and 60 db between alternate outlets



\$19.95

Model 594

- **2 Pole 2 Position**
- **Crosstalk 45db** (measured at 30 MHz)



\$22.00

Specifications for both switches

- **Power** 1 KW-2 KW PEP
- **Impedance** 50-75 ohms
- **VSWR** 1.2:1 up to 150 MHz
- **Dimensions** 1 1/4" high, 5" wide, 3" deep
- **Weight** 1 lb.
- **Mount** Wall or desk



✓11

Available at your B&W dealer



Barker & Williamson, Inc.
10 Canal St. Bristol, Pa. 19007
Telephone: (215) 788-5581



2 METER 90 WATT OUTPUT AMPLIFIER WITH 18 DB GAIN PREAMP

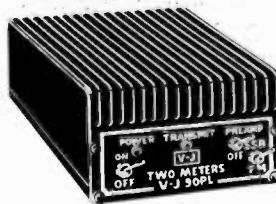

Model 90PL
FOR ONLY

\$139.95*

FACTORY DIRECT

PLUS SHIPPING

- **FREQUENCY** range 144 - 148 MHz
- **OPERATION** FM or SSB (completely linear) Class AB1
- **RF DRIVE** 1 to 30 watts
- **KEYING** RF activated with high quality relays
- **SSB** operation built in delay
- **POWER REQUIREMENTS** typical 10 watts drive, 13 amps at 13.8 VDC
- **IDLE** current 20 mills
- **MOBILE** or **FIXED** operation
- **PREAMP** 18DB gain minimum
- **NOISE FIGURE** less than 1.5 DB
- **PREAMP KEYING** independent — separately RF activated relays
- **CONSTRUCTION** wrap around aluminum heat sink 2 pieces 360 degrees cooling
- **SIZE** 7"(w) x 6"(d) x 3"(h) — **WEIGHT** 3 lbs. 9 ozs.
- **IMMEDIATE SHIPMENT**

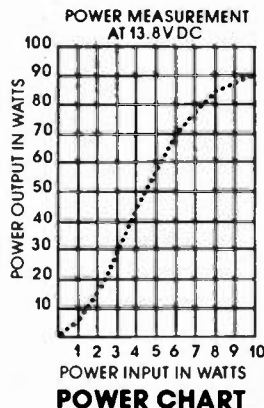

SPECIAL OFFER

Matching Power Supply

\$99.95*

PLUS SHIPPING

15 AMP SUPPLY wt. 13 lbs. size 8"(w) x 5"(h) x 6"(d)

IMMEDIATE SHIPMENT

ALL PARTS AND LABOR WARRANTED ONE FULL YEAR

VJ90PL Amplifier \$139.95 plus \$3.00 shipping

VJ15 POWER Supply \$99.95 plus \$7.00 shipping

*Prices USA only

VISA, MASTER CHARGE, M.O. or C.O.D. • PHONE (713) 477-0134

V-J PRODUCTS, INC.

505 East Shaw, Pasadena, Texas 77506
SERVING THE ELECTRONICS INDUSTRY SINCE 1965

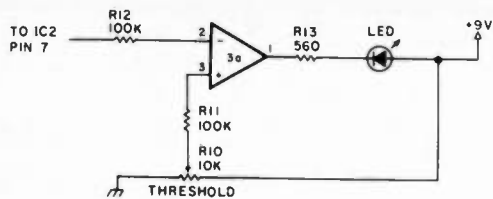

Fig. 6. Visual peak indicator.

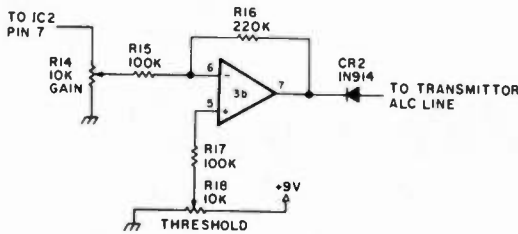

Fig. 7. ALC detector.

had at a lower level. (Many transmitters develop a/c voltage when grid current is drawn, at which point distortion is already occurring.) With R18 at the ground end, a/c will be developed as soon as there is rf input. R14 determines the amount of voltage output. Increasing R18 towards +V permits a

higher rf level before a/c starts to develop. CR2 keeps any positive voltage from reaching the a/c line.

Both the circuits of Fig. 6 and 7 can be connected to IC2 simultaneously without any interaction. Again, change the value of C1 if you wish to change the time

constant. Most likely, you will want to reduce C1 to 0.2 to 0.5 μ F for a/c purposes. A switch may be added to Fig. 1 to select various values for C1.

Another use for the peak detector circuit is to use it in conjunction with an FM receiver as a peak-deviation meter. Using the Fig. 4 modification, connect R19 to the output of the discriminator through a 0.1- μ F capacitor. Calibration can be done best using a signal generator with calibrated FM modulation. If C1 is switched out of the circuit, the meter will then read average deviation. This may be useful to show how much the transmitted audio is limited in the peak clipper. In any case, the readings will only be correct if the received signal is full quieting. A scope may be connected to the output of IC1B for viewing the audio signal.

If you have looked at the proposed rewrite of the amateur rules, you noticed that the FCC is trying to come up with a different way to determine transmitter power, other than the present dc-input method. This peak adapter can be an invaluable aid, should power determination need to be in terms of peak power. Personally, I would like the rules to be changed to power output measurements, as is done commercially. This could then permit less efficient transmitters to run at a higher input power. We also would have a better idea of the efficiency of our equipment which would indicate when the finals are getting "soft."

This circuit can make your wattmeter into a more useful instrument at a fraction of the cost of a ready-made peak-reading unit and serve other purposes as well. ■

TERMINALL

apple* + TRS-80*

TERMINALL is a hardware and software system that converts your personal computer into a state of the art communications terminal. Terminall features simple connections to your computer and radio plus sophisticated and reliable software.

Simplicity

TERMINALL was designed from the outset to be easy to connect to your radio and easy to use. Plug into your receiver headphone jack and copy Morse Code or radioteletype (RTTY). Plug into your CW key jack and send Morse Code. Attach a microphone connector and send Baudot or ASCII RTTY using audio tones (AFSK). That's all there is to hooking it up.

The software is loaded into your computer from disk or cassette. Enter your call sign and the time and you will start receiving immediately. No settings or adjustments are necessary to receive Morse Code, it's fully automatic - and it works! You may type your message while receiving or transmitting.

You will be on the air, receiving and transmitting in any mode, in minutes. As we said, **TERMINALL** is simple.

More for your money.

■ **TERMINALL** has the RTTY terminal unit - demod and AFSK - built in. This results in a lower total cost.

■ **Fantastic Morse reception.** Six stage active filter demodulator copies the weak ones. Auto adaptive Morse algorithm copies the sloppy ones. Received code speed displayed on status line.

■ **Outstanding documentation.** Professionally written, 90 page user manual contains step-by-step instructions.

■ **Built in, separate, multi-stage, active filter RTTY and CW demodulators.** No phase lock loops. RTTY demodulator has 170 and either 425 or 850 Hz shift-keyboard selectable - and uses either the panel meter or scope outputs for easy tuning. Copy the weak ones. Copy the noisy ones. Copy the fading ones.

■ **Built in crystal controlled AFSK.** Rock stable for even the most demanding VHF or HF applications. A must on many VHF RTTY repeaters.

■ **Built in 110 or 220 volt AC power supply.**

■ **Built in parallel printer driver software.** Simply attach a parallel ASCII printer (e.g., the EPSON Mx-80) to your printer port to obtain hardcopy in all modes.

■ **Multi-level displays** - allows examining and editing of historical text.

■ **Word wrapping,** word mode editing, diddle, ignore carriage returns, user programmable end of line sequence, adjustable carriage width, multiple user defined WRU, transmit delay (fixed, none or auto adaptive), break mode and more!

■ **The all-in-one TERMINALL design** makes it great for use on HF or VHF, Ham, Commercial, SWL or MARS! SWL's: **TERMINALL** may be jumpered for either 425 or 850 Hz reception to copy news and weather services.



System Requirements

TERMINALL T1 Communications terminal for the TRS-80 Model I. Requires a Model I TRS-80, 16K RAM and Level II BASIC. Includes software on cassette and disk, assembled and tested hardware and an extensive instruction manual. \$499.

TERMINALL T3 Communications terminal for the TRS-80 Model III. Requires a Model III TRS-80, 16K RAM and Model III BASIC. Includes software on cassette and disk, assembled and tested hardware and an extensive instruction manual. \$499.

TERMINALL T2 Communications terminal for the APPLE II. Requires an APPLE II or APPLE II PLUS with 48K RAM and disk. Software is provided on disk in DOS 3.2 format. Use MUFFIN utility to convert to DOS 3.3 format. Includes software on disk, assembled and tested hardware and an extensive instruction manual. \$499.

TO ORDER (209) 634-8888 or 667-2888

We are experiencing telephone difficulties. - Please keep trying.

*TRS-80 is a Registered Trademark of Tandy Corp.

Apple is a Registered Trademark of Apple Computer Inc.

1 yr. Parts & Labor - Limited Warranty.



15 Day Money Back Trial Period
on Factory Direct Orders

MACROTRONICS, inc.®

1125 N. Golden State Blvd.
Tullock, California 95380

DEPT. 73

✓ 44

The communications terminal that does it all!



WACOM

DUPLEXERS

U.S. Patent No. 4,080,601

OUR NEW BANDPASS-REJECT DUPLEXERS WITH EXCLUSIVE **B₇B₇ CIRCUIT FILTERS**®

... provides superior performance, especially at close frequency spacing.

Models available for all commercial and ham bands. Special prices for amateur repeater clubs.

✓79



WACOM PRODUCTS, INC.

P.O. BOX 7127 • WACO, TEXAS 76710
817/848-4435

MFJ RF NOISE BRIDGE

Lets you adjust your antenna quickly for maximum performance. Measure resonant frequency, radiation resistance and reactance. Exclusive range extender and expanded capacitance range gives you much extended measuring range.



- Exclusive range extender
- Expanded capacitance range
- Series Bridge

\$59⁹⁵

Order from MFJ and try it — no obligation. If not delighted, return it within 30 days for a refund (less shipping). This bridge is unconditionally guaranteed for one year.

To order, simply call us toll free 800-647-1800 and charge it on your VISA or MasterCard or mail us a check or money order for \$59.95 plus \$4.00 for shipping and handling for MFJ-202.

Put this MFJ Noise Bridge to work improving your antenna. Order from MFJ or see dealer.

CALL TOLL FREE ... 800-647-1800

Call 601-323-5869 for technical information, or order/repair status. Also call 601-323-5869 outside continental USA and in Mississippi.

MFJ ENTERPRISES, INCORPORATED

Box 494, Mississippi State, MS 39762

GOTHAM ANTENNAS

(305) 294-2033



SMALL LOT TRAP DIPOLES ✓417

MODEL	BANDS	LGTH	PRICE
TSL 8040	80 40	78'	\$49.95
TSL 4020	40,20,15	40'	\$47.95

SMALL LOT SHORTENED DIPOLES

MODEL	BANDS	HGHT	PRICE
SL-8010	80 40 20, 15 10	75'	\$59.95
SL-160	160	130'	\$38.95
SL-80	80	63'	\$37.95
SL-40	40,15	33'	\$36.95

FULL SIZE PARALLEL DIPOLES

MODEL	BANDS	HGHT	PRICE
FPD-8010	80,40,20, 15 10	130'	\$49.95
FPD-4010	40,20,15,10	63'	\$44.95

NEW! PORTABLE VERTICAL! IDEAL FOR APARTMENTS, CAMPING, TRAILERS!

Folds to 5' Package. No Radials Required. Fully Assembled Full Legal Limit. 1:1 VSWR

MODEL	BANDS	HGHT	PRICE
PV-8010	80 10	13'	\$59.95

PROVEN DESIGN GOTHAM ALL BAND VERTICALS

MODEL	BANDS	HGHT	PRICE
V-160	160,80,40,20, 15 10,6	23'	\$44.95
V-80	80,40,20, 15 10,6	23'	\$42.95
V-40	40,20,15,10,6	23'	\$40.95

FAMOUS GOTHAM QUADS

2 Elements—3 Bands Complete \$149.95

CHAMPIONSHIP GOTHAM BEAMS

Full Size Complete from \$99.95

DEALER INQUIRIES INVITED

CALL OR SEND LARGE SASE FOR CATALOG

Shipping: Dipoles & Verticals

\$2.50 USA; \$7.00 Canada; \$5.00 FPO, APO

Beams & Quads Shipped UPS or Freight

Collect Fla. Add 5% Sales Tax

1415 First St. • Key West, FL 33040

SATELLITE SYSTEM HEADQUARTERS

Don't wait. Get Your TVRO System TODAY!

- Receivers featuring the DEXCEL and Automation Techniques units
- Modulators
- Complete System ready to install from \$2850
- Call today for more information



CHAPARRAL "Super Feed" feed horn \$85.00



DEXCEL 120 low noise amplifiers \$495.00



SATELLITE ANTENNAS MDS POWER SUPPLIES \$35.00

1900 to 2500 MHz Microwave Downconverters Kit \$28.50
Assembled..... \$48.50

ALSO AVAILABLE
Commercial M.D.S. System \$169.95
SLOTTED ARRAY ANTENNA \$28,50

PB RADIO SERVICE

✓404

1950 E. PARK ROW • ARLINGTON, TX 76010

CALL ORDER DEPT. TOLL FREE
(800) 433-5169

FOR INFORMATION CALL
(817) 460-7071



The \$100 TVRO Receiver

— Satellite Central, part VIII

Stephen Gibson
PO Box 38386
Hollywood CA 90038

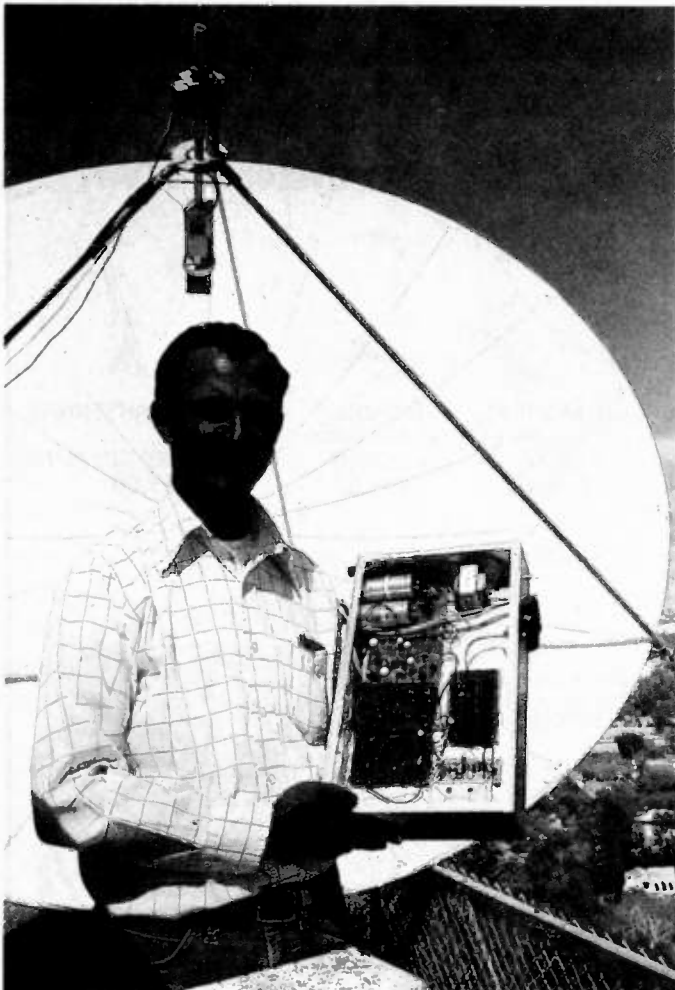

Dwight "Rex" Rexroad with his Cheap Trick receiver.

"See first run movies, sporting events, and nightclub acts as secret network feeds!" That's the sort of ballyhoo you read about satellite television nowadays. But the price for even a kit setup can run sky high! The only way to cut the cost is for you to do it all yourself.

But those build-it-yourself pitfalls can leave you wishing you'd never tried. For one thing, you're on your own with only plans that are vague or, even worse, a set of PC boards that won't work. So, being first on your block seems to carry its own set of problems. What you need is a "Cheap Trick"!

In the December, 1981, "Satellite Central," I wrote a brief overview of TVRO receiver design. If you

priced some of the components, you know that a receiver, especially a dual-conversion job, will cost \$500 to \$700 to build. And, if you want real quality you'd better plan on spending more. So how can something any good cost less? As a matter of fact, just a voltage-tuned oscillator (VTO) runs a hundred bucks! So who's kidding whom?

But hold on there. Just when you think it isn't possible, along comes a very clever engineer like Dwight (Rex) Rexroad who does it with a flair that shows that hobbyist thinking and ingenuity hasn't stagnated after all. "The secret here," says Rex, "is to make the design non-critical and to use parts that anyone can find with ease. Nothing in this design is weird. Everything is off

the shelf." Out of Rex's unique approach comes "Cheap Trick," the ham's answer to a TVRO receiver you can build for under \$100!

Cheaper Is Better

Look at the diagram in Fig. 1(a); Rex downconverts all twelve transponders on a satellite (3.7 to 4.2 GHz) to the 500- to 1000-MHz region where he can use cheaper components. He uses a fixed-frequency local oscillator (LO), a mixer, and a broadband amplifier, all of which may be mounted at the dish in a small box. The advantage to this arrangement is that the lower-frequency signals can be passed into your house via RG-59 or RG-6 rather than expensive cable needed for piping 4-GHz signals.

No tuning is done in the first conversion—see Fig. 1(b). Instead, tuning is applied at the second conversion by another cheap trick, a UHF TV tuner. The saving is enormous, especially since the tuner needs very few changes to make it pass 30-MHz-wide signals to a 70-MHz bandpass filter and intermediate frequency (i-f) amplifier. Despite its reduced performance at 70 MHz, Rex uses a typical TV i-f IC, the MC1350. It's a logical choice for the i-f amplifier because of its low price and easy availability. Razor-sharp tuning is easily accomplished using just two op amps with a solid afc thrown in to boot.

The amplified 70-MHz i-f signals are halved to 30 MHz by a divide-by-two circuit and applied to an MC1357 quadrature detector IC which, with suitable input, can deliver pictures that may exceed in excellence those of a PLL-type detector. The detected video is clamped and de-emphasized before output to your TV monitor or modulator. The sound demodula-

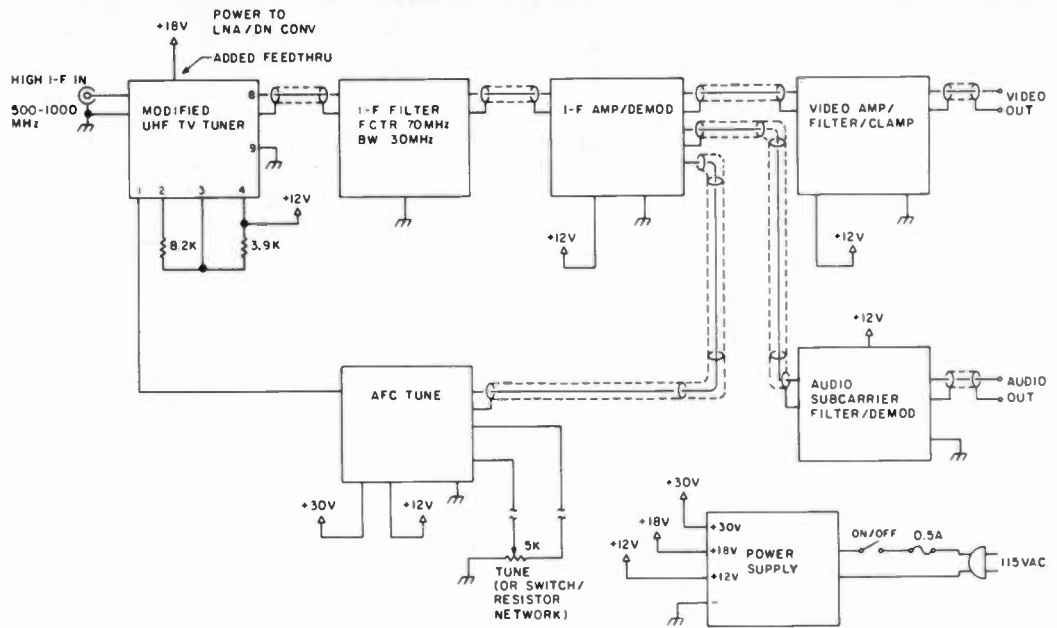

Fig. 1(a). Block diagram of the Cheap Trick receiver.

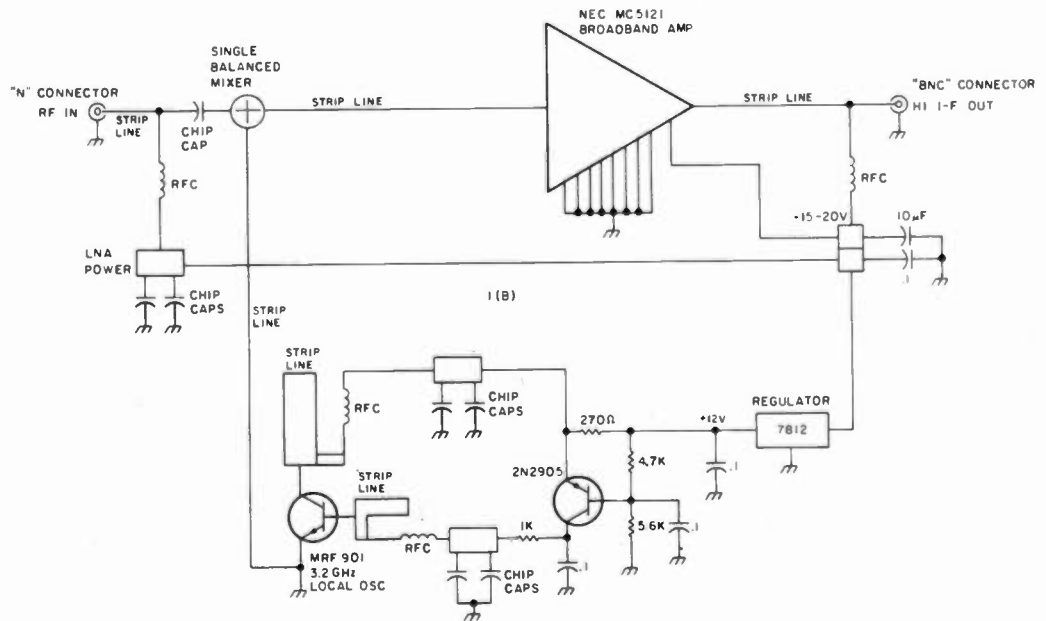

Fig. 1(b). First stage of the receiver downconverter, including balanced mixer and local oscillator.

tor uses circuitry similar to that found in most television sets.

Power Supply and Downconverter

This month, we'll delve into the power supply and clever downconverter design and save the baseband circuits for next month. It should be remembered that this project is labor-intensive. If you just want to watch satellite television, then you really should buy a receiver rather than fiddle

with the "Cheap Trick." Some of the techniques used here will surely challenge your experimenting abilities.

According to Rex, "The power supply is not quite typical... but close. I use a 26-volt, 1-Ampere transformer that is center-tapped. This is a common transformer. Radio Shack has them. [Rex needed 30 volts for tuning and took the easy way with an LM317 adjustable voltage regulator—see Fig. 2.] I found that

bypassing the LM317 got rid of a lot of noise, especially since we are dealing with the tuning voltage where noise could easily FM your tuner! It's clean as a whistle."

The really clever technique used here is to raise the centertap to get about half the voltage (18 volts) to feed the LNA-downconverter combination. A 7812 regulates it down to 12 volts to feed the rest of the receiver. While Rex admits this is not an optimum design bal-

ance-wise, it offers something more important: It's cheap!

Looking now at the downconverter in Fig. 3, Rex built the whole unit on a piece of double-sided $\frac{1}{2}$ " Teflon™ fiberglass. In true one-of-a-kind experimenter fashion, he used only an X-acto® knife to cut out the prototype. You can, too. The board is only 4 inches long, so the input and output connectors are all that are needed to attach the board to the top of a sealed metal case.

The circuit includes a dc block so that both the downconverter and the LNA can receive their supply voltage through the signal coax. Beginning at the input, Rex uses a type-N connector since that's about the only thing that works well at these frequencies. An rf choke... which is nothing more than a short piece of wire at 4 GHz, feeds dc to the LNA.

"We do a little bypassing

with two chip caps—a 4.7-pF and a .001-mF work pretty well at these frequencies. I bypass darned near everything because stability is very important. Especially when you home brew," he says.

"I used a fixed-tuned MRF-901 for the oscillator so that I could save big bucks right there! The real credit for this stable design belongs to BBC engineer Steve Birkill. The oscillator runs at 3.2 GHz (downside injection) and is easily set by trimming the length of the baseline with a knife.

"I used a 7812 voltage regulator, but a 78L12 would also work since we need only about 15 mA. The 2N2905 is a PNP transistor that acts as an active bias for the oscillator. It's the negative feedback loop that makes this trick work. In fact, it may be more stable than expensive pre-packaged oscillators if you use good construction technique. And don't think

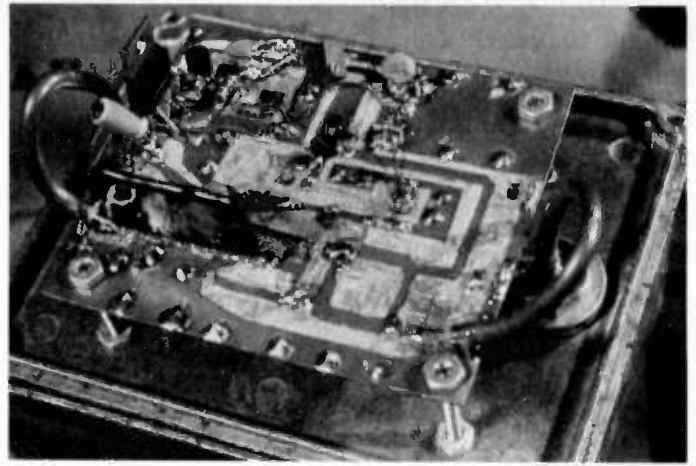

Fig. 3. The mixer, MRF-901 oscillator, and broadband amplifier fit on a homemade PC board.

you're locked into a 2N2905. Any other silicon PNP of the same beta should work just as well."

The oscillator will come out low in frequency using the layout size in Fig. 4. That way, you can simply use a knife to chop away enough trace to put it right on. The line from the oscillator is a 50-Ohm stripline. Both the oscillator and input signal feed a balanced stripline mixer which has about 7-dB insertion loss depending on the diodes. Now, rather than use a \$55.00 mixer, Rex literally chose to roll his own. He uses HN-1 diodes at about \$2.00 each. Quite a saving! It really doesn't matter how you install the diodes; just be sure they are backwards or you'll have a problem. If you use the popular MBD-101 diodes, you may have to deal with slightly more noise out of the mixer.

This may not be a problem if you use a large dish and a commercial LNA.

The NEC MC5121 broadband amp is the most expensive part of the whole receiver. It costs about \$13.30 from Alaska Microwave, a 73 advertiser. Kick in another 25 cents and you can get the spec sheets, too. The MC5121 will give you about 20-dB gain, so the overall converter gain is about 14 dB not counting coax losses. Either a BNC or type-F connector will work on the output since the signal is now running somewhere between 500 and 1000 MHz. On a typical system, you can tolerate about 15-dB loss from the coax feeding the baseband unit. The +15 to +20 volts of power for the converter is tapped off the output coax with a 6-turn choke and some dc bypassing. There is no coupling capacitor on the MC5121 since it has its own internal caps.

Making It Work

Probably the hardest part of this project will be acquiring the parts. Yes, you can do it for less than \$100. In fact, Rex built his for \$75.00!

Dropping down in the scale of hardness, we come to troubleshooting. According to Rex: "A spectrum analyzer helps. Use a micro-

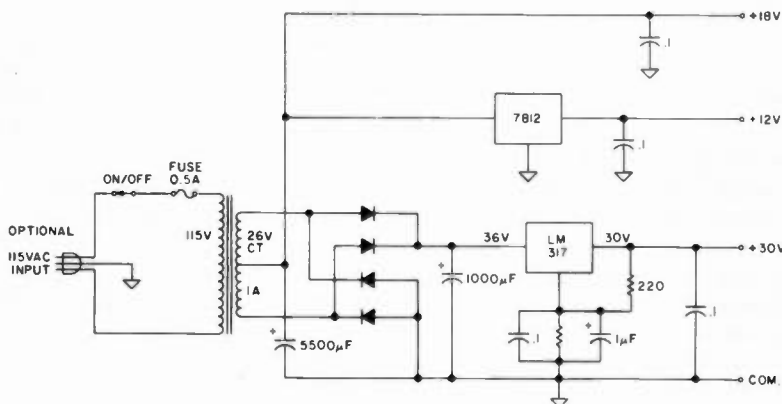
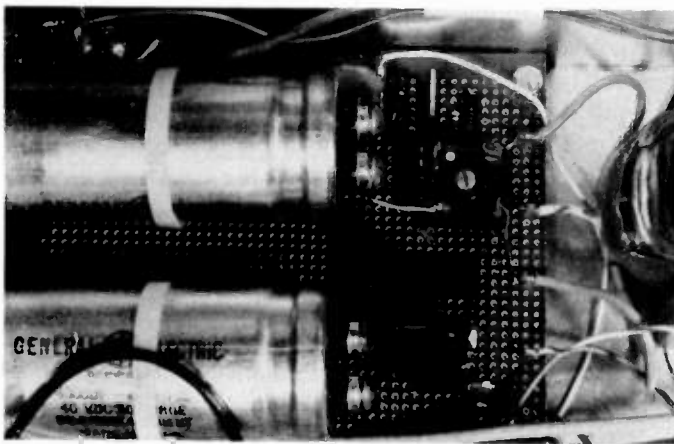
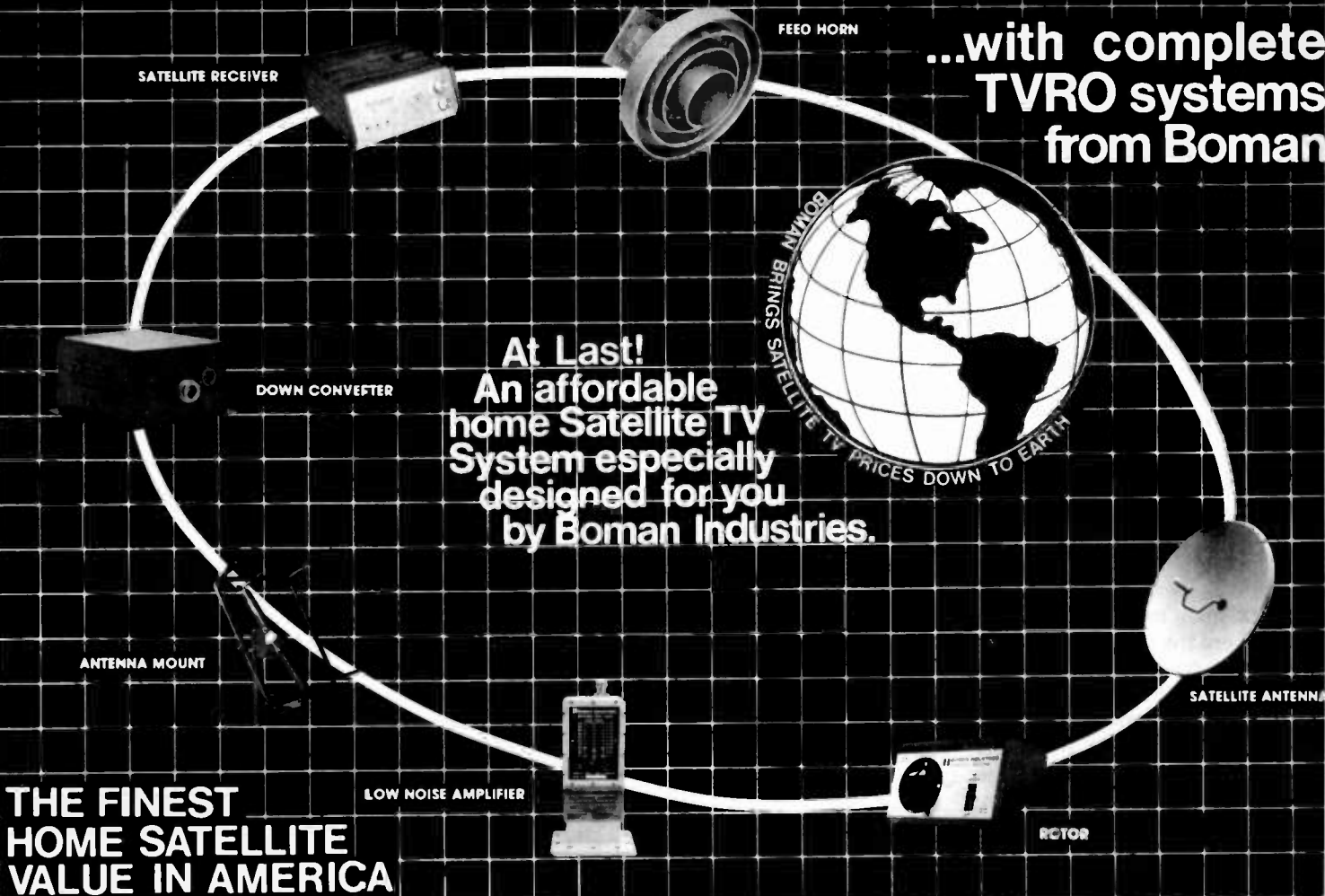

Fig. 2. The power supply furnishes +30, +18, and +12 volts dc.

DO IT YOURSELF... SEE THE WORLD!

...with complete TVRO systems from Boman



THE FINEST HOME SATELLITE VALUE IN AMERICA

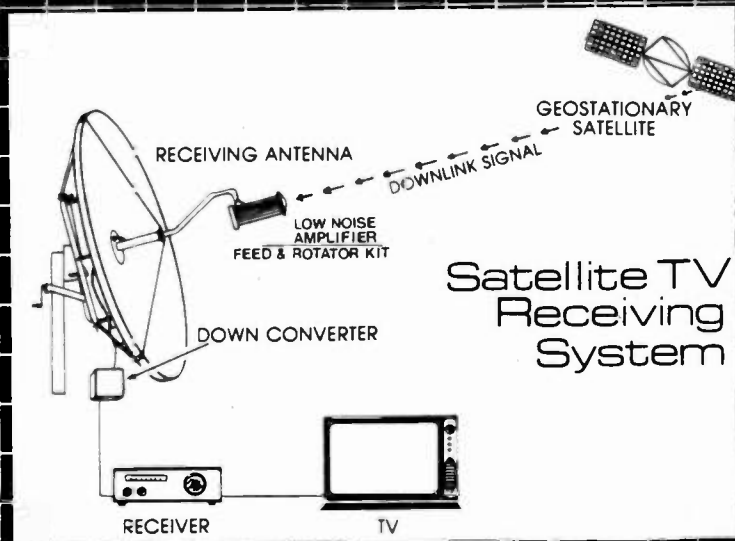

Boman Industries offers complete Satellite Television Systems designed specifically for installation by the purchaser. You will receive broadcasts from GeoStationary satellites with your choice of 3 DIFFERENT Fiberglass Parabolic Antennas (9, 10, 11 ft.) The electronics are the latest in Satellite TV equipment utilizing state-of-the-art components and circuit design. A fully illustrated instruction booklet is supplied with each system to explain the easy, step-by-step installation procedures, programming information and antenna alignment directions. Your complete system will arrive in only 2 containers for prompt assembly by you or by your dealer.

For information about your local Dealer, Distributor & the affordable high-quality line of Boman Satellite Television Products, please use the reader card service for prompt reply.

B **BOMAN INDUSTRIES**
SATELLITE PRODUCTS DIVISION
9300 HALL RD., DOWNEY, CA 90241

✓ 157

Toll Free Numbers:
Inside Ca.: (800) 352-2553
Outside CA.: (800) 421-2533

wave frequency counter attached to the hybrid to tune the LO. Not everyone has one, so I suggest you simply apply power to the unit and tweak the oscillator until the bottom frequency corresponds to transponder one. You'll need a dish and an LNA that are working to do it.

"One thing that's nice: Being off 100 MHz in either direction will get you in the ballpark enough to trim it up. Of course, having a friend with another TVRO always helps."

It is possible that the LO will not be stable or, worse, may not start at all. In that event, Rex suggests you move the shorting strip seen in Fig. 5. Do a tack-solder job. You may find a region where the oscillator is operating on many frequencies at once. It makes for rotten pictures, so move the shorting strip to cure the problem. Trial and error are the only ways to do the trimming without an analyzer.

New Life for UHF Tuners

Once the signal is converted to the 500-to-1000-MHz range, it is fed down the coax into the UHF tuner. Use top-notch RG-59 or better. No CB stuff. Rex used a Mitsumi UES-A55F which he bought at a swap meet for five bucks. See Fig. 7. Various mail-order houses carry this model for something like \$25.00. If you do some scrounging for other parts used in this project, you still can build Cheap Trick for less than \$100.

Now, most tuners have a narrow bandwidth. So you must modify yours to pass 30-MHz-wide FM. Not all tuners can be modified, so you should try to track down this particular model. On the other hand, if you've stayed with us this far, you can probably handle anything that comes your way! As a rule, the i-f output stage is the culprit. See the

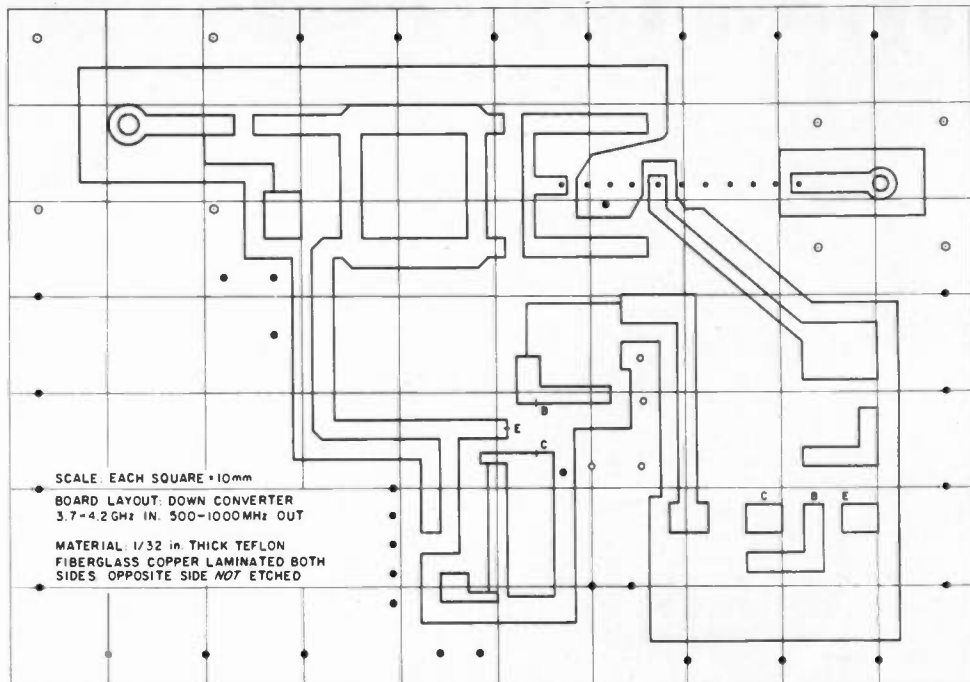

Fig. 4. Circuit board layout for downconverter.

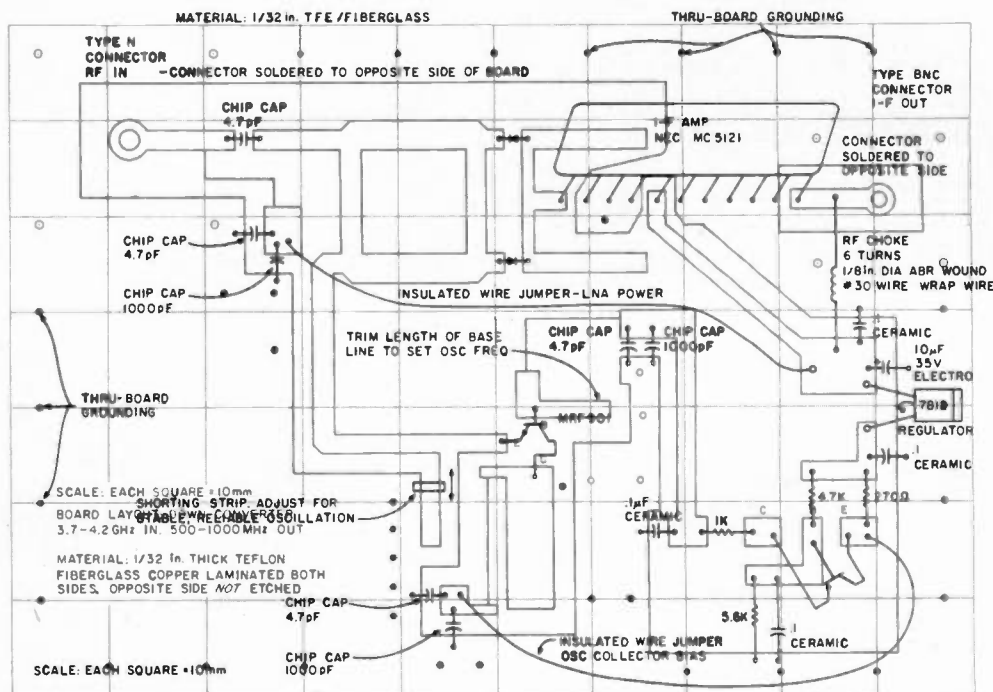

Fig. 5. Parts placement for downconverter.

"before" and "after" modification circuits in Figs. 8(a) and 8(b). According to Rex, "I replaced the final stage impedance-matching network with a broadband transformer wound on a ferrite bead. Amidon 101-43 beads work pretty well. I used them everywhere in the project."

The input stage should

also be modified for a coax input. Some models of the Mitsumi already have a 75-Ohm input. "But if you were stuck with a 300-Ohm model," says Rex, "just look for the place on the board called L1 which was designed for a 75-Ohm link. You can couple to it with a little ceramic capacitor so you can use a 6-turn choke

to provide a dc block to feed the coax power for the downconverter and LNA. You'll need to drill a hole in the tuner for this feed. I used a feedthrough cap so that I'd have a place to hook it.

"After these two mods, the bandwidth of the tuner should be about 45 MHz, and it will just cover the



UNIVERSAL COMMUNICATIONS

A Division of
Innovative Labs, Inc.

SPECIAL OFFER!

SUPER

SUPER SAVINGS SALE ENDS OCTOBER 1 SAVINGS!

2300 MHz DOWN CONVERTER	\$19.95
ASSEMBLED	\$39.95
12v POWER SUPPLY	\$19.95
ASSEMBLED	\$29.95
(Stationary or variable)	
SELECTIVE PRE-AMP	\$26.95
SUPERVERTER I	\$75.00
(Crystal Board and PA)	
CIGAR ANTENNA	\$19.95
4 FT. DISH ANTENNA	\$47.95
(KD-44 25 DB OVERALL GAIN)	
DRIFTMOD	\$1.25
HIGH GAIN TRANSISTOR	\$9.95
VIDEO STABILIZER	\$39.95

KIT SPECIAL #1	
Down Converter,	
Power Supply,	
Cigar Antenna	\$49.95
KIT SPECIAL #2	
Down Converter,	
Power Supply,	
4 Ft. Antenna	\$79.95

For information or ordering
(817) 860-1641

MC, VISA, Phone or Mail Orders Accepted.

Hours, 8:30-4:30 CDST; Mon.-Fri.

Our product may be copied, but the performance is never equaled.

UNIVERSAL COMMUNICATIONS

P.O. Box 339
Arlington, TX 76004-0339

SATELLITE TV SYSTEMS

"COMPARE OUR QUALITY, PRICES AND SERVICE!"

WE MANUFACTURE:

PARABOLIC DISHES
POLAR MOUNTS
DEMO TRAILERS
CUSTOM PARTS

MOTORIZATION SYSTEMS
LNA HOLDERS
ALUMINUM HORNS

WE STOCK:

WASHBURN
KLM
AVANTEK
GARDINER

GILLASPIE
DRAKE
LOWRANCE

ALLIANCE
ATV
CABLE & CONNECTORS
SWITCHES & HARDWARE

CALL, WRITE OR ✓ FOR OUR LATEST BROCHURE AND PRICES.

AUSTIN C. LEWIS
K4GGC
901-784-2191

LEWIS CONSTRUCTION CO.
P.O. BOX 100
HUMBOLDT, TN. 38343

"IN BUSINESS AT THIS LOCATION SINCE 1964" ✓452

AVANTEK

GPD SERIES AMPLIFIERS

GPD 401,402,403

12 - 14 DB GAIN

5 - 500 MHZ POWER 15 VDC T05 MOUNTING
IDEAL FOR COUNTER AND TV PREAMPLIFIERS
COMPLETE WITH CIRCUIT BOARD FOR MOUNTING
\$25.00 EA., SET OF THREE \$65.00

AMATEUR

MICROWAVE DOWNCONVERTER

COMPLETE - ASSEMBLED - READY TO INSTALL - NOT A KIT

SPECIAL \$179.95

INCLUDING SHIPPING (U.P.S.)

VISA AND MASTERCARD ACCEPTED

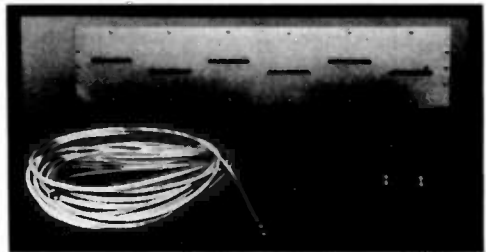

50+ dB SYSTEM GAIN
TUNES 2.1 Ghz. to 2.4 Ghz.
PREAMPLIFIER 20+ dB GAIN @2.5 dB NF
OUTPUT TUNES TV CHANNELS 2 TO 6

OUTPUT IMPEDANCE 75 OR 300 OHMS
FULL YEAR WARRANTY
PERFORMANCE GUARANTEED OR
YOUR MONEY REFUNDED

CALL (804) 489-2156 ✓447

ELECTRONIC HOBBY INNOVATIONS

7510 GRANBY STREET SUITE 207 NORFOLK, VIRGINIA 23505

2 GHz Dual Stage Microwave Preamplifiers

Use the **Ampire 2001** to improve the performance of your microwave receiving system. The broadband design lowers the system Noise Figure and increases the overall system gain. Use the **Ampire 2001** for the TV band and the **Ampire 1690N** for the GOES and METOSAT satellite band.

Ampire 1690N *139**

Ampire 2001 *129**

Shipping: USA... *200 Foreign... *1000 ✓135

TEM Microwave Corporation

22518 - 97th Avenue North
Corcoran, MN • 55374

612-498-8014



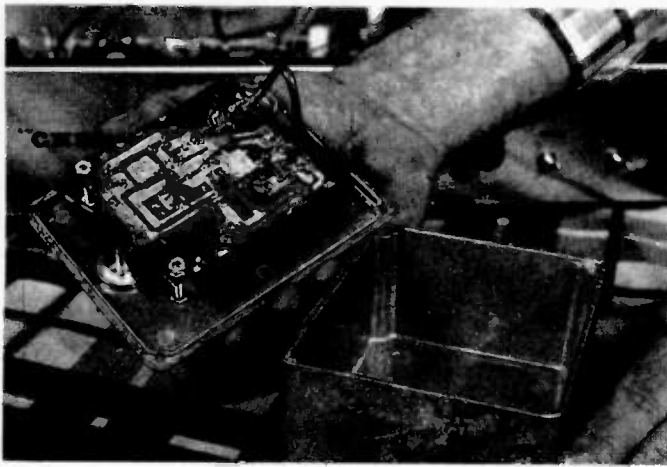

Fig. 6. The completed downconverter is housed in a water-tight box. The PC board is held in place by the input and output connectors. A heavy dose of rubber cement will make a good seal.

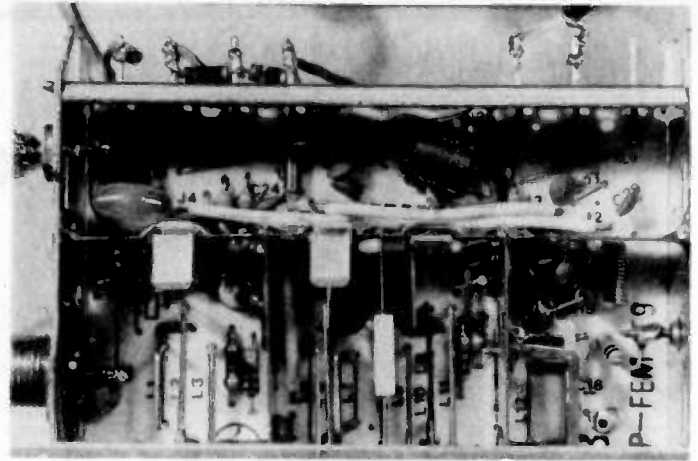

Fig. 7. A Mitsumi UES-A55F UHF tuner acts as the second converter with only two mods. The i-f output coil is replaced with a hand-wound toroid. Also, the input matching network is easily converted for 75-Ohm input. Mount the tuner inside the receiver chassis.

tuning range of all the input signals (500 MHz) with a little to spare. Here is where you must tweak the LO in the downconverter so that you get all transponders over the range of the UHF tuner. It's harder to say it than do it, despite the fact the tuning diodes don't give

you much more than the needed 500-MHz range."

Rex suggests, "If you just drop one transponder, then fiddle the tuner coils. But if you drop two transponders, you'll need to trot out to the LO/downconverter at the dish. You may have a fellow ham with a frequen-

cy counter in this range which should make the whole process very simple."

The tuner agc bias should be about 8 volts. The resistors seen in Fig. 1 form a suitable voltage divider. Eight volts is maximum gain.

Next Month: Part Two

After the tuner comes baseband processing, which I'll cover next month. Rex uses some clever ideas to make this last part of the project look easy. In the meantime, start hunting for parts. ■

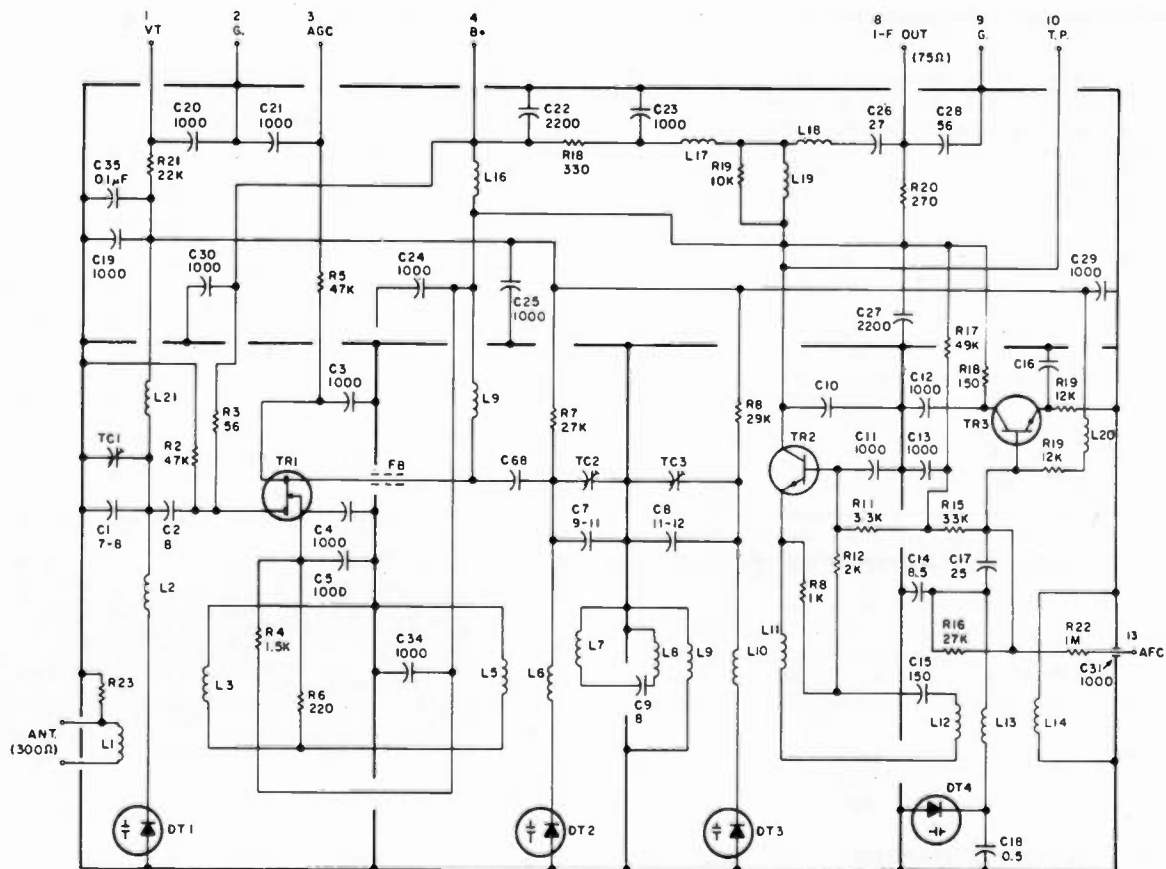

Fig. 8(a). Mitsumi VES-A55F tuner prior to modification. (1) Receiving channels—14-83 ch. (470-890 MHz). (2) P.I.F.—45.75 MHz; S.I.F.—41.25 MHz. (3) Supply voltage: BT—12 V; AFC—6.8 V; AGC—0.8 V; VT—0.5-28 V. (4) TR1—3SK53; TR2—2SC1070; TR3—2SC1730; DT1-DT4—15V59. All capacitance values in pF; all resistance values in Ohms.

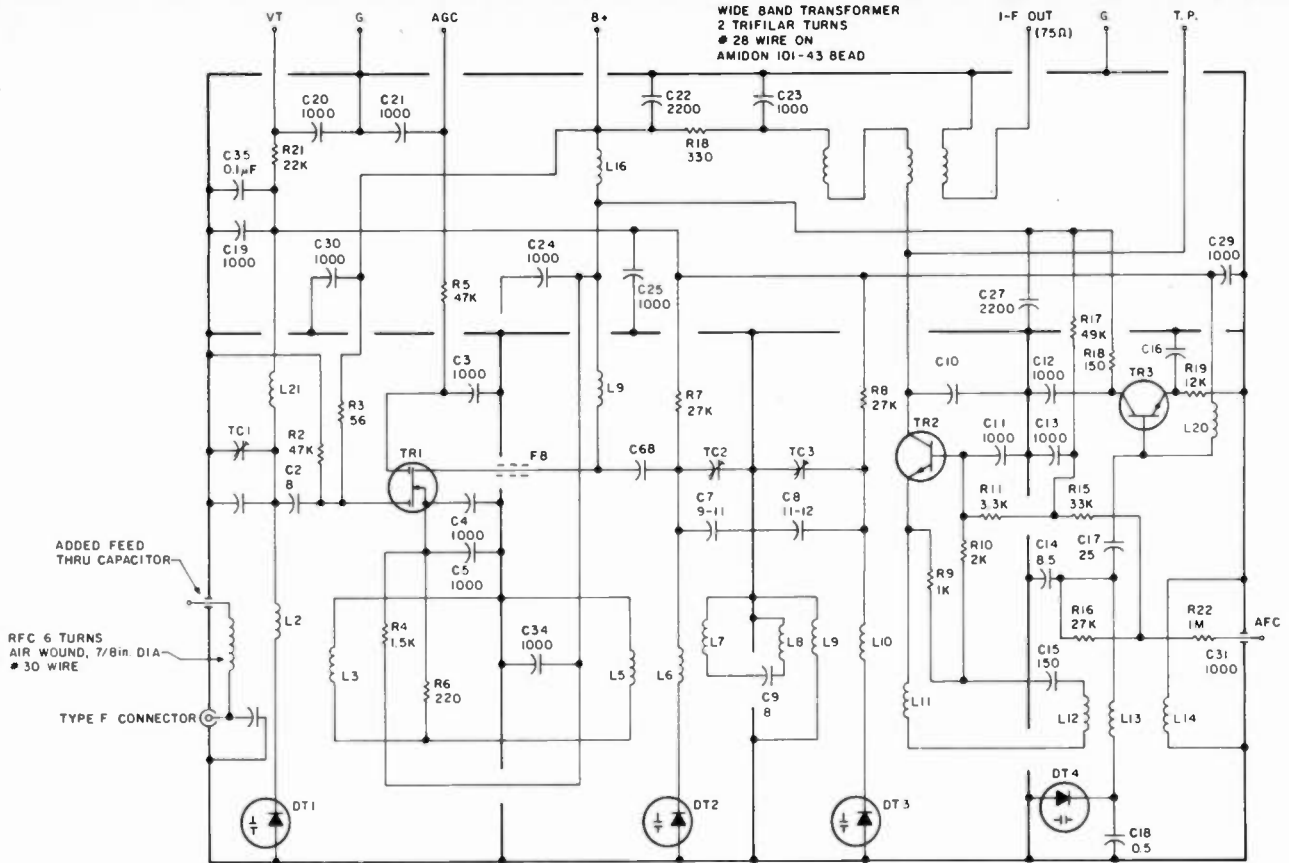
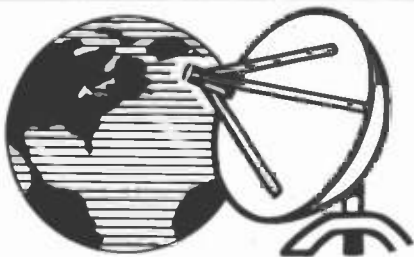

Fig. 8(b). Tuner after modification.



SATELLITE TELEVISION SYSTEMS

WE WILL NOT BE UNDERSOLD!!

Complete Systems, Antennas,
Receivers, LNA's & Accessories
CALL US TODAY!

812-238-1456

hoosier electronics

"Nation's Largest Total Communications Distributor"
P.O. BOX 3300 • TERRE HAUTE, INDIANA 47803



FRANCIS
ENTERPRISES INCORPORATED
P. O. Box 906
Papier Bluff, Mo.
314-989-3248
WE ARE LOCATED 11 MI. SO. ON 87 HWY.

We Build Quality Into Our Products

MANUFACTURERS DISTRIBUTORS
GRAIN BINS · INDUSTRIAL · ELECTRICAL · IRRIGATION EQUIP.

Satellite Television

Whether you need 1 system or 100 we have the highest quality antenna to meet your utmost expectations and quality standards, at easy to live with prices.

Send:
\$7.95 for
Introduction to
Satellite manual.

Pictured is our 11 ft
Dish with our easy
setting one man in-
stallation trailer.

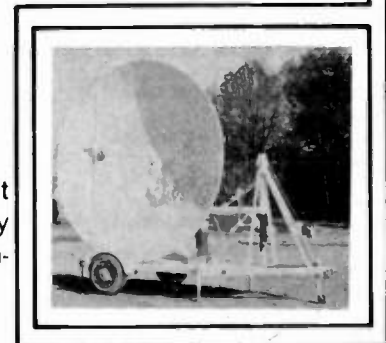

✓ 151

Write or call us for more information.

Your own satellite TV system for \$2,586.⁰⁰

10 FT. PARABOLIC

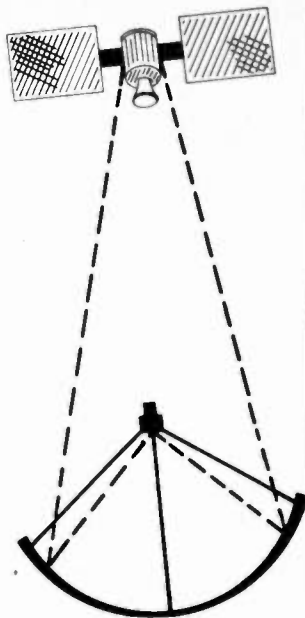

What the system will do:

You can receive up to 60 channels of T.V. direct from satellites to your home receiver. Movies, sporting events, religious programs, other T.V. stations, and much more.

What the system includes:

1. 10 ft. fiberglass dish made of reflective metal bond with fiberglass. Weather-resistant and virtually maintenance-free. Dish comes in 4 sections.
2. Single pedestal heavy duty polar mount for extra strength and installation simplicity; easy satellite to satellite adjustment.
3. Four pole rotator mount for more stability, square tube legs and rotator included.
4. All aluminum LNA mount and horn holder for accurate aiming of LNA. All aluminum, weather-proof LNA cover.
5. Drake ESR-24 Receiver or Auto-Tech Receiver. Your choice. Down converter located at the dish.
6. Ampica or Avantek LNA 120°.
7. Chapparel Feed Horn for unsurpassed quality.
8. All accessories included.

Complete Systems, Receivers, Antennas, LNA's & Accessories
CALL US TODAY! 901-795-4504

NEW WEST COAST SHIPPING WAREHOUSE
13 FT. PARABOLIC DISHES

TENNESSEE ELECTRONICS
 — P.O. BOX 181108 —
MEMPHIS, TENNESSEE 38118



Star View Systems™

CRAIG



- ### STAR VIEW MODEL 12K
- Complete System
 - Easy to Install
 - Reasonably Priced
 - UPS Shippable Weight 125 Pounds
 - More than 100 Channels Accessible

THE STAR VIEW 12K SYSTEM KIT CONTAINS:

- 12 Foot Antenna
 - Azimuth Elevation Mount
 - 24 Channel Receiver
 - 120° Low Noise Amplifier
 - Feed Horn
 - Cables & Connectors
 - No Modular Included
- (May be ordered separately for \$79.95)

\$2595.00

Available through your local Craig Star View dealer • Call or write for information • Dealership inquiries welcome • Price subject to change without notice.

H&R COMMUNICATIONS, INC. Subsidiary of Craig Corp.
 Route 3, Box 103G
 Pocahontas, Arkansas 72455

Call 800-643-0102
 or 501-647-2291

MICROWAVE TELEVISION SUBSCRIPTION TELEVISION

MICROWAVE TELEVISION EDUCATION MANUAL \$16.25

Our updated manual includes microwave concepts, antennas, and downconverters. Includes detailed schematics and P.C. board layouts.

SUBSCRIPTION TELEVISION EDUCATION MANUAL \$14.95

Two scrambling & decoding systems are explored in depth. Signal capture and modification techniques are presented for educational analysis.

AMATEUR MICROWAVE RECEIVER SYSTEM \$169.95

Continuing in the high quality and performance that you've come to know in the HMRll, this receiver has a new design and increased gain.

INFORMATION PACKAGE ON ALL VIDEO PRODUCTS AND KITS \$2.00

ORDER INFORMATION:
 Please add 5% shipping and handling. CA residents add 6% or 6.5% sales tax. VISA and MASTERCARD accepted.

ABEX
 P.O. Box 26601-G
 San Francisco, CA 94126-6601

✓ 114

SATELLITE TVRO

RECEIVER COOKBOOK

- Build a good, solid understanding of satellite receiver technology.
- Step by step guide of each stage.
- Complete theory, schematics, and construction details.

TVRO RECEIVER KIT

- Pre-assembled, tested RF section.
- No complex alignment or special test gear required.
- Ultra-low cost/high performance.
- Designed from cookbook circuits.

.....

\$9.95 Cookbook
 \$159.95 Cookbook plus Kit

Send to:
NORTH COAST MICROWAVE
 PO Box 5663, Cleve., Ohio 44101

✓ 107

QUALITY MICROWAVE TV SYSTEMS

2.1 to 2.6 GHz Antennas 34 db Gain (or Greater)

Complete System as pictured \$149.95
 Down Converter Probe (Mounted, Assembled & Tested) \$64.95
 Power Supply (12V to 16V) Assembled & Tested \$59.95
 Data Information (Plans) \$9.95

Phillips-Tech Electronics
 P.O. Box 33205
 Phoenix, AZ 85067
 (602) 274-2885

✓ 421
 C.O.D.'s
 Special Quantity Pricing

6 MONTH WARRANTY PARTS & LABOR

MasterCard VISA

Attention radio amateurs!

8-LEVEL ASCII TELEPRINTER SALE!

Model 33ASR SF
Good Working Condition

~~\$400~~
Now
\$300!
plus tax and shipping.

Code: ASCII
Speed: 10 cps, 100 baud.
Interface: 20/60 mA,
EIA optional
Data Set Optional
From RCA Service Company.
Nationwide Service Available.

RCA H-270

Write:
J.H. Bell
RCA Service Company
Bldg. 204-2, Route #38
Cherry Hill, New Jersey 08358
Or call collect: (609) 338-4375

TVRO RELIEF!



POLATRON™
ELECTRONIC ROTOR

ELECTRONIC SATELLITE POLARITY SELECTION

- NO MOVING PARTS
- NO MOTORS TO FAIL
- NO WAITING
- INSTANT POLARITY SELECTION
- PEAKING CONTROL
- ELECTRONIC ROTOR & SCALAR FEED COMBINED

POLATRON™ 189.95
Controller/Power Supply 44.50

**INTERNATIONAL
SATELLITE VIDEO
CORPORATION**

POST OFFICE BOX 5685
ORANGE, CALIFORNIA 92667
(714) 998-6080 / 633-1370

APPLIED INVENTION

THE SOURCE FOR SOLID STATE / STATE-OF-THE-ART

GaAs FETS by MITSUBISHI

VHF through 18 GHz
MGF-1200 \$10.20 (0.25dB NF at 144 MHz)
MGF-1400 (2SK273) \$13.90 MGF-1402 (2SK274) \$15.00
1412 (2SK275) TESTED and GUARANTEED NF at 4 GHz
1/1/82 0.8dB \$85.50 0.9dB \$51.10 1.0dB \$33.50
1403 (2SK276) (fmax=90GHz Super Low Noise amp.)
\$97.00 \$161.75 NF sorted - call for data
1801 (2SK278) (150mW linear PO at 10GHz) \$54.25

Microwave Modules

MITSUBISHI X BAND Hybrid Integrated Circuits with
Dielectric Resonator (0.12MHz/°C) GaAs FET Oscillators
FO-1010X - 10.4 GHz, 15mw out, UER100 Flange \$37.50
FO-1210Y - 11.5 or 12.0 GHz, UER120 Flange \$37.50
FO-UP11KF Heterodyne receiver, 10-11GHz \$34.50
All modules tuneable ±150 MHz, oscillators can be
optically FM'd with IR (suggest LD271 below)
X-Band Horn antenna (15dB UER100/WR190 Flange) \$16.00

Components

NEW! RETICON R5620 digitally programmed Universal Active Filter.
Switched capacitor type. NO external components 16pin DIP. \$ 8.00
with application package \$10.00

2SC2876 bipolar transistor, MRF-901 replacement, F1=7GHz \$ 1.50

VITRAMON 7800 Microwave Rated caps for bypass/coupling
7802P7G02 0.7-1.4GHz 7800P7G04 1.3-2.6GHz
7800P7G01 2.6-4.2GHz 5 for \$5.00

VOLTRONICS ultra miniature shuttle caps and Hi D piston caps
Shuttle: CP2 0.1-2.5pf CP10 0.5-9.0pf \$3.19
Piston: ET9Q 0.6 9pf. 0 = 5000 @ 100 MHz \$3.41

SOLDER-IN DISK CAPACITORS for VHF-UHF bypassing
RMC JF series 100, 220, 470, 680pf 10 for \$2.50

OPTOELECTRONICS from MITSUBISHI and SIEMENS
MITSUBISHI ML3001 LASER DIODES 3mW at 830 nm CW
30mA threshold, built in monitor \$100.00 ea.
SIEMENS: LD271 high efficiency IR LED, 15 mW \$0.75
BPW-34 fast, large area PIN detector \$3.00

MELCOR FRIGICHP - THERMOELECTRIC HEAT PUMPS - Write for data

MINIMUM ORDER: \$5.00. ADD POSTAGE & HANDLING
\$3.75 on Modules (UPS) \$2.50 on other items
✓ 71 N.Y. STATE RESIDENTS ADD 6% SALES TAX
SEND SELF-ADDRESSED STAMPED ENVELOPE FOR CATALOG

R.D.2 ROUTE 21 HILLSDALE, NY 12529
518-325-3911

Alaska Microwave Labs

4335 E. 5TH STREET ANCHORAGE, ALASKA 99504
(907) 338-0340 DEPT 73

CHIP CAPACITORS

1.2, 2.2, 3.3, 4.7, 6.8, 10, 18, 22, 27, 47, 100, 120,
180, 220, 270, 330, 390, 470, 560, 680, 820, 1K, 1.2K
1.8K, 3.9K, 8.2K, 10K, 100K \$ 6.00

GaAs FETS

MGF1400 NF 2.00B @ 4GHZ MAG 150B \$19.00
MGF1412 NF 0.80B @ 4GHZ MAG 180B \$85.00
MCF1200 NF 1.00B @ 1GHZ, NF 2.20B @ MAG 140B @
4GHZ \$14.00

COAX CONNECTORS

BNC CHASSIS MOUNT SQUARE FLANGE \$1.95
BNC PLUG FOR RG-58 \$1.95
SMA CHASSIS MOUNT SQUARE FLANGE \$6.10
SMA CHASSIS MOUNT PLUG SO. FLANGE \$8.50
SMA CHASSIS MOUNT STRIP-LINE TAB \$6.75
SMA PLUG FOR RG-58 \$6.75
SMA PLUG FOR RG-174 \$6.75
SMA PLUG FOR .141 SEMI RIGID \$3.98
TYPE N CHASSIS MOUNT SQUARE FLANGE \$3.75
TYPE N PLUG FOR RG-9/RG-8 \$3.75
TYPE N DOUBLE MALE \$7.25
TYPE N FOR .141 SEMI-RIGID \$15.00
TYPE N CHASSIS MOUNT PLUG SQUARE FLANGE \$14.00

SILVER PLATING KIT

Will plate Copper, Brass, Bronze, Nickel, Tin, Pewter,
Gold, and most white metal alloys. \$36.00

VTO

V72T-1 2.7GHZ TO 3.2GHZ MIN POWER OUT 10 MW
TUNING VOLTAGE 0 TO 20V Vcc +15 VDC @ 60 MA \$98.00
V82T-1 SAME AS V72T-1 BUT FREQ: 3.6GHZ TO 4.2GHZ \$98.00

TEFLON CIRCUIT BOARD DBL SIDED 1 OZ.

APPROX 3.25" x 5.0" x .010 \$5.50
APPROX 3.25" x 5.0" x .0312 \$6.50
APPROX 3.25" x 5.0" x .0625 \$10.50

FEED-THRU CAPACITORS

1000 PF SOLDER TYPE \$ 50
470 PF SOLDER TYPE \$ 50

LEADLESS CERAMIC CAPACITORS

1000 PF \$2.50
NO WARRANTY ON SEMICONDUCTORS

OPEN AT 8 PM EST CLOSED 8PM PST
ORDERS ARE POSTAGE PAID
COD - VISA - MASTERCARD

AVAILABLE NOW

AZDEN PSC-300

TWO-METER HANDHELD

PCS-300 HT \$285.00
PCS-3000 XCVR 285.00
Remote cable 37.00
Phase II ant. 28.50
Other acc. Call

KDK

2025A Mk II
(W/TT mic.)
\$265.00

Free shipping in U.S.A
for all XCVR or HT orders

B. G. CARL ELECTRONICS

11128 Claire Ave.
Northridge, Calif. 91326
Call: (213) 363-1216—anytime

2 GHz Microwave Receiving Systems

The new Micro-System features a machined 18" parabolic reflector for maximum efficiency, a linear feed-point downconverter with ceramic high performance RF preamplifier transistor, a variable 12 to 18 volt regulated power supply and 50' of 75Ω coaxial downlead, including a 3' jumper and matching transformer. The Micro-System includes a full 6 month warranty.

Micro-System (MS-021) \$159**
Micro-System (MS-578) \$169**
Micro-System (MS-645) \$179**

Shipping & Handling: USA \$400 AK, HI & PR \$100**

Data Service Company

612-636-9469

3110 Evelyn Street
Roseville, MN • 55113



When it comes to
**AMATEUR
RADIO QSL's...**



it's the
ONLY BOOK!

US or Foreign Listings

1982 callbooks

Here they are! The latest editions. World-famous Radio Amateur Callbooks, the most respected and complete listing of radio amateurs. Lists calls, license classes, address information. Loaded with special features such as call changes, prefixes of the world, standard time charts, world-wide QSL bureaus, and more. The U.S. Edition features over 400,000 listings, with over 70,000 changes from last year. The Foreign Edition has over 370,000 listings, over 60,000 changes. Place your order for the new 1982 Radio Amateur Callbooks, available now.

	Each	Shipping	Total
<input type="checkbox"/> US Callbook	\$18.95	\$3.05	\$22.00
<input type="checkbox"/> Foreign Callbook	\$17.95	\$3.05	\$21.00

Order both books at the same time for \$39.95 including shipping.

Order from your dealer or directly from the publisher. All direct orders add shipping charge. Foreign residents add \$4.55 for shipping. Illinois residents add 5% sales tax.



SPECIAL LIMITED OFFER!
Amateur Radio
Emblem Patch
only \$2.50 postpaid

Pegasus on blue field, red lettering. 3" wide x 3" high. Great on Jackets and caps.

ORDER TODAY!

RADIO AMATEUR
callbook INC.



Dept. B
925 Sherwood Drive
Lake Bluff, IL 60044, USA

✓61



NEW MORSEMATIC™ MM-2 KEYER

THE MORSEMATIC KEYER BY
AEA HAS BEEN PROCLAIMED
BEST OF ALL PADDLE KEYERS
ON THE MARKET

Now you can get all the features of the world's first and still best microcomputerized keyer at a 25% reduction in price. The new model MM-2 has all the outstanding features of the MM-1 predecessor such as dual microcomputers with copywritten software, 500 character soft-partitioned™ memory with editing, exclusive beacon mode, exclusive automatic speed increase trainer mode, and exclusive automatic serial number generator. In addition, the MM-2 comes complete with CMOS memory and provisions for internal memory keep alive battery. The MM-2 operates from external 12 VDC at approximately 350 Ma.

ACCESSORIES:

Model AC-2 350 Ma 12VDC Wall Adaptor \$ 9.95
Model ME-2 Factory Installed (2000 Character Memory Expansion) \$39.95

If you have hesitated buying the best because of price, you need to wait no longer, the best is now available in an improved form at a price you can afford.

PRICES AND SPECIFICATIONS SUBJECT TO CHANGE WITHOUT NOTICE

call or visit:

Britt's 2-Way Radio Sales & Service

2508 Atlanta Street
Smyrna, GA 30080
(404) 432-8006

✓142

AEA
Brings you the
Breakthrough!

IRON POWDER and FERRITE PRODUCTS

AMIDON
Associates ✓334

Fast, Reliable Service Since 1963

Small Orders Welcome

Free 'Tech-Data' Flyer

Toroidal Cores, Shielding Beads, Shielded Coil Forms
Ferrite Rods, Pot Cores, Baluns, Etc.

12033 OTSEGO STREET, NORTH HOLLYWOOD, CALIFORNIA 91607

AFFORDABLE CW KEYBOARD FROM \$69.95



Transmits perfect Morse Code * Built-in 16 character buffer * Internal speaker and sidetone * Reed relay output eliminates keying problems * All solid state circuits and sockets for reliability * Speed range 5-45 WPM * Perfect companion to our CODE★STAR all-mode code reader.

MORSE-A-KEYER KIT, model MAK-K, Complete kit of parts & manual \$159.95

MORSE-A-KEYER, model MAK-F, Factory wired & tested \$199.95

MORSE-A-KEYER ESSENTIAL PARTS KIT, model EPK-K \$ 69.95

(Essential parts kit for home-brewers consists of pc board, board parts and manual. You supply ASCII keyboard, cabinet, power supply & miscellaneous parts.)

Send check or money order. Use your VISA or MasterCard. Add \$5.00 shipping and handling for Continental U.S. Wisconsin residents add 4% Wisconsin State Sales Tax.

Microcraft

Corporation Telephone: (414) 241-8144
Post Office Box 513G, Thiensville, Wisconsin 53092 ✓50

Is this new KDK FM 2030 the best 2 meter FM radio in the world?



“...best...in the world?”

That's a pretty strong claim considering the competition.

Let's look at some of the features . . .

- KDK continues the tradition of being the ultimate in VHF FM mobile operations. We make maximum use of multiple function, multiple shaft controls and only three sets of knobs are located on the front panel. Still many new features have been added, such as digital RIT, reverse button, memory channel readout number and more!

- The new KDK 4 bit microprocessor chip has in-house developed software which makes all these new features possible.

- Modern styled front panel with dials intelligently arranged so you can best utilize the multi-function, easy to handle controls. We gave it a very heavy textured paint finish that is highly resistant to scratching!

- Frequency coverage 143.005 - 148.995 mhz. S/N better than 35 db at 1 uv input. Better than .2 uv at 12 db SINAD. Squelch sensitivity better than .15 uv. Bandwidth at -6db: ± 6 khz, at -60db: ± 16 khz. Image ratio better than 70db. Double superhetrodyne. Transmitter uses variable reactance frequency modulation with maximum deviation set at ± 5 khz.

- RF power is a good, clean no spurious signal of 25 watts on high and 5 watts (adjustable) on low.

- Good audio with the famous KDK audio output capability of 1.5 watts . . . you can't blow out our audio IC!

- Nicads for memory retention built in, nothing extra to buy. Disconnect the FM2030 from the power source and the memories remain!

- Easy to use mobile mount with instant disconnect knobs for fast, simple removal. DC Cable and mounting hardware, spare fuse, external speaker plug and complete simplified instruction book includes circuit diagrams and even complete alignment instructions! No extras to purchase!

\$309

INTRODUCTORY PRICE!

Includes Tone Pad Microphone and all accessories. Shipping: \$5.00 eastern U.S.A. \$7.50 western U.S.A.

- 10 memories in 2 memory banks of 5 each (A&B). Any memory can be changed instantly.

- Control functions: Select memories, show memory channel number, or select memories and show frequency of channel, or dial frequencies with two speed selectable control. Instant choice of either 5 or 100 khz tuning steps. Programmable band scan limits and memory scan.

- Frequency shown in 5 bright LED digits. LED indicator shows when signal is received (unscelched), LED indicator shows transmit. Modern LED bar meter shows signal strength of received signal and on transmit shows relative output power.

- Microphone includes tone pad, and up and down buttons to change dial frequency or memory channels.

- A standard microphone with up-down buttons only is available separately.

- The FM 2030 is basically as easy to use as a crystal receiver with rotary switch frequency selection for full "eyes-on-the-road" mobile operation.

- And, in case we forgot to mention it, we are proud to continue our famous KDK quality and ruggedness!

- Smaller case size: 55mm (2 3/16") high, 162mm (6 3/8") wide, 182mm (7 3/16") deep.

WORLD'S FAIR NEWS! KDK 2 meter radios are the only FM units chosen to be used at the World's Fair Ham Station!

NOW YOU HAVE JUST SOME OF THE FEATURES . . . IT'S UP TO YOU TO DECIDE!

WRITE FOR BROCHURE - DEALER INQUIRIES INVITED!

Warranty information available from your dealer or direct.

Company reserves the right to change specifications and prices without notice.

Exclusive USA, Central and South American Distributor

Mail Order - COD - Bank Cards  

ORDER NOW DIRECT
CALL TOLL FREE

800-251-4141

This number for ORDERS ONLY!

ORDER DIRECT or at your dealer!
DISTRIBUTED BY:



81 KDK DISTRIBUTING CO., INC.

617 SOUTH GALLATIN ROAD - MADISON, TN 37115 - PHONE (615) 865-7949 - TELEX 80-8327

VUM: Volume Units Meter

— makes measuring decibels easy

Have you ever wondered if the audio filter in your CW receiver is really as sharp as it is supposed to be? What's the frequency response of your stereo amplifier? How much insertion loss do you get when you stick that audio filter into that line? What's the trouble in that malfunctioning audio amplifier?

If you're a good troubleshooter, you can answer most of those questions with a scope, an audio oscillator, a VOM, and a calculator, but you can't do it either quickly or easily.

But a handy little device has been sitting on my bench for years which provides the answers quickly and accurately. It gets almost as much use as the VOM and a lot more use than the grid-dipper, and it costs very little to build.

Let's call it, affectionately, the V-U-M, for lack of a fancier term. Some electronics manufacturers make similar instruments which they call a "gain meter," and they have a very fancy price.

Basically, the VUM is an audio amplifier which has a calibrated step attenuator

on the input and an audio voltmeter calibrated in decibels on the output. The meter itself is commonly seen on audio equipment of all kinds, such as good-quality tape decks, audio consoles, and such, and it goes by the name of "VU meter."

That's because it was originally devised for the broadcast industry to monitor "volume units" of complex voice and music waveforms so that audio input to an AM transmitter could be held within reasonable limits by the audio engineer "riding gain" on the program. In that sort of situa-

tion, one "volume unit" only approximates one decibel. But when sine waves are used, as they are in virtually all applications of the VUM, one VU exactly equals one dB.

These meters often can be picked up on the amateur market or at hamfests for a buck or two. They're available from most parts houses for anywhere from \$6 to as much as \$125, depending on how big they are and how fancy they get. Mine was rescued from a lightning-damaged Heath phone patch.

When using the VUM to solve bench or design problems, it is important to understand something about that interesting little animal, the decibel. It is a unit of measurement of power, voltage, or current, but you can't stick a VUM probe into an amplifier and say, "Ah-ha! It reads one dB!" That's like spotting a hitchhiker on the road and exclaiming, "Ah-ha! He's gone about halfway!"

Halfway from where to where?

A decibel is a measure of comparison. It is a ratio. It is used to state the difference between one level of energy and another.

It is also a rather com-

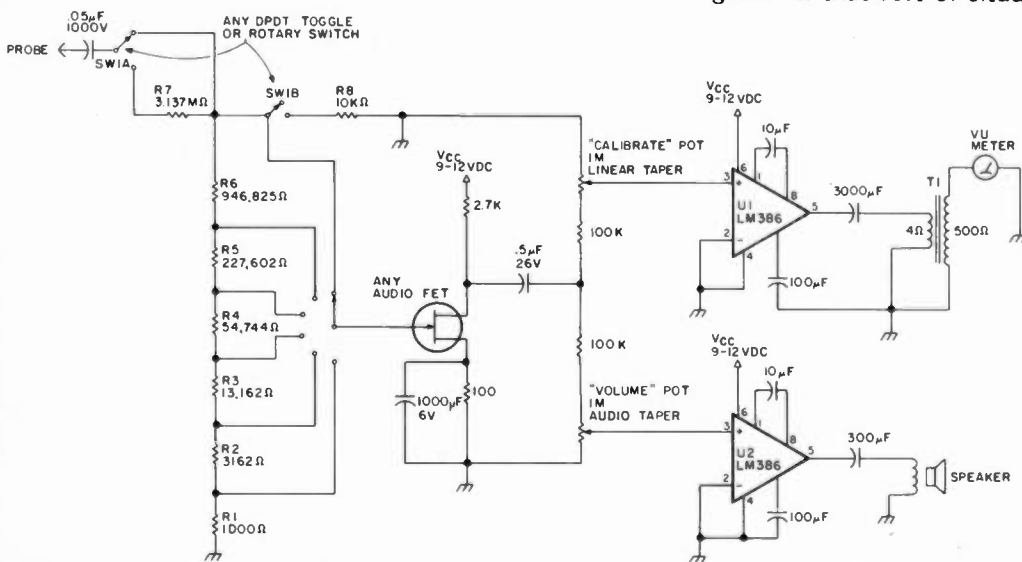

Fig. 1. The VUM (volume units meter), or calibrated audio dB meter.

plex little animal. It is not linear; it is exponential in nature. If you increase your transmitter output from 10 Watts to 20 Watts, the difference is 3 dB. If you increase it again, from 20 Watts to 40, the difference is again 3 dB. Ten Watts to 40 Watts is 6 dB, or two 3-dB steps.

If you increase line voltage from 120 volts to 240 volts, however, the increase is 6 dB. The basic formula for determining the dB difference between two voltages or between two currents is: $\text{dB} = 20 \log V_2/V_1$.

Now, let's have another look at the VUM, this time in a little more detail. It is a convenient package of several different units:

- A voltage divider resistor string in which each tap on the divider provides 10 dB less signal than the one above it.
- An audio amplifier whose input is taken from the taps on the voltage divider and which drives the VU meter.
- A separate audio amplifier to let you hear what you're measuring.

Additionally, you will need a variable-frequency audio oscillator with adjustable output level. This easily can be built into the VUM as an integral part of the same package if you don't already have such an oscillator. It can be a fairly simple oscillator, covering the range from, say, 50 Hz to 20 kHz, built with ICs. But there are plenty of construction articles about these units and I won't get into that project here.

Essentially, the audio oscillator provides a tone of measurable strength and approximately-known frequency and the VUM measures what happens to that tone as it passes through amplifiers, filters, attenuators, and other exotic devices used by hams and audiophiles.

In my VUM (Fig. 1), the

audio amplifiers are LM386 IC chips (available from Radio Shack for about one dollar each), which put out a potent little 400 mW and have a very wide frequency response, from well below the audible range, well into the superaudible. Other amplifier chips such as the LM2277, LM1877, or LM377 also can be used. They provide two 2-Watt amplifiers in the same chip.

One 386 drives the loudspeaker for aural monitoring. The other drives the meter. An even better meter driver might be constructed from an op amp, such as a 741 or TL081, which could drive the meter directly without help from a transformer.

The calibrated voltage attenuator is simply a resistive divider across the input. A standard shielded probe with a ground clip is used for pickup. A blocking capacitor keeps dc from being applied to the divider, and hence to the FET pre-amplifier gate.

The entire voltage divider, with its switches, lead wires, and input capacitor, should be shielded from stray pickup. Without shielding, it is subject to hum, rf, and other stray pickup which shows on the meter and is audible in the monitor. The input impedance is approximately one megohm. Many of the pickup problems can be solved by shunting the whole string with a one-meg (or lower value) resistor, thereby lowering the input impedance without changing the 10-dB interval between attenuator taps. (If this is done, it is necessary to recalculate the value of R7 to give 50 dB attenuation with the new divider resistance.) You might provide a switch to do this, so that you can retain the one-meg input impedance for use when you're working with very high impedance sources.

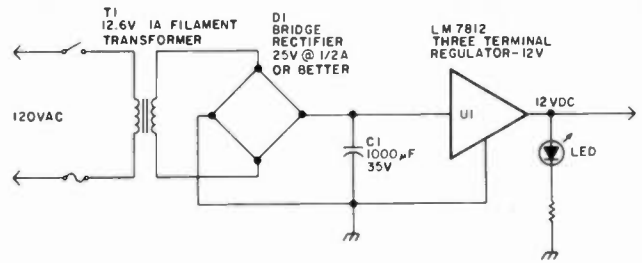

Fig. 2. Power supply for the VUM.

Resistance values are chosen such that each switch position gives 10 dB less signal than the one above it, for a total of 50 dB attenuation below the input signal. When the "high level" switch is flipped, an additional, fixed 50-dB attenuator is thrown into the circuit and the switch then reads in 10-dB steps from 50 to 100 dB below the input—and that's a lot of attenuation!

How do you determine the resistance values? That caused me a lot of floundering around with my trusty TI-55 calculator and a ream of paper smeared with several grams of graphite scribbles, but it finally came clear. As I said, the secret is that a dB is a ratio between two values, and you have to start with one known value and go from there.

You arbitrarily can assume a total value for the divider of one megohm, and calculate each step as a portion of that, or you can arbitrarily assume some value for R1 and calculate each step from there. I chose the latter because it enabled me to use a 10-dB ratio in all calculations, thus greatly simplifying the calculator work.

Now, let's go back to the basic formula stated earlier and solve it for 10 dB: $10 \text{ dB} = 20 \log V_2/V_1$. Therefore, $\text{antilog } V_2/V_1 = 10/20 = 0.5$. The antilog of 0.5, obtainable from the calculator or a log table, is 3.1622777. So: $V_2/V_1 = 3.16$ and $V_2 = 3.16 V_1$.

In any purely resistive network, voltage divides in

exact direct ratio to the resistance, so we can substitute R1 and R2 for V1 and V2 and restate the formula $R_2 = 3.16 R_1$.

Now, let's assume a value of 1000 Ohms for R1 (see Fig. 1). R2 is then $3.1622777 \times 1000 = 3162$ Ohms.

That gives us the values of two resistors in the string. Now let's get the value of R3. We want a value which will give us 10 dB less voltage across R1 + R2 than is applied across R1 + R2 + R3. So, R1 for this calculation is actually the sum of R1 and R2, or 4162 Ohms. Therefore: $R_3 = 3.16 (R_1 + R_2) = 3.16 \times 4162 = 13,146$ Ohms.

To get the value of R4, use the same method, making "R1" equal the sum of R1 + R2 + R3. And so on, until you have the value of all six resistors in the string.

Now, it happens that 1000 Ohms is a standard resistance value. That's why I chose it. Three thousand Ohms, however, is not a standard value, and 3162 certainly is not! However, 2700 and 470 are standard values, and they add up to 3170 Ohms, which is only 0.2 percent off the calculated value! Certainly close enough for amateur work.

13,146 isn't standard, but 13k is, and it is only about 1.0 percent off. If you want to be really finicky, you could use 13k and 150-Ohms in series, but, unless you're using very expensive 1% tolerance resistors, the difference is academic. Five percent is certainly close enough and ten percent probably will do nicely.

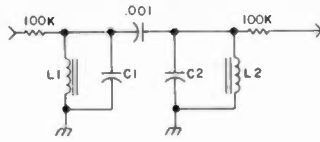
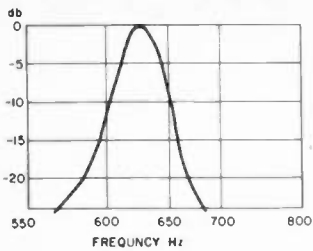

Fig. 3. Frequency response of two-toroid CW filter determined with the aid of the VUM. L1, L2—88-mH toroids; C1, C2—0.68 μ F. Bandwidth: 25 Hz at -3 dB; 40 Hz at -5 dB; 55 Hz at -10 dB; 60 Hz at -15 dB.

Calculated values of the other resistors can be approximated in the same way, using standard values in series, parallel, or series-parallel. In most cases, quarter-Watt composition resistors will do fine. However, composition tends to change value slowly over a period of years, especially when subjected to heat and/or high-voltage stresses. You could avoid this with metal film resistors, at much expense, but one-Watt or even two-Watt composition resistors will hold their values for many years before they change enough to affect the accuracy of your readings.

The resistors are easily mounted on a small piece of perfboard with wires running to the six-position rotary switch, but keep the leads fairly short, keep them away from output leads going to the speaker or meter, and keep them away from power-supply leads. If possible, enclose the whole resistor bank and switch in a shielded compartment, though this may not be necessary.

The FET amplifier is not needed to provide gain, though it provides about 10 dB. It is there to offer a very high impedance to the voltage divider. The input impedance of the LM386s, in parallel, is about 25k and if this impedance paralleled the attenuator, it would seriously affect the accuracy of the steps, especially at the small attenuation settings. Any inexpensive

audio-type N-channel FET will work nicely. The FET drives the two pots which provide separate level controls for the amplifiers.

The meter amplifier is coupled to the 4-Ohm winding of a small audio transformer with a 500- or 600-Ohm secondary, such as those used to couple speakers to music distribution lines. The purpose of the transformer is to step up the low-voltage output of the amplifier to the higher voltage which the meter needs. The meter is designed to work across a nominal 600-Ohm load.

Except for lead dress and shielding of the input circuits, nothing is critical about construction. The audio amps, including the FET circuit, can be built on a single universal circuit board such as the "experimenter printed circuit board" sold by Radio Shack (catalog number 276-170) or any other "universal" board with 0.1-inch perforation centers. It can be built on perfboard without foil using wire-wrap or point-to-point wiring.

A regulated power supply (Fig. 2) using a three-terminal 12-volt IC chip is used because the regulator provides a high degree of hum filtration. Voltages are not critical at all, but don't exceed 15 volts—the 386s cannot take more than that. Nine-volt batteries should work fine.

After checking for wiring errors, plug in the ICs and check for output. You

should find none until you provide an input signal. If hum appears on the meter and/or in the speaker, especially at the 0-dB attenuation setting, short out the probe terminal and see if it disappears. If it does, your problem is hum pickup in the attenuator board.

Occasionally IC amplifiers will oscillate. This would show up as squeals, hisses, crackles, and distortion in the speaker and as a reading on the meter, even with the probe input shorted or switched to high attenuation. This usually can be cured with an RC filter (0.05 μ F and 10 Ohms in series) from the IC output to ground. Sometimes a 0.005- μ F capacitor across the input terminals at the IC will be necessary. The FET can be eliminated as a suspect oscillator by grounding its gate or by removing its drain voltage.

After checking out and debugging, hook a source to the input of the VUM. The best source is an audio oscillator, but for this test, any steady tone will do.

You should hear it in the speaker and should be able to adjust its loudness with the "volume" pot.

The tone also should register on the meter. If it pegs the meter, rotate the attenuator switch until the meter drops back on scale. If little or no meter reading occurs, set the "calibrate" (Cal) pot at about half rotation or a little more, and then, if necessary, rotate the attenuator switch toward the 0-dB position.

Checking Calibration

Adjust the output level of the oscillator until you can set the attenuator at 0 dB and get the meter down to 0 VU (about two-thirds scale) with the Cal pot. Now flip the attenuator to -10 . The meter should drop to -10 . Reset Cal and, if necessary, the oscillator output, to get 0 VU again, and switch the attenuator

to -20 . The meter should again drop to -10 .

Check all six steps in the attenuator in this way. You may find it necessary to adjust a resistor value here or there to get exact 10-dB steps. (Remember that R6 controls the first step from 0 dB to -10 dB. R5 controls the next step and so on.)

The full range of the Cal pot will give you about 25 or 30 dB of adjustment.

Using the VUM

Now you're ready to put the VUM to practical use. You have an audio filter for use in CW reception. How sharp is it? Put it on the bench and arrange to drive its input with the audio oscillator instead of the receiver. Be sure that the input and output of the filter see the same impedances they see when it is in the receiver, then put the VUM across the output of the filter. Let's assume that the filter was designed to peak at 700 Hz.

Adjust the frequency of the oscillator until it hits the filter peak, giving maximum reading on the VUM. Select an attenuation on the switch which will let you set the meter on 0 VU with the Cal pot.

Note that your oscillator frequency is 690 Hz when the filter output is peaked—pretty close, if you designed it for 700 Hz. Now, keeping the output level of the oscillator the same, switch the frequency to 700 Hz. You'll note a slight drop in the VUM reading. Note that at 690 Hz, the VUM read 0 VU and at 700 it read, say, -0.5 dB.

Change frequency again, to 710 Hz, and note that the meter reading drops to -1 dB (or VU). Keep going up frequency one step at a time until your meter readings drop below -20 dB. Then go down frequency from 690 Hz a step at a time, noting the meter and frequency readings each time.

When you finish, plot your results on a piece of semi-log graph paper, using the logarithmic scale for frequency and the linear scale for your dB readings. The results will be similar to those in Fig. 3, which represents an actual two-toroid CW filter I've used for years. The response curve was plotted with the aid of the VUM.

In a similar manner, you can determine the frequency response of a stereo amplifier, beginning in the middle of the audio range, say at 1000 Hz, to establish a 0 VU reference point. You will note that the meter readings begin to drop off as the frequency reaches some low value, perhaps below 100 Hz, depending on the quality of the amplifier. A similar drop-off occurs at the high end of the audio range, say, above 15 kHz.

The frequency response curve of the VUM itself is

shown in Fig. 4 and this must be taken into account when testing another amplifier. The low frequency drop-off is caused, most likely, by the core losses in the small output transformer used to couple the amplifier to the meter. Up to a certain point, increasing the value of the output coupling capacitor will extend the low frequency response. You should use at least a 3000- μ F coupling capacitor.

An op amp, such as an LM741 or TL081 driving the meter directly and omitting the output transformer, probably would improve the extreme low end response of the VUM. Since I have seldom, if ever, been called on to make accurate measurements at these frequencies, I have not explored that improvement. The high frequency response is virtually flat at least to 40 kHz.

Now, suppose you have a

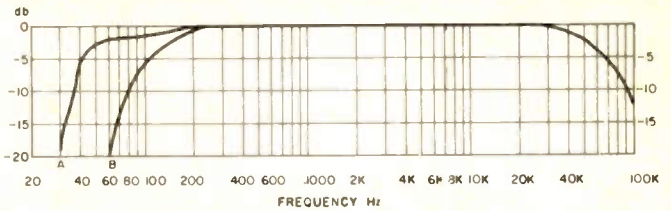

Fig. 4. Frequency response of the VUM. ± 1 dB, 100 Hz to 40 kHz; ± 3 dB, 40 Hz to 65 kHz. A—response with 200- μ F output coupling capacitor to meter. B—1200 μ F.

solid-state audio amp which gives only low, distorted output. Apply a tone, such as 1000 Hz, to the input, at a level which the amplifier is designed to handle. Apply the probe of the VUM to the input, adjust the attenuator, and set Cal for 0 dB on the meter.

Now move the probe to the output of the first stage in the amp and note that you must switch in two more steps of attenuation—20 dB—and the meter then reads +2. (Don't touch Cal.)

The readings translate to mean that the first stage is

providing 22 dB of amplification—a very healthy performance.

Reset Cal to give 0 on the meter and move the probe to the output of the second amplifier stage. This time, it isn't necessary to switch in any more attenuation. The meter reads -5 dB. That "amplifier" stage is offering a 5-dB loss! It is obviously sick and needs TLC.

The uses of the VUM are numerous and you probably can think of other ways to use it to compare the levels of any two audio signals. Often, that tells the whole story. ■

THE RTTY ANSWER



THINKING OF RTTY??
 APPLE ... TRS ... HEATH ... DEDICATED SYSTEM? SOFTWARE?
 INTERFACE? PERFORMANCE? PRICE? We know you have questions ...
 check our answers. Call today for information on our terminal units!

IRLTM
 700 TAYLOR RD.
 COLUMBUS, OHIO 43230
 (614) 864-2464
 VISA OR MASTER CHARGE ACCEPTED
IMMEDIATE DELIVERY

Analog Isn't Dead

— don't be LED astray by the digital revolution

Sometimes it seems that everything is going digital. At first it was a novelty to have a digital clock—you know, the kind with the metal plates that would flip down a new number every minute. With the emergence of the cheap LED seven-segment device, the movement to digitalize everything accelerated. First it was digital watches and clocks, then calculators; now it's used on thermometers, bathroom scales, radio dials, gas pumps, and almost everything on some luxury cars. Even a farmer friend of mine brags that the speedometer and tachometer on his new tractor is digital. Digital is becoming synonymous with modern, while analog is considered outdated. Is the analog device a twentieth-century dinosaur doomed to extinction in this era of rapidly advancing technology? The answer is a definite "no!" Old Charlie Darwin would agree that as long as a species is successful within its niche, it will survive. As it has evolved because of technology, the digital species has displaced the analog species from certain niches

in which the analog species was only marginally fit, yet digitals are unable to compete with analogs in other areas.

Analog and digital devices each have distinct advantages and disadvantages. By understanding the merits of each system, the designer/user can intelligently select the better device. As a rule, a merit of one system is a shortcoming in the other system.

Precision

The digital device wins hands-down in the precision department. Precision is limited only by the number of digits you can afford or can read without confusion. But don't get confused between precision and accuracy. Accuracy is the measure of how close you are to the real value, while precision is the measure of your confidence in the measured value. If your new Rockcruncher 2000 all-digital transceiver says that you're transmitting on 21,447.605 kHz (a very precise measurement), but you are actually transmitting on 21,452 kHz (a very accurate measurement), then you are

still likely to get a pink slip from the FCC. Moral: An ounce of accuracy is worth a pound of precision. However, if you have a high degree of accuracy but low precision, you won't be able to know just how accurate you are. You just won't collect as many pink slips.

Quick quiz: Which digital frequency meter is better (greater accuracy and precision) for measuring a signal at 420.0000000 MHz: a 6-digit meter with 1 ppm accuracy or a 10-digit meter with 4 ppm accuracy? Answer: Of course you knew all along that it was the 6-place meter, because:

6-place counter:
 $1/1,000,000 \times 420.0000000$
 $+ 420.0000000 = 420.000$
(remember, only 6 digits).

10-place counter:
 $4/1,000,000 \times 420.0000000$
 $+ 420.0000000 = 420.0016800.$

Wow! The 10-place counter is really impressive with all those numbers. It's too bad that the accuracy extends only to five significant figures. The 6-place counter is not as flashy, but it provides accuracy and

precision to six significant figures.

The slide rule was displaced by the digital calculator simply because the slide rule was unable to compete with the superior accuracy and precision of the digital calculator.

Rate Measurement

Imagine that you have decided to update your old Rockcruncher 1000 (1967 model with analog frequency dial and old-fashioned D'Arsonval swinging-needle meter movement). Being short of funds, you select a \$19.95 3½-digit LED meter kit to replace the old analog movement. After three weekends, one trip to the hospital emergency room, and the kind assistance from a friend who just happens to have an MSEE degree, you get the thing installed. To celebrate the occasion, you turn on the rig to 40 meters for a little QSO to brag about how you dragged your old Rockcruncher 1000 kicking and screaming out of the 1960s and into the 1980s.

As you tune in the first station, you get the first hint that all is not well with your new, state-of-the-art, digital

meter. It is impressive to see all those LEDs flashing, but it would be better if they were readable instead of blurred. Well, that's the price of progress.

Then you start to tune up the rig. The old peak-and-dip ritual is suddenly a wild and crazy experience. Unless you tune very slowly, the meter displays a string of eights. Not only that, but finding the peaks and dips is almost impossible. Unfortunately, the final tubes hate non-resonance so much that by the time you are almost tuned up, they collapse in a molten puddle.

Exaggerated? Well, maybe, but the point is that digital displays are not suitable for measuring rapidly changing values. The digital display blurs, while the analog display provides a usable rate-of-change display by observation of the angular velocity (sweep speed) of the indicator's pointer. An example would be to compare the analog and digital display of an aircraft's altitude. During an aircraft's descent, the analog altimeter's pointer "unwinds" at a velocity proportional to the slope of the descent. The display remains readable at all times. The digital display will blur in the units position during the slightest descent, and as descent rate increases, the tens, hundreds, and eventually thousands positions will blur. While the analog altimeter provides continuous rate information over a wide range (slow "unwinding" through fast "unwinding"), the digital altimeter displays the descent rate in a limited number of discrete steps. For example: units blurred—slight descent; tens blurred—moderate descent; hundreds blurred—steep descent; thousands blurred—dive; ten-thousands blurred—don't even think about it.

Why do race cars still use old-fashioned analog ta-

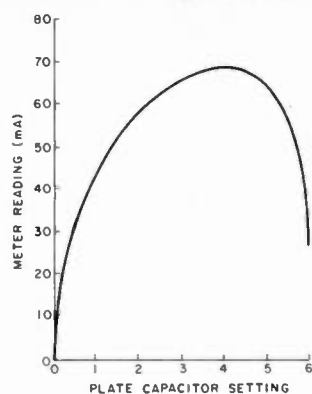

(a)

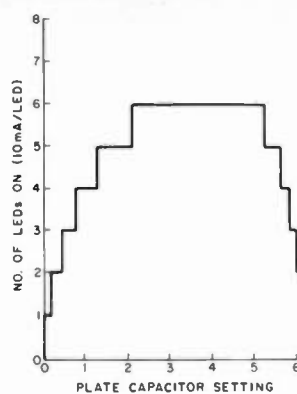

(b)

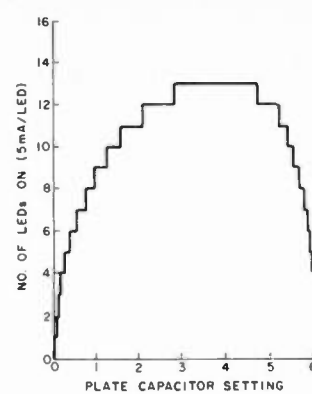

(c)

Fig. 1.

chometers instead of the spiffy new digital tachometers that Warshawsky and Co. sells? It comes down to economics. An over-revved engine with pieces littering the track simply cannot win a race. If a digital tach blurs on acceleration, the driver will be more likely to over-rev the engine (an expensive mistake). The subject of race car instruments leads into the next criterion for selection of the appropriate analog or digital device.

When I first saw the instrument panel on a race car, I noticed that the instruments were installed askew, with some turned clockwise and others turned counterclockwise. Later I was informed that it wasn't sloppy installation, but an intentional arrangement. The driver doesn't have time to read the numbers on each gauge, so the gauges are aligned so the pointer is at 12 o'clock at the ideal (or maximum) setting. A deviation is then readily noticeable. An analog device will show where you are with respect to the range of position. An analog defines its limits (empty-full, low-high, 0-1 mA, 0-120 mph) and the device's pointer simultaneously indicates its relative position on the range of values.

Comparing the ability of analog and digital devices to measure position can be demonstrated by the story about the hot-air balloon-

ists who became lost while drifting over the countryside. One of the balloonists sighted a farmer in a field and began releasing gas from the balloon. As the balloon passed over the farmer, the balloonists yelled, "Where are we?" The farmer replied, "Bout a hunnerd foot up in a hot-air balloon." The information transferred was absolutely correct, yet absolutely useless since there was neither a horizontal point of reference nor a distance and direction from the point of reference. Frequently a value alone can be meaningless unless accompanied by boundary limits. When using digital devices, you often must be aware of limits which are not displayed. Since analog devices display the entire range, hazardous or undesirable regions may be flagged by using a colored band as a warning marker. This flagging is generally not available for digital displays; however, red/green bidirectional LEDs in a 7-segment configuration could be used in circuitry that would allow a color change as an undesirable region is entered.

Another kind of position utilization in analog displays is incremental measurement. A good example is the wristwatch worn by a nurse. It is never digital and always has a second hand. The reason is that nurses

take frequent readings of patients' vital signs—pulse and respiration. To save time (a survival skill in nursing), the pulse and respiration are each measured for 15 seconds. The procedure is to find the pulse, start counting the pulse as the second hand passes any 5-second increment, continue counting until the second hand has traversed 90° from the starting point, and finally multiply this 15-second count by 4. The starting and stopping points are of no consequence, but rather the 90° sweep of the second hand which measures a 15-second increment. A similar incremental measurement is used in transmitter tuning. The actual plate current reading is of little value until tuning is completed. The important things are the relative peaks and dips as the circuit is brought to resonance.

Continuous vs. Stepped Readings

There is a little gadget on the market called the LED bar-graph display which looks like an analog device, yet is still digital. It has the advantage of position display and may be used marginally for rate measurement. Its weakness is the one distinct advantage usually found in digital devices—precision. Precision is limited by the discrete number of steps (LEDs) on the bar display. If 8 LEDs

SATURN V

STATE-OF-THE-ART

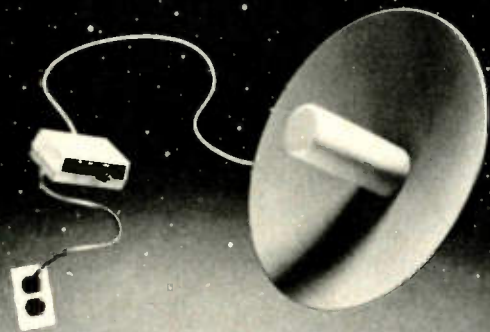

The Saturn V is a deep fringe microwave receiver for homeowners that are outside of the service area of local pay TV stations (i.e., HBO, Showtime). It is normally used within line of sight of a transmitting tower in a 50 mile range and is simply attached to your antenna mast. This unit is completely ready to install including all cable and mounting hardware. It is designed to be installed by the homeowner.

We accept MasterCharge & Visa

Microwave and Satellite Systems

JDI Industries TM

4558 Auburn Blvd., Suite 208
Sacramento California 95841 (916) 454-2130 ✓72

1-3	\$165.00
4-11	\$120.00
12-49	\$105.00
50-99	\$ 95.00
100-149	\$ 85.00
150-up	\$ 80.00

are used to measure a range of 0 to 8 units, then no LED would light until one unit is reached, the second LED would light only when two units is reached, and so on. The drawback is that 1.00 and 1.99 units are displayed as being the same. Now it's obvious that trying to use this bar graph to tune a transmitter would be difficult. Fig. 1 shows a comparison of a D'Arsonval meter movement and two LED bar graphs. Fig. 1(a) shows the actual plate current (as displayed on the D'Arsonval meter). Fig. 1(b) shows an 8-LED bar graph, and Fig. 1(c) shows a 16-LED bar graph. The "peak" on the 8-LED bar covers over half of the capacitor tuning range, and the 16-LED bar graph "peak" covers over a third of the capacitor tuning range. Neither bar graph has the sensitivity for tuning that the analog display has.

Conclusions

Use a digital device where precision is needed, but remember that high precision cannot improve accuracy. Digital devices are especially suited as frequency indicators on transceivers and frequency counters. However, if the frequency counter you are thinking about buying has 9 digits and 10 ppm accuracy, then you are wasting money on the last 4 digits. Six digits and 1 ppm accuracy is just right. Don't use an LED bar graph if precision is essential.

If position-orientation, -tracking, or -setting are important, stay with an analog device. And finally, rate measurement belongs to analog devices.

As an equipment designer/user, select the better device to meet your own needs—even if it means being old-fashioned. ■

For reliability ...



... and increased resale value, rely on Cover Craft Dust Covers.

Try our low-cost protection for ALL your equipment ... before it's too late.

- Protects equipment and investment.
- Great looking.
- 100's of designs.
- Extra strength heavy gauge vinyl.
- Machine stitched.
- Satisfaction guaranteed.

See your dealer or contact:
COVER CRAFT CORPORATION

Box 555Q • Amherst, NH 03031 • (603) 889-6811

ONLY \$6.95

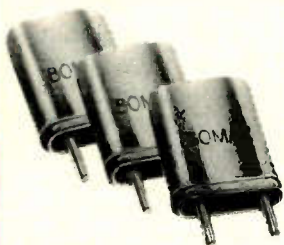

WE'RE ROLLIN' IN CRYSTALS!

2 Meter Crystals — \$3.95 each
(10 or More — \$3.50 each)
Quick Delivery

We Stock Crystals For:

Clegg Drake Icom
Kenwood Midland Regency
Standard Willson Yaesu
Lafayette Tempo VHF Eng

Rollin Distributors

P.O. Box 436 Department 7
Dunellen, N.J. 08812
201-469-1219

(Custom Crystal Orders Accepted.) Precision Cut Land Mobiles Available

MOR-GAIN

1/2-size (75M only 66")

Multi-Band (5, 4, 3 bands)
80/75M thru 10M

Broadbanded - no traps used

Prices start at \$82.50

MOR-GAIN

THE MOR-GAIN HD DIPOLES are the most advanced, highest performance multi-band HF dipole antennas available. Patented design provides length one-half of conventional dipoles. 50 ohm feed on all bands, no tuner or balun required. Can be installed as inverted VEE. Thousands in use worldwide. 22 models available including two models engineered for optimum performance for the novice bands. The Mor-Gain HD dipoles N/T series are the only commercial antennas specifically designed to meet the operational requirements of the novice license. Our 1-year warranty is backed by nearly 20 years of HD dipole production experience.

For detailed 10-page brochure, write or phone directly to **MOR-GAIN**, P.O. Box 329T, Leavenworth, Ks. 66048, Tel. (913) 682-3142.

MOR-GAIN

MADISON

Electronics Supply

YAESU FT-ONE



LIST \$2995.00

- 73 MHz first IF
- 0.3 uV sensitivity
- full break in
- Curtis 8044 keyer available as option
- front panel keyboard
- ten VFO's
- one year factory warranty

Your Price \$2395.00
Accessories Available

ANNOUNCING THE NEW



ICOM 740

- Transmitter
 - RF Power
 - SSB (A³ J)
 - CW (A1) RTTY (F1)
 - FM (Option)
 - 200W PEP INPUT
 - 200W INPUT
 - 200W INPUT
- Receiving Mode
 - A³ A³ J (USB LSB) F¹
 - F¹ (Option)
- Emission Mode
 - A³ J SSB (USB & LSB)
 - A1 CW
 - F1 RTTY
 - F3 (28MHz)
- Sensitivity
 - SSB CW RTTY Less than 0.3 μV for 10dB S+N/N
 - (Preamp - On) Less than 0.15 μV for 10dB S+N/N
 - FM (Preamp - On) Less than 0.3 v for 20 dB quieting

ANTENNAS



BUTTERNUT
New HF6V
125.00

HYGAIN
18AVT/WB
100.00

HUSTLER
5 BTV
100.00

TH7DXX
HYGAIN
349.00



cushcraft
A3-169.00
A4-209.00

YAESU

THE NEW FT-102

- Operating Modes: LSB, USB (A3/J3E); CW (A1/A1a); AM (A3/A3E) and FM (F3/F3E)**
- Transmitter Power Input: (1.8 - 25 MHz) (28 - 29.9 MHz), SSB, CW, AM, FM, 240W DC, 80W DC, 160W DC, 80W DC, 160W DC
- Carrier suppression: Better than -40dB at 14 MHz
Sideband suppression: Better than -60 dB (14 MHz, 1 kHz tone)
- Modulation types: A3/J3E: balanced modulator
A3/A3E: low level amplitude modulator
F3/F3E: variable reactance modulator
- Receiver
Image rejection: Better than 70dB from 1.8 - 21.5MHz
Better than 50dB from 24.5 - 29.9MHz

DONS CORNER

The Ratings continue - 2 meter mobile month: Kenwood TR9130, excellent sensitivity, easy operation, light output; ICOM IC290A, good performance, cheaper pricing; Yaesu FT480R, great reliability, medium pricing.

ICOM IC25A - Kenwood TR7730 - Yaesu FT 230 - All popular, All the same basic flavor. Yaesu FT208R - biggest seller; Kenwood TR2500 - durable; Santec S1144 μP- most features; ICOM IC2AT - basic reliable workhorse.

Consider the various Mod Kits out FOXTANGO, W6TOG, ICOM-Kenwood users, etc.: Our repair dept. has tried several & they are excellent, plus an affordable way to "upgrade" an old radio (TS820?). Remember our service dept. What we can't fix with a hammer, we don't work on.

See you next month!

BELDEN

RG8/u Dbl Shield	Part Number 9888	65 c/ft.	No. of Cond - 8	AWG (in mm) - 6-22 (7 x 30)	8448 27 c/ft.
RG8/u Foam 81VF	8214	36 c/ft.	2-18 (16 x 30) (1 19)		
RG8/u Regular 66VF	8237	32 c/ft.	No. of Cond - 8	AWG (in mm) 2-16 (26 x 30)	9405 45 c/ft.
RG 213 Non-contaminating	8267	43 c/ft.	6-16 (16 x 30), (1 17)		

Belden Mini RG-8 (9258)-19c/ft.

COLLINS KWM 380

LIST \$4495.00
Madison's Price CALL

713-658-0268

* CALL FOR QUOTES

1508 MCKINNEY 45
HOUSTON, TEXAS 77010

TUFTS ELECTRONICS

61 Lowell Rd., Hudson, N.H. 03051
9-6 Daily (603) 883-5005 12-5 Sunday

...TOWERS... ROTORS... ANTENNAS... COAX... HF XCVRS...
Over 1000 different amateur radio items are listed on these two pages, and most of them are in stock! Open SEVEN DAYS every week and NO SALES TAX in New Hampshire. You'll find that our DISCOUNT PRICES are hard to beat and our FRIENDLY SERVICE is second to none. We're only 30 mins from Rte 128 in BOSTON via Rte 3, and only 45 mins from LOGAN International Airport in Boston. If you cannot visit us then try our FAST mail order service. Most mail and PHONE orders are shipped in one day. Send \$1 for our ENLARGED CATALOG, free with orders.

DISCOUNTS - FREE CATALOG - EXPORTS - PACKAGES

ALLIANCE MFG	REPAIR	SALE
U-10 10 WATT WATER METER	32.95	14.50
U-10 10 WATT WATER METER (500V)	32.95	14.50
ALPHA AMPS	1895.00	1495.00
75A 750 WATT LINEAR BEAM TUBE	2795.00	2295.00
75A 750 WATT LINEAR BEAM TUBE 170V	2795.00	2295.00
75A 750 WATT LINEAR BEAM TUBE 170V 170V	2795.00	2295.00
75A 750 WATT LINEAR BEAM TUBE 170V 170V	2795.00	2295.00

BOOKS	REPAIR	SALE
AMERICAN CALLBOOK 1972 NEW EDITION	12.95	12.95
AMERICAN CALLBOOK 1972 NEW EDITION	12.95	12.95
AMERICAN CALLBOOK 1972 NEW EDITION	12.95	12.95
AMERICAN CALLBOOK 1972 NEW EDITION	12.95	12.95
AMERICAN CALLBOOK 1972 NEW EDITION	12.95	12.95

COBRA CB	REPAIR	SALE
1000 WATT 1000 WATT	12.95	12.95
1000 WATT 1000 WATT	12.95	12.95
1000 WATT 1000 WATT	12.95	12.95
1000 WATT 1000 WATT	12.95	12.95
1000 WATT 1000 WATT	12.95	12.95

COAX CABLES	REPAIR	SALE
100 FT 100 FT	12.95	12.95
100 FT 100 FT	12.95	12.95
100 FT 100 FT	12.95	12.95
100 FT 100 FT	12.95	12.95
100 FT 100 FT	12.95	12.95

HAN-KAY	REPAIR	SALE
100 FT 100 FT	12.95	12.95
100 FT 100 FT	12.95	12.95
100 FT 100 FT	12.95	12.95
100 FT 100 FT	12.95	12.95
100 FT 100 FT	12.95	12.95

HITACHI OSCILLOSCOPES	REPAIR	SALE
100 FT 100 FT	12.95	12.95
100 FT 100 FT	12.95	12.95
100 FT 100 FT	12.95	12.95
100 FT 100 FT	12.95	12.95
100 FT 100 FT	12.95	12.95

INDISPENSIBLE	REPAIR	SALE
100 FT 100 FT	12.95	12.95
100 FT 100 FT	12.95	12.95
100 FT 100 FT	12.95	12.95
100 FT 100 FT	12.95	12.95
100 FT 100 FT	12.95	12.95



the indispensable
WV43B
THRU LINE
WATTMETER

Power Range	2	25	150	500	1000
10-100W	10A	10K	100	100	100
10-100W	10A	10K	100	100	100
10-100W	10A	10K	100	100	100
10-100W	10A	10K	100	100	100
10-100W	10A	10K	100	100	100

BARKER & WILLIAMS' BROAD BAND FOLDED DIPOLE 370-15

B & W Broad Band folded Dipole covers an amazing frequency from 3.5-30 MHz. Being used throughout the world, it's the most reliable antenna for HF. It's a 10 element, 50 ft long, 2 1/2" diam. 30 MHz. Bumped construction for long life. Can be installed on lat top mounted tower or mast. Also available for 22 MHz. Completely assembled with no. 8 type cable with SO connector. Terminated with no. 8 type connector on each end. Patent Pending.
Price \$49.50

BENCHER, INC.

REPAIR	SALE
100 FT 100 FT	12.95
100 FT 100 FT	12.95
100 FT 100 FT	12.95
100 FT 100 FT	12.95
100 FT 100 FT	12.95

MICROLOG

REPAIR	SALE
100 FT 100 FT	12.95
100 FT 100 FT	12.95
100 FT 100 FT	12.95
100 FT 100 FT	12.95
100 FT 100 FT	12.95

AFFILIATE STORES
BUZZARDS BAY ELECTRONIC
196 Main Street
Buzzards Bay, Mass 02532
617-759-3376

DX COMMUNICATIONS
3214 Transit Road
West Saueca, NY 14224
716-668-8873

Please contact our Hudson, NH office for details about our affiliate store program.

SEE US FOR THE BEST DEAL



HUSTLER	REPAIR	SALE
100 FT 100 FT	12.95	12.95
100 FT 100 FT	12.95	12.95
100 FT 100 FT	12.95	12.95
100 FT 100 FT	12.95	12.95
100 FT 100 FT	12.95	12.95



DRAKE	REPAIR	SALE
100 FT 100 FT	12.95	12.95
100 FT 100 FT	12.95	12.95
100 FT 100 FT	12.95	12.95
100 FT 100 FT	12.95	12.95
100 FT 100 FT	12.95	12.95

FLUKE	REPAIR	SALE
100 FT 100 FT	12.95	12.95
100 FT 100 FT	12.95	12.95
100 FT 100 FT	12.95	12.95
100 FT 100 FT	12.95	12.95
100 FT 100 FT	12.95	12.95

JANEL PRE-AMPS	REPAIR	SALE
100 FT 100 FT	12.95	12.95
100 FT 100 FT	12.95	12.95
100 FT 100 FT	12.95	12.95
100 FT 100 FT	12.95	12.95
100 FT 100 FT	12.95	12.95

KANTRONICS	REPAIR	SALE
100 FT 100 FT	12.95	12.95
100 FT 100 FT	12.95	12.95
100 FT 100 FT	12.95	12.95
100 FT 100 FT	12.95	12.95
100 FT 100 FT	12.95	12.95



ICOM	REPAIR	SALE
100 FT 100 FT	12.95	12.95
100 FT 100 FT	12.95	12.95
100 FT 100 FT	12.95	12.95
100 FT 100 FT	12.95	12.95
100 FT 100 FT	12.95	12.95



HY-GAIN ANTENNAS	REPAIR	SALE
100 FT 100 FT	12.95	12.95
100 FT 100 FT	12.95	12.95
100 FT 100 FT	12.95	12.95
100 FT 100 FT	12.95	12.95
100 FT 100 FT	12.95	12.95

HY-GAIN MOTORS	REPAIR	SALE
100 FT 100 FT	12.95	12.95
100 FT 100 FT	12.95	12.95
100 FT 100 FT	12.95	12.95
100 FT 100 FT	12.95	12.95
100 FT 100 FT	12.95	12.95

LAUREN QUICK POINT	REPAIR	SALE
100 FT 100 FT	12.95	12.95
100 FT 100 FT	12.95	12.95
100 FT 100 FT	12.95	12.95
100 FT 100 FT	12.95	12.95
100 FT 100 FT	12.95	12.95



CUSHCRAFT 20/220/430 ANTENNAS	REPAIR	SALE
100 FT 100 FT	12.95	12.95
100 FT 100 FT	12.95	12.95
100 FT 100 FT	12.95	12.95
100 FT 100 FT	12.95	12.95
100 FT 100 FT	12.95	12.95

CUSHCRAFT 1HP ANTENNAS	REPAIR	SALE
100 FT 100 FT	12.95	12.95
100 FT 100 FT	12.95	12.95
100 FT 100 FT	12.95	12.95
100 FT 100 FT	12.95	12.95
100 FT 100 FT	12.95	12.95

FLUKE	REPAIR	SALE
100 FT 100 FT	12.95	12.95
100 FT 100 FT	12.95	12.95
100 FT 100 FT	12.95	12.95
100 FT 100 FT	12.95	12.95
100 FT 100 FT	12.95	12.95

DISCOUNT CATALOG

MDR-61N HALF-SIZE FULL PERFORMANCE Multi-Band HF Communications Antennas



- Maximum efficiency - no traps, loading coils, or stubs
- Full standing and phasing - no matching, no cutting
- An extra band - 1.8V AM 2.8 MHz CW or PEP SSB
- 100% SWR - no SWR meters, no SWR meters
- Proven performance - more than 10,000 have been delivered
- Items sold in the quantities of today's band tests
- One form for operation on all bands
- Lowest cost/greatest performance antenna on the market today
- Highest performance for the price as well as the 1.8V CW AM

MODEL	RETAIL	SALE
MDR-61N	109.00	81.50
MDR-61N-1	109.00	81.50
MDR-61N-2	109.00	81.50
MDR-61N-3	109.00	81.50
MDR-61N-4	109.00	81.50
MDR-61N-5	109.00	81.50
MDR-61N-6	109.00	81.50
MDR-61N-7	109.00	81.50
MDR-61N-8	109.00	81.50
MDR-61N-9	109.00	81.50
MDR-61N-10	109.00	81.50
MDR-61N-11	109.00	81.50
MDR-61N-12	109.00	81.50
MDR-61N-13	109.00	81.50
MDR-61N-14	109.00	81.50
MDR-61N-15	109.00	81.50
MDR-61N-16	109.00	81.50
MDR-61N-17	109.00	81.50
MDR-61N-18	109.00	81.50
MDR-61N-19	109.00	81.50
MDR-61N-20	109.00	81.50
MDR-61N-21	109.00	81.50
MDR-61N-22	109.00	81.50
MDR-61N-23	109.00	81.50
MDR-61N-24	109.00	81.50
MDR-61N-25	109.00	81.50
MDR-61N-26	109.00	81.50
MDR-61N-27	109.00	81.50
MDR-61N-28	109.00	81.50
MDR-61N-29	109.00	81.50
MDR-61N-30	109.00	81.50

MODEL	RETAIL	SALE
MDR-61N-31	109.00	81.50
MDR-61N-32	109.00	81.50
MDR-61N-33	109.00	81.50
MDR-61N-34	109.00	81.50
MDR-61N-35	109.00	81.50
MDR-61N-36	109.00	81.50
MDR-61N-37	109.00	81.50
MDR-61N-38	109.00	81.50
MDR-61N-39	109.00	81.50
MDR-61N-40	109.00	81.50
MDR-61N-41	109.00	81.50
MDR-61N-42	109.00	81.50
MDR-61N-43	109.00	81.50
MDR-61N-44	109.00	81.50
MDR-61N-45	109.00	81.50
MDR-61N-46	109.00	81.50
MDR-61N-47	109.00	81.50
MDR-61N-48	109.00	81.50
MDR-61N-49	109.00	81.50
MDR-61N-50	109.00	81.50

MODEL	RETAIL	SALE
MDR-61N-51	109.00	81.50
MDR-61N-52	109.00	81.50
MDR-61N-53	109.00	81.50
MDR-61N-54	109.00	81.50
MDR-61N-55	109.00	81.50
MDR-61N-56	109.00	81.50
MDR-61N-57	109.00	81.50
MDR-61N-58	109.00	81.50
MDR-61N-59	109.00	81.50
MDR-61N-60	109.00	81.50
MDR-61N-61	109.00	81.50
MDR-61N-62	109.00	81.50
MDR-61N-63	109.00	81.50
MDR-61N-64	109.00	81.50
MDR-61N-65	109.00	81.50
MDR-61N-66	109.00	81.50
MDR-61N-67	109.00	81.50
MDR-61N-68	109.00	81.50
MDR-61N-69	109.00	81.50
MDR-61N-70	109.00	81.50

MODEL	RETAIL	SALE
MDR-61N-71	109.00	81.50
MDR-61N-72	109.00	81.50
MDR-61N-73	109.00	81.50
MDR-61N-74	109.00	81.50
MDR-61N-75	109.00	81.50
MDR-61N-76	109.00	81.50
MDR-61N-77	109.00	81.50
MDR-61N-78	109.00	81.50
MDR-61N-79	109.00	81.50
MDR-61N-80	109.00	81.50
MDR-61N-81	109.00	81.50
MDR-61N-82	109.00	81.50
MDR-61N-83	109.00	81.50
MDR-61N-84	109.00	81.50
MDR-61N-85	109.00	81.50
MDR-61N-86	109.00	81.50
MDR-61N-87	109.00	81.50
MDR-61N-88	109.00	81.50
MDR-61N-89	109.00	81.50
MDR-61N-90	109.00	81.50

MODEL	RETAIL	SALE
MDR-61N-91	109.00	81.50
MDR-61N-92	109.00	81.50
MDR-61N-93	109.00	81.50
MDR-61N-94	109.00	81.50
MDR-61N-95	109.00	81.50
MDR-61N-96	109.00	81.50
MDR-61N-97	109.00	81.50
MDR-61N-98	109.00	81.50
MDR-61N-99	109.00	81.50
MDR-61N-100	109.00	81.50

MODEL	RETAIL	SALE
MDR-61N-101	109.00	81.50
MDR-61N-102	109.00	81.50
MDR-61N-103	109.00	81.50
MDR-61N-104	109.00	81.50
MDR-61N-105	109.00	81.50
MDR-61N-106	109.00	81.50
MDR-61N-107	109.00	81.50
MDR-61N-108	109.00	81.50
MDR-61N-109	109.00	81.50
MDR-61N-110	109.00	81.50

MODEL	RETAIL	SALE
MDR-61N-111	109.00	81.50
MDR-61N-112	109.00	81.50
MDR-61N-113	109.00	81.50
MDR-61N-114	109.00	81.50
MDR-61N-115	109.00	81.50
MDR-61N-116	109.00	81.50
MDR-61N-117	109.00	81.50
MDR-61N-118	109.00	81.50
MDR-61N-119	109.00	81.50
MDR-61N-120	109.00	81.50

MODEL	RETAIL	SALE
MDR-61N-121	109.00	81.50
MDR-61N-122	109.00	81.50
MDR-61N-123	109.00	81.50
MDR-61N-124	109.00	81.50
MDR-61N-125	109.00	81.50
MDR-61N-126	109.00	81.50
MDR-61N-127	109.00	81.50
MDR-61N-128	109.00	81.50
MDR-61N-129	109.00	81.50
MDR-61N-130	109.00	81.50

MODEL	RETAIL	SALE
MDR-61N-131	109.00	81.50
MDR-61N-132	109.00	81.50
MDR-61N-133	109.00	81.50
MDR-61N-134	109.00	81.50
MDR-61N-135	109.00	81.50
MDR-61N-136	109.00	81.50
MDR-61N-137	109.00	81.50
MDR-61N-138	109.00	81.50
MDR-61N-139	109.00	81.50
MDR-61N-140	109.00	81.50

MODEL	RETAIL	SALE
MDR-61N-141	109.00	81.50
MDR-61N-142	109.00	81.50
MDR-61N-143	109.00	81.50
MDR-61N-144	109.00	81.50
MDR-61N-145	109.00	81.50
MDR-61N-146	109.00	81.50
MDR-61N-147	109.00	81.50
MDR-61N-148	109.00	81.50
MDR-61N-149	109.00	81.50
MDR-61N-150	109.00	81.50

MODEL	RETAIL	SALE
MDR-61N-151	109.00	81.50
MDR-61N-152	109.00	81.50
MDR-61N-153	109.00	81.50
MDR-61N-154	109.00	81.50
MDR-61N-155	109.00	81.50
MDR-61N-156	109.00	81.50
MDR-61N-157	109.00	81.50
MDR-61N-158	109.00	81.50
MDR-61N-159	109.00	81.50
MDR-61N-160	109.00	81.50

MODEL	RETAIL	SALE
MDR-61N-161	109.00	81.50
MDR-61N-162	109.00	81.50
MDR-61N-163	109.00	81.50
MDR-61N-164	109.00	81.50
MDR-61N-165	109.00	81.50
MDR-61N-166	109.00	81.50
MDR-61N-167	109.00	81.50
MDR-61N-168	109.00	81.50
MDR-61N-169	109.00	81.50
MDR-61N-170	109.00	81.50

MODEL	RETAIL	SALE
MDR-61N-171	109.00	81.50
MDR-61N-172	109.00	81.50
MDR-61N-173	109.00	81.50
MDR-61N-174	109.00	81.50
MDR-61N-175	109.00	81.50
MDR-61N-176	109.00	81.50
MDR-61N-177	109.00	81.50
MDR-61N-178	109.00	81.50
MDR-61N-179	109.00	81.50
MDR-61N-180	109.00	81.50

MODEL	RETAIL	SALE
MDR-61N-181	109.00	81.50
MDR-61N-182	109.00	81.50
MDR-61N-183	109.00	81.50
MDR-61N-184	109.00	81.50
MDR-61N-185	109.00	81.50
MDR-61N-186	109.00	81.50
MDR-61N-187	109.00	81.50
MDR-61N-188	109.00	81.50
MDR-61N-189	109.00	81.50
MDR-61N-190	109.00	81.50

MODEL	RETAIL	SALE
MDR-61N-191	109.00	81.50
MDR-61N-192	109.00	81.50
MDR-61N-193	109.00	81.50
MDR-61N-194	109.00	81.50
MDR-61N-195	109.00	81.50
MDR-61N-196	109.00	81.50
MDR-61N-197	109.00	81.50
MDR-61N-198	109.00	81.50
MDR-61N-199	109.00	81.50
MDR-61N-200	109.00	81.50

MODEL	RETAIL	SALE
MDR-61N-201	109.00	81.50
MDR-61N-202	109.00	81.50
MDR-61N-203	109.00	81.50
MDR-61N-204	109.00	81.50
MDR-61N-205	109.00	81.50
MDR-61N-206	109.00	81.50
MDR-61N-207	109.00	81.50
MDR-61N-208	109.00	81.50
MDR-61N-209	109.00	81.50
MDR-61N-210	109.00	81.50

MODEL	RETAIL	SALE
MDR-61N-211	109.00	81.50
MDR-61N-212	109.00	81.50
MDR-61N-213	109.00	81.50
MDR-61N-214	109.00	81.50
MDR-61N-215	109.00	81.50
MDR-61N-216	109.00	81.50
MDR-61N-217	109.00	81.50
MDR-61N-218	109.00	81.50
MDR-61N-219	109.00	81.50
MDR-61N-220	109.00	81.50

MODEL	RETAIL	SALE
MDR-61N-221	109.00	81.50
MDR-61N-222	109.00	81.50
MDR-61N-223	109.00	81.50
MDR-61N-224	109.00	81.50
MDR-61N-225	109.00	81.50
MDR-61N-226	109.00	81.50
MDR-61N-227	109.00	81.50
MDR-61N-228	109.00	81.50
MDR-61N-229	109.00	81.50
MDR-61N-		

Long's best ham values!

SAVE \$579!



ALL FOR ONLY \$899

List Price 1478.00
I.N. YAEFT107DEAL
Add 9.74 shipping & handling

- One low price! You get**
- FT-107M HF SSB transceiver (a \$1149.00 value)
 - FP-107 Internal power supply (a \$139.00 value)
 - SP-107P speaker/phone patch (a \$65.00 value)
 - DMS-107 digital memory shift (a \$125.00 value)

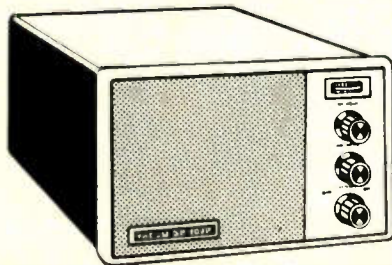

Get the YAESU FT-107M HF SSB transceiver complete with digital memory shift, internal power supply and speaker/phone patch for one unbelievable low price!

A super fantastic buy on a great DX rig and accessories! The FT-107M's all solid-state design makes instant band changes possible and also provides exceptional performance. Features digital and analog frequency display, RF and AF gain controls, variable IF bandwidth using 16 poles of crystal filtering, 12 channel memory and adjustable AGC. Covers 160 thru 10 meters including WARC bands. Comes complete with FP-107 internal power supply, SP-107P speaker/phone patch and DMS-107 digital memory shift. All for one low price!



SAVE \$200!

599.50

List Price 799.50
I.N. DENCLIPL
Add 9.94 shipping & handling

Our lowest price ever on the DENTRON Clipperton L linear amplifier

The Clipperton L makes operating on 160 thru 15 meters more fun than ever. It features four 572B triodes operating in a grounded grid, HI-LO power switching with linear bypass through the front panel, adjustable ALC, coverage of most MARS frequencies and continuous duty power supply. Operates on 117V or 234V AC. Produces 2000W PEP input on SSB and 1000W DC input on CW, RTTY and SSTV. Built-in forced air cooling ensures reliable operation even during sustained high power operation. Harmonic suppression easily meets or exceeds all FCC standards. Order now and save \$200!

Long's Electronics



MAIL ORDERS: P.O. BOX 11347 BIRMINGHAM, AL 35202 • STREET ADDRESS: 3131 4TH AVENUE SOUTH BIRMINGHAM, AL 35233

Complete satellite TV system!

\$1995

List Price 4015.00 Item No. MISSY40
Shipped Freight Collect

10 FT. PARABOLIC DISH

What the system will do:

You can receive up to 60 channels of TV direct from satellites to your home receiver. Movies, sporting events, religious programs, other TV stations and much more.

What the system includes:

1. 10 ft. fiberglass dish made of reflective metal bonded with fiberglass. Weather resistant and virtually maintenance-free. Comes in 4 sections for easy assembly.
2. Single-pole polar mount complete with azimuth and elevation cranks for easy satellite-to-satellite adjustment.
3. LNA mount complete with rotor for adjusting horizontal and vertical polarity of LNA. Extension poles not included.
4. KLM Sky Eye IV receiver: Consists of two pieces, receiver and downconverter. The receiver can be placed indoors and linked to the downconverter by remote cable. Features video inversion, AFC defeat and single conversion electronics.
5. Amplicon CD305305 low noise amplifier: A 120 degree uncooled LNA. Takes the weak signals reflected by the dish and amplifies them to a point where they can be converted to a TV picture.
6. Chaparral feed horn: Provides 0.5 dB gain improvement over conventional rectangular horns for superior picture and sound quality. Virtually eliminates system noise.

Note: Customer provides small cables that run from receiver box to control box inside. (Approx. cost \$40.) Customer must feed audio and video through VCR or use RF modulator. (Approx. cost \$125.)

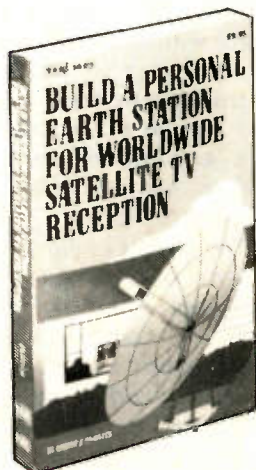
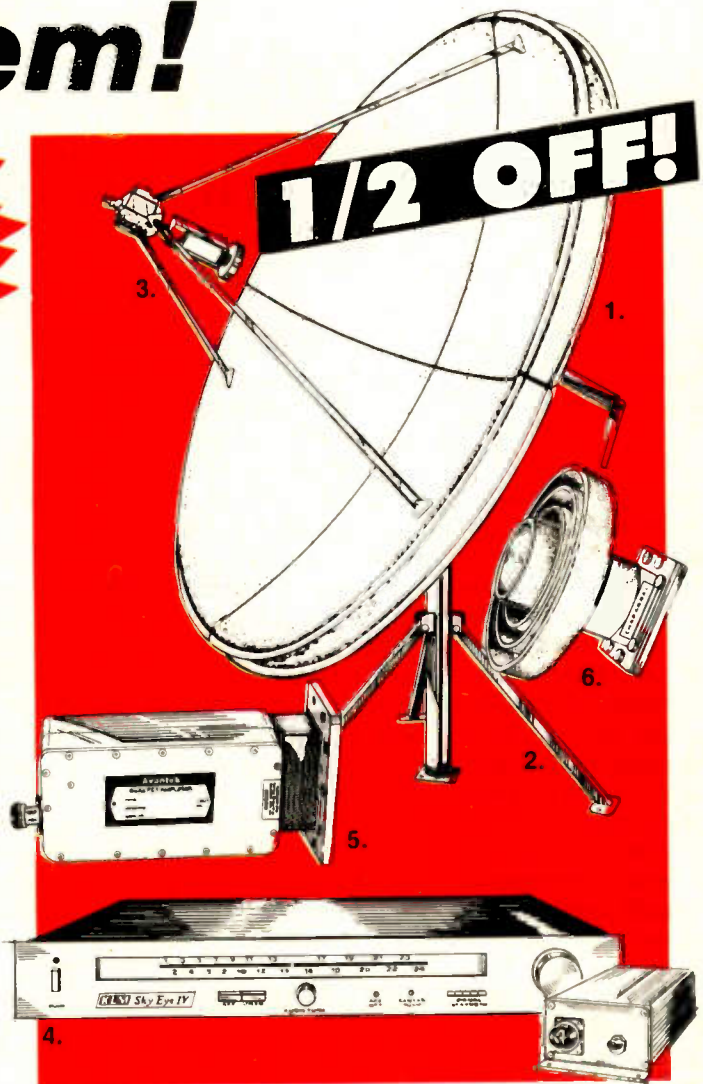

Read all about Satellite TV!

9.95

Item No. BOOTAB1409
Add 1.36 shipping & handling

At last! A complete guide to satellite TV!
"Build a Personal Earth Station for Worldwide Satellite TV Reception"

A complete guide to gaining access to the large amount of TV programming available from satellite transmissions. You can choose to build your own system or purchase one ready-to-operate, and both ways are thoroughly covered in this book. It begins with a review of basic television fundamentals and satellite transmission and reception. Building your own system is covered and the complicated task of installing the antenna and aiming it to pick up the signals you want is simplified. There's even a complete list of available satellite programming.

Learn to:

- Design
- Operate
- Build
- Maintain

Call Toll Free **1-800-633-3410**

IN ALABAMA CALL 1-800-292-8668 9 AM TIL 5:30 PM CST, MONDAY THRU FRIDAY

Line Voltage at a Glance

— at last, a useful gadget

L. B. Cebik W4RNL
5105 Holston Hills Road
Knoxville TN 37914

A line voltage monitor can help you protect your equipment investment from problems that fuses and circuit breakers cannot cure. However, most monitors start with relatively expensive meters. To expand their scales for the 90-to-140-volt range may require additional circuitry. There must be an easier way.

The little monitor described here is inexpensive, easy to build, and provides LED indication of the line voltage in five-volt increments, which is as close as most of us need. Its accuracy is good because you can calibrate it against factory- or lab-calibrated instru-

ments. Finally, the entire works are small enough to fit inside another piece of gear, or you can use a separate small case. Apart from the case, \$10-12 should buy you new parts, although I suspect most junk boxes have everything except the IC and the LEDs.

Monitoring the line voltage to the shack has always been fairly important. In recent years, the increasing incidence of brownouts and other line variations has made monitoring even more important. Occasionally voltages will rise or fall to levels which may endanger some equipment, especially motorized equipment. Less catastrophically, a line voltage monitor can help you trace unusual glitches, such as excessive power consump-

tion, to the voltage entering the equipment. At the end of the article, we will look at some applications of the simple monitor described here.

The Circuit: An LM3914

The LM3914 dot/bar display driver is a versatile 18-pin IC available from many sources, including Radio Shack. Pins 1 and 18 through 10 provide terminations for LEDs, which can be set up to come on one at a time or to come on progressively, depending upon how pin 9 is connected. Pins 2 through 8 provide the supply, control, and signal inputs. Fig. 1 shows the basic layout of the chip.

The 3914 consists of a highly accurate voltage divider chain controlling the LED pins through complex

internal circuitry. By setting the high and low limits of the divider, we can achieve a smooth linear progression of lights as the voltage moves up and down at the input terminal, pin 5. Most applications of the 3914 are geared to low voltages, such as audio voltage meters, battery checkers, and the like. However, with a little care, we also can have the 3914 track higher voltages.

To make the 3914 function as a line voltage monitor, we simply need a low dc voltage which varies with the rms value of the ac voltage at our wall plugs. A 9- to 12-volt dc power supply with a relatively constant load will do just this, if the supply is loaded neither too lightly nor heavily. Additional drops across a resistor will also track the ac. In the circuit shown in Fig. 2, tracking by these means has proven as accurate as the expanded-scale ac meters against which the unit was checked.

The circuit in Fig. 2 is an adaptation of the 3914 configuration used by Weinstein and Gartman in their auto battery checker.¹ The resistor divider networks connected to pins 4, 6, and 8 set the lower and upper limits of the readout, while the resistor connected to pin 7 controls the brightness of the LEDs. Pin 5 samples the incoming voltage across another resistor

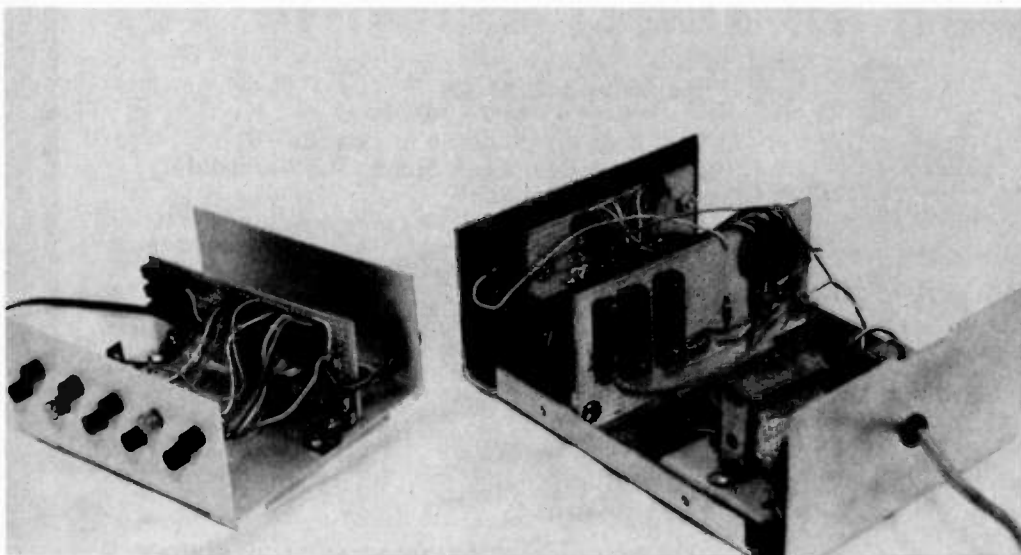

Interior view of these monitors shows two layout possibilities using perfboard construction.

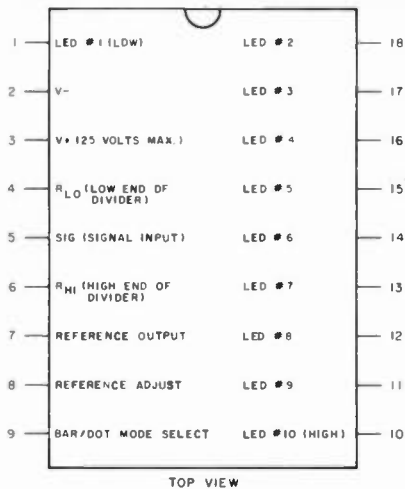

Fig. 1. Pinout of the LM3914 dot/bar display driver.

divider. Jumpering pins 9 and 11 allows the LEDs to light one at a time.

Each LED lights for a five-volt increment from 90 to 140 volts. The one exception is the last LED, at the upper limit, which remains lit when the voltage exceeds 140. The 50-volt range was chosen for several reasons. First, 50 divides neatly by 10. Second, the middle four increments cover the range from 105 to 125 volts, the recommended range for the operation of most electronic equipment. Hence, the readout has a nice symmetry. This fact also allowed me to use different colored LEDs: green for the safe range, red at the dangerous extremes, and amber in between.

The zener in the line feeding the limit-setting resistors is needed to hold the voltage constant to the limit pins. The exact value is not critical, as long as a range of 1 to 3 volts is available from the potentiometers. The pots are 10-turn miniature trimmers for ease of calibration. (Remember that what is called a 10-turn mini pot may have from 8 to 15 turns depending upon the model and manufacturer.) The input trimmer is the same sort of miniature potentiometer, set to give around 2 volts for an ac rms line voltage of 110.

The LEDs can be any

type of the many available across the counter or through mail sources. The object is to create an easy-to-read display, remembering that pin 1 is the lowest, pin 18 is next, and pin 10 the highest value. The 1.8k resistor controls the brightness of the LEDs, and the value shown provides an easy-to-read level without being too obtrusive.

The remainder of the circuit is shown in Fig. 3 and consists of two different power sources for the meter. The original prototype was built with power supply components on hand, while a second version uses a 10-volt ac adapter, with the parts molded into the plug. Anything from 9 to 12 volts will work, so that the ac adapter for a dead transistor radio, tape recorder, etc., can be pressed into service with good results. The meter requires little current, so the current capability of the power supply is not a problem. However, whether you opt for a home-brew supply or an adapter, additional filtration and a load resistor (the 1k resistor in the schematic) are needed to provide a minimum load on the supply.

Construction and Components

The meter itself, as shown in Fig. 2, will fit on a

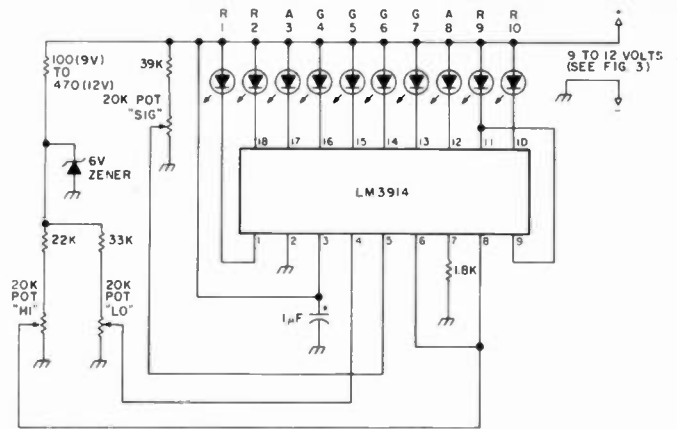

Fig. 2. The metering and LED sections of the line voltage monitor. LEDs: R = red, A = amber, G = green.

2" x 3 1/2" piece of perf-board, assuming the LEDs are panel-mounted elsewhere. A socket for the IC simplifies wiring. Since only a few of the IC pins have more than one connection, wiring is so easy that no printed-circuit techniques have been used, although an enterprising builder might wish to create a board for himself.

Again, with the exception of the LEDs, there are so few external components that layout is no problem. The only caution is to mount the trimmer pots so that they are accessible for calibration. Since they are of the same value, it will pay to label them as HI, LO, and SIG. There is nothing more exasperating than to have the unit in the final tweaking stages of calibration, only to move the screwdriver adjustment of the wrong pot and have to start over.

Different types of LEDs and panel arrangements can be used with equal success. Rectangular bar-graph LEDs from Radio Shack have been used in one model. They are mounted on a piece of perfboard, with leads running to terminal pins on the board. A smaller unit uses jumbo LEDs in plastic mounting lenses. The zigzag line of the unit makes identification of the five-volt incre-

ment very easy, and once panel markings are added, readout is even simpler.

Fig. 4 shows a sketch of the front panel with the colors of LEDs identified. The arrangement from red through amber to green and back again is not only symmetrical, but also reflects the levels of potential trouble from line voltages that wander too far from the norm. In purchasing LEDs, especially green jumbos, be sure to buy more than you need and match them for brightness. The reds and ambers seem to be most consistent, but surplus greens appear to vary quite a bit.

The importance of using LEDs of approximately the same brightness stems from the fact that as the voltage nears a transition from one increment to another, two LEDs may be lit simultaneously. If the LEDs are well-matched, the relative brightness of the two will tell you which side of the dividing line the voltage is on at a given moment. Mismatched LEDs can misinform you. This trouble was not encountered with bar-graph LEDs. The degree of overlapping of LEDs seems to vary from IC to IC, but in no case has it proven to be such a problem as to produce false impressions of the line voltage.

If you use a home-brew power source, you can

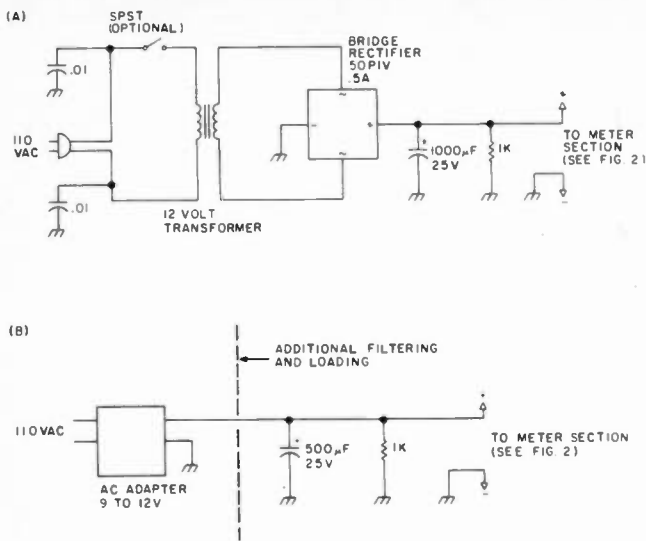

Fig. 3. Power and signal source for the line voltage monitor. (a) Home-brew power source. (b) Ac adapter module power source.

build it on a separate board or use one board for the supply and meter sections. With an ac adapter, the additional components can go on the meter board with the IC and pots. The only precaution with the power source is to use it for no other purpose. The varying load created by a secondary use will alter the voltage to the signal input, destroying the utility of the meter.

The entire assembly is compact and will fit cases as small as 2" x 2" x 4" (with an ac adapter supply). The components also can be mounted within another piece of equipment as long as there is room somewhere for the LED display. If your shack has a master ac control panel, a small corner will be enough for the LED array.

Calibrating the Meter

Many of us have grown accustomed to using fixed components or having equipment factory-calibrated. In the process, we may lose sight of the fact that building an adjustable circuit can lead to a far more accurate instrument. Hence, potentiometers have been used rather than fixed voltage dividers.

The line voltage monitor

described here can be calibrated at two levels of accuracy: close and right on. Close calibration requires only a fairly accurate VTVM and a little arithmetic. To get the meter right on requires a factory-calibrated meter (for ac and dc voltages) and a simple test circuit. The close calibration technique is also a good preliminary step for later, more precise calibration.

Let's begin with a little math. Suppose we let a signal input voltage of 2 volts dc to pin 5 of the LM3914 equal 110 volts ac. The voltage division factor is 55. (We could, of course, use other ratios, within limits.) This factor will apply throughout the meter range. Dividing 90 volts ac by 55 gives us a value of 1.64 volts dc as the lower limit control. Measure the voltage at pin 4 and set the LO pot for this voltage. Similarly, 140 volts ac divided by 55 gives 2.55 volts dc as the value we want at pin 6; adjust the HI pot for this value. The HI and LO pots may interact a bit for this degree of accuracy, so tweak both several times to set the final values. Now adjust the SIG pot until the correct LED lights for the actual value of ac voltage.

Use caution here. Most kit VTVMs were aligned for 110 volts ac from the existing line voltage. Thus, they will be no more accurate on ac than the original adjustment. If you can borrow a well-calibrated instrument or visit a lab bench for a few minutes, you can set the line monitor on target quickly. Do not expect to read exactly 2 volts for 110 volts ac, because there will be a slight offset, but the degree of inaccuracy caused by this is under 1 percent. With a little tweaking back and forth of the signal input pot, you will be able to set the voltage very accurately by watching for the overlap effect on the LEDs.

The monitor is very usable calibrated this way, but if you wish to be more accurate, try the circuit in Fig. 5. This circuit lets you vary the ac voltage to the monitor across the full range of the instrument. Use care, because the voltage can be lethal, and there is a tendency to grow a bit careless after handling the low voltages we use on ICs. The 5k pot should be 4 Watts or more and well insulated from your hands.

As the drawing shows, we will monitor the line voltage as we calibrate the meter. If we wish, we also can monitor the voltage to the control and signal pins, but this is not strictly necessary. If we have performed an initial calibration as described above with some care, we should be close enough to make the precision calibration easy.

First, recheck that the correct LED lights with a voltage in the 110-to-120 range. Now we will run the ac voltage up and down, checking the voltage at which the LEDs change from one to the next. (For these tests we will ignore the absolute limits, since the transitions are more accurate.) If the voltage tran-

sitions are not at the five-volt marks and they are consistently off by a constant amount in the same direction (for example, a volt too high or a volt and a half too low), then adjust the SIG pot to bring the transitions on line. If the amount of error at transition toward the low end of the scale is not constant after bringing the SIG pot as close as possible to the right point, then adjust the LO pot until the changes, especially the 95-volt transition, are correct. Do the same for the upper end of the range.

Remember that the two pots may interact just a bit, so recheck each end of the line. Be sure to make all adjustments slowly, and verify that you are moving in the correct direction before making a sizable change. Large hasty changes can throw everything off. But if everything does go askew, you can set it back in the ball park with a repeat of the first alignment procedure.

Now recheck the alignment, and you should be right on. At most, you may have to adjust the SIG pot a hair more. Although the resistor divider circuits show combinations of fixed and variable resistors, they could be replaced by 50k pots. However, there would be a loss of fine calibration control, so the cost of the three fixed resistors is well justified.

After using the monitor for several weeks, recheck the calibration. Components do change value during their lives, but most of the change (if not catastrophic) is either very early or very late in their lifetimes. Hence, after "burning in" the monitor for a few weeks, a check of the calibration should produce a stable monitor that needs to be tested only during your regular station maintenance checks.

The Standard for Comparison

New **AZDEN® PCS-300** 2-M Handheld FM Transceiver



Shown Actual Size

8 MHz COVERAGE • 142 to 149.995 MHz in 5 kHz steps, including CAP and MARS

IDEAL SIZE & WEIGHT DISTRIBUTION • 7.3" high by 2.5" wide by 1.8" deep; 1.4 lbs.

MICROCOMPUTER CONTROL • All frequency operations are done by means of a microcomputer keyboard with acquisition tone.

LCD DISPLAY WITH TIMED LAMP • Draws almost no current. Lamp times out automatically after 20 seconds.

16 KEY AUTOPATCH • Keyboard works as a Touchtone® pad while transmitting.

PL TONE SWITCH • Actuates optional subaudible tone module.

PROGRAMMABLE "ODD SPLITS" • Transmit and receive on any possible frequency combination. Reset in seconds.

9 CHANNEL MEMORY WITH SCAN • Eight addressable channels and one externally accessible up/down channel retain frequency and standard offset. Backup drain is a scant 10 microamps!

AUTOMATIC INCLUSIVE OR EXCLUSIVE PROGRAMMABLE BAND SCAN • Limits may be reset in seconds. Scans either inside or outside the limits.

BUSY AND VACANT SCAN MODES • Scan for either an occupied or empty frequency.

KEYBOARD LOCK • Prevents accidental change of frequency or scan status.

TRANSMIT LOCK • Avoids unintentional transmission.

DIGITAL S/RF AND MEMORY ADDRESS METER • Shows relative signal strength on receive, relative power on transmit. Also shows memory address.

HIGH OR LOW POWER • 3 watts high, 1 watt low. Low power is continuously adjustable from 0.5 to 3 watts.

TRUE FM • Not phase modulation—Unparalleled audio quality.

AUTOMATIC FRONT END TUNING • RF-stage i.f. varactor tuned for superior sensitivity and selectivity.

RUGGED COMMERCIAL-GRADE MODULAR CONSTRUCTION
The PCS-300 is built to take years of the toughest operating conditions.

SUPERIOR RECEIVER • Sensitivity is 0.25 μ V for 20 dB quieting, 0.2 μ V for 12 dB SINAD.

BNC ANTENNA CONNECTOR

STANDARD ACCESSORIES • Heavy duty NiCAD battery pack (500 mAh), belt clip, hand strap connector, flexible rubber antenna, earphone, ac charging unit, and special stand for table-top operation.

OPTIONAL ACCESSORIES • Deluxe leather case, mobile dc charging cord, external speaker/microphone, and PL tone module.

MANUFACTURER: **AZDEN** JAPAN PIEZO CO., LTD.
No. 12-17, 1-chomé, Kami-Renjaku, Mitaka, Tokyo, Japan, Telex 781-2822452

EXCLUSIVE DISTRIBUTOR: **AMATEUR-WHOLESALE ELECTRONICS, INC.**
1207 S.W. 120 Terrace, Miami, Florida 33176 Telephone (305) 233-3631 Telex: 80-3356 Toll-free (800) 327-3102

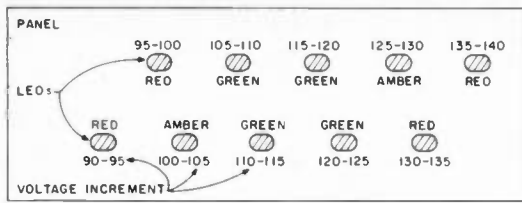

Fig. 4. One of many possible panel layouts for the LEDs.

What the Monitor May Tell You

The line voltage monitor described here is designed to be accurate, but not to yield precise voltage measurements. Within close limits, it will indicate the five-volt range of the current ac line voltage feeding your equipment. For many purposes, these readings will be sufficient. Closer readout of the voltage requires either a meter or a redesign of the present circuit. By adjusting the upper and lower limits, a smaller voltage range can be spread across the same ten LEDs. For example, within the general parameters of the two-step calibration procedure described earlier, setting the LO-HI range between 2.09 and 2.27 volts would permit you to read the ten volts between 115 and 125. If such precision is desired, a second set of resistor dividers might be switched in and out of the circuit (in place of the 50-volt dividers) with a DPDT switch.

Since the primary function of a line voltage monitor in the shack is to warn of possibly dangerous conditions, such precision is rarely required. Most of the monitor's utility is provided by the wider limits. This is especially true in this day and age of brownouts, when power companies—with or without warning—may lower the line voltage to 100 volts or less. Likewise, in some regions with a heavy industrial daytime load, early evening voltages have been reported occasionally to reach 135 volts.

Most household equip-

ment, including ham gear, falls into four main categories: motors, lighting, heating, and electronic devices. Variations in line voltage can affect all four types of equipment, some more radically than others. Motorized equipment such as furnace fans, refrigerators, air conditioners, vacuum cleaners, stove fans, and the like all operate less efficiently as the voltage is reduced. Some types of motors can be damaged if the voltage drops too low and the motor is loaded heavily. In general, if the voltage either drops below 105 or rises above 125, it is best to shut down motors which must work hard. This includes air conditioners, refrigerators, power tools, and similar equipment. Lighter duty motors, such as fans, may be run to wider voltage limits, but do not be surprised should one fail. If any part of the motor has a weak spot, radical voltage excursions are one way of discovering it. These cautions do not mean that every drop or rise in voltage will mean catastrophe; rather, they are suggestions for preventing a possibly sizable replacement cost.

Lighting devices are generally of two sorts: incandescent and fluorescent. Light bulbs will react to line voltage variations by producing more or less light and heat. The power drawn by the bulb will vary approximately as the square of the voltage changes, since the current will also rise and fall with the voltage. The relationship is not exact, since filaments change their resistance with heat. While reduced volt-

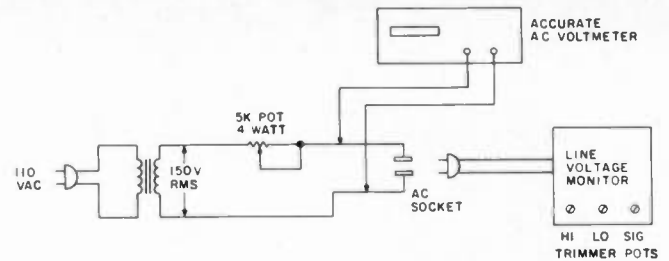

Fig. 5. Test setup for calibrating the line voltage monitor.

age is an annoyance due to the reduced light output of bulbs, excess voltage is a bulb killer. A 10% voltage rise means approximately a 20% power increase, with an accompanying increase in heat. Using the national average ac line voltage of 117 as a standard, as little as 129 volts will produce this effect. Fluorescent fixtures are less evident in their reaction to line voltage variations, but harder starting may not always mean a bad condenser. A quick check with the line voltage monitor is in order first.

Electrical heating devices, such as stove and oven elements, are much like incandescent bulbs. Their heat output will vary as the line voltage varies, and so will the mechanical wear of the element. These are usually hardy devices, and often the adjacent wiring has a shorter lifetime than the element. Nonetheless, expect slower cooking during brownouts.

Electronic devices react to line voltage variations in many ways. Simple devices, such as tabletop radios and stereo equipment, usually show no effects from moderate drops or rises in line voltage. More complex equipment, such as television sets, may show some effects, especially with age. If accumulated dirt and other factors have lowered the high voltage to where it just holds the picture at full size, a brownout can show itself as picture shrinkage. Other effects are usually minor.

Critical equipment, such

as computer terminals, should have heavy, very well regulated supplies, and the voltage feeding the regulator should not be marginal. If these conditions are met, then there are usually few problems. However, if the supply voltage to the regulator is marginal, a severe drop in line voltage may yield a temporarily unregulated supply, with consequent problems in TTL chips, memory, and other parts of the system.

Amateur transmitters and amplifiers will show the effects of line voltage variations in power output readings. In a transceiver or an average transmitter, plate voltage is usually not metered. Suppose your power output meter shows a 10% drop from the previous day's reading. One suspicion that naturally arises is that the final tubes might be going soft. However, a drop in line voltage can produce the same effect. A 10% drop in line voltage may reduce the plate voltage by 60 to 75 volts, depending upon transmitter design. Control positions also may change under these conditions, since the tube now exhibits a different plate resistance.

Rising line voltage also can yield misleading symptoms. Many of us have grown used to tuning up a transmitter to maximum power output, as read from an rf wattmeter or relative power indicator. A 10% rise in plate voltage may give us a temporary boost in power output, a condition which may make us proud for a moment of the equipment

manufacturer's ingenuity. However, if the line voltage is in fact high, then the best bet is to reduce power slightly in exchange for longer tube life. The miniscule difference in power at a receiving station cannot be noticed, but the cost of replacement finals is almost always noticeable.

Amplifiers capable of the maximum legal power for amateurs must have a means of measuring both voltage and current so that we can hold them within limits. Since most amplifiers are capable of loading to greater than 1000 Watts dc or 2000 Watts PEP input, we cannot simply choose a standard level of plate current and assume that we are within the legal power limit. A 10% rise in line voltage can produce a corresponding rise in plate voltage. Reducing plate current is then the only way to hold the power within limits.

These sample potential problems and conditions make a strong case for monitoring line voltage. Some of us are lucky enough to live in areas which never—or hardly ever—have brownouts. High line voltages are even more rare. However, the small price of a monitor will be more than offset if we detect a condition early enough to save the cost of a service call or replacement parts. For this degree of safety and preventive medicine, we need an accurate monitor, although we do not always need to know the exact number of volts. The LED line monitor described here can fulfill the need, while providing an interesting weekend of building and calibrating. ■

Reference

"Guard Your Battery with PM's Charge Checker," Weinstein and Gartman, *Popular Mechanics*, May, 1979, p. 94.

NOT JUST ANOTHER REGULATED POWER SUPPLY!

The **FASTRAK**® model 2001 voltage regulator module is ideal for making reliable power supplies in a jiffy. Use it to power your mobile rig, other **FASTRAK**® series modules or as a general purpose bench supply.

- ▶ Component selection sets output voltage (3.3 to 400 V dc) and current capability (5 mA to 100 A). Over voltage protection and remote shutdown included. Uses no ic's.
- ▶ One evening assembly using 2 × 3.6 inch pc board and comprehensive instructions supplied.
- ▶ Price: \$10.80

Price includes: glass-epoxy, etched, plated, drilled pc board; instruction manual; postage in U.S.A. (Ohio residents add 5% sales tax).

Send \$1.00 for illustrated **FASTRAK**® product catalog and refund coupon.



PROHAM ELECTRONICS INCORPORATED
34620 LAKELAND BLVD EASTLAKE OH 44094
(216) 951-2110

✓ 159

the DX-PEDITER



A HAM RADIO PROGRAM FOR THE APPLE® COMPUTER
By Fred Pearlman WD0DLM

BASH DOES IT AGAIN...

... ON DISC, WITH DOCUMENTATION!!!

Computerize your DX operations. Speed up and simplify your DXCC efforts. Locate any of the 318 approved countries by name, number or prefix... and find out if you've worked it... with the callsign, band, date, time, heading and distance—displayed instantly. DX-PEDITER'S memory contains all the info you need. ENTER AND UPDATE new and pertinent information as to country status and how and when you worked it... and much more.

(Now Available at Your Dealer)

If ordering direct: Retail \$29.95. Add \$2.00 shipping/handling
California residents, please add \$1.95 Sales Tax

BASH EDUCATIONAL SERVICES, INC.
P.O. Box 2115 San Leandro, CA 94577
(415) 352-5420

✓ 26

WORK THE U.H.F. BANDS

Add a transverter or converter to your existing 10m, 6m or 2m equipments. Choose from the largest selection of modules available for DX, OSCAR, EME, ATV.

TRANSVERTERS



MMT 50-144 \$209.95
MMT 144-28 \$199.95
MMT 432-28 (S) \$299.95
MMT 439-ATV \$349.95
MMT 1296-144 \$374.95
OTHER MODELS AVAILABLE
write for details

POWER AMPLIFIERS

all models include RF VOX & Low Noise RX Pre-Ampl.
(no pre-amp in MML432-100)

2 Meters:	100W output	MML144-100-LS	1W or 3W in	\$284.95
	100W output	MML144-100-S	10W input	\$264.95
	50W output	MML144-50-S	10W input	\$239.95
	30W output	MML144-30-LS	1W or 3W in	\$124.95
	25W output	MML144-25	3W input	\$114.95

432 MHz:	100W output	MML432-100	10W input	\$444.95
	50W output	MML432-50	10W input	\$239.95
	30W output	MML432-30-L	1W or 3W in	\$ ask

1268-1296 MHz: Coming soon. Watch for details.

ANTENNAS (incl. 50 ohm balun)

2 Meter J-Beams: 12.3 dB gain
8 over 8 Horizon'l pol D8-2M \$63.40
8 by 8 Vertical pol D8-2M-vert 76.95
1250-1300 MHz Loop-Yagi 1296-LY \$49.75

Send 36¢ stamps for full details of all our VHF/UHF items.

Pre-selector filters
Low-pass filters
Varactor triplers
Pre-amplifiers

Transverters
Converters
Antennas
Crystal Filters

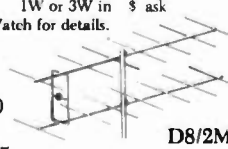

D8/2M



Spectrum International, Inc.
Post Office Box 1084S
Concord, Mass. 01742 USA

✓ 336

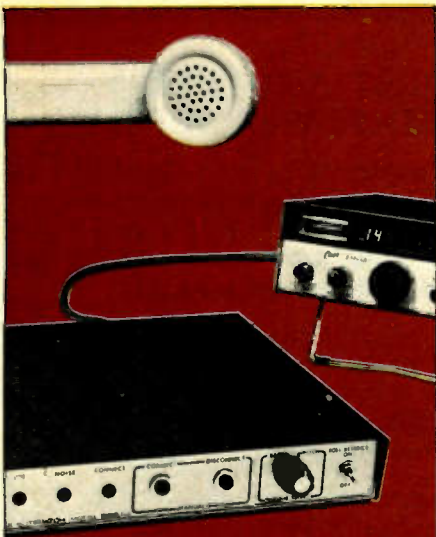

INTRODUCING THE CES 500SA SIMPLEX AUTOPATCH

The First Affordable
Private Phone Patch

As described in 73 Magazine, 6/81.

Now, for the first time! Every amateur operator can enjoy the unparalleled freedom of a private phone patch in an economical package.

The dramatic new CES 500SA Autopatch is all the equipment you need to patch an FM base station to your home or other telephone line, without expensive repeaters, cavities, or other equipment. Connections with any standard FM base station are rapid and simple.

Bypass the congestion and expense of shared repeaters — break through to greater privacy and convenience with the new CES 500SA Autopatch.

COHERENCE IN
COMMUNICATIONS TECHNOLOGY



COMMUNICATIONS ELECTRONICS
SPECIALTIES, Inc.

PO. Box 507
Winter Park, Florida 32790
Telephone: (305) 645-0474

-462

Radio World

CENTRAL NEW YORK'S MOST COMPLETE HAM DEALER

ROBOT 800

ICOM IC-720

KENWOOD TS830S

DRAKE TR7-DR7

YAESU FT707

Featuring Kenwood, Yaesu, Icom, Drake, Ten-Tec, Swan, Dentrone, Alpha, Robot, MFJ, Tempo, Astron, KLM, Hy Grain, Mosley, Larsen, Cushcraft, Hustler, Mini Products, Bird, Mirage, Vibroplex, Bencher, Info-Tech, Universal Towers, Callbook, ARRL, Astatic, Shure, Collins, AEA. *We service everything we sell!*

Write or call for quote. You Won't Be Disappointed.

We are just a few minutes off the NYS Thruway (I-90) Exit 32

OUT OF STATE
ORDER TOLL FREE
800-448-9338

ONEIDA COUNTY AIRPORT TERMINAL BUILDING
ORISKANY, NEW YORK 13424
N Y Res Call (315) 736-0184

Warren - K2IXN
Bob - WA2MSH
Al - WA2MSI

AMATEUR RADIO

SHORTWAVE SCANNERS

SPECTRONICS

Specialists in Amateur Radio,
Short-Wave Listening
And Contemporary
Electronic Gear.

Full Service Shop • Spectrum Analysis • Antennas
New and Used Equipment • CW-SSB-FM, Etc. • Towers
FCC Study Guides • Code Tapes • Books • Accessories

HOURS
MON, TUES, WED.: 9:30-6:00 PM
THURS, FRI.: 9:30-8:00 PM
SAT.: 9:30-3:00 PM

SPECTRONICS, INC.
1009 GARFIELD ST. OAK PARK, IL. 60304

(312) 848-6777

Take your favorite H.T. out for a drive tonight.

VISA or MASTERCARD for
same day shipment.

For \$69.95 you get the most efficient, dependable, fully guaranteed 35W 2 meter amp kit for your handy talkie money can buy. Now you can save your batteries by operating your H.T. on low power and still get out like a mobile rig. The model 335A produces 35 watts out with an input of 3 watts, and 15 watts out with only 1 watt in. Compatible with IC-2AT, TR-2400, Yaesu, Wilson & Tempo! Other 2 meter models are available with outputs of 25W and 75W, in addition to a 100W amplifier kit for 430MHZ.

Communication Concepts Inc.
2648 N. Aragon Ave., Dayton, OH 45420
(513) 296-1411

PORTAPEATER™

M100 A

INSTANT REPEATER

ANY BAND ANY MODE

\$179.00 assembled unit

- * 4 Channel PROM CW I Der
- * VOX or COR operation
- * 250 volt switching capability

\$99.00 assembled board

- * Works with any type radios
- * Complete Timer Functions
- * Built In Test Functions
- * 20 Page Technical Manual

An Instant Repeater (Fully tested, programmed, assembled)

W-S ENGINEERING P.O. BOX 58, PINE HILL, N.J. 08021
(201-852-0269)

BEGINNER'S RUSSIAN

In order to understand a foreign culture, you must know its language. In today's international politics and commerce, one of the most valuable languages to know is Russian. The Beginner's Russian package can put you well on the road to learning this vital language.

The three programs in this package will give you on-screen displays of the Cyrillic letters, detailed instructions on their proper pronunciation, and exercises that will have you recognizing and speaking simple Russian words.

This package is ideal for students, businessmen, scientists—perfect for anyone who is interested in learning the Russian language. Model I, Level II, 16K; Model III, 16K; Recommended age level 10 to adult.

0136R (Tape) \$9.95

Instant Software

Peterborough, N.H. 03458 USA A subsidiary of Wayne Green Inc.

To order call toll free

1-800-258-5473



Fly Around the World!

(and develop a world of business!)

Expand your sales world-wide. Meet importers and manufacturers in Asia and Europe at a series of electronics/computer trade shows arranged for your convenience in Tokyo, Taipei, Hong Kong, Beijing, Canton, Seoul, and Munich. Join about 200 fellow businessmen in taking advantage of this world market for sales and buying. Despite the reasonable tour price it includes some fabulous meals and first class hotels.

Far East Electronics Tour
(Oct. 24–Nov. 7, 1982)

Optional Around-the-World Tour
Including Electronica '82 in Munich
(Nov. 9–13, 1982)

Call Sara collect for more information.
Tel.: (415) 433-3072; (415) 433-3408

Commerce Tours International
870 Market Street, Suite 742
San Francisco, CA 94102

ALL YOUR GEAR AT YOUR FINGERTIPS IN A CONVE- NIENT CONSOLE DESK

Requires only 60" corner space
Formica desk top and shelves
Shelf height adjustable
Solid maple legs
\$495.00 check or M.O.
Shipped freight collect
Allow 30–45 days delivery
Send for detailed brochure

CQ PRODUCTS

8280 Janes Ave.

Suite 137-1700

Woodridge, IL. 60517



(Chair and equipment not included)

Weight of table is 250 lbs.

152

HAVE RTTY—WILL TRAVEL



Yes, now you can take it with you! The new HAL CWR-6850 Telereader is the smallest RTTY and CW terminal available, complete with CRT display screen. Stay active with your RTTY and CW friends even while traveling. Some of the outstanding features of the CWR-6850 are:

- Send and receive ASCII, Baudot, and Morse code
- RTTY and Morse demodulators are built-in
- RTTY speeds of 45, 50, 57, 74, 110, and 300 bau⁻¹
- High or Low RTTY tones
- Send and receive CW at 3 to 40 wpm
- Built-in 5 inch green CRT display
- Four page video screen display
- Six programmable HERE IS messages
- Pretype up to 15 lines of text
- External keyboard included
- Runs on +12 VDC @ 1.7 Amperes
- Small size (12.75" × 5" × 11.5")

Write or call for more details. See the CWR-6850 at your favorite HAL dealer.

345



HAL COMMUNICATIONS CORP.

BOX 365

URBANA, ILLINOIS 61801

217-367-7373

SOCIAL EVENTS

Listings in this column are provided free of charge on a space-available basis. The following information should be included in every announcement: sponsor, event, date, time, place, city, state, admission charge (if any), features, talk-in frequencies, and the name of whom to contact for further information. Announcements must be received at 73 Magazine by the first of the month, two months prior to the month in which the event takes place. Mail to Editorial Offices, 73 Magazine, Pine Street, Peterborough NH 03458.

FLAGSTAFF AZ JUL 30-AUG 1

The Amateur Radio Council of Arizona will hold its 32nd annual hamfest from July 30 through August 1, 1982, at the Fort Tut-kill Fairgrounds, just a few miles south of I-40, Flagstaff AZ. There will be thousands of dollars in prizes, improved XYL activities, a swapfest, a transmitter hunt, speakers, forums, awards, exhibits, and entertainment on Friday and Saturday nights. Overnight camping facilities will be available. Talk-in on 147.870/146.270. For further information, contact Wm. Oliver Grieve W7WGW, 4301 N. 31st Avenue, Phoenix AZ 85017, or call (602)-246-0200.

KINGSFORD MI JUL 31-AUG 1

The Mich-A-Con ARC will hold the 34th annual UP Hamfest on Saturday, July 31, and Sunday, August 1, 1982, at the Dickinson County Armory on M-95, Kingsford MI. Tickets are \$2.50 at the door (no advance sales) and registration will begin at 9:00 am on both days. There will be prizes, family activities, and a Saturday night banquet. Advance banquet reservations are needed since seating is limited. Plenty of free parking will be available. Talk-in on 146.25/.85 and .3922. For further information, write UPHAMFEST-82, 105 East Breitung Avenue, Kingsford MI 49801.

ANGOLA IN AUG 1

The Steuben County Radio Amateurs will hold the 24th annual FM Picnic and Hamfest on Sunday, August 1, 1982, at Crooked Lake, Angola IN. Admission is \$2.50. There will be prizes, picnic-style BBQ chicken, inside tables for exhibitors and vendors, and overnight camping. (A fee will be charged by county park.) Talk-in on 146.52 and 147.81/.21.

PITTSBURGH PA AUG 1

The 45th annual South Hills Brass Pounders and Modulators Hamfest will be held on August 1, 1982, from 10:00 am to 4:00 pm, at South Campus, Community College of Allegheny County, Pittsburgh PA. Admission is \$2.00 or 3 for \$5.00. There will be computer, OSCAR, and ATV demonstrations, as well as a flea market. Talk-in on 146.13/.73 and 146.52. For further information, contact Andrew L. Pato WA3PBD, 1433 Schaffler Drive, West Homestead PA 15120.

BELVIDERE IL AUG 1

The Big Thunder ARC will hold its annual hamfest on Sunday, August 1, 1982, at the

Boone County Fairgrounds, Route 76, Belvidere IL. Admission is \$2.00 in advance and \$2.50 at the gate. A fee will be charged for 8-foot tables and there will be indoor space available in the exhibit building, as well as outdoor space in swappers' row. Sellers will be able to set up Saturday evening or at 7:00 am on Sunday. Features will include door prizes, a main prize, food, and refreshments. Camping will be available on Saturday evening (there will be a charge for electricity). Talk-in on 146.52 and 147.975/147.375. For further information or tickets, send an SASE to Jim Grimsby, 418 Beacon Drive, Belvidere IL 61008.

LEVELLAND TX AUG 1

The Hockley County Amateur Radio Club and the Northwest Texas Emergency Net will hold their 17th annual picnic and swapfest on Sunday, August 1, 1982, beginning at 8:00 am at the city park in Levelland TX. This event is for the entire family. Bring your own picnic basket for lunch at 12:30. A two-meter FM transceiver is the grand prize. A \$3.00 registration is requested but not required. There will be swapping all day, with tables provided. Talk-in on .28/.88.

GLEN MI AUG 1

The Black River Amateur Radio Club will hold the 29th annual Southwestern Michigan VHF Picnic on Sunday, August 1, 1982, at the West Side County Park near Glen MI. (Take exit 30 from I-196 and follow the signs.) There will be swimming, a playground, a small flea market, and door prizes. There is no food available at the park, so bring your own picnic basket. Registration is \$1.00. For additional information, contact Ed Alderman KI8Z, RR #2, Box 44, Lawrence MI 49064.

POMONA CA AUG 7

The Tri-County Amateur Radio Association will hold its annual hamfest/picnic on Saturday, August 7, 1982, from 7:00 am to 1:00 pm, at the Los Angeles County Fairgrounds, Pomona CA. All buyers, sellers, and computer buffs are welcome. There will be prizes, exhibits, and refreshments. Talk-in on 146.025/.625. For more information, write to TCARA Hamfest Chairman W6ELZ, PO Box 142, Pomona CA 91769.

JACKSONVILLE FL AUG 7-8

The Greater Jacksonville Hamfest Association will hold the annual Jacksonville Hamfest and Northern Florida ARRL Convention on August 7-8, 1982, at the Orange Park Kennel Club, located near the intersection of I-295 and US 17 just south of Jacksonville. Advance registration is \$3.50 and is available from Robert J. Cutting W2KGI, 1249 Cape Charles Avenue, Atlantic Beach FL 32233. Registration at the door is \$4.00. The FCC will administer amateur and commercial radio operator exams on Friday, August 6th, at the hamfest site. Those wishing to take the exams should apply to the Atlanta FCC office as soon as possible. Swap tables are \$12.00 per table for both days (no one-day tables) and table reservations, as well as advance registrations, are available from Andy Burton

NX4G, 5101 Younis Road, Jacksonville FL 32218. A full slate of programs is scheduled, along with meetings of statewide and regional nets and organizations, plus competitions including a rabbit hunt and pileup contest. The headquarters hotel is the Best Western First National Inn just across from the hamfest. Special rates may be obtained by writing to Jim Canfield KD4CG, 996 Dostie Circle, Orange Park FL 32073. Talk-in on 146.16/.76 and 146.07/.67.

MONTGOMERYVILLE PA AUG 8

The Mid-Atlantic Amateur Radio Club announces its annual J. B. M. Hamfest to be held on Sunday, August 8, 1982, from 9:00 am to 4:00 pm, rain or shine. Tailgate setup begins at 8:00 am. Located at the Route 309 Drive-In Theater, 1/4 mile north of Route 63, Montgomeryville, PA (6 miles north of the Fort Washington interchange of the Pennsylvania Turnpike). Admission: \$2.50, with \$1.00 additional for each tailgate space. Non-licensed XYLs and children admitted free. Ample parking, refreshments, raffles, door prizes, and more. Talk-in on WB3JOER (147.66/.06) or 146.52 simplex. For further information, write the club, PO Box 352, Villanova PA 19085.

SAUK RAPIDS MN AUG 8

The St. Cloud Radio Club will hold its annual hamfest on Sunday, August 8, 1982, from 8:30 am to 4:00 pm, at the Sauk Rapids Municipal Park, Sauk Rapids MN. Talk-in on 146.34/.94. For more information, contact Mike Lynch, 2115-1st Street, St. Cloud MN 56301, or call (612)-251-2297.

SONOMA CA AUG 8

The Valley of the Moon Amateur Radio Club will hold its third annual ham breakfast and swap meet on Sunday, August 8, 1982, from 9:00 am to 4:00 pm, at the Sonoma Community Center, 276 East Napa Street, Sonoma CA. Breakfast is \$3.50 each for adults and \$1.75 each for children under 12. Waitresses will serve breakfast to people manning swap tables. Hot dogs will be served for lunch. Swap spaces are \$5.00 each and tables can be set up beginning at 8:00 am. (Since there are only 30 tables available, plan to bring your own.) Admission, including a raffle ticket, is \$1.00 and tykes, YLs, and XYLs will be admitted free. Featured will be computer displays and demonstrations, an operating 10-meter FM station, a Sonoma Valley Quilters' table, an amateur television display, an open auction at 2:00 pm, and a raffle at 3:30 pm. Talk-in on 147.47 simplex and 146.13/.73. For further information, call Darrel WD6BOR at (707)-938-8086; for swap space reservations, write VOMARC, 358 Patten Street, Sonoma CA 95476, enclosing payment of \$5.00.

HOUSTON TX AUG 13-15

The Texas VHF Society 1982 Summer Meeting will be held on August 13-15, 1982, at the Nassau Bay Resort Motor Inn, Johnson Spacecraft Center, Houston TX. Pre-registration is \$5.00 for all three days and includes one free ticket for a pre-registration drawing. Each additional prize ticket is \$1.00. Registration at the door is \$6.00 and does not include a prize ticket. There will be special tours of NASA, exhibits, a flea market, a ham astronaut speaker, space shuttle communications, and VHF and ARRL seminars. Prizes include an all-mode VHF transceiver. Talk-in on 146.04/.64 and 147.75/.15. For pre-registration information, write

Texas VHF-FM Society, Summer Session, c/o PO Box 73, Texas City TX 77590.

TACOMA WA AUG 14-15

The Radio Club of Tacoma will hold Hamfair 82 on August 14-15, 1982, at the Pacific Lutheran University campus, Tacoma WA. Registration is \$5.00 and dinner is \$7.50. Activities will include technical seminars, a flea market, commercial booths, an ARRL meeting, a repeater forum, a VHF tweak and tune clinic, prizes, raffles, and a loggers' breakfast. Talk-in on 147.88/.28. For more information, contact Grace Teitzel AD7S, 701 So. 120th, Tacoma WA 98444, or phone (206)-564-8347.

WILMINGTON DE AUG 15

The seventh annual New Delmarva Hamfest will be held on Sunday, August 15, 1982, from 8:00 am to 4:00 pm at Gloriland Park, Bear DE (5 miles south of Wilmington). Admission is \$2.25 in advance, \$2.75 at the gate. Tailgating is \$3.50. Limited tables will be available under the pavilion, but bring your own to be sure. Food and drinks will be available. First prize is an Atari® Home Video Game System. Talk-in on .52 and .13/.53. For more information and a map, send an SASE to Stephen Momot K3HBP, 14 Balsam Road, Wilmington DE 19804. For advance tickets, make checks payable to Delmarva Hamfest, Inc.

AMES IA AUG 15

The Iowa 75 Meter Net will hold a picnic and swapfest on Sunday, August 15, 1982, at River Valley Park, Ames IA. A potluck meal will be held at 12:00 noon, with a program and prizes to follow. Talk-in on .16/.76. For further information, contact Lovelle J. Pederson WB0JFF, Hudson IA 50643.

LAFAYETTE IN AUG 15

The Tippecanoe Amateur Radio Association will hold its 11th annual hamfest on Sunday, August 15, 1982, beginning at 7:00 am, at the Tippecanoe County Fairgrounds, Teal Road and 128th Street, Lafayette IN. Tickets are \$3.00. Features will include a large flea market, dealers, fun, refreshments, and prizes. Talk-in on .13/.73 or .52. For advance tickets or additional information, write Lafayette Hamfest, Route 1, Box 63, West Point IN 47992.

TIOGA COUNTY PA AUG 21

The Tioga County PA ARC 6th Annual Amateur Radio Hamfest will be held on Saturday, August 21, 1982, from 0800 to 1600 at a new location at Island Park, just off US Rte. 15, Blossburg PA. There will be a flea market, food, free camping, an auction, an H/T door prize, etc. Talk-in on .19/.79 and .52. For more information or advance tickets, write Tioga Co. ARC, PO Box 56, Mansfield PA 16933, or contact Paul Sando KC2AZ, 606 Reynolds Street, Elmira NY 14904 on .19/.79 or .96/.36.

DUNKIRK NY AUG 21

The Northern Chautauqua Amateur Radio Club will hold the 4th annual Lake Erie International Hamfest on Saturday, August 21, 1982, at the Chautauqua County Fairgrounds, Dunkirk NY. There will be plenty of outdoor and indoor flea-market space. Prizes will include an Icom IC-2A. Talk-in on 146.25/.85 and 146.07/.67. For more informa-

... at last ...
your shack organized!
 A beautiful piece of furniture — your XYL will love it!

\$184.50 S-F RADIO DESK
Deluxe - Ready to Assemble

Designed with angled rear shelf for your viewing comfort and ease of operation.

FINISHES: Walnut or Teak Stain.
 Floor Space: 39" Wide by 30" Deep

SF

Additional Information on Request.
 Checks, Money Orders, BankAmericard and Master Charge Accepted.

F.O.B. Culver City. (In Calif. Add 6% Sales Tax.)
 _____ DEALER INQUIRIES INVITED _____

S-f Amateur Radio Services

4384 KEYSTONE AVENUE • CULVER CITY, CALIF. 90230 — PHONE (213) 837-4870

Radio equipment not included

Also Available
 Floor Space: 51" Wide by 30" Deep
\$199.50

✓ 65

Confidential Frequency List



New 5th edition by Perry Ferrell

Bigger and better than the world-acclaimed 4th edition, this new book has 30% more stations listed, more than 7500 operating between the international broadcasting and amateur radio bands, spanning 4-28 MHz. Listings by both frequency and callsign reflect present and post-WARC assignments. Complete list of Coastal CW stations plus Embassy, Aeronautical, Military, Time Sigs, Feeders, VOLMET, FAX, INTERPOL, etc. New details on scheds, emergency channels, alternates, and never-before-published IDs.

In USA: \$9.95 Book Mail, or \$12.00 UPS.
 Outside USA: Book Mail US\$11.00.
 Overseas Airmail: US\$14.00 + US\$3.30
 Registration to assure delivery.

GILFER SHORTWAVE
 DEPT. 738, BOX 239, PARK RIDGE NJ 07656

DIRECTION FINDING?

- ★ Doppler Direction Finding
- ★ No Receiver Mods
- ★ Mobile or Fixed
- ★ Kits or Assembled Units
- ★ 135-165 MHz Standard Range



- ★ Circular LED Display
- ★ Optional Digital Display
- ★ Optional Serial Interface
- ★ 12 VDC Operation
- ★ 90 Day Warranty

New Technology (patent pending) converts any VHF FM receiver into an advanced Doppler Direction Finder. Simply plug into receiver's antenna and external speaker jacks. Use any four omnidirectional antennas. See June 1981 issue of 73 for technical description. Kits from \$270. Assembled units and antennas also available. Call or write for full details and prices.

DOPLER SYSTEMS, 5540 E. Charter Oak, (602) 998-1151
 Scottsdale, AZ 85254

✓ 425

ASSOCIATED RADIO

913-381-5900

8012 CONSER BOX 4327
 OVERLAND PARK, KANSAS 66204

BUY—SELL—TRADE

All Brands New & Reconditioned



YOU WANT A DEAL — WE WANT TO DEAL
CALL NOW!!!



SAVE — SAVE — SAVE



NOTE: SEND \$1.00 FOR OUR CURRENT CATALOG OF NEW AND RECONDITIONED EQUIPMENT
 SEND \$1.00 FOR OUR WHOLESALE LIST OF UNSERVICED & OVERSTOCK ITEMS.
 SEND \$2.00 FOR BOTH. THEY WILL BE MAILED SEPARATELY.

tion, contact Ron Warren WA2LPB, PO Box 455, Dunkirk NY 14048.

**OAKLAND NJ
AUG 21**

The Ramapo Mountain Amateur Radio Club (WA2SNA) will hold its 6th annual flea market on August 21, 1982, at the Oakland American Legion Hall, 65 Oak Street, Oakland NJ, only 20 miles from the GW Bridge. Admission is \$1.00; non-ham family members will be admitted free. Indoor tables are \$6.50 and tailgating is \$3.00. There will be a quality open kitchen, and door prizes, including an Icom IC-2AT, will be given away. Talk-in on 147.49/146.49 and 52. For additional information, contact Walt Zierenberg WD2AAI, 344 Union Avenue, Bloomingdale NJ 07403, or phone (201)-838-7565.

**HUNTSVILLE AL
AUG 21-22**

The Huntsville Hamfest will be held on Saturday and Sunday, August 21-22, 1982, at the Von Braun Civic Center in Huntsville AL. There is no admission charge. There will be prizes, exhibits, forums, an air-conditioned indoor flea market, and non-ham activities. Tours of the Alabama Space and Rocket Center are available for the family. A limited number of camping sites with hookups are available at the VBCC on a first-come, first-served basis. Flea-market tables are available for \$4.00 a day. Talk-in on 3.965 and .34/.94. For more information, write Huntsville Hamfest, PO Box 4563, Huntsville AL 35802.

**MARYSVILLE OH
AUG 21-22**

The Union County Amateur Radio Club will hold the Marysville Hamfest on Saturday afternoon and all day Sunday, August 21-22, 1982, at the fairground in Marysville (near Columbus) OH. Admission is \$2.00 in advance or \$3.00 at the gate. Flea market space is \$1.00. Food, beverages, and free overnight camping, movies, and popcorn will be available. Featured on Saturday night will be a free square dance (with a live band) followed by a big country breakfast available all night. Door prizes, ladies' programs, and ARRL, FCC, and MARS meetings will be featured on Sunday. Talk-in on 146.52 and 147.99/.39. For additional information, write UCARC, 13613 US 36, Marysville OH 43040, or call (513)-644-0468.

**WENTZVILLE MO
AUG 22**

The St. Charles Amateur Radio Club, Inc., will hold Hamfest 82 on August 22, 1982, at the Wentzville Community Center, Wentzville MO. Tickets in advance are \$1.00 each or 4 for \$3.00; at the door, they are \$1.50 each or 4 for \$5.00. Admission is \$1.00 per car. There will be prizes, contests, a flea market, food, and air conditioned exhibitions buildings. For tickets, motel and camping information, prize lists, dealer reservations, etc., write SCARC Hamfest 82, c/o Mike McCrann WD0GSY, 25 Elm Street, St. Peters MO 63376.

**ST. CHARLES IL
AUG 22**

The Fox River Radio League will host the Illinois State ARRL Convention in conjunction with its annual hamfest, both to be held on August 22, 1982, from 8:00 am to 4:00 pm, at the Kane County Fairgrounds, St. Charles IL. Tickets are \$2.00 in advance and \$3.00 at the gate. For advance tickets, send an SASE to J. Dubeck KA9HQY, 1312

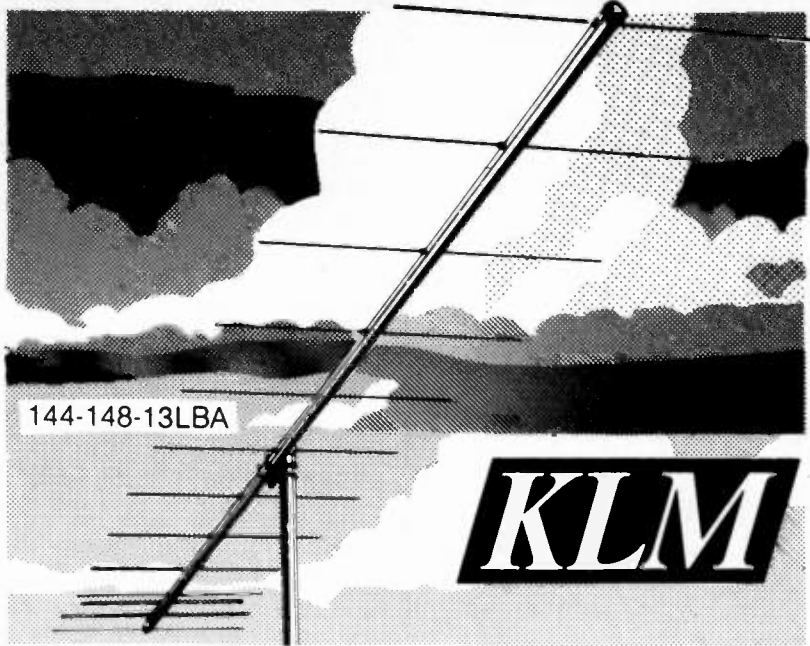

144-148-13LBA

KLM

WHY SETTLE FOR HALF THE BAND?

Enjoy super-gain, low VSWR, and FULL COVERAGE, 144 through 148 MHz, with less weight and windload. Dual-driven elements, balanced feed for a better match and clean pattern.

Bandwidth:	144-148 MHz	Balun:	2KW 4:1
Gain:	15.5 dBd	Boom:	21' 5/1 1/2"
VSWR:	1.2:1 & less	Windload:	1.6 sq ft
Beamwidth:	28°	Weight:	9 lbs

CIRCULAR POLARIZED For the Phase IIIB satellite and terrestrial DX, ATV, and FM. Minimizes multipath and flutter fading. Rugged symmetrical construction.

Bandwidth:	420-450 MHz
Gain:	12 dBdc
VSWR:	1.5:1 & less
F/B:	20 dB

Baluns:	2KW, 4:1 (2)	Windload:	5 sq ft
Boom:	88"/1"	Weight:	3.6 lbs

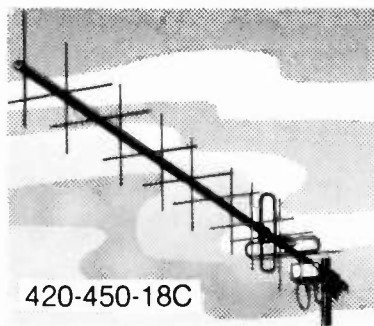

420-450-18C

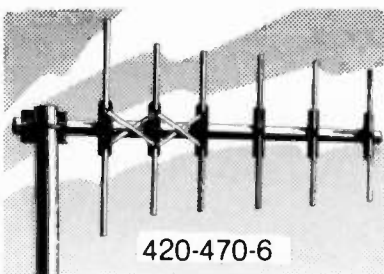

420-470-6

IDEAL for point-to-point and repeater control. Rear-mounted, vertically polarized, compact. Continuous coverage, 420-470 MHz. Direct coax feed suitable for most installations.

Bandwidth:	420-470 MHz
Gain:	8dBd
VSWR:	1.2:1 & less
Beamwidth:	60°
F/B:	20 dB, min
Boom:	2'/1" O.D.
Weight:	1.2 lbs

SEE YOUR KLM DEALER:

KLM Electronics, Inc. P.O. Box 816, Morgan Hill, CA 95037
(408) 779-7363

Bluebell Lane, Batavia IL 60510. There will be commercial exhibits, a flea market, contests, demonstrations, forums, prizes, and hot food. Talk-in on 146.94. Exhibitors, dealers, and vendors should contact G. R. Isely WD9GIG, 736 Fellows Street, St. Charles IL 60174.

**ARGOS IN
AUG 29**

The 7th annual Marshall County ARC Hamfest will be held on Sunday, August 29, 1982, from 8:00 am to 2:00 pm, at the Marshall County 4H Fairgrounds, Argos IN. Eight-foot tables are available for \$3.00 and dealers will be able to set up at 6:00 am. Features will include commercial exhibits, a flea market, refreshments, and hourly drawings. Grand prize is \$200. Talk-in on .071.67, 146.52, and 222.9/224.5. For additional information or reservations, write MCARC, Box 151, Plymouth IN 46563.

**FLINT MI
AUG 29**

The Genesee County Radio Club, the Bay Area Amateur Radio Club, the Lapeer County Amateur Radio and Repeater Club, the Saginaw Valley Amateur Radio Association, and the Shiawassee Amateur Radio Association will hold the sixth annual Five County Swap-n-Shop on Sunday, August 29, 1982, from 8:00 am to 3:00 pm, at Bentley High School, 1150 Belsay Road, Flint MI. Tickets in advance are \$2.00 per person; at the door, \$3.00. Children under 12 will be admitted free. There will be a food concession, free parking, and prizes, including a first prize of a Ten-Tec 580 Delta and 280 power supply or \$500 cash. Talk-in on 146.52 and 147.87/27. For table reservations, contact Perry Baker WA8THK, 9055 Grand Blanc Road, Gaines MI 48436, or phone (313)-635-7287.

**LEBANON TN
AUG 29**

The Short Mountain Repeater Club will hold the Lebanon Hamfest on Sunday, August 29, 1982, at Cedars of Lebanon State Park, US Highway 231, Lebanon TN. There will be outside facilities only and exhibitors should bring their own tables. Food and drink will be available. Talk-in on 146.31/146.91. For further information, contact Mary Alice Fanning KA4GSB, 4936 Danby Drive, Nashville TN 37211.

**SEWELL NJ
AUG 29**

The Gloucester County Amateur Radio Club will hold its fourth annual GCARC Ham/Compfest on Sunday August 29, 1982, from 8:00 am to 3:00 pm at the Gloucester County College, Tanyard Road, Sewell NJ. Tickets are \$2.00 in advance and \$2.50 at the door. The tallgaters' and dealers' charge is \$6.00 and includes one free admission. Doors will open at 7:00 am for setup. There will be speakers, seminars, contests, FCC exams, and prizes, including a Radio Shack TRS-80 computer and a Yaesu FT-208R. Talk-in on 146.52 and 147.78/18. For more information, contact GCARC Hamfest Committee, P.O. Box 370, Pitman NJ 08017, or phone (609)-456-0500 or (609)-338-4841 (days) or (609)-629-2064 (evenings).

**HARRISBURG PA
SEP 5**

The Central Pennsylvania Repeater Association will hold the 9th annual Hamfest/Computerfest on September 5, 1982, beginning at 8:00 am, at the Harrisburg Farm Show parking lot, off the Route 81 Cameron Street exit. (Follow the

**Homebrew
Headquarters**

**R-X
NOISE
BRIDGE
KIT
\$33.45**

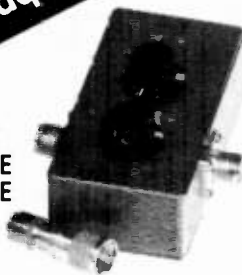

plus \$2.50 shipping & handling

**DON'T TUNE UP ON THE AIR!
USE A NOISE BRIDGE!**

Complete parts kit including pre-drilled diecast enclosure. Measures both resistance and reactance.

Resistance limits: 0-250 ohms
Reactance limits: ±180 pF
Frequency range: 1.5 MHz-30 MHz

Self-contained, uses your receiver as detector.

IN STOCK:
Ladder Line
Antenna Wire
Antenna Traps
Insulators
SWL Antenna
Portable Whip Antenna
and much more!

1982 CATALOG 50c

RADIOKIT

Box 411S, Greenville, NH 03048
(603) 878-1033 ✓454

TALK FARTHER

VoCom Power Amplifiers

Drive Level	Output Power	Model Number
150-200mW	25W	2C025-200mW
1.5W	20-25W	2C025-2W
1.5W	45-50W	2C050-2W
1.5W	80-90W	2C100-2/25
2W-5W	>30W	2C025-2W
2W-5W	>50W	2C050-2W
2W-5W	>100W	2C100-2/25
10W	100W	2C100-10/25
25W	100W	2C100-2/25
25W	100W	2C100-10/25



**with range-extending products
from VoCom**

25, 50, or 100 Watts Power — Whatever your present output level — from 200 mW hand-held on "battery saver" mode to 25W mobile or base — you can use that to drive a compact, 12V power amp from VoCom for much more talk-out power (see chart). Each model has a front panel switch to let you go "barefoot" for short hauls, plus an L.E.D. indicator to show the mode you're in. Full 10 MHz bandwidth gives you virtually unchanged power across the entire 2-meter band. High efficiency design holds down generated heat, low input VSWR saves battery drain by your radio's final amp. Use the chart to see which VoCom Power Amplifier gives you the power out you'd like from the power that you now have.

Power Pocket™ Mobile Amplifier/Charger — Simply plug in your Icom IC-2A(T) and you have a 25W synthesized mobile rig — take it out again, all charged and ready, when you want hand-held operation. Accepts any IC-2A version. Delivers 25W RF output, 2½W audio with 4" speaker to overcome road noise. Charge pocket accepts all Icom battery packs, has independent charging switch, indicator. Mic preamp makes Power Pocket compatible with any mobile microphone and with Icom speaker/mic.

5/8 HT Gain Antenna boosts reception while giving your hand-held full quieting out of spots you're nearly dead in with a rubber duck; provides excellent improvement. Only 8" telescoped, 47" extended. Better than 1.5:1 VSWR. BNC connector.

Spring-loaded 1/4 wave antenna and 4" stubby duck also available. See your favorite amateur radio dealer.

**VoCom
PRODUCTS CORPORATION**

65 East Palatine Road
Prospect Heights, IL 60070
(312) 459-3680

90
Icom and IC-2A are trademarks of Icom America, Inc.
Power Pocket and VoCom are trademarks of VoCom
Products Corp. © 1982 by VoCom Products Corp.

signs to the Farm Show building.) Registration is \$3.00; sellers' 10-foot space, \$5.00; tailgating, \$1.00. Talk-in on 144.875.47, 146.16/.76, and .52. For more information or a map, contact Irvin Sanders K3IUY, RD #3, Box FA53, Harrisburg PA 17112, or phone (717)469-2185.

**HAMBURG NY
SEP 10-11**

Ham-O-Rama '82 will be held on Friday and Saturday, September 10-11, 1982, at the Erie County Fairgrounds near Buffalo NY. Hours are 6:00 pm to 9:00 pm on Friday and 7:00 am to 5:00 pm on Saturday. Advance tickets are \$3.50 (deadline: September 1st) and tickets at the gate will be \$4.50. Children under 12 will be admitted free. The outside flea market is \$3.00 per space and the inside flea market is \$10.00 per space. Features will include new equipment displays, computers, technical programs, ladies' programs, and valuable awards. Talk-in on 146.31/.91. For advance tickets, send an SASE to Dave Baco WA2TVT, 130 Vegola Avenue, Cheektowago NY 14225.

**UNIONTOWN PA
SEP 11**

The Uniontown Amateur Radio Club will hold its 33rd annual gabfest on Saturday, September 11, 1982, on the club grounds located on the Old Pittsburgh Road, just off Route 51 and the 119 bypass, Uniontown PA. The pre-registration fee is \$2.00 each or 3 for \$5.00. There will be free parking, free coffee, and free swap and shop setups with registration. Prizes will be awarded, including a first prize of a Ten-Tec Argosy 525 HF. Featured will be a DX contest, demonstrations, and refreshments. Talk-in on 147.045/.645, 144.57/145.17 and 146.52/.52. For further information, contact UARC Gabfest Committee, c/o John T. Cermak WB3DOD, PO Box 433, Republic PA 15475, or phone (412)246-2870.

**AUGUSTA NJ
SEP 11**

The Sussex County Amateur Radio Club will hold its fourth annual SCARC '82 hamfest on Saturday, September 11, 1982, at the Sussex County Farm and Horse Show grounds, Plains Road off Rte. 206, Augusta NJ, just north of Newton. Pre-registration for outdoor flea-market sellers is \$4.00; at the gate, \$5.00. Pre-registration for indoor flea-market sellers is \$5.00; at the gate, \$6.00. Other registration is \$2.00. There will be door prizes and acres of free parking. Talk-in on 147.90/.30 and 146.52. For additional information or pre-registration, write Sussex County Amateur Radio Club, PO Box 11, Newton NJ 07860, or Lloyd Buchholtz WA2LHX, 10 Black Oak Drive, Vernon NJ 07462.

**MARION IN
SEP 11**

The Grant County Amateur Radio Club Hamfest will be held on Saturday, September 11, 1982, at McCarthy Hall, Marion IN, from 8:00 am until 4:30 pm. Admission is \$2.00 in advance and \$3.00 at the gate. There will be good home cooking, hourly drawings, and major prizes. Talk-in on 146.19/.79 and 146.52. For more information or tickets, send an SASE to Beecher Waters WB9YHF, RR #1, Box 357, Converse IN 46919.

**MELBOURNE FL
SEP 11-12**

The Platinum Coast Amateur Radio Society will hold its 17th annual hamfest and indoor swap-and-shop flea market on September 11-12, 1982, at the Melbourne

Auditorium, Melbourne FL. Admission is \$3.00 in advance and \$4.00 at the door. Swap tables are \$10.00 for one day and \$15.00 for both days. There will be unlimited free parking, a tail-gate area, air-conditioned swap and exhibit area, awards, forums, and meetings. Talk-in on .25/.85 and .52/.52. For reservations, tables, and information, write PCARS, PO Box 1004, Melbourne FL 32901, or call (305)245-5116.

**BUTLER PA
SEP 12**

The Butler County Amateur Radio Association will hold its annual hamfest on Sunday, September 12, 1982, from 9:00 am to 4:00 pm, at the Butler Farmshow Grounds at Roe Airport, Butler PA. Fly-in at Butler Farmshow Airport. Admission is a \$1.00 donation and children under 12 will be admitted free. Overnight campers are welcome and food and refreshments will be available. There will be an indoor flea market (vendor space will be \$3.00 per 8-foot table), a free outside flea market, free parking (including for the handicapped), and prizes, including a Kenwood TS-8305 HF transceiver. Talk-in on 147.96/.36, .52, and 147.84/.24. For additional information, contact Leighton Fennell, Crestmont Drive, RD 6, Butler PA 16001, or phone (412)586-9822.

**WILLIMANTIC CT
SEP 12**

The Natchaug Amateur Radio Association will hold a giant flea market on Sunday, September 12, 1982, from 9:00 am until 4:00 pm, at the Elks home, off Rtes. 32 and 6, Willimantic CT. Tables may be reserved in advance for \$5.00 until September 1st; after that date, they will be \$7.00 at the door. Admission is \$1.00. There will be free parking, as well as raffles and door prizes. Talk-in on 147.30 and 147.90/.50. For further information, contact Clifton Pease KA1HYW, 268 Main Street, Willimantic CT 06226, or phone (203)456-1432 after 4:00 pm.

**CARTERVILLE IL
SEP 12**

The Shawnee Amateur Radio Association will hold its 26th hamfest, SARAFEST '82, on Sunday, September 12, 1982, at John A. Logan College, Highway 13, Carterville IL. Admission is \$2.00 in advance and \$3.00 at the door. There will be an air-conditioned flea market, forums, computers, refreshments, contests, and prizes, including a first prize choice of a Kenwood 130S HF transceiver, a microwave oven, an RCA color TV, or an automatic dishwasher. Talk-in on 146.25/.85, 146.52, and 3.925. For further information, contact William May KB9QY, 800 Hilldale Avenue, Herrin IL 62948, or phone (618)942-2511 days.

**GRAND RAPIDS MI
SEP 18**

The Grand Rapids Amateur Radio Association, Inc., will hold its annual Swap and Shop on Saturday, September 18, 1982, at the Hudsonville Fairgrounds. There will be prizes and dealers, with an indoor sales area and an outdoor trunk swap area. Gates will open at 8:00 am for both swappers and the public. Talk-in on 146.16/.76. For more information, write Grand Rapids Amateur Radio Association, Inc., PO Box 1248, Grand Rapids MI 49501.

**PEORIA IL
SEP 18-19**

The Peoria Area Amateur Radio Club will hold the Peoria Superfest '82 on September 18-19, 1982, at the Exposition Gardens, W. Northmoor Road, Peoria IL. The gate opens at 6:00 am; the commercial building at 9:00

am. Admission is \$3.00 in advance or \$4.00 at the door. Activities include forums, amateur radio and computer displays, a free flea market, and, on Saturday evening, an informal get-together at the Heritage House Smorgasbord. At the hamfest site, there will be free movies Saturday night. Full camping facilities are available, as well as a Sunday bus to Northwoods Mall for the ladies. Talk-in on 146.16/.76. For more information, contact Charles W. Kuhn WD9EGW, PAARC Director, 7005 N. Tobi Lane, Peoria IL 61614.

**MONTGOMERY AL
SEP 19**

The Central Alabama Amateur Radio Association will hold its 5th annual hamfest on Sunday, September 19, 1982, at the Civic Center, downtown Montgomery AL. There will be free admission, free parking, and 22,000 square feet of air-conditioned activities, including a flea market. Setup will be at 0600, doors will be open from 0800 to 1500, and a prize drawing will be held at 1400 CDT. Restaurants and motel accommodations are located within a short walk of the Civic Center and refreshments will be available in the Civic Center. Talk-in on 146.04/.64, 146.31/.91, 147.78/.18, or 147.045 ± 600T. For further information or market reservations, write Hamfest Committee, 2141 Edinburgh Drive, Montgomery AL 36116, or call Phil at (205)272-7980 evenings.

**VENICE OH
SEP 19**

The Forty-Fifth Annual Cincinnati Hamfest will be held on Sunday, September 19, 1982, at Stricker's Grove, State Route 128, Venice (Ross) OH. Admission and prize ticket, \$5.00. There will be exhibits and booths, a flea market (radio-related products only), a hidden transmitter hunt, and an air show. Food and refreshments will be available. For further information, write Lillian Abbott K8CKI, 317 Greenwell Road, Cincinnati OH 45238.

**NEW KENSINGTON PA
SEP 19**

The Skyview Radio Society will hold its annual hamfest on Sunday, September 19, 1982, from noon until 4:00 pm, at the club grounds on Turkey Ridge Road, New Kensington PA. Registration fee is \$2.00; vendors, \$4.00. There will be awards. Talk-in on .04/.64 and .52.

**NEWTOWN CT
SEP 19**

The Candlewood Amateur Radio Association will hold a flea market and auction on Sunday, September 19, 1982, rain or shine, at the Essex House, Rte. 6, exit 8 off I-84, Newtown CT, from 10:00 am to 4:00 pm. Admission fee of \$1.00 includes one door prize chance. Tables are \$6.50. Featured will be an equipment raffle of a TR-2500 hand-talker, dealers, and a magic show for the kids. Refreshments will be available. Talk-in on 147.72/.12. For advance table reservations, write CARA, PO Box 188, Brookfield Center CT 06805. For more information, call George WB2THN at (914)533-2758, Ken KA1GDS at (203)744-6953, or George AF1U at (203)438-0549.

**ELMIRA NY
SEP 25**

The Elmira Amateur Radio Association will hold the seventh annual Elmira International Hamfest on September 25, 1982, at the Chemung County Fairgrounds. Breakfast will be available for several hours after

the gates open at 6:00 am. Advance tickets are \$2.00 and tickets at the gate are \$3.00. Featured will be tech talks, a free flea market, dealer displays, and prizes, including a grand prize of an Icom IC-730. Friday night camping will be available on a limited basis at the fairgrounds and lunch will be available starting at 11:00 am on Saturday. Talk-in on 147.96/.36, 146.10/.70, and 146.52. For advance tickets, write John Breesse, 340 West Avenue, Horseheads NY 14845.

**GAINESVILLE GA
SEP 26**

The 9th annual Lanierland ARC Hamfest will be held on September 26, 1982, beginning at 9:00 am, in the Holiday Hall at Holiday Inn, Gainesville GA. There will be free tables and an inside display area for dealers and distributors (doors will open at 8:00 am for dealer setups). Prize tickets are \$1.00 each or 6 for \$5.00. Food and drink will be available, as well as a large parking lot for a free flea market. A boat anchor auction will be held and all activities and facilities will be free. Talk-in on 146.07.67. For information and free space to dealers, contact Phil Loveless KC4UC, 3574 Thompson Bend, Gainesville GA 30506, or phone (404)532-9160.

**YONKERS NY
OCT 3**

The Yonkers Amateur Radio Club will hold its electronics fair and flea market on Sunday, October 3, 1982, from 9:00 am to 5:00 pm, rain or shine, at Yonkers Municipal Parking Garage, corner of Nepperhan Avenue and New Main Street. Admission is \$2.00 each; children under 12 will be admitted free. Sellers' spaces are \$6.00 (bring your own table) and include one admittance. Gates will be open to sellers at 8:00 am. There will be live demonstrations, hourly prizes, an auction, free parking, refreshments, and unlimited free coffee all day. Talk-in on 146.265/146.853, .52, or CB channel 4. For further information, write YARC, 53 Hayward Street, Yonkers NY 10704, or phone (914)969-1053.

**CHELSEA MA
OCT 17**

The 19-79 Repeater Association of Chelsea MA will hold its annual flea market on Sunday, October 17, 1982, from 11:00 am to 4:00 pm (sellers admitted at 10:00 am), at the Beachmont VFW Post, 150 Bennington Street, Revere MA. Admission is \$1.00. Sellers' tables are \$6.00 in advance and \$8.00 at the door, if available. Talk-in on .19/.79 and .52. For table reservations, send a check to 19-79 Repeater Association, PO Box 171, Chelsea MA 02150.

**NORTH HAVEN CT
NOV 7**

The Southcentral Connecticut Amateur Radio Association's (SCARA's) third annual electronics flea market will be held on Sunday, November 7, 1982, indoors at the North Haven Recreation Center on Linsley Street in North Haven CT. Regular admission is \$1.25; children under 12 with an adult will be admitted free. Sellers' spaces are \$6.00. The best spaces will be assigned first. A limited number of free tables will be provided to the first reservations received. When those tables are gone, space will be available for selling from the floor or from your own table. Food will be available. Sellers may set up at 8:00 am, and walk-ins will be admitted from 9:00 until 3:00. For reservations, send check or money order payable to "SCARA" to Ed Goldberg WA1ZZO, 433 Ellsworth Avenue, New Haven CT 06511. Include an SASE for confirmation.

HAM HELP

I need information on an Abbott TR-4 and an Abbott TR-4B. I would also like information on Navy type CRI-43044, a unit of Model TBY-8 and Model TBY-7.

Craig Renier
7418 Lesada Dr.
Baltimore MD 21207

I need operating/maintenance manuals for the following equipment: Yaesu FT-707; Astro 150A; Hewlett-Packard Model 122AR oscilloscope; Anton Elect. Corp. TS-505 D/U VTVM; and Shallcross ZM-3/U capacitance analyzer.

I will buy originals or pay for copying.

H. Hutchison
N4GQE, HP1XHH, N4GQE/YSI
USMILGP, El Salvador
APO MI 34023

I am looking for an instruction or technical manual for an old BC 211M frequency meter as well as for a CW filter for a Galaxy GI 550A transceiver. I will pay.

Bob Currier KA5ETF
5529 Marblehead
Jackson MS 39211

I would appreciate any information on a frequency counter which could be used with the Collins 51S-1 and 51J-4 receivers. I am also looking for anyone who has modified a 51J-4 to receive FM or who may be able to supply a suitable modification.

Ciano Strachan C6ANI
PO Box N4106
Nassau NP
Bahamas

I am in need of a schematic or manual for an RCA Institute scope. Tubes are 1V2, 6BL8, 6D10, 6X4WA, (2) 12AU7s, and WX5078 P1. I will pay for the information.

J. W. Hopson W4AEM
959 Overhill Drive
Alexander City AL 35010

I need the QSL cards of those who are Church of Christ hams for the 1983 Church of Christ Callbook I am putting together.

Ray Hawk NW4L
1461 East Chester
Jackson TN 38301

I would like to purchase original manuals for the Hickok Model 1805A oscilloscope and Tektronix Model N preamp.

Eichi Takarada
1423 Vassar Rd.
Rockford IL 61103

Would the fellow who sold me the Comco business-band handle-talkie at the Dayton Hamvention please contact me. I would like to buy the Model 43 Teletype machine that you had shown me. Please call collect after 6:00 pm: (614)-922-2652.

Daniel Durgin KA1AFJ/8
121 Lake St.
Uhrichsville OH 44683

I would like to hear from anyone who has a cure for the S-meter drift problem in the Tempo 1 transceiver.

Dick Roux N1AED
25 Greenfield Dr.
Merrimack NH 03054

NEMAL ELECTRONICS COAXIAL CABLE SALE

This Month's
Specials
Same Day
Shipping

POLYETHYLENE DIELECTRIC

RG213 noncontaminating 95% shield mil spec. 36¢/ft.
RG174/U mil spec. 96% shield. 10¢/ft.
RG11U 96% shield, 75-ohm mil spec. 25¢/ft.
RG8U 96% shield, mil spec. \$27.95/100 ft. or 31¢/ft.
RG6A/U double shield, 75-ohm. 25¢/ft.
RG58AU stranded mil spec. 12¢/ft.
RG58 mil spec. 96% shield. 11¢/ft.

LOW LOSS FOAM DIELECTRIC

RG8X 95% shield (black, white or gray).....\$14.95/100 ft.
17¢/ft.
RG8U 80% shield.....18¢/ft.
RG58U 80% shield.....07¢/ft.
RG58U 95% shield.....10¢/ft.
RG59U 100% foil shield, TV type.....\$7/100 ft. 10¢/ft.
RG8U 97% shield 11 ga. (equiv. Beiden 8214).....31¢/ft.

Rotor Cable 8-con. 2-18 ga, 6-22 ga.....19¢/ft.

Connectors—shipping 10% add'l, 2.50 minimum

Cable—shipping \$3.00 1st 100 ft., \$2.00 each add'l 100 ft.

1327 NE 119th Street, Dept. RLO, No. Miami, FL 33161 Call (305) 661-5534

RG8U-20 ft., PL-259 ea. end.....\$4.95
RG214U dbi silver shield, 50 ohm.....\$1.35/ft.
100 ft. RG8U with PL-259 on each end \$19.95
BELDEN Coax in 100 ft. rolls
RG58U #9201.....\$11.95
Grounding strap, heavy duty tubular braid
3/16 in. tinned copper.....10¢/ft.
3/8 in. tinned copper.....30¢/ft.

CONNECTORS MADE IN USA

Amphenol PL-259.....79¢
PL-259 push-on adapter shell.....10/\$3.89
PL-259 & SO-239.....10/\$5.89
Double Male Connector.....\$1.79
PL-258 Double Female Connector.....98¢
1 ft. patch cord w/RCA type plugs each end.....3/\$1.00
Reducer UG-175 or 176.....10/\$1.99
UG-255 (PL-259 to BNC).....\$3.50
Elbow (M359).....\$1.79
F59A (TV type).....10/\$2.15
UG 21D/U Amphenol Type N Male for RG8.....\$3.00
BNC UG88C/U, male.....\$1.25
3/16 inch Mike Plug for Collins etc.....\$1.25
UG273 BNC to PL-259.....\$3.00

FREE CATALOG

COD add \$1.50—FLA. Res. add 5% Sales Tax

Ducks are getting
smaller!
and...

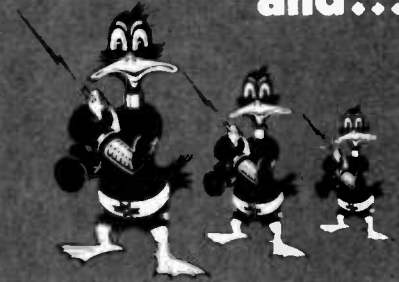

better!

Because you and the leading radio manufacturers want the best-performing, the best looking antenna, Centurion has grown to be the Duck leader. We've developed many smaller antennas to make the hand-held radio perform better and now the newest duck...the 1/4 Duck 'mini'. It's shorter (about 3") yet it's a full 1/4 wave radiator on VHF.



Actual Size

CENTURION
TOP DUCK
ANTENNAS

CENTURION

Phone 402-467-4493

Telex 48-1327-CENTURION LCN

P.O. Box 88846, Lincoln, NE 68501

DAIWA

ACTIVE AUDIO FILTERS - ADD ON TO ANY SET
AF406 \$96. AF606 WITH PLL CW DET. \$110.

CROSS NEEDLE POWER AND SWR METERS
CN520 HF 2KW \$65 CN540 VHF \$75

AUTOMATIC ANTENNA TUNER 2.5KW PEP
3.5-30 MHZ DUMMY LOAD CNA2002 \$449.

MANUAL ANTENNA TUNER CROSS NEEDLE
METER CNW518 1KW \$297. CNW418 \$189.

MOBILE ANTENNA DA100 4.1dB 2M \$33.
DA200 5.2dB 2M \$45. DA500 DUAL BAND
2.7 dB 2M AND 3.4 dB 440MHZ \$36.
MOUNTS GM500 GUTTER OR TM400 TRUNK
INCLUDES COAX AND PL259 \$19.

ELECTRONIC KEYS 8-50 WPM SIDETONE
DK200 \$80. DK210 WITH LED SPEED \$96.

ANTENNA ROTATOR CHOOSE PRE-SET (X)
OR ROUND (R) WORLD MAP CONTROLLER
DR7500() \$200. DR7600() \$260.

2M 30W HT POWER BOOSTER 150MW (A)
300 MW (B) OR 1.5 W (C) INPUT LA2030() \$110.

POWER SUPPLY 9-15V ADJUSTABLE PS300
30 A \$225. PSR1250 SWITCHING 50 A \$595.

INFRARED CORDLESS MIKE RM940 \$75.
SPEECH PROCESSOR PHOTOCOUPLER RF670 \$75.

KDK

FM2030 25WATT DTMF MIKE \$299.

PANASONIC

5" COLOR TV AND VIDEO MONITOR 110/112 V
PORTABLE VARACTOR TUNE CT5511 \$420.

VCR CAMERA AND MONITOR ALL BATTERY
POWER COLOR SYSTEM PV3100 PK800 TY26A
CT5511 TY361R \$2344.

GENERAL COVERAGE SHORTWAVE RF4900
\$399. RF3100 \$299. RF2600 \$219.

SPECIALS

DAIWA DA200 WITH MOUNT \$58.95 CHOOSE
GM500 TM400 LARSON MAG OR TMB

FM ATLAS AND STATION DIRECTORY - DATA
ON FM BROADCAST STATIONS \$6.95

TDK C180 3 HOUR CASSETTE \$6.00

TDK CONTINUOUS LOOP 30 SEC \$4.50
3 MIN \$3.50 12 MIN \$4.50

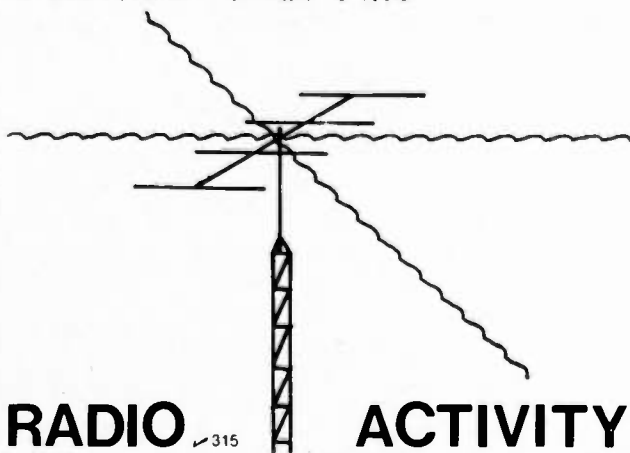

RADIO ✓315 **ACTIVITY**
531 WEST COLLINS DRIVE
CASPER, WYOMING 82601



Tune In...With

MONITORING TIMES

Published Bi-Monthly



Take charge of your scanner or short wave receiver. Learn where to look and when to listen with help from MONITORING TIMES, the only broad-spectrum publication written for serious listeners.

There's an adventure waiting at your fingertips. Tune in drug smuggling communications, spy networks, Space Shuttle support broadcasts, military and government air-to-ground radio, pirate and clandestine transmissions, ship-to-shore links--and much, much more.



Send for **FREE** sample copy today.
Please write to:

MONITORING TIMES
140 Dog Branch Road
Brasstown, N.C. 28902



Organize your shack with a
**CLUTTERFREE MODULAR
CONSOLE \$203.35**

- Large, 42" H x 57" W x 29"D
- Strong groove-construction
- Mar-resistant wood grain finish
- Options, drawers & face plate
- For ham or home computer
- Visa and Master Charge

CLUTTERFREE MODULAR CONSOLES

P.O. Box 5103 Tacoma, WA 98405
(206) 272-8321 ✓89

SOME BASIC MATH

FROM MICROLOG



START WITH
THE FANTASTIC
ATR-6800 SYSTEM
FOR RTTY/CW ...

PLUS!

“BASIC” COMPUTER LANGUAGE

+

COMMUNITY MAILBOX

+

CONTEST DUPE SHEET

+

MESSAGE EDITOR

+

24K BATTERY-BACKED MEMORY

— Write and load programs in easy to use “BASIC”.

— Enter, store, replay, delete etc. individual messages remotely.

— Did you work him or not? When? etc. or use for personal station log.

— Create perfect message quality text with editing capabilities.

— Never lose your MAILBOX, station LOG, DUPE sheet or program. 24K = 24576 characters.

=

The most complete communications system available today
(or for years to come!)

With the addition of this one internal multi-function board and basic module to your ATR-6800, ALL of the above features are available, as well as the superior RTTY/CW performance in one attractive RFI PROOF package.

Factory installed for \$599, contact us for scheduling at 18713 Mooney Dr., Gaithersburg, Md. 20879. Tel. 301-258-8400.
ATR-6800 with 9” video \$2,495.

MICROLOG

51

INNOVATORS IN DIGITAL COMMUNICATIONS

Confessions of a Counter Evolutionary

— the best circuit yet?

Editor's Note: The LSI Computer Systems LS7030 counter chip used in this project is available from Belco Electronics, 43 South 49th Ave., Bellwood IL 60104, for \$12.75 plus shipping. Next month we'll bring you the conclusion of WA2FPT's discussion.

As many of you may have done already, I had vowed never again to be lured into reading another frequency counter article, one more of those ubiquitous "counter updates," or even another of the scores of ads splashed over the pages of ham maga-

zines. I was certain that I had been told more than I ever wanted to know about counters.

Why have I yielded to temptation (lured by the possibility of publication) and become a part of this ever-increasing problem? I confess! The truth is, I was seduced by an LSI counter chip, the LS7030 from LSI Computer Systems, Inc. This little beauty measures a full 40 (pins, that is) and is an 8-decade, multiplexed up counter. It counts directly to 5 MHz, is CMOS and TTL-voltage compatible,

and has BCD and 7-segment multiplexed display outputs. It also employs and enjoys leading-zero blanking and very low power consumption. A real gem!

Even with all this on a chip, what would cause anyone, much less an impatient convenience-seeker like me, to take the trouble to design a frequency counter when there are a host of appetizing kits well within the one "centibuck" range? I'll answer this in terms of the WA2FPT 7030 Universal Counter's features:

- 10-MHz oven-controlled crystal oscillator
- Full 8-digit resolution with no least-significant-digit bobble (no ± 1 count uncertainty)
- Four selectable timebase gate times: .01, .1, 1, and 10 seconds
- Hi-Z dc to 5-MHz preamp input
- Lo-Z 5-500-MHz preamp prescaler input
- Kiloherzt, megahertz readout with automatic decimal point placement
- Period measurement with 20-period average,

with direct readout in μsec to 99,999,999 (equivalent to .01 Hz)

- Events mode (totalizing) with manual front-panel controls and remote rear-panel control inputs
- Separate power regulators for the master oscillator, front ends, displays, and counter
- 10-MHz TTL test output and 6 additional buffered CMOS oscillator timebase signal outputs from 10 Hz to 1 MHz
- 25-pin E1A RS-232C type monitor jack for future remote-data acquisition and control
- Push-button front-panel operation with LED indicators—no rotary switches
- 90% wire-wrapped non-critical construction

If these features are interesting, then read on to see how to build this deluxe counter for truly a fraction of the cost of a commercial equivalent.

Before we get tangled up in our wire-wrapping, here's a short review for those who don't live and breathe digital counters. If you are one of those fortunate few



Photo A. Push-button selection is used to control the 7030 Universal Counter.

who do, then skip this short primer.

Elementary Counting

The simplest form of a counter is one that only totalizes incoming events. Fig. 2 shows three basic functional parts. The input conditioner transforms a physical event into electrical signals that are used to increment the second part. The decade counter counts from 0 to 9 and provides a carry-out to the next digit counter. The third vital element is the indicator. It decodes and converts the outputs of the decade counter to a visual presentation hopefully useful to some observer.

Fig. 3(a) shows a simple frequency counter. To count frequency, a "window" or "gate" must open and close for a specified time interval to give counts per second, or even "furlongs per fortnight." Any number of something counted in a unit of time is an expression of frequency. Simple enough.

Two extra items are needed, however, to make a frequency counter useful: a reset and a holding or loading device. The reset is needed to ensure that the counter begins counting from zero at the beginning of the gate time. The loading device retains the value of the last count and then updates the display with that value after the counting window has shut. This "new improved" simple frequency counter is shown in Fig. 3(b).

Period counters measure the time between events. Often period measurement is used to accurately calculate very low frequencies. This becomes necessary as the value of the frequency approaches the frequency of the counting gate. To appreciate the added resolution available for such low-frequency measurement, suppose you wanted to measure the ac line frequency. It's 60 Hz, right?

Well, if you want to measure it to four significant digits, you would need a gate time of at least 100 seconds (to give a 60.00-Hz display)—a long time to wait. A simple period counter could enable us to obtain the required resolution by using our "unknown" line frequency (suitably conditioned for our digital circuitry) as the gate for a much higher known frequency, say 10 kHz (often readily available in timebase oscillator divider chains).

Suppose these 10-kHz pulses are then counted and displayed as before. Fig. 4 shows how the 60-Hz signal gives a count of 1668. This value is .01668 seconds, the period of the line frequency. As frequency = 1/period, and vice-versa, our 4-place readout is readily converted to frequency by using a calculator to divide 1 by 0.01668. Answer: 59.95 Hz. All we did to get this handy period counter was to interchange the "unknown" signal and the gate time. There is no waiting 100 seconds, either, as the display could normally be updated about 60 times per second.

Now that you're all enlightened, let's be counter productive and get back to the real counter.

Master Oscillator

The evolution and progression of the WA2FPT Universal Counter will be covered in pieces by looking in some detail at each of the Fig. 1 blocks.

The beating heart of any counter, the master oscillator, will be described first. The one shown in Fig. 5 is based on a 10-MHz AT high accuracy series-mode quartz crystal matched to its 85° oven. Both the crystal and oven were purchased from International Crystal Manufacturing Co., 10 North Lee, Oklahoma City OK 73102. The bucks spent here or on a similar

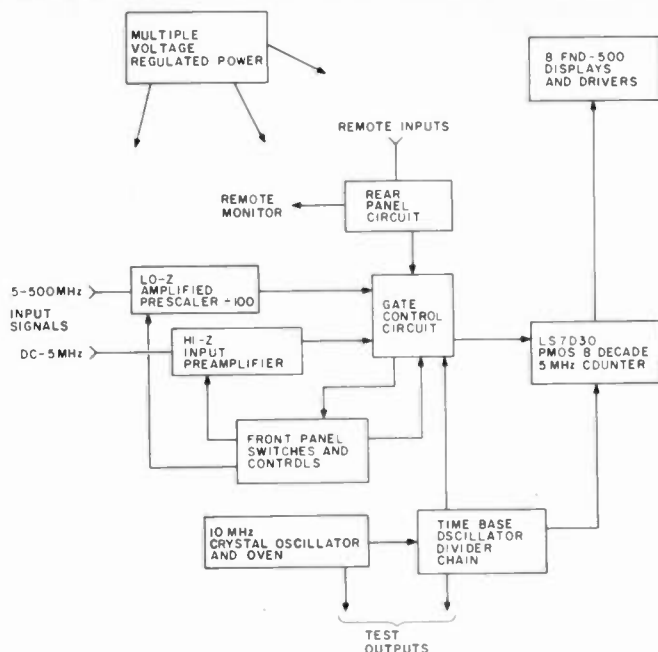

Fig. 1. Block diagram.

affair will be well worth it to provide stability and accuracy for your counting machine.

The oscillator itself is a 5400 TTL quad 2-input gate. A 7400 could be used, but the "Milspec" 5400 in its ceramic package was also chosen for stability (and because I had one!). The voltage regulation for the oscillator is provided by a dedicated 723 wired to give a 5-6-volt, 150-mA output. The oscillator, along with a 74LS90 decade divider, draws about 130 mA, which provides a desirably constant load. The variable capacitor serves as a coarse frequency trimmer. Except for the frequency and the 723 portion, this circuit is the same as the one WA1FUE described in his excellent counter article in the December, 1976, issue of *73 Magazine*.

I had hoped originally to build the 5400 into the oven, but soon found there

wasn't enough room. Because there is a double oven, there is room for a trimmer cap as well as the crystal inside. The oven plugs into an octal socket mounted on a small aluminum minibox containing the 5400, the 723, and the rest of the oscillator components.

An extremely simple printed circuit board layout is shown in Fig. 6(a). This full-size board is copper-clad epoxy glass with 0.1" centered holes (Vector 169P44C1 or equivalent).

Keeping the trimmer capacitor in the oven solves a significant source of oscillator variance due to trimmer cap temperature drift. As the oven heats up to 85° C, the trimmer heats up, and, as the oven stabilizes, so does the trimmer. As you might imagine, a decent mica or ceramic trimmer (25-75 pF or so) is required here. The oven cover may have to be left off, depend-

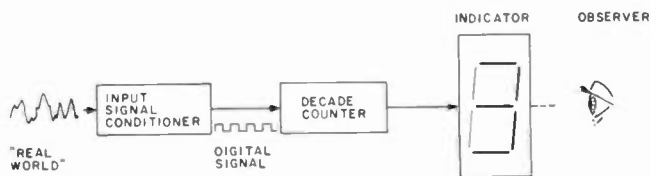

Fig. 2. Simple events counter.

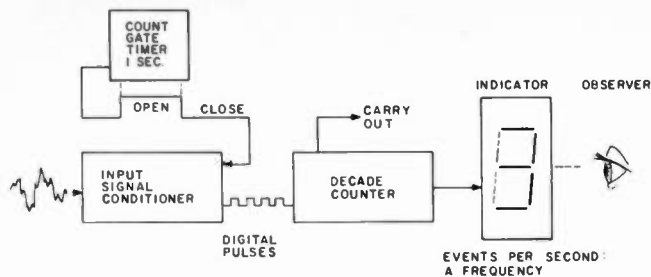

Fig. 3(a). Basic frequency counter.

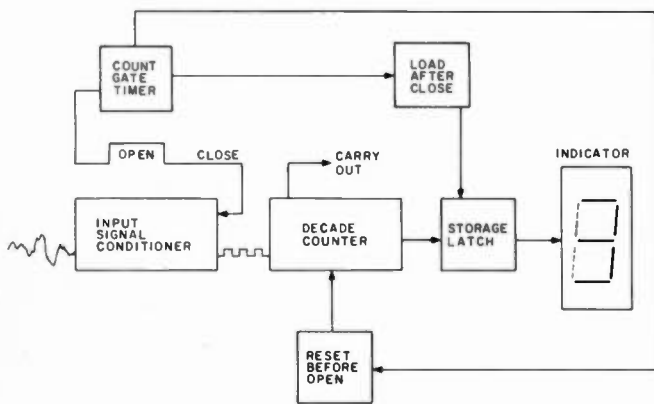

Fig. 3(b). Improved simple frequency counter.

ing on the size and/or accessibility of the capacitor's adjustment screw.

In addition to the trimmer capacitor, there is a fine frequency adjustment. The 723 has a ten-turn 500-Ohm pot to give controlled millivolt level changes in the 5-6-volt range of the 723 output. This allows minute tweaking of the output frequency. A screwdriver access hole for the trimmer pot screw was planned and cut in the minibox housing and through the counter chas-

sis. Binding posts were provided on top of the minibox near the plug-in crystal oven for monitoring the output of the 723. This, with a rear-panel BNC 10-MHz test jack, allows convenient access to long-term oscillator drift and aging data versus voltage, if there should be a need for such logging. The 74LS90 is wired to produce a symmetrical 1-MHz square wave, and miniature coax, RG-174 or its equal, routes this signal to pin 22 of a 44-pin edge connector on the main counter board.

Timebase Oscillator Dividers

The timebase oscillator dividers (TBOD) are mounted on wire-wrapped sockets on the main board of the counter—a 4.5" x 6" Vector 3662. The wiring for the TBOD is shown in Fig. 7. ICs 3, 8, 9, and 10 are 74C90s, while ICs 2, 5, and 6 are 4029 types.

The 74C90 devices are wired as decade dividers, with the output of the $\div 5$ portion, pin 11, fed into the input of the $\div 2$ section at pin 14. The 4029 is a dual-mode (decade or binary) up-down (user-selectable) counter in a 16-pin package. In this application it is wired as a decade up counter. There is no reason why 74C90s could not be used exclusively as they are cheaper to buy and use cheaper sockets. I used both chips because I had a few of each on hand.

The TBOD, as is customary in electronic counters, provides a number of important signals that are distributed throughout the machine. The signal frequency and its destination, together with a brief description, comprise the list of pulses picked off the IC chain (see Table 1). As long as the master oscillator runs, these signals are present.

Display

The eight seven-segment common-cathode displays in this counter are FND 500 .5" right-hand decimal-point devices. They can be purchased for under a dollar apiece from many sources and are entirely adequate.

The displays are multiplexed, which is a fancy way of saying that one digit is lit at a time. Our persistence of vision will see all eight digits lit, however, if the scanning rate is fast enough. This technique greatly reduces power supply drain and just happens to be built into the 7030

chip. The 7030 implements this feature with an on-board digit-scanning generator that strobes the digits sequentially from left to right (digits 8 to 1) when a pulsing signal is input to pin 39. There is also a built-in digit-scanner oscillator requiring only an external capacitor between pins 39 and 40. Since the TBOD has a plentiful supply of signals, a 1-kHz signal was used for scanning, and it works well. A scan reset is needed, according to the 7030 data sheet, to avoid display damage and for leading-zero blanking. I used a 20-Hz signal, allowing 50 display scans before a reset blanks the display.

The result is a nice bright display with an almost imperceptible flicker. Faster scanning rates are possible, and faster resets will produce no visible flicker whatsoever, but the brightness will suffer. This is because the digit strobe duty cycle is only about 12%. The scanning-oscillator signal is divided into eight such sequential strobes.

These strobes, as MOS outputs, are not sufficient to drive display diodes directly. Instead, the strobes are sent to 75492 hex MOS-to-LED drivers, which have six drivers per package, each capable of sinking 250 mA.

The seven-segment information is similarly amplified by 75491s, which are quad MOS-to-LED segment drivers. The seven segments, labeled a-g, plus the decimal point, fully use two 75491 chips.

In a multiplexed display system, the seven-segment outputs are "daisy-chained" to all digits. That is, all the "a" segments for all the digits are wired together, and the "b" segments are wired to each other, and so on.

As the seven-segment information is sent to all those diodes, only the di-

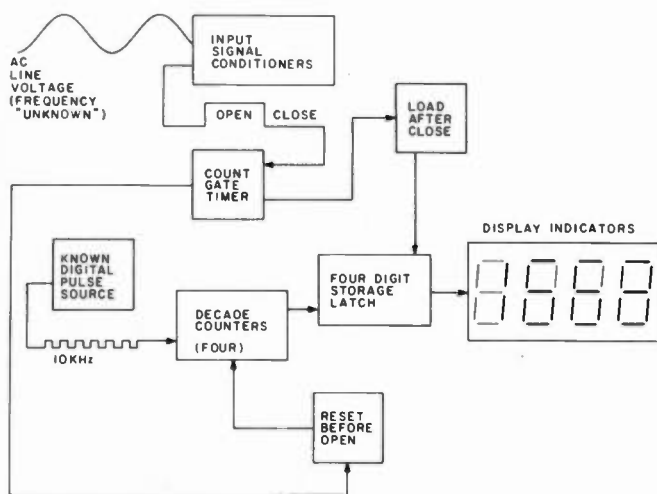

Fig. 4. Period counter example.

odes in the digit that receives a strobe will light up.

A simplified pseudo-schematic could help illustrate this in Fig. 8. Assume that the three digits 8, 7, and 6 all have ones to be displayed. The active segment outputs from the 75491 are the "b" and "c" segments that will give a one when each digit is strobed. To forward bias the LEDs, the high pulse to the 75492 is inverted to a low, which will provide the proper bias solely for digit 8. The next strobe will activate digit 7 (turning off 8), and the next, digit 6 (turning off 7). All seven-segment information is synchronized by the digit strobes, and we see the result arranged as numbers 0-9. When the scan reset occurs, the scan oscillator restarts at position 8, the most significant digit.

One of the many economies resulting from display multiplexing is the elimination of the usual current-limiting resistors. They are not needed here because the scanning rate is sufficient to keep the average current through the LEDs at an acceptable level. A "direct drive" 8-digit display with decimal points could require 8 latches, 8 decoder drivers, and 64 current-limiting resistors. The overall brightness of the display may be varied by changing

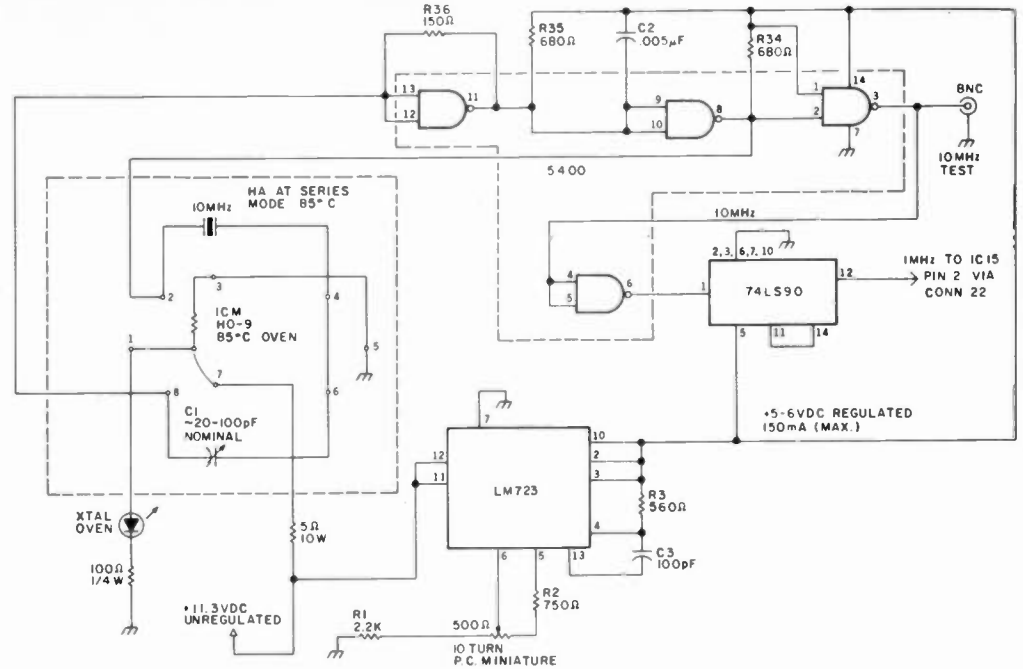

Fig. 5. Master oscillator.

the supply voltage to the 75491 and 75492 devices and the scan rate.

The FND 500s are not as efficient as they are inexpensive, and the overall brightness was enhanced by using an 8-volt regulator, an LM340T-8, solely for the panel LEDs and the eight seven-segment display drivers.

If you decide to use different displays in your version, you will probably want to experiment a little with different voltages and scanning rates to optimize

the display presentation to your liking. Fig. 9 shows the complete 8-digit wiring used in this counter.

The 7030 has a lamp-test input (pin 38) that, when brought high (+5 volts), will light all segments of all eight digits, showing all 8s. I couldn't resist putting a "lamp-test" push-button on the front panel for that purpose. The circuit used, though, does provide a useful function, because a counter overflow condition is also incorporated.

The 7030 has its three

most significant decade overflow outputs for digits 8, 7, and 6 brought out to pins 14, 15, and 16, respectively, of IC1. Because this machine is an 8-digit counter, it made sense to use the eighth decade overflow output from pin 14 to set the overflow input latch at pin 13 of the 7030. An internal flip-flop holds the overflow indication until a counter reset (not a scan reset) occurs. As the overflow output becomes active, it sets the 4013 IC31 in the lamp-test circuit, causing a

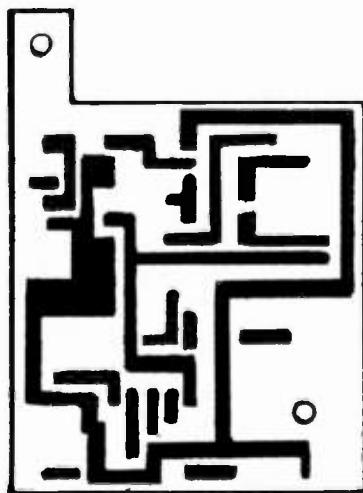

Fig. 6(a). Master oscillator PC layout.

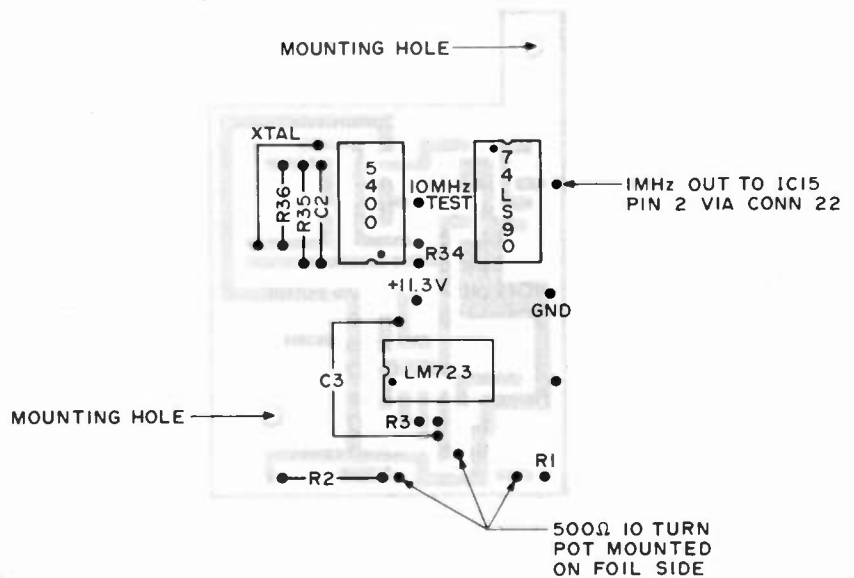

Fig. 6(b). Parts placement for master oscillator board.

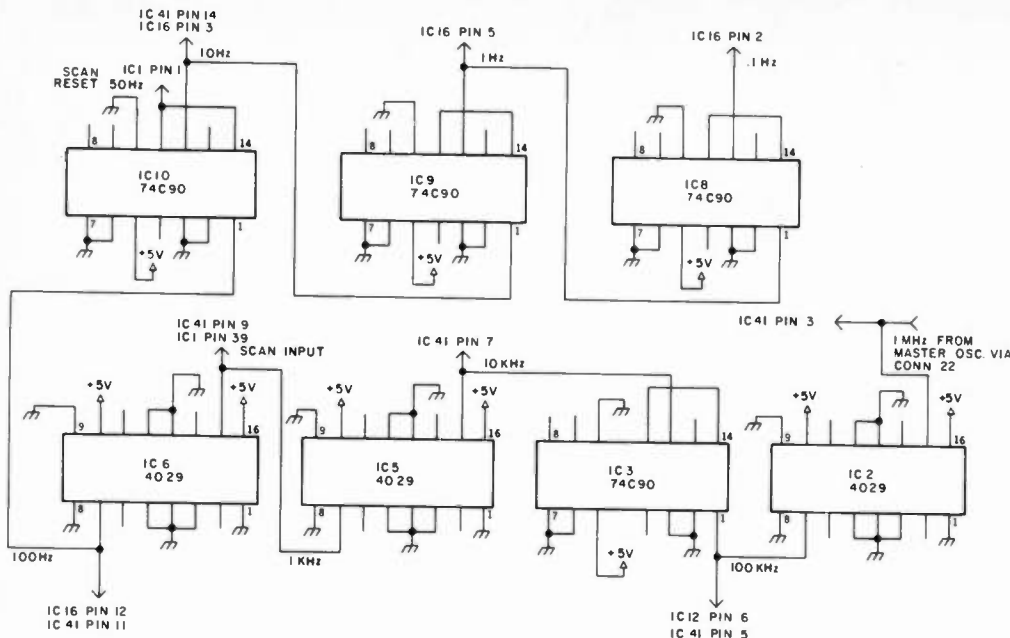

Fig. 7. Timebase oscillator divider chain.

display of all 8s. They will remain lit until the counter is reset. Should the overflow input be left unused, the counter display will "wrap around" to zero after 99,999,999 and begin counting again from zero. This probably wouldn't occur in frequency counting, but could be an important consideration in events totalizing.

The manual lamp-test push-button (as shown in Fig. 10) is connected to activate the lamp-test flip-flop (IC31) via the direct set input. An unused 74C00 gate is used as an inverter. The overflow latch output is sent to the data input, and

when clocked by a convenient source (1 kHz here), it also activates the lamp test, separately from the previously-described manual operation.

This arrangement is only one of several possibilities, but it uses leftover gates and flip-flops. Other unused gates don't appear in the schematic, but have their inputs grounded. The CMOS doesn't like loose ends.

Counter Tactics

Now that the timebase and display have been described, let's journey into the bowels of the counter.

The counter has two in-

puts, in contrast to the simple demonstration example. These two inputs are shown with the gate controls in Fig. 11(a). The two input sources are conditioned to provide CMOS-compatible square waves that swing from almost ground to the supply voltage of +5 volts.

The PM line controls which of the two input signals is allowed through the remaining two input NAND gates of IC14. These comprise a 2-to-1 data selector; that is, the condition (GND or +5) of the PM line always enables one or the other, but not both, of the signals through the gates to finally output the signal to be counted on pin 6 of IC14. A low on the input of a NAND will keep its output high. Because of this, IC14 A and C will be controlled by the PM line with the aid of IC14 D, an inverter made from the remaining NAND gate. As the signal will suffer two inversions, whether through the path of IC14 C and B, or A and B, the output at pin 6 is logically identical to either of the selected inputs.

The input then goes to a 74C90, whose ÷10 output is used solely in the period mode, and then into a

74C157. The 74C157 is a device containing four 2-to-1 multiplexers that operate logically the same as the one formed by IC14. The 74C157 uses a single select line (pin 1) to route one of the two inputs for passage at a time. The two inputs A and B are shown for each of the four 2-to-1 multiplexers native to a 74C157. A high (or 1) level (~5 volts) on the select input chooses the B input for transmission, while a low (or 0) level (~GND) lets the A input pass.

Fig. 11(b) shows the gate synchronizer lifted out of the rest of the schematic for clarity. The input to the counter will not be the incoming frequency when the P (for Period) line is at a 1 level. For events totalizing and for frequency mode, the signal pulses are sent to a NAND gate (pin 4) and to the clock input (pin 3) of IC13, a 74C74 D-type flip-flop. The purpose of the other half of IC13 will be explained shortly.

Notice how the output of IC13, pin 5, is combined with the clock signal in the NAND gate accompanying pins 4, 5, and 6. This is the circuit that synchronizes the timebase with the input to eliminate the least-significant-digit jitter. The flip-flop "remembers" the timebase input at the pin 2 data input and transfers the rise or fall of the timebase signal to the Q output *only when clocked by the incoming event*. This timebase output enables the NAND gate, and the resulting output at pin 6 is the integer-valued pulse train that is counted by the 7030 at pin 32. The 7030 counts on the negative edge of the incoming signal, so NAND provides exactly the right combination of input and output levels. When the timebase at pin 5 falls, the output of the NAND goes high, shutting the gate to the 7030 counter.

This is an example of the

Signal	Source	Destination	Comments
1 MHz	Master oscillator	IC41 pin 3	CMOS buffer
	Edge connector pin 22	IC2 pin 15	Input to TBOD
100 kHz	IC2 pin 7	IC3 pin 1	TBOD
		IC41 pin 5	CMOS buffer
		IC12 pin 6	Lamp test
10 kHz	IC3 pin 12	IC41 pin 7	CMOS buffer
1 kHz	IC5 pin 7	IC1 pin 39	Scan input for multiplexed display
		IC41 pin 9	CMOS buffer
100 Hz	IC6 pin 7	IC16 pin 12	Gate time .01 sec
		IC41 pin 11	CMOS buffer
20 Hz	IC10 pin 11	IC1 pin 38	Scan reset
			Resets display
10 Hz	IC10 pin 12	IC16 pin 13	Gate time 0.1 sec
		IC41 pin 14	CMOS buffer
1 Hz	IC9 pin 12	IC16 pin 5	Gate time 1 sec
0.1 Hz	IC8 pin 12	IC16 pin 2	Gate time 10 sec

Table 1.

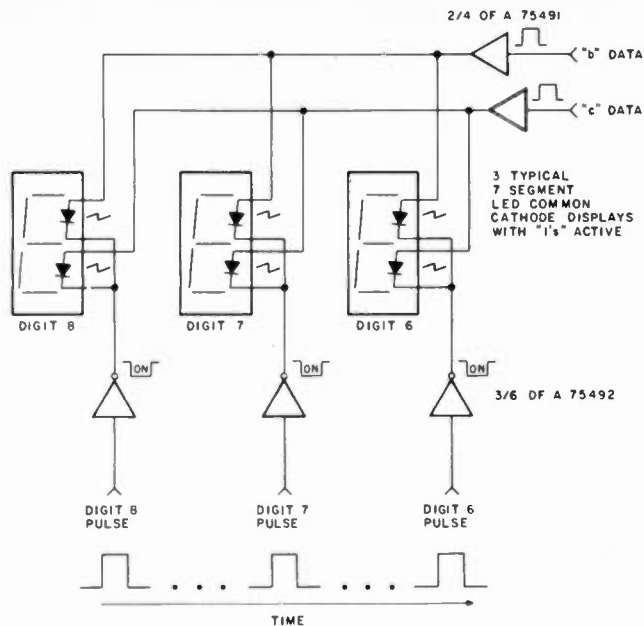

Fig. 8. Simplified multiplexed display example.

incoming pulses both starting and stopping the actual timebase at IC13 pin 2, which is shifted by the interval between event pulses. As long as this period of

time between arriving pulses is longer than the difference between the propagation delay of the 74C74, the circuit will synchronize beautifully, allowing only

whole numbers of pulses to be counted. This limitation is never realized because of the 5-MHz maximum count frequency into the 7030.

Page 208 in Don Lancaster's *TTL Cookbook* sparked my imagination and curiosity about eliminating the usual last-digit jitter found in most digital counting instruments. This ± 1 digit ambiguity is an error source that is inversely proportional to the measurement frequency. To keep the following example simple, let's assume a 1-second timebase. For a 10-Hz frequency, the ± 1 count results in a $\pm 10\%$ error per sample. At 100 kHz, the error decreases to $\pm .01\%$. If anyone wants an easily-forgotten formula, try this: % error = $\pm 100/(H \times g)$, where H = frequency in Hz and "g" is the gate time in seconds. Notice that this par-

ticular source of measurement imprecision is in addition to timebase instability, noise, jitter in triggering, and all the other digital counter gremlins.

Now you can appreciate the slight cost of the couple of extra ICs to eliminate this error, especially for lower-frequency measurements. This important feature is overlooked by virtually all manufacturers of digital instrumentation in the hobbyist's realm.

If you are wondering about the other half of IC13, it is used to produce the proper duration of the timebase. Feeding pin 8 back to pin 12 gives a toggle action, dividing the incoming timebase by two. This gives a symmetrical signal high for the originally selected time, and then low for the same time. This "open gate" signal exits from pin 9 and then goes to the pin 2 data input of the previously-explained gate synchronizer.

A green LED on the front panel indicates gate interval. It is taken from IC13 pin 5, enabled by the AND gate in IC18 and driven from IC39, a 75492. A 220-Ohm resistor limits the current. An interesting side benefit is that uneven triggering of the gate synchronizer will show up as irregular flashing of the gate LED. This is a "poor man's" trigger-threshold indicator, since the incoming events must be continually starting the timebase and turning on the gate LED for reliable counting.

Remember the reset and update/load functions needed to make our ultra-simple counter accurate and convenient? Here's how they are generated in this counter.

The timebase representation from Fig. 3(a) will serve as a point of reference. Ideally, the load/update signal for the display should occur immediately after OPEN, at the beginning of

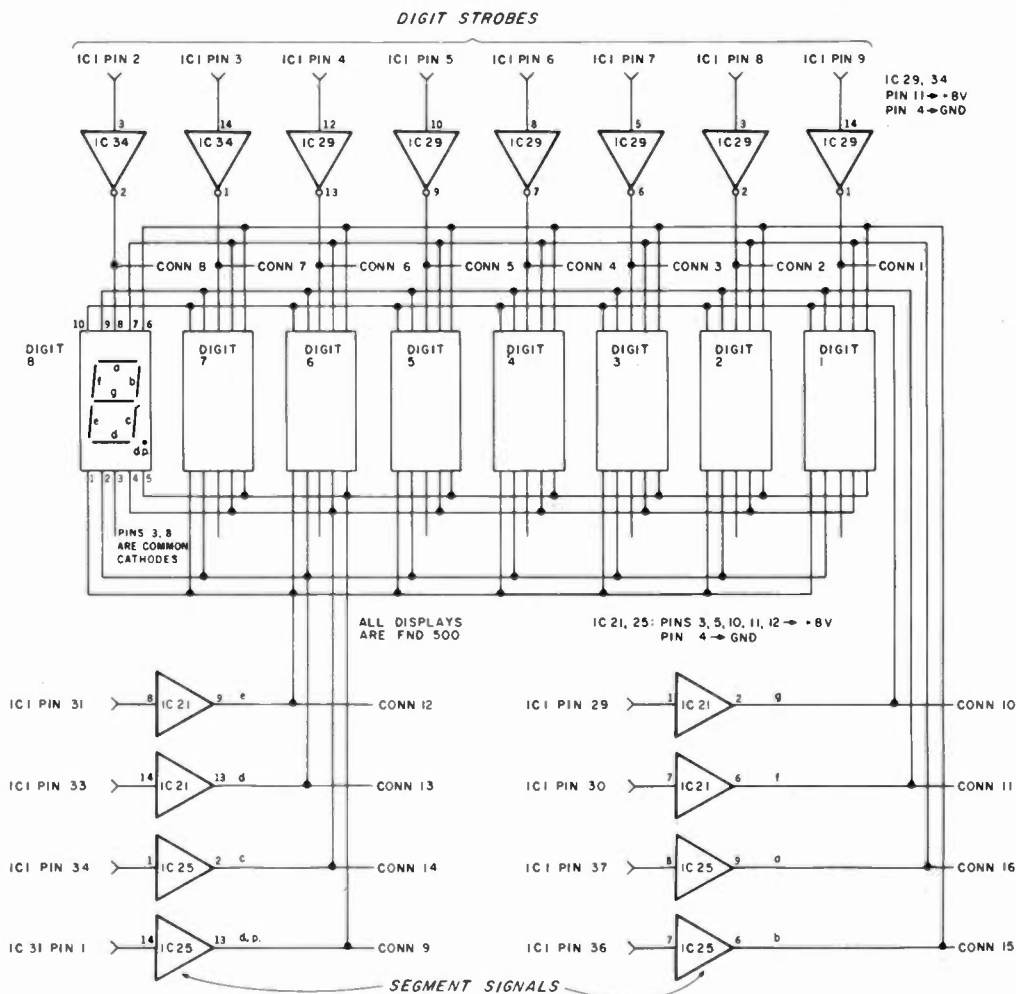

Fig. 9. Eight-digit multiplexed display.

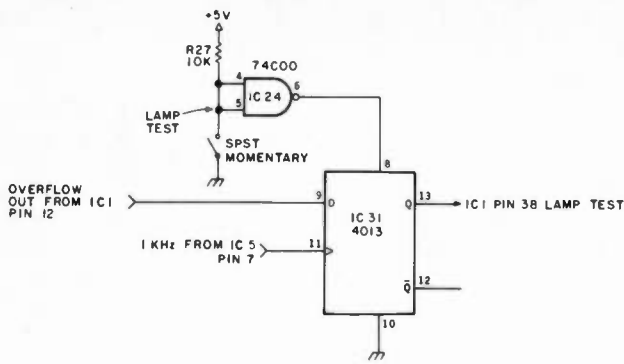

Fig. 10. Overflow lamp-test circuit.

CLOSE. The reset pulse should occur just prior to the start of the OPEN time, at the end of CLOSE time. We have to ensure that the 7030 is undisturbed for the entire prescribed interval, or the display will not be valid.

The load/update pulse is derived economically from the falling edge of the timebase Q_2 output of IC13 at pin 5. This signal is capacitively coupled through the parallel combination of C_6 and C_7 to the resistor network of R_6 and R_7 . Normal-

ly held at +4 volts, the junction of all these components will dip low on the falling edge of the timebase. This "down" time is determined by the RC time constant of $C_6 + C_7$ (capacitive values add in parallel connections) and R_6/R_7 . This is close to $15 \mu s$ for the values shown. The 7030 needs a load pulse of at least $12 \mu s$ to allow for internal settling.

The $\overline{\text{reset}}$ pulse is slightly more trouble. It cannot be taken directly from the rising edge of the count interval because that would result in a reset pulse occurring within the counting interval, destroying any hope of an accurate count. Not wanting to infringe on that

accuracy, the $\overline{\text{reset}}$ has to occur after the load pulse, or the counter would display only zeros!

After some trial and error (mostly error), I discovered a combination that provides the properly-timed pulse. The successful circuit is shown in Fig. 11(b). Half of IC15 is used. The raw timebase frequency (before division by two) from the clock input (pin 11) of IC13 is enabled for the "no count" time by IC13 pin 6, which, of course, is the out-of-phase (opposite polarity) synchronized timebase. The resulting output at IC15 pin 11 is the inverse of what is needed, so it is inverted by the next NAND at pin 8. Events mode disables the $\overline{\text{reset}}$ by forcing a high output with a low at pin 9. The output at pin 8 is the needed high-to-low transition that occurs only during the no-count interval and not during events mode. From there it goes to the RC network where, similar to the load RC network, a brief negative pulse is generated. In this case it is about $5 \mu s$, the proper duration for the 7030 $\overline{\text{reset}}$ circuitry.

In both these RC networks, the rising edge "glitch" will be ignored because of the bias level produced by the selected resistors and the forgiving characteristics of CMOS.

The mechanism for obtaining the period of the input is basically the same as the one used in the Elementary Counting section above. The timebase and the input signal are swapped with portions of a 74C157 doing the traffic direction. The input signals are first sent through IC7, a 74C90, for division by ten, and then through half of IC13 for an additional division by two. This gives a signal, now divided by twenty, that will become the "timebase" in period measurement. The P (for Period) se-

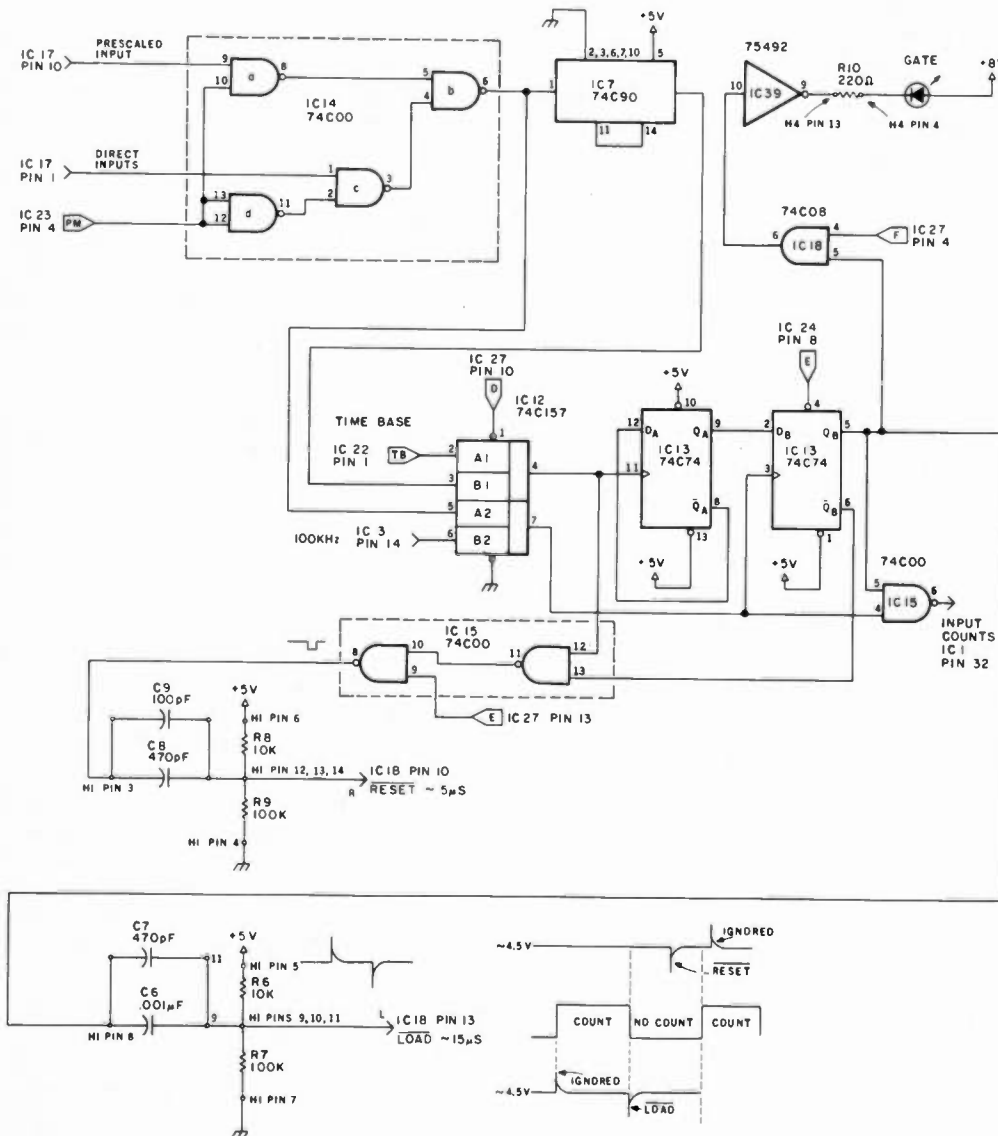

Fig. 11(a). Gate controls.

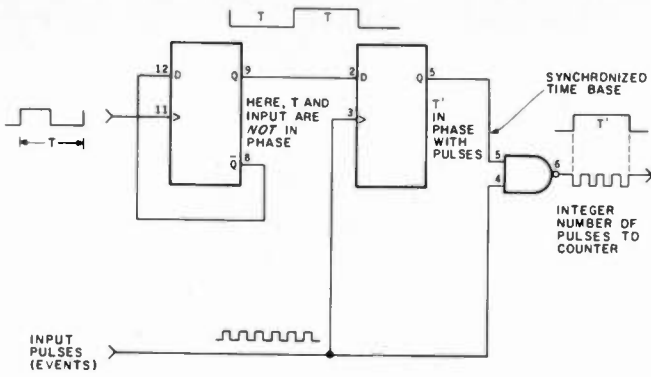

Fig. 11(b). Gate synchronizer.

lect line properly routes the B inputs of IC12 to accomplish this. When P is low, however, the A signals are digitally massaged to provide the normal frequency display.

Now that our period function has a timebase, the counter needs a source of pulses to count. A 50-kHz signal is picked off the TBOD chain. This frequency, when gated by a signal divided by twenty, gives a

readout in microseconds. The $\overline{\text{load}}$ and $\overline{\text{resets}}$ remain the same as before.

The reason for prescaling the "unknown" low frequency is to reduce effects of noise on the input signal. Because low-frequency signals for which the period mode is used often are slow-rising leisurely functions of time, noise on the signal can cause false, premature, or late triggering of the counter. The ran-

dom nature of noise can be put to use in the prescaling, or averaging, of the input signal. The uncertainty in triggering is reduced by the corresponding scale factor. This counter uses a factor of 20 for period averaging as a reasonable compromise between extreme precision and convenient utility.

The price to be paid for the averaging improvement is a correspondingly longer interval before the calculated period display is updated. For instance, if the period of a 20-Hz signal was directly measured, the updates would arrive every .05 seconds. Prescaling by 20 would divide the noise error by 20, but the display would be updated only every second (20 times .05 = 1 second). If your requirements dictate greater period averaging factors, more 74C90 dividers could readily be insert-

ed into the period-measurement circuitry, with another pulse source chosen to give a display of the resulting period in μsec .

The events-mode operation of the counter only requires the withholding of the timebase and the subsequent resets of the counter. By having manual as well as automatic controls over resets and display updates in the counter, elapsed time/event functions are defined.

You're still here? Great! Next month I will cover the rest of the Universal Counter. We'll look at the front-panel design which features push-buttons rather than rotary-style switches. The counter's front end, decimal point, and power supply circuitry are waiting, too. Rounding out the story will be a discussion of construction techniques. Just why did I wire-wrap my counter? Read next month's article and find out. ■

LIMITED SPECIAL \$555.00

HAMEG Oscilloscopes

20 MHz
DUAL TRACE

to meet every need

WITH PROBES: $\times 1$ & $\times 10$

- ONE YEAR FULL WARRANTY
- SOLID STATE
- ASSEMBLED & CALIBRATED

NEW RECTANGULAR CRT

MODEL HM-302

(603)434-5371

DEALER INQUIRIES INVITED

✓ 133 Rivendell Assoc. ✓

RFD-5 DERRY, N.H. 03038 WARNER HILL

LINEAR

2 TO 400 MHZ

PLANBOOK

15 to 1000 WATT

14 Different Models, 100 pgs \$11.95

A.P. Systems

Box 263 sm.

Newport, RI 02840 (401) 846-5627

✓ 149

Hi Pro LB-VHF-UHF REPEATERS

SOON TO BE FCC TYPE ACCEPTED

Hi Pro RECEIVER AND TRANSMITTER NOW USED IN ALL HI PRO REPEATERS

ASSEMBLED SMALL SIZE 3 7/8 x 6 1/8"

HI PRO TRANSMITTER DESIGNED FOR REPEATER SERVICE WITH EXCELLENT AUDIO, STABILITY, HARMONIC REJECTION AND LOW SIDEBAND NOISE.

ADJUSTABLE POWER OUTPUT UP TO 5 WATTS FROM THE EXCITER BOARD COOL OPERATION

ASSEMBLED SMALL SIZE 3 7/8 x 6 1/8"

HI PRO RECEIVER THIS RECEIVER IS THE HEART OF THE REPEATER AND BOASTS SUPERIOR SQUELCH ACTION NEEDED FOR THIS TYPE OF SERVICE EXCELLENT SENSITIVITY, STABILITY AND SELECTIVITY

USE THIS RECEIVER TO REPLACE THAT TROUBLESOME RECEIVER IN YOUR PRESENT REPEATER

ASK ABOUT OUR NEW COMPUTER CONTROL SYSTEMS WITH VOICE SYNTHESIZER TWO MODELS TO CHOOSE FROM.

Maggore Electronic Laboratory

590 SNYDER AVE. WEST CHESTER, PA. 19380

TELEX: 499-0741-MELCO PHONE 215-436-6051

✓ 46

NEW FAST CHARGE For Your Battery Packs

RECHARGE YOUR HAND HELD RADIO BATTERY PACKS TO FULL CAPACITY IN AS LITTLE AS 45 min. EXAMPLE—Fully Charge ICOM BP3 in 30-45 Minutes.

SEPERATE FUSES PROVIDED INTERNALLY FOR A.C. AND D.C. OPERATION. —BUILT IN REVERSE POLARITY PROTECTION.

All Solid State Precision Components Used Throughout. In A Unique Circuit Allows Fast Charging Without Any Perceptible Heating Of Cells. Charger Measures Remaining Charge In Cells Constantly And Turns Off Automatically When Battery Is Fully Charged. Battery Can Be Left Connected Indefinitely.



ONE UNIT DOES IT ALL Charge, ICOM, YAESU, KENWOOD, TEMPO, SANTEC and Others Automatically in Your Home, Car, Boat, R.V. or Airplane with Built-in Heavy Duty Power Supply or 12 to 24 V. External D.C. Supply Such as Cigar Lighter in Your Car.

INCLUDES: Removable 6 Ft. Cord for A.C. Operation and 2 Mating Connectors for D.C. Input and Battery Leads.

FEATURES: High Quality, Custom Designed Heavy Gauge Aluminum Cabinet.

FULL 1 YR. WARRANTY ON PARTS AND WORKMANSHIP

ACCESSORY CONNECTOR TO FIT ICOM BATTERY PACKS, BP-2, BP3, BP4, BPS, \$3
PRE-PAID ORDERS INCLUDE \$3 SHIPPING & HANDLING
PHONE ORDERS—CALL [209] 586-7059 or [209] 928-3608

\$79.00

CALIF. RESIDENTS INCLUDE 6% TAX

MAIL PRE-PAID ORDERS TO:

GR DESIGN INC

P.O. BOX 4463 SONORA, CALIF. 95370

DEALER INQUIRIES INVITED

✓ 149

Orbit



ORBIT is the Official Journal for the Radio Amateur Satellite Corporation (AMSAT), P.O. Box 27, Washington, DC 20047. Please write for application.

For a **FREE SAMPLE COPY** please send \$1 to cover First Class Postage and handling to: Orbit, 221 Long Swamp Road, Wolcott, CT 06716.

ALL NEW 15 Meter Mobile CW & USB



21.000—21.450 MHz

High 10W (PEP) low 2W (PEP); VFO tuning; noise blanker; fine-tune SB, KHz ± CW off-set; digital frequency counter; 13.8V dc @ 3A, negative ground; L 9.5" x W 9" x H 2.5"; weight (2.3 kg) 5.7 lbs.; mobile mounting bracket.

SERIOUS DEALER LISTS AVAILABLE



✓ 318

1275 N. GROVE ST.

ANAHEIM, CALIF. 92806 (714) 630-4541

NOTE: Price, specifications subject to change without notice and obligation.



CALL TOLL FREE 1-800-238-6168

In TN. call 901-683-9125

MEMPHIS AMATEUR ELECTRONICS

(Formerly-Germantown-Sere-Rose)

Authorized Dealer for: Kenwood, Yaesu, Icom, Drake, Mirage, AEA, Info-Tech, Ten-Tec, MFJ, Cubic, and B&W.

MON-FRI 9:00—5:00
SAT 9:00—12:00

✓ 139

Write: 1465 Wells Stat. Rd., Memphis, Tn. 38108



Are You a Big Gun Contester?

The small number of elite operators at the top of the list when the results are published know what it takes to win a major contest... do you? These winners reveal their secrets in THE CONTEST COOKBOOK by N6OP. You will find 170 pages of suggestions for the first-time contester as well as tips that will increase the score of a seasoned operator. Domestic, DX, and specialty contests are all discussed... complete with photographs and diagrams that show the equipment used by the top scorers. Winning a contest means more than having a kilowatt and a beam—it takes a good operator with lots of determination. Don't settle for being a Little Gun... order THE CONTEST COOKBOOK today by using the order card in this magazine. Send a check for \$5.95 plus \$1.50 for the first book, \$1.00 each additional book and \$10.00 per book foreign airmail, or include detailed credit card information. Sorry, no C.O.D. orders accepted. The Contest Cookbook BK7308 \$5.95.

GET READY NOW FOR THE CONTEST SEASON!
CALL TODAY 1-800-258-5473

Wayne Green Books, Attn. Mail Order, Peterborough, NH 03458

A WAYNE GREEN PUBLICATION

MOVING?

Let us know 8 weeks in advance so that you won't miss a single issue of 73 Magazine.

Attach old label where indicated and print new address in space provided. Also include your mailing label whenever you write concerning your subscription. It helps us serve you promptly. Write to:

73 magazine

Subscription Department
P.O. Box 931
Farmingdale NY 11737

- | | |
|--|---|
| <input type="checkbox"/> Address change only | <input type="checkbox"/> Payment enclosed |
| <input type="checkbox"/> Extend subscription | |
| <input type="checkbox"/> Enter new subscription | <input type="checkbox"/> Bill me later |
| <input type="checkbox"/> 1 year \$19.97 (Canada \$22.97, Foreign \$39.97/US funds) | |
| Foreign air mail, please inquire. | |

If you have no label handy, print OLD address here.

Name _____ Call _____

Address _____

City _____ State _____ Zip _____

print NEW address here:

Name _____ Call _____

Address _____

City _____ State _____ Zip _____

AFFIX LABEL

**Dealers...
BELL**

Selling 73 Magazine will make money for you. Consider the facts:

Fact #1: Selling 73 Magazine increases store traffic—our dealers tell us that 73 Magazine is the hottest-selling amateur radio magazine on the newsstands.

Fact #2: There is a direct correlation between store traffic and sales—increase the number of people coming through your door and you'll increase sales.

Fact #3: Fact #1 + Fact #2 = INCREASED SALES, which means more money for you. And that's a fact.

For information on selling 73 Magazine, call 800-343-0728 and speak with Ginnie Boudrieau, our bulk sales manager. Or write to her at 73 Magazine, 80 Pine St., Peterborough, NH 03458.

73 MAGAZINE

80 Pine Street Peterborough, NH 03458

800-343-0728

Radio Bookshop

NEW from **73**

THE NEW WEATHER SATELLITE HANDBOOK

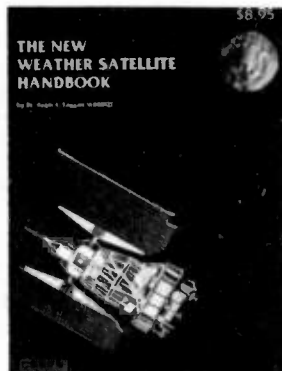

BY DR. RALPH E. TAGGART

Here is the completely updated and revised edition of the best-selling **Weather Satellite Handbook**—containing all the information on the most sophisticated and effective spacecraft now in orbit. Dr. Taggart has written this book to serve both the experienced amateur satellite enthusiast and the newcomer. The book is an introduction to satellite watching, providing all the information required to construct a complete and highly effective ground station. Not just ideas, but solid hardware designs and all the instructions necessary to operate the equipment are included. For the thousands of experimenters who are operating stations, the book details all procedures necessary to modify their equipment for the new series of spacecraft. Amateur weather satellite activity represents a unique blend of interests encompassing electronics, meteorology and astronautics. Join the privileged few in watching the spectacle of earth as seen from space on your own monitoring equipment. Order BK7383 \$8.95

SAVE \$2.95

WEATHER SATELLITE HANDBOOK (first edition)

By Dr. Ralph E. Taggart WB8DQT. Valuable information in this first edition is *not included* in Dr. Taggart's just published book, **The New Weather Satellite Handbook** (see above). Chapters such as "How to Build an Electric Timer for Satellite Tracking" and "Building an Automatic Control for the Satellite Receiving Station" will no longer be available when this edition is out of print. This is a good entry level text for those discovering the exciting new use of weather satellites. Regular price: \$4.95. **SPECIAL PACKAGE PRICE—BOTH BOOKS FOR ONLY \$10.95, SAVE \$2.95!** (This offer available only while supplies last.) Order WS7300 and receive both editions of the Weather Satellite Handbook for only \$10.95 (plus \$1.00 shipping and handling charge).

*Use the order card in this magazine or itemize your order on a separate piece of paper and mail to: 73 Radio Bookshop • Peterborough NH 03458. Be sure to include check or detailed credit card information. Add \$1.50 first book, \$1.00 each additional book, \$10.00 per book foreign airmail. Note: Prices subject to change on books not published by 73 Magazine. Questions regarding your order? Please write to Customer Service at the above address. Please allow 4-6 weeks for delivery. No C.O.D. orders accepted. For Toll Free ordering call 1-800-258-5473.

From **73** = MAGAZINE
THE MOST UP-TO-DATE REPEATER ATLAS AVAILABLE!
INCLUDES:

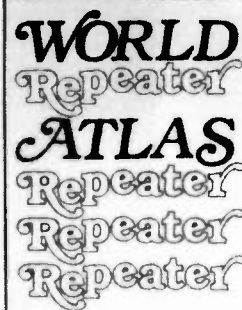

- LISTINGS BY STATE AND COUNTRY
- LISTINGS BY FREQUENCY
- MAPS FOR EACH STATE
- 28 MHZ THROUGH 1296 MHZ
- PERFECT FOR MOBILING
- WORLD REPEATER ATLAS—BK7315—Completely updated, over 230 pages of repeater listings are indexed by location and frequency. More than 50 maps pinpoint 2000 repeater locations throughout the USA. Foreign listings include Europe, the Middle East, South America and Africa. \$4.95.

IN STOCK AND READY TO SHIP

*Use the order card on the Reader Service page of this magazine or itemize your order on a separate piece of paper and mail to: 73 Radio Bookshop • Peterborough NH 03458. Be sure to include check or detailed credit card information. No C.O.D. orders accepted. Add \$1.50 handling charge for the first book; \$1.00 for each additional book. Questions regarding your order? Please write to Customer Service at the above address. Please allow 4-6 weeks for delivery.

FOR TOLL FREE ORDERING CALL 1-800-258-5473

NEW From **73** MAGAZINE

THE 1982 EDITION GENERAL LICENSE STUDY GUIDE

by Timothy M. Daniel N8RK

This is the complete guide to the General License. Learning rather than memorizing is the secret. This is not a question-and-answer guide that will gather dust when the FCC issues a new test. Instead, this book will be a helpful reference, useful long after a ham upgrades to General. Includes up-to-date FCC rules and an application form.

ORDER yours today and talk to the world.
SG7358 \$6.95

Please call regarding availability

*Use the order card on the Reader Service page of this magazine or itemize your order on a separate piece of paper and mail to: 73 Radio Bookshop • Peterborough NH 03458. Be sure to include check or detailed credit card information. No C.O.D. orders accepted. Add \$1.50 handling charge for the first book; \$1.00 for each additional book. Questions regarding your order? Please write to Customer Service at the above address. Please allow 4-6 weeks for delivery.

**FOR TOLL FREE ORDERING
CALL 1-800-258-5473**

RADIO BOOKSHOP

FOR THE NOVICE

New, updated editions

of our famous novice

license study guide and novice study tapes.

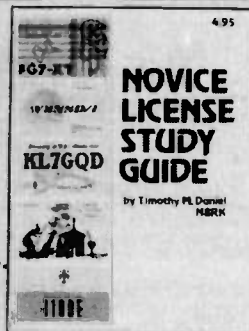

● **NOVICE LICENSE STUDY GUIDE**—by Timothy M. Daniel N8RK. Here is the most up to date novice guide available. It is complete with information about learning Morse Code, has the latest FCC amateur regulations and the current FCC application forms. This guide is *not* a question/answer memorization course but rather it emphasizes the practical side of getting a ham license and putting a station on the air. It reflects what the FCC expects a Novice to know without page after page of dull theory. The most current information still available at last year's price. SG7357 \$4.95.

● **NOVICE STUDY TAPES**—If you are just getting started in ham radio, you'll find these tapes indispensable! This up-to-the-minute revision of the 73 Study Course is the perfect way to learn everything you need to breeze through the Novice written exam. Theory, FCC regulations, and operating skills are all covered, and you'll be amazed at how fast you learn using these tapes!

Once the test is behind you, these tapes will go right on being useful, because they are packed with the latest information on setting up your own ham station, and getting on the air.

Thousands of people have discovered how easy learning from cassette can be—order now and enter the fascinating world of ham radio! CT7300 Set of 3—\$15.95.

Scientists have proven that you learn faster by listening than by reading because you can play a cassette tape over and over in your spare time—even while you're driving! You get more and more into each time you hear it. You can't progress without solid fundamentals. These three hour-long tapes give you all the basics you'll need to pass the Novice exam easily. You'll have an understanding of the basics which will be invaluable to you for the rest of your life! Can you afford to take your Novice exam without first listening to these tapes?

Special Offer! Both Novice License Study Guide and Novice Study Tapes \$19.95 Order NP7300.

GENERAL LICENSE STUDY GUIDE

NEW
NEW
NEW
NEW

GENERAL LICENSE STUDY GUIDE—By Timothy M. Daniel N8RK This is the complete guide to the General License. Learning rather than memorizing is the secret. This is not a question-and-answer guide that will gather dust when the FCC issues a new test. Instead, this book will be a helpful reference, useful long after a ham upgrades to General. Includes up-to-date FCC rules and an application form. Order yours today and talk to the world. SG7358 \$6.95



Style W



Style Y



Style X

● **QSL CARDS**—73 turns out a fantastic series of QSL cards at about half the cost of having them done elsewhere because they are run as a fill-in between printing books and other items in the 73 Print Shop. 250 Style W—QW0250—for \$8.95; 500 Style W—QW0500—for \$13.95; 250 Style X—QX0250—for \$8.95; 500 Style X—QX0500; 250 Style Y—QY0250—for \$8.95; 500 Style Y—QY0500—for \$13.95.* Allow 6-12 wks. for delivery.

● **LIBRARY SHELF BOXES**—These sturdy white, corrugated, dirt-resistant boxes each hold a full year of 73, *Kilobaud Microcomputing* or *80 Microcomputing*. With your order, request self-sticking labels for any of the following: 73, *Kilobaud Microcomputing*, *80 Microcomputing*, *CQ*, *QST*, *Ham Radio*, *Personal Computing*, *Radio Electronics*, *Interface Age*, and *Byte*. Order 1—BX1000—for \$2.00; order 2-7—BX2002—for \$1.50 each; order 8 or more—BX1002—for \$1.25 each.*

For Your
Ham Shack

● Preserve and protect your collection for a lifetime! Order these handsome red binders with gold lettering. \$7.50 for 1, 3 for \$21.75, 6 for \$42.00. (Postpaid within USA, please add \$2.50 per order outside USA.) Check or money orders only, no phone or C.O.D. orders. 73 Binders, P.O. Box 5120, Philadelphia, PA 19141.

*NOTE—Above address for Binders only.

73 Code Tapes

any four tapes for

\$15.95! \$4.95 each

"GENESIS"

5 WPM—CT7305—This is the beginning tape for people who do not know the code at all. It takes them through the 26 letters, 10 numbers and necessary punctuation, complete with practice every step of the way using the newest blitz teaching techniques. It is almost miraculous! In one hour many people—including kids of ten—are able to master the code. The ease of learning gives confidence to beginners who might otherwise drop out.

"THE STICKLER"

6+ WPM—CT7306—This is the practice tape for the Novice and Technician licenses. It is made up of one solid hour of code, sent at the official FCC standard (no other tape we've heard uses these standards, so many people flunk the code when they are suddenly—under pressure—faced with characters sent at 13 wpm and spaced for 5 wpm). This tape is not memorizable, unlike the zany 5 wpm tape, since the code groups are entirely random characters sent in groups of five.

"BACK BREAKER"

13+ WPM—CT7313—Code groups again, at a brisk 14 per so you will be at ease when you sit down in front of the steely-eyed government inspector and he starts sending you plain language at only 13 per. You need this extra margin to overcome the panic which is universal in the test situations. When you've spent your money and time to take the test, you'll thank heaven you had this back-breaking tape.

"COURAGEOUS"

20+ WPM—CT7320—Code is what gets you when you go for the Extra class license. It is so embarrassing to panic out just because you didn't prepare yourself with this tape. Though this is only one word faster, the code groups are so difficult that you'll almost fall asleep copying the FCC stuff by comparison. Users report that they can't believe how easy 20 per really is with this fantastic one hour tape.

"OUTRAGEOUS"

25+ WPM—CT7325—This is the tape for that small group of overachieving hams who wouldn't be content to simply satisfy the code requirements of the Extra Class license. It's the toughest tape we've got and we keep a permanent file of hams who have mastered it. Let us know when you're up to speed and we'll inscribe your name in 73's CW "Hall of Fame."

SSTV TAPE

● **SLOW SCAN TELEVISION TAPE—CT7350**—Prize-winning programs from the 73 SSTV contest. Excellent for Demo! \$5.95.

● **BACK ISSUES**—Complete your collection; many are prime collectables now, classics in the field! A full collection is an invaluable compendium of radio and electronics knowledge!

73300	73 BACK ISSUE—BEFORE JULY 1980	\$ 3.00
73350	73 BACK ISSUE JULY 1980 THRU OCT. 1981	\$ 3.50
73350P	73 BACK ISSUE NOV. 1981 TO PRESENT	\$ 3.50
73005	73 BACK ISSUE—5 YOUR CHOICE	\$10.75
73010	73 BACK ISSUE—10 YOUR CHOICE	\$16.00
73025	73 BACK ISSUE—25 YOUR CHOICE	\$27.00
73125	73 BACK ISSUE—25 OUR CHOICE	\$14.00

Shipping: Please add \$1.00 per magazine. Orders of ten magazines or twenty-five magazines add \$7.50 per order.

*Use the order card in this magazine or itemize your order on a separate piece of paper and mail to: 73 Radio Bookshop • Peterborough NH 03458. Be sure to include check or detailed credit card information. No C.O.D. orders accepted. All orders add \$1.00 handling. Please allow 4-6 weeks for delivery. Questions regarding your order? Please write to Customer Service at the above address. (Prices subject to change on books not published by 73 Magazine.)

FOR TOLL FREE ORDERING CALL 1-800-258-5473

RADIO BOOKSHOP

HAND BOOKS FOR THE HAMSHACK

THE COMPLETE SHORTWAVE LISTENER'S HANDBOOK, 2nd EDITION by Hank Bennett and Harry L. Helms. This comprehensive volume contains loads of new information from all over the world on the latest developments in SWL technology clubs, associations, practices and stations. A thorough guide to stations of the world by general continental area and frequency is included. BK1241 \$9.95

THE TEN METER FM HANDBOOK—by Bob Hell K9EID. This handbook has been published to help the ten meter enthusiast learn more about the many methods of conversions and tricks that are used to make existing units work better. Join the great "linkers" of the world on ten FM and enjoy the fantastic amount of fun in communicating with amateur stations worldwide on ten meter FM. BK1190 \$4.95.*

THE PRACTICAL HANDBOOK OF AMATEUR RADIO FM REPEATERS—by Bill Pasternak WA6ITF (author of 73 Magazine's monthly column "Looking West") This is the book for the VHF/UHF FMr, compiled from material submitted by over a hundred individuals, clubs, organizations and equipment manufacturers. A "must have" for your ham shack shelf. BK1185 \$12.95.*

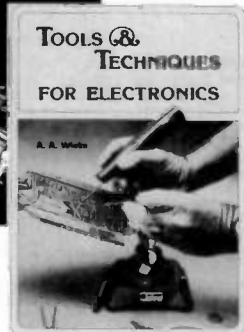

TOOLS & TECHNIQUES FOR ELECTRONICS—by A. A. Wicks is an easy-to-understand book written for the beginning kit-builder as well as the experienced hobbyist. It has numerous pictures and descriptions of the safe and correct ways to use basic and specialized tools for electronic projects, as well as specialized metal-working tools and the chemical aids which are used in repair shops. BK7348 \$4.95.*

BEHIND THE DIAL—This book explains, in detail, what's going on on all the frequencies, from shortwave up to microwave. It gives the reader a good idea of what he can find and where to find it, including some of the secret stations such as the C.I.A. and the F.B.I. Everything is covered short of microwave monitoring. Anyone interested in purchasing a shortwave receiver should have a copy of this book. Surveillance, station layout consideration, antenna systems, interface, and the electromagnetic spectrum, are included. BK7307 \$4.95

THE NEW WEATHER SATELLITE HANDBOOK—by Dr. Ralph E. Taggart WB8DQT. Here is the completely updated and revised edition containing all the information on the most sophisticated and effective spacecraft now in orbit. This book serves both the experienced amateur satellite enthusiast and the newcomer. It is an introduction to satellite watching, providing all the information required to construct a complete and highly effective ground station. Solid hardware designs and all the instructions necessary to operate the equipment are included. For experimenters who are operating stations, the book details all procedures necessary to modify equipment for the new series of spacecraft. Amateur weather satellite activity represents a unique blend of interests encompassing electronics, meteorology and astronautics. Join the privileged few in watching the spectacle of earth as seen from space on your own monitoring equipment. BK7383 \$8.95.*

THE 73 TEST EQUIPMENT LIBRARY

VOL. II AUDIO FREQUENCY TESTERS—Jam-packed with all kinds of audio frequency test equipment, if you're into SSB, RTTY, SSTV, etc., this book is a must for you... a good book for hi-fi addicts and experimenters, too! LB7360 \$4.95.*

VOL. III RADIO FREQUENCY TESTERS—Radio frequency waves, the common denominator of amateur radio. Such items as SWR, antenna impedance, line impedance, RF output, and field strength; detailed instructions on testing these items includes sections on signal generators, crystal calibrators, grid dip oscillators, noise generators, dummy loads, and much more. LB7361 \$4.95.*

VOL. IV IC TEST EQUIPMENT—Become a troubleshooting wizard! In this fourth volume of the 73 TEST EQUIPMENT LIBRARY are 42 home construction projects for building test equipment to work with your ham station and in servicing digital equipment. Plus a cumulative index for all four volumes for the 73 TEST EQUIPMENT LIBRARY. LB7362 \$4.95.*

RF AND DIGITAL TEST EQUIPMENT YOU CAN BUILD—BK1044—Rf burst, function, square wave generators, variable length pulse generators—100 kHz marker, i-f and rf sweep generators, audio osc, af/rf signal injector, 146 MHz synthesizer, digital readouts for counters, several counters, prescaler, microwave meter, etc. 252 pages. BK1044 \$5.95.*

THE 73 TECHNICAL LIBRARY



THE CHALLENGE OF 160—The growth of amateur radio today is encouraging the use of 160 meters. All the information necessary to get started on this unique band, the all-important antenna and ground systems are described in detail. Also, how to get on, top-band operating tips, top-band transmitters, propagation, weather receiving equipment, and more are covered in full. The introduction contains interesting photos of Stew Perry's (the King of 160) shack. This reference is useful to new and experienced top-band operators. BK1230 \$4.95

INTERFERENCE HANDBOOK—by William R. Nelson, WA6EQG—This timely handbook covers every type of RFI problem and gives you the solutions based on practical experience. Covers interference to TV, radio, hi-fi, telephone, radio amateur, commercial and CB equipment. Power line interference is covered in depth—how to locate it, cure it, work with the public, safety precautions, how to train RFI investigators. Written by an RFI expert with 33 years of experience, this profusely illustrated book is packed with practical easy-to-understand information. BK1230 \$8.95.*

OWNER REPAIR OF RADIO EQUIPMENT—by Frank Glass K6RO. Here's a book that will teach you an approach to troubleshooting without a shack full of test equipment. Written in a narrative, non-mathematical style, it will encourage you to successfully fix your own rig problems 80 to 90% of the time. Even if you don't want to fix, you can learn a lot about how things work and fail. Add to your library and personal expertise. BK7310 \$7.95.*

FOR THE CONTESTER



THE CONTEST COOKBOOK—This book reveals the secrets of that elite group of operators who top the list when the contest results are published. It contains detailed suggestions for the first-time contestee as well as tips for the advanced operator. Domestic, DX, and specialty contests are all discussed, complete with photographs and diagrams showing the equipment and operating aids used by the top scorers. For the serious contestee. BK7308 \$5.95.

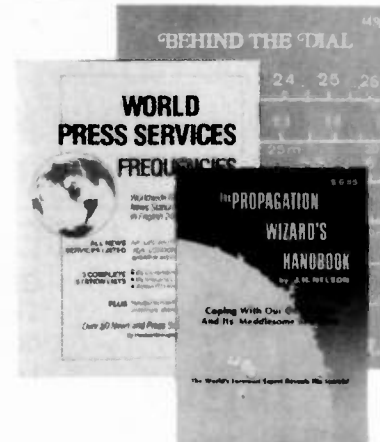

WORLD PRESS SERVICE FREQUENCIES—by Thomas Harrington Can't wait to hear the evening news, or are you wondering about the news that you aren't hearing? Receive by Radio Teletype (RTTY) all the world news and financial happenings from the world capitals on a 24 hour a day basis. This book gives you the frequencies and times of broadcast of such news services as AP, UPI, Reuters, TASS, VOA and London Press. Also included is an introduction to RTTY with information on equipment, antennas, abbreviations—everything you need to get started in RTTY. BK1202 \$7.95*

SSB... THE MISUNDERSTOOD MODE—by James B. Wilson. Single Sideband Transmission... thousands of us use it every day, yet it remains one of the least understood facets of amateur radio. J. B. Wilson presents several methods of sideband generation, amply illustrated with charts and schematics, which will enable the ambitious reader to construct his own sideband generator. A must for the technically-serious ham. BK7351 \$5.50.*

PROPAGATION WIZARD'S HANDBOOK—by J. H. Nelson. When sunspots riddled the worldwide communications networks of the 1940s, John Henry Nelson looked to the planets for an answer. The result was a theory of propagation forecasting based upon interplanetary alignment that made the author the most reliable forecaster in America today. The book provides an enlightened look at communications past, present, and future, as well as teaching the art of propagation forecasting. BK7302 \$6.95.*

IC OP-AMP COOKBOOK—by Walter G. Jung. Covers not only the basic theory of the IC op amp in great detail, but also includes over 250 practical circuit applications, liberally illustrated. 592 pages, 5 1/2 x 8 1/2, softbound. BK1028 \$14.95.*

*Use the order card in this magazine or itemize your order on a separate piece of paper and mail to: 73 Radio Bookshop • Peterborough NH 03458. Be sure to include check or detailed credit card information. No C.O.D. orders accepted. All orders add \$1.00 handling. Please allow 4-6 weeks for delivery. Questions regarding your order? Please write to Customer Service at the above address. (Prices subject to change on books not published by 73 Magazine.)

FOR TOLL FREE ORDERING CALL 1-800-258-5473

RADIO BOOKSHOP

ANTENNA BOOKS

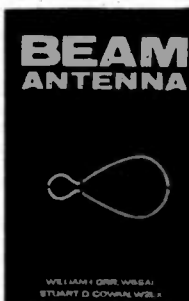
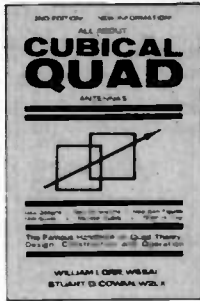

VHF ANTENNA HANDBOOK—The new *VHF Antenna Handbook* details the theory, design, and construction of hundreds of different VHF and UHF antennas... a practical book written for the average amateur who takes joy in building, not full of complex formulas for the design engineer. Packed with fabulous antenna projects you can build. BK7368 \$5.95.*

● **BEAM ANTENNA HANDBOOK** (New 5th edition)—BK1197—Yagi beam theory, construction and operation. Information on wire beams, SWR curves and matching systems. A "must" for serious DXers. \$5.95*

● **VHF HANDBOOK FOR RADIO AMATEURS**—BK1198—Contains information on FM theory, operation and equipment, VHF antenna design and construction, satellite-EME, and the newest solid-state circuits. \$6.95*

● **THE RADIO AMATEUR ANTENNA HANDBOOK**—BK1199—All about wire antennas, beams, tuners, baluns, coax, radials, SWR and towers. Clear and complete information. \$6.95*

● **SIMPLE, LOW-COST WIRE ANTENNAS FOR RADIO AMATEURS**—BK1200—All new data and everything you want to know about low-cost, multi-band antennas, inexpensive beams, "invisible" antennas for hams in "tough" locations. \$6.95*

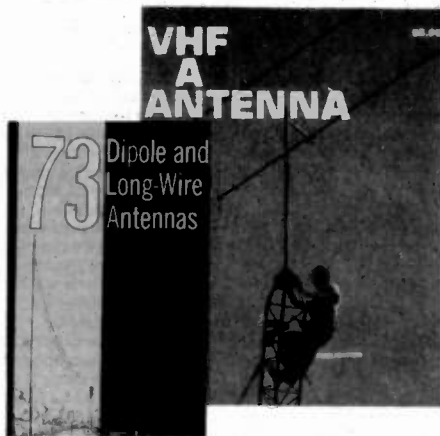

PRACTICAL ANTENNAS FOR THE RADIO AMATEUR—A manual describing how to equip a ham station with a suitable antenna. A wide range of antenna topics, systems, and accessories are presented giving the reader some food for thought and practical data for construction. Designed to aid the experienced ham and novice as well. Only BK1015 \$9.95.*

73 DIPOLE AND LONG-WIRE ANTENNAS—by Edward M. Noll W3FQJ. This is the first collection of virtually every type of wire antenna used by amateurs. Includes dimensions, configurations, and detailed construction data for 73 different antenna types. Appendices describe the construction of noise bridges, line tuners, and data on measuring resonant frequency, velocity factor, and swr. BK1016 \$5.50.*

● **ALL ABOUT CUBICAL QUAD ANTENNAS** (2nd edition)—BK1196—The "Classic" on Quad design, theory, construction, and operation. New 2nd edition contains new feed and matching systems and new data. \$5.95.*

● **HOW TO DEFEND YOURSELF AGAINST RADAR**—BK1201—by Bruce F. Bogner and James R. Bodnar, a lawyer and radar expert. This book gives you the ammunition to challenge the radar "evidence" that usually leads to a speeding conviction. The major part of the book details the inner workings of radar—you'll become more of an expert than most police officers and judges. The remainder of the book outlines how to defend yourself against a speeding ticket—the observations, measures and testimony you must obtain to defend yourself without the help of a lawyer. The price is a lot less than a fine! \$6.95*

MICROCOMPUTER BOOKS

ANNOTATED BASIC—A NEW TECHNIQUE FOR NEOPHYTES. VOL 1 & 2—Annotated BASIC explains the complexities of modern BASIC. It includes complete TRS-80* Level II BASIC programs that you can use. Each program is annotated to explain in step-by-step fashion the workings of the program. Programs are flowcharted to assist you in following the operational sequence. And—each chapter includes a description of the new concepts which have been introduced. Volume 1 BK7384 \$10.95 Volume 2 BK7385 \$10.95

HOBBY COMPUTERS ARE HERE! If you want to come up to speed on how computers work—hardware and software—this is an excellent book. It starts with fundamentals and explains the circuits and the basics of programming, along with a couple of TVT construction projects, ASCII, Baudot, etc. This book has the highest recommendations as a teaching aid. \$4.95.* BK7322

KILOBAUD KLASSROOM—By George Young and Peter Stark. Learning electronics theory without practice isn't easy. And it's no fun to build an electronics project that you can't use. *Kilobaud Klassroom* the popular series first published in *Kilobaud Microcomputing*, combines theory with practice. This is a practical course in digital electronics. It starts out with very simple electronics projects, and by the end of the course you'll construct your own working microcomputer! BK7386 \$14.95

● **40 COMPUTER GAMES**—BK7381—Forty games in all in nine different categories. Games for large and small systems, and even a section on calculator games. Many versions of BASIC used and a wide variety of systems represented. A must for the serious computer gamesman. \$7.95*

● **UNDERSTANDING AND PROGRAMMING MICROCOMPUTERS**—BK7382—A valuable addition to your computing library. This two-part text includes the best articles that have appeared in 73 and *Kilobaud Microcomputing* magazines on the hardware and software aspects of microcomputing. Well-known authors and well-structured text helps the reader get involved. \$10.95*

TEXTEDIT—A Complete Word Processing System in Kit form—by Irwin Rappaport. *TEXTEDIT* is an inexpensive word processor that you can adapt to suit your needs, from writing form letters to large texts. It is written in modules, so you can load and use only those portions that you need. Included are modules that perform right justification, ASCII upper/lowercase conversion, one-key phrase entering, complete editorial functions, and much more! *TEXTEDIT* is written in TRS-80* Disk BASIC, and the modules are documented in the author's admirably clear tutorial writing style. Not only does Irwin Rappaport explain how to use *TEXTEDIT*; he also explains programming techniques implemented in the system. *TEXTEDIT* is an inexpensive word processor that helps you learn about BASIC programming. It is written for TRS-80 Models I and III with TRS-DOS 2.2/2.3 and 32K. *TRS-80 and TRSDOS are trademarks of the Radio Shack Division of Tandy Corporation. BK7387 \$9.97

● **SOME OF THE BEST FROM KILOBAUD/MICROCOMPUTING**—BK7311—A collection of the best articles that have recently appeared in *Kilobaud Microcomputing*. Included is material on the TRS-80 and PET systems, CP/M, the 8080/8085/Z80 chips, the ASR-33 terminal. Data base management, word processing, text editors and file structures are covered too. Programming techniques and hardware construction projects for modems, high speed cassette interfaces and TVTs are also included in this large format, 200 plus page edition. \$10.95.*

● **THE NEW HOBBY COMPUTERS**—BK7340—This book takes it from where "HOBBY COMPUTERS ARE HERE!" leaves off, with chapters on Large Scale Integration, how to choose a microprocessor chip, an introduction to programming, low cost I/O for a computer, computer arithmetic, checking memory boards...and much, much more! Don't miss this tremendous value! Only \$4.95.*

COOK BOOKS

TTL COOKBOOK—by Don Lancaster. Explains what TTL is, how it works, and how to use it. Discusses practical applications, such as a digital counter and display system, events counter, electronic stopwatch, digital voltmeter and a digital tachometer. BK1063 \$9.50.*

CMOS COOKBOOK—by Don Lancaster. Details the application of CMOS, the low power logic family suitable for most applications presently dominated by TTL. Required reading for every serious digital experimenter! BK1011 \$10.50.*

TVT COOKBOOK—by Don Lancaster. Describes the use of a standard television receiver as a microprocessor CRT terminal. Explains and describes character generation, cursor control and interface information in typical, easy-to-understand Lancaster style. BK1064 \$9.95.*

THE WELL EQUIPPED HAM SHACK

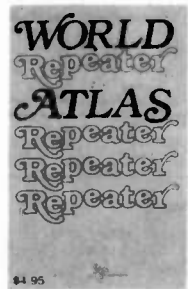
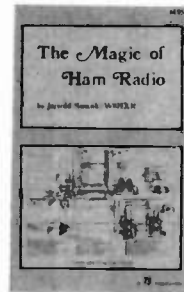

WORLD REPEATER ATLAS—Completely updated, over 230 pages of repeater listings are indexed by location and frequency. More than 50 maps pinpoint 2000 repeater locations throughout the USA. Foreign listings include Europe, the Middle East, South America, and Africa. \$4.95.* BK7315

THE MAGIC OF HAM RADIO—by Jerrold Swank W8HXR begins with a brief history of amateur radio and of Jerry's involvement in it. Part 2 details many of ham radio's heroic moments. Hamdom's close ties with the continent of Antarctica are the subject of Part 3. In Part 4 the strange and humorous sides of ham life get their due. And what of the future? Part 5 peers into the crystal ball. \$4.95.* BK7312

A GUIDE TO HAM RADIO—by Larry Kahaner WB2NEL. What's Amateur Radio all about? You can learn the basics of this fascinating hobby with this excellent beginner's guide. It answers the most frequently asked questions in an easy-going manner, and it shows the best way to go about getting an FCC license. A Guide to Ham Radio is an ideal introduction to a hobby enjoyed by people around the world. \$4.95.* BK7321

WORLD RADIO TV HANDBOOK 1982, 25TH EDITION—This book is the bible of international broadcasters, providing the only authoritative source of exact information about broadcasting and TV stations world wide. This 1981 edition is completely revised, giving comprehensive coverage of short, medium and long wave. 560 pages of vital aspects of world listening. \$16.50 BK1184

* Use the order card in this magazine or itemize your order on a separate piece of paper and mail to: 73 Radio Bookshop • Peterborough NH 03458. Be sure to include check or detailed credit card information. No C.O.D. orders accepted. All orders add \$1.00 handling. Please allow 4-6 weeks for delivery. Questions regarding your order? Please write to Customer Service at the above address. (Prices subject to change on books not published by 73 Magazine.)

FOR TOLL FREE ORDERING CALL 1-800-258-5473

The Sweet Sounding Repeater

MARK 3CR



A Stradivarius is more than a body, neck, and strings. The name alone says it is an instrument of outstanding quality and beautiful sound.

In repeaters the name for optimum performance and clean, natural sound is Mark 3CR. And Mark 3CR also means:

- Receiver sensitivity $< 0.25 \mu\text{V}$.
- Schmitt trigger squelch to capture fading signals
- 13 Morse messages
- Spurious rejection $> 65 \text{ dB}$.
- Autopatch and reverse autopatch
- 15 Function controlled outputs
- Die cast aluminum receiver and transmitter enclosures

For the Finest in

Repeaters • Controllers • Power Amplifiers • Link Transceivers

MICRO CONTROL SPECIALTIES ✓ 49

23 Elm Park, Groveland, MA 01834 (617) 372-3442

S-LINE OWNERS ENHANCE YOUR INVESTMENT

with

TUBESTERS™

Plug-in, solid state tube replacements

- S-line performance—solid state!
- Heat dissipation reduced 60%
- Goodbye hard-to-find tubes
- Unlimited equipment life

TUBESTERS cost less than two tubes, and are guaranteed for so long as you own your S-line.

SKYTEC
Box 535
Talmage, CA 95481

Write or phone for
specs and prices.
(707) 462-6882

✓ 433

TUSA

A WHOLE NEW WORLD OF TV VIEWING WITH TUSA'S NEW MODEL CVU-40, 40 CHANNEL CABLE TV CONVERTER. Receive all the EXTRA CABLE TV "MIDBAND" & SUPERBAND CHANNELS on your UHF DIAL. Eliminates the need for renting or leasing. This stable and reliable system converts extra cable TV channels so they can be received on the UHF tuner of your TV set. Provides the extra midband and superbond channels now distributed by most cable companies. Channels 2 to 13 can also be seen directly on the VHF portion of your tuner.

A MUST FOR VIDEO-TAPING FROM CABLE TV!
The system allows you to program both day pay TV decoder required and standard cable channels for taping on any VCR — while you are watching a different channel on your TV.

Simple to install and operate on any make of TV with UHF.

\$2895
PLUS POSTAGE

POPULAR IC'S

TOP QUALITY NO SECONDS

TYPE	DESCRIPTION	1-8	10-UP
LM 3002	5 Volt Audio Power Amp	\$1.49	\$1.29
LM 3058A	Low Voltage Audio Amp	1.59	1.39
	5000mV	12.95	11.95
NE 5541	Phase Locked Loop	3.50	3.15
LM 555A	Digital Phase Locked Loop	1.49	1.29
LM 723A	Phase Locked Loop	1.69	1.44
MC 1330	Video Detector	2.49	1.89
MC 1349	Video If Amp	2.06	1.85
MC 1350	Video If Amp	1.75	1.55
MC 1352	Video If Amp AGC	2.69	2.09
MC 1358	Audio If Amp	1.95	1.79
MC 1374P	RF Modulator	3.19	2.87
MC 1458	Dual Comp. Op Amp	.85	.79
MC 1464A	Audio If Amp	1.79	1.59
LM 1800	PLL Stereo Decoder	4.49	3.95
LM 1809	Video Modulator	2.95	2.49

LINEAR VOLTAGE REGULATORS

LM-7025	5 Volt Positive Volt. Reg.	1.39	1.25
LM 7008	9 Volt Positive Volt. Reg.	1.39	1.25
LM 7812	12 Volt Positive Volt. Reg.	1.39	1.25
LM 7815	15 Volt Positive Volt. Reg.	1.39	1.25
LM 7818	18 Volt Positive Volt. Reg.	1.39	1.25
LM-7824	24 Volt Positive Volt. Reg.	1.39	1.25

WINEGARD

75 OHM UHF YAGI ANTENNAS

12 db GAIN CHANNELS 44-52 \$89^{ea}

OPTIONAL Winegard UHF Antenna Preamp 1675 Gain \$39^{ea}

BRAND NEW UHF VARIATOR TUNERS

YOUR CHOICE

Sanyo 45 MHz Output \$24^{ea}

Mitsumi Equivalent 45 MHz Output

POPULAR MICROWAVE PARTS

MRF-801	\$2.75
8-Up	2.19
MRF-811	3.45
8-Up	3.12
MFD-101	.98
CHIP CAPS - 500 mid	.50
26-Up	.30
216803 (formerly MRF 802)	11.98

MV-2109

33pf Tuning Diode

1-9 \$1.20 ea.

10-Up .98 ea.

5% MICA CAPS 5%

10pf .42c ea	500pf .66c ea.
43pf .36c ea	1200pf .89c ea.
110pf .38c ea	3000pf 1.39c ea.

POWER TRANSFORMERS

18V @ 1 Amp	\$4.89
10-Up	3.95
24VCT @ 400 mA	\$3.69
10-Up	3.29

PROJECT BOXES

Woodgrain

This box is 11 1/2" W x 4 1/2" H x 6 1/2" D with a removable aluminum U-shaped chassis 11" W x 3 1/2" H x 6" D inside.

4 or more \$11.95 ea.

12.50 ea.

SURPLUS AUDIO & VIDEO RF MODULATORS

Hook up sheet included \$6.49 ea.

CABLE CONNECTOR

F.99 Male connector for RG-59U cable. Complete with ferrule. Mates with female "F" connectors.

25c ea.

100 for \$14.70

SURPLUS SYLVANIA VHF VARIATOR TUNERS

45 MHz output Channels 2 through 13 as well as the midband channels. Schematic included.

WHILE THEY LAST! \$13.95 ea.

UHF - VHF - FM SPLITTER

40-900 MHz

Low Loss 3.5-4 db, Low VSWR Waterproof Housing \$2.49 ea.

POPULAR MISCELLANEOUS PARTS

10K Volume Control with DPDT switch	\$ 1.49
10-Up	1.19
8x10 Speaker Cabinet with speaker	10.95
2 or more	8.95
Toroids - T30-12	.46
20-Up	.25
Toroids - T37-2	.36
20-Up	.25

R.F. ELECTRONICS

1056 N. STATE COLLEGE BLVD., DEPT. G ANAHEIM, CALIFORNIA 92806

MAIL ORDERS WELCOME — PLEASE INCLUDE POSTAGE — ORDERS SHIPPED SAME DAY RECEIVED OPEN TUESDAY - FRIDAY 10 - 8 — SATURDAY 10 - 8 — CLOSED SUNDAY & MONDAY

TOLL FREE (ORDER ONLY) LINE OUTSIDE CALIFORNIA 800-854-4855

INFORMATION AND ALTERNATE ORDER LINE 714-635-5000

✓ 156

FUN!

John Edwards K12U
78-56 86th Street
Glendale NY 11385

HAM RADIO'S GOLDEN YEARS

When were ham radio's golden years? It probably all depends on when you first entered the hobby. My golden years were the 1960s: Benton Harbor lunch boxes, Allied catalogues, New York's radio row and the introduction of transistors. For others, the 60s may have meant incentive licensing, a declining ham population, and the first Cbers hitting our bands. For me, however, those years will always be the sweetest.

This month's column is all about ham radio's golden years. I hope you'll find a question or two about your era.

ELEMENT 1—CROSSWORD PUZZLE (Illustration 1)

Across

- | | |
|--------------------------|----------------------------|
| 1) Old top ticket | 3) No danger |
| 7) Iran prefix | 4) Morse greeting (abbr.) |
| 9) A traditional ham | 5) A satellite signal path |
| 12) A Zepp, for instance | 6) Bug maker |
| 14) Big time for traffic | 8) Old modulation (abbr.) |
| 16) Not ac (abbr.) | 10) Signal way |
| 17) First tube | 11) Operates |
| 21) VHF rice container | 13) Spark discharge |
| 23) Slang for 17 across | 15) Ireland prefix |
| 26) Iceland prefix | 16) Morse slash |
| 27) Amateur practice | 18) Contest double-copy |

Down

- | | |
|---|----------------------------------|
| 1) Commission before the FCC
(2 words) | 22) New electronics type (abbr.) |
| 2) Plate current (abbr.) | 24) Transceiver |
| | 25) Morse double dash |

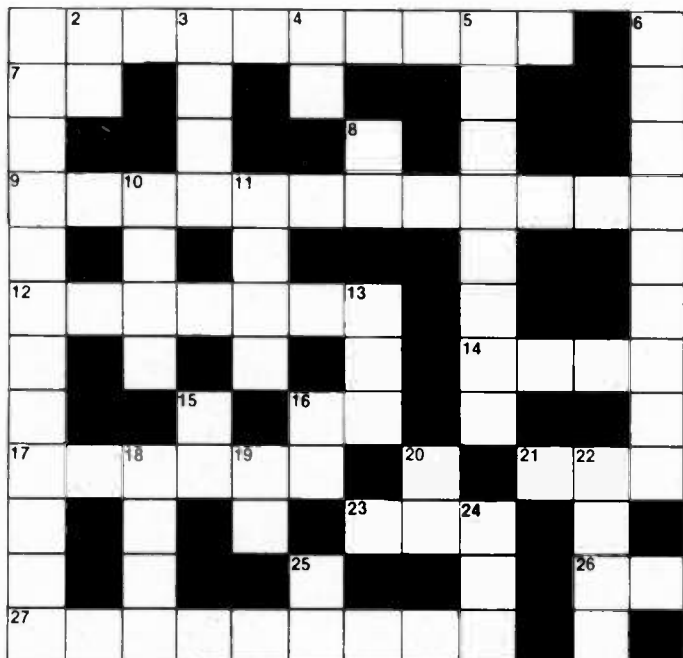

Illustration 1.

ELEMENT 2—MULTIPLE CHOICE

- In 1958, Lee De Forest was asked by a reporter what would have been his reaction if transistors had suddenly been developed during the early years of the century. What did De Forest reply?
 - "I would have fainted."
 - "I would have invented the printed circuit board."
 - "I might never have invented the audion."
 - "Weren't they?"
- What news did thousands of amateurs hear over their wireless sets on the night of November 8, 1916?
 - News of the formation of the ARRL
 - The first election night broadcast
 - News of the sinking of the *Titanic*
 - Word of the first transatlantic QSO
- Remember those Fort Orange Radio ads that appeared in *QST* in the 1950s? In the ad, what was flying out the end of Uncle Dave's cigar?
 - Lightning bolts
 - Smoke
 - Radios
 - Money
- Which year saw the introduction of the Hallicrafters SX-71?
 - 1920
 - 1934
 - 1950
 - 1958

- In the introduction, I mentioned New York's "radio row." What stands on this site today?
 - The new Madison Square Garden
 - The Metropolitan Opera House
 - Shea Stadium
 - The World Trade Center

ELEMENT 3—TRUE-FALSE

- | | True | False |
|--|-------|-------|
| 1) Howard Hughes was a ham. | _____ | _____ |
| 2) The man who played Andy, on radio's "Amos 'n' Andy," was a ham. | _____ | _____ |
| 3) The Conditional class license was phased out beginning in 1976. | _____ | _____ |
| 4) In 1951, the US government forbade the ARRL to send its publications to the Soviet Union. | _____ | _____ |
| 5) In its advertisements for the KWS-1, Collins claimed that SSB signals were "distortion free." | _____ | _____ |
| 6) The 1947 WARC was held in New Jersey. | _____ | _____ |
| 7) Novices have never had phone privileges. | _____ | _____ |
| 8) The Heath Company got its start with "build-them-yourself" airplane kits. | _____ | _____ |
| 9) NBVM was a popular operating mode in the 1930s. | _____ | _____ |
| 10) A "Model 15" was a type of SSTV gear. | _____ | _____ |

ELEMENT 4—SCRAMBLED WORDS

Unscramble these names of 1950s ham equipment manufacturers.

- | | | | |
|---------|---------|----------|-------|
| SNOHJNO | LINLCOS | IONTANLA | LAMCE |
| NORAS | SNEOGT | HTAIKHTI | |

THE ANSWERS

Element 1:
See Illustration 1A.

- Element 2:
1—3 That Lee. What a wit.
2—2 The only problem was, the broadcast proclaimed Charles

Evans Hughes—instead of Woodrow Wilson—as the winner. Oh, well—guess they had to wait for the invention of the computer.

3—1 Forming the phrase “calling CQ.” Love them rf cigars.

4—3 A staple for many Novices in the 1960s.

5—4 And I still feel bitter.

Element 3:

1—True. Yes, indeed. His call was 5CY.

2—False. Freeman Gosden, “Amos,” was the ham.

3—True. To the dismay of cheats everywhere.

4—True. Wouldn't want the Russkies to get any of the League's precious secrets, would you?

5—True. No consumer advocates back then.

6—True. Atlantic City, to be precise.

7—False. They must have had the privileges back in the 1960s, or a lot of my friends were breaking the law.

8—True. Troubleshooting section: Plane flies backwards. Check motor polarity.

9—False. Baldwin's folly.

10—False. Better check “RTTY Loop.”

Element 4:

JOHNSON, SONAR, COLLINS, GONSET, NATIONAL, HEATHKIT, ELMAC.



Illustration 1A.

SCORING

Element 1:

Twenty-five points for the completed puzzle, or one-half point for each question correctly answered.

Element 2:

Five points for each correct answer.

Element 3:

Two and one-half points for each correct answer.

Element 4:

Three and one-half points for each correct answer.

How's your memory?

1-20 points—Erased

21-40 points—Faulty

41-60 points—16K

61-80 points—Sharp

81-100 + points—Golden Oldies!

FUN! MAILBOX

I feel I must point out an error in the True-False section of the May column. The Hazel episode that dealt with TVI showed a pretty good example of misunderstanding and jumping to conclusions. Mr. Baxter thought his TVI was caused by the ham—because his son was visiting the neighbor ham at the same time. Mr. Baxter also injured his back playing golf and was using a heating pad while he was trying to watch TV. At the end of the program an engineer from the electric company tracked down the TVI with an RDF unit. The heating pad had a bad thermostat and this was the cause.

Daniel L. Quigg WD4IRK
Lexington KY

You're absolutely correct. I'd like to say that I slipped in that question just to keep my readers on their toes, but I didn't. I goofed. For penance, I had myself strapped into a chair and forced to watch that episode 50 times on my VCR. As Hazel would say, "What a doozey!"—J. E.

READER'S CORNER

Well, I finally got around to checking the responses to February's Reader's Corner. The Magic Square's solution, not surprisingly, is "73." The following readers correctly guessed the answer: Frank Waldhaus WB1CSE, Dick Milewski N2ABA, Edward Baker N3CLP, Jim Higgins KB3PU, Bernie Lavezza N4FOC, Jim Morris WA6KGB, David Fox KA8CXQ, John Hufschmid K19J, Dave Karr KA9FUR, Wayne Schuler A19Q, I. Zender W9IQK, and Jerry Moore W0HMA.

Late arrival: Found one solution to January's DX puzzle—J. Edgar McDermott AH2K.

LETTERS

VIVA "QLF, OM"

I've been receiving 73 for 3 months now. So far, so good. I'm surprised to see someone agrees with my philosophies so extensively. Keep up the good work.

As far as getting more youngsters into ham radio goes, I think the key is reaching out more on their level: demonstrations in

science classes and public places; offering classes in ham radio for beginners (WA3WKA and I have had several successful "graduates"); and finally just showing ourselves in a good light all the way around. And, of course, once the spark takes, it must be kindled with good examples from the old-timers. One of the reasons for some of the bad operating practices today is that the old-timers can't or won't put their feet

down and correct a beginner's mistakes. (Is letting him develop into a lid doing him a favor? Viva QLF!)

Larry Gotts WA3UKC
Pleasant Mount PA

P.S. I'd sure like to catch you on the air, or for an eyeball sometime, Wayne. We'd have a lot to rag chew about!

Larry, you're right about getting teenagers interested. If they don't see amateur radio working, how can they get interested in it? Look for me around the low end of 20m phone. That's where I hang out when I get on.—Wayne.

RIGHT ON, WAYNE!

I have always wanted to drop you a line; renewal time seems to be a good time to do so. I have been following your articles, magazines, and other achievements since I was first licensed in 1959. You have not always been in the forefront of popularity, but you have usually been "right," and I have enjoyed all of it. I am a member of the ARRL and therefore feel that I am entitled to say whatever I wish. All organizations I have ever been associated with have benefited from criticism, and the ARRL should be no exception. I sometimes tire of those who at-

tack you or *73 Magazine* because you choose to change.

Change is usually for the better. I joined the ranks of amateurs in the middle of the furor over AM vs. SSB, a change for the better. The same happened on 6 and 2 meters, where I worked AM. Now we have a nice proliferation of repeaters. I remember the huge rock-mounted transmitters and now you could hold the modern equivalent in one hand. Drive on, Wayne! There are many loyal supporters in your "silent majority." You do grace the bands with your presence, and it is a pleasure to work you.

**Mike Davis K4WYC
Durham NC**

By golly, Mike, it has been a long time. Yep, I generated a lot of unfans when I pushed for sideband. More when I pushed for solid state in the 60s. Then a whole new bunch hated me when I pushed for FM and repeaters on VHF. I don't seem to be able to shut up and leave things alone. Oh, I grumble and beef when the FCC does something silly or bad for us... ditto when the ARRL does it... or Bash. But you know, there are a lot of hams... a whole lot... who agree about the FCC, agree about Bash... and then get furious when I mention the ARRL. No, you can't be honest about them or try to put 'em into perspective. It's like religion and politics, a matter of emotion and to hell with facts. Guess I'll never learn to keep my mouth shut or my typewriter turned off. Thanks for sticking with me for so long, Mike.—Wayne.

IDIOTS?

After years of being interested in ham radio from afar, last year I got with it and got my license. I find the technology fascinating, but it wasn't long until I became disenchanted with the content of the QSOs on the air. Banal ramblings which go on and on and on yet say nothing... excruciatingly redundant callsign exchanges with every transmission... and, of course, the very prevalent "CB syndrome," which manifests its presence with seemingly uncontrollable overmodulation and heavy breathing in the mike. Idiots. I thought that there was intelligent life on the ham bands. There are exceptions, of

course, but it seems like hardly anyone wants to discuss anything of any consequence. Has it always been like this?

**Keith Orosz N6FQE
Seal Beach CA**

Intelligent life on the ham bands? Surely you are jesting! No, as a matter of fact, though it is hidden from casual detection, it is there. But I have some bad news for you... it will rarely show its head. The fact is that before you will discover intelligence, you have to exhibit it. I realize that this is a painful fact to face. Keith, I've been hamming for a long time now and I manage to find interesting people to talk with. Often. Oh, I agree that there are some hams who are almost without redeeming qualities. There are some who are so afraid of talking that the best you can get is an antenna discussion, which is not one of my favorite topics. Keith... if you look hard and work out ways of getting through the layer of insulation, you'll find absolutely fascinating people who will enjoy talking with you. There are a thousand things I enjoy talking about. I give hints about some of them in my editorials. I'm alive with information, ideas, interesting experiences... and yet hundreds... perhaps thousands... of hams have contacted me without ever giving either of us a chance to enjoy the contact. Thousands have contacted me and had a contact to remember. It's all in you, Keith, not us.—Wayne.

MORE ABOUT CHARLIE

Upon returning from a meeting of the Montserrat Amateur Radio Society last night, I opened your magazine (which had been given to me that day) and I found your article "Messages from Station Charlie."

During the war, I was a member of the Women's Transport Service, F.A.N.Y., and I was stationed both at the camp shown in the photograph and also at another nearby station. I was a W.T. operator. I was able to recognize the faces in the picture, but unfortunately I was unable to put names to the faces.

It may interest you to know that the Special Forces Association Signals Section is still very much a group, having a newsletter published every four months and meetings twice yearly.

Several of the members are still operating.

I will be writing to the Association to tell them all about the article. I thank you for helping me to contact the people mentioned in the article.

**Ursula M. Sadler
Montserrat, West Indies**

FIRST-CLASS TAPES

I passed my amateur Extra exam last week in Atlanta and would like to extend my thanks for your first-class code practice tapes. My only complaint is that the text proved to be so much easier than the random groups on the tape that I could have gone a couple of weeks earlier! Hi.

**Alan P. Biddle WA4SCA
Huntsville AL**

Sure, Alan, you could have gone earlier... but I wanted you to be so good at the code that you would not freeze up when faced with the test. By making you able to copy far faster than needed, you probably found yourself feeling confident when the code test started... and able to go right on through it with no problem. Remember that with the old-style code test, you had to copy only one minute solid of that test, but with the new one if you don't get the whole test solid, you can get tripped up by one of the questions. No, you want to have that code sound slow when you sit down to copy it and that's what my tape does for you.—Wayne.

CRANKY CURMUDGEONS?

As a new ham, here are a few observations on this wonderful world of amateur radio. But first: I am retired, having been a professional pilot and a businessman for, well, a long time.

I received my Novice license in November, 1981, my Technician this past February, and plan the General soon. Ham radio was a natural selection since my fascination with electronic things began with watching the old Collins airborne transceivers whir and grind to produce some new frequency that would let you talk to where you were going. That was especially nice if you had been flying over water for about 8 hours. But enough of that or shortly I'll be talking Ford Tri-motors.

So, what is this piercing clarity I propose to offer about amateur radio? First, that I like it very much. The logic of the licensing program (learn and work code as a Novice; upgrade for additional privileges) seems too delicious to have been government-produced. And the things you hear about meeting great people on the air are really true.

But I am dumbfounded at the customer relations to be found in a radio store. Passing the FCC tests is a minor part of becoming a ham. The big thing to learn is how to get along with the omniscient, crotchety people who sell the radios.

Perhaps I can never achieve the stature of these Ancient Icons, but, boy, I really tire of the idiot treatment. And if I am not received as an imbecile, I am labeled an intruder wantonly invading the A.I.'s busy-work-destroying thoughts of dreadful complexity.

I really feel that a person using the simplest sales technique (be cheerful, knowledgeable, helpful) could walk off with the business.

These observations don't emanate from just one store. They include everybody. Wayne, you have sagely said that amateur radio needs new blood. I think the first new blood to hit the sales end of hamming will blow the curmudgeon contingent right out of the water. I would not weep.

But I love the rest of it. I really do. I guess that's really why I wrote this letter.

**R. J. Richardson KA6RJJ
Burbank CA**

Hey, is R. J. right about this? I have been so well received in the ham stores I've visited that I am not a good judge of what the newcomer faces. How about some letters from readers which might help ham dealers understand what is going on... and how to fix it?—Wayne.

RAG-CHEW AWARDS

After having read and appreciated your editorials for several years, two ideas come to mind for your or anyone's consideration.

First off, why doesn't someone establish an award for DX rag chewing? I can't do it myself. Say the minimum qualifica-

tions to be a half-hour QSO on phone or SSTV or fifteen minutes on CW or RTTY with one ham from each of 100 countries. Additional endorsements could be for conversing with a second ham in each of the same 100 countries or for each of the 100 QSOs to be in the DX ham's native tongue. The certificate awarded should be suitable for the effort involved; 25-50 hours as a minimum amount of time requires brass plaques on walnut or similar certificates.

Second, I strongly suspect that there is a huge demand for radios with an amateur appearance, especially in the 2-meter FM field. By amateur appearance, I mean big, bulky, ugly boat anchors with a myriad of gauges, knobs, levers, handles, and hasps rather than miraculous, neat little units which could fit in a shirt pocket. I find nothing wrong with the neat units on the market, but somehow I think that non-hams expect us to show up with boat anchors. Recently, at an emergency communications center, after just seeing the neat little boxes, a person in control referred to the hams in attendance as a group of Cbers. Major bloodshed was averted only by heroic efforts.

So maybe I'll buy a big, ugly, military surplus chassis and stuff it with a 2-meter rig, power supply, thermos for coffee, and

a cooler for the beer. I'll hang some gauges on it and be prepared for the next emergency.

**Chris Creasy III WB3AAM
Catawissa PA**

Chris, I used to have an award for long-winded folk like me. It was the Real Rag Chewers Club (RRCC) and one had to talk with a station for at least six hours to get the award. Several hundred were awarded.—Wayne.

BANGING CODE

First off—keep gunning! Amateur radio needs awakening if it's to continue as a living, growing service.

I agree with you about the relaxed technical standards needed for a given license. I am not a ham—I have an A.A.S. in electronics and am taking a General class study class that the Kalamazoo amateur club offers. I was totally surprised at how little I had to know about electronics to pass a test! The code should be an added privilege (frequencies w/ license grade)—not a requirement for a license. Most newer hams are more interested in interfacing a computer to their rigs, ATV, microwaves, etc., than banging code. I'm having trouble learning the code and may have to settle for a Technician's license, which would be OK since my main interest is with the possibilities

available to me at VHF and above.

Once again, Wayne, keep rattling the cage, and let's both hope the Amateur Radio Service lasts long enough for the old blood to pass on and the newer aspirations of innovation come into control to "pressure" the FCC into awakening.

**John E. Allgaier, Jr.
Kalamazoo MI**

YES TO CODE

I think you are wrong about a code-free test for a ham ticket.

I am 75 years old and I passed the code test 3 years ago with no problem. The main reason you want to get more hams on the air is to sell more of your magazines and books.

The biggest reason why more people don't go ham, is the cost.

Instead of all the adds for TV satellite material, print more plans for low-cost transmitters and receivers for beginners.

I have had a lot of young people talk to me about ham radio and when you tell them what it costs to start, they lose interest.

I have contacted most of the European countries with only 30 Watts output.

I am sure some of the companies could put out low-priced sets for people who can't afford \$700 to \$2,000.

Yes, most of the people who

take the Bash Test pass. But 2 days after the test, they couldn't answer one simple question on theory.

What we need is a way to get young people interested.

I am willing to give free code lessons and simple theory to anyone in my area.

If other hams would do this, I am sure it would work. Keep the CW.

**R. Spencer KA1CEV
Franklin MA**

So the whole thing is a con to sell magazines, eh? You sure are a nasty one, Spencer. And with HTs costing a couple hundred dollars, I'm not as convinced as you about money being any serious problem. Indeed, it has been my experience that kids seem to have little trouble getting the money they need for drugs and cars, so perhaps ham gear would not be that difficult if they were interested. My high school informants are adamant when they say that it is the code which is turning the kids off. They want to know why they should learn the code to operate phone, RTTY, slow scan, and so on. I don't have a rational answer for them. And I note that the FCC seems to be going in the same direction, with a dropping of the code requirement for the Tech ticket a good bet. By the way, Spencer, a couple of companies did put out low-cost low-band rigs and no one would buy them.—Wayne.

CONTESTS

Robert Baker WB2GFE
15 Windsor Dr.
Atco NJ 08004

NEW JERSEY QSO PARTY
2000 GMT August 14 to
0700 GMT August 15
1300 GMT August 15 to
0200 GMT August 16

The Englewood ARA invites all amateurs worldwide to participate in the 23rd annual NJ QSO Party. Phone and CW are considered the same contest. A station may be contacted once on each band. Phone and CW are considered separate "bands," but CW contacts may not be made in phone band segments. NJ stations may work

other NJ stations, and NJ stations are requested to identify themselves as "DE NJ".

EXCHANGE:

QSO number, RS(T), and ARRL section, country, or NJ county.

FREQUENCIES:

1810, 3535, 3900, 7035, 7135, 7235, 14035, 14280, 21100, 21355, 28100, and 28610. Suggest phone activity on the even hours; 15 meters on the odd hours (1500 to 2100 GMT); 160 meters at 0500 GMT.

SCORING:

Out-of-state stations multiply

CALENDAR

Aug 7-8	ARRL UHF Contest
Aug 14-15	European DX Contest—CW
Aug 14-16	New Jersey QSO Party
Aug 21-22	SARTG Worldwide RTTY Contest
Aug 21-22	A5 Magazine FSTV UHF Contest
Aug 28-29	Occupation Contest
Aug 28-29	Ohio QSO Party
Sep 11-12	ARRL VHF QSO Party
Sep 11-12	European DX Contest—Phone
Sep 11-12	Cray Valley RS SWL Contest
Sep 18-19	New Mexico QSO Party
Sep 18-20	Washington State QSO Party
Oct 2-3	California QSO Party
Oct 16-17	ARCI QRP CW QSO Party
Oct 16-17	Pennsylvania QSO Party
Oct 16-17	BCOA Jamboree-on-the-Air
Nov 6-7	ARRL Sweepstakes—CW
Nov 13-14	European DX Contest—RTTY
Nov 20-21	ARRL Sweepstakes—Phone
Dec 4-5	ARRL 160-Meter Contest
Dec 11-12	ARRL 10-Meter Contest
Dec 19	CARF Canada Contest
Jan 8	73 Magazine 40-Meter World SSB Championship
Jan 9	73 Magazine 80-Meter World SSB Championship
Jan 15-16	73 Magazine 160-Meter World SSB Championship



GEARVAKf

— BULLETIN —

NEWSLETTER CONTEST WINNER

For more than 22 years, the *GEARVAKf Bulletin* has inflicted its own peculiar brand of madness on the world of amateur radio newsletter publishing. It's time the *Bulletin* received recognition for its many journalistic achievements.

Founded sometime in the murky past by the very distinguished Dr. Felix R. Onehundredton, GEARVAKf is more properly known as the Greater Enon Amateur Radio Vention And Kite fly (the "f" is silent). Depending solely on reader contributions, this august society produces one and sometimes two issues of its amusing *Bulletin* each year.

The *GEARVAKf Bulletin* strives to cover stories which are overlooked or ignored by traditional amateur journals. Two years ago, for instance, the *Bulletin* broke the exclusive story of the raging fire that nearly destroyed the 20-meter band. A follow-up article detailed FCC plans to install a sprinkler system to guard against future conflagrations.

Strong technical content is a hallmark of the *GEARVAKf Bulletin*. The newsletter has published pioneering articles on such diverse subjects as the Exploding Rat Amplifier and the early closing of the 10- and 15-meter bands due to FCC budget cuts. The exploits of researchers such as Dr. Phugoid G. Dutch-roll keep GEARVAKf at the cutting edge of technology.

The *Bulletin* frequently publishes the results of GEARVAKf member polls, which are conducted by the GEARVAKf Public Opinion Subcommittee. Members were asked recently, "How do you feel about current issues?" Fully 84% voted "no," with 11% "yes" and 5% "undecided" about current issues. That says it all.

For wackiness above and beyond the call of duty, editor/ringleader K8DMZ and his cronies deserve heartiest applause. Congratulations to our newsletter of the month, the *GEARVAKf Bulletin*.—WB8BTH.

the number of complete contacts with NJ stations by the number of NJ counties worked (21 maximum). NJ stations count 1 point per W/K/VE/VO QSO and 3 points per DX QSO. Multiply total QSO points by the number of ARRL sections (including NNJ and SNJ; maximum: 74). KP4, KH6, KL7, etc., count as 3-point DX contacts and as section multipliers.

AWARDS:

Certificates will be awarded to the first-place station in each NJ county, ARRL section, and country. In addition, a second-place certificate will be awarded when 4 or more logs are received. Novice and Technician certificates will also be awarded.

ENTRIES:

Logs must show date/time in GMT, band, and emission. Logs must be received not later than September 11th. The first contact for each claimed multiplier

must be indicated and numbered and a check list of contacts and multipliers should be included. Multi-operator stations should be noted and calls of participating operators listed. Logs and comments should be sent to: Englewood Amateur Radio Assoc., Inc., Post Office Box 528, Englewood NJ 07631-0528.

A #10 size SASE should be included for results. Stations planning active participation in NJ are requested to advise the EARA by August 1st of their intentions so that they can plan for full coverage from all counties. Portable and mobile operation is encouraged.

EUROPEAN DX CONTEST—CW

Starts: 0000 GMT August 14
Ends: 2400 GMT August 15

Sponsored by the Deutscher Amateur Radio Club (DARC). Only 36 hours of operation out

RESULTS

3RD ANNUAL 160-METER SSB CONTEST*
(Claimed Scores Over 100,000)

SINGLE OPERATORS:

Call sign	QTH	Claimed Score
W9RE	IN	371,580
W8LRL	WV	350,700
WB3GCG	MD	322,660
WB8JBM	OH	315,315
W1CF1	MA	236,280
WD8CRY	MI	234,240
WB9CMM	CO	230,895
KJ9D	IN	184,670
KC8P	MI	169,800
N5IJ	TX	169,650
N8ATR	OH	164,640
K9QLL	IL	160,950
W9CM	KS	147,600
K9RJ	IL	142,500
KB8HW	MI	138,320
N5CG	OK	135,810
W3BGN	PA	135,730
W9DUB	WI	135,660
KC4OV	TN	130,140
K1MNS	NH	120,725
K1LPS	VT	119,610
W4TMR	NC	117,720
KA7BTQ	ID	111,805
K0STI	SD	109,080
W4VKK	GA	106,020
W2FJ	NJ	104,430
N7DF	UT	103,880
N4IN	FL	101,100

MULTI-OPERATOR:

W8NGO	MI	273,900
W4CN	KY	238,950
AK2E	NY	224,750
K9ZUH	IN	213,280
K9YUG	IL	152,400
K9ZX	IL	130,560

Full details and final scores will be featured in a future issue of 73. Well over 1,000 stations competed—the best year EVER!

*sponsored by 73 Magazine

of the 48-hour period are permitted for single-operator stations. The 12 hours of non-operation may be taken in not more than three periods at any time during the contest. Operating classes include: single-operator, all-band and multi-operator, single-transmitter. Multi-operator, single-transmitter stations are only allowed to change band one time within a 15-minute period, except for making a new multiplier. Use all amateur bands from 3.5 through 28 MHz. A contest QSO can only be established between a non-European and a European station. Each station can be worked only once per band.

EXCHANGE:

Exchange the usual six-digit number consisting of RST and progressive QSO number starting with 001.

SCORING:

Each QSO counts 1 point. Each QTC (given or received) counts 1 point. The multiplier for

non-European stations is determined by the number of European countries worked on each band. Europeans will use the last ARRL countries list. In addition, each call area in the following countries will be considered a multiplier: JA, PY, VE, VO, VK, W/K, ZL, ZS, UA9/UA0. The multiplier on 3.5 MHz may be multiplied by 4, on 4 MHz by 3, and on 14 through 28 MHz by 2. The final score is the total QSO points plus QTC points multiplied by the sum total multipliers.

QTC TRAFFIC:

Additional point credit can be realized by making use of the QTC traffic feature. A QTC is a report of a confirmed QSO that has taken place earlier in the contest and is later sent back to a European station. It can only be sent from a non-European station to a European station. The general idea is that after a number of European stations have been worked, a list of these stations can be reported back during a QSO with another sta-

tion. An additional one-point credit can be claimed for each station reported.

A QTC contains the time, call, and QSO number of the station being reported, e.g., 1300/DA1AA/134. This means that at 1300 GMT you worked DA1AA and received number 134. A QSO can be reported only once and not back to the originating station. Only a maximum of 10 QTCs to a station are permitted. You may work the same station several times to complete this quota, but only the original contact has QSO-point value. Keep a uniform list of QTCs sent. QTC 3/7 indicates that this is the 3rd series of QTCs sent and that 7 QSOs are reported. Europeans may keep the list of the received QTCs on a separate sheet if they clearly indicate the station that sent the QTCs.

AWARDS:

Certificates to the highest scorer in each classification in each country, reasonable score provided. Continental leaders will be honored with plaques. Certificates will also be given stations with at least half the score of the continental leader or with at least 250,000 points. The minimum requirements for a certificate or a trophy are 100 QSOs or 10,000 points.

ENTRIES:

Violation of the rules, unsportsmanlike conduct, or taking credit for excessive duplicate contacts will be deemed sufficient cause for disqualification. The decisions of the Contest Committee are final. It is suggested you use the log sheets of the DARC or equivalent. Send a large SASE to get the wanted number of logs and summary sheets (40 QSOs or QTCs per sheet). SWLs apply the rules accordingly. Entries should be sent no later than September 15th to: DARC DX AWARDS, PO Box 1328, D-895 Kaufbeuren, West Germany.

EUROPEAN COUNTRY LIST:

C31, CT1, CT2, DL, DM, EA, EA6, EI, F, FC, G, GC Guer, GC Jer, GD, GI, GM, GM Shetland, GW, HA, HB9, HB0, HV, I, IS, IT, JW Bear, JW, JX, LA, LX, LZ, M1, OE, OH, OH0, OJ0, OK, ON, OY, OZ, PA, SM, S, SV, SV Crete, SV Rhodes, SV Athos, TA1, UA1346, UA2, UB5, UC2, UN1, UO5, UP2, UQ2, UR2, UA Franz Josef Land, YO, YU, ZA, AB2, 3A, 4U1, 9H1.

A5 MAGAZINE FSTV UHF CONTEST Starts: 1800 EDT August 20 Ends: 1800 EDT August 22

Over \$750 worth of prizes will be awarded in the 1982 A5 Magazine North American FSTV UHF Contest. This 48-hour ATV contest is designed for the UHF specialized communications operator to work as many FSTV contacts as possible with rewarding bonus multipliers and additions for quality picture transmissions, DX distance accomplishments, and bands utilized. All ATV stations in the United States, Canada, and Mexico are eligible for entry. Even stations without transmit capability can participate utilizing a secondary frequency for voice confirmation of received video. Please note that dates and times are in Eastern Daylight Time (EDT).

Contacts must be made on authorized amateur bands and within power limitations as set forth by the governing agency. Transmission of TV signals in recognized SSB, EME, FM, or satellite portions of the UHF bands will not be recognized and becomes grounds for immediate disqualification of entry. No station may claim another station more than one time per band. Crossband contacts are encouraged and authorized.

Portable, mobile, and automobile, etc., contacts are allowable as long as verification of location and simplex transmission is used. Contacts via repeaters or any type of relaying device are prohibited. This is not to discourage ATV repeater use, but merely to establish operator and station self-accomplishment. Secondary audio frequencies for signal coordination are recommended, such as 146.43 MHz FM, 7.290 MHz, and 3.990 MHz. Any locally-utilized secondary voice frequency may be used.

For a valid contact to occur, verification must be established by both the receiving and transmitting stations. This can be accomplished by video return, voice communications, hard-copy photography, or lettered QSL. Proof of contact to be included as logbook entry with required information or enclosed photographs to A5.

At the core of the Big Apple

JUNIOR HIGH SCHOOL 22, ARC
111 Columbo Street
New York, N.Y. 10002

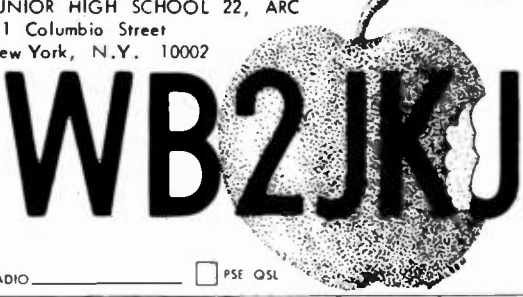

RADIO _____ PSE QSL TNX

DATE	UTC	RST	RIG	ANTENNA	OPERATOR

QSL OF THE MONTH: WB2JKJ

Joe Fairclough WB2JKJ had this to say:
I am a Junior High School English teacher and have been since 1968. I have been an amateur operator since 1962.

After several years of using the conventional methods of teaching English and finding they simply do not work on the 7th and 8th graders I'm dealing with, I decided it was time for a change. There had to be a better way. If a child is interested and *wants* to be in school, he will learn.

With the idea of creating interest and excitement, I took the standard English curriculum and revised it all around ham radio. Very basically and briefly, this is what I developed:

1. Teach the children Morse at the beginning of the term and get them to a point at which they can copy their spelling and vocabulary in CW.
2. Use the Novice handbook as the class textbook. Diagram its sentences, examine its parts of speech, etc.
3. Reading assignments from 73, QST, CQ, and any other suitable publications.

Our program receives no funds from any government agency or even the school itself. We are totally self-supporting. All our equipment was purchased from the fund-raising efforts of the students and myself. Even down to the postage, it's all done by the kids. It's very difficult to survive this way, but it makes for a great spirit of everyone pulling together, and besides, hams are great people and without them, this wouldn't be possible.

So listen for us on 15. We'll be listening for you.

RESULTS

1982 SSTV CONTEST RESULTS

Activity during this year's SSTV contest was relatively mild, but there were indications of video enthusiasm and acceptance by amateurs on the bands. Slow-scanners were noted on several HF bands, many exchanging reports via color rather than black-and-white SSTV. Quite often, we also noticed contest activity giving way to general-interest SSTV views and idea exchanges. Great! If such interests are sparked and a general attitude of friendship developed, a worthwhile purpose is definitely served. DX signals poured into the US on both 10 and 20 meters during the contest's morning periods, and again during the last hours of each day's operation.

We've received requests for shifting the SSTV contest period from April to January or February (its close proximity to Dayton in April creates a "strain" on contesters). What's your opinion? Another item of interest concerns holding "crossband" SSTV activities between Advanced class and General class SSTVs during the first 15 minutes of each contest hour. Let's hear your opinions either via mail or via the Saturday SSTV net—and soon. Announcement deadlines for the next contest are nigh. Truthfully, we must show more contest participation, gang, or the contest will be doomed to failure. We know many of you operated, but where are those logs?

This year's SSTV contest winner was Mike Di Persio KC2Q, of Bradley Beach NJ. Congratulations, Mike, and enjoy your year's subscription to 73.

Thanks to all for the participation, and we look forward to your support next time. See you on the Saturday SSTV net (1800 UTC, 14,230 kHz).

Dave Ingram K4TJW
Richard "Brooks" Kendall W1JKF

Video pictures transmitted must contain as a minimum the station call sign and location along with a signal report of the video received. Standard "P" signal reports will be used.

Quality multipliers, DX distance additions, and band usage multipliers will be used as shown later. Standard air or road maps may be used to determine recorded distances. A circle radius should be drawn from the location of the operating station with increments of 25 miles and dots showing locations of stations worked. The map used must be submitted to the *A5 Magazine* contest editor along with all log entry information.

Winners with the highest score in each US call area, Canadian province, or Mexican XE1, XE2, or XE3 areas will receive a free one-year subscription to *A5 Magazine*, a copy of the new ATV book *Everything You Always Wanted To Know About ATV But Were Afraid To Ask*, and a gold Specialized Communications Achievement Award certificate suitable for framing. All entries, regardless of placement, will receive a gold certificate showing participa-

tion. The highest-scoring North American winner will also receive a wooden plaque engraving with a large orthodon video tube similar to the *A5 Magazine* Good Image award, along with his photo in *A5 Magazine*.

All entries are encouraged to send photos of station operation and contacts received which will be returned by *A5 Magazine*. Entries must be postmarked no later than September 1st, allowing one week for lettered verifications. All logs will be returned. Please include *A5 ATV Magazine* subscription expiration date information with your entry.

SCORING:

The base points awarded are determined by the type and strength of signal received. Many times on long distance contacts or weak band conditions, only the sync bar level is seen, without a video picture. If indeed verification can be accomplished by both stations on a secondary frequency utilizing the "on-off" method with the receiving station stating the actual "on-off" reception test signals, then low-level points can be achieved. It is to the advantage of both stations to

watch the bands or apply more power to obtain a better-quality contact with higher points. Continued quality upgrades, including color reception with sound, enhance higher point totals. In case of better conditions further along in the contest, previous claimed contacts may be erased and upgraded if desired.

OHIO QSO PARTY

Starts: 0000 GMT August 28

Ends: 2400 GMT August 29

Sponsored by the Cuyahoga Falls Amateur Radio Club, the contest is open to all radio amateurs worldwide.

EXCHANGE:

RS(T) and ARRL section, DXCC country, or Ohio county.

SCORING:

Score 2 points for each contact with an Ohio station. Contacts with a Falls member will be worth 10 points and contacts with W8VPV, the club station, will count 25 points. Outside Ohio, multiply your total QSO points by the number of Ohio counties worked on all bands. Ohio stations will score 5 points for out-of-state contacts plus the member and club station bonuses. Multiply your QSO point total by the sum of counties (max.: 88), ARRL sections (max.: 74), and DXCC countries on each band. Phone and CW are considered two bands.

AWARDS:

Plaques to the top station in Ohio and outside Ohio. Certificates to the top station in each ARRL section, Ohio county, and DXCC country. All awards will be made out to the station call on the entry.

ENTRIES:

Each log must show the date/time in GMT, band and mode, and the complete exchange. A copy of the official log sheet and reporting form are available

from the club by sending an SASE. Dupe sheets must be completed for any stations with more than 200 contacts. Some form of summary sheet showing the scoring and usual signed declaration are also requested. Send a large SASE for a copy of the results. Deadline for logs is Sept. 29th. All entries and requests for forms/logs should be addressed to: The Cuyahoga Falls ARC, PO Box 6, Cuyahoga Falls OH 44222.

OCCUPATION CONTEST

Starts: 1800 GMT August 28

Ends: 2400 GMT August 29

The Radio Association of Erie PA is sponsoring their second annual contest. The contest is open to all amateur radio operators.

EXCHANGE:

RS(T); occupation; and state, province, or country. Please try to keep occupations in general fields such as engineer, technician, machinist, salesman, etc.

FREQUENCIES:

CW—50 kHz from the bottom of the ham bands. Phone—50 kHz from the top of the ham bands. Repeater contacts are not permitted.

SCORING:

Count 1 point per QSO, with multipliers determined by the number of similar occupations worked. One multiplier point is given for every 3 similar occupations. Final score is the product of the QSO points times the total multiplier.

AWARDS:

A plaque will be given to the top-scoring station. Certificates for the top stations in each state, province, and country.

ENTRIES:

The mailing deadline for logs is Oct. 1st. They are to be sent to: Chris Robson KB3A, 6950 Kreider Rd., Fairview PA 16415.

FSTV UHF CONTEST SCORING

Base Point Table

Points	Contact Type
1	1-way, verified sync or audio tone bar display
2	2-way, verified sync or audio tone bar display
3	1-way, audio sound detected only (subcarrier or on-carrier)
6	2-way, audio sound detected only (subcarrier or on-carrier)
10	1-way, video picture (b&w) detected
15	1-way, video picture (b&w) detected with sound
20	2-way, video picture (b&w) detected
30	2-way, video picture (b&w) detected with sound
40	1-way, color picture detected
45	1-way, color picture and sound detected
80	2-way, color picture detected
85	2-way, color picture with sound

Picture Quality Multipliers

(Base point times P signal quality level)

Base times 1 = P-0 to P-1 picture

Not usable, lost in noise, limited use

Base times 2 = P-2 picture

Passable picture, high noise level

Base times 3 = P-3 picture

Fair picture, noticeable noise

Base times 4 = P-4 picture

Good picture, slight noise visible

Base times 5 = P-5 picture

Excellent, closed circuit, no noise visible

DX Distance Addition

(Base point times P-signal quality multiplier plus DX points)

Note: Distance figured in miles and rounded to nearest 25-mile marker. Plus 25 points for 25 miles, 50 points for 50 miles, 75 points for 75 miles, etc.

Band Used Multipliers

(Base times P-signal multiplier plus DX times band used)

1200 MHz = times 2

2300 MHz = times 3

Higher frequencies = times 4

HAM HELP

I would like to know if the speaker-microphone SMC-24 is available for the Kenwood TR-2400 2-meter HT from a commercial distributor or an individual.

Stephen J. O'Malley N2CLE
35-54 169 Street
Flushing NY 11358

I am looking for any information on the Bendix Aviation Corp. Model 2V13E 450-MHz FM mobile radio—particularly the manual and schematic.

Michael Blouw N1BEE
Forty Plantations
Cranston RI 02920

TRAC



TRAC*ONE + DELUXE CMOS KEYSER

\$119.95

Features: Model TE-464

- * True CW signal reproduction—Single signal reception
- * Removes all QRM and QRN
- * Digs out CW signal, decodes it with Phased Lock Loop Tone Decoder then reproduces it with full operator control over Gain, Freq, Tone, Delay.
- * All controls on front panel
- * Freq control variable 300 Hz to 2500 Hz will match any rig.
- * LED flashes during decoder operation
- * Operates in line with rig audio—leave in line on OFF/BYPASS
- * Built in speaker
- * Headphones jack rear panel
- * Battery or AC adaptor, 9VDC operation

PLUS:

- * Deluxe CMOS Keyer—"State-of-the-art" CMOS circuitry
- * Self-completing dots and dashes
- * Both dot and dash memory
- * Iambic keying with any squeeze paddle
- * 5:50 w.p.m.
- * Speed, Volume, Tone, Tune and Weight controls
- * Sidetone and speaker
- * Semi-auto switch for bug or straight key
- * Deluxe quarter-inch jacks for keying and output
- * Keys grid block or solid state rigs



TRAC*ONE CW PROCESSOR

\$89.95

Features: Model TE 424

- * True CW signal reproduction—Single signal reception
- * Removes all QRM and QRN
- * Digs out CW signal, decodes it with Phased Lock Loop Tone Decoder then reproduces it with full operator control over Gain, Freq, Tone, Delay.
- * All controls on front panel
- * Freq control variable 300 Hz to 2500 Hz will match any rig.
- * LED flashes during decoder operation
- * Operates in line with rig audio—leave in line on OFF/BYPASS
- * Built-in speaker
- * Headphones jack rear panel
- * Battery or AC adaptor, 9 VDC operation ✓ 76

SEND FOR BROCHURE ON OUR FULL PRODUCT LINE
ELECTRONICS, INC.
1106 RAND BLDG.
BUFFALO, NY 14203
(716) 852-8188

MICROWAVE TELEVISION

The standard RP downconverter package shown above gives you a proven converter design mounted in a weatheright antenna that features low wind loading and easy installation.

With this package you are ready for hours of Amateur television entertainment. Just aim the antenna, connect one 75 cable from the antenna to the power supply and a second line from the power supply to your TV, and you are on the air.

All downconverter models use microstrip construction for long and reliable operation. A low noise microwave preamplifier is used for putting in weak signals. The downconverter also includes a broad-band output amplifier matched to 75 ohms. The RP model is recommended for up to 15 miles. Over a range of 15 to 25 miles, the RP+ which has a lower noise and higher gain RF amplifier stage, provides better television reception. These ranges are necessarily approximate, as signal strength is very sensitive to line of sight obstructions. For installations over 25 miles, an RPC unit which uses a separate antenna is available. All models are warranted for one year.

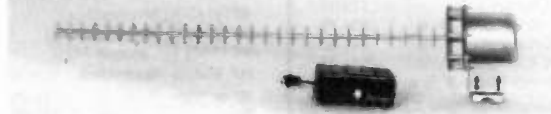

Prices including UPS shipment are as follows:

Model RP receiver package.....\$135
Model RP + receiver package.....\$155
Model RPC receiver package.....\$155

✓ 165
K. & S. Enterprises
P.O. Box 741, Mansfield, MA 02048

Put Your Computer "On-The-Air"

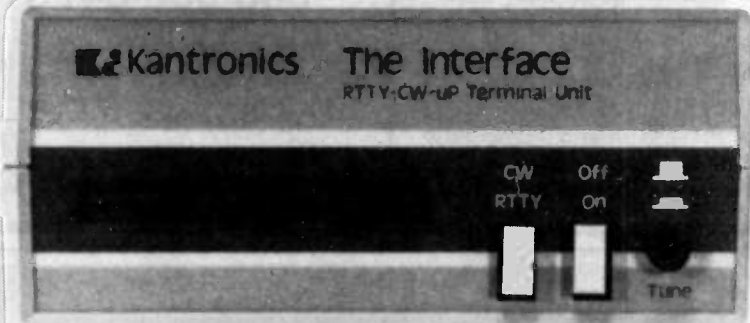

The Interface™ Sugg. Price \$189.95

Your personal computer becomes a complete CW/RTTY/ASCII send and receive terminal with The Interface linking it to your transceiver.

If you own an Apple II or Apple II Plus, Atari 400 or 800, TRS-80 Color Computer, or VIC-20, The Interface will put your computer "On-The-Air".

Software for each system features split screen display, buffered keyboard, status display, and message ports. Attach any Centronics compatible printer for hard copy. Software is available, on diskette for the Apple and program boards for the others, at an additional cost.

Apple diskette	Atari board	VIC-20 board	TRS-80C board
\$29.95	\$49.95	\$49.95	\$59.95

See The Interface at your authorized Kantronics dealer, or contact:

Kantronics

(913) 842-7745 1202 E. 23rd Lawrence, Kansas 66044

CUSHCRAFT

A3 3 Element Triband Beam	\$167.00
A4 4 Element Triband Beam	\$204.00
A743 7 & 10 MHz Add On for A3	\$55.00
A744 7 & 10 MHz Add On for A4	\$55.00
AV3 3 Band Vertical 10-20m	\$41.00
AV4 4 Band Vertical 10-40m	\$82.00
AV5 5 Band Vertical 10-80m	\$88.00
R3 14.21.28 MHz Ringo	\$204.00
32.19 Boomer 19 Element 2m	\$75.00
214B Jr. Boomer 14 Element 2m	\$61.00
A147-11 2m 11 Element Antenna	\$34.00
A147-4 2M 4 Element Antenna	\$23.00
ARX-2B 134-164 MHz Ringo Ranger II	\$34.00
A144-10T 145 MHz 10 Element	\$41.00
A432-20T 432 MHz 20 Element	\$41.00
A14T-MB Twist Mounting Boom & Bracket	\$21.00

Full Line Available on Sale Call.

ROHN

20G 10 ft. Stacking Section	\$32.00
25G 10 ft. Stacking Section	\$39.50
45G 10 ft. Stacking Section	\$87.50
25AG 2.3 or 4 Top Section	\$52.50
HDBX 48 48 ft. Free Standing Tower	\$320.00
HBX56 56 ft. Free Standing Tower	\$340.00
FK2548 48 ft. 25G Foldover Tower	\$725.00
TB3 Thrust Bearing	\$48.00
SB25G Short Base for 25G	\$16.50
BPH25G Hinged Base Plate	\$59.75
AS25G Accessory Shelf	\$9.50
HB25AG 14" House Bracket	\$14.50
BPC25G Cement Base Plate	\$32.00
BAS25G Short top section w/acc. shelf	\$36.00
M200 16 gauge, 10 ft. 2" O.D. Mast	\$19.50
M200H 1/8" wall, 10 ft. 2" O.D. Mast	\$36.00

Freight prepaid on Fold-over towers. Prices 10% higher west of Rocky Mts.



MINI-PRODUCTS

HQ-1 Mini-Quad 6/10/15/20m Antenna	\$129.95
B-24 2 Element HF Mini-Beam 6/10/15/20m	\$99.00
RK-3 3rd Element Add-on for B-24	
Improves 10-20m	\$67.00
C-4 Mini-Vertical 6/10/15/20m	\$59.00

The Antenna Bank
(703) 569-1200

HUSTLER

4BTV 40-10 Mtr. Vertical	\$79.00	
5BTV 80-10 Mtr. Vertical	\$100.00	
M01/M02 HF Mobile Mast	\$18.00	
HF Mobile Resonators, Std. 400W .SUPER 2KW		
10 or 15m	\$9.00	\$13.00
20m	\$11.00	\$16.00
40m	\$13.00	\$18.00
75 or 80m	\$14.00	\$29.00
BM-1 Bumper mt. with S.S. Strap	\$13.00	
SSM-2 Commercial S.S. Ball	\$14.00	
SF-2 5/8 Wave, 2 Meter Antenna	\$9.00	
HOT Hustloff Mt. with Swivel ball	\$14.00	
G6-144B 2M Colinear, fixed Station, 6db	\$68.00	
G7-144 2M Colinear, fixed Station, 7db	\$99.00	

Full Line Available on Sale Call

ORDERS ONLY
800-336-8473

- Shipping charges not included
- Prices subject to change without notice
- Limited quantities
- No COD's

Van Gordon and B&W in stock at special prices.

HY-GAIN

TH3JRS Jr Thunderbird, 750W PEP	\$150.00
HQ-25 Hy-Quad, 2 Element	\$235.00
TH5DXS Thunderbird, 5 Element	\$215.00
TH3MK3S Thunderbird, 3 Element	\$195.00
TH2MK3S Thunderbird, 2 Element	\$128.00
TH7DX Thunderbird, 7 Element	\$336.00
392S TH6DXX Conversion Kit to TH7DX	\$135.00
105BAS 5 Element 10m "Long John"	\$114.00
155BAS 5 Element 15m "Long John"	\$161.00
205BAS 5 Element 20m "Long John"	\$269.00
14AVQ/WBS 10-40m Vertical	\$49.95
18AVT/WBS 10-80m Vertical	\$87.50
V-2S Colinear Gain Vertical 138-174 MHz	\$33.75
BN-86 Ferrite Balun, 10-80 meters	\$13.00
HDR-300 Deluxe Rotor, Digital Readout	\$378.00

SUPER HY-GAIN PACKAGE

HG52SS 52 Self Sup. Crank-Up	
TH7DX Thunderbird, 7 Element	
HM IV Rotor	
COA (3) Coax Arms	
HG-10 Mast Mast 10	
\$1377 SALE SAVE \$449.90	
HG50MT2 50 ft. side sup. Crank-up tower	
TH3MK3S 3 Element Thunderbird	
CD-45 Rotor	
COA 3 Coax-Arms	
HG-5 Mast	
\$1005.00 SALE SAVE \$303.45	

Philly Stran Guy Cable in stock

NO SUBSTITUTIONS PLEASE

ROTORS & CABLES

CDE HAM IV Rotor	\$175.00
CDE T2X Rotor	\$244.00
CDE 45 Rotor	\$92.00
Alliance HD-73 Rotor	\$92.00
Alliance U100 Rotor	\$42.00
RG-8/U Foam Coax 95% Shield	24¢/ft.
RG-213 Coax. Mil. Spec.	28¢/ft.
Mini-8 Coax 95% Shield	12¢/ft.
Rotor Wire 8 Conductor	16¢/ft.
4 Conductor	7.5¢/ft.

MIDCOM

CALL NUMBER ONE!

**CARLOAD INVENTORIES • ROCK BOTTOM PRICES
SUPER-FAST SERVICE**

LINES: AEA	ALPHA	CUSHCRAFT	DENTRON	KANTRONICS	MINI-PRODUCTS	NYE	TEN TEC
AVANTI	BEARCAT	COLLINS	HY GAIN	KLM	MOR GAIN	PALOMAR ENG	UNIVERSAL
ASTRON	BIRD	CDE	HUSTLER	KENWOOD	MIRAGE	REGENCY	UNARCO-ROHN
ALLIANCE	BENCHER	DRAKE	ICOM	MICROLOG	MFJ	SWAN	VIBROPLEX

CALL TOLL FREE 1-800-325-3609 IN MISSOURI
314-961-9990
MID-COM ELECTRONICS • 8516 MANCHESTER ROAD • BRENTWOOD, MO 63144



1900 - 2500 MHZ KITS

DOWN CONVERTER KIT

\$19.95

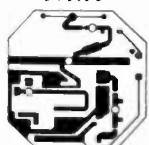

ANTENNA KIT

\$19.95

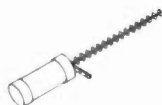

POWER SUPPLY KIT

\$19.95



- 1 P.C. BOARD
PRE-DRILLED AND
SOLDER FLOWED
- 3 MRF901 TRANS.
- 2 HP DIODES
- 6 CHIP CAPS "LARGE"
- 8 RESISTORS
- 4 PREPARED COILS,
FACTORY WOUND
- 1 10 MFD CAP.

- 33 WASHERS
- 32 SPACERS
- 1 3 FOOT ROD
- 2 NUTS
- 1 8" PVC PIPE
- 2 4" END CAPS
- 1 MOUNTING BAR
- 1 "F" CONNECTOR
- 1 NUT AND BOLT

- 1 P.C. BOARD
- 1 POWER TRANSF.
- 1 317L ADJUSTABLE
REGULATOR
- 1 FINE TUNING POT.
WITH SWITCH
- 1 COARSE TUNING POT.
- 2 KNOBS
- 3 "F" CONNECTORS
- 4 POWER DIODES
- 1 RF CHOKE
- 3 RESISTORS
- 3 DISK CAPS.
- 1 1000 MFD CAP.
- 1 DDPDT MINI TOGGLE
SWITCH
- 1 LED WITH HOLDER

SUPPLY CABINETS

ALUMINUM CABINETS PREPARED TO FIT
POWER SUPPLY KIT \$19.95

MANUFACTURED CABLE SETS

100FT. PLUS ST. \$19.95
150FT. PLUS ST. \$25.95
200FT. PLUS ST. \$32.95

DISCOUNTS

1 TO 4 10%
5 TO 9 15%
10 TO 24 20%
25 TO 49 25%
50 TO 99 30%
100 TO 999 35%
1000 UP 40%
DIFFERENT KITS CAN NOT BE ADDED
FOR QUANTITY DISCOUNT.

MAIL ORDERS

ADD \$5.00 FOR SHIPPING AND HANDLING. TRIONYX IND. INC.
INDIANA RESIDENTS ADD 4% SALES TAX. 6219 COFFMAN RD.



INDIANAPOLIS, IND.
46268 ✓ 104
(317) 291-7280
(317) 291-2995

FAST

SCAN

\$399

Have you tried it yet? ATV TRANSMITTER/CONVERTER



TC-1

- * 10 Watts Output
- * Standard Frequencies Available
- * Broadcast Standard Sound
- * High-resolution & color video
- * Regulated AC Supply Built In
- * Tuneable Downconverter & Preamp

Connect to the antenna terminals of any TV set, add a good 450 MHz antenna, a camera and there you are... Show the shack, home movies, computer games, video tapes, etc.

ATV DOWNCONVERTER

For those who want to see the ATV action before they commit to a complete station, the TVC-4 is for you. Great for public service setups, demos, and getting a buddy interested. Just add an antenna and a TV set tuned to CH. 2, 3, or 4 and plug in to 117 volts a.c. **\$89.00**



TVC-4

TVC-4L extra low-noise version... \$105 delivered in USA

HOME BREWERS: ASK FOR OUR BASIC FOUR-MODULE PACKAGE

CALL OR WRITE FOR OUR COMPLETE LIST OF SPECIFICATIONS, station set-up diagrams, and optional accessories which include antennas, modulators, detectors, test generators, cameras, etc. WE ARE A FULL-LINE SUPPLIER OF ALL YOUR ATV NEEDS.

TERMS: VISA or MASTER CARD by telephone or mail, or check or money order by mail. All prices are delivered in USA. Allow three weeks after order for delivery.

P.C. ELECTRONICS (213) 447-4565
Tom W6ORG Maryann WB6YSS 2522 Paxson Lane,
Arcadia, California 91006

COMMUNICATIONS DIVISION



(We Speak Your Language.)

Backed by over 54 years of experience, Harvey continues to offer the broadest selection and finest service available for the amateur radio community. This experience has taught us that the ham needs special treatment and that is why Harvey has established a special division dedicated to the needs of the U.S. and foreign ham alike.

One thing is for certain. A ham will never get the run around from Harvey. If we don't have something in stock, we say so and will order it for you—or—tell you where to get it. However, we are sincerely dedicated to the ham community and, as a result, our

expansive inventory means that, more than likely, we will have what you are looking for in stock.



ICOM IC-720A

Yaesu FT-One

- AGA
- Alliance
- Antenna Specialists
- Astron
- Bearcat
- Bencher
- B&W
- Centurlon
- C.D.E.
- Cushcraft
- R.L. Drake
- Gotham Antennas
- Grundig
- Henry Radio
- H.M. Electronics
- Icom
- Kantronics

- K.D.K.
- Larsen
- McKay Dymek
- M.F.J.
- Midland
- J.W. Miller
- Mirage
- Wm. M. Nye
- Pace
- Regency

- Ritron
- Russell
- Signals
- Sinclair
- Telex Hygain
- Trilectric
- System One
- VoCom
- W.S. Engineering
- Yaesu

CALL TOLL FREE:

1-800-223-2642

Ask for Dou "Joe" Chin—KB2MU

HARVEY

25 W. 45th St., N.Y., N.Y. 10036 (212) 921-5920

NEW PRODUCTS

LINEAR AMPLIFIER

A 1200-Watt SSB, 1000-Watt CW linear amplifier covering 160, 80, 40, 30, 20, 17, and 15 meters is available from DenTron Radio Co.

The "Galion" amplifier features a rugged, reliable 3-500 grounded grid triode, full-function metering, and internal in-out switching. A built-in dual power supply allows it to operate from either 120- or 240-V ac lines while reduced voltage tune ensures peak efficiency regardless of mode. The Galion amplifier includes a tuned input circuit for compatibility with either solid-state or tube-type exciters of any manufacturer.

Improved reliability and performance are provided through an exclusive linearity test circuit, which instantly verifies proper tune-up and operation, and a two-speed blower to provide high volume cooling capacity.

A modification kit available for the Galion amplifier will extend frequency coverage to the 12- and 10-meter amateur bands and associated MARS frequencies. The Galion amplifier is priced at \$695.

For more information on the Galion linear amplifier, contact *DenTron Radio Co., Inc., 1605 Commerce Drive, Stow OH 44224; (216)-688-4973*. Reader Service number 482.

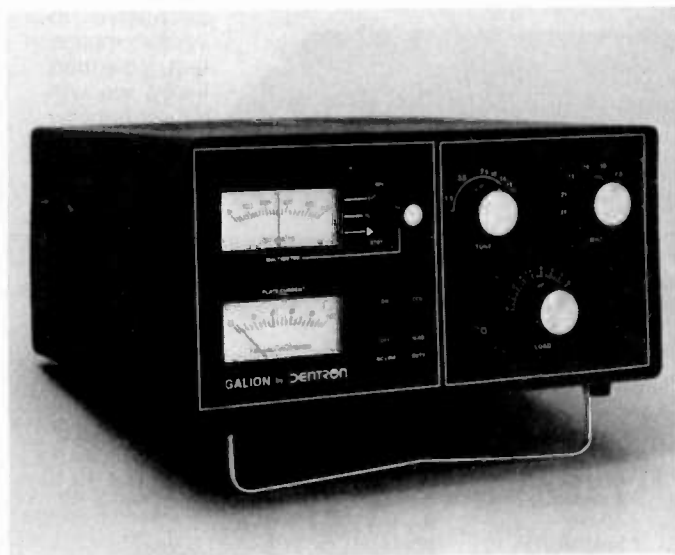

The Galion linear amplifier from DenTron.



TERMINALL communications terminal from Macrotronics.

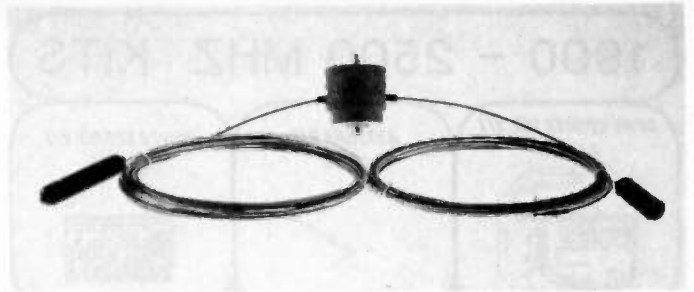

Compensating dipole antenna from Snyder.

COMPENSATING DIPOLE

Snyder Antenna Corporation now offers self-compensating dipoles that offer all the advantages of a conventional dipole plus increased efficiency. These full-band antennas have no resistors or capacitors and can be used with 50- or 70-Ohm feedlines. Available in 40-meter, 75/80-meter, and 160-meter models, prices start at \$109.95. For more information, contact *Snyder Antenna Corporation, 250 East 17th St., Costa Mesa CA 92627; (714)-760-8882*. Reader Service number 485.

COMMUNICATIONS TERMINAL

Macrotronics, Inc., has introduced TERMINALL, an integrated hardware and software system which converts the Apple II or Apple II Plus into a state-of-the-art communications terminal.

TERMINALL includes all the necessary computer-interfacing, audio-demodulating, AFSK tone-generating and transmitter-keying hardware integrated in one cabinet. This reduces equipment interconnection to a minimum and allows the operator to be on the air receiving and transmitting Morse or RTTY or ASCII in minutes. Plug it into the receiver headphone jack and copy Morse code, Baudot, or ASCII. Plug it into the CW key jack and send Morse code. Attach a

microphone connector and send Baudot or ASCII using audio tones (AFSK).

TERMINALL T2 requires an Apple II or Apple II Plus, 48K RAM, and disk drive. Software provided on disk in DOS 3.2 format (MUFFIN to 3.3). Latched and buffered cable plugs into any card slot (1 through 7).

TERMINALL comes complete with software on disk, assembled and tested hardware, and an extensive instruction manual. List price is \$499. For complete information, contact *Macrotronics, Inc., 1125 N. Golden State Blvd., Turlock CA 95380; (209)-667-2888*. Reader Service number 484.

6-METER MULTIMODE

The IC-505 is a fully-synthesized multimode transceiver covering 50 to 54 MHz on FM (option), USB, LSB, and CW. Utilizing an internal battery pack (9 C-size batteries), the IC-505 puts out 3 Watts of rf power when run on its batteries, or 10 Watts when connected to an external 13.6-volt dc source; low power is 0.5 Watts.

IC-505 features include an LCD frequency display for low battery consumption, provision for internal memory backup, dual vfo's, 5 memories plus a call channel, memory scan, program scan, sideband squelch, LCD annunciators for vfo, scan,



IC-505 transceiver from Icom.

memory channel, call and split, and split frequency operation. The transceiver has a list price of \$449.

For more information, contact *Icom America, Inc.*, 2112 116th Ave. NE, Bellevue WA 98004; (206)-454-8155.

SOLAR MODULE

A photovoltaic module that produces 40 Watts of peak power using 35 solar cells is available from ARCO Solar, Inc.

The M51 module is designed for high voltage applications where efficiency and reliability are critical considerations. It maximizes Watt-hours per day while keeping balance of system costs down. It has been successfully tested beyond industry standards.

The new 1'x4' module is 10.75% efficient. Using single crystal silicon cells, it can even charge batteries at five to ten percent of noontime sun. Under such low light level conditions, ARCO Solar analyses show the M51 can deliver up to 25 percent more energy than a typical module of polycrystalline design.

Solar cells in the M51 are 100 percent electrically matched to ensure maximum power output. Each series-connected cell em-

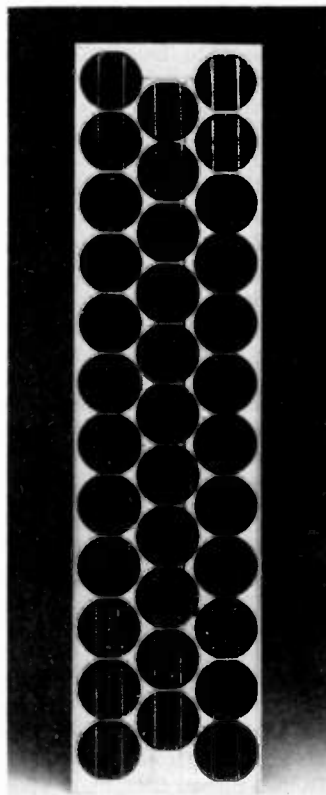

ARCO Solar's M51 module.

loys 44 contacts for enhanced reliability.

For more information, contact *ARCO Solar, Inc.*, 20554 Plummer Street, Chatsworth CA 91311; (213)-700-7458. Reader Service number 481.

SATELLITE RECEIVER

The unique two-piece design of the International Crystal ICM TV-4400 satellite receiver permits mounting the downconverter at the LNA. Signal is fed to the baseband unit via RG-59 coax at 70 MHz. The dual-conversion receiver features step-switch tuning with variable fine-tuning control. A subcarrier output may be used with audio accessories. There are two standard audio outputs and a built-in dc block for LNA power. The ICM TV-4400 has a list price of \$1295 and is available from *International Crystal Mfg. Co., Inc.*, 10 North Lee, Oklahoma City OK 73102. Reader Service number 478.

INTERFERENCE TRAP

The Model 3966 is a microwave trap for preventing strong microwave carriers from reaching Earth station downconverters.

The trap can block out up to 6 microwave telephone carriers (offset 10 MHz from transponder frequencies). Connectors are type N and the trap passes dc power to the LNA.

The trap is custom-made to customer's specific microwave offenders. Price is \$180.00 for a single carrier trap plus \$90.00 per additional interfering carrier. Delivery is 10 days. For more information, contact *Emily Bostick, Microwave Filter Co., Inc.*, 6743 Kinne Street, East Syracuse NY 10357; 1-(800)-448-1666. Reader Service number 483.

1:1 BALUN

Hustler, Inc., now offers a 1:1 ratio balun to complement their line of HF amateur antennas.

The balun, designated model "BLN," features a low-loss air-core design eliminating saturation at high power levels while maintaining a uniform power balance in the system.

BLN features include a 1-kW input rating and bandwidth of 7 to 35 MHz with under 2:1 vswr.

All stainless-steel hardware and flying leads are supplied for connection to the driven element of beams, quads, or di-

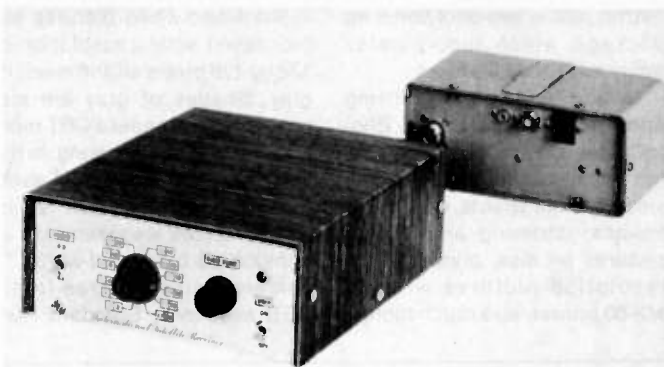

TV-4400 satellite receiver from International Crystal.

poles and coax termination into an SO-239 connector. The BLN is priced at \$21.95.

For additional information, contact *Hustler, Inc.*, Sales Department, 3275 North B Avenue, Kissimmee FL 32741.

Ameco Novice Guide. The introductory price is \$21.95. For more information, contact *VHF Communications*, 915 North Main St., Jamestown NY 14701. Reader Service number 479.

APPLE SSTV

The COMMSOFT PhotoCaster™ provides an easy way for hams who own Apple computers to get started on SSTV with a full-featured black-and-white and color system. PhotoCaster includes a circuit board to interface an APPLE to a TV camera and a receiver/trans-

NOVICE COURSE

A complete Novice course is available from VHF Communications. The course features six hours of theory sent by Morse code. The copy is then given in voice so that the student may check his or her progress. The package includes a copy of the

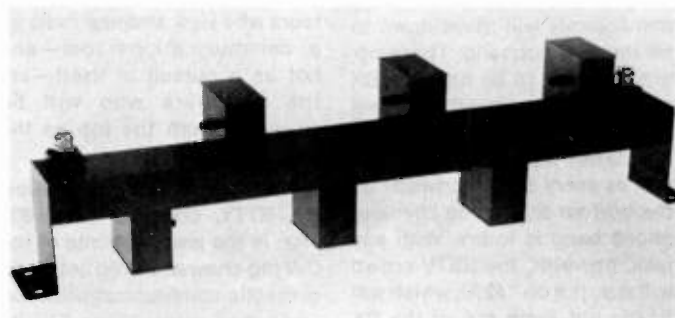

Earth station interference trap from Microwave Filter Co.

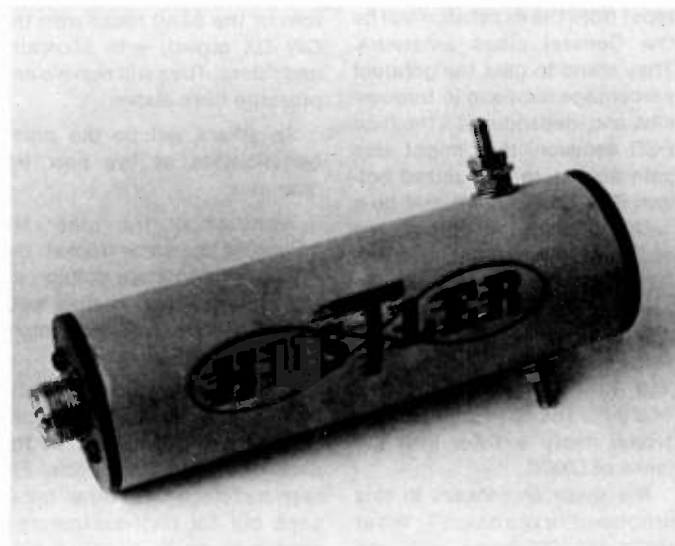

1:1 BLN balun from Hustler.

mitter, plus a two-disk software package which incorporates many advanced features.

In addition to transmitting and receiving pictures, PhotoCaster has provisions for adding titles and graphics, creating video special effects, enhancing images, retrieving and storing pictures on disk, printing high-resolution pictures with an MX-80 printer, and much more.

Black-and-white pictures are processed with a resolution of 128 by 128 pixels and 16 levels of gray. Shades of gray are presented on a standard CRT monitor by using dot dithering. In the color mode, 8 colors are available with 16 saturation levels. Color pictures are taken with an unmodified black-and-white TV camera using a three-frame RGB sequence. Standard RGB

transmission formats are available in addition to a unique Apple-to-Apple single frame color mode which takes 8 instead of the usual 24 (or more) seconds to transmit a color picture.

PhotoCaster requires an Apple II or Apple II Plus computer with 48K of RAM and one disk drive. The price of PhotoCaster is \$499.95 for the basic system

which includes an assembled and tested circuit board and software. A complete system consisting of a Panasonic WV1400 camera, board, and software is available for \$749.95.

For more information, contact *COMMSOFT, Inc.*, 665 Maybell Avenue, Palo Alto CA 94306; (415)-493-2184. Reader Service number 480.

DX

Chod Harris VP2ML
Box 4881
Santa Rosa CA 95402

FCC SAYS MORE 20-METER SSB FREQUENCIES

Expand the 20-meter phone subband? The FCC is considering just this action. Add good sunspots and you have DXer heaven! But what will FCC Docket 82-83 really do for DX?

The DXers, nets, and DX presently in the 14200-14250 range immediately will move down to fill the new subband. These operators want to be near the DX portion of the band and will move accordingly. In weeks—if not days—the new frequencies will be every bit as crowded as the bottom end of the 20-meter phone band is today. With any luck, however, the SSTV crowd will stay put on 14230, which will finally get them out of the DX area!

The hams who will benefit the most from the expansion will be the General class amateurs. They stand to gain the greatest percentage increase in frequencies and (depending on the final FCC decision) they might also gain access to that prized bottom 50 kHz! Wouldn't that be a switch! They would go from the status of a poor relation in the 20-meter DX world to head-to-head battles with top DXer W6AM. More likely, the FCC will settle for contiguous subbands and the Generals will gain 14225-75. The 66% increase will propel many a DXer into the ranks of DXCC.

Are there any losers in this proposed expansion? What about the DX hams who use 14150-14200 now? The top half

of that range contains many of the DXers, DX nets, and long-haul communications. These hams will share with those stateside or move down, depending on interference to their operation. Below this DX layer lurk the personal, non-DX QSOs: long-standing skeds, families and friends, non-English QSOs. They will be the real losers. The RTTY just below 14100 acts as a floor to phone operators; voice communication below 14100 is almost unknown. Those amateurs who view amateur radio as a communications tool—and not as a pursuit in itself—are the amateurs who will be squeezed from the top as the DXers descend.

Will these hams jump below the RTTY, down to 14050-80? That is the present home of the CW rag-chewer, traffic nets, and domestic communications. You won't find many sharp CW filters here and SSB interference will hurt. Further down, the bottom of the band roars with the CW DX crowd, with kilowatts and filters. They will survive any pressure from above.

So DXers will be the prime beneficiaries of the new frequencies.

What about the other HF bands? In the same docket, the FCC wants amateur opinion on expanding other phone subbands, 80-10 meters. How might these changes affect DX?

Ten meters doesn't need any more phone frequencies; we seldom fill what we have at the peak of the sunspot cycle. Fifteen meters, on the other hand, cries out for phone expansion almost as much as 20. A hundred additional kHz, relocating

the Novices to 21050-21150, would attract a lot of the 20-meter operators except at the bottom of the sunspots.

Any 40-meter expansion would force the Novices to move down to 7050-7100, still head-to-head with the VEs, but at least away from the shortwave broadcast stations. This move might be a welcome change! But there is no DX outside the western hemisphere above 7100, so phone expansion would be meaningless to the DXer. Now, if they could only get the foreign broadcast stations to go someplace else (I can think of a certain, overly-warm location), 40 meters could be a great band. But phone expansion? No, thank you.

An additional 25 kHz on 75 meters wouldn't revolutionize DX on the band, but it might go a long way in that direction. 75-meter DX is the exclusive province of the Extra. If other license classes get privileges below 3800, a whole new world of 75-meter DX might open up.

But don't rush onto the proposed 20-meter frequencies just yet. The FCC moves slower than New Hampshire molasses in January, and it will be a while before we can begin moving down. To help our DX totals meanwhile, we might keep an ear out for Erik SMØAGD, from somewhere in the South Pacific.

ERIK SJOLUND SMØAGD: DXPEDITIONER EXTRAORDINAIRE

Erik Sjolund left this spring for an extended DXpedition through the South Pacific, as one of the four-man crew of the 50' yacht *Marathon AQ*. Erik was lured from "retirement" from DXpeditioning by the fact that the skipper of the ship is a descendant of Leif Ericson. The support of the Sundsvall DX group and the Northern California DX Foundation help make

the trip possible. The trip's itinerary reads like an atlas of the area (and a ham's dream-come-true): North Cook Islands ZK1, Tokelau ZM7, Central Kiribati T31, American Phoenix KH1, East Kiribati T3, Tuvalu T2, and more. The 1983 itinerary is even more ambitious and includes Spratly 1S! The last group to operate from Spratly had to dodge bullets (more about Spratly in a future column).

What kind of amateur would head off on a scheduled two-year voyage, which includes actively disputed territories, just to hand out radio contacts to the deserving few? Erik Sjolund SMØAGD is a very special amateur and a special person who has operated from more than his share of rare and difficult locations.

Erik began his DXpeditioning career about 11 years ago, when he traveled to Rhodes SVØ for a vacation. Although he had been an active amateur for about 20 years prior, this was the first time Erik operated from outside his native Sweden. The DXpedition bug bit, and bit hard.

Erik traveled extensively through his job with the European Space Agency, and he carried a radio everywhere he went: Easter Island CEØA, the Falklands (or is it the Malvinas?) VP8, and others. Erik then began traveling for the Swedish government to various embassies all over the world.

The well-known neutrality of the Swedish government helped open many doors for Erik. Swedish embassies in such out-of-the-way places as Bangladesh or Botswana were perfect locations for radio operations, and Erik's diplomatic connections paved the way for licensing. Erik also operated from Lesotho 7P8, Guinea-Bissau CR3, Laos XW8, Iraq Y1, Turkey TA, and many more. Quite an impressive list! Finally, Erik "retired" and re-

turned to his home and wife, only to head off again this spring.

On his way to the South Pacific, Erik stopped by the International DX Convention in Visalia CA. While there he shared some of his experiences, including his recent trip to J5, Guinea-Bissau, with the hundreds of CA amateurs and guests.

THE SUNDSVALL DXPEDITION TO GUINEA-BISSAU J5AD

Erik had always wanted to reward his hard-working and dedicated QSL manager, Jorgen Svensson SM3CXS, with a fully-conducted DXpedition. His chance came in 1981, when Erik unexpectedly received permission to operate from Guinea-Bissau J5. Although greatly troubled by a bad knee, Erik immediately began preparing for the trip: food, hotel, transportation, equipment, customs, antennas. A seasoned DXpeditioner, Erik completely constructed and fully tested each antenna before leaving Sweden.

The travel arrangements centered on Gambia C5, a popular tourist spot for Scandinavians on the west coast of Africa. Erik, Jorgen, and other members of the Sundsvall DX Group arranged to fly a small plane the 300 km from Gambia to the tiny capital of Bissau. To see the countryside, they would chance driving back—a decision which would almost prove their undoing!

Use of the small plane severely restricted the amount of weight the group could carry, and radio gear consumed most of that. Erik had purchased enough food for the entire two-week trip, but there simply was too much weight. So the group sat down to eat the two weeks worth of food before they left two days later!

Erik maneuvered the group's gear, including 2 Icom transceivers, 2 amps, and a couple of vertical antennas, through Gambia customs and rendezvoused with their pilot, C5ADX. A sandstorm in Guinea-Bissau delayed departure for a day, but the group finally arrived and was met by J5HTL, who helped secure licenses and provided other local assistance.

Their troubles were not over, however. Minutes after firing up the radios and getting on the air for the first time, bang! The room went dark. No power. Out-

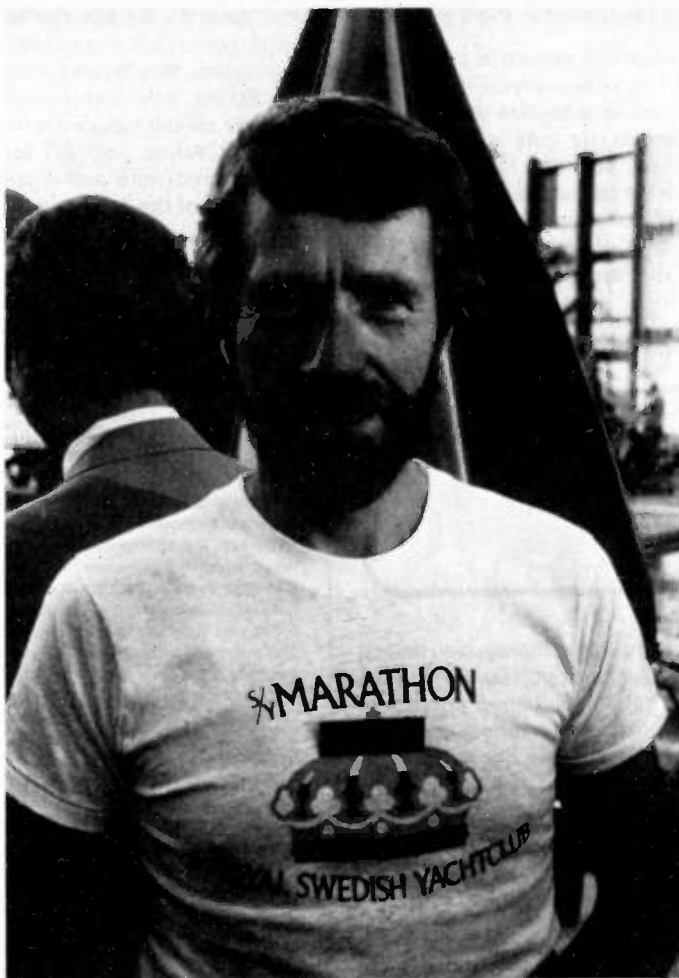

Erik Sjolund SM0AGD on his way to an extended DXpedition to the South Pacific.

side, the entire town of Bissau was dark. "Maybe we shouldn't have used the amplifier," Erik mumbled, looking out over the dark city of 110,000 people.

The lack of power turned out to be a regular occurrence. Whenever the enormous football (we call it soccer) stadium turned on its lights, the entire city was blacked out. Fortunately (that's experience and foresight), Erik's radios could operate on car batteries, without the amplifiers. A portable generator powered the amplifier when the group was away from the hotel.

Despite the hardships of inconstant power and stomach problems from trying to eat two weeks' worth of food in two days, J5AD managed 20,400 QSOs in 9 days. Contacts were about evenly split between SSB and CW.

Now came the drive back to Gambia, 300 km north. "10 hours," the driver promised. That's about 20 mph on the tortuous dirt roads. The driver appeared with his battered "taxi," but the trunk was completely

filled with a barrel of oil. The driver claimed he needed that much oil for the trip, and there wouldn't be any gas stations along the way. More likely, he was afraid someone would steal his precious barrel of oil if he left it behind for a day. He was probably right.

Erik finally convinced the driver to unload the oil and load their gear, and the car began to lurch toward Gambia. But Gambia is a small country completely surrounded by Senegal, and one must pass through Senegal on the way to Gambia. The trouble began at the Senegal border.

Dead tired from the trip and still bothered by his bad knee, Erik refused to pay the implied bribe for passage through Senegal. The border guards retaliated with a three-hour lunch, leaving the Sundsvall DX Group sweltering in the tropical sun. Finally, the two sides reached a compromise and Erik's party headed north. But now the border guard insisted on accompanying the travelers and claimed the front seat. It was a

long ride to Banjul, Gambia.

Erik Sjolund and friends survived the trip, however, and pleased thousands of amateurs in the process. And now the modern-day Leif Ericson is off again, this time with transceiver in hand, and SM0AGD portable wherever is on the air again.

QSL Erik's operation via SM3CXS, as usual. Please include a separate envelope for each different callsign, since the cards will be handled in more than one location.

You can recognize Erik by his clean, crisp operating style and his courtesy. Erik also works an even balance between phone and CW. In honor of Erik, and to compensate for the remarks above about the expansion of the phone bands, let's look at a CW topic: zero-beating.

ZERO-BEATING FOR DX FUN AND PROFIT

Zero-beating is the process of aligning the transmitting frequency to that of another station. While important in SSB operation, zero-beating is crucial to successful CW DXing.

The best way to work a DX station in a CW pileup is to transmit on exactly the same frequency as the last successful station. This implies the ability to align the transmitting frequency to that of another station. How do you accomplish this?

The DXer can zero-beat separate receivers and transmitters by means of the spot switch: Tune in the desired frequency on the receiver, press the spot button, and adjust the vfo for an identical note in the receiver. The transmitter is now on the same frequency as the receiver.

But most of us have transceivers without separate external vfo's. No spot switch. Now what?

Again, tune in the desired frequency on the rig. Most transceivers employ an 800-Hz offset for CW. This means that when the dial is aligned on 14030, for example, the CW receiving beat oscillator in the rig (which generates the audible tone in the product detector) oscillates 800 Hz away from the frequency of the transmitting oscillator. If the audible tone is 800 Hz, the transmit and receive frequencies are identical.

But I prefer to copy CW at a lower frequency than 800 Hz. If I adjust my receiver to my preferred note of 650-700 Hz, my transmit frequency will move up 100-150 Hz above that of the other station. That station will shift up in frequency to match my transmitted frequency.

I then shift up still further when the DX station comes back, and we dance up the band. More likely, we will lose contact

or never meet in the first place.

We can avoid this problem in either of two ways. First, we can learn to recognize and listen to the 800-Hz note which the rig manufacturers have selected. Or we can adjust the RIT or clarifier to compensate for our personal preferences. I prefer the latter approach.

Tune in a strong, steady carrier, such as WWV. In the CW po-

sition, tune across the carrier until the note drops in tone until it disappears. Now move up exactly 800 Hz. Your transmitted frequency should be exactly on the carrier. Adjust your RIT for your preferred note and mark the position of the pointer.

Now, to zero-beat the DX station, tune the rig for your favorite beat note and you will be very close to the correct frequency!

NOTES FROM HERE AND THERE

The French amateur radio society suggests watching for 3A2ARM, the official club station of Monaco, which is often on 14 and 21 MHz Saturdays, 0900-1100Z.

Heard Island plans move ahead, with the support of the Wireless Institute of Australia. An extended stay on Heard is scheduled for early '83.

REVIEW

THE HEIL EQ-200 MICROPHONE EQUALIZER

If you actively seek to improve your transmitter's audio, sooner or later you'll discover the concept of equalization (hereafter referred to as EQ). Simply put, EQ is the boosting or cutting of specific frequencies (or bands of frequencies) within the audio spectrum. In public address systems, EQ is used to flatten out the frequency response of the system, allowing maximum gain at all frequencies before feedback. In the recording studio, engineers apply EQ to sweeten sound and make it more pleasing to the ear.

Obviously, in amateur radio we needn't concern ourselves with either audio feedback or sweetening our sound. So why worry about equalization? Because many years ago researchers discovered that boosting certain bands of frequencies improved intelligibility. A slight boost, say, in the upper-mid-

range area, makes our voices easier to understand. Because of this, microphone and transmitter manufacturers have been building such a boost into their equipment for years. More than anything else, this accounts for the subjective differences we detect between the qualities of various microphones and rigs. And it is precisely where we begin to run into some interesting compatibility problems. There is no agreement between manufacturers as to how much boost is necessary or at what frequency it should take place. Worse, some feel that the equalization should be done at the microphone, while others argue that it should be done at the rig. You can imagine the problems this presents! If both the microphone and the rig you buy have substantial boosts at the same frequencies, your audio is likely to sound "honky" and unpleasant. And if a manufacturer designed his rig with the charac-

EQUALIZING THE MOBILE SIGNAL

When a commercial sound contractor writes the specifications for a sound system to be installed in a large auditorium, he must know the room's resonant frequency. The dominance of this frequency can cause feedback, resulting in a less than optimal gain value for the sound system. By adding an active equalizer that notches out the room's dominant frequency, the likelihood of feedback is reduced, allowing more gain to be used.

The very same sound analysis procedure was applied to the internal cavity of four automobiles. The results were astonishing! From a Honda Civic to a GMC van, they exhibited a large rise in the 400- to 700-Hz range, the exact same place that mobile signals have a large peak in their audio.

If you think about it, you will probably realize that all mobile signals sound alike. It makes no difference what kind of microphone or transmitter is being used. These signals are characterized by low frequency rumble and very little high-end audio response, and in most cases are very hard to copy when they are immersed in noise.

The fact is that the frequency of the car's internal cavity is reproduced through the mobile microphone and causes all of the signals to include a rumble. The hand-held microphones favored by most mobile operators only make matters worse; they have very little high-end response, with their "hinge point" often lying as low as 1800 Hz.

Results from a typical on-the-air mobile setup are shown in Fig. 1. A Kenwood TS-120 transceiver with MC-30S microphone was installed in a GMC van. The signal was received on a Kenwood TS-820S and analyzed with a Heil AA-1 audio analyzer. Before equalization, a pronounced peak was found at 500 Hz, verifying the resonance check. By using a two-band equalizer between the microphone and rig, the resonant frequency of the passenger compartment was notched out, giving the audio a flat response. Next, boost was added to the high end, making up for the deficiency of the microphone. Receiving stations and the audio analyzer back in the lab all reported a 6- to 10-dB difference and there was a marked improvement in the intelligibility of the speech.

We found that articulation is the key factor in understanding a mobile signal. The all-important articulation is lost when the low frequencies predominate. In the worst case, these lows can overdrive the microphone preamplifier, leading to terrible distortion. The application of proper equalization to the audio section of an SSB transmitter will provide this necessary articulation without distortion.

Bob Heil K9EID
Marissa IL

teristics of a particular microphone in mind, results will be unpredictable with another mike. The combination may lack

highs, lows, or anything in between. Or it might have too much of something!

Which brings us to the Heil



The Heil EQ-200 microphone equalizer. (Photo by KA1LR/4)

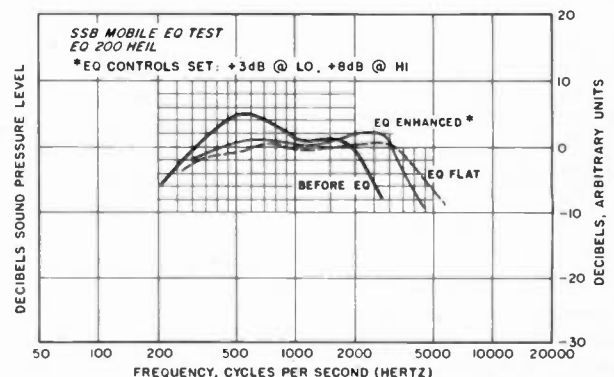

Fig. 1. SSB mobile EQ test results for the Heil EQ-200.

microphone equalizer. The idea is to connect the equalizer between microphone and rig. The LO and HI controls allow you to cut or boost the two bands of frequencies, correcting any deficiencies and hopefully improving intelligibility. A third control permits you to match the output level to what your rig wants to see. Does it work? Well, yes and no. If you just need to perk up your audio a little bit, dialing in a little LO or HI boost can improve things. But it's important to remember that changes you make will only be audible to someone listening to your signal. If you are dumb enough to adjust your rig on the basis of what someone you may or may not know is telling you over the air, you deserve what you get! You really need a means of listening to your own signal while you make adjustments. You're in good shape if you have one of the few transceivers with a monitor circuit. Turn it on, plop on a pair of headphones, and you'll get a pretty good idea of what you sound like to the rest of the world. If you have a second receiver, you are even better off.

One problem we noted in our installation is that the gain control had to be run at a fairly high level. The EQ-200 uses a pair of 741 op amps to do its work, and the noise performance of these devices is less than exciting—i.e., you hear some hiss. While this may or may not be noticeable in other installations, I recommend that Heil use a slightly better op amp in the future. After all, if someone is picky enough to want to EQ their mike line, they aren't going to want to add hiss to their signal!

The second problem I see is the placement of the controls on the front panel. Once you have gone to all the trouble to carefully set them, you don't want anybody messing them up. Internally mounted trimpots with three small access holes for a screwdriver would make the most sense to me.

Conclusions

Used correctly, the Heil EQ-200, which sells for \$49.95, can improve the intelligibility of many microphone/transceiver combinations. Used incorrectly, it could make a good signal sound terrible. Please, if you don't have the knowledge or patience to adjust this or any other audio processing device correctly, don't buy it!

For more information, contact *Heil Sound, Marissa IL 62257*. Reader Service number 475.

**Paul Grupp KA1LR
Casselberry FL**

Editor's note: Heil Sound reports that a design change was made to the final amplifier stage of the EQ-200. By lowering the gain, they achieved a 20-dB reduction of the noise level leaving the unit. This should help in solving the problem, reviewer Grupp reports.

SILICON SYSTEMS DTMF DECODER

Anyone who has tried to tame a dual-tone frequency (DTMF) decoder using the ubiquitous 567 IC has probably thought that touchtone™ control probably isn't worth the hassle. The 567 decoder, although versatile, is far from ideal for decoding DTMF signals that have a variety of levels of distortion and volume. The 567 can give false outputs if input levels aren't carefully controlled, and frequency stability is only as good as the timing network. In short, getting a 567-based decoder working reliably at a remote repeater site is a lot like searching for an honest man—you're always disappointed in the end.

But take heart. Time and technology have passed the 567 by, and thanks to the development of switched-capacitor filters, we now have DTMF decoders in a single package which offer more features and better reliability than a handful of 567s. Silicon Systems, Inc., the people who first made commercial use of switched-capacitor technology, have a chip representative of this new breed in their SSI-201, a 22-pin IC which requires only four external components to operate as a complete DTMF decoder.

The SSI-201 uses 40 poles of switched-capacitor filtering to detect the presence of valid DTMF tones at the input. The filter center frequencies and bandwidths are controlled by a 3.58-MHz crystal (one of the outboard components), so frequency drift and temperature instability are a thing of the past. A valid tone can be detected in as little as 20 milliseconds and the audio input can be anything from 53 mV to 1.3 V. A 60-Hz notch filter on the chip reduces sus-

ceptibility to overload from hum.

Implementing the SSI-201 is very easy. Power required is 12 volts at about 30 mA. When valid tones are present at the input, the four output lines present either a hexadecimal (similar to BCD) or binary-coded 2-of-8 output, selectable by tying one pin high or low respectively. The outputs may be configured for either standard CMOS or tri-state (high impedance) use. Another control pin allows detection of the full 16-digit set or the more standard 12-digit set. A strobe output is available to ease interface with clocked-logic systems.

A minor flaw with the SSI-201 is that the problem of temperature immunity has not been completely solved. The chip is specified to operate only down to 0° C (32° F), so you'll have to provide some sort of heat at your outdoor repeater site. The answer could be as simple as letting some current flow through a couple of resistors mounted near the chip.

This chip isn't cheap—\$60 in single units (if you buy 10 or more, the price drops to \$40.64). I buffered all its connections with the real world. I used a 741 op amp as an audio buffer, bypassed the power bus, used a series diode to protect against reverse polarity, and used a 4049 inverter package to buffer the digital outputs. All this may not be necessary, but I feel a lot safer knowing that there's an op amp between the phone line and my expensive chip.

When all things are considered, using a chip like the SSI-201 is well worth the additional cost. Now I know that my control system is reliable and that old Ernie with the weird voice won't bring up the autopatch every time he says, "Well, fine business, old man."

For more information, contact *Silicon Systems, Inc., 14351 Myford Road, Tustin CA 92680*. Reader Service number 477.

**John Ackermann AG9V
Green Bay WI**

ASTRON RS-7A POWER SUPPLY

The RS-7A is one of a series of 13.8-V-dc supplies with ratings ranging from 4 to 35 Amps. The 7A is good for 5 Amps continuous or 7 Amps at 50% duty cycle. I paid \$64.95 for mine.

Ripple is spec'd at 5 mV peak-

to-peak, full load and minimum line voltage. Load regulation is 50 mV. This is what would be expected from an industrial power supply, but it's much better than many of the supplies built for amateur service. A look at the schematic and the construction explains the performance. The regulator is a 723 IC, a somewhat elderly but altogether respectable chip. Regulator sensing is done at the output terminals, and the sense leads are twisted to minimize magnetic pickup from the transformer. The circuit includes not only foldback current limiting, but a crowbar circuit as well! Thus the unit resists damage very effectively, and if the regulator or the pass transistor should ever malfunction, the crowbar will blow the primary fuse and shut everything down in a millisecond or so. The pass transistor is mounted on a heat sink outside the back of the case, so ventilation is unnecessary. This keeps dirt out of the guts. That, in turn, means that the regulator is unlikely to become humidity-sensitive in its old age.

My unit has a varistor across the transformer primary, although the schematic doesn't show it. Nothing could be more convincing evidence of a thoroughly professional job of power-supply design. If the rig is expected to be available for operation in a disaster, it's extremely important to protect the circuitry against lightning damage. Several pieces of gear in my shack failed during a lightning storm a couple of years ago. After I put varistors across power and telephone line connections, there was no more trouble in subsequent storms. If there are any early-production units out there without varistors (or any other kind of station supply, for that matter), I recommend putting a GE V150LA20B across the primary.

The packaging is what's required, and no more. It's a simple modified steel minibox-style case, with the lid held on with sheet metal screws. Nothing is mounted on the cover; the unit is structurally complete when opened up for service. The line cord is solidly anchored.

The parts are good quality. The main capacitor looks to be either industrial grade or computer grade. I didn't recognize the part number, but it sure isn't any fugitive from a TV set. The

transformer was obviously custom-designed for the job, a requirement when a linear-regulator supply has to operate efficiently over the 105-125-V range.

On-the-air tests... I hooked it up to my UV-3 and dialed up a couple of repeaters I could hit full quieting. The signal reports said there was no audible hum. Key-down operation for 30 seconds caused barely noticeable warming up of the heat sink. Not having access to a power supply test set these days, I didn't carry the testing beyond that. From looking at the size of the heat sink, I'd have some doubts about running at 5 Amps continuously at the maximum rated line voltage, but if that became necessary it would be no trick at all to put on a heat sink about four times as big.

To summarize: Whoever designed this thing has an understanding of what a ham station indoor power supply has to do and knows how to design power supplies. This is probably the most cost-effective supply possible, and it leaves nothing to be desired technically. It's the kind you turn on and just forget about.

For more information, contact Astron Corporation, 2852 Walnut—Unit E, Tustin CA 92680. Reader Service number 476.

John A. Carroll AB1Z
Bedford MA

HAMEG HM203 OSCILLOSCOPE

The Hameg HM203 oscilloscope is much like ham radio: both are international phenomena. The HM203, a newcomer to the US market, features a rugged yet precise feel that one would expect of a piece of gear designed and originally manufactured in West Germany. The outstanding performance/price ratio reminds you of similar gear from the Far East. And not to be neglected is the fact that the HM203 is manufactured and serviced right here in the United States.

Oscilloscopes can be incredibly useful test instruments. Unfortunately, many hams are only familiar with the expensive laboratory-grade units found at work and school or the inexpensive surplus or used models that sell for a song at any swapfest. Hameg has managed to come up with an excellent compro-

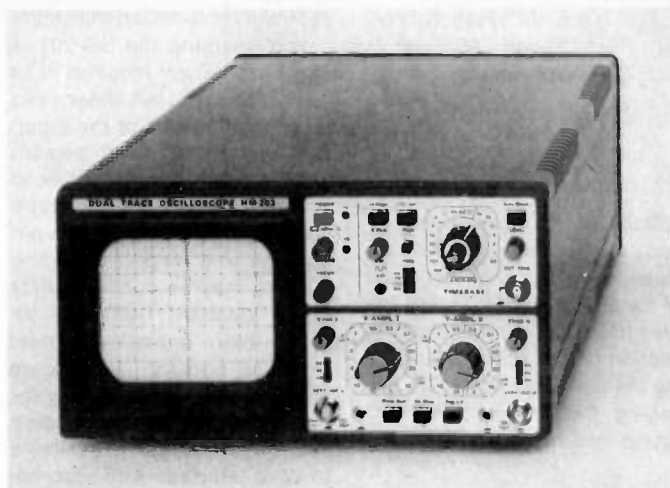

Hameg's HM203 dual-trace oscilloscope.

mise. Now you can have a dual-trace scope that has a 20-MHz (-3-dB) or 30-MHz (-6-dB) bandwidth, 3% accuracy, and variable triggering for under \$600.

Weighing just over 12 pounds and measuring approximately 6 inches high, 11 inches wide, and 15 inches deep, the HM203 is designed with field-service applications in mind. The unit's compact front panel also lends itself to fitting into a tightly-packed workbench. One half of the unit is devoted to the cathode ray tube, which measures 5 inches diagonally. The usable screen is an adequate 10 cm x 8 cm, and the dark red grid allows you to interpolate measurements to about 0.1 cm.

One feature common to all Hameg oscilloscopes is a subdivided control section. The upper half of the HM203 is devoted to the power switch, intensity, and focus control, plus all of the timebase or horizontal display functions.

The lower half consists of controls for the two Y or vertical channels. The back panel is void except for ac power connection (with removable line cord) and sockets for direct connection to the CRT's vertical and horizontal control plates.

Dual Trace Capability

Two identical vertical channels are available. Each has a 12-step frequency-compensated input attenuator giving scales from 5 mV/cm to 20 V/cm. The attenuator is followed by a diode-protected FET preamplifier that has a 40-MHz bandwidth. Conspicuous by its absence was any kind of continuously-variable vertical sensitivity con-

trol. The lack of this kind of control did not prove to be a serious problem, I just made do by adjusting the vertical position potentiometer.

The 1-megohm, 25-picofarad vertical inputs can be switched between ac, dc, and ground. For single-trace or "mono" applications, you can use either channel. For those jobs that require two signals to be displayed, just push in the mono-dual switch and you connect your second signal. Triggering can be done on either channel. (More on triggering later.)

The Alt/Chop switch is an important part of successful dual-trace operations. If the signals have a low frequency (less than 1 kHz), the display will tend to flicker if both traces are displayed independently. By choosing the Chop mode, the scope switches back and forth between the traces at a 120-kHz rate, displaying both signals on the same sweep and eliminating the flicker.

Timebase

According to Hameg, the HM203 uses a new type of triggering circuit. There is no need for any sort of stability adjustment, since most of the processing is done by a voltage comparator chip whose TTL output drives the sweep generator directly. The result is trouble-free triggering, even with fast-changing, high-frequency, or low-amplitude signals.

The sweep can be triggered by either vertical channel, the line, or an external source. A choice can be made between a positive or negative trigger edge and the trigger level is adjustable. A time axis can be dis-

played even when no signal is present—just place the 203 in the Auto trigger mode. Service technicians may be interested in the TV trigger mode which operates off the line or frame frequency.

A non-swept or X-Y mode is available by pressing the Hor Ext switch. The X signal is provided via the Y channel I input. The bandwidth of the X amplifier is approximately 2 MHz, with any phase difference between the two axes becoming apparent above 50 MHz.

Looking Inside

In addition to the controls and inputs already mentioned, the HM203 has front-panel access to the TR (trace rotation) control, which allows you to compensate for variations in the earth's magnetic field that cause a misalignment of the trace. The back panel includes access to the power supply fuse and the ability to change between 110-, 125-, 220-, and 240-volt power sources.

Taking the HM203 apart is simple. You just remove two screws and slide the case off the chassis. Once it's apart, you'll discover a straightforward yet impressive layout. The vast majority of the 203's components reside on two circuit boards. This includes most of the controls which are connected to the front panel via mechanical links. With service in mind, Hameg has used sockets for most of the ICs and FETs. The cathode ray tube is surrounded by Mumetal screening, reducing the likelihood of stray magnetic fields causing a problem.

Accessories and Documentation

The HM203 is ready to use the day it arrives. Each one comes with two X1/X10 probes. The Hameg penchant for quality is seen here—the probes include a compensation adjustment and feature interchangeable tips. Although the 203 is good to almost 30 MHz, the probes supplied top out at around 10 MHz. For measurements in the higher range, you can try some of the other Hameg probes. The line of accessories includes test cables, a 50-Ohm terminator, and a simple component testing jig (to be reviewed in a future issue of 73).

The HM203 manual thor-

oughly documents correction operation of the instrument and even includes a brief discussion of errors that can affect your measurements. Plenty of service information is given, with emphasis on diagnosing and correcting the problem without using expensive test gear. A complete set of schematics is included and they are large enough to be pored over by the armchair circuit-design crowd.

Conclusions

Six weeks of using an HM203 at home and at work have reinforced my first opinions about this scope. It works as billed. The drawbacks such as the absence of a continuously-variable vertical attenuator are offset by extras like a built-in calibration signal. I found that the HM203 fulfilled my needs, which vary from designing simple digital-electronics circuits to troubleshooting a flaky SSB modulator to monitoring the stability of the power in the 73 darkroom. (In the darkroom application, the HM203 was left turned on for almost three days and exhibited no signs of instability or drift!)

I would be the first to admit that the HM203 does not equal the performance you get from many laboratory-grade instruments. But how often do you need 100-MHz bandwidth and features such as trace highlight-

ing? The HM203 is adequate for many service jobs and should fill the needs of almost any hobbyist. With a special amateur price of \$529, it beats just about everything, including units that you build from a kit.

The HM203 is available from *Rivendell Associates, RFD 5, Warner Hill, Derry NH 03038*. Reader Service number 487.

Tim Daniel N8RK
73 Magazine Staff

MICRO CONTROL SPECIALTIES' VHF/UHF CONTINUOUS-DUTY POWER AMPLIFIER

Reliability is the name of the game when repeater hardware is concerned. The equipment must be of conservative design unless you enjoy unscheduled trips to the repeater site—trips which always seem to entail a 20-mile drive through the season's worst storm.

The power amplifier is a case in point. You can't simply graft an everyday, mobile-type amplifier onto a repeater system and expect it to provide trouble-free service. Such amplifiers are not designed for the long periods of continuous duty which are faced by most repeaters during some part of each day.

A better choice is an amplifier built from the ground up for re-

peater operation, such as the PA-75 power amplifier from Micro Control Specialties (MCS). This continuous-duty, 75-Watt amplifier is available in 144-, 220-, and 440-MHz versions. It provides full output with 10-15 Watts of drive. In the interest of reliability, each PA-75 is burned in for four (count 'em, four) days before being shipped.

Most VHF/UHF amplifier circuits are designed to operate from a 12-V dc power source. In contrast, the circuits in the PA-75 use 24 V dc, which is produced by a built-in 105-125-V ac supply. The 24-V design means that the amplifier runs more efficiently, and it allows the power supply to be made physically smaller. The amp will operate from an external 12-V dc source and automatically switches from the ac lines to the dc source in the event of an ac power failure. Output power is reduced to 50 Watts when the amp operates on 12 V dc. A pair of 2N5643 final transistors gives the PA-75 its punch. The amp features excellent output filtering, with harmonics suppressed at least 65 dB.

The enclosure of the PA-75 fits standard 19-inch equipment racks. The front panel is kept as simple as possible—just three fuse holders and a dc ammeter for measuring amplifier current. Cooling for the finals is provided

by a large heat sink and a high-volume fan. The fan also cools the power supply.

In our 2-meter repeater installation, an amplifier was needed to improve the signal on the far side of a mountain ridge. Since we were already using the MCS Mark 3CR repeater with good success, it seemed only natural to give the matching PA-75 a tryout.

Installation could not have been easier. We simply placed the amp in-line after the exciter output and plugged it in. Voila! Our repeater was transformed from a 15-Watt into a 75-Watt machine.

The amateur net price for the PA-75 is \$493 for the 2-meter version, \$544 for 220 MHz and \$595 for 440 MHz. A \$50 discount is available if the amp is purchased at the same time as an MCS repeater.

In five months of operation, our PA-75 has been completely trouble-free. It has performed precisely as advertised and has enabled us to fill some annoying gaps in our coverage. The PA-75 is a rugged, reliable answer to the repeater amplifier question.

For more information, contact *Micro Control Specialties, 23 Elm Park, Groveland MA 01834*. Reader Service number 486.

Jeff DeTray WB8BTH
73 Magazine Staff

AWARDS

Bill Gosney KE7C
Micro-80, Inc.
2665 North Busby Road
Oak Harbor WA 98277

WORKED TRUMBULL COUNTY AWARDS

The Warren (Ohio) Amateur Association, Inc., announces its Worked Trumbull County (WTC), Worked Trumbull County Mobile (WTC-M), and Worked Trumbull County YL (WTC-YL) awards. These programs are designed to promote increased amateur radio activity among and with Trumbull County Amateur Radio Operators. The awards are also award operating achievements.

Application: Send applications and all correspondence to Don Lovett K8BXT, Awards

Chairman, WARA, PO Box 809, Warren OH. One dollar must accompany applications from W, K, and VE amateurs; all others should send three IRCs with application. Only Trumbull County applicants must submit actual QSL cards. All others should have certification letters from two other radio amateurs who signify that they have seen and checked the applicant's QSLs. Each application must also be accompanied by a list of the calls worked, with full log data for each contact.

Requirements:

● WTC—For each certificate or endorsement, Trumbull County applicants must have 20 contacts with other Trumbull County amateurs. Other W, K, and VE

stations must contact 10 Trumbull County amateurs, while DX applicants must have five contacts.

● WTC-M—For each certificate or endorsement, Trumbull County applicants must have 20 contacts with other Trumbull County amateurs operating mobile in Trumbull County. Other W, K, and VE stations must contact 10 Trumbull County amateurs operating mobile in Trumbull County, while DX applicants must have five contacts.

● WTC-YL—For each certificate or endorsement, W, K, and VE stations must contact 10 Trumbull County YL or XYL amateurs, while DX applicants must have three contacts.

Award: A certificate will be issued on each approved application but in order to appear on the certificate, special endorsements must be filed with the initial filing, each containing at least 25 percent new contacts. Initial endorsements are free of

charge but endorsements made on later dates will take the form of WTC certificates. Applications for these must contain proper filing fees. Endorsements may be "All One Mode," "All One Band," "All Mobile-to-Mobile," or "All Members of the Warren Amateur Radio Association, Inc."

Net contacts, contacts made through repeaters, and contacts made before January 1, 1959, cannot be counted.

WORLDWIDE AWARDS DIRECTORY, VOL. I

If you like to go after awards or win contests, this directory is a must! Volume I lists over 270 awards from all over the world, with names and addresses, costs, and descriptions. \$9.95 brings Volume 1 to your doorstep. Volume 2 is in production now and will cost \$5.95 for an additional 130 awards. Why not order Volumes 1 and 2 for a combined price of \$12.75? The

Worldwide Awards Directory is for the amateur radio operator who is interested in showing his proficiency to others at radio communications throughout the world. You will never know how easy it is unless you know how to go about it. You probably already have enough QSLs in your files for some of the awards. \$9.95 includes all postage and handling. COD extra. Quantity discounts available.

Also, if you know of some awards that you would like listed, please let Larry know and they will appear in the next volume. Write to: Larry Keibel KB0ZP, 736-39th Street, West Des Moines IA 50265.

HONG KONG AWARDS

HARTS meets every Tuesday at 1700 local, excluding public holidays, at the China Fleet Club, Arsenal Street, Wanchai, Hong Kong Island.

Nine Dragons Award

One contact with a country in each of the following 9 zones: 18, 19, and 24 to 30. Contact for zone 24 must be a VS6. Stations within the 9 zones require 2 contacts in each zone, with 2 VS6 contacts. Contacts after Jan. 1, 1979, only, are valid. Fees are US \$3, Aust. \$3, £1.50p. postal order, or 24 IRCs.

Firecracker Award

Six contacts with different VS6 stations. Stations in zones 18, 19, and 24 to 28 require 10 contacts with different VS6 stations. Contacts after January 1, 1964, only, are valid. Fees are US \$2, Aust. \$2, £1 postal order, or 10 IRCs.

Usual Conditions

Certified log extracts only—no QSL cards are required. Payment to be made in cash; no bank drafts. Postal orders to be left blank. Claims to: Awards Manager, HARTS, GPO Box 541, Hong Kong.

HAROAA AWARDS AND CERTIFICATES

These awards are of high quality and will make a very nice addition to any radio room. The awards are available to all licensed amateurs and amateur stations. Please do not send QSL cards. A list showing full details of the contacts (log information) should be certified by one other amateur or radio club officer. Photocopies of your QSL cards or original log will

also be permitted. At your request, special endorsements will be added, such as: CW, SSB, all YL, QRP, RTTY, SSTV, one band, etc. If you so desire, you may request separate awards for each special endorsement. Contacts may be made over any period of years. Contacts made through repeaters cannot be used. Satellites permitted. Please pass this award information along to another amateur or post it at your local club. All correspondence or applications should be sent to: HAROAA, PO Box 341, Hinckley OH 44233, Attn: Awards Manager Gary Zimmerman WB8RTR.

Application for each award must be accompanied by three US dollars to cover handling and award costs. Payment may be made by cash, personal check, money order, ten IRCs, or first-class-rate US postage stamps. DX applicants may send a money order made out in US funds, ten IRCs, or any of the above.

If at any time your award is lost, misplaced, or damaged in any way, send the date, award number, and pertinent information, and we will replace it free of charge. All awards include the special HAROAA gold seal.

Great Lakes Award

This requires one contact with each state bordering the Great Lakes: New York, Pennsylvania, Ohio, Michigan, Indiana, Illinois, Wisconsin and Minnesota.

Super Certificate Hunter Award

This HAROAA award is designed for the serious certificate hunter. To earn this award, you must have a minimum of ten amateur radio operating awards. Simply list the awards that have been issued to you. Special endorsements are 10, 25, 50, 75, 100 plus.

HAROAA DX Award

This is obtained by working DX stations. It is the number of stations worked that is important. Each DX station counts as one, even if several are from the same country or area. Special endorsements for this award are 10, 25, 50, 75, 100, 200 and 500 DX contacts.

HAROAA Insomnia Award

This award is earned by communicating with one other amateur radio station for a minimum of one hour between

the hours of 1:00 and 5:00 am. A super conversation piece for your shack.

HAROAA Super Operator Award

This certificate is rendered for those providing a service on behalf of amateur radio, such as weather observation, public service, emergency work, helping a new ham, providing communications for a community function, etc. The requirements are for the applicant to briefly describe the event or service. The officials of HAROAA will determine whether it deserves this special recognition.

HAROAA Official Traffic Handler Award

This award is a self-issued achievement, allowing you to display the fact that you are indeed an official handler of radio traffic.

ISLAND DX AWARD

The IDX Award, sponsored by the Whidbey Island DX Club, is probably one of the most sought after awards in the DX community. This award is available to licensed amateurs and short-wave listeners worldwide.

The IDX Award is issued for

ISLAND DX COUNTRY LISTING

The IDX Awards Program uses DXCC countries which are bona fide "Islands" as recognized by the National Geographic Society. The first criterion is that they must have been DXCC countries on or after October 1, 1977, as stated on the DXCC List of the ARRL. Any "qualifying" DXCC country omitted from this list by error or which has been recognized for DXCC after the release of this listing will be added the next time it goes to press. In the meantime, applicants may count these new countries in their tally.

A3	KH1, KB	VP2S
A9X	KH2, KG6	VP2V
BV	KH3, KJ	VP5
C2	KH4, KM	VP8 (Falkland)
C6	KH5, KP6 (King)	VP8, LU (Orkney)
CE0A	KH5, KP6 (Palmyra)	VP8, LU (Sandwich)
CE0X	KH6, AH6, WH6, NH6 (Haw)	VP8, LU (Shetland)
CE0Z	KH6, KH7 (Kure)	VP8, LU (Georgia)
CO, CM, KG4	KH8, KS6	VP9
CT2	KH9, KW	VQ9
CT3	KH0, KH2, KG6 (Mari)	VR1 (See T3)
D4	KC6 (West)	VR4 (See H4)
D6	KC6 (East)	VR7
DU	KP (Desoth)	VS5, 9M6, 9M8
EA6	KP1, KC4 (Navassa)	VS6
EA8	KP2, KV	VS9 (See 8Q)
EI, GI	KP3, KS4, HK0 (Ran-Ser)	VS9K
FB8W	KP4, NP4 (Puerto Rico)	VU7 (Andaman)
FB8X	KX	VU7 (Lacca)
FB8Z	OH0	XF4
FC	OJ0	XP (See OX)
FG (Guad)	OX, XP	YB, YC, YD
FG, FS	OY	YJ
FH8	P29	YV0
FK	PJ (Neth Ant)	ZD7
FM	PJ (St Maarten)	ZD8
FO (Clipperton)	PY0 (Fern)	ZD9
FO (Tahiti)	PY0 (Peter-Paul)	ZF
FP	PY0 (Trini)	ZK1 (North)
FR (Glor.)	S7	ZK1 (South)
FR (Juan)	S9, CR5	ZK2
FR (Reunion)	SV (Crete)	ZL (New Zealand)
FR (Tromlin)	SV (Dodecan)	ZL (Auck-Camp)
FW	T3, VR1 (Central Kiril)	ZL (Chatham)
G, GM, GW (G. Brit)	T3, VR1 (East Kiribat)	ZL (Kerm)
GC, GU (Guern)	T3, VR1 (West Kiribat)	ZM7
GC, GJ (Jersey)	TF	ZS2 (Mari-Pr Ed)
GD	Ti9	1S
GI, EI	UA1, UK1 (Franz Jos)	3B6, 3B7
H4, VR4	VE1 (Sable)	3B8
HC8	VE1 (St Paul)	3B9
HH, HI	VK (Lord Howe)	3C0
HK0 (Bajo)	VK9 (Willis)	3D2
HK0 (Malp)	VK9 (Christmas)	3Y
HK0 (San An)	VK9 (Cocos)	4S
IS	VK9 (Melilish)	5B, ZC
J3, VP2G	VK9 (Norfolk)	5R
J6, VP2L	VK0 (Heard)	5W
J7, VP2D	VK0 (Macquarie)	6Y
JA-JR, KA	VP2A	8Q, VS9
JD, KA1 (Mina)	VP2D (See J7)	8P
JD, KA1 (Ogasa)	VP2E	9H
JD, J71 (Okino)	VP2G (See J3)	9M6, 9M8 (See VS5)
JW	VP2K	9V
JX	VP2L (See J6)	9Y
KG4 (See CO, CM)	VP2M	

2 x SSB, 2 x CW, 2 x RTTY, 2 x SSTV, and mixed mode, as well as mixed- and single-band accomplishments. To meet the minimum qualifications, applicants must work fifty (50) IDX islands for the basic award. Endorsements are given in increments of 50 islands, up to and including the maximum number of islands possible.

All DXCC countries which are bonafide "islands" are the only qualifying contacts. A special IDX listing appears within this column. To be valid, all contacts must have been made after October 1, 1977.

To apply, prepare a list of qualifying contacts in prefix order. Please number your contacts 1 through 50, etc. Include the call of the station worked, IDX island name, band, mode, date, and GMT.

Do not send QSL cards! Have your list verified by two amateurs or local radio club officials. Confirmation of each contact must be in the applicant's possession at the time it is being verified.

Send your list of contacts along with \$4 in US funds only and a 4 x 9-inch business-size self-addressed stamped envelope to the following address (foreign stations may substitute for the fee by enclosing an SASE and 20 IRCs): Whidbey Island DX Club, Attn: IDX Award, 2665 North Busby Road, Oak Harbor WA 98277.

Rules governing this award program are reviewed annually in the month of September. Please enclose an SASE with any enquiries regarding this award program.

ELMIRA NY

Elmira area amateurs will operate W2ZJ from Chemung County's 1st Annual Good Neighbor Festival 1300Z, July 31 through 2100Z, Aug. 1. Frequencies: 30 kHz up from the lower edge of the General-class phone band on 20, 40, and 80 meters. Special certificate for large SASE to: ARS W2ZJ, General Delivery, Elmira NY 14904.

MT. DAVIS PA

The Somerset County ARC will operate AK3J for the second annual DXpedition from the highest point in Pennsylvania, Mt. Davis, from 1800 UTC August 7th to 1800 UTC August 8th. Frequencies will be the first

25 kHz in the General section for phone and the Novice section for CW. A beautiful certificate will be sent upon receipt of QSL card and \$1.00. QSL to Box 468, Somerset PA 15501.

SMYTH COUNTY VA

The amateur radio operators of Smyth County VA, in celebration of the county's sesquicentennial, will be on the air Aug. 21, 1982 from 0000Z until 2100Z. Frequencies will be 15, 40, and 80 meters, up 10 kHz from the bottom of the general phone band and Novice CW band (as activity dictates). The call used will be W4KON. Please QSL with a large SASE for an attractive certificate and booklet about the county to: Ken Sturgill KC4IH, PO Box 526, Marion VA 24354.

SOUTH BASS ISLAND OH

The Huron County Amateur Radio Club will celebrate the 169th anniversary of the Battle of Lake Erie by operating from Perry's Victory and International Peace Memorial on South Bass Island in Lake Erie. The station, WA8HUR, will be on the air beginning at 1000Z August 21, 1982, til 0000Z August 22, 1982. Operating on SSB, the frequencies will be: 3910, 7250, 14280, 21360 and 28550 kHz. The CW station will be found at 40 kHz up from the bottom of each HF band. A Novice station will be found at 3720 kHz and at 7115 kHz. An FM station will be operated on 146.52 MHz. A special QSL card will be issued to all those making contact who send their QSL and an SASE to ARS KF8O.

FLUSH KS

The Kansas State University Amateur Radio Club, W0QQQ, Manhattan, Kansas, and the Manhattan Area Amateur Radio Society announce the first annual DXpedition to Flush, Kansas, in Pottawatomie County. It will be held on August 29, 1982, for 24 hours of continuous operation beginning at 0000Z.

CW operators can work W0QQQ around 21.112 MHz or 7.112 MHz, and phone operators will find W0QQQ around 14.292 MHz or 3.892 MHz, depending on band conditions.

Successful participants will receive a handsome 8" x 10" certificate by sending an SASE

to W0QQQ, Electrical Engineering Dept., Kansas State University, Manhattan KS 66506.

Flush is a quaint metropolis in the beautiful Flint Hills region of Kansas, 12 miles east of Manhattan, home of Kansas State University.

MT. PLEASANT IA

The Mount Pleasant Amateur Radio Club will be operating a station at the Midwest Old Threshers Reunion in Mount Pleasant, Iowa, September 2-6, 1982. Using club call W0MME, they will be operating in the General portion of 80, 40, and 20 meters.

Amateurs from the Mount Pleasant area will also be handling emergency communications on the grounds and will be providing talk-in on 147.99/39 (W0MME/R) and 146.52 simplex for those attending.

Several hundred amateurs are among the 250,000 people annually that attend this display of memorabilia from America's past. Such things as steam engines, vintage cars, trolley cars, antique radios, and threshing by horse and steam power will be on display.

Hams attending are invited to visit the ham shack and sign the guest book. Admission for the five day event is \$4.00. Camping is available on the grounds. For further information, contact Dave Schneider WD0ENR, 507 Vine, Mount Pleasant IA 52641.

PIQUA OH

The Piqua Amateur Radio Club (W8SWS/8) of Piqua, Ohio, will operate from the Colonel John Johnston Farmstead, an historical Indian museum, on September 4-6 from 1400 to 0000 UTC.

Colonel Johnston, a federal Indian agent, built his Dutch colonial farmhouse in 1808; it's the

only Indian agent house in Ohio. This is Piqua Heritage Festival Days, the first celebration of its kind in the state. Piqua is celebrating its 175th birthday.

A special picture QSL card and 8½" x 11" certificate will be sent to all stations who QSL with a large SASE to Larry Underwood W8UO, 811 N. Sunset Dr., Piqua OH 45356.

Frequencies for W8SWS/8 will be SSB 3.900, 7.250, 14.290, 146.460, and 7.115 (1800-2000 UTC).

PALMYRA

The M.O.T.H.E.R.S. (Marengo Over-The-Hill Electric Radio Society), an informal group of radio amateurs in the north-central Illinois area, have been planning a DXpedition for some time. So far, the destination and duration of the expedition had only been speculation. Last month, however, the destination, Palmyra, was announced. This came after confirmation of a landing permit and operating permission had been received from local authorities. The fact that this Palmyra is located in south-central Wisconsin hasn't dampened the spirits of WB9NKH, K9UA, KF9E, KC9DC, or WA9TAH, the expected operators.

The DXpedition will attempt the landing, initial setup, and possibly some limited operation on September 11, 1982, with a full-blown multi-transmitter operation expected on September 12, 1982, from approximately 0700 to 2100 CDT. The operating frequencies will be up 30 kHz from the bottom of the CW band edges and the General phone band edges.

Since Wisconsin and Illinois have fully reciprocal licensing agreements, the DXpedition will use the call WA9TAH, with QSLs available for an SASE.

CORRECTIONS

The crystal X1 used in the British VHF converter project (April, 1982) is correctly listed as 38.667 MHz in the text and Parts List. The value shown on the schematic is incorrect.

Minor engineering changes

made since the design was published include substituting BF274s for the BFW92s used for Q3 and Q4. C6 has been changed from 22 pF to 47 pF.

Tim Daniel N8RK
73 Magazine Staff

Wayne Green Books

NEW
ARRIVALS

TEXTEDIT

a complete
word processing
system in kit
form.

by
Irwin Rappaport

A WAYNE GREEN
PUBLICATION

TEXTEDIT—A Complete Word Processing System in kit form

by Irwin Rappaport

TEXTEDIT is an inexpensive word processor that you can adapt to suit your needs, from writing form letters to large texts. It is written in modules, so you can load and use only those portions that you need. Included are modules that perform:

- right justification
- ASCII upper/lowercase conversion
- one key phrase entering
- complete editorial functions
- and much more!

TEXTEDIT is written in TRS-80 Disk BASIC, and the modules are documented in the author's admirably clear tutorial writing style. Not only does Irwin Rappaport explain how to use TEXTEDIT, he also explains programming techniques implemented in the system. TEXTEDIT is an inexpensive word processor that helps you learn about BASIC programming. It is written for TRS-80 Models 1 and III with TRSDOS 2.2, 2.3 and 32K.

BK7387 \$9.97 Disk Available DS7387 \$19.97

Annotated BASIC—A New Technique for Neophytes.

BASIC programming was supposed to be simple—a beginner's programming language which was so near to English that it could be easily understood. But, in recent years, BASIC has become much more powerful and therefore much more difficult to read and understand. BASIC simply isn't basic anymore.

Annotated BASIC explains the complexities of modern BASIC. It includes complete TRS-80 Level II BASIC programs that you can use. Each program is annotated to explain in step-by-step fashion the workings of the program. Programs are flowcharted to assist you in following the operational sequence. And—each chapter includes a description of the new concepts which have been introduced.

Annotated BASIC deals with the hows and whys of TRS-80 BASIC programming. How is a program put together? Why is it written that way? By observing the programs and following the annotation, you can develop new techniques to use in your own programs—or modify commercial programs for your specific use.

Annotated BASIC Volume 1 contains Projecting Profits, Surveyor, Things to Do, Tax Shelter, Introduction to Digital Logic, Camelot, The Soundex Code, Deduction, Op Amp, Contractor Cost Estimating.

BK7384 \$10.95 ISBN 0-88006-028-X AVAILABLE NOW!

Annotated BASIC Volume 2 contains Rough Lumber List, Trip Mileage, Flight Plan, OSCAR Data, SWR/Antenna Design, Supermaze, Petals Around the Rose, Numeric Analysis, Demons, Air Raid, Geography Test, Plumbing System Design.

BK7385 \$10.95 ISBN 0-88006-037-9

Order Both Volumes and Save! BK738402 \$18.95

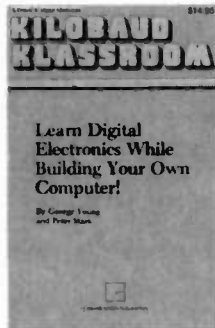
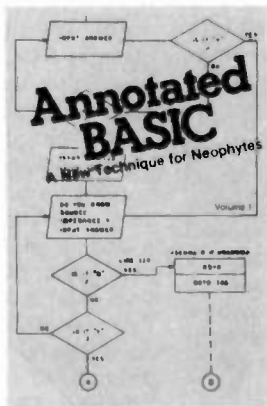

KILOBAUD CLASSROOM—

A practical course in digital electronics

By George Young and Peter Stark

Learning electronics theory without practice isn't easy. And it's no fun to build an electronics project that you can't use. *Kilobaud Classroom* the popular series first published in *Kilobaud Microcomputing*, combines theory with practice. This is a practical course in digital electronics. It starts out with very simple electronics projects, and by the end of the course you'll construct your own working microcomputer!

Authors Young and Stark are experienced teachers, and their approach is simple and direct. Whether you're learning at home or in the classroom, this book provides you with a solid background in electronics—and you'll own a computer that you built yourself!

Kilobaud Classroom contains Getting the Ball Rolling, Gates and Flip-Flops Explained, J.K. Flip-Flops and Clocked Logic, PC Boards and Power Supplies, Hardware Logical Functions, Voltage, Current and Power Supplies, Transistors, Diodes and OP Amps, Pulses and More Pulses, Counters and Registers, Bus Traffic Control, ROM and RAM Memories, I/O Circuitry, Parallel and Serial I/O Ports, Computer I/O III, Computer I/O IV, Computer I/O V, Processor Connections, Finally... The Kilobaud Crescendo, EPROMs and Troubleshooting, Expansions and Programming, Machine-Language Programming, Assembly-Language Programming, Connecting to the Outside World.

ISBN: 0-88006-027-1 AVAILABLE NOW! BK7388 \$14.95

THE NEW WEATHER SATELLITE HANDBOOK—

By Dr. Ralph E. Taggart WB8DQT—

Here is the completely updated and revised edition of the best-selling *Weather Satellite Handbook*—containing all the information on the most sophisticated spacecraft now in orbit. Dr. Taggart has written this book to serve both the experienced amateur satellite enthusiast and the newcomer. This book is an introduction to satellite watching, that tells you how to construct a complete and highly effective ground station. Not just ideas, but solid hardware designs and all the instructions necessary to operate the equipment are included. An entire chapter is devoted to microcomputers and the Weather Satellite Station, and for the thousands of experimenters who are operating stations, *The New Weather Satellite Handbook* details all the procedures necessary to follow the current spacecraft.

Weather Satellite contains Operational Satellite Systems, Antenna Systems, Weather Satellite Receivers, A Cathode Ray Tube (CRT) Monitor for Satellite Picture Display, A Direct-Printing Facsimile System for Weather Satellite Display, How to Find the Satellite, Test Equipment, Microcomputers and the Weather Satellite Station, Station Operations.

ISBN 0-88006-015-8 available now! BK7383 \$8.95

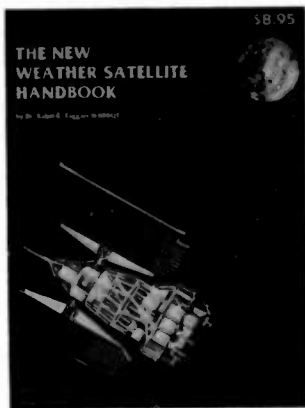

*TRS-80 and TRSDOS are trademarks of the Radio Shack Division of Tandy Corporation.

FOR TOLL-FREE ORDERING CALL 1-800-258-5473
WAYNE GREEN BOOKS • PETERBOROUGH NH 03458

Use the order card or itemize your order on a separate piece of paper and mail to Wayne Green Books Attn: Sales • Peterborough NH 03458. Be sure to include check or detailed credit card information. (Visa, Master Charge or American Express accepted.) No C.O.D. orders accepted. All orders add \$1.50 for the first book, postage and handling; \$1.00 each additional book; \$10.00 per book foreign air mail. Please allow 4-6 weeks after publication for delivery. Questions regarding your order? Please write to Customer Service at the above address.

Better by the dozen.

- 1. NEVER SAY DIE**—If you want controversy, Wayne Green W2NSD/1 will give it to you. His popular column ranges from travelogue to tirade and is guaranteed to entertain, inspire and enlighten you.
- 2. DX**—This globe-trotting column keeps you informed about the news of the DX world from Kingman Reef to Bahrain.
- 3. CONTESTS**—You get all the news on the contest world from Robert Baker WB2GFE. He'll give you information on upcoming events and results from recent contests.
- 4. FUN**—Just for fun, John Edwards K12U provides you with wacky puzzles, quizzes, and games that test your ham mettle.
- 5. FCC**—If you're looking to the future, these outtakes from the Federal Register chronicle changes in policy and regulations that relate to amateur radio.
- 6. RTTY LOOP**—To keep you abreast of radioteletype developments, Marc Leavey WA3AJR explains the new RTTY equipment, the increasing role of computers in RTTY, and other matters of interest to digital communications fans.
- 7. REVIEWS**—Before you buy, save yourself some money... check 73's in-depth evaluation of the latest gear.
- 8. HAM HELP**—As a service to you, 73 prints your questions in our magazine. This helps you to obtain hard-to-get parts, schematics, and owner's manuals.
- 9. SATELLITES**—From Phase III to TVRO, 73 Magazine covers the news of the satellite world like no other radio amateur magazine.
- 10. NEW PRODUCTS**—This brief look at the latest ham equipment on the market keeps you on top of new developments in amateur radio.
- 11. AWARDS**—To find out what certificates are available where, read Bill Gosney KE7C's coverage of all the ham radio awards.
- 12. CONSTRUCTION**—The builder's magazine... that's 73. You get the best projects from the best authors every month.

Send me a dozen issues of

73 MAGAZINE
for the dozen reasons listed!

- 1 year, USA \$19.97
 1 year, CANADA, US funds \$22.97
 1 year, Foreign Surface, \$39.97, drawn on U.S. banks only.
 MC VISA AM. EXP. CHECK/MO

Name _____

Address _____

City _____ State _____ Zip _____

Card # _____ Ex. Date _____

Interbank # _____

Signature _____

Mail to:
73 Magazine Subscription Dept.
P.O. Box 931, Farmingdale, NY 11737
Please allow 4-6 weeks delivery

328B6

73
MAGAZINE
FOR RADIO AMATEURS

Subscription Department
P.O. Box 931
Farmingdale, NY 11737

1-800-258-5473

For orders only please.
Foreign air mail, please inquire.



SATELLITES

SOVIET SURPRISE!

On May 17, World Telecommunications Day, the Soviet Union placed yet another amateur radio satellite into orbit. However, the unusual manner of its launch and the technical details so far released make it clear that this is no ordinary amateur bird.

The satellite, called ISKRA-2 ("iskra" is Russian for "spark"), was put into orbit by two Soviet cosmonauts who simply pushed the spacecraft out an airlock aboard the Salyut 7 orbiting space station. Several sources, including Radio Budapest, have said that ISKRA-2 carries a 15-to-10-meter communications transponder, which would be the first use of the 21-MHz band for an amateur communications satellite. Telemetry beacons from the new bird have been copied on the high end of 10 meters at 29.576 and 29.875 MHz, using the callsign RK02. At press time, no transponder activity had been heard.

ISKRA-2 is in a rather low orbit, less than 225 miles high. This means that the satellite will have a rather limited lifetime, unless it carries some means by which to raise its orbit.

The launch, which was shown on Soviet television, is apparently only the second of its kind. In 1972, the Apollo 16 astronauts placed a small satellite into orbit around the moon.

PHASE IIIB

It now appears that the long-awaited launch of the Phase IIIB

satellite will take place next January and not this summer, as had been hoped. The delay comes as a result of problems with the government and scientific satellites which are the primary payloads for the European Space Agency's Ariane rocket.

Phase IIIB is now scheduled to fly aboard the seventh flight of Ariane, but until the problems with the other satellites are solved, no launches can take place. Meanwhile, the amateur Phase IIIB bird is ready to go.

Thanks to AMSAT Satellite Report.

THAT BIG TABLE

Our monthly table of amateur satellite data this month takes on a new form, designed to pack a lot more information into only a little more space. Joining the usual data for OSCAR 8 are reference orbit predictions for four of the Soviet Radio Sputniks, RS-5 through RS-8. Each of these five satellites carries at least one operating communications transponder or robot (automatic QSO device).

This table provides reference orbit data for each day of the month on the cover of this magazine, plus the first half of the following month. For each day during this period, two items of information are given for each of the five satellites. The first number (UTC) is the time (Universal Coordinated Time—same as GMT for most purposes) of the satellite's first northbound equatorial crossing of the day. The second number (EQX) is the longitude (degrees west) at which that crossing occurs. The data in the table is based on the Project OSCAR, Inc., orbital predictions.

Using these two numbers, there are a variety of ways to determine when any of the satellites will be within range of your location. If you have a microcomputer or programmable calculator at your disposal, you can make use of one of several programs published in 73 and other amateur publications. The new AMSAT Software Exchange has a good selection of satellite tracking programs. The OSCARLOCATER package from the ARRL gets the job done in a simple but effective manner. A completely manual method for making rough estimates of satellite accessibility was presented in the October, 1981, issue of 73, page 178.

Addresses: AMSAT Software Exchange, Box 338, Ashmore IL 61912. ARRL, 225 Main Street, Newington CT 06111.—Jeff DeTray WB8BTH.

DON'T TIME OUT... TIME IN

Model TI-10 time alert for repeater operators to avoid timing out repeater. (Patented)
 *Sensitive enough for H.T.S.
 *Automatic. Senses RF carrier-no connections to sig.
 *Battery powered.
 *Resets on carrier drop-out
 *Adjustable timing period.
 *Size 5 1/4 x 3 5/16 x 1 3/4



Introducing Toggle Time

Toggle Time is a 10 minute timer that would be utilized by a ham to keep within FCC 10 min. ID rules. It is actuated by a toggle switch which serves two purposes:

1. Starts Timer
2. Turns on Power

Only one switch on box is all that is present. Price \$14.95 includes battery.

*Weight 8 oz./226.8 Grams
 Piercing. 6.5 KHz alert tone
 Model TI-10 assembled \$69
 Model TI-10, kit form \$57
 Shipping and handling add \$3
 Printed Circuit Board and Documentation \$20

When ordering, please specify model

COMSTAR RESEARCH

P.O. BOX 771 Madison Heights, MI 48071

REGENCY SCANNERS

T720 Air	169.00	D810	270.00
D100	159.00	M100	205.00
D300	209.00	M400	245.00

All Bundy low profile I.C. Sockets just 1¢ per pin
 Example: 8 pin—8¢; 40 pin—40¢ per pin
 Ham IV Rotor—\$165.00
 Columbia 8 Con (2#18/6ft 22)—17¢/ft.
 Columbia RG 59v 100 foil shield TV type—7¢/ft.
 Berk Tek Grey 96% RG 8X—14¢/ft.
 US made PL 259—10/\$5.50

Call for Quantity Quotes

(904) 394-2511
 (313) 278-8217



Universal Dist.
 RAYMOND RICHARD
 RT. 1, BOX 25E
 CLERMONT, FL 32711

155

Amateur Satellite Reference Orbits

Date	OSCAR 8		RS-5		RS-6		RS-7		RS-8		Date
	UTC	EQX	UTC	EQX	UTC	EQX	UTC	EQX	UTC	EQX	
Aug 1	0022	79	0021	159	0148	183	0153	183	0153	182	1
2	0026	81	0016	159	0133	180	0144	182	0150	182	2
3	0031	82	0010	159	0117	178	0134	181	0148	183	3
4	0035	83	0005	159	0102	176	0124	181	0145	184	4
5	0039	84	0000	159	0047	174	0115	180	0142	185	5
6	0044	85	0154	190	0031	171	0105	179	0139	186	6
7	0048	86	0148	190	0016	169	0056	178	0136	186	7
8	0053	88	0143	190	0000	167	0046	177	0133	187	8
9	0057	89	0138	190	0144	194	0036	176	0131	188	9
10	0101	90	0132	190	0128	192	0027	175	0128	189	10
11	0106	91	0127	190	0113	189	0017	174	0125	190	11
12	0110	92	0122	191	0058	187	0007	174	0122	190	12
13	0115	93	0116	191	0042	185	0157	203	0119	191	13
14	0119	95	0111	191	0027	182	0147	202	0117	192	14
15	0123	96	0106	191	0011	180	0138	201	0114	193	15
16	0128	97	0100	191	0155	208	0128	200	0111	194	16
17	0132	98	0055	192	0139	205	0118	199	0108	195	17
18	0137	99	0050	192	0124	203	0109	198	0105	195	18
19	0141	100	0044	192	0109	201	0059	197	0102	196	19
20	0002	76	0039	192	0053	198	0049	196	0100	197	20
21	0007	77	0034	192	0038	196	0040	195	0057	198	21
22	0011	78	0028	193	0022	194	0030	195	0054	199	22
23	0015	79	0023	193	0007	191	0021	194	0051	199	23
24	0020	80	0018	193	0150	219	0011	193	0048	200	24
25	0024	81	0012	193	0135	216	0001	192	0046	201	25
26	0029	83	0007	193	0120	214	0151	221	0043	202	26
27	0033	84	0002	194	0104	212	0141	220	0040	203	27
28	0037	85	0156	224	0049	209	0132	219	0037	204	28
29	0042	86	0150	224	0033	207	0122	218	0034	204	29
30	0046	87	0145	224	0018	205	0112	217	0031	205	30
31	0050	88	0140	224	0003	202	0103	217	0029	206	31
1 Sep 1	0055	90	0134	224	0146	230	0053	216	0026	207	1
2	0059	91	0129	225	0131	228	0043	215	0023	208	2
3	0104	92	0124	225	0115	225	0034	214	0020	208	3
4	0108	93	0118	225	0100	223	0024	213	0017	209	4
5	0112	94	0113	225	0044	221	0014	212	0015	210	5
6	0117	95	0108	225	0029	218	0005	211	0012	211	6
7	0121	97	0102	226	0014	216	0154	240	0009	212	7
8	0126	98	0057	226	0157	243	0145	239	0006	213	8
9	0130	99	0052	226	0141	241	0135	238	0003	213	9
10	0134	100	0046	226	0126	239	0125	238	0000	214	10
11	0139	101	0041	226	0111	236	0116	237	0157	245	11
12	0000	77	0036	227	0055	234	0106	236	0155	246	12
13	0004	78	0030	227	0040	232	0057	235	0152	247	13
14	0009	79	0025	227	0025	229	0047	234	0149	248	14

W2NSD/1 NEVER SAY DIE

editorial by Wayne Green

from page 8

hibit had a nice restaurant with no wait at all, right in the middle of the lunch hour.

Sherry and I went to the restaurant in the Chinese exhibit for dinner. Tom Salvetti, of Ten-Tec, was with us and we went right in with no wait at all. The food was real Chinese. It was good, but not outstanding. Sherry prefers to use chopsticks when eating Asian food and this was a bit of a problem. The waiter, a Chinese lad from the Knoxville area, explained that they only had three sets of chopsticks for the whole restaurant! He managed to get one of the sets for her, but the rest of us had to eat with forks.

The food prices are a bit above what I'd normally expect, but not astronomical. China seems to be getting all she can out of the fair (they need dollars, so that's not a surprise), with their dinners running around \$14 per person. That's as bad as a banquet price. Belgian waffles were \$2.10 instead of perhaps \$1.50... and so on. High, but not prohibitive. They have to get their \$110 million back some way, don't they?

In all, I would suggest that if you are going to be anywhere near the Knoxville area, you should allow a couple of days to see the fair. Never mind all the put-downs... it's a good show and the people couldn't be more friendly.

ROCHESTER

The debacle of '81 still hung heavy over the 1982 running of the Rochester Hamfest. It's still a shadow of former years, but perhaps with the relaxation of harassment by the tax people, the exhibitors and then the crowds will be back.

This year there was but *one* major manufacturer exhibiting: Hy-Gain/Telex. A few dealers were there, hoping that the New York tax people would not bring in the police and threaten again to close down the whole show.

The dealers seemed to feel that business was okay, considering the economy.

There is a plan to move the banquet to Friday night and keep the show to one day on Saturday. This would allow hams to arrive the night before, attend the banquet, and then spend the day at the show. After a full day of browsing around the flea market, most hams are too tired to wait for the banquet; they just drive home to rest. It may be better to run it Friday night. It's worth a try.

After all of the fuss from CQ about attending hamfests, guess who was not there? Heh, heh! But then *Ham Radio* was also conspicuously absent. They seem to have pulled in their horns almost completely and become invisible. 73's Jim Gray was there to keep 'em honest... answer questions and fly the flag.

Speaking of the magazines, guess who was at the ARRL booth? There were a lot of rotten remarks about Harry being dead and refusing to lie down. I think that sort of thing is in poor taste. As I've written, I think the least the board could have done for Harry is to make him a president emeritus like they did the previous president. And if they have any real case against him for malfeasance, I think they should bring it out in the open, not just make sly hints about it. Harry should be given the credit he deserves for building up the League, for promoting satellite communications, and for his enthusiasm for packet communications, RTTY, and so on. Let's not have another of those crummy deals like they pulled on Don Miller.

Other than that, Rochester was upbeat this year, looking better. But Harold Smith was almost invisible again this year... where are you, Harold? He's the one who almost single-handedly organized and built up the hamfest over the years, turning it from a small independent effort into a genuine ARRL hamfest.

FCC NEWS

The FCC has extended the deadline for filing comments on Docket 82-83 to August 16. Reply comments are due September 16. Docket 82-83 proposes wider phone bands. For more information, see pages 143-145 of the May, 1982, issue of 73.

The return time limit for Novice exams was extended to 60 days, effective May 6, 1982. This change will be of interest to volunteer examiners who previously had 30 days to return the test papers.

SADDLE STITCHING

In addition to the cover design change, we are also changing to what is called "saddle stitching" of the binding. The idea is to get back to the way we used to be when 73 was running a raft of small construction projects. We want to make the magazine easy to open up while you are working on a project. With the square binding, called "perfect binding," the magazine may look better, but it is a bitch to keep open on the workbench. I really hate it when the magazine flips closed while I'm wiring some chips together.

We're going to be concentrating on publishing as many relatively simple construction projects as we can scare up for you, so get your soldering iron out and start shopping for parts.

A NEW COVER... AGAIN?

Sure, why not? Every few years we get kind of fed up with everything being the same. We look around for ways to make 73 better... or worse, depending on your reactions to change.

The new cover solves some serious problems for us. First, it will stop the continuous flack we've been getting from 73 readers who liked the old contents type of covers. It is a lot easier to find things when the table of

contents is right there on the cover, no question about that. And since virtually 100% of the 73 readers save their magazines religiously and use them for reference, this is a big plus.

Another problem was our desire to use color pictures brought back from DXpeditions on the cover. If you are not into photography, you may not know that 35mm color pictures can't be enlarged to the full cover size without getting fuzzy. Normally we would want to use a larger film format camera for cover shots... such as a 6x6 cm or a 6x7 cm such as the Hasselblad or Mamiya RB-67 cameras. These will enlarge and provide sharp cover pictures. Just look at some of the cover pictures on QST in recent months and you'll see what I mean... fuzzy.

By running the pictures in a smaller format on the cover, they will be nice and sharp... and look better. Also, we'll be able to run maybe two or three pictures instead of just one.

I realize that you probably are no more a fan of change than I am and will take a few months to get used to the new look. For all my insistence on change being important in amateur radio, I'm as much of a stick in the mud when it comes to change as you probably are. Let's try it and see how it plays.

HAM HELP

I need help on my code speed for the General ticket.

Howard Halperin WB7WDI
4122 West Flower St.
Phoenix AZ 85019

Wanted: Information on the Gonset Model 900A 2-meter Sidewinder. I would like to get in touch with anyone with parts for this unit or who can suggest where these parts can be found.

Peter Mitroff VE3DSW
8 Marsten Dr.
St. Catharines ONT L2N 3C7
Canada

I would like any information on the Globe Electronics HG 303, including manuals and schematics. I will purchase at a reasonable price or will make copies and send an extra set of copies back to you with the original.

Al Wilde W8JZZ
5580 E. Galbraith Rd.
Cincinnati OH 45236

I need a Johnson Viking Model 122 vfo to use with a Johnson Adventurer.

Jack Speer N1BIC
70 Florida Hill Rd.
Ridgefield CT 06877

NEW! **A 2-Meter Space Beater! DRRR**

The Repeater Beater

- With as little as one square foot of ground plane, the unique CR2A two-meter antenna provides communication from virtually anywhere.
- Low SWR match to a 50 ohm line across the entire band.
- Magnetic mount included.
- Space Beaters are available for single or multi-band operation from 3.5-148 MHz.

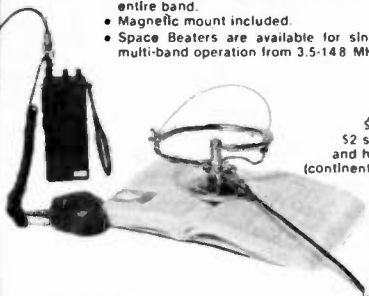

\$39 plus \$2 shipping and handling (continental USA)

COM - RAD, INC.
1635 WEST RIVER PARKWAY
GRAND ISLAND, NEW YORK 14072
(716) 773-1445

Visa and MasterCard accepted

✓ 163

WANTED FOR CASH

Your Military Surplus Electronic Material - Airforce, Navy or Army Equipment, Modules, Tubes, or Parts. It costs nothing to get our highest offer

Call Collect NOW
201-440-8787

35 Ruta Court
South Hackensack, N. J. 07606
SPACE ELECTRONICS Co.
Our 22nd Year

✓ 162

(((BIT "O" BYTE)))

ALL Prices include Shipping and Tax in the U.S.A.
ALL DISKS are WARRANTED against material defects for 90 days from date of purchase.

- (1) 5 1/4 inch Diskettes (soft sector), Center Reinforcing Ring, Jacket and plastic box stand. They ARE TOP Quality and used by the software houses. = \$27 for 10 diskettes or \$2.70 each for the first 20 to 100 will be \$2.50 each.
- (2) SYMTEC HIGH RES LIGHT PEN—With software = \$185.00
- (3) 16K RAM CARD for the APPLE II(+) BARE BOARD = \$30.00
This card is compatible with any language system, Integer-Applesoft-Pascal-Fortran-etc.
- (4) PADDLE ADAPPLE brings the game paddle port out to a convenient location. For only = \$27.50
- (5) MAGIC KEYBOARD a numeric key pad (hex or des) with the apple keyboard. For only = \$86.00

Both products are from Southern Cal. Research Group and advertised in SoftTalk magazine for Apples and carry a 90 day warranty.

- (6) RAMDISK 320 by Axion, 320K of ram, that holds over 2 disk of programs, DOS & pascal 1.1 compatible, battery backup, slot independent, draws no power from your Apple II(+). It is advertised in SoftTalk. Suggested price \$1395.00 My Price \$1225.00
- (7) I will carry other items in the future. If there is something of interest to you but is too expensive, drop me a note, I will get the lowest price I can and pass it on to you.
The prices may change without notice.
Please send ORDERS with payment or inquiries to—

BIT "O" BYTE
P.O. Box 60972
Sunnyvale, CA 94088

✓ 153

CB TO TEN METER CONVERSION KITS

KITS for AM—SSB—FM 40 Channel PLL chassis conversions
DETAILED INSTRUCTIONS for easy installation with minimum time and equipment
BAND COVERAGE flexibility provides up to 1 MHz coverage for most PLL chassis.
PRICES Low cost prices range from \$8.00 to \$50.00

All kits are in stock including several different FM kits.
FREE CATALOG Write or call today.

✓ 78 **INDEPENDENT**
CRYSTAL SUPPLY COMPANY
P.O. Box 183
Sandwich, Ma. 02563-0183
(617) 888-4302

NEW DX ANTENNAS

QUALITY - ECONOMY

WE MANUFACTURE:
MONOBAND YAGI BEAMS
TRI BAND YAGI BEAMS
CENTER INSULATORS - BALUNS
DUMMY LOADS - AND MORE!

All DX products are fully guaranteed. Send large S.A.S.E. for free catalog. Dealer inquiries are welcome.

DX Signal Co.
P.O. BOX 37, Locon, IL 61540
Phone (309) 246-2087

YAESU FT-207R OWNERS
AUTO SCAN MODULE AND BATTERY SAVER KIT



15 minutes to install; scan restarts when carrier drops off; busy switch controls automatic scan on-off; includes module and instructions.
Model AS-1. \$25.00

FT-207R BATTERY SAVER KIT MODEL BS-1 \$14.95

- * No more dead batteries due to memory backup
- * 30% less power drain when squelched
- * Simple to install; step-by-step instructions and parts included
- * 4 mA memory backup reduced to 500 uA.
- * 45 mA receiver drain reduced to 30 mA.
- * Improved audio fidelity and loudness

ENGINEERING CONSULTING
P.O. Box 3966
ANAHEIM, CALIFORNIA 92803

WRITE FOR CLUB DISCOUNTS

✓ 400

DIGITAL DISPLAY

30 DAY FREE TRIAL



New **YAESU** display converted for FT101 series, FR101, FT301 and **KENWOOD** TS520 TS820 TS900 R599. Plug into external VFO Jack for signal and power. 5 active 3/8" red LED digits read down to 10Hz. Rear panel 10Hz dig. defeat switch. 1 3/8" high, 4 1/2" wide and 6 1/2" deep. Case is black and lower front panel is brushed aluminum.

Send model no. & \$95.00 U.S.-M.O.

Models for **HEATH** SB100-102 SB300-301 HB100-101 and HR160. Same as above except case is green and comes with a plug in power supply/transformer, off switch, any wire, plugs, jacks and information required to connect.

Send model no. & \$105.00 U.S.-M.O.

COLLINS S line models same specs and price as HEATH Case is grey. **DRAKE** 4 series same. Case is black.

If your external VFO Jack is used for a VFO, a receiver or transmitter add: \$5.00 for a male/female plug/jack.

Units for FT620B TS600 TS700 Mod. no. & \$100.00 U.S.-M.O.
VC 2 2 1 for **F7221**. New stock. Clearout at \$65.00 US MS.
>30 day money back. You pay return postage. Write with model and serial no. for more information on your model display.
All units duty and postpaid US & Can.. 6 months warranty. Also FTDX100 FTDX400 FTDX601 and FRDX receivers as HEATH.

GRAND SYSTEMS
GENERAL DELIVERY OF 20352 40A AVE
BLAINE WASHINGTON LANCASTER O C
U S A 98028 CANADA V3A2T0
(800) 538 4851 ✓ 132

UNIQUE

TRIPOLE MULTI-BAND



The **TRIPOLE** antenna covers the 160, 80, 40, 20, 15, 10 and 6 meter bands without retuning or a tap change. 80 to 120 ft. length. 2 KW PEP. Twin inverted V and horizontal without an antenna tuner. Neat appearance, built-in balun, rugged, aids mast or tower guying. A best choice for an all-around amateur station antenna.

Guaranteed. Kit T80-K \$74.95; Assembled T80-A \$84.95
Prices postpaid cash. TX residents add 5% sales tax.

Call or send card for information on **TRIPOLE** antennas and feedline kits. Order direct or ask your Dealer.

UNIVERSAL RADIO CO.
Dept. Q1 P.O. Box 26041
El Paso, Texas 79926 (915) 592-1910

VISA or MASTER CHARGE

Call or Send for Free

SINTEC
ELECTRONIC PARTS CATALOG



Thousands of Quality Components
No Mail Order "Seconds"!

Call Toll Free
800-526-5960

NJ Residents call 201-996-4093
Sintec, Drawer Q,
Milford, NJ 08848

✓ 112

ALL BAND TRAP ANTENNAS!



PRE-TUNED - COMPLETELY ASSEMBLED - ONLY ONE NEAT SMALL ANTENNA FOR ALL BANDS! EXCELLENT FOR CONDO'S - APARTMENTS - LIGHT STRONG - ALMOST INVISIBLE!

FOR ALL MAKES & MODELS OF AMATEUR TRANSCEIVERS! GUARANTEED FOR 2000 WATTS SSB INPUT FOR NOVICE AND ALL CLASS AMATEURS! IMPROVED DESIGN!

COMPLETE with 90 ft. RG58U-52 ohm feedline, and PL259 connector, insulators, 30 ft. 300 lb. test dacron end supports, center connector with built in lightning arrester and static discharge - molded, sealed, weatherproof, resonant traps "XG" - you just switch to band desired for excellent worldwide operation - transmitting and receiving! Low SWR over all bands - Tuners usually NOT NEEDED! Can be used as inverted V's - slopers - in attics, on building tops or narrow lots. The ONLY ANTENNA YOU WILL EVER NEED FOR ALL BANDS - WITH ANY TRANSCEIVER - NEW - NO BALUNS NEEDED!

80-40-20-15-10 - 2 trap - 104 ft. - Model 998BUC. \$79.95
40-20-15-10 - 2 trap - 54 ft. - Model 1001BUC. \$78.95
20-15-10 meter - 2 trap - 26ft. - Model 1007BUC. \$77.95

SEND FULL PRICE FOR POSTAGE INSURED. DEL. IN USA. (Canada is \$5.00 extra for postage - clerical - customs etc.) or order using VISA - MASTER CARD - AMER. EXPRESS. Give number and ex. date. Ph 1-308-236-5333 9AM - 6PM week days. We ship in 2-3 days. ALL PRICES MAY INCREASE ORDER NOW! All antennas guaranteed for 1 year. 10 day money back trial if returned in new condition! Made in USA. FREE INFO. AVAILABLE ONLY FROM

WESTERN ELECTRONICS ✓80

Dept. A7-B Kearney, Nebraska, 68847

NEW AUTOPATCH

Now at last, an autopatch designed for the sophisticated FM Amateur. "Private Patch" works through existing repeaters as well as simplex. Gives you access to your home phone within the coverage area of any selected repeater. "Private Patch" requires no modifications to your base FM transceiver. Connects only to MIC and speaker jacks. Conversation is very natural because "Private Patch" does not use the sampling technique. CW ID sends your call. Five digit owner programmable access code and operator/long distance inhibit protect your phone bill. Self contained AC supply. No tone encoders required. All CMOS digital logic, no analog timing used. Compare our standard features. Send for additional information. Available in spring.

AUTO CONNECT

Box 4155 ✓130

Torrance, CA 90510

CONNECT YOUR TRS-80 TO THE AIRWAVES

MORSECOPY \$29.95
Prints incoming Morse on the screen in Alpha-Numeric. Simply connect speaker to CLOAD jack. No hardware required. Specify cassette or diskette.

MORSEFILE \$19.95
Transmits disk files as Morse code audio from CSAVE jack. Supplied on diskette.

HAMCALL \$49.95
Can be used by clubs or individuals to maintain mailing lists of radio amateurs. Provides call sort on prefix, suffix, or on last name or zip code. Provides labels or printout. Requires 1-2 drives and 32-48K.

SERIES STRING RESISTIVE DIVIDER ANALYSIS PROGRAM
4K Version \$14.95 16K Version \$24.95
Program performs a complete worst case analysis of a series resistive divider of up to five resistors. Program draws a schematic of the divider with min/max values shown. Computes the min/max possible voltages at each node and max possible power dissipation. You change input parameters and update results.

THE PERIPHERAL PEOPLE

P.O. BOX 21123 - SEATTLE, WA 98111 (206) 236-2066

✓161



IT'S INCREDIBLE!

CODE QUICK

Master code or upgrade in a matter of days. Code Quick is a unique breakthrough which simplifies learning Morse Code. Instead of a confusing maze of dits and dahs, each letter will magically begin to call out its own name! Stop torturing yourself! Your amazing kit containing 5 power-packed cassettes, visual breakthrough cards and original manual is only \$39.95! Send check or money order today to WHEELER APPLIED RESEARCH LAB, P.O. Box 3261, City of Industry, CA 91744. Ask for Code Quick #103, California residents add 6% sales tax.

One User Comments:

"First new idea in code study and the darn thing works! So much fun you don't realize how much you're learning."

M.S. Grenada, Miss.

Hundreds of satisfied customers!

You can't lose! Follow each simple step. You must succeed or return the kit for a total immediate refund!

SYNTHESIZED SIGNAL GENERATOR

MADE IN USA



MODEL SG1000 \$349.95 plus shipping

- Covers 100 to 185 MHz in 1 kHz steps with thumb-wheel dial • Accuracy 1 part per 10 million at all frequencies • Internal FM adjustable from 0 to 100 kHz at a 1 kHz rate • Spurs and noise at least 60 dB below carrier • RF output adjustable from 5-500 mV at 50 ohms • Operates on 12 Vdc @ 1/2 Amp • Available for immediate delivery • \$349.95 plus shipping
- Add-on Accessories available to extend freq. range, add infinite resolution, voice and sub-audible tones, AM, precision 120 dB calibrated attenuator
- Call for details • Dealers wanted worldwide.

VANGUARD LABS ✓311

106-23 Jamaica Ave., Hollis, NY 11423
Phone: (212) 468-2720

RED HOT SPECIALS!

New KDK FM2030 w/TT mike. \$279.00
Azden PCS-3000 2M transceiver. 283.00
Azden PCS-300 2M handheld. 283.00
Azden PCS-2800 10M FM transceiver. 283.00
Ten-Tec Argosy transceiver. 435.00
Ten-Tec Delta transceiver. 675.00
Ten-Tec Omni D transceiver. 965.00
All MFJ items. 12% off list
Santec 144 Microprocessor
2M handheld. 293.00
Janel OSA-5 2M receiver preamp. 37.50
Santec 440 Microprocessor
440 MHz handheld. 327.00
AEA Isopole 144 MHz antenna. 32.00
Bearcat 20-20 Scanner. 269.00
Cushcraft 147-11 11 element 2M beam. 32.00
Large Stock Used Equipment. write for list

Ben Franklin Electronics

115 1/2 N Main Hillsboro KS 67063

316-947-2269

✓439



SAVE 90%

YES you can save up to 90% on a computer system of your own.

\$150.00 buys a 4MHz Z80A with 64KB & a real Front Panel

\$200.00 buys a Full Function 24x80 CRT with Keyboard

You can have your own computer and be running Fortran, Basic, Pascal, etc. If you get our

FREE BROCHURE TODAY

DIGATEK CORP.
Suite 50A
2723 W. Butler Dr.
Phoenix AZ 85021
ROLL-YOUR-OWN TECHNOLOGY AND SAVE A BUNDLE

✓144

C.B. SPECIAL

(Repeat of a sell out)

CONVERT THESE TO 10 METER FM

New My Gain 40 channel printed circuit boards assembly (Squelch pot, volume control and channel switch not included) Boards sold as is. Dimension 6" X6"

1-9 pcs \$7.50 ea.
10-49 pcs \$6.50 ea.

(while quantities last)

REMOTE 40 CHANNEL C.B.

Remotes have a metal frame. Speaker, plastic case, and control mic not included. Sold as is.

\$14.95 ea

C.B. BARGAIN

C.B. boards missing parts or damaged. Can be used for spare parts. Buy several!

\$3.50 ea

Order information: Please add \$4.00 for S/H via UPS. COD's accepted for orders totaling \$50.00 or more. Florida residents add 4% sales tax. Minimum order \$15.00. Foreign orders US funds only add 20% for S/H. MASTER CARD and VISA accepted.

Surplus Electronics Corp.

7294 NW 54th St. ✓69
Miami FL 33166
P.H.# 305-887-8228

CONTACT-80...

An ultra sophisticated yet simple to operate RTTY System for the demanding operator at an affordable price.

Features:

- * Disk I/O; SAVE, LOAD, KILL & DIR
- * TRI-SPLIT screen, user defined
- * 20 CANNED MESSAGES with DYNAMIC BUFFER ALLOCATION
- * Live HARDCOPY for parallel printers
- * Keyboard CONTROL of STATION
- * AUTO-ID; RTTY, CW (selectable ON/OFF)
- * CLOCKED OUTPUT rate
- * All BAUDOT speeds plus ASCII (110)
- * NAME, DATE, TIME from computer
- * On screen BIT PATTERN SCOPE

Requires TRS-80, MOD-III with Disk, your CALL SIGN plus TU with 60ma loop.

CUSTOM SOFTWARE plus CONTROLLER INTERFACE \$279.00 Post Paid

COMM TEK (404) 946-9314

4493 Orleans Dr.,

✓150

Dunwoody, GA 30338

DX-Notes

- *2000+ DXCC Band/Mode Countries!
 - *SEVEN wide Worked/Confirmed Columns!
 - *Log the entire DX Callsign!
 - *YOU Designate the Modes and Bands!
- PLUS *Buro! *3rd Party! *Reciprocal Licensing!
- *Space to enter YOUR World Atlas page #
 - *JARU Continent! *ITU Zone! *CQ Zone!
 - *Unique "Rareness" Rating!
 - *Latitude! *Longitude!
- PLUS Info computed for YOUR QTH!
- *Time Zone Difference! *Propagation Factor!
 - *Distance in Kilometers! *Distance in Miles!
 - *EXACT Beam Headings - Including DX to You!
- PLUS Complete Prefix and Name Guides!
- 1200+ Prefixes are cross-referenced!
 - 400+ Countries are indexed alphabetically!
- DX-Notes do the work - YOU do the DX-ing!

SEND Call, Name, Address, Time Zone, QTH Info (Latitude & Longitude OR Direction & Distance From a nearby town to Your QTH) and \$12.50PPD TO:

OR: Call HAWAII!

Randall Sherman KH6MD (808) 877-7371 (18-02Z)
 PO Box 158 879-4080 (04-17Z)
 Kahului, Maui, Hawaii 96732 VISA MC ✓ 147

SUPER LOW PRICES!

- AZDEN PCS-3000 2-METER \$279.00
- AZDEN PCS-300 2-METER HT \$285.00
- SANTEC 144UP 2-METER HT \$289.00
- SANTEC 440UP F:ANDHELD \$319.00
- KENWOOD 2500 HANDHELD \$299.00
- YAESU FT-208R 2-METER HT \$309.00
- YAESU FT-708R 440 HT \$329.00
- TEMPO S-15 2-METER HT \$249.00
- TEMPO S-2 220 HT \$249.00
- ALL KENWOOD & ICOM HF RIGS 12% OFF.
- ALL LARSEN 2-METER ANTENNAS 15% OFF.
- ALL YAESU & TEN-TEC HF RIGS 15% OFF.
- ALL HYGAIN & HUSTLER ANT. 30% off.
- ALL MFJ PRODUCTS 15% OFF LIST.
- RADIOS, ANTENNAS & ACCESSORIES ARE IN NEW, FACTORY SEALED CARTONS.
- FULL MANUFACTURERS WARRANTY.
- PRICES CASH & SHIPPING. CREDIT CARDS ADD 3%.

SHAVER RADIO, INC.
 1378 S. Bascom Ave. San Jose, Calif. 95128
 408-998-1103 ✓ 148

Subscription Problem?

73 Magazine does not keep subscription records on the premises, therefore calling us only adds time and doesn't solve the problem.

Please send a description of the problem and your most recent address label to:

73 Magazine
 Subscription Dept.
 PO Box 931
 Farmingdale, NY 11737

Thank you and enjoy your subscription.



sample issue only \$2.50 PPD

OUR 15TH YEAR!

AMATEUR TELEVISION MAGAZINE ✓ 115

"FOR THE SPECIALIZED COMMUNICATION RADIO AMATEUR"

	Surface U.S./Canada	Surface All Mexico Foreign	Airmail Central S. America	Airmail All Other Foreign
1/2 year	\$ 10.00	\$ 13.00	\$ 20.00	\$ 23.00
1 year	\$ 20.00	\$ 26.00	\$ 40.00	\$ 46.00
2 year	\$ 38.00	\$ 50.00	\$ 78.00	\$ 90.00
3 year	\$ 56.00	\$ 74.00	\$116.00	\$134.00

ATV-SSTV-FAX-RTTY-Satellites-EME Microwave and Computers.

Published 12 times per year by Mike Stone WB0QCD
 P.O. Box H, Lowden, Iowa 52255 0408

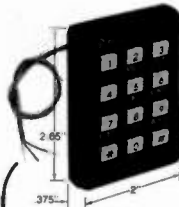

THE PROFESSIONAL TOUCH TONE ENCODER

An ultra high quality encoder for professional application. Absolute reliability and function makes the difference. There's a Pipocommunications encoder for every system and application. Totally serviceable, easy to operate and install. Call or write for free catalog and information! (213) 852-1515 or P.O. Box 3435, Hollywood, CA 90028.

PATENTED

• AT&T

Pipocommunications®
 Emphasis is on Quality & Reliability ✓ 300

this publication is available in microform



University Microfilms International

300 North Zeeb Road
 Dept. P.R.
 Ann Arbor, MI 48106
 U.S.A.

18 Bedford Row
 Dept. P.R.
 London, WC1R 4EJ
 England

RIG TROUBLES GOT YOU DOWN?

- YOU COULD SHIP YOUR RIG TO THE FACTORY FOR REPAIR.
- YOU COULD SHIP IT TO RQ SERVICE CENTER FOR REPAIR.
- BUT YOU STAND A GOOD CHANCE OF FIXING IT YOURSELF WITH HELP FROM YOUR OWN COPY OF "OWNER REPAIR OF RADIO EQUIPMENT"
- THIS BOOK WILL BE SHIPPED POSTPAID FROM K6RQ FOR \$8.95

RQ SERVICE CENTER
 14910 LG Blvd.
 Los Gatos, CA 95030

GO MOBILE WITH YOUR H.T.!

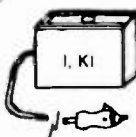

Model I—Icom IC-2A/T, Etc.
 Model K-1 for TR-2500
 —slides on bottom of radio

Guaranteed!



Model K—TR-2400;
 —powered thru battery plug
 Model N—FT-208R
 Model T—Simple mod for Tempo

NOW FOR FT-208R & TR-2500

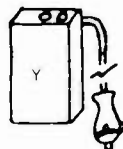

Model Y—FT-207R,
 —fits into battery compartment
 A unique battery eliminator
 HANDI-TEK Regulator allows constant hand-held operation from auto DC or base supply with no nicad drain and WITHOUT RADIO MODIFICATION! \$24.95 PPD in USA. CA add \$1.50 Sales Tax. ✓ 460

HANDI-TEK

P.O. BOX 2205, LA PUENTE, CA 91746

PRESERVE

73 MAGAZINE BINDERS & FILE CASES

Keep your issues of 73 Magazine together, handy and protected in handsome and durable library files or binders. Both styles bound in red leatherette with the magazine logo stamped in gold.

Files: Each file holds 12 issues, spines visible for easy reference, \$5.95 each, 3 for \$17.00, 6 for \$30.00

Binders: Each binder holds 12 issues and opens flat for easy reading. \$7.50 each, 3 for \$21.75, 6 for \$42.00

(Postage paid in USA. Foreign orders include \$2.50 per item)

Please state years: 1977 to 1983

Send check or money order to:

JESSE JONES BOX CORP.

P.O. Box 5120

Philadelphia, PA 19141

Allow 4 to 6 weeks for delivery



ICOM

FOR THE PROFESSIONAL AMATEUR

N&G



DISTRIBUTING
7201 N.W. 12 ST.
MIAMI, FLA. 33126
(305) 592-9685
(305) 763-8170
WATTS 800-327-3364

SPECIAL LIMITED OFFER

SSB-CW MODE PORTABLE RADIOS

IC-502-A 6 METER
LIST 239.00 N&G PRICE 189.00
IC-202-S 12 METER
LIST 279.00 N&G PRICE 215.00



IC-730 H.F.
LIST \$829.00

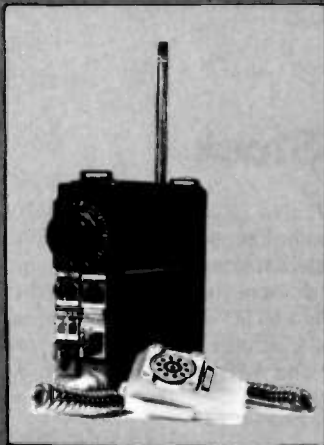

IC-720A H.F.
LIST \$1349.00

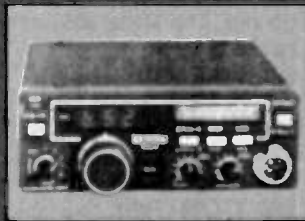

IC-25-A
LIST \$349.00



IC-451A U.H.F.
LIST \$899.00



IC-2AT, IC-3AT, IC-4AT
Accessories Stocked

*** B E C * Bullet Electronics Corp. P.O. Box 401244E Garland, TX. 75040 (214) 278-3553**

THE PRESIDENT SAYS: "HOGWASH!!"

After taking one look at the TRIPUT POWER SUPPLY our engineer declared that the units were worth several hundred dollars each. He pointed out the engineering, high quality construction and state-of-the-art integrated design in support of his position. The President of BEC more pragmatically pointed out the already full warehouse and the two trailer truck loads of power supplies waiting in the parking lot, and set the price to move them QUICKLY! We have a large quantity, but the supply won't last long. The only thing we ask is please read the ordering rules.

QUALITY DOUBLE SIDED GLASS BOARD



REGULATOR ASSEMBLY
(part of unit)

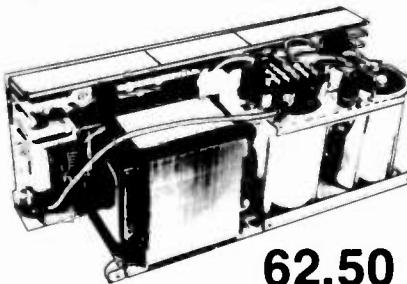

COMPLETE UNIT
(as you receive it) 21 lbs.

62.50

Plus Freight

ORDERS SHIPPED WITHIN CONTINENTAL U.S. ONLY! 6 x 5 1/4 x 12
ORDERING RULES

1. Mail check or MO for \$62.50 + \$5.00 for shipping or phone (214) 278-3553 to charge VISA/MC or COD order. (UPS COD only, add \$2.50 COD fee)
2. Texas residents include 5% sales tax.
3. Orders for this unit will be shipped within 48 HOURS or we pay the freight! (weekends or holidays excluded)
4. ONE TIME OFFER! LIMIT TWO (2) SUPPLIES PER CUSTOMER.

13.6V @ 20A MODIFICATION

By changing a few parts on the board the Tripup Power Supply will do 11 - 14V (adjustable) at up to 20A. Perfect for that 2 meter linear amp! We send step by step instructions and necessary parts. Modification per instructions will not void the 30 day warranty.

- +12V @ 7A; +5V @ 10A; -12V @ 5A
- UNIT IS COMPLETELY ASSEMBLED!
- Fused primary and DC sections
- HUGE SHIELDED TRANSFORMER
- 2% Load & Line Regulation
- Low Ripple (< 100mv)
- Short Circuit Protection
- Overvoltage Protection on all three outputs
- 25A Bridge Rectifier
- Over 60,000 mfd of filters
- High Efficiency Switching Regulator reduces heatsink area
- Schematics and service guide included
- Thermal Shutdown
- Status LED's (3)

Introducing TVRO CIRCUIT BOARDS Satellite Receiver Boards—Now in Stock

DUAL CONVERSION BOARD \$25.00

This board provides conversion from the 3.7-4.2 band first to 900 MHz where gain and bandpass filtering are provided and, second, to 70 MHz. The board contains both local oscillators, one fixed and the other variable, and the second mixer. Construction is greatly simplified by the use of Hybrid IC amplifiers for the gain stages.

SIX 47pF CHIP CAPACITORS

For use with dual conversion board \$6.00

70 MHz IF BOARD \$25.00

This circuit provides about 43dB gain with 50 ohm input and output impedance. It is designed to drive the HOWARD/COLEMAN TVRO Demodulator. The on-board bandpass filter can be tuned for bandwidths between 20 and 35 MHz with a passband ripple of less than 1/2 dB. Hybrid IC's are used for the gain stages.

SEVEN .01 pF CHIP CAPACITORS

For use with the 70 MHz IF board \$7.00

DEMODULATOR BOARD \$40.00

This circuit takes the 70 MHz center frequency satellite TV signals in the 10 to 200 millivolt range, detects them using a phase locked loop, de-emphasizes and filters the result and amplifies the result to produce standard NTSC video. Other outputs include the audio subcarrier, a DC voltage proportional to the strength of the 70 MHz signal, and AFC voltage centered at about 2 volts DC.

SINGLE AUDIO \$15.00

This circuit recovers the audio signals from the 6.8 MHz frequency. The Miller 9051 coils are tuned to pass the 6.8 MHz subcarrier and the Miller 9052 coil tunes for recovery of the audio.

DUAL AUDIO \$25.00

Duplicate of the single audio but also covers the 6.2 range.

DC CONTROL \$15.00

SPECIAL SET OF FIVE BOARDS \$100.00

INCLUDING DUAL AUDIO (2 single audio boards)

1900 to 2500 MHz MICROWAVE DOWNCONVERTER

MICROWAVE RECEIVER This receiver is tunable over a range of 1900 to 2500 MHz approximately, and is intended for amateur use. The local oscillator is voltage controlled, making the I.F. range approximately 54 to 88 MHz for standard TV set channels 2 thru 7.

P.C. BOARD with DATA 1 to 5 \$15.00 6 to 11 \$13.00 12 to 26 \$11.00 27 - up \$9.00

P.C. Board with all parts for assembly \$49.99 P.C. Board with all chip caps soldered on . . . \$30.00

P.C. Board with all parts for assembly P.C. Board assembled & tested \$69.99

plus 2N6603 \$69.99 P.C. Board assembled & tested with 2N6603 \$79.99

HMR II DOWNCONVERTER with Power Supply, Antenna (Dish) & all Cables for installation. 180 Day Warranty.

1 to 5 \$150.00 6 to 11 \$140.00 12 - up \$125.00

YAGI DOWNCONVERTER with Power Supply, Antenna (Yagi) & all Cables for installation. 90 Day Warranty.

1 to 5 \$150.00 6 to 11 \$140.00 12 - up \$125.00

YAGI DOWNCONVERTER as above but Kit. (NO CABLES) With Box.

1 to 5 \$125.00 6 to 11 \$115.00 12 - up \$100.00

HMR II DOWNCONVERTER as above but Kit. (NO CABLES) With PVC.

1 to 5 \$125.00 6 to 11 \$115.00 12 - up \$100.00

SPECIAL NEW STOCK OF CARBIDE DRILL BITS—YOUR CHOICE \$1.99

1.25mm	13/64	36	47	55	63
1.45mm	19	37	48	56	64
3.2mm	20	38	49	57	65
3.3mm	24	39	50	58	67
1/8	26	40	51	59	68
3/16	29	44	52	60	69
5/32	30	45	53	61	
7/32	31	46	54	62	

PRICES SUBJECT TO CHANGE WITHOUT NOTICE

Start taking calls in curious places with the revolutionary, new Cordless *Escort*[®] Phone.

Special Purchase—The *Escort*[®] Cordless Telephone!

We are pleased to announce the Escort Mark III is now available at special pricing. We bought the manufacturer's entire inventory-- and we are passing the savings on to you!

The Escort Mark III was originally designed to retail for \$199.95. Now, we suggest a retail price of \$169.95 to \$189.95. Or, you can move them out at \$149.95. In any event, you'll like the profit margins.

QUANTITY	DEALER PRICE	GROSS PROFIT AT \$149.95
1—2 units	69.75 each	53%
3—5 units	64.50 each	57%
6—11 units	62.50 each	58%
12—23 units	60.75 each	59%

On all orders of 12 or more, we pay the freight! This is your opportunity to stock up for the Christmas buying season. These are ideal gift items, that will really move out!

ESCORT MARK III SPECIFICATIONS

VHF DUPLEXERS

This duplexer was made for RF Harris Mobile Phones and Two Way Radios. These duplexers can be used in any mobile phone or two way radio system, along with having the capabilities to be modified for UHF use. The physical dimensions are 3 3/5" Long, 4 2/5" Wide, and 1 1/10" Deep. The approximate weight is 18 oz./1 lb. 2 oz.. PRICE \$74.99



- Operates as a regular telephone on touch-tone or rotary dial systems
- Range up to 300 feet
- Ni-Cad rechargeable batteries included in telephone
- Charger built into base transmitter
- Simple plug-in Installation!
- High-performance antenna
- Full duplex, answer and dial out
- Full FCC approval

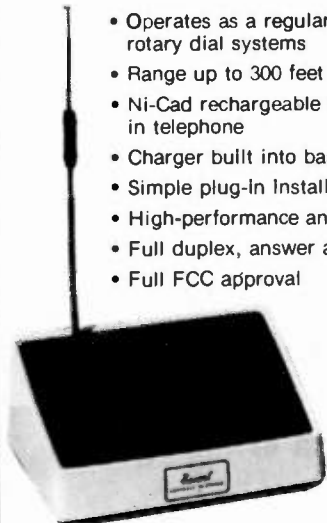

HOW WE CUT THE CORD.

The new Cordless Phone works on a simple, highly sophisticated principle. A small base station plugs into your regular phone jack, and an electrical wall outlet. The base station then transmits any in- or out-going call to the handheld receiver, anywhere up to 300 feet.

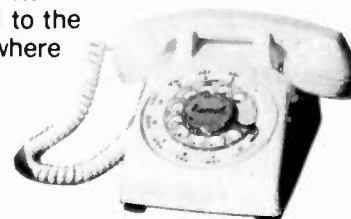

Exactly As Shown

PRICES SUBJECT TO CHANGE WITHOUT NOTICE

**Toll Free Number
800-528-0180
(For orders only)**

MHz electronics

GaAs, TUNNEL DIODES, ETC.

PART	PRICE	PART	PRICE	PART	PRICE
MA47100	\$ 3.05	MRF503	\$ 6.00	PT4186B	\$ POR
MA47202	30.80	MRF504	7.00	PT4209	POR
MA47771	POR	MRF509	5.00	PT4209C	POR
MA47852	POR	MRF511	8.65	PT4566	POR
MA49558	POR	MRF605	20.00	PT4570	POR
MB4021	POR	MRF629	3.47	PT4571	POR
MBD101	1.00	MRF644	23.00	PT4571A	POR
MDO513	POR	MRF816	15.00	PT4577	POR
MHW1171	42.50	MRF823	20.00	PT4590	POR
MHW1182	48.60	MRF901	3.00	PT4612	POR
MHW4171	49.35	MRF8004	2.10	PT4628	POR
MHW4172	51.90	MS261F	POR	PT4640	POR
MHW4342	68.75	MT4150 Fair.	POR	PT4642	POR
MLP102	25.00	MT5126 Fair.	POR	PT5632	POR
MM1500	32.32	MT5481 Fair.	POR	PT5749	POR
MM1550	POR	MT5482 Fair.	POR	PT6612	POR
MM1552	50.00	MT5483 Fair.	POR	PT6626	POR
MM1553	50.00	MT5596 Fair.	POR	PT6709	POR
MM1614	10.00	MT5764 Fair.	POR	PT6720	POR
MM2608	5.00	MT8762 Fair.	POR	PT8510	POR
MM3375A	11.50	MV109	.77	PT8524	POR
MM4429	10.00	MV1401	8.75	PT8609	POR
MM8000	1.15	MV1624	1.42	PT8633	POR
MM8006	2.30	MV1805	15.00	PT8639	POR
MO277L	POR	MV1808	10.00	PT8659	POR
MO283L	POR	MV1817B	10.00	PT8679	POR
MO3757	POR	MV1863B	10.00	PT8708	POR
MP102	POR	MV1864A	10.00	PT8709	POR
MPN3202	10.00	MV1864B	10.00	PT8727	POR
MPN3401	.52	MV1864D	10.00	PT8731	POR
MPN3412	1.00	MV1868D	10.00	PT8742	POR
MPSU31	1.01	MV2101	.90	PT8787	POR
MRA2023-1.5 TRW	42.50	MV2111	.90	PT9790	41.70
MRF212/208	16.10	MV2115	1.55	PT31962	POR
MRF223	13.25	MV2201	.53	PT31963	POR
MRF224	15.50	MV2203	.53	PT31983	POR
MRF237	3.15	MV2209	2.00	PTX6680	POR
MRF238	12.65	MV2215	2.00	RAY-3	24.99
MRF243	25.00	MWA110	7.45	40081	POR
MRF245	34.50	MWA120	7.80	40281	POR
MRF247	34.50	MWA130	8.25	40282	POR
MRF304	43.45	MWA210	7.80	40290	POR
MRF315	23.00	MWA220	8.25	RF110	25.00
MRF420	20.00	MWA230	8.65	SCA3522	POR
MRF421	36.80	MWA310	8.25	SCA3523	POR
MRF422	41.40	MWA320	8.65	SD1065	POR
MRF427	16.10	MWA330	9.50	SS43	POR
MRF428	46.00	NEC57835	5.30	TP1014	POR
MRF450/A	13.80	ON382	5.00	TP1028	POR
MRF453/A	17.25	PPT515-20-3	POR	TRW-3	POR
MRF454/A	19.90	PRT8637	POR	UT0504 AvanteK	70.00
MRF455/A	16.00	PSCQ2-160	POR	UT0511 AvanteK	75.00
MRF458	19.90	PT3190	POR	V15	4.00
MRF463	25.00	PT3194	POR	V33B	4.00
MRF472	1.00	PT3195	POR	V100B	4.00
MRF475	2.90	PT3537	POR	VAB801EC	25.00
MRF477	11.50	PT4166E	POR	VAB804EC	25.00
MRF502	1.04	PT4176D	POR	VAS21AN20	25.00

Toll Free Number
800-528-0180
(For orders only)

MHz electronics

PRICES SUBJECT TO CHANGE WITHOUT NOTICE

RF TRANSISTORS, MICROWAVE DIODES

PART	PRICE	PART	PRICE	PART	PRICE
1S2199	\$ 7.50	2N6083	\$ 13.25	CA2612 (TRW)	\$ 25.00
1S2200	7.50	2N6084	15.00	CA2674 (TRW)	25.00
2N1561	25.00	2N6094 /M9622	11.00	CA2881-1 (TRW)	25.00
2N1562	25.00	2N6095 /M9623	12.00	CA4101 (TRW)	25.00
2N2857	1.55	2N6096 /M9624	15.50	CA4201 (TRW)	25.00
2N2857JAN	2.55	2N6097	17.25	CA4600 (TRW)	25.00
2N2876	11.00	2N6136	21.85	CD1889	20.00
2N2947	18.35	2N6166	40.25	CD2545	20.00
2N2948	15.50	2N6201	50.00	CMD514AB	20.00
2N2949	3.90	2N6459	18.00	D4959	10.00
2N2950	4.60	2N6603	12.00	D4987M	20.00
2N3375	8.00	2N6680	80.00	D5147D	10.00
2N3553	1.57	2SC756A	7.50	D5506	10.00
2N3632	13.80	2SC781	2.80	D5827AM	20.00
2N3818	5.00	2SC1018	1.00	DMD6022	30.00
2N3866	1.30	2SC1042	12.00	DMS-2A-250	40.00
2N3924	3.35	2SC1070	2.50	HEP76	4.95
2N3927	17.75	2SC1239	2.50	HEPS3002	11.30
2N3950	25.00	2SC1251	12.00	HEPS3003	30.00
2N4072	1.80	2SC1306	2.90	HEPS3005	10.00
2N4127	21.00	2SC1307	5.50	HEPS3006	19.90
2N4427	1.30	2SC1760	1.50	HEPS3007	25.00
2N4428	1.85	2SC1970	2.50	HEPS3010	11.34
2N4957	3.45	2SC2166	5.50	HTEF2204 H.P.	112.00
2N4958	2.90	8B1087 (M.A.)	25.00	5082-0112 H.P.	14.20
2N4959	2.30	A50-12	20.00	5082-0253 H.P.	105.00
2N5090	13.90	A283B	5.00	5082-0320 H.P.	58.00
2N5108	4.00	ALD4200N (AVANTEK)	395.00	5082-0386 H.P.	POR
2N5109	1.70	AM123	97.35	5082-0401 H.P.	POR
2N5160	3.45	AM688	100.00	5082-0438 H.P.	POR
2N5177	21.62	BB105B	.52	5082-1028 H.P.	POR
2N5179	1.00	BD4/4JFBD4 (G.E.)	10.00	5082-2711 H.P.	23.15
2N5583	4.00	BFQ85	1.50	5082-3080 H.P.	2.00
2N5589	8.65	BFR90	1.30	5082-3188 H.P.	1.00
2N5590	10.35	BFR91	1.65	5082-6459 H.P.	POR
2N5591	13.80	BFW92	1.50	5082-8323 H.P.	POR
2N5635	10.95	BFX89	1.00	35826E H.P.	POR
2N5637	15.50	BFY90	1.00	35831E H.P.	29.99
2N5641	9.20	BGY54	25.00	35853E H.P.	71.50
2N5642	10.95	BGY55	25.00	35854E H.P.	75.00
2N5643	15.50	BGY74	25.00	HPA0241 H.P.	75.60
2N5645	13.80	BGY75	25.00	HXTR3101 H.P.	7.00
2N5646	20.70	BL161	10.00	HXTR3102 H.P.	8.75
2N5691	18.00	BLX67	11.00	HXTR6101/2N6617 H.P.	55.00
2N5764	27.00	BLY568CF	25.00	HXTR6104 H.P.	68.00
2N5836	5.45	BLY87	13.00	HXTR6105 H.P.	31.00
2N5842	8.00	BLY88	14.00	HXTR6106 H.P.	33.00
2N5849	20.00	BLY89	15.00	QSCH1995 H.P.	POR
2N5913	3.25	BLY90	20.00	JO2000 TRW	10.00
2N5922	10.00	BLY351	10.00	JO2001 TRW	25.00
2N5923	25.00	C4005	20.00	JO4045 TRW	25.00
2N5941	23.00	CA402 (TRW)	25.00	K3A	10.00
2N5942	40.00	CA405 (TRW)	25.00	MA450A	10.00
2N5944	9.20	CA612B (TRW)	25.00	MA41487	POR
2N5945	11.50	CA2100 (TRW)	25.00	MA41765	POR
2N5946	19.00	CA2113 (TRW)	25.00	MA43589	POR
2N6080	9.20	CA2200 (TRW)	25.00	MA43636	POR
2N6081	10.35	CA2213 (TRW)	25.00	MA47044	POR
2N6082	11.50	CA2418 (TRW)	25.00	MA47651	25.50

Toll Free Number
800-528-0180
(For orders only)

PRICES SUBJECT TO CHANGE WITHOUT NOTICE

MHz electronics

"TRANSISTORS"

WATKINS JOHNSON WJ-M62 3.7 to 4.2GHz Communication Band Double Balanced Mixer \$100.00

SSB Conversion Loss 4.9dB Typ. 6dB Max. fR 3.7 to 4.2GHz
5.5dB Typ. 6.5dB Max. fI DC to 1125MHz fL fR

SSB Noise Figure fI 880MHz fL fR
fR 3.7 to 4.2GHz
4.9dB Typ. 6dB Max. fI 30 to 1125MHz fL fR
5.5dB Typ. 6.5dB Max. fI 880MHz fL fR

Isolation
fL at R 30dB Min. 40dB Typ. fL 2.8 to 5.35GHz
fL at I 25dB Min. 30dB Typ. fL 4.5 to 5.35GHz
20dB Min. 30dB Typ. fL 3.6 to 4.5GHz
15dB Min. 25dB Typ. fL 2.8 to 3.6GHz

Conversion Compression 1dB Max. fR Level +2dBm

Flatness .2dB Peak to Peak Over any 40MHz Segment of fR=3.7 to 4.2GHz

Third Order Input Intercept +11dBm fR1=4GHz fR2=4.01GHz Both at -5dBm fL=4.5GHz

Group Time Delay .5ns Typ. .75ns Max. fR3.7 to 4.2GHz fL 3480MHz @ +13dBm

VSWR
L-Port 1.25:1 Typ. 2.0:1 fL 2.8 to 5.35GHz
R-Port 1.25:1 Typ. 2.0:1 fR 3.7 to 4.2GHz fL fR
1.4 :1 Typ. 2.0:1 fR 3.7 to 4.2GHz fL fR
I-Port 1.5 :1 Typ. 2.0:1 fI=100MHz
1.3 :1 Typ. 2.0:1 fI=500MHz
1.8 :1 Typ. 2.5:1 fI=1125MHz

SGS/ATES RF Transistors

Type.	BFQ85	BFW92
Collector Base V	20v	25v
Collector Emitter V	15v	15v
Emitter Base V	3v	2.5v
Collector Current	40ma	25ma
Power Dissipation	200mw	190mw
HFE	40min. 200max.	20min. 150max.
FT	4GHz min. 5GHz max.	1.6GHz Typ.
Noise Figure	1GHz 3dB Max.	500MHz 4dB Typ.
Price	\$1.50	\$1.50

Motorola RF Transistor

	MRF901	2N6603
	25v	25v
	15v	15v
	3v	3v
	30ma	30ma
	375mw	400mw
	30min. 200max.	30min. 200max.
	4.5GHz typ.	2GHz min.
	1GHz 2dB Typ.	2GHz 2.9dB Typ.
	\$2.00	\$10.00

National Semiconductor Variable Voltage Regulator Sale !!!!!!!!!

LM317K	LM350K	LM723G/L	LM7805/06/08/12/15/18/24
1.2 to 37vdc	1.2 to 33vdc	2 to 37vdc	5, 6, 8,12,15,18,24vdc
1.5Amps	3Amps	150ma.	1Amp
T0-3	T0-3	T0-100/T0-116	T0-220/T0-3
\$4.50	\$5.75	\$1.00 \$1.25	\$1.17 \$2.00

P & B Solid State Relays Type ECT1DB72

5VDC Turn On 120VAC Contact 7Amps
20Amps on 10"x10"x.062" Alum.Heatsink with
Silicon Grease \$5.00

*May Be Other Brand Equivalent

Toll Free Number
800-528-0180
(For orders only)

MHz electronics

PRICES SUBJECT TO CHANGE WITHOUT NOTICE

"MIXERS"

WATKINS JOHNSON WJ-M6 Double Balanced Mixer

LO and RF 0.2 to 300MHz	IF DC to 300MHz	\$21.00
Conversion Loss (SSB)	6.5dB Max. 1 to 50MHz	
Noise Figure (SSB)	8.5dB Max. .2 to 300MHz	WITH DATA SHEET
	same as above	
Conversion Compression	8.5dB Max. 50 to 300MHz	
	.3dB Typ.	

NEC (NIPPON ELECTRIC CO. LTD. NE57835/2SC2150 Microwave Transistor

NF Min F=2GHz	dB 2.4 Typ.	MAG F=2GHz	dB 12 Typ.	\$5.30
F=3GHz	dB 3.4 Typ.	F=3GHz	dB 9 Typ.	
F=4GHz	dB 4.3 Typ.	F=4GHz	dB 6.5 Typ.	

Ft Gain Bandwidth Product at Vce=8v, Ic=10ma. GHz 4 Min. 6 Typ.
 Vcbo 25v Vceo 11v Vebo 3v Ic 50ma. Pt. 250mw

UNELCO RF Power and Linear Amplifier Capacitors

These are the famous capacitors used by all the RF Power and Linear Amplifier manufacturers, and described in the RF Data Book.

5pf	10pf	18pf	30pf	43pf	100pf	200pf	1 to 10pcs.	\$1.00 ea
5.1pf	12pf	22pf	32pf	51pf	110pf	220pf	11 to 50pcs.	\$.90 ea
6.8pf	13pf	25pf	33pf	60pf	120pf	470pf	51 up pcs.	\$.80 ea
7pf	14pf	27pf	34pf	80pf	130pf	500pf		
8.2pf	15pf	27.5pf	40pf	82pf	140pf	1000pf		

NIPPON ELECTRIC COMPANY TUNNEL DIODES

		MODEL 1S2199	1S2200	\$7.50
Peak Pt. Current ma.	Ip	9min. 10Typ. 11max.	9min. 10Typ. 11max.	
Valley Pt. Current ma.	Iv	1.2Typ. 1.5max.	1.2Typ. 1.5max.	
Peak Pt. Voltage mv.	Vp	95Typ. 120max.	75Typ. 90max.	
Projected Peak Pt. Voltage mv.	Vpp Vf=Ip	480min. 550Typ. 630max.	440min. 520Typ. 600max.	
Series Res. Ohms	rS	2.5Typ. 4max.	2Typ. 3max.	
Terminal Cap. pf.	Ct	1.7Typ. 2max.	5Typ. 8max.	
Valley Pt. Voltage mv.	VV	370Typ.	350Typ.	

FAIRCHILD / DUMONT Oscilloscope Probes Model 4290B

Input Impedance 10 meg., Input Capacity 6.5 to 12pf., Division Ration (Volts/Div Factor) 10:1, Cable Length 4Ft. , Frequency Range Over 100MHz.
 These Probes will work on all Tektronix, Hewlett Packard, and other Oscilloscopes.

PRICE \$45.00

MOTOROLA RF DATA BOOK

List all Motorola RF Transistors / RF Power Amplifiers, Varactor Diodes and much much more.

PRICE \$7.50

Toll Free Number
800-528-0180
(For orders only)

MHz electronics

PRICES SUBJECT TO CHANGE WITHOUT NOTICE

"SOCKETS AND CHIMNEYS"

EIMAC TUBE SOCKETS AND CHIMNEYS

SK110	Socket	\$ POR	SK626	Chimney	\$ 7.70
SK406	Chimney	35.00	SK630	Socket	45.00
SK416	Chimney	22.00	SK636B	Chimney	26.40
SK500	Socket	330.00	SK640	Socket	27.50
SK506	Chimney	47.00	SK646	Chimney	55.00
SK600	Socket	39.50	SK711A	Socket	192.50
SK602	Socket	56.00	SK740	Socket	66.00
SK606	Chimney	8.80	SK770	Socket	66.00
SK607	Socket	43.00	SK800A	Socket	150.00
SK610	Socket	44.00	SK806	Chimney	30.80
SK620	Socket	45.00	SK900	Socket	253.00
SK620A	Socket	50.50	SK906	Chimney	44.00

JOHNSON TUBE SOCKETS

124-115-2/SK620A	Socket	\$ 30.00	124-113	Bypass Cap.	\$ 10.00
124-116/SK630A	Socket	40.00	122-0275-001	Socket	10.00
			(For 4-250A, 4-400A, 3-400Z, 3-500Z)		2/\$15.00

CHIP CAPACITORS

.8pf	10pf	100pf*	430pf
1pf	12pf	110pf	470pf
1.1pf	15pf	120pf	510pf
1.4pf	18pf	130pf	560pf
1.5pf	20pf	150pf	620pf
1.8pf	22pf	160pf	680pf
2.2pf	24pf	180pf	820pf
2.7pf	27pf	200pf	1000pf/.001uf*
3.3pf	33pf	220pf*	1800pf/.0018uf
3.6pf	39pf	240pf	2700pf/.0027uf
3.9pf	47pf	270pf	10,000pf/.01uf
4.7pf	51pf	300pf	12,000pf/.012uf
5.6pf	56pf	330pf	15,000pf/.015uf
6.8pf	68pf	360pf	18,000pf/.018uf
8.2pf	82pf	390pf	

PRICES: 1 to 10 - .99¢	101 to 1000 .60¢	* IS A SPECIAL PRICE: 10 for \$7.50
11 to 50 - .90¢	1001 & UP .35¢	100 for \$65.00
51 to 100 - .80¢		1000 for \$350.00

WATKINS JOHNSON WJ-V907: Voltage Controlled Microwave Oscillator \$110.00

Frequency range 3.6 to 4.2GHz, Power output, Min. 10dBm typical, 8dBm Guaranteed.
 Spurious output suppression Harmonic (nf₀), min. 20dB typical, In-Band Non-Harmonic, min. 60dB typical, Residual FM, pk to pk, Max. 5KHz, pushing factor, Max. 8KHz/V, Pulling figure (1.5:1 VSWR), Max. 60MHz, Tuning voltage range +1 to +15volts, Tuning current, Max. -0.1mA, modulation sensitivity range, Max. 120 to 30MHz/V, Input capacitance, Max. 100pf, Oscillator Bias +15 +/-0.05 volts @ 55mA, Max.

Toll Free Number
800-528-0180
(For orders only)

MHz electronics

PRICES SUBJECT TO CHANGE WITHOUT NOTICE

TUBES

TYPE	PRICE	TYPE	PRICE	TYPE	PRICE
2E26	\$ 5.69	KT88	\$ 20.00	6562/6974A	\$ 50.00
2K28	100.00	DX362	50.00	6832	22.00
2X1000A	300.00	DX415	50.00	6883/8032A/8552	7.00
3B22	19.75	572B/T160L	49.00	6897	110.00
3B28/866A	7.50	592/3-200A3	144.00	6907A	75.00
3-500Z	102.00	807	7.50	6939	15.00
3-1000Z	400.00	811	10.00	7094	125.00
3CX1000A/8283	428.00	811A	15.00	7117	17.00
3CX1500A7/887	533.00	812A	35.00	7211	60.00
3X2500A3	200.00	813	50.00	7289/3CX100A5	34.00
3CX3000A7	490.00	829B	38.00	7360	11.00
4-65A/8165	45.00	832A	28.00	7377	67.00
4-125A/4D21	58.00	4624	310.00	7408	4.00
4-250A/5D22	75.00	4662	80.00	7650	250.00
4-400A/8432	90.00	4665	585.00	7695	8.00
4-400C/6775	95.00	5675/A	25.00	7843	58.00
4-1000A/8166	300.00	5721	200.00	7854	83.00
4B32	22.00	5768	85.00	7868	5.00
4E27A/5-125B	155.00	5836	100.00	7894	12.00
4CS250R	146.00	5837	100.00	8072	65.00
4X150A/7034	30.00	5861/EC55	110.00	8117A	130.00
4X150D/7035	40.00	5876A	25.00	8121	60.00
4X150G/8172	100.00	5881/6L6W	6.00	8122	100.00
4X250B	30.00	5893	45.00	8236	30.00
4CX250B/7203	45.00	5894/A	50.00	8295/PL172	506.00
4CX250F/G/8621	55.00	5894/B	60.00	8462	100.00
4CX250K/8245	100.00	5946	258.00	8505A	73.50
4CX250R/7580W	69.00	6080	10.00	8533W	92.00
4CX300A/8167	140.00	6083/AX9909	89.00	8560/A	65.00
4CX350A/8321	83.00	6098/6AK6	14.00	8560AS	90.00
4CX350F/J/8904	95.00	6115/A	110.00	8608	34.00
4X500A	282.00	6146	7.00	8637	38.00
4CX600J/8809	607.00	6146A	7.50	8643	100.00
4CW800F	625.00	6146B/8298A	8.50	8647	123.00
4CX1000A/8168	340.00	6146W	14.00	8737/5894B	60.00
4CX1500B/8660	397.00	6156	66.00	8873	260.00
4CX5000A/8170	932.00	6159	15.00	8874	260.00
4CX10000D/8171	990.00	6161	233.00	8875	260.00
4CX15000A/8281	1260.00	6291	125.00	8877	533.00
4PR60A	100.00	6293	12.00	8908	12.00
4PR60B/8252	175.00	6360	5.00	8930/651Z	71.00
4PR400A/8188	192.00	6524	53.00	8950	12.00
5CX1500A	569.00	6550	10.00		
6BK4C	6.00	6JM6	6.00	6LQ6 (Sylvania)	7.50
6DQ5	5.00	6JN6	6.00	6LU8	6.00
6FW5	6.00	6JS6B	6.00	6LX6	6.00
6GE5	6.00	6KG6/EL505	6.00	6ME6	6.00
6GJ5	6.00	6KM6	6.00	12BY7A	4.00
6HS5	6.00	6KN6	6.00	12JB6A	6.00
6JB5/6HE5	6.00	6LF6	6.00	6KD6	6.00
6JB6A	6.00	6LQ6 (GE)	6.00	6JT6A	6.00
				6KD6	6.00

NOTICE ALL PRICES ARE SUBJECT TO CHANGE WITHOUT NOTICE !!!
TUBES MAY EITHER BE NEW OR SURPLUS CONDITION !!!

Toll Free Number
800-528-0180
(For orders only)



PRICES SUBJECT TO CHANGE WITHOUT NOTICE

TEKTRONIX OSCILLOSCOPES	PRICE	MODEL 544 50 MHz Bench Scope with a CA Dual Trace.	\$ 650.50
MODEL 453 Portable 50 MHz Dual Trace.	\$1200.00	MODEL 543A 33 MHz Bench Scope with a CA Dual Trace.	\$ 475.50
MODEL 453A Portable 60 MHz Dual Trace.	\$1400.00	HEWLETT PACKARD OSCILLOSCOPES	
MODEL 454 Portable 150 MHz Dual Trace.	\$1800.00	MODEL 180A Main Frame.	\$ 675.00
MODEL 454A Portable 150 MHz Dual Trace.	\$2000.00	MODEL 180E Main Frame.	\$ 750.00
MODEL 455 Portable 50 MHz Dual Trace.	\$1800.00	MODEL 181A Main Frame.	\$1000.00
MODEL 475 Portable 200 MHz Dual Trace.	\$2640.00	MODEL 182A Main Frame.	\$ 900.00
MODEL 475A Portable 250 MHz Dual Trace.	\$2940.00	MODEL 183A Main Frame.	\$1000.00
MODEL 7514 Storage Oscilloscope with a 7A15A and a 7A15AN-11 Amplifier and a 7B50 Time Base.	\$3500.00	MODEL 180 SERIES PLUG-INS	
MODEL 577D1 Storage Curve Tracer with a 177 adapter.	\$3233.00	1801A Dual Trace 50 MHz.	\$ 495.00
MODEL 577D2 Curve Tracer with a 177 adapter.	\$2796.00	1803A Differential.	\$ 775.00
Tektronix Lab Cart Model 3	\$ 316.00	1804A Quad Trace 50 MHz	\$ 795.00
		1807A Dual Trace 50 MHz	\$ 375.00
		1815A TDR/Sampler with a 1816A DC to 4 GHz.	\$1500.00
		1821A Time Base & Delay Generator.	\$ 495.00
		1822A Time Base & Delay Generator.	\$ 525.00
		1831A Direct Access 600 MHz.*	\$ 200.00
		1840A Time Base & Delay Generator.*	\$ 450.00
		1841A Time Base & Delay Generator.*	\$ 675.00
		*For 183A Only. !!!!!!!	
		TELEQUIPMENT MODEL D83 Oscilloscope Dual Trace Portable 50 MHz With a V4 and S2A Plug-In.	\$1200.00
MODEL 547 50 MHz Bench Scope. With a 1A1 Dual Trace.	\$ 722.50	DUMONT MODEL 1062 Oscilloscope Dual Trace 65 MHz portable.	\$ 750.00
With a 1A2 Dual Trace.	\$ 637.50	TEKTRONIX	
With a 1A4 Quad Trace.	\$ 872.50	MODEL RM565 Dual Beam Oscilloscope 10 MHz with a 3A6 Dual Trace and a 3A72 Dual Trace.	\$1107.50
With a 1A5 Differential.	\$ 722.50	MODEL 549 Storage Oscilloscope Bench 50 MHz with a CA Dual Trace.	\$1000.00
With a 1A6 Differential.	\$ 612.50	MODEL 647A Oscilloscope Bench 100 MHz with a 10A2 Dual Trace and a 11B2A Time Base.	\$1200.00
or with 1 of each above.	\$1667.50		
MODEL 545 30 MHz Bench Scope with a CA Dual Trace.	\$ 412.50		
MODEL 545A 30 MHz Bench Scope with a CA Dual Trace.	\$ 437.50		

ORDERING INSTRUCTIONS

DEFECTIVE MATERIAL: All claims for defective material must be made within sixty (60) days after receipt of parcel. All claims must include the defective material (for testing purposes), our invoice number, and the date of purchase. All returns must be packed properly or it will void all warranties.

DELIVERY: Orders are normally shipped within 48 hours after receipt of customer's order. If a part has to be backordered the customer is notified. Our normal shipping method is via First Class Mail or UPS depending on size and weight of the package. On test equipment it is by Air only, FOB shipping point.

FOREIGN ORDERS: All foreign orders must be prepaid with cashier's check or money order made out in U.S. Funds. We are sorry but C.O.D. is not available to foreign countries and Letters of Credit are not an acceptable form of payment either. Further information is available on request.

HOURS: Monday thru Saturday: 8:30 a.m. to 5:00 p.m.

INSURANCE: Please include 25¢ for each additional \$100.00 over \$100.00, United Parcel only.

ORDER FORMS: New order forms are included with each order for your convenience. Additional forms are available on request.

POSTAGE: Minimum shipping and handling in the US, Canada, and Mexico is \$2.50 all other countries is \$5.00. On foreign orders include 20% shipping and handling.

PREPAID ORDERS: Order must be accompanied by a check.

PRICES: Prices are subject to change without notice.

RESTOCK CHARGE: If parts are returned to MHZ Electronics due to customer error, customer will be held responsible for all extra fees, will be charged a 15% restocking fee, with the remainder in credit only. All returns must have approval.

SALES TAX: Arizona must add 5% sales tax, unless a signed Arizona resale tax card is currently on file with MHZ Electronics. All orders placed by persons outside of Arizona, but delivered to persons in Arizona are subject to the 5% sales tax.

SHORTAGE OR DAMAGE: All claims for shortages or damages must be made within 5 days after receipt of parcel. Claims must include our invoice number and the date of purchase. Customers which do not notify us within this time period will be held responsible for the entire order as we will consider the order complete.

OUR 800 NUMBER IS STRICTLY FOR ORDERS ONLY
NO INFORMATION WILL BE GIVEN. 1-800-528-0180.

FAIRCHILD VHF AND UHF PRESCALER CHIPS		PRICE
95H90DC	350MC Prescaler divide by 10/11	\$ 8.50
95H91DC	350MC Prescaler divide by 5/6	8.50
11C90DC	650MC Prescaler divide by 10/11	15.50
11C91DC	650MC Prescaler divide by 5/6	15.50
11C06DC	UHF Prescaler 750MC D Type Flip Flop	12.30
11C05DC	1GHz Counter Divide by 4 (Regular price \$75.00)	50.00
11C01FC	High Speed Dual 5/4 Input NO/NOR Gate	15.40
82S90	Pre-settable High Speed Decade/Binary Counter used with the 11C90/91 or the 95H90/91 Prescaler can divide by 100. (Signetics)	5.00
11C24DC	This chip is the same as a Motorola MC4024/4324 Dual TTL Voltage Control Multivibrator.	3.37
11C44DC	This chip is the same as a Motorola MC4044/4344 Phase Frequency Detector.	3.37

GENERAL ELECTRIC CO. GUNN DIODE MODEL Y-2167
 Freq. Gap (GHz) 12 to 18, Output (Min.) 100mW, Duty (%) CW, Typ. Bias (Vdc) 8.0, Type. Oper. (MAdc) 550, Max. Thres. (mAdc) 1000, Max. Bias (Vdc) 10.0. **\$39.99**

VARIAN GALLIUM ARSENIDE GUNN DIODES MODEL VSX-9201S5
 Freq. Coverage 8 to 12.4GHz, Output (Min.) 100mW, Bias Voltage (Max.) 14vdc, Bias current (mAdc) Operating 550 Typ. 750 Max., Threshold 850 Typ. 1000 Max. **\$39.99**

VARI-L Co. Inc. MODEL SS-43 AM MODULATOR
 Freq. Range 60 to 150MC, Insertion Loss 13dB Nominal, Signal Port Imp. 50ohms Nominal, Signal Port RF Power + 10dBm Max., Modulation Port BW DC to 1KHZ, Modulation Port Bias 1ma. Nominal. **\$24.99**

AVANTEK CASCADABLE MODULAR AMPLIFIERS			
	Model UTO-504	UTO-511	
Frequency Range	5 to 500 MHz	5 to 500 MHz	
Gain	6dB	15dB	
Noise Figure	11dB	2.3dB to 3dB	
Power Output	+ 17dB	- 2dB to - 3dB	
Gain Flatness	1dB	1dB	
Input Power Vdc	+ 24	+ 15	
mA	100	10	
	PRICE \$70.00	PRICE \$75.00	

HEWLETT PACKARD MIXERS MODELS			
Frequency Range	10514A	10514B	
	2MHz to 500MC	2MHz to 500MC	
Input/Output Frequency L & R	200KHz to 500MC	200KHz to 500MC	
	X	DC to 500MC	DC to 500MC
Mixer Conversion Loss (A)	7dB	7dB	
(B)	9dB	9dB	
Noise Performance (SSB) (A)	7dB	7dB	
(B)	9dB	9dB	
	PRICE \$49.99	PRICE \$39.99	

FREQUENCY SOURCES, INC MODEL MS-74X MICROWAVE SIGNAL SOURCE
 MS-74X: Mechanically Tunable Frequency Range (MHz) 10630 to 11230 (10.63 to 11.23GHz) Minimum Output Power (mW) 10, Overall Multiplier Ratio 108, Internal Crystal Oscillator Frequency Range (MHz) 98.4 to 104.0, Maximum Input Current (mA) 400.

The signal source are designed for applications where high stability and low noise are of prime concern. These sources utilize fundamental transistor oscillators with high Q coaxial cavities, followed by broadband stable step recovery diode multipliers. This design allows single screw mechanical adjustment of frequency over standard communications bands. Broadband sampling circuits are used to phase lock the oscillator to a high stability reference which may be either an internal self-contained crystal oscillator, external primary standard or VHF synthesizer. This unique technique allows for optimization of both FM noise and long term stability. List Price is \$1158.00 (THESE ARE NEW) **Our Price—\$289.**

HEWLETT PACKARD 1N5712 MICROWAVE DIODE
 This diode will replace the MBD101, 1N5711, 5082-2800, 5082-2835 ect. This will work like a champ in all those Down Converter projects. **\$1.50 or 10/\$10.00**

MOTOROLA MHW1172R LOW DISTORTION WIDEBAND AMPLIFIER MODULE.
 Frequency Range: 40 to 300 MHz., Power Gain at 50MHz 16.6min. to 17.4max., Gain Flatness ± 0.1 Typ. ± 0.2 Max. dB., DC Supply Voltage - 28vdc, RF Voltage Input + 70dBmV **PRICE \$29.99**

GENERAL ELECTRIC AA NICADS
 Model #41B905HD11-G1
 Pack of 6 for \$5.00 or 60 Cells, 10 Packs for \$45.00
 These may be broken down to individual cells.

ORDERING INSTRUCTIONS

TERMS: DOMESTIC: Prepaid, C.O.D. or Credit Card

FOREIGN: Prepaid only, U.S. Funds—money order or cashier's check only.

C.O.D.: Acceptable by telephone or mail. Payment from customer will be by cash, money order or cashier's check. We are sorry but we cannot accept personal checks for C.O.D.'s.

CONFIRMING ORDERS: We would prefer that confirming orders not be sent after a telephone order has been placed. If company policy necessitates a confirming order, please mark "CONFIRMING" boldly on the order. If problems or duplicate shipments occur due to an order which is not properly marked, customers will be held responsible for any charges incurred, plus a 15% restock charge on returned parts.

CREDIT CARDS: WE ACCEPT MASTERCARD VISA AND AMERICAN EXPRESS.

DATA SHEETS: When we have data sheets in stock on devices we do supply them with the order.

MHz electronics



(602) 242-3037
 (602) 242-8916
 2111 W. CAMELBACK ROAD
 PHOENIX, ARIZONA 85015

Toll Free Number
 800-528-0180
 (For orders only)

PRICES SUBJECT TO CHANGE WITHOUT NOTICE

ramsey

the first name in Counters!



9 DIGITS 600 MHz \$129⁹⁵ WIRED

PRICES:

CT-90 wired, 1 year warranty	\$129.95
CT-90 Kit, 90 day parts warranty	109.95
AC-1 AC adapter	3.95
BP-1 Nicad pack + AC Adapter/Charger	12.95
OY-1 Micro power Oven time base	49.95
External time base input	14.95

The CT-90 is the most versatile, feature packed counter available for less than \$300.00! Advanced design features include: three selectable gate times, nine digits, gate indicator and a unique display hold function which holds the displayed count after the input signal is removed! Also, a 10MHz TCXO time base is used which enables easy zero beat calibration checks against WWV. Optionally, an internal nicad battery pack, external time base input and Micro-power high stability crystal oven time base are available. The CT-90, performance you can count on!

SPECIFICATIONS:

Range:	20 Hz to 600 MHz
Sensitivity:	Less than 10 MV to 150 MHz Less than 50 MV to 500 MHz
Resolution:	0.1 Hz (10 MHz range) 1.0 Hz (60 MHz range) 10.0 Hz (600 MHz range)
Display:	9 digits 0.4" LED
Time base:	Standard-10,000 mHz, 1.0 ppm 20-40°C. Optional Micro-power oven-0.1 ppm 20-40°C
Power:	8-15 VAC @ 250 ma

7 DIGITS 525 MHz \$99⁹⁵ WIRED



SPECIFICATIONS:

Range:	20 Hz to 525 MHz
Sensitivity:	Less than 50 MV to 150 MHz Less than 150 MV to 500 MHz
Resolution:	1.0 Hz (5 MHz range) 10.0 Hz (50 MHz range) 100.0 Hz (500 MHz range)
Display:	7 digits 0.4" LED
Time base:	1.0 ppm TCXO 20-40°C
Power:	12 VAC @ 250 ma

The CT-70 breaks the price barrier on lab quality frequency counters. Deluxe features such as: three frequency ranges - each with pre-amplification, dual selectable gate times, and gate activity indication make measurements a snap. The wide frequency range enables you to accurately measure signals from audio thru UHF with 1.0 ppm accuracy - that's .0001%! The CT-70 is the answer to all your measurement needs. In the field, lab or ham shack.

PRICES:

CT-70 wired, 1 year warranty	\$99.95
CT-70 Kit, 90 day parts warranty	84.95
AC-1 AC adapter	3.95
BP-1 Nicad pack + AC adapter/charger	12.95

7 DIGITS 500 MHz \$79⁹⁵ WIRED



PRICES:

MINI-100 wired, 1 year warranty	\$79.95
AC-Z Ac adapter for MINI-100	3.95
BP-Z Nicad pack and AC adapter/charger	12.95

Here's a handy, general purpose counter that provides most counter functions at an unbelievable price. The MINI-100 doesn't have the full frequency range or input impedance qualities found in higher price units, but for basic RF signal measurements, it can't be beat! Accurate measurements can be made from 1 MHz all the way up to 500 MHz with excellent sensitivity throughout the range, and the two gate times let you select the resolution desired. Add the nicad pack option and the MINI-100 makes an ideal addition to your tool box for "in-the-field" frequency checks and repairs.

SPECIFICATIONS:

Range:	1 MHz to 500 MHz
Sensitivity:	Less than 25 MV
Resolution:	100 Hz (slow gate) 1.0 KHz (fast gate)
Display:	7 digits, 0.4" LED
Time base:	2.0 ppm 20-40°C
Power:	5 VDC @ 200 ma

8 DIGITS 600 MHz \$159⁹⁵ WIRED

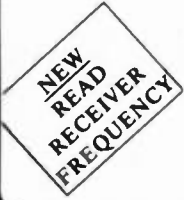

SPECIFICATIONS:

Range:	20 Hz to 600 MHz
Sensitivity:	Less than 25 mv to 150 MHz Less than 150 mv to 600 MHz
Resolution:	1.0 Hz (60 MHz range) 10.0 Hz (600 MHz range)
Display:	8 digits 0.4" LED
Time base:	2.0 ppm 20-40°C
Power:	110 VAC or 12 VDC

The CT-50 is a versatile lab bench counter that will measure up to 600 MHz with 8 digit precision. And, one of its best features is the Receive Frequency Adapter, which turns the CT-50 into a digital readout for any receiver. The adapter is easily programmed for any receiver and a simple connection to the receiver's VFO is all that is required for use. Adding the receiver adapter in no way limits the operation of the CT-50, the adapter can be conveniently switched on or off. The CT-50, a counter that can work double-duty!

PRICES:

CT-50 wired, 1 year warranty	\$159.95
CT-50 Kit, 90 day parts warranty	119.95
RA-1, receiver adapter kit	14.95
RA-1 wired and pre-programmed (send copy of receiver schematic)	29.95

DIGITAL MULTIMETER \$99⁹⁵ WIRED



PRICES:

DM-700 wired, 1 year warranty	\$99.95
DM-700 Kit, 90 day parts warranty	79.95
AC-1, AC adaptor	3.95
BP-3, Nicad pack + AC adapter/charger	19.95
MP-1, Probe kit	2.95

The DM-700 offers professional quality performance at a hobbyist price. Features Include: 26 different ranges and 5 functions, all arranged in a convenient, easy to use format. Measurements are displayed on a large 3 1/2 digit, 1/2 inch LED readout with automatic decimal placement, automatic polarity, overrange indication and overload protection up to 1250 volts on all ranges, making it virtually goof-proof! The DM-700 looks great, a handsome, jet black, rugged ABS case with convenient retractable tilt bail makes it an ideal addition to any shop.

SPECIFICATIONS:

DC/AC volts:	100uV to 1 KV, 5 ranges
DC/AC current:	0.1uA to 2.0 Amps, 5 ranges
Resistance:	0.1 ohms to 20 Megohms, 6 ranges
Input impedance:	10 Megohms, DC/AC volts
Accuracy:	0.1% basic DC volts
Power:	4 °C cells

AUDIO SCALER

For high resolution audio measurements, multiplies UP in frequency.

- Great for PL tones
- Multiplies by 10 or 100
- 0.01 Hz resolution!

\$29.95 Kit \$39.95 Wired

ACCESSORIES

Telescopic whip antenna - BNC plug	\$ 7.95
High impedance probe, light loading	15.95
Low pass probe, for audio measurements	15.95
Direct probe, general purpose usage	12.95
Tilt bail, for CT 70, 90, MINI-100	3.95
Color burst calibration unit, calibrates counter against color TV signal.	14.95

COUNTER PREAMP

For measuring extremely weak signals from 10 to 1,000 MHz. Small size, powered by plug transformer-included.

- Flat 25 db gain
- BNC Connectors
- Great for sniffing RF with pick-up loop

\$34.95 Kit \$44.95 Wired

ramsey electronic's, inc.



2575 Baird Rd. Penfield, NY 14526

PHONE ORDERS
CALL 716-586-3950

TERMS

Satisfaction guaranteed - examine for 10 days, if not pleased, return in original form for refund. Add 5% for shipping insurance to a maximum of \$10. Overseas add 15%. COD add \$2. Orders under \$10 add \$1.50. NY residents add 7% tax.



**FOR THE BEST DEAL
WITH OR WITHOUT TRADE-IN
ON:**

- ★ KENWOOD
- ★ TEN-TEC
- ★ HAL
- ★ DRAKE

- ★ YAESU
- ★ ICOM
- ★ INFO-TECH
- ★ COLLINS

**DIAL YOUR DEAL TOLL-FREE
1-800-325-3636**

**ALSO CALL FOR PRICES ON AVAILABLE
USED EQUIPMENT
WE TRADE ON NEW OR USED**

HAM RADIO CENTER

8340-42 Olive Blvd. • P.O. Box 28271 • St. Louis, MO 63132



IN MISSOURI CALL **1-314-993-6060**





FULL LINE ALL PARTS & COMPUTER PRODUCTS

P.O. Box 4430M
Santa Clara, CA 95054
Will call: 2322 Walsh Ave.
(408) 988-1640

ELECTRONICS

Same day shipment. First line parts only. Factory tested. Guaranteed money back. Quality IC's and other components at factory prices.

INTEGRATED CIRCUITS

Phone orders only (800) 538-8196

74001TL	LM317T	1.55	CD4017	1.05	8126	1.69	UARY1F10	DE95	1.88
74001	LM317	1.55	CD4018	1.05	8128	1.95	AY5-1013	DA15P	2.10
74002N	LM318	1.49	CD4019	1.49	8129	1.95	AY5-1013	DA15S	2.10
74004N	LM320M-1.5	1.25	CD4020	1.25	8130	1.95	Complete Set	9.50	31W
74009N	LM320M-1.5	1.33	CD4021	1.33	8131	1.95	Complete Set	9.50	31W
74100N	LM320M-1.5	1.33	CD4022	1.10	8132	1.95	1702A	4.50	Stapleack Kit 26.95
74141	LM320T-8	85	CD4023	2.8	8133	1.95	1702A	4.50	Auto Clock Kit 17.95
7420N	LM320T-8	85	CD4024	7.5	8134	1.95	2932	17.50	Digital Clock Kit 17.95
7430N	LM320T-15	85	CD4025	2.3	8135	1.95	2708	2.35	RESISTORS w/val % 1982
7442N	LM320T-15	85	CD4026	1.63	8136	1.95	2708	2.35	10 per type .02
7443N	LM320T-15	85	CD4027	5.5	8137	1.95	2716	1.5	100 per type 018
7447N	LM320T-15	85	CD4028	1.63	8138	1.95	2716	1.5	1000 per type 012
7448N	LM320T-15	85	CD4029	9.5	8139	1.95	2716	1.5	5000 per type 008
7474N	LM340M-1.5	1.33	CD4030	4.5	8140	1.95	2716	1.5	5000 per type 015
7476N	LM340M-1.5	1.33	CD4031	1.42	8141	1.95	2716	1.5	5000 per type 015
7485N	LM340M-1.5	1.33	CD4032	1.42	8142	1.95	2716	1.5	5000 per type 015
7490N	LM340M-1.5	1.33	CD4033	1.42	8143	1.95	2716	1.5	5000 per type 015
7492N	LM340M-1.5	1.33	CD4034	1.42	8144	1.95	2716	1.5	5000 per type 015
7495N	LM340M-1.5	1.33	CD4035	1.42	8145	1.95	2716	1.5	5000 per type 015
74100N	LM340T-8	85	CD4036	1.42	8146	1.95	2716	1.5	5000 per type 015
74107N	LM340T-12	75	CD4037	1.42	8147	1.95	2716	1.5	5000 per type 015
74123N	LM340T-15	75	CD4038	1.42	8148	1.95	2716	1.5	5000 per type 015
74125N	LM340T-15	75	CD4039	1.42	8149	1.95	2716	1.5	5000 per type 015
74145N	LM340T-24	75	CD4040	1.42	8150	1.95	2716	1.5	5000 per type 015
74152N	LM340T-24	75	CD4041	1.42	8151	1.95	2716	1.5	5000 per type 015
74153N	LM340T-24	75	CD4042	1.42	8152	1.95	2716	1.5	5000 per type 015
74154N	LM340T-24	75	CD4043	1.42	8153	1.95	2716	1.5	5000 per type 015
74155N	LM340T-24	75	CD4044	1.42	8154	1.95	2716	1.5	5000 per type 015
74156N	LM340T-24	75	CD4045	1.42	8155	1.95	2716	1.5	5000 per type 015
74157N	LM340T-24	75	CD4046	1.42	8156	1.95	2716	1.5	5000 per type 015
74158N	LM340T-24	75	CD4047	1.42	8157	1.95	2716	1.5	5000 per type 015
74159N	LM340T-24	75	CD4048	1.42	8158	1.95	2716	1.5	5000 per type 015
74160N	LM340T-24	75	CD4049	1.42	8159	1.95	2716	1.5	5000 per type 015
74161N	LM340T-24	75	CD4050	1.42	8160	1.95	2716	1.5	5000 per type 015
74162N	LM340T-24	75	CD4051	1.42	8161	1.95	2716	1.5	5000 per type 015
74163N	LM340T-24	75	CD4052	1.42	8162	1.95	2716	1.5	5000 per type 015
74164N	LM340T-24	75	CD4053	1.42	8163	1.95	2716	1.5	5000 per type 015
74165N	LM340T-24	75	CD4054	1.42	8164	1.95	2716	1.5	5000 per type 015
74166N	LM340T-24	75	CD4055	1.42	8165	1.95	2716	1.5	5000 per type 015
74167N	LM340T-24	75	CD4056	1.42	8166	1.95	2716	1.5	5000 per type 015
74168N	LM340T-24	75	CD4057	1.42	8167	1.95	2716	1.5	5000 per type 015
74169N	LM340T-24	75	CD4058	1.42	8168	1.95	2716	1.5	5000 per type 015
74170N	LM340T-24	75	CD4059	1.42	8169	1.95	2716	1.5	5000 per type 015
74171N	LM340T-24	75	CD4060	1.42	8170	1.95	2716	1.5	5000 per type 015
74172N	LM340T-24	75	CD4061	1.42	8171	1.95	2716	1.5	5000 per type 015
74173N	LM340T-24	75	CD4062	1.42	8172	1.95	2716	1.5	5000 per type 015
74174N	LM340T-24	75	CD4063	1.42	8173	1.95	2716	1.5	5000 per type 015
74175N	LM340T-24	75	CD4064	1.42	8174	1.95	2716	1.5	5000 per type 015
74176N	LM340T-24	75	CD4065	1.42	8175	1.95	2716	1.5	5000 per type 015
74177N	LM340T-24	75	CD4066	1.42	8176	1.95	2716	1.5	5000 per type 015
74178N	LM340T-24	75	CD4067	1.42	8177	1.95	2716	1.5	5000 per type 015
74179N	LM340T-24	75	CD4068	1.42	8178	1.95	2716	1.5	5000 per type 015
74180N	LM340T-24	75	CD4069	1.42	8179	1.95	2716	1.5	5000 per type 015
74181N	LM340T-24	75	CD4070	1.42	8180	1.95	2716	1.5	5000 per type 015
74182N	LM340T-24	75	CD4071	1.42	8181	1.95	2716	1.5	5000 per type 015
74183N	LM340T-24	75	CD4072	1.42	8182	1.95	2716	1.5	5000 per type 015
74184N	LM340T-24	75	CD4073	1.42	8183	1.95	2716	1.5	5000 per type 015
74185N	LM340T-24	75	CD4074	1.42	8184	1.95	2716	1.5	5000 per type 015
74186N	LM340T-24	75	CD4075	1.42	8185	1.95	2716	1.5	5000 per type 015
74187N	LM340T-24	75	CD4076	1.42	8186	1.95	2716	1.5	5000 per type 015
74188N	LM340T-24	75	CD4077	1.42	8187	1.95	2716	1.5	5000 per type 015
74189N	LM340T-24	75	CD4078	1.42	8188	1.95	2716	1.5	5000 per type 015
74190N	LM340T-24	75	CD4079	1.42	8189	1.95	2716	1.5	5000 per type 015
74191N	LM340T-24	75	CD4080	1.42	8190	1.95	2716	1.5	5000 per type 015
74192N	LM340T-24	75	CD4081	1.42	8191	1.95	2716	1.5	5000 per type 015
74193N	LM340T-24	75	CD4082	1.42	8192	1.95	2716	1.5	5000 per type 015
74194N	LM340T-24	75	CD4083	1.42	8193	1.95	2716	1.5	5000 per type 015
74195N	LM340T-24	75	CD4084	1.42	8194	1.95	2716	1.5	5000 per type 015
74196N	LM340T-24	75	CD4085	1.42	8195	1.95	2716	1.5	5000 per type 015
74197N	LM340T-24	75	CD4086	1.42	8196	1.95	2716	1.5	5000 per type 015
74198N	LM340T-24	75	CD4087	1.42	8197	1.95	2716	1.5	5000 per type 015
74199N	LM340T-24	75	CD4088	1.42	8198	1.95	2716	1.5	5000 per type 015
74200N	LM340T-24	75	CD4089	1.42	8199	1.95	2716	1.5	5000 per type 015
74201N	LM340T-24	75	CD4090	1.42	8200	1.95	2716	1.5	5000 per type 015
74202N	LM340T-24	75	CD4091	1.42	8201	1.95	2716	1.5	5000 per type 015
74203N	LM340T-24	75	CD4092	1.42	8202	1.95	2716	1.5	5000 per type 015
74204N	LM340T-24	75	CD4093	1.42	8203	1.95	2716	1.5	5000 per type 015
74205N	LM340T-24	75	CD4094	1.42	8204	1.95	2716	1.5	5000 per type 015
74206N	LM340T-24	75	CD4095	1.42	8205	1.95	2716	1.5	5000 per type 015
74207N	LM340T-24	75	CD4096	1.42	8206	1.95	2716	1.5	5000 per type 015
74208N	LM340T-24	75	CD4097	1.42	8207	1.95	2716	1.5	5000 per type 015
74209N	LM340T-24	75	CD4098	1.42	8208	1.95	2716	1.5	5000 per type 015
74210N	LM340T-24	75	CD4099	1.42	8209	1.95	2716	1.5	5000 per type 015
74211N	LM340T-24	75	CD4100	1.42	8210	1.95	2716	1.5	5000 per type 015
74212N	LM340T-24	75	CD4101	1.42	8211	1.95	2716	1.5	5000 per type 015
74213N	LM340T-24	75	CD4102	1.42	8212	1.95	2716	1.5	5000 per type 015
74214N	LM340T-24	75	CD4103	1.42	8213	1.95	2716	1.5	5000 per type 015
74215N	LM340T-24	75	CD4104	1.42	8214	1.95	2716	1.5	5000 per type 015
74216N	LM340T-24	75	CD4105	1.42	8215	1.95	2716	1.5	5000 per type 015
74217N	LM340T-24	75	CD4106	1.42	8216	1.95	2716	1.5	5000 per type 015
74218N	LM340T-24	75	CD4107	1.42	8217	1.95	2716	1.5	5000 per type 015
74219N	LM340T-24	75	CD4108	1.42	8218	1.95	2716	1.5	5000 per type 015
74220N	LM340T-24	75	CD4109	1.42	8219	1.95	2716	1.5	5000 per type 015
74221N	LM340T-24	75	CD4110	1.42	8220	1.95	2716	1.5	5000 per type 015
74222N	LM340T-24	75	CD4111	1.42	8221	1.95	2716	1.5	5000 per type 015
74223N	LM340T-24	75	CD4112	1.42	8222	1.95	2716	1.5	5000 per type 015
74224N	LM340T-24	75	CD4113	1.42	8223	1.95	2716	1.5	5000 per type 015
74225N	LM340T-24	75	CD4114	1.42	8224	1.95	2716	1.5	5000 per type 015
74226N	LM340T-24	75	CD4115	1.42	8225	1.95	2716	1.5	5000 per type 015
74227N	LM340T-24	75	CD4116	1.42	8226	1.95	2716	1.5	5000 per type 015
74228N	LM340T-24	75	CD4117	1.42	8227	1.95	2716	1.5	5000 per type 015
74229N	LM340T-24	75	CD4118	1.42	8228	1.95	2716	1.5	5000 per type 015
74230N	LM340T-24	75	CD4119	1.42	8229	1.95	2716	1.5	5000 per type 015
74231N	LM340T-24	75	CD4120	1.42	8230	1.95	2716	1.5	5000 per type 015
74232N	LM340T-24	75	CD4121	1.42	8231	1.95	2716	1.5	5000 per type 015
74233N	LM340T-24	75	CD4122	1.42	8232	1.95	2716	1.5	5000 per type 015
74234N	LM340T-24	75	CD4123	1.42	8233	1.95	2716	1.5	5000 per type 015
74235N	LM340T-24	75	CD4124	1.42	8234	1.95	2716	1.5	5000 per type 015
74236N	LM340T-24	75	CD4125	1.42	8235	1.95	2716	1.5	5000 per type 015
74237N	LM340T-24	75	CD4126	1.42	8236	1.95	2716	1.5	5000 per type 015
74238N	LM340T-24	75	CD4127	1.42	8237	1.95	2716	1.5	5000 per type 015
74239N	LM340T-24	75	CD4128	1.42	8238	1.95	2716	1.5	5000 per type 015
74240N	LM340T-24	75	CD4129	1.42	8239	1.95	2716	1.5	5000 per type 015
74241N	LM340T-24	75	CD4130	1.42	8240	1.95	2716	1.5	5000 per type 015
74242N	LM340T-24	75	CD4131						

- FM • SSB • CW • ATV • OSCAR
- LINKS • REPEATERS • TRANSMITTERS
- RECEIVERS • PREAMPS • CONVERTERS
- TRANSCEIVERS • POWER SUPPLIES • PA'S

QUALITY VHF/UHF KITS AT AFFORDABLE PRICES

- NEW -

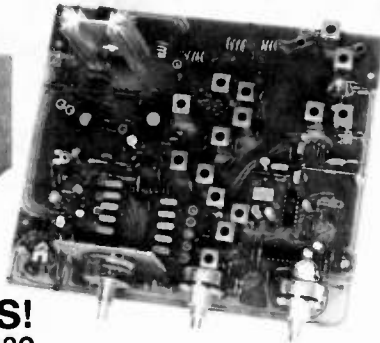

FM-5 PC Board Kit - **ONLY \$159.95**
complete with controls, heatsink, etc.

**SAVE A BUNDLE ON
VHF FM TRANSCEIVERS!**
10 watts, 5 Channels, for 6M, 2M, or 220

★
**SPECIAL
OFFER**
Free cabinet kit, complete
with speaker, knobs, connectors,
hardware. A \$59.95 value,
yours free with purchase
of kit. Hurry!
Offer limited. ★



HIGH QUALITY FM MODULES FOR REPEATERS, LINKS, TELEMETRY, ETC.

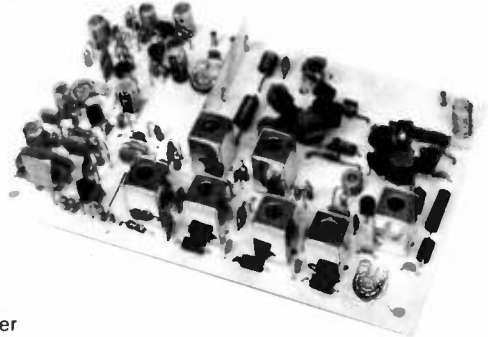
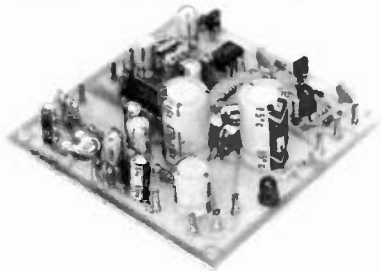

- **R76 VHF FM RECEIVER** for 10M, 6M, 2M, 220, or commercial bands. Fantastic selectivity options. Kits from \$84.95 to \$109.95
- **R450 UHF FM RECEIVER** for 380-520 MHz bands. Kits in selectivity options from \$94.95
- **R110 VHF AM RECEIVER** Kit for vhf aircraft band or ham bands. Only \$84.95.

- **COR KITS** With audio mixer and speaker amplifier. Only \$29.95.
- **CWID KITS** 158 bits, field programmable, clean audio. Only \$59.95.
- **A16 RF TIGHT BOX** Deep drawn alum. case with tight cover and no seams. 7 x 8 x 2 inches. Only \$18.00.
- **SCANNER CONVERTERS** Copy 72-76, 135-144, 240-270, 400-420, or 806-894 MHz bands on any scanner. Wired/tested Only \$79.95.

- **T51 VHF FM EXCITER** for 10M, 6M, 2M, 220 MHz or adjacent bands. 2 Watts continuous. Kits only \$54.95.
- **T451 UHF FM EXCITER** 2 to 3 Watts on 450 ham band or adjacent. Kits only \$64.95.
- **VHF & UHF LINEAR AMPLIFIERS.** Use on either FM or SSB. Power levels from 10 to 45 Watts to go with exciters & xmtg converters. Kits from \$69.95.



VHF & UHF TRANSMITTING CONVERTERS

For SSB, CW, ATV, FM, etc. Available for 6M, 2M, 220, 440 with many IF input ranges. Converter board kit only at \$79.95 (VHF) or \$99.95 (UHF) or kits complete with PA and cabinet as shown.



VHF & UHF RECEIVING CONVERTERS

20 Models cover every practical rf and if range to listen to SSB, FM, ATV, etc. on 6M, 2M, 220, 440, and 110 aircraft band. Even convert weather down to 2M! Kits from \$39.95 and wired units.



VHF & UHF RECEIVER

PREAMPS. Low noise.

VHF Kits from 27 to 300 MHz. UHF Kits from 300 to 650 MHz. Broadband Kits: 20-650 MHz. Prices start at \$14.95 (VHF) and \$18.95 (UHF). All preamps and converters have noise figure 2dB or less.

- **Call or Write for FREE CATALOG**
(Send \$1.00 or 4 IRC's for overseas MAILING)
- **Order by phone or mail** • Add \$2 S & H per order
(Electronic answering service evenings & weekends)
Use VISA, MASTERCARD, Check, or UPS COD.

hamtronics, inc.

65-R MOUL RD. • HILTON NY 14468
Phone: 716-392-9430

Hamtronics® is a registered trademark

COMMUNICATIONS CENTER

1-800-228-4097

PHONE HOURS: 8 am-5 pm CDT Mon.-Sat.

★ SPECIALS OF THE MONTH ★

☆ MIRAGE ☆ C22



2W IN — 20W OUT

FEATURES:

- All-mode SSB, FM and CW
- Small Size
- Automatic antenna change over

Frequency Range 220 to 225 MHz
 RF Power In 200 mw to 5 Watts
 RF Power Out 30 Watts (2 in — 20 out)
 Modes SSB, FM and CW
 DC Power 13.6 VDC 5 Amps
 Warranty ... 5 years (1 year RF Power Trans.)



☆ J.I.L. SX-100 ☆
**SPECIALLY PRICED
 AT ONLY \$199.95**



☆ J.I.L. SX-200 ☆

TYPE: FM & AM
FREQUENCY RANGE: a) 26-57.995 MHz Freq. Space 5kHz:
 b) 58-88 MHz Space 12.5 kHz: c) 108-180 MHz Space 5kHz:
 d) 380-514 MHz Space 12.5 kHz
SENSITIVITY: FM a) 26-180 MHz 0.4 uV S/N 12 dB
 b) 380-514 MHz 1.0uV S/N 12 dB AM a) 26-180 MHz
 1.0uV S/N dB b) 380-514 MHz 2.0uV S/N 10 dB
SELECTIVITY: FM ... More than 60 dB at +25 kHz
 AM ... More than 60 dB at +10 kHz

SUPER VALUE FOR ONLY \$389.95

★ ANTENNA SPECIALS ★

HUSTLER G7-144
 HUSTLER G6-144B
 HUSTLER 5BTW

\$99.95
 69.95
 99.95

HUSTLER 4BTW
 HYGAIN TOWERS
 CDE ROTORS

\$79.95
 CALL
 CALL

**WE
 TRADE**

**CALL FOR
 QUOTE**



CALL NOW FOR DISCOUNT PRICES

KENWOOD
 ICOM
 YAESU
 TELEX

CDE
 HYGAIN
 MIRAGE
 DENTRON

DRAKE
 BENCHER
 HUSTLER
 AVANTI

CALLBOOK
 DAIWA
 ETO
 KANTRONICS

PANASONIC
 TRAC
 CENTURION

SAVE SAVE SAVE SAVE SAVE SAVE SAVE SAVE SAVE

YOUR ELECTRONICS CENTER

1840 "O" Street Lincoln, Nebraska 68508

In Nebraska Call (402) 476-7331



WE TRADE



We now have available a bunch of goodies too good to bypass. Items are limited so order today

Call Your Phone Order in Today
TERMS: Satisfaction guaranteed or money refunded. C.O.D. add \$2.00. Minimum order \$6.00. Orders under \$10.00 add \$1.50. Add 5% for postage, insurance, handling. Overseas add 15%. N.Y. residents add 7% tax.

**MINI KITS - YOU HAVE SEEN THESE BEFORE NOW
HERE ARE OLD FAVORITE AND NEW ONES TOO.
GREAT FOR THAT AFTERNOON HOBBY.**

<p>FM MINI MIKE</p>  <p>A super high performance FM wireless mike kit! Transmits a stable signal up to 300 yards with exceptional audio quality by means of its built in electret mike. Kit includes case, mike, on-off switch, antenna, battery and super instructions. This is the finest unit available.</p> <p>FM-3 Kit \$14.95 FM-3 Wired and Tested 19.95</p>	<p>Color Organ</p> <p>See music come alive! 3 different lights flicker with music. One light each for high, mid-range and lows. Each individually adjustable and drives up to 300 W. runs on 110 VAC.</p> <p>Complete kit, ML-1 \$8.95</p>	<p>Video Modulator Kit</p> <p>Converts any TV to video monitor. Super stable, tunable over ch 4-6. Runs on 5-15V, accepts sid video signal. Best unit on the market! Complete kit, VD-1 \$7.95</p>	<p>Super Sleuth</p> <p>A super sensitive amplifier which will pick up a pin drop at 15 feet! Great for monitoring baby's room or as general purpose amplifier. Full 2 W rms output, runs on 6 to 15 volts, uses 8-45 ohm speaker. Complete kit, BN-9 \$5.95</p>
	<p>Led Blinky Kit</p> <p>A great attention getter which alternately flashes 2 jumbo LEDs. Use for name badges, buttons, warning panel lights, anything! Runs on 3 to 15 volts. Complete kit, EL-1 \$2.95</p>	<p>CPO-1</p> <p>Runs on 3-12 Vdc. 1 watt out. 1 KHZ good for CPO. Alarm, Audio Oscillator. Complete kit \$2.95</p>	<p>Tone Decoder</p> <p>A complete tone decoder on a single PC board. Features: 400-5000 Hz adjustable range via 20 turn pot, voltage regulation. 567 IC. Useful for touch-tone burst detection, FSK, etc. Can also be used as a stable tone encoder. Runs on 5 to 12 volts. Complete kit, TD-1 \$5.95</p>
<p>FM Wireless Mike Kit</p>  <p>Transmits up to 300' to any FM broadcast radio, uses any type of mike. Runs on 3 to 9V. Type FM-2 has added sensitive mike preamp stage.</p> <p>FM-1 kit \$3.95 FM-2 kit \$4.95</p>	<p>Whisper Light Kit</p> <p>An interesting kit, small mike picks up sounds and converts them to light. The louder the sound, the brighter the light. Includes mike, controls up to 300 W, runs on 110 VAC. Complete kit, WL-1 \$6.95</p>	<p>60 Hz Time Base</p> <p>Runs on 5-15 VDC. Low current (25ma) 1 min/1000 accuracy. TB-7 Kit \$5.95</p>	<p>60 Hz Time Base</p> <p>Runs on 5-15 VDC. Low current (25ma) 1 min/1000 accuracy. TB-7 Kit \$5.95</p>
<p>Universal Timer Kit</p> <p>Provides the basic parts and PC board required to provide a source of precision timing and pulse generation. Uses 555 timer IC and includes a range of parts for most timing needs.</p> <p>UT-5 Kit \$5.95</p>	<p>Mad Blaster Kit</p> <p>Produces LOUD ear shattering and attention getting siren like sound. Can supply up to 15 watts of obnoxious audio. Runs on 6-15 VDC.</p> <p>MB-1 Kit \$4.95</p>	<p>60 Hz Time Base</p> <p>Runs on 5-15 VDC. Low current (25ma) 1 min/1000 accuracy. TB-7 Kit \$5.95</p>	<p>60 Hz Time Base</p> <p>Runs on 5-15 VDC. Low current (25ma) 1 min/1000 accuracy. TB-7 Kit \$5.95</p>

CLOCK KITS

Your old favorites are here again. Over 7,000 Sold to Date. Be one of the gang and order yours today!

Try your hand at building the finest looking clock on the market. Its satin finish anodized aluminum case looks great anywhere, while six 4" LED digits provide a highly readable display. This is a complete kit, no extras needed, and it only takes 1-2 hours to assemble. Your choice of case colors: silver, gold, black (specify).

Clock kit, 12/24 hour, DC-5 **\$24.95**
Clock with 10 min. ID timer, 12/24 hour, DC-10 **\$29.95**
Alarm clock, 12 hour only, DC-8 **\$29.95**
12V DC car clock, DC-7 **\$29.95**

For wired and tested clocks add \$10.00 to kit price. SPECIFY 12 OR 24 HOUR FORMAT

Car Clock

The UN-KIT, only 5 solder connections

Here's a super looking, rugged and accurate auto clock which is a snap to build and install. Clock movement is completely assembled - you only solder 3 wires and 2 switches, takes about 15 minutes! Display is bright green with automatic brightness control photocell - assures you of a highly readable display, day or night. Comes in a satin finish anodized aluminum case which can be attached 5 different ways using 2 sided tape. Choice of silver, black or gold case (specify).

DC-3 kit, 12 hour format **\$22.95**
DC-3 wired and tested **\$29.95**

<p>Calendar Alarm Clock</p> <p>The clock that's got it all! 6-5" LEDs, 12/24 hour, snooze, 24 hour alarm, 4 year calendar, battery backup and lots more. The super 7001 chip is used. Size 5x4x2 inches. Complete kit, less case (not available) \$34.95</p>	<p>Under Dash Car Clock</p> <p>12/24 hour clock in a beautiful plastic case features 6 jumbo RED LEDs, high accuracy (0.01%), easy 3 wire hookup, display blanks with ignition and super instructions. Optional dimmer automatically adjusts display to ambient light level. OC-11 clock with mtg bracket \$27.95 kit OM-1 dimmer adapter \$2.50 Add \$10.00 Assy and Test</p>
<p>Video Terminal</p> <p>A completely self-contained, stand alone video terminal card. Requires only an ASCII keyboard and TV rates (to 9600), complete computer and keyboard control of cursor. Parity error control and display. Accepts and generates serial ASCII plus parallel keyboard input. The 6416 is 64 char by 16 lines with scrolling, upper and lower case (optional) and has RS-232 and 20ma loop interfaces on board. Kits include sockets and complete documentation. RE 6416 terminal card kit (add \$60.00 for wired unit) \$109.95 Lower Case option \$13.95 Power Supply \$14.95 RF Modulator kit \$7.95</p>	<p>30 Watt 2 mtr PWR AMP</p> <p>Simple Class C power amp features 8 times power gain. 1 W in for 8 out, 2 W in for 15 out, 4 W in for 30 out. Max output of 35 W, incredible value, complete with all parts, less case and T-R relay. PA-1, 30 W pwr amp kit \$22.95 TR-1, RF sensed T-R relay kit 6.95</p>

PARTS PARADE

<p>IC SPECIALS</p> <p>LINEAR</p> <p>301 \$1.35 324 \$1.50 380 \$1.50 555 \$1.45 556 \$1.00 565 \$1.00 566 \$1.00 567 \$1.25 741 \$1.25 1458 \$1.50 3900 \$1.50 3914 \$2.95 8038 \$2.95</p> <p>CMOS</p> <p>4011 .50 4013 .50 4046 \$1.85 4049 .50 4059 \$9.00 4511 \$2.00 4518 \$1.35 5639 \$1.75</p> <p>READOUTS</p> <p>FNO 359 4" CC \$1.00 FNO 507/510 5" CA 1.00 MAN 72/HP730 33" CA 1.00 HP 7651 43" CA 2.00</p> <p>TRANSISTORS</p> <p>2N3904 NPN C-F 15/11.00 2N3906 PNP C-F 15/11.00 2N4403 PNP C-F 15/11.00 2N4410 NPN C-F 15/11.00 2N4918 FET C-F 4/11.00 2N5401 PNP C-F 5/11.00 2N6028 C-F 4/11.00 2N6371 NPN Silicon 1/15.00 2N5179 UHF NPN 3/12.00 Power Tab NPN 40W 3/11.00 Power Tab PNP 40W 3/11.00 MNF 102/2N5484 8.90 NPN 3904 Type T-R 50/32.50 PNP 3906 Type T-R 50/32.50 2N3055 5.80 2N2646 UJT 3/32.00</p>	<p>TTL</p> <p>74S00 \$.40 7447 \$.65 7475 \$.50 7490 \$.50 74196 \$1.35</p> <p>SPECIAL</p> <p>11C90 \$15.00 10116 \$ 1.25 7208 \$17.50 7207A \$ 5.50 7216D \$21.00 7107C \$12.50 5314 \$ 2.95 5375AB/G \$ 2.95 7001 \$ 6.50</p> <p>FERRITE BEADS</p> <p>With info and specs 15/15.00 6 Hole Balun Beads 5/31.00</p>	<p>Resistor Ass't</p> <p>Assortment of Popular values - 1/4 watt. Cut lead for PC mounting, 1/2" center 1/8" leads, bag of 300 or more. \$1.50</p> <p>Switches</p> <p>Mini toggle SPDT \$1.00 Red Pushbuttons N/O 3/31.00</p> <p>Earphones</p> <p>3" leads, 8 ohm, good for small tone speakers, alarm clocks, etc. 5 for \$1.00</p> <p>Mini 8 ohm Speaker</p> <p>Approx 2 1/2" diam Round type for radios, mike etc. 3 for \$2.00</p> <p>Slug Tuned Coils</p> <p>Small 3/16" Hex Slugs, turned coil, 3 turns. 10 for \$1.00</p> <p>CAPACITORS</p> <table border="1"> <tr> <th>TANTALUM</th> <th>ALUMINUM</th> <th>OISK CERAMIC</th> </tr> <tr> <td>Dipped Epoxy</td> <td>Electrolytic</td> <td>01 16V disk 20/1.00</td> </tr> <tr> <td>1.5 uF 25V 3/1.00</td> <td>1000 uF 16V Radial 1.50</td> <td>1 16V 15/1.00</td> </tr> <tr> <td>1.8 uF 25V 3/1.00</td> <td>500 uF 20V Axial 1.50</td> <td>001 16V 20/1.00</td> </tr> <tr> <td>22 uF 25V 3/1.00</td> <td>150 uF 16V Axial 1/1.00</td> <td>100 pF 20/1.00</td> </tr> <tr> <td></td> <td>10 uF 15V Radial 10/1.00</td> <td>047 16V 20/1.00</td> </tr> </table>	TANTALUM	ALUMINUM	OISK CERAMIC	Dipped Epoxy	Electrolytic	01 16V disk 20/1.00	1.5 uF 25V 3/1.00	1000 uF 16V Radial 1.50	1 16V 15/1.00	1.8 uF 25V 3/1.00	500 uF 20V Axial 1.50	001 16V 20/1.00	22 uF 25V 3/1.00	150 uF 16V Axial 1/1.00	100 pF 20/1.00		10 uF 15V Radial 10/1.00	047 16V 20/1.00	<p>Crystals</p> <p>3 579545 MHZ \$1.50 10 00000 MHZ \$5.00 5 248800 MHZ \$5.00</p> <p>AC Adapters</p> <p>Good for clocks, nicad chargers, all 110 VAC plug one end. 8.5 vdc @ 20 mA \$1.00 16 vdc @ 160mA \$2.50 12 vdc @ 250mA \$3.00</p> <p>Solid State Buzzers</p> <p>small buzzer 450 Hz, 85 dB sound output on 5-12 vdc at 10-30 mA, TTL compatible \$1.50</p> <p>AC Outlet</p> <p>Panel Mount with Leads 4/1.00</p>
TANTALUM	ALUMINUM	OISK CERAMIC																			
Dipped Epoxy	Electrolytic	01 16V disk 20/1.00																			
1.5 uF 25V 3/1.00	1000 uF 16V Radial 1.50	1 16V 15/1.00																			
1.8 uF 25V 3/1.00	500 uF 20V Axial 1.50	001 16V 20/1.00																			
22 uF 25V 3/1.00	150 uF 16V Axial 1/1.00	100 pF 20/1.00																			
	10 uF 15V Radial 10/1.00	047 16V 20/1.00																			
<p>Diodes</p> <p>5.1 V Zener 20/1.00 1N914 Type 50/1.00 1KV 2Amp 8/1.00 100V 1Amp 15/1.00</p> <p>25 AMP 100V Bridge \$1.50 each</p> <p>Mini-Bridge 50V 1 AMP 2 for \$1.00</p>	<p>Crystal Microphone</p> <p>Small 1" diameter 1/4" thick crystal mike cartridge \$.75</p> <p>Coax Connector</p> <p>Chassis mount BNC type \$1.00</p> <p>9 Volt Battery Clips</p> <p>Nice quality clips 5 for \$1.00 1/2" Rubber Grommets 10 for \$1.00</p> <p>Parts Bag</p> <p>Asst of chokes, disc caps, tan resistors, transistors, diodes, MICA caps etc. am bag (100 pc) \$1.00 lg bag (300 pc) \$2.50</p> <p>Connectors</p> <p>6 pin type gold contacts for mpa-1003 car clock module .75 ea.</p> <p>Trimmer Caps</p> <p>Sprague - 3-40 pf Stable Polypropylene .50 ea.</p>	<p>DC-DC Converter</p> <p>-5 vdc input prod. -9 vdc @ 30ma -9 vdc produces -15 vdc @ 35ma 1.25</p> <p>Ceramic IF Filters</p> <p>Mini ceramic filters 7 kHz B.W. 455 kHz \$1.50 ea.</p>	<p>Regulators</p> <p>7812 \$1.00 7815 \$1.00 7905 \$1.25 7912 \$1.25 7915 \$1.25</p> <p>Mini TO-92 Heat Sinks</p> <p>Thermalloy Brand 5 for \$1.00 TO-220 Heat Sinks 3 for \$1.00</p>																		

600 MHz PRESCALER

Extend the range of your counter to 600 MHz. Works with all counters. Less than 150 mv sensitivity specify - 10 or -100

Wired, tested, PS-1B **\$59.95**
Kit, PS-1B **\$44.95**

Power Supply Kit

Complete triple regulated power supply provides variable 6 to 18 volts at 200 ma and +5 at 1 Amp. Excellent load regulation, good filtering and small size. Less transformers, requires 6.3 V 1A and 24 VCT. Complete kit, PS-3LT **\$6.95**

OP-AMP Special

BI-FET L F 13741 - Direct pin for pin 741 compatible, but 500,000 MEG input z. super low 50 pa input current, low power drain.
50 for only **\$9.00** 10 for **\$2.00**

Shrink Tubing Nubs

Nice precut pcs of shrink size 1" x 1/4" shrink to 1/4". Great for springs **50/1.00**

Opto Isolators - 4N28 type **\$1.00 ea.**
Opto Reflectors - Photo diode + LED **\$1.00 ea.**

Molex Pins

Molex already precut in length of 7. Perfect for 14 pin sockets. 20 strips for **\$1.00**

CDS Photocells

Resistance varies with light, 250 ohms to over 3 meg **\$1.00**

ANTENNA SPECIALISTS • AVANTI • ARAI PUBS • AMECO • BASH • BEARCAT • BENCHER • B&W • BIRD • CALLBOOK • COMMUNICATIONS
 SPECIALISTS • CUSHCRAFT • DRAKE • HAM KEY • HUSTLER • HY-GAIN • ICOM • KANTRONICS
 LARSEN • MFJ • MORGAIN • PANASONIC • RAMSEY • SHURE • SONY • TELEX • TEN TEC • TRAC • TRANSCOM • VAN GORDON • VOICOM

NEW! **SONY SUMMER VALUES!** **PRICES GOOD THRU AUGUST!**



ICF 4800
SIX-BAND POCKET WORLD RECEIVER
• 6-band pocket world receiver—SW 1-5 plus MW
• Extremely compact and lightweight—palm sized!
• SW band spread dial—easy tuning • Tuning indicator
• FET RT amplifier for clean, low-noise reception along with high sensitivity and selectivity

\$89⁹⁵
plus \$3.00 shipping (Cont'l U.S.)

31-BAND ICF-6800W PORTABLE WORLD RECEIVER

~~\$699.95 LIST~~ **\$549.95 REG.** **ONLY \$529⁹⁵** plus \$8.00 shipping (Cont'l USA)

ICF-2001 INSTANT ACCESS DIGITAL SHORTWAVE SCANNER

~~\$349.95 LIST~~ **\$299.95 REG.** **ONLY \$279⁹⁵** plus \$5.00 shipping (Cont'l USA)

5-BAND ICF-6500W PORTABLE SW RECEIVER

~~\$199.95 LIST~~ **\$179⁹⁵** **ONLY** plus \$5.00 shipping (Cont'l U.S.)

TALKMAN™ 2-WAY COMMUNICATIONS SET



\$119⁹⁵ **plus \$3.00 shipping (Cont'l USA)**

- VOX for total hands-free operation
- 1/4-Mile range
- No license required

POPULAR HAMFEST SPECIALS!

SUB-AUDIBLE TONE HEADQUARTERS

ENCODERS plus \$2.00 shipping
\$29⁹⁵ EACH (Cont'l USA only)

We stock Communications Specialists SS-32 and SS-32M encoders for most any mobile or hand-held applications including the very popular Icom Handhelds.

AMECO PREAMPS
add \$3.00 shipping (Cont'l USA only)

Model PLF-2 \$52.95
Model PLF-2E (240V) \$57.95
Model PT-2 \$79.95
Model PT-2E (240V) \$84.95



MORGAIN MULTI-BAND ANTENNAS

Add \$5.00 for shipping (Cont'l U.S.A.)

80-40HD/A 80/40 Mtr bands (69) 99.00
75/40HD/A 75/40 Mtr bands (66) 94.50
75-10HD/A 75/40/20/15/10 Mtr (66) ... 126.95
80-10HD/A 80/40/20/15/10 Mtr (69) ... 132.00

FAMOUS "EAVESDROPPER" SW RECEIVING ANTENNA



\$59⁹⁵ plus \$3.00 shipping (Cont'l U.S.)

VoCom POWER POCKET



plus \$8.00 shipping (Cont'l USA) **\$179⁹⁵**

Accepts any version of the IC-2A, applies its output to a wide-band rf amplifier, and delivers 25 watts to your mobile antenna. Mobile talk-out power!

ICOM IC25A



NEW! IC3AT (220 MHz) IC4AT (440 MHz)

ICOM IC2A, IC2AT



- Compact
- Quality Construction
- Versatile
- Affordable
- Wide Range of Accessories Available

CALL FOR PRICE & AVAILABILITY

SPECIAL PURCHASE! **"REDISCOVER" AM BROADCAST LISTENING!**

ORDER WHILE QUANTITIES LAST! **SONY ICF-S5W SUPER-SENSITIVE AM-FM PORTABLE**

The ICF-S5W offers outstanding sensitivity and selectivity, which means better reception of weak, hard-to-tune signals and clean, clear reception in crowded dial areas. And, in the city or outlying rural areas, the ICF-S5W makes tuning simple. All stations can be tuned on the unit's regular dial scale. In addition, a special Zone Dial Selector helps you tune major stations by their call letters.

You simply select your broadcast zone, then pick the station by name without referring to dial-scale numerals. It's a lot of performance and convenience in a little radio, which projects rich, powerful sound through a big 4" speaker.



01 CT, ME, MA, NH, RI, VT; 02 NJ, NY, 03 DE, MD, PA, WASH, DC, 04 AL, FL, GA, KY, NC, SC, TN, VA, 05 AR, LA, MS, MO, OK, TX, 06 CA, 07 AZ, ID, MT, WY, OR, UT, WA, WY, 08 MI, OH, WY, 09 IL, IN, WI, 10 CO, IA, KS, MN, NE, ND, SD

Regular dial scale, plus Zone Dial for easy tuning of some stations by their call letters



PRICE CUT!
\$59⁹⁵
plus \$5.00 shipping (Cont'l U.S.)

TO ORDER: CALL OR WRITE. MASTER CARD, VISA, MONEY ORDERS ACCEPTED. (PERSONAL CHECKS TAKE 3 WEEKS TO CLEAR.) INTERNATIONAL ORDERS WELCOME, PLEASE REQUEST PRO FORMA INVOICE. ILLINOIS RESIDENTS ADD 6% SALES TAX.

HOURS: MON. THRU WED. 9:30-6:00, THURS-FRI. 9:30-8:00, SAT. 9:30-3:00

STOP BY AND VISIT WHEN IN THE CHICAGOLAND AREA!!

SPECTRONICS, INC. **PHONE (312) 848-6777**

1009 GARFIELD ST. OAK PARK, IL. 60304



DEALER DIRECTORY

Phoenix AZ

The Southwest's most progressive communications company stocking Kenwood, ICOM, Yaesu, MFJ, B&W, Astron, Larsen, Cushcraft, Hy-Gain, Bearcat, and more. Would like to serve you! Power Communications Corp., 1640 West Camelback Rd., Phoenix AZ 85015, 241-Watt.

Fontana CA

Complete lines ICOM, DenTron, Ten-Tec, Mirage, Cubic, Lunar, over 4000 electronic products for hobbyist, technician, experimenter. Also CB radio, landmobile. Fontana Electronics, 8628 Sierra Ave., Fontana CA 92335, 822-7710.

San Diego CA

We buy and sell Surplus Army Navy Electronics, also Terminated Material. What do you want to sell? Write for catalogue. Electronic-town, Inc., 440-7th Avenue, PO Box 2048, San Diego CA 92112, 232-9379.

San Jose CA

Bay area's newest Amateur Radio store. New & used Amateur Radio sales & service. We feature Kenwood, ICOM, Azden, Yaesu, Ten-Tec, Sante & many more. Shaver Radio, Inc., 1378 So. Bascom Ave., San Jose CA 95128, 998-1103.

Smyrna GA

For your Kenwood, Yaesu, ICOM, Drake and other amateur needs, come to see us. Britt's Two-Way Radio, 2508 N. Atlanta Rd., Smyrna GA 30080, 432-8006.

Preston ID

Ross WB7BYZ has the Largest Stock of Amateur Gear in the Intermountain West and the Best Prices. Call me for all your ham needs. Ross Distributing, 78 So. State, Preston ID 83263, 852-0830.

Terre Haute IN

Your ham headquarters located in the heart of the midwest. Hoosier Electronics, Inc., #9 Meadows Center, P.O. Box 3300, Terre Haute IN 478003, 238-1456.

Baltimore MD

Always buying lab grade test equipment HP, Tek, Gr. L&N, Etc. Also buy microwave coaxial & waveguide HP, frr, waveline, Etc. Prefer "K", "P", "R" but will consider larger wgt too. Cadisco 514 Ensor St. Balto, MD 21202, 685-1883.

Littleton MA

The ham store of N.E. you can rely on. Kenwood, ICOM, Wilson, Yaesu, DenTron, KLM amps, B&W switches & wattmeters. Whistler radar detectors, Bearcat, Regency, antennas by Larsen, Wilson, Hustler, CAM. TEL-COM Inc. Communications & Electronics. 675 Great Rd., Rt. 119, Littleton MA 01460, 486-3040.

Ann Arbor MI

See us for products like Ten-Tec, R. L. Drake, DenTron and many more. Open Monday through Saturday. 0630 to 1730. WB8VGR, WB8UXO, WD6OKN and W8RP behind the counter. Purchase Radio Supply, 327 E. Hoover Ave., Ann Arbor MI 48104, 666-8696.

Hudson NH

New England's Distributor and Authorized Service Center for all Major Amateur Lines. Tufts Radio Electronics, Inc., 61 Lowell Road, Hudson NH 03051, 883-5005.

Somerset NJ

New Jersey's only factory-authorized ICOM and Yaesu distributor. Large inventory of new and used specials. Most major brands in stock. Complete service and facilities. Radios Unlimited, 1760 Easton Avenue, P.O. Box 347, Somerset NJ 08873, 469-4599.

Buffalo NY WESTERN NEW YORK

Niagara Frontier's only full stocking Amateur dealer. Also Shortwave, CB, Scanners, Marine, Commercial. Operating displays featuring Kenwood and others. Towers, Antennas, Sales and Service. DX Communications, 3214 Transit Road, West Seneca NY, 668-8873.

Amsterdam NY UPSTATE NEW YORK

Kenwood, ICOM, Drake, plus many other lines, Amateur Dealer for over 35 years. Adiron-dack Radio Supply, Inc., 185 West Main Street, Amsterdam NY 12010, 842-8350.

Syracuse-Rome-Utica NY

Featuring: Kenwood, Yaesu, ICOM, Drake, Ten-Tec, Swan, DenTron, Alpha, Robot, MFJ, Tempo, Astron, KLM, Hy-Gain, Mosley, Larsen, Cushcraft, Hustler, Mini Products. You won't be disappointed with equipment/service. Radio World, Oneida County Airport-Terminal Building, Oriskany NY 13424, 337-0203.

Columbus OH

The biggest and best Ham Store in the midwest featuring quality Kenwood products with working displays. We sell only the best. Authorized Kenwood Service. Universal Amateur Radio Inc., 1280 Aida Dr., Reynoldsburg (Columbus) OH 43068, 866-4267.

Bend OR

Satellite TV. Known brands. Call today for more information and inquire about our dealer program. WESPERCOM, P.O. Box 7226, Bend OR 97708, 389-0996.

Philadelphia PA/ Camden NJ

Waveguide & Coaxial Microwave Components & Equipment. Laboratory Grade Test Instruments, Power Supplies, Buy, Sell & Trade all popular makes—HP, GR, FXR, ESI, Sorensen, Singer, etc. Electronic Research Labs, 1423 Ferry Ave., Camden NJ 08104, 541-4200.

Scranton PA

ICOM, Bird, Cushcraft, Beckman, Fluke, Larsen, Hustler, Antenna Specialists, Astron, Avanti, Beiden, W2AU/W2VS, CDE, AEA, Vibroplex, Ham-Key, CES, Amphenol, Sony, Fanon/Courier, B&W, Ameco, Shure. LaRue Electronics, 1112 Grandview St., Scranton PA 18509, 343-2124.

Dallas TX

Dealer in Used Computer Hardware & Electronic Parts. Special on Daisy Wheel Printers. Xerox Word Processing Equipment, Dual Card Printers and Display Systems. Catalog \$1.00. Rondure Company (The Computer Room) Dept. 73, 2522 Butler St., Dallas TX 75235, 630-4621.

San Antonio TX

Amateur, Commercial 2-way. Selling Antenna Specialists, Avanti, Azden, Bird, Hy-Gain, Standard, Vibroplex, Midland, Henry, Cushcraft, Dielectric, Hustler, ICOM, MFJ, Nye, Shure, Cubic, Tempo, Ten-Tec and others. Appliance & Equipment Co., Inc. 2317 Vance Jackson Road, San Antonio TX 78213, 734-7793.

Vienna VA

The Washington metropolitan area's leading supplier of the latest in Amateur Radio and Test Equipment. On your next trip to the Nation's Capital, stop by and see us. Electronic Equipment Bank, Inc., 516 Mill St. N.E., Vienna VA 22180, 938-3350.

DEALERS

Your company name and message can contain up to 25 words for as little as \$150 yearly (prepaid), or \$15 per month (prepaid quarterly). No mention of mail-order business or area code permitted. Directory text and payment must reach us 60 days in advance of publication. For example, advertising for the Oct. '82 issue must be in our hands by Aug. 1st. Mail to 73 Magazine, Peterborough NH 03458. ATTN: Nancy Ciampa.

PROPAGATION

J. H. Nelson
4 Plymouth Dr.
Whiting NJ 08759

EASTERN UNITED STATES TO:

	GMT:	00	02	04	06	08	10	12	14	16	18	20	22
ALASKA	14	14	14	7	7	7	7	7	14	14	14	14	14
ARGENTINA	21	14A	14	14	7	7	14	21	21A	21A	21A	21A	21A
AUSTRALIA	14	14	14	14B	7B	7B	7B	14B	7B	7B	14A	21	
CANAL ZONE	21A	14	14	14	7	7	14	14	21	21	21A	21A	
ENGLAND	7A	7	7	7	7	7A	14	14	21	21	21A	21A	
HAWAII	21	14	14	7	7	7	7	14	14	14	14A	21	
INDIA	14	14	7B	7B	7B	7B	14	14	14	14	14	14	
JAPAN	14	14	7B	7B	7B	7B	14	14	14	14	14	14	
MEXICO	14A	14	14	7	7	7A	14	14	14A	21	21		
PHILIPPINES	14	14	14	7B	7B	7B	7B	14B	14	14	14	14	
PUERTO RICO	14	14	7A	7	7	7	14	14	14	14	14A	14A	
SOUTH AFRICA	14	7B	7B	7A	14	14	14A	21	21A	21A	21	14	
U. S. S. R.	7	7	7	7	7	7A	14	14	14A	14A	14A	14	
WEST COAST	21	14A	14	7A	7	7	7	14	14A	14A	21	21	

CENTRAL UNITED STATES TO:

ALASKA	14	14	14	7	7	7	7	7	14	14	14	14	14
ARGENTINA	21	14A	14	14	7	7	14	14	21	21A	21A	21A	21A
AUSTRALIA	21	14A	14	14	14B	7B	7B	14B	7B	7B	14A	21	
CANAL ZONE	21A	14	14	14	7	7	14	14	21	21	21A	21A	
ENGLAND	7A	7	7	7	7	7	14	14	14	14	14	14	
HAWAII	21	21	14	7	7	7	7	14	14	14A	21	21	
INDIA	14	14	7B	7B	7B	7B	14B	14	14	14	14	14	
JAPAN	14	14	14	7B	7B	7B	7B	14	14	14	14	14	
MEXICO	14	14	7	7	7	7	7A	14	14	14	14	14A	
PHILIPPINES	14	14	14	7B	7B	7B	7B	14B	14	14	14	14	
PUERTO RICO	14A	14	14	7A	7	7	14	14	14A	14A	21	21	
SOUTH AFRICA	14	7B	7B	7B	7B	7B	14	14	14A	21	14	14	
U. S. S. R.	7	7	7	7	7	7	7	14B	14	14	14	14	

WESTERN UNITED STATES TO:

ALASKA	14	14	14	7	7	7	7	7	7	14	14	14	14
ARGENTINA	21	14A	14	14	14	7	7	14	14	21	21A	21A	21A
AUSTRALIA	21A	21A	21	14	14	14	14	14B	7B	7B	14A	21	
CANAL ZONE	21A	21	14	14	7	7	7	14	21	21	21A	21A	
ENGLAND	7A	7B	7	7	7	7	7B	14B	14	14	14	14	
HAWAII	21A	21	21	14	14	14	14	14	14	21	21	21A	
INDIA	14	14	14	7B	7B	7B	7B	14	14	14	14	14	
JAPAN	14A	14A	14	14	14	7	7	14	14	14	14	14A	
MEXICO	21	14	14	7	7	7	7	14	14	14	14	14A	
PHILIPPINES	14A	14A	14	14	14B	7	7B	14B	14	14	14	14A	
PUERTO RICO	21	14A	14	14	7	7	7A	14	14A	21	21	21	
SOUTH AFRICA	14	7B	7B	7B	7B	7B	14	14	14A	14A	14	14	
U. S. S. R.	7B	7B	7	7	7	7	7B	7B	14B	14	14	14	
EAST COAST	21	14A	14	7A	7	7	7	14	14A	14A	21	21	

A = Next higher frequency may also be useful.
B = Difficult circuit this period.

First letter = night waves. Second = day waves.

G = Good, F = Fair, P = Poor. * = Chance of solar flares.

= Chance of aurora.

NOTE THAT NIGHT WAVE LETTER NOW COMES FIRST.

AUGUST						
SUN	MON	TUE	WED	THU	FRI	SAT
1 F/F	2 F/F	3 F/F*	4 P/F*	5 F/F*	6 F/G	7 G/G
8 G/G	9 G/G	10 G/G	11 G/G	12 F/F	13 F/F	14 F/G
15 G/G	16 G/G	17 G/G	18 G/G	19 F/G	20 F/G	21 G/G
22 G/G	23 G/G	24 G/G	25 F/F	26 P/F	27 P/F	28 F/G
29 F/G	30 F/G	31 G/G				

FT-230R: QUITE A SIGHT! (AND EASY TO SEE, TOO!!)

Sporting an all-new Liquid Crystal Display, the FT-230R is Yaesu's high-performance answer to your call for a very affordable 2 meter mobile rig with an easy-to-read frequency display! The FT-230R combines microprocessor convenience, a sensitive receiver, a powerful yet clean transmitter strip, and the new dimension of LCD frequency readout. See your Authorized Yaesu Dealer today — and go home with your new FT-230R!



SALE SUBJECT
FCC CERTIFICATION

- LCD five-digit frequency readout with night light for high visibility day or night.
- Two VFOs for quick QSY across the band.
- Ten memory slots for storage and recall of favorite channels.
- Selectable synthesizer steps (5 kHz or 10 kHz) in dial or scanning mode.
- Priority channel for checking a favorite frequency for activity while monitoring another.
- Unique VFO/Memory Split mode for covering unusual repeater splits.
- Up/Down band scan plus memory scan for busy or clear channel. Scanning microphone included in purchase price.
- Full 25 watts of RF power output from extremely compact package.
- Built-in automatic or manual tone burst.
- Optional synthesized CTCSS Encode and Decode boards available.
- Lithium memory backup battery with estimated lifetime of five years.
- Optional YM-49 Speaker/Microphone and YM-50 DTMF Encoding Microphone provide maximum operating versatility.



FT-208R
FM Handheld
2 Meters



FT-708R
FM Handheld
70 cm

And don't forget! Yaesu has a complete line of VHF and UHF handheld and battery portable transceivers using LCD display!!!



FT-290R - 2 Meters
SSB/CW/FM Portable
FT-690R - 6 Meters
USB/CW/AM/FM Portable

YAESU
The radio.



Price and Specifications Subject To
Change Without Notice or Obligation

Top-Notch.



VBT, notch, IF shift, wide dynamic range

TS-830S

Now most Amateurs can afford a high-performance SSB/CW transceiver with every conceivable operating feature built in for 160 through 10 meters (including the three new bands). The TS-830S combines a high dynamic range with variable bandwidth tuning (VBT), IF shift, and an IF notch filter, as well as very sharp filters in the 455-kHz second IF. Its optional VFO-230 remote digital VFO provides five memories.

TS-830S FEATURES:

- **160-10 meters, including three new bands**
Covers all Amateur bands from 1.8 to 29.7 MHz (LSB, USB, and CW), including the new 10, 18, and 24-MHz bands. Receives WWV on 10 MHz.
- **Wide receiver dynamic range**
Junction FETs (with optimum IMD characteristics and low noise figure) in the balanced mixer, a MOSFET RF amplifier operating at low level for improved dynamic range (high amplification level not needed because of low noise in mixer), dual resonator for each band, and advanced overall receiver design result in excellent dynamic range.

Matching accessories for fixed-station operation:

- SP-230 external speaker with selectable audio filters
- VFO-230 external digital VFO with 20-Hz steps, five memories, digital display
- AT-230 antenna tuner/SWR and power meter
- MC-50 desk microphone
- HC-10 digital world clock
- YG-455C (500-Hz) and YG-455CN (250-Hz) CW filters for 455-kHz IF
- YK-88C (500-Hz) and YK-88CN (270-Hz) CW filters for 8.83-MHz IF
- HS-5 and HS-4 headphones
- MC-30S and MC-35S noise-cancelling hand microphones

Other accessories not shown:

- TL-922A linear amplifier
- SM-220 Station Monitor
- PC-1 phone patch

- **Variable bandwidth tuning (VBT)**
Continuously varies the IF filter passband width to reduce interference. VBT and IF shift can be controlled independently for optimum interference rejection in any condition.
- **IF notch filter**
Tunable high-Q active circuit in 455-kHz second IF. For sharp, deep notch characteristics.
- **IF shift**
Shifts IF passband toward higher or lower frequencies (away from interfering signals) while tuned receiver frequency remains unchanged.
- **6146B final with RF NFB**
Two 6146B's in the final amplifier provide 220 W PEP (SSB)/180 W DC (CW) input on all bands. RF negative feedback provides optimum IMD characteristics for high-quality transmission.
- **Built-in digital display**
Six-digit large fluorescent tube display, backed up by an analog dial. Reads actual receive and transmit frequency on all modes and all bands. Display Hold (DH) switch.
- **Adjustable noise-blanker level**
Built-in noise blanker eliminates pulse-type (such as ignition) noise. Front-panel threshold level control.

- **Various IF filter options**
Either a 500-Hz (YK-88C) or 270-Hz (YK-88CN) CW filter may be installed in the 8.83-MHz first IF, and a very sharp 500-Hz (YG-455C) or 250-Hz (YG-455CN) CW filter is available for the 455-kHz second IF.
- **More flexibility with optional digital VFO**
VFO-230 operates in 20-Hz steps and includes five memories. Also allows split-frequency operation. Built-in digital display. Covers about 100 kHz above and below each 500-kHz band.
- **Built-in RF speech processor**
For added audio punch and increased talk power in DX pileups.
- **RIT/XIT**
Receiver incremental tuning (RIT) shifts only the receiver frequency, to tune in stations slightly off frequency. Transmitter incremental tuning (XIT) shifts only the transmitter frequency.
- **SSB monitor circuit**
Monitors IF stage while transmitting, to determine audio quality and effect of speech processor.

More information on the TS-830S is available from all authorized dealers of Trio-Kenwood Communications, 1111 West Walnut Street, Compton, California 90220.

 **KENWOOD**
...pacesetter in amateur radio



Specifications and prices are subject to change without notice or obligation.