

# 73 MAGAZINE FOR RADIO AMATEURS



E = MC<sup>2</sup> YOU SAY? WHAT FOLLY!...



YOU'RE IN HERE FINE BUSINESS! HI! WHERE'S YOUR PAD? HI!...



MY MEMORY KEYSER HAS TWO MICRO-COMPUTERS - BEACON MODE AND AUTOMATIC MORSE TRAINER MODE...



I ALWAYS ADD A PINCH OF SALT TO THE RECIPE..



CQ CONTEST  
CQ CONTEST  
CQ CONTEST  
CQ CONTEST  
CQ CQ CQ  
CQ CQ..



Are You Ready for the Fun-Ceiver?

CQ de Turks & Caicos!

Dayton's Dilemma

Linn K4PP



**2K**

# Classic

A new

## edition of the world's most famous linear amplifier



The 2K Classic represents the culmination of fifteen years experience in developing, manufacturing and improving the 2K series. It remains as always a "workhorse", engineered and built to loaf along at full legal power for days or weeks without rest. A look inside shows why! No expense has been spared to make the 2K a truly "Classic" Amateur amplifier. Heavy duty, top quality components along with its rugged construction assures you of trouble free operation. The 2K Classic offers engineering and features second to none. It will put your signal on the air with greater strength and clarity than you ever dreamed possible. The 2K Classic operates on all amateur bands, 80 through 15 meters (export models include 10 meters).

**Features:**

- Two rugged Eimac 3-500Z grounded grid triodes
- Pi-L plate circuit with silver plated tank coil
- Resonant cathode pi input circuit
- Maximum legal input on all modes
- Price: \$1195.00

*The* **1KD-5** ...Another fine member of the famous Henry Radio family of superior amplifiers. And we're still convinced that it's the world's finest linear in its class. The 1KD-5 was designed for the amateur who wants the quality and dependability of the 2KD-5 and 2K-4, who may prefer the smaller size, lighter weight and lower price and who will settle for a little less power. But make no mistake, the 1KD-5 is no slouch. Its 1200 watt PEP input (700 watt PEP nominal output) along with its superb operating characteristics will still punch out clean powerful signals...signals you'll be proud of. Compare its specifications, its features and its fine components and we're sure you will agree that the 1KD-5 is a superb value at only \$695.

*The* **2KD-5** We have been suggesting that you look inside any amplifier before you buy it. We hope that you will. If you "lift the lid" on a 2KD-5 you will see only the highest quality, heavy duty components and careful workmanship...attributes that promise a long life of continuous operation in any mode at full legal power. The 2KD-5 is a 2000 watt PEP input (1200 watt PEP nominal output) RF linear amplifier, covering the 80, 40, 20, and 15 meter amateur bands. It operates with two Eimac 3-500Z glass envelope triodes and a PI-L plate circuit with a rotary silver plated tank coil. Price \$945.

And don't forget the rest of the Henry family of amateur amplifiers...the Tempo 2002 high power VHF amplifier and the broad line of top quality solid state amplifiers. Henry Radio also offers the 3K-A and 4K-Ultra superb high power H.F. amplifiers and a broad line of commercial FCC type accepted amplifiers for two way FM communications covering the range to 500 MHz.



### Announcing!

A brand new "super" linear...the 3K Classic! Designed for the most critical Amateur Radio operator...the individual who wants and appreciates owning the finest. Available in spring 1981.

*F.C.C. approval pending*



Please note, as of Dec. 1, 1980 we will occupy our new world headquarters building with a new Los Angeles address and phone number.

2050 S. Bundy Dr., Los Angeles, CA 90025 (213) 820-1234  
931 N. Euclid, Anaheim, CA 92801 (714) 772-9200  
Butler, Missouri 64730 (816) 679-3127

TOLL FREE ORDER NUMBER: (800) 421-6631  
For all states except California.  
Calif. residents please call collect on our regular numbers.

# Henry Radio

Prices subject to change without notice

# FIVE STORE BUYING POWER! SPRING SPECIALS

SHIPPING REGULARLY TO COUNTRIES IN ALL CONTINENTS.

**SERVING HAMS  
BETTER.**

North...south...east...west.

Bob Ferrero, W6RJ/K6AHV,  
Jim Rafferty, N6RJ  
other well known hams  
give you courteous,  
personalized  
service.



**FREE PHONE**

**800  
854-6046**

CALIF. CUSTOMERS PLEASE  
CALL OR VISIT LISTED STORES

**FREE  
SHIPMENT**

(UPS Brown)

CONTINENTAL  
U.S.A.



**HAM  
RADIO  
OUTLET™**

**ANAHEIM, CA 92801**

2620 W. La Palma,  
(714) 761-3033 (213) 860-2040  
Between Disneyland & Knott's Berry Farm

**BURLINGAME, CA 94010**

999 Howard Ave., (415) 342-5757  
5 miles south on 101 from S.F. Airport.

**OAKLAND, CA 94609**

2811 Telegraph Ave., (415) 451-5757  
Hwy 24 Downtown. Left 27th off-ramp.

**SAN DIEGO, CA 92123**

5375 Kearny Villa Road (714) 560-4900  
Hwy 163 & Clairemont Mesa Blvd.

**VAN NUYS, CA 91401**

6265 Sepulveda Blvd., (213) 988-2212  
San Diego Fwy at Victory Blvd.

**OVER-THE-COUNTER**

Mon. thru Sat. 10AM to 5:30PM

AEA • ALLIANCE • ALPHA • AMECO • AMPHENOL • ARRL • ASTRON  
• AVANTI • BENCHER • BERK-TEK • BIRD • B&W • CALLBOOK • CDE  
• COLLINS • CUBIC • CURTIS • CUSHCRAFT • DAIWA • DATONG  
• DENTRON • DRAKE • DX ENGINEERING • EIMAC • HUSTLER  
• HY-GAIN • ICOM • J.W.MILLER • KENWOOD • KLM • LARSEN  
• LUNAR • METZ • MFJ • MICRO • LOG • MINI • PRODUCTS  
• MIRAGE • NYE • PALOMAR • ROBOT • ROHN • SHURE • SWAN  
• TELEX • TELREX • TEMPO • TEN-TEC • TRISTAO  
• YAESU and many more!

**ETD ALPHA**



**77DX**  
REGULAR  
\$4945 \*

**78**  
REGULAR  
\$3185 \*



\* CALL NOW FOR YOUR SPRING SPECIAL PRICES



**76PA**  
REGULAR  
\$2195 \*

**374A**  
REGULAR  
\$2395 \*



**YAESU FT-207R  
HANDIE**

REGULAR  
\$299 \*

Includes:

NBP-9  
battery pack.  
NC-9B wall charger.  
FEP-1 earphone,  
rubber flex. ant.

\* ASK FOR YOUR PRICE



**MIRAGE B-1016 2M  
AMPLIFIER**

160 W OUTPUT  
SSB, FM, CW.



Freq. range: 144-148MHz • RF out: 160W nom.  
(10W in) • RF power in: 5-15W • DC operating  
pwr: 13.8VDC @ 20-25A • Intermittent duty  
cycle • Built-in receiver pre-amp. Auto-  
matic internal or external relay keying.

REGULAR  
\$279.95 YOUR PRICE **\$249.95**

**R.L. DRAKE TR-7/DR-7**



REGULAR \$1549

ASK FOR YOUR PRICE

**COLLINS KWM-380**



NEW REGULAR PRICE \$3496

LIMITED NUMBER AT OLD PRICE **\$2695**

**KENWOOD**



**TS-130S**  
REGULAR \$759.95

**TR-2400**



**TS-830S**  
REGULAR \$929.95



REGULAR  
\$395



**TR-7800**  
REGULAR \$399.95

**CALL NOW FOR YOUR  
SPRING SPECIAL PRICES**

Prices, specs subject to change without notice

Calif. residents please add sales tax.

# INFO

## Manuscripts

Contributions in the form of manuscripts with drawings and/or photographs are welcome and will be considered for possible publication. We can assume no responsibility for loss or damage to any material. Please enclose a stamped, self-addressed envelope with each submission. Payment for the use of any unsolicited material will be made upon acceptance. All contributions should be directed to the 73 editorial offices. "How to Write for 73" guidelines are available upon request.

## Editorial Offices:

Pine Street  
Peterborough NH 03458  
Phone: 603-924-3873, 924-3874

## Advertising Offices:

Elm Street  
Peterborough NH 03458  
Phone: 603-924-7138

## Circulation Offices:

Elm Street  
Peterborough NH 03458  
Phone: 603-924-7296

## Subscription Rates

In the United States and Possessions:  
One Year (12 Issues) \$25.00  
Two Years (24 Issues) \$38.00  
Three Years (36 Issues) \$53.00

## Elsewhere:

Canada—\$27.00/1 year only, U.S. funds. Foreign surface mail—\$35.00/1 year only, U.S. funds. Foreign air mail—\$62.00/1 year only, U.S. funds.

## To subscribe, renew or change an address:

Write to 73 Magazine, Subscription Department, PO Box 931, Farmingdale NY 11737. For renewals and changes of address, include the address label from your most recent issue of 73. For gift subscriptions, include your name and address as well as those of gift recipients. Postmaster: Send form #3579 to 73 Magazine, Subscription Services, P.O. Box 931, Farmingdale, NY 11737.

## Subscription problem or question:

Write to 73 Magazine, Subscription Department, PO Box 931, Farmingdale NY 11737. Please include an address label.

73 Magazine (ISSN 0098-9010) is published monthly by 73, Inc., 80 Pine Street, Peterborough NH 03458. Second class postage paid at Peterborough NH 03458 and at additional mailing offices. Copyright (c) 1981 by 73, Inc. All rights reserved. No part of this publication may be reprinted or otherwise reproduced without written permission from the publisher. Microfilm Edition—University Microfilm, Ann Arbor MI 48106.

# MOBILE ANTENNAS

From CUBIC, Builders of America's finest HAM Radio Equipment.

Exclusive heavy duty construction all-band manual switching antenna for 10, 15, 20, 40 and 75 meters. Power rated at 500 watts PEP. Has a patented high-Q tapped coil with GOLD PLATED switch contacts.

## M-45

5 Band Manual Switching up to 75 Meters at 500 Watts PEP

M-45

## MMBX

Switchable Antenna matchbox. Seven impedance ratios above or below 50 ohms from 1.7 to 30 MHz.



## M-34

Up to 4 Bands at 200 Watts, PEP

M-34

The M34 mobile antenna gives you three bands—10, 15 and 20 meters. For a fourth band, add our optional 160, 80 or 40 meter coil and top section.

You end up with full capability 4-band mobile antenna requiring no coil change or adjustments after initial tuning.

Call or write for a complete antenna brochure.

 **CUBIC** COMMUNICATIONS, INC. ✓ 70

305 Airport Road, Oceanside, CA 92054  
(714) 757-7525/Telex: 695435;  
ANS BK: CUBICOM, OCEN.

# R-X Noise Bridge



- Learn the truth about your antenna.
- Find its resonant frequency.
- Adjust it to your operating frequency quickly and easily.

If there is one place in your station where you cannot risk uncertain results it is in your antenna.

The Palomar Engineers R-X Noise Bridge tells you if your antenna is resonant or not and, if it is not, whether it is too long or too short. All this in one measurement reading. And it works just as well with ham-band-only receivers as with general coverage equipment because it gives perfect null readings even when the antenna is not resonant. It gives resistance and reactance readings on dipoles, inverted Vees, quads, beams, multiband trap dipoles and verticals. No station is complete without this up-to-date instrument.

Why work in the dark? Your SWR meter or your resistance noise bridge tells only half the story. Get the instrument that really works, the Palomar Engineers R-X Noise Bridge. Use it to check your antennas from 1 to 100 MHz. And use it in your shack to adjust resonant frequencies of both series and parallel tuned circuits. Works better than a dip meter and costs a lot less. Send for our free brochure.



The price is \$55.00 in the U.S. and Canada. Add \$3.00 shipping/handling. California residents add sales tax.

Fully guaranteed by the originator of the R-X Noise Bridge.

**ORDER YOURS NOW!**

# Palomar Engineers

Box 455, Escondido, CA. 92025  
Phone: [714] 747-3343

<b>Dayton Dilemma '81</b> — which new gear do you buy? . . . . . KA1LR	22
<b>The Fun-Ceiver</b> — easy-to-build companion to February's QRP Fun-Mitter . . . . . WA0RBR	32
<b>Review:</b> <b>The Kenwood TS-130S</b> — a good rig done better. . . . . KA1LR	38

<b>The History of Ham Radio</b> — part XVI. . . . . W9CI	58
<b>Review:</b> <b>The Radio Amateur's Conversation Guide</b> . . . . . KA1LR	65

<b>Aerial Heirlooms</b> — towers from the past. . . . . AK0Q	66
---	----

<b>Amateur Telemetry</b> — monitor your repeater's vital signs with this simple system. . . . . W2FPP	72
--	----

<b>Rallying the HP-55</b> — gentlemen, start your calculators! . . . . . Lutz	80
--	----

<b>Icing on the IC-2A Cake</b> — nonstandard offsets for Icom's hand-held . . . . . WA4TEM	84
---	----

# 73 MAGAZINE

July 81



Turks—12



Dayton—22



Grandma—102

<b>Review:</b> <b>The NCG-15 SSB/CW Monoband Transceiver</b> — a moving tale of mobile hamming. . . . . KA1LR	42
---	----

<b>The Incredible Shrinking Antenna</b> — give your vertical a top hat. . . . . W1GV/4	44
---	----

<b>Review:</b> <b>The Micro Control Specialties Mark 3CR</b> — a hassle-free repeater that does it all. . . . . KA1LR	46
---	----

<b>Review:</b> <b>Radio Amateur's License Manual</b> — don't memorize, learn! . . . . . N8RK	48
--	----

<b>The CCD Antenna — Another Look</b> — theoretical justification and answers to some frequently asked questions. . . . . W4FD, W4ATE	50
--	----

<b>Flexible Couplings</b> — for every project there is a reason . . . . . turn, turn, turn. . . . . WB6GZW	90
---	----

<b>The Bobtail Curtain: Round Three</b> — wherein this author turns two previous articles upside down. . . . . W6RCL	92
---	----

<b>The Micro-Generator</b> — this diminutive device has a price tag as small as its size. . . . . WA3RJS	94
---	----

<b>Grandma Packs a Seabag</b> — lady ham takes to the high seas . . . . . K7NZA	102
--	-----

<b>Review:</b> <b>The Datong ASP Speech Processor</b> — will this give you a British accent? . . . . . W8YA	118
---	-----

Never Say Die — 6, **73 On the Air** — 6, Social Events — 96, Ham Help — 99, 112, 124, 141, 145, 148, 157, DX — 125, Awards — 127, Kahaner Report — 130, Looking West — 131, FCC — 133, 141, Leaky Lines — 134, New Products — 135, Fun! — 139, Corrections — 141, RTTY Loop — 142, Contests — 143, Letters — 146, OSCAR Orbits — 158, Dealer Directory — 178, Propagation — 178

# W2NSD/1 NEVER SAY DIE

editorial by Wayne Green

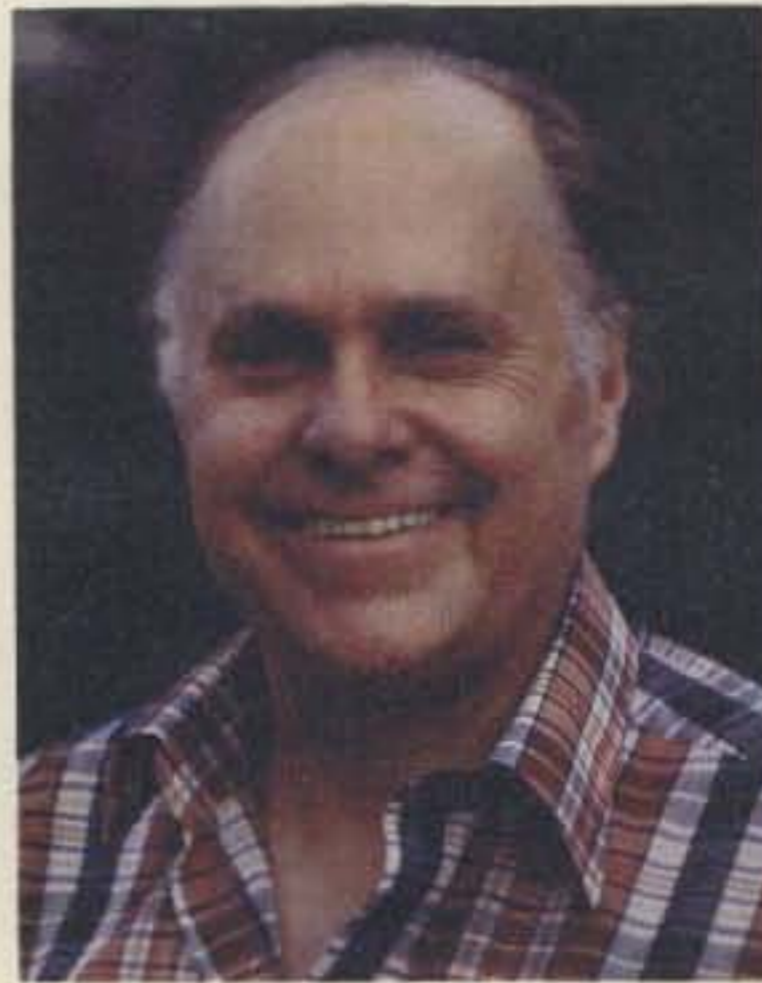

## DAYTON!

No matter what any hamfest claims, there is no question but that Dayton is the biggest of 'em all. Indeed, if you want to get your car or van into the flea market on Saturday, you'd better get up mighty early. Even parking within walking distance of the show calls for an early start.

Thousands of happy hams were seen carrying or dragging home trophies from the flea market. Others were haggling with the few dealers who attended this year, trying to get the price down another dollar on a new rig. One chap had a price on his heart's desire from every dealer in the place. I know he had to have spent the better part of a day doing nothing else. If anyone offered to pay him at the rate he was using his time to save a buck, he would have been furious.

There were some new items

...lots of them. Probably the most popular new development is the Morse code keyer/reader, with RTTY and ASCII provisions. A couple of years ago we saw one or two of these... this year they were all over the place. If the number of these gadgets being designed and made has any effect on amateur radio, we're in for a lot of high-speed CW and RTTY in the next few years.

Another mushrooming interest which was represented in force was the satellite TV makers. Several well-known ham firms have gotten into this field...and more are coming. I've just been waiting for the ground around our ham shack to thaw so we could plant a couple of small dishes and see what they grow into.

## QST EVENTS

With the announced retirement of Baldwin, rumors have been flying about Harry Dannals

taking over the spot upon *his* retirement, which surprisingly just precedes Baldwin's. While the move may not be all that beneficial to loyal QST subscribers, frankly I'm delighted.

The QST people stayed away from Dayton this year, almost totally. I don't know whether that had to do with the awful mess over Don Miller or whether QST is on the outs with the Hamvention. Miller was certainly there, as were thousands of furious Indiana hams, so perhaps it was a good time to avoid that heat. Did I smell some tar being boiled?

Dannals, who is a company man through and through, has been working at Sperry, if my memory serves. I thought it was really nice of the HQ gang to sort of look the other way as far as that stupid restriction they have about letting people who work for firms making radios not be eligible as directors. I think Dannals has been working as a union organizer or shop steward at Sperry.

In looking over the roster of HQ people who might be tapped for the top spot, I really can't think of anyone I'd rather see running things. Be sure to do all you can to get your director to see that Dannals is properly honored for all of the fine work he has done for QST...and its subscribers.

One of the 73 spies was able to sneak into the QST Forum at Dayton (using a wig). He reported that much of the time during this meeting was spent in the airing of complaints about the inadequacies of the latest QST repeater list.

## CHARLOTTE

One of the things I really enjoy about Dayton is that just about everyone in amateur radio is there. Unfortunately, there is such a mass of people that it is possible to go for three days and still miss seeing a number of good friends. I would like to personally thank the several thousand people who recognized me wandering around and who took the time to say hello and say nice things about the magazine. And, yes, I know you enjoy the editorial "but don't always agree with what I write." I could be smart about that and point out that we don't have an IQ test as part of the subscription acceptance, but on the other hand, I reserve the right to change my mind about things. Also, there may be cases where I have not been able to get all of the facts...or, forbid!, where *you* may not have all of the facts.

Which brings me to Charlotte. Out of the whole weekend I got one single hard time. I was told that I had at sometime said something bad about the Charlotte ham club. Boy, if I did, I have absolutely no recollection of it. I can't even imagine what would occasion anything like that. Heck, I used to live in North Carolina...got my W4NSD call while I was there. And I *loved* the place. I was in Southern Pines and I made more friends there in a week than I find possible in most places around the country in a year. North Carolinians are the most friendly people in the whole country and I have nothing but good feelings about 'em. I am very dismayed that anyone thinks otherwise.

I have to admit that the chap I talked with seemed to have no sense of humor at all. I do have a

## TOOTING OUR OWN HORN

We're extremely pleased to report that two long-time 73 authors walked away with the top awards at this year's Dayton Hamvention. It's the first time these prestigious awards have gone to journalists.

The Ham of the Year Award went to Eric Shalkhauser W9CI. "Shaw" is the author of the "History of Ham Radio" series which appears in 73 and in QCC News. He was honored "...for his very long dedication to amateur radio and its history."

Bill Pasternak WA6ITF is familiar to 73 readers as the author of our "Looking West" column. Pasternak and Bill Orenstein KH6IAF received the Hamvention's Specific Achievement Award "...for their contribution of time and effort to the operation of the Westlink Amateur Radio Network." Westlink is a weekly, prerecorded summary of amateur radio news distributed on cassette to many ham clubs and repeater groups.

Congratulations to the winners. It's great to have you as a part of the 73 team!

## W2NSD ON-THE-AIR SCHEDULE JULY, 1981

7	40m-80m CW (Novice)
14	20m-40m Phone
21	15m-20m Phone
28	15m-20m CW

Look for us in the first 25 kHz of the General portion of each band. We'll be on the higher frequency band first.

# Power up.

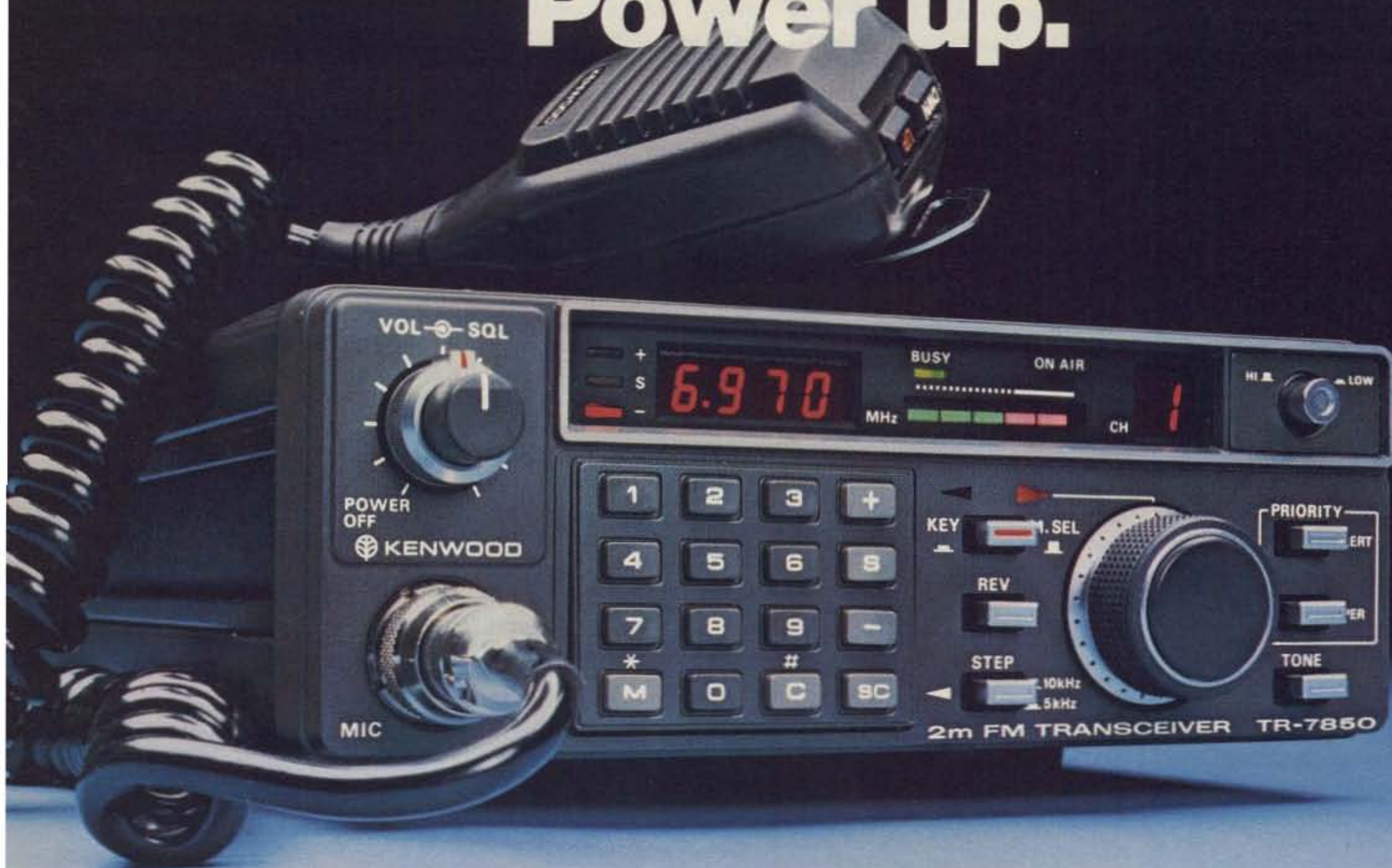

## 40 W, 15 memories/offset recall, scan, priority, DTMF touch-pad

### TR-7850

Kenwood's remarkable TR-7850 2-meter FM mobile transceiver provides all the features you could desire, including a powerful 40 watts RF output. Frequency selection is easier than ever, and the rig incorporates new memory developments for repeater shift, priority, and scan, and includes a built-in autopatch touch-pad (DTMF) encoder. A 25-watt output version, the TR-7800, is also available.

#### TR-7850 FEATURES:

- **Powerful 40 watts power output**  
Selectable high or low power operation. High 40-watt output provides reliable signal for wide area coverage.
- **15 multifunction memory channels, easily selectable with a rotary control**  
M1-M13... memorize frequency and offset ( $\pm 600$  kHz or simplex). M14... memorize transmit and receive frequencies independently for nonstandard offset. M0... priority channel, with simplex,  $\pm 600$  kHz, or nonstandard offset operation.
- **Internal battery backup for all memories**  
All memory channels (including transmit offset) are retained when four AA NiCd batteries (not Kenwood supplied) are installed in battery holder inside TR-7850. Batteries are automatically charged while transceiver is connected to 12-VDC source.
- **Extended frequency coverage**  
143.900-148.995 MHz, in switchable 5-kHz or 10-kHz steps.

- **Priority alert**  
M0 memory is priority channel. "Beep" alerts operator when signal appears on priority channel. Operation can be switched immediately to priority channel with the push of a switch.
- **Built-in autopatch touch-pad (DTMF) encoder**  
Front-panel touch pad generates all 12 telephone-compatible dual tones in transmit mode, plus four additional DTMF signaling tones (with simultaneous push of REV switch).
- **Front-panel keyboard**  
For frequency selection, transmit offset selection memory programming, scan control, and selection of autopatch encoder tones.
- **Autoscan**  
Entire band (5-kHz or 10-kHz steps) and memories. Automatically locks on busy channel; scan resumes automatically after several seconds, unless CLEAR or mic PTT button is pressed to cancel scan.
- **Up/down manual scan**  
Entire band (5-kHz or 10-kHz steps) and memories, with UP/DOWN microphone (standard).

- **Repeater reverse switch**  
Handy for checking signals on the input of a repeater or for determining if a repeater is "upside down."
- **Separate digital readouts**  
To display frequency (both receive and transmit) and memory channel.
- **LED bar meter**  
For monitoring received signal level and RF output.
- **LED indicators**  
To show: +600 kHz, simplex, or -600 kHz transmitter offset; BUSY channel; ON AIR.
- **TONE switch**  
To actuate subaudible tone module (not Kenwood-supplied).
- **Compact size**  
Depth is reduced substantially.
- **Mobile mounting bracket**  
With quick-release levers.

More information on the TR-7850 is available from all authorized dealers of Trio-Kenwood Communications, Inc., 1111 West Walnut Street, Compton, California 90220.

 **KENWOOD**  
...pacesetter in amateur radio

#### Matching accessory for fixed-station operation:

- KPS-12 fixed-station power supply for TR-7850
- Other accessories not shown:
  - KPS-7 fixed-station power supply for TR-7800
  - SP-40 compact mobile speaker



Specifications and prices are subject to change without notice or obligation.

# STAFF

**PUBLISHER/EDITOR**  
Wayne Green W2NSD/1

**EXECUTIVE VICE PRESIDENT**  
Sherry Smythe

**ASSISTANT PUBLISHER/EDITOR**  
Jeff DeTray WB8BTH

**ASSOCIATE PUBLISHER/DIRECTOR OF PUBLICATIONS**  
Edward Ferman WA1UFY

**MANAGING EDITOR**  
John Burnett

**ASST. MANAGING EDITOR**  
Susan Philbrick

**NEWS EDITOR**  
Gene Smarte WB6TOV

**EDITORIAL ASSISTANTS**  
Nancy Noyd  
Richard Phenix

**CONTRIBUTING EDITORS**  
Chris Brown KA1D  
Alyson Grupp N1BEJ  
Paul Grupp KA1LR  
Larry Kahaner WB2NEL

**ADMINISTRATIVE ASSISTANT**  
Pat Graham

**ASSOCIATES**  
Robert Baker WB2GFE  
Bill Gosney KE7C  
Sanger Green  
Dave Ingram K4TWJ  
Joe Kasser G3ZCZ  
Dr. Marc Leavey WA3AJR  
Dave Mann K2AGZ  
Bill Pasternak WA6ITF  
John Schultz W4FA  
Peter Stark K2OAW

**PRODUCTION MANAGER/PUBLICATIONS**  
Nancy Salmon

**ASST. PRODUCTION MANAGER/PUBLICATIONS**  
Michael Murphy

**ART DIRECTOR**  
Diana Shonk

**ADVERTISING GRAPHICS MANAGERS**  
Robert Drew  
Steve Baldwin  
Bruce Hedin

**PRODUCTION**  
Frances Benton  
Fiona Davies  
Linda Drew  
Gary Graham  
Kenneth Jackson  
Ross Kenyon KA1GAV  
Dianne Kritson  
Theresa Ostebo  
Jane Preston  
Deborah Stone  
Susan Symonds  
Thomas Villeneuve  
Donna Wohlfarth

**PHOTOGRAPHY**  
William Heydolph  
Terrie Anderson  
Bill Suttentfield  
Paul Babich

**TYPESETTING**  
Barbara Latti  
Sara Bedell  
Mary Kinzel  
Karen Stewart  
Michele DesRochers  
Steve Jewett  
Luann Keddy

**CORPORATE CONTROLLER**  
Charles Garniss, Jr.

**EXECUTIVE ASSISTANT**  
Leatrice O'Neil

**ACCOUNTING MANAGER**  
Knud Keller KV4GG/1

**CIRCULATION MANAGER**  
Debra Boudrieau

**CIRCULATION**  
Doris Day  
603-924-7296  
Pauline Johnstone

**BULK SALES MANAGER**  
Ginnie Boudrieau

**ADVERTISING**  
603-924-7138  
Jim Gray W1XU, Mgr.  
Nancy Ciampa, Asst. Mgr.

problem with this in that I am serious only a small part of the time. Thus, when people start taking everything I say or write seriously *they* have a problem. I tend to take advantage of this at times, I'm afraid.

I mentioned Dannals earlier . . . and one of his great charms for me is his total lack of humor. He takes everything I write or say seriously, so we get along superbly . . . hi.

## ST. LUCIA DELAY

In the May issue of 73 I mentioned that I was planning to get on the air from St. Lucia around the 16th and 17th of the month. Well, I got into trouble over commitments made for the TRS-80 Expo in New York the following

weekend. My magazine, *80 Microcomputing*, is the sponsor of the show, so I suddenly found myself with a bunch of television and radio appearances in New York starting the 18th to hype the computer show. Rather than cut my trip to St. Lucia to a couple of days, I decided to move it to the middle of June.

Even that date is going to be a bit tight for me since I will probably have to get over to Ireland to attend the opening of our Instant Software plant in Dublin sometime in June . . . and I was hoping to attend the yearly reunion of the crew of my old submarine, *USS Drum*, which is at Mobile, Alabama . . . tied up next to the battleship *Alabama*.

And, with a new computer magazine being readied for a

fall start, I will be needed more than a little at home. The new magazine, in case I haven't mentioned it before, will be aimed directly at businessmen and will be the first computer magazine to be published in English . . . rather than a subset of English known as computerese.

The new magazine has generated a good many problems . . . such as the need for about 50 people plus the space to put them. If you are ever up this way, stop in and marvel at how many people we are able to pack into a 230-year-old home . . . plus six other local buildings. The staff is up to 175 right now, with no end in sight.

At any rate, my plans are to get down to St. Lucia, rig in hand, and get on the air for a few

## Well . . . I Can Dream, Can't I?

by Bandel Linn K4PP



"You will create a magazine called 73 . . . In July, 1981, you will publish your 250th issue . . ."



# ICOM IC-290

The Latest State of the Art in 2 Meter Mobile



## 5 Memories/ Priority/ Scan/Squelch on SSB.

### FM Ease.

- Five memories + 2 VFO'S - store your favorite repeaters.
- Priority channel - check your most important frequency automatically.
- Programmable offsets - for odd repeater splits.
- 5 KHz or 1 KHz tuning.

### SSB/CW Convenience.

- Squelch on SSB - silently scan for signals.
- 2 VFO's with equalizing capability - mark you signal frequency with the touch of a button.
- RIT - receiver incremental tuning.
- 1 KHz or 100 Hz tuning.
- CW sidetone.
- AGC - selectable slow or fast in SSB and CW.
- NB - Noise blanker - suppresses pulse type noises on SSB/CW.

### Full Capability Scanning.

- Scan the whole band/scan between VFO's/scan memories and VFO's.
- Automatic stop and automatic resume scan after carrier drop or predetermined adjustable delay.
- Adjustable scan rate.
- 15 KHz or 5 KHz FM scanning steps.
- Stop on busy or empty channels.

### ICOM Performance.

- 143.8 to 148.199.9 MHz coverage.
- Remote tuning from optional HM 10 microphone.
- Digital frequency display - significant digits only.
- Hi/low power switch.
- LED indicators - REC/SND/PRI/DUP
- LED bar meter.
- Provision for retention of memory with optional NiCd battery system.
- Touch Tone® with optional HM8 microphone.
- Compact size - 6 11/16W x 2 1/2H x 8 5/8D.



2112 116th Avenue N.E., Bellevue, WA 98004  
3331 Towerwood Dr., Suite 307, Dallas TX 75234



114.8	2000	118.8	2100
110.9	841	123.0	2150
107.2	852	127.3	2200
103.5	1050	131.8	2250
100.0	770	136.5	2300
97.4	1000	141.3	2350
94.8	1800	146.2	2400
91.5	1600	151.4	2450
88.5	807	156.7	2500
85.4	1750	162.2	2550
82.5	1700	167.9	2600
79.7	1800	173.8	2650
77.0	1600	179.9	2700
74.4	1500	186.2	2750
71.9	1000	192.8	2800
67.0	800	203.5	2850
OFF			

Communications Specialists TE-64

# Food for thought.

Our new Universal Tone Encoder lends it's versatility to all tastes. The menu includes all CTCSS, as well as Burst Tones, Touch Tones, and Test Tones. No counter or test equipment required to set frequency-just dial it in. While traveling, use it on your Amateur transceiver to access tone operated systems, or in your service van to check out your customers repeaters; also, as a piece of test equipment to modulate your Service Monitor or signal generator. It can even operate off an internal nine volt battery, and is available for one day delivery, backed by our one year warranty.



- All tones in Group A and Group B are included.
- Output level flat to within 1.5db over entire range selected.
- Separate level adjust pots and output connections for each tone Group.
- Immune to RF
- Powered by 6-30vdc, unregulated at 8 ma.
- Low impedance, low distortion, adjustable sinewave output, 5v peak-to-peak.
- Instant start-up.
- Off position for no tone output.
- Reverse polarity protection built-in.

## Group A

67.0 XZ	91.5 ZZ	118.8 2B	156.7 5A
71.9 XA	94.8 ZA	123.0 3Z	162.2 5B
74.4 WA	97.4 ZB	127.3 3A	167.9 6Z
77.0 XB	100.0 1Z	131.8 3B	173.8 6A
79.7 SP	103.5 1A	136.5 4Z	179.9 6B
82.5 YZ	107.2 1B	141.3 4A	186.2 7Z
85.4 YA	110.9 2Z	146.2 4B	192.8 7A
88.5 YB	114.8 2A	151.4 5Z	203.5 M1

- Frequency accuracy,  $\pm .1$  Hz maximum - 40°C to + 85°C
- Frequencies to 250 Hz available on special order
- Continuous tone

## Group B

TEST-TONES:	TOUCH-TONES:	BURST TONES:
600	697 1209	1600 1850 2150 2400
1000	770 1336	1650 1900 2200 2450
1500	852 1477	1700 1950 2250 2500
2175	941 1633	1750 2000 2300 2550
2805		1800 2100 2350

- Frequency accuracy,  $\pm 1$  Hz maximum - 40°C to + 85°C
- Tone length approximately 300 ms. May be lengthened, shortened or eliminated by changing value of resistor

Wired and tested: \$79.95



**COMMUNICATIONS SPECIALISTS**

426 West Taft Avenue, Orange, California 92667  
(800) 854-0547/ California: (714) 998-3021

days to say hello to as many friends as possible. I'll QSL all contacts. Tim Daniel N8RK of the 73 staff will be along, as will Chuck Martin WA1KPS of Tufts Electronics. Since stopping his ads in 73, his business has slowed way down, so he figures he might as well take a vacation before running more ads and getting so busy he won't be able to leave.

I'll probably spend half of my time under water, scuba diving and taking pictures, and the other half hamming and adding a pound or two to my already substantial waist. I'll be looking for as many of you as I can contact on 20m, 15m, and possibly a bit on 10m and 75m. I like 20 the best.

### TURKS AND CAICOS

Unless you're a ham, it is unlikely that you've ever even

heard of these islands. After operating from there for a few days, I can assure you that about 75% of the hams don't know where they are either.

It all started out during the winter. Jeff DeTray, my Assistant Publisher/Editor, got struck with wanderlust and had cooked up a scheme to go to the Turks and Caicos Islands for the March DX contest. Tim Daniel N8RK, also of the 73 staff, was going, too, so they could operate around the clock as a multi-operator, single-rig station.

Having recently read a review in *Undercurrent* of the skin diving at Provo, the island to which they were heading, I invited myself along. What can you say when the boss invites himself on *your* DXpedition? The news was received with strained grace by Jeff and Tim. Jeff even

offered to send and get my license for me.

Tim and Jeff headed out a couple days early to get their contest station and antennas hooked up. I ran schedules with them on 15m to see how they were doing. They'd gotten VP5TDX for Tim and VP5JDT for

Jeff. They were not tickled with these calls, perhaps having hoped for something simpler for the contest, like VP5A. My ticket hadn't come through yet. Hmm.

Sherry, Chuck Martin, and I took off from Boston on March 5th, landing first in Miami... where I made a few contacts on



This is South Caicos Island... and fairly typical of the relatively uninhabited islands making up the group. There's an airport at the lower right.

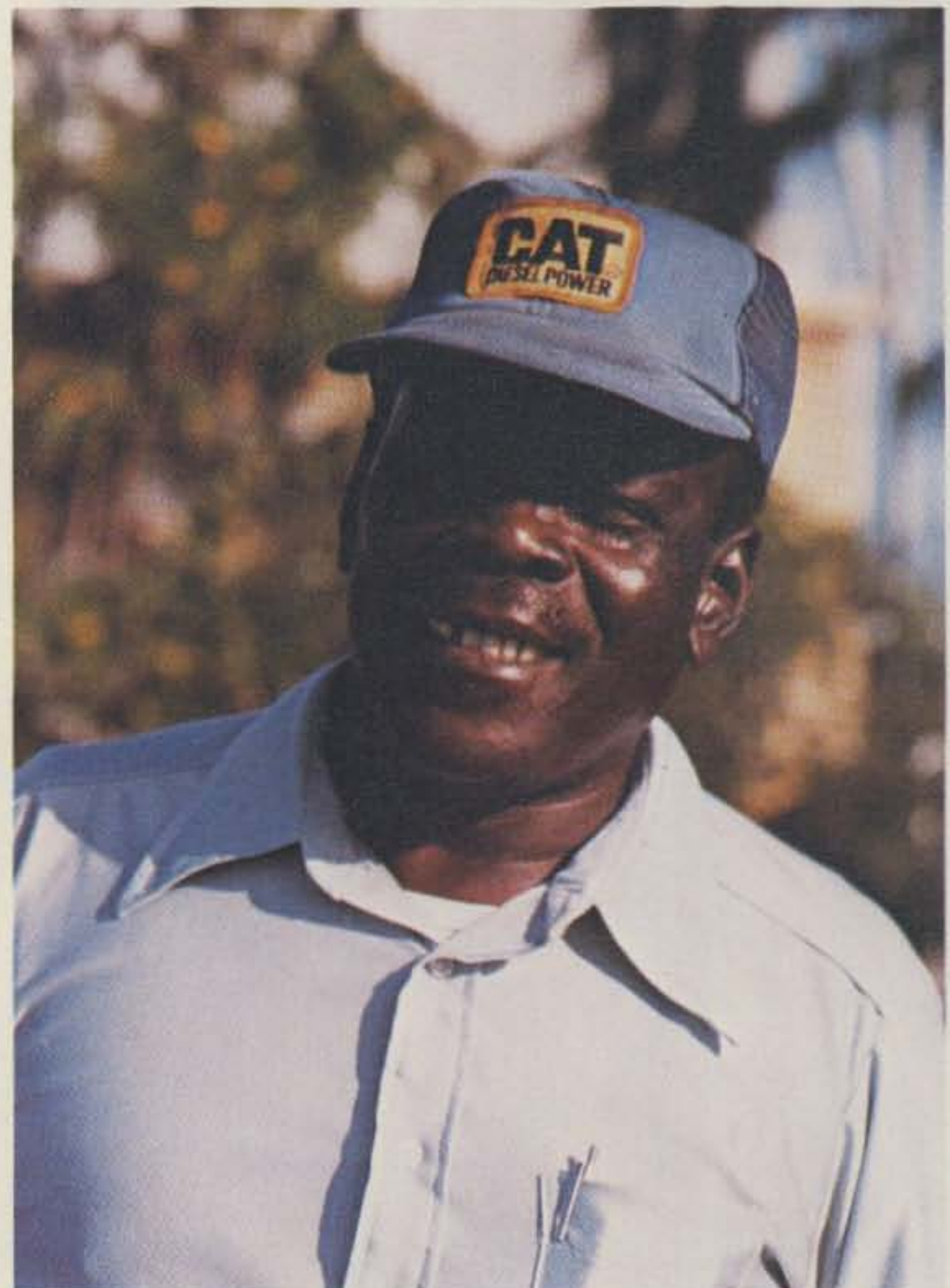

One of the cab drivers at Grand Turk is Art VP5AQ. We lucked onto Art when we zipped downtown between flights to check into our ham tickets. Chuck got his ticket (VP5KPS) and I'm still waiting for mine.



With hotel space for only a few dozen guests, the Turks and Caicos Islands are not yet a full-fledged mecca. With service by Air Florida, hotels are abuilding. Reciprocal ham tickets are relatively simple to get... if you do your homework ahead of time. The Grand Turk airport is a short flight out of Miami. They're just building the new terminal building.



This is the cottage where our contest station mowed 'em down. It's part of the Third Turtle Inn. I was lucky enough to have the room next to the contest station, thus not missing hearing a contact, even in the wee hours of the morning. After a couple of nights of that, I moved.

# Power Pair



**The amp with clout...  
and the tuner to handle it.**

**Heathkit SB-221 2kW Amplifier** has the power to punch your signal through. Rugged Eimac 3-500Z's deliver 2000 watts PEP and load to 1 kW in on both CW and RTTY. A broad-band, pre-tuned pi-input delivers maximum efficiency with extremely low distortion over the 80 to 15 meter spectrum. And now there's a tuner to put that power to efficient use.

**Heathkit SA-2060 Deluxe Antenna Tuner** puts you in complete control with continuous tuning in the 160 to 10 meter spectrum. Built-in dual wattmeter/SWR bridge makes tuning a snap. Bypass switch automatically disconnects tuner for dummy load or beam. It's a super tuner.

**Build-it-yourself and save.** Find out how easy it is to build it yourself and how much you can save. Send today for the latest **free** Heathkit Catalog or pick one up at your nearby Heathkit Electronic Center.\*



#### Send for free catalog

Write to Heath Company, Dept. 011-794,  
Benton Harbor, MI 49022

In Canada, contact Heath Co., 1480 Dundas  
Highway East, Mississauga, Ontario, L7R 2R7.

303

#### Visit your Heathkit Store

Heathkit products are displayed, sold and serviced at Heathkit Electronic Centers\* in major cities in the U.S. and Canada. See your telephone white pages for locations.

\*Units of Veritechnology  
Electronics Corporation in the U.S.



# Heathkit®

2m. Next we went via Air Florida to Grand Turk Island.

There was just a bit less than an hour between the time our plane arrived and when the

TCNA (Turks and Caicos National Airlines) plane was due to leave for Provo, so Chuck and I grabbed a cab and headed for town to see about our missing

ham tickets. It was one of those amazing coincidences when we found that our taxi driver was VP5AQ! He took us to the licensing office and we eventually got a gal to check through the license applications. Though Jeff had sent mine in a week before Chuck had sent his, they had absolutely no record of mine! The magistrate was out at the moment, but they said our licenses would be issued that day and mailed over to Provo for us.

would be glad to take us to Provo on a charter. His price was more than TCNA, but it seemed to be the only transportation, so we agreed. We began to have second thoughts when he told us that his was a small plane and that we would have to go without our bags... which he would pick up the first thing in the morning and bring over for us at six o'clock.



*Tim Daniel VP5TDX (N8RK/1) of the 73 staff, happily DXing away, racking up CW contacts... which are a lot of fun until QSL time arrives.*

We dashed back to the airport to catch the plane to Provo. We needn't have rushed so much. Despite confirmed reservations, when the plane was ready to load we were told that they had just two seats left... which of us would volunteer to wait until the next day? We looked at each other, but were unable to discover any volunteers.

A fellow named Harold came up and said he had a plane and

Oh well... if we don't go this way we'll have to find a place to stay on Grand Turk and be delayed a whole day in getting to Provo. We were not all that encouraged about this part of the adventure when Harold rolled his plane out of the hangar and backed a car up to it for a jump start. We piled into the Piper and were off, heading about 50 miles across the water to Providenciales Island at the far end of the Turks and Caicos group... and the Third Turtle Inn.

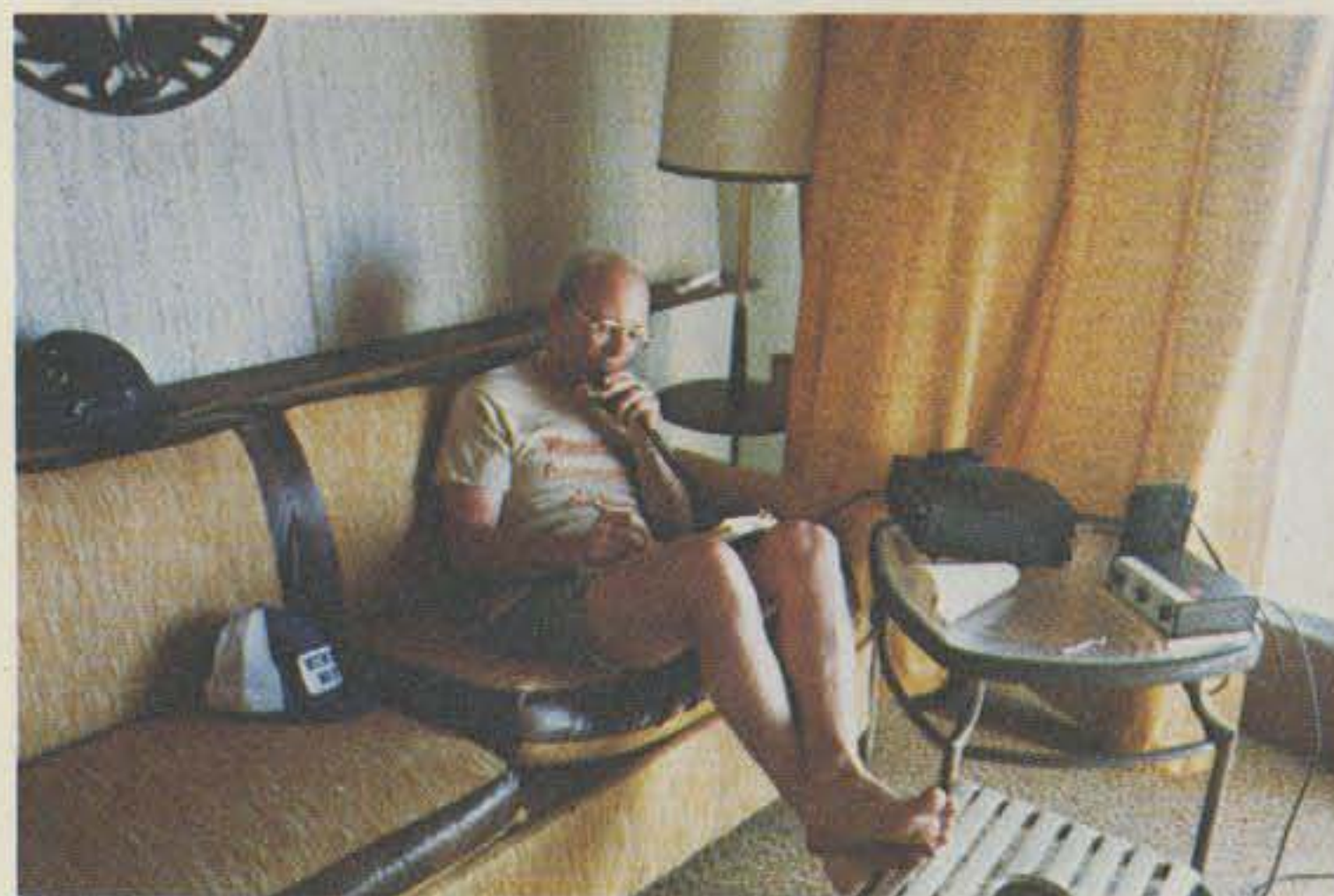

*It doesn't take much of a setup to work a lot of DX. This simple station, operated in between scuba diving trips, leisurely meals, exploration, and a lot of local rag-chewing, still managed over 2,000 QSOs in a couple of days. That's Chuck sitting back in his "Wherein-the-hell's Providenciales?" tee shirt. My W2NSD hat is on the couch.*



*This is the Latitude 22 hotel, right next to the Third Turtle Inn. Chuck set up his VP5KPS station there... in the end cottage. Even with a simple traveling dipole, he got out on all bands. Next time... an amplifier and a beam!*



*Here I go, over the side, with my scuba gear, down to take some pictures. The GREEN TEAM tee shirt comes from the company volleyball team, the Peterborough winners this year, coming from behind to wipe out Byte and all of the other volleyball teams.*



*The scenery underwater is even more magnificent than that above. We went diving down the sea wall of coral which started from a bottom of about 50 feet and went down far beyond the depth of my new Casio 100m watch... which flooded out at 85 feet. Tsk.*

OMNI-C has what it takes to filter the crowds. To narrow the Amateur Radio world right down to the particular signal you want. The selectivity, sensitivity, dynamic range and operational features you need to cut any crowd down to size. **Tailored i-f response.** OMNI is equipped with the potential for *seven* response curves to handle any listening situation.

Standard filters include an excellent 8-pole 2.4 kHz crystal ladder filter and, in addition, a 150 Hz active audio cw filter with three ranges (450, 300, 150 Hz).

Optional filters include 1.8 kHz 8-pole crystal ladder ssb filter, 500 Hz 8-pole cw filter, and 250 Hz 6-pole cw filter.

Front panel switches put any optional filter in series with the standard filter for up to **16 poles of filtering** for near ultimate skirt selectivity.

Four i-f response curves for ssb and three for cw. That's response tailoring, that's crowd control.

**Optimized sensitivity and dynamic range.** The OMNI sensitivity range of 0.3  $\mu$ V typical (slightly less on 160 & 80M) combines with a 90 dB dynamic range to provide an ideal balance that will handle any situation from copying a weak signal half way 'round the world to keeping the next-door kilowatt from muscling in. And a PIN diode switched 18 dB attenuator is included for extra insurance against overload.

**More crowd-handling features—and all standard equipment.** **Built-in notch filter.** To drop out unwanted signals or carriers. Tunable from 200 Hz to 3.5 kHz, with a 50 dB notch depth.

**3-mode, 2-range offset tuning.** To put you where the others aren't and where the elusive DX is. Move just the OMNI receiver, or just the transmitter section, or the entire transceiver,  $\pm 500$  Hz or  $\pm 4$  kHz. For complete freedom of frequency movement to get away from the crowds.

**Built-in noise blanker** for those times when your noise-generating neighbor is crowding your receiver. Filtered to handle the big signals easily.

**2-speed break-in.** When QRM or QRN is heavy, switch to "Slow." Use "Fast" for instant, full break-in for enjoyable rag-chews or stalking DX. **OMNI-C features stand out in any crowd.** **All solid-state**—from the pioneer, Ten-Tec.

**Built-in noise blanker** for those times when your noise-generating neighbor is crowding your receiver. Filtered to handle the big signals easily.

**2-speed break-in.** When QRM or QRN is heavy, switch to "Slow." Use "Fast" for instant, full break-in for enjoyable rag-chews or stalking DX. **OMNI-C features stand out in any crowd.** **All solid-state**—from the pioneer, Ten-Tec.

**OMNI-C features stand out in any crowd.** **All solid-state**—from the pioneer, Ten-Tec.

**All solid-state**—from the pioneer, Ten-Tec.

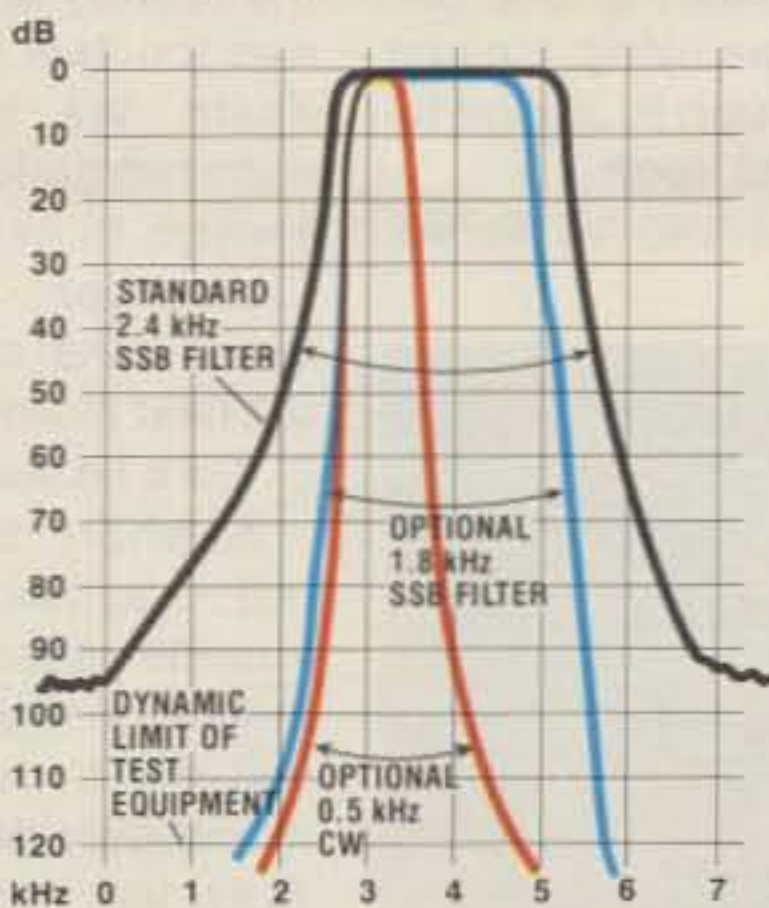

OMNI/SERIES C I-F RESPONSES WITH STANDARD AND OPTIONAL FILTERS.

**"Hang" AGC** for smoother action. **WWV reception** on the 10 MHz band. **Digital readout in two colors**, red for the 5 significant places, green for the 6th digit (100 Hz). Instant recognition.

**Separate receiving antenna capability.** Switch receiver to a common antenna for transceive or separate receive-only antenna; the system also acts as receiving antenna by-pass with an instant break-in linear amplifier or transverter.

**"S"/SWR meter**, electronically switched. **200 watts input, all bands**, with 50-ohm load. 5 year pro-rata warranty.

**100% duty cycle** on all bands up to 20 minutes. Full RTTY and SSTV power.

**Built-in VOX and PTT** with front panel controls.

**Built-in phone patch jacks** for easy interface.

**Built-in zero-beat switch** for spotting the exact frequency of a DX station.

**Built-in adjustable sidetone volume and pitch.**

**Adjustable threshold ALC**, optimum power for driving a linear. Provides means of working into a high SWR.

**Front panel control of linear or antenna.** The rear panel bandswitch terminals control relays or circuits in step with front panel band-switch.

**Automatic sideband selection** plus reverse.

**Low distortion audio**, less than 2%; a Ten-Tec trademark.

**Clean signal**, exceeding FCC requirements.

**High stability** over wide temperature and voltage excursions.

**Built-in speaker**, compression-loaded; in bottom of cabinet.

**Plug-in circuit boards** for fast easy service.

**12-14V dc power** for easy mobile use.

## The Rig That Filters The Crowd



## TEN-TEC OMNI-C

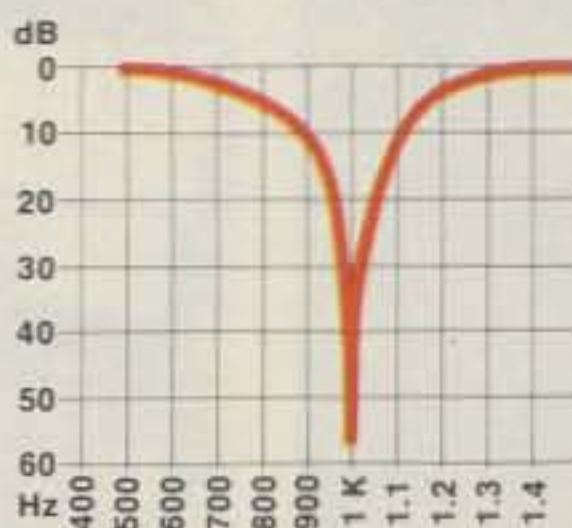

NOTCH FILTER PERFORMANCE ADJUSTED TO 1 kHz POINT.

All 9 hf bands—only crystals are needed for 18 and 24.5 MHz bands.

**Broadband design** for instant band change without tune-up or danger of damage to the final amplifier. Another Ten-Tec original.

### Full complement of accessories:

Model 280 Dual Primary AC Power Supply, \$169; Model 255 Deluxe Power Supply/Speaker Combo, \$199; Model 243 Remote VFO, \$189; Model 215 PC Microphone, \$34.50; Model 214/234 Microphone/Speech processor, \$39/\$139; Model 645 Dual Paddle Keyer, \$85; Model 670 Single Paddle Keyer, \$39; Model 227 Antenna Tuner, \$79; Filters \$55 ea.

Made in the U.S.A.

Model 546 OMNI-C transceiver \$1289

Get out of the crowds with OMNI-C. See your TEN-TEC dealer or write for details.

**TEN-TEC, INC.**  
SEVIERVILLE, TENNESSEE 37862

I'm game for anything, so I didn't worry. That's one of the main reasons I got rid of my own plane when I first was starting *73 Magazine*. I knew that if I continued to fly I would sooner or

later finish myself off. I had a lot of adventures during the two years or so I was flying. I'm just not careful enough to survive indefinitely at that sport.

When we arrived at Provo,

Harold bounced the plane down the runway and we piled out. It was too dark for him to take off again. We arrived with perhaps two gallons of gas left, just enough to get to South Caicos . . . perhaps. Oh well, Harold would take care of everything the next morning bright and early. Sure he would.

A short taxi ride to the Inn . . . a taxi ride in these islands seems to cost \$10 minimum if you haggle, \$25 if you don't. Jeff and Tim were moderately delighted to see us. They, too, had had to charter a flight to Provo, though they managed to get a more professional pilot. We found out later, from a TCNA pilot, that Harold

had no license, his plane was not certified. . . and he had no insurance. Ooops!

The Inn and Provo are absolutely gorgeous. The weather is gorgeous. The ocean and beaches are gorgeous. Flowers are everywhere. It soon became obvious that Jeff had no intention of letting loose of his mike for anyone . . . he was in ham heaven . . . in a rare country with the bands piled high with stations calling. I mumbled about one of the rigs being from my ham shack . . . he didn't hear me. Luckily Chuck had packed an extra rig, which we eventually got on the air . . . otherwise I might have had to do Jeff serious bodily damage.



The dish and studio building of WIV. The antennas pick up TV from Miami during openings. They also send the satellite signals via channel 7 to a hilltop, where a solar-powered transmitter rebroadcasts on channel 4 for the whole island. It's free for now, but Bob intends to encode the signals and charge . . . much like cable TV.



This 20' dish is outside the new WIV television studios. Yes, I know they can't use a "W" prefix in Turks and Caicos. Their answer: "Who says so?" We arrived on a very unusual day . . . when the sun was exactly behind the satellite, thus creating a good deal of sun noise on the signal. Notice shadow of the LNA (low-noise amplifier) in the exact center of the dish. It happens about once a year. That's me, Coop, and Chuck, with Sherry carrying my camera bags.



Here are some of the monitors, switching, and other paraphernalia needed to put on a professional television broadcasting service.



The video recorders can furnish programs when the satellite channels are barren, which is seldom. They do allow television programs run at weird times to be sent during prime time. The station receives the satellite signals, converts them to channel 4, and rebroadcasts them for the island populace. When the station is complete, they will be able to put on locally-done programs as well as satellite and video tape programs.



The TV studio is, for the time being, the kids' playroom and living room for Bob and his family. Once the house is built next door, they will move there and be able to put on live TV from this studio. Talk about living in a goldfish bowl!



# The CT2100 Communications Terminal

HAL COMMUNICATIONS CORP

NEW PRODUCTS

DATE: 1-26-81

SCALE: 1/2

DRN BY: GWH  
APP BY: PTT

No: B1251

*Available  
July 1981*

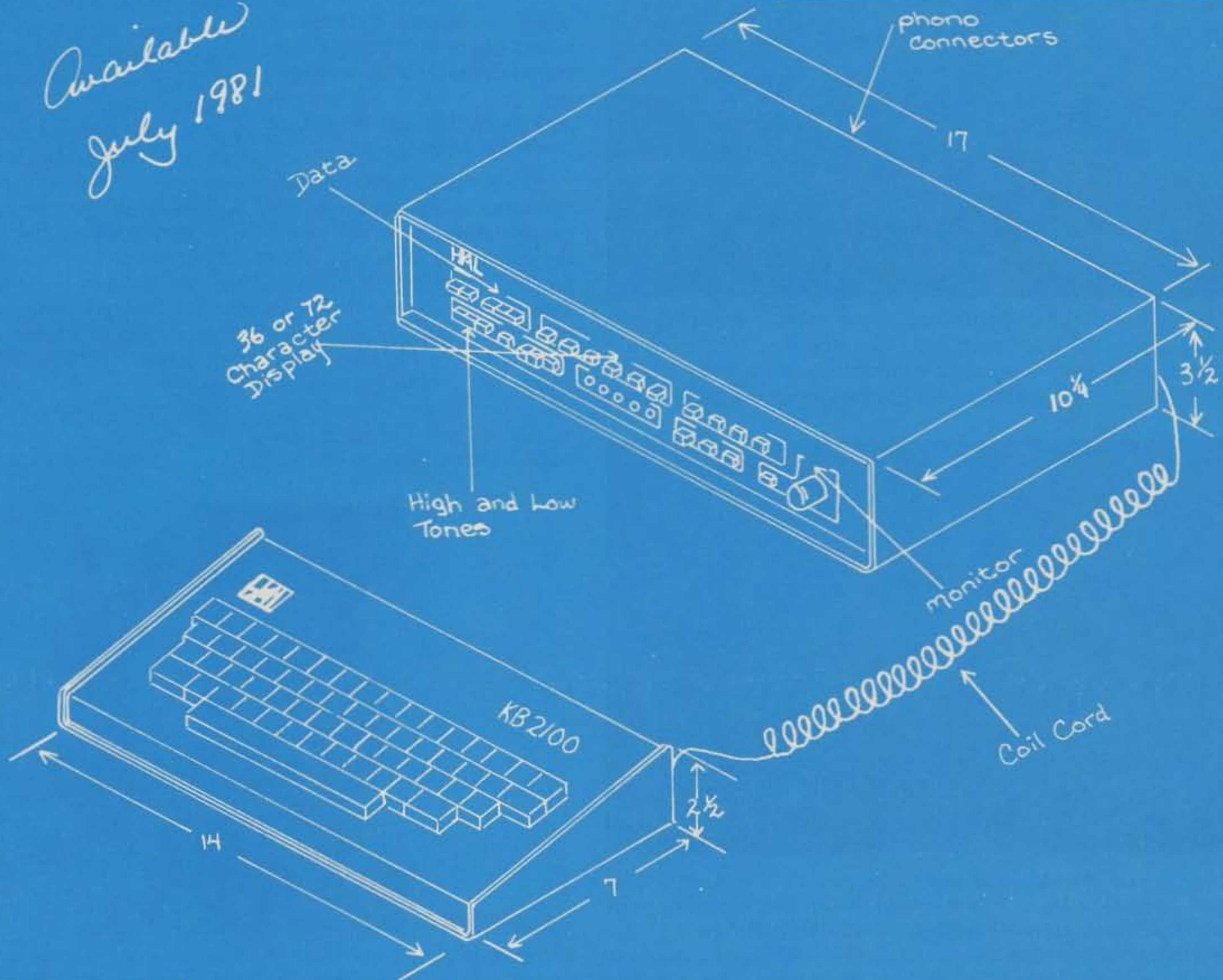

## SPECIFICATIONS:

- Two cabinets - basic CT2100 plus separate KB2100 keyboard.
- RTTY and Morse demodulators and video circuits included in CT2100.
- Small keyboard size; connects with one "coil-cord" for popular "lap operation".
- Streamlined CT2100 cabinet is attractive and small - may also be rack mounted.
- Satin finish black vinyl front panel with multicolor graphics.
- 26 control switches; red for "primary" and blue for "secondary" controls.
- 16 rear panel connectors - standard phono connectors.
- On-screen tuning indicator, LED indicators, and external scope connections.
- LED indicators for mark, space, cw tune, RTTY tune, audio overload, and KOS.
- CT2100 demodulates, decodes, and displays received Morse and Baudot or ASCII RTTY.
- CT2100 with KB2100 transmits and receives Morse, Baudot, or ASCII.
- Morse receive circuit tracks speed and minor frequency variations; 5 to 100 wpm.
- Morse transmit 5 to 100 wpm; key negative or positive key lines.
- Baudot or ASCII data rates of 45, 50, 57, 74, 100, 110, 150, 300, 600 or 1200 baud.
- Internal RTTY demodulator for both "high" and "low" RTTY tones plus two sets of modem tones (1070/1270 Hz or 1200/2200 Hz). Narrow shift CW ID included.
- All three RTTY shifts (170/425/850 Hz) for both "high" and "low" tones.

- Input/output connections for audio, tape recorder, RTTY loop, or RTTY RS232 data.
- RTTY mark-hold autostart, normal/reverse, full or half duplex, KOS transmit control.
- Large character (36 per line) or standard display (72 characters per line).
- White characters on black screen or reverse video.
- Two pages of receive display.
- Split screen for transmit buffer - pretype WHILE receiving.
- Two user-programmable 32 character HERE IS messages.
- Eight non-volatile 250 character EPROM stored brag-tape and HERE IS messages.
- Serial printer output prints all received text, Morse, Baudot, or ASCII.
- Built-in 120/220 50/60 Hz power supply.
- Receive-only users need only the CT2100 - add the KB2100 for transmitting later.

### LOW COST!

CT2100 Receive Only Communications Terminal . . . . .	\$845.00
KB2100 Transmit Option Keyboard . . . . .	\$175.00
ESM914/TR930 TV Monitor - 9" . . . . .	\$169.00



HAL COMMUNICATIONS CORP.

Box 365 <sup>✓345</sup>  
Urbana, Illinois 61801  
217-367-7373

We settled down to dinner...which was fine. The prices were scary, particularly for a registered skinflint like me.

I never really was able to relax and forget the money those damned meals cost. Hoot mon! But then nothing is cheap in



*This is the view out of the front of the Cooper establishment. Miles of perfect beach. Oh well, it probably won't be long until there are hotels from one end of the beach to the other. The government owns the beach and it will always be kept public, which is a good move.*



*Providenciales (Provo) looks weird from the air. There are access roads all over the place. The idea is to sell vacation home sites, so they have already put in the roads. It's a little difficult to get to... but not impossible. You have a fantastic climate year 'round... some of the best swimming you can ask for... remoteness. You get your water from catchments on your roof or in the yard and keep your water in a cistern under your house.*



*This is Tim, resting up a bit during lunch. I never did get pictures of Jeff, who just wouldn't leave the rig, even for meals. Note the ever-present HT.*

these islands. Power runs 35¢ a kWh, to give you an example. And I mentioned the two-mile \$10 taxi rides.

The next morning, dressed in my suit since my island clothes and bathing suit were still over on Grand Turk, we sat around and talked ham radio, ate a very expensive breakfast, and leisureed. Along about 10 am I talked Chuck into going to the airport to see if our bags were in yet...six o'clock, you remember? That's the last we saw of Chuck until dinner time.

It turned out that Harold was still hanging around. Chuck got him going and went with him in the death ship to South Caicos for gas...and then on to Grand Turk for the bags. While he was there he pooped downtown again and got his ham ticket. There was nothing there for me... thanks, Jeff. So eventually VP5KPS and our bags were back in the air, heading again to

Provo. They made it, against rather stiff odds. Chuck mentioned having to fix the compass in the plane and that the radio went out during the trip. Lot of water down there.

The next morning Chuck had his rig set up, but the scuba trip was about to leave, so Chuck, Sherry, some other guests, and I headed out to the reefs in a small power boat. I had my diving gear and a Nikonos IV camera along. It was very rough going...and the trip took over a half hour. The nervous part was when we had to go over the reef. We had to wait for just the right wave and go with it over the reef so we wouldn't get stuck on it and perhaps lose the boat. This drama did not help Sherry, whose complexion was beginning to match her GREEN TEAM tee shirt.

Nothing bothers me, so I

*Continued on page 120*

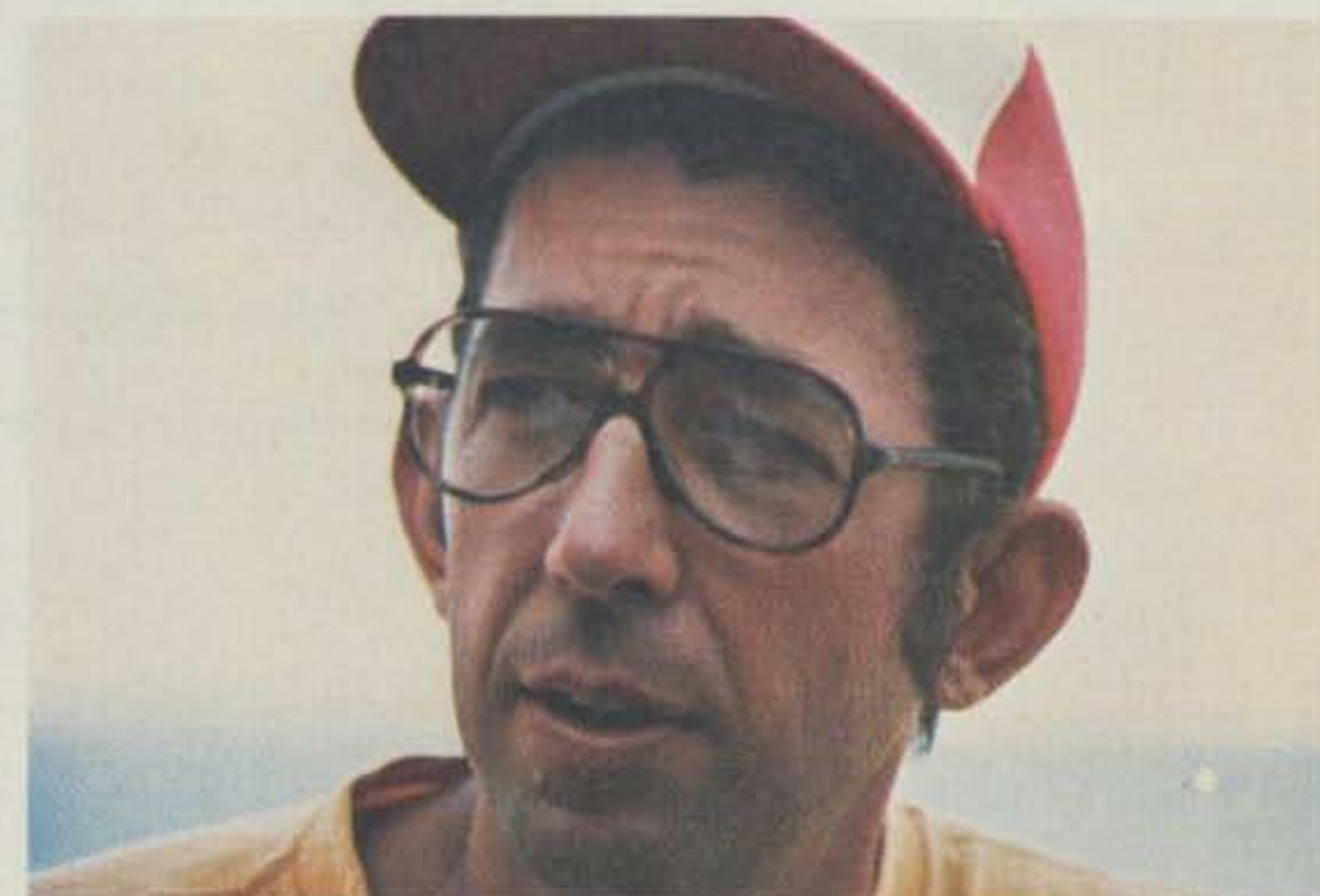

*Bob Cooper VP5D. Bob is one of the pioneers of the home reception of satellite television. His monthly publication, Coop's Notes, is the main source of information for the field. Bob's been at this longer than anyone else and is the guru of satellite TV.*



*Chuck Martin VP5KPS/WA1KPS, the owner of Tufts Electronics, the largest ham store in New England and, if ham sales continue to drop and force others out of business, perhaps the largest in the east.*

# A superb frequency counter is frequently not counted—just because it doesn't have a high price-tag.



The truth is, our 8000B is an excellent 1 Gigahertz frequency counter. In fact, it's preferred by many engineers, technicians, and electronic enthusiasts. Not a single competitor on the market today can surpass our price/performance ratio.

And we've deliberately kept our prices down. First, we've refused to join everybody else in their high mark ups. Instead of "charge what the market will bear," for us it's "charge a fair price." Second, we sell what we manufacture, directly to you. So extra costs of extra steps are automatically eliminated. Third, we have to build a lot of frequency counters to meet the demand. Because we do sell so many, we don't have to charge a high price to make a profit.

And about quality . . . Sabtronics frequency counters always have the most innovative features available. For example, our 8000B 1 Gigahertz Frequency Counter has a 10 Megahertz precision crystal timebase. But most important, the 8000B, using the most advanced LSI circuitry, has a guaranteed sensitivity of 30 millivolts up to 1 Gigahertz, with 20 millivolts typical. The three-stage differential amplifier IC makes this possible. Altogether, the 8000B uses only 6 IC's, making the chance of failure virtually nonexistent.

Three selectable gate times provide the measurement speed you need — and greater resolution. The resolution is further enhanced by our counter's 9-digit display.

Like the 8000B, Sabtronics' 8610B is a high-quality precision frequency counter. It features only 4 IC's, and offers a frequency range up to 600 Megahertz.

For more critical requirements, you can order either model with an optional TCXO timebase with a stability of 0.5 ppm at 0° — 45°C.

The cases of both counters are high strength impact-resistant ABS plastic. Elegant but very rugged. Sabtronics doesn't believe in skimping on the high quality construction that brings excellent performance. But we're not about to charge a high price just because we could get it!

## BRIEF SPECIFICATIONS:

**Frequency Range:** 20Hz to 1 GHz (Model 8000B), 20 Hz to 600 MHz (Model 8610B); **Timebase:** Frequency: 10 MHz, Stability:  $\pm 1$  ppm (18 to 28°C.), Aging Rate:  $< 1$  ppm/year; **Sensitivity** (adjustable): Input A  $< 15$  mV to 100 MHz, Input B  $< 30$  mV, 100 MHz to 1 GHz (Model 8000B),  $< 30$  mV, 100 MHz to 600 MHz (Model 8610B); **Gate Times:** .1 sec., 1 sec., 10 sec.; **Resolution:** 0.1 Hz to 10MHz, 1 Hz to 100 MHz, 10 Hz to 1 GHz; **Display:** 9-digit LED 0.4"; **Power Requirements:** 4.5 to 6.5 VDC (4 C-cells) or optional AC adapter; **Dimensions:** 8" wide X 6.5" deep X 3" high (203 X 165 X 76 mm), 1.3 pounds (590 g) excluding battery.

Making Performance Affordable

**sabtronics** INTERNATIONAL INC. 

Sabtronics International, Inc., 5709 N. 50th Street, Tampa, FL 33610, (813) 623-2631.

Please send me the following:

<input type="checkbox"/> Model 8000B 1 GHz Frequency Counter(s), Assembled @ \$239.00 each	\$ _____
<input type="checkbox"/> Model 8610B 600 MHz Frequency Counter(s), Kit @ \$169.00 each	\$ _____
<input type="checkbox"/> Optional 0.5 ppm TCXO for either model @ \$79.00	\$ _____
<input type="checkbox"/> AC120 AC Adapter (120V/60 Hz input) @ \$10.00	\$ _____
Shipping and handling, \$6.00 per unit*	\$ _____
10% deposit for C.O.D. orders	\$ _____
Florida residents add 4% Sales Tax	\$ _____

I enclose  check  money order. (Allow two to three weeks for personal checks to clear.)

Charge:  Visa  Master Charge

Account No. \_\_\_\_\_ Exp. Date \_\_\_\_\_

Name \_\_\_\_\_

Address \_\_\_\_\_

City \_\_\_\_\_ State \_\_\_\_\_ ZIP \_\_\_\_\_

\*U.S. only. Canada \$7.50; overseas air mail \$25.00.

Prices subject to change without notice.

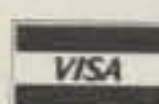

# Save

# \$571<sup>75</sup>

## On this Gigantic Package Deal from

316

# TELEX<sup>®</sup>

# hy-gain<sup>®</sup>

## TH5DX Thunderbird

5 elements—superb gain and front-to-back ratio on 20, 15 and 10 meters.

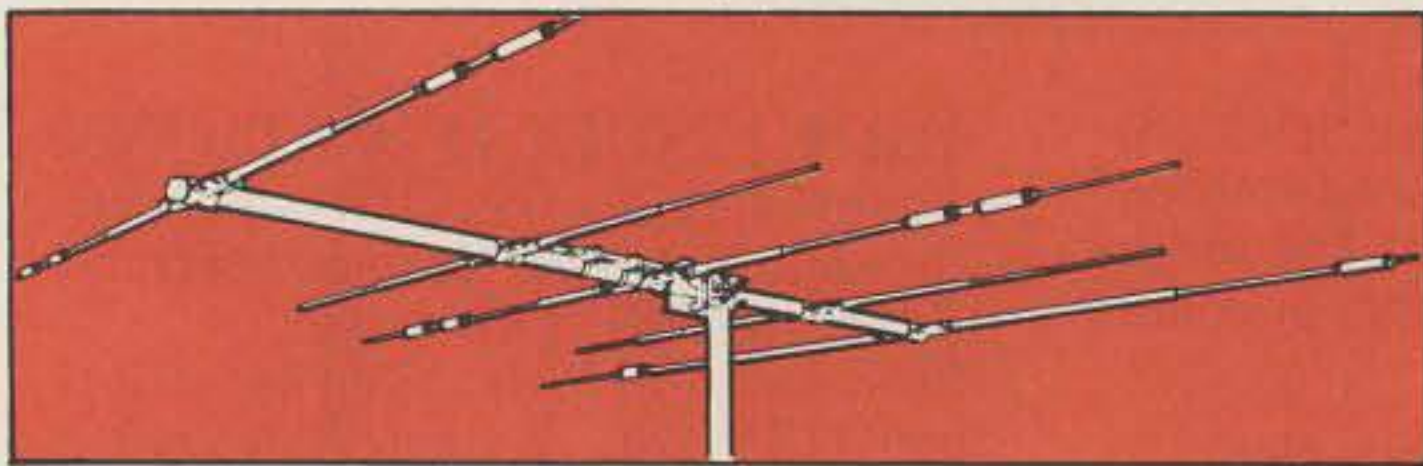

The installation of a ham's first directional antenna system is a memorable event because of the substantial improvement in the capability of the station. You really have to experience using a directional array at your station to appreciate the thrill of improved performance.

A Hy-Gain TH5DX can do more for operating pleasure than an expensive new state-of-the-art receiver and maximum power amplifier combined. The TH5DX is the result of 25 years of experience in designing and building multi-band beams, and represents a focused effort to optimize performance and reduce size. Hy-Gain Beta Match provides dc ground, optimizing energy transfer to the antenna. Air dielectric Hy-Q traps have also been used. The elements are taper swaged to reduce tubing diameter and weight which greatly reduces wind load.

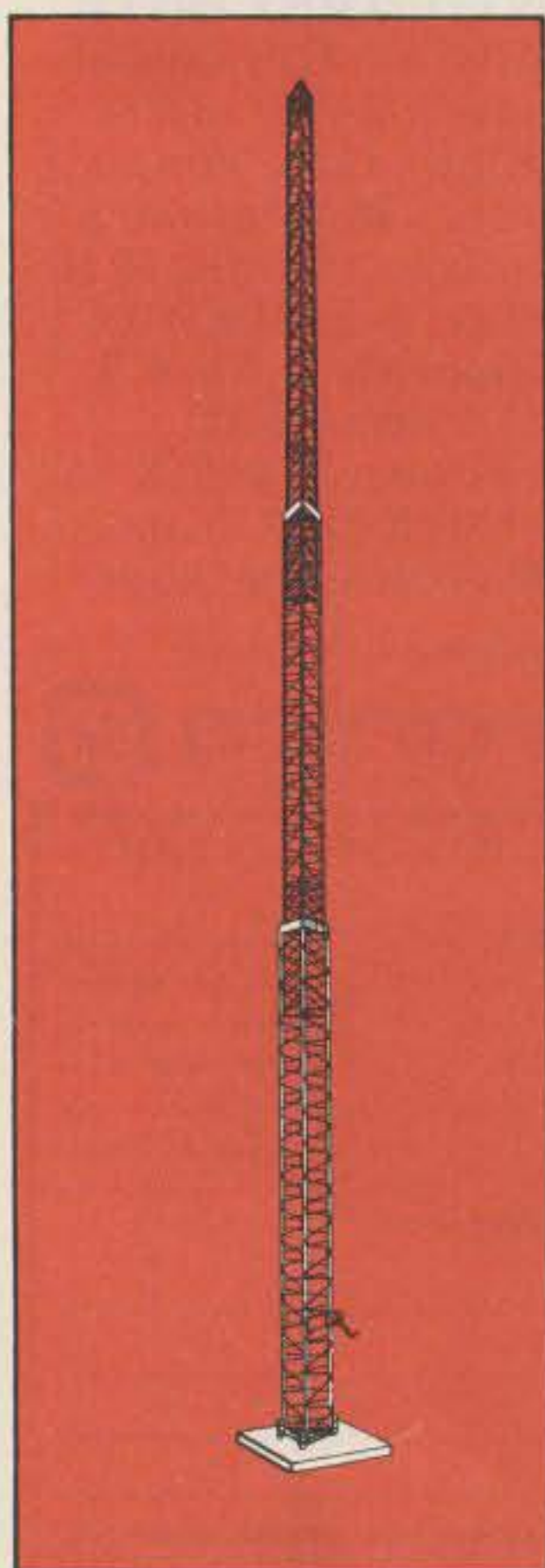

## HG52SS

### Self-Supporting Crank-Up Tower

This all steel crank-up tower has an improved guide system which provides a rigid close-tolerance structural support. The ends of the tubes are left open to allow complete hot dipped galvanizing of both inside and outside surfaces after welding as well as unrestricted moisture drainage. It comes complete with base mount and rotator mounting plate and requires no guying. It stands 52' (15.8 m) extended and retracts to 21' (6.4 m).



## 2DBQ

### Trap Doublet for 40 and 80 meters

This Hy-Q trap doublet provides true half-wave length performance on both frequencies featuring individually pretuned matched traps for each band. Traps are large diameter for exceptionally favorable L/C ratio and power handling ability.

## HDR300

### Heavy Duty Rotator



This is a commercial/industrial grade rotator with enough reserve strength to easily rotate the TH5DX and more. The good-looking control console features a digital azimuth readout accurate to  $\pm 1^\circ$ .



## PLUS!

One HG10 Heavy duty 10 foot mast (enough mast to stack a vhf with the TH5DX)  
 Three HGCOA Coax extension arms  
 Two BN86 Broad band Ferrite Baluns

# Here's what you get!

Model No.	Description	Ham Net Price
HG52SS	Crank-up Tower	990.00
TH5DX	Tri-Band Antenna	289.95
2DBQ	Trap Doublet for 40 to 80 meters	59.95
HDR300	Rotator	499.95
HG10	10 foot mast	56.00
HGCOA	Coax Arms (3)	39.00
BN86	Baluns (2)	31.90

Total Ham Net Value 1,966.75

You Pay Only 1,395.00

**YOU SAVE 571.75**

## PLUS FREE DELIVERY

This once-in-a-lifetime package deal is available for a short time only (expires August 31st). Simply contact your favorite participating Hy-Gain Amateur Distributor and ask for the Super 5-Bander Promo and the complete package will be delivered to you promptly with NO DELIVERY CHARGE! Free delivery is offered for shipping points within the contiguous 48 United States only. Offer is extended through participating Telex/Hy-Gain distributors only.

**ACT NOW!**  
Offer expires  
**August 31st**

**TELEX** **hy-gain**

TELEX COMMUNICATIONS, INC. ✓ 316

9600 Aldrich Ave. So., Minneapolis, MN 55420 U.S.A.  
Europe: 22, rue de la Légion-d'Honneur, 93200 St. Denis, France.

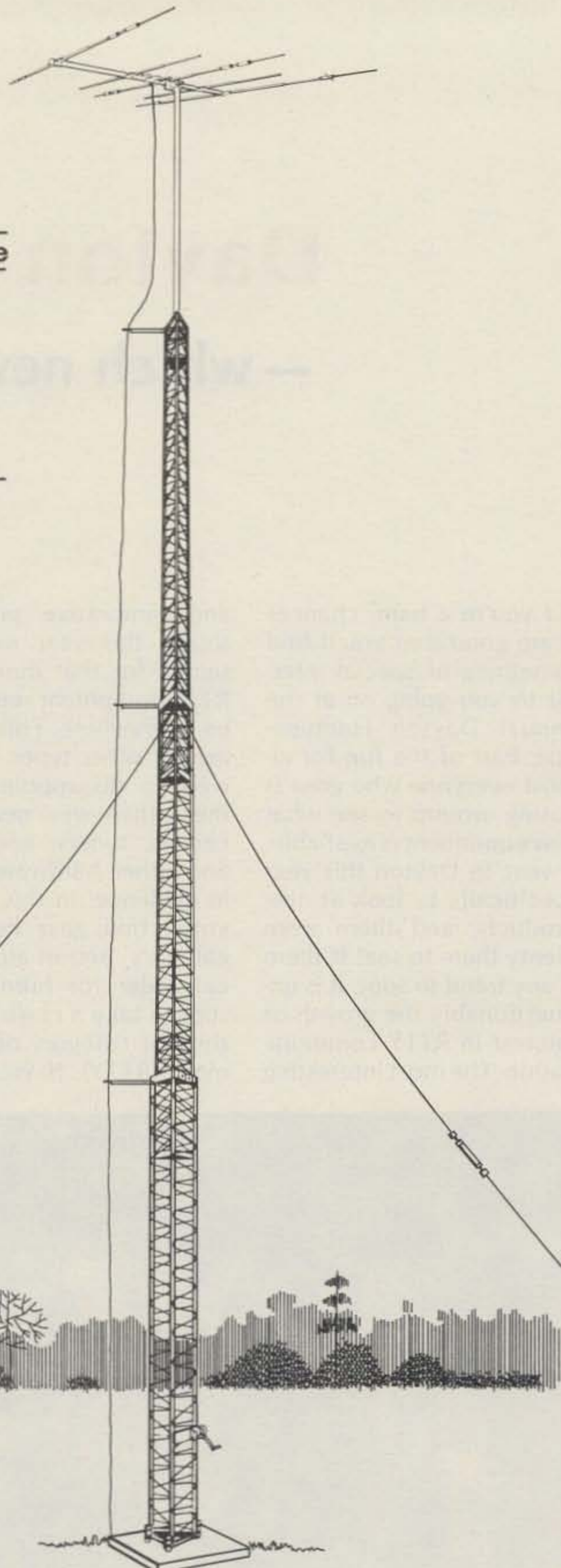

# Dayton Dilemma '81

## — which new gear do you buy?

If you're a ham, chances are good that you'll find something of special interest to you going on at the annual Dayton Hamvention. Part of the fun for almost everyone who goes is nosing around to see what new equipment is available. I went to Dayton this year specifically to look at new products, and there were plenty there to see! If there is any trend to spot, it is unquestionably the growth of interest in RTTY communication. The most interesting

and innovative products shown this year were designed for that mode, and RTTY equipment seemed to be everywhere. Folks looking for other types of gear weren't disappointed either—there were new transceivers, tuners, amplifiers, and other hardware much in evidence. In this article, you'll find gear listed by category, and in alphabetical order for fairness. Be sure to take a close look at the last category of equipment (RTTY). If you're not

interested in RTTY yet, there are a lot of manufacturers out there who are after your attention.

Of course, deciding what is new and what isn't can be a formidable task. We decided to include only those products that were first announced at Dayton or announced just a few weeks previously. If you know of something that should have been included but wasn't, please accept our apologies—the decision of the 73 judges is final. Enjoy!

### New Rigs

Starting with the most esoteric, Advanced Receiver Research of Burlington CT was showing the TR10GA, a 10-GHz full-duplex FM/CW transceiver with provisions for an internal or external gunplexer. The transceiver requires 13 V dc at 0.5 Amps, and is equipped with a tripod mounting ring.

Cubic Communications was showing a rig to cause the most jaded DXpeditioner's heart to flutter—the Astro-C HF SSB transceiver designed for commercial and military use. At \$8000 it's not for everyone, but in all seriousness, it may have a few things going for it. The thing is built to take abuse and, in the words of the manufacturer, is designed for "...continuous operation in the severest of environmental conditions." The front panel offers a waterproof and blast-protected speaker, a few knobs, a key pad for function selection, and an LCD readout to keep you informed of what the transceiver's microprocessor controller is up to. 10 memories are maintained by a lithium battery with a



Dayton '81!



Cubic's Astro-C.



The new Icom 730.

projected life of ten years! No need to carry a remote vfo either—split operation is a snap. Frequency coverage is from 1.6 to 30 MHz, in 100-Hz steps, in your choice of SSB, CW, AM, and RTTY. Power output is 100 Watts SSB/CW and 25 Watts AM. In case you are wondering, the Astro-C is not just a 102BX in olive drab—the 7" × 17" × 17" 42-pound beast is designed to bring high performance to the battlefield. Planning a DXpedition to Spratley Island? This has got to be the ideal rig!

A little more conventional is the DenTron HF-200D HF transceiver, shown in prototype form and slated for release sometime this summer. Hopefully the new digital readout will help this rig fare better than DenTron's previous efforts in the field.

For a lot of us, the Icom IC-730 stole the show. By now you've seen the pictures. I spent about half an hour experimenting with the controls, using the minimal antenna that Icom had plugged into it at the show. I was very impressed. I'm a confirmed audio nut and the receiver audio quality seemed to be better than what the IC-701 provides. Whatever you think of the novel configuration of the i-f shift, you'll have to admit that it functions beautiful-



# 2300

MHz

CONVERTER KIT.....	\$38.50
<small>COMPLETE WITH PC BOARD, PARTS, AND 10 PAGE BROCHURE</small>	
COMPLETE BOARD.....	\$65.00
<small>ASSEMBLED AND TESTED</small>	
POWER SUPPLY.....	Kit \$19.50
<small>(PLASTIC BOX)</small>	
POWER SUPPLY.....	Kit \$21.95
<small>(DELUXE ALUMINUM BOX)</small>	
CIGAR ANTENNA.....	\$28.50
<small>33 ELEMENTS, PHYSICALLY STRONGER THAN LOOP YAGI. EQUAL IN GAIN.</small>	
MRF 901 TRANSISTORS.....	\$2.75 each
BOGNER COMMERCIAL-QUALITY ASSEMBLED UNITS.....	\$188.00 each
SUBVERTER #1—The ultimate in converters, with dual-stage selective preamp, mixer, I-F amp, xtal-controlled oscillator (no drift); better than any commercial unit ever seen.....	\$109.95 each
SUBVERTER #2—Consists of our proven stopsign board converter with added-on preamp; complete kit.....	\$79.95 each
SELECTIVE PREAMP—Unlike some of the wide-band preamps you have seen (this one works with any converter). Will add on our existing board. Bring your converter up to date.....	\$49.95 each

COMING SOON—COMPLETE SATELLITE TV RECEIVERS WITH ALL ACCESSORIES... ASK

The **stopsign** board was developed at our lab for optimum performance at low cost. Although this is the most copied board around—we can say with pride that we don't have to copy other people's products to stay ahead. We are the leaders!

---

TERMS: COD—MO, BANK CARD, CHECK      HOURS: 8:30 AM—4:30 PM C.S.T. M.—F.



## 800-433-5172

TELEPHONE ORDERS ONLY



---

P.O. BOX 339S, ARLINGTON, TEXAS 76010  
817-265-0391



Santec's 440-MHz HT.

ly; it should be love at first sight for CW addicts! The 730 continues the Icom tradition of packing the maximum number of useful features into a small package. The layout is one of the most functional I have seen and should be equally at home as a main rig or in a vehicle.

The Icom 22S is seeing yet another re-release, this time as the IC-22U. Banished is the diode programming and rotary channel selector—they've been replaced with push-button channel selection of 800 channels. The rig has got to win some kind of an award for longevity!

Japan Radio Company, still looking for a US distributor, was showing a fascinating (and expensive!) set of HF twins that have been on the Japanese market for a while but haven't had wide-spread distribution in the US yet. The NRD-515 receiver offers continuous coverage from 100 kHz to 30 MHz, in PLL-synthesized 100-Hz steps. Design is of the up-conversion dual-conversion variety, with a first i-f at 70.455 MHz. Features include passband tuning, digital readout, bfo pitch control, four i-f filters, and completely modular design. The NRD-515 is one of the few receivers that could do a first-class no-compromise job as both an SWL rig and a ham receiver. The NSD-515 transmitter is equally versatile, covering 160-10 meters (including the new WARC bands). Features of the transmitter include speech processor, VOX, FSK input terminal, and 100 Watts output. Used with the NRD-515, the transmit and receive frequencies can be set from either vfo, and split operation should be a breeze. All things considered, this pair of rigs could become quite popular in the US—I hope Japan Radio finds a distributor!

Kenwood was showing the TS-530S, a new rig that took many of us by surprise. The 530 offers many of the features of the venerable

TS-820S, in a package that matches the TS-830S flagship. If sales of the 520S that this rig replaces are any indication, this rig will be very, very popular.

Moving abruptly to the UHF spectrum, Santec was pleased with the interest shown in their ST-7T 440-MHz synthesized handheld. The unit tunes 2000 channels in 5-kHz steps, with thumbwheel-switch frequency selection. Control operators for repeaters should be happy about the standard 16-tone DTMF pad and the optional synthesized CTCSS encoder. High power output is rated at 3 Watts, medium at 1 Watt, and low at .05 Watt.

Ten-Tec displayed a new compact HF rig, the Argosy, offering a lot of features at an inexpensive price. The solid-state finals provide 40-50 Watts output rather than the usual 100, and the readout is analog only. On the positive side, features include RIT, notch filter, and a built-in swr meter. At \$549 list, they'll no doubt be getting a lot of orders!

Yaesu's new FT-290R multi-mode portable 2m transceiver should be of special interest to types who want to get a lot of mileage out of their equipment. Built-in batteries allow mountaintopping fun with two Watts out on FM and SSB. Put the rig indoors with an amplifier brick and



FT-290R from Yaesu.



Daiwa's 1.8-to-60-MHz swr meter.



*New!* **AZDEN® PCS 3000**

**BLAZING THE FRONTIER OF**

**MICROCOMPUTER  
COMMUNICATIONS**

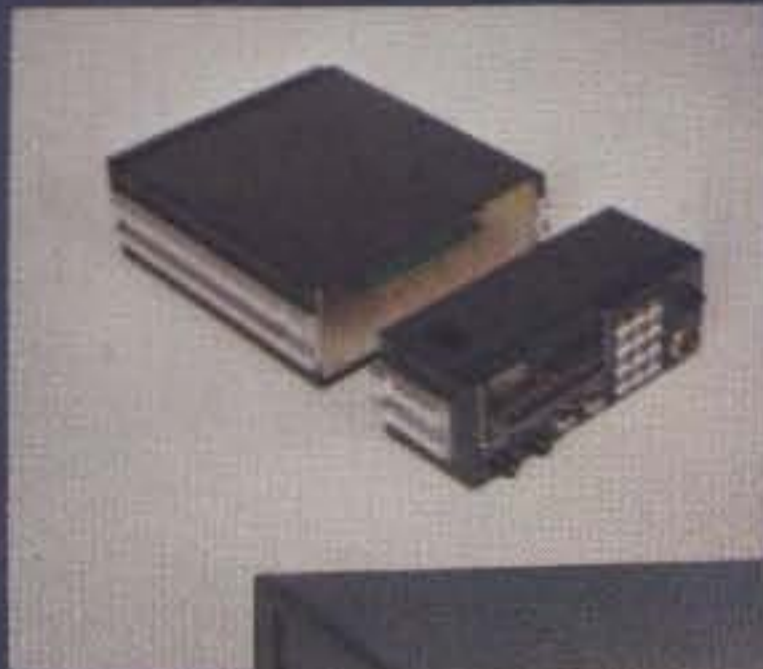

**SUPERIOR  
COMMERCIAL GRADE  
2-METER FM TRANSCEIVER**

INTRODUCTORY PRICE

**\$339<sup>00</sup>**  
**FREE** TOUCH-TONE®  
PAD KIT INCLUDED

**COMPARE THESE FEATURES WITH ANY UNIT AT ANY PRICE**

- **8 MHZ FREQUENCY COVERAGE, INCLUDING CAP/MARS BUILT IN:** Receive and transmit 142.000 to 149.995 MHz in selectable steps of 5 or 10 kHz. **COMPARE!**
- **SIZE:** Unbelievable! Only 6¾" by 2¾" by 9¾". **COMPARE!**
- **MICROCOMPUTER CONTROL:** All frequency control is carried out by a microcomputer.
- **MUSICAL TONE ACCOMPANIES KEYBOARD ENTRIES:** When a key is pressed, a brief musical tone indicates positive entry into the microcomputer. **COMPARE!**
- **PUSHBUTTON FREQUENCY CONTROL FROM MICROPHONE OR PANEL:** Frequency is selected by buttons on the front panel or microphone.
- **8 CHANNEL MEMORY:** Each memory channel is reprogrammable and stores the frequency and offset. Memory is backed up by a NICAD battery when power is removed.
- **INSTANT MEMORY 1 RECALL:** By pressing a button on the microphone or front panel, memory channel 1 may be accessed immediately.
- **MEMORY SCAN:** Memory channels may be continuously scanned for quick location of a busy or vacant frequency.
- **PROGRAMMABLE BAND SCAN:** Any section of the band may be scanned in steps of 5 or 10 kHz. Scan limits are easily reprogrammed.
- **DISCRIMINATOR SCAN CONTROL (AZDEN EXCLUSIVE PATENT):** The scanner stops by sensing the channel center, so the unit always lands on the correct frequency. **COMPARE** this with other units that claim to scan in 5-kHz steps!
- **THREE SCAN MODES WITH AUTO RESUME:** "Sampling" mode pauses at busy channels, then resumes. "Busy" mode stops at a busy channel, then resumes shortly after frequency clears. "Vacant" mode stops at a vacant channel and resumes when signal appears. If desired, auto resume may be prevented by pressing one button. **COMPARE!**
- **REMOVABLE HEAD:** The control head may be located as much as 15 feet away from the main unit using the optional connecting cable. **COMPARE!**

- **PL TONE OSCILLATOR BUILT IN:** Frequency is adjustable to access PL repeaters.
- **MICROPHONE VOLUME/FREQ. CONTROL:** Both functions may be adjusted from either the microphone or front panel.
- **NON-STANDARD OFFSETS:** Three accessory offsets can be obtained for CAP/MARS or unusual repeater splits. CAP and Air Force MARS splits are **BUILT IN!** **COMPARE!**
- **25 WATTS OUTPUT:** Also 5 watts low power to conserve batteries in portable use.
- **GREEN FREQUENCY DISPLAY:** Frequency numerals are green LEDs for superior visibility.
- **RECEIVER OFFSET:** A channel lock switch allows monitoring of the repeater input frequency. **COMPARE!**
- **SUPERIOR RECEIVER:** Sensitivity is better than 0.28  $\mu$ V for 20-dB quieting and 0.19  $\mu$ V for 12-dB SINAD. The squelch sensitivity is superb, requiring less than 0.1  $\mu$ V to open. The receiver audio circuits are designed for maximum intelligibility and fidelity. **COMPARE!**
- **ILLUMINATED KEYBOARD:** Keyboard backlighting allows it to be seen at night.
- **TRUE FM, NOT PHASE MODULATION:** Transmitted audio quality is optimized by the same high standard of design and construction as is found in the receiver. The microphone amplifier and compression circuits offer intelligibility second to none.
- **OTHER FEATURES:** Dynamic microphone, built-in speaker, mobile mounting bracket, external remote speaker jack (head and radio) and much, much more. All cords, plugs, fuses, microphone hanger etc. included. Weight: 6 lbs.
- **ACCESSORIES:** CS-ECK 15-foot remote cable . . . \$39.95. CS-6R 6-amp ac power supply . . . \$59.95. CS-AS remote speaker . . . \$18.00. CS-TTK touch-tone® microphone kit (wired and tested) . . . \$45.00

✓5

**AMATEUR-WHOLESALE ELECTRONICS** ORDER NOW TOLL FREE

8817 S.W. 129th Terrace, Miami, Florida 33176  
Telephone (305) 233-3631 • Telex: 80-3356  
HOURS: 9 - 5 Monday thru Friday  
• U.S. DISTRIBUTOR • DEALER INQUIRIES INVITED



**800-327-3102**

CREDIT CARD HOLDERS MAY USE OUR TOLL FREE ORDERING NUMBER.



The DenTron Clipperton T.



Heath's SA-2000 tuner.

the LSB/USB capabilities will let you into the world of OSCAR. Wherever you use it, the five memories should add to the fun.

### Amplifiers

A good handful of new amplifiers was shown. As with the transceivers above, the emphasis was on evolu-

tion, rather than revolution.

2-meter DX and EME addicts will no doubt be interested in DenTron Radio's Clipperton-V 500-Watt two-meter linear. Drake introduced a relatively inexpensive 1.5-kW unit for the HF bands—the L-75 160-15 amplifier.

Heath was showing two

new linear amplifiers for 2 meters—the VL-2280 and VL-1180. Both offer 75 Watts out for 10 Watts of drive. The 2280 sports a built-in ac power supply that will power both the amplifier and a transceiver; it should be an ideal companion to one of the multi-mode 2-meter rigs. The 1180 operates on 12 V dc and is designed for mobile use.

Icom showed a compact 10-Watt amplifier for the 2-meter band. Designed to mate with the IC-2AT, it should be right at home with any of the other popular hand-helds.

Last but certainly not least, Lou Anciaux of Lunar Electronics was showing the 4-40P linear 2-meter amplifier, which also features a receive preamp with a better than 2-dB noise figure. One-to-four-Watts input yields 10-40 Watts out. Should be the ideal companion for Yaesu's new FT-290R multi-mode portable!

### Antennas

There were plenty of new antennas in evidence. Daiwa showed a very interesting line of mobile antennas, including a duoband 2-meter and 450-MHz model with 2.5-dB gain on 2 and 5.5-dB gain on 450.

Hy-Gain introduced the V2 3-dBd-gain vertical antenna for 2 meters. Claim-

ing a low angle of radiation and effective decoupling of the feedline, Hy-Gain is competing with the Cushcraft ARX-28 and the AEA Isopole in the high-technology gain antenna race.

KLM had a variety of new antennas to announce, from 40 meters on up to two. There are two new shortened beams for 40 meters, one with three elements and one with two. For two meters there was the JV2 2-meter vertical with 5 dB of omnidirectional gain. Also shown was the 144-148-4X four-element beam, with a folded-dipole driven element. The antenna is supplied with an RG-142 balun, rated to 2 kW. The rear-mounted antenna has a claimed gain of 8.5 dBd.

Lunar introduced a pair of beams for 430 MHz and 2 meters, with 19 and 11 elements, respectively.

### Miscellaneous Items

AEA is entering the FM direction-finding sweepstakes with the PFDF radio direction indicator, operating on the Doppler principle. The unit offers several sophisticated features, including an automatically-triggered sample and hold circuit for instant pinpointing of the kerchunker variety of wild turkey.

Daiwa introduced more new products than any oth-

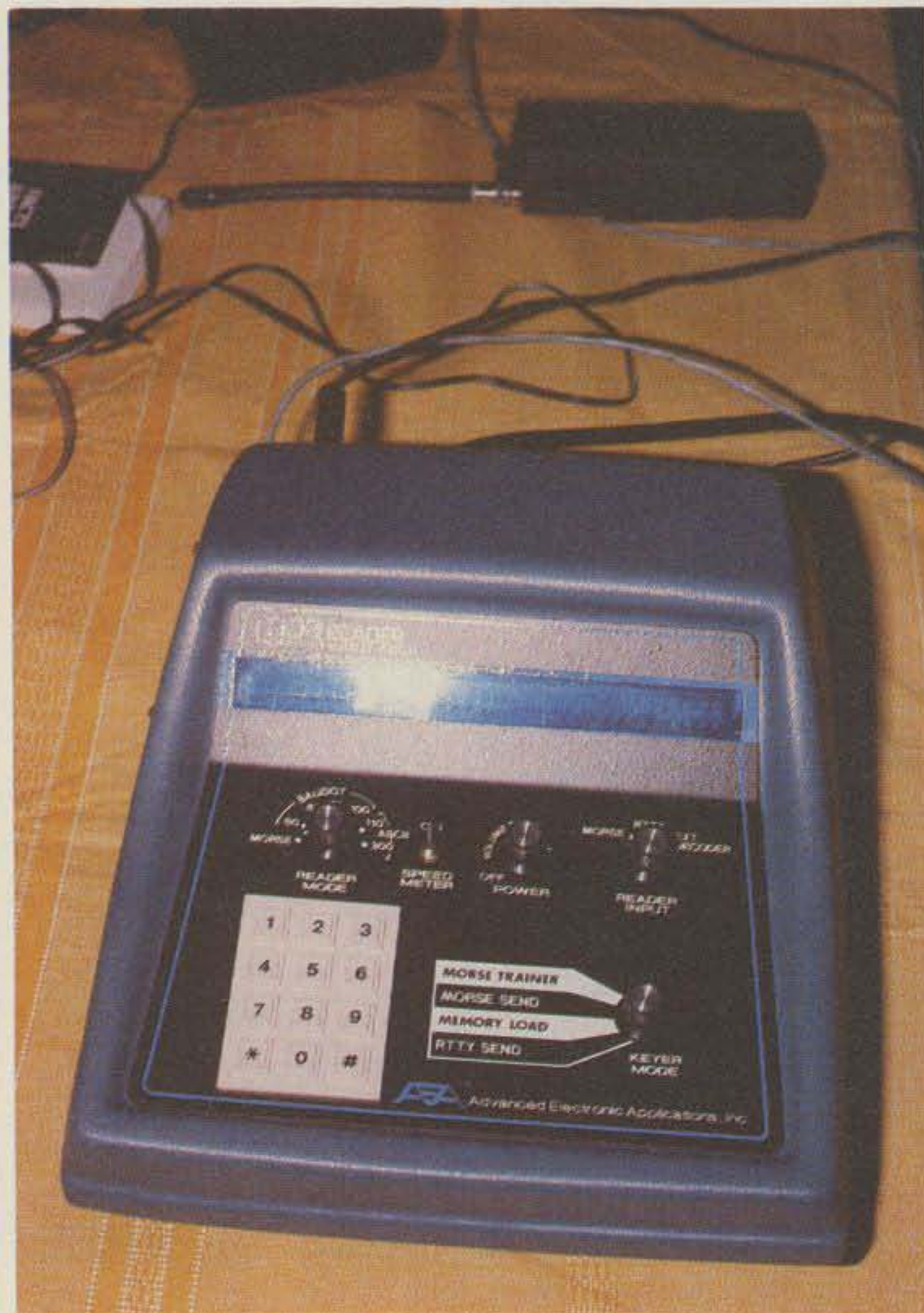

The MBA-1 from AEA.

# N&G

Call TOLL FREE  
1-800-327-3364



## DISTRIBUTING

7201 N.W. 12th ST.  
MIAMI, FLORIDA 33126  
1-305-592-9685 • 1-305-763-8170

WE ALSO CARRY MANY  
MARINE & AIRCRAFT RADIOS

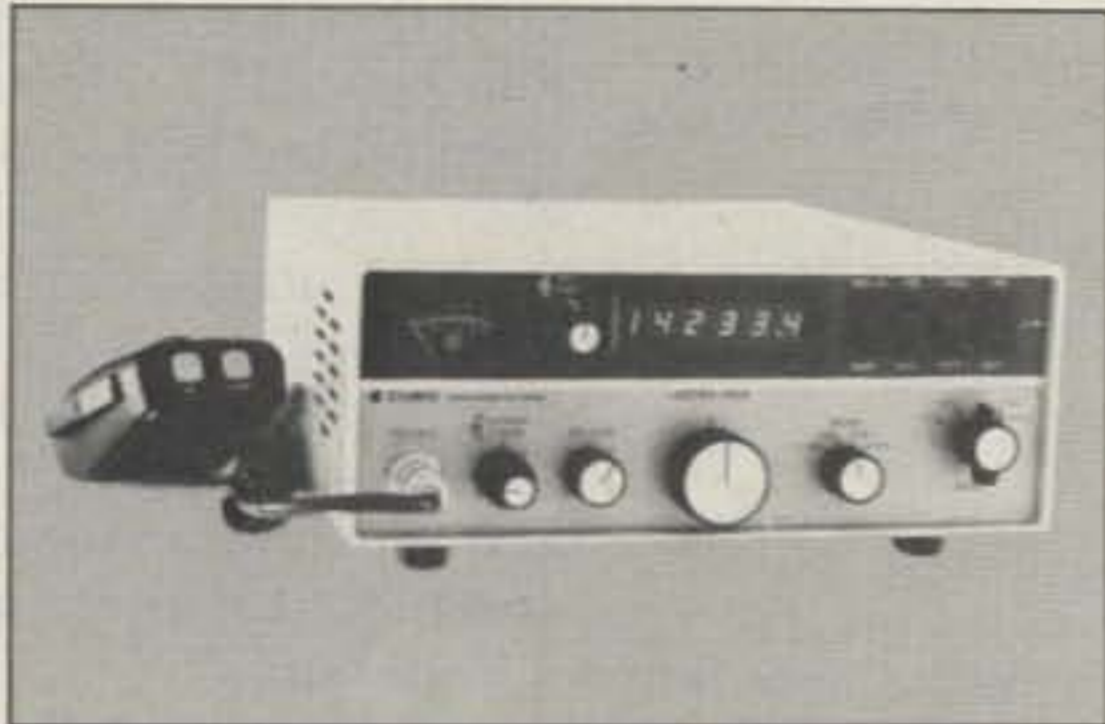

ASTRO 150 \$975.00  
MATCHING POWER SUPPLY 179.95  
MATCHING ANTENNA TUNER 169.95

General Frequency Range  
160 Meter Band - 1.8-2.4 MHz†  
80 Meter Band - 3.0-4.5 MHz  
40 Meter Band - 6.0-8.3 MHz  
20 Meter Band - 13.8-16.0 MHz  
15 Meter Band - 20.8-23.0 MHz  
10 Meter Band - 28.0-30.0 MHz††  
† Model 151 only  
†† Model 150 only

HF/SSB  
PORTABLE  
RADIO STATION  
100 WATT

115/230V  
50/60 Hz AC  
OR 12V DC  
IS AVAILABLE

# CUBIC



DIPLOMAT 150



BATTERY PACK CHARGER



ST 2 TUNER  
ASTRO 150  
PSU 5 POWER SUPPLY  
1500Z Amp.  
LIST PRICE 3000.00

### BIRD WATT METERS & ACCESSORIES LARGEST SELECTION IN THE EAST



35 AMP Reg. P.S.  
LIST 250.00  
N&G PRICE 149.00



20 AMP Reg.  
LIST 129.00  
N&G PRICE 79.95

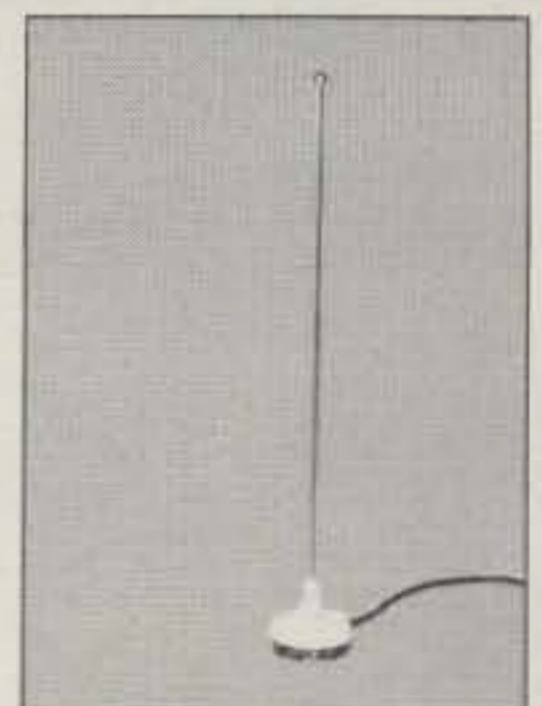

WAVE MAG  
LIST 24.95  
N&G PRICE 15.00



6 AMP Reg.  
LIST 89.95  
N&G PRICE 39.95



MA 25B  
LIST 279.00  
N&G PRICE 249.95



BIRD 43 142.00  
All Bird Prod. in Stock

ALL PRICES ARE SUGGESTED RETAIL PRICES • PLEASE CALL FOR QUOTES.



Drake RTTY/CW keyboard.

er manufacturer and with good reason. Daiwa markets an extensive line of high-quality products in Japan and their new distributor in the US plans to import a good many of those items. Included in the lineup is a very compact audio CW filter with built-in amplifier and speaker, a

speech processor, two world map rotators, an incredible variety of compact cross-needle swr meters, and a cordless mobile microphone, complete with speech processor!

DenTron Radio was showing the prototype model of the Clipperton-T 3-kW antenna tuner, which

should be available later this summer. The tuner offers full metering and lots of other nice features, and is of course an ideal companion to the Clipperton-L linear amp.

For proud owners of the Drake 7-line with a taste for matching equipment, there was the Drake CW keyer. Front-panel controls are limited to speed and volume, so this unit appears to be designed for the casual CW op.

Elkhart Industries is cashing in on the current keyboard craze in ham radio with two new enclosures for keyboards and computers.

Heathkit had a new antenna tuner that adds an swr meter to their previously-available tuner. Of special interest to Field-Day ops is the surprisingly compact gas-in, ac-out generator. By the time you read this, the 73 gang will have put one through the wringer during this year's Field-Day festivities!

Last on our list of miscellaneous introductions was Radiokit, offering the K9CW contest keyer in kit form—contest season is just around the corner!

#### RTTY/CW Gear

As promised, I've saved the best for last. The big news at Dayton was unquestionably computerized RTTY/CW gear. New keyboards, readers, and computer interfaces were available everywhere I looked, and could very well represent the ham trend of the eighties.

I had a very difficult time tearing myself away from the AEA booth, where all concerned were justifiably proud of their MBA-1 Morse, Baudot, and ASCII reader. Kept as a deep dark secret until the first day of the show, the MBA might be an ideal way for hams to get into RTTY. It sports a 32-character vacuum dis-

play designed to give the user plenty of time to read high-speed messages and especially to help copy weak signals in high-QRM situations. The MBA seemed able to track speed changes extremely well, suggesting that it might do an excellent job of copying sloppy CW. The most innovative aspect of the MBA is its MBA-01 code converter option, which allows you to join the RTTY crowd and transmit in ASCII or Baudot with a Morse keyer! This is such a great idea that I can't imagine why it hasn't been done before, but in any case it's available now and provides an interesting and practical alternative to a keyboard.

Commsoft showed their new software package for the Heath H-89 computer. The system uses almost any demodulator and provides a three-level split-screen display, pretype buffer, disk-based autostart/mailbox system, automatic CW ID, and excellent user's manual. I was pleased to note that the manual provided lots of information about operating on RTTY for the first time, what to look for in transmitters and receivers for RTTY, and an extensive list of RTTY books and publications.

Crown Microproducts had the ROM-113 computer interface up and running with the TRS-80 Model III computer, and software for both the Model I and III has been improved, offering more buffer memories and a host of new features. Hams contemplating purchasing a computer and RTTY interface will be interested to know that the new TRS-80 Model III reportedly causes virtually no interference to ham gear, unlike its noisy predecessor.

Drake is making the Tono Theta 7000E CW/RTTY terminal available in the US sometime this summer. Fea-



HAL's CT-2100/KB-2100.

# The *KLM* Spotlight on:

The new pacesetter  
for tribander performance

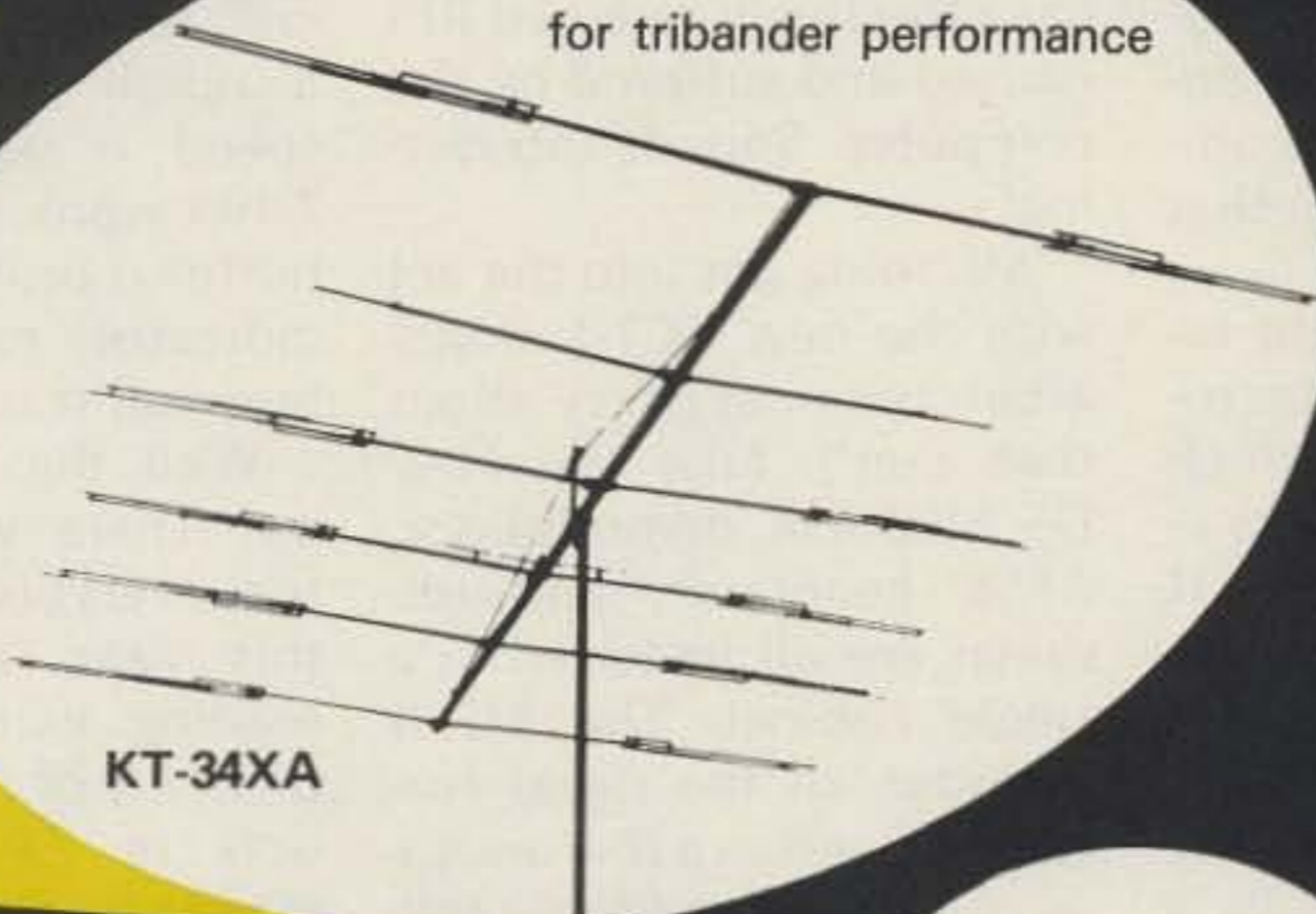

KT-34XA

For the new age  
of satellite DX



420-450-18C

Handie Power!  
35W, Charger, Preamp



MA-35BL

See your  
KLM dealer

144-148-13LB



Maximum gain,  
across the whole band

Broadbanded  
hi-performance  
Verticals

SSV  
80-40-15

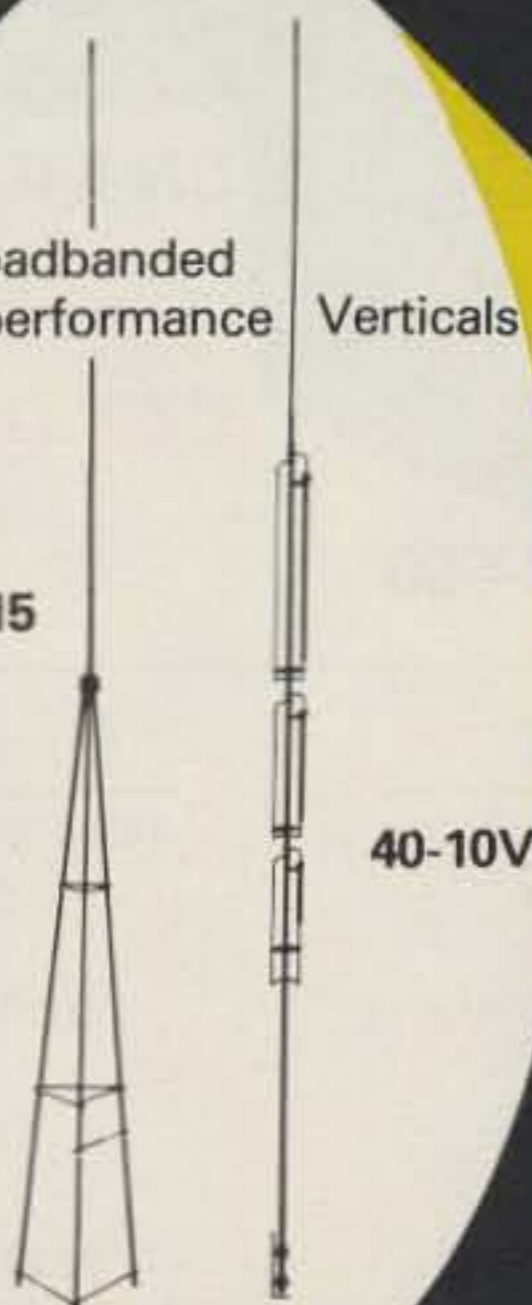

40-10V

The ultimate H.F. monobanders

KLM's  
"BIG STICKERS"



Plus much, much more!  
Write for a complete catalog

**KLM** P. O. Box 816, Morgan Hill, CA 95037  
(408) 779-7363

tures include seven 64-character memories with battery backup to retain memory when power is off, 53-character keyboard buffer, auto word-wrap, scope outputs, automatic T/R switch, two-page display memory, split-screen video, and a well-shielded cabinet for RFI protection. Interestingly, the 7000E will operate on 13 V dc at one Amp, which opens the way for some interesting mobile or portable work!

HAL no doubt is feeling pretty smug about the new interest in RTTY, and they were showing two new RTTY/CW terminals: the DS-2050 KSR and the CT-2100/KB-2100. The 2050 is essentially a DS-2000 terminal and an ST-5000 demodulator combined in one compact package. The system is loaded with the usual pretype buffers, status indicators, and pretype-while-receiving features. Considering its relatively low

price, the DS-2050 KSR might be an ideal way to get into RTTY communications.

The CT-2100/KB-2100 combination is HAL's up-market terminal and offers virtually every feature the dedicated RTTY fanatic could desire. The CT-2100 receive terminal can be used alone, but the KB-2100 is needed to transmit. HAL has obviously been listening carefully to RTTY enthusiasts, and this new combination is the result of that research.

TRS-80 owners might be interested in the Macrotronics, Inc., terminal which is offered in two models—one for the 16K Level II TRS-80 and one for the 16K Model III. Macrotronics deserves some kind of an award for the most number of features available in a computer/interface RTTY system. There are 16 soft-sectored buffer memories, a four-word user-defined

WRU, a complete terminal-status display line, word-wrapping, pretype buffers, and more. The hardware side includes a six-stage active-filter CW demodulator, a hardware clock, and a multi-stage active-filter RTTY demodulator. By terminating the data and address busses at the computer end of an active buffered cable, Macrotronics has effectively reduced RFI caused and suffered by the computer. Sounds interesting!

Microlog got into the act with the new ACT-1 stand-alone terminal (sorry about that pun!). Like the HAL DS-2050 KSR, demodulator, AFSK generator, and terminal are all included in a single cabinet. The ACT-1 includes all the usual features as well as a few unusual ones. A random-code generator and a hand-key input are provided for Morse practice, and the unit can be used as an SSTV

generator. Also included are several test messages, SELCAL, autostart, and a real-time clock.

For the do-it-yourself CW-only operator, AJR Electronics of Evansville IN is offering PC boards and manual for their Skipjack keyboard. The estimated final cost is about \$200, depending on how careful a parts shopper you are. Special Morse characters are available (AR, KN, etc.) and speed is adjustable from 7-104 wpm. A 64-character buffer is provided with LED indicators to let you know how full it is.

Well, that about wraps it up! There was something for everybody at Dayton this year, and you'll be reading extensive reviews on many of these new products in 73 in upcoming months. Got something you'd particularly like to see reviewed? Drop us a line and let us know—we appreciate your input! ■

## The Convenience of Cross-Needle Metering, Only from DAIWA

Daiwa brings state-of-the-art technology and quality to SWR metering. Read forward power, reflected power, and SWR simultaneously! DAIWA convenience now comes in a smaller package—that's right for both mobile and base applications. Available in three different configurations, one is sure to be right for you.



CN-540

CN-520

CN-550

**SEE THEM IN ATLANTA  
JUNE 20-21**

### CN-520

Frequency Range:	1.8-60 MHz, 50 Ohms
Power Range: Forward	200w/2Kw
Reflected	40w/400w
Accuracy:	± 10% Full Scale
SWR Measurement:	1:1-1:00
Detection Sensitivity:	40 Watts Min
Input/Output Connectors:	SO-239
Dimensions (In Millimeters):	72W x 72H x 96D

### CN-540

Frequency Range:	50-150 MHz, 50 Ohms
Power Range: Forward	20w/200w
Reflected	4w/40w
Accuracy:	± 10% Full Scale
SWR Measurement:	1:1-1:00
Detection Sensitivity:	4 Watts Min
Input/Output Connectors:	SO-239
Dimensions (In Millimeters):	72W x 72H x 96D

### CN-550

Frequency Range:	140-250 MHz, 50 Ohms
Power Range: Forward	20w/200w
Reflected	4w/40w
Accuracy:	± 10% Full Scale
SWR Measurement:	1:1-1:00
Detection Sensitivity:	4 Watts Min
Input/Output Connectors:	SO-239
Dimensions (In Millimeters):	72W x 72H x 96D

Write for catalog. Dealer inquiries invited.

MCM Communications is the exclusive agent for these DAIWA products. ✓451

**MCM**  
COMMUNICATIONS

858 E. Congress Park Drive  
Centerville, Ohio 45459



**DAIWA**  
INDUSTRY CO., LTD.

# MORE PERFORMANCE FOR YOUR DOLLAR! COMPETITORS KNOW ABOUT THE ISOPOLE™

## DO YOU? STUDY THE FACTS ...

The IsoPole is building a strong reputation for quality in design and superior performance. The IsoPole's acceptance has already compelled another large antenna producer to make a major design modification to his most popular VHF Base Station antenna. Innovative IsoPole conical sleeve decouplers (pat. pend.) offer many new design advantages.

All IsoPole antennas yield the **maximum gain attainable** for their respective lengths and a zero degree angle of radiation. Exceptional decoupling results in simple tuning and a significant reduction in TVI potential. Cones offer greater efficiency over obsolete radials which radiate in the horizontal plane and present an unsightly bird's roost with an inevitable "fallout zone" below. The IsoPoles have the broadest frequency coverage of any comparable VHF base station antenna. This means no loss of power output from one end of the band to the other, when used with SWR protected solid state transceivers. **Typical SWR is 1.4 to 1 or better across the entire band!**

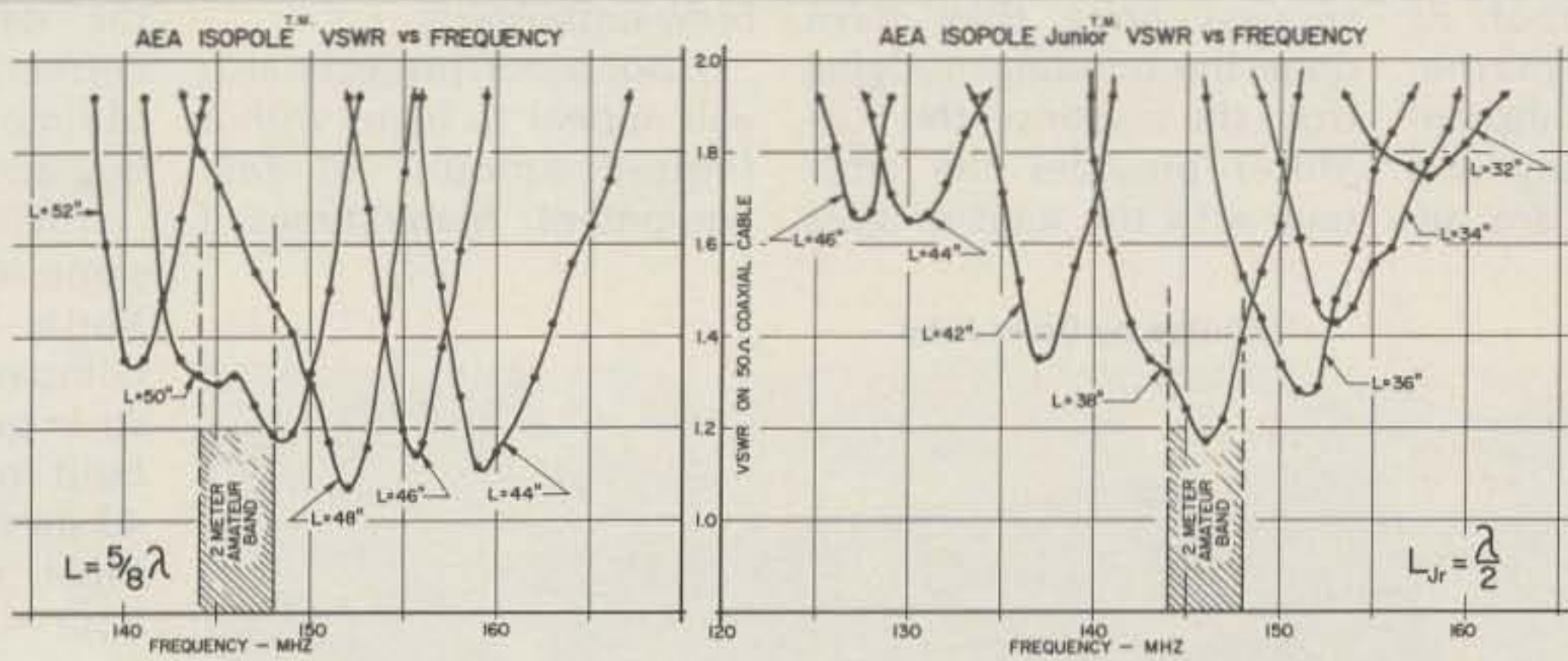

Outstanding mechanical design makes the IsoPole the only logical choice for a VHF base station antenna. A standard 50 Ohm SO-239 connector is recessed within the base sleeve (fully weather protected). With the IsoPole, you will not experience aggravating deviation in SWR with changes in weather. The impedance matching network is weather sealed and designed for maximum legal power. The insulating material offers superb strength and dielectric properties plus excellent long-term ultra-violet resistance. All mounting hardware is stainless steel. The decoupling cones and radiating elements are made of corrosion resistant aluminum alloys. The aerodynamic cones are the only appreciable wind load and are attached directly to the support (a standard TV mast which is **not supplied**)

Operating on MARS or CAP? The IsoPole and IsoPole Jr. antennas will typically operate at least  $\pm 2$  MHz outside the respective ham band without re-tuning. However, by simple length adjustment, the IsoPoles can be tuned over a wider range outside the ham bands.

Our competitors have reacted to the IsoPole, maybe you should too! Order your IsoPole or IsoPole Jr. today from your favorite Amateur Radio Distributor. For more information on other exciting AEA products, contact

Advanced Electronic Applications, Inc., P.O. Box 2160,  
Lynnwood, WA 98036.  
Call 206/775-7373

# AEA Brings you the Breakthrough!

PRICES AND SPECIFICATIONS SUBJECT TO CHANGE WITHOUT NOTICE OR OBLIGATION.



ISOPOLE 144  
\$49.95  
ISOPOLE 220  
\$44.95  
MAST NOT  
SUPPLIED



ISOPOLE  
144JR  
ISOPOLE  
220JR  
\$39.95

MAST NOT  
SUPPLIED

# The Fun-Ceiver

## — easy-to-build companion to February's QRP Fun-Mitter

The Fun-Mitter 5-Watt transmitter ("The Fun-Mitter—A Goof-Proof Rf Project," *73 Magazine*, February, 1981) confirmed my ideas about hams and home-brew. Hams are, in-

deed, anxious to build their gear if they can be sure of success once they have done the building! Judging from the response, the Fun-Mitter provides the amateur with the kind of gear

that interests the first-time and the short-of-time home-brew enthusiasts.

Goof-proof projects also will appeal to hams with a limited amount of test equipment. Many times a

project is bogged down when, upon completion, the device doesn't work correctly and a great deal of time must be used to debug and/or redesign it.

This project follows the same ideas as for the Fun-Mitter—to provide a simple companion receiver that also is goof-proof. It can be built for either 80 meters or 40 meters and provides an ideal receiver to further your all-home-brew station. It can also be used with other transmitters or can be used by itself as a standby or portable receiver. As with the transmitter, the receiver uses a minimum of parts and can be assembled easily in an afternoon.

The design criteria and design goals for the receiver are similar to those for the transmitter. There basically are six goals for the design:

- Compatible with Fun-Mitter.
- Same size as Fun-Mitter.
- Costs less than \$30 with new parts.
- All parts available from Radio Shack.
- No variable capacitors or tuning adjustments.
- As simple as possible.

Photos by Dave Jehu



View of Fun-Mitter, companion receiver, and audio amp.



The finished receiver meets the six goals. It will tune any 70-kHz segment of the 40-meter band or any 50-kHz segment of the 80-meter band. Sensitivity is very good. The selectivity is adequate in the basic receiver and can be improved with the optional audio filter. As can be seen in Fig. 1, the receiver is very simple. Only a tuning knob and an on-off switch are used. This makes construction and operation easier but does not compromise performance.

Designing the receiver (as with all home-brew rigs) was a great deal of fun. Setting goals in advance provided a challenge that took me through four revisions of the receiver board. Originally, the receiver utilized a JFET detector and op-amp audio stage but it evolved slowly to its current form. Fortunately, Radio Shack introduced dual-gate MOSFETs in the 1981 catalog and that provided the impetus to continue. The dual-gate MOSFET provides a more sensitive, easier-to-match-impedance detector than does the JFET. Although it has drawbacks, such as AM detection and hum, it makes for a good direct-conversion detector. These drawbacks are reduced considerably by utilizing a double-tuned input network and by using an enclosed case with a battery supply.

Radio Shack rf chokes were again used as resonant-circuit inductors and, again, perform quite well. They are modified as described later to provide the necessary inductances for the circuit. The physical size of the chokes, however, necessitated a larger PC board than might otherwise have been used.

Variable-frequency tuning is provided by using general-purpose diodes as

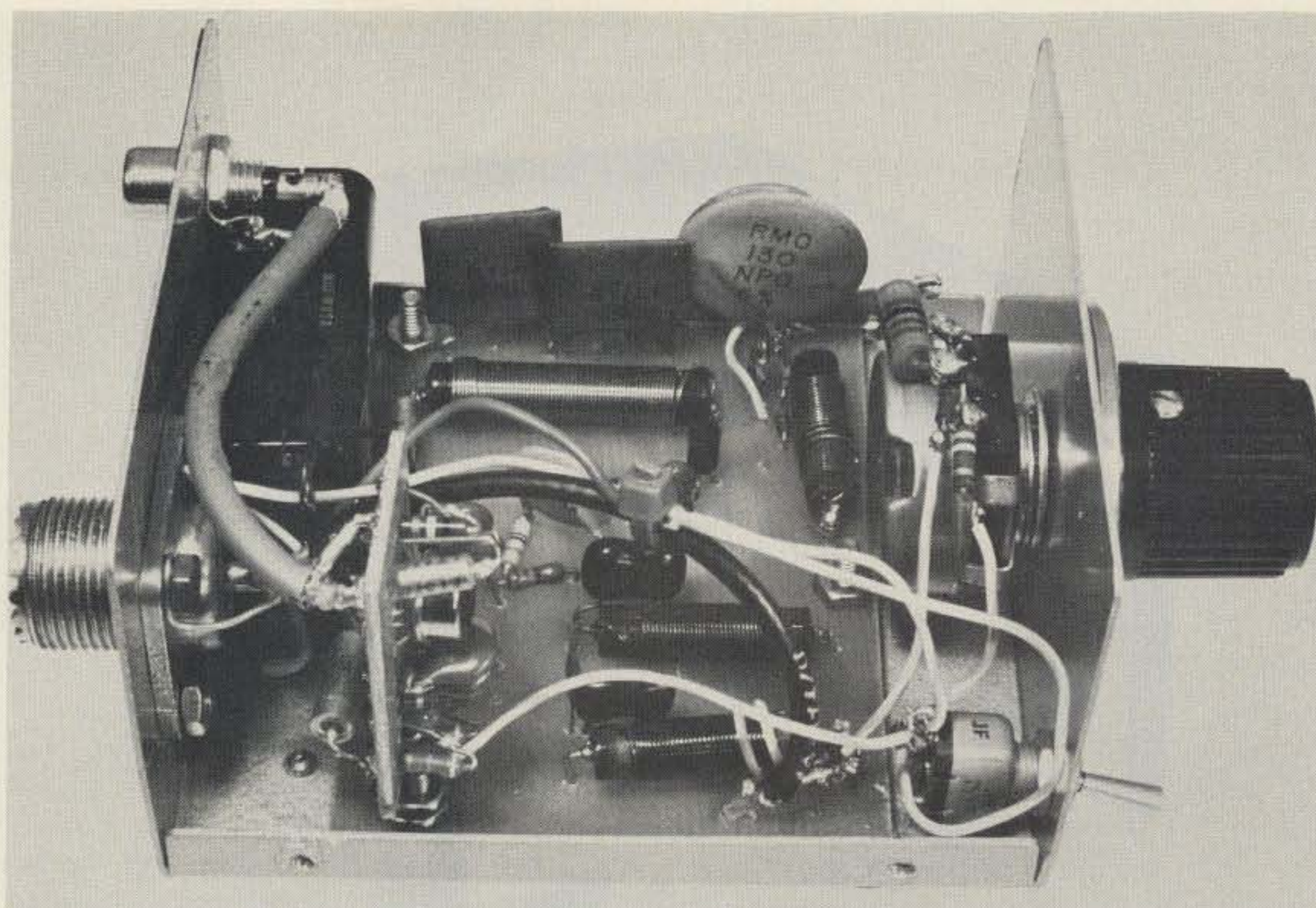

View of inside of companion receiver.

voltage-variable capacitors. The voltage to the diodes is varied by a front-panel potentiometer which in turn changes the capacitance of the diodes to vary the frequency of the oscillator.

### Circuit Description

The receiver is the ultimate in simplicity but still performs quite well. It is shown in schematic form in Fig. 1. As can be seen, it is a direct-conversion receiver

utilizing a product detector, Q1, and a variable-frequency oscillator, Q2, which operates at the same frequency as the incoming signal.

L2, C1 and L3, C3 comprise a double-tuned input network which provides good out-of-band signal attenuation. L1 matches the 50-Ohm antenna impedance to the high impedance of gate 1 of the MOSFET. To construct L2 and L3, the same procedure is used as

was used for the Fun-Mitter. For 80 meters 8 turns should be removed, and for 40 meters the choke should be left intact. Small-gauge hookup wire or magnet wire can be used for L1.

Audio output is taken from Q1 through a .1-uF capacitor (C7). C6 is used to bypass the detector drain at high frequencies. The audio output is routed to J2. From there the audio is routed to a 200-mW Radio Shack audio amplifier through a

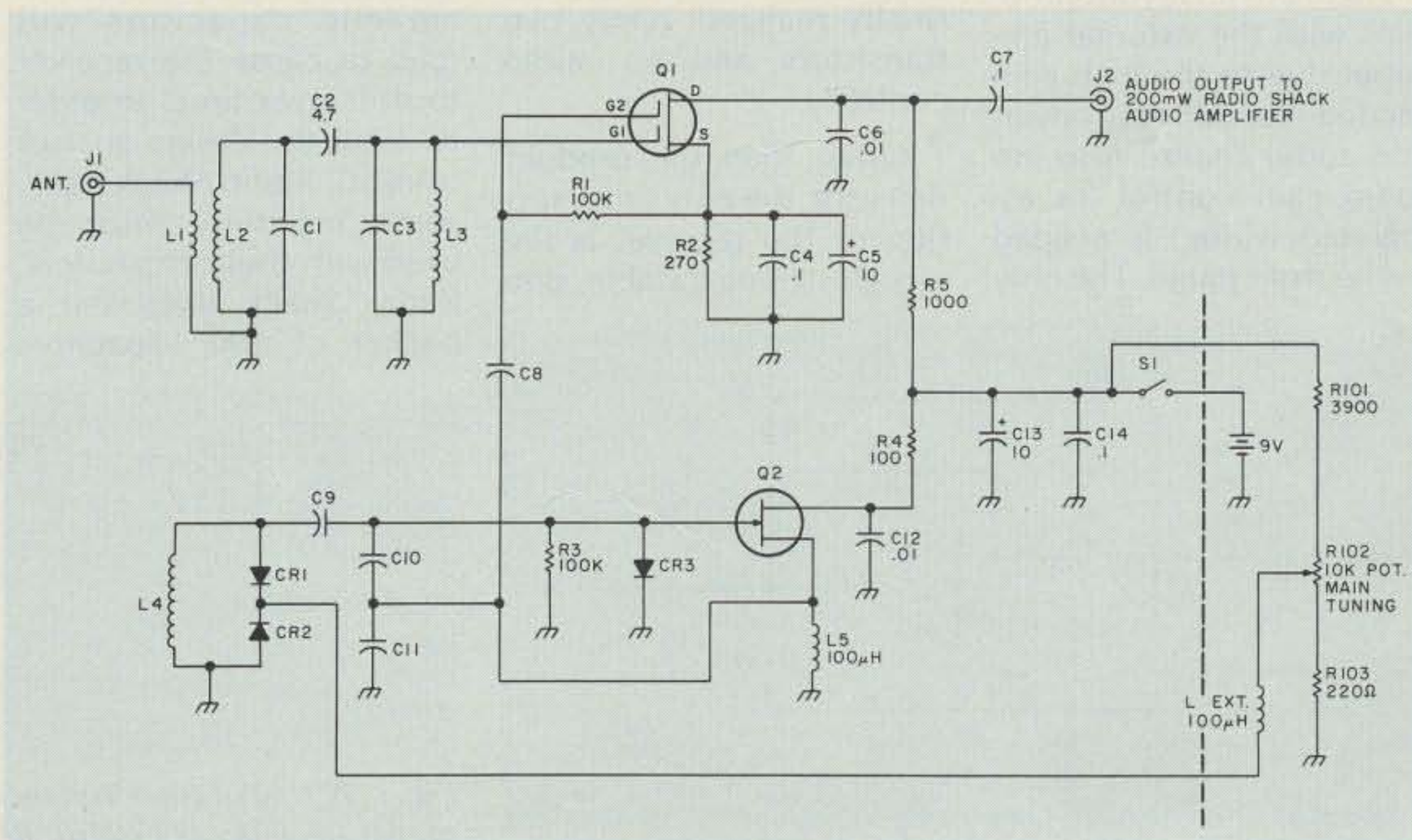
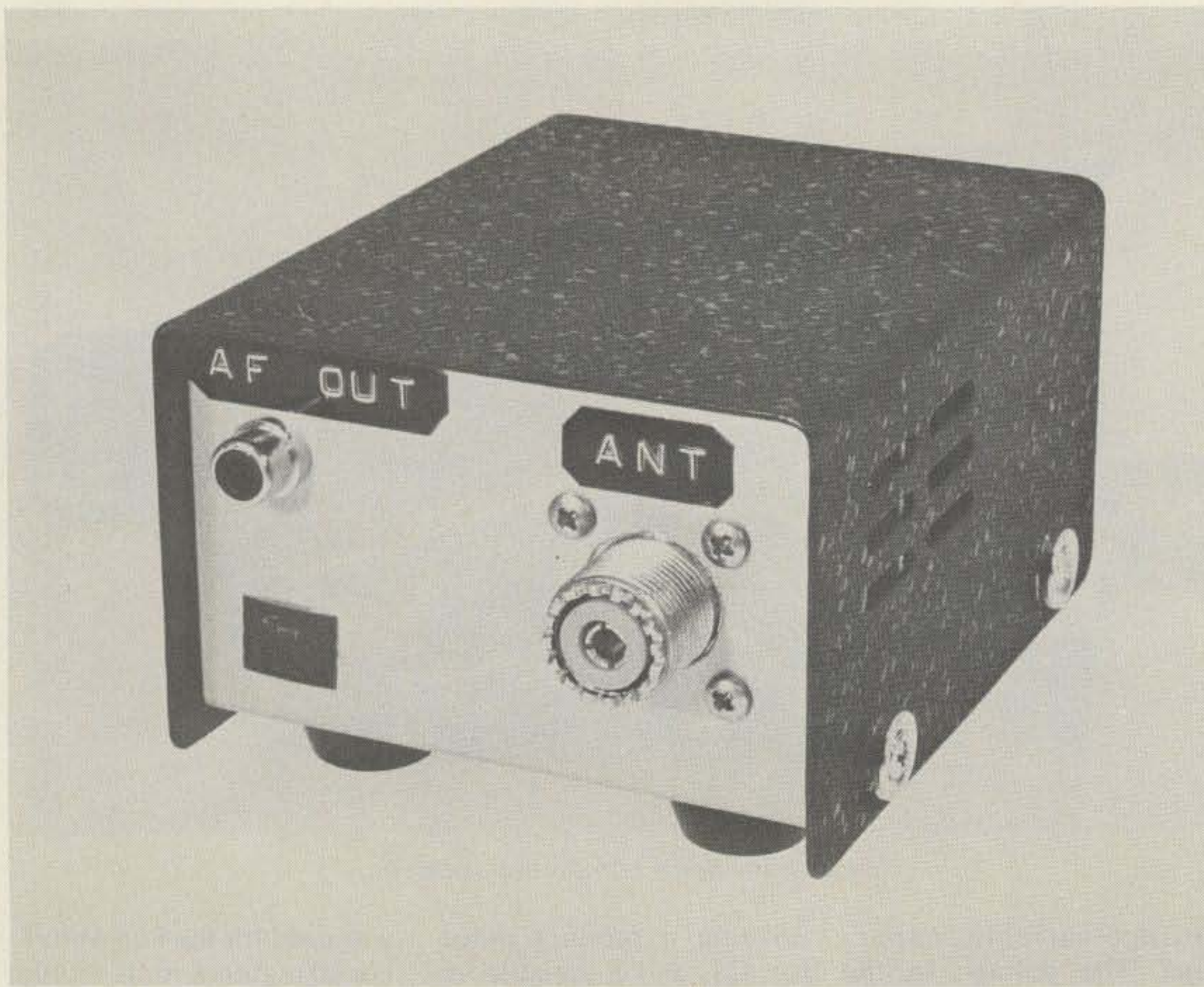

Fig. 1. Schematic of companion receiver.



View of back of companion receiver.

shielded cable. This is a significant departure from normal design procedures but it was done for several reasons. Not including any audio amplification on the receiver board made the receiver much simpler. This, in turn, makes the receiver easier and faster to assemble.

There are no layout problems with the external amplifier due to the high gain needed for direct-conversion audio chains. Also, no audio gain control (or associated wiring) is needed on the front panel. The only

drawback to the external Radio Shack amplifier is its \$12 price tag. I feel the advantages more than outweigh this cost, however, and the amplifier can be used for other projects. Once the decision was made to use the external amplifier, the project really began to take shape. The simplicity of the rig was finally realized! (Only two transistors and no audio control!)

Other than the product detector, the only other section of the receiver is the vfo. Designing a stable, sim-

ple vfo from Radio Shack parts was definitely a challenge. However, the design of Fig. 1 provides one. The circuit is configured as a parallel-tuned Colpitts oscillator. The frequency-determining components are L4, CR1, CR2, C9, C10, and C11. Stable capacitors must be used for C9 through C11. Ordinary disc ceramic capacitors will tend to cause the receiver to drift over time. In order to meet the design goal of using all Radio Shack parts, some ingenuity must be used with these capacitors. Radio Shack does sell a packet of 100 capacitors

(part number 272-801) that contains a large number of capacitors marked NPO. This denotes a capacitor that doesn't change value with temperature.

I found in several packs that the values needed existed with the NPO designation. If the values given in the parts list do not exist in the packet you purchase, use the parallel- and serial-capacitance formulas to obtain the needed capacitance: For parallel capacitors:  $C_T = C_1 + C_2 + \dots$ . For series capacitors:  $C_T = 1 / (1/C_1 + 1/C_2 + \dots)$ . These NPO capacitors will yield very acceptable drift characteristics. After a five-minute warm-up the receiver has no noticeable frequency change. If you have silver mica capacitors available, they will perform even better.

L4 consists of a single modified inductor for 40 meters. For 80 meters, the same size inductor is placed in series with an unmodified inductor to provide the needed inductance. As mentioned in the Parts List, the last three turns of the modified inductor should be spread out over the rest of the inductor body to provide a method of setting the operating frequency.

The receiver is powered from an internal 9-V battery. Current drain is approximately 5 mA, so the battery life should be long. The use of the internal battery eliminates the problem of a separate supply or reg-

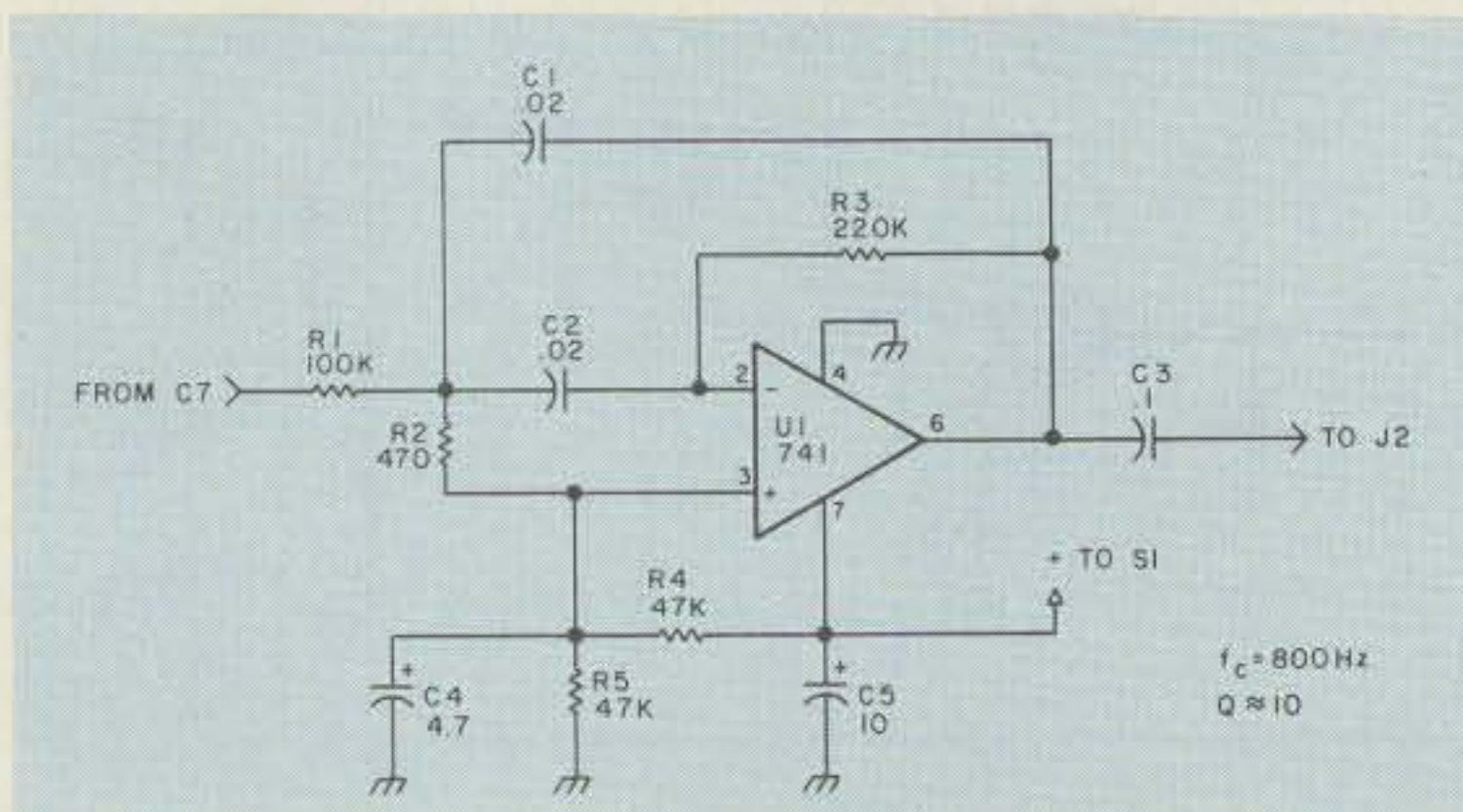

Fig. 2. Optional audio filter.

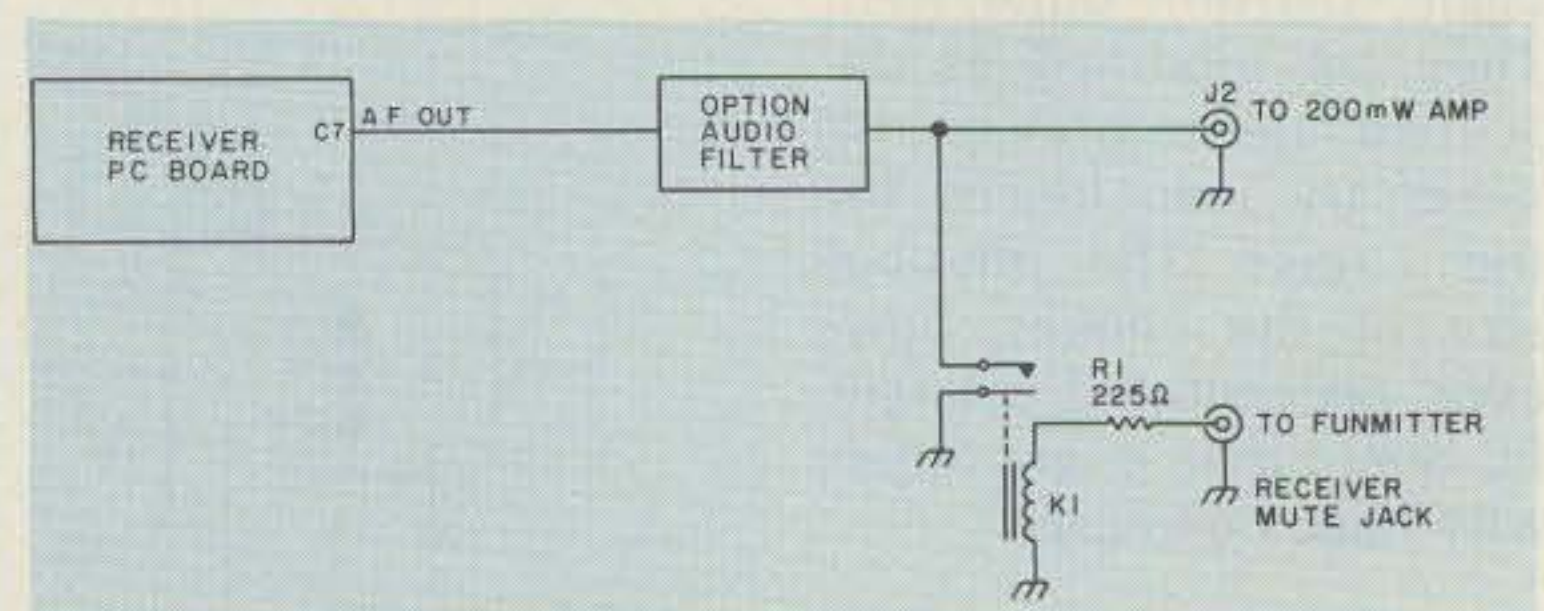
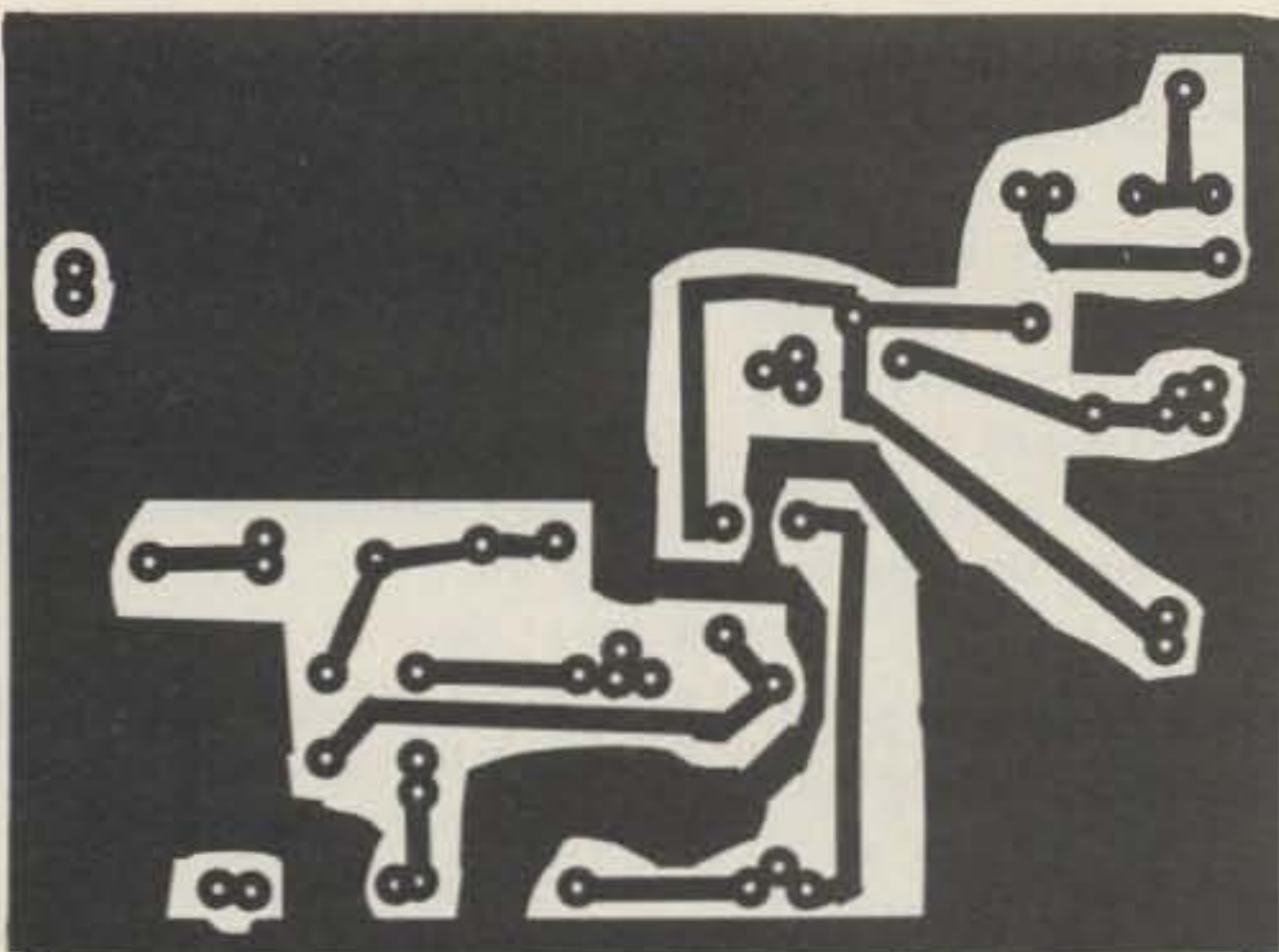
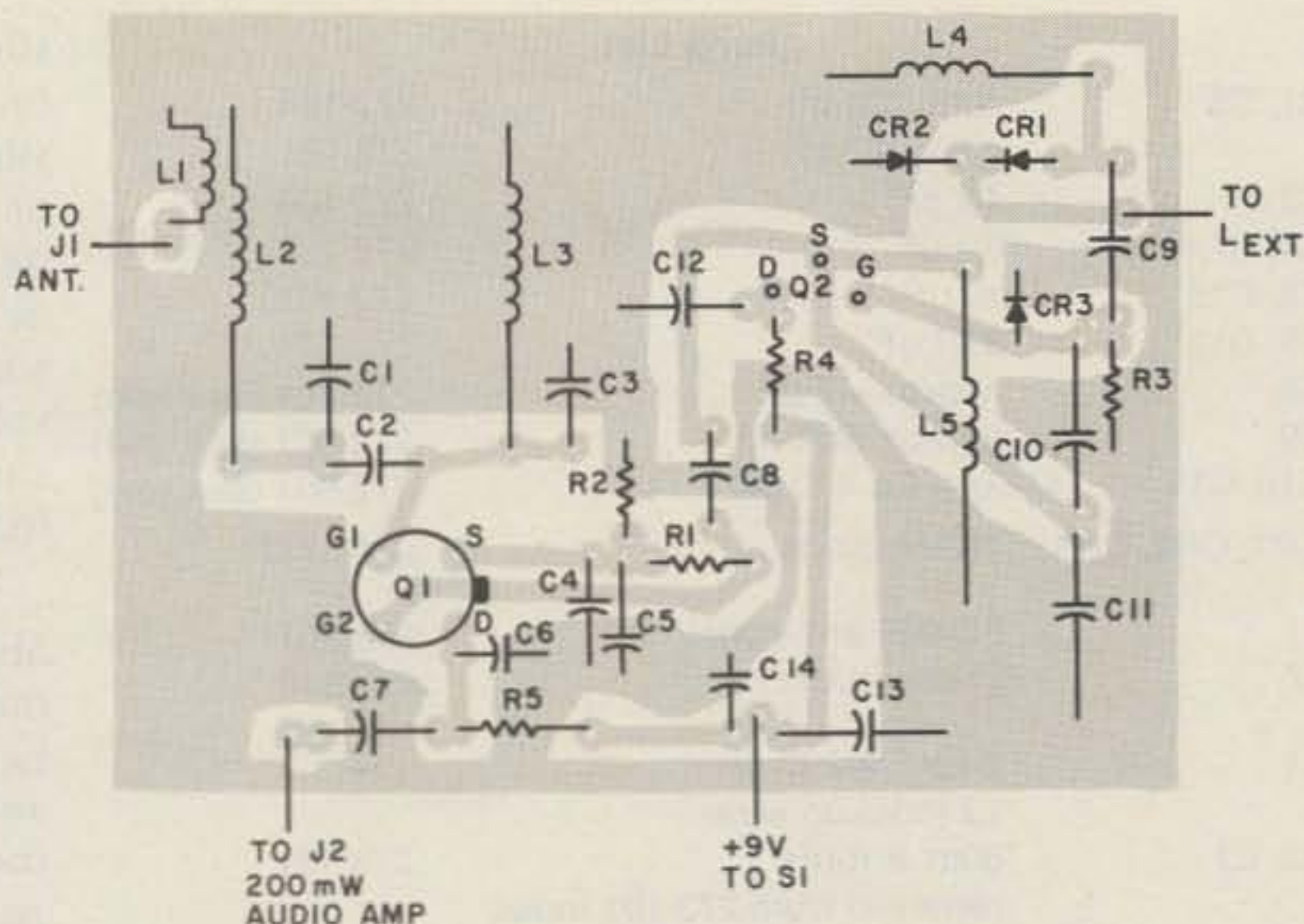

Fig. 3. Wiring of filter and receiver mute options. K1 — SPDT miniature relay (275-216); R1 — three 680Ω, 1/2-W resistors wired in parallel.



Foil side, receiver PC board.



Component layout, receiver PC board (foil side shown).

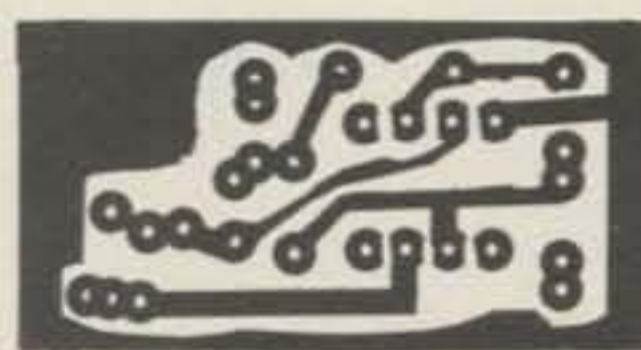

Foil side, filter PC board.

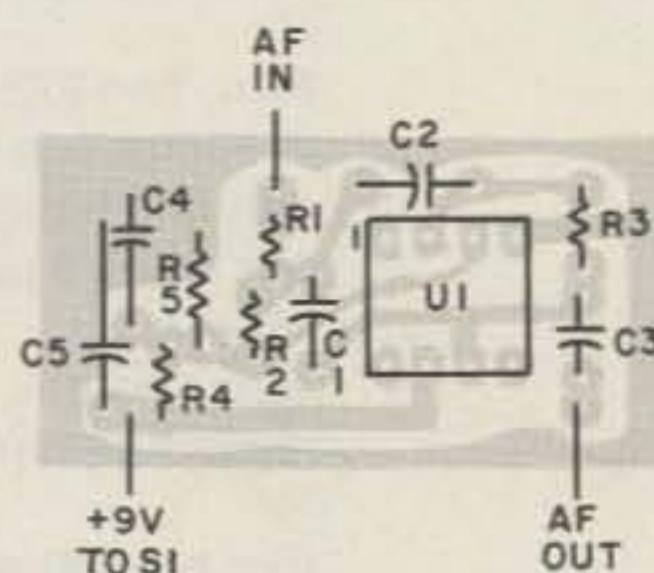

Component layout, filter PC board (foil side shown).

light-gauge aluminum can be drilled easily with a hand drill, and the holes enlarged with a file or knife.

The tuning potentiometer and its associated resistors and inductor should be mounted on the front panel. Small-gauge wire can be used between 9-V and R101 and between one side of L (external) and the PC board. Coax should be used between the antenna connector and the PC board. Audio cable should be used for the connection from C7 on the PC board and the phono connector, J2. Audio cable should also be used between the receiver and the audio-amp input.

Mount the board at least 1/4" above the cabinet base

so that the PC traces will not short to ground. The PC board should be mounted in such a way that both the front-panel controls and the battery will fit easily. The battery can be tucked neatly between the board and the rear panel and a 9-V battery clip used to connect it to the circuitry. Dress the battery wires neatly along the side, away from the components, and attach them to the on-off switch.

### Operation

Before the receiver is turned on, a few simple checks should be made. Vi-

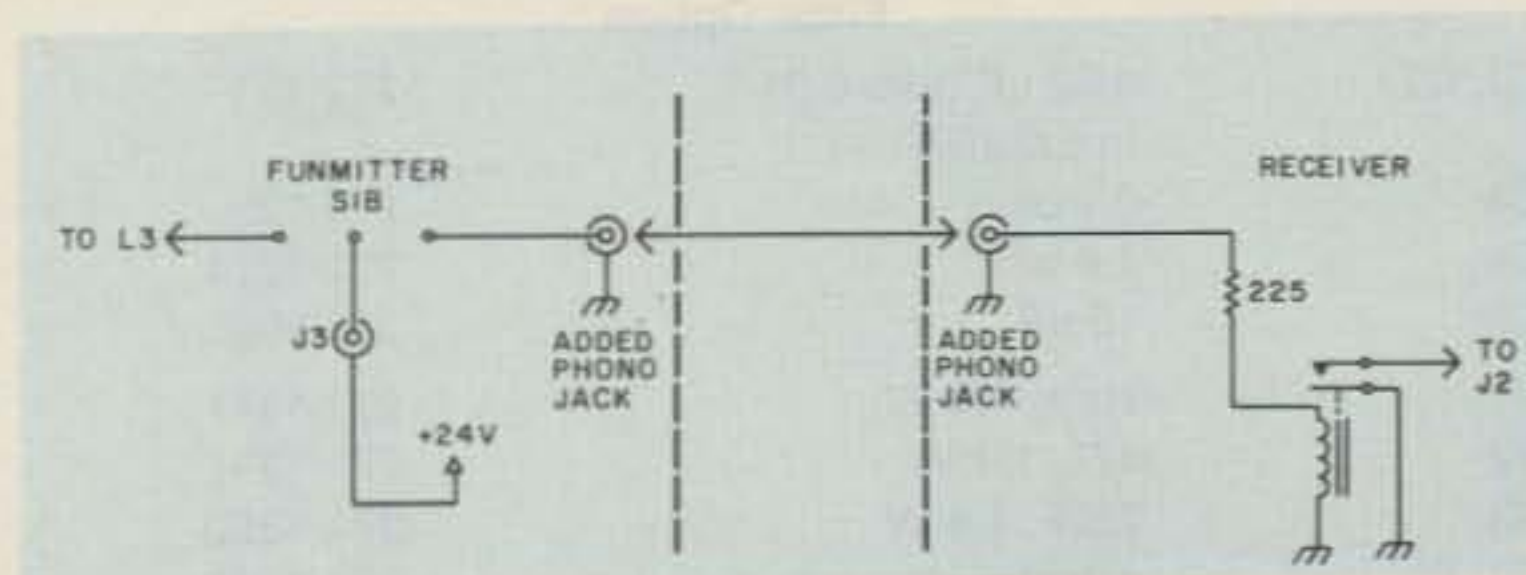

Fig. 4. Needed modifications to transmitter and receiver to include receiver mute option.

ulator for the receiver. It also aids in reduction of hum caused by the 60-Hz power-line frequency that is common with ac-operated, direct-conversion receivers. Again, simplicity is the key word!

### Options

Two options have been designed for use with the receiver to make operation more enjoyable. An audio filter, shown in Fig. 2, can be added before the audio amplifier to provide good audio selectivity. The filter is a bandpass type with a center frequency of 800 Hz. The filter will cause signals to peak at 800 Hz.

The filter is inserted at the af output (after C7). The PC board can easily be mounted inside the receiver box. Ideally, a front-panel switch should be added which will either bypass or include the audio filter. This will make tuning much easier. If the switch is not included, tune very slowly across the signals or the band will appear dead! For best results with the filter, headphones should be used. This is because the high-Q filter will cause an unpleasant ringing at the higher audio levels needed for speaker use.

The second option allows the receiver to be silenced during transmit. If this is not done, the audio

level from the receiver can become quite uncomfortable during transmit. Most designs use a transistor switch to short the audio to ground, but for simplicity sake I chose to use a relay as shown in Fig. 3. This provides a very easy method to mute the receiver audio and can be added to the receiver at any time. Control voltage comes from the transmitter. A phono jack can be added to the FunMitter and wired to the receive side of the transmit/receive switch, as shown in Fig. 4.

### Construction

The receiver is constructed on a 2 1/4" x 3" single-sided PC board. Although the layout of the board can be changed, it should be emphasized that the receiver needs to be built on a PC board. Point-to-point wiring or breadboard wiring can lead to wiring errors and also can create unwanted ground loops in the receiver. Loading time of the parts on the PC board should be less than one hour.

For best operation, the board should be mounted in an enclosure. A very suitable one is mentioned in the Parts List. Front- and rear-panel controls and jacks should be mounted for best use and looks. If the Radio Shack cabinets are used, the metalwork becomes an easy task. The

### Parts List

C1, C3	80m: 220 pF 40m: 47 pF	272-124 272-121
C2	4.7 pF	272-120
C4, C7, C14	0.1 uF	272-135
C5, C13	10 uF	272-1025
C6, C12	0.01 uF	272-131
C8	approx. 47 pF	272-801 (see text)
C9	approx. 200 pF	272-801 (see text)
C10, C11	approx. 470 pF	272-801 (see text)
CR1, CR2, CR3	1N914 diode	276-1122*
J1	SO-239 ant. conn.	278-201
J2	Phono conn.	274-346
L1	2-turn link over L2 (hookup wire)	
L2, L3	80m: 8 turns removed from 273-101 inductor	273-101
	40m: no turns removed from 273-101 inductor	273-101
L4	80m: Two 273-101 inductors in series; one with no turns removed; one with 10 turns removed	273-101
	40m: 10 turns removed from 273-101 inductor (For both 80 and 40m, the modified inductor should have last 3 turns spread out over rest of form.)	273-101
L5	100-Uh choke	273-102
Q1	Dual-gate MOSFET	276-2045
Q2	FET	276-2035
R1, R3	100k, 1/4 W	271-1347
R2	270, 1/4 W	271-1314
R4	100, 1/4 W	271-1311
R5	1000, 1/4 W	271-1321
S1	SPST min. switch	275-612
Misc.	200-mW audio amp metal cabinet knob 9-V battery clip 9-V battery Misc. Hardware	277-1008 270-251 274-392 270-325
<i>Not on PC board:</i>		
R101	3900, 1/4 W	271-1329
R102	10k linear pot	271-1721
R103	220 1/4 W	271-1313
L (external)	100 uH	273-102

### Filter Option

C1, C2	0.02 uF (two 0.01 in parallel)	272-131
C3	0.1 uF	272-135
C4	4.7 uF	272-1024
C5	10 uF	272-1025
R1	100k, 1/4 W	271-1347
R2	470, 1/4 W	271-1317
R3	220k, 1/4 W	271-1350
R4, R5	47k, 1/4 W	271-1342

\*For 80 meters, for CR1, CR2 use two 1N914 in parallel (piggyback).

sually inspect all the traces on the PC board to make sure that there are no solder or etching shorts between pads. Also check all soldered connections to make sure that there are no cold solder joints. Components should also be checked for loading accuracy.

If an ohmmeter is available, a reading of approximately 200Ω should exist between the hot side of S1 and ground (with S1 off!). If the ohmmeter reads near zero Ohms, then a short exists somewhere and the PC board and all wiring should be reinspected.

After these checks have been made, the receiver is ready for frequency adjustment. All of the receivers I have constructed have worked the first time, and yours should not be an exception. The only adjustment to be made is that of adjusting L4 for the correct frequency. For either 80 or 40 meters the procedure is the same.

Using another receiver, listen for the vfo signal. To do this, hook a length of wire to the antenna connector of the listening receiver. Drape the other end of this wire near the companion receiver's PC board. Tune the listening receiver to the bottom of the segment to which you desire to set your tuning range (for instance, 3700 kHz on 80 meters). Using a non-metallic tool, compress or widen the 3 adjusting turns of L4 until the vfo signal is heard on the frequency you are tuned to. This adjustment will need to be done slowly and may need to be repeated once or twice until you are right on frequency.

That is the only adjustment necessary. For best re-

sults, the receiver should be operated initially without the 800-Hz filter (or with it bypassed). This will allow you to familiarize yourself with the receiver. You may find you don't even need it. I prefer headphones because the brain seems to do a great deal of filtering for you when using them. Any 8-Ohm phones can be used provided an adapter is made to connect the amplifier output to them. (The amplifier output is a mini-jack, whereas most 8-Ohm headphones have 1/4" standard plugs.)

A 50-Ohm resonant antenna will provide best results. If the receiver is to be used with the Fun-Mitter, a short coax jumper can be used between the two. If the receiver mute option is used, a short wire should be connected between the two and it should be verified that the audio disappears when the transmit-receive switch is switched to transmit.

The receiver provides surprisingly good results. Because of the simplicity and low cost, several receivers can be built for different frequencies. I have even built one for a 75-meter SSB net for use as a monitor receiver.

### Conclusion

All home-brew contacts can now be completed with the construction of the receiver. The companion receiver provides the simplest method, without compromising performance, to complete your station. In the months to come, a vfo, amplifier, and other projects will be presented which will further enhance your station. ■

PC boards are available from the author: Receiver PC board —\$7.00 ppd; Filter PC board—\$3.50 ppd. PC boards for the Fun-Mitter transmitter (73 Magazine, February, 1981) are also available from the author—\$7.00 ppd.

# BY POPULAR REQUEST...

The Best Features Of Two Proven HAL RTTY Models  
Are Now Available In ONE Convenient New Unit—

The

## DS2050 KSR



**DS2050—\$649.00**

(Available April 24, 1981)

- Self contained RTTY and CW terminal —RTTY demodulator is now internal!
- Best features of BOTH the DS2000 and ST5000 in one package.
- Simplified connections to your transceiver with standard phono connectors.
- Front panel tuning meter (rear panel scope connectors).
- Both 170Hz and 850Hz shifts for receive and transmit.
- Full high voltage loop<sup>1</sup> compatible for printers, keyboards, and tape transmitters (TD's).
- Full length 72 character lines—24 line screen.
- Pretype either 255 character transmit buffer or the full 1728 character screen.
- Two programmable HERE IS messages with CW ID.
- Keyboard Operated Switch (KOS) for automatic TX/RX control.
- Bright-dim display of received or transmitted text.
- 1-100 wpm CW; 60, 66, 75, 100, 133 wpm Baudot RTTY; 110 or 300 baud<sup>2</sup> ASCII RTTY.
- Word wrap-around, Unshift On Space (USOS), and Synchronous Idle Transmit.
- Edit as you type with WORD transmit mode.
- Built-in demodulator is a proven ST5000 demodulator, not a simple compromise.

<sup>1</sup>Use your own high voltage loop supply.

<sup>2</sup>External modem recommended for 300 baud.

WHEN OUR CUSTOMERS TALK *WE LISTEN*



HAL COMMUNICATIONS CORP.

BOX 365 ✓345

URBANA, ILLINOIS 61801

217-367-7373

DS2050 .....\$649.00  
MR2000 .....\$169.00  
ESM914.....\$169.00

# The Kenwood TS-130S

## — a good rig done better

**W**hen Kenwood introduced the TS-120S some time ago, it was an instant success. There weren't many rigs like it available at the time and Kenwood's engineers managed to cram an incredible number of useful features into a very small box.

After WARC, Kenwood decided to upgrade their HF transceivers to include the new amateur frequency allocations, and the TS-130S was one of the first of the improved rigs to appear on the dealers' shelves.

Not content to merely add a few new positions to the bandswitch, Kenwood listened carefully to TS-120S owners and included some useful new features in the package. For example, when mobiling an HF rig, every Watt of transmit power counts, and the lamentable omission of a speech processor from the 120S has been corrected in the 130S. Many CW operators like to be able to choose between wide and narrow CW filtering, depending on band conditions. With the 120S,

once the narrow filter is installed, it is automatically selected whenever the mode switch is in the CW position. CW operators have been placated by the addition of a wide/narrow filter switch on the front panel of the 130S. Small changes? Maybe, but they can make a big difference if they happen to be important to you!

After owning an Icom IC-701 for over a year and using a Yaesu FT-707 for the last several months, I thought I would round out

my experience with small HF rigs and get a Kenwood TS-130S. Here is what I discovered.

### The Features

When you sit down in front of a 130S for the first time, it doesn't take long to discover that while it is small, it is a complete rig. In fact, it incorporates almost all the features of much larger transceivers like the TS-820S. Here are a few of the facilities available to the operator of the 130S: full filtering available for both CW and SSB, i-f shift, RIT, speech processor, complete VOX facilities, built-in relay for linear-amplifier switching, digital and analog readout, 25-kHz calibrator, noise blanker, and 80-10 meter coverage, including the new WARC bands. Not bad for a rig of any size!

The good stuff isn't just inside the rig. There is an extensive line of matching accessories for the 130S, including several different types of remote vfo's, an external speaker for hi-fi audio fanatics, several microphones, an antenna tuner, a mobile mounting bracket, a monitor scope, and a phone patch. Kenwood has understood for years that hams like to have



Kenwood's TS-130S HF transceiver.

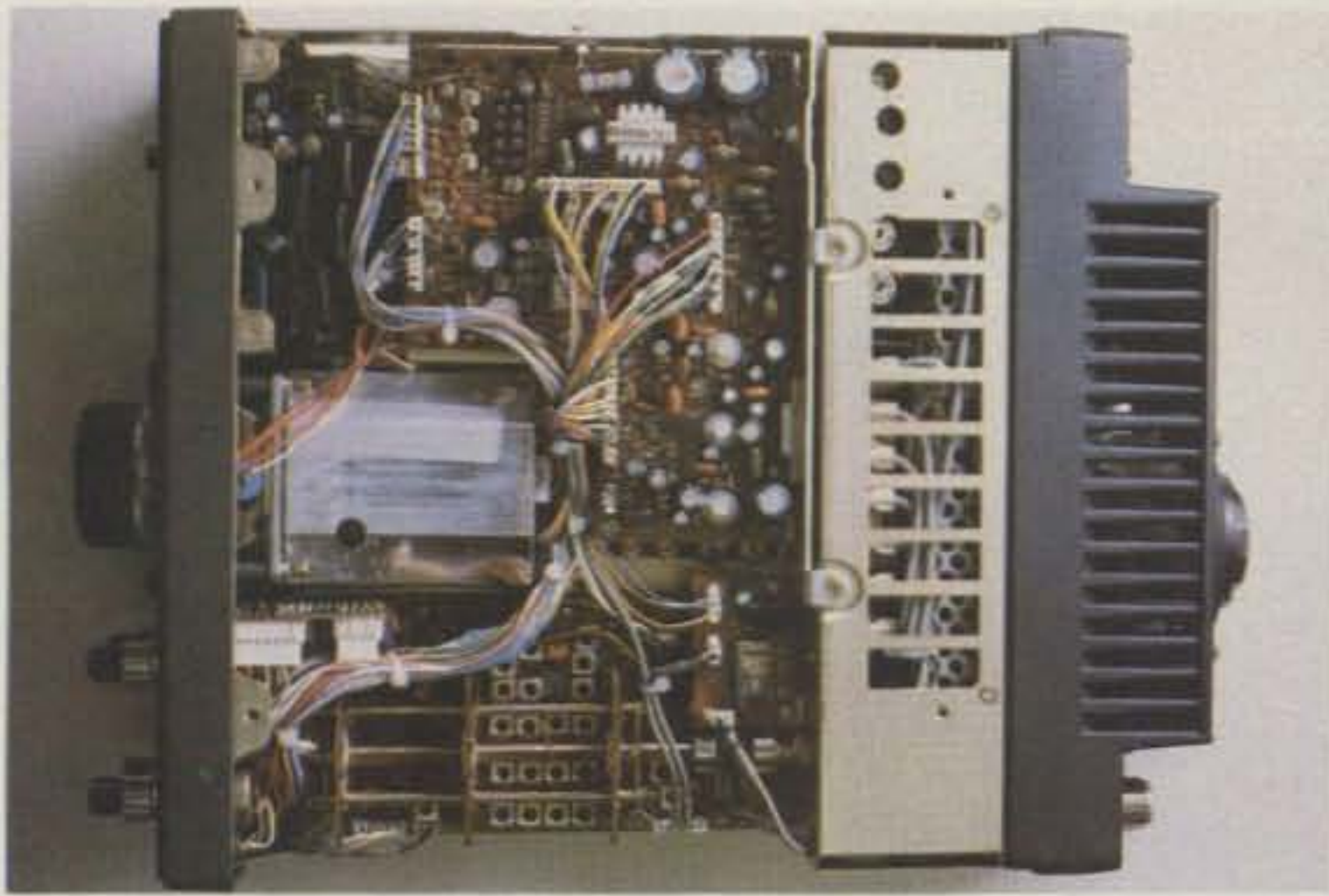

Top view of the 130S.

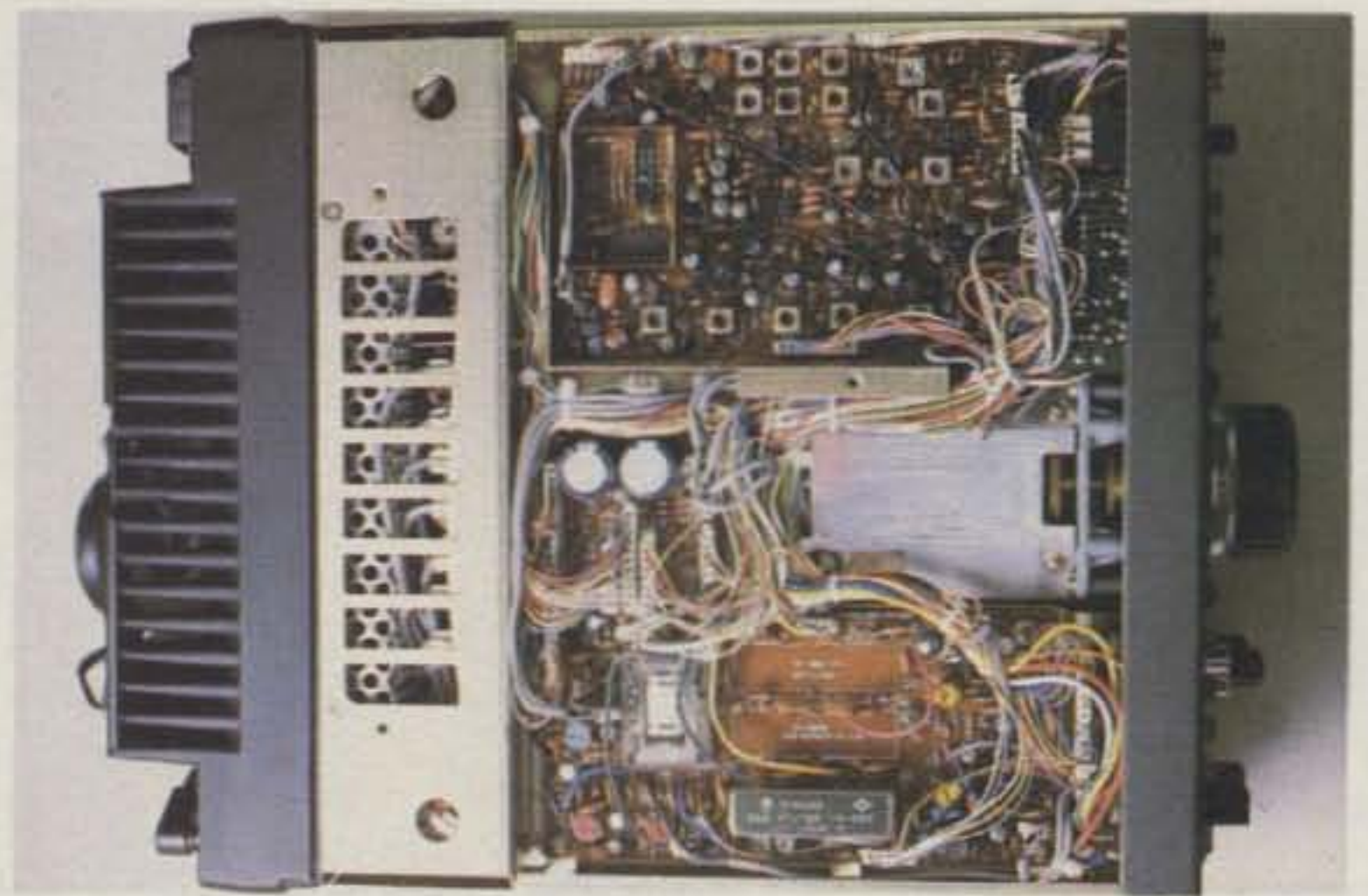

Bottom view of the 130S.

a lot of accessories to choose from for their stations (are you listening, Icom?) and they are doing their best to provide them.

When the 130S arrived, it saw a couple of months' service in the 73 ham shack, where it performed well. Its microphone, remote vfo, and linear amplifier connectors are compatible with those on the TS-830S,

allowing fast changeover for both rigs. In side-by-side comparison with the 830S, the 130S fared remarkably well. Any differences in sensitivity were deemed inconsequential, but the 830S was a slightly better performer in the selectivity department. Our admittedly subjective tests indicated that when both rigs were tuned to the same frequen-

cy, under certain conditions adjacent frequency "garbage" caused slightly more interference to the 130S than it did to the 830S. Otherwise, the 130S kept right up with its bigger brother. The i-f shift is several orders of magnitude more useful than similar controls on some other transceivers. It really works! The internal speaker provides better

than average audio quality, although it occasionally rattles when driven to the high levels favored by some staff members. When the rig is plugged into an external speaker, it provides typical Kenwood hi-fi audio at any practical level. The headphone jack on the front panel is wired to ac-

*Continued on page 109*

## NEW PRODUCTS FROM HAL-TRONIX

### 2304 MHz DOWNCONVERTERS

Frequency Range 2000-2500 MHz

- 2304 Model 1: Basic three-stage, less case and connectors.....**\$49.95**
- 2304 Model 2: Three-stage, includes preamp, with die-cast case and connectors.....**\$59.95**
- 2304 Model 3: With high-gain preamp, die-cast case and connectors.....**\$69.95**

The above models complete with high-quality drilled PC boards, all electronic components, etc., with 15-page manual.

Note: Any of the above, factory wired, \$50 additional

#### POWER SUPPLIES FOR THE DOWNCONVERTERS:

- Power supply kit # 1, less case and connectors.....**\$19.95**
- Power supply kit # 2, includes case & connectors.....**\$24.95**
- Power supply—already built, complete.....**\$34.95**

#### PARTS FOR THE NTSC RF MODULATOR FOR CHANNELS 3, 4, or 5.

This is **not** a complete kit. The hard-to-get parts include the LM-1889, the .08 microhenry tank coil, the 7-14 microhenry adjustable coil, the 10 microhenry RF coil, with schematic (no PC board) as used in Bob Cooper's satellite TV receiver. Real buy at.....**\$5.95**

#### SHIPPING INFORMATION

ORDERS OVER \$20.00 WILL BE SHIPPED POSTPAID EXCEPT ON ITEMS WHERE ADDITIONAL CHARGES ARE REQUESTED. ON ORDERS LESS THAN \$20.00 PLEASE INCLUDE ADDITIONAL \$1.50 FOR HANDLING AND MAILING CHARGES. SEND SASE FOR FREE FLYER

### TOUCHTONE DECODER KITS

- HAL 567-12:** single line in, 12 lines out, complete with 2-sided plated-through G-10 board and all components. Uses seven 567's and three 7402's.....**\$39.95**
- HAL 567-16:** single line in, 16 lines out, complete with 2-sided plated-through G-10 board and all components; includes 22-pin edge connector. Uses eight 567's and four 7402's. (See construction article in April 1981 Radio & Electronics for complete writeup.).....**\$69.95**

### TOUCHTONE ENCODER KITS

- HAL ECD-12:** 3 x 4 twelve-character encoder utilizing the ICM 7206 Intersil chip. Kit comes complete with both LED and audio-coupled outputs (speaker included). With aluminum anodized case.....**\$24.95**
- HAL ECD-16:** 4 x 4 sixteen-character encoder utilizing the ICM 7206 Intersil chip. Kit comes complete with LED and audio-coupled outputs (speaker included). With aluminum anodized case.....**\$39.95**

**"HAL" HAROLD NOWLAND  
W8ZXH**



✓31

**HAL-TRONIX**

P. O. BOX 1101  
SOUTHGATE, MICH. 48195  
PHONE (313) 285-1782

MICROLOG  
**ACT-1**

**\$995\***



We proudly announce our Amateur Communications Terminal, the ACT-1. It's the best value in the Amateur Radio market for your RTTY/CW requirements. Check the combination of features and proven MICROLOG quality. You'll agree, the ACT-1 is a "Tough ACT to follow." Microlog Corp. 4 Professional Dr. Suite 119, Gaithersburg, MD 20760, Tel. 301-948-5307 Telex 908778.

Sales through your local dealer

**MICROLOG**

51

INNOVATORS IN DIGITAL COMMUNICATION

- SIMPLE DIRECT CONNECTION to your Transceiver.
- COMPLETE SYSTEM, built-in Demodulator & AFSK Modulator with keyboard programmable tone pairs from 500 to 3000 Hz.
- SPLIT-SCREEN operation with keyboard selectable line location
- 1400 character text buffer.
- TEN, 40 CHAR. programmable message memories, plus ID's WRU & SELCALs.
- RANDOM CODE generator & hand key input for practice.
- Baudot 60 to 132 WPM.
- ASCII 110 & 300 baud.
- SYNC-LOCK & NON standard speed ASCII operation from 10 to 200 baud, (slow speed = noise immunity).
- RECORDER INTERFACE for "BRAG-TAPE" or recording off-the-air.
- CODE CONVERTED Printer output in Baudot or ASCII.
- SSTV/GRAPHICS transmit.
- FULL 63 KEY Computer grade keyboard.

\*9" monitor \$199.



*You knew we could do it!*

## The innovation leader in digital communications presents the ACT-1 Specifications:

---

**INPUTS:** Receiver audio right off the speaker terminals, TTL levels, or hand key.

**OUTPUTS TO TRANSCEIVER:** Positive & negative switching for CW or FSK keying, AFSK & SSTV tones at mic compatible levels, T/R (PTT) control.

**PRINTER OUTPUT:** Serial TTL selectable Baudot or ASCII (Code converted, regardless of on-the-air mode). Keyboard command on/off.

**PRINTER FORMAT:** Keyboard programmable from 40 to 140 characters per line.

**VIDEO OUTPUT:** Standard 1 Volt P-P to monitor or video modulator for use with your television.

**SCOPE OUTPUT:** Vert. & Horiz. to scope for RTTY tuning aid.

**BRAG TAPE:** Allows recording off-the-air or for making a long pre-recorded message for later transmission. Keyboard control record/play.

**MEMORIES:** TEN, 40 character user programmable. Can be stacked for longer than 40 char message. Can be loaded at any time.

**TEXT BUFFER:** Allows you to "Type-Ahead" up to 1400 characters while receiving (Text entered into the buffer is visible above the SPLIT-SCREEN line for correction).

**AUTO-START:** Inhibits the display of non-RTTY data.

**VIDEO DISPLAY VARIATIONS:** Black letters on white background or reversed white on black. NORMAL/ZOOM (twice normal char. size). All keyboard selectable. 40 Characters - 24 Lines.

**TUNING INDICATORS:** Scope output for RTTY, Audio (pitch) reference tone for CW & RTTY. LED for both.

**SSTV TRANSMIT:** Outputs standard tones for sending character and computer graphics. Compose full screen and XMT just as in RTTY.

**SSTV FORMAT:** Three rows of six letters white on black, or black on white.

**W R U (who are you?):** Automatically responds with call sign whenever a user programmable sequence up to 15 characters is received.

**FULL SPEED OPERATION:** Morse — 5 to 199 WPM, Baudot — 60, 66, 75, 100, 132 WPM, STD ASCII — 110 & 300 baud, NON-STD ASCII — from 10 to 200 baud.

**MORSE SPEED TRACKING:** Automatic or speed lock.

**SELCAL:** Two, 15 character user programmable sequences. Receipt of SELCAL #1 enables the printer and outputs a TTL level. Receipt of SELCAL #2 disables the printer and drops the TTL level for unattended message store (mailbox).

**TEST MESSAGES:** Quick Brown Fox and RYRY's in Baudot, U\*U\* in ASCII, VVV in Morse.

**SYNC:** Transmits "Blank-Fill" in RTTY and BT in Morse when Text Buffer is empty and unit is in transmit. Keyboard command on/off.

**T/R (PTT):** Fully automatic control of your XMTR via the Push-to-Talk line in both RTTY & Morse.

**UN-SHIFT on Space:** Automatically shifts back to "LETTERS" upon receipt or transmission of space. Keyboard command on/off.

**OUTPUT MODES:** CHAR. - outputs each character as typed. WORD - outputs full word when spacebar is typed. LINE - outputs full line when carriage return is typed. BUFFER - outputs full buffer (up to 1400 char) On command.

**REAL-TIME CLOCK:** Keyboard set, always on screen display, hours, minutes, seconds. Can also be inserted in transmit text buffer by keyboard command.

**WORD WRAP AROUND:** Prevents splitting words at the end of a line. Works in receive as well as transmit.

**DETECTION CIRCUIT — MORSE:** Single tone Phase Correlation detector AGC, and 100 Hz wide bandpass filter tuned to 800 Hz center frequency.

**DEMODULATOR — RTTY:** Dual tone computer enhanced circuit. Keyboard selectable tone pair, HI - 2125/2295 Hz. LO - 800/970 Hz. (Can be preset 500 to 3000 Hz.) Directly compatible with Bell 103 tone pairs for access to remote time sharing computers.

**CODE PRACTICE:** Random 5 char generator sends at any speed you set via the keyboard. Hand-Key input allows use as a code practice oscillator that will also read your sending!

**KEYBOARD DIMENSIONS:** 17.8 x 3 x 9.5 inches; weight, 7 lbs.

**STATUS DISPLAY** can be called up to show the condition and control commands for 20 programmable parameters, such as AFSK tone freqs, UNOS, printer etc. Useful as a "HELP" command in case you misplace the manual. There's also a constant "TOP-LINE" display of Time, Mode, Speed, & Code in use.

**CW ID & Normal ID:** Two independent 16 character memories for either 2 calls or one normal and one with AUTO-CW ID for RTTY.

---

# MICROLOG

# The NCG-15 SSB/CW Monoband Transceiver

— a moving tale of mobile hamming

Ever been curious about that NCG-15 15-meter SSB/CW QRP transceiver that's been advertised in 73 lately? I have. In fact, I've been seeing tantalizing ads for it since 1978 in *CQ HAM RADIO*, Japan's premier ham radio magazine. When the rig finally appeared on Columbia's shore, I knew I had to have one. At \$235, it seemed almost impossible to go wrong, so I promptly fired off an order.

By the time the rig arrived, I was more than a little curious and excited.

Careful unpacking yielded the rig itself, a U-bracket mobile bracket, a package of hardware, a Hi-Z handheld microphone, and a perfectly atrocious operating manual. Whoever is responsible for that manual couldn't have more than a nodding acquaintance with the English language! Fortunately, schematics are a universal language, and that essential document appears to be adequate for any service or modifications that a ham might contemplate.

The manual may be less than useful, but the rig is so straightforward that no manual is needed. Within three minutes of connecting the rig to a small 12-volt supply and a fifty-foot random wire, I was exchanging signal reports with F6EXL, near Paris! After signing with him, I had a pleasant QSO with a ham in Florida, and then with another in Arizona.

For the next couple of months, though, the rig languished unused on the shelf. I am afflicted with an

incurable case of DXitis, and with my marginal antenna system, when I heard someone I wanted to talk with I always reached for one of the more powerful transceivers in my arsenal. I could see that the QRP rig wasn't going to see much action until I installed my tower, an operation scheduled some two months in the future.

One day as I sat in my shack lost to the world, idly spinning the knob on my IC-701, my gaze came to rest on the NCG-15, and a lightning bolt of inspiration struck. Why not mobile the NCG! At this point some explanation is necessary. When I bought my IC-701 two years ago, I had great plans for mobile operations with it. I bought a mobile mount for it, and a Hustler mobile antenna with resonators for 40, 15, and 10 meters.

I soon discovered that the Icom's chances of seeing mobile operation were slim. Once it was wired into the home station with ground, linear control, antenna, keyer, speaker, and other accessory cables, pulling it out to use it in the car threatened to be a for-



The NCG-15 15-meter monoband transceiver.

Continued on page 111

# ICOM IC-720A



**Multi mode operation** includes CW/AM/SSB/RTTY — Normally used side band selected automatically.

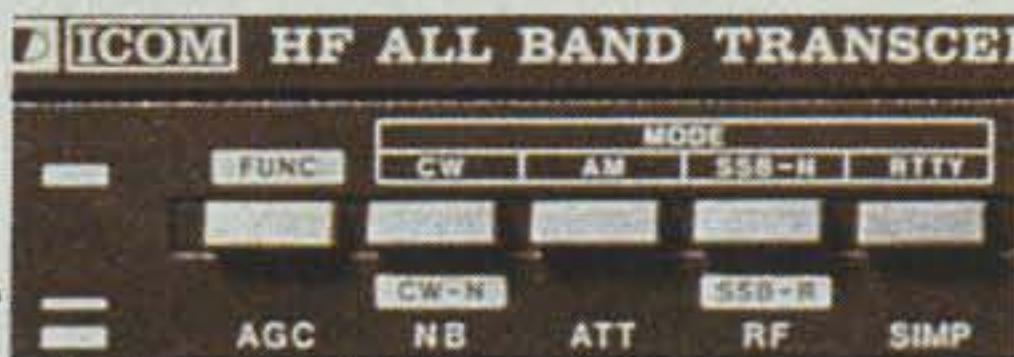

**Simple to use Dual VFO's standard** Data transfer button for marking a frequency of interest and storing it in unused VFO.



**Continuously variable power** from 10W to full power — speech processor — LDA channeling module included provides auto band changing capability when increasing your power using the IC-2KL broadbanded solid state linear.



**Broadbanded solid state transceiver operation** on the 9 amateur HF bands — Readout of mode in use and VFO — Status LEDs for push button functions.



**General coverage receiver** from a 0.1KHz to 29.999.9MHz — Split VFO operation — Frequency memorized in standby VFO.



**Use of RF/ALC switch** in conjunction with the internal top hatch cover switches allows monitoring relative RF Out, SWR, collector current and ALC.



## The ICOM HF System. We Have You Covered.



HF/VHF/UHF AMATEUR AND MARINE COMMUNICATION EQUIPMENT



# ICOM

ICOM AMERICA, INCORPORATED

Sales Service Centers located at:

2112 116th Avenue NE  
Bellevue, WA 98004  
Phone (206) 454-8155

3331 Towerwood Dr., Suite 307  
Dallas, TX 75234  
Phone (214) 620-2780

# The Incredible Shrinking Antenna

— give your vertical a top hat

You might not believe it if I told you that you can build a vertical antenna for 40 meters that has a 2:1 SWR bandwidth of over 1 MHz, is highly efficient, is only 12' high, and will withstand wind velocities to an extent that it will probably never blow down.

It probably sounds too good to be possible. And yet, it can be done easily us-

ing a technique that I have seen very little of at amateur frequencies: oversized capacity hats. The antenna described here was built from the remnants of an old 14AVQ 4-band trap vertical, a few feet of wire, and three ordinary porcelain insulators.

## Capacitive Loading

Take a drive around your local ham neighborhood and observe the trap vertical antennas being used. Most of them have a little top hat consisting of three

or four prongs about a foot long. What is the purpose of this little thing? Basically, it increases the capacitance of the high-voltage end of the antenna. Capacitive loading brings down the impedance value at the top of a vertical antenna, reducing chances for "corona" effects. It also increases the bandwidth somewhat on the lowest band; not much, but a little is better than nothing. The capacity hat also makes the antenna look much more sophisticated and increases the

wind loading. (Isn't that great?)

Actually, capacitive loading is under-utilized on the 40-, 80-, and 160-meter amateur bands. While the radius of the capacity hat on a commercially manufactured trap vertical is about 12", which translates to an electrical length of 0.008 wavelength on 40 meters or 0.004 wavelength on 80 meters, it is possible to have a capacity hat radius of up to about 0.1 wavelength without producing detrimental effects on antenna efficiency. This is true because most of the radiation from an antenna occurs where the current is highest, and that's near the bottom of a quarter-wave vertical.

In general, a capacity hat of radius  $r$ , consisting of three or four elements, increases the effective height of a quarter-wave vertical by about  $2r$ . This is illustrated in Fig. 1. The physical size of 0.1 wavelength is about 12' at 40 meters, 24' at 80 meters, and 48' at 160 meters.

## The 40/15-Meter Vertical

Fig. 2 shows the design of the 40- and 15-meter antenna I constructed. Actually, I

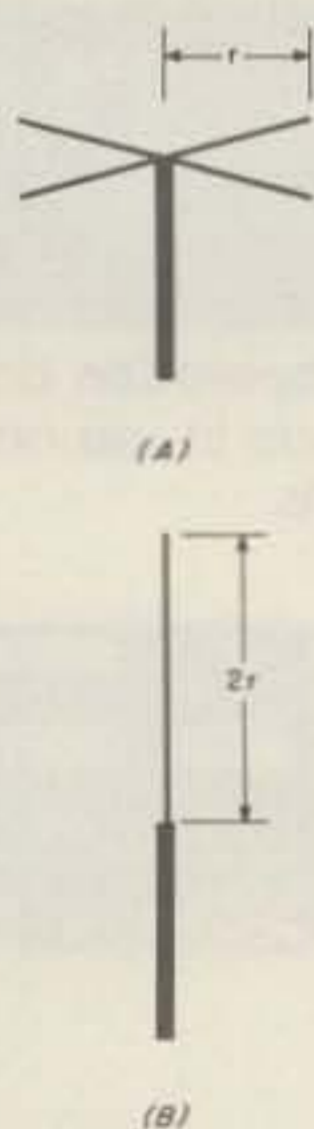

Fig. 1. A Capacity hat of radius  $r$  increases effective antenna height by twice its radius, or  $2r$ . That is, the antenna at A and the antenna at B will have about the same resonant frequency if the lower section (thick line) is identical in both cases.

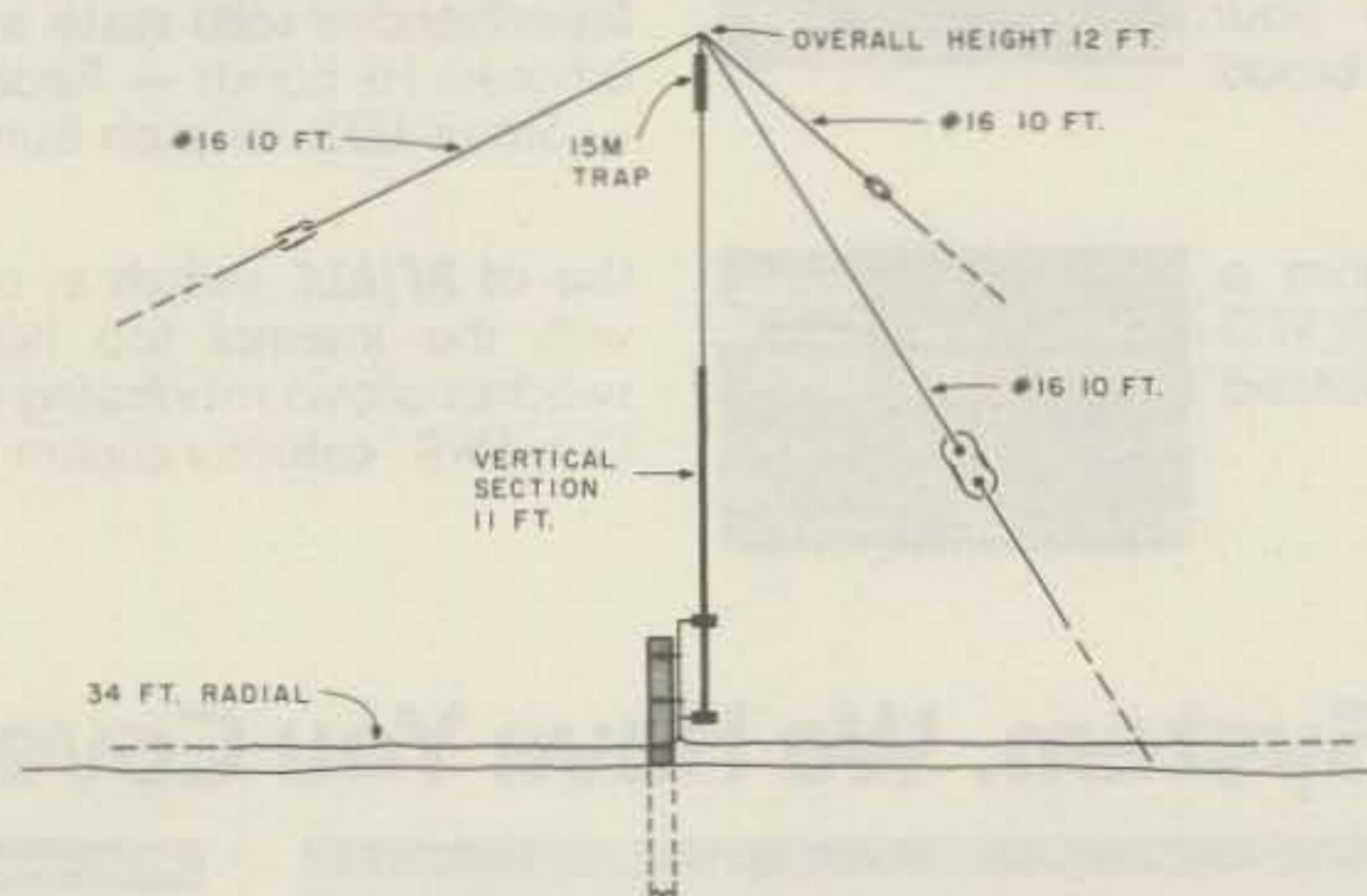

Fig. 2. The basic design of the 12' 40/15-meter vertical. The trap and base mount are from the original 14AVQ. The capacity hat wires were attached to the top of the trap via an ordinary hose clamp. The fine details of construction are not critical, and the builder may use whatever methods suit his situation.

designed the antenna with only 40 meters in mind, but it turned out that the lengths and inductance values required were close enough to allow the inclusion of 15-meter capability. The entire antenna system is resonant as a quarter-wave vertical on 40, and the 11' section underneath the 15-meter trap operates as a quarter-wave system on 15.

I installed six radials, each 34' long, simply by laying them on the grass (after warning the landlord to have me remove them before he cut the lawn!). This is admittedly a marginal system; actually it takes dozens of radials to make a ground-mounted vertical optimum. But, being basically lazy (and frugal), I felt quite content with only six. This proved to be entirely adequate on the air.

Using the formula that the 10' radius of the capacity hat translates to about 20' of additional height for the antenna, you can see that the effective height of this vertical is pretty close to a full quarter wave on 40 meters. Actually, the swr bandwidth is astonishing. Fig. 3 shows the swr measurements across the 40-meter band.

Of course, you may say that Fig. 3 doesn't tell us much about the antenna; after all, a dummy load would have a swr curve every bit as flat, and even lower! And, if this antenna were radiating almost nothing but happened to have a ground resistance close to 50 Ohms, you might get a curve similar to that shown in Fig. 3. This is a valid point. So, I checked out the swr on 20 and 80 meters; it should be very high if the antenna is working properly—it is. The broad resonant response of this antenna is, no doubt, attributable to the effects of the gigantic capacity hat.

One note if you happen to have a 4-band trap verti-

cal and are thinking about trying this idea: The radius of the capacity hat may vary a little bit, depending on the ground characteristics in your vicinity and the Q of your 15-meter trap. However, the radius should be between 8' and 12' in almost any situation.

#### On the Air

Then came the ultimate test, the real checkout. There's only one way to see whether an antenna works after all the engineering and swr checking is done. The question was, of course: Will this antenna "get out"?

On the air, the antenna performed as expected for a vertical. Nearby stations (within a radius of about 300 miles) were relatively weak, and stations further away were strong. A lot of DX was heard and worked, especially from Europe in the evening and Japan and New Zealand in the morning. Many of these DX stations were as strong as stateside W2 stations.

I'm not about to make any extraordinary claims for this antenna. In operation, it seemed to outperform the original 14AVQ with respect to DX; it proved essentially the equivalent of a full-size, 33' structure which I subsequently built and tested. This little antenna certainly is more physically rugged than the full-size job. The latter strained perilously against mere 20-mph winds, while the little 12' antenna was indifferent to gusts in excess of 40 mph. By indifferent, I mean that it hardly moved. And, of course, during a heavy thunderstorm, I would much rather have a 12' metal structure in my yard than a 33' metal structure!

#### Considerations for 80 and 160

Since 40 meters is my favorite band by far, I did not

## We've got a Secret...

*Our products and customer service will soon be one of the best known secrets in communications monitoring.*

*Want to know more?*

WRITE TO  
DEPT. K  
FOR  
CATALOG.



"... searching for the sounds of tomorrow"



**GROVE ENTERPRISES, INC.**

Brasstown, North Carolina 28902

consider applying this technique to 80 or 160. However, these low bands are even better candidates for the idea than 40 meters.

If you are interested in building an antenna of this kind for 80 or 160 meters, remember that the maximum radius of the capacity hat is 0.1 wavelength, or 24' on 80 and 48' on 160. These values are probably best. Why go for anything shorter? As for height, choose the maximum height you

feel comfortable with. On 80 meters, 16' would be a good choice, since the coil or trap would allow resonance on 20 meters also.

In place of the trap, it is recommended that an air-core coil be used, which can be tapped until the proper value of inductance is obtained. The trial-and-error process may take a while, but resonance should be very broad, so the task should not be that difficult. ■

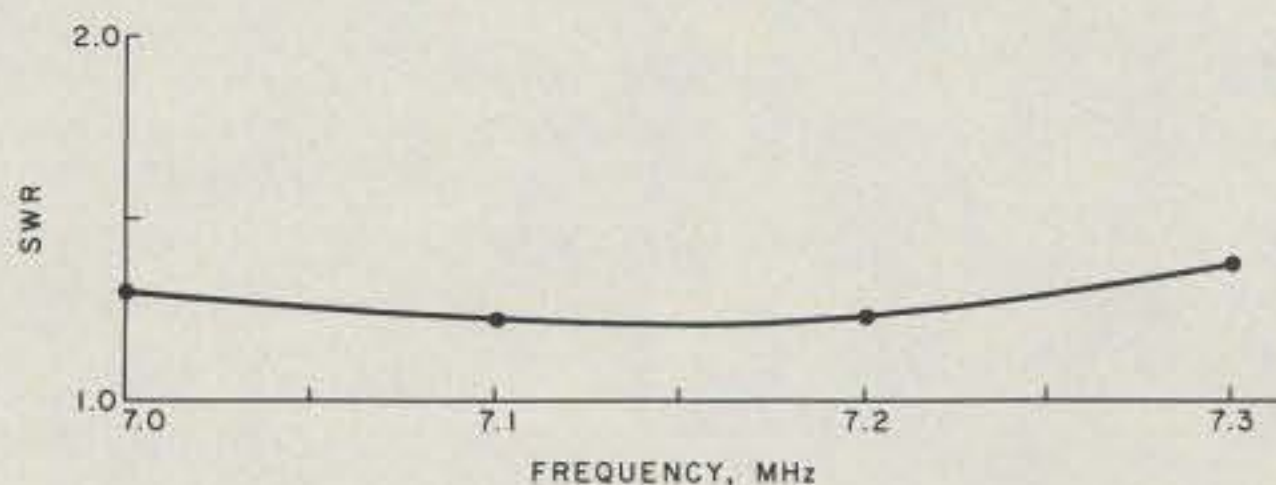

Fig. 3. The swr curve for this antenna is almost flat. The exact value will depend on the number of radials used and the conductivity of the ground. Anything less than 2:1 is generally regarded as acceptable. The important characteristic here is the flatness of the curve, indicating a very low Q attributable to the large size of the capacity hat.

# The Micro Control Specialties Mark 3CR

— a hassle-free repeater that does it all

Not so very long ago, if you wanted to put a repeater on the air, you had two choices. You could buy a commercial repeater from Motorola, GE, or RCA at a breathtaking price, or you could kludge-together something on your own, producing a unique blend of home-brew, amateur market, and commercial equipment. Over the last few years, several firms have been marketing repeaters specifically designed for the amateur market, without the hefty price tags of commercial equipment. At first, these "amateur-grade" repeaters were sneered at by the old stalwarts of the VHF bands. Recently, the performance and capabilities of these

repeaters have improved to the point where they can no longer be ignored.

The Micro Control Specialties Mark 3CR repeater is an excellent example of what can be done by an enterprising company that sets out to meet the unique needs of the amateur community. Its microprocessor controller is the most versatile and practical I have ever seen—it would take a book to describe all its capabilities! In this review, I'll try to give you a general idea of what the repeater is capable of, and how it performs in day-to-day use.

### Physical Characteristics

Physically, the repeater is rather unassuming—it is mounted in a box on a stan-

dard 19" rack panel, 5-1/4" high and 12-1/2" deep. On the front panel are two knobs, two switches, a mike jack, and a cluster of 12 LEDs. Period. One of the knobs is the squelch control for the main receiver; the other is the volume control for the local speaker. The switch on the left of the mike jack is the power switch, and on the right is the "command" switch. More on the command switch later. The LEDs on the right-hand side of the front panel are status indicators. Some are assigned at the factory, others are free to be assigned to specific tasks by the end user.

If the front panel fails to indicate the vast range of functions available to the

owner of a Mark 3CR, comprehension will surely dawn after even the most cursory examination of the rear panel. It sports two terminal strips with a total of 30 connection points for control of external devices, and six phono jacks for various audio inputs and outputs. An octal socket allows access to various voltages for metering purposes, and a pair of banana connectors is provided for a 12-volt backup power supply, such as a deep-cycle marine battery. Three SO-239 connectors are provided for antenna connection to the receiver, transmitter, and an on-board control receiver.

*Continued on page 109*



Front view of the Mark 3CR.



Top view of the Mark 3CR.

## Alaska Microwave Labs

4335 E. 5TH STREET - DEPT. 73  
ANCHORAGE, ALASKA 99504  
(907) 338-0340

✓406

### TRANSISTORS

MRF901	FT4.5GHZ	\$3.00
MRF911	FT5.0GHZ	\$4.00
BFR90	FT5.0GHZ	\$3.00
BRF91	FT5.0GHZ	\$3.50
NEC 02137	FT4.5GHZ	\$3.25
NEC 02135	FT4.5GHZ	
TYPE NF 2.7DB MAG 12DB	@ 2.0GHZ	\$5.00
NEC 64535	FT8.5GHZ	
NF 2.0DB MAG 15DB	@2.0GHZ	\$14.00

### HOT CARRIER DIODES

MBD101	UHF-MICRO	\$1.50
ND4131 4GHZ	NF=5.75DB	\$21.00
HN-1 4GHZ	NF=6.5DB	\$2.00

### CHIP CAPACITORS

1.2, 2.2, 3.3, 4.7, 6.8, 10, 18, 22, 27, 47, 100, 120, 180, 220, 270, 330, 390, 470, 560, 680, 820, 1K, 1.2K, 1.8K, 3.9K, 8.2K, 10K, 100K	\$ 6.00
---	---------

### TEFLON CIRCUIT BOARD

APPROX. 3.25" x 5.0" x .010	\$5.50
APPROX. 3.25" x 5.0" x .312	\$6.50
APPROX. 3.25" x 5.0" x .0625	\$10.50

### FEED-THRU CAPACITORS

1000 P1 SOLDER TYPE	\$ 50
470 P1 SOLDER TYPE	\$ 50

### DUAL GATE MOSFET

RCA 40673	\$1.50
-----------	--------

### GaAs FETS

MGF1400 NF 2.0DB @ 4GHZ MAG 15DB	\$28.50
MGF1412 NF 0.8DB @ 4GHZ MAG 18 DB	\$75.00

### CHIP RESISTORS

SET OF 3 1% CHIP RESISTORS FOR 50 OHM T NETWORK 3DB PAD	\$6.00
--	--------

### COAX CONNECTORS

SMA Chassis Mount Square Flange	\$6.10
SMA Chassis Mount Plug sq. Flange	\$8.50
SMA Chassis Mount Strip-line Tab	\$6.75
SMA Plug for RG-58	\$6.75
SMA Plug for RG-174	\$6.75
SMA Plug for .141 Semi-rigid	\$3.98

### X BAND COMPONENTS

GUNN SOURCE 10.525 GHZ 10+/-5MW WR-90 WAVEGUIDE MOUNTING	\$37.00
IMPATT SOURCE 10.5 to 10.55GHZ 50+/-20MW WR-90 MOUNTING	\$39.00
FILTER/MIXER 8.2 to 12.4GHZ WR90 MOUNTING	\$30.00
HORN ANTENNA 18+/-1DB GAIN AT 10.525GHZ WR-90 MOUNTING	\$13.75
WAVE GUIDE FLANGE WR-90	\$4.00

### SILVER PLATING KIT

Will plate Copper, Brass, Bronze Nickel, Tin, Pewter, Gold and most white metal alloys	\$30.00
--	---------

### RF CABLE

141 Semi-rigid Cable, Approx. 24 DB Loss per 100 ft @ 4GHZ. Price is per ft +/- inch max length is 5 ft. Other lengths by special order.	\$4.00
---	--------

### PISTON TRIMMERS

TRIKO 201-01M .3-1.8 pf 5-3 pf 1-8 pf	\$2.50
---------------------------------------	--------

NO WARRANTY ON SEMI-CONDUCTORS

OPEN AT 8PM EST  
CLOSED AT 8PM PST

IF YOU DO NOT SEE  
WHAT YOU WANT ASK

ORDERS ARE POSTAGE PAID  
COD-VISA-MASTERCHARGE

## HI-Q BALUN

- For dipoles, yagis, inverted vees & doublets
- Replaces center insulator
- Puts power in antenna
- Broadbanded 3-40 MHz
- Small, lightweight and weatherproof
- 1:1 Impedance ratio
- For full legal power and more
- Helps eliminate TVI
- With SO 239 connector

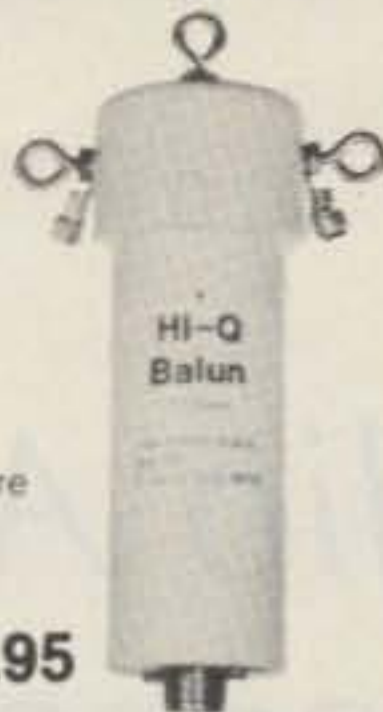

\$10.95

### HI-Q ANTENNA CENTER INSULATOR



Small, rugged, lightweight, weatherproof

Replaces center insulator

Handles full legal power and more

\$5.95 With SO 239 connector

### HI-Q ANTENNA END INSULATORS



Rugged, lightweight, injection molded of top quality material, with high dielectric qualities and excellent weatherability. End insulators are constructed in a spiral unending fashion to permit winding of loading coils or partial winding for tuned traps.

May be used for

- Guy wire strain insulators
- End or center insulators for antennas
- Construction of antenna loading coils or multiband traps

\$4.95

Patent No. 4,091,350

## DIPOLES

MODEL	BANDS	LENGTH	PRICE WITH HI-Q BALUN	WITH HI-Q CENTER INSULATOR
<b>Dipoles</b>				
D-80	80,75	130	\$28.95	\$24.95
D-40	40,15	66	25.95	21.95
D-20	20	33	24.95	20.95
D-15	15	22	23.95	19.95
D-10	10	16	22.95	18.95
<b>Shortened dipoles</b>				
SD-80	80,75	90	31.95	27.95
SD-40	40	45	28.95	24.95
<b>Parallel dipoles</b>				
PD-8010	80,40,20,10,15	130	39.95	35.95
PD-4010	40,20,10,15	66	33.95	29.95
PD-8040	80,40,15	130	35.95	31.95
PD-4020	40,20,15	66	29.95	25.95
<b>Dipole shorteners - only, same as included in SD models</b>				
S-80	80,75			\$11.95 pr
S-40	40			\$10.95 pr

All antennas are complete with a HI-Q Balun or HI-Q Antenna Center insulator, No. 14 antenna wire, ceramic insulators, 100 nylon antenna support rope (SD models only 50) rated for full legal power. Antennas may be used as an inverted V and may also be used by MARS or SWLs.

**Antenna accessories**—available with antenna orders  
Nylon guy rope 450# test 100 feet \$3.49  
Ceramic (Dogbone Type) antenna insulators .70 pr  
SO-239 coax connectors .55

All prices are postpaid USA 48  
Available at your favorite dealer or order direct from

Van Gorden Engineering  
Dealer Inquiries Invited

BOX 21305, S. EUCLID, OHIO 44121

✓373

## HUSTLER HF MOBILES DELIVER FIXED STATION PERFORMANCE

Hustler HF antennas deliver outstanding signal reports — wherever you're mobile!

Design your own HF mobile from a full selection of top-quality; U.S.-made stainless steel ball mounts, quick disconnects, masts, springs, and resonators. You can cover any 6-to-80-meter band. Choose from medium or high power resonators with broadest bandwidth and lowest SWR for optimum performance on any band. Easy band change and garaging with Hustler's fold-over mast, too.



Ask any ham — the best HF mobiles on the road come from: Hustler — still the standard of performance.

**HUSTLER**

3275 North "B" Avenue  
Kissimmee, Florida 32741

An ARMIATRON Company

# Radio Amateur's License Manual

## — don't memorize, learn!

Radio Amateur's License Manual, American Radio Relay League, 225 Main St., Newington CT 06111.

Any book that gets as far as a 78th edition has to be doing something right. The American Radio Relay League's *Radio Amateur's License Manual* is a classic. It has nurtured thousands of hams from Novice to Extra. Over the years, the *License Manual* has tried to keep pace with changes in the rules and exam content. With "memorize-the-answers" publications gaining in popularity, I was interested to see how the League's tried and true "Publication #9" kept up.

The *Radio Amateur's Li-*

*cence Manual* has always offered something for everybody. In the space of 175 pages it includes coverage of the Technician/General, Advanced, and Extra class exam subjects, plus a copy of the FCC's Part 97 rules and regulations. Among the other useful bits of information are details about international regulations, reciprocal licenses, and third-party agreements. Rounding out the broad range of topics is a list of addresses for the FCC field offices and a frequency allocation chart. All this in one 8½" x 11" softbound book that costs \$4.00.

The ARRL editorial staff has done a good job of presenting a tremendous

amount of material in a limited space. If you are very dedicated and have a solid background in amateur radio practices and theory, the *License Manual* will probably get you through the exams on the first try. Less experienced readers will want to use other materials to supplement the contents of the ARRL book.

As a firm believer in learning rather than just memorizing, I like the "new" *License Manual's* style. The large format lends itself to a lot of figures and diagrams that help clarify technical topics. There are multiple-choice questions at the end of each section. No, they are not pirated from the FCC

exams, but they do make a nice way to review.

For the majority of the hams contemplating the purchase of this book, all the lists, rules, and other extras are not as important as a pertinent, well-explained discussion of the topics on the exams. Each of the exam topics is covered, but not always in the depth required to be confident in answering the test questions. The approach used in this guide resembles shooting in the dark at a very small target, with a limited amount of ammunition. While the 78th edition of the *Radio Amateur's License Manual* is not a bull's-eye, it is better than completely missing the target. ■

## VANI-PLATE™



VEHICLE  
CALL SIGN PLATE  
— WEATHERPROOF —  
— DURABLE PLEXIGLAS —

YOUR CALL OR NAME IN ATTRACTIVE RAISED PLEXIGLAS LETTERS (SPECIFY BLACK OR WHITE) UP TO EIGHT WELDED ON A BLUE, WHITE, BLACK, RED OR BROWN PLEXIGLAS MOUNTING PLATE. OR CHOOSE THE ATTRACTIVE FLECK MOUNTING PLATE; SELECT FROM RED, GREEN, GOLD, BLUE OR SILVER COLOR.

STD. VANI-PLATE - \$9.95 FLECK PLATE, ADD \$3.00 UPS CHARGE - \$1.95  
HEAVY CHROME FRAME - \$2.99 24-HOUR DELIVERY  
DELUXE CHROME FRAME - \$7.99

— SEND 25¢ FOR 1981 CATALOG —

VANI-PLATE COMPANY  
P.O. Box 136, W. Yarmouth, MA 02673 ✓437  
(617) 394-8595

## AMATEUR CALLSIGN DISPLAY



Ideal for desk, shack, and operating position

Neat, attractive, colorful

Top quality throughout

Size: 3" x 8"

Available with or without clear Plexiglass holder

Colors available: Black, blue, red, green, or wood-grain background with white letters; or white or yellow background with black letters.

©Copyright 1979

Price: (without holder) \$6.00 plus \$.75 shipping

(with holder) \$8.50 plus \$1.00 shipping

Please specify

2nd choice

Shipment guaranteed within two weeks of your order

Checks, cash or money orders accepted

(517) 588-6255

of color

**G & T SERVICE COMPANY** ✓410

3210 N. County Line Road, Farwell, MI 48622





# From Spec Comm

## 10M FM Receiver & Transmitter Boards or, Complete Shielded Subassemblies!

### For 10M FM REMOTE BASES, REPEATERS, OR TRANSCEIVERS!

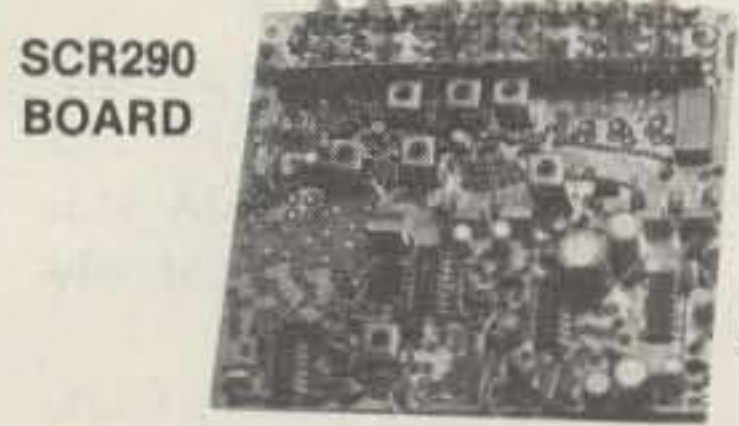
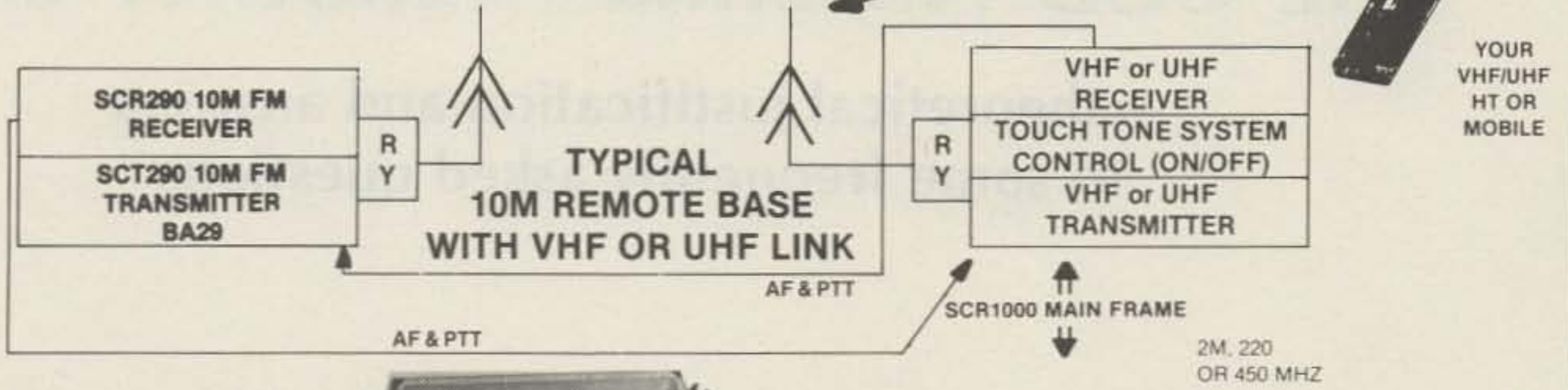

SCR290 BOARD

• *Totally New Advanced Design!*

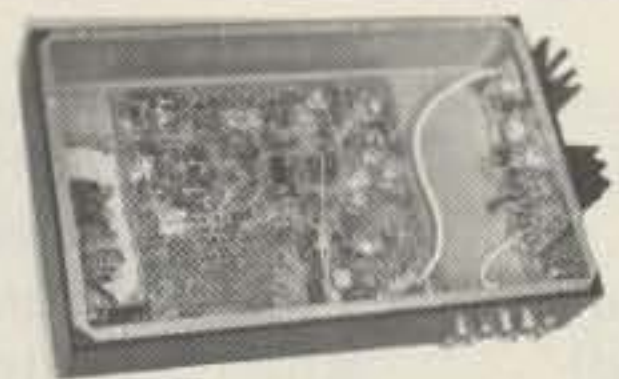

SCT290 XMTR. ASSY.  
SCT290 Xmtr/Exciter Board



#### SCR290 Receiver Board

- Wide dynamic range! Reduces overload, 'desense,' and IM.
- Sens. 0.3 uV/12dB SINAD typ.
- Sel. -6dB @ ±6 KHz, -104dB @ ±15 KHz. (8 Pole Crystal Fitr & 4 Pole Ceramic Fitr.!
- 5 Pole Front End Fitr.
- 'S Meter,' Discriminator & Deviation Mtr. Outputs
- Exc. audio quality! Fast squelch! w/0.0005% Crystal. \$169.95.

#### SCR290 Receiver Assembly

- SCR290 mounted in shielded housing
- Completely asmbld. w/ft caps, SO239 conn., \$235.00

- 2 or 35 Wt. Units. 100% Duty Cycle
- Infinite VSWR proof
- 1 chan.—expandable up to 6
- New Design—specifically for continuous rpt. or remote base service.
- Spurious -70 dB
- With .005% xtal. \$139.95—2W. Bd.
- 35 W. Unit includes Heat Sink, 3 sec. L.P. Filter & rel. pwr. sensor. \$215.00

#### SCT290 Transmitter Assembly

- SCT290 mounted in shielded housing
- Ready to "drop into" your system!
- Completely asmbld. w/F.T. caps, SO239 conn.
- 2 or 35 Wt. unit. \$235./290.00

- **JOIN THE FUN ON 10M FM!** This new phase of Amateur Radio is growing every day and is one of the most exciting new modes of operation in years!
- **10M FM COMBINES ALL OF THE BENEFITS OF VHF FM OPERATION WITH HF "LOW BAND" OPERATION;** i.e., the quiet, noise-free QSOs of 2M FM *except better ground wave range*, with less mobile fading and flutter due to hills and trees, etc. *Plus—occasional "Skip" contacts all over the country and around the world...* with all of the clarity, "solidness" and ease of cross-town channelized 2M FM contacts!
- **ON 10M FM**, you can use low cost, cutdown CB antennas and accessories. And, low cost 10M FM Transceivers are now available from other manufacturers, which will help to increase activity.
- **ON 10M FM**, you can avoid the crowded conditions on other bands!

**Now you have a complete source for all of your 10M FM Remote Base, Repeater, Link or Transceiver needs!** Spectrum can supply you with a complete set of *fully wired & tested* Rcvr. & Xmtr. Boards for 10M FM, (or 2M, 220 or 440MHz Links)! Also available are our **COR, ID** and **Touch Tone Control boards** which have been used by the thousands in Repeater systems throughout the world.

Or, if you wish, we'll build the complete system for you! 10M FM Remote Base with VHF/UHF Link, or Complete Split Site Repeater with Touch Tone and/or CTCSS control. (\$2995.00). Note that all of our equipment is of the highest Professional "Commercial Grade" quality as opposed to the "low cost kits" on the market.

Write or Call for Details.



# SPECTRUM COMMUNICATIONS

1055 W. Germantown Pk, Dept. S7 • Norristown PA 19401 • (215) 631-1710

Harry A. Mills W4FD  
 Box 409 Bullard Route  
 Dry Branch GA 31020

Gene Brizendine W4ATE  
 600 Hummingbird Dr. SE  
 Huntsville AL 35803

# The CCD Antenna — Another Look

— theoretical justification and answers  
 to some frequently asked questions

**R**esponse to our first article (73 for October, 1978) describing the high-gain Controlled Current Distribution antenna, has been exciting. Many telephone calls and letters have come from coast to coast, universities, and from out in the Pacific.

Enthusiastic comments and data were volunteered by Professor Arthur Erdman W8VWX of Ohio State Uni-

versity. His experience is quoted with his kind permission:

"My previous 14-MHz inverted dipole was 45 feet from earth at the center, and surrounded by five trees. It was fed with low-loss 300-Ohm twinlead and a tuner, and produced very poor DX results. Then, a CCD was built

and substituted for the inverted dipole, at the same height and using the same tuner and feedline. The results are amazing! My DX is summarized: 14-MHz Inverted Dipole

1. Could work only the S-9 DX stations — my reports were S-4 to S-5.
2. Never any answers

- to my DX CQs.
3. Last one in a pileup. 14-MHz CCD Antenna
  1. Can work DX stations I can scarcely hear!
  2. After ordinary CQs, more DX stations answer.
  3. Usually 5th to 10th in large pileups!"

The Ohio State University Electrical Engineering Department feels that further research into the CCD principle is definitely justified. Professor Erdman will direct the investigation, utilizing already-written computer programs.

Additional data are presented in this article that will be helpful in constructing and understanding the superior antenna. There also is a section on theory. Finally, the questions most often asked are addressed below, in the order of most concern to those interested in the CCD's advantages.

## Testing

Previous comparisons of CCD antenna performance against a reference dipole at 7 MHz had been cumbersome, due to the sheer distances required to separate test antennas from the Ferris Model 32-B laboratory-type field-intensity measuring instrument. But to con-

DATE TIME	STATION CALLED	CALLED BY	HIS FREQ. OR DIAL	HIS SIGNALS	MY SIGNALS	FREQ. ACC.	EMIS- SION TYPE	POWER INPUT WATTS	TIME OF ENDING QSO	OTHER DATA	NAME	QSL
11/17/78					579							
2017	WA1VAB	X	3556	579	449	CCD ANT			2030	MASS	HENRY	
191750	CQ	WA2RVO	14097	599	599	"			1800	PORT MONMOUTH, N.J.	STAN	
1930	FGATQ	X	14035	589	56/79	"			1931	MABELLE	JO	
1820	W9JUM	X	14053	589	599	"			1835	BELLEVILLE, ILL.	NELSON	
1835	X	IGANZ	14053	579	579	"			1840			
1840	Y02BEO	X	14053	579	589	"			1845			
1915	CQ	YU3NEQ	14092	449	579	"			1925	MARIBOR		
1930	CQ	EA7TU	14046	579	579	"			1935	CADIZ	JESA	
1945	HA8UY	X	14035	589	599	"			1950	JLASZLO	IMRE	
1955	CQ-DX	PY2BAN	14021	579	589	"			2000	SAN PAULO	MARC	
2010	IY4FGM	X	1404	589	589	QSL VIA I9BY	2015			nr BOLOGNA	ARTENO	
2025	IZ0MO	X	14020	589	579	"			2030	nr VARESE	PRIMO	
2200	UA9URS	X	14035	579	579	"			2205		GENE	
1810	CQ	W5BVM	14060	579	579	nr Dallas	6845		1430	FRISCO, TEX	SG <sup>o</sup> F SMITTI	
1755	CQ	DKLBH	14023	579		"			1800		WALD	
1745	CQ	VE2BA	14017	579	589	"			1750	VERDUN	AL	
1751	CQ	G8FR	14052	579	569	"			1752	nr PORTSMOUTH	WALT	
1752	CQ	WD4MMV	14054	589	599	ONE WATT			1753	PORT SAINT JOE, FLA.	STEVE	
1807	CQ	N6HS	14053	579	579	63 yr - Retired			1830	SAN BRUNO, CA.	BILL	
1835	CQ	F6DJT	14053	589	569	"			1836	ANDERNOS	ALAIN	
1836	X-CQ	IGANZ	14053	379	559	"			1840			
1845	CQ	K6AYB	14034	579	589	54YK			1900	SOUTH SAN FRANCISCO	JACK	
2110	CQ	VE7ENG	14096	589	579	"			2113	QUESNEL BC.	DALE	
1940	CQ	I0LY	14097	579	579	"			1944	ROMA	DOMEN	
1945	CQ	G3ZDW	14097	579	589	"			1800	nr LINCOLN	ROGER	
1830	VP9JH	X	14098	579	599	"			1833	PAGET	JACK	
1833	CQ	G3SCOB	14098	589	589	"			1840		JOHN	
1840	SP2BLC	X	14098	579	579	"			1845			
1850	CQ	ILXWG	14055	579	579	"			1855	SARZANA	ENRICO	

157 WATTS CCD ANT

Fig. 1. A sample log sheet from W8VWX, while using the CCD antenna and 150 Watts input.

struct a valid antenna range for HF antenna measurements becomes a monumental task: building an adequate, level ground plane of suitable dimensions, maintaining constant spacing of test antennas, and clearing of vegetation.

VHF frequencies permit closer control of test conditions, due to both smaller radiators and antenna range dimensions. A Taco/Jerrold Model AIM 719-B laboratory-level field-intensity instrument covering 54 through 900 MHz and calibrated to 1 dB was purchased, and construction of a VHF antenna range was begun.

A section of level land was selected, and vegetation cleared to a radius of 63 feet (approximately 9.2 wavelengths at 144 MHz). Projecting near-future plans to test many CCD beam configurations, a ground plane twenty feet square was constructed, using close-mesh woven wire. A rigid support post for test antennas was mounted at plane-center, with a compass and means for accurately spacing radiators at specific heights above the effective ground.

Two independent power sources were provided: commercial 115-volt and lead-acid storage battery. Operation solely from the battery would quickly reveal any distortion of radiated field patterns which might result from reflections by commercial power feedlines. Also importantly, the more constant battery power would eliminate errors in pattern measurements that could result from commercial power fluctuations.

Five different designs of 2-meter CCD radiators have been used at W4FD to consistently activate repeaters 90 miles away while using one-Watt power. The CCD design selected for the ini-

tial range measurements was 7 feet long, made up of 40 sections of 3/4-inch OD aluminum tubing, each 2 inches long. (Except: two sections at the feedpoint and also the two at each end are 2 1/2 inches long.) The 38 fixed capacitors connecting these are each 24 pF.

Two identical simple dipoles were constructed of 3/4-inch OD aluminum tubing, each 3 3/4" long. One serves as the reference dipole, the other as the field-meter antenna, located 9.2 wavelengths from the test antennas.

For valid comparisons of the CCD versus the reference dipole, the precise adjustment of equal input power to each is most critical, and was greatly facilitated by use of a line-to-antenna impedance-matching system which we call the "trombone match."

Some disturbing variations in field-meter readings were caused by the movement of personnel. By also applying the trombone match, immunity to such movements was achieved, and uniform readings were then possible from any convenient position.

Careful preliminary measurements were first made with power to the range supplied through a 115-volt ac line laid flat on the ground and laborously positioned at 90 degrees to the test antenna during measurement at each 10-degree point around the range. Then the ac source and line was completely removed from the range and replaced by storage battery. The same readings were again taken at each 10 degrees of azimuth for both the CCD and reference dipole test antennas, each mounted in exactly the same position. Absolutely no difference in values was found (the AIM 719-B instrument is easily read to 0.1 dB).

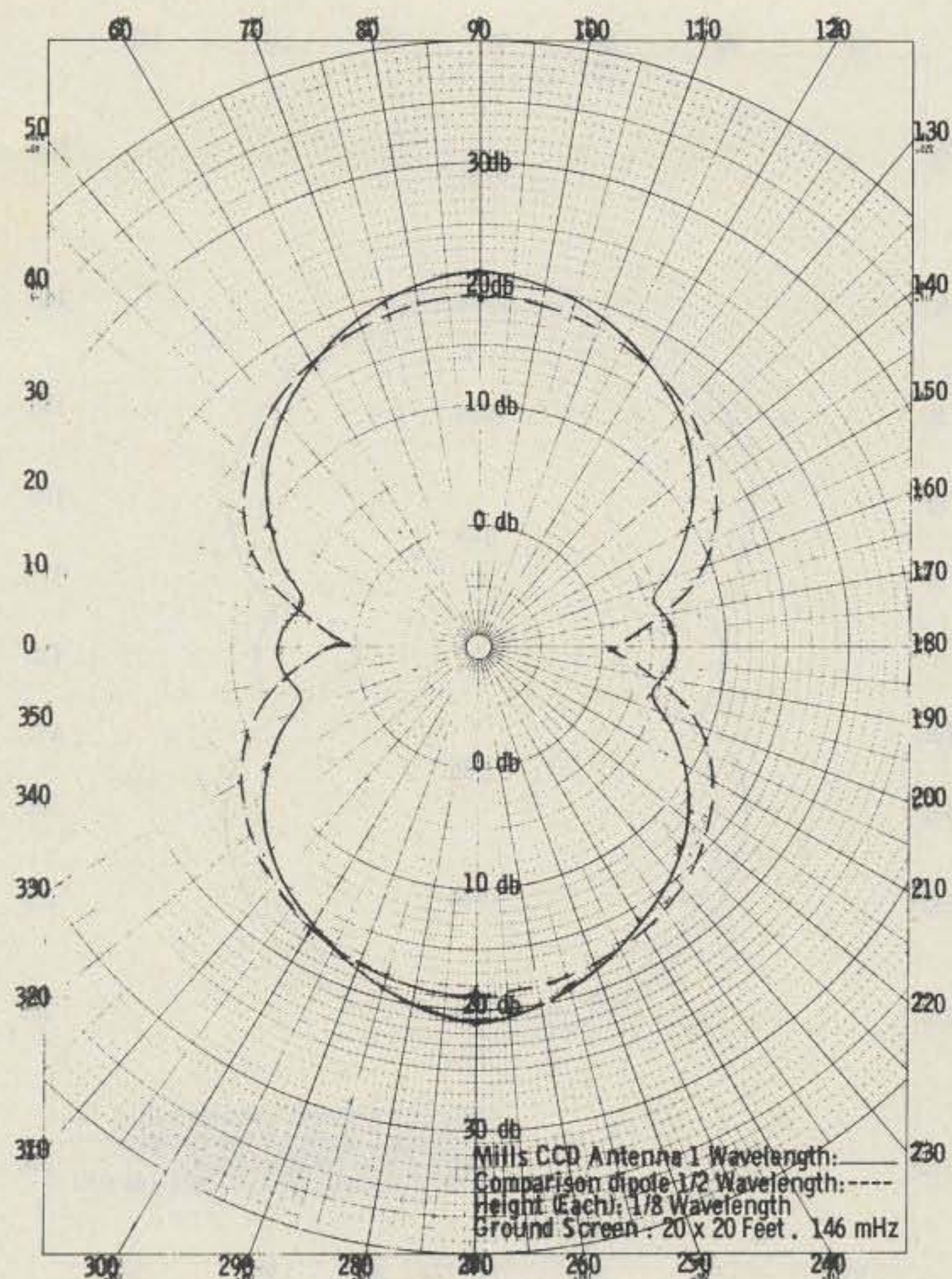

Fig. 2.

As mentioned, the 2m range was fitted with a flat, close-mesh ground plane 20 by 20 feet square, and the new Taco/Jerrold Model AIM 719-B laboratory-level field-intensity instrument, which covers 54 through 900 MHz and is calibrated to 1 dB, was used. In order to eliminate the possibility of pattern distortion by proximity of the transmitting equipment, an excavation underneath the ground plane contained the TS-700 SP 2-meter transceiver and power source.

The new range will be used to make vertical pattern slice measurements at varying angles, equidistant from ground, to reveal the low-angle characteristics which are so vital to DX communications. It also will be used to study the effects of adding capacitive loading discs at the CCD radiator ends, to extend current flow even more to the antenna ends. Following

this, measurements will be made of patterns radiated from multi-element CCD arrays, showing the gains and advantages which can be obtained when employing all-driven or parasitic elements. The trombone match will be utilized to provide equal power division to driven array elements.

### Some Theory

An antenna is a transducer for coupling rf energy into space. Its function is analogous to that of a loudspeaker and its system of baffling which functions to couple low frequency energy into the air to achieve efficient sound reproduction.

Over many long years, we have become accustomed to regard space as being "empty." This is because early scientists and physicists advanced a medium theory whereby radio and other magnetic energy

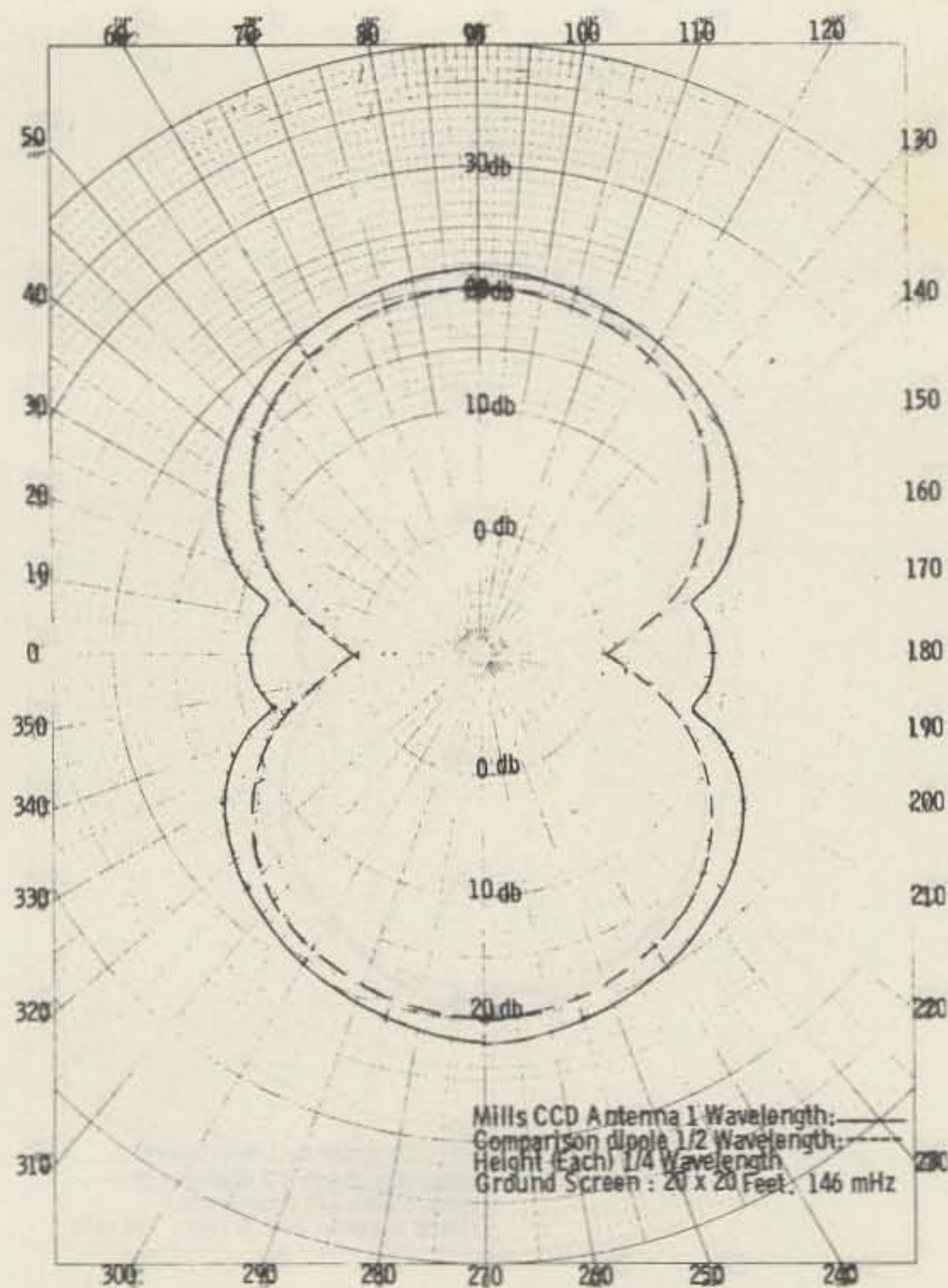

Fig. 3.

fields traveled through the "ether," an unfortunate choice of words, which suggested that propagation was through a medium of gas. That concept has fallen into disuse. However, the vast radiation energies now known to be resident in space provide ample reason for keeping an open mind to any new explanation of electromagnetic theory.

We express an opinion that consideration should be given to the theory that light itself, that ever-present photon, may be the medium through which many forms of radiations are propagated through space. Some known facts lending credence to this theory include: 1) Light is known to have definite mass (as does any "solid") a determinant in its velocity which is 186,000 miles per second (the same velocity as other known radiations). 2) Light is "bent" by the presence of

intense magnetic fields, as theorized by Dr. Einstein and proven by actual tests. 3) The sun's light rays, interacting with our planet, form ionized radiation around it. 4) Light may be said to be "modulated" by vortical changes in the temperature of the light-emitting body, as sunspots create intense magnetic fields which occasionally disrupt communications as far away as our planet. 5) Stars throughout the universe emit light; even planets may be said to emit photons, although the level is below the detection threshold of human eyesight. (Light is present, even in the darkest cave, only our unaided eyes are not sensitive enough to detect its low level). 6) A photon is a single quantum of electromagnetic energy. Maxwell's equations form the basis of classical electromagnetic theory, but quantum theory requires that we postulate the existence of

photons to carry the energy of electromagnetic radiation. Quantum field theory pictures the coulomb forces and magnetic forces between particles as being associated with a kind of photon exchange between particles. The pressure of sunlight is very small. It has, however, been observed to have a measurable effect on the orbits of earth satellites, particularly on that of the large satellite *Echo I*, launched in 1960.<sup>1</sup>

#### Questions and Answers

*Q. My real estate seems too small for the CCD antenna dimensions given. What are my options?*

A. Several space-saving arrangements are possible without reducing CCD efficiency. When mounted as an inverted dipole, much less ground space is required. Also, since the new design is a low-impedance device with greatly reduced high-voltage points, it may be arranged effectively in a zigzag configuration. Another space-saving plan is to mount the middle portion horizontally and allow the ends to hang vertically. This latter scheme will add vertical polarization to the composite pattern, which is beneficial during some propagation conditions. When antennas for different bands are desired but space is limited, they may be efficiently fed by a single feedline. The low-Z property of the CCD renders it very tolerant to nearby trees and structures, with much less detuning and losses than is experienced with a conventional dipole. This factor reduces the space requirements, and, surprisingly, a CCD radiator performs very well on DX when only 7 feet above ground. So, the importance of tall supporting towers is greatly reduced and most city lots will accommodate 14-MHz and higher frequency CCD an-

tennas which will rival a rotary beam in performance.

*Q. Why is one full wavelength at the lowest operating frequency used instead of some shorter length?*

A. At approximately one physical wavelength, a desirable condition such as cancellation or near-cancellation of the wire section inductive reactance by the capacitive reactance of the next adjoining capacitor in the series chain results. Also, a great reduction of end effects occurs when the overall radiating system is made resonant. Reflections from the radiator ends are markedly reduced, so that a traveling wave may move efficiently from the transmission line and the radiator into space.

*Q. I have a number of capacitors on hand other than the values specified in the guidelines table. May these be used efficiently in a CCD antenna?*

A. Yes, definitely. It is necessary only to adjust section wire lengths and the number of sections proportionately. For example, suppose that 470-pF capacitors are on hand and a 7-MHz CCD is desired.

First, find the even number of wire sections required, finding K for 7 MHz from Table 1 in original article:  $470 \text{ pF} / 8.48 = 56$ . Overall antenna length (from Table 1) is 140 feet or 1680 inches.

Next, find the length of each wire section:  $1680 / 56 = 30$  inches. The number of capacitors is always 2 less than the number of wire sections; 54 in this example.

*Q. How many capacitors are necessary in the CCD, and should they have a high-voltage rating?*

A. There is no set number of capacitors required. Within practical reason, the larger the number of capacitors used, the more uniform the current distribution and the more effective

the radiator. In general, 40 to 60 fixed capacitors will provide very effective current smoothing throughout the antenna. (Upward of 1,000 capacitors have been successfully employed at W4ATE.)

Best broadside gain results when all capacitors are of equal capacitance. When as many as 40 capacitors are connected in series with wire sections of the CCD radiator, the rf voltage applied across each individual capacitor is quite small (typically under 80 volts, even with 1 kW input to the final amplifier). This permits the use of conventional-sized polycarbonate (most stable), polystyrene (lightest weight), silvered mica, mica, dipped mylar®, and other low-loss capacitors. The capacitance tolerance should be within 5%, which narrows the off-the-shelf choice to the first three types named. Wider tolerance capacitors may be used provided that they are selected by accurate measurement to the 5% tolerance required. Any units selected should have substantially strong wire leads or terminals.

*Q. What type of antenna will perform best inside a building or attic (assuming no metallic Faraday shielding is present)?*

A. Definitely, the CCD type of radiator. It should be remembered that the high-voltage, high-impedance characteristics that exist over the large outer portion (away from the center) of the conventional dipole produce high dielectric loss in the radiator even though the walls, ceiling, and roof are of dry wood and shingles. Therefore, design your antenna as a current-operated device free from points of high voltage throughout, and the dielectric losses from the surroundings will be greatly reduced. W4FD had these advantages amply demon-

strated while working DX with attic CCD antennas on 10, 15, and 20 meters under the previous call W3UZ, in Washington, DC.

The increasing trend toward condominium and apartment living with their restrictions against outdoor antennas, presents another application where an indoor CCD will provide performance which is much superior to the conventional indoor dipole. Even where outdoor antennas are employed, very little dielectric loss will occur when the CCD antenna is strung through trees or shrubbery.

*Q. Why does the CCD antenna produce good signals and provide good DX reception at heights of only six to eight feet (albeit down about 10 dB from one elevated to 1/2 wavelength) whereas a simple dipole at the same low level usually does not?*

A. This is a question for which all the answers are not yet formulated. However, it is believed that there are several reasons for the improved performance of the CCD at very low elevations. First, it is known that low-angle radiation (the requirement for DX) occurs in the center, highest-current portion of the conventional dipole, and for the simple horizontal dipole at low heights, the radiation resistance is known to drop off very rapidly, nullifying most if not all of the low-angle radiation. Not only is the dipole then coupled closely to its ground "image" but the "hot spotting" center current produces excessive ground losses, as does the dielectric end effect. That energy which would have been reflected at least partially at lower angles (assuming a 1/2-wavelength height) is sporadically reflected at higher angles, chiefly useful for close-in communications.

In sharp contrast, the low-mounted CCD antenna

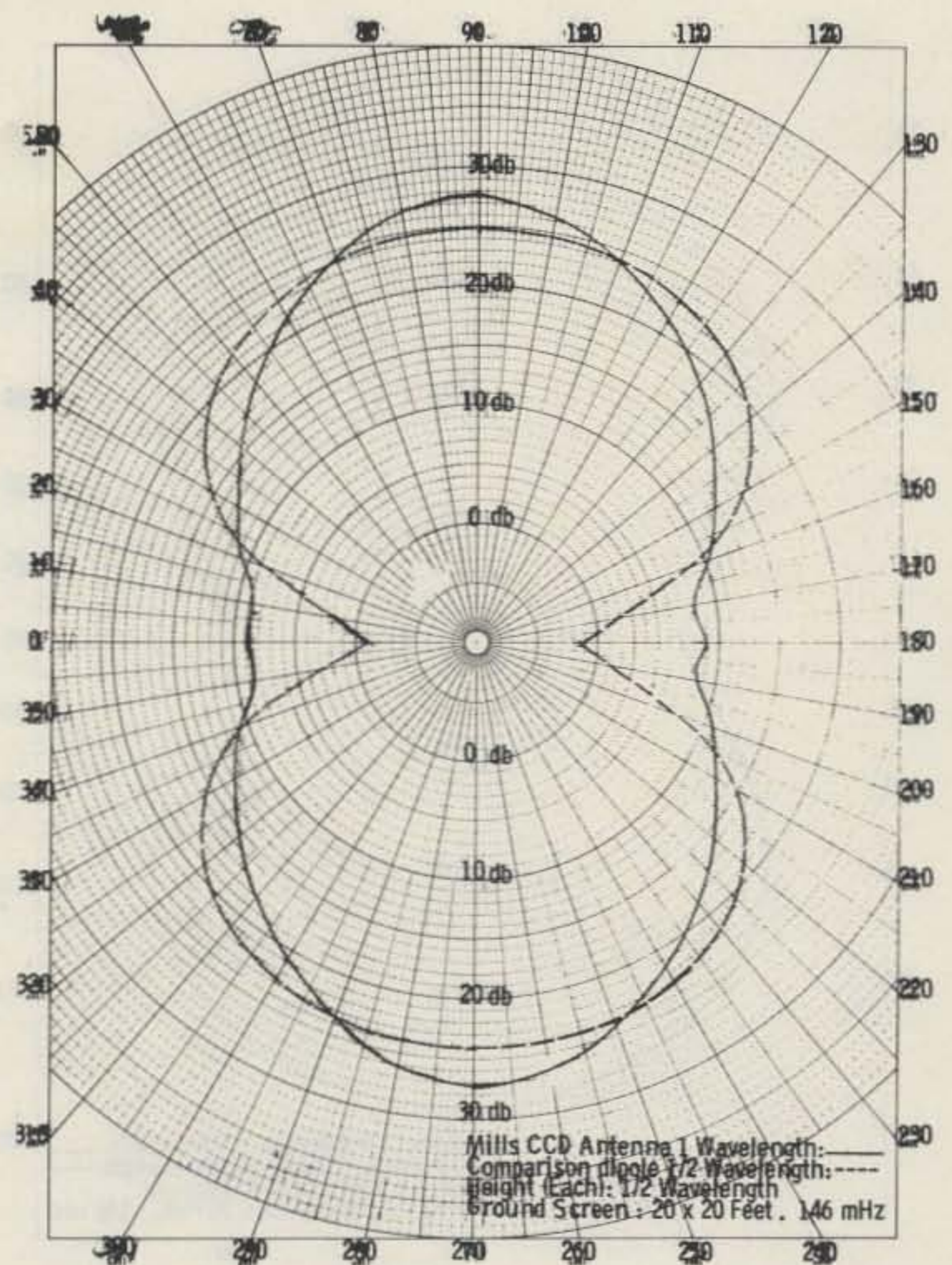

Fig. 4.

stretches out the antenna current to the very ends of the radiator (when end-loading capacity-producing discs are added). Now the antenna current is no longer bunched at the center portion, but tends to produce a focus or aggregation of lower-angle currents across the radiator. When the CCD is mounted at widely varying heights, the center feedpoint impedance variation is only a fraction of the excursions produced when the height of a simple dipole is changed the same amount.

During actual tests, DX beyond three or four thousand miles has been worked with the CCD antenna lying flat on the ground, although the reported level is then down 20 to 30 dB. Field Day hams take note!

*Q. How does the bandwidth of the CCD antenna compare with the conventional dipole bandwidth?*

A. A CCD antenna which

contains near or equal capacitance values and wire section lengths has a three to four times wider bandwidth than the usual dipole counterpart. Extremely wide bandwidths have been attained (at some sacrifice in gain) when the capacitor values and radiator section lengths are made progressively smaller, beginning at the feedpoint and with the smallest values at the radiator ends. This form of CCD results in a reflection-free radiator with waves traveling in only one direction from the feedline, through the antenna and into space, without standing waves. Measurements show that voltage and current disappear at the antenna ends. This configuration has produced a UHF radiator that is matched across 340 to 550 MHz.<sup>2</sup>

*Q. What are the antenna resistance (load impedance) characteristics of the CCD antenna?*

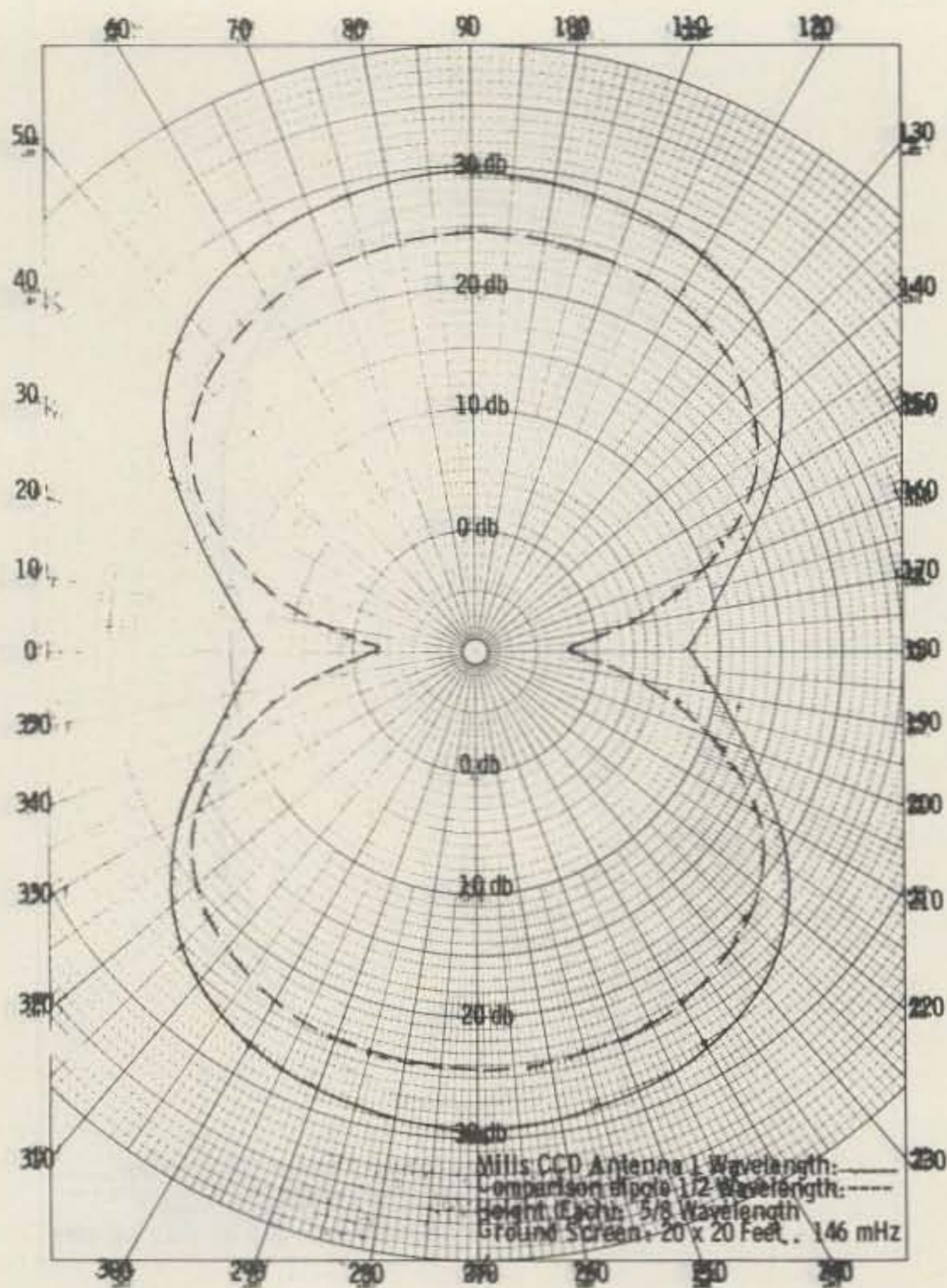

Fig. 5.

A. The load impedance of a conventional horizontal dipole (antenna resistance at resonance) may vary as much as 10 times or more, with wide variations in antenna height. The controlled-current distribution antenna resistance change is only a fraction of this for the same variations in height. Indeed, the main determinant of the antenna resistance will be the design selection of the wire section lengths and capacity values, together with any loading screens employed at the radiator ends. With capacitor and wire section values within the ranges covered by the formula, antenna resistance values around 250 Ohms may be expected.

Thus, 300-to-450-Ohm, open-wire balanced line used with a transmatch will work well with very long transmission line lengths. For shorter lines, 50-to-73-Ohm coaxial line with a 4-

to-1 balun at the antenna terminals works quite well. The very high ratio of radiation resistance to loss resistance and the greater aperture of the CCD produce a much greater signal than can be realized with the conventional dipole design.

Q. How effective is a 160-meter horizontally-polarized CCD antenna, both as a nighttime skywave radiator and a ground-wave daytime antenna?

A. The results from testing the 160-meter CCD under these conditions will agreeably surprise many readers. Nighttime performance was as good or better than with the best of conventional antennas. Our mutual friend John Sharpe W5AB at Houston, Texas, is broadside on the southwest lobe of the W4FD 160-meter CCD, and reported both CW and SSB signals were never below S9. He further reported that 90% of the time the signal was

20 to 25 dB over S9. Contacts were made on two different nights on 1808 kHz, with the same reports. The power input was 100 Watts to the Swan 160X equipment. Daytime coverage has been 80 to 100 miles with the same input power.

Q. Is there a value of radiation resistance in Ohms which, if maintained, will produce optimum radiating efficiency?

A. This question has been of great interest to us for some time. Although no firm answer has yet been formulated, there are indications suggesting such a possibility. The following is intended to arouse interest among members of the amateur fraternity, to encourage experimentation along these lines.

Assuming that light may indeed be the medium in which signals are propagated through space and that the intrinsic impedance of space itself is 377 Ohms, would a continuous radiation resistance of 377 Ohms (or even crossing through this impedance value many times), produce optimum coupling efficiency to the radiator? This is a most intriguing question.

The radiation resistance of the simple dipole sweeps through 377 Ohms only twice. It occurs a number of times in the collinear antenna and even more in the rhombic. Each type of antenna produces an ascendingly improved efficiency. The CCD antenna produces scores of sweeps through 377 Ohms. Aside from any theoretical considerations, tests with the multi-section CCD suggest that there may be some optimum (if continuously maintained) radiation resistance such as 377 Ohms.

Q. How may I determine that capacitors out to the very end of my CCD antenna are all functioning?

A. In a properly con-

structed CCD (wire lengths and capacitors correct according to formula), defective capacitors will be revealed by exploring the radiator with any simple voltage or current indicator while low power is applied. The indicator may be a hand-held neon or fluorescent lamp, a miniature diode feeding a solid-state diode and sensitive dc current meter, or a dip meter in the diode mode. Starting at the feed point, be sure that an indication of rf is present while the indicator is moved out to the extreme end of each half of the CCD. If a point is reached where no indication is obtained, the last capacitor passed over may be defective. If, however, an rf indication is lost at both ends of the antenna and at approximately the same distance from the feedpoint, the wire section lengths may be shorter or the capacitors may be larger than specified by the formula. Both values should be carefully verified.

Also, it is possible that one is attempting to operate the CCD below its resonant frequency, in which case it functions as a high-pass filter, preventing rf from traveling beyond a few sections from the feedpoint.

To explore this possibility, temporarily feed twice the design frequency, i.e., 14 MHz to a 7-MHz CCD, and repeat the preceding rf probing tests. If indications of rf are then obtained out to the radiator ends, the capacitors are functioning, and steps must be taken to resonate the CCD to a frequency near the low-frequency end of the design band, as described earlier.

Wire sections which are shorter than specified by formula will prevent rf from reaching the antenna ends because the  $X_C$  will be much larger than the  $X_L$ . Also, when wire sections

which are too short are used, one may continue to add any number of sections and never achieve resonance! This can be very baffling and discouraging until the importance of making  $X_L$  approximately equal to  $X_C$  is realized.

*Q. Will you please furnish the calls of some successful builders of the CCD antenna so that I might contact them and profit from their experiences?*

*A. Yes; we believe that the following constructors will willingly share their ideas regarding the CCD when you furnish an SASE:*

K2GGN, W2IMU, W2SVJ, W4DNX, W4KIX, W4OQT, W4KXC, W8VWX, WD4DSX, AC5P, K8AA, AA6US, WB8RGN, and KK4X.

*Q. Can the CCD antenna be operated at harmonics of the fundamental frequency?*

*A. Yes. But please note that the positive inductive reactance,  $X_L$ , and the negative capacitive reactance,  $X_C$ , move in diametrically opposite directions, when the exciting frequency is changed, to a series circuit such as the CCD. Therefore, harmonics as we are accustomed to regard them, will never occur close to whole number multiples. For example, in a reasonably well-balanced chain of alternate wires and capacitors in series, with fundamental resonance at 14 MHz, a second "harmonic" indication at average antenna height occurs at slightly over 1.6 times the fundamental frequency.*

These relationships between fundamental and "harmonic" frequencies in a typical, balanced CCD are shown graphically in Fig. 1 of our previous article. In another example (from the same graph), in order to produce a second harmonic near 28 MHz, a CCD radiator would necessarily have a fundamental resonance

near 17 MHz. In a futuristic example, the harmonic of a CCD designed for the new 18-MHz band falls neatly near 28.9 MHz!

Actually, this offbeat harmonic relationship provides a great advantage in practical operation. Instead of the wide swings in load impedance experienced with a conventional dipole when changing from even to odd harmonics, the CCD user employing a transmatch will find relatively small changes in loading. Moreover, the effects of improved current distribution and smoothing out of the broadside radiation field pattern will carry over to the second and third frequency multiples.

*Q. Is there a simple formula or formulas which I may use in a step-by-step manner to calculate with reasonable accuracy, the design parameters for a CCD operating at any frequency within the HF bands?*

*A. Definitely yes.*  
*Formula 1.*  $S-2 = fC/59.35$ , where  $S-2$  = number of capacitors,  $S$  = number of wire sections, and  $f$  = resonant frequency in megahertz. (Note: 59.35 is an empirically derived constant.)

*Formula 2.*  $L_T = 984/f \times 12$ , where  $L_T$  = total length in inches (for 1 wavelength) and  $f$  = resonant frequency in megahertz. 984 is double the usual 492 because the CCD is one wavelength overall.

*Formula 3.*  $L_S = L_T/S$ , where  $L_S$  = length of sections in inches,  $S$  = number of wire sections (from Formula 1), and  $L_T$  = total length in inches (for one wavelength).

These three simple formulas can be combined in a single comprehensive formula. However, it has been found that less confusion results when specific parameter values are determined by using the formulas in the above order. A

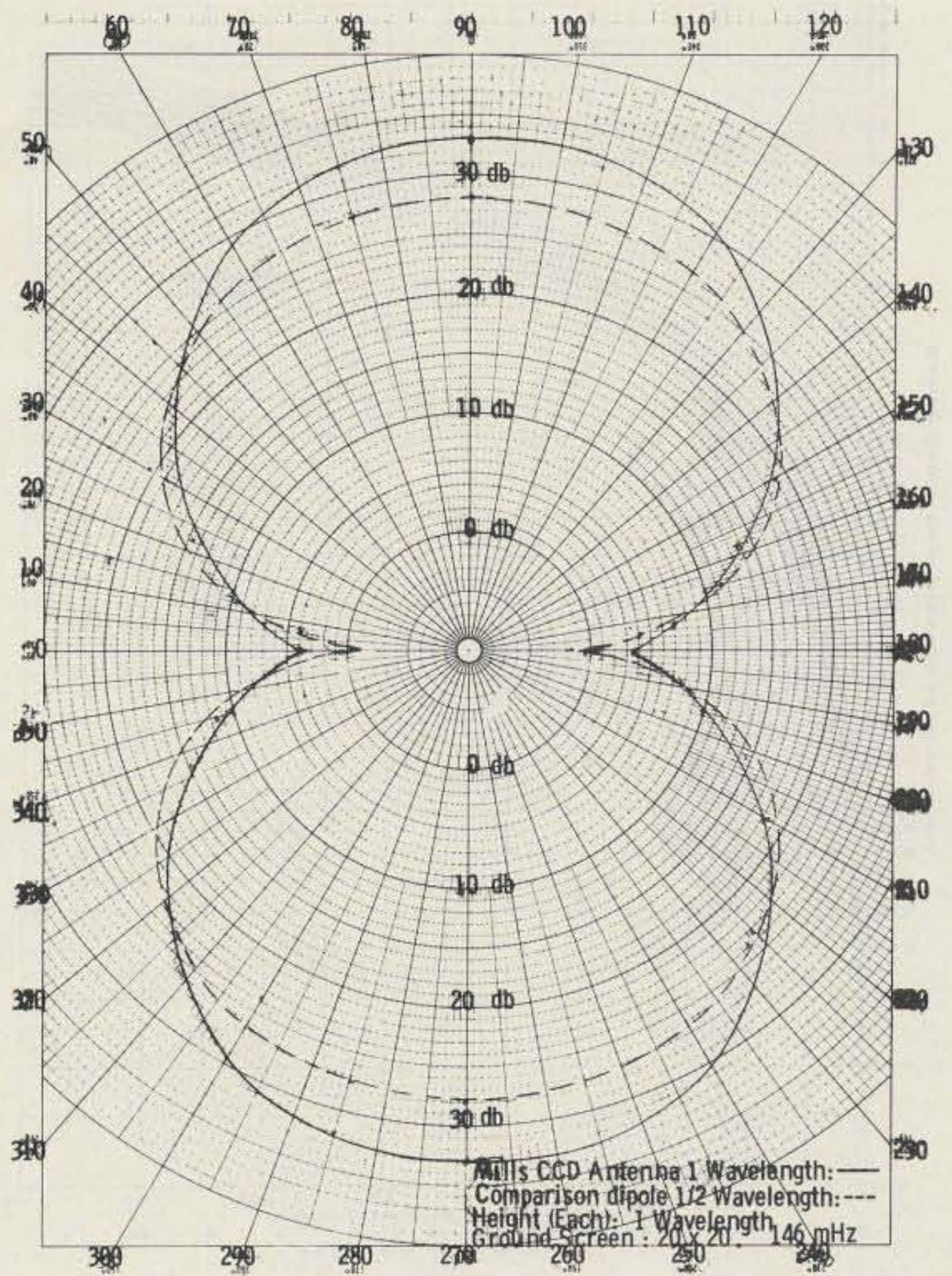

Fig. 6.

sample calculation is contained in the answer to the following question.

*Q. I have on hand 50 fixed mica capacitors, each 390 pF in value. Do I have enough of them to construct a 7-MHz CCD antenna, assuming that I have a sufficient amount of #14 copper wire? How do I determine all antenna dimensions?*

*A. Applying Formula 1:*  $S-2 = (7 \text{ MHz} \times 390 \text{ pF})/59.5 = 46$  capacitors. Then,  $S = 46 + 2 = 48$  wire sections.

Applying Formula 2:  $L_T = (984/7 \text{ MHz}) \times 12 = 1686.85$  inches overall length.

Applying Formula 3:  $L_S = 1686.85/48 = 35.14$  inches, the length of the sections.

In summation, we have 46 fixed capacitors, each 390 pF, 48 wire sections, each 35 inches long, and a total CCD antenna length of 1686.8" or 140.57 feet.

Wire sizes 18, 16, and 14 all have a sufficiently small length-to-diameter ratio when utilized at the 7-MHz operating frequency.

*Q. Can the CCD antenna be operated effectively on frequencies either above or below its resonant frequency?*

*A. It should be recognized at the outset that this type of radiator is a very broad characteristic type of high-pass filter. It will perform well at all frequencies above its resonant point, but should not be used on amateur bands whose frequencies fall below resonance. The broadband nature of this antenna is such that it will operate most efficiently on the lowest frequency band for which it is designed, even in instances where resonance occurs at or near the high frequency end of a band. It is most desirable that the CCD be made resonant within the*

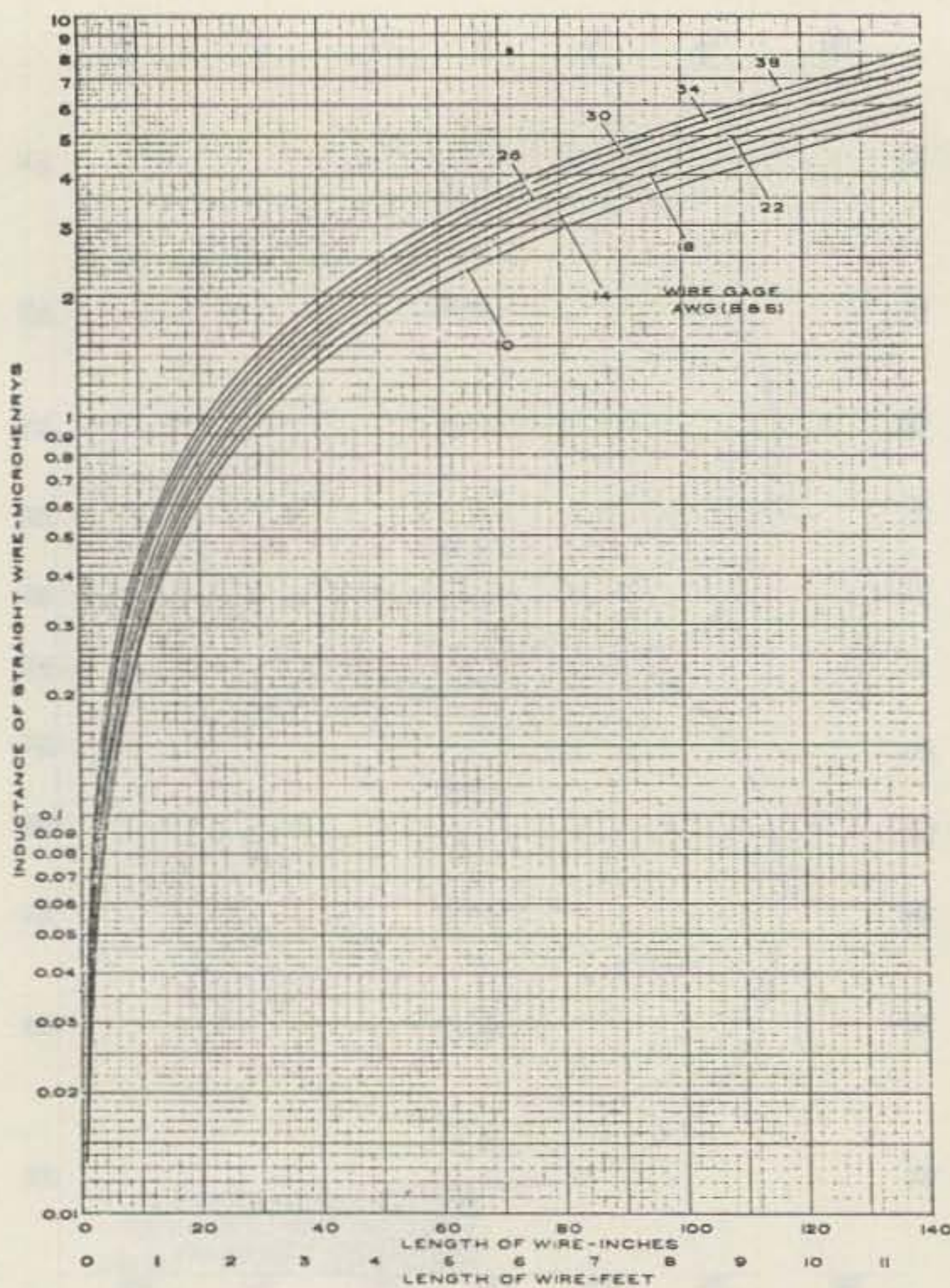

Fig. 7. Graph for determining the self-inductance of straight lengths of wire.

lower frequency half of the band.

**Q.** What effect does height-above-ground have on the radiated pattern of the CCD antenna?

**A.** Although complete pattern data has not yet been obtained and analyzed, preliminary measurements made with a commercial field-intensity instrument at the 2-meter range indicate that the sharper pattern lobes occur when the CCD is elevated  $1/2\lambda$  or higher. At heights of  $5/8\lambda$  and above, side levels (off the radiator ends) are 22 to 24 dB below the broadside lobes. Dropping the height from  $1/2\lambda$  to  $1/8\lambda$  gradually collapses the major broadside lobes. At the  $1/4\lambda$  height, the broadside-to-side radiation differs by slightly more than 12 dB. At  $1/8\lambda$  elevation, the difference is even less. See Figs. 2 through 6 for various elevations.

It is interesting to note that the off-end radiation begins to increase markedly below  $1/4\lambda$  height, and can become almost equal to the broadside value as the elevation is reduced below  $1/8\lambda$ .

These preliminary measurements were made with both the test antennas and the field-intensity instrument antennas horizontal to flat ground, well in the clear and at the same height. The probing point was  $5\lambda$  away. A ground-plane screen had been installed at this time.

The test CCD antenna was rotated through 360 degrees and field-intensity readings were taken at each 15-degree interval between full broadside and 30 degrees. Between 30 and 0 degrees, readings were recorded at each 7.5 degree point. Directly off the CCD ends, minor lobes were noted which were approximately

1 dB above the minimum skirt levels of the side radiation. A power input of 1 Watt at 146 MHz was used during all pattern measurements.

**Q.** What are the advantages gained by the use of capacity-loading disc screens at the ends of a CCD radiator?

**A.** Although the use of loading discs is not essential to efficient operation of the CCD, some of the valuable refinements are increased radiation resistance, improved broadbanding, improved current distribution, almost complete elimination of end effects, and final adjustment of resonant frequency.

In particular, more current will then flow in the very ends, resulting in a more efficient radiator. Wire screens are recommended over solid discs, for reduced wind resistance. For the 7-MHz band, 16-inch diameter discs are suitable, the diameter increasing in inverse proportion to frequency, for other bands.

The constructor will find that the added discs cause a slight lowering of the antenna's resonant frequency. By adding the discs one at a time and noting a slight frequency decrease with each addition, a positive indication is obtained that all sections are functioning.

A CCD is installed as an inverted dipole at W4ATE, where it is found convenient to replace the discs with small fixed capacitors soldered between the radiator ends and the supporting wire, which is grounded. The desired value of capacitor may be determined by the temporary use of two variable capacitors which may be adjusted for proper operation and then replaced with fixed capacitors.

When loading discs are not employed, it is suggested that the two outer wire sections be dimensioned

about 50% longer than the others.

**Q.** Is there a method whereby a directional array of multi-elements can be optimally adjusted at a particular frequency, or even changed to another band within a few minutes without conflicting reactions?

**A.** Definitely, yes, where the CCD antenna system is utilized in directional arrays. The method involves a full tuneup of all the radiating elements (CCD or conventional) directly from the operating position, with a simple means for power division to the individual elements. The scheme eliminates the troublesome common-point junction bottleneck and uses an inexpensive tube or solid-state amplifier feeding each antenna element to permit rapid system tuning without interaction problems, which many amateurs already recognize with conventional systems.

**Q.** Is there a method, particularly adaptable to solid-state linear amplifiers and to transmatch tuners, whereby the conventional, cumbersome wide-spaced tuning capacitors can be eliminated from tank, and the open-end or toroidal coils be henceforth ferrite-loaded and five or six amateur band tanks placed in the area now occupied by one tank?

**A.** Fortunately, yes. The method involves a controlled-voltage distribution (CVD) system, a blood brother of the CCD scheme developed at the same time. The basic plan is very much like the CCD in that capacitive loading is utilized.

**Q.** Although my CCD antenna usually produces a stronger signal than my reference test antenna, there are times when my reference antenna produces the stronger signal. Why is this?

**A.** It is well known that



under certain conditions of sunspot activity and other circumstances in which the Earth's field-ionization pattern is altered (as caused by the sun's activity), the usual ionized layers existent at a particular time of day can become greatly changed. Signals normally bent to Earth by the reflecting action of one or more ionized layers may, because of alterations in the usual layer heights and thickness, be reflected to a higher or lower angle than usual.

Since the CCD antenna is known to produce a considerably lower reflection angle, any circumstance which changes the reflection angle from the ionized layer(s) at which the antenna maximizes, will necessarily produce a weaker signal. Many amateurs who use both horizontal and vertical radiators often find that one or the other polarization produces a stronger signal. Since the CCD antenna's radiation angle can be even lower than that produced by either of the aforementioned conventional antennas, it not only becomes a very helpful third form of advantage, but, on occasion, can receive signals otherwise not even detected. Also, several observers have noted that under most circumstances the CCD antenna will produce the least signal fading.

**Q.** How may I determine the inductive reactance of straight-wire sections, for further experimental study?

**A.** This information does not appear in standard wire tables, but may be derived after the inductance value is calculated according to the formula  $L = l(2 \log 4l/d - 3/2)10^{-3}$ , where  $L$  = self-inductance,  $l$  = length of wire in centimeters, and  $d$  = diameter of wire in centimeters. However, the design chart in Fig. 7 more readily provides the self-inductance values of various

copper or aluminum wire sizes useful for CCD antenna construction.

For example, to find the inductive reactance at 7 MHz of a piece of #14 copper wire which is 35 inches long, first locate 35 inches along the bottom of the chart. Trace directly up to the curve for #14 wire. From that point, go to the left edge of the chart and read approximately 1.33  $\mu$ H.

Last, insert this value into the usual formula,  $X_L = 2\pi fL$ , where  $f$  is frequency in MHz and  $L$  is inductance in microhenrys:

$$X_L = (6.2832)(7)(1.33) = 58.4 \text{ Ohms.}$$

**Q.** Can a CCD dipole be used as a basic element or building block for more complex arrays?

**A.** Yes. The CCD principle may be employed in most existing systems and configurations with improved efficiency. The resulting radiation patterns will be different from those with conventional arrays.

### Final Remarks

We are grateful for the enthusiasm and suggestions of commercial antenna engineers and many amateurs who have phoned or written: Frank K8AA, for comparison tests with 7-MHz European stations, using less than one-Watt input to his CCD, Ben W5TM, for suggesting static protection resistors across the phasing capacitors, the encouraging notes of Dick W2IMU and Art W8VWX, and for useful construction ideas from the imaginative mind of Larry AA6US.

Larry's experience is typical of CCD builders: "Out here in Los Angeles, I suffer from the 'copper curtain' syndrome. California kilowatts wipe out fellows using 100-200 Watts like myself. Oh, we can rag chew with ZLs across the Pacific, but spanning the long overland haul to Europe was unheard of for me. But last

## RTTY Demodulators



**FSK-1000™**



**FSK-500™**

Order direct on Visa or MC  
700 Taylor Road  
Columbus, Ohio 43230  
T.M. Call (614) 864-2464

Here is no compromise design and construction:

- Unparalleled selectivity achieved with sophisticated limiterless design utilizing ultrasharp active filters and decision level correction circuits
- The most flexible interface system available to computers and high voltage loops
- Built in 170 volt loop supply
- Selectable bandwidths of 55 and 100 Hz. (copies 110 Baud ASCII)
- Continuously tunable shift coverage
- Rugged construction - commercial quality throughout
- Full complement of rear panel connectors for easy interface
- Keyboard activated switch for break in operation
- Individual tuning meters and LED's for quick, accurate tuning

This RTTY demodulator is designed for computer interface but is a fine stand alone unit:

- Easy computer interface with RS-232 or 5 volt logic signals
- Three shift coverage without straddle tuning
- Selectable bandwidths give you optimal Baudot or 110 Baud ASCII copy
- Input bandpass preselector using active filters
- High voltage loop keyer output
- Autostart built in
- Three shift AFSK keyer plus narrow shift CW ID
- Fully wired and tested: ready to copy!
- The FSK-500 is the best demodulator available for under \$500.00 (Except for our FSK-1000!)
- Positive tuning with meter and LED's

night on 14 MHz, I was reading a TA2 in Turkey and G3 stations on the inverted-dipole, 7-MHz CCD antenna. I could not hear them at all on either my 14-MHz dipole or a 130-foot, all-band doublet up 60 feet. Also, when using the CCD my signal reports are usually two S-units above my tried and

true 7-MHz double-extended Zepp." ■

### References

1. Shortley and Williams, *Principles of College Physics*, Prentice-Hall, Englewood Cliffs NJ, 1967, pp. 593, 833, and 858.
2. Hallen, *Electromagnetic Theory*, Chapman & Hall, also Wiley & Sons, New York, 1962, pp. 501-504.

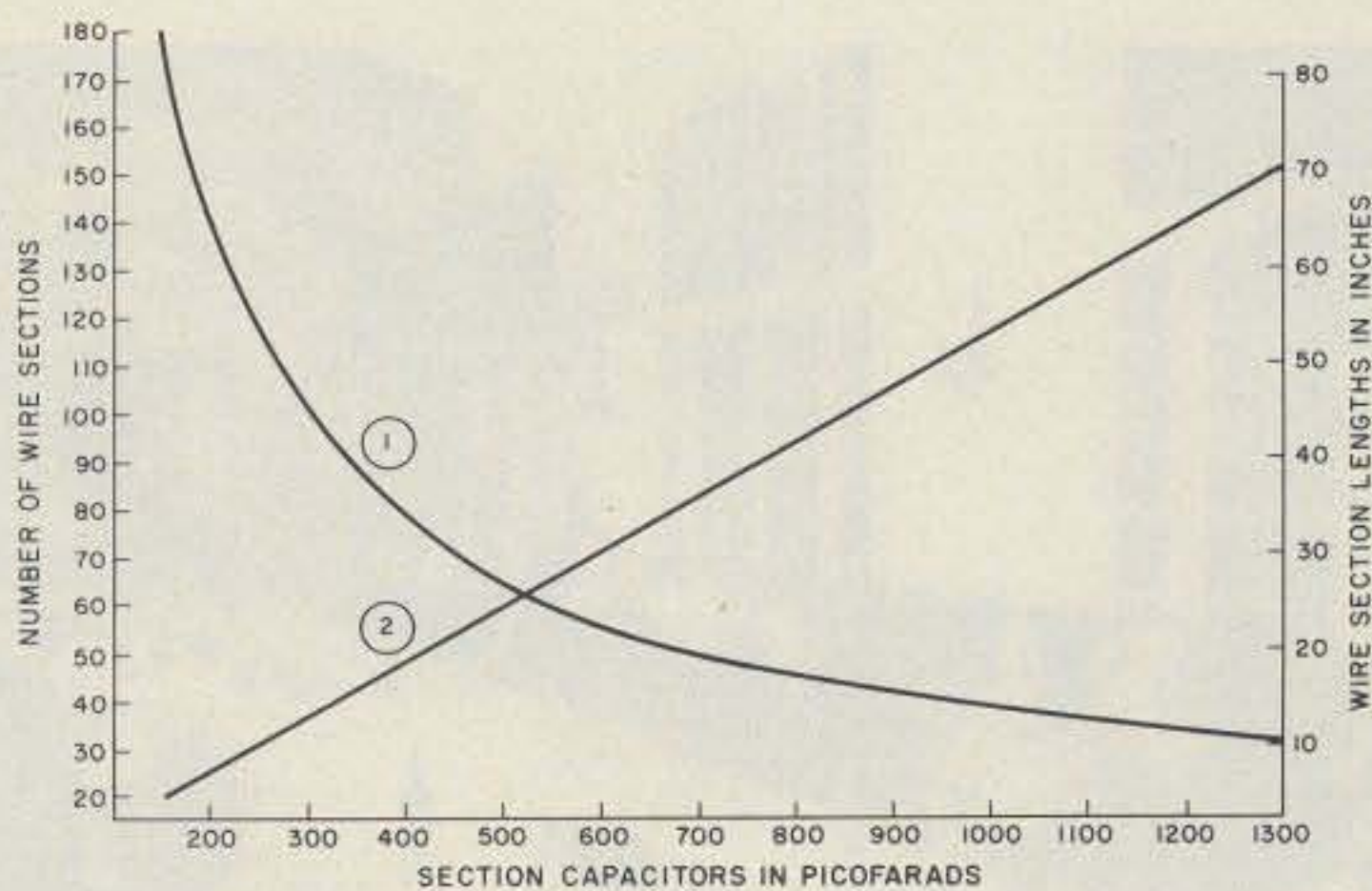

Fig. 8. CCD antenna design chart for a 1-wavelength element. Use curve 1 for wire-section length, and use curve 2 for number of wire sections and capacitor value. The number of capacitors is two less than the number of sections. (Curves derived at 7 MHz.)

# The History of Ham Radio

## — part XVI

Reprinted from *QCC News*, a publication of the Chicago Area Chapter of the QCWA.

In 1920, the urge to span global miles via amateur wireless communication was the radio amateur's prime endeavor. The *sine qua non* of hamdom.

In the pre-WWI years, maximum distances were covered via relay routes from one location to another wherever amateur operators were active. They relayed messages from station to station by the fastest and most direct routes. To span great distances, to direct messages across the continent in one hop, to succeed in crossing the Atlantic, the Pacific, was just a wish and a hope to dream about.

Officially, the International Amateur Radio Union received its start on March 12, 1924. A preliminary negotiation meeting was held in Paris. See Photo A. For the first time, ARRL President Hiram Percy Maxim and a group of amateur representatives from thirteen countries assembled at the Hotel Lutetia. There was no doubt that worldwide international association was needed to bring about a common understanding toward an eventual world organization.

### Early 1920

Soon after the armistice was signed, amateurs in the

United States were authorized to resume radio operation in their typical former fashion. However, it did not take long for them to realize that the rotary-gap generator had to give way to the vacuum tube. No longer would the desire to belong to the 200-meter club give satisfaction when it was discovered that the shorter waves held the solution to greater and more reliable DX.

What chance of being heard did signals have crossing the Atlantic if there were no listeners?

Where were the ama-

teurs in foreign countries available to participate in tests?

### December 1919

In England, a group of wireless enthusiasts were gathered at an outdoor field day. They were just ordinary experimenters, having organized themselves into a club called the Three Towns Wireless Club of Plymouth (Photo B). They had no permit to use either transmitting or receiving apparatus, since a license to operate was not available. The club secretary was authorized to write a



Photo A. The dinner in Paris where the International Amateur Radio Union was formed.



Photo B. Members of the Three Towns Wireless Club, Plymouth, England.

When it comes to  
**AMATEUR  
RADIO QSL's...**



it's the  
**ONLY BOOK!**  
US or DX Listings

1981  
**callbooks**

Here they are! The latest editions. World-famous Radio Amateur Callbooks, the most respected and complete listing of radio amateurs. Lists calls, license classes, address information. Loaded with special features such as call changes, prefixes of the world, standard time charts, worldwide QSL bureaus, and more. The U.S. Edition features over 400,000 listings, with over 100,000 changes from last year. The Foreign Edition has over 300,000 listings, over 90,000 changes. Place your order for the new 1981 Radio Amateur Callbooks, available now.

	Each	Shipping	Total
<input type="checkbox"/> US Callbook	\$17.95	\$2.55	\$20.50
<input type="checkbox"/> Foreign Callbook	\$16.95	\$2.55	\$19.50

Order both books at the same time for \$37.45 including shipping.

Order from your dealer or directly from the publisher. All direct orders add \$2.55 for shipping. Illinois residents add 5% sales tax.



**SPECIAL LIMITED OFFER!**  
**Amateur Radio  
Emblem Patch  
only \$2.50 postpaid**

Pegasus on blue field, red lettering. 3" wide x 3" high. Great on jackets and caps. Sorry, no call letters.

**ORDER TODAY!**

✓61

RADIO AMATEUR  
**callbook INC.**



Dept. B  
925 Sherwood Drive  
Lake Bluff, IL 60044, USA

## This MFJ RF Noise Bridge . . .

lets you adjust your antenna quickly for maximum performance. Measure resonant frequency, radiation resistance and reactance. Exclusive range extender and expanded capacitance range gives you much extended measuring range.



• Exclusive range extender • Expanded capacitance range • Series Bridge

# \$54<sup>95</sup>

This new MFJ-202 RF Noise Bridge lets you quickly adjust your single or multiband dipole, inverted Vee, beam, vertical, mobile whip or random system for maximum performance.

**Tells resonant frequency** and whether to shorten or lengthen your antenna for minimum SWR over any portion of a band.

**MFJ's exclusive range extender**, expanded capacitance range ( $\pm 150$  pf) gives unparalleled impedance measurements, 1 to 100 MHz. Simple to use. Comprehensive computer proven manual.

**Works with any receiver or transceiver.** SO-239 connectors. 2 x 3 x 4 inches. 9 volt battery.

**Other uses:** tune transmatch; adjust tuned circuits; measure inductance, RF impedance of amplifiers, baluns, transformers; electrical length, velocity factor, impedance of coax; synthesize RF impedances with transmatch and dummy load.

Order from MFJ and try it — no obligation. If not delighted, return it within 30 days for a refund (less shipping). This bridge is unconditionally guaranteed for one year.

To order, simply call us toll free 800-647-1800 and charge it on your VISA or MasterCard or mail us a check or money order for \$54.95 plus \$3.00 for shipping and handling.

Don't wait any longer to enjoy maximum antenna performance. Order today.

**CALL TOLL FREE . . . 800-647-1800**

Call 601-323-5869 for technical information, order/repair status. Also call 601-323-5869 outside continental USA and in Mississippi.

**MFJ ENTERPRISES, INC.**  
BOX 494, MISSISSIPPI STATE, MS 39762

## New from **BLACKCAT**



**Antenna Sw./Wattmeter/SWR Meter \$169.50 ppd.**

**BlackCat JB-4000SW**—every shack needs it, every ham can afford it.

**4-position Antenna Switch.** Heavy duty coax switch rated at 2 kW PEP. Three positions for antennas (AUX may be used for dummy load). Fourth position parallels positions 1 and 2 for receive use only.

**Dual-reading RF Power Meter.** Switch to RMS or Peak. Three ranges: 20, 200, and 2000 watts, full scale.

**Built-in SWR Meter.** Shows SWR from 1:1 to 7:1. Two-position "Set/SWR" switch plus RF level control. Calibrated for 80-10 meters, 50 ohm non-inductive load.

**JB-1000 KW Dummy Load**



50 ohm oil-cooled, temperature-stable, resistive load handles up to 1 kW with low SWR. Less oil. **\$29.95 ppd.**



And more! Those of us who still enjoy occasionally operating AM appreciate the Modulation-Percent meter scale and earphone monitor jack. And the rugged metal cabinet with black vinyl-clad steel cover and black anodized aluminum panel has white nomenclature for easy reading. Size: 9½"W x 6"H x 5½"D.

**WAWASEE ELECTRONICS** ✓398  
Dept. 772 Box 36, Syracuse, IN 46567  
Phone: 219/457-3191

Enclosed is \$\_\_\_\_\_ (UPS shipping prepaid)  
(No CODs. Indiana res. add 4% sales tax.)  
Please send Model(s) \_\_\_\_\_

Charge It:  Visa  Mastercard  
Exp. Date: \_\_\_\_\_ Card No. \_\_\_\_\_

Name \_\_\_\_\_ (please print)

Address \_\_\_\_\_

City \_\_\_\_\_

State \_\_\_\_\_

Zip \_\_\_\_\_



Photo C. Mr. Deloy at the National Convention, in a group showing amateurs of three countries. Left to right: Charles H. Stewart 3Z3, ARRL Vice-President and Manager, Atlantic Division; Mr. Deloy, French 8AB; Mr. W.D. Terrell, Chief Supervisor of Radio, Bureau of Navigation; A.H. Keith Russell, Canadian 9AL, ARRL Canadian General Manager.



Photo D. A little international group in the courtyard of the Faculte des Sciences, with seventeen nations represented. (Photo—ROL, Paris.)

letter to the American Radio Relay League expressing a desire and a sincere hope that the League might resolve to become an international association for the exchange of ideas and mutual information for future activities and planning.

The American amateurs, who enjoyed wireless privileges not available to their English or French counterparts, were well aware of the plight of their foreign brethren, who were constantly imploring their governments to grant them similar operating privileges.

#### February 1920

As early as February in 1920, Captain F.G. Loring, RN, one of the club members, suggested the following at the first annual conference of the Affiliated Wireless Club of England:

1) To issue receiving licenses freely to all approved persons, with exceptions as regards the use of valves in certain limited areas.

2) To issue 10-Watt licenses wherever this can be done without interference with government installations to approved applicants who can satisfy the Post Office that their personal qualifications, apparatus, knowledge of the subject, and objectives are sufficiently good to justify the grant. License will not be granted for mere inter-communication purposes.

3) To issue licenses for the use of power exceeding 10 Watts in special cases.

4) To issue licenses for the use of an artificial aerial when desired. Here the applicant has in view some definite object of scientific research of general public utility.

5) To issue special permits for specific tests of apparatus on any power and wavelength over and above the conditions of the license. Application for such permit will have to be made in writing at least a week before the test. Such permits to be issued to persons who can satisfy the Post Office that they have occasion to try out in practice an arrangement which had been thoroughly prepared in the laboratory.

6) Make provision that all transmitting licenses be restricted as regards both waves and hours of working.

#### Early 1921

The ARRL made plans and contacted British radio amateurs and experimenters hoping that they would listen in the vicinity of 200 meters to signals coming from United States amateur stations. All of these planned schedules, however, were unsuccessful.

The few French amateurs also had serious misgivings concerning participation. Their efforts in being allowed to erect receiving aerials fell on silent ears.

Officially, any grant given by their government stipulated that reception of only time signals and meteorological information would be allowed, provided they registered and paid an annual tax to the Director of Posts and Telegraphs.

#### Late 1921

During the fall and winter months of 1921, amateurs made a serious attempt to span the Atlantic. In England, Philip B. Coursney, British 2JK, editor of the *Radio Review* (London), agreed to take complete charge of the receiving stations in England and other European countries where amateurs would be listening and logging signals heard. The ARRL, by request of its Board of Directors, dispatched Paul F. Godley, an American amateur, over to Scotland in an attempt to record any amateur signals crossing the Atlantic. Using his own home-built receiver, the "Paragon," Godley was very successful in recording United States amateur station signals. (Part VI, "History of Ham Radio," *73 Magazine*, October, 1978.)

#### June 1922

The Board of Directors of the ARRL established a new committee designated the International Advisory Committee of the ARRL, whose function was to aid

in the development of amateur relay routes in foreign countries. The League did not deem it wise to undertake the formation of foreign branches of the ARRL, even upon request, but agreed to assist in the formation of societies "for and by the amateur" in such countries. One of the more significant tests conducted by the amateurs during the year 1922 proved conclusively that signals originating from east coast United States amateur stations could be heard by English and French amateurs.

#### July 1922

Even at this date, the British amateurs were still expressly forbidden to transmit general calls, news, etc. Transmissions were permitted for an aggregate maximum of two hours in each twenty-four-hour period, provided that no transmission would commence without previous listening in on the wavelength which was to be used, and provided that no single transmission would last more than ten consecutive minutes. Wavelengths allotted: 150 meters to 200 meters inclusive for Spark, CW, and Telephony.

#### Fall 1922

By the fall of 1922, the British amateur enthusiast,

## DON & MIKE'S

### SPECIALS

Cubic - Swan 103 .....	\$1195.00
Astro 150A .....	849.00
Mirage B23 1 watt-30 watt amp .....	89.95
Robot 800A .....	749.00
Cushcraft A3 Tribander ...	169.00
AEA Morsematic .....	169.00
Bird 43, Slugs .....	Call
CDE Ham-4 Rotor .....	199.00
Ham-X .....	269.00
BT-1 HF/VHF Rotator .....	79.95
FDK Palm 2 Handie with BP/AC .....	149.00
GE 572B .....	38.00
Kenwood Service Manuals Stock .....	10.00 ea.
Telrex TB5EM .....	425.00
Telrex Monobanders .....	Call
Santec HT-1200 Synthesized .....	299.00

**Order Your  
KWM380 Now!  
Old Pricing**

#### Rockwell Accessories in Stock

Adel Nibbling Tool .....	8.95
Janel QSA5 .....	41.95
Rohn Tower .....	20% off dealer
25G, 45G Sections	
Belden 9405 Heavy Duty Rotor Cable 2#16, 6#18 ...	45¢/ft
Belden 8214 RG-8 Foam ...	36¢/ft
Belden 9258 RG-8 Mini-coax ...	19¢/ft
Alliance HD73 Rotor .....	109.95
Amphenol Silverplate PL259 .....	1.00
ICOM 255A 2M Synthesized w/touch-tone mike (limited qty.)	339.00
ICOM 260A 2M SSB/FM/CW	449.00

#### Late Specials:

Kenwood TS-530, TS-130S .....	Call
ICOM IC2AT/TTP/NICAD ..	249.00
Bearcat 300 .....	399.00
Lunar 2M4-40P .....	109.00
Call for TS830S, TS130S plus accessories	

#### MASTER CHARGE • VISA

All prices fob Houston except where indicated. Prices subject to change without notice, all items guaranteed. Some items subject prior sale. Send letterhead for Dealer price list. Texas residents add 6% tax. Please add sufficient postage, balance collect. ✓45

# MADISON

**Electronics Supply, Inc.**

1508 McKinney

Houston, Texas 77010

**CALL TOLL FREE**

Nights: **(800) 231-3057**

6-10 PM, CDST, M,W,F

Days: **713/658-0268**

## NEW MFJ ALL BAND

# XCVR PRESELECTOR

Copy weak, barely readable signals. Reject images, out-of-band signals. 1.8 to 54 MHz. Up to 20 db gain. Automatic bypass. PTT. 20 db attenuator. Use 2 ant., 2 rigs.



**Copy weak, barely  
readable signals.  
Automatic XCVR bypass.**

# \$99<sup>95</sup>

**NEW MFJ-1040 transceiver/receiver preselector** lets you copy weak, barely readable signals.

**Rejects** out-of-band signals, images.

**Strong signal ability** reduces cross mod, overloading. Excellent signal-to-noise ratio.

**Continuous 1.8 to 54 MHz:** all HF amateur, shortwave bands. Up to 20 db gain. Gain control. Dual gate MOSFET, bipolar transistors for low noise, high gain, strong signal ability.

**Push button switches** for 20 db attenuator, ON/OFF BYPASS, 2 antennas, 2 receivers.

**Dual coax and phono jacks** for antennas, receivers. RF sensing relay automatically bypasses preselector when transmitting up to 350 watts input. Delay control. Jack for push-to-talk.

**LED.** 9-18 VDC or 110 VAC. 8x2x6 inches.

**MFJ-1045, \$69.95.** Same as MFJ-1040, less attenuator, xcvr auto bypass, delay control, PTT.

Use 1 ant., 1 rcvr. 5x2x6 in. 9 V bat., 9-18 VDC or 110 VAC with optional AC adapter, \$7.95.

**Order from MFJ and try it — no obligation.** If not delighted, return it within 30 days for refund (less shipping). One year limited warranty by MFJ.

**Order today.** Call toll free 800-647-1800. Charge VISA, MC or mail check, money order for \$99.95 for MFJ-1040 or \$69.95 for MFJ-1045 plus \$4.00 shipping and handling.

**Don't wait any longer** to pull out weak, rare DX.

**CALL TOLL FREE ... 800-647-1800**

Call 601-323-5869 for technical information, order/repair status. Also call 601-323-5869 outside continental USA and in Mississippi. ✓47

**MFJ ENTERPRISES, INC.**  
BOX 494, MISSISSIPPI STATE, MS 39762

## BROAD BAND FOLDED DIPOLE

BARKER &  
WILLIAMSON'S  
MODEL  
370-15

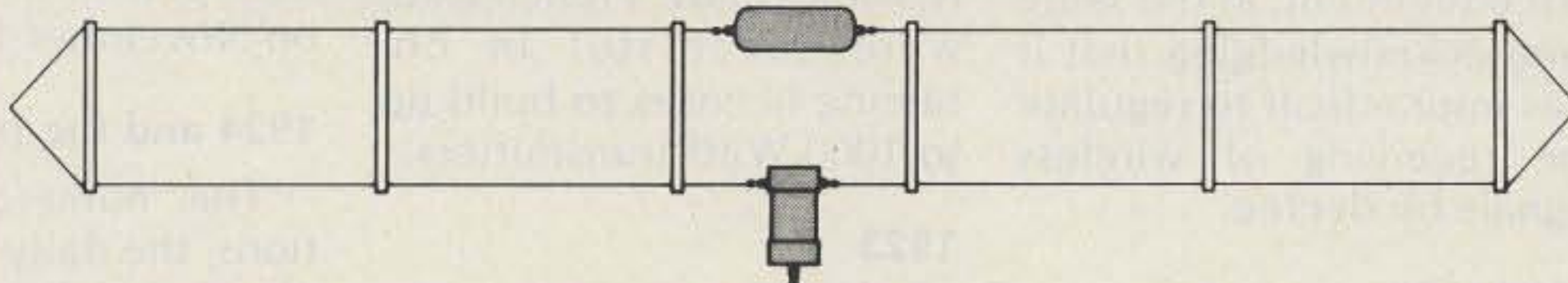

B & W's Broad Band Folded Dipole covers all amateur bands including the new 12, 17, and 30 meter bands. Also covers CAP frequencies, MARS, Military or any frequency from 3.5–30 MHz. Being used throughout the world! Total length only 90 feet long—spreader spacing 19 inches.

SWR—Less than 2:1 from 3.5–30 MHz

Supplied completely assembled with 50 feet RG 8U type coax and PL259.

Rugged construction for long life.

Can be installed as a flat top—inverted "V" or sloper

Also available for 2–22 MHz

Power handling capability 2 KW–4 KW PEP

PATENT PENDING

See your dealer or write:



Barker & Williamson, Inc. ✓11  
10 Canal Street  
Bristol, Pa. 19007  
Phone #215-788-5581

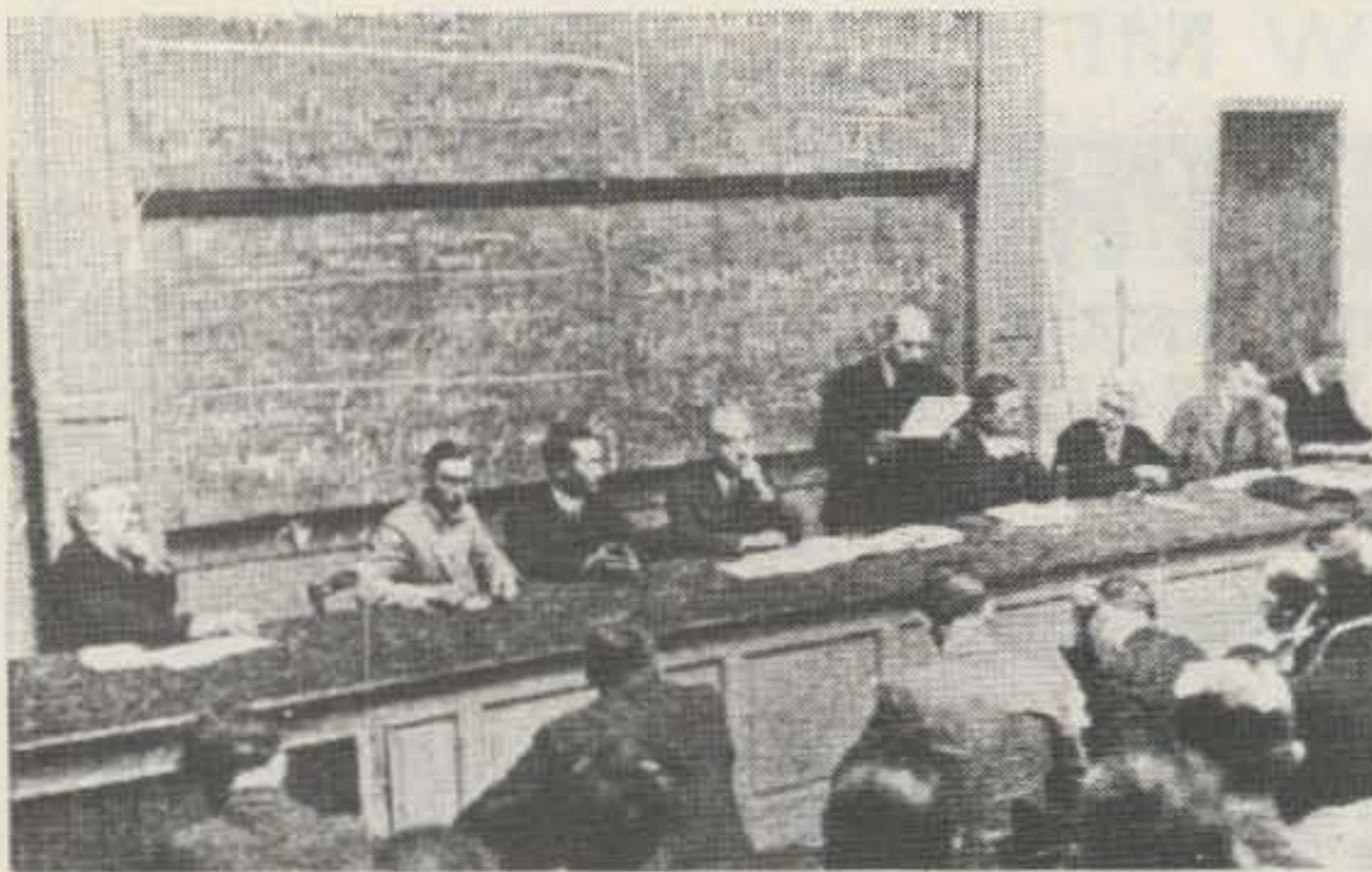

Photo E. The Amateur Congress in session. The Bureau sits at the long table. Left to right: M. Tirman, president of the Legal Congress; Lloyd Jacquet u20Z and Leon Deloy f8AB, interpreters; M. Belin, president of the Amateur Congress; M. Beauvais, Secretary; Jean G. Mezger f8GO, interpreter; Mr. Maxim; Mr. Warner; a stenographer. (Photo—Delano, Paris.)

undaunted, finally obtained permission from the Postmaster General to form a British Wireless Relay League and to solicit correspondence with British radio amateurs. Conditions in other European countries still gave amateurs no outlet for participation in even simple listening pleasures. Governments in general passed decrees which forbade the use of simple test equipment, at the same time acknowledging that it was impractical to regulate the receiving of wireless signals by decree.

#### 1922-1923

During the winter of

1922-1923, a series of tests arranged by the ARRL resulted in signals being copied both in England and on the continent. The French wireless enthusiasts, few in number, having obtained permission to operate by declaration to the Postal Telegraph Administration, enthusiastically prepared themselves to fully participate. A few of their number, and especially Leon Deloy, French 8AB, were successful in obtaining licenses to build up to 1000-Watt transmitters.

#### 1923

The year 1923 was a year of triumph. Many tests were

planned and carried out successfully. Two-way schedules were met and both oceans were crossed. Reports of reception came from Australia, from China, from Iceland, and from all over South America. With such gratifying results accomplished to the surprise of the various governments, it became possible for the British amateurs to be granted permission to organize The Amateur Society of Great Britain and obtain licenses to operate up to 1000-Watt transmitters. In Australia, a radio league was formed under the auspices of the Wireless Institute of Australia, its object being to organize a system of relay communication routes throughout Australia and New Zealand.

The second International Amateur Radio Convention, held in Chicago, brought together amateurs by the thousands. They came from every location in the United States, from France, England, and Canada. Actual two-way communication across the Atlantic via amateur wireless took place for the first time on November 17, 1923.

#### 1924 and the IARU

The numerous conventions, the daily exchange of messages between amateurs now worldwide, the many committees formed

to discuss plans and to formulate decisions... all of these activities gave the Board of Directors of the ARRL an opportunity to initiate a most imposing event, culminating in a meeting of all international amateurs. In March, 1924, there was convened in Paris, France, The Congress of International Amateur Union. During several preliminary meetings at this congress, a temporary committee of organization was named. All assembled agreed that a second meeting would convene in the following year in Paris.

Delegates from the various national societies of radio amateurs met at the *Faculte des Sciences* in Paris on April 17, 1925, in the first International Amateur Congress. They elected officers, adopted a constitution, and formed four national sections. All agreed that the International Amateur Radio Union would henceforth be the coordinating vehicle to foster international amateur two-way communication. Membership was available to anyone interested in the objectives of the Union. Twenty-five or more members from each country would organize as a National Section and be part of the Union.

The IARU thus brought all radio amateurs together under one canopy. ■



Photo F. Four members of the IARU Executive Committee. From left: M. Mezger, France; Hiram P. Maxim, USA; Mr. Marcuse, Great Britain; Mr. Warner, USA.



Photo G. Hiram P. Maxim, member #1 of the IARU, in the "static room" of the SS Belgenland, on his return trip to the USA.

## WORLD TIME WATCH

the first microprocessor watch made especially for hams



- 24 hr. timer
- microprocessor
- water resistant
- solar assist
- New Low Price  
-\$59.95

The HAM-1 functions include local time, world time, (G.M.T. too) count-up and count down chronometer, day, month, date, alarm and hourly chime. It's ideal for log-keeping, DX time conversion and 10 minute I.D. timing. The HAM-1 features a high contrast Seiko display and solar cell battery assist. Battery life is better than 4 years. The HAM-1 is water resistant to 20 meters, the case is 100% solid stainless steel and the crystal is scratch resistant mineral glass. The HAM-1 is rugged and durable and has a 1 year warranty.

## 2 METER AMPLIFIER



- 1-2 Watts In, 10-16 Watts Out • \$59.95
- V.S.W.R. Protected • Can be Used for F.M. & S.S.B. • Led Status Indicators • Low Loss SO-239 Connectors • Current Drain Less Than 2.5A at 13.6 V.D.C. • Massive Heatsink

## TEMPO S-1 UPGRADE KITS \$39.95

Upgrade your early Tempo S-1 to current Production Specifications, kits include: • 450 M.A.H. Battery Pack • New Case Assembly • All New Escutcheons • Spkr./Mic. Jack w/Dust Cap • New Earphone & Jack • P.C.B. and Parts for Easy Installation • Detailed Instruction Manual • For Radios With & Without T.T. Pad.

- Other Accessories Available:
- Spkr/Mic. Designed for S-1's. . . \$24.95
  - Heavy Duty Belt Clip. . . . . 7.50
  - Flex Antenna . . . . . 6.00

To Order Call or Write to:  
**ADVANCED COMMUNICATIONS INTERNATIONAL**  
 2411 Lincoln Avenue  
 Belmont, CA. 94002 U.S.A.  
 (415) 595-3949

Add \$3.00 per order for shipping & handling. California residents add 6% sales tax. Visa, Master Charge accepted.

## NEW MFJ VHF Converter lets you HEAR POLICE/FIRE CALLS

and more on 2 meter rigs. Receive 154-158 MHz. Direct freq. readout on synthesized, VFO 144-148 MHz FM rig. Covers nearly all FCC allocated police/fire VHF-hi frequencies.



Direct freq. readout on synthesized and VFO rigs. Scanning rigs become policefire scanner.

# \$49<sup>95</sup>

Hear exciting police/fire calls and more on your 2 meter rig.

Scanning rigs become police/fire scanner. This ingenious MFJ VHF Converter turns your synthesized or VFO 144-148 MHz FM rig into a hot police/fire receiver (154-158 MHz) with direct frequency readout on your rig.

Enjoy all benefits of your rig such as squelch, excellent sensitivity, selectivity, stability, limiting, AM rejection. For handhelds, too.

Two MOSFETS (tuned RF amp, mixer), bipolar crystal oscillator gives excellent performance.

Bypass/off switch allows transmitting. Won't burn out if you transmit (up to 25 watts) with converter on. Low insertion SWR.

"On" LED. SO-239 coax connectors. 9 to 18 VDC. Mobile mounting brackets. 3x4x1 inches.

Aluminum cabinet. Black and eggshell white. Order from MFJ and try it — no obligation. If not delighted, return it within 30 days for refund (less shipping). One year unconditional guarantee.

Order today. Call toll free 800-647-1800. Charge VISA, MC or mail check, money order for \$49.95 plus \$4.00 shipping/handling for MFJ-311.

Don't wait any longer to enjoy exciting police and fire calls, order now. Call MFJ or see dealer.

**CALL TOLL FREE ... 800-647-1800**

Call 601-323-5869 for technical information, order/repair status. Also call 601-323-5869 outside continental USA and in Mississippi.

**MFJ Enterprises, Inc.**  
 BOX 494, MISS. STATE, MS 39762

## 2300 MHz MICROWAVE

- LNA-1 2300 2 stage preamp, includes PC board, PC board parts and instructions. Use with UCC-1, SMC-1, SMC-2, & other converters. \$49.95
- UCC-1 Basic downconverter, includes PC board, PC board parts and brief instructions. (LNA-1 and UCC-1 made by Universal Communications, Arlington, Texas.) \$38.50
- SMC-1 Deluxe Introduction to Microwave package. Includes UCC-1, very detailed step by step assembly manual, more parts, the Microwave Antenna Cookbook. Lots of information on performance. \$51.95
- SMC-2 SMC-1 package with the HOT-1 transistor. \$63.95
- PER-1 Broadband IF Amplifier, compensates for long coax runs and poor TV front end noise figure. 2/\$20.00 3/\$29.00 \$11.95
- ANT-1 2300 MHz Microwave Antenna Cookbook. 2nd revision, greatly expanded. Includes coupon worth \$5.00 towards purchase of SMC-1 or SMC-2. The Original. \$7.96
- ANT-2 Disks and spacers for 32 element, 22db gain antenna. \$20.00
- HOT-1 High performance RF amplifier transistor, spec sheet, improves UCC-1 or SMC-1. 2/\$27.50 \$15.00
- TU-8 Deluxe PS kit, includes case. PER-1 will mount inside. \$44.95

NEW 4 page catalog SASE

All prices postpaid in US. VISA & MC on orders over \$40. COD add \$3. VA residents add 4% sales tax. Orders (703) 255-2918 9-12 EST M-F

**SMP** ✓376

Superior Microwave Products, Inc.  
 P.O. Box 1241  
 Vienna, VA 22180



**FREE!**  
 1981 DISCOUNT ELECTRONICS CATALOG

### JOIN THE PAK!

Send for our Free catalog and become a member of our exclusive Pak. Our members receive Poly Paks'

exciting catalog several times a year. We offer:

Penny Sales, Free

Premiums and Low,

Low Prices on a wide variety of

Electronic Products such as Computer Peripherals, Integrated Circuits, Speakers, Audio Equipment, Rechargeable Batteries, Solar Products, Semiconductors, and much, much more!

Take advantage of our 25 years as America's foremost Supplier of discount electronics.

**RUSH ME YOUR FREE DISCOUNT CATALOG!**

NAME: \_\_\_\_\_

ADDRESS: \_\_\_\_\_

CITY: \_\_\_\_\_

STATE: \_\_\_\_\_ ZIP: \_\_\_\_\_

CLIP AND MAIL COUPON TODAY TO:

**POLY PAKS, INC.** ✓58

P.O. Box 942, ST7

S. Lynnfield, MA. 01940

(617) 245-3828

Over 4.5 Million Satisfied Customers

## BUTTERNUT'S TWO-METER TROMBONE™ ...

A cut above its competition!

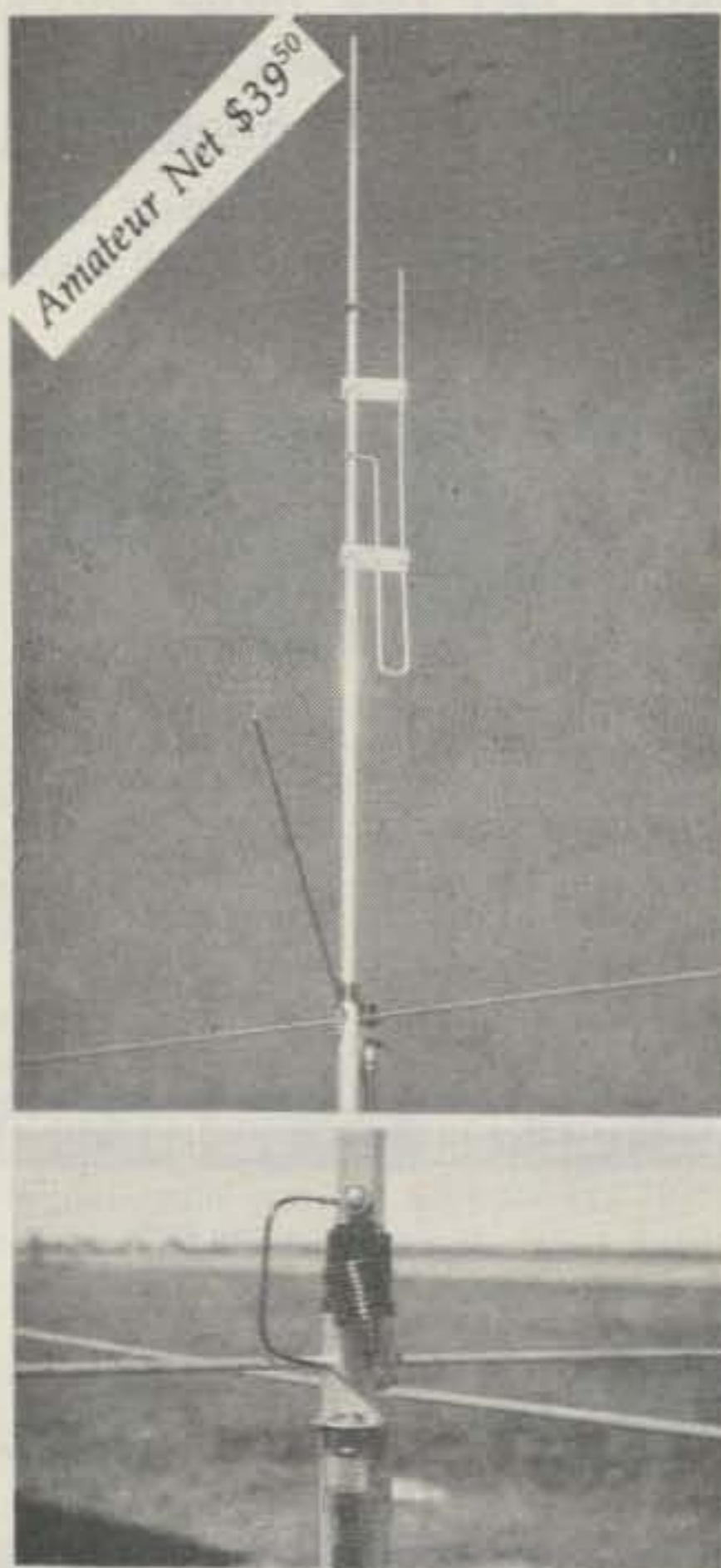

Butternut's 2MCV collinear gain antenna with its patented Trombone phasing section offers performance unmatched by other 2 meter antennas in its price class and holds its own against taller and much more expensive gain antennas.

ECONOMY, RELIABILITY AND LONG-HAUL PERFORMANCE MAKE THE 2MCV TROMBONE THE IDEAL CHOICE FOR YOUR NEXT BASE OR REPEATER ANTENNA.

### ELECTRICAL AND MECHANICAL SPECIFICATIONS

Height: 117.5 in./298.5 cm.  
Weight: 2 lbs./9kg.  
Shipping Weight: 3 lbs./1.4 kg.  
Feed: SO-239 accepts standard PL-259  
Effective radiating length: three-half wave (nominal)  
Gain: 6 dB  
Feedpoint impedance: 50-53 ohms  
VSWR at resonance: 1.1:1  
Power Rating: Legal Limit

Write for free literature and complete BEC catalogue, or ask your dealer

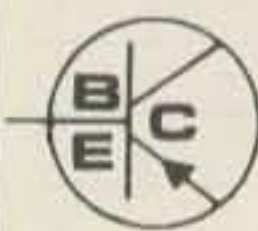

**BUTTERNUT  
ELECTRONICS  
CO.** ✓391

P.O. Box #1411  
San Marcos, Texas 78666

## SIGNALCRAFTER® Automatic Computing Power Meter

- Automatic SWR Reading
- Precision Power Measurement

The new SIGNALCRAFTERS computing SWR/POWER METERS are in a class by themselves. SIGNALCRAFTERS EXCLUSIVE integrated circuit CHIPS compute SWR automatically, thus eliminating the need for any "set" or "sensitivity" control. The built-in analog computer operates over a power range of one watt to several kilowatts. All models feature: —Selectable Peak or Average Power response —Self-indicating Push Buttons —Rugged taut-band meters —Interchangeable Plug-in directional couplers that can be remote mounted if desired —Handsome heavy-duty low profile metal cabinets that compliment the latest transceiver designs —D.C. Output Receptacle supplies a voltage that follows meter readings. These outputs are used to drive many different possible accessories, such as A-D converters, remote meters, alarm and control devices.



The Model 30 SWR/POWER METER dual display unit. Both Power and SWR are handled automatically. Auto-ranging automatically selects the proper power range according to the level detected on the transmission line and indicates the range on front panel LED's. Operator can override this feature if desired by selecting

any of the three basic ranges manually. Two large taut-band meters indicate forward power and SWR. Complete hands-off operation! And there is more! Self-indicating front panel push-buttons allow antenna selection as well. Full scale accuracy is  $\pm 6\%$  at 1 to 1 SWR. Selection of three antennas and a dummy load is possible. Accessory jack on rear panel provides 12 volts 60 Hz AC for any remote antenna relays. (Operates from 110 volts 60 Hz AC.) Width: 8½", Height: 4¼", Depth: 6".

Model 30 (less coupler) ..... \$250.00

The Models 31 and 32 are both single meter units—each in a class by itself. They are portable battery operated micro power instruments. A single meter displays either SWR or POWER as desired. The Model 31 has a single power range. The Model 32 features

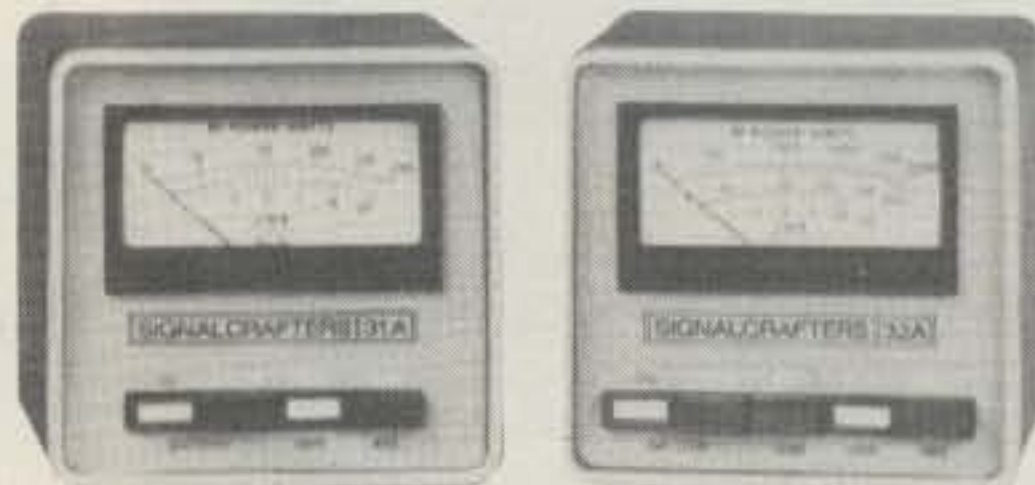

dual power ranges and both have an instant battery check feature. Both models perform with the same accuracy and precision as the Model 30 and an advanced low current design provides battery life that is truly outstanding. The units operate from a standard, easily available, 9-volt battery which is included or can be operated from a standard 110 volts 60Hz AC to 9 volts DC adapter (available as an optional unit). Width: 4½", Height: 4½", Depth: 5".

Model 31 (31A—0 to 200W) (less coupler) ..... \$175.00

Model 31 (32A—0 to 200W, 0 to 2000W) (32B—0 to 20W, 0 to 200W) (less coupler) ..... \$200.00

### SIGNALCRAFTER DIRECTIONAL COUPLERS

**MODEL HF 231 (1.8 to 30 MHz) for use with 50 ohm coaxial cable.** Less than 1.05 dB insertion SWR (max.) Equipped with two SO-239 UHF connectors (1 input-1 output) which plugs directly into rear of Models 30, 31, and 32, or can be remote mounted.

Model HF 231 ..... \$66.00

**MODEL HF 231A (1.8 to 30 MHz) for use with 75 ohm coaxial cable,** otherwise same as HF 231

Model HF 231A ..... \$66.00

**MODEL UV900 (50 to 900 MHz) for use with 50 ohm coaxial cable.** Less than 1.1 dB insertion SWR. Response:  $\pm 5$  dB over complete range of 50 to 550 MHz,  $\pm 1.0$  dB from 30 to 1000 MHz. Equipped with type "N" connectors. Plugs into Models 30, 31 or 32 by using any length remote cable. RCA phono-type receptacles used (2). Model UV900 ..... \$90.00

OTHER COUPLERS AND ACCESSORIES AVAILABLE — contact factory.

### SIGNALCRAFTERS INC.

5460 BUENA VISTA DRIVE, SHAWNEE MISSION, KANSAS 66205  
913/236-7300; TELEX: 42-4171

Prices include shipment to all U.S.A. Kansas residents add 3% percent  
VISA and MasterCard accepted

✓66



## The Radio Amateur's Conversation Guide

The Radio Amateur's Conversation Guide by Jukka Heikinheimo OH1BR and Miika Heikinheimo OH2BAD. Published by Transelectro-America, 2301 Canehill Ave., Long Beach CA 90815.

There's no question about it—English is the *lingua franca* of the ham bands. When working DX, few American hams ever pause to consider that the person on the other end of the QSO may be speaking a language that is not his native tongue. Still, in most countries in Africa, Asia, and Europe, if a ham is speaking English, chances are good that he went to a lot of trouble to learn it. To a ham who has spent many years in countries where English is rarely spoken, some of the comments heard from Americans about the linguistic abilities of foreign hams seem a bit hypocritical. I always wonder how well-acquainted the complainer is with French, Spanish, Russian, or even Arabic! In my humble opinion, the South American station who can barely get out his signal report and QTH in English is light years ahead of his American counterpart who refuses to venture even two words in Spanish.

In all fairness, it is rather hard for Americans to pick

up the proper vocabulary in another language. Bearing this in mind, OH1BR and OH2BAD have taken on the formidable task of producing a conversation guide for hams. 147 phrases commonly used on the air are given in English, German, French, Italian, Spanish, Portuguese, Russian, and Japanese. Having trouble copying the suffix of that EA9 station in Ceuta? No problem—just say "No he copiado su indicativo!"

Once you make the decision to learn a bit of another ham's language, you are on the way to making your hobby far more meaningful. There is nothing about the English language that makes it inherently superior to other languages, and the fact that you are struggling to learn another ham's language can create instant bonds of friendship and understanding. If nothing else, you will become acutely aware of the effort required to hold a conversation in another language.

How is the book laid out? Well, an English phrase is listed, followed by the translation in seven different languages. Some of the phrases are only marginally useful, such as "The sensitivity of my receiver is 1 microvolt" or "I have been QRT for five years." Others

you may find yourself using frequently, like "I know only a few sentences in..." or "Please send me your QSL."

I'm not going to list all 147 of the phrases here, but the general topics include starting a QSO, pleasantries, signal reports, name and QTH, equipment and antennas, weather, signal quality, contest jargon, and the all-important QSL. Also included is a list of phonetics and numbers in each of the languages (very useful when exchanging addresses!) and a dictionary of words unlikely to be found in a more traditional dictionary.

With the exception of Russian and Japanese, the phrases are printed in the original language, with no attempt made to phonetically spell them. A set of cassettes is offered as a companion to the book, to aid in learning pronunciation. The tapes weren't supplied with our review copy of the book, so I can't comment on their usefulness. Without the tapes, a raw beginner at a language may have difficulty with pronunciation, since phonetic spellings or pronunciation hints are not offered in the book. For example, "Sorry, but I did not understand completely" is written as "Sumimasenga kanzenniwa rikaidekimasen" in the book's Japanese transla-

tion. The same phrase in German is "Tut mir leid, ich habe nicht alles verstanden." I don't know about you, but not knowing the first thing about the proper pronunciation of these languages, I have a rough time guessing how these phrases are supposed to sound. In my case, the French translations in the book are easy going, because I remember enough of my college French to pronounce the words properly. Someone else who knows some German but never studied French may find the French difficult and the German a piece of cake. If you haven't studied a particular language at some point in your life, you'll want to get someone more knowledgeable to teach you the basics of pronunciation, or check out the cassettes that go with this book.

One use that doesn't require pronunciation help is writing QSL cards. You might enjoy filling out a card in the other ham's own language as much as I do, but be careful: You might get an extensive reply that you won't be able to translate!

However you use this book, it is a bargain at \$10.00 and deserves a place in the ham shack of every DXer interested in something beyond a mere signal report. ■

# Aerial Heirlooms

## — towers from the past

**T**he history of the early days of radio is well established and documented. It has been searched and researched until it is now uncommon to uncover something truly new on the subject of Marconi's early experiments.

But history, besides being a great healer, is perhaps the greatest forgetter. In the end, only the highlights of the first, the greatest, the most powerful, etc., finally survive the test of time. Often the fascinating

glimpses of work by common people and events close to the historical highlights are forgotten forever.

Likewise, only a few historical objects can be preserved. It is relatively easy to preserve a spark-gap transmitter, crystal receiver, telegraph key, or pair of headphones when compared to the monumental task of preserving the towers or antennas. But without these truly historical items, there could never be radio memorabilia. Old

towers eventually rot or rust away, fall prey to wind, lightning, salty sea air, or other elements, and are finally completely lost. For example, at Poldhu, England, where the first transatlantic signals were broadcast, all that remains is a Cornish granite memorial. Hardly a trace can be found of the famous towers which graced the spot for 33 years. For this type of historical object, we must rely on photographs, if there are any, and written records

about them.

Recently, I rediscovered a tape recording which combined the rare personal insights of one who worked on early Marconi projects with some almost forgotten details about Marconi's early tower construction. The tape was made by a man who helped construct some of the early towers used by Marconi.

This rare personal glimpse is from a speech made by Reverend Wilfred Wallis, speaking in February, 1956. My father, Loren Greiner WØGTW, had the foresight to tape the brief speech. Now, with the help of Mrs. B. Hance, the Marconi Company Historian, I have been able to corroborate part of the facts given by Reverend Wallis (who died in 1973 after serving the United Methodist Church in Pawnee City, Nebraska, for 20 years) and add some fascinating details about those early towers.

After the first transatlantic transmissions and Marconi's diligently objective diary notation that "sigs were heard at 12:30, 1:10, and 2:20 on December 12, 1901," the growth of radio communications took a giant leap. The discovery that radio signals could travel long distances was literally the light at the end of an aeons-long tunnel of isolation for ships who were

Photos courtesy of Marconi Company, Ltd., Marconi House, Chelmsford, Essex, England.

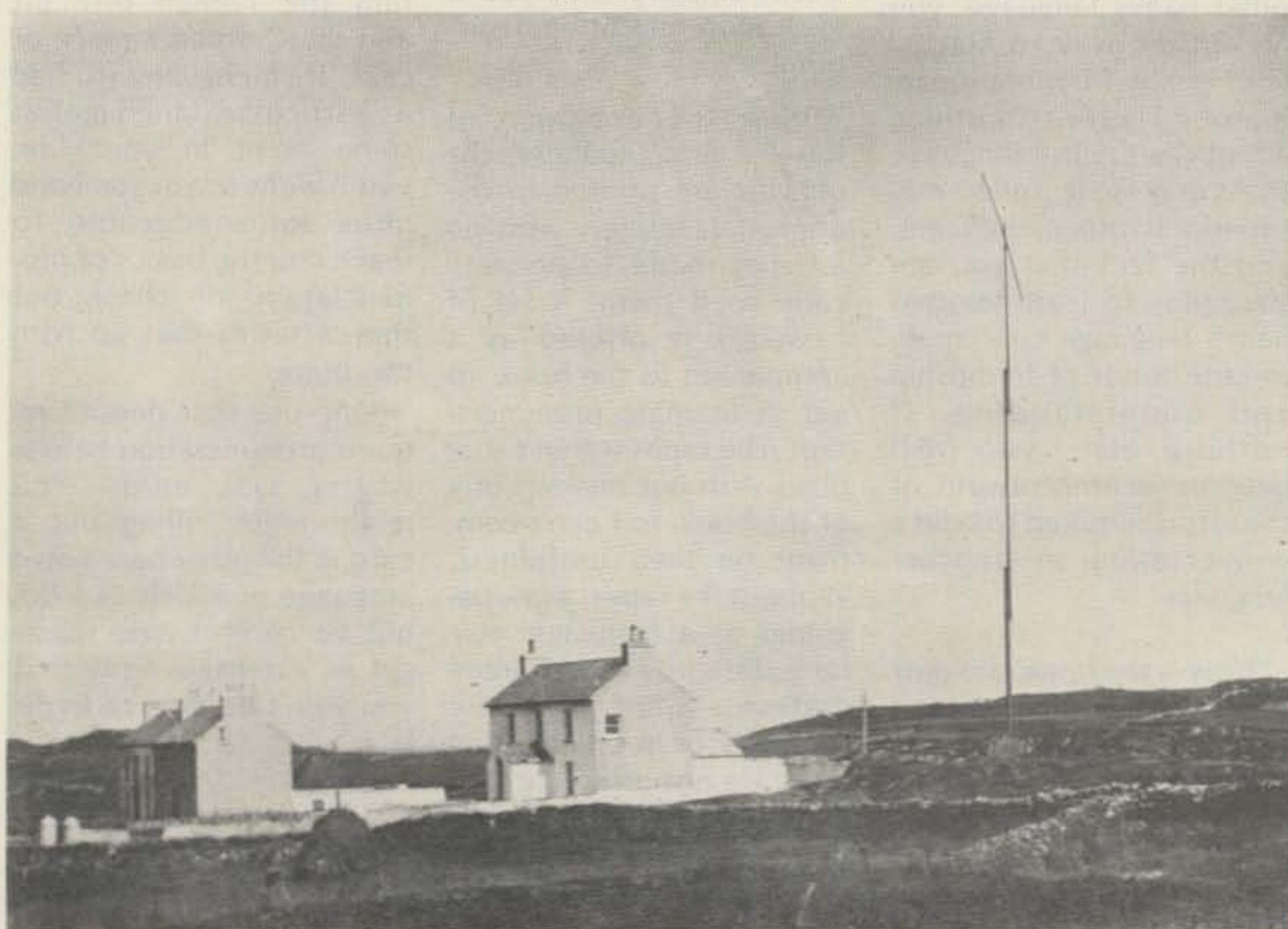

Photo A. The Marconi wireless station at Crookhaven, Ireland, shows the use of three lapped pole towers fashioned from ships' masts.

# IF YOU DIDN'T CALL THIS NUMBER

TOLL-FREE

# 1-800-325-3636

BEFORE BUYING

- Collins
- Dentron
- Drake
- ICOM
- Kenwood
- Tempo
- Ten-Tec
- Swan
- Yaesu

# YOU

PROBABLY

# PAID TOO MUCH !!

## HAM RADIO CENTER

8340-42 Olive Blvd. • P.O. Box 28271 • St. Louis, MO 63132 ✓32



out of touch with the world for the duration of their voyages.

Immediately, experiments were begun to improve receiver sensitivity and study propagation to find a way to improve on the reliability of transmissions. About this time, other transmitting and receiving stations were installed by Marconi and others. Finally, on June 4, 1903, the silence barrier for ships was truly broken when the prestigious Cunard ship line began a series of onboard daily newspapers called the *Cunard Bulletin* to help travelers keep in touch with the rest of the world.

About this time, Reverend Wallis contributed, in a small way, to the development of radio communication. Here, in his own words, is the story of his involvement.

"I was an apprentice in the shipbuilding yard. I was in what was called the mast-making department. They moved the apprentices from one department to another, every six months, to learn this phase of shipbuilding, then some other, and so on. At each stage you would have an instructor for that department.

"So, I was in the mast department, and word came one day that we were to build three sets of masts in two parts—what they called a lower mast and a top mast: One fits onto the other. As I remember, they were to be 180 feet long. We would take pine trees that they would keep in the yard all the time, and then cut them down and make them round to make a straight mast.

"Ordinarily, in those days, most of our masts were steel, but we also made wooden masts for some of the smaller ships and for some of the boats. So, we had the order for these sets of masts, and



Photo B. These Cape Cod towers were made of wooden planks similar to those described in the text. Close inspection reveals a man about halfway up the tower on the far left (look for him on the left edge of the tower).

everything was sort of secretive. We didn't know a great deal about it, although my instructor was one of the men who had a great deal to do with it. He was in charge of the work on them. They were to be set up at one harbor, the long harbor. In fact, it was large enough to house all the British ships. There was always a number of ships there. There they could come out the open part of the harbor, what they call

the Land's End. That was the first station to be built in this particular series. The second station using the next pair of masts was to be at Scilly Isle; the third was to be at Roche's Point in Ireland.

"So, the masts were finally finished and all the fittings put on them, and being an apprentice, I had the disappointment of my life. The instructor got to go over to Ireland to set up the mast there and another

man was sent to the other places. When I tried to go, they said 'No! Apprentices are not allowed to go out of the country.' "

Although the masts constructed by Reverend Wallis were made of two parts, many early towers were made of masts from three poles, as shown in Photo A. Each pole had its own set of guy wires. It seems only fitting that a service so related to ships at sea should have its early towers made of

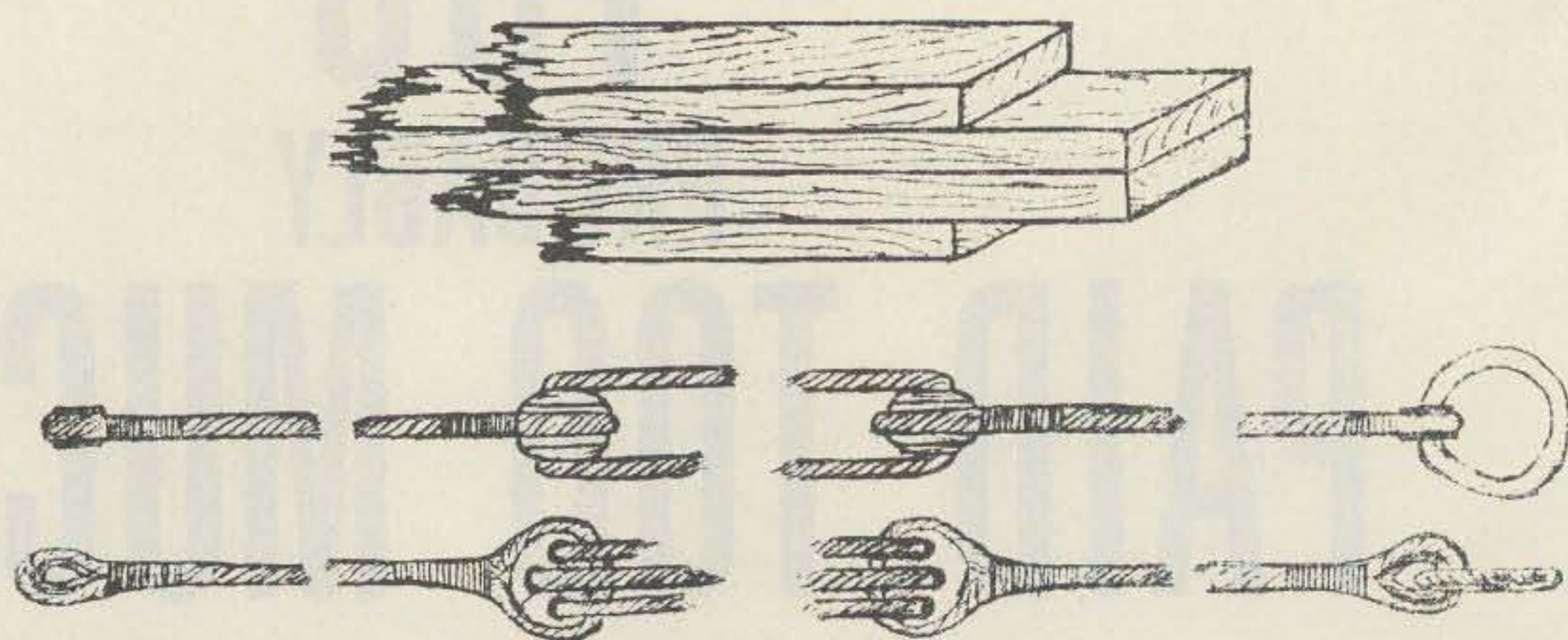

Fig. 1. Drawings from tower specifications for the Marconi wireless station at Poldhu, England. The upper drawing shows the arrangement of planks in a four-sided tower. The lower drawings show the construction of lanyard insulators. These towers were to be built after the first signal crossed the Atlantic.

COMPLETE - ASSEMBLED AND TESTED - READY TO INSTALL - NOT A KIT

## AMATEUR TELEVISION

### MICROWAVE RECEIVER DOWNCONVERTER

ELECTRONIC HOBBY INNOVATIONS is proud to present to the Amateur Radio Market a high gain, low noise, modern technology S-Band Microwave receiver converter. This converter will let you explore the unknown frontier of Amateur and commercial radio, for your personal enjoyment. In this region of line-of-sight reception, tune in the band of Amateur, digital, FM, AM, or TV modes of transmission using the downconverter and your own television set. This unit was designed for Amateur use, reception of other TV signals is the responsibility of the owner.

#### COMPARE THESE SPECS!

Cavity tuned front end - Hewlett-Packard low noise transistor - fully tested  
Hewlett-Packard 5082-2835, quality Hot Carrier Microwave Mixer Diodes  
Stable, Voltage Tuned Oscillator, for smooth tuning range  
Single, light weight unit, completely self contained for easy installation.  
Weather tight Chromated Aluminum Case for long endurance to weather

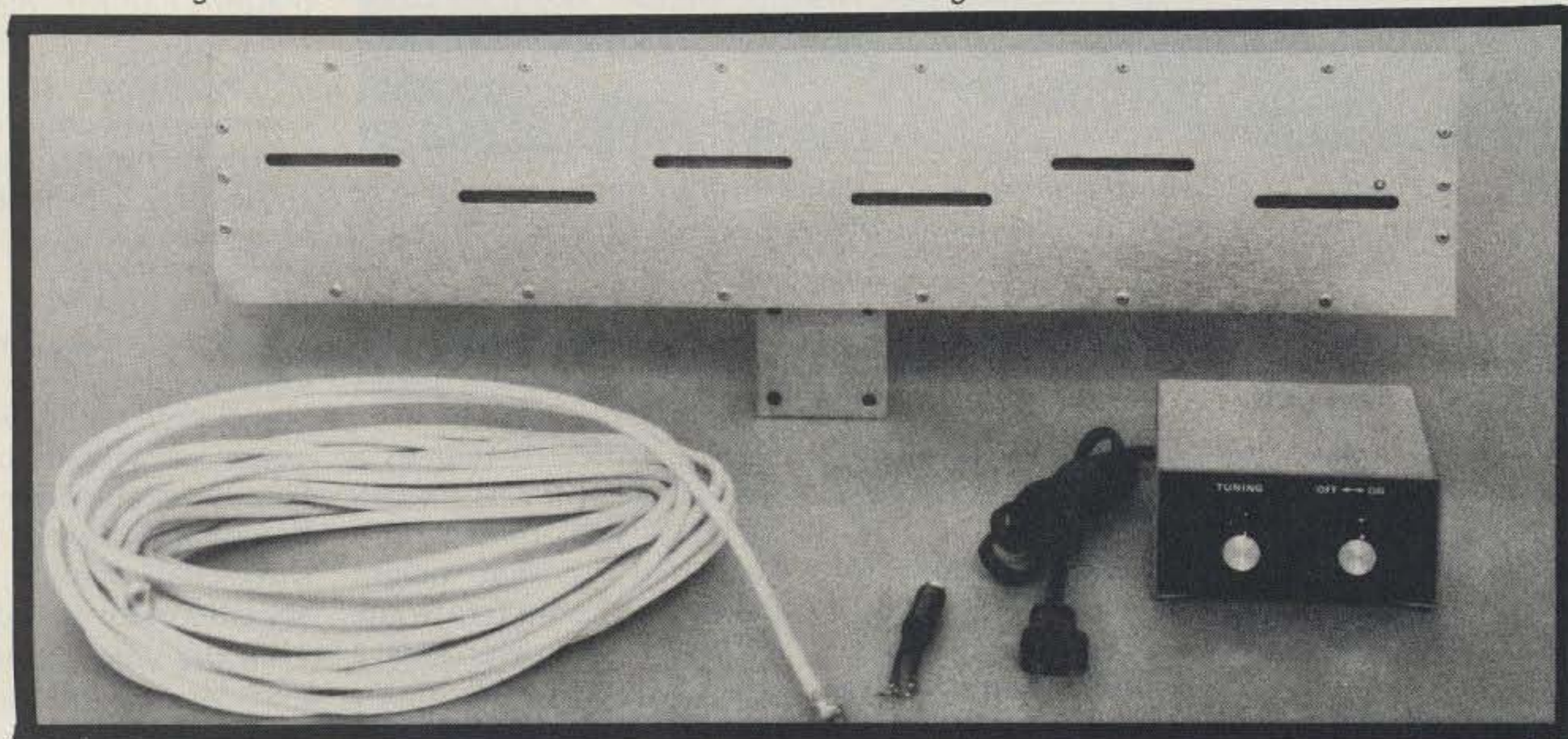

Tunes 2.10 GHz. through 2.40 GHz.

Preamplifier has 10 dB nominal gain with a 2.5 dB noise figure

Output tunes TV channels 2 to 6, Output Impedance 75 or 300 Ohms

Performance Guaranteed or your money fully refunded, Full Year Warranty

AMATEUR SPECIAL \$179.95 Including shipping (UPS)

VISA and MASTERCARD charges accepted, Call (804) 489-2156, COD's OK  
Call refunded on all orders, Virginia residents please add 4% state sales tax

Available Separately

Preamplifier - Fully Assembled and tested - \$59.95

Slotted Array Antenna - 15 dB nominal gain - \$29.95

Power Supply - Fully Assembled and tested - \$34.95

Downconverter Board - Fully Assembled and tested - \$69.95

ELECTRONIC HOBBY INNOVATIONS

7510 GRANBY STREET SUITE 207

NORFOLK, VIRGINIA 23505

✓447

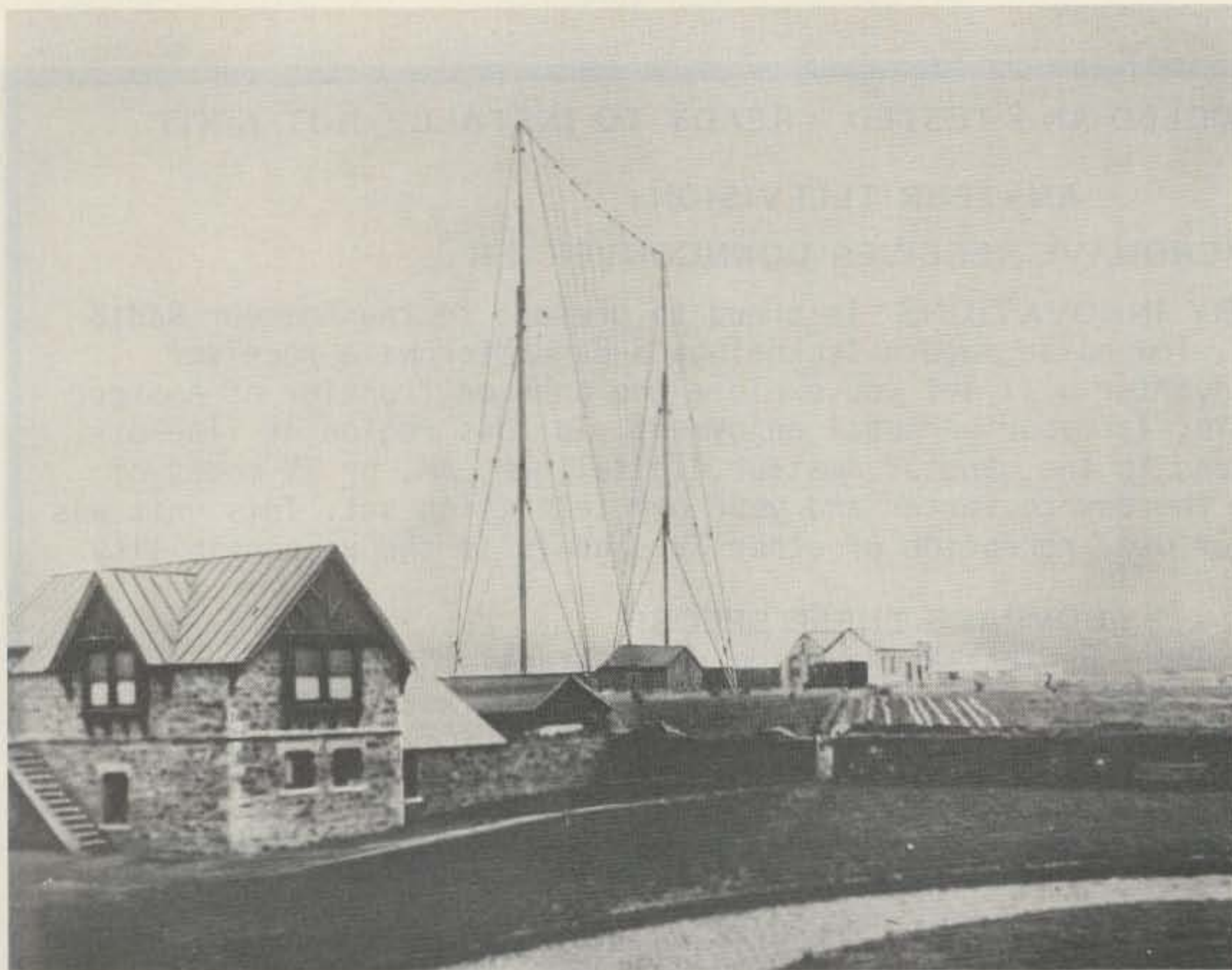

Photo C. This is the Poldhu wireless station from which the first transatlantic signals were sent. As with most early towers, these, too, were made from lapped poles like those used in ships' masts.

these ships' masts erected on land.

Being an apprentice, Reverend Wallis's view of the operation was no doubt tempered by his position, and the fact, as he noted, that the whole operation was somewhat secretive. Records from the Marconi Company shed light on a few of the problems of building radio towers from ships' masts.

Comments by E. A. N. Pochin, a Marconi assistant, have been preserved in the Marconi Company archives. They indicate that one of the major problems was that all of England did not have enough large logs to make some proposed towers, and the designers were faced with project delays of two months if they chose to wait for larger logs to be imported from the United States. As Pochin wrote in July, 1901, less than six months before the first transatlantic transmission:

"I made it perfectly clear to Messers Blythe and Pas-

coe that the logs must be sound, and insisted on their quotation specifying the fact of the timber being for mast work to prevent their pleading ignorance." (This sounds like most any purchasing agent making sure he's covered in the event the vendor doesn't deliver the goods.)

In any event, the work on the mast was to continue on the assurances from the builders' chief carpenter that the best available logs would "work up perfectly clean." Final approval, however, rested with Marconi.

Even as the first signals were crossing the Atlantic, plans were being drawn up for replacement towers at the Poldhu transmitting station. Specifications dated December 9, 1901, called for four-sided towers like those shown in the often published photographs of the Glace Bay, Nova Scotia, station.

When finally erected, these towers must have

been an impressive sight. The four wooden towers were to be placed in a square, with 210 feet to a side. They were to be 215 feet tall, with three and a half feet of that height buried in a concrete foundation. Each tower was a gigantic twenty-one and a half feet square at the bottom and nine feet square at the top.

In today's world, we would think the wooden construction would be standard materials like 2x4s or perhaps 2x12s. Not so. Records indicate the tower legs were made of boards sized 11" x 3" x 12'. Four planks were arranged together as shown in Fig. 1. Zigzag braces were made of 9" x 3" wood and bolted at each end with 3"-square washers under each bolt head and nut. For extra strength, they had diagonal tie bolts every seven and a half feet.

In order to brace the towers against the possibility of 92-mph winds at Poldhu,

the four towers were each guyed with ten wires called "stays." The guys were to be connected at the top of each tower, and at the middle, rather than below the top as with typical modern construction. Guy wires were of 13/16" steel wire with a breaking strength of 18 tons. Upper guy wires were to have two insulators, while lower guys were to have only one insulator.

In today's world, where every broadcast tower uses high-quality porcelain insulators, it is hard to imagine how radio pioneers might have improvised their insulators. The answer lies in the details of the stay in Fig. 1. Marconi's specifications call for "elm dead-eyes spliced in... connected by means of 3" circumference hemp rope lanyard, having a breaking strain of 2.5 tons in single length or a total of 15 tons in the six parts."

The entire guy wire, including insulators, was to be covered with "two good coats of Stockholm tar." Finally, each tower was to be painted with two or three coats of paint, with no specific color specified.

In the years after Reverend Wallis's participation in the construction of Marconi's pole towers, I know he felt proud to have been a small part of such tremendous events which contributed to greater safety on the seas and better communication between continents. In the same way, the other men and women who participated in unknown but important ways to the building of other Marconi towers and equipment must have known of the importance of their work to these earthshaking events. Perhaps this short glimpse into that forgotten part of history can help us all to honor average people, without whom the more famous pioneers could have never succeeded. ■

# MIDCOM

**DEAL WITH #1!**

**CARLOAD INVENTORIES • ROCK BOTTOM PRICES**

**24-HOUR SERVICE**

LINES:

AEA	ALPHA	CUSHCRAFT	DENTRON	KLM	MOR GAIN	PALOMAR ENG.	UNIVERSAL
AVANTI	BEARCAT	COLLINS	HY GAIN	KENWOOD	MIRAGE	REGENCY	UNARCO-ROHN
ASTRON	BIRD	CDE	HUSTLER	MICROLOG	MFJ	SWAN	VIBROPLEX
ALLIANCE	BENCHER	DRAKE	ICOM	MINI-PRODUCTS	NYE	TEN TEC	Kantronics

**CALL TOLL FREE 1-800-325-3609** IN MISSOURI  
**314-961-9990**  
**MID-COM ELECTRONICS • 8516 MANCHESTER ROAD • BRENTWOOD, MO 63144**



✓ 52

## BUILD THIS SSB TRANSCEIVER FROM OUR MODULES

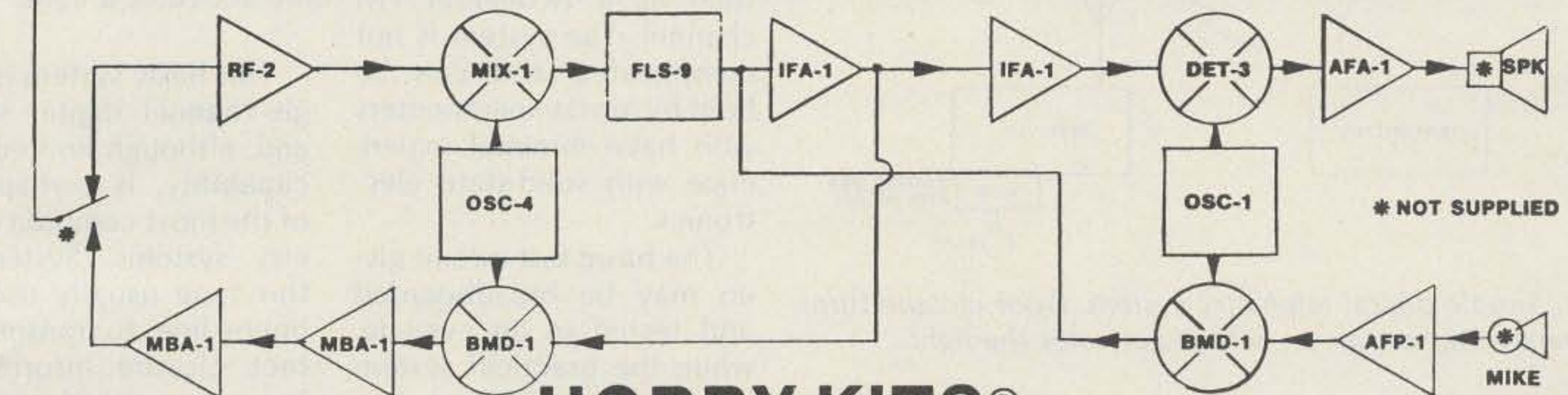

### HOBBY KITS®

EXPERIMENT — LEARN ELECTRONICS; BUILD AND DESIGN YOUR OWN AM, FM, CW, OR SSB RECEIVERS, TRANSMITTERS AND ETC. WITH OUR MINI-LINEAR CIRCUIT KITS

All kits Come Complete With Etched and Drilled Circuit Boards and All Parts Needed To Function As Described

AFA-1 AUDIO AMP, LM-380 1-2 Watts 4-16 OHM Output.....	\$4.95	MBA-1 FREQ. MULT. Tuned Output Buffer-Mult-Amplifier To 250 MHZ.....	\$5.95
AFP-1 AUDIO PREAMP, Dual Audio Preamp — For Mike Etc.....	\$3.95	OSC-1 CRYSTAL OSC. 100 KHZ — 20 MHZ Not Tuned.....	\$3.95
BMD-1 BAL. MIX. LM 1496 Mixer — S.B. Modulator Tuned Output.....	\$9.95	OSC-2 CRYSTAL OSC. Ov. 18-200 MHZ Tuned Output.....	\$4.95
DET-1 AM DET. Am Envelope Detector With AGC Output.....	\$3.95	OSC-3 VARIABLE FREQ OSC Varactor Tuned 455KHZ.....	\$5.95
DET-2 FM DET. LM 3065 FM Detector (455 KHZ or 4-11 MHZ).....	\$7.95	OSC-4 VARIABLE FRFY OSC Varactor Tuned 4-11 MHZ.....	\$5.95
DET-3 SSB DET. LM 1496 SSB Detector (Needs OSC-1 or OSC-4).....	\$9.95	PSV-1 POWER SUPPLY LM 723 With Pass Transistor, 3 amps max.....	\$7.95
IFA-1 IF AMP. CA 3028 30 DB Gain, Optional AGC (455 KHZ or 9-11 MHZ).....	\$6.95	PLL-2 TONE DETECTOR LM567 PLL Tone Detector.....	\$5.95
FLS-9 SSB FILTER 9 MHZ/2.1 KHZ BW with USB XAL for OSC-1.....	\$49.95	RF/MIX-1 RF-AMP/MIXER CA 3028 — Tuned RF AMP/Mixer 1-100 MHZ.....	\$7.95
IFA-2 IF AMP. CA 3028 30 DB Gain 1-100 MHZ Optional AGC.....	\$6.95	RF/MIX-2 RF-AMP/MIXER 3N204 Tuned RF AM/Mixer 1 — 250 MHZ.....	\$7.95

MANY OTHER MODULES AVAILABLE

TERMS: CASH WITH ORDER  
 OR 25% DEPOSIT FOR C.O.D.

SEND \$2.00 FOR FULL CATALOG  
 WITH CIRCUIT DIAGRAMS AND  
 TYPICAL RECEIVER AND  
 TRANSMITTER HOOK-UPS

**ELECTRONICS SPECIALTIES SALES CO.** ✓419  
 P. O. BOX 2122 • MIAMI, FLORIDA 33152 • PHONE 305-759-2318

COMPLETE SET OF MODULES TO BUILD A  
 1-WATT SSB/CW MONO-BAND TRANSCEIVER  
 LESS CASE, CONTROLS, PWR SUPPLY  
 (12 VDC), SPK AND MIKE  
**\$149.95 (Specify Band)**

# Amateur Telemetry

## — monitor your repeater's vital signs with this simple system

A telemetry system is a system for making a measurement of some property such as voltage, current, or temperature, and transmitting the measurement to a remote observer via a communications link. Telemetry systems may be either analog or digital and

may be designed to transmit either a single measurement or up to several hundred measurements over a single communications link.

Telemetry systems in the world of commercial communications often are very

complex, designed to transmit many channels of information over communication links using sophisticated digital techniques. The telemetry system described in this article is an elementary, single-channel, analog system and is designed to transmit voltage readings over a communications link such as a two-meter FM channel. The system is not complicated and can be built by most experimenters who have minimal experience with solid-state electronics.

The basic test circuit given may be breadboarded and tested in an evening, while the practical system will take two or three evenings more. The completed practical system will enable an experimenter to monitor a voltage remotely, using either a telephone line or an FM or AM radio link. There is no special equipment needed to build and test these circuits. The only equipment needed is two meters capable of measuring from 0 to 10 V and a pair of earphones to check the operation of one of the circuits.

### Simple Telemetry Systems

Fig. 1 shows a telemetry system in one of its simplest

forms. This system monitors a door closure by using a transmitter and a receiver in conjunction with a carrier-operated relay. When the door is closed, the transmitter is turned on, sending a carrier to the receiver at some remote location. The receiver detects the carrier, and the carrier-operated relay activates a light.

This basic system is a single-channel digital system and, although limited in its capability, is perhaps one of the most common telemetry systems. Systems of this type usually use telephone lines to transmit contact closure information. Examples are the remote fire and burglary alarms offered by numerous protection and security firms. These security systems offer door entry and fire monitors which activate a relay which, in turn, sends a current down a telephone line to activate a light or audible alarm at a police station or security office.

Another simple telemetry system is shown in Fig. 2, a diagram of a simple analog telemetry system. In this case, a long pair of wires connects the voltage to be measured to a remote

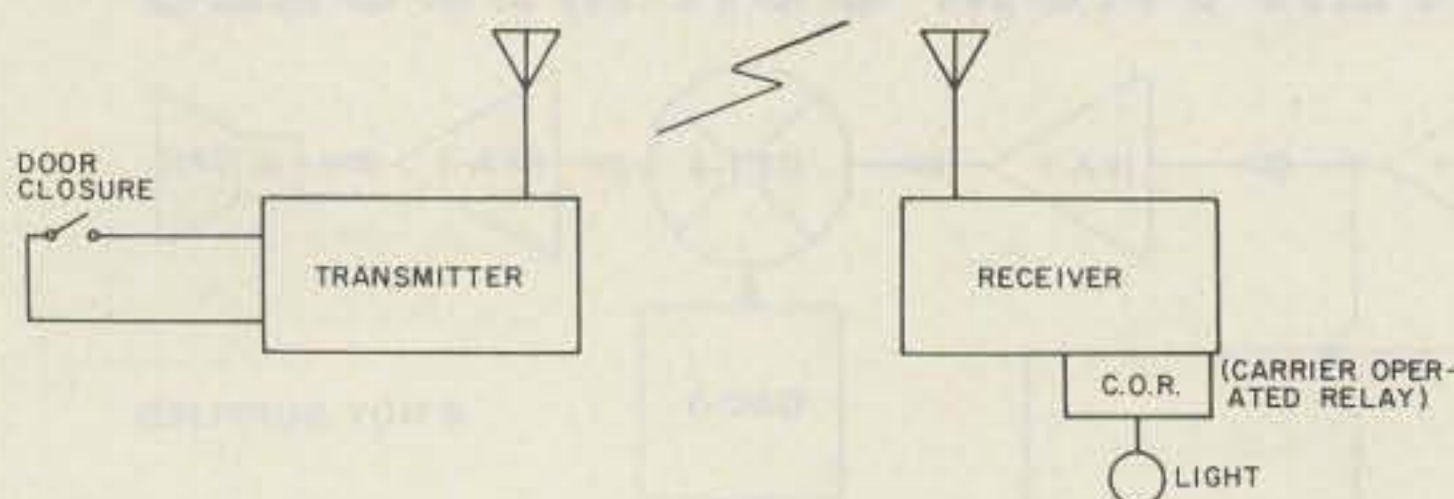

Fig. 1. Simple digital telemetry system. Door closure turns the transmitter carrier on, which activates the light.

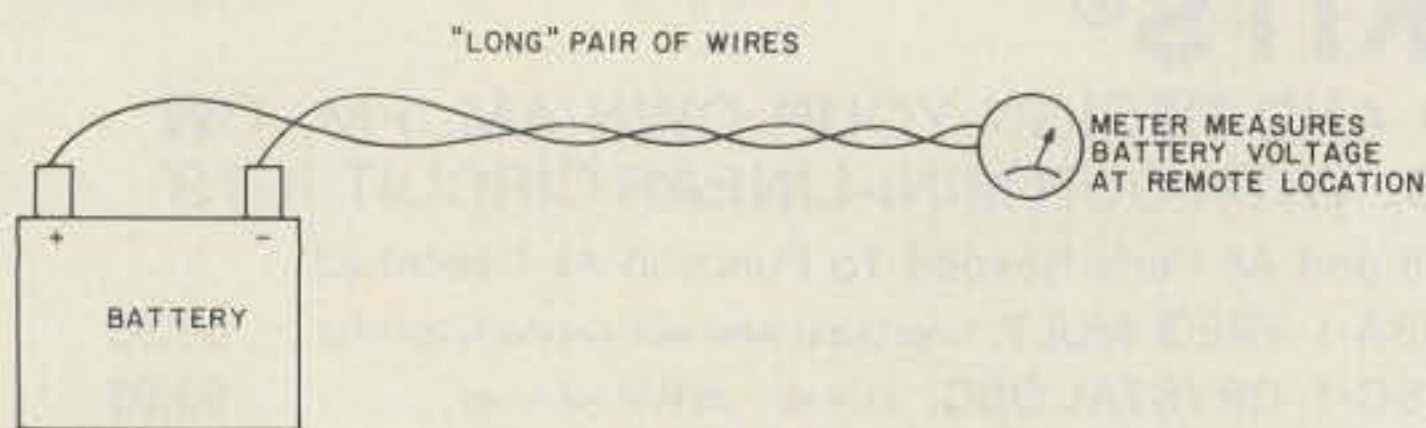

Fig. 2. Simple analog telemetry link. Because of resistance in the wire, there is a voltage drop in the wire. Actual meter reading is  $V_{BAT} - V_{DROP}$ .

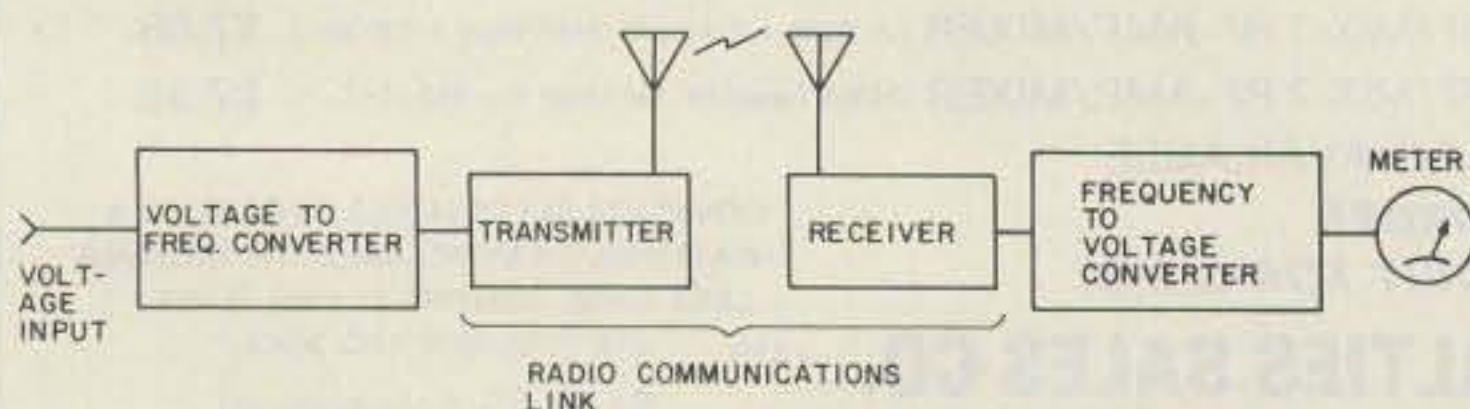

Fig. 3. A single-channel, analog telemetry system.



meter. This system is common, but normally is limited to cases where the distance between the two points is relatively short—perhaps less than 100 feet. This system suffers from accuracy problems since a voltage drop will occur due to the resistance in the wire. The actual reading at the remote location will be  $V - IR$ , where  $I$  is the current through the meter and  $R$  is the resistance of the wire. If large gauge wire is used (to keep the resistance low) or if the distance is kept short, there will be no problems; if the distance is great, however, the remote reading may be erroneous.

As an example, assume that we wish to measure the voltage of a 12-volt battery at a distance of about 25,000 feet (about five miles). If 24-gauge wire is used (with a resistance of about 21 Ohms/thousand feet), the wire will have a resistance of about 525 Ohms. If the meter draws one milliampere, then the voltage drop will be about 1/2 volt. Obviously, the large amount of wire has introduced an error at the meter end. Admittedly, a calibration chart could be made up to correct for the errors, but where will you come up with five miles of wire and how will you string it? While this problem is a bit exaggerated and may seem farfetched, the problem is encountered daily in remote areas. The solution, of course, is to use a radio telemetry system.

### A Radio Telemetry System

The problem of monitoring the contact closures shown in Fig. 1 is handled easily by a radio communications link; the problem as shown in Fig. 2, is not. The remote metering problem uses a dc voltage, and there is no way to put dc voltage directly into the transmitter, as if it were a pair of wires. Some means must be

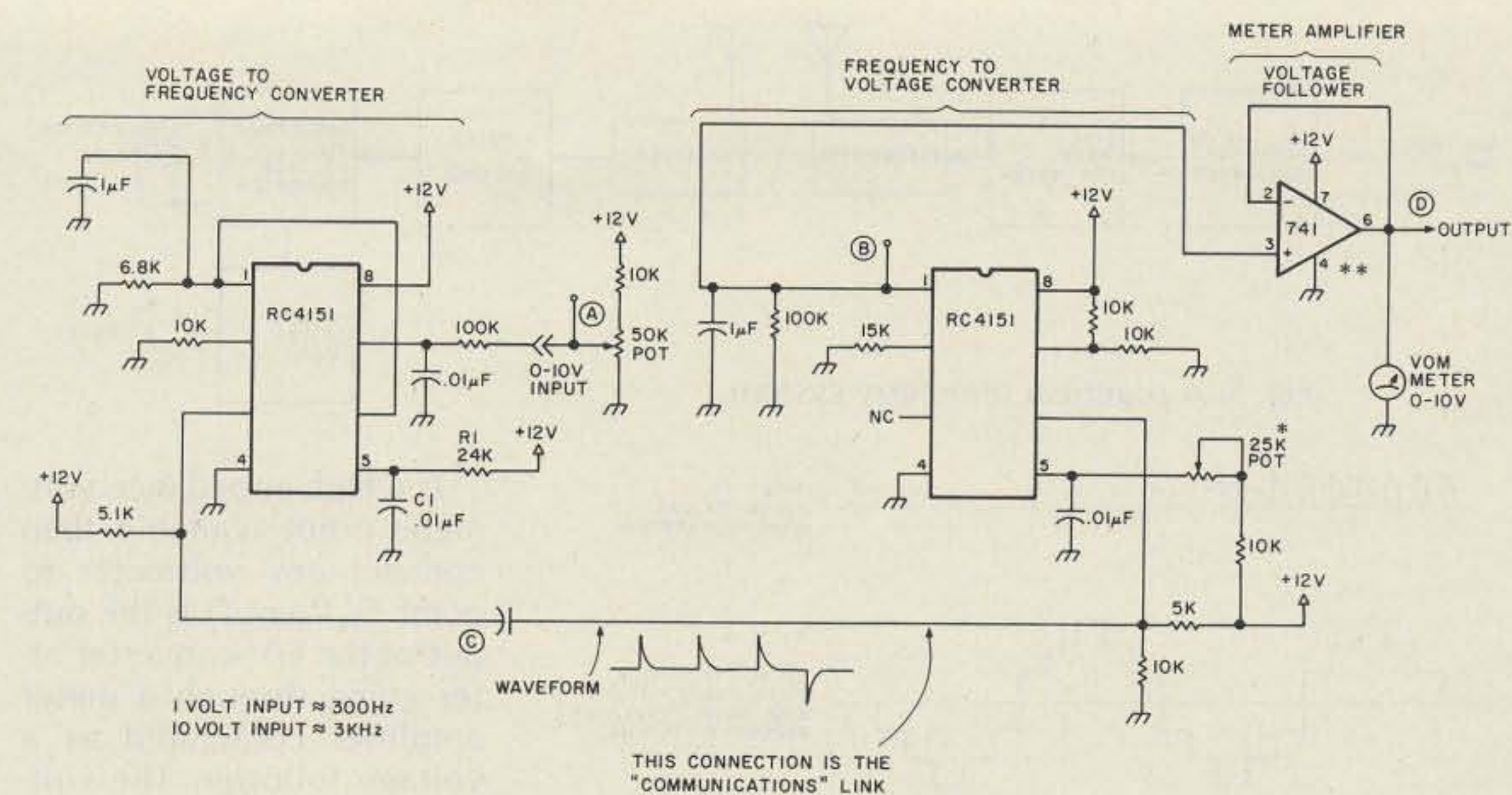

Fig. 4. Breadboard test setup for voltage-to-frequency, frequency-to-voltage converters. Note: 12 V is a nominal value. May be any voltage from 8 to 15. \*Calibration pot—adjust so that VOM is the same as point A. \*\*Pin numbers shown are for 741 in the 8-pin DIP package.

used to convert the dc voltage into a form that can be transmitted by radio. While there are numerous methods to do this, one of the easiest is to use a tone-modulation system in which a tone frequency is produced as a direct function of the voltage to be measured. This technique is used to transmit electrocardiograms and other voltage measurements via telephone lines, and may be adapted for radio communications systems.<sup>1</sup>

Fig. 3 shows a single-channel, analog telemetry system. In this example, the voltage to be measured is converted to a tone frequency. The frequency tone modulates the transmitter portion of the radio link, while the receiver demodulates the received signal and sends the tone to a frequency-to-voltage converter. The converter drives a meter to indicate the measured voltage.

Fig. 4 shows a breadboard example of a voltage-to-frequency/frequency-to-voltage telemetry system. This circuit consists of three parts, a V/F (voltage-to-frequency) converter, an F/V (frequency-to-voltage) con-

verter, and a meter amplifier. For ease of testing and experimentation, I recommend that this circuit be breadboarded on a Global Specialties or Radio Shack (276-174) breadboard. This circuit is not difficult to build and should work the first time that it is turned on. The input voltage is not critical and may be any voltage from 8 to 15 V. If a 12-volt battery or supply is not available, an inexpensive 9-V transistor battery may be used. Note that measurements shown on the circuit diagrams were made using 12-V power.

A pair of earphones may be connected to point C through a 0.01-µF capacitor to give an audible indication of the operation of the circuit.

The Raytheon RC4151 V/F, F/V integrated circuit is used in this design in order to reduce the parts count and construction time. Other methods may be used,<sup>1</sup> but this chip reduces the construction time of a practical telemetry system to two or three evenings. The RC4151 can be programmed to operate over any frequency range from 1 Hz to 100 kHz by choosing  $R1$

and  $C1$  according to the expression  $f = 0.75/R1C1$ , where  $f$  is the output frequency with an input voltage equal to the supply voltage. Using the components shown in Fig. 4, the frequency will vary over a range of 0 to about 3.1 kHz for inputs of 0 to 12 volts. The F/V converter will convert to voltage over the same frequency range.

The circuit can be tested over this range by connecting voltmeters to points A and B (a high-impedance voltmeter, 1 meg or better, must be used for point B). Point A will indicate the input voltage, while point B will indicate the output voltage. In an ideal circuit, these two points will track together, always giving the same reading. In the real world, however, the voltages may differ due to component variations. The resistor and capacitor connected to pin 5 of the RC4151 determine the frequency range of the circuit. If the values of the components used with the V/F and F/V chips are identical, then the two units will track perfectly and the input and output voltages will be the same. If, however, component variations occur, then the

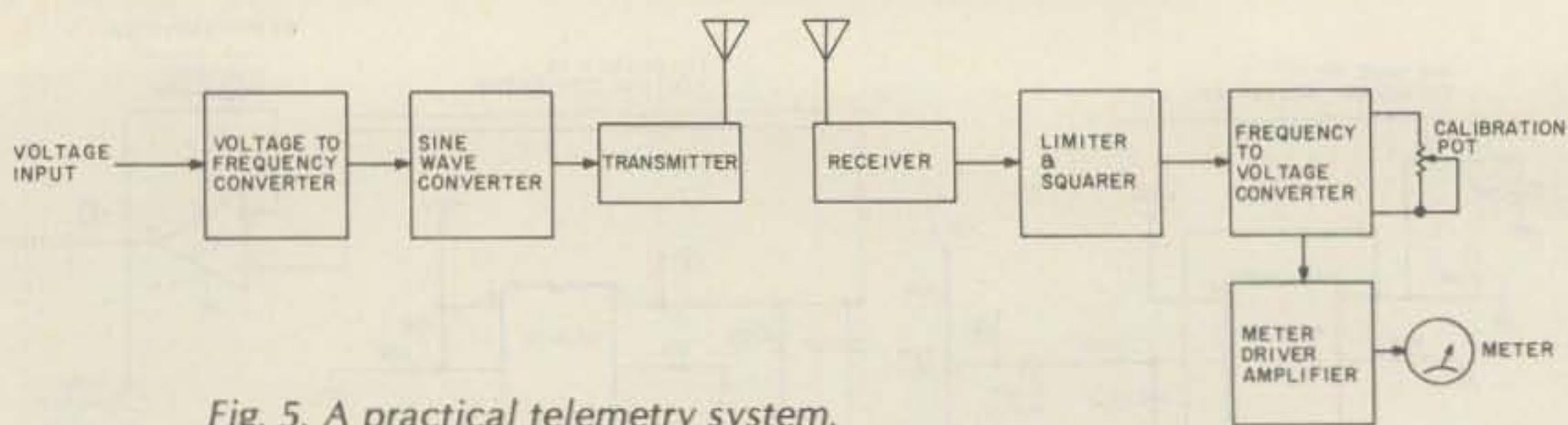

Fig. 5. A practical telemetry system.

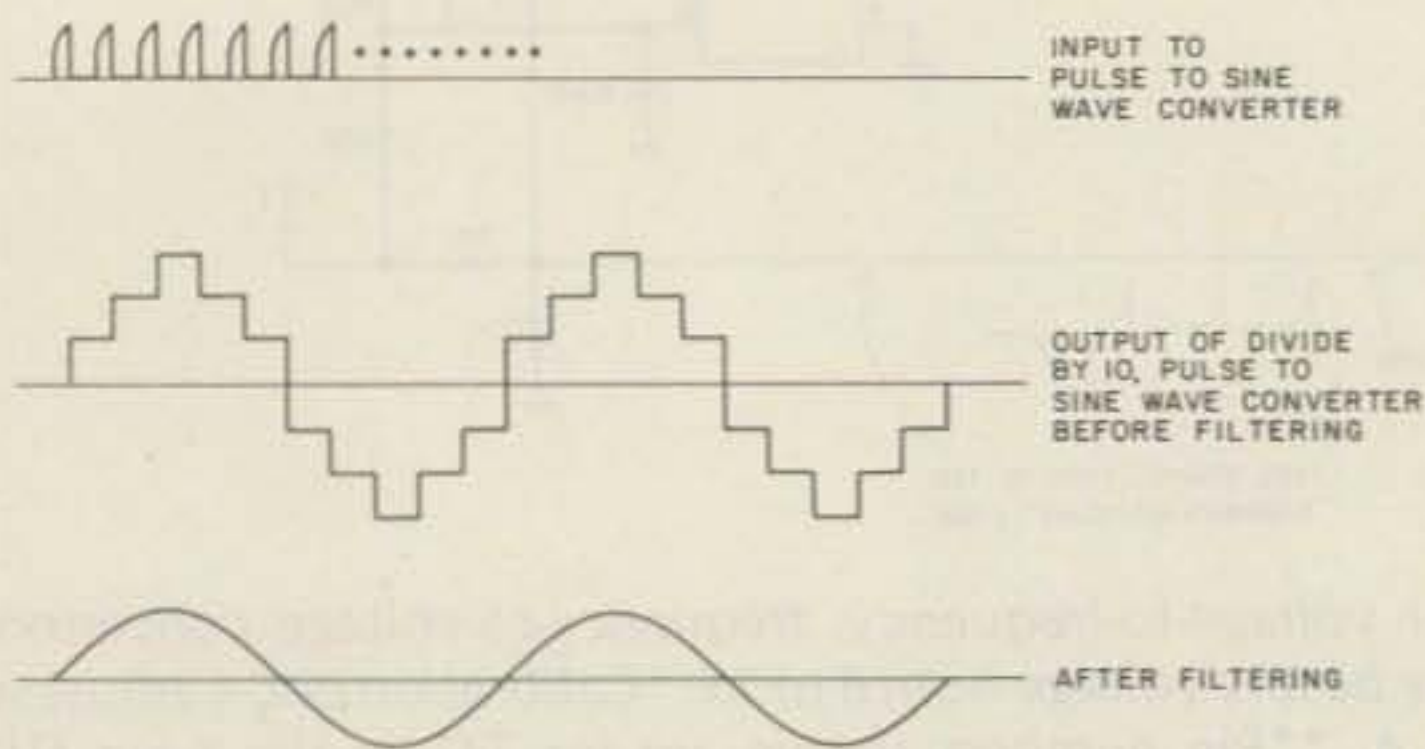

Fig. 6. Waveforms of pulse-to-sine-wave converter.

two circuits may be calibrated by adjusting the 25k pot so that the voltages are identical. This adjustment need be made only once to calibrate the units over the

entire voltage range. For ease of calibration, set the input voltage to about 6 volts and adjust the pot so that the output indication is 6 volts.

If a high-impedance voltmeter is not available, then connect any voltmeter to point D. Point D is the output of the F/V converter after going through a meter amplifier configured as a voltage follower. The voltage follower has a gain of one and is used as a buffer between the high-impedance output of the RC4151 and a lower-impedance meter. The voltage follower is configured for a single-supply voltage, and because of this will operate only over the range of 2 to 10 volts. Keep this limitation in mind when using the voltage follower as part of your test setup. If you use a voltage of less than 12 volts, then the voltage follower will follow voltages to about 2 volts less than the supply voltage.

The RC4151 has a linear relationship between voltage and frequency. If the device is set to deliver an output of 3000 Hz for an input of 10 volts, then the output would be 300 Hz at 1 volt, 600 Hz at 2 volts, and so on. If a frequency counter is available, this can be verified by connecting the counter to point C and noting the change in frequency while varying the input voltage.

This basic test circuit has some limitations and is not suitable for integration directly into a communications link. First, the output of the RC4151 is a pulsed output similar to a square wave with a nonsymmetrical duty cycle. This pulsed output will not properly modulate a transmitter such as an FM transmitter. Second, the

F/V circuit requires a pulse input with a fast negative-going pulse. The output from a receiver will be sine wave for the most part and will not be decoded properly in the F/V converter. Note that in this test circuit the F/V converter, under some conditions at around 9 to 10 V, will not see a good input pulse and will become a bit unreliable, producing fluctuations in the output voltage.

### A Practical Telemetry System

Fig. 5 is a block diagram of a practical telemetry system. In this diagram, two items have been added to the breadboard test setup to make a practical telemetry system. A sine-wave converter has been added to the output of the V/F converter and a limiter has been added to the input of the F/V converter.

The sine-wave converter in this design is based around a 4018 Johnson counter. This circuit generates a staircase output, approximating a sine wave, for every 10 input pulses (Fig. 6). The output of the sine-wave converter is fed to a simple RC filter to smooth the staircase output to a good sine-wave approximation. Note that the output of the sine-wave converter, after the simple filter, is not constant with changes in frequency but decreases as frequency increases. This is of little consequence for this experimental telemetry system since a limiter is included with the receiving system. For a sophisticated system, an automatic gain-control circuit could be placed after the filter to provide constant amplitude output.

Since the sine-wave converter divides by 10 during the process of converting the pulse input to a sine-wave output, it is necessary to increase the frequency range of the V/F converter by a factor of 10. This is

# Orbit



**ORBIT** is the Official Journal for the Radio Amateur Satellite Corporation (AMSAT), P.O. Box 27, Washington, DC 20047. Please write for application.

For a **FREE SAMPLE COPY** please send \$1 to cover First Class Postage and handling to: Orbit, 221 Long Swamp Road, Wolcott, CT 06716.

done by decreasing the value of C1 to 1/10 of the previous value. The V/F converter then will operate in the 0-to-30-kHz range, and the output of the sine-wave converter will be in the 0-to-3 kHz range. This frequency range was chosen since many transmitters and phone lines have a maximum transmittable frequency of about 3 kHz. The frequency range of the system may be changed easily as required merely by changing the frequency-determining components.

The lowest transmittable frequency, usually about 300 Hz, also must be considered. Since the meter amplifier in the circuit is limiting the minimum voltage to 2 volts, the minimum frequency transmitted will be about 600 Hz, which is above the lower limit of most communications systems.

When monitoring a voltage or making a measurement via a telemetry system, it is important to consider the overall stability of the system. If off-the-shelf resistors and disc ceramic capacitors are used, the stability of the system will be poor. These components will change value as they age and as the temperature changes, giving results that may vary from day to day and hour to hour. In order to maintain a stable, reliable system, low-temperature coefficient, high-tolerance components must be used. For the frequency-determining resistors connected to pin 5 of the RC4151s, precision 1%, low-temperature coefficient resistors of the RN60D variety should be used. For the frequency-determining capacitors connected to the same pins, either mylar™ or polyester film capacitors should be used.

On the receive end, a 4001 CMOS chip is biased into the linear region to act as a high-gain amplifier. The remaining gates are con-

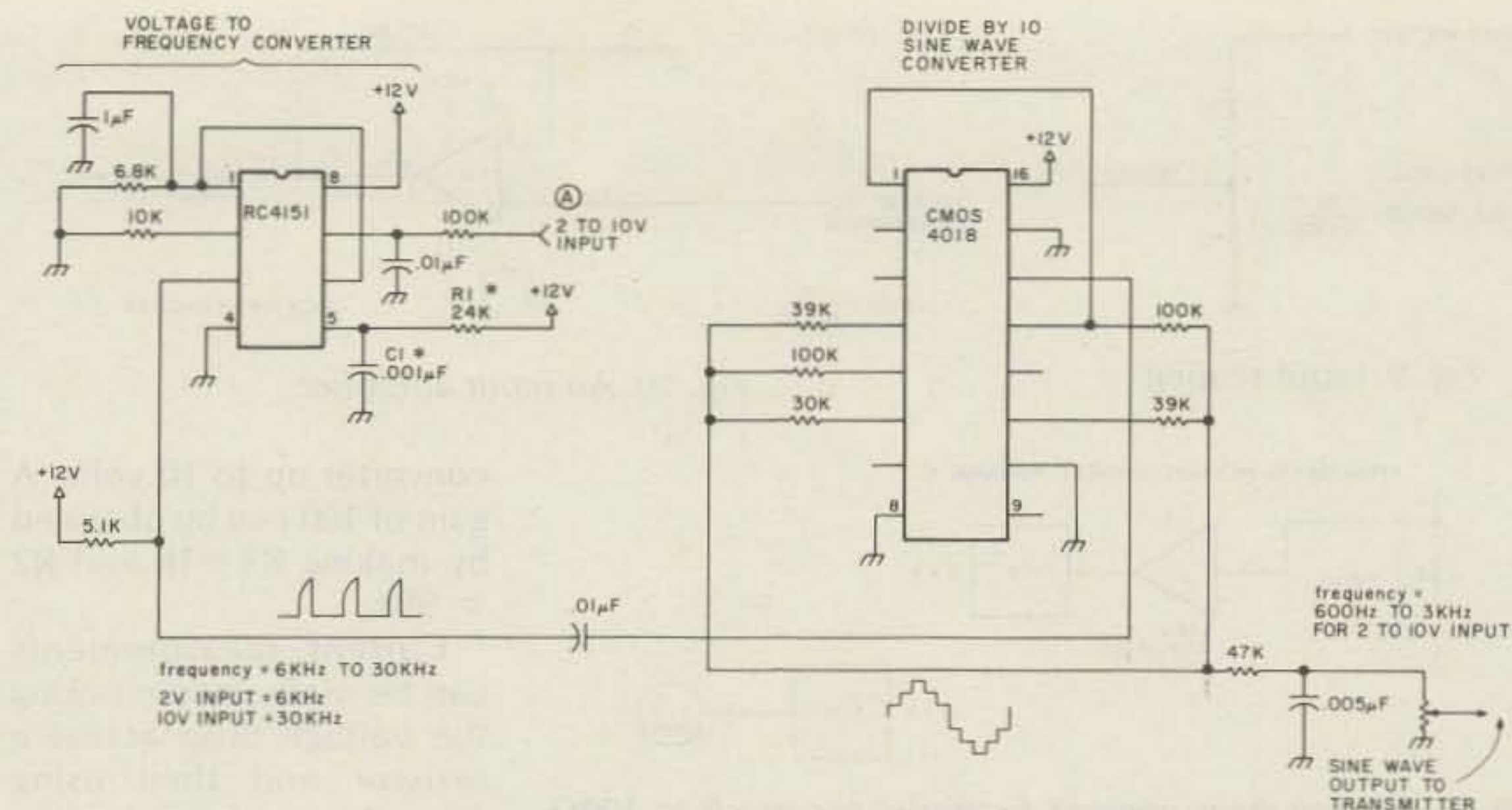

Fig. 7. Practical voltage-to-frequency circuit. \*For best results with frequency-determining components, use low temperature coefficient, high-tolerance components.

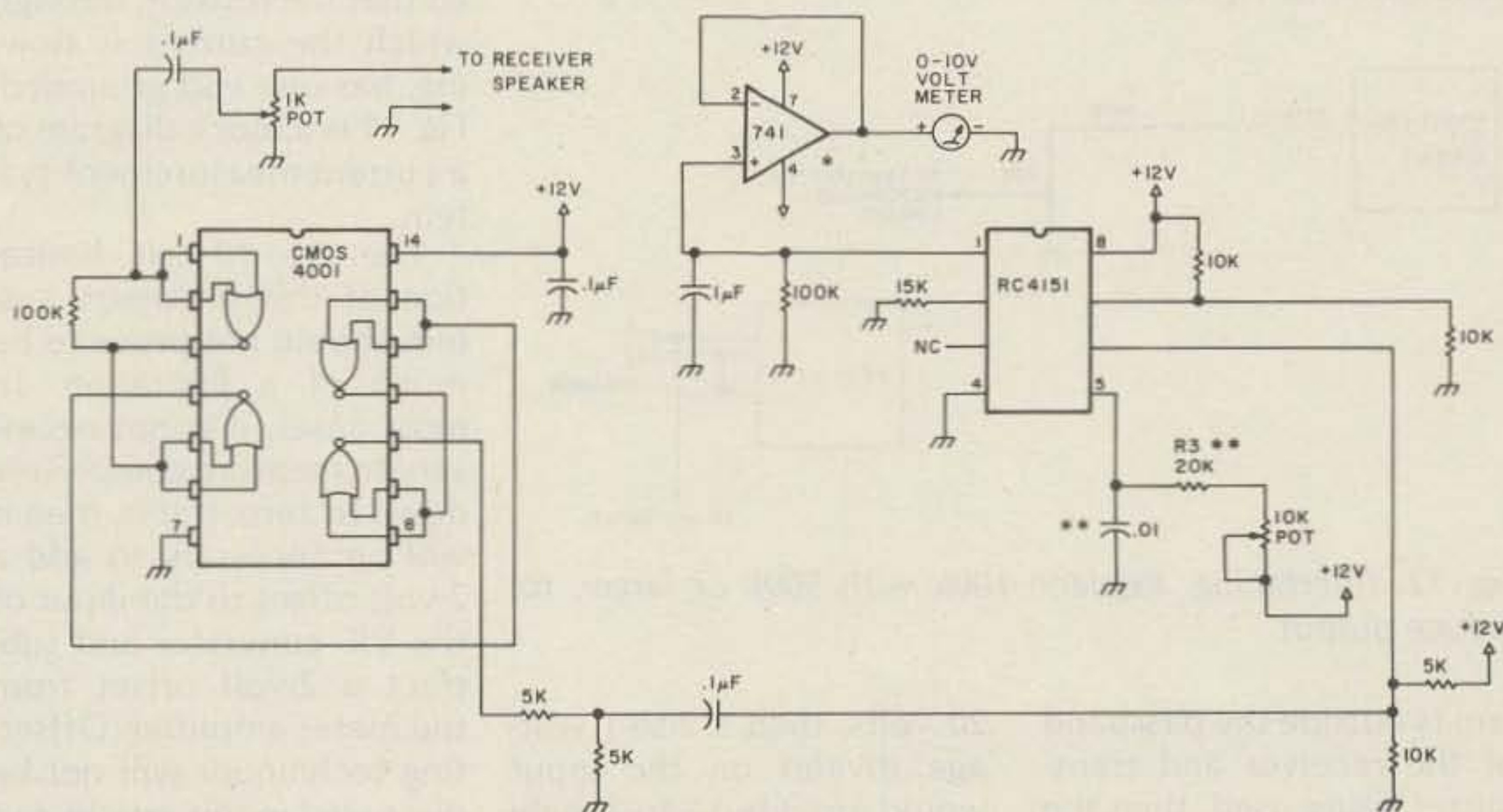

Fig. 8. Practical frequency-to-voltage circuit. \*741 pin connections for 8-pin DIP. \*\*For best results with frequency-determining components, use low temperature coefficient, high-tolerance components.

nected into the circuit to help shape the input pulses into square waves with a steep negative-going edge. This limiter will limit with an input of about 0.3 to 0.4 volts peak-to-peak, and should have sufficient gain so that it can be connected to the speaker terminals of most receivers. The output of this limiter is then directed to the input of the F/V converter.

As previously mentioned, the meter amplifier (voltage follower) will operate over a voltage range of 2 to 10 volts, corresponding to a

frequency range of 600 Hz to 3000 Hz. The inclusion of this amplifier into the circuit limits the measurement capabilities of the system to the range of 2 to 10 volts. This is not a serious limitation for most purposes, and can be overcome at the transmitting end, if required, by using a scaling technique I will describe later.

The practical telemetry system may be calibrated by measuring the input voltage at point A of the V/F converter (Fig.7) and adjusting the 10k pot on the F/V

converter (Fig. 8) so that the meter readings are identical. Note that it is of no importance to know the exact frequency range of the V/F and F/V converters. It is important only to calibrate them so that their ranges are identical. For calibration purposes, merely feed the output of the practical V/F circuit to the input of the limiter of the F/V circuit. The calibration will not change when the units are connected into a radio link.

If the 3-kHz maximum audio frequency of the sys-

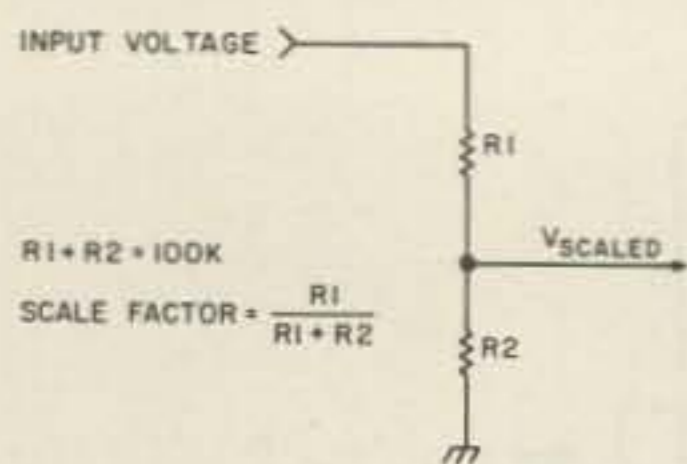

Fig. 9. Input scaling.

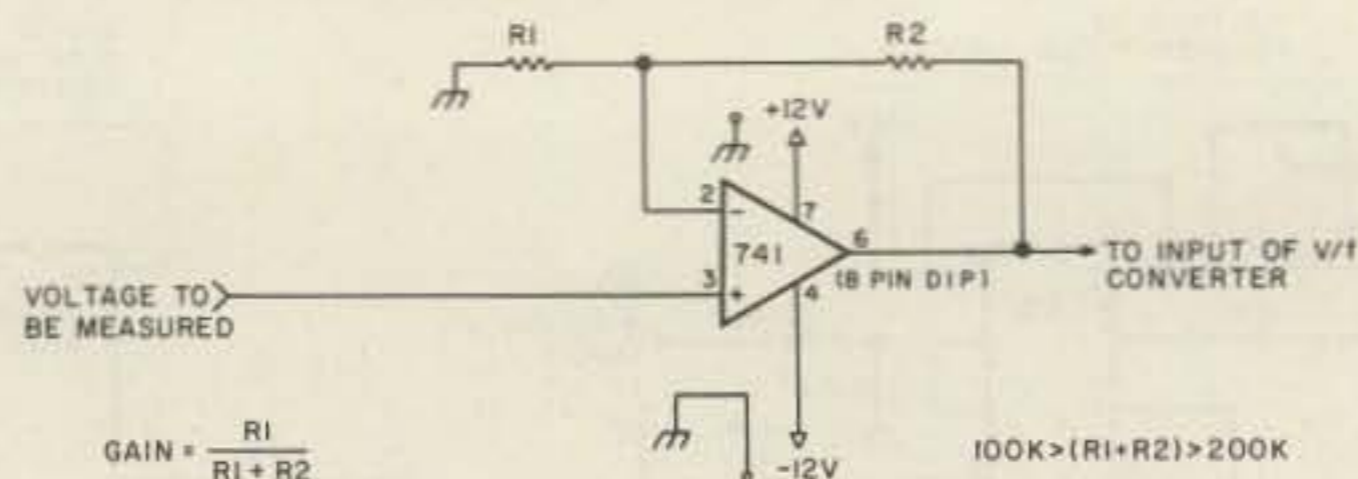

Fig. 10. An input amplifier.

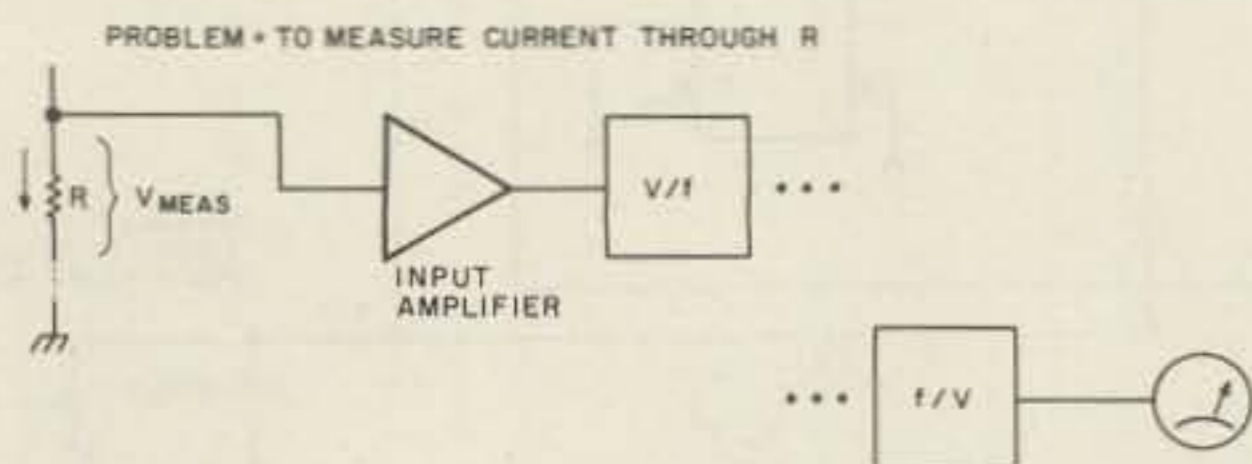

Fig. 11. Current measurement. Example: Assume  $R = 100\Omega$ .  $I_{MAX}$  to be measured = 0.010 Amps (10 mA). Then  $V_{MEAS} = 0.01 \times 100 = 1$  volt. The amplifier must have a gain of 10 to bring the V/F input up to 10 volts maximum. The meter will read from 0 to 10 mA.

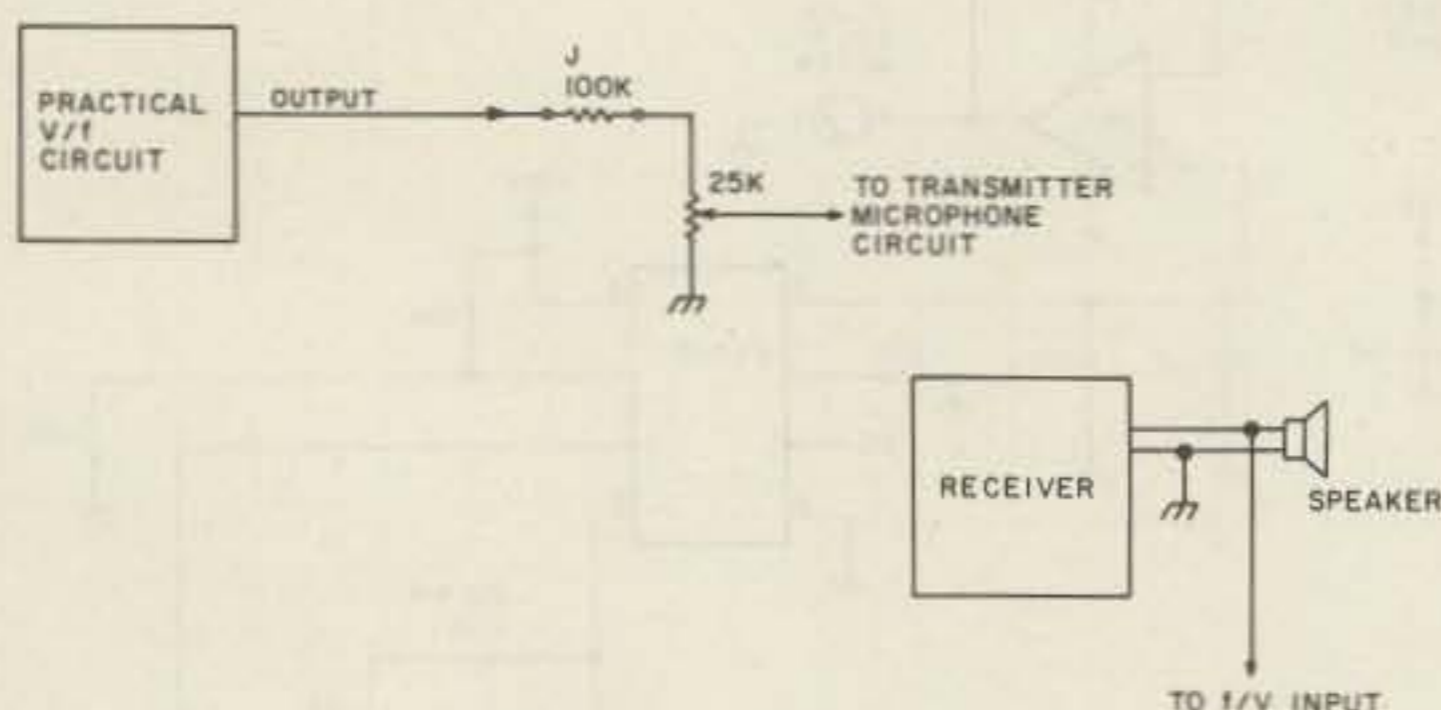

Fig. 12. Interfacing. Replace 100k with 500k or larger, to reduce output.

tem is outside the passband of the receiver and transmitter being used, then the range may be lowered by changing the value of resistor  $R_1$  of the V/F converter, according to the formula  $R_1 = .75/C1f$ . To lower the maximum frequency to 2500 Hz,  $R_1$  should be changed from 24k to 30k. On the receiving end, the 20k resistor,  $R_3$ , should be changed to about 25k. Note that  $R_3$  should be about 5k less than  $R_1$  to allow for the adjustment range of the 10k pot.

### Input Scaling

The practical telemetry system can handle input voltages over a wide range by using a scaling circuit on the input to the V/F converter. For example, if the maximum input voltage is to be

20 volts, then a 2-to-1 voltage divider on the input would provide a 2-to-1 scale factor on the receiving end (Fig. 9). In this example, an input of 20 volts would provide a reading of 10 volts on the receiving end. The scale factor in this case would be two. All meter readings would be multiplied by 2 to give the correct reading. While scale factors may be anything, it is convenient to use whole numbers.

If the maximum input voltage to be measured falls below the 2-to-10-volt range of the system, an op-amp dc amplifier can be placed on the input as shown in Fig. 10. As an example, suppose that the maximum input voltage is to be 0.1 V. The amplifier would need a gain of 100 to bring the input of the V/F

converter up to 10 volts. A gain of 100 can be obtained by making  $R_1 = 1k$  and  $R_2 = 99k$ .

Current measurements can be made by measuring the voltage drop across a resistor and then using Ohm's law to determine the current. The amplifier in Fig. 10 can be used for current measurements provided that the resistor, through which the current is flowing, has one end grounded. Fig. 11 is a block diagram of a current-measurement system.

The 2-to-10-volt limitation of this telemetry system should not prove to be much of a limitation. In most cases, it is not necessary to measure completely down to zero. If it is, then it will be necessary to add a 2-volt offset to the input of the V/F converter and subtract a 2-volt offset from the meter amplifier. Offsetting techniques will not be discussed in this article, but will be left to the ingenuity of experimenters.

### Interfacing

The V/F and F/V portions of the practical telemetry system may be interfaced to almost any AM or FM transmitter or receiver available today. The system cannot be used with a single-sideband communications link, however, since any receiver tuning error will change the received tone and this will change the meter reading. Fig. 12 shows the interface to a typical FM transmitter and receiver. Care should be taken not to overload the input stage to the transmitter. If the transmitted tone sounds distorted, then addi-

tional resistance should be added where shown.

### Applications

Applications of the practical telemetry system are limited only by the imagination. This system may be used to monitor measurements from a remote repeater site such as emergency battery voltage, power output, building temperature, discriminator voltage, and first limiter voltage. The V/F output could be placed periodically on the repeater signal by using a timer, thus using the repeater to transmit the remote measurements. A touchtone™ decoder at the repeater site could be used to switch various inputs to the V/F converter so that many different parameters from the remote site could be monitored upon command.

### Conclusion

This article is not meant to be the last word in developing a telemetry system and does not begin to cover all possibilities and all of the various techniques that could be used to make an analog telemetry system. The article was written to provide a starting point for the average experimenter who is interested in telemetry, to help him modify, enhance, and fit the ideas given to his particular application. It is hoped that this article will encourage telemetry experimentation. ■

### References

1. "Analog Telemetry Techniques," Joseph J. Carr K4IPV, 73 Magazine, October, 1979.
2. Raytheon Semiconductor publication on linear ICs.

### Parts Notes

All parts except the precision resistors may be obtained from Jameco Electronics. Precision resistors of the RN60D type may be obtained from any major electronics distributor.

The National Semiconductor LM131, LM231, and LM331 are pin-for-pin replacements for the RC4151.



# INSTANT SOFTWARE DOES

With our latest in HAM radio, electronics and utility programs, Instant Software proposes to: 1) organize you 2) keep you up-to-date 3) solve your microcomputing problems (well . . . some of them) 4) entertain you, and 5) save you money. Sound too good to be true? Read on!

## ELECTRONICS I

If you're still designing circuits the old-fashioned way, let the Electronics I package introduce the latest way to go:

**Tuned Circuits & Coil Winding**—Design tuned circuits for audio and radio frequencies. This two-part program will find the two missing values from any two of the following: frequency, capacitance, inductance, or reactance. The coil-winding section will calculate the number of turns and wire gauge required for a close-wound, air-, or slug-tuned coil from the inductance, diameter, length, and permeability of the coil.

**555 Timer Circuits**—Timers, both monostable (one-shot) and astable (oscillator), can be easily designed with this two-part program. The program will also draw a complete schematic on the screen of your TRS-80.

**LM 381 Pre-Amp Design**—You too can quickly design an IC preamp. With this program all you need to do is enter the parameters of the performance you want, and the program does the rest—right down to drawing a detailed schematic of your circuit on the screen!

**Order No. 0008R \$7.95.**

## QSL MANAGER

Did you remember to send a QSL card to the op you worked last week? Maybe you sent a QSL, but can't recall getting one in return. The QSL Manager program will help you set up a computerized log book for instant access to your records.

Make complete log entries which include: date, time, callsign, name, band, both the Sent and Received signal reports, the mode, QSL sent/received, and any remarks you may want to add.

No more fumbling with index cards during a QSO, because the QSL Manager has a built-in search function to locate and display information on any callsign in your records. You can even list all the QSO's for a particular date, time, band worked, mode or a specific signal report. Up to 1400 entries can be accessed

from your disk (depending on how many disk drives you have).

The program has built-in editing features that help you keep your log book up-to-date.

There's also a command that lets you output your log entries to a printer for hard copy.

In that next QSO, knock their socks off with your infallible memory. (T2)

**No. 0151RD \$19.95 Disk.**



## HOME ELECTRONICS TROUBLESHOOTER

The three programs in this package will help us non-technical types to locate the most common problems in home electronic equipment. You'll be shown step-by-step procedures for:

1. Analyzing common problems
2. The simple and logical solution to the problem
3. A general cost-guide to commercial repairs

It can be used to diagnose problems with these types of consumer electronic equipment: B&W and Color TV's, Stereo Receivers/Amplifiers, Turntables, Cassette and Eight-Track Decks, Portable and Table Radios, Portable Phonographs and Handheld Cassette Recorders.

In some cases the repair may be relatively simple and you may wish to fix it yourself. Other times, you might locate a general problem area, but you may not be able to correct the fault. In this event, the repair should be referred to a qualified service shop. Even if your appliance needs professional help, the repair cost may be reduced by informing the shop of what you have learned by using this program. (T1)

**No. 0169R \$9.95.**

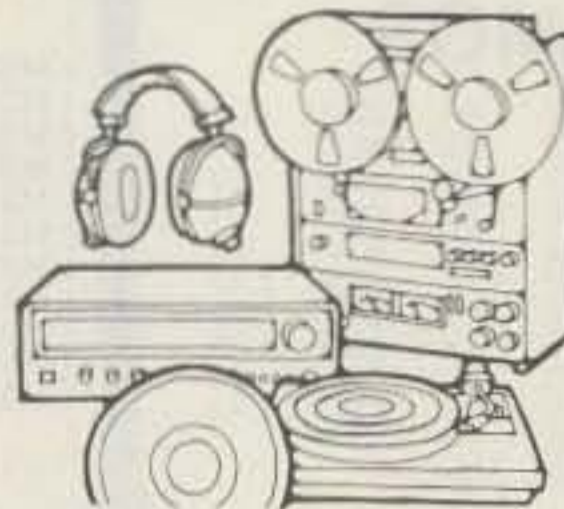

## BASIC PROGRAMMING ASSISTANT

The BASIC Programming Assistant utility program helps you to code and debug BASIC programs. Writing and debugging can be a frustrating, time-consuming process, especially for lengthy programs. BPA helps you control and track the variables, BASIC words, and line numbers in your programs. It reduces the time and effort needed to get a program running properly.

BPA does three things for you:

1. BPA will list the variables used in a BASIC program. You can have BPA list only a particular variable, list all the variables, or list all the multiple letter variables that begin with a specific letter. If you wish, it will also list the line numbers where each variable appears; the variable-type symbol (string, integer, single, or double precision); whether or not the variable is a dimensioned array; and where the variable is changed.

2. BPA will produce a cross-reference list of line numbers for GOTO's, GOSUB's, and IF . . . THEN statements.

3. BPA will list the line numbers where a selected BASIC function word (such as INPUT, PRINT, etc.) is used. Optionally, it lists only the lines where the BASIC word appears with a specified variable.

The minimum system required for BPA is TRS-80 Level II 16K computer, although it will operate on the 32K and 48K versions as well as in Disk BASIC (both TRS-DOS and NEWDOS).

**Order No. 0203R \$14.95.**

## HAM PACKAGE I

Use this versatile package to solve many problems commonly encountered in electronics design. It's ideal for technicians who must frequently apply fundamental electronic formulas.

**Ohm's Law**—Easily performs calculations involving voltage, current, resistance, and power.

**Series and Parallel Calculations**—Find the value for capacitors or resistors in parallel or series circuits.

**Voltage Dropping and Voltage Dividing**—This will give you the value of a dropping resistor and the effective resistance of the load.

\*TRS-80 is a trademark of Tandy Corporation.

# Instant Software Inc.™

PETERBOROUGH, NEW HAMPSHIRE 03458 603-924-7296

# IT WITH FREQUENCY

**R/C Time Constants**—This section will calculate the resistance, capacitance, or the time delay of an R/C circuit.

**Dipole and Yagi Antennas**—These two programs will compute the dimensions of an antenna to your exact frequency and give you an on-screen display—complete with all measurements! (T1)

**No. 0007R \$9.95.**

## AMATEUR RADIO ADVANCED CLASS STUDY GUIDE

Now you can use your TRS-80 to help you prepare for your Advanced Class license test. You can take 100 sample questions designed to test your knowledge of all the areas of skill required to be an Advanced Class operator. The study guide shows you, based on how you answer the questions, which knowledge areas you need to examine more closely, while it familiarizes you with the format of the exam given by the FCC. The program will serve to see how well prepared you are for the exam, and hopefully, make the exam easier for you. It will not take the place of hours of dedicated study, but it will help you determine when you are ready to take the exam. This program is a valuable tool for radio amateurs striving to upgrade their licenses. (T1)

**No. 0252R \$14.95.**



## TO ORDER:

See your local

Instant Software dealer.

If these packages are

unavailable, order direct.

CALL TOLL FREE

1-800-258-5473

Orders Only

In New Hampshire Dial

1-603-924-7296

(T1) = TRS-80 Model I, Level II, 16K RAM.

(T2) = TRS-80 Model I, Level II 16K, Expansion Interface 16K + 1 disk drive.

All these programs are Model III compatible except Basic Programming Assistant and Dynamic Device Drivers.

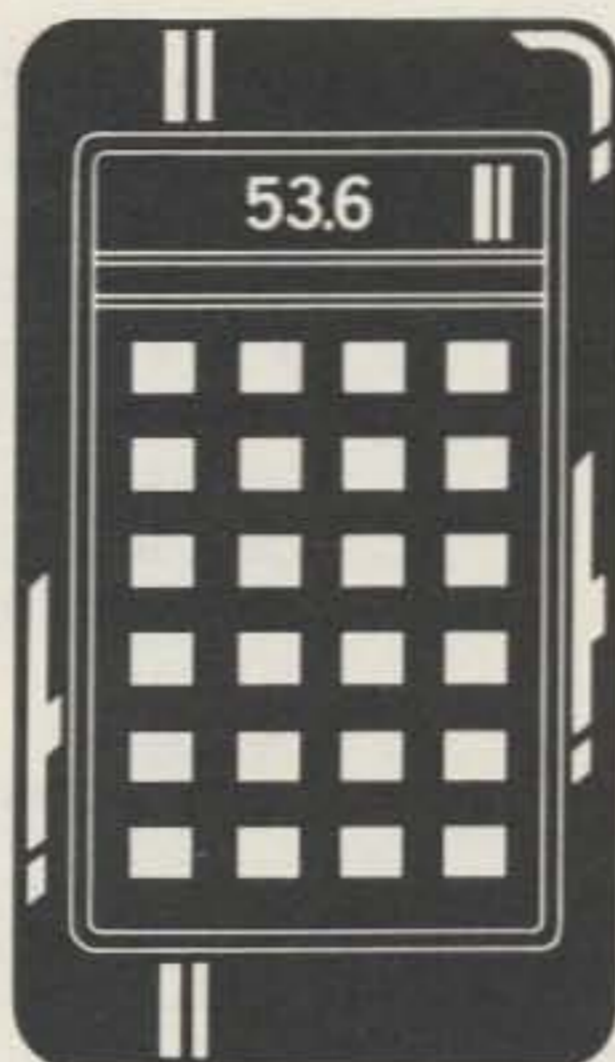

## ELECTRONIC DESIGN CALCULATOR

Electronics is a busy and creative field. Even the best technicians and theoreticians can use some help with the myriad calculations necessary to develop new products. That help has arrived!

The Electronic Design Calculator from Instant Software makes your TRS-80 the hardest worker in your lab (next to you, of course).

The Electronic Design Calculator brings dozens of complex calculations down to size in seconds. It can calculate two of the four possible values of Ohm's Law for A.C. and D.C., given the other two. It can also produce calculations for reactance, resonant frequency, resistors and capacitors in parallel and series, frequency and wavelength, decibel formulas and over two dozen others.

Free yourself from the drudgery of endless calculating. Make your work simpler and more accurate with the Electronic Design Calculator. (T1)

**No. 0204R \$9.95.**

## DYNAMIC DEVICE DRIVERS

Are you tired of working around all of the little "obstacles" that are built into your TRS-80? Ever wish that there was some way to "repair" those imperfections?

Well here it is! The Dynamic Device Drivers package has all of these features:

**Programmable Key Debounce:** Your keyboard can be "tuned" to your typing style.

**Programmable Repeating Key Function:** Every key has a repeat function.

**Lowercase Modification Support:** You have a choice of standard or shift-for-lowercase letters. (A lowercase hardware modification must be installed.)

**Better Than Nothing Graphics:** Graphics characters will be converted to the closest ASCII character.

**Printer/Screen Auto Switching:** If your printer is accidentally turned off, your program won't bomb.

**Programmable Printer Forms Control:** You control the format for printer output.

**Programmable Keyboard Lock:** Only you will know the secret code to unlock your keyboard.

With the Dynamic Device Drivers package, you can look forward to working WITH your TRS-80, instead of against it! (T1)

**No. 0228R \$19.95.**

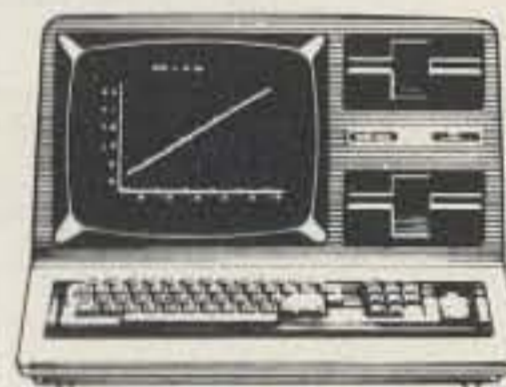

## TRS-Tests

TRS-Tests: three TRS-80 diagnostics will tell you if there are any problems with your computer. This machine-language utility checks Level II ROMs for dropped or defective bits by performing 128 consecutive checksums on each of the three ROM chips.

The Keybounce test helps to identify dirty or defective keys.

The RAM test tells you if your computer has a defective RAM chip, and will identify the chip according to the standard TRS-80 schematics.

Whether you repair computers for a living or only want to check out your own computer, you need TRS-TESTS. (T1)

**No. 0184R \$9.95.**

445

# Instant Software™ Inc.

PETERBOROUGH, NEW HAMPSHIRE 03458 603-924-7296

# Rallying the HP-55

— gentlemen, start your calculators!

Many of the ham radio operators I have known also rally their sports cars. There seems to be something of a kinship between the precision re-

quired for rallying and the technical affinities of amateur radio.

Here's a program for your HP-55 calculator (which can be adapted to

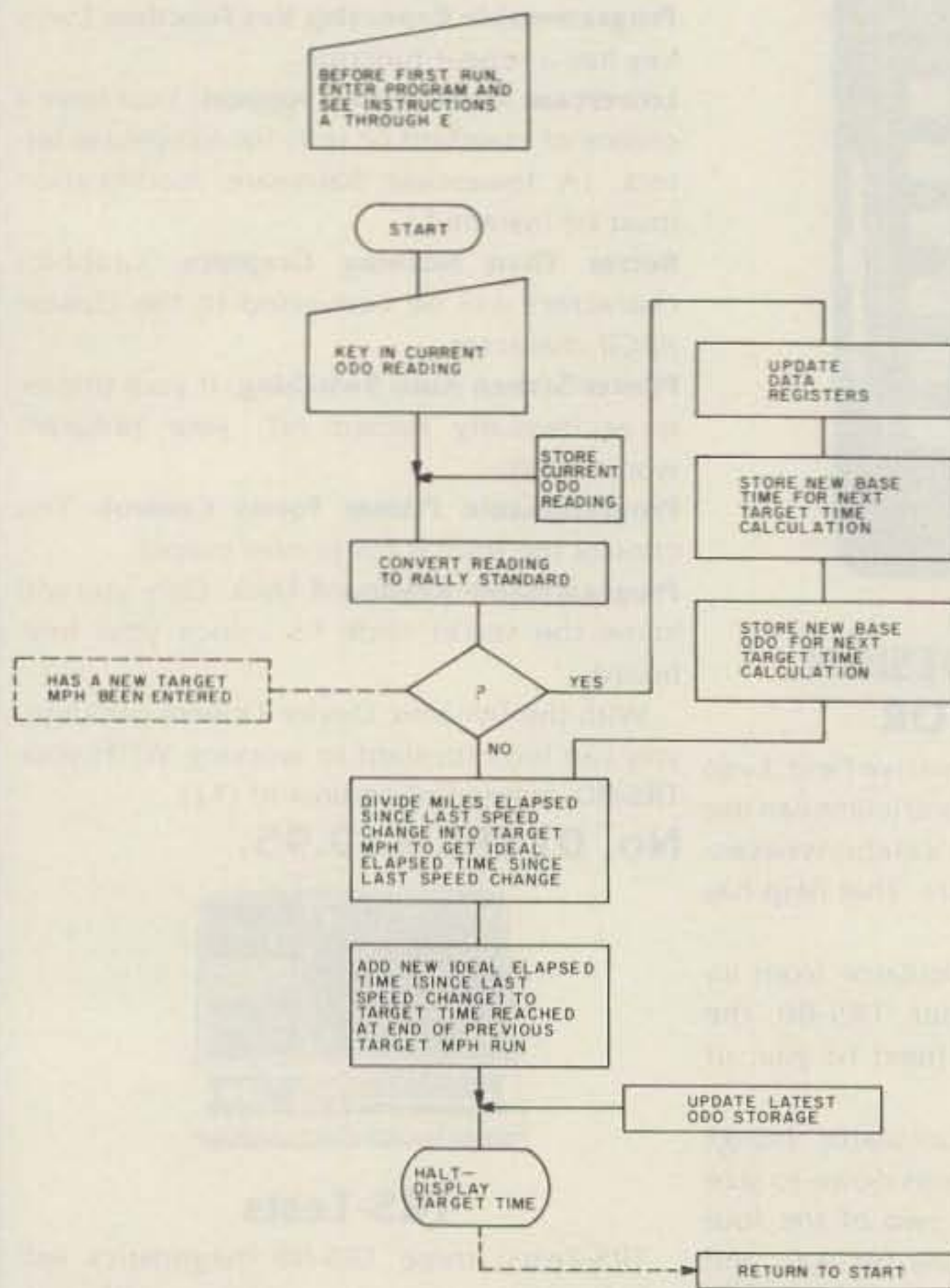

Rallybuster flowchart.

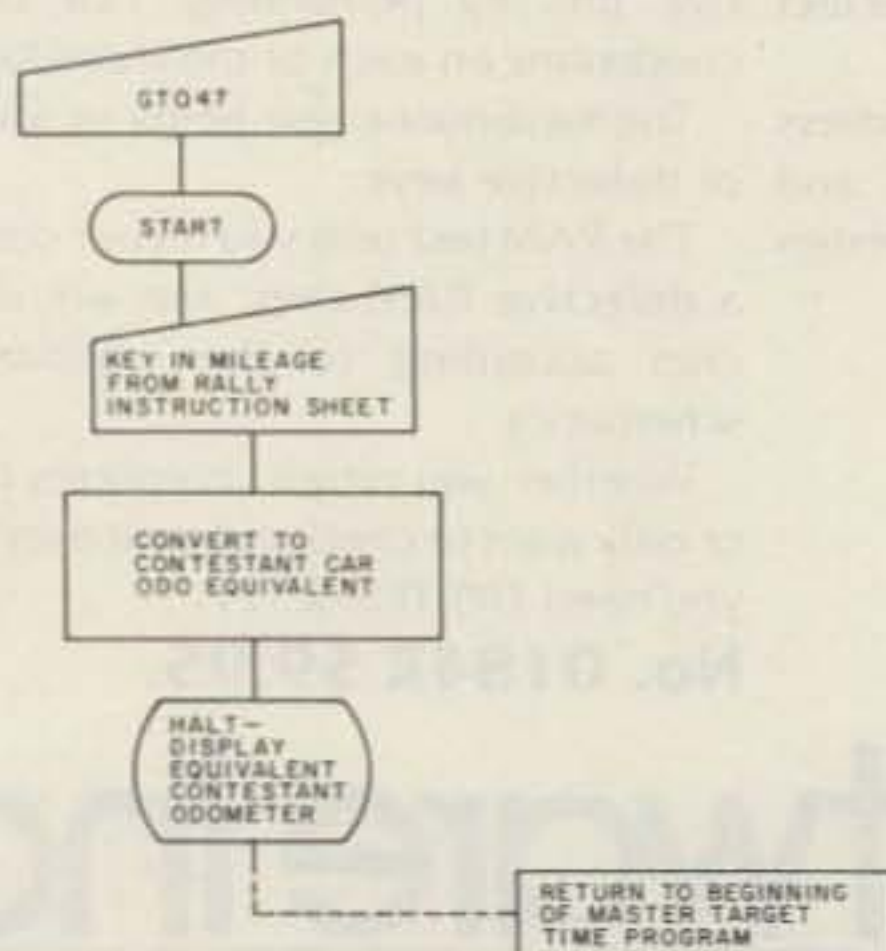

Auxiliary flowchart.

Display Line	Code	Key Entry	Comments
00			KEY IN current odometer reading and punch R/S.
01	33	STO	Saves current odo for use as new base odo for possible change in instruction speed.
02	07	7	
03	34	RCL	Compares instruction speed from last calculation with current instruction speed in R8
04	09	9	(see instruction H) to determine if a new "target mph" has been encountered. If none, program pointer jumps to step 19.
05	34	RCL	
06	08	8	
07	32	g	
08	-19	GTO19	
09	33	STO	If steps 03-07 detect a new speed in R8, this sequence resets the data base. This has the effect of terminating a rally section driven at a given speed and setting the termination mileage and TARGET TIME as the base for the section at a new speed. Thus, each section at a given mph is treated, in effect, as a separate rally "leg." Therefore, encountering a speed change <i>must</i> be the occasion for an odo entry and program run. See instruction H.
10	09	9	
11	34	RCL	
12	04	4	
13	33	STO	
14	01	1	
15	34	RCL	
16	03	3	
17	33	STO	
18	00	0	
19	34	RCL	Steps 19-22 save current odo reading in R3 for use in the next calculation if it entails a change in instruction speed.
20	07	7	
21	33	STO	
22	03	3	
23	34	RCL	The base odo at the beginning of the current instruction speed is recalled and subtracted from current odo reading and the result converted, using factor in R6, to rallymaster's odo standard.
24	00	0	
25	51	-	
26	34	RCL	
27	06	6	
28	81	+	
29	34	RCL	Recalls latest instruction speed and divides it into miles traveled to determine proper time elapsed since last speed change.
30	08	8	
31	81	+	
32	32	g	Time elapsed since last speed change is converted from decimal time to format HH.MMSS.
33	01	→H.MS	
34	24	FIX	Sets four decimal places to ensure that result will be displayed as HH.MMSS.
35	04	4	
36	34	RCL	Recalls base time from last speed change to be added to time elapsed to derive TARGET TIME for ideal arrival at current odo reading.
37	01	1	
38	31	f	
39	41	H.MS +	
40	33	STO	New TARGET TIME is saved in R4 for use if next calculation involves a speed change.
41	04	4	
42	-00	GTO00	Pointer returned to step 00 for next calculation.
43	34	RCL	This auxiliary program, accessed by keying GTO43, will convert an instruction sheet mileage to your odo's equivalent. It accommodates navigation errors (see instruction K) and cars without a trip odometer. Calculator returns to master program for next TARGET TIME calculation.
44	06	6	
45	71	x	
46	34	RCL	
47	05	5	
48	61	+	
49	-00	GTO00	

Program listing.



### A TYPICAL RALLY Before Setting Out

- A. Load program, set switch to RUN, and key BST.
- B. STORe your assigned starting time in R1, as clock time in format HH.MMSS, or 00.0000 if you're using a stopwatch.
- C. STORe in R8 and R9 the initial assigned speed from the rally instruction sheet.
- D. STORe your beginning odometer reading in R0, R3, and R5. This will be 00.0 for a trip odo, but for a car without one, can be any number appearing on the odometer.
- E. STORe 1.0 in R6. (See instruction F.)

### Upon Completing The Calibration Run

- F. STORe the odometer conversion factor in R6. This is derived by the formula:

$$\frac{\text{Your car's odometer reading}}{\text{Rallymaster's instruction odo}} = \text{Conversion factor}$$

Note: For armchair test runs, simply use 1.0 in R6.

### During The Rally

- G. Keep track of your status. Simply KEY IN your current odo reading and punch R/S. Displayed result is your TARGET TIME to that mileage.
- H. When rally instructions require a speed change, first KEY IN your current odo and punch R/S. This gives you a TARGET TIME readout for that mileage and (more important) resets the data base for calculations to be made at the new speed. Then KEY IN the new speed and STORe it in R8.
- I. As with any HP-55 program, you can extend battery life by keying the decimal point to quench the display. But, press CLX before your next odo entry; if you don't, you'll be entering .325 instead of 32.5, for example.
- J. If you wish to convert an instruction mileage to your car's odo, KEY GTO43. Then KEY IN the instruction-sheet figure and punch R/S. Calculator automatically returns to 00 for your next TARGET TIME calculation.
- K. If you find you've made a bad turn and must backtrack, determine the total mileage error (usually double your backtrack distance) and add it to the odo settings in R0, R3, and R5 by keying it into the display and pressing STO + 0, STO + 3, and STO + 5. After doing this, you can continue to enter mileages as they appear on your odometer as though you'd made no navigation error. Readout will show that you have a specific amount of time to make up. Conversions using instruction J will also be accommodated.

### Registers

R0 Base odo reading	R5 Beginning odo
R1 Base time	R6 Conversion factor
R2 Available (see below)	R7 Current odo
R3 Saves latest odo	R8 Instruction speed
R4 Saves TARGET TIMEs	R9 Saves last instruction speed

R2 is available to keep track of accumulated points. After initial entries, normally only R8 (speed changes) is hand entered. All other registers are updated by the program, but R0, R3, and R5 are also modified by adding error miles (see instruction K).

### Sample Rally

Rally instructions in hand, and having synchronized your digital wristwatch with the rallymaster's, you prepare for victory by following instructions A through E. After (A) loading the program, you (B) STORe your assigned starting time of 1:09 PM in R1 as 1.0900, and (C) STORe in R8 and R9 the first speed called for in the instructions, which is 22.5 mph. Then (D), you STORe your beginning odometer of 14,631.6 in R0, R3, and R5. Finally (E), you STORe 1.0 in R6. Precisely at 1:09 PM, you're flagged onto the route, which begins with a calibration zone, often 10 miles in length. Soon, you begin checking your status:

Odometer	Readout	Your Watch	Status
14635.1	1.1820	1:18:20	Exactly right (it would seem).
14637.7	1.2516	1:25:09	Driving fast (7 seconds).
14640.6	1.3300	1:32:59	Running 1 second fast.
14641.5	1.3524	1:35:25	Arrived here 1 second late.

At this point, your instructions tell you that you've finished the calibration zone and that its total length has been exactly 10.0 miles. You determine that your odometer has measured this distance as 9.9 miles (by entering your current odo reading and subtracting the contents of R5 from it). Following instruction F, you now divide your car's 9.9 by the rallymaster's 10.0 and find the calibration factor is .99, which you STORe in R6 (erasing the 1.0 you used in instruction E).

Being a perfectionist, you now recompute the first portion of the rally, which you attempted to run at 22.5 mph. You do this by again KEYING IN your odo of 14641.5 and punching R/S. Now the corrected readout gives you this information:

14641.5	1.3540	1:35:45	Your status is that having taken 20 seconds to figure the conversion factor, you're just :05 behind schedule. The readout says you should have arrived here at 1:35:40, and your watch says the time is 1:35:45.
---------	--------	---------	--

Now navigating according to the clues in the rally instructions, you continue on at 22.5 mph and check your progress:

14647.5	1.5150	1:51:45	You've gained 10 seconds, making up the 5 you were behind and adding a margin of 5.
14651.0	2.0115	2:01:10	Still running fast 5 seconds.

A bit further on, you encounter a speed change (following a rally instruction that says "At sign DONUTS change to 36 mph."). Having rehearsed carefully for this, you now follow instruction H with dispatch, entering your mileage of 14653.5 and getting as output, 2:07:59. Having done this (and seeing that you're still 5 seconds ahead because your watch reads 2:07:54), you KEY IN the new speed (36) and STORe it in R8. Now your status checks yield this kind of information:

14655.5	2.1121	2:11:16	Still a 5-second margin.
14660.0	2.1856	2:18:52	Margin reduced to :04.
14662.3	2.2248	2:22:42	Now running fast :06, a reasonable margin.

Suddenly you realize, because the instructions just don't make sense any longer, that you missed a turn clue and you're off course! No matter, for your HP-55 will get you out of this pinch. Reversing course in a handy driveway, you note that your odometer reads 14664.4. KEY that INto the HP's display, and press ENTER. Now you watch (more carefully this time) for the turn clue and discover it. As you do, you KEY IN your new odo reading of 14665.6, hit the minus key, and see a readout of -1.2. KEYing CHS gets rid of the pesky minus sign, and then you double that figure (2,x) to 2.4, which is the exact error you've made. Following instruction K, you now KEY STO + 0, STO + 3, STO + 5.

Now you're running behind schedule, obviously, but how much? Your HP-55 will tell you. Give it your odometer as input, and it'll tell you what time it should be!

14664.7 2.2248

Aha! 2:22:48! Same readout as your last calculation before you realized you were lost! (You were probably watching the HP-55 do its stuff instead of watching for clues!) but now your watch reads 2:26:18, and it's clear that you have time to make up. 3.5 minutes (3:30) to be exact, though there's no critical need yet to determine just how bad the situation is. Better to watch for clues than to be punching HP-55 buttons just now! It's sufficient to know that you're behind, and that as you catch up, your HP-55 output will begin to look more like your wristwatch time. So you continue, driving faster than the instruction mileage in an attempt to catch up. And you calculate, eventually:

14670.7	2.3254	2:33:30	Having gone 50 mph since picking up the route again, now you're only :36 late.
---------	--------	---------	--

But here, while still :36 behind ideal time, you see a clue that commands a speed change. Since a tenth of a mile has passed since your calculation, you run another one (following instruction H):

14670.8 2.3304

You don't bother to compare this with your watch, knowing you are behind anyway. But you do KEY IN the new instruction speed of 25.6 mph and STORe it in R8. Now you can do another calculation to check your status:

14671.0	2.3333	2:33:52	Good! Now you're only :19 behind schedule. Run just a bit faster than the 25.6 called for, and soon you'll be fine.
---------	--------	---------	---

Great! In the last 2.1 miles you not only made up your deficiency of :19, but you're now running ahead by 2 seconds.

At this point, you realize that your HP-55 has not only kept you constantly informed of your status, but it also has discounted the error mileage and is still giving you results based strictly on input from your odometer readings—with no need for you to adjust! (If it could only spot the clues, too!)

Now you come upon an instruction which reads, "At 41.4 accumulated mileage, turn left." Here's a situation where you need to know what that "41.4" is on your car's odometer. No problem. KEYing GTO43, you then KEY IN the 41.4, and get as readout, 14674.9860. This rounds to 14675.0. At that odo reading, you make your left turn. As you do, you run another check, knowing that your HP-55 has returned to step 00 and is ready for a TARGET TIME calculation:

14675.0	2.4259	2:42:56	You're running ahead :03.
---------	--------	---------	---------------------------

Now, still moving at the latest rally instruction speed of 25.6 mph, you round a bend and sight the rally's first checkpoint. Foot off the gas, you coast in and run a calculation just as you are stopwatched in by the checkpoint captain:

14675.3	2.4344	2:43:44	Great! No points here! (It should be so easy!)
---------	--------	---------	--

In practice, of course, the "you" in this exercise should be the rally navigator, who manages TSD while the driver drives and watches for clues. And while this exercise shows that the HP-55 program can accommodate a rally car with no trip odometer, the numbers will usually be less complex in a rally-equipped sports car. Either way, the program handles all the number-crunching for you: mileage conversions, accumulated mileage errors, and reverse mileage conversions. One last reminder: Keep your batteries charged!

other programmables) that will help you hit those rally checkpoints on the nose.

Since road rallying is a time-speed-distance (TSD) competition in which the driver and his or her navigator attempt to arrive at checkpoints at precisely calculated times, seconds (or hundredths of minutes) are critical. By the usual scoring methods, every hundredth of a minute early or late at a checkpoint

counts as a point. Would-be winners strive for the lowest possible number of points by following route instructions accurately and by precisely maintaining the speed called for in the rallymaster's instructions.

Winning rallyists are successful because they manage TSD calculations well, drive with precision, and keep their eyes peeled for the often obscure clues that show up in the instructions.

It's important to spend the minimum possible time doing TSD calculations, because those roadside clues are crucial.

For advanced rallyists, this can mean dedicated computers, electronic or mechanical, tied into their car odometers—but that's an expense that only the fanatics can afford.

The program set forth here not only turns your HP-55 into a TSD manager,

but also converts your car's odo reading, almost always at variance with that of the rallymaster when he laid out the course and wrote the instructions, to the odo standard being used by all contestants. It also can be used on casual practice runs to sharpen a driver's ability to hold a given average speed despite variations caused by road conditions and traffic.

During execution, the on-



# AEA

Brings you the breakthroughs!

## MODEL MM-1 MORSEMATIC

### COMPUTERIZED KEYER

### GREAT FOR CONTESTING, DX OR CODE PRACTICE.

## \$199.95



- CK-1 CONTEST KEYER \$129.95
- MK-1 STANDARD KEYER \$79.95
- MT-1 MORSE TRAINER \$99.95
- KT-1 MORSE KEYER/TRAINER \$129.95
- ME-1 MEMORY EXPANSION BOARD FOR MM-1 KEYER \$59.95
- AC-1 600 Ma. A.C. SUPPLY FOR MM-1 KEYER \$14.95
- AC-2 350 Ma. A.C. SUPPLY FOR ALL OTHER KEYERS \$9.95

WRITE FOR COMPLETE SPECIFICATIONS WE STOCK KENWOOD, ICOM AND YAESU. WRITE FOR COMPLETE CATALOG

### HAND HELD TRANSCEIVERS:

- YAESU FT-207R 2 METER \$269.95
- ICOM IC-2AT 2 METER \$242.50
- KENWOOD TR-2400 2 METER \$375.00
- TEMPO S1T 2 METER \$275.00

### ISOPOLE VHF ANTENNAS

- ISOPOLE-144 JR. BASE ANTENNA \$39.95
- ISOPOLE-144 BASE ANTENNA \$49.95

**No Sales Tax in Montana.**

Finally — a properly decoupled antenna with superior performance at a reasonable cost. Raise more repeaters or increase your simplex distance!

**CALL TODAY 406-259-9554**  
**CONLEY RADIO SUPPLY**  
318 N. 16th St. Billings, Montana 59101

ly input the program requires (aside from speed-command changes, which are STORED in Register 8) is your odometer reading. As output, it displays a TARGET TIME at which you should have reached that odometer reading. Then, a quick comparison with your time standard (stopwatch, wristwatch, or car clock) tells you whether you're running fast, slow, or on the button. Most drivers attempt to run slightly ahead of schedule, reasoning that they can more easily lose time than gain time as they sight a checkpoint.

The program provides two bonuses. It allows you to correct automatically for misspent mileage after a navigation error, and it provides an auxiliary six-step "reverse mileage conversion." While you'll mostly want to have the program automatically convert your car's odometer readings to

TARGET TIMES, sometimes you'll want to look ahead by converting the other way — from instruction-sheet mileages to your car's odometer. Both features are covered here in the instructions.

The program, with comments, and the operating instructions explain details of the program's calculation. You might want to cut them out and mount them on opposite sides of cardboard as an addition to your rally kit.

Some armchair runs are called for, of course, before you, your favorite navigator, and your HP-55 set out to devastate the competition. But in operation, the program is straightforward and designed for easy use in the competitive environment of a rally. With a little practice, you should be cutting points off your checkpoint times next weekend.

Good luck — and drive to survive! ■

## FAST SCAN ATV

### WHY GET ON FAST SCAN ATV?

- You can send broadcast quality video of home movies, video tapes, computer games, etc. at a cost that is less than slocan.
- Really improves public service communications for parades, RACES, CAP searches, weather watch, etc.
- DX is about the same as 2 meter simplex — 15 to 100 miles.

### ALL IN ONE BOX



**TC-1 Transmitter/Converter . . . . .**  
Plug in camera, ant., mic, and TV and you are on the air. Contains AC supply, T/R sw, 4 Modules below . . . . . \$ 399 ppd

### PUT YOUR OWN SYSTEM TOGETHER



**TXA5 ATV Exciter** contains video modulator and xtal on 434 or 439.25 MHz. All modules wired and tested . . . . . \$ 89 ppd

**PA5 10 Watt Linear** matches exciter for good color and sound. This and all modules run on 13.8 vdc. . . . . \$89 ppd

**TVC-2 Downconverter** tunes 420 to 450 MHz. Outputs TV ch 2 or 3. Contains low noise MRF901 preamp. . . . . \$ 55 ppd

**PACKAGE SPECIAL** all four modules \$249 ppd

**FMA5 Audio Subcarrier** adds standard TV sound to the picture . . . . . \$ 29 ppd

### SEND SELF-ADDRESSED STAMPED ENVELOPE FOR OUR LATEST CATALOG INCLUDING:

Info on how to best get on ATV, modules for the builder, complete units, b&w and color cameras, antennas, monitors, etc. and more. 20 years experience in ATV. Credit card orders call (213) 447-4565. Check, Money Order or Credit Card by mail.



Maryann WB6YSS

## P.C. ELECTRONICS

2522 PAXSON  
ARCADIA, CA 91006

Tom W6ORG



# FACTORY-DIRECT INFLATION FIGHTERS! PRICES SLASHED DRAMATICALLY!

**MULTIMETER WITH SWR/  
POWER METER  
MODEL MM-1 ..... \$35.**



The MM-1 is high quality 20K-ohm/VDC Multimeter usable as the SWR/Power Meter as well by connecting the directional coupler unit included.

**Specifications:**

DC Volt 0 — 0.3, 1.2, 6, 30, 120, 600V (20K-ohm/V) ± 3%  
 AC Volt 0 — 6, 30, 120, 600V (8K-ohm/V) ± 4%  
 DC mA 0 — 60uA, 3, 300mA ± 3%  
 OHM Rx1, Rx10, Rx1K  
 dB —20 — +18 0 — +32dBm  
 C 200pF — 0.5uF  
 LI 0 — 0.1, 10, 100mA  
 Frequency Coverage 3.5 — 150MHz  
 VSWR 1:1 — 3:1  
 RF Power Range 0 — 20, 200, 1000W ± 10%  
 Accessory Included Directional coupler unit with relevant connector cable, test leads and battery  
 Dimensions 4 1/8"(W) x 6 1/4"(H) x 2"(D): Multimeter  
 4 3/4"(W) x 2 1/4"(H) x 2"(D): Coupler  
 Net Weight 1.06 lbs. (480 grams): Multimeter  
 0.75 lbs. (340 grams): Coupler



**SWR & POWER METER FOR HF/VHF BAND  
MODEL PM-3HV ..... \$40.**

High quality SWR/Watt meter designed as SWR and power can be measured independently at a time. With meter illumination and "On-the-Air" indicator lamp.

**Specifications:**

Frequency Coverage 3 — 150MHz  
 RF Power Range 0 — 20, 200, 1,000W, 3 ranges ± 10% accuracy  
 Power Source 12V AC/DC (for meter illumination only)  
 Accessory Included 7ft. long connector cable with fuse for meter illumination purpose  
 Dimensions 7"(W) x 3"(H) x 3 1/2"(D)  
 Net Weight 1.8 lbs. (0.8 kgs)



**SWR & POWER METER FOR HF/VHF BAND  
MODEL PM-4HV ..... \$30.**

Compact and light weight SWR/Watt meter designed for mobile operation as well as base station use.

**Specifications:**

Frequency Coverage 3 — 150MHz  
 RF Power Range 0 — 20, 200, 1,000W, 3 ranges ± 10% accuracy  
 Accessory Included Velcro double back adhesive mounting for mobile installation  
 Dimensions 6"(W) x 2 3/4"(H) x 2 1/2"(D)  
 Net Weight 1 lb. (0.44 kgs)

Mfg. by: AKIGAWA ELECTRONICS CORP. • Exclusive Distributors: McCAW ELECTRONICS, INC. • P.O. Box 66; Carlsbad, CA 92008; Phone: (714) 434-1078; TELEX: 181743 MACAW CSBD

✓ 56

Prices do not include shipping and handling and are subject to change without notice.

✓ 47

## MFJ DELUXE Versa Tuner II

\$139.95 buys you one of the world's finest 300 watt antenna tuners with features that only MFJ offers, like . . . dummy load, SWR, forward, reflected watt meter, antenna switch, balun. Matches everything from 1.8 thru 30 MHz: coax, random wires, balanced lines.



**MFJ's Best Versa Tuner II . . .  
Built-in SWR/Wattmeter, dummy  
load, antenna switch.**

# \$139<sup>95</sup>

This is MFJ's best Versa Tuner II. And one of the world's finest 300 watt (RF output) tuners.

The MFJ-949B Deluxe Versa Tuner II gives you a combination of quality, performance, and features that others can't touch at this price . . . or any price.

**PERFORMANCE:** You can run your full transceiver power output — up to 300 watts RF output — and match your transmitter to any feedline from 1.8 thru 30 MHz whether you have coax, balanced line or random wire.

**FEATURES:** A 200 watt 50 ohm dummy load lets you tune up for maximum performance.

A sensitive meter lets you read SWR with only 5 watts and both forward and reflected power in two ranges (300 and 30 watts).

A flexible antenna switch lets you select 2 coax lines direct or thru tuner, random wire or balanced line and dummy load.

A large efficient airwound inductor 3 inches in diameter gives you plenty of matching range and less losses for more watts out.

1:4 balun. 1000 volt capacitors. SO-239 coax connectors. Binding post for balanced line, random wire, ground. All aluminum cabinet. 10x3x7 ins.

**QUALITY:** Every single unit is tested for performance and inspected for quality. Solid American construction, quality components.

The MFJ-949B carries a full one year unconditional guarantee.

Order from MFJ and try it — no obligation. If not delighted, return it within 30 days for a re-

fund (less shipping).

To order, simply call us toll free 800-647-1800 and charge it on your VISA or Master Charge or mail us a check or money order for \$139.95 plus \$4.00 for shipping/handling.

Don't wait any longer to tune out that SWR and enjoy solid QSO's. Order your Deluxe Versa Tuner II today. Call MFJ or see your dealer.

**CALL TOLL FREE . . . 800-647-1800**

Call 601-323-5869 for technical information, order/repair status. Also call 601-323-5869 outside continental USA and in Mississippi.

**MFJ ENTERPRISES,  
INCORPORATED**  
Box 494, Mississippi State, MS 39762

# Icing on the IC-2A Cake

## — nonstandard offsets for Icom's hand-held

Photos by Vic Klein WA4THR

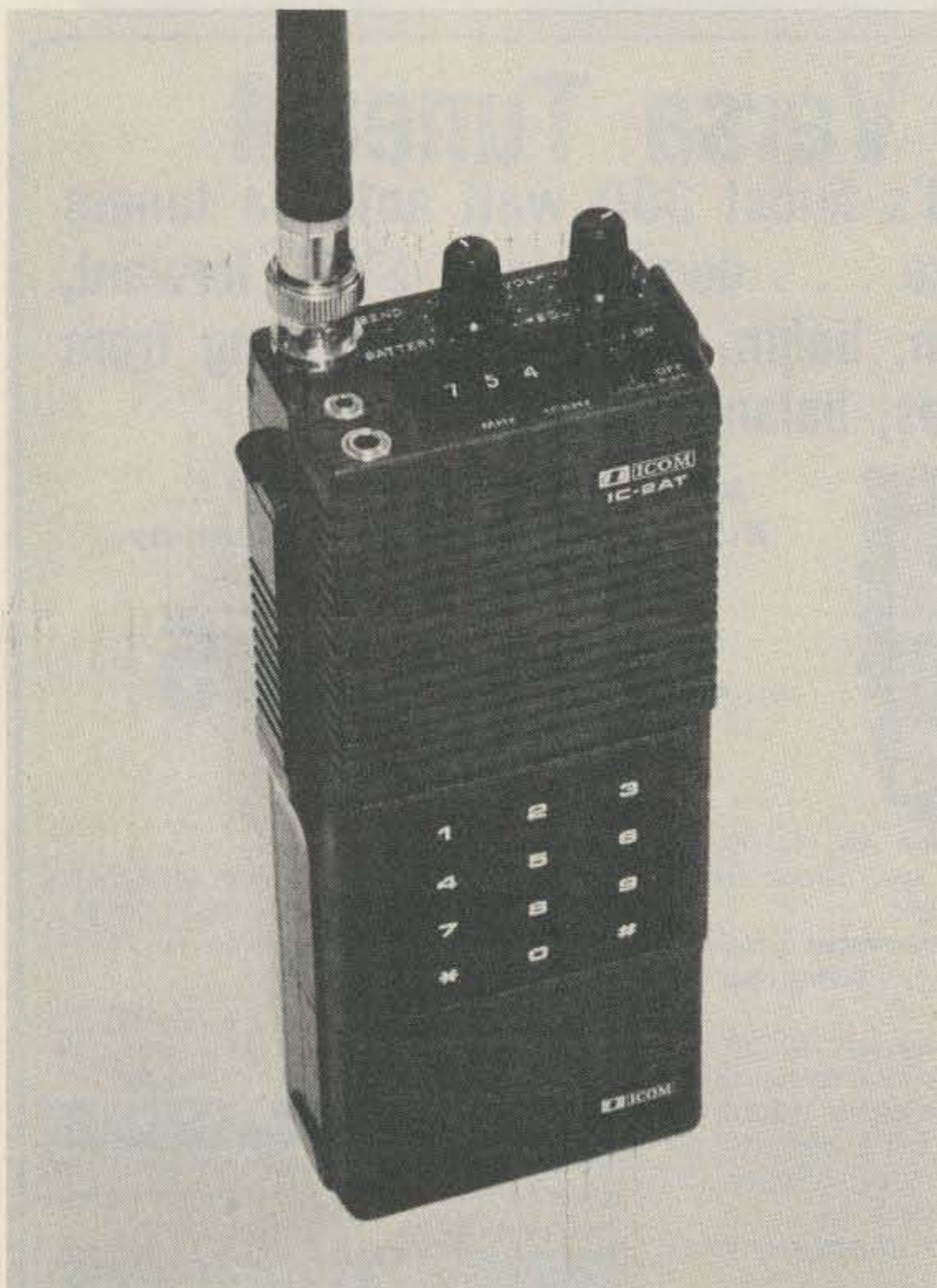

Photo A. The Icom IC-2A.

Robin Rumbolt WA4TEM  
1134 Glade Hill Drive  
Knoxville TN 37919

When I first saw Icom's new synthesized handie-talkie, the IC-2A, at the Dayton hamfest, I was impressed by its small size and modest current-drain specifications. I had to dismiss it for my use though, because it was not capable of working odd repeater splits. Furthermore, Icom's representative at the hamfest told me that any modification for odd splits would be difficult if not impossible to make. Since I am caretaker for a repeater with an odd split (1.14 MHz) this handie-talkie was obviously not for me.

Several months later, I began to realize that a syn-

thesized portable rig was becoming a necessity. I didn't need fancy scanning and many-memory capabilities, but I did need ruggedness and long battery life. The IC-2A came to the forefront of my mind.

After conferring a little more with the folks at Icom, I decided to take a chance and see if I could modify the radio for my odd split. I ordered one, and three weeks later I had what I consider to be the perfect handie-talkie.

This modification requires no holes to be drilled or extra switches added, does not change the functions of any of the existing controls, and is completely reversible at a later date, thereby not decreasing the rig's resale value.

Switch Settings	Binary Code	Function
Simplex + 600	00	Duplex with odd offset
Simplex - 600	01	Simplex
Duplex + 600	10	Duplex with + 600-kHz offset
Duplex - 600	11	Duplex with - 600-kHz offset

Fig. 1. DUP-SIMP switch outputs after modification.

## How It Works

There are three transmit offset crystals in the IC-2A's synthesizer system. They are for simplex transmit, +600-kHz transmit, and -600-kHz transmit. These crystals are switched in and out by the use of a dc voltage to forward bias selected switching diodes. This means that the DUP-SIMP switch and the (-600)-(+600) switch are merely switching dc voltages and not the crystals themselves. Since two switches are available, with only slight modification two on-off binary bits could be made available. Two binary bits have four possible combinations. These combinations and what they represent after modification are shown in Fig. 1. Only three of the four combinations are used normally. Thus, we have a fourth combination available for switching in the odd split.

To decode the two binary bits of information from the switches into four dc output lines for the crystal switching circuits, I chose a CD4051 analog demultiplexer integrated circuit for the job. This IC merely routes an input signal, be it ac or dc, to an output line addressed by a binary input. Since this IC is CMOS, it adds only a negligible few microamps of current to the *transmit* battery drain.

The resulting circuit for the entire modification is shown in Fig. 2. Note that the diode switching circuit for the odd offset crystal is identical to the circuit used for the other offset crystals. The two coils shown, LB89 and LB91, are fairly critical so it is best to order them directly from Icom at the address shown at the end of this article. The diodes, 1S553s, are also critical. 1N914s did not work in my unit. The 1S553 diodes also should be ordered from

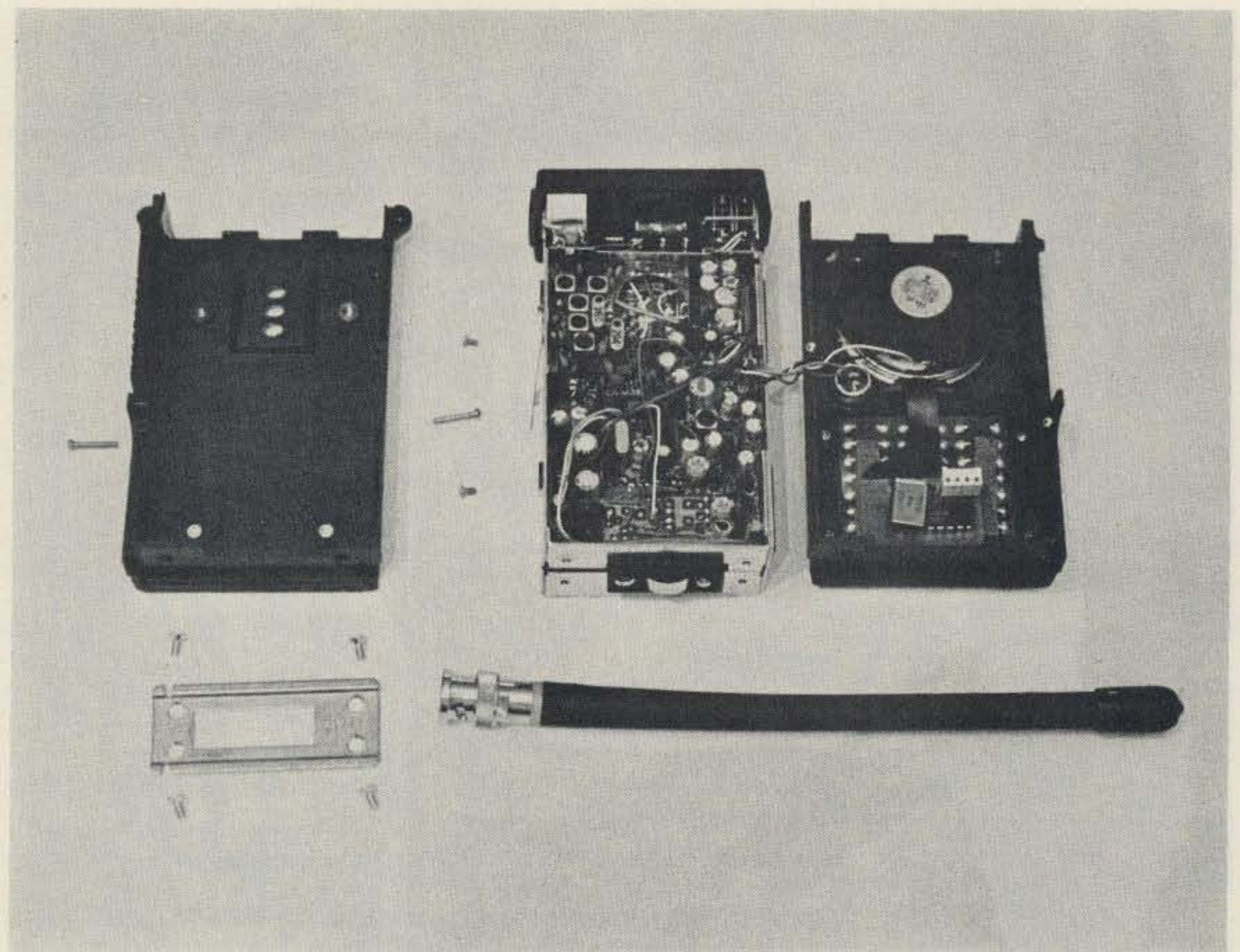

Photo B. A disassembled IC-2AT.

Icom. Information for crystal ordering is in Fig. 3.

## Installation

The Icom people did a very good job at miniaturization and getting the most into the least amount of space. Consequently, this modification should be attempted only by persons with very good eyesight and a steady hand, a very small-tipped, *low-wattage* soldering iron, and experience in working with miniature circuitry. Others would best serve themselves by turning the project over to a trusted friend having the above qualifications.

Begin the modification by first cutting the unused pins off each of the two

coils. Then bend the two remaining leads out at right angles. Wire the remaining components, except for the IC, as shown in Fig. 4. Electrical tape should be wrapped around the crystal to keep it from shorting out other connections. Flex the crystal leads as little as possible to keep from breaking

them off. All leads should be kept as short as possible. The entire circuit should also be kept as flat as possible. (No circuit board is used because there just isn't any room for it.) Once this circuit is wired, set it aside for a while. Do not install it in the rig at this time.

Remove the battery pack

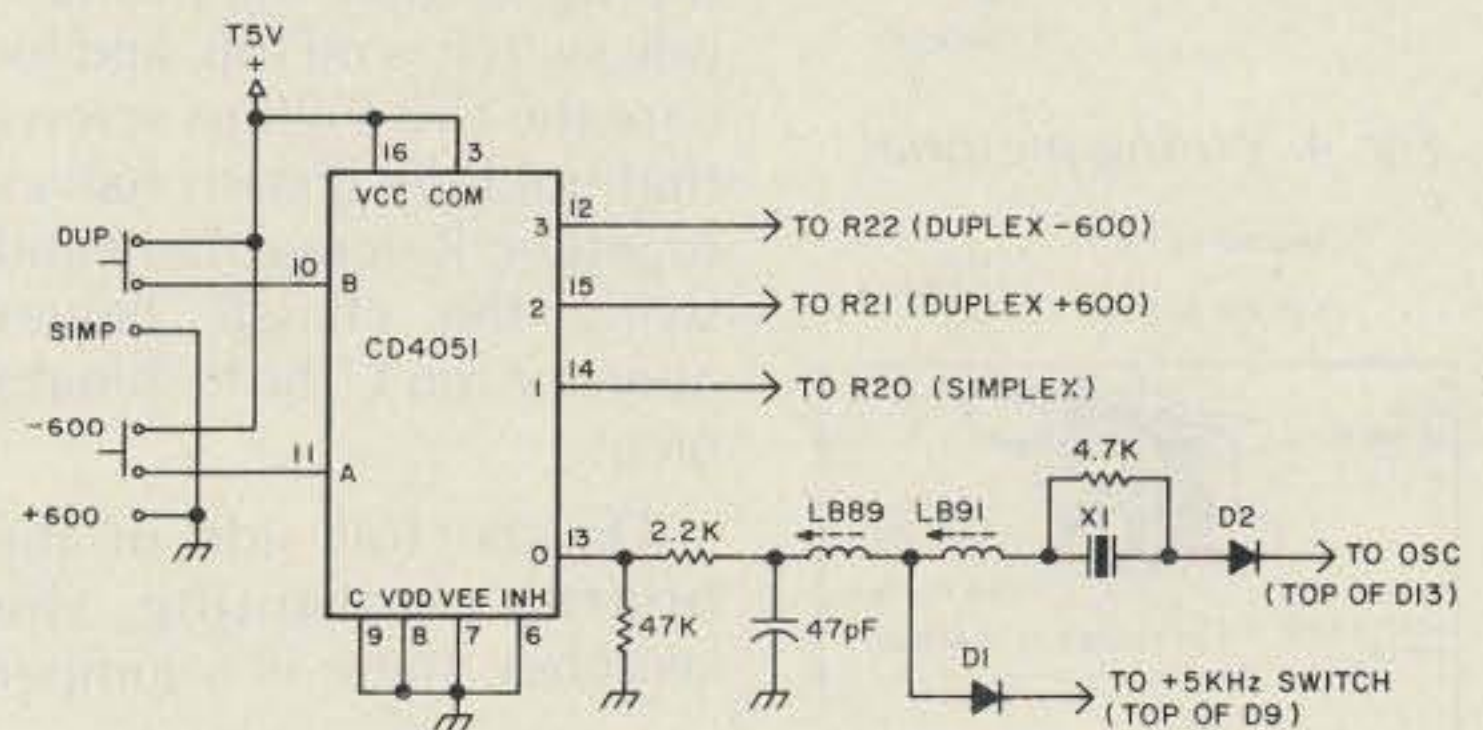

Fig. 2. Odd-split circuit schematic.

$$\text{Crystal operating frequency} = 35.00125 \text{ MHz} + \text{offset}/4$$

$$\text{Example: For a repeater with 146.40 input/147.54 output, offset needed} = -1.14 \text{ MHz}$$

$$\text{Crystal frequency} = 35.00125 \text{ MHz} - 1.14 \text{ MHz}/4 = 34.71625 \text{ MHz}$$

Order: series resonant, 3rd overtone  $\pm .005\%$  tolerance, HC-18 holder with wire leads. \$5.50 from Jan Crystals, 2400 Crystal Drive, Ft. Myers FL 33907 (813)-936-2397.

Fig. 3. Crystal frequency calculation and ordering information.

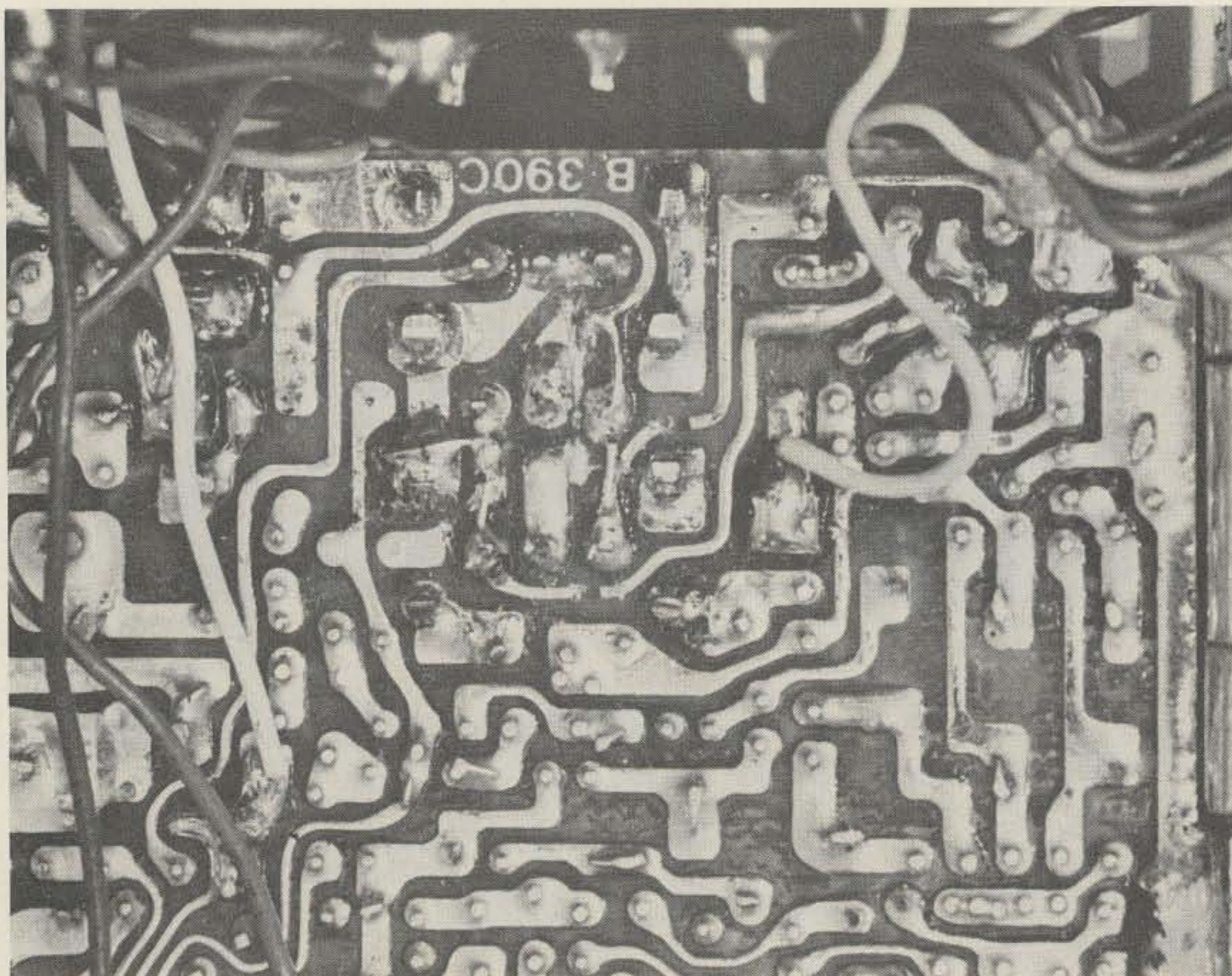

Photo C. Foil side of the PLL circuit board after the traces have been cut and the jumpers installed.

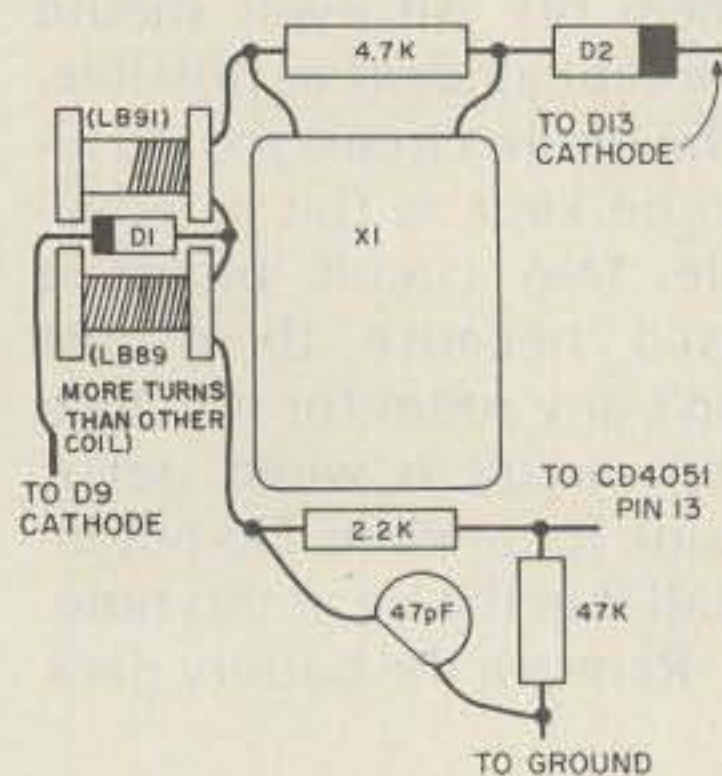

Fig. 4. Wiring pictorial.

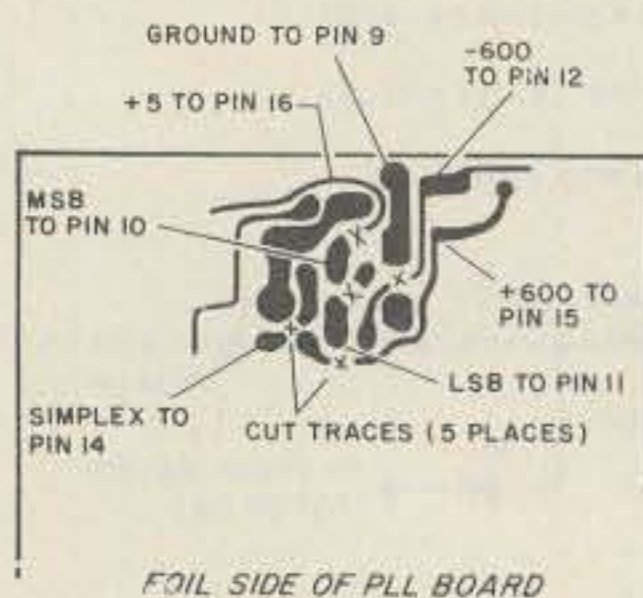

Fig. 5(a).

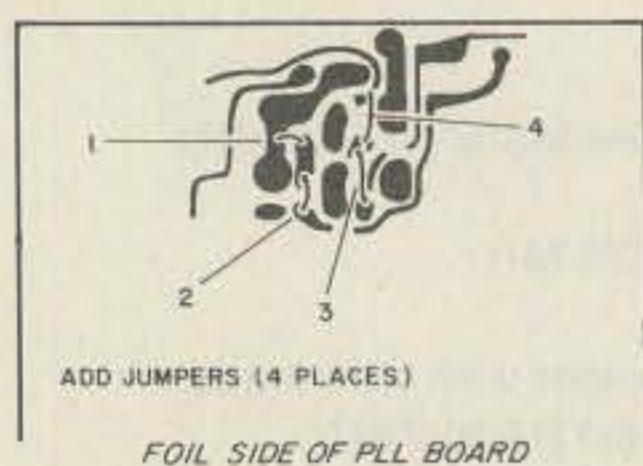

Fig. 5(b).

from the IC-2A. Then take out the four Phillips-head screws holding on the battery clip. Next remove the two Phillips screws on either side of the transceiver case. Now the case back cover can be removed by lifting it from the bottom and pulling it outward. Turn the rig so that the push-to-talk switch is on top, and locate the two Phillips screws that hold the chassis halves together. Remove them and swing the chassis halves apart. Aren't those hinges nice!

On the foil side of the board, containing the switches, there is a jumper

wire about 1/2-inch long that serves to hold down several other wires. Carefully remove this jumper, but note where it attaches since it will need to be replaced later. Move the wires beneath the jumper to one side, cut the five traces as shown in Fig. 5(a), and add the jumpers as shown in Fig. 5(b). The PC should look like Photo C after the cuts and jumpers are installed.

Now set the rig aside for a few minutes and get out the CD4051 CMOS IC. Normally, a CMOS IC should be handled as little as possible, but that is not possible in this situation. My only suggestion to avoid static damage in the steps that follow is to work on a grounded metallic surface in as humid an atmosphere as possible. The next step is to carefully cut off the "skinny" portion of each IC lead.

Using small-gauge wire such as wire-wrap wire, solder a minimum-length jumper between pins 3 and

16 of the IC. Solder a 2-inch piece of small-gauge wire to pin 16. Then jumper pins 6, 7, 8 and 9 together leaving a two-inch wire extending from pin 9. Continue by soldering 2-inch individual lengths of wire to each of pins 10, 11, 12, 14, and 15. Solder a 3-inch wire to pin 13. Carefully pull the leads out perpendicular to the IC, parallel to each other, and all on one side of the IC. Then bend the 3-inch lead on pin 13 to the other side of the IC. Remember to use as little heat as possible, allowing the IC to cool between each connection. Once all the wires and jumpers are soldered on, wrap the IC with electrical tape as shown in Fig. 6.

Take the tape-wrapped IC and, inserting it from the component side of the PLL board, route the connecting wires between the top edge of the circuit board and the flex printed circuit attached to the thumbwheel switches. The wire from pin 13 must remain on the component side of the board. Be sure that pin 16 of the IC is toward the switches. The IC should fit nicely into the upper-left corner of the rig when viewed from the back side, as shown in Photo D.

Now solder all wires coming from the IC (except for the one coming from pin 13) to the points shown in Fig. 5(a). When you're confident that everything is right, locate the 1/2-inch jumper removed earlier. Solder one end of it down. Group all the loose wires pushed aside earlier under the jumper. Then, being careful not to melt any insulation, tack the other end down at its original point. Reclose the chassis halves and put the two Phillips screws back in place.

The last task, now, is to install the coil-crystal assembly. First, make a double thickness of electrical tape about 3/4-inch long and place it over the area on the

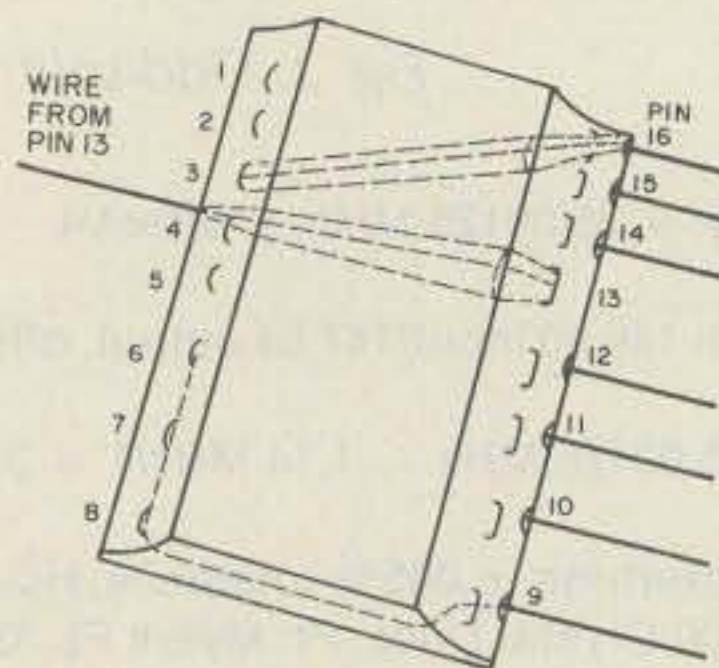

Fig. 6.

component side of the PLL circuit board where the flex circuit from the thumb-wheels attaches to the main board. This is directly over IC1 and just to the left of the shielded enclosure. Make sure that the tape covers all the protruding solder connections. Now take the coil-crystal assembly and fit it on the taped-over area so that one lead of the 47k resistor goes over the shielded enclosure and so that the coils point to where the battery case is normally. Solder the lead from the 47k resistor to the shielded enclosure. Your assembly should now look like that shown in Photo E.

Solder the cathode lead of D2 on the coil-crystal assembly to the cathode lead of either D12 or D13, which can be found in a group of four cathode leads sticking up just below the three other offset crystals and to the left of the switches. Make this a quick, low-heat solder connection to avoid

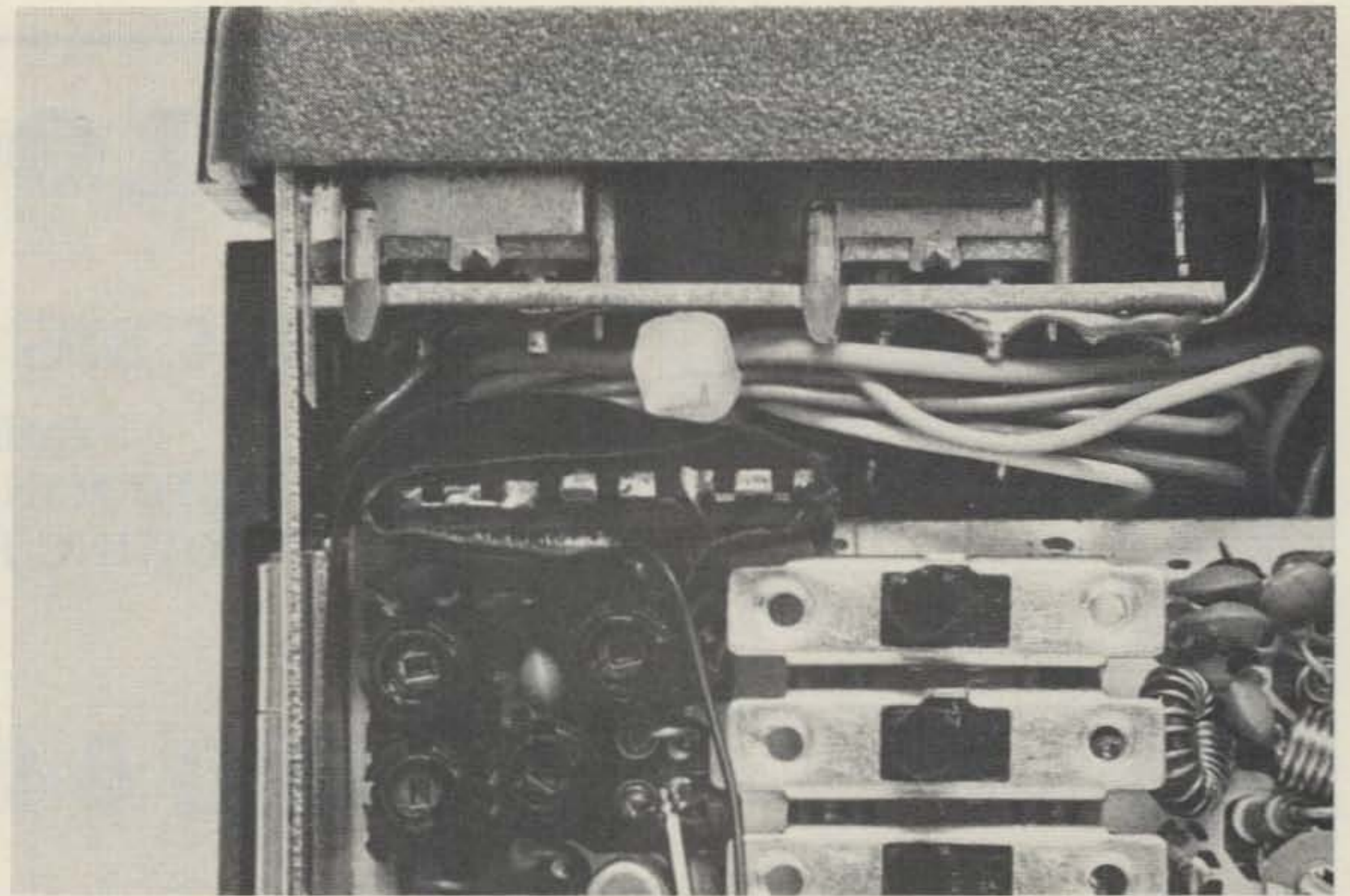

Photo D. Placement of the tape-wrapped CD4051.

overheating any of the diodes.

The next step is to find the cathode lead of D8 or D9. These diodes are a pair which can be found above

the offset crystals to the left of the switches and immediately to the right of a couple of coil forms. Quicksolder one end of a piece of small wire to one of these

cathode leads. The other end of the wire attaches to the cathode lead of D1 on the coil-crystal assembly. Finally, connect the lead coming from pin 13 of the

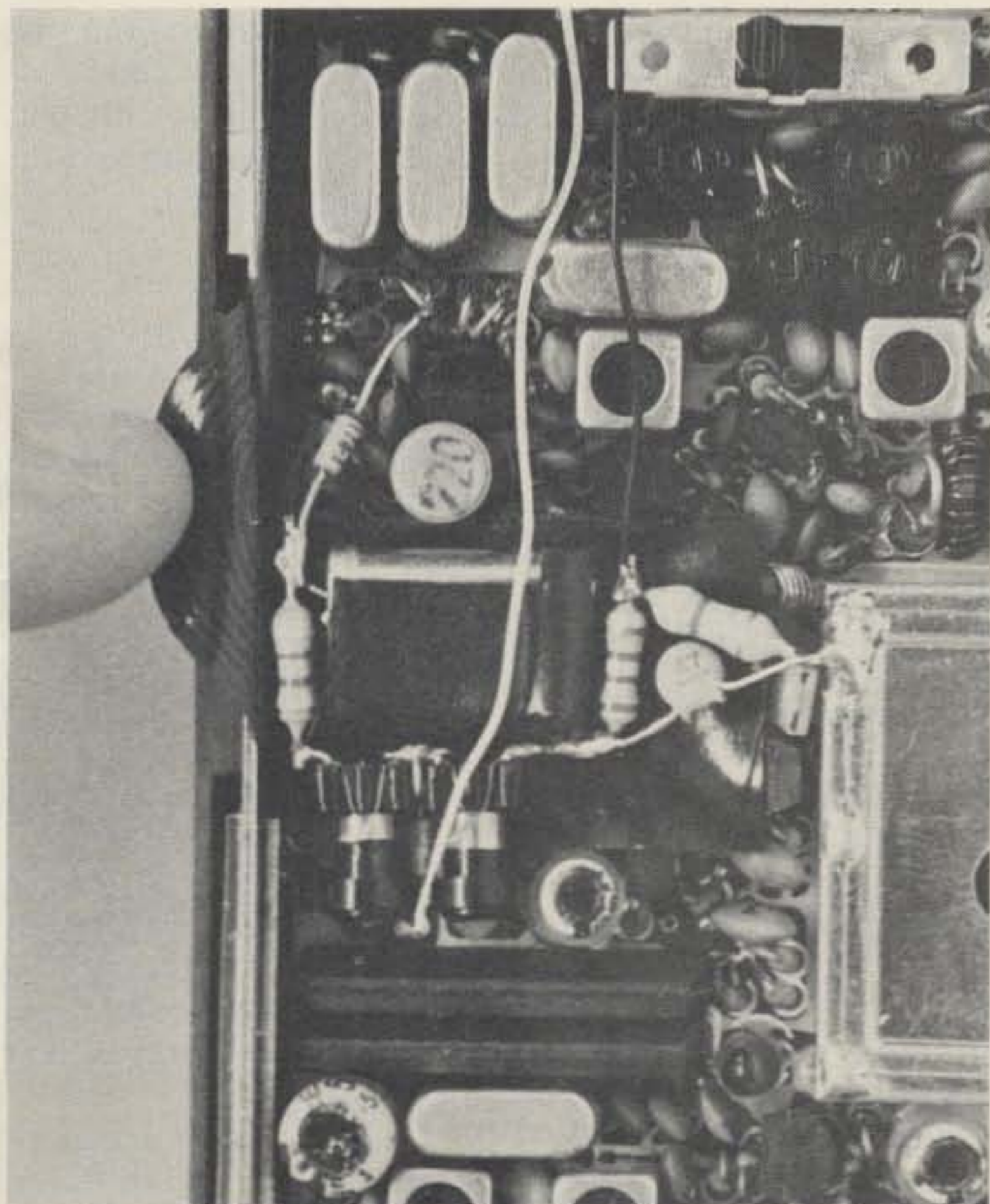

Photo E. Placement and orientation of the coil-crystal assembly.

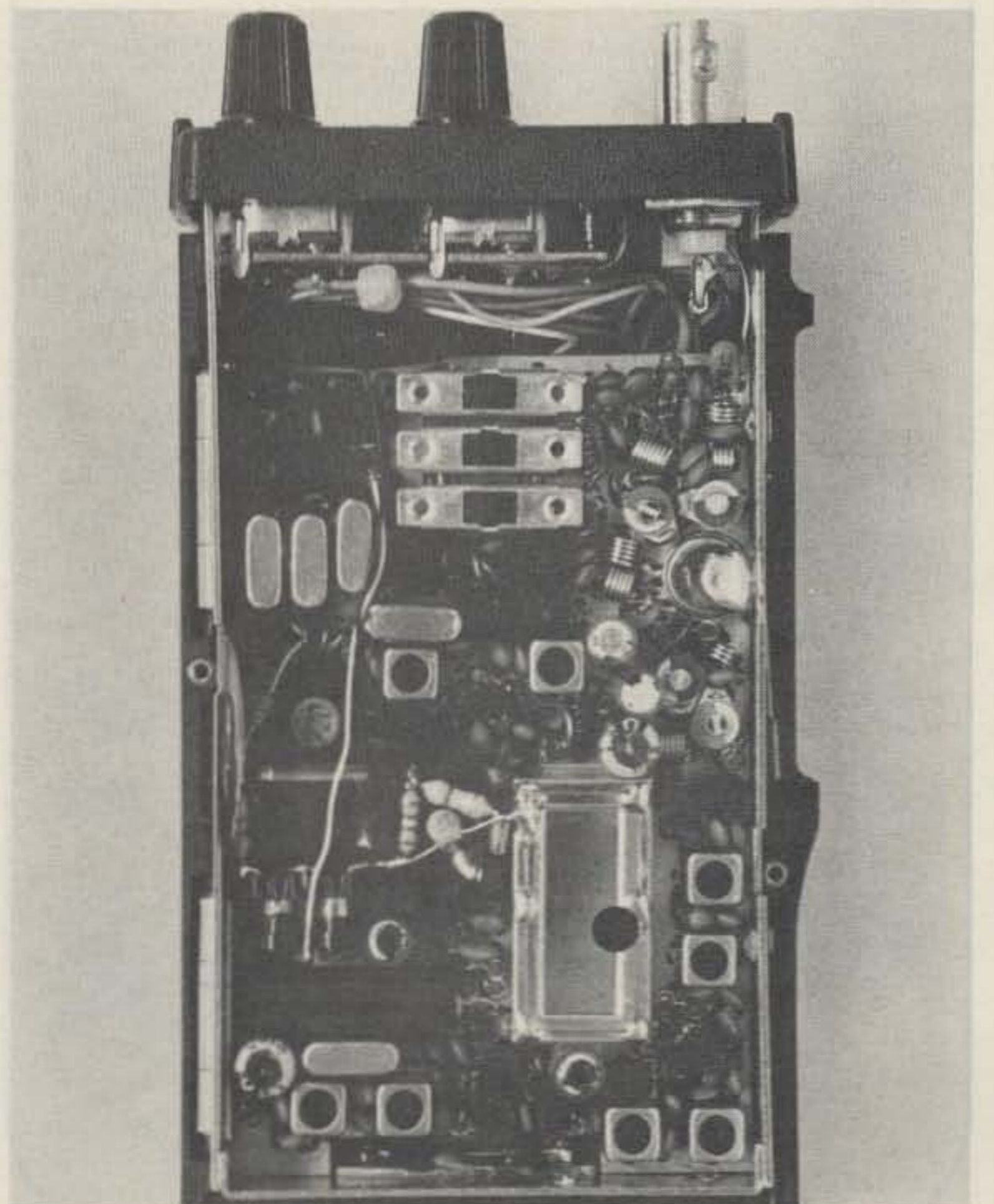

Photo F. The PLL circuit board after modification.

## FREQUENCY COUNTERS



**COMPLETE KITS:** CONSISTING OF EVERY ESSENTIAL PART NEEDED TO MAKE YOUR COUNTER COMPLETE. **HAL-600A** 7-DIGIT COUNTER WITH FREQUENCY RANGE OF ZERO TO 600 MHz. FEATURES TWO INPUTS: ONE FOR LOW FREQUENCY AND ONE FOR HIGH FREQUENCY; AUTOMATIC ZERO SUPPRESSION. TIME BASE IS 1.0 SEC OR 1 SEC GATE WITH OPTIONAL 10 SEC GATE AVAILABLE. ACCURACY  $\pm 0.01\%$ . UTILIZES 10-MHz CRYSTAL 5 PPM.

**COMPLETE KIT** ..... \$129

**HAL-300A** 7-DIGIT COUNTER WITH FREQUENCY RANGE OF ZERO TO 300 MHz. FEATURES TWO INPUTS: ONE FOR LOW FREQUENCY AND ONE FOR HIGH FREQUENCY; AUTOMATIC ZERO SUPPRESSION. TIME BASE IS 1.0 SEC OR 1 SEC GATE WITH OPTIONAL 10 SEC GATE AVAILABLE. ACCURACY  $\pm 0.01\%$ . UTILIZES 10-MHz CRYSTAL 5 PPM.

**COMPLETE KIT** ..... \$109

**HAL-50A** 8-DIGIT COUNTER WITH FREQUENCY RANGE OF ZERO TO 50 MHz OR BETTER. AUTOMATIC DECIMAL POINT. ZERO SUPPRESSION UPON DEMAND. FEATURES TWO INPUTS: ONE FOR LOW FREQUENCY INPUT, AND ONE ON PANEL FOR USE WITH ANY INTERNALLY MOUNTED HALTRONIX PRE-SCALER FOR WHICH PROVISIONS HAVE ALREADY BEEN MADE. 1.0 SEC AND 1 SEC TIME GATES. ACCURACY  $\pm 0.01\%$ . UTILIZES 10-MHz CRYSTAL 5 PPM.

**COMPLETE KIT** ..... \$109

### PRE-SCALER KITS

**HAL 300 PRE** ..... \$14.95  
(Pre-drilled G10 board and all components)

**HAL 300 A/PRE** ..... \$24.95  
(Same as above with preamp)

**HAL 600 PRE** ..... \$29.95  
(Pre-drilled G10 board and all components)

**HAL 600 A/PRE** ..... \$39.95  
(Same as above but with preamp)

### TOUCH TONE DECODER KIT

HIGHLY STABLE DECODER KIT. COMES WITH 2 SIDED, PLATED THRU AND SOLDER FLOWED G-10 PC BOARD, 7-567's, 2-7402, AND ALL ELECTRONIC COMPONENTS. BOARD MEASURES 3 1/2 x 5 1/2 INCHES. HAS 12 LINES OUT. ONLY \$39.95

**DELUXE 12-BUTTON TOUCHTONE ENCODER KIT** utilizing the new ICM 7206 chip. Provides both VISUAL AND AUDIO indications! Comes with its own two-tone anodized aluminum cabinet. Measures only 2 3/4 x 3 3/4". Complete with Touch-Tone pad, board, crystal, chip and all necessary components to finish the kit.

**PRICED AT** ..... \$29.95

For those who wish to mount the encoder in a hand-held unit, the PC board measures only 9/16" x 1 3/4". This partial kit with PC board, crystal, chip and components.

**PRICED AT** ..... \$14.95

**ACCUKEYER—MEMORY OPTION KIT** THIS ACCUKEYER MEMORY KIT PROVIDES A SIMPLE, LOW COST METHOD OF ADDING MEMORY CAPABILITY TO THE WB4VVF ACCUKEYER. WHILE DESIGNED FOR DIRECT ATTACHMENT TO THE ABOVE ACCUKEYER, IT CAN ALSO BE ATTACHED TO ANY STANDARD ACCUKEYER BOARD WITH LITTLE DIFFICULTY. \$16.95

**ACCUKEYER (KIT)** THIS ACCUKEYER IS A REVISED VERSION OF THE VERY POPULAR WB4VVF ACCUKEYER ORIGINALLY DESCRIBED BY JAMES GARRETT, IN QST MAGAZINE AND THE 1975 RADIO AMATEURS HANDBOOK. \$16.95

**ACCUKEYER—MEMORY OPTION KIT—TOGETHER ONLY \$32.00**

### 6-DIGIT CLOCK • 12/24 HOUR

COMPLETE KIT CONSISTING OF 2 PC G10 PRE-DRILLED PC BOARDS, 1 CLOCK CHIP, 6 FND 359 READOUTS, 13 TRANSISTORS, 3 CAPS, 9 RESISTORS, 5 DIODES, 3 PUSH-BUTTON SWITCHES, POWER TRANSFORMER AND INSTRUCTIONS. DON'T BE FOOLED BY PARTIAL KITS WHERE YOU HAVE TO BUY EVERYTHING EXTRA.

**PRICED AT** ..... \$12.95

**CLOCK CASE** Available and will fit any one of the above clocks. Regular Price \$6.50 But Only \$4.50 when bought with clock

**SIX-DIGIT ALARM CLOCK KIT** for home, camper, RV, or field-day use. Operates on 12-volt AC or DC, and has its own 60-Hz time base on the board. Complete with all electronic components and two-piece, pre-drilled PC boards. Board size 4" x 3". Complete with speaker and switches. If operated on DC, there is nothing more to buy.

**PRICED AT** ..... \$16.95

Twelve-volt AC line cord for those who wish to operate the clock from 110-volt AC. \$2.95

### SHIPPING INFORMATION

ORDERS OVER \$20.00 WILL BE SHIPPED POSTPAID EXCEPT ON ITEMS WHERE ADDITIONAL CHARGES ARE REQUESTED ON ORDERS LESS THAN \$20.00 PLEASE INCLUDE ADDITIONAL \$1.50 FOR HANDLING AND MAILING CHARGES. SEND SASE FOR FREE FLYER.



"HAL" HAROLD C. NOWLAND  
WBZXH

**HAL-TRONIX** ✓ 31

P. O. BOX 1101  
SOUTHGATE, MICH. 48195  
PHONE (313) 285-1782

# "LOOK"

THIS BIG  IS THE  
SYMBOL OF  
METROLINA'S FASTEST  
GROWING HAM DEALER  
(803)366-7157

## 800-845-6183

 **G.I.S.M.O.** ✓27  
2305 CHERRY ROAD  
ROCK HILL, S.C. 29730

Service Department  
Call 803-366-7158

CD4051 to the junction of the 2.2k and 47k resistors on the coil-crystal assembly. This completes the modification.

### Check Out

Before putting the case back together, connect the battery to the rig with a couple of jumper leads and turn on the rig. Everything should function normally except when the switches are set for simplex and +600. This combination should switch in your odd offset crystal.

A frequency counter should be used to check the offset frequency. Adjust LB89 on the coil-crystal assembly to adjust the frequency. Then switch the +5-kHz switch on and adjust LB91 to 5 kHz higher. Switch back then to 0 kHz and readjust LB89. Repeat this procedure a couple of times until both frequencies are correct. When the

frequencies are to your satisfaction, cover the coil-crystal assembly with one more piece of tape and reassemble the case.

### Conclusion

This modification has been made to several IC-2As in my area with complete satisfaction. While no undesirable side effects have been observed to date, I cannot, however, assume any liability for damages or faulty operation incurred by the installation or use of this modification.

Special thanks to Bill Tackett KN4N for offering the use of his week-old IC-2AT as the guinea-pig rig for development of this modification, and to Vic Klein WA4THR for the excellent photographs.

Coils and diodes can be obtained from Icom America, Inc., 2112 116th Avenue, N.E., Bellevue WA 98004. ■



# BASSETT HELIUM TRAP ANTENNAS



# BASSETT HELIUM MOBILE ANTENNAS

**NEW!**



Heavy duty inductors with transparent tube covers.

The result of nearly two years of continuous development and nearly fifty years of amateur and commercial antenna design and manufacture Bassett helium filled antennas are for the amateur who demands the very best in American made automatic bandchange systems and mobile antennas that are compatible with all transceivers including the new "no tune" units. Trap systems are fundamental dipoles on each band and do not require antenna tuners.

- Helium filled traps impervious to all weather
- Maintains precise resonance and efficiency
- Systems easily handle legal amateur power
- Multiband amateur and MARS with one coax
- Fully compatible with "no tune" transceivers
- Short enough to fit on a small 50' by 100' lot
- Rugged white traps only 1" diameter, 5" long
- Uses your RG-8 or RG-58 coax in any length
- Center "isolator" equipped to accept a PL-259
- Solid Copperweld, stainless, nylon end lines

- Helium filled for a lifetime of high efficiency
- Completely adjustable to precise resonance
- Power handling capability to 750 watts PEP
- Beautiful white 32" Fiberglass lower section
- Stainless 38" 17-7 tapered top whip section
- Very low weight. VAC-20 weighs 6.5 ounces
- Low wind drag. Holds vertical at high speed
- All chrome plated polished brass hardware
- Models for all bands with a 2 meter collinear
- Mates with any standard 3/8-24 mobil mount

### MULTIBAND BROADSIDE DIPOLES

VAC-40/75--\$69.50	VAC-20/40/75--\$89.50	VAC-10/15/20/40----\$119.50
VAC-20/40--\$69.50	VAC-15/20/40--\$89.50	VAC-15/20/40/75----\$119.50
VAC-15/20--\$69.50	VAC-10/15/20--\$89.50	VAC-10/15/20/40/75--\$149.50

### SINGLE-BAND MOBILES

VAC-2 collinear for 2 meter mobile---\$39.50
VAC-6, VAC-10, VAC-15, VAC-20 ---\$39.50
VAC-40---\$44.50                      VAC-75---\$49.50

**NEW!** VAC-10m/18m/24m----\$89.50  
For the 3 new amateur bands

Postpaid to 48 States. Florida residents add 4% Fla. sales tax.  
Prices and specs subject to change without notice or obligation.  
Special systems available for any use. Write for price quotes.

✓ 440

## REX BASSETT ELECTRONICS, INC.

1633 N.E. 14th AVENUE, FORT LAUDERDALE, FLORIDA 33305 TEL: 305-561-1400



## TERMINALL

**Simplicity of Operation — Superior Performance**  
What are you waiting for? **THIS IS THE WAY TO GO!**

\$499.00



- **TERMINALL** is a hardware and software system which converts your TRS-80\* (model I or III) into a state of the art communications terminal. TERMINALL works with a general purpose computer, is expandable, has superior performance and is simple to use. TERMINALL has it all!
- **Simplicity.** TERMINALL is easy to connect to your radio and easy to use. Plug into your receiver headphone jack and copy Morse code, Baudot or ASCII. Plug into your CW jack and send Morse code. Attach a microphone connector and send Baudot or ASCII using audio tones (AFSK). That's all there is to hooking it up. You will be on the air and transmitting in minutes!
- **Complete software on cassette**, assembled and tested hardware and extensive instruction manual. Specify Model I or III. Level II BASIC, 16K required.

### THE COMMUNICATIONS TERMINAL THAT DOES IT ALL!

- **Software** may be loaded into your computer on cassette or disk. Enter your callsign and the time and you will start receiving immediately. No adjustments are needed to receive Morse code. It's fully automatic. It works. You will be on the air and transmitting in minutes.
- **Full ASCII capabilities.** Upper and lower case, control codes, even/odd/no parity, 6, 7 or 8 data bits, 75 to 110 baud.
- **Buffered ASCII parallel printer output:** any or all text, or WRU activated (AUTO START).
- **Hardware clock** maintains correct time during all operations. Programmable time/date format.
- **Flexible Interfacings:** Separate CW and RTTY demodulators, AFSK, CW and PTT keying, 60 mil loop interconnect, RS232 IN and OUT, hand key input, and side tone output.
- **Multilevel Displays:** Edit Window to enter transmit text or program messages. Status Window displays mode, operating parameters, prompts and error messages. Dialogue Window displays received and transmitted text. Review window for examining and editing historical text.
- **Fantastic Morse Reception:** Six stage active filter demodulator and auto adaptive Morse algorithm copies the weak and sloppy ones.
- **Multiple user defined WRU.** Four WRU functions You can select any combination of (1) initiate sequence, (2) Terminate sequence, (3) what to transmit back (if anything), (4) whether to save on tape or not. WRU functions work in all modes (Morse, Baudot or ASCII).
- **Word wrapping,** word mode editing, diddle, ignore carriage returns, user programmable end of line sequence, adjustable carriage width, transmit delay (fixed, none, auto adaptive), break mode, keyboard selectable: baud rate, shift, CW keying, unshift-on-space and signal invert.
- **General Purpose vs Dedicated:** TERMINALL works with a general purpose computer so the majority of your investment has many different applications.

✓ 44



**MACROTRONICS, inc.®**

1125 N. Golden State Blvd.  
Turlock, California 95380



C.O.D.

USE OUR TOLL FREE NUMBER TO ORDER  
**(800) 344-7493**

In CA use (209) 667-2888  
**15 DAY MONEY BACK TRIAL PERIOD**  
1 Yr. Parts and Labor limited Warranty  
\*TRS-80 is a registered trademark of Radio Shack

# Flexible Couplings

— for every project there is a reason . . .  
turn, turn, turn

In constructing a remotely-tuned antenna matcher for my ham station, I ran into the problem of coupling a variable-capacitor shaft to a pot shaft. (The pot is used to transmit information on the position of the variable capacitor.) The amount of space I had in the unit was not great enough to permit use of a flexible insulated coupling that is commercially available. Also, misalignment of the shafts was unavoidable due to the lack of space. The sideways force on the shaft of the pot also was of concern.

A simple solution came

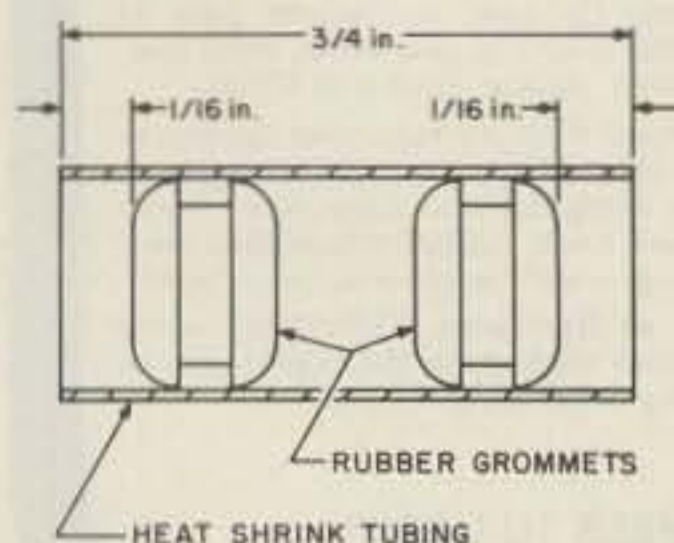

Fig. 1. Cutaway view showing placement of grommets in heat-shrink tubing.

to me after I had racked my brains on this problem for a couple of days. Why not use some rubber grommets connected together with some heat-shrink tubing? Well, I tried it and it worked. Now I could finish up my antenna matcher.

## Construction

The shaft size must be measured before selection of grommet size. Selection of heat-shrink tubing can be made next. The pot shaft and capacitor shaft were 1/4" diameter in my antenna matcher. I selected grommets with an inside diameter of 3/16". This fit tightly enough on the shafts so that the pot could turn without the grommet slipping.

Next, a size of heat-shrink tubing was selected that would let the grommets slip into the inside of the tubing. The heat-shrink tubing, when shrunk, must grip the grommets tightly.

As shown in Fig. 1, the length of tubing I used was

about 3/4". Longer lengths can be used—more on that later. The grommets are pushed into each end of the tubing leaving about 1/16" of tubing overhang. Next, shrink the tubing with the grommets in place. That's all there is to it.

## Limitations

There are some limitations to this type of homemade coupling. First and foremost is the amount of torque that is required to turn the shaft. In my case, the pot shaft takes very little torque to turn. Mount the grommet on whatever is to be coupled and try turning the grommet with your fingers. If the grommet rotates instead of the shaft, this type of coupling will not work. Something else must then be considered.

The heat-shrink tubing can be longer than I used by inserting a piece of rubber hose into the tubing. The length of hose is determined by the length of the tubing minus the total

width of the grommets plus the 1/16" overhang of heat-shrink tubing on each end. The diameter of rubber hose must not be greater than the outside diameter of the grommets nor smaller than the inside diameter of the grommets. When the heat-shrink tubing is shrunk, it will grip the inserted rubber hose and add support to the extra length. Some trial and error assemblies may be necessary to get the results you need.

This type of coupling can melt if it is too close to some component that produces much heat. Also, make sure there is no grease or oil on the shafts when mounting the coupling or slippage may result.

In conclusion, this grommet and heat-shrink tubing combination has been working fine in my antenna matcher. As long as the torque requirements are taken into consideration, this coupling works great and, most important, it is cheap to make! ■

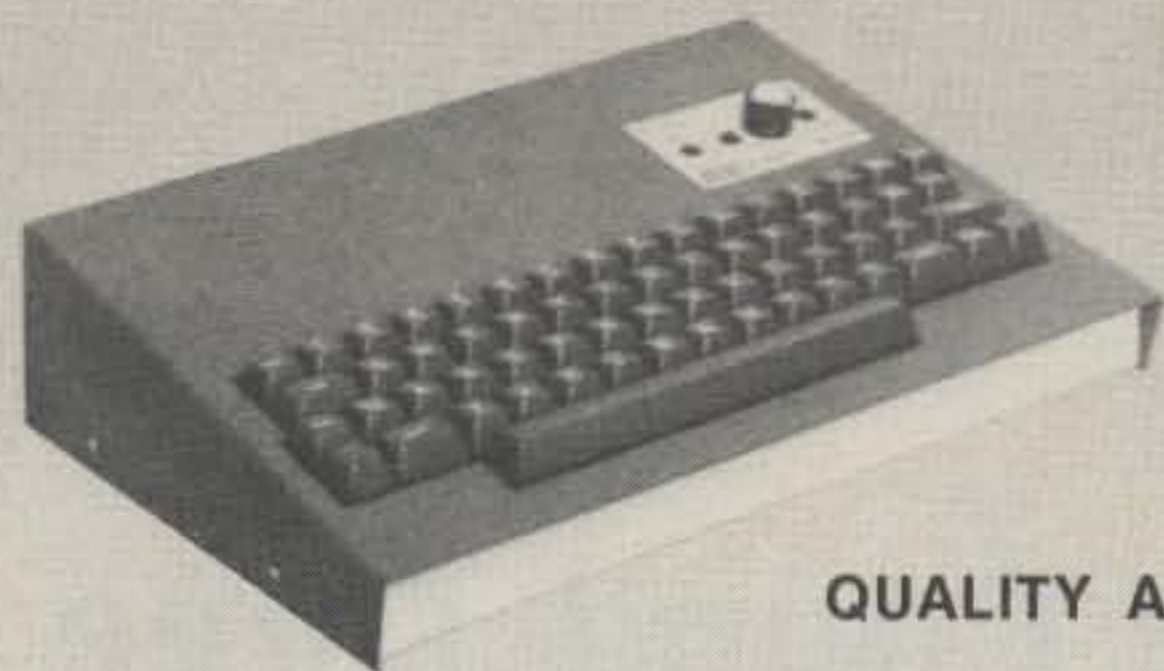

# MORSE RTTY ASCII

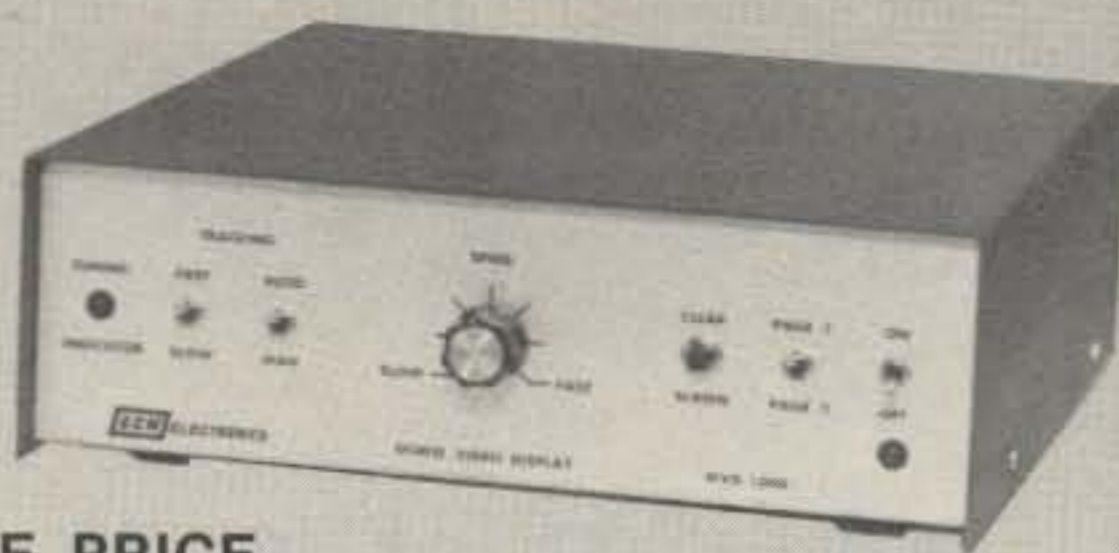

QUALITY AT AN AFFORDABLE PRICE

## MKB-2000

- Complete set of alphanumeric, punctuation, and special function keys
- 512 character text buffer
- 10 reprogrammable 50 character message memories
- 5-99 WPM, keyboard selectable
- Built-in sidetone with adjustable tone and volume
- Buffer/Memory fullness indicators
- 1 year warranty on parts and labor
- Attractive anodized brushed aluminum and gray wrinkle finish case, only 13.3 x 9.4 x 3.5 in.
- RTTY/ASCII option includes—"Brag Tape" interface, CW ID, QBF and RY test messages, auto CR/LF and LTR/FIG shift
- Other options—Memory expansion, AFSK modulator

MKB-2000 (Morse Only) \$319.00  
RTTY/ASCII Option 75.00

## MVD-1000

- Copies Morse Code directly from your receiver
- Automatic speed tracking with self calibration
- 6-60 WPM speed range
- Manual speed tracking to give operator more control
- Active filters and digital sampling for increased noise rejection
- Operates with any TV set, no expensive monitor needed
- Two page display with 16 lines of 32 characters per page
- Attractive anodized brushed aluminum and gray wrinkle finish case, only 3 x 10 x 10 in.
- RTTY/ASCII option includes demodulator

MVD-1000 (Morse Only) \$369.00  
RTTY/ASCII Option 89.00

Send For

Free Information

Add \$5.00 per unit for shipping U.S.A.



787 BRIAR LANE, BELOIT, WISCONSIN 53511 (608) 362-0410

## ASSOCIATED RADIO

913-381-5900

8012 CONSER BOX 4327  
OVERLAND PARK, KANSAS 66204

# BUY—SELL—TRADE

All Brands New & Reconditioned



We Want to DEAL—Call Us—We'll Do It Your Way.  
**WE'RE #1**



NOTE: SEND \$1.00 FOR OUR CURRENT CATALOG OF NEW AND RECONDITIONED EQUIPMENT.

★ ALSO WE PERIODICALLY PUBLISH A LIST OF UNSERVICED EQUIPMENT AT GREAT SAVINGS.  
A BONANZA FOR THE EXPERIENCED OPERATOR.

TO OBTAIN THE NEXT UNSERVICED BARGAIN LIST SEND A SELF ADDRESSED STAMPED ENVELOPE.

# The Bobtail Curtain: Round Three

— wherein this author turns two previous articles upside down

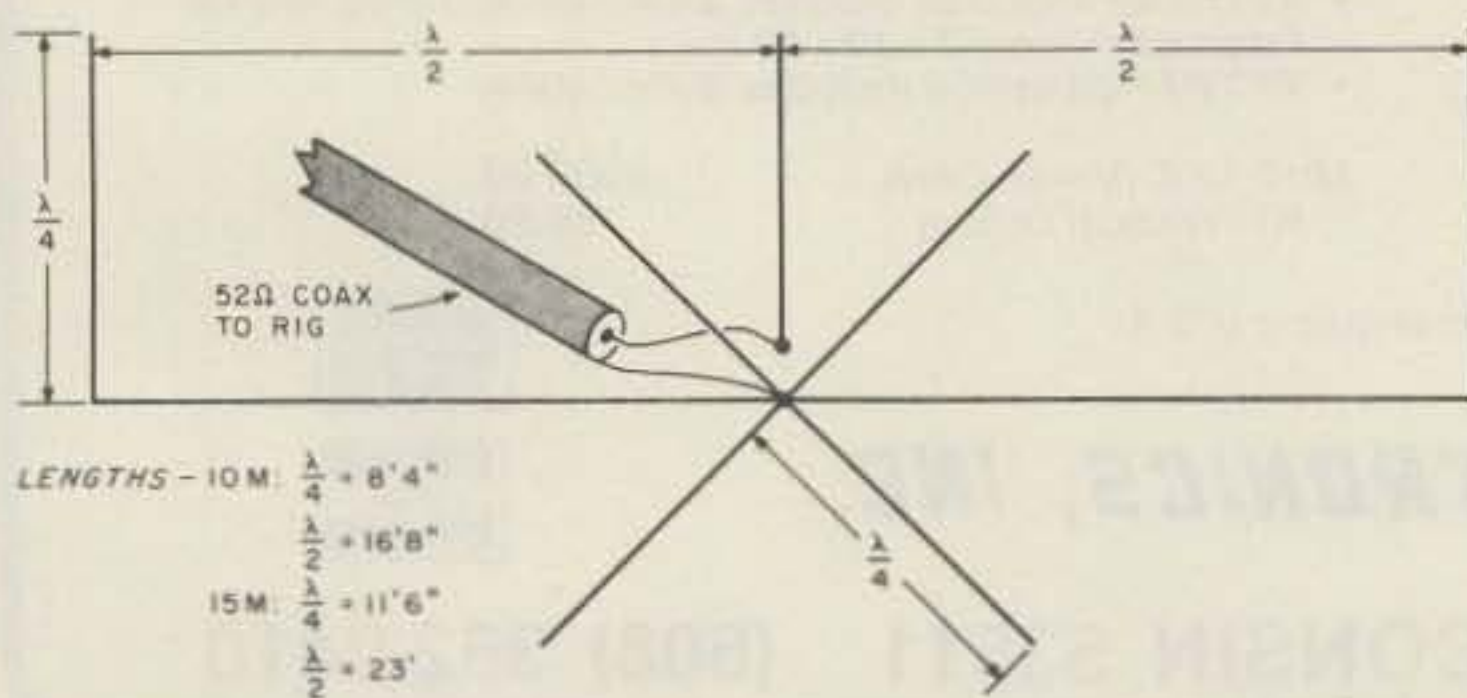

Fig. 1. The upside-down Bobtail curtain. Direction of radiation is broadside. The radials are each one-quarter wavelength long and spaced 90°.

Alan Kaul W6RCL  
 21717 Lassen Ave., Apt. 223  
 Chatsworth CA 91311

The first time W8HXR wrote about the Bobtail curtain in *73 Magazine* (May, 1980, p. 44), I thought it sounded like an interesting antenna but the elaborate matching device was far too elaborate for me to build. The second time he wrote (*73 Magazine*, December, 1980, p. 110) I knew he had something that even I could handle, a top-phased, top-fed array.

The first article discussed voltage-feeding the antenna, that is, feeding the antenna at the bottom (at a voltage point), which required a tuning network. His second article suggested current feed (at the top at a current point which would be a good match for 52-Ohm coax).

The more I looked at the sketch of his design, the more I wondered why the antenna couldn't be turned upside down so it could be bottom fed. After I looked at it long enough, I decided to do just that. I decided on an antenna for 15 meters

which would not use wire for the vertical sections, but tubing, so it would be self-supporting atop the roof. It works better than I expected. See Fig. 1.

I constructed the vertical elements out of 6' lengths of 0.058" wall aluminum tubing (Fig. 2). I used 3/4" o.d. pieces for the three base sections and 5/8" o.d. pieces for the tops. I chose 11'6" as my arbitrary starting point and slipped the smaller diameter tubing inside the larger to a depth of about 6", drilled through one wall of both tubes, and fixed them in place with a sheet-metal screw.

I mounted each of the verticals inside a piece of 3/4" i.d. PVC sprinkler pipe for an insulator and mounted each of those to the top of the house wall (it pays to have a flat roof) so the metal part of the antenna started about 9" above the roof and rose vertically from there. I spaced the three verticals 23' apart (it also pays to have a house 46-feet long on at least one

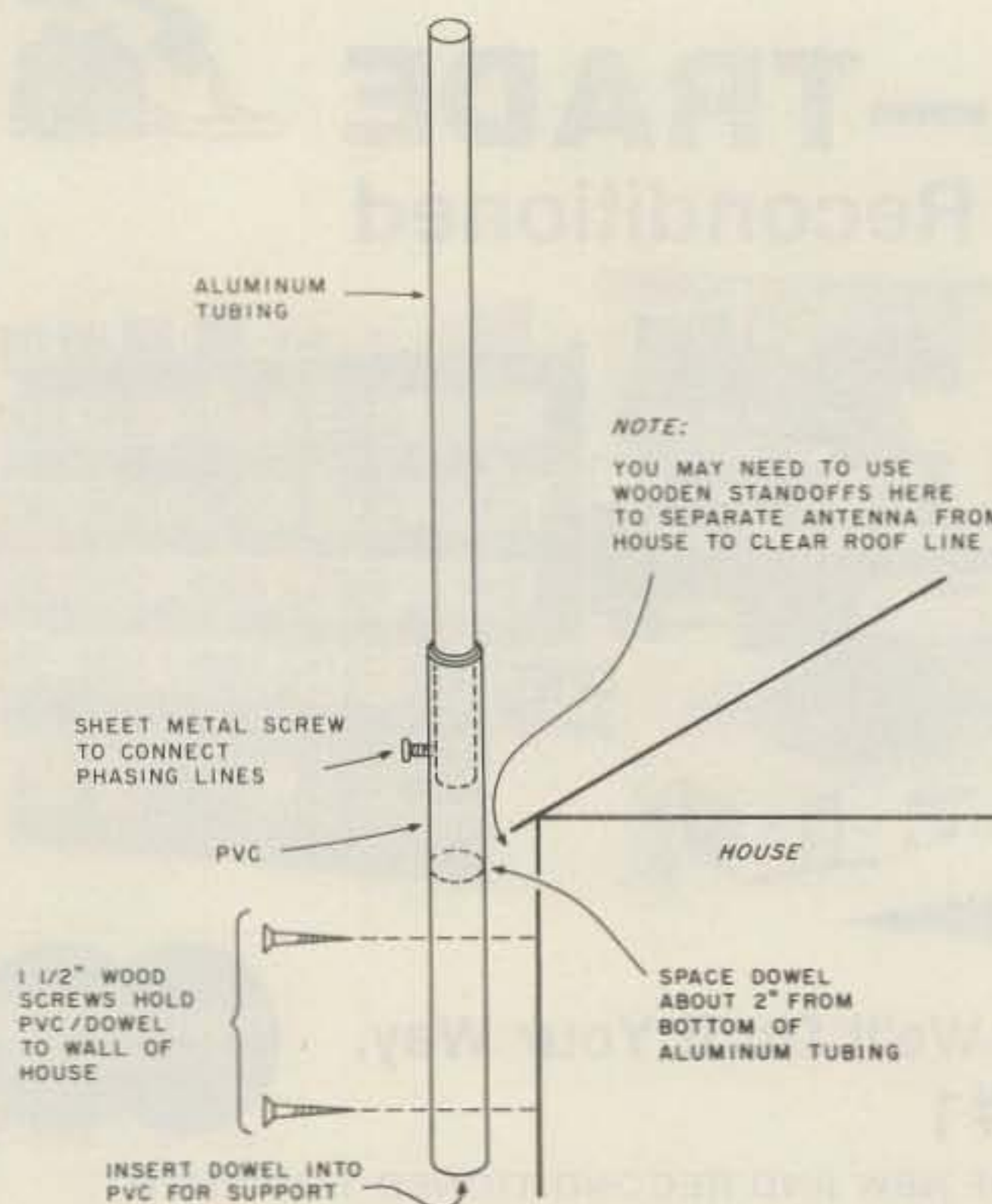

Fig. 2. Vertical element mounting details. Note that this mounting method is not strong enough to support vertical elements for 20 meters.

side). I drilled a hole in each vertical element about 1/2" from the bottom of the aluminum tubing (drill through one wall of the PVC and into one wall of the aluminum). I put a sheet-metal screw into each hole and prepared to attach the coax and the wire phasing lines. Since I made each vertical element 11'6" long and they were 1/4 wavelength long, I doubled the figure to get the half wavelength for spacing.

Since I needed two half-wave phasing lines, I decided to cut a single piece of wire a full wavelength long—46 feet. Each end of the wire attaches to the sheet-metal screws on the two outer verticals. The center conductor of a piece of 52-Ohm coax connects to the sheet-metal screw on the center vertical and the outer shield attaches to the center of the one-wavelength phasing wire. I used another sheet-metal screw through the center vertical PVC to hold the phasing line and ground shield away from the conductor.

Now, remember at this point that I was using the empirical method of antenna construction (cut and try). I knew 11'6" was close to a quarter wave (not taking time to use the formula, length = 243/f(MHz) and to calculate the Q of the tubing). So, for the smoke test I fired up the rig, loaded it up for CW with an swr bridge in the line, and was pleasantly surprised that the vswr was below 1.5 to 1 over the entire 15-meter band.

I tuned around, looking for DX, and I found two countries I had never heard before with the trap vertical I had been using. The two countries were Senegal and the Republic of Volta. Then I heard a lot of South American stations and decided to listen in the phone band.

Call areas 4 and 5 sounded the loudest, and since the three verticals run in a line roughly northeast-southwest, I concluded that W8HXR was right, that the antenna radiates broadside the best.

Later that evening, with Steve AA6AA assisting, I found that his signals were about 15 dB stronger on the Bobtail than on the trap vertical using the S-meter on the TS-120S. He reported that my carrier was about 15 dB stronger on the TS-820 when I transmitted with the Bobtail. Two nights later, when 15 meters sounded dead at about 0230 GMT, I heard VU2USA in Bangalore coming through to answer my call (with about 160 Watts dc input to the TS-120S) and I knew the Bobtail curtain was the antenna for me. His longpath signal confirmed that the antenna worked better than I had ever hoped for.

What I didn't count on was making another discovery while trying to improve the signals on 10 and 20 meters on the trap vertical. I reasoned that if a three-element Bobtail works, a two-element Bobtail also must work. So, I decided to set off empirically (again!) in search of a two-element antenna which would use the Hy-Gain 14AVQ as one element and a vertical piece of wire running to a nearby tree as the other. If W8HXR were right and a 20-meter Bobtail would also work on 10 meters, then all I had to do was modify the 20-meter antenna to get two bands for the price of one.

Since the 14AVQ already had a coax feed at the base, I decided to run a half-wavelength radial on 20 meters (33') to a tie point on top of the roof. I mounted the end of the new radial (with an insulator) to a vent

## MICROWAVE DOWN CONVERTERS

### 2000-2500 MHz

NO CHIP CAPS TO  
MESS WITH!

FEWER COILS  
TO WIND!

Converter Kit.....	35.00
Complete with PC board parts, and ten page instruction brochure	
Printed Circuit Board & 10 page Instruction Brochure.....	15.95
Complete Board.....	60.00
Assembled and tested	
Adjustable Power Supply Kits.....	25.00
Adjustable Power Supply	
Assembled and tested, with case ...	40.00
Yagi Cigar Antenna .....	35.00
MRF 901 transistor.....	3.50
Down Converter, Assembled and tested, encased and waterproofed, with yagi antenna, 50 feet RG59 coaxial cable, and 3 feet RG59 with 75 to 300 ohm adapter, and power supply .....	170.00

TERMS: CASHIER CHECK, MONEY ORDER, BANK CARD, PERSONAL CHECK.

### HIGH FREQUENCY TECHNOLOGY SYSTEMS

10 a.m. - 7 p.m. CST  
Mon. thru Fri.

7308 AMY STREET  
DALLAS, TEXAS 75217  
(214) 343-1017

pipe. I then took a 16'6" piece of wire, soldered one end to the radial end and installed an insulator on the other. I climbed a nearby tree and pulled the new vertical up and affixed the insulator to a tree branch. The test showed the vswr was okay—not over 2 to 1 on the 10- and 20-meter frequencies that I normally operated. Wow! The thought at the time was that I would install a separate 10-meter Bobtail antenna. (I've never gotten around to it.)

But I did decide to make a change in the original 15-meter Bobtail. I concluded that since the two-element antenna worked well on 10 and 20 meters with four radials for each band, I at least ought to try installing radials on the 15-meter antenna. Since I was already on a streak with the 11'6" measurement, I cut four radials and spaced

them 90 degrees apart and attached them to the coax shield at the base of the center vertical. The vswr got even better—no higher than 1.1 to 1 from 21.000 to 21.275 MHz and still below 1.3 to 1 at 21.450 MHz.

What a terrific surprise this whole experiment was. I expected to cut and try various lengths on 15 meters and somehow I lucked out on the first attempt. Then I expected I might run into trouble by adding a Bobtail radiator to the trap vertical—but I didn't. The vswr did go up a little, but nothing unmanageable. And I suspect that if I cut and tried a little harder, I'd be able to solve that, too. So, for an afternoon, a few bucks, and a little inverting of someone else's antenna design, I must say I'm pleased. If you want to write me about the antenna, please include an SASE. ■

# The Micro-Generator

— this diminutive device has a price tag as small as its size

An audio generator is a very handy piece of test equipment to have around the shack. I needed one to meet two design criteria; small size and low cost. I decided that the LM566 voltage-controlled oscillator chip would make an excellent building block since it is cheap, readily available, and requires a minimum number of external components to make it a general-purpose oscillator.

Using National Semiconductor data and making a few calculations, I came up with this circuit (see Fig. 1). This unit is continuously tunable from five Hertz through five hundred kilohertz and has selectable square- or triangle-wave output adjustable from 0 to 5 and 0 to 2.5 volts, respectively. Frequency selection is accomplished by selecting the midband frequency with S1 and then tuning in the desired frequency with

R1. The choices for the mid-band frequencies are 10 Hz, 100 Hz, 1 kHz, 10 kHz, and 100 kHz. R1 will vary the chosen midband frequency from one-half to five times its value.

Construction is not particularly critical. Everything can be bought at Radio Shack, but it is cheaper to shop the 73 ads and use the junk box. Power is supplied by two nine-volt transistor batteries connected in series. The capacitor values should be kept close to the indicated values for frequency readout accuracy. I paralleled junk-box capacitors to obtain the desired values. I labeled R1 as a frequency multiplier control since I wanted to keep the cabinet small. This scheme has accurate frequency readout on all but the high band. If a larger cabinet is used, direct-reading frequency scales for each band will give excellent frequency readout accuracy. Calibration of R1 can be accomplished with a counter or scope. If one is not available, this formula can be

used to determine the frequency for a given value of  $R1: F_o = 2(V_{cc} - V_s)/RCV_{cc}$ .

$V_{cc}$  is the supply voltage (18 volts),  $R$  is  $R1$  plus 2000 Ohms,  $C$  is the capacitor value chosen by S1,  $V_s$  is the voltage from pin five to ground (15.65 volts), and  $R$  should be kept between 2k and 20k. Some of the settings for  $R1$  and the corresponding frequencies are: 8k/center frequency, 18k/one-half the center frequency, and 0 Ohms corresponds to five times the center frequency.

I tested my prototype at a University of Maryland lab where I work. The unit had symmetric waveforms and good frequency readout accuracy through the audio range. The 566 is rated to one megahertz, but the waveforms start to become distorted, and frequency does not follow the formula at frequencies much higher than 100 kHz. Overall performance is excellent. The micro-size audio oscillator should make a nice addition to any test bench. ■

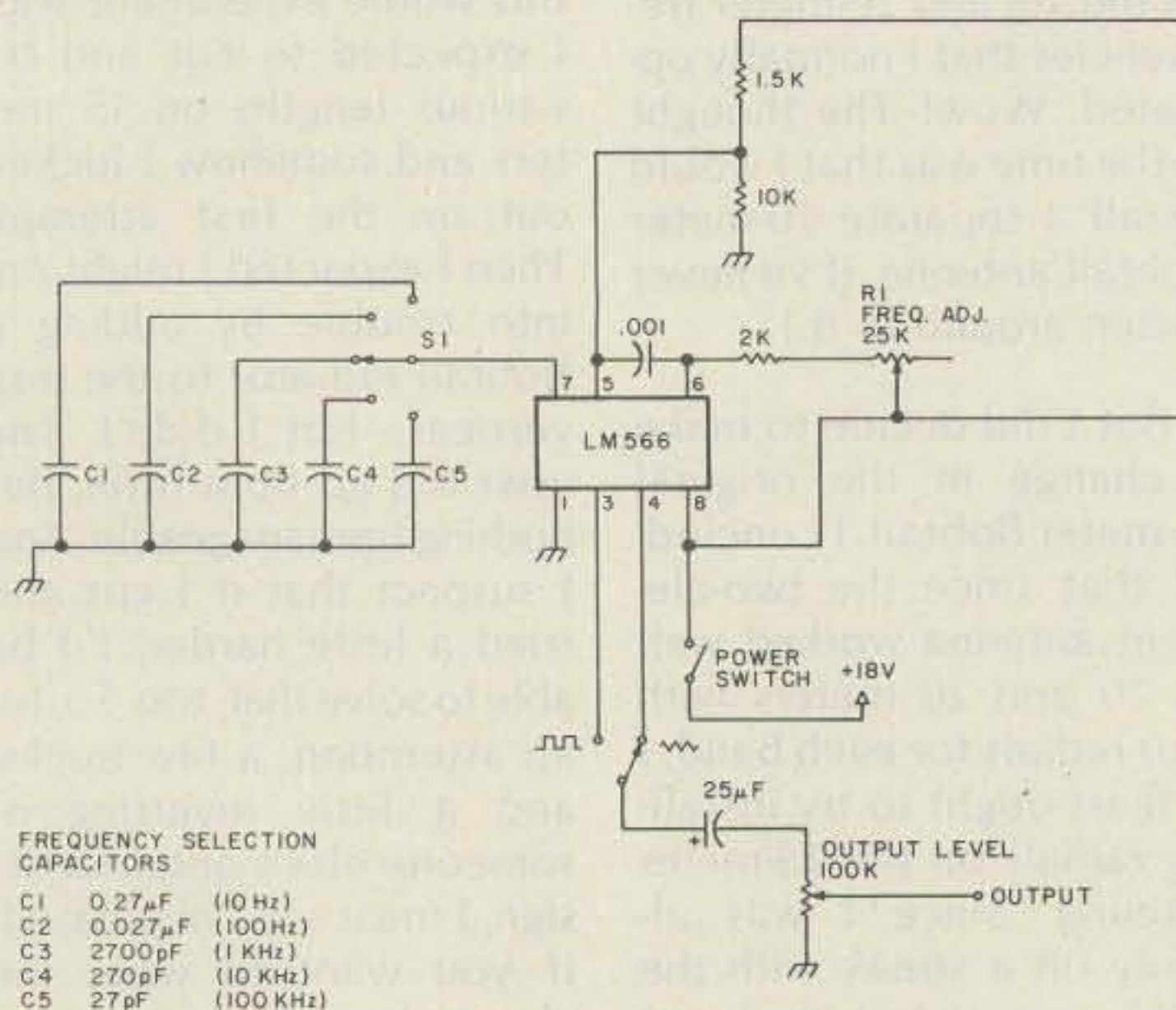
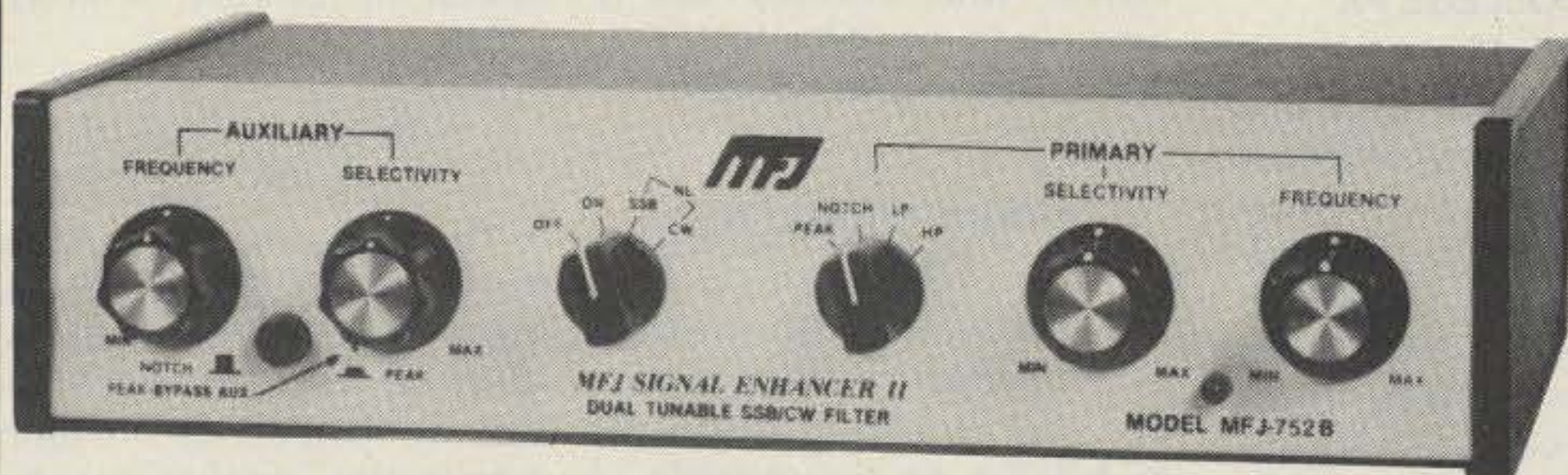

Fig. 1. Schematic for a micro-size audio signal generator.

# MFJ Dual Tunable SSB/CW Filter

lets you zero in SSB/CW signal and notch out interfering signal at the same time. Primary Filter has tunable peak, notch, lowpass, highpass. Auxiliary Filter has peak, notch. Noise limiters for SSB, CW.

*Adjust primary filter for optimum readability. Use auxiliary filter to eliminate interference.*



## \$89<sup>95</sup>

The MFJ-752B Signal Enhancer dual tunable active filter system gives you signal processing performance and flexibility that others can't match.

For example, select optimum Primary Filter mode for SSB signal, zero in with frequency control and adjust bandwidth for best response. Then with the Auxiliary Filter notch out an interfering heterodyne . . . or peak the desired signal.

For CW, peak both Primary and Auxiliary Filters for narrow bandwidth to give skirt selectivity that others can't touch. Or use Auxiliary Filter to notch out a nearby QSO.

The Primary Filter lets you peak, notch, lowpass, or highpass signals with double tuned filter for extra steep skirts. The Auxiliary Filter lets you notch a signal to 70 db. Or peak one with a bandwidth down to 40 Hz.

Tune both Primary and Auxiliary Filters from 300 to 3000 Hz. Vary the bandwidth from 40 Hz to almost flat. Notch depth to 70 db.

MFJ has solved problems that plague other tunable filters to give you a constant output as bandwidth is varied. And a linear frequency control. And a more effective notch filter.

Works with any rig. Plugs into phone jack. 2 watts for speaker. Inputs for 2 rigs. LED for power.

Switchable noise limiter for impulse noise; trough clipper removes background noise.

Simulated stereo feature for CW lets ears and brain reject QRM. Yet hear off frequency calls.

Speaker and phone jacks. Speaker is disabled by phones. OFF bypass filter. 10x2x6 ins. 9-18 VDC or 110 VAC with optional AC adapter, \$7.95.

Every single unit is tested for performance and

inspected for quality. Solid American construction.

Order from MFJ and try it — no obligation. If not delighted, return it within 30 days for refund (less shipping). One year unconditional guarantee.

Order today. Call toll free 800-647-1800. Charge VISA, MC or mail check, money order for \$89.95 plus \$4.00 shipping/handling for MFJ-752B.

Don't wait any longer to tune out interfering signals, order now. Call MFJ or see dealer.

**CALL TOLL FREE . . . 800-647-1800**

Call 601-323-5869 for technical information, order/repair status. Also call 601-323-5869 outside continental USA and in Mississippi.

**MFJ ENTERPRISES, INCORPORATED**  
Box 494, Mississippi State, MS 39762

### RAPID MOBILE CHARGER

The DEB-TED Rapid Mobile Charger is a constant voltage charger that will charge your batteries off a 12 Volt source in 4-6 hours. You may use the charger at all times, this includes transmit and receive periods. It is equipped with a cigarette lighter plug on the input side and the appropriate charging plug on the output side. Models available now for the Kenwood TR2400, Yaesu 207R, Tempo S1, S2, S5 and the Wilson Mark II and IV. Other models available also please call or write for info . . . . . \$34.95.



**NEW AC VERSION NOW AVAILABLE**

### VEHICLE INTRUSION ALARM

An easy to assemble and install kit that offers options not normally found in other alarm systems. Hidden switch mounts under the dash. Kit has provisions for sensors and remote control switch. Programmable time delays for exit, entry and alarm periods. Basic hook-up utilizes dome light circuit activating when doors are opened. The alarm will drive a siren or pulse horn at a 1HZ rate. Not prone to false alarm do to reliable CMOS circuitry. No external switch required! Complete kit with easy to follow instructions and diagrams . . . . . \$12.95  
Wired and Tested . . . . . \$19.95

### "SEE THE WORKS" CLOCK

OUR EASIEST CLOCK TO ASSEMBLE!

6 Digits 12 or 24 Hour Format Clock rests between two pieces of clear plexiglas A GREAT CONVERSATION PIECE! Kit is complete including top

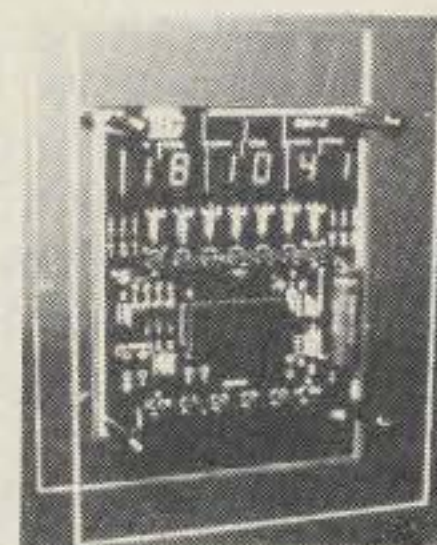

quality PC board, all components pre-cut and drilled plexiglas and all hardware. \$29.95  
Wired and Tested . . . . . \$39.95

SPECIAL



SPECIAL

MODEL 5314 CLOCK KIT 12 or 24 hour format 6 large "5 Digits. Kit is complete with all parts, pc board and custom designed cabinet. (specify white or black). . . . . \$29.95



**DEBCO ELECTRONICS**  
P.O. BOX 9169  
CINCINNATI, OHIO 45209

- Add 5% Shipping for U.S. & Canada
  - All foreign orders add 10%
  - COD orders add \$1.40
  - Master Charge and Visa Welcome
  - Orders under \$20.00 add \$1.00 handling
  - Ohio residents add 5½% Tax
- CALL OR WRITE FOR CATALOG

# SOCIAL EVENTS

Listings in this column are provided free of charge on a space-available basis. The following information should be included in every announcement: sponsor, event, date, time, place, city, state, admission charge (if any), features, talk-in frequencies, and the name of whom to contact for further information. Announcements must be received two months prior to the month in which the event takes place. They should be sent directly to Editorial Offices, 73 Magazine, Pine Street, Peterborough NH 03458, Attn: Social Events.

## MAPLE RIDGE BC CAN JUL 4-5

The Maple Ridge ARC will hold its Hamfest '81 on July 4-5, 1981, at the Maple Ridge Fairgrounds, located 30 miles east of Vancouver, Maple Ridge BC. Registration for hams is \$4.50, a program with a ticket for a drawing is \$2.50, and the dinner and dance is \$10.00. Registration for non-hams over 12 years old is \$2.00; non-hams under 12 will be admitted free. There will be food and camper space (without hookups) available. Features will include prizes, a swap and shop, a bunny hunt, a ladies' program, and much more. Talk-in on 146.34/.94 and 146.19/.79. For more information and advanced registration, contact Bob Haughton VE7BZH, Box 292, Maple Ridge BC V2X 7G2.

## OAK CREEK WI JUL 11

The South Milwaukee Amateur Radio Club, Inc., will hold its annual swapfest on Saturday, July 11, 1981, at the American Legion Post #434, 9327 South Shepard Avenue, Oak Creek WI. Admission is \$2.00 and includes a happy hour with free beverages. Prizes include a \$100 first prize and a \$50 second prize. Activities will begin at 7:30 am and continue until 5:00 pm. Parking, a picnic area, hot and cold sandwiches, as well as liquid refreshments, will be available on the grounds. Overnight camping is also available. Talk-in on 146.94. More details, including a map, may be obtained from The South Milwaukee Ama-

teur Radio Club, PO Box 102, South Milwaukee WI 53172.

## STATE COLLEGE PA JUL 11

The Nittany Amateur Radio Club will hold its annual Mount Nittany Hamfest on Saturday, July 11, 1981, at the HRB-Singer, Inc., picnic grounds in State College PA. Registration and admission is \$2.00 in advance with no charge for spouse and children; \$3.00 at the gate. Flea market space is \$3.00 in advance; \$5.00 on-site. Along with the flea market, features will include an auction, dealer displays and sales, door prizes including a synthesized 2m handheld transceiver, and free parking. Refreshments will be available. The Central Pennsylvania Festival of the Arts will be taking place at Penn State University the same weekend. Talk-in on .16/.76 and .25/.85 from I-80 and major central Pennsylvania routes; talk-in on .52 for local directions. For further information, write Mount Nittany Hamfest, NARC, Box 614, State College PA 16801, or call Dave Buckwalter N3BBH at (814)-234-0759.

## PITTSFIELD MA JUL 11-12

The Northern Berkshire Amateur Radio Club will hold its annual hamfest on Saturday and Sunday, July 11-12, 1981, at the Cummington Fairgrounds, Cummington MA (off Rte. 9). General admission is \$3.00 in advance, and \$4.00 at the gate. Family admission is \$5.00 in advance and \$6.00 at the gate. Dealers are welcome. Talk-in on 146.31/.91. For further information, contact Herb Blake, PO Box 567, North Adams MA 01247.

## DUNSEITH ND JUL 11-12

The 18th annual Peace Garden Hamfest will be held July 11th and 12th on the American side of the International Peace Gardens (which are located 13 miles north of Dunseith ND). Registration will be at the Lodge from noon to 6:00 pm on Satur-

day and from noon to 3:00 on Sunday. There will be swap tables and other activities on Saturday, followed by the dance at 9:00 pm. There will be breakfast Sunday morning for all those registered, followed by TX hunts and other activities. The general assembly will be Sunday afternoon. For more information, write Ramsey County Amateur Radio Club (WD0FFQ), Box 5, Devils Lake ND 58301.

## MOUNT SINAI LI NY JUL 12

Radio Central ARC will hold its 3rd annual hamfest on Sunday, July 12, 1981, from 9:00 am to 4:00 pm on the grounds of Mount Sinai Elementary School, Rte. 25A, Mount Sinai LI NY. Admission for buyers is \$1.50; XYLs and harmonics will be admitted free. Sellers' spaces are \$3.00. There will be door prizes, a grand prize drawing at 3:00 pm, a contest, and refreshments. Talk-in on 145.15 (WA2UEC) and 146.52. For more information, contact Lew Franklin at (516)-265-5614.

## MCKEESPORT PA JUL 12

The Two Rivers Amateur Radio Club, Inc., will hold its 17th annual hamfest on Sunday, July 12, 1981, at the Pennsylvania State University McKeesport Campus, McKeesport PA, from 8:00 am to 4:00 pm. The indoor hamfest will be in the Frable Building and the outdoor event will be in the main parking lot. There is no admission charge. Inside setup is \$3.00 per table and outside setup is free. Hot food and cold drinks will be available and door prizes will be awarded throughout the day. There are forums and displays planned. Our location at the corner of Eden Park Boulevard and University Drive in the Renziehausen Park Area is easily accessible from most major routes. Talk-in on 146.22/.82.

## ALEXANDER NY JUL 12

The Genesee Radio Amateurs, Inc., will hold the first annual ARRL-approved Batavia Hamfest on Sunday, July 12, 1981, from 7:00 am to 6:00 pm at Alexander Firemen's Grounds, Rte. 98 (nine miles south of Batavia), Alexander NY. Admission is \$2.00 in advance, \$3.00 at the gate, and \$1.00 for the flea

market. There will be many prizes, a large exhibit area, programs, YL activities, contests, and plenty of food. Overnight campers are welcome. A boat anchor auction will take place at 4:30 pm. Talk-in on 146.04/.64 (W2RCX), 144.71/5.31, and .52. For more information and advance tickets, send an SASE to GRAM, Inc., Box 572, Batavia NY 14020.

## INDIANAPOLIS IN JUL 12

The Indianapolis Amateur Radio State Convention and Hamfest will be held on Sunday, July 12, 1981, at the Marion County Fairgrounds. For further information, write Indianapolis Amateur Radio Association, Box 11086, Indianapolis IN 46201.

## WILKES-BARRE PA JUL 12

The Broadcasters' Amateur Radio Club will hold its fourth annual hamfest on July 12, 1981, from 9:00 am to 4:00 pm at Pocono Downs Race Track, Rte. 315, 1½ miles north of Wilkes-Barre PA. Admission is \$3.00, XYLs and children will be admitted free, and there will be no additional charge for sellers. Gates will open at 8:00 am for setup. There will be unlimited outdoor and indoor space, refreshments, prizes, a free FM clinic, and ac power available. Talk-in on 147.66/.06 and 146.52. For more information, contact Charles Baltimore WA3NUT, BARC, 62 S. Franklin Street, Wilkes-Barre PA 18773, or phone (717)-823-3101.

## GLACIER NATIONAL PARK MT JUL 17-19

The Great Falls Area Amateur Radio Club will sponsor the Glacier-Waterton International Hamfest on July 17-19, 1981, at Three Forks Campground, Highway 2 between East and West Glacier. Features will include forums, technical presentations, exhibits, demonstrations, and ladies' and children's activities, including horseback riding. Until July 7, 1981, pre-registration is \$6.00; after that, \$7.00. Campsites are \$5.00 for a full hookup and \$4.00 without. For more information, contact Glacier-Waterton Hamfest, Shirley Smith, Secretary, 1822 14th Avenue South, Great Falls MT 59405, or phone (406)-452-1886.



**HARBOR SPRINGS MI  
JUL 18**

The Straits Area Amateur Radio Club will hold its annual hamfest on July 18, 1981, at the Harbor Springs High School, Harbor Springs MI, from 9:00 am to 4:00 pm. Donations are \$2.00 at the door and table space is \$2.50. Sellers will be admitted at 8:00 am and tables may be reserved in advance. Features include lunch served from 11:00 am to 1:00 pm, one main door prize and several smaller prizes hourly, free overnight parking for self-contained RVs, and refreshments available all day. Talk-in on .52/.52 and 146.07/.67. For more details, contact Mr. Bernie Slotnick KB8RE, 630 Ann Street, Harbor Springs MI 49740, or phone (616)-526-5614.

**MANCHESTER NH  
JUL 18**

The New Hampshire FM Association will hold an electronic flea market on Saturday, July 18, 1981, at the Manchester Municipal Airport, Manchester NH, beginning at 9:00 am. General admission will be 50¢ per person; sellers: \$2.00. Sellers should bring their own tables or tailgate. Commercial displays are welcome. Refreshments will be available and door prizes will be awarded. Talk-in on 146.52 FM and 124.9 AM. For further information, contact Dick DesRosiers W1KGZ at (603)-668-8880, or Doug Aiken K1WPM, 30 Meadowglen Drive, Manchester NH 03103, (603)-622-0831.

**CHARLESTON SC  
JUL 18-19**

The Charleston Amateur Radio Society, Inc., will hold its eighth annual Charleston Hamfest on July 18-19, 1981, at the Omar Shrine Temple, 44E Battery Street, Charleston SC. There will be overnight security guards and refreshments available. For more information, contact the Charleston Hamfest Committee, PO Box 30643, Charleston SC 29407, or phone (803)-747-2324/496-3660.

**LOUISVILLE OH  
JUL 19**

The Tusco Amateur Radio Club and the Canton Amateur Radio Club will present the 7th annual Hall of Fame Hamfest on Sunday, July 19, 1981, at the Nimishillen Grange, 6461 Easton Street, Louisville OH. Admission is \$2.50 in advance and \$3.00 at the gate per person. People under 16 will be admitted free. There will be a flea market, food, XYL activities, forums, contests, distributors, and awards. For qualified dealers of electronic and ham-radio-related products, 30" x 8' tables are available in an indoor display

area (with 110-V ac) on a reserved basis at \$3.50 each. Talk-in on 146.52/.52, 146.19/.79, and 147.72/.12 (W8ZX or W8AL). For table reservations or tickets, send a check payable to Hall of Fame Hamfest, 10877 Hazelview Avenue, Alliance OH 44601, or phone (216)-821-8794.

**BOWLING GREEN OH  
JUL 19**

The 17th annual Wood County Ham-A-Rama will be held on July 19, 1981, at the Bowling Green Fairgrounds, Bowling Green, Ohio. Gates open at 10:00 am; there will be free admission and parking. Trunk-sale space and food will also be available, as well as prizes. Talk-in on .52 (K8TIH). Tickets are \$1.50 in advance and \$2.00 at the door. For information, write to: Wood County ARC, Eric Willman, 14118 Bishop Rd., Bowling Green OH 43402. Advance table rental is available to dealers only (\$3.00 per table, payable in advance). Saturday setup will be available. Send checks for tables to: Bill Wilkins, 16220 Portage Rd., Bowling Green OH 43402.

**WRIGHTSTOWN NJ  
JUL 19**

The 3rd annual West Jersey Radio Amateurs Hamfest will be held on Sunday, July 19, 1981, from 9:00 am to 4:00 pm at McGuire Air Force Base, Wrightstown NJ. Admission is \$2.50 and spouses and children will be admitted free. Tailgate or table space is \$2.50 per space; bring your own table. Refreshments and activities, including contests and films, will be available. Door prizes will be awarded continuously. Talk-in on 146.52, 147.15, and 145.47. Advance tickets and information are available from any club member or send an SASE to Bill Luebke W2LCC, 116 Country Farms Road, Box 140, Marlton NJ 08053, (609)-983-8844 (between 6:00 pm and midnight).

**OKLAHOMA CITY OK  
JUL 24-26**

The Central Oklahoma Radio Amateurs will hold the West Gulf Division ARRL Convention and "Ham Holiday" on July 24-26, 1981, at the Myriad Convention Center, Oklahoma City OK. Pre-registration will be \$6.00



**Long Island  
HAMFEST**

Radio Central ARC will hold its 3rd Annual Hamfest on Sunday, July 12, 1981, from 9 a.m. to 4 p.m. on the grounds of Mt. Sinai Elementary School, Route 25A, Mt. Sinai, Long Island, New York. Door prizes, food, a grand drawing at 3 p.m. and a CW contest are featured. Buyers \$1.50, XYL and Harmonics free, sellers \$3.00 per space. Talk-in on WA2UEC repeat 145.150 or 146.520 Simplex.

(516) 265-5614

for further information  
Lew Franklin WB2VJO  
6 Jackson Street  
Nesconset, N.Y. 11767

**BRIGHT  
FREQUENCY  
COUNTERS**

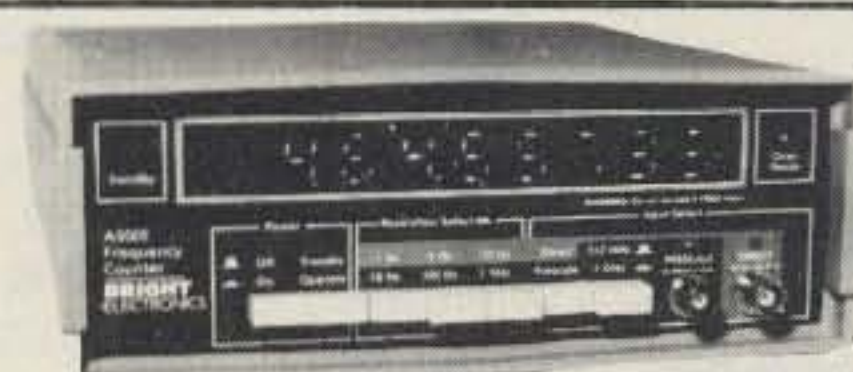

WITH VFA

**A500 \$229.00 (complete with accessories) Extended range 1.1Ghz and Commercial versions available**

- Measure all bands
- Use with any transmitter
- High accuracy 10MHz timebase
- Fully tested & calibrated
- Voice Frequency Annunciation

\*(VFA) option now available. (Repeater operators and sightless hams call for details.)

Remember the days we used to wonder what frequency we were on? Then, with Collins and Drake, frequency could be read to 1KC. Times have changed and now we say Hertz. today with a BRIGHT counter you can be on freq to 1Hz at HF or 10Hz at VHF/UHF. BRIGHT counters are more than their name implies. BRIGHT invests in high performance components. The A500 series is so sensitive, it will read a 2 meter hand-held from 20' away or a 100 watt HF rig from 50' without any direct connection.

Check these features ● 10MHz shielded timebase to reduce interference ● Easy operation with color keying and input select indicators ● 3 sample rates (gate -times) ● 8 big digits, plus overflow ● Full factory testing ● NBS traceable calibration.

Parameter	A500	A500E
Frequency range	50Hz-500Mhz	50Hz-1100MHz
Sensitivity	10Mv-50Mv	10Mv-100Mv
Accuracy (17-30°)	.1PPM	.1PPM
Timebase type	Proportional oven	Proportional oven
Price	\$229.00	\$259.00

Be bright, buy a BRIGHT counter.

OPTION: Nicad Pack (29.95).  
Commercial models: A500C (295.00)  
A500EC (349.00)

TERMS: MC, VISA, AMEX, UPS, COD. Add 7.50 shipping.  
WE REPAIR DSI COUNTERS.  
WRITE FOR INFO PACKAGE.

**BRIGHT** ✓428  
**ELECTRONICS**

P.O BOX 76972  
ATLANTA, GA 30328  
TO ORDER CALL 404-952-0968

if received before July 17th; after that, registration will be \$7.00. The program will include an ARRL forum, technical talks, a QCWA breakfast, and a Wouff Hong initiation. In addition, a full program is scheduled for the ladies. Other events will be a Saturday evening banquet with speaker Harry Dannals, President of the ARRL, Sunday noon drawings for the Icom 260 pre-registration and TS-830S grand prizes, plus others, and an indoor exhibitor and swapfest area. Tables are free to non-commercial registrants. Mail your registration to CORA, PO Box 20118, Oklahoma City OK 73120.

#### **WELLINGTON OH JUL 25**

The Northern Ohio Amateur Radio Society will hold its 4th annual ARRL-approved NOARSfest on Saturday, July 25, 1981, from 7:00 am to 5:00 pm at the Lorain County Fairgrounds, one mile west of Rte. 58 on Rte. 18, Wellington OH. Admission tickets are \$2.50 in advance, \$3.00 at the gate, and are good for all prize drawings. Tickets for prize drawings only are available by mail or at the gate for \$1.00 each. Children under 12 will be admitted free. There will be plenty of food, free parking, a large indoor exhibit hall for dealers, a huge blacktopped midway for flea market and trunk sales, and free camping (no hookups) outside the gates on Friday night. The gates will open at 6:00 am for sellers and dealers. A Ten-Tec Delta transceiver and a Den-Tron GLA-1000B linear amplifier will be among the prizes awarded. For advance registration, information, or tickets, write NOARSfest, PO Box 354, Lorain OH 44052.

#### **OLIVER BC CAN JUL 25-26**

The Okanagan International Hamfest will be held on July 25-26, 1981, at a new location, Oliver Centennial Park, 6th Street, Oliver BC. Registration is Saturday, July 25th, at 9:00 am (PDT). There will be activities from 1:00 pm Saturday to 2:30 pm Sunday. Also on Sunday there will be a potluck luncheon at noon as well as entertainment and bunny hunts. YLs are asked to bring their hobbies for display or sale and also their flea-market items. Talk-in on .34/.94 and .76/.76. For addition-

al information, contact John Juul-Andersen VE7DTX, 8802 Lakeview Drive, Vernon, BC V1B 1W3, or Lota Harvey VE7DKL, 584 Heather Road, Penticton, BC V2A 1W8.

#### **ANDERSON IN JUL 26**

The MCARC Hamfest will be held on Sunday, July 26, 1981, from 8:00 am to 3:30 pm (vendors' setup is at 7:00 am) at the National Guard Armory, N 109 Bypass, Anderson IN. Ample parking and refreshments will be available. Advance tickets are \$2.50 each; at the door, \$3.50. Spaces with tables are \$2.50 each; without tables, \$1.75 each. First prize is an Icom IC-2AT. Talk-in on 146.22/.82 and 146.52/.52. For advance tickets and space, send your check to Everett G. Riley, Activities Chairman, RR 4, Box 354, Alexandria IN 46001.

#### **NASHVILLE TN JUL 26**

The Radio Amateur Transmitting Society (RATS) will hold the Nashville Hamfest on Sunday, July 26, 1981, at the National Guard Armory, Sidco Drive, Nashville TN. Doors will open at 8:00 am. Admission is \$2.00 and tables are \$5.00 each. Refreshments will be available. Talk-in on .90/.30. For more info, contact RATS, PO Box 2892, Nashville TN 37219.

#### **CENTERVILLE MI JUL 26**

The Amateur Radio Public Service Association will hold a swap and shop on July 26, 1981, at the St. Joseph County Fairgrounds, M-86, Centerville MI. Admission at the door is \$2.00 and tables are \$3.00. Gates will open at 7:00 am. Talk-in on 146.52.

#### **WEST FRIENDSHIP MD JUL 26**

The Baltimore Radio Amateur Television Society (BRATS) will hold its annual Maryland Hamfest on Sunday, July 26, 1981, at the Howard County Fairgrounds, Route 144 at Route 32, adjacent to Interstate 70, about 15 miles west of Baltimore, in West Friendship MD. Tickets are \$3 (XYLs and children under 12 will be admitted free), tailgating spaces are \$2, and tables are \$5 each. For additional information, write BRATS, Box 5915,

Baltimore MD 21208, or call Mayer W3GXX at (301)-655-7812.

#### **WEST YELLOWSTONE MT JUL 31-AUG 2**

The WIMU (WY-ID-MT-UT) Hamfest will be held from July 31-August 2, 1981, in West Yellowstone MT. Lodging and campgrounds are available. There will be product displays as well as activities for YLs and harmonics. Talk-in on 146.52, 3.920 or 1.250. For further information, contact "WIMU '81," c/o Les Belyea N7AIK, Box 327, Belgrade MT 59714.

#### **JACKSONVILLE FL AUG 1-2**

The Greater Jacksonville Hamfest Association will hold the ninth annual Jacksonville Hamfest and Northern Florida Section ARRL Convention on August 1-2, 1981, at the Orange Park Kennel Club, located at the intersection of I-295 and US 17 just south of Jacksonville. Advance registration is \$3.50 and registration at the door is \$4.00. Swap tables are \$12.00 per table for both days (no one-day tables). All events will be held indoors and will include a full slate of programs as well as meetings of several statewide and regional organizations. Door prizes will be awarded at both hourly and grand prize drawings. Plenty of free parking will be available. The headquarters hotel is the Best Western First National Inn just across from the hamfest site on US 17. Special hamfest rates will be available. Talk-in on 146.16/.76 and 146.07/.67. For advance registration, hotel rates, or more information, contact Robert J. Cutting W2KGI, 1249 Cape Charles Avenue, Atlantic Beach FL 32233, or Andy Burton, Jr., WA4TUB, 5101 Younis Road, Jacksonville FL 32218. For swap tables, contact WA4TUB at the address listed above.

#### **ESCANABA MI AUG 1-2**

The Delta County Repeater Association will hold the 33rd annual Upper Peninsula hamfest on August 1-2, 1981, at the Flat Rock Township Hall, Escanaba MI. Registration is \$2.00. The many activities will include a DX forum, an ARPSC workshop, a satellite-TV seminar, net meetings, and a swap and shop. There will be prizes

and a banquet on Saturday evening. For more information, contact Aileen Gagnon WA8DHB, co-chairman of the prize committee, Kipling Loc., Mtd. Rte., Gladstone MI 49837.

#### **ANGOLA IN AUG 2**

The Steuben County Radio Amateurs will hold their 23rd annual FM Picnic and Hamfest on Sunday, August 2, 1981, at Crooked Lake, Angola IN. Admission is \$2.50. There will be prizes, picnic-style BBQ chicken, inside tables for exhibitors and vendors, and overnight camping (with a fee charged by the county park). Talk-in on 146.52 and 147.81/.21.

#### **BELVIDERE IL AUG 2**

The annual Big Thunder ARC Hamfest will be held on August 2, 1981, at the Boone County Fairgrounds, Highway 76. Advance tickets are \$2.00. Indoor tables are available at a nominal cost and there will be acres of outdoor space available free. Camping is permitted. For advance tickets, send an SASE and check to Bob Anderson K9DCG, 910 W. Locust Street, Belvidere IL 61008.

#### **COLBY KS AUG 2**

The first Northwest Kansas Amateur Radio Swap Meet will be held on Sunday, August 2, 1981, beginning at 9:00 am at the Community Building, Colby KS. Admission is \$1.00 and tables are \$1.00 each (same for dealers). An auction will be held at 2:00 pm. Other features will include a TVRO demonstration, activities for the ladies, and old-fashioned informal swapping, selling, and visiting. Lunch will be available. Talk-in on 146.22/.82 and .52/.52. For more information, contact WA0GBN or KA0FBQ.

#### **MOBERLY MO AUG 2**

The third annual North Central Missouri Hamfest will be held on Sunday, August 2, 1981, at the air-conditioned Municipal Auditorium, 201 West Rollins, Moberly MO. doors open at 9:00 am. Tickets are \$1.50 in advance and \$2.00 at the door. Features include commercial dealers, a flea market (no charge for tables), an ARRL display, exhib-

its, prizes, women's programs, a special forum with Bob Heil K9EID on CB-to-10-meter conversions, and a buffet lunch. Drinks and hot dogs will be available all day. Talk-in on 147.69/.09, 146.52, and 3963. For more information, contact Charles Coy WB0ENV, 601 McKinley, Moberly MO 65270.

#### LEVELLAND TX AUG 2

The Hockley County Amateur Radio Club and the Northwest Texas Emergency Net will sponsor their 16th annual picnic and swapfest on Sunday, August 2, 1981, beginning at 8:00 am at the city park in Levelland TX. This event is for the entire family.

Bring your own picnic basket for lunch at 12:30. A \$3.00 registration is requested. There will be swapping all day, with tables provided. Talk-in on .28/.88 (WR5AFX).

#### BURLINGTON VT AUG 8-9

The Burlington Amateur Radio Club will hold its annual International Hamfest on August 8-9, 1981, at the Old Lantern Campground, Charlotte VT (14 miles south of Burlington, just off Rte. 7). Admission is \$4.00 (US funds). Planned events include a flea market, commercial exhibits, a CW contest, a tower-raising contest, an HT transmitter hunt, and the traditional

Canadian-American tug-of-war. Talk-in on .34/.94. For more information, contact Hap Preston W1VSA, PO Box 312, Burlington VT 05402. For campground reservations, call Old Lantern Campground at (802)-425-2120.

#### WILLOW SPRINGS IL AUG 9

The Hamfesters Radio Club will hold its 47th annual hamfest on Sunday, August 9, 1981, at Sante Fe Park, 91st and Wolf Road, Willow Springs IL.

#### MONTGOMERYVILLE PA AUG 9

The Mid-Atlantic Amateur Radio Club will hold its annual J.B.M. Hamfest on Sunday, Au-

gust 9, 1981, from 9:00 am to 4:00 pm, rain or shine, at the Budco 309 Drive-In Theatre, 1/4 mile north of the intersection of Rtes. 63 and 309, Montgomeryville PA (6 miles north of the Fort Washington interchange of the Pennsylvania Turnpike). Admission is \$2.50 with \$1.00 additional for the first tailgate space and 75¢ for each additional space. Tailgate setup begins at 8:00 am. Featured will be an Alternate Energy Fair which will include exhibitions of various energy resources, as well as door prizes and a flea market for both the hamfest and the Alternate Energy Fair. Refreshments

*Continued on page 108*

## HAM HELP

I need a manual or schematic for a Hystar model 100 10-meter transceiver imported from Korea by the Vendetta Corp., Houston TX. This is an AM/SSB rig based on a 40-channel CB unit. I will pay all associated costs.

**Bruce Pickering N5CBK**  
5705 Firewood Dr.  
Arlington TX 76016

I recently acquired a Digital model PDP8/E with a teletype model with a paper tape punch and reader. Any help on how to use this or books on it would be appreciated. (Digital seems impractical to try to talk to!)

**J.E. Ansley K8ONM**  
22514 East 9 Mile Road  
St. Clair Shores MI 48080

I would like references or info about converting a CB set to 10 meters, a TRC-458 Navaho from Realistic. Any help would be appreciated.

**Michael C. Christ XE1MD**  
Cda Norena 40  
Mixcoac D.F. 19  
Mexico City, Mexico

I am in need of a schematic and operations manual for a Precision Instruments model PI-2107 seven-channel instrumentation tape recorder. Please call or write if any help is

available. I'll pay mailing and reasonable reproduction costs.

**John C. Street KA4EPQ**  
PO Box 275  
Niceville FL 32578  
(904)-678-5410

I would like to buy, borrow, or copy a manual for the BC-654A. I am willing to pay for postage, Xeroxing, etc. I am also looking for an RS-1 or RS-6 radio.

**Gary Cain W8MFL**  
2464 Hand Rd.  
Niles MI 49120

I am looking for a circuit and/or service manual for a Northern Radio Co., Inc., frequency shift converter type 107, model 2, serial no. 1273. Can anyone help?

**Lionel L. Sharp VK4NS,**  
19 Kelso Street  
Chermside, Queensland 4032  
Australia

I need an operating manual and/or schematic for a Kepco power supply, model #SC-18-1M, range 0-18 V, 1 Amp, fully regulated. I will pay for a copy or will copy and return original. Thank you.

**Geoff Chadwick**  
Box 361  
Red Lodge MT 59068

I lost everything—QTH, rigs, logs, QSLs—in a fire on Jan. 9, 1981. I would appreciate dupe

QSLs from phone/CW stations worked since Dec. 13, 1979. I also need help to get back on HF.

**Art Hadley WA4UDE**  
PO Box 134  
Prince George VA 23875

Help! I need a schematic diagram/owner's manual for a Gonset 2-meter rf power amplifier using a 4X150A tube. I will pay copying and postage fees.

**Ruth Valentino KA8GVY**  
6234 Mentor Pk. Blvd.  
Mentor OH 44060

I would like to contact anyone concerning the construction of or conversion of commercially-available converters to 1691 MHz for the reception of WEFAX GOES weather satellites. Thank you for your time and assistance.

**Charles T. Huth WB8NLM**  
146 Schonhardt Street  
Tiffin OH 44883

I am in need of a Collins 32S1 transmitter in any condition. Please state condition and price.

**Herman F. Schnur**  
115 Intercept Ave.  
North Charleston SC 29405

I am in need of a schematic for a Hallicrafters AM/short-wave receiver (late 40s, early 50s), model number TW-2000. The radio is powered by battery or ac. I would be happy to pay for a copy of such.

**Chuck Dicken WD8ICP**  
1627 Juniper Drive  
Bowling Green OH 43402

I need a manual or schematic for a Hammarlund HQ-170A and a Heath VFO-1. I will be glad to pay for copying costs and postage. Thanks.

**Richard Smith**  
214 Wittel Avenue  
Opelika AL 36801

I wonder if any readers could tell me what area in Boston sells nuts, bolts, sheet aluminum, and similar items—roughly equivalent to Canal Street in New York.

**Neil Johnson W2OLU**  
Box 585  
South Orleans MA 02662

I am in serious need of a Collins mechanical filter number F455B08. I am willing to pay any reasonable price.

**Tim Goad KA9AMO**  
RR 2  
Princeton IN 47670

I need a service manual for a Hallicrafters S-120 receiver and a National NCX-3 transceiver. I will pay for copying and postage.

**A. Hoogenraad WB0RAF**  
7204 E. 28th St.  
Kansas City MO 64129

All hams who are also broadcast engineers are invited to join the Society of Broadcast Engineers chapter-of-the-air. The net is called every Thursday evening at 7:00 pm Mountain Time on 7285, then moved off frequency. SBE membership is not required.

**Chuck Kelly WB9GOE**  
Durango CO

**MAKE  
MONEY...  
SELL  
73 MAGAZINE**

Selling 73 Magazine, the ham radio magazine that offers quality and quantity, brings the ham into your store. Once through the door you can sell him anything.

Our dealers are telling us that "73" outsells them all...so call today and join the dealers who make money with 73 Magazine.

For information on selling 73 Magazine call 603-924-7296 and speak with Ginnie Boudrieau, our Bulk Sales Manager. Or write to her at:

**73 MAGAZINE**  
80 PINE STREET  
PETERBOROUGH NH 03458

**Radio Bookshop**

**NEW** from **73**

**THE  
NEW  
WEATHER  
SATELLITE  
HANDBOOK**



**BY DR. RALPH E. TAGGART**

Here is the completely updated and revised edition of the best-selling **Weather Satellite Handbook**—containing all the information on the most sophisticated and effective spacecraft now in orbit. Dr. Taggart has written this book to serve both the experienced amateur satellite enthusiast and the newcomer. The book is an introduction to satellite watching, providing all the information required to construct a complete and highly effective ground station. Not just ideas, but solid hardware designs and all the instructions necessary to operate the equipment are included. For the thousands of experimenters who are operating stations, the book details all procedures necessary to modify their equipment for the new series of spacecraft. Amateur weather satellite activity represents a unique blend of interests encompassing electronics, meteorology and astronautics. Join the privileged few in watching the spectacle of earth as seen from space on your own monitoring equipment. Order BK7383 \$8.95

**SAVE \$2.95**

**WEATHER SATELLITE  
HANDBOOK (first edition)**

By Dr. Ralph E. Taggart WB8DQT. Valuable information in this first edition *is not included* in Dr. Taggart's just published book, **The New Weather Satellite Handbook** (see above). Chapters such as "How to Build an Electric Timer for Satellite Tracking" and "Building an Automatic Control for the Satellite Receiving Station" will no longer be available when this edition is out of print. This is a good entry level text for those discovering the exciting new use of weather satellites. Regular price: \$4.95. **SPECIAL PACKAGE PRICE--BOTH BOOKS FOR ONLY \$10.95, SAVE \$2.95!** (This offer available only while supplies last.) Order WS7300 and receive both editions of the Weather Satellite Handbook for only \$10.95 (plus \$1.00 shipping and handling charge).

\*Use the order card in this magazine or itemize your order on a separate piece of paper and mail to: 73 Radio Bookshop • Peterborough NH 03458. Be sure to include check or detailed credit card information. Add \$1.00 handling charge. Note: Prices subject to change on books not published by 73 Magazine. Questions regarding your order? Please write to Customer Service at the above address. Please allow 4-6 weeks for delivery. No C.O.D. orders accepted. For Toll Free ordering call 1-800-258-5473.

The right design — for all the right reasons. In setting forth design parameters for ARGOSY, Ten-Tec engineers pursued the goal of giving amateurs a rig with the right features at a price that stops the amateur radio price spiral.

The result is a unique new transceiver with selectable power levels (convertible from 10 watts to 100 watts at the flick of a switch), a rig with the right bands (80 through 10 meters including the new 30 meter band), a rig with the right operational features plus the right options, and the right price for today's economy—just \$549.

**Low power or high power,** ARGOSY has it. Now you can enjoy the sport and challenge of QRPp operating, and, when you need it, the power to stand up to the crowds in QRM and poor band conditions. Just flip a switch to move from true QRPp power with the correct bias voltages to a full 100 watt input.

**New analog readout design.** Fast, easy, reliable, and efficient. The modern new readout on the ARGOSY is a mechanical design that instantly gives you all significant figures of any frequency. Right down to five figures ( $\pm 2$  kHz). The band switch indicates the first two figures (MHz), the linear scale with lighted red bar-pointer indicates the third figure (hundreds) and the tuning knob skirt gives you the fourth and fifth figures (tens and units). Easy. And efficient—so battery operation is easily achieved.

**The right receiver features.** **Sensitivity** of  $0.3 \mu\text{V}$  for 10 dB S+N/N. **Selectivity:** the standard 4-pole crystal filter has 2.5 kHz bandwidth and a 2.7:1 shape factor at 6/50 dB.

Other cw and ssb filters are available as options, see below. I-f frequency is 9 MHz, i-f rejection 60 dB. **Offset tuning** is  $\pm 3$  kHz with a detent zero position in the center. **Built-in notch filter** has a better than 50 dB rejection notch, tunable from 200 Hz to 3.5 kHz. An optional noise blanker of

utes on all bands. **3-function meter** shows forward peak power on transmit, SWR, and received signal strength. **PTT** on ssb, **full break-in** on cw. PIN diode antenna switch. **Built-in cw sidetone** with variable pitch and volume. **ALC control** on "high" power only where needed, with LED indicator.

**Automatic** normal sideband selection plus reverse. **Normal 12-14V dc** operation plus ac operation with optional power supply.

**The right styling, the right size.** Easy-to-use controls, fast-action push buttons, all located on raised front panel sections. New meter with lighted, easy-to-read scales. Rigid steel chassis, molded front panel with matching aluminum top, bottom and back.

Stainless steel tilt-up bail. And it's only 4" high by 9½" wide by 12" deep (bail not extended) to go anywhere, fit anywhere at home, in the field, car, plane or boat.

**The right accessories**—all front-panel switchable.

Model 220 2.4 kHz 8-pole ssb filter \$55; Model 218 1.8 kHz 8 pole ssb filter \$55; Model 217 500 Hz cw filter \$55; Model 219 250

Hz cw filter \$55; Model 224 Audio cw filter \$34; Model 223 Noise blanker \$34; Model 226 internal Calibrator \$39; Model 1125 Dc circuit breaker \$10; Model 225 117/230V ac power supply \$129; Model 222 mobile mount, \$25; Model 1126 linear switching kit, \$15.

**Model 525 ARGOSY — \$549.** Make the right choice, ARGOSY—for the right reasons *and* low price. See your TEN-TEC dealer or write.

**TEN-TEC, INC.**  
SEVIERVILLE, TENNESSEE 37862

## Here's a Concept You Haven't Seen In Amateur Radio For A Long Time— Low Price.



## New TEN-TEC Argosy \$549

the i-f type has 50 dB blanking range. **Built-in speaker** is powered by low-distortion audio (less than 2% THD)

**The right transmitter features.** **Frequency coverage** from 80 through 10 meters, including the new 30 meter band, in nine 500 kHz segments (four segments for 10 meters), with approximately 40 kHz VFO overrun on each band edge. **Convertible power:** 100 or 10 watts input with 100% duty cycle for up to 20 min-

# Grandma Packs a Seabag

— lady ham takes to the high seas

**W**hen Scottsdale's Lodi Yarbrough AC7V tossed her seabag over the rail of the *SS Cove Communicator* in September, 1980, she sailed as the only lady radio officer in the nation's three major maritime radio unions. And she just might be the only brass-pounding grandma on the high seas.

Lodi is the diminutive YL of Dr. Carl Yarbrough WB7DYC, Scottsdale dermatologist. Her delicate fingers once roamed the keyboard of a Steinway, demonstrating piano technique to hopeful pianists, but now she's known as "Sparkette" on the maritime frequencies.

Lodi's saga in radio began five years ago when she bought Carl a CB radio to brighten his drives from their eagle's-nest home high up on Mummy Mountain to his office in Scottsdale. Fortunately for both Carl and Lodi, there was such a plethora of activity on the CB bands that the good

doctor was driven to thinking about ham radio in the hope of establishing a place for himself in that larger sphere. And that's where Lodi got into the act. Early in 1976 she signed up for a Novice radio operator's course in the Scottsdale Educational Enrichment Service.

"I just had to get involved," Lodi said. "Carl had been a radioman in the Navy in World War II, and I knew when he began talking ham radio with such enthusiasm that there had to be a place in it for me."

Lodi asked Carl to help her learn the code, and he was delighted to do it.

"She was so determined to learn the code that she had me drumming it out with my fingers wherever we might be," Carl said. "Sometimes people around us thought we were a little crazy."

Carl studied Lodi's textbooks, and he and Lodi got their Novice tickets to operate with code in May of 1976. By midsummer, the pair had learned enough



*The American-flag SS Cove Communicator.*

about ham radio to get Advanced licenses, and they began broadcasting with voice from their Mummy Mountain home overlooking Paradise Valley. "That was really great," Lodi said. "We began meeting so many wonderful people on the air."

Lodi and Carl continued studying radio theory, and in September of 1976, Lodi flew to Los Angeles for her amateur Extra license test. There she received her first setback. She laughed about it later. "I was so nervous," Lodi said, "that I couldn't hit the paper with my pencil. I failed the code test."

However, the Scottsdale Radio Club, which Lodi and Carl had joined, showed their faith in Lodi by electing her club president.

"They showed me that it didn't matter that I had failed the test," Lodi said. "That helped."

And then Tom Moore W7FCQ, station manager at Barry Goldwater's Military Affiliate Radio Station, gave Lodi's confidence a further boost by inviting her to become a volunteer operator handling "morale builder" messages for service people in the Pacific. Lodi accepted and donated her time for the next four years.

In November and December of 1976, *73 Magazine* published the "See The World And Get Paid" article by Gerald Hargett, and the idea of doing exactly what the title suggested took root in Lodi's mind. She read and reread the two-part article, carefully stowing away in her mind the methods of getting a radio officer's ticket.

Meanwhile, Lodi kept studying for her amateur Extra license and got it in September of 1977. That's when the Hargett article really began to have an effect. Lodi decided that she had to have an FCC radio-telegraph license, so she

began studying for it. The idea of sailing as a radio officer had captivated her imagination.

By 1978, Lodi was getting confident about getting her commercial license, and when she took a Caribbean cruise that summer she took her radio books along so that she could top off her studying. "It was so calm and peaceful at sea that I had a great chance to study radio," Lodi said, "and I did plenty of that."

Several months after the cruise ended, Lodi passed her commercial test. The Federal Communications Commission examiner asked her which ship she was going to sail on.

"None, yet," Lodi told him. "I might just use my license for wallpaper."

But the spirit of sailing and the challenge of maritime radio operating had become Lodi's goal, and it wasn't long before she was checking on maritime unions. "I located not the oldest or the biggest but the best one, and I joined it," Lodi said. "Then the union went to work to find a job for me."

Cove Shipping, Inc., of New York City was the lucky winner of Lodi's radio services. The MEBA/AMO District 2 union (Marine Engineers Beneficial Association/American Maritime Officer) arranged for her to sign onto the tanker *SS Cove Communicator* as apprentice radio officer.

Lodi's whole family caught the spirit of adventure from Lodi, and they supported her going to sea. But when Lodi's November, 1979, departure was imminent, her mother threw out the anchor. Like a good mother-in-law, her visions of Lodi's husband, Carl, without a wife were more than she could bear. "What about poor Carl?" she demanded of Lodi.

"I had signed on for six months," Lodi said, "and



Lodi poses at Krupp navigational radar on bridge of *SS Cove Communicator*. The Captain and mates normally operate the radar to keep watch on sea around for other vessels. Lodi checks the circuitry if the Krupp goes out.

Mother thought I'd be out to sea for the whole time."

Lodi explained to her mother that she would be in and out of port, and once a month she would fly home to visit Carl, or he could catch a flight to wherever she was, and they would be together for the two to four days it would take to load the ship with oil or to unload it. "Mother decided that it would be all right for me to go," Lodi said.

When Lodi boarded the *Cove Communicator* for her first assignment, she found that all of the crew members with the exception of the captain and the radio officer were in their twenties.

"I quickly became Mama to the whole crew," Lodi said. "But before they con-

sidered me a full-fledged crew member, they waited to see if I could climb the ship's ladder with a big carton of Coke and other supplies under my arms."

Somehow, Lodi made it up the ladder, and when she reached the top the whole crew cheered and said, "Now, Lodi, you are part of the crew!"

Like Gerald Hargett, Lodi has high praise for the radio officer's job. "It's a better job even than the captain's," Lodi said. She explained that she is on duty from eight to twelve, three to five, and six to eight. All the rest of the time is her own. "I'm off duty in port and can sightsee or do anything I want to do," she said.

Lodi got her six-months' endorsement in June of

1980 and was then qualified to sail as first radio officer. As an officer, she eats at the captain's table, gets her fourteen-by-twenty-foot cabin cleaned and her bed made, and she gets her sheets and towels washed.

"But I still have to do my personal laundry," Lodi said, "and in an old hand-wringer washer at that."

When Lodi goes on duty, her first job is to tune up all of the radio equipment. Then she gets a time check from the National Bureau of Standards radio station, WWV, at Fort Collins, Colorado, and pipes it up to the bridge for the captain. During her watch, Lodi must record one message heard on the 500-kHz frequency every fifteen minutes. She also gets weather reports from coastal stations and listens for three minutes every half hour for emergency signals from ships in distress.

"I've heard two relayed SOSs from stricken ships and one triple-X emergency signal from a burning ship," Lodi said.

Besides her radio duties, Lodi does all of the clerical work for the captain, signs all hands on and off the ship, and makes up the payroll for the thirty-man crew. One of her most appreciated duties is radioing in for the eight to ten movies that the crew gets to watch every month.

"They're usually movies that I've seen ashore," Lodi said, "but the crew enjoys them."

Once when the ship docked at New Orleans, Carl flew in with a new Atlas 210X amateur radio for Lodi to use aboard ship. Lodi asked Captain Dillon, master at the time, if she could install it on the ship so that she could talk to her husband back in Arizona every day. The captain gave his permission, and Lodi and Carl promptly hooked up the Atlas and installed a

vertical antenna on the bridge.

"Lodi comes booming in to the valley every noon and evening," Carl said, "and I go home every day to talk to her. It sure helps to beat that lonesomeness."

Life at sea does not require Lodi to wear a special uniform as sailors do in the Navy or on pleasure cruisers. "The men wear regular work clothes, and I wear a blouse and slacks because of all the ladders we have to climb," Lodi said. "I take short-sleeve blouses for Florida and the Gulf coasts and long-sleeve blouses for the New England waters. I've got so many winter clothes aboard that you wouldn't believe it. Even thermal underwear."

"We go from the tropics to the freezing north in five days," Lodi said, "but everybody comes prepared, and there are very few illnesses at sea."

Lodi describes the food aboard the tanker as good but nothing fancy. "We have wine on the table only at special times like Christmas," she said.

On her first journey, Lodi found her hair curlers and clothes iron to be superfluous, so she sent them home. "It was impossible with the wind and bad weather to keep my hair set and my clothes pressed, so I wear a scarf over my head and wear my clothes as they come out of the dryer," she said.

A big event on board the ship is "slop chest," according to Lodi. Once a week after fire drill and abandon-ship drill, the captain opens a locker near the radio room and sells cigarettes, candy, and personal things.

"The first time I went to 'slop chest' I stood in line and when I got to the captain I asked for lipstick and perfume," Lodi said. "The captain looked a little shocked and said, 'That's the first time I've had a re-

quest for those things.' I told him times were changing, and he'd better get them in!"

Lodi had high hopes that there would be some feminine touches added to the *Cove Communicator*, but when she got back on board for her second assignment in September of 1980, the slop chest still didn't carry a stock of perfume and lipstick.

"I may have to wait for that until we get a woman master on the ship," Lodi said, "and that may not be long in coming." Lodi said that the wife of the owner of the Pointe Shipping Company has offered a \$10,000 bonus to the first woman who gets a master's license, and there are several in training for the position now.

Lodi describes her quarters on the *Communicator* as plain but rather large, much roomier than cabins on luxury liners. Besides a table for her ham radio, she has a chair, a sofa, and a cot that is bolted to both the floor and a ship's bulkhead. She found out in a storm off Cape Hatteras why the cot was bolted down.

"We hit force ten winds—near hurricane strength," she said. "They rocked the ship so violently that I was thrown right over backwards with my chair in the radio room." At night, Lodi stacked pillows against the rails on her bed to prevent getting thrown against them. She said the wind blew the windows right out of the bridge on another ship, but the *Cove Communicator* was able to take on seawater ballast and was low enough to weather the storm without damage.

"It always rains at mealtime," Lodi said, "and even going to the mess hall can be a wild experience during a storm." She explained that the radio room is in the center of the ship and the

mess hall is a hundred yards away, back by the fantail.

"You have to hang onto anything you can when there's a storm and you want to go to eat," she said.

Lodi keeps a careful log of her sailing experiences. It tells of the time the ship struck something in the Mississippi River and tore a hole in the bow, requiring an eleven-day delay while waiting for repairs.

Probably the most dangerous experience Lodi had was when the hold of the ship filled up with fumes when an exhaust valve failed to work.

"The chief mate went down into the hold with an oxygen mask on, and the others worked on the valve from up above," Lodi said. "The men eventually were able to clear the hold of fumes."

One of Lodi's favorite notes in her log is dated December 25, 1979. She was stuck in port in Port Arthur, Texas, and couldn't get back to Arizona to spend Christmas with Carl.

"I couldn't even contact him on ham radio," Lodi said, "but I luckily hooked up with Tom Hoff WA7MAL in Cheyenne, Wyoming, and he patched me in with Carl. Without that, it would have been a mighty lonely Christmas."

Carl agrees. "We certainly appreciated that phone patch, and do you know," he said, "WA7MAL felt so good about putting us together that he never even sent us a bill for the long distance call."

When Lodi got her six-months' endorsement in June of 1980, she thought of shipping out on one of the Cove Company's supertankers. She thought it would be fun for Carl to go along on a cruise, since each officer can take a spouse along occasionally.

"But I talked to crew members on the supertankers," Lodi said, "And they



told me the crew's quarters are right back by the three big engines that drive the ship, and the vibration is so bad that cups and saucers jump all over the table."

When the time came for Lodi to go out as first radio officer and the call came for her to rejoin the crew of the *Cove Communicator*, Lodi was happy. "It was like going back to an old friend," she said.

Lodi expressed a bit of trepidation about going to sea for the first time as chief radio officer, but her operating experiences and her five years of dedicated study paid off. She handled the usual operating and maintenance duties with no trouble.

"I had to call for a technician a couple of times in port," Lodi said, "but even the old-timers do that. Anyway, I had isolated the problems for the repairmen."

Once, during a hurricane, the VHF antenna broke in two and Lodi had to fix it. "I just grabbed a long extension cord," Lodi said, "and I climbed up and soldered it together again. It worked fine."

Back in Arizona, Carl had decided that he and Lodi wouldn't spend another Christmas apart, so he flew to New Orleans on December 18 and went aboard the *Communicator* as Lodi's guest for a voyage up the eastern seaboard. "The crew accepts Lodi as one of their own," Carl observed, "but the guys still watch their language for 'Sparkette.'"

Carl said that the funniest things that happen to Lodi aboard ship are caused by the responses of shore people who expect the radio officer to be a man. Once when Lodi and Carl were together on the *Communicator*, Captain Hiram Glotfelter greeted a pilot officer in their presence and introduced him to

"Radio Officer Yarbrough." The pilot thought the captain meant Carl and turned to shake his hand.

"Oh, no," said the captain to the discomfiture of the pilot, "I mean the lady."

Another time, the captain sent an ITT (International Telephone and Telegraph) inspector to the lounge to look for the radio officer, and he walked right past Lodi. He went back to the bridge and reported to the captain that there was nobody in the lounge but some woman.

"Then you're going to have to go right back to the lounge," said the captain. "That woman is the radio officer."

Another ITT inspector was sent to Lodi's cabin looking for the radio officer and found Lodi drying polish on her nails.

"Oh, pardon me," said the wide-eyed inspector. "I was looking for the radio officer."

"I'm the radio officer," Lodi said, "and if you don't mind waiting until I've dried my nails, I'll talk to you."

"I've waited for a lot of things," said the inspector, smiling, "but this is the first time I've had to wait for that."

Recently, Lodi talked to the radio officer of the *SS Williamsburg*, the ship that rescued the passengers and crew of the *Prinsendom* in the Gulf of Alaska, and the man called Lodi "old man" in customary ham parlance. Lodi quickly informed him that she was a YL. The surprised operator said he didn't know there were any YLs in the big maritime radio unions and asked Lodi to meet him on forty meters for a QSO after going off watch. Lodi agreed, but when it came time for the QSO, her rig wouldn't tune on her trap antenna, and she had to sit and read the mail while the *Williamsburg* operator came on the air



Ex-Navy radioman and now Scottsdale dermatologist Dr. Carl Yarbrough hurries home at lunch time to work Lodi when she is out to sea. He says WB7DYC gets mighty lonesome for petite AC7V when she is riding the high seas as a radio officer.

and called her and finally hooked up with some other hams and told them about the YL radio officer on the *Cove Communicator*.

Forms of recreation are scarce on board a tanker, Lodi said. Besides watching movies, the crew reads a lot of good books and shares them with each other. The big social event is off-duty officers getting together in the officers' lounge in the evening to pop popcorn and talk.

"We like so much to eat popcorn out at sea," Lodi said, "that when we come into a port, we sometimes walk for miles to find a store to replenish our stock."

The only time the crew can pick up television programs is when the ship is

running north close to the Florida coast, which isn't very often. "Sometimes we're out so far for so long without seeing anything that when a bird comes along, it's a positive delight," Lodi said.

In early January, a banded pigeon came aboard the *Communicator* off the coast of Florida and made three trips from the Gulf ports to New England as the pet of the crew.

"It was really something," said Lodi, "to see those big, burly seamen vying with each other to pluck the pigeon off the fantail and take it into their cabins for the night. They even walked into town from the ports to buy it bird food."

Last year at Christmas time, the *Cove Communica-*

**C.B. TO 10 METER KITS  
AMERICA'S #1 SOURCE FOR  
10 METER C.B. KITS**

**IN STOCK**—Kits for most C.B. Models—  
A.M. and S.S.B.

**COMPLETE KITS**—Includes all parts and de-  
tailed instructions for both crystal and  
P.L.L. synthesizers.

**CUSTOM ENGINEERED**—For easy installa-  
tion with minimum amount of time and test  
equipment.

**FLEXIBLE BAND COVERAGE**—To provide 1  
MHz coverage for most P.L.L. chassis and  
up to 2 MHz on special order for some  
types.

**LOW COST**—Kit prices range from \$10.00  
to \$50.00, according to parts required.  
Average kit price under \$25.00.

**Free catalog**—write or call today for our  
free 10 meter catalog. Includes details on  
kits and our many other products.

**AMERICAN CRYSTAL SUPPLY COMPANY**  
**P.O. BOX 638**  
**WEST YARMOUTH, MA. 02673**  
**(617) 771-4634**

tor was stuck in bad weather at the Staten Island anchorage. The weather was so miserably cold and windy that the motor launches quit running crews to shore or back to their ships. Gales swept the area, and half of the *Communicator's* crew couldn't get back on board for Christmas dinner. But Lodi and Carl were together. Carl had brought Lodi a large case full of radio repair tools, and the ship had been decorated for Christmas.

"They even had a tree in the officers' lounge," Carl said.

While the storm raged around them, Lodi and Carl enjoyed Christmas dinner with those of the crew who had beaten the storm back to the ship. The next day the winds abated, and Carl was able to get ashore and catch a plane back to Phoenix. Lodi, on the *Cove*

*Communicator*, headed for the Hudson River.

"It had been a lousy winter in the East," Lodi said, "so rough and cold. We went up the Hudson all the way to Albany, breaking ice all the way."

Lodi stayed aboard the *Cove Communicator* until late in January, and then she flew home for a four-month vacation in the Arizona sun. When her stay ends and she says goodbye to Carl and her mother and to her children and grandchildren, she'll go back to sea again on a tanker as radio officer, but now she's got her eye on another goal.

"I'd like to get more into troubleshooting," Lodi said. "The time is coming when the radio officer will be the electronics officer and be responsible for all of the electronics equipment on the ship. I'm going to be ready when that time comes." ■

## close encounter



### Dateline Dayton Hamvention . . .

To demonstrate the selectivity of our Mark 3CR repeater we keyed a transmitter 15 KHz off frequency and set it directly against the receiver input. Our Mark 3CR didn't even notice the close encounter.

Sure the Mark 3CR can withstand severe interference. . . it uses both crystal filtering and double conversion. And that's just the beginning. Its performance continues with a transmitter that meets commercial specs plus a microprocessor controller that gives you 39 functions and 13 Morse messages. For peak performance have your own close encounter with a Mark 3CR / Repeater or Mark 3C Controller.



call or write for specifications ✓49

**MICRO CONTROL SPECIALTIES**  
**23 Elm Park, Groveland, Ma. 01834**  
**(617) 372-3442**

## MSB-1 AUDIO FILTER

SSB / CW / RTTY  
\$84.95



8-Pole Tunable Lowpass Filter  
Tunable Bandpass Filter

Tunable Notch Filter  
6-Pole Fixed Highpass  
Audio Amplifier  
Power Requirements

FLP = 300-3000 Hz.  
FBP = 300-3000 Hz.  
Bandwidth-Less than 75 Hz. to greater than 1500 Hz.  
F Notch = 300-3000 Hz., Notch depth-50 dB  
FHP = 300 Hz.  
1 Watt  
12-14 VDC @300 MA  
110 Vac with optional adapter (\$8.95)

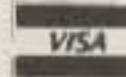

ORDER TODAY. If not completely satisfied, return within 15 days for a prompt refund (less shipping and handling). Add \$2.50 shipping and handling. SEND TODAY for complete list of products. Dealer inquiries welcome.

**M&M ELECTRONICS, INC.**

P. O. BOX 1206/BREWTON, ALABAMA 36427/PHONE (205) 867-2496

✓ 432

## Handful of POWER

Give your low-power 2-meter rig real punch by delivering a potent 25-watt signal with only two watts of drive (also available set up for 200 milliwatts drive). Compact and convenient to mount, VoCom's Model 2C025 is ideal for car, boat or anywhere you've got a 12 VDC source. At only \$84.95 (\$99.95 for 200 mW drive), it's the perfect companion for your Drake, Encomm, Henry, Icom, Kenwood, Motorola, Standard, Wilson, Yaesu or other 2-meter FM portable!



- 2 or 2 watt nominal drive (specify)
- 2 watt model delivers 15-20 watts with only one watt of drive
- 10 MHz bandwidth for CAP or MARS
- Meets all applicable FCC specifications
- 200 mW drive model permits operating Icom IC-2A or Yaesu FT-207R on their battery-saving low-power mode
- Only \$84.95 (\$99.95 for 200 mW drive)

## Even More POWER

Give your 2-meter hand-held 50 watts of punch with the Model 2C050, or 100 watts with the Model 2C100 amplifiers. Or use the Model 2C100 with your 25-watt output 2-meter rig, by plugging in the appropriate drive-programming module.

Compact and reliable, all VoCom power amplifiers feature front-panel on-off switching for convenient shut down when they're not needed for short hauls, plus an LED status indicator.

See your dealer or contact VoCom today for a copy of our detailed four-page catalog.

## ANTENNAS for 2-meter Hand-Helds

### 5/8-Wave Gain Antenna

Provides nearly 10-dB gain over a rubber ducky when extended to its full 47", yet telescopes to only 8" for listening or carrying. Works with any BNC equipped radio... Only \$24.95

### NEW! Short, Compact "UGLY DUCKLING"

Only 4 1/2" short, yet performs like a "full size" ducky. Available for either BNC or threaded mounts.

Only \$14.95 (BNC), \$12.95 (threaded)

Available now from your local amateur radio dealer or order direct:

**VoCom** PRODUCTS CORPORATION 65 East Palatine Road, Suite 111, Prospect Heights, IL 60070  
(312) 459-3680

✓ 90

Copy RTTY, ASCII  
and Morse  
from the palm  
of your hand.



Have you waited to get into code reading until you found out what this latest fad was about? You can stop waiting, because it's no longer a fad.

Amateurs everywhere are tossing the gigantic clanking monsters of yesteryear that once performed the job of reading radioteletype. They are trading them in for state-of-the-art code-reading devices that are incredibly small, noiseless if desired and infinitely more versatile than their antique predecessors.

Kantronics, the leader in code-reading development, has just introduced the latest and most-advanced breakthrough in the copying of Morse code, radioteletype and ASCII computer language.

The Kantronics Mini-Reader reads all three types of code, displays code speed, keeps a 24-hour clock, acts as a radioteletype demodulator and reads all of its decoded information out on a traveling display of 10 easy-to-read characters. It is so compact that it fits in a hand-held, calculator-size enclosure.

At \$314.95, the Mini-Reader outperforms anything within another \$400 of its price range.

Call or visit your Authorized Kantronics Dealer now to find out what the latest in technology has done to code-reading.

**Kantronics**

(913) 842-7745  
1202 E. 23rd Street  
Lawrence, Kansas 66044

# SOCIAL EVENTS

from page 99

will be available. Talk-in on 147.66/.06 (WB3JOE) or 146.52. For further information, call Don Schuenemann WB3AYT at (215)-822-9076.

## AUSTIN TX AUG 14-16

The Austin Amateur Radio Club and the Austin Repeater Organization will hold the ARRL-approved VHF '81, a combination state convention of the Texas VHF FM Society and the second annual Super Central Texas Swapfest, on August 14-16, 1981, at the Hilton Inn, Austin TX. Registration is \$5.00 in advance (August 1st deadline) or \$6.00 at the door. Tickets are good for technical sessions, seminars, the swapfest, and more (all indoors and air-conditioned). Other features include the hidden transmitter hunt, the Saturday night boat ride, and the Texas barbecue dinner, prizes, an ARRL forum, and dealers. Talk-in on 146.19/.79. For additional information, contact VHF '81, PO Box 13473, Capitol Station, Austin TX 78711.

## OAKLAND NJ AUG 15

The Ramapo Mountain Amateur Radio Club (WA2SNA) will hold its 5th annual flea market on August 15, 1981, at the American Legion Hall, 65 Oak Street, Oakland NJ, only 20 miles from the GW Bridge. Admission is \$1.00; YLs and harmonics will be admitted free. Indoor tables are \$6.50 and tailgating is \$3.00. Door prizes will be awarded and refreshments will be available. Talk-in on 147.49/146.49 and 146.52. For more information, contact Walt Zierenberg WD2AAI, 344 Union Avenue, Bloomingdale NJ 07403, or phone (201)-838-7565.

## TACOMA WA AUG 15-16

The Radio Club of Tacoma will hold its annual Hamfair on August 15-16, 1981, at Pacific Lutheran University in Tacoma, WA. Featured will be many out-

standing technical seminars, games and contests for all members of the family, a large flea market and commercial display area, dinner and after-dinner entertainment, and valuable door prizes. Trailer parking and lodging are available. For more details, contact Eva Anderson WB7QNS, 517 Berkeley Avenue West, Tacoma WA 98466, or phone (206)-564-8347.

## MARYSVILLE OH AUG 22-23

The Union County Amateur Radio Club will hold its fifth annual Hamfest-81 on August 22-23, 1981, at the Union County Fairgrounds, Marysville (near Columbus) OH. Gates open until Sunday at 4:00 pm. Admission is \$2.00 in advance and \$3.00 at the gate. Children will be admitted free. Featured on Saturday night will be movies, popcorn, round and square dancing to a live band, and overnight camping with hookups, all free. Food will be available all night with a big country breakfast starting at 3:00 am. On Sunday there will be forums, door prizes, and meetings. There will be no extra charge for sellers at the flea market which opens at 4:00 pm on Saturday and 6:00 am on Sunday. Talk-in on 147.99/.39 and .52. For more information, write Union County Amateur Radio Club, 13613 US 36, Marysville OH 43040.

## WENTZVILLE MO AUG 23

The Saint Charles Amateur Radio Club, Inc., will hold Hamfest '81 on August 23, 1981, at the Wentzville Community Center, West Main Street, Wentzville MO. Advance tickets are \$1.00 each or 4 for \$3.00; at the door tickets are \$1.50 each or 4 for \$5.00. Parking is \$1.00 per car (no camping on hamfest site). Featured will be a reserved flea market for amateurs, a free general flea market area, free bingo, a cake walk, refreshments, and prizes (including a first prize of a Kenwood TS-130S transceiver). Free doughnuts and coffee will be available to the early birds. Talk-in on .07/.67 and .52. For in-

formation on motels, tickets, displays, prize lists, camping, etc., write Bill Graham WB0ZEH, 215 Bermuda, O'Fallon MO 63366.

## BLUEFIELD WV AUG 23

The East River Amateur Radio Club, Inc., will hold the Bluefield Hamfest '81 on Sunday, August 23, 1981, at the Brushfork Armory/Civic Center located on US 52, one mile north of Bluefield WV. Admission is \$2.00 in advance and \$3.00 at the gate, and includes a prize ticket. Tailgaters are \$2.00 each and tables are \$5.00 each (3 or more are \$4.00 each). There will be food, dealers, a flea market, forums, and entertainment. Talk-in on .89/.49 and .52/.52. For more information, write Bluefield Hamfest '81, 2113 Hemlock Hill, Bluefield WV 24701.

## TIOGA COUNTY PA AUG 29

The Tioga County Amateur Radio Club will hold its 5th annual hamfest on Saturday, August 29, 1981, from 8:00 am to 4:00 pm, at the Tioga County Fairgrounds just off Rte. 6, between Wellsboro and Mansfield PA. There will be a free outdoor flea market and inside space will be available. Registration is \$3.00. Features will include prizes, demonstrations, and food. Pennsylvania's Grand Canyon is nearby. Talk-in on 146.19/.79 and .52. For more information, write PO Box 56, Mansfield PA 16933.

## SEWELL NJ AUG 30

The Gloucester County Amateur Radio Club will hold the GCARC Hamfest on August 30, 1981, from 8:00 am to 3:00 pm (7:00 am for tailgaters and dealers) at the Gloucester County College, Tanyard Road, Sewell NJ. Admission is \$2.00 in advance and \$2.50 at the door. Tailgaters' and dealers' charge is \$6.00 (which includes one free admission). Refreshments and free parking will be available. Features will include seminars, prizes, contests, and speakers Dale Smith, from the ARRL, and Miles (Brownie) Brown W2PAU, an RCA antenna expert. FCC exams will be given from Tech through Advanced. Talk-in on 146.52 and 147.78/.18. For more information and reservations, send an SASE to GCARC Ham-

## LA PORTE IN AUG 30

The La Porte and Michigan City Amateur Radio Clubs will hold their annual La Porte County Hamfest on Sunday, August 30, 1981, rain or shine, at the County Fairgrounds on Highway 2, west of La Porte IN (50 miles SE of Chicago). There will be an outdoor paved flea market area, indoor tables at \$1.00 each, a satellite TV demonstration, and overnight trailer parking for early birds. Advance tickets are \$2.00. For reservations or information, send an SASE to PO Box 30, La Porte IN 46350.

## GEORGETOWN IL SEP 5-6

The Illiana Repeater System will hold the 12th annual Danville Area Hamfest on September 5-6, 1981, at the Georgetown Fairgrounds, Georgetown IL. The gates will open at 6:30 am. Tickets are \$1.50 in advance and \$2.00 at the gate. There will be a flea market, forums, family entertainment, many prizes (including a Santec synthesized hand-held), and free parking. Talk-in on 146.22/.82 and 146.52. For more information or advance tickets, contact Lowell Wells WD9AFG, Hamfest Chairman, RR 3, Box 215, Danville IL 61832, or phone (217)-759-7560.

## AUGUSTA NJ SEP 12

The Sussex County Amateur Radio Club will hold its third annual SCARC '81 hamfest on Saturday, September 12, 1981, from 8:00 am to 3:00 pm at the Sussex County Farm and Horse Show grounds, Plains Road off Rte. 206, Augusta NJ. Pre-registration for outdoor flea-market sellers is \$4.00; at the gate, \$5.00. Pre-registration for indoor flea-market sellers is \$5.00; at the gate, \$6.00. Other registration is \$2.00. There will be door prizes and plenty of free parking. Talk-in on 147.90/.30 and 146.52. For additional information or pre-registration, write Sussex County Amateur Radio Club, PO Box 11, Newton NJ 07860, or Lloyd Buchholtz WA2LHX, 10 Black Oak Drive, Vernon NJ 07462.

commodate either mono or stereo headphones. Transmit audio was good with the three microphones we tried—a D-104, a Shure 444D, and a Yaesu hand microphone.

Kenwood deserves praise for the quality of the 130S instruction manual. Lots of practical information is provided on installation and use, for mobile as well as fixed operation. As is typical with Kenwood products, no service and alignment procedures are included in the instructions; you'll have to buy a separate service manual for that information. For emergency repairs by those hams brave enough to work on the 130S themselves (see interior photographs), complete schematics and a block diagram are included with the rig.

#### On the Road!

While the 130S is perfectly at home on the ham shack bench, it really comes into its own when installed in a vehicle. I operated it for several weeks from my car and grew very fond of it in that mode of operation. I sat it on the front seat beside me and ran the power lead directly to the battery. It draws too much current to use with my noise filter, and I was pleasantly surprised when I didn't hear the alternator whine I hear with other rigs that aren't connected

through the filter. One feature that I found indispensable in mobile use was the speech processor—it can make a real difference on the other end of the QSO. With the processor on or off, adjusting the mic gain for the proper level using the ALC meter is a simple task. The ballistics of the meter allow sure and fast reading. The mic gain should be readjusted when the processor is turned on or off. The noise blanker did an excellent job of cleaning up ignition noise and I left it on all the time.

A characteristic that I found less than admirable was the limited bandsread of the main vfo knob. Tuning in a signal while jouncing down the road is a challenge—one flick of the knob and you've jumped ten kHz! I eventually learned how to handle the knob with reasonable dexterity, but bandsread is an area in which the 130S

could use improvement. Whatever one thinks of the bandsread, it is important to note that frequency stability is not a problem—the rig occasionally became airborne when my driving got, ah, shall we say, over-enthusiastic, but the frequency never drifted.

If the poor bandsread really gets to you, it might help to know that Kenwood offers a nice digital frequency controller that allows tuning of the rig from push-buttons on the microphone.

The real test of the transceiver came on the yearly pilgrimage to the Dayton Hamvention in the infamous *73 Magazine* S-100 van. We installed the 130S on a countertop in the back of the van, connected up a D-104 microphone, and used a Hustler mobile antenna to distribute the rf. The 130S did everything it was supposed to and more, shrugging off a couple of

nasty spills onto the floor of the van, a fall of about three feet! A solar disturbance prohibited us from working any DX that weekend, but stations all over the United States were worked, mostly on forty meters.

#### Conclusions

Considering the price and performance of the 130S, it represents an excellent buy for either fixed or mobile operation. It faces a lot of competition in the small transceiver market, but the current crop of rigs is so varied in concept that each has its own devoted following. If ease of operation, good audio, and a wide range of accessories strike your fancy, the TS-130S might be the rig for you!

For further information, contact *Trio-Kenwood Communications, Inc.*, 111 West Walnut, Compton CA 90220. ■



## WE'RE ROLIN IN CRYSTALS! ✓418

2 Meter Crystals — \$3.95 each  
(10 or More — \$3.50 each)

#### We Stock Crystals For:

Clegg	Drake	Icom
Kenwood	Midland	Regency
Standard	Wilson	Yaesu
Lafayette	Tempo	VHF Eng

#### Rolin Distributors

P.O. Box 436 Department 7  
Dunellen, N.J. 08812  
201-469-1219

(We Also Accept Orders For Custom Crystals.)

#### Mark 3CR from page 46

Inside, the circuitry has the deceptive aura of simplicity that often accompanies microprocessor-controlled hardware. A couple of glass-epoxy circuit boards take care of all control functions. One handles audio processing such as gating, level adjustments, DTMF decoding, and auto-patch phone-line interfac-

ing, and the other is essentially a single-board 6502 computer that performs all the I/O functions for the repeater and any external devices added by the user. A third circuit board contains the front-panel status LEDs and their drivers. The receiver and transmitter boards are housed in separate, fully-shielded cabinets. There is space for an optional receiver on 220 or

440 MHz to be used for control commands to the microprocessor controller.

#### Selection of Functions

Virtually all commands and functions are selected with a three-digit DTMF code. There are a total of 36 different codes that the controller is programmed to recognize. For security, these codes can be changed instantly by flipping a set of

switches inside the repeater. How the controller receives this code is up to its owner. You can use a command receiver, a phone line, or the repeater input for control commands. Using the input frequency is discouraged due to the wild-turkey bonanza this would provide, and is illegal in any case. Flipping the command switch on the front panel removes the ca-

pability of repeater control on the input frequency for all but a select few user commands, such as autopatch access and hangup, and autodial numbers. All other command codes will only be recognized by the controller if they come from the command receiver or the phone line. When a command is received via the control link, it is acknowledged with RRR in Morse the next time the repeater is keyed. This can be a little confusing to users, who inevitably will hear an RRR from time to time in the middle of a conversation.

### Basic Features

The basic operating parameters of the Mark 3CR are similar to other repeaters, with some interesting twists. There is a beep at the end of each transmission to let you know when the time-out timer is reset. This timer can be set in 30-second increments from 30 seconds to three minutes via the control link. If a user doesn't wait for the beep before transmitting, he runs the risk of timing out the repeater. If this occurs, the machine will ID and send a CW message such as "beer" or "time" when it comes back on again. There is a timer-reset code that allows users to reset the repeater without waiting for it to recycle.

Any of three preprogrammed CW tail messages can be sent on the repeater tail at the end of each transmission. Oft-chosen messages are Net, 73, and Meet. These messages are enabled and disabled via the control link.

One of the nicest features of the Mark 3CR is its anti-kerchunk system. The controller looks at transmission time and recent repeater activity, and if it decides that there is a pattern of extremely short transmis-

sions, it inhibits the transmitter until a signal remains on for a longer period of time. In practice, this system is extremely effective at discouraging all but the most malicious of kerchunkers, without imposing any inconvenience on other users. It's one of the most effective systems I have seen.

### Tones and More Tones!

In a repeater so dependent on DTMF tones, it is important to have a trustworthy decoder. There are two six-pole active filters for high-group and low-group tone conditioning, and the output of these goes to a Mostek MK5102 digital tone decoder. The decoding system is extremely fast and reliable, at the expense of tolerance of improperly-adjusted tone pads. If a user's tone level is set too high, the repeater will not accept his tones. To aid users in adjusting their pads, a clever test sequence is included in the Mark 3CR controller. You send either a row or a column of tones in sequences, and if the level of each tone is correct, the repeater replies with OK in Morse. If the tones are off frequency or incorrect in amplitude, it doesn't do anything. This facilitates adjustment of even the most primitive tone pads.

All the circuitry for autopatch operation is included in the Mark 3CR—just connect the patch to a phone line. It can be configured to operate with either pulse or touchtone™ systems. At present, the patch is not FCC-registered, so if your group is picky about the letter of the law, you'll want to get a Ma Bell approved coupler. Practically speaking, the patch is optically coupled to the phone line, so you're unlikely to encounter any problems with Ma's minions—they can't sense the

presence of the patch on the line.

Numbers dialed with the standard autopatch access code can only have seven digits and cannot start with zero or one. A special long-distance access code can be sent via the control link to permit long-distance calls. Five autodial numbers may be preprogrammed, each with its own access code. These autodial numbers may be accessed even when the normal autopatch function is inhibited, allowing emergency access to police, fire, etc., when no control operator is available.

Reverse autopatch is possible, and the procedure is complicated enough to discourage abuse. It would be very difficult for an unauthorized person to "break" the system. It operates like this: When an incoming call is received on the autopatch line, the processor connects the call after about five rings. The caller must enter the reverse autopatch code within five seconds, or the connection will be terminated. If the code is entered correctly, the repeater will transmit a series of Morse Ts. Importantly, the repeater's transmitter will not be activated at all without the correct code. If a user listening to the repeater decides to answer the call, he can enter the usual autopatch code and the call will then proceed as a normal autopatch. It's debatable, of course, but as long as the autopatch phone number and access codes are carefully protected, I'd say that this procedure probably meets the FCC criteria for screening before a reverse patch takes place. The chances of anyone calling your repeater's number and guessing the correct code within five seconds without making a mistake are statistically improbable. Being extremely selective about

who gets the code (only hams?) constitutes screening, in my humble opinion. Should someone ever abuse the reverse-autopatch privilege, you can always change the code or disconnect the patch. The FCC may hold a different opinion, however, so you are on your own. If in doubt, don't use the reverse autopatch feature!

### The Good Stuff

While the basic operating parameters are almost airtight and very pleasant to have available, things really get exciting when you start using the command and user functions. The Mark 3CR repeater was designed to allow very easy interfacing with external devices. Remember those terminals on the back panel? Here's where they come in!

There are two classes of user functions—those which keep the transmitter on all the time (class I) and those which don't (class II). There are seven class I outputs and four class II outputs. Nominal time-out limits are three minutes for class I and ten minutes for class II outputs. To round out the package, there are three outputs that are enabled and disabled through the control link. How do you use 'em? Simple! Each of the 14 outputs is assigned to a terminal on the rear panel, and each output is enabled by a three-digit DTMF tone. When the controller receives the correct code, the terminal changes state from low to open circuit. The logic outputs are buffered with high-voltage open-collector buffers that can sink up to 30 mA. External pull-up resistors are used to pull the output high. All of you who have suffered long hours with a hot soldering iron and a crate of TTL chips putting together multi-digit tone decoders will understand the value of having the in-

terfaces already in place, ready to go. Link receivers, crossband receivers and transmitters, amplifiers, directional antennas, recordings, all can be added with very little effort and an extremely low external parts count.

An example: Suppose you want to add a tape recording to welcome new users to the repeater. An old eight-track or continuous-loop cassette player takes care of the hardware. Recording the message will be your hardest task! The audio output from the player goes into the auxiliary audio input on the back of the repeater and the control terminal activates a relay to turn the tape drive on and off. Publish the access code for that particular function and you'll be in the "taped-welcome" business! When you grasp the fact that the repeater is capable of supporting fourteen external devices with very little effort involved in interfacing them, you will understand what all the excitement is about.

With all these capabili-

ties, it seems like a terrible waste to put a machine with these capabilities on two meters. I feel like the car buff who is mortified by the Hollywood starlet who uses a Maserati to drive to the supermarket! It would be fitting to put the repeater on 220 or 450 where it could be used in a remote-base configuration with links to 10 FM, a multi-channel 2m rig, and all the other bells and whistles that the spoilers at the FCC won't let us have on two meters. I guess that's one of the benefits of microprocessor technology—products can inexpensively have more flexibility than is really needed for a particular task.

### Rf Section

The sophisticated control circuitry of the Mark 3CR threatens to steal the show, but the rf sections of the repeater deserve a fair share of attention. Both receiver and transmitter are conservatively designed, and acquit themselves handsomely at W2NSD/RPT. Special care was given to temperature stability in

the transmitter, and immunity to overload and high adjacent-channel rejection in the receiver. Receiver and transmitter boards for 144 and 220 MHz are available. Interface cards to use the Mark 3C controller with GE Masterpro and Motorola Micor repeaters are available for all you old die-hards who won't touch anything else.

### Power Supply

The 7812 and 7805 regulators used in the power supply ensure that the controller will function correctly under wide ac line-voltage fluctuations. Both sides of the ac line are bypassed to ground with 470-pF, 2 kV caps. The optional 12-volt backup circuitry is highly recommended. Should the ac line voltage fall below an acceptable level, the backup battery is switched in instantly. When the backup supply is in use, a Morse "EP" is sent on the transmitter tail. Should the power ever fail completely with no backup available, a Morse "PF" will be sent on

the tail when power is restored. These Morse messages will appear on the tail until removed by a control operator.

### Conclusions

No ham product is as uniquely suited to microprocessor control as a repeater, and the flexibility of repeaters like the Mark 3CR is only limited by the imagination of its owners. Best of all, this flexibility is not at the expense of dependability, since the hardware in this controller has a lower parts count than many repeaters that offer only basic features. Its potential for remote-base operation promises to allow that type of setup to enjoy widespread popularity. Whether you use it as a basic local repeater on two or a remote base on 220 MHz, a Mark 3CR should give you or your group years of trouble-free enjoyment.

For more information, contact *Micro Control Specialties*, 23 Elm Park, Groveland MA 01834. Reader Service number 489. ■

### NCG-15 from page 42

midable task. I also had some reservations about hanging my life's savings under the dashboard of my car. After careful consideration, the Hustler antenna was consigned to the yawning void of the ham-shack closet. With the NCG now available, all these problems were solved and it looked like I might be doing some mobiling after all!

With a war whoop that brought my faithful hound, Rufus, running, I made for the closet and extricated the Hustler antenna from the forest of aluminum that resides there. Rufus and I grabbed my power drill, some RG-8X, and the NCG, and headed outdoors for the car.

After a quick appraisal of the situation, I concluded that the operation's chances of success were encouraging. I already had a Kenwood TR-7600 2-meter rig screwed to the transmission hump of my Dodge Colt, so I simply placed four squares of 3M double-sided foam tape on top of the Kenwood, and stuck the NCG's bracket to that. If you have never used this tape, you owe it to yourself to try a sample. It has a grip that doesn't quit, yet it rarely leaves any residue when you remove it. I use it to stick radios and accessories together all the time, and even with rambunctious driving on New Hampshire's back roads, it has never come unstuck.

The power connection

was a cinch, since I sort of expect this madness to strike from time to time, and I have installed a line from the battery that terminates with a small enclosure inside the car. The enclosure contains a hefty noise filter and a lot of terminal strips to accommodate future expansion of my rolling ham shack.

The antenna was another matter altogether. I suddenly recalled that one of the reasons this particular madness had never struck before was my lack of a mount for the Hustler antenna. Since mounts cost money and money was in short supply, it looked like I would either have to wait until payday or improvise. Rufus was much too excited about the project to put

it off until payday, so I decided to improvise.

The rear bumper of the Colt offers a thick flat steel surface that is parallel with the road, and the underside of the surface is accessible. This looked promising! Back in the ham shack, I rifled through my parts drawers, and came up with some thick plastic washers with a raised lip on one side, a couple of lock-washers, a long 3/8-24 bolt, and a female-to-female 3/8-inch threaded collar. I measured the diameter of the washers as I walked back to the car, and promptly blasted a 1/2-inch hole in the bumper. I drilled another, much smaller hole next to the big one to provide a grounding point for the coax.

I used the two plastic

washers to make a sandwich out of the bumper, and then ran the long bolt through a lock-washer to which I attached the center conductor of the coax. The bolt went through the plastic washers and the bumper and the threaded collar was screwed securely onto that. I soldered the shield of the RG-8X to a lug, which was then bolted to the underside of the bumper through the small hole I had previously drilled. All that remained was to screw the antenna itself into the now-complete mount. Once it was in, I stood back and surveyed my work. As it turned out, I'm glad I didn't spring for a commercial ball-type bumper mount—this turned out much better!

I performed the usual series of mundane tests with ohmmeter and swr meter, and finally jumped in the car and grabbed the NCG's microphone with one hand and the vxo knob with the other, intent on some serious operating.

W5XX in Mississippi was calling CQ. I called him and he came back immediately, reporting that although my signal strength was weak, the audio quality was good. That's just what I wanted to hear!

For the next several days, I operated whenever I had the chance; I had a lot of rewarding rag-chews, as well as some "59, good-bye" contacts. Some high points included VK4NIC/3X, C5ACA, PV8GG, M1C, and K4EIN/T14, all with 6 Watts into the antenna, often while rolling down the road! When the DX wasn't rolling in, I had many enjoyable contacts with just about every corner of the US. The NCG provides an extremely high fun-per-Watt and -dollar ratio!

#### Features and Performance

If you've stuck with me this far, and haven't dropped the magazine in disgust to go fire up your three-kilowatt linear, you might be interested in learn-

ing some specifics about the NCG.

The front panel offers the traditional items; volume, squelch, rf gain, mic gain, S-meter, noise-blanker switch, Tx/Rx LEDs, high/low power selector, and an LED digital frequency readout with 5-kHz resolution. Only 5 kHz, you exclaim in dismay? Aye, earthling! The tuning system is unusual for an HF rig, bearing some resemblance to the system found on the Kenwood TR-7400 2-meter transceiver and similar rigs. Rotary switches select the 100-kHz and 10-kHz segments of the band and a push-button adds 5 kHz to the frequency you select. Fine tuning (plus or minus 8 kHz) is facilitated by the vxo knob next to the digital readout. What all this means is that while the radio covers the entire 15 meter band, it is inconvenient to scan from one band edge to the other as you would with a more traditional tuning arrangement. In practice, the tuning system is reasonably workable and you learn to manipulate the controls quickly. There is a sweep control that allows you to scan through the vxo range at a rapid rate but I found that control to be less than useful for my style of operating.

Once you learn to cope with the tuning system, everything else is straightforward. The single-conversion superhet receiver is competent, offering better-than-expected sensitivity, selectivity, and dynamic range for a transceiver in this price range. The agc has a tendency to pump on strong signals, an annoying effect which is easily cured by reducing the setting of the rf gain control. The noise blanker performs as expected, cleaning up a bit of ignition noise without noticeably altering the receiver's performance in any other respect. Audio

output is about two Watts and the built-in speaker is perfectly usable, which comes as a pleasant surprise. Only one other rig that I've used in my car has not needed an external speaker for adequate performance!

The transmitter offers no surprises either. There is no provision for ALC metering, but the mic gain control is extremely forgiving, a fact proven to my own satisfaction when I listened at home while someone else operated the NCG from my car. Informal observations by myself and many others indicate that the rig's output is clean and the audio is good. The rig has provision for low-power operation with about three Watts output on voice peaks. Thanks but no thanks—six Watts is enough of a challenge for me! Those of you with monobanders at 70 feet or a penchant for self-abuse may find the low-power position exciting, but I religiously avoid it!

#### Conclusions

I found the NCG to be a very enjoyable transceiver to work with. For a beginner looking for an inexpensive way of getting on the air, or the mobile or QRP operator, the NCG-15 represents an outstanding value. True, it has a tuning system that only its mother could love, but where else can you get so much rig for so little money? I hope that rigs like this will begin to wean us from the "power trip" so many of us seem to be on. When we use high power to ride over the interference from other hams, rather than to compensate for poor propagation, it's time to rethink our operating habits. See you on 15-meter QRP!

For further information, contact NCG Co., 1275 N. Grove Street, Anaheim CA 92806. Reader Service number 477. ■

## HAM HELP

Does anyone know anything about the technical operation of the ATC/Zenith "SAVVY" instrument? I will pay a finder's fee for the first good information.

**Mike Reynolds W0KIE**  
3826 So. 92 E. Pl.  
Tulsa OK 74145

I am in need of operating instructions and especially the schematic for a Royce CB, model I-636. The fine-tune control is causing some FMing when it is used for a swing of more than 4 kHz. Any comments would be welcomed. I will gladly pay for a copy of the operating instructions and schematic. Many thanks.

**Herman H. Franke F0FXX**  
RAMC—AmEmbassy  
APO New York 09777

Can anyone provide me with copies of schematics and/or op-

eration manuals for an Eico model 324 signal generator and an Eico model 368 TV-FM sweep generator and marker? I'll pay copying costs and postage. Any info would be appreciated. Thank you.

**Gene Smarte WB6TOV**  
RFD #1, Box 717  
Hancock NH 03449

I am looking for instruction books or diagrams for a WRL Multi-Pak Model PSA-63A power supply and a WRL Meteor Model SB-175 transmitter. I will pay for copies or original manuals. Anyone needing Montana for a sked? Can do, on RTTY, CW, or SSB on 80-10 meters. (And thanks, 73, for this service. I've been helped before and been able to help others.)

**Neil Zimmerman W7MAF**  
1815-17th Ave. So.  
Great Falls MT 59405



# WHAT WILL YOUR NEW RIG BE LIKE?

## Read 73 and Find Out

The magic of digital electronics is coming to ham gear . . . and you'll be able to read about these developments in 73. There probably will be more changes in ham equipment in the next few years than ever before in history. You'll see these changes coming in 73, where you'll read about the experiments and pioneering. 73 has more articles than any other ham magazine . . . often more than all the others combined.

When sideband got started, it was moved along by the many pioneering articles in 73. In the 60s it was solid state, with several times as many articles on the subject than in all the other magazines combined. When repeaters and FM got going about ten years ago there were over five times as many articles on the subject published in 73 as in all other ham magazines combined . . . and you can see what changes that brought to hamming. Now we're looking at exciting developments such as narrow band sideband for repeaters . . . which might give us six times as many repeaters in our present bands. We're looking at automatic identification systems which may make it possible for us to read out the call letters of any station tuned in . . . and even the development of self-tuning receivers.

Will stereo double sideband techniques make it possible to have up to 30 times as many stations within a given HF band as is now possible? Hams will be experimenting and reporting on these developments in 73. 73 is an encyclopedia of hamming . . . present and future . . . and just a bit of the past, too.

Without the endless fillers on station activities and club news, 73 is able to publish far more information . . . valuable information . . . on hamming and ham equipment.

You may or may not be a pioneer, but you certainly will want to keep up with what is happening and what the new rigs are going to be like. And, frankly, your support of 73 is needed to keep this type of information coming.

**Yes,** bill me for 1 year of 73 Magazine at \$25.00

316B6

Name \_\_\_\_\_

Address \_\_\_\_\_

City \_\_\_\_\_ State \_\_\_\_\_ Zip \_\_\_\_\_

Canadian \$27/1 year only, US funds. Foreign \$35/1 year only, US funds  
Please allow 4 to 6 weeks for delivery  
73 Magazine • PO Box 931 • Farmingdale, NY 11737



# List of AdvertisERS

\*Please contact these advertisers directly.

To receive full information from our advertisers please complete the following postage-paid card.

R.S. No.	Page	R.S. No.	Page	R.S. No.	Page	R.S. No.	Page
* AEA/Advanced Elect. Applications, Inc.	31	* Digital Research Parts	175	409 JDR Microdevices	77	381 Radio Systems Techn.	159
3 AED Electronics	147	425 Doppler Systems	159	38 Jameco Electronics	177	397 Radio World	152
448 Advanced Comm. Int'l.	63	91 ETCO Electronics	153	486 Jameco Electronics	138	62 Ramsey Electronics	169, 174
406 Alaska Microwave Labs	47	* 80 Microcomputing	149	* KLM Electronics	29	418 Rolin Distributors	109
429 Amateur Accessories	160	447 Electronic Hobby Innovations	69	* Kantronics	107	487 SGL Waber Electric	138
* Amateur Radio Profiles	136	419 Electronic Specialties	71	* KB Microcomputing	149	376 SMP	63
5 Amateur-Wholesale Electronics	25	400 Engineering Consulting Service	159	* Kenwood	Cov. IV, 7, 38	* Sabtronics International, Inc.	19
7 American Crystal Supply	106, 161	413 Equipment Exchange	156	* Long Island Hamfest	97	65 S-F Amateur Radio Services	151
334 Amidon Associates	150	* Erickson Comm.	155	56 McCaw Electronics	83	64 Semiconductors Surplus	170-172
356 Anteck	151	439 Ben Franklin Electronics	160	451 MCM Electronics	39	* 73 Magazine	100, 113-117, 149, 159
* Appl. & Equipment Co., Inc.	160	22 Fair Radio Sales	159	434 M & M Electronics	107	66 Signalcrafters	64
* Associated Radio	91	323 Fox-Tango Corp.	156	47 MFJ Enterprises	59, 61, 63, 83, 95	433 Skytec	160
358 Astron Corp.	153	27 G.I.S.M.O.	88	48 MHz Electronics	164-167	367 Slep Electronics	157
402 BNF Enterprises	160	410 G & T Service Co.	48	44 Macrotronics	89	309 Spacecoast Research	159
11 Barker & Williamson	61	* Giffer Shortwave	150	480 Macrotronics	135	* Spectronics	150, 176
440 Rex Bassett Electronics, Inc.	89	* Global Electronics	160	45 Madison Electronics	61	68 Spectrum Comm.	49
488 Benjamin Michael Industries	137	393 H. M. Goodwin	161	46 Maggiore Electronic Lab	156	436 Spectrum International	149
426 Bilal Co.	151	417 Gotham Antenna	154	49 Micro Control Specialties	106	403 Stewart Quads	154
428 Bright Electronic Corp.	97	* Grove Enterprises	45	489 Micro Control Specialties	46	430 TEM Microwave Corp.	161
12 Bullet Elect.	163	345 Hal Comm.	17, 37	313 Micro Management Systems	158	316 Telex Comm., Inc.	20, 21
391 Butternut Electronics	64	31 Hal-Tronix	30, 88	50 Microcraft Corp.	152	* Ten-Tec, Inc.	15, 101
483 Century Electronics	138	30 The Ham-Key Co.	154	383 Micro-80, Inc.	159	76 Trac Electronics	147
13 Clegg	155	32 Ham Radio Center	67	51 Microlog Corp.	40, 41	481 Trac Electronics	136
89 Clutterfree Modular Consoles	154	* Ham Radio Outlet	3	52 MidCom Electronics, Inc.	71	482 Trans Com	137
382 Comm. Concepts, Inc.	160	449 The Ham Shack	152	355 N & G Distributing	27	438 Trylon Mfg. Co.	151
377 Communications Electronics	162	33 Hamtronics, NY	173	318 National Comm. Group Co.	157	77 Tufts Electronics	160
15 Comm. Specialists	10, 11	303 Heath Co.	13	477 National Comm. Group Co.	42	37 UPI Comm. Systems, Inc.	156
444 Computer Plus	159, 161	478 Heath Co.	136	412 Nema Electronics	150	* Universal Communications	23
* Conley Radio Supply	82	34 Henry Radio	Cov. II	* Orbit Magazine	74	485 Universal Electronics	150
* Crown Micro Products	155	* High Frequency Tech. Systems	93	452 OrCom Distributors	156	485 Valor Enterprises	137
70 Cubic Comm.	4	446 Home Science Experiments	160	404 P.B. Radio Service	153	311 Vanguard Labs	161
330 Debco Electronics	95	* Hustler, Inc.	47	* P.C. Electronics	82	373 Van Gorden Engineering	47
411 DGM Electronics, Inc.	91	316 Hy-Gain Div. of Telex Comm., Inc.	20, 21	* Palomar Engineers	4, 137	437 Vani-Plate Co.	48
346 Data Service	161	* ICOM	9, 43	421 Phillips Techn. Electronics	161	90 VoCom Products Corp.	107
476 Datong/AR Technical Products	118	* IRL	57	* Pecos Valley Amateur Radio Supply	152	398 Wawasee Electronics	59, 151
		414 Inotek Engineering	161	479 Plainview Electronics	137	80 Western Electronics	150
		445 Instant Software	78, 79	58 Poly Paks	63	83 Yaesu Electronics Corp.	Cov. III
				60 Quest Electronics	168	336 Z Associates	161
				61 Radio Amateur Callbook, Inc.	59		

## 73 MAGAZINE

# Books, ETC.

To order, complete the following postage-paid card, or itemize your order including detailed credit card information or check and mail to:  
73 Magazine/Mail Order Dept./Peterborough NH 03458.

Catalog #	Item	Price	Catalog #	Item	Price	Catalog #	Item	Price
BK1016	73 DIPOLE & LONG WIRE ANTENNAS	\$ 5.50	BK7312	MAGIC OF HAM RADIO	\$ 4.95	BX1002	SHELF BOXES—8 AND UP	\$1.25 each
ST0000	Single back issue before July 1981	\$ 3.00	BK1033	MASTER HANDBOOK OF HAM RADIO CIRCUITS	\$ 8.95	BK7311	SOME OF THE BEST FROM KILOBAUD	\$10.95
ST2500	25 our choice	\$12.00	BK7340	THE NEW HOBBY COMPUTERS	\$ 4.95	BK7351	SSB THE MISUNDERSTOOD MODE	\$ 5.50
ST0500	5 your choice	\$ 8.75	CT7300	NOVICE THEORY TAPES	\$15.95	CT7350	SSTV TAPE	\$ 5.95
ST1000	10 your choice	\$14.00	BK7310	OWNER REPAIR OF RADIO EQUIPMENT	\$ 7.95	SG1081	STUDY GUIDE—ADV. CLASS	\$ 6.95
ST0250	Single back issue after July 1981	\$ 3.50	BK7305	POWER SUPPLY HANDBOOK	\$ 9.95	SG1080	STUDY GUIDE—EXTRA CLASS	\$ 5.95
ST2501	25 your choice	\$25.00	BK1015	PRACTICAL ANTENNAS FOR THE RADIO AMATEUR	\$ 9.95	SG7357	STUDY GUIDE—NOVICE CLASS	\$ 4.95
BK7307	BEHIND THE DIAL	\$ 4.95	BK1185	THE PRACTICAL HANDBOOK OF FM REPEATERS	\$ 9.95	LB7359	TEST EQUIP LIB V1—COMPONENT TESTERS	\$ 4.95
BK7309	CHALLENGE OF 160	\$ 4.95	BK7302	PROPAGATION WIZARD'S HANDBOOK	\$ 6.95	LB7360	TEST EQUIP LIB V2—AUDIO TESTERS	\$ 4.95
CT7305	CODE TAPE—5 WPM	\$ 4.95	QW0250	QSL CARDS—STYLE W—250	\$ 8.95	LB7361	TEST EQUIP LIB V3—RADIO EQUIP.	\$ 4.95
CT7306	CODE TAPE—6 + WPM	\$ 4.95	QW0500	QSL CARDS—STYLE W—500	\$13.95	LB7362	TEST EQUIP LIB V4—IC TEST EQ.	\$ 4.95
CT7313	CODE TAPE—13 + WPM	\$ 4.95	QX0250	QSL CARDS—STYLE X—250	\$ 8.95	BK7348	TOOLS & TECHNIQUES	\$ 4.95
CT7320	CODE TAPE—20 + WPM	\$ 4.95	QX0500	QSL CARDS—STYLE X—500	\$13.95	BK1063	TTL COOKBOOK	\$ 9.50
CT7325	CODE TAPE—25 + WPM	\$ 4.95	QY0250	QSL CARDS—STYLE Y—250	\$ 8.95	BK1064	TVT COOKBOOK	\$ 9.95
CT7394	CODE TAPES (ANY FOUR ABOVE)	\$15.95	QY0500	QSL CARDS—STYLE Y—500	\$13.95	BK7382	UNDERSTANDING & PROGRAMMING MICROCOMPUTERS	\$10.95
BK7308	THE CONTEST COOKBOOK	\$ 5.95	BK1044	RF & DIGITAL TEST EQUIPMENT	\$ 5.95	BK1069	VERTICAL BEAM & TRIANGLE ANTNS	\$ 5.50
BK7381	40 COMPUTER GAMES	\$ 7.95	BK7347	RTTY HANDBOOK	\$ 5.95	BK7368	VHF ANTENNA HANDBOOK	\$ 5.95
BK7304	GIANT BOOK OF AMATEUR RADIO ANTENNAS	\$12.95	BK1059	RTL COOKBOOK	\$ 6.50	BK7370	WEATHER SATELLITE HANDBOOK	\$ 2.50
BK7321	A GUIDE TO HAM RADIO	\$ 4.95	BX1000	SHELF BOX—1	\$ 2.00	BK1184	WORLD RADIO TV HANDBOOK	\$16.50
BK7322	HOBBY COMPUTERS ARE HERE	\$ 4.95	BX1001	SHELF BOXES—2-7	\$1.50 each	BK7315	WORLD REPEATER ATLAS	\$ 4.95
BK7325	HOW TO BUILD A MICROCOMPUTER & REALLY UNDERSTAND IT	\$ 9.95						
BK1028	IC OP AMP COOKBOOK	\$12.95						

# RADIO BOOKSHOP

## FOR THE NOVICE

**73 CODE TAPES**  
**ANY FOUR TAPES**  
**FOR \$15.95!**  
**\$4.95 EACH**

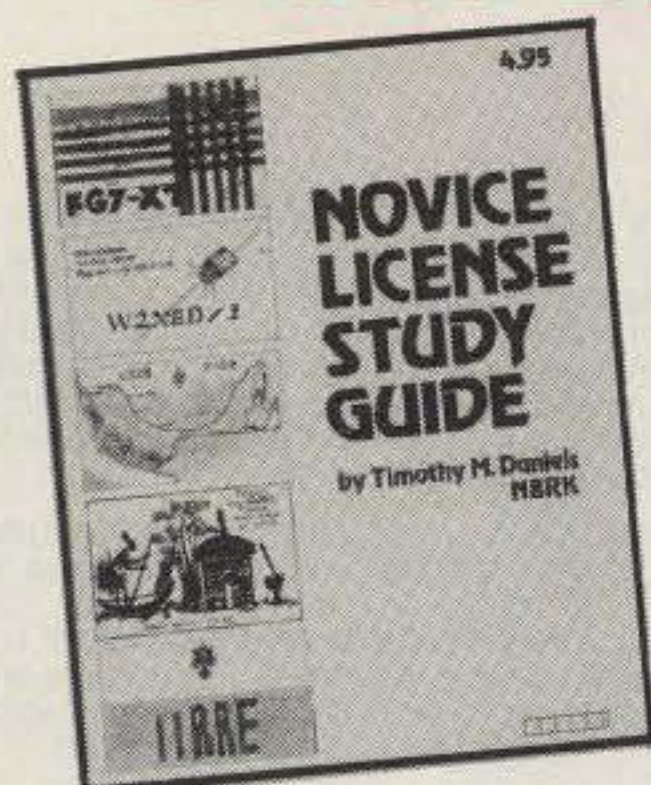

### NEW, UPDATED EDITIONS OF OUR FAMOUS NOVICE CLASS STUDY GUIDE AND NOVICE THEORY TAPES

● **NOVICE STUDY GUIDE—SG7357**—Here is a completely new study guide and reference book for the potential ham. This is not a question/answer memorization course. Electronic and radio fundamentals are presented and explained in an easy-to-understand fashion, preparing the beginner for the Novice exam. Includes the latest FCC amateur regulations, as well as application forms. Easily the best path into the exciting world of ham radio! \$4.95.\*

● **NOVICE THEORY TAPES—CT7300**—Startling Learning Breakthrough. You'll be astounded at how really simple the theory is when you hear it explained on these tapes. Three tapes of theory and one of questions and answers from the latest Novice exams give you the edge you need to breeze through your exam. 73 is interested in helping get more amateurs, so we're giving you the complete set of our tapes for the incredibly low price of **ONLY \$15.95.\***

Scientists have proven that you learn faster by listening than by reading because you can play a cassette tape over and over in your spare time—even while you're driving! You get more and more info each time you hear it. You can't progress without solid fundamentals. These four hour-long tapes give you all the basics you'll need to pass the Novice exam easily. You'll have an understanding of the basics which will be invaluable to you for the rest of your life! Can you afford to take your Novice exam without first listening to these tapes? Set of 4—\$15.95.\*

**SPECIAL OFFER! Both Novice Class Study Guide and Novice Theory Tapes \$20.00 Order NP7300.**

## OTHER STUDY GUIDES

● **EXTRA CLASS LICENSE STUDY GUIDE—SG1080**—Before going for your 1 x 2 call, it pays to be a master of the Extra class electronics theory. This study guide is the logical extension of the 73 theory course. All the theory necessary to pass the exam is presented. Antennas, transmission lines, swr are discussed, as well as noise, propagation, and specialized communication techniques. This book is not a classroom lecture or memorization guide, but rather a logical presentation of the material that must be *understood* before attempting the Extra exam. Save yourself a return trip to the FCC and try the 73 method first! \$5.95.\*

● **ADVANCED CLASS LICENSE STUDY GUIDE—SG1081**—Ready to upgrade your license? To prevent retaking the FCC theory exam, you need the 73 Advanced theory guide. SSB, antenna theory, transmitters, and electronics measuring techniques are covered in detail in this easy-to-follow study guide. Special modes and techniques, such as RTTY, are also treated. An engineering degree is *not* necessary to master the Advanced theory—try this book before visiting the examiner's office! \$6.95.\* (Published by TAB Books previous to recent changes in FCC exam material.)

## FOR YOUR HAMSHACK

● **QSL CARDS**—73 turns out a fantastic series of QSL cards at about half the cost of having them done elsewhere because they are run as a fill-in between printing books and other items in the 73 Print Shop. 250 Style W—QW0250—for \$8.95\*; 500 Style W—QW0500—for \$13.95\*; 250 Style X—QX0250—for \$8.95\*; 500 Style X—QX0500; 250 Style Y—QY0250—for \$8.95\*; 500 Style Y—QY0500—for \$13.95.\* Allow 6-12 wks. for delivery.

● **LIBRARY SHELF BOXES**—These sturdy white, corrugated, dirt-resistant boxes each hold a full year of 73, *Kilobaud Microcomputing* or *80 Microcomputing*. With your order, request self-sticking labels for any of the following: 73, *Kilobaud Microcomputing*, *80 Microcomputing*, *CQ*, *QST*, *Ham Radio*, *Personal Computing*, *Radio Electronics*, *Interface Age*, and *Byte*. Order 1—BX1000—for \$2.00\*; order 2-7—BX2002—for \$1.50 each\*; order 8 or more—BX1002—for \$1.25 each\*.

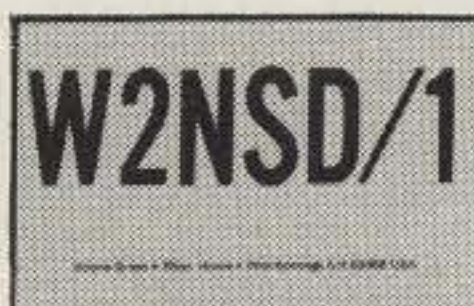

Style Y



Style W



Style X

● Preserve and protect your collection for a lifetime! Order these handsome red binders with gold lettering. \$7.50 for 1, 3 for \$21.75, 6 for \$42.00. (Postpaid within USA, please add \$2.50 per order outside USA.) Check or money orders only, no phone or C.O.D. orders. 73 Binders, P.O. Box 5120, Philadelphia, PA 19141.

\*NOTE—Above address for Binders only.

\*Use the order card in this magazine or itemize your order on a separate piece of paper and mail to: 73 Radio Bookshop • Peterborough NH 03458. Be sure to include check or detailed credit card information. No C.O.D. orders accepted. All orders add \$1.00 handling. Please allow 4-6 weeks for delivery. Questions regarding your order? Please write to Customer Service at the above address. (Prices subject to change on books not published by 73 Magazine.)

**73 MAGAZINE BINDERS**

### "GENESIS"

**5 WPM—CT7305**—This is the beginning tape for people who do not know the code at all. It takes them through the 26 letters, 10 numbers and necessary punctuation, complete with practice every step of the way using the newest blitz teaching techniques. It is almost miraculous! In one hour many people—including kids of ten—are able to master the code. The ease of learning gives confidence to beginners who might otherwise drop out.

### "THE STICKLER"

**6+ WPM—CT7306**—This is the practice tape for the Novice and Technician licenses. It is made up of one solid hour of code, sent at the official FCC standard (no other tape we've heard uses these standards, so many people flunk the code when they are suddenly—under pressure—faced with characters sent at 13 wpm and spaced for 5 wpm). This tape is not memorizable, unlike the zany 5 wpm tape, since the code groups are entirely random characters sent in groups of five.

### "BACK BREAKER"

**13+ WPM—CT7313**—Code groups again, at a brisk 13 per so you will be at ease when you sit down in front of the steely-eyed government inspector and he starts sending you plain language at only 13 per. You need this extra margin to overcome the panic which is universal in the test situations. When you've spent your money and time to take the test, you'll thank heaven you had this back-breaking tape.

### "COURAGEOUS"

**20+ WPM—CT7320**—Code is what gets you when you go for the Extra class license. It is so embarrassing to panic out just because you didn't prepare yourself with this tape. Though this is only one word faster, the code groups are so difficult that you'll almost fall asleep copying the FCC stuff by comparison. Users report that they can't believe how easy 20 per really is with this fantastic one hour tape.

### "OUTRAGEOUS"

**25+ WPM—CT7325**—This is the tape for that small group of overachieving hams who wouldn't be content to simply satisfy the code requirements of the Extra Class license. It's the toughest tape we've got and we keep a permanent file of hams who have mastered it. Let us know when you're up to speed and we'll inscribe your name in 73's CW "Hall of Fame."

## SSTV TAPE

● **SLOW SCAN TELEVISION TAPE—CT7350**—Prize-winning programs from the 73 SSTV contest. Excellent for Demo! \$5.95.\*

## BACK ISSUES

● **BACK ISSUES**—Complete your collection; many are prime collectables now, classics in the field! A full collection is an invaluable compendium of radio and electronics knowledge!

ST0000—Single back issue before July 1980.....\$3.00  
 ST0250—Single back issue after July 1980.....\$3.50  
 ST0500—5 your choice.....\$8.75  
 ST1000—10 your choice.....\$14.00  
 ST2500—25 our choice.....\$12.00  
 ST2501—25 your choice.....\$25.00

● **FREE BACK ISSUE CATALOGS** are yours for the asking... specify 73 Magazine, Kilobaud Microcomputing, and/or 80 Microcomputing back issue catalog when you send your name and address to us on a postcard.

**FOR TOLL FREE ORDERING CALL 1-800-258-5473**

# RADIO BOOKSHOP

## THE 73 TECHNICAL LIBRARY

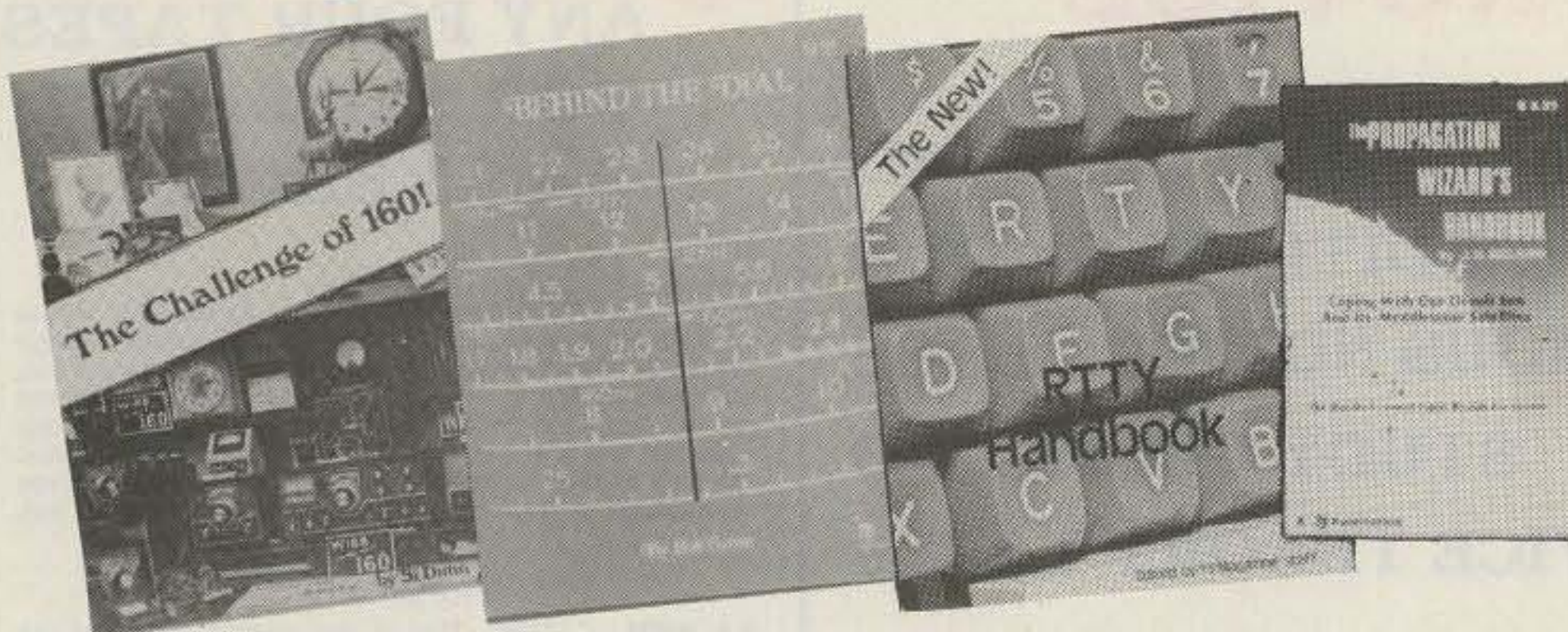

● **BEHIND THE DIAL**—BK7307—By Bob Grove. Get more fun out of shortwave listening with this interesting guide to receivers, antennas, frequencies and interference. \$4.95.\*

● **THE CHALLENGE OF 160**—BK7309—is the newest book in the 73 technical library, dedicated to 160 meter operating. Si Dunn provides all necessary information to get started on this unique band. The all-important antenna and ground systems are described in detail. The introduction contains interesting photos of Stew Perry's (the King of 160) shack. This reference is a must for new and experienced "Top Band" operators. Price: \$4.95.\*

● **SSB... THE MISUNDERSTOOD MODE**—BK7351—by James B. Wilson. Single Sideband Transmission... thousands of us use it every day, yet it remains one of the least understood facets of amateur radio. J. B. Wilson presents several methods of sideband generation, amply illustrated with charts and schematics, which will enable the ambitious reader to construct his own sideband generator. A must for the technically-serious hams. \$5.50.\*

● **PROPAGATION WIZARD'S HANDBOOK**—BK7302—by J. H. Nelson. When sunspots riddled the worldwide communications networks of the 1940's, John Henry Nelson looked to the planets for an answer. The result was a theory of propagation forecasting based upon interplanetary alignment that made the author the most reliable forecaster in America today. The book provides an enlightened look at communications past, present, and future, as well as teaching the art of propagation forecasting. \$6.95.\*

● **TOOLS & TECHNIQUES FOR ELECTRONICS**—BK7348—by A. A. Wicks is an easy-to-understand book written for the beginning kit builder as well as the experienced hobbyist. It has numerous pictures and descriptions of the safe and correct ways to use basic and specialized tools for electronic projects as well as specialized metal working tools and the chemical aids which are used in repair shops. \$4.95.\*

● **THE NEW RTTY HANDBOOK**—BK7347—is a new edition and the only up-to-date RTTY book available. The state of the art has been changing radically and had made all previous RTTY books obsolete. It has the latest circuits, great for the newcomer and expert alike. \$5.95.\*



**PUBLISHER'S  
CLOSE-OUT  
SALE  
50%**

● **WEATHER SATELLITE HANDBOOK**—BK7370—By Dr. Ralph E. Taggart WB8DQT. Valuable information in this edition *will not be included* in the newest edition of the Weather Satellite Handbook (available in Spring 1981). Chapters such as "How to Build an Electronic Timer for Satellite Tracking" and "Building an Automatic Control for the Satellite Receiving Station" will no longer be available when this edition is out of print. This is a good entry level text for those discovering the exciting new use of weather satellites. Regularly \$4.95, SPECIAL SALE PRICE \$2.50.

● **MASTER HANDBOOK OF HAM RADIO CIRCUITS**—BK1033— This is an encyclopedia of amateur radio circuits, gleaned from past issues of 73 Magazine and carefully selected according to application. You'll find many you've never seen before, some new twists on the tried and true, and several that have been long forgotten but are well worth remembering. Where your interest ranges from ragchewing to EME, from CW to slow-scan TV, from DX to county nets, this handbook will be a welcome addition to your shack. \$8.95.\*

● **OWNER REPAIR OF RADIO EQUIPMENT**—BK7310—Frank Glass K6RQ shares over 40 years of operating, servicing, and design experience in this book which ranges from the elementary to the highly technical written for the top engineers in the field. It is written in narrative style on the subjects of electronic servicing, how components work, and how they are combined to provide communication equipment. This book will help you understand the concepts required to service your own station equipment. \$7.95.\*

● **IC OP-AMP COOKBOOK**—BK1028—by Walter G. Jung. Covers not only the basic theory of the IC op amp in great detail, but also includes over 250 practical circuit applications, liberally illustrated. 592 pages, 5 1/2 x 8 1/2, softbound. \$14.95.\*

● **THE POWER SUPPLY HANDBOOK**—BK7305—Need a power supply for a gadget you're building? In the **POWER SUPPLY HANDBOOK** there are dozens ready-to-build, plus detailed steps for designing your own. There are circuits and parts lists for all kinds of supplies, ranging from simple DC types to highly stable regulated versions. If you need a circuit to convert a DC voltage to a higher or lower voltage, turn DC into AC, or AC to DC—then this is the book you need. With more than 400 pages, you should be able to find just the circuit you need. Without a doubt one of the best power supply source books available, compiled by the editors of 73. \$9.95.\*

## HANDBOOKS FOR THE HAMSHACK

● **THE TEN METER FM HANDBOOK**—BK1190—by Bob Heil K9EID. This handbook has been published to help the ten meter enthusiast learn more about the many methods of conversions and tricks that are used to make existing units work better. Join the great "tinkerers" of the world on ten FM and enjoy the fantastic amount of fun in communicating with amateur stations worldwide on ten meter FM. \$4.95.\*

● **THE PRACTICAL HANDBOOK OF AMATEUR RADIO FM REPEATERS**—BK1185—by Bill Pasternak WA6ITF (author of 73 Magazine's monthly column "Looking West") This is the book for the VHF/UHF FMer, compiled from material submitted by over a hundred individuals, clubs, organizations and equipment manufacturers. A "must have" for your ham shack shelf. \$9.95.

## The 73

## Test Equipment Library



● **VOL. I COMPONENT TESTERS**—LB7359—... how to build transistor testers (8), diode testers (3), IC testers (3), voltmeters and VTVMs (9), ohmmeters (8 different kinds), inductance (3), capacity (9), Q measurement, crystal checking (6), temperature (2), aural meters for the blind (3) and all sorts of miscellaneous data on meters... using them, making them more versatile, making standards. Invaluable book. \$4.95.\*

● **VOL. II AUDIO FREQUENCY TESTERS**—LB7360—... jam packed with all kinds of audio frequency test equipment. If you're into SSB, RTTY, SSTV, etc., this book is a must for you... a good book for hi-fi addicts and experimenters, too! \$4.95.\*

● **VOL. III RADIO FREQUENCY TESTERS**—LB7361—Radio frequency waves, the common denominator of Amateur Radio. Such items as SWR, antenna impedance, line impedance, rf output and field strength; detailed instructions on testing these items includes sections on signal generators, crystal calibrators, grid dip oscillators, noise generators, dummy loads and much more. \$4.95.\*

● **VOL. IV IC TEST EQUIPMENT**—LB7362—Become a troubleshooting wizard! In this fourth volume of the 73 TEST EQUIPMENT LIBRARY are 42 home construction projects for building test equipment to work with your ham station and in servicing digital equipment. Plus a cumulative index for all four volumes for the 73 TEST EQUIPMENT LIBRARY. \$4.95.\*

● **RF AND DIGITAL TEST EQUIPMENT YOU CAN BUILD**—BK1044—Rf burst, function, square wave generators, variable length pulse generators—100 kHz marker, i-f and rf sweep generators, audio osc, af/rf signal injector, 146 MHz synthesizer, digital readouts for counters, several counters, prescaler, microwave meter, etc. 252 pages. \$5.95.\*

## FOR THE CONTESTER

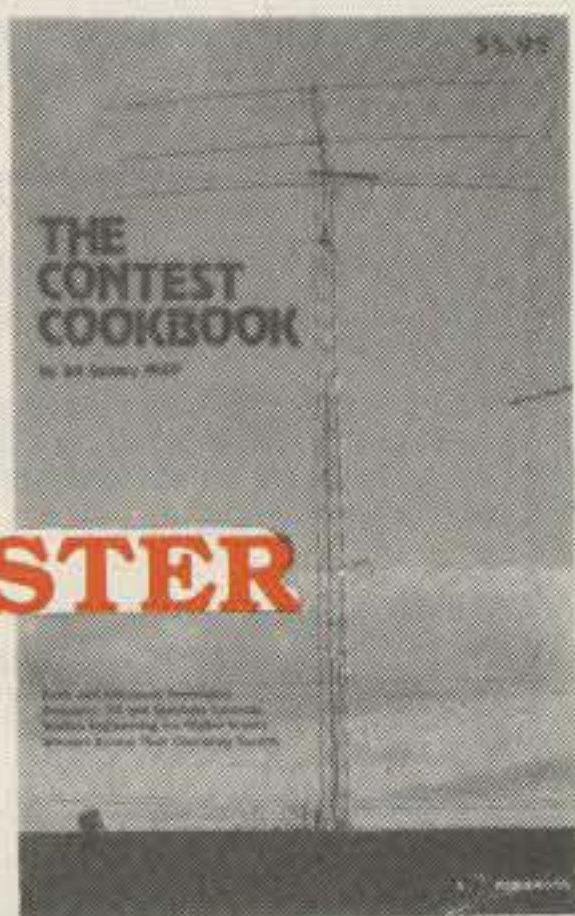

● **THE CONTEST COOKBOOK**—BK7308—reveals the secrets of the contest winners (Domestic, DX and specialty contests), complete with photos and diagrams of equipment used by the top scorers. Find out how to make 150 contacts in one hour. \$5.95.\*

\*Use the order card in this magazine or itemize your order on a separate piece of paper and mail to: 73 Radio Bookshop • Peterborough NH 03458. Be sure to include check or detailed credit card information. No C.O.D. orders accepted. All orders add \$1.00 handling. Please allow 4-6 weeks for delivery. Questions regarding your order? Please write to Customer Service at the above address. (Prices subject to change on books not published by 73 Magazine.)

**FOR TOLL FREE ORDERING CALL 1-800-258-5473**

# RADIO BOOKSHOP

## ANTENNA BOOKS 5 NEW ANTENNA BOOKS

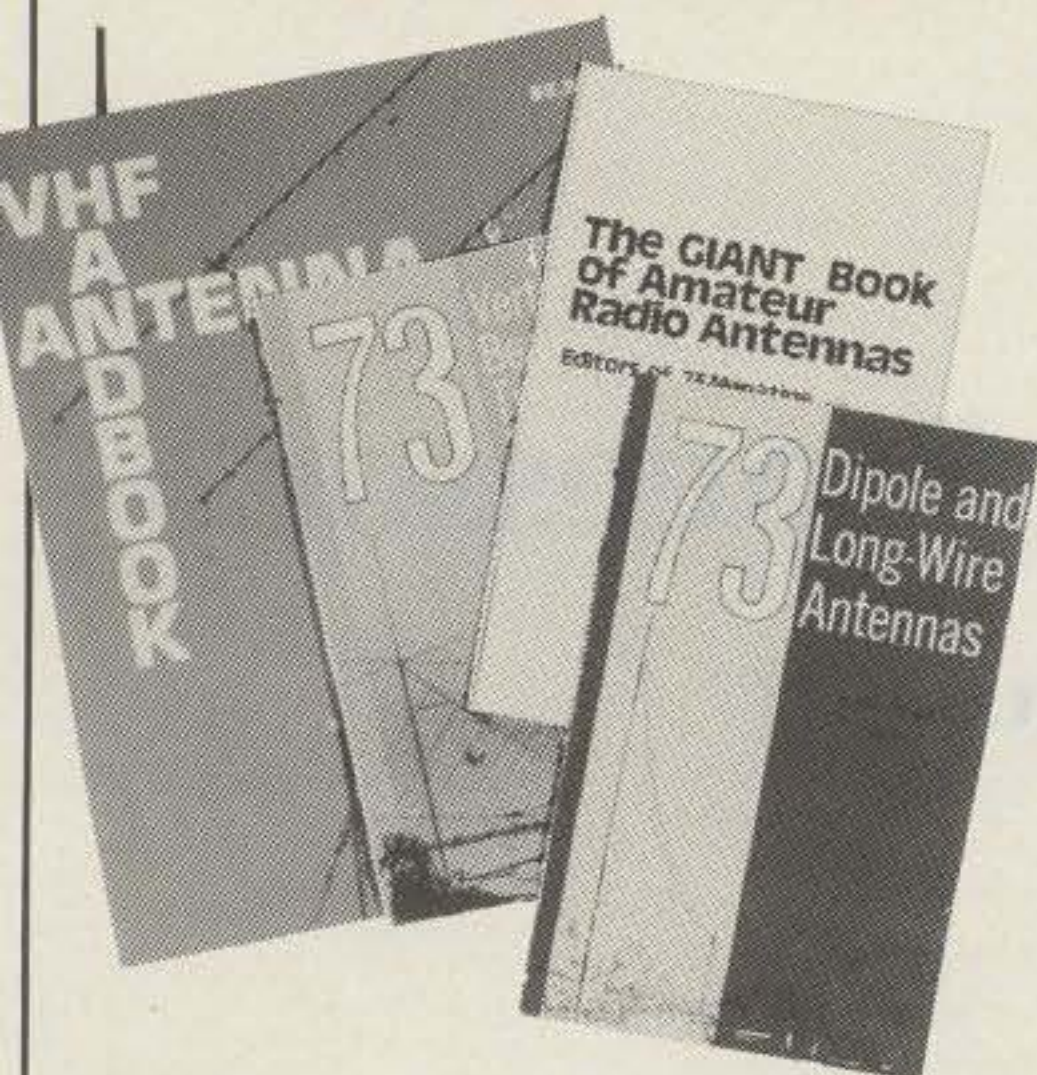

● **VHF ANTENNA HANDBOOK**—BK7368—The NEW VHF Antenna Handbook details the theory, design and construction of hundreds of different VHF and UHF antennas... A practical book written for the average amateur who takes joy in building, not full of complex formulas for the design engineer. Packed with fabulous antenna projects you can build. \$5.95.\*

● **THE GIANT BOOK OF AMATEUR RADIO ANTENNAS**—Over 450 pages of design ideas, theory and reference data make this book live up to its title. The 7 chapters cover everything from basic antenna theory through designs for DIY accessories, as well as dozens of antenna designs. Whether planning to build or buy, design or admire, test or enjoy a ham antenna—this is the book for you. Hardcover \$12.95.\*

● **73 VERTICAL, BEAM AND TRIANGLE ANTENNAS**—BK1069—by Edward M. Noll W3FQJ. Describes 73 different antennas for amateurs. Each design is the result of the author's own experiments covering the construction of noise bridges and antenna line tuners, as well as methods for measuring resonant frequency, velocity factor, and standing-wave ratios. 160 pages. \$5.50\*

● **73 DIPOLE AND LONG-WIRE ANTENNAS**—BK1016—by Edward M. Noll W3FQJ. This is the first collection of virtually every type of wire antenna used by amateurs. Includes dimensions, configurations, and detailed construction data for 73 different antenna types. Appendices describe the construction of noise bridges, line tuners, and data on measuring resonant frequency, velocity factor, and swr. \$5.50.\*

● **PRACTICAL ANTENNAS FOR THE RADIO AMATEUR**—BK1015—A manual describing how to equip a ham station with a suitable antenna. A wide range of antenna topics, systems, and accessories are presented giving the reader some food for thought and practical data for construction. Designed to aid the experienced ham and novice as well. Only \$9.95.\*

- **ALL ABOUT CUBICAL QUAD ANTENNAS** (2nd edition)—BK1196—The "Classic" on Quad design, theory, construction, and operation. New 2nd edition contains new feed and matching systems and new data. \$4.75\*
- **BEAM ANTENNA HANDBOOK** (New 5th edition)—BK1197—Yagi beam theory, construction and operation. Information on wire beams, SWR curves and matching systems. A "must" for serious DXers. \$5.95\*
- **VHF HANDBOOK FOR RADIO AMATEURS**—BK1198—Contains information on FM theory, operation and equipment, VHF antenna design and construction, satellite-EME, and the newest solid-state circuits. \$6.95\*
- **THE RADIO AMATEUR ANTENNA HANDBOOK**—BK1199—All about wire antennas, beams, tuners, baluns, coax, radials, SWR and towers. Clear and complete information. \$6.95\*
- **SIMPLE, LOW-COST WIRE ANTENNAS FOR RADIO AMATEURS**—BK1200—All new data and everything you want to know about low-cost, multi-band antennas, inexpensive beams, "invisible" antennas for hams in "tough" locations. \$6.95\*

## COOK BOOKS

● **TTL COOKBOOK**—BK1063—by Donald Lancaster. Explains what TTL is, how it works, and how to use it. Discusses practical applications, such as a digital counter and display system, events counter, electronic stopwatch, digital voltmeter and a digital tachometer. \$9.50.

● **CMOS COOKBOOK**—BK1011—by Don Lancaster. Details the application of CMOS, the low power logic family suitable for most applications presently dominated by TTL. Required reading for every serious digital experimenter! \$10.50.\*

● **TVT COOKBOOK**—BK1064—by Don Lancaster. Describes the use of a standard television receiver as a microprocessor CRT terminal. Explains and describes character generation, cursor control and interface information in typical, easy-to-understand Lancaster style. \$9.95.\*

**Save over 50%  
SALE PRICE \$3.00**

● **RTL COOKBOOK**—BK1059—by Donald Lancaster. Explains the how and why of RTL (Resistor-Transistor Logic) and gives design information that can be put to practical use. Gives a multitude of digital applications ranging from the basic switch to the sophisticated counter. 240 pages; Regular price \$6.50, Sale price \$3.00!

### SPECIAL OFFER

#### Chart of UNITED STATES AMATEUR RADIO PRIVILEGES

by class of license, emission type, and frequency from 160 thru 2 meters, including provision for the new 30, 17, and 12 meter bands. This 22 x 28 in, twelve-color chart is the first of its kind to be both informative and decorative. \$3.00 value, only \$1.95 with the purchase of 1 or more books from the Radio Bookshop. (Supplies limited, order now.)  
CH7300 \$1.95.

## THE WELL EQUIPPED HAM SHACK

NEW  
COMPLETELY  
UPDATED

**WORLD  
Repeater  
ATLAS  
Repeater  
Repeater  
Repeater**



● **WORLD REPEATER ATLAS**—BK7315—Completely updated, over 230 pages of repeater listings are indexed by location and frequency. More than 50 maps pinpoint 2000 repeater locations throughout the USA. Foreign listings include Europe, the Middle East, South America, and Africa. \$4.95.

● **THE MAGIC OF HAM RADIO**—BK7312—by Jerrold Swank, W8HXR begins with a brief history of amateur radio and of Jerry's involvement in it. Part 2 details many of ham radio's heroic moments. Hamdom's close ties with the continent of Antarctica are the subject of Part 3. In Part 4 the strange and humorous sides of ham life get their due. And what of the future? Part 5 peers into the crystal ball. \$4.95.\*

● **A GUIDE TO HAM RADIO**—BK7321—by Larry Kahaner WB2NEL. What's Amateur Radio all about? You can learn the basics of this fascinating hobby with this excellent beginner's guide. It answers the most frequently asked questions in an easy-going manner, and it shows the best way to go about getting an FCC license. A Guide to Ham Radio is an ideal introduction to a hobby enjoyed by people around the world. \$4.95.\*

● **WORLD RADIO TV HANDBOOK 1981, 35TH EDITION**—BK1184—This book is the bible of international broadcasters, providing the only authoritative source of exact information about broadcasting and TV stations world wide. This 1981 edition is completely revised, giving comprehensive coverage of short, medium and long wave, 560 pages of vital aspects of world listening. \$16.50.

## MICROCOMPUTER BOOKS FROM 73



● **SOME OF THE BEST FROM KILOBAUD/MICROCOMPUTING**—BK7311—A collection of the best articles that have recently appeared in Kilobaud/ MICROCOMPUTING. Included is material on the TRS-80 and PET systems, CP/M, the 8080/8085/Z80 chips, the ASR-33 terminal. Data base management, word processing, text editors and file structures are covered too. Programming techniques and hardware construction projects for modems, high speed cassette interfaces and TVTs are also included in this large format, 200 plus page edition. \$10.95.\*

● **40 COMPUTER GAMES**—BK7381—Forty games in all in nine different categories. Games for large and small systems, and even a section on calculator games. Many versions of BASIC used and a wide variety of systems represented. A must for the serious computer gamesman. \$7.95\*

● **THE NEW HOBBY COMPUTERS**—BK7340—This book takes it from where "HOBBY COMPUTERS ARE HERE!" leaves off, with chapters on Large Scale Integration, how to choose a microprocessor chip, an introduction to programming, low cost I/O for a computer, computer arithmetic, checking memory boards... and much, much more! Don't miss this tremendous value! Only \$4.95.\*

● **UNDERSTANDING AND PROGRAMMING MICRO-COMPUTERS**—BK7382—A valuable addition to your computing library. This two-part text includes the best articles that have appeared in 73 and Kilobaud Microcomputing magazines on the hardware and software aspects of microcomputing. Well-known authors and well-structured text helps the reader get involved. \$10.95\*

● **HOW TO BUILD A MICROCOMPUTER—AND REALLY UNDERSTAND IT**—BK7325—by Sam Creason. The electronics hobbyist who wants to build his own microcomputer system now has a practical "How-To" guidebook. This book is a combination technical manual and programming guide that takes the hobbyist step-by-step through the design, construction, testing and debugging of a complete microcomputer system. Must reading for anyone desiring a true understanding of small computer systems. \$9.95.\*

● **HOBBY COMPUTERS ARE HERE!**—BK7322—If you want to come up to speed on how computers work... hardware and software... this is an excellent book. It starts with fundamentals and explains the circuits, and the basics of programming, along with a couple of TVT construction projects, ASCII-Baudot, etc. This book has the highest recommendations as a teaching aid. \$4.95.\*

\*Use the order card in this magazine or itemize your order on a separate piece of paper and mail to: 73 Radio Bookshop • Peterborough NH 03458. Be sure to include check or detailed credit card information. No C.O.D. orders accepted. All orders add \$1.00 handling. Please allow 4-6 weeks for delivery. Questions regarding your order? Please write to Customer Service at the above address. (Prices subject to change on books not published by 73 Magazine.)

**FOR TOLL FREE ORDERING CALL 1-800-258-5473**

# The Datong ASP Speech Processor

— will this give you a British accent?

R. Stanley Dicks W8YA  
Department of English  
Wheeling College  
Wheeling WV 26003

**P**ersonally, I have never liked speech processors, and my on-the-air friends have tired of hearing me talk about how

lousy they sound. I dislike them because almost everyone who uses one turns the gain up too much, thereby causing his signal to become wide and sloppy, and because most operators insist on leaving them on even when they're rag-chewing with strong signals, making their audio sound

as though it's coming from the bottom of a galvanized garbage can.

I have tried several processors and have never kept any of them. With the alc on my transmitter adjusted properly, processing didn't seem to help much unless the level was turned up so high that I got reports of a

spread out, garbled-sounding signal. I resold all of them pretty quickly.

Lately, though, the state of the art in audio processing has improved considerably. The crude diode-clipper-type compressors of years ago have been replaced with sophisticated circuitry using integrated circuits and considerably more filtering than the earlier circuits had. And, I have heard more and more signals on the air from operators who were using processing and whose audio still sounded OK. So, after deciding to give one of the new circuits a try, I went with the Datong ASP.

I chose the Datong unit for several reasons. Datong is a British company which has a somewhat unusual philosophy. In this era of mass-produced, often shoddily-constructed products, Datong believes in turning out quality equipment with some "extra" features. Their receiving audio filters are becoming known among DXers as the best on the market and they introduced a new one at Dayton in 1980 that is incredi-



Datong's ASP.

ble—it's like having a tunable crystal filter. I have used one of their filters for a couple of years and I admired the quality of the components and the workmanship in it. The unit has performed quite well (see the review in the October, 1979, 73) and it contains some unusually advanced, state-of-the-art circuitry. Because of all of this, the Datong ASP processor seemed to be a logical choice for a try. The results have not been disappointing.

The ASP is an rf clipping device; it has been proven fairly well that rf clipping can provide more average gain with less distortion than audio compression. The disadvantage with most clippers is that they have to be wired internally into the transmitter circuitry. Because they contain filtering circuitry at one of the transmitter's intermediate frequencies, they cannot be interchanged from one rig to another. The ASP unit, however, will work with any transmitter because the rf clipping is all done within the ASP itself.

The unit is hooked up, like audio processors, between the microphone and the mike input of the rig. The audio signal from the microphone goes into the ASP where it is first processed by a special audio processor circuit. The circuit is designed to maintain a constant peak-to-peak speech amplitude no matter how wide the variations in input levels. It also includes a five-second hang time, which means that once the circuit has adjusted itself to a certain input level, the background noise remains constant during speech pauses or loud transients. The circuit thus feeds a controlled, regulated audio signal to the rf clipper and also prevents the clipped, on-again, off-

again background rush noise that many processors introduce. The processing in this circuit alone provides considerable enhancement of the audio, and it can be used by itself with no rf clipping simply by pushing a button on the unit's front panel. On-the-air reports indicate that my audio (from an Electrovoice EV-676 mike and a Drake TR-7) is fuller and has more "presence" when the unit is used in this position.

After being processed, the audio is converted into rf through an internal if mixer, after which it is fed into another rf stage where it is clipped. The level of clipping is variable in 6-dB increments from 0 dB to 30 dB. After being clipped, the signal is reconverted from rf to af and is then fed directly into the rig's audio input. Because the clipping is all done internally in the ASP, no connections to the transmitter rf circuitry are necessary; you merely plug the mike into the ASP and the ASP into the transmitter.

The ASP comes in an attractive two-tone grey, wrap-around metal cabinet, and shielding seems to be excellent. The only feedback problem I encountered, even while running a full kilowatt, was with a high swr and lots of rf in the shack while operating on 10 meters. The unit requires 6 to 16 V dc at 15 mA; mine is powered, along with several other devices, by a small 12-V dc supply. The front panel contains the mike input connector, push-button controls for on/off and for the clipping level, and three LEDs: one to indicate the unit is on and two to give the operator an indication of how the unit is functioning.

In operation, the unit is switched to the desired clipping level and is immediately operable. There are no gain controls because the

unit automatically adjusts in input level from the mike such that just the right amount of af is supplied to the rf clipping section. There is a gain balance adjustment on the back of the unit so that its gain can be matched to the rig in use—this is a one-time, set-it-and-forget-it adjustment. It takes the unit about one second to "learn" the input level from the operator's voice and to adjust to it. Once this learning occurs, the unit "hangs" for about five seconds and keeps itself adjusted during speech pauses. It does this even if the mike push-to-talk button is lifted or the VOX relay drops to receive. If the input voice level is too low, an LED labeled "OK" lights up. If the input is too high, both LEDs light up. A third LED, labeled "SPEECH," follows the operator's voice pattern while speaking. If it stays on during pauses, the background noise is too high and the operator should move closer to the mike or should reposition the mike. I have been amazed at how accurately the three LEDs indicate what is going on with the unit; they tell the operator so much that a meter is hardly necessary.

The ASP has a couple more interesting features. There is a switch on the front panel which allows instant changing from low- to high-impedance microphone inputs, thus allowing for rapid comparison of various mikes. Also, the unit has a push-button labeled "TONE." When this button is depressed, a 700-Hz sine wave is fed into the rig, allowing for rig audio adjustment and even tune-up of the tank circuit.

All of these features add up to a unit that is extremely easy to operate. Usually, using the unit requires merely the pushing of one button and the operator can then forget about it.

The operation of the unit is excellent also. On-the-air tests with friends indicate that the audio sounds beautiful in the 6-dB and 12-dB positions and that it then begins to get a little "fuzzy" in moving from 18 dB to 30 dB. Even at 30 dB, however, the signal does not broaden and distortion products are not generated in the transmitter. Compare this to most processors, where setting them at 30 dB, if they will even go that high, produces audio so distorted that it sounds like a tape recording of Custer's Last Stand.

When rag-chewing, I generally leave the unit in the 6-dB position, as my buddies say that they actually prefer it to my normal, unprocessed audio! When trying to bust through a pile-up or work weak stations, I switch to the 18-dB or 24-dB positions. From what I can tell, the unit gets me through pile-ups much faster than with unprocessed audio. I have never had a single report or complaint of "dirty" audio, no matter what setting the ASP has been in. I have to confess it—the ASP has converted me from an anti-processor person into one who will tolerate processing and even use it himself.

The Datong ASP is a top-quality af and rf speech processing device with many extra features. It is probably the fanciest unit on the market today and is also the most expensive (\$229.95). It is certainly not meant for the casual operator. However, for serious DXers, weak-signal VHFers, contesters, or avid traffic handlers, the ASP is a unit which can provide a great many benefits.

The ASP is imported and marketed in the states by AR Technical Products, Post Office Box 62, Birmingham MI 48012; (313)-644-5698. Reader Service number 476. ■

# W2NSD/1 NEVER SAY DIE

editorial by Wayne Green

from page 18

donned my regulator, tank, mask, fins, depth gauge, and my new Casio skin-diving watch... good to 100 meters. I'd picked that up in Tokyo for about \$25. Not bad compared to the old Rolex I used to use, which now costs about \$500. Spa-loosh, and I was over the side in about 50 feet of water. It was beautiful and worth all the trouble. I headed for the bottom and the coral-encrusted drop-off nearby... where the head wall dropped beyond sight.

I swam around taking pic-

tures of the fish, the three other divers, the coral... having a fantastic time. I've been scuba diving for at least 25 years... all over the world...so this was blissful for me.

My depth gauge went to 75 feet... then to 85 feet. My watch was doing great at 75 feet... and was out of commission by 85 feet. Hey, Casio! What's this baloney? Without a watch one has a problem. With about 50 minutes of air one likes to keep track of time. It is very difficult when you run out of air at 85 feet and have to work back toward the surface trying to suck the



With everything but the co-pilot seat filled, I got that choice seat. The hat was to keep my brains from frying in the sun... which is very hot down there.



This is the Piper which brought us to Provo from Grand Turk. Chuck brought his guitar... he's getting awfully good at bluegrass these days.

tank through the regulator. And one really has no way to keep track of time under water without a watch. Your sense of time is lost in this slow-motion environment where you are weightless and can go anywhere in three dimensions at will. It's like flying.

Despite the rumor of hordes offering special prayers for disaster from somewhere in central Connecticut, all went well. I got a lot of fine pictures and emerged in euphoria.

Sherry was still a bright green. Chuck had been snorkeling (he hadn't been checked out for scuba yet). We headed back to the Inn... a long, long trip over a very bounding main.

Once ashore, Sherry recovered quickly and was ready for lunch when it was served a few minutes later. Hamburgers.

In the afternoon, Jeff made the mistake of going to the bathroom and I grabbed the rig, whipping off about a hundred contacts before he was able to wrest the mike from me again.

I was surprised and pleased to find that an old friend of mine had moved to Provo and was living there. Bob Cooper, the king of the satellite TV game, was there with his family, a big dish, and TV service for the island. Bob and his wife came over to the hotel and we had dinner with them, talking over old times. It was about 25 years ago I first visited him in California as K6EDX.

We arrived at Provo on Thursday evening... got our bags Friday evening. I went scuba diving Saturday and Sunday mornings... and got in about a thousand contest contacts from

Chuck's station in his hotel room. This was about a couple hundred yards from the Third Turtle Inn... at the Latitude 22 (hotel). He had a wonderful location there, with lots of room for his traveling dipole antenna.

On Sunday afternoon we all (except Jeff, who was contesting) visited Bob's television setup. Formidable. He picks up the signals from the satellites, sends them on channel 7 to the only real hill on the island, and rebroadcasts them from there on channel 4, with a repeater station which is entirely sun-powered. This provides TV for the island... which has a population of perhaps a thousand. Bob eventually will be charging for this service at around \$12 per month/per user, which should keep him in the chips. That's one of the better aspects of a small island government system... it is flexible enough to be practical.

Jeff and Tim did very well in the contest. Jeff was operating at the last minutes and got a scare when his rig blew up just as the contest ended. He was just starting to get some scores from the others when a curl of smoke brought the news... and the rig gasped. The problem is that the rig was not designed for wide variations in power voltage... and a sudden surge wiped out the filter capacitors.

I've found that there are few smaller countries where the power does not go through unbelievable gyrations. I would strongly suggest that anyone going on a DXpedition put in higher voltage filter capacitors... ones which will withstand fast surges to 150 or more



Turks and Caicos National Airlines is about to add our luggage to that of the other passengers... and the commercial cargo... and mail. They just barely were able to squeeze it all in.



line volts. Your rig should also perk at 95 volts, because that is all you're going to get at times. Tim swiped the filters from a second set (which went west during the contest, too, but not with filter troubles), and they were back on the air again... after a couple of hours. The next morning (Monday) Chuck and I went for a swim not far from the Inn, where we found some coral and I took more pictures. Then we had to pack and catch the TCNA plane from Provo (they had room this time, but just barely). By the time they had packed all of our rigs (Tim and Jeff were with us this trip), Chuck's guitar and rig, my suitcases of cameras, skin-diving gear, and other toys, the plane was so loaded the pilot was not sure it would be able to lift off.

We made the takeoff...and eventually got to Grand Turk, where we boarded an Air Florida plane. We stopped off at the Dominican Republic for a half hour...and then were off to Miami, flying up the Bahama chain. We eventually got back to Boston at about 1 am. It was a fun trip and well worth all the troubles...and perhaps even the expense.

#### CAVEAT EMPTOR

It's bad enough to read a serious review about an antenna which is a hoax, even if the manufacturer doesn't know enough about antennas to know it, but worse things are out there to waste your money on if you are not damned careful. That review came complete with an ad for the silly antenna. I have not permitted that antenna to be advertised in 73.

Will that same magazine start running ads for a "new" firm which recently turned up? I sure hope not, but apparently ethics are not a primary problem with all of our publications, so buyer beware...*beware!*

It wasn't long ago that a ham firm sort of disappeared after accepting orders, I am told, from about 5,000 people. They'd been at a lot of hamfests, selling their products, so no one suspected what was coming. It is estimated that hams and experimenters were ripped off for about \$750,000 and suppliers for another \$200,000 or so...damned near \$1 million...tax-free, apparently.

One ham mentioned to me that he'd been at a hamfest and seen the owner of the business pocket some \$30,000 in cash. Was this going into the company later on? No, apparently not. In one case, I understand that the cash was converted into a cashier's check, which later went into a personal bank account and then was used as a down payment for a very expensive home. Mind you, this chap and his wife were taking home about \$100,000 in declared income.

In another case, he paid someone helping him with his booth out of the roll in his pocket, pointing out that this was all tax-free. Well, if people want to steal money from their company, I suppose that would normally be a problem for the government to worry about... but when the hams get it in the neck and someone walks away free and clear, then I *do* take an interest in scuttlebutt. There are a lot of totally innocent people being hassled and even convicted by our government, so I really hate to see someone using amateur radio to clean up... and get away with it.

Other magazines may make a big deal about protecting their readers, but I still see them taking ads from firms which I won't accept. I assure you that this reincarnated firm will have to advertise elsewhere.

Speaking of refusing ads, I ran into Jim Penny at the March San Francisco computer show. He used to run Dycomm and said he didn't need ads in 73 to stay in business. I refused to run his ads because his 2m amplifiers would not meet published specs. So he advertised in *QST*...and went out of business. He's now living in Egypt, selling air-conditioning equipment.

I do my best to keep the crooks out of 73, as well as those firms which are so shaky that they may be going under, those whose equipment I think is poor, or firms which I have a reason to believe may not be giving good service. I reserve the right to refuse ads for any reason...or without any reason. I'm not perfect in protecting you, but I think I'm the best you've got.

If you have any problems with any ham firm, please let me know about it right away. I want to know about anything crooked



Chuck and me. Most of the time I'm taking the pictures, so I don't get into a lot of them. I mostly use a Nikon FE, with a Nikonos IV for underwater shots.



Sherry, our Vice President (someone has to do the work!). She's wearing a Casio C-80 watch. I had mine on when I was swept up in the current while trying to cross a canal. It got dunked to about six feet but didn't suffer. My Casio skin diving watch flooded at 85 feet. We've recently switched to the new Casio CA-90, much the same as the C-80, except they have an alarm and an hourly beeper.

you see going on...bum service support and so on.

#### CLIPPING SERVICE

This is my way of thanks to all of the readers who have been taking the time to clip newspaper and magazine items which they think might interest me. They do...and I really appreciate the thought. I'm particularly interested in anything about amateur radio, WWII submarines, microcomputers, radar detectors, etc.

#### NIAC

A couple of years ago, I was surprised to find myself recommended as a member of the FCC advisory committee on amateur radio emergency measures. This is the National Industry Advisory Committee (NIAC). Well, I'm game to do anything which looks as if it might benefit ama-

teur radio...despite rumors coming from my good friends to the south that I'm out to destroy amateur radio (and, presumably, my magazine). I also perceived the position as one of honor, so my ego puffed up slightly.

Now, with a couple of NIAC meetings under my belt, I think it might be time to throw the light of day on this group. I suspect that not one ham in a hundred even knows that NIAC exists... I know that I was only vaguely aware of it before the knock on the door. When you consider that this is the *only* amateur radio group with an input to the Commission, you perhaps can understand why it *could* have some benefits for us.

The committee used to be run 100% by the ARRL, with the chairmanship passed down from friend to friend without even a vote by the committee.



*Chris Payne seems a bit disappointed over the chairman problem. He seems very anxious for NIAC to get in there and tackle the problems of the day and get the committee to take some initiative.*

The committee also has an unblemished record of doing virtually nothing. When I was in high school I belonged to an "honor" society like this. It was called the Book Club and I got to be a member by virtue of having been a member of the St. Paul's Choristers (St. Paul's Church was nearby). Well, it provided a private room and a freedom from going to study hall, so who

could complain? Yes, I was a choirboy before my voice changed...and a good one, too.

The makeup of NIAC has been changing in recent years. There are about 17 members, of which about 60% manage to get to the meetings. Recent new members, other than me, have been Tony Curtis of TAB Books and Alan Dorhoffer of CQ

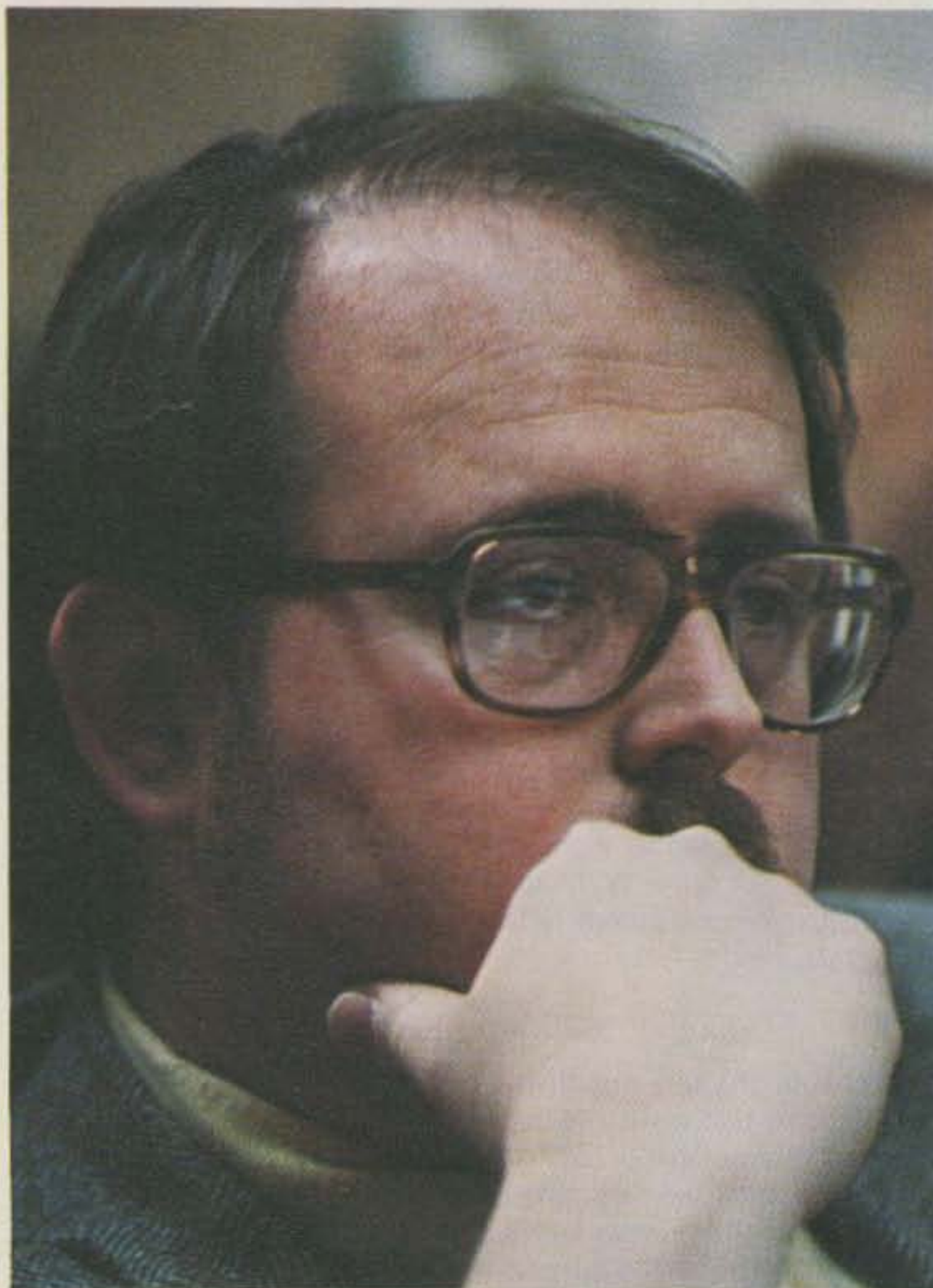

*Tony Curtis managed to stay awake... just barely... through a long film on Three Mile Island. No one was sure why the film was shown.*



*The March, 1981, meeting of NIAC. On the left we see Charlie Dunn K7RMG, an FCC secretary to take the minutes, and Chris Imlay N3AKD. At the end of the table is Sherry, with Tony Curtis K3RXX of Tab Books, then Chris Payne W3IRC of NAB, Alan Dorhoffer W2EEK of CQ, and Hal Todd W7ZXM with the red jacket. On the right, from the back, are Rafael Estevez WA4ZZG, Mike Renfro (FCC), and Herb Newman (FCC). The chap in front with his back to us is John Obradavich W3IS, the chairman.*

*Magazine*, neither particularly rubber-stamp-type hams.

There was a good deal of irritation among the more enthusiastic members over the abrupt cancellation of the meeting scheduled for last October. I don't know about the others, but I had gone to a lot of trouble to work my schedule so I could attend that meeting. I felt there were some urgent matters which should be considered by the group. Then, with little warning, the chairman of the committee sent a note saying that he had cancelled the meeting. Hell, he hadn't even come to the previous one in May, 1980!

When asked at the March, 1981, meeting why he had cancelled the October meeting, he said that he had looked over the agenda and decided that there was really nothing important. Without consulting the members of the committee, he sent out the cancellation letters. This triggered an attempt spearheaded by Chris Payne (NAB) to get him replaced as chairman. This was deftly sidestepped and Mr. Obradavich is still sitting in The Chair.

While the cancellation was irritating, particularly since it was so heavy-handed, I really didn't think that a change of chairman was called for. Besides, there was always that lurking fear that I would be asked to take the spot. What does one say to that? There is no way that I could do the job that should be done... it would be impossible.

I won't bore you with the burdens I've taken on, but they are more than full time as it is and there is just so much of me to spread around. If I'd been sure that it might go to Payne or one of the others, I would have been more enthusiastic.

One of the limitations of the committee has to do with being involved only with ham emergency matters. As such, the committee has been grinding very small matters into dust rather than taking advantage of its position as a group with the ear of the Commission. To get around that little drawback I pointed out to the committee that any emergency communications system is going to be useless unless it is in regular daily use by amateurs. No special emergency system can be relied upon to work if it isn't in common use. That's the way things go.

With this proviso, we could start discussing special amateur radio satellite communications systems, special modes of communications, and all of the developments which are so desperately needed by amateur radio these days. Further, without some sort of spark to get amateur radio growing again, we may not have an emergency service available.

The "plain language" rules came in for some serious discussion. It had not escaped everyone that the new rules have done away with *all* of the reasons for amateur radio to ex-



Alan Dorhoffer played it cool, letting the others fight.

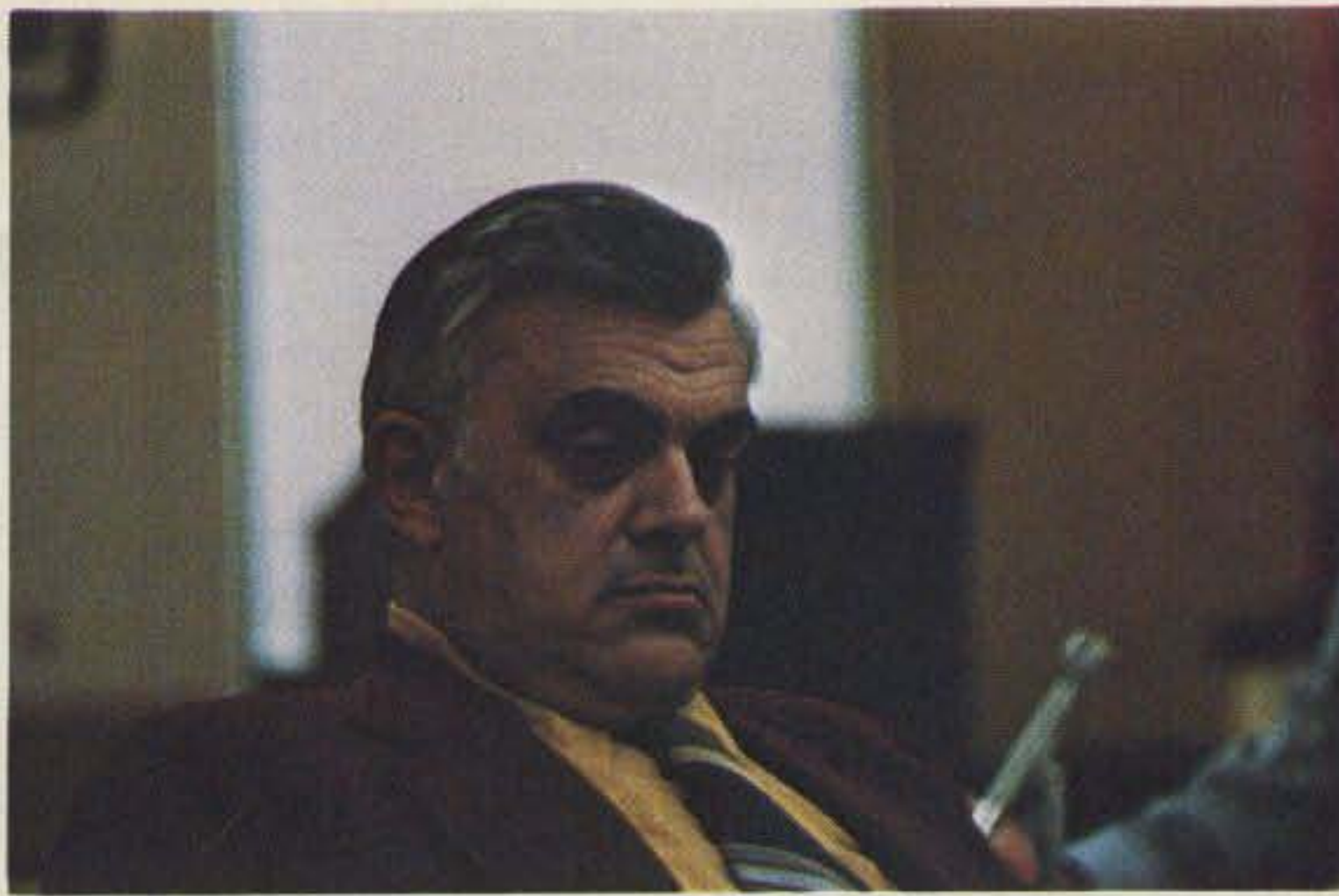

Hal Todd came a long way for the meeting.

### BEEFS

A reader mentioned he had read some beefs about 73 not being at hamfests these days. Well, we can't get to 'em all, of course, but we do get to as many as we can. Actually, it is rare that someone from our staff doesn't get to the larger hamfests.

At Orlando we had both Bob Lyons and Jim Gray. Bob went from there to the Charlotte hamfest. Just about everyone from our place went to Boxboro last fall, though I was in Tokyo at the time, getting together with the Tokyo International Amateur Radio Association... and visiting the Trio-Kenwood people.

Those of you who went to Dayton this year had your chance to see and hear me.

The microcomputer aspect of my publishing has put a big strain on me, and much of my travel has been involved with that, but I've had to cut down on computer shows, too... such

as the recent one in Dallas. I did get to the CES in Vegas in January, the West Coast Computer Faire in April, and NCC in April. Ooops, I almost forgot the NIAC trip to Washington in March... a strictly ham event.

### MILLER HASSLE

The storm is still raging over the firing of Don Miller as ARRL director. The Indiana hams seem to be extremely upset over this and most resistant to the HQ-named replacement: Metzger.

Though I was away from the 73 booth at Dayton at the time, one of the 73 team (we had nine people there) reported that some chap claiming to be Metzger's lawyer came by and yelled about the pro-Miller letters we published, threatening to sue over it. There was a general agreement that this chap was loud and obnoxious.

Hear this, Metzger: Threats of lawsuits are not going to keep

us from printing the facts. They never have.

Several years ago I had a run-in with another Don Miller, who I understand is now in prison in California for trying to have his wife killed. This chap was DX-peditioning and I exposed his game of claiming to be one place while in reality being elsewhere. He sued for \$650,000. He never got a dime from me.

Then Ma Bell sued because I ran some articles showing circuits the phone company wanted kept secret. Only \$100,000 that time. I paid them nothing.

The CCAT crowd sued because I ran 2-GHz receiver circuits... and lost the case. Now we're counter-suing to get the legal costs back. They lost double because before they brought the suit they had been able to scare people into not selling receivers on threat of a suit. Now, with that loss on the

ist. Under the new rules amateur radio comes out looking incredibly like another Citizens Band service. There were so many changes of the rules built into the rewrite that it was difficult to do anything but recommend that the whole project be scrapped. No real plusses were found, and the negatives were legion.

Another NIAC meeting is scheduled for this fall. Other than getting rid of that stupid 10m linear rule, what moves do you think the FCC could make which would improve amateur radio?...with particular emphasis on emergency communications? Is there anything the Commission might do which you think might get amateur radio started growing again?

I did make a stereo tape of the whole meeting, if anyone or any club is interested in hearing several hours of an FCC advisory committee at work. There are about four hours of tapes, so send \$10 for the lot.



Here's a photo of me talking to the TIARA group... and thanks to JK1UFW for sending in the photo. Note the buffet, which was first rate. Yes, I'll fly 10,000 miles for a good meal.



This is the top brass of Kenwood (note Anniversary issue of 73), posing with Sherry and me. Also note those boxes on the right... a complete TR-2400 system. If you're active on 2m, you'll hear me using it when I get to your town... and I do get around a lot.

record, they have little with which to threaten people.

I'm currently being sued for \$3,000,000 by a firm because I won't let them advertise. Isn't that ridiculous?

I really hate lawsuits, but I damned well don't back off from them when someone tries to use the threat of one to stop me from printing something I think you should have.

Getting back to the Miller case...it sure looks as if he was shafted by the ARRL because he asked too many questions. I hope they enjoy Metzger.

### WIND JAMMERS

A recent talk with some FCC people brought out that the Commission is getting record numbers of complaints of the jamming of ham communications...by hams. To say that this is counterproductive for us is a great understatement. Add this to the other frustrations and you perhaps can understand why many of us were not surprised at the degradation of the amateur "service" which turned up in the proposed "plain language rules."

To understand what is going on you have to look at things from the viewpoint of the FCC, not from *your* position. First, the Carter commissioners came into office at a bad time from our standpoint. They were faced with a serious problem brought on by the illegal use of amplifiers by CBers and HFers. Previous actions by the Commission

had put the manufacturers of well-designed "clean" linears out of business, leaving the field to unscrupulous underground firms which spewed out cheap, cruddy amplifiers which were virtual TVI factories.

Rather than tackle the real problem, the FCC went the typical governmental route and chose to stop the manufacture of ham amplifiers which might be used on the Citizens Band. I note that the number of TVI complaints is up substantially for 1980, despite the linear ban and a large drop in CB activity.

We could have prevented this ridiculously futile exercise if the ham industry and the ARRL had worked together and proposed some reasonable solutions for the FCC's problems. What happened was one of the worst debacles in ham history...second only to the 1963 proposed license changes which stopped amateur radio growth for over ten years.

With all of these other problems, one of the things we need the least is to continually frustrate the FCC with complaints that we are no longer able to be self-policing. For many years amateurs had proudly pointed out that they were the least bothersome service due to our ability to do our own policing. Amateurs apparently have just about given up on even trying to be self-policing.

Frankly, I think it is about time that we again assume responsibility for our own hobby...or

"service" as the FCC prefers to consider it. Now, I do not question for one minute that our service nets are of great value, but if they are going to continue to get us in trouble with the FCC through their inability to handle their own problems, then perhaps it is time for reevaluation of their worth to us. This going crying to the FCC over jamming is intolerable. The same thing holds for repeater jamming.

It is time that we took the business of being self-policing seriously. I'm open to any articles for 73 which will tackle this problem. I'm open for ideas on why we are having these jamming problems. Some of it is brought on by officious control operators. Many is the time that I have called into a net or in on a repeater only to be met with arrogance and an infuriating attitude. My first reaction is to get even with the damned bastards. That's when I turn off the big switch and walk away from my rig and do something which is more fun. When hamming stops being fun, I stop hamming.

During my recent stint from VP5, I found my signals being jammed every now and then. It was malicious, there was no question about that. On the one hand I was pleased that this happened so infrequently, but on the other I felt this was a problem that needs to be tackled. The jammer(s) were trying to spoil my fun...and the enjoyment of the hundreds of operators who were trying to get through for a contact. There was no way that my fun could be spoiled, for if hamming got to be a pain in the ass, there was always scuba diving, lying in the sun ruining my skin and prematurely aging me, reading (Hey, have I got a good book I'm reading! Grab it if you see it...paperback, but not a pocket-sized book, called *Human Scale*. You'll love it!), talking with Coop about satellite television, etc.

Let's see what we can do to work out solutions to our jamming problems. It may take some cooperation of ham clubs and some direction-finding...if so, let's see articles on this. It may take some psychology. We may just be dealing with insanity, which seems to be a problem predominantly centered in the L.A. area, but which may be

leaking out. I feel that since there are more of us who are interested in bettering amateur radio than in destroying it, the good guys can win if they gang together and swap ideas.

If you...or your club...decide to actually do anything to help amateur radio in this time of distress, please feel that 73 is your means of communications with others similarly interested.

### PROJECTS

If we are going to get amateur radio moving again, I think we should do all we can to tackle some of the technical projects which seem worthy of experimentation. This holds even more in the light of the recent FCC thaw on Special Temporary Authority (STA) permits for experimentation. I assure you that 73 will do all it can to provide the communications that intensive amateur experimentation needs...so if you are doing any serious experimental work, be sure to report on your progress in 73.

Some of the projects which show promise for amateurs are: (1) automatic identification of all transmissions...probably via ASCII using subaudible tones; (2) stereo double sideband, which may permit us to get ten to thirty times the number of stations in a given band without serious interference; (3) SSB repeaters for our VHF bands, which may allow us to squeeze in at least three times as many channels in the band as we have at present (just what we needed...more 2m repeaters); (4) packet transmissions; (5) high-speed message-handling and perhaps the development of automatic forwarding of messages; (6) SSTV transmission of single pictures, probably using a ROM for the picture storage as an inexpensive method of sending along a photo of the operator or the ham station; and (7) the development of amateur use of commercial satellites as an emergency measure...but which will have to be in everyday use to be ready for the emergencies.

With digital electronics moving ahead rapidly, it is up to us to not only keep up with technical developments, but also to be the ones to push the frontiers ahead. 73 is ready to help...if you will grab the ball.

## HAM HELP

I need a copy of the operating manual and schematic for a Hallicrafters SX-122 receiver. I will be glad to pay copying costs and postage.

**Ronald Rubin**  
1722 Canterbury Circle  
Casselberry FL 32707

I would like to buy a matching power supply for a Galaxy V transceiver. Must be reasonably priced. No junk, please.

**James King WA5HOE**  
914 Henslee  
Eules TX 76039

I need a Model 28 or a Model 15. I am willing to swap a Model 35, in good condition, for one of the above. If you are interested in this trade, please write for details. Thank you.

**Robert Rice K1MIM**  
Route 1, Box 289  
Hillsboro NH 03244

I would like to get in touch with other amateurs who are pathologists.

**Philip Altman, M.D.**  
1050 Linden Avenue  
Long Beach CA 90801

# DX



Yuri Blanarovich VE3BMV  
Box 292  
Don Mills  
Ontario M3C 2S2  
Canada

## WORLD OF DXING AND CONTESTING

Welcome to this new column. When I was asked to write the DX column, I felt that there was perhaps a need to have something more: a touch of contesting; most of the magazines have DX columns and contest columns. I agree with the *NCJ (National Contest Journal)* that contesting is growing and the amount of space devoted to contesting in the magazines is shrinking. Most of them have only a contest calendar and results or rules for the contests that they sponsor.

DXing and contesting are very close because they have one thing in common: competition. Contesting requires quite a bit of work and effort and generally is confined to 48 hours or less. DXing is more relaxed; there is more time available and deficiencies in the equipment can be "covered up" by persistence.

Contesters often are the better operators, and when they go on a DXpedition, things run more smoothly. DXers enjoy picking at the rare stuff during the contests and provide some precious points and multipliers.

In this column, I would like to report on the past activities from the rare and not-so-rare DX countries, list QSL information, elaborate on some pressing issues of DXing and contesting, and report on what is new and interesting that would help us to improve our equipment and skills.

Due to the lead time required to publish the magazine, it is virtually impossible to write about

most of the upcoming DXpeditions. Those hard-core DXers interested in timely DX activity will have to rely on the variety of weekly or biweekly bulletins or DX information nets.

To those planning DXpeditions or Contestpeditions, please let me know in advance (about 3 months) and we will publish the information here. We also solicit your input—especially pictures (color and black and white) and slides.

*"You have to keep trying new things. Sometimes you'll succeed and sometimes you'll fail but you have to continue to meet the challenges. That's how you grow!"—Mary Tyler Moore*

I like this quotation and I think this is what drives many people on their path towards excellence. Amateur radio is a very special hobby or sport (DXing and contesting) and those who started experimenting way back in the pioneering days of radio have done a lot to get us where we are today.

The question is: "Do we want to sit around with our crystal sets, or do we want to operate today's marvels of technology with all the bells and whistles?" The competitive part of ham radio was there almost from the beginning, when the first transatlantic contact was made. Our fathers wanted some kind of indicator to evaluate their achievements: number of different stations worked, countries, distances spanned, etc.—DX and contests were born.

Being fortunate to be involved in ham radio for a while, I have had the opportunity to get my feet wet in almost all aspects of our hobby: equipment building, communicating, DXing, satellite communication, computers, antenna design, propagation studies, and contesting.

There usually occurs at a certain point in time a situation in which we reach a plateau, or are close to it. Then the interest can start to fade away. One of the most beautiful things about

ham radio is the fact that it is always changing and remains challenging.

Let me make one thing clear: I am not against any aspect of our hobby. I went through most of them and I love them all. My longest-lasting "obsession" is contesting. Why? I think it is because with each contest there is always a new challenge. You are starting from scratch at 0000 GMT and it is a new competition for the next 48 hours. It doesn't matter how long you have been licensed or if you were around when Clipperton was activated. It is up to you and your station as to how you'll perform in that short time frame.

What many DXers find after a while is this: After you get all (or almost all) of them, you start asking yourself, "What now?" Many will continue collecting a variety of awards, building, or experimenting with circuits. Some will get involved with contesting. Some of the really hard-core DXers who reach that magic 318 mark become just statistics on the Honor Roll, and you never hear them on the air anymore.

Contesting means that as things get more competitive, you have to dig deeper to get that extra dB out of your antenna installation, improve your equipment, better your operating skills. It is a lot harder to show up in the top six world high listings or beat the old record in the contest. Only few of many that are competing can get there. This is why I think contesting presents more of a challenge.

In the world of DXing, things are a little bit more relaxed. If you get that new one an hour later, that's OK. The contest station has to go further. One more dB of gain from your antenna might bring you another 500 contacts with "little guys"—more points. The competition is getting fierce—one almost can't afford to go to the washroom. Everyone is on his own, as it used to be back in the old days of DXing when there were no repeaters, nets, lists, and bulletins. You had to hunt, and your DXCC total meant something.

But, DXing is getting more popular; newcomers get the bug and want to show up on the Honor Roll as soon as possible. This is natural and is to be expected. All you need is to work them all

and, most importantly, *get that QSL card*. And here is where quite often it is believed that the end justifies the means. *Anything* to get that QSL! What starts happening? Some "clever" things get invented: lists, nets, repeaters, bulletins, etc.

Let's have a look at lists. I believe that there is room for them. Especially when some poor, unsuspecting brand-new ham becomes "wanted" because he happens to be in Burma, and after his first CQ, the whole "animal farm" descends on him. He wouldn't know that it is not his receiver oscillating, but that the whole DX world is calling him. So then someone will "undertake" the list and things will somehow get rolling. If the new DX baby is born, let's help him to start walking, give him a hand. But let's not keep him in his walker. Let's help him to get on his own feet and eventually teach him to run. Or, do we want to end up as a bunch of handicapped crawlers, being carried over the finish line on a stretcher?

There is a breed of professional list undertakers. They are just waiting for something juicy to show up on the band. They are ready to take the list and get things "organized." When we were on St. Paul Island (the XJ3ZZ/1 DXpedition), we had about four list undertakers come on our frequency and ask us to work the list they had collected. This was usually at the time when we were working the world on our own, at up to 6 stations a minute! How many can you work on the list? Looks like there are quite a few undertakers on this ego trip. You have to get on your knees to get on the list and then wait, sometimes a day or two, to work that rare one. Fun? Sure, just like shooting animals in the zoo.

This is where contesting helps. By operating in a contest you can learn how to manage the pileups and learn to walk by yourself and eventually run. Wasn't that refreshing to hear LU3ZY work the stuff in the contest one after another, rather than sitting like a duck on a string on all those lists? Is it a big challenge to work the stuff on the list? Does it make you or the "lister" grow?

Do you want to grow? If yes, you have to work at it. Nothing

comes easy. You can always make up for the deficiencies in the area of equipment—just use your brain and skills! I am sure that you will be a lot happier that way, rather than being carried over the Honor Roll finish line on the stretcher of lists and nets!

#### DX NEWS

**Bahrain**—A9XCE is active on CW. Could be found between 14020 and 14050 kHz daily from 0100Z to set up skeds for your 5BDXCC. QSL to PO Box 5750, Bahrain.

**Benin**—K4YT operated from TYA11 (incorrectly-issued call-sign) until April 25. QSL for this operation to W2TK. Another operator, ON5NT, operated the same station until May 2, strictly CW. QSL via ON5NT home address.

**Glorioso** was to be on by FR7AI/G until May 11, time permitting. QSL to FR7AI *Callbook* address.

**Kingman Reef**—A change in the schedule brought this one on before the Palmyra operation. AD0S/KH5K and KB7NW/KH5K were active on all bands with a good signal. The next stop was supposed to be on Palmyra, with calls AD0S/KH5 and KB7NW/KH5. QSL via AD0S.

**Saipan** is active on 10m near 28580 kHz on weekends from 2100Z; call is KH0AC. QSL to Box 66, Capitol Hill, Saipan, CM 96950. Also look for brand-new AH0AA on high bands. QSL via bureau.

**Heard Island**—VK9NS (P29JS) writes about his try for Heard Island DXpedition: The transportation was off due to the short weather window. He will be renewing his VK0JS license and he is still hoping for an operation this coming autumn. Jim had 256 donations to the Heard Island DX Association and they were acknowledged by receipt. He says other small (\$1) contributions were received which have not been acknowledged, for obvious reasons. Jim VK9NS has opened a number of doors for future operations, and be they by him or someone else, he will be trying.

**1A0KM**—K3ZJ found the following: The Sovereign Military Order of Malta is an extraterritorial area of Rome. I0MXM, chairman of International Committee of Radio Amateurs for UNICEF, applied to the ARRL for its separate status for DXCC. The following is the endorsement for the validity of the

application: The *National Geographic Atlas* recognizes SMOM as the smallest country in the world. The SMOM has been in continuous existence since 1100 AD, making it the oldest diplomatically-recognized state in the world. The courts of Italy recognize their lack of jurisdiction over SMOM territory. Full diplomatic relations were maintained in 1980 with at least 45 countries on all continents. The SMOM has a complete functioning government structure, its passports are recognized by all countries, it issues its own stamps and currency, and the Prince-Grand Master, as head of SMOM, is ceremonially accorded full Head-of-State status when on official visits outside of the SMOM. (Tnx LIDXB)

**CE0Z**—Dr. Dave Gardner K6LPL opened from Juan Fernandez as planned on March 11 on all bands 80-10 SSB and CW. He was making the trip alone with the second "passenger" being two transceivers, which he had to buy the tickets for. The limit per passenger was 22 pounds, so the linear was left behind. Excellent operation as usual. Dave was supposed to leave the antenna on the island for the next

expedition by the Chilean RC. Dave made about 10,000 QSOs in four days of operating. (TDXB) **VK9NYG Cocos**—Quite active on 10m around 28540 at 12-1300Z, running 40 W and dipole. Usually calls the stations on CQ. Quite a pleasant surprise call to many during the ARRL Phone contest. QSL via VK6NE.

**GU3HFN Guernsey**—Operated in the ARRL CW, made about 3000 QSOs, with operators N6RA, GU3MBS, and GU4CHY. QSL via GARS, Box 100, Guernsey, Channel Islands.

**A51PN**—Pradhan is using "business" rig. He is looking for donation of the rig to ensure the continuation of his operation. Anyone interested should contact W5GAI. (TDXB)

**OJ0AM Market Reef**—Wayne W6EUF will be accompanying the Helsinki DX gang, with OH1BR and OH2BAD, during the operation from July 6 through 14. The reef will be taken over by the military in the fall so it may become rare. (SCDXC)

**5N0DOG**—Terminated operation from Nigeria. Dave handed out many contacts and multipliers in the contests. Excellent operation appreciated by many DXers and testers.

#### QSL INFORMATION

A22ZM	via KA2GNJ	HM1AQ	JA2AUI	TYA11	ON5NT	XT2AU Enno	WA1ZEZ
A7XE	DF4NB	JA8AQN/JD1	JA8JL	KA4DQR/TI	KA4FHG	YB0ACL	W4LCL
AN3SF	EA3SF	HG19HB	HA5PP	TU2DP	KC4IR	YJ8NPS	KB2KN
C31IU	W8JAQ	WD9IHC/HK4	WD4PTO	VK0JS/VK9	VK9NS	YT0R	YU7BCD
C31VM	EA3BKZ	J5AG	SM3CXS	VK2DCO/LH	K2UO	YT0RA	YU1EXY
C5ADR	DK9KD	HC9A	K8LJG	VP1MK	N0BNY	YZ3F	YU3TAQ
C5ADZ	DK9KD	HL9TU	K2KSY	VP1OA	KB0U	ZF2EC	WA4OBH
CE0CJA	CE5CN	JY9RC	W1CKA	VP1RY	K0BJ	ZF2EX	K4PJ
CT2DQ	W4PKM	J3AE	J3AAG	VP1TKJ	WA0TKJ	ZF2EO	K0CS
DJ5RT/6W8	DK9KD	J88AQ	W2MIG	VP2MU	VE3HD	ZF2EK	W8TN
DL7NS/HB0	DL7NS	KA1AA	KA6CWR	VP2MCL	K1ZZ	3A8EE	3A2EE
EF6BDX	EA6CE	K6LPL/CE0Z	W6ORD	VP2MFC	K1ZZ	4A9LCH	WD8NKT
ED2DSB	EA2OS	KH3AB	KB7MO	VP2M	W1CDC	4N7NS	YU7BPQ
EN3D	UK2DAU	KH6D/KH3	KH6D	VP2MM	W1CDC	4V2BM	KA4MRE
EL5G	K3RB	KL7Y	KL7GNP	VP2MO	KA4BOT	4N0RA	YU1ELM
EL6A	K4SE	KS6DV	WB6FBN	VP2MLB	W2IRS	4Z4WZ	DJ5SQ
EL9A	K4WSB	KN5N/VP2A	K9MK	VP2MN	W1CDC	5Z4YV	JA2KLT
FG0FOO/FS	N6RA	K6SAD/KG6	VE5QY	VP2MLB	W2IRS	5V7HL Rod	KB7HB
FW0AA	N0RR	N4ADJ/KH2	WB4CCT	VP2VIA	W0ANZ	5T5AZ	KB7HB
FB8YH	F3KH	KC6BS	JH7LMZ	VP2VGS	W0JRN	5W1DF	KL7CQ
FB8YI	F3KH	LJ2Z	LA6ZW	VP5KPS	W2NSD	DJ6SI/6W8	DK9KD
FG0GDI/FS	F6AXX	OH3XT/OH0	OH3XT	VP5RFS	N5BET	6Y5DA	VE4JK
FR7AI/G	FR7AI	OH0XX/OJ0	OH2BBM	VP5TDX	W1HCS	8P6M	VE3JTK
FH8OM	DJ1TC	OH0XZ/OJ0	OH2KI	W2BBK/PJ8	W2BBK	8P6CQ	W2LZX
FO8GW	K6FM	OX3KM	OZ4KM	W5JW/KX	W5JW	8P6JW	W3HNC
FR7BY	IS0IFA	P29GT	K0BTH	WA1SQB/CE0	K1RH	8P6OL	VE3AMJ
FR7CE	DF2OU	PP2ZDD	W4BAA	WB9TIY/VP2A	WB9	8P7A	WB4RRK
G3MUV/CE0	WD4HMG	DK5BD/ST2	DF1BP	VP2VHK	N6ZV	8P6PF	VE3LVK
G3PQA/5N0	G3RPB	DF3NZ/ST2	DARC	VP2VJR	VE3MJ	8Q7BF	JA1ITE
GJ4JVO	GJ2LU	W5JMM/SU	KA5AZT	VP8AEN	GM3ITN	9Q5AB	DL7AH
HG1W	HA1KVM	SV0AO	KA2FRP	VQ9XX	K6OZL		
HG6V	HA6KVB	TL8RC	F6EZV	XT2AU Karl	W2TK		

Thanks: *DX News*, *The DX Bulletin*, *VE CanadX* reports.

6Y5KG Jamaica—VE3KGK on between March 21 and 28, all bands, mostly 10, 15, and 20.

JA1JWP/JD1 Ogasawara—On until March 25 operating CW and SSB. Also showed up in the ARRL Phone.

VP8AEO/CE9—South Shetlands active till end of March, Geological Scientific Group. QSL G4DSE.

OY0A, OY5JA—Bunch of pi-

rates! Those callsigns were never issued. Apparently they were quite active in the contests. If you worked them, don't bother to QSL. They are busy enough.

Y11DBG Iraq—Workable on list with "undertaker" I1AGC on Thursdays, 14292 at 2000Z.

ZD9—Expedition by ZD7BW delayed until July.

DJ6SI—Started from 6W8.

Should continue to TZ, C5, and possibly 3X. QSL via DK9KD.

VP2MFC Montserrat—Operation by Dave K1ZZ during last two weeks in March and WPX SSB.

VP5—N. Florida contest bunch to fire up from Turks & Caicos during the WPX with monoband stations on 10-40.

5R8AL Malagasy Republic—Being encouraged by 5T5JD to

come up more often on 21300 around 1900.

ZL0—Prefix being issued to visitors. J87—Issued to visitors, J88 to "natives." Replaces VP2S. T4—replaces CM and CO for Cuba. T5—Replaces 6O. T6—Replaces YA ("free" Afghanistan?).

Thanks: Long Island DX Bulletin, The DX Bulletin, Long Skip.

## AWARDS

Bill Gosney KE7C  
Micro-80, Inc.  
2665 North Busby Road  
Oak Harbor WA 98277

### DX AWARDS CONTROL BOOK

Today's mail brought one of the finest operating aids I have seen in a long time. Sponsored by the Susquehanna Amateur Radio Society (SARS), the *DX Awards Control Book* is a must buy for any serious DXer. Wouldn't you know it, my pal and yours, Hal Dennin AC3Q, is the driving force behind it!

With this well-published manual, you may organize and document your contacts with a single entry. Thirty-three legal-size pages itemize all the DX countries and their prefixes as you would expect to find them. The book comes spiral-bound at the top for easy access and is personalized with your callsign on the cover.

Using the *DX Awards Control Book* is relatively simple. First log the call worked in the appropriate band column. Note the date and mode of operation. When marking the mode, it is suggested it be color-coded for quick identification. Finally you check the award(s) you wish to apply this contact to. Four common awards are listed: DXCC, WAC, WAZ, and ITU. One of the nice features of the format is that space is provided for up to three calls worked per band. Also included is a block for indicating QSLs sent and received.

The cost of the *DX Award Control Book* is \$7.00 to an address within the 50 US states and any territorial possession.

Foreign stations must enclose \$8.00 in US funds.

The sponsors are so confident in the acceptance of their new operating aid that they will provide a 10-day money-back guarantee that you'll be satisfied with your purchase.

Send your remittance, name, call, and address to SARS, PO Box 326, Montoursville PA 17754.

### BEGONIA AWARD

Today I received a very nice letter from Maurie Batt, representing the Ballarat Amateur Radio Group of Victoria, Australia. Maurie enclosed the details about two very challenging awards.

To earn the Begonia Award, operators in VK-land must contact 10 Ballarat stations, while all DX outside Australia must contact a minimum of 5 amateur stations in Ballarat. There are no restrictions as to band or mode.

The following stations qualify as Ballarat contacts: VK3DS, VK3GM, VK3GR, VK3HW, VK3IV, VK3KU, VK3KY, VK3LJ, VK3NU, VK3PH, VK3SE, VK3VU, VK3ZL, VK3AAG, VK3ABI, VK3ADT, VK3AGL, VK3AJR, VK3ALM, VK3AMH, VK3ANH, VK3AQM, VK3ARS, VK3AXH, VK3AGY, VK3AZE, VK3BMH, VK3BML, VK3BNC, VK3BNT, VK3BPK, VK3BQE, VK3BSC, VK3BTX, VK3BWC, VK3NBN, VK3NCU, VK3NGL, VK3NGY, VK3NHN, VK3NHT, VK3NIH, VK3NLH, VK3NLY, VK3NLZ, VK3NRS, VK3NTG, VK3NUI, VK3NUC, VK3NUY, VK3NVC, VK3NVF, VK3NVJ, VK3NVZ, VK3NWN, VK3NWV, VK3NWS, VK3VEE, VK3VEZ, VK3VEI,

VK3VOM, VK3VON, VK3VMO, VK3VQA, VK3VQQ, and VK3VSE.

To apply for the Begonia Award, send your list of contacts and \$2.00 (Australian) or equivalent to: Maurie Batt, R.S.D. Rokewood Junction, Victoria 3351, Australia.

### THE WASHINGTON TOTEM AWARD

The Western Washington DX Club, the northwest's largest and most active DX group, takes pleasure in issuing the first major W7 award. This award is issued to any licensed radio amateur who submits proof of two-way contact with the state of Washington.

Applicants must submit proof of QSOs with 100 different Washington stations. Twenty (20) of these must be confirmed

contacts with different Western Washington DX Club members. DX stations need only confirm 25 Washington stations including 10 WWDXC members.

GCR apply. Submission of QSL cards is not required. DX stations may submit log data in lieu of QSL card confirmation. All contacts must be dated January 1, 1973, or after. Certified lists must be sent in alphabetical order with date and time in GMT.

The Washington Totem Award is free to all stations outside the United States. Stations within the US must enclose \$1.00 to defray the cost of processing and mailing your award.

If a special endorsement is required, merely forward supporting documentation or information to substantiate your claim.

If you wish a WWDXC

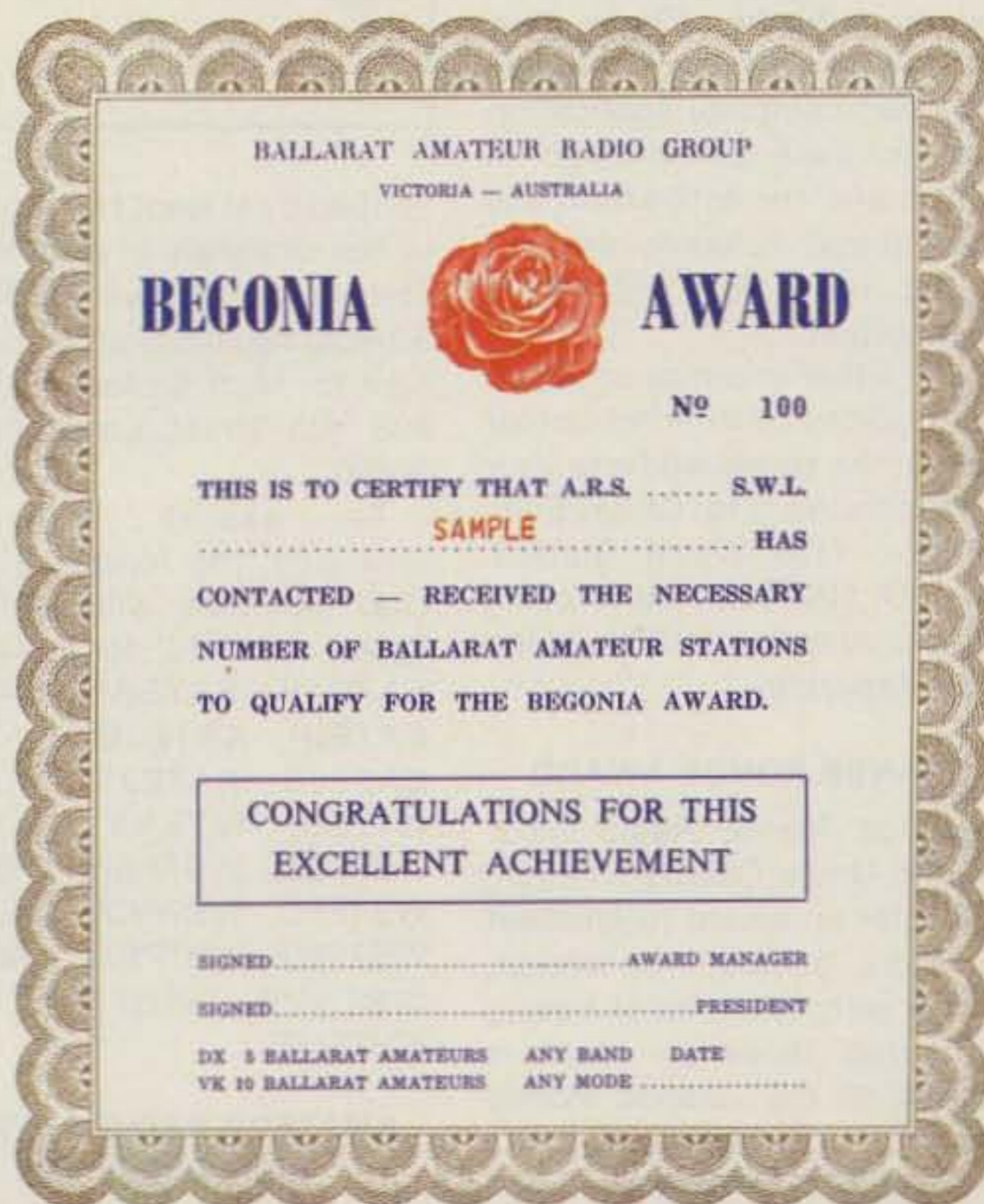

membership list to determine the calls of its members, send an SASE to: Awards Chairman, WDXC, PO Box 224, Mercer Island WA 98040 USA.

### DX AWARDS GUIDE

Contrary to popular belief, neither I nor *73 Magazine* are in any way affiliated with the publication, *The DX Awards Guide*, which I might add consists of numerous volumes. To clear the air about this very popular "guide" and to answer the flood of letters I've been getting about it, I highly endorse the contents. To date, it represents the most composite set of awards information I have received since beginning this column over 2½ years ago.

The price of *The DX Awards Guide* is \$6.95 per volume with the exception of Volume C, which is only \$4.95. Guides mailed within North America are sent prepaid. All other addresses require additional monies be sent to cover 10 oz. postage per volume. Any extra will be refunded promptly.

Many letters have asked about the contents of each volume, so I will attempt to list the awards as best I can. I apologize to *The DX Awards Guide* publisher and to my readers for any mistakes that may appear.

One of the nice features of this *DX Awards Guide* series is that the publisher, Chuck Ellis, has made every effort to provide a full and complete application blank for each award listed. In most cases, the entire form and the required columns are formatted into a very impressive presentation.

For further information about these guides or to order one or more of the series, address your correspondence to: Chuck Ellis, PO Box 1136 Welch Station, Ames IA 50010. Be sure to tell Chuck you read about his guide in *73 Magazine*!

### GRANDE RONDE AWARD

Grande Ronde Radio Amateurs in Union County, Oregon, now offer an award to amateur operators, domestic or foreign, who submit evidence of having contacted three (3) stations located in the Grande Ronde Valley.

Contacts may be on any band or mode. Do not send QSL cards. Have your list of contacts

### VOLUME A (Europe):

Action 40  
Amsterdam DX  
Cheshire  
Cracovia  
Diplome de l'Union Francais  
DIG Trophy & Plaques  
DUF Universe  
EU-DX-D  
EUR-DIP  
EU-PX-A  
International Airport  
Kingdom Belgium, HF & VHF  
Olimpiada-80  
Polska  
P-75-P  
RAEM  
Slovensko  
Two Modes  
Worked All Europe (WAE)  
Worked All Italian Provinces  
Worked All Norwegian Communities  
Worked DTG Members  
Worked German Large Cities  
Worked Hamburg & Harbors  
Worked Norwegian Cities  
ZMT-24  
ZMT  
9H Diploma  
100 OK

### VOLUME B (Europe):

British Commonwealth Radio Transmissions  
BULL  
Commonwealth DX Award  
Cosmos  
Diploma G. Marcone  
Diploma Mediterranean  
Diploma des 100  
Gold Sardinia  
Hampshire County  
Helvetia 26  
IARU Region 1  
ONION  
R-6-K  
R-10-R  
R-15-R  
R-100-0  
R-150-S  
Serenissima  
Sylt  
S-6-S  
WANCA

Germany  
Netherlands  
England  
Poland  
France  
Germany  
France  
Germany  
Germany  
Germany  
Belgium  
USSR  
Poland  
Czechoslovakia  
USSR  
Czechoslovakia  
Germany  
Germany  
Italy  
Norway  
Germany  
Germany  
Germany  
Norway  
Czechoslovakia  
Czechoslovakia  
Malta  
Czechoslovakia

White Rose  
Wool City, HF & VHF  
Worked All Gozo  
Worked All LA  
Worked British Commonwealth  
Worked DX Stations  
W-100-U  
1,000,000 Award

England  
Belgium  
Malta  
Norway  
England  
Germany  
USSR  
Germany

### VOLUME C (Europe):

Baronie DX Group  
DIG Diploma 77  
IOTA  
Mercury  
Millenium of Liege  
Morokulien  
Noord-Brabant, HF & VHF  
OHA  
OK SSB  
S. R. Macedonia  
Worked All Zone 14  
Worked ITU Zones 17/18  
Worked All SM Laens I & II  
Worked District Hamburg  
W-DIG-OE

Belgium  
Germany  
England  
England  
Belgium  
Norway  
Netherlands  
Finland  
Czechoslovakia  
Yugoslavia  
Sweden  
Sweden  
Sweden  
Germany  
Austria

### VOLUME D (USA):

All Call Areas  
BEARS Award  
Century Cities  
Countries, Zones & Continents  
CQ DX  
District Endurance Award  
DX Capitals of the World  
DX-YL  
DX-YLCC  
Island DX Award (IDX)  
Lehigh Valley  
Newark News Radio Club  
Port of Stockton  
Specialty Communications Award  
Ten Meter DX Decade Award  
Ten Meter 10-40 Award  
WAC  
WAC/YL  
WAS  
WAS/YL  
WAZ  
White Tail Deer  
Worked All USA Award

*73 Magazine*  
CQ Magazine  
*73 Magazine*  
*73 Magazine*  
Whidbey Island  
DX Club (KE7C)  
*73 Magazine*  
*73 Magazine*  
*73 Magazine*  
IARU  
ARRL  
CQ Magazine  
*73 Magazine*

verified by at least two amateurs or the secretary of a radio club. The fee for this award is \$1.00 or 3 IRCs. Applications should be sent to: Matt Sirrine WB7PMG, 803 14th Street, La Grande OR 97850.

To assist interested amateurs, the following list of club members will qualify as "good contacts" for this award: KA7BAK, KA7BBE, KA7EIM, KA7EIP, KA7EJB, KA7EJC, KA7EJS, KA7EJT, KA7EPS, W7IES, W7KVV, W7ULC, WB7FBG, WB7FBH, WB7FDB, WB7FFC, WB7PKX, WB7PME, WB7PMF, WB7PMG, WB7RVO, WB7RVP, WB7RVQ, and WB7WJR.

### AMATEUR RADIO STATION CERTIFICATION

While we are discussing the award incentives being spon-

sored by the Susquehanna Amateur Radio Society, one cannot go without mentioning their very handsome Amateur Radio Station Certificate.

Display this unique certificate

on the wall of your shack, den, or family room for all visitors to see. Jet black olde English lettering on expensive tinted parchment gives this certificate the elegance any amateur would

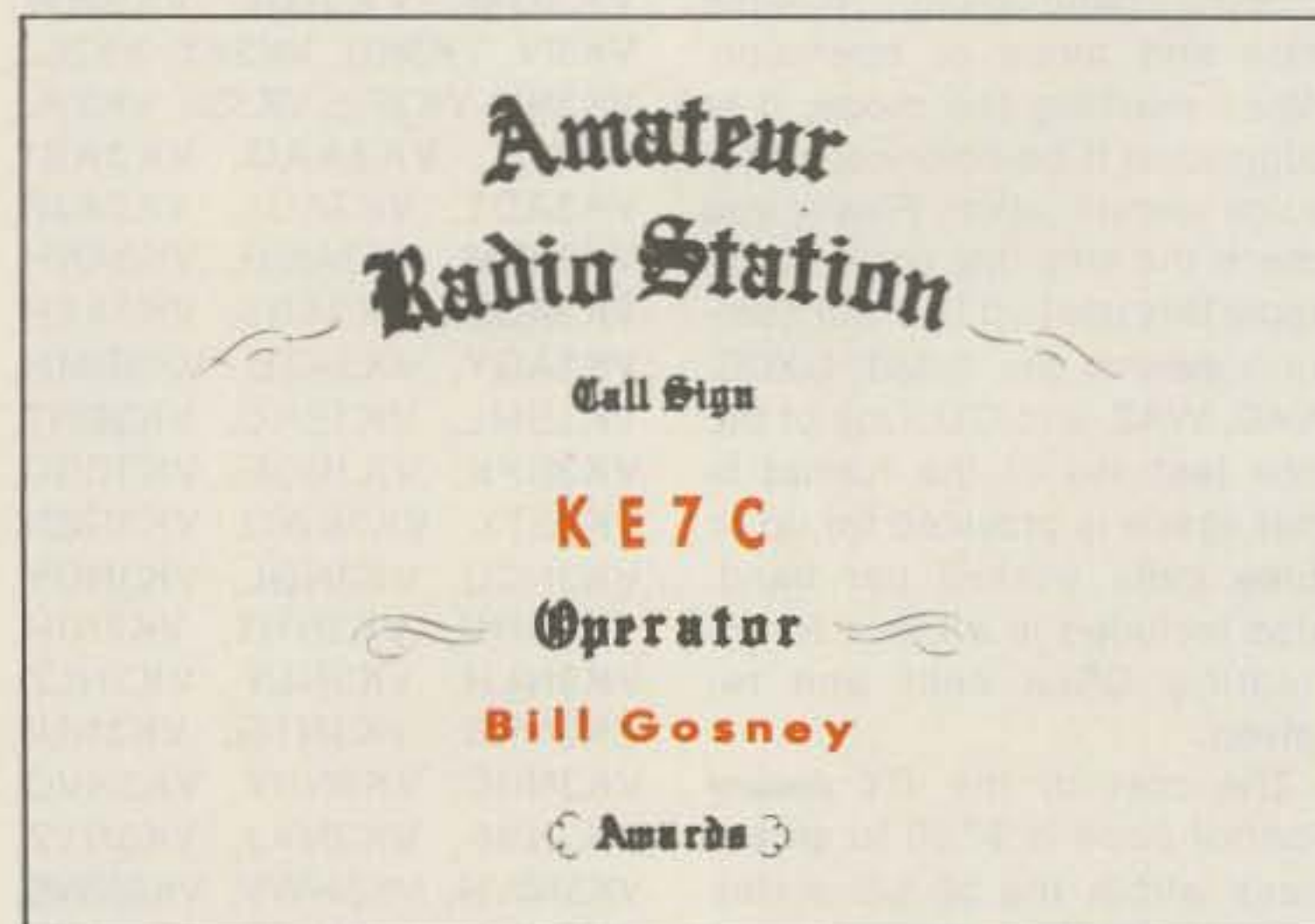



Worked the World Award  
Worked All Millford  
Worked All Vermont  
Worked Oswego County  
Worked 100 Nations  
73 DX Country Club

73 Magazine  
ITU  
73 Magazine

Bird of Paradise  
Captain James Cook  
Endeavour  
ENZART  
Guam Award  
New Zealand Award  
Oman Award  
Rev. John Flynn Memorial  
Royal Jordanian, Coral & Silver  
VK8 Outback Australia  
W.A.R.O.  
Worked All Liberia  
Worked All New Zealand  
Worked All Pacific  
Worked All Queensland Cities  
Worked All Queensland Shires  
Worked All New Zealand Counties  
Worked All Transkei  
Worked All VK Call Areas  
YLZL  
ZLA, ZL Districts, 5 x 5

P.N.G.  
Australia  
Australia  
New Zealand  
Guam Island  
New Zealand  
Oman  
Australia  
Jordan  
Australia  
New Zealand  
Liberia  
New Zealand  
New Zealand  
Australia  
Australia  
New Zealand  
Transkei  
Australia  
New Zealand  
New Zealand

**VOLUME E (USA):**

Consecutive Country Award  
Distinguished PARS Communicator  
DX Award  
DXCC  
DXCC Milliwatt

ARRL  
QRP International  
WABCNN  
WØRSP

DXCC QRPP  
DXCC QRPP  
Fort Wayne Radio Club Award  
Great Lakes Award  
KMW

Master Novice Award  
Novice Six Country  
Ohio Valley

73 Magazine

Q-5 Award of Excellence  
Senior CW-50  
Southern California Award  
Upper Chesapeake Bay Award  
WAC QRP

QRP International  
QRP International  
QRP International

WAS QRP

WAS QRPP

Washington Totem Award

Western  
Washington DX Club  
CQ Magazine

WAZ—5 band  
Worked All Lynchburg Ladies  
Worked Broward County Cities  
Worked DX Mobiles, Air, Land, Sea  
Worked 100 Amateurs  
WPX/WPX Honor Roll

CQ Magazine

**VOLUME F (Africa & Oceania):**

Algoa Branch Award

South African  
Relay League  
South African  
Relay League  
South African  
Relay League  
New Zealand  
Arabia

Algoa CW Merit Award

All African Award (AAA)

Antipodes Award  
Arabian Knights

**VOLUME G (Asia & South America):**

All Japan Districts  
All Japan DX Award  
All Mediterranean Countries  
All Zone 11 Prefixes  
BRYLEA  
Certificate of Radio Club of Paraguay  
CRV  
CWMG  
CWSP  
Diploma Department of Paraguay  
Diploma Paraguay  
Diploma Sud-America  
GPCW  
Japan Century Cities  
Japan Osaka Century  
Low Band Century Certificate  
Mexico DX Award  
Nine Dragon Award  
PPC  
Tropics of Cancer & Capricorn Award  
UBR Award  
Worked All Guns  
Worked All Japan  
Worked All Japan Prefixes  
Worked All ZP  
Worked 15 KA Stations  
XE-EA Award  
ZP3 Award  
8-PX  
100-X

Japan  
Japan  
Paraguay  
Paraguay  
Brazil  
Paraguay  
Argentina  
Brazil  
Brazil  
Paraguay  
Paraguay  
Paraguay  
Brazil  
Japan  
Japan  
Japan  
Japan  
Mexico  
Hong Kong  
Brazil  
Paraguay  
Brazil  
Japan  
Japan  
Japan  
Paraguay  
FEARL  
Paraguay  
Paraguay  
Japan  
Mexico

KP4 (Puerto Rico), KS6 (American Samoa), KV4 (Virgin Islands), or KZ5 (Canal Zone).

Applicants are asked not to send QSL cards! You may have your contacts verified by a local radio club secretary or by two licensed amateurs. As a last resort if no amateurs are available in your area, a notary public may countersign your claim.

Forward your verified list along with \$4.00 USC or 12 IRCs in a self-addressed envelope to SARS, PO Box 326, Montoursville PA 17754.

**EURD AWARD**

The DARC announces their new EURD Award to promote RTTY activities. It is available to all amateur and club stations holding the required RTTY contacts. It is based on 2-way contact with different European countries and their prefixes.

Class III requires written confirmation (QSL) from at least 20 different countries (regardless of band) and a minimum of 100 prefix points. The WAE European prefix counts for 1 prefix point per band.

Class II requires at least 30 different countries and a minimum of 150 points.

Class I requires at least 40 different countries and a minimum of 200 points.

The EURD Trophy requires at least 50 countries and a minimum of 250 prefix points.

All amateur bands may be used including VHF; QSLs must confirm 2-way RTTY and shall be dated after January 1, 1965, to be valid.

Contacts made during the European DX Contest, WAEDC, RTTY portion may be used for EURD endorsements, provided the log of the requesting station has also been received. Should this be the case, claims for the EURD Award should not be made until after the contest results have been published.

The fee for each certificate is DM 10 or 15 IRCs. Send a list which has been verified by a local radio club official and the fee to: Klaus Zielski DF7FB, PO Box 1147, D-6455 Erlensee, West Germany.

The following WAE List of DX Countries applies: C31, CT1, CT2, DL, EA, EA6, EI, F, FC, G, GC, GD, GI, GJ, GM, GM (Shetland), GW, GU, HA, HB9, HB0, HV, I, IS, IT, JW, JW (Baer), JX, LA, LX, LZ, M1, OE, OH, OH0,

be proud of. Even the XYL will be impressed!

Forward \$5.00 for postpaid delivery of this certificate to your door. As with all awards

sponsored by SARS, your satisfaction is guaranteed 100% or your money back within 10 days. Along with the US funds, include your name, callsign, address, and any awards you may wish to

itemize at the bottom of the certificate.

Send your request to: SARS, PO Box 326, Montoursville PA 17754.

**U.S. ELECTORATE'S AWARD**

This award is printed on expensive parchment-like paper stock with jet black olde English lettering highlighting the diploma. This unique combination adds a richness not found in a lot of other awards being offered today. Measuring 11" x 14" the certificate is ready for framing.

The award is sponsored by the Susquehanna Amateur Radio Society. To qualify for this award, the applicant must work all (50) fifty states plus the following voting territories: KG6 (Guam), KG6S, T (Marianas),

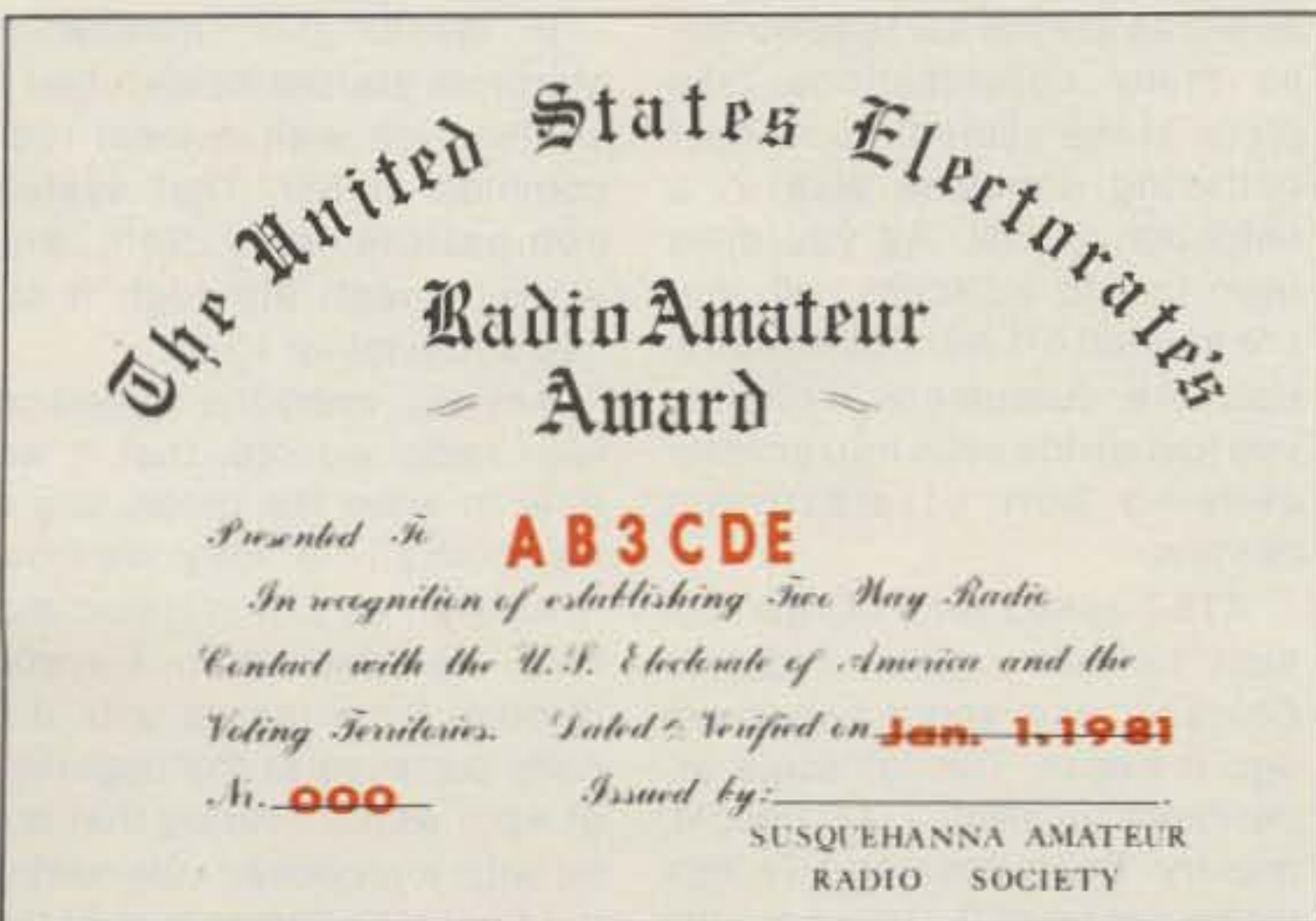

OJ0, OK, ON, OY, OZ, PA, SM, SP, SV, SV (Crete), SV (Rhodes), SV (Athos), TA1, TF, UA1, 3, 4, 5, 6, UA2, UA (Franz), UB5, UC2, UO5, UN1, UP2, UQ2, UR2, YO, YU, Y2, ZA, ZB2, 3A, 4U, and 9H1.

### THE FIRST CLASS DX WIDOWS AWARD

This award is also sponsored by the Ballarat Amateur Radio Group of Australia. I am proud to announce that once and for all there is an award celebrating the misgivings of the many XYLs who are married to dedicated DX husbands. Rightly given the title of The First Class DX Widows Award, this certificate requires practically nothing more than your utmost patience as a XYL.

"Wives, for your outstanding patience shown by you during the many endless cold nights alone in bed while the bands were open... for the exemplary tolerance displayed towards the nasty TVI and RFI the rig created and for calming the irate neighborhood on account of it... for ignoring the weird noises and kooky language coming from the shack (which was supposed to be your room, anyway)... for turning a blind eye to truckloads of assorted spares, rigs, and things-that-may-come-in-handy-one-day about the house... for going cheerfully without the new dress, color TV, or perm when

the cash was more urgently needed for replacement parts or a new antenna, after the last one blew down in the storm... or for not grumbling (too much) when we came home from the contest or field day rather the worse for wear and in no mood for romance... this certificate of recognition is only for the deserving—the XYL in waiting!"

If you are an XYL, or husbands, if this sounds like something your own XYL deserved long ago, perhaps the least you could do is enclose \$2.00 and request this award by sending your remittance direct to: Maurie Batt, R.S.D. Rokewood Junction, Victoria 3351, Australia.

### MOUNTAIN STATE AWARD

The Logan County ARC will hold its first annual Mountain State Award expedition from 1600 UTC August 22 until 1600 UTC August 23, 1981. Operations will take place on a West Virginia mountaintop in Logan County, which is located in the heart of southern West Virginia's billion-dollar coal fields.

Phone operating frequencies will be approximately 25 kHz from the low end of the General phone bands as propagation allows. Novice-band frequencies of 3725 and 7125 should be checked each hour from 1600 UTC August 22 to 0400 UTC August 23.

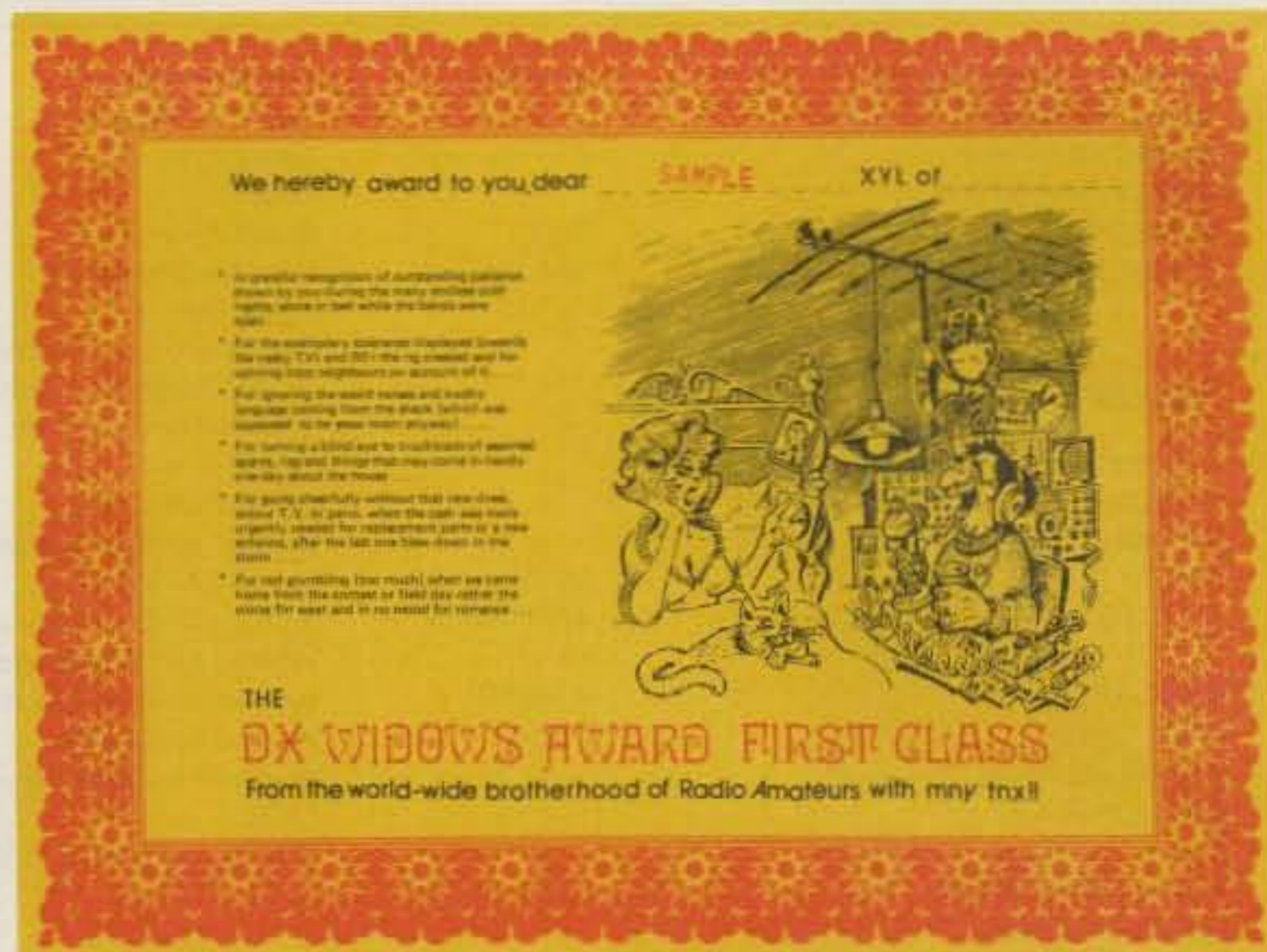

The callsign WD8KWC will be used. A handsome 8" x 10" certificate will be awarded to all contacts submitting a QSL and legal-size SASE to Basil Napier WD8KWC, RFD 1, Box 198, Chapmanville WV 25508.

### TIMBER CARNIVAL

The Mid-Willamette ARC will be operating from the World Championship Timber Carnival in Albany, Oregon, 1900 UTC, Friday, July 3, until 2300 UTC, Sunday, July 5. Look for W7SO on 3.975, 7.275, 14.285, 21.375, and 28.575 MHz, and for club members operating their own stations on various other frequencies. A special certificate will be sent to each station sending a QSL card and an 8½"

x 11" SASE to Mid-Willamette ARC, PO Box 1226, Albany OR 97321.

### THREE MILE ISLAND DXPEDITION

The Central PA DX Club will hold a TMI Fun DXpedition on August 22-23, 1981, from 1200Z Saturday until 2100Z Sunday. Tentative frequencies on phone are 3900, 7240, 14260, 14290, 21325, 21375, 28625, and 146.58. Tentative CW frequencies are 21125 and 7125. The callsign used will be WB3DNA/portable TMI. A QSL card will be sent to all contacts upon receipt of an SASE or IRCs. QSL to CPDXC, c/o WB3DNA, T. Fanus, 6140 Chambers Hill Road, Harrisburg PA 17111 USA.

## KAHANER REPORT

Larry Kahaner WB2NEL  
PO Box 39103  
Washington DC 20016

### REACH OUT AND CRUSH SOMEONE

You wouldn't think that the world's largest corporation, one with a \$6 billion net income, needed a boost, a little help to compete in the marketplace. Well, think again. In its ruling on cellular radio—a new mobile telephone service that promises a dial tone in every Dodge—the FCC handed AT&T a competitive edge so sharp that others wanting to enter the field may

never get a chance to try. First, some background.

It all began about 12 years ago when the FCC and others realized that the then state-of-the-art mobile phone service was heading for disaster. Channels were crowded, voice quality was poor, and waiting lists swelled with those who needed phones in their cars. Things didn't get better and, indeed, couldn't get better because the system just couldn't support high numbers of users. Each city had one mobile operator who had one transmitter and about a dozen frequencies for thousands of users. You waited your turn to

get through while someone calling home tied up the frequency all over town. Now, enter the cellular radio concept.

It didn't rely on one transmitter—it relied on many, each in a different section of the city, each called a "cell." They're low power as are the car telephones, so many conversations take place at the same time without bothering someone else in a neighboring cell. As you drive from cell to adjacent cell, you are handed off without interruption. As customers increase, you just divide cells into smaller cells—a sort of electronic mitosis.

AT&T asked for FCC permission to test cellular radio in Chicago, and about two years ago it began. The full-scale experiment involved 2,000 people, mostly businessmen. Things worked splendidly. Voice quality

rivalled that of regular landline telephones, and blocking (how often you couldn't get a dial tone) checked in at about 2 in 100 times. Satisfied mobile dialers deluged the Commission with fan mail, saying: "We need this and we need it now."

In Washington, meanwhile, Motorola started its own test in conjunction with a local radio common carrier. That system, compatible with Bell, also worked great, although it still had some minor kinks.

Anyway, everyone agreed cellular radio worked, that it was time to wave the green flag so we could all dial while we drove.

As with all Commission matters, cellular radio traveled through legal mazes until it finally surfaced at the beginning of April with a hearing that ended with a proposed rulemaking, the final step before law. At that

meeting, the FCC decided all sorts of technical and economic issues such as where the service will operate (800 MHz), who can manufacture equipment (anyone), and whether it is indeed in the public interest (of course—what are you, crazy?).

But the most controversial part was the number and kind of common carriers in each market. Two kinds of common carriers exist: wireline and wireless, also called radio common carriers. Wireline common carriers serve the public with copper wires, e.g., telephone companies. Non-wireline common carriers use airwaves, e.g., paging companies.

The FCC decided that each market would host a maximum of two cellular operators, one wireline and one wireless (even though the cellular systems are identical). Each would receive a 20-MHz spectrum chunk. The Commission also said that in each market the wireline allotment would be held for five years. No one else could touch it. Now, the good part.

Since wireline carriers are guaranteed a slot, and AT&T is the dominant wireline carrier (the only wireline carrier in many regions), AT&T is virtually ensured a hook into any market it chooses. And while radio common carriers remain locked in comparative hearings amongst themselves for their 20-MHz piece of the pie, AT&T would have sucked up prime sections of prime markets for themselves. Reach out and crush someone, Ma Bell.

The Commission justified the 2-slot method by saying it's the best way to get cellular radio to

the public quickly. They said AT&T might not invest in a market unless it was ensured a clear shot. Also, it deserved special consideration because it did most of the experimental work.

The Justice Department called the split method "blatantly anti-competitive" in a reply it filed last July during FCC procedures. Travis Marshal, Motorola's vice president handling cellular matters, said FCC actions amounted to giving AT&T a lock on the market while everyone else "scrambles for the remains."

One small radio common carrier, Millicom, filed suit in the US Court of Appeals for the District of Columbia, asking the court to overrule the FCC. They said markets should be open to competition no matter who you are or what kind of carrier you are. If AT&T wins, so be it; but let's have free competition, they said. More lawsuits are expected.

All the FCC's general counsel said publicly on the subject was: "The position is defensible in court."

Why the FCC believed it had to give the world's largest corporation a leg up on a system it could dominate very easily on its own is unknown. However, one thing is clear: In its belief that helping AT&T would move things along, the FCC may have inadvertently shifted cellular mobile radio into reverse.

#### ALL I GET IS BILLS

The FCC would get authority to set minimum interference standards for TV sets and other home entertainment devices under a bill introduced into the

Senate by Barry Goldwater. We've seen this sort of thing before—in fact, several times before.

Bill S-929, titled "Amateur Radio Service and Private Land Mobile and Fixed Services Act of 1981," differs from past bills in that it increases amateur license terms from five to 10 years and allows hams and CBers to act as volunteer monitors for the FCC.

Perhaps the most important provision gives the FCC power to regulate or prohibit delivery of transmitters to unlicensed persons. This means you can't buy a rig until your license arrives. Manufacturers and retailers are certain to put up a fuss over that section.

#### FCC UNHAPPY WITH JUSTICE DEPT OVER ANTI-CASTRO BROADCASTER

The FCC's enforcement teams are bitter over the Justice Department's refusal to prosecute a Miami radio pirate caught broadcasting anti-Castro propaganda in the 40m band. Commission officials say they spent more time on that case than on any other unlicensed operator enforcement matter in recent years. Staffers are particularly miffed because they believe Justice dropped the case for political rather than legal reasons.

The incident involved Jose Gonzalez, charged with unlicensed operation after his transmissions showed up on neighbors' TV sets. Hams all over the world complained of interference, too. The Miami and Fort Lauderdale monitoring stations tracked Gonzalez's clan-

destine activities from December, 1979, to April, 1981, logging more than 1,000 man-hours. The FCC presented the case to the Justice Department but, on April 14, US Attorney Atlee Wampler dropped the charges on the condition that Gonzalez cease operation from his home. The Justice Department still retains the right to prosecute Gonzalez if he transmits from another site.

Former chief of investigations Jeff Young said that in his personal opinion, because Gonzalez was popular in the Cuban community, Justice decided to drop the case rather than stir up resentment in a neighborhood suffering severe racial problems. Fort Lauderdale engineer-in-charge James Feagles gave us similar thoughts. "We were frustrated... It wasn't our decision, of course; it was Justice's and we have to believe that [politics] was the case in their decision." He said that without Justice's support, illegal operations will continue. "I'm concerned that the Cuban community in Miami might perceive this as a victory. It might lead to increased activity," said Feagles.

Atlee Wampler said politics played no part in his decision. "It's simply not true. Those accusations are blatantly false." He added that with all the criminal cases he must handle, dropping this case seemed justified. "With all the crime perpetrated by Cuban criminals from Castro's jails, prosecuting one 60-year-old man without a criminal record seemed ridiculous," he noted.

He has a point. So does the FCC staff.

## LOOKING WEST

Bill Pasternak WA6ITF  
c/o The Westlink Radio Network  
Suite 718  
7046 Hollywood Blvd.  
Hollywood CA 90028

One question often asked of this reporter is why we delay in reporting actions by the FCC and other agencies regarding malicious interference. There is a very sound reason for this, which has to do with the Consti-

tutional guarantee that states that a person is presumed to be innocent of a crime until found guilty. While it is very tempting to any reporter to "cash in" as it were on hot news items, especially those which involve the current wave of jamming sweeping over our amateur bands, I always have taken the view that the guarantees afforded to an individual under our Constitution are far more important than

any story I might write. Hence, while a matter is under litigation, as was the case in the item you are about to read, I refrained from commenting on it.

Only after a decision has been reached by the powers that be will I go into detail about such matters.

What you are about to read is an actual story about a license revocation in the Amateur Service. This in itself is nothing new. Amateurs have lost their licenses for various reasons, usually some form of major violation to Part 97. Again, this was the case here. But the reasoning

behind the license revocation issued against K6EOA is possibly a first on the part of the Commission. It could have far-reaching effects on the eligibility of anyone to hold an amateur license.

The following report was written by Alan Kaul K6RCL, who assists me in the preparation of the weekly Westlink newscasts. It was the lead story in Westlink "QST" number 167 which aired the week of April 11th, 1981. It was prepared from the actual FCC Report and Order dated March 24, 1981, which ordered that the amateur license of John W. Munson, Jr. K6EOA be re-

voked. Here is that report.

"This story centers on an FCC license revocation, but it may be a milestone case because an administrative law judge has decided that mental incompetence is grounds for license denial. The judge also said that when an individual applies for an amateur license, he or she must abide by federal radio regulations, and thus as a licensee does give up certain First Amendment rights.

"The case involves K6EOA, John W. Munson, Jr., of Los Angeles. On October 2, 1979, Munson was alleged to have transmitted an A0 emission on 147.435 MHz, jamming transmissions on a Los Angeles repeater. FCC engineers Lawrence Guy and James Zoulek of the Long Beach, California, FCC office were nearby monitoring the transmission in a van equipped with direction-finding equipment. They recorded the transmission, then knocked on Munson's door. They showed their identification and attempted to inspect his station, log, and license.

"But Engineer Guy said later in his official report that they were not permitted entry and that Munson refused to show them his license or the records of his station. They returned to their monitoring vehicle and again started their tape recorder. This time they not only recorded more A0 emissions, but also threats on their lives if they attempted to inspect the amateur station again. And, as Guy testified later, a threat to kill another amateur as well.

"As a result of the threats against the lives of two federal officers, Guy went to the US Attorney and a complaint was issued which included a warrant to search the premises of Munson's home. Technically, a search warrant wasn't needed because the engineers had witnessed an infraction of federal law, and under Part 97 an amateur who is observed violating the law with his radio transmissions must open his station, log and license to inspection.

"Three days later, on October 5, 1979, Munson showed up at the FCC Office in Long Beach and was arrested. [Note: At the time of the arrest, he had voluntarily gone to the FCC office to give to them an official written apology for his actions.] Guy

also served him with the search warrant and entered the ham shack of K6EOA. A stolen portable receiver, a loaded rifle, marijuana plants, and transmitting equipment were seized. On March 19, 1980, a federal grand jury in Los Angeles returned an indictment against Munson for violation of federal radio law and for threatening the lives of FCC enforcement officers.

"But, two months later, the indictments were dismissed when a court-appointed psychiatrist found that Munson was legally insane; he lacked the mental capacity to discern the unlawful nature of his actions.

"In September, 1980, state charges were filed against Munson, and in what is called by lawyers a four-count "criminal information" he was accused of threatening bodily harm. In November, Munson entered a guilty plea to one of the state counts and in January of this year the judge ordered him to pay a \$500 fine, not to use his amateur equipment, and to undergo psychotherapy. He was also placed on three years probation.

"At this point one would think this would have been the end of the Munson case, but it wasn't. The FCC reentered the act and ordered a hearing on licensing before the Chief Administrative FCC Law Judge, Lenore Ehrig of Washington DC. [Note: The actual hearing was held in a Federal Building here in Los Angeles.]

"In her findings, Judge Ehrig held that since Munson was not mentally competent to discern right from wrong in his Federal prosecution, he was not mentally competent to operate a lawful amateur radio station, that oper-

ating such a station would require adherence to the law.

"The Judge also held that when one applies for an amateur license under Part 97, one also implies consent to certain federal regulations. One doesn't give up his right to free speech, but at the same time, some lawyers would argue that a ham license doesn't entitle you to exercise your right of free speech on amateur radio. As an analogy, you can play music at home, in your car, or just about anywhere else you want except on the amateur bands using your amateur transmitter.

"We might be a bit premature in calling these precedents and findings as landmark decisions, but the actions of the FCC Administrative Law Judge in this case have affirmed the right of the Commission to make laws and to enforce them."

#### Commentary:

If space had permitted, I would have published the entire 11-page FCC finding in this case. I do have it, but please do not request copies. I have neither the time nor the funds. If you need a copy, I can only suggest that you contact the FCC in Washington and request it. There will probably be a charge for the transcript, though I have no idea as to the exact costs. For those interested, there are a number of news services that supply such information. "FCC Observer Services" you might call them. They're expensive, but if you are an FCC watcher, they're worth their weight in gold.

As to the Munson case itself, I think that I should explain that

there is a definite reason for my not writing directly on the matter until now. There are actually several reasons, not the least of which was that I was one of probably hundreds listening the evening that the now proven violation occurred. As you know from my past writings in this column and elsewhere, I am strongly opposed to permitting wanton regulatory violations to continue. I honestly felt that after listening to things first hand, I could not be objective in my reporting. Nor did I want to see John Munson or anyone else "tried and convicted in the press." I do not know the man personally. I had spoken with him on two meters prior to the episode which cost him his license. I had also talked with him on the phone. While our views were not in accord and probably never can be, I still felt a strong obligation to both him and the Commission to permit them to solve things themselves. I told this to John and the local FCC people at the outset, and at that point I removed myself from handling the matter in this column or on Westlink.

Those of you who heard about John Munson's problems either on Westlink or in *H.R. Report* should be made aware that those were from official reports, court news releases, and other such sources. To paraphrase a well-known expression from the long-expired television program, "Dagnet," it was a case of having one of my coproducers provide "the facts m'am... simply the facts." Maybe you could call this my own personal fairness doctrine, but having Alan write what now appears to be the final chapter in this story was in keeping with what I felt obligated to do. Not being an "ear-witness" to the initial happening afforded him a certain objectivity I might not have been able to achieve.

#### NAB-IT DEPARTMENT

The initials NAB stand for the National Association of Broadcasters, and each year this august body, which represents every aspect of today's broadcast technology, holds an annual get-together. This year it was the city of Las Vegas that played host to the NAB Convention on the weekend of April 12th, and I had the opportunity to get to NAB '81 thanks to Rupe Good-



Satellite communication is definitely the wave of the future, as this parking lot full of ground stations will attest.



This is a complete mobile television studio capable of directly feeding a satellite from any location.

speed WA6QLE and Western Airlines; the former going up and the latter for the return trip.

My reasons for attending NAB were purely business, having nothing whatever to do with amateur radio, but nonetheless, I did have the foresight to bring along my Wilson hand-held. I soon found that I was not the only one who had thought of this. As you are probably aware, many people in the broadcast industry have their roots in amateur radio, and 146.52 simplex was very much alive as the unofficial intercom channel. In my 30 short hours I heard someone from every US prefix district, including such well-known people as Jean Shepard K2ORS come onto the channel. By the way, the VoCom gain antenna seemed to garner a lot of attention each time I found it necessary to utilize its efficiency for communication with someone who was marginal on the rubber-duckie. Again, that antenna has come in quite handy, and I can again say for the record that its performance meets its claims.

Probably the most interesting exhibit was in the parking lot adjoining the main exhibit hall. Never before have I seen so many dishes in one place at the same time. I didn't have a wide enough lens to catch everything aimed skyward.

Other equipment shown included the latest in mini-cameras and portable recorders for use in electronic news gathering. Each year the size of field-production equipment seems to shrink, with the old 40-pound cameras giving way to the new lightweight varieties. I was very impressed by one from a company you probably never heard of unless you are involved in television production. The company is called Ikegami, and for many years they have been the trend-setters in portable field-production camera equipment. Many cameramen consider their HL-79 series the state of the art standard. Having used the HL-79 myself, I can see why. They have a new smaller camera called the HL-83. It's a professional 3-tube prism beamsplitter



Named by the Dayton Amateur Radio Association to receive the 1981 Specific Achievement Award are (left) Bill Pasternak WA6ITF and Bill Orenstein KH6IAG, for their work in producing the weekly Westlink news bulletins.

camera that weighs less than most home cameras, with an electronics package that will make your mouth water. It even has provision for attachment on one of the new mini-VCRs directly to it making a one-man ENG operation possible. The only drawback for you and me is the price: many kilobucks.

If equipment was of use to any part of the broadcast industry, it could be found someplace on the convention floor. I spent many hours ogling some of the new production audio recorders shown; wishing I had the kilobucks to buy them for Westlink. Alas, like many other things in life, this is but a dream.

While NAB is not the kind of show that the average amateur will ever attend, it is an interesting experience if only from the standpoint that what one sees at NAB will, in a simpler, less complex form, find its way into the average American home. Today, we take owning a VCR for granted. Five years ago they

were found only in television stations, educational institutions, and similar environments. What happens at "that" end of the media stream eventually affects us all. It's nice to see it first-hand and even nicer to be able to share a bit of it with you.

#### A QUICK THANK-YOU

On behalf of Bill Orenstein KH6IAF, Alan Kaul W6RCL, Burt Hicks WB6MQV, Jim Davis KA6IUH, and everyone else who make up Westlink Radio Network operation, I wish to express my humble and sincere gratitude to the Dayton Amateur Radio Association for selecting the Westlink operation to receive the 1981 Specific Achievement Award. Though the award names Westlink, Bill Orenstein, and myself as recipients, it is something we all share collectively. For the honor you have bestowed upon us, we say thank you for the recognition. It is an honor we will hold dear all of our lives.

## FCC

### APPLICANTS FOR SPECIAL TEMPORARY AUTHORIZATIONS MUST FOLLOW THESE PROCEDURES

The FCC has announced that requests for Special Temporary Authorizations (STAs) in all Private Radio Services, except Private Operational Fixed Microwave, must be sent to a new address: Federal Communications

Commission, Consumer Assistance Branch, Box 441, Gettysburg, Pennsylvania 17325.

STA requests for Private Operational Fixed Microwave (POFM) should continue to be sent to the Federal Communications Commission, Washington, D.C. 20554.

All information must be submitted, in writing, to the FCC

preferably on business or company letterhead. Requests should reach the FCC at least ten (10) days before the proposed date of operation.

In an extreme emergency, FCC rules allow a request to be filed by telegram or telephone. Such a request, however, must be followed by a written signed request within ten (10) working days of the telegram or telephone call. If the written request is not received within that time, the FCC will rescind the STA.

General questions concerning STAs and other licensing activities will be answered by the

Consumer Assistance Staff in Gettysburg, Pennsylvania. Call (717)-334-9167 or 334-7631.

### EXTERNAL RADIO POWER AMPLIFIER TYPE-ACCEPTANCE REQUIREMENTS EXTENDED INDEFINITELY (DOCKET NO. 21117)

The Commission has adopted a rule change extending indefinitely its type-acceptance requirements for external radio frequency power amplifiers.

The requirements apply to all amplifiers and amplifier kits capable of operation below 144

MHz. They cover most amplifiers used in the Amateur Radio Service. Type acceptance requires submission of a sample of each model amplifier, together with technical information, to the FCC for approval before it can be manufactured and marketed. Only 10 prototype units may be built in preparation for model submission for type acceptance.

The Commission on December 18 instructed its staff to draft an order that would extend the type-acceptance and related technical requirements indefinitely. The requirements were adopted in 1978, effective for three years, to cope with the problems created by the large number of amplifiers being marketed and promoted for use in and around the CB frequencies. External power amplifiers of the sort used to amplify CB signals illegally can cause serious interference to TV and radio reception.

The effectiveness of type acceptance in halting promotion of amplifiers for illegal applications indicates that it should be maintained, the Commission said then. Numerous manufacturers and distributors of amplifiers designed or promoted for illegal operation have ceased manufacture or marketing since type acceptance was imposed.

The rule change took effect April 28.

Action by the Commission March 23, 1981, by Second Report and Order (FCC 81-118). Commissioners Lee (Acting Chairman), Quello, Washburn, and Fogarty, with Chairman Ferris not participating. For further information, contact John Reed at (202)-653-6288.

#### FCC REFUSES TO CONSIDER ELIMINATION OF NEW AMATEUR RADIO SERVICE CLUB LICENSES (DOCKET NO. 21135)

The Commission has denied

the petition of the Capitol Hill Amateur Radio Society (Capitol Hill) for reconsideration of its action in discontinuing the issuance of new Amateur Radio Service club licenses.

In June, 1980, the Commission determined that no new licenses would be issued for club, military recreation, and Radio Amateur Civil Emergency Stations, except for modification or renewal of licenses.

Capitol Hill claimed that the Commission was deficient procedurally in discontinuing new club licenses, in that it did not consider the alternative of continuing the system of issuing club station call signs from the regular format calls. The Commission said it had considered the option of continuing such licensing and rejected it.

Capitol Hill also contended that the amended rules are not in the public interest because they do not foster amateur growth to serve the public in

times of emergency. It also maintained that eliminating future club station licenses lessens the likelihood of such emergency preparedness.

The Commission said that operations now conducted by club stations may, in the future, be conducted either by club members operating portable stations or acting as control operators of another member's station. The Commission said it does not believe eliminating club licenses will result in a disinclination of the public to form amateur radio clubs or in failure of educational institutions to fund amateur radio clubs.

Action by the Commission March 26, 1981, by Memorandum Opinion and Order (FCC 81-123). Commissioners Lee (Acting Chairman), Quello, Washburn, Fogarty, and Jones, with Chairman Ferris not participating. For additional information, please contact John Borowski at (202)-632-7597.

## LEAKY LINES



Dave Mann K2AGZ  
3 Daniel Lane  
Kinnelon NJ 07405

There are hams who have been at it for decades, people who have devoted their best efforts to one or another phase of the hobby with great dedication. In other fields of human endeavor there are tangible rewards to be gained. If you were to dedicate all the energy that is expended by the average ham into, say, the study of some musical instrument, chances are that you would eventually become so accomplished that you could earn a great deal of money. If you devoted yourself with equal persistence to university studies, you could earn an advanced degree. If you displayed as much ingenuity and tenacity in

the position you now hold, you might be in your company's top echelon of management.

People find it hard to understand why we amateurs become so deeply involved in such activity, one from which relatively few tangible rewards can be gained. To many ordinary laymen, hams seem like a company of superannuated fools who play with childish toys. Even the families of some amateurs display a degree of vague embarrassment when the subject arises; they would feel much more comfortable if Dad were a yachtsman, a golfer, a fisherman, a photographer, or even a bird-watcher. Such activities are regarded as normal, but for some unfathomable reason, ham radio makes little or no sense at all. You explain that you communicate with others all over the globe, and they view it as something akin to what they did when they were kids and cultivated "pen pals" whom they wrote to during their summer vacations. You tell them that you handle traffic during emergencies, and they tell you about the time some CB oaf on

the next block interfered with their TV reception. You show them your RTTY equipment, and they ask you if you can receive police calls or the daily stock quotations.

The most frequently asked question of all is, "What do you get out of all this?" They are unable to fathom any other motivating factor. To them, unless something tangible can be gained, there's no sense in devoting time, energy, and money to such activities. They cannot relate any accomplishment, however worthy, to success unless there is some sort of a payoff.

Like as not, if you were to assemble a group of amateurs and ask each to give his motivation, his purpose in being a ham, you would be likely to get a dif-

ferent answer from each of them. But I doubt that even those who actually work in allied fields would cite material reasons. Sure! There are hams whose careers opened as a direct result of their participation in ham radio, but if you ask them, you will learn that they never regarded the hobby as a mere means to the end.

For at bottom, practically all of us are hams because of one single word—*enjoyment*. I don't care what your bag is... handling traffic, slow scan TV, CW, DX, RTTY, satellite, QRP operation, designing and construction, mobile hamming, antenna development, digital techniques, antique wireless, county hunting, public service nets, or just plain garden-variety rag-

#### NO-CODE POLL RESULTS

The response to the no-code license question that appeared in the April Leaky Lines was rather one-sided: 94% said to keep the code! The remainder indicated that they thought the code requirement should be dropped. However, some of those wanting to keep the code said that they thought the code speed requirement should be reduced for a variety of reasons.

What we found particularly interesting was that the Fun! column poll in the March issue had a larger number of hams respond to it than to the no-code poll, although without the vehemence. Well, there certainly is no accounting for taste.

We would like to thank all who responded, and particularly those who included a comment or two along with their votes.

chewing... I know that I must have omitted at least a dozen more. The essential reward we derive is enjoyment. Not the enjoyment of the sudden flush of an easy victory such as one might feel when winning at cards... not the sort that comes from a sudden stroke of luck. But the sort of enjoyment one feels from honest accomplishment based upon dedicated work and an understanding of problems and obstacles to be overcome. There's a great difference.

I think it is significant that this column, which began as a polemic against the sick public preoccupation with materialistic goals, one of the distressing manifestations of our era, has automatically turned toward another direction. It has become a declaration of pride in the world's greatest hobby—amateur radio. It is the queen of hobbies. To be sure, there are faults to be found; nothing is perfect. But the faults are enormously outweighed by the positive values. And we do tend to focus on the bad rather than the good.

But, for the most part, we hams are chauvinists, in a way; we don't run down other people's preferences, but we are quite firmly convinced that when it comes to hobbies, ours is unquestionably the best.

Well, I'm sure that anglers, philatelists, and photographers must feel the same way. But there is an enormous and most significant difference; ours is a hobby whose entire progress and history is characterized by contributions to the society of mankind. Others have contributed, too... amateur astron-

omers have produced significant discoveries; amateur explorers have accomplished feats of importance. But there is no avocation which has so consistently broken new ground in the art and science of communications in ways that have so positively affected the lives of those who inhabit the planet.

Radio amateurs have made so many contributions which are now taken for granted, continue to do so to this very day, and will do so in the future. But, as always, whenever you have a record of accomplishment, you must guard it vigorously against those who would seek to exploit it for undue advantage or personal gain. There are those, unfortunately, who are forever scheming toward such ends, and there must be constant vigilance on the part of thoughtful amateurs.

One of the unmistakable hallmarks of the bonanza seekers is their constant emphasis on the growth of numbers rather than increased quality. I must declare that if all the current agitation in favor of the code-free, entry-level amateur license was originating among hams themselves, I would view it with far less apprehension. Whenever there is a cry raised for proposed changes that would increase our numbers through the elimination or lowering of standards, you don't have to search very far to find out where it's coming from. It is inspired by those who don't give a tinker's damn about the future of amateur radio, except in terms of the money that it represents.

They view that huge, untapped ocean of potential cus-

tomers who will be in the market for equipment, and the saliva oozes from the corners of their slavering mouths!

I honestly and sincerely believe that this is the true origin of each and every proposal of this sort. And I also believe that those among us who have been led to endorse such plans, although they fail to grasp the fact, are simply being used as unwitting pawns. And because I have stated this, there are those who have said of me that "he has an axe to grind."

I wonder... does anyone have a bigger axe to grind than those who seek to sacrifice the integrity and quality of amateur radio on the altar of financial profit? And what about those Judas goats who aid and abet them?

I leave the answer to you. Do you seriously believe that, if I were to deliberately set out to harm the League (although I can't see how my opposition to a code-free license could possibly hurt it), it could be as great a threat as certain people's willingness to do anything for money? Do you think that my interest in promoting increased subscriptions and newsstand sales of this magazine are as great a threat as our failure to organize immediate, vigorous opposition to any FCC proposal that would deleteriously affect amateur radio? What is this mysterious "axe" that I have to grind?

I have been a loyal member of the ARRL for many years. I support it in every possible way. But that support includes an obligation to oppose paths which I consider harmful. And I do not think that the League has to run

a referendum or take a poll in order to learn that the huge majority of its members strenuously oppose code-free licensing. I don't care who proposes it—the FCC, the manufacturers of electronic equipment, or goodness knows which of the several lobbies which represent special interest groups. The League should respond to such proposals immediately, with vigor and in no uncertain terms. It should never give the impression as to the slightest doubt about where its overwhelming majority stands by delaying its response pending further study or discussion. Opposition should come immediately and automatically.

This was the point of my piece in the April issue. It had come to my attention that when the FCC first floated this code-free idea, vigorous League opposition did not ensue immediately. It was delayed, and I suspect that the delay was inspired by a certain tendency toward slavishness on the part of a few people who feel that we must kowtow to the Commission, hat in hand. Well, diplomacy is wonderful, but it doesn't do much good in a life-threatening situation. You can't reason with a guy who has a knife poised at your throat!

If K2AGZ has any axe to grind at all, it is simply that he believes we need to develop some militancy in our dealings with the FCC and with those in positions of power who are or may be in the hip pockets of forces which don't have the future of amateur radio in mind. That's my "axe," and I intend to keep right on grinding it!

## NEW PRODUCTS

### MACROTRONICS' MAILBOX RTTY SYSTEM

Macrotronics, Inc., has announced the development of a disk-based "mailbox" RTTY system into a sophisticated RTTY communications terminal. The system has been designed for simplicity yet contains many new features. Some of these are:

- Disk-based WRU with "mail-

box" storage and retrieval of messages.

- Disk-based programmable messages.

- Disk-based storage and replay of received text.

- Transmission and reception of BASIC programs, assembly source listings, object code, and data files in INTEL Hex format with error-checking and direct-save on disk in executable form.

- Auto 10-minute ID timer.
- User-programmable end-of-file sequence.
- Word mode editing.
- On-line buffered ASCII printer-driver.
- Communications through the Macrotronics interface or the Radio Shack RS232C interface board.

It is expected that the system will particularly appeal to:

- Repeaters: Set up in the WRU mode, it lets repeater users leave or play back messages. Special announcements, W1AW bulletins, propagation forecasts, DX bulletins, etc., can be

made available. These may be created from the keyboard, created "offline" using the "Electric Pencil" (a registered trademark of Michael Shroyer Software) or "SCRIPSIT" (a registered trademark of Tandy Corporation) or saved off the air (and edited later with the "Electric Pencil" or "SCRIPSIT" if desired).

- MARS/Traffic handlers: The operator can save a message off the air to disk, replay it anytime on command, transfer it to another station's "mailbox," and let him call it up later. With the "Electric Pencil" or "SCRIPSIT" disk program, he can edit the

received text to correct "hits," insert "misses," add new text, rearrange paragraphs, etc. If his net requires a special end-of-line character sequence, he can program his own. Traffic can be originated by using either keyboard entry or the word processing capabilities of the "Electric Pencil" or "SCRIPSIT" disk program to create text and save it to disk. It can be transmitted at any time under keyboard control or transferred to a mailbox for automatic call-up by the destination station. For hard copy of all traffic, the operator simply has to turn on a parallel ASCII printer connected to the Radio Shack parallel printer port, and all received as well as transmitted text is output to both video and the printer.

● Program swappers: Programs and/or data files can be exchanged direct, disk to disk. This includes BASIC, assembly source, and object code. Using INTEL Hex format, the user can communicate in either the Baudot or ASCII modes. A checksum gives automatic error-detection. Programs received in this way are directly executable from disk.

● High-speed ASCII buffs: The system allows communication through the Radio Shack RS232C interface board. The user can attach a conventional telephone modem and communicate over the air (or telephone) using Bell 103 tones and 300 baud. The system will communicate through the RS232C board at baud rates from 50 to 1200.

The M8000 disk-based RTTY system requires the Model I TRS-80 with at least 32K RAM and one Radio Shack disk drive, plus a Macrotronics ham interface (models M80, CM80, or TM80).

The M8300 disk-based system requires the Model III TRS-80 with at least 32K RAM and one Radio Shack disk drive, plus a Macrotronics ham interface (models M83, CM83, or TM83).

Both systems come complete with customized program on disk, extensive User Guide in three-ring binder, quick reference card, and conversion module.

For further information, contact Macrotronics, Inc., 1125 N. Golden State Blvd., Turlock CA 95380; (209)-667-2888. Reader Service number 480.

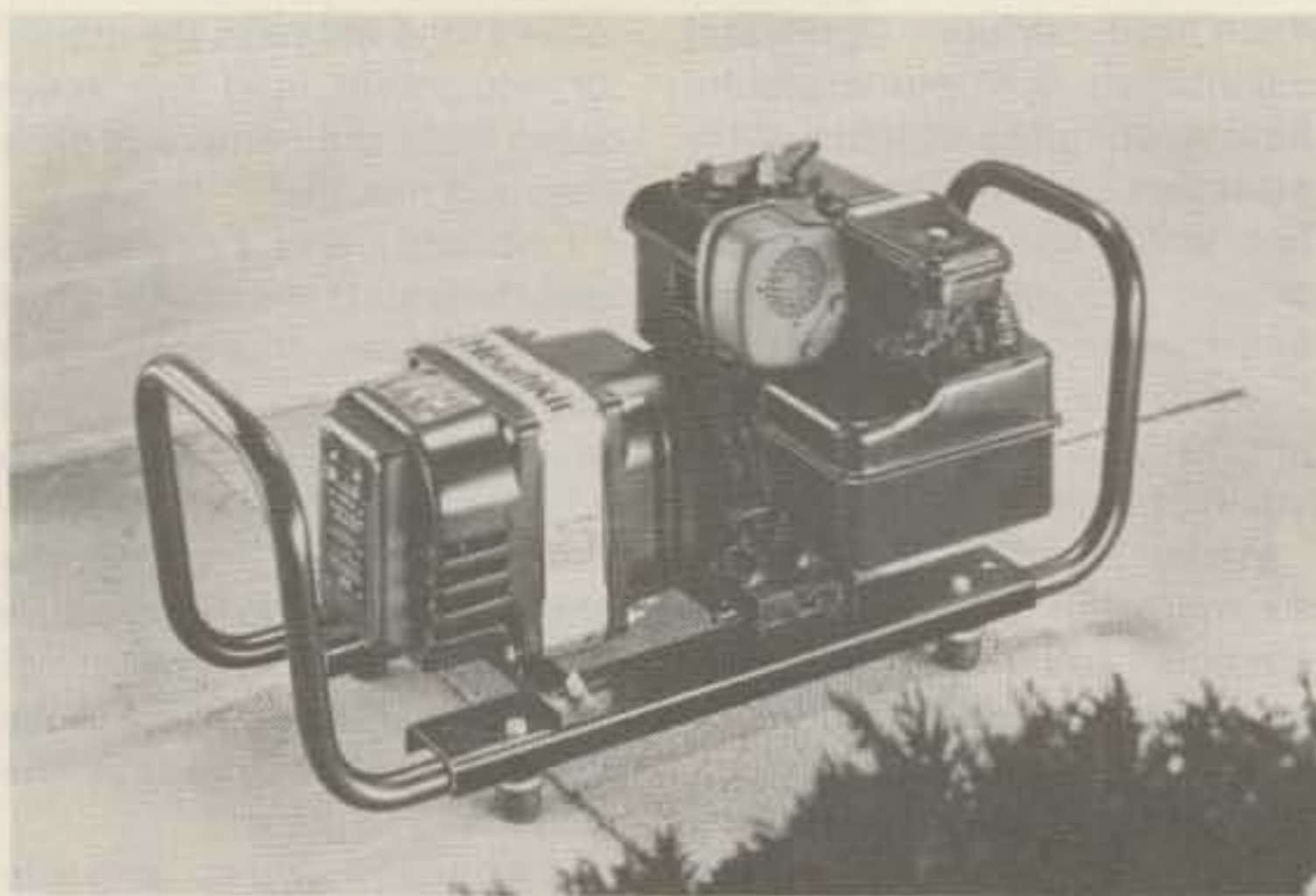

Heath's GU-1820 portable power system.

### HEATH GU-1820 PORTABLE GENERATOR

Heath Company has announced its entry into the emergency/auxiliary/portable power market with the Heathkit GU-1820 portable power system. This lightweight alternator can produce up to 2200 Watts of 120-V ac, 60-Hz power—enough to operate a ham station, an electric chain saw, or a refrigerator-freezer during a blackout.

The GU-1820 is designed for ham radio clubs, home owners, civil defense, and police and fire departments. It can also provide on-location power for construction and logging crews, campers, hunters, woodcutters, and others.

Voltage is regulated to within  $\pm 5\%$  and frequency variation is limited to  $\pm 4$  Hz, from no load to full load at 3600 revolutions per minute (rpm). Radio-frequency interference is eliminated by a resistive spark plug. The 5-horsepower Briggs and Stratton gas engine can run up to  $1\frac{3}{4}$

hours at half load on a tankful of regular gas, or gasohol. Noise is controlled by a low-tone muffler; to reduce sparking to a minimum, the optional GUA-1820-1 spark-arresting muffler (required in California) is available.

For more information on the GU-1820 portable power system, contact *Heath Company, Dept. 350-035, Benton Harbor MI 49022.* (In Canada, write *Heath Company, 1480 Dundas Street East, Mississauga, Ontario L4X 2R7.*) Reader Service number 478.

### NEW PRODUCTS FROM TRAC

TRAC Electronics, Inc., has announced the introduction of two unique products for the CW enthusiast.

The TRAC\*ONE CW Processor, Model TE-424, is an advanced CW audio processor which receives the audio from any rig, passes it through a phased-locked-loop tone decoder (removing all QRN and

QRM), and reproduces a fully adjustable CW audio signal. Front-panel controls allow full adjustment of frequency, tone, delay, and gain. The frequency control is adjustable from 300 Hz to 2500 Hz, a match for any rig. While the CW signal is being decoded, a front-panel LED flashes in sync with the signal, establishing that the unit is locked onto the audio from the rig. The TRAC\*ONE contains a built-in speaker, a headphone jack on the rear panel, and is operated on a 9-V dc battery or with an ac adapter. In the bypass position, the Model TE-424 may be left in line and the rig audio is passed through to the speaker.

The TRAC\*ONE + Deluxe CMOS Keyer, Model TE-464, combines the full-featured TRAC\*ONE with a deluxe state-of-the-art CMOS electronic keyer. The keyer contains self-completing dots and dashes, dot and dash memory, iambic keying with any squeeze paddle, 5-50 wpm, speed, volume, tune, and weight controls, sidetone and speaker, rear-panel switch for use with a bug or straight key, and quarter-inch jacks for keying and output. The Model TE-464 keys both grid-block and solid-state rigs and operates on one 9-V dc battery or a 9-V dc ac adapter.

For further information, contact *TRAC Electronics, 1106 Rand Bldg., Buffalo NY 14203.* Reader Service number 481.

### AMATEUR RADIO PROFILES

A new publication is now available to the amateur ranks in the form of a quarterly technical journal. *Amateur Radio Profiles*, a worldwide publication, contains factual reviews on amateur equipment performance, quality, and service. It is written by amateurs who have used, tested, and compared—and will "tell it like it is."

Equipment evaluations not only include the typical bench-test specifications, but the important on-the-air appraisal and how it compares to present state-of-the-art units. It's written in plain, easy-to-understand language by amateur enthusiasts who have actually done the testing, comparing, and rating.

Both old and new market introductions are evaluated, and ARP is designed so that it can



New products from TRAC.



be retained and stored for future reference.

A unique feature of *ARP* is the "GBBU Equipment Ratings," in which the good, better, best, and ultimate dollar values versus performance are listed for study and comparison.

*Amateur Radio Profiles*, a new introduction for 1981, has already reviewed over 100 amateur products, including 61 HF and VHF antenna systems. Popular transceivers, receivers, amplifiers, and hand-held products have also been reviewed and rated!

With its unique style of equipment reporting, *ARP* should prove invaluable for the amateur as a source for product study.

For further information, contact *Amateur Radio Profiles*, Box 164, Cataula GA 31804.

#### PORTABLE TWO-METER QUAD

A new collapsible antenna has been introduced by Palomar Engineers. It extends the range of low-power two-meter transceivers by providing the gain and front-to-back discrimination of a two-element quad. It is ideal for boating, backpacking, mountaintopping, and other portable applications since it gives the gain of a linear amplifier but does not require additional battery power.

The entire beam assembly is housed in an 18" carrying case that will fit in a suitcase. For use, it unfolds to form a two element full-size quad complete with stabilized mounting stand.

For further information, contact *Palomar Engineers*, 1520-G Industrial Avenue, Escondido CA 92025.

#### BENJAMIN MICHAEL INDUSTRIES' MODEL 273 CLOCK

Benjamin Michael Industries, Inc., has announced the addition of the Model 273 to its line of 24-hour military-time-format clocks. The 273 is housed in a standard three-inch aircraft instrument case and is designed for mounting in the aircraft panel. The large, highly visible, LCD-type display provides the pilot with a direct readout of GMT time and eliminates the need to convert from local time. The highly efficient four-digit liquid-crystal display remains visible in bright sunlight and internal, push-button-activated

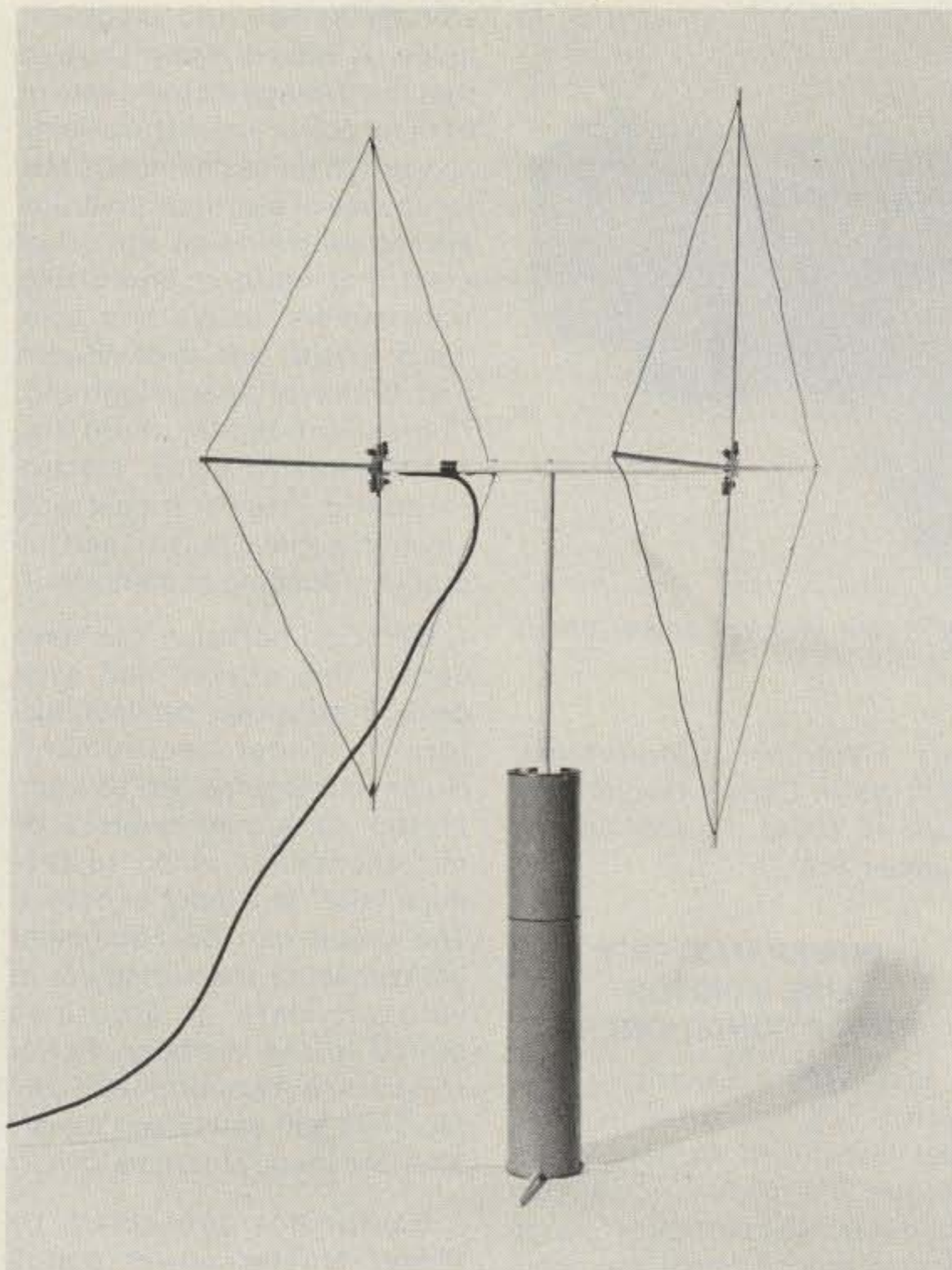

*Palomar Engineers' portable two-meter quad.*

backlighting is provided for night viewing (though cabin or post lighting is usually sufficient).

Installation of the 273 is facilitated by the fact that the unit is powered entirely by an internal battery; connection to aircraft power is not required. The

clock will operate for well over a year on a single 1.5-volt battery and the unit need not be removed for battery replacement. An identical 12-hour clock with AM and PM indicators is also available as the Model 272.

For further information, contact *Benjamin Michael In-*



*Benjamin Michael Industries' Model 273 clock.*

*dustries, Inc.*, 65 E. Palatine Road, Prospect Heights IL 60070. Reader Service number 488.

#### CATALOG ON TADIRAN LITHIUM BATTERIES PUBLISHED BY PLAINVIEW ELECTRONICS

Tadiran lithium thionyl chloride (inorganic electrolyte) batteries are prized for their high cell voltage, safety, long life, high energy density, and wide operating temperature, and are used as power sources for CMOS circuits, memories, and in high-reliability instrumentation. The new Plainview Electronics catalog describes 4 popular sizes— $\frac{1}{2}$ AA, AA, C, and D—including complete operating specifications and applications hints. Each cell's nominal working voltage is 3.4 volts. At room temperature, shelf-life is greater than 10 years.

For further information, contact *Plainview Electronics Corp.*, 28 Cain Drive, Plainview NY 11803. Reader Service number 479.

#### TRANS COM 401 TUNABLE CTCSS ENCODER

Trans Com, Inc., has introduced a new subaudible tone encoder. Measuring only 1.0" x .6" x .3", the 401 can be installed in radios in which similar encoders will not fit. Operating voltage is anywhere from 7 to 20 volts dc, with an average current consumption of only 4 mA. Tuning range is from 67 to 251 Hz, and frequency stability over a broad temperature range is claimed. Tone level is adjustable from 0 to 2 V p-p, with THD less than 1%. For more information, contact *Trans Com, Inc.*, 1104A Ridge Avenue, Lombard IL 60148. Reader Service number 482.

#### OMNI-GAIN MOBILE ANTENNA

The "Omni-Gain" mobile antenna has been introduced by Valor Enterprises, Inc. The unique construction of the "Omni-Gain" omits the copper coil by combining a 17-7 stainless steel whip, a 6061-T6 electroplated aluminum coaxial matching section, and a chrome-plated brass 3/8-24 ferrule.

The "Omni-Gain" is rated at 200 Watts with 5/8-wavelength and 3-dB gain. It is field-tunable to a typical vswr of less than

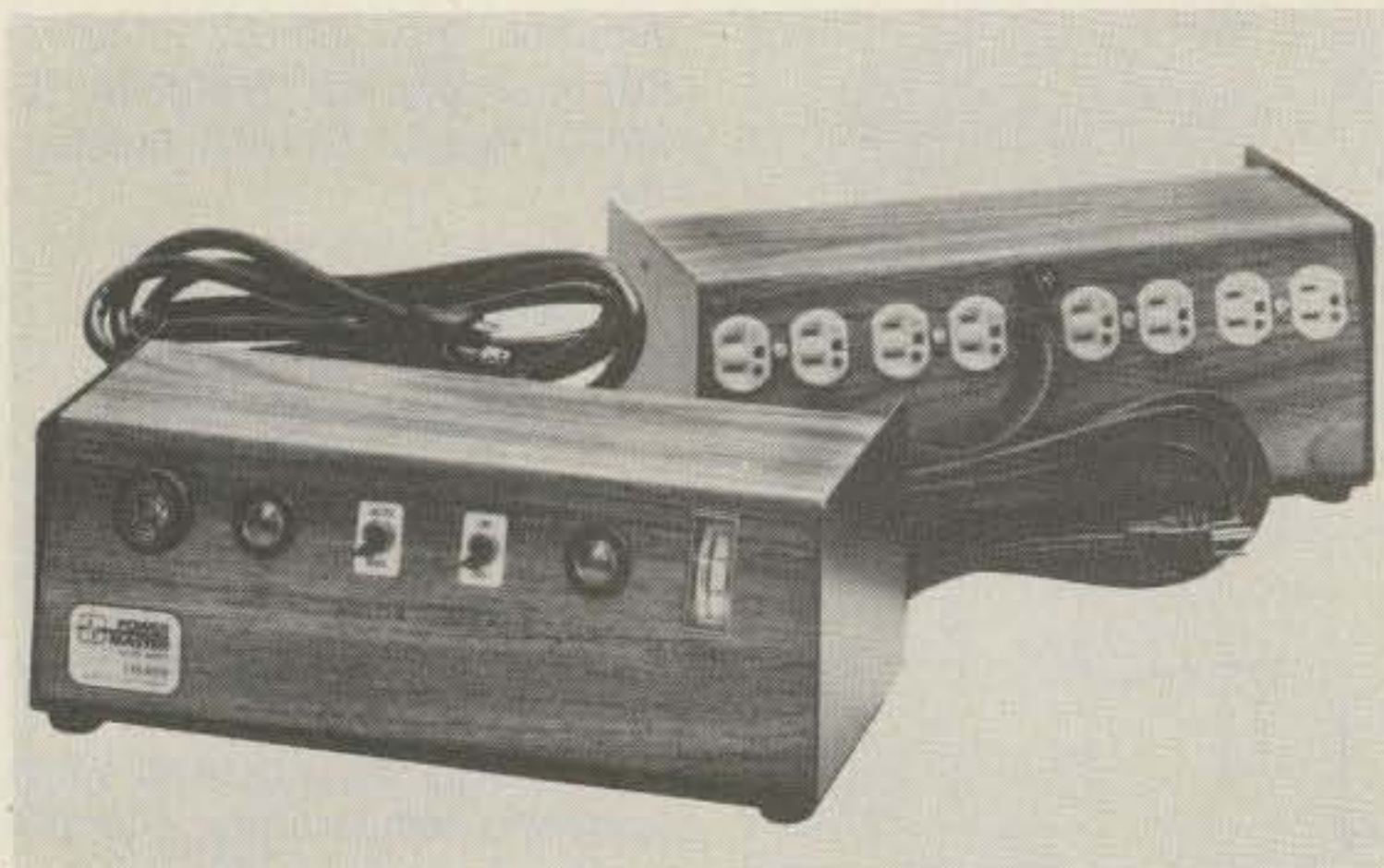

SGL Waber Electric's Power Master™ line monitor power conditioner.

1.5:1 at resonance. The mobile antenna is available for the 2-meter and 220-MHz amateur bands.

For further information, contact Valor Enterprises, Inc., West Milton OH 45383. Reader Service number 485.

#### ECONO-PAK GL-25 RESISTOR KIT

The GL-25 resistor kit consists of a specially designed resistor organizer and 840 ¼-Watt 5% carbon film resistors. 20 each of 42 different values are supplied. Immediate delivery is available from Cen-

trury Electronics Corporation, 3511 North Cicero Avenue, Chicago IL 60641. Reader Service number 483.

#### POWER MASTER™ LINE MONITOR POWER CONDITIONERS

SGL Waber Electric, a division of SGL Industries, Inc., has just introduced its new Power Master line monitor power conditioners. These power conditioners reduce "electrical pollution" coming through electrical power lines and branch circuits to solid-state electronic equipment which is sensitive to

voltage spikes and electrical noise. A recent study showed that the average incident rate of harmful power line disturbances is over 128 times per month. Major causes of electrical pollution are the switching on and off of electrical motors; energizing transformers, relays and solenoids; power line overvoltages and undervoltages; lightning; fluorescent lights; radio frequency interferences; electromagnetic interferences; and electromagnetic pulses; and improper grounding of equipment.

Electrical pollution can have devastating effects and even destroy sensitive semiconductors in modern equipment. Noise interference can be interpreted as actual signals by microcomputer chips to produce false data input or output. The result can be equipment breakdown or the wiping out of valuable data or programs stored in the memory. Power Master line monitor power conditioners will safely and simply alleviate these problems.

Equipment protected by Power Master power conditioners includes minicomputers, word processors, electronic instruments, photocopiers, cash registers, personal computers, automatic bank tellers—any electronic equipment with semiconductors, all of which are sensitive to voltage spikes and electrical noise.

The product line consists of eight power conditioner models which vary in complexity from a wall plug-in unit to a very

sophisticated console or rack-mounted unit. The simplest models contain varistors to clamp or reduce voltage spikes. The more sophisticated units include a multi-stage filter network which has spike suppression capability, transverse and common mode electrical noise filtration, as well as an undervoltage warning system, with indicator lights which are activated when the incoming electrical line voltage drops below a safe level. In addition, an ac voltmeter allows the operator to inspect the incoming ac power.

For further information, contact SGL Waber Electric, 300 Harvard Avenue, Westville NJ 08093; (609)-456-5400. Reader Service number 487.

#### ADJUSTABLE DUAL POWER SUPPLY KIT

Recently announced by Jameco Electronics is the Model JE215 adjustable dual power supply kit. The supply provides independently adjustable positive and negative output voltages from 5 to 15 V dc regulated. Separate adjustment for each supply allows the user unlimited applications for integrated circuit requirements. Power output for each supply ranges from 5 V dc @ 500 mA to 15 V dc @ 175 mA; an onboard LED indicates power-on condition.

For further information, contact Jameco Electronics, 1355 Shoreway Road, Belmont CA 94002. Reader Service number 486.

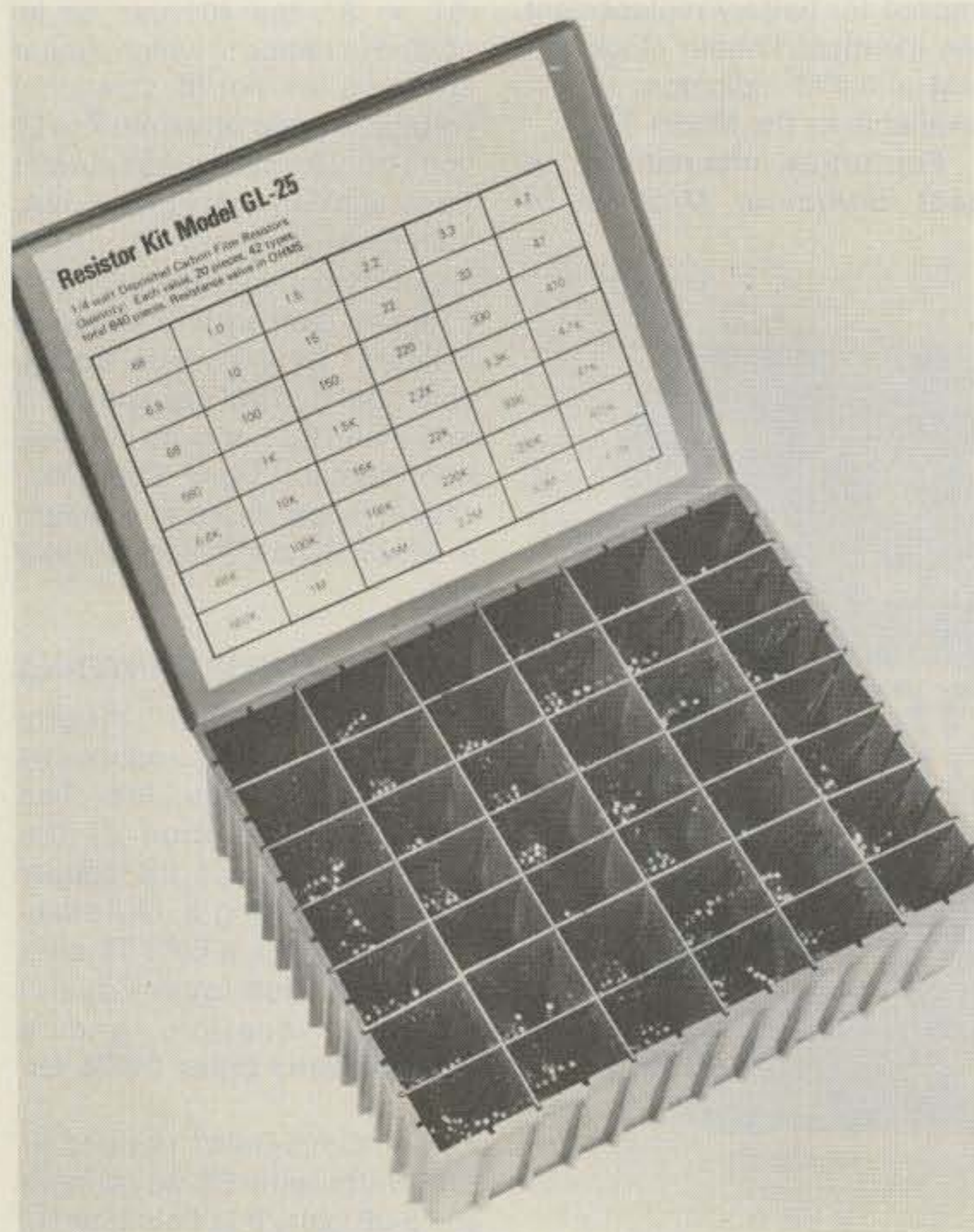

Century Electronics' Econo-Pak GL-25 resistor kit.

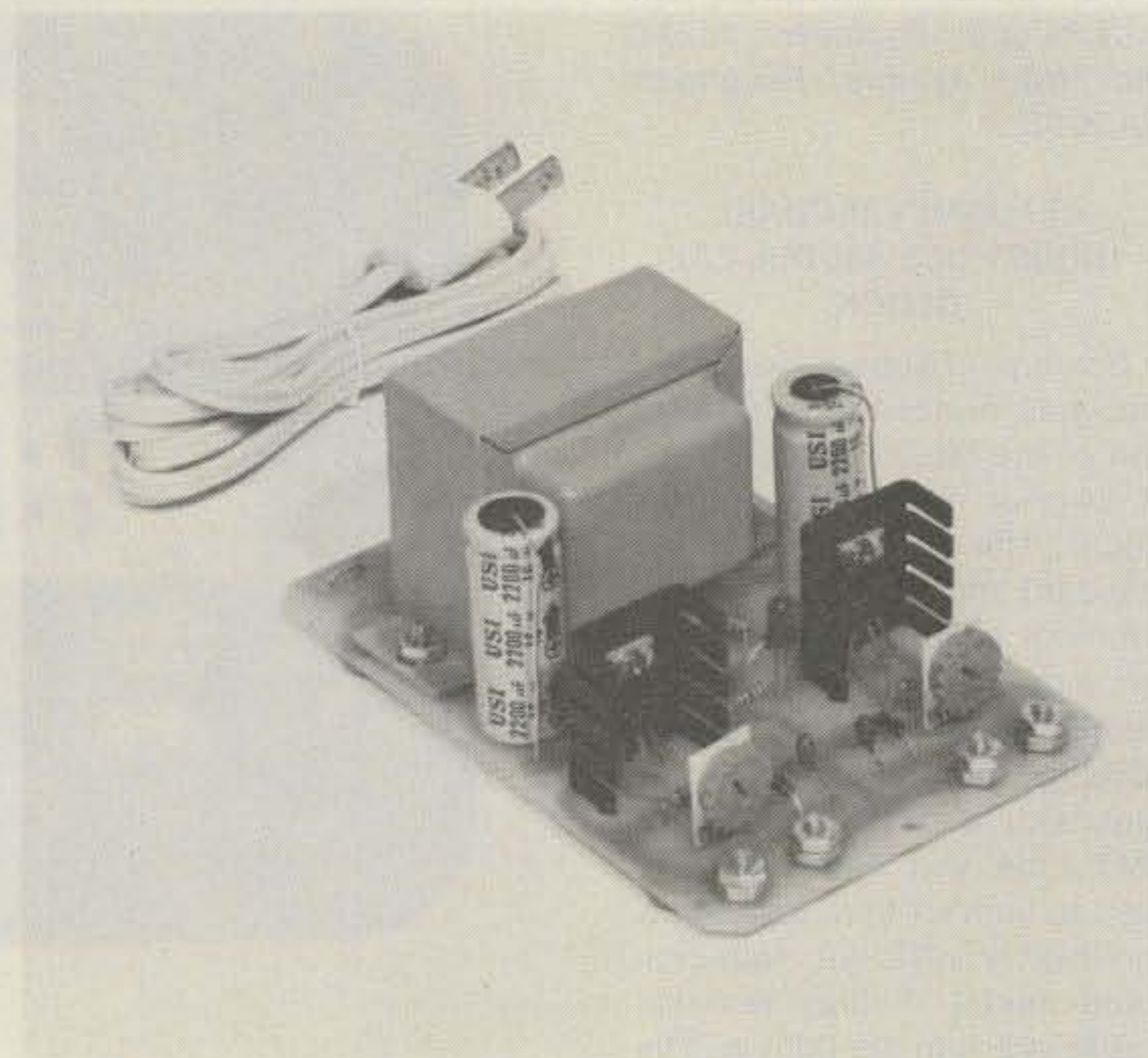

Jameco's JE215 adjustable dual power supply kit.

# FUN!



John Edwards KI2U  
78-56 86th Street  
Glendale NY 11385

## ELECTRONIC AND RADIO THEORY

Okay, gang, time to shape up! So far we've been coddling you with puzzles on purely social and operating matters. Now we start the tough stuff—technical material. Remember technical material, all that funny junk the FCC asked you about on that test you took? Oh, you do remember. And you hated it? Well, no matter, everything can't be as much fun as repeater operating.

### ELEMENT 1—CROSSWORD PUZZLE

(Illustration 1)

#### Across

- 1) A conveyance of electrical energy
- 9) Revolutions per minute (abbr.)
- 10) Oscillator type (abbr.)
- 11) Portable memory unit (abbr.)
- 12) Neon's symbol (abbr.)
- 14) The amateur's curse (abbr.)
- 15) The frequency synthesizer's friend (abbr.)
- 16) Engineering society (abbr.)
- 18) Query in Morse
- 19) Two parts of Ohm's Law
- 20) Millifarad (abbr.)

- 21) Crystal cut
- 23) A lie
- 25) Worldwide radio rulemakers (abbr.)
- 26) Connected circuit branches
- 27) Director, for instance (abbr.)
- 28) Input/output (abbr.)
- 29) Rural Electrification Administration (abbr.)
- 32) Absence of
- 33) Indefinitely long time
- 34) Symbol: pair of grid voltages
- 36) Charged electron or molecule
- 37) Opposite of off

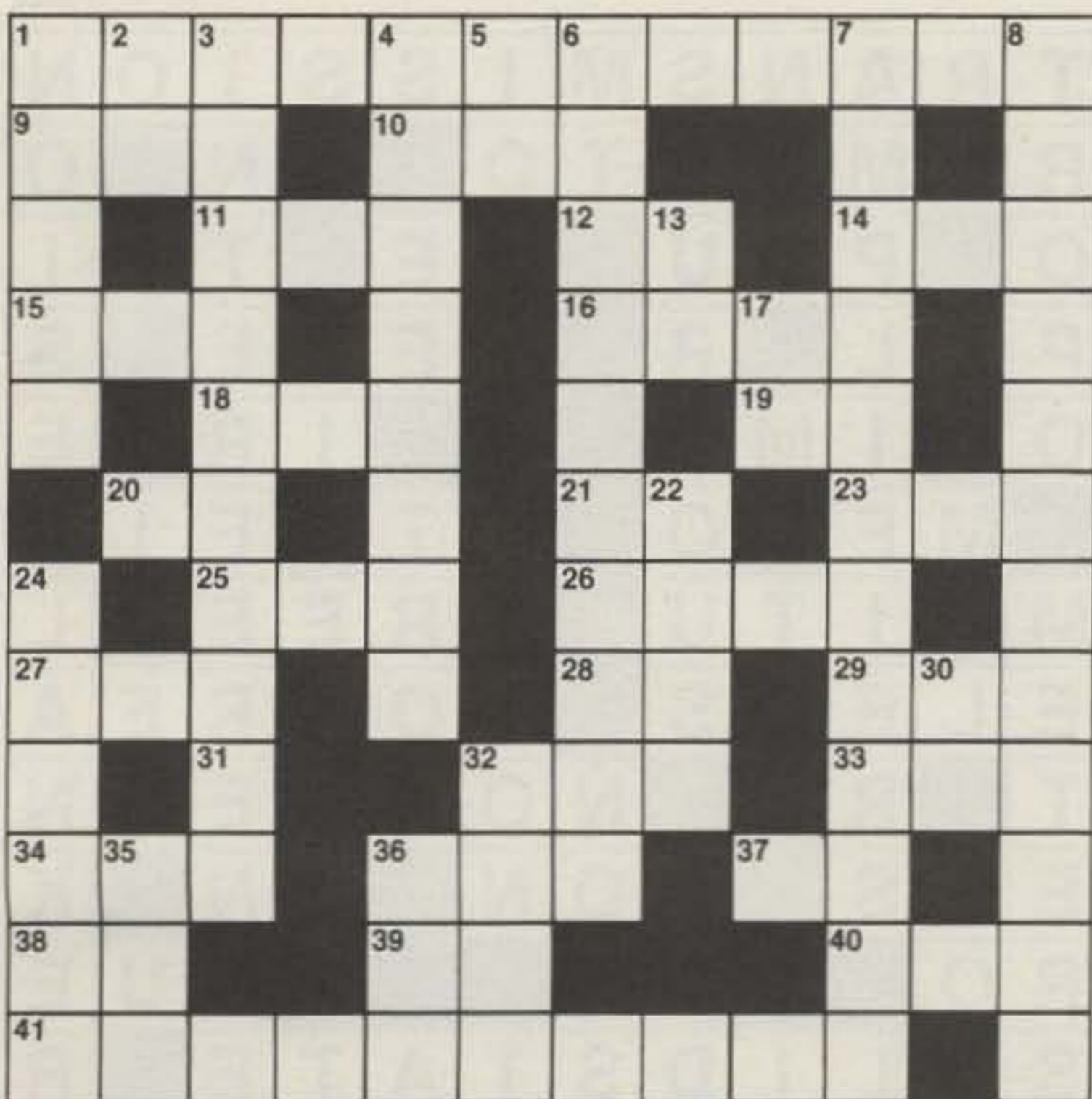

Illustration 1.

- 38) Symbol: output resistance
- 39) Memory register (abbr.)
- 40) Alerting signal
- 41) Semiconductor devices (2 words)

- 6) Process of 36 across
- 7) QRN or QRM
- 8) Din eradicator (2 words)
- 13) Degree suffix
- 17) Force and current (abbr.)
- 22) Elec \_\_\_\_\_
- 24) D'Arsonval or 160
- 30) Symbol: output voltage
- 32) NOT-ORs (abbr.)
- 35) Silicone grease
- 36) Intermodulation distortion (abbr.)

#### Down

- 1) Propagation type (abbr.)
- 2) Symbol: plate resistance
- 3) Class A, B, C
- 4) Not a genuine emission
- 5) Metric ton (abbr.)

### ELEMENT 2—ALPHABET GAME

Complete the nine words below by placing letters of the alphabet on every dash. Use each letter only once.

A B C D E F G H I J K L M  
N O P Q R S T U V W X Y Z

- 1) \_ E \_ E \_
- 2) \_ R E \_ \_ E N \_ Y
- 3) \_ U \_ E R R E \_ E N E R \_ T I V E
- 4) P E R M \_ A \_ I L I T \_
- 5) \_ I \_ O \_ A T \_
- 6) S C \_ E \_ A T \_ C
- 7) \_ I P \_ L E
- 8) \_ O \_
- 9) \_ O U L E

### ELEMENT 3—NAME THE EQUATION

Here are some common equations used in radio and electronics—name them.

- 1)  $I = \frac{E}{R}$
- 2)  $X_C = \frac{1}{2\pi f C}$
- 3)  $P = EI$
- 4)  $L(\mu H) = \frac{a^2 n^2}{9a + 10b}$
- 5)  $\text{length} = \frac{492}{f}$
- 6) frequency observed =  $\left( \frac{V + W - V_o}{V + W - V_s} \right)$  (frequency of source)
- 7)  $F = \frac{Q_1 Q_2}{d^2}$
- 8)  $n = \sqrt{Z_p / Z_s}$
- 9)  $X_L = 2\pi f L$
- 10)  $Q = \frac{R}{X}$

### ELEMENT 4—FILL IN THE BLANK

- 1) SSB receivers must use a \_\_\_\_\_ detector.
- 2) The more elements on a beam antenna, the greater its \_\_\_\_\_.
- 3) The two RTTY tones are called \_\_\_\_\_ and space.
- 4) A voltmeter should have \_\_\_\_\_ internal resistance.
- 5) Propagation ducts often form in the \_\_\_\_\_.
- 6) A "Clapp" is a type of \_\_\_\_\_.
- 7) "Hertzian waves" is the old term for \_\_\_\_\_ waves.
- 8) \_\_\_\_\_ is an alloy used in electronics to join metallic surfaces.
- 9) Electrical noise on a CRT is often called \_\_\_\_\_.
- 10) "Capture" is the term for a strong signal eliminating a weak signal in the \_\_\_\_\_ mode.

- 11) A two-element tube is a \_\_\_\_\_.
- 12) A \_\_\_\_\_ chart is a polar chart using circles to show resistance and reactance.
- 13) The process of adding known impurities to a semiconductor is called \_\_\_\_\_.
- 14) A V beam is \_\_\_\_\_-directional.
- 15) The unit of electrical charge is the \_\_\_\_\_.
- 16) Most long-distance (HF) radio communication is accomplished by reflecting signals off the \_\_\_\_\_-layer.
- 17) A device which passes or rejects a certain frequency while rejecting or passing others is known as a \_\_\_\_\_.
- 18) The siemens used to be the \_\_\_\_\_.
- 19) A valuable metal with low rf resistance is \_\_\_\_\_.
- 20) A "No. 47" is a common \_\_\_\_\_ light.

### ELEMENT 5—MATCH THE TRANSISTOR

Match the transistor types listed below with the schematic symbols in Illustration 2.

- 1) Dual-gate MOSFET
- 2) Unijunction
- 3) MOSFET
- 4) Junction FET
- 5) Bipolar

### THE ANSWERS

#### Element 1:

See illustration 1A.

#### Element 2:

1—ZENER, 2—FREQUENCY, 3—SUPERREGENERATIVE, 4—PERMEABILITY, 5—KILOWATT, 6—SCHEMATIC, 7—DIPOLE, 8—VOX, 9—JOULE.

#### Element 3:

1—Ohm's Law, 2—Capacitive reactance, 3—Power formula, 4—Coil inductance, 5—Half-wave dipole length, 6—Doppler effect, 7—Coulomb's Law, 8—Impedance matching, 9—Inductive reactance, 10—Q of a parallel circuit.

#### Element 4:

1—product, 2—directivity, 3—mark, 4—high, 5—troposphere, 6—oscillator, 7—electromagnetic, 8—Solder, 9—snow, 10—FM, 11—diode, 12—Smith, 13—doping, 14—bi, 15—coulomb, 16—F, 17—filter, 18—mho, 19—gold, 20—pilot.

#### Element 5:

1—E, 2—B, 3—A, 4—D, 5—C.

### SCORING

#### Element 1:

Twenty points for the completed puzzle, or 1/2 point for each question correctly answered.

#### Element 2:

Two points for each word deciphered. Two bonus points if you get all nine.

#### Element 3:

Two points for each equation named.

#### Element 4:

One point for each blank filled.

#### Element 5:

Four points for each transistor matched.

Rate yourself:

1-20 points—CBer

21-40 points—A passing interest in electronics

41-60 points—Junior Engineer

61-80 points—Engineer

81-100+ points—Senior Engineer

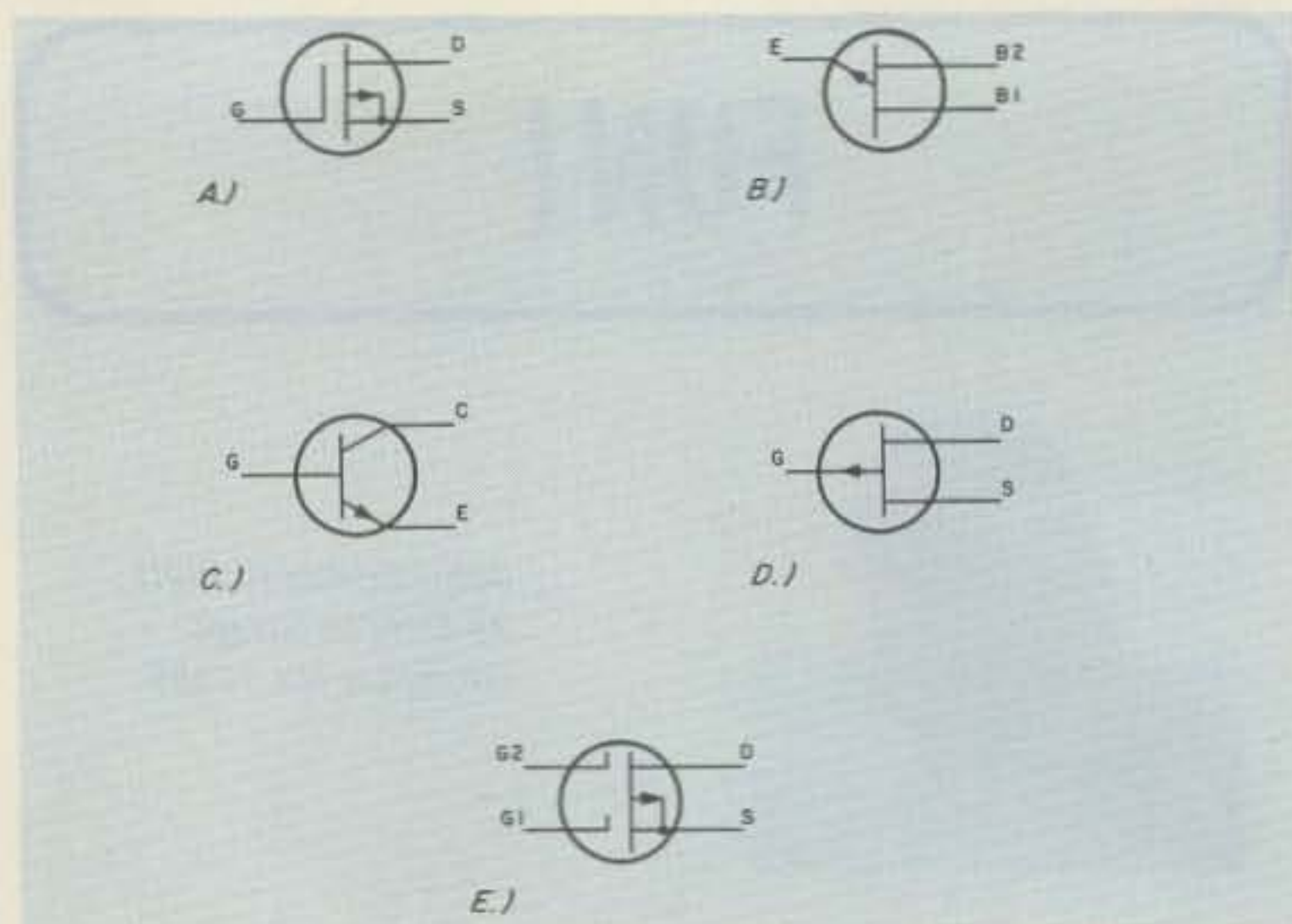

Illustration 2.

### FUN! MAILBOX

Each month, as space permits, we'll try to print interesting letters from readers.

I've just gone through my February 73 and feel compelled to comment on your FUN! column. Specifically on Element 3, question 8 (I am an Advanced class ham so I am qualified to comment on Element 3—hi). The correct answer should be FALSE; KP2 is not THE new prefix for KV4 but A new prefix for KV4. NP2 and WP2 are also new, and issued, prefixes for KV4 (and people accuse the FCC of tricky exams).

Jim Lommen NP2AE  
St. Croix, U.S. Virgin Islands

*Pardon my article.—JE*

Your interest in the ham fraternity is admirable. Too bad the guys at the ARRL don't have the same curiosity.

What we need is a second fraternity organization to formally represent ham radio. I will be a charter member.

Jim Owens W5JQE  
Pottsboro TX

*Thanks for the nice words, but I was never one for frats—the hazings are too rough.—JE*



Illustration 1A.

# CORRECTIONS

Some changes have been made which affect my article, "Operating Overseas" (February, 1981), and I would like to bring things up to date. At the time I submitted the story, there were no guest licenses available in South Africa. In the meantime, new procedures were introduced and quite a few have since been issued.

The first one was issued by the Telecommunications Department in Pretoria to a visitor from the USA. Bob W2TK/ZS was the first amateur with a guest license: GL1. Bob visited the clubhouse of the Johannesburg Branch of the South African Radio League. Guest licenses have been issued also to two visitors from Japan.

I hope the introduction of guest licenses will get more amateurs to bring their rigs to

South Africa or to operate the various club stations available. Regrettably, some visitors fail to understand that it is illegal for a person without a license to operate an amateur station. We have no third-party facilities in South Africa.

I hope this will clear any doubts.

**Peter Strauss A2CPS  
Gaborone, Botswana**

In "The Earth Mover," on page 48 of the May, 1981, issue, in Fig. 2, (a) and (b) are reversed. The pattern at the top is that with the reflector open and the antenna 1/2 wavelength above ground. The one at the bottom is the pattern with the antenna 1/4 wavelength above the reflector.

In (a) the reflector is removed

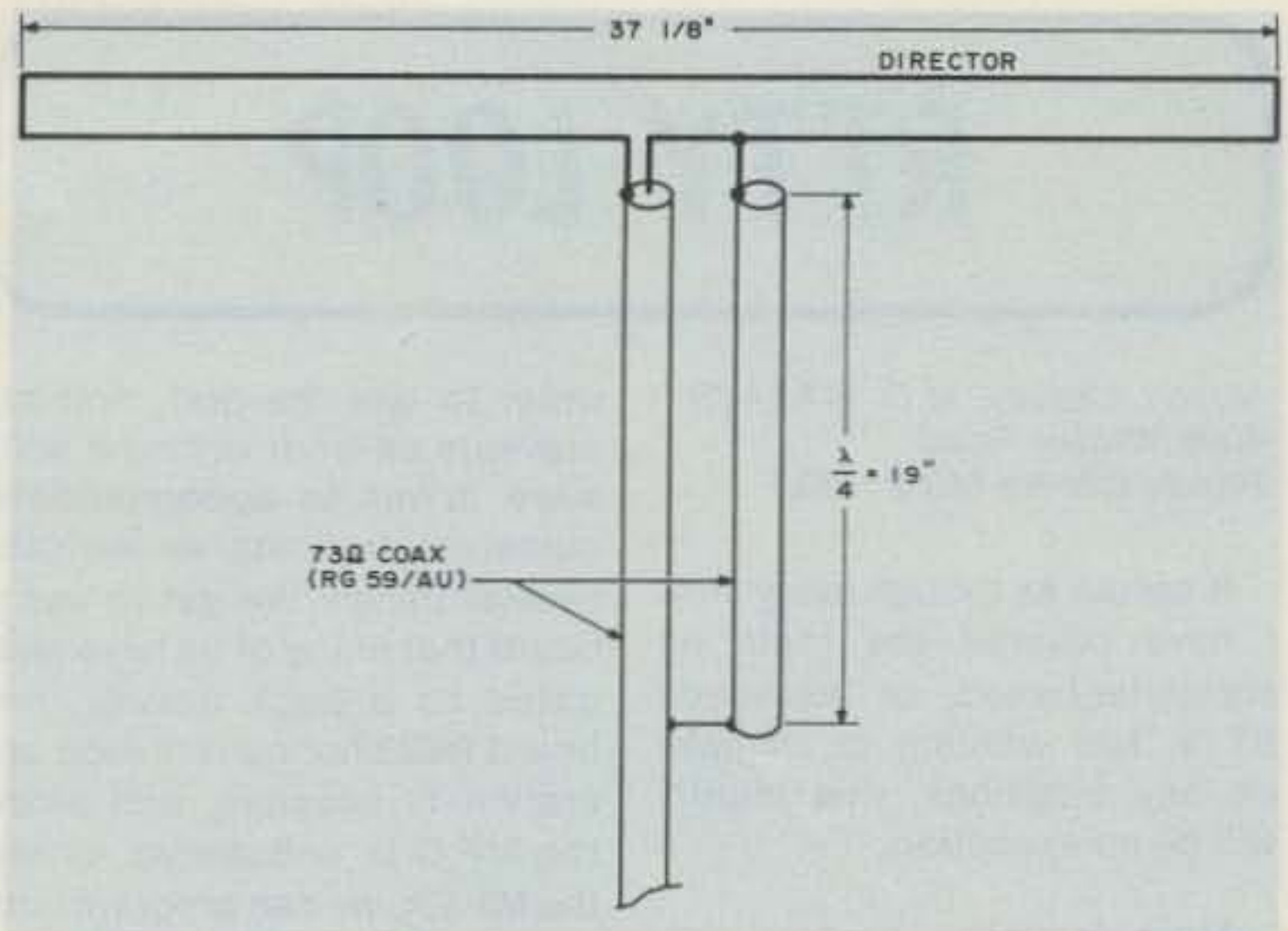

Revised Fig. 3. Dimensions given for the 1-to-1 balun are for 146.5 MHz. For other frequencies, balun length in inches is calculated from  $2942 \times .95 \div \text{MHz}$ .

and in (b) the reflector is 1/4 wavelength below the dipole.

**Jerrold A. Swank W8HXR  
Washington Court House OH**

In my article, "The ZL/DF Special" (March, p. 40), I made an error in calculating the balun length; the velocity factor

should have been .95. The revised Fig. 3 and caption are shown here.

My sincere apologies to 73 and its readers, and my thanks to W9PJF for bringing the mistake to my attention.

**Jane Rice AD6Z  
Oceanside CA**

# FCC

## Reprinted from the Federal Register

### Radio Service; Amendment of the Commission's Rules To Establish Procedures To Minimize Potential Interference to Radio Astronomy Operations

**AGENCY:** Federal Communications Commission.

**ACTION:** Final rule.

A. Part 95 of Chapter I of Title 47 of the Code of Federal Regulations is amended, as follows:

In § 95.17, a new paragraph (g) is added, as follows:

§ 95.17 Filing of applications.

(g) In order to minimize possible harmful interference at the National

Radio Astronomy Observatory site located at Green Bank, Pocahontas County, West Virginia, and at the Naval Research Laboratory site at Sugar Grove, Pendleton County, West Virginia, any applicant for a license (other than mobile, temporary base, or temporary fixed) for a new station or for modification of an existing station in a manner which would change either the frequency, power, antenna height or directivity, or location of such a station within the area bounded by 39° 15' N. on the north, 78° 30' W. on the east, 37° 30' N. on the south, and 80° 30' W. on the west shall, at the time of filing such application with the Commission, simultaneously notify the Director, National Radio Astronomy Observatory, P.O. Box No. 2, Green Bank, West

Virginia, 24944, in writing, of the technical particulars of the proposed station. Such notification shall include the geographical coordinates of the antenna, antenna height, antenna directivity, if any, proposed frequency, type of emission, and power. In addition, the applicant shall indicate in his application to the Commission the date notification was made to the Observatory. If an objection to the proposed operation is received, within 20 days of the receipt of the application, from the National Radio Astronomy Observatory for itself or on behalf of the Naval Research Laboratory, the Commission will consider all aspects of the problem and take whatever action is deemed appropriate.

B. Part 97 of Chapter I of Title 47 of the Code of Federal Regulations is amended, as follows:

In § 97.85, a new paragraph (f) is added, as follows:

§ 97.85 Repeater operation.

(f) The licensee of an amateur radio station, before modifying an existing station in repeater operation in the

National Radio Quiet Zone, or before placing his/her amateur station in repeater operation in the National Radio Quiet Zone, shall, after May 13, 1981, give written notification thereof to the Director, National Radio Astronomy Observatory, P.O. Box No. 2, Green Bank, West Virginia, 24944. Station modification is any change in frequency; power; antenna height or directivity; or the location of the station.

(1) The notification shall include the geographical coordinates of the antenna, antenna height, antenna directivity, if any, proposed frequency, type of emission, and power.

(2) The National Radio Quiet Zone is the area bounded by 39° 15' N. on the north, 78° 30' W. on the east, 37° 30' N. on the south, and 80° 30' W. on the west.

(3) If an objection to the proposed operation is received by the Commission from the National Radio Astronomy Observatory at Green Bank, Pocahontas County, West Virginia, for itself or on behalf of the Naval Research Laboratory at Sugar Grove, Pendleton County, West Virginia, within 20 days from the date of notification, the Commission will consider all aspects of the problem and take whatever action is deemed appropriate.

# HAM HELP

greatly appreciated.

**James E. Kowing  
Serra E Mar  
Apartado #167  
Portimao, Algarve  
Portugal**

I need a manual on a Johnson Valiant transmitter and also instructions for converting it to single sideband operation.

I will be glad to pay a reasonable price for a copy of either or both sets of informa-

tion or will copy and return if permissible.

**W. E. George W4LHJ  
1731 Country Club Drive  
Tullahoma TN 37388**

I am looking for any kind of SSTV monitoring equipment, used or brand new. I would appreciate any help.

**Felipe Rojas HK3DJV  
61 Preakness Plaza  
Orange Park FL 32073**

I have been trying for several months to get in touch with a manufacturer of paging systems. I would like to communicate with a couple of them as soon as possible.

I need to supply a base

system and about 100 units for use by volunteer firemen.

The specifics are: operation on 220/240 volts, coverage of a large area, and units which are nonselective.

Any help in this area would be

# RTTY LOOP

Marc I. Leavey, M.D. WA3AJR  
4006 Winlee Road  
Randallstown MD 21133

It seems as though every July I have covered the topic of computer-based, or assisted, RTTY. Not wanting to trample on any traditions, this month will be no exception.

Most longtime readers are aware that my preference in computer systems is the 6800. While this stems from my years of experience(!) in owning and programming one, it is boosted by the many letters I receive from other 6800 owners who enjoy the ease with which such a system can be put on RTTY.

In the past, I have presented simple schemes to receive or transmit RTTY, using software timing and a PIA (parallel port) for interfacing. Several readers have expressed an interest in RS232 interfacing, and a general curiosity about the MP-C control interface exists, since it is a PIA used for serial interfacing with the MIKBUG™ monitor.

Fig. 1 is a diagram of the MP-C interface. As can be seen, several input and output devices are tied to the PIA I/O lines. While MIKBUG requires a specific configuration of bit patterns in

order to use the port, nothing prevents us from writing a software driver to accommodate ourselves. In doing so, we gain several things: We get to use a board that many of us have relegated to a back drawer, on-board RS232 or current-loop operation is possible, and since the MP-C is unbuffered, unlike the MP-LA, we can program individual PIA lines for input or output, if we need to.

For example, a 1 written to bit 0, the least-significant bit, of the A side (PA0) will output a mark level on both the RS232 and TTY outputs. Similarly, a 0 will output a space. Note that this is a bit different than with the MP-LA, where a 1 is output as a high state, which is space in RS232 and mark on TTY. Using the MP-C board interfacing greatly simplifies things.

With this in mind, look at Program 1. This is not a whole program, but an I/O driver segment and initialization routine. The initialization, of course, would be called once, at the beginning of the program. The assumption is made that the output routine is called with the character to be sent in the A accumulator, in five-level code, similarly to the programs presented here be-

fore. That is, the Baudot/Murray data is left justified within the eight-bit character. For this demonstration, Letters or Figures is not considered. Thus, an S, which is 1-0-1-0-0 in Baudot/Murray, would be represented as 10100000 in eight-level code. By the way, this is *not* ASCII, even though it is eight bits. ASCII defines a specific code, covered here several months ago, and just because a character is seven or eight bits long makes it no more ASCII than a frog.

The output routine works similarly to a straight PIA routine, but the output, taken from the appropriate MP-C output, is true RS232 or TTY level. Try it!

Along these lines comes a letter from Gary Fender W6SZX in Santee, California, who is looking for ways to interface his 6800 system with a 60-mA loop. Gary is using an old TT/L-2 terminal unit and is having problems interfacing it to the computer. You might try isolating the optoisolator normally used for 20-mA TTY output from the computer power supply and placing that in the loop. Alternatively, using the output of the MP-C board to drive another optoisolator may solve your problem. Let me know how it goes.

Interest in full programs to receive and/or transmit RTTY continues unabated. Leon Howe AH2AG, on Guam, is looking for the program we pub-

lished some time back to transmit RTTY from the computer to the transmitter. Another request for the transmit and receive programs comes from Kurt Wenger, in Steinhausen, Switzerland. Copies of the programs are on their way to both and remain available for \$1.00 each to cover expenses.

A 6800-based system that has received little coverage is the Heathkit ET-3400 trainer. Mike Clare WB3ILM, in Wyoming, Delaware, has an ET-3400 and a HAL ST-5000 demodulator. He wonders if it is possible to put the ET-3400 on RTTY. While I have little information about the ET-3400, I see no obvious reason why any 6800 system having one parallel line in and one line out could not be used on RTTY. The programs mentioned above do not use any features truly unique to SWTPC systems. The system clock frequency would have to be taken into consideration when setting up timing loops, but it should be a doable project. Any readers now using the ET-3400 on RTTY or who know of any problems with doing so are invited to write us with the details.

Along the lines of more established systems, Charles Plaisted WA1ZDA, of Rockland, Maine, has a problem. Charles has acquired bits and pieces of a 6800 system and is trying to assemble them into a workable system. He states that he has the MP-A2 CPU board, two MP-M 4K memory boards, and two MP-8M 8K memory boards. He is not sure what the monitor chip is and wants help in getting his bits and pieces assembled into a computer.

To begin with, you will need at least two more items to start on your way: a mother board and a power supply. Suitable mother boards for the SS-50 bus are available from a number of sources, including Thomas Instrumentation, 168 Eighth Street, Avalon NJ 08202, and GIMIX, Inc., 1337 West 37th Place, Chicago IL 60609. The mother-board configuration for the SS-50 bus includes 50-pin connectors for CPU, memory, and accessory cards, and 30-pin connectors for I/O cards. The power supply needs to supply +8 V dc, +12 V dc, and -12 V dc at enough current to supply all operating boards.

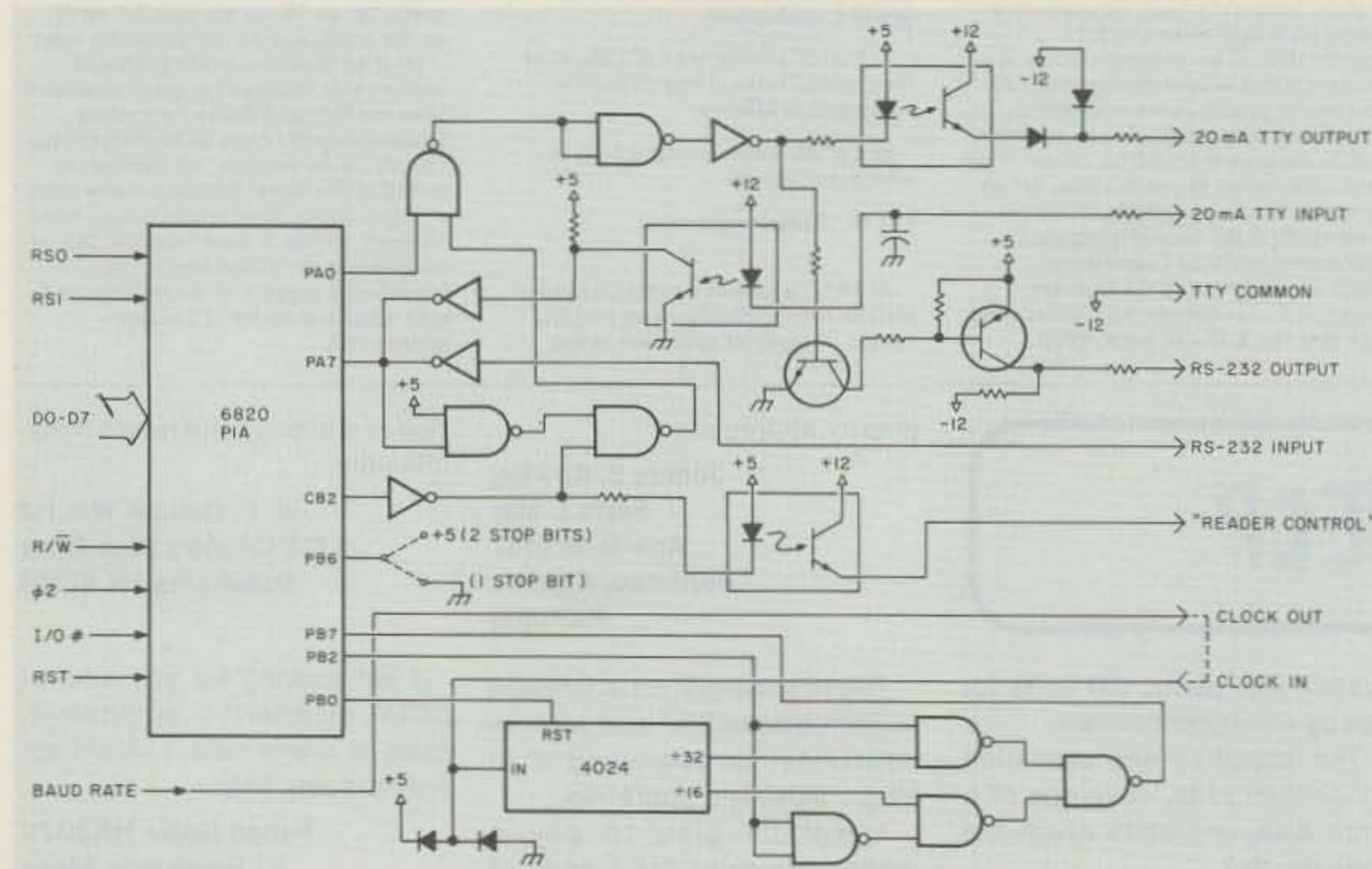

Fig. 1. Partial schematic of MP-C interface.

Now, about that monitor chip. If the top of the chip reads "MCM6830P8," then it is MIKBUG. The later monitor sold by Southwest Technical Products Corp., SWTBUG™, had the "SWTBUG" and version number on the top.

Input and output may be provided by an MP-C, such as diagrammed here, or by an ACIA board, available from the above sources. Another source of information is the series written on 6800 computers by Pete Stark, and others, carried in our sister publication, *Kilobaud Microcomputing*. Good luck, and let me know how you make out.

Interested in a full RTTY program for the 6800? So are many others. Ron Cohen K3ZKO, of Cheltenham, Pennsylvania, is putting his system up and looking for a program. So is Bob Wilson K8MPV, of Milford, Michigan. The 6809 evokes its share of interest with both of the above gentlemen, as well as Bob Saylor KB8DR and others mentioning the new Radio

Shack 6809-based Color Computer. Well, to all of you, watch the pages of 73 carefully for a full transceiver program for the 6800, which should be convertible to a 6809 with a minimum of effort.

Other items to watch out for, by the way, include a newly revised edition of 73's *RTTY Handbook*, including material published since the last revision in 1977. New material on video RTTY and computers will also be included. We are also hoping to bring out a compilation of RTTY Loop covering the first few years of this column, for those of you who came in late. Watch for the announcement in the 73 Radio Bookshop section. While you're in the neighborhood, by the way, take a look at many of the fine offerings presented there. Some mighty fine material, don't 'cha know!

Speaking of reading material, next month will feature something to read and something to write! Interested? Don't miss next month's RTTY Loop.

```

1:      NAM  MP-C DEMO
2:      OPT  NDS
3:      *****
4:      # Demonstration Program for sending #
5:      # serial data out through MP-C card #
6:      # on Port 5. Output routine entered #
7:      # with left-justified five level code #
8:      # in A accumulator. Sent out at 60 #
9:      # words per minute, assuming a one #
10:     # MHz system clock. #
11:     #-----#
12:     # RTTY Loop : July, 1981 #
13:     # Marc I. Leavey, M.D. #
14:     #-----#
15:     # SYSTEM EQUATES
16:     PORT EQU  $B014      Port 5
17:     *****
18:     # Initialization Routine #
19:     *****
20:     INITAL CLR  PORT+1    Set up the PIA
21:     CLR  PORT            for output on
22:     LDA  A  #$FF         the A side
23:     STA  A  PORT
24:     LDA  A  #$04
25:     STA  A  PORT+1
26:     RTS
27:     *****
28:     # Character Output Routine #
29:     *****
30:     OUTPUT LDA  B  #$5    Set up five bit counter
31:     STA  A  STOREA       Store A for a bit
32:     LDA  A  #$00         0=space -> Start Bit
33:     STA  A  PORT         Send the Start
34:     BSR  DELAY          Wait one bit length
35:     OUTLUP CLC          Clear the carry for sport
36:     LDA  A  STOREA       Get the old A value
37:     ASL  A              Shift out the left bit
38:     STA  A  STOREA       Save the new A value
39:     BCC  SENDO         If carry clear, send space
40:     SEND1 LDA  A  #$01   Load a Mark
41:     STA  A  PORT         Stick it in the port
42:     BSR  DELAY          Never let it fade away
43:     BRA  ENDCHR         See if we are done
44:     SEND0 LDA  A  #$00   Load a Space
45:     STA  A  PORT         Again into the port
46:     BSR  DELAY          Linger a little longer
47:     ENDCHR DEC  B       Take one off the counter
48:     BNE  OUTLUP         If it is not 0 we have more
49:     LDA  A  #$01         All done, send a stop
50:     STA  A  PORT         by putting out mark for
51:     BSR  DELAY          time after
52:     BSR  DELAY          ... time (a bit long here!)
53:     RTS                And go home, satisfied!
54:     DELAY LDX  #$0C00   This is an approximate value
55:     DLOOP DEX          for a 22 mSec delay. I would fool
56:     BNE  DLOOP         around before I'd trust it.
57:     RTS
58:     STOREA RMB  1      A place to put your A.
59:     END

```

Program 1.

# CONTESTS



Robert Baker WB2GFE  
15 Windsor Dr.  
Atco NJ 08004

## COLOMBIAN INDEPENDENCE DAY CONTEST

Starts: 1800 GMT July 18  
Ends: 1800 GMT July 19

Entry classes include: A) single operator/single band; B) single operator/multi-band; C) multi-operator/multi-band/one rig; D) multi-operator/multi-band/multi-transmitter. Use all bands, 160 through 10 meters, on SSB and/or CW. Contest call is "CQ HK TEST." Only one contact per band with the same station. No crossband or crossmode contacts are allowed.

### EXCHANGE:

Non-HK stations send RS(T) and three-digit serial number starting with 001. HK stations will send RS(T) and 171. The number 171 represents the years of commemorated independence.

### SCORING:

QSO points for non-HK stations are as follows: 10 points for each HK station, 3 points per DX QSO, and 1 point for QSO with stations in the same country. QSO points for HK stations are 5 points for each DX QSO and 1 point for each HK station worked. In all cases, the multiplier is the number of DXCC countries worked on each band. Multiply the total QSO points by the sum of multipliers per band for the final score.

### AWARDS:

Silver cup and plaques for world winner and first and second places in each operating category for both HK and non-

HK stations. A minimum of 100 QSOs must be shown when applying for any award.

### ENTRIES:

Keep a separate log sheet for each band. Enter the country only the first time worked. Show all times in GMT. Each entry must be accompanied by a summary sheet indicating scoring information. The logs not summarized according to the above mentioned instructions will be used only as check logs. Normal disqualification rules apply. Entries must be postmarked no later than August 30th and must be received before December 30th to be eligible for awards. Send all entries to: LCRA, Contest and Awards Manager, Apartado 584, Bogota, Colombia, South America.

### SWOT QSO PARTY

Starts: 0000 GMT July 17  
Ends: 2359 GMT July 23

There are no restrictions on the number of hours devoted to the contest during the one-week contest period. All licensed amateurs with operating privileges on two meters are eligible to participate. All contacts must be made using CW or SSB only.

Any station may be worked once on each mode for QSO score. Contacts must be made direct without the aid of satellites, repeaters, or retransmission of any kind. EME contacts may be counted if they meet all requirements. All contacts must be made from one geographic location. Portables or mobile stations operating in more than one geographic location may submit from the location where they obtained the highest score.

### EXCHANGE:

To qualify for contact credit the following information must be exchanged: call signs, geographic location (county and state, territory, or equivalent), SWOT numbers for SWOT members.

### SCORING:

The SWOT member credit equals the total number of SWOT member QSOs times the number of geographic locations times two. The non-SWOT member credit equals the total number of non-SWOT QSOs multiplied by the number of geographic locations. The final score equals the sum of the above two totals.



### QSL OF THE MONTH

Our QSL of the Month Contest's first winner is W.C. Cloninger, Jr., K3OF of Rockville, Maryland. Mr. Cloninger works for the Ford Motor Company and is a member of the Ford Amateur Radio League (also known as the Tin Lizzie Club). The vehicle pictured on his QSL is his unrestored 1930 Model A Town Sedan.

If you would like to enter the contest, put your QSL in an envelope and mail it along with your choice of a book from 73's Radio Bookshop to 73 Magazine, Pine Street, Peterborough NH 03458, Attention: QSL of the Month. Entries which do not use an envelope (the Postal Service does occasionally damage cards) and do not specify book choice will not be considered. Sorry.

#### AWARDS:

The highest final score will receive the 1981 SWOT trophy. Certificates will be awarded to the highest scorer in each ARRL section in which more than one entry is received. In the event of ties, the entry with the earliest postmark will be the winner. Winners will be announced in the *SWOT Bulletin* at the earliest possible date.

#### ENTRIES:

Logs should not be submitted unless requested. Send a summary postmarked not later than August 21st to: Dean Figgins WA7EPU, PO Box 1141, Carefree AZ 85377. Include your name, callsign, address (with county and ARRL section), SWOT number (if member), and all necessary scoring information.

#### CW COUNTY HUNTERS CONTEST

Starts: 0000 GMT July 25  
Ends: 0200 GMT July 27

The CW County Hunters Net invites all amateurs to participate in this year's contest. All mobile and portable operation in less active counties is welcomed and encouraged. Stations may be worked once on each band and again if the station has changed counties. Portable or mobile stations chang-

ing counties during the contest may repeat contacts for QSO points.

#### EXCHANGE:

QSO number; category (P for portable, M for mobile); RST; state, province, or country; and US county. Stations on county lines give and receive only one QSO number, but each county is valid for a multiplier.

#### FREQUENCIES:

3575, 7055, 14070, 21070, and 28070. It is strongly requested that only P or M category stations call CQ or QRZ on 40 meters below 7055 and on 20 meters below 14070, with all other stations spreading out above those frequencies.

#### SCORING:

QSOs with fixed stations are 1 point; QSOs with portable or mobile stations are 3 points. Multiply the number of QSO points times the number of US counties worked. Mobiles and portables calculate with their score on the basis of total contacts within a state for the state certificate, and calculate their score on all operation if they operated from more than one state in competition for the High Portable or High Mobile Trophy.

# RESULTS

Results of the 1980 CALIFORNIA QSO PARTY  
Sponsored by the Northern California Contest Club

#### California Single Ops

Call	CW Qs	SSB Qs	Mult.	Score
N6BT (WA6VEF, Op)	373	1833	58	277,530
N6RZ (WB6SHD, Op)	98	2240	58	276,892
N6TR	181	2112	58	276,486
N6BV	555	1563	56	268,296
W6SZN	206	1733	57	232,788
W6OUL	304	997	57	165,642
N6RO	172	939	56	134,064
WA7LQO/6	176	868	53	119,356
WA6OYV	429	466	52	115,388
K6HNZ	0	884	55	97,240

#### California Multi-Single

AA6KB	86	1457	56	177,632
K6YA	100	370	47	48,880

#### California Multi-Multi

K6XO/6	349	1857	58	276,138
--------	-----	------	----	---------

#### Out of State

WA6AVL	98	574	54	77,868
K9BG	182	331	51	61,608
WD8EWD	120	392	50	57,200
N4BAA	90	266	46	36,892
K4LTA	133	207	45	36,585
WA5DTK	128	178	43	31,820
WB5KIA	53	261	45	30,645
W3HDH	130	140	45	30,150
W5WG	148	105	40	26,160
WA1FCN	82	155	43	23,908

#### AWARDS:

Certificates will be awarded in three categories:

1) Highest fixed or fixed portable station in each state, province, and country with 1,000 or more points.

2) Highest station in each state operating portable from a county which is not his normal point of operation with 1,000 or more points.

3) Highest station in each state operating mobile from 3 or more counties with a minimum of 10 QSOs in at least each of 3 counties.

Trophies will be awarded to the highest single-operator station in the US in categories P and M. The Awards Committee will issue additional awards where deemed appropriate.

#### ENTRIES:

Logs must show category, date/time in GMT, station worked, band, exchanges, QSO points, location, and claimed score. All entries with 100 or more QSOs must include a check sheet of counties worked or be disqualified from receiving awards. Enclose a large SASE if

results are desired. Logs must be postmarked by September 1st and sent to: CW County Hunters Net, c/o Jeffrey P. Bechner W9MSE, 673 Bruce Street, Fond du Lac WI 54935.

#### EUROPEAN DX CONTEST—CW

Starts: 0000 GMT August 8  
Ends: 2400 GMT August 9

Sponsored by the Deutscher Amateur Radio Club (DARC). Only 36 hours of operation out of the 48-hour period are permitted for single-operator stations. The 12 hours of non-operation may be taken in one but not more than three periods at any time during the contest. Operating classes include single-operator, allband and multi-operator, single transmitter. Multi-operator, single-transmitter stations are only allowed to change band one time within a 15-minute period, except for making a new multiplier. Use all amateur bands from 3.5 through 28 MHz. A contest QSO can only be established between a non-European and a European station. Each station can be worked only once per band.



### EXCHANGE:

Exchange the usual six-digit number consisting of RST and progressive QSO number starting with 001.

### SCORING:

Each QSO counts 1 point. Each QTC (given or received) counts 1 point. The multiplier for non-European stations is determined by the number of European countries worked on each band. Europeans will use the last ARRL countries list. In addition, each call area in the following countries will be considered a multiplier: JA, PY, VE, VO, VK, W/K, ZL, ZS, and UA9/UA0. The multiplier on 3.5 MHz may be multiplied by 4, on 7 MHz by 3, and on 14 through 28 MHz by 2. The final score is the total QSO points plus QTC points multiplied by the sum total multipliers.

### QTC TRAFFIC:

Additional point credit can be realized by making use of the QTC traffic feature. A QTC is a report of a confirmed QSO that has taken place earlier in the contest and later sent back to a European station. It can only be sent from a non-European station to a European station. The general idea is that after a number of European stations have been worked, a list of these stations can be reported back during a QSO with another station. An additional 1 point credit can

<h1>CALENDAR</h1>	
* Jul 1	CARF Canada Contest
Jul 17-23	SWOT QSO Party
Jul 18-19	Colombian Independence Day Contest
Jul 25-27	CW County Hunters Contest
Aug 8-9	European DX Contest—CW
Aug 15-16	SARTG Worldwide RTTY Contest
Aug 15-17	Rhode Island QSO Party
Aug 15-17	New Jersey QSO Party
Aug 22-23	Ohio QSO Party
Aug 29-30	Occupation Contest
Sep 12-13	European DX Contest—Phone
Sep 12-13	G-QRP Club CW Activity Weekend
Sep 12-14	Washington State QSO Party
Sep 26	DARC Corona—10-Meter RTTY
Oct 3-4	California QSO Party
Oct 24-25	CQ Worldwide DX Contest—Phone
Nov 8	DARC Corona—10 Meter RTTY
Nov 8	OK DX Contest
Nov 14-15	European DX Contest—RTTY
Nov 28-29	CQ Worldwide DX Contest—CW
Dec 26-31	G-QRP Club Winter Sports

\* = see last issue

be claimed for each station reported.

A QTC contains the time, call, and QSO number of the station being reported, i.e., 1300/DA1AA/134. This means that at 1300 GMT you worked DA1AA and received number 134. A QSO can be reported only once and not back to the originating station. Only a maximum of 10 QTCs to a station are permitted. You may work that same station several times to complete this quota, but only the original con-

tact has QSO point value. Keep a uniform list of QTCs sent. QTC 3/7 indicates that this is the 3rd series of QTCs sent and that 7 QSOs are reported. Europeans may keep the list of the received QTCs on a separate sheet if they clearly indicate the station who sent the QTCs.

### AWARDS:

Certificates to the highest scorer in each classification in each country, reasonable score provided. Continental leaders

will be honored with plaques. Certificates will also be given to stations with at least half the score of the continental leader or with at least 250,000 points. The minimum requirements for a certificate or a trophy are 100 QSOs or 10,000 points.

### ENTRIES:

Violation of the rules, unsportsmanlike conduct, or taking credit for excessive duplicate contacts will be deemed sufficient cause for disqualification. The decisions of the Contest Committee are final. It is suggested that the log sheets of the DARC or equivalent be used. Send a large SASE to get the wanted number of logs and summary sheets (40 QSOs or QTCs per sheet). SWLs apply the rules accordingly. Entries should be sent no later than September 15th. North American residents may send their applications and logs to: Hartwin E. Weiss W3OG, PO Box 440, Halifax PA 17032 USA.

### EUROPEAN COUNTRY LIST:

C31, CT1, CT2, DL, DM, EA, EA6, EI, F, FC, G, GC (Guer), GC (Jer), GD, GI, GM, GM (Shetland), GW, HA, HB9, HB0, HV, I, IS, IT, JW (Bear), JW, JX, LA, LX, LZ, M1, OE, OH, OH0, OJ0, OK, ON, OY, OZ, PA, SM, S, SV, SV (Crete), SV (Rhodes), SV (Athos), TA1, UA1346, UA2, UB5, UC2, UN1, UO5, UP2, UQ2, UR2, UA Franz Josef Land, YO, YU, ZA, AB2, 3A, 4U1, 9H1.

## HAM HELP

I have acquired a DuMont model 208-B oscilloscope, serial number 10237, for which I am looking for information, schematic, manual, etc. Willing to pay for copying or will copy and return original.

**H. L. Church W0KXP/9**  
309 W. St. Louis St.  
Lebanon IL 62254  
(618)-537-4498 or 537-6666

I acquired an old radio some time ago. I do not have any idea as to what tube it requires or what voltage is necessary to operate same.

The radio was manufactured in 1925, by Kutzen Radio Mfg.

Co., Racine WI. It is serial #019690, Model #SM-1. On the top lid of the radio there is another ID plate with "Radio Receiver #1371, build by W. F. Main Radio Co., Cedar Rapids, Iowa." I believe this to be the case manufacturer.

I would appreciate any and all information anyone can supply about this unit.

**Edmund L. Ogle**  
109 Sumac St.  
Greybull WY 82426

I need schematics, manuals, or any available information on the following items: Ray Jefferson model 914 transceiver;

T-195(B)/GRC-19 transmitter; MI<sup>2</sup> model 101 TWX Data Unit; CV-278/GR FSK demodulator; MD-203/GR FSK modulator; and a set of manuals for my 33ASR.

I would like to hear from anyone who has converted an RT-594/ARC38A SSB transceiver for normal ham service—also need manual or diagram. I will gladly pay all postage and other costs. Thanks.

**Tommy Norris KA4RKT**  
Route #1, Box 412  
Auburn KY 42206  
(502)-542-6343, after 0000UTC

I need a schematic for a 10-Ampere power supply, filtered, highly stable, variable, and regulated. On hand I have the following parts, which I hope to use in the supply:

● Transformer—117-ac input, 19-ac output under no load

● Full-wave bridge rectifier rated at 25 Amperes

● 25000 uF filter capacitor rated at 100 volts dc

● PNP power transistor no. 2N1653

● Motorola regulator no. LM317K

● Heat sink to mount the power transistor and regulator on

Can anyone help?

**Clinton E. Pratt WB4MXI**  
3509 Ballylinn Ct.  
Virginia Beach VA 23464

I will pay for technical help on a part-time basis. I need help in designing oscillators, multipliers and amplifiers up through UHF—all solid-state breadboarding.

**D. W. Straham**  
9625 Catlett  
La Porte TX 77571  
(713)-479-1614

# LETTERS

## RE NO CLICKEE

In regard to J. Olsen's "A New Proposal" letter and Wayne's reply, May, 1981, "Olsen...no clickee, no tickee" seems a hard-line reply as Olsen's ideas were interesting and may have some merit.

My own objection would be that people like my XYM, with his first-class commercial ticket and a ham ticket sans code (as Olsen proposes), could not legally operate commercially-available equipment they may have already purchased. My XYM also has found the code difficult to corral and would welcome a ticket sans code. But not with restrictions as spelled out by Olsen, because we do own "store-bought" rigs which I then could operate and he could not (even though we would then *both* have our ham tickets).

**E. Nadine Hardy KA5GRH  
Tijeras NM**

## PLENTY OF SPACE

Perhaps my previous letter (December, 1980) was not clear and Wayne's comment at the end seemed to lend flavor to the fact that I was for a "code-free, theory-free" license. This is far from the truth.

I have never advocated a code-free license nor do I advocate a theory-free test. What I am against is the necessity of the depth of the theory involved. The FCC should place greater emphasis on rules of the road and proper operating procedure. Basic understanding of some electronics is necessary but do we have to know "What speed characteristics does TTL have as compared to 4000 CMOS?" or "Determine the Boolean equation for the circuit shown"? Who cares? Does knowing this make anyone a better or worse ham? I think not. These are just a few of the absurd questions on the test.

If we are going to go this far, why don't we just make it a requirement to have a degree in electronic engineering. Then we can really have an elitist group.

Just how far do you want to go?

We, as a group, need a greater influx of hams to have a greater voice in Congress and with the FCC. Stop worrying about overcrowding on the bands. There is plenty of space available. Maybe if we had a few fewer contests and nets (I like both) there would be more space. Do we really need so many contests and nets, though?

For those who wrote and called in support of me—thank you. For those that indulge in hate letters—you call yourselves hams? Ha! Constructive dialogue is what is needed. Bickering and name calling only serves to divide, and we all lose.

**Alan G. Davis KB7HM  
Salt Lake City UT**

## INSPIRATION

In reference to the letter from J. Olsen in the May issue, I find I must reply. If Mr. Olsen wanted an amateur license, he could get one anytime. After all, "code recognition" is not that hard. My nine-year-old son learned the letters of the alphabet in one week.

Mr. Olsen is 31 years old. So what? I was 28 when I got my Novice ticket and I got my Extra last year. A friend of mine (WB5IIR) was 67 when he got his Novice. He is also an Extra now.

Mr. Olsen's attitude is like a six-year-old saying, "I don't want to learn to read. So why should everyone else have to?" I really don't think Mr. Olsen *can* learn the code, at least not as long as he persists in not wanting to. I hope this letter inspires him to get off his lazy tail and get to work. I'm sure some ham in his area would be glad to help him.

**Mike Kilgore KG5F  
Richardson TX**

## MAYDAY

I really enjoyed listening to an emergency net going on 27.425—that's right 27.425. From what I can figure out, a boat left Antigua for someplace or another. Well, this fellow,

Whiskey Jack 6605, got into trouble and .425 was in an uproar. (Let me say before I go on that this fellow had his marine radio out for repairs and his compass also was on the fritz.)

Ok, on with the story. Poor 6605 is out there floating around and the frequency lights up with help. You name it, sand baggers, Whiskey Jacks, HF Charlies, April club, and Whiskey Whiskies come flying out of the woodwork to help. All I could get from all this was mass confusion and one station telling another station to get off the Mayday channel.

At one point, somebody asked if poor 6605 had tried to get in touch with an amateur station since he did have a ham rig. "Oh, no," came the answer. "You know how those hams are. They just sit and listen but wouldn't answer anybody but one of their own."

Now the Coast Guard is said to be waiting for a call from anybody who could tell them where soggy 6605 may be; call collect, of course. Oh, oh! The phone number given out is the wrong number says someone, that number is the Puerto Rican Coast Guard, not the Martinique one. Now we're back on the track; numbers squared away and we're off with flares.

One fine gent comes up with the idea of shooting off flares every 30 minutes. Old soggy (by now) 6605 was to shoot one and all the islands were to shoot one, a different color for each island. Well, the response was overwhelming. Texas got a couple off, Canada for luck, and Florida, being that they were pretty close. At 2325 UTC, I was in the frenzy of the search. What am I to do—no flare gun?

Wait! A road flare thrown from the top of my tower might do the trick. What the hell. If the Coast Guard, Navy, and the whole of 10½ meters couldn't help old soggy bottom, I'm going to try. But what do you think happened? A lavender flare lights up the sky from Dover, New Jersey—skunked again.

Poor 6605 is still out there floating around and I'm going to sit and see what happens. I'll let you know what happens soon. Can the Whiskey Jacks pull off the 10½ meter rescue before the Coast Guard or the Navy ruins their chance to make the

pages of QST? Stay tuned for the next installment.

**Name withheld by request**

## TRIBUTE

You are the only one getting this letter from me. I am spending my last few hours with my beloved Heath SB-102, which is probably the best transceiver that company ever made. For several years, I have thrilled over the way it could pull a signal from the back of the band and put it front and center for a rock-solid QSO. For several years, I have enjoyed compliments from the other end on how clean my signal was.

I paid for the rig, like all of us, with income left over from family expenses, food, rent, etc.

For several years now I have felt great pride every time I tuned up and logged in. Tomorrow that ends. I'm selling my rig tomorrow so that I can pay my income tax. It's the only way. My 1980 income is the same as 1979 income. My 1980 deductions were higher than in '79. In '79, I got a forty-dollar refund from the IRS. This year I have to pay, pay, pay. I'm sick of paying those creeps in Washington who sleep with lobbyists, pay off criminals, and lie to the rest of us.

I don't want any sympathy from the world. I want concern. I bet I'm not the only one in this country selling a prized possession so the bums in Washington can continue their screwball activities. Thank God I didn't have to sell my car. Thank God I have health and love and ditto for my family.

This country doesn't need sugar, pomp, or rampant liberalism. We need hell raised and hell to be paid.

**Larry Myers KA2DDX  
E. Amherst NY**

## THE ONLY GAME

I appreciate your printing of my communication on the "ARRL swindle."

However, I am *not* the Secretary/Treasurer of the Indiana Radio Club Council. This fine organization is made up of various radio clubs around the state. I am a member of the Indianapolis Repeater Association.

We all would like to be members of the ARRL, but we



**"BRAND NEW"**  
**CHAMPION MESSAGE  
 MEMORY KEYER**  
 Model TE-292  
**\$125.95**

**Features:**

- State-of-the-Art-CMOS Circuitry
- Choice of Message Storage
  - A. Six 50 character messages
  - B. Twelve 25 character messages
  - C. 27 combinations of message C. programming.
- Records at any speed—plays at any speed.
- Memory operating LED
- Use for daily QSO or contests

**PLUS:**

- Self-completing dots and dashes
- Both dot and dash memory
- Iambic Keying with any squeeze paddle
- 5-50 w.p.m.
- Speed, volume, tone, tune and weight controls
- Sidetone and speaker
- Low current drain CMOS battery operation—portable
- Rear panel Jack for auxiliary power
- Deluxe quarter-inch jacks for keying and output
- Keys grid block and solid rigs
- WIRED AND TESTED FULLY GUARANTEED—LESS BATTERY

**\$89.95**

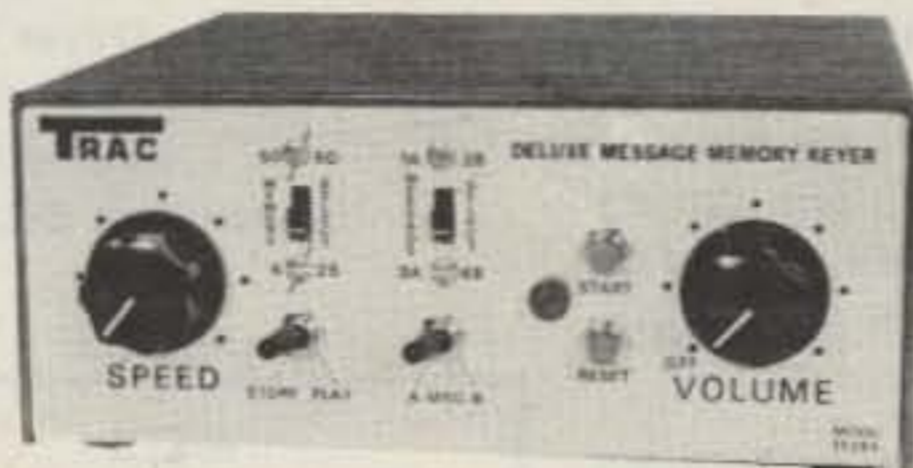

**Features: Model TE-284**

- State-of-the-Art CMOS Circuitry
- Three choices of Message Storage
  - A. Two (50 character each) message storage
  - B. Four (25 character each) message storage
  - C. One 50 character and two 25 character message storage
- Records at any speed—plays at any speed
- Memory operating LED
- Use for daily QSO or contests

**PLUS:**

- Self-completing dots and dashes
- Both dot and dash memory
- Iambic Keying with any squeeze paddle
- 5-50 w.p.m.
- Speed, volume, tone, tune and weight controls
- Sidetone and speaker
- Low current drain CMOS battery operation—portable
- Deluxe quarter-inch jacks for keying and output
- Keys grid block and solid rigs
- WIRED AND TESTED FULLY GUARANTEED—LESS BATTERY



**MESSAGE  
 MEMORY KEYER**

Model # TE201

**\$69.95**

**Features:**

- Advanced CMOS message memory
- Two (50 char each) message storage
- Repeat function
- Records at any speed—plays back at any speed
- Longer message capacity  
 Example: send CQ CQ CQ DX de WB2YJM WB2YJM K—then play second message on contact—de WB2YJM QSL NY NY 579 579 Paul Paul K
- Use for daily QSOs or contests

**PLUS:**

- State-of-the-art CMOS keyer
- Self completing dots and dashes
- Both dot and dash memory
- Iambic keying with any squeeze paddle
- 5-50 wpm
- Speed, volume, tone, tune and weight controls
- Sidetone and speaker
- Low current drain CMOS battery operation—portable
- Deluxe quarter-inch jacks for keying and output
- Keys grid block and solid state rigs
- WIRED AND TESTED FULLY GUARANTEED—LESS BATTERY



Model # TE144

**\$59.95**

**Features: Deluxe CMOS  
 Electronic Keyer**

- State-of-the-art CMOS circuitry
- Self completing dots and dashes
- Both dot and dash memory
- IAMBIC keying with any squeeze paddle 5-50 wpm
- Speed, weight, tone, volume tune controls & sidetone and speaker
- Semi-automatic "bug" operation & straight keying—rear panel switch
- Low current drain CMOS battery operation—portable
- Deluxe quarter inch jacks for keying and output
- Keys grid block and solid state rigs
- Wired and tested—fully guaranteed—less battery

MODEL TE133—same as TE144 with wgt and tone control internal, less semi-auto keying. **\$49.95**

MODEL TE122—same as TE133 less wgt, tune, solid state keying **\$39.95**

AT YOUR DEALER OR SEND CHECK OR MONEY ORDER.

Plus \$2.00 S/H NY Res add tax

**TRAC**

**ELECTRONICS, INC**  
**1106 RAND BLDG.**  
**BUFFALO NY 14203**

✓76

**YAESU, ICOM, AZDEN  
 OWNERS  
 AUTO-RESUME SCAN  
 MODULES**

now available for the  
**YAESU: FT227RA, FT227RB  
 FT207R, CPU2500R**

**AZDEN: PCS2000, PCS 2880**

**ICOM: IC255A**

- Update the factory-installed scanner in your rig with our new automatic resume-scan Module.
- No more waiting for a continuous-carrier repeater to drop off.
- No more manually-operating the scanner-resume control.
- The scanner for your rig will be controlled exactly as before.
- The only difference is now your scanner will sample a received signal by automatically by-passing a busy frequency in 8 seconds regardless of whether or not the carrier stays on.
- Now, you will be able to scan the entire band without lifting a finger.
- Installs easily in fifteen minutes.
- Clear, concise step-by-step instructions included.
- Preassembled and tested Module reg price 29.95 special 24.95

**SCANNERS:**

**IC2AT OWNERS ALSO  
 KENWOOD TR7400A, TR7600,  
 & TR7625  
 TEMPO (S-1, S-1A, S-2, S-5),  
 KDK 2015R, KDK 2016A,  
 ICOM IC22S,  
 MIDLAND 13-510, 13-513,  
 CLEGG FM-28, COMTRONIX,  
 YAESU FT227R**

- AED continues to expand its line of quality scanners.
- All of AED's scanners are custom designed to install completely inside of their respective rigs.
- Installation is simple. Unlike other competitive products all AED scanners are designed so that it is totally unnecessary to cut any wires inside your rig during installation.
- All P.C.B.s are silk-screened and tin plated for easier and more effective soldering.
- The kit comes complete with all parts and a detailed instruction manual including schematics.
- In the scanner OFF mode the rig operates normally. In the scanner ON mode the scanner locks on an occupied frequency, pauses for a preset time (about 5 sec.) and then resumes scanning (except 22S).
- The frequency being scanned is displayed on the digital readout (except 22S and IC2AT and Tempo).
- This gives you the ability to eavesdrop all over the band without lifting a finger. When you hear something interesting, you flip the switch to the LOCK mode and the rig is ready to transmit.

**KIT PRICE \$39.95  
 (TEMPO & IC2AT  
 PREASSEMBLED ONLY)  
 SPECIAL PREASSEMBLED: REG \$59.95  
 SPECIAL NOW \$49.95**

**FM ADAPTER NOW AVAILABLE**

**CONVERTS EXISTING HF  
 TRANSCEIVERS TO  
 TRANSMIT AND RECEIVE 10-M FM  
 Kit \$39.95  
 Preassembled \$49.95**

INCLUDE \$1.50 FOR POSTAGE AND HANDLING PER ITEM

**AED ELECTRONICS**

750 LUCERNE RD., SUITE 120 DEPT. A  
 MONTREAL, QUEBEC, CANADA H3R 2H6  
 TEL. 514-737-7293



want them to clean up their act.

As Wayne says, "it's the only game in town." It could use competition.

**T. James Barnes K9TFI  
Greenwood IN**

### TS-830 REVISITED

In his review of the new Kenwood TS-830 transceiver, WB8BTH didn't give the TS-830 credit for all its capabilities, and didn't recognize its heritage.

He stated that the TS-830 maintains the dual-conversion scheme of the TS-820. The TS-820 is a single-conversion rig, and with the exception of the i-f shift, there is no similarity between the TS-830 receiver and the TS-820 receiver. The TS-830 receiver is very similar to the R-820 receiver sans the 50-kHz third i-f.

Points of interest missed by the author of the TS-830 review include:

1) The crystal filter in the 8.83-MHz i-f and the ceramic filter in the 455-kHz i-f combine to give the rig a shape factor of 1.5 (-6-dB and -60-dB points), and ultimate rejection matched by few other rigs.

2) The combined shape factor of the two i-fs is degraded when the VBT is used to narrow the passband, but nevertheless, the impact on QRM is incredible.

3) Kenwood has provided an incredible array of CW filter options that should make this rig the dream of most CW operators. (Unfortunately, QSK operation was not included.) The filter options boil down to the following (in order of increasing performance and cost): a) Use rig without additional CW filters. Combined shape factor just over 5 (i.e., about 500 Hz wide at -6 dB and about 2550 Hz wide at -60 dB). b) Install 500-Hz optional filter in 8.83-MHz i-f; shape factor of 3. c) Install 500-Hz optional filter in 455-kHz i-f; shape factor of 1.6. d) Install 270-Hz optional filter in 8.83-MHz i-f; shape factor of 4. e) Install 250-Hz optional filter in 455-kHz i-f; shape factor of 2. f) Install 500-Hz optional filters in both i-fs; combined shape factor is about 1.3 with VBT not in use. g) Install 270-Hz optional filter in 8.83-MHz i-f and 250-Hz optional filter in 455-kHz i-f. Combined shape factor is about 1.3 with VBT not in use.

The VBT circuit is useful with whatever combination of filters

is installed, but really performs magic only if matched filters are installed in both i-fs (i.e., a pair of 500-Hz filters or the 250- and 270-Hz filters).

The author erroneously indicates that the rf clipper has two stages, one in the VBT circuit and one in the i-f circuit. Actually, there are three stages, all in the 455-kHz i-f. The quality of the TS-830 audio even under heavy clipping is largely due to the fact that the 455-kHz ceramic filter precedes the clipper, and the 8.83-MHz crystal filter follows the clipper.

**Harrison Clark KA2R  
Clifton Park NY**

*Thanks to KA2R for his corrections and additions to my review of the TS-830S. Based on his comments, I am eager to install CW filters in our 830.*

*By the way, the equipment reviews in 73 are purposely kept less technical and more subjective than the reviews found in some other publications. We find that parameters such as shape factor and 3rd-order IMD simply do not mean very much to the average ham. Since these technical aspects are well covered in other magazines, we tend toward reviews which emphasize actual on-the-air impressions.—WB8BTH.*

### COMPARISON TESTS

Hats off to Bob Glorioso W1IS for his surprising and highly informative article (May, 1981) on 2-meter antennas! Bob's comparison test provided this amateur with plenty of concrete detail on how to improve his 2-meter station, especially as I look up at the 5/8-wave ground plane presently on my roof.

More direct comparisons in 73 would be much more appreciated than the typical reports on individual products. Maybe W1IS will start such a trend?

**Bill Dryer WB2CQP  
Rutherford NJ**

### PACKET'S PROGRESS

The Vancouver Amateur Digital Communications Group (VADCG) is devoted to creating a packet switching network via amateur radio, and is experimenting with high-speed HDLC protocol transmissions.

Current efforts include a smart terminal node controller board which interfaces any parallel or asynchronous serial device to the network, an S-100 card to provide the centralized station node network control, and a 1200-baud modem card for mike-jack connection to VHF transceivers. Some public domain software is available and more will be provided as it is developed. A practical continent-wide network protocol is under development and geosynch satellite experiments will probably begin this year. Our newsletter subscription is \$10.

**D.A. Oliver VE7AOG  
Secretary-Treasurer, VADCG  
818 Rondeau St.  
Coquitlam BC, Canada  
V3J 5Z3**

### NETS

Anyone who worked anywhere at any time at a land-based tributary or relay station (government, military, commercial, or whatever) that handled message traffic by means of cable, wire, wireless, or radio, using a hand key or teleprinter or cable or wireless perforator, IBM Radiotype, radioteletype, or any other device, please send dates, locations, office calls, call signs, and routing indicators, to me.

I am compiling histories of the old War Department Radio Net, the Alaskan Communications System, and the Army Airways Communications System that existed before World War II. I also am compiling histories of the same and for all other networks (wherever) that were in existence during World War II.

I ask that you send me a stamped envelope with your return address printed legibly on it. For this, you will receive a copy of these histories. Those who send significant contributions will be mentioned. Those who send material and wish to have it sent back to them please say so.

**Arnold J. Madloli  
436 Orchard Ave.  
Grand Haven MI**

### FIRST?

Thank you for the December, 1980, article, "Who Really Invented Radio" and the related letter from Mr. Troy Cory Stubblefield printed in the April, 1981, issue of 73.

Agreement may never be reached about who actually "invented radio" but it is most certainly possible to credit the men who first transmitted their voices electromagnetically, without the use of connecting wires.

This honor goes to Mr. Alexander Graham Bell and his laboratory assistant, Mr. Sumner Tainter, whose voice was transmitted over a beam of modulated sunlight in early 1880, more than 101 years ago.

This marvelous event was reported in *Scientific American* (see "50 and 100 Years Ago" in the October, 1980, issue) and in the excellent book, *Light Beam Communications* by Forest M. Mims III, Howard W. Sams and Company, Indianapolis, 1975.

I hope you find this information as interesting as it has been for me.

**John N. Henning  
Miami FL**

## HAM HELP

Wanted: schematic and/or manual for a Lafayette KT-340 general-coverage shortwave receiver. Usual offer for copies. Thank you.

**Lawrence Joy KB9C  
1932 Lawndale Drive  
Fort Wayne IN 46805**

Has anyone synthesized the Kenwood TR-2200A two-meter portable transceiver? I would appreciate receiving any infor-

mation on designing or constructing such a circuit.

**Lloyd Gosa WB8TNC  
1423 Upland Dr.  
Kalamazoo MI 49001**

I need an operator's manual for the Heathscope O-7. I will pay copying and mailing costs.

**John P. Iorio WD4MWH  
5228 Longview Dr.  
New Port Richey FL 33552**

CAN 20% BE WRONG?



A recent survey showed that 20% of the 73 subscribers also read Kilobaud MICROCOMPUTING magazine . . . and enjoy it. This is the best way to learn and keep up with the rapidly developing world of microcomputers. There's nothing to be afraid of, you just have to read an interesting magazine and you'll learn. Try a subscription to Kilobaud MICROCOMPUTING and see for yourself.

- New subscription     Renewal     12 issues for \$25.00  
 Payment enclosed \$ \_\_\_\_\_     24 issues for \$38.00  
 VISA     MC     AE     Bill me     36 issues for \$53.00

Card # \_\_\_\_\_ Interbank # \_\_\_\_\_

Signature \_\_\_\_\_ Exp. date \_\_\_\_\_

Name \_\_\_\_\_

Address \_\_\_\_\_

City \_\_\_\_\_ State \_\_\_\_\_ Zip \_\_\_\_\_

—for even faster ordering service call toll free (800) 258-5473

Canadian: \$27, one year only, U.S. funds. Other foreign:  
\$35, one year only, U.S. funds. Please allow 6-8 weeks for  
delivery.

317B6

MICROCOMPUTING • POB 997 • Farmingdale NY 11737

# TRS 80\* OWNERS ARISE!



Arise and subscribe to 80 MICROCOMPUTING, the newest and fastest growing microcomputer magazine. This is full of news about programs, accessories and theory on the world's largest selling computer, the TRS-80\*. Definitely beginner level and includes lots of program listings. Find out what all the fuss is about.

- New subscription     Renewal     12 issues for \$18  
 Payment enclosed \$ \_\_\_\_\_     24 issues for \$30  
 VISA     MC     AE     Bill me     36 issues for \$45

Card # \_\_\_\_\_

Interbank # \_\_\_\_\_ Exp. date \_\_\_\_\_

Signature \_\_\_\_\_

Name \_\_\_\_\_

Address \_\_\_\_\_

City \_\_\_\_\_ State \_\_\_\_\_ Zip \_\_\_\_\_

Please allow 6 to 8 weeks for delivery  
Canadian: 1 yr. only/\$20 in U.S. Funds  
Foreign: 1 yr. only/\$28 in U.S. Funds

**80** microcomputing™

• P.O.B. 981 • Farmingdale N.Y. 11737

\*TRS-80 is a trademark of Tandy Corporation.

317B6

## WORK THE U.H.F. BANDS

Add a transverter or converter to your existing 10m, 6m or 2m equipments. Choose from the largest selection of modules available for DX, OSCAR, EME, ATV.

### TRANSVERTERS



- MMT 432-28 (S) \$339.95  
 MMT 439-ATV \$369.95  
 MMT 1296-144 \$425.95

### CONVERTERS

Choose from many models to suit your needs.  
Examples: MMC 432-28, MMC 426/439—ATV  
MMK 1296-144, MMC 1280—ATV

Write for details and available options.

### 10FILTERS



- Prevent OSCAR 8 Mode J desense  
 Use MMF200-7 \$42.95  
 Stop receiver IMD birdies  
 Use PSF432 \$59.95

### ANTENNAS

- 420-450 MHz J-beams  
 48 el. 15.7 dBd \$75.75  
 88 el. 18.5 dBd—Ask  
 1250-1300 MHz loop yagi 1296-LY \$49.75

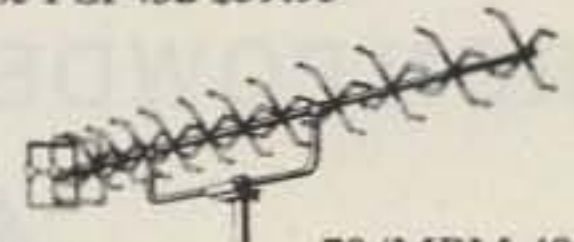

70/MBM 48

Send 36¢ stamps for full details of all our VHF/UHF items.

- Pre-selector filters  
 Low-pass filters  
 Varactor triplers  
 Pre-amplifiers

- Transverters  
 Converters  
 Antennas  
 Crystals



**si** 436

Spectrum International, Inc.  
Post Office Box 1084S  
Concord, Mass. 01742 USA

# MOVING?

Let us know 8 weeks in advance so that you won't miss a single issue of 73 Magazine.

Attach old label where indicated and print new address in space provided. Also include your mailing label whenever you write concerning your subscription. It helps us serve you promptly. Write to:

**73** magazine

Subscription Department  
P.O. Box 931  
Farmingdale NY 11737

- Address change only     Payment enclosed  
 Extend subscription  
 Enter new subscription     Bill me later  
 1 year \$25.00

If you have no label handy, print OLD address here.

AFFIX LABEL

Name \_\_\_\_\_ Call \_\_\_\_\_

Address \_\_\_\_\_

City \_\_\_\_\_ State \_\_\_\_\_ Zip \_\_\_\_\_

print NEW address here:

Name \_\_\_\_\_ Call \_\_\_\_\_

Address \_\_\_\_\_

City \_\_\_\_\_ State \_\_\_\_\_ Zip \_\_\_\_\_

317B6

**NEW, MOLDABLE PLASTIC  
COAX-SEAL®**

Seals coax fittings from moisture and corrosion

- Only material that will adhere to poly vinyl or vinyl outer coax jackets.
- Forms and seals over odd shaped and difficult fittings.
- Non-contaminating and non-conductive.
- Wide ambient temperature range (-30°F to +180°F).
- Stays flexible for years thus insuring moisture proof connections.
- Reuseable - allows you to quickly disconnect fittings and reseal them with the same material.
- A must for satellite TV - microwave work - wire antenna at solder joints - in the shack.

**COAX-SEAL®**... the new space age material that is quick and simple to apply. Remove backing from approximately 6" of plastic. Wrap outer covering toward fitting. After wrapping, knead to form a smooth surface and force out air. **EFFECTIVE - FOOL PROOF - INEXPENSIVE.**

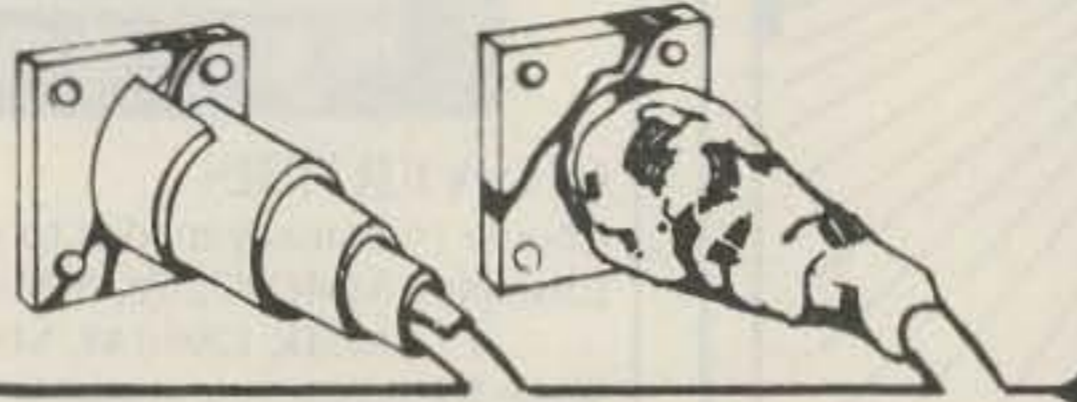

2 rolls \$4.00 post paid. ✓407  
**DEALER  
INQUIRIES WELCOME**

**Universal Electronics, Inc.**  
1280 Aida Drive, Reynoldsburg, Ohio 43068

**IRON POWDER and FERRITE PRODUCTS**

**AMIDON**  
*Associates* ✓334

Fast, Reliable Service Since 1963

Small Orders Welcome Free 'Tech-Data' Flyer

Toroidal Cores, Shielding Beads, Shielded Coil Forms  
Ferrite Rods, Pot Cores, Baluns, Etc.

(213) 762-2418

12033 OTSEGO STREET, NORTH HOLLYWOOD, CALIFORNIA 91607

**ALL BAND TRAP ANTENNAS!**



PRE-TUNED - COMPLETELY ASSEMBLED - ONLY ONE NEAT SMALL ANTENNA FOR UP TO 7 BANDS! EXCELLENT FOR CONGESTED HOUSING AREAS - APARTMENTS LIGHT - STRONG - ALMOST INVISIBLE!

FOR ALL MAKES & MODELS OF AMATEUR TRANSCEIVERS - TRANSMITTERS - GUARANTEED FOR 2000 WATTS SSB 1000 WATTS CW. INPUT FOR NOVICE AND ALL CLASS AMATEURS!

COMPLETE AS SHOWN with 90 ft. RG58U-52 ohm feedline, and PL259 connector, insulators, 30 ft. 300 lb. test dacron end supports, center connector with built in lightning arrester and static discharge - molded, sealed, weatherproof, resonant traps 1"X6"- you just switch to band desired for excellent worldwide operation - transmitting and receiving! Low SWR over all bands - Tuners usually NOT NEEDED! Can be used as inverted V's - slopers - in attics, on building tops or narrow lots. THE ONLY ANTENNA YOU WILL EVER NEED FOR ALL DESIRED BANDS - WITH ANY TRANSCEIVER - NEW - EXCLUSIVE! NO BALUNS NEEDED!

80-40-20-15-10-6 meter - 2 trap --- 104 ft. with 90 ft. RG58U - connector - Model 998BUA... \$79.95  
40-20-15-10 meter --- 2 trap --- 54 ft. with 90 ft. RG58U - connector - Model 1001BUA... \$78.95  
20-15-10 meter --- 2 trap --- 26ft. with 90 ft. RG58U - connector - Model 1007BUA... \$77.95

SEND FULL PRICE FOR POSTPAID INSURED. DEL. IN USA. (Canada is \$5.00 extra for postage - clerical-customs etc) or order using VISA - MASTER CHARGE - CARD - AMER. EXPRESS. Give number and ex. date. Ph 1-308-236-5333 9AM - 6PM week days. We ship in 2-3 days. ALL PRICES WILL INCREASE... SAVE - ORDER NOW! All antennas guaranteed for 1 year. 10 day money back trial if returned in new condition! Made in USA. FREE INFO. AVAILABLE ONLY FROM  
WESTERN ELECTRONICS Dept. A7-7 ✓80 Kearney, Nebraska, 68847

**GILFER SHORTWAVE**

**GILFER Custom  
Yaesu FRG-7700**



All the features for less.  
Covers from 0.15 to 29.999 MHz with PLL synthesized up-conversion circuitry - crystal lattice filter 48 MHz first IF. 12-channel memory. Dual readouts. Clock and timer. RF attenuator. Noise blanker. GILFER selectivity of 2.4, 4.0 and 6.0 kHz (at -6 dB). Receives AM, USB, LSB, CW, NBFM with 0.5 µV sensitivity. 100/117/200/230 VAC, 12 VDC.  
**\$725+shipping**

New Catalog—25¢



North America's Shortwave Mail Order Place  
■ Receivers ■ Converters  
■ Antennas ■ Preselectors  
■ Clocks ■ Filters ■ Lists  
■ World Radio TV Handbook  
**GILFER SHORTWAVE**  
Dept. 737 Box 239  
Park Ridge, NJ 07656

**REGULATED POWER SUPPLY**

13.8V  
3.3 Amp  
cont.



Heavy Duty, Filtered & Fused  
**50% OFF SALE**  
**\$15.95** \$2.50 Shipping

**COAXIAL CABLE SALE**

POLYETHYLENE DIELECTRIC	
RG213 noncontaminating 95% shield mil spec.....	36¢/ft.
RG11AU 75ohms 97% shield mil spec.....	27¢/ft.
RG62U 93 ohms.....	09¢/ft.
RG8U 80% shield.....	18¢/ft.
RG58CU noncontaminating 95% shield mil spec.....	12¢/ft.
LOW LOSS FOAM DIELECTRIC	
RG-8X (mini 8) 95% shield. Blue Jacket.....	22¢/ft.
RG8U 97% shield white jacket.....	30¢/ft.
RG58U 80% shield.....	07¢/ft.
RG58U 95% shield.....	10¢/ft.
RG58AU stranded center 80% shield.....	11¢/ft.
Rotor cable 2-18ga 6-22ga.....	19¢/ft.
* Cable—shipping \$2.50 1st 100 ft., \$2.00 each add'l 100 ft.	
CONNECTORS	
PL-259 to BNC (UG-255).....	\$3.50 ea.
PL-259 push-on adapter shell.....	10/\$3.89
PL-259 & SO-239.....	10/\$5.89
Double Male Connector.....	\$1.79
1 ft. patch cord w/RCA type plugs each end.....	3/\$1.00
Reducer UG-175 or 176.....	10/\$1.89
UHF T (M358).....	\$2.59
Elbow (M359).....	\$1.79
F59A (TV type).....	10/\$1.99
Connectors—shipping 10% add'l, \$1.50 minimum	
FREE CATALOG—VISA/MASTER CHARGE—	
C.O.D. ADD \$1.50—FLA. RES. ADD 4%	

✓412  
**NEMAL ELECTRONICS**  
5685 S.W. 80th ST., DEPT. RLO, MIAMI, FLORIDA 33143  
TELEPHONE (305) 661-5534

**AMATEUR RADIO**

**SHORTWAVE**

**SCANNERS**

**SPECTRONICS**

Specialists in Amateur Radio,  
Short-Wave Listening  
And Contemporary  
Electronic Gear.

**HOURS**  
MON, TUES, WED.: 9:30-6:00 PM  
THURS, FRI.: 9:30-8:00 PM  
SAT.: 9:30-3:00 PM  
CLOSED SUNDAYS, HOLIDAYS

**Full Service Shop • Spectrum Analysis • Antennas  
New and Used Equipment • CW-SSB-FM, Etc. • Towers  
FCC Study Guides • Code Tapes • Books • Accessories**

**SPECTRONICS INC.**  
1009 GARFIELD ST. OAK PARK, IL. 60304 (312) 848-6777



# TRYLON ABC TOWERS

### Features:

- **RUGGED** triangular construction
- **TO 96 FEET** in 8 ft. sections
- **PRE-ENGINEERED** for heavy loads
- **GALVANIZED** A526 quality steel
- **ECONOMICAL** as low as \$7/ft.
- **KIT FORM** easy to assemble

for

**TV  
HAMS  
MOBILE  
LIGHTING**

also available  
TILT-OVER/CRANK-UP TOWERS

**TRYLON MANUFACTURING CO.**  
438 50 HIGH ST. LL7  
BUFFALO N.Y. 14203  
(716) 881-0937



# ANTECK, INC.

STAINLESS STEEL WHIP—FIBERGLASS LOADING COIL  
— PATENT APPLIED. NO COILS TO CHANGE.  
— LESS THAN 1.5 VSWR (ENTIRE TUNING RANGE)  
TUNE 3.2 TO 30 MHz FROM THE OPERATORS POSITION  
— FAST AND SLOW SCAN RATES

The Model MT-1RT mobile antenna tunes 3.2 to 30 MHz inclusive. 750 watts CW, 1500 watts PEP for hams, military, MARS, CAP, and commercial service. Center loaded for high efficiency. Enables tuning to exact resonance to wanted frequency. Allows full output from solid state finals. No worry about reduced output from shut down circuits. Output is unaffected by moisture and the elements. Tuned by a control box at the operator's position. Mast section contains a double action hydraulic cylinder driven by two miniature hydraulic pumps and 12 volt DC motors for positive control. No creeping during operation or mobile motion. Can be removed up to 500 ft. from antenna.

MT-1RT amateur net \$240.00  
MT-1RTR (retro kit for all MT-1's) \$118.00  
MT-1 amateur net 129.95  
MT-1A (marine) stainless steel \$179.95

9.00 UPS shipping in U.S.  
7.00 UPS in U.S.  
7.00 UPS in U.S.  
7.00 UPS in U.S.

✓356

Route 1, Box 415

**ANTECK, INC.** Hansen, Idaho 83334 208-423-4100



*... at last ...*  
**your shack organized!**  
A beautiful piece of furniture — your XYL will love it!

**\$16450 S-F RADIO DESK**  
Deluxe - Ready to Assemble

Designed with angled rear shelf for your viewing comfort and ease of operation.

FINISHES: Walnut or Teak Stain.  
Floor Space: 39" Wide by 30" Deep

Additional Information on Request.  
Checks, Money Orders, BankAmericard and Master Charge Accepted.

F.O.B. Culver City. (In Calif. Add 6% Sales Tax.)  
— DEALER INQUIRIES INVITED —

**S-f Amateur Radio Services**  
4384 KEYSTONE AVENUE • CULVER CITY, CALIF. 90230 — PHONE (213) 837-4870



Radio equipment not included

Also Available . . .  
Floor Space: 51" Wide by 30" Deep  
\$192.50

✓65

# Isotron Antennas

THE ULTIMATE space savers...  
for 80, 40, and 20 meters



Isotron 80 Ht. 4 1/2'  
Isotron 40 31"  
Isotron 20 17"

THIS HIGH PERFORMANCE ANTENNA IS DIRECTLY FED WITH 50Ω COAX. RADIALS OR MATCHING DEVICES ARE NOT USED. WHETHER YOU ARE LIMITED IN SPACE OR NOT, THE ISOTRONS WILL GIVE YOU THE PERFORMANCE YOU EXPECT FROM A HARMONIC ANTENNA. CALL OR WRITE:

DEALERSHIPS AVAILABLE ✓426

**BILAL COMPANY**  
(303) 687-3219  
STAR ROUTE FLORISSANT, CO. 80816

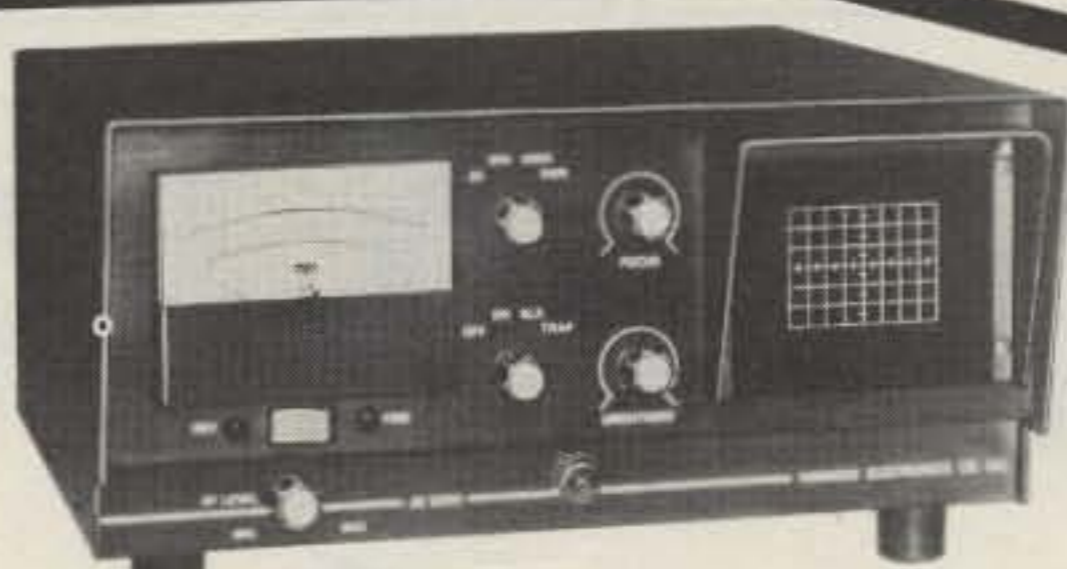

✓398

## The Essential Instrument

### Scope/Wattmeter/SWR Bridge \$274.50 ppd.

**BlackCat JB-1000SM.** The 3-in-1 instrument. The one instrument to have in the shack when you're having only one.

**3" Monitor Scope.** You'll soon interpret scope patterns to determine power output, distortion, audio noise, ALC action, carrier suppression, spurs, flat topping, even AM modulation characteristics. Has sine and trapezoid patterns.

**3-range Wattmeter.** Reads peak power to 20, 200, and

2000 watts, from 80-10 meters.

**Built-in SWR Bridge.** Shows SWR ratios of 1:1, 1.5:1, 2:1, and 3:1. Has Forward and Reflected switch.

Rugged metal cabinet with black vinyl-clad steel cover and black anodized aluminum panel has white nomenclature; size: 5 1/2"H x 12 1/2"W x 12"L.

### Wattmeter/SWR Bridge



Peak reading wattmeter has 3 ranges (20, 200, 2000 watts), operates 80-10 meters. SWR ratios of 1:1, 1.5:1, 2:1, 3:1, forward and reflected. RF level control.

Model JB-2000SW, \$87.50 ppd.



**WAWASEE ELECTRONICS**  
Dept. 771 Box 36, Syracuse, IN 46567  
Phone: 219/457-3191  
Enclosed is \$ (UPS shipping prepaid)  
(No CODs. Indiana res. add 4% sales tax.)  
Please send Model(s)

Charge It:  Visa  Mastercard  
Exp. Date: \_\_\_\_\_ Card No. \_\_\_\_\_

Name: \_\_\_\_\_ (please print)

Address: \_\_\_\_\_

City: \_\_\_\_\_

State: \_\_\_\_\_

Zip: \_\_\_\_\_



**The HAM SHACK**

✓ 449

808 N. Main  
Evansville, IN 47711

**TEN-TEC**

546 Omni C	\$1060.00
580 Delta	760.00
280 Power Supply	150.00
255 Power Supply/Spkr.	170.00
243 Vfo — Omni	169.00
283 Vfo — Delta	169.00
444 Hercules Amp.	1340.00

**ARGOSY**

TEN-TEC 525	\$485.00
-------------	----------

AEA 2 meter Isopole	\$36.00
CUBIC Astro 103	1175.00
MFJ 496 Keyboard	295.00
ALLIANCE HD 73 rotator	\$99.00
AZDEN PCS 3000	315.00
HY-GAIN TH6DXX	240.00
TH5DX	210.00
TH3MK3	180.00
TH3JR	140.00
KANTRONICS Mini-reader	279.00
SANTEC HT 1200	325.00

812-422-0231

MON-FRI 9AM-6PM • SAT 9AM-4PM

**Microcraft's New Morse-A-Word**

Eight character moving display.  
Built-in code practice oscillator.  
Excellent for learning Morse Code.  
Complete — no CRT or expensive extras needed.  
Decodes audio CW signals from your receiver's speaker and displays letters, numbers, punctuation and special Morse characters as the code is received.



MORSE-A-WORD Kit with 4 character readout	MAWK-4	\$149.95
MORSE-A-WORD Kit with 8 character readout	MAWK-8	\$169.95
MORSE-A-WORD wired & tested with 8 character readout	MAWF	\$249.95

Send check or money order. Use your VISA or Master Charge. Add \$3.50 shipping and handling for continental U.S. Wisconsin residents add 4% State Sales Tax.

✓ 50 *Microcraft* Corporation Telephone: (414) 241-8144  
P. O. Box 513G, Thiensville, Wisconsin 53092



*Radio World*



CENTRAL NEW YORK'S MOST COMPLETE HAM DEALER

YAESU



ROBOT 800



ICOM IC-720



KENWOOD TS830S



DRAKE TR7-DR7



FT707

Featuring Kenwood, Yaesu, Icom, Drake, Ten-Tec, Swan, Dentron, Alpha, Robot, MFJ, Tempo, Astron, KLM, Hy Gain, Mosley, Larsen, Cushcraft, Hustler, Mini Products, Bird, Mirage, Vibroplex, Bencher, Info-Tech, Universal Towers, Callbook, ARRL, Astatic, Shure. We service everything we sell!



Write or call for quote. You Won't Be Disappointed.  
We are just a few minutes off the NYS Thruway (I-90) Exit 32



OUT OF STATE ONEIDA COUNTY AIRPORT TERMINAL BUILDING  
CALL TOLL FREE ORISKANY, NEW YORK 13424

800-448-9338

N.Y. Res. Call (315) 337-0203 or 736-0470

✓ 397

Warren - K2IXN  
Bob - WA2MSH

CALL  
TOLL  
FREE

**800-545-7814**

CALL  
NOW

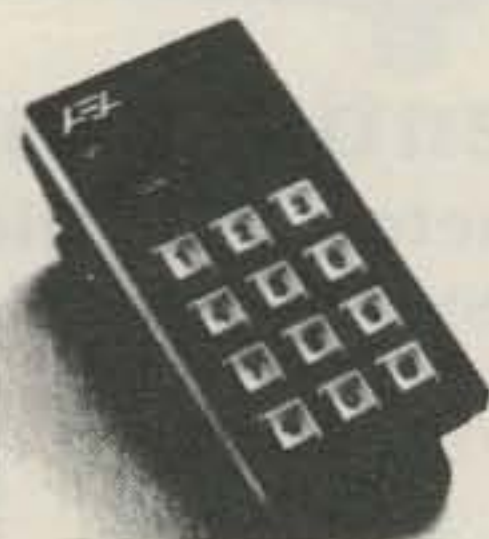
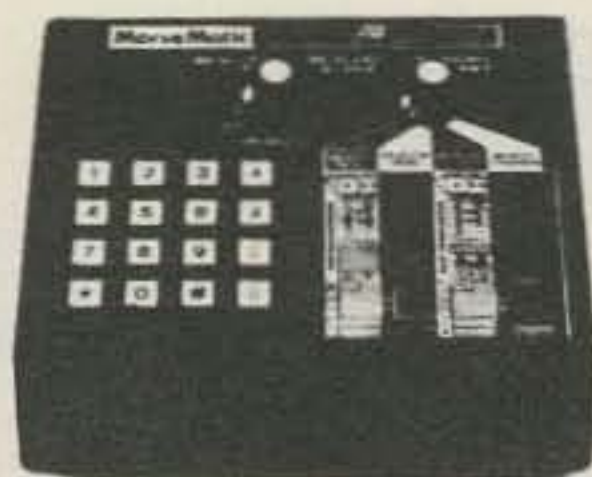

Contest Keyer

**AEA** Brings you the Breakthrough!

All AEA in stock for quick delivery  
Call for quote on Morsematic, Contest Keyer, Keyers & Trainers. Special Package Deals available with Bencher Paddles  
CALL NOW!!! TOLL FREE!!!



**ICOM**

IN STOCK - CALL FOR YOUR PRICE  
TOLL FREE!!!

We have the lowest prices, fast delivery, free shipping most items, & TOLL FREE Orderline.

Also Stocking: AZDEN-ICOM-BENCHER-HYGAIN-KANTRONICS-LARSEN-MIRAGE-AVANTI  
KENWOOD-SANTEC-MFJ-CUSHCRAFT-TENTEC-ASTRON

*Pecos Valley Amateur Radio Supply*

OPEN 10-5 M-F &  
10-4 Sat  
MC & VISA Welcome

112 W. First St., Roswell, NM 88201 • (505) 623-7388 in New Mexico, Evenings, & Sundays



# ASTRON POWER SUPPLIES

• HEAVY DUTY • HIGH QUALITY • RUGGED • RELIABLE •

## SPECIAL FEATURES

- SOLID STATE ELECTRONICALLY REGULATED
- FOLD-BACK CURRENT LIMITING Protects Power Supply from excessive current & continuous shorted output.
- CROWBAR OVER VOLTAGE PROTECTION on Models RS-7A, RS-12A, RS-20A, RS-35A, RS-20M & RS-35M
- MAINTAIN REGULATION & LOW RIPPLE at low line input Voltage.
- HEAVY DUTY HEAT SINK • CHASSIS MOUNT FUSE
- THREE CONDUCTOR POWER CORD
- ONE YEAR WARRANTY • MADE IN U.S.A.
- VOLT & AMP METER ON MODELS RS-20M & RS-35M



### ASTRON 20 AMP REGULATED POWER SUPPLY Model RS-20M

16 Amps continuous  
20 Amps ICS\*  
5" (H) x 9" (W) x 10.5" (D)  
Shipping Weight 20 lbs.  
Price ..... \$117.95

## PERFORMANCE SPECIFICATIONS

- INPUT VOLTAGE: 105 - 125 VAC
- OUTPUT VOLTAGE: 13.8 VDC ±0.05 volts (Internally Adjustable: 11-15 VDC)
- RIPPLE: Less than 5mv peak to peak (full load & low line)
- REGULATION: ±0.5 volts no load to full load & low line to high line

Other popular POWER SUPPLIES also available: (Same features and specifications as above)

Model	Continuous Duty (amps)	ICS* (amps)	Size (in.) H x W x D	Shipping Wt. (lbs.)	Price
RS-35M	25	35	5 x 11 x 11	29	\$179.95
RS-35A	25	35	5 x 11 x 11	29	\$159.95
RS-20M	16	20	5 x 9 x 10½	20	\$124.95
RS-20A	16	20	5 x 9 x 10½	20	\$104.95
RS-12M	9	12	4½ x 8 x 9	13	\$ 99.95
RS-12A	9	12	4½ x 8 x 9	13	\$ 79.95
RS-7A	5	7	3¾ x 6½ x 9	10	\$ 59.95
RS-4A	3	4	3¾ x 6½ x 9	5	\$ 43.95

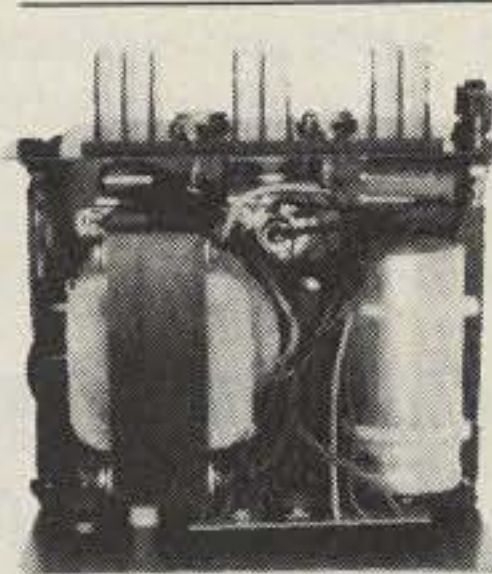

Inside View — RS-12A

\*ICS — Intermittent Communication Service (50% Duty Cycle)  
If not available at your local dealer, please contact us directly.

# ASTRON CORPORATION

2852 Walnut Unit E  
Tustin, CA 92680  
(714) 832-7770 ✓ 358

# 2300 MHZ MICROWAVE DOWNCONVERTERS

## DOWNCONVERTERS

KIT\* ..... 35<sup>00</sup>  
ASSEMBLED ..... 65<sup>00</sup>

## 2300 MHZ PREAMPS

PREAMP #1  
KIT\* ..... 28<sup>50</sup>  
ASSEMBLED ..... 48<sup>50</sup>

## SUPER AMP (Commercial Quality)

KIT\* ..... 48<sup>50</sup>  
ASSEMBLED ..... 68<sup>50</sup>

POWER SUPPLY KIT\* ..... 19<sup>50</sup>

\*All kits include P.C. board, parts, and detailed instructions

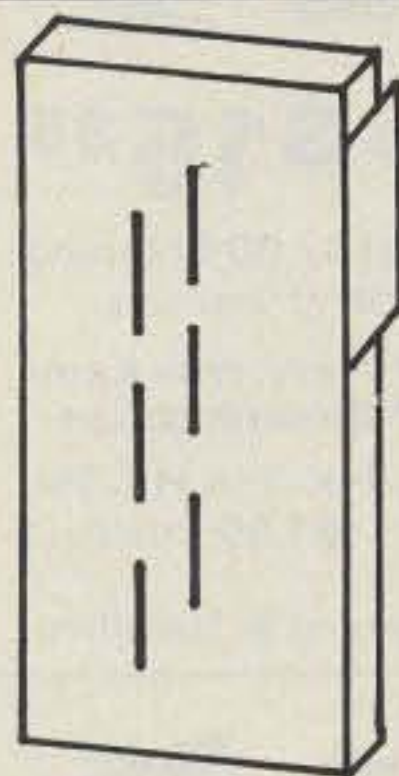

(with box for down converter)

**SLOTTED ARRAY ANTENNA 35<sup>00</sup>**

**ALSO AVAILABLE: COMMERCIAL SYSTEMS, BOGNER ANTENNAS, PARABOLIC ANTENNAS, MICROWAVE PARTS AND SATELLITE T.V. KITS**

# P.B. Radio Service

1950 E. Park Row • Arlington, TX 76010

Call Order Dept. Toll Free

1-800-433-5169

VISA



For Information Call

1-817-460-7071

# ETCO

## CABLE TV CONVERTERS AND OTHER GOOD STUFF!

SMASHING ALL SALES RECORDS — OUR NEW 30 CHANNEL CABLE TV CONVERTER!

Converts mid & super band cable channels for viewing on your TV set!  
No. 351AE47 **39<sup>95</sup>** \$34.95 ea./5

HOT NEW IMPORT! REMOTE CONTROL 30 CHANNEL CABLE TV CONVERTER!  
Includes remote TV on/off switch and fine tuning control!  
No. 351VA275 **89<sup>95</sup>** \$79.95 ea./5 \$74.95 ea./10

ETCO MKII WIRELESS — THE ULTIMATE CABLE TV CONVERTER!  
Set TV to channel 3 and the hand-held remote control does it all!  
No. 3512A008 **189<sup>00</sup>**

VIDCOR 2000 CONVERTER ELIMINATES PROBLEMS WHEN VIDEOTAPING FROM CABLE TV  
Restores your VCR's capability for programming. Restores remote channel control. Enables videotaping of one cable program while watching another.  
No. 351VA95C **89<sup>95</sup>** \$17.50 ea./10

UNUSUAL FACTORY SURPLUS MID-BAND — SUPER-BAND CABLE TV TUNER  
Converts cable channels to a common IF frequency. Experimenters—build cable converters, decoders, etc. With schematic. No. 351VA342  
351V7 389—Detailed schematic & spec. sheet—\$1.50 **19<sup>95</sup>** \$17.50 ea./10

FACTORY SURPLUS UHF TUNERS  
Brand new production surplus. All solid state. Ideal for experimental work building cable TV converters, etc. No. 351SU099 **4<sup>95</sup>** \$3.95 ea./10

MINIATURE FM WIRELESS MICROPHONE  
Hides in the palm of your hand. Reception on any standard FM radio or receiver.  
No. 351VA482 **29<sup>95</sup>** \$27.50 ea./5 \$24.95 ea./10

QUARTER-MILE WIRELESS MICROPHONE & RECEIVER SYSTEM  
FCC approved crystal controlled wireless mike & receiver. All battery operated. Electret wide-range response. VU meter.  
No. 351VA093 **69<sup>95</sup>** \$49.95 ea./5

FACTORY SURPLUS VHF / UHF "TWIN" VARACTOR TUNERS!  
Admiral No. NC 3143-1 BRAND NEW! Ideal for building or repairing electronically tuned TV "FRONT ENDS." A hard-to-find item at a sensational price!  
No. 351VC308 **39<sup>95</sup>** \$34.95 ea./5

DUMPING! NORELCO ENDLESS LOOP CASSETTES!  
Impossible to find at any price!  
3 minutes—No. 351VA605  
6 minutes—No. 351VA606 **4<sup>95</sup>** \$4.49 ea./10

IN STOCK — THE MURA CORDLESS TELEPHONE SYSTEM!  
Answer & originate calls with this wireless pocket phone. 400 ft. range! Rechargeable! Last number recall! Paging feature! Use with rotary, touch systems!  
No. 351VA274 **144<sup>88</sup>** \$129.95 ea./5

SALE OF QUARTZ BATTERY-OPERATED CLOCK MOVEMENTS!  
Accuracy of 1 min./year up to 4 years operation on 1 alkaline "C" cell. Imported from West Germany. No. 351VA561  
351VA565 Matching hands—\$2.49/set. \$1.95/set/5 **9<sup>95</sup>** \$8.95 ea./5

20 AMP REGULATED 12VDC POWER SUPPLY!  
13.8 vdc no load, 12.5 vdc full load. Easily handles ham station, marine radio, SSB lineups up to 400 W P.E.P. Brand new, factory sealed. 110 VAC No. 351VA394 **69<sup>88</sup>** \$59.88 ea./5

Key #358 **FREE** OUR LATEST 98 PAGE FASCINATING CATALOG — jam packed with unique items, electronic bargains and unusual offers. Write or circle the information card number below.

ETCO ELECTRONICS NORTH COUNTRY SHOPPING CENTER PLATTSBURGH, N.Y. 12901  
Check with order, please. Visa & Mastercard OK. Sorry, no C.O.D.s add 15% for UPS & Handling (Excess refunded) N.Y. State residents add 7% sales tax Dealer & Export inquiries invited. Our telephone order desk never closes.  
cell 1 518 561 8700

# GOTHAM ANTENNAS

(813) 584-8489



## SMALL LOT TRAP DIPOLES ✓ 417

MODEL	BANDS	LGTH	PRICE
TSL 8040	80,40	78'	\$49.95
TSL 4020	40,20,15	40'	\$47.95

## SMALL LOT SHORTENED DIPOLES

SL-8010	80,40,20,15,10	75'	\$59.95
SL-160	160	130'	\$36.95
SL-80	80	63'	\$35.95
SL-40	40,15	33'	\$34.95

## FULL SIZE PARALLEL DIPOLES

FPD-8010	80,40,20,15,10	130'	\$49.95
FPD-4010	40,20,15,10	63'	\$44.95

## NEW! PORTABLE VERTICAL! IDEAL FOR APARTMENTS, CAMPING, TRAILERS!

Folds to 5' Package. No Radials. Required. Fully Assembled. Full Legal Limit. 1:1 VSWR

MODEL	BANDS	HGHT	PRICE
PV-8010	80-10	13'	\$59.95

## PROVEN DESIGN - GOTHAM ALL BAND VERTICALS

V-160	160,80,40,20,15,10,6	23'	\$39.95
V-80	80,40,20,15,10,6	23'	\$37.95
V-40	40,20,15,10,6	23'	\$35.95

## FAMOUS GOTHAM QUADS

2 Elements — 3 Bands Complete \$119.95

## CHAMPIONSHIP GOTHAM BEAMS

Full Size Complete from \$79.95

CALL OR SEND LARGE SASE FOR CATALOG. Shipping: Dipoles & Verticals \$2.50 USA; \$7.00 Canada; \$5.00 FPO, APO Beams & Quads Shipped UPS or Freight Collect. Fla. add 4% Sales Tax

P.O. Box 776 • Largo, FL 33540



## Organize your shack with a CLUTTERFREE MODULAR CONSOLE \$179.95

- Large, 42" H x 57" W x 29" D
- Strong groove-construction
- Mar-resistant wood grain finish
- Options, drawers & face plate
- For ham or home computer
- Visa and Master Charge

# CLUTTERFREE MODULAR CONSOLES

P.O. Box 5103 Tacoma, WA 98405  
(206) 759-1611 ✓ 89



(Radio not included)

## BEAT YOUR BATTERIES!

OPERATE your SYNTHESIZED HT CONTINUOUSLY from any 12-30v D.C. source: Auto, Truck, RV, Light Aircraft (12 or 28v system), Home D.C. Power Supply!!!

STEWART'S New "BATTERY-BEATER" provides the proper REGULATED voltage for your rig and plenty of current for CONTINUOUS FULL POWER TRANSMIT! All day travel, all evening Simplex Net with NO QRT TO RE-CHARGE! TRANSMIT EVEN WITH DEAD NiCads!!!!

• NOT a battery charger but a FULL POWER SOURCE with TWO PROTECTION CIRCUITS!

• RUGGED ALUMINUM CASE! NEW, IMPROVED MODEL FOR ICOM! SO TOUGH THE AVERAGE MAN CAN STAND ON IT!

• YOUR NiCads REMAIN IN PLACE! Simply unplug for INSTANT PORTABILITY!!

• DESIGNED by an engineer from NASA's Jet Propulsion Laboratory with components rated 50% beyond requirements!

• PRE-WIRED JACK for your radio with detailed, step-by-step installation instructions.

• TWO 5 FT. POWER CORDS - 10 FT. TOTAL REACH! VELCRO pads to mount anywhere! 1 FULL YEAR WARRANTY!!

• NO INTERFERENCE with PL's! LONGER LIFE FOR NiCads!

• The ONLY accessory power supply that can claim all these exciting features, and more!!

• NOW AVAILABLE for TEMPO S-1,2,5;

• YAESU FT-207R; ICOM IC-2A/T; WILSON MK II, MK IV;

• SANTEC HT-1200! (MEMORY RIGS RETAIN MEMORY!!)

• PRICE: ALL MODELS - \$30.00 Post Paid. Ca. Res. add \$1.00 Tax. C.O.D.'s - You pay Postage and COD fees.

• PHONE: 1-213-357-7875 for C.O.D.

STEWART QUADS P.O. Box 2335 IRVINDALE, CA. 91706

# HAM-KEY® ✓ 30

## RADIO TELEGRAPH SENDING DEVICES

**New Lower Prices**



Model **HK-3M** ~~\$19.95~~

**Now \$15.95**

Add \$2.00 Shipping & Handling. (U.S.A.)

- Deluxe straight key
- Anti-tip bracket. Can't tip
- Heavy base. No need to attach to desk

Model AT-B anti-tip bracket only, to convert any HK-3 to HK-3M. \$1.50 Postpaid

CC-3P shielded cable & plug for HK-3M \$1.50

Add \$ .50 Shipping & Handling.



Model **HK-1** ~~\$29.95~~ **Now \$24.95**

Add \$2.00 Shipping & Handling. (U.S.A.)

- Dual lever squeeze paddle
- For use with all electronic keyers
- Heavy base with non-slip rubber feet
- Paddles reversible for wide or close finger spacing

Model HK-2, same as HK-1 but less base for incorporation in your own keyer. \$16.95

Add \$1.00 Shipping & Handling

CC-1P shielded cable & plug for HK-1 \$2.00

Add \$ .50 Shipping & Handling.

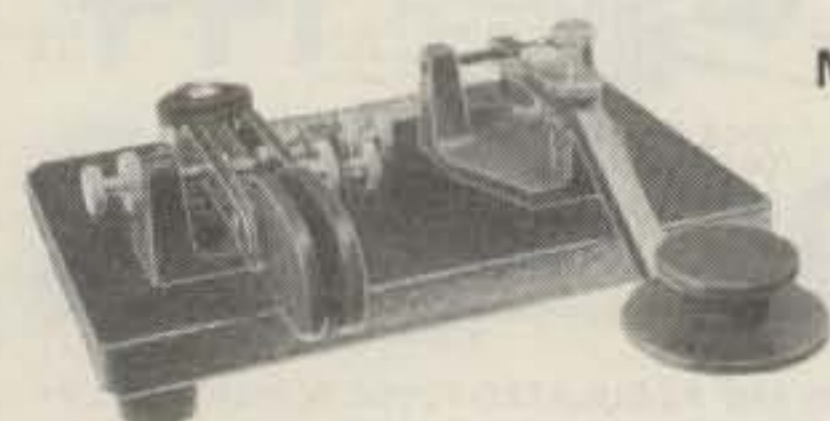

Model **HK-4** ~~\$44.95~~

**Now \$37.95**

Add \$2.00 Shipping & Handling. (U.S.A.)

- Combination HK-1 & HK-3 on same base
- Straight key may be used conventionally or as a switch to trigger a memory.

CC-1/3P Shielded cable with plugs for HK-4 \$3.50

Add \$1.00 Shipping & Handling



Model **HK-5A** Electronic Keyer

~~\$69.95~~ **Now \$54.95**

Add \$2.00 Shipping & Handling. (U.S.A.)

- Iambic circuit for squeeze keying
- Self completing dots & dashes
- Dot & dash memory
- Built-in sidetone
- Battery operated with provisions for external power
- Uses Curtis 8044 keyer chip
- Grid block or direct keying
- Speed, volume, tone & weight controls on front panel
- Use with HK-1 or HK-4

IF NOT IN STOCK AT YOUR DEALER, ORDER DIRECT FROM

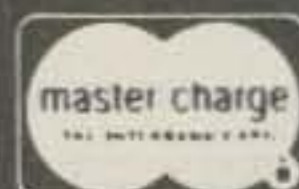

P.O. Box 28271

**The HAM-KEY Co.**

St. Louis, MO 63132

Phone TOLL-FREE 1-800-325-3651





## "ONV SAFETY BELT"

A "must" for Safety!

'73 Bill Salerno



W20NV  
President



OSHA Approved



**NOW AVAILABLE  
ONV TOOL POUCH  
DESIGNED FOR ONV SAFETY BELT  
\$9.95 EACH**

Shipping & Handling Prepaid



Immediate UPS Del'ry

### UPI Communication Systems, Inc.

Mail To: P.O. Box 902 • Saddle Brook, N.J. 07662  
N.J. (201) 279-7528 • (800) 526-5277  
(Office) 481 Getty Ave. • Paterson, N.J. 07503  
Cable: Unipage Telex: 642597

✓37

At last!! — a safety belt designed to meet the safety needs of radio amateurs, radio stations, TV stations, boat owners, painters, construction workers, maintenance people — anyone with the need to climb — now at an affordable price.

Our "ONV Safety Belt" is fitted with two drop forged steel "D" rings. Onto one is spliced a 3 foot length of 1/2" diameter nylon rope fitted with a drop forged steel snap hook. The 3" wide nylon body comfort pad is secured to 1 3/4" wide, 9500 lb. test nylon webbing, which is resin or latex treated for abrasion resistance. The belt is adjustable up to size 46" waist.

Only \$39.95 plus \$3.00 for postage and handling. NJ residents add 5% sales tax.

Looking for gear?  
Don't use all your gear?  
Upgrading your station?  
Starting out?

✓413

602-326-1105

# Equipment Exchange

Radio Brokerage

QSL or business SASE to:

Suite 73  
2509 N. Campbell Ave.  
Tucson, Arizona 85719

## PEOPLE WHO KNOW QUALITY

AND NEED RELIABILITY  
Demand FOX-TANGO Filters



WANT TO KNOW WHY?

Send for descriptive brochure and information

**FOX-TANGO OWNERS: JOIN FOX-TANGO CLUB**

✓323 \$8.00 US, \$9.00 CANADA—\$12 OVERSEAS

Dealer Inquiries Welcome!

Full FT Catalog \$1.00 Refundable



**FOX-TANGO CORPORATION**

Box 15944S, West Palm Beach, Florida 33406

## Satellite T.V. By: rCom

### CONFIDENTIAL DEALER PRICE LIST

Why spend \$5K to \$10K on a satellite Earth Station when you can buy at dealer prices. You can receive 60 and more television stations, current uncut movies, Pro games each Sunday, sporting events not available on commercial T.V., live Los Vegas entertainment, special children's and religious programming and much, much more.

Buy one, your choice at Dealer prices. Systems for home or commercial use. We will also make recommendations for your Earth Station location as to equipment needed. Complete systems, all major brands.

Send \$2.00 with S.A.S.E. today for confidential Dealer Price List Catalog.

For Information call (318) 233-6941

✓452



**rCom Distributors**  
164 Acadian, Lafayette, LA 70503

With courtesy  
beep and beacon  
capability.

144

# REPEATERS

220

New and Improved  
Receivers  
and Transmitters

(Included in All Repeaters)



**COR Identifier:** All on one band, programmable, Fully adjustable, time out (.5-7 min.), hang time (0-1 min.), identifier (1-10 min.), tone, speed, volume, L.E.D. outputs, low current drain, CMOS logic, plugs for easy installation and removal plus much more

### Basic Repeater

2M 130-175 MH/Basic Repeater for 2 meters with all the features of the Hi Pro Mk I less the power supply and front panel controls and accessories.

**Maggiore Electronic Laboratory** ✓46

845 Westtown Rd.  
West Chester, PA 19380 Phone (215) 436-6051

### OPTIONS

Duplexers  
Basic auto patch  
Matching cabinet  
.0005% High stability  
crystals

## Hi Pro Mk I

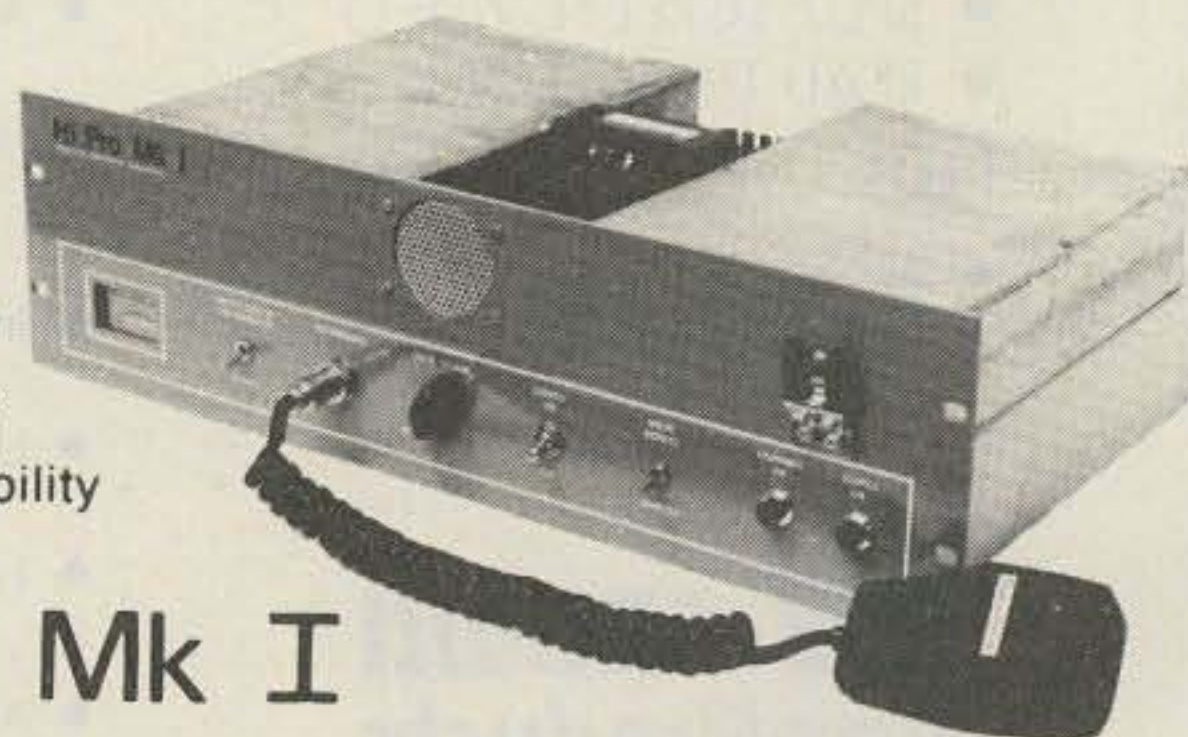

144 or 220 MHz also 450

# HAM HELP

I would like help in finding a schematic diagram for a Hallcrafters dc power supply, model PS-500-DC.

**L. D. Olmstead**  
RR #1  
Moorhead MI 56560

I need manuals and schematics for an Eico VTVM, model 232 and a Triumph Oscillograph-Wobbulator, model 830. I'll pay copying costs.

**Chuck Killgore KB7I**  
16626 S.E. 11th St.  
Bellevue WA 98008

I would appreciate a copy of the owner's and/or service manual for the Yaesu FT-202R handie-talkie. I would immediately return your originals or be glad to cover the cost of duplicating and postage.

**Art Chapman WB2JHN**  
30 Cymbeline Dr.  
Old Bridge NJ 08857

I have a Precision cathode oscillograph, Series ES-500A, and need a photocopy of the owner's manual and service manual. I'll gladly pay all expenses.

**Vance Newton N8ATO**  
6120 King Arthur Dr.  
Swartz Creek MI 48473

I would like to purchase outright an original copy of manual NAVAIR 16-30 ARC38-502 (revised July, 1966), for radio set AN/ARC-38A. I also need manuals and/or schematics for the following: Hallicrafters type CSM-50-1/CA-2 transceiver, Motorola model P33AAC-1101AM transceiver, and an Automatic Radio model IPS-7299C Industrial Power Supply. I can copy and will pay for postage or purchase outright.

**Barry Fuerst**  
218 Flournoy St.  
Oak Park IL 60304

## ALL NEW 15 Meter Mobile CW & USB



**21.000—21.450 MHz**

High 10W (PEP) low 2W (PEP); VFO tuning; noise blanker; fine-tune SB, KHz  $\pm$  CW off-set; digital frequency counter; 13.8V dc @ 3A, negative ground; L 9.5" x W 9" x H 2.5"; weight (2.3 kg) 5.7 lbs.; mobile mounting bracket.

Introductory price \$289.50.  
Ask your dealer for a demonstration.

# NCG Co.

1275 N. GROVE ST.  
ANAHEIM, CALIF. 92806 (714) 630-4541

NOTE: Price, specifications subject to change without notice and obligation.

## TEST EQUIPMENT

<b>HP608C</b> SIG GEN, 10 MHZ THRU 480 MHZ, AM/CW OR PULSE MODULATION, CALIBRATED ATTENUATOR	<b>\$375.00</b>
<b>HP608D</b> SIG GEN, 10 MHZ THRU 420 MHZ, AM/CW OR PULSE MODULATION, CALIBRATED ATTENUATOR	<b>375.00</b>
<b>HP612A</b> SIG GEN, 450 MHZ THRU 1230 MHZ, AM/PULSE MODULATION, CALIBRATED ATTENUATOR	<b>475.00</b>
<b>HP614</b> SIG GEN, 900 THRU 2100 MHZ, AM/PULSE MODULATION, CALIBRATED ATTENUATOR	<b>345.00</b>
<b>TS-403/URM-61</b> SIG GEN, 1.8 GHZ THRU 4 GHZ, AM/PULSE, CALIBRATED ATTENUATOR, MILITARY EQUIVALENT TO HP616A	<b>345.00</b>
<b>TS-621/URM-52</b> SIG GEN, 3.8 TO 7 GHZ, AM/PULSE, CALIBRATED ATTENUATOR, MILITARY EQUIVALENT TO HP618A	<b>345.00</b>
<b>HP620A</b> SIG GEN 7 TO 11 GHZ, AM/PULSE, CALIBRATED ATTENUATOR	<b>475.00</b>
<b>TS-510/U</b> SIG GEN, 10 MHZ THRU 420 MHZ AM/CW OR PULSE MODULATION, CALIBRATED ATTENUATOR, MILITARY EQUIVALENT TO HP608D	<b>375.00</b>
<b>AN/URM-26</b> SIG GEN, 4 MHZ THRU 405 MHZ, AM/CW MODULATION, CALIBRATED ATTENUATOR, SMALL COMPACT SIZE 10 $\frac{3}{4}$ x 11 $\frac{1}{2}$ x 14.	<b>285.00</b>
<b>SG-3/U</b> FM SIG GEN 50 MHZ THRU 400 MHZ IN 3 BANDS, METERED RF OUTPUT 0-1V, METERED FM DEVIATION 0-150 KHZ, VARIABLE 500 OHM ATTENUATOR. PERFECT FOR ALIGNING VHF AMATEUR, COMMERCIAL OR STEREO FM RADIOS	<b>385.00</b>
<b>SG-12/U</b> FM SIG GEN, 20 MHZ THRU 100 MHZ IN 5 RANGES, METERED OUTPUT AND DEVIATION, CALIBRATED ATTENUATOR, USED FOR LOW BAND FM MILITARY, AMATEUR OR COMMERCIAL ALIGNMENT	<b>185.00</b>
<b>TS-497/URR</b> SIG GEN RANGE 2 MHZ THRU 50 MHZ, CALIBRATED ATTENUATOR, AM/CW MODULATION, MILITARY VERSION OF MEASUREMENTS MODEL 80	<b>225.00</b>
<b>SG-13/U</b> VOR/ILS MILITARY SIG GEN, 108 MHZ THRU 135.9 MHZ, AND 329.9 TO 335 MHZ, OUTPUT SIGNALS FOR LOCALIZER AND GLIDESLOPE. SAME AS COLLINS 479T-2, OPERATES FROM 28 VDC AT 3 $\frac{1}{2}$ AMPS BENCH POWER SUPPLY OR AIRCRAFT BATTERYS. IDEAL FOR AIRCRAFT RADIO REPAIR.	<b>265.00</b>
<b>HP606A</b> SIG GEN 50 KHZ THRU 65 MHZ, AM/CW, CALIBRATED ATTENUATOR	<b>475.00</b>
<b>OS-121/USM-140</b> OSCILLOSCOPE WITH MX3078/USM HORIZ CHANNEL PLUG-IN AND MX-2930 DUAL TRACE PLUG-IN, 5" CRT, INTERNAL SWEEP, 24 CALIBRATED RANGES WITH SWEEP EXPANSION, TRIGGER MODES, CALIBRATOR, DC-22 MHZ, HOUSED IN VENTED AIR COOLED CABINET, SIZE 22" L x 14" H x 19" W. A BEAUTIFUL MILITARY OSCILLOSCOPE.	<b>295.00</b>
<b>HP302A</b> WAVE ANALYZER	<b>325.00</b>
<b>HP410B</b> VACUUM TUBE MULTIMETER	<b>89.00</b>
<b>HP5261A</b> VIDEO AMP PLUG-IN FOR 5245/46 COUNTER	<b>125.00</b>
<b>HP211A</b> SQUARE WAVE GENERATOR	<b>45.00</b>
<b>HP212A</b> PULSE GENERATOR	<b>45.00</b>
<b>HP460A</b> WIDE BAND AMPLIFIER	<b>45.00</b>
<b>URM-32A</b> FREQUENCY METER 125 KHZ THRU 1000 MHZ	<b>65.00</b>
<b>TS-186/U</b> FREQUENCY METER	<b>65.00</b>
<b>TS-382/U</b> AUDIO OSCILLATOR	<b>49.00</b>
<b>UPM-6B</b> RADAR TEST SET	<b>125.00</b>
<b>HICKOK 539C</b> TUBE TESTER	<b>65.00</b>
<b>TS-2B/U</b> TELETYPEWRITER TEST SET	<b>49.00</b>
<b>HP803</b> VHF BRIDGE	<b>75.00</b>
<b>SIERRA 126B</b> FREQUENCY SELECTIVE VOLTMETER	<b>95.00</b>
<b>HP415B</b> STANDING WAVE INDICATOR	<b>45.00</b>
<b>LAMPKIN 205A</b> FM MODULATION METER	<b>95.00</b>
<b>TEKTRONIX 585A</b> OSCILLOSCOPE WITH TYPE M FOUR TRACE PLUG-IN	<b>650.00</b>
<b>HP741A</b> AC/DC DIFFERENTIAL VOLTMETER DC STANDARD	<b>345.00</b>
<b>TEKTRONIX 0670-0513-00</b> CALIBRATION FIXTURE TUNNEL DIODE PULSE GENERATOR	<b>145.00</b>
<b>HP3440A</b> DIGITAL VOLTMETER WITH 3445 AC/DC PLUG-IN	<b>125.00</b>

WE SHIP BEST WAY FOB OTTO, N.C., 30 DAY MONEY BACK GUARANTEE. SEND CHECK, VISA OR MASTER CHARGE. WE EXPORT. PHONE BILL SLEP 704-524-7519.



Electronic  
Distributors

## Slep Electronics Company

P. O. BOX 100, HWY 441, DEPT. 73  
OTTO, NORTH CAROLINA 28763

✓ 367



# Satellite TV

FOR THE HOME

Sick of Network TV?

Our receiver lets you get over 75 channels of television directly from earth-orbiting cable TV satellites! HBO, Showtime, super stations, sports and movies worldwide.



We don't just sell information! We Manufacture Hardware!

From offshore oil rigs, data links to hotels and backyard installations, we wrote the book. Constantly updated, our 94 Page

technical information book and catalog gives you all the facts. Inexpensive dishes, feeds, telemetry software, kits and more. Recommended reading by NASA, The Office of Consumer Affairs and quality companies like Rockwell/Collins. Send \$7.95 today!

CALL 309

24-hrs. C.O.D. Hotline  
(305) 339-7600

**SPACECOAST**  
RESEARCH CORPORATION

P.O. Box 442-D, Altamonte Spgs, FL 32701



## Subscription Problem?

73 Magazine does not keep subscription records on the premises, therefore calling us only adds time and doesn't solve the problem.

Please send a description of the problem and your most recent address label to:

73 Magazine  
Subscription Dept.  
PO Box 931  
Farmingdale, NY 11737

Thank you and enjoy your subscription.

## YAESU FT-207R OWNERS

AUTO SCAN MODULE AND BATTERY SAVER KIT



15 minutes to install; scan restarts when carrier drops off; busy switch controls automatic scan on-off; includes module and instructions.

Model AS-1. \$25.00

WRITE FOR CLUB DISCOUNTS

new

FT-207R BATTERY SAVER KIT  
MODEL BS-1 \$14.95

\*No more dead batteries due to memory backup

\*30% less power drain when squelched

\*Simple to install; step-by-step instructions and parts included

\*4 mA memory backup reduced to 500  $\mu$ A.

\*45 mA receiver drain reduced to 30 mA.

\*Improved audio fidelity and loudness

**ENGINEERING CONSULTING**

P. O. BOX 94355

RICHMOND, B. C. V6Y2A8, CANADA

## SUPER LOG™ II

FOR THE  
TRS-80 MODEL I & MODEL III

- THE ULTIMATE COMPUTERIZED LOG
- STORES & RETRIEVES INSTANTLY
- LIGHTNING SEARCH & SORT
- FREE BONUS PROGRAM INCLUDED: "SUPER DUPE II"

BOTH PROGRAMS ONLY

**\$16<sup>95</sup>** PREPAID

383

80™

**MICRO-80™ INC.**

S-2665 No. Busby Road  
Oak Harbor, WA 98277

## PILOTS



Build your own aircraft radios.

381 FREE CATALOG.

OUT OF STATE? CALL TOLL FREE.

800  
824-5978  
OTHERWISE  
916  
272-2203

**Radio Systems  
Technology, Inc.**

10985-G GRASS VALLEY AVE.  
GRASS VALLEY, CA 95945

## COLLINS 180L-2

Collins 180L-2 Automatic Antenna Coupler designed for use with 50-180 watt transceivers in the 2 to 25 Mhz range. Has 7-970 pf 3 KV vacuum variable capacitor and variable silvered-ribbon 32 uHY inductor — both with 28 VDC drive.



Also smaller roller inductor and SWR meter circuit. Requires 28 VDC 3 amps, 250 or 400 VDC 35 ma, and 115 VAC 400 Hz 20 VA. 10 1/2 x 7 3/4 x 11 1/2", 24 lbs. sh. Used:

\$99.50

Collins 180L-3 Antenna Coupler, same as 180L-2 except incorporates an antenna transfer relay which automatically transfers an antenna to a receiver or receiver section after the transmitter is unkeyed; 25 lbs. sh. Used:

\$119.50

### R-648/ARR-41 RECEIVER

190-550 Khz and 2-25 Mhz AM-CW in five bands; mechanical digital tuning in 1 Khz steps. 500 Khz IF and two mechanical filters. Requires 24 VDC 4 amps for dynamotor. 7 1/2 x 16 x 13 1/4", 35 lbs. sh. Used, checked: \$205. Manual, partial repro: \$15. Prices F.O.B. Lima, O. • VISA, MASTERCARD Accepted. Allow for Shipping • Write for New 1981 CATALOG Address Dept. 73 • Phone: 419/227-6573

**FAIR RADIO SALES** 22

1016 E EUREKA • Box 1105 • LIMA, OHIO • 45802

this publication is available in microform



University Microfilms International

300 North Zeeb Road  
Dept. P.R.  
Ann Arbor, MI 48106  
U.S.A.

18 Bedford Row  
Dept. P.R.  
London, WC1R 4EJ  
England

LOWEST POSSIBLE PRICES  
BEST POSSIBLE WARRANTY



model III 16K

**\$859**

color  
computer 4K

**\$310**



444 call TOLL FREE 1-800-343-8124

**computer plus**  
Write for your free catalog.

245A Great Road  
Littleton, MA 01460  
617 • 486 • 3193

TRS-80 is a registered trademark of Tandy Corp.

## DIRECTION FINDING?



New Technology (patent pending) converts any VHF FM receiver into a modern Doppler Radio Direction Finder. No receiver mods required. See June 1981 issue of 73 for technical description. Kits available from \$235. Write for full details and prices.

425

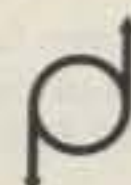

**DOPPLER SYSTEMS**  
111 E. Moon Valley Drive  
Phoenix, Arizona 85022

## Enjoy Satellite TV Now



Better than Cable TV—Over 200 TV and radio services. Why waste money? Learn the whole story and build a video system the family can enjoy. No commercials, **FREE** movies, sports and Vegas shows—worldwide, crystal clear reception connects to any TV set. Big (8 x 11 in.) book loaded with details, photos, plans, kits—**TELLS EVERYTHING! Satisfaction Guaranteed.**

Send \$7.95 TODAY! Add \$2.00 for 1st class (air mail) or call our 24 hour C.O.D. rush order line (305) 862-5068.  
**GLOBAL ELECTRONICS,**  
 P.O. Box 219-H, Maitland, Florida 32751



## BE HEARD!

### WITH THESE LOW-COST 2-METER AMPLIFIERS.

Anyone who can operate a 2-meter rig can assemble these low cost amplifiers. Our detailed, step-by-step instructions allow you to build these 2-meter kits without an SWR bridge, wattmeter or other type of equipment.

**Model 225** Designed to allow any 2-meter, hand-held FM transceiver, with an output of 350 milliwatts or more, to produce an output of 25 watts. Input BNC connector allows your hand-held to be connected and disconnected easily.

**Model 335** Operate up to 35 watts on FM with an input of only 3 watts. Also operates with less power; 2 watts yields 30 watts, and 1 watt yields 15 watts. Current drain of 4-5 amps @ 13.6 VDC.

**Model 875** Full 75 watts on FM or SSB with 10 watts input.

**Model KEB 430 MHz 100 Watt Linear Amplifier**

This high power kit is designed for ATV, SSB or FM operation in the 420 to 450 MHz band.

Write or call for our latest brochure. ✓435

**Communication Concepts Inc.**

2648 North Aragon Avenue • Dayton, Ohio 45420 • (513) 296-1411

## 10 METER RIG? CB BOARD

Hygain 40 channel CB board, with PLL IC, 9W amp w/heat sink, RF & modulator xistors, lots more! A few connections and alterations makes a 10 meter rig (as described in a 73 Mag series). With typical schematics. 12 oz., #D1KS0007. . . \$9.88 each!

## ASC11 ENCODED KEYBOARD

Sanders 720 surplus keyboard, with parallel output. This nice unit has been written up for projects numerous times in 73 and other computer mag's. Sh. Wt. 5 Lbs. . . #1A30126 . . \$39.95 ea.

LOTS MORE SURPLUS COMPUTER PERIPHERAL EQUIPMENT AVAILABLE!  
 CIRCLE READER SERVICE FOR OUR CATALOG

Terms: Add Postage. MC / VISA / AE Welcome!  
 Phone orders welcome on credit card orders!

## FREE GIANT CATALOG of ELECTRONIC BARGAINS

SPEAKER KITS/COMPUTER MAT'L/KITS/GADGETS TOOLS/POWER SUPPLIES/SEMI'S/TRANSFORMERS 1,000's of Electronic Parts! Use Reader Service Card!

**BNF Enterprises**  
 119 Foster St. Peabody, MA. 01960 (617) 531-5774

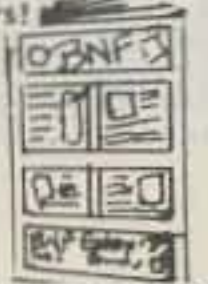

## Human Ingenuity vs. Human Aging

Human ingenuity will either affect the aging process or not.

At home, participate in our studies of the chemistry of human aging. For example, which cosmetics, foods, vitamins, etc. are best for your own unique body chemistry? A specific photographic record of a person's physical changes compared with their diet etc. might be useful if coordinated by us.

If thoughtful people voluntarily devote themselves to these and other studies we have planned, as part of a systematic hobby at home, we might discover many things sooner than otherwise.

With dedication, the results of your home investigations, sent to us for evaluation and safekeeping, may prove valuable to all mankind.

For further details, send a self-addressed stamped envelope to:

The Exact Chemical Institute  
 Home Science Experiments®  
 11759 San Vicente Blvd.  
 Los Angeles, California 90049  
 The United States of America

✓446

## TUFT'S Electronic Department Store

NEW ENGLAND'S HAM STORE  
 Stocking Distributor for Major Equipment and Accessories

## CODE & THEORY

CLASSES ARE IN PROGRESS—INSTRUCTION FROM *NOVICE* TO *EXTRA*. CALL TODAY FOR THE NEXT STARTING DATE!

(617) 391-3200  
 206 MYSTIC AVENUE  
 MEDFORD, MASS. 02155

## OUR NAME SAYS IT ALL!

### Amateur Accessories

The new and ACTIVE dealer in Richmond/Tidewater for quality Amateur Radio products you know and trust:

MFJ	NYE VIKING
HYGAIN/TELEX	VAN GORDEN
VOCOM	ASTRON POWER SUPPLIES
AZDEN (new PCS 3000)	ALLIANCE
BENCHER	MINI PRODUCTS
HAM KEY	AKIGAWA METERS
PALOMAR	B&W

Watch us add more lines in the near future!

CALL or WRITE for our price on:

KEYERS & PADDLES	COAX SWITCHES
HEADPHONES	ROTATORS
MICROPHONES	SPEECH PROCESSORS
TUNERS	PHONE PATCHES
2M RIGS & AMPLIFIERS	CW/SSB FILTERS
ANTENNAS—HF, VHF	MORE—NOW & FUTURE

We look forward to quoting your needs. Ask about delivery to the Richmond/Tidewater areas!

13817 BARNES SPRING ROAD  
 MIDLOTHIAN, VIRGINIA 23113  
 (804) 744-3861

✓429



## S-LINE OWNERS ENHANCE YOUR INVESTMENT

with

## TUBESTERS™

Plug-in, solid state tube replacements

- S-line performance—solid state!
- Heat dissipation reduced 60%
- Goodbye hard-to-find tubes
- Unlimited equipment life

TUBESTERS cost less than two tubes, and are guaranteed for so long as you own your S-line.

✓433

### SKYTEC

Box 535  
 Talmage, CA 95481

Write or phone for specs and prices.  
 (707) 462-6882

## Radio Amateurs

### Tempo Handheld

S-1	\$251.10	2 Meter
S-1T	278.10	with Tone Pad
S-2	315.00	220 MHz
S-2T	359.00	with Tone Pad
S-4	314.10	440 MHz
S-4-T-12	359.00	12 Button Pad
S-4-T-16	377.00	16 Button Pad
S-5	278.10	2 Meter, 5 Watt
S-5T	314.10	with Tone Pad

Azden PCS-3000 2 Meter	\$339.00
Cubic/Swan Astro 1020X	895.00
Ten-Tec Omni C	1082.76

Amateur equipment accessories & antennas.

COD's USA. Export Anywhere.

Amateur & commercial repair service.

2317 Vance Jackson Rd. San Antonio, TX 78213

(800)531-5405 (512)734-7793 in Texas

F.O.B. ORIGIN

## RED HOT SPECIALS!!

Icom IC2A Handheld	215.00
with Touchtone Pad	235.00
Icom IC720A XCVR	1199.00
Icom IC730 XCVR	699.00
Icom IC-560 6 Meters	420.00
Icom 551D 80W 6M	599.00
Icom 2KL Linear Amp	1599.00
Icom IC260 2m All Mode	415.00
Azden PCS 3000 2m	315.00
Janel QSA 5 Preamp	36.50
Bearcat 220 Scanner	269.00
Kantronics FDII Code Reader	360.00
Santec HT1200 Handheld	315.00

Price subject to change without notice. SASE for other RED HOT SPECIALS, new and used.

## Ben Franklin Electronics

115½ N Main Hillsboro KS 67063

316-947-2269

✓439



## PRO-25 MICROWAVE ANTENNAS 2.0-3.0 Ghz

### FEATURES:

- Precision 25" parabolic reflector
- Seamless aluminum feed-horn
- Sturdy "spyder" mount
- All metal construction
- Easy assembly
- Superior gain

Only Data Service Co. antennas offer the superior mechanical and electrical performance of antennas manufactured to commercial standards at a residential price!

Call, write or ✓ for our data sheets.

AMPEX T-120 and L-500 VTR tapes in stock.



✓346

Data Service Company  
3110 Evelyn Street  
Roseville, MN 55113  
612-636-9469

## CB TO 10 METER

### 10 METER CONVERSION KITS FOR MOST C.B. MODELS

- Kits for over 300 Models of CB Radios
- Low Cost from \$10.00  
Easy to Install with All Instructions  
Tune-Up Procedure Alignment
- KITS FOR MOST POPULAR UNITS  
Over 5,000 Satisfied Customers
- Write or Call Today for Our Free  
10 meter catalog

### AMERICAN CRYSTAL SUPPLY COMPANY

PO Box 638  
W Yarmouth, MA 02673  
(617) 771-4634 ✓7

## QUALITY MICROWAVE SYSTEMS

### 2100 TO 2600 MHz ANTENNAS MINIMUM 24 db GAIN OR GREATER

Complete System as pictured (6 month warranty)	\$199.95
PC board, assembled and tested	\$79.95
Power Supply, assembled & tested	\$69.95
PC board with parts, unassembled	\$59.95
Data Information (plans)	\$9.95

Send cash, check or money order to:

### Phillips-Tech Electronics

Dept. SP-73 ✓421  
5025 N. 68th St.  
Scottsdale,  
Arizona 85253

For special quantity pricing, C.O.D.'s, Mastercharge, and VISA call:

(602)

945-7419



## THE BRAKE LITTLE GIANT

BEND & FORM  
.060 ALUM.  
& STEEL!



EASY TO USE!

BUILD CUSTOM CABINETS YOU'LL BE PROUD OF! COMMERCIAL QUALITY at 1/10 THE COST!!

GUARANTEED!

clamps not incl.

21<sup>95</sup>

NO COD OR CREDIT CARDS.  
ALL ORDERS IN US FUNDS.  
ALL FOREIGN ORDERS ADD  
\$5.50 SHIPPING IN ADDITION  
TO P&H. ✓336

**Z ASSOCIATES**  
P O BOX 757  
3050 NE 55 TH AVE.  
SILVER SPRINGS, FLA. 32688

+2<sup>00</sup>  
P&H

### LOWEST POSSIBLE PRICES BEST POSSIBLE WARRANTY

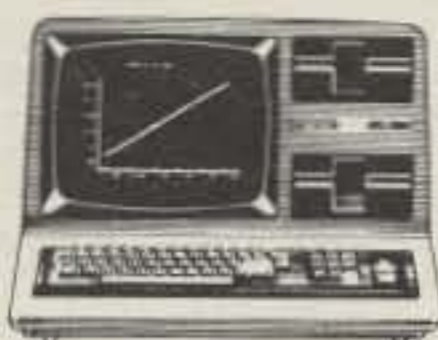

model III 16K

\$859

color  
computer 4K

\$310



✓444 call TOLL FREE 1-800-343-8124

**computer plus**  
245A Great Road  
Littleton, MA 01460  
617 • 486 • 3193

Write for your free catalog.

TRS-80 is a registered trademark of Tandy Corp.

### MICROWAVE DOWNCONVERTER RX-2300

SPECIAL INTRODUCTORY OFFER — \$140

- Quality metal enclosure w/hardware
- Fully assembled, NOT a kit!
- Temperature compensated
- Low noise preamplifier
- 90-day warranty

The RX-2300 downconverter is a state-of-the-art microwave converter that converts 1900 - 2700 Mhz microwave signals down to VHF. It is especially suited for line-of-sight reception of amateur and TV transmissions and will drive either a VHF receiver or a standard television.

Call, write or ✓ for additional data.

✓430 **TEM MICROWAVE CORP.**

22518 - 97th Avenue North, Route 1  
Corcoran, MN 55374  
612-498-8014

## INOTEK ENGINEERING PRESENTS: RTTY!

✓414

### GOT THOSE METER TUNING BLUES??

NOW YOU CAN SEE WHETHER THAT SIGNAL HAS DRIFTED, AND WHICH WAY. BRIGHT, SOLID STATE LED ARRAY. INSTANTLY IDENTIFIES 170HZ, 425HZ, AND 850HZ SHIFTS.

REQUIRES ONLY +5 AND ±12 VOLT REGULATED POWER SUPPLY.

JUST ANOTHER "SIMPLE" RTTY PROJECT

"SIMPLE RTTY TUNER"

drilled p.c. board with documentation - \$15.95  
complete kit \$60.00

**ONLY:  
\$69.95**

assembled and aligned

P.O. Box 110  
Spanish Fork  
Ut. 84660

### SYNTHESIZED SIGNAL GENERATOR

made in  
U.S.A.



model SG-100C

\$329.95

- Covers 100 to 179.999 MHz in 1 kHz steps with thumb-wheel dial
- Accuracy .00001% at all frequencies
- Internal frequency modulation from 0 to over 100 kHz at a 1 kHz rate
- Spurs and noise at least 60dB below carrier
- RF output adjustable from 5 to 500mv across 50 ohms
- Operates on 12vdc @ 1/2 amp
- Price \$329.95 plus shipping.

In stock for immediate shipping. Overnight delivery available at extra cost. Phone: (212) 468-2720. ✓311

**VANGUARD LABS**  
196-23 Jamacia Ave. Hollis, NY 11423

### 2300 MHZ Antenna



This antenna is for your 2300 MHz down converter. Design gain of up to 20DB. Some assembly required. Variable voltage, 150MA power supply for down converters, 8V-15V.

	PRICE	SHIP. & HNDL.
2300 MHZ antenna only	45.00	5.00
Power supply kit	35.00	2.00
Power supply PC board only	5.00	PPD
2300 MHz PC Board w/Data	15.00	PPD

Complete system: 230 MHz converter, antenna, power supply, 18" coax, 50' coax. Ready to hook up and turn on. \$225.00 PLUS \$5.00 shipping.

No C.O.D. Cash only in money order or cashier check

**H.M. GOODWIN W5EEY**  
11421 FERNALD AVE.  
DALLAS, TX 75218 ✓393

# Save on Scanners! NEW Products!

Chances are the police, fire and weather emergencies you'll read about in tomorrow's paper are coming through on a scanner right now. All scanners sold by **Communications Electronics** bring the real live excitement of action news into your home or car. With your scanner, you can monitor the exciting two-way radio conversations of police and fire departments, intelligence agencies, mobile telephones, energy/oil exploration crews, and more.

Some scanners can even monitor aircraft transmissions! You can actually hear the news *before* it's news. If you do not own a scanner for yourself, now's the time to buy your new scanner from **Communications Electronics**. Choose the scanner that's right for you, then call our toll-free number to place your order with your Visa or Master Charge card.

We give you excellent service because **CE** distributes more scanners worldwide than *anyone* else. Our warehouse facilities are equipped to process thousands of scanner orders every week. We also export scanners to over 300 countries and military installations. Almost all items are **in stock for quick shipment**, so if you're a person who prefers fact to fantasy and who needs to know what's *really* happening around you, order your scanner today from **CE!**

## NEW! Bearcat® 350

**The Ultimate Synthesized Scanner!**

Allow 60-120 days for delivery after receipt of order due to the high demand for this product. List price \$599.95/CE price \$419.00  
**4-Band, 50 Channel • Alpha-Numeric • No-crystal scanner • AM Aircraft and Public Service bands. • Priority Channel • AC/DC Bands: 30-50, 118-136 AM, 144-174, 421-512 MHz.** The new **Bearcat 350** introduces an incredible breakthrough in synthesized scanning: Alpha-Numeric Display. Push a button—and the Vacuum Fluorescent Display switches from "numeric" to word descriptions of what's being monitored. 50 channels in 5 banks. Plus, Auto & Manual Search, Search Direction, Limit & Count, Direct Channel Access, Selective Scan Delay, Dual Scan Speeds, Automatic Lockout, Automatic Squelch, Non-Volatile Memory. Reserve your **Bearcat 350** today!

## Bearcat® 300

List price \$549.95/CE price \$349.00  
**4-Band, 50 Channel • Service Search • No-crystal scanner • AM Aircraft and Public Service bands. • Priority Channel • AC/DC Bands: 32-50, 118-136 AM, 144-174, 421-512 MHz.** The **Bearcat 300** is the most advanced automatic scanning radio that has ever been offered to the public. The **Bearcat 300** uses a bright green fluorescent digital display, so it's ideal for mobile applications. The **Bearcat 300** now has these added features: Service Search, Display Intensity Control, Hold Search and Resume Search keys, Separate Band keys to permit lock-in/lock-out of any band for more efficient service search.



**NEW! Bearcat® 350**



**NEW!  
Bearcat  
160**

## Bearcat® 250

List price \$429.95/CE price \$279.00  
**50 Channels • Crystalless • Searches Stores • Recalls • Digital clock • AC/DC Priority Channel • 3-Band • Count Feature.** Frequency range 32-50, 146-174, 420-512 MHz. The **Bearcat 250** performs any scanning function you could possibly want. With push button ease you can program up to 50 channels for automatic monitoring. Push another button and search for new frequencies. There are no crystals to limit what you want to hear. A special search feature of the **Bearcat 250** actually stores 64 frequencies and recalls them, one at a time, at your convenience.

## Bearcat® 220

List price \$449.95/CE price \$289.00  
**Aircraft and public service monitor.** Frequency range 32-50, 118-136 AM, 144-174, 420-512 MHz. The **Bearcat 220** is one scanner which can monitor all public service bands plus the exciting AM aircraft band channels. Up to twenty frequencies may be scanned at the same time.

Not only does this new scanner feature normal search operation, where frequency limits are set and the scanner searches between your programmed parameters, it also searches marine or aircraft frequencies by pressing a single button. These frequencies are already stored in memory so no reprogramming is required. The **Bearcat 220** is crystalless and features push button programming of desired frequencies. A decimal display indicates channels, frequencies and operations programmed into the scanner. The **Bearcat 220** also features a Priority channel, Dual scanning speeds, Patented track tuning and AC/DC operation.

## Bearcat® 210XL

List price \$349.95/CE price \$229.00  
**18 Channels • 3 Bands • Crystalless • AC/DC** Frequency range: 32-50, 144-174, 421-512 MHz. The **Bearcat 210XL** scanning radio is the second generation scanner that replaces the popular **Bearcat 210** and 211. It has almost twice the scanning capacity of the **Bearcat 210** with 18 channels plus dual scanning speeds and a bright green fluorescent display. Automatic search finds new frequencies. Features scan delay, single antenna, patented track tuning and more!

## NEW! Bearcat® 160

List price \$299.95/CE price \$189.00  
**16 Channels • 3 Bands • AC only • Priority Dual Scan Speeds • Direct Channel Access** Frequency range: 32-50, 144-174, 440-512 MHz. Would you believe...the **Bearcat 160** is the least expensive **Bearcat** crystalless scanner.

This scanner presents a new dimension in scanning form and function. Look at the smooth keyboard. No buttons to punch. No knobs to turn. Instead, finger-tip pads provide control of all scanning operations, including On/Off, Volume and Squelch. Of course the **Bearcat 160** incorporates other advanced **Bearcat** features such as Priority, Direct Channel Access, Dual Scan Speeds, Automatic Channel Lockout, Scan Delay and Auxiliary. All this performance in sleek, contemporary styling. And at a price so low, it astounds even us!

## Bearcat® 5

List price \$134.95/CE price \$94.00  
**8 Crystal Channels • 3 Bands • AC only** Frequency range: 33-50, 146-174, 450-508 MHz. The **Bearcat 5** is a value-packed crystal scanner built for the scanning professional — at a price the first-time buyer can afford. Individual lockout switches. Order one crystal certificate for each channel.

## Bearcat® Four-Six ThinScan™

List price \$189.95/CE price \$124.00  
Frequency range: 33-47, 152-164, 450-508 MHz. The incredible, **Bearcat Four-Six Thin Scan™** is like having an information center in your pocket. This three band, 6 channel crystal controlled scanner has patented Track Tuning on UHF. Scan Delay and Channel Lockout. Measures 2¾ x 6¼ x 1". Includes rubber ducky antenna. Order crystal certificate for each channel. Made in Japan.

### TEST ANY SCANNER

Test any scanner purchased from **Communications Electronics™** for 31 days before you decide to keep it. If for any reason you are not completely satisfied, return it in original condition with all parts in 31 days, for a prompt refund (less shipping/handling charges and rebate credits).

## Fanon Slimline 6-HLU

List price \$169.95/CE price \$109.00  
**Low cost 6-channel, 3-band scanner!** The **Fanon Slimline 6-HLU** gives you six channels of crystal controlled excitement. Unique Automatic Peak Tuning Circuit adjusts the receiver front end for maximum sensitivity across the entire UHF band. Individual channel lockout switches. Frequency range 30-50, 146-175 and 450-512 MHz. Size 2¾ x 6¼ x 1". Includes rubber ducky antenna. Order crystal certificates for each channel. Made in Japan.

## Fanon Slimline 6-HL

List price \$149.95/CE price \$99.00  
**6-Channel performance at 4-channel cost!** Frequency range: 30-50, 146-175 MHz. If you don't need the UHF band, get this model and save money. Same high performance and features as the model **HLU** without the UHF band. Order crystal certificates for each channel. Made in Japan.

### FANON SCANNER ACCESSORIES

**SCMA-6** Mobile Adapter/Battery Charger.....\$49.00  
**CHB-6** AC Adapter/Battery Charger.....\$15.00  
**CAT-6** Carrying case for Fanon w/Belt Clip.....\$15.00  
**AUC-3** Auto lighter adapter/Battery Charger.....\$15.00

### OTHER SCANNERS & ACCESSORIES

**Regency® M400** Scanner.....\$259.00  
**Regency® M100** Scanner.....\$199.00  
**Regency® R1040** Scanner.....\$169.00  
**SP50** AC Adapter.....\$9.00  
**SP51** Battery Charger.....\$9.00  
**SP58** Carrying Case for **Bearcat 4-6 ThinScan™**...\$12.00  
**FB-E** Frequency Directory for Eastern U.S.A.....\$12.00  
**FB-W** Frequency Directory for Western U.S.A.....\$12.00  
**FFD** Federal Frequency Directory for U.S.A.....\$12.00  
**MK350** Mobile mounting kit for **Bearcat 350**.....\$12.00  
**B-4** 1.2 V AAA Ni-Cad's for **ThinScan™** and **Fanon**...\$9.00  
**A-135cc** Crystal certificate.....\$3.00  
Add \$3.00 shipping for all accessories ordered at the same time.

### INCREASED PERFORMANCE ANTENNAS

If you want the utmost in performance from your scanner, it is essential that you use an external antenna. We have six base and mobile antennas specifically designed for receiving all bands. Order **#A60** is a magnet mount mobile antenna. Order **#A61** is a gutter clip mobile antenna. Order **#A62** is a trunk-lip mobile antenna. Order **#A63** is a ¾ inch hole mount. Order **#A64** is a ¾ inch snap-in mount, and **#A70** is an all band base station antenna. All antennas are \$35.00 and \$3.00 for UPS shipping in the continental United States.

### BUY WITH CONFIDENCE

To get the fastest delivery from **CE** of any scanner, send or phone your order directly to our Scanner Distribution Center.™ Be sure to calculate your price using the **CE** prices in this ad. Michigan residents please add 4% sales tax. Written purchase orders are accepted from approved government agencies and most well rated firms at a 10% surcharge for net 10 billing. All sales are subject to availability. All sales on accessories are final. Prices, terms and specifications are subject to change without notice. Out of stock items will be placed on backorder automatically unless **CE** is instructed differently. Most products that we sell have a manufacturer's warranty. Free copies of warranties on these products are available prior to purchase by writing to **CE**. International orders are invited with a \$20.00 surcharge for special handling in addition to shipping charges. All shipments are F.O.B. Ann Arbor, Michigan. No COD's please. Non-certified and foreign checks require bank clearance.

Mail orders to: **Communications Electronics™**, Box 1002, Ann Arbor, Michigan 48106 U.S.A. Add \$7.00 per scanner or phone product for U.P.S. ground shipping and handling, or \$14.00 for faster U.P.S. air shipping to some locations. If you have a Master Charge or Visa card, you may call anytime and place a credit card order. Order toll free in the U.S.A. Dial 800-521-4414. If you are outside the U.S. or in Michigan, dial 313-994-4444. Dealer inquiries invited. All order lines at **Communications Electronics™** are staffed 24 hours.

Scanner Distribution Center™ and **CE** logos are trademarks of **Communications Electronics™**.  
† **Bearcat** is a federally registered trademark of Electra Company, a Division of Masco Corporation of Indiana.  
‡ **Regency** is a federally registered trademark of Regency Electronics Inc.

Copyright ©1981 **Communications Electronics™**



**COMMUNICATIONS ELECTRONICS™**

854 Phoenix □ Box 1002 □ Ann Arbor, Michigan 48106 U.S.A.  
Call TOLL-FREE (800) 521-4414 or outside U.S.A. (313) 994-4444

**We're first  
with the best.™**

# BULLET ELECTRONICS

P.O. BOX 401244 E  
GARLAND, TX. 75040  
214 - 278-3553

## Microprocessor Station Clock



**ZONE CHANGE**  
Selects one of THREE WORLD TIMEZONES Local time (12hr format) and TWO 24hr zones of your choice

**ID INDICATOR**  
Comes on when ID,er is activated. FLASHES at 10 minutes. Different AUDIO TONES are produced momentarily at 8 and 9 minutes with continuous TUNE at 10 minutes

**YOUR CALL HERE**

**.6 INCH HIGH INTENSITY ORANGE LED's**  
Readable at 20 FEET or MORE!

**12 VOLTS AC OR DC**

**ADJUSTABLE BRIGHTNESS**

### ZOLU 3T2™

is a full blown MICROPROCESSOR and ROM that unlike other standard Clock IC's it allows exceptional flexibility. Almost a year in development, it makes obsolete other clock designs. Own the most advanced Station Clock on the market at our amazing low price! DEVELOPED AND SOLD ONLY BY

BULLET ELECTRONICS AND OUR AUTHORIZED DEALERS.

**49.95**

COMPLETE KIT INCLUDING CASE & WALLPLUG XFMR FOR 117VAC OPERATION.

**79.95**

WIRED AND TESTED

**92.50**

WITH REMOTE TEMP. OPTION ON WIRED UNIT. (INCLUDES CALIBRATION).

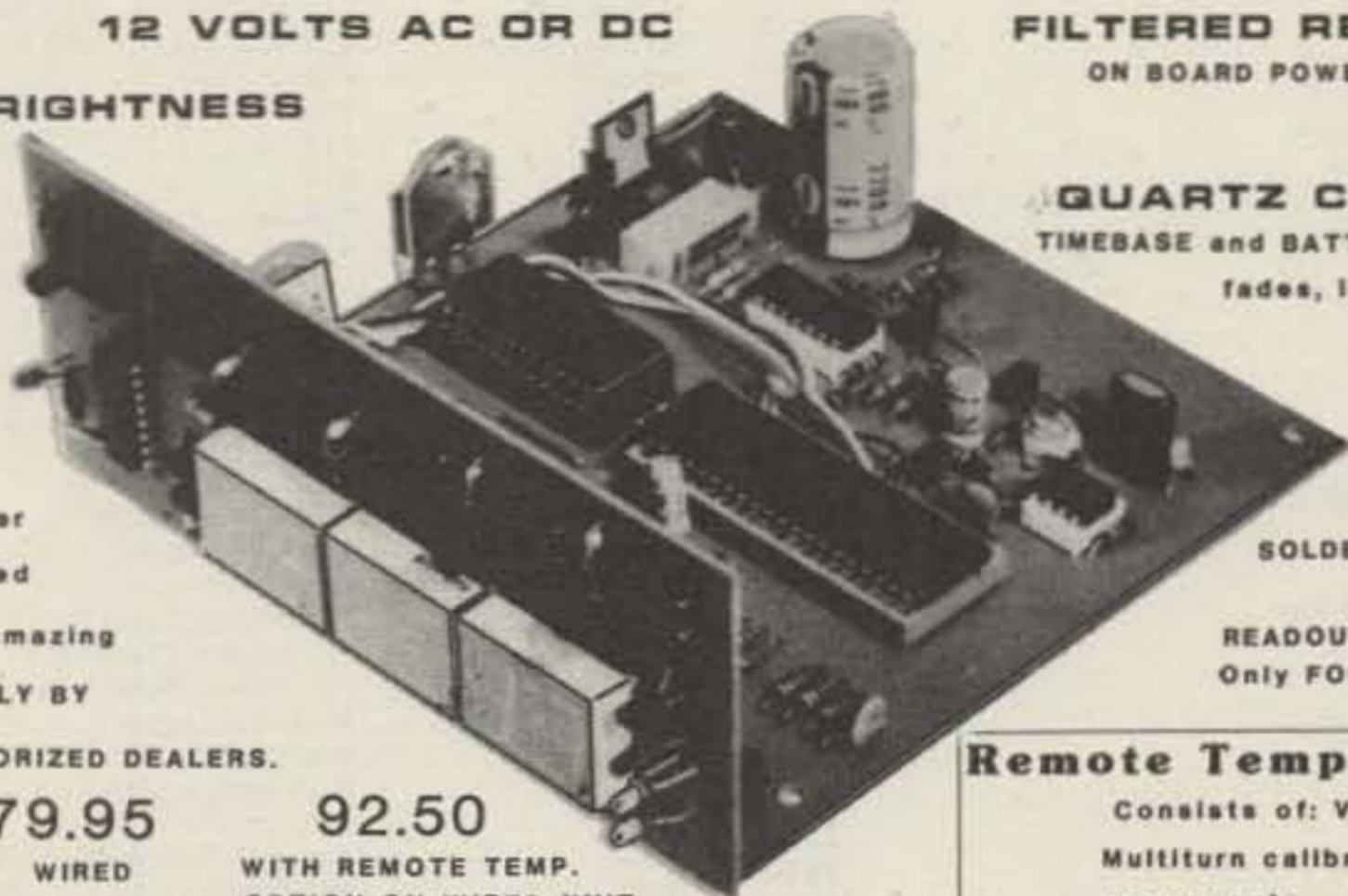

**SET SWITCHES**

Short-throw POSITIVE CLICK Keyboard switches allow quick and accurate TIMESETTING

**SECONDS**

RESET/HOLD provides easy SYNCHRONIZATION with WWV

**TEMP**

Addition of optional TEMPERATURE components (available separately) will allow remote temperature display

**HIGH IMPACT MOLDED CASE**

**RFI PROTECTED**

**ZONE INDICATORS**  
3 COLORS of LED's show which timezone is being displayed

**AUXILIARY TIMER OUTPUT**  
Provides one ON and one OFF setpoint per 24 hour period on LOCAL ZONE. Will drive relay or triac to control external appliances. Backpanel Switch included

**FILTERED REGULATED ON BOARD POWER SUPPLY**

**QUARTZ CRYSTAL**

TIMEBASE and BATTERY BACKUP Makes unit immune to power fades, line noise or AC failure!

**QUALITY PC BOARDS**

SOLDER MASKED Parts locations printed on top

READOUT BOARD mates directly with clock board Only FOUR WIRES required

**Remote Temperature Option \$9.95**

Consists of: V to F IC, Ultra stable Voltage Reference, Multiturn calibration pots precision resistors and misc. components -20F to -120F RANGE Coax cable (RG174) required for runs over 10 feet (not included)

### Sound Effects Kit \$18.50

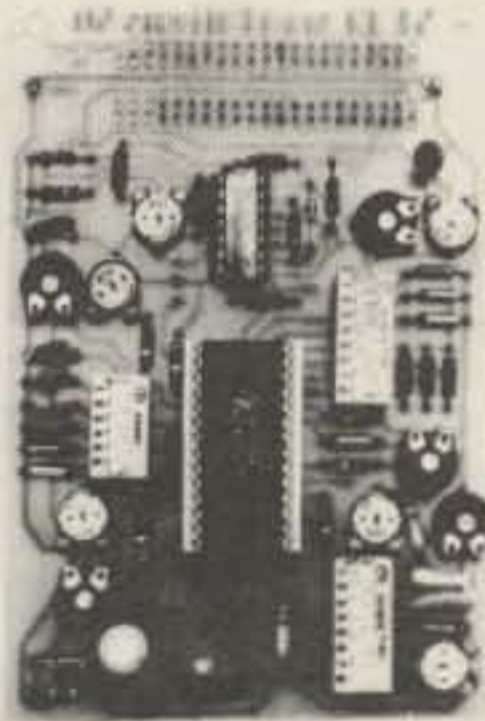

The SE-01 is a complete kit that contains all the parts to build a programmable sound effects generator. Designed around the new Texas Instruments SN76477 Sound Chip, the board provides banks of MINI DIP switches and pots to program the various combinations of the SLF Oscillator, VCO, Noise, One Shot, and Envelope Controls. A Quad Op Amp IC is used to implement an Adjustable Pulse Generator, Level Comparator and Multiplex Oscillator for even more versatility. The 3 1/2" x 5" PC Board features a prototype area to allow for user added circuitry. Easily programmed to duplicate Explosions, Phasor Guns, Steam Trains, or almost an infinite number of other sounds. The unit has a multiple of applications. The low price includes all parts,

assembly manual, programming charts, and detailed 76477 chip specifications. It runs on a 9V battery (not included). On board 100MW amp will drive a small speaker directly, or the unit can be connected to your stereo with incredible results! (Speaker not included). 76477 is included. Available separately for \$3.15 each

### New! Doomsday Alarm

If you have trouble sleeping and you would like the rest of the neighborhood to share your misery then this little kit will be for you! There is no way to accurately describe the unearthly howls, screams and tones that come out of this kit. Four separate tone oscillators are mixed, cancelled and stepped at a varying rate. 10 Watts of crazy sounds. A great fun kit or a practical burglar alarm. Complete with PC board and all necessary components less speaker. For 6-12 VDC.

**9.95**  
KIT

ORDER DA-01

### 7 Watt Audio Amp Kit \$5.95

SMALL, SINGLE-HYBRID IC AND COMPONENTS FIT ON A 2" x 3" PC BOARD (INCLUDED). RUNS ON 12VDC. GREAT FOR ANY PROJECT THAT NEEDS AN INEXPENSIVE AMP. LESS THAN 3% THD @ 5 WATTS. COMPATIBLE WITH SE-01 SOUND KIT.

### Overvoltage Protection Kit \$6.95

Protect your expensive equipment from overvoltage conditions. Every computer should have one! Works with any fused DC power source from 10 to 20 volts up to 25 amps

### Super Value Power Transformer

Well made, open frame transformer with mounting ears. Build a +5 and ±12 supply with inexpensive parts. Free schematics of several designs. Primary 117VAC. SEC #1 15VAC @ 5A SEC #2 15 VAC @ 5A SEC #3 8VAC @ 2.5A

**SPECIAL BONUS:** Order 2 Get free 723 voltage regulator IC!

ORDER: **BET-0005**  
**\$2.95** Each

- NO C.O.D.s
- SEND CHECK M.O. OR CHARGE CARD NO.
- PHONE ORDERS ACCEPTED ON VISA AND MASTERCARD ONLY.
- ADD 5% FOR SHIPPING
- TX. RES. ADD 5% STATE SALES TAX
- ALL FOREIGN ORDERS ADD 30% FOR SHIPPING CHARGES. U.S. FUNDS ONLY. (214) 278-3553

### The Greatest Breakthrough In Electronic Music Ever!

**The Super Music Maker**  
REVISION 2  
**\$24.95**  
(Basic Kit)

Does not include speaker switches or 2708 ROM.



Now you can play hundreds of songs using the Bullet Super Music Maker. The unit features a single factory programmed microprocessor IC that comes with 20 programmed short tunes. By adding the additional PROMS (2708's) the system can be expanded to play up to 1000 notes per PROM. Just think... a compact electronic instrument that will play dozens, hundreds or even thousands of selections of music. The kit comes with all electronic components (less the PROM), and a drilled, plated and screened PC Board which measures 4" x 4 1/2". The 7 watt amplifier section is on the same PC board and drives an 8 ohm speaker (not included), from a whisper to ear splitting volume. Since the unit works on 12 VDC or 12 VAC\*, vehicle or portable operation is possible. What do you get for \$24.95? Everything but a speaker, transformer, case, switches, and PROM. Additional 2708 albums containing popular tunes are available for \$15.00 each or you can program your own PROMS using information provided with the kit instructions. Lists of available PROM albums are available on request. (Note: Unit plays electronic music one note at a time, it is not possible to play chords or a melody with harmony simultaneously.)

- \* Envelope control gives decay to notes.
- \* "Next tune" feature allows sequential playing of all songs.
- \* On board inverter allows single voltage (+12) operation.

#### OPTIONAL ACCESSORIES

- DIP Switches One 8 pos., One 5 pos. **2.00/Set**  
(Can be directly soldered to PC Bd. to access tunes)
- Rotary Switches Two 5 position **2.50/Set**  
(For remote wiring to PC Bd. to access tunes)
- Attractive Plastic Case **6.50**
- Wallplug Transformer **3.00**  
(For operation on 117VAC house voltage)

MANY OTHER COMPONENTS AND KITS AVAILABLE IN OUR COMPLETE CATALOG. CALL OR WRITE FOR FREE CATALOG.

## MICROWAVE COMPONENTS

### ARRA

2416	Variable Attenuator	\$ 50.00
3614-60	Variable Attenuator 0 to 60dB	75.00
KU520A	Variable Attenuator 18 to 26.5 GHz	100.00
4684-20C	Variable Attenuator 0 to 180dB	100.00
6684-20F	Variable Attenuator 0 to 180dB	100.00

### General Microwave

Directional Coupler 2 to 4GHz 20dB Type N	75.00
---	-------

### Hewlett Packard

H487B	100 ohms Neg. Thermistor Mount (NEW)	150.00
H487B	100 ohms Neg. Thermistor Mount (USED)	100.00
477B	200 ohms Neg. Thermistor Mount (USED)	100.00
X487A	100 ohms Neg. Thermistor Mount (USED)	100.00
X487B	100 ohms Neg. Thermistor Mount (USED)	125.00
J468A	100 ohms Neg. Thermistor Mount (USED)	150.00
478A	200 ohms Neg. Thermistor Mount (USED)	150.00
J382	5.85 to 8.2 GHz Variable Attenuator 0 to 50dB	250.00
X382A	8.2 to 12.4 GHz Variable Attenuator 0 to 50dB	250.00
NK292A	Waveguide Adapter	65.00
8436A	Bandpass Filter 8 to 12.4 GHz	75.00
8471A	RF Detector	50.00
H532A	7.05 to 10 GHz Frequency Meter	300.00
G532A	3.95 to 5.85 GHz Frequency Meter	300.00
J532A	5.85 to 8.2 GHz Frequency Meter	300.00
809A	Carriage with a 444A Slotted Line Untuned Detector Probe and 809B Coaxial Slotted Section 2.6 to 18 GHz	175.00
X347A	8.2 to 12.4 GHz noise source	500.00
S347A	2.6 to 3.95 GHz noise source	600.00
G347A	3.95 to 5.85 GHz noise source	500.00
J347A	5.85 to 8.2 GHz noise source	500.00
H347A	7.05 to 10 GHz noise source	540.00
349A	400 to 4000 MHz noise source	310.00
P532A	12.4 to 18 GHz Frequency meter	400.00
M532A	Frequency meter	500.00
P382A	0 to 50 DB attenuator	520.00
355C	0.5 Watts 50 OHMs DC to 1000 MC attenuator	132.50
NK292A	Adapter	100.00
3503	Microwave switch	100.00
3300IC	Pin absorption modulator	295.00
11660A	Tracking generator shunt	50.00
11048C	Feed-through termination	25.00
10100B	Termination	25.00
H421A	7.05 to 10 GHz Crystal Detector	75.00
H421A	7.05 to 10 GHz matched pair	200.00

### Merrimac

AU-26A/	801162 Variable Attenuator	100.00
---------	----------------------------	--------

### Microlab/FXR

601-B18	X to N Adapter 8.2 - 12.4 GHz	35.00
Y6100	Coupler	75.00

### Narda

4013C-10/	22540A Directional Coupler 2 to 4 GHz 10db Type SMA	90.00
4014-10/	22538 Directional Coupler 3.85 to 8 GHz 10dB Type SMA	90.00
4014C-6/	22876 Directional Coupler 3.85 to 8 GHz 6dB Type SMA	90.00
4015C-10/	22539 Directional Coupler 7.4 to 12 GHz 10dB Type SMA	95.00
4015C-30/	23105 Directional Coupler 7 to 12.4 GHz 30dB Type SMA	95.00
3044-20	Directional Coupler 4 to 8 GHz 20dB Type N	125.00
3040-20	Directional Coupler 240 to 500 MC 20dB Type N	125.00
3043-20/	22006 Directional Coupler 1.7 to 4 GHz 20dB Type N	125.00
3003-10/	22011 Directional Coupler 2 to 4 GHz 10dB Type N	75.00
3003-30/	22012 Directional Coupler 2 to 4 GHz 30dB Type N	75.00
3043-30/	22007 Directional Coupler 1.7 to 3.5 GHz 30dB Type N	125.00
22574	Directional Coupler 2 to 4 GHz 10dB Type N	125.00
3033	Coaxial Hybrid 2 to 4 GHz 3dB Type N	125.00
3032	Coaxial Hybrid 950 to 2 GHz 3 dB Type N	125.00
784/	22380 Variable Attenuator 1 to 90dB 2 to 2.5 GHz Type SMA	550.00
22377	Waveguide to Type N Adapter	35.00
720-6	Fixed Attenuator 8.2 to 14.4 GHz 6 dB	50.00
3503	Waveguide	25.00

### PRD

U101	12.4 to 18 GHz Variable Attenuator 0 to 60dB	300.00
X101	8.2 to 12.4 GHz Variable Attenuator 0 to 60dB	200.00
C101	Variable Attenuator 0 to 60dB	200.00
205A/367	Slotted Line with Type N Adapter	100.00
195B	8.2 to 12.4 GHz Variable Attenuator 0 to 50dB	100.00
185BS1	7.05 to 10 GHz Variable Attenuator 0 to 40dB	100.00
196C	8.2 to 12.4 GHz Variable Attenuator 0 to 45dB	100.00
170B	3.95 to 5.85 GHz Variable Attenuator 0 to 45dB	100.00
588A	Frequency Meter 5.3 to 6.7 GHz	100.00
140A,C,D,E	Fixed Attenuators	25.00
109J,I	Fixed Attenuators	25.00
WEINSCHEL ENG.	2692 Variable Attenuator +30 to 60dB	100.00

## COMPUTER I.C. SPECIALS

### MEMORY

DESCRIPTION	PRICE	
2708	1K x 8 EPROM	\$ 7.99
2716/2516	2K x 8 EPROM 5Volt Single Supply	20.00
2114/9114	1K x 4 Static RAM 450ns	6.99
2114L2	1K x 4 Static RAM 250ns	6.99
2114L3	1K x 4 Static RAM 350ns	7.99
4027	4K x 1 Dynamic RAM	3.99
4060/2107	4K x 1 Dynamic RAM	3.99
4050/9050	4K x 1 Dynamic RAM	3.99
2111A-2/8111	256 x 4 Static RAM	3.99
2112A-2	256 x 4 Static RAM	3.99
2115AL-2	1K x 1 Static RAM 55ns	4.99
6104-3/4104	4K x 1 Static RAM 320ns	14.99
7141-2	4K x 1 Static RAM 200ns	14.99
MCM6641L20	4K x 2 Static RAM 200ns	14.99
9131	1K x 1 Static RAM 300ns	10.99

### C.P.U.'s ECT.

MC6800L	Microprocessor	13.80
MCM6810AP	128 x 8 Static RAM 450ns	3.99
MCM68A10P	128 x 8 Static RAM 360ns	4.99
MCM68B10P	128 x 8 Static RAM 250ns	5.99
MC6820P	PIA	8.99
MC6820L	PIA	9.99
MC6821P	PIA	8.99
MC6821P	PIA	9.99
MCM6830L7	Mikbug	14.99
MC6840P	PTM	8.99
MC6845P	CRT Controller	29.50
MC6845L	CRT Controller	33.00
MC6850L	ACIA	10.99
MC6852P	SSDA	5.99
MC6852L	SSDA	11.99
MC6854P	ADLC	22.00
MC6860CJCS	0-600 BPS Modem	29.00
MC6862L	2400 BPS Modem	14.99
Mk3850N-3	F8 Microprocessor	9.99
Mk3852P	F8 Memory Interface	16.99
Mk3852N	F8 Memory Interface	9.99
Mk3854N	F8 Direct Memory Access	9.99
8008-1	Microprocessor	4.99
8080A	Microprocessor	8.99
Z80CPU	Microprocessor	14.99
6520	PIA	7.99
6530	Support For 6500 series	15.99
2650	Microprocessor	10.99
TMS1000NL	Four Bit Microprocessor	9.99
TMS4024NC	9 x 64 Digital Storage Buffer (FIFO)	9.99
TMS6011NC	UART	9.99
MC14411	Bit Rate Generator	11.99
AY5-4007D	Four Digit Counter/Display Drivers	8.99
AY5-9200	Repertory Dialler	9.99
AY5-9100	Push Button Telephone Diallers	7.99
AY5-2376	Keyboard Encoder	19.99
AY3-8500	TV Game Chip	5.99
TR1402A	UART	9.99
PR1472B	UART	9.99
PT1482B	UART	9.99
8257	DMA Controller	9.99
8251	Communication Interface	9.99
8228	System Controller & Bus Driver	5.00
8212	8 Bit Input/Output Port	5.00
MC14410CP	2 of 8 Tone Encoder	9.99
MC14412	Low Speed Modem	14.99
MC14408	Binary to Phone Pulse Converter	12.99
MC14409	Binary to Phone Pulse Converter	12.99
MC1488L	RS232 Driver	1.00
MC1489L	RS232 Receiver	1.00
MC1405L	A/D Converter Subsystem	9.00
MC1406L	6 Bit D/A Converter	7.50
MC1408/6/7/8	8 Bit D/A Converter	4.50
MC1330P	Low Level Video Detector	1.50
MC1349/50	Video IF Amplifier	1.17
MC1733L	LM733 OP Amplifier	2.40
LM565	Phase Lock Loop	2.50

# MHz <sup>48</sup> electronics

Toll Free Number

800-528-0180

(For orders only)

(602) 242-8916

2111 W. Camelback

Phoenix, Arizona 85015

**MRF454**

\$21.83

**NPN SILICON RF POWER TRANSISTORS**

... designed for power amplifier applications in industrial, commercial and amateur radio equipment to 30 MHz.

- Specified 12.5 Volt, 30 MHz Characteristics -
  - Output Power = 80 Watts
  - Minimum Gain = 12 dB
  - Efficiency = 50%

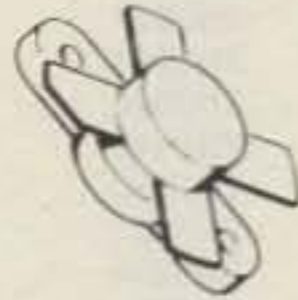

**MRF458**

\$20.68

**NPN SILICON RF POWER TRANSISTOR**

... designed for power amplifier applications in industrial, commercial and amateur radio equipment to 30 MHz.

- Specified 12.5 Volt, 30 MHz Characteristics
  - Output Power = 80 Watts
  - Minimum Gain = 12 dB
  - Efficiency = 50%
- Capable of Withstanding 30:1 Load VSWR @ Rated P<sub>out</sub> and V<sub>CC</sub>

**NPN SILICON RF POWER TRANSISTOR**

... designed primarily for use in large-signal output amplifier stages. Intended for use in Citizen-Band communications equipment operating at 27 MHz. High breakdown voltages allow a high percentage of up-modulation in AM circuits.

- Specified 12.5 V, 27 MHz Characteristics -
  - Power Output = 4.0 Watts
  - Power Gain = 10 dB Minimum
  - Efficiency = 65% Typical

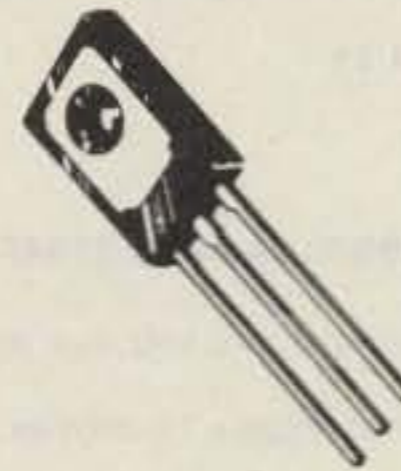

**MRF472**

\$2.50

**MRF475**

**NPN SILICON RF POWER TRANSISTOR**

... designed primarily for use in single sideband linear amplifier output applications in citizens band and other communications equipment operating to 30 MHz.

- Characterized for Single Sideband and Large-Signal Amplifier Applications Utilizing Low-Level Modulation.
- Specified 13.6 V, 30 MHz Characteristics -
  - Output Power = 12 W (PEP)
  - Minimum Efficiency = 40% (SSB)
  - Output Power = 4.0 W (CW)
  - Minimum Efficiency = 50% (CW)
  - Minimum Power Gain = 10 dB (PEP & CW)
- Common Collector Characterization



\$5.00

**MHW710 - 2**

\$46.45

440 to 470MC

**UHF POWER AMPLIFIER MODULE**

... designed for 12.5 volt UHF power amplifier applications in industrial and commercial FM equipment operating from 400 to 512 MHz.

- Specified 12.5 Volt, UHF Characteristics -
  - Output Power = 13 Watts
  - Minimum Gain = 19.4 dB
  - Harmonics = 40 dB
- 50 Ω Input/Output Impedance
- Guaranteed Stability and Ruggedness
- Gain Control Pin for Manual or Automatic Output Level Control
- Thin Film Hybrid Construction Gives Consistent Performance and Reliability



**Tektronix Test Equipment**

B	Wideband High Gain Plug In	\$ 51.00
CA	Dual Trace Plug In	120.00
K	Fast Rise DC Plug In	63.00
N	Sampling Plug In	200.00
R	Transistor Risetime Plug In	116.00
W	High Gain Differential Comparator Plug In	293.00
TU-2	Test Load Plug In for 530/540/550 Main Frames	50.00
1A2	Wideband Dual Trace Plug In	216.00
151	Sampling Unit with 350PS Risetime DC to 1GHZ	730.00
2A61	AC Differential Plug In	133.00
353	Dual Trace Sampling DC to 1GHZ Plug In	250.00
3576	Dual Trace Sampling DC to 875MHZ Plug In	250.00
3177A	Sampling Sweep Plug In	250.00
3L10	Spectrum Analyzer 1 to 36MHZ Plug In	1000.00
50	Amplifier Plug In	50.00
51	Sweep Plug In	50.00
		25.00
53/54B	Wideband High Gain Plug In	45.00
53/54C	Dual Trace Plug In	112.50
53/54D	High Gain DC Differential Plug In	38.00
53/54G	Wideband DC Differential Plug In	68.00
		68.00
84	Test Plug In for 580/581 Main Frames	75.00
107	Square Wave Generator .4 to 1MHZ	48.00
RM122	Preamplifier 2Hz to 40KHZ	63.00
123	AC Coupled Preamplifier	25.00
131	Current Probe Amplifier	50.00
184	Time Mark Generator	363.00
8240	Program Control Unit	150.00
280	Trigger Countdown Unit	84.00
535A	DC to 15MHZ Scope Rack Mount	2000.00
543	DC to 33MHZ Scope	2500.00
561	DC to 10MHZ Scope Rack Mount	250.00
561A	DC to 10MHZ Scope Rack Mount	263.00
		300.00
		150.00
		200.00

**Scopes with Plug-ins**

561A	DC to 10MHZ Scope with a 3576 Dual Trace DC to 875MHZ Sampling Plug In and a 3177A Sweep Plug In. Rack Mount	600.00
565	DC to 10MHZ Dual Beam Scope with a 2A61 Diff. and a 2A61 Diff. Plug In's	900.00
581	DC to 80MHZ Scope with a 82 Dual Trace High Gain Plug In	650.00

**Tubes**

2E26	\$ 5.00	4CX350FJ	\$116.00	6146W	12.00
3-500Z	102.00	4CX1000A	300.00	6159	10.60
3-1000Z	268.00	4CX1500B	350.00	6161	75.00
3B26/866A	5.00	4CX15000A	750.00	6293	18.50
3X2500A3	150.00	4E27	50.00	6360	6.95
4-65A	45.00	4X150A	41.00	6907	40.00
4-125A	58.50	4X150D	52.00	6939	14.75
4-250A	68.50	4X150G	74.00	7360	12.00
4-400A	71.00	5728/1160L	39.00	7984	10.40
4-1000A	184.00	6L6	5.00	8072	49.00
5-500A	145.00	6L6	5.00	8106	2.00
4CX250B	65.00	811A	12.95	8156	7.85
4CX250F/G	55.00	813	29.00	8226	127.70
4CX250K	113.00	5894/A	42.00	8295/PL172	328.00
4CX250R	92.00	6146	5.00	8458	25.75
4CX300A	147.00	6146A	6.00	8560A/A5	50.00
4CX350A	107.00	6146B/8298A	7.00	8908	9.00
				8950	9.00

### FAIRCHILD VHF AND UHF PRESCALER CHIPS

95H90DC	350 MHz Prescaler Divide by 10/11	\$9.50
95H91DC	350 MHz Prescaler Divide by 5/6	9.50
11C90DC	650 MHz Prescaler Divide by 10/11	16.50
11C91DC	650 MHz Prescaler Divide by 5/6	16.50
11C83DC	1 GHz Divide by 248/256 Prescaler	29.90
11C70DC	600 MHz Flip/Flop with reset	12.30
11C58DC	ECL VCM	4.53
11C44DC/MC4044	Phase Frequency Detector	3.82
11C24DC/MC4024	Dual TTL VCM	3.82
11C06DC	UHF Prescaler 750 MHz D Type Flip/Flop	12.30
11C05DC	1 GHz Counter Divide by 4	50.00
11C01FC	High Speed Dual 5-4 input NO/NOR Gate	15.40

### CARBIDE — CIRCUIT BOARD DRILL BITS FOR PC BOARDS

Size: 35, 42, 47, 49, 51, 52	\$2.15
Size: 53, 54, 55, 56, 57, 58, 59, 61, 63, 64, 65	1.85
Size: 66	1.90
Size: 1.25 mm, 1.45 mm	2.00
Size: 3.20 mm	3.58

### CRYSTAL FILTERS: TYCO 001-19880 same as 2194F

10.7 MHz Narrow Band Crystal Filter	
3 dB bandwidth 15 kHz min. 20 dB bandwidth 60 kHz min. 40 dB bandwidth 150 kHz min.	
Ultimate 50 dB: Insertion loss 1.0 dB max. Ripple 1.0 dB max. Ct. 0 + / - 5 pf 3600 ohms.	\$5.95

### MURATA CERAMIC FILTERS

Models: SFB-455D 455 kHz	\$2.00
CFM-455E 455 kHz	7.95
SFE-10.7 10.7 MHz	5.95

### TEST EQUIPMENT — HEWLETT PACKARD — TEKTRONIX — ETC.

<b>Hewlett Packard:</b>		
608C	10 mc to 480 mc .1 uV to .5V into 50 ohms Signal Generator	500.00
608D	10 to 420 mc .1 uV to .5V into 50 ohms Signal Generator	500.00
612A	450 to 1230 mc .1 uV to .5V into 50 ohms Signal Generator	750.00
614A	900 to 2100 mc. Signal Generator	500.00
616A	1.8 to 4.2 Gc Signal Generator	400.00
616B	1.8 to 4.2 Gc Signal Generator	500.00
618A	3.8 to 7.2 Gc Signal Generator	400.00
618B	3.8 to 7.2 Gc Signal Generator	500.00
620A	7 to 11 Gc Signal Generator	500.00
623B	Microwave Test Set	900.00
626A	10 Gc to 15 Gc Signal Generator	2500.00

<b>Alltech:</b>		
473	225 to 400 mc AM/FM Signal Generator	750.00
<b>Singer:</b>		
MF5/VR-4	Universal Spectrum Analyzer with 1 kHz to 27.5 mc Plug In	1200.00
<b>Keltek:</b>		
XR630-100	TWT Amplifier 8 to 12.4 Gc 100 watts 40 dB gain	9200.00
<b>Polarad:</b>		
2038/2436/1102A	Calibrated Display with an SSB Analysis Module and a 10 to 40 mc Single Tone Synthesizer	1500.00

### RF TRANSISTORS

TYPE	PRICE	TYPE	PRICE	TYPE	PRICE
2N1561	\$15.00	2N5590	\$8.15	MM1550	\$10.00
2N1562	15.00	2N5591	11.85	MM1552	50.00
2N1692	15.00	2N5637	22.15	MM1553	56.50
2N1693	15.00	2N5641	6.00	MM1601	5.50
2N2632	45.00	2N5642	10.05	MM1602/2N5842	7.50
2N2857JAN	2.52	2N5643	15.82	MM1607	8.65
2N2876	12.35	2N6545	12.38	MM1661	15.00
2N2880	25.00	2N5764	27.00	MM1669	17.50
2N2927	7.00	2N5842	8.78	MM1943	3.00
2N2947	18.35	2N5849	21.29	MM2605	3.00
2N2948	15.50	2N5862	51.91	MM2608	5.00
2N2949	3.90	2N5913	3.25	MM8006	2.23
2N2950	5.00	2N5922	10.00	MMCM918	20.00
2N3287	4.30	2N5942	46.00	MMT72	1.17
2N3294	1.15	2N5944	8.92	MMT74	1.17
2N3301	1.04	2N5945	12.38	MMT2857	2.63
2N3302	1.05	2N5946	14.69	MRF245	33.30
2N3304	1.48	2N6080	7.74	MRF247	33.30
2N3307	12.60	2N6081	10.05	MRF304	43.45
2N3309	3.90	2N6082	11.30	MRF420	20.00
2N3375	9.32	2N6083	13.23	MRF450	11.85
2N3553	1.57	2N6084	14.66	MRF450A	11.85
2N3755	7.20	2N6094	7.15	MRF454	21.83
2N3818	6.00	2N6095	11.77	MRF458	20.68
2N3866	1.09	2N6096	20.77		
2N3866JAN	2.80	2N6097	29.54		
2N3866JANTX	4.49	2N6136	20.15	MRF502	1.08
2N3924	3.34	2N6166	38.60	MRF504	6.95
2N3927	12.10			MRF509	4.90
2N3950	26.86			MRF511	8.15
2N4072	1.80	2N6439	45.77	MRF901	3.00
2N4135	2.00	2N6459/PT9795	18.00	MRF5177	21.62
2N4261	14.60	2N6603	12.00	MRF8004	1.60
2N4427	1.20	2N6604	12.00	PT4186B	3.00
2N4957	3.62	A50-12	25.00	PT4571A	1.50
2N4958	2.92	BFR90	5.00	PT4612	5.00
2N4959	2.23	BLY568C	25.00	PT4628	5.00
2N4976	19.00	BLY568CF	25.00	PT4640	5.00
2N5090	12.31	CD3495	15.00	PT8659	10.72
2N5108	4.03	HEP76/S3014	4.95	PT9784	24.30
2N5109	1.66	HEPS3002	11.30	PT9790	41.70
2N5160	3.49	HEPS3003	29.88	SD1043	5.00
2N5179	1.05	HEPS3005	9.95	SD1116	3.00
2N5184	2.00	HEPS3006	19.90	SD1118	5.00
2N5216	47.50	HEPS3007	24.95	SD1119	3.00
2N5583	4.55	HEPS3010	11.34		
2N5589	6.82	HEPS5026	2.56		
		HP35831E/		TRWMRA2023-1.5	42.50
		HXTR5104	50.00	40281	10.90
		MM1500	32.20	40282	11.90
				40290	2.48

### CHIP CAPACITORS

1pf	27pf	220pf	1200pf
1.5pf	33pf	240pf	1500pf
2.2pf	39pf	270pf	1800pf
2.7pf	47pf	300pf	2200pf
3.3pf	56pf	330pf	2700pf
3.9pf	68pf	360pf	3300pf
4.7pf	82pf	390pf	3900pf
5.6pf	100pf	430pf	4700pf
6.8pf	110pf	470pf	5600pf
8.2pf	120pf	510pf	6800pf
10pf	130pf	560pf	8200pf
12pf	150pf	620pf	.010mf
15pf	160pf	680pf	.012mf
18pf	180pf	820pf	.015mf
22pf	200pf	1000pf	.018mf

We can supply any value chip capacitors you may need.

### PRICES

1 to 10	1.49
11 - 50	1.29
51 - 100	.89
101 - 1,000	.69
1,001 up	.49

### ATLAS CRYSTAL FILTERS FOR ATLAS HAM GEAR

5.52-2.7/8	
5.595-2.7/8/U	
5.595-.500/4/CW	
5.595-2.7LSB	
5.595-2.7USB	
5.645-2.7/8	
9.0USB/CW	

YOUR CHOICE \$4.99

YOUR CHOICE \$24.95

# MHz electronics

Toll Free Number  
800-528-0180  
(For orders only)

## 1900 MHz to 2500 MHz DOWN CONVERTER

This receiver is tunable a range of 1900 to 2500 mc and is intended for amateur radio use. The local oscillator is voltage controlled (i.e.) making the i-f range approximately 54 to 88 mc (Channels 2 to 7)

PC BOARD WITH DATA.....	\$19.99
PC BOARD WITH CHIP CAPACITORS 13.....	\$44.99
PC BOARD WITH ALL PARTS FOR ASSEMBLY.....	\$69.95
PC BOARD WITH ALL PARTS FOR ASSEMBLY PLUS 2N6603.....	\$89.00
PC BOARD ASSEMBLED AND TESTED.....	\$79.99
PC BOARD WITH ALL PARTS FOR ASSEMBLY, POWER SUPPLY AND ANTENNA.....	\$159.99
POWER SUPPLY ASSEMBLED AND TESTED.....	\$49.99
YAGI ANTENNA 4' LONG APPROX. 20 TO 23 dB GAIN.....	\$39.99
YAGI ANTENNA 4' WITH TYPE (N, BNC, SMA Connector).....	\$64.99
2300 MHz DOWN CONVERTER includes converter mounted in antenna, power supply, plus 90 DAY WARRANTY.....	\$259.99
2300 MHz DOWN CONVERTER HMR11, with dish antenna, plus SIX MONTH WARRANTY.....	\$200.00
OPTION #1 MRF902 in front end (7 dB noise figure).....	\$299.99
OPTION #2 2N6603 in front end (5 dB noise figure).....	\$359.99
<b>2300 MHz DOWN CONVERTER ONLY</b>	
10 dB Noise Figure 23 dB gain in box with N conn Input F conn Output.....	\$149.99
7 dB Noise Figure 23 dB gain in box with N conn Input F conn Output.....	\$169.99
5 dB Noise Figure 23 dB gain in box with SMA conn Input F conn Output.....	\$189.99
DATA IS INCLUDED WITH KITS OR MAY BE PURCHASED SEPARATELY.....	15.00

### Shipping and Handling Cost:

Receiver Kits and \$1.50. Power Supply add \$2.00. Antenna add \$5.00. Option 1/2 add \$3.00. For complete system add \$7.50.

## HOWARD/COLEMAN TVRO CIRCUIT BOARDS

### DUAL CONVERSION BOARD

This board provides conversion from the 3.7-4.2 band first to 900 MHz where gain and bandpass filtering are provided and, second, to 70 MHz. The board contains both local oscillators, one fixed and the other variable, and the second mixer. Construction is greatly simplified by the use of Hybrid IC amplifiers for the gain stages. Bare boards cost \$25.

### 47 pF CHIP CAPACITORS

For use with dual conversion board. Consists of 6-47 pF

### 70 MHz IF BOARD

This circuit provides about 43 dB gain with 50 ohm input and output impedance. It is designed to drive the HOWARD/COLEMAN TVRO Demodulator. The on-board band pass filter can be tuned for bandwidths between 20 and 35 MHz with a passband ripple of less than 1/2 dB. Hybrid ICs are used for the gain stages. Bare boards cost \$25.

### .01 pF CHIP CAPACITORS

For use with 70 MHz IF Board. Consists of 7-.01 pF

### DEMODULATOR BOARD

This circuit takes the 70 MHz center frequency satellite TV signals in the 10 to 200 millivolt range, detects them using a phase locked loop, deemphasizes and filters the result and amplifies the result to produce standard NTSC video. Other outputs include the audio subcarrier, a DC voltage proportional to the strength of the 70 MHz signal, and AFC voltage centered at about 2 volts DC. The bare board cost \$40.

### SINGLE AUDIO

This circuit recovers the audio signals from the 6.8 MHz frequency. The Miller 9051 coils are tuned to pass the 6.8 MHz subcarrier and the Miller 9052 coil tunes for recovery of the audio.

### DUAL AUDIO

Duplicate of the single audio but also covers the 6.2 range.

### DC CONTROL

This circuit controls the VTO's, AFC and the S Meter

### TERMS:

WE REGRET WE NO LONGER ACCEPT BANK CARDS.

PLEASE SEND POSTAL MONEY ORDER, CERTIFIED CHECK, CASHIER'S CHECK OR MONEY ORDER.

PRICES SUBJECT TO CHANGE WITHOUT NOTICE. ALL RETURN ORDERS ARE SUBJECT TO PRIOR APPROVAL BY MANAGEMENT

ALL CHECKS AND MONEY ORDERS IN US FUNDS ONLY.

ALL ORDERS SENT FIRST CLASS OR UPS.

ALL PARTS PRIME AND GUARANTEED.

WE WILL ACCEPT COD ORDERS FOR \$25.00 OR OVER. ADD \$2.50 FOR COD CHARGE.

PLEASE INCLUDE \$2.50 MINIMUM FOR SHIPPING OR CALL FOR CHARGES.

WE ALSO ARE LOOKING FOR NEW AND USED TUBES, TEST EQUIPMENT, COMPONENTS ETC.

WE ALSO SWAP OR TRADE.

FOR CATALOG SEE JANUARY, 1980, 73 Magazine, 10 Pages

(602) 242-8916

2111 W. Camelback  
Phoenix, Arizona 85015





We now have available a bunch of goodies too good to bypass. Items are limited so order today

716-586-3950

Call Your Phone Order in Today

TERMS: Satisfaction guaranteed or money refunded. C.O.D. add \$2.00. Minimum order \$6.00. Orders under \$10.00 add \$1.50. Add 5% for postage, insurance, handling. Overseas add 15%. N.Y. residents add 7% tax.

**MINI KITS - YOU HAVE SEEN THESE BEFORE NOW  
HERE ARE OLD FAVORITE AND NEW ONES TOO.  
GREAT FOR THAT AFTERNOON HOBBY.**

<p><b>FM MINI MIKE</b></p>  <p>A super high performance FM wireless mike kit! Transmits a stable signal up to 300 yards with exceptional audio quality by means of its built in electret mike. Kit includes case, mike, on-off switch, antenna, battery and super instructions. This is the finest unit available.</p> <p>FM-3 Kit <b>\$14.95</b> FM-3 Wired and Tested <b>19.95</b></p>	<p><b>Color Organ</b></p> <p>See music come alive! 3 different lights flicker with music. One light each for, high, mid-range and lows. Each individually adjustable and drives up to 300 W. runs on 110 VAC.</p> <p>Complete kit, ML-1 <b>\$8.95</b></p>	<p><b>Video Modulator Kit</b></p> <p>Converts any TV to video monitor. Super stable, tunable over ch. 4-6. Runs on 5-15V, accepts std. video signal. Best unit on the market! Complete kit, VD-1 <b>\$7.95</b></p>	<p><b>Super Sleuth</b></p> <p>A super sensitive amplifier which will pick up a pin drop at 15 feet! Great for monitoring baby's room or as general purpose amplifier. Full 2 W rms output, runs on 6 to 15 volts, uses 8-45 ohm speaker. Complete kit, BN-9 <b>\$5.95</b></p>	<p><b>CLOCK KITS</b></p> <p>Your old favorites are here again. Over 7,000 Sold to Date. Be one of the gang and order yours today!</p> <p>Try your hand at building the finest looking clock on the market. Its satin finish anodized aluminum case looks great anywhere, while six .4" LED digits provide a highly readable display. This is a complete kit, no extras needed, and it only takes 1-2 hours to assemble. Your choice of case colors: silver, gold, black (specify).</p> <p>Clock kit, 12/24 hour, DC-5 <b>\$24.95</b> Clock with 10 min. ID timer, 12/24 hour, DC-10 <b>\$29.95</b> Alarm clock, 12 hour only, DC-8 <b>\$29.95</b> 12V DC car clock, DC-7 <b>\$29.95</b></p> <p>For wired and tested clocks add \$10.00 to kit price. SPECIFY 12 OR 24 HOUR FORMAT</p>
	<p><b>FM Wireless Mike Kit</b></p>  <p>Transmits up to 300' to any FM broadcast radio, uses any type of mike. Runs on 3 to 9V. Type FM-2 has added sensitive mike preamp stage.</p> <p>FM-1 kit <b>\$3.95</b> FM-2 kit <b>\$4.95</b></p>	<p><b>Whisper Light Kit</b></p> <p>An interesting kit, small mike picks up sounds and converts them to light. The louder the sound, the brighter the light. Includes mike, controls up to 300 W, runs on 110 VAC. Complete kit, WL-1 <b>\$6.95</b></p>	<p><b>Tone Decoder</b></p>  <p>A complete tone decoder on a single PC board. Features: 400-5000 Hz adjustable range via 20 turn pot, voltage regulation, 567 IC. Useful for touch-tone burst detection, FSK, etc. Can also be used as a stable tone encoder. Runs on 5 to 12 volts. Complete kit, TD-1 <b>\$5.95</b></p>	<p><b>Siren Kit</b></p> <p>Produces upward and downward wail characteristic of a police siren. 5 W peak audio output, runs on 3-15 volts, uses 3-45 ohm speaker. Complete kit, SM-3 <b>\$2.95</b></p>
<p><b>Universal Timer Kit</b></p> <p>Provides the basic parts and PC board required to provide a source of precision timing and pulse generation. Uses 555 timer IC and includes a range of parts for most timing needs.</p> <p>UT-5 Kit <b>\$5.95</b></p>	<p><b>Mad Blaster Kit</b></p> <p>Produces LOUD ear shattering and attention getting siren like sound. Can supply up to 15 watts of obnoxious audio. Runs on 6-15 VDC. Complete kit, MB-1 <b>\$4.95</b></p>	<p><b>60 Hz Time Base</b></p> <p>Runs on 5-15 VDC. Low current (25ma) 1 min/month accuracy. TB-7 Kit <b>\$5.50</b> TB-7 Assy <b>\$9.95</b></p>	<p><b>Calendar Alarm Clock</b></p> <p>The clock that's got it all! 6-5" LEDs, 12/24 hour, snooze, 24 hour alarm, 4 year calendar, battery backup, and lots more. The super 7001 chip is used. Size 5x4x2 inches. Complete kit, less case (not available) DC-9 <b>\$34.95</b></p>	
			<p><b>Under Dash Car Clock</b></p> <p>12/24 hour clock in a beautiful plastic case features 6 jumbo RED LEDs, high accuracy (.001%), easy 3 wire hookup, display blanks with ignition, and super instructions. Optional dimmer automatically adjusts display to ambient light level. DC-11 clock with mtg. bracket <b>\$27.95 kit</b> DM-1 dimmer adapter Add \$10.00 Assy. and Test <b>\$2.50</b></p>	
			<p><b>Video Terminal</b></p> <p>A completely self-contained, stand alone video terminal card. Requires only an ASCII keyboard and TV set to become a complete terminal unit. Features are: single 5V supply, XTAL, controlled sync and baud rates (to 9600), complete computer and keyboard control of cursor, parity error control and display. Accepts and generates serial ASCII plus parallel keyboard input. The 6416 is 64 char by 16 lines with scrolling, upper and lower case (optional) and has RS-232 and 20ma loop interfaces on board. Kits include sockets and complete documentation. RE 6416, terminal card kit (add \$60.00 for wired unit) <b>\$189.95</b> Lower Case option <b>\$13.95</b> Power Supply <b>\$14.95</b> RF Modulator kit <b>\$7.95</b></p>	

**PARTS PARADE**

<p><b>IC SPECIALS</b></p>		<p><b>Resistor Ass't</b></p> <p>Assortment of Popular values - 1/4 watt. Cut lead for PC mounting, 1/2" center, 1/8" leads, bag of 300 or more. <b>\$1.50</b></p>	<p><b>Crystals</b></p> <p>3.579545 MHz <b>\$1.50</b> 10.00000 MHz <b>\$5.00</b> 5.248800 MHz <b>\$5.00</b></p>	<p><b>Audio Prescaler</b></p> <p>Make high resolution audio measurements, great for musical instrument tuning, PL tones, etc. Multiplies audio UP in frequency, selectable x10 or x100, gives .01 HZ resolution with 1 sec. gate time! High sensitivity of 25 mv, 1 meg input z and built-in filtering gives great performance. Runs on 9V battery, all CMOS.</p> <p>PS-2 kit <b>\$29.95</b> PS-2 wired <b>\$39.95</b></p>	<p><b>600 MHz PRESCALER</b></p>  <p>Extend the range of your counter to 600 MHz. Works with all counters. Less than 150 mv sensitivity, specify -10 or -100</p> <p>Wired, tested, PS-1B <b>\$59.95</b> Kit, PS-1B <b>\$44.95</b></p>
<p><b>LINEAR</b></p> <p>301 <b>\$ .35</b> 324 <b>\$1.50</b> 380 <b>\$1.50</b> 555 <b>\$ .45</b> 556 <b>\$1.00</b> 565 <b>\$1.00</b> 566 <b>\$1.00</b> 567 <b>\$1.25</b> 741 <b>10/\$2.00</b> 1458 <b>\$ .50</b> 3900 <b>\$ .50</b> 3914 <b>\$2.95</b> 3038 <b>\$2.95</b></p>	<p><b>TTL</b></p> <p>74S00 <b>\$ .40</b> 7447 <b>\$ .65</b> 7475 <b>\$ .50</b> 7490 <b>\$ .50</b> 74196 <b>\$1.35</b></p>	<p><b>Switches</b></p> <p>Mini toggle SPDT <b>\$1.00</b> Red Pushbuttons N.O. <b>3/\$1.00</b></p>	<p><b>AC Adapters</b></p> <p>Good for clocks, nicad chargers, all 110 VAC plug one end.</p> <p>8.5 vdc @ 20 mA <b>\$1.00</b> 16 vac @ 160mA <b>\$2.50</b> 12 vac @ 250mA <b>\$3.00</b></p>	<p><b>30 Watt 2 mtr PWR AMP</b></p> <p>Simple Class C power amp features 8 times power gain, 1 W in for 8 out, 2 W in for 15 out, 4W in for 30 out. Max output of 35 W, incredible value, complete with all parts, less case and T-R relay.</p> <p>PA-1, 30 W pwr amp kit <b>\$22.95</b> TR-1, RF sensed T-R relay kit <b>6.95</b></p>	
<p><b>CMOS</b></p> <p>4011 <b>.50</b> 4013 <b>.50</b> 4046 <b>\$1.85</b> 4049 <b>.50</b> 4059 <b>\$9.00</b> 4511 <b>\$2.00</b> 4518 <b>\$1.35</b> 4639 <b>\$1.75</b></p>	<p><b>SPECIAL</b></p> <p>11C90 <b>\$15.00</b> 10116 <b>\$ 1.25</b> 7208 <b>\$17.50</b> 7207A <b>\$ 5.50</b> 7216D <b>\$21.00</b> 7107C <b>\$12.50</b> 5314 <b>\$ 2.95</b> 5375AB/G <b>\$ 2.95</b> 7001 <b>\$ 6.50</b></p>	<p><b>Earphones</b></p> <p>3" leads, 8 ohm, good for small tone speakers, alarm clocks, etc. 5 for \$1.00</p>	<p><b>Solid State Buzzers</b></p> <p>small buzzer 450 Hz, 86 dB, sound output on 5-12 vdc at 10-30 mA, TTL compatible. <b>\$1.50</b></p>	<p><b>Power Supply Kit</b></p> <p>Complete triple regulated power supply provides variable 6 to 18 volts at 200 ma and +5 at 1 Amp. Excellent load regulation, good filtering and small size. Less transformers, requires 6.3 V @ 1 A and 24 VCT. Complete kit, PS-3LT <b>\$6.95</b></p>	
<p><b>READOUTS</b></p> <p>ND 359 4" C.C. <b>\$1.00</b> ND 507/510 5" C.A. <b>1.00</b> AAN 72/HP7730 33" C.A. <b>1.00</b> HP 7651 43" C.A. <b>2.00</b></p>	<p><b>Sockets</b></p> <p>8 Pin <b>10/\$2.00</b> 14 Pin <b>10/\$2.00</b> 16 Pin <b>10/\$2.00</b> 24 Pin <b>4/\$2.00</b> 28 Pin <b>4/\$2.00</b> 40 Pin <b>3/\$2.00</b></p>	<p><b>DC-DC Converter</b></p> <p>+5 vdc input prod. -9 vdc @ 30ma +9 vdc produces -15 vdc @ 35ma <b>\$1.25</b></p>	<p><b>Ceramic IF Filters</b></p> <p>Mini ceramic filters 7 kHz B.W. 455 kHz <b>\$1.50 ea.</b></p>	<p><b>OP-AMP Special</b></p> <p>BI-FET LF 13741 - Direct pin for pin 741 compatible, but 500,000 MEG input z, super low 50 pa input current, low power drain.</p> <p>50 for only <b>\$9.00</b> 10 for <b>\$2.00</b></p>	
<p><b>TRANSISTORS</b></p> <p>N3904 NPN C-F <b>15/\$1.00</b> N3906 PNP C-F <b>15/\$1.00</b> N4403 PNP C-F <b>15/\$1.00</b> N4410 NPN C-F <b>15/\$1.00</b> N4916 FET C-F <b>4/\$1.00</b> N5401 PNP C-F <b>5/\$1.00</b> N6028 C-F <b>4/\$1.00</b> N3771 NPN Silicon <b>\$1.50</b> N5179 UHF NPN <b>3/\$2.00</b> Power Tab NPN 40W <b>3/\$1.00</b> Power Tab PNP 40W <b>3/1.00</b> MPF 102/2N5484 <b>\$.50</b> NPN 3904 Type T-R <b>50/\$2.50</b> PNP 3906 Type T-R <b>50/\$2.50</b> N3055 <b>\$.80</b> N2646 LJT <b>3/\$2.00</b></p>	<p><b>Diodes</b></p> <p>5.1 V Zener <b>20/\$1.00</b> 1N914 Type <b>50/\$1.00</b> 1KV 2Amp <b>8/\$1.00</b> 100V 1Amp <b>15/\$1.00</b></p>	<p><b>Crystal Microphone</b></p> <p>Small 1" diameter 1/2" thick crystal mike cartridge <b>.75</b></p>	<p><b>Mini RG-174 Coax</b></p> <p>10 ft. for <b>\$1.00</b></p>	<p><b>Regulators</b></p> <p>7812 <b>\$1.00</b> 7815 <b>\$1.00</b> 7905 <b>\$1.25</b> 7912 <b>\$1.25</b> 7915 <b>\$1.25</b></p>	
	<p><b>25 AMP 100V Bridge</b></p> <p><b>\$1.50 each</b></p>	<p><b>Coax Connector</b></p> <p>Chassis mount BNC type <b>\$1.00</b></p>	<p><b>9 Volt Battery Clips</b></p> <p>Nice quality clips <b>5 for \$1.00</b> 1/4" Rubber Grommets <b>10 for \$1.00</b></p>	<p><b>Shrink Tubing Nubs</b></p> <p>Nice precut pcs of shrink size: 1" x 1/4" shrink to 1/8". Great for splices. <b>50/\$1.00</b></p>	
	<p><b>Mini-Bridge 50V 1 AMP</b></p> <p><b>2 for \$1.00</b></p>	<p><b>Parts Bag</b></p> <p>Asst of chokes, disc caps, tant. resistors, transistors, diodes, MICA caps etc. sm bag (100 pc) <b>\$1.00</b> lg. bag (300 pc) <b>\$2.50</b></p>	<p><b>Connectors</b></p> <p>6 pin type gold contacts for mA-1003 car clock module price <b>.75 ea.</b></p>	<p><b>Mini TO-92 Heat Sinks</b></p> <p>Thermalloy Brand <b>5 for \$1.00</b> To-220 Heat Sinks <b>3 for \$1.00</b></p>	
		<p><b>Leds - your choice, please specify</b></p> <p>Mini Red, Jumbo Red, High Intensity Red, Illuminator Red <b>8/\$1</b> Mini Yellow, Jumbo Yellow, Jumbo Green <b>6/\$1</b></p>		<p><b>Opto Isolators - 4N28 type</b></p> <p>Opto Reflectors - Photo diode + LED <b>\$1.00 ea.</b></p>	
		<p><b>Varactors</b></p> <p>Motorola MV 2209 30 PF Nominal cap 20-80 PF - Tunable range - <b>.50 each or 3/\$1.00</b></p>		<p><b>Molex Pins</b></p> <p>Molex already precut in length of 7. Perfect for 14 pin sockets. <b>20 strips for \$1.00</b></p>	

# SEMICONDUCTORS SURPLUS

2822 North 32nd Street, #1 • Phoenix, Arizona 85008 • Phone 602-956-9423 ✓64

## MEMORY

	Description	Price
2708	1K x 8 Eprom	\$ 5.00
2716/2516	2K x 8 5V single supply	9.99
2114/9114	1K x 4 Static	5.00
4027	4K x 1 Dynamic Ram	2.99
2117/4116	16K x 1 Dynamic Ram	5.00
2732-6	32K Eprom	39.95

## C.P.U.'s, Etc.

MC6800P	Microprocessor	9.99
MC68B21P	PIA	6.99
MC6845P	CRT Controller	25.00
MC6850P	ACIA	4.99
MC6852P	SSDA	5.00
8008-1	Microprocessor	5.00
8080A	Microprocessor	5.00
Z80A	Microprocessor	10.99
Z80	Microprocessor	8.99
Z80A	PIO	9.99
Z80	SIO/O	22.50
Z80	SIO/I	22.50
8212	8 Bit input/output part	3.99
8251	Communication Interface	6.99
TR1602/AY5-1013	UART	6.99
TMS1000NL	Four Bit Microprocessor	4.99
PT1482B	PSAT	5.99
8257	DMA Controller	8.99
3341	64 x 4 FIFO	3.00
MM5316/F3817	Clock with alarm	5.99
8741		60.00
8748	8 Bit Microcomputer with programmable/erasable EPROM	60.00
MC1408L/6	6 Bit D/A	3.25
COM2502		9.99
COM2601		9.99

## CRYSTAL FILTERS

TYCO 001-19880 Same as 2194F  
 10.7 MHz narrow band  
 3 dB bandwidth 15 KHz min.  
 20 dB bandwidth 60 KHz min.  
 40 dB bandwidth 150 KHz min.  
 Ultimate 50 dB insertion loss 1 dB max.  
 Ripple 1 dB max. Ct. 0+/-5 pf -3600 Ohms  
 \$3.99 each

MRF454, same as MRF458 12.5 VDC, 3-30 MHz  
 80 Watts output, 12 dB gain \$17.95 each

## MRF472

12.5 VDC, 27 MHz  
 4 Watts output, 10 dB gain  
 \$1.69 each

CARBIDE CIRCUIT BOARD DRILL BITS  
 for PCB Boards  
 5 mix for \$5.00

## MURATA CERAMIC FILTERS

SFD 455D	455 KHz	\$2.00
SFB 455D	455 KHz	1.60
CFM 455E	455 KHz	5.50
SFE 10.7 MA	10.7 MHz	2.99

## ATLAS CRYSTAL FILTERS FOR ATLAS HAM GEAR

5.52 - 2.7/8	
5.595 - 2.7/8/U	
5.645 - 2.7/8	
5.595 - .500/4/CW	YOUR CHOICE
5.595 - 2.7 USB	\$12.99 each
5.595 - 2.7/8/L	
5.595 - 2.7 LSB	
9.0 - USB/CW	

J310 N-CHANNEL J-FET 450 MHz  
 Good for VHF/UHF Amplifier,  
 Oscillator and Mixers 3/\$1.00

## AMPHENOL COAX RELAY

26 VDC Coil SPDT #360-11892-13  
 100 Watts Good up to 18 GHz  
 \$19.99 each

78M05 Same as 7805 but only 1/2 Amp @  
 5 VDC 49¢ each or 10/\$3.00

## NEW TRANSFORMERS

F-18X	6.3 VCT @ 6 Amps	\$6.99 ea
F-46X	24 V @ 1 Amp	5.99 ea
F-41X	25.2 VCT @ 2 Amps	6.99 ea
P-8380	10 VCT @ 3 Amps	7.99 ea
P-8604	20 VCT @ 1 Amp	4.99 ea
P-8130	12.6 VCT @ 2 Amps	4.99 ea
K-32B	28 VCT @ 100 MA	4.99 ea
E30554	Dual 17V @ 1Amp ea.	6.99 ea

EIMAC FINGER STOCK #Y-302  
 36 in. long x 1/2 in. \$4.99 each

NO ORDERS UNDER \$10

# SEMICONDUCTORS SURPLUS

2822 North 32nd Street, #1 • Phoenix, Arizona 85008 • Phone 602-956-9423

MRF203	\$P.O.R.	BFW92A	\$ 1.00
MRF216	19.47	BFW92	.79
MRF221	8.73	MMCM913	14.30
MRF226	10.20	MMCM2222	15.65
MRF227	2.13	MMCM2369	15.00
MRF238	10.00	MMCM2484	15.25
MRF240	14.62	MMCM3960A	24.30
MRF245	28.87	MWA110	6.92
MRF247	28.87	MWA120	7.38
MRF262	6.25	MWA130	8.08
MRF314	12.20	MWA210	7.46
MRF406	11.33	MWA220	8.08
MRF412	20.65	MWA230	8.62
MRF421	27.45	MWA310	8.08
MRF422A	38.25	MWA320	8.62
MRF422	38.25	MWA330	9.23
MRF428	38.25		
MRF428A	38.25	TUBES	
MRF426	8.87	6KD6	\$ 5.00
MRF426A	8.87	6LQ6/6JE6	6.00
MRF449	10.61	6MJ6/6LQ6/6JE6C	6.00
MRF449A	10.61	6LF6/6MH6	5.00
MRF450	11.00	12BY7A	4.00
MRF450A	11.77	2E26	4.69
MRF452	15.00	4X150A	29.99
MRF453	13.72	4CX250B	45.00
MRF454	21.83	4CX250R	69.00
MRF454A	21.83	4CX300A	109.99
MRF455	14.08	4CX350A/8321	100.00
MRF455A	14.08	4CX350F/J/8904	100.00
MRF472	2.50	4CX1500B/8660	300.00
MRF474	3.00	811A	20.00
MRF475	2.90	6360	4.69
MRF476	2.25	6939	7.99
MRF477	10.00	6146	5.00
MRF485	3.00	6146A	5.69
MRF492	20.40	6146B/8298	7.95
MRF502	.93	6146W	12.00
MRF604	2.00	6550A	8.00
MRF629	3.00	8908	9.00
MRF648	26.87	8950	9.00
MRF901	3.99	4-400A	71.00
MRF902	9.41	4-400C	80.00
MRF904	3.00	572B/T160L	44.00
MRF911	4.29	7289	9.95
MRF5176	11.73	3-1000Z	229.00
MRF8004	1.39	3-500Z	129.99
BFR90	1.00		
BFR91	1.25	TO-3 TRANSISTOR SOCKETS	
BFR96	1.50	Phenolic type 6/\$1.00	

UHF/VHF RF POWER TRANSISTORS  
 CD2867/2N6439  
 60 Watts output  
 Reg. Price \$45.77  
 SALE PRICE \$19.99

1900 MHz to 2500 MHz DOWNCONVERTERS  
 Intended for amateur radio use  
 Tunable from channel 2 thru 6  
 34 dB gain 2.5 - 3 dB noise  
 Warranty for 6 months  
 Model HMR II with dish antenna  
 Complete Receiver and Power Supply  
 \$225.00 (does not include coax)  
 4 foot Yagi antenna only  
 \$39.99

Downconverter Kit - PCB and parts  
 \$69.95  
 Power Supply Kit - Box, PCB and parts  
 \$49.99

Downconverter assembled  
 \$79.99  
 Power Supply assembled  
 \$59.99

Complete Kit with Yagi antenna  
 \$109.99

#### REPLACEMENT PARTS

MRF901 \$ 3.99  
 MBD101 1.29  
 .001 Chip Caps 1.00  
 Power supply PCB 4.99  
 Downconverter PCB 19.99

Bogner down converter, industrial version. 1  
 year guarantee \$225.00

86 PIN MOTOROLA BUS EDGE CONNECTORS  
 Gold plated contacts  
 Dual 43/86 pin .156 spacing  
 Solder tail for PCB \$3.00 each

CONTINUOUS TONE BUZZERS  
 12 VDC \$2.00 each

110 VAC MUFFIN FANS  
 New \$11.95 Used \$5.95

PL-259 TERMINATION 52 Ohm 5 Watts  
 \$1.50 each

NO ORDERS UNDER \$10

# SEMICONDUCTORS SURPLUS

2822 North 32nd Street, #1 • Phoenix, Arizona 85008 • Phone 602-956-9423

2N2857JAN	\$ 2.50
2N2949	3.60
2N2947	15.00
2N2950	4.60
2N3375	8.00
2N3553	1.57
2N3818	5.00
2N3866	1.00
2N3866JAN	2.50
2N3866JANTX	4.00
2N3925	10.00
2N3948	2.00
2N3950	25.00
2N3959	3.00
2N3960JANTX	10.00
2N4072	1.60
2N4427	1.10
2N4429	7.00
2N4877	1.00
2N4959	2.00
2N4976	15.00
2N5070	8.00
2N5071	15.00
2N5108	4.00
2N5109	1.50
2N5179	1.00
2N5583	4.00
2N5589	6.00
2N5590	8.00
2N5591	11.00
2N5635	5.44
2N5636	11.60
2N5637	20.00
2N5641	5.00
2N5643	14.00
2N5645	10.00
2N5842	8.00
2N5849	20.00
2N5942	40.00
2N5946	14.00
2N5862	50.00
2N6080	7.00
2N6081	10.00
2N6082	11.00
2N6083	13.00
2N6084	14.00
2N6095	11.00
2N6096	20.00

2N6097	\$28.00
2N6166	38.00
2N6368	22.99
2N6439	40.00
A210/MRF517	2.00
BLY38	5.00
40280/2N4427	1.10
40281/2N3920	7.00
40282/2N3927	10.48

NE555V TIMERS  
39¢ each or 10/\$3.00

NEW DUAL COLON LED  
69¢ each or  
10/\$5.00

HEP170 1000 PIV  
2.5 Amps 25¢ each or  
100/\$15.00

HIGH VOLTAGE CAPS  
420 MFD @ 400 VDC OR  
600 MFD @ 400 VDC  
\$6.99 each

NEW ROTRON BISCUIT FANS  
Model BT2A1 115 VAC  
\$12.99 each

TORIN TA700 FANS NEW  
Model A30340  
230 VAC @ .78 Amps  
Will also work on 115 VAC  
\$29.99 each

DOOR KNOB CAPS  
470 pf @ 15 KV \$3.99 each  
Dual 500 pf @ 15 KV 5.99 each  
680 pf @ 6 KV 3.99 each  
800 pf @ 15 KV 3.99 each  
1000 pf @ 20 KV 5.00 each  
2700 pf @ 40 KV 5.99 each

NEW & USED BCD SWITCHES  
3 switch with end plates  
New \$8.99  
Used \$6.95

## ORDERING INSTRUCTIONS

Check, money order, or credit cards welcome. (Mastercharge and VISA only) No personal checks or certified personal checks for foreign countrys accepted. Money order or cashiers check in U.S. funds only. Letters of credit are not acceptable.

Minimum shipping by UPS is \$2.35 with insurance. Please allow extra shipping charges for heavy or long items.

All parts returned due to customer error will be subject to a 15% restock charge.

If we are out of an item ordered, we will try to replace it with an equal or better part unless you specify not to, or we will back order the item, or refund your money.

PRICES ARE SUBJECT TO CHANGE WITHOUT NOTICE. Prices superseade all previously published. Some items offered are limited to small quantities and are subject to prior sale.

We now have a toll free number but we ask that it be used for CHARGE ORDERS ONLY. If you have any questions please use our other number. We are open from 8:00 a.m. - 5:00 p.m. Monday thru Saturday

Our toll free number for orders only is 800-528-3611.

JUMBO LED's		MEDIUM LED's
Red	8/\$1.00	Red 6/\$1.00
Clear	6/\$1.00	Green 6/\$1.00
Yellow	6/\$1.00	
Green	6/\$1.00	
Amber	6/\$1.00	

NEW G.E. OPTO COUPLERS 4N26  
69¢ each or 10/\$5.00

MICRO-MINI WATCH CRYSTALS  
32.768 Hz \$3.00 each

NEW 2 inch ROUND SPEAKERS  
100 Ohm coil 99¢ each

PLASTIC TO-3 SOCKETS 4/\$1.00

NO ORDERS UNDER \$10

# Quality VHF/UHF Kits at Affordable Prices ~

## These Low Cost SSB TRANSMITTING CONVERTERS

Let you use inexpensive recycled 10M or 2M SSB exciters on UHF & VHF!

- Linear Converters for SSB, CW, FM, etc.
- A fraction of the price of other units; no need to spend \$300 - \$400!
- Use with any exciter; works with input levels as low as 1 mW.
- Use low power tap on exciter or simple resistor attenuator pad (instructions included).
- Link osc with RX converter for transceive.

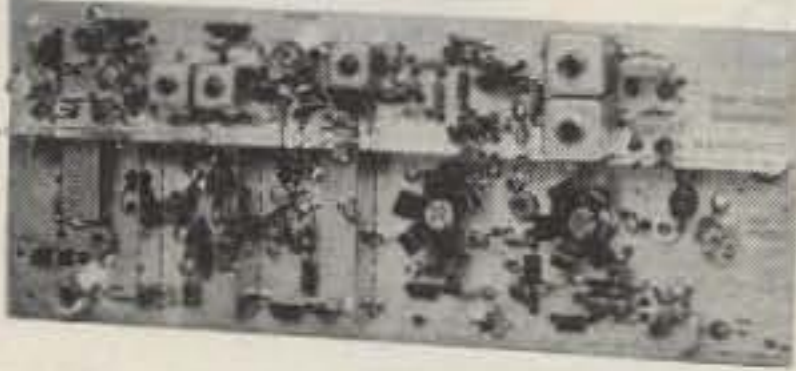

### XV4 UHF KIT — ONLY \$99.95

28-30 MHz in, 435-437 MHz out; 1W p.e.p. on ssb, up to 1½W on CW or FM. Has second oscillator for other ranges. Atten. supplied for 1 to 500 mW input, use external attenuator for higher levels.

Extra crystal for 432-434 MHz range ..... \$5.95  
XV4 Wired and tested ..... \$149.95

### XV2 VHF KIT - ONLY \$69.95

2W p.e.p. output with as little as 1mW input. Use simple external attenuator. Many freq. ranges available.

MODEL	INPUT (MHz)	OUTPUT (MHz)
XV2-1	28-30	50-52
XV2-2	28-30	220-222
XV2-4	28-30	144-146
XV2-5	28-29 (27-27.4 CB)	145-146 (144-144.4)
XV2-7	144-146	50-52

XV2 Wired and tested ..... \$109.95

### XV28 2M ADAPTER KIT - \$24.95

Converts any 2M exciter to provide the 10M signal required to drive above 220 or 435 MHz units.



### NEW! COMPLETE TRANSMITTING CONVERTER AND PA IN ATTRACTIVE CABINET

Far less than the cost of many 10W units!

Now, the popular Hamtronics® Transmitting Converters and heavy duty Linear Power Amplifiers are available as complete units in attractive, shielded cabinets with BNC receptacles for exciter and antenna connections. Perfect setup for versatile terrestrial and OSCAR operations! Just right for phase 3! You save \$30 when you buy complete unit with cabinet under cost of individual items. Run 40-45 Watts on VHF or 30-40 Watts on UHF with one integrated unit! Call for more details.

MODEL	KIT	WIRED and TESTED
XV2/LPA2-45/Cabt (6, 2, or 220)	\$199.95	\$349.95
XV4/LPA4-30/Cabt (for UHF)	\$229.95	\$399.95

## Easy to Build FET RECEIVING CONVERTERS

Let you receive OSCAR and other exciting VHF and UHF signals on your present HF or 2M receiver



- NEW LOW-NOISE DESIGN
- ATTRACTIVE WOODGRAIN CASE
- Less than 2dB noise figure, 20dB gain

MODEL	RF RANGE	OUTPUT RANGE
CA28	28-32 MHz	144-148 MHz
CA50	50-52	28-30
CA50-2	50-54	144-148
CA144	144-146	28-30
CA145	145-147-or-144-144.4	28-30 27-27.4 (CB)
CA146	146-148	28-30
CA220	220-222	28-30
CA220-2	220-224	144-148
CA110	Any 2MHz of Aircraft Band	26-28 or 28-30
CA432-2	432-434	28-30
CA432-5	435-437	28-30
CA432-4	432-436	144-148

Easily modified for other rf and if ranges.

STYLE	VHF	UHF
Kit less case	\$34.95	\$49.95
Kit with case	\$39.95	\$54.95
Wired/Tested in case	\$54.95	\$64.95

## Professional Quality VHF/UHF FM/CW EXCITERS

- Double tuned circuits for spurious suppression
- Easy to align with built-in test aids



T51-30	10 Meter, 2W Kit	\$44.95
T51-50	6 Meter, 2W Kit	\$44.95
T51-150	2 Meter, 2W Kit	\$44.95
T51-220	220 MHz, 2W Kit	\$44.95
T450	450 MHz, 3/4W Kit	\$44.95
T451	450 MHz, 3 W Kit	\$59.95
A14T	5 Chan Adapter (T51&T451)	\$9.95

## See our Complete Line of VHF & UHF Linear PA's

- Use as linear or class C PA
- For use with SSB Xmtg Converters, FM Exciters, etc.

LPA2-15	6M, 2M, 220; 15 to 20W	\$59.95
LPA2-30	6M, 2m; 25 to 30W	\$89.95
LPA2-40	220 MHz; 30 to 40W	\$119.95
LPA2-45	6M, 2M; 40 to 45W	\$119.95
LPA4-10	430MHz; 10 to 14W	\$79.95
LPA4-30	430MHz; 30-40W	\$119.95

See catalog for complete specifications

## FAMOUS HAMTRONICS PREAMPS

Let you hear the weak ones too!

Great for OSCAR, SSB, FM, ATV. Over 14,000 in use throughout the world on all types of receivers.



- NEW LOW-NOISE DESIGN
- Less than 2 dB noise figure, 20 dB gain
- Case only 2 inches square
- Specify operating frequency when ordering

MODEL P-30 VHF PREAMP, available in many versions to cover bands 28-300 MHz.

MODEL P432 UHF PREAMP, available in versions to cover bands 300-650 MHz.

STYLE	VHF	UHF
Kit less case	\$12.95	\$18.95
Kit with case	\$18.95	\$26.95
Wired/Tested in Case	\$27.95	\$32.95

## NEW VHF/UHF FM RCVRs

Offer Unprecedented Range of Selectivity Options

- New generation
- More sensitive
- More selective
- Low cross mod
- Uses crystal filters
- Smaller
- Easy to align



R75A\* VHF Kit for monitor or weather satellite service. Uses wide L-C filter. -60dB at ± 30 kHz..... \$69.95

R75B\* VHF Kit for normal nbfm service. Equivalent to most transceivers. -60dB at ± 17 kHz, -80dB at ± 25 kHz... \$74.95

R75C\* VHF Kit for repeater service or high rf density area. -60dB at ± 14kHz, -80dB ± 22kHz, -100dB ± 30kHz... \$84.95

R75D\* VHF Kit for split channel operation or repeater in high density area. Uses 8-pole crystal filter. -60dB at ± 9kHz, -100dB at ± 15kHz. The ultimate receiver!... \$99.95

\* Specify band: 10M, 6M, 2M, or 220 MHz. May also be used for adjacent commercial bands. Use 2M version for 137 MHz WX satellites.

R450( ) UHF FM Receiver Kits, similar to R75, but for UHF band. New low-noise front end. Add \$10 to above prices. (Add selectivity letter to model number as on R75.)

A14 5 Channel Adapter for Receivers..... \$9.95

## NEW R110 VHF AM RCVR

AM monitor receiver kit similar to R75A, but AM. Available for 10-11M, 6M, 2M, 220 MHz, and 110-130 MHz aircraft band \$74.95. (Also available in UHF version.)

## IT'S EASY TO ORDER!

- Write or phone 716-392-9430 (Electronic answering service evenings & weekends)
- Use Credit Card, UPS COD, Check, Money Order
- Add \$2.00 shipping & handling per order

Call or Write to get **FREE CATALOG** With Complete Details

(Send 4 IRC's for overseas mailing)

HAMTRONICS® IS A REGISTERED TRADEMARK

# hamtronics, inc.

65N MOUL RD · HILTON, NY 14468

ramsey

# the first name in Counters!



## 9 DIGITS 600 MHz \$129<sup>95</sup> WIRED

**PRICES:**

CT-90 wired, 1 year warranty	\$129.95
CT-90 Kit, 90 day parts warranty	109.95
AC-1 AC adapter	3.95
BP-1 Nicad pack + AC Adapter/Charger	12.95
OV-1, Micro-power Oven time base	49.95
External time base input	14.95

The CT-90 is the most versatile, feature packed counter available for less than \$300.00! Advanced design features include; three selectable gate times, nine digits, gate indicator and a unique display hold function which holds the displayed count after the input signal is removed. Also, a 10MHz TCXO time base is used which enables easy zero beat calibration checks against WWV. Optionally, an internal nicad battery pack, external time base input and Micro-power high stability crystal oven time base are available. The CT-90, performance you can count on!

**SPECIFICATIONS:**

Range:	20 Hz to 600 MHz
Sensitivity:	Less than 10 MV to 150 MHz Less than 50 MV to 500 MHz
Resolution:	0.1 Hz (10 MHz range) 1.0 Hz (60 MHz range) 10.0 Hz (600 MHz range)
Display:	9 digits 0.4" LED
Time base:	Standard-10.000 MHz, 1.0 ppm 20-40°C. Optional Micro-power oven-0.1 ppm 20-40°C
Power:	8-15 VAC @ 250 ma

## 7 DIGITS 525 MHz \$99<sup>95</sup> WIRED



**SPECIFICATIONS:**

Range:	20 Hz to 525 MHz
Sensitivity:	Less than 50 MV to 150 MHz Less than 150 MV to 500 MHz
Resolution:	1.0 Hz (5 MHz range) 10.0 Hz (50 MHz range) 100.0 Hz (500 MHz range)
Display:	7 digits 0.4" LED
Time base:	1.0 ppm TCXO 20-40°C
Power:	12 VAC @ 250 ma

The CT-70 breaks the price barrier on lab quality frequency counters. Deluxe features such as; three frequency ranges - each with pre-amplification, dual selectable gate times, and gate activity indication make measurements a snap. The wide frequency range enables you to accurately measure signals from audio thru UHF with 1.0 ppm accuracy - that's .0001%! The CT-70 is the answer to all your measurement needs, in the field, lab or ham shack.

**PRICES:**

CT-70 wired, 1 year warranty	\$99.95
CT-70 Kit, 90 day parts warranty	84.95
AC-1 AC adapter	3.95
BP-1 Nicad pack + AC adapter/charger	12.95



## 7 DIGITS 500 MHz \$79<sup>95</sup> WIRED

**PRICES:**

MINI-100 wired, 1 year warranty	\$79.95
MINI-100 Kit, 90 day part warranty	59.95
AC-Z Ac adapter for MINI-100	3.95
BP-Z Nicad pack and AC adapter/charger	12.95

Here's a handy, general purpose counter that provides most counter functions at an unbelievable price. The MINI-100 doesn't have the full frequency range or input impedance qualities found in higher price units, but for basic RF signal measurements, it can't be beat! Accurate measurements can be made from 1 MHz all the way up to 500 MHz with excellent sensitivity throughout the range, and the two gate times let you select the resolution desired. Add the nicad pack option and the MINI-100 makes an ideal addition to your tool box for "in-the-field" frequency checks and repairs.

**SPECIFICATIONS:**

Range:	1 MHz to 500 MHz
Sensitivity:	Less than 25 MV
Resolution:	100 Hz (slow gate) 1.0 KHz (fast gate)
Display:	7 digits, 0.4" LED
Time base:	2.0 ppm 20-40°C
Power:	5 VDC @ 200 ma

## 8 DIGITS 600 MHz \$159<sup>95</sup> WIRED



**SPECIFICATIONS:**

Range:	20 Hz to 600 MHz
Sensitivity:	Less than 25 mv to 150 MHz Less than 150 mv to 600 MHz
Resolution:	1.0 Hz (60 MHz range) 10.0 Hz (600 MHz range)
Display:	8 digits 0.4" LED
Time base:	2.0 ppm 20-40°C
Power:	110 VAC or 12 VDC

The CT-50 is a versatile lab bench counter that will measure up to 600 MHz with 8 digit precision. And, one of its best features is the Receive Frequency Adapter, which turns the CT-50 into a digital readout for any receiver. The adapter is easily programmed for any receiver and a simple connection to the receiver's VFO is all that is required for use. Adding the receiver adapter in no way limits the operation of the CT-50, the adapter can be conveniently switched on or off. The CT-50, a counter that can work double-duty!

**PRICES:**

CT-50 wired, 1 year warranty	\$159.95
CT-50 Kit, 90 day parts warranty	119.95
RA-1, receiver adapter kit	14.95
RA-1 wired and pre-programmed (send copy of receiver schematic)	29.95



## DIGITAL MULTIMETER \$99<sup>95</sup> WIRED

**PRICES:**

DM-700 wired, 1 year warranty	\$99.95
DM-700 Kit, 90 day parts warranty	79.95
AC-1, AC adaptor	3.95
BP-3, Nicad pack + AC adapter/charger	19.95
MP-1, Probe kit	2.95

The DM-700 offers professional quality performance at a hobbyist price. Features include; 26 different ranges and 5 functions, all arranged in a convenient, easy to use format. Measurements are displayed on a large 3 1/2 digit, 1/2 inch LED readout with automatic decimal placement, automatic polarity, overrange indication and overload protection up to 1250 volts on all ranges, making it virtually goof-proof! The DM-700 looks great, a handsome, jet black, rugged ABS case with convenient retractable tilt bail makes it an ideal addition to any shop.

**SPECIFICATIONS:**

DC/AC volts:	100uV to 1 KV, 5 ranges
DC/AC current:	0.1uA to 2.0 Amps, 5 ranges
Resistance:	0.1 ohms to 20 Megohms, 6 ranges
Input impedance:	10 Megohms, DC/AC volts
Accuracy:	10.1% basic DC volts
Power:	4 'C' cells

### AUDIO SCALER

For high resolution audio measurements, multiplies UP in frequency.

- Great for PL tones
- Multiplies by 10 or 100
- 0.01 Hz resolution!

\$29.95 Kit \$39.95 Wired

### ACCESSORIES

Telescopic whip antenna - BNC plug	\$ 7.95
High impedance probe, light loading	15.95
Low pass probe, for audio measurements	15.95
Direct probe, general purpose usage	12.95
Tilt bail, for CT 70, 90, MINI-100	3.95
Color burst calibration unit, calibrates counter against color TV signal	14.95

### COUNTER PREAMP

For measuring extremely weak signals from 10 to 1,000 MHz. Small size, powered by plug transformer-included.

- Flat 25 db gain
- BNC Connectors
- Great for sniffing RF with pick-up loop

\$34.95 Kit \$44.95 Wired

ramsey electronic's, inc. 2575 Baird Rd. Penfield, NY 14526



PHONE ORDERS CALL 716-586-3950

**TERMS** Satisfaction guaranteed - examine for 10 days, if not pleased, return in original form for refund. Add 5% for shipping - insurance to a maximum of \$10. Overseas add 15%. COD add \$2. Orders under \$10 - add \$1.50. NY residents, add 7% tax.

# DIGITAL RESEARCH: PARTS

"TOP QUALITY PARTS FOR LESS"

## 9 Watt Stereo Amplifier

Brand New!

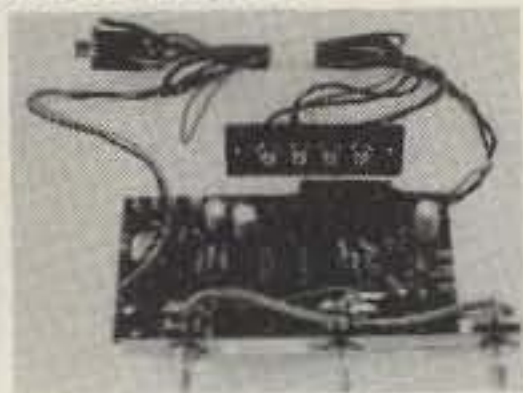

**6<sup>50</sup>**

Fantastic!

One of the neatest items we have come up with. Operates on 8 to 20V. A.C. or D.C. (on board diodes).

- Separate tone control pots
- Balance control
- Volume control

Separate inputs for phono, radio, recorder, etc. Separate jack for head phones.

Replace your car stereo amp. Easy hook up — approximately 10 min. with our "how to" instructions.

Transformer for above — \$3.50

## 4 Digit - 12 Hour D.C. Clock Module

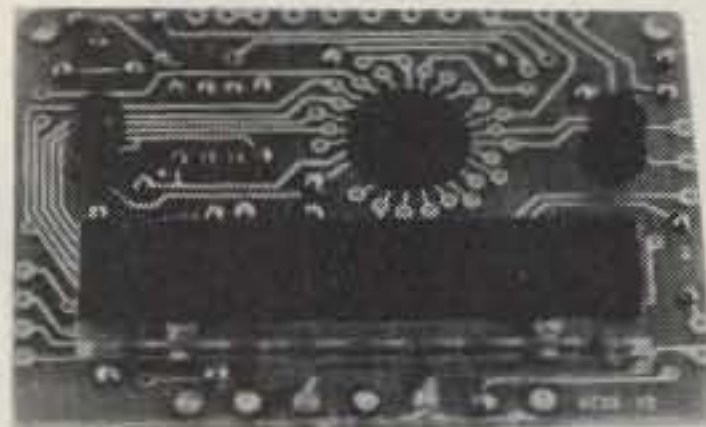

**4<sup>00</sup>** or 3 for 10<sup>50</sup>

On board time base using popular MM5369. Operates on 12 Volt D.C. Display can be blanked.

Draws 30 MA-Display On. 13 MA - Display Off. Includes standard 3 x 4 Matrix control board (not shown). Module measures 2 3/8" x 1 3/4". Extra bright magnified digits. Display contains 2 extra digits for custom applications (calendar, lap counter, or ?).

## Video Game Board

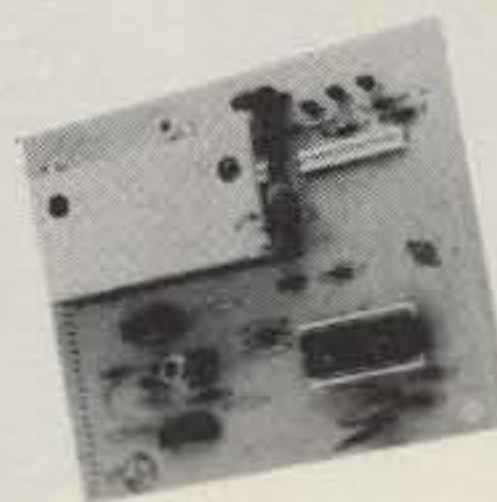

**4<sup>45</sup>**

3 for 12<sup>00</sup>

Hockey • Tennis • Handball

- General Instruments AY3-8500
- Features Exciting Sounds
- On Screen Scoring
- Speed & Paddle Controls
- 1 or 2 Players
- Works on 8-15 Volts D.C.

Each board comes with RF Modulator (Ch. 3 or 4) and schematic. The only parts needed to complete game are speaker, 2-1 Meg Pots & Switches.

## IC Specials!

LM1889-2<sup>25</sup>

MC1310 - 1<sup>00</sup>

LM3820 - A.M.

Radio on a chip w/specs.



2/1<sup>00</sup>

## 16 Pin Header

4/1<sup>00</sup>

## Power Transistor TO220 Case

3/1<sup>10</sup>

1 Amp 30 Watts 100 Volt  
TIP 30C (PNP)  
TIP 29C (NPN)



## Gold Wire Wrap Sockets

Not Gold Inlay as Sold By Others.

Super 3 Level Gold Wire Wrap.

14 Pin - 10/3<sup>95</sup>, 25/8<sup>75</sup>  
16 Pin - 10/4<sup>95</sup>, 25/11<sup>25</sup>



## Video Paddle Controls

2 for 1<sup>00</sup>

1 Meg

Can be used with game board above.



## Voltage Regulator

LM309K

1<sup>00</sup>

5 Volt - 1 Amp Regulator TO3 Case. Super Special!



## Sprague RFI Filter 3<sup>85</sup> or 3/9<sup>00</sup>

Perfect for Computers, or anything that needs to be "glitch" free. By the #1 name in filtering, Sprague. JN17-5109B. Has I.E.C. Power Line Connector. 2x3 Amp. 115/220 VAC 60 Hz. 2 1/8" x 2 1/2" x 3" deep.

## Switch Banks



- Non Canceling
  - DPDT-PC or Solder
  - Switches Easily Removed
  - Push On/Push Off
- 2<sup>50</sup>  
THAT'S INCREDIBLE!

## Telephone Accessories

by Edwards

48 V Loud

4<sup>50</sup>



## Rectifier Diode IN4007

11/1<sup>00</sup>

1000 Volts, 1 Amp DO-41 Case • Prime • Long Lead • Marked.

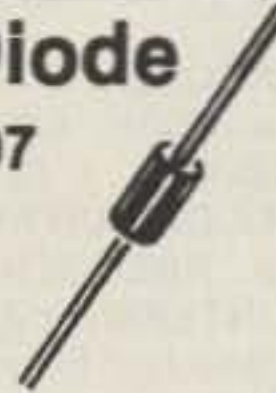

## RCA Triac

79<sup>c</sup>

5 for 3<sup>50</sup>

T2800M-TO220 Case  
6 Amp 600 Volt



## JFET OP AMP

Super High Input Impedance (10<sup>12</sup> OHMS) — High Frequency Response. TO 4 MHZ. Large DC Voltage Gain 106 DB — New generation OP-AMP with Vastly Superior Features!

LF356BH - 75<sup>c</sup> or 3/2<sup>00</sup>

## Micro Mini Toggle Switch

99<sup>c</sup>

6 for 5<sup>00</sup>

SPDT • Made in USA with Hardware



DON'T MISS THE 7205 TOSHIBA POWER AUDIO AMP ON PAGE 13 OF OUR FREE CATALOG!

### TERMS:

Add 50 postage, we pay balance. Orders under \$15 add 75 handling. No C.O.D. We accept Visa, MasterCard and American Express cards. Tex. Res. add 5% Tax. Foreign orders (Canada 10%) add 20% P & H.

# Digital Research: Parts

P.O. Box 401247 • Garland, Texas 75040

(214) 271-2461

• VISA • MASTERCARD • AMERICAN EXPRESS •

# INTRODUCING SONY'S NEW DIGITAL DIRECT ACCESS RECEIVER!



only **\$299<sup>95</sup>** plus \$5.00 shipping

## Revolutionary Instant Access Digital Shortwave Scanner

- Continuous Scanning of LW, MW, SW, & FM Bands
- Instant Fingertip Tuning—No More Knobs!
- 6 Memories for Any Mode (AM,SSB/CW, & FM)
- Dual PLL Frequency Synthesized—No Drift!

**A WHOLE NEW BREED OF RADIO IS HERE NOW!** No other short wave receiver combines so many advanced features for both operating convenience and high performance as does the new Sony ICF-2001. Once you have operated this exciting new radio, you'll be spoiled forever! Direct access tuning eliminates conventional tuning knobs and dials with a convenient digital keyboard and Liquid Crystal Display (LCD) for accurate frequency readout to within 1 KHz. Instant fingertip tuning, up to 8 memory presets, and continuous scanning features make the ICF-2001 the ultimate in convenience.

Compare the following features against any receiver currently available and you will have to agree that the Sony ICF 2001 is the best value in shortwave receivers today:

**DUAL PLL SYNTHESIZER CIRCUITRY** covers entire 150 KHz to 29.999 MHz band. PLL<sub>1</sub> circuit has 100 KHz step while PLL<sub>2</sub> handles 1 KHz step, both of which are controlled by separate quartz crystal oscillators for precise, no-drift tuning. **DUAL CONVERSION SUPERHETERODYNE** circuitry assures superior AM reception and high image rejection characteristics. The 10.7 MHz IF of the FM band is utilized as the 2nd IF of the AM band. A new type of crystal filter made especially for this purpose realizes clearer reception than commonly used ceramic filters. **ALL FET FRONT END** for high sensitivity and interference rejection. Intermodulation, cross modulation, and spurious interference are effectively rejected. **FET RF AMP** contributes to superior image rejection, high sensitivity, and good signal to noise ratio. Both strong and weak stations are received with minimal distortion.

### EXTENDED SPECTRUM CONTINUOUS TUNING

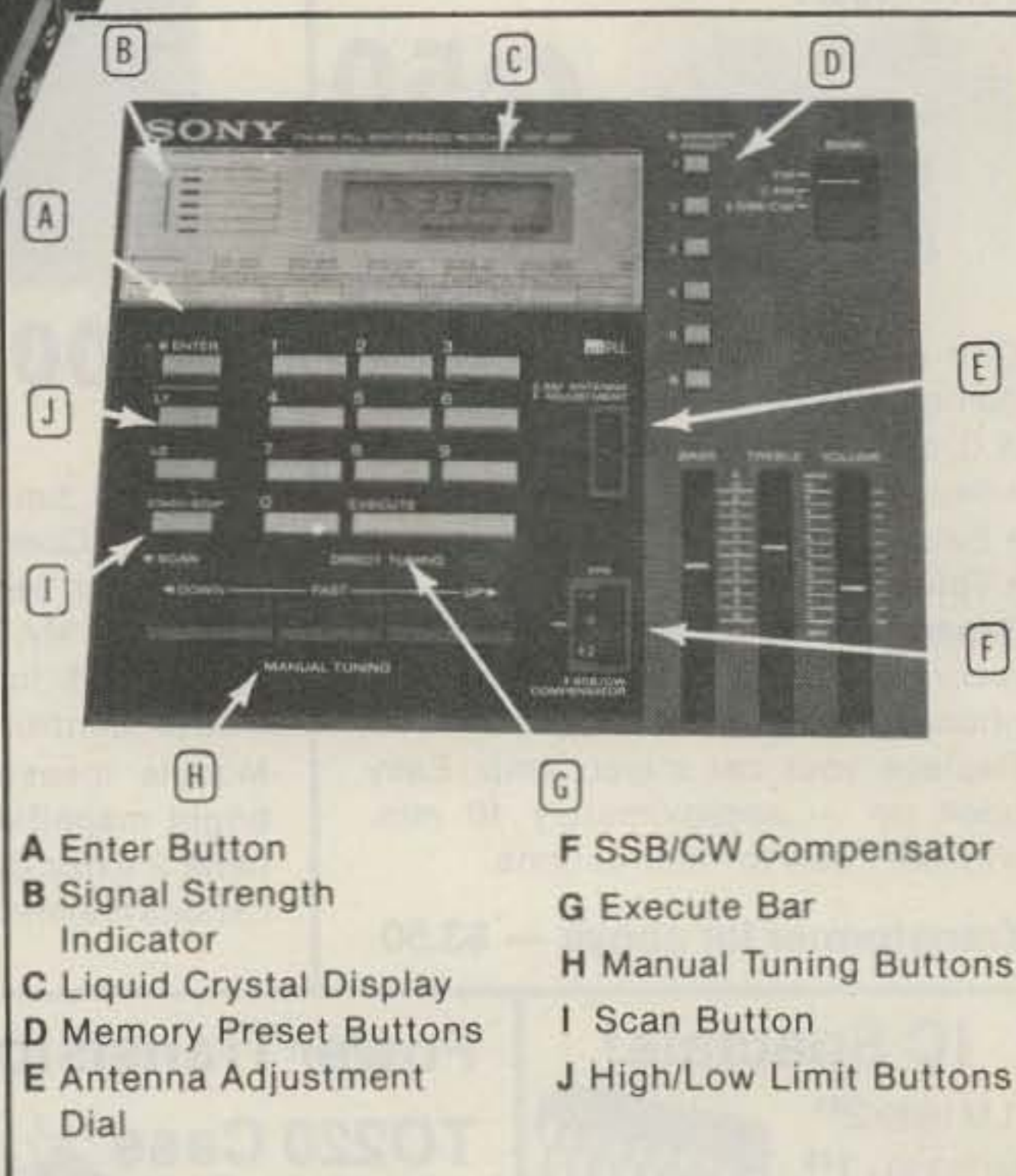

- |                             |                               |
|-----------------------------|-------------------------------|
| A Enter Button              | F SSB/CW Compensator          |
| B Signal Strength Indicator | G Execute Bar                 |
| C Liquid Crystal Display    | H Manual Tuning Buttons       |
| D Memory Preset Buttons     | I Scan Button                 |
| E Antenna Adjustment        | J High/Low Limit Buttons Dial |

### OPERATIONAL FEATURES

**INSTANT FINGERTIP TUNING** with the calculator-type key board enables the operator to have instant access to any frequency in the LW, MW, SW, and FM bands. And the LCD digital frequency display confirms the exact, drift-free signal being received. **AUTOMATIC SCANNING** of the above bands. Continuous scanning of any desired portion of the band is achieved by setting the "L<sub>1</sub>" and "L<sub>2</sub>" keys to define the range to be scanned. The scanner can stop automatically on strong signals, or it can be done manually. **MANUAL SEARCH** is similar to the manual scan mode and is useful for quick signal searching. The "UP" and "DOWN" keys let the tuner search for you. The "FAST" key increases the search rate for faster signal detection. **MEMORY PRESETS.** Six memory keys hold desired stations for instant one-key tuning in any mode (AM, SSB/CW, and FM), and also, the "L<sub>1</sub>" and "L<sub>2</sub>" keys can give you two more memory slots when not used for scanning. **OTHER FEATURES:** Local, normal, DX sensitivity selector for AM; SSB/CW compensator; 90 min. sleep timer; AM Ant. Adjust.

### SPECIFICATIONS

**CIRCUIT SYSTEM:** Fm Superheterodyne; AM Dual conversion superheterodyne. **SIGNAL CIRCUITRY:** 4 IC's, 11 FET's, 23 Transistors, 16 Diodes. **AUXILIARY CIRCUITRY:** 5 IC's, 1 LSI, 5 LED's, 25 Transistors, 9 Diodes. **FREQUENCY RANGE:** FM 76-108 MHz; AM 150-29,999 KHz. **INTERMEDIATE FREQUENCY:** FM 10.7 MHz.; AM 1st 66.35 MHz., 2nd 10.7 MHz. **ANTENNAS:** FM telescopic, ext. ant. terminal; AM telescopic, built-in ferrite bar, ext. ant. terminal. **POWER:** 4.5 VDC/120 VAC **DIMENSIONS:** 12 1/4 (W) X 2 1/4 (H) X 6 3/4 (D). **WEIGHT:** 3 lb. 15 oz. (1.8 kg)



**SPECTRONICS, INC.**  
1009 GARFIELD ST. OAK PARK, IL. 60304

PHONE  
**(312) 848-6777**









# THE EVOLUTION OF A CHAMPION!

## FT-101ZD Mk III



The FT-101ZD Mk III is the latest chapter in the success story of the FT-101 line. Armed with new audio filtering for even better selectivity, the FT-101ZD now includes provision for an optional FM or AM unit. Compare features and you'll see why active operators everywhere are upgrading to Yaesu!

### Variable IF Bandwidth

Using two 8-pole filters in the IF, Yaesu's pioneering variable bandwidth system provides continuous control over the width of the IF passband — from 2.4 kHz down to 300 Hz — without the shortcomings of single-filter IF shift schemes. No need to buy separate filters for 1.8 kHz, 1.5 kHz, etc.

### Improved Receiver Selectivity

New on the FT-101ZD Mk III is a high-performance audio peak/notch filter. Use the peak filter for single-signal CW reception, or choose the notch filter for nulling out annoying carriers or interfering CW signals. In the CW mode, you can choose between the 2.4 kHz SSB filter and an optional CW filter (600 or 350 Hz) from the mode switch.

### Diode Ring Front End

The FT-101ZD now sports a high-level diode ring mixer in the front end. This type of mixer, well known for its strong signal performance, is your assurance of maximum protection from intermod problems on today's crowded bands.

### WARC Bands Factory Installed

The FT-101ZD Mk III comes equipped with factory installation of the new 10, 18, and 24 MHz bands recently assigned to the Amateur Service at WARC. In the meantime, use the 10 MHz band for monitoring of WWV!

### RF Speech Processor

Not an additional-cost option, the FT-101ZD RF speech processor provides a significant increase in average SSB power output, for added punch in those heavy DX pile-ups. The optimum processor level is easily set via a front panel control.

### Worldwide Power Capability

Every FT-101ZD comes equipped with a multi-tap power transformer, which can be easily modified from the stock 117 VAC to 100/110/200/220/234 VAC in minutes. A DC-DC converter is available as an option for mobile or battery operation.

### Convenience Features

Designed fundamentally as a high-performance SSB and CW transceiver, the FT-101ZD includes built-in VOX, CW sidetone, semi-break-in T/R control on CW, slow-fast-off AGC selection, level controls for the noise blanker and speech processor, and offset tuning for both transmit and receive. The Mk III optional FM unit may be used for 10 meter FM operation, or choose the optional AM unit for WWV reception or VHF AM work through a transverter (AM and FM units may not both be installed in a single transceiver).

### Full Line of Accessories

See your Yaesu dealer for a demonstration of the top performance accessories for the FT-101ZD, such as the FV-101Z External VFO, SP-901P Speaker/Patch, YR-901 CW/RTTY Reader, FC-902 Antenna Tuner, and the FTV-901R VHF/UHF Transverter. Watch for the upcoming FV-101DM Digital Memory VFO, with keyboard frequency entry and scanning in 10 Hz steps!

### Nationwide Service Network

During the warranty period, the Authorized Yaesu Dealer from whom you purchased your equipment provides prompt attention to your warranty needs. For long-term servicing after the warranty period, Yaesu is proud to maintain two fully-equipped service centers, one in Cincinnati for our Eastern customers and one in the Los Angeles area for those on the West Coast.

Note: A limited quantity of the earlier FT-101ZD (with AM as standard feature) is still available. See your Yaesu dealer. FT-101ZD Mk III designates transceivers bearing serial #240001 and up, with APF/Notch filter built in and AM/FM units optional.

681

Price And Specifications Subject To  
Change Without Notice Or Obligation

**YAESU** <sup>83</sup>  
**The radio.**



YAESU ELECTRONICS CORP., 6851 Walthall Way, Paramount, CA 90723 • (213) 633-4007  
YAESU Eastern Service Ctr., 9812 Princeton-Glendale Rd., Cincinnati, OH 45246 • (513) 874-3100

# Dyna-"mite."



## Miniaturized, 5 memories, memory/band scan

### TR-7730

The TR-7730 is an incredibly compact, reasonably priced, 25-watt, 2-meter FM mobile transceiver with five memories, memory scan, automatic band scan, UP/DOWN manual scan from the microphone, and other convenient operating features.

#### TR-7730 FEATURES:

- **Smallest ever Kenwood mobile**  
Measures only 5-3/4 inches wide, 2 inches high, and 7-3/4 inches deep, and weighs only 3.3 pounds. Mounts even in the smallest subcompact car, and is an ideal combination with the equally compact TR-8400 synthesized 70-cm FM mobile transceiver.
- **25 watts RF output power**  
Even though the TR-7730 is so compact, it still produces 25 watts output for reliable mobile communications. HI/LOW power switch selects 25-W or 5-W output.
- **Five memories**  
May be operated in simplex mode or repeater mode with the transmit frequency offset  $\pm 600$  kHz. The fifth

memory stores both receive and transmit frequency independently, to allow operation on repeaters with nonstandard splits. Memory backup terminal on rear panel.

- **Memory scan**  
Automatically locks on busy memory channel and resumes when signal disappears or when SCAN switch is pushed. Scan HOLD or microphone PTT switch cancels scan.
- **Extended frequency coverage**  
Covers 143.900-148.995 MHz in switchable 5-kHz or 10-kHz steps, allowing simplex and repeater operation on some MARS and CAP frequencies.
- **Automatic band scan**  
Scans entire band in 5-kHz or 10-kHz steps and locks on busy channel. Scan resumes when signal disappears or when SCAN switch is pushed. Scan HOLD or microphone PTT switch cancels scan.
- **UP/DOWN manual scan**  
With UP/DOWN microphone provided, manually scans entire band in 5-kHz or 10-kHz steps.
- **Offset switch**  
Allows VFO and four of five memory

frequencies to be offset  $\pm 600$  kHz for repeater access (or to be operated simplex) during transmit mode.

- **Four-digit LED frequency display**  
Indicates receive and transmit frequency during simplex or repeater-offset operation.
- **S/RF bar meter and LED indicators**  
Bar meter of multicolor LEDs shows relative receive and transmit signal levels. Other LEDs indicate BUSY, ON AIR, and REPEATER offset.
- **Tone switch**  
Activates internal subaudible tone encoder (not Kenwood-supplied).

#### Optional accessories:

- **MC-46** 16-button autopatch (DTMF) UP/DOWN microphone
- **SP-40** compact mobile speaker
- **KPS-7** fixed-station power supply

More information on the TR-7730 and TR-8400 is available from all authorized dealers of Trio-Kenwood Communications, Inc., 1111 West Walnut Street, Compton, California 90220.

## Synthesized 70-cm FM mobile rig

### TR-8400

- **Synthesized coverage of 440-450 MHz**  
Covers upper 10 MHz of 70-cm band in 25-kHz steps, with two VFOs.
- **Offset switch**  
For  $\pm 5$  MHz transmit offset on both VFOs and four of five memories, as well as simplex operation. Fifth memory allows any other offset by memorizing receive and transmit frequencies independently.
- **DTMF autopatch terminal**  
On rear panel, for connecting DTMF (dual-tone multifrequency) touch pad (for

accessing autopatches) or other tone-signaling device.

- **HI/LOW RF output power switch**  
Selects 10 watts or 1 watt output.
- **Virtually same size as TR-7730**  
Perfect companion for TR-7730 in a compact mobile arrangement.
- **Other features similar to TR-7730**  
Five memories, memory scan, automatic band scan (in 25-kHz steps), UP/DOWN manual scan, four-digit LED receive frequency display (also shows transmit frequency in memory 5), S/RF bar meter and LED indicators, tone switch, and same optional accessories.

**KENWOOD**  
...pacesetter in amateur radio



Specifications and prices are subject to change without notice or obligation.