

# 73

## AMATEUR RADIO

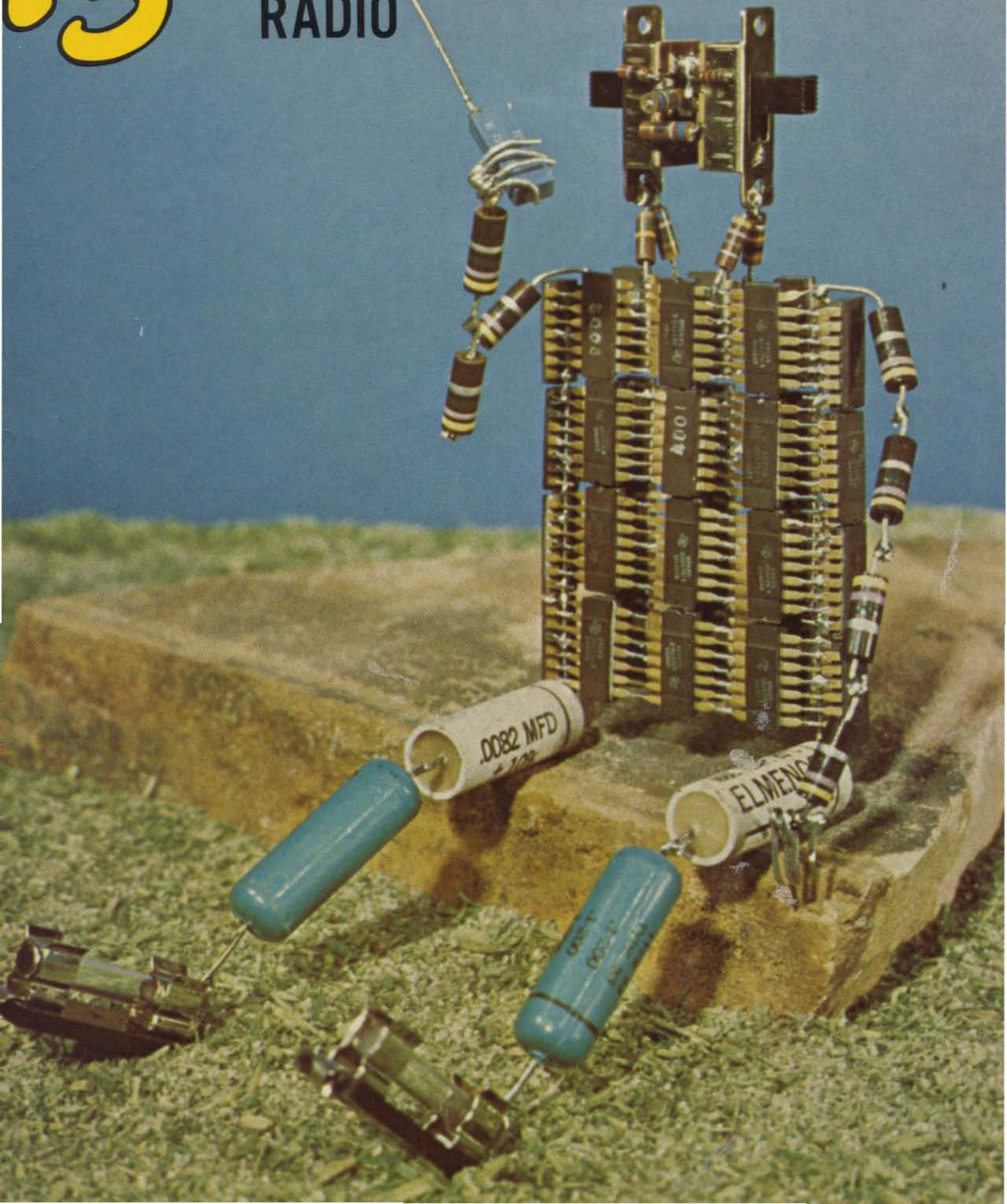



# **KLM** presents...

## **KR-400, precision-built azimuth rotator at a very reasonable price.**

- Rotation rate: one minute for 360°.
- Husky disc brake on motor holds antenna column securely, prevents wind-milling.
- Supports 400 lbs (181 KG) vertical weight.
- Accommodates masts 1.5 to 2.5 inches in diameter (38 to 63.5 mm).
- Limit switch cuts off motor at 360° rotational extremes, prevents line "wrap-up".
- 6-wire control cable (not supplied).
- Precision aluminum die casting.
- Stainless steel hardware.
- 115VAC, 50-60 Hz. 40 VA.
- Shipping weight: 18 lbs (8.16 KG).
- Also available: **KR-500**, heavy-duty elevation rotator.

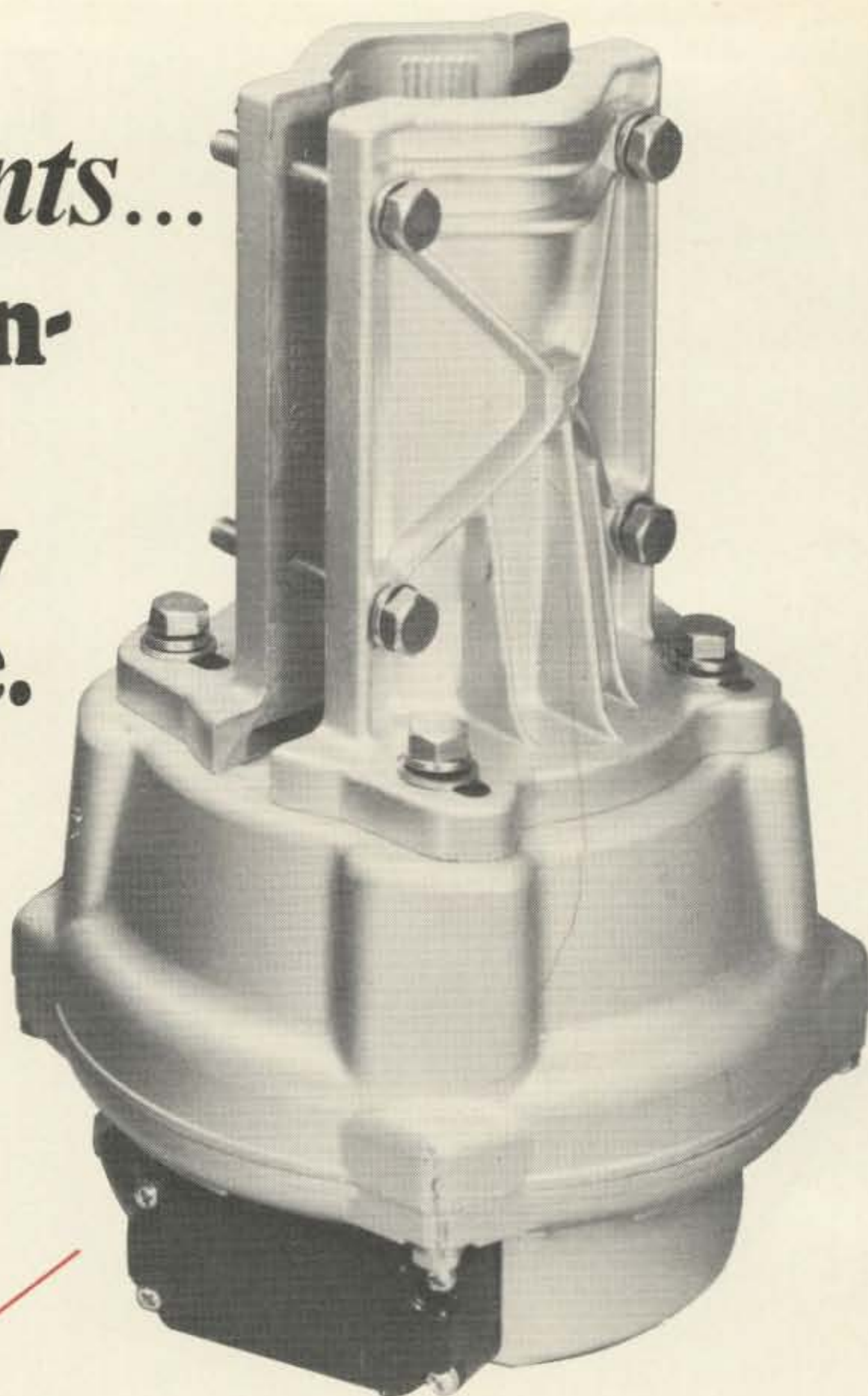

**KR-400, a high quality rotator for VHF and UHF arrays or most 3 element multi-band HF beams.\***

Motor housing and mast clamp assembly are precision, corrosion-resistant aluminum die castings, heavily reinforced at stress points. Mast clamp assembly has slotted bases and takeups to adjust for various mast diameters. Motor housing base has 4 tapped mounting holes at 90° spacing on 2.342" (59.5mm) radius.

Assembly is protectively coated; motor housing, control cable entry box sealed against moisture. Stainless steel hardware.

Professional looking control unit blends with any decor, has illuminated meter scale calibrated in degrees which tracks with rotary potentiometer in rotator housing. Solid-state bridge circuitry is voltage regulated to maintain meter accuracy. Hold down push switches control rotation direction.

Model KR-400 rotator is precision constructed for long, trouble-free operation... price-wise is without equal.

\*KLM HD-1500, heavy duty rotator is available for "Xmas trees," 40 meter beams or other large antennas.



### **109.95**

At your dealer. Write for brochure.

## **KLM** electronics, inc.

17025 Laurel Road, Morgan Hill, CA 95037 (408) 779-7363



IMAGINE A 25 WATT  
SYNTHESIZED 2 METER  
FM TRANSCEIVER WITH  
FULL BAND COVERAGE  
FOR LESS THAN \$360!

# MEET THE ALL NEW SUPER PERFORMING

## Clegg FM-28



ONLY \$359.95 COMPLETE WITH MICROPHONE, MOBILE MOUNT ETC.  
AVAILABLE ONLY FROM CLEGG. PHONE TOLL FREE TO ORDER

- Digitally Synthesized
- Non-Standard Repeater Splits
- 5 KHz Steps
- Modular Construction
- Compact
- Rugged
- 25 Watts Output
- .25 uv Receiver
- Large S Meter
- Full Coverage 144 - 148 MHz on Both Receive and Transmit
- Bright 6 Digit Numeric Frequency Display
- Super Selectivity with 15 Poles IF Filtering + 5 Pole Front End Filter
- Multi-purpose Accessory Receptacle

We took our fabulous FM-DX to Japan and asked them to make their version of the "DX." We expected to get a much lesser transceiver. We were more than pleased with the "Japanese Copy" and its cost. Since Clegg sells directly to you, we are able to offer this super transceiver with all its desirable features plus Cleggs' warranty and service at a price that belies the quality of the product.

Compare them all for performance, specifications and reliability – your choice will be the NEW CLEGG FM-28.



**Clegg** Communications Corp.

208 Centerville Road, Lancaster, Pa. 17603  
Toll free sales & service. Phone 800-233-0250  
In Pa. call 717-299-7221 collect.





# 73

**EDITOR/PUBLISHER**  
Wayne Green W2NSD/T

**EXECUTIVE VICE PRESIDENT**  
Sherry Smythe

**EXECUTIVE EDITOR**  
John Molnar WA3ETD

**MANAGING EDITOR**  
John C. Burnett

**ASSISTANT MANAGING EDITOR**  
Susan G. Phibbrick

**ASSISTANT EDITOR**  
Warren C. Eily WA1GUD

**EDITORIAL ASSISTANT**  
Beth Turin

**I/O EDITOR**  
John Craig

**PUBLICATIONS EDITOR**  
Rich Fayer WB1ASL

**PUBLICATIONS ASSISTANT**  
Nancy Chandler

**PRODUCTION MANAGER**  
Lynn Panciera-Fraser

**ART DEPARTMENT**  
Craig Brown  
Gayle Cabane  
Bob Drew  
Michael Murphy  
Weston Parker  
Bob Sawyer  
Nate R. Self WB1ARP  
Robin M. Sloan

**PRINT SHOP MANAGER**  
Mutsaer Foster

**PRINTING**  
John Bieschi  
William Gering  
Dwight Perry

**PHOTOGRAPHY**  
Bill Heydolph  
Terrell Cluff

**TYPESETTING**  
Barbara J. Latti  
Sandy White  
Marie Walt  
Dorene Pike

**COMPTROLLER**  
Krud E. M. Keller KV4GG/I  
Marge Nielsen  
Dorothy Fifield  
Eleanor G. Jensen

**CIRCULATION**  
Dorothy Gibson  
Barbara Block  
Fran Dillon  
Janet Ames  
Janette Dyer  
Florence Goldman

**DATA ENTRY**  
Judy Waterman  
Mary Jo Sporneller  
Judy Brumaghin  
Susan Brumaghin

**MARKETING**  
Sherry Smythe  
Cher Dean  
Lisa Josephs  
Karen McDonough

**INVENTORY CONTROL**  
Ethan Perry

**TRAFFIC**  
Theresa Toussaint  
Carol Crocker  
Lisa Hesley  
Maureen Toussaint

**PLANT MAINTENANCE**  
Bill Barry  
Lorraine Pickering  
Ken Cox

**RECEPTIONIST**  
Dani Jarvis

**SHIPPING**  
Susan Chandler  
Carol Dillon  
Karen Kogler

**ASSOCIATES**  
Robert Baker WB2GFE  
E. H. Barnett WB8UX  
Shirley Cox W8LHO  
Tom Dillon W8KZD  
Terry Fox WB4JF1  
W. Singer Green  
Dave Ingram K4TWJ  
Joe Kauer G3ZCZ  
Bill Pasternak WA6TF  
John Schultz W4FA  
Walter Scott K8DIZ  
Peter Stark K2QAW  
Bill Turner W8ABJ

**COMPUTER SYSTEMS MANAGER**  
Bob Leach W8BCC/I

**COMPUTER PROGRAMMING**  
David E. Williams  
Richard J. Dykema

**DRAFTING**  
Bill Morille  
Lynn Mals

**ADVERTISING**  
Bill Edwards W8RFD/I  
Nancy Cluff WA1WSU  
Gary Dwyer  
Tobias Phipps



NEVER SAY DIE

...de W2NSD/I

EDITORIAL BY WAYNE GREEN

### WHEN THE JAMMER HITS

One of these days, unless the laws of chance have been repealed, your repeater is going to be the target of a persistent kerchunker or even a dedicated jammer, complete with a four letter vocabulary which would be more fitting to the current run of movies than to amateur radio. Outside of panic, what should you do?

The first thing, obviously, is to make some tapes and get together with the FCC. Horsepucky. Leave the FCC alone — they are not anxious to hear from you and would prefer not to be bothered. No, the first thing to do is give a big yawn and try to get some sleep. If, after a few days, the chap shows better than average stamina and keeps on messing things up, despite every effort of the repeater users to totally ignore him, then it's time to swing vigorously into phase two ... a little longer nap, possibly with a dash of television viewing to break the monotony.

Okay. I can see you are determined to let this bugger get under your skin and you want action and you want it right now. Well, sigh, how about making up a couple of direction-finding loops and learning how to use them? Yes, I know the FCC can do this, but they are busy. Do it yourself and learn something. Two fellows with direction-finders can get a good idea of where the miseries are originating, and you can close in. Once you've located the jerk, you have to figure what to do about him. No, you can't do that.

Look on the bright side ... fox hunting is a lot of fun and the exercise will be excellent for the club. The fact is that your club should be ready for this and have some practice before the fan gets hit. Get some transmitter hunts organized so the equipment will

be ready to use and a few of the fellows will know how to use it.

The FCC has some direction-finding (DF) equipment which will give the bearing of a transmitter within a second. Now that amateurs have discovered microcomputers, perhaps it is time that we developed some of the same hardware. You can bet that the pages of 73 are open to any good DF articles and will make it worthwhile for fellows who dream up some good DF techniques.

One technique, which I've mentioned before, but of which little has been written, is one which examines the leading or trailing edge of a transmitter's carrier and puts it on a scope. My understanding is that every transmitter is a little bit different ... that each rig has its own kerchunkprint. This means that when someone tries to transmit without his call, you can check out his kerchunkprint and compare that with some later time when he is just using the repeater to talk and gives his call.

Let's get busy with fox hunting circuits and apply some digital techniques to them which will make instant DF possible. And let's not forget to write it up!

### NEW ORLEANS HAMFEST/COMPUTERFEST

The 1976 show came off so well that the New Orleans group has gotten bigger digs for this year. It's going to be at the Hilton Inn in Kenner this year, right across from the New Orleans International Airport. The dates are September 24-25th. Info can be had by writing box 10111, Jefferson LA 70181. Unfortunately, this is the same weekend as a hamfest in Hartford, so I'll have to miss New Orleans ... perhaps the dates will not coincide next year ... New Orleans is

quite an attraction and I hate to miss it.

### MAKE A MILLION

Forgive my enthusiasm, but every now and then a brilliant idea comes along and gets me all excited. Perhaps someone reading this magazine is looking around for an idea for a product which will sell like crazy, which wouldn't be very expensive to make, and which just about everyone needs. I have such a product in mind. It's so simple I don't know why it isn't available.

The chances are good that you are a coffee drinker ... or at least tea? You may just drink it at dinner, but you are probably more like the rest of us in that you have several cups through the day. Most businessmen have coffee every now and then to keep the wheels churning. And how many of you don't have a mug on the operating desk with an inch of cold coffee in it?

Cold coffee ... that's what did it to me. I was deep in a contact with a friend in Spain and I absentmindedly picked up my cup and took a swig of cold coffee. Iced coffee is something else ... I can drink that, but cold coffee is an abomination and I came to my senses with a shock as the vile stuff hit my taste buds.

Someone is going to design a simple mug with a heater and thermostat built in to keep coffee warm. It can sit in a holder with the power transformer built in, making contact when you put the cup down ... something like the rechargeable soldering irons, only without batteries. The electrical contact shoes can be built into the bottom of the mug and the mating spring contact in the holder. Will you

Continued on page 174



The New Orleans Hamfest/Computerfest.



# TR-7500



There are a number of good 2 meter FM transceivers on the market. You may already own one. But, even if you do, we suggest that you put your radio to this test. And, if you're thinking of buying one, this test should be a helpful guide.

	NO	YES
Is it PLL synthesized?	<input type="checkbox"/>	<input type="checkbox"/>
Does it have 100 channels (88 pre-programmed)?	<input type="checkbox"/>	<input type="checkbox"/>
Does it have 12 extra diode programmable channels?	<input type="checkbox"/>	<input type="checkbox"/>
Does it have single knob channel selection?	<input type="checkbox"/>	<input type="checkbox"/>
Does it have a LED digital frequency display?	<input type="checkbox"/>	<input type="checkbox"/>
Does it have a powered tone pad connection?	<input type="checkbox"/>	<input type="checkbox"/>
Does the receiver have helical resonators?	<input type="checkbox"/>	<input type="checkbox"/>

If your answer is NO to any of these, the TR-7500 is the radio that you should own. And, in addition to these important features, you get proven Kenwood quality, value and service.



## TR-7500 Specifications

Semiconductors: Transistors	41
FETs	8
ICs	7
Diodes	35
Frequency Range: 146.01 to 147.99 MHz	
Mode: FM	
No. of Channels: 100	
Operating Temperature: -20 to +50 degrees C	
Power Voltage: 11.5 to 16.0V DC (13.8V DC nominal)	

Grounding Polarity: Negative ground  
Antenna Impedance: 50 Ohms

Current drain: Less than 0.5A in receive with no input signal  
Less than 3A in transmit (HI) Less than 1.5A in transmit (LOW) (at 13.8V DC)

Dimensions: 172 mm (6-3/4") wide  
250 mm (9-7/8") deep  
75 mm (2-15/16") high

Weight: Approximately 2.2 kg (4.8 lbs.)

### TRANSMIT SECTION

RF Output Power: High: 10 Watts  
Low: 1 Watt (approximately)

Modulation: Variable reactance frequency shift

Frequency Deviation: ±5 KHz

Spurious Radiation: Better than -60dB

Tone Pad Input  
Impedance: 600 Ohms

Microphone: Dynamic microphone with PTT switch, 500 Ohms

### RECEIVE SECTION

Receive System: Double conversion superheterodyne

Intermediate Frequency: 1st IF: 10.7 MHz  
2nd IF: 455 kHz

Sensitivity: Better than 0.4 uV for 20dB quieting Better than 1 uV for 30dB S/N

Squelch Sensitivity: Better than 0.25 uV

Selectivity: 12kHz at -6dB down  
40 kHz at -70dB down

Image Rejection: Better than -70dB

Spurious Interference: Better than -60dB

Audio Output: More than 1.5 watts across 8 Ohms load 10% distortion

Intermodulation: Better than 66dB



# Briefs

Compiled by Warren Ely WA1GUD

*Got a good ham radio news story? Drop us a line, or call it in, and take home the 73 publication of your choice, provided we publish your news tip. Be sure to specify which book you want. OK?*

It seems that "confidential document" Jack Anderson referred to in his national attack on ham radio (see 73 for June) came from the Electronics Industries Association (EIA). Southwest ARRL director John Griggs had quite a bit to say both about the EIA and Anderson during a talk at the Poinsettia ARC in California.

Anderson himself backed down a bit in his column published during the week of April 25th, claiming he never intended to attack hams. "We merely pointed out," Anderson wrote, "that the airwaves belong to the public, that there are far more citizens using CBs than ham equipment and that some of the federal regulators were hams." Anderson extensively quoted Senator Barry Goldwater K7UGA in the follow-up column, reprinted here from the *Washington Post*. "Goldwater complained that the CB enthusiasts often operate without a license and amplify their transmitters beyond the 5 Watt limit. They have also abused the system, he charged, in complete objection to all concepts of decency and gentlemanliness on the air. While this doesn't apply across the board, there are enough offenders that, I

don't care how many frequencies they have, they are slowly going to destroy their own function. Many of these CBers never use their call signs or their names. There are many who use profanity and what they discuss should never be carried on any airwaves. In many cities, prostitutes use these frequencies to solicit business, and I could go on and on." Concluded the senator, "I think I can safely say, Jack, that the amateurs throughout the years have contributed more to the art of communications than all of the so-called experts in the field. Our frequencies have been diminishing, not increasing. We have great pride in our craft."

Shortly after the second Anderson column appeared, an ARRL official told 73 that the Anderson situation was "under control." He went on to say that the author of the original story was now taking a Novice license course and was greatly interested in ham radio. We were unable to confirm that through a call to Anderson's Washington office, but we did learn that the original column had already been added to the EIA's battery of handouts promoting additional frequencies for CB. Official ARRL

reaction to the Anderson mess came in two steps during late April. First, a directive to all League officials to "stand by" while headquarters found out how the column was written in the first place. Then, two weeks later, word came that the League has taken a strong step to offset the bad PR... a new award for any amateur whose response to the Anderson column was published or publicized. It's called the "Amateur Radio Promotion" award and is available only to League members.

Dayton's official attendance figure came in at 16,290, according to Dayton Amateur Radio Club officials. Well over 1,500 attended the Saturday night banquet, which featured NBC correspondent Roy Neal K6DUE, and a Special Event Achievement Award to the Pack Rat's Colombian EME DXpedition as HK1TL. At the AMSAT seminar, W8DX won a Special Communications Recognition Certificate for his long service to the OSCAR program. At the ARRL forum, President Harry Dannels W2HD raised a few eyebrows with news that the League may send a representative to Washington (this on the heels of similar discussions at a meeting of ARMA, the manufacturer's association). The League is apparently changing its long controversial stand that General Counsel Robert Booth, based in Washington, was all the representation that the ARRL needed in the capital. ARMA meanwhile voted to put the question of a Washington lobbyist to a committee, with a report upcoming at a future meeting.

A federal grand jury has indicted the head of the FCC's Gettysburg Special Licensing Division on bribery charges. According to a US Attorney connected with the case, Richard C. Zeigler's indictment was the result of an FBI investigation conducted in several US cities over a three month period. Zeigler is accused in the indictment of accepting four separate \$100 bribes from amateurs seeking 1 x 2 (two letter) call signs. US Attorney David Queen refused to name the amateurs, or comment beyond the

indictment, but it was learned that Zeigler pleaded not guilty at his arraignment and posted \$5000 bail. If convicted, Zeigler could receive 15 years in prison and \$25,000 in fines for each of the four alleged violations. Zeigler's trial was expected to get underway in early June. Zeigler himself could not be reached for comment, and officials in the FCC's Personal Radio Division in Washington refused comment.

The Japanese government subsidizes the Japanese electronics industry — that was the ruling of a US Customs Court in mid-April, and it may have far-reaching implications for amateur gear (not to mention automobiles, TV sets, and hi-fi equipment). By court order the US government was told to raise import duties on Japanese imports, but, with billions of dollars at stake (not to mention the balance of payments situation), the appeals from Japanese interests are expected to tie up the case for years, if not kill it outright. An American TV manufacturer brought the court case, but business observers are not exactly "bullish" on its implications — since Japan (and other countries likely to be affected) are certain to retaliate with higher duty on American products, should the court order withstand the appeals.

No sign of the licensing boom slowing down... Gettysburg reports another record month in March, with the amateur population passing the 300,000 mark for the first time ever! Amateurs, then, have increased their numbers by over 35,000 in the last 12 months. Indications are that the growth will continue, with 350,000 licensees expected on the FCC computer by 1978.

CW comprehension exams should be in effect everywhere by the time this issue of 73 reaches you. The long delay in start-up was blamed on contract problems with contractors paid to produce the tapes and duplicates for each field office. FCC officials say test runs of the exams in

Dayton  
**HAMVENTION**  
26<sup>th</sup>  
Friday  
Saturday  
Sunday  
April 29, 30  
and May 1  
1977  
Hara Arena  
& Exhibition  
Center  
Dayton, Ohio  
Sponsored by  
The Dayton  
Amateur Radio  
Association Inc



By Saturday afternoon the Hara was adrift in a sea of cars. For miles in every direction latecomers parked along the highways. Those lucky enough to make it through the 3-hour traffic jam gladly paid their parking fees.



the Washington DC office showed an 80 percent pass rate, compared to less than 50 percent for the old exams. Several who had taken the comp exams told us in Dayton that the new tests were actually harder . . . but FCC spokesmen countered that it was probably just their reaction to a new way of doing things.

The Illinois Attorney General's probe into the activities of Israel Treger (Trigger Electronics) has taken another turn . . . at deadline Treger was being held on \$25,000 bond in the Cook County Jail. According to Deputy AG John McPhee, evidence was presented to the judge in Treger's consumer fraud case that Treger was planning to leave Illinois. On a writ of no exeat, Treger was arrested by local police. He was ill at the time of his arrest, and was taken first to Cook County Hospital. Treger, unable to post the bond, was then transferred to the County Jail Hospital. McPhee continues to process the fraud complaints against Treger, which reportedly amount to between \$15,000 and \$20,000. Trigger Electronics has been closed for some weeks now, after the landlord evicted Treger for failure to pay his rent. The eviction followed a court injunction barring Trigger from mailing catalogs or advertising, after the IL AG's office presented evidence that alleged the company was taking orders without inventory, and refusing to make refunds.

The president of H. F. International, John Randall, has refused to testify in an FCC hearing called to revoke his CB license. According to an FCC spokesperson, Randall was one of 21 HFers ordered to show cause why their CB licenses should not be revoked due to their involvement in HF International, an organization of pseudohams operating between 11 and 10 meters with amateur equipment, high power, and big antennas. Known as "Jack HF 61," Randall was charged with various violations of the FCC rules and Communications Act of 1934. The FCC alleged he had assigned call letters to CB operators for use instead of their FCC call signs,

that he had allegedly formulated rules instructing the unlicensed pseudohams to operate illegally on frequencies assigned to the Industrial and Business Radio services. The FCC notice also contended that Randall had published and sold lists which contained HF numbers, first names, and states of the pseudohams, thus avoiding FCC identification of their CB calls or locations. Randall refused to answer any of the FCC's questions, taking the 5th amendment instead. "Applicant therefore respectfully asserts his privilege against self-incrimination and his privilege not to give evidence against himself as set forth in the Constitution of the US and in particular the 5th Amendment thereto." Hearing Judge Walter C. Miller allowed Randall his right to remain silent, but added that a determination would come whether Randall had abused the Commission's rules by refusing to answer. In other words, Judge Miller would get his answers when the case reached the hearing stage. But before that could happen, Randall withdrew his application for renewal of his CB license. FCC officials say they have searched the files for an amateur license, and are sure Randall doesn't hold one. In all, 21 HFers were ordered to show cause why their licenses should not be revoked. Several will be going to hearing before this issue gets to you, and at least one of them has been refused a ham ticket by the FCC. That case came in Alabama, when a former CBer (whose license had been revoked for numerous violations) applied for an amateur license but failed to appear for a hearing called to air the FCC's objections to giving him one. As one FCC staffer put it, "Every now and then we get lucky, but for every one we catch there seem to be a hundred more."

The fourth notice on WARC has been released by now, although its significance to amateurs is limited. Number five is the big one, and we expect to have details in our next issue. FCC spokesmen say it will be released around the first of June, and it will be a critical point for amateurs, since it could be the last allocations chart produced by the FCC prior to

the 1979 WARC conference. Notice number four relates largely to technical matters, such as how to designate a given emission and so on. The two inch thick fifth notice was due before the Commission just as this issue was going to press.

The antenna/zoning case of Hank Greenberg W2LTP (May 73) has become snarled in the kind of local politics New Jersey is famous for. Greenberg attorney Elson Kendal W2INL has moved for dismissal of the case, charging Cranford area officials with destroying records and intimidating witnesses subpoenaed by the defense. Kendal says the tension surrounding the case proved too much for Greenberg, who was hospitalized in late April with a heart condition. His release (and a final session of the Union County Court hearing Greenberg's appeal) was expected at deadline . . . but Kendal fully expects a further appeal, possibly in the form of a jury trial. Greenberg, in the midst of the zoning dispute over erection of four telephone pole antenna supports, attracted national publicity for his role in the rescue of a ship sinking in the Caribbean with nine persons aboard. As for the fund drive organized in Hank's behalf, several hundred dollars have been collected thus far. Sid Lieberman WA2FXB, the organizer of the drive, says the fund is currently \$4500 in the hole, with New Jersey amateurs the major factor missing! Lieberman told 73 that had surprised him, since he felt hams closest to the case would be the most willing to help out. As for the ARRL, Lieberman says the League has flatly refused to cooperate in the Greenberg case, other than to offer minimal advice. The address for contributions is The Amateur Radio Legal Defense Fund for the Benefit of Hank Greenberg W2LTP (ARLDF/W2LTP), Midlantic National Bank/Raritan Valley, PO Box 996, Edison NJ 08817, Attention Mr. S.J. Lieberman WA2FXB.

Although a Federal court decision is preventing it from collecting license fees, the FCC continues to spend



money. There is no solution to the fee problem in sight, but the need for more funding hasn't faded. In 1977, the FCC budget came in at over \$55 million, but FCC officials have now requested an additional \$1.6 million. A Washington spokesman told 73 the prime problem is the CB crunch — not only in new license applications, but in the cost of field operations teams tracking down illegal CB operators. There is also the cost of lab work, which has increased dramatically with the 40 channel changeover and adaption of new performance specifications. Congressional sources, though, are not so anxious to accept the FCC's judgment on the budget. As one House Appropriations Committee source put it, "The bureaucracy has to stop someplace . . . and it is not only the FCC that has some trimming to do . . ." The 1978 FCC budget request totaled nearly \$60 million, but that may not be enough — a supplemental request is already in the works according to committee sources.

Much has been said and written about Texas, and the extraordinary lengths to which Texans will go to be "biggest." But the testimony of The American Radio Council, in support of Texas House Bill #1440, offers a view rarely seen of the RFI/TVI situation. Before the House Committee on Business and Industry, the ARC argued that all TV sets ought to be filtered to reject unwanted signals. (That's the thrust of bill #1440.)

"Consider, if you will, the



The Dayton flea market at its peak on Saturday . . . fleas as far as the eye can see.



The Sea-Q-DX Convention, set for July 29-31, is being held in Seattle. It is a combined affair, with the Northwest Division ARRL, QCWA National, Northwest Computer Club, and AF MARS Region 5 conferences all rolled into one event. 73 publisher Wayne Green will be featured speaker at the QCWA Luncheon.



following facts: (1) By FCC estimates, there are now 23,000,000 CB radios in use in the US. In 1958, there were basically none. (2) The State of Texas has over 1,500,000 CB radios in use today, using the FCC 'rule of thumb' of 2.5 CB radios per licensed CBER. (3) There are over 800,000 licensed CBERs in the State of Texas, which leads the country in CB radio saturation. Texas has 50% more Citizens Band radio stations than the next largest state (California). Yet Texas has only 50% of the population of California. (4) Nationwide, the FCC received 40,000 RFI complaints from consumers in 1974. Of these 40,000 complaints, 36,000 of them would never have come to the FCC's attention if the manufacturers had corrected design deficiencies in their home entertainment products at the time of manufacture. They expect 200,000 such complaints this year!"

The ARC's testimony went on to say interference has reached crisis proportions in Texas. As for the alternatives to requiring built-in filters, a former FCC engineer-in-charge was quoted as saying, "To require a radio operator stay off the air under such circumstances is similar to requiring a motorist to stay off the highway because another motorist with no brakes is using it!"

The Amateur Radio Manufacturer's Association (ARMA) held a meeting at Dayton to discuss the new FCC radiation limits and pending dockets on linear amplifiers and type acceptance. But the thrust of the session was Docket 20777 and the effect of the new harmonic limits on the ham radio business.

ARMA's hope is to grandfather existing gear, and the gear already on the production line or waiting for sale on dealers' shelves. January 1, 1978, is the retail cutoff date requested by ARMA, with an April 15, 1977, cutoff for manufacturing purposes.

As portrayed at the ARMA meeting in Dayton, the 20777 specifications came as a result of two distinct but related pressures. The first is the ITU international radio regulations, the basis of the upcoming 1979 WARC frequency allocations conference. It was felt in Washington, said ARMA's Bob Levine, that we must enforce the ITU limits here at home in order to have any right to limit the importation of amps considered illegal by American regulations. That's the second pressure point... information from various government agencies that huge shipments of broadband amps manufactured in Mexico, Korea, and Taiwan were headed for US markets. The new harmonic and spurious limits, then, were aimed at blocking further importation of "black box" amplifiers. Until now, the ARMA members were told, most bogus "black box" amps were manufactured here in the US, and it was the threat of thousands more coming in from abroad that forced the FCC's hand. Where all this leaves the American manufacturer of legal amateur radio equipment remains to be seen.

At deadline, the FCC had not acted

**19 jamboree-on-the-air  
jamboree-sur-les-ondes**

**+ RADIO SCOUTING '76**



**World Scout Bureau  
Bureau Mondial du Scoutisme**

Case postale 78 1211 Geneva 4 Switzerland

on ARMA's grandfather clause proposal. ARMA itself was suffering growing pains, taking on new members and forming committees to deal with both pending and yet to be announced FCC proposals. Type acceptance is the prime fear, with most manufacturers convinced it will only raise prices and end up hurting the consumer.

The feeling is that anything — even 20777 — is better than type acceptance. The question is whether ARMA, or anyone in the industry, can find a better answer to the FCC's dilemma with the out-of-band pseudohams, the so-called HFers. And time, at this writing, is running out.

What can you do about supporting Senator Goldwater's RFI bill now before the Congress? Write your senator in support of the legislation which now has reached the Senate Commerce, Science and Transportation Committee. Of special interest are the members of the committee, whose home constituents carry some weight. The members include: Warren Magnuson (WA), the chairman, Howard Cannon (NV), Russell Long (LA), Ernest Hollings (SC), Daniel Inouye (HI), Adlai Stevenson (IL), Wendell Ford (KY), James Pearson (KS), Robert Griffin (MI), Ted Stevens (AK), John Durkin (NH), Edward Zorinsky (NE), Donald Riegle (MI), John Melcher (MT), Barry Goldwater (AZ), Bob Packwood (OR), Harrison Schmitt (NM), and John Danforth (MO). If you live in any of

those states you are in a good position to urge an early hearing on the bill and have some positive effect on its progress through Congress. At deadline no hearing had yet been scheduled.

Twenty-five years ago in Norway, a man named Les Mitchell decided to add a dimension to scouting. Amateur radio was the natural choice due to its accessibility by scout troops around the world. An annual international event grew out of Mitchell's efforts, known as the Jamboree on the Air. And the 1976 version set new records for participation, with over 12,000 stations on the air representing nearly every country that embraces scouting. Here in the US, the BSA (Boy Scouts of America) fielded over a thousand stations, ranging from complex multi-operator setups at BSA headquarters in New Jersey, to deep woods portable operations in the Pacific Northwest. The idea is to demonstrate ham radio, while at the same time promoting scout friendship among the millions of scouts around the world. As one organizer put it after overseeing the operation of AC1NRG at Meriden, Connecticut, "The scouts traded information about their projects, made contacts to trade patches, but one thing seemed to always arise — they wanted to know who the other guy on the radio thought would win the World Series." Condensed from the *Report of the Nineteenth Jamboree On The Air*, World Scout Bureau, Geneva, Switzerland.

The debate over business use of repeaters continues... this latest word comes right from the FCC, via *The Hilltopper*, bulletin of the Tompkins County ARC, Lansing NY. (Anyone who disagrees with this should contact FCC Rules and Legal Branch chief John Johnson in Washington DC, since these are his interpretations.)

In considering the legality of a transmission, you first have to consider if there is a third party involved in any manner (i.e., someone besides the two amateur operators who are talking to each other). If no third party is involved, and providing an amateur is not regularly engaged in buying or selling radio equipment for a living, two amateur operators may consummate a sale of a piece of radio equipment without violation of regulations. However, Mr. Johnson "recommends" that actual prices not be discussed.

An amateur not regularly engaged in buying and selling radio equipment may also inform other amateurs during a net that he has a certain piece of equipment for sale or trade, but again, it is "recommended" that exact price not be discussed. Now, this is all changed if the two amateurs are handling this traffic to or for any person except themselves.

No third party traffic may be handled if either operator or any other person derives monetary gain from the transaction. One amateur asks another amateur to call or contact a hamburger stand ordering burgers, fries, etc. . . . Mr. Johnson replied that although the call seems innocent enough, a third party (the hamburger stand) has a monetary consideration and the call is interpreted as not permitted. Calls to commercial establishments are permitted providing that the purpose of the call involves, at least in part, the welfare of a person or persons. A nonroutine call to a commercial establishment such as to a motel while traveling in another city to find a room is permitted.

In other words, if you are sort of desperate, such as needing a part for a stalled car out on the highway, or a wrecker to tow you into town, it is all right to pass such a call by amateur radio. However, if you made a call just to find a particular color of seat covers, the call would not be permitted. The crucial key as to whether a third party call or message is permitted depends on how desperate the situation is concerning the welfare of one or more persons. Apparently, the discussion of price of the article or service should be avoided. The writer realizes that this is most difficult to decide, what is welfare and what is not (reminds one of the definition of "sin"), but these are the only guidelines we have been able to get from the FCC. Thanks to W5EKP.

The folks who really got CB going — the truck drivers — may well get a new phase of the personal communications boom going. That's the illegal use of amateur VHF gear to escape the QRM on 27 MHz. A number of



clubs have reported that truckers are buying 2m rigs and gathering on 146.58 MHz, CB handles and all! WB0ECX, via *Grid Leak*, reports he's on the lookout for bogus calls in the Denver area, after a check by area amateurs came up with 75 suspected phony calls in less than a day of casual monitoring. Thanks to *Grid Leak*, bulletin of the Pueblo Ham Club, Pueblo CO.

From club bulletins comes the news that 10m intruders are a growing problem. Several clubs report discussions on the topic, but most stopped short of any concrete action, choosing instead to "express our concerns to the ARRL." FCC officials are anxious for reports on the intruder problem both on HF and VHF, with your district engineer topping the list of where to send the information.

Illinois is the latest state to add anti-scanner laws. But amateurs are exempt in the final version of the legislation, largely through the work of statewide amateur clubs and organizations. The law bans the use of VHF and UHF monitors and transmitters in cars, unless the operator holds an FCC license (amateur or commercial). Most states with scanner laws on the books do exempt amateurs, but the best advice is to carry a photocopy of both the law and your license, to prove your point to law enforcement authorities. The Illinois law was expected to take effect October 1st, but will have to be added to the scores of other laws needing revision should the CB band be moved into the VHF/UHF region.

Tests are supposed to begin next fall on the new early warning over-the-horizon radar under construction in Maine by GE. The 39 million dollar system features 100 mile spacing between transmitter and receiver, a "footprint" of 1 million square miles in area, a transmitting antenna measuring 2,276 feet wide and 135 feet high, and 21 transmitters, rated at 100 kW each. Seven of them are to be used at a time over frequencies ranging from 5 to 30 MHz. *Electronics* magazine also reports that the beam can be scanned in azimuth and range simply by shifting frequency. The receive end has a 5,816 foot antenna, and will relay 96 three stage superheterodyne receivers to processors, and then into the Air Force radar system. Big Noise, anyone?

Another 10m beacon has been established here in the US. It's N4RD at Englewood FL on 28.075 MHz, full time. Power is 45 Watts output to a ground plane antenna. Owner/operator Robert Davis K4BRD says he's received over 100 QSLs since putting the beacon on the air at noon April 3rd. "This project was first conceived about a year ago," Davis told 73. "I was listening on the 10m band and it was completely dead. I tuned down to

the CB band, and it was very active. I realize that there is a difference in propagation between 11m and 10m, but it did not seem possible that there was that much difference. I came to the conclusion that no one was transmitting on ten. But how many were listening? What would be the result if there were a beacon on 10m? If the beacon was heard by someone, perhaps if they called CQ they could make a contact." Davis then found out that the IARU supervises beacons internationally, and he was assigned his frequency after contacting the coordinator in London, England. N4RD is home brew, with a Morse identifier. Other US 10m beacons include WA1IOB in Massachusetts on 29.150 MHz. For other beacon stations see May 73, page 13.

New Hampshire and Massachusetts are not exactly the best of neighbors. NH Governor Meldrim Thomson regularly criticizes the "mess" south of his state's border, while Massachusetts officials are quick to point out the lack of services available to New Hampshire residents compared to those offered in their state. A real war is underway between the two states over lotteries, liquor stores, horse and dog racing, and a half dozen other perennial issues, all debated over the Boston TV stations both states share. New Hampshire, says Governor Thomson, will not take a back seat to anyone... and he especially means Massachusetts. With that background in mind, it won't be hard to understand the logic of a bill introduced in the current session of the New Hampshire legislature, to specifically allow the use of microphones while mobile. Massachusetts ("Briefs," April 73) has a little known law banning operation of motor vehicles without both hands on the wheel. At deadline the NH bill was before the house transportation committee. Anyone for a radiotelegraph endorsement? Thanks to WA1YEG.

With thanks to the never tiring editor of the *West Coast DX Bulletin*, here are a few tidbits from the DX world. The logs, equipment, and QSLs of D2ASW were confiscated by the Angolan authorities, and the operator headed for Portugal in quite a hurry... all this in light of recent problems

in Angola. In Dahomey, 9G1JN ran into problems trying to get a TY license... seems a coup attempt may be responsible. W6YO appeared for 24 hours from Pitcairn on a CW only visit. Many CW DX types reportedly were grumbling about too much rag chewing and not enough QSOing. CE0AE, faced with rig problems, got a new Atlas onto Easter Island via W6YO, who's returning the original for factory repair. It seems Atlas played a big role in forwarding the replacement pending arrival of the ailing unit. A late March fire destroyed the Central Bureau of VERON at Arnhem in the Netherlands. Some records and subscription lists were lost, so those receiving *DX-Press* or awaiting correspondence are asked to write VERON, Box 1166, Arnhem, The Netherlands.

*At deadline:* The FCC approved a 30 day extension for comments on dockets 21116 (the proposed ban on linears capable of 24-32 MHz) and 21117 (type acceptance of ham gear). It was also reported that the manufacturer's association bid to enact a grandfather clause covering docket 20777 (bandwidth) was near approval.

Little reaction has been forthcoming on the disturbing suggestion in the book *The Real Spy World* by Miles Copeland, a former CIA organizer, that amateur transmissions are sometimes used for clandestine intelligence operations. He suggests that high speed "squirt" or "screech" signals are sometimes played in the background of ordinary ham radio messages. Copeland claims that squirt recordings "are still used to good effect on ham radio transmissions." It is hoped that if the CIA or any other organizations have ever used amateur radio in this way, the practice has long ceased. Reprinted from *The Indian Radio Amateur*, New Delhi.

George Bailey W2KH, a communications pioneer and a former ARRL President, died in Nashville TN last December at age 89. Bailey was the first American ham to be heard in Europe on the old 5m band. Bailey was instrumental in organizing the US scientific and engineering effort for WWII. He directed the Signal Corps,

see page 206



HOW TO MAKE BETTER QSLs

and was a founding father of the IEEE. As an amateur, Bailey was first to hear news of a sinking steamship, the *Viking*, which blew off course off Newfoundland in March, 1931. He also received first news of the Long Beach CA earthquake in March of 1933. Reprinted from the *IEEE Journal*.

One of the men who pioneered in the field of transducer design, Richard J. Billette, has died after more than twenty years of work in solid state engineering. He was 45.

Before helping to found National Semiconductor Corporation's transducer group in 1972, Mr. Billette spent one year in India establishing a technical school under the auspices of Dunwoodie Institute, Minneapolis, where he taught engineering. Prior to that, he held an influential position in the transducer activities of Honeywell's solid state electronics center in Minneapolis.

Mr. Billette held a key transducer circuit patent, and an important transducer application patent (flow meter) stemming from his work at National, in addition to a number of previous patents from Honeywell. A tireless and prolific worker, Mr. Billette was responsible for conceiving and implementing many new transducer concepts, features and applications. (Transducer devices are fairly recent electronic advances, which act as sensors to provide pressure readings and other important sense inputs for computer based systems. They have uses in many automotive, avionic and process control applications. They are said to "transform a computer into a robot," because they provide necessary external information for artificial intelligence, functioning as the "eyes," "ears," and "fingertips" of the computer.) Thanks to National Semiconductor Corporation.

Electrical storms, next to Murphy, are one of the amateur's worst enemies. Take the case of a Long Beach CA ham, as reported in the *Long Beach Independent*. "A lightning bolt struck the roof antenna of a ham radio set at the Long Beach home of Frederick Fowler. The roof and attic burst into flames. Fire Capt. Ralph Wallace said two engine companies and a ladder truck went to the Fowler home and extinguished the blaze in 15 minutes. He said Fowler

Thank you for your QSL.  
Your QSL is No. \_\_\_\_\_

**FLORIDA BEACON**

26.56N 82.22W  
28.2075 MHZ  
45 WATTS OUT  
N4RD  
ENGLEWOOD, FL

N4RD's QSL - another beacon to help predict 10m openings.



and his wife were not operating any electrical equipment and consequently were not injured, but the house 'looked like a machine gun had ripped through it.' Electrical sockets, light fixtures and a doorbell button were blown apart, Wallace said. Metal corners used to hold the plaster during construction were electrified and bent, knocking plaster all over, he added, and the concussion moved a couch several feet. Part of the cedar shingle roof and part of the attic were destroyed, with damage estimated at \$6,000. Fowler's radio set, however, was unplugged and was not damaged." How many of us would be able to say the same thing if an intense electrical storm hit our home QTH? Thanks to James Ross, Long Beach CA.

There are antennas, and then there are antennas, but we'd be hard pressed to do LU7MAL one better! Mel's Mendoza diggings include the six element 20m beam pictured here, on a 65 foot boom. According to Al OA4XX, who sent along the pictures, Mel started out with separate five and seven element arrays for comparison purposes, and discovered that although he didn't gain much on the transmit side between the two antennas, the big gain was on the receive end. Ultimately a six element antenna was decided on and constructed. One of the best points about the array is the way it folds over for

adjustment and tuning. What's more, the antenna can be locked up in any direction to counter high winds, a major concern in maintaining large arrays anywhere, but especially near the Andes Mountains where Mel lives. Judging by the photos, the USA does not have the only claim to the "big gun" factor in the Americas. The rig at LU7MAL is as ultimate as the antenna farm, with full legal power and a well-known signal at contest time. Thanks to OA4XX.

Local ham radio operators and the Coast Guard teamed up to rescue the 37-foot sailing sloop *Porsoius* when it lost steerage 25 miles off Ocean Park in the Pacific Ocean.

Lyle Clark W7RDR, Chuck Laird W7BCJ, and Jay Shepherd W7FBM combined their skills and equipment to locate the boat when it was discovered that the exact location was in doubt.

The story started when Laird and other operators were talking, using the Astoria WA repeater after a routine emergency drill on the radios.

The talk was interrupted when Bill Blaker WA6MUY, aboard the stricken vessel, called for Coast Guard assistance.

Laird set up a direct communications link with Air Astoria. The hams determined the boat's location and a helicopter was dispatched to find it.

It was located at 12:02 am within four miles of the position determined by radio triangulation. A Coast Guard spokesman said drift could easily account for that.

Three hours later the motor lifeboat 44304 skippered by BM-2 Simonsen arrived on scene and took the vessel under tow. The 52-foot *Triumph* was dispatched, took over the tow, and just after noon Tuesday the *Porsoius* was safely moored in Ilwaco harbor.

The *Porsoius*, with three persons aboard, had a line foul the rudder, causing it to fall into the prop. The boat was dead in the water. Thanks to W7UFL (reprinted from the *Chinook Observer*, Long Beach WA).

Units of the Dallas TX County RACES played a key role in handling last February's railroad tank car explosion and fire. Within 15 minutes of the first explosion, the local net was activated and 56 units were available for crowd control, traffic duty, and communications. A command post was set up beside Dallas police headquarters, with information relayed to a half dozen police departments, fire departments and other emergency agencies. When officials thought a third rail car loaded with polyvinyl chloride might explode and spread toxic fumes, they needed to know the wind speed and direction and were surprised to find a meteorologist in the National Weather Service Office at Fort Worth monitoring the RACES net and ready with the answer. RACES personnel also manned barricades and set out flares, thus freeing many officers to return to their patrol duties. CB REACT teams also worked with the disaster team, manning barricades on the outer perimeter and urging the public to keep away via channels 9 and 19. Interestingly enough, the same Dallas County RACES group first spotted and tracked a major tornado that hit Dallas last May. Reprinted from *In the DARC*, a monthly publication of the Dallas Amateur Radio Club, Dallas TX.

The Pueblo (CO) Ham Club won some great PR with the news it would

help the National Weather Service track tornadoes and other weather emergencies. An article in the *Pueblo Star Journal* reported a demonstration by the club, organized to show NWS officials 2m coverage on a volunteer basis. Fifty stations checked in, from as far away as Denver (110 miles), and the reaction was enthusiastic — the chief weather officer said he was amazed at how readily the amateurs responded to the practice alert. He went on to ask for the Pueblo club's help on a permanent basis. The club will maintain the weather watch 24 hours per day, seven days a week. Thanks to the PHC PR staff.

There's more feedback on amateur emergency efforts during this past winter's worst — W0SIN reports that the "Springs Repeater" near Colorado Springs was in action around the clock during the blizzard of late March under the direction of W0PT. A 75 meter link was maintained by K0CNV. Thanks to W0SIN.

*There are two sides to every story, and the CB story is no different. The following appeared in the North Manchester IN News-Journal, for Monday, March 18th. — Ed.*

Pleasant Township Fire Department has answered its last anonymous CB fire alarm, according to Capt. Jesse Trickle of the Pleasant force.

Pleasant volunteers decided to crack down on false alarms received by CB radio after taking two false calls Friday from CBers. Trickle said the department would no longer respond to fire alarms reported over CB radio unless the caller gives his name, address, and call letters.

Friday's runs brought to seven the number of false calls received over the CB airways by Pleasant Township this year and has resulted in the wasting of over 100 gallons of gasoline as well as the time of the volunteers.

Trickle reported that Friday's calls were reporting fires on SR 15 and at the Laketon Refinery. Firemen were told that an 18 wheeler was on fire on SR 15 but nothing was found.

When firemen returned, they received another call that said the

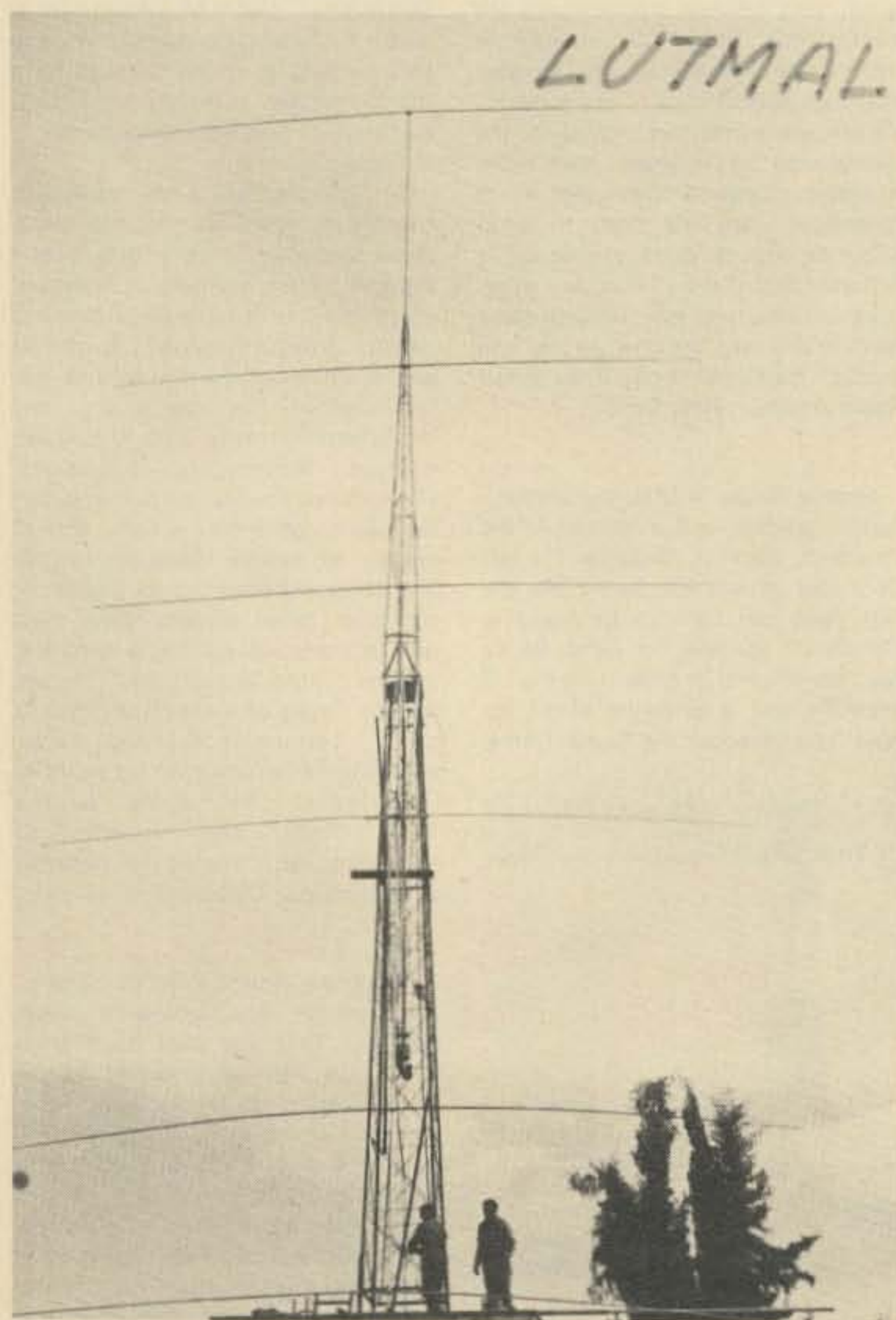

The huge beam's best feature is probably the way it folds over for maintenance.

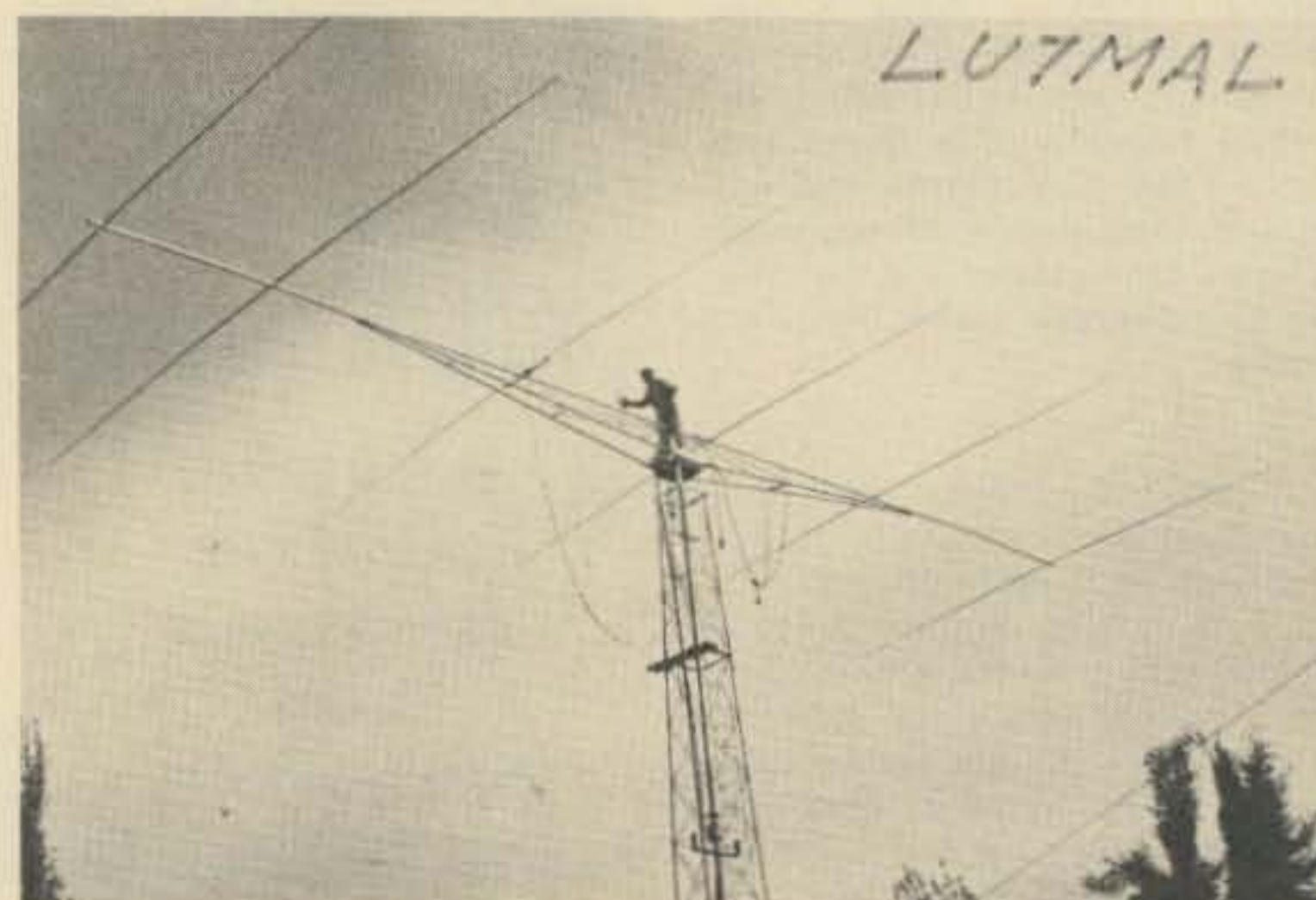

Six elements on a 65 foot boom for 20m — that's the reason for such an outstanding signal from LU7MAL.



previous report was a mistake and there was a fire at the Laketon Refinery. Firemen went to the Refinery only to find the same thing as they had on SR 15. Thanks to WB9VKI.

A new blockbusting phenomenon is reported in certain Texas towns, where "FOR SALE" signs proliferate wherever the hated 11 meter ground plane dominates a local rooftop. Vigilante counter measures reportedly used by an aroused citizenry range from tape recording the offending transmission and giving it back to the CB neighbor via 150 Watts of stereo audio through an open 3 am window, to putting a straight pin through the offender's coax, and waiting for him to turn on his linear. Thanks WA6NCX, W6NIR, and PAARA *Graphs*, bulletin of the Palo Alto CA ARA.

The Environmental Protection Agency in Washington DC is considering a regulation to limit the height of all self-supporting towers less than 2.5 square feet (base cross section) to 34 feet.

It seems that free-standing towers experience wind shear effects which shake the towers. It also seems that, especially in the late spring and summer, this shaking is transmitted to the surrounding earth. The vibrations disturb earthworms, causing them to come to the surface (often during the hottest part of the day). Exposure of the earthworm to the sun's direct rays causes them to die from sunstroke. Earthworms are very important facets of the ecology — hence the EPA's concern. Thanks to the Cascades Amateur Radio Society *Action Mini-Mag*, Jackson MI.

Many of us dream of the ultimate station, but few of us ever seem to get that far. One who has is Ted Gamlin K1VBL of Chester NH. The photos show only a portion of Ted's multi-op setup, from the antenna farm viewpoint. Since Ted took these pictures, the winter of '77 has done its dirty work, and the big 165-foot tower (which supported a six element 20m

beam and the stationmaster for Ted's 220 MHz DXalert repeater) came down. Also lost on at least two occasions was the 4 element 40m yagi, but not before the station, signing W1RR, put in a strong showing in the ARRL DX contest. Now that the warmer weather has arrived, Ted is busily rebuilding, spreading out the towers and in general beefing up the system for next winter ... and the next contest season.

This is, of course, the Silver Jubilee of the reign of Queen Elizabeth II. And, not unlike the American Bicentennial which preceded it, the Jubilee means special calls for amateurs. A "GE" prefix is substituted for the normal one, at the individual amateur's option. The event lasts from 0001 GMT June 4th through 2359 GMT on June 12th, but it isn't being received with exactly open arms among English hams. A report in *Mobile News*, the Journal of the Amateur Radio Mobile Society, put it this way — "Obviously, if this nonsense is adopted, nobody will have a clue what country they are working. When poor Arthur Milne G2MI read this out on the 80m bulletin, he couldn't help muttering about the confusion it would cause to the QSL bureau. We can only hope that this one will go off like the proverbial damp squib, as did the American Bicentennial calls which were utterly confusing."

An FCC news release says alien hams gaining American citizenship must take the American amateur exams to continue operating. That applies even when the old license is still in effect. However, aliens will be able to keep their US calls granted initially under reciprocal agreement.

Canadians planning to operate in the US must first obtain form 410 from the FCC. Reports that current reciprocal agreements between the two countries allow "instant" operation on either side of the border are simply untrue. Operation without authorization may be in the cards in the future, however, since both the

FCC and the Canadian DOC have reportedly agreed on it, but a treaty has not yet been signed. Thanks to *Transborder*, bulletin of the International Repeater Group, Fredericton NB.

A Wayne King special feature in the Sunday *New York Times* gives us some insights into a few of the 100,000 complaints from the public received by the FCC in 1976. They represent some of the more fascinating items of RFI.

The strident tones of "jelly belly" startling a poor housewife as she opened her electronic oven ... A character called "rubber ducky" shouting, "I'm comin' home, warm up the bean pot, honey" just as the minister was closing the coffin during funeral services ... As another pastor said, "forgive us our trespasses," one "dragon lady" in less than dulcet tones came bleeding through the PA speakers with "That's a big 10-4, good buddy," — such ain't the way to perorate the Lord's prayer.

A raucous "hey, what say, good buddy" ruined the romantic moment for a Houston couple who were therefore using to best advantage the soft music on their stereo. A Dallas police chief was equally upset when his electric organ started talking with a trucker's twang, even though the switch was off, and a southern chanteuse named Cheryl Russell



found herself suddenly off-key and mentally anguished when her night club mike talked back to her. The New Mexico Cooperative Interference Committee investigated 11 meter signals which drove a local citizen to a psychiatrist — the fillings in his teeth were picking up more than one good buddy. CBers trying to get 9 pounds out of a 5 pound Tiger 23 have caused widespread havoc with electronic controls on fuel injection systems ranging from spitting VWs to sputtering Mercedes.

The FCC announces publication of a new 35 page booklet, "How To Resolve Radio-TV Interference Problems." It will be available from the GPO beginning in late June, for \$1.50.



The K1VBL antenna farm last fall. Since the picture was taken, winter has done its dirty work, taking out the largest tower and forcing a rebuilding program this spring.

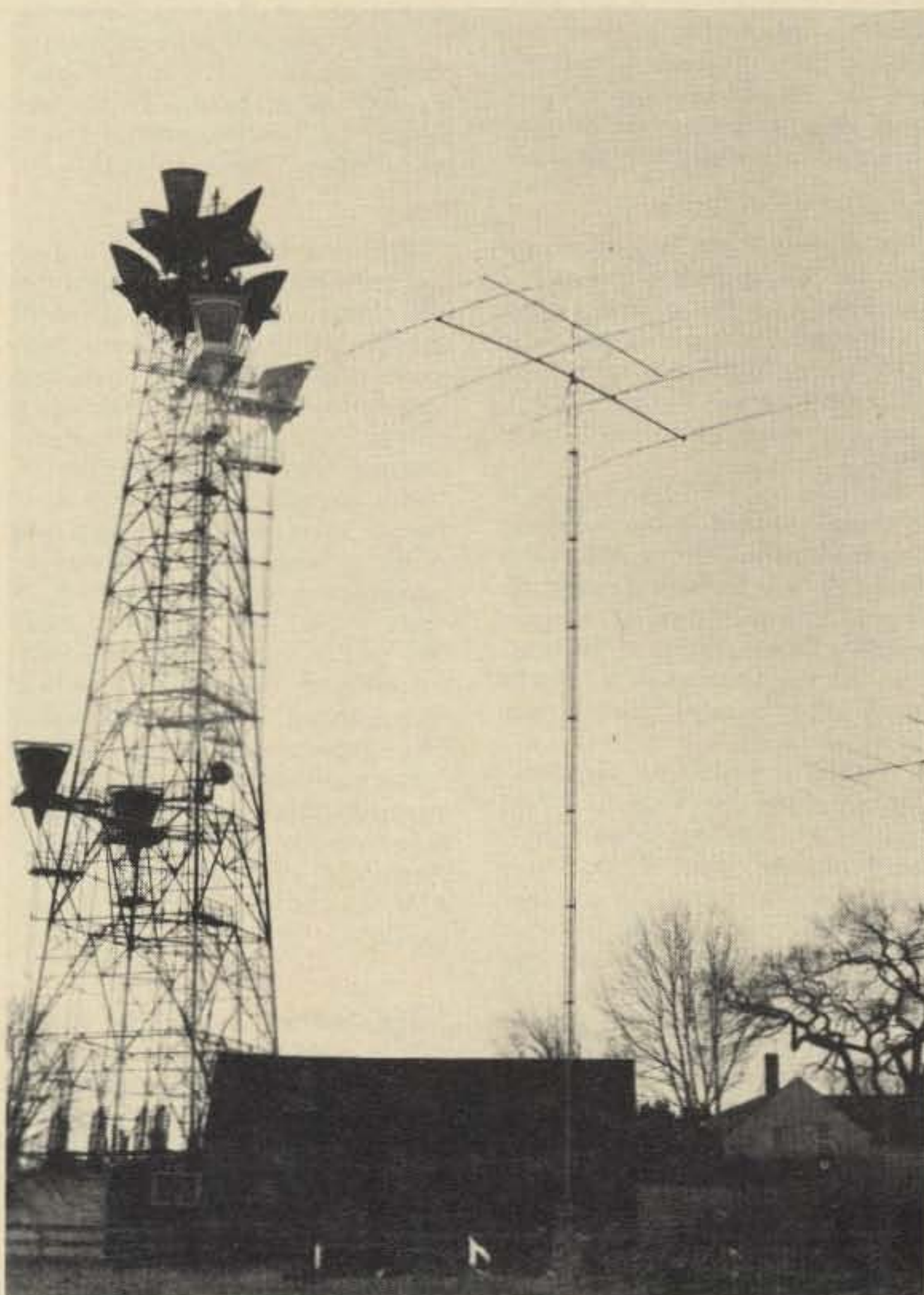

As is obvious from this shot, K1VBL let Ma Bell do his site research work for him. Most contestors are by now aware that it's paying off.



booklet includes interference information on TVs, BC radios, telephones, stereo systems, and other electronic devices.

Amateurs everywhere owe Fred Maia W5UTT a vote of thanks. Maia was a major contributor to the successful introduction of an RFI bill in this year's session of the Texas legislature. The RFI bill's introduction followed withdrawal of a measure that would have set criminal penalties on interference cases, strictly from the ham's or CBer's point of view. The new bill would force the installation of interference filters on TV sets at the dealer level, and place either a \$100 fine or actual damages (whichever is greater) for interference caused by the lack of a filter. But the Texas amateurs and their supporters did not stop there. A section was added to the bill suspending normal legislative procedures to allow for early action and an immediate effective date for the new law upon passage!

The CB problem in Australia has become so bad that the state police can stop and search any vehicle suspected of carrying illegal 27 MHz equipment. All amateurs in Australia are advised by *Amateur Radio* magazine to carry their license or a photocopy of it with them. It is also required that they carry their license renewal certificate and a log book. Amateurs are further instructed to remove their mobile gear if they lend their car to spouses or friends, so the driver does not get booked for illegal possession of radio transmitting gear.

In "Briefs" in the May issue (page 40), an item appears which gives a false impression of the facts. It says, "A licensed amateur . . . was fined \$100 . . . for inadvertent jamming of radio and TV shows . . . for which he could have been fined a maximum of \$1600."

The facts are that damages of \$25 each were awarded to four neighbors who had sued the user of a CB station for \$400 damages each because, for about a year, despite repeated complaint, their radio and TV reception had been marred by a "strange voice" which intruded "at all hours of the day and evening."

In Canada, the Radio Regulations still forbid the use of CB for "transmissions of a frivolous nature" and "a communication used in itself as a diversionary or recreational activity," but in fact these prohibitions are not enforced. But another provision says, "no station . . . shall be operated so as to cause interference to any licensed radio station or a private receiving station." The sensible ham or CBer operates his gear with discretion, knowing that there is a fine and debatable line between his right to operate and the right of his neighbors to enjoy their listening and viewing.

The court case which ended in the judgment against the CBer was argued around the principle that the exercise of an act of ownership is subject to



## Amateur Radio News Service

the exercise of the same right for neighboring owners. It was found that "the owner of such a device is responsible for its injudicious use if such use causes inconvenience to others. The theory of misuse of right must be applied here. The fact that one exercises a right does not mean that one may thoughtlessly, albeit without malice, interfere with others in the exercise of their rights."

Another interesting reference is to the possibility of high pass filter protection on the TV sets. "It is false to claim that the owners of television sets should provide their sets with special filters, since the use of a television set is not regulated to the same extent as that of a CB device. Thus, the intangible damages incurred by the applicant must not be given any less weight because he did not provide his own television set with special filters." Thanks to VE7BS.

We've heard about the ATV madness sweeping the country, but things are clearly getting out of hand! Consider the proposal of some Baltimore (MD) ATVers, as published tongue-in-cheek in *The Milliwatt*, bulletin of the Baltimore Radio Amateur Television Society (BRATS). "Have you noticed that most commercial TV stations stop transmitting at night? Apparently they are not interested in using their spectrum 24 hours a day. Tell you what. When they go off, allow the hams to transmit ATV on those unused channels. Betcha dollars to donuts ATV would fill up those unused channels fast and attract more viewers than those moldy all-night movies. BRATS hereby announces its preliminary plan for channel 11 input, channel 2 output, ATV repeater for Baltimore." Thanks to K3SVC.

The Amateur Radio News Service was founded many years ago as a result of a need for the exchange of ideas among and between those radio amateurs concerned with club newsletters and public relations. In the newsletter field, ARNS attempts to cover all aspects of producing and mailing a club paper. To one entering the field it soon becomes evident that producing a club paper is somewhat of a unique process, primarily because

standard practices of printing will not necessarily apply. The publisher seldom has equipment available and in many cases must operate without any equipment at all! Few club paper editors have had any experience in the field. It has been demonstrated that, through information available through the Amateur Radio News Service, a new paper editor can easily surmount many of the problems involved in producing a club paper.

The monthly publication, *The ARNS Bulletin*, contains in each issue helpful hints for producing the paper. Currently each issue contains an installment of the booklet "The Club Paper," bringing the publication up to date. These installments cover all aspects of producing a club paper, from the origin of the text to finally placing the papers in the mail. When completed, each member will receive a copy.

ARNS numbers among its members many professionals possessing expertise in almost any subject of producing a paper. Thus the newcomer has access to a recognized expert who can answer almost any question relative to producing a club paper. Because of the improvement in the club paper and since the editor has access to continuing information, most clubs pay the nominal cost of the editor's membership in the Amateur Radio News Service.

In the Public Relations field the Amateur Radio News Service endeavors to cover suggestions for operating in the public relations field, including types of items to be submitted to the media. Again, ARNS has among its members many who are professional public relations individuals, and each member has access to information available from them.

The Amateur Radio News Service has members in many foreign countries. It is a service for amateur radio editors and does not issue "news" items as such. However, each issue of *The ARNS Bulletin* contains quotes from other club papers which can be copied for use in any club paper. Thanks to W9MOL and WA3HEN.

For those interested in building the TV game circuit presented in the Oct., 1976, issue of 73 ("Hey, Look What My Daddy Built!"), and have either had trouble finding the AY-3-8500-1

chip or did not want to spring for the \$35, we have good news! Poly Paks now has the chip listed on the front page of its newest (221) catalog, for \$14.95. We thought this might make some of you happy. —WB1ASL.

Hams have come up with some ingenious uses for beeps. LIMARC, the Long Island Mobile Amateur Radio Club, uses a beep to tell you when you have paused long enough between transmissions for the machine to recycle. When you hear the beep, start talking.

Vancouver's VE7RPT machine beeps users when their regular power has ceased and emergency battery power is being used. Dave Williams VE7MQ says that the battery supply gives full emergency capabilities, but only for a finite duration. "If the beep tone is on," he writes in the *British Columbia FM Communication Association Bulletin*, "please be exceedingly brief, or better yet, limit your use to emergency traffic."

The Miami Valley FM Association *FM Scanner* reports that their 04/64 machine emits a double beep if an emergency is in progress. Monitoring stations are instructed to stand by and listen when the double beep is heard. Net control will then ask for check-ins if needed.

A wide area communications system, which has received FCC authorization, will consist of 6 or 7 strategically located repeater stations capable of retransmitting signals from weak stations, such as HTs, throughout the 30,000 square mile area around Kansas City. Each of the linked repeaters can be tone or carrier accessed as desired by the control operator. The repeaters may also be operated independently without interference between terminals. A complex set of commands will be given by the headquarters communications center (W0SHQ), which can monitor traffic on each repeater. A minicomputer, located at headquarters, controls the entire system.

The Association of Saint's Church Radio Amateurs, headquartered in Independence MO, says that the system is the only one outside of the western US to have such a large coverage area. Mountain-based repeaters in the west easily provide 200 mile coverage, while plains states have no such height advantage.

Congratulations are in order to the Cuyahoga ARS of Cleveland OH, after providing assistance to the local American Cancer Society during its annual fund drive. Mobile stations were provided by the local club, whose members delivered 365 cubic feet of literature and informational packets to zone captains for distribution throughout Cuyahoga County. Thirteen locals participated, along with a prospective amateur (a security guard at the Cancer Society headquarters building) who gave up a day off to join the hams! Thanks to WA8GEO.



# We've just made the impossible... a professional 3½ digit DMM Kit for less than \$60.



The Sabtronics Model 2000 is an impossible \$59.95! And that price still includes phenomenal accuracy, range and professional features.

This all-new bench/portable multimeter, reading to  $\pm 1999$ , has a basic accuracy of  $0.1\% \pm 1$  digit, and has five functions giving 28 ranges, 100% overrange and overload protection. So you know it's no toy!

Besides, what toys are as automatic as the 2000? With automatic overrange indication, automatic polarity, even automatic zeroing!

Yet the 2000 is easy to assemble. We send you all the parts you need, even the high-impact case. We also send you clear, step-by-step assembly instructions.

So you end up with a professional quality 3½ digit DMM for the unheard-of price of less than \$60. From Sabtronics, specialists in digital technology. And manufacturers of the impossible.

Order yours today!



Made in U.S.A.

**sabtronics**   
INTERNATIONAL INC.

P.O. Box 64683 Dallas, Texas 75206 (214) 369-7310

## GUARANTEE:

Our guarantee to you; examine the 2000 DMM kit for 10 days. If you're not satisfied, return it unassembled for a full refund of purchase price.

## SPECIFICATIONS:

DC volts in 5 ranges:  $100\mu\text{V}$  to 1000V.  
AC volts in 5 ranges:  $100\mu\text{V}$  to 1000V.  
DC current in 6 ranges: 10nA to 2A.  
AC current in 6 ranges: 10nA to 2A.  
Resistance in 6 ranges:  $1\Omega$  to  $20\text{M}\Omega$   
Input Impedance:  $10\text{M}\Omega$   
Display: 9mm (.36") LED.  
Power requirements: 4.5 VDC to 6.5 VDC  
(4 "C" cells - not included).  
Size: 8"W x 6.5"D x 3.0"H.  
(203W x 165D x 76H mm).

To: Sabtronics International, Inc.  
P.O. Box 64683, Dallas, TX 75206

Please send me \_\_\_\_\_ Sabtronics Model 2000 DMM kit(s) at  
\$59.95 each. \_\_\_\_\_ subtotal

Shipping and Handling, \$3.50 per unit\* \_\_\_\_\_ subtotal

Texas Residents Add Sales Tax \_\_\_\_\_

TOTAL enclosed \_\_\_\_\_

Name \_\_\_\_\_

Street Address \_\_\_\_\_

City \_\_\_\_\_

State \_\_\_\_\_ Zip \_\_\_\_\_

\*USA only. Canada, \$4.50. All Other Countries, \$9.00



Editor:  
Robert Baker WB2GFE  
15 Windsor Dr.  
Atco NJ 08004

# CONTESTS

Official logs, check sheets, and summary sheets for the CAN-AM Championship Contest may be obtained from CANADX, Box 717, Station Q, Toronto, Ontario M4T 2N7, Canada. Include a large SASE for samples. Full rules for this contest will appear in the next issue!

## QRP SUMMER CONTEST

Starts: 1500 GMT  
Saturday, July 2  
Ends: 1500 GMT  
Sunday, July 3

The contest is organized by the DL Activity Group-CW. Work 15 hours maximum during the 24 hour contest period, with no more than two pause periods. Select up to 5 bands from 160 to 10 meters. General call is "CQ QRP TEST." A station is not handicapped if CO/VXO control and VFO control are used on the same band or the input power of a commercial rig is reduced to below 2.5 Watts. QRO stations - same rules, but work only QRP stations and sign ".../QRO"; scoring is the same.

### EXCHANGE:

RST, QSO number, and input (1 to 9). Add "x" if transmitter is CO or VXO controlled. Example - 579 000/8x.

### SCORING:

QSOs with all stations are valid unless running QRO; then only QSOs with QRP stations count. Contacts with your own country count 1 point, own continent = 2 points, DX = 3 points, and score 3 additional points for a QSO with another QRP station. Score additional handicaps as follows: 1 handicap point for each station

using below 3.5 Watts input or crystal controlled transmitter. Maximum handicap is 4 for any QSO. Both stations multiply QSO points times the handicap points plus one (QSO pts x 5 max) to find total QSO points for that contact. Multipliers are as follows: own continent = 1, DX = 2 points per band and country according to latest DXCC list, but call areas in JA, PY, VE, VK, W, and ZS count extra. Final score is total QSO points (including handicap pts) times the total multiplier.

### ENTRIES:

Send entry including a "mini-log" to Hartmut Weber DJ7ST, D-3201 Holle, Kleine Ohe 5, Fed. Rep. of Germany. Logs should be postmarked no later than Feb. 15.

## ARRL STRAIGHT KEY NIGHT

Complete rules in June issue of QST!

If similar to last year, starts 0100 GMT July 3rd and ends 0700 GMT July 4th. Send "SKN" instead of "RST" during QSOs to identify contest stations. Try 60 to 80 kHz up from bottom edge of the band. After contest period, send a list of calls of the stations contacted during the contest period plus your vote for the best fist heard. All entries should be addressed to ARRL, 225 Main St., Newington CT 06111.

## APOLLO II 8th ANNIVERSARY CONTEST

July 16 to 17  
6 pm to 9 pm local time  
Use all VHF/UHF bands, all modes - except repeaters!

Power classes as follows: Class I - 100 to 300 Watts input; Class II - 25 to 100; Class III - 5 to 25; Class IV - 1 to 5. Special XYL class - any power permitted. Club class - aggregated scores.

### SCORING:

Each completed contact counts 2 points. Same station may be reworked on different mode and/or band for additional 2 point scores. Each different zip code worked will count as 1 multiplier; like zip codes worked will not be counted as a multiplier.

### AWARDS/ENTRIES:

Trophy plaque to highest score in each power class and XYL and Club classes. Space Net certificates to second and third places in all classes. All logs to be postmarked no later than Aug. 10, 1977, to: VHF Space Center, Box 15, Sumterville FL 33585.

## TEN-TEN INTERNATIONAL NET SUMMER QSO PARTY

Starts: 0000 GMT July 16  
Ends: 2400 GMT July 17

The contest is open to all amateurs, but only members are eligible for awards. All contacts must be made on 10 meters, but any mode may be

used.

### EXCHANGE:

Name, QTH, and 10-10 number.

### SCORING:

Score 1 point per contact and add 1 point if with a 10-10 member (max. 2 pts per QSO). Give name of your chapter for chapter credit.

### AWARDS:

1st and 2nd place certificates for each US Dist, KH6, KL7, VE districts, Central America and Caribbean, South America, Europe, Africa and South Atlantic, Asia and North Pacific, Australia-New Zealand and South Pacific.

### ENTRIES:

Members only send logs to Grace Dunlap K5MRU/0, Box 13, Rand CO 80473 no later than Aug. 31, 1977. Results will be published in the Fall Bulletin. Special certificates for all CW scores and if 10 or more logs are received from Novice members.

## CW COUNTY HUNTERS CONTEST

Starts: 0000 GMT July 23  
Ends: 0600 GMT July 25

The CW County Hunters Net invites all amateurs to participate in the 1977 CW Contest with all mobile and

# RESULTS

## RESULTS OF THE TEN-TEN INTERNATIONAL NET WINTER QSO PARTY

WA1UAD	323/610	VE2DZO	78/109
WA1STR	304/566	VE2XL	30/53
K9EGA/2	398/729	**VE3AHN	152/223
WB2MAN	248/461	VE4VV	71/136
K3LYW	478/872	VE4UO	7/12
W3RJ	240/434	VE6BCC	13/23
W4MNZ	491/942	VE7CNY	181/326
WB4CHK	401/748	VE7DHE	121/217
WA5JDU	560/1029	HP1GD	175/334
WB5EHF	456/860	LU7FAG	287/531
WA6UZA	376/698	CE3EZ	266/480
WA6NAU	289/520	VK4JP	58/89
K7PXI	345/650	VK4AMO	54/79
WA7BPF	299/553	JA3XOG	52/79
WB8FAG	456/835	JA9NGS	47/73
W8DMY	294/552		
**W9NIN	315/586	**Multi-operator station.	
WA9IXF	205/393	Ten-Ten Net Chapters:	
W9BPU	208/392	Southern New England 7614/14,426	
WB0QHV	710/1308	Gateway (Missouri) 5683/11,010	
WB0CEI	396/733	Cincinnati Area	
KH6IAA	435/796	Ten Tuners 4920/9,374	
KH6ILF	374/665	Colorado 3316/6,251	
		Bay Area (Cal.) 3242/6,137	

# CALENDAR

July 2-3	QRP - Summer - Contest
July 4	ARRL Straight Key Night
July 9-10	IARU Radiosport Championship
July 16-17	Apollo II 8th Anniversary Contest
July 16-17	10-10 Net Summer QSO Party
July 23-25	CW County Hunters Contest
Aug 20-21	New Jersey QSO Party
Aug 20-21	Worldwide SARTG RTTY Contest
Aug 20-22	CAN-AM Championship Contest
Aug 27-28	All Asian Phone Contest
Sept 10-11	Washington State QSO Party
Sept 10-11	ARRL VHF QSO Party
Sept 24-25	Delta QSO Party
Oct 1	Open CD Party - CW
Oct 15-16	Open CD Party - Phone
Oct 15-17	Manitoba QSO Party
Nov 5-6	ARRL Sweepstakes - CW
Nov 12-13	IPA Contest
Nov 13	OK DX Contest
Nov 19-20	ARRL Sweepstakes - Phone
Nov 19-20	WWDXA International CW Contest
Nov 19-20	All Austria Contest
Dec 3-4	ARRL 160 Meter Contest
Dec 3-4	TOPS CW Contest
Dec 10-11	ARRL 10 Meter Contest



# Look closely at the new MT-3000A. You've never seen anything like it.

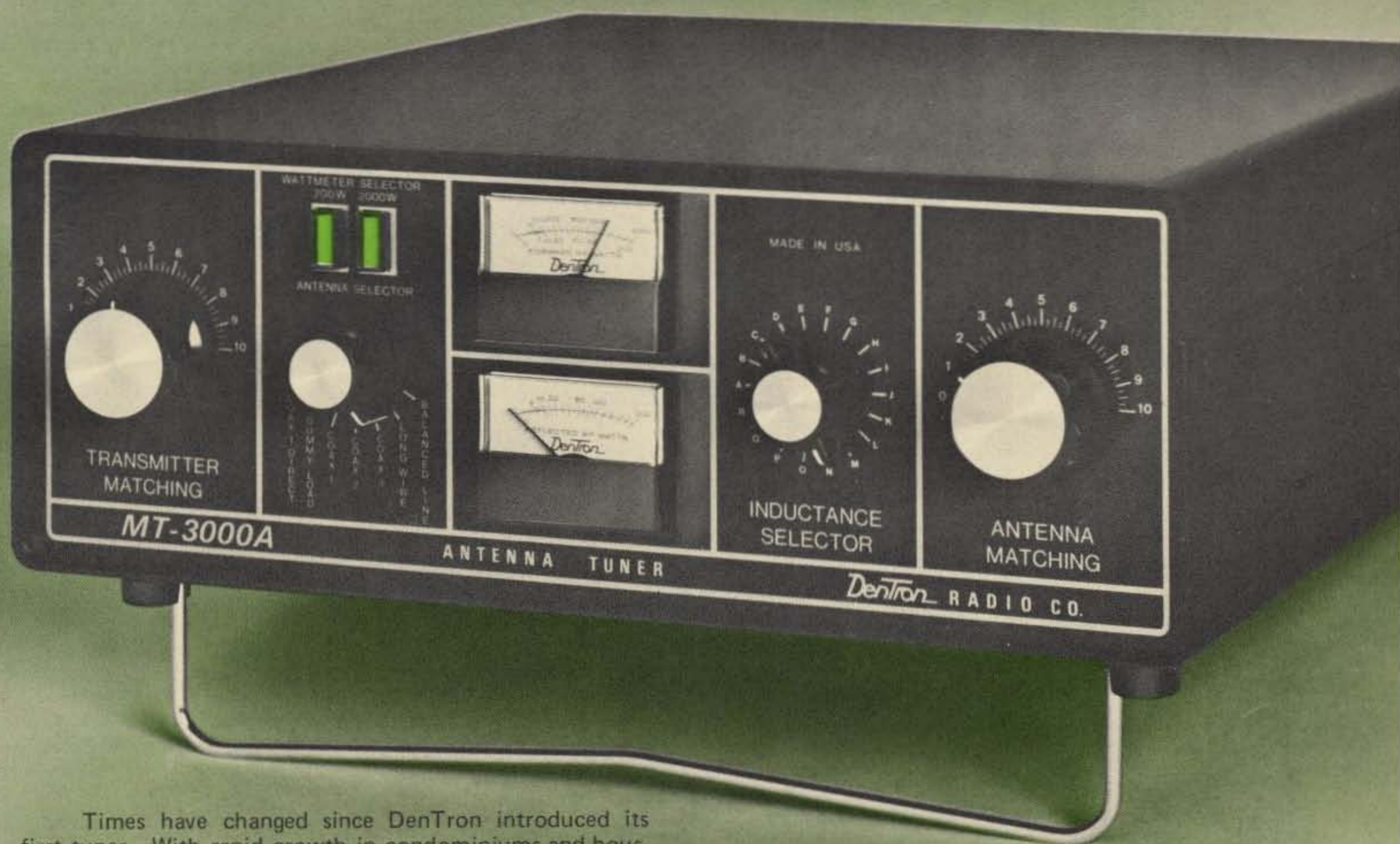

Times have changed since DenTron introduced its first tuner. With rapid growth in condominiums and housing developments, we have new problems that require new solutions.

DenTron decided to rethink the tuner and what its total capabilities should be.

The MT-3000A is a capsulized solution to many problems. It incorporates 4 unique features to give you the most versatile antenna tuner ever built.

First, as a rugged antenna tuner the MT-3000A easily handles a full 3KW pep. It is continuous tuning 1.8-30mc. It matches everything between 160 and 10 meters.

Second, the MT-3000A has built-in dual watt meters.

Third, it has a built-in 50 ohm dummy load for proper exciter adjustment.

Fourth, the antenna selector switch; (a) enables you to by-pass the tuner direct; (b) select the dummy load or 5 other antenna systems, including random wire or balanced feed.

The compact size alone of the MT-3000A (5½" x 14" x 14") makes it revolutionary. Combine that with its four built-in accessories and we're sure you'll agree that the MT-3000A is one of the most innovative and exciting instruments offered for amateur use.

At **\$349.50** the MT-3000A is not inexpensive. But it is less than you'd expect to pay for each of these accessories separately.

As unique as this tuner is, there are many things it shares with all DenTron products. It is built with the same meticulous attention to detail and American craftsmanship that is synonymous with DenTron.

After seeing the outstanding MT-3000A, wouldn't you rather have your problems solved by DenTron?

**DenTron**  
Radio Co., Inc.

2100 Enterprise Parkway  
Twinsburg, Ohio 44087  
(216) 425-3173



portable operation in less active counties welcomed and encouraged. General call "CQ CH." Stations may be worked once per band and again if the station has changed counties. Portable/mobile stations changing counties during the contest may repeat contacts for QSO points. Stations on county lines give and receive only one number per QSO but count each county for a multiplier.

**EXCHANGE:**

QSO number, category (P = portable, M = mobile), RST, state-province-country, and county (for US stations).

**FREQUENCIES:**

3575, 7055, 14070, 21070, 28070.

**SCORING:**

QSOs with fixed station count 1 point, portable/mobile stations = 3 pts; multiply QSO points times

number of US counties worked. Mobile/portables calculate their score on the basis of total contacts within a state.

**AWARDS:**

Certificates awarded in three categories: F — Highest fixed or fixed portable in each state, province, and country with 1,000 or more points; P — Highest station operating portable (not normal point of operation) with 1,000 or more points; M — Highest mobile in each state operating from 3 or more counties with a minimum of 10 QSOs per county.

Trophies to highest single operator station in categories P and M. Additional awards where deemed appropriate.

**ENTRIES:**

Logs must show category, date/time in GMT, station worked, exchanges, band, QSO pts, location, and claimed score. All entries with 100 or more QSOs must include a check sheet of counties worked or be disqualified from receiving awards. Enclose large SASE if results desired. Logs must be postmarked by Sept. 1 and sent to: CW County Hunters Net, c/o Jeffrey P. Bechner W9MSE, 673 Bruce St., Fond du Lac WI 54935.

**TENTH ANNIVERSARY  
JERUSALEM AWARD**

The Jerusalem Award Committee announces the creation of a new certificate to commemorate the tenth anniversary of the unification of Jerusalem. The certificate will be

made available to both amateurs and SWLs. To qualify, contact 8 amateur stations in Israel, with at least 3 of them located in Jerusalem, the capital. All contacts must be made in the year 1977! Have log entries certified by another radio amateur and send log extracts along with 10 IRCs to: Jerusalem Award, PO Box 4079, Jerusalem 91 040, Israel.

Also of note: The requirements for the regular Jerusalem award have been changed to require contacts with 8 stations in Israel, with 3 in Jerusalem. The address is the same as shown above.

**IARU RADIOSPORT  
CHAMPIONSHIP**

Complete rules in the June '77 issue of QST!

# Oscar Orbits

Oscar 6 Orbital Information				Oscar 7 Orbital Information			
Orbit	Date (July)	Time (GMT)	Longitude of Eq. Crossing "W"	Orbit	Date (July)	Time (GMT)	Longitude of Eq. Crossing "W"
NA 21530 BTN	1	0021:23	67.1	12006 B	1	0050:11	66.1
N 21543	2	0116:19	80.9	12019 A	2	0144:28	79.7
NA 21555 BTN	3	0016:15	65.9	12031 B	3	0043:48	64.5
N 21568	4	0111:11	79.6	12044 A	4	0138:05	78.1
NA 21580 BTN	5	0011:07	64.6	12056 B	5	0037:26	63.0
NA 21593 BTN	6	0106:02	78.4	12069 AX	6	0131:43	76.6
N 21605	7	0005:58	63.4	12081 B	7	0031:04	61.4
NA 21618 BTN	8	0100:54	77.1	12094 A	8	0125:21	75.0
N 21630	9	0000:50	62.1	12106 B	9	0024:41	59.8
NA 21643 BTN	10	0055:45	75.9	12119 A	10	0118:59	73.4
N 21656	11	0150:41	89.6	12131 BQ	11	0018:19	58.3
NA 21668 BTN	12	0050:37	74.7	12144 A	12	0112:36	71.8
NA 21681 BTN	13	0145:33	88.4	12156 BX	13	0011:57	56.7
N 21693	14	0045:29	73.4	12169 A	14	0106:14	70.3
NA 21706 BTN	15	0140:24	87.2	12181 B	15	0005:34	55.1
N 21718	16	0040:20	72.2	12194 A	16	0059:52	68.7
NA 21731 BTN	17	0135:16	85.9	12207 B	17	0154:09	82.3
N 21743	18	0035:12	70.9	12219 A	18	0053:29	67.1
NA 21756 BTN	19	0130:08	84.7	12232 B	19	0147:47	80.7
NA 21768 BTN	20	0030:04	69.7	12244 AX	20	0047:07	65.5
N 21781	21	0124:59	83.4	12257 B	21	0141:24	79.1
NA 21793 BTN	22	0024:55	68.4	12269 A	22	0040:45	64.0
N 21806	23	0119:51	82.2	12282 B	23	0135:02	77.6
NA 21818 BTN	24	0019:47	67.2	12294 A	24	0034:22	62.4
N 21831	25	0114:42	80.9	12307 BQ	25	0128:40	76.0
NA 21843 BTN	26	0014:38	65.9	12319 A	26	0028:00	60.8
NA 21856 BTN	27	0109:34	79.7	12332 BX	27	0122:17	74.4
N 21868	28	0009:30	64.7	12344 A	28	0021:38	59.3
NA 21881 BTN	29	0104:26	78.4	12357 B	29	0115:55	72.8
N 21893	30	0004:22	63.4	12369 A	30	0015:16	57.7
NA 21906 BTN	31	0059:17	77.2	12382 B	31	0109:33	71.3

The listed data tells you the time and place OSCAR crosses the equator in an ascending orbit for the first time each day. To calculate successive orbits, make a list of the first orbit number and the next twelve orbits for that day. List the time of the first orbit. Each successive orbit is 115 minutes later (two hours less five minutes). The chart gives the longitude of the first crossing. Add 29° for each succeeding orbit. When OSCAR is ascending on the other side of the world, it will descend over you. To find the equatorial descending longitude, subtract 166 degrees from the ascending longitude. To find the time it passes the north pole, add 29 minutes to the time it passes the equator. You should be able to hear OSCAR when it is within 45 degrees of you. The easiest way to do this is to take a globe and draw a circle with a radius of 2480 miles (4000 kilometers) from the home QTH. If it passes right overhead, you should be able to hear it for about 24 minutes total. OSCAR will pass an imaginary line drawn from San Francisco to Norfolk about 12 minutes after passing the equator. Add about a minute for each 200 miles that you live north of this line. If OSCAR passes 15 degrees from you, add another minute; at 30 degrees, three minutes; at 45 degrees, ten minutes.

OSCAR 6: Input 145.85-145.95 MHz; Output 145.90-146.00 MHz; Output Mode B: Input 29.45-29.55 MHz; Telemetry beacon at 29.45 MHz; Output 432.125-432.175 MHz; Output 145.925-145.975 MHz.

Orbits designated "X" are closed to general use. "ED" are for educational use. "BTN" orbits contain news bulletins. "Q" orbits have a ten Watt ERP limit. "L" indicates link orbit. "N" or "S" indicates that Oscar 6 is available only on northbound or southbound passes. Satellites are not available to users on "NA" days.

# Corrections

Thank you very much for printing my crystal checker circuit on page 164 of the April, 1977, issue of your great magazine. There is only one small error in the schematic. Due to a misprint (I hope), the transistor part number reads 50011. It should be S0011. I think that whoever builds the circuit will understand the error.

John Mairs WD4CEA  
Springfield VA

I have had considerable mail response on my article that was in the May, 1977, issue of 73, "All-Electronic SELCAL." I have one thing to say: "These hams who are supposed to be dummies can really pick out the errors." It has been brought to my attention that all the 5 volt power leads to the 7473 flip-flops have been reversed. That would be IC1, 2, 3, 4 and 5. Also, Q1 and Q2 have been labeled incorrectly — they should be reversed. These are all my errors; I

should have caught them but did not. You did make one error, and that is that resistor R3, which goes to the collector of the 2N706 and got its base driven from input 15, should also be connected to the vertical line that goes past it on the right-hand side (to the manual reset button).

A. Sperduti WB2MPZ  
Hamburg NY

My apologies to those people who have had problems with the "NASA-type Beeper" in the January 1977 issue. The value of C5 which determines the tone of the beep should be .01 uF instead of the .001 called for. The .001 produces a beep of around 10 kHz — high enough that most people thought that the circuit was not working at all. With this change, a 1 kHz tone is produced.

Also, in Fig. 2, the ground pin of U1 is labeled GND but not connected to ground, which it, of course, should

be. Fig. 1 is correct as shown.

Bob Shattuck WB3GCP  
Gillett PA

This note is to advise you that there is an error in the text that accompanies the circuit I sent you for the Circuits<sup>2</sup> section of 73 which appeared in the April, 1977 issue, page 164. The schematic is correct as printed, but the fuse rating should be less than the current rating of the SCR. This is so that the fuse will blow before the rating of the SCR is exceeded. If the SCR's rating was exceeded, the SCR would be destroyed,

of course.

I thought that you would like to be advised of this error. Thank you.

Paul Hurm WB8CLF  
Seven Mile OH

I was very pleased to see my circuit published in the April issue of 73. However, I must point out a mistake. The 470k resistor on the output of the op amp in series with the bipolar LED is incorrect. The value which I originally used was 470 Ohms.

Michael Black VE2BVW  
Montreal, Quebec

# Tracking the Hamburglar

RIPPED OFF: In Jersey City NJ, Regency HR-212 #24-01529 with 34-94, 52-52, 28-88, 73-73, 37-97, 31-91, 94-94, 58-58 and 55-55.

Duplex transmit and receive. Jack Smith WB2CDL, 53 Orange Ave., Staten Island NY 10302.



# the TEMPO 2020



## ...an accepted and proven performer

- Phase lock-loop (PLL) oscillator circuit minimizes unwanted spurious responses.
- Hybrid Digital Frequency Presentation.
- Advanced Solid-state design...only 3 tubes.
- Built-in AC and 12 VDC power supplies.
- CW filter standard equipment...not an accessory.
- Rugged 6146-B final amplifier tubes.
- Cooling fan standard equipment...not an accessory.
- High performance noise-blanker is standard equipment...not an accessory.
- Built-in VOX and semi-break in CW keying.
- Crystal Calibrator and WWV receiving capability.
- Microphone provided.
- Dual RIT control allows both broad and narrow tuning.
- All band 80 through 10 meter coverage.
- Multi-mode USB, LSB, CW and AM operation.
- Extraordinary receiver sensitivity (.3u S/N 10 db) and oscillator stability (100 Hz 30 min. after warm-up)
- Fixed channel crystal control on two available positions.
- RF Attenuator.
- Adjustable ALC action.
- Phone patch in and out jacks.
- Separate PTT jack for foot switch.
- Built-in speaker.
- The TEMPO 2020...\$759.00.
- Model 8120 external speaker...\$29.95. Model 8010 remote VFO...\$139.00.

Send for descriptive information on this fine new transceiver, or on the time proven Tempo ONE transceiver which continues to offer reliable, low cost performance.

## *Henry Radio*

11240 W. Olympic Blvd., Los Angeles, Calif. 90064 213/477-6701  
 931 N. Euclid, Anaheim, Calif. 92801 714/772-9200  
 Butler, Missouri 64730 816/679-3127

Prices subject to change without notice.



# LETTERS

## NOT SURE

Last year I saw an article in your magazine (I think it was your magazine, but I'm not sure) which interested me very much, but I have forgotten what it was. I wrote the name of the article in my notebook after I had read it, but I have lost the notebook.

I have also lost the magazine which the article was in. Will you please send me another copy of the magazine, if it was your magazine?

Wayne Schuler EP2US  
Tehran Iran

P.S. Keep up the good work ... whatever it is you do.

Try the Guide to Periodical Literature, Wayne. Perhaps you'll find a reference to your missing article! — Ed.

## HARMONY

I harmonize with your February 1977 73 editorial. But I cannot sing, so I yodel. I am heart hurt over the ARRL QST format, monstrosity advertisements, miniscule matter of direct interest to me (licensed since 1935 — W6MMZ and KL7DG only calls — past 12 years with FCC Monitoring, Anchorage). I am an ARRL member and once served as Alaska SCM. Recently I subscribed to *Sky and Telescope* in place of renewing QST.

Enclosed is a copy of my QRPp 27 meter band proposal which *World-radio* carried for me but QST would not print. Can you give this idea some emphasis? FCC has not yet responded to my proposal of January 7, 1977, but I am braced for a long wait in this quarter.

John P. Trent KL7DG  
Anchorage AK

I am proposing shared use of 11.300 to 11.325 MHz by very low power A-1 emission only for the Amateur Radio Service with the Aeronautical Mobile Service on a shared non-interference basis, worldwide.

Power limit for the Amateur Radio Service would be 5 Watts input. This would provide better than 15 dB protection in all areas of the world.

This proposal has been prepared in an original and 19 copies in response to Docket No. 20271 dated 6 December 1976 which treats WARC-79 allocations with the binding effect of treaty to signatory countries

until the year 2000.

In this Docket No. 20271, the Amateur Service is marked for a reduction of its 15 meter allocation by 250 kHz shaved off the top of this band and reallocated to the Maritime Mobile Service. This is a significant loss of frequencies not entirely offset by proposing the addition of 50 kHz to the bottom of the 20 and 40 meter bands and the establishment of 160 to 190 kHz low frequency band for amateurs.

For more than a decade, the 11.300 to 11.325 MHz section has been observed by me. I have noted quite limited use of these frequencies by the Aeronautical Mobile (R) Service. On a nightly basis, unlicensed Chinese fishing boats with spurious A-1 emission use the 11.300 to 11.325 MHz frequencies for navigation and commercial fish catch information.

Insertion of a vaccine type active amateur on very low power will serve to develop thousands of intruder watchers to assure the band purity for primary use by Aeronautical Mobile Service.

John Trent KL7DG

## HIGH STANDARDS

First of all, I would like to congratulate you for the fine efforts that you have put into amateur radio and also *73 Magazine*. I do not always agree with you, nor do I enjoy computer articles, but it is impossible to please all of us.

Being from Canada, perhaps it is wrong for me to criticize the FCC license standards, but I feel it is wrong to keep lowering the high standards of amateur radio to accommodate a small group of lazy individuals who cannot be bothered to put forth a reasonable amount of time and effort to become amateurs. I for one am not against a Novice class license, as it provides valuable on-the-air experience, but I do feel that the present code and theory tests are too relaxed (with the recent power increases). If the present trend continues, all we will get out of this is a glorified Citizens Band, which I am sure no serious amateur ever wants to see. The present rules which allow a person to go from Novice to Extra class in almost no time at all are wrong, as a lot of extra studying does not make up for time-tested experience.

The majority of amateurs are far too eager to get onto voice. Anyone can learn how to talk into a mike. It's done every day by common people, but it takes a good amateur to become proficient in CW. Tune across the CW

portion and see how much really good CW you can find. Sure, there's a lot of speed, improper spacing or none at all, and Es and Rs sent like Fs. CW is nothing to be ashamed of — it was the beginning of amateur radio.

The benefit of properly conducted code and theory classes, along with good study material, cannot be over-emphasized. The 73 code tapes and study guides are excellent, whether you are just starting out or are planning to upgrade your license.

I would like to explain what a Canadian amateur has to do to get his first license. First of all, there are only two classes: Amateur and Advanced. The first item is the following seven diagrams: (1) an AM and CW amateur receiver; (2) an AM and CW amateur transmitter; (3) a full wave tube-type or solid state power supply and necessary filters; (4) an overmodulation indicator; (5) a series or parallel wave trap; (6) a frequency measuring device (100 kHz crystal calibrator); and (7) a key click filter. A pass mark of 50% on diagrams is required. The theory exam consists of 50 questions, 25 on theory and 25 on rules and regulations. There are 4 different exams for those who write in groups, so the person beside you will get a different exam. The pass mark on theory exam is 70%. Many of the questions on our first exam appear on your Advanced or Extra class exam. The code exam is 10 wpm on both send and receive, and lasts for three minutes. The pass mark is 100%.

Our first license allows us to go on any portion of any of the HF amateur bands, but with CW privileges only. We are allowed voice on 6m and above. After six months we may apply for a 10m voice endorsement, but we must send in our logbook so that the DOC can be sure we have enough hours logged before it is approved.

Before we are allowed to write the Advanced exam, we must have held the first license for at least one year. The Advanced consists of a more stringent theory exam and a 15 wpm code exam (both send and receive, again for three minutes).

Power limits are 1000 Watts input for both classes, but on 160 and 432 there is considerably less allowed.

Garry Miller VE6AKW  
Redcliff, Alberta  
Canada

## THE AVERAGE

I have been reading your magazine for about a year now, and overall I am very pleased with it. The articles are broad in scope and cater to many varied interests. However, from my own point of view, perhaps I can offer some constructive criticism.

I consider myself to be typical of the "average" ham. My station is fairly modest, and I operate SSB and CW, although I do have a desire to branch out into other areas. The trouble is, I really haven't seen the type of introductory articles in 73 that are both informative and easy to read. The articles I have seen are either at one extreme or the other: so

basic that they offer virtually no concrete information, or so technical as to be above my head. I guess I'm referring specifically to RTTY and SSTV. Many excellent articles regarding other areas have appeared. How about some intro articles or even a series for guys like me?

You get input to your magazine from people like me who take the time to write. But what about all the other "silent" pens out there? Have you ever considered printing a detachable survey in an issue of 73? I think there are a lot of guys out there who would like to see some really practical articles, e.g., how to build a steel tower using readily available materials, beam construction, etc.

I've been tempted to write a couple myself, but don't really know how to go about getting them published. So much for my criticisms. Regarding yours (of the ARRL), I think that while at times it is outspoken and unfounded, it is necessary. The ARRL could use some changes, and someone has to speak out. As an ARRL member, I can't recall them asking me if it was OK to build that new wing on their building. Perhaps the funds could have been put to better use elsewhere.

Maybe you don't agree with some of my ideas, but I think it is important that you get as much feedback about 73 and amateur radio as possible. And seriously, have you ever considered starting an organization analogous to the ARRL?

Gregg Corsello WB3CDK  
Pittsburgh PA

Check our new "RTTY LOOP" column for beginning info, Gregg. — Ed.

## RISQUE

A great deal has been published in 73 and several other amateur magazines concerning improper operation, questionable conduct, and risque comments on the ham bands. However, a major problem has been ignored, or forgotten.

I have been a ham for almost a decade, and have heard just about everything on the bands, including a favorite (?) station in Newington CT, which chases to jump right on the West Virginia phone net, the night following the disaster in that area, only to announce, over the net control, that the frequency, 3990 kHz, was an emergency frequency. This is almost minor, though, compared with the problem of prospective hams being driven away by the "ham in a rut." Such operators consist of people like one I spoke with on the air the other night, who kept referring to "we" ("we are studying for our doctorate ... we have been licensed for fifteen years," and so on). I honestly believed that the person with him (his wife) was also a ham, and was also studying for a doctorate. He sounded upset when I congratulated him and his wife on their achievement, as he must have thought everyone knew that "we" means "I".



Boy, am I weird!

Other all-time greats include "XYL" (how would a male operator like to be called XYM?), and the assumption that all hams are OMs. My wife Nancy recently received her Novice ticket, and has received subscription offers from QST and Ham Radio which opened with "Dear OM." Her name is not usually used to name anything but women or girls, right? And then they have the nerve to expect her to subscribe? Those letters were promptly filed, not by a person who objects to being called a person's wife, but by a lady who objects to being called "OM."

Then there is the usual "Hi-hi" which is often used for a laugh on phone. If a person responded to a joke while talking with you in person by saying "Hi-hi" you may be tempted to call for the men in the white uniforms. It is also rare that you hear a contact (pronounced kyoo-soh) which does not contain at least ten "Rah-gers," or someone saying "ahhhhhhhhhhhhh," while trying to think of something else to say.

Nobody should be expected to use perfect grammar at all times, but if you record your half of your next few contacts on tape, you may find that you may be boring other people into oblivion! I tried this method, and cured myself of saying "uhh" (too many "uhhs" can drive a prospective ham away forever). I have heard from many a Novice who could not understand why the clichés used on the air have to be used at all. Do they?

Jerry E. Falletta WA2DWN  
Elmira NY

No! You said it, Jerry. Unfortunately, many of the old CW timesavers have been applied to phone where they lose all their value. Let's speak English. — Ed.

### KNEE JERK

How about a reasonable approach to the CB problem? At least they could try it while holding off a little while on the linear ban. I hope you will push this or some reasonable alternative.

Roger H. Taylor K9ALD  
Champaign IL

Federal Communications Commission  
Washington DC

Gentlemen:

I seldom write to any government agency, but your proposal for a ban on linear amplifiers capable of operating at 27 MHz, and for type acceptance of amateur equipment, has got to be one of the poorest thought-out regulations ever conceived. Let me point out a few of the negative aspects and then go on to make a much more workable suggestion.

First of all, you are punishing, both economically and otherwise, a large group of innocent people, namely amateur radio operators, for the law-breaking activities of an entirely different group of people. You would

also be perpetrating a serious negative effect on the various purposes of amateur radio, particularly Sec. 97.1b, and many of your previously restrictive regulations have made it difficult enough for amateurs to live up to that section. Despite this, virtually every major advance in the communications art has come from amateur radio, as you well know. Don't hamper us even more.

Your proposal is a typical "knee jerk" bureaucratic reaction to public and congressional pressure to do something even if it is wrong and shows a real lack of understanding of human psychology and the facts of life, as many of your past decisions have also shown (such as the \$20 CB fee that started the mass illegal operations on CB). Your proposal will do nothing to solve the problem that now exists or affect it for the next ten years at least. There are millions of linears now in existence and in the hands of CB operators. You will simply put many more people to work in their basements turning out bootleg amplifiers. Your proposal will have the same success as prohibition — for the same reason. Many CB operators use high power amateur equipment without linears anyway, and if you think that type acceptance of equipment will prevent modification, regardless of any laws passed, you have your head in the sand and no real appreciation of the technical competence and ingenuity of the American people.

Your limited resources have already forced the abandonment of some type acceptance for CB. Why on earth do you want to add even more of a load when you can't handle what you have got already? There is a much simpler way. Make detection and punishment for illegal operations much more probable, in the following manner. Since it is in the interest of the broadcasting industry to eliminate unlawful interference, ask their cooperation in making a few "public service" announcements, briefly stating why it is in the public interest to maintain legal, proper, and interference-free use of the public airways for everyone's benefit. Give a toll-free number for people to call to report interference, and ask them to give as much information as possible. A few of these announcements, which you could start next week, would drastically reduce the problems immediately. Just the knowledge that the FCC was really serious about stopping it, and the availability of a number that would be used to pinpoint illegal operation, would have real effectiveness. Your publicized raids have had a real effect already. Use psychology to help you, instead of trying to row upstream against it. If I knew that every time I fired up an illegal transmitter several people within a block of me were going to tell the FCC where I was (within a few hundred feet), do you seriously think I would do so?

This is a real opportunity for a government bureau to show both Congress and the American people that they can act quickly and effectively against a real problem by enlisting the aid and cooperation of the people, rather than taking many

months to impose ever more restrictive and unworkable regulations. The cost to both the government and the public would be minimal. Certainly the broadcast industry would be willing to carry a public service announcement by the FCC which regulates them and is definitely in their own interest at no cost to the government. Abraham Lincoln said that the government should do nothing for the people that they can do for themselves. It is about time the government realized the wisdom and value of that statement. The political benefits from this approach and the publicity from a visible cooperative effort between a government agency and the public can't help but benefit both. If you really want the interference problem solved in the foreseeable future, this is a swift and sure way to do it while punishing *only* those who are guilty. The publicity and fear of detection alone would stop over 90% of it and make the rest of your cleanup job infinitely easier.

Somewhat along the same lines, the opening of ten meters to the Technician license would strongly encourage the transfer of the millions of CB operators who are now becoming interested in radio communication to join the ranks of the amateurs. The jump from nothing to the General class license is just too big for most of them. There is no logical reason to restrict ten meters, now relatively empty, to General class licensees, with millions of people wanting to use it if they had a fighting chance of earning a license to do so. Amateur radio has shown a tremendous ability to be self-policing and there is something about earning that license that makes people want to use their privileges properly. You brought in incentive licensing, which has stymied amateur growth for 10 years; now use that concept in a positive way by making it easier and more attractive to those who are interested in long distance amateur operation to get started in the type of operation they desire on the (near) frequencies they are used to using. You started this whole CB mess and have compounded the problems with some very unwise and short-sighted decisions. Don't punish the wrong people with even more of the same.

Roger H. Taylor W9ALD  
Champaign IL

### UPSALA QUAD

When building a boomless, 3 band, single feeder quad, I faced the following problems:

1. Element lengths had to be adjustable, which meant adjustable fastening points on the spreaders (no stubs were used).

2. Because of the complex geometry caused by the common feedpoint, the corner points of the elements also had to be adjustable in order to divide stress between elements and assure a perfect quad shape.

As most magazine quad designs were found to use very primitive



methods for element fastening, I found I had to work out my own solution. The following points should be noted:

1. A hose clamp allows sliding the element along the spreader.
2. The element is made from soft plastic-covered stranded wire that slides, when necessary, relative to the piece of copperless glass/epoxy board.
3. A small stainless steel shackle (can be obtained from distributors of yachting equipment) allows complete removal of the element.

Erik Basilier SM5ASO  
Florag. 15  
S-752 28 Upsala  
Sweden

### EXPEDIENCE

Two articles in March 73 concerning MARS have caught my eye.

In the first, by Marc I. Leavey WA3AJR-ACM3AJR, it appears that Dr. Leavey is either not very familiar with Air Force MARS callsigns, or that Air Force MARS has made an error in mine. And I'm relatively certain that the latter is not the case.

Having been the Air Force State MARS Director for Kansas at the time the callsign changes were made, I became fairly familiar with them. AF MARS callsigns formerly were:

Prefix	Air Force
Wn	AFn
Kn	AFAn
WAn	AFBn
WBn	AFCn
WNn (Novice)	AFNn

When changed to the three letter prefix, the callsigns became:

Wn	AFWn
Kn	AFAn
WAn	AFBn
WBn	AFCn
WBn (Novice)	AFCn (Novice)

The most expedient route, that involving the least additional paperwork, was to change the Wn call to AFWn. During a time when paper costs have been rapidly increasing, Air Force MARS should be commended for its insight.

Novice calls remained unchanged until the FCC began issuing them WBn calls, at which time they also became AFCn.

In the second article, where it is stated, "There is a place where Tech-



nician class licensees can operate SSB on HF, and where Novices can operate voice on 2 meter FM," just what is there to prevent a Novice from now operating SSB on HF? I think that he may in Air Force MARS.

Further in this article, extra privileges, distinctive call signs, and access to surplus equipment are alluded to. But if a potential member signs up in MARS solely to obtain excess property, he just may find himself storing excess government junk along with that that he can use. For in the past, some items have come out in that condition. Steps have been taken to rectify this situation, so it should be better in the future.

One final thought. The address given for further information is that of Army MARS only. Perhaps you should dig out the addresses for the other MARS services also, and present them. The AF MARS address is Command MARS Director, Hq AFCS/DOYR, Richards-Gebaur AFB MO 64030.

D. M. Casselman  
WA0GSY/AFB0GSY  
Conway Springs KS

#### KEYER UPDATE

You may be interested in the enclosed comments on "Build the World's Simplest Keyer." Re your May article, "Stop Timeouts!", I hope that you can join with us in trying to kill the idea of "10 minute timers." What the timer says is, "You just broke a regulation!" Better to set them at 8 minutes or 9 minutes. Of course, the timer with readout partially fixes this.

Another problem is short transmissions, since the other guy might take over and still be sending when your ID is due. Therefore, it is always best to give one sign when turning over. Also, note that phonetics generally are necessary with phone, to prevent misunderstanding the call.

E. H. Conklin K6KA  
La Canada CA

Andy Ring  
Yarmouth ME

I was interested in your article in *73 Magazine* (May). It may be that it can be simplified some more, and improved.

I note the relay, which is a "no-no" in CW because of the mushy key clicks when one gets contact bounce in them. Note *73* for September, 1965, ("Der Kleiner Keyer," by E. L. Klein). He simply used a PNP transistor, handling 150 volts, and keyed the transmitter grid circuit directly, with no relay. Cheaper than the relay, too!

Next, there are four pots. That makes it both complicated and expensive. For one thing, one might get rid of the "weight control," as being undesirable. Second, it may be possible to use only one pot to control both the dot and dash sides, possibly by using the right capacitors for the dots and dashes and the one pot. It appears that there are some



"Kitty" is WB0DQW's latest ham convert.

alternatives to the second (dash) 555. One is to make it simply fill in the space between dots, as "Der Kleiner Keyer" does with a flip-flop. It seems that it can be arranged. The other alternative is to dispense with the 555 and use a flip-flop to do the filling in, with no adjustments at all.

As to VR1, it may not be required. I don't use any in the Kleiner keyer. If one uses a bridge rectifier and a 6.3 volt transformer, if available, one comes up with a pretty fair voltage to operate the keyer if no VR is used. The possible shortcoming might be not having completion of a suitable space after each dot or dash. Where there is a free running MV, this may be almost automatic, of course, within a letter. So putting in something for space between letters may be a complication.

You might look at the combination ICs which include a multivibrator. They may handle most of the keyer in one piece without a lot of external parts, if you find the right thing. It might be best to look at the CMOS availability anyhow, in order to cut the power drain down so far that you can go to a battery and throw away the on/off switch, remembering that the 2N398B keyer transistor runs off the exciter grid current, and does not get any power from the keyer.

E. H. Conklin K6KA

#### MORE TECH DEBATE

I am writing regarding the letter in your Feb. '77 issue, "Tech Relax," from L. N. Thompson. I apparently missed your editorial on the subject, but agree strongly with Mr. Thompson.

I feel that Technicians should be allowed use of SSB phone privileges on some parts of the 10-160 meter HF bands. If not, then I believe that the current 13 wpm code standard for General class should be reduced to 10 wpm. I have written the ARRL and the Chief of the Personal Radio Division concerning the above.

I urge everyone who feels that the present 13 wpm code speed is too high for the General license and that Technicians should be granted some SSB phone privileges on the HF bands to write the FCC and their congressmen and senators. I personally am sick

and tired of hearing the older hams make statements like, "If they want higher privileges, let them work for them like we did." No wonder there is such a high dropout rate of Novices and Techs. No wonder so many Techs get on 2m FM and stay there. I admit that 2 meters is a busy band, but I have yet to hear it sounding like the CB frequencies — so that is no excuse for denying HF SSB phone privileges to Technicians!

Most of us have spent a lot of money on our hobby and equipment only to be denied use of it because of snobbish and archaic standards established many years ago.

Although my subscription just started this year, I am renewing for another year. Keep up the good work and the excellent articles.

John A. Magness III WD4BVU  
Murray KY

#### HEX TO BINARY

Small point, but I'm curious why Joe Larson's letter (page 116, Feb. 73) misquotes the figures he is using for illustration. Joffe's article uses the expression "3A7B"/Decimal 14971 (page 94, Holiday issue). Larson quotes this as "39BD"/Decimal 14781. Larson's points are well made, especially the conversion from hex to binary.

Bill Straley  
Campbellsville KY

#### NO PR-40?

WA4KDC's operating system appearing in the March, 1977, I/O section of *73 Magazine* is fantastic! The only problem is that although everyone should have it, not everyone does have a PR-40 printer.

I thought you would be interested to know how I slightly modified the program to allow printout on my Teletype. The modification consists of modifying addresses beginning at 01EE with the following:

01EE BD E1D1  
01F1 33  
01F2 FE A014  
01F5 39

Jim Huffman WA7SCB  
Hufco, Inc.  
Provo UT

#### KITTY

Enclosed are some photos which may be of interest to you. As you can see, my recruiting efforts for amateur radio do not stop at human beings. Kitty didn't think much of the key, though.

Thanks for your fine magazine. Keep up the good work!

Neil Preston WB0DQW  
Kansas City MO

#### EARTHQUAKE

On the evening of Saturday the 5th of March, I assisted people searching for relatives in Romania during the recent earthquake there.

I wish to remark here that besides all kinds of complaints about the traffic on the upper part of the European 80 meter band, the traffic was handled in a very efficient way, with little amateur QRM. Everyone requested to stand by or QSY did so in the best possible way.

The network established traffic between Western European and Israeli stations, via Daniel YO8AHL in Iassy (located about 500 km north of Bucharest), to Bucharest, the capital city, where other amateurs and what was left of the telephone system did the rest. Also, I would like to thank the Yugoslavian stations that gave me assistance in finding the Romanian emergency network's frequency.

Jac Lirola F6CVU  
Truchtersheim  
France

#### THE HFERS

One of the acknowledged factors in the increasing proliferation of the so-called "Hfers" is the easy availability, without challenge, of amateur equipment to non-amateur persons. This accessibility has led to serious talk, even a Notice of Proposed Rule Making, of banning the sale of linear amplifiers capable of operation between 25 and 35 MHz.

It seems, therefore, that because of a few unscrupulous dealers eager to make a quick buck, many amateurs may either be unable to buy a 10 meter linear, or will have to pay a higher price to offset type acceptance costs. At least one dealer in Chicago and one in Milwaukee have no interest in whether a potential customer is or is not a licensed amateur. Spectronics in Chicago, on the other hand, states quite clearly, in ads and in their store, "No call, no sale."

It makes me proud that Art Houserholder and company have chosen to eschew a few extra sales to help preserve the integrity of the hobby. And, he enjoys my business as a result. My challenge to you is to do your part in preserving the integrity of the hobby by tightening up your already comprehensive advertising policy to refuse space to those dealers who do not restrict sales of amateur transmitting equipment to licensed



amateurs.

Word of mouth is a pretty effective policing system (witness Trigger), and any advertiser not living up to the rules would be quickly exposed. Remember — today the linears, tomorrow the transceivers.

Rod Peterson WB9UQX  
Carol Stream IL

### THE NEW BREED

I am writing this letter to you and to those who would submit construction articles to you in the future. I would like to think that I am speaking for several thousand newcomers to amateur radio as well. Most of us cannot read schematics. Most of us do not have "junk boxes" stuffed with scrap suitable for use in construction projects. And many of us do not have a fully equipped machine shop at our disposal. The nearest electronic parts supplier is usually a Radio Shack store. And, we do not appreciate being referred to as the new breed of ham who buys his rig and plugs it in, but with such poorly illustrated construction articles, you don't leave us much choice. If a picture is worth a thousand words, then many of the projects could be shortened with the insertion of pictures showing the parts layout.

So please help us gain the expertise you have by submitting and publishing complete photos of your projects, parts lists, and suppliers of parts. Please be accurate in your details.

Think back to when you were a newcomer to amateur radio and help us get off to the right start.

John A. Magness III WD4BVU  
Murray KY

P.S. I would like to buy any back issues you may still have. Please send list and price.

*Right on, John. Old-timers, take note! Check any recent issue of 73 for a list of back issues. — Ed.*

### THE FAMILY

I just finished reading "HAM vs CB" in the May W2NSD/1 editorial. I am one of the many hams who came here through the CB family, as you called it. I received my membership papers to the family in February, 1976, and by March was so discouraged with the situation that I immediately contacted the Bluegrass Amateur Radio Club to get information on a Novice class they were holding. By July I held WA4RUW with Novice privileges. It's nearly a year later, and I am still a Novice, but I don't want to get back on 11 meters just to operate phone. You feel that CB is in a different family and hams have no business messing in those affairs — I agree partially. But when I go down to 10 meters to look for a rare 10m QSO, all I find is "Harry

Top" talking to "Junk Yard Dog," on 28.169 MHz! Do you still feel like we shouldn't mess in those affairs? Being an ex-CBer, I used the old tactic of more power and zero beat, and started calling CQ on frequency. The reaction was surprising — more power and four letter words! The two handles used are fictitious, but the incidents are true. With 11 and 10 meters so close, CB is a close cousin to ham, and I feel there are some family affairs we need to concern ourselves with.

Bob Cornett WA4RUW  
Lexington KY

### 11M TO 10M

I read with great pleasure the article by Bob Wilder ("CB to 10... A Legal Alternative," May, 1977), and strongly endorse his plea to encourage the use of CB transceivers on ten meters. I would, however, suggest one major consideration which I think should be worthy of serious thought, at least as a viable alternative: the use of an external transverter, rather than internal modification. A number of transverter articles for VHF bands have been published. The advantages of this approach are numerous: no modifications to the CB set to destroy its resalability; no tampering with the transmitter section rendering the set illegal for further CB use; simple external switching would provide alternate CB or ten meter use. The band plan suggested by Bob Wilder would still maintain its integrity, as the heterodyning transverter would still provide the ten kHz incremental tuning which he suggests. A standardized (hint to prospective manufacturers) transverter would be applicable to any CB transceiver, and complicated internal synthesizer formulas would no longer be a consideration. See you on ten!

Bob Grove WA4PYQ  
Davie FL

### OSCAR ORBITS

A common assumption regarding the OSCAR satellites is that the period (time of one orbit) and increment (number of degrees west the satellite appears to move) both remain constant. Several programs appearing in 73 Magazine recently use this principle to calculate the position of the satellites by inputting a starting position (equatorial crossing point) and time, and incrementing the constant interval for the succeeding orbits.

I wrote a simple BASIC program to do exactly this, and everything looked fine until I ran out the calculations to the end of the year (4500 or so orbits). There was a small but appreciable error which I couldn't account for when I compared my results with the book of orbital times published by Skip Reymann W6PAJ. This book was compiled from data computed by Tom Clark WA3LND, so I wrote him. To quote his note to me,

"Since the period and orbital longitude increment are *not* constant, . . . I provided W6PAJ with weekly period/longitude increment data, but he chose to print one value for the year."

So, programmers beware — your results will be close, and will be usable, but they won't be entirely correct.

Warren Munro KH6GSH  
Aiea HI

### CHEAPER THAN EVER

I have subscribed to 73 for about four months now, and I have come to conclude that it is the best amateur radio magazine on the market. When I pick up a magazine, I expect to see articles that I can get some good reading out of and that I can learn a thing or two from.

I really enjoy your I/O section and I hope it will stay the way it is even though the new magazine *Kilobaud* has come out. I really wish I could subscribe to *KB* but my budget doesn't allow it.

I am really interested in WA0TSY's idea about converting CBs to 10 meters, since I used to be an avid CBer and have some equipment around that I am willing to make the switch with. I hope others will see this idea so that it may catch on, as CBs are cheaper than ever, and this would be an economical way to get on 10 meters. Maybe you could include some articles on this idea and conversion details in your upcoming issues of 73.

John H. Peeler WA4UYI  
Denver TN

*They have started coming, John. See last month's issue. — Ed.*

### PC REFORM

A hearty "well done" to your staff for the articles on printed circuitry! I just had a chance to finish reading both of them and I must say I wish I could have read these articles three years ago when I started working with printed circuitry. I had to develop my own methods and spend an indecent amount of money to get good results. Your readers may not realize how difficult it normally is to get good information on PC fabrication. The majority of the trade manuals are as vague on such items as exposure times and others as a politician is on political reform. And many magazine articles leave out critical information, to boot! Thanks again for putting a light at the end of the tunnel!

I can't resist putting my two cents worth in. If you are working with PC fabrication for the first time, follow each step carefully and use fresh materials. Then, after you are successful, you can take shortcuts. If you start with the shortcuts, you will probably end up with a bad board and no idea of what went wrong. And that means confusion!

If you have a problem with the resist washing off the board during the

### NEW BOOK



### RTTY HANDBOOK

see page 205

etching process, this means either that the copper was too dirty or the copper was too smooth. You can often solve this problem on the next try by drying the exposed and developed board in a warm oven. Once the moisture evaporates, the resist tends to stick tight. Try it!

Let me wrap this thing up by quoting a phrase I heard from many a PC professional fabricator: "You can't make PCs for under about \$100,000!"

Gary McClellan  
General Manager  
McClellan and Company  
La Habra CA

### THE RUB

I enjoy the contents of 73 except for one thing. Whenever *QST* is mentioned, it usually gets its nose rubbed in the dirt. Doing that does not help your magazine. If anything, it detracts from your publication. Perhaps jealousy is the motive? Why not improve your own magazine by omitting the derogatory remarks about *QST*?

David Keith WB0GUE  
Marble Rock IA

*None of the other publications seem to have any opinion at all, David. If your only suggestion for improving 73 is the elimination of controversy, I guess we are doing pretty well. — Ed.*

### KUDOS 1

While I am spending postage to write about another matter, I thought I would let you know about the quick efficient service that Hamtronics, Trevoise PA provides — time after time!

Edwin Steeble K3IXD  
Glenwood MD

### KUDOS 2

I bought a Gold Line coax switch at a local radio store only to find out that it didn't have a connection on position number two. So I wrote Gold Line a letter explaining the difficulty. A few days later I received a new switch from them, postpaid. Just thought that I would let you in on it, and the other readers, too.

Dan Renfro WA4PXV  
Mt. Pleasant NC



# BE MY GUEST

visiting views from around the globe

## Dayton: Reporter's Notebook

Dayton 1977 was the biggest yet, with thousands more than the organizers expected. At deadline, the estimate of attendance was well over 16,000, although ticket numbers higher than that were heard over the hamvention PA during the closing hours. It was the ham radio event of the year in several ways — the growth of the hobby was obvious as crowds six and seven deep kept the booths busy most of the day Saturday. A three hour traffic jam around the Hara Arena earlier in the day forecast the afternoon crunch. Dayton's flea market was everything it was promised to be ... acres and acres, with waiting lines in the early hours. (The local repeaters had warned in advance that flea market types better get plenty of sleep Friday night, so they could get a good spot or catch some good deals.) They opened the flea market doors at 6 am both Saturday and Sunday!

There were over a hundred exhibitors. Many said there were more dealers than manufacturers this year, showing less new equipment than expected. Dentron Radio, for example, put off introduction of their new transceivers until fall, while Drake was ready with their new UV-3 triband VHF/UHF transceiver. The radio offers a fully synthesized FM system covering 2m, 220 MHz, and 450 MHz, 25 Watts output, plus a variety of accessories. The unit can be separated from the power supply and main section, for remoting the control head. The Drake uses a PLL system for frequency control, with digital readout. There was also the return of the Signal One transceiver, from yet another manufacturer, Signal One Corporation. The price is up to \$3999.95, but company representatives say the new CX-11A is totally redesigned (although the appearance of the rig remains much the same).

There were also the new CIR transceivers, which feature digital tuning of the 80 through 10m bands. Two switches control frequency, one a fast attack, the other a slow scan rate. The size is very small, considering the fact that the Astro 200 is rated at 100 Watts output. Accessories include a station operating console, speaker, and ac supply (the CIR normally runs on 12 to 14 V dc). CushCraft introduced a new line of HF trap vertical antennas, while Dentron showed a new 1200 Watt HF amplifier (half the MLA-2500 package, but without 160m coverage) and a new tuner to match the MLA series, complete with built-in 250 W dummy load and twin front panel wattmeters for continuous monitoring of forward and reflected power.

Among the more interesting accessories introduced at Dayton was RF Engineering's DFD-100 digital frequency display for use with Collins, Drake, Kenwood, Atlas, and Swan equipment. Readout is accurate to the nearest 100 Hz without band switching or mode switching. Hookup is easy, especially for Drake or Collins gear where the necessary frequencies are available at the back panel of the radio. Spectronics showed a unique outboard device for the popular Icom 22S 2m rig. It's called the SpecsScan, and it does a score of things, including full scan of the 146-147 MHz band in 15 kHz steps and VARI-SCANTM which allows full scanning control of the scan rate in either direction. Power consumption is less than 500 mA, and automatic channel lockout lets you scan past any portion of the band. All this can be done without major surgery or giving up normal operation of the 22S.

Heath had a prototype of their new CW transmitter, which matches the HR-1680 receiver, while KLM was showing off their newly acquired 6m SSB rig, a National (of Japan) import. It is similar in style to the Hy-Gain 3750 HF transceiver, which is also made by National in Japan. Atlas, aside from enjoying the high demand for their popular 210X and 215X transceivers, showed their new 350-XL transceiver, although they were not expected to be available

"It was the ham radio event of the year in several ways — the new growth of the hobby was obvious ..."

until early summer. Robot kept a crowd with videotape of NBC correspondent (and hamvention banquet speaker) Roy Neal K6DUE explaining SSTV to a national TV audience via a Today Show segment last winter. The story covered the N6V operation during the Mariner mission to Mars and marked the first time that both ends of an amateur QSO were broadcast live on national TV. Kenwood kept everybody wondering how they could afford a new TS-820 transceiver. The icing on the cake was Saturday's visit of Neil Rapp WB9VPG, the world's youngest licensed ham. Kenwood had given Neil a TS-520 for his 6th birthday, and his appearance at the Kenwood booth only added to the crunch around the company's display.

On the whole, dealers outnumbered manufacturers, and it was clearly a buyer's market. Prices were slashed early, with some dealers complaining that it would have been better to stay home and sell their goods without the pressure of the price cuts. There were also grumblings about the hours booths were open, as many exhibitors returned to their motels with sore feet and mild cases of exhaustion each night of the hamvention. While the exhibitors were resting, convention goers were treated to dozens of informal gatherings, ranging from the annual "FM Bash," to an ATVer's session. The parties went well into the night.

The forums were well attended, with something for everyone. The biggest turnout was, of course, for the FCC forum, which proved to be a bit disappointing. FCC Personal Radio Chief John Johnston did not take questions, presumably because of that Federal Court ruling on the Commission's alleged failure to follow its own rule making procedures. The ruling ("Briefs," June 73) limits informal comments, such as hamfest bull sessions, without a written record for the appropriate public file.

In his talk, Johnston was strongly critical of high power amplifiers, knocking QST for publishing a recent construction article on the subject, and terming "brazen" the sale of a 10,000 Watt linear in the hamvention flea market. Johnston was preaching QRP, and, in light of the Carter Administration's energy proposals, his warning that "the day of the over-powered bully operator" must be numbered rang especially true. (Full details of the FCC forum can be found elsewhere in this issue.)

On WARC, amateur radio advisory

"A big part of the Dayton story was what happened outside the Hara, on the roads into the city, along the interstates and in the air terminals, where amateurs flocked for transportation to Ohio ..."



One of the Dayton VIPs was Carl Mosley of Mosley Antenna fame.



committee chairman Peter Hurd K4NSS presented a half hour long explanation of what the frequency conference is all about and how the US is preparing for it. Hurd was thin on details about what is actually happening, although there were some hints — his reference to the Jack Anderson column, and the "tremendous interest" of the civil sector in the rf spectrum as a "gold mine" over the long term. (Hurd told the forum that the Anderson column could be traced to those same interests.)

He also warned that there had been a lack of reaction to the WARC proposals. "The concrete is beginning to harden on these proposals," Hurd said, "and comments are very important." Hurd identified the key issues ahead as a definition of what criteria would be acceptable for sharing bands, and what to do about 220 MHz. "The committee would appreciate your input on why we need 220 MHz," he said, "and why we can't share it with Class E CB."

As for keeping frequencies, Hurd showed several charts illustrating how amateur radio's position has changed over the years. In 1935, for example, the amateur population dominated the stations on the air in the US, whereas there is but a small percentage of hams (as compared to other users) on the air today. Hurd put the

"I nearly drove off the road on the way home, when Dave WD8CYV drove by on his motorcycle holding both hands in the air and showing the classic 52 signal . . ."

committee's feelings this way: "We're not on the air because of numbers, but rather because of the quality of the service we provide."

He went on to warn that we have to grow up into the 10 GHz band and beyond, to look 20 years down the road and plan for the future of amateur radio. "It's a long-term investment," said Hurd, "with the viability of today's bands limited to a very real point by how convinced the decision-makers are as to how well we're using those frequencies." Hurd did not appear optimistic, in great contrast to the League official who was telling convention-goers that "WARC and Jack Anderson are under control . . . we're right on top of it . . ." Hurd's advice to amateurs worried about WARC? "Remember that every frequency is an international one — whether it be 2m or 20m, the internationals are listening." Hurd pointed out that foreign governments maintain offices in major US cities, thus opening the door to reports home on the use of virtually every band. He also noted that the next step in WARC would be the release of a 5th notice from the FCC,

due out by late May.

A big part of the Dayton story was what happened outside the Hara, on the roads into the city, along the interstates and in the air terminals, where amateurs flocked for transportation to Ohio. On Interstate 90, horns would turn to CW, with "52 . . . 52," or a simple "73" exchanged as hams passed. I nearly drove off the road on the way home, as Dave WD8CYV drove by on his motorcycle holding both hands in the air and showing the classic 52 signal! But it wasn't all fun on the highways home, as one group met disaster near Philadelphia. Driving in a sports car, they mixed it up with some big trucks, reportedly killing the driver and seriously injuring two passengers.

Dayton, the city, lived up to what was advertised — the Air Force Museum was super, the motels were generally good, and the town does shut down tight promptly at 6 pm (or shortly thereafter). Getting dinner after a day's work at the hamvention proved to be pretty rough. The first night we got hopelessly lost without a radio (better not take it, I was advised, since it will probably get ripped off),



and the second night we waited in line at a restaurant for nearly an hour before catching on to the fact that the hostess needed \$25 or \$30 stuffed in her hand before we could get seated. We left instead.

The hamvention itself seemed to have outgrown its bounds . . . the traffic was intense, the hours long, and the crowd huge. It looks like the Dayton club is going to consider moving from the Hara next year, possibly to a fairgrounds nearby. But Dayton is still the biggest . . . it was great fun, although it may just be getting too big for its own good.

Warren Elly WA1GUD  
Assistant Editor

If there was a theme in the FCC forum at Dayton, it was probably QRP. Personal Radio Chief John Johnston K3BNS offered some strong words about high power operation, even going so far as to criticize the ARRL for publishing a recent linear amplifier construction article in *QST*. Johnston warned that the day of the "overpowered bully operator" must come to an end, with more work on QRP and developing new ways to measure power. He called the search for new power-measuring devices the greatest contribution amateurs could make to the state of the art.

With FCC staffers taking notes on the sidelines, Johnston came as close as possible to covering recent rule making proposals, without crossing the line on *ex parte* comments as prohibited in a recent federal court decision. ("Briefs," June 73.) He said the FCC staff had been "under the gun" to deregulate amateur radio by Commission order. In fact, said Johnston, that was his first job after taking over as Personal Radio Division chief. Noting that 1976 marked the relaxation of more regulations affecting the amateur service than any other single year in history, Johnston said amateur radio had turned around, with more growth than the Gettysburg FCC staff can handle.

The growth has created new problems, according to Johnston, problems that are so serious that the licensing structure of amateur radio may have to be changed as a practical matter. License applications were up 50 percent last year, at a rate of around 12,000 per month . . . that's four thousand more applications than the Gettysburg staff can be expected to

process. This year applications are arriving at 3 times the rate that Gettysburg can handle, and 13 staffers have been moved from the CB section to cover the amateur overflow. That brought applause at the Dayton forum, but Johnston cautioned that it was not exactly something to cheer about since he'd be forced by budget considerations to put the 13 workers back on CB tickets in early June.

The licensing boom may be great for ham radio, but it represents a serious emergency for the FCC. Counting repeater applications alone, there is a backlog of over 1300 waiting for callsigns. A closed season has been called on secondary station licenses, and the Commission is looking at the Novice class license as a time-consuming wrench in the works. As Johnston put it, "Amateur applications must drop off, or classes of license will have to be simplified to increase production." "Otherwise," he added, "we will sink in a sea of applications and complaints." Ironically, at that point in the forum the lights went out. Johnston remarked that he couldn't even read the jokes . . . but what he was saying was no joking matter.

The Gettysburg computer was

portrayed as a red tape monster, requiring 40 different programs just to grant one amateur license! In the case of Novice tickets, the granting of a license is only the last step in a complicated process which includes checking the credentials of volunteer examiners, certification of code proficiency, mailing of the written exam, plus keeping track of the exam papers until they are returned. Johnston put it bluntly, saying that Gettysburg soon won't be able to do both the Novice applications and all the other classes. A new computer (and the associated programs) are due next year to replace the rental unit currently in use, and some innovations are possible (like 1 x 3 for Advanced class), but the backlog remains.

Then it was on to the latest bombshell from Washington — the first new regulations from Docket 20777 (bandwidth). Johnston explained that the new limits (40 dB below 30 MHz, 60 dB above) on harmonics and spurs were a reflection of international agreements designed to replace the old "according to good engineering practice" provisions of the current rules. Johnston contends that most manufacturers can meet the new specifications with current equipment,

but he warned that it was high time for amateur radio operators to start putting higher technical standards on their equipment and operations. Johnston noted that there had been several petitions for reconsideration from the ARRL and manufacturers claiming severe business consequences, but he did not speculate on how successful the delay tactics would be. (At a meeting of ARMA, the Amateur Radio Manufacturer's Association, President Dennis Had ruled out any postponement, pointing instead to an ARMA-proposed grandfather clause designed to ease the impact of 20777.)

On callsigns, Johnston told the crowd that all W/K 1 x 2 calls were gone in the 4th and 6th districts. What Johnston did not volunteer (or did not know at the time) was that the chief of the FCC's Special Licensing Division in Gettysburg had been indicted on four bribery counts for allegedly taking \$100 payments in exchange for 1 x 2 amateur calls. (See "Briefs," this issue.) Johnston, noting that all Extra class licensees will be eligible for 1 x 2s in July '77, said that the major problem in the phased changeover had been allowing people to choose their own calls. Many inter-

## Dayton: FCC Forum



pretended that to mean no more listings of first, second, or third choices for future call sign availabilities.

Johnston also spoke about the long-awaited comprehensive code exams, which FCC officials assure us are in effect by now at all offices. At Dayton, the word was that all district engineers would be using the new

---

**"The Gettysburg computer was portrayed as a red tape monster, requiring 40 different programs just to grant one amateur license . . ."**

---

multiple choice CW tests within "days."

There were no questions asked of Johnston, as has been traditional at Dayton, but he did remain after the

forum to field some from individuals. Overall, the FCC's most important man (from an amateur view) left quite a few questions unanswered, at least from the podium. But there were

enough strong statements in his remarks to give you the feeling that deregulation and more changes in the amateur service can't be far away. Prime targets seem to be power amplifiers and the licensing structure.

Warren Elly WA1GUD  
Assistant Editor

# De WA3ETD

## PERSONAL SAFETY

More and more hams are becoming active on UHF. If you don't believe it, check out the advertising in the pages of 73. KLM and VHF Engineering are two notable firms that deal almost exclusively in VHF and UHF gear. The number of outfits that provide some sort of 2m gear is amazing. It has been said that at least fifty percent of the active amateur population is on 2m; I don't doubt it for one moment. The trend in the VHF/UHF tinkers' community is to reach higher and higher in frequency. At least one progressive company, Microwave Associates, has responded by providing a specially designed microwave transceiver for the ham market. (The product is the 10.5 GHz Gunnplexer, discussed in May's New Products section.) If you are not an OSCAR satellite fan, listen in on the 2m downlink some evening if you have a tunable rig for two meters. Any old omnidirectional antenna will do — those Mode B signals are pretty strong! After chastising yourself for not being on OSCAR, recall that each of those two meter signals was the result of a 432 MHz uplink signal, and if 432 is not UHF, I don't know what is! Many OSCAR users probably do not consider themselves UHF enthusiasts, and are more concerned with the communications aspect of their hobby. The point of all this is that daily more and more hams are using UHF. This trend will most certainly continue as more manufacturers jump into the ring. And don't forget the new OSCAR launch this fall — the one with a 2m uplink and 435 MHz downlink — the first bird to actually use an amateur satellite frequency!

As with any new band, there are precautions to observe. Remember the first time you were on two, and ran 250 feet of war surplus RG-58 up to the old horizontal beam? Didn't get too far, huh! Not only does UHF have its share of technical problems, but also there are questions of personal safety that must be observed.

Most hams have seen or used the now familiar "microwave oven," a device that uses high frequency energy to heat organic material from the "inside out." The relationship between heating effect and rf frequency is not agreed upon by the

experts, but one thing is for sure — UHF energy from an amateur transmitter in the 420 MHz band and up can be dangerous in some instances. The problem results when tissues are heated by the radiation faster than can be compensated for by normal blood flow. The eyes are particularly sensitive to UHF radiation. The experts also do not agree on what "power density" can cause damage to human tissue and at what frequency the power must be applied, etc. Industry currently accepts a standard stating that a power density of 10 mW/cm<sup>2</sup> is safe, that is, at the point of exposure the amount of energy passing through a square centimeter in space is less than 10 mW. There has been considerable pressure from medical and research groups to lower that figure, as there has been evidence that eye damage can occur at considerably lower power densities. No one knows for sure. For additional information concerning the effects of microwave radiation and research into the problem, refer to an excellent series, "Microwaves," by Paul Brodeur, that appeared in the Dec. 13 and Dec. 20, 1976, issues of *The New Yorker* magazine. Back to amateur transmitters!

It should be obvious that any amateur UHF transmitter capable of generating power is potentially dangerous. Power density is enhanced by beam antenna systems, dishes, horns, or whatever device is employed to focus the transmitted signal. One should never needlessly expose oneself to UHF radiation. Do not stand in front of a beam operating at 420 MHz and especially avoid exposing the head. Under no circumstances look into the end of a horn or waveguide antenna while the transmitter is operating. Why take a chance when so little is known about the subject of heating and neurological effects?

Microwave Associates Gunnplexers are bound to become increasingly popular. I have been doing considerable experimenting with a pair of these devices and employ a simple method to avoid exposure. The mobile "radar detectors" which are currently transcending CB radios in popularity are broadband devices and will respond with a whistle or whine to almost any microwave radiation below 20 GHz. I keep an el-cheapo

variety detector activated in the room when experimenting with Gunnplexers, and does it go off when the 'plexer is fired up! It sure keeps me aware when microwaves are present, even though the devices are "aimed" away from myself and anyone else around. One night, Rich Force WB1ASL, 73's publications editor, and myself ran a test with a Gunnplexer and the radar detector. The detector went off at distances over 200 yards away from the source of microwaves, and I ran out of space to back up. If you don't feel like springing for a detector, build a simple device using a UHF diode — be smart!

## DOES THE FCC KNOW ABOUT MICROWAVES?

A silly question, you say! I received a call late last Friday from a concerned research group on the West Coast. It is common knowledge that a new Citizens Band is proposed for the 900 MHz region. (Microwave ovens function with energy in that band!) Some people are concerned that personal safety may not be the ultimate goal of the Personal Communications Department (FCC). Imagine running 100 Watts into a well-designed beam at 900 MHz. Could get warm, and that's what we are concerned about!

This morning I called Personal Communications Engineering and talked to Mr. Will McGibbon. It turns out that the Chief Engineer, Mr. Ray Spence, was concerned enough with the problem of biological radiation effects that he asked Mr. McGibbon to research the problem. The FCC is well aware of potential problems, and I was assured that the biological question will be addressed before any new bands are opened for public use. There are tons of literature and reports to wade through, culminating in an international convention to be held this fall. Hopefully the question of "radiation standards" will be resolved. There is considerable evidence that the 10 mW/cm<sup>2</sup> standard may be unsafe, although much of the supporting research was conducted by the Russians. Many of the experiments have not been able to be duplicated. I am personally interested in this subject. All UHF experimenters should be. This column will pass along information as it becomes available, but for a primer, try *The New Yorker* articles.

## AUTHORS TAKE NOTE

The editorial staff at 73 is busier than ever! Everyone on the 73 end of things has at least two functions, ranging all the way from "pasting up" articles to insuring that authors get paid for their work as fast as possible. The phone also rings several times a day with calls from authors wondering

what the situation is with their articles. Possibly a bit of explanation about our system will be helpful at this time.

Articles arrive at a rate of four or five a day, on the average, and are opened and dated by me. Hopefully, within the week they are read, and, if accepted, priced. Rejected articles are immediately returned with no funny business. At the time of acceptance I fill out and mail a postcard indicating acceptance. The card states that "a check and author's proofs are forthcoming." It should say "... forthcoming in four to six weeks," as our production and financial people work on a monthly cycle. Once the card is received, you can expect a check in about a month, maybe sooner if it's the end of our cycle, and author's proof sheets, which indicate how your article will look in print. It is very important to carefully check the proof sheets for errors, especially in the schematics and diagrams. Your integrity is at stake as well as ours! Please do not phone two weeks after sending your article wondering why your check has not been mailed — it's on the way! As you know, 73 pays authors upon acceptance, which is unusual in this field. We try our best to publish all material as space permits!

Writing for 73 is easy and fun! There is no better way to partially finance your hobby and become published at the same time! If you have been sitting on a pet project, let us know about it — share your inventiveness with others. Send an SASE for a copy of "How To Write For 73," which outlines the rules to follow when preparing your manuscript. Please, NO handwritten material. If you can't type, have your article typed — it's cheap. After reading for six or eight hours every day, you would understand why typing is important — thanks!

## COMPUTERMANIA

The biggest hobby computer trade show of them all is being held on August 25-27. The place is the Commonwealth Pier in Boston. Sponsored by *Kilobaud* (you have a subscription, right?), the show will cater to microcomputer hobbyists, calculator freaks, the mini crowd, and the small businessman requiring an insight into small systems. All the micro systems will be represented on the exhibit floor, and a steady stream of forums and demos by the manufacturers will be offered to keep you posted on the micro industry. Mark your calendar, and stay tuned to 73 for information as it becomes available.

John Molnar WA3ETD  
Executive Editor



Jim Beedle W9NIN and Art Reis WB9YOB have prepared a guide on how to write your congressmen and senators in support of the Goldwater RFI Bill, and its counterpart in the house. They suggest you handwrite your letters, be concise, and stick to just one issue — S-864. See "Briefs" for a listing of key senators. — Ed.

#### WHY S-864 MUST BE MADE LAW

I. Constitutional Reasons. The Constitution was designed, among other reasons, to protect what the Declaration of Independence referred to as "certain inalienable rights," including the rights to "Life, Liberty, and the Pursuit of Happiness." And, the First Amendment goes a long way toward fulfilling that protection. Precedent and common sense have further established that "one's rights end where another's nose begins."

As long as the activities of one are not at fault in denying the rights of others, as mentioned above, there is nothing truly illegal about them. Specifically, amateur radio operators and Citizens Banders, as long as their transmitting equipment is designed, adjusted, and filtered properly for the prevention of RFI, have every Constitutional right to be on the air. Likewise, their neighbor has every right to watch his TV or listen to the radio or stereo in peace, as long as he doesn't infringe on the rights of others (i.e., too loud for the neighbors). However, the makers of such home electronic equipment have misused their right to pursue their happiness by making their wares as cheaply and as shoddily as possible in certain respects, while selling them for whatever the market will bear. This is not inherently evil, except insofar as their pursuit of happiness infringes upon the rights of both the consumer and the radio operator/hobbyist to enjoy their separate avocations in peace and harmony in the same neighborhood. Then it's time to do something about it. With 20 million CB sets and 300,000 amateur radio sets out there, they have to put them somewhere. And that includes your neighborhood. The personal communications explosion says it loud and clear: The time is now to clean it up!

II. The Government. It's time to save the FCC. Like many Federal agencies, the FCC is underfunded, understaffed, and overworked. In 1974, the Commission received over 40,000 RFI complaints from consumers. When these were carefully analyzed, ninety percent were found to be the fault of the design and/or construction of the equipment interfered with, and not of the transmitters involved. In 1977, the FCC expects to receive 200,000 of these complaints. Considering how small the Commission's kitty is, couldn't some of that be used for better purposes than chasing down RFI complaints? We think so.

III. The Consumer. Joe Consumer is a babe in the woods on this issue, and in one major respect, he is being ripped off. But, unfortunately, he is blaming the wrong guy. When Joe spends a lot

of his hard-earned money on a new TV, stereo, or whatever, he almost expects that it be made by God, and that it is perfect. Well, we have news. It is not. If the amateur radio or CB buff down the street tears up the picture and/or sound, Joe Consumer's logic says: "It didn't happen before he got on the air. It must be his fault." Joe doesn't know what makes his little box work. All he cares about is whether the picture or sound is there, in good quality. He doesn't realize that it takes something else besides what meets the eye or ear to make his equipment a truly quality device. But, for the money that they've just extracted from him, the manufacturer of that equipment should have seen to that end of it, so that Joe won't have to worry about it. We think that it's time he did.

Oh, yes, the television manufacturers have long offered filters, free, to anyone with a TVI problem. But they've never made any publicity about it, so chances are good that Joe knows nothing about it, or how to get such a filter. If in the off chance he does get the filter, then why does Joe have to pay the \$20 or so installation fee, after shelling out all that other dough to get the set in the first place? And what if the problem were caused by lack of shielding, which a filter can't fix? What does all this tell you about how the manufacturers feel about their products? And, what about the RFI problems of other types of consumer electronic equipment? What's being done for the consumer by them? Do you see why we're fighting to make the manufacturers clean up their act, before the consumer buys it?

IV. Radio Operator/Hobbyist. He's in the vise here. When he operates, even if he's clean, he's hated by someone in his neighborhood. Joe Consumer casts him as the villain in this game, when 90% of the time he's not. Bill Operator may not be interfering with his own TV or stereo (which can prove that he's "clean"), but that cuts no mustard with Joe Consumer down the street. If this sort of thing keeps up, Bill Operator may face some nasty situations, such as vandalism against his equipment, or worse, local nuisance ordinances, local tower bans, or a total ban on his operations by local authorities. And, nine chances out of ten, it's not his fault. It's not fair, and we believe that a court test would eventually support Bill's right to operate in peace. But, must we go through that? No ... not if S-864 passes.

V. The Manufacturer. At least one manufacturer now puts a high pass filter at the front end of its TV sets.

Hurray for them, whoever they are. But, for the rest, it's still business as usual. Not that any of them haven't done something about this. Another major TV manufacturer has researched the cost per degree of RFI protection built into a TV set. Our sources tell us that it comes out to about a dollar a set. Obviously, that makes such protection economically feasible for Joe Consumer. So, why don't they? Because they haven't been told to, yet!

Over the past few years, metal shielding has disappeared from the American TV set. Its place has been taken by plastic. Couple this with the coming of the transistor, which is much more RFI-prone than vacuum tubes, and you have a major RFI problem. Add in poorly designed circuitry, built only with low cost in mind, without the proper design to get rid of strong adjacent local signals (such as Bill Operator), and maybe an old, corroded antenna with lead-in, and you have the makings of disaster. Period.

You know, there are other countries that don't put up with this sort of situation. Japan and Germany require that all home entertainment equipment made for domestic sale be RFI resistant. There, the RFI problem is but a tiny fraction of what it is in this country. And the cost to the consumer is little more than it is here. If it works there, it will work here.

And the manufacturers know that. And they will continue to fight such improvements, just as they did in 1964, when the All-Channel Set Law was being debated. The manufacturers screamed that the prices of TVs would be pushed out of sight if the law passed. It did pass; the price rise was very moderate. The situation is no different here, with S-864. Only the stakes are higher. So, why not support it?

VI. The Broadcaster. Jim Broadcaster is involved in this fight from several angles. The low band VHF TV broadcaster, particularly, has a problem with local signals from six meter amateur radio operations, and in some cases, signals from the FM broadcast band may wipe him out. If a certain TV's i-f stage is unshielded, a strong local signal may enter there and wipe out all reception of all TV channels. AM broadcasters get it from two directions. Spurious radiation given off by nearby TV sets operating with poorly designed sweep circuitry and wide-open cabinets clobber their signals in the fringe areas of their coverage — or even closer in. Meanwhile, the AMer himself may interfere with a PA system being used near his transmitter site.

All broadcasters are affected if the radios or TVs receiving their stations are blown away by a strong local signal coming into the audio stages of the receiver. Then the local signal will wipe out the broadcaster's audio, and Joe Consumer may end up playing cribbage rather than listening to your ad messages.

A major problem for the AM broadcaster is industrial noise, and we believe now that much of it is caused by radio frequency emissions from home TV sets. It never occurred to you, did it?

Remember: As long as the amateur radio operator or CBER is running a "clean" rig, he is not the one to be condemned. Go after the guy who built the TV, stereo, whatever is being interfered with. He's ripping you off! Support S-864.

#### WHAT BILL S-864 IS

It is simply an amendment to the Communications Act of 1934, which allows the FCC to set standards for the manufacture of consumer electronic equipment, with regard to its susceptibility to interference from nearby transmitters which are properly licensed, designed, and operated. That means that the passage of this legislation into law is only the first of two steps needed to make this whole problem of RFI go away. Later, we will offer, in petition form, a set of standards for the FCC's consideration, and again we will ask your support to put an end to this problem once and for all.

#### TO ALL AMATEUR RADIO OPERATORS AND CBERS

S-864 must become law if we are to remove a major threat to both personal communications and the right to view and listen in this country. Therefore, you are strongly urged to (1) write your representatives in Washington, demanding their support of Bill S-864 and its House counterpart. Feel quite free to use any and all arguments used here. Your own words will help. And (2) pass this information on to a friend, neighbor, or relative.

Remember, if you don't support this legislation, and it fails, and you later have an interference problem with your new, TV, stereo, amateur or CB rig, you have no one but yourself to blame. Don't put it off, write to your elected representatives now!

Jim Beedle W9NIN  
Hanover Park IL  
Art Reis WB9YOB  
Wonder Lake IL

Continued

# Make S-864 Law!



# The Duty

*With news of a US Customs Court decision ordering higher import duties on Japanese imports (see "Briefs"), the stage has been set for another round in the debate over foreign manufactured electronics goods. But not all American companies favor higher import duties, especially those who use foreign components, as illustrated by this news release from National Semiconductor. — Ed.*

Mr. E. Floyd Kvamme, vice president and general manager of National Semiconductor Corporation's semiconductor division, appeared in Washington on March 15, 1977 to testify at US International Trade Commission hearings. The ITC is conducting an investigation for Congress regarding the possible economic repercussions of a proposed duty on imports of digital watches and components.

Mr. Kvamme spoke on behalf of the Western Electronics Manufacturers Association (WEMA), a trade association of firms that account for most of the high technology semiconductor devices used in digital watches as well

as in computers and modern electronic products. National is a Santa Clara, California based company that is one of the largest manufacturers of both semiconductors and of the finished watches.

The bills under consideration by Congress would more than triple the duties on digital watch components assembled for American manufacturers at offshore locations. "Both the conventional watch industry and the new digital timepiece industry sustain US production and employment by shifting certain activities offshore," Mr. Kvamme said.

According to WEMA, the levy on imports of the solid state watch modules used in digital watch manufacture is supported chiefly by US companies that make conventional (non-digital) watches. They favor the tariff increases to protect themselves against stiffening competition from increasingly popular low priced digital watches. Because of lower production costs, many American semiconductor and digital watch manufacturers have located some assembly operations in plants in the Far East. Mr. Kvamme characterized the situation as "a

marketing problem between different segments of the US timekeeping industry," rather than a straightforward case of foreign manufacturers flooding the US with cheap products.

If the tariffs were increased, the US companies would probably be forced to close these offshore plants, and the growing availability of inexpensive digital watches would be reversed. Adverse economic effects would be triggered, culminating in the loss of thousands of jobs in the US semiconductor and electronic watch industries.

"In 1976, the US semiconductor industry recorded annual sales of \$3.4 billion and employed over 100,000 people. The manufacture of integrated circuits and displays in the US together with the final assembly of digital time-pieces in this country will, and in fact has, provided new employment opportunities for thousands of Americans. If HR 14600 were enacted, however, not only would new job opportunities be lost, but existing jobs would disappear."

Mr. Kvamme pointed out that many of the electronic circuits and numeric displays used in foreign made watches and other electronic products are produced by US firms such as National Semiconductor. One danger of the proposed import duty is that it would probably cause a retaliatory reaction from foreign countries who are now heavy importers of both digital watches and electronic parts from the US. Many foreign governments are trying to encourage the development of their own semiconductor industries.

"US companies, if allowed to compete fairly on the international scene, are expected to increase their market share during the remainder of this decade to 68% of the market, or \$7.2 billion."

Mr. Kvamme noted that the low prices of digital watches (about 75% of all solid state watches sold for under \$25) allowed the US to capture about three-fourths of the world's market for digital watches in 1976. He predicted that the demand for digital watches would be about two and a half times as great by the end of the decade, resulting in a significant increase in jobs.

The overwhelming supremacy of American electronic circuitry in the world market has resulted in a highly favorable trade balance for the US semiconductor industry. The US posted a trade deficit of \$5.9 billion in 1976.

"The semiconductor industry, if allowed to operate with maximum freedom from artificial trade barriers, could change the American watch industry from one that operates with an unfavorable balance of trade to one with a favorable trade balance."

Mr. Kvamme concluded by saying that the proposed tariffs would "hamper a growing and dynamic US industry, will result in higher prices for the US consumer, and will produce retaliation on the part of our foreign trading partners. It will result in the loss of both existing and future US jobs."

National Semiconductor  
Santa Clara CA

# Breakdown

"Breakdown in communications" is a catch phrase heard about all sectors of life. Is it afflicting hams? As you listen to your favorite band the QRM may immediately convince you that more and more people are talking. Are they enjoying it less and less? Since the breakdown in communications in families, between husbands and wives, among friends and in various other parts of society is mentioned so often, it is no wonder that many hams are feeling unsatisfied with their QSOs. And that other demon, the "generation gap," takes its toll here, too. Old-timers (of whom there are thousands) feel uneasy talking with someone whom they feel knows everything about solid state and computers but really has no love of ham radio because he knows nothing about the old days of homemade equipment, class B modulators, Super Gainer receivers and wire antennas. The younger ham (of whom there are also thousands) feels uncomfortable talking with someone who yearns for the golden days of the

'30s.

The ham population is further fragmented by special interests: TV, phone, CW, RTTY, FM, phone patching, DXing, etc. This is clearly indicated by band subdivisions if one is blind to the poorly concealed contempt that some members of one group often have for members of another group. The barriers are also noted by the various closed repeaters as well as the many nets that occupy the lower bands. The unwary intruder is often told to get out much as a bouncer would throw out a stranger at a Frank Sinatra wedding.

While the modern situation is much more complex, its roots are found in the special interests which were felt from the very beginning of ham radio. There were those who enjoyed rag chewing and it didn't matter much if their Ford-coil spark set only reached the guy on the other side of town. The distance, or DX, mattered very much to others. Their thrills were measured by the mile. Still others felt

guilty if they were not of public service, and their pleasure was handling messages free of charge.

Seeing that there have been different aspects with varying appeals from the start, does this mean the FM repeater man, for example, and the lower band DX fan will never have much in common? Not necessarily. But neither does it mean that we are all going to develop an overwhelming interest in one mode of transmission and one amateur band. What is possible, and what our goal should be, is better communications between hams as humans, as people, better communications involving the individual as a person.

Communications is an art, it is said. It basically means expressing yourself and your ideas clearly to another. Sometimes, of course, we do not want to express ourselves too vividly. Guests are invited into the living room, so to speak, but not into the rest of the house. Guests are envious of the new furniture (the new radio equipment) a fellow ham has just bought, but the host doesn't say he still owes ten payments on it or that he and his wife had a terrible family fight because he bought it. But what about the things we *do* want to express?

Enthusiasm is the best vehicle to get them to their target. There is no other ingredient which will so help us get to the heart and mind of our fellow man. It views things through

the eyes of a child, and with the heart of a lover. It acts as a self-releasing power and helps focus the entire force of personality on a subject. It lifts your listener into the clouds with you and makes him see the thrills, mystery, romance and fascination which has captured you. It transports your audience from the humdrum into a new world of wonder — your world.

But remember that communication is a two-way road. It is not an attempt to impress another with how great you are or with the expensive equipment you are using. Let's say, for a ham, it's an invitation to another person to share some delights, to have some fun together for a few minutes. Its aim is to encourage two people of similar interests to confide in one another and get to know one another, to build friendship, to create what the Greeks called *phileo*, fraternal love.

Sincerity comes into the picture, too, then. This helps us to see that the enthusiasm mentioned is not the empty backslapping of a high pressure salesman which perhaps has its parallel in the fancy warm phrases of friendship printed on some QSL cards. If it really was a pleasure to talk with another ham, let us be sincere enough to *write* it on our QSL cards rather than have it printed. Don't the Christmas and birthday cards that you appreciate the most have a hand-written line or two on them? Don't those few phrases truly mean more to the recipient than whether the card cost



twenty cents or a dollar?

Stereotyped QSOs have been condemned so many times in so many columns in ham magazines that only a few words are necessary here. What is bad is not necessarily that we say more or less the same thing to each new station with which we talk. What is bad is that we say the same thing everyone else is saying. How boring if the fellow you're talking with at the moment says essentially the same thing the two dozen hams before him said! Let's spice things up with a little originality.

Yes, of course we generally discuss the same things. We all sob over the poor band conditions, mention the equipment we're using and the antenna we have. So, where's the originality? Well, suppose you find out the other fellow is using the same kind of equipment you are. Why not tell him if you've had a problem, what the symptoms were, how you identified the bad component, and so on. This little bit of information is sure to interest him, and he'll tell you if he's had the same problem or a different one and perhaps pass along something that can help you. Or, have you used the equipment in an unusual situation? Is there some feature of the gear you particularly enjoy? Or something that annoys you?

Other ideas? Well, is your shack in an unusual location or an unusual room in the house? Are you using an alternate source of energy to power your rig? Made any modifications to your equipment you're happy about? Helped anyone get his ticket? Offered to give a talk on ham radio to the local grade or high school and had any takers? Any results? Other hobbies in the family? Your occupation?

With the transistorized pre-amplifiers available, some hams are using antique microphones, and anyone can use an antique telegraph key. If you enjoy such things, let the other fellow know about it. How you got interested, how old the antique is, who used it before — is it all original, etc. If you have a conversation piece in your shack, then talk about it.

Regardless of where you live, mention it by name as well as saying near such and such large city. Many people travel extensively these days. I was talking recently with a Kentucky ham and had to ask three times where he lived. Finally he confessed, "Pikeville." He was amazed that I had visited there several times, and we had quite a talk. Another fellow was in Crossville, Tennessee, but I learned this only by being insistent. Neither of these men could believe that a ham in Peru could be interested in their exact location. On the other hand, I am surprised at how many I talk with who have visited Arequipa. Those who have always tell me about it and ask what part of town I live in, and we usually have a nice visit. Did you know that Arequipa is 450 years old? Has one of the oldest medical universities in this part of the world? Enjoys a climate unsurpassed anywhere?

How old is *your* town? What made people settle there? What are the main industries? Were you born there or did

you move there? Would you like to leave? Why? Where do you want to go? Why? Besides the temperature, what else can you say about the weather? Is it raining? Is that good? How is the weather affecting your lawn or garden? What do you see from your window?

What about your family? Do you mention them on the air? A fellow down here in South America was telling me about his equipment one morning when he interrupted himself. He was back in just a moment saying, "That was my wife. I'm always up before her and at my radio. Then when she gets up she fixes me a cup of coffee and brings it to me and gives me a kiss. We've been married 20 years, and she kisses me good morning every day." I felt I had been admitted into the family circle, and that I knew him better. I complimented him on such a loving companion, and we enjoyed a chat about marriage. When we signed off he left me wondering what I'm doing wrong that I don't get a kiss every morning. I'll never forget him.

Some hams on the air for years seem to still have a bit of "mike fright." Perhaps it is because they have concentrated on the technical things of life and are unsure of their grammar and pronunciation. My advice to them is to forget it and enjoy talking. Dizzy Dean was a huge success as a baseball TV play-by-play announcer partly because of the things he did to our language. "He slud into third" was the first expression that caused comment. Later he varied "slud" with "slood" and then one afternoon he came up with, "The trouble with them boys is, they ain't got no spart." When the color man asked at the end of the game for an explanation, Dizzy said, "Spart is pretty much the same as fight or pep or gumption. Like the 'Spart of St. Louis,' that plane that Lindberg flowed to Europe in." If you enjoy something as much as Dizzy Dean loved baseball, your language will not matter much. People will be thrilled to hear you talk about it.

A word of caution for DX contacts. Remember that for most of those operators English is a second language. Speak slowly and distinctly. This is more understandable for them at any time and is more intelligible under poor conditions. Avoid slang and idiomatic expressions and keep it simple.

Your accent shows up on CW as well as phone. I will always remember the Novice I worked on 15. His Morse was about the worst I have ever been able to copy. Of course, he wanted a QSL. I slowly sent him the suggestion that he slow down, that he should try to improve his code and told him I would like to have a couple of IRCs for the airmail QSL. He sent me a hot letter telling me he could send better than he could receive and that he had a certificate for copying W1AW at 20 wpm. He further thought I was a crumb for asking for two IRCs for the QSL. He concluded by stating that the keyer he was using was out of adjustment, and if the code he sent was not readable, it wasn't his fault!

So, if you're on CW, whatever you are using to send with, be sure it is properly adjusted and that you feel comfortable with it. And if you're on phone, turn your mike off before you clear your throat, cough, sneeze or shout at the kids in the other room.

A comment about profanity might be in order. It is against the law, in the first place. And it is a sad commentary on a man's masculinity when he feels that he must show it by his choice (?) of words. But considering that a night doesn't pass without some of these words being heard on TV, perhaps it is too much to suggest that they be eliminated. But if one has to work one or two into every transmission, I personally can not help but feel that he has a limited vocabulary. Sometimes, perhaps, nothing else fits. Anyone who enjoyed the hours long movie "Gone With The Wind" could not help leaving profoundly impressed by Clark Gable's concluding word. Would the FCC, then, overlook every four to six hours one really appropriate "damn"?

Listening is the other half of conversation which, together with talking, makes up communication. If no one listens, it is useless to talk, a point not always realized by those talking. And listening doesn't just mean separating the words from the QRM. It involves understanding or interpreting both the literal meaning of the words as well as the speaker's intention. If someone says to you, "Why you old son of a gun!" the phrase is an insult, but the warmth and affection in the voice indicates exactly the opposite.

Most people, including hams, are not very good listeners. We generally talk more than we listen. And while we're supposed to be listening, most of us are making mental notes preparing something to say just as soon as the other fellow shuts up and gives us the chance. Learning to really listen is not difficult, just rare. Usually considered a passive thing as when listening to some favorite music, listening should be a quite active thing... as a real jazz buff carries the melody in his head while listening to the group improvise with various counterpoints,

# 73

Study Guides  
and  
Code Tapes —  
The Best Available

see page 204

themes and melodies. A stream of words entering our ears must be interpreted not only by our minds as to literal meaning, but by our hearts, too, for the often more important meaning. How close can you come to what the other fellow is really trying to say? Speech is often full of symbols, and the well-trained listener can identify them immediately. The aim of careful listening is to actively seek to discover how the other fellow feels about what he is talking about and what kind of person he is.

And how do you conclude a contact? If you listen, you'll see that many hesitate, stumble, tie the ribbons on, have a final and then a final-final, all giving the feeling they want to sign off but don't want to offend the listener. Have you noticed the same tendency among some of the guests who visit in your home? They get ready to leave, get to the door, and then stand there talking for fifteen minutes. Let's learn something from the "good buddies" on CB. When they say, "I'm gone," they are gone. So, let's not rush, let's say what we want to, let's give the other fellow a chance to talk and really listen to him, but when we sign off, let's shut up and not drag it out like a soft-hearted lover who has decided to break it off but then can't bring himself to say the fatal words and keeps on talking, talking, talking. I'm gone.

George Brumley OA6CV  
Arequipa, Peru

## Mauritius

*Pete Smith K4FOK has recently completed a DXpedition to Africa that was intended to put Zambia on the air in a big way. But it was not to be... as we learn from Pete himself, via the West Coast DX Bulletin. — Ed.*

As must be abundantly clear by now, I did not get on from Zambia. My application for a license was turned down with the explanation that the Zambian government does not license foreign amateurs for stays

of less than one year. My appeals of this decision, and requests for any sort of temporary permission to operate, went quite high up... but were all denied.

Anyway, on to Mauritius where it was a different story. I was issued 3B8DT, largely on the strength of my US license, though, as I understand it, the Mauritian authorities appreciate it if the foreign applicant has some sort of Commonwealth license. I would certainly have a UK reciprocal license



in hand if I were doing it again.

I was able to set up at a beautiful hotel on the northwest coast of the island, with a clear shot toward the US. Unfortunately, I did not arrive until late on March 17th, had business all day (the 18th), and finally got back and fired up the equipment for the first time after midnight (local time) — about 2000Z on March 18th.

The first twelve hours of the ARRL DX Test were an utter disaster

with something like seven contacts, but things picked up after that. Good conditions on 15, fair on 20, and 40/80 mostly not so hot as much of the time I was in daylight and the QRN was over S9. I think I shook a few people in the waning hours of the contest answering their CQs on forty.

The total reads 583 US contest QSOs without duplicates. There were about 15 with the West Coast and about 500 with non-US stations, these during periods when the bands were

not open to the states. All but thirty of the QSOs were CW. Unhappily, I had to pack the gear and head for home on March 21st, and I did not get the chance for the phone operation I would have liked to have had.

Although I was unable to get on from 7Q7 Malawi, and had understood that all operation there had been suspended back in June 1975, while listening one evening on twenty I heard 7Q7LW working through a pile of JAs. She gave a box number in

Zomba as address, and there was no reason to think that she was not genuine.

Thanks to the Northern California DX Foundation for equipment and other assistance, including QSLing. The DX Foundation tells me that they intend to QSL every contact through bureaus as soon as the QSL cards are ready.

Pete Smith K4FOK/3B8DT  
Reston VA

## Pitch

*In light of recent efforts by Jack Anderson to discredit ham radio, many amateurs replied with the other point of view in letters and telegrams to their congressmen and hometown newspapers. Some, like Larry Schwartz WB3DBI, took another route — in this case a high school newspaper. — Ed.*

Last year, over 6,000,000 new CBers received their licenses, bringing their total number to over 8,000,000. But throughout the US there exists another group of radio operators.

In contrast, they form a much smaller group, about 300,000. Whereas CBers run four Watts of power, these people legally run as much as 2000.

CBers operate on 40 channels while the other operators have literally thousands. While most CB equipment costs between \$100 and \$300, the other group can pay this price or invest thousands of dollars in a station. The Federal Communications Commission (FCC) also permits this other group to construct their own equipment if they so desire.

Who are these other people? They form a group of radio operators commonly known as "hams." Hams communicate all over the world using Morse code, voice, and Teletype. The FCC even allows hams to use television to communicate. Additionally, where facilities permit, hams can use their radios to place local phone calls while remaining in their cars.

With all of these privileges, why doesn't everyone become a ham? Mr. Donald Smith, an electronics teacher and a ham radio operator, explained, "Ham radio shows technical knowledge and not everybody has the desire to go into it."

To qualify as a ham, one must first pass a Morse code test and then pass a test dealing with electronics and radio law. Passing tests of greater difficulty qualifies the applicant to operate at more frequencies. Put another way, they receive a larger portion of the radio spectrum.

Junior Ari Hirschman, a ham radio operator, told why he got started: "I liked the feeling that I would be able to talk over such long distances and sometimes be able to do it with equipment I built myself. I also like the technical aspects involved."

Sophomore Paul Schmidt, also a ham, gained an interest in ham from his brother. "When I first became interested, I hardly knew anything about radio and it sounded like a neat idea."

Paul said that recently on the air he met somebody who challenged him to chess. The whole game was conducted over the radio.

Hams also perform many public services. During the Guatemala earthquake in 1976, hams went into action. Hams flew to Guatemala and, using their equipment, sent reports back to the US about the situation there. Many times during a parade hams will monitor the parade route and keep in touch with the police.

Hams also form many on-the-air groups. These groups may handle and relay messages, such as those during a disaster. The groups may also discuss electronics or play games. Many hams even do their homework over the air.

Recently, courses for people interested in studying for their ham licenses have grown. The Montgomery (MD) County Department of Recreation offers courses providing the electronic theory needed to pass a ham test. Interested persons should phone 468-4050.

Larry Schwartz WB3DBI  
Bethesda MD

*Reprinted from Pitch, published by Walter Johnson High School, Bethesda MD.*

## Respect

Your personal help is requested in achieving more harmony in our overcrowded 20 meter phone band. Working DX is the major interest of many worldwide amateurs — SSTV, net operation (handling important and vital traffic), and, then too, just plain rag chewing enjoyed by many, many hams.

Let's examine the space allocated for SSB on 20 meters — 14,200 to 14,350 kHz. Yes, only 150 kHz! It is a well-known fact that most DX is worked at the low end of the band, 14,200 kHz and up. Let's arbitrarily suggest 10% of the 150 kHz for DX. This would give the DXers 14,200 to 14,215 kHz. The 14,230 kHz + or - 3 or 4 kHz is the SSTV area. How about 10% for nets and traffic? This group is pretty well established in the area 14,300 to 14,315 kHz.

Irate SSTV, DX, net and rag chewers continually harass SSTV, DX,

net and rag chewers with carriers, tapes, CQs and other noises. Effective, yes, but definitely not the answer to the problem. The resulting QRM renders the frequency useless to all, and everyone loses. Tempers flare, anger, irritation and frustration prevail. Our hobby is degraded. This could all be avoided if amateurs used better judgment in selecting the proper frequencies for SSTV, DX, nets and rag chewing.

You will note that I said above "arbitrarily" when I suggested the frequencies for the various groups. You could never reach a definite agreement among all the hams on 20 meter phone, but this could be a start!

Henry Lührman W4PZV  
W Palm Beach FL

*Reprinted from The Mike and Key, bulletin of the Greater Cincinnati ARA, Cincinnati OH.*

## Eye Bank

In the United States, eye banks are served by a network of volunteer ham radio operators. Three hundred and sixty-five days every year without a holiday, this rapid nationwide network stands ready to flash the news of emergency requests for eyes, and where eyes are available.

In emergencies, from fire, a laboratory explosion, an auto accident, certain acute infections, where immediate corneal transplants are necessary, the Eye Bank Emergency Radio Network serves as a means of saving the eyesight of hundreds of people. It assures that a donor's eyes will be rushed anywhere that an emergency exists.

The Eye Emergency Net, a true public service net, has been in continuous operation for almost fourteen years through the untiring efforts of a distinguished and highly dedicated group of amateur radio

operators.

Briefly stated, the purpose of the Eye Emergency Net is to handle information regarding the need for and the availability of human eyes for emergency corneal surgery for the various eye banks throughout the country. In accordance with this simple purpose of trying to be of assistance in preventing the loss of sight in an emergency situation, it has been decided that henceforth only emergency needs for eyes and the availability of eyes will be listed and carried on the several Eye Emergency Nets by the net control operators.

Each amateur radio operator is requested to so inform the eye bank he or she represents of this policy of listing only emergency needs and/or the availability of eyes. This will improve the efficiency of the Eye Emergency Nets and will eliminate needless repetition of unnecessary and



useless information as has crept into the operation in the past. Naturally, each amateur radio operator should keep in close contact with his or her eye bank to keep them informed of emergencies listed and/or availabilities. In this manner we can carry out our avowed purpose of helping to save sight in emergencies and, in addition, operate more efficiently with less time occupying crowded radio frequencies.

The policy stated on this page is to acquaint my fellow amateurs with the Eye Emergency Net. I am a net member representing the Midsouth

Eye Bank of Memphis, Tennessee. There are several nets which meet every day of the week, every week of the year. The only exception is the first one, which doesn't meet on the weekend. (All times are EDST.) 0600-3970 kHz; 0645-3970 kHz; 0800-7294 kHz; 1845-7294 kHz; and at 1900-3970 kHz. I check into the net that meets at 0645 on 3970 kHz. I have found that I can meet this net and be on the road to work by 0700. It only lasts about five or ten minutes. I also call the eye bank and leave a message with the answering service as to the need or the availability of donor eyes. All this and I am still on

the road to work by 0700 and usually earlier than that. As you can see, the net is quick and to the point, and serves a great need to the Eye Banks of America. Can you find five or ten minutes in your busy schedule to help a person to gain back his eyesight? If not, close your eyes and walk to the refrigerator, pour yourself a glass of milk, then turn on the TV, sit back and relax.

Guy Speck WA4WHQ  
Memphis TN

Reprinted from Telstar, bulletin of the Memphis Pioneer ARC.



A recent editorial in the March, 1977, issue of *Ham Radio* magazine caused me so much pain that I feel compelled to take pen in hand and do something about it. The author has a good topic (the 40th anniversary of the invention of the klystron) and he traces its development in a well-informed manner. His summary and call to action, however, fall far short of what could be a noble point. The editorial writer calls for more activity on the microwave frequencies to protect our allocations in light of WARC '79. This conclusion is less than worthy for three reasons. First, nobody in positions of importance would know, nor would they care, if amateur activity on 10 GHz increased ten times over. Secondly, the contribution the amateur service could make to the microwave state of the art is nil. Finally, the people who might spend their time working on amateur microwave could make a very important name for amateur radio. They could make a name that would be heard and recognized where it matters.

The microwave frequencies are familiar and well-known territory to military and commercial communicators. The frequency congestion in some parts of the country makes the California two meter repeater problem look like the wide open spaces. Millions of people daily talk over long and short distances on 15 GHz and up without causing any excitement. Digitized transmission systems are becoming the rule and are replacing the old analog modulated networks. It is not in the best interest of a vibrant and progressive amateur radio service to try to duplicate the plumbing and hardware developed so well so long ago. The fourteenth inventor of the wheel probably got very little notice. There is nothing much for us in the microwave frequencies. There is not much utility, no new ground to be plowed, no records to be set, nothing but a lost wandering in a wasteland full of funny machine shop products.

Now that I have alienated everybody who even knows what a klystron is, here is where I propose we put our efforts. We must skip around everything that is too high for coax and keep going. Go up to the new communications ground where the future is full of real frontiers. Go up to where new developments and uses are waiting to bring riches to individ-

uals and pride to amateur radio. Go up to light!

The use of light for communications is just passing out of its infancy. Its first real steps were recently taken when the Bell System began using a light pipe to connect switching facilities in Chicago. Amateur use of light for communications can follow two very important parallel paths.

When amateurs think of using light for communications, they naturally think about transmission systems. This means shooting a light beam to some other guy and modulating it in some way. It does not necessarily mean relatively expensive lasers and high voltage power supplies. Light can be reflected, for instance. Sunlight for reflection is plentiful and free. The same hams who can design a moonbounce array can certainly figure out a cheap and easy way of modulating a reflected beam. Clouds might be a problem, but we have lived with the ionosphere all of these years, so what are a few clouds?

Light as a transmission system is certainly line of sight (unless you bounce it, that is). There are probably more and better ways to bounce a light beam than a microwave beam. They just need to be developed. Instead of a repeater on a mountaintop, how about a mirror? Want to talk to somebody? Just kerchunk the mirror. Not as good as two meters for mobile, probably, but a whole lot better than 10 GHz. On field day you could rent one of those searchlights they use at shopping center openings! Moonbounce is still a good bet, too. During the day your moonbounce reflector could probably provide hot water for your house. (Please don't write to me and tell me you can't reflect light off the moon. I'll have a whole generation of song writers ready to pounce on you.)

Along with light as a transmission system, there is another path that amateurs can explore which will be far in advance of available commercial systems. Light can be filtered, chopped, amplified, heterodyned, attenuated, modulated, and detected (and just about anything else that can be done to rf). It is not, however, inherently leaky. When contained in a glass or plastic light pipe, it is immune to electromagnetic hum, crosstalk, rf feedback, etc. Light pipes can be driven by our everyday friend, the

LED. Light can be used, then, at lower level stages instead of af or rf to generate and process signals that can use rf, af, or light as a transmission system at higher stages. What I'm suggesting is that your Sooper Blinker 20 meter SSB rig of 1982 might very well use light starting right at the microphone to generate and process the audio that would eventually modulate the 14 MHz rf stage. Why? Because sand (glass) is cheaper than copper ore. Light needs less shielding and is less troubled by ground loops, etc. All sorts of neat processing can be done with the spectrum available.

This means that amateurs who don't want to use light as a transmission system can still experiment

In 1978, hams all over the world will witness an event that will bring them undreamed-of fame - The Ham Radio Olympics. The HRO will accomplish what years of public relations could not, making ham radio a respected household word throughout the world, in Africa as well as in California.

Since 1979 will be the decisive year for ham radio, in the World Administrative Radio Conference (WARC) which will meet to decide what frequencies ham will use, the HRO will come at just the right time. The good press the HRO will obtain, and the national prestige it will engender, will carry over into the WARC and we will see countries competing with each other to get the best deal for ham radio.

Later this year, the International Amateur Radio Union will proclaim 1978 the year of the HRO and will notify all the governments which it represents. A committee will meet in Geneva to make simple preparations. What the committee will have to work out is what kind of events will not favor large countries and power amplifiers. There will be events of skill, perhaps tests of code reception and transmission, total number of con-

with and develop very important techniques in their own shacks. This activity is very much in keeping with the historic experimental tradition of amateur radio. The size and cost are low, and the potential is enormous.

I call on the gadget lovers and tinkerers in amateur radio to get with it. Quit trying to interface your SSTV to your microprocessor, let microwaves cook baked potatoes, and move up to light. *73 Magazine* has led the way in slow scan, 2 meter FM, and microcomputers. It is now time to start sending in articles on the newest and grandest development yet. Do you see the light?

Capt. Frank J. Derfler K9KIC  
APO San Francisco

## HRO

tacts, longest distance per Watt on each band, or the ability to work through a satellite.

After the week or so of competition, the committee will convene, report on what they heard, and vote. They will present awards to the winning hams and their countries.

It will take a lot of work and much organizing, but we can do it. 1978 will be a year for all hams to remember, the year of the Ham Radio Olympics, the year ham radio became the "in" thing, the year governments started favoring ham radio, the year before the WARC when hams came out with far more than even the ARRL dreamed of asking for.

Gabriel Gargiulo WA1GFJ  
East Hartford CT



# Ham Help

A few years ago I ran across a construction project in the library of a fellow ham. Now we cannot locate the project, but if my memory serves me correctly, I think it may have been in one of your publications. I would appreciate your help in locating it.

The project was a solid state device to track thunderstorms. This is the solid state version of an original article, "An Electronic Storm Finder," which first appeared in "The Amateur Scientist" column in *Scientific American*, May, 1963, p. 167.

Jared A. Ketner WA0QWU  
506 E. 14th  
Wahoo NE 68066

I require a schematic diagram and alignment procedures for a Hallcrafters "Skyrider 23" receiver. The manufacturer says it's out of print. Many thanks.

J. Sutherland  
P.O. Box 210  
Hampton, N.B.  
Canada E0G 1Z0

I am writing to try and find something about a new animal we are all beginning to know if not love: interfacing. I wish to develop a teletype system for my shack that is as noise-free as possible. I live in military quarters here in Germany and complaints about RFI are bad enough

without having the neighbors complaining about the noise of TTY machines. I am also trying to keep the cost of the whole thing within a military salary type budget. This obviously knocks out HAL products.

I would like to develop the system around an AFSK type demod. This will prevent extensive modifications to the radio equipment. Now comes the interfacing problem. I have been faithfully reading all the I/O articles and the ham TTY articles, and hopefully have developed a vague reading knowledge of the medium. I have also seen that most of the different systems would be totally incompatible with each other. ASCII-to-Baudot/Baudot-to-ASCII converters look great to tie a computer to a TTY machine, but will they tie an ASCII encoded keyboard to a TTY demod? Will they tie the demod to an ASCII video character display?

What I would really like to know: Have you any suggestions for kits that would be compatible and not overly expensive? I'm not trying to force a manufacturer's recommendation from you. I realize that you have to maintain a fair outlook towards them all. I'm merely trying to keep from a lot of experimentation with some rather expensive devices that might not like one another at all. My working knowledge of digital circuitry is limited to the speed keyer and digital

counter level. I haven't dived into LAI circuitry at all as of yet. I do see a computer in the future, but it is a financially far future.

If I haven't completely confused you by now, I hope you have something which will point me in the right direction. I will be QRV for any suggestions to keep the old TT-15 from keeping the neighbors awake.

Sgt. Anton M. Giroux  
DA1NF/WB4ART  
HHT 2nd ACR  
APO NY 09093

I am an ardent home brewer and lover of CW. Since reading about the attributes of the FYO key, I have become interested in attempting to build or buy one. Could you or any of the readers of 73 assist me in this effort, such as pictures of an FYO or perhaps a source of the key itself? Thank you.

Bob Best WB1AQM  
Pine Tree Rd., RR #2  
Coventry RI 02816

I would like to get in touch with other hams who read science fiction literature... such as Clarke, Asimov, Heinlein, etc.

Neil Preston WB0DQW  
7024 Bales  
Kansas City MO 64132

WANTED: Hams near Chicago to form a DX and Contest Club - Novices to Extras wanted. Please contact me for information.

Randy Terborg WB9SAD  
10137 Kostner  
Oak Lawn IL 60453

WANTED: A manual and/or schematic for an Ameco 2 and 6 meter transmitter, model TX-62. I could either purchase the manual or make a copy of it, then return it to the owner. Any help would be appreciated.

Charles Dedon WA5WZ1  
Rt. 1A, Box 500  
Walker LA 70785

Even though I am not (and cannot become) an amateur, due to disability in my hands, I do read your magazine. I teach electronics free to any young person who is really interested, enough to give up an hour or two a day. We use mostly surplus material to build projects, and have great difficulty in getting data on much of it.

Can anyone provide addresses or sources where we might obtain data on integrated circuits, nixie tubes, or related components? For instance, we have a 12 tube readout, alphanumeric, which we would like to use, but can find no information on.

The tubes are 13 pin (5 in front, 6 in back, a blue sleeved lead on each side). Monogram on back: ISE-DG12C-HB:D. ICs: DP4, DN2, HD3107DM, M5B201, M5B205, M5B207, and one M5B212, with associated transistors, diodes, and resistors, which we do have data on.

On the board are these numbers: HEC 011 EPA, 504-PCB-B, and 13925-H. Please send any information.

Edwin O. Griffith  
614 E. Court  
Montpelier OH 43543

# RTTY Loop

This month we are going to discover just how Teletype is sent. For the purposes of this discussion, forget all you know about radio. During the next few minutes, the only way to get information from point A to point B is by stringing wires. You'll see why later. Now let's look into non-voice communication systems.

I am here, and you are there, and I want you to get me a hamburger. So I

string a wire from me to you and connect a switch, battery, and bell. See Fig. 1. We agree that one ring means "hamburger," two means "7-Up," and three is for "french fries." What do we do for chicken soup? Clearly this system is limited, and some encoding form is needed. Obviously, that is what alphabetic codes, such as Samuel F. B. Morse's, do. But this type of system did not

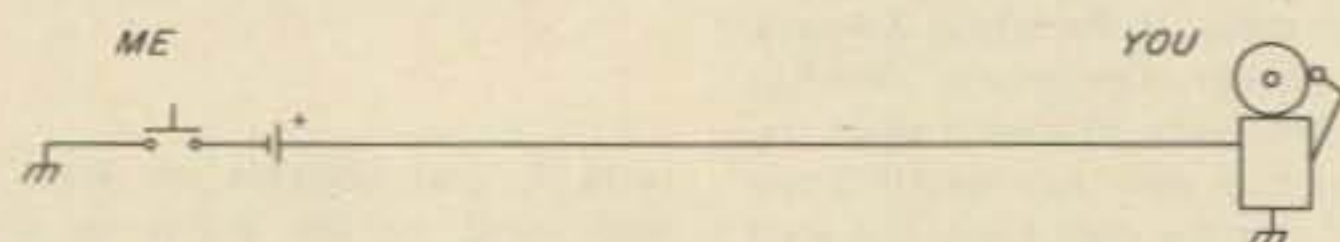

Fig. 1.

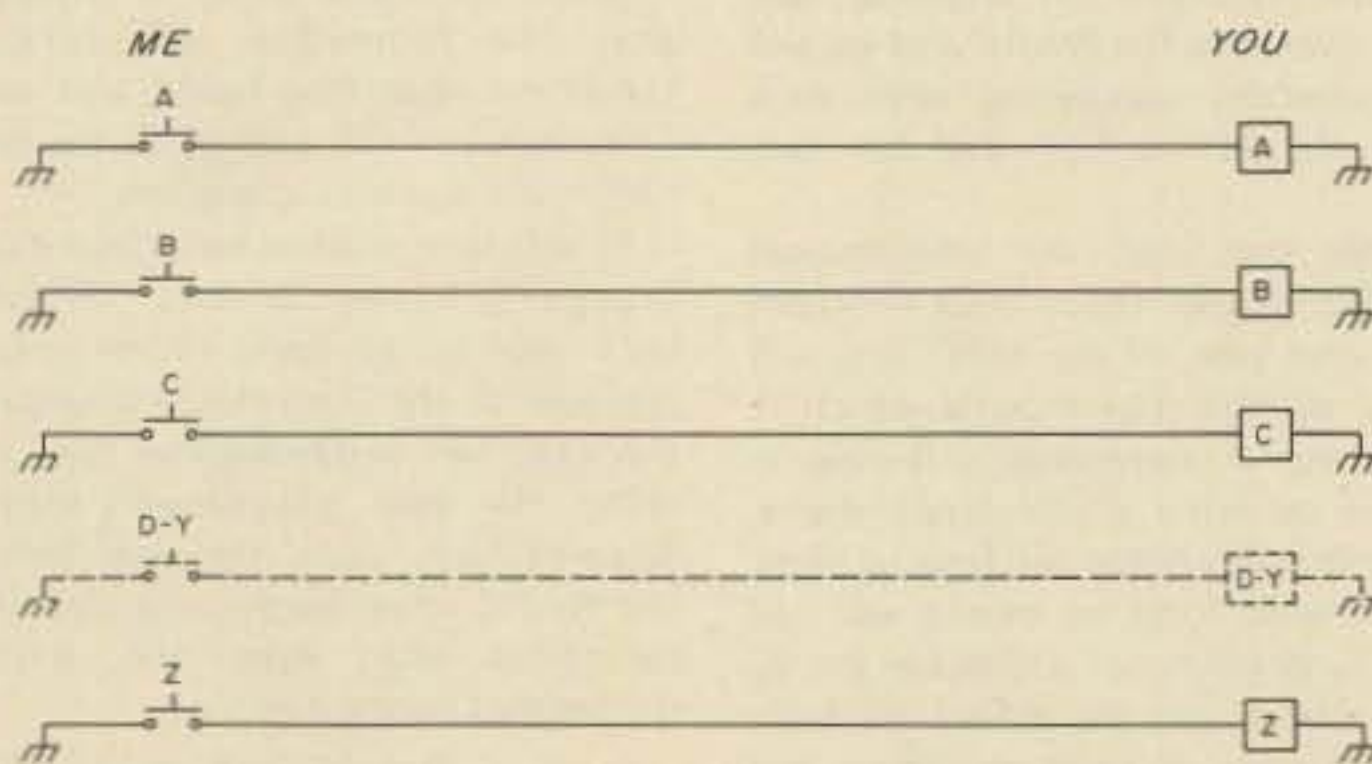

Fig. 2.

lend itself to automated systems in the PICE (pre-integrated circuit era). We need a way to send each letter and figure from me to you and have a machine interpret it.

Refer to Fig. 2. Twenty-six buttons, plus any figures or punctuation, are at my station. Each of these buttons (arrange them in a keyboard if it will make you happy) is connected to a long wire which spans the gap 'twixt you and me. At your end, each wire feeds an electromagnet with some linkages resembling an electric typewriter. I hit the "Q", the "Q" wire is energized, your "Q" magnet pulls in, and a "Q" is typed. Add some means of returning the carriage (CAR RET) and feeding paper (LINE FEED) and you have a workable system. (These two are also abbreviated CR and LF.)

But wait a minute. You have to

string more than 30 wires who knows how far just to do this. If you will pardon a bit of borrowed terminology from the computer folks, this is a "parallel" system. That is, all wires (bits) are there (read) at the same time. All we have to do is convert this to a serial system and send each bit sequentially, and then we can go back to one wire between stations.

Take a glance at Fig. 3. Now we have added a motor-driven selector switch to each station. Now when you push a button, two things happen: The clutch engages and a "START" pulse is sent, and the appropriate letter pulse is sent at the correct time. At the other end, the "START" pulse engages the clutch, and, since the motors are turning at *exactly* the same speed, when the pulse for the letter sent arrives, the receiving selector switch will be at the appropriate

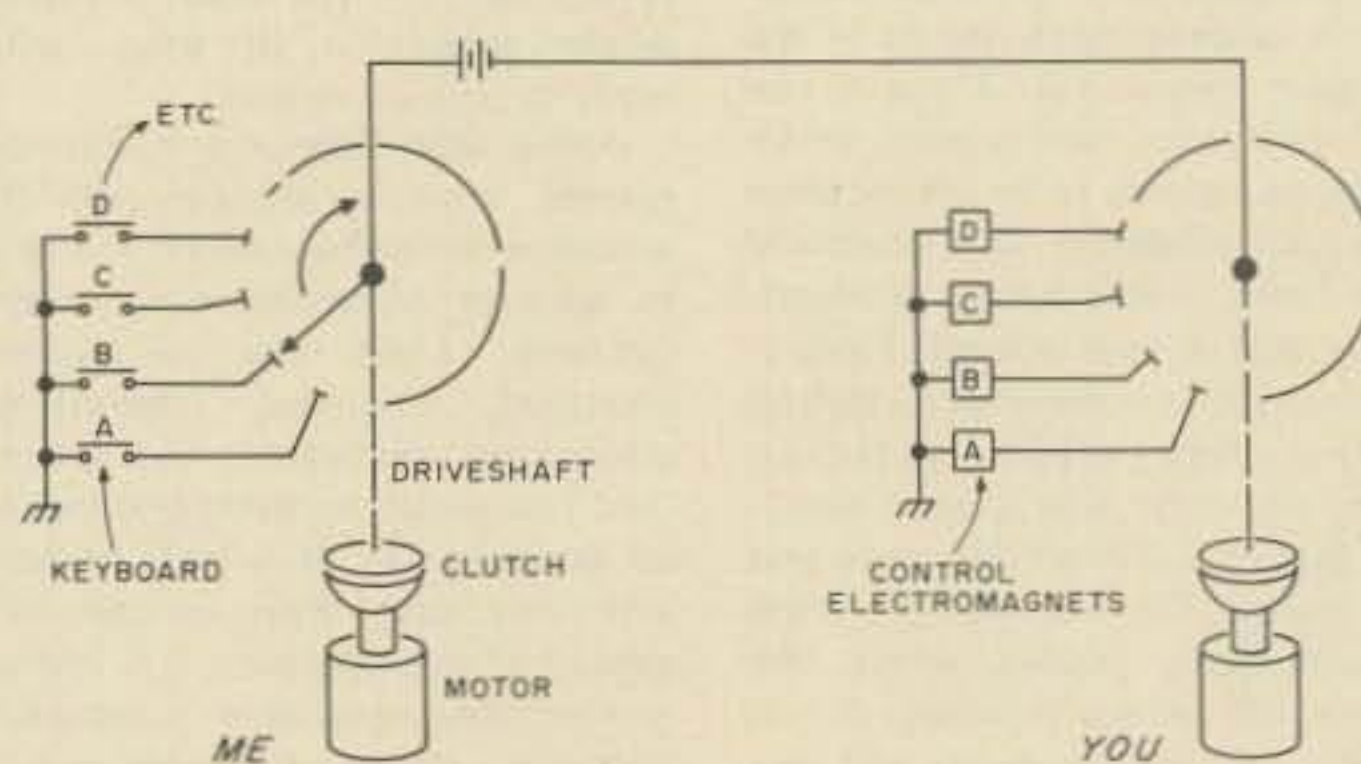

Fig. 3.



terminal to activate the corresponding magnet. Neat, huh?

*Only one problem.* Just to send the letters of the alphabet, you need 26 pulses plus the START and STOP pulses. Twenty-eight bits! At, let's say, 25 ms per bit, a reasonable speed, it would take almost 3/4 of a second to send each letter. That works out to around fifteen words per minute. There has got to be a better way. There is . . .

Take five bits and encode them in a binary progression. This gives 2<sup>5</sup> or 32 possible characters. To get more, without using more bits, use both upper and lower case. Fig. 4 shows one possible scheme. Now, reduce the switching of Fig. 3 to send just five bits plus a start and stop, and you can send whatever you want, with 22 ms pulses, at 60 words per minute. Make the pulses shorter and you can send faster, and this really works!

To make it practical, when you push a key on the keyboard, mechanical linkages set up the appropriate five-bit code, which is then scanned by the motor-driven switch and sent down the line. A selector magnet driven off that line pulls levers in as a toothed wheel allows brief samples of each pulse interval. The received letter is sequentially encoded and, at the conclusion, read out in parallel form. Levers and trip hammers are set, and the proper key is struck on the platen. For the computer buffs out there, note that the characters are first generated in *parallel*, converted to *serial* for transmission, then received *serially*, and reconverted to *parallel*.

A common problem for RTTY

BINARY	LC	UC	BINARY	LC	UC	BINARY	LC	UC	BINARY	LC	UC
00000*	BL	BL	01000*	LF	LF	10000	E	3	11000	A	-
00001	T	5	01001	L	)	10001	Z	"	11001	W	2
00010*	CR	CR	01010	R	4	10010	D	\$	11010*	J	'
00011	0	9	01011	G	&	10011	B	?	11011*	FG	FG
00100*	SP	SP	01100	I	8	10100*	S	BE	11100	U	7
00101*	H		01101	P	0	10101	Y	6	11101	Q	1
00110	N	,	01110	C	:	10110	F	!	11110	K	(
00111	M	.	01111	V	;	10111	X	/	11111*	LT	LT

*\*Notes on individual codes:*

- 00000 - BLANK, cycles machine in open condition. Will shut down machine in some loops.
- 00010 - CARRIAGE RETURN, usually abbreviated CR or CAR RET, returns type basket to left hand margin.
- 00100 - SPACE, advances typing basket one space without printing.
- 00101 - H, in upper case may be £ (pounds sterling) or STOP. This, used as stop key in some circuits, has no radio use.
- 01000 - LINE FEED, usually abbreviated LF, advances one line of paper.
- 10100 - S, upper case usually BELL, which rings a loud bell in the machine. Some machines type ' instead, and use upper case J for BELL.
- 11010 - J, upper case ' (apostrophe). See note for 10100, above.
- 11011 - FIGURES, usually abbreviated FIGS, puts machine in upper case.
- 11111 - LETTERS, usually abbreviated LTRS, puts machine in lower case.

Fig. 4. Binary Teletype Code.

operators involves the mechanical speed of Teletype equipment on each end of the "loop." Again referring to Fig. 3, it can be seen that the receiving machine must be in the "start" position when the transmitter sends a start pulse. Imagine for a moment what would happen if the two machines were not synchronized to each other! Most likely, an invalid "garbage" character would be printed, which is exactly what happens when RTTY is transmitted over a noisy path. Some method of insuring machine synchronization is required, and fortunately the problem is easy to solve. The power company maintains close watch over the frequency of our line current, and, while voltage may vary considerably, the frequency is always very close to 60 Hz. This fact is employed to our advantage in most TTY machines. The motors that drive the

mechanical linkages in the machines are usually "synchronous" motors; that is, their speed is a function of power supply frequency, not voltage. Most synchronous motors will maintain speed over a wide voltage range, although their torque suffers at voltages much below 100. Thus, when the TTY machines at both ends of a path are driven by synchronous motors from the power line, they are automatically "in step" with each other. True, there are adjustments on all machines that can cause misprinting. These will be discussed at a later time. The moral of the story is to be sure that any surplus machine you purchase has a synchronous motor. This fact can be verified by checking the information plate on the motor. It should say "synchronous." Avoid machines with "shunt" or "series" motors. Usually they are not worth

the effort, no matter how attractive the price. These machines are synchronized by mechanical governors and springs that are never accurate over the long term. Many military machines fall into this category, as they were designed for field ac/dc usage. Pass them up if anything else is available! Future columns will describe the equipment available for beginning RTTY applications.

Hopefully you are now aware of the "mechanics" of Teletype transmission and reception. The next step is to eliminate the wires between the transmitting and receiving stations. After all, the "R" in RTTY stands for radio. Next month's column will outline the encoding and transmission of TTY pulses over radio.

Marc I. Leavey M.D. WA3AJR  
4006 Winlee Rd.  
Randallstown MD 21133

# Looking West

Bill Pasternak WA6ITF  
24854-C Newhall Ave.  
Newhall CA 91321

## LINKING AMERICA

Just another normal Sunday evening on .01/.61 in Los Angeles. Let's see. There was myself, Mary WA6LUC, "Uncle" Earl WB6MUQ, Doug K4SWJ and Bill WB2RXQ, to name but a few. Why should this be of note? Well, you see, Doug and the rest of the "4 landers" were in Atlanta, and Bill RXQ and the rest of the "W2" stations were in Staten Island, New York (and we must not forget that fine group of "1's" on the WR1ABB system near Boston). Not exactly what one thinks of as your average "run of the mill" evening QSO on a local two meter system. In reality, though, it's not your average two meter anything.

What it was and continues to be is a project in repeater interlinking spearheaded by Sam Davis WA1GQY/WB6GDM. Not long ago, Sam placed into operation what he calls his "magic talking box," better known as the WR6AYY 220 repeater/remote system. He got the

idea that there was more that could be done with it than just talk locally. Heck, why not link it to another machine in another part of the country and let the people in both places rap with one another for a while? Since Doug had been a popular resident member of the L.A. repeater fraternity when he lived out here, the first choice was evident: a link to Atlanta. However, we thought that using AYY (a private 220 system with a dozen or so members) might not be as much fun as having access to this link from a major high traffic open machine. Since AYY was a remote base as well as a repeater, it would be easy to tie it to virtually any two meter system. That's how WR6AUD (WR6ABB) got involved.

At about 7:00 pm on Sunday, May 2, 1977, a group of W4's suddenly appeared on 146.61 in L.A. They could easily be talked to by transmitting on 146.01. Involved in the linkup were the aforementioned WR6AYY, WR6AUD and WR1ABB, as well as WR4AAE (Atlanta) and WR2ADP (New York). I only wish there were room to list everyone who took part, but space restrictions force

me to limit kudos to Bill Helfand WA6JEU of PARC (for his technological wizardry), Mary Stocksdale WA6LUC (who spent about four hours as "emcee" here in Los

Angeles, keeping the whole show moving along), and Sam Davis WA1GQY. Sam's "let's do it" attitude had the effect of uniting an entire continent via amateur FM relay com-



The WR6AYY "Magic Talking Box," with its creator, Sam Davis WA1GQY/WB6GDM. Photo by Norm Smith WB6DGF.





Linking America's "control central," at the home of Sam Davis WA1GQY/WB6GDM. Photo by Norm Smith WB6DGF.

munication, with a slight help and a large phone bill from Ma Bell. When I asked Sam why he did it, he simply answered, "It was fun."

If you happen to have such a system, that "wants to get involved" and also happens to have autopatch facilities, you might drop a line to Linking America, c/o Sam Davis WA1GQY/WB6GDM, PO Box 1502, Sun Valley CA 91352. Who knows? If you do, one of these Sunday evenings we might get a chance to QSO as well.

#### REPEATER APPRECIATION WEEK

After the storm: Contrary to what you may have read elsewhere, the event previously described in this column in detail has had a profound and lasting effect on overall repeater operation in this area. Now that enough time has passed to really evaluate it, I have to reach the conclusion that the prime reason for its overwhelming success is that none of us, myself included, ever wants to have to live through another such repeaterless time.

In the basin, the day of the repeater hog and abuser is waning. It is giving way slowly but steadily to the day of the good guy, the average "Joe Ham" who was for a long while the target of the abusive minority that had almost made "repeater life" untenable. Repeater Appreciation Week changed all this, however. It made old "Joe" aware of the fact that if the privilege granted him by his peers was to continue, then he would have to take on the most important burdens of all — setting the best possible example for the rest of the amateur community, and being his own "repeater cop" when necessary.

To cite one example, six months ago it was quite common to hear a bunch of people rattling off about some unknown poor "flake" who had gotten his jollies by jamming or

harassing a given system. Nowadays, about the only time you hear such a complaint is at off-the-air meetings. Not that all the on-the-air jammer recognition has abated, but the unofficial word seems to have proliferated enough that most people know these days that if you want to really frustrate a jammer, foul mouth or sickie, the best way to accomplish this is to totally ignore his existence. I'm willing to bet that there is more complaining going on on the telephone on this topic these days than on the air.

In the years I have been writing Looking West, no topic has brought the mail load that this one has. In fact, some has come from as far away as Germany, which at least lets me know that this column gets read. In general, responses from densely populated areas were positive on the action taken by the "Ad Hoc Committee for Open Repeater Appreciation," while those from less populous parts of the country went as far as to say (in certain instances) that the overall deterioration level we had described could not possibly have existed. Some said that no matter how bad things had become, no one had the "right" to take away the repeaters. A few went so far as to say that, whether supported or not, the repeaters belonged to the people who used them. Therefore, they reasoned, the licensees should be prepared to take anything that comes. Most, however, cited the whole affair as being not only a shame to have happen in the first place, but also a "blot" on the overall face of the amateur service. Having personally lived through the period of decay, the action itself, and the subsequent revitalization now going on, I could not agree more with this last view.

Another interesting point is that, with few exceptions, those responding

negatively gave little or nothing in the way of counterproposals that could have been attempted before any such drastic action was taken. Most negative comments were just that — negative on the basis of "right to operate," or to the effect that "something else" should have been done. Never could we figure out what this elusive "something else" was, however. Many letters claimed that I had not been objective enough in my reporting on this topic and had given too much column space to the "positive results" (while downplaying the negative aspects). To this I can only say that we judged by what we heard on the air, and never once did a confirmed, "self-professed" bad guy, "repeater hog," or "jammer" call us on the phone to complain.

I had hoped to be able to reproduce a few of the comments and responses received. However, due to space limitations and the desire to avoid repetition of things already discussed, I think it best to put this one to rest with the following summary. For us, the concept of "Repeater Appreciation Week" did work. It did have what has turned out to be a long-lasting positive effect. It did lead to "cleaner" overall area operation in general, although we are still far from being the "world's showplace." If we ever were able to achieve the status of "showplace," I suspect that it would probably make for a rather lifeless, sterile, and uninteresting format of operation. While such might be welcomed by some, to the vast majority of local amateurs a totally sterile atmosphere would in itself create another form of decay: attrition of both amateur relay communication and the numbers in our ranks. We can afford to lose the bad guys, the troublemakers, foul mouths and the like, but losing the good people, those who appreciate what others have done for them and show that appreciation through due respect for their fellow men, we cannot tolerate.

In essence, we are again climbing the ladder. We are looking for a happy medium some place in between, a place that fits and suits the lifestyle that is Southern California. This time we are aware of the pitfalls that mistakes lead to. I suspect that this awareness is the insight we need to reach the "happy medium" we are striving to attain. If we fall along the way, we will only have ourselves to blame.

To those who have asked if I recommend action such as this to others, I respond by placing the responsibility for finding this answer back on their shoulders. Because it worked for us does not mean that it is the ultimate answer to all the problems plaguing open repeaters everywhere. You alone can judge the degree of the problems in your area. You alone can determine if all other avenues have been attempted to correct these problems and if taking drastic action, such as holding a "Repeater Appreciation Week" in your area, will solve anything. It is not a solution in itself but only another

tool in attaining a one. I sincerely hope that you never find yourselves having to implement such drastic action as was seen here in January. Be wary; the fact that it helped us does not guarantee that it will work for you. Use your own individual and collective judgments.

#### THE WAY UP NORTH: THE CENTRAL VALLEY IS ALIVE, WELL AND ON TWO METERS

Another subject that has brought a heck of a lot of mail, mostly from the Central Valley area of California, was part one of my November '76 trip to Northern California and the San Francisco area. It seems that I may have hurt a lot of people's feelings in the Central Valley by not mentioning the activity I found there. To those I may have offended, I apologize; to those that were kind enough to write me with updated activity information, I say thank you; to those who spent many paragraphs berating my ownership and use of a CB radio, I have nothing to say whatsoever. Correction: To the latter group I suggest that energies could be better spent in more constructive ways than tirades against CB. Sure, it has its problems, and true, it's not "ham radio" type communications, and yes, there can indeed be a language barrier. I have come to the conclusion that in a crowded urban area such as L.A., the lower 23 are usually so crowded as to be useless, with the possible exception of channel 9. However, once out of a city like L.A. (with its massive numbers of spectrum users) and "on the road," you won't find me making any long trip without one. Enough on this, though: Let's get into the activity we found heading north on I-5, and fill in the material supplied on what we missed heading south on 101.

After running out of the range of the Los Angeles area systems our Denshi radio was crystallized for, our first interesting encounter came on that popular channel pair of .28/.88. Thanks to Ken WA6TCP, we were provided with the following information about WR6AIF (and a rather enjoyable 25 minute QSO, as well). WR6AIF is a wide coverage open system located atop a 5700' "bump" known as Blue Ridge, which, for those of you trying to pinpoint these things on a topographic map, is about 22 miles east of the city of Visalia. The system runs about 40 Watts erp, is open carrier squelch access, and is owned and sponsored by the Tulare County Amateur Radio Club, Inc. One of the nicest things about it was the totally relaxed atmosphere we found.

The timeout timer is approximately two minutes and forty-five seconds, so it is quite easy to compose your thoughts as you proceed with a QSO. Ken says that while it's usually a fairly quiet daytime operation, weekends, holidays and evenings the system really comes alive and a QSO is not hard to come by. In our case, we were weekday travelers, but found no problem finding a friendly hello on WR6AIF. If you are in the area and



see a sign marked Exeter or Visalia, you might give a call on .28/.88. I suspect that the ensuing QSO will be one you will enjoy.

A little farther up I-5, just past junction 44, we found ourselves in QSO with Dick W6OV via the WR6ACU repeater located at about the 4000' level at Meadow Lakes. ACU is, according to the latest NARC listings, one of three open .34/.94 repeaters in their jurisdictional coordination area (along with three others which are tone access). Meadow Lakes is located just northeast of Fresno, and is the kind of vantage point that gives ACU good coverage over most of the Central Valley, from an area just north of Bakersfield to the intersection of Route 580. That, friends, is what we call coverage. While I did not have .31/.91 in my radio, Dick informed us that WR6ACE (located atop McKittrick) had similar wide coverage characteristics. Again, the kind of welcome we found on ACU was outstanding, and causes me to wonder a bit about stories we hear from time to time about a traveler in a given area "getting run off a repeater" because he did not belong to the "in crowd." We were strangers on a heck of a lot of systems on our trip, and never once were we made to feel unwelcome anywhere. If these things do happen, it's surely not in the Central Valley or San Francisco area.

Once north of ACU's area of service, we began the normal ritual of running through our 10 repeater pairs. As we came to .01/.61, we found ourselves eavesdropping on a rather interesting QSO on the WR6AFA repeater. I like a good technical discussion, so after a few minutes we made our presence known. We soon found ourselves in QSO with AFA's owner, Steve WA6SBM. We never did ask Steve where AFA was located. However, we accessed it about the time we ran out of ACU, and were with it for about an hour (until Steve informed us that we might be at a point where we could gain acquisition of WR6ACV near Stockton).

It turns out that Steve is one of the "new pioneers" of VHF up there. He already has in the works a 220 system (that will be on the "low .34/.94" pair), a UHF system, and a six meter system (that he plans to link to another six meter system running in the Marin area). He plans a few autopatches in this web of rf as well. Steve was a veritable gold mine of information, and since our QSO took place about five months ago, a lot of what he described to me as being a part of the future may have already come to pass. A word of thanks to Ray WB6GUK, who sort of got placed on the sidelines as Steve and I rambled on. One of these days I've got to make this trip again, if for no other reason than to see how much of Steve's major undertaking has been accomplished to date. I found myself that fascinated.

I wanted to get hold of my buddy Dave WB6IRL who lives in the Stockton area. That part of the world is serviced quite well from the .28/.88 WR6ACV repeater atop Mt. Oso. Dave

and I first met at a training session here in L.A. being given by the company we both worked for at that time. At any rate, after finding that we could work into Mt. Oso, we gave Dave a call and were surprised to get a response from his XYL (who we did not know had obtained her ticket). We were informed that Dave was out at the moment, and that as soon as he returned he would be summoned to the magic talking radio. A while later, just as we were leaving ACV's service area, we did manage a few minutes with Dave (which were continued the following evening via landline).

I-5 sort of skirts the prime coverage area of WR6ACV. However, with nominal power and a good receiver it is possible to work this system over a good number of miles. In most places, our 12 Watts and 5/8 wave GAM were more than sufficient. ACV is a system-designed repeater, in that it is one where if you can hear it, you can work it. Conversely, if the road takes a dip and you go away for a few minutes, you won't hear it either. In practice, this is considered proper overall system design, and is exactly what those involved in commercial land mobile service strive to attain. We finally lost ACV altogether as we started the "big climb up the hill" that leads down into the "City by the Bay." In the interim, however, we had a chance to chat with Dave, Joyce, and a large number of other super people who make WR6ACV their home.

Since we have already covered much of the activity we found in the Bay area in a previous column, let's say a quick farewell to the Golden Gate and start south via Highway 101. Heading south in the rain, we found a rather interesting QSO on WR6ABM. As we found out from our QSO, ABM is an open wide coverage repeater located in the Oakland area, designed to serve both the San Francisco Bay area and the Sacramento Valley. From what we noted, ABM fulfills its task quite well; we found ourselves able to access it for almost two solid hours. As usual, those we met on the air were warm, friendly, and always eager to give us any information we found ourselves in need of. When questions were asked about the system, there was always a sense of pride obvious in the response.

ABM seemed to be the home of the two meter SSB enthusiasts. Those whom I QSOed with were quite interested in finding out about SSB activity in the L.A. area (the number of people using that mode, the times they operated, and the most popular calling frequencies). We tried our best to supply the requested information, and I can only hope that a few good QSOs occurred consequently. It seems that SSB is going like wildfire up there, so if you are into that mode, you might give a listen down near the low end near 145 if you think you are within earshot of San Francisco (especially during that summer phenomenon known as VHF skip). Remember, for the past two summers running, Hawaii has been worked from L.A. on both FM and SSB. Why

not San Francisco to who knows where? As you read this in July, the "season" is here, so if it's going to happen, it's probably now or never. Not that it be "E" or "F2" necessarily. Many of the most knowledgeable have come to the conclusion that the Hawaii to L.A. thing was ducting.

We were on .16/.76 and hunting for a place to eat when we became part of an existing QSO on WR6ADE. Almost immediately, a very warm welcome came our way from Dave WB6KHP, who informed us that ADE was located on Mt. Chual in the Santa Cruz Mountains, approximately halfway between San Jose and Santa Cruz. There is a definite order of responsibility among those who operate ADE. For the repeater to be operational, there must be a control station present. ADE has two control levels (as explained to me). At all times, a primary control station is monitoring the system (as Dave said, there are usually three or four). There is also a secondary level of control, and a secondary level control operator must be present and obvious or the system reverts away from open access. Therefore, as I understand it, ADE operates as an open system when both levels of control and responsibility are present, and as a limited access system at other times.

Hospitality on ADE? During the QSO I had with Dick, Ian, and the rest of the ADE people, a fellow Angelino, Jesse W6BFO, came on channel needing a phone call to the San Jose area. Ian had to leave, so Dave took secondary control and waited for Jesse to reach a point where he was solid into ADE. Then, using the ADE autopatch facility, Dave handled Jesse's traffic. Sitting back and listening to the patch, I was reminded again of what our hobby/service is really all about. While it was noted that the ADE autopatch is normally limited to use by their group, it is my opinion that their willingness to share with an outsider is really a positive statement for a rather fine group of fellow amateurs. We had reached a restaurant by the time the patch was completed, so we said our "73s" to both Dave and Jesse. Dave reverted the system to primary control, and Sharon and I went to lunch. At least I thought that's what had happened.

Some twenty minutes later, when we again took to the road, we found that WR6ADE was still up and that Jesse was in QSO with Al W6MEO. Heavens... was all of L.A. up here this evening? As I found out, as I left for lunch, Al, who had been up north, was en route back to L.A. about 15 minutes or so ahead of me. Another secondary control station had taken over, in order to enable Jesse and Al to continue their QSO. That's just another touch of the hospitality afforded by the WR6ADE group. Soon, however, as we drove south near Soledad, we found ourselves leaving the service area of WR6ADE.

From that point until we reached the area of San Luis Obispo, our 12 Watts and 12 channels proved futile, except for a few quick .94 simplex QSOs with fellow transients. We did finally manage to get in touch with

Al, who by now was about a half hour in the lead, and decided that dinner was in order. We met at a Denny's along the road and took an hour's break from the concrete and asphalt to renew an old friendship.

According to some of the letters we received, we should have been able to be in almost constant repeater contact. However, such was not the case. To this day I can't tell you why. The following letter from Ernie WB6HJW, very indicative of some of the mail that part one of this story brought, is probably the most up-to-date info available on activity in that area.

Bill Pasternak WA6ITF  
14725 Titus St. #4  
Panorama City CA 91402

Dear Bill:

Just a short letter to let you know that amateur radio is alive and well in the Santa Maria area, despite what you indicate in your April column.

In Santa Maria we have a repeater (WR6AHZ, on 147.81/.21) which has been in operation since 1974. WR6ASW, 146.34/.94, is now located on a hilltop south of Santa Maria, although I believe it was at ground level when you made your trek north. WR6AEL, 146.22/.82, is located on Cuesta Grade (north of San Luis Obispo) and covers from Camp Roberts to Buellton. WR6ADS, 146.16/.76, is on the campus at Cal Poly (San Luis Obispo). WR6AVI, 147.72/.12, is on Harris Grade, near Lompoc, covers from San Luis Obispo to south of Buellton, and has been on since 1973 (formerly as WR6AEB). WR6AFI, 147.60/.00, is on Broadcast Peak above Santa Barbara, and covers from Paso Robles to the Mexican border (of course, not solidly).

WR6AHZ has autopatch into Nipomo, Arroyo Grande, Grover City, Pismo Beach, San Luis Obispo, Avila Beach, Baywood Park, and Los Osos. WR6ASW has autopatch into Santa Maria, Guadalupe, Nipomo, and Los Alamos. WR6AVI has autopatch into Lompoc and Vandenberg Air Force Base.

There are other repeaters in the Santa Barbara area (on 146.31/.91 and 146.19/.79) which are accessible south of Gaviota.

All repeaters in San Luis Obispo and Santa Barbara counties are open, and persons passing through the area are welcome to use them. Repeater use is monitored by control stations, but I have never heard any control operator interfere with any amateur's lawful use of a repeater. Most area repeaters are on 24 hours a day.

I hope on your next trip north (maybe for the Southwestern Division ARRL Convention to be held in Santa Maria, Oct. 7-8-9) that you find this area more hospitable on two meters and that you won't have to resort to CB to talk to someone. With almost 200 amateurs in the area on two meters, the repeaters are jumping.

Ernie Kappahn WB6HJW  
Santa Maria CA

We wish to express our gratitude to

Continued on page 167



# Circuits<sup>2</sup>

Want a free copy of any 73 publication? Sure you do. Just send in your favorite circuit, or even one that you don't especially like. If we print it, you take home the book of your choice. Just be sure to specify which book you want. OK?

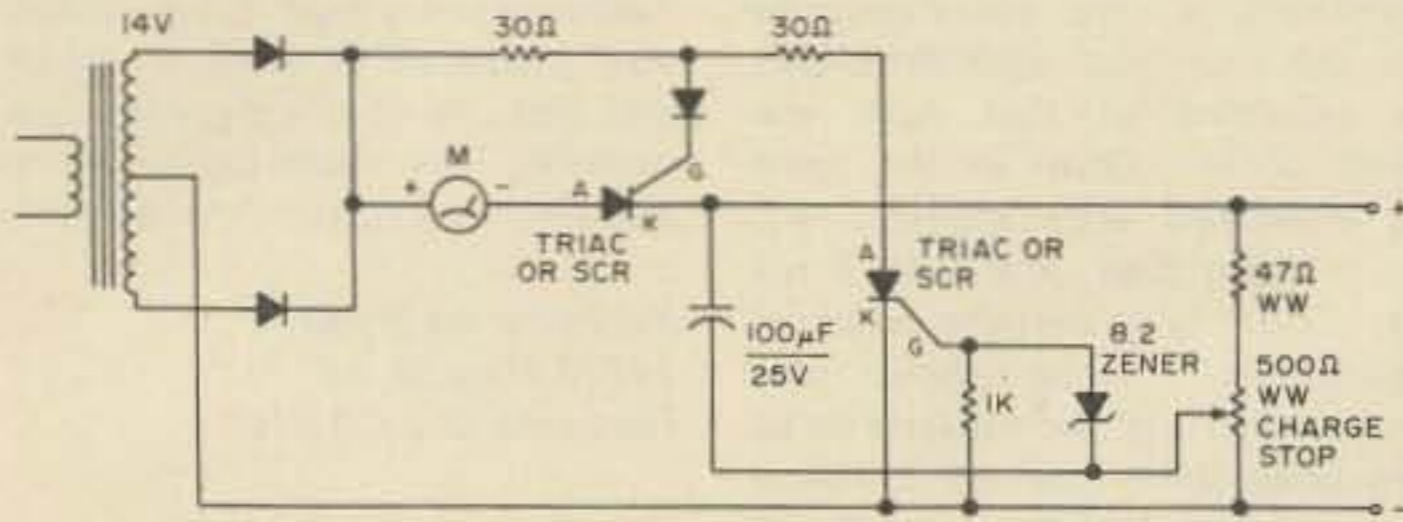

An automatic shutoff battery charger which will not dry out batteries. Must be adjusted by setting 500 Ohm resistor while attached to a fully charged battery. Thanks to W6ZNX.

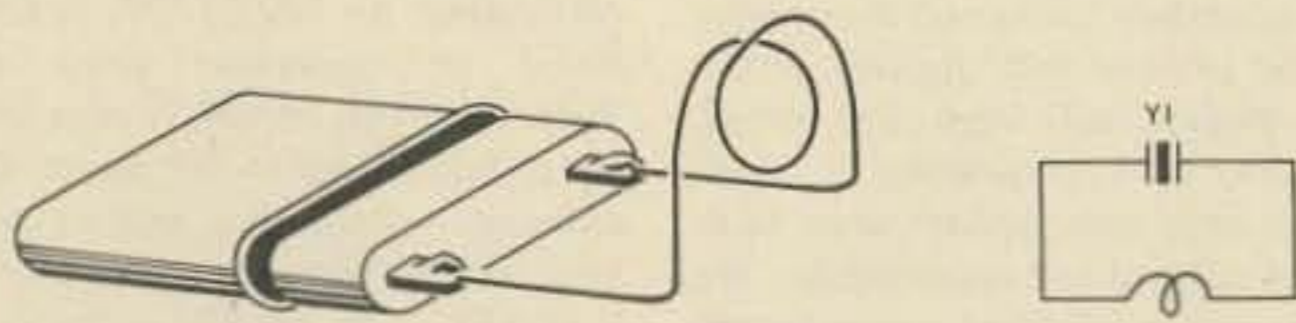

The simplest circuit yet for checking crystals. Attach a one-turn coil to a crystal socket and plug in the crystal. A grid dip meter coupled to this turn will dip at the resonant frequency. Thanks to W5QFH.

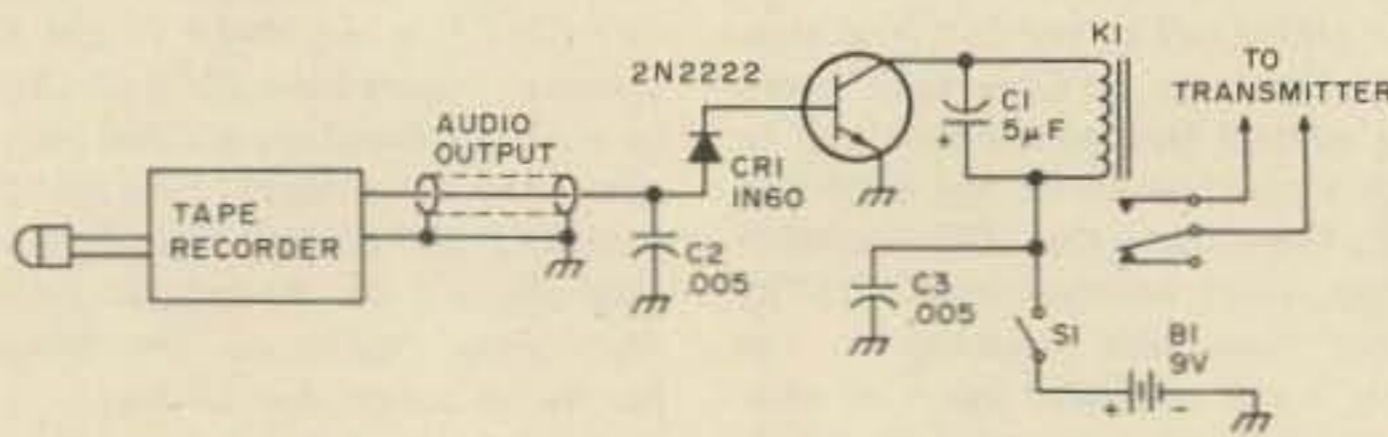

The tightwad special keyer memory for contest types needing memory for CQs and so on, but unwilling to assemble the conventional type. Construction and operation are simple, but be sure to keep stray rf out of the system through shielding. An audio oscillator is keyed into the microphone of the recorder and put on tape. Then the recorder is rewound and played into the circuit. Sensitivity is adjusted at the output of the recorder. Thanks to WB8TSY.

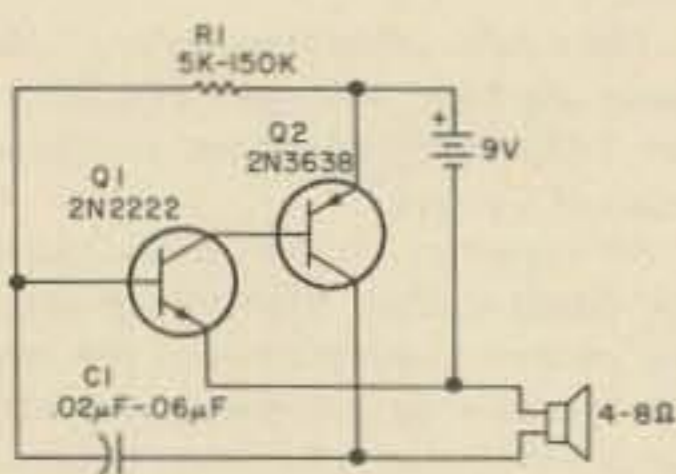

A good audio oscillator circuit. Almost any transistors will work, while R1 and C1 will vary the tone. The circuit has been used to find the correct pins on unknown transistors and as a simple test for good or bad. Thanks to M. S. Reid WA3JEF.

News? We need input, and one of the best sources is the club newsletter. Got one? We reiterate our longstanding offer of a free subscription to 73 or Kilobaud in exchange for a spot on your ham or computer club newsletter mailing list. Deal?

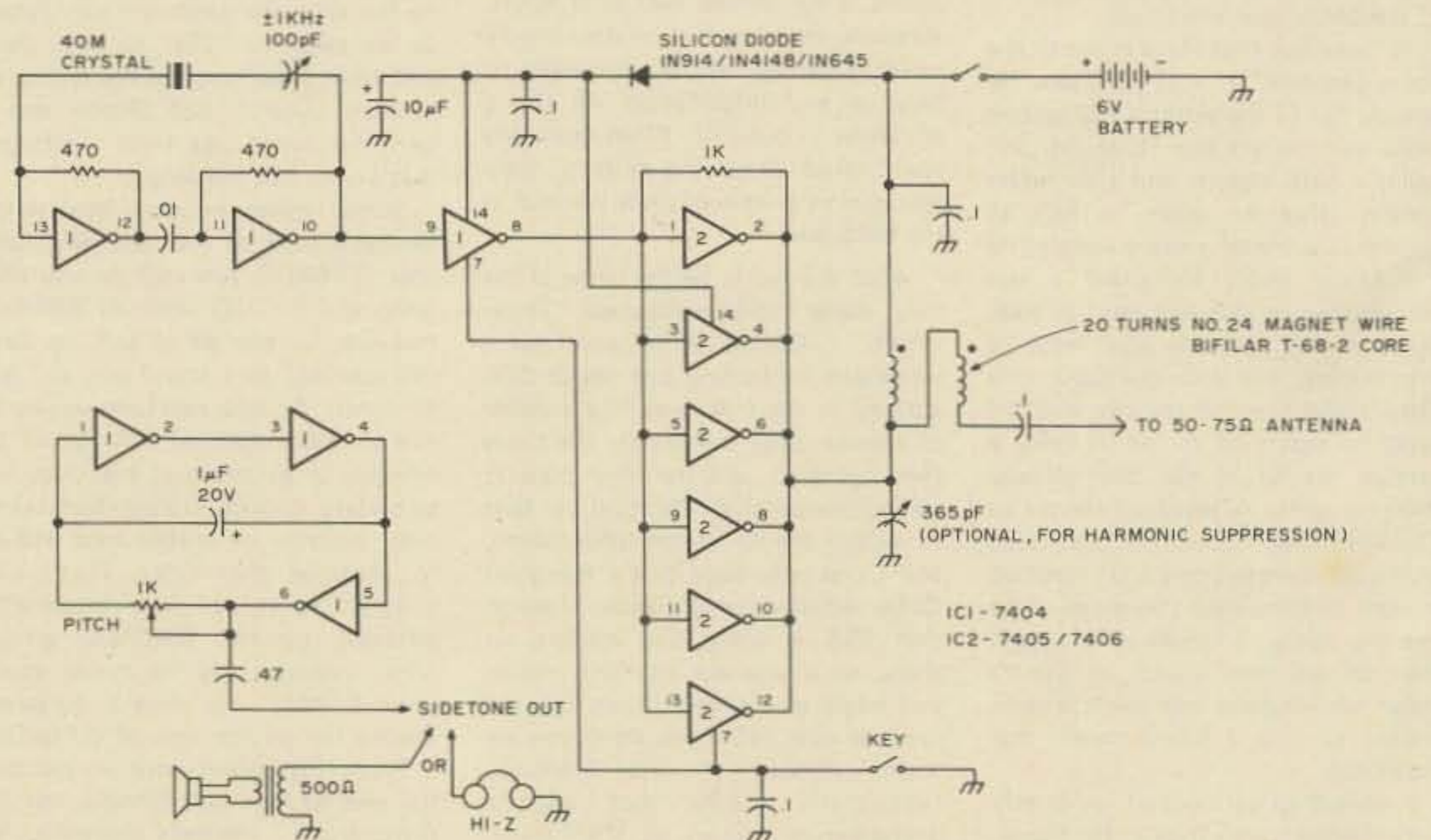

A super cheap 40m CW transmitter with sidetone monitor. Rf output is about 250 mW, and the cost should be under \$5. Thanks to WB4CTC.

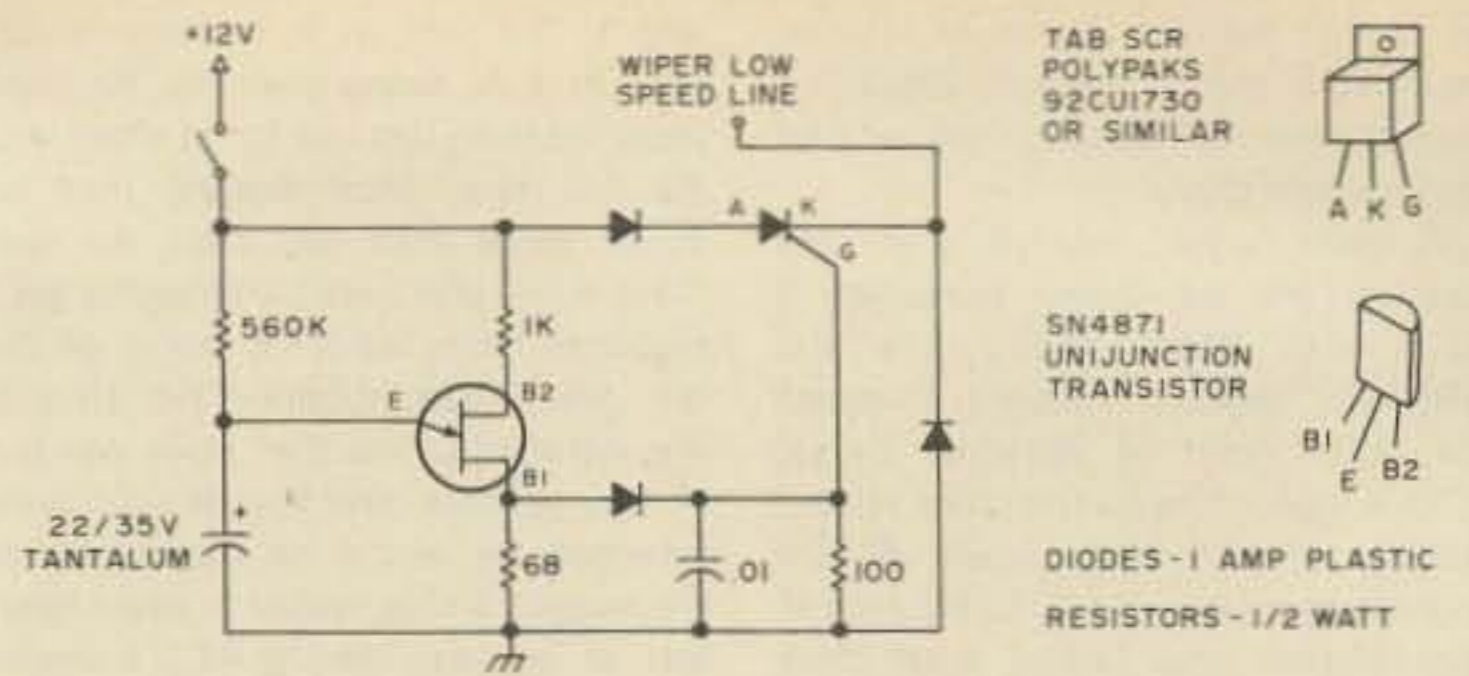

A good way to set your windshield wipers on an interval circuit. Only two connections to the car's wiper control, plus ground, are required. Variable control can be accomplished by substituting a 500k pot in series with a 100k fixed resistor in place of the 560k. Thanks to VE3OE.

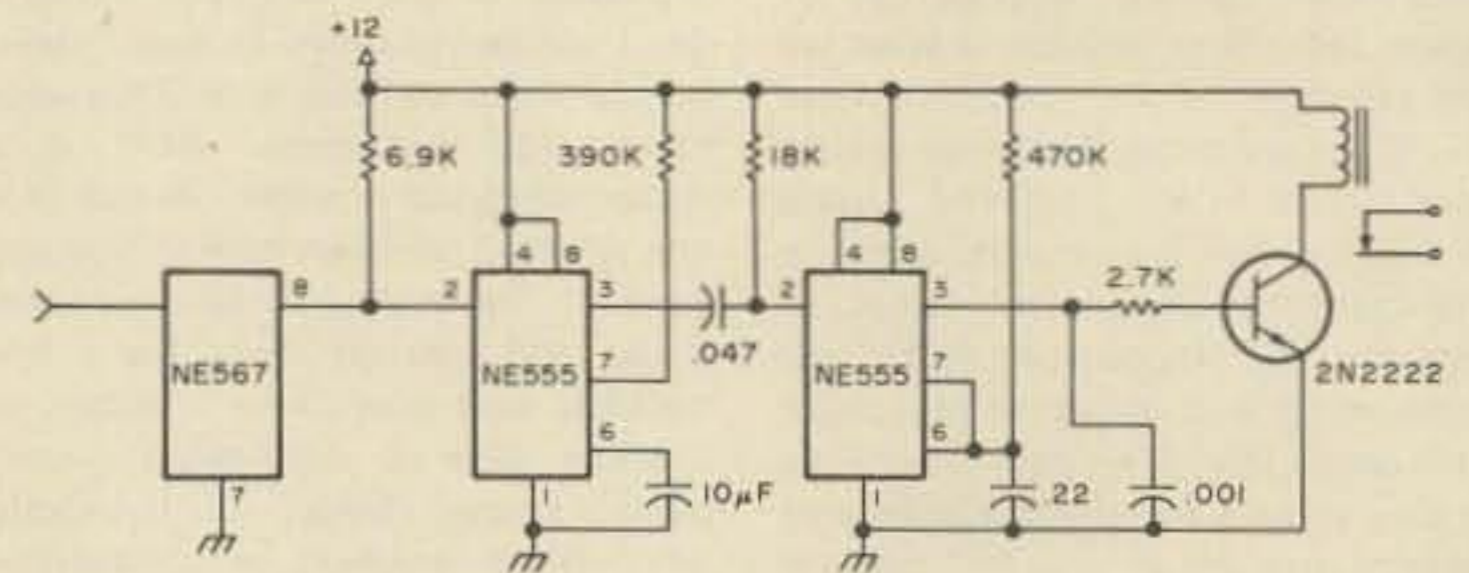

This circuit was designed to give about eight seconds worth of delay after a reset tone is applied to the control receiver of a remote base. A tone can be applied for 1 or 2 seconds without appearing on the transmitter output. Thanks to W7CJB.

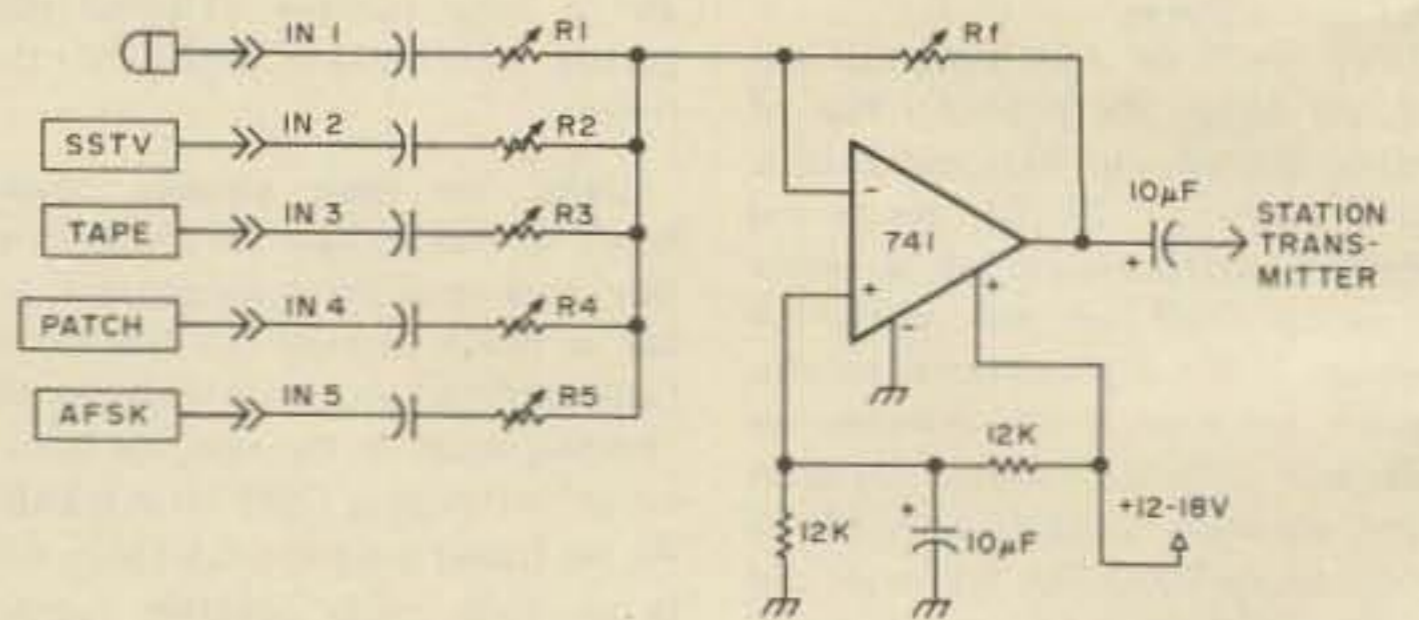

Here's a good way to input several audio sources to your station transmitter. It's an op amp in the "summing amplifier" mode. Overall gain is set by Rf while individual inputs are adjusted by their respective controls. Thanks to K7HKL.



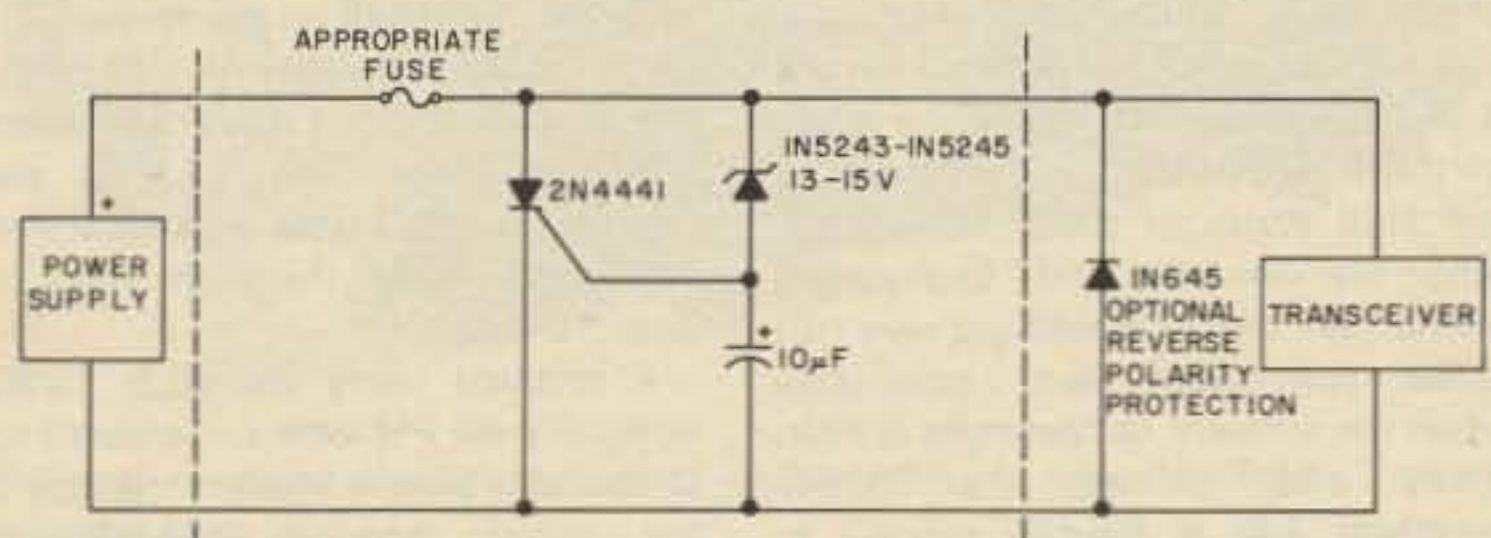
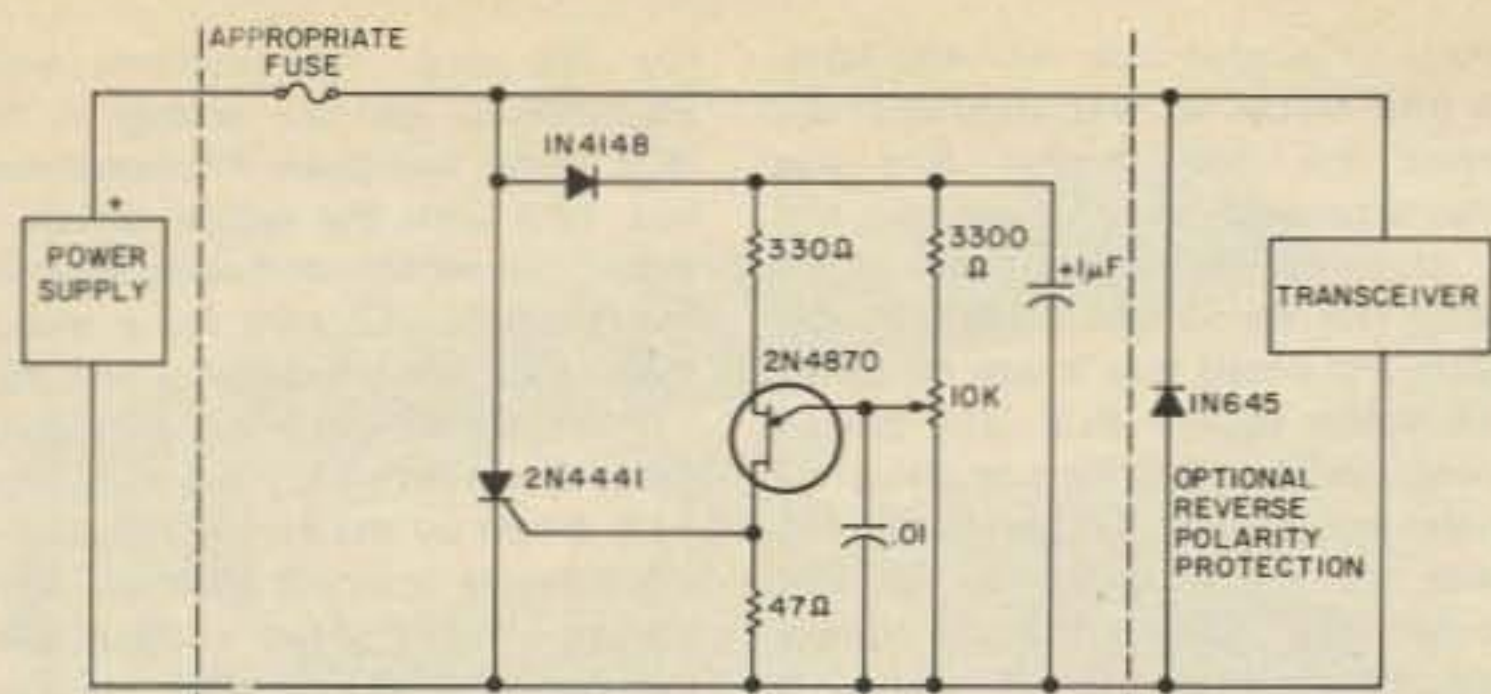

A way to avoid grief when using 12 V power supplies with mobile transceivers. Most p.s. circuits leave room for a short circuit failure of the series pass transistor, which will do a job on your rig! Here are two crowbar circuits which will deliver protection by clamping the power line and blowing the fuse within microseconds of the beginning of an overvoltage condition. The idea here is to incorporate the crowbar directly into your transceiver, thus protecting the radio wherever you go with it. The chief difference between the two circuits is that the less complex of the two leaves you at the mercy of component tolerances for the exact trigger level, while the other includes a unijunction trigger to permit precise setting of the operating point. Thanks to W1DGD.

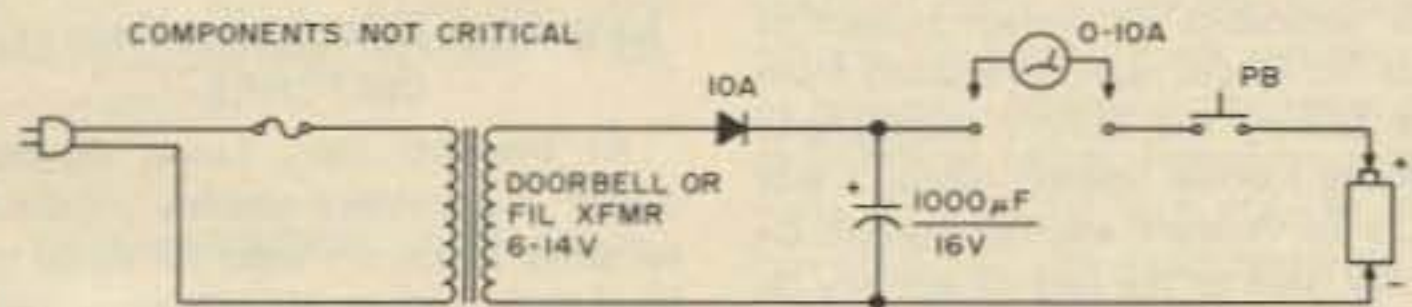

The nicad zapper used to restore dead or bum nicads. To operate, connect nicad to output and press button for 3 seconds. Thanks to K6JQD.

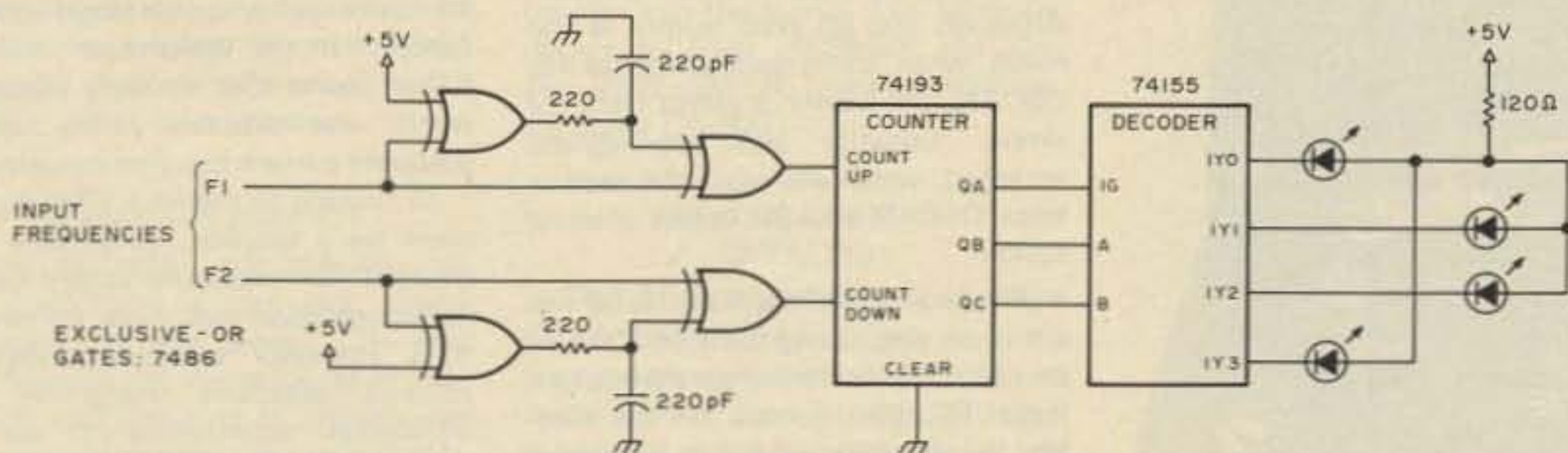

This circuit uses LEDs to display the beat frequency of two-tone oscillators. Only one LED is on at a time, and the apparent rotation of the dot is an exact indication of the beat frequency. When  $f_1$  is greater than  $f_2$ , a dot of light rotates clockwise; when  $f_1$  is less than  $f_2$ , the dot rotates counterclockwise; and when  $f_1$  equals  $f_2$ , there is no rotation. Thanks to WB8TFN.

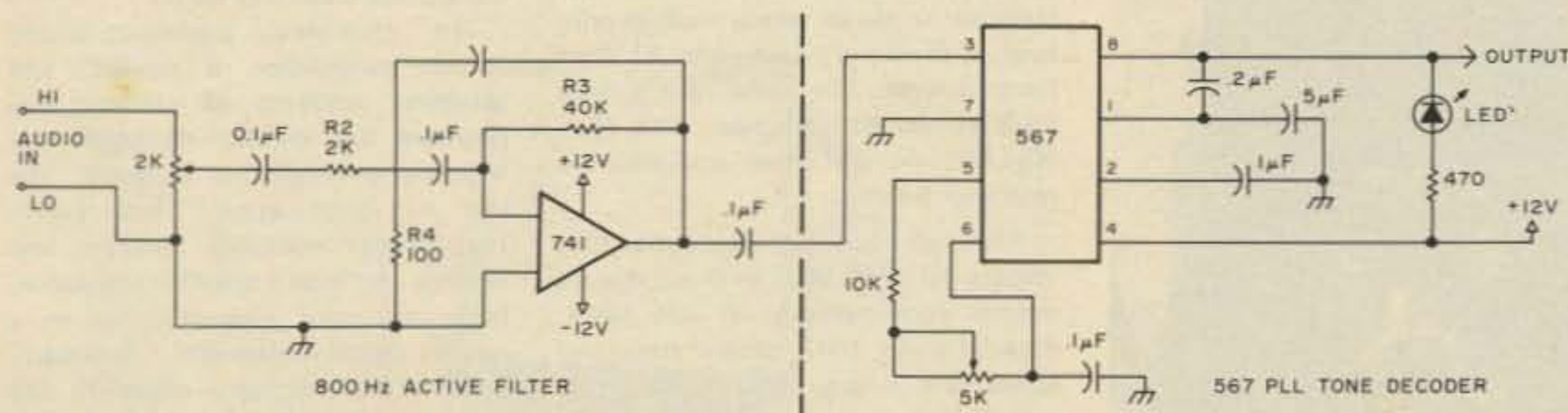

Here's a Morse code decoder for the handicapped. It will copy very weak signals due to the narrow bandpass of the active filter on the PLL input. This can be powered by two 9 volt transistor batteries. Thanks to WA5SWM/5.

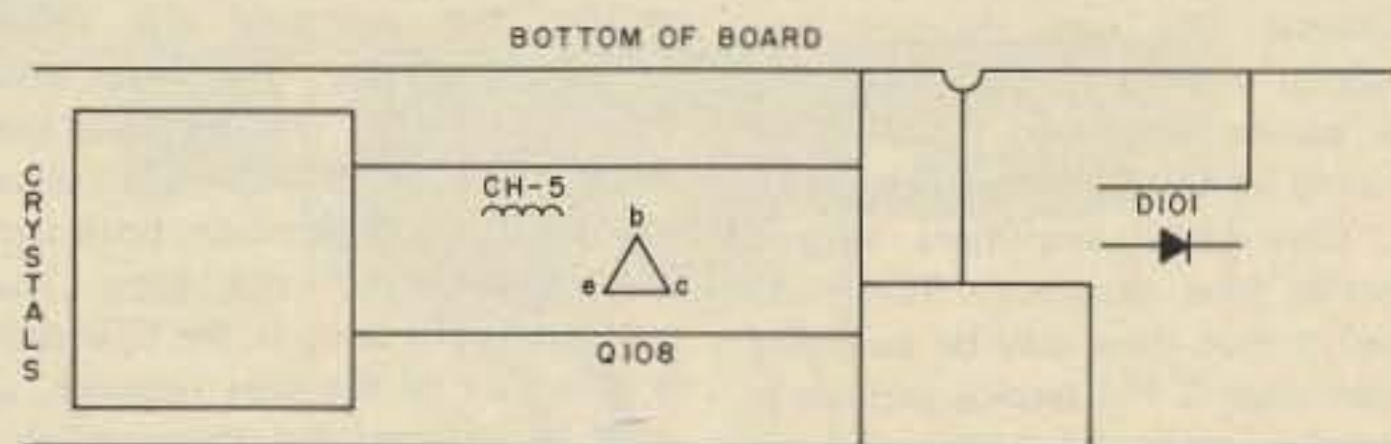
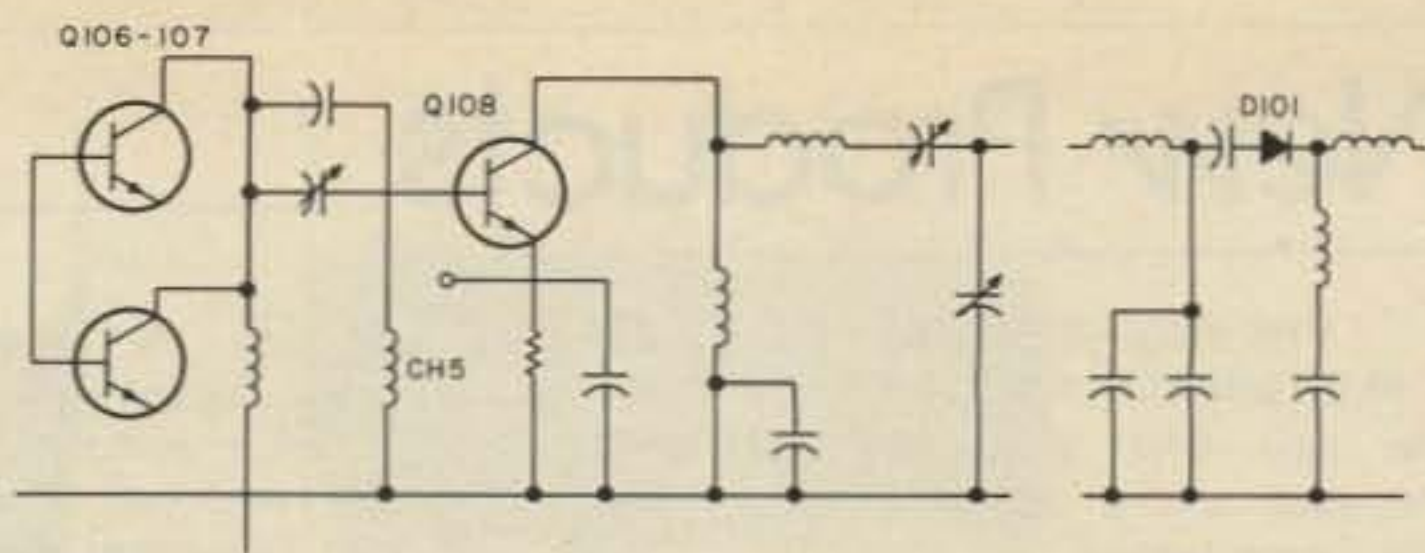

Wilson 1402 HT modification for those experiencing problems with diode D101. First replace choke 5 with a 100 Ohm resistor, then add a 25 pF capacitor from the base of Q108 to ground, and finally replace diode D101 with a jumper wire. Thanks to WBURX, through the LEARA Newsletter, CA.

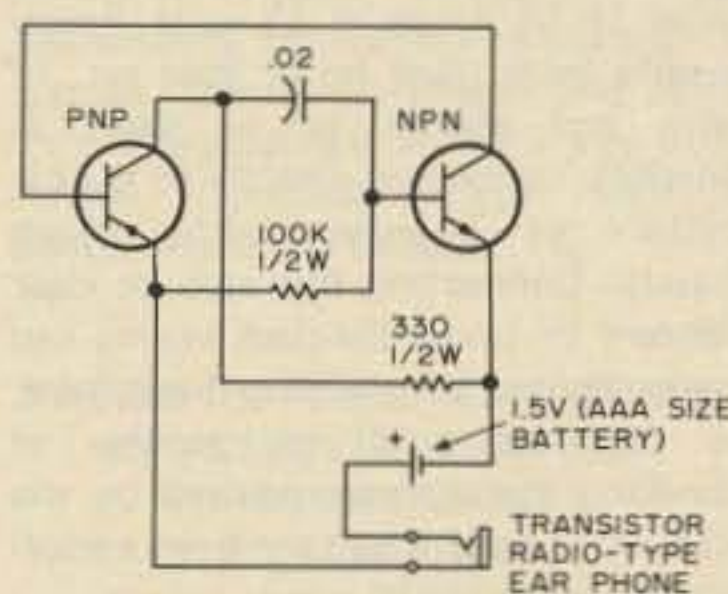

The simplest transistor checker yet! Choose a general purpose PNP/NPN and construct in a plastic box or small container. Color code the transistor and its socket. To check a suspect device: no tone, ng; low tone or chirp, so-so; steady tone, OK. A great circuit for matching transistors. Thanks to Bill Wentzel W3GWA.

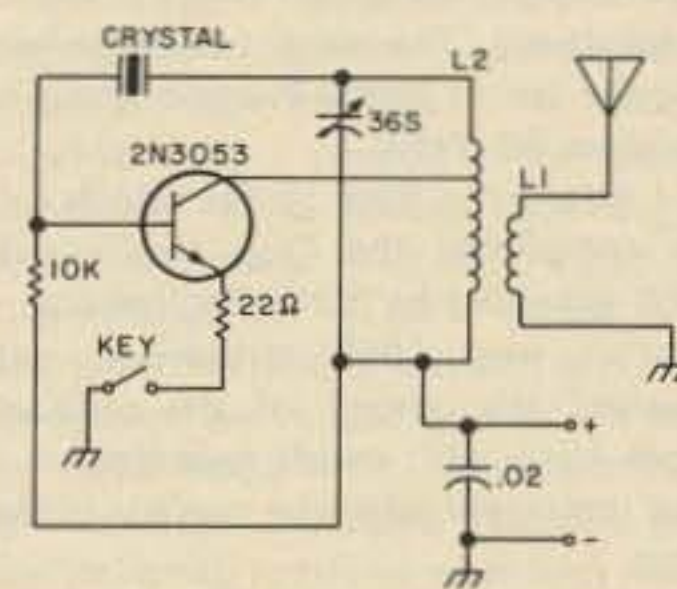

Another QRP transmitter, this time using a 2N3053 and fundamental crystals. Runs about 2 Watts output. Thanks to WB60MV.

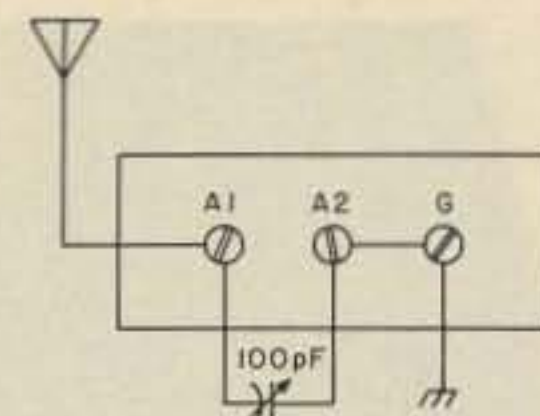

Many low-priced receivers for the 160-10m amateur bands do not have an antenna trimmer control. To peak up reception on your favorite band, mount a small variable capacitor (100 or 140 pF) at the antenna terminals on the rear of the receiver, as shown. Tune the capacitor for a maximum reading on the S-meter. For a more permanent arrangement, the capacitor may be mounted inside the receiver cabinet and tuned from the front panel by an extension shaft and knob. Thanks to W3WTO.

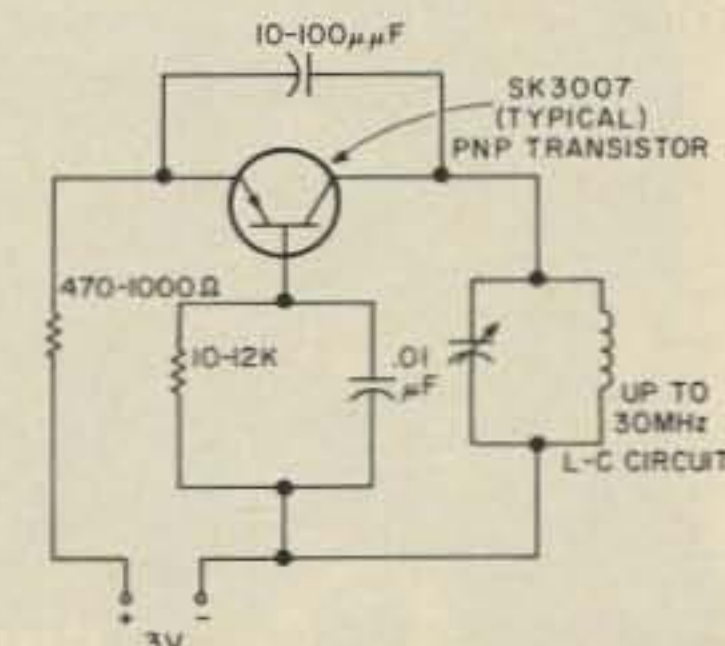

An rf oscillator useful up to 30 MHz. An SK 3007 PNP transistor is recommended. Thanks to WA5RON.



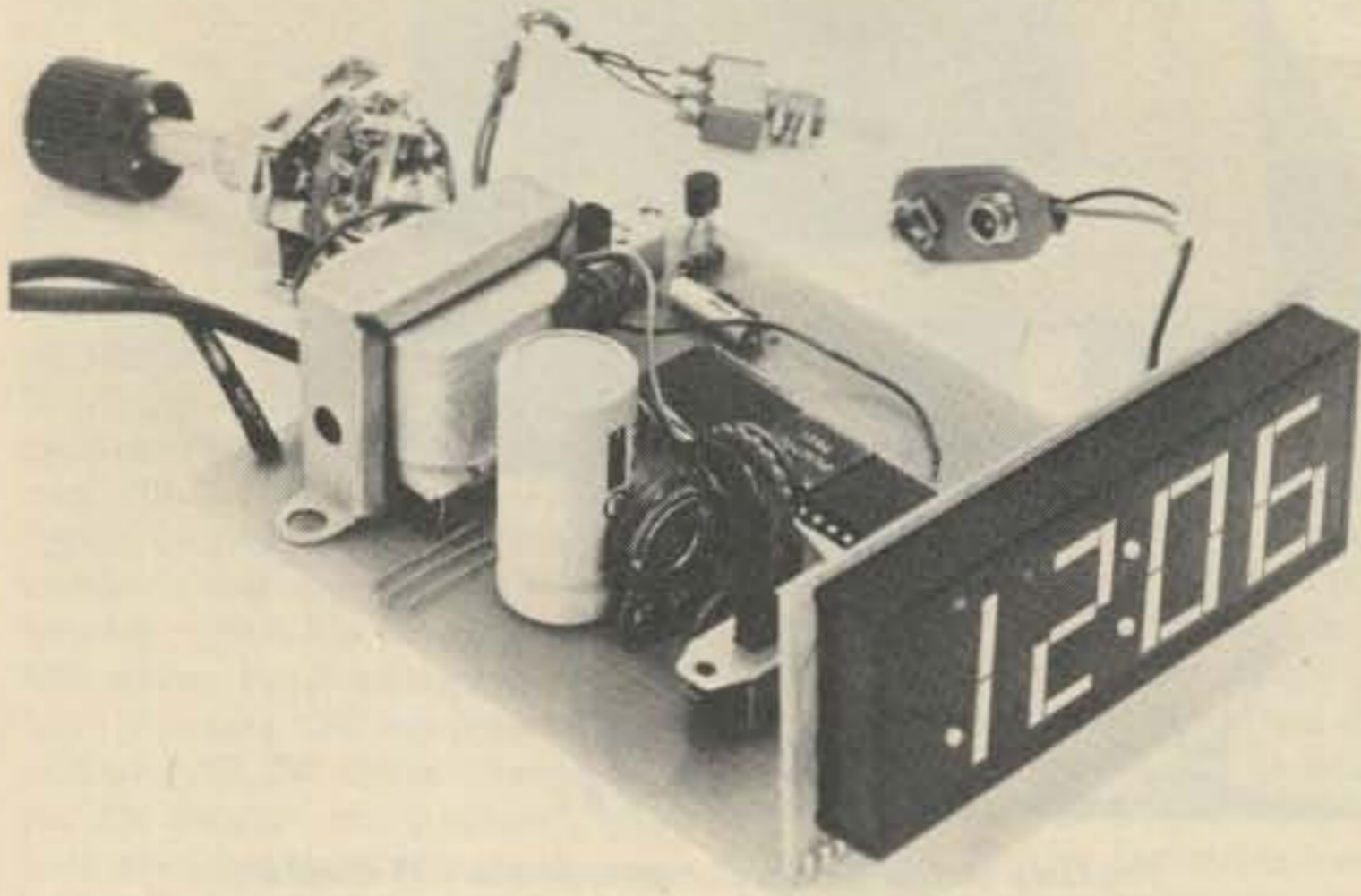

The Fairchild 0100 clock/calendar Technology Kit™.

electronics Division of Fairchild Camera and Instrument Corporation.

The 0100 alarm clock/calendar features an .8 inch, 3½ digit LED display with am/pm indicator. The clock, which displays time for eight seconds and date for two seconds, has connections for radio applications and may be connected to a nine volt battery.

The 0101 wall clock uses a 2½ inch, 6 digit LED display comprised of 175 LED lamps. The display, visible at up to 50 feet under normal conditions, alternates between time and date. If desired, constant time or date readout can be selected. The wall clock can also be connected to a radio with direct current for an external speaker, and contains programmable alarm features. Fairchild Camera and Instrument Corporation, 4001 Miranda Ave., Palo Alto CA 94303.

These clocks, three years under development, are available in four styles and several kinds of solid hardwoods: walnut, mahogany, maple, cherry, and light and dark oak. The modern clock face is made of 1/8" acrylic with scribed markings to identify time positions. There are no moving parts, gears, motor, or hands. An outer ring of sixty lamps indicates seconds, and each successive illumination takes place at one second intervals. The middle ring of sixty lamps indicates minutes and changes each time the sixtieth second is illuminated. The inside ring of twelve lamps indicates hours and changes when the sixtieth minute lamp is illuminated. Actual time is shown by position of the three lamps that are illuminated at the given instant of reading. Amelect Inc., P.O. Box 367, Goodland IN 47948.

**NEW AMELECT CLOCK**

A new, revolutionary concept of displaying the time of day by means of the position of illuminated light emitting diodes (LEDs) in three concentric rings on a mirror-like acrylic face has been announced by Amelect, Inc.

**NEW VHF ENGINEERING 30 AMP POWER SUPPLY**

The PS-3012, a high current, 13.8 V regulated power supply originally designed for commercial two-way radio applications, is now being introduced into the amateur market by VHF Engineering of Binghamton



The VHF Engineering PS-3012.

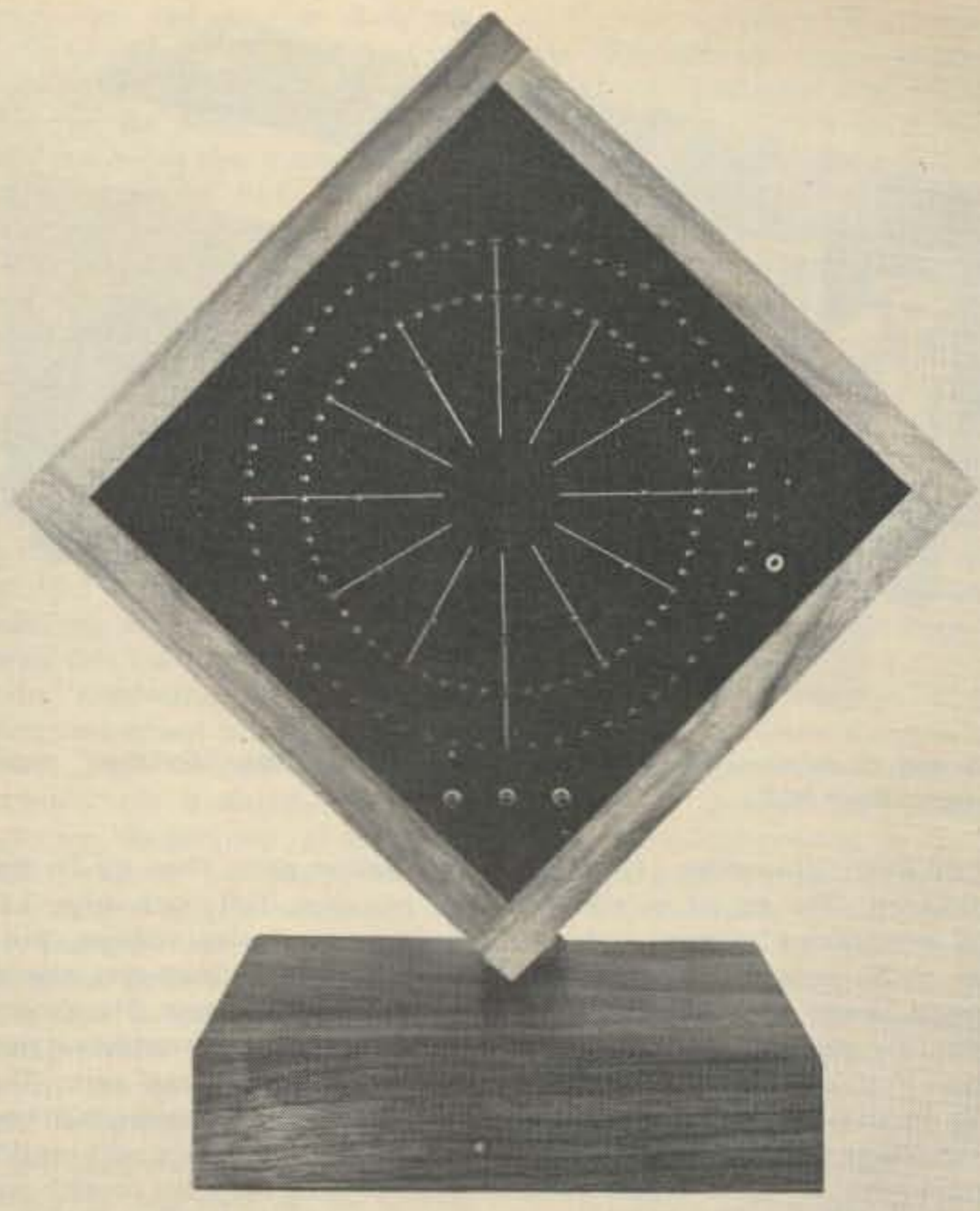

The Amelect CL 7401A with base.

NY. This power supply has been designed for demanding commercial applications through the use of a heavy duty transformer, dual heat sinks, and ruggedized case. The PS-3012 delivers 30 Amps at a 50% duty cycle, and 20 Amps at a continuous duty cycle.

The PS-3012 is available for \$239.95 as a wired and tested unit from VHF Engineering, 320 Water St., Binghamton NY 13902. A rack mounted version is available as an option.

**VIP-60 CONVERSION KIT**

Valley Instrument Products of Bartlett IL has introduced a new programming device for the popular Icom 22S 2m transceiver. The VIP-60 conversion kit offers 56 pre-programmed frequencies, including all standard repeater channels, plus any four additional frequencies you choose. Valley Instrument Products, P.O. Box 339, Bartlett IL 60103.

Continued on page 106

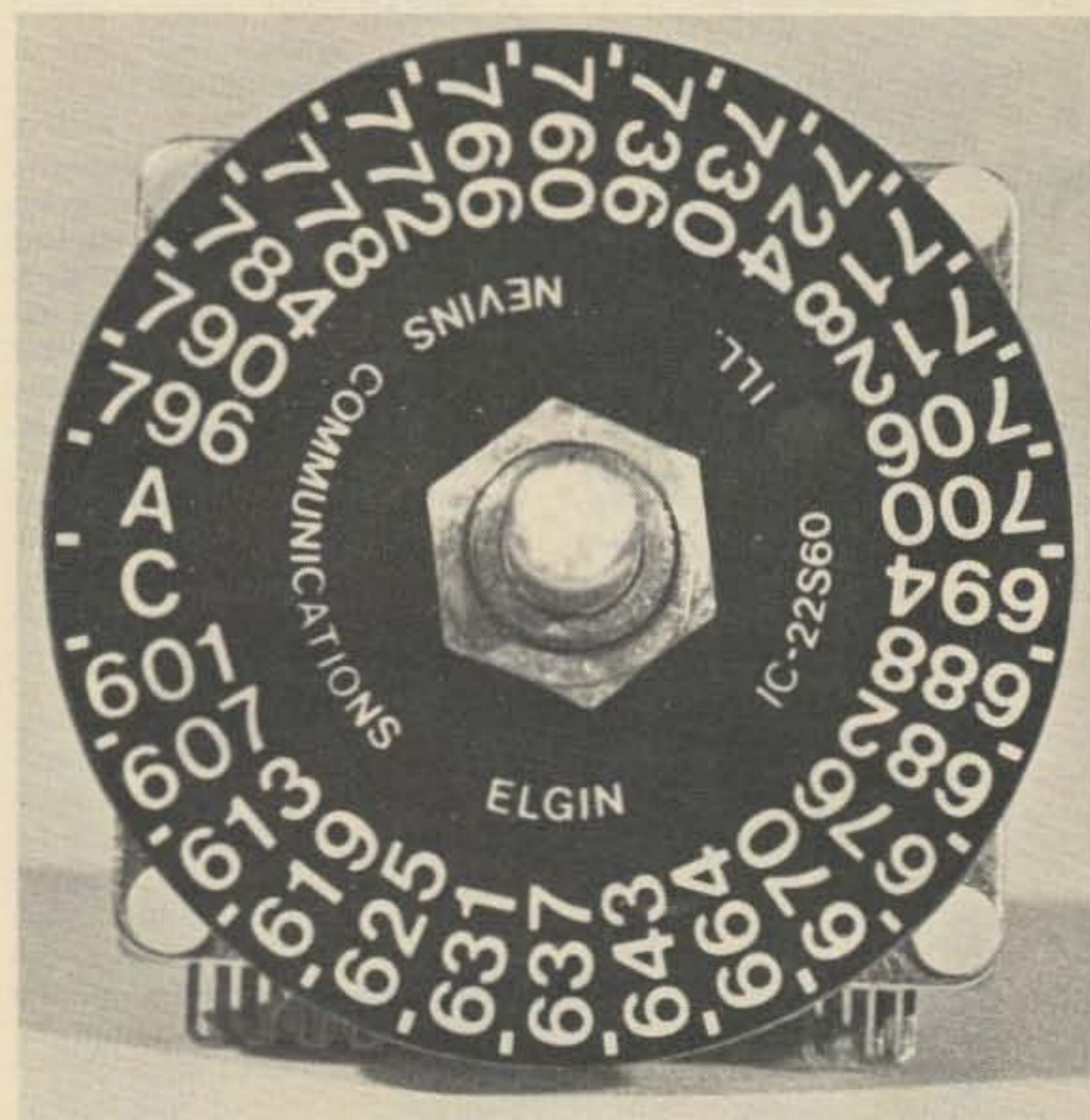

The Valley Instrument Products VIP-60 conversion kit for the Icom 22S.



# ME-3 microminiature tone encoder

Compatible with all sub-audible tone systems such as: Private Line, Channel Guard, Quiet Channel, etc.

- Powered by 6-16vdc, unregulated
- Microminiature in size to fit inside all mobile units and most portable units
- Field replaceable, plug-in, frequency determining elements
- Excellent frequency accuracy and temperature stability
- Output level adjustment potentiometer
- Low distortion sinewave output
- Available in all EIA tone frequencies, 67.0 Hz-203.5 Hz
- Complete immunity to RF
- Reverse polarity protection built-in

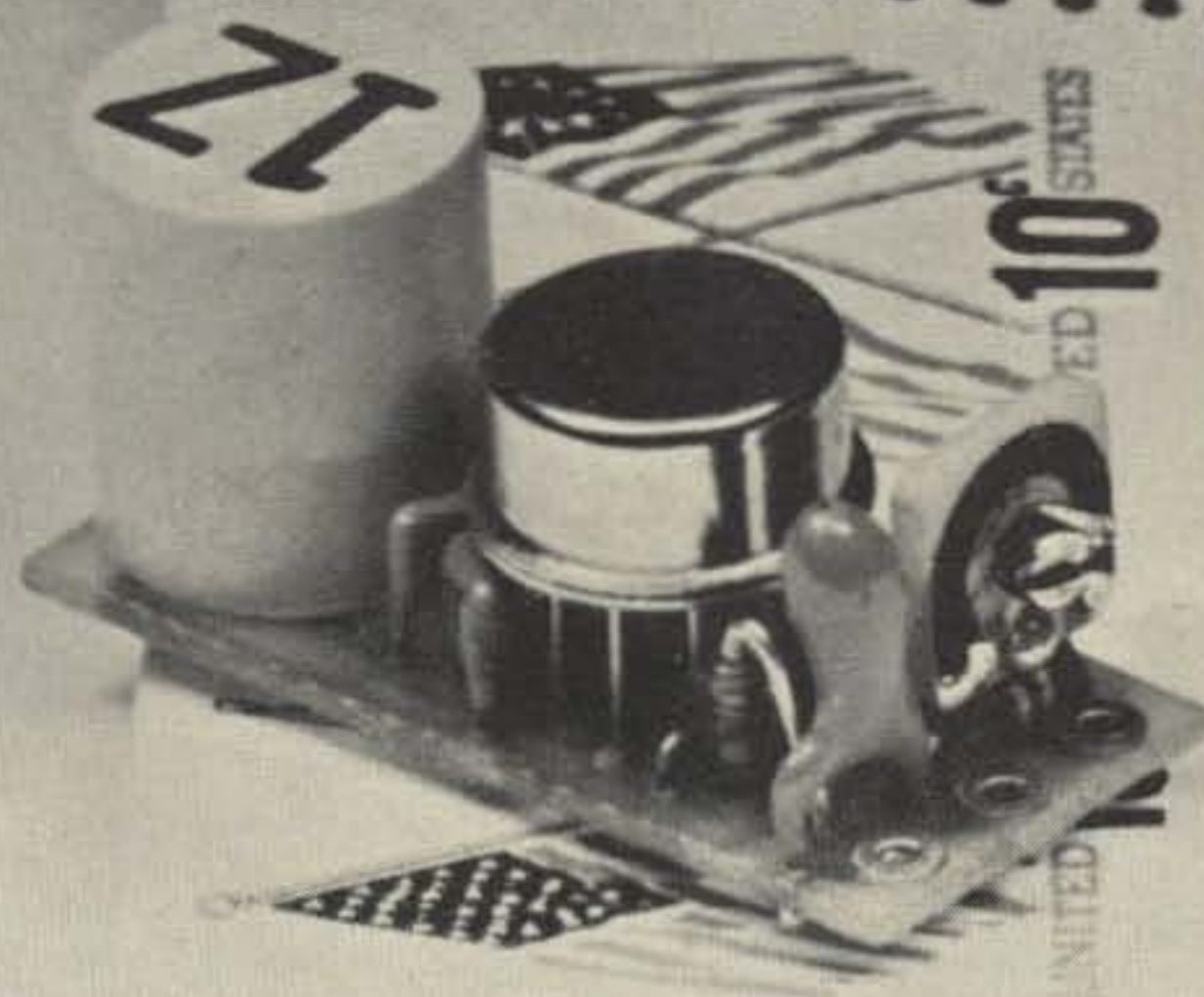

**\$29.95 each**

Wired and tested, complete with K-1 element



**communications specialists**

P. O. BOX 153  
BREA, CALIFORNIA 92621

(714) 998-3021

K-1 FIELD REPLACEABLE,  
PLUG-IN, FREQUENCY  
DETERMINING ELEMENTS

**\$3.00 each**



# Motorcycle Mobile

## - - combining summer pastimes

**T**he great outdoors. The clean air. You, riding off down the road, the wind in your face, on your trusty motorcycle heading off into the sunset. Ah, freedom! But the specter of a chain breaking, plugs fouling, or a tire going flat and you twenty miles from nowhere looms nearby. Anyway, riding around with all that freedom is lonely. There's no one to talk to. Even if you are with a group of people communica-

tion is limited to waving arms and sign language. There is a better way! Whether it be CB, HF, or two meter FM, motorcycle mobile is the answer to getting more fun from your bike.

First you have to decide what type of rig you are going to use. Unless your motorcycle has the battery and electrical system of a Harley-Davidson, you are limited to the many transistorized mobile or portable

radios on the market.

The obvious answer is the handie-talkie. It's nice and small, very portable, has its own power supply, and is hand-held. Wait a minute! How are we going to go down the road using only one hand to operate the bike?

Well, maybe you could use a belt clip and some sort of external microphone/speaker combination like the law enforcement motormen use. This is OK if you don't mind

your \$200-\$400 talkie flapping about on your hip, exposed to the elements (maybe bouncing down the road behind you?) plus the extra cash for buying the external microphone/speaker box. Anyway, how are you going to key the thing while under way? It looks like the obvious answer needs some rethinking.

OK, how about using that larger mobile rig? Well this, believe it or not, has got possibilities. The next question is, where am I going to put it?

It has got to be handy, so some place up front would be nice. Putting the rig on the handle bars might work, but you would have to fabricate some sort of exotic mount for it, not to mention covering up the instruments (in the case of the speedometer, this would be costly) and adding extra mass to the front fork assembly which could be dangerous to the bike's handling characteristics.

A tank bag would work fine. This is a bag (approximately 12" x 8" x 8") of leather or vinyl material that straps on top of the gas tank. The bottom is padded so it won't scratch your paint job and the whole bag unbuckles in seconds so you can take it with you. It was designed for carrying one or two changes of clothes with you on a short trip. It is usually waterproof too. The cost is about \$40.

The best alternative is the space inside of a good frame-mount fairing. A fairing is a combination windshield/cowling protective device made from ABS plastic or fiberglass, which protects the rider and bike from the elements and road hazards. One week after I had bought a new 550 four cylinder Honda with a Windjammer fairing, a curb that was lurking in the dark jumped out in front of me. I broke the windshield in the resulting crash. The windshield had to be replaced, but the fairing, which was just a little

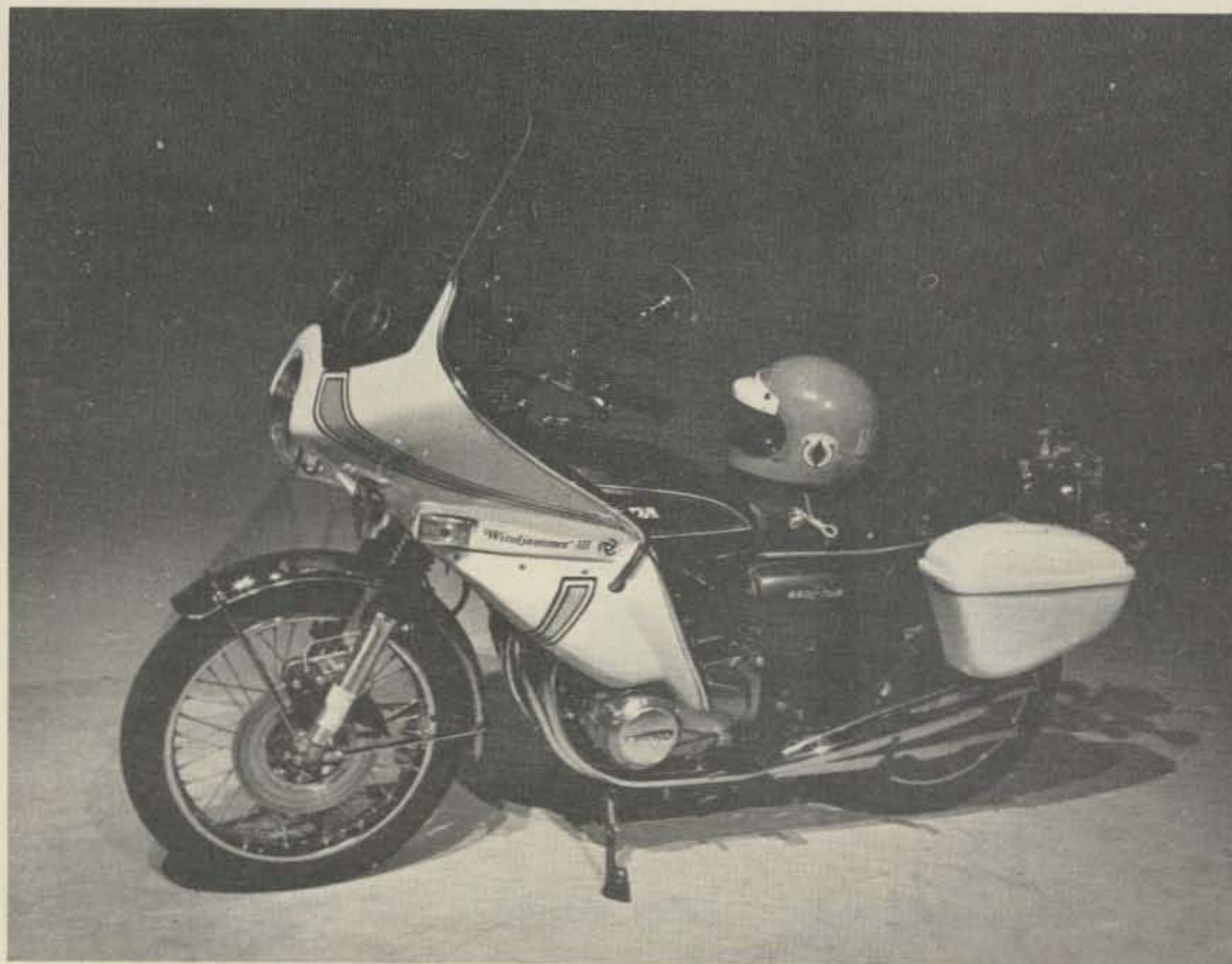

Motorcycle mobile — note connecting cord from helmet.



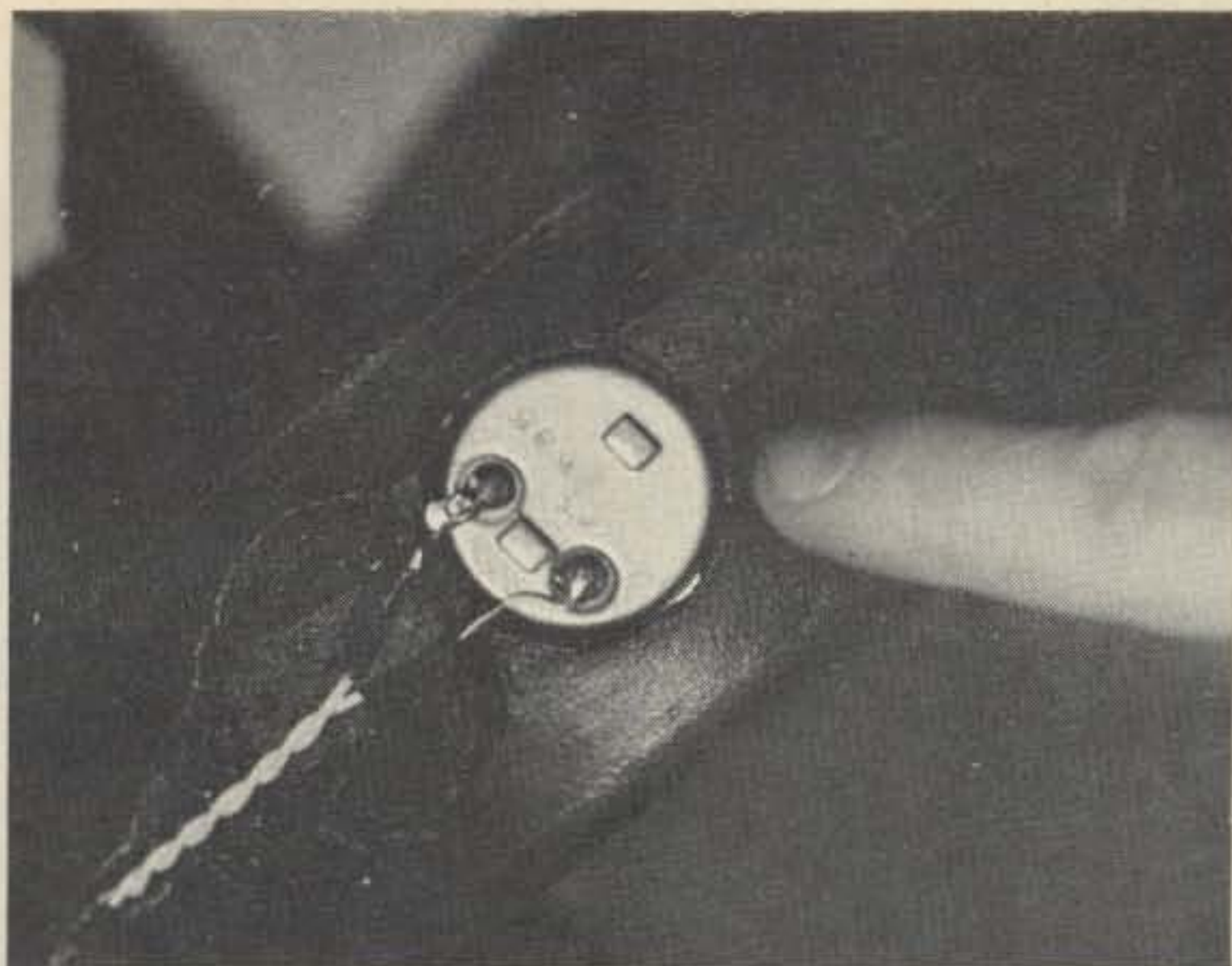

*Rear view of front crash padding removed from helmet showing rear of microphone.*

bit scratched, had saved me and, more importantly, my new motorcycle from any damage. So at about \$300 they are worth the money. Besides, the fairing has lots of storage space inside which is protected from the elements. Most mobile rigs will easily slide into one side of a fairing leaving still more room for extra microphones, headsets, and rain gear.

Now that we have the rig attached to the machine, how do we use it? First, we will have to make some sort of arrangement for a speaker. You may be able to use the rig's internal speaker if it's on the front or top of the rig and you are using a tank bag. If this is not the case, then an external speaker jack must be installed in the radio.

Now you have a couple of options: a speaker mounted on the handle bars, or an earphone/headset under your helmet. I went the speaker route first. It worked all right, but the rig has to be turned up so loud to override the sound of the motor, wind noise, and the natural attenuation of my helmet, that late at night I was in danger of being cited for disturbing the peace. Next, I tried a transistor radio earplug. This only had two problems: The audio quality was non-existent, and I did not like the feeling of that "thing" in

my ear. I then decided to modify my helmet. I will get into the helmet modification a little later.

After solving the speaker problem, the microphone problem is next. If you are using any helmet other than a full coverage type (one that comes down in front of your mouth and chin with a large slot for you to see out of), you can use a hand-held microphone with good success. Just drape it over the handle bars and (unless you want to use the clutch lever) pick it up, put it under your face shield and talk. The face shield really cuts down on the amount of wind noise that gets picked up by the microphone. Working the microphone close to your mouth helps, too. (You won't have any choice if the microphone is between you and the face-shield.) Using the hand-held microphone also eliminates the push-to-talk switch (PTT) problem that we are about to run into.

If we do not use the standard microphones, then we have a few problems: Where are we going to put the PTT, and how are we going to hang the microphone in front of our mouth for hands-off operation? Now we get into how to modify your helmet.

All good helmets have lots of crash padding inside. Usually it's styrofoam and



*Styrofoam helmet liner showing earphone and cord detail.*

foam rubber. The main protection over the head is the one half to one inch thick styrofoam. Foam rubber is sometimes used in front of the mouth in full coverage helmets and in a few other places such as around the ears. What most people don't know is that you can take the padding completely out of the fiberglass or plastic shell of the helmet. The padding is generally in two pieces, split from front to back down the middle. The crack may be covered up by a small decorative strip and/or a piece of foam rubber. Now comes the fun! You have to work one of the styrofoam halves out of the helmet shell. If you are careful and persistent, you will emerge victorious in this

little bout with your helmet. The liner will be a bit stubborn, possibly because some of the cheaper helmets may use a little rubber cement to hold it inside the shell, but forge ahead! Remember, if it's a cheap helmet, they are too cheap to use a lot of glue on it.

Once you get the first half out the other side will probably fall out. Now you can start the real modifying. I took an old headset that had a boom microphone on it and canabalized it. The earphone element was about 1.5 inches in diameter and about 1/2 inch thick. I then cut a hole in the styrofoam next to my ear and pushed the element into the hole. Since my element used a plastic membrane for its

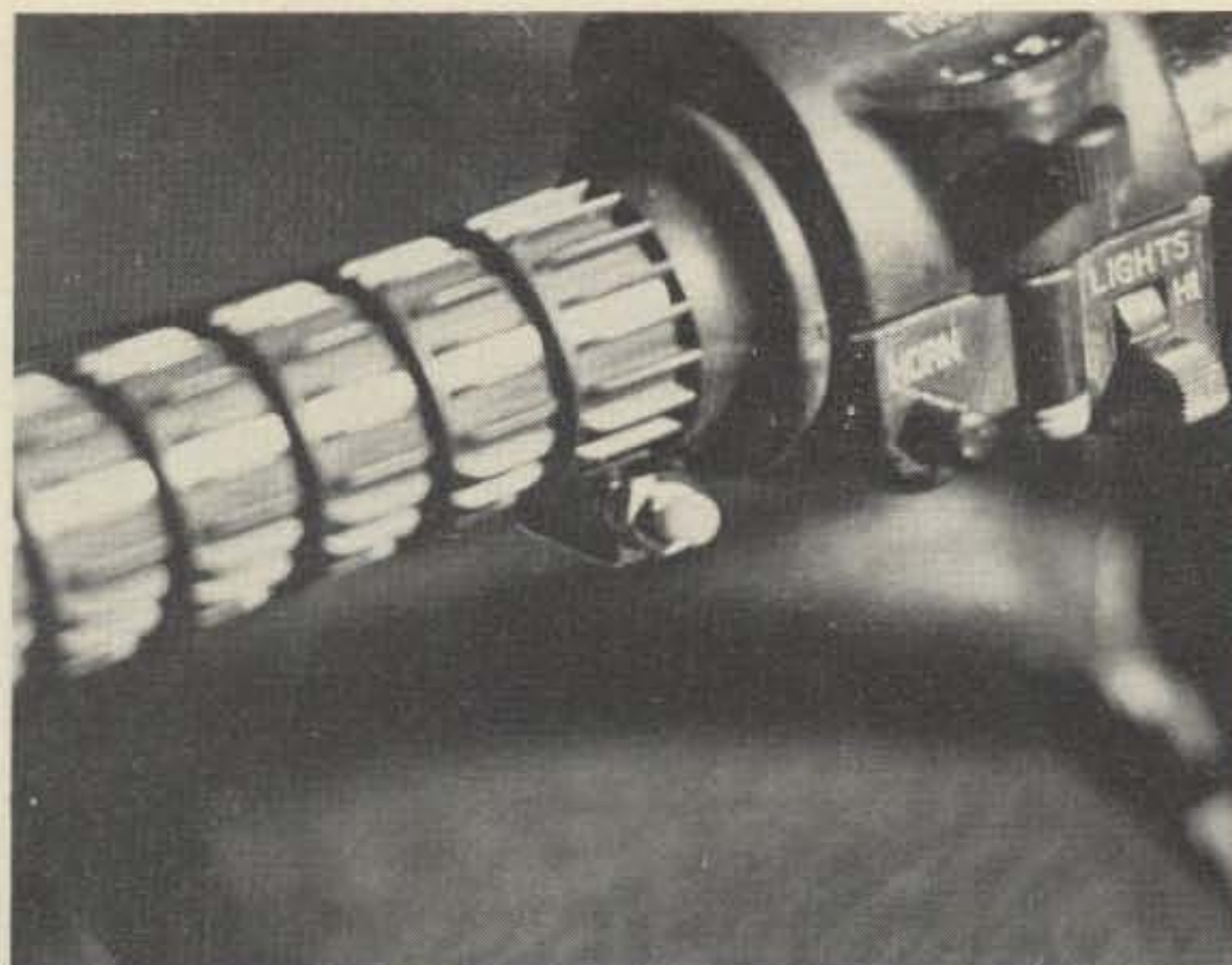

*PTT switch and bracket. Front view.*



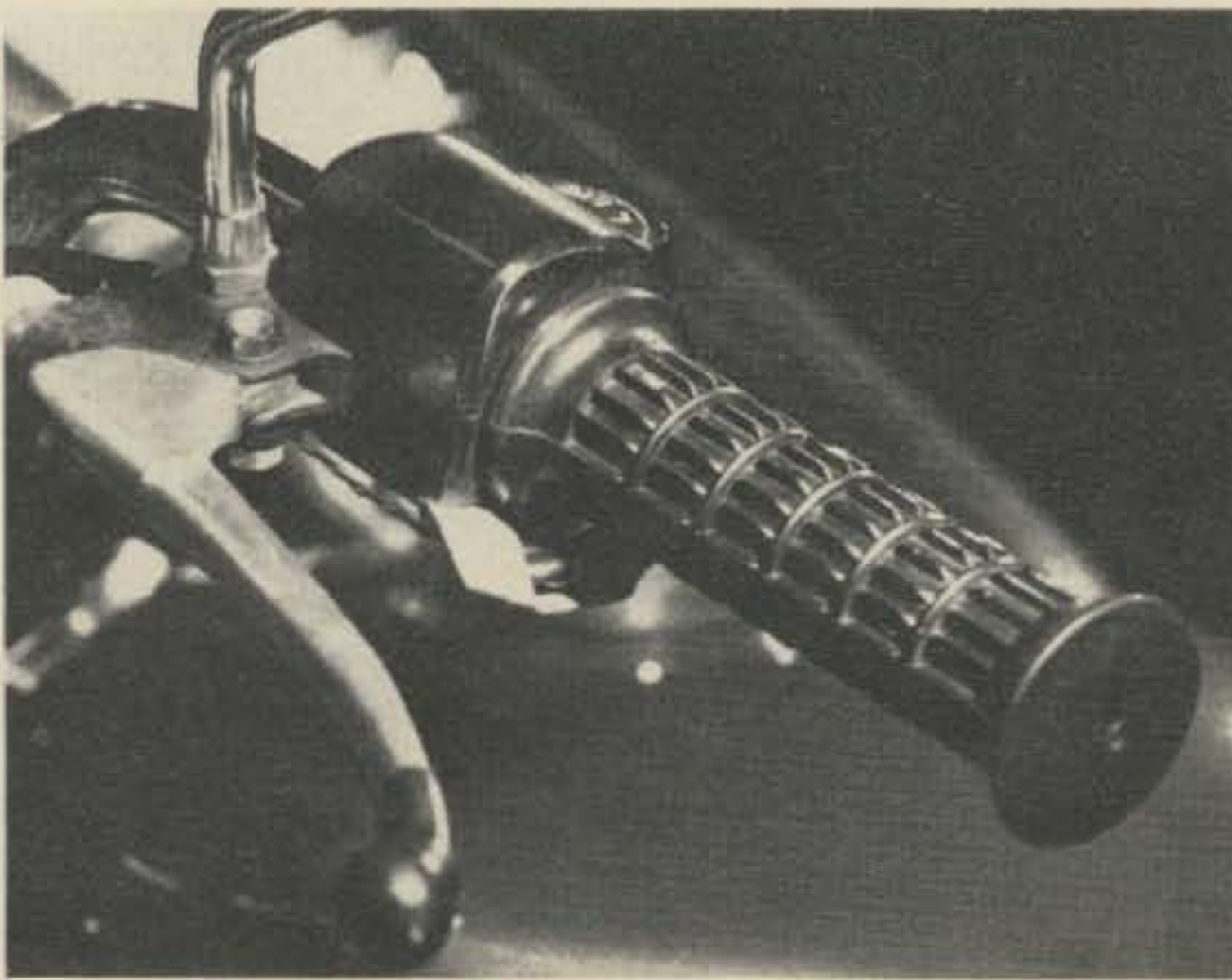

*PTT switch and bracket. Rear view.*



*Helmet jacks mounted in fairing.*

diaphragm, I put a hard plastic cover over it. The guard was a retaining cover from an old telephone type carbon microphone on a boom that telephone operators used to use. It just happened to fit over my earphone element. Anything that has holes in it that will prevent damage to the diaphragm can be used. I then ran the wires out the back of the liner. First, though, you can use a razor blade to cut a shallow trough in the styrofoam (the side that will contact the hard shell of the helmet) for the routing of the microphone and earpiece wires out of the helmet.

If you have a full coverage helmet, you can use the same procedure to mount a micro-

phone element in the padding in the front of the helmet. For all other types of helmets you must make up some sort of microphone boom. The boom can be made with brass tubing from a hobby shop (approximately 1/8 inch diameter) bent into a smooth, gentle curve. The end of the boom where the wires come out can be epoxied into the styrofoam after a suitable trough has been notched out for it. Be careful about using glues on styrofoam. It may melt. Rubber cement may be better than epoxy.

Finding a suitable microphone element was the hardest part of the project. I had a small dynamic microphone element that came out of an old headset that I had

salvaged the earphone and cord from, but the element was bad. After scrounging in many other people's junk boxes to no avail, I finally went to the local Radio Shack. There I found brand new replacement CB microphones (dynamic and ceramic) for only \$8, which was about \$3 to \$4 cheaper than the replacement element I could get for my Sure microphone. Also, the element in the microphone from Radio Shack was only about 3/4 of an inch in diameter. This would fit very nicely into the crash padding in the front of my helmet.

After you get all the elements in place in the crash padding, use some duct tape to keep it all from falling out before you get the liner back inside the helmet. Now all that's left is to put a jack in the fairing for the helmet to plug into and, oh yes, the PTT switch.

I tried two methods for PTT. The first is usable but is almost like using a hand-held microphone. I epoxied a small push-button normally open switch (five for \$2 at Radio Shack) into an inverted cover that screws over a 1/4 inch phone jack, and ran the wires out the smaller opening in the opposite end. I would then attempt to grab this assembly while motoring around town. I never realized that it was so small. After

about two weeks of attempted use with this PTT, I found the better way. I built a small bracket out of aluminum and mounted the switch and bracket to a handy screw in the left-hand grip assembly on the handle bars. The switch is conveniently located right next to the horn button and can be easily actuated by the thumb on my left hand.

The last two items are the easiest. We have to have power for the rig, and we need a place for the antenna. If your motorcycle has a twelve volt battery, you have it made. Just run two wires from the battery to the rig. I would suggest running two wires rather than relying on the frame ground for your dc return. This keeps things nice and direct and avoids any intermittent ground problems cropping up later. Also check to make sure that your motorcycle electrical system ground is the same polarity as your rig. Motorcycles are not all standard twelve volt negative ground systems, and if this is different from your rig, you may pick up problems through the coax braid which will be grounded to the motorcycle chassis at the antenna mount.

The antenna mount I used was nothing more than some aluminum stock drilled and bent to mount on the rear fender attached to the rear tail light assembly. An



*Rig going into place in fairing.*



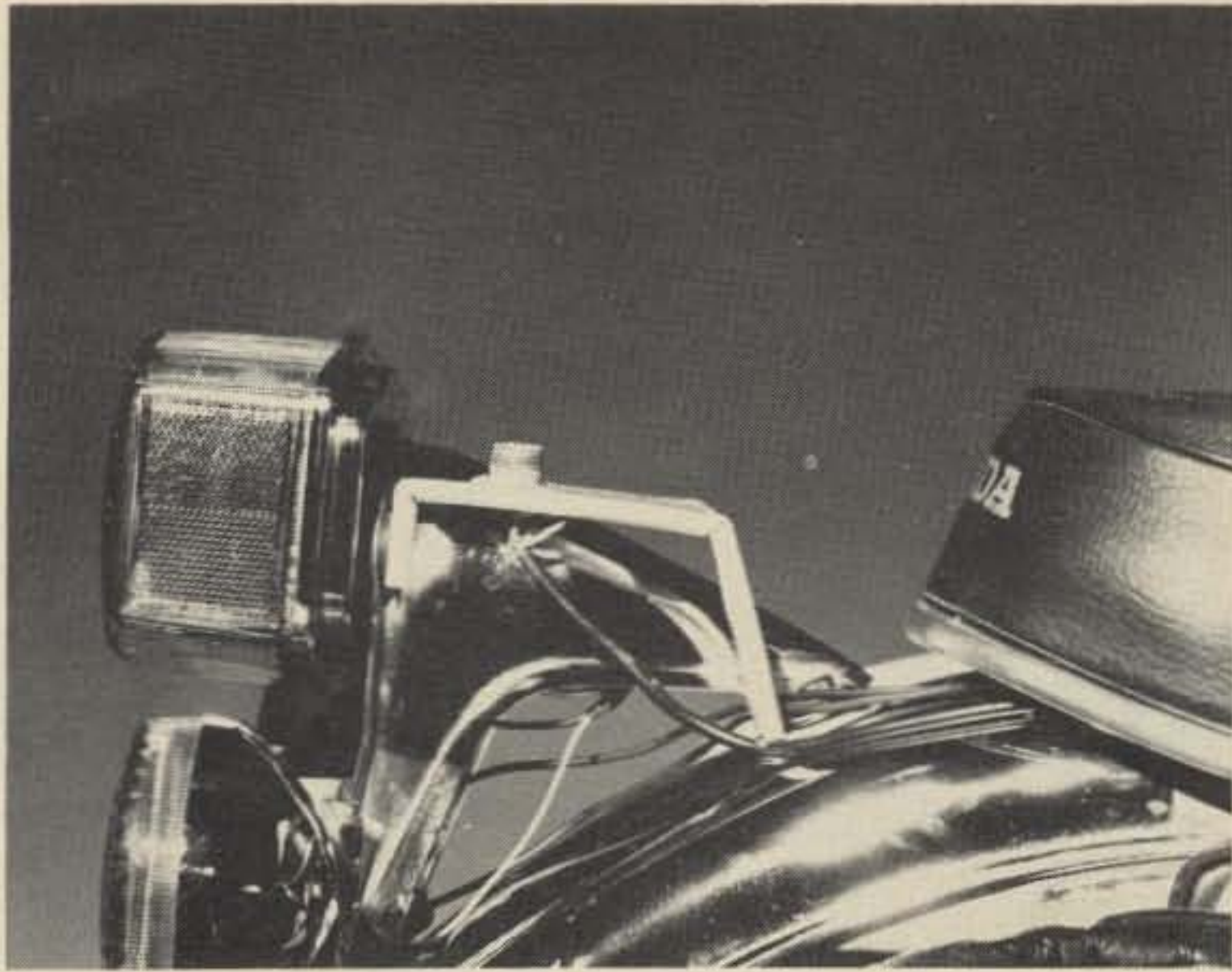

*Antenna mounting bracket detail.*

SO-239 chassis connector was mounted in the bracket. This way I can use either the traditional 1/4 wave whip in a PL-259 or the home brew 5/8 wave antenna which also ends in the same type connector. (See *73 Magazine*, "5/8 Wave Power for your HT," May, 1976, page 118.) If you then want to park the bike and not advertise the fact that you have a radio on board the antenna is easily removed. The battery wires and antenna coax are easily routed under the seat and gas tank and brought out from under the tank at some convenient spot. If you want to you can use tape or plastic cable ties to hold the wires in place as they go along the frame members. This will keep the wires off the hot engine and also keep them from getting pinched under the rubber supports of the seat and tank.

Now that you are ready to ride off in a cloud of dust, let me add a few words about operation of radios and motorcycle electrical systems. Most motorcycle electrical systems are marginal in capacity. You may find that you may have to be less long-winded than normal when operating motorcycle mobile to keep from running the battery down, depending, of course, on how much current your rig draws. I am currently using an HR 2 and have not had any problems keeping the

battery charged due to the radio. However, my quartz headlight and extra marker lights in the fairing make me recharge the battery about every 3-4 weeks of constant use.

Also, a word about ignition noise. My Honda 550 four cylinder is very noisy electrically. Although it came with swamping resistors in the spark plug caps and I shielded the high voltage wires and coils, none of this had any effect on reducing the noise. I found out that Honda Fours have a very peculiar high voltage system. The ignition coil secondaries are not grounded on one side like they are in a car. They put two spark plugs in series with each other so the spark goes from the tip of one plug to ground, through ground to the other plug and then jumps to the tip of the second plug returning to the coil. So, the problem is that the engine case is a radiator rather than a shield for the spark. The only way I can see around this problem is to use four coils, one per plug, and ground one side of each secondary. Most of the time the ignition noise is down to a comfortable listening level as long as the repeater's signal strength is fairly high. However, when you're trying to receive weak signals the ignition noise can be fierce. Honda Twins (two cylinder



*First try at going mobile — external speaker and hand-held microphone.*

engines) are not set up this way. They have a separate coil for each plug. If you experience problems, check your manual to see what kind of system you have. If it can be shielded, do it. Don't forget to add resistor caps and plugs along with any shielding you do, if the engine is not already equipped with them. After adding your improvements, you can use your rig or a transistor AM radio as an rf sniffer to check your thoroughness. Please take note: If your engine performance deteriorates after installing resistor caps or plugs, you may have to go back to the original equipment. Remember, motorcycle electrical systems are marginal. This includes

the ignition system, too.

I have been operating motorcycle mobile for about eight months now with good success. Most stations I talk to can't tell the difference between me operating on the motorcycle and other people operating in cars. Frequently, surprised people ask me to repeat what I said when I sign with "Motorcycle Mobile." Then I am usually deluged with all sorts of questions about how other people can do it also.

Now you are ready to enjoy two loves at the same time, radio and motorcycling. I hope this will encourage you to take the plunge and become one of the few stations identifying with motorcycle mobile. ■

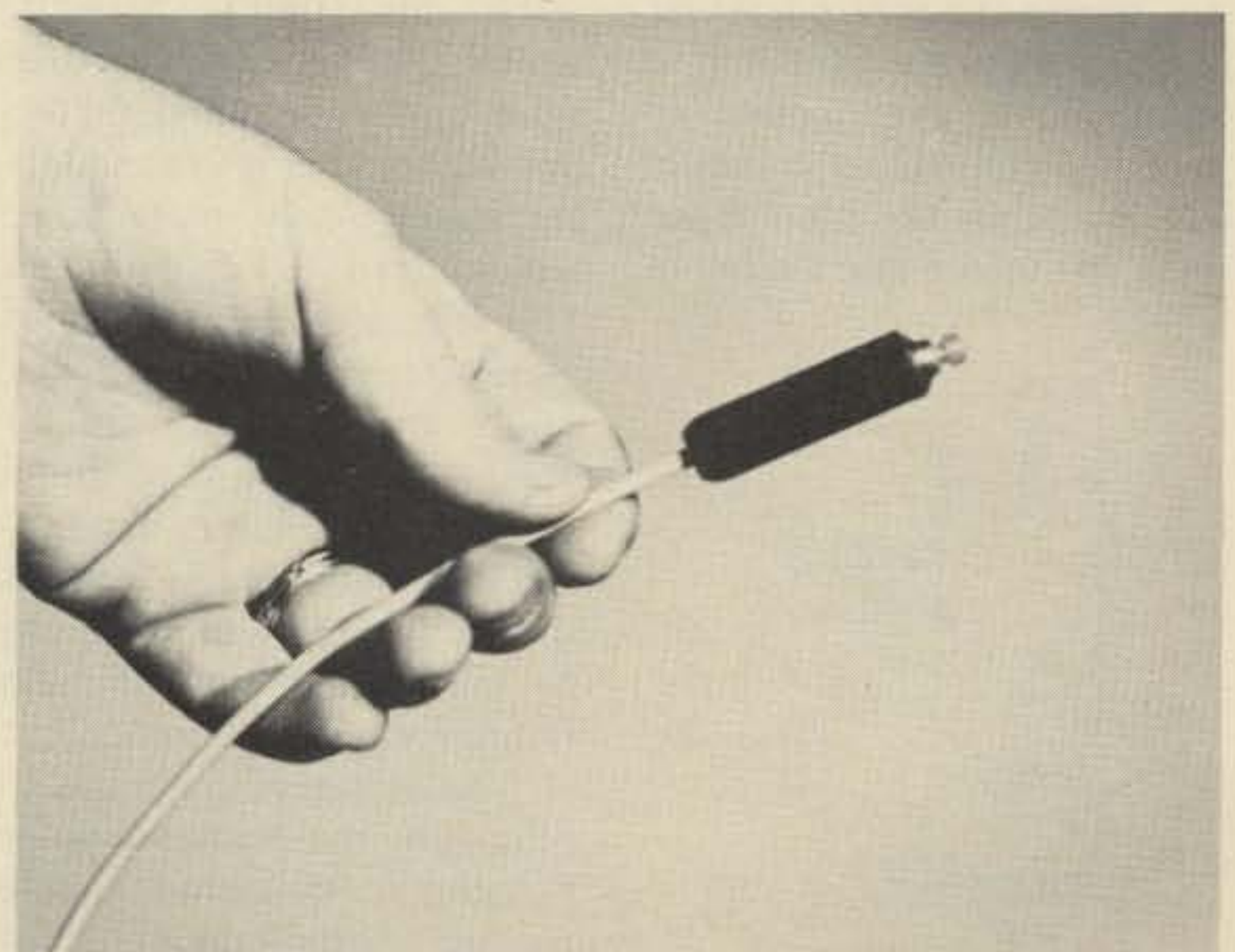

*First external PTT switch. Hand-held, no bracket.*



# Inside the Bird

## -- a wattmeter exposed

Robert E. Bloom W6YUY  
8622 Rubio Ave.  
Sepulveda CA 91343

**D**id you ever wonder how the Bird wattmeter does its thing? I did, after butting my head trying to get a Bendix directional coupler to operate at a power level far beyond its specs. So I started hunting for every piece of design information I could lay my hands on. I found out that the information was not

only difficult to find, but also very sketchy when found.

The Bird Model 43 wattmeter consists of three main sections: a directional coupler, a detector, and a calibrated readout. Let's start with the unit's readout, which is a very high quality 30 uA (microampere) meter. The meter face is kept simple by having only three basic scales: zero to 25, 50, and 100. The plug-in detectors of varied frequency and power ranges are all made in multiples and divisions of these scales. The meter incorporates about three feet of shielded cable and thus can be separated from the main frame for remote viewing.

The detectors are made to plug into the main frame or housing so that they couple to the center conductor of the directional coupler in a

precise fashion for just the right amount of coupling for the specified power rating. The plug-in detectors have precision contacts that connect mechanically to the meter section. By rotating the detector 180° in its socket, one can take both a forward and reverse power reading. By applying the two readings into a simple formula, one derives vswr (the voltage standing wave ratio) on the transmission line:

$$\rho = \frac{1 + \sqrt{\phi}}{1 - \sqrt{\phi}} \quad \text{and} \quad \phi = \left[ \frac{\rho - 1}{\rho + 1} \right]^2$$

where  $\rho = \text{vswr}$  and  $\phi = P_r/P_f$ .

I knew that would scare some of you! But look at the formula again with an open mind this time, and see how really simple the formula is. Let's look at  $\phi$ . This is nothing more than the Greek letter "phi" that says the following relates to some

voltage, magnetic flux, or angle relationship, and the symbol is easier to use than the equation it represents. In this case,  $\phi$  or phi is equal to  $P_r/P_f$ .  $P_r$  is the reverse power reading and  $P_f$  is the forward reading. The forward reading is that which you get when the arrow on the detector plug is pointing in the direction of the antenna. And reverse power is that reading when you turn the plug 180° so that the arrow is pointing to the generator or source.

Now, with your calculator, take the forward reading, e.g., 50 Watts, and place it into the denominator (the divisor in the formula). Take the reverse reading, e.g., 5 Watts, and put it into the numerator. We now have  $\phi = 5/50$  or .1. Now let's take the rest of the formula or rho resistivity:

$$\rho = \frac{1 + \sqrt{.1}}{1 - \sqrt{.1}}$$

Take your calculator again and find that  $\sqrt{.1} = .32$ . If you can't believe that, multiply .32 by itself and find that it equals .1.  $\rho = 1 + .32 / 1 - .32$  or  $1.32 / .68$ , which equals 1.94, which is the vswr, 1.94 to 1 or roughly 2/1.

Now that you are convinced that you can easily find vswr by measuring two powers, it's even easier to just refer to the curves furnished with the instrument. Then there are no mathematical calculations whatever. But now you know. Let's go on. The detector probe couples to a 50 Ohm cavity, the dimensions of which have been calculated by the relationships of the outside diameter of the center conductor to the inside diameter of the cavity, e.g.,  $Z = 138 \log(d_1/d_2)$ . The formula is more involved where the dielectric is other than air.

The cavity in this case is a thru-line lumped constant directional coupler; the detector probe or sensor extracts a sample of rf energy

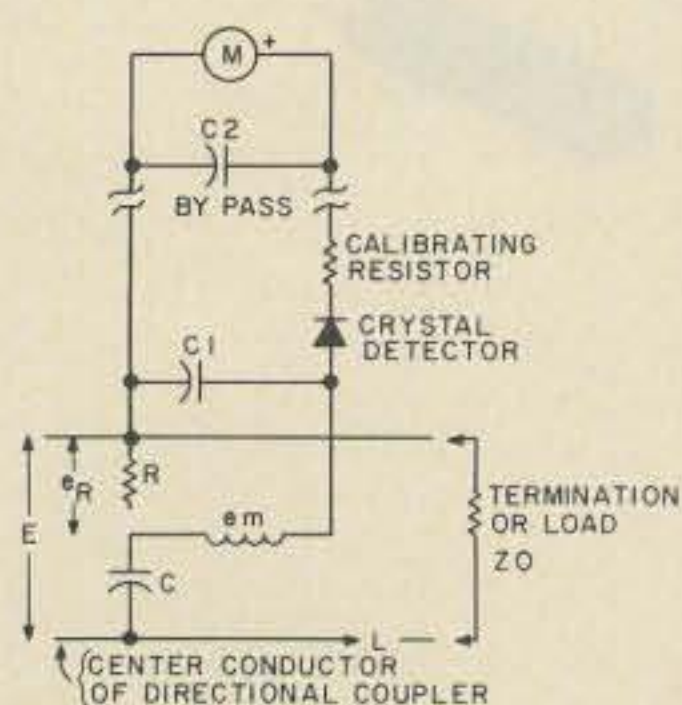

Fig. 1.



from the line in either a forward or reflected direction. Fig. 1 is a representation of the sensor makeup. It can be likened to an AM detector receiving a CW signal. The signal is rectified and the dc actuates the meter readout.

Basically, the sensor is comprised of a resistor R and a loop of wire which couples to the cavity conductor by mutual inductance M. When the plug faces the forward direction, M is positive. Rotating the plug 180°, M becomes negative.

The capacity between the junction of the resistor R and loop M and the center conductor of the line section makes up the capacity component C. The loop, being a small fraction of a wavelength, will discriminate between the forward and reflected waves.

Looking again at Fig. 1, C and R make up a voltage dividing network. M is the mutual inductance between the loop and the line section center conductor. E is the voltage between the center and outer conductors of the line section. I is the current in the line.

The voltage and power sensitivity are proportional to the distance between the coupling loop and the line section center conductor. Now, looking at the transmission line, the voltage "E" at any point on this line is equal to the sum of the (f) forward and (r) reflected voltage,  $E_f + E_r$ , and the current "I" is  $(E_f/Z_0) - (E_r/Z_0)$ . Since the reflected wave travels in the opposite direction,  $I_r = E_r/Z_0$ ,

$$e \rightarrow = j\omega M \left( \frac{E}{Z_0} + I \right)$$

$$= j\omega M \left\{ \frac{E_f + E_r}{Z_0} + \frac{E_f - E_r}{Z_0} \right\}$$

$$= \frac{j\omega M}{Z_0} (2 E_f)$$

and turning the element toward the source, it becomes:

$$e \leftarrow = j\omega M \left( \frac{E}{Z_0} - I \right)$$

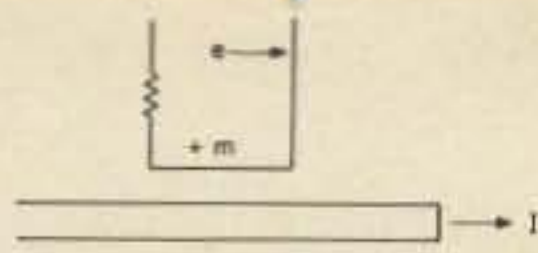

Fig. 2. Element in forward direction.

$$= j\omega M \left\{ \frac{E_f + E_r}{Z_0} - \frac{E_f - E_r}{Z_0} \right\}$$

$$= \frac{j\omega M}{Z_0} (2 E_r)$$

The "j" term simply means that the pickup voltage and current is 90 degrees out of phase with the line voltage and current.

The two formulas show that the rf output voltage from the sensing element is directional and proportional to the voltage in the line due to either the forward or reflected wave. It is also directly proportional to  $\omega = 2\pi f$ . In order to make it frequency independent, we terminate e in a capacitive reactance which is inversely proportional to  $\omega$ . The voltage across this capacitor is rectified, filtered, and displayed on the meter scale, calibrated in Watts.

Previously, we stated that E at any point on a line is equal to the sum of the forward and reflected voltage on a flat line (one terminated into its characteristic impedance or one with unity standing wave ratio). The voltage at any point on this line will be equal, as there is no reflected wave ( $E = e_f + e_r$ ). This makes sense as the line is a flat 50 Ohms at any point along its length. If this is so, then the current will also remain constant. From this, the power at any point is equal to  $I^2 R = IXE$ .

However, the line is not always terminated into its characteristic impedance, as some of us well know by past experience. This tells us that on such an improperly terminated line, not only E but also I will vary. Because the wattmeter sensing element's loop M length is a small fraction of a wavelength, we can sample the vswr at any point on the line; both forward and

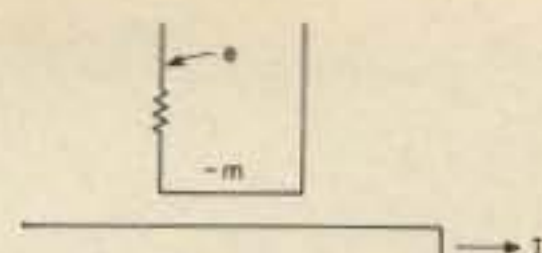

Fig. 3. Element in reverse direction.

reverse current are sampled at the same point and  $E = e_f + e_r$ . Have I convinced you? I can hear the opposition already.

True, some of you have made measurements on UHF and in essence can show that I and E did not remain constant on your supposedly properly terminated line. I hope you did not use 80' to 100' of RG-58/U. There is a logical explanation for this. At the higher frequencies, it is necessary to use low loss line. If not, the losses in the line will produce data that can give you the impression that you have a well-matched load at the antenna end. 100' of RG-58/U has approximately 3 dB of loss at 150 MHz. Only 1/2 the power gets up to the antenna, and if the antenna does not look like the feedline, what is reflected is attenuated by 3 dB on the way back. By the time it gets to the source and to the point where you are making the measurement, everything looks rosy. In this case, you might take a second measurement at the antenna end (between the feedline and the antenna). The difference between the power measured at the source and at the load will tell you the loss of power in the line.

Sometimes it is easier to find lower loss 70Ω coax than the comparable 50Ω line. I use CATV semi-rigid and rigid 70Ω line which has a fraction of the loss of RG-8/U at UHF. Before concluding, there is another point of interest to many using a 50Ω Bird and 70Ω or 90Ω coaxial lines. With certain limitations, good results may be obtained on 70 Ohm coaxial cable with a 50 Ohm wattmeter. The insertion of a Bird Mod 43 thru-line wattmeter in a line adds 4 inches of 50 Ohm air line plus con-

nectors into the system. This will change the load on the transmitter from its original condition without the meter.

Even on 50 Ohm systems above 100 MHz where the vswr is above 1.5, removing the wattmeter will cause a change. This is so because changing the length of line between a mismatched load and the source transforms the impedance of the load as seen at the source. If the adjustments for maximum energy transfer were made with a feedthru wattmeter in place, removing the meter afterwards will change the conditions. However, conditions on a line repeat themselves every 1/2 wavelength. The conditions on the line with the wattmeter inserted can be duplicated when the meter is removed by inserting an additional length of coax along with the meter, the total length of 50Ω coax and wattmeter equaling 1/2 wavelength. Be sure to take the velocity factor (dielectric constant) of the coax and connectors into consideration, removing both meter and added line section as one unit after all adjustments have been completed.

Another interesting method which I use (fully described by WB4KSS in the May, 1975, issue of *Ham Radio*, entitled, "Measuring Complex Impedance with an SWR Bridge") utilizes a double data system of measurements and a computer set of readouts made from a series of Smith chart plots. This method is especially good when using a 50Ω bridge and transmission lines of higher impedance.

Many hams now possess the treasured 50Ω wattmeter. With a little understanding of its abdominal functions, you should be able to find more uses for it than just measuring the output power of your transmitter. More power to you! ■

#### References

*Watts News* from Bird — Vol. 1, No. 2, Jan., 1964; Vol. 2, No. 2, Mar.-Apr., 1965; Vol. 4, No. 1, Jan.-Feb., 1967.



# Introducing Autotrak!

## -- digital antenna tracking system

It has been a long time (over two years) since the big winter wind (I swear it was Murphy's big mouth) took down our first EME array attempt. The horizontal boom (40' tower) was too weak, the drive system left a lot to be desired in the elevation mode and was not too great in azimuth mode either, and so on. Oh well, live and learn.

In this article I hope to point out some of the correc-

tions for any of you enterprising large array freaks like me, and also explain the most advanced — and in the future useful — piece of electronics added while we were down and muttering through the chill of two winters.

The electronics improvement I'm referring to is the Autotrak. If you are not interested in the EME work, don't stop reading now. How about all of you OSCAR fans? Want to track that little

devil automatically so you can concentrate on making contacts and not have to grow six hands? Read on. Also, how about you die-hard contest ops? This unit will swing the beam around to precise headings on any preset timetable, and you choose the timetable!

The antenna array here is an el-az type driven in elevation and azimuth, not a polar mount. This makes it a little tougher to track celestial objects (i.e., the moon), but it is much easier for satellites, tropo, etc. To give you some idea of our setup, there are sixteen 11 element Cushcraft modified 147-11 yagis mounted for horizontal polarization, approximately 1 wavelength apart from each other in both horizontal and vertical dimensions. This gives an overall array size of approximately 36' wide (tower), 20' top to bottom (vertical masts), and 12' deep (antenna booms). Big, in other words! This leads to special problems, but none that can't be overcome with a machine shop, super mechanical ability, or a Jeep engine for a rotor. The azimuth drive is handled by the old-time ham's workhorse — the prop-pitch motor (\$3.00 at hamfest), the transformer for its power (\$1.00 as a military

surplus battery charger transformer — tapped input, tapped output, 20 Amps — hamfest), shaft coupler to absorb shaft misalignment (3/4" plywood doughnut and 1" x 3/16" flat steel — big oversize flexible coupler — hardware store parts), 4 heavy duty wheels for a lazy Susan type arrangement on top that allows rotary motion in azimuth (scrapped off factory package cart with 3' x 5' bed, 4" wheels with roller bearings, super heavy duty, and free), constructed wooden "doghouse" that tower lays in on 4 more of the cart wheels (plywood, well varnished and painted — wood *can* survive outdoors if you do it right). So much for azimuth.

Elevation is accomplished by building up a triangular tower (ours is Spaulding HDX) so it is circular in two places (more 3/4" plywood, double thickness) and putting 1" x 3/16" strap steel around it to form 2 metal rim "wheels" spaced just barely wider than the doghouse width. More package cart wheels are used as "bearings" (4), and the tower rotates along its own centerline. Therefore, anything attached to vertical booms running 10' above and 10' below the tower horizontal centerline remains in balance as the whole tower is rotated. This means you only have to overcome the metal rim "wheels" to package cart "bearings" friction. To do this and get the kind of resolution you need, use a pair of RCA through type rotors mounted horizontally to the back floor of the doghouse with a 1 1/4" o.d. waterpipe between them and through both. This becomes the drive "drum" for aircraft cable drive that push-pull drives a drum built around the center of the tower in the doghouse. This drum is constructed much like the tower metal rim "wheels." Two wooden discs form the outside edges and cable "guides," and 1/4" x 20 3" long bolts are passed

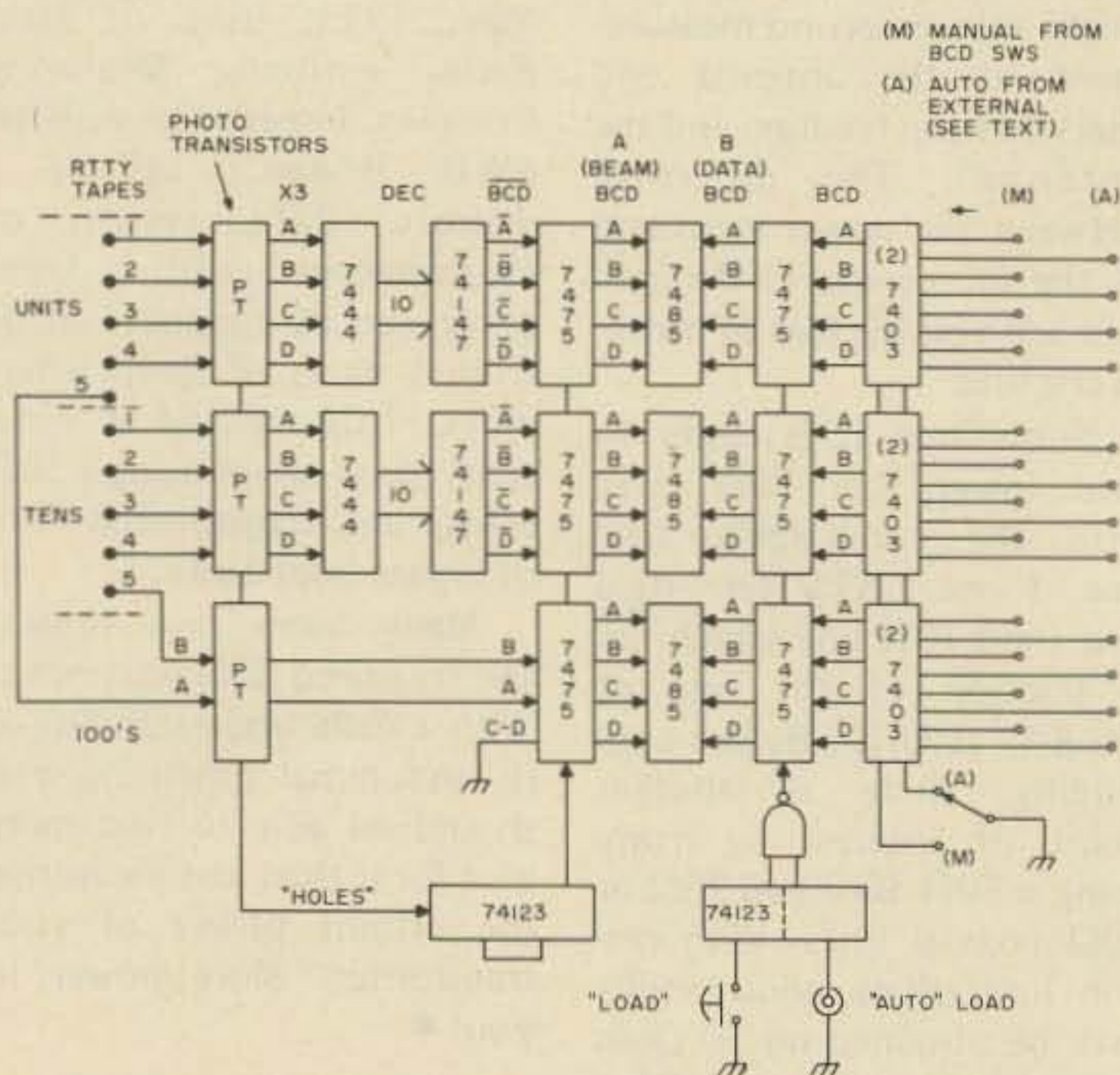

Fig. 1. Autotrak block diagram shown for azimuth (3 digits). Delete 100s for elevation. Elevation note: 5th line holes used for determining north or south quadrants in elevation (- or +). See schematic for details.



between them from alternate sides every 2" on a diameter that just touches the three tower legs. The wooden guide edges are made 1" larger than the bolt circle to hold the cables on the bolt circle. The bolts themselves are covered by another piece of 1" x 3/16" strap steel formed into a drum over the bolts. Cables are fed 1 turn around the drum and then to the pipe drive drum. One cable goes one direction around the drum and the same way around the drive drum (pipe). The other cable goes the opposite way, for a push-pull action. Sufficient cable turns are placed around the drive drum to allow the tower to turn through a full 180°, or full front over top to full rear. This allows full 360° azimuth and 180° elevation coverage, but only requires the actual azimuth to turn 180°, east through south to west. West through north to east is taken care of by bringing the elevation up from 0° through 90° and on over into the north quadrants. Some may question the inverted horizontal polarization. One, we don't see any difference at all in the tests we ran. Two, very little work will be done in the north quadrants anyway except for initial North Star sighting and original bearing calibration.

This has been a rough detail of what we run, and an article will follow describing things in detail with (hopefully) many pictures, but you can see the problems with steering and tracking such a large array with such narrow beamwidths, both horizontal and vertical. You can't imagine how small that moon can be until you go looking on a cloudy night when visual tracking is out.

This brings us to our answer to steering this whole beast. The electronic tracking control is all TTL IC type quite common nowadays, and cheap! First, I'll try to describe it in function and peripheral equipment, and then by circuits.

In general, from the antenna end, two paper or mylar RTTY type "tapes" mount to a round clear plastic cake pan that is mounted to the azimuth shaft. These tapes are easily done by yourself or a fellow amateur with RTTY gear. They are punched using the Baudot holes, but the code is *not* Baudot. It requires all 5 holes for one number in Baudot, or 15 holes (three tapes) for the azimuth readings. I devised a "fake" code table that will allow you to punch the two tapes using the letters common on the "green keys," but the holes that result are later read as follows. One tape (top in our case) is called units and represents the ones of degrees on lines one to four. The hole code if you read it as line 1 = A, line 2 = B, line 3 = C, and line 4 = D, is really Excess 3 gray code. The advantage is that as each number changes up or down a degree at a time, only one A, B, C, or D line changes, unlike BCD or binary where many often do (i.e., in BCD 7 to 8 transition, all four change!). This helps in error reading reduction, settling time, etc., and much more than we can go into here. It works much better, ok?

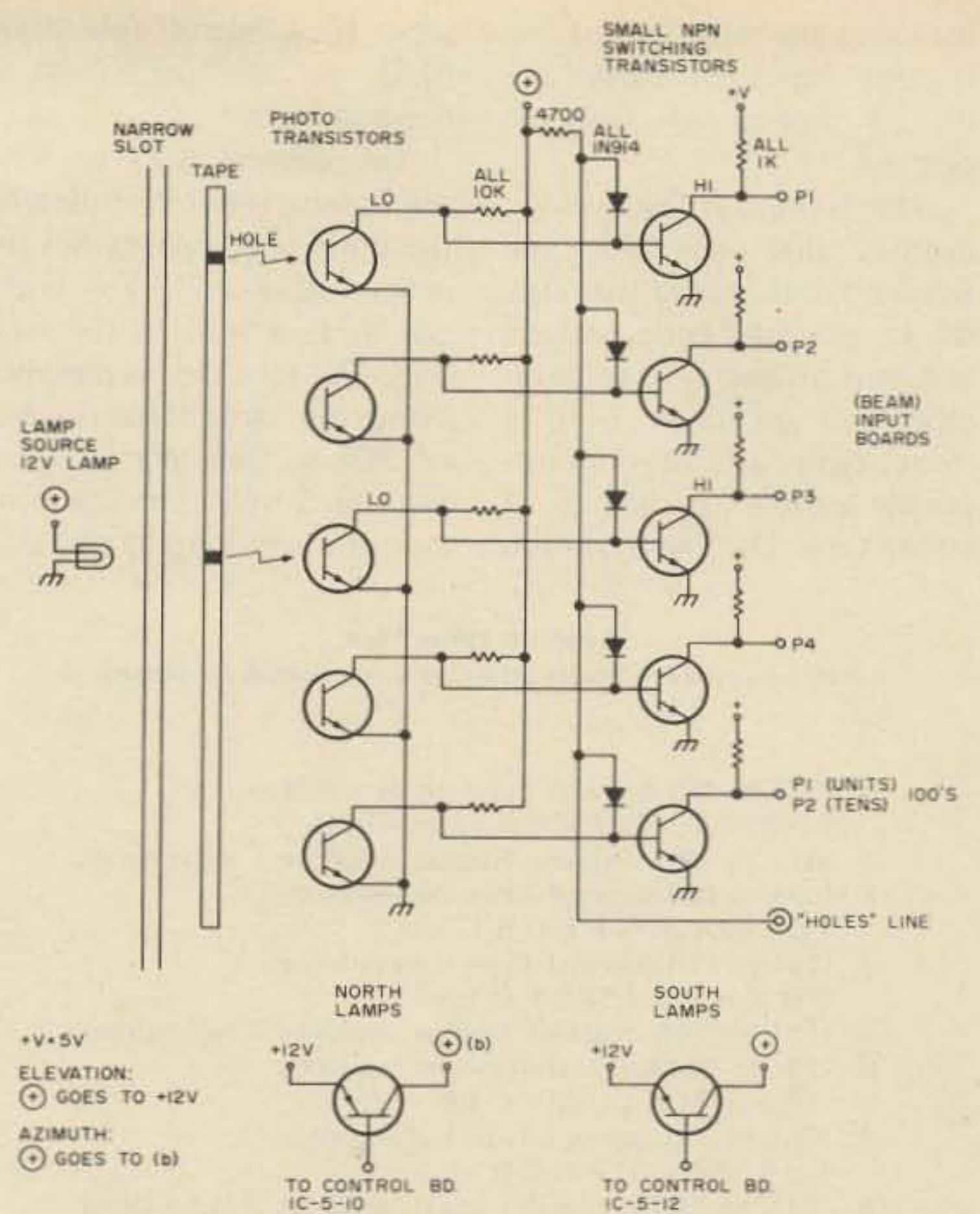

Fig. 2. Lamps and photo transistor "readers," 6 for full system: 2 elevation, 2 north quadrant az, 2 south quadrant az.

These tapes are fastened to the clear cake pan rim or side walls and are read by a lamp source on the inside and a phototransistor type pickup outside (5 per tape, see detail).

The second tape is called a

tens tape and lines one to four carry the 10s of degrees in Excess 3 gray code much like the units tape, but the preparation or encoding is quite different. We manage to "fake" the two tapes into taking care of the three digits

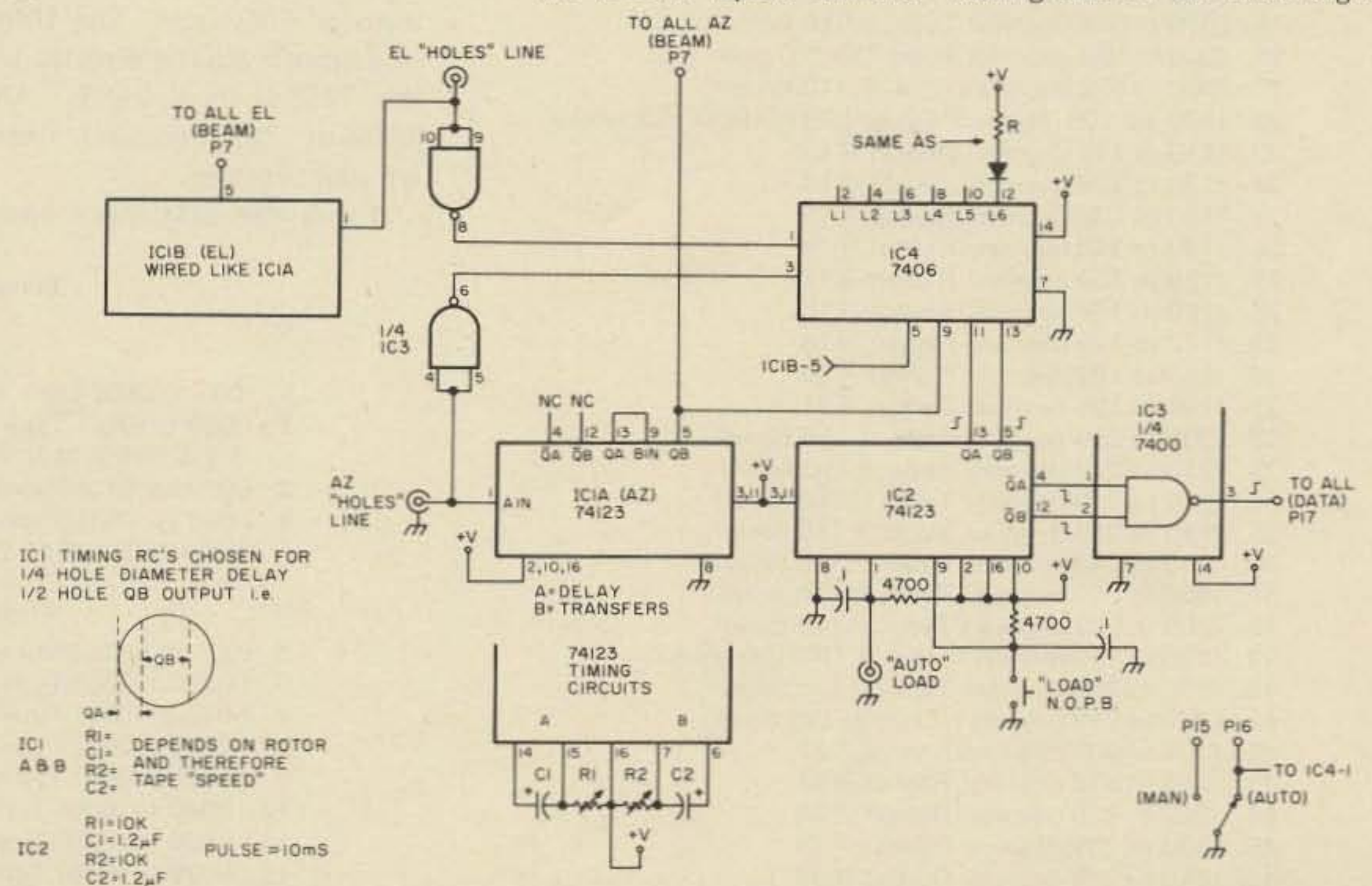

Fig. 3. Control and status board and front panel, part 1. L1 — holes detected, el; L2 — holes detected, az; L3 — beam input transfer, el; L4 — beam input transfer, az; L5 — auto-load; L6 — load. R to suit LED I limits (<40 mA).



by using the fifth line of the Baudot tapes to carry the 0-1-2-3 figures of 100s of degrees.

This is done as follows: On degrees 000 to 099, the Baudot letter is used that cuts the proper gray code on tape one and proper gray code on tape two on lines 1 to 4 respectively, and yet does not punch a hole on line 5 of either tape. Or, line 5 of each

tape is a blank (no hole) (0,0), or B = 0, A = 0, decimal zero.

On degrees 100 to 199, the Baudot letter is chosen on the units tape that causes the proper gray code for units, but adds a hole in the fifth line. The tens tape is punched using the same letter system of 000 to 099 degrees using no line 5 hole. Or, line 5 on tape units is a hole, and tape

two tens is blank (no hole) (0,1), or B = 0, A = 1, a decimal one (C and D are understood zero and are not needed to represent any number from zero to four).

On degrees 200 to 299, the fifth line hole combination reverses (1,0), or B = 1, A = 0, a decimal two.

On degrees 300 to 360 (399 possible numbers, but only 360 degrees), both tapes have the fifth line hole (1,1), or B = 1, A = 1, a decimal three.

You may now have noted the output from the fifth lines are the 100s information in direct BCD code. It seems to be OK here since the transitions only occur infrequently and at three places in the entire 360 degrees (099 to 100, etc.).

To use the gray codes from the 1s and 10s, you must convert it to BCD for use in TTL comparators. I use SN7444 gray code to decimal ICs to do this, then use SN74147 ICs to go from decimal to  $\overline{\text{BCD}}$ . This  $\overline{\text{BCD}}$  is fed to the inverted arrangement shown in the SN7475 latches, and when the transfer line goes high, it is transferred to the A0 to A3 inputs of the 7485 comparators as BCD, right side up. More on the transfer lines later. The 100s of azimuth are fed directly to the 7475s, then 7485s. All azimuth 7475 transfer lines are tied together.

From the data input end,

let's cover the manual mode first. This is a mode where you can enter a "go to" degrees command via a set of 5 thumbwheel BCD output switches like many synthesized 2m rigs now have. The outputs of the first three switches (azimuth) are gated through manual/automatic gates to 7475 latches. The transfer lines of these latches are fed from one half of a dual one-shot 74123. That half is fed by a panel push-button marked "load." To use this mode, information is put into the switch in decimal form the way you think for 100s, 10s, and 1s of degrees, the manual/automatic (man/auto) is placed in manual, and the "load" switch is momentarily depressed. The one-shot puts a nice clean high pulse on the transfer lines, and the gate information fed into the manual (M) gates is transferred to the 7475s and held there. That's all there is to it.

A brief word of explanation is in order here. Since all of our towerhouse gear is remote controlled by wire from my basement, the only time the system does not then go immediately into search or motion automatically is when the power off switch is placed to off. Any other time the antenna position information (BEAM) does not agree with the output information from the man/auto side 7475s

#### Azimuth Units Tape

Key Sequence — Insert no extra keys, spaces, or blanks.

#

1. (001 to 010 degrees) Type the sequence:  
I U S SPACE N F K C R LINE FEED
2. (011 to 090 degrees) Repeat sequence 1 eight times:
3. (091 to 100 degrees) Type the sequence:  
I U S SPACE N F K C R L
4. (101 to 110 degrees) Type the sequence:  
P Q Y H M X LTRS V G L
5. (111 to 190 degrees) Repeat sequence 4 eight times:
6. (191 to 200 degrees) Type the sequence:  
P Q Y H M X LTRS V G L F
7. (201 to 210 degrees) Type the sequence:  
I U S SPACE N F K C R L F
8. (211 to 290 degrees) Repeat sequence 7 eight times:
9. (291 to 300 degrees) Type the sequence:  
I U S SPACE N F K C R L
10. (301 to 310 degrees) Type the sequence:  
P Q Y H M X LTRS V G L
11. (311 to 360 degrees) Repeat sequence 10 five times:

#### Azimuth Tens Tape

12. (001 to 009 degrees) Type: LINE FEED (9 times)
13. (010 to 019 degrees) Type: I (10 times)
14. (020 to 029 degrees) Type: U (10 times)
15. (030 to 039 degrees) Type: S (10 times)
16. (040 to 049 degrees) Type: SPACE (10 times)
17. (050 to 059 degrees) Type: N (10 times)
18. (060 to 069 degrees) Type: F (10 times)
19. (070 to 079 degrees) Type: K (10 times)
20. (080 to 089 degrees) Type: C (10 times)
21. (090 to 099 degrees) Type: R (10 times)
22. (100 to 109 degrees) Type: LINE FEED (10 times)
23. (110 to 119 degrees) Repeat #13
24. (120 to 129 degrees) Repeat #14
25. (130 to 139 degrees) Repeat #15
26. (140 to 149 degrees) Repeat #16
27. (150 to 159 degrees) Repeat #17
28. (160 to 169 degrees) Repeat #18
29. (170 to 179 degrees) Repeat #19
30. (180 to 189 degrees) Repeat #20
31. (190 to 199 degrees) Repeat #21
32. (200 to 209 degrees) Type: L (10 times)
33. (210 to 219 degrees) Type: P (10 times)
34. (220 to 229 degrees) Type: Q (10 times)
35. (230 to 239 degrees) Type: Y (10 times)
36. (240 to 249 degrees) Type: H (10 times)
37. (250 to 259 degrees) Type: M (10 times)
38. (260 to 269 degrees) Type: X (10 times)
39. (270 to 279 degrees) Type: LTRS (10 times)
40. (280 to 289 degrees) Type: V (10 times)
41. (290 to 299 degrees) Type: G (10 times)
42. (300 to 309 degrees) Repeat #32
43. (310 to 319 degrees) Repeat #33
44. (320 to 329 degrees) Repeat #34
45. (330 to 339 degrees) Repeat #35
46. (340 to 349 degrees) Repeat #36
47. (350 to 359 degrees) Repeat #37
48. (360 degrees) Type X (one time)

Table 1.

#### Elevation Units Tape

#

1. (001 to 090) Same as azimuth units 001 to 090.
2. (-089 to -080) Type the sequence:  
G V LTRS X M H Y Q P L
3. (-079 to -070) Repeat sequence 2 seven times:
4. (-009 to -001) Type the sequence:  
G V LTRS X M H Y Q P

#### Elevation Tens Tape

5. (001 to 090) Same as azimuth units 001 to 090.
6. (-089 to -080) Type: V (10 times)
7. (-079 to -070) Type: LTRS (10 times)
8. (-069 to -060) Type: X (10 times)
9. (-059 to -050) Type: M (10 times)
10. (-049 to -040) Type: H (10 times)
11. (-039 to -030) Type: Y (10 times)
12. (-029 to -020) Type: Q (10 times)
13. (-019 to -010) Type: P (10 times)
14. (-010 to -001) Type: L (9 times)

Table 2.



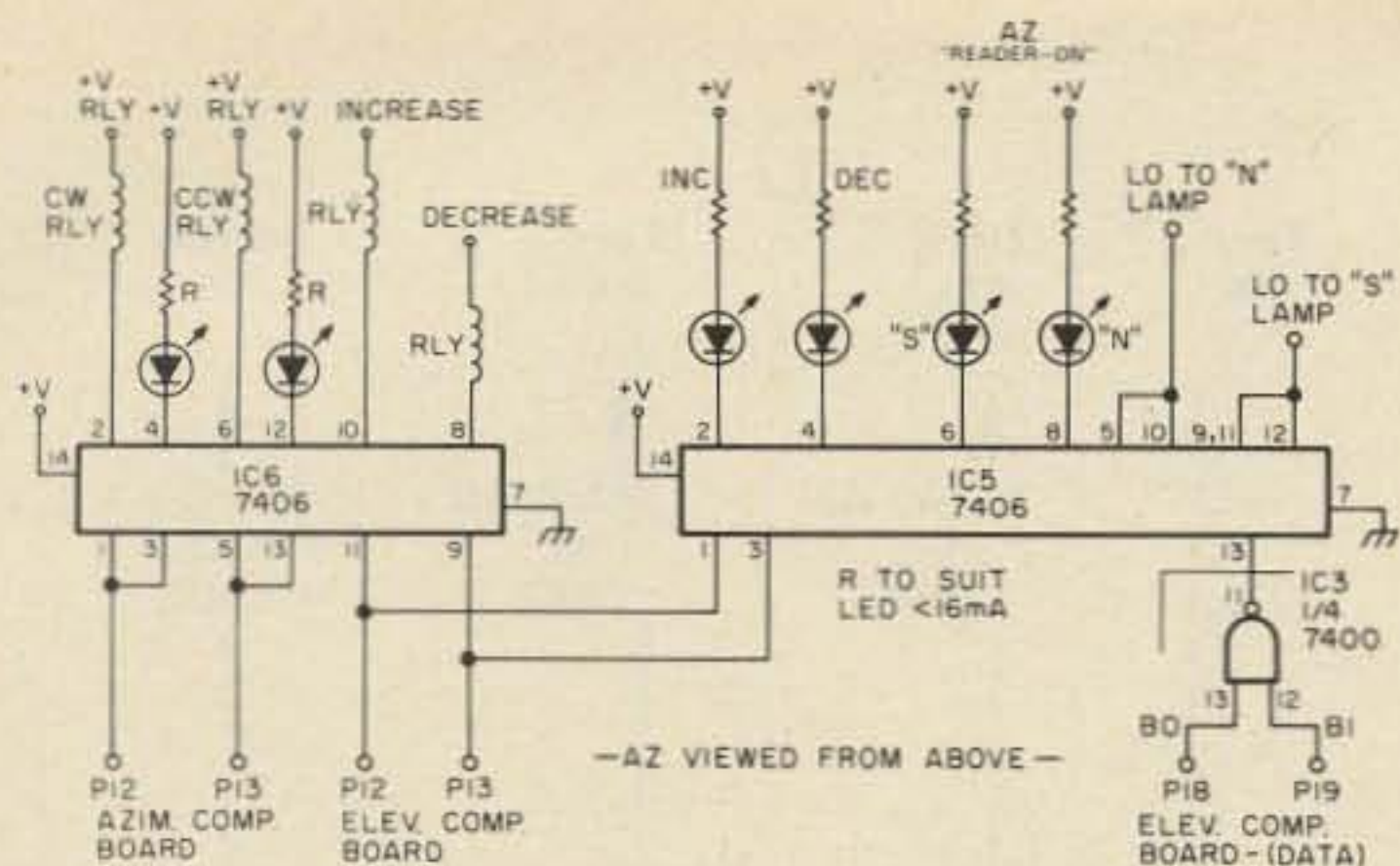

Fig. 4. Control, part 2, full system.

(DATA), the antennas move to correct this. Thus if for any reason (wind, etc.) the antennas move away by themselves, they are automatically correct as soon as the gray code error is noted — assuming the power is on. This neat feature has many side benefits. For instance, if you look back to the Nov., 1976, 73 Magazine, page 84, article by me, you will see a wind indicator device whose output is in degrees and BCD code. That device was no accident, and if fed into the automatic inputs of this control unit, and the unit left in automatic mode and on, the beams will always face into the wind! In some parts of this country, that almost makes these two projects worthwhile on that reasoning alone. Our tower horizontal section is braced, etc., such that our best way is facing into the wind. I would advise, however, you only sample and compare 100s and 10s of degrees to keep the array from forever "hunting" and burning out motors, etc.

In the automatic mode, information (DATA) from the automatic mode gates (A) is routed to the data 7475s. It is transferred only when the transfer line is brought high. This is accomplished in the auto mode by any TTL level low applied to the auto-load input connector.

I failed to mention the single gate that allows tying both outputs of the 74123 to the latch line. I'm sure you are all doing your 73 reading and I/O homework, but since

it is an inverted use of a NAND gate 7400, I'll explain. The inputs to either 74123 are low going transitions. This creates a pulse output determined by the RC chosen for each one-shot. You then use the normally high output of each 74123 to feed the 7400 inputs. Normal condition is (with no inputs) both 7400 inputs high, output or transfer line low, no transfer. If either input sees a low transition, the one-shot goes low, the 7400 output goes high, and transfer occurs.

Skipping where the automatic input (DATA) comes from for a minute, the auto transfer input in our case has several possibilities. Of course the "load" push-button is one of them, even if the man/auto switch is in auto. Another is an S.D. Sales 60 Hz timebase driving one of our older TTL

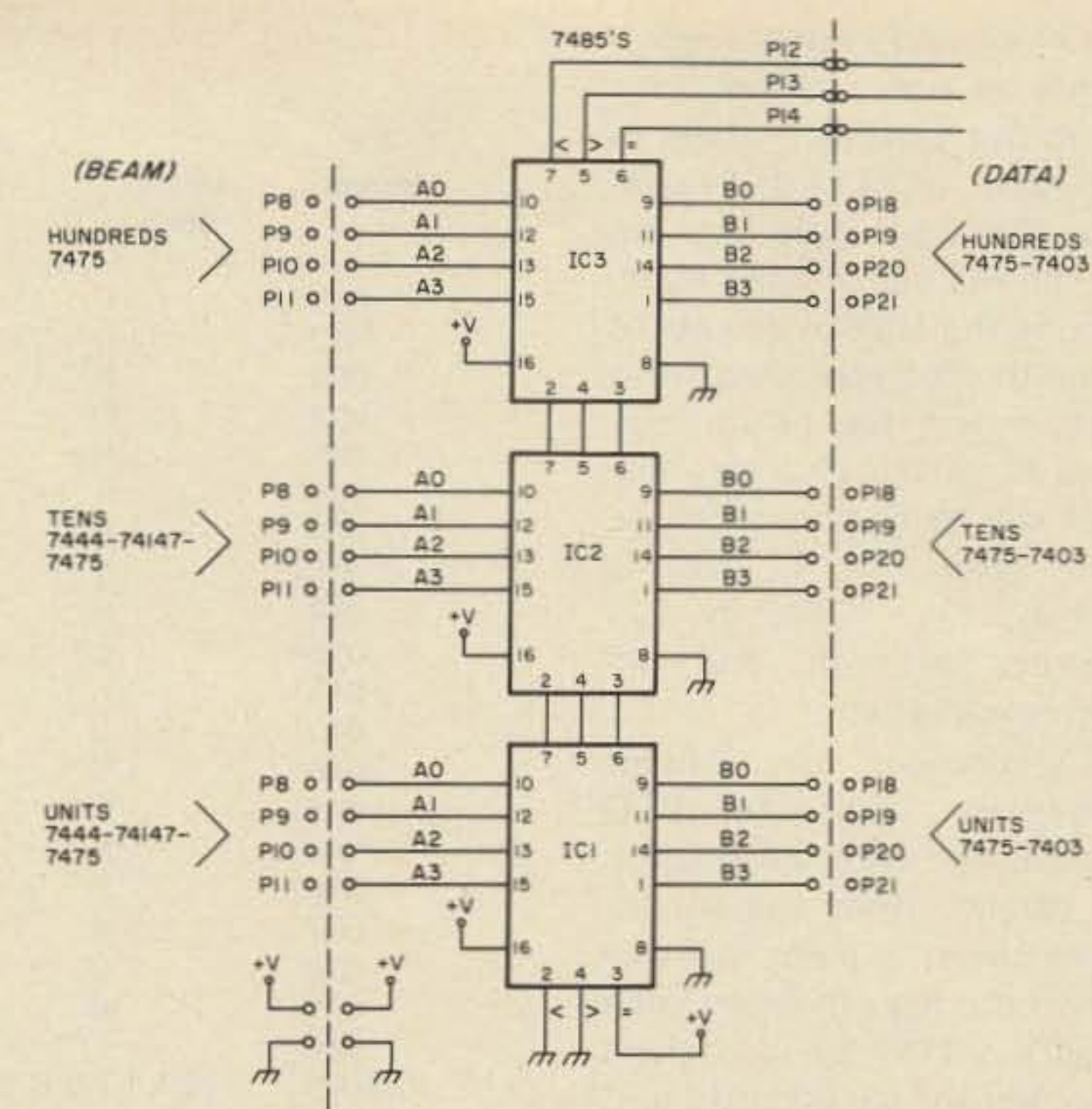

Fig. 5. Azimuth comparator module. Note: Elevation — same board; see "Comparator Operation — Elevation."

real time clocks, and the 1 ppm, 1p/2m, etc., lines brought out through a rotary switch (you obviously want new data faster, more often, on OSCAR than with EME) and a BNC jack over to the beam control (Autotrak) unit, which incidentally will be all buttoned up in a Drake TR-6 case when finished to match the rest of the console, to give you some idea of size. Another source for use on schedules, and for our eventual use remote from Indy stations and members of

ECHO, is a set of 7485 comparators added to the old clock and four more BCD switches. You dial in a time in hours and minutes (4 digits — GMT) and at the appointed hour it turns on many things in the station via the A = B output (high) to the 6 inputs of a hex inverter/line driver IC whose outputs (low) do the controlling. One of these lines (low) turns on the antenna control, another "hits" the transfer line indirectly. Since these outputs are there for the full minute

	1 = M = Hole				Track 1 = A, 2 = B, 3 = C, 4 = D.				
	X3 Gray Code				Baudot Track				RTTY
	D	C	B	A	4	3	2	1	5 Letter
0	0	0	1	0	0	0	1	0	0 LINE FEED
1	0	1	1	0	0	1	1	0	1 L
2	0	1	1	1	0	1	1	1	0 I
3	0	1	0	1	0	1	0	1	1 P
4	0	1	0	0	0	1	0	0	0 U
5	1	1	0	0	0	1	0	0	1 Q
6	1	1	0	1	1	1	0	1	0 S
7	1	1	1	1	1	1	1	1	1 Y
8	1	1	1	0	1	1	1	0	0 SPACE
9	1	0	1	0	1	1	1	0	1 H
					1	1	0	0	0 N
					1	1	0	1	1 M
					1	1	1	0	0 F
					1	1	1	1	1 X
					1	1	1	1	0 K
					1	1	1	0	1 LTRS
					1	1	1	0	0 C
					1	0	1	0	1 V
					1	0	1	0	0 R
					1	0	1	0	1 G

Table 3. Baudot to X3 Gray Table.



the clock and switches agree, plenty of time is allowed for a positive control. A tape in our case (RTTY) is loaded into the tape reader and set on the first set of holes representing the 100s of degrees of azimuth. For your own information and for future articles, all of our data information will be in azimuth-elevation, 100s, 10s, 1s, 10s, 1s format, i.e., 10545 is 105 degrees azimuth and 45 degrees elevation.

A decoder for Baudot (numbers only) to BCD accepts the tape information in parallel from the reader, using the stop pulse to transfer to the next memory latch (digit). 7475s are used here also, but the data control unit is the subject of the next article, so more on it there. The control mode is as follows, however: (1) it is time to read tape - 1 ppm from clock, etc.; (2) This pulse turns on the tape reader FF and therefore the tape reader; (3) As long as there is tape in, reader tape advances, putting info into the latches; (4) When the fifth digit is loaded (az-el), a pulse is formed in the data control unit, resetting the tape reader FF, shutting off the tape reader, and the same pulse "hits" the (DATA) side 7475 transfer lines; (5) 7485s compare data and run beams to new headings as required.

You will no doubt realize, too, that a UART having ASCII output has lines 1 to 4 already in BCD code for numbers. You can now detect the serial stop pulse to advance the memory latches and have a keyboard input. Baudot owners can run in the FIGS mode into our control unit and do the same thing. You may recall my rotary dial decoder also in the Nov., 1976, *73 Magazine*, and it is mentioned in there the control device used here as a data control unit. It works very similarly to the dial decoder, since one was an outgrowth of the other.

Due to their general lack of use until recently in amateur

Table 4.

AZ Degrees	Units 5th	AZ	Tens 5th	Units 5th	EL	Tens 5th	EL Degrees
001	I		LF				
002	U		LF				
003	S		LF				
004	SP		LF				
005	N		LF				
006	F		LF				
007	K		LF				
008	C		LF				
009	R		LF				
010	LF		I				
011	I		I				
012	U		I				
013	S		I				
014	SP		I				
015	N		I				
016	F		I				
017	K		I				
018	C		I				
019	R		I				
020	LF		U				
021-029	RPT I TO R SEQ.		U				
030	LF		S				
031-039	RPT I TO R SEQ.		S				
040	LF		SPACE				
041-049	RPT I TO R SEQ.		SPACE				
050	LF		N				
051-059	RPT I TO R SEQ.		N				
060	LF		F				060
061-069	RPT I TO R SEQ.		F				061-069
070	LF		K				070
071-079	RPT I TO R SEQ.		K				071-079
080	LF		C				080
081-089	RPT I TO R SEQ.		C				081-089
090	LF		R	LF		R	090
091	I		R	5thG	5th	V	MINUS 89
092	U		R	V		V	MINUS 88
093	S		R	LTR		V	MINUS 87
094	SP		R	X		V	MINUS 86
095	N		R	M		V	MINUS 85
096	F		R	H		V	MINUS 84
097	K		R	Y		V	MINUS 83
098	C		R	Q		V	MINUS 82
099	R		R	P		V	MINUS 81
		5th HOLE		5th			
100	L		LF	L		V	-80
101	P		LF	G		LTR	-79
102	Q		LF	V		LTR	-78
103	Y		LF	LTR		LFT	-77
104	H		LF	X		LTR	-76
105	M		LF	M		LTR	-75
106	X		LF	H		LTR	-74
107	LTRS		LF	Y		LTR	-73
108	V		LF	Q		LTR	-72
109	G		LF	P		LTR	-71
110	L		I	L		LTR	070
111-119	RPT P TO G SEQ.		I	RPT G TO P SEQ.		X	069-061
120	L		U	L		X	060
121-129	RPT P TO G SEQ.		U	RPT G TO P SEQ.		M	059-051
130	L		S	L		M	050
131-139	RPT P TO G SEQ.		S	RPT G TO P SEQ.		H	049-041
140	L		SP	L		H	040
141-149	RPT P TO G SEQ.		SP	RPT G TO P SEQ.		Y	039-031
150	L		N	L		Y	030
151-159	RPT P TO G SEQ.		N	RPT G TO P SEQ.		Q	029-021
160	L		F	L		Q	020
161-169	RPT P TO G SEQ.		F	RPT G TO P SEQ.		P	019-011
170	L		K	L		P	010
171-179	RPT P TO G SEQ.		K	G		L	009
180	L		C	V		L	008
181-189	RPT P TO G SEQ.		C	LTR		L	007
190	L		R	X		L	006
191	P		R	M		L	005



192	Q	R
193	Y	R
194	H	R
195	M	R
196	X	R
197	LTRS	R
198	V	R
199	G	R
200	LF	L
201	I	L
202	U	L
203	S	L
204	SP	L
205	N	L
206	F	L
207	K	L
208	C	L
209	R	L
210	LF	P
211-219	RPT I TO R SEQ.	P
220	LF	Q
221-229	RPT I TO R SEQ.	Q
230	LF	Y
231-239	RPT I TO R SEQ.	Y
240	LF	H
241-249	RPT I TO R SEQ.	H
250	LF	M
251-259	RPT I TO R SEQ.	M
260	LF	X
261-269	RPT I TO R SEQ.	X
270	LF	LTR
271-279	RPT I TO R SEQ.	LTR
280	LF	V
281-289	RPT I TO R SEQ.	V
290	LF	G
291	I	G
292	U	G
293	S	G
294	SP	G
295	N	G
296	F	G
297	K	G
298	C	G
299	R	G

	5th	5th
300	L	L
301	P	L
302	Q	L
303	Y	L
304	H	L
305	M	L
306	X	L
307	LTR	L
308	V	L
309	G	L
310	L	P
311-319	RPT P TO G SEQ.	P
320	L	Q
321-329	RPT P TO G SEQ.	Q
330	L	Y
331-339	RPT P TO G SEQ.	Y
340	L	H
341-349	RPT P TO G SEQ.	H
350	L	M
351	P	M
352	Q	M
353	Y	M
354	H	M
355	M	M
356	X	M
357	LTR	M
358	V	M
359	G	M
360	L	X

END OF AZ TAPES

5th = no 5th hole.

H	L	004
Y	L	003
Q	L	002
P	L	001

END OF EL TAPES

gear, the 7485 may seem a bit strange to you. The cascade inputs on these devices work great, but be careful to hook up as shown with the LSB digit getting the hardwired inputs, and the outputs coming from the MSB digit (azimuth 100s, elevation 10s). Reverse it and you are in for some real surprises. When you are working the underside of a board, it is easy to transpose LSB and MSB digit. Please don't ask me how I know this so well — nobody's perfect!

The elevation works just the same way as azimuth with one less number to worry about. We use linear tapes punched the same as for azimuth; it's just easy to get them in the doghouse that way rather than around a drum. Same data table ap-

plies. The same decoding, comparing, data in, all works the same.

For those of you who have counter (digital counting, readout type) dials on your receivers now or are planning it, consider our much modified BC 348s for a minute. If we use a dc drive (sawtooth waveform) to control the varactor group to "scan" the receiver, something very similar to this article has proven very useful and will be an upcoming article when we get back to the Space Age Junque series. Meanwhile, I'll let you brave ones ponder it on your own.

One: thumbwheel switches for a BCD frequency input. Push the auto scan button and an FF starts the scan. The final 7485 comparator A = B output stops the scan at the desired dialed-in frequency.

Our system does not really use sawtooth scan, though it looks like it does. When the auto scan button is pushed

★★ *The Friendliest* ★★ *The Friendliest* ★★

**The 4th ANNUAL**

# **BOLD CITY HAMFEST**

**MUNICIPAL AUDITORIUM**  
*"...where US 90 meets the Sea!"*  
**JACKSONVILLE BEACH, FLORIDA**

## **August 6 & 7**

<b>Giant Swapfest !</b>	<b>Group &amp; Net Meetings !</b>
<b>Exhibits !</b>	<b>Technical &amp; DX Forums !</b>
<b>New Products !</b>	<b>Ladies Programs !</b>
<b>Rabbit Hunt !</b>	<b>1/2 Block from Ocean !</b>
<b>FCC Exams !</b>	<b>Prize Drawings !</b>

**Sponsored By The**  
**Jacksonville RANGE Association**

**For Ramada Inn (Hamfest HQ) reservations, please  
write 1201 N. 1st St., Jkvl Bch 32250 (800-228-2828)**



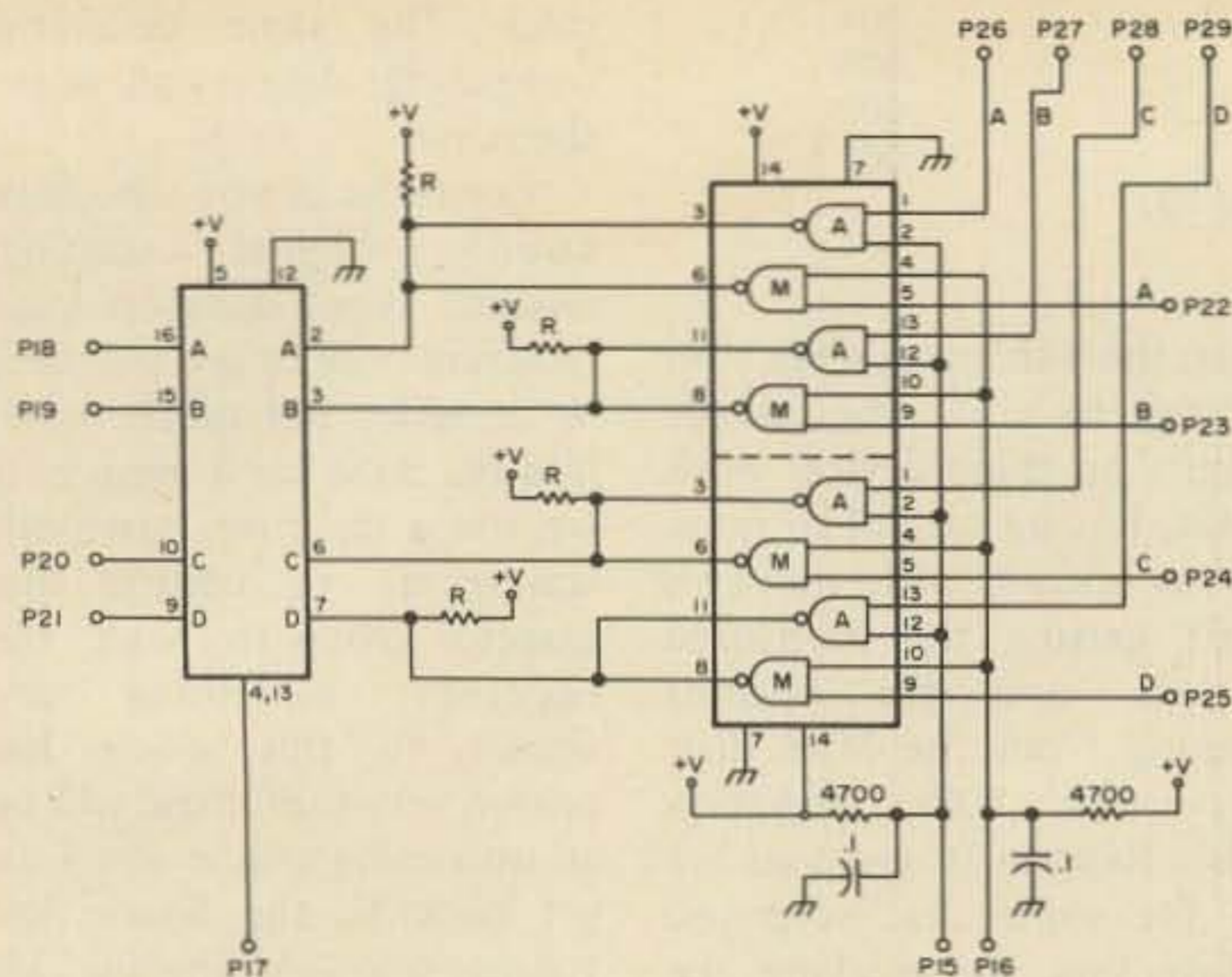

Fig. 6. Data input boards, 5 required.  $R = 1k$ .

(or is called up remotely from Indy), the FF for this starts the scan by turning on the "charge" switch (transistor) of a dc memory module similar to the RCA remote control memory modules of a couple of years ago. The memory output is 1 to 10 V dc and controls the frequency varactors. There is a counter on the BC 348 for a dial readout (348 rack mount,

readout, control, master oscillator, etc., console mounted), and the counter begins to follow the frequency upward. Upper limit is a set of jumpers to hardwire upper and lower limit gates. A stop command, AFC zero crossing plus AGC (station heard), or output from counter = limit switches comparison in 7485s, will stop the up scan. In the first two cases it is stop

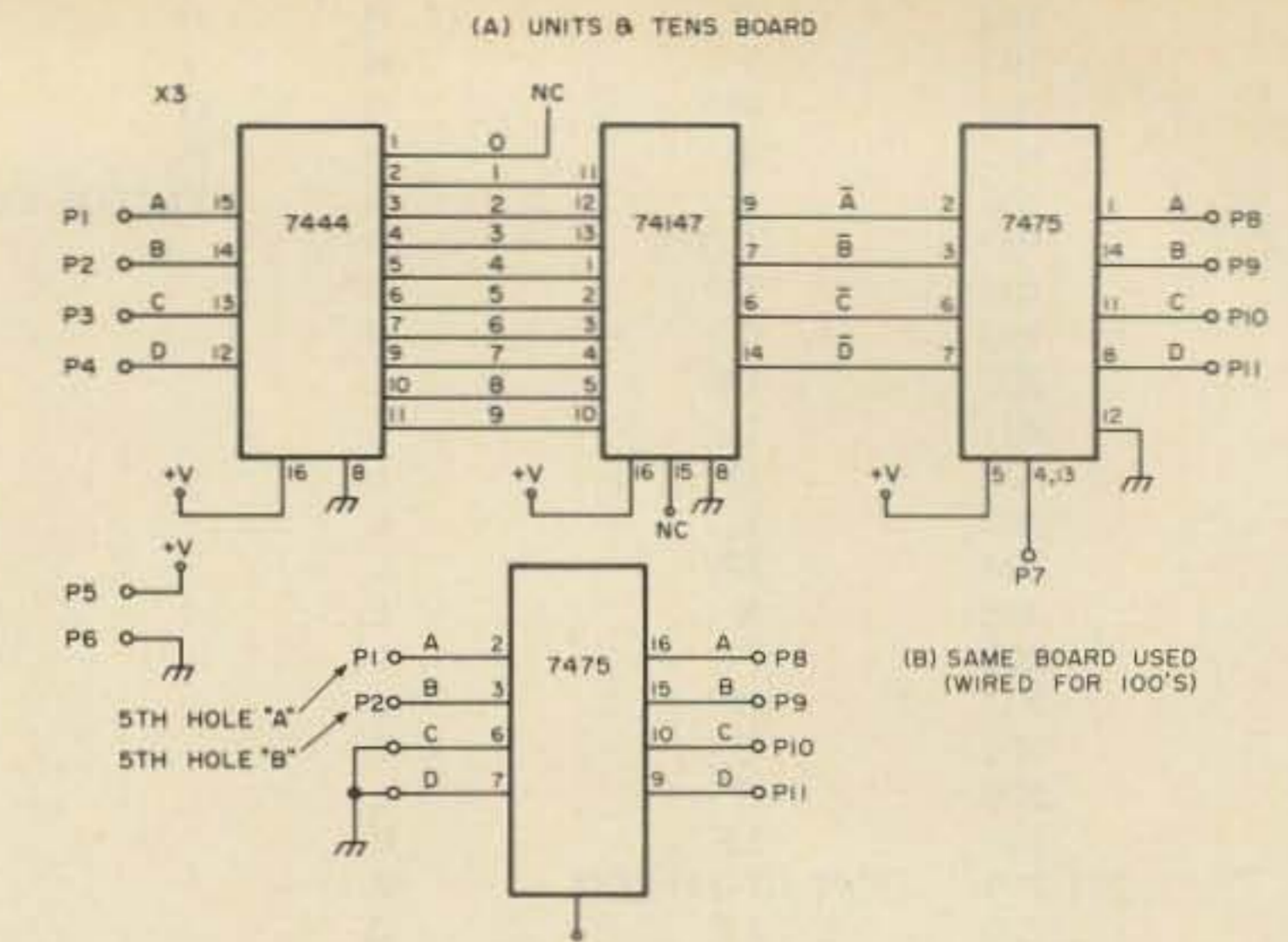

Fig. 7. Beam input boards. 4 wired (a) Az - 10s, 1s; E1 - 10s, 1s. 1 wired (b) Az - 100s.

and hold, and in the latter it tells the scan FF to reverse. The "discharge" switch in the dc memory module takes over and causes a downward scan with the same features. Keying of the transmitter will generate a stop command and hold followed by a one-shot delay in resuming after carrier drop (sense COR on incoming remote link receiver).

One more? OK, last one for now. Consider we have a receiver with a counter dial. Doesn't take much to have a receiver with digital AFC, does it? You can ponder that one awhile - it takes one more IC!

SASE if you have problems. This should reduce the Bufferin sales to OSCAR users. ■

Stuart W. Hawkinson  
6106 Lillywood Lane  
Knoxville TN 37921

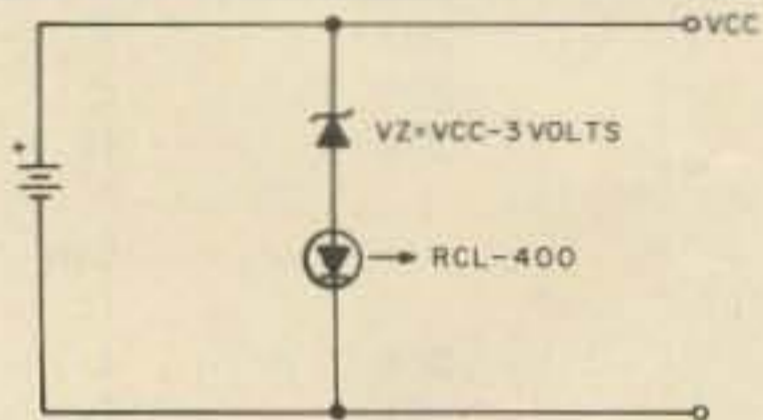

Fig. 1.

switched off by the internal IC voltage sensing circuit to give a low voltage indication. Since the device has a relatively constant current demand in the on region (~ 10 mA), the zener power rating need only be 1/4 W for most battery-powered equipment. One precaution is necessary: You must be sure that the voltage across the LED does not exceed 5 V (its maximum rating).

For low voltage IC circuits using a nominal 4.5 V battery pack, the required value of  $V_z$  is only 1.5 V. It is easy to obtain this value by simply substituting a pair of silicon diodes in series with the LED. ■

# A Battery Voltage Monitor

-- how simple can an IC project get?

A device introduced by Litronix, Inc., has wide application as a voltage monitor in all types of battery-operated equipment. The RCL-400 Battery Status Indicator is a current-controlled LED which has a voltage

sensing integrated circuit incorporated into a small LED package.

The only additional circuit component necessary to build a voltage monitor is a suitable zener diode, or string of forward biased diodes, to bring

the device into its normal operating range. The RCL-400 is designed to turn on at 3 V and off at 2 V; thus normal operation can be provided by selecting  $V_z = V_{cc} - 3$  V (See Fig. 1). When  $V_{cc}$  drops to  $V_z + 2$  V, the LED is



# Genave amateur radio tomorrow... today!



**GTX-200T**  
(incl. 146.94 MHz)  
**\$249<sup>95</sup>**

*Engineered and designed for the quality conscious 2-meter enthusiast*

Genave's GTX-200T offers the FM operator up to 100 channel combinations incorporating 10.7 MHz first IF and 455 MHz second IF for outstanding sensitivity, minimizing effects of adjacent channel interference.

### ADDITIONAL FEATURES INCLUDE:

- 30 watts output power, nom. 25 watts min. @ 14 VDC input
- Separate controls for independent transmit and receive frequency selection
- Switch for lock-in of pre-selected frequency pairs allows one-knob operation
- Supersensitive dual-gate MOSFET in receiver head end.
- Blacklighted for night operation
- Factory-installed, front panel mount 12 digit tone encoder.



**GTX-2**  
2-meter FM, 10 channels, 30 watts with pushbutton frequency selector (incl. 146.94 MHz) **\$189<sup>95</sup>**



**GTX-200**  
2-meter FM, 100 channel combinations, 30 watts (incl. 146.94 MHz) **\$199<sup>95</sup>**



**GTX-10-S**  
2-meter FM, 10 channels, 10 watts (Xtals not included) **\$149<sup>95</sup>**

**GTX-IT**  
**\$299<sup>95</sup>**

*Hand-Held 2-meter FM, 6-channel, 3.5 watts hand-held with factory-installed tone encoder*

**GTX-I**  
**\$249<sup>95</sup>**

*Hand-Held 2-meter FM, 6-channel, 3.5 watts hand-held*



### CHECK THESE FEATURES:

- All metal case
- American made
- Accepts standard plug-in crystals
- Features 10.7 MHz crystal filter
- Trimmer caps on TX and RX crystals
- 3.5 watts output
- Battery holder accepts AA regular, alkaline or nicad cells
- Mini hand-held measures 8" high x 2.625" wide x 1.281" deep
- Rubber ducky antenna.
- Wrist safety-carrying-strap included
- 6 channels
- Factory-direct to you!

### Accessories Available

- Nicad battery pack
- Charger for GTX-1 battery pack
- Leather carrying case
- TEIII tone encoder for auto patch

### STONE ENCODER PAD

Plug-in installation on most amateur transceivers.

TE-II **\$29<sup>95</sup>** TE-I **\$59<sup>95</sup>**



**HURRY! USE THIS HANDY ORDER FORM OR CALL COLLECT TODAY!**  
**(317) 546-7959**



4141 Kingman Dr., Indianapolis, IN 46226  
Phone-in orders accepted (317+546-1111)

NAME \_\_\_\_\_  
ADDRESS \_\_\_\_\_ CITY \_\_\_\_\_  
STATE & ZIP \_\_\_\_\_ AMATEUR CALL \_\_\_\_\_

Payment by:  
 Certified Check/Money Order  Personal Check  
 C.O.D. Include 20% Down

Note: Orders accompanied by personal checks will require about two weeks to process.  
20% Down Payment Enclosed. Charge Balance To:

BankAmericard # \_\_\_\_\_ Expires \_\_\_\_\_  
 Master Charge # \_\_\_\_\_ Expires \_\_\_\_\_  
 Interbank # \_\_\_\_\_ Expires \_\_\_\_\_

IN residents add 4% sales tax: \$ \_\_\_\_\_

All orders shipped post-paid within continental U.S.

- GTX-200-T **\$249<sup>95</sup>**
- GTX-200 **\$199<sup>95</sup>**
- GTX-10-S **\$149<sup>95</sup>**
- GTX-2 **\$189<sup>95</sup>**
- GTX-1 **\$249<sup>95</sup>**
- GTX-IT **\$299<sup>95</sup>**

- Ringo Ranger ARX-2 6db 2-M Base Antenna **\$29<sup>95</sup>**
  - Lambda/4 2-M and 6-M Trunk Antenna **\$29<sup>95</sup>**
  - TE-I Tone Encoder Pad **\$59<sup>95</sup>**
  - TE-II Tone Encoder Pad **\$49<sup>95</sup>**
  - PS-I AC Power Supply for use with all makes of transceivers 14 VDC—6 amp **\$69<sup>95</sup>**
- and the following standard crystals @ \$4.50 each \_\_\_\_\_  
Non-standard crystals @ \$6.50 each: \_\_\_\_\_

Add \$4 per Radio for Shipping, Handling, and Crystal Netting.

### ACCESSORIES FOR GTX-1 and GTX-IT

- PSI-18 Optional Nicad battery pack **\$29<sup>95</sup>**
- PS-2 Charger for GTX-1(T) battery pack **\$39<sup>95</sup>**
- GLC-1 Leather carrying case **\$12<sup>95</sup>**
- TE-III Tone Encoder (for use with GTX-1) **\$49<sup>95</sup>**

73-7



# The Morse Clock

## -- timely repeater ID

Robert J. Souza WAIMXV  
46 Fielding St.  
New Bedford MA 02745

A clock which sends the time of day in Morse code can be a useful addition to any modern repeater. Aside from providing mobiles with the correct time of day, the clock may be used to write the time of day on cassette tape for logging pur-

poses when an autopatch or other event occurs. This article describes such a clock constructed for the WR1ADR 60/00 repeater in South Dartmouth, Massachusetts.

The Morse code clock has the following features:

1. Low chip count (17 ICs compared to 30 in previous designs).
2. Easy timesetting (hours fast, minutes fast and hold).
3. Variable code speed.

4. Six digit LED time display (impressive).
5. Protected against power failure (won't lose time).
6. Time may be sent to either 12- or 24-hour format.

### Circuit Description

The heart of the Morse code clock is a National MM5318 PMOS clock chip (Fig. 2). This chip was designed to be used in a system which displays the time of

day on a television screen. Unlike most other clock chips which have only multiplexed seven segment outputs, the 5318 has both seven segment and BCD outputs available. Furthermore, each digit (hours, tens-of-hours, etc.) may be selected for output by applying the proper code to the Dx, Dy and Dz digit select lines. This is ideal for application in the Morse code clock, since we want to be able to look at the digits one at a time in order to translate them into Morse and send them. The clock requires either a 50 or 60 Hz input signal. This may be obtained from either the power line or a crystal time base. (More on this later.) The clock chip will operate in either a twelve or twenty-four hour format and has leading zero blanking in the twelve hour mode.

### The Design Technique

I decided that a straight-

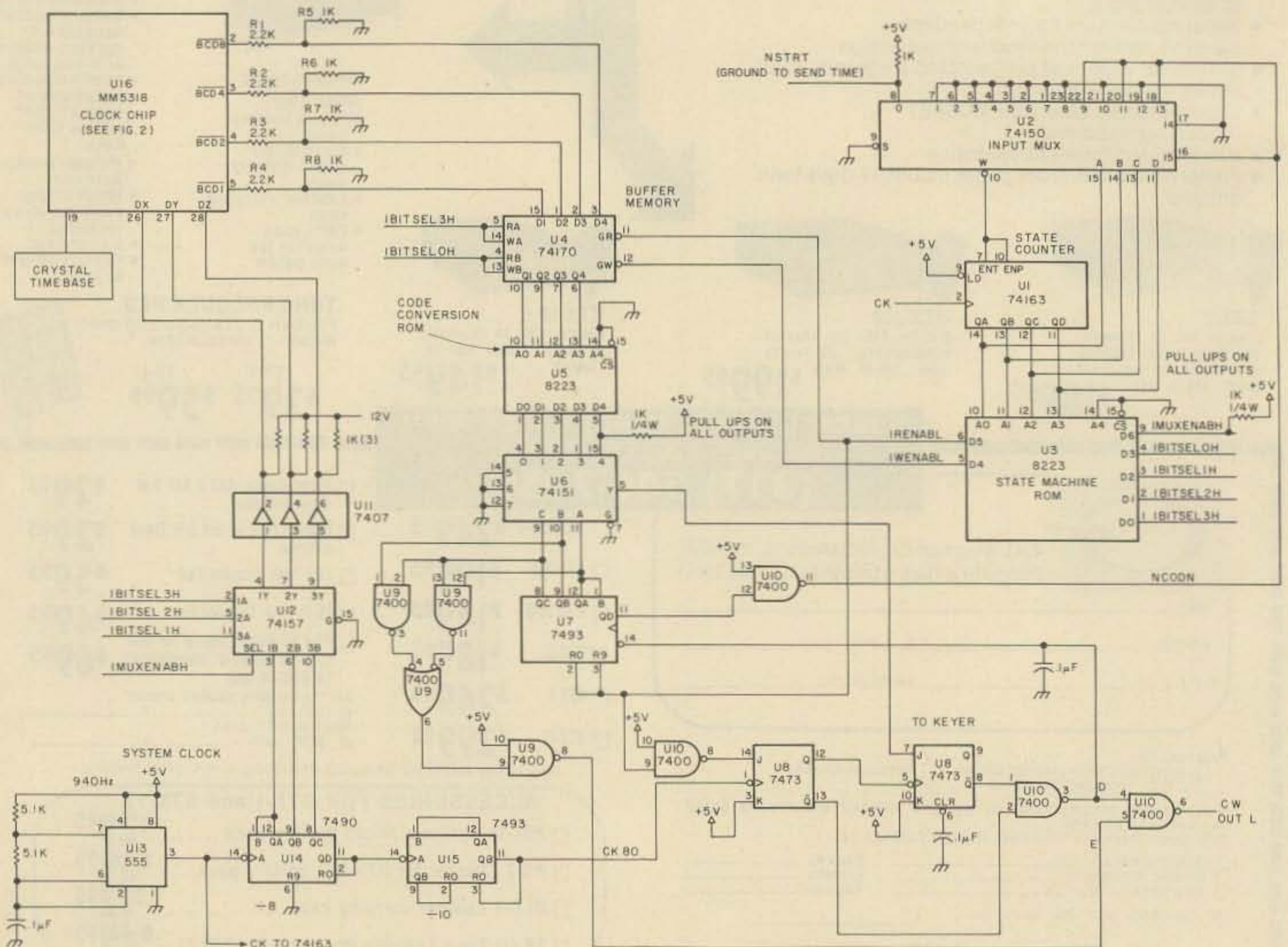

Fig. 1. Morse code clock.



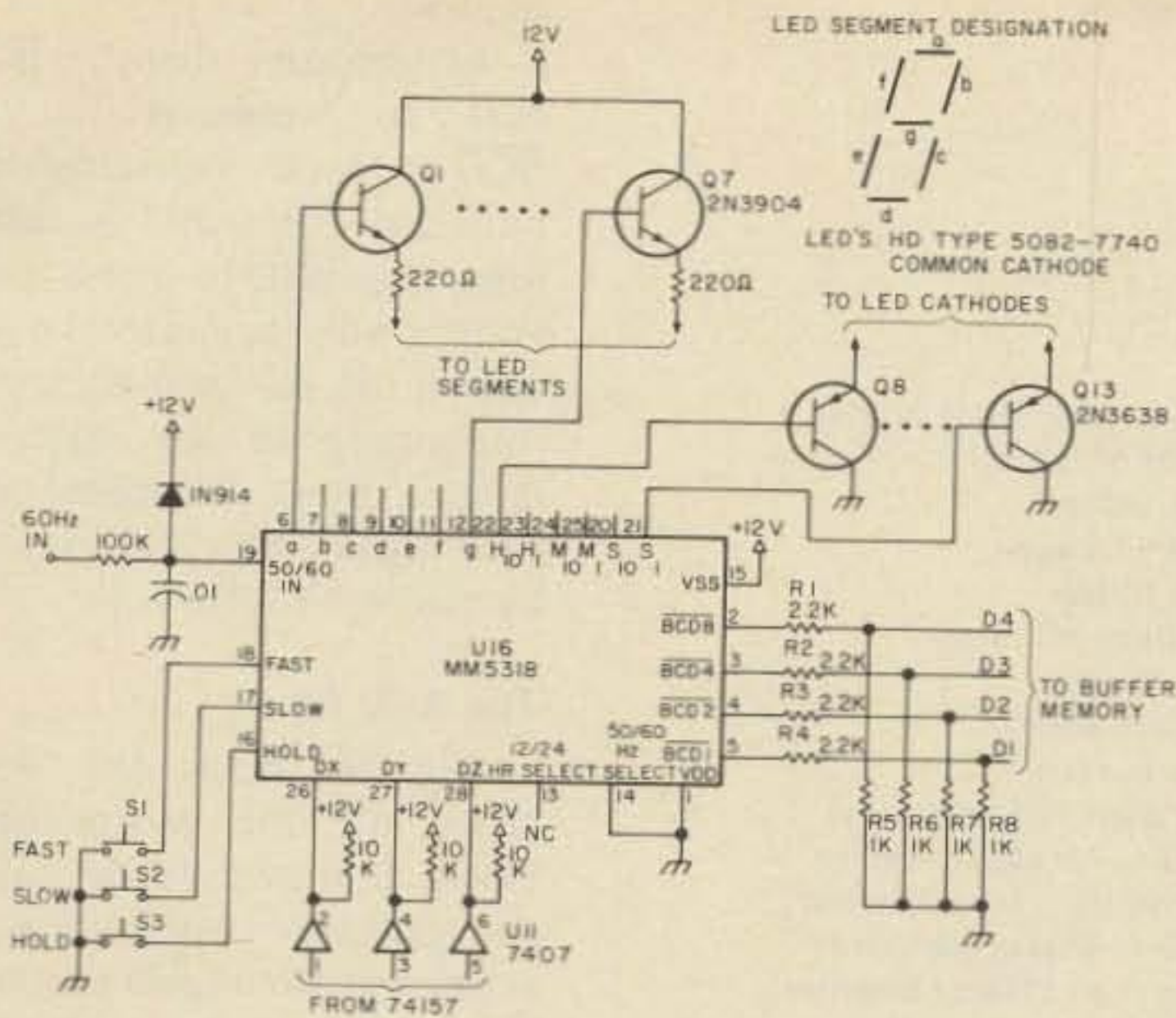

Fig. 2. Clock chip and display circuitry.

forward way to design the clock was to use the *algorithmic state machine* or ASM design technique. This is a very popular and powerful technique that is often used for the design of computer central processing units (CPUs).

The first step in the ASM technique is to decide exactly what you want the device to do. I did this in the *operational flow chart* of Fig. 3. Initially the clock sits with its seven segment display multiplexed and waits for a START signal. When it receives this signal, it rapidly stores the time of day in a buffer memory. It then reads the digits out of the buffer one at a time and sends them in Morse code. After the last digit has been sent, the display is again multiplexed and the clock waits for another START signal. The time of day must be rapidly read into the buffer because it is possible for the time of day to change while it is being sent. This could cause an error. Consider the case where the time changes from 2359 to 0000 after the first digit (the "2") had been sent! Rapidly loading the time into the buffer minimizes the chance of an error occurring.

Fig. 4 shows the *system block diagram* for the Morse code clock. A ROM centered

state machine controller is driven by the system clock and controls three peripheral circuits. These are the clock chip and display, the buffer memory, and the BCD-to-Morse converter.

#### System Clock (U13, U14, U15)

The system clock is an LM555 timer IC wired as an astable multivibrator with a free running frequency of about 940 Hz. It is divided by a 7490 and 7493 counter (U14 and U15) to about 12 Hz for use in the BCD-to-Morse converter. The output lines of the 7490 (U14), which are varying at a 940 Hz rate, are used to multiplex the seven segment display when the clock is not sending the time.

#### The State Machine

The state machine controller is made up of U1, U2 and U3. These three chips control the operation of the rest of the circuit. U1, a 74163 4-bit synchronous counter, is the state counter. Its binary outputs determine the present state. There are sixteen possible states for this machine.

The state counter is driven by the system clock, but the only way to have it advance to the next (sequential) state is to have a logic "1" present on the 74163 enable inputs (ENT and ENP). The enable inputs are connected to the

output of U2, a 74150 16-to-1 data selector. U2 is the input multiplexer. It acts like a single pole, 16-throw logic switch. The input select lines of U2 are connected to the state counter output lines, so that we look at a given input in each state. The way to advance to the next (sequential) state, then, is to have the selected input condition be true. (Note that the output of the 74150 is inverted, so for the output of the MUX to be true, or logic "1", the input must be false, or logic "0".)

U3, an 8223 32 x 8 ROM, is called the *state machine ROM*. Its address lines are connected to the state counter's output lines. In any state, the ROM may be programmed to generate any combination of eight possible outputs. (Only seven of the outputs were needed for the Morse code clock.) The ROM is simply a replacement for the combinational logic (NAND and NOR gates, etc.) which would be required to generate the outputs. The contents of the state machine ROM are shown in Fig. 5.

In a given state (as determined by the state counter output lines) certain outputs are issued from the state machine ROM and a given input condition is tested by the input MUX. If the condition is false, the machine remains in the present state and continues to issue the outputs required in that state. If the condition is true, the machine advances to the next sequen-

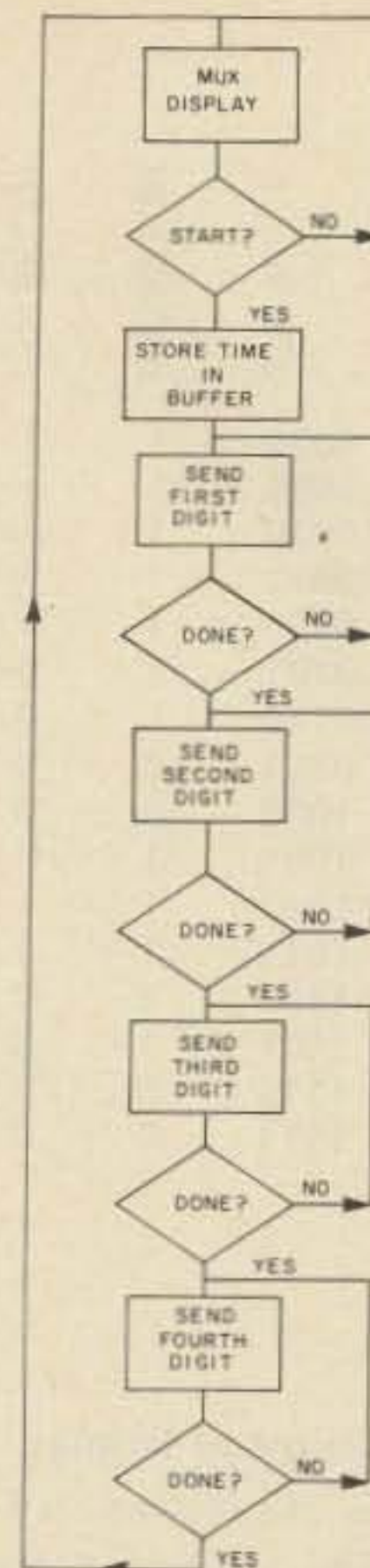

Fig. 3. Operational flowchart.

tial state on the next positive transition of the system clock. This is often represented graphically as in Fig. 6, which illustrates the case in which the machine waits in state A, corresponding to state counter output 0010, and issues output LITEON (which is active-high as indicated by the H prefix) until input PUSH goes to 0.

A little thought will reveal that this is a very powerful design technique. Since the outputs are programmed into ROM, they may be changed by merely reprogramming, without making any circuit

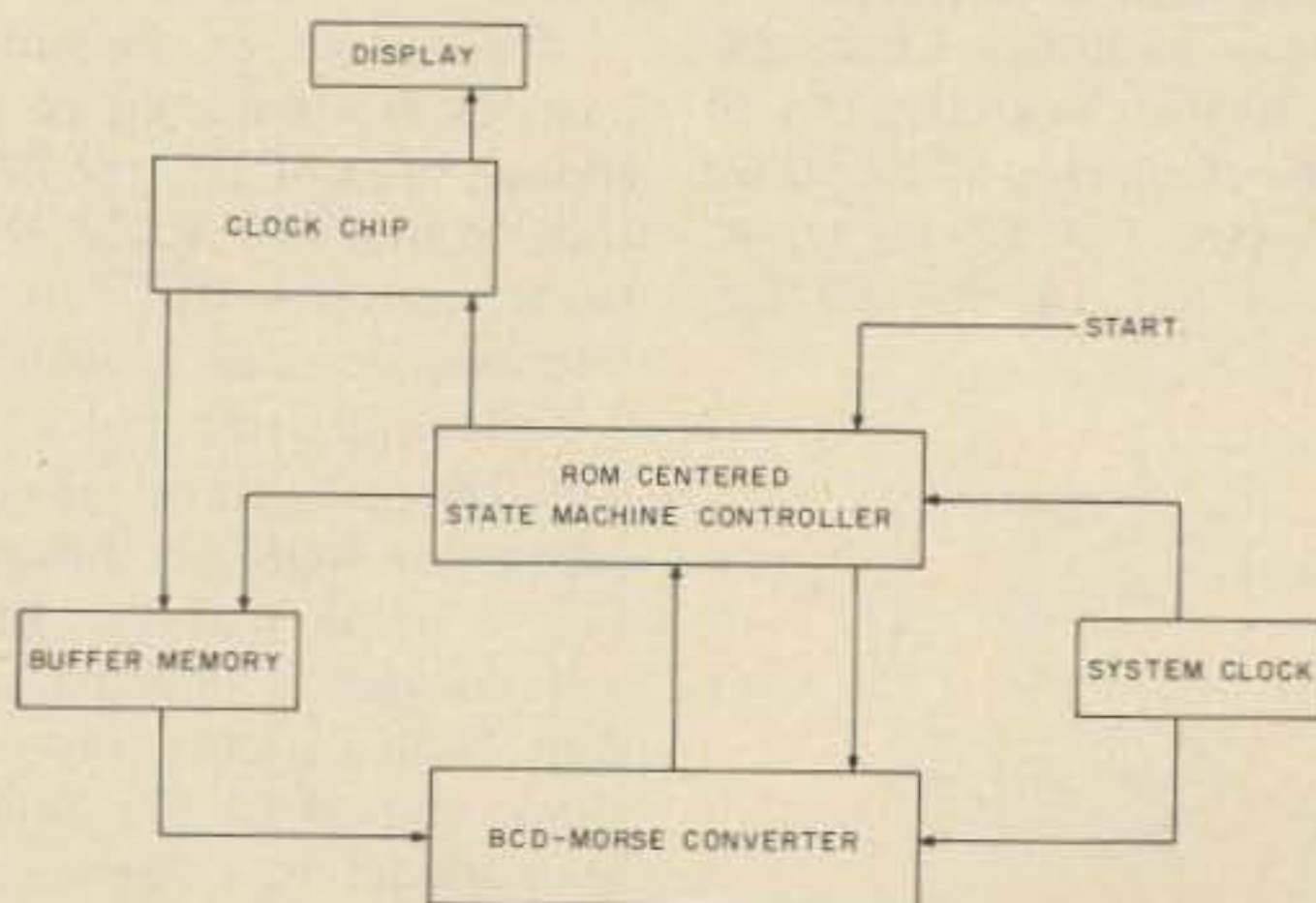

Fig. 4. System block diagram.



## ROM Output Lines

STATE	IBITSEL3H	IBITSEL2H	IBITSEL1H	IBITSEL0H	IWENABL	IRENABL	IMUXENABH	COMMENTS
0000	1	1	1	0	1	1	1	wait for NSTRT, MUX display
0001	1	1	1	0	1	1	0	address 10s of hours
0010	1	1	1	0	0	1	0	write into buffer
0011	1	1	0	1	1	1	0	address 1s of hours
0100	1	1	0	1	0	1	0	write into buffer
0101	1	0	1	1	1	1	0	address 10s of minutes
0110	1	0	1	1	0	1	0	write into buffer
0111	0	0	1	0	1	1	0	address 1s of hours
1000	0	0	1	0	0	1	0	write into buffer
1001	1	1	1	0	1	0	0	send first digit (10s of hours)
1010	1	1	0	1	1	1	0	clear BCD-to-Morse converter
1011	1	1	0	1	1	0	0	send second digit (1s of hours)
1100	1	0	1	1	1	1	0	clear BCD-to-Morse converter
1101	1	0	1	1	1	0	0	send third digit (10s of minutes)
1110	0	0	1	0	1	1	0	clear BCD-to-Morse converter
1111	0	0	1	0	1	0	0	send fourth digit (minutes)

Fig. 5. Control ROM program.

changes.

### Clock Chip and Display

The features of the MM5318 clock chip have already been described. U11, a 7407 high voltage open collector buffer, acts as an interface between the TTL and MOS logic levels for the clock chip Dx, Dy and Dz lines. U12, a 74157 quad 2-to-1 MUX, acts as a 4PDT logic switch and causes the binary code applied to the MM5318 digit select lines to come from either U14 (which causes the display to multiplex) or from the state machine ROM. The 74157 is also controlled by the state machine ROM. R1-R8 are voltage dividers and convert the MOS levels out of the clock chip to TTL levels. Transistors Q1-Q13 and associated resistors are used to interface the common-cathode LED display to the clock chip. Pin 19 of the clock chip is the 50/60 Hz input. For 60 Hz input, ground pin 14, for 50 Hz,

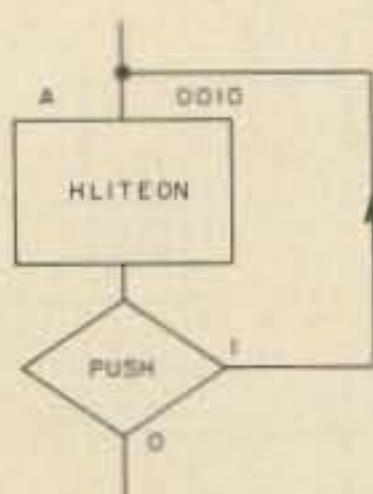

Fig. 6.

leave it open. If you choose to use a crystal timebase instead of stealing the 60 Hz from the power line, the 1N914 and RC network at pin 19 may be eliminated. The timebase I used was purchased from S. D. Sales and assembled according to their instructions. It was cheaper to buy the timebase from S. D. Sales than to build my own. S1-S3 are push-button switches which are used to set the time.

### The Buffer Memory

U4, a 74170 4 x 4 register file, is used as the buffer memory for the time. The time of day output from the clock chip (in BCD) is written into and read from the buffer memory under direct control of the state machine ROM.

### BCD-to-Morse Converter

The output of the buffer memory is connected to the address lines of U5, the 8223 code conversion ROM. This ROM converts BCD to an intermediate code in which a 0 represents a dit and a 1 a dah. The contents of the code conversion ROM are shown in Fig. 7. Note that the ROM will convert a blanked first digit (which occurs when the clock chip is in the twelve-hour mode) to a Morse code 0. Say, for example, that a "7" (1000 - remember, the

BCD is inverted) is input to the ROM. 00011 will appear on the ROM output lines. With reference to the schematic and the timing diagram (Fig. 8), when the state machine brings RENABL low, U7, a 7493 counter, is enabled, and the 74151 MUX (U6) passes the least-significant bit of the ROM output (a "1" in this case). U8, a dual J-K flip-flop, and NAND gate U10 make up a variation of the well-known TO keyer. The "1" on the MUX output causes the TO keyer to send a dah. U7 clocks on the falling edge of the dah causing the MUX to select the next most significant bit of the ROM output. After the five bit ROM output has been scanned and sent, the MUX selects input lines 5, 6 and 7, which are hardwired to logic "0". This will cause three additional dits to be sent. U9, a 7400, blanks these dits and they form the space between numerals. After five code elements and a space have been sent, output NCODN goes low, signalling to the state machine that a complete Morse code numeral, including space, has been sent. The state machine may then bring RENABL high to reset the converter, present new BCD data (by changing the buffer memory address), and bring RENABL low to repeat the

sequence.

In summary then, if BCD data is presented to the BCD-to-Morse converter input and RENABL is taken low, the BCD-to-Morse converter will generate the sequence of dits and dahs corresponding to the inputted data, a three dit space, and then signal that it is finished by taking NCODN low.

### The ASM Chart

Fig. 9 shows the ASM chart for the Morse code clock. It shows all the states, the outputs issued in each state, and the inputs required to advance to the next state. If no input condition is shown in a given state, it is assumed that the machine advances to the next sequential state on the next positive transition of the system clock. A table of the state machine inputs and outputs is shown in Fig. 10.

### Power Supply

The power supply for the Morse code clock is shown in Fig. 11. A 12.6 volt 1.2 Ampere transformer (from Radio Shack) is used in a full wave bridge to provide 12 volts for the display and the clock chip. An LM309K regulator (mounted on a heat sink) provides a regulated 5 volts for the TTL logic. Diodes D1 and D2 are used to automatically switch in a nicad pack if the power fails. Note that the nicads will reverse-bias D1, turning off the display when the power fails to conserve current. R1 is used to trickle charge the nicads and should be selected to provide the required charging current.

### Construction Notes

The clock was built on a wire-wrap prototyping board. I like this method of construction because it allows me to test the circuit as I build and also allows for easy modification (and correction of mistakes!). The wire-wrap board was mounted in a 9" x 11" x 2" chassis along with the power supply and time



Digit	ROM Address	ROM Contents
0	1111	11111
1	1110	10000
2	1101	11100
3	1100	11000
4	1011	10000
5	1010	00000
6	1001	00001
7	1000	00011
8	0111	00111
9	0110	01111
blank	0000	11111

Fig. 7. Code conversion ROM contents.

setting buttons. The six digit LED display was mounted on the front panel of the repeater in an IEE six readout mounting bezel which was purchased from Tri-Tek. This bezel makes a very professional looking and reasonably inexpensive display. The LED display is connected to the clock with a 14 wire ribbon cable.

The clock tends to run quite warm (especially the ROMs and the Buffer Memory) so I punched six 1" holes around the perimeter of the chassis. The holes were covered with perforated aluminum to complete the shielding of the clock.

The clock chip and the chip in the crystal timebase are MOS devices and as such are susceptible to damage from static discharge. Handle

them with care. Do not remove them from their protective packaging until ready to install them. Do not insert or remove them from the circuit with the power on. If you choose to solder these chips in, ground the tip of your soldering iron.

The programming procedure for the Signetics 8223 ROMs has been described many times before and will not be repeated here. The references at the end of the article should be consulted for the proper procedure.

Vcc was bypassed to ground with 0.01 uFd 50 volt ceramic capacitors at the rate of one capacitor for every three ICs. Do not omit the 0.1 uFd capacitor from pin 6 of U8 to ground. It performs a power-on reset for the flip-flop. The capacitor in the

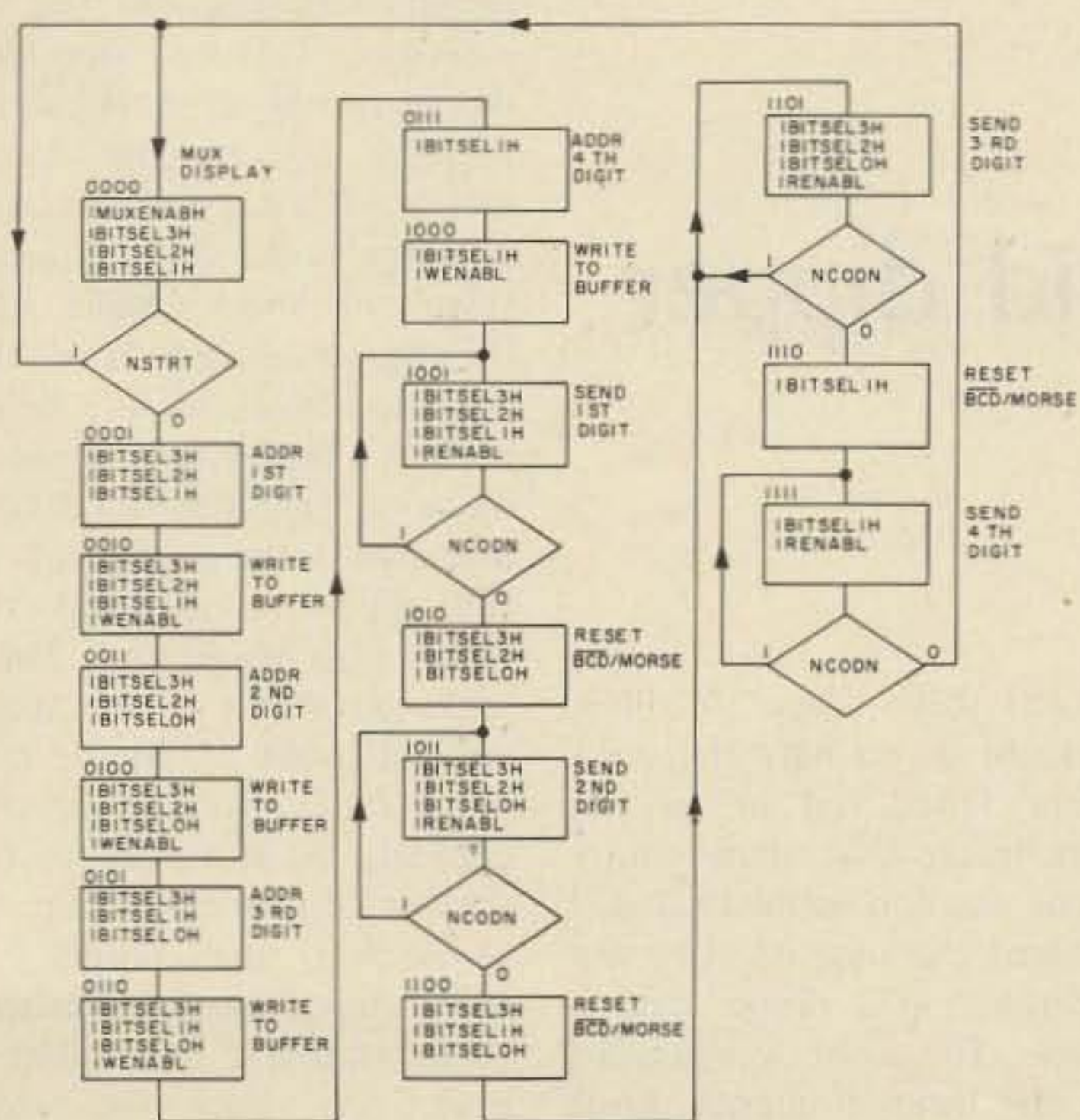

Fig. 9. Morse clock ASM chart.

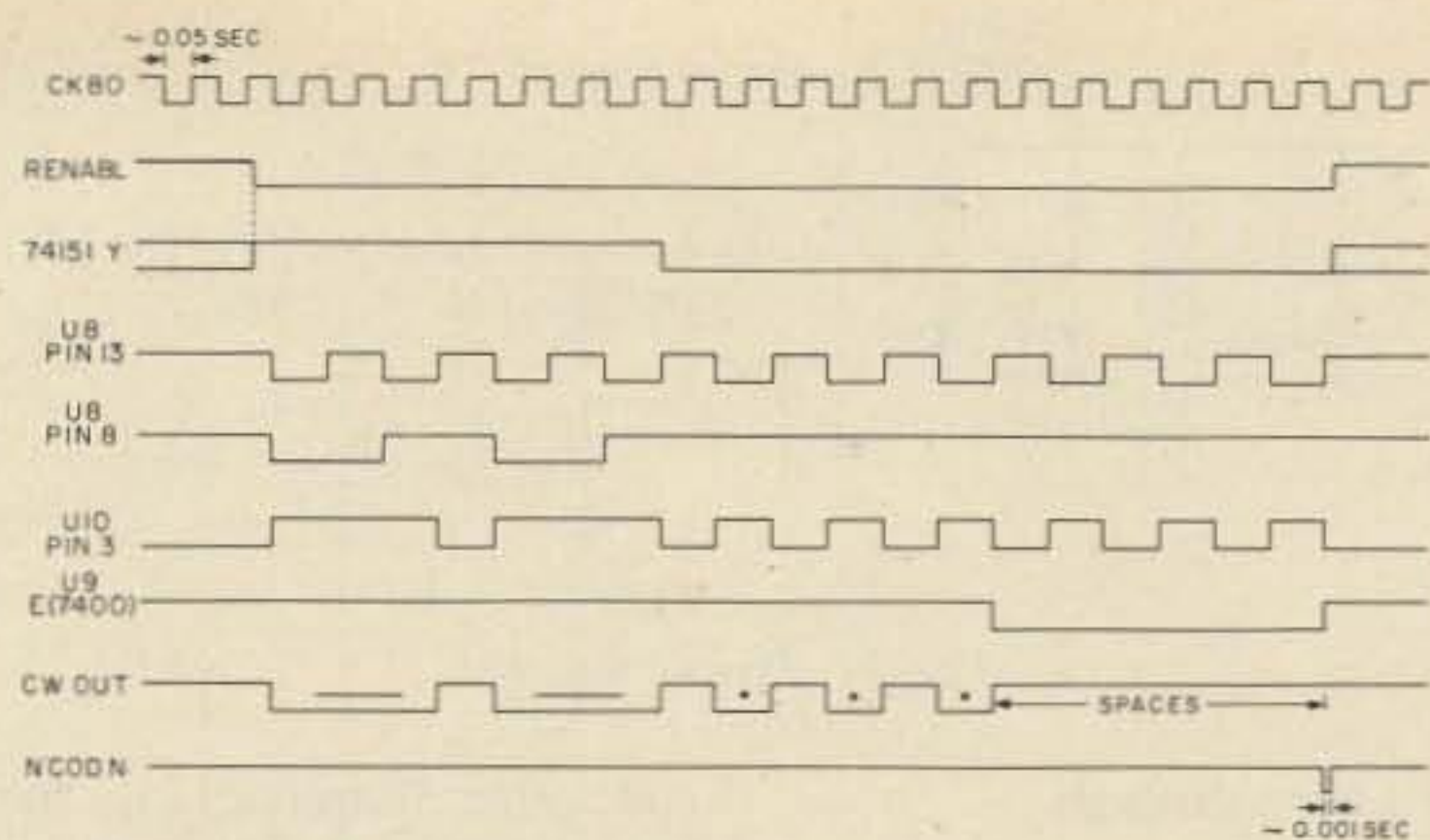

Fig. 8. BCD-Morse converter timing diagram.

system clock circuit determines the system clock frequency and ultimately the CW speed. If a cheap ceramic capacitor is used here the CW speed will change as the clock heats up. I used a sealed mylar unit.

### Interfacing the Clock and Repeater

All interconnections between the clock and the repeater control logic are active-low. This allows the clock to be removed from the repeater without affecting the repeater logic.

Grounding input NSTRT will start the time sending cycle. NSTRT should return to 5 volts before the clock is finished sending the time or else it will repeat. In our repeater NSTRT comes from the touchtone™ decoder output. The clock is activated by a single touchtone digit.

Output IMUXENABH goes low during the time

sending cycle and may be used to hold the repeater transmitter on.

CWOUTL is the active-low CW output from the clock. It may be used to drive an audio oscillator as shown in Fig. 12 if none is available in the repeater.

Push-button switches S1 and S2 cause the clock to advance one hour per second and one minute per second respectively. S3 will stop the clock for synchronization to the exact second with WWV or CHU.

When the clock is first powered up it may begin sending the time. It will cycle once and then stop. Also, all the digits in the display may not be illuminated. Merely advance the clock with S1 and S2 until all the digits light up. It is a good idea to cycle the clock through all 24 hours when first powering it up, since it is possible for it to count up to 30 hours the

### OUTPUTS

IBITSEL3H  
IBITSEL2H  
IBITSEL1H  
IBITSEL0H

select clock digit and buffer memory address

IWENABL

when low, writes time into buffer

IRENABL

when low, reads time from buffer and sends it in Morse

IMUXENABH

when high, causes LED display to multiplex, when low causes clock digit to be selected by IBITSEL0-IBITSEL3

### INPUTS

NSTRT

goes low to start time sending sequence

NCODN

goes low to indicate that a complete numeral and space have been sent in CW

### State Machine Signals

Fig. 10.



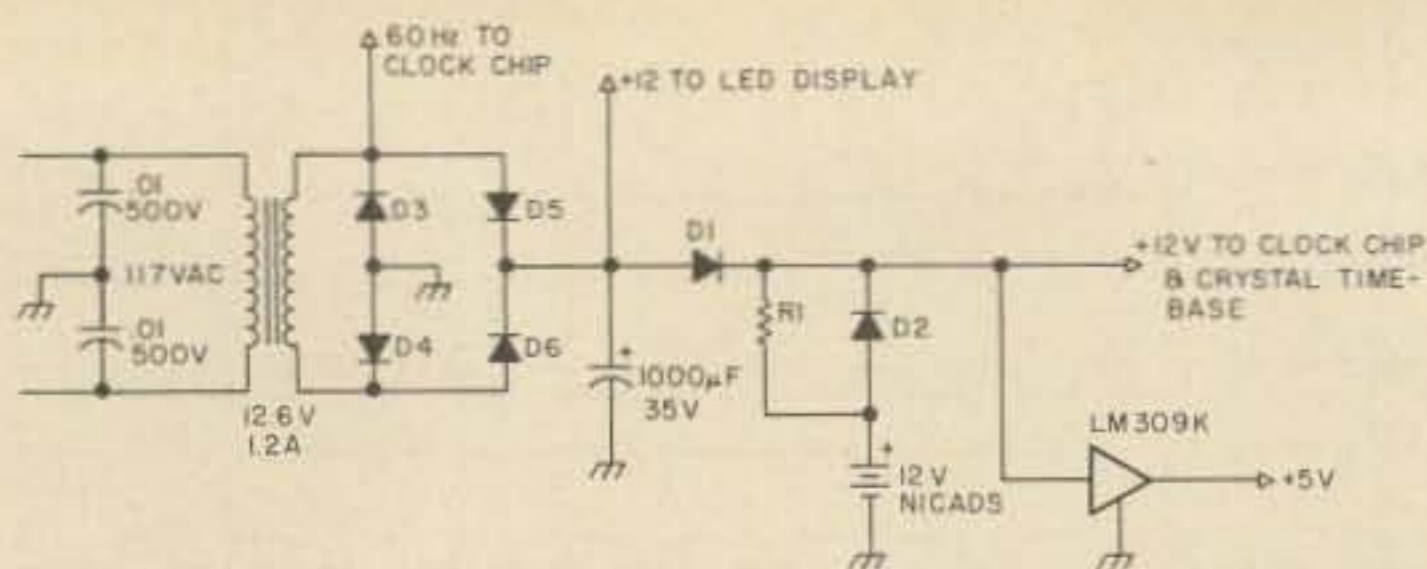

Fig. 11. Power supply.

first time through.

### Changing the CW Speed

The speed of the CW output is determined by the frequency of CK80, the input to the BCD-to-Morse converter. The output speed is equal to 1.2 times CK80, in wpm. CK80 in my clock is 940/80, or 11.75 Hz. The output speed is then 1.2 x 11.75, or 14.1 wpm.

CK80 may be varied by changing the value of the 0.1 µF capacitor in the system clock. This is not really a good idea, since the system clock is also used to multiplex the seven segment display, which will flicker if the

multiplex frequency is too low. A better way to alter the CW speed is to change the division ratio of U15. Say, for example, that an output of 10 wpm is needed. CK80 must therefore be 10/1.2, or 8.33 Hz. This requires a division ratio in U15 of 94/8.33, of 11.28. If U15 is set to divide by 12 (by connecting pin 2 to pin 8 instead of pin 9), the output speed will be 9.4 wpm. The CW output speed may be varied from 9.4 wpm to over 100 wpm by merely changing the division ratio of U15.

### Getting the Parts

At the time of writing,

nearly all of the parts for the Morse code clock were available from James Electronics. I bought the HP 5082-7740 common cathode seven segment LED readouts and the crystal timebase from S. D. Sales. The chassis and other odds and ends were obtained locally.

Thanks to the ASM design, the Morse code clock worked immediately when powered up. It has been in operation at the WR1ADR 60/00 repeater in South Dartmouth MA for about six months without any problems. My thanks to K1IBR and the rest of the crew at SEMARA for their cooperation and sup-

port. I will be glad to correspond about the Morse code clock or ASM design. An SASE would be appreciated. ■

### References

1. C. R. Clare, *Designing Logic Systems Using State Machines*, McGraw-Hill.
2. R. Jaeger, "Microprogramming: A General Design Tool," *Computer Design*, August, 1974, p. 150.
3. J. B. Peatman, *The Design of Digital Systems*, McGraw-Hill.
4. L. I. Hutton, "Code Converter Using PROMs," *73 Magazine*, May, 1976, p. 84.
5. G. W. Kufchak, "The PROM Zapper," *73 Magazine*, September, 1976, p. 112.
6. B. D. Lichtenwalner, "The Computer QSO Machine," *73 Magazine*, January, 1976, p. 80.

dipper coil was placed near any building wiring. Reducing the scope sensitivity, the grass was barely noticeable. We probed around. It didn't take long to locate a relay used for aircraft obstruction lights that was defective, with pitted chattering contacts.

Any battery operated dipper can be used. It can be hooked up to the audio section of a battery operated portable radio for use away from the shack. Make sure the dipper switch is in the diode position, so it is being used as a field strength meter. To hook the dipper up, solder one wire to the output side of the dipper diode and the other wire to ground. These wires go either to the scope vertical input or, in the case of a radio, to the volume control. Do not wire to the volume control center tap.

Tuning the dipper to harmonics, hunting parasitics, or debugging a transmitter is easy, too, since the scope gives an excellent visual display. ■

# Hunting Noise

## - - with a grid dipper

John P. Dieringer W6RVP  
9010 Ramsgate Avenue  
Los Angeles CA 90045

Noise external to receiving equipment can sometimes be difficult to pinpoint. A spectrum analyzer is beyond the reach of most amateurs. Here is a cheap

substitute that has been proven.

Some time ago man-made interference was tearing up communications across a wide spectrum, seriously upsetting some military operations. Engineers tried to solve this with a spectrum analyzer and failed. As hams, a friend and myself were asked if we

could solve this. A little thought as to why the engineers failed led us to the conclusion that their equipment was too sophisticated. I devised the idea of using my Heathkit grid dipper and a scope. The scope was hooked to the internal dipper diode and ground. At 2 MHz there was plenty of grass when the



# WHEN SYSTEM 3000 BYTES



## you will never let go !

**Edgecom Inc.** proudly announces a totally new concept in amateur radio: **SYSTEM 3000**, a computerized two-meter transceiver that provides you with operational flexibility found in no other transceiver. Some of the extraordinary features of **SYSTEM 3000** are:

- **TEN FRONT-PANEL-PROGRAMMABLE PRIORITY CHANNELS** for storage of frequency, transmitter offset, and tone encoder/decoder mode/frequency.
- **BUILT-IN SCANNER** for automatic tuning in user-selected one or four MHz bands. Scan speed 2.5 sec/MHz, adjustable pause.
- **PRIORITY CHANNEL SILENT MONITOR** so you can operate on one frequency while monitoring another.
- **TWO FREQUENCY TONE ENCODER/DECODER** provides two selectable, fully adjustable, subaudible tones for transmit and/or tone-coded squelch.
- **ANY TRANSMITTER OFFSET** without additional crystals.
- **AUDIO/VISUAL ALARM** to let you know when the monitored priority channel is occupied or when tone-coded squelch is activated.
- **ADVANCED PLL SYNTHESIZER** covers 144.000 – 147.995 MHz with full push-button tuning.
- **SUPERIOR RECEIVER** with sensitivity, selectivity and intermodulation characteristics that are more like military than amateur.
- **POWER OUTPUT ADJUSTABLE TO 25 WATTS.**
- **EXTRAORDINARY WARRANTY.** Every **SYSTEM 3000** is warranted to be free from defects for two full years, and it is American made so servicing is no problem.
- **SMALL SIZE.** Designed for mobile and fixed operation, **SYSTEM 3000** is only 5.3 inches wide, 2.6 inches high and 11 inches deep.
- **VERY COMPETITIVELY PRICED.** Introductory price is only \$499.

For more details on these and the other fine features of **SYSTEM 3000**, see one at selected dealers or write to us for a brochure.

**Edgecom Inc.**

2909 OREGON CT.-A3  
TORRANCE CA 90503  
(213) 533-0433

E18



# CMOS Oscillators

## -- practical techniques

Over the past few years, many articles have appeared in various electronics magazines dealing with the subject of oscillators and their applications. Of these articles, the majority have dealt primarily with transistor and TTL circuits.

While these devices have performed exceedingly well in many applications, there are other devices available that may be more suitable for certain applications. For example, CMOS devices perform well in low power circuits and can operate satisfactorily from a wide range of supply voltages (typically +3

to +15 volts). These two features make CMOS devices ideal for compact, low power, portable equipment capable of operating from a variety of power sources.

This article, then, is an attempt to provide basic application information on CMOS oscillator circuits as well as providing an overview of basic CMOS features and characteristics. As you will see, they are very versatile devices that are easy to use once you become accustomed to their peculiarities.

CMOS integrated logic circuits offer several distinct advantages over other logic

families. Some of these advantages may be summarized in the following:

1. *High Noise Immunity:* To understand this characteristic, it will be necessary to refer to the transfer characteristic curve for a typical CMOS IC inverter. Fig. 1 shows this transfer characteristic, which is the relationship between the input and output voltages. Note that the output voltage is affected by a change in the input voltage only at the transfer point. The steepness of this curve also indicates that as the transfer point is reached, there is an abrupt change or a "toggling" of the output.

Usually, the transition voltage is specified to occur between 30% and 70% of the power supply voltage. Thus,

for a 15 volt power supply, the input noise transient would have to exceed 4.5 volts for it to affect the output. This feature provides for very stable monostable multivibrator circuits where the CMOS device is used as a one shot trigger source.

2. *Low Power Requirements:* Almost everyone is now familiar with the low power consumption of CMOS devices. This feature is one of the primary considerations for using CMOS devices in digital watch circuits.

The CMOS family exhibits low power consumption due to the way the output transistors are connected — in series, so that power is consumed only during transition states. All CMOS devices incorporate at least two MOS transistors in series — one p-channel and one n-channel. Consequently, only one transistor is turned on at a time and there is no direct path for current to flow. The only exception to this rule is during transition states, and then only for very short time periods. Fig. 2 is a diagram showing the output transistors.

Note that as the frequency of the oscillator circuit is increased, the conduction times also increase, so that power consumption is directly proportional to the operating frequency. Typical quiescent dissipation for an inverter, however, is less than 300 uW per package for a 10 volt supply (CD4009A).

3. *Wide Range of Power Supply Voltage:* Another fea-

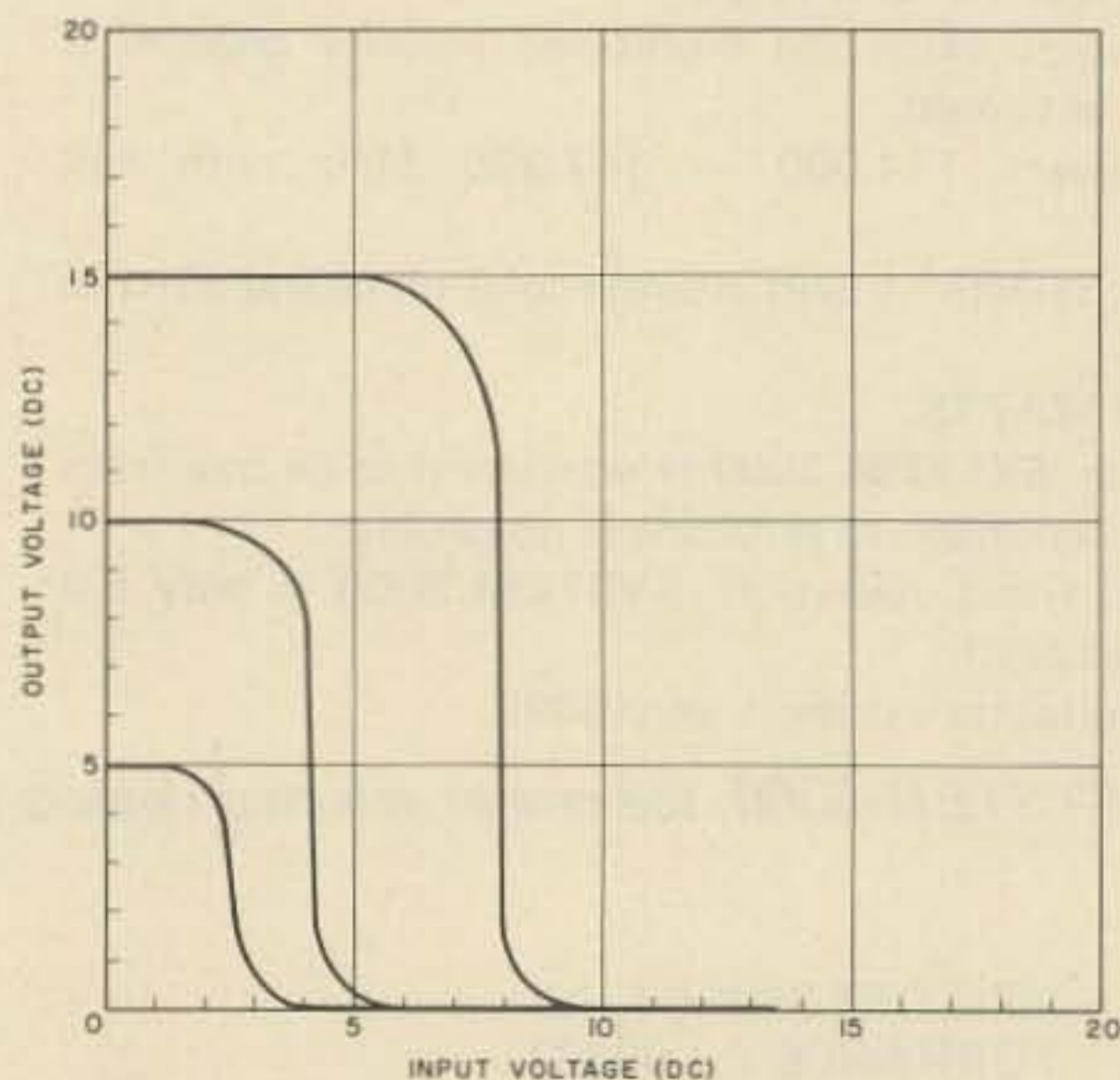

Fig. 1. Transfer characteristics for a typical CMOS inverter at 5V, 10V, and 15V.

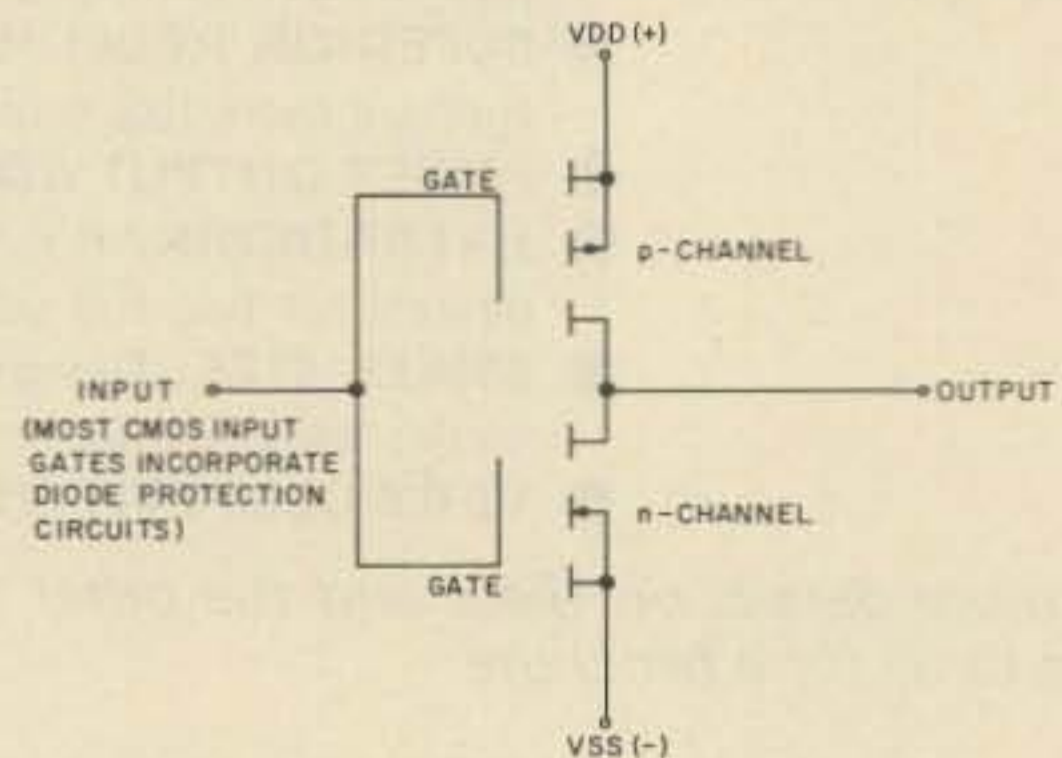

Fig. 2. Typical CMOS inverter stage (simplified). Except for short periods during switching of states, only one output transistor is on at a time. This results in extremely low power consumption.



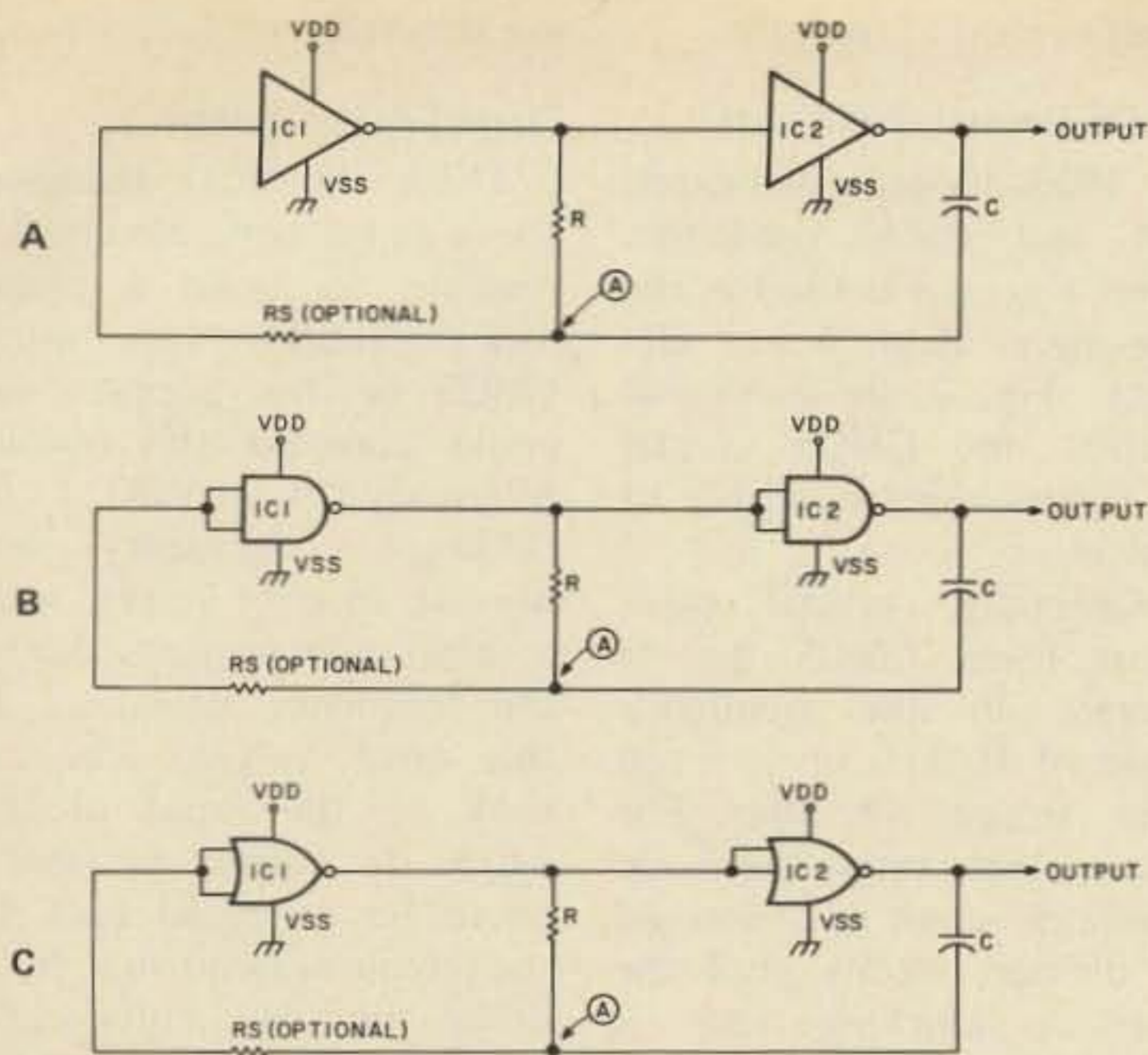

Fig. 3. Three typical CMOS astable multivibrator circuits. (a) CMOS inverter astable multivibrator. IC1, IC2 = 1/6 CD4069. (b) CMOS NAND astable multivibrator. IC1, IC2 = CD4011. (c) CMOS NOR astable multivibrator. IC1, IC2 = CD4001.

ture that is unique to CMOS devices is the wide range of supply voltages over which they will perform satisfactorily. Typically, most manufacturers guarantee operation over a range of 3 volts to 15 volts. However, some versions will operate up to 18 volts. With this feature, it's not necessary to design well-regulated power supplies and, in most cases, batteries work just fine. Also, the voltage range makes CMOS devices ideal for automotive or mobile applications.

**4. Wide Temperature Range:** The usual package most hams or hobbyists will be working with is the dual-in-line plastic package (suffix AE or BE). This unit is suitable for a temperature range of  $-40^{\circ}\text{C}$  to  $+85^{\circ}\text{C}$ . The more expensive ceramic version (suffix AF or BF) will operate over a temperature range of  $-55^{\circ}\text{C}$  to  $+125^{\circ}\text{C}$ .

**5. High Input Impedance:** The input gates of all CMOS devices have impedances on the order of  $10^{12}$  Ohms. This results in extremely low input current requirements (typically  $\pm 10$  pA) and consequently very little loading on the input circuit. Another advantage resulting from this high input impedance is directly applicable to oscillator

circuits. The high input impedance makes it possible to obtain large time constants without the use of large capacitors. This means that CMOS devices can provide cost and size reductions in most multivibrator circuits.

Before we get into some actual multivibrator applications, a word of caution is in order. Since an inverter functioning as an oscillator operates a considerable amount of time in the linear region of its transfer curve, some CMOS devices cannot withstand the high power dissipation. These devices include the CD4009A and CD4010A. Instead of using these devices, the CD4049 and CD4050 would make a better choice.

#### Astable Multivibrator Circuits

An astable multivibrator is basically an oscillator that generates a square wave output at a specific frequency. The frequency of the square wave may be determined by an RC circuit, crystal, or analog voltage.

Astable multivibrators may be constructed from a basic inverter IC or from NAND or NOR gates connected as inverters. Fig. 3 shows three basic types of astable RC multivibrators.

All CMOS gates have a

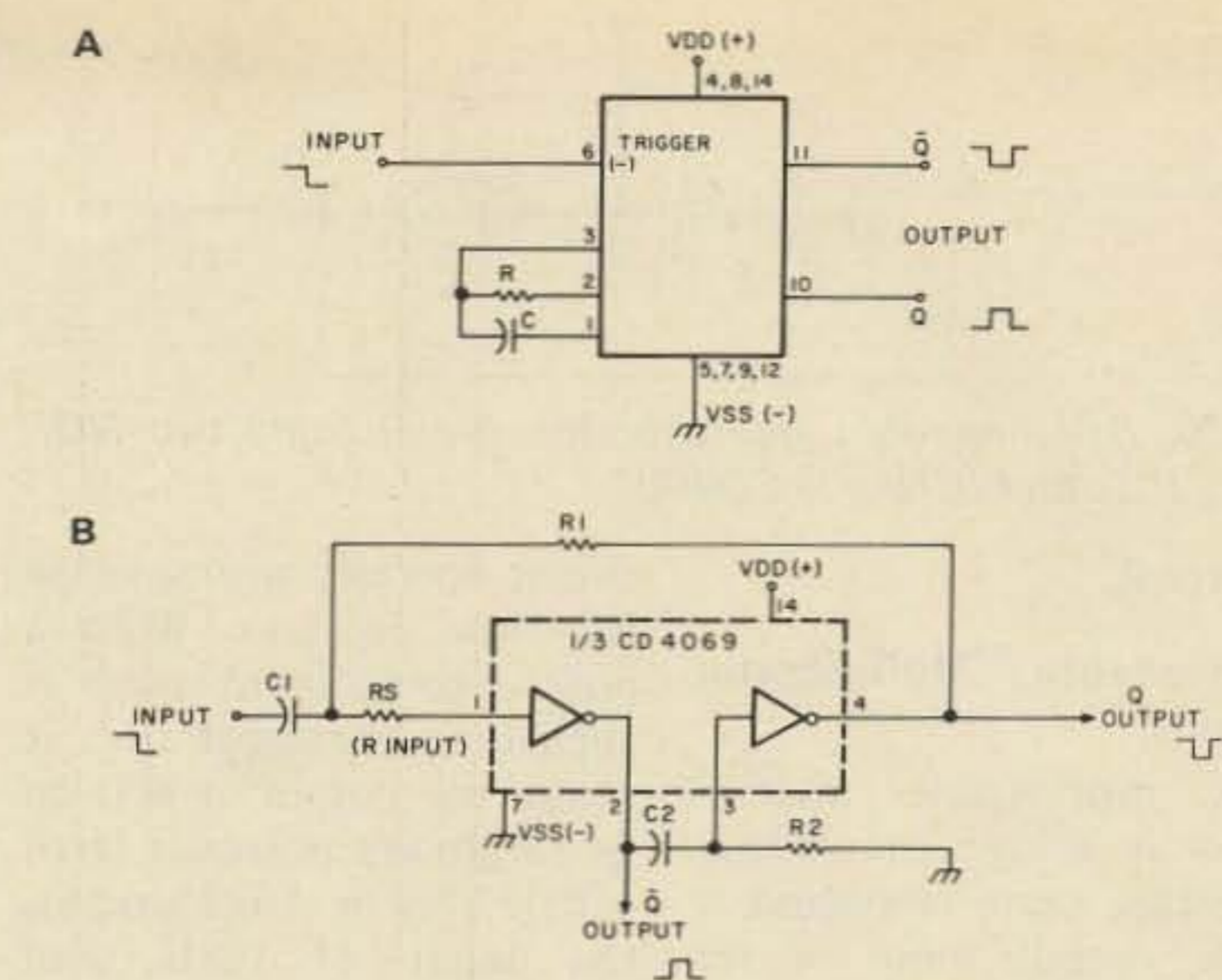

Fig. 4. Monostable multivibrator circuits for negative-going input pulses. (a) CD4047. (b) CD4069 (hex inverter).

built-in diode protection circuit to clamp large input voltages and prevent the gate from being destroyed. To minimize the effect of this input circuit on stability, a resistor ( $R_s$ ) is connected from the timing circuit to the input of the first inverter. This, in effect, limits the current to the input gate.

In operation, the input of the first inverter is clamped at approximately  $V_{dd}$  or  $V_{ss}$ , whichever is appropriate. At any particular instant, capacitor  $C$  will be charging or discharging through resistor  $R$ . When the capacitor is discharging, the voltage decays at point A until transfer occurs for inverter 1 and its output switches from zero

level to the power supply voltage, causing the output of IC2 to switch from the power supply voltage to zero. When this occurs, capacitor  $C$  begins to charge. This continues until the voltage at point A builds to the transfer point. When this occurs, the output of IC1 switches to zero volts, causing the IC2 output to switch to the positive supply voltage. At this point, the cycle is ready to begin again.

The frequency of the square wave output will be dependent on the values chosen for  $R$  and  $C$ . Also, to limit current at the input gate of IC1, the rule of thumb is that  $R_s$  should be approximately twice the value of

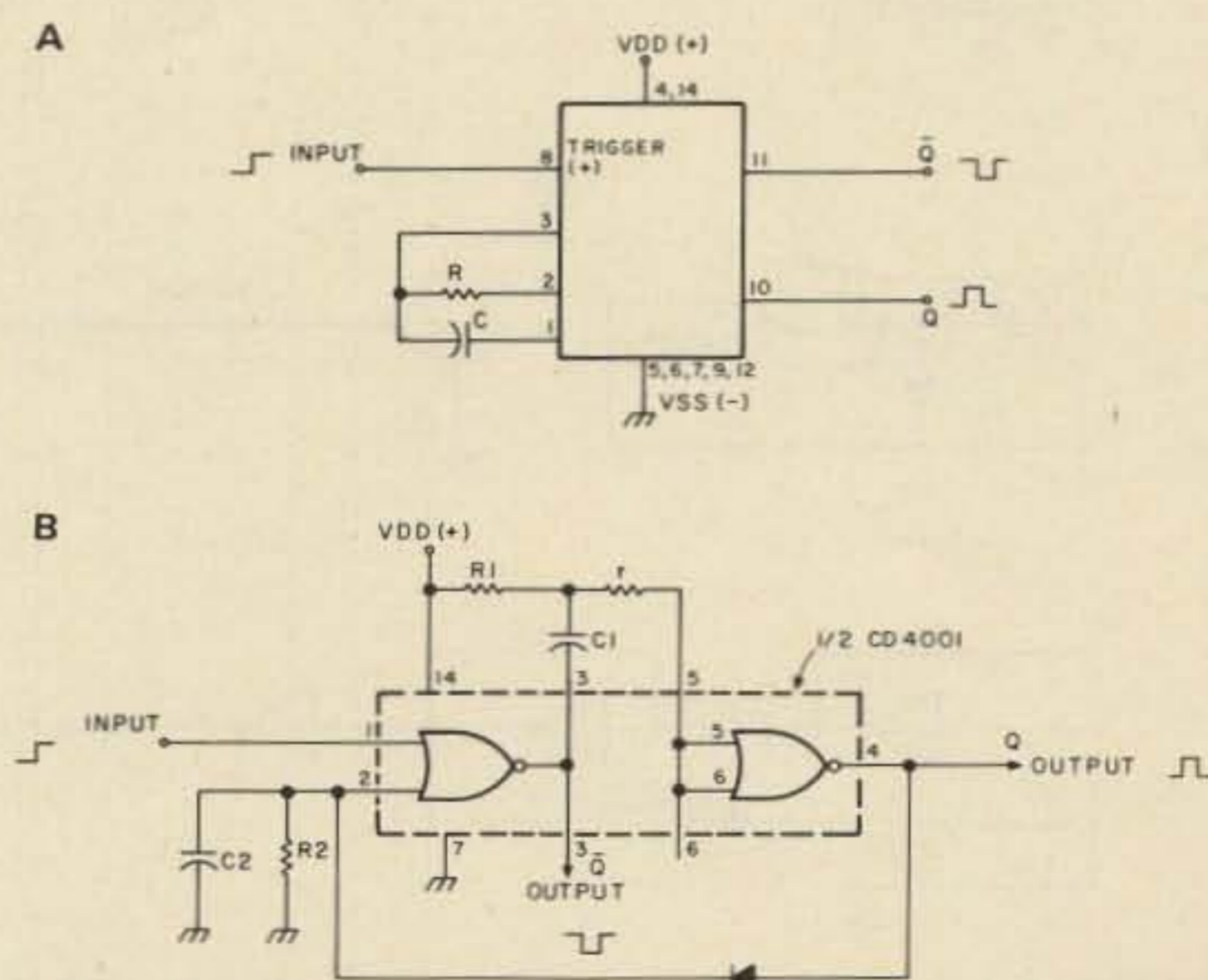

Fig. 5. Monostable multivibrator circuits for positive-going input pulses. (a) CD4047. (b) CD4001 two-input quad gate.



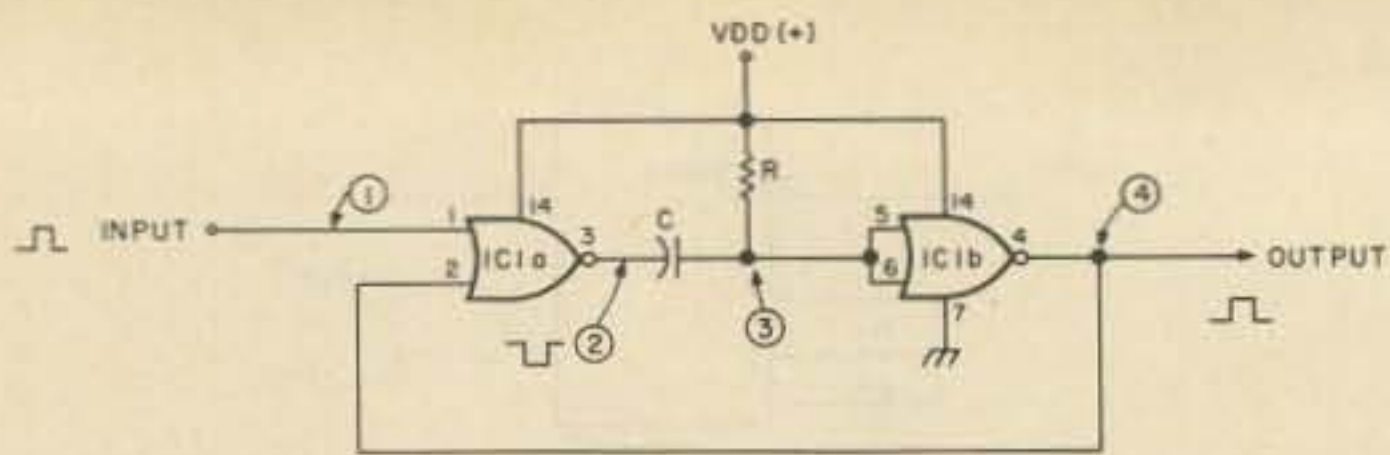

Fig. 6. Basic one-shot multivibrator circuit using two NOR gates. IC1a and IC1b = 1/2 CD4001.

resistor R.

### Monostable Multivibrator Circuits

A monostable multivibrator is a logic circuit that generates, upon command, a single output pulse of set duration. It is commonly referred to as a "one-shot" multivibrator. There are monostable circuits that are triggered by a negative-going input pulse (Fig. 4), as well as circuits that are triggered by a positive-going pulse (Fig. 5). Both of these circuits may not be retriggered until they return to steady state conditions. Hence, they are often used to debounce mechanical switches in a variety of applications.

To understand how monostable multivibrators function, refer to the circuit shown in Fig. 6. This diagram shows two NOR gates from a quad CD4001 connected in series. This basic one-shot

circuit operates with a single RC time constant. When a positive-going input pulse is applied to the input at 1, it causes the output of IC1a to go to ground potential (zero volts). This in effect grounds the input of IC1b until capacitor C charges up to the transfer level. During this timing period, the output of IC1b is at V+. When point 3 reaches the transfer level, the output of IC1b switches to zero, causing the input of IC1a to become zero. Assuming there is no input signal on the other input, the output of IC1a switches to V+ and the circuit is ready to be triggered again. It is important to note that this circuit, once triggered, is immune to further triggering (or noise) until the timing cycle is complete and the circuit is reset.

If the power source (V+) is greater than +5 volts, you may want to include a series resistor at IC1b to limit the

input current at the gate.

### CMOS Crystal Oscillators

CMOS devices make excellent and stable oscillators when a crystal is used as the frequency determining element. Fig. 7 shows several circuits for CMOS crystal oscillators using a variety of devices.

Generally, crystal oscillators using CMOS devices operate in the frequency range of 10 kHz up to a top limit around 10 MHz. For lower clock rates, the basic oscillator stage is connected to divider circuits until the correct clocking rate is achieved.

### Voltage Controlled Oscillators

Previously, we discussed a type of oscillator whose frequency was determined by a fixed RC circuit. By changing the value of R (or C), the frequency of the oscillator will be varied proportionately.

A voltage controlled oscillator is merely a standard RC astable multivibrator in which the value of the resistor R is varied by a control voltage. Just how this is accomplished is illustrated in Fig. 8. "R" has been replaced by a semiconductor device whose resistance varies from 1k to 10k. These limits are determined by a parallel combination of R1 (10k) and the resistance of an n-channel device which varies from 1k ("on" state) to 10<sup>9</sup> Ohms ("off" state). The center frequency of the VCO may be determined by vary-

ing the value of capacitor C.

### Phase Locked Loops

Using the VCO discussed above as the basic circuit, it's possible to build a phase locked loop (PLL) using CMOS devices. Suppose we could compare the output frequency of a VCO to a reference frequency and develop an error voltage with a magnitude proportional to the frequency deviation. If this error voltage was fed back to the input of the VCO, its output frequency could be corrected back to the reference frequency. In so doing, the two circuits would lock in phase at the reference frequency.

It is interesting to note that the CMOS family of devices has a phase locked loop element which is unique to the CMOS family — there is no TTL equivalent. This device is the CD4046 and a typical PLL circuit is shown in Fig. 9.

In this circuit, the minimum output frequency occurs when the input control voltage is at zero. When the input control voltage is at the power supply level, the output frequency is at a maximum.

### Frequency Multipliers

In this application, CMOS devices may be used to build circuits that generate output signals having a frequency equal to a multiple of the input signal frequency.

An example of a multiply-by-two circuit is shown in Fig. 10. It's also possible to

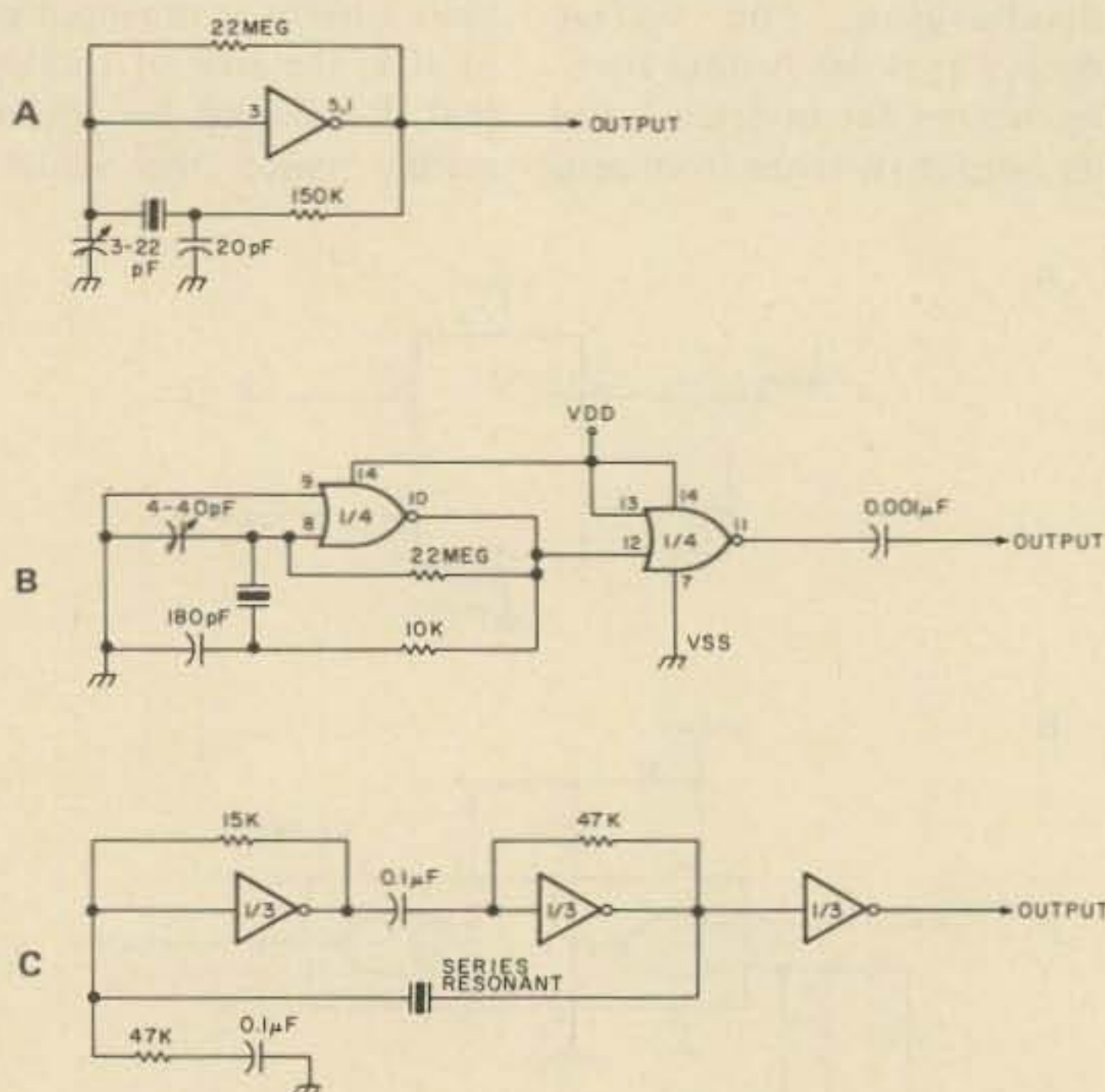

Fig. 7. CMOS crystal oscillators. (a) MC14007 or CD4007. Pin 7 — Vss. Pin 14 — Vdd. Note: Pins 5 and 1 must be connected together for proper operation. (b) CD4001. (c) CD4049.

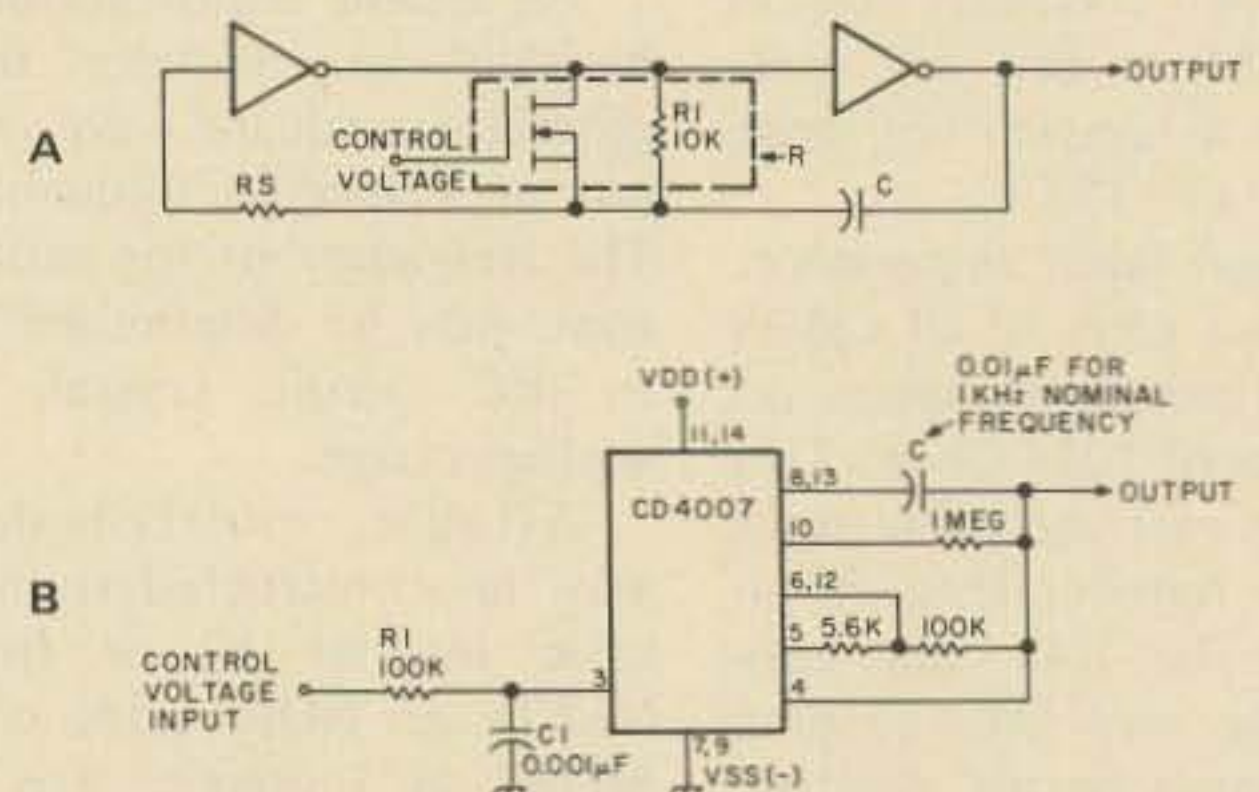

Fig. 8. CMOS voltage controlled oscillator. (a) Basic diagram, CD4007. (b) Practical circuit.



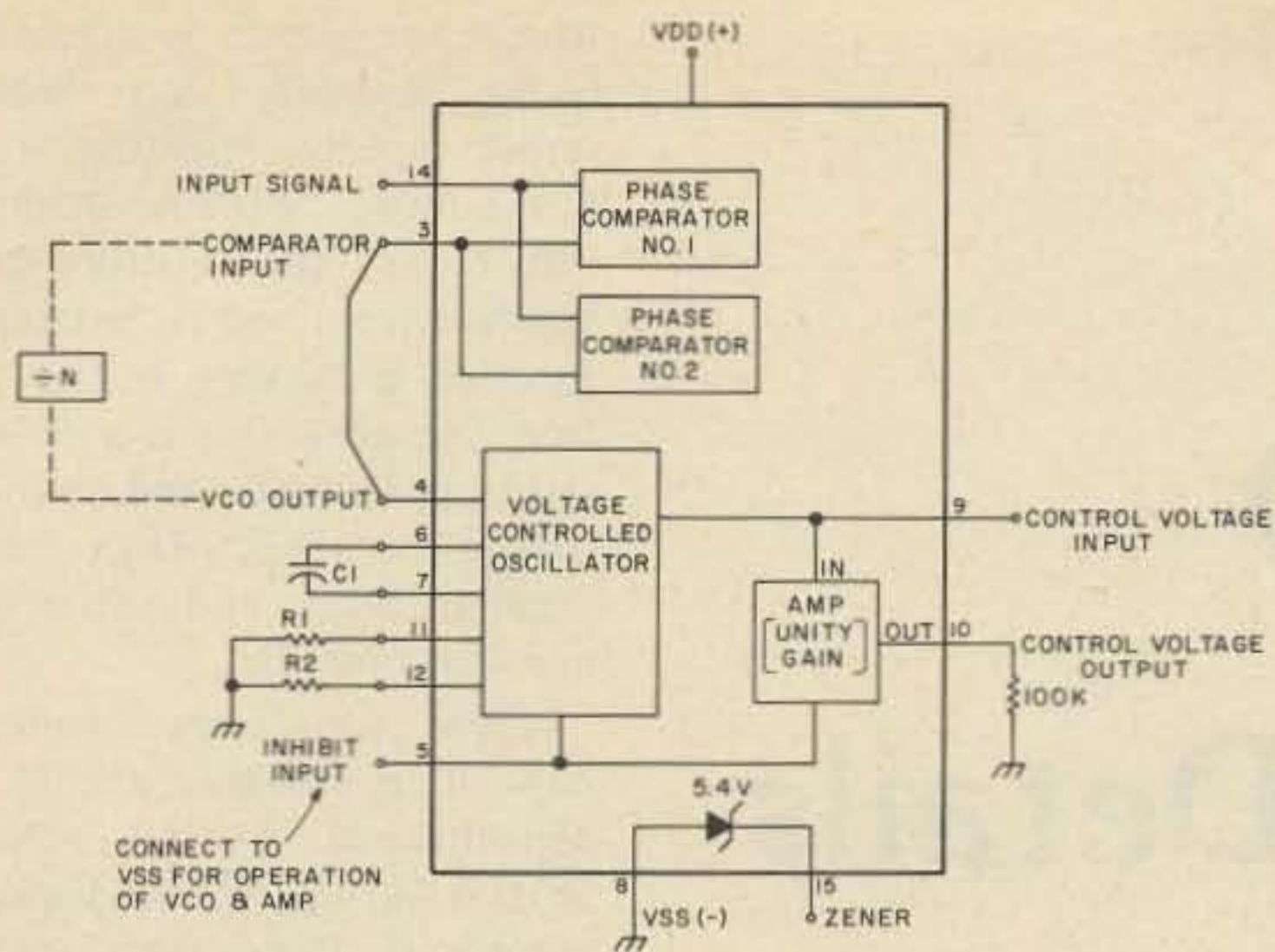

Fig. 9. CD4046 CMOS phase locked loop (PLL). For 1 kHz: R1 - 1 meg; R2 - 00; C1 - 0.01 uF.

build more sophisticated multiply-by-n circuits by using a PLL and a divide-by-n in the feedback circuit.

In the multiply-by-two circuit, two RC circuits are used with an inverter to produce negative pulses on one input of the NAND gate when the input goes positive. A second negative pulse occurs at the input of the other NAND

gate when the input signal goes negative.

As with any two-input NAND gate, a negative pulse on either input gate causes the output to become positive. Hence, the output frequency will be twice the input frequency.

#### Additional Information

There are several sources

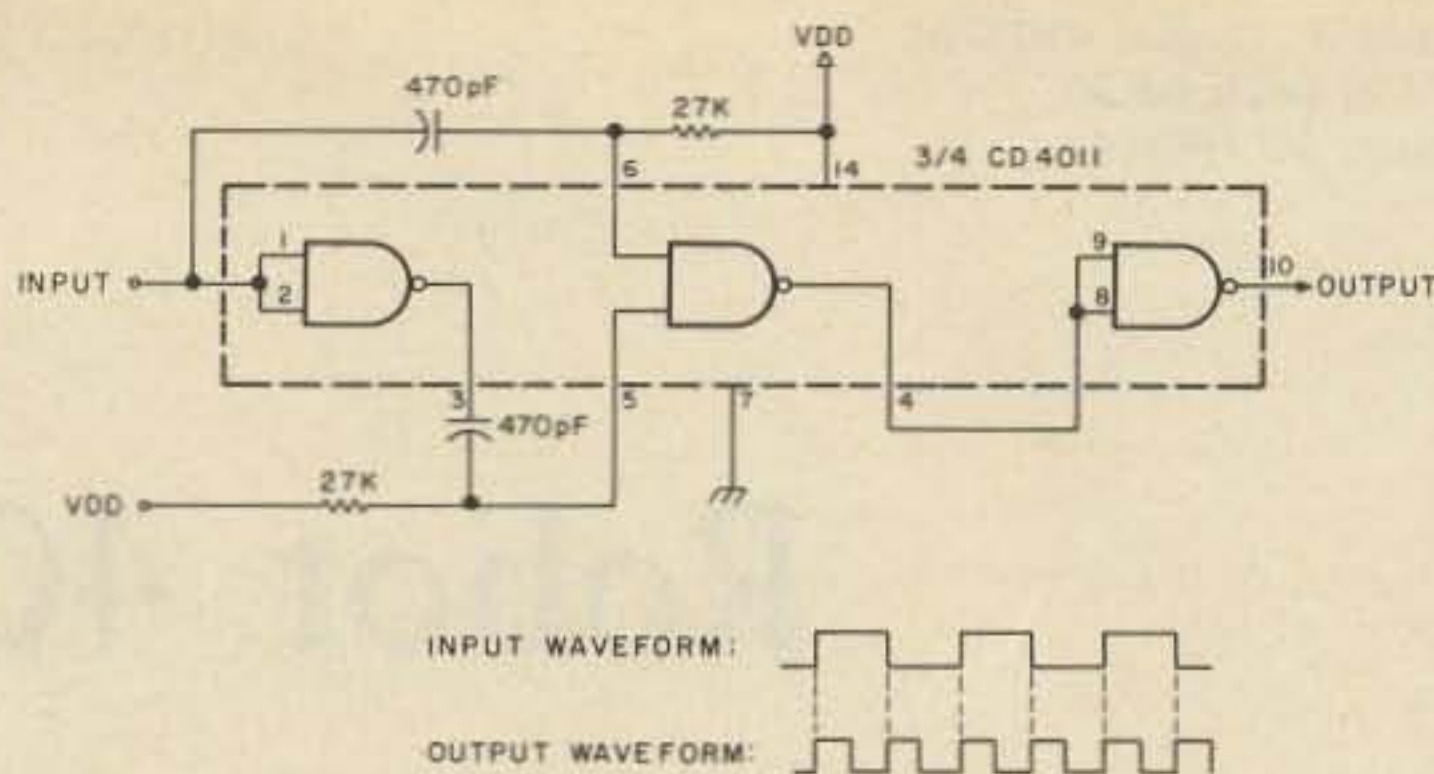

Fig. 10. CMOS multiply-by-two circuit.

of information available to you for further investigation of CMOS devices. The following publications will provide you with a wide range of reference information: "Understanding CMOS Integrated Circuits," R. Melen & H. Garland, (H.W. Sams); "COS/MOS Integrated Circuits," RCA Solid State; "MOS/CCD Data Book," Fairchild Semiconductor; "CMOS Integrated Circuits," National Semiconductor; "McMOS Handbook," Motorola.

In addition, the "Elec-

tronics Sourcebook" contains a handy index of industry application notes and publications relating to CMOS devices. It's available for \$3.75 postpaid from Technical Publications, 1405 Richland Ave., Metairie, LA 70001.

I would be interested in hearing from readers who have unique applications for CMOS devices as described in this article. If there is enough response, there may be a follow-up article about CMOS devices in other applications. ■

Stanley P. Sears W2PQG  
188 Concord Dr.  
Paramus NJ 07652

# A Dial for the FM-DX

- - in case the LEDs fail

Readers of 73 may be interested in a modification performed on my FM-DX. Recently I had one of the LEDs in the digital display go out on me, presenting the problem of guessing how to dial up frequencies.

While waiting for a new LED to arrive, I solved the guessing game by installing indexed knobs on the three selector switches. As the picture shows, with no LED display, it is now possible to dial up a frequency using only the knobs. This also helps when operating in

direct sunlight.

The knobs used were obtained at Radio Shack (Cat. No. 274-413) and are numbered 0-9, exactly as needed for this application. The diameter of these knobs was too large, however, and required removal of approximately 1/8" from the outside edge. A little careful machining with a drill press and file corrected this problem.

Catalogs show other knobs available in smaller diameters which would be more suitable, but I had to act in haste for the immediate emergency. ■





# Robot 400

## Scan Converter Details

-- conventional TV as SSTV monitor

If you ask experienced SSTV operators what the major barrier to widespread acceptance of slow scan television might be, you will almost always get the same answer — the display system! Most amateurs are now familiar with the major aspects of the slow scan system first developed by Copthorne MacDonald in the late 1950s. SSTV involves the transmission of a 128 line picture which is transmitted over a period of approximately 8 seconds. This

extended frame time, coupled with the modest number of scanning lines, results in a picture format that is compatible with voice bandwidth signals and thus can be transmitted on the high frequency bands using normal SSB phone equipment. At first glance one might assume that the 128 line picture with its limited resolution might be a problem, but most amateurs on seeing a photograph of an SSTV image are quite impressed by the quality of the pictures. The real problem

arises when a convert sees his first SSTV demonstration. In order to view a picture that requires 8 seconds for transmission, a conventional monitor must employ a cathode ray tube with a long persistence phosphor, usually a P7 CRT. The long persistence component of this phosphor is not very bright and the pictures can only be viewed effectively under subdued light, hardly the conditions that exist for most demonstrations. The phosphor is quite bright

where the screen is actually being scanned, but fades rather rapidly, resulting in a pronounced "window shade" effect as the picture is scanned from top to bottom. Another disturbing feature is that the phosphor is yellow, resulting in black and yellow images rather than the familiar black and white of monochrome TV.

Slow scan experimenters have long recognized that a conventional TV set represents a very effective display system if there were some means available to convert the slow scan image into a conventional TV picture. This conversion process is known as *scan conversion*. In theory, scan conversion requires some means of storing the incoming SSTV picture and then repeatedly reading out the stored video information at scanning rates compatible with conventional television display. The two most promising approaches to this problem to date have been *analog* scan conversion and *digital* scan conversion, and amateurs have pioneered in the development of each. The analog process involves the storage of the picture by means of a vidicon-like tube with a special silicon target. The picture is painted electronically on the target by scanning at the SSTV rates and, once it is impressed on the target of the tube, it is retained for a considerable period. The charge distribution resulting from the SSTV image is then scanned repeatedly at fast scan rates to produce a conventional TV video signal. The first SSTV analog scan converter was produced by W9NTP and displayed at Dayton several years ago. W2DD and a number of other amateurs successfully experimented with modifications of commercial analog scan converters with some success, and Robot Research of San Diego eventually introduced their Model 300 analog scan converter. This was an effective unit that could not only

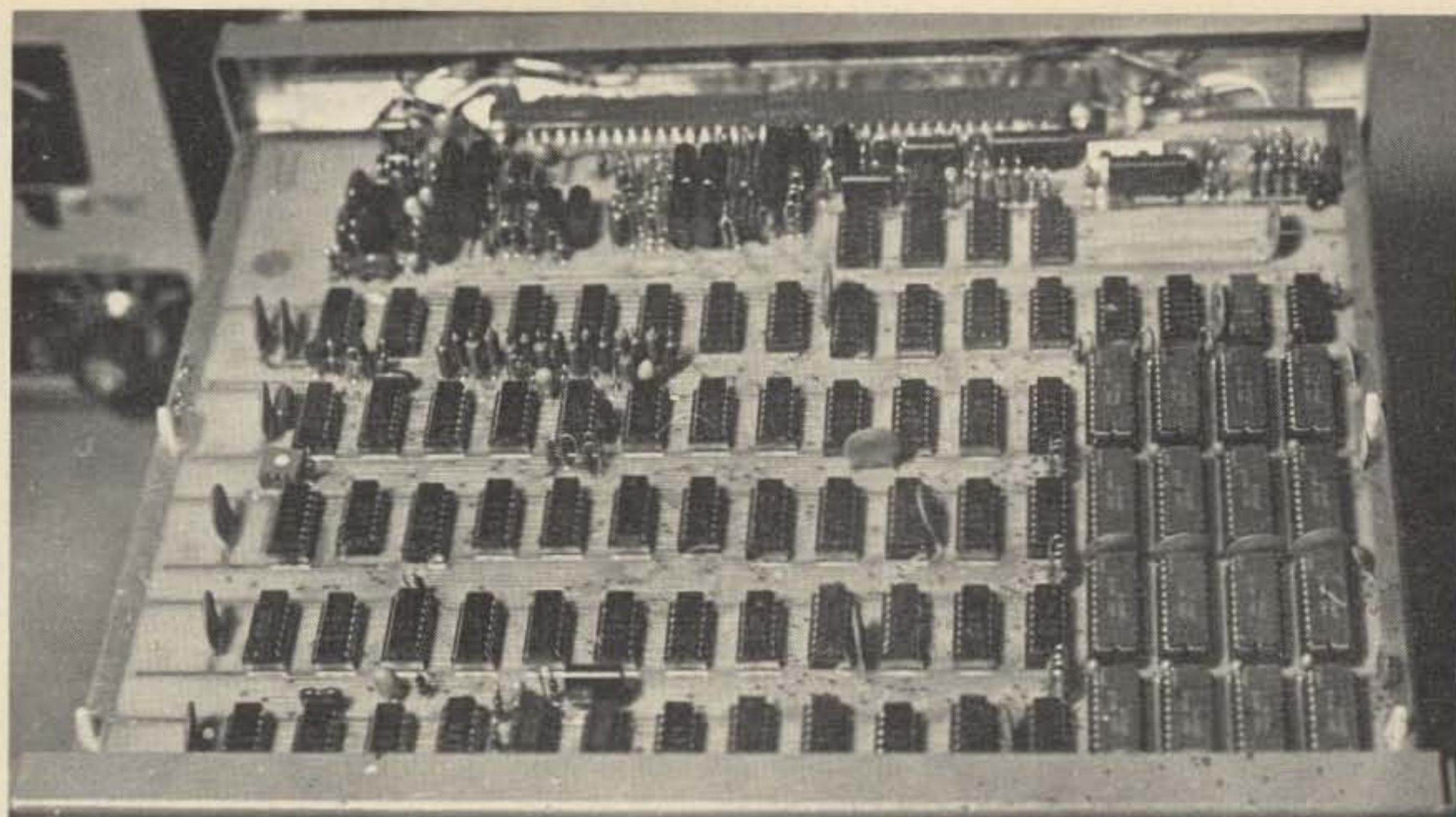

Fig. 1. The Robot Model 400 digital scan converter and the Sony TV-770 which has been modified to serve as a video monitor. A set of this size is ideal for viewing at the distances encountered in most installations. The 400 is very compact and generates essentially no heat, allowing it to be placed anywhere that is convenient.



provide fast scan display of an SSTV picture, but it was also capable of storing a single frame from a fast scan closed circuit TV (CCTV) camera that could then be transmitted in the SSTV format. There were several major restraints to both amateur and commercial efforts in the analog area. The first was cost, due almost entirely to the expense of the special storage tube. Secondly, because such converters are analog devices, the scan converters had a great many interacting level controls that took some practice to use effectively. Finally, the image storage in the tube is not perfect, and the image begins to fade after 10-20 minutes of display. Although the retention factor is not important in some applications, it does limit the device.

The other alternative — digital scan conversion — appeared to offer the greatest long-term promise, but development was impeded by the sheer complexity of the circuitry required. One of the major problems was the sheer size of the digital memory. A 128 line SSTV picture consists of 128 x 128 picture elements or *pixels* — a grand total of 16,384. The solid state memory (in the form of shift registers or later RAM) would have to have a capacity of at least 16,384 bits to store an SSTV picture without loss of resolution. Digital storage, however, is in the form of low or high data bits so that even a 16K bit memory could only store a picture of either white or black pixels with no intermediate gray scale values! Storing gray scale values requires still more memory. Too few gray scale shades and the picture will have a crude paint by numbers appearance known as *video contouring*. Video contouring is essentially unnoticeable on a standard TV display if 32 gray shades are employed, but the memory requirements are excessive. 16 gray scale



*Fig. 2. Internal view of the Model 400 with the top cover removed. Virtually all of the active circuitry is confined to the single large plug-in circuit board. The 16 large ICs in the lower right are the 4K RAM chips that comprise the main memory. All of those other little packages are required to address the memory, perform A/D and D/A conversions, and process both SSTV and fast scan video. Cabinet space below the circuit board is devoted to power supply components. Controls are mounted on the front panel with I/O jacks on the rear panel. The controls and jacks have few discrete components associated with them, and those which are present are used mostly for rf bypassing, resulting in excellent resistance to RFI. Note that sockets are employed for all ICs, easing any problems with servicing and making it relatively easy to experiment with the unit.*

shades (requiring four bits of memory for coding for each pixel) appears to be the best compromise between memory size and picture fidelity. The memory must therefore consist of 16,384 x 4 bits — a total of 65,536 bits. If the memory is in the form of 1024 bit shift registers, as it is in most current amateur designs, a total of 64 shift register chips are required for the main memory alone. To this must be added the SSTV signal processing circuits, analog to digital conversion (A/D) to convert the analog video to a digital format, slow scan clocks, clocks to circulate the main memory, fast scan clocks and sync circuits, the D/A converters to convert the digital video back to analog form, and finally a series of input and output line buffers (more memory) to clock the video in and out of the main memory. Needless to say, a digital scan converter is a complex project. Beginning just a few years ago, the design and building efforts of WØLMD, W9NTP, and

WB9LVI produced working scan converters that were displayed at the annual Dayton extravaganza. Anyone who viewed the clear, non-fading, black and white images displayed by these units could not help but realize that digital scan conversion of SSTV pictures was the wave of the future. Other amateurs worked up PC board layouts for such projects, the LVI unit was described in *QST*<sup>1</sup> and, despite the complexity of undertaking such projects, the home brew SSTV exhibit at Dayton last spring consisted almost entirely of digital scan conversion units. What was needed to bring such technology from the experimenters to the average ham shack was the introduction of comparable commercial equipment. Robot Research, true to its position as a pioneer in the area of commercial SSTV equipment, has done just that with the recent introduction of their Model 400 digital scan converter. One of the early model 400s was obtained to

perform an evaluation of the unit's potential, and what follows is the result of that evaluation.

The Model 400, in conjunction with a closed circuit TV monitor or, in some cases, a modified TV set, and a standard CCTV camera, will perform virtually all of the operations required for working two-way slow scan TV. On the display side, it will take an SSTV signal from *any* source — the receiver, tape recorder, SSTV camera, flying spot scanner, or keyboard — and display the picture on a TV monitor. With the flick of a switch you can have each new picture replace the previous one, bit by bit as it comes in, or you can freeze the picture in memory and view it as long as power is applied to the scan converter. Recordings of incoming SSTV pictures can be made directly from the source or from the digital information stored in the memory. A very handy feature of the 400 is its ability to provide "instant replay" of pictures received



over the air. If a received picture is held in memory, you can transmit from the memory and thus show the station at the other end what a representative frame looked like at your end. This is particularly useful in critiquing pictures as it is possible to show the other operator that contrast, lighting, composition, or some other factor requires improvement.

The 400 also functions in generating SSTV pictures from a fast scan CCTV camera or other video source. A single frame of fast scan video can be "snatched" and stored in the 400's memory and read out in the SSTV format for transmission and/or recording. Frame snatch can be initiated manually at any time desired or it can occur automatically at the beginning of each SSTV frame. Since a single fast scan frame, occurring over a time interval of 1/60 of a second, is all that is required, motion no longer distorts the image and the subject need not remain motionless during the SSTV frame interval. The 400 permits real time viewing of the fast scan video in its digitized form so that there is no doubt as to how the picture will look when snatched. Levels are set up in the 400 so that the picture as viewed on the monitor is exactly how it will appear at the other end. All frames obtained using the snatch function have a four step gray scale inserted in the last couple of lines in the frame. This is an extremely useful feature as it provides you with a constant contrast reference when setting up the picture as well as providing the operator at the other end with an unambiguous reference against which to judge tuning, his contrast and brightness adjustments, and your video "swing."

The 400 also incorporates a precision 4 step digital gray scale to assist in setting the brightness and contrast on received pictures and pro-

viding a comparison scale for setting up the same values in pictures to be transmitted. In short, it would seem that the 400 can do just about anything. Let's look briefly at the physical and electrical characteristics of the unit and then see how this performance potential is actually realized in practice.

### Physical Description

The 400 arrives beautifully packed and is unlikely to suffer damage in shipment. It weighs 12 pounds and is packaged in a rugged two-piece aluminum cabinet measuring 12.5 inches wide, 6 inches high, and 11.75 inches deep. The unit is finished in the two-tone gray that is characteristic of the Robot equipment line. A front panel view of the 400 is shown in Fig. 1. All of the active circuitry (including the 16 4K RAM chips for the main memory, 77 other ICs, 19 transistors, and an array of discrete components) is contained on a single magnificent circuit board (Fig. 2). The rest of the cabinet simply serves to hold the power supply, front panel controls, the I/O jacks on the rear apron, and a few components associated with the controls. The main circuit board is a work of art and all of the components and wiring are of the highest quality.

The front panel control layout is well engineered with a largely functional grouping of controls. Power is controlled by a single central toggle switch with an LED indicator. The unit can be ordered to operate on 115 or 230 V ac at 50 or 60 Hz. Line voltage and frequency must be specified when ordering since there is some change in clocking and associated circuits when operated at 60 Hz as opposed to 50 Hz. Input to the main memory for display is selected by a front panel rotary switch (MEMORY INPUT). Options include GRAY SCALE, CAMERA (fast scan CCTV), RECEIVER, TAPE, and OTHER

(SSTV sources such as cameras, flying spot scanners, keyboards, or alternate receivers or recorders). A MEMORY INPUT toggle switch permits continuous display of new pictures or freezing the existing picture in memory. BRIGHTNESS and CONTRAST controls are provided to adjust these values for SSTV display. Another control (WIDTH) adjusts the internal oscillator to accommodate pictures from 60 Hz and 50 Hz sources.

The remaining controls function on the transmit side of the SSTV operations. A TRANSMIT SELECT rotary switch controls the signals routed to the transmitter and tape recorder. These options include VOICE (station microphone audio in transmit and unprocessed audio from the receiver when recording), MEMORY (the contents of the main memory), REVERSE (a black to white reversal of the image in the memory which is handy for special effects), TAPE (pictures previously recorded on tape), and OTHER (other SSTV sources which can be transmitted or recorded without going through the 400's digital memory). A DISPLAY toggle switch permits real time viewing of the digitized output of the fast scan camera or viewing of the memory contents. A SNATCH push-button permits manual updating of the fast scan camera image in memory. The fast scan snatch function has its own front panel CONTRAST and BRIGHTNESS controls so that good video swing can be obtained from cameras whose fast scan output may be of marginal quality.

The rear panel has the ac cord and circuit breaker plus the multitude of jacks required for interconnecting the 400 with the other equipment. Two of the jacks are BNCs (input from the CCTV camera and output to the video monitor) and Robot supplies a 5 foot length of

coax with BNCs on each end for connection between the 400 and the monitor. Two jacks are 3 conductor phone jacks, one of which is for the station microphone and the other for a cable between the 400 and the audio input to the transmitter. Robot supplies a cable for the latter and you simply have to equip your microphone with a 3 conductor 1/4" plug. Normal microphone PTT functions are looped through the 400. The microphone provides the audio to the transmitter in the VOICE position of the TRANSMIT SELECT switch while other positions select video sources as described previously. A front panel LED indicator comes on when video has been selected and a gain control on the rear apron lets you set the video output from the 400 to a level compatible with your transmitter audio input, eliminating the need to alter the transmitter audio gain. This gain control only functions when the 400 is generating the SSTV signal from its memory. Outside sources such as tape or other SSTV cameras must have their levels adjusted at the source. All of the other jacks on the rear apron are standard phono jacks for the receiver output, input from other sources, and input and output from the tape recorders). Robot supplies a cable for connection to the receiver and all other interconnections can be made with suitable shielded hi-fi cables.

### Circuit Description

There is no way that a few well-chosen words or paragraphs are going to do justice to a complex circuit such as the 400 or any other scan converter for that matter. All I will attempt here is to hit some of the high points in describing the operation of the unit. The heart of the 400 is its digital memory. The memory is composed of 16 UPD411D random access memory (RAM) chips, each with a capacity of 4092 bits



THAT NEW **ROBOT 400** SSTV CONVERTER SURE PRODUCES A GREAT PICTURE BILL, BUT IS THERE MUCH SSTV ACTIVITY ON THE 'HAM BANDS YET?

SSTV IS REALLY GROWING PAUL. AT LAST COUNT THERE WERE OVER 3,000 SSTV STATIONS IN OPERATION IN OVER 100 RADIO COUNTRIES AND IT KEEPS GROWING EVERY DAY.



DOES IT TAKE LONG TO MAKE CONTACT?

NO SIR! JUST TUNE IN TO 14.230 MHz AND YOU'LL GET ALL KINDS OF SSTV ACTIVITY.



MOST SSTV'ERS ARE REALLY HAPPY TO RAG CHEW AND EXCHANGE PICTURES. THERE'S EVEN AN SSTV NET THAT OPERATES ON SATURDAY AFTERNOONS.

IS 14.230 THE ONLY FREQUENCY FOR SSTV?

OH, THERE'S PLENTY OF BANDS DESIGNATED FOR SSTV, PAUL. THE FCC HAS AUTHORIZED SSTV OPERATION ON ALL PHONE BANDS EXCEPT 160 AND THE GENERAL CLASS PORTIONS OF THE PHONE BANDS ON 80, 40, 20 AND 15 METERS. EXCEPT FOR THESE YOU CAN OPERATE SSTV ON THE SAME FREQUENCIES YOU OPERATE PHONE.



BILL, DX'ING IS ONE OF THE MAJOR HAM ACTIVITIES. IS THERE ANY DX'ING WITH SSTV?

SURE THING. THERE'S TREMENDOUS DX ACTIVITY WITH SSTV. PLENTY OF STATIONS ALREADY HAVE WAC, AND SEVERAL HAVE MADE DXCC ON SSTV.



AND ALL YOU HAVE TO BUY IS THE **ROBOT 400** CONVERTER, CONNECT IT TO YOUR HOME TV SET\* AND YOU'VE GOT AN SSTV STATION?

RIGHT! AND THE **ROBOT 400** CONVERTER IS JUST \$695.



WRITE TODAY FOR YOUR SSTV FACT PACK FROM **ROBOT**. IT'S FREE AND TELLS YOU ALL ABOUT SSTV.

**ROBOT RESEARCH INC.**

**ROBOT**

7591 CONVOY CT. SAN DIEGO, CA 92111



R9

\* The Robot 400 Converter can be connected to the antenna terminal of a home TV set by means of the Robot RF Adapter Kit option for \$25.



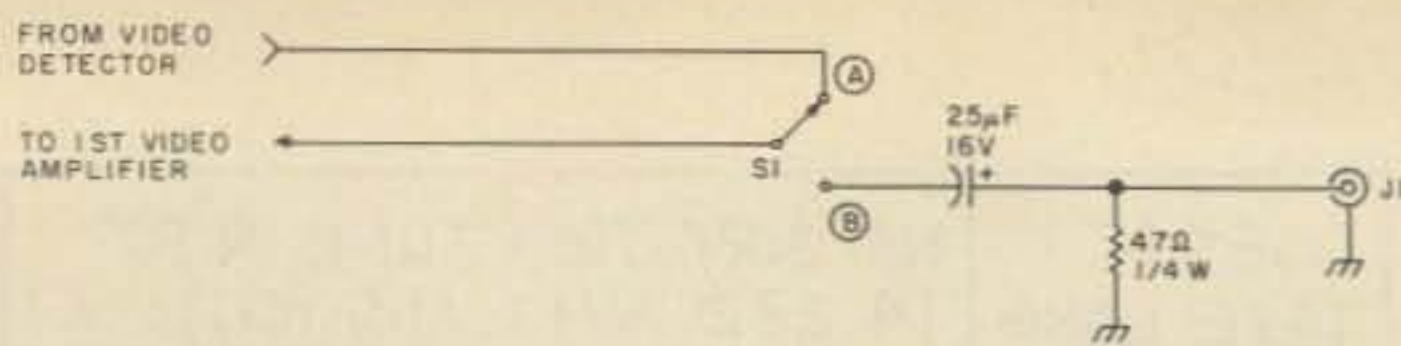

Fig. 3. Modification of a small solid state TV set for use as a video monitor. The set must be transformer operated with a grounded chassis to avoid a shock hazard and possible damage to the 400. J1 is a BNC jack and S1 is an SPDT toggle switch. Position A is for normal TV viewing, while in B the set functions as a video monitor. Similar conversions can be implemented in a variety of sets. The one I use is a Sony TV-770. In the 770, the line from the detector to the first video amp is a small piece of gray coax with a brown stripe. The coax is disconnected from the video board and soldered to the switch contacts (A). A small piece of subminiature coax is routed from the common switch lug back to the disconnect point on the video board. In converting the 770 or any other set, you should obtain a schematic or, better yet, a Sams Photo-facts booklet for the set prior to surgery. All of the SSTV pictures for this article were taken using the TV-770 and it does an excellent job.

(4K). These are dynamic memories and hence require a refresh cycle to retain their stored data. The 400 circuitry is set up so that the refresh cycling is provided in conjunction with the fast scan read operation which is going on continuously as long as power is applied to the 400.

Processing of SSTV signals is fairly conventional with op amps employed as limiters and active filters to provide the video waveform and sync signals to appropriate Schmitt triggers interfacing the SSTV sync signals to system logic levels. Incoming SSTV clocking is derived from a free running oscillator whose frequency is set by the WIDTH control on the front panel. The oscillator is triggered by the horizontal sync pulses derived from the incoming SSTV signal, thus locking the clock to the incoming video format. The A/D converter is composed of a series of 711 voltage comparators. The use of 1% resistors in the A/D circuits assures a precise A/D conversion. Initial A/D conversion is to gray code with onboard conversion from gray code to binary.

Fast scan clocking and sync and all internal slow scan clocking from memory is referenced to an onboard crystal oscillator assuring rock

stable clocking at all points in the system. The RAM memory is multiplexed in the 400 to achieve the speed required for fast scan display. The D/A conversion is accomplished with a 7486 and a series of 1% weighting resistors with several discrete transistors providing the interface to the external video monitor.

When snatching video from a fast scan source, the fast scan sync pulses from the source lock up an oscillator which serves as the reference for clocking the fast scan frame into memory. Readout from memory in the slow scan format is achieved with a custom VCO chip factory set for the 1200 Hz sync and 1500 and 2300 Hz black and white levels. Active devices are used throughout the 400 for digital and analog switching functions, thus vastly simplifying the interconnections between the board and the 400 controls and I/O ports.

The 400 manual provides a complete schematic and quite a detailed circuit description, and your ability to understand the inner workings of the beast should largely be limited only by your effort in studying the manual. Should you want to do a little digital design work yourself, the 400

is a marvelous store of interesting design approaches.

### Performance

Hooking up the 400 to perform all of its tricks will require a video monitor and a standard CCTV camera. Suitable video monitors can be purchased from Robot or CCTV outlets and you can expect to pay between \$250 and \$300 for a suitable monitor going this route. Excellent monitors can often be obtained at very good prices from computer stores and at the larger hamfests. It is also possible to modify a standard TV set for use as a monitor but you must not use a set with a hot chassis. Such a set can be dangerous to your health and, what is worse, will almost certainly damage the 400. The set shown in Fig. 1 is a Sony TV-770 converted to video monitor service as shown in Fig. 3. A small screen monitor is a must and you should not consider a screen size larger than 9" unless you plan to use it strictly for large group demonstrations. Screen sizes between 5 and 8" are ideal for normal viewing distances and the TV-770 is just about ideal and costs about \$140 maximum. If you absolutely must use a set with a hot chassis, then you should go the rf route, converting the 400 video output to an rf signal for viewing on an unused VHF channel. Robot markets a board (\$25) for this purpose. The rf route is the only safe approach to using a hot chassis set since the manufacturers have taken great pains to isolate the antenna terminals from the dc circuitry. Personally, I would only resort to rf display for occasional use in large demonstrations where it is feasible to use any large screen set that might be available.

CCTV cameras can also be purchased from Robot, CCTV outlets, or at the larger hamfests. As noted later, almost any camera with standard video (not rf) output

can be used. Bargains in used cameras can usually be obtained from CCTV outlets, security operations, or community TV companies.

An experienced slow scanner can have the 400 displaying pictures within ten minutes after the package arrives at the door, but I would suggest that you spend some time with the instruction manual as it has an excellent description of the function of the various controls and should answer all of your questions about interconnection with your own equipment. In terms of all of its functions, the unit I received worked right out of the box, but I did notice an apparent problem with a lack of sensitivity at the SSTV inputs (receiver, tape, and SSTV sources). This was particularly noticeable when the level from external SSTV sources was reduced for proper transmitter operation, for at the proper output levels, the 400 would not lock up reliably. The specifications indicated that the SSTV inputs should limit with a signal level of 20 mV, but a quick check showed that this was not the case. A call to Robot revealed that this had been a problem with some of their first production units and that current production models had some resistor changes that eliminated the problem. Substitution of the new values immediately brought my unit up to specs and it is unlikely to be a problem with any 400s other than the first sets that left the factory.

The 400 was very easy to set up for proper video display and has performed flawlessly. Noise immunity is the equal of the best home brew circuits I have used, and the unit does an excellent job even under current band conditions. The major feature I felt was lacking was a tuning indicator to assure proper carrier insertion when tuning the HF sideband gear. If the pictures you are receiving have normal contrast, tuning





Fig. 4. A collection of miscellaneous SSV pictures logged on 20 meters and displayed on the Robot 400. Only a simple dipole was used for the antenna system and, despite the current state of the band, the 400 delivered excellent pictures. Picture quality in terms of sharpness and contrast is limited only by the care with which pictures are set up at the transmitting end. If you are willing to alter the receive BRIGHTNESS and CONTRAST controls from their proper settings, even pictures of poor quality can be improved considerably. I tend not to alter these controls once they are properly set, as I want to be constantly in a position to realistically evaluate picture quality, and the replay (from the 400 memory) of a station's pictures can do wonders in getting the operator at the other end to set the pictures up more carefully!

is quite easy — you simply tune for maximum contrast and you will be right on the money. Unfortunately, there are still too many operators who are grinding out pictures that are low in contrast, and these can result in errors in tuning as you attempt to optimize video display. An LED tuning indicator can easily be added to the 400 (see the *73 SSV Handbook* for circuit possibilities) if you desire. The lack of a tuning indicator does not really detract from the 400's performance — I just like the convenience they provide. A number of representative pictures are included to show you what can be expected under normal band conditions.

Tape display is extremely

reliable even with cassette recorders. Despite Robot's caution to use recorders with good wow and flutter specifications, a number of 10 year old tapes — recorded on a battery operated reel-to-reel recorder — actually displayed quite nicely. Given the over-the-air performance, one might expect that display of local SSV sources would present no problems, and this is definitely the case. A variety of SSV cameras, flying spot scanners, and an SSV keyboard were tried with excellent results being obtained in all cases.

Experienced slow scanners may be curious to know how the 400 shapes up in the contouring department since it does not employ line averaging or psuedo-random

noise techniques. The key here is the use of a small screen monitor. With the proper monitor display, contouring has little or no subjective impact when the pictures have a normal contrast range. Contouring will always be visible with 16 gray scale shades if you take the trouble to look for it, but none of the people who have seen pictures on my 400 have even mentioned the effect. Contouring is more easily noticed if there are extensive areas of the picture with little or no detail, such as the background of an ID sign that is not evenly lighted, or in pictures with too little contrast. In the latter case, you are attempting to display a picture using too few gray scale steps and the effect is

that of using a system with fewer gray shades.

One operational convenience of the 400 that I did not anticipate was the case in making demonstration tapes. I usually record pictures off the air using a cassette tape deck. Such tapes typically have many frames marred by QRM and intervals of conversation. When such a tape is reviewed, you can freeze a particularly good frame in the memory, remove the tape from the machine, and substitute your demo cassette. You can then record two or three frames from the 400 memory, replace the tape again, and begin looking for other good frames. A single small cassette can thus contain the best pictures from a large number of tapes, result-



ing in an excellent record of your contacts as well as a good tape to play at radio clubs or hamfests to generate a little interest in SSTV. Many tape decks do not incorporate automatic level control, and these are often tedious to use since you have to ride the gain control to keep a reasonably constant signal level when recording pictures off the air. This problem can be eliminated if the transmit select switch is placed in the memory position during recording. You are thus recording from the 400 memory and the signal will have a constant amplitude regardless of the input variations in the incoming SSTV signal. The only disadvantage of this technique is that you do not preserve the audio commentary. If the voice signal is desirable, you can simply switch the transmit select to voice when pictures are not coming in, but you will have to ride the gain!

The 400 does an equally good job in terms of all of its transmit functions as well. In common with past Robot equipment, the 400 handles the interconnection of the tape recorder and other SSTV signal sources to the transmitter with the ability to select either voice or a video source. Where it really shines, however, is in frame grabbing from fast scan sources such as a CCTV camera. With the display switch in the camera position, you view the fast scan picture in real time, but

in its digitized form. The brightness and contrast controls for the snatch function let you compensate quite nicely for poorer than average subjects or flat camera output. The signal you see is precisely what will be stored in memory, so setup is no problem. With the memory input toggle switch in the continuous position, a new fast scan frame is snatched at the start of each SSTV frame. In the hold position, frame snatch is manually controlled with a front panel push-button. This is particularly nice if the camera is in an inconvenient position as you can face the camera, leer, and press the button, and then return to scratching or whatever else you do when the camera is not "live." A variety of cameras were used with the 400, ranging from some excellent new cameras with built-in viewfinders to an old Dage and several ancient home brew cameras. If you take the trouble to bring the broadcast video out of a TV set, you can also frame grab from that source. Broadcast video is excellent for test setups and demonstrations since it invariably has excellent resolution and contrast, but it is questionable whether you should transmit it on the air. I have seen quite a bit of snatched broadcast material on the air in the last few weeks, but it is worth noting that technically the practice is illegal since it involves the relay of material from the broadcast service via

the amateur service. In any case, the material from soaps or afternoon game shows hardly raises the quality of 20 meter operations! The 400 will also frame grab nicely from a video tape recorder if you are lucky enough to have one of those goodies to play with. The frame grab capability of the 400 is simply so convenient that I will gradually be phasing much of my slide pickup and special effects cameras from SSTV to fast scan format, probably with a common sync source so that all can be tied in effectively with my fast scan operations on 440 MHz. The 400 has some interesting possibilities here since fast scan video from 440 can be frame grabbed and relayed via SSTV on 2 meters to stations that are outside of the normal ATV range in our area.

#### Summary

The components, workmanship, and performance of the 400 are simply first rate, and it is my own personal opinion that it represents the finest piece of commercial SSTV equipment on the market today. You can build a somewhat more versatile scan converter than the 400 and you would probably be able to do it for somewhat less than the \$695 price tag of the Robot gear. Such an effort, however, would be a major project — probably one of the most complex projects that amateurs can undertake these days — and a careful evaluation would be required

to determine if the small margin in performance that you might obtain would be worth the effort. The 400 is an excellent package at a good price for the value received. Its performance is such that I have no plans to put together a conventional scan converter for SSTV. I am in the process of adding additional memory and video circuits to accommodate real time color display, but any attempt to duplicate the features of the 400 itself is simply not worth the effort unless you enjoy building for its own sake.

Once you have used a digital scan converter, you will simply not be satisfied with a conventional monitor. Digital scan conversion is going to be responsible for another burst of growth in SSTV and a great deal of that potential growth will be chalked up courtesy of Robot and their 400. The unit is well-engineered and can be expected to perform well in the hands of a neophyte or an experienced operator. By all means seek one out for a demonstration — it will be worth the effort. ■

#### References

<sup>1</sup> Steber, George R., 1975, "SSTV to Fast Scan Converter." *QST*: Part I in March issue, Part II in May issue. This article is must reading for anyone interested in digital scan conversion. It not only describes an excellent scan converter (using 1024 bit shift registers), but it also has excellent sections on the theory of scan conversion and some approaches to image processing.

## FAST SCAN AMATEUR TELEVISION EQUIPMENT

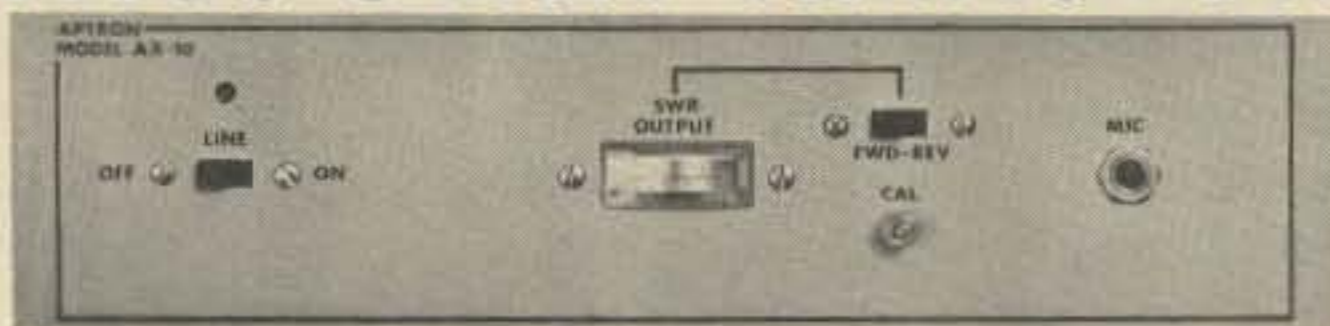

AX-10 TRANSMITTER

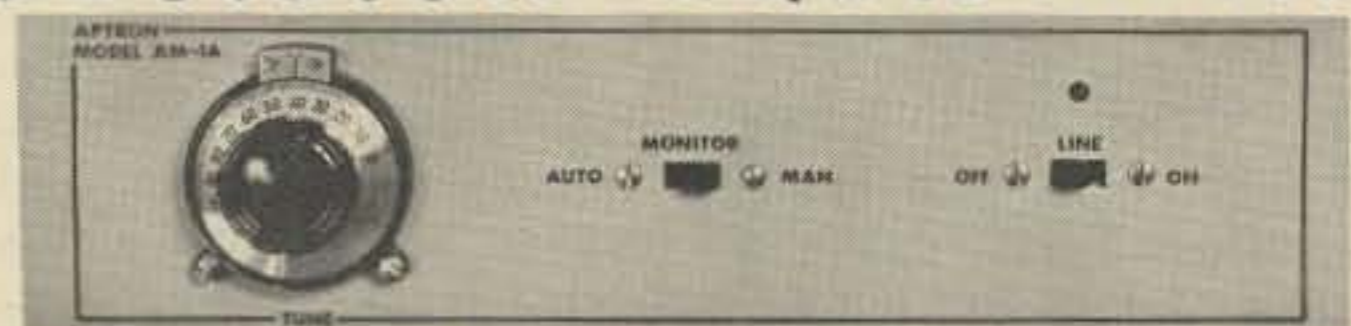

AM-1A RCVR MODEM

**BROADCAST  
QUALITY  
PERFORMANCE**



**Aptron Laboratories**

Box 323 Bloomington IN 47401

**SOLID  
STATE**

A6



# Bounceless TTL Decoder

-- a single chip does it!

**D**o you remember the first time you went to the doctor and your mother told you that it wasn't going to hurt? Well, that trick only

worked once, didn't it? I had much the same feeling the first time I tried to interface some TTL logic to the outputs of 567 decoders. No-

body told me that those nice decoders take several milliseconds to stabilize and, as we all know, TTL will count each and every little glitch just as if it were the real thing.

tastic. How does it work? The same — fantastic!

Fig. 1 is the schematic of a circuit I built for our repeater. The 567s go directly into TTL gates to generate 12 data lines, 0-9, \* and #. The gates faithfully transmit all the glitches supplied by the decoders. Reviewing the operation of the 14490s (Figs. 2 and 3) shows that basically all it does is wait until the signal on its input has been stable for four clock periods before the output will change to be the same as an input. Another handy feature is that by putting a single capacitor between two pins, a clock oscillator is formed. This same oscillator can be used to clock several chips. Interfacing the inputs of an MC14490 to a switch or TTL output is easy because pull-up resistors are included right on the chip. This means unused inputs can be left open, unlike normal CMOS inputs. But that is not all. Each output of a 14490 is capable of driving one TTL load. In our system, we decided that a 20 ms delay was desirable as it would eliminate all glitches from the 567s and tend to eliminate false noise decoding. The 0.01 capacitor results in an oscillator frequency of approximately 200 Hz, which gives four clock pulses every 20 ms.

The MC14050s are included to give enough current to drive the subsequent TTL logic used to decode various numbers and sequences we don't want dialed by our autopatch.

So, armed with MC14490s, no one should get stung by 567s, switches, or anything else that generates similar TTL-eating glitches. ■

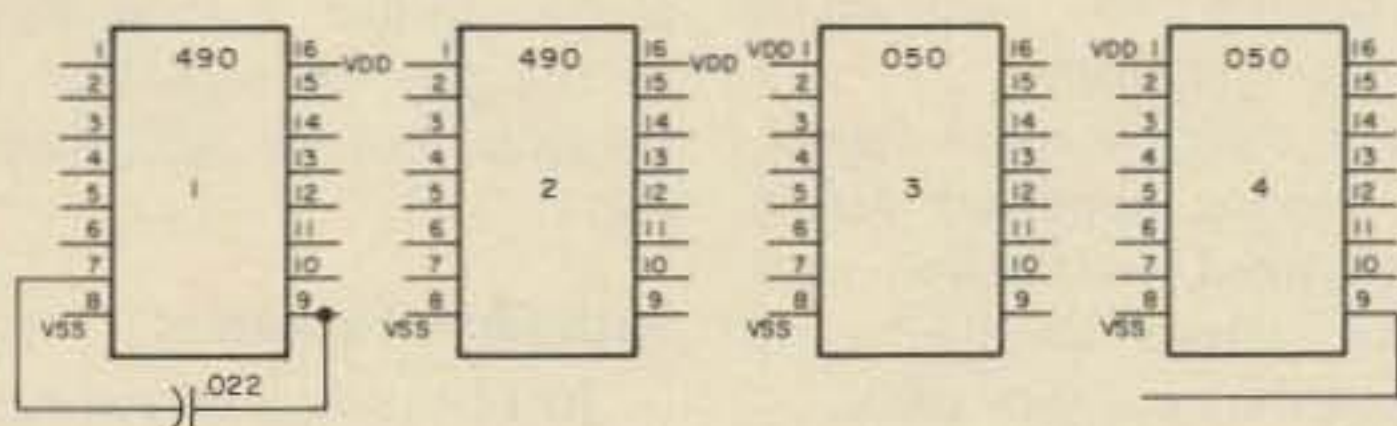

Fig. 1. Debouncer.

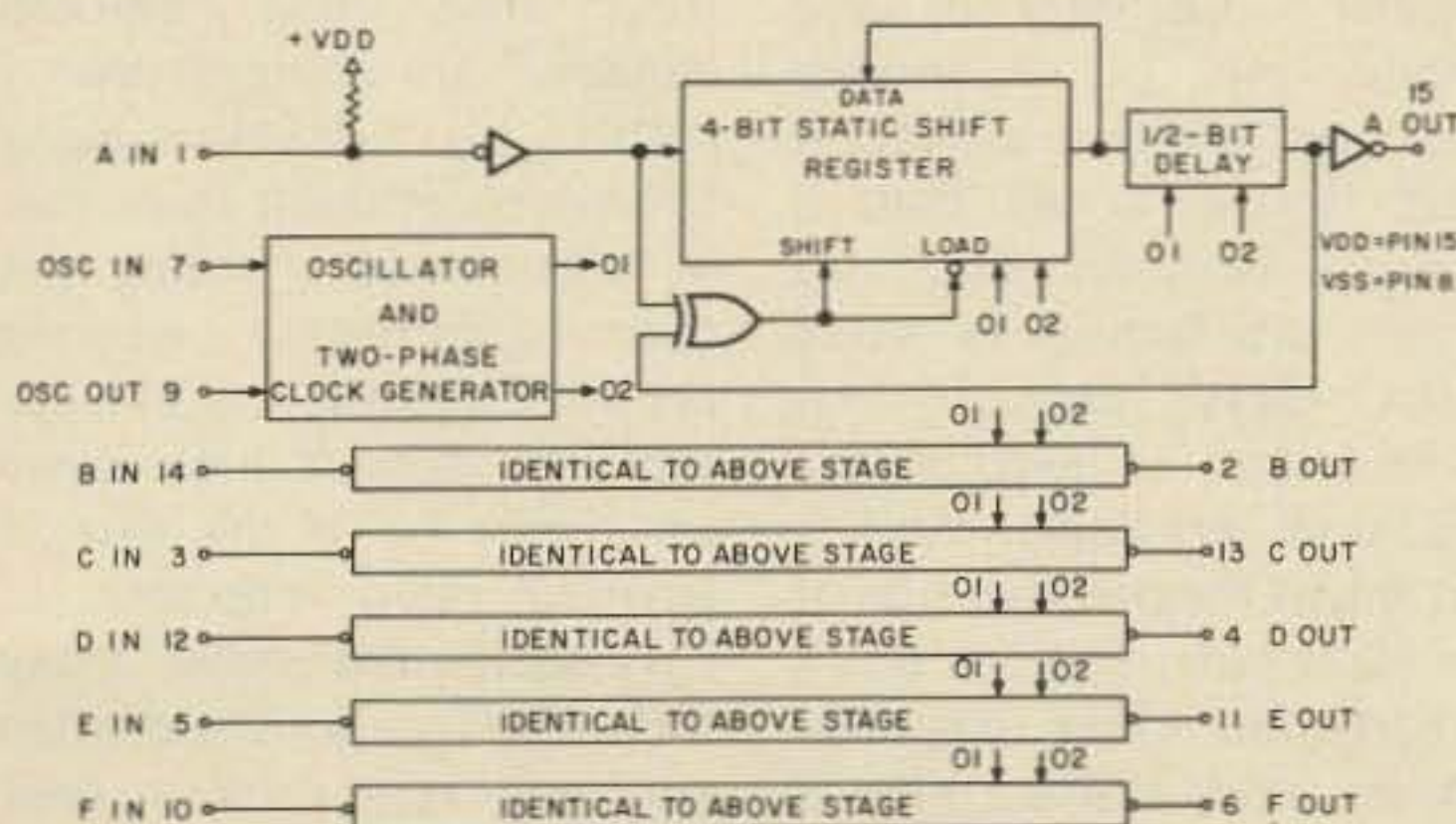

Fig. 2. Block diagram.

So, how do you debounce seven 567s without building some kind of one-shot or flip-flop for each one? Easy, especially if you have a Motorola CMOS data book. Look in it for an MC14490 and you will discover that it is a hex contact debouncer. How about that — 6 debouncers in one chip! Fan-

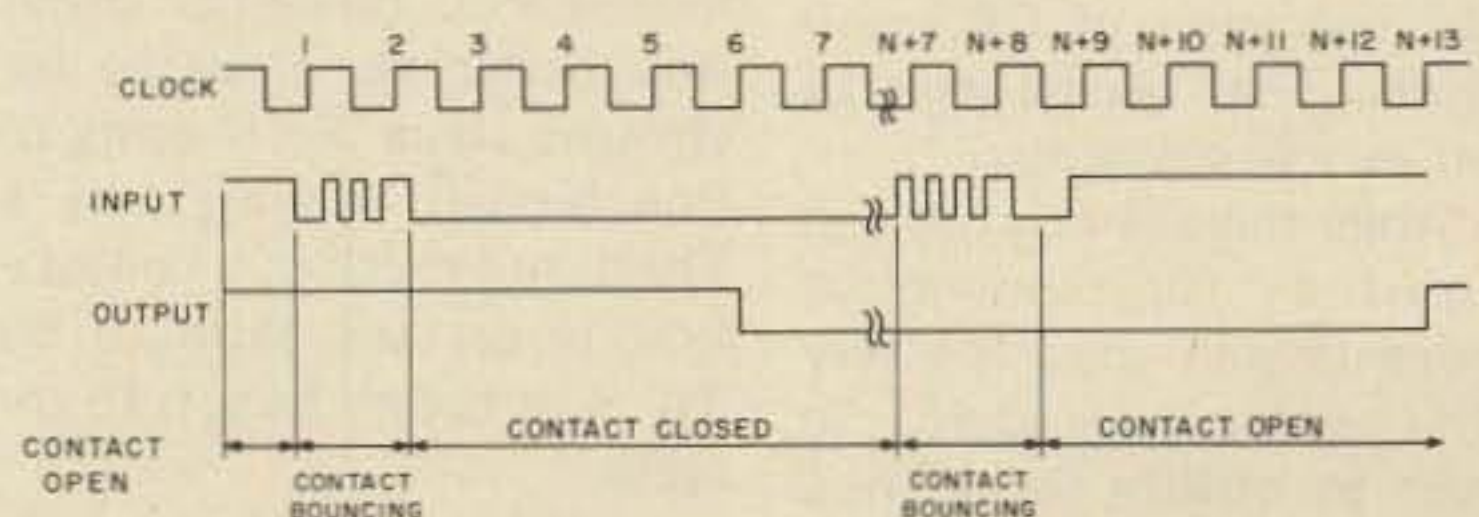

Fig. 3. Timing diagram.



# Hams Profit From CB

## -- how to set up a service center

David F. Norman  
622 W. Sunset Blvd.  
Fort Walton Beach FL 32548

Okay, most of the communicating community agrees — if somewhat grudgingly — that Citizens Band has a place in the scheme of things and even serves its user quite well at times. What most non-CB users and new CB users don't know is that there is a definite shortage of qualified CB technicians — and the shortage gets more acute each day. This is not to say that there aren't a lot of would-be CB repairmen. There are. The shortage is of *licensed* qualified technicians.

Under current FCC Rules and Regulations, only the holders of First or Second Class Radiotelephone operator's licenses can make repairs which can affect the legal operation of CB transceivers. That license isn't all that easy to get, either.

While there is no code test required for commercial phone tickets, there is a very stiff testing procedure. In order to qualify for a Third Class license — little more than a glorified Restricted

Operator's Permit — elements I and II must be passed with a score of 70 or better. That is duck soup. These two elements are only to check the applicant's familiarity with basic FCC rules and proper operating procedures. Unfortunately, a Third Class license does not entitle the holder to do anything other than *operate* certain classes of radios — which are not germane to this article.

In order to qualify for a Second Class license, element III must be passed in addition to elements I and II. This is where it gets binding.

Element III is 2 to 4 hours of the hardest multiple choice questions that you can imagine. The closest parallel to it in amateur service is the Extra Class exam. The applicant who goes to the nearest FCC office had damn well better be prepared for element III or he is going to find himself winning only a Third (not much of a consolation prize) and facing a 60 day wait before he gets to try again.

If, however, he feels confident and really well pre-

pared, he can add another buck and take element IV as well. The test applicant who passes elements I through IV, inclusive, gets to have his name typed on a beautiful, suitable-for-framing, First Class Radiotelephone operator's license (Fig. 1). Actually, element III is the hard one. Element IV only checks the applicant a little more closely in areas mostly pertaining to commercial broadcast stations.

For a couple more dollars, the passing applicant gets a wallet-sized verification card which attests to his having passed the necessary tests.

If you only want to work on non-commercial transmitters — CB, marine, land mobile, etc. — or smaller broadcast stations, a Second Class license is all that is required. However, there is a certain satisfaction in being "First Class" even if you never intend to exercise the additional privileges. And it just might happen that one of the local radio stations needs a part-time chief engineer. For an extra dollar, there is nothing to lose by trying for it.

If an amateur is pretty well up on his theory — General Class or higher — learning the extra knowledge required to pass the commercial tests will be a simple matter. The only additional materials that a commercial aspirant will need to borrow or buy are study guides or outlines for elements I through IV. Many local libraries have such volumes — which are published by TAB, Sams, Hayden, and others — on the shelves to lend. If your library doesn't have one or the one it has is several years old, either check in a larger bookstore or newsstand or watch for ads in electronics publications such as 73.

The study guides that you used for brushing up on theory before taking the General test and the *ARRL Radio Amateur's Handbook* are excellent for taking a different approach on a point which gives you trouble. For more than one electronics hobbyist, that First or Second Class ticket has been the passport into a whole new career. If the holder of a commercial license has any ability at all to troubleshoot and repair electronic equipment, he can always make a living at it. Maybe he will have to move from where he is, and maybe he won't always do just what he wants at the pay he feels that he deserves, but he will always eat.

### Attitude is Important

Just because a person has a crisp new First or Second ticket on his wall doesn't mean that those "chicken banders" are going to beat a path to his door. He is going to have to let them know that he is interested in seeing that their equipment is working properly and that, as an amateur, he doesn't look down on them. As is the case in amateur radio, operators of CB equipment have many different vocations and often are very, very good in their particular fields. A case in point is a recently overheard



QSO on 40 meters where the ham was remarking that the friend in the shack with him had a trenching machine and was digging the footings for the tower and guy anchors for the tower which the ham was in the process of building. That is the kind of friend to have. Dig?

As CBers learn of a new repair service in the area, word travels quickly. The bad word travels fastest. The good word travels farthest.

In almost every town, there is at least one CB dealer selling CB gear without having any real service department. A polite call on him to ask for his business and assure him that you are not interested in competing with him may be the beginning of a profitable relationship. The current rash of discounting takes a lot of profit out of the selling part of the business, anyway — you can make more on an installation than he does on the sale.

Taking all of your business from various dealers has at least one real advantage. If you deal strictly with dealers, you spend little time just talking to retain customers. On the other hand, the dealers may not provide you with as much business as you would like to have.

If the latter is the case, you should spend a few bucks taking out ads in CB club papers or local newspapers. If you plan your ads carefully and schedule them often enough to keep your service in the eyes of those you wish to serve, a few dollars will do a lot of good.

One fringe benefit of dealing directly with your customers rather than through dealers is the additional exposure that you can give amateur radio. (It's also a good way to move that older gear that you wish to replace with more sophisticated equipment.) Each year thousands of CBers will decide to get further into radio. What better way to spark this interest than offering to give demonstrations — you can

even schedule a group to watch — some slow weekend?

A positive, non-condescending attitude will go a long way towards making friends and regular customers among local CBers.

### Equipping Your Shop

If you intend to do any large amount of CB repairs, you will need to have some kind of shop. The shop can be your shack, if space and the XYL permit. However, a garage or small outbuilding is much better.

If you have a shop isolated as much as possible from the house, you have a more peaceful atmosphere in which to work; your customers won't be as likely to disturb your family or vice versa. If space at home doesn't permit a shop or zoning restrictions preclude it, you have at least two alternatives.

In most areas, there are small shop spaces for rent for 50 to 100 dollars per month. The drawback is that the locations are usually less than choice. If you are not geared for walk-in trade and keep erratic hours, this can be an advantage, especially if dealers provide the bulk of

your business.

Another possibility is that one of your dealers may have a small back room that he will let you use. This is a little sticky, though, if you are doing work for more than one dealer. In any event, these are just ideas. If you have a friend who wants to work with you, he may have another alternative.

If you are really an active experimenter, you may already have much of the test equipment that you will need for CB service. Even if you have to start from scratch, you can do it for less than you might think. A lot depends on your resourcefulness. A successful dealer really hungry for service just might be willing to help you acquire what you need.

What do you really need for CB service?

Actually, \$5000 will just about make it — plus parts inventory. However, let's assume that you *don't* have \$5000 to invest in service equipment at this stage of the game.

### Frequency Measuring Equipment

After the small tools and diddlesticks, soldering irons and wrenches, screwdrivers

and drills, the first item to acquire is some device for measuring frequency. A Cushman or H-P or Lampkin would be nice, but none of these is a necessity. Among others, Heath makes several counters which work just fine for CB.

An older heterodyne frequency meter can also be used. All that is required is that transmitters tested meet or exceed FCC requirements. At CB frequencies, the tolerance is plus or minus 50 parts per million. However, only a poor technician or one faced with an unusual situation would ever pass a piece of CB equipment which was barely within the law. Most modern CB transceivers are selective enough now that a station anywhere close to the legal limit would sound distorted and range would suffer.

### Signal Generator

Unfortunately, many small shops try to cut corners with signal generating equipment. When this is the case, the technician spends much longer than he should tuning a receiver. Rock-solid signal generating equipment capable of attenuation to below one



Fig. 1. An FCC First or Second Class Radiotelephone license is well worth the trouble it takes to get it.



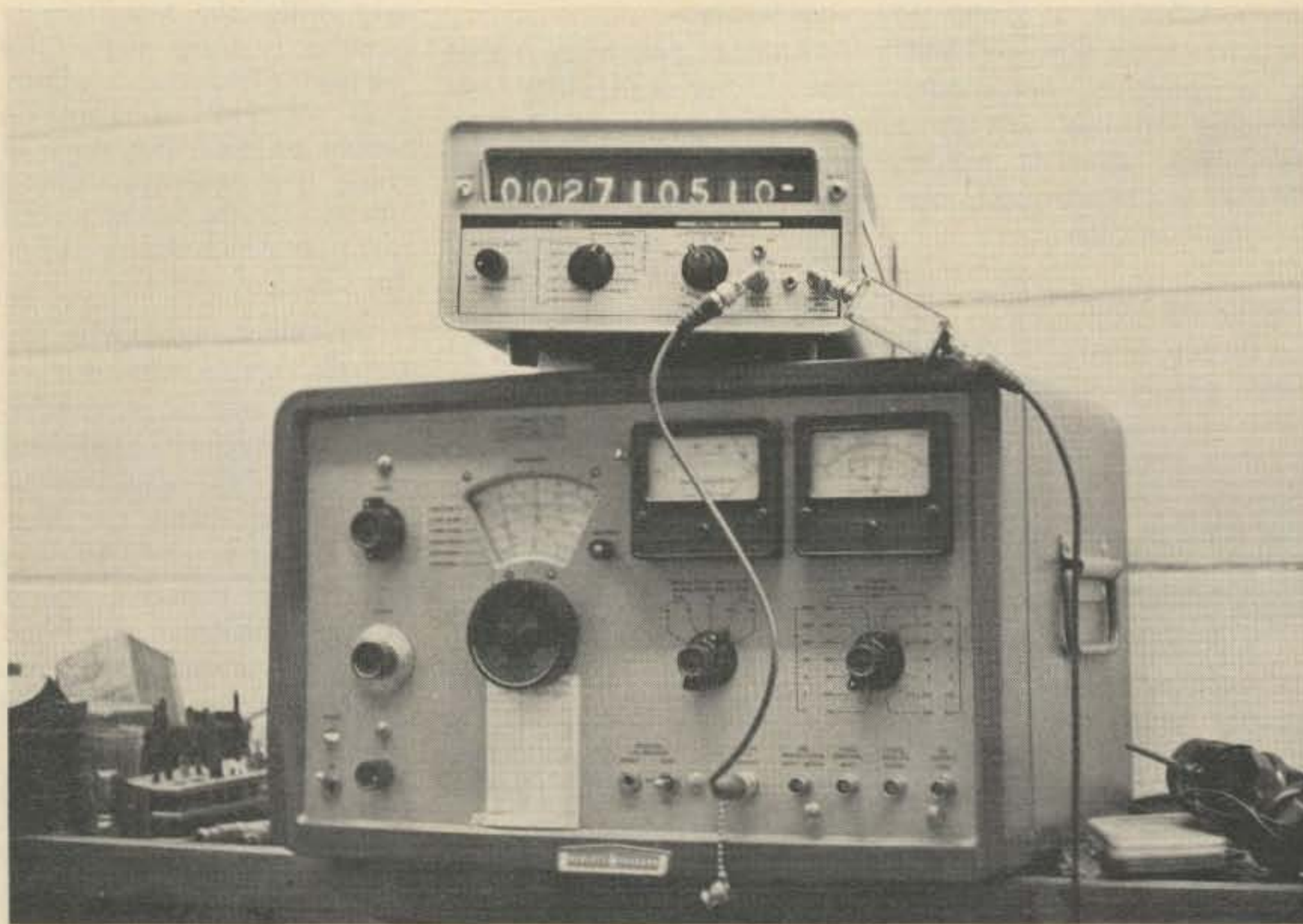

Fig. 2. Stable signal generating and frequency measuring equipment is essential for profitable CB service. Many hams already have such equipment sitting idle on their bench.

microvolt with adjustable amplitude modulation is hard to come by on a budget (Fig. 2).

In order to do the job with less equipment, you may have to constantly check the frequency output against your shop counter or frequency

meter. This takes time and, if overlooked, can mean that the whole procedure must be redone. One technician solved the problem with an old CB transceiver.

This particular unit had good oscillators, but the power stages had been fried

by reversing the power polarity and overfusing. The buffer stage was still good in the transmitter and the audio driver still worked.

He stripped out all of the damaged circuitry and coupled the buffer output to the antenna terminal. He then jiggered around with the driver in the audio section until he got feedback on it. This tone was adjusted, by varying the amount of feedback capacitance, and coupled through a pot to the buffer stage in the transmitter. The push-to-talk switch was replaced with a toggle switch, and he had a reasonably useful crystal generator with variable modulation. There were only two drawbacks.

Some of the crystals were off-frequency several hundred Hertz and the rf spray from the unit was terrific. Our hero merely disconnected the offending crystals and installed the unit in another chassis. When the seams were sealed with aluminum tape, spray was reduced to a tolerable level. A homemade attenuator between the original chassis and the outer

chassis allowed him to reduce the output to close to one microvolt.

As units vary considerably, and this particular one is reposing in a junk pile somewhere, no specifics are offered for such modification. The item was mentioned strictly for its inspirational value. If you don't think that the idea is worth toying with, though, just try to price a commercial piece of equipment designed to do the same thing.

### Scope

There is probably more controversy regarding the use of a scope than there is about all of the other test equipment combined. Some technicians use a scope for practically every test that they make, and constantly monitor the performance of one thing or the other with it. Other technicians seldom use a scope except for audio work. Most of us take the middle road and use the scope anytime that we need to compare audio or rf voltages and need the frequency discrimination provided by the scope's adjustable sweep rate.

Most inexpensive scopes share two disadvantages. They are grossly insensitive at high frequencies, and input impedance is so low that many small-signal circuits are swamped by the probe. At high frequencies, low capacitance probes usually lower overall vertical gain even more than do regular probes.

Obviously, one solution would be to get a 30 MHz scope. Unfortunately, the price of such exotic tools is quite high, even when they are surplus. Another solution is to buy a scope with as high a frequency response as the budget will stand and use it wherever possible.

For CB work, the wisest choice is probably to opt for an inexpensive 5 MHz scope and add blocking caps and a dummy load to the vertical deflection plates for viewing of modulation patterns. See

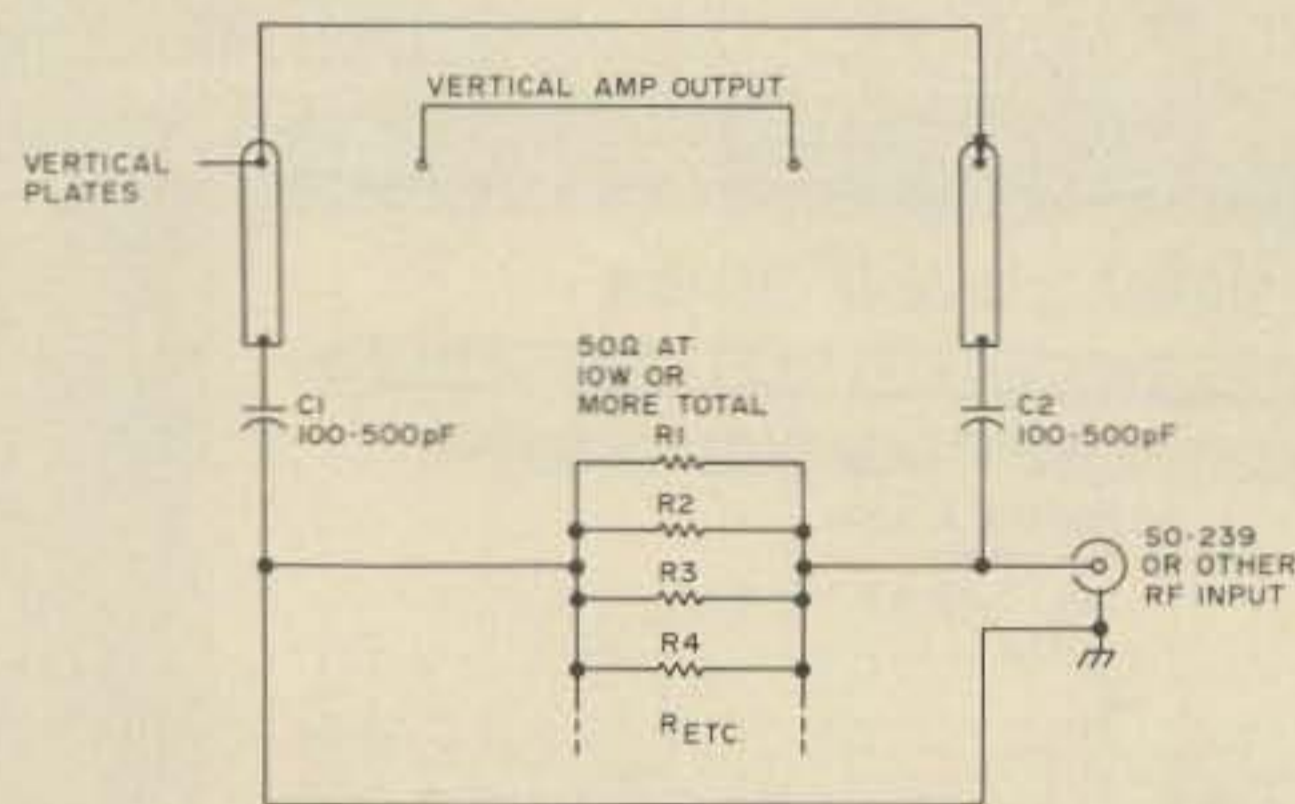

Fig. 3. A simple modification will permit practically any scope to directly handle 27 MHz transmitter output. A visual indication of modulated rf output can tell a technician not only how much modulation is present, but also how much distortion is present as well. On some scopes, it may be necessary to build the termination/coupling network so that it may be removed from the circuit when not in use. Care should be taken to see that the vertical amplifiers are not fed excessive levels of rf; average CB units will have 13-15 volts rms of rf across 50 Ohm load. Resistors should be carbon — not wirewound — paralleled as necessary for 50-52 Ohms total with a power rating of at least 10 Watts. Values of C1 and C2 should be adjusted for adequate deflection with minimum loading or swr on input.



Fig. 3.

### Electronic Voltmeters and Multimeters

Each CB shop needs at least one high impedance electronic voltmeter and at least one small, tough VOM for the abuse which such instruments always get. The old H-P 410B with the UHF rf probe is always a good choice for the budget bench. Not only are these instruments accurate, but they are also fairly cheap now.

With the whole world racing to become metric and digital, there are still some old ways that are better. Maybe the digital meters are handier for most purposes, but it is hard to beat an analog meter when it is being used to monitor a tuning response. Perhaps someone would prefer to dip a final with a digital meter, but most people prefer the smoother swing of a needle. The point is simply that brand new digital equipment is not indispensable.

### Swr Meters and Wattmeters

A well-equipped ham shack has some means of measuring rf output power and either vswr or reflected power (Fig. 4). Legal CB transceivers, however, operate at very low power levels compared to most amateur equipment. This being the case, you may have to purchase special test instruments for CB service. If there is a Bird in the house, all that is necessary is an element for high accuracy at CB frequencies. If not, one of the multi-purpose CB transceiver testers on the market will do just fine.

The scope dummy load mentioned earlier can be calibrated against a known reference to handle bench checks, and a separate swr meter will handle the tests into operating antennas. The swr meters are not expensive and usually are quite reliable.

### Bench Power Supply

Most of the transceivers

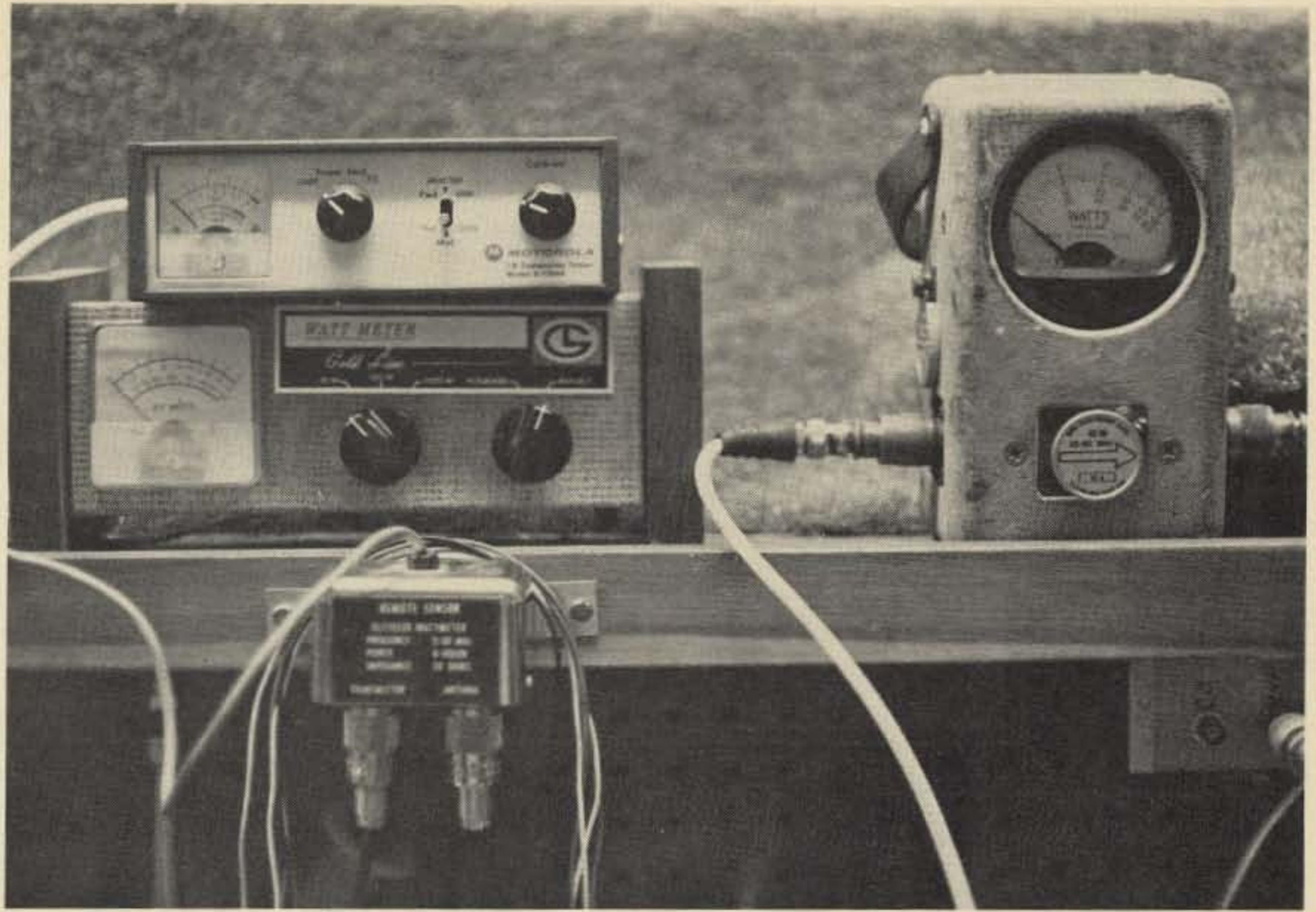

Fig. 4. FCC Rules require that CB rf output not exceed 4 Watts. These instruments measure reflected power or swr, as well as forward power.

which you will service are mobile 12 V dc units which draw about 1 to 2 Amperes at 13.8 V dc. A regulated and metered bench supply is absolutely essential for profitable CB service. In lieu of a neatly packaged bench supply, a battery with a well-filtered charger and a voltmeter/ammeter readout in the bench panel (Fig. 5) works very well. If you like to build and design, add switches to control charging, a circuit breaker to protect the meter and equipment being serviced, and as many status lights as desired.

A good bench safety feature is a panic button which will shut down all ac line power at once. If the ac switch — which can be an inexpensive wall panel circuit breaker — and the dc switch are mounted close together, you can kill everything instantly when you get smoke — as you surely will sooner or later.

### Antennas, Library, Jumpers, and Misc.

This last category is sort of a catchall. But watch it. The shop antennas, technical

library, and various cables for connecting this to that can entail a considerable investment. However, to attempt to service CB equipment without them is to turn what could be a good part-time business into an expensive hobby.

If you intend to offer installations — and you should as part of the service — you can expect to lay out more bucks for tools. Don't try to cut corners with your hand tool budget. There is nothing in this world more frustrating than having a

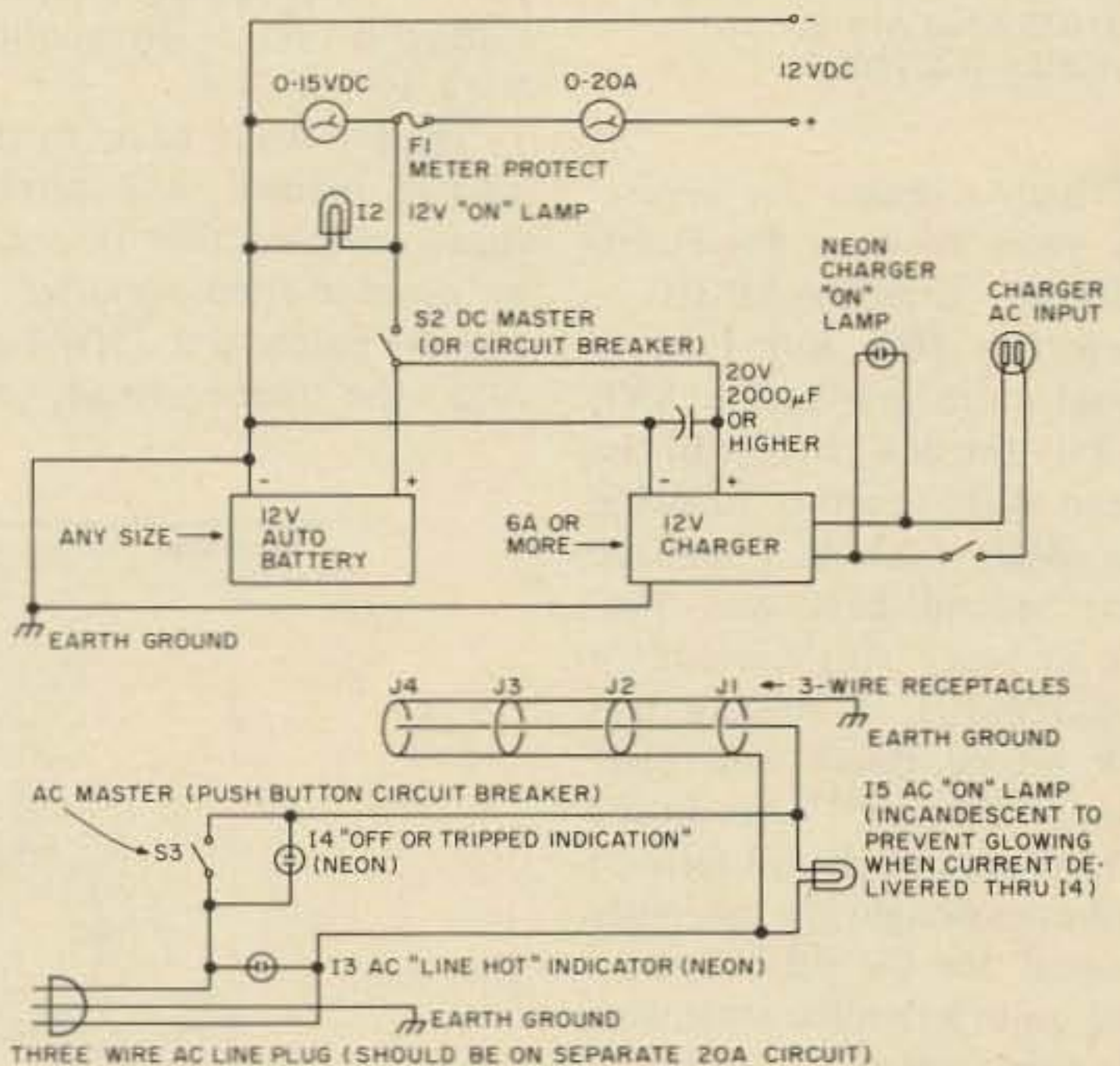

Fig. 5. Simplified schematic of bench power supply. This battery supply provides plenty of stable, well-filtered dc power. While few CB units use more than 2 Amperes at 13.8 V dc, the ambitious technician may soon find himself expanding into other fields. 14 may be omitted if it is desired to remove all leakage.



cheap tool break right in the middle of a job. If the customer is looking on, it's even worse — it's unprofessional as hell.

### Parts Inventory

Most CB units are combinations of very common parts — resistors, caps, diodes, transistors, etc. — and extremely rare parts — channel selector switches, crystals (sometimes impossible to get even on new units), and special chassis parts. In most

cases, the manufacturers can supply you with the parts unique to their respective units — for a price and after a time. In other cases, the time and expense involved may make the job economically unfeasible.

There is no pat solution to the parts problem. You may find that it is worthwhile for you to accumulate a few junkers of assorted brands. Some parts may be available from a "manufacturer" who markets a unit nearly identi-

cal to the one on your bench but under another name. This is where your most important tool comes into play — your brain.

No matter how limited your budget or cramped your quarters, you always have room to keep your brain. This handy item can often take the place of a whole shelf of test equipment. Remember that most problems can be diagnosed without taking the unit out of its case — if you only know what

symptoms to look for and what they mean when you have them. This same tool can pull your fat out of the fire when you remember that the unit on the bench is just like the one that you have in the junk pile except for the label on the front.

One way to take care of this tool and even improve its performance is to keep a notebook on every job that you do. After a few months, the data begins to add up to increased profits. ■

# Patch Up Your 101

## - - simple mod for the HW-101

Edward W. Robinson K7VUA  
31033 42nd Ave. S.  
Auburn WA 98002

I had a dream for several years to own the Heath SB-100 — then the SB-101 — then the 102, but I never could quite get: a) the XYL to buy the deal; and/or b) the green stuff together to swing the deal! Finally, I realized that second best was "on-the-air best," so I laid out for the HW-101. I already had the phone patch and electronic keyer by Heath. In the dream days of the SB series, I had even bought the assembly manual for the SB-102, so I had quite a familiar start with the new project.

Anxious to have the phone patch, I was surprised to find no mention of it in my first "charge" through the assembly manual for the 101! I checked the index and every

part of the manual, carefully studied it even — no mention at all. Hmmm!

Then I went back to the SB-102 manual, and careful study revealed that it would be quite a simple matter to add the patch to the HW-101. And, the place already ex-

isted for the parts needed when I checked the Modulator Circuit Board in my kit. The holes are drilled and the board appears to be the same one used in the SB-102 unit.

All that's needed is a ½ Watt, 22 kΩ resistor, 2 feet of RG 174/U coax and the

spare jack on the back of the HW-101 chassis. If you are putting a new kit together as I was, provide for it at this time. If not, just remove the covers and get down to where the action is.

Fig. 1 shows the corner of the modulator circuit board right around V1, foil side up. This is also available to you kit builders on page 188 of your manual, and is the upper right-hand corner of the illustration. The 22 kΩ resistor goes in the position indicated. Then the coax is put in as shown: the center conductor to the same island as the resistor and the braid to the outside or ground portion of the board. Holes are already there for the components.

Next, dress the coax back to the spare jack on the rear of the chassis. There you solder the center conductor of the coax to the center lug on the jack, and solder the shield to the ground lug. Be sure that you make a neat job of the coax as it runs back through the chassis; tie it off or thread it so that it will stay in place. Incidentally, there was enough spare coax in my kit to make up the piece for this purpose. If not, a 2-foot piece of RG 174/U will do the job.

Now all you need do is plug in your phone patch and you're ready to go. Since most of the components are the same as for the SB-102, you have actually made your kit more valuable, if you have done it neatly.

Happy patchwork! ■

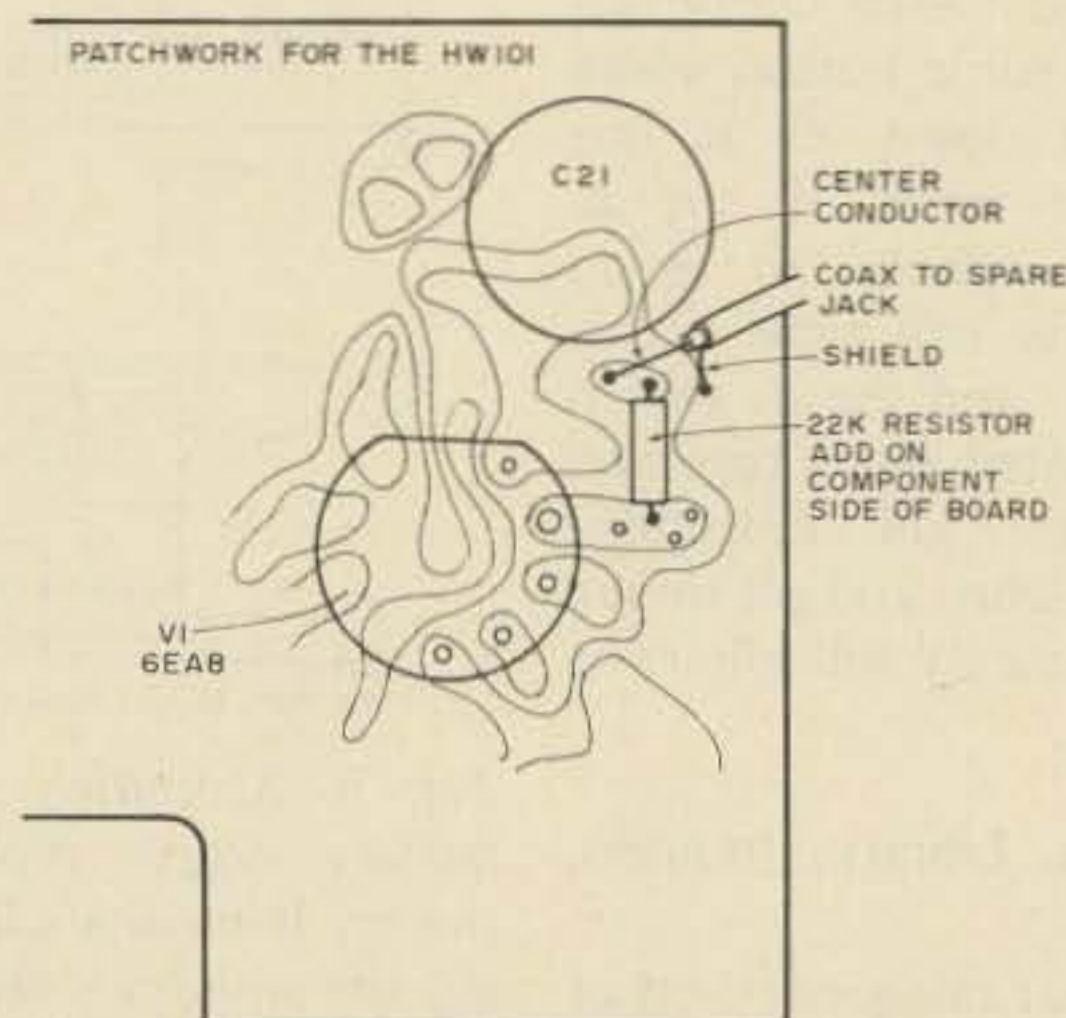

Fig. 1. Modulator circuit board (foil side).



## Optimize your antenna system.



Whatever your station set-up, there's an Amphenol® connector to complete it. And make it work right.

**Specify** the standard UHF solder-type termination for RG-8 cables or RG-58/RG-59 with reducing adapters: 83-1SP (PL-259) plug.

**Minimize** impedance mismatch with adapters designed to mate with 83-1SP: 83-1AP angle, 83-1T tee and 83-1J double-female.

**Home-brew** your gear with the commercial choice: 83-1R UHF receptacle.

**Ensure** a moisture-tight antenna connection with a weatherproof series N plug: 82-3202.

See these precision connectors at your Amphenol dealer.

**AMPHENOL** BUNKER RAMO

## Vanguard now has a HOT 2m converter ~ at a price you can afford

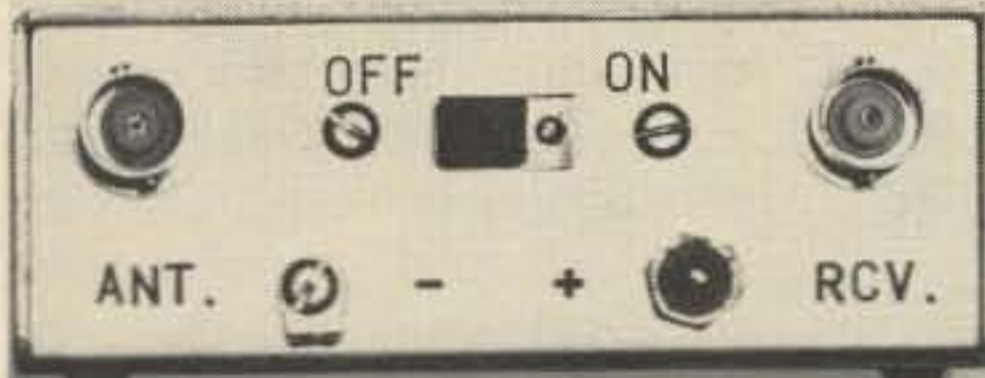

**MODEL C-144-A ONLY \$39.95**

**READ THE SPECIFICATIONS & SEE WHY IT'S THE BEST CONVERTER VALUE AVAILABLE ANYWHERE!!**

- Dual-gate MOSFET r.f. stage with diode protected input.
- Dual-gate MOSFET mixer for minimum cross modulation. Every converter tested for noise figure (2.5 — 3.0 dB max.) with Hewlett Packard noise measuring equipment.
- 6 tuned circuits.
- More than 20 dB gain. .1 microvolt sensitivity guarantee when used with receivers having 1 microvolt or better sensitivity.
- Complete with one .005% plug-in crystal to cover 144-146 or 146-148 MHz (be sure to specify which, or get both for only \$6.00 more). Standard output is for 28-30 MHz.
- 16 gauge aluminum case with BNC receptacles and antenna/power switch. Measures 3½" x 2¾" x 1¼"

**IN STOCK NOW FOR IMMEDIATE C.O.D. SHIPMENT. Call Monday through Friday 9 AM to 4 PM (212) 468-2720. V1**

**VANGUARD LABS**

196-23 Jamaica Ave., Hollis, New York 11423



## THE FM LEADER



**2 METER**  **220 MHz**   
**6 METER**  **440 MHz** 

### FEATURING THE ...

#### HR-2B



12 Channels  
15 Watts  
\$229<sup>00</sup> Amateur Net

#### The Master in 2 Meter FM

Positive performance at a practical price makes our HR-2B tops on 2 meters. Individual trimmer capacitors give bull's-eye accuracy for working repeaters or point-to-point. The .35µV sensitivity and Hi/Lo power switch insure your hearing and being heard . . . clearly and reliably . . . the Regency way.

### ... AND THE

#### HR-440



12 Channels  
10 Watts  
\$349<sup>00</sup> Amateur Net

#### UHF—The Ultimate in FM

440 is fresh . . . it's new . . . and with our HR 440 you can use UHF without using-up your budget. So, pioneer some new ground! Put a compact HR 440 under your dash or at your desk. It's the best way to usher yourself into UHF.

 **REGENCY, INC.** 7707 Records Street  
Indianapolis, Indiana 46226

© 1976



# The History of Ham Radio

## -- part IV

Eric Shalkhauser W9CI  
527 Spring Creek Road  
Washington IL 61571

During 1921, for sending their signals, amateurs were still thinking in terms of spark transmitters. The vacuum tube, as a simple three-element detector, was being advertised prominently and illustrated profusely in all the wireless literature. Not until the VT-1, 201, 202 and other tubes came along could much conversion from spark transmitters take place. It was well into the 1921-1922 period

that this happened with the realization that wavelengths below 200 meters were of considerably more advantage for DX and better tuning characteristics than at 200 meters and above.

While in the Signal Corps Officer's Training Camp in College Park MD in 1918, I saw and operated the first three-tube transmitter. It was similar in appearance to the first three-tube DeForest set which was extensively advertised in radio periodicals in 1921. It came equipped with Western Electric VT-1 tubes.

Construction articles ap-

peared monthly in the 1920 and 1921 magazines. These were simple circuit diagrams showing application. The Fessenden, Marconi, the Telefunken, the Colpitts and many others were displayed. The radio amateur was doing a lot of experimenting in adapting this new device to all sorts of circuit layouts toward improving reception and transmission of signals.

Amateurs and commercial interests devised all sorts of receiving circuit combinations under such names as the *neutrodyne*, the *amplidyne*, the *Roberts*, the *Cockaday*, etc.

One must remember that radio broadcasting had its real beginning in earnest right after World War I, and the general public became all agog over this new mysterious phenomenon entering their homes. Hearing strange voices and music out of nowhere . . . through earphones . . . without wires . . . It was unbelievable!

From now on the ham was no longer alone with his dots and dashes in his little cubicle, carrying on his own brand of mysterious private conversation.

Serious consideration was being given by the amateurs to the possibility of making improvements in signal reception by adding several stages of tube amplification to the detector. The single crystal detector and the old coherer could now be permanently replaced and abandoned. Those weak and often inaudible signals could now be picked out with ease and at a greater distance. And so, with the discovery of the regenerative circuit by Major Armstrong, the vacuum tube started to oscillate and gave signals a thousand fold boost in strength.

The vacuum tubes were not quite ready for transmission purposes. Their lack of ruggedness, their size, their cost and their scarcity held back adaptation by the amateur fraternity of tubes for strong CW signal generators. After the war, and even into 1922, amateurs who had served Uncle Sam were still operating their spark transmitters.

Many of us were familiar with either the Army Signal Corps or the Navy gear. They all looked and operated alike. In the beginning of wireless adaptation to the armed services, very little innovation could be expected for field combat purposes. The quenched gap transmitter stood out as a most reliable unit. To the ham this was proven equipment. True, it operated in many instances from a 500 cycle source of



Peoria Radio Sales Co., 1923-1924.



power, but it was regarded as a dependable unit to cover fairly long distances and was used by commercial companies in the field. It was semiportable when loaded on a horse, a mule, or two-wheeled cart.

The returning amateur was trained in the use of such transmitting equipment and took a fancy to the unit. He was very familiar with its performance, knew how to operate it, and had practical knowledge of its capabilities and application. During his period of service he was always thinking in terms of adapting it to his own use if and when he got back home. The one and only drawback was the 500 cycle power input. Replacing the quenched gap in the circuit proved a minor drawback.

When we examine the spark gap circuit used in all stations as illustrated and described in the literature of the early 1920s, it can be said that it was really quite simple and direct, and not difficult to understand in operation and performance.

The "spark-gap-ham" preferred to build his own condenser. He would use glass plates, mostly 8" x 10" in size, obtained from a photographer who was ready to discard them. (Exposures were made on glass plates "in them olden days.") These were covered, both sides, with tin or aluminum foil or other thin metal sheets. Tobacco pouches were often sources of foil. Enough plates were coated so that the assembled condenser gave a value of .01-.012 uF. To make sure that the unit could withstand potential surges as high as 25,000 volts, four of these sections were connected in series-parallel, making the capacitance still the correct value, approximately 0.01 uF. The whole thing was immersed in oil. Not to do so caused corona discharges around the edges. Being well soaked made them stand up much better under the high potentials. Even then they

## Radio Pictorial

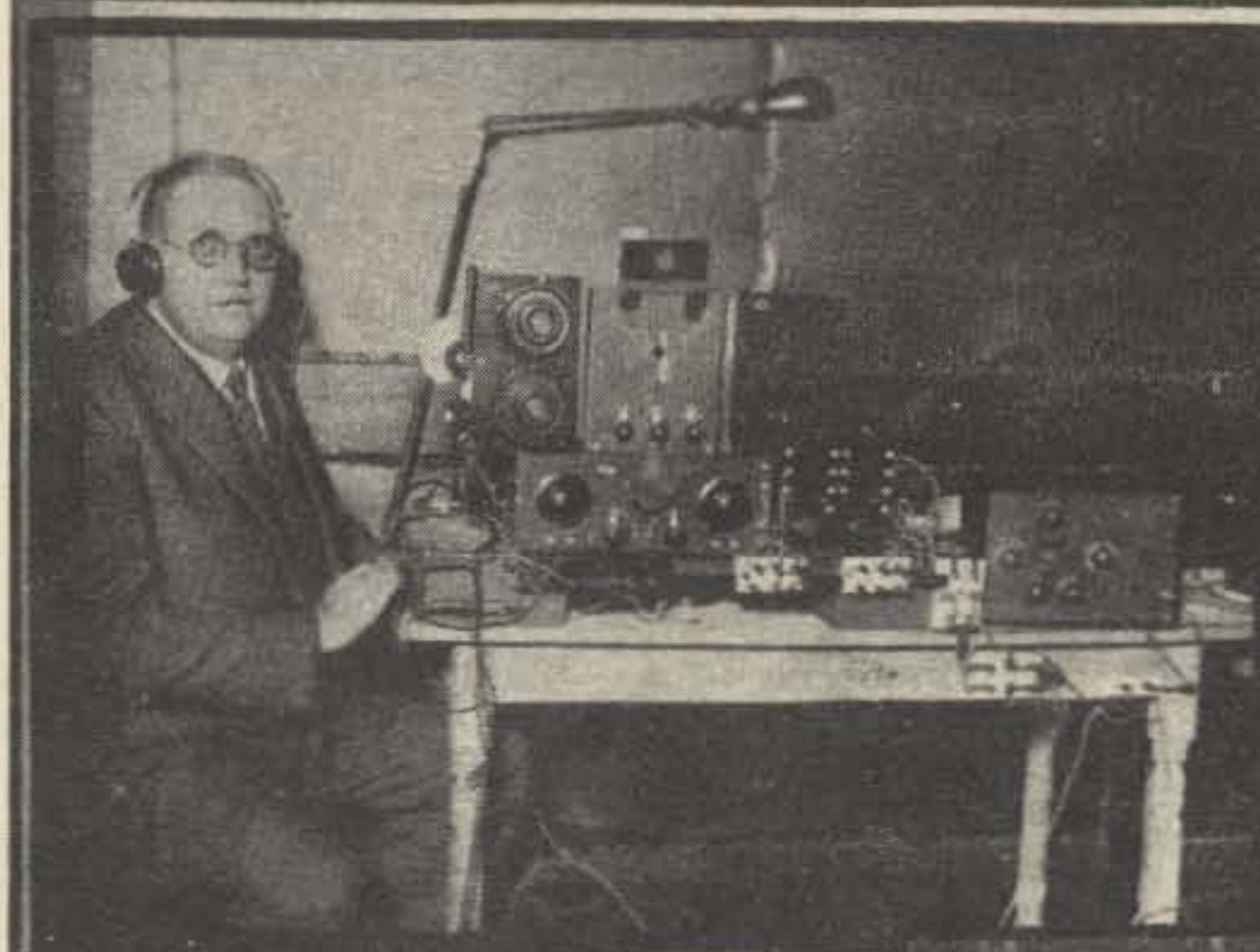

Just Recently Major Armstrong Started the World With His Regenerative Receiver. Dr. Franklin Lary Satterlee, Noted X-Ray Specialist, Now Makes Public His Discovery on a Non-Regenerative Set Making One Detector Bulb Do the Work of Two Stages of Radio Frequency. It is Claimed With This Set that a Greater Receiving Range is Made than Heretofore Accomplished. This is the Set that Strongly Interested Gen. Squier, Chief Signal Officer of the United States, Who Said he Would Give but 15 Minutes to Test this Receiver, and Actually Gave Three Hours.

The Photo on the Left Shows Dr. Satterlee Comparing the Large Radio Sets with the Small One-Bulb Set on the Extreme Right, His New Invention, Embodying the Same Principles as the Large Set.

Few Users of the Vacuum Tubes Realize Just How Much Work is Involved in the Manufacture of These Tubes, and How Radio Engineers are Constantly Experimenting and Doing Research Work with a View to Improving Them. The Photo Below Shows Mr. Shu S. Men, Graduate of the Hong Kong University of China, Plotting the Characteristics of Vacuum Tubes at Columbia College, N. Y.

(c) K. & H.



Above is the Latest Innovation, a Portable Radio Outfit, Including Loop, Batteries and Loud Speaker. It Can Be Operated Anywhere—on the street, in a Motor Car, on a Boat or in Any Building.

(c) Photo News.

While the Fordham University Station Was Designed Primarily for Relay Work Between the Various Colleges, It Has Proved so Successful that it Now Broadcasts Football Games Within a Radius of Many Miles. The Station Operates on 200 Meters and Uses Two to Four UV-200 Tubes.

(c) K. & H.

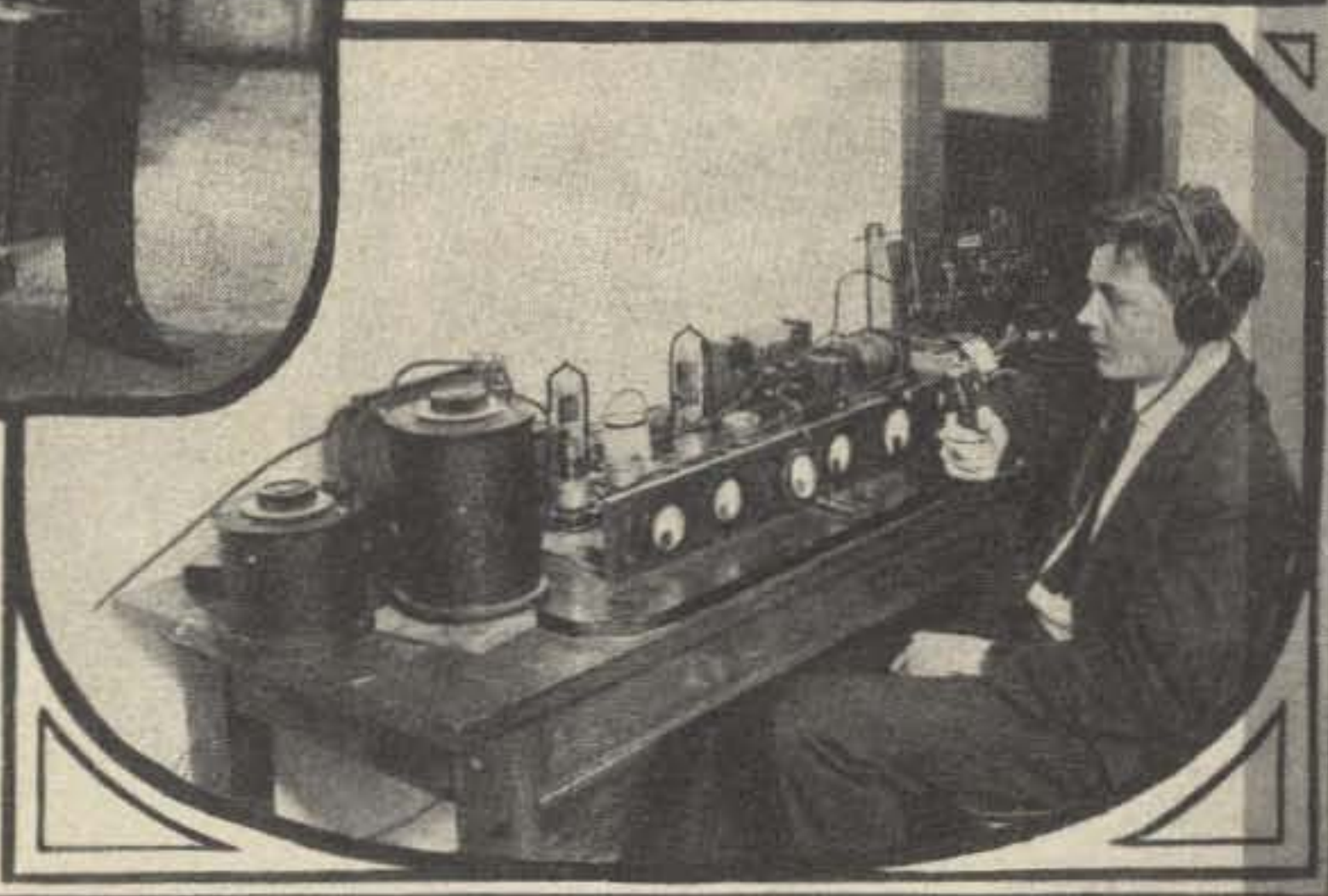

punctured unexpectedly!

The high potential was quite dangerous around the place. It was important that the condenser box be surrounded by a protective wall and openly marked: DANGER — HIGH VOLTAGE — KEEP YOUR DISTANCE!

The discharge gap in the circuit is in series with the primary spiral inductance, usually made of flat-wound

brass or copper ribbon. This was known as the oscillation transformer. Every time the key in the low voltage primary circuit was closed, the charged condenser let loose for the shortest fraction of a second, in rapid fire, and discharged across the spark gap. On discharge, the energy surged around the helical coil, and, in turn, the secondary coil inductively coupled to

the primary received a burst of electromagnetic energy. This in turn sent a damped wave signal out into the ether by way of the antenna configuration. A hot wire ammeter in series with the antenna to ground connection indicated the amount of current being emitted. A fuse block in the main power line provided protection against overloads.

Although the circuit



looked quite simple, we amateurs had other problems to contend with in meeting the 200 meter (or less) wavelength requirements. The condenser design value had to stay within the above stated uF limits. I will not attempt to delve into the mathematical equations to prove the point. Remember that we had a wrong concept of wavelength versus distance in those days.

Some amateurs were in a position to obtain 500 cycle power generators. Many signals could be heard on the air using such units. The signal coming from a 500 cycle source had a distinct tone quality. It was music to many an ear.

By way of interest, here is a statement which appeared in *Radio Amateur News* in 1920:

"Surely the US government is not imposing upon the American amateur when he limits the operating wavelength of your transmitter to 200 meters.

Contrast this law to that of Canada where the limit is placed at 50 meters. As a Canadian amateur recently remarked, with this short wave we may consider ourselves fortunate indeed to cover the extraordinary distance of one mile. As for democratic England, the would-be amateur is simply out of luck, for no license or permission is at present even obtainable under any condition. From the foregoing, we may therefore deduce the timely moral: *Keep your transmitter on the lawful side of 200 meters.*"

The amateurs up to now had really not discovered the potentially great advantage of the shorter wavelengths.

The rotary gap caused havoc on many occasions, since the studs had a tendency to become pitted after a short time of operation unless constructed of stuff that

withstood the constant arcing in an open oxygen atmosphere. Of considerable help was an enclosed gap, sufficiently airtight to exclude oxygen to the extent possible.

Much experimenting with the number of studs on the rotor and the speed of the motor improved the efficiency of the system. An 1800 rpm synchronous motor and a wheel with twelve well-designed studs, made of material that could withstand pitting, usually provided the right kind of pitch and whine to satisfy the critical ham in his quest to excel on the air.

By the characteristic frequency over the air, most ham stations were recognized without the usual QTH report. "I know the sound of his spark" was a common remark among hams.

After a station had its mechanical problems fairly well under control, the problem of decrement of the signal emitted received considerable attention. Specifications from the bureau in Washington decreed that the decrement could not, or should not, be higher than 0.2 when the energy was transferred to the antenna. Otherwise the signal emitted would be unduly broad with accompanying increased interference due to high damping.

What was this decrement all about? The subject was discussed at great lengths. It took front and center attention and was good for an argument anywhere, anytime. Decrement and how to meet its requirements waxed hot and furious from many podiums at conventions. Today you never hear the subject mentioned any more.

Decrement, logarithmic decrement: Nobody knew very much about the subject, even though the Department of Commerce issued their well known Bureau of Standards book entitled *Radio Instruments and Measurements* #74, on March 23, 1918. This gave technicians and engineers an in-depth documenta-

tion on the subject. Mr. B. West ex-8KEZ discussed spark dischargers at the St. Louis convention in 1920. In the course of his presentation, he was interrupted repeatedly by well-meaning listeners in the audience, as they confused the issue by introducing the "damping factor" and then wondering what was meant by *napierian*. The confusion usually brought down the house, and the heated discussion ended in a draw. Not even well-meaning intellectual cowhands from the western ranches knew what to make of these arguments and decided to leave well enough alone when they got back to their radio shacks.

So decrement, damping factor, impulse excitation, and increment — all these factors — were eventually solved the usual "over-the-ether-waves-reporting" way — experimentally — trial and error methods prevailing. It was understood that a low resistance (the lower the better) in the secondary discharge circuit gave a low decrement and allowed the energy to oscillate freely with consequent low heat loss. We seldom worried about impulse excitation any more.

Our problems were put away for a while until the next convention came along. This was to be the First National American Radio Relay League super meeting at the Edgewater Beach Hotel in Chicago, to be reviewed in the next chapter.

We go back to our midnight operating hours when all is quiet and serene about the house. The ham does not want disturbances to interfere with his concentration on distant code from some far-off place. Besides, when the key is closed, the spark noise could disturb the neighbors, and any intruders into the privacy of the shack would be overcome by the ozone that often permeated the atmosphere. QRX till we meet later on when fully recovered in fresh air environment. ■

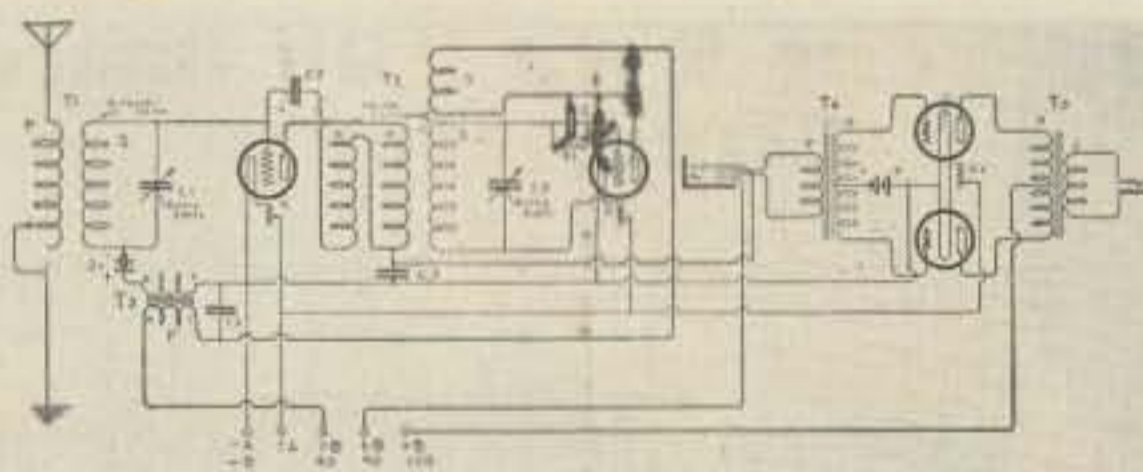

Reprinted from "Radio Receiver" by special permission

## ROBERTS SETS

The famous Roberts Circuits have given a wonderful degree of satisfaction to thousands who have built them. Excellent selectivity, fine tone quality, and extraordinary volume. The two-tube set gives volume equal to the ordinary three-tube set, and the four-tube set, using push-pull amplification, gives volume equal to the ordinary five-tube outfit. If you haven't built a Roberts set, you've missed one of the best bets in radio to-day.

### Complete Parts 2-Tube Set

1 Set Nanzley Coils	\$ 8.00
2 Hayes-Griffin Extra Plate Vernier Condensers	10.00
2 mica Condensers .002 Mfd.	.80
1 mica Condenser .0025 Mfd.	.40
1 Amertran Audio Transformer	7.00
1 10 Ohm Rheostat with Knob	.75
1 UV 201A Socket	1.00
1 UV 190 Socket	.50
2 25 Ohm Resistance Strips	.50
1 Grid Condenser .0025 Mfd.	.45
1 Grid Leak 2 Meg.	.50
1 Switch Lever	.20
7 Contact Points	.07
7 Binding Posts	.35
1 Hard Rubber Panel 7 x 21 x 3/16 (Un-drilled)	2.30
1 Wood Base	.75
Misc. Spaghetti, Bus Bar, Screws, Nuts, Bolts	.75
	\$34.32

### Complete Parts 4-Tube Set

1 Hard Rubber Panel 7 x 21 x 3/16, Drilled and Engraved	\$ 4.00
1 Base Board	.75
1 Set Nanzley Coils	8.00
2 Hayes-Griffin Extra Plate Vernier Condensers .005 Mfd.	10.00
1 Switch Arm	.20
7 Switch Points	.07
2 Switch Stays	.02
4 Sockets \$1.00 ea.	4.00
1 Amertran Transformer	7.00
2 Push Pull Transformers (set) Com.	12.50
3 Rheostats, \$ .75 each	2.25
2 Jacks (Open and Double Cir.)	1.40
7 Binding Posts	.35
1 Neutralizing Condenser	.50
1 Grid Leak (3 to 7 Megohms)	.50
1 Grid Condenser .0025 Mfd.	.45
2 Mica's .005 and .0025	1.00
2 C Batteries 4 1/2 Volts, @ \$ .60	1.20
Misc. Bus Wire, Spaghetti, Screws, Bolts, Nuts, Lugs, Etc.	1.00
1 Set Layout and Direction Sheet	1.00
	\$56.19

#### WELL WORTH HAVING

"Radio Broadcast's" booklet describing the famous Roberts Knockout Series of Receivers. Tells the whole story of these wonderfully efficient sets. Send for your copy now. Price, 50c.

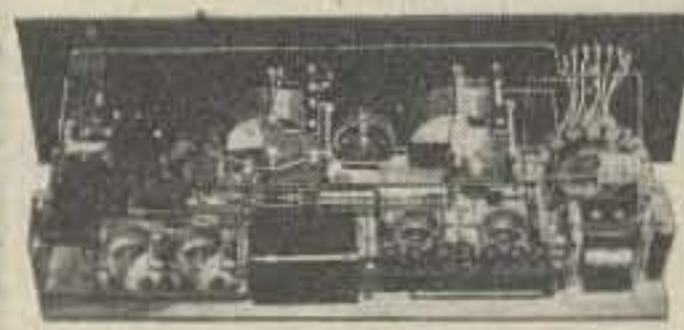
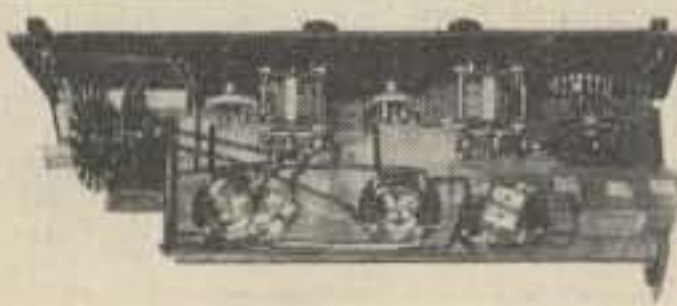



# SPECIALS FROM

# MHz electronics

## Fairchild VHF Prescaler Chips

11C01FC	High Speed Dual 5-4 Input no/nor	15.40
11C05DC	1 GHz Counter Divide by 4	74.35
11C05DM	1 GHz Counter Divide by 4	110.50
11C06DC	UHF Prescaler 750 MHz D Type flip/flop	12.30
11C24DC	Dual TTL VCM same as MC4024P	2.60
11C44DC	Phase Freq. Detector same as MC4044P	2.60
11C58DC	ECL VCM	4.53
11C70DC	600 MHz flip/flop with reset	12.30
11C83DC	1 GHz 248/256 Prescaler	29.20
11C90DC	650 MHz Prescaler Divide by 10/11	16.00
11C90DM	same as above except Mil. version	24.00
11C91DC	605 MHz Prescaler Divide by 5/6	16.00
11C91DM	same as above except Mil. version	24.00
95H90DC	350 MHz Prescaler Divide by 10/11	9.50
95H90DM	same as above except Mil. version	16.50
95H91DC	350 MHz Prescaler Divide by 5/6	9.50
95H91DM	same as above except Mil. version	16.50
T.I. TMS4060/C2107, 4K RAM		19.01

## Batteries

Gel-Cell 12 volts at 1.5 Amp Hr. #GC-1215 \$19.95

## Crystals

1.000000 MHz	4.95	JUST ARRIVED! These radios have just been pulled out of service, Set up for approx. 150 MHz. Clean. All tubes included. No accessories. Prices FOB Phoenix.	
5.000000 MHz	4.95		
10.000000 MHz	4.95		
3579.545 KC	2.95	Motorola U43 GGT	\$49.95
		GE TPL	\$99.95
		GE MT-33	\$39.95
		GEMT42N	\$79.95

10.7 MHz Narrow band Crystal Filters type 2194F \$7.95

## 10.7 MHz Ceramic Filter

MuRata SFW10.7MA ..... \$3.95

## Johanson and Johnson

### Trimmer Capacitors

1 to 14 pf.	\$1.95
1 to 20 pf.	\$1.95

### Ferrite Beads

12 for .99 or
120 for 9.99

## FET's

2N3070	1.50	2N5460	.90	MFE3002	3.35
2N3436	2.25	2N5465	1.35	MPF102	.45
2N3458	1.30	2N5565	5.45	MPF121	1.50
2N3821	1.60	3N126	3.00	MPF4391	.80
2N3822	1.50	MFE2000	.90	U1282	2.50
2N4351	2.85	MFE2001	1.00	MMF5	5.00
2N4416	1.05	MFE2008	4.20	40673	1.39
2N4875	1.75	MFE2009	4.80	40674	1.49

## TUBES

2E26	5.00	811	6.95	7984	4.95
3B28	4.00	811A	9.95	8072	32.00
4X150A	15.00	931A	11.95	8156	3.95
4X150G	18.00	5849	32.00	8908	9.95
4CX250B	24.00	6146A	5.25	8950	5.50
4CX350A/8321	35.00	6146B/8298A	6.25	4-400A	29.95
4CX15000	\$150.00	6360	7.95	4-250A	24.95
DX415	25.00	6907	35.00	4-125A	20.95
572B/T160L	25.00	7377	40.00	4-65A	15.95

## RF TRANSISTORS

2N1561	15.00	2N5590	6.30
2N1562	15.00	2N5591	10.35
2N1692	15.00	2N5635	4.95
2N1693	15.00	2N5636	11.95
2N2631	4.20	2N5637	20.70
2N2857	1.80	2N5643	20.70
2N2876	12.35	2N5641	4.90
2N2880	25.00	2N5643	20.70
2N2927	7.00	2N5764	27.00
2N2947	17.25	2N5841	11.00
2N2948	15.50	2N5842/MM1607	19.50
2N2949	3.90	2N5849/MM1622	19.50
2N2950	5.00	2N5852	50.00
2N3287	4.30	2N5942	49.50
2N3300	1.05	2N5922	10.00
2N3302	1.05	2N6080	5.45
2N3307	10.50	2N6081	8.60
2N3309	3.90	2N6082	11.25
2N3375/MM3375	7.00	2N6083	12.95
2N3553	1.80	2N6084	14.95
2N3571	4.10	2N6094	5.75
2N3818	6.00	2N6095	10.35
2N3824	3.20	2N6096	19.35
2N3866	1.09	2N6097	28.00
2N3866 JAN	4.14		

New Motorola Carbon Microphone Model P-7255A. This unit is a "noise cancelling" palm type microphone. These mikes come with or without cables. Price without cables \$19.95; with cables \$29.95.

H.P. 612A UHF Signal Generator 450 MHz to 1230 MHz \$900.00  
H.P. 624B Microwave test set 6565 MHz to 7175 MHz \$900.00  
Beckman Meter and Heterodyne Plug-in/Freq meter D.C. to 1 GHz \$900.00

Motorola MC14410CP CMOS tone generator uses 1 MHz crystal to produce standard dual frequency telephone dialing signal. Directly compatible with our 12 key Chomeric pads. Kit includes the following.

1 MC14410CP  
1 1 MHz Crystal  
1 Printed Circuit Board (From Ham Radio Sept. 1975)  
And all other parts for assembly. \$15.70

Fairchild 95H90DC Prescaler divide by 10 to 350 MHz. Will take any 35 MHz Counter to 350 MHz. Kit includes the following.

1 95H90DC  
1 2N5179  
2 UG-88/u BNC's  
1 Printed Circuit Board  
And all other parts for assembly. \$29.95

Fairchild 11C90DC Prescaler divide by 10 to 650 MHz. Will take any 65 MHz Counter to 650 MHz or with a 82S90 it will divide by 10/100 to 650 MHz. This will take a 6.5 MHz counter to 650 MHz. Kit includes the following.

1 11C90DC  
1 2N5179  
2 UG-88/U  
1 MC7805CP  
1 Bridge  
1 Printed Circuit Board and all other parts for assembly.  
82S90 add \$5.70 to total. \$59.95

## TRANSFORMERS

F-18X	6.3vct at 6 amps	3.56
F-93X	6.5v to 40v at 750 ma.	3.53
F-92A	6.5v to 40v at 1 amp	4.59
N-51X	Isolation 115vac at 35va.	2.80
Model D-2	6.5v at 3.3 amps	4.95
	6.5v at 3.3 amps	
BE-12433-001	30v at 15 ma.	.49
BGH-9	6.3vct at 10 amps	
	115 vac at 100va Isolation	6.95
F-107Z	12V @ 4A or 24 V @ 2A	7.80

P6377 12v at 4 amps or 24v at 2 amps. \$6.30

P6378 12v at 8 amps or 12v at 4 amps. \$10.31

P8196 80vct at 1.2 amps \$6.28

## DIODES

1N270 Germanium Diodes \$7.95/c  
HEP170, 2.5A, 1000 PIV \$4.95/20  
Semtech SFMS 20K, 20KV, 10 ma, fast recovery \$1.26 ea.

## FANS

Pamotor Fans, Model 4500C 117 VAC, 60 Hz, 19 w. .... \$7.95

## RF TRANSISTORS

MRF207	2.00	Amperex BLY90	22.50	MM3002	1.65
MRF208	10.20	Amperex A209	8.60	MM3009	1.80
MRF209	12.35	MSC 2001	20.00	MM3375	7.00
MRF237	1.85	MSC 3000	20.00	MM3904	1.50
MRF238	8.55	MSC 3001	20.00	MM3906	1.43
MRF450	16.55	MSC 3005	20.00	MM4000	1.24
MRF453	19.55	MSC 80205	20.00	MM4001	1.39
MRF504	6.75	MSC 80206	20.00	MM4003	1.85
MRF509	5.50	MSC 80255	20.00	MM4036	1.60
MRF511	8.60	Fairchild SE7056	3.00	MM4044	3.00
MRF620	27.00	MM1051	2.00	MM4545	3.00
MRF8004	1.90	MM1500	32.20	MM8006	2.15
HEPS3013/75	2.95	MM1550	10.00	MM1552	50.00
HEPS3014/76	4.95	MM1601	5.50	MM1553	56.50
HEPS3002	11.03	MM1602	7.50	HEPS5026	2.48
HEPS3003	29.88	MM1607/2N5842	8.65	MSC 80256	20.00
HEPS3005	9.55	MM1614	2.75	CTC D1-28	20.00
HEPS3006	19.90	MM1620	17.50	CTC D10-28	20.00
HEPS3007	24.95	MM1622/2N5849	19.50	CTC E1-28	20.00
HEPS3008	2.18	MM1661	15.00		
HEPS3010	11.34	MM1669	17.50		
RCA TA7994	50.00	MM1943	3.00		
RCA 40290	2.48	MM2605	3.00		
Kertron K2126	5.50	MM2608	5.00		
Kertron KB6008	5.50				

# MHz electronics

2543 N. 32nd STREET  
PHOENIX, ARIZONA 85008  
PH. 602-957-0786



NO C.O.D. M8



# Dipole Designer Program

-- calculates coils  
and length

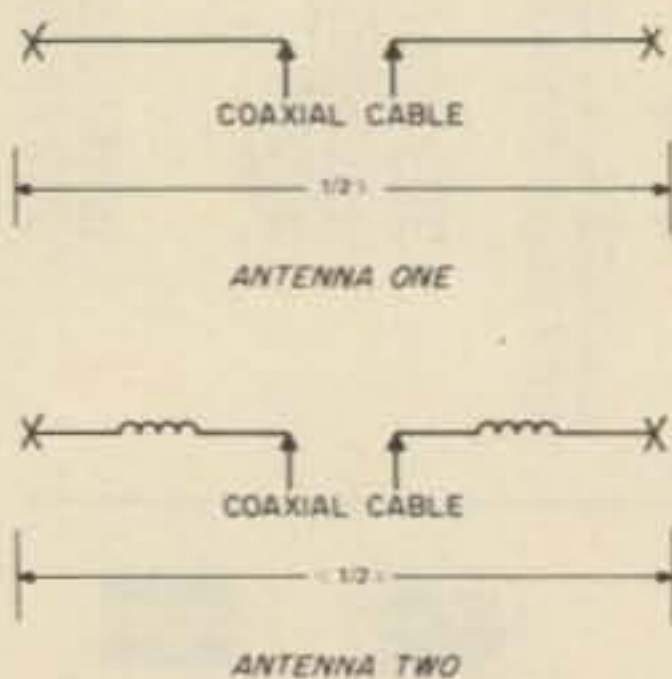

Fig. 1. Dipole Antenna Considerations.

The resonant half wavelength dipole can be shortened considerably using a pair of loading coils to provide lumped inductance between the center feed point and the ends of the antenna (Fig. 1). Both of these configurations can be resonant at the same frequency.

What's the tradeoff? The reduced physical length costs you bandwidth at any swr

level of your choice. If you're using less than a couple hundred feet of RG-8 or RG-11 and your lot is as small as mine, then that's an attractive exchange.

The Dipole Designer pro-

gram is written to help you juggle the variables involved. It can be broken down into 3 areas.

## Program Description

The first area is the calcu-

```

2 FOR K = 1 TO 16: #""":NEXT K
4 #""LOADED DIPOLE DESIGN"
6 #""<-----L----->
   >"
8 #""X-----<>-----<>
   -----X"
10 FOR K = 1 TO 4
12 #""           ↑↑":NEXT K
14 #""<>= LOADING COIL"
16 #""X-TO-X DISTANCE = OVERALL ANTENNA"
18 #""LENGTH."
20 #""THE DIPOLE IS FED IN THE CENTER"
22 #""& THE FEEDLINE TO LOADING COIL"
24 #""DISTANCE IS A VARIABLE YOU WILL"
26 #""INPUT ":FOR K = 1 TO 9000:NEXT K
28 FOR K = 1 TO 16: #""": NEXT K
30 #""           DATA INPUT"
32 #""           -----"
34 INPUT "PLEASE ENTER THE TARGET
   RESONANT FREQ. IN MHZ",F
36 IF F <= 0 THEN 34
38 IF F > 31 THEN #""THIS PROGRAM IS ONLY
   VALID TO APPROXIMATELY 30 MHZ"
40 IF F > 31 THEN 34
42 FOR K = 1 TO 16: #""":NEXT K
44 #""ONE HALF WAVELENGTH DIPOLE AT"
46 #F;" MHz"
48 #""HAS AN OVERALL LENGTH OF"
50 #468/F;" FEET": FOR K = 1 TO 2000:NEXT:
   FOR K = 1 TO 16: #""":NEXT K
52 INPUT "WHAT IS THE DISTANCE IN FEET
   FROM THE CENTER OF THE DIPOLE
   TO EACH LOADING COIL?", B
54 IF B <= 0 THEN 52: IF B > 230/F THEN 52
56 INPUT "WHAT GAGE WIRE ARE YOU USING?",
   G1
58 IF G1 < 2 THEN 56
60 IF INT (G1/2)=(G1)/2 THEN G=G1 ELSE G=G1+1
62 IF G > 32 THEN 56
64 GOSUB 138
66 INPUT "WHAT IS THE OVERALL ANT.
   LENGTH IN FEET?",L
68 IF L <= 0 THEN 66
70 IF L > 465/F THEN #""TOO LONG, YOU WILL NEED
   CAPACITIVE LOADING"
72 IF L > 465/F THEN 66
74 IF L < 2*B THEN #""COILS ARE OUTSIDE
   OF ANTENNA TRY AGAIN!!"
76 IF L < 2*B THEN 66
78 GOSUB 112
80 #""THE REQUIRED LOAD INDUCTANCE"
82 #""IS =": C0;"MICROHENRYS."
84 INPUT "JUMP TO COIL DESIGN?
   (Y OR N)",AS
86 IF AS = "Y" THEN GOSUB 176
88 FOR K = 1 TO 1000:NEXT K
90 #""WANT?"
92 #""1 - COIL DESIGN"
94 #2 - STOP": #3 - EXAMINE EFFECT ON
   VARIABLE CHANGES":#4 - RESTART"
96 INPUT K
98 IF K = 1 THEN AS = "Y"
100 IF K = 1 THEN 86
102 IF K = 2 THEN 110
104 IF K = 3 THEN GOSUB 226

```



```

106 IF K = 3 THEN 90
108 IF K = 4 THEN 30
110 END
112 C1 = 1.E6/(69*9.8696*F*F)
114 C2 = LOG((24/D)*(234/F-B))-1
116 S = (1-(F*B)/234)
118 S2 = S*S
120 C3 = S2-1
122 C4 = (234/F)-B
124 C5 = LOG((24*(L/2-B))/D)-1
126 T = (F*L/2-F*B)/234
128 T2 = T*T
130 C6 = T2-1
132 C7 = (L/2)-B
134 C0 = C1*((C2*C3/C4)-(C5*C6/C7))
136 RETURN
138 IF G = 2 THEN D = .258
140 IF G = 4 THEN D = .204
142 IF G = 6 THEN D = .162
144 IF G = 8 THEN D = .129
146 IF G = 10 THEN D = .102
148 IF G = 12 THEN D = .081
150 IF G = 14 THEN D = .064
152 IF G = 16 THEN D = .051
154 IF G = 18 THEN D = .040
156 IF G = 20 THEN D = .032
158 IF G = 22 THEN D = .025
160 IF G = 24 THEN D = .020
162 IF G = 26 THEN D = .016
164 IF G = 28 THEN D = .013
166 IF G = 30 THEN D = .010
168 IF G = 32 THEN D = .008
170 RETURN
172 GOSUB 176
174 GOTO 226
176 # "THE VALUE OF INDUCTANCE CURR-"
178 # "ENTLY IN MEMORY IS:"
180 # C0: # "DO YOU WANT TO USE THIS"
182 # "VALUE IN DESIGNING A COIL?"
184 INPUT "ENTRY Y OR N", A$
186 IF A$ = "Y" THEN 190
188 INPUT "PLEASE ENTER THE NEW VALUE IN
MICROHENRYS", C0
190 IF C0 = 0 THEN 176
192 INPUT "WHAT IS THE DIAMETER OF THE COIL
IN INCHES?", R
194 IF R = 0 THEN 192
196 R = ABS (R/2)
198 INPUT "ENTER THE NUMBER OF TURNS PER INCH
OF COIL LENGTH", T
200 T = ABS(T)
202 IF T = 0 THEN 198
204 # "-----"
206 # "COIL DIAMETER = "; 2*R; "INCHES"
208 # "COIL WOUND AT"; T; "TURNS/INCH"
210 L(1) = ((10*C0)+SQRT((100*C0*C0)-(4*R*R*T*T
*(-9)*R*C0)))/(2*R*R*T*T)
212 L(2) = ((10*C0)-SQRT((100*C0*C0)-(4*R*R*T*T
*(-9)*R*C0)))/(2*R*R*T*T)
214 IF L(1) > L(2) THEN L(3) = L(1)
216 IF L(2) > L(1) THEN L(3) = L(2)
218 # "COIL LENGTH = "; L(3); "INCHES"
220 # "TOTAL TURNS = "; T*L(3)
221 # "INDUCTANCE = "; C0; "MICROHENRYS: #"-
-----"
222 FOR K = 1 TO 5000:NEXT K
224 RETURN
226 # "TO EXAMINE THE EFFECT ON COIL"
228 # "INDUCTANCE OF CHANGING A"
230 # "VARIABLE, ENTER AN APPROPRIATE"
232 # "NUMBER"
234 # "1-FEEDPOINT TO COIL DISTANCE"
236 # "2-OVERALL LENGTH"
238 # "3-WIRE SIZE"
240 # "4-RETURN FOR NEW DESIGN"
242 # "5-RETURN TO COIL DESIGN"
244 INPUT "#", V
246 IF V = 1 THEN 258
248 IF V = 2 THEN 298
250 IF V = 3 THEN 336
252 IF V = 4 THEN 30
254 IF V = 5 THEN 172
256 GOTO 226
258 # "LOAD CHANGE WITH FEEDPOINT"
260 # "TO LOADING COIL DISTANCE"
262 # "CHANGE"
264 FOR K = 1 TO 1000:NEXT K
266 # "OVERALL LENGTH = "; L; "FT"
268 # "RESONANT FREQ. = "; F; "MHZ"
270 # "WIRE SIZE = "; G; "GAGE"
272 # "-----"
274 FOR K = 1 TO 1000:NEXT K
276 # "CENTER TO COIL INDUCTANCE"
278 # "DIST.(FT) MICROHENRYS"
280 Q = B
282 FOR B = (.05*L) TO (.45*L) STEP (.05*L)
284 #B;
286 GOSUB 112
288 #TAB(16);C0
290 NEXT B
292 B = Q
294 INPUT "READY TO CONTINUE?", AS
296 GOTO 226
298 # "LOAD CHANGE WITH CHANGE IN"
300 # "OVERALL ANTENNA LENGTH:"
302 FOR K = 1 TO 1000:NEXT K
304 # "CENTER TO COIL DISTANCE = "; B; "FT."
306 # "RESONANT FREQ. = "; F; "MHZ"
308 # "WIRE SIZE = "; G; "GAGE"
310 FOR K = 1 TO 2000:NEXT K
312 Q = L
314 # "-----"
316 # "TOTAL LENGTH INDUCTIVE LOAD"
318 # "FEET MICROHENRYS"
320 FOR L = (2.4*B) TO (465/F) STEP (((230/F)
-(2.4*B))/4)
322 #L;
324 GOSUB 112
326 #TAB(16);C0
328 NEXT L
330 L = Q
332 FOR K = 1 TO 3000:NEXT K
334 GOTO 294
336 # "CHANGE IN LOAD WITH CHANGE"
338 # "IN ANTENNA WIRE SIZE"
340 FOR K = 1 TO 1000:NEXT K
342 # "RESONANT FREQUENCY = "; F; "MHZ"
344 # "LENGTH = "; L; "FT"
346 # "CENTER TO COIL DIST. = "; B; "FT"
348 FOR K = 1 TO 2000:NEXT K
350 # "-----"
352 # "WIRE SIZE INDUCTANCE LOAD"
354 # "(GAGE) MICROHENRYS"
356 P = G
358 FOR G = 6 TO 28 STEP 2
360 # " "; G;
362 GOSUB 138
364 GOSUB 112
366 #TAB(16);C0
368 NEXT G
370 G = P
372 GOTO 294

```

lation of the size of the inductive loading coil you will need to insert in each leg of the antenna. The computer asks you to input:

a) the desired resonant frequency in MHz;

b) the distance in feet from the center of the antenna to where you want to place the loading coils;

c) the size of wire you are going to use in constructing the antenna. This information

is entered as wire gauge size. Buried in the program is a wire gauge to wire diameter conversion lookup table;

d) the overall length from end to end that your new antenna will have to be in

order to fit in the space you have available.

The computer will then promptly display the inductance in microhenrys required to meet the above design variables.



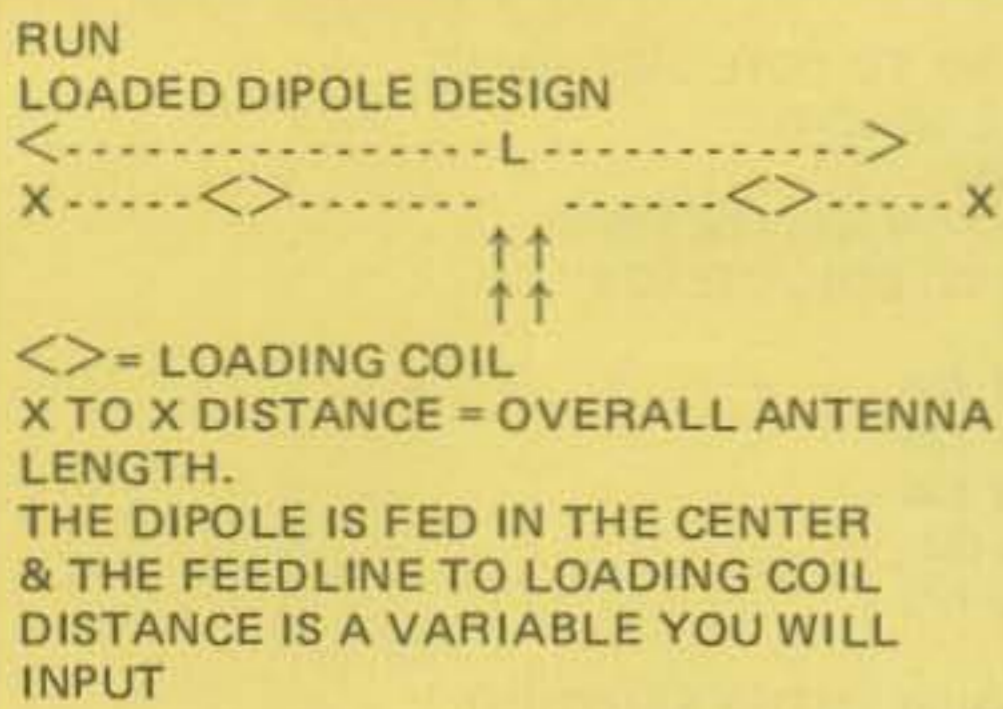

DATA INPUT

PLEASE ENTER THE TARGET RESONANT FREQ. IN MHZ -  
7.123  
ONE HALF WAVELENGTH DIPOLE AT 7.123 MHZ HAS AS OVERALL LENGTH OF 65.702 FEET  
WHAT IS THE DISTANCE IN FEET FROM THE CENTER OF THE DIPOLE TO EACH LOADING COIL?  
5  
WHAT GAGE WIRE ARE YOU USING?  
18  
WHAT IS THE OVERALL ANTENNA LENGTH IN FEET?  
37.5  
THE REQUIRED LOAD INDUCTANCE IS = 11.54 MICROHENRYS.  
JUMP TO COIL DESIGN? (Y OR N)  
Y  
THE VALUE OF INDUCTANCE CURRENTLY IN MEMORY IS:  
11.54  
DO YOU WANT TO USE THIS VALUE IN DESIGNING A COIL?  
ENTER Y OR N  
Y  
WHAT IS THE DIAMETER OF THE COIL IN INCHES?  
2  
ENTER THE NUMBER OF TURNS PER INCH OF COIL LENGTH  
8

-----

COIL DIAMETER = 2 INCHES  
COIL WOUND AT 8 TURNS/INCH  
COIL LENGTH = 2.46 INCHES  
TOTAL TURNS = 19.69  
INDUCTANCE = 11.54 MICROHENRYS

-----

WANT?  
1 - COIL DESIGN  
2 - STOP  
3 - EXAMINE EFFECT OF VARIABLE CHANGES  
4 - RESTART  
?  
3

TO EXAMINE THE EFFECT ON COIL INDUCTANCE OF CHANGING A VARIABLE, ENTER AN APPROPRIATE NUMBER:  
1 - FEEDPOINT TO COIL DISTANCE  
2 - OVERALL LENGTH  
3 - WIRE SIZE  
4 - RETURN FOR NEW DESIGN  
5 - RETURN TO COIL DESIGN  
1

LOAD CHANGE WITH FEEDPOINT TO LOADING COIL DISTANCE CHANGE  
OVERALL LENGTH = 37.5 FT.  
RESONANT FREQ. = 7.123 MHZ  
WIRE SIZE = 18 GAGE

CENTER TO COIL DIST. (FT.)	INDUCTANCE MICROHENRYS
1.875	9.606
3.750	10.655
5.625	12.050
7.500	13.970
9.375	16.734
11.250	20.973
13.125	28.128
15.000	42.333
16.875	82.605

READY TO CONTINUE?  
Y  
TO EXAMINE THE EFFECT ON COIL INDUCTANCE OF CHANGING A VARIABLE, ENTER AN APPROPRIATE NUMBER:  
1 - FEEDPOINT TO COIL DISTANCE  
2 - OVERALL LENGTH  
3 - WIRE SIZE  
4 - RETURN FOR NEW DESIGN  
5 - RETURN TO COIL DESIGN  
#2  
LOAD CHANGE WITH CHANGE IN OVERALL ANTENNA LENGTH.  
CENTER TO COIL DISTANCE = 5 FT.  
RESONANT FREQ. = 7.123 MHZ  
WIRE SIZE - 18 GAGE

TOTAL LENGTH FEET	INDUCTANCE LOAD MICROHENRYS
12.	155.760
17.072	52.082
22.145	31.047
27.217	21.399
32.300	15.619
37.362	11.630
42.435	8.620
47.507	6.205
52.580	4.178
57.652	2.412
62.724	0.851

READY TO CONTINUE?  
Y  
TO EXAMINE THE EFFECT ON COIL INDUCTANCE OF CHANGING A VARIABLE, ENTER AN APPROPRIATE NUMBER:  
1 - FEEDPOINT TO COIL DISTANCE  
2 - OVERALL LENGTH  
3 - WIRE SIZE  
4 - RETURN FOR NEW DESIGN  
5 - RETURN TO COIL DESIGN  
#3  
CHANGE IN LOAD WITH A CHANGE IN ANTENNA WIRE SIZE.  
RESONANT FREQ. = 7.123 MHZ  
LENGTH = 37.5 FT.  
CENTER TO COIL DISTANCE = 5 FT.

WIRE SIZE (GAGE)	INDUCTIVE LOAD MICROHENRYS
6	9.489
8	9.822
10	10.166
12	10.504
14	10.849
16	11.182
18	11.538
20	11.865
22	12.226
24	12.553
26	12.880
28	13.185

READY TO CONTINUE?

At this point you're probably wondering where you stashed that coil design slide rule. Look no further, because that's section two of the program.

First you're given a choice of starting with the value of inductance just calculated or a new value. In either case it's in microhenrys. The program then asks you to input:

- coil diameter in inches, and
- the number of turns per inch you plan to wind the coil at.

Using this data the computer will return both the overall coil length and the total number of turns required to obtain the design inductance.

Curious about what effect the wire size really has? How about changes in overall length? Or what happens when you move those coils away from the center of the antenna toward the ends? The third section of the program takes care of these variables.

### Using the Program

Just select the appropriate option after the list is displayed and a table will be generated showing the change in inductive load (in microhenrys) with one of the design parameters changed over a wide range.

The first option is an analysis of what happens when feedpoint to loading coil distance is changed. The inductance of the loading coil required to produce resonance is listed in one column of the table and the center to load distance in a second column. The number of feet the coil is from the feedline starts at 5% of the overall antenna length you previously inputted and goes to 45% of the overall length in 5% increments. Does the inductance of the coil increase or decrease as it moves away from the feedpoint?

Choose the second option, and your computer will generate a table of load inductance in one column

Sample run of Loaded Dipole Design program.



and overall dipole length in the other column. The center to coil distance you originally specified is used. The overall antenna length starts at 2.4 times the center to coil distance and goes to almost one half wavelength. Sure enough, the inductance approaches zero as the overall length approaches half wavelength.

How about the wire size? Why is it even taken into consideration? Well, choose option three and look at a

comparison of required inductive load to wire size with wire size going from 6 gauge to 28 gauge in steps of 2. Interesting.

A few comments about the program. It runs in about 4.6K of BASIC, not counting the memory consumed by the BASIC interpreter. I have it running on an 18K Z-80 Digital Group System. If memory capacity is a problem, the program can be chopped into 3 major areas described and portions

deleted as required.

You could also delete the wire gauge to wire radius conversion section and enter wire radius in inches, to save a couple hundred words.

There are no remarks. However, I think the liberal use of print commands makes the program fairly easy to follow.

Formatted print commands were deliberately avoided to save confusion in applying this program with different systems. The lan-

guage is Digital Group Software Systems Maxi-BASIC Version 1.

How about adding a section for inverted vee configurations? Extracting the loading for verticals and whips should be relatively easy, too. ■

#### References

1. *Reference Data for Radio Engineers*, 5th Edition, 4th Printing, 1972, Copyright H.W. Sams, 1968, pages G-1, G-3.
2. *QST*, September, 1974, page 209.

### MULTI-BAND ANTENNA TRAPS

Having trouble finding air-space for an 80 meter dipole? Restricted to 40 meters? Let PACE-TRAPS provide the answer! Five-Band no-compromise coverage in 105 feet! Four bands in the same space as your 40 meter dipole! PACE-TRAPS are quality-built, use proved, resonant circuits, described in most hand-books and designed to make-up into an all-band system. Four models available. NG-series 300 watt rated ... 4 or 5 band model ... \$14.95 pair FG-series ... kw rated 4 or 5 band model ... \$17.95 pr. Stranded Copper-weld equiv. to #12 ... handles like soft drawn ... out to length ... 112 feet ... \$6.50 + \$1.00 UPS. Full installation details provided. Use with or without a transmatch. Shipped post-paid in USA. CT residents add 7% tax. Check or MO to

**PACE-TRAPS** BOX 234 Upland Rd.  
Middlebury CT 06862  
(203) 758-9228 P15

## ATTENTION: HAM OPERATOR/COMPUTER OWNERS

At last the missing components for implementing a true automated ham shack are available and they are all products of International Data Systems, Inc. The following boards plug into any ALTAIR, IMSAI, or other S100 bus compatible computer and provide the needed hardware capability for maintaining time of day in a form the computer can easily manipulate, measure (and/or compute) the frequency of your transmitter and receiver up to 600MHz, decode Morse Code or RTTY, and key your transmitter for CW and RTTY operation. Extensive software is included with all modules and software is provided in MITS BK BASIC, PICO BASIC 5, and Assembler source and object listings.

### S100 BUS COMPATIBLE BOARDS (ALTAIR 8800/IMSAI 8080, etc.)

	USES	KIT PRICE
<b>88-SPM Clock Module</b>	Your computer constantly knows the time of day and can use it in applications such as tracking OSCAR, automatically time stamping log data for contests, or more trivial applications such as performing 10 minute station time or time of day clock display functions.	\$ 96.00
<b>88-UFC Universal Frequency Counter</b>	Use it to select from 4 software selectable signal inputs and compute signal frequency, event periods, or count total number of events. Use it to monitor and display transmit and receive frequency, automatic frequency logging for contests and contests, and even measure inside and outside temperature when used in conjunction with the TSM peripheral module listed below. Measures frequency to 600 MHz. Includes program to use 88-UFC to decode RTTY.	\$179.00

### PERIPHERAL DEVICES FOR USE WITH ANY COMPUTER:

<b>MCTK Morse Code Trainer/Keyer</b>	This hardware/software package is the best thing to happen to ham radio since OSCAR. Use it to teach Morse Code or to key your transmitter. Provides double isolation between your computer and your transmitter. Generates audio waveform for headphones or speaker. All software included! Uses "NEW CODE METHOD" in trainer mode.	\$ 29.00
<b>TSM Temperature Sensing Module</b>	Use it with the 88-UFC to measure temperature inside or outside. For temperature monitor and control applications or just to be able to report current conditions during your QSO. Resolution is 1 degree.	\$ 24.00

Terms: Payment with order or C.O.D. Delivery: Stock to 30 days. Product descriptions available for all items listed above plus many non-ham related items. Assembled units available at higher prices. Telephone (703) 536-7373

**IDS** INTERNATIONAL DATA SYSTEMS, INC. **IDS** 110  
400 North Washington Street, Suite 200, Falls Church, Virginia 22046, U.S.A.

# IN WIRE-WRAPPING HAS THE LINE...

## HOBBY-WRAP-30 WIRE-WRAPPING, STRIPPING, UNWRAPPING TOOL FOR AWG 30 (.025 SQUARE POST)

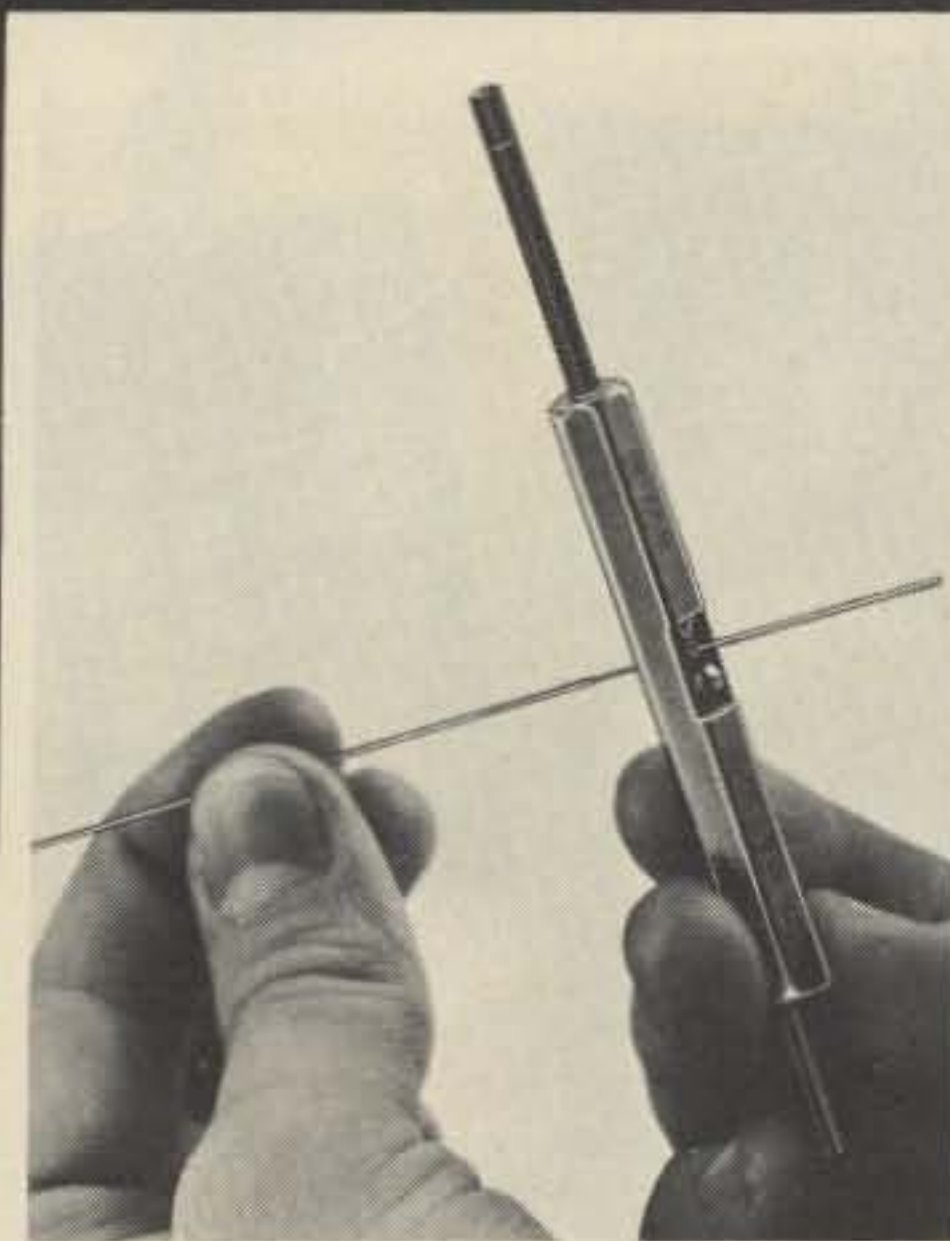

**STRIP**



**WRAP**



**UNWRAP**

**\$ 5.95**

SHIPPING CHARGE \$1.00  
NEW YORK STATE RESIDENTS ADD SALES TAX

**OK MACHINE & TOOL CORPORATION**

3485 CONNER STREET, BRONX, NEW YORK, N.Y. 10475 U.S.A. • PHONE (212) 994-6600

TELEX: 125091 TELEX: 232395

O5





## WIN A FREE PRE-AMP

WOW! Just think of it! For every 100 pre-amps we sell between now and August 31, 1977 we will have a drawing and refund the purchase price to the lucky winner. You can't get better odds for winning anywhere, and the more pre-amps you order, the better your chance of winning. Actually, nobody loses because if you buy a Vanguard Model 201 pre-amp, you will have the best pre-amp money can buy. The same pre-amp is now in use throughout the world in sophisticated installations like weather stations and radio astronomy. Our pre-amps are chosen for their low noise (typically 2.5 dB @ 150 MHz), high gain (30 dB @ 150 MHz), and excellent stability (we use RCA dual-gate MOSFETs). Phone your order in today for that pre-amp you've been wanting to buy and we'll deduct \$1.50 for your phone call and ship the order COD by air parcel post within 2 days. The Model 201 is available tuned to any frequency between 5 and 260 MHz (be sure to specify) with a 3% bandwidth and your choice of BNC or RCA connectors. Operates on 12 V dc @ 10 mA.

Phone: 212-468-2720

**\$29.95**

# Vanguard Labs

196-23 JAMAICA AVE.  
HOLLIS, N. Y. 11423 V1

**\$699 builds Equinox 100™**

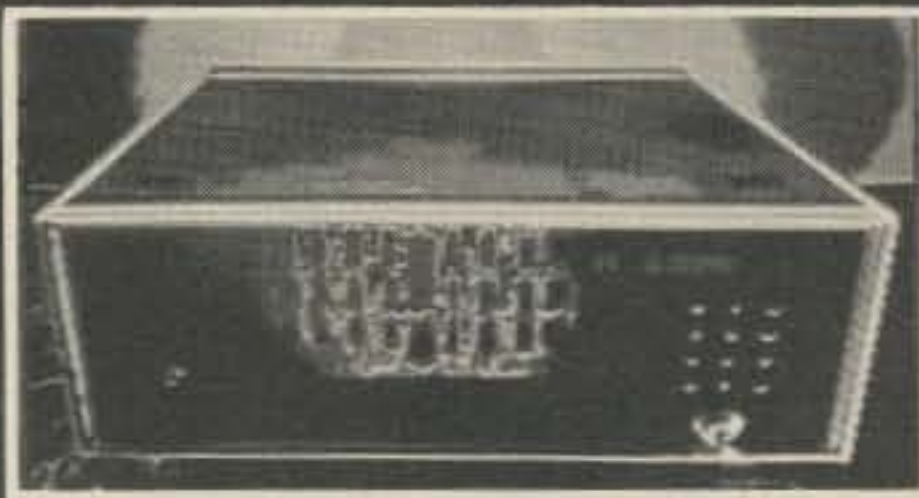

## THE FRONTRUNNER

Equinox 100™ is the 8080 CPU / S-100 Bus computer kit that's years in front of Altair® and IMSAI in design, function and front-panel programming capability. At \$699, it's clearly **The Frontrunner**. Write for free specs to Parasitic Engineering, P.O. Box 6314, Albany, CA 94706.

# EQUINOX 100

The Frontrunner from Parasitic Engineering

\*A trademark of MITS Inc

## CANADIANS!

Eliminate the Customs Hassles. Save Money and get Canadian Warranties on IMSAI and S-100 compatible products.

IMSAI 8080 KIT \$ 838.00  
ASS. \$1163.00

(Can. Duty & Fed. Tax Included).

AUTHORIZED DEALER

Send \$1.00 for complete IMSAI Catalog.

We will develop complete application systems.

Contact us for further information.

**Rotundra Cybernetics**



Box 1448, Calgary, Alta. T2P 2H9  
Phone (403) 283-8076

R13

# THE PAIA 8700 COMPUTER/CONTROLLER

An exceptional price on an applications oriented 6503 based micro-processor system featuring:

- 1K bytes RAM locations (512 bytes supplied)
- 1K bytes ROM locations (256 byte monitor included)
- 2 - 8 bit input ports
- 2 - 8 bit output ports (1 latched, 1 buffered)
- 24 key touch operated keypad (used by the monitor to allow entry and execution of user programs - also user definable.)
- 2 - latched seven segment displays (used by monitor to display memory location and contents - easily user programmed)
- Optional cassette interface (\$22.50) fits entirely on the processor board.

**THE IDEAL, LOW COST SOLUTION TO IMPLEMENTING ALL THOSE WILD COMPUTER BASED CONTROL SYSTEMS YOU'VE BEEN DREAMING OF!**

PAIA software currently available or under development includes:

- Electronic music synthesizer interface.
- Home applications package including: Multi-zone fire & burglar alarm, real time clock, energy saving heat/air conditioning control, computer generated "door-bell".
- Model railroad controller
- More.....

**8700 COMPUTER/CONTROLLER KIT ..... \$149.95**

(requires 5v. @ 1.2A.; 12v. @ 150 ma.)

Shipped direct to you by PAIA (add \$3.00 postage & handling)

**DETAILS ON PAIA KITS IN OUR FREE CATALOG ..... WRITE FOR IT TODAY!**

**.. OR PHONE OUR 24HR DEMO/ORDER LINE (405) 843-7396 BAC & MC ORDERS ALSO ACCEPTED.**

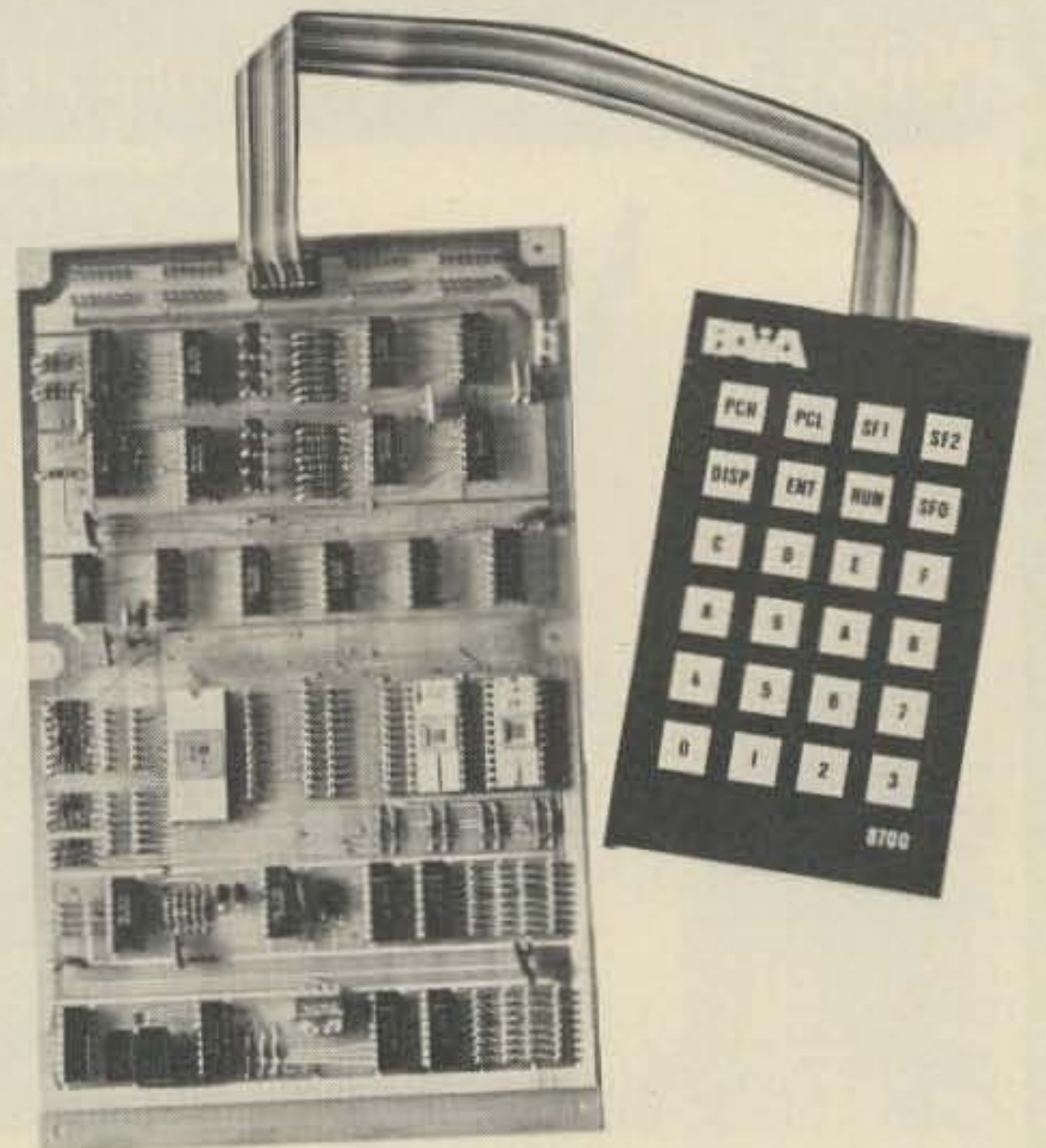

Also available at FULL-LINE Computer stores.

**PAIA ELECTRONICS, INC.**

Dept. 7-H 1020 W. Wilshire Blvd.  
Oklahoma City, OK 73116



# FANTASTIC SOFTWARE

This **LIBRARY** is a complete do it yourself kit. Knowledge of programming not required. **EASY** to read and **USE**. Almost **FREE** Less Than \$1 / Program Complete

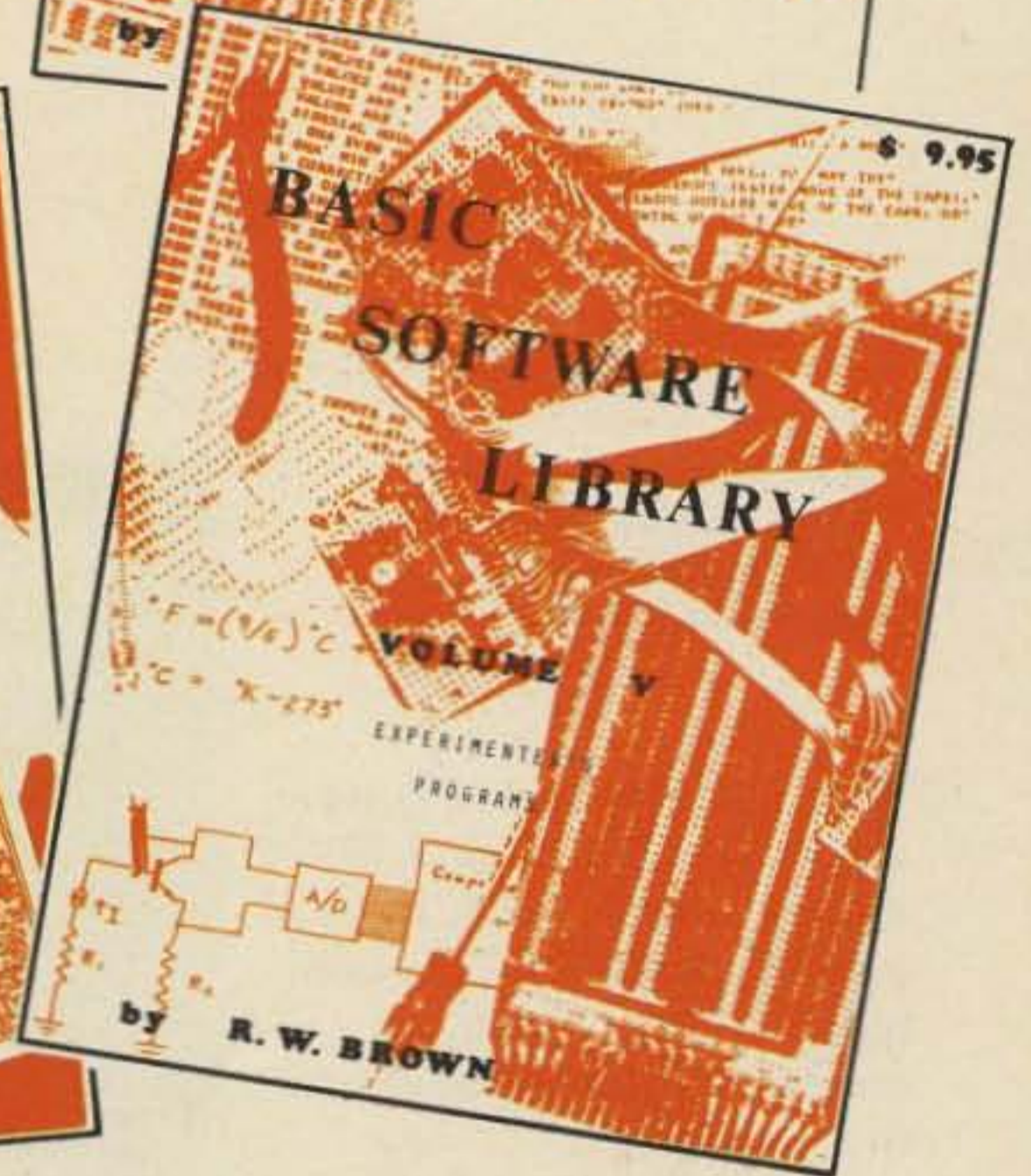
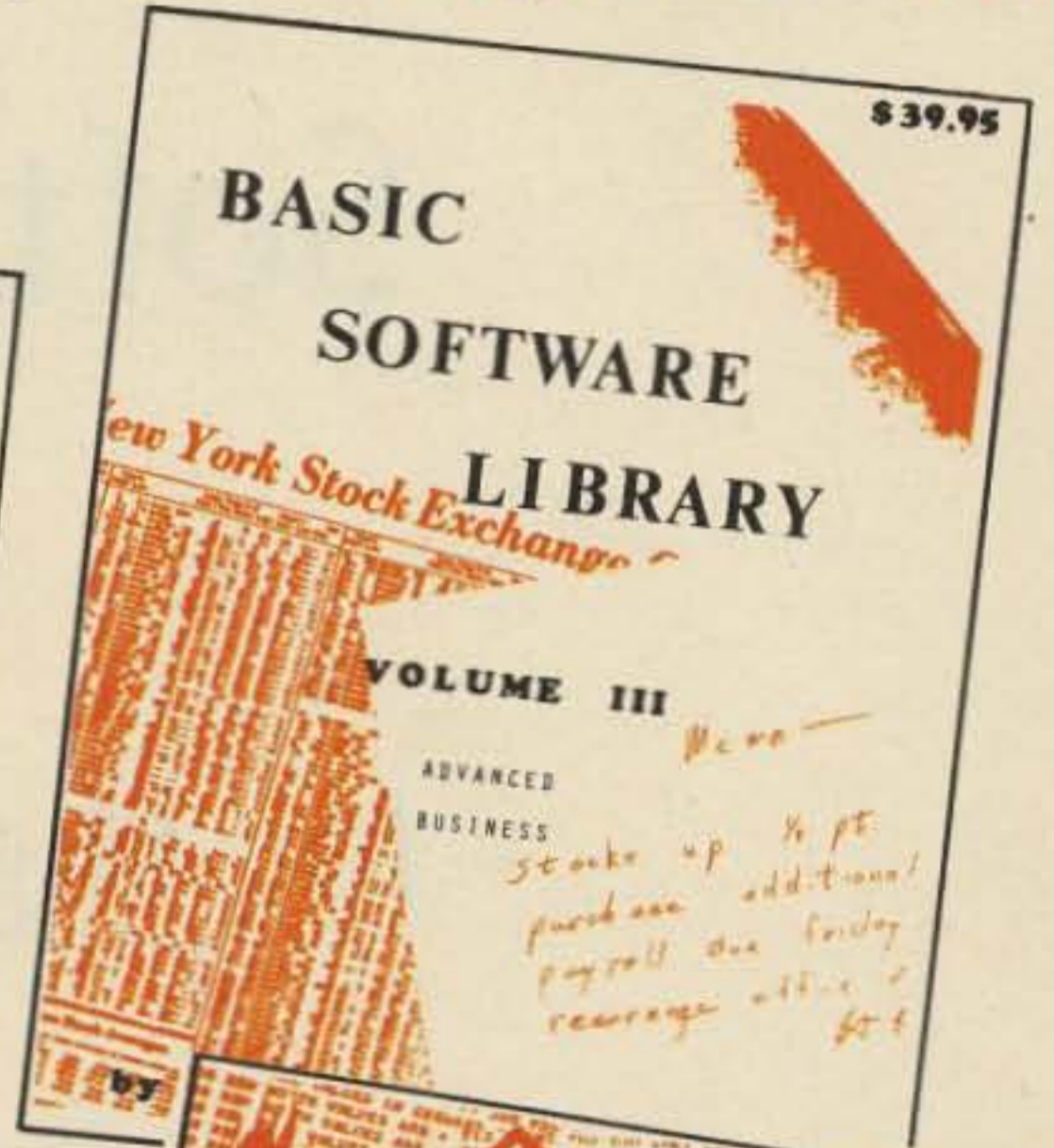
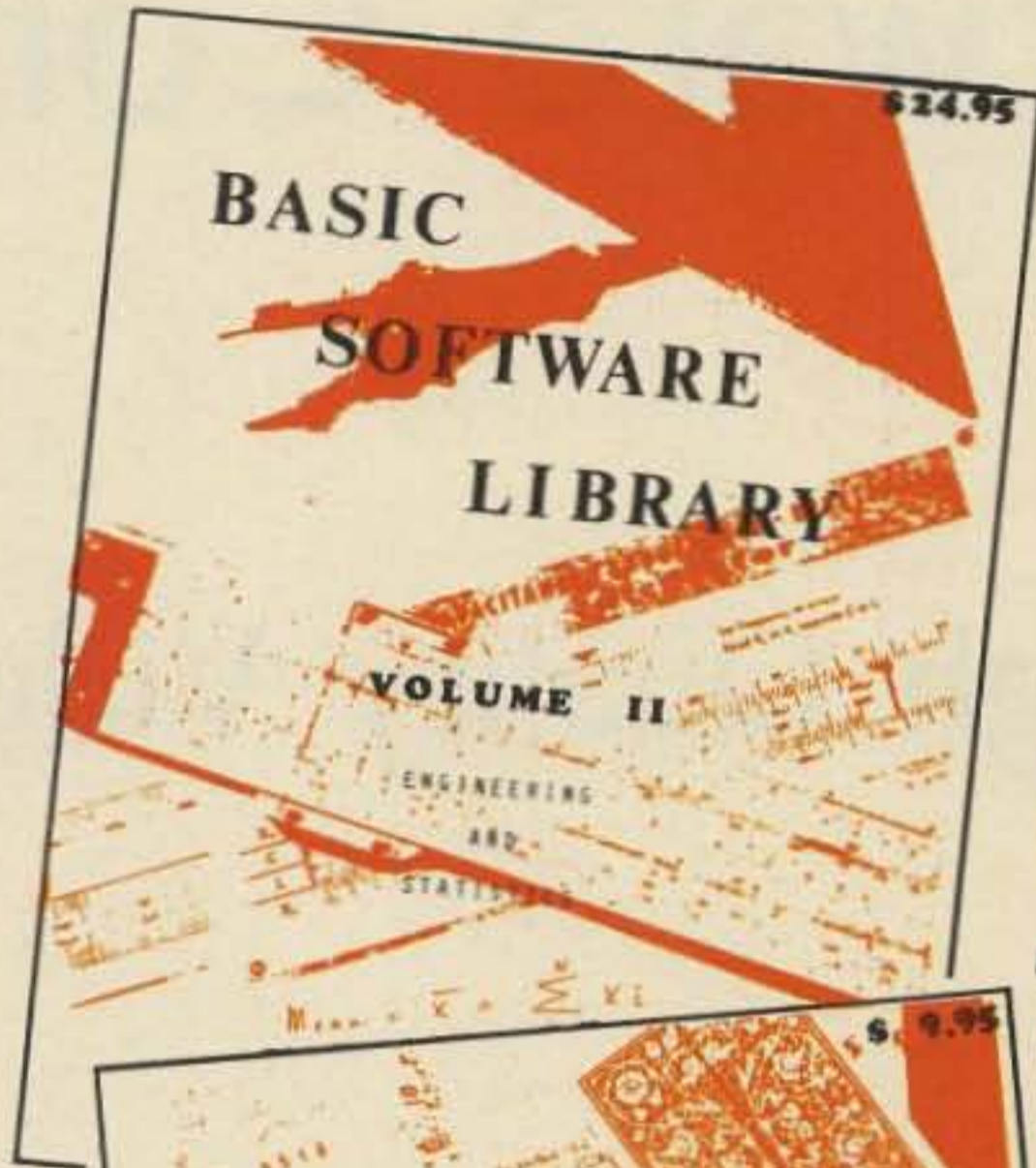
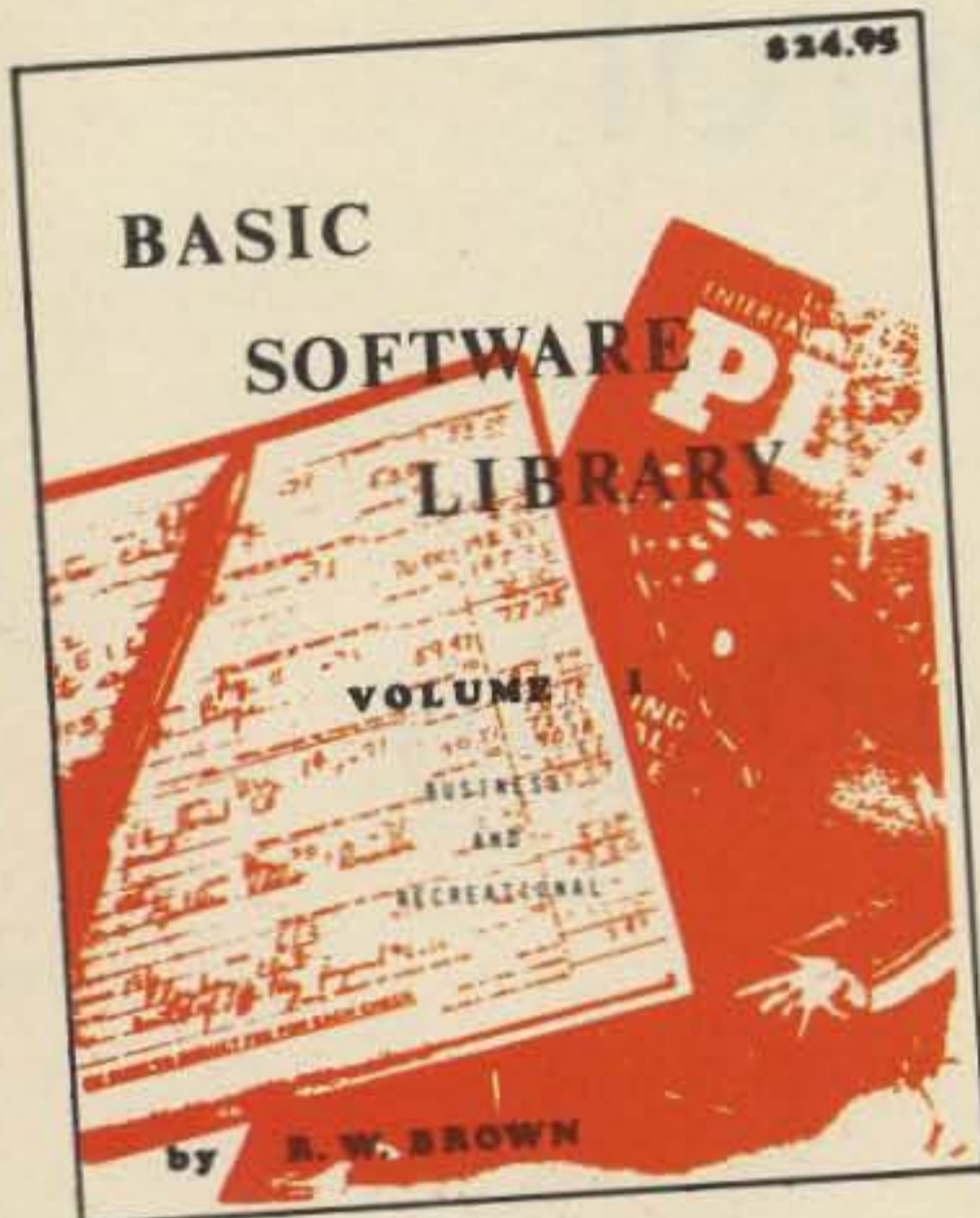

- VOLUME I .. \$24.95  
BOOKKEEPING  
GAMES  
PICTURES
- VOLUME II .. \$24.95  
MATH & ENGINEERING  
PLOTTING & STAT  
BASIC STATEMENT DEF
- VOLUME III .. \$39.95  
ADVANCED BUSINESS  
BILLING  
INVENTORY  
PAYROLL
- VOLUME IV .. \$9.95  
GENERAL PURPOSE
- VOLUME V .. \$9.95  
EXPERIMENTER

This library is the most comprehensive work of its kind to date. There are other software books on the market but they are dedicated to computer games. The intention of this work is to allow the average individual the capability to easily perform useful and productive tasks with a computer. All of the programs contained within this Library have been thoroughly tested and executed on several systems. Included with each program is a description of the program, a list of potential users, instructions for execution and possible limitations that may arise when running it on various systems. Listed in the limitation section is the amount of memory that is required to store and execute the program.

Each program's source code is listed in full detail. These source code listings are not reduced in size but are shown full size for increased readability. Almost every program is self instructing and prompts the user with all required running data. Immediately following the source code listing for most of the programs is a sample executed run of the program.

The entire Library is 1100 pages long, chocked full of program source code, instructions, conversions, memory requirements, examples and much more. ALL are written in compatible BASIC executable in 4K MITS, SPHERE, IMS, SWTPC, PDP, etc. BASIC compilers available for 8080 and 6800 under \$10 elsewhere.

Available NOW !!! at most computer stores

The "HOW-TO-DO IT" Books for the "DO-IT" Person

Written in compatible **BASIC** immediately executable in **ANY** computer with at least 4K, **NO** other peripherals needed.

See Our List Of Dealers

Add \$1.50 per volume for postage and handling.

## SCIENTIFIC RESEARCH



1712-T FARMINGTON COURT  
CROFTON MD 21114

Phone Orders call (800) 638-9194

Information and Maryland Residents Call (301)-721-1148

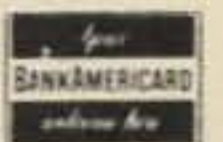

Personal checks — allow 4 weeks for shipping. Pricing subject to change without notice. If air mail shipping is desired add \$3 per volume to price, Continental U.S. only. Foreign orders add \$8 for each volume.



# Software Control

- - for High Quality Video Display

Don Alexander WA8VNP  
Microcomputer Ventures, Inc.  
4497 Indianola Ave.  
Columbus OH 43214

In the March, 1977, issue of 73 I described a video display which is seen to be a part of memory by the computer. This article is to present a software driver for that display.

The operation of the display is essentially that of a window to a portion of the computer's memory. The computer can read or write randomly to any portion of the display memory just as it can with its normal memory. In fact, programs may even be executed from the display memory. When the processor is not accessing the display memory, the display circuitry takes over and uses that memory to generate a video signal. As a result, display functions such as line feeding or erasing are software processes.

The program provides these basic functions:

1. Carriage return;

```
Video Display Driver  MAC80 Version 2(30)-2 running on 5-May-77 17:52:42  Page 1
File DSKAD:VIDEO.M80[4,40] created 5-May-77 17:50:00

1          TITLE      Video Display Driver
2          ;
3          ; This routine is a general purpose display driver. A character is
4          ; supplied in the accumulator and this routine is invoked causing that
5          ; character to be transferred to the display memory. If that character
6          ; is a control character, then a special action may take place such a
7          ; clearing the screen or changing the location of the cursor.
8          ;
9          ; The following calling format is used:
10         ;
11         ; LXI      H,BLOCK ;Get the argument block
12         ; CALL    VIDEO ;invoke the display processor
13         ; always return here
14         ;
15         ; BLOCK: DB      n      ;Beginning line of display block
16         ;         DB      m      ;Ending line of display block
17         ;         DW      addr   ;Address of next character (updated by VIDEO)
18         ;
19         ; A "display block" is a group of lines on the screen that are acted
20         ; upon together. If the block is scrolled, for example, only those lines
21         ; between the starting and finishing lines are scrolled. The "cursor" is
22         ; the location of the next character on the screen. The cursor is
23         ; represented on the screen by inverting the video at that location.
24         ; Most characters are displayed at the current cursor location and that
25         ; location is advanced one position after each call unless a special
26         ; character changes the cursor address.
27         ;
28         ; The following special control characters are recognized:
29         ; CR      carriage return Move the cursor (next character position) to the
30         ;         beginning of the current line.
31         ; LF      line feed       Move the cursor down one line. If there are no
32         ;         more lines in the block, then the rest of the
33         ;         block is scrolled upwards and the cursor
34         ;         position is unchanged.
35         ; BKSP    backspace       Move the cursor backwards one character. If the
36         ;         cursor is already at the leftmost position on
37         ;         the screen, then no action is taken.
38         ; TAB     tab             Move the cursor forward to the next tab stop.
39         ;         If the cursor is already at the rightmost
40         ;         position on the screen, then no action is taken.
41         ;         Tabstops are implicitly set every 8 columns
42         ;         beginning at column 9.
43         ; FF      form feed       Clear the entire block and position the cursor
44         ;         to the first character position of the first
45         ;         line of the block.
46         ; CTRL-X control X       Clear the current line and move the cursor to
47         ;         the first position of the line.
48         ; BELL    bell           Temporarily invert all of the video on the
49         ;         screen. The cursor position is unaffected.
50         ;         This is an attention getting function.
51         ; DEL     delete         Do nothing. This character is sometimes used as
52         ;         a filler character, therefore it is ignored.
53         ;
54         ; PAGE
55         ; Define all characters of interest.
56         ; .CHCRT="015 ;Carriage return
57         ; .CHLFD="012 ;Line feed
58         ; .CHBEL="07  ;Bell
59         ; .CHBKS="010 ;Backspace
60         ; .CHTAB="011 ;Tab
61         ; .CHCNX="030 ;Control X
62         ; .CHFFD="014 ;Form feed
63         ; .CHDEL="0177 ;Delete (rubout)
64         ;
65         ; Define dimension of display (assume 64 characters per line)
66         ; TOP="H8000 ;Starting address of display memory
67         ; DISLIN=32 ;Number of lines on display
68         ; PAUSE="H8000 ;Number of wait loops for bell
```



# IN WIRE-WRAPPING **ok** HAS THE LINE.....

## MODEL **WD-30**



## WIRE DISPENSER

- 50 FT. ROLL OF 30 AWG. KYNAR® WIRE-WRAPPING WIRE
- CUTS THE WIRE TO LENGTH
- STRIPS 1 INCH OF INSULATION

AVAILABLE IN FOUR COLORS

- WD-30-B BLUE WIRE
- WD-30-Y YELLOW WIRE
- WD-30-W WHITE WIRE
- WD-30-R RED WIRE

# \$345

EACH

MINIMUM BILLING \$25.00  
ADD SHIPPING CHARGE \$1.00  
NEW YORK STATE RESIDENTS  
ADD APPLICABLE TAX

PATENT PENDING

©KYNAR PENNWALT

### OK MACHINE & TOOL CORPORATION

3455 Conner St., Bronx, N.Y. 10475 (212) 994-6600 / Telex 125091

```

69 000000 365 VIDEO: PUSH PSW ;Save registers
70 000001 305 PUSH B
71 000002 325 PUSH D
72 000003 106 MOV B,M ;Get parameters, starting line
73 000004 043 INX H
74 000005 116 MOV C,M ;Stopping line
75 000006 043 INX H
76 000007 136 MOV E,M ;Low cursor address
77 000010 043 INX H
78 000011 126 MOV D,M ;High cursor address
79 000012 345 PUSH H ;Save H and L as well
80 000013 376 015 CPI .CHCRT ;Is this a carriage return?
81 000015 312 110 000 JZ XCRT ;If so, do a carriage return
82 000020 376 012 CPI .CHLFD ;Is this a line feed?
83 000022 312 211 000 JZ XLFD ;If so, do a line feed
84 000025 376 007 CPI .CHBEL ;Is this a bell?
85 000027 312 333 000 JZ XBEL ;If so, invert the entire screen
86 000032 376 010 CPI .CHBKS ;Is this a backspace?
87 000034 312 147 000 JZ XBKS ;If so, do a backspace
88 000037 376 030 CPI .CHCNX ;Is this a control X?
89 000041 312 164 000 JZ XCNX ;If so, do a control X
90 000044 376 011 CPI .CHTAB ;Is this a tab?
91 000046 312 122 000 JZ XTAB ;If so, do a tab
92 000051 376 014 CPI .CHFFD ;Is this a form feed?
93 000053 312 305 000 JZ XFFD ;If so, do a form feed
94 000056 376 177 CPI .CHDEL ;Is this a delete?
95 000060 312 076 000 JZ CURSRI ;If so, go do nothing.
96 PAGE
97 ;Here for non-special characters.
98 000063 022 STAX D ;Put the character in display memory
99 000064 023 INX D ;Point to next character
100 000065 173 MOV A,E ;Get the low address bits
101 000066 346 077 ANI ^H3F ;Check for the start of a new line
102 000070 312 205 000 JZ LFI ;If so, do an automatic line feed
103 000073 315 024 001 CURSOR: CALL INVCHR ;Invert this character
104 000076 341 CURSRI: POP H ;Restore HL
105 000077 162 MOV M,D ;Update caller's cursor address
106 000100 053 DCX H
107 000101 163 MOV M,E
108 000102 053 DCX H
109 000103 053 DCX H ;Point HL back where it was
110 000104 321 POP D ;Restore other registers
111 000105 301 POP B
112 000106 361 POP PSW
113 000107 311 RET ;Return to caller
114
115 ;Here for a carriage return.
116 000110 315 024 001 XCRT: CALL INVCHR ;Invert this character back to ordinary
117 000113 173 MOV A,E ;Get the address
118 000114 346 300 ANI ^HCO ;Make it point to beginning of line
119 000116 137 MOV E,A ;Put it back in E
120 000117 303 073 000 JMP CURSOR ;Go do cursor
121
122 ;Here for a horizontal tab DECsystem-10 style.
123 000122 315 024 001 XTAB: CALL INVCHR ;Turn off inversion
124 000125 173 MOV A,E ;Get low address
125 000126 346 370 ANI ^7 ;Zero bottom 3 bits
126 000130 137 MOV E,A ;Put back into E
127 000131 041 010 000 LXI H,8 ;Add 8 to cursor address
128 000134 031 DAD D
129 000135 353 XCHG
    
```

Continued

2. Line feed;
3. Backspace;
4. Horizontal tab;
5. Form feed (erases the display);
6. Clear line;
7. Bell (an inaudible bell, no less);
8. Cursor;
9. Do nothing. (Most terminals accept a filler character which does nothing.)

Calling parameters to the program are used to define the beginning and end lines of the display block to be used and to specify the current cursor address. On return from the display routine all registers and status flags are restored, and the cursor address in the parameter list will have been updated.

Most normal applications of the display use all 32 lines and therefore would specify lines 0 and 31 in the parameter list. But, referring to page 82 of the March, 1977, 73, you will see an example where I have several display blocks in use simultaneously.



```

130      000136 173          MOV      A,E          ;Get low address
131      000137 346 077     ANI      ^H3F        ;Check for new line
132      000141 312 205 000 JZ       LFI         ;If so, do a line feed
133      000144 303 073 000 JMP      CURSOR      ;Otherwise do a cursor
134
135      ;Here for backspace.
136      000147 315 024 001 XBKS:    CALL     INVCHR    ;Uninvert this character
137      000152 173          MOV      A,E          ;Get low address
138      000153 346 077     ANI      ^H3F        ;At beginning of line?
139      000155 312 073 000 JZ       CURSOR      ;If so, don't backspace
140      000160 033          DCX      D            ;Otherwise back up one
141      000161 303 073 000 JMP      CURSOR      ;Move cursor
142
143      ;Here for a control X.
144      000164 016 077     XCNX:    MVI      C,63    ;Get 63 in C
145      000166 173          MOV      A,E          ;Get low address
146      000167 366 077     ORI      ^H3F        ;Adjust to end of line
147      000171 137          MOV      E,A          ;Restore address
148      000172 076 040     MVI      A," "       ;Get a blank
149      000174 022     CXLOOP: STAX     D      ;Write blank to display
150      000175 015          DCR      C            ;Decrease count
151      000176 372 073 000 JM       CURSOR      ;If minus, go move cursor
152      000201 033          DCX      D            ;Move pointer back
153      000202 303 174 000 JMP      CXLOOP      ;And go blank it out
154
155      ;Here to do a line feed.
156      000205 033          LFI:     DCX      D            ;Entry for auto line feed
157      000206 303 214 000 JMP      XLPD1        ;Do not invert
158      000211 315 024 001 XLPD:    CALL     INVCHR    ;Uninvert present character
159      000214 041 000 010 XLPD1:   LXI      H,-TOP  ;Get negative of screen start
160      000217 031          DAD      D            ;Add cursor address to get count
161      000220 175          MOV      A,L          ;Get low count
162      000221 007          RLC          ;Get high two bits into low two bits
163      000222 007          RLC          ;Zero the other bits
164      000223 346 003     ANI      3           ;Zero the other bits
165      000225 157          MOV      L,A          ;Save this number
166      000226 174          MOV      A,H          ;Get high count
167      000227 007          RLC          ;Multiply by four
168      000230 007          RLC          ;Add to get line number
169      000231 205          ADD      L            ;Add to get line number
170      000232 271          CMP      C            ;Compare to end of line
171      000233 332 271 000 JC       LF2         ;If less, go point to next line
172      000236 315 007 001 CALL     LINES        ;Go get address for scroll
173      000241 353          XCHG     DE          ;Put address into DE
174      000242 041 100 000 LXI      H,64         ;Get 64
175      000245 031          DAD      D            ;Add it to start address
176      000246 006 100     SETLP:  MVI      B,64    ;Get characters per line
177      000250 176          LFOOP:  MOV      A,M          ;Load character
178      000251 022          STAX     D            ;Store it one line up
179      000252 043          INX     H            ;Increment pointers
180      000253 023          INX     D            ;Increment pointers
181      000254 005          DCR      B            ;Decrease count
182      000255 302 250 000 JNZ     LFOOP        ;Loop for this line
183      000260 015          DCR      C            ;Decrement line count
184      000261 302 246 000 JNZ     SETLP        ;Loop for all lines
185      000264 353          XCHG     DE          ;Get end address of last line in DE
186      000265 033          DCX      D            ;Adjust by one
187      000266 303 164 000 JMP      XCNX        ;Go erase last line
188
189      ;Here for line feed that does not require scroll.
190      000271 041 100 000 LF2:     LXI      H,64         ;Get 64
191      000274 031          DAD      D            ;Add to cursor address
192      000275 124          MOV      D,H          ;Put back high address
193      000276 175          MOV      A,L          ;Get low address
194      000277 346 300     ANI      ^HCO        ;Adjust to point to line beginning
195      000301 137          MOV      E,A          ;Put back in low address
196      000302 303 073 000 JMP      CURSOR      ;Go do cursor
197
198      ;Here to erase entire screen.
199      000305 315 007 001 XFFD:    CALL     LINES        ;Get starting address and line count
200      000310 345          PUSH     H            ;Save start address
201      000311 006 040     STLOOP: MVI      B," "   ;Get a blank
202      000313 026 100     ERLOOP: MOV      M,B      ;Get characters per line
203      000315 160          MOV      M,B          ;Erase this character
204      000316 043          INX     H            ;Point next
205      000317 025          DCR      D            ;Decrease count
206      000320 302 315 000 JNZ     ERLOOP        ;Loop for all characters in line
207      000323 015          DCR      C            ;Decrement line count
208      000324 362 313 000 JP       STLOOP       ;Loop for all lines
209      000327 321          POP      D            ;Retrieve start address in DE
210      000330 303 073 000 JMP      CURSOR      ;Go make cursor
211
212      ;Here to do a bell. Invert the entire screen.
213      000333 325          XBEL:    PUSH     D            ;Save cursor address
214      000334 315 361 000 CALL     INVDIS       ;Invert display
215      000337 041 000 200 LXI      H,PAUSE      ;Get pause time
216      000342 055          WAIT:   DCR      L            ;Loop PAUSE times
217      000343 302 342 000 JNZ     WAIT         ;Loop PAUSE times
218      000346 045          DCR      H            ;Loop PAUSE times
219      000347 302 342 000 JNZ     WAIT         ;Loop PAUSE times
220      000352 315 361 000 CALL     INVDIS       ;Invert the display again
221      000355 321          POP      D            ;Restore cursor address
222      000356 303 076 000 JMP      CURSR1      ;Go do cursor
223
224      ;Here to invert the entire display.
225      000361 041 000 370 INVDIS: LXI      H,TOP    ;Get start address
226      000364 026 200     MVI      D,^H80      ;Get a high order bit
227      000366 016 040     MVI      C,DISLIN    ;Get lines
228      000370 006 100     INVLP2: MVI      B,64     ;Get characters per line
229      000372 176          INVLP1: MOV      A,M          ;Get a character
230      000373 252          XRA      D            ;Invert it fast
231      000374 167          MOV      M,A          ;Put the character
232      000375 043          INX     H            ;Point next
233      000376 005          DCR      B            ;Decrement characters per line
234      000377 302 372 000 JNZ     INVLP1        ;Loop for this line
235      000402 015          DCR      C            ;Decrement lines per screen
236      000403 302 370 000 JNZ     INVLP2        ;Loop for all lines
237      000406 311          RET          ;Return
238
239      ;Here to calculate start address in HL and total number of
240      ;lines in C for any display block.
241      000407 041 000 370 LINES:  LXI      H,TOP    ;Get start address
242      000412 021 100 000 LXI      D,64         ;Get double byte 64
243      000415 005          LINELP: DCR      B            ;Decrement start line count
244      000416 370          RM          ;If minus, then all done
245      000417 015          DCR      C            ;Decrement stop line count
246      000420 031          DAD      D            ;Add 64 to start address
247      000421 303 015 001 JMP      LINELP       ;Loop for all lines
248
249      ;Here to invert the video and vice versa.
250      000424 032          INVCHR: LDAX     D      ;Get character from screen
251      000425 356 200     XRI      ^H80        ;Complement high bit
252      000427 022          STAX     D            ;Put the character back on the screen
253      000430 311          RET          ;Return from whence we came
254      000431          END

```

display routine using lines 2-11 in its parameter list. Likewise, the transmitter routine calls the display driver using lines 15-31. The two one-line areas are from special function routines which call the display driver with the beginning and end lines defined to be the same.

The cursor function is provided by using the inversion capability of the display. Any character may be displayed as white on black or black on white as described in the March article. The software presented here uses that feature for the cursor and to implement the inaudible bell (invert the entire screen for about a half of a second.)

The cursor address is part of the calling program's parameter list since it is possible (as illustrated above) to have more than one cursor. Use of the display is facilitated by having any routine which uses the display driver to initialize its corresponding display block. This is accomplished by calling the display routine with a form feed (octal 14) in the accumulator. This will erase the specified portion of the display and will initialize the cursor address in the calling routine's parameter block to point to the upper left character of the display block.

The program listing is reasonably well documented so you should be able to follow the program flow without too much trouble.

I do want to mention that in the schematic on page 78 of the March 73 the line labeled "011" (center-left in the schematic) should be labeled C7. Also, the text on the same page says that part of the row counter is a 7490. It is really a 7493 as the schematic indicates.

I wish to express thanks to Victor Kean WA1LKU who took a program listing from my model 19 Teletype, complete with comments in free-hand scrawl, and retyped the source and comments on a local DEC-System 10 to produce a readable listing. ■

[M80NED No errors detected]  
[M80P8K Program break is 000431]  
[M80CPT CPU time used 0:00:03]

(The picture on page 83 is labeled as split screen but it is not. It is merely an assembler

listing.) In the example on page 82 I have the screen split into four blocks, two each of one line and two larger blocks. The program which is receiving the RTTY calls the



# NEW FROM

# SEALS

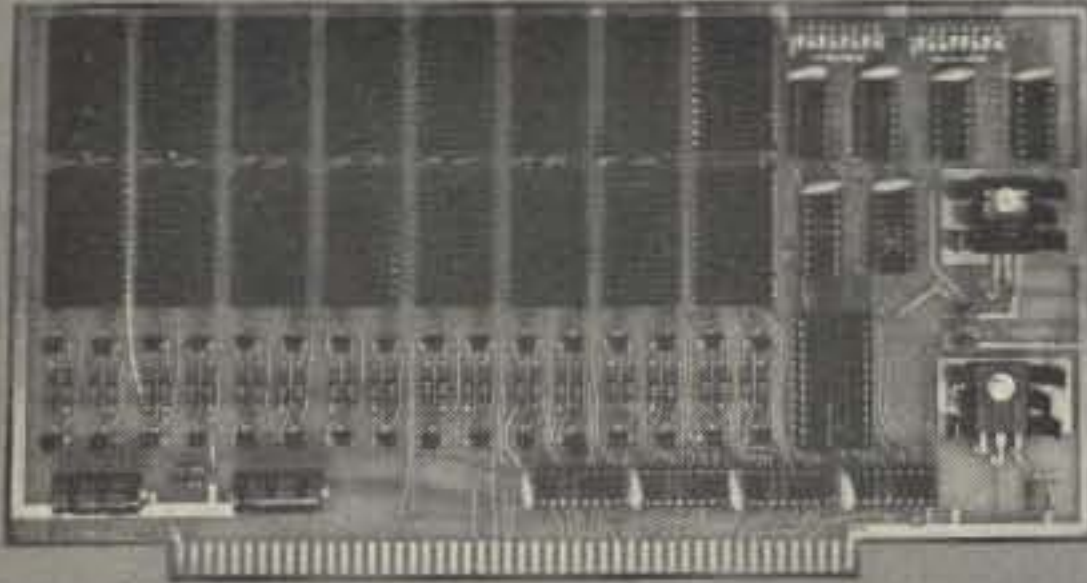

## 4K ROM

### READ ONLY MEMORY

- Will accept up to 16 ea. 1702A or 5203 EProm Providing up to 4096 Words of non-volatile memory for Boot Loads to Complete Programs.
- Programming Available at Factory for \$3.00 per EProm when accompanied by binary formatted tape.
- Each 1702-A has its own V<sub>cc</sub> clocked for Low Power Consumption. Will work with the weakest power supply based S-100 buss computer.
- Switched Selected Address in 4K Blocks.
- Switch selected wait states so that even the slowest 1702-A can work in your system.
- Solder masked on both sides of PC Board.
- Component Screened on Component Side of PC Board.

Kit Price:  
**\$119.00**

Assembled Price:  
**\$179.00**

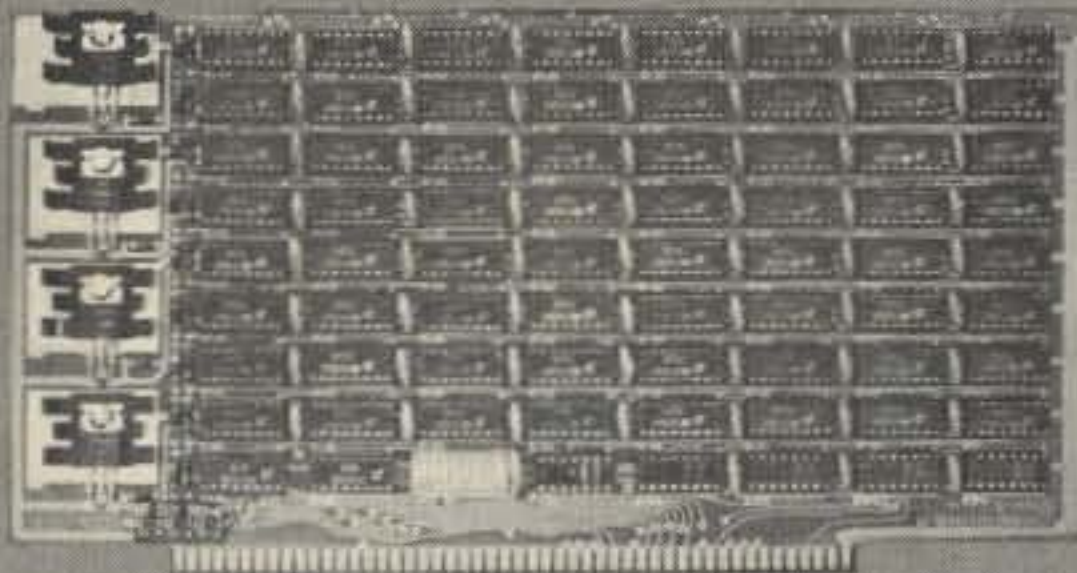

## 8KSC-Z

### STATIC MEMORY CARD

- ALTAIR<sup>®</sup>, IMSAI<sup>®</sup> and S-100 buss compatible.
- Access Time: 250 nsec max.
- Zilog Speed Compatible up to 4 mhz.
- Memory Chip: 2102LHPC or 2102-2.
- Battery Standby: >1.5 to 4 volts.
- Address Select: 8 ea. Spst. Dip Switch.
- Wait States: None.
- Current Req.: Less than 200 ma per 1K.
- All Address, Control, and Data Out lines fully buffered.
- All IC's supplied with IC Sockets.
- Solder Masked on both front and back of P.C. board.

Kit Price:  
**\$295.00**

Assembled Price:  
**\$395.00**

# SEALS



## ELECTRONICS, INC.

BOX 11651, KNOXVILLE, TN. 37919

TELEPHONE # 615/693-8655

S22

# HATRY electronics

500 Ledyard St., Hartford CT 06114  
203-527-1881

(1 block east of Wethersfield Ave. off Airport Rd. Rte. 6)

See Ward W1WRQ — John W1JJR  
or  
Dave WA1HFE

### HEADQUARTERS for 2M FM

Tempo VHF/ONE, SSB/ONE adaptor, Tempo VHF amplifiers, FMH-2, FMH-5; Drake TR 33C, AA 10, AC 10; Regency HR 2B, HR 312, AR 2, P 110 & crystals for all lines listed above.

### FM GAIN ANTENNAS

For mobile, fixed or portable operation by Cush-Craft, Hy-Gain, Antenna Specialists & New-Tronics.

### ANTENNA STUFF

Open wire feedline — #18, #14, #12 ga. bare copperweld wire — #14, #12 enamel copper — insulators — W2AU baluns 1-1 or 4-1 — lowloss coax cable — Rohn 25G towers & accessories — Blitzbug lightning arrestors — glassline guy — B&W antenna switches — Belden 72 & 300 ohm KW twinlead — Amphenol UHF & BNC connectors.

### AMATEUR GEAR

Drake, Swan, Tempo, Ten-Tec, Dentron, Regency, Mosley, Hy-Gain, CushCraft.

(Canadian Amateurs Send U.S. Funds Only)

F.O.B. Hartford

Please include postage

## CONNECTICUT'S OLDEST HAM STORE

H15



# KENWOOD ..the Pacesetter in

2 METERS



There's excitement on the 2-meter band and Kenwood's TS-700A is the number one way to get there. There's more than just FM repeaters. SSB DX, OSCAR Satellite, CW... and do it all with the TS-700A.

## TS-700A

4 MHz band coverage (144 to 148 MHz), completely solid state, AC and DC capability, automatically switches transmit frequency 600 KHz for repeater operation (146-148 MHz).

All this at a very attractive price.



### SP-70

This companion external speaker provides outstanding audio characteristics for your TS-700A and TS-600.

6 METERS



TS-600



# W H F



The hottest 2-meter mobile rig on the market. Features a brand new and unique squelch system with continuous tone coded squelch, tone burst, or carrier squelch. Full 4 MHz band coverage and 25 watt output. It's phase-locked loop (PLL) frequency synthesizer provides operation on 800 channels. The TR-7400A's list of features goes on and on, but even more important is its superb performance and dependability... and all at a surprisingly low price.

## TR-7400A

## TR-7200A

Kenwood's other 2-meter FM mobile transceiver... compact, rugged and packed with features like a priority channel for your favorite frequency, 146-148 MHz coverage, 22 channels (6 supplied), completely solid state, and 10 watt output. Shown with the PS-5 AC power supply for home operation.



## TV-502

An easy way to get on the 2-meter band with your TS-520, TS-820, (and most other transceivers.) Simply plug it in and you're on... SSB and CW.

## TR-2200A



A high performance portable 2-meter FM transceiver that's Kenwood throughout. 146-148 frequency coverage, 12 channels (6 supplied), 2 watts or 400 mW RF output, and provisions for external 12 VDC operation.



## TV-506

Discover the excitement of 6-meters with your TS-520, TS-820, (and most other transceivers) together with the TV-506 transverter. Its 10 watt output will provide you with many hours of enjoyable 6 meter operation.

Want more information? See this fine equipment at an authorized Kenwood dealer or write for detailed specifications.

Kenwood has opened the 6-meter band to the amateur who wants to go first class without paying an arm and a leg. Behind its pretty face is a ruggedly built, versatile performer offering full 4 MHz coverage (50-54), all modes (SSB, FM, CW, and AM), and 10 watts out.





# KENWOOD'S NEW TS-520S AND DG-5 DIGITAL FREQUENCY DISPLAY

## A NEW STANDARD IN ECONOMY TRANSCEIVERS

The NEW TS-520S combines all of the fine, field-proven characteristics of the original TS-520 together with many of the ideas, comments, and suggestions for improvement from amateurs worldwide. Kenwood's ultimate objectives . . . to make quality equipment available at reasonable prices.

### FULL COVERAGE TRANSCEIVER

The new TS-520S provides full coverage on all amateur bands from 1.8 to 29.7 MHz. Kenwood gives you 160 meter capability, WWV on 15,000 MHz., and an auxiliary band position for maximum flexibility. And with the addition of the TV-502 and TV-506 transverters, your TS-520S can cover 160 meters to 2 meters on SSB and CW.

### DIGITAL DISPLAY DG-5 (option)

The new Kenwood DG-5 provides easy, accurate readout of your operating frequency while transmitting *and* receiving.

### OUTSTANDING RECEIVER SENSITIVITY AND MINIMUM CROSS MODULATION

The new TS-520S incorporates a 3SK-35 dual gate MOSFET for outstanding cross modulation and spurious response characteristics. The 3SK35 has a low noise figure (3.5 dB typ.) and high gain (18 dB typ.) for excellent sensitivity.

### NEW IMPROVED SPEECH PROCESSOR

A new audio compression amplifier gives you extra punch in the pile ups and when the going gets rough.

### VERNIER TUNING FOR FINAL PLATE CONTROL

A new vernier tuning mechanism allows

easy and accurate adjustment of the plate control during tune-up.

### FINAL AMPLIFIER

The new TS-520S is completely solid state except for the driver (12BY7A) and the final tubes. Rather than substitute TV sweep tubes as final amplifier tubes in a state of the art amateur transceiver, Kenwood has employed two husky S-2001A (equivalent to 6146B) tubes. These rugged, time-proven tubes are known for their long life and superb linearity.

### HIGHLY EFFECTIVE NOISE BLANKER

An effective noise blanking circuit developed by Kenwood that virtually eliminates ignition noise is built-in to the TS-520S.

### RF ATTENUATOR

The new TS-520S has a built-in 20 dB attenuator that can be activated by a push button switch conveniently located on the front panel.

### VFO-520 — NEW REMOTE VFO

The VFO-520 remote VFO has been designed to match the styling of the TS-520S and provide maximum operating flexibility on the band selected on your TS-520S.

### AC POWER SUPPLY

The TS-520S is completely self-contained with a rugged AC power supply built-in. The addition of the DS-1A DC-DC converter (option) allows for mobile operation of the TS-520S.

### EASY CONNECTION PHONE PATCH

The TS-520S has 2 convenient RCA phono jacks on the rear panel for PHONE PATCH IN and PHONE PATCH OUT.

### CW-520 — CW FILTER (OPTION)

The CW-520 500 Hz filter can be easily installed and will provide improved operation on CW.

### AMPLIFIED TYPE AGC CIRCUIT

The AGC circuit has 3 positions (OFF, FAST, SLOW) to enable the TS-520S to be operated in the optimum condition at all times whether operating CW or SSB.

The TS-520S retains all of the features of the original TS-520 that made it tops in its class: RIT control • 8-pole crystal filter • Built-in 25 KHz calibrator • Front panel carrier level control • Semi-break-in CW with sidetone • VOX/PTT/MOX • TUNE position for low power tune up • Built-in speaker • Built-in Cooling Fan • Provisions for 4 fixed frequency channels • Heater switch.





## Specifications

Amateur Bands: 160-10 meters plus WWV (receive only)  
 Modes: USB, LSB, CW  
 Antenna Impedance: 50-75 Ohms  
 Frequency Stability: Within  $\pm 1$  kHz during one hour after one minute of warm-up, and within 100 Hz during any 30 minute period thereafter  
 Tubes & Semiconductors:  
 Tubes ..... 3 (S2001A x 2, 12BY7A)  
 Transistors ..... 52  
 FETs ..... 19  
 Diodes ..... 101  
 Power Requirements: 120/220 V AC, 50/60 Hz, 13.8 V DC (with optional DS-1A)  
 Power Consumption: Transmit: 280 Watts Receive: 26 Watts (with heater off)  
 Dimension: 333(13 $\frac{1}{4}$ ) W x 153 (6-0) H x 335(13-13/16) D mm(inch)  
 Weight: 16.0 kg(35.2 lbs)  
**TRANSMITTER**  
 RF Input Power: SSB: 200 Watts PEP CW: 160 Watts DC  
 Carrier Suppression: Better than -40 dB  
 Sideband Suppression: Better than -50 dB  
 Spurious Radiation: Better than -40 dB  
 Microphone Impedance: 50k Ohms  
 AF Response: 400 to 2,600 Hz

### RECEIVER

Sensitivity: 0.25  $\mu$ V for 10 dB (S+N)/N  
 Selectivity: SSB: 2.4 kHz/-6 dB, 4.4 kHz/-60 dB  
 Selectivity: CW: 0.5 kHz/-6 dB, 1.5 kHz/-60 dB (with optional CW-520 filter)  
 Image Ratio: Better than 50 dB  
 IF Rejection: Better than 50 dB  
 AF Output Power: 1.0 Watt (8 Ohm load, with less than 10% distortion)  
 AF Output Impedance: 4 to 16 Ohms

### DG-5

#### SPECIFICATIONS

Measuring Range: 100 Hz to 40 MHz  
 Input Impedance: 5 k Ohms  
 Gate Time: 0.1 Sec.  
 Input Sensitivity: 100 Hz to 40 MHz... 200 mV rms or over, 10 kHz to 10 MHz... 50 mV or over  
 Measuring Accuracy: Internal time base accuracy  $\pm 0.1$  count  
 Time Base: 10 MHz  
 Operating Temperature: -10° to 50° C/14° to 122° F  
 Power Requirement: Supplied from TS-520S or 12 to 16 VDC (nominal 13.8 VDC)  
 Dimensions: 167(6-9/16) W x 43(1-11/16) H x 268(10-9/16) D mm(inch)  
 Weight: 1.3 kg(2.9 lbs)

## DG-5 (optional)



The luxury of digital readout is available on the TS-520S by connecting the new DG-5 readout (option). More than just the average readout circuit, this counter mixes the carrier, VFO, and heterodyne frequencies to give you your exact frequency. This handsomely-styled accessory can be set almost anywhere in your shack for easy to read operation... or set it on the dashboard during mobile operation for safety and convenience. Six bold digits display your operating frequency while you transmit and receive. Complete with DH (display hold) switch for frequency memory and 2 position intensity selector. The DG-5 can also be used as a normal frequency counter up to 40 MHz at the touch of a switch. (Input cable provided.)

NOTE: TS-520 owners can use the DG-5 with a DK-520 adapter kit.

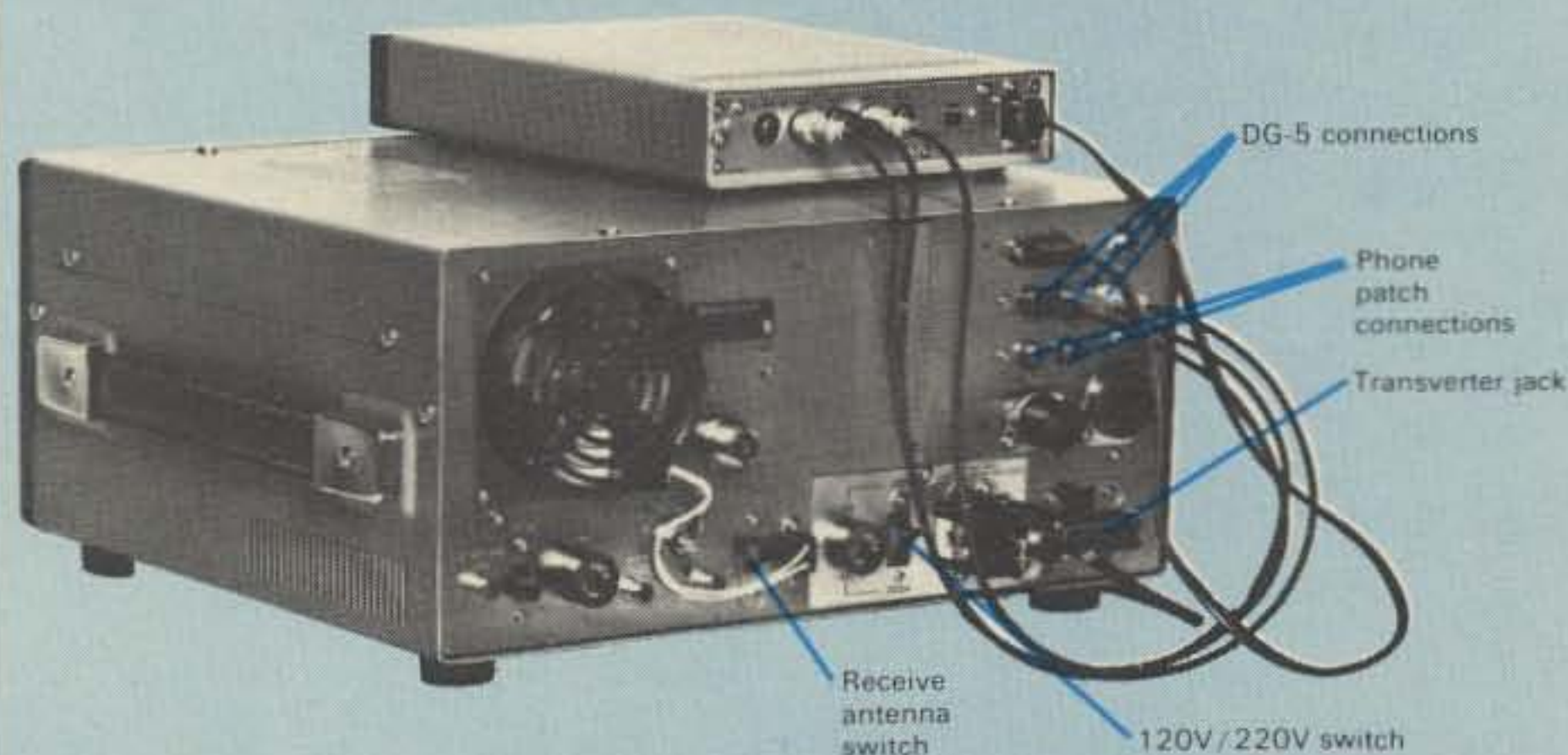



# TS-820S



We told you that the TS-820 would be the best. In little more than a year our promise has become a fact. Now, in response to hundreds of requests from amateurs, Kenwood offers the TS-820S\*... the same superb transceiver, but with the digital readout factory installed. The worldwide demand for the TS-820 far exceeded our initial production plans. However, production capacity has been substantially increased and our objective is to make the TS-820S more readily available to you. As an owner of this beautiful rig, you will have at your fingertips the combination of controls and features that even under the toughest operating conditions make the TS-820S the Pacesetter that it is.

## Features

Following are a few of the TS-820S' many exciting features.

**SPEECH PROCESSOR** • An RF circuit provides quick time constant

compression using a true RF compressor as opposed to an AF clipper. Amount of compression is adjustable to the desired level by a convenient front panel control.

**IF SHIFT** • The IF SHIFT control varies the IF passband without changing the receive frequency. Enables the operator to eliminate unwanted signals by moving them out of the passband of the receiver. This feature alone makes the TS-820S a pacesetter.



**PLL** • The TS-820S employs the latest phase lock loop circuitry. The single conversion receiver section performance offers superb protection against unwanted cross-modulation. And now, PLL allows the frequency to remain the same when switching sidebands (USB, LSB, CW) and eliminates having to recalibrate each time.

**DIGITAL READOUT** • The digital counter display is employed as an integral part of the VFO readout system. Counter mixes the carrier, VFO, and first heterodyne frequencies to give exact frequency. Figures the frequency down to 10 Hz and digital display reads out to

100 Hz. Both receive and transmit frequencies are displayed in easy to read, Kenwood Blue digits.

## Specifications

**FREQUENCY RANGE:** 1.8-29.7 MHz (160 - 10 meters)  
**MODES:** USB, LSB, CW, FSK  
**INPUT POWER:** 200W PEP on SSB  
 160 W DC on CW  
 100 W DC on FSK  
**ANTENNA IMPEDANCE:** 50-75 ohms, unbalanced  
**CARRIER SUPPRESSION:** Better than -40 dB  
**SIDEBAND SUPPRESSION:** Better than -50 dB  
**SPURIOUS RADIATION:** Greater than -60 dB (Harmonics more than -40 dB)  
**RECEIVER SENSITIVITY:** Better than 0.25uV

**RECEIVER SELECTIVITY:**  
 SSB 2.4 kHz (-6 dB)  
 4.4 kHz (-60 dB)  
 CW\* 0.5 kHz (-6 dB)  
 1.8 kHz (-60 dB)  
 \*(with optional CW filter installed)  
**IMAGE RATIO:** 160-15 meters: Better than 60 dB  
 10-meters: Better than 50 dB  
**IF REJECTION:** Better than 80 dB  
**POWER REQUIREMENTS:** 120/220 VAC, 50/60 Hz, 13.8 VDC (with optional DS-1A DC-DC converter)  
**POWER CONSUMPTION:** Transmit 280 Watts  
 Receive: 26 Watts (heaters off)  
**DIMENSIONS:** 13-1/8" W x 6" H x 13-3/16" D  
**WEIGHT:** 35.2 lbs (16 kg)

**VFO-820**  
 Function switch provides any combination of transmit/receive/transceive with the TS-820S. Both are equipped with VFO indicators showing which VFO is in use.

**SP-520**  
 Although the TS-820S has a built-in speaker, the addition of the SP-520 provides improved tonal quality. A perfect match in both design and performance.

**TV-502**  
 The TV-502 transverter puts you on 2-meters the easy way. Operates in the 144.0-145.7 MHz frequency range with a 145.0-146.0 MHz option. Completely compatible with the TS-820S, the TS-520S and most any HF transceiver.

**TV-506**  
 Similar to the TV-502 except that it opens up the 6-meter band (50.0-54.0 MHz) to your HF rig.  
 \*The TS-820S and DG-1 are still available separately.



# QSL Tips

## -- how to bat 1.000

Marty Barrack  
200 S. Lincoln  
Sterling VA 22170

This month we interview Sir Henry Peter Fox, the world's greatest authority on QSL cards. Sir Henry works as a gun bearer on the Dark Continent, keeping the natives restless. He used to teach marksmanship until one of his students, Albert Scaramanga (known to his CB buddies as the Triple Nipple), tried to shoot a member of the British Secret Service. Ruddy awful business! After that, Sir Henry turned to QSL collecting. When we approached he was explaining to one student how to tell from looking at the edge of a QSL where the tree from which it came grew and the time of year it was cut down. In response to another question he named every ham in the world from memory, how many countries he had confirmed, and exactly how many cards he had outstanding and at which bureaus. I asked Sir Henry how to get a lot of QSL cards. He replied, "Get a CB and wait until 1980." I explained that we were interested in ham QSLs. "Oh," he said, "order from Brownie by the thousand." I tried again. "No. Already filled out." "Ah, why didn't you say so? Rob a QSL Bureau."

Sir Henry downed a Bud and continued, "There are two ways to get QSL cards after you work a station. You can send your card directly to the station you worked, or you can send it through the bureaus." I asked why go through all the intermediary bureau stages. His answer was strikingly clear. "Money." He explained that, to send a card directly, you have to fill in the data, look up the DX station's name and address in the callbook, and type it on a 9½" envelope. Then you type your own name and address on a 6½" envelope. If you can get it, put sufficient air postage in the stamps of the DX country on the small envelope. Otherwise, put several International Reply Coupons in the large envelope. Also put in the large envelope your QSL card, properly filled in, and the small envelope. Then put sufficient U.S. stamps on the large envelope and mail it promptly. Odds are such a mailing will cost about two dollars in IRCs and stamps for just one card.

I told him it seemed very expensive. He opened another ice cold Bud and went on. "It is. But it's fast. You have to decide for yourself whether the speed is worth it. Usually, if you have a small station and only work DX occasionally, you may as well get your souvenir fast and direct.

But if you work 'em three a minute, your costs will go out of sight. Now, the bureau system will do the job slower, but for a fraction of a penny per card! Start by filling in all your cards, just the data section, don't address them. Then put them in alphabetical order by prefix. Put the cards in a box with a dollar and a copy of a current QST mailing label and address it to Outgoing QSL Bureau, ARRL, 225 Main St., Newington CT 06111.

"ARRL sorts the cards and mails a bundle off to each foreign bureau every week. Then it takes 30-90 days for the surface mail to travel from ARRL to the foreign bureau. Then figure 30-90 days for the foreign bureau to sort it and get it to the foreign ham you worked. The ham will probably take about 30 days to actually fill in his card for you and send it back to the foreign bureau. The foreign bureau may take another month to six months to get it on a boat; the big foreign bureaus such as DL, G, YU, F, ON, etc., will usually get a card out within a month. Then figure another 30-90 days on the high seas before the card gets back to the U.S. Then it goes to a U.S. bureau. The fellows in the bureaus, by the way, are the real unsung heroes of DXing. They do a super job of sorting. Every DXer in the

call area keeps a 5" x 7" manila envelope, self addressed and with 13¢ postage stuck on and another 13¢ stamp clipped on, on file. The bureau man with your letter puts all the cards addressed to you in your envelope. When the weight of the envelope approaches the maximum postage limit, the bureau mails it off full of cards you earned the year before!"

"Will they really do the same job?" I asked. He fondled the beautiful woman sunbathing at his side and said, "Look at two guys in the Sterling Park club. WA4HPF has 260 countries confirmed and spent about \$200 in IRCs. K4VT has 260 countries confirmed and never spent a dime. Of course, K4VT has been around a lot longer."

I asked Sir Henry how many countries he had. "Eleven," he replied proudly. I told him it seemed a small number compared with N4KW's 300+ countries, and asked if N4KW was a better operator. "You asked how many countries I had," he answered. "I own eleven countries. I have QSLs from every country, naturally."

I questioned Sir Henry about the practice of putting a dollar bill in with a directly sent QSL to encourage the DX to send his card in return. "Yes," he said, "some of the less experienced fellows do that. The sharp boys know how to do it right. You open an irrevocable letter of credit with a bank in the DX station's country. When the DX station sends off the card the bank releases a draft to the DX operator."

The sun was starting to set. Its orange light reflected off Sir Henry's station, especially the shiny black Collins HF-80s. Outside I could see W6AM patiently waiting to ask Sir Henry Peter Fox how to work DX and get QSLs. I shook Sir Henry's hand warmly, wished him well, and took out the ropes and pitons for the long trip down. ■



# CB to 10

## -- part III: converting the TRC-47

With the slowdown in the CB boom and the recent expansion to 40 channels, the CB equipment manufacturers have been caught off guard with thousands of 23 channel radios in warehouses. These are being dumped on the market at very low prices. I've seen advertisements as low as \$39.95 for a 23 channel AM rig. A very good one can be had for well under \$100.00.

Most of these radios are very easily converted to ten meters at a cost of under forty dollars.

First, for those of you not familiar with the way these crystal synthesized rigs operate, a few basics, then I will go into specific details of the conversion of a Radio Shack TRC-47, a very common AM & SSB rig.

There are two basic 23 channel synthesizer schemes, the 14 crystal and the 12 crystal. First the 14 crystal type, the more common.

The 14 crystal radios usually have a single conversion receiver with an i-f of 455 kHz. The crystals are in three groups which I will call group A, group Bt, and Br. In my example, I will use the following crystal frequencies: group A - 16.465,

16.515, 16.565, 16.615, 16.665, 16.715; group Bt - 10.500, 10.510, 10.520, 10.540; group Br - 10.955, 10.965, 10.975, 10.995.

In operation, one crystal from group A is used, and one from group Bt on transmit and one from Br on receive. For example, on channel 1 (26.965 MHz) on transmit, 16.465 and 10.500 are mixed to get the operating frequency, and on receive 16.465 and 10.955 are mixed to get 27.420 MHz, which conveniently just happens to be 455 kHz above the operating frequency of 26.965. So if we add 1.735 MHz to each crystal in group A, we can get frequencies in the range of 28.700 to 28.990 MHz, with channel 9 working out to 28.800, the AM calling frequency. How about that?

So, with a 14 crystal AM rig, all that has to be done to put it on ten is to change six crystals and retune some coils. With minimal test equipment, a VTVM, signal generator (that old VFO), a wattmeter or swr bridge, and a dummy load, the whole job can be done in under one hour.

The most difficult part of the job is figuring out what crystals to order. Table 1 is a

chart of the common heterodyne scheme and channel frequencies. Notice the 10-10-20-10 kHz spacing of the channels.

Note the channel marked \*\* is indicated by the dot on the dial between 22 and 23 and on some radios can be had by just installing a jumper or clipping one. Some other radios would require major mechanical modifications to the channel switch to get it.

When you decide what frequencies on ten meters you want, on the 10-10-20-10 spacing pattern, just subtract 26.965 from the lowest one and add this result to the frequency of each crystal in group A, order the new crystals from your favorite purveyor of quartz, wait for the post office, wait for the post office some more, and, when they come, get out the old trusty soldering iron and swizzle sticks, and soon you'll be on ten.

Now, for the 12 crystal rigs. These are cheaper to convert, as only 2 have to be changed. The receivers in these are usually better because they are dual conversion. The heterodyning scheme here is similar to the 14 crystal type but there are

only 6 group A and 4 group B crystals, and 2 i-f crystals. Table 2 is an example from a Sanyo TA-923 which I still use on 11 meters.

In this type of radio, one crystal from group A and one from group B are used for both transmit and receive and are mixed to form a product in the 38 MHz range which is run through a bandpass filter at this frequency.

An example for channel 09 (27.065 MHz): Grp A = 23.390; Grp B = 14.950; A + B = 38.340 MHz.

On transmit this 38.34 MHz is mixed with 11.275 to get the operating frequency of 27.065, run through a bandpass filter at 27 MHz, amplified, and modulated. On receive, the 38.34 is injected into the first mixer to get the Rx first i-f at 11.275, which is then mixed with the 11.730 to get the second i-f of 455 kHz. Simple, isn't it? All that has to be done here is to lower the 11 MHz crystals by the amount you want to go up in operating frequency. For example, to make channel 09 come out on 28.800 lower them by 1.735 MHz making the Tx i-f = 9.540 MHz and the Rx i-f crystal = 9.995 MHz, retune the appropriate coils, and you're on the air on ten.

Now, down to the real nitty-gritty of one that I have had on the air on SSB for several months now, in use both at home and in the car. The one I picked is a Radio Shack TRC-47, about the same size as an Icom IC-22. It has a very good crystal filter centered at 11.2735 MHz which gives about 50 dB unwanted sideband suppression. The TRC-48 uses the same filter and oscillator PC board, so conversion data for it is identical to the TRC-47. The TRC-48 is slightly larger and fancier (it has an "S" meter, PA, and switchable noise blanker) and more expensive. They are both rated at 4 Watts rf output on AM and 12 Watts PEP on SSB. I am getting 10 Watts PEP out of mine on 28.600

Grp A/Grp Bt	10.500	10.510	10.520	10.540
16.465	26.965-01	26.975-02	26.985-03	27.005-04
16.515	27.015-05	27.025-06	27.035-07	27.055-08
16.565	27.065-09	27.075-10	27.085-11	27.105-12
16.615	27.115-13	27.125-14	27.135-15	27.155-16
16.665	27.165-17	27.175-18	27.185-19	27.205-20
16.715	27.215-21	27.225-22	27.235-**	27.255-23

Table 1.



MHz. That's only 10 dB down from the typical SSB exciter which has at best 100 Watts output, most of them more like 70 or 80 on ten meters. So what if I'm 1 or 2 "S" units down; it makes up for all the mobile noise from my own and other cars on the road. If I can hear them in the car, I can work them.

Now, how to do it to it.

### Step 1: Getting the radio — new or used?

If you have a bit of test equipment you can probably get a better deal on a used radio, but check it out first! Check rf output on AM. If below 2.5 W or above 5.5 W when operated on 13.5 V dc or the ac line if a base station, forget it and go on to the next one. On SSB the output should indicate 8-16 Watts when you whistle into the mike. Check out the receiver on an antenna. Find a few strong local signals and make sure they disappear when switching to the next channel on either side. They should be way down when switching sidebands if SSB.

Next, take the covers off and have a good look inside for modifications. If you see any, put the covers back on and forget it, unless it is quite obvious that the mods will not affect operation of the radio in the manner in which it was designed to operate. As far as dust, dirt, and smudges go, they can easily be cleaned up, so don't let that bother you. Look for ads in the newspaper or in the local weekly *Buy and Sell*. Bargain over price as most sellers are not firm on asking price, and, after all, it's a buyer's market now for 23 channel radios, especially for SSB. Make a call to the local police to make sure it's not hot. For a new radio, shop around at a few stores. Again, it's a buyers market, and even at the chain stores you can get quite a good deal. So make an offer; they might just take it.

### Step 2: Figuring it out

If at all possible, get the

service manual! This will tell you all you ever wanted to know, but were afraid to ask. For the Radio Shack radios, it can be ordered from the store (they're everywhere just like MacDonald's) if they don't have an extra one in stock. It's well worth the two bucks. Most radios have a schematic diagram in the owner's manual, and some even have one glued inside the top cover. This may be all you need, but the service manual gives complete alignment information and a description of circuit operation which can help a lot.

### Step 3: Plotting and Scheming — just what has to be done?

Which crystals to change? Determine the type of synthesizer and do the arithmetic. If you have trouble, write me enclosing a copy of the schematic and existing crystal frequencies and one SASE, and I will be glad to help you. Next, order the new crystals and wait, and wait.

What about tuning on SSB? All the SSB rigs have a clarifier control which will move the receiver + or - about 1 kHz. On many of the rigs it also moves the transmitter the same amount. Don't worry if it doesn't move the Tx; it's easy to fix it so it will. What about moving more than 1 kHz? If you can't figure it out, ask one of the unscrupulous CB servicemen who advertize in the personal column of the local newspaper how to put in a slider. This will give you about a 20 kHz spread on each channel. Follow all signal paths on the schematic

Group A:	23.290	23.340	23.390	23.440	23.490	23.540
Group B:	14.950	14.960	14.970	14.990		
Tx i-f:	11.275					
Rx i-f:	11.730					

Table 2.

so you can figure out which circuits will need retuning.

### Step 4: The Mod Squad Attacks

For the TRC-47 (and -48), which uses sort of a cross between the 12 and 14 crystal synthesizers, the existing crystals are shown in Table 3.

In this scheme, one crystal from group A is always used, one from group Bu for AM and USB, and one from group B1 for LSB only. The 11.275 is used for AM Tx and for USB. The 11.272 is used for LSB, and the 11.730 for AM Rx only.

Change the group A crystals to: 24.865, 24.915, 24.965, 25.015, 25.065, and 25.115 MHz. The clarifier control is a fairly large variable capacitor of two sections, with a fixed capacitor in parallel with each section. Clip these two fixed capacitors out of the circuit. This now gives you more range on the clarifier, about -1 to +4 kHz. Seeing as how nobody uses LSB on ten meters, remove the two resistors (1 K) which bias the diodes for switching the BFO crystals and short the diode for the USB BFO crystal (11.275). By doing this, when you move the mode switch to LSB the radio stays on USB, but you get a downward frequency shift of about 3 kHz. You now have two 5 kHz wide bands with a 2 kHz overlap for each of the 23 channels. Now retune the bandpass filters at 38 and 27 MHz to 39.6 and 28.6 MHz, peak the receiver front end, peak the transmitter driver and final coils. Do not adjust any of the pots in the transmitter unless you have access

to and can use a spectrum analyzer, as this will affect drive level and bias and will affect intermodulation distortion just as much if not more than it will affect power output. The extra one or two dB you can get, just isn't worth the trouble.

### Step 5: The Smoke Test

Get in contact with a local ham who can work ten meters, and arrange a sked to make sure that it is working on the frequency you think it is, and while he is transmitting on a known frequency, make sure you can tune him in where you think he should be. Then and only then, try out the transmitter to see if he can hear you. Also have him tune up and down the band to make sure you are only transmitting in one place and the radio has reasonably good audio quality. If you want to use an external speaker on it, be careful how far you advance the audio gain, as these rigs have much more audio than you will probably ever need on receive, as the Rx audio output is also the AM modulator. It will give you up to 5 Watts of audio, enough to wake the silent keys. They usually have resistors in series with the internal speaker to prevent the voice coil from smoking at an early age.

### Step 6: Operating it, CQ CQ 10 CQ 10 CQ 10-10, etc.

Generally accepted calling frequencies are 28.600 USB and 28.800 AM, and activity seems to be centered about these, but it's best to check with a local who is active on ten to make sure first. There may be a local net or club using some other frequency

Group A:	23.330	23.380	23.430	23.480	23.530	23.580
Group Bu:	14.910	14.920	14.930	14.950		
Group B1:	14.907	14.917	14.927	14.947		
BFO u:	11.275	BFO 1:	11.272	Rx 2nd mixer for AM only	11.730	

Table 3.



that you may want. On many of these radios the squelch control works very well, so it's easy to monitor a specific frequency for calls, and have things quiet when there is no signal present, just like two meter FM. Local coverage, both mobile and fixed, seems to be about the same as two meter simplex operation, but more fun when it opens up, which is getting to be more often now that the sunspot cycle is on the upswing again.

#### Some Notes on Antennae for Ten.

For mobile operation I use one of the four foot long top loaded fiberglass whips with 12 turns removed from the top of the coil. This makes it resonate nicely at about 28.6 MHz. It's only about 1.5 dB down from a full quarter wave, and it's a lot easier to fit into the garage.

At home I use a Radio Shack 5/8 wave ground plane

for 11m with the capacity hat removed, but everything else exactly as it comes out of the box and assembled following the directions. Removing the top hat (3 wires) makes it resonate at about 28.5 MHz with an swr of less than 1.4:1, not bad for an antenna which takes only about 15 minutes to assemble and erect.

#### What About Crystals?

They can be had from any

of the manufacturers advertising in the magazine elsewhere, or you just may have some in your junk box. Canadians can order from Lesmith Ltd., PO Box 703, Oakville, Ont., at a price of six dollars per crystal. Delivery of crystals should take 4-6 weeks.

Best of luck, and hope to hear you on ten. If you have any trouble be sure and drop me a line, and I will try to help you out. ■

## We Don't Claim That Your ALPHA Linear Will Run A Kilowatt Key-Down FOREVER . . .



## . . . But We Don't Put A Time Limit On It, Either.

YOU'LL PROBABLY NEVER SET A BRICK ON YOUR KEY FOR 26,000 MINUTES, BUT WE DID IT TO ILLUSTRATE WHAT ETO'S NO TIME LIMIT (NTL) CONTINUOUS DUTY RATINGS REALLY MEAN TO EVERY ALPHA AMPLIFIER OWNER.

**April 7th:** A standard ALPHA 76 was taken from production, loaded up to a full 1000 watts key-down dc input, and left operating with a brick on the key.

**April 25th:** The '76 was still operating completely normally, delivering about 675 watts of continuous rf carrier output into a very hot dummy load — after 18 days — 435 hours — some 26,000 consecutive minutes key-down at a full kilowatt. You may have seen the same unit running key-down all day long the following week-end at the Dayton Hamvention. It's still as good as new — a fact which will surprise no one who knows how all ALPHA's are built. You'd expect no less.

The point is, every ALPHA linear amplifier — including the power- and value-packed ALPHA 76 and the exclusive NO-TUNE-UP ALPHA 374 — is meticulously engineered and built to handle continuous operation IN ANY MODE AT MAXIMUM LEGAL POWER [NTL] . . . No Time Limit. And ETO's warranty on every ALPHA amplifier protects you FOR EIGHTEEN MONTHS — FIVE TIMES LONGER than most amateur equipment warranties!

## ALPHA: SURE YOU CAN BUY A CHEAPER LINEAR . . . BUT IS THAT REALLY WHAT YOU WANT?

A LINEAR AMPLIFIER IS A BIG INVESTMENT . . . MAKE IT WISELY. For an enlightening glimpse at what goes into the design of every ALPHA by ETO's power professionals, or to aid you in comparing one linear with another, call or write for our brief guide entitled, "EVERYTHING YOU ALWAYS WANTED TO KNOW ABOUT (COMPARING) LINEARS . . . BUT DIDN'T KNOW WHOM TO ASK." We'll also send you fully detailed and illustrated literature describing the entire ETO line of superb ALPHA power amplifiers and ALPHA/VOMAX — the new split-band speech processor that's your key to rf clipper type "talk power" combined with easy mike-line installation and low-distortion, practically foolproof operation.



EHRHORN TECHNOLOGICAL OPERATIONS, INC.  
P.O. BOX 708 — INDUSTRIAL PARK  
CANON CITY, CO. 81212 PHONE (303) 275-1613

## NEW!

A \$29.95  
DVM Kit.

Thanks to a product breakthrough, digital voltmeters are available at a bargain price. What are you waiting for?

- Features:
- 1) Uses new Motorola 3 1/2 digit DVM chip.
  - 2) Autozero, autopolarity with minus.
  - 3) Up to ±0.05% accuracy.
  - 4) Over-voltage protected, NO JUNK PARTS. Jumbo LED Display.
  - 5) Two voltage ranges: 0-199.9 mV, 0-1.999 V. Attenuators for higher ranges available, AC volts, Ohms ranges available.

Add \$1.50 for postage. CA residents add \$1.80 tax. Buy two and save \$3.00!

Gary McClellan and Co. Box 2085  
1001 W. Imperial Hwy.  
La Habra CA 90631

**POSITIVE RESIST**  
**carbide bits**  
**w.h. brady; datak**  
**1X PCartwork 2X**  
**BUBBLE ETCHERS**

SEND STAMP & ADDRESS LABEL FOR FLYER VIA FIRST CLASS MAIL

**TRUMBULL COMPANY**  
833 Balra Dr., El Cerrito, Ca. 94530



# CB to 10

## - - part IV: Johnson 123A mod

Tom Goldsmith WB4EQU  
49 Memorial Parkway NW  
Fort Walton Beach FL 32548

David F. Norman  
622 W. Sunset Blvd.  
Fort Walton Beach FL 32548

As any fool can plainly see, the transceiver shown in Fig. 1 is a very common, midpriced CB unit. Right? Wrong. This particular E. F. Johnson Messenger 123A started out that way, but a few simple modifications have turned it into a 23 channel, crystal controlled 10 meter amateur rig.

When we were finished with the modification and

tuning, we ran a performance check on this unit. Radio frequency output exceeded 3.5 Watts and receiver sensitivity was on the order of 0.5 microvolts for 10 dB signal plus noise/noise. That ain't bad. With the coming increase in sunspot activity, conversions such as this should be good for some very interesting low power DX.

The idea was sparked by

the realization that many underpriced CB units were made available when the CB manufacturers began dumping 23 channel units to make room for the 40 channel models. An amateur with only basic skills should be able to buy and convert a 23 channel CB unit to 10 meters for less than \$80 — of course,

if the unit chosen for conversion is more exotic and costs more to begin with, the total price can be much higher.

Our primary reason for choosing the 123A over other models was simple ... we had an extra one gathering dust on the shelf. We could have used practically any unit on the market, and so can



Fig. 1. No, it's not another CB. It's a hot little 10 meter conversion.

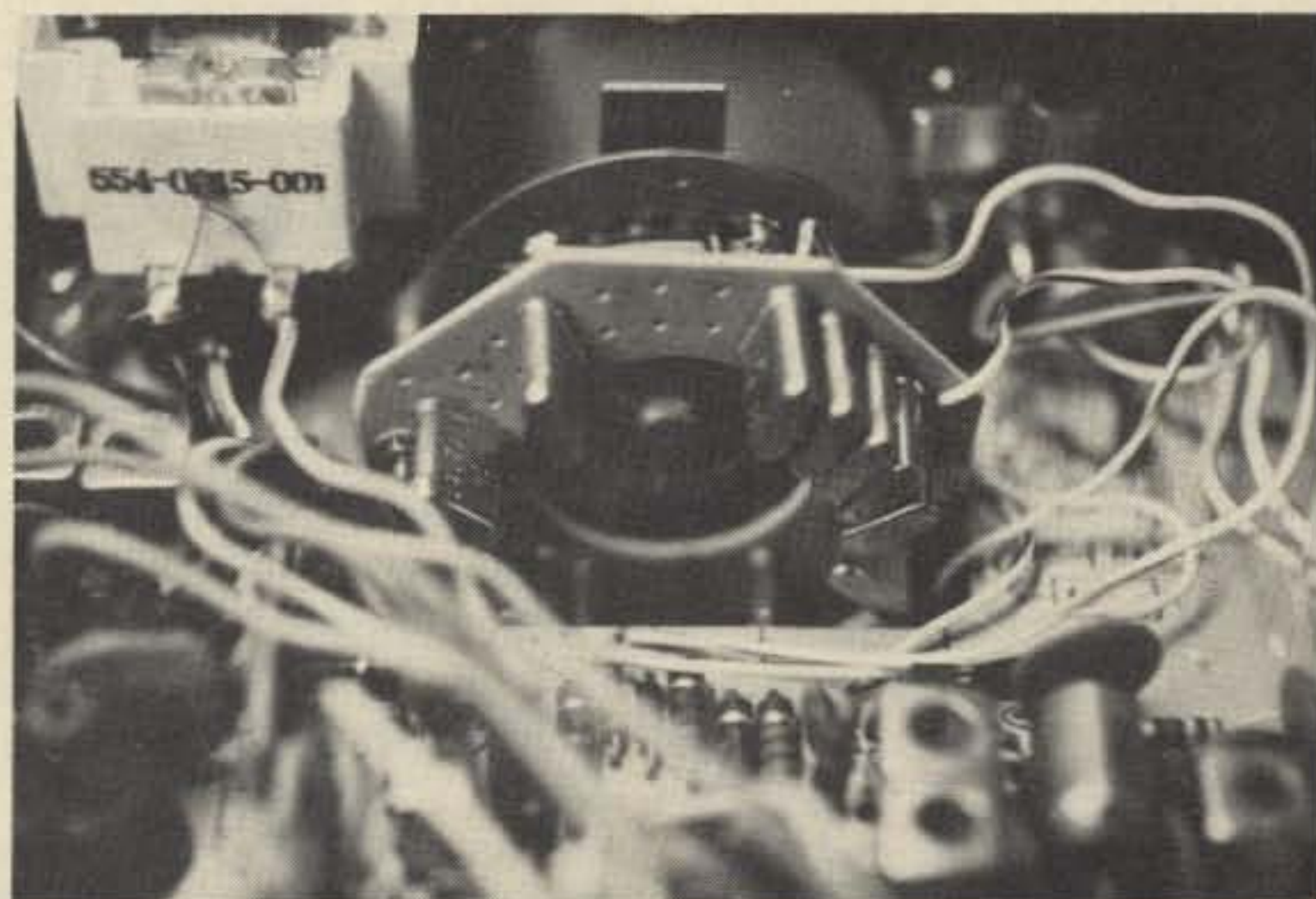

Fig. 2. The crystal bank PCB should be removed for easy access to the crystals.



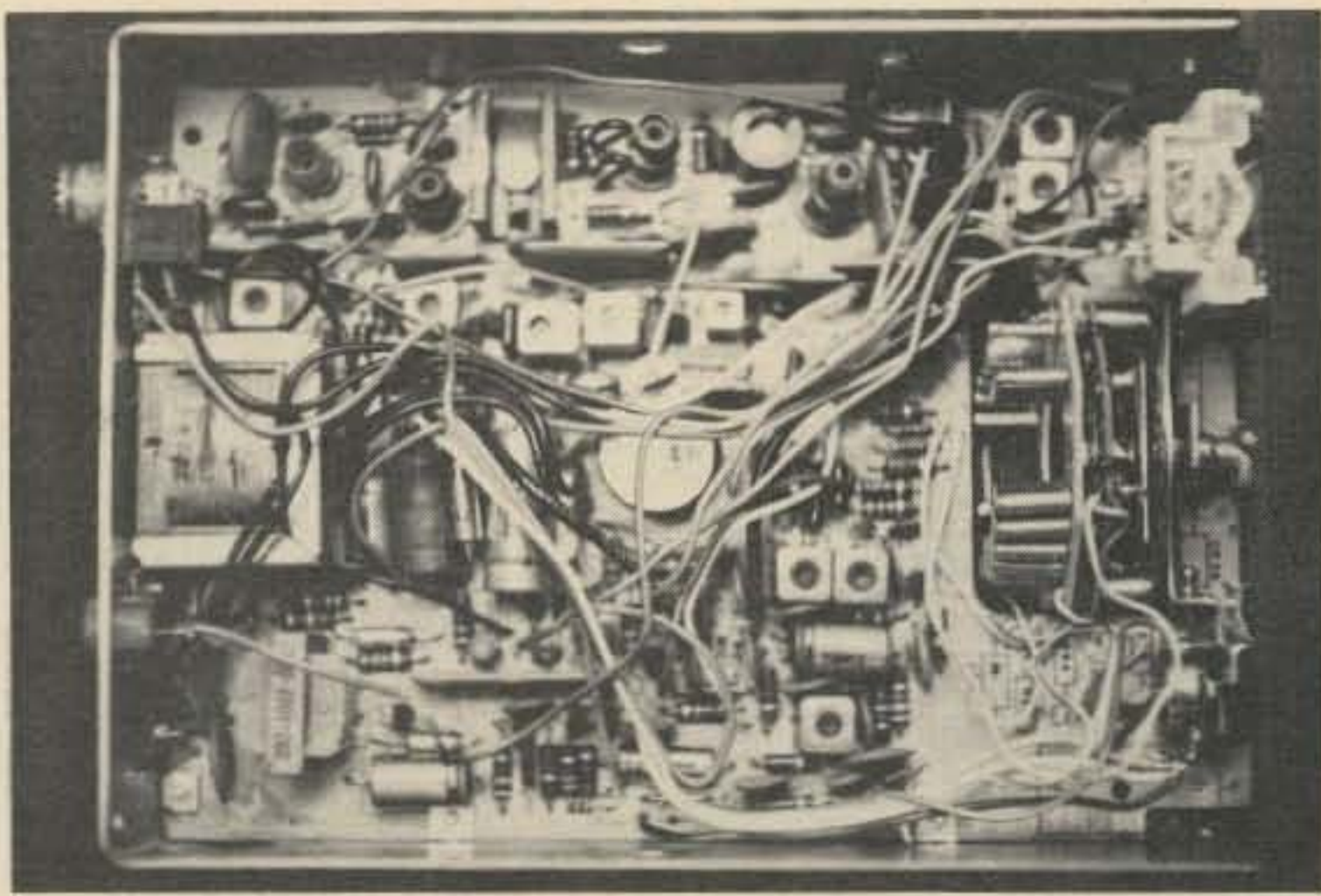

Fig. 3. Interior shot of the 123A showing the transmitter strip at the top.

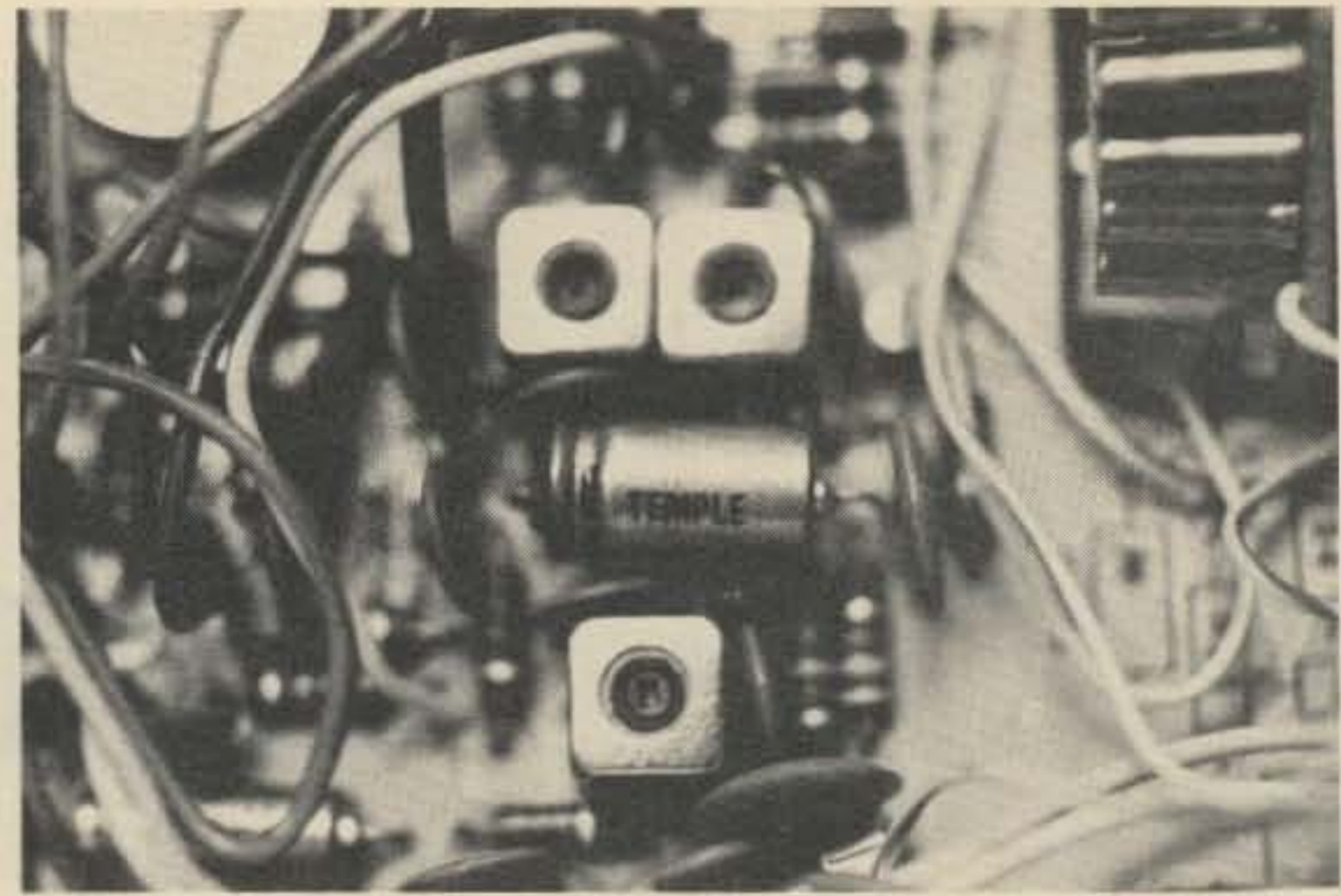

Fig. 4. Detail of the oscillator synthesizer mixer tuning adjustments and test points.

you. However, let's go through this particular conversion step-by-step, since most conversions will differ only in minor details. If you follow what we did here, you should have no trouble with other makes or models.

The 123A is a single-conversion synthesized unit using a channel frequency minus 455 kHz input to the receiver mixer. This is accomplished by mixing the output from a high frequency oscillator with that of a low frequency oscillator and using the difference frequency.

For example, when the unit is tuned to CB channel 1 (26.965 MHz), the high frequency oscillator operates at 32.700 MHz. The low frequency oscillator on channel 1 operates at 6.190 MHz. The difference frequency is 26.510 MHz, which is 0.455 MHz below the channel frequency.

When the unit is switched to the transmit mode — still on channel 1 — the high frequency oscillator continues to operate at 32.700 MHz, but the low frequency oscillator has a 5.735 MHz crystal switched into the circuit and the 6.190 MHz crystal is switched out. This new difference frequency — 26.965 MHz (same as the channel frequency) — is simultaneously switched to the transmitter strip, and the receiver is muted.

While the 123A is a 23 channel unit and only uses 14

crystals in all, each crystal must control several channels. If you start at the lower end of the band (channel 1) and change channels all the way to the top (channel 23), you will find that the high frequency crystals are switched after four consecutive channels and the low frequency crystals are switched for each channel and repeat every fourth channel. Table 1 should make that clearer.

We decided that since we had to start somewhere, a frequency jump of exactly 2 MHz would simplify matters, so that is what we used. It would have been as good from an operating standpoint to shift the low frequency crystals, but for economy we decided that it made much more sense to change only six crystals rather than eight. (Another reason to use the higher oscillator for changes is that low frequency oscillators are sometimes pretty narrow banded. We didn't want to have to change any tuning components if we didn't have to do so.)

By referring to Table 1, you can see that to raise receiver and transmitter frequencies 2 MHz, you simply raise the high frequency oscillator 2 MHz. The new difference frequencies (28.965, etc.) fall into the 10 meter phone band.

We ordered the new crystals and put the unit back on the shelf until they arrived. When they finally got

in after several weeks, we took the unit out of the case and began the conversion.

Removing the crystal bank — it surrounds the channel selector switch — in the 123A is a relatively simple matter of taking off the front panel knobs, the four screws which secure the front panel to the chassis, and the two tiny bolts which fasten the crystal bank to the channel selector switch. In Fig. 2 you can see one of the nuts which holds the crystal bank located at the left center of the picture.

When the fiber PCB which holds the crystals is loose, it is a simple matter to remove the high frequency oscillator crystals and replace them with the new crystals. Use a good clean iron for the job in order to minimize damage to the PCB.

When all of the new crystals are soldered in place and the leads trimmed, reassemble the whole mess and you are ready to start tuning.

Tuning can be very simple if you have the right equipment. If you don't, we would suggest that you borrow it. In this case the right equipment is a diddlestick and an rf VTVM.

Look at Fig. 3. Slightly to the right and below center you can see two tiny transformers. Below them you will see one more. The lower transformer sitting all by itself is T7. Transformer T7 tunes the output of the high frequency oscillator.

Fig. 4 is an expanded view of T7 and its associated components. Just to the right of T8 and T9 is transistor Q14, the synthesizer mixer. The output from the high frequency oscillator is coupled through T7 to the emitter of Q14. With the unit in the receive mode, connect the rf probe to the emitter of Q14 and tune T7 for maximum. The reading should be somewhere between 0.5 and 1.0 volts rms of rf. After you have tuned T7 for maximum, switch through all of the channels. If you are measuring the right output, after every four channels the reading will momentarily dip as you switch in another crystal. When you turn the channel selector to the blank space between channels 22 and 23, the reading should go to zilch. In this unit, as in many others, the channel selector switch has a cutout to prevent operation in this position. (It used to be called channel 22a, 27.235 MHz, which was illegal under the old CB rules.)

After you are satisfied that the oscillator is working properly, move the rf probe to the diodes to the left of the filter capacitor directly above T7. The cathodes of these two diodes are connected, and this is your next test point. Tune T8 and T9 for maximum at this point. You may have to go back and touch up T7 as you load it by tuning T8 and T9.



If you get something between 0.3 and 0.5 volts rf at this test point, it is downhill all the way from here. If not, go back and start over again at T7.

In Fig. 3 you can see two small transformers above the channel selector. These are T10 and T11. To tune them, connect the rf probe to the collector of rf pre-driver Q15 (in Fig. 3 Q15 is obscured by the mike cord, but it is the first transistor in the transmitter strip and is close to T10/T11). When the probe is connected, connect a dummy load to the rf output of the unit and key the mike. The rf output measured on the collector of Q15 should be several volts. If you have it, move the probe to the next transistor in the transmitter strip and tune each stage for maximum before going on to the next. By this time, you should have a Watt or two of rf at the transmitter's output, and you can complete tuning with a wattmeter if you have one — and you either do or have a friend who does.

Before you do any receiver tuning, complete the trans-

mitter tuning. When you are finished, you should have 3.0 Watts or more at 13.6 volts dc input. Transformers T10/T11 may need to be stagger-tuned to optimize output on all channels. All other transmitter tuning should be done at or near the center of the band (channel 12 or 13). After you have maximum output, whistle into the mike. The wattmeter will probably kick down. If you have tuned to maximum, you may be showing as much as 5.0 Watts of output. The 123A will usually not modulate that much power fully and transmitter tuning should be touched up a little.

Between the rf final amplifier and the output connection you can see two tuning coils. After the unit has been tuned to maximum, insert a diddlestick into the coil nearest the final amplifier. Using short whistles, turn the slug clockwise into the coil until the wattmeter begins to kick up slightly on the peaks. Then go to the last tuning coil and retune it for maximum output. Do this back and forth until you have the

maximum output which will allow the wattmeter to show a slight kick upwards on peaks. If this point happens to be in excess of 5 Watts, fine. If it is less — and it probably will be — that's okay too. In any event, that point is where the unit should operate for cleanest, best modulated output.

Now you are ready to tune the receiver section. Assuming that the unit was working properly on CB frequencies, you have only two minor adjustments to make.

Look at Fig. 3 again. Directly below and parallel to the transmitter strip is the receiver rf and i-f strip. Don't disturb any adjustments except those of the two cans closest to the rear of the chassis. The can sitting by itself near the modulation transformer is T1, the receiver rf input tuning. The next can in the line is the mixer input tuning, T2. There are two easy ways of tuning these two cans.

If you have a stable signal source and can be certain that it is on frequency, set it for 29.085 MHz (new channel

11-10m), couple it to the transceiver and tune for maximum output or S-meter reading.

The other way is to connect the unit to an antenna which exhibits a low vswr on 10 meters and tune for maximum noise. Normal precautions against tuning to an image frequency should be observed. As a general rule, if you tune to the first peak that you come to from the original positions, you will be right on the money the first time. Measure the output frequencies with a counter, check it out with a friend across town, and you are on the air. Total time involved? A couple of hours.

In our prototype unit, we noticed only one unusual item. On channel 4-10m (you have to call them something), we have a relatively strong received signal present even when the antenna is not connected. Since we have 22 other channels to use, we decided to forget it and not go looking for spurs. The same problem may or may not show up on your conversion.

As mentioned before, we chose this unit simply because we had it. If you have another make or model, your conversion may be a little harder. If the crystals are of the plug-in type, the conversion may be easier. When you begin to tune the unit, take it one step at the time. Few if any CB units will operate at a new frequency without careful retuning.

The 2 MHz jump seems to be a good idea to us. Channelization means that mobile operation is simple and fiddle-proof. As a suggestion, it seems to us that channel 1-10m (29.965 MHz) would be a good calling channel. If everyone who makes a +2 MHz conversion monitors this channel as the band opens this summer and fall, there should be a good chance of making contacts. If everyone jumps around all over the band, the chances go way down. Be seeing you on 10. ■

CHANNEL	HF CRYSTAL	RECEIVE LF CRYSTAL	RECEIVE OUTPUT	TRANSMIT LF CRYSTAL	TRANSMIT OUTPUT
1	32.700	6.190	26.510	5.735	26.965
2	32.700	6.180	26.520	5.725	26.975
3	32.700	6.170	26.530	5.715	26.985
4	32.700	6.150	26.550	5.695	27.005
5	32.750	6.190	26.560	5.735	27.015
6	32.750	6.180	26.570	5.725	27.025
7	32.750	6.170	26.580	5.715	27.035
8	32.750	6.150	26.600	5.695	27.055
9	32.800	6.190	26.610	5.735	27.065
10	32.800	6.180	26.620	5.725	27.075
11	32.800	6.170	26.630	5.715	27.085
12	32.800	6.150	26.650	5.695	27.105
13	32.850	6.190	26.660	5.735	27.115
14	32.850	6.180	26.670	5.725	27.125
15	32.850	6.170	26.680	5.715	27.135
16	32.850	6.150	26.700	5.695	27.155
17	32.900	6.190	26.710	5.735	27.165
18	32.900	6.180	26.720	5.725	27.175
19	32.900	6.170	26.730	5.715	27.185
20	32.900	6.150	26.750	5.695	27.205
21	32.950	6.190	26.760	5.735	27.215
22	32.950	6.180	26.770	5.725	27.225
23	32.950	6.150	26.800	5.695	27.255

Table 1. Synthesizer scheme. If 2 MHz is added to each frequency in the HF Crystal column, the Receive output and Transmitter output also increase by 2 MHz. NOTE: All frequencies in MHz.



# CB to 10

-- part V:

## converting the Hy-Gain 670B

As a result of the recent dump of 23 channel Citizens Band radios on the market in anticipation of a big push for the new 40 channel units, there are many 23 channel units at real bargain prices. I paid \$40.00 for the one I purchased, a Hy-Gain 670B (Hy-range I). The radio that I bought lends

itself very handily to conversion to the 10 meter ham band. The Hy-range I is a 23 channel, synthesized, 4 Watt output, AM radio. If you choose another type radio make sure you get one that uses crystals, not phase locked loop. The newer types with the synthesizer lend themselves to conversion

better than the older types that use one crystal for transmit and one for receive. With the newer units you get a lot more useable channels for a lot less cost.

Looking at the schematic that came with the radio, I located the bandswitch and the oscillator crystals were next to it. The Hy-Gain

schematic has a chart that shows the crystals required to synthesize the unit. What you want to do is to change the smallest number of crystals possible due to the cost factor. I decided to use the 4 crystals in the 14 MHz oscillator section and leave the 23 MHz section alone as it contains 6 crystals. It may be possible to change only the offset oscillator crystals, in this case, 11.275 and 11.730 MHz. I did not try this as I believed that the coils in the front end of the receiver and in the transmitter would probably tune the proper range without modification. This proved correct. The i-f section may or may not tune. I'll leave that to someone else to try together with the chance of blowing the price of a couple of crystals.

The crystal needed for the Hy-Gain is determined as follows: Channel 1 is to be 29.000 MHz. The 23 MHz oscillator frequency is subtracted from 29.000 MHz. Then the offset oscillator frequency of 11.730 MHz is added to that figure giving the required frequency, in this case 17.440 MHz.

With one crystal then, I set my radio up on 6 channels which came out this way:

- Channel 1 ... 29.000 MHz
- Channel 5 ... 29.050 MHz
- Channel 9 ... 29.100 MHz
- Channel 13 ... 29.150 MHz
- Channel 18 ... 29.210 MHz
- Channel 22 ... 29.260 MHz

I felt that 6 channels were enough to start off with. The other channels will no longer transmit after the coils have been retuned, thus any possibility of transmission of unwanted frequencies will be avoided in case the channel selector happens to get off on a channel that is not set up on 10 meters.

In order to make it simple to keep track of what frequencies are combining to form the desired frequencies, I made up a chart giving all of the frequencies involved.

When you order a crystal, be sure and give all the in-

Channel	11 Meters	10 Meters	23 MHz	Old 14 MHz	New 17 MHz
1	26.965	29.000	23.290	14.950	17.440
2	26.975	29.010	23.290	14.960	17.450
3	26.985	29.020	23.290	14.970	17.460
4	27.005	29.040	23.290	14.990	17.480
5	27.015	29.050	23.340	14.950	17.440
6	27.025	29.060	23.340	14.960	17.450
7	27.035	29.070	23.340	14.970	17.460
8	27.055	29.090	23.340	14.990	17.480
9	27.065	29.100	23.390	14.950	17.440
10	27.075	29.110	23.390	14.960	17.450
11	27.085	29.120	23.390	14.970	17.460
12	27.105	29.140	23.390	14.990	17.480
13	27.115	29.150	23.440	14.950	17.440
14	27.125	29.160	23.440	14.960	17.450
15	27.135	29.170	23.440	14.970	17.460
16	27.155	29.190	23.440	14.990	17.480
17	27.165	29.200	23.490	14.950	17.440
18	27.175	29.210	23.490	14.960	17.450
19	27.185	29.220	23.490	14.970	17.460
20	27.205	29.240	23.490	14.990	17.480
21	27.215	29.250	23.540	14.950	17.440
22	27.225	29.260	23.540	14.960	17.450
23	27.255	29.290	23.540	14.990	17.480

Fig. 1.



formation on your radio along with the frequency wanted. The Hy-Gain takes a 4342743 CS 26C 47 pF (International Crystal Co.).

#### Conversion

After taking the covers off, locate the 14 MHz oscillator section. This is the 4 crystals grouped together with their designation printed on the chassis. Locate X7 (14.950 MHz) and unsolder. Replace it with the 17.440 MHz crystal. Tune L2 and L3

down two full turns. Also tune L4 and L5 down two full turns. By now you should be seeing some output on a wattmeter or use the meter on the front of the radio. Tune the pre-drivers, driver and rf power amplifier for maximum output, in my case I easily got 6 Watts. It is important to tune L2 and L3, L4 and L5 in or down in the coil so that the synthesizer will end up with the sum (40.730 MHz) rather than the difference as I did at first.

For the receiver section, the coils to be tuned down two turns are L10 and L11. L12, L13, and L14 go only about one turn down. Using an external signal source on 29.000 MHz, apply a signal until the S-meter gives an indication, then peak the coils for maximum. The final sensitivity was as good as the manufacturer's specifications on the 27 MHz band.

The possibilities are numerous that these converted units can be put to

Inexpensive walkie-talkies can be converted. How about hidden transmitter hunts? CB antennas can be easily converted by reducing the length a couple of inches. The radio only draws about 100 mils when in a squelched condition, so it could be left on in order to catch band openings or local calls. So how about it fellows? Let's use all that space on 10 meters! Will be monitoring Channel 1 ... (29.000 MHz) ... see you on 10! ■

Harry J. Miller  
991 42nd St.  
Sarasota FL 33580

# World's Smallest Continuity Tester

- - it's almost minute

Using a rubber-type two-pronged plug, the few components that make up this tester are mounted inside the plug. The hole in the end of the plug through which the cord enters is used for the NE-2 neon bulb.

Two small holes opposite each other are made near the base of the plug for the probe wires to extend, and the two 100k, 1/2 Watt resistors within the plug cavity, being in series with the probe cords, prevent shock. A piece of 5/8 inch i.d. aluminum tubing 1/2 inch long, placed over the bulb end of the plug, with a 5/8

inch o.d. clear plastic lens pressed into the tube, protects the bulb and enhances the appearance of the miniscule tester. Make the probe wires long enough to suit your needs. ■

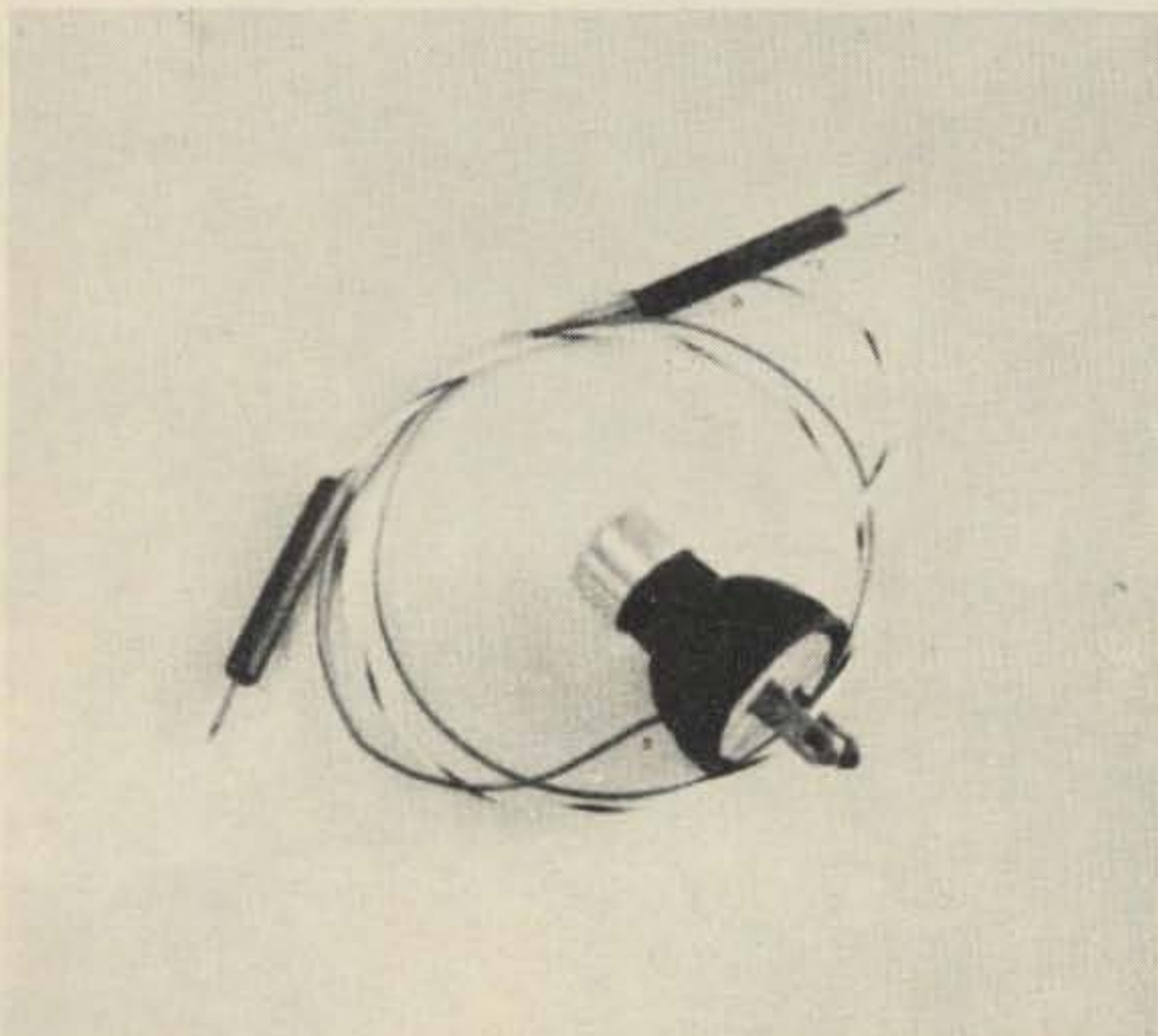

Fig. 1.

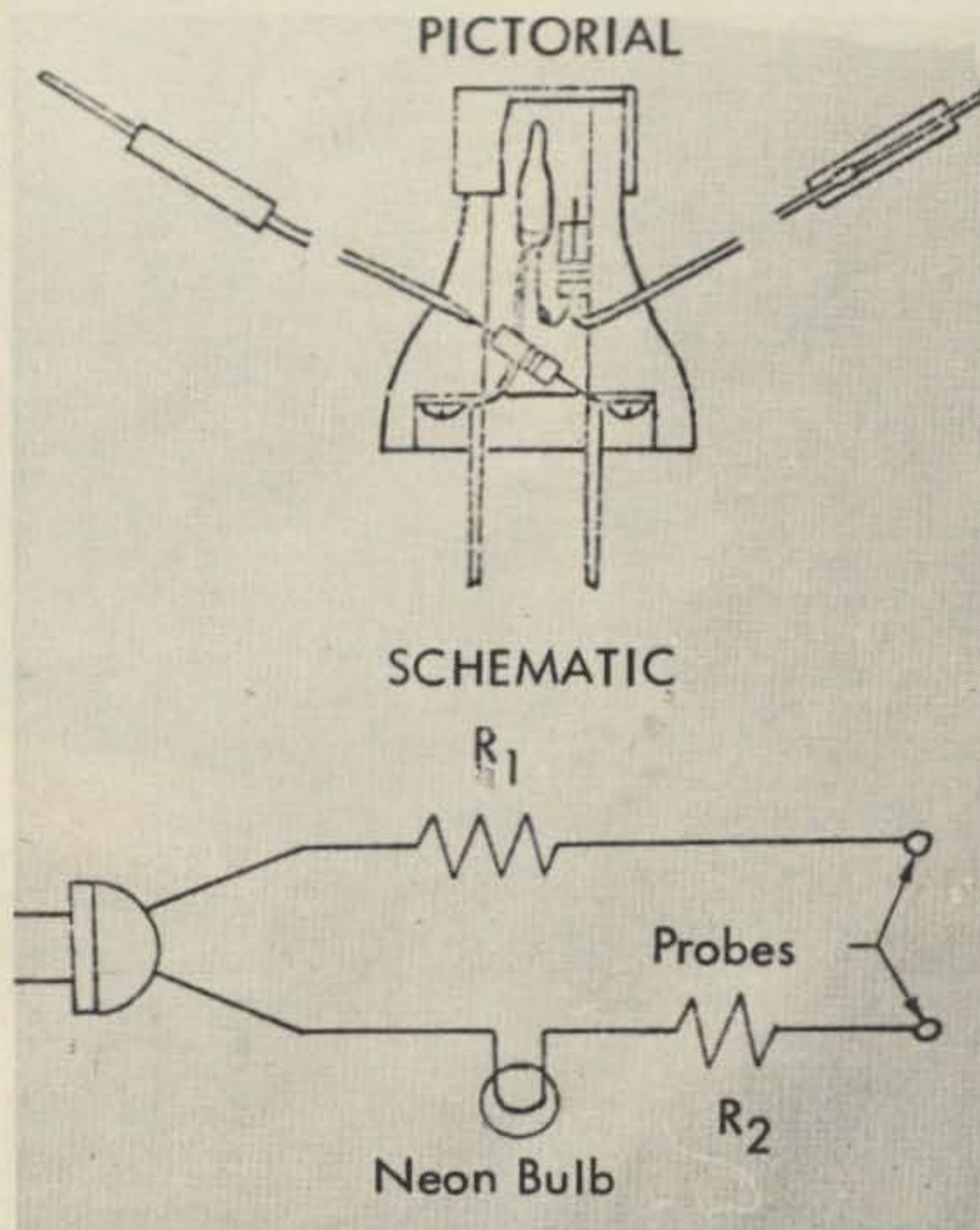

Fig. 2.



# New Products

from page 38

## VHF ENGINEERING PROFILE

Most hams into VHF experimenting are familiar with VHF Engineering products. The ubiquitous "RX" and "TX" receiver/transmitter strips have probably been responsible for getting more amateurs on VHF FM than any other series of products. VHF Engineering is an amateur success story.

The company was founded in a basement by Robert Brown W2EDN early in 1972. Brown's philosophy was based upon mass buying of components: Why not provide an inexpensive kit whose parts individually purchased would otherwise be overly expensive? The idea worked, and the small company soon expanded. To date, over 10,000 TX transmitter kits have been sold. An original product line of three devices has expanded to over 130.

VHF Engineering is now located on Water Street in Binghamton NY, the former site of McIntosh Labs, a manufacturer of quality high-fidelity gear. Most of VHF's business is amateur-related (about 70%), although the company also has military and civil contracts. Brown and Marv Druskoff K2VIV have designed most of the company's products. All of the pre-built VHF products are hand

soldered and tested, as the company is not involved in high volume production. The company is actually a subsidiary of Brownian Electronics Corp., which is owned by Brown and William Kupfrian. They are presently projecting sales of over \$1 million in the near future.

A look at VHF's product line will provide an insight into Brownian's success. The popular receiver and transmitter strips are multi-purpose devices that are the basis for many other products. The TX and RX strips are available for all VHF bands, and are also used in the company's hand-held transceivers and repeaters. Those repeaters are another story! VHF Engineering can provide complete repeater installations or any part of one, based upon customer requirements. Each module is available as a kit or pre-assembled, allowing complete flexibility in designing individual stations. The experience gained in repeater design has been valuable, as Brownian plans upon entering the two-way commercial marketplace in the future.

The product line also contains a wide range of power supplies and VHF/UHF power amplifiers, along with the most recent addition, a digital frequency synthesizer. The "building-block" concept allows the ham to select whatever components fit his operating environment, all the

way from power supply to final amplifier. VHF's latest line of power amplifiers is the Blue Line series, which are designed for high power UHF applications. Of course, the amplifier can be driven by a VHF Engineering TX strip! VHF also provides a complete line of accessories such as crystal decks, tone encoders, and cables.

Many hams would probably not be on the VHF bands had it not been for Brown's basement operation. The company is constantly expanding, and only time will tell what new devices from Binghamton will arise to excite today's VHF/UHF amateur.

John Molnar WA3ETD  
Executive Editor

## NEW WIRE DISPENSER ALSO CUTS AND STRIPS

The new WD series wire dispenser features unique cutting and stripping capability. Wire is drawn out of dispenser to the required length. Then, a built-in plunger cuts the length free from the roll, while a gentle pull through the stripping blade removes the insulation without nicking the wire. Repeating procedure removes insulation from second end. Although designed particularly for wire-wrapping, the inexpensive dispenser is ideal for many applications. The dispenser includes a 50 ft. (15m) roll of AWG 30 (0.25mm), top industrial quality, Kynar™-insulated, OFHC silver-plated solid copper wire. Insulation is offered in blue, white, yellow or red. Available

from your local electronics distributor or directly from *OK Machine and Tool Corporation, 3455 Conner Street, Bronx NY 10475.*

## NEW CATALOG COVERS LIGHT EMITTING DIODE (LED) DISPLAYS

National Semiconductor has prepared a full-color short form catalog detailing its complete line of optoelectronic products. The catalog contains photographs, outline drawings, and specifications of National's red, yellow, and green light emitting diode (LED) lamps, large area (0.3", 0.5" and 0.7" high) multi-digit numeric displays, small calculator-type numeric arrays, and watch display die. *National Semiconductor Corporation, 2900 Semiconductor Drive, Santa Clara CA 95051.*

## NEW CONTINENTAL SPECIALTIES CATALOG

Continental Specialties Corporation, manufacturers of breadboarding and test equipment for the professional and hobbyist, announces the release of their new 1977 catalog. This 16-page catalog features the complete line of Continental Specialties QT sockets, proto-clips, proto-boards, logic probes, logic monitors and design mates, and introduces the new Experimentor sockets.

Catalogs are available from — *Continental Specialties Corporation, 44 Kendall Street, PO Box 1942, New Haven CT 06509.*

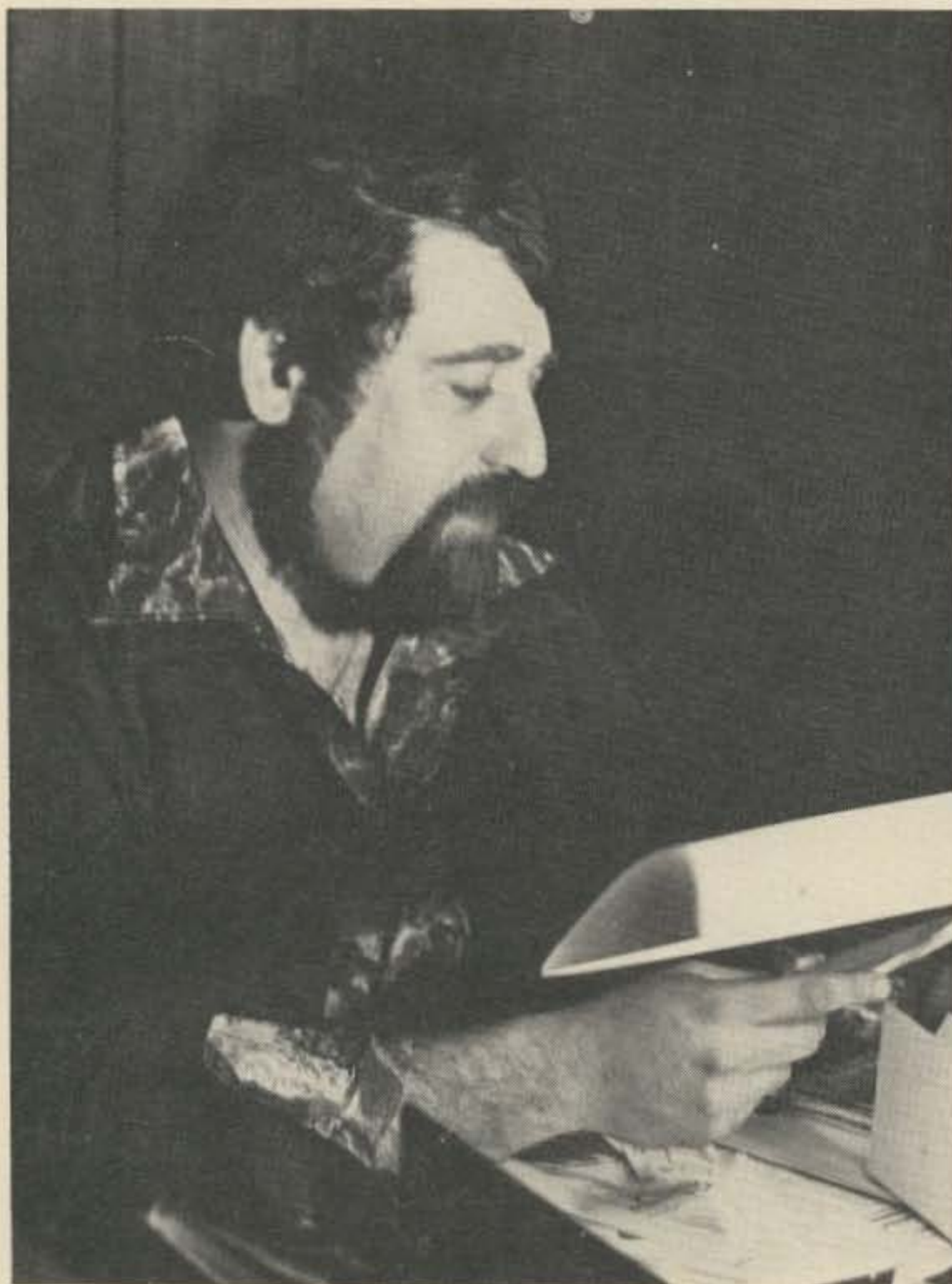

Marv Druskoff K2VIV.

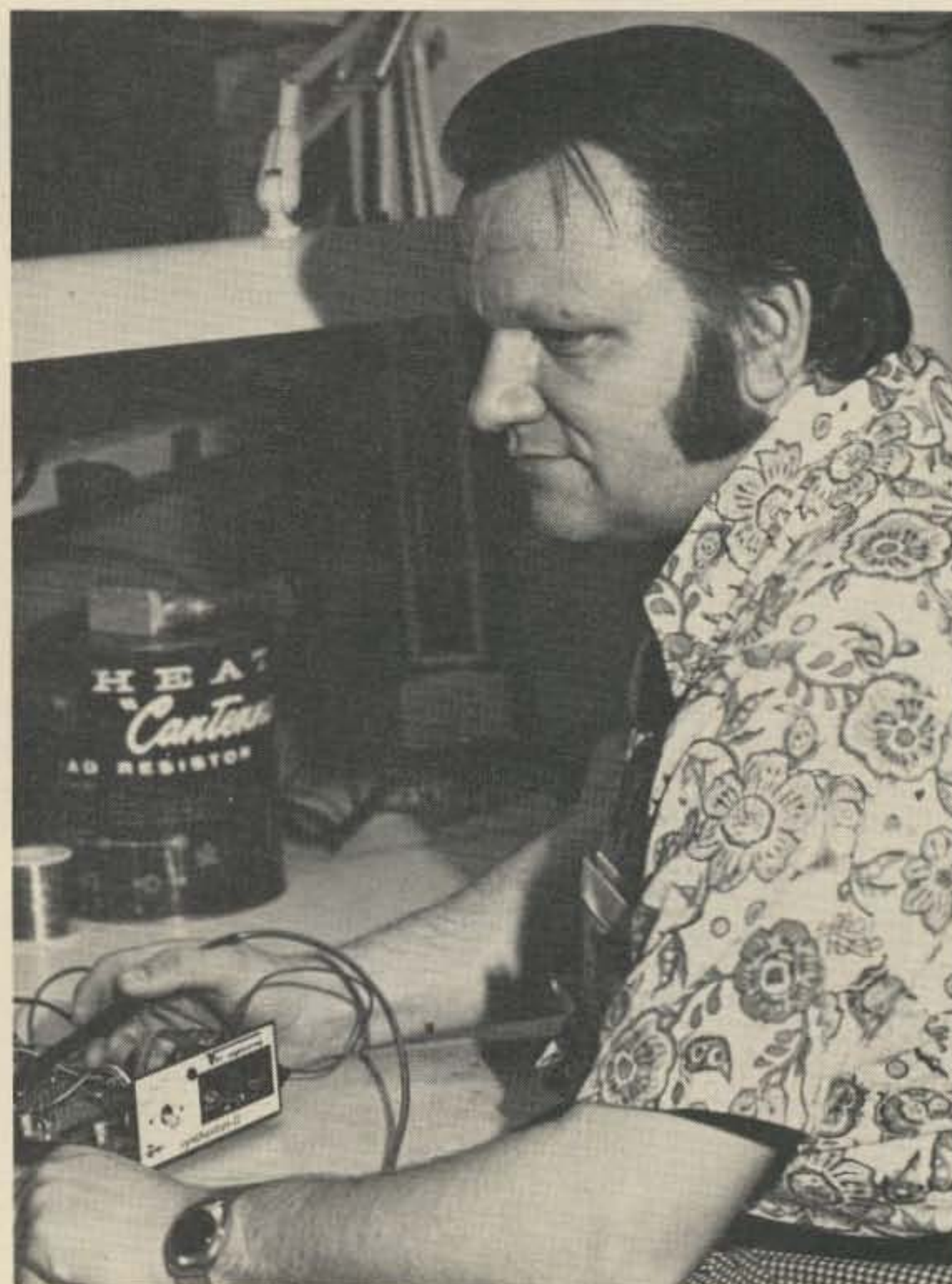

Bob Brown W2EDN.



144 MHz, 220 MHz, 432 MHz  
*You have tried the rest...*

# NOW TRY THE BEST! 6 METERS

## WHY SIX METERS?

1. Consistent coverage of over 100 miles is not unusual with use of modern equipment.
2. The variety of propagation affords an opportunity of working lots of DX-Stations from 400-2,000 miles away on multi-hop sporadic E, F<sub>2</sub> Skip during the upcoming peak sunspot cycle of over 2,000 miles. Plus transequatorial propagation is good up to several thousand miles.

**Vhf engineering** offers a complete line of six meter FM kits and equipment.

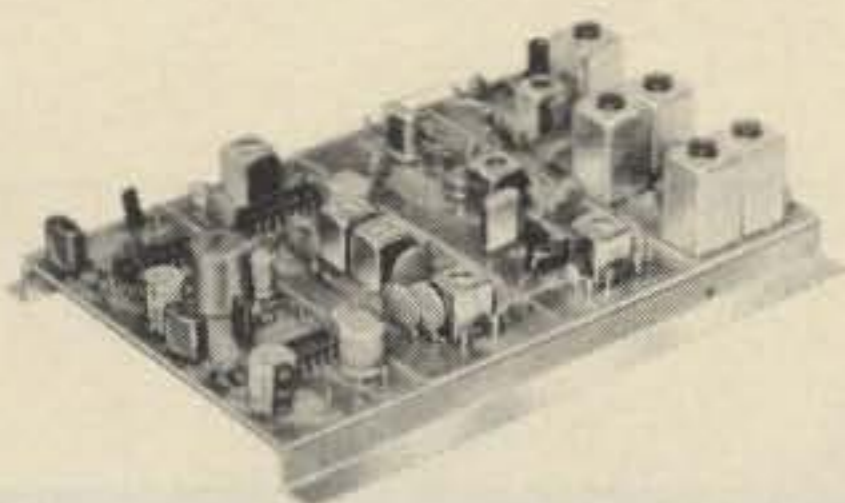

The RX50 is a NBFM 30-60 MHz Receiver Kit. Sensitivity is .3uV for 20 db squelch threshold .2uV Audio output, 2 watts.  
 Kit . . . . . \$59.95

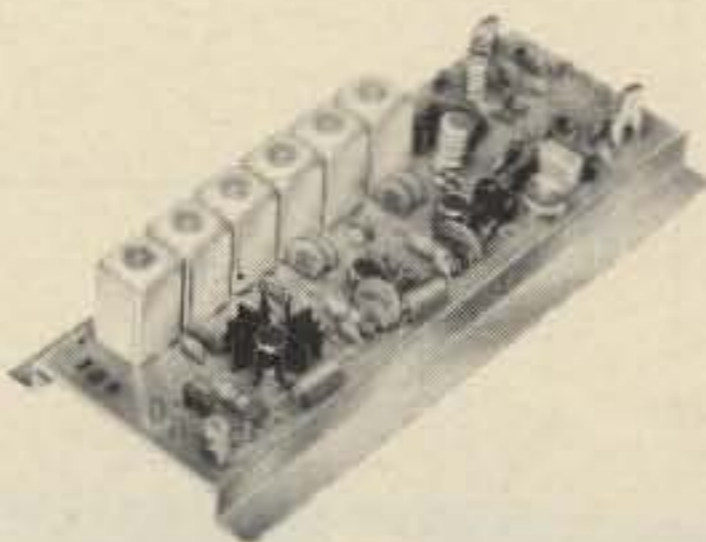

TX50 1 watt true fm 6 meter transmitter  
 Kit . . . . . \$39.95

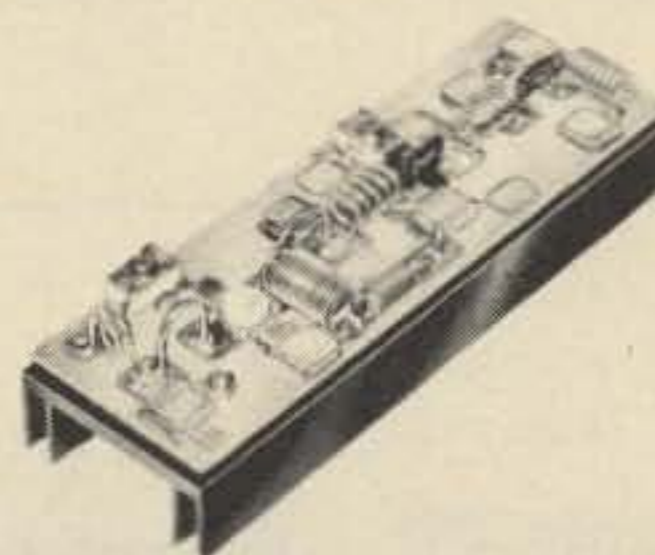

PA50/25 6 meter power amp  
 1 watt in, 25 watt out  
 Kit . . . . . \$49.95



THE RPT50  
 SIX METER  
 NBFM  
 REPEATER  
 Kit . . . . . \$465.95  
 wired & tested . . \$695.95

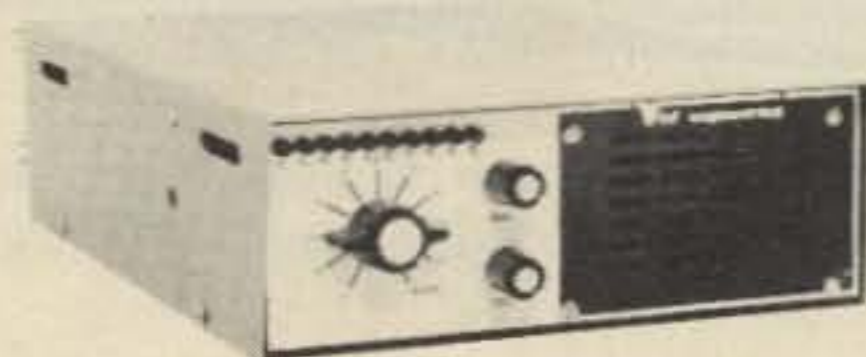

TRX50 complete 6 meter transceiver kit.  
 25 watt out, 10 channel scan.  
 (Less mike and crystals.)  
 Kit . . . . . \$229.95

THE NEW RPT 50 IS A COMPLETELY SELF-CONTAINED ALL SOLID STATE REPEATER. It is conservatively rated, and built of high quality components. Much care and attention to make this repeater versatile as well as reliable.

The Model RPT 50 is supplied as complete repeater system. The receiver, transmitter, control circuitry, C.W. Identifier & 115/230 Volt AC power supply are all contained on a standard relay-rack panel and chassis unit. For most installations a user supplies AC

power and suitable antennas with 50 OHM coaxial feed (PL 259 fittings). External connections for autopatch, tone control, etc. are provided. Built-in identifier programmed with up to 159 bits. Automatic emergency battery power changeover capability.

To best take advantage of the DX as well as the extended range capabilities we recommend our optional tone squelch board TS-1 and TD-3 touch tone decoder.

*Export prices slightly higher. Prices and specifications subject to change.*



DIVISION OF BROWNIAN ELECTRONICS CORP.

BOX S / 320 WATER ST. / BINGHAMTON, N.Y. 13901 / Phone 607-723-9574



**WE HAVE WHAT YOU NEED AT...**



YD-844  
Dynamic Mike

# YAESU

**ADVANCED COMMUNICATION  
EQUIPMENT**



QTR-24  
World Clock

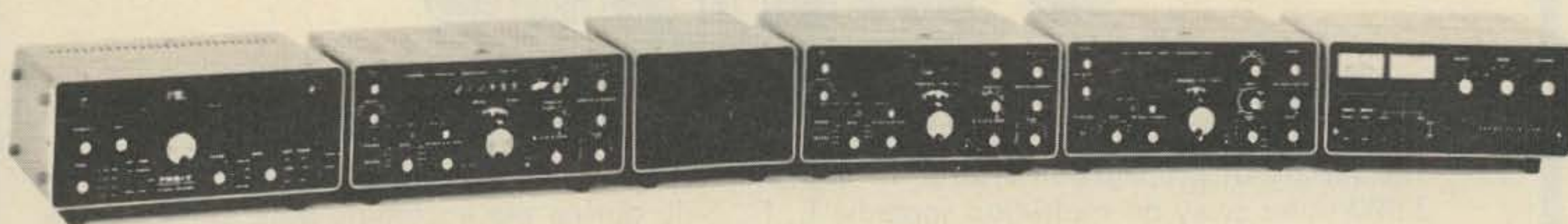

Left to right - FRG-7, Solid State Synthesized Communications Receiver • FR-101 Digital, Solid State Receiver • SP-101B, Speaker • FR-101, Digital Solid State Receiver • FL-101, 100 W Transmitter • FL-2100B, 1200 W PEP Input Linear Amplifier

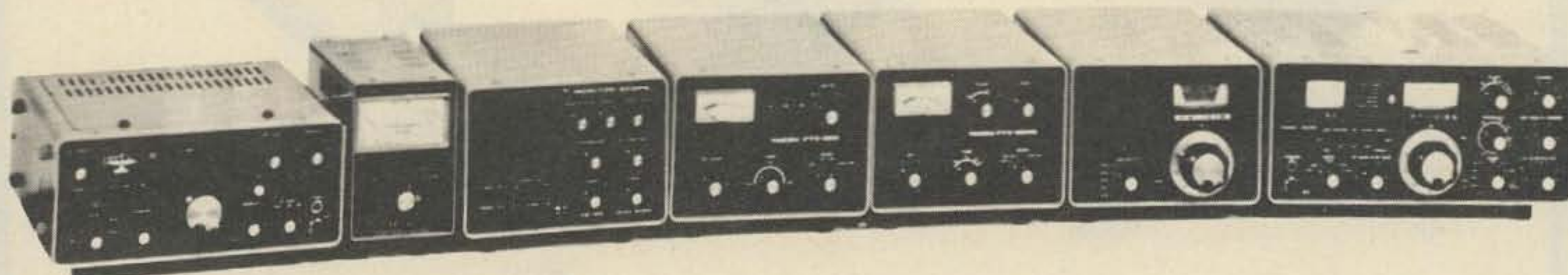

Left to right - FT-620B, 6 Meter Transceiver • YP-150, Dummy Load Wattmeter • YO-100, Monitor Scope • FTV-250, 2 Meter Transverter • FTV-650, 6 Meter Transverter • FV-101B, External VFO • FT-101E 160-10 M Transceiver



Left to right - YC-601, Digital Frequency Display • YC-355D, Frequency Counter • FP-301, AC Power Supply • FT-301S Digital, All Solid State Transceiver • FV-301, External VFO • FT-221, 144-148 All Solid State All Mode Transceiver

**USED GEAR • TRADE UP • FREE UPS SHIPPING ON PREPAID ORDERS**

# \$2,000,000 HAM INVENTORY

**HAMTRONICS - WHERE THE HAM IS KING**



# THE LOWEST POSSIBLE PRICES

 **KENWOOD**

**THE PACESETTER  
IN AMATEUR RADIO**



**TS-700A** \$599.00

**2M ALL MODE BASE/MOBILE TRANSCEIVER.** SSB (upper and lower), FM, AM and CW. AC and DC. 4 MHz band coverage (144 to 148 MHz). Dial in receiver frequency and TS-700A automatically switches xmitter freq. 600 KHz for repeater operation. Xmit, Rcv capability on 44 Ch. with 11 xtals.



**TR-7400A** \$399.00

**2M MOBILE TRANSCEIVER.** Synthesized PLL. Selectable output, 25 watts or 10 watts. 6 Digit LED freq. display. 144-148 MHz, 800 CH. in 5 KHz steps. 600 KHz repeater offset. Continuous tone-coded squelch (CTSC). Tone Burst.



**TS-820** \$869.00

**SSB TRANSCEIVER.** PLL RF Monitor Noise Blanker. Digital hold locks counter & display at any frequency, but allows VFO to tune normally. True RF compressor adjustable speech processor. IF shift control. RF attenuator. VOX, GAIN, ANTIVOX and VOX delay controls. RF negative feedback. Optional digital readout. DRS Dial. High stability FET VFO.



**TS-520** \$629.00

**SSB TRANSCEIVER.** Proven in the shacks of thousands of discriminating hams, field day sites, DX and contest stations and mobile installations. Superb engineering and styling.

**SP-520** \$22.95

Optional external speaker for better readability.

**TV-502** \$249.00

**TRANSVERTER.** Puts you on 2M the easy way. 144-145.7 MHz or optional 145-146 MHz.

**PS-5** \$79.00

**BYNOMIC MICROPHONE.** Designed especially for homes. PTT and lock switches. 600 or 50K ohm.



**TR-7200A** \$249.00

**2M MOBILE/BASE FM TRANSCEIVER.** Ignition interference control. 2 pole Xtal filter in IF rcvr. Protection for final stage transistor & reverse polarity connections. Priority Ch. switch. Quick release mount. LED CH. indicators. Switchable 10W or 1W output.



**MC-50** \$39.50

Dynamic microphone designed expressly for amateur radio operation. Complete with PTT and LOCK switches, and a microphone plug. (600 or 50k ohm)



**COMMUNICATIONS RECEIVER.** 1.8 to 29.7 MHz, WWV and CB band. 50 MHz, 144 MHz converter optional. Stable VFO & oscillator for 5 fixed channels. 1 KHz dial readout. Xtal filters (SSB/8 pole, CW/8 pole, AM/6 pole). Squelch. S meter. Noise blanker.

**S-599-\$19.94 R-599A-\$459.00 T599D-\$479.00**

**SSB TRANSMITTER.** 3.5 to 29.7 MHz. Stable VFO. 1 KHz dial readout. 8 pole Xtal filter. AM Xmission available. Built-in AC pwr supply. Split frequency control available.



**VFO-820** \$145.00

Designed exclusively for use with TS-820. RIT circuit and control switch. Fully compatible with optional digital display.

**VFO-520 (Not Shown)** \$116.00

Solid State Remote VFO. RIT circuit with LED indicator.



**TR-2200A** \$229.00

**PORTABLE 2M FM TRANSCEIVER.** 12 Ch. capacity. Removable telescoping antenna. External 12 VDC or internal NI-CAD batteries. 146-148 MHz. 6 CH. supplied. Switchable 2W or 400mW output.



**R-300** \$239.00

**ALL BAND COMMUNICATIONS RECEIVER.** AC, batteries or external DC. 170 KHz to 30 MHz in 6 bands. Foreign broadcasts or ham radio in AM, SSB and CW. Dual gate MOS/FET transistors & double conversion. Band spread dial. 500 KHz marker.

THE BIG 'H' FOR ALL YOUR HAM NEEDS!

**MASTERCHARGE & BANKAMERICARD ACCEPTED**

**HAMTRONICS**

DIVISION OF TREVISE ELECTRONICS  
4033 Brownsville Rd • Trevose, Pa. 19047



# WE HAVE WHAT YOU NEED AT...



## DRAKE®

### KNOWN FOR QUALITY THROUGHOUT THE WORLD

HAMTRONICS-WHERE THE HAM IS KING



#### RECEIVERS

SSR-1	General Coverage, .5 to 300 MHz	\$350.00
SPR-4	Programmable, Solid State	\$629.00
DSR-2	VLF-HF Digital Synthesized SSB, AM, CW, ISB, RTTY	\$2950.00
R-4C	C-Line. HF. 160-10M	\$599.00
4NB	Noise Blanker for R-4C	\$52.00
5NB	Noise Blanker for SPR-4	\$70.00

#### TRANSMITTER

T-4XC	C-Line. HF. 160-10M	\$599.00
-------	---------------------	----------

#### TRANSCEIVERS

TR-4CW	80-10M. SSB, AM, CW	\$649.00
TR-33C	2M, FM, 12 CH. Portable	\$229.95
MMK-33	Mobile/Dash/Desk Mount for TR-33C	\$12.95
34PNB	Plug-In Noise Blanker for TR-4 Series	\$100.00
MMK-3	Mobile Mount for TR-4	\$7.00
RV-4C	Remote VFO for TR-4 CW	\$150.00
FF-1	Crystal Control for TR-4	\$46.95

#### SYNTHESIZER

FS-4	General Coverage for 4-Line and SPR-4	\$250.00
------	---------------------------------------	----------

#### LINEAR AMPLIFIER

L-4B	Linear and w/power supply & tubes	\$895.00
------	-----------------------------------	----------

#### MATCHING NETWORKS

MN-4	Antenna Matching Network. 200W	\$120.00
MN-2000	Antenna Matching Network. 1000W	\$240.00
RCS-4	Remote Control Antenna Switch	\$120.00

W-4	RF Wattmeter, 1.8 to 54 MHz	\$72.00
WV-4	RF Wattmeter, 20 to 200 MHz	\$84.00
7072	Hand Held Microphone	\$19.00
7075	Desk Top Microphone	\$39.00
1525EM	Pushbutton Encoding Microphone	\$49.95
HS-1	Head Phones	\$10.00
AA-10	10W, 2M Amplifier	\$49.95
TV-300-HP	300 ohm High Pass TV Set Filter	\$10.60
TV-75-HP	75 ohm High Pass TV Set Filter	\$13.25
TV-42-LP	Transmitter Low Pass Filter. 100W	\$14.60
TV-3300-LP	Transmitter Low Pass Filter. 1000W	\$26.60
TV-5200-LP	Transmitter Low Pass Filter. 1000W. 100W, 6M	\$26.60

USED GEAR • TRADE UP • FREE UPS SHIPPING ON PREPAID ORDERS

# \$2,000,000 HAM INVENTORY



# THE LOWEST POSSIBLE PRICES

## COLLINS AMATEUR EQUIPMENT



**KWM-2A TRANSCEIVER** **\$3533.00**  
 Unmatched for mobile and fixed station applications. 175W on SSB, 160W on CW. Switch select up to 14 optional Xtals. Can be used for RTTY. Filter type SSB generation. Automatic load control. Inverse RF feedback. Reimability-tuned variable oscillator.



**75S-3C RECEIVER** **\$2504.00**  
 Sharp selectivity. SSB, CW and RTTY. Single control rejection tuning. Variable BFO. Optional mechanical filters for CW, RTTY and AM. 2.1 KHz mechanical filter. Zener regulated oscillators. 3-position AGC.

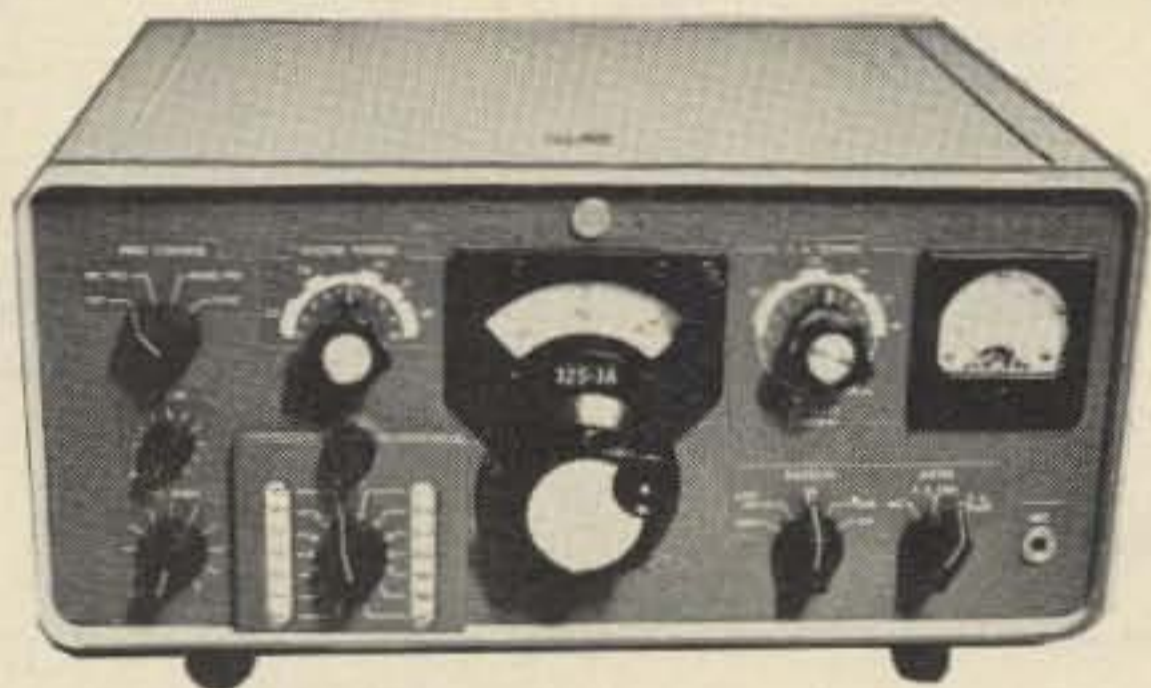

**32S-3A TRANSMITTER** **\$2597.00**  
 Covers all ham bands between 3.4 MHz and 30 MHz. Nominal output of 100W. 175W, SSB and 160W CW. Dual conversion. Automatic load control. RF inverse feedback. CW spotting control. Collins mechanical filter.

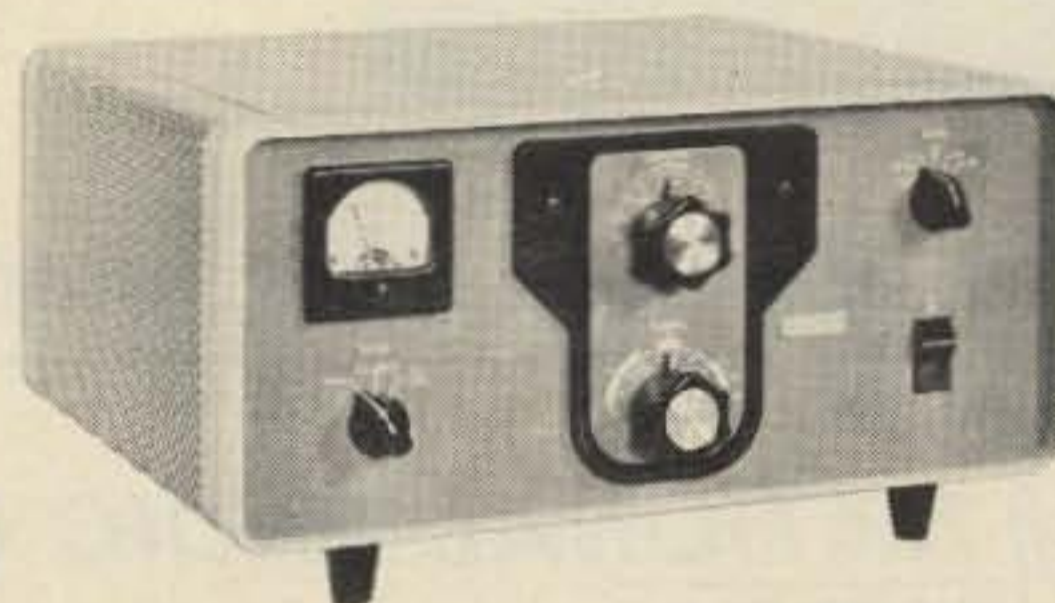

**30L-1 LINEAR AMPLIFIER** **\$1536.00**  
 1000 watts PEP on SSB and 1000 Average on CW. Single control rejection tuning (50 dB). Variable BFO. 2.1 kHz Mechanical filter. Zener regulated oscillators. 3 position AGC. Exclusive comparator circuit.



**312B-3 SPEAKER**  
**\$80.00**

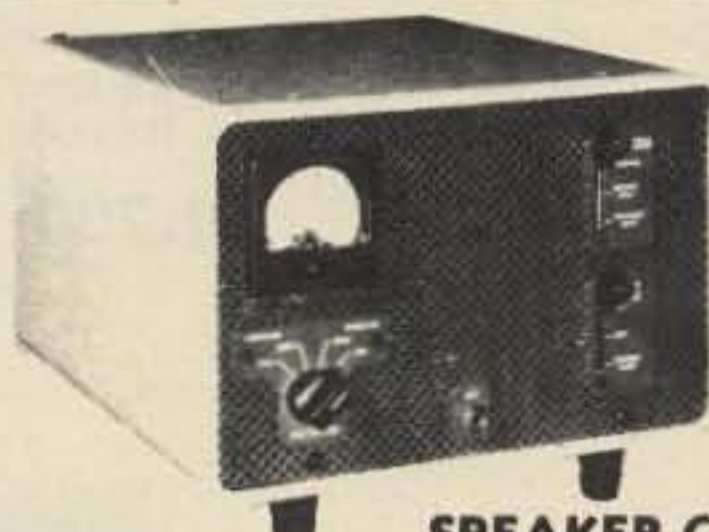

**312B-4 SPEAKER CONSOLE**  
**\$546.00**



**312B-5 VFO CONSOLE**  
**\$1212.00**



**516F-2 AC POWER SUPPLY**  
**\$440.00**



**302C-3 DIRECTIONAL WATT METER**  
**\$360.00**



**DL-1 DUMMY LOAD**  
**\$270.00**

**MASTERCARD & BANKAMERICARD ACCEPTED**

# HAMTRONICS

DIVISION OF TREVISE ELECTRONICS  
 4033 Brownsville Rd • Trevose, Pa. 19047  
 (215) 357-1400 / (215) 757-5300

**THE BIG 'H' FOR ALL YOUR HAM NEEDS!**



# WE HAVE WHAT YOU NEED AT...

## BIRD THRULINE® WATTMETER

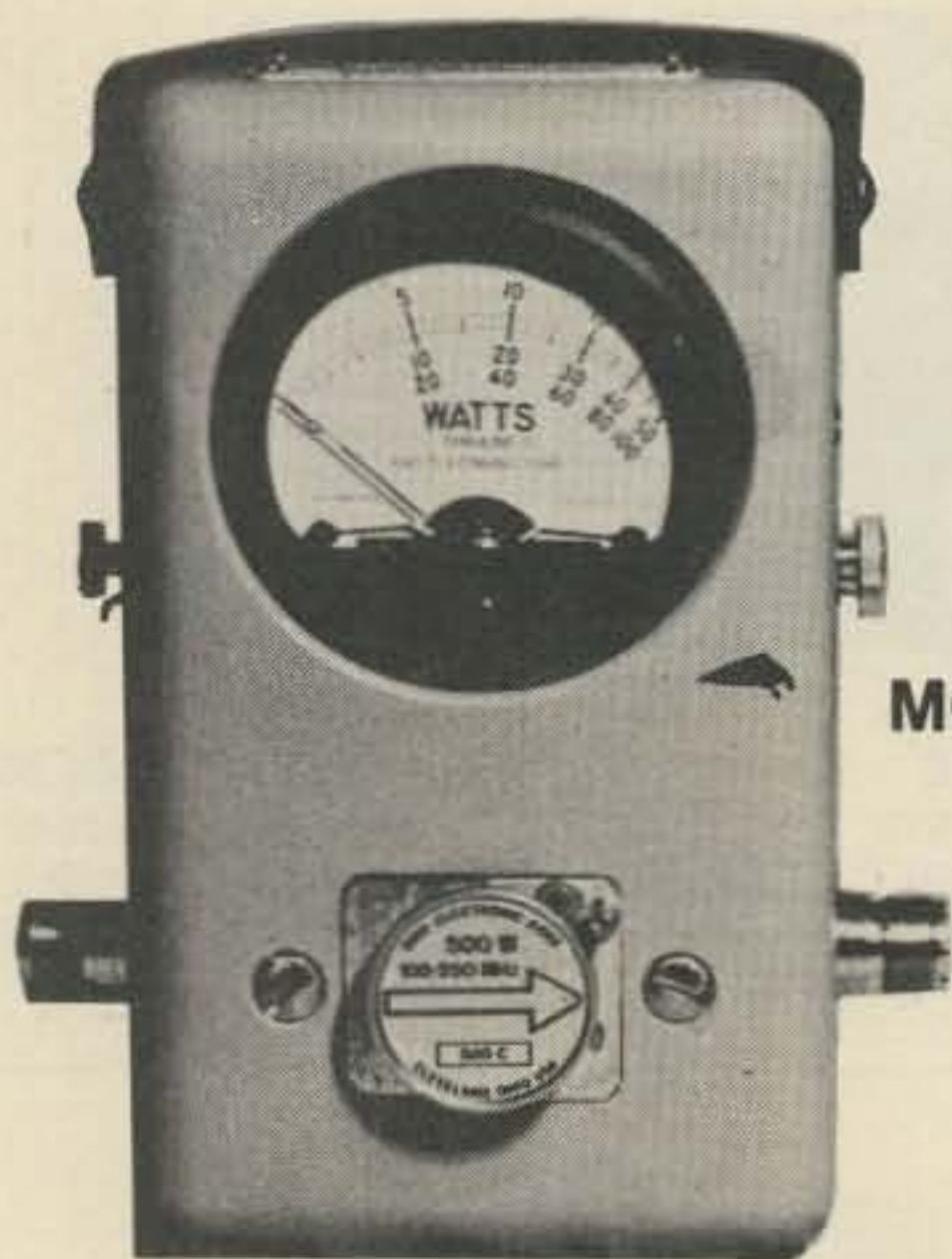

MODEL 43

- BUY ONLY THE ELEMENTS YOU NEED AND ADD EXTRA RANGES AT ANY TIME
- READ RF WATTS DIRECTLY

Table 1  
STANDARD  
ELEMENTS

Power Range	Frequency Bands (MHz)					
	2-30	25-60	50-125	100-250	200-500	400-1000
5 watts	—	5A	5B	5C	5D	5E
10 watts	—	10A	10B	10C	10D	10E
25 watts	—	25A	25B	25C	25D	25E
50 watts	50H	50A	50B	50C	50D	50E
100 watts	100H	100A	100B	100C	100D	100E
250 watts	250H	250A	250B	250C	250D	250E
500 watts	500H	500A	500B	500C	500D	500E
1000 watts	1000H	1000A	1000B	1000C	1000D	1000E
2500 watts	2500H					
5000 watts	5000H					

Table 2  
LOW-  
POWER  
ELEMENTS

1 watt	Cat. No.	2.5 watts	Cat. No.
60-80 MHz	060-1	60-80 MHz	060-2
80-95 MHz	080-1	80-95 MHz	080-2
95-125 MHz	095-1	95-150 MHz	095-2
110-160 MHz	110-1	150-250 MHz	150-2
150-250 MHz	150-1	200-300 MHz	200-2
200-300 MHz	200-1	250-450 MHz	250-2
275-450 MHz	275-1	400-850 MHz	400-2
425-850 MHz	425-1	800-950 MHz	800-2
800-950 MHz	800-1		

WE HAVE A COMPLETE STOCK OF ALL BIRD WATTMETERS AND SLUGS



**NATIONAL RADIO COMPANY, INC.**

**NRCI**



NCX-1000

The only 1000 watt, "single package" transceiver. Heavy duty design... results of 50 years of design leadership in amateur equipment. State of the art speech processing, linear amplifier, power supply, all in one package. Nothing extra to buy. Covers all amateur bands in the HF spectrum... AM, SS' CW' **\$1,600**

NCL-2000

Linear Amplifier. A full 10 dB gain. 20 watts in 2000 watts out. Can be driven with one watt. Continuous duty design utilizes two 8122 ceramic tetrode output tubes, designed for both AM and SSB operation. The industry standard for 12 years. Thousands in use all over the world.

**\$1,200**

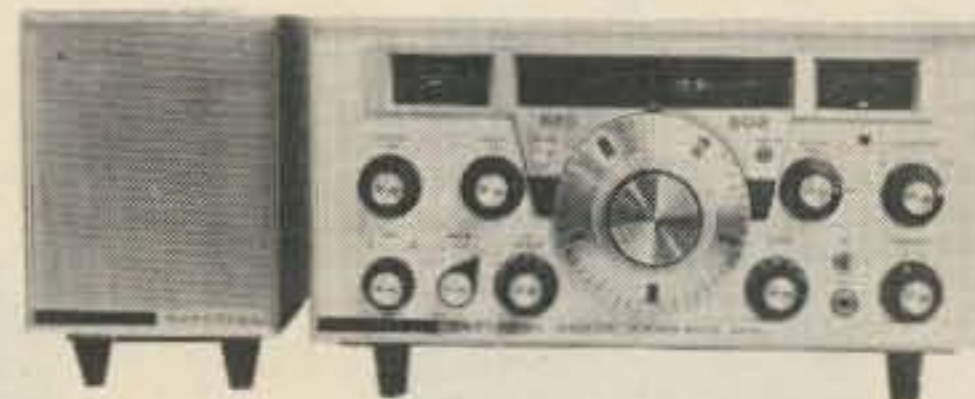

HRO-500

The ultimate short wave receiver. This synthesized (phase lock loop) receiver incorporates all facilities for AM, Single Side Band (SSB), and CW reception in all frequencies from the bottom of the very low frequency band (VLF) to the top of the high frequency band (HF). National's "dead accurate" dial means no searching for transmissions. Dial up the frequency and it's there: aeronautical, marine, CB, amateur, military, etc. Continuous coverage.

**\$3,000**

USED GEAR • TRADE UP • FREE UPS SHIPPING ON PREPAID ORDERS

# \$2,000,000 HAM INVENTORY

HAMTRONICS-WHERE THE HAM IS KING



# THE LOWEST POSSIBLE PRICES



## ICOM

### VHF/UHF AMATEUR & MARINE EQUIPMENT



#### VHF/UHF AMATEUR & MARINE EQUIPMENT

IC-245. 146 MHz FM 10W XCVR. LSI synthesizer with 4 digit LED readout. Xmit & Rcv frequencies independently programmable. 60 dB spurious attenuation.

**\$499.00**

IC-215. 2 METER FM PORTABLE. Three narrow filters for superb performance. 3W or 400 mW. 15 CH. capacity. MOS FET RF Amp & 5 tuned ckt. S-meter front panel.

**\$229.00**



**\$249.00**

IC-502. 6 METER SSB & CW PORTABLE XCVR. Includes antenna & battery pack. 3W PEP & stable VFO for fun & FB QSO's. Covers first 800 KHz of 6M band, where most activity is.



IC-211. 4 MEG, MULTI-MODE 2M XCVR. 144-145 MHz on SSB & CW, plus 146-147 MHz on FM. Work AMAT OSCAR six or seven. LSI synthesizer with 7 digit LED. MOS FET RF Amp, 5 helical cavities, FET mixer & 3 I.F. filters.

**\$749.00**

**\$299.00**



IC-22S. 145 MHz FM 10W XCVR. CMOS synthesizer can be set to any 15 KHz ch. between 146 & 148 MHz by diode matrix board. Spurious attenuation far better than FCC spec. 10W or 1W. IDC modulation control.



IC-21A. 146 MHz FM 10W XCVR. MOS FET RF Amp & 5 helical resonator filter, plus 3 I.F. filters. IDC modulation control. Variable output pwr: 500 MW to 10W Front panel discriminator meter. SWR bridge. 117 VAC and 13.6 VDC pwr supplies.

**\$399.00**

DV-21. DIGITAL VFO. Use with IC-21A to complete 2M band.

**\$299.00**

IC-202. 2 METER SSB PORTABLE XCVR. Puts sideband in your hand! Internal C batteries or external 12 VDC. 3W PEP. True I.F. noise blanker. 144.0, 144.2 on two other 200 KHz bands, selectable. Hamtronics stocks 145.2 and 145.8-146.0 MHz for calling frequency & satellite band.

**\$259.00**



IC-30A. 450 MHz FM LOW XCVR. 1W or 10W. Low noise MOS-FET RF Amp & 5 section helical filter. 22 CH. capacity. S-meter & relative power output meter. IDC modulation control.

**\$399.00**

MASTERCHARGE & BANKAMERICARD ACCEPTED

# HAMTRONICS

DIVISION OF TREVOSSE ELECTRONICS  
4033 Brownsville Rd • Trevose, Pa. 19047

(215) 257-1100 / (215) 757-5200

THE BIG 'H' FOR ALL YOUR HAM NEEDS!



# WE HAVE WHAT YOU NEED AT...

## TEMPO



TEMPO ONE	HF Transceiver. 80-10M. USB, CW & AM	399.00
AC/ONE	Power Supply for TEMPO ONE	99.00
VF/ONE	External VFO for TEMPO ONE	109.00
TEMPO VHF/ONE	Transceiver. 2M. 144 to 148 MHz. PLL	399.00
TEMPO SSB/ONE	SSB Adapter for TEMPO VHF/ONE	199.00
TEMPO 2020	Transceiver. 80-10M. USB, LSB, CW and AM. PLL. Digital	759.00
FMH	2W, VHF/FM, 6 Ch. Hand Held. 144-148 MHz	199.00
RBF-1	Wattmeter & SWR Bridge	42.95
DM-20	Desk Mike. 600 or 50K ohm. PTT & Lock Switches	39.00
MS-2	4 Ch. Pocket Scanning Rcvr.	99.00

## SWAN



700 CX	Transceiver. 700W PEP. SSB. 80-10M. USB, LSB or CW	649.95
VX-2	Plug-In VOX for 700 CX	44.95
SS-16B	Super Selective IF Filter for 700 CX	99.95
MARK II	Linear Amplifier Full Legal Power. W/100W input. 80-10 M.	849.95
1200 X	Portable Linear Amplifier. 1200W PEP. SSB. 700W, Ch. 300W, AM. 80-10M.	349.95
FP-1	Hybrid Telephone Patch. Connect Rcvr/Xmitter to Phone lines	64.95

## ATLAS



210X	Transceiver. 10-80M. 200W	679.00
215X	Transceiver. 15-160M. 200W	679.00
OMK	Deluxe Mtg. Kit for 210X & 215X	48.00
220CS	AC Console for 210X & 215X	149.00
350-XL	Transceiver. SSB. Solid State. 10-160M. 350W.	995.00
DD6-XL	Digital Dial Readout for 350-XL	195.00
305	Plug-In Auxiliary VFO. For 350-XL	155.00
311	Plug-In Auxiliary Crystal Oscillator for 350-XL	135.00
350-PS	AC Pwr Supply w/Spkr & Phone Jack for 350-XL	195.00
DMK-XL	Mobile Mounting Bracket for 350-XL. Easy Plug-In	65.00



FC-76	Frequency Counter. 5 Digit LED	169.95
WM6200	In-Line Precision Wattmeter for 2M. 2 Scales to 200W. Reads SWR.	59.95
FS-2	SWR & Field Strength Meter	15.95
SWR-3	Pocket SWR Meter	12.95
SWR-1A	Relative Power Meter & SWR Bridge	25.95
W2000	In-Line Wattmeter. 3 Scales to 2000W. 3.5 to 30 MHz	59.95
WM-3000	Peak/RMS Wattmeter. Tells The Truth About SSB	79.95
FS-1	Pocket Field Strength Meter	10.95
WM1500	In-Line Wattmeter. 4 Scales to 1500W. 2 to 50 MHz	74.95
MARK II	Linear Amplifier. Full Legal Power. W/100W input. 80-10 M.	849.95
1200 X	Portable Linear Amplifier. 1200W PEP. SSB. 700W, CW. 300W, AM. 80-10M.	349.95

USED GEAR • TRADE UP • FREE UPS SHIPPING ON PREPAID ORDERS

# \$2,000,000 HAM INVENTORY

HAMTRONICS - WHERE THE HAM IS KING



# THE LOWEST POSSIBLE PRICES

## NYE VIKING



No. 114-310-003 \$8.25

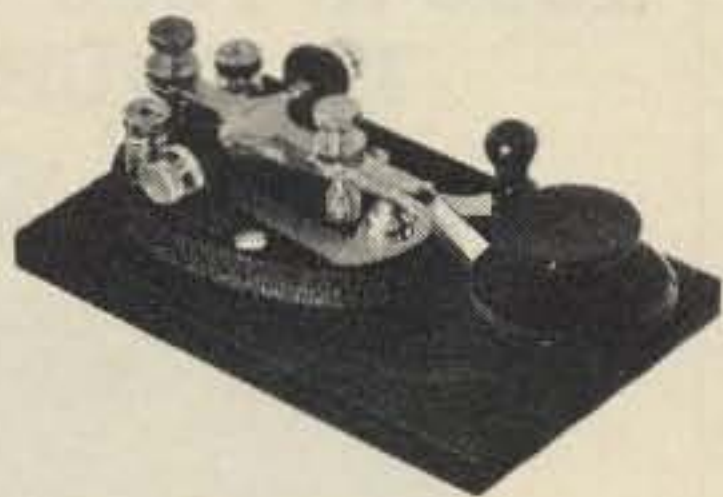

No. 114-310-004GP \$50.00

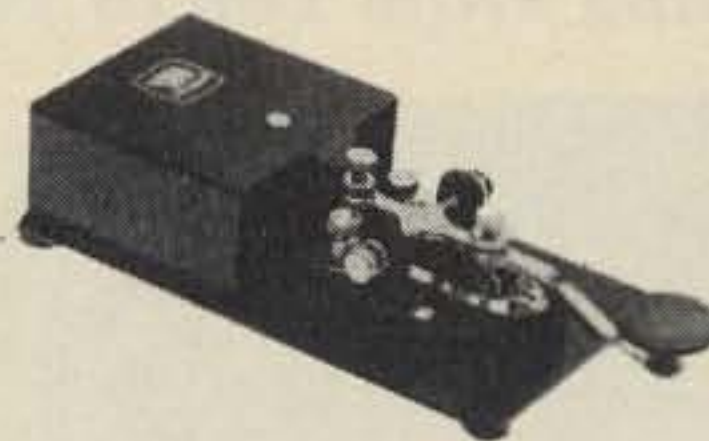

No. 114-404-002 \$18.50

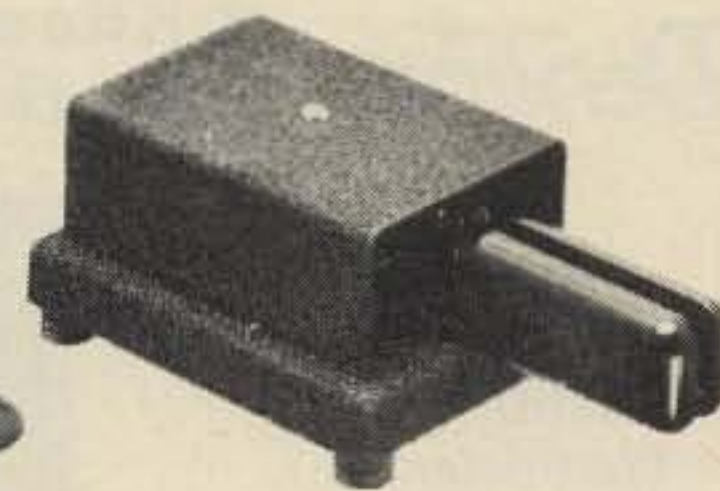

No. SSK-1 \$23.95

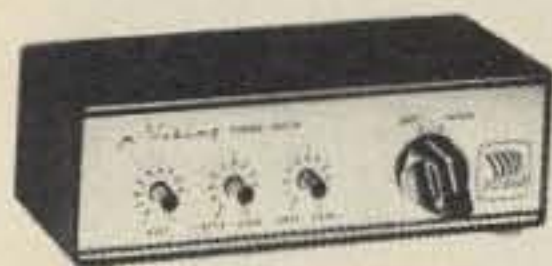

No. 250-46-1 \$36.50



No. 250-46-3 \$44.50



No. 250-20-1 \$19.95



No. 250-0025-003 \$212

## NPC

2.5 AMP



12CB4 29.95

4 AMP



103R 39.95

6 AMP



104R 49.95

12 AMP

108 RM  
99.95



25 AMP

109R 149.95



## VIBROPLEX

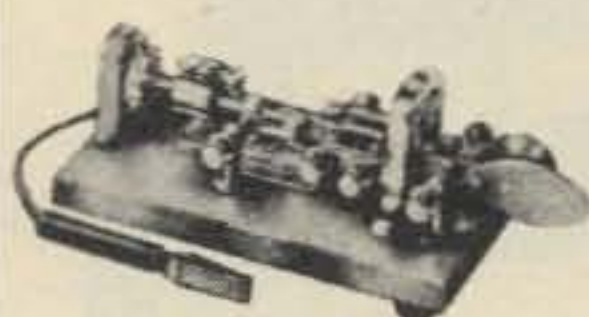

"PRESENTATION"  
66.00



"ORIGINAL"  
39.95



"LIGHTNING BUG"  
39.95



"CHAMPION"  
31.50

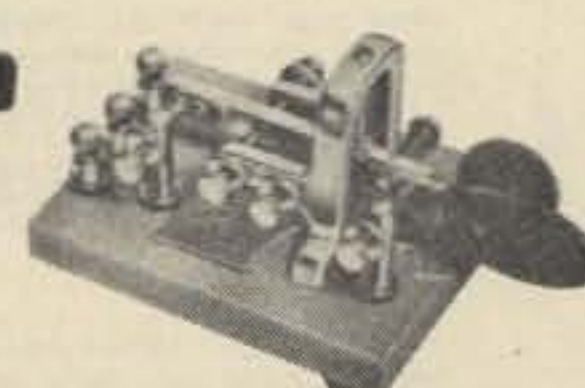

VIBRO-KEYER  
33.00

MASTERCHARGE & BANKAMERICARD ACCEPTED

# HAMTRONICS

DIVISION OF TREVISE ELECTRONICS  
4033 Brownsville Rd • Trevose, Pa. 19047

THE BIG 'H' FOR ALL YOUR HAM NEEDS!



# WE HAVE WHAT YOU NEED AT...

## DenTron 3 Kilowatt Tuner Matches Everything From 160 to 10

160-10 MAT

Built-In  
Wattmeter

Front Panel Antenna  
Selector for  
Coax, Balanced  
Line and Random  
Wire.



only \$299.50

## 1000 to 1200 WATTS OUTPUT TO YOUR ANTENNA

## DenTron SUPERAMP

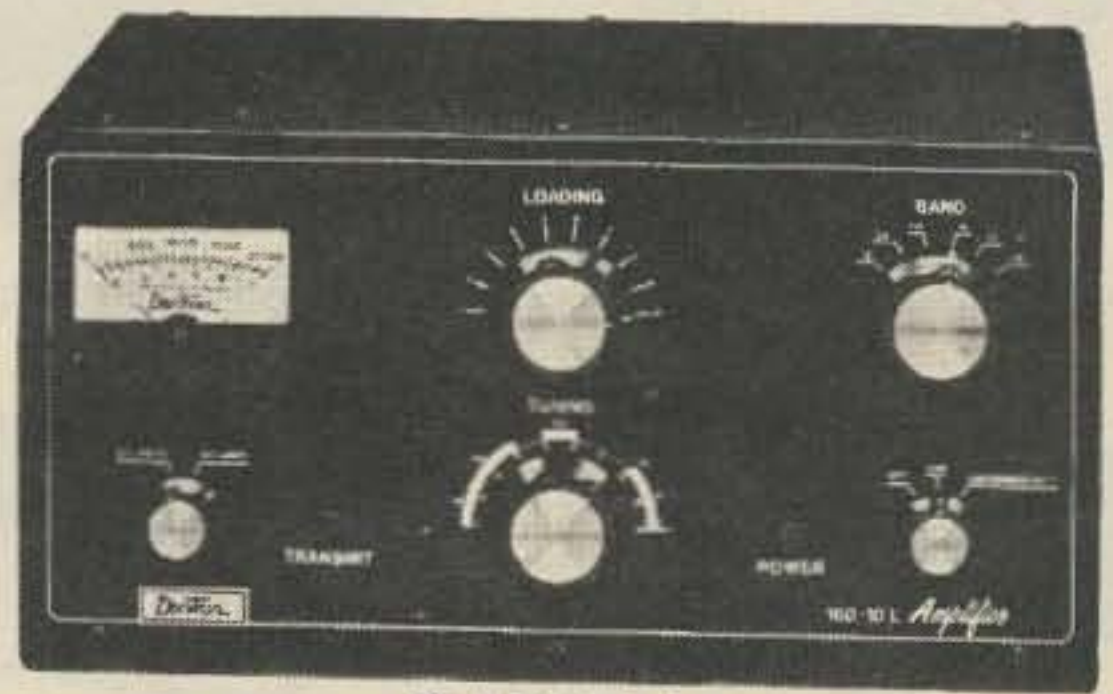

\$499.50

If the amplifier you're thinking of buying doesn't deliver at least 1000 to 1200 watts output, to the antenna, you're buying the wrong amplifier.

Our New Super Amp is sweeping the country because hams have realized that the DenTron Amplifier will deliver to the antenna, (output power), what other manufacturers rate as input power.

The Super Amp runs a full 2000 watts P.E.P. input on SSB, and 1000 watts DC on CW, RTTY or SSTV 160-10 meters, the maximum legal power.

The Super Amp is compact, low profile, has a solid one-piece cabinet assuring maximum TVI shielding.

The heart of our amplifier, the power supply, is a continuous duty, self-contained supply built for contest performance.

We mounted the 4 - 811 A's, industrial workhorse tubes, in a cooling chamber featuring the on-demand variable cooling system.

The hams at DenTron pride themselves on quality work, and we fight to keep prices down. That's why the dynamic DenTron Linear Amplifier beats them all at \$499.50.

NOW AVAILABLE WITH 572 B<sup>3</sup> FOR **\$574.50**



## DenTron Super Tuner

160-10 Meters  
Balanced Line,  
Coax, Random  
or Long Wire

Maximum Power Transfer, Xmitter to Antenna.

1 KW Model \$129.50

3 KW Model \$229.50

## DenTron ANTENNAS The Sky Openers

### SKYMASTER

A fully developed and tested 27 foot vertical antenna covers entire 10, 15, 20, and 40 meter bands using only one cleverly applied wave trap. A full 1/4 wave antenna on 20 meters. Constructed of heavy seamless aluminum with a factory tuned and sealed HQ Trap, SKYMASTER is weather-proof and withstands winds up to 80 mph. Handles 2 KW power level and is for ground, roof or tower mounting. Radials included in our low price of

**\$84.50**

Also 80 m resonator for top mounting on SKYMASTER.

**\$29.50**



### TRIM-TENNA

The antenna your neighbors will love. The new DenTron Trim-Tenna with 20 meter beam is designed for the discriminating amateur who wants fantastic performance in an environmentally appealing beam. It's really loaded! Up front there's a 13 foot 6 inch director with precision Hy-Q coils. And, 7 feet behind is a 16 foot driven element fed directly with 52 ohm coax. The Trim-Tenna mounts easily and what a difference in on-the-air performance between the Trim-Tenna and that dipole, long wire or inverted Vee you've been using. 4 & 6 Forward Gain Over Dipole.

**\$129.50**

### SKYCLAW

A tunable monoband high performance vertical antenna, designed for 40, 80, 160 meter operation. SKYCLAW gives you the following spectrum coverage:

BAND (Meters)	BANDWIDTH (kHz)
160	50
80	200
40	entire band

Tuning is easy and reliable. Rugged construction assures that this self-supporting unit is weatherproof and survives nicely in 100 mph winds. Handles full legal power limit.

**\$79.50**

### EX-1

The DenTron EX-1 Vertical Antenna is designed for the performance minded antenna experimenter. The EX-1 is a full 40 meter, 3/4 wave, 33', self-supporting vertical. The EX-1 is the ideal vertical for phasing.

**\$59.50**

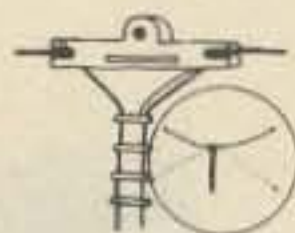

### ALL BAND DOUBLET

This All Band Doublet or inverted Type Antenna covers 160 thru 10 meters. Has total length of 130 feet (14 ga. stranded copper) although it may be made shorter if necessary. This tuned Doublet is center fed through 100 feet of 450 ohm PVC covered balanced transmission line. The assembly is complete. Add rope to the ends and pull up into position. Tune with the DenTron Super Tuner and you're on 10 through 160 meters with one antenna! Now just for the DenTron All Band Doublet.

**\$24.50**

## DenTron ANTENNA TUNER

### The 80-10 Skymatcher

Here's an antenna tuner for 80 through 10 meters, handles 500 w P.E.P. and matches your 52 ohm transceiver to a random wire antenna.



- Continuous tuning 3.2 - 30 mc
- "L" network
- Ceramic 12 position rotary switch
- SO-239 receptional to transmitter
- Random wire tuner
- 3000 volt capacitor spacing
- Tapped inductor
- Ceramic antenna feed thru
- 7" W. 5" H. 8" D., Weight: 5 lbs.

**\$59.50**

## DenTron W-2 PAD INLINE WATTMASTER

Read forward  
and reflected  
watts at the  
same time



Tired of constant switching and guesswork?

Every serious ham knows he must read both forward and reverse wattage simultaneously for that perfect match. So upgrade with the DenTron W-2 Dual in line Wattmeter.

**\$99.50**

USED GEAR • TRADE UP • FREE UPS SHIPPING ON PREPAID ORDERS

# \$2,000,000 HAM INVENTORY

HAMTRONICS-WHERE THE HAM IS KING



# THE LOWEST POSSIBLE PRICES

**TEN-TEC** INC.

## TRITON IV EQUIPMENT



### TRANSCEIVERS

MODEL 540-200W, SSB/CW  
3.5 - 30 MHz \$699.00

MODEL 544- DIGITAL, 200W  
SSB/CW, 3.5 - 30 MHz  
\$869.00

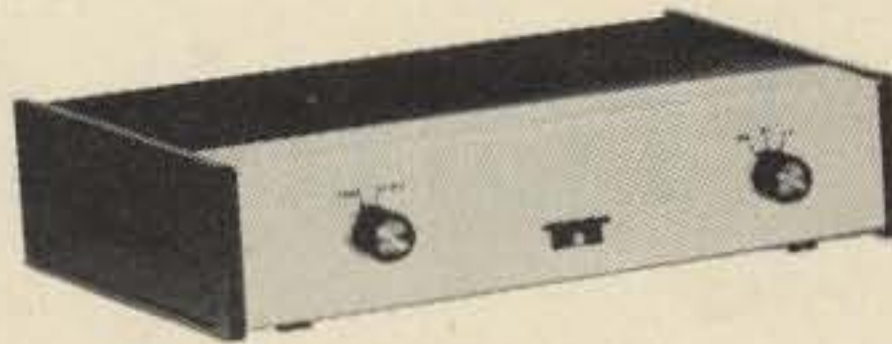

MODEL 240 \$97.00  
ONE - SIXTY CONVERTER



MODEL 242 \$169.00  
REMOTE VFO

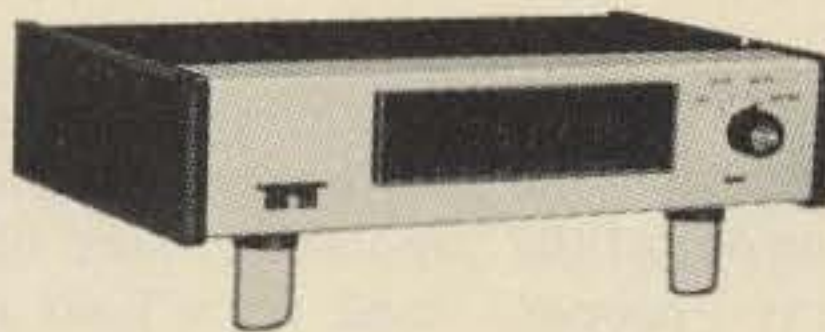

MODEL 244 \$197.00  
DIGITAL READ OUT/COUNTER



MODEL 262-G \$129.00  
DELUXE POWER SUPPLY



### ARGONAUT

MODEL 509 \$329.00  
SW, SSB/CW, 3.5-30 MHz

### LINEAR AMPLIFIER

MODEL 405 \$159.00  
100W, 3.5 - 30 MHz



AMMETER  
207 \$14.00

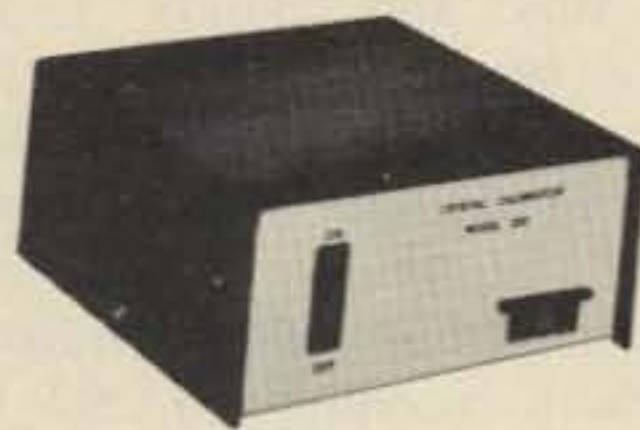

XTAL CALIBRATOR  
206 \$26.95

### KEYERS

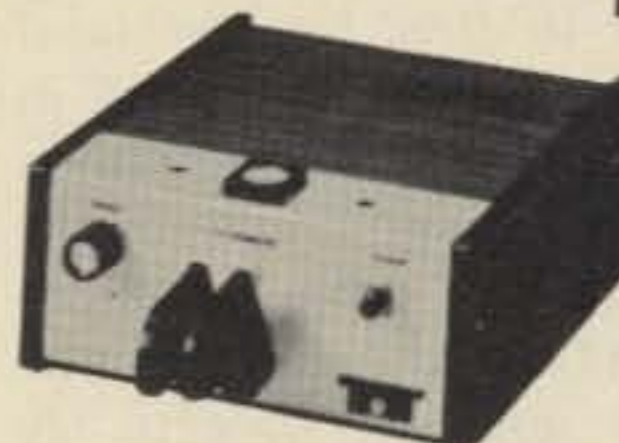

ELECTRONIC KR-50  
\$110.00

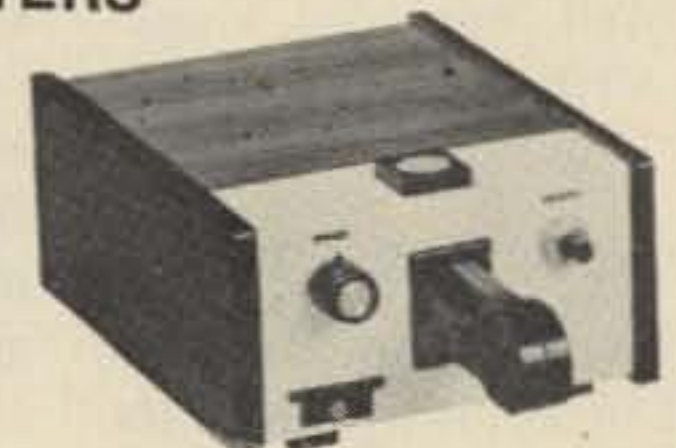

ELECTRONIC  
KR20-A \$67.00



ELECTRONIC KR-5A  
\$38.50



KR-2A \$15.00

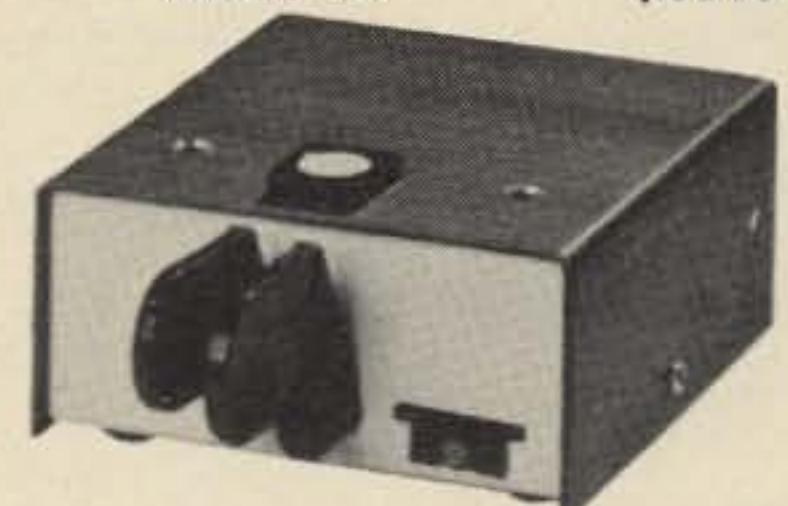

KR1-A \$35.00

MASTERCHARGE & BANKAMERICARD ACCEPTED

**HAMTRONICS**

DIVISION OF TREVISE ELECTRONICS  
4033 Brownsville Rd • Trevose, Pa. 19047

THE BIG 'H' FOR ALL YOUR HAM NEEDS!



# Open New Frontiers!

## -- VHF sideband

I heard some "lowbanders" (HF types) chatting away the other day about some "crazy VHFer in Santa Cruz" (not me, by the way) who claimed to work Los Angeles, Fresno, and the like . . . even some mobiles out to about 150 miles on *two meters*!

The other fellow said, "Ah, sure. It's them repeaters, you know."

"Nope," replied the first. "This guy was using one of those little three Watt rice box rigs on *sideband direct* . . . not on any repeater, so he says!"

"Oh," replied number two. "Well, everyone knows those VHF SSB types are liars!"

### Where's the Fun Gone?

I'm not so old and I haven't been in ham radio for

much more than a dozen years, but it seems that some of the fun has gone out of the hobby for many people. Maybe it's because of the loss of so much of the "new blood" to CB, leaving us devoid of the enthusiasm generated by newcomers to the hobby. Maybe it's because of the rich man's war that has made 20 and 40 meter beams and kilowatts *required* equipment nowadays rather than luxuries. Maybe it's because unless you really dig CW (which can be operated with a minimum of cash outlay) or really like to stand in line on the local repeater for 25 minutes in order to get your *very own* three minutes (down to one minute on some machines around here), then you're either going to have to lay

out a few kilobucks for gear or buy some ancient metal monster that's *already* been used for a boat anchor. The latter is not any more likely to make "brownie points" with the wife than the former!

Frankly, when I got back on two meters after a few years' absence due to higher education, I wasn't enthralled by what I heard. True, to each his own, but I couldn't quite relate to tone bursts and 25 minute waiting lines on the local repeaters. I also balked at the four page lists of "dos" and "don'ts" that were being handed out by some repeater groups. Of course, the \$20 initiation fee and \$10 yearly assessment was a bit beyond my meager student income, too. So I stuck to the small but still active group of AMers left on the band.

Unfortunately, when I moved from the Bay Area to Santa Cruz, the 3000 foot mountains put a real dent in my signal. Though I could hear the boys across the hills on my receiver/converter combination, they had trouble picking me out of the noise on their Communicators and the like. If only those two meter AM rigs modulated like CB sets, had

noise limiters, and good sensitivity!

At the time, two meter SSB was a once-a-week, Tuesday night net thing with about 15 active stations. However, I found a two meter single sideband transceiver (so it said on the label) made by Belcom so I put the thing on the air and made some noise! Having worked all the then-active SF Bay Area stations and finding the rig a nice package, I took it up to the SRI VHF/UHF Society meeting to a show-and-tell session and showed it off. Bruce Clark K6JYO scanned it with interest and shot off for home shortly after the meeting so that he could work me mobile all the way home to Santa Cruz . . . some 45 miles through those 3000 foot mountains. After this successful test, Bruce got KLM interested in the unit and the rest is history!

### Why Single Sideband?

This isn't a question that's asked on the HF bands much any more, where sideband's advantages in a crowded band and for DX are obvious. On VHF there are fewer people who have been exposed to its advantages.

Single sideband has the same advantages on VHF that it has on the HF bands. It requires low average power drain for a given effective power, extends PA life and reduces heat sink requirements due to lower *average* power dissipation, reduces multipath and phase distortion, increases potential sensitivity by reducing required bandwidth, allows break-in operation, and provides excellent weak signal recovery.

These last two features have been responsible for the increase in medium range "DX" contacts on two meters in recent years. With increased activity, weak signals are often heard between syllables during a local QSO (something not possible with FM), and though the signal may not be copyable, with SSB *something* can be heard

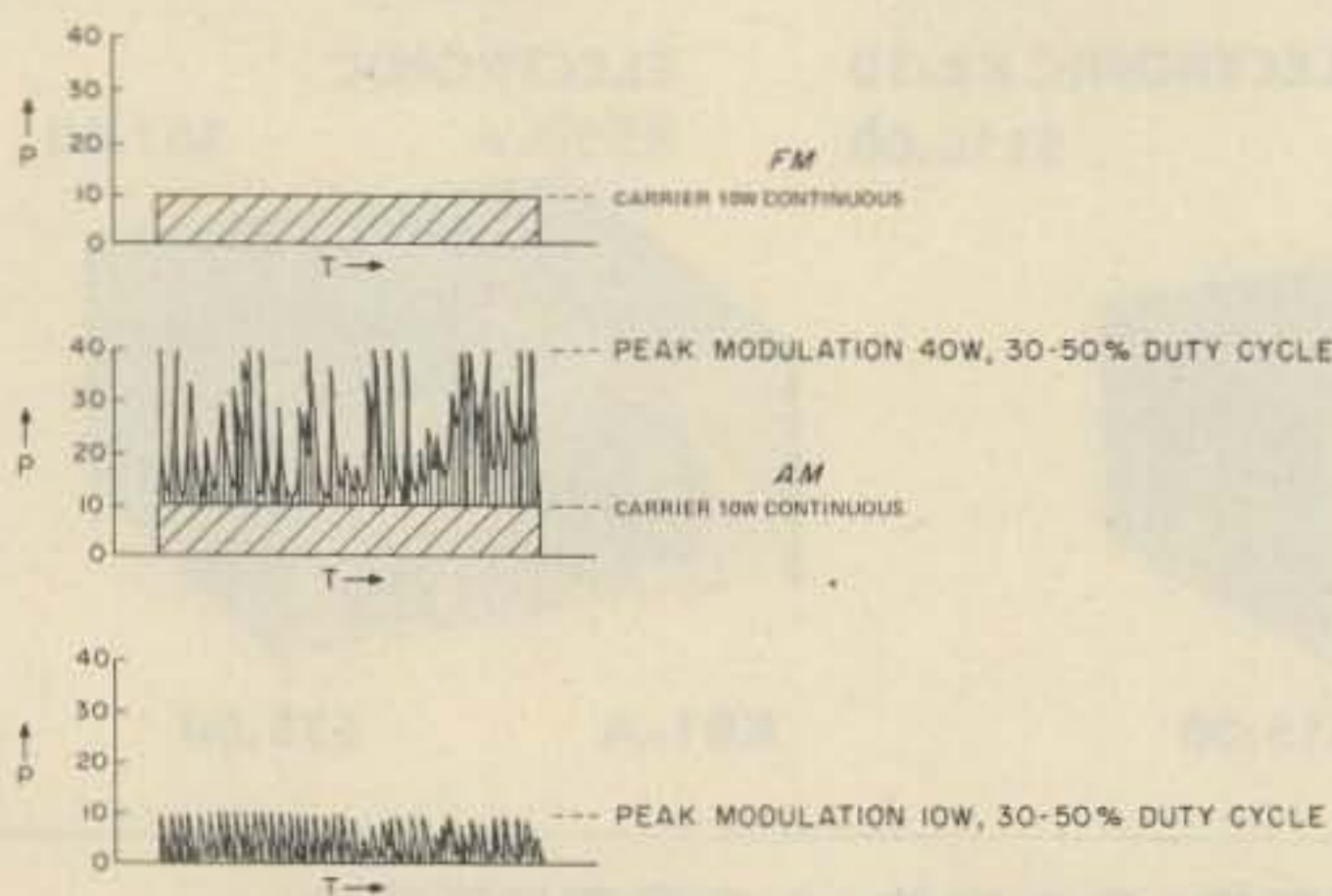

Fig. 1. Average power.



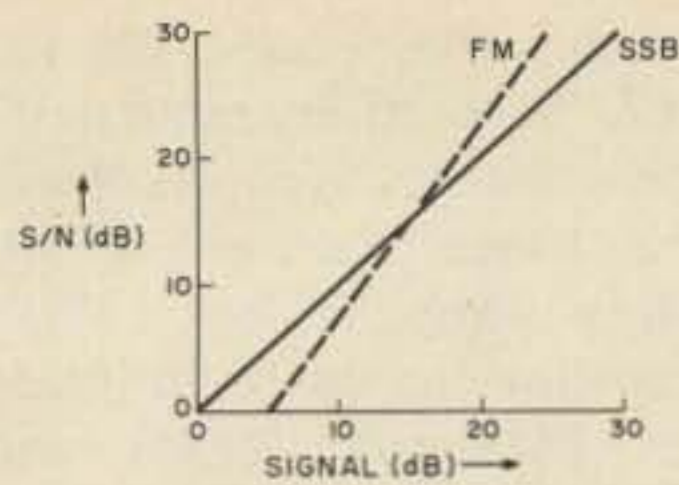

Fig. 2. Weak signal effectiveness. FM s/n is better than SSB above 10 dB s/n, but SSB is superior on weak signals below 10 dB s/n. This makes SSB better able to find and copy weak DX stations.

and beams be brought around to peak up the station — or the old VHF wait-for-the-peak game can begin.

### Sideband Working Distance

In everyday terms, sideband extends the radio horizon 50% to 100%. In hilly terrain where multipath is a problem, sideband's advantage over FM can be even greater than 100%!

Here in hilly California, repeaters have a typical working range of 50-150 miles radius. Ten Watt sideband stations typically run equal range *and better* with higher powered stations (50-150 W), getting frequent contacts out to three or four hundred miles.

It is not uncommon, for example, for Santa Clara Valley stations running 10-20 W to work into Los Angeles on a good night. Well located, high powered stations like Mike Stahl of KLM or Jay Shaffer W6BWB can work LA and San Diego almost any time of day or night!

### Special Modes

In addition to regular point-to-point communication, there *is* one repeater on two meters (though sidebanders prefer the term "translator") that is used quite extensively throughout the United States. It has a beautiful location about 1000 miles above sea level and has a working radius of some 2500 miles! Oscar VI and more recently Oscar VII provide a fascinating means of SSB and CW contacts for

anyone with a Technician class license or higher.

From the East Coast, Britain and Western Europe can be worked via Oscar. Canada and Mexico, Central and parts of South America can be worked throughout the U.S. Japan and the Pacific are available to West Coast hams.

### Getting Started

There are several approaches to VHF SSB. The easiest for the HF operator with a rig having a low power transverter output is to buy the transverter made for his rig.

Those who prefer not to tie up their HF rig when they get on VHF SSB may prefer one of the separate transceivers available.

Those who already operate two meter FM may want to trade up to one of the AM/FM/SSB/CW multimode rigs now available.

The following listing gives a brief overview of what's available, including some general remarks about the strengths and weaknesses of each rig.

### THE KLM ECHO II

The KLM Echo II was the first two meter transceiver available (discounting the Gonset Sidewinder from several years back). It is totally solid state and runs off 11-15 V dc (no built-in ac supply). It is conveniently mobile, measuring only 2.5 x 8.5 x 10 inches, and has squelch (the only unit that does on SSB), an effective noise blanker, and excellent stability (crystal control with a VXO and RIT).

### Specifications

Sensitivity: under .18  $\mu$ V typical\*;  
Selectivity: 2.1 kHz @ 6 dB, 4.2 kHz @ 50 dB typical\*;  
Af Output: 3 W into 4 Ohms

\*Values marked with an asterisk are units that I have tested or had dealings with. Sensitivity = 12 dB SINAD. Tx IMD referenced to each tone. Spurs and harmonics references to PEP output.

@ 10% THD;

Rf Output: 10 W PEP typical @ -22 dB 3rd order distortion\*;

Spurious: -55 dB typical\*;

Harmonics: -60 dB typical\*;

Af Response: 150-2250 Hz typical\*;

Features: S/RFO meter, Crystalplexed synthesizer with VXO ( $\pm 6$  kHz) and RIT ( $\pm 2.5$  kHz receive only), squelch, noise blanker, ALC, vswr protection, semi break-in CW, bandswitch (up to 5 bands, 230 kHz each with 145-145.23 and 145.77-146 included), ext. key for linear, ext. spkr. jack, upper and lower sideband mod kit (for Oscar VII downlink), and accessory FET preamp (improves AGC action and gives .08  $\mu$ V/12 dB SINAD or better);

Price: \$390.

### Pluses and Minuses

On the plus side, the Echo II is easy to service, has plenty of room available for modifications, and costs less than the multi-mode rigs. The only other SSB-only rig is only 3 W PEP and isn't easily modified for lower sideband for Oscar reception. The VXO allows good frequency control and resettability, so that finding frequencies for skeds is easy. Given two Echo IIs, if each moves up 30 kHz (three channels) they will end up within 100 Hz of each other. This is great for mobile where QSYing can be safely done by merely counting one channel for each 10 kHz *without looking* at the dial.

The major drawback with the receiver is the lack of AGC below 1  $\mu$ V. This is quite bothersome when working strong locals with weak DX. The KLM preamp helps with this, as do other mods.

The transmitter is frequently accused of being "muffled" or "bassy." This can be helped by tuning the BFO frequency until a 400 Hz tone in the mike input drops to  $\frac{1}{2}$  W from a starting level of 2 W (6 dB). Of course, this drops the CW

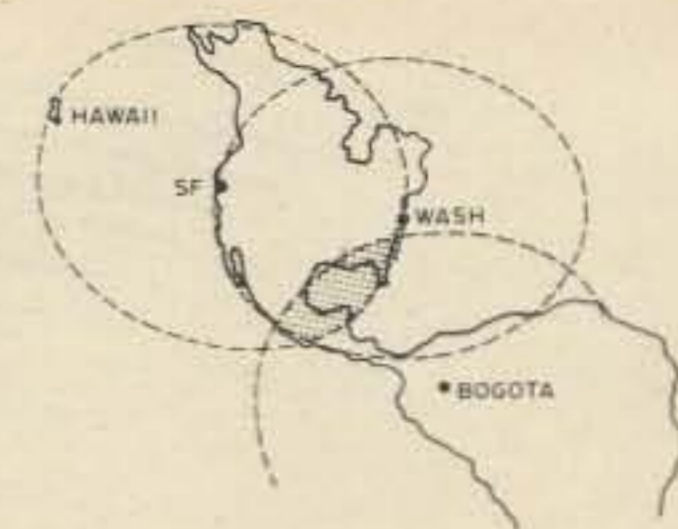

Fig. 3. Oscar working radii. Overlapping areas can work each other.

output quite a bit as well. Another approach is to find a mike with a natural roll-off below 1 kHz. (Note: A D-104 *doesn't* work unless its high output is transformer-coupled to the 500 Ohm Echo II input.)

### THE ICOM IC-202

The Icom IC-202 is SSB only. It is a "walkie-talkie" similar in size to the TR-22 FM rig. About 2.5 x 6.5 x 7.5 inches, it has a built-in whip antenna in addition to its normal output jack. The unit covers 200 kHz with a VXO multiplied up from 14 MHz and calibrated in 5 kHz increments. There are positions for four crystals, with 144.0 and 144.2 MHz standard. Why Icom doesn't make 145 MHz one of the standard crystals, I have no idea, considering that it would about *double* their potential customers by adding the Technicians.

The receiver works quite well with a MOSFET/JFET front end which gives 70 dB intermod and crossmod rejection. AGC is reasonable . . . about 15 dB change from .3  $\mu$ V to 1000  $\mu$ V input change. Provision is made for an external VFO, although none is presently available.

### Specifications

Sensitivity: under .125  $\mu$ V typical\*;  
Selectivity: 2.4 kHz/4.8 kHz (6 dB/60 dB), 70 dB ultimate;  
Af Output: 1.0 Watt @ 10 THD into 4 Ohms\*;  
Rf Output: 3.2 W PEP typical @ -30 dB 3rd order distortion\*;  
Spurious: -60 dB or better (most below 70 dB\*);  
Harmonics: -60 dB or better;



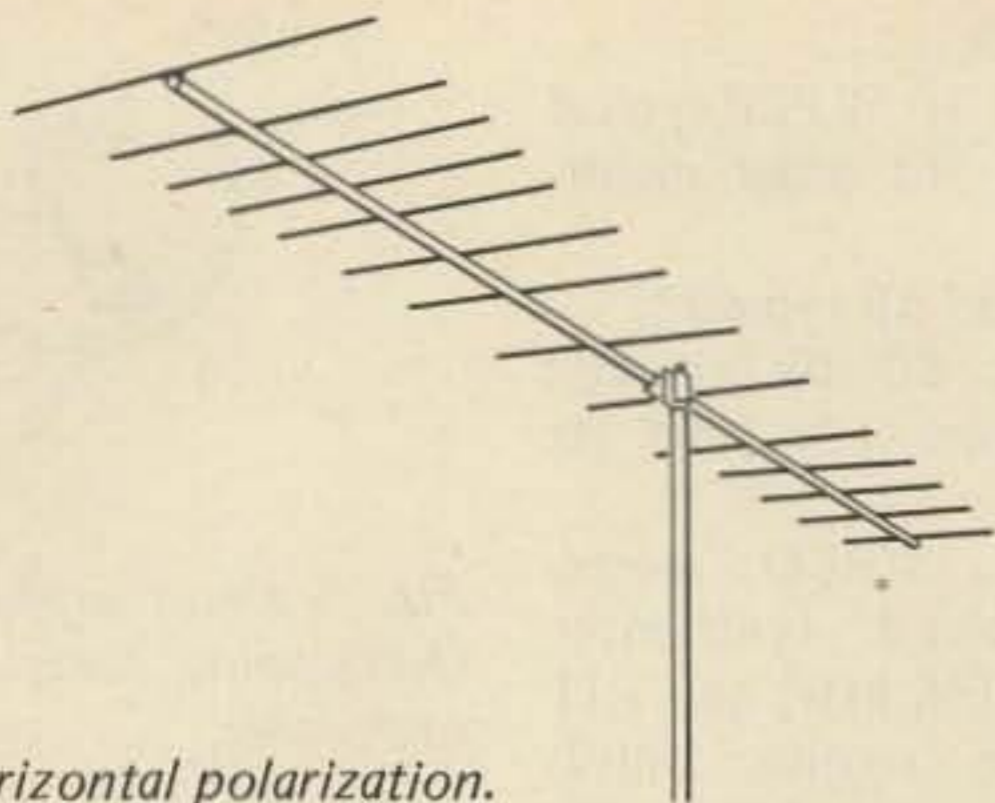

Fig. 4. Horizontal polarization.

Af Response: 500-2900 Hz typical\*;

Features: S/RFO meter, 200 kHz VXO calibrated in 5 kHz steps, noise blanker, ALC, RIT with center off detent, CW/SSB switch, bandswitch (four bands, 144.0, 144.2 included), external speaker jack, VFO input jack, built-in battery compartment (uses nine "C" cells), carrying strap, pilot light/panel light on/off switch (to conserve power on batteries), built-in whip antenna;

Price: \$280.

#### The Good, the Bad, and ...

The IC-202 comes with a very good, large size schematic in spite of the 202's small size. It is extremely portable and fun to take on trips or mountaintopping. Numerous 202s have shown up on the air in the Monterey Bay Area and San Francisco Bay Area while their owners were on vacation or on business in the area. It also is a natural for emergency and public service operation. The unit's range varies depending on terrain and location, but normally has good signals over 5-10 miles with marginal results as far as 25-30 miles. Mountaintoppers can expect 100 miles easy with the built-in whip — and more with a beam.

The 202's receiver is remarkably free from spurious, crossmod, and intermodulation problems. Under some conditions, the noise blanker will cause cross modulation by very strong in-band stations. Most of the time it does not, though. Its sensitivity is about what is needed for a 3 Watt rig, but

can be improved. I suggest using a preamp of the FET type (*not* MOSFET), with about 10-15 dB gain mounted in the power amplifier box if one is added later. The J-310 or U-310 (Siliconix) are popular on the West Coast for this.

All 202s have a slight drift problem, especially if cheaper US crystals are used in the VXO. Some retuning in any ten minute period is often required, but it is by no means as bad as what we used to put up with on 2m AM several years back. Checks in the lab show about 500 Hz drift over a temperature range of -30 to +50 degrees Centigrade. Normal variations can then be expected to be 100-200 Hz at room temperature. (By the way, if your shack has the kind of temperature range we used in the lab, I suggest you install a heater in the place!)

The 1 Watt audio output is adequate for most applications. However, in noisier vehicles like my VW bus, the af output is marginal. A well placed external speaker would probably help.

The size of the IC-202 is both a blessing and a curse. Of course, it makes it very convenient for mobile operation, but it also makes it difficult to service or modify. This is why I suggest putting any preamps in the power amplifier instead of trying to put it inside. It also makes it difficult (probably impractical) to put lower sideband into the 202.

#### THE KENWOOD TV-502

The first transverter that became apparent on the

market in the recent sideband boom was the Kenwood TV-502. It covers 144-146 in two bands, with the 144-145.7 range included normally (converting from 28.0-29.7 MHz). The transmitting section seems to be very clean sounding and puts out around 8 W PEP. The receiving converter lacks gain and noise figure, so that its sensitivity is only around .5 uV; an additional preamp is almost always necessary. There *is* room to build the preamp inside the unit. The 502 matches the Kenwood HF line, of course. Price class ... \$260.00.

#### YAESU

Yaesu also makes a transverter for their equipment, but none has shown up in this area as yet. Little information (specs, price, etc.) is given in the ads by Yaesu, but performance equivalent to the Kenwood seems likely, with a price to match. It seems that there is little effort on Yaesu's part to promote this unit, as they don't tell enough about it to get anyone interested in it!

#### THE EUROPA B

A different approach can be seen in the Europa B transverter ads. Through small ads by a small company, I can learn that the unit uses 5894s in the final with about 80 W PEP output, interfaces with the Yaesu line with no external power required, is 9 x 4-3/4 x 4-1/2 inches, has MOSFETs in the converter section, and requires about 100 mW of drive. It costs \$299 (\$279 without tubes).

#### THE KLM MULTI-2000

An early comer to two meter SSB was the ITC Multi-2000. Unfortunately, the small size of the importing company did not result in good enough quality control, and numbers of these multimode, synthesized rigs got out to the field with out-of-band spurs only 25-35 dB down! The FAA got upset, since these were falling on

aviation frequencies, and the FCC "respectfully requested" some changes. Well, KLM was the change that came about. They bought out ITC's franchise for the Multi (made by FDK of Japan) and bought an HP Spectrum Analyzer so that *each unit* could be checked before going out. They also sent a test unit to the FCC, which gave it a clean bill of health. So now the Multi-2000 is one of the four multimode rigs on the market.

#### Specifications

Sensitivity: .1 uV typical (less if peaked for 1 MHz of the band)\*;

Selectivity: 2.4 kHz;

Af Output: 2 Watts into 4 Ohms @ 10% THD;

Rf Output: around 10 W PEP;

Spurious: -55 to -60 dB or better;

Harmonics: -60 dB or better;

Af Response: 300-2700 Hz;

Features: S/RFO meter, digital synthesizer with 10 kHz steps across the entire 2m band, VXO ( $\pm 10$  kHz), RIT ( $\pm 5$  kHz), noise blanker, ALC, CW/AM/FM/SSB, upper and lower SSB, ext. key for linear, ext. spkr. jack, wideband and narrowband FM, 600 kHz up or down or simplex, three crystal channels, FM squelch, FM 1 W or 10 W position, rf gain control, ac and dc power supplies built in.

#### Strengths and Weaknesses

Unlike the other multimode rigs, the Multi-2000 features a PLL synthesized 10 kHz step frequency control, which makes frequency setting for FM (and SSB, for that matter) very easy. Each click is ten kHz, making mobile operation safer by not requiring the operator to tune by a meter or VFO, etc. Of course, there are times when the VFO is better, as when operating SSB. However, the VXO and RIT allow good flexibility here, too.

The Multi's AGC has had some problems according to some users. It's not as bad as



the Echo II, but perhaps not quite as good as the FT-221 or TS-700. I get an impression from off-the-air comments that the difference is slight, however.

As previously mentioned, the early Multi's had out-of-band spurious problems with a vengeance. This has been cured by KLM's quality control.

Some feel that the Multi-2000's transmit audio is not quite as good as the other multimode units. While I agree that it usually does not sound as "hi-fi," I think that I have heard about as many FT-221s and TS-700s with bad audio as Multi's. A good 221 or 700 sounds very good, but a bad one sounds really bad.

### THE KLM MULTI-2700

Another entry in the multimode market is the KLM Multi-2700. This rig has a stiff \$800 price tag, but it has some unique features, too. These include a VFO or PLL 10 kHz per step synthesizer, converter built in to receive the 10m Oscar downlink with reception tracking the two meter transmitter, VOX, LED readout, and user programmable FM repeater splits in addition to the normal  $\pm 600$  kHz splits.

#### Specifications

Sensitivity: .1  $\mu$ V;  
 Selectivity: 2.4 kHz;  
 Af Output: 2 W into 4 Ohms @ 10% THD;  
 Rf Output: 10 W PEP (10 W or 1 W FM);  
 Spurious: -60 dB or better;  
 Harmonics: -60 dB or better;  
 Af Response: 400-2800 Hz;  
 Features: S/RFO meter, PLL 10 kHz step synthesizer or VFO, VOX, RIT, CW/FM/SSB, upper and lower SSB, noise blanker, ALC, ext. key for linear, ext. spkr. jack, FM squelch, built-in ac and dc supply (incl. 220 V European standard with 115 V ac and 14 V dc), space for 50 MHz or 432 MHz converters, LED readout, tracking converter for Oscar 10m downlink (but cannot

receive while transmitting), 600 kHz up/down split or user programmed, built-in VOX.

As this unit is barely introduced as I write this, little is known of its performance. Listening to this unit, I noted that it is clean, but not "hi-fi." The Oscar feature is nice. One drawback is that the 10m downlink can't be monitored while transmitting, since the unit is a transceiver having a common i-f. The RIT can be used to approximate the Doppler shift, but this is imprecise, to put it mildly! It is still quite usable in this mode, even if not as convenient as a separate receiver.

### THE YAESU FT-221

As soon as it hit the market, the FT-221 was a success. By preceding the TS-700 by a few weeks and by being more readily available in stock early in the game, the 221 has enjoyed a great deal more popularity in *this* area than the TS-700. One frequently mentioned reason is the modularized construction the rig sports. Cosmetic-wise, the two are essentially similar, but the 221 has its circuits on vertically-mounted cards, providing good isolation and ease of replacement. The theory goes that service is easier, too. If you happen to have a substitute board, I suppose this is true, but unless you have extender boards (not supplied), service of a "live" circuit is out of the question! So, it's six-of-one-and-half-a-dozen-of-the-other.

#### Specifications

Sensitivity: .2  $\mu$ V or less on SSB;  
 Selectivity: 2.4 kHz/4.1 kHz 6/60 dB;  
 Af Output: 2 Watts into 4 Ohms @ 10% THD;  
 Rf Output: 12 W PEP nominal (14-16 W typical, 18 W on FM);  
 Spurious: -60 dB;  
 Harmonics: -60 dB;  
 Af Response: 300-2700 Hz;  
 Features: S/RFO/FM tuning

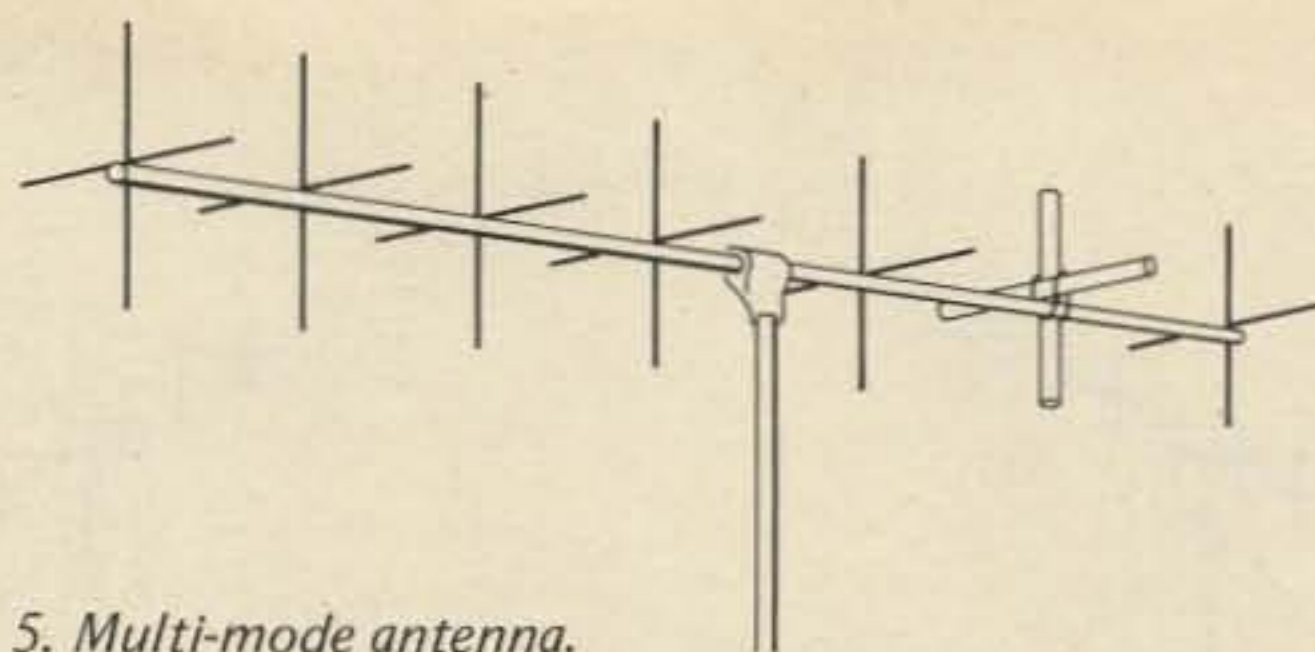

Fig. 5. Multi-mode antenna.

meter, phase locked VFO covering all of two meters in 500 kHz bands, 1 kHz readout, AM (2 W), FM, CW, SSB, upper and lower SSB, noise blanker, ALC, ext. spkr. jack, FM squelch, ac and dc power supplies, tx/rx or rx only clarifier.

#### Bouquets and Brickbats

The only real problem that has been noted on the FT-221 is that the gain setting for FM and SSB on the mike gain control is not the same. With normal FM mike gains, SSB tends to overdo it a bit, causing distortion. Since this level is front panel controlled, no problem should exist once proper levels are established for the two modes.

Even with proper settings, some FT-221s have bassy and mushy audio. Most units are very clean and good sounding, but *some* have this problem.

Some 221s have lacked sensitivity. Most are good, but *some* seem to get through Yaesu's quality control department.

On the plus side, most 221 owners are quite happy with the units on both SSB and FM. Good ones sound *very good*.

### THE KENWOOD TS-700A

Kenwood's TS-700A is similar in function and performance to the FT-221. It also features full coverage of two meters in 500 kHz segments (VFO) and has AM/FM/SSB/CW. Styling is also similar. One notable difference is that the 700 has final load and drive controls, making its operation less "hands-off" than the Multi-2000 or FT-221. I'm told by users that these controls are

very broad, requiring little adjustment over a given band segment, however.

#### Specifications

Sensitivity: .1  $\mu$ V/12 dB SINAD;  
 Selectivity: 2.4 kHz/4.8 kHz @ 6/60 dB;  
 Af Output: 2 Watts into 4 Ohms @ 10% THD;  
 Rf Output: 10 W PEP, 3 W AM;  
 Spurious: -60 dB;  
 Harmonics: -60 dB;  
 Af Response: 400-2600 Hz (published);  
 Features: S/RFO meter, FM tuning meter, PLL VFO in 500 kHz bands across 144-148 MHz, 1 kHz readout, AM/FM/SSB/CW, upper and lower SSB, noise blanker, ALC, ext. spkr. jack, FM squelch, built-in ac/dc power supply tx/rx or rx only clarifier;  
 Price: Around \$700.

#### Ups and Downs

Most sound very good on the air, with a resonant "broadcast quality" tone. The tone is not necessarily "natural," however, and under weak signal conditions *some* voices do not "punch through" too well. Adjustment could be made by microphone choice or BFO frequency shift, if desired.

Most comments of TS-700 owners parallel those of FT-221 owners. The AGC in both cases is reasonable, but not as good as might be desired for working DX and locals simultaneously. A preamp could be useful, especially if a linear is added to the system (j-310, or equivalent).

#### Which Way To Go?

As you can see, the options for two meter side-



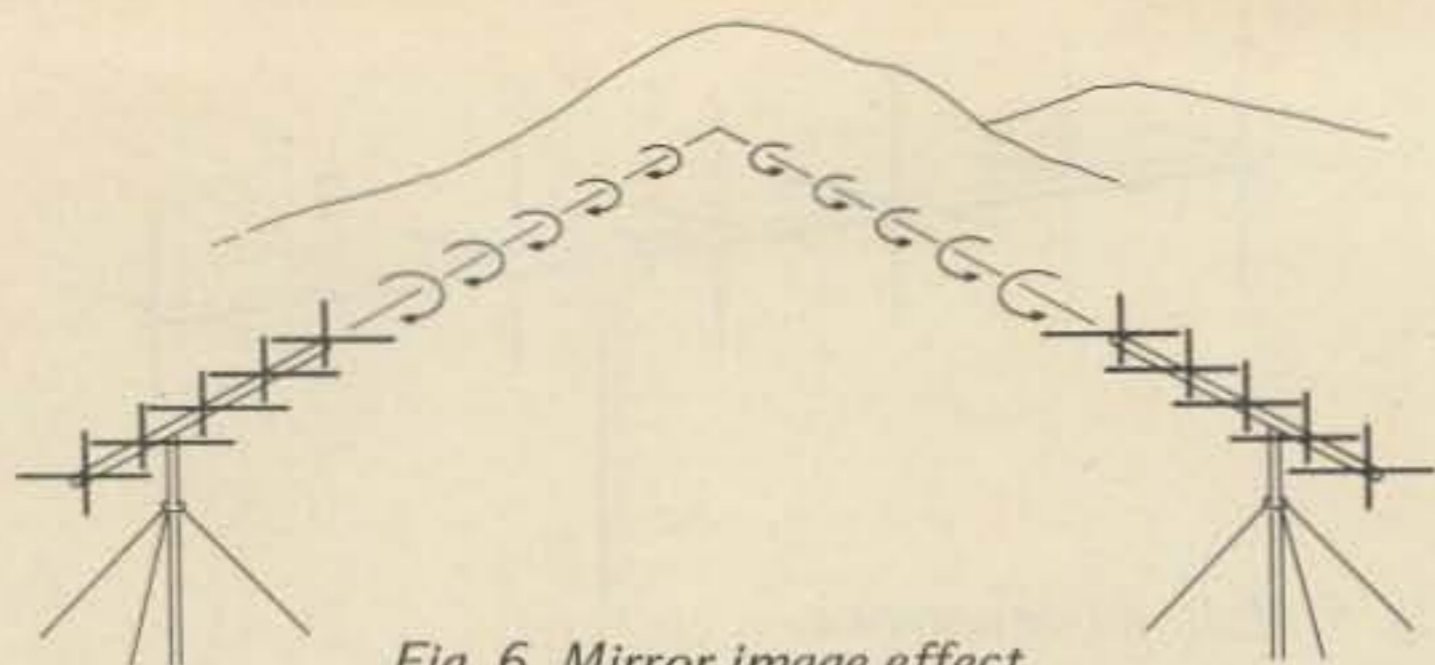

Fig. 6. Mirror image effect.

band have rapidly expanded in the past two years. Since KLM broke the waters with the Echo II, sideband has been growing very rapidly, with several manufacturers jumping on the bandwagon. Your final choice should be based on your operating habits and taste. But don't let your *current* operating habits have too much influence, as you may decide to *change them* once you've been on sideband for a while!

Of course, the best thing is to compare units side by side. Unfortunately, not all stores stock all units, and their open hours are often not during peak operating hours. So you may have to socialize a bit and find someone who has the unit(s) you are interested in and give him a visit. This is a good bet, anyway, since he can give you an idea of the idiosyncrasies of the rig, along with its good points. He can also give you pointers on other aspects of setting up a VHF SSB station.

As far as one method of getting on over another ... transceiver or transverter, etc. ... it depends on your budget and needs. If you don't mind tying up the HF rig while operating VHF SSB, a transverter is an inexpensive way to get on. Consider, however, that unless your HF rig has a noise blanker, the transverter method suffers 6-20 dB degradation in performance on reception when ignition or other noise exists. It can also be annoying!

If you have FM and just want to add SSB with little additional outlay, the IC-202 or Echo II would look good. This also allows simultaneous

monitoring of SSB and FM (which could be a plus in emergencies).

Full coverage and all modes are the attractive features of the 2000, 2700, 221, and 700 multi-mode rigs. Trading up to these rigs buys not only SSB but full frequency FM coverage as well!

#### Other Things

Of course, a beam antenna, horizontally polarized, is likely to be something you'll want to add. Vertical beams or ground planes and the like are good for repeater use, but the cross polarization is going to cost you 10-30 dB when you try to work SSB stations (all of which are horizontal except for newcomers). There's good reason behind horizontal. This polarization has less sensitivity to noise than vertical, and seems to have better consistency over long-haul paths. In 1963, several Santa Cruz VHFers experimented with WB6IZF in King City ... a path of about 100 miles. WA6YOG used an antenna rotatable in polarity from full vertical to full horizontal, as did IZF. Over a period of several months, horizontal showed better signal levels and less fading than vertical, and horizontal gave up to 6 dB improvement in noise rejection on the AM signals. Cross polarization showed 10-30 dB of loss, as would be expected.

As for what antenna to buy, your budget may be the limiting factor. Here in the West we are partial to the KLM line of antennas. Perhaps it's because Mike and Mel of KLM are quite active on 2m SSB out here, but it is also because their broadband,

rugged antennas work exceptionally well. Many of the top moonbounce stations are using the KLM 12 or 14 element beams in their arrays, simply because they are made of heavy gauge aluminum. Since they cover the entire two meter band with low vswr and high gain, they are easy to stack without worrying about detuning one antenna with another close by.

On the other hand, the antennas made by CushCraft and Hy-Gain are also good, though made with lighter aluminum and narrower bandwidth (standard yagi) design. Their prices are very attractive compared to KLM's, being roughly one-half to two-thirds as much. *At resonance*, they can perform as well as the KLM units, but bandwidth will only be about one megacycle for 5 elements and around 500 kHz for long yagis. Stacking can be problematical beyond two antennas, as well.

One interesting consideration for owners of multi-mode rigs is the circularly polarized antennas that use only one feedline. These allow SSB and FM operation without switching antennas for vertical and horizontal polarization. KLM, CushCraft, and Hy-Gain all make them. KLM's cover all of two meters, but cannot have the polarity switched from left- to right-hand polarization. The others are normally cut with the vertical elements favoring 146-148 MHz and the horizontal elements favoring 144-146.

There is one caution to be noted here, though, and that is that two stations using circularly polarized antennas over a reflected path (bounced off a mountain, etc.) will end up cross polarized because of the "mirror image" effect. If one station is able to reverse his polarization (e.g., right-hand to left-hand), this problem can be eliminated. There is no such provision on the KLM antenna (KLM 16-C). The others show how it can be done, and

since the elements are cut for opposite ends of the band, true CP doesn't really exist (it's more elliptical than circular).

Another caution is that CP causes a 3 dB drop in signal strength over the equivalent linearly polarized antenna, since half of the power goes to the vertical antenna and half to the horizontal. If working a horizontal station, he only receives the horizontal radiation. The same is true for vertical. Of course, when working another CP station, the 3 dB is *not* lost, and considering that 10-30 dB is lost by being *cross polarized* when using a vertical beam working a horizontally polarized station, the 3 dB loss is a good compromise!

So again, it boils down to your needs and choices. Five elements for SSB should be a minimum. Twelve or fourteen is typical. For Oscar satellite use, three or four elements, vertically polarized, tiled up from the horizon by about 30-40 degrees, work very well. Twenty-five to fifty foot antenna height is average, but higher antennas can give a decided advantage for stations shadowed by mountains close by. Figure about 6 dB every time you *double* the antenna height.

Be careful of cheap, CB-type coax. This stuff (sold by Radio Shack and others) has only partial shielding (recognizable by the loose weave of the shield) and is *not* good for two meters! It is lossy and may cause vswr problems.

Use a good grade Belden or Times Wire, RG-58 or RG-59, for runs up to 35-45 feet, total. Up to 100 foot runs, RG-8 or RG-11 is good. Above 100 feet, RG-17, though quite expensive, really pays off. Make sure the coax you use is the right impedance for your system. (58 and 8 are 50 Ohms, 59 and 11 are 75 Ohms.)

If you buy a cheaper antenna, make sure to trim it so that it is tuned for your



operating frequency. If you do this, you'll get optimum results and you'll have saved some money. If you don't, you may not be as happy as you would have been if you did.

### Worrywarts of America

If that three minute timer's got you fretting about getting cut off in mid-sentence and you don't mind someone making nasty remarks under your five minute monologue (which you can

do on sideband and everyone but the guy with the mike button pushed will hear it), get on board two meter sideband! We may sound like a bunch of higher class CBers on those occasions when our mood is less than sober (we like to have fun), but I dare say that most of our joking around would go right over the heads of the eleven meter crowd. You'll get few comments about your operating procedures on SSB (unless you're one of those who likes

to run 15 kHz wide FM on the sideband frequencies... we *do* get unblest by *some* things!). Not only that, but occasional "drop in" DX makes the band quite interesting. And when the marginal fringe (say, 150-250 miles) starts coming in like it was local, extended rag chews

with stations you normally say "hello"/goodbye" to make for a community spirit. Who knows? Someday I may even join an FM repeater group, but for now I'm enjoying myself too much on the lower end of two meters! Hope to meet *you* there someday! ■



Fig. 7. Cheap coax: bad on left, good on right.

## ALL BAND TRAP ANTENNA!



5 BAND OPERATION - ONLY ONE NEAT SMALL ANTENNA. FOR CONGESTED HOUSING AND APARTMENT DWELLERS! FOR ALL AMATEUR HF TRANSMITTERS GUARANTEED FOR 1,000 WATTS POWER. LIGHT. NEAT WEATHERPROOF.

Complete as shown total length 102 ft. with 90 ft. of 52 ohm RG58U coax and PL259 connector. Hi-impact molded resonant traps. (wt. 3 oz. 1" x 5" long) You just tune to desired band for excellent reports! Excellent for ALL world-wide receivers and amateur transmitters. For NOVICE AND ALL CLASS AMATEURS! NO EXTRA TUNERS OR GADGETS NEEDED! Eliminates 5 separate antennas with excellent performance guaranteed. Can be used as inverted V. NO HAYWIRE HOUSE APPEARANCE! EASY INSTALLATION!

80-40-20-15-10 meter bands. Complete ..... \$34.95  
 40-20-15-10 meter bands. 54-ft. ant. .... \$33.95  
 20-15-10 meter bands. 24-ft. ant. .... \$32.95  
 SEND ONLY \$3.00 (cash, ck., mo.) and pay postman balance COD plus postage on arrival or send full price for pp. del. BankAmericard - - Master Charge - - Ph 308-236-5333 Free info. available only from. WESTERN ELECTRONICS Dept. A7-7 Kearney, Nebraska, 68847 W18

## The Incomparable Brookfield

# 703

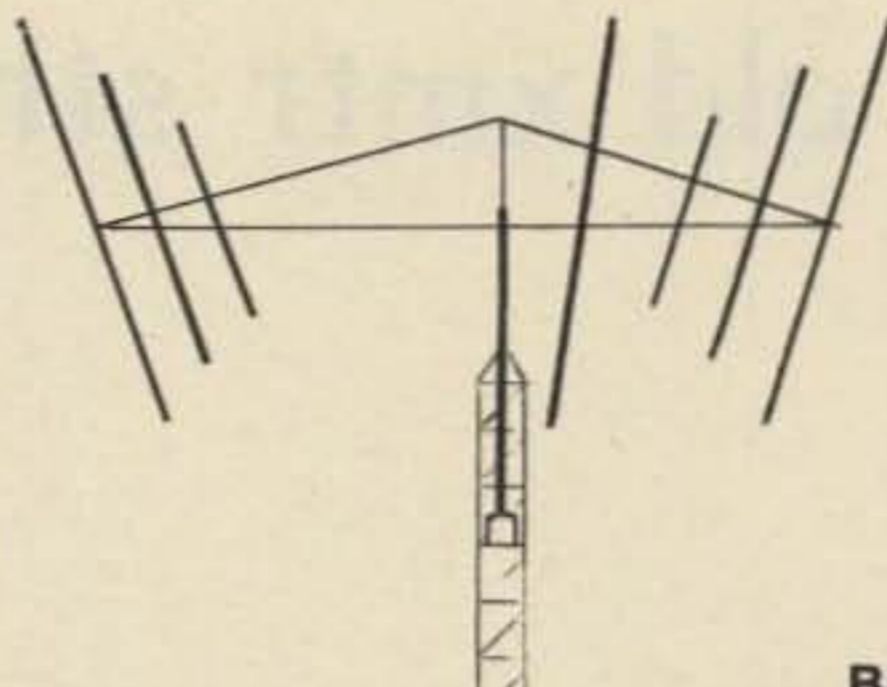

- Seven Elements
- Three Bands (10-15-20)
- Single Feed Line
- Flexible Tuning
- Close To Mono-Bander Specs With Optimum Spacing For:  
 High Forward Gain  
 High F:B & F:S Ratios

**\$395** Delivered U.S.A.  
 Except Alaska & Hawaii

**BROOKFIELD MANUFACTURING CO.**  
 RFD 5, Pocono Road  
 Brookfield, CT 06804  
 (203) 775-3665

B13

**"Right on" with Jan Crystals**

for

- General Communication & Industry
- Citizen's Band (Standard & Synthesized)
- Two-Meter - Monitor - Scanners
- Marine VHF • Amateur Bands

Depend on Jan Crystals made in U. S. A. for

- Frequency Control • Frequency Stability
- High Performance

Send 10¢ for our latest catalog Write or phone for more details

2400 Crystal Drive  
 Ft. Myers, Florida 33901  
 all phones (813) 936-2397

J2

Hooker Electronics  
 P.O. Box 386 H17  
 Hanford, CA 93230

[WHERE THE . . . IS HANFORD?]

Resistors now available in multiples of 5 of one value for \$.25 or 100 for \$4.25. 1/4 W 10% or better [most are 5%] 10, 22, 47, 68, 100, 150, 220, 270, 330, 470, 560, 680, 820, 1K, 1.5K, 2.2K, 2.7K, 3.3K, 4.7K, 6.8K, 8.2K, 10K, 15K, 22K, 27K, 33K, 47K, 100K, 220K, and 330K. Other values available soon. **All Prime**

\*\*\*\*\*  
 NSL 5053 Red LED with mounting clip \$.20 each or 10 for \$1.80. **Prime**

\*\*\*\*\*  
 2N3904 6 for \$1.00 **Prime**  
 2N3906 6 for \$1.00

\*\*\*\*\*  
 GE Transistors and Tubes  
 Pace & Johnson CB Equipment

\*\*\*\*\*  
 DISC CERAMIC CAPS **Prime**  
 .1MF 50V 6 for \$1.00  
 .01MF 50V 10 for \$1.00

\*\*\*\*\*  
 CA RESIDENT ADD 6% tax  
 \$.75 POSTAGE FOR ENTIRE ORDER  
 HAM CLUBSTAKE 5% DISCOUNT  
 [Order on Letterhead]  
 Please Send CHECK OR MONEY ORDER

Send For Your Copy Today!

\$2.95

## 1977 AMATEUR RADIO EQUIPMENT DIRECTORY

Featuring ham radio equipment of over 60 manufacturers, contains descriptions, pictures, specifications & prices . . . no advertisements! A must addition to every ham library. (136 pages)

**\$2.95** Postpaid (U.S.)

**KENGORE CORP — Dept. C**  
 9 James Ave. Kendall Park, NJ 08824  
 CLUB DISCOUNT 15% (MIN. 10 COPIES)

**MAIL NOW** K11

Enclosed is my  Check  MO for \$2.95  
 Please send the 1977 Amateur Radio Equipment Directory.

Name \_\_\_\_\_  
 Address \_\_\_\_\_  
 City \_\_\_\_\_ State \_\_\_\_\_ Zip \_\_\_\_\_







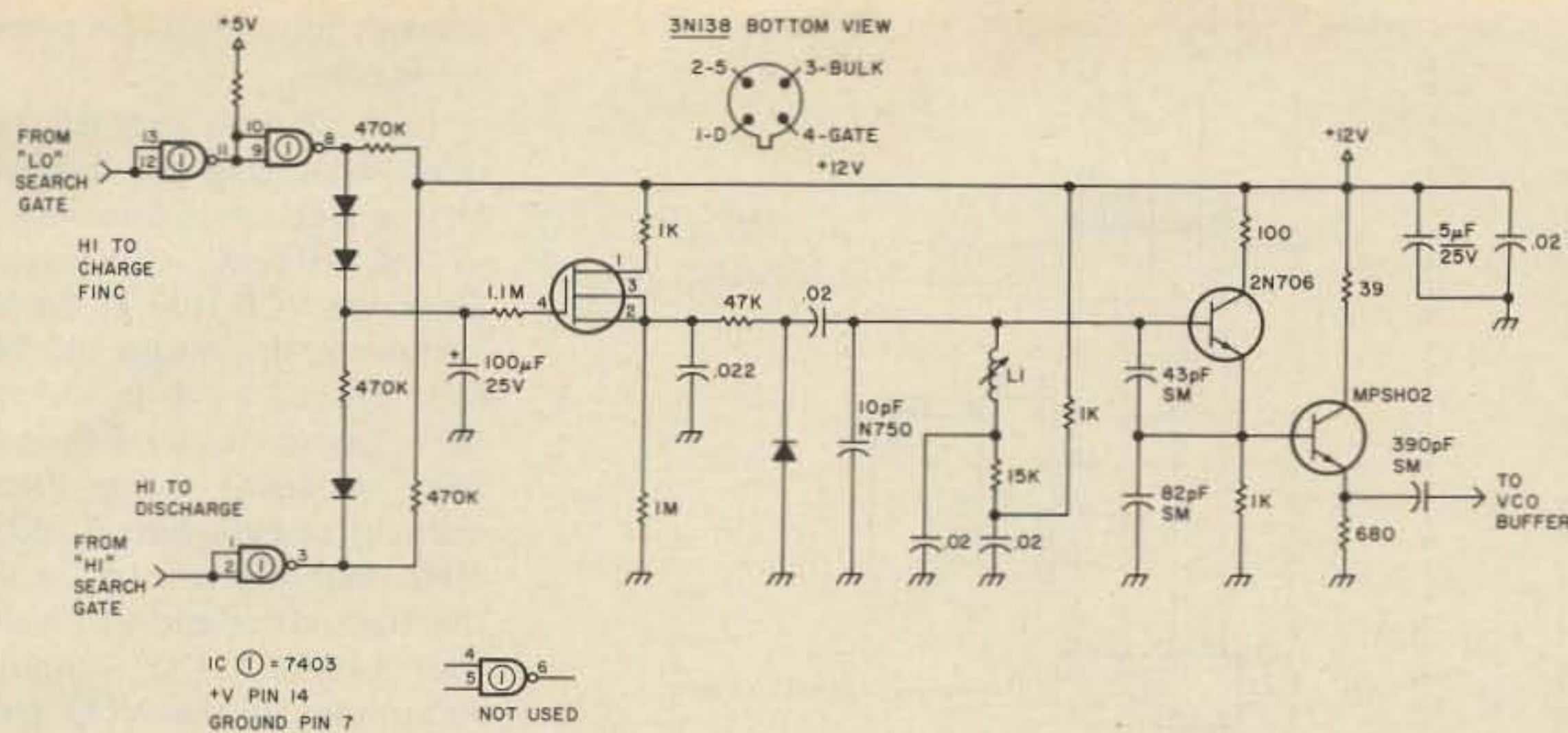

Fig. 2. VCO and "memory." L1=5½T #20 enam. ¼" form.

low cost now, and to do all this be of a divide nature (TTL) rather than multiplication type (discrete tuned circuits, bandwidth, etc.). The last requirement was going to be hard enough to do just getting the bandwidth out of the commercial strips — or so I thought.

I believe you will find it very beneficial to your success if you do things in a specific order on this project. If you already have the Motorola strip transmitter and a schematic and tune-up information on it, you are a long way along. If you have not already put it on some frequency on 2m, I suggest you do so and be sure it is all running right before you add this frequency unit. In fact, I would suggest you choose your favorite frequency and crystal up for it and leave it as F1. Then add an F2 deck modified to an amplifier as shown, so you have a backup if something fails, and a constant other normal oscillator source to compare to during the tune-up of the new unit. This way you can shift back and forth between the two sources to assure all is well during hookup.

The new unit works because it was designed very much for and around the unit it was intended to drive — the Motorola strip. Therefore, a word of introduction to that unit, and my apologies if I can't guarantee its perfect operation right off the bat

with other units. The GE tube transmitter should be a very good substitute; however, I don't have one to try it on.

The strip used was a 30 W, single 2E26 final, 1 to 3 frequency model of the PA8664 chassis type. It requires an oscillator of 6.0 to 6.166— MHz for the output frequency to fall within the 144 to 148 MHz band. It should be noted and remembered these strip units are not broadband, and the 144 to 148 MHz figures are given for the new frequency unit's normal range. The transmitter should be peaked or stagger-tuned over the range you really intend to use (i.e., the 146 to 147 MHz range for me).

It should be pointed out that this is a digital VFO (VCO? — DVFO?) unit of sorts, and as such can be used with any number of tube type transmitters — FM or not!

One of the reasons this unit works is the very scheme that Motorola uses to get from the 6 MHz oscillator region to the 2m output (high band 150 to 174 MHz in their case). The multiplication scheme on these transmitters is oscillator times 24, but it happens as oscillator, doubler, tripler, doubler, doubler, to output. This is an important fact that is causing problems working out a similar scheme for the 6m and 450 MHz gear in the same

cabinet. When you follow through the scheme I used, you will no doubt see what I mean.

The frequency unit runs a VCO oscillator in the 36 to 37.5 MHz range that is controlled the same as our "digital HFO" used on the EME BC-348s. Any VCO is dc controlled and our dc source is an FET-capacitor combination that has two separate and discrete electronic charge and discharge switches. Possibly the best part of using a dc controlled VCO is the fact that digital scanning, AFC, etc., can be added to these VCOs at a later date if desired. We don't want all this in the base FM

station, but you will be able to see how it can be done as I manage to get the "Junque" series on BC-348s completed and turned in to *73 Magazine*. In fact, you will see a lot of the same circuitry used on a more than one item basis around here. This allows "modules" to be built, and repetitive results to be obtained time and time again.

Assuming the 36 MHz VCO works for the moment, let's carry that on out to the point it can run a transmitter. The VCO is quite capable, given the proper range, to run any 6m, 2m, or 450 MHz Motorola strip station. The dial in frequency comparison is where the hitch creeps in, so let's show how the VCO works on all first. The 2m transmitter, which I have mine running for, starts at the 36 MHz VCO and goes to a TTL gate and buffer to square up the VCO output for further TTL processing. From the buffer, in the transmitter chain direction, it goes to a divide by 6 TTL IC (7492) and has an output of 6.0 to 6.166— MHz. It is best to do the divide by 6 as a divide by 3, then divide by 2, for a symmetrical square wave output. The transmitter is usually narrow enough, and the feedline to transmitter

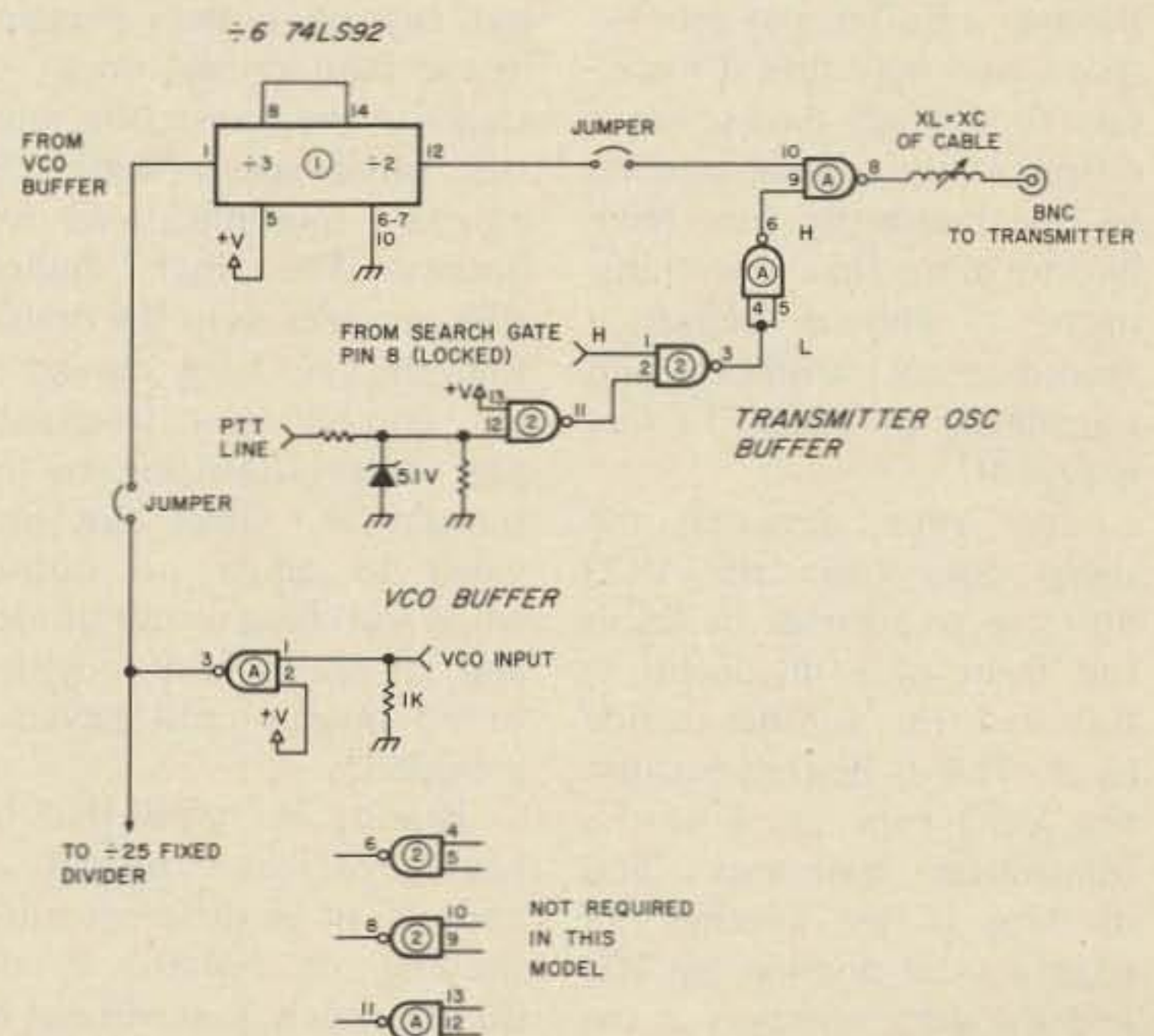

Fig. 3. Buffers and oscillator divider. IC1 — 7492; IC2 — 7400.



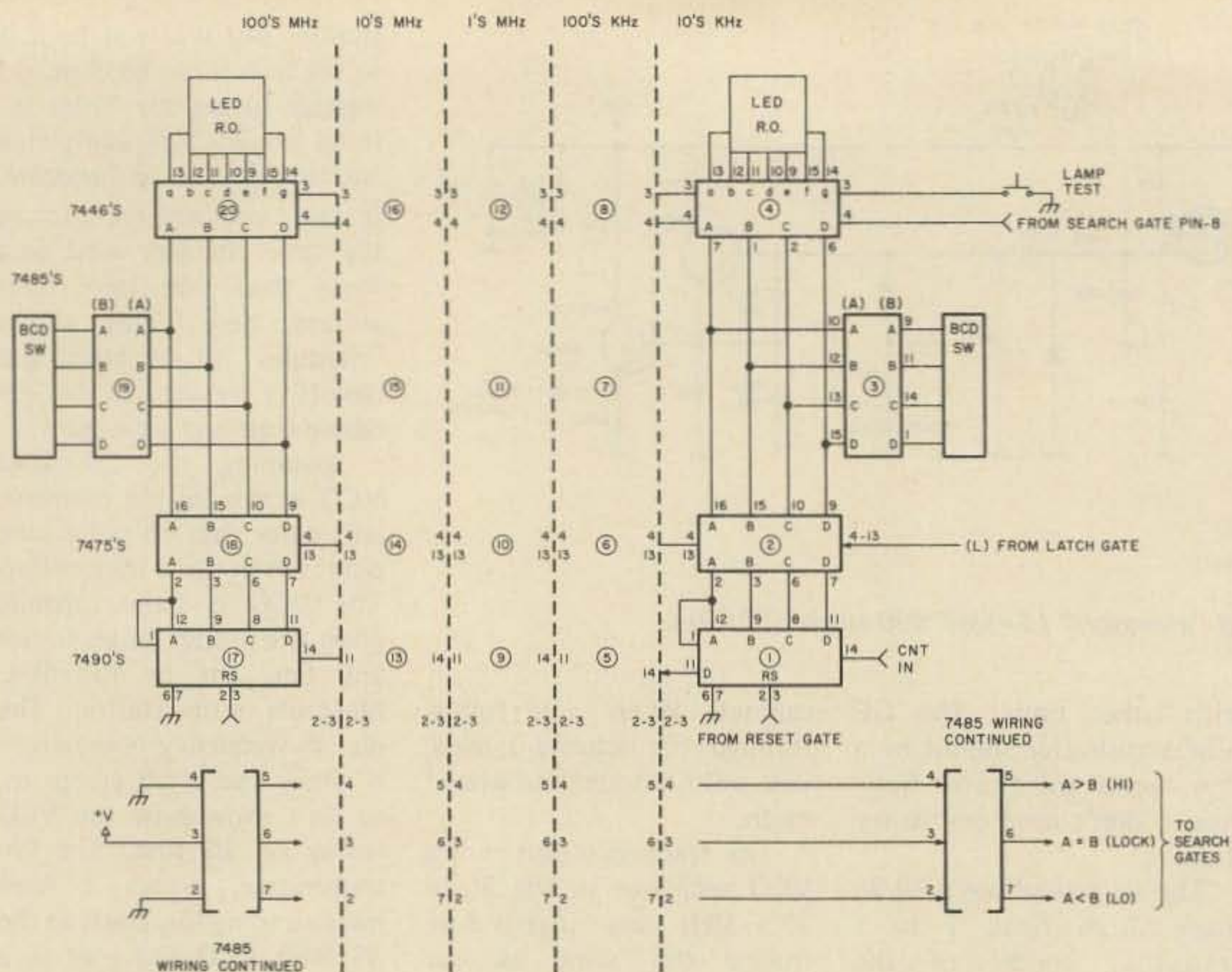

Fig. 4. Counter/comparator.

good enough, to remove the undesired harmonics of a square wave, but I did not want to chance that on a pulse type asymmetrical waveform you get from a divide by 2, then divide by 3. This is entirely unimportant for waveforms feeding more TTL, as only the high to low transition is important. The output 6 MHz signal goes through a buffer and gate for those who may find it necessary to shut off the oscillator output to the coaxial feedline to the transmitter (one feedline to more than one transmitter — choose frequency according to transmitter and transmitter by what PTT line is keyed).

The other direction the signal goes from the VCO buffer is to a divide by 25 in the form of a divide by 5, followed by another divide by 5. This is desired because the VCO runs at  $\frac{1}{4}$  of the transmitter frequency, and dividing it by another 25 gives a total division by 100 and the same numbers as the output frequency only at  $\frac{1}{100}$  the frequency. This all allows a digital comparison to

be made between this new  $\frac{1}{100}$  frequency and the BCD frequency select switches. Please note: The fact that this divided frequency and the switches match will show a "lock" condition and will run a transmitter by supplying it the proper oscillator frequency, but does *not* assure in any way that you are on frequency at the output any more than plugging in the right crystal does. All stages in the transmitter must still be properly tuned to proper multiplication frequency. The "lock" indication provides only the indication the VCO has moved to the correct new frequency and it is outputting to the transmitter. Gates are provided to allow no output while searching or out of lock and, of course, the provision of no output until keyed is included.

Bearing in mind that by keying oscillator output on and off, or to different transmitters, or holding it off during search, you will not be keying the oscillator VCO on and off, you can see that chirp and run-up is no prob-

lem. The oscillator is always running, and when it reaches proper frequency and the "lock" or transmitter ready indication shows, it merely means the oscillator output is gated on and frequency is being fed to the strip oscillator now converted to an amplifier. Some who read through the notes on this article shrieked at oscillator chirp and Class C stages running without drive in the transmitter, etc. For your, and their, piece of mind, this paragraph was added.

We are now down to the count and compare lines, and it is here the sneaky part enters. By feeding a 1.4 MHz region signal to what really is a frequency counter with a comparator added, a number that is  $\frac{1}{100}$  the output is counted. Since only the most significant 5 digits are important, that is all we count, by using a gate time of .01 second instead of 1 second. If a 1 second gate were used, the counter would overflow, too much time would be required to set up and keep comparing the VCO to keep it on frequency, and this

scheme just plain becomes less feasible.

Let's take an example to show what goes on. 146.94 MHz is a common frequency, so let's follow it through. Since the VCO runs at the  $\frac{1}{4}$  frequency, this means 146.94 MHz divided by 4 or 36.735 MHz. Divide this by 6 (to get the oscillator range frequency) and you have 6.1225 MHz. Multiply this by 24 in the transmitter and you have the 146.94 MHz output. Returning to the VCO frequency of 36.735 MHz and dividing by the fixed divide by 25 ICs, we have 1.469400 MHz to feed the counter. If you use a .01 second gate, then the counter will count and load .01 times 1.469400 MHz, or 14694 Hz. If the switches are set up for 14694, then, and only then, will the lock indication come on showing the delta dc module is not being turned on to charge or discharge, a fixed dc is being applied to the VCO, and a steady frequency is leaving the VCO that when divided by 6 is giving the right 6 MHz region oscillator signal. The nice part of all this versus frequency multipliers is that TTL division is quite fixed by the device when wired correctly. A divide by 6 is a divide by 6, etc.

You may have noted that the range of the VCO is all that limits how far you go on excursions with the VCO counter/comparator portion. Further, there is no need for fancy VHF PLLs, or dividers, or multiple PLL-mixers, etc. This alone made it worth trying for me. The very idea of an analog circuit where a digital one will work has a bad taste for me. I guess it is the fact it is so much easier to build, troubleshoot, maintain, etc., digital circuits, since everything is either on or off!

Now I mentioned earlier the idea was to run this whole thing as a digital master oscillator for all 3 bands (and later ideas of 1296 MHz FM!), but there came a few snags I am still working on. Let's take







# Selecting A Frequency Counter

## -- pitfalls to avoid

Thanks to microcircuits, there has been a major revolution in test equipment within the last few years. The prices of devices such as digital voltmeters, triggered sweep oscilloscopes, and others have dropped dramatically, a neat trick considering inflation! But more important, this excellent, low cost gear is getting into the hands of servicers and electronics enthusiasts where good equipment is both useful and necessary to cope with today's advanced products. The frequency counter has also benefitted from microcircuits and price cuts, but only recently has it begun to "take off" with electronic

hobbyists and service people. I think that this may be due to the past high prices, and a misunderstanding of what a frequency counter can do. But these things are going to change as more people are discovering what a counter can do for them!

I am going to show you some of the things to look for when you shop for a counter, and some of the not-too-obvious pitfalls to avoid. There's a lot more than specs to consider, too — all counters have special features that may be obvious or not in the advertising literature. In short, I am going to try to make your selection a better one by showing the more

important *general* features and explaining them, so you'll know what to look for. As for myself, I work for a company that makes counters, and I have to use them nearly every day. So I am in a very good position to help you!

Some of you skeptics are probably thinking, "Why do I need a counter?" A good question, indeed. Have you ever designed/built an oscillator and couldn't find the frequency? Then spent hours pruning the circuit to the proper frequency? A counter would tell you where you are at a glance. Or have you ever aligned a filter or trap or i-f stage and found that the center frequency was a city block off? A counter would help you keep tabs on the calibration of your signal generator and get a better alignment in the bargain!

Have you ever had trouble accessing the local 2 meter repeater? A counter can tune up that tone generator in a jiffy. Ditto the transmitter with a VHF counter. Or, perhaps you are a CBer and people complain that you "bleed" on several channels. This could be caused by a sick transmitter with a bad crystal(s). A qualified technician can easily check this out with a good counter. Anybody still skeptical? Remember that you can do far more with a counter if you put your imagination to work!

### A Wee Bit of History

You might be interested in how frequency counters evolved. The first method of frequency measurement evolved around the turn of the century when it was necessary to measure the frequency of radio transmitters. The gadget was called a *wave-meter* and it consisted of a paralleled coil, variable capacitor, and spark gap (later replaced with a meter or light bulb). The capacitor had a calibrated dial, and it was adjusted until a spark appeared at the gap. The frequency was either read off the dial or extrapolated from a coil/capacitor chart if the dial read pFs. By the '30s, another form of frequency measurement came into vogue: the *frequency meter*. This unit had a built-in frequency standard and the unknown was mixed with it; the meter was adjusted until the signals "zero beated" in the headphones that were part of the unit. Old-timers will no doubt recall the

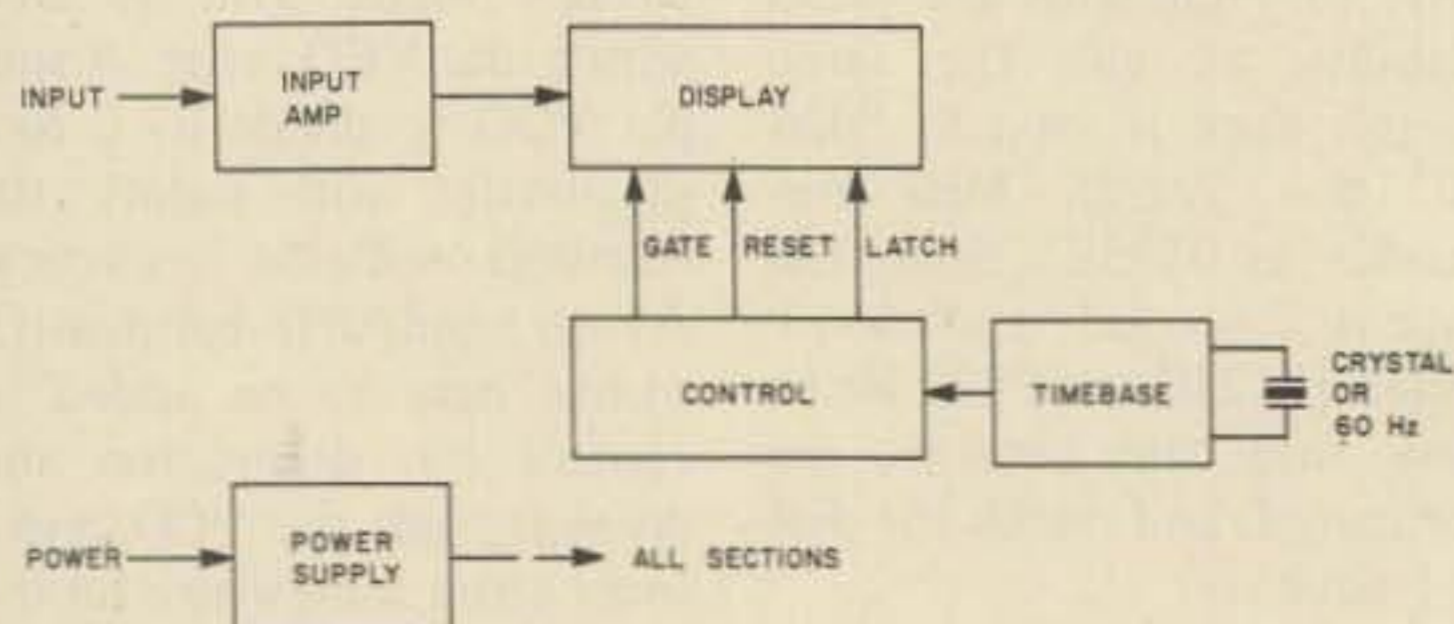

Fig. 1. Block diagram of a basic counter. The circuitry of modern counters is in ICs — mostly 20 to 30 packages of TTL.



BC-221 and LM frequency meters of WW II vintage with this mention — they were very famous! Digital electronics was the next development, and a digital frequency counter appeared in the early '50s. The first ones had 40-plus tubes, had neon lamps arranged in 0-9 columns for a readout, and were called EPUTs (Events Per Unit Time meters). The top frequency of those early counters was only a few MHz at most, although VHF range extenders appeared quickly. The early manufacturers were Berkley Scientific and Hewlett-Packard. The next step was in the '60s when ICs became available. Counters became smaller and much cheaper, too. Many companies are still using these warmed-over circuit designs today, despite advances such as CMOS. Recently, one semiconductor company has introduced a "2 chip" counter, where all of the major parts of a 6 digit counter are on 2 LSI chips! Needless to say, the future has much to hold!

#### A Look at Basic Specs

You have probably looked over enough of the ads by now to realize that selecting the right counter takes some thought and an understanding of counter fundamentals. Without these things, you could end up with a 3 digit "toy" and have to align a generator that is 10 times more accurate, or a unit that is so versatile it does everything but makes the morning coffee (extra cost option), to check a phono oscillator. So, needless to say, the way to start is to sit down and analyze *your own needs*. Ask yourself such questions as, "What am I going to use a counter for?" and "What do I expect to be doing with my counter within a few years?" These questions will help you decide the *primary* features that you must have in the counter you select.

For example, suppose you are an experimenter and you

like to work with audio circuits and TTL logic. This suggests that you should start looking for a counter with a 20 MHz maximum range, because that is probably the highest frequency you are working with (frequency limit of standard TTL). Accuracy probably isn't critical to you and you might be able to settle for a unit that is 0.03% accurate.

Or perhaps you are a professional servicer and you are getting into CB repair. Your requirements are more strict. Since CB is 27.255 MHz maximum, you need one of the popular 30 MHz counters. Also, you need a counter that is 0.001% or "10 parts per million" (abbreviated 10 ppm) accurate to satisfy FCC requirements.

Consider the future, too. If the experimenter upgrades to, say, CB, he'll need a faster counter. But there are devices such as *prescalers* to extend the range of counters at low cost. So, when the day arrives, he might only have to add a low cost black box to his counter.

On the other hand, if the servicer upgrades to commercial radio repair, he may have to replace the counter. Why? The frequency tolerance of commercial gear is often 0.0005% and that requires a counter of 0.00001% or 1 ppm. That spec is 10 times better than the old unit's! These are a few thoughts to keep in mind when you start your search for the right counter. Try to anticipate the future!

Let's list the primary specs of a frequency counter and then discuss them. *Note:* They are not necessarily listed in order of importance.

1. Accuracy
2. Input sensitivity
3. Minimum and maximum frequency range
4. Display
5. Power supply
6. Special features or options

#### Accuracy

The accuracy of a fre-

quency counter is determined by a quartz crystal or sometimes the ac power line (60 Hz). Fig. 1 shows a block diagram of a simple frequency counter. As you can see, the crystal/60 Hz is divided in frequency to operate the rest of the counter; this entire section is called the *timebase*. The timebase (or TB, for short) is the heart of the counter and its accuracy determines the accuracy of the counter. Price is also a function of the quality of this section. You'll

find counters that use the 60 Hz line as a frequency element that sell for up to \$150, and you'll see units that have crystals in *ovens* (temperature stable enclosures) that sell for \$6000 or more. The difference in accuracy is incredible: The 60 Hz TB counter will average 0.034% accuracy, the average accuracy of the 60 Hz coming out of the wall, to 0.0001% and better for the crystal oven unit! This is clearly one area where money talks. Typical counters run 0.005%

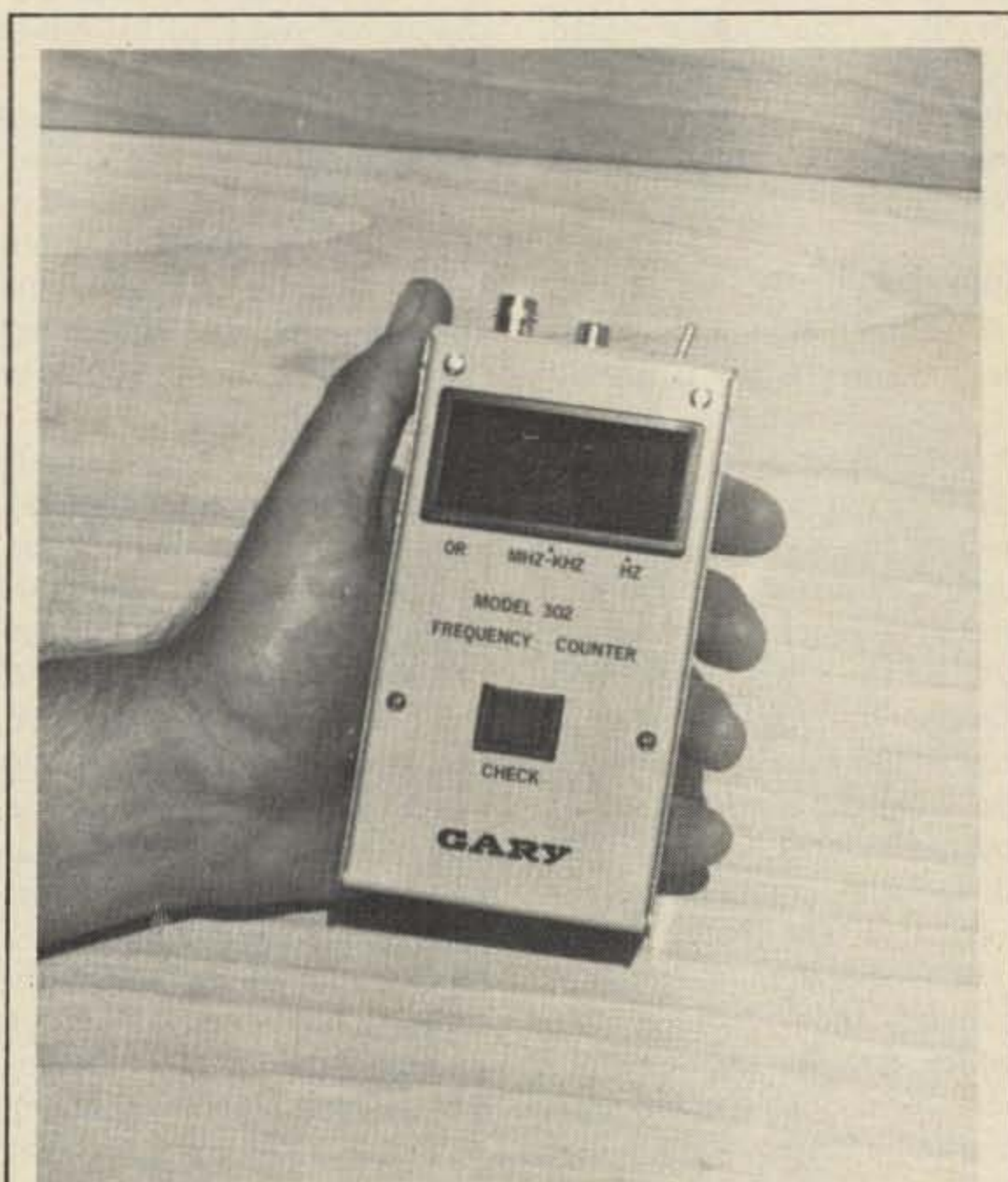

*Inside a Modern Counter*

*The frequency counter is still undergoing some changes, as this photo of the Gary Model 302 Pocket Counter shows. You are looking at a 20 MHz, 4 digit unit that can be expanded to show up to 6 digits of readout. Power consumption is under 0.63 Watt, as compared to the 5 to 7 Watts required by a comparable TTL unit. The secret of this unit is hybrid construction of CMOS and TTL logic. The heart of this unit consists of 3 CMOS/LSI chips. The DCU section which many hobbyists would build with 12 or more chips is contained in one special CMOS IC. The timebase section has two more CMOS ICs, replacing at least 6 TTL chips. The front end or Schmitt trigger deserves special attention because the input amplifier is the hardest part to design in a counter. This one has an FET amplifier and a biased NAND gate that serves as a Schmitt trigger. Sensitivity is excellent — 50 mV at 20 MHz with this arrangement. As you can see, counters have changed quite a bit, and they will continue to do so as more people continue to show so much interest in them.*



(50 ppm) to 0.001% (10 ppm). They use 4 MHz or 10 MHz crystals without ovens for low cost. These crystals are usually custom ground and the TB is carefully adjusted to get this degree of accuracy.

When you shop for a counter, try to get a counter with as much accuracy as you can to suit your needs. Remember you need at least a 10 ppm timebase for CB repair work, if that is your interest. The 60 Hz units are not for serious electronics work; 0.034% accuracy is terrible in the counter world. Anyhow, the few units available with these may be off the market by the time you read this!

### Input Sensitivity

Another sign of a counter's quality is the sensitivity it has to measure the frequency under question. Fig. 1 shows an *input amplifier*, the section that has to do with the input sensitivity, and Fig. 2 shows a block diagram. The job of the input amplifier is simple: It amplifies the input signal and converts the signal to a corresponding set of pulses that is necessary to drive the counter's digital circuitry. The heart of the unit is the *Schmitt trigger*; it converts the incoming signal, which may be any kind of a waveform, into the necessary digital square wave. Generally, when you read input sensitivity specs, you must assume that the sensitivity refers to the minimum signal required at the maximum rated frequencies of the counter to get a steady reading. In other words, the specs

are worst case. Generally, the sensitivity of most counters is not flat over frequency, hence the min-signal-at-max-frequency bit. Fig. 3 shows the sensitivity plot of the Gary Model 301 Counter, a 32 MHz unit. As you can see, the input sensitivity is not flat! But in this case, a non-flat sensitivity curve can work to your advantage: The high gain at audio frequencies allows use of devices such as microphones and magnetic pickups for organ tune-ups and tachometers. The lower gain at 32 MHz reduces the chance of overload by radio transmitters, too.

Typical input sensitivity is on the order of 10 mV to 120 mV for most counters. It is desirable to get a counter with slightly more than enough sensitivity to do the job; in most labs, 100 mV worst-case does fine.

You will also find a maximum input voltage spec on some units. This refers to the maximum voltage you can apply to the counter without damage. This is always the *peak* ac signal plus any dc that may be present in the signal. For example, suppose you are measuring the signal of a homemade oscillator directly at the collector of the output transistor. You have, say, 9 volts dc at this point, plus, say, a 6 V peak-to-peak signal: You are applying 9 V dc + 3 V peak or 12 volt worst case to your counter! Fig. 4. illustrates this. This spec isn't really important to you unless you work around high voltage tube circuits and moderate to high power transmitters. In this case, there are counters built with

range switches (usually calibrated x1, x10, x100, etc.) for use around high voltages. Typical maximum voltages are 20 to 100 volts for counters without range switches and 500 volts for the ones with them. These voltages are rated at a counter's maximum rated frequency, where the maximum input voltage must be reduced to prevent damage to the input amplifier. At low frequencies, such as 60 Hz, most counters will handle 120 V ac without problem.

### Min/Max Frequency Range

This is probably the most advertised feature of frequency counters. Everywhere you look you are bombarded with ads screaming, "30 MHz Counter," "80 MHz Counter," "Or How About A 250 MHz Counter . . ." and so on. Yet top frequency isn't all that important. A 30 MHz counter measures a 27 MHz signal as readily as an 80 MHz unit or even a 250 MHz unit or above. Yet, the price difference between these models can be at least several hundred dollars. All you are getting for the extra money of a faster counter is a unit with more capability. And that's fine if you sometimes need a counter to measure VHF signals; otherwise you can save money if you stick to a lower cost, lower frequency counter that will read the maximum frequency you expect to be working with. Remember, too, that low cost prescalers are available that

divide the input signal by 10, so you can have your cake and eat it too! (Gary McClellan and Company now offers two counters with built-in prescalers. — Ed.)

An often ignored spec is the minimum frequency a counter will display. This depends upon the timebase and the sensitivity of the input amplifier. In order to get any accuracy from a counter when measuring slow signals, at least 10 Hz must be displayed on the standard MHz range switch set to *kHz* (actually 1 second gate time). Why? All counters have a built-in  $\pm 1$  count inaccuracy due to the circuitry. That's 10% of 10 Hz — in other words, your 10 Hz is 10% accurate! Also, TB errors show up in these digits, and can worsen or even improve accuracy at this point. The input amplifier sensitivity may drop at this point, too, making it hard to pick up low frequency signals. It's safe to say that the low frequency limit of most counters is 50 Hz for good accuracy (5x the minimum frequency is good test equipment practice) even though the counter will read lower frequencies. If you do a great deal of measuring at low frequencies, you should consider a counter with a 10 second gate time, or a unit with a frequency multiplier, notably the Heath IB-1103. They will give you a display such as 60.1 Hz (10 sec TB) or 60.030 Hz (IB-1103).

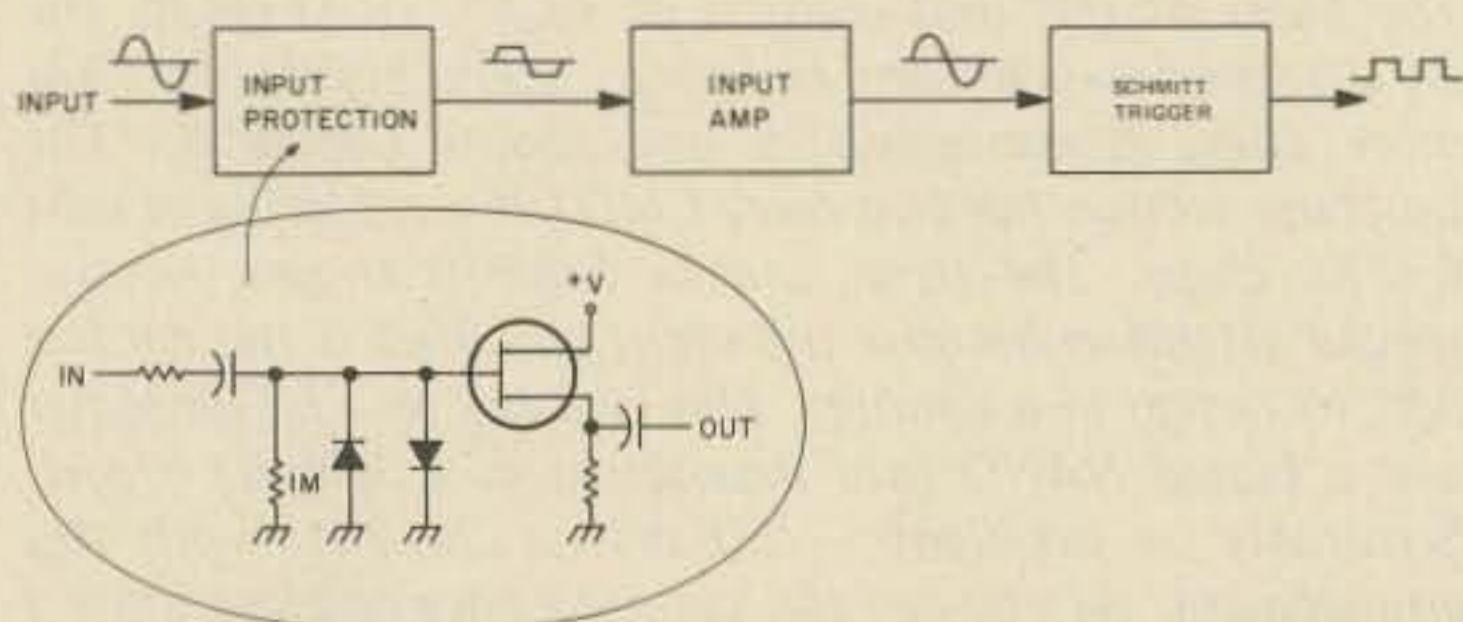

Fig. 2. Expanded drawing of input amplifier and a rough schematic of a typical input circuit.

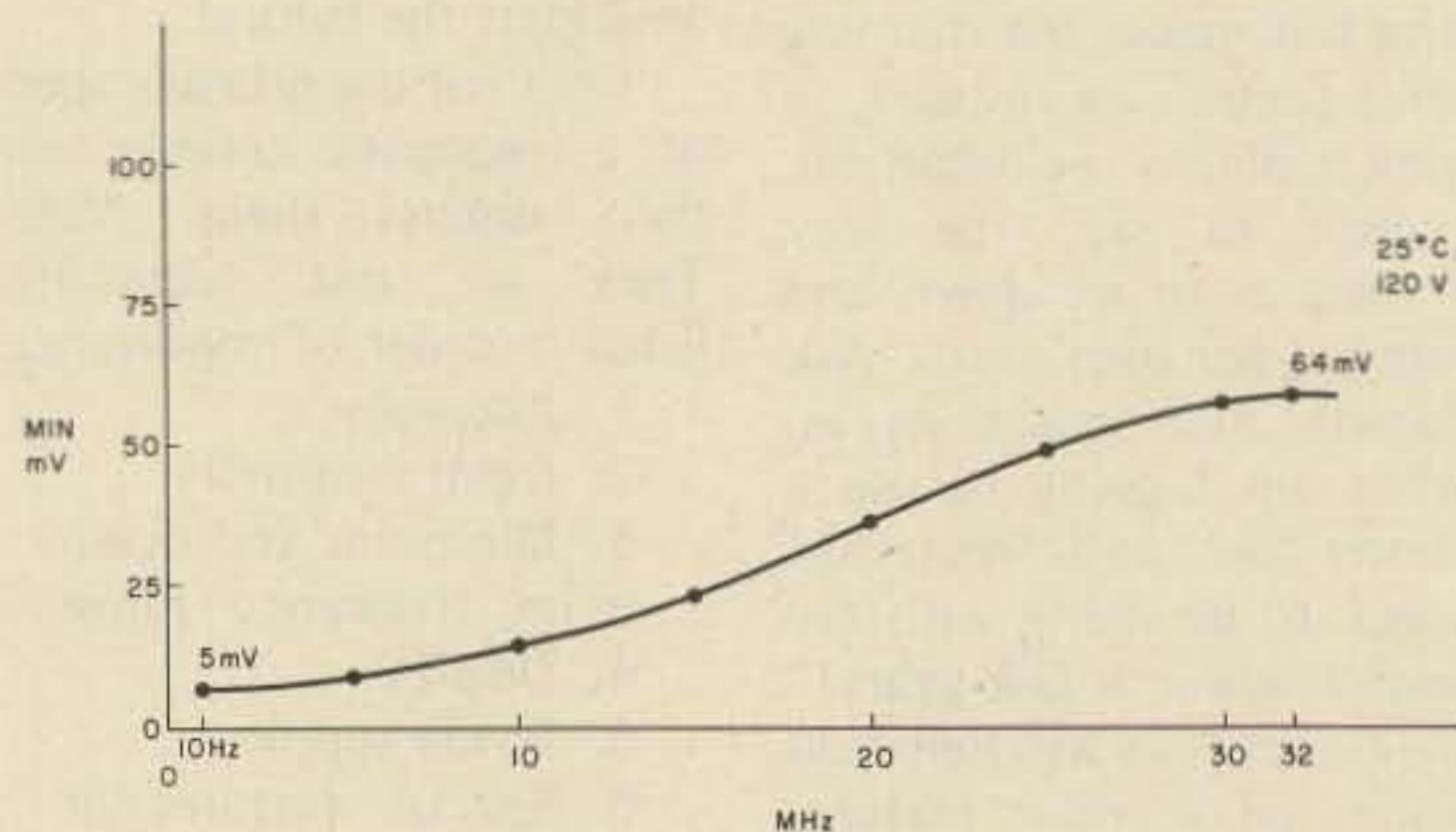

Fig. 3. Input sensitivity of a commercial counter. This plot shows the minimum voltage required to get a stable reading on the counter.



## Display

The display on a counter can have a powerful bearing on whether you buy a certain model or pass it up. Important things here are the appearance of the digits and the number of them. LED type displays currently reign supreme in counters, so this is mostly what you'll see. Nixie tubes are seen in some older ac-only counters, but their use is dying out. Liquid crystals show promise for the future, because they don't require the high current of LEDs and the high voltage of Nixies. When you shop, look for the largest and brightest display you can get, but do not let the appearance of the display bias your thinking: Accuracy and sensitivity are far more important in determining your choice.

The number of digits should be considered, also. As a rule of thumb, five to six digits are about the optimum number. Fewer (such as the three digits found on an inexpensive kit) require complicated range switching or more knob turning for you. And more digits can be confusing to read. Ever see 146.96 MHz read out on a large counter as 146960001 Hz? It's very confusing at times. Also, large digit counters consume larger amounts of power; consider that if you are buying an ac/battery model!

## Power Supply

Some counters offer you

different ways to power themselves, often at no extra cost. The most common power source is 120 volts, 60 Hz. You'll find many units that can be wired for 240 volts ac, but you may have to check the operator's manual to find this out. There are also counters that have 120 V plus 12 V dc connections. You can often plug them into a cigarette lighter for working on mobile electronics. A few battery operated counters are becoming available, but at present none have the full features of the other models.

## Special Features/Options

A whole plethora of special features are available on counters. Switching ranges from a simple kHz/MHz switch to a full blown range switch of 0.01 ms to 10 sec. Inputs range from simple jacks to complicated attenuators and trigger level controls. Input impedances may be different, too. You'll find the standard 1 meg plus 10 to 50 pF input and a straight 50 Ohm input (for VHF) on some units. Some of the more expensive units have timers/stopwatches and time interval measuring features built in. And the list could go on. Base your selection on what features you really need and not what looks nice. It makes no sense to buy a \$300 counter/timer, then use the timer once and spend the rest of the time measuring frequency!

Most options can be quite

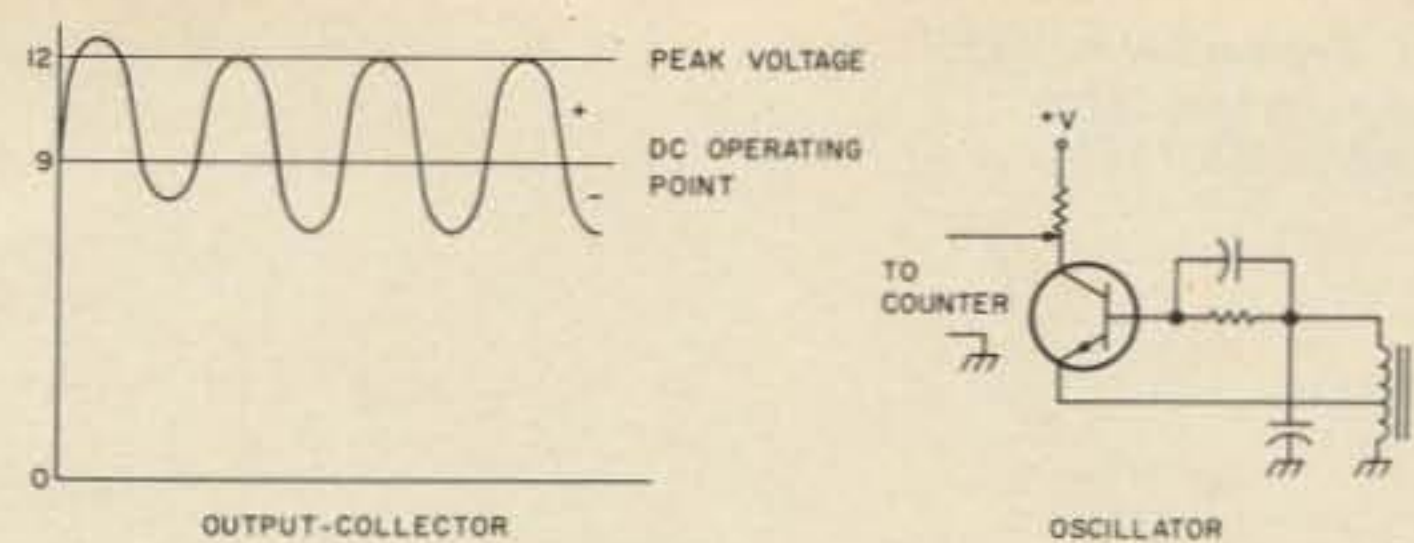

Fig. 4. Calculation of peak or worst case voltage that could appear across a counter input. Note sample circuit.

useful. Some popular options include frequency range extenders, high stability TBs, power cords, etc. Also, don't overlook good probes and cables. A x10 scope probe is often used with the standard 1 meg input counter and will increase the maximum input voltage 10 times, preventing overload in most cases, and making connection to the equipment under test much easier. Needless to say, this is a very handy option and one that you should consider! If you feel that you must go for options, try to anticipate future needs. Sending a counter back to the manufacturer for modifications at a future date is usually much more expensive than ordering everything at the same time.

## Some Pitfalls

Let's wrap this discussion of counters up by briefly mentioning some pitfalls that can trap you. In the past sections, I have mentioned problem areas and pointed out ways to avoid them. But here are some of the other areas to watch. Accuracy specs are sometimes hard to find on a counter data sheet,

and when you do find them, they may not be complete! Although the data sheet may say "Accuracy: 10 ppm," nothing is said about the temperature or supply voltage, all of which affect the accuracy slightly. If accuracy is important to you and you are in this situation, it may pay to contact the manufacturer. Input amplifiers also have questionable areas. The input circuit of counters without attenuators should have an overvoltage protection network, usually diodes. Check. If the counter doesn't have one, avoid it or you'll be doing a lot of repair work on the counter! Finish up your evaluation by looking over the counter for any other features that you think will cause trouble.

If possible, try to get a "hands on" demonstration of the unit you select. Make sure that everything works to your satisfaction, and that the counter lives up to your expectations. With the information I have given you, the selection should be easier, as you should be aware of the basic things to look for in a counter. Good hunting! ■

Manufactured & Guaranteed by  
MOR-GAIN  
2200T South 4th Street  
Leavenworth, Kansas 66048  
(913) 682-3142

# MOR-GAIN

BankAmericard and Mastercharge available

Fully Air Tested - Thousands Already in Use

#16 40% Copper Weld wire annealed to it handles like soft Copper wire - Rated for better than full legal power AM/CW or SSB-Coaxial or Balanced 50 to 75 ohm feedline - VSWR under 1.5 to 1 at most heights - Stainless Steel hardware - Drop Proof Insulators - Terrific Performance - No coils or traps to break down or change under weather conditions - Completely Assembled ready to put up - Guaranteed 1 year - ONE DESIGN DOES IT ALL.

## EXCLUSIVE 66 FOOT, 75 THRU 10 METER DIPOLES

### NOTES

1. Models prefaced '\*\*\*' will be available 1/77.
2. All models above are furnished with crimp/solder lugs.
3. All models can be furnished with a SO-239 female coaxial connector at additional cost. The SO-239 mates with the standard PL-259 male coaxial cable connector. To order this factory installed option, add the letter 'A' after the model number. Example: 40-20 HD/A.
4. 75 meter models are factory tuned to resonate at 3950 kHz. (SP) models are factory tuned to resonate at 3800 kHz. 80 meter models are factory tuned to resonate at 3650 kHz. See VSWR curves for other resonance data.

MODEL	BANDS (Meters)	PRICE	WEIGHT (Oz/Kg)	LENGTH (Ft/Mtrs)
40-20 HD	40/20	\$49.50	26/7.3	36/10.9
**40-10 HD	40/20/15/10	59.50	36/1.01	36/10.9
80-40 HD	80/40 + 15	57.50	41/1.15	69/21.0
75-40 HD	75/40	55.00	40/1.12	66/20.1
75-40 HD (SP)	75/40	57.50	40/1.12	66/20.1
75-20 HD	75/40/20	66.50	44/1.23	66/20.1
75-20 HD (SP)	75/40/20	66.50	44/1.23	66/20.1
75-10 HD	75/40/20/15/10	74.50	48/1.34	66/20.1
75-10 HD (SP)	75/40/20/15/10	74.50	48/1.34	66/20.1
**80-10 HD	80/40/20/15/10	76.50	50/1.40	69/21.0

## NO TRAPS—NO COILS— NO STUBS—NO CAPACITORS

MOR-GAIN HD DIPOLES... • One half the length of conventional half-wave dipoles. • Multi-band, Multi-frequency. • Maximum efficiency - no traps, loading coils, or stubs. • Fully assembled and pre-tuned - no measuring, no cutting. • All weather rated - 1 KW AM, 2.5 KW CW or PEP SSB. • Proven performance - more than 15,000 have been delivered. • Permit use of the full capabilities of today's 5-band xcvs. • One feedline for operation on all bands. • Lowest cost/benefit antenna on the market today. • Fast QSY - no feedline switching. • Highest performance for the Novice as well as the Extra-Class Op.

Write or phone for full information or contact your favorite dealer.

M11



counter.<sup>1,2,3</sup> This is entirely adequate for most uses an amateur has, but I wanted better performance at audio frequencies. This article describes the frequency scaler I came up with and details the design process I went through in achieving the final circuit. If you are interested only in the final product, please feel free to skim the article for details. But if you'd like to "look over my shoulder" to watch the design evolution, perhaps you can benefit from my experiences in your own ham projects.

# Build A

## Multiplying Prescaler

- - adds value to any counter

### Project Goals

What I wanted was a circuit to use with a counter to enable me to measure audio frequencies of 20 Hz or higher to within 0.1 Hz or so. For example, a widely used subaudible squelch tone is 114.8 Hz. I wanted to be able to measure this frequency and know that it was 114.8 Hz and not 114.7 or 114.9. The basic unmodified K20AW counter will not do this. Its maximum resolution is 1 Hz. This is so because in the Hz mode it counts the number of cycles that occur in one second (see Fig. 1). Therefore, it would read 114 or 115 Hz because only that many cycles occurred. Being digital in nature, it cannot resolve fractions of cycles. (Because of the rounding off error of the gate there is a  $\pm 1$  count uncertainty. Unless otherwise specified, this will

For several years I've been fascinated by tone signalling like subaudible squelch, touchtone,\* tone burst and sequential tone paging systems. If I had been rich or lazy, I probably would have bought commercial modules for my experimentation, but since I am neither, I've been trying to build my own. One large advantage in

buying any electronic device is that one needs a minimum of test equipment to get it working. However, if you "roll your own," the more sophisticated the performance you want, the more sophisticated your test equipment must be. Like most home experimenters, I have an oscilloscope and VOM and have managed to acquire an audio oscillator, power supply and ac millivoltmeter at

relatively low cost at local hamfests. The one piece of gear I've been badly lacking is a frequency counter. Fortunately, there have been numerous construction articles for them in the last ten years in the ham and hobbyist magazines. The one I built is similar to the K20AW

\*AT&T trademark.

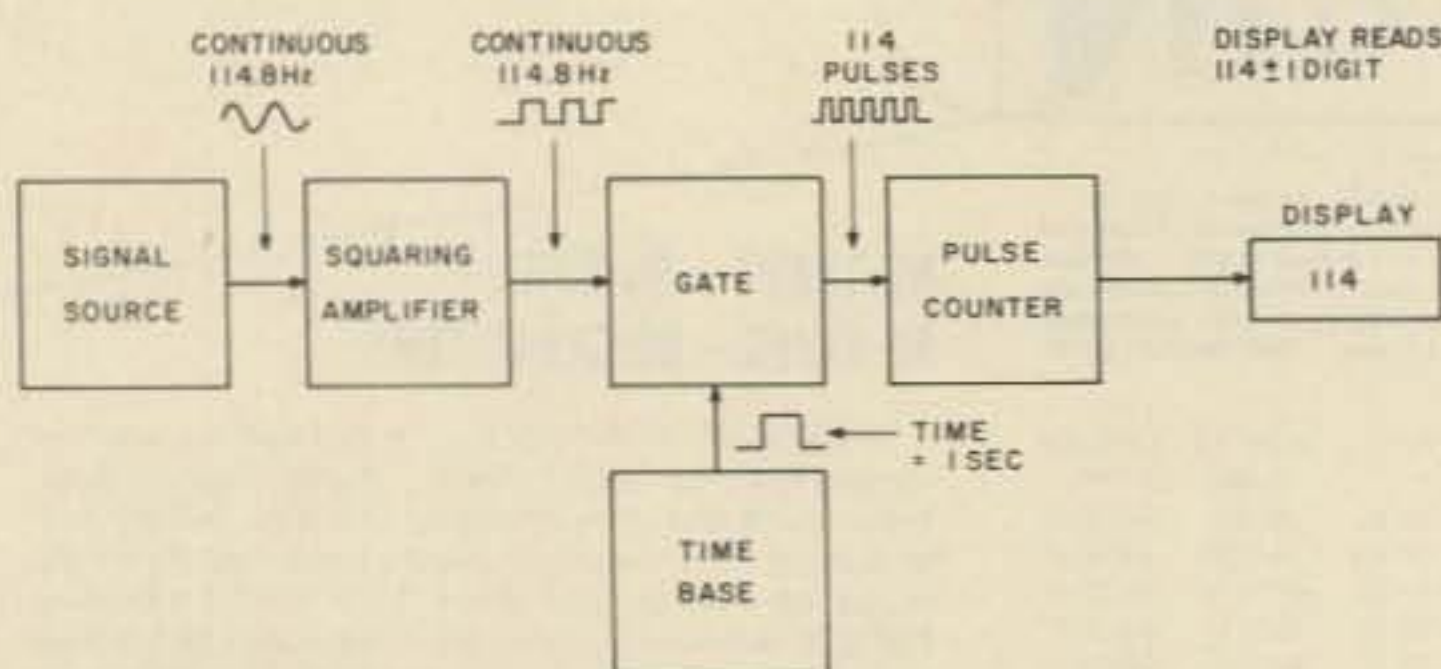

Fig. 1. K20AW counter in Hz mode. Gate opens for 1 second, allowing 114 pulses to be registered in pulse counter and displayed.

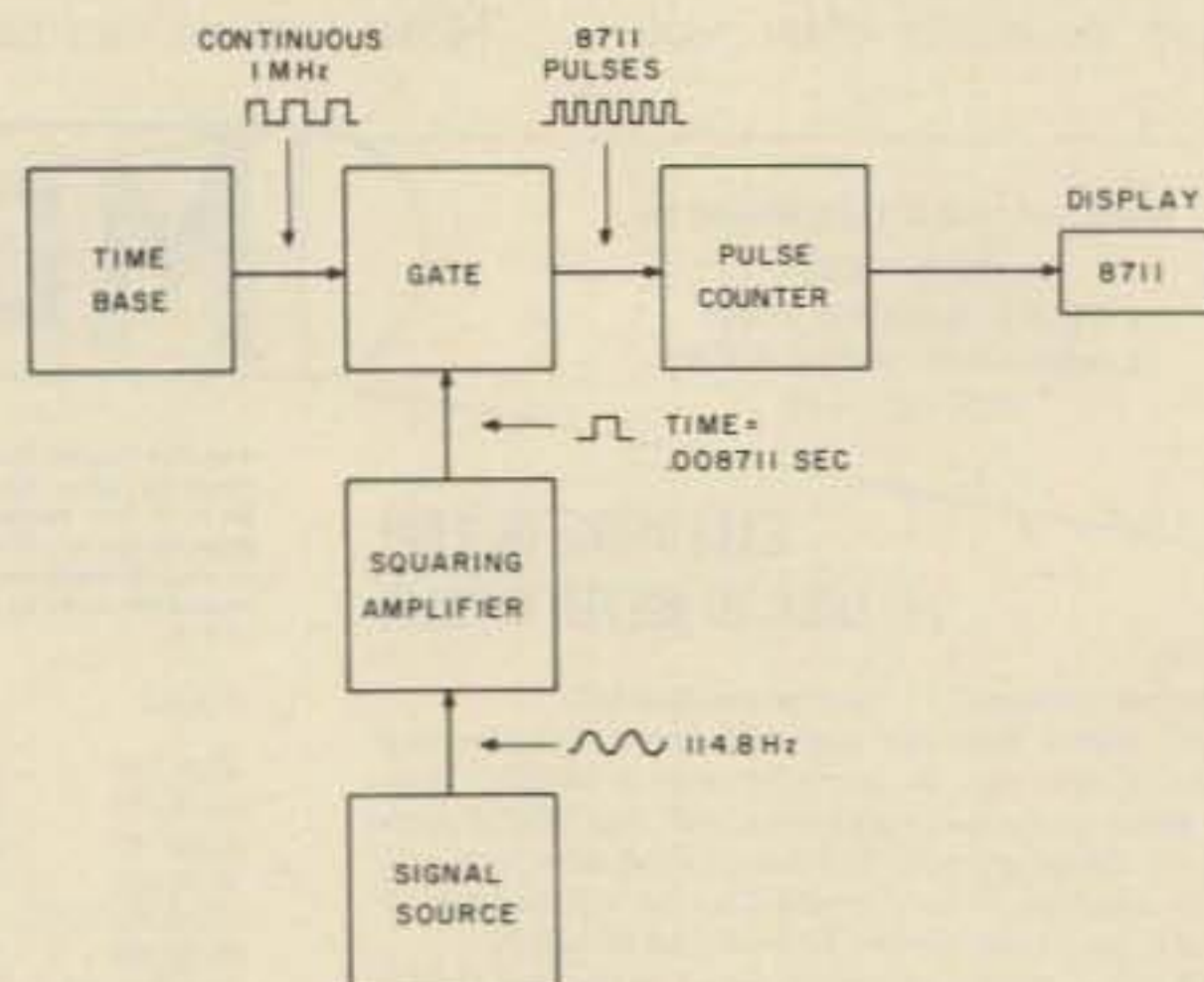

Fig. 2. High resolution can be obtained by measuring the input signal's period rather than its frequency.



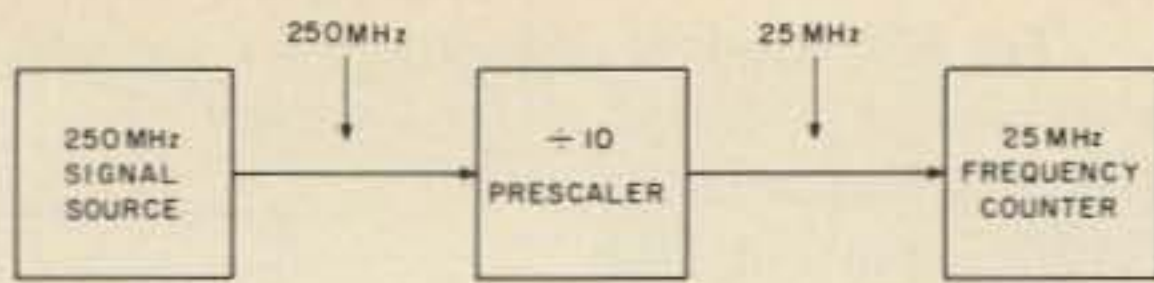

Fig. 3. Using a (dividing) prescaler to extend the high frequency capability of a simple counter.

be assumed for the rest of this article.)

The simplest method of gaining added resolution is to allow the gate of the counter to remain open longer so that it will pass more pulses. To get 0.1 Hz resolution means that the gate would have to allow 1148 pulses to go through; thus the gate time would be 10 seconds rather than 1 second. This approach works and has been used in frequency counters for years. But 10 seconds is a long time to wait for a reading. In fact, in the K2OAW counter, the update would take 20 seconds because of the nature of the gate circuitry. When you're setting an oscillator or filter on frequency, a 20 second wait between adjustments seems like an eternity. Needless to say, this simple method was not what I wanted.

Another way of quickly getting good resolution is to sort of turn the counter around. Instead of allowing the timebase to open the gate and pass the incoming signal to the counter section to be counted, it is possible to open the gate in response to the incoming signal and then pass pulses from the timebase to the counter section. Fig. 2 shows this setup. Here the input to the gate is a 1 MHz square wave from the counter's timebase. The input signal opens the gate, allowing the 1 MHz signal to pass to the counter section. At 114.8 Hz, the gate opens for  $1/114.8 = 0.008711$  seconds, allowing 8711 pulses from the timebase to be counted and displayed. This setup measures the *period* of the signal source in microseconds. To get frequency, you have to take the reciprocal of the period. So,  $1/0.008711 = 114.79738$ , according to my

pocket calculator. Rounding off to the nearest tenth of a Hertz, we get 114.8 Hz. The period method, as presented, gives the required resolution, and gives fast reading updates, but it doesn't give a readout directly in frequency. Numerous commercially available frequency counters measure period. It can be handy to measure time, but it's awkward for frequency measurements.

Some frequency counters, like the Heathkit SM109 and the HP 5360 get around this problem by adding a "brain" to the basic counter. They are called "computing counters" and include logic circuits between their counter and display sections. The logic circuits take the reciprocal of the period and display a frequency readout directly. Anyone so inclined could interface a microprocessor or cheap calculator chip to perform the inversion. One brave soul has done just that.<sup>4</sup> His combined frequency counter, calculator, etc., is an elegant way to build a computing counter. But I already had a frequency counter and didn't need a little computer, too.

The scheme I finally decided on is analogous to the method used to extend the high frequency range of an inexpensive frequency counter. This scheme is known as prescaling. K2OAW used the prescaling technique to enable his 25 MHz counter to read up to 250 MHz. The method is shown in block diagram form in Fig. 3. The frequency counter won't operate by itself much above 25 MHz, because the ICs used operate too slowly. The prescaler, however, uses a special divider IC which will operate up to 250 MHz and produce an output at 1/10 of

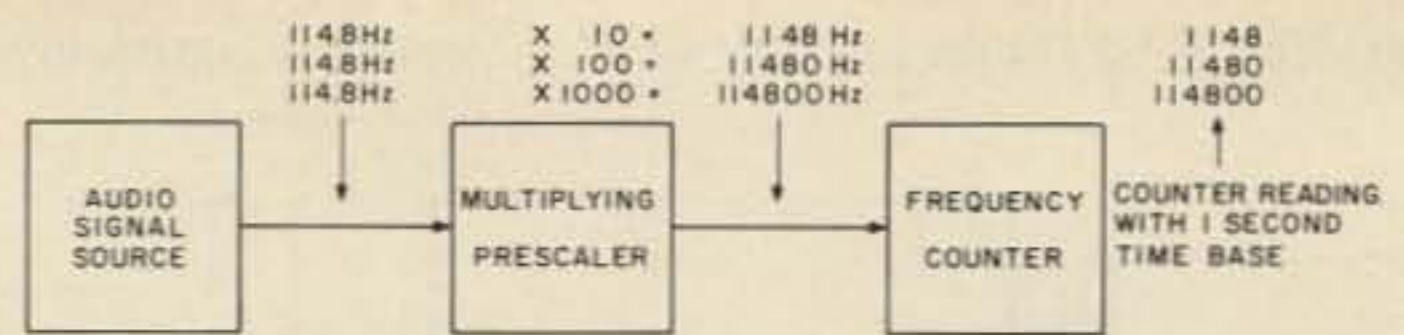

Fig. 4. Using a multiplying prescaler to improve measurement resolution at low frequencies.

the input frequency. Thus, for 250 MHz input, the output is at 25 MHz, which the basic counter can handle. The price paid for this frequency range extension is in measurement resolution. If the input to the prescaler is 200,000,001 Hz, its output would be 20,000,000.1 Hz. With one Hertz gating, the 1/10 Hz digit would be lost, so the best resolution of this counting method would be 10 Hz at 200 MHz.

What does this loss of resolution at VHF have to do with added resolution at 20 Hz? That's simple. To gain low frequency resolution, we use a prescaler that multiplies the input frequency instead of dividing it. Fig. 4 illustrates the use of a multiplying prescaler. If the prescaler multiplies the input frequency by 10, the last digit of the output frequency corresponds to 1/10 Hz of the input frequency. Similarly, a x100 multiplier has an output corresponding to 1/100 Hz in the last digit. If the frequency counter uses a one second gate, then, a x10 multiplier gives 1/10 Hz resolution, x100 gives 1/100 Hz, and x1000 allows you to see 1/1000 Hz as the last digit of the input frequency. No sacrifice in counting speed is incurred, and the only arithmetic involved is remembering where the decimal point

has to be placed in the counter's display. I wish I had thought of this method first so that I could patent it, but I'm years behind the test equipment industry. Systron-Donner and others for several years have manufactured frequency counters that use the same principle.

Now then, how do we multiply the input frequency by the right factor? Well, one way involves the use of a phase locked loop (PLL). Fig. 5 shows the block diagram of such a multiplying loop. The input signal is compared in phase with a signal from the divider shown, to produce an error output voltage. This voltage, in turn, is filtered and applied to a voltage-controlled oscillator (VCO). This voltage tends to retune the oscillator so that the output of the phase comparator is minimized. The net effect is to keep the frequencies of the two phase comparator inputs identical, but with a slight phase difference. The output of the VCO, however, is at 10 (or 100 or 1000) times the input frequency, and its frequency is locked to the input frequency. Thus, if the input is 114.8 Hz and a ÷10 divider is used, the VCO output is 1148 Hz, which is exactly the desired result. The above is an exceedingly oversimplified description of PLL operation, but it should

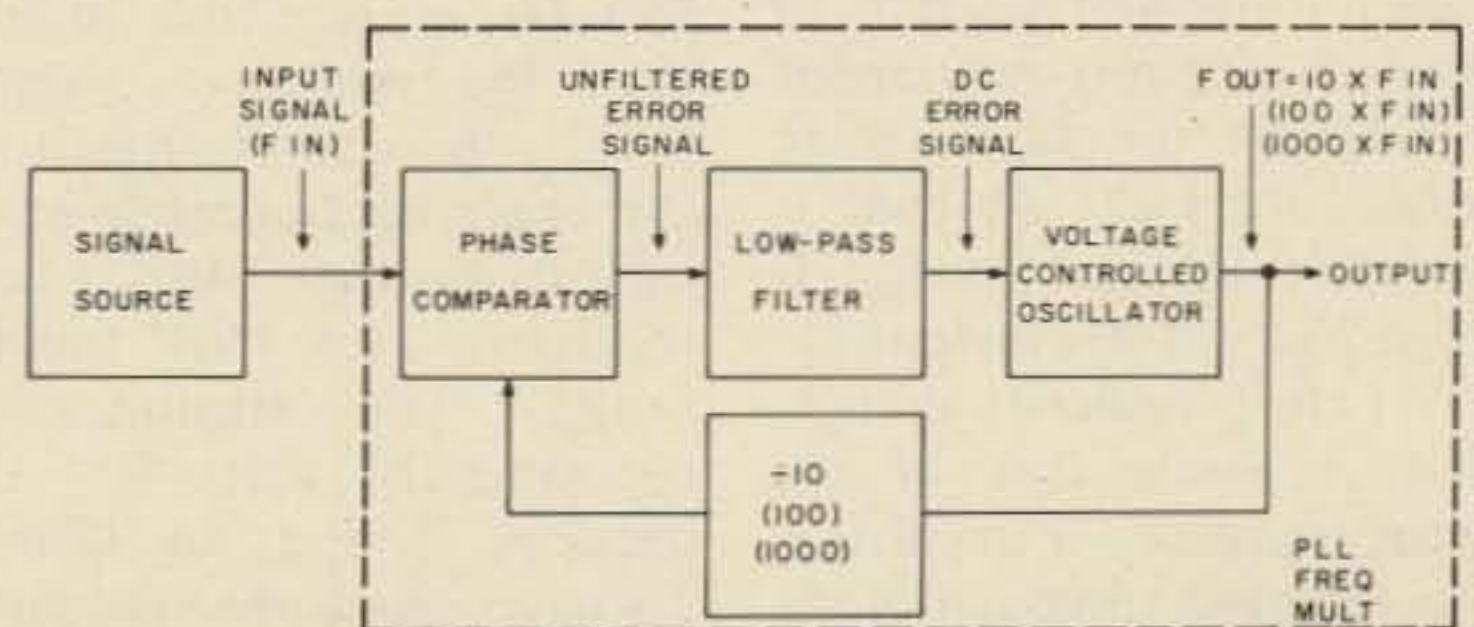

Fig. 5. Phase locked loop frequency multiplier.



Fig. 6(a). First circuit attempt of PLL frequency multiplier.

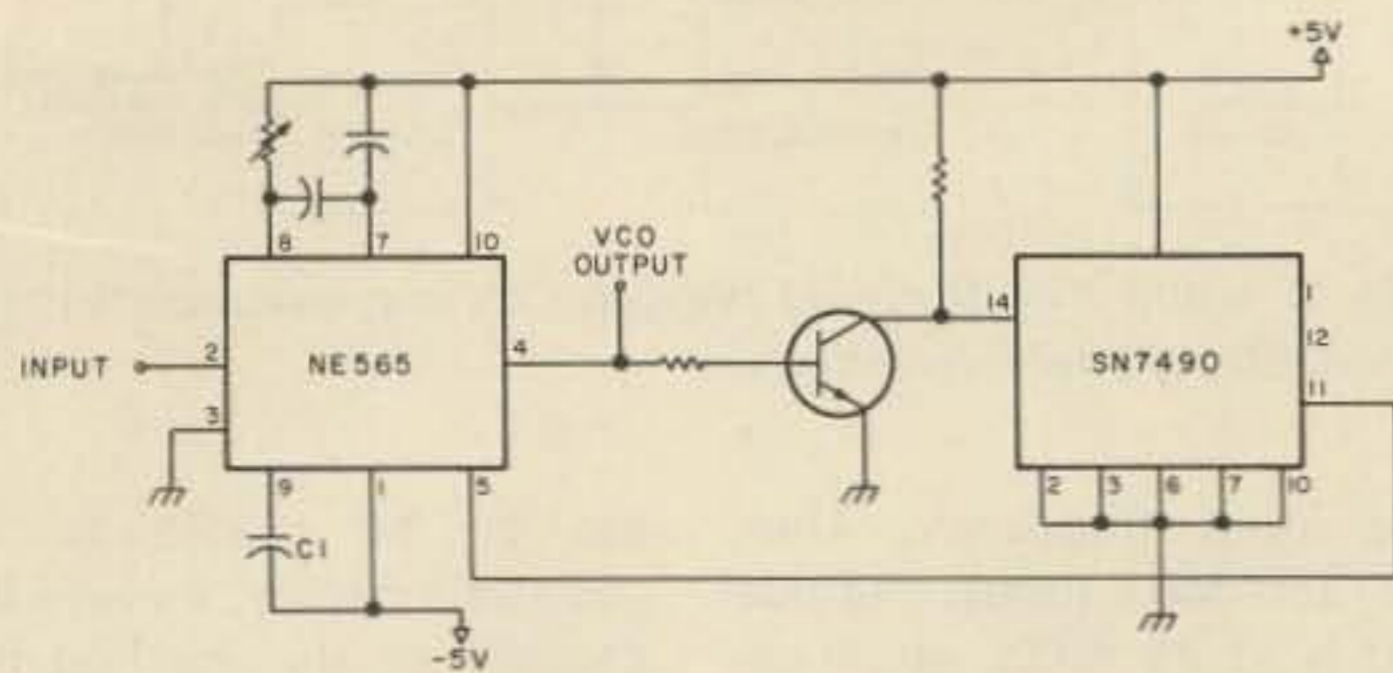
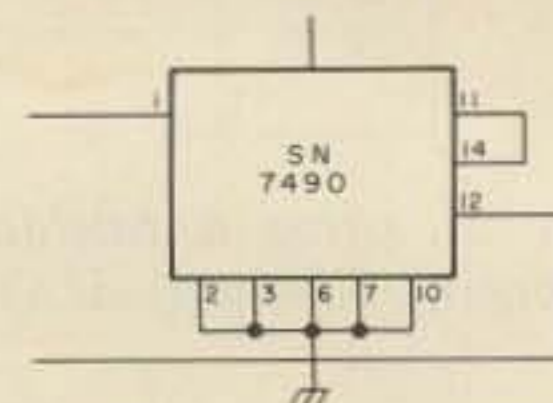

Fig. 6(b). Correct connections for symmetrical  $\div 10$ .



be adequate to demonstrate the multiplication principle. By the way, digital frequency synthesizers use the same basic principles with variable dividers to lock VHF signals onto lower frequency crystal oscillators.

Well, so much for the design concept. The thinking outlined above took lots of spare time over a six month period. After all that mental effort, I wanted to heat up my soldering iron and build something! The first attempt is shown in Fig. 6(a). The circuit was "borrowed" from a Signetics data sheet for the NE565 PLL chip. Component values have been intentionally omitted so that you won't be tempted to build it. Theoretical operation is the same as for Fig. 5. The input signal is applied to one input of the phase comparator via pin 2 of the NE565. The VCO in the 565 runs at 10 times the input signal frequency. The VCO output is divided by 10 by the 7490 and applied to the second phase comparator input via pin 5. The phase comparator output *should* try to lock the VCO at ten times the input frequency. It didn't. I tried different devices, readjusted component values, varied supply voltages, rewired the circuit several times, and nearly fried the 565 with too much input signal. But the #@\*!! thing would not lock! At least it wouldn't lock at  $10 \times F_{in}$ . It liked  $20x$  and  $30x$  instead.

I had noticed, though, that it would lock at the input frequency if the divider was removed and pin 4 of the 565 was jumpered to pin 5. Similarly, locking was possi-

ble at  $F_{in} \times 2$  with a  $\div 2$  divider,  $F_{in} \times 4$  with a  $\div 4$  divider and  $F_{in} \times 8$  with a  $\div 8$  divider. This was a clue that something was wrong with the  $\div 10$  section. The output waveform was perfect except for one thing: It wasn't symmetrical. It had a 20% duty cycle, since the output pin was high during only the last two input cycles out of ten. Very quickly I set up the 7490 for a symmetrical output as shown in Fig. 6(b). Finally, I could get the VCO to lock at ten times the input frequency. Further reading on phase comparators revealed that the doubly-balanced multiplier used in the NE565 likes to see signals with a 50% duty cycle. If it strays far from 50%, screwy things happen just like I had noticed.

Now that I had a working breadboard circuit, I wanted to see how well it would work. I tried to get it to multiply various frequencies in the audio range. One serious drawback very quickly appeared, though. The capture range was too small. That is, the circuit wouldn't lock onto a signal very far from its free-running frequency. For example, if it free-ran at 600 Hz, it would only lock from 450 Hz to 750 Hz or so. That meant that the multiplier would have to be coarsely tuned to the operating frequency each time it was used. Also, I was restricted to a 10:1 tuning range. The manufacturer recommends that R1 be between 2k and 20k Ohms. To cover the audio spectrum from 20 Hz to 20 kHz would require switching in 3 differ-

ent values of C1 in addition to a "diddle" pot for fine tuning. This seemed awfully awkward. What I really wanted was a minimum of controls.

Just about the time I reached the impasse, though, I had a need to use some phase locked loop techniques at work. I had all sorts of practical knowledge from my lunchtime and evening work with the multiplier, so I dug out the textbooks, application notes and IC data books for some theory. After too much math and sore eyes from reading, I found that using a PLL with a doubly-balanced modulator phase detector wouldn't do the job. It's fine for relatively narrow-band PLLs and works well with noisy signals, but had too many drawbacks to be practical for my multiplier. Something like the Motorola MC4044 seemed much more practical.

The 4044 is really a phase frequency detector. It consists of interconnected logic gates and flip-flops which give it an interesting characteristic. For signals close in phase on its inputs, it gives an output proportional to the phase difference between the two signals. But if the signals are not close in phase, it outputs a steady dc level. The second characteristic makes the 4044-type phase comparator far different from the doubly-balanced mixer. The 4044, in contrast to the 565-type comparator, is very useful for a wideband phase locked loop. Incidentally, it's also useful for narrowband PLLs, too. Many commercial frequency synthesizers use this IC.

The 4044, though, was of no use to me in my project at work. It simply consumed too much power. The system that I wanted to put the PLL in used all CMOS (Complementary Metal Oxide Semiconductor) integrated circuits, running at less than 5 V and consuming microamps of

current. The 4044 needs 5 volts at 40 mA! Further research of the data books revealed the RCA CD4046. This was just the IC I needed, both for my work and home projects.

The 4046 is a CMOS IC which contains two phase comparators and a VCO. See Fig. 7. Phase comparator I is an exclusive OR gate which behaves like the doubly-balanced mixer phase detector. Phase comparator II, however, is what RCA calls an "edge-controlled digital memory network." Forget the long name. It's basically the same phase frequency comparator that the MC4044 uses. Phase comparator II is intended for use in wideband PLLs. The 4046 is almost like the NE-565 in low power form. And it's more versatile.

Now that I had a practical and theoretical background in PLLs, it took only a few hours to come up with the bare bones of the working multiplier as shown in Fig. 8. For a first attempt, I set the VCO just below 60 Hz and connected the VCO output (pin 4) directly to the phase detector (pin 3). Sure enough, when I applied a 60 Hz signal to pin 14 (the input), the VCO locked on and read exactly 60 Hz. Excitedly, I connected a CD4017 to divide by 10 and hooked it between pins 3 and 4 of the CD4046. Next, I replaced C1 with a new capacitor one tenth its original value. With no input signal, the VCO now read about 500 Hz. When the 60 Hz source was reconnected, the VCO read precisely 600 Hz! At long last, the multiplier was a reality.

Next, I calculated resistor and capacitor values per the RCA CMOS data book to



tune the VCO over the range of 20 kHz to 200 kHz. For these values, the multiplier is useful over the usual audio range of 20 Hz to 20 kHz. For 20 Hz to 200 Hz, the VCO runs at 1000 times  $F_{in}$  and the required divider (Fig. 5) is a  $\div 1000$ . For 200 Hz to 2 kHz, the multiplication is 100 with a divider of 100. Finally, the 2 kHz to 20 kHz range is multiplied 10 times using a  $\div 10$  between the VCO and phase comparator. Keeping the VCO tuning range constant and changing dividers is the most practical method of using the multiplier over the audio range. Little is sacrificed in having a smaller multiplication factor for the higher audio frequencies, though, since my method provides a constant resolution percentagewise over the whole range.

The original breadboard was wired up on an AP Superstrip.<sup>TM</sup> These strips are rather expensive (about \$18), but are extremely useful for anyone who likes to experiment because you can try out a new circuit almost as fast as you can draw its schematic. Since the circuit was easy to change, I tried all three multiplication ratios just to be sure. This only meant changing a few wires, and I wanted to be sure that all was working on the breadboard. I wanted no surprises in the final version.

Now that the breadboarding was successful, I decided to build the circuit in final form and put it in a cabinet. I didn't want to bother with a PC board, since I was building only one, so I used the wire-wrapping technique. I used wire-wrap IC sockets (10¢ each at a hamfest) and 0.1 inch vectorboard. Wire-wrapping was accomplished with a \$2.50 tool made by Cambion (their part number 45-1816-01-00-16). This tool, incidentally, is widely available at electronics parts houses. It's great for small wrapping jobs and costs less than \$3.00, as opposed to \$50 or more for motorized

wrappers. At the same time that I hooked up the multiplier, I added an input amplifier which will be described later.

When I fired up the wrapped wire version, all sorts of strange things happened. First, the VCO kept locking up at the high end of its range without any input signal. This shouldn't be, because the phase comparator should have zero output with no input. And when I applied an input signal, the loop would try to lock, and then wander all over the place in seemingly random fashion. I was really perplexed because the breadboard had worked so well. My scope showed that there were pulses at the phase comparator output even with the input of the linear amplifier grounded! But when the input to the PLL IC was grounded, the pulses disappeared. Obviously, there was junk coming out of the linear amplifier, but I couldn't see it on my oscilloscope. I took the circuit into work the next day, to have a look at it with a decent scope. Sure enough, there were very narrow spikes being fed to the PLL IC even when the linear amplifier's input was bypassed to ground. I found that if the PLL IC was disconnected (pulled from its socket), the pulses went away. Now the light came on. The VCO signals from the PLL IC were being coupled to the linear amplifier by stray wiring capacitance. With the Superstrip, this coupling didn't occur, but wire-wrapping gives much more possibility of this stray coupling to exist. The linear amplifier was constructed from CMOS, so its high impedance inputs were very susceptible to capacitive coupling.

CMOS is extremely insensitive to noise when used in digital circuits, because the outputs are full "on" transistors at either ground or  $V_{cc}$ . However, the output impedances are much higher when

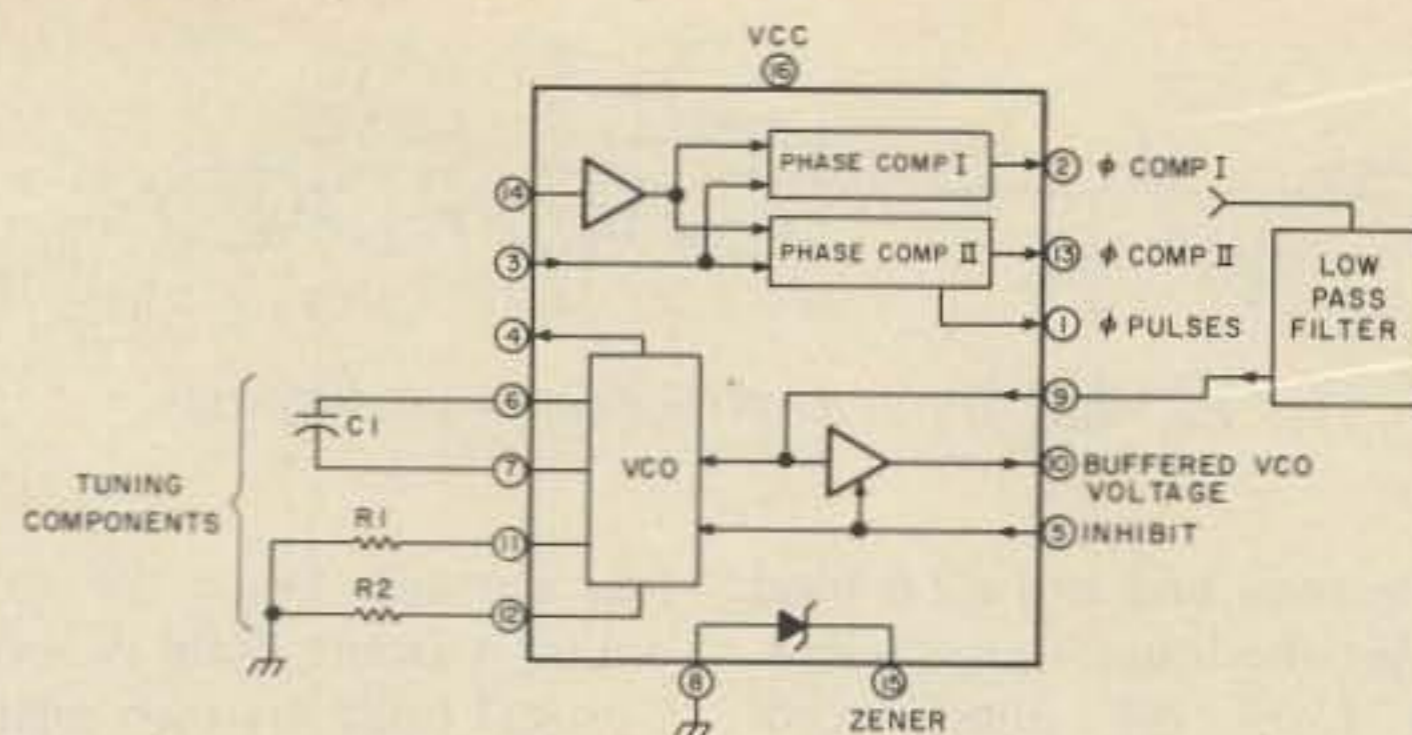

Fig. 7. RCA CD4046 phase locked loop IC.

the devices are biased in between to work as linear amplifiers.

To eliminate the problem of coupling, I built the input amplifier using point-to-point wiring on a piece of perf-board, leaving the PLL IC and dividers connected in wrapped wire fashion. The circuit behaved much better, although there was still a trace of VCO instability. This was cured by connecting the VCO tuning components R1, R2, and C1 to the IC with short-direct point-to-point wiring, and dressing the pulse-carrying wires away from these components. Apparently there had been the same strays noted earlier being induced into the VCO. Finally, everything worked well using point-to-point wiring for the linear amplifier and PLL IC, and wire-wrapping for the digital dividers.

When I got tired of the boards lying loose on the bench with wires dangling all over the place, I put it in a cabinet, a 2 x 4 x 6 shadow-box from Lafayette. Since then, two additional models have been built, and a half dozen or so sets of ICs substituted. All of them worked okay, except that one of the PLL ICs required a slight

readjustment of the VCO range pot.

### The Final Circuit

Several minor revisions occurred in the process of building the three packaged versions mentioned. Fig. 9 is the schematic diagram now that the design is "frozen."

The input circuit is detailed in Fig. 9(a). IC1 is a CD4001AE CMOS integrated circuit designed for logic circuits. In this application, it is an ideal amplifier and squaring circuit. The first gate, the "A" section, is biased as a linear amplifier by the 1.5 megohm feedback resistor. Input signals to it are ac coupled by two capacitors, and a sensitive control potentiometer sets the input level. The 47 pF feedback capacitor rolls off the amplifier's high frequency response to lessen sensitivity to stray pickup and high frequency transients. Gates B, C and D shape the input signal from a sine wave into a steep-sided square wave of about 5 volts p-p.

The phase locked loop section is shown in Fig. 9(b). IC2, the CD4046, is the actual PLL, while IC3, 4 and 5 are digital dividers. R1, R2 and C1 are the VCO tuning components. R1 sets the high

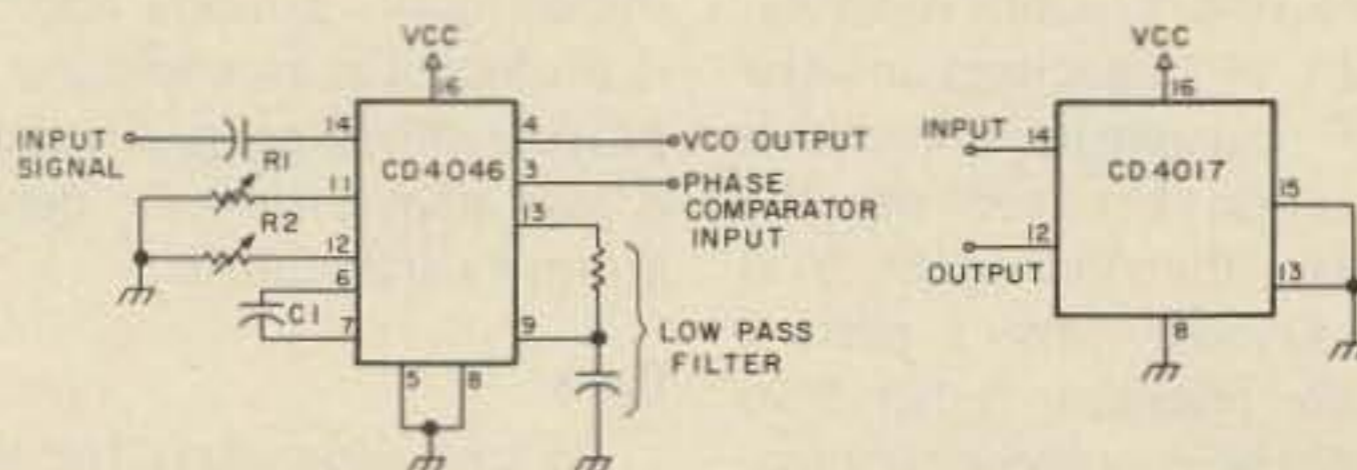

Fig. 8. Breadboard circuit for the successful PLL frequency multiplier.



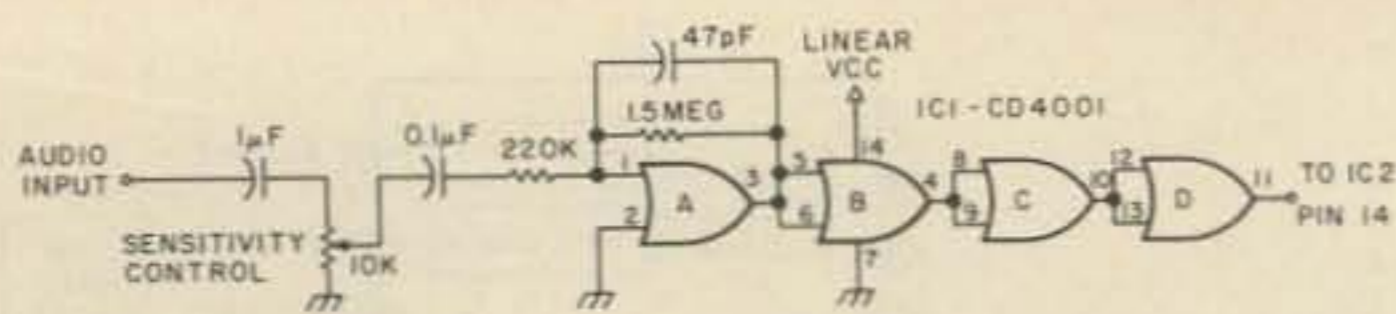

Fig. 9(a). Input amplifier and wave shaping.

frequency end and R2 is used to set the low frequency end. Dc from the phase comparator output at pin 3 is filtered by R3, R4, and C2, and is fed to the VCO control terminal, pin 9. The VCO output at pin 4 is fed to the output connector through R5, which prevents loading of the VCO by the external frequency counter.

The output level is 5 volts peak-to-peak into an open circuit. IC3, 4 and 5 are each  $\div 10$  circuits. Since the VCO tuning range is 20 kHz to 200 kHz, the output of IC3 feeds a 2 kHz to 20 kHz signal back to the phase comparator (pin 3) when S1 is in the x10 position. In this configuration, a signal in the range of 2 kHz to 20 kHz fed through the input amplifier is multiplied 10 times at the output terminal. Similarly, having S1 in the x100 position results in 100 times multiplication for inputs of 200 Hz to 2 kHz. And the x1000 position multiplies 20 Hz to 200 Hz signals by 1000.

Dc power is provided by the power supply of Fig. 9(c). A 9 V transistor radio battery is the prime source. This voltage is reduced to a regulated 5 volts by Q1, Q2, D1, and associated resistors. This is a pretty good regulator, by the way, for currents up to 20 mA or so. It stays in regulation until battery voltage drops to about 6.5 V, and is usable at inputs up to 20 volts. Decoupling is provided by the two 47 Ohm resistors, the 0.1 uF capacitors and the 5 uF capacitor, preventing interaction between the ICs through the Vcc lines. You may wonder why I used a discrete regulator rather than one of the new three terminal IC devices. Well, that's easy: a) I had the parts; and b) the IC versions don't work well at

low current. Since the total circuit current drain is about 5 mA, I built my own regulator. The regulator circuit is copied from a design used in some industrial control equipment, so I claim no originality.

### Construction

This is one project that does have critical parts layout. As I mentioned earlier, CMOS in logic circuits is noise immune, but CMOS in linear circuits is noise susceptible. The input amplifier and the IC2 wiring must be cleaner than the rest of the circuit. Point-to-point wiring on 0.1 in. x 0.1 in. vector-board is fine, so long as the leads are kept short and direct. If you're ambitious, a PC board would be excellent. In any case, keep the wires with steep-sided pulses from the logic dividers away from the small-signal wiring of the input stages. Wiring of the divider stages and power supply regulator doesn't require any special precautions. In addition, it's a good idea to wire the audio input and VCO output lines with shielded cable to minimize any unwanted coupling. For guidance purposes, Fig. 10 shows the layout of the most recent point-to-point wired version. If you're ambitious and want a really neat construction job, a PC board version would be ideal — but so far I've been too lazy to build this multiplier that way. Incidentally, a metal cabinet is preferred as an enclosure to provide shielding, particularly if you plan to use the device around a transmitter.

### Parts

In choosing parts for this project, I relied heavily on my junkbox. Admittedly, mine is probably better

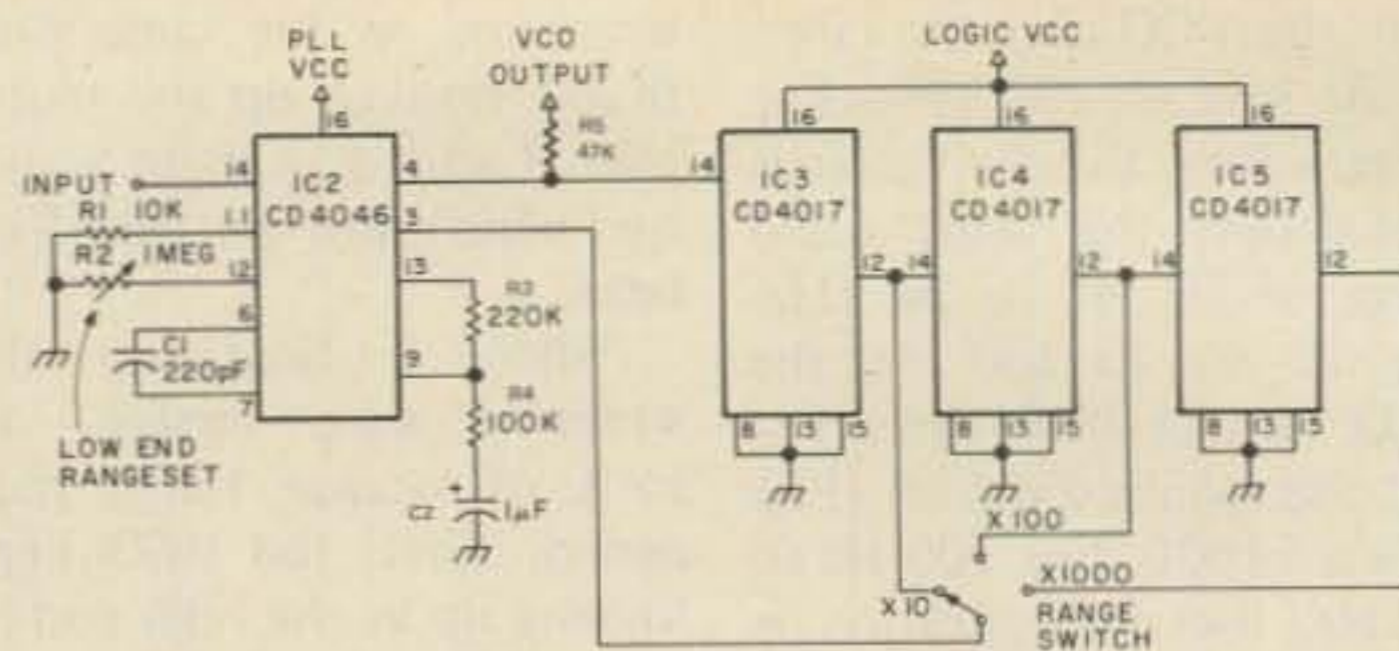

Fig. 9(b). PLL and logic for multiplier.

stocked with modern components than those of many other hams I know, but this is true only because I'm a hard core scrounger. I'll give you a few ideas about what components to use, but feel free to try those you have. If you substitute intelligently, your parts will work as well as mine.

The only really critical capacitor is the 220 pF capacitor used for VCO tuning. An ordinary disc ceramic will probably drift too much, even with the usual room temperature changes, causing the VCO lock range to vary from day to day. You should use a dipped mica or polystyrene capacitor for best results. The 1 uF input coupling capacitor should have paper or mylar dielectric and be rated at 100 V or so, since often you don't know what dc voltage you'll put on it making frequency measurements. The other capacitors of 1 uF or larger rating can be any electrolytic or tantalum types rated at 6 volts or more. All remaining capacitors can be disc ceramic types with 12 volt or higher voltage ratings. The CA4001 (IC1) and CD4046 (IC2) were purchased from James Electronics (a 73 advertiser) at reasonable cost. IC3, IC4 and IC5 are also available from James, but I took a cheaper route. The local Radio Shack store has been selling IC divider assortments for \$1.98 (cat. no. 276-1607). They claim to be 100% functional devices, although I found a reject rate of about 20%. At any rate, several packs of them contained one good 7490 (a TTL device not used

here), and several CD4017 and CD4018 devices each. For less than \$4.00 (excluding tax), I got enough ICs to build two multipliers. Please note that the schematic in Fig. 9 shows the wiring for the 4017 dividers; if you have 4018 units refer to the RCA CMOS Databook for the correct wiring. If you are brave, try the Radio Shack assortment. If not, the devices are available from James and others at low cost. I recommend using sockets for all of the ICs. They often cost as much as the ICs themselves, but they make initial check-out and future troubleshooting much easier. The input potentiometer is a sensitivity adjustment; thus a panel-mounted control is most convenient. The VCO range pot, R2, can be a single turn PC mount device because its setting is not touchy. The remaining resistors can be  $\frac{1}{4}$  or  $\frac{1}{2}$  Watt 10% carbon composition. The schematic shows a 1N5231 for the power supply zener diode. You can use any other  $\frac{1}{4}$  Watt to 1 Watt device. The two transistors used in the regulator are not special. I've built this regulator in dozens of projects, and any NPN small signal silicon device such as 2N5172, 2N2222, 2N3394, 2N3904, or 2N4401 has worked equally well at this voltage and current level.

### Checkout and Adjustment

When I designed the multiplier, I tried to make it as easy to build and use as possible. Ditto for adjustment. When you have it all assembled correctly, connect power, turn it on, and check



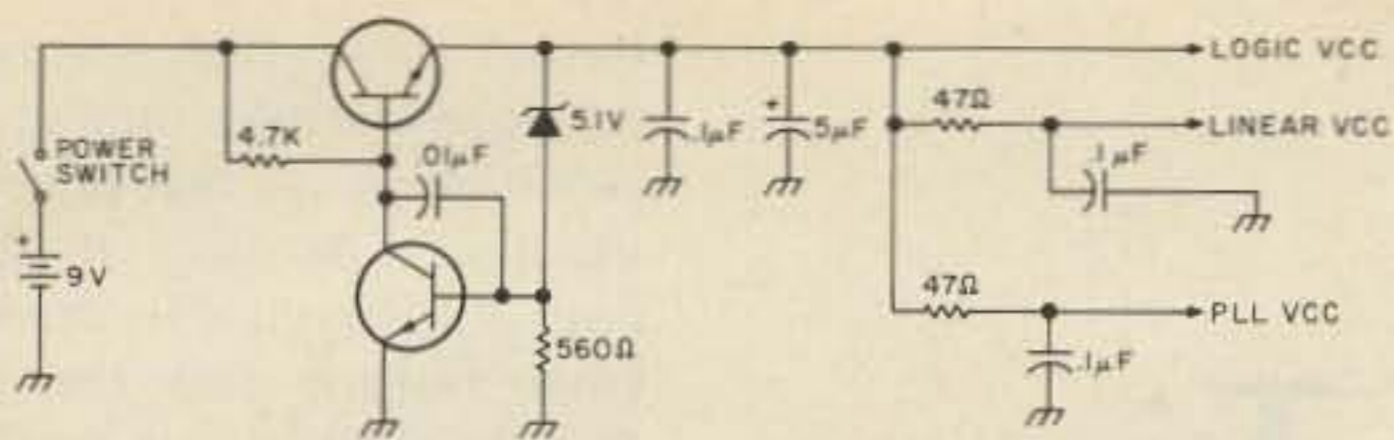

Fig. 9(c). Power supply regulator.

the power supply voltage at pin 14 of IC1 and pin 16 of IC2, 3, 4, and 5. When all is well, it should be between 5 and 6 volts. If not, disconnect power and check your wiring. Should you have any remaining problems, the simplest troubleshooting method is to remove the ICs one at a time while checking the Vcc line. Incorrect regulated voltage with all of the ICs disconnected means a gross wiring error or bad components in the regulator.

When all is well power-wise, connect a frequency counter to the VCO output. Temporarily short circuit pin 9 of IC2 to ground. With pin 9 at ground, the VCO free runs at the low end of its range. You should be able to adjust the VCO frequency as read on the counter, with R2. Set the low end frequency at about 15 or 16 kHz. Now connect pin 9 to Vcc. This puts the VCO at its upper end, which should be 200 kHz or higher. If it is not between 220 and 280 kHz, change the value of C1 slightly — more capacitance for lower frequency and vice versa. After either adjustment, check both ends of the VCO range to make sure there is some overlap (low

end less than 20 kHz and upper end above 200 kHz). In my prototypes, any CD4046 I've tried will fall easily within the above limits.

Now you can make an operational check. First use a 60 Hz source, such as the output of a filament transformer. *Do not* use the ac line directly. The multiplier won't be damaged by ac up to 20 V rms or so, but you can be severely fried playing with the ac line. First, connect the frequency counter to the ac source directly to verify the presence of 60 Hz ac. Then connect the counter to the multiplier output and the ac source to the multiplier input. Set the multiplier range switch to the x1000 position. By adjusting the input level control, you should be able to get the multiplier to lock on, causing your counter to read 60000. The input level control is not at all critical above some minimum setting. Once you've gotten this far, it's probably best to get hold of a signal generator and check the multiplier over its whole range of 20 Hz to 20 kHz. Should you have difficulty getting the device to function properly, a good oscilloscope is invaluable, and the aid of a

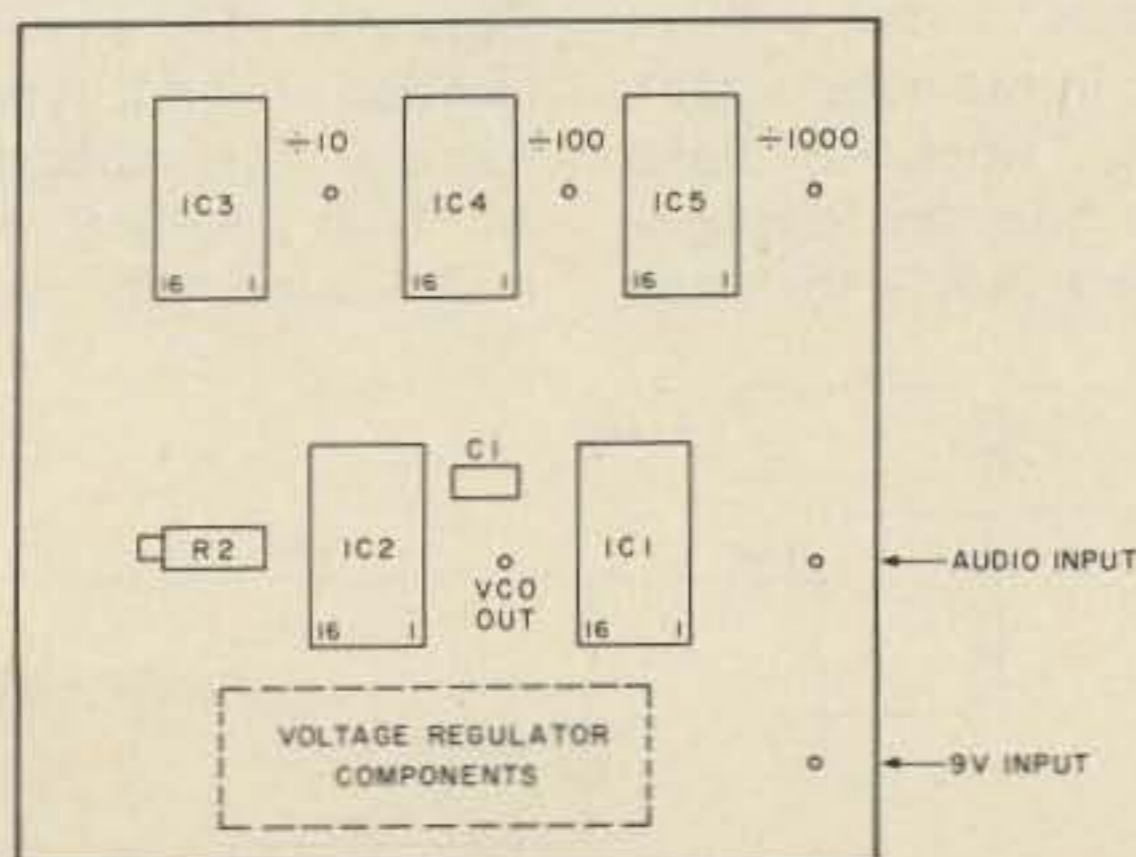

Fig. 10. Frequency multiplier parts layout.

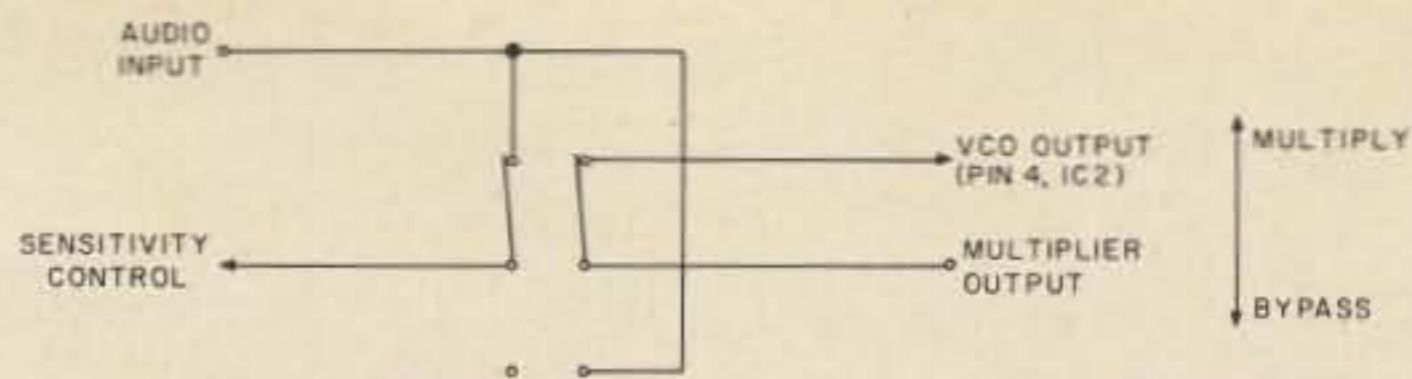

Fig. 9(d). Bypass switch wiring.

friend familiar with digital circuits is recommended.

### Usage

A prescaling multiplier is a valuable addition to an ordinary frequency counter for fast, precise measurement of audio frequencies. Fig. 11 is a typical test setup for measuring the frequency of an audio oscillator. To set the multiplication factor of the prescaler, you must first know the approximate frequency of the signal being measured. To measure this quickly, set the prescaler's INPUT switch to the BYPASS position, so that the signal will go directly to the frequency counter. Taking note of the frequency, set the RANGE switch to the appropriate position. (For signals from 20 Hz to 200 Hz, use the x1000 range, for 200 Hz to 2 kHz use x100, and for 2 kHz to 20 kHz use the x10 setting.) You'll remember that there is some overlap in the ranges from the VCO tuning adjustment mentioned earlier. Now set the INPUT switch to the MULTIPLY position, turn the unit on and turn the SENSITIVITY control clockwise. If the signal is greater than 50 mV or so, the prescaler should lock on in several seconds and the frequency counter will read the oscillator frequency scaled up according to the multiplier setting. Thus, with an input signal of 50 Hz and the RANGE switch set for x1000, the VCO output is 50,000 Hz. With the fre-

quency counter's timebase at 1 second, it will read 50000. Set at .1 second we get 5000, for .01 second 500, and finally, for .001 second the display reads 50. So by setting the counter timebase, you can tradeoff measurement resolution for faster updates. This makes setting the oscillator frequency much easier.

### Final Comments

This has been a multi-purpose article. Its overall purpose has been to present the circuit for a unique piece of test equipment. But, in addition, I've thrown in some theory and a bit of the background on how the device was conceived and implemented. Hopefully, it will prove valuable to brainy types who could come up with a similar gadget given enough time, and also maybe it will give some incentive to the average home builder who hasn't successfully gotten through the design of any modern circuitry. Whatever your background, I hope the article has been interesting and informative. At any rate, the frequency multiplier is easy to build and an extremely useful addition to any frequency counter. ■

### References

- 1, 2, 3. Peter A. Stark K2OAW, "A Modern VHF Frequency Counter," *73 Magazine*, May, July, and September, 1972.
4. Robert Johnson, "The Calculating Counter," *73 Magazine*, September, 1975, p. 22.



Fig. 11. Test setup for high resolution frequency measurement.



# Phone Patch Tips

- - a lost art ?

Donald H. Johnson WB6MXD  
943 Cameron Court  
Arroyo Grande CA 93420

Here are a few tips for you home brewers who have tried to build phone patches from scratch parts which for one reason or another never quite turned out right. I've built quite a few, and these are some tips I think you will find helpful.

The first problem is to connect the speaker to the phone for the person on the other end to hear. Then we have to connect the phone line to the transmitter. This can be done in a number of ways. One of the simplest is shown in Fig. 1. It is fairly common to find such a transformer on the surplus market, and it makes a quick and easy phone patch. I have one with a 500 Ohm, a 50 Ohm and a 50,000 Ohm winding. It works quite well, but it does have its drawbacks.

In the very simple patch the audio from the speaker is always connected to the phone line, so you must mute the speaker completely when

you are transmitting. Any hiss in the receiver output will be transmitted along with the voice of the person on the other end of the patch. Also, when you are in the receive mode the receiver output is crammed back into the transmitter. This means that it will be impossible to operate VOX. In fact, some transceivers may share audio sections with transmit and receive, and this loud signal into the mike jack may crossover into the receiver section. A simple solution is to get a DPDT switch and use it to key the transmitter and mute the mike as in Fig. 2.

If you would like to avoid the hassle of having the switch or perhaps would like to be able to operate VOX, you want to go to a hybrid phone patch. There are several different types of hybrid phone patches. The hybrid patch usually uses one or two transformers (coils) which are connected in such a way that the signal from the receiver is coupled to the phone line but is cancelled by an opposite signal in the lead that goes to the microphone. Attenuation in a good hybrid

is typically around 40 dB, or about one one-hundredth of the receiver output gets to the transmitter.

In the one coil hybrid in Fig. 3 the flux set up by the speaker winding in the transformer core produces a voltage across the secondary windings and across the phone line. Notice the capacitor. This keeps the dc from the phone line from flowing through the transformer windings and saturating the core. If this happens the transformer will behave unpredictably and most certainly will not give you a good null between speaker and mike. Now if we look carefully at the mike winding we see that when current enters the speaker winding (with the dot) it leaves through the mike winding with the dot making the ends of both windings positive. The voltage across the mike winding bucks the voltage across the speaker winding, so the speaker audio will be cancelled in the mike output. However, when a signal comes in from the telephone it sets up a flux in the trans-

former core which seems to set up the same situation for cancellation as the previous situation. Actually it does not. The secret is in the 430 Ohm resistor and the fact that the signal is coming from the phone line rather than the speaker. In this case the current from the speaker is flowing through the 430 Ohm resistor in the opposite direction. And so instead of bucking each other they add, and the signal gets through.

Fig. 4 shows a typical two coil hybrid. It achieves its nulling effect by using the two cross connected number 1 windings. The 2.15 uF capacitor and the 900 Ohm resistor are typical values for nominal telephone line impedance. To get the best match you could put a capacitance meter across the line and find the exact capacitance of your line and then use a variable resistor to find the best null between speaker and mike. One important thing to remember when adjusting the null or "balance" is that you should place a call to a friend when you do so. Your telephone line impedance looks different after you complete a call. The phasing on the number 3 windings are different for each installation depending on how many phase inversions take place in the audio sections of your rig. Flipping one of the leads over might help you get that extra couple of dB isolation if your patch doesn't quite work as well as you would like on VOX. But for the most part the phasing is unimportant. Otherwise T1 and T2 are identical hybrid type transformers. The capacitors "C" are both identical non-electrolytics about 1.0 to 2.0 uF.

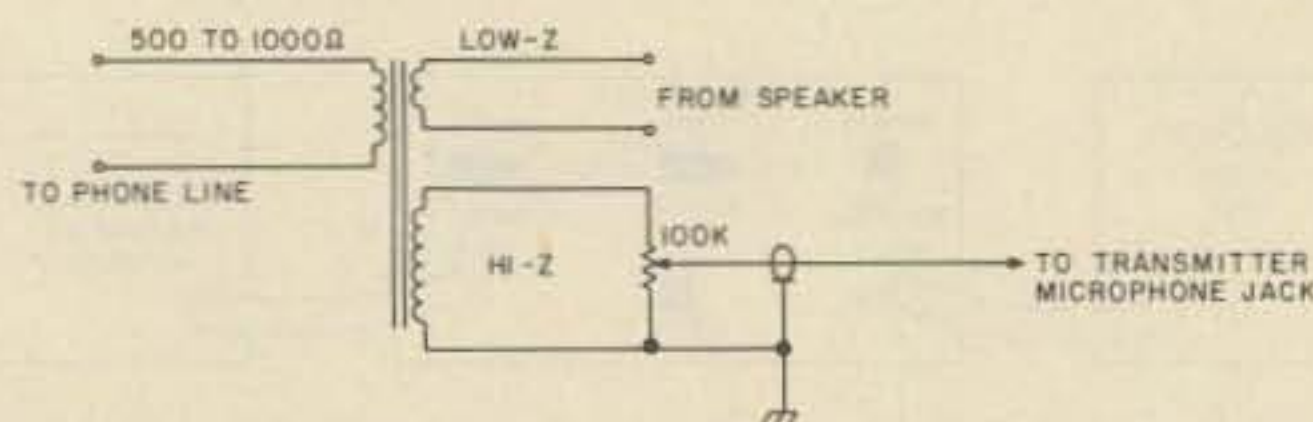

Fig. 1. Single transformer as a simple patch.

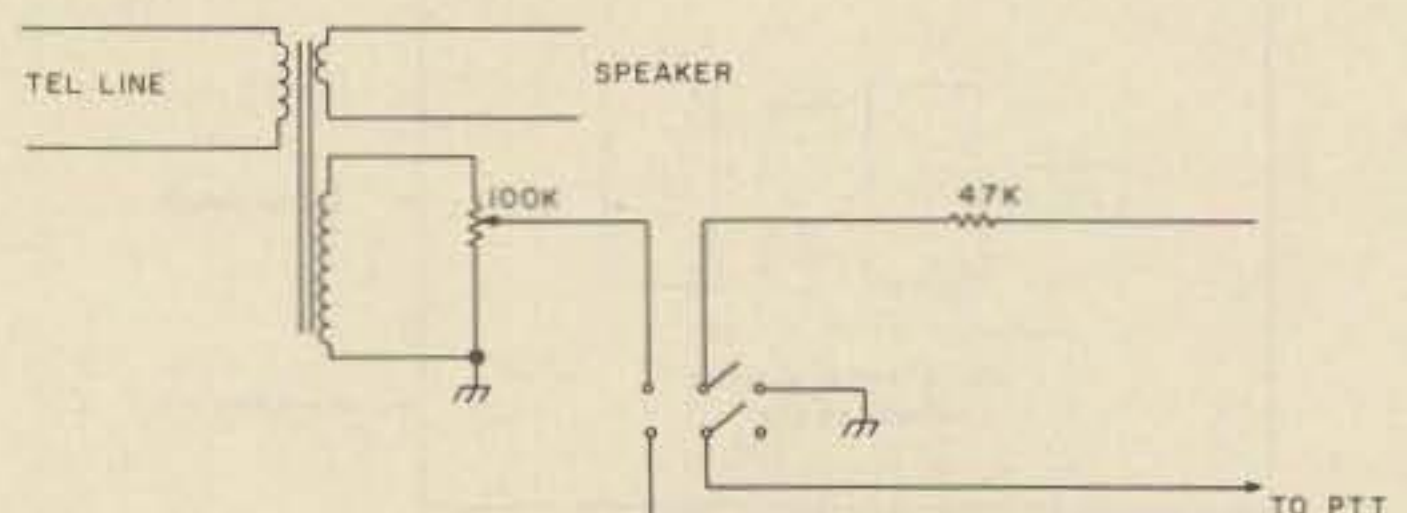

Fig. 2.



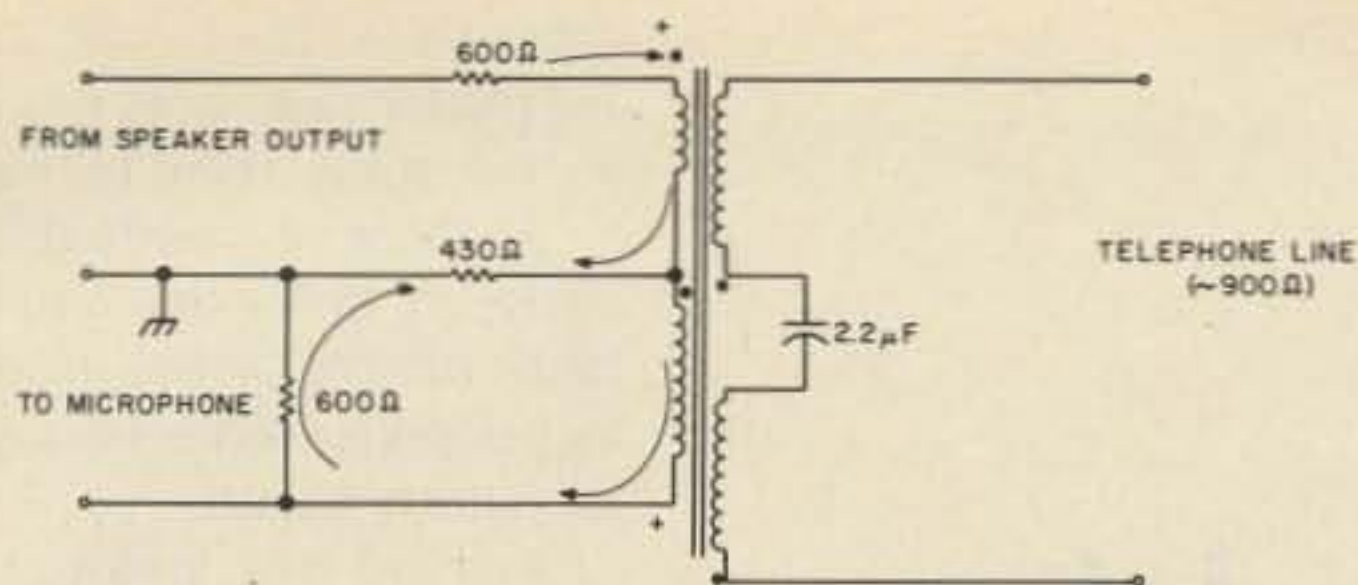

Fig. 3. One coil hybrid.

Again, it is very important to keep dc off the windings. But it is also necessary to provide a path for dc to keep the phone company equipment from seeing an off-hook condition and hanging up the phone. This can be done by simply keeping your phone off the hook, but any noise in the shack seems to come over much louder than the person on the other end of the picture. You could just slap a 500 Ohm resistor across the line, but that loads the patch. You have to crank up the gain, and you unbalance your hybrid if you are using one.

The phone companies have a real slick and simple solution for this problem. They call it a retard coil. All it amounts to is a 1:1 transformer with its windings set up to buck each other. Fig. 5 shows how a 1:1 transformer would be wired to act as a retard coil. By placing a switch in the center of the two windings you can go on or off hook as you desire. Place a dial in series with the switch and you can dial right from your patch. I have one set up like this, and it really works well. The resistor limits the current you draw from the line to a safe value. If your old homemade patch relies on current flowing through the patch transformer to hold it off hook put a 2 to 5 uF capacitor in series with your patch and try a retard coil to hold it. I'm sure you will find an improvement

in frequency response. I used a cheap little 500 Ohm to 500 Ohm transistor transformer and it works fine.

Once you can hang up your phone during the patch you need some means to monitor the conversation so you can throw the switch or retune the receiver if necessary. Earphones work fine but you have to be careful about loading the line. Put a 0.1 uF capacitor (or larger) in series with a 2.2k resistor to your phones. Stereo headphones work quite well. Just connect the right and left channel in series by just using the two tips on the jack. No connection to the common or ground side is necessary. This works quite well and affords the people on the patch a little more privacy, or so it seems. (See Fig. 6.)

Store bought phone patches have nice meters on them to monitor audio levels. Regular VU meters are a little on the expensive side but they give a good indication. However, I chose to use one of the cheaper level meters you see advertised in ads in this magazine for \$1.50 or \$2.00. I ordered a couple from Poly Paks and found that they are about 140 uA full scale with 100 uA being about "0 VU." Plenty sensitive but they are dc meters. I used a diode bridge to rectify the audio. I used four germanium diodes and made it

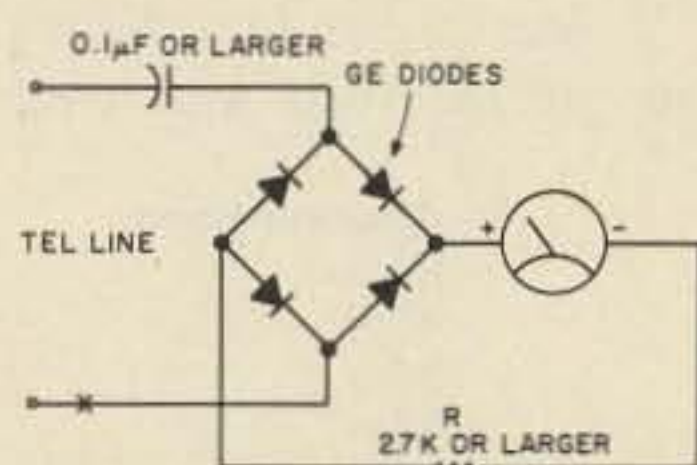

Fig. 7. Meter circuit.

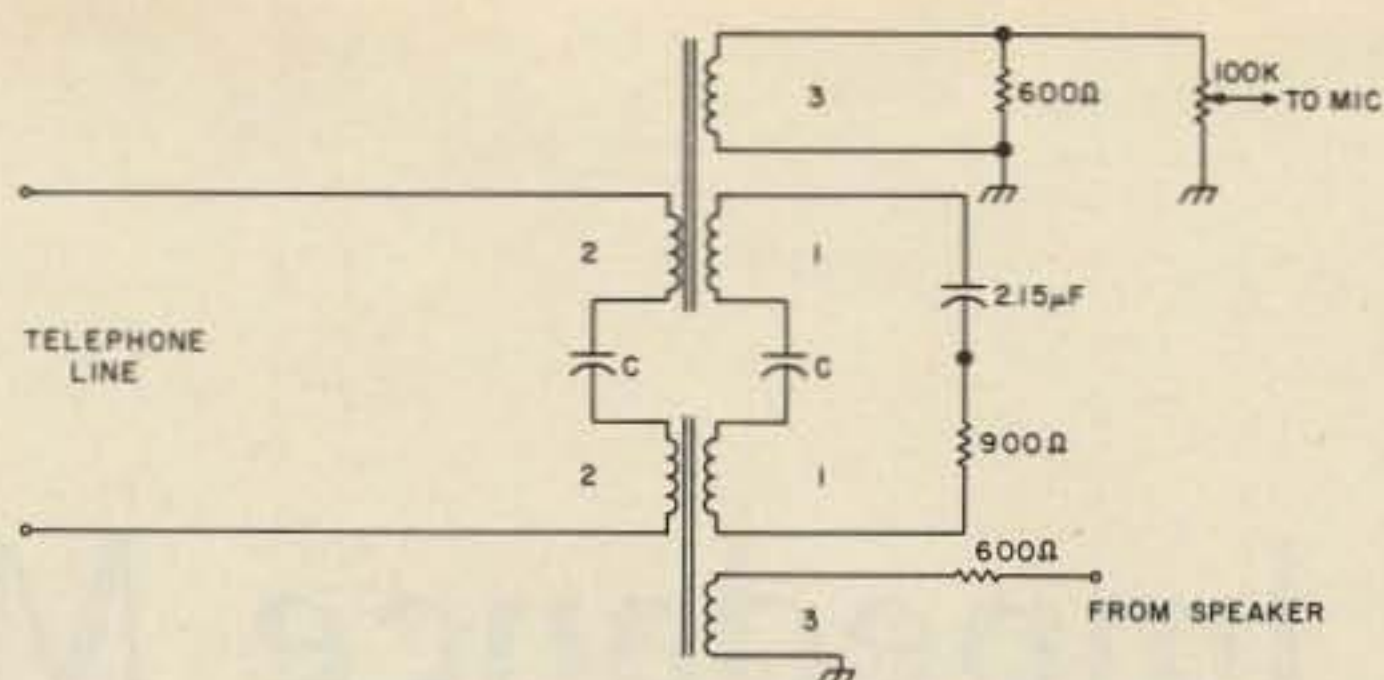

Fig. 4. Two coil hybrid.

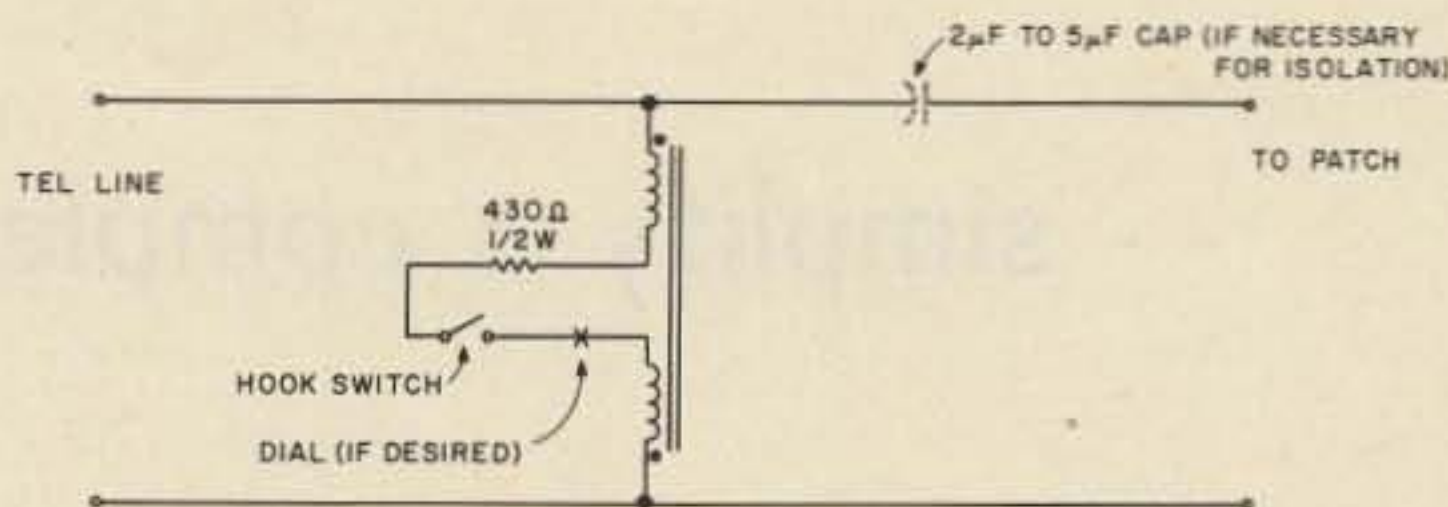

Fig. 5. Retard coil.

myself. Be sure you have germanium diodes. Their lower forward voltage drop (0.2 V instead of 0.6 V for silicon) makes them preferable for rectifying low voltages. Fig. 7 shows the finished meter circuit. The resistor R is a fixed resistor that is chosen experimentally to give the desired meter deflection. Again I urge you to keep it on the large side. If 3.3k and 3.9k both look pretty good choose 3.9k. This is best chosen by calling someone and having them tell you when the signal from the patch sounds like a comfortable listening level. Then change resistors until the meter peaks around two-thirds of the way up the meter face. You may want to put a switch in series with the meter circuit, so it will not peg out when you are dialing or when your phone rings.

Which brings up another interesting idea. If you are hard of hearing or have a high noise level in your shack and have the bell on the telephone in your shack turned down you can see your tele-

phone ring by hooking a neon light across the line. The ac ringer voltage will light the light when the bell rings. Don't forget to put a current limiting resistor in series with the light. It can be a small light or a larger one that can be seen for quite a distance. (See Fig. 8.)

It's always a good idea to keep rf out of your patch and the phone lines. Fig. 9 shows a brute force type line filter. The ground shown should be a good earth ground. If you get rf into your meter try a 0.01 uF ceramic type capacitor across the terminals.

Following these tips and with good construction practices you should be able to come up with a very good phone patch that you can be proud of. Just remember to keep dc currents from flowing through your patch transformer. If nothing else put a 2 to 5 uF capacitor in series with the winding. Try the retard coil gimmick and phones, and see if the people you patch together don't like it much better. ■

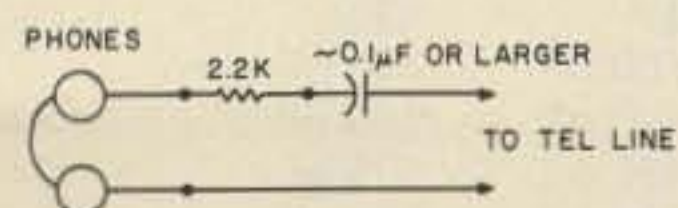

Fig. 6. Headphone monitor for tel line.

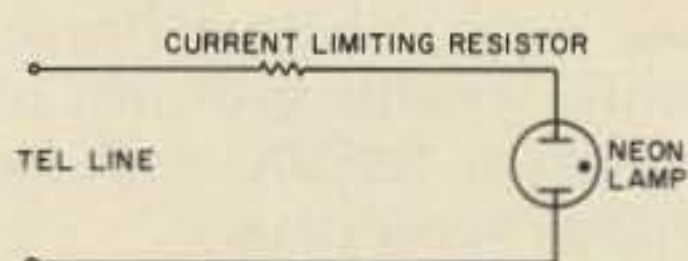

Fig. 8. Visual ringer.

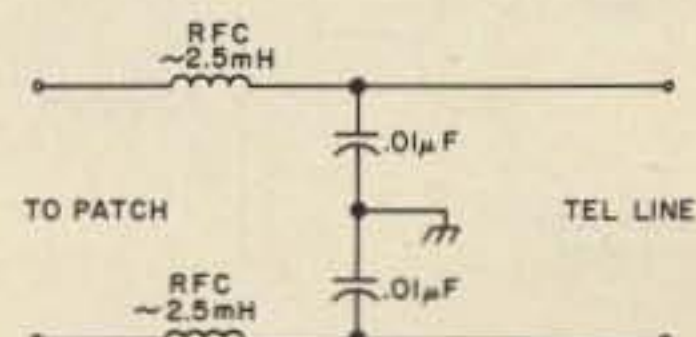

Fig. 9. Rf filter.



# Impedance Matching

- - simplify a complex process

Mark E. Pecan WB5HEQ  
18 Willow Creek Place  
Richardson TX 75080

In designing an antenna system or matching network, a radio amateur many times finds the need to measure the actual complex impedance of a transmission line, antenna, or network at the rf operating frequency. This can be done simply and accurately by using a directional wattmeter and various lossless mismatches constructed from capacitors, without the expense of measuring equipment such as network analyzers and RX bridges costing upward from several thousand dollars.

## Materials Needed

— A directional wattmeter having the capability to

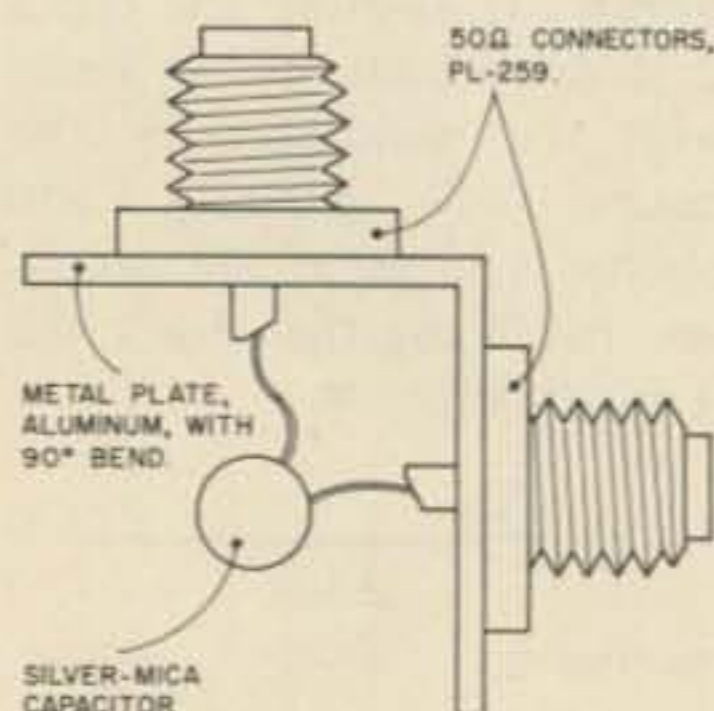

Fig. 1. Construction of capacitive mismatches for impedance measurements.

measure forward and reflected power at the operating frequency. An accurate vswr meter may also be used. — Transmitter or exciter capable of transmitting a CW signal at the operating frequency with enough magnitude to properly operate the power meter or vswr bridge. (The output impedance of the exciter should be equal to the characteristic impedance of the transmission line being used; in most cases, 50  $\Omega$  for amateur applications.)

— A dummy load of proper resistive impedance and power dissipation characteristics to terminate the output of the exciter, having a vswr of not more than 1.2:1 (not more than approximately 1% reflected power). The closer the load is to a 1.0:1 match, the more accurate the impedance measurements will be.

— Capacitors, silver mica, not less than 500 WV dc (see text).

— Coaxial cable for connection of the exciter to the input of the wattmeter or vswr meter, having a characteristic impedance of that of the exciter (usually 50  $\Omega$  for amateur applications).

## Construction of the Capacitive Mismatches

The capacitors used should provide an imaginary impedance of approximately  $-j0.5$  to  $-j3.0$  at the operating frequency. This means that the range of reactance of the capacitors used can be from  $0.5Z_0$  to  $3.0Z_0$ .

In a 50  $\Omega$  system,

$$\begin{aligned} 0.5Z_0 &= 0.5(50 \Omega) = 25 \Omega \\ 3.0Z_0 &= 3.0(50 \Omega) = 150 \Omega \end{aligned}$$

So, the capacitive reactance can range from 25  $\Omega$  to 150  $\Omega$  at the rf operating frequency for a 50  $\Omega$  system (see Table 1).

## Calibration Procedure

1. Construct measurement circuit as shown in Fig. 2. Select two capacitors that fall in the proper capacity range for the frequency at which the impedance measurement is to be made.

2. Measure and record the vswr of the load with each

capacitor in the circuit. If the wattmeter used does not have an swr scale, refer to Fig. 3.

3. Draw a constant vswr circle on the Smith chart for each of the vswr measurements taken with the capacitors in the circuit.

4. Find the point along the resistance circle,  $R=1$ , where intersection with each of the constant vswr circles occurs.

5. Record the value of each of the reactive components at the points of intersection,  $(-jX)$ . These values are the reactive values of the capacitive mismatches that are to be used in measuring complex complex impedances at the rf frequency at which the calibration was made.

## Impedance Measurement

1. Construct measurement circuit as shown in Fig. 4. Measure and record vswr of the load.

2. Construct measurement circuit as shown in Fig. 5. Measure and record the vswr of the load in series with each of the capacitive mismatches.

3. Plot and label the vswr circles of the measurement of the load vswr and the vswr of the load plus each of the series mismatches.

4. Find the resistance circle on which  $\Delta jX$  (the change in  $jX$ ) between the load vswr circle and the load-plus-mismatch vswr circles is equal to that of the value recorded for each value of  $-jX$  recorded in the calibration measurement.

5. Follow the resistance circle to the point where it intersects the vswr circle of the load only. This point of intersection is the value of the complex impedance of the load,  $R + jX$ .

## Example

The frequency at which

Amateur Band	-j0.5	-j3.0
80m	1700 pF	280 pF
40m	890 pF	150 pF
20m	450 pF	75 pF
15m	300 pF	50 pF
10m	220 pF	37 pF

Table 1.



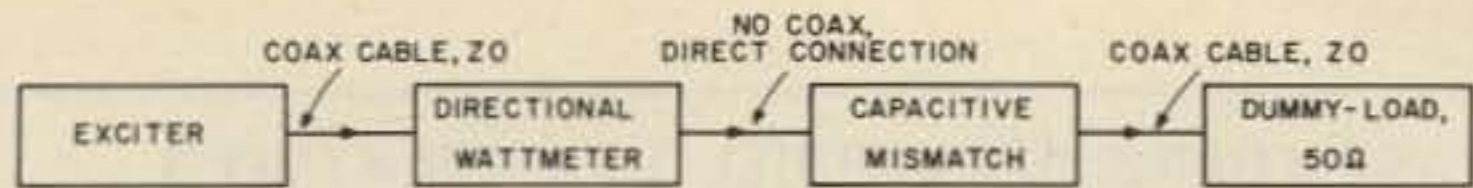

Fig. 2. Measurement circuit for calibration of the capacitive mismatches at the rf operating frequency.

$$swr = \frac{1 + p}{1 - p}$$

$$p = \log_{10}^{-1} \left( \frac{10 \log_{10} \left( \frac{P_{\text{forward}}}{P_{\text{reflected}}} \right)}{-20} \right)$$

Fig. 3. Conversion of forward and reflected power to vswr.

the impedance measurement is to be made is 14.250 MHz.

The value of the capacitors in the two capacitive mismatches, ZX<sub>1</sub> and ZX<sub>2</sub>, equals:

Capacitor, ZX<sub>1</sub> = 400 pF  
Capacitor, ZX<sub>2</sub> = 120 pF

#### Calibration (50 Ω system)

1. Measurement circuit in Fig. 2 was constructed. Two capacitors were selected for use in the capacitive mismatches, corresponding to

the limits specified in Table 1.

2. The vswr of the dummy load plus each of the capacitive mismatches was measured and recorded.

vswr, ZX<sub>1</sub> + load = 1.8:1  
vswr, ZX<sub>2</sub> + load = 5.2:1

3. Constant vswr circles were drawn for each measurement. See Smith chart A.

4. The points of intersection with the R=1 resistance circle were found and labeled, points A and B.

5. The value of each of

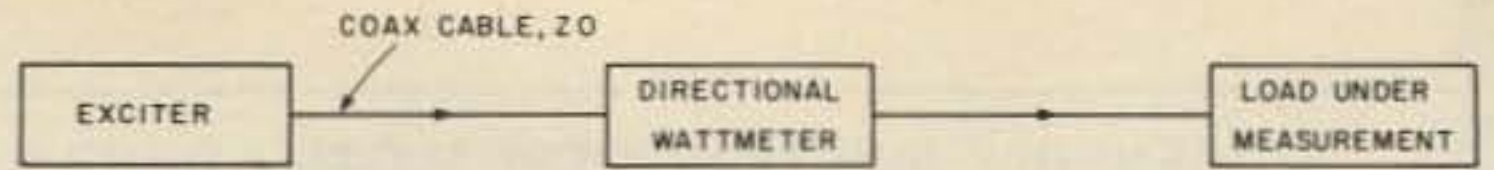

Fig. 4.

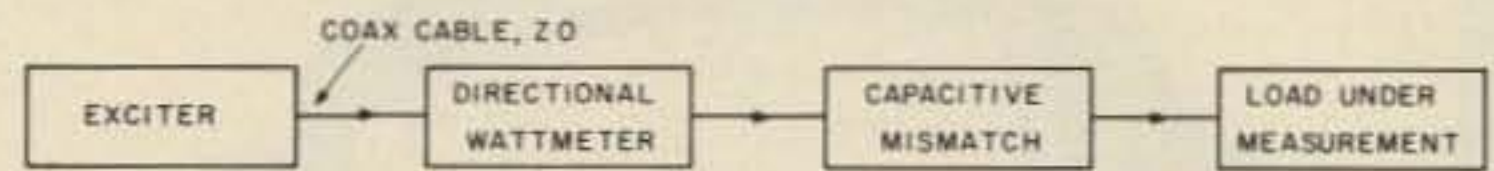

Fig. 5.

the reactive components of ZX<sub>1</sub> and ZX<sub>2</sub> were recorded from points A and B of the Smith chart.

ZX<sub>1</sub> = -j0.62  
ZX<sub>2</sub> = j1.85

#### Impedance Measurement

1. The measurement circuit in Fig. 4 was constructed. The vswr of the load was measured and recorded.  
vswr, load = 2.5:1

2. The measurement circuit in Fig. 5 was constructed. The vswr of the load plus each of the capacitive mismatches was measured and recorded.

vswr, load plus ZX<sub>1</sub> = 1.78:1

vswr, load plus ZX<sub>2</sub> = 5.2:1

3. Constant vswr circles were plotted for the measure-

ment of the load vswr and the vswr of the load plus each of the series mismatches. See Smith chart B.

4. The resistance circle on which ΔjX between the load vswr circle and the load-plus-mismatch vswr circles is equal to that of the recorded value of -jX found in the calibration measurement located on Smith chart B. ΔjX between points Q and R = (-j0.62) = 0.62. ΔjX between points R and S = (-j1.85) = 1.85.

5. The 0.55Z<sub>0</sub> resistance circle is drawn from point S to point Q, as indicated by the arrow. Point Q lies on the vswr circle of the load only, so point Q is equal to the value of the complex impedance of the load, R + jX. So, the load impedance = 0.55 + j0.55. ■

IMPEDANCE OR ADMITTANCE COORDINATES

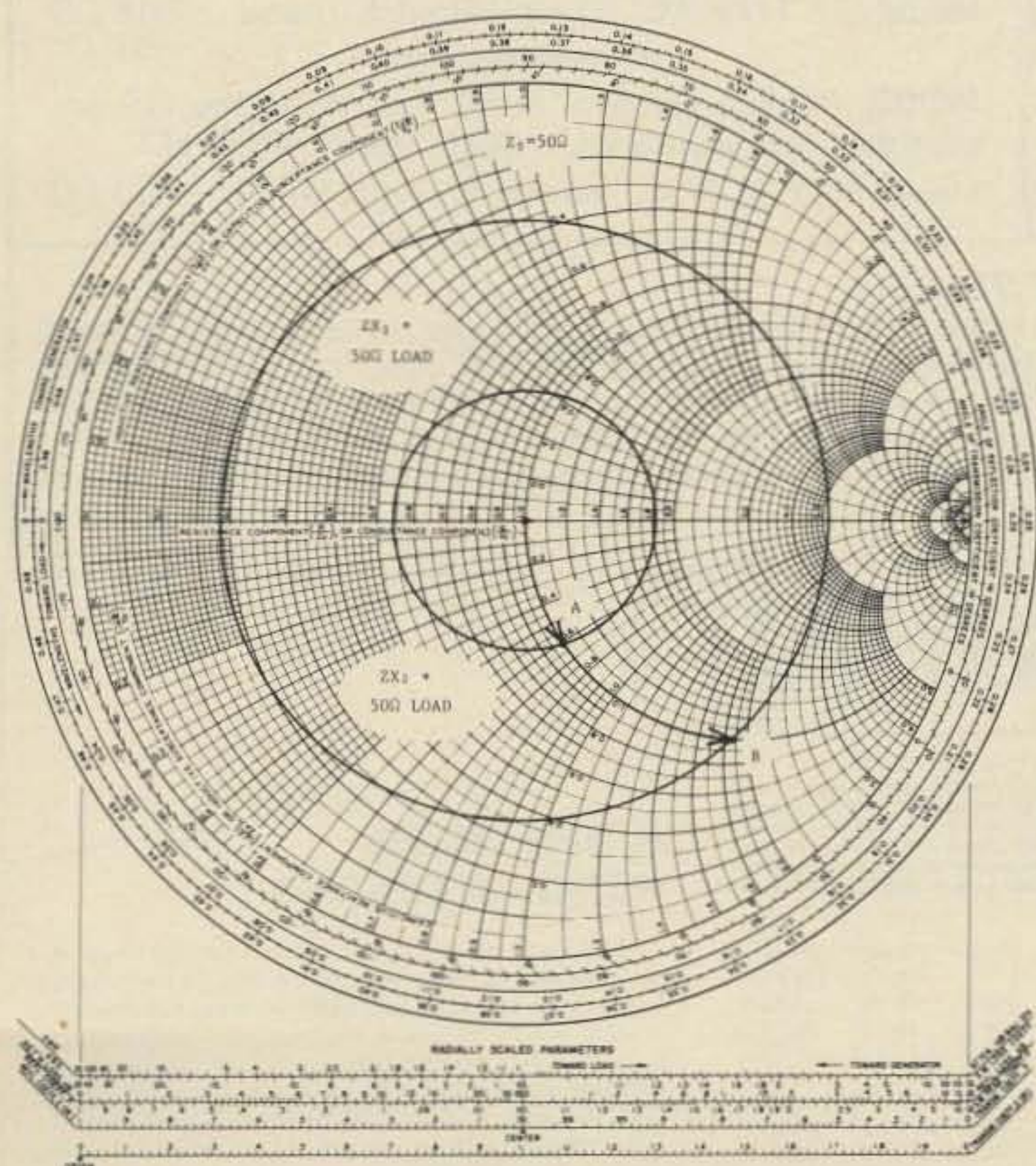

Smith Chart A.

IMPEDANCE OR ADMITTANCE COORDINATES

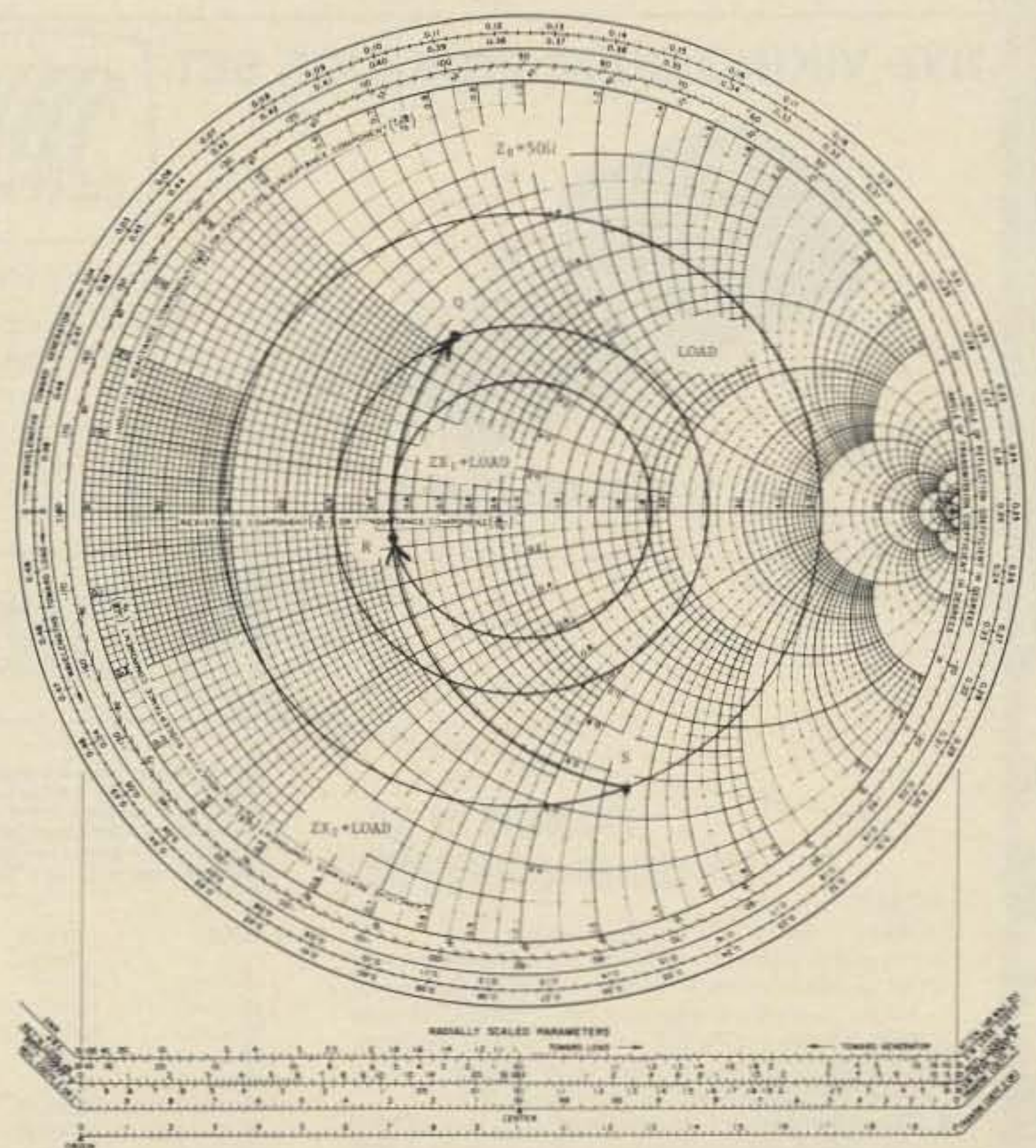

Smith Chart B.



GENERAL MULTI-PURPOSE V-O-Ms • DROP RESISTANT • HAND SIZE • MODEL 310 V-O-M • TYPE 3



Model 310  
Cat. No. 10-2856 \$2.10  
Vinyl pouch case.

1. Drop-resistant, hand-size V-O-M with high-impact thermoplastic case.
2. 20,000 Ohms per volt DC and 5,000 Ohms per volt AC; diode overload protection with fused Rx1 Ohms range.
3. Single range switch; direct reading AC Amp range to facilitate clamp-on AC Ammeter usage.

RANGES

DC Volts: 0-3-12-60-300,1,200 (20,000 Ohms per Volt).  
 AC Volts: 0-3-12-60-300-1,200 (5,000 Ohms per Volt).  
 Ohms: 0-20k-200k-2M  $\Omega$ -20M  $\Omega$  (200 Ohm center scale on low range).  
 DC Microamperes: 0-600 at 250 mV.  
 DC Milliampers: 0-6-60-600 at 250 mV.  
 Accuracy:  $\pm 3\%$  DC;  $\pm 4\%$  AC; (full scale).  
 Scale Length: 2-1/8".  
 Meter: Self-shielded; diode overload protected; spring backed jewels.  
 Case: Molded, black, high impact thermoplastic with slide latch cover for access to batteries and fuse, 2-3/4" w x 1-5/16" d x 4-1/4" h.  
 Batteries: NEDA 15V 220 (1), 1 1/2V 910F (1): Complete with 42" leads, alligator clips, batteries and instruction manual. Shpg. Wt. 2 lbs.  
 Model 310 Cat. No. 3018 ..... \$53.00

Novice Crystals (Specify Band Only)  
**BOMAR Crystal Company**



TWO METERS  
 CRYSTALS IN STOCK

Motorola HT 220 Crystals  
 In Stock!



Standard • Icom • Heathkit • Ken • Clegg • Regency • Wilson • VHF  
 Eng • Drake • And Others! \$4.50 @ Lifetime Guarantee

Make/Model	Xmit Freq.	Rec. Freq.

ALL BAND PREAMPLIFIERS



- 6 THRU 160 METERS
- TWO MODELS AVAILABLE
- RECOMMENDED FOR RECEIVER USE ONLY
- INCLUDES POWER SUPPLY

MODEL PLF employs a dual gate FET providing noise figures of 1.5 to 3.4 db., depending upon the band. The weak signal performance of most receivers as well as image and spurious rejection are greatly improved. Overall gain is in excess of 20 db. Panel contains switching that transfers the antenna directly to the receiver or to the Preamp.

Model PLF 117V AC, 60 Hz. Wired & Tested .... \$44.00

NYE VIKING CODE PRACTICE SET

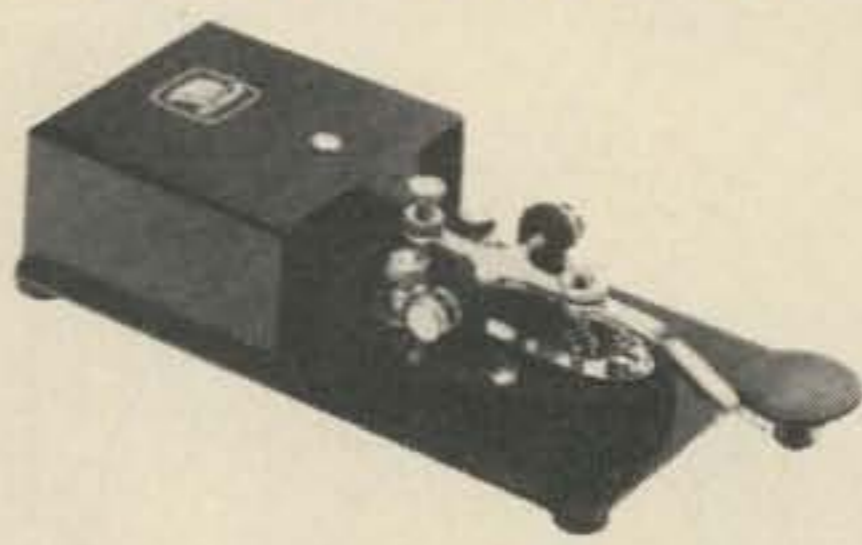

No. 114-404-002 \$18.50

Get the RIGHT START!

With a NYE VIKING Code Practice Set you get a sure, smooth, Speed-X model 310-001 transmitting key, a linear circuit oscillator and amplifier, with a built-in 2" speaker, all mounted on a heavy duty aluminum base with non-skid feet. Operates on standard 9V transistor type battery (not included). Units can be connected in parallel so that two or more operators can practice sending and receiving to each other. List price, \$18.50.

**MOR-GAIN**

Fully Air Tested - Thousands Already in Use

#16 40% Copper Weld wire annealed to it handles like soft Copper wire - Rated for better than full legal power AM/CW or SSB-Coaxial or Balanced 50 to 75 ohm feedline - VSWR under 1.5 to 1 at most heights - Stainless Steel hardware - Drop Proof Insulators - Terrific Performance - No coils or traps to break down or change under weather conditions - Completely Assembled ready to put up - Guaranteed 1 year - ONE DESIGN DOES IT ALL.

EXCLUSIVE 66 FOOT,  
 75 THRU 10 METER DIPOLES

NOTES

1. Models prefaced '\*\*\*' will be available 1/77.
2. All models above are furnished with crimp/solder lugs.
3. All models can be furnished with a SO-239 female coaxial connector at additional cost. The SO-239 mates with the standard PL-259 male coaxial cable connector. To order this factory installed option, add the letter 'A' after the model number. Example: 40-20 HD/A.
4. 75 meter models are factory tuned to resonate at 3950 kHz. (SP) models are factory tuned to resonate at 3800 kHz. 80 meter models are factory tuned to resonate at 3650 kHz. See VSWR curves for other resonance data.

MODEL	BANDS (Meters)	PRICE	WEIGHT (Oz/Kg)	LENGTH (Ft/Mtrs)
40-20 HD	40/20	\$49.50	26/73	36/10.9
**40-10 HD	40/20/15/10	59.50	36/10.1	36/10.9
80-40 HD	80/40 + 15	57.50	41/1.15	69/21.0
75-40 HD	75/40	55.00	40/1.12	66/20.1
75-40 HD (SP)	75/40	57.50	40/1.12	66/20.1
75-20 HD	75/40/20	66.50	44/1.23	66/20.1
75-20 HD (SP)	75/40/20	66.50	44/1.23	66/20.1
75-10 HD	75/40/20/15/10	74.50	48/1.34	66/20.1
75-10 HD (SP)	75/40/20/15/10	74.50	48/1.34	66/20.1
**80-10 HD	80/40/20/15/10	76.50	50/1.40	69/21.0

NO TRAPS—NO COILS—  
 NO STUBS—NO CAPACITORS

MOR-GAIN HD DIPOLES ... • One half the length of conventional half-wave dipoles. • Multi-band, Multi-frequency. • Maximum efficiency - no traps, loading coils, or stubs. • Fully assembled and pre-tuned - no measuring, no cutting. • All weather rated - 1 KW AM, 2.5 KW CW or PEP SSB. • Proven performance - more than 15,000 have been delivered. • Permit use of the full capabilities of today's 5-band xcvs. • One feedline for operation on all bands. • Lowest cost/benefit antenna on the market today. • Fast QSY - no feedline switching. • Highest performance for the Novice as well as the Extra-Class Op.



SST T-1 RANDOM WIRE ANTENNA TUNER



All band operation (160-10 meters) with most any random length wire. 200 Watt power capability. Ideal for portable or home operation. A must for Field Day. Size: 2 x 4-1/4 x 2-3/8. Built-in neon tune-up indicator. Guaranteed for 90 days. Compact — easy to use. Only \$29.95.



ASTATIC MICROPHONES

SILVER EAGLE — \$69.95

- T-UG8-D104, transistorized . . . . . \$48.60
- T-UG9-D104, "Golden Eagle," transistorized \$95.40
- T-UG9-D104, "Silver Eagle," transistorized . \$69.95
- UG-D104, ceramic or crystal . . . . . \$42.60



Model 200 V



Model 210



Model 220

CES Touch Tone Pads

- Model 200V — acoustic coupling. \$59.95
- Model 210 — for mounting on walkies or hand-helds. \$54.95
- Model 220 — CES can now offer you a TOUCH TONE back for Standard Communications hand-held radios. This is the complete back assembly with the TOUCH TONE encoder mounted and ready to plug into the private channel connector. Also included is a LED tone generator indicator and an external tone deviation adjustment. \$74.95.

talk power by **TPL**

TPL for an Economy Price? THAT'S RIGHT!

introducing the ECONO-LINE

Model	Input	Output	Typical	Frequency	Price
702	5-20W	50-90W	10 in/70 out	143-149 MHz	\$139.00
702B	1-4W	60-80W	1 in/70 out	143-149 MHz	\$169.00

Now get TPL COMMUNICATIONS quality and reliability at an economy price. The new Econo-Line gives you everything that you've come to expect from TPL at a real cost reduction. The latest mechanical and electronic construction techniques combine to make the Econo-Line your best amplifier value. Unique broad-band circuitry requires no tuning throughout the entire 2-meter band and adjacent MARS channels. See these great new additions to the TPL COMMUNICATIONS product line at your favorite amateur radio dealer.

For prices and specifications please write for our Amateur Products Summary! FCC type accepted power amplifiers also available. Please call or write for a copy of TPL's Commercial Products Summary.

**SLINKY!** Kit \$43.95

A LOT of antenna in a LITTLE space  
New Slinky® dipole\* with helical loading radiates a good signal at 1/10 wavelength long!

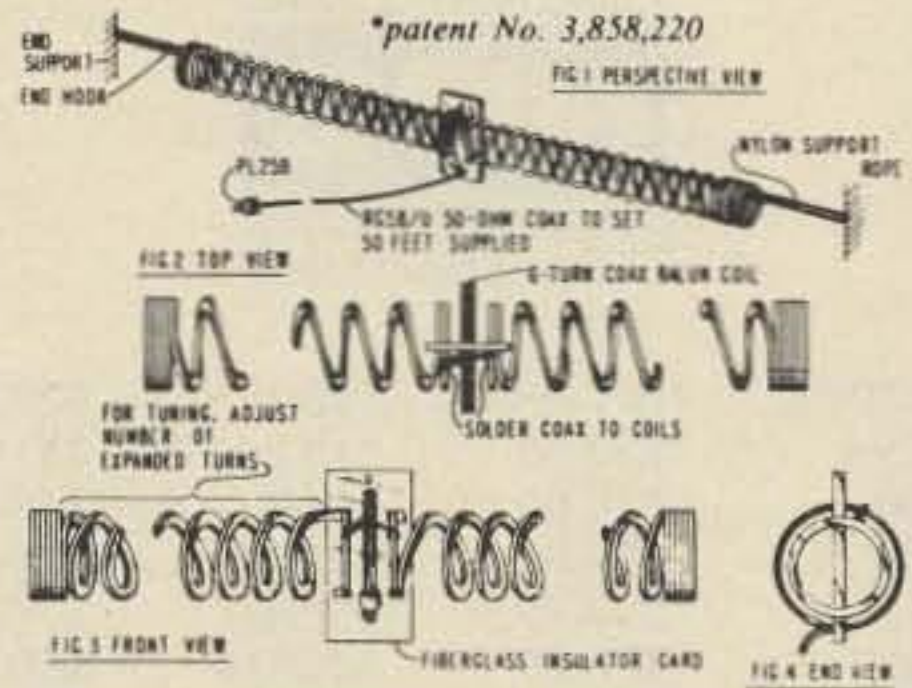

\* This electrically small 80/75, 40, & 20 meter antenna operates at any length from 24 to 70 feet • no extra balun or transmatch needed • portable—erects & stores in minutes • small enough to fit in attic or apartment • full legal power • low SWR over complete 80/75, 40, & 20 meter bands • much lower atmospheric noise pickup than a vertical and needs no radials • kit includes a pair of specially-made 4-inch dia. by 4-inch long coils, containing 335 feet of radiating conductor, balun, 50 ft. RG58/U coax, PL259 connector, nylon rope & instruction manual • now in use by US Dept. of State, US Army, radio schools, plus thousands of hams the world over.



FT-101E TRANSCEIVER

**YAESU**

FT 301	160M-10M Transceiver — 200 WPEP	\$769
FP 301 DIG	160M-10M Transceiver — 200 WPEP	935
FP 301	AC Power Supply	125
FP 301 CID	AC P.S. w/Clock and CW ID	209
FRG-7	General Cov. Synthesized Receiver	299
QTR-24	Yaesu World Clock	30
FT-101-E	XCVR W/Processor	729
160-10M		
FT-101EE	XCVR W/O Processor	649
160-10M		
FT-101EX	XCVR W/O Processor	589
160-10M	AC Only, Less Mike	399
FL-2100B	Linear Amplifier	199
FTV-650B	6M Transverter	199
FTV-250	2M Transverter	109
FV-101B	External VFO	22
SP-101B	Speaker	59
SP-101PB	Speaker/Patch	199
YO-100	Monitor Scope	29
YD-844	Dynamic Base Mike	15
FA-9	Cooling Fan	19
MMB-1	Mobile Mount	79
RFP-102	RF Speech Processor	40
XF-30C	600 Hz CW Filter	
FR-101S	160-2M/SW RCVR	489
SOLID STATE		
FR 101 DIG	160-2M/SW RCVR	599
SOLID STATE		
FT 301S	160-10M 40WPEP	559
FT 301S	160-10M 40WPEP Digital	765

Accessories:		
FC-6	6M Converter	24
FC-2	2M Converter	25
FM-1	FM Detector	20
	Aux/SW Crystals	5
XF-30B	AM-Wide Filter	40
XF-30C	600 Hz CW Filter	40
XF-30D	FM Filter	49
SP-101B	Speaker	22
FL-101		
SOLID STATE	160-10M	
TRANSMITTER		525
Accessories:		
RFP-101	RF Speech Processor	79
MONITOR/TEST EQUIPMENT		
YC 500 J	500 MHz (10 PPM) Counter	249
YC 500 S	500 MHz (1 PPM) Counter	365
YC 500 E	500 MHz (0.02 PPM) Counter	489
YO-100	Monitor Scope	199
YP-150	Dummy Load/Watt Meter	69
YC-601	Digital Readout (101/401 series)	169
VHF FM & SSB TRANSCEIVERS		
FT-620B	6M AM/CW/SSB	365
FT-221	2M AM/FM/CW/SSB	629
Accessories:		
MMB-4	Mobile Mount (FT-620B, FT-221)	19

**TUFTS**

Name \_\_\_\_\_ Call \_\_\_\_\_  
 Address \_\_\_\_\_  
 City \_\_\_\_\_ State \_\_\_\_\_ Zip \_\_\_\_\_  
 Order: \_\_\_\_\_

MasterCharge  
 American Express  
 BankAmericard  
 accepted on  
 MOST items!

Radio Electronics

209 Mystic Avenue  
 Medford MA 02155  
 (617) 395-8280

Check enclosed  
 BankAmericard  MasterCharge  American Express  
 Credit card # \_\_\_\_\_ Interbank # \_\_\_\_\_  
 Signature \_\_\_\_\_ Card expiration date \_\_\_\_\_

**FREE Gift With Every Order!**

Cash orders over \$1200 deduct 5%. No other discounts offered. All sales final.

Prices FOB Medford MA. All units can be shipped UPS. MA residents add 5% sales tax. Minimum \$3.00 for shipping & handling on all orders. \$10.00 merchandise minimum please.

TUFTS RADIO CATALOG



# HAM RADIO / MOBILE COMMUNICATIONS



MODEL	NET PRICE	MODEL	NET PRICE
12V4	\$19.95	*13 HM 4	\$41.95
600	\$20.50	104R	\$49.95
102	\$24.95	12/115	\$69.95
612	\$27.95	108RA	\$79.95
107	\$28.95	108RM	\$99.95
12 HM 4	\$29.95	109R	\$149.95

## MODEL 12HM4

NPC 2.5 Amp Regulated Power Supply. Solid State. Short Circuit Protected.



ALSO! Available as 13 HM 4 with built-in loudspeaker.

	TYPICAL	MAXIMUM
Output Voltage	13.5 ± 5VDC	14VDC
Continuous Current	1.5 Amp	
Regulation	2.5 Amp	
Ripple/Noise	5 mV RMS	10 mV RMS

Case: 3" (H) x 4" (W) x 5 1/4" (D). Shipping Weight: 3 lbs.

Low cost regulated power supply quietly converts 115 volts AC to 13.5 volts DC ± 200 millivolts. 1.5 amps continuous, 2.5 amps reg. Ideally suited for operating mobile CB transceivers in your home or office base station.



## MODEL 103R

NPC 4 Amp Regulated Power Supply. Solid State. Dual Overload Protection.



Converts 115 volts AC to 13.6 volts DC ± 200 millivolts. Handles 2.5 amps continuous and 4 amps max. Ideally suited for applications where no hum and DC stability are important such as CB transmission, small Ham radio transmitter, and high quality eight-track car stereos. Can also be used to trickle-charge 12 volt car batteries.

	TYPICAL	MAXIMUM
Output Voltage	13.6 ± 2 VDC	13.6 ± 3 VDC
Line/Load Regulation	20 mV	50 mV
Ripple/Noise	2 mV RMS	5 mV RMS
Transient Response	20 uSec	
Current Continuous	2.5 Amp	
Current Limit	4 Amp	
Current Foldback	1 Amp	

Case: 3" (H) x 4 1/4" (W) x 5 1/4" (D). Shipping Weight: 4 lbs.

## MODEL 107

NPC 4 Amp Power Supply, 6 Amp Max. Solid State. Overload Protected



Functions silently in converting 115 volts AC to 12 volts DC. 4 amps continuous, 6 amps max. Enables anyone to enjoy CB radio, car 8-track cartridge, cassette player or car radio in a home or office.

Continuous Current (Full Load)	4 Amp
Output Voltage (No Load)	16 V max
Output Voltage (Full Load)	12 V min
Filtering Capacitor	10,000 uF
Ripple (Full Load)	5 V RMS
Short Circuit Protection	Thermal Breaker

Case: 3" (H) x 4 1/4" (W) x 5 1/4" (D). Shipping Weight: 5 lbs.

## MODEL 109R

NPC 25 Amp Regulated Power Supply. 4-Way Protected. Output Voltage and Current Meters.

Extra heavy-duty unit quietly converts 115 volts AC to 13.6 volts DC ± 200 millivolts. 10 amps continuous, 25 amps max. All solid state. Features dual current overload, overvoltage and thermal protection. Ideally suited for operating mobile Ham radio and linear amplifier in your home or office. Excellent bench power supply for testing and servicing of mobile communications equipment.

	TYPICAL	MAXIMUM
Output Voltage	13.6 ± 2VDC	13.6 ± 3VDC
Line/Load Regulation	50 mV	100 mV
Ripple Noise	5 mV RMS	10 mV RMS
Transient Response	20 uSec	
Current Continuous	10 Amp	
Current Limit	26 Amp	
Overvoltage Protection	14.5 V	15 V
Thermal Overload	180°F	

Case: 4 1/4" (H) x 9" (W) x 8 1/2" (D). Shipping Weight: 15 lbs.

## MODEL 12V4

NPC 1.75 Amp Power Supply. 3 Amp Max.



Functions silently in converting 115 volts AC to 12 volts DC. Ideally suited for most applications including 8-track stereo, burglar alarm, car radio and cassette tape player within power rating.

Continuous Current (Full Load)	1.75 Amp
Output Voltage (No Load)	16 V max
Output Voltage (Full Load)	12 V min
Filtering Capacitor	5,000 uF
Ripple (Full Load)	4 V RMS
Short Circuit Protection	Thermal Breaker

Case: 3" (H) x 4" (W) x 5 1/4" (D). Shipping Weight: 3 lbs.

## MODEL 108RM

NPC 12 Amp Regulated Power Supply. Solid State. 3-Way Protected. Current Meter.



This heavy duty unit quietly converts 115 volts AC to 13.6 volts DC ± 200 millivolts. 8 amps continuous, 12 amps max. All solid state. Features dual current overload and overvoltage protection. Ideally suited for operating mobile Ham radio 2 meter AM-FM-SSB transceivers in your home or office. Can also be used to trickle-charge 12 volt car batteries.

	TYPICAL	MAXIMUM
Output Voltage	13.6 ± 2VDC	13.6 ± 3VDC
Line/Load Regulation	20 mV	50 mV
Ripple/Noise	2 mV RMS	5 mV RMS
Transient Response	20 uSec	
Current Continuous	8 Amp	
Current Limit	12 Amp	
Current Foldback	2.5 Amp	
Overvoltage Protection	14.5 V	15 V

Case: 4 1/4" (H) x 7 1/4" (W) x 5 1/4" (D). Shipping Weight: 9.5 lbs.

ALSO AVAILABLE AS MODEL 108RA WITHOUT METER AND OVERVOLTAGE PROTECTION.

## MODEL 104R

NPC 6 Amp Power Supply Regulated. Solid State. Dual Overload Protection.



Converts 115 volts AC to 13.6 volts DC ± 200 millivolts. Handles 4 amps continuous and 6 amps max. Ideally suited for applications where excellent DC stability is important, such as CB transmission, small Ham radio transmitter, and high quality eight-track car stereos. Can be used to trickle-charge 12 volt car batteries.

	MAXIMUM	TYPICAL
Output Voltage	13.6 ± 2 VDC	13.6 ± 3 VDC
Line/Load Regulation	20 mV	50 mV
Ripple/Noise	2 mV RMS	5 mV RMS
Transient Response	20 uSec	
Current Continuous	4 Amp	
Current Limit	6 Amp	
Current Foldback	2 Amp	

Case: 3 1/2" (H) x 5 1/4" (W) x 6 1/4" (D). Shipping Weight: 6 lbs.



## MODEL 102

NPC 2.5 Amp Power Supply. 4 Amp Max. Solid State. Overload Protected.

Functions silently in converting 115 volts AC to 12-volts DC. 2.5 amps continuous, 4 amps max. Enables anyone to enjoy CB radio, car 8-track cartridge, cassette tape player or car radio in a home or office.

Continuous Current (Full Load)	2.5 Amp
Output Voltage (No Load)	16 V max
Output Voltage (Full Load)	12 V min
Filtering Capacitor	5,000 uF
Ripple (Full Load)	.6 V RMS
Short Circuit Protection	Thermal Breaker

Case: 3" (H) x 4 1/4" (W) x 5 1/4" (D). Shipping Weight: 4 lbs.



Output Voltage (No Load)	12 VDC 1N	14 VDC 1N
Output Voltage (Full Load)	115 V RMS	130 V RMS
Frequency (No Load)	100 V RMS	115 V RMS
Frequency (Full Load)	58 Hz	66 Hz
Power Continuous	54 Hz	62 Hz
Power Peak	200W	
Parallel Connection	240W	
	350W	

All Values Are Typical

# MARINE & RV

## MODEL 12-115

NPC 12-115 Solid State Inverter. 200 W. Parallel Connection for Higher Power up to 350 W.

Converts 12 volts DC to 115 volts AC @ 60 Hz output. 200 watts continuous operation with peak power up to 240 watts. All silicon semiconductors assure high reliability at excessive ambient temperatures. The output voltage is a square wave. The inverter is not recommended where high transients are not tolerable.

The 12-115 allows you to have AC house current in your boat, car, truck, camper, house trailer, or houseboat. Will operate small household appliances, T.V., hand tools, electric shaver, AC radios, and lights within power rating. Built-in overload protection.

Case: 4 1/2" (H) x 7 1/4" (W) x 5 1/4" (D). Shipping Weight: 7 lbs.

## MODEL 612

Model 612 Power Converter

NPC 612 converts 6 volt negative ground or 12 volt positive ground electrical systems to 12 volt negative ground operation. Provides full 3 amp continuous power. The inexpensive solution for installing car radios, stereo and cassette tape players, in vehicles with 6 volt negative ground or 12 volt positive ground systems.

Case: 2 1/4" (H) x 3" (W) x 5" (D). Shipping Weight: 1 lb.







● Handle full 200 watts ● low-low V.S.W.R. ● Deliver 3 dB gain and more! ● Pick the one that best fits your needs:

## Larsen Kulrod® Antennas

### MAGNETIC MOUNT

stays put even at 100 mph!

MM-JM-150 for 144 MHz use }  
MM-JM-220 for 220 MHz use } **Only \$38.50**  
MM-JM-440 for 440 MHz use } complete



### TRUNK LID MOUNT

No holes and low silhouette too!

TLM-JM-150 for 144 MHz use }  
TLM-JM-220 for 220 MHz use } **Only \$38.50**  
TLM-JM-440 for 440 MHz use } complete

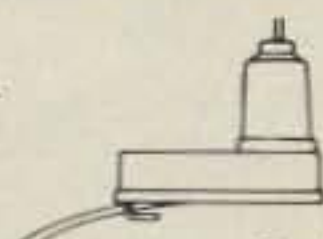

And 1/4 wave antenna for trunk and magnetic mount — \$18.50

### ROOF or FENDER MOUNT

Goes on quick and easy in 3/8" or 3/4" with fewest parts.

JM-150-K for 144 MHz use }  
JM-220-K for 220 MHz use } **Only \$31.50**  
JM-440-K for 440 MHz use } complete



And 1/4 wave antenna for roof and fender mounts \$11.50

Above antennas all complete with mounting hardware, coax, connector plug, allen wrench and complete instructions.

#### model 372 CLIPREAMP



Model 372 — \$27.50

Get maximum legal modulation without danger of splatter. Solid-state speech preamplifier and clipper for transmitters, public-address systems, and tape recorders needs no external power.

• specifications  
Input Impedance 100,000 ohms  
Input Levels 5 millivolts to 20 millivolts  
Voltage Gain 10 dB  
Output Level 60 millivolts  
Output Impedance 50,000 ohms  
Power 9-volt transistor battery, Burgess 2U6 or equivalent  
Size 2-3/4" x 3" x 4-1/2"  
Shipping Weight 7 oz.  
Connectors Terminal strip

#### COAXIAL ANTENNA CHANGEOVER RELAY

model 377



Model 377 — \$17.95

Economical and reliable. Can be operated from VOX circuit for completely automatic operation or from PTT or manual T/R switch. Receiver input is automatically grounded when the relay is in the Transmit position. Wide AC operating voltage range and low operating current.

• specifications  
Power Rating 1000 watts CW (2000 watts SSB)  
VSWR Less than 1.15:1, DC to 150 MHz  
Power Requirements 0.015 Amperes, 48 to 130 volts AC  
Connectors UHF Type SO-239  
Dimensions 3-1/2" x 1-1/2"  
Shipping Weight 1 lb.

#### UNIVERSAL HYBRID COUPLER II PHONE PATCH

model 3002W and model 3001W



Model 300 2W with Compreamp — \$125.00

Connect your station to the telephone lines. Five switch-selectable modes give complete flexibility for patching the station to the line and for tape recording and playback to or from the line or the station. The hybrid circuit provides for effortless VOX operation of the phone patch. A built-in Compreamp speech preamplifier/limiter (in Model 3002W) increases the level of weak phone signals and also prevents overmodulation when the local telephone is used as the station microphone. (The Compreamp also functions as a preamplifier/limiter with the station microphone, if desired.)

• specifications  
Inputs from:  
Line 600 ohms  
Receiver 4 ohms  
Microphone High impedance (50,000 ohms) crystal or dynamic  
Tape Recorder 4 ohms  
Outputs to:  
Transmitter 50,000 ohms  
Receiver Speaker 4 ohms  
Tape Recorder 0.5 megohm  
Size 6-1/2" x 7-1/2" x 3"  
Shipping Weight 3-1/2 lbs.  
Power 9-volt battery, Burgess 2U6 or equivalent  
Connectors Phone

Model 300 1W without Compreamp — \$85.00



BARKER & WILLIAMSON, INC.

Model 359 — \$37.50



Increase your transmitter's effective speech power up to four times. Or use it with your tape recorder or public address system for improved performance. This two-stage, transistorized Audio Preamplifier/Limiter can be used with all types of transmitters. Powered by a long-lasting dry-cell battery—no external power needed. Installs without any wiring changes in your transmitter. Just connect the Compreamp between your microphone (50,000-ohm dynamic or high-impedance ceramic) and your transmitter's microphone input connector. Front-panel rocker switch lets you bypass the Compreamp when you want to. Compression level is adjustable, too.

• specifications  
Input Impedance 100,000 ohms  
Input Level 5 millivolts to 20 millivolts  
Voltage Gain 10 dB  
Output Level 60 millivolts  
Output Impedance 50,000 ohms  
Power 9-volt transistor battery, Burgess 2U6 or equivalent  
Size 2-3/4" x 3" x 4-1/2"  
Shipping Weight 6-1/2 oz.  
Connectors Terminal strip

#### COAXIAL SWITCHES AND ACCESSORIES

for antenna selection and RF switching

These high-quality switches have set the standard for the industry for years. Ceramic switches with silver-alloy contacts and silver-plated conductors give unmatched performance and reliability from audio frequencies to 150 MHz.

B&W coaxial switches are designed for use with 52- to 75-ohm non-reactive loads, and are power rated at 1000 watts AM, 2000 watts SSB. Connectors are UHF type. Insertion loss is negligible, and VSWR is less than 1.2:1 up to 150 MHz.

Crosstalk (measured at 30 MHz) is -45 dB between adjacent outlets and -60 dB between alternate outlets.

Models are available for desk, wall, or panel mounting, and with or without protective grounding of inactive outputs. Radial (side-mounted) connector models can be either wall or panel-mounted; axial (backplate-mounted) connector models are for panel mounting only, save panel space.

Use the selector chart below to choose the models you need.

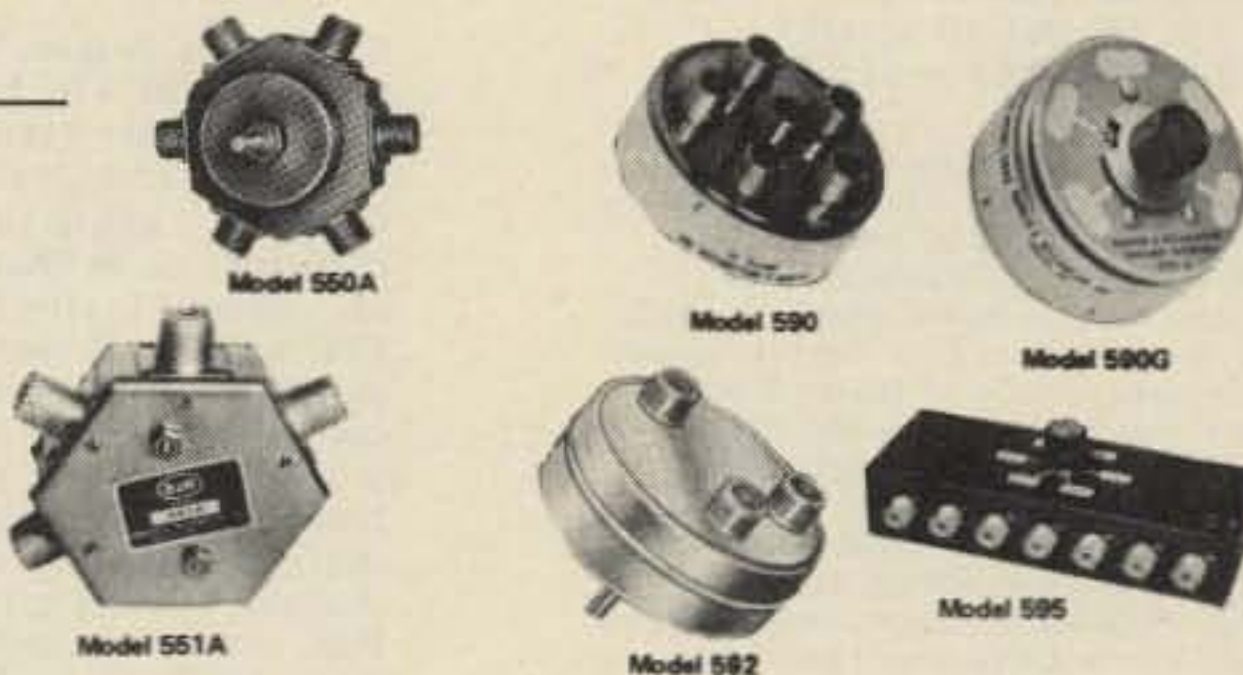

#### COAXIAL SWITCH SELECTOR CHART

Model	PRICE	Outputs	Connector Placement	Mounting			Automatic Grounding	Dial Plate	Remarks
				Panel	Wall	Desk			
375	18.95	6	Axial	x			x	Supplied	PROTAX switch. Grounds all except selected output circuit.
376	18.95	5	Radial	x	x		x	Supplied	PROTAX switch. Grounds all except selected output circuit. Sixth switch position grounds all outputs.
550A	14.00	5	Radial	x	x			DP-5	
550A-2	12.50	2	Radial	x	x			DP-2	
551A	17.50	2	Radial	x	x			DP-2	Special 2-pole, 2-position switch used to switch any RF device in or out of series connection in a coaxial line. See figure (lower).
556	.95	—	—		x			—	Bracket only, for wall mounting of radial connector switches.
590	17.95	5	Axial	x				DP-5	
590G	17.95	5	Axial	x			x	Supplied	Grounds all except selected output circuit.
592	16.50	2	Axial	x				DP-2	
595	18.50	6	In-line		x	x	x		Grounds all except selected output circuit.



TUFTS RADIO CATALOG



There is no substitute for quality, performance, or the satisfaction of owning the very best.

Hence, the incomparable Hy-Gain 3750 Amateur transceiver. The 3750 covers all amateur bands 1.8-30 MHz (160-10 meters). It utilizes advanced Phase-Lock-Loop circuitry with dual gate MOS FET's at all critical RF amplifier and mixer stages. There's a rotating dial for easy band-scanning and an electronic frequency counter with digital readout and a memory display that remembers frequencies at the flip of a switch. And that's just the beginning.

Matching speaker unit (3854) and complete external VFO (3855) also available.

See the incomparable Hy-Gain 3750 at your radio dealer or write Department MM. There is no substitute.



3854 - \$59.95

3750 - \$1895.00

3855 - \$495.00

**There is no substitute.**

**hy-gain**  
Amateur Radio Systems.

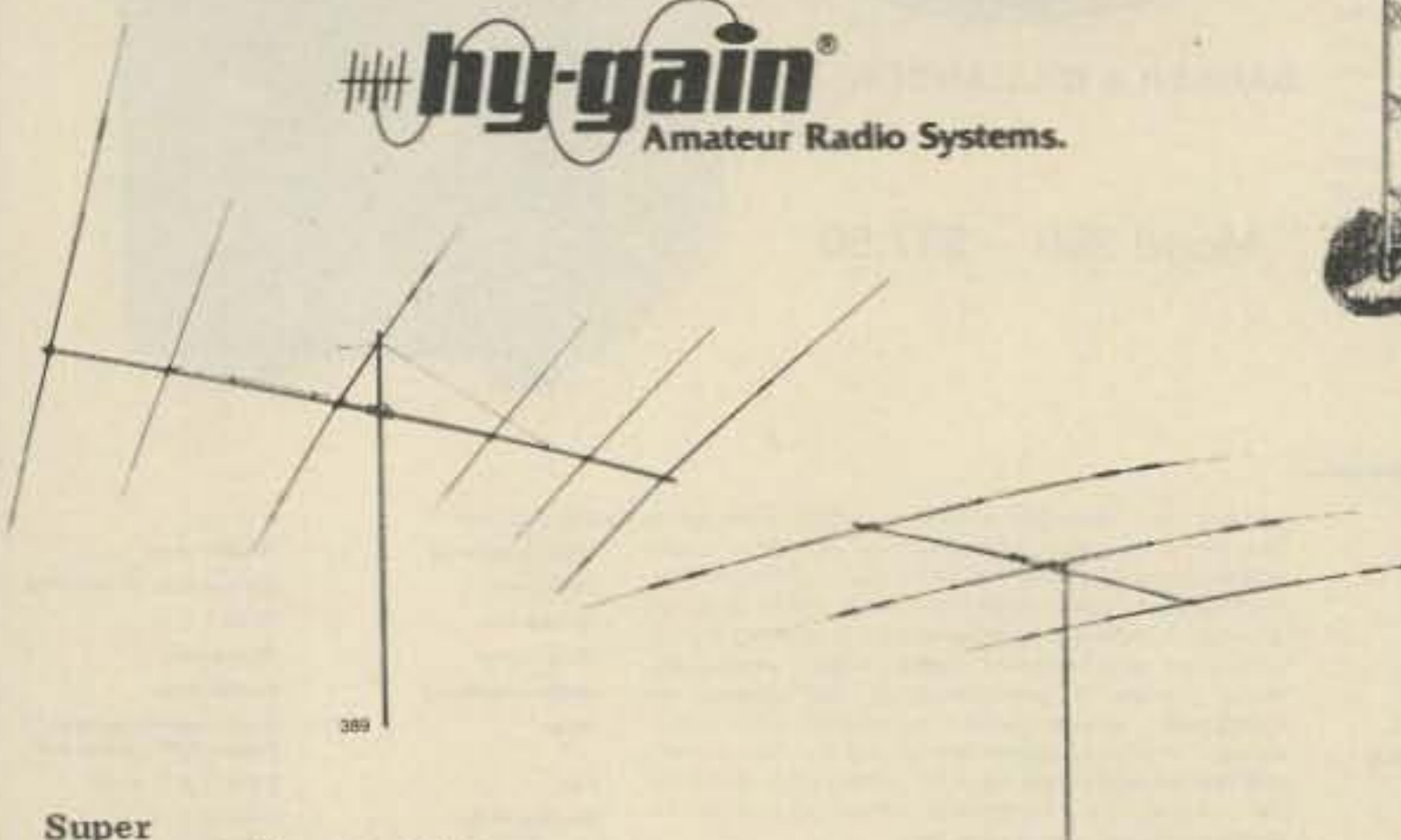

**Super 3-Element Thunderbird for 10, 15 and 20 Meters Model TH3Mk3 - \$199.95**

Hy-Gain's Super 3-element Thunderbird delivers outstanding performance on 10, 15 and 20 meters. The TH3Mk3 features separate and matched Hy-Q traps for each band, and feeds with 52 ohm coax. Hy-Gain Beta Match presents tapered impedance for most efficient 3 band matching, and provides DC ground to eliminate precipitation static. The TH3Mk3 delivers maximum F/B ratio, and SWR less than 1.5:1 at resonance on all bands. Its mechanically superior construction features taper swaged slotted tubing for easy adjustment and larger diameter. Comes equipped with heavy tiltable boom-to-mast clamp. Hy-Gain ferrite balun BN-86 is recommended for use with the TH3Mk3.

**6-Element Super Thunderbird DX for 10, 15 and 20 Meters Model TH6 DXX \$249.95**

Separate HY-Q traps, featuring large diameter coils that develop an exceptionally favorable L/C ratio and very high Q, provide peak performance on each band whether working phone or CW. Exclusive Hy-Gain beta match, factory pretuned, insures maximum gain and F/B ratio without compromise. The TH6DXX feeds with 52 ohm coaxial cable and delivers less than 1.5:1 SWR on all bands. Mechanically superior construction features taper swaged, slotted tubing for easy adjustment and re-adjustment, and for larger diameter and less wind loading. Full circumference compression clamps replace self-tapping sheet metal screws. Includes large diameter, heavy gauge aluminum boom, heavy cast aluminum boom-to-mast clamp, and heavy gauge machine formed element-to-boom brackets. Hy-Gain's ferrite balun BN-86 is recommended for use with the TH6DXX.

Electrical	TH6DXX	TH3Mk3
Gain—average	8.7dB	8dB
Front-to-back ratio	25dB	25dB
SWR (at resonance)	Less than 1.5:1	Less than 1.5:1
Impedance	50 ohms	50 ohms
Power rating	Max legal	Max legal

Mechanical	TH6DXX	TH3Mk3
Longest element	31.1'	27'
Boom length	24'	14'
Turning radius	20'	15.7'
Wind load at 80 MPH	156 lbs.	103.2 lbs.
Maximum wind survival	100 MPH	100 MPH
Net weight	57 lbs.	36 lbs.
Mast diameter accepted	1 1/4" to 2 1/2"	1 1/4" to 2 1/2"
Surface area	6.1 sq. ft.	4.03 sq. ft.

**HY-GAIN'S INCOMPARABLE HY-TOWER FOR 80 THRU 10 METERS**

Model 18HT

- Outstanding Omni-Directional Performance
- Automatic Band Switching
- Installs on 4 sq. ft. of real estate
- Completely Self-Supporting

By any standard of measurement, the Hy-Tower is unquestionably the finest multi-band vertical antenna system on the market today. Virtually indestructible, the Model 18HT features automatic band selection on 80 thru 10 meters through the use of a unique stub decoupling system which effectively isolates various sections of the antenna so that an electrical 1/4 wavelength (or odd multiple of a 1/4 wavelength) exists on all bands. Fed with 52 ohm coax, it takes maximum legal power ... delivers outstanding performance on all bands. With the addition of a base loading coil, it also delivers outstanding performance on 160 meters. Structurally, the Model 18HT is built to last a lifetime. Rugged hot-dipped galvanized 24 ft. tower requires no guyed supports. Top mast, which extends to a height of 50 Ft., is 6061ST6 tapered aluminum. All hardware is iridite treated to MIL specs. If you're looking for the epitome in vertical antenna systems, you'll want Hy-Tower, Shpg. Wt., 96.7 lbs. Order No. 182, Price: \$279.95

NEW Special hinged base assembly on Model 18HT allows complete assembly of antenna at ground level ... permits easy raising and lowering of the antenna.

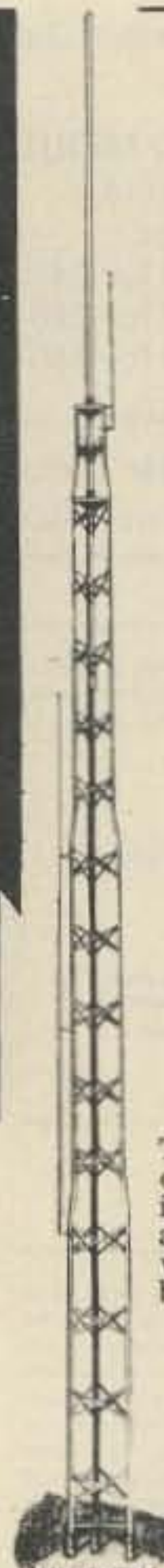

**BROAD BAND DOUBLET BALUN for 10 thru 80 meters Model BN-86 \$15.95**



The model BN-86 balun provides optimum balance of power to both sides of any doublet and vastly improves the transfer of energy from feedline to antenna. Power capacity is 1 KW DC. Features weatherproof construction and built-in mounting brackets. \$15.95 Shpg. Wt. 1 lb. Order No. 242

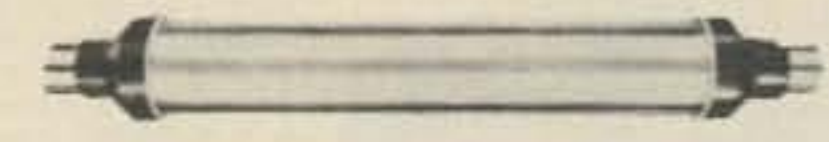

**MULTI-BAND HY-Q TRAP DOUBLET Hy-Q Traps**

- Install Horizontally or as Inverted V
- Super-Strength Aluminum Clad Wire
- Weatherproof Center and End Insulators

Installed horizontally or as an inverted V, Hy-Gain doublets with Hy-Q traps deliver true half wavelength performance on every design frequency. Matched traps, individually pretuned for each band feature large diameter coils that develop an exceptionally favorable L/C ratio and very high Q performance. Mechanically superior solid aluminum trap housings provide maximum protection and support to the loading coil. Fed with 52 ohm coax, Hy-Gain doublets employ super-strength aluminum clad single strand steel wire elements that defy deterioration from salt water and smoke ... will not stretch ... withstand hurricane-like winds. SWR less than 1.5:1 on all bands. Strong, lightweight, weatherproof center insulators are molded from high impact cyolac. Hardware is iridite treated to MIL specs. Heavily serrated 7-inch end insulators molded from high impact cyolac increase leakage path to approximately 12 inches.

**MODEL 2BDQ for 40 and 80 meters. 100' 10 1/2" overall. Takes maximum legal power. Shpg. Wt., 7.5 lbs \$49.95 Order No. 380**

**MODEL 5BDQ for 10, 15, 20, 40 and 80 meters. 94' overall. Takes maximum power. Shpg. Wt., 12.2 lbs. \$79.95 Order No. 383**

**CENTER INSULATOR for Multi-Band Doublets Model CI**

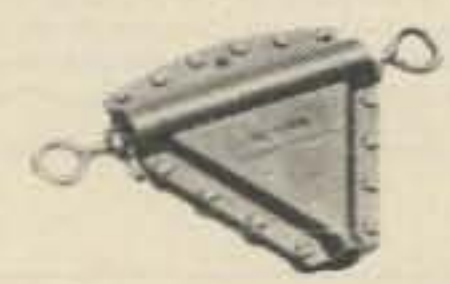

Strong lightweight, weatherproof Model CI is molded from high impact cyolac. Hardware is iridite treated to MIL specs. Accepts 1/4" or 3/8" coaxial. Shpg. Wt., 0.6 lbs. \$5.95 Order No. 155

**MULTI-BAND ANTENNA Dipole Antenna - Model DIV-80 \$13.95**

For 10 thru 80 meters - choice of one band

A dipole antenna for the individuals who prefer the "do-it-yourself" flexibility of custom-designing an antenna for your specific needs. (Work the frequencies you wish in the 10 through 80 meters bands).

The DIV-80 features: Durable Copperweld wire for greater strength, Mosley Dipole Connector (DPC-1) for RG-8/U or RG-58/U coax and all the technical information you will need to construct your custom-designed antenna.

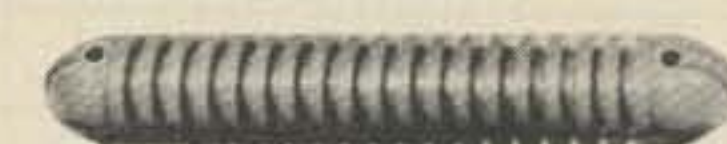

**END INSULATORS for Doublets Model EI**

Rugged 7-inch end insulators are molded from high impact cyolac that is heavily serrated to increase leakage path to approximately 12 inches. Available in pairs only. Shpg. Wt., 0.4 lbs. \$3.95 Order No. 156



- Remote
- Motor Controlled



### RCS-4

#### COAX ANTENNA SWITCH



- Control unit works on 110/220 VAC, 50/60 Hz, and supplies necessary DC to motor.
- Excellent for single coax feed to multiband quads or arrays of monobanders. The five positions allow a single coax feed to three beams and two dipoles, or other similar combinations.
- Control cable (not supplied) same as for HAM-M rotator.
- Selects antennas remotely, grounds all unused antennas. GND position grounds all antennas when leaving station. "Rain-Hat" construction shields motor and switches.
- Motor: 24 VAC, 2 amp. Lubrication good to -40°F.
- Switch RF Capability: Maximum legal limit. Price: \$120.00

#### MATCHING NETWORKS



**MN-4**  
200 watts  
Price: \$110.00



**MN-2000**  
2000 watts PEP  
Price: \$220.00

**General:** • Integral Wattmeter reads forward power in watts and VSWR directly; can be calibrated to read reflected power • Matches 50 ohm transmitter output to coax antenna feedline with VSWR of at least 5:1 • Covers ham bands 80 thru 10 meters • Switches in or out with front panel switch • Size: 5 1/2" H, 10 3/4" W, 8" D (14.0 x 27.3 x 20.3 cm), MN-2000, 14 3/4" D (36.5 cm).  
• Continuous Duty Output: MN-4, 200 watts; MN-2000, 1000 watts (2000 watts PEP) • MN-2000 only: Up to 3 antenna connectors selected by front panel switch.



#### RF WATTMETERS

**W-4** 1.8-54 MHz Price: \$ 72.00  
**WV-4** 20-200 MHz Price: \$ 84.00

Reads forward and reflected power directly in watts (VSWR from nomogram). Two scales in each direction. Size: 5 1/2" H, 3 3/4" W, 4" D (14.0 x 9.5 x 10.2 cm).

Model	Full Scale	Calibration Accuracy
W-4	200 watts	±(5% of reading + 2 watts)
	2000 watts	±(5% of reading + 20 watts)
WV-4	100 watts	±(5% of reading + 1 watt)
	1000 watts	±(5% of reading + 10 watts)



### SSR-1 COMMUNICATIONS RECEIVER

**GENERAL:** • All amateur bands 10 thru 80 meters in seven 600 kHz ranges • Solid State VFO with 1 kHz dial divisions • Modes SSB Upper and Lower, CW and AM • Built-in Sidetone and automatic T/R switching on CW • 30 tubes and semi-conductors • Dimensions: 5 1/2" H, 10 3/4" W, 14 3/4" D (14.0 x 27.3 x 36.5 cm), Wt.: 16 lbs. (7.3 kg).  
**TRANSMIT:** • VOX or PTT on SSB or AM • Input Power: SSB, 300 watts P.E.P.; AM, 260 watts P.E.P. controlled carrier compatible with SSB linears; CW, 260 watts • Adjustable pi-network.  
**RECEIVE:** • Sensitivity better than 1/2 µV for 10 dB S/N • I.F. Selectivity 2.1 kHz @ 6 dB, 3.6 kHz @ 60 dB. • AGC full on receive modes, variable with RF gain control, fast attack and slow release with noise pulse suppression • Diode Detector for AM reception.

Price: \$649.00

- 34-PNB Plug-in Noise Blanker . . . . . 100.00
- FF-1 Crystal Control Unit . . . . . 46.95
- MMK-3 Mobile Mount . . . . . 7.00
- RV-4C Remote VFO . . . . . 120.00

- Synthesized • General Coverage
- Low Cost • All Solid State • Built-in AC Power Supply • Selectable Sidebands
- Excellent Performance

**PRELIMINARY SPECIFICATIONS:** • Coverage: 500 kHz to 30 MHz • Frequency can be read accurately to better than 5 kHz • Sensitivity typically .5 microvolts for 10 dB S+N/N SSB and better than 2 microvolts for 10 dB S+N/N AM • Selectable sidebands • Built-in power supply: 117/234 VAC ± 20% • If the AC power source fails the unit switches automatically to an internal battery pack which uses eight D-cells (not supplied) • For reduced current drain on DC operation the dials do not light up unless a red pushbutton on the front panel is depressed.

The performance, versatility, size and low cost of the SSR-1 make it ideal for use as a stand-by amateur or novice-amateur receiver, short wave receiver, CB monitor receiver, or general purpose laboratory receiver.

Price: \$350.00



### TR-4CW SIDEBAND TRANSCEIVER

- POWER SUPPLIES**
- AC-4 Power Supply . . . . . \$120.00
  - DC-4 Power Supply . . . . . 135.00

### 2 METER FM PORTABLE TRANSCEIVER Model TR-33C



Amateur Net \$229.95

- SCPC\* Frequency Control
- 12 Channels with Selectable Xmtr Offsets.
- All FET Front-end and Crystal Filter for Superb Receiver Intermod Rejection.
- Expanded Antenna Choice.
- Low Receiver Battery Drain.
- Traditional R. L. Drake Service Backup.
- Single Crystal Per Channel.

### LINEAR AMPLIFIER Model L-4B



L-4B Linear Amplifier . . . . . 895.00

- 2000 Watts PEP-SSB • Class B Grounded-Grid — two 3-500Z Tubes • Broad Band Tuned-Input • RF Negative Feedback • Transmitting AGC • Directional Wattmeter • Two Tautband Suspension Meters • L-4B
- 13-15/16" W, 7-7/8" H, 14-5/16" D. Wt.: 32 lbs. • Power Supply 6-3/4" W, 7-7/8" H, 11" D, Wt.: 43 lbs.

- POWER SUPPLIES**
- AC 4 Power Supply . . . . . \$120.00
  - DC 4 Power Supply . . . . . 135.00

## Touch-n-go with DRAKE 1525EM Push Button Encoding Mike



Drake 1525EM, microphone with tone encoder and connector for TR-33C, TR-22, TR-22C, ML-2 . . . . . \$49.95

- Microphone and auto-patch encoder in single convenient package with coil cord and connector. Fully wired and ready for use.
- High accuracy IC tone generator, no frequency adjustments.
- High reliability Digitran® keyboard.
- Power for tone encoder obtained from transceiver through microphone cable. No battery required. Low current drain.
- Low output impedance allows use with almost all transceivers.
- Four pin microphone plug: directly connects to Drake TR-33C without any modification in transceiver. Compatible with all previous Drake and other 2 meter units with minor modifications.
- Tone level adjustable.
- Hang-up hook supplied.



why waste watts?  
(SWR-1A \$25.95)



**SWR-1 guards against power loss**  
If you're not pumping out all the power you're paying for, our little SWR-1 combination power meter and SWR bridge will tell you so. You read forward and reflected power simultaneously, up to 1000 watts RF and 1:1 to infinity VSWR at 3.5 to 150 MHz.

Got it all tuned up? Keep it that way with SWR-1. You can leave it right in your antenna circuit.



**DELUXE 742 TRI-BAND MOBILE ANTENNA**  
• Automatically adjusts to proper resonance for 20, 40 and 75 meters.  
• Power rated at 500 Watts P.E.P.  
• Includes base section, automatic coil and whip top section. 742 Antenna  
Price: \$109.95

**EXCLUSIVE DELUXE 5-BAND MOBILE 45 ANTENNA**  
• All band manual switching antenna for 10, 15, 20, 40 and 75 meters.  
• Power rated at 1000 Watts P.E.P.  
• Includes base section with mobile coil and six foot whip top section. 45 Antenna  
Price: \$119.95



## JMR MOBIL-EAR™

Two-way-radio headset with superior fidelity  
Electret-Capacitor boom microphone and palm-held talk switch.

\$69.95



MODEL 1015-A

FOR BROADCAST-QUALITY TRANSMISSION AND RECEPTION FOR BOTH MOBILE UNITS AND BASE STATIONS.

- Boom-mounted electret-capacitor microphone delivers studio-quality, undistorted voice reproduction. Variable gain control lets you adjust for optimum modulation.
- Cushioned earcup lets you monitor in privacy - no speaker blare to disturb others. Blocks out environmental noises, too. Made of unbreakable ABS plastic.
- Headband self-adjusts for comfortable wear over long hours. Spring-flex hinge lets you slip headset on and off with just one hand. Reversible for right or left ear.
- Headset can be hung on standard microphone clip.
- Compact palm-held talk switch lets you keep both hands on the wheel for safer driving. Made of unbreakable ABS plastic.
- Built-in FET transistor amplifier adapts microphone output to any transceiver impedance.
- Compatible with most two-way radios including 40-channel CB units.
- Built-in Velcro pad for easy mounting of the talk switch.
- Made in U.S.A.

## SWAN METERS HELP YOU GET IT ALL TOGETHER

These wattmeters tell you what's going on.

With one of these in-line wattmeters you'll know if you're getting it all together all the time. Need high accuracy? High power handling? Peak

power readings? For whatever purpose we've got the wattmeter for you. Use your Swan credit card. Applications at your dealer or write to us.



**WM2000 In-Line Wattmeter With Muscle.** Scales to 2000 watts. New flat-response directional coupler for maximum accuracy.  
\$59.95



**WM3000 Peak-reading Wattmeter.** Reads RMS power then with the flick of a switch, true peak power of your single-sideband signal. That's what counts on SSB.  
\$79.95



**WM1500 High-Accuracy In-Line Wattmeter.** 10% full scale accuracy on 5, 50, 500 and 1500 watt scales, 2 to 30 MHz. Forward and reflected power. Use it for trouble-shooting, too.  
\$74.95



**SWAN LINEAR AMPLIFIERS A Mark II 2000 watt P.E.P.** full legal input power unit or the 1200X matching Cygnet 1200 watt P.E.P. input powerhouse with built-in power supply. The choice is yours. \$849.95



**NEW Swan MMBX Impedance Matcher**  
It keeps your transmitter and your antenna on speaking terms for a song. Price: \$23.95

### CYGNET 1200X PORTABLE LINEAR AMPLIFIER

To quadruple the output of the 300B Cygnet *de novo*, simply add this matching unit for more than a kilowatt of power. Complete with self-contained power supply and provision for external ALC, this Cygnet offers exceptionally high efficiency and linearity. \$349.95



Additional Swan products include: fixed and mobile antennas, VFO's telephone patch, VOX, wattmeter, microphones and mounting kits. As another extra service, only Swan Electronics offers factory-backed financing to the amateur radio community. Visit an authorized Swan Electronics dealer for complete details



### SPECIFICATIONS

- Earphone impedance and type: 8 ohms, dynamic
- Microphone type: Electret capacitor
- Microphone frequency response: 200-6000 Hz
- Amplifier type: FET transistor, variable gain
- Amplifier battery 7-volt Mallory power: TR-175
- Switching: Relay or electronic

### IDEAL FOR EVERY TWO-WAY RADIO COMMUNICATIONS NEED . . .

- CB operators • Amateur radio operators • Police and fire vehicles • Ambulances and emergency vehicles • Taxis and truckers • Marine pleasure and work boats • Construction and demolition crews • Industrial communications • Security patrols • Airport tower and ground crews • Remote broadcast and TV-camera crews • Foresters and fire-watch units •





TEN-TEC



ARGONAUT #509

AMPLIFIER #405

ARGONAUT, MODEL 509

Covers all Amateur bands 10-80 meters. 9 MHz crystal filter. 2.5 kHz bandwidth. 1.7 shape factor @ 6/50 dB points. Power required 12-15 VDC @ 150 mA receive, 800 mA transmit at rated output. Construction: aluminum chassis, top and front panel, molded plastic end panels. Cream front panel, walnut vinyl top and end trim. Size: HWD 4 1/2" x 13" x 7". Weight 6 lbs.

LINEAR AMPLIFIER, MODEL 405

Covers all Amateur bands 10-80 meters. 50 watts output power, continuous sine

wave. RF wattmeter. SWR meter. Power required 12-15 VDC @ 8 A, max. Construction: aluminum chassis, top and front panel, molded plastic side panels. Cream front panel, walnut vinyl top and end trim. Size: HWD 4 1/2" x 7" x 8". Weight 2 1/2 lbs.

Argonaut, Model 509 . . . . \$359.00

Linear Amplifier, Model 405 . 159.00

Power Supply, Model 251

(Will power both units) . . . . . 79.00

Power Supply, Model 210

(Will power Argonaut only) . . 30.00

The new ultra-modern fully solid-state TRITON makes operating easier and a lot more fun, without the limitations of vacuum tubes.

For one thing, you can change bands with the flick of a switch and no danger of off-resonance damage. And no deterioration of performance with age.

But that's not all. A superlative 8-pole i-f filter and less than 2% audio distortion, transmitting and receiving, makes it the smoothest and cleanest signal on the air.

The TRITON IV specifications are impeccable. For selectivity, stability and receiver sensitivity. And it has features such as full CW break-in, pre-selectable ALC, off-set tuning, separate AC power supply, 12 VDC operation, perfectly shaped CW wave form, built-in SWR bridge and on and on.

For new standards of SSB and CW communication, write for full details or talk it over with your TEN-TEC dealer. We'd like to tell you why "They

Don't Make 'Em Like They Used To" makes Ham Radio even more fun.

TRITON IV \$699.00

ACCESSORIES:

- Model 240 One-Sixty Converter...\$ 97.00
- Model 244 Digital Readout ..... 197.00

- Model 245 CW Filter .....\$ 25.00
- Model 249 Noise Blanker ..... 29.00
- Model 252G Power Supply ..... 99.00
- Model 262G Power Supply/VOX.. 129.00

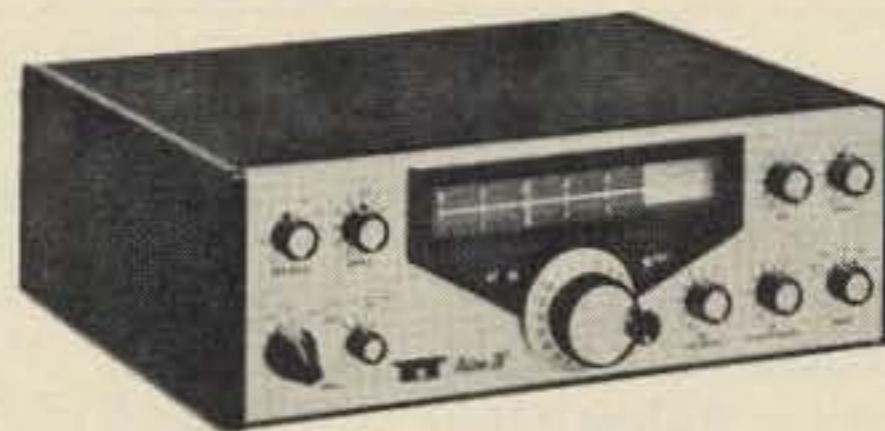

KR20-A ELECTRONIC KEYS

A fine instrument for all-around high performance electronic keying. Paddle actuation force is factory adjusted for rhythmic smooth keying. Contact adjustments on front. Weighting factor factory set for optimum smoothness and articulation. Over-ride "straight key" conveniently located for emphasis, QRS sending or tune-up. Reed relay output. Side-tone generator with adjustable level. Self-completing characters. Plug-in circuit board. For 117 VAC, 50-60 Hz or 6-14 VDC. Finished in cream and walnut vinyl. Price \$57.50

character keyers, as used in the KR20-A. Price \$15.00

KR50 ELECTRONIC KEYS

A completely automatic electronic keyer fully adjustable to your operating style and preference, speed, touch and weighting, the ratio of the length of dits and dahs to the space between them. Self-controlled keyer to transmit your thoughts clearly, articulately and almost effortlessly. The jambie (squeeze) feature allows the insertion of dits and dahs with perfect timing.

An automatic weighting system provides increased character to space ratio at slower speeds, decreasing as the speed is increased, keeping the balance between smoothness at low speeds and easy to copy higher speed. High intelligibility and rhythmic transmission is maintained at all speeds, automatically.

Memories provided for both dits and dahs but either may be defeated by switches on the rear panel. Thus, the KR50 may be operated as a full iambic (squeeze) keyer, with a single memory or as a conventional type keyer. All characters are self-completing. Price \$110.00

SPECIFICATIONS

Speed Range: 6-50 w.p.m.  
Weighting Ratio Range: 50% to 150% of classical dit length.

Memories: Dit and dah. Individual defeat switches.

Paddle Actuation Force: 5-50 gms.

Power Source: 117VAC, 50-60 Hz, 6-14 VDC.

Finish: Cream front, walnut vinyl top and side panel trim.

Output: Reed relay. Contact rating 15 VA, 400 V. max.

Paddles: Torque drive with ball bearing pivot.

Side-tone: 500 Hz tone.

Adjustable output to 1 volt.

Size HWD: 2 1/2" x 5 1/2" x 8 1/4"

Weight: 1 3/4 lbs.



KR50

NORTH SHORE RF TECHNOLOGY

DUPLEXER & CAVITY KITS...



NOW AVAILABLE FOR YOU FULLY ASSEMBLED & TUNED!

- UPGRADE YOUR REPEATER WITH AN RF TECHNOLOGY DUPLEXER.
- ALL DUPLEXERS AND CAVITIES ARE TEMPERATURE COMPENSATED WITH INVAR® AND MEET ALL COMMERCIAL STANDARDS
- ONLY TOP QUALITY MATERIALS GO INTO OUR PRODUCTS.
- BOTH KITS & ASSEMBLED DUPLEXERS AND CAVITIES ARE AVAILABLE TO YOU AT A SAVINGS TO YOU.

Mod. 62-3 . . . 6 cav., 2 mtr., insertion loss 0.6 db with isolation 100 db typical;

pwr. 350 w. Kit \$399 ea. — Assembled \$499.

Mod. 4220-3 . . . 4 cav. 220 MHz insertion loss 0.6 db with 80 db isolation typical; pwr. 350 w. Kit \$279 ea. — Assembled \$349.

Mod. 4440-3 . . . 4 cav. 440 MHz, insertion loss 0.6 db with 80 db isolation typical; pwr. 350 w. Kits \$249 ea. — Assembled \$329.

Mod. 30 Cavity Kits: 2 mtr. \$75 ea., 220 MHz \$65 ea., 440 MHz \$65 ea.; 6 mtr. \$115 ea. Add \$15 for Assembled Kit.

Also available: 6 mtr., 4 cav. Kit \$399 — Assembled \$499, 2 mtr. 4 cav. Kit \$299 — Assembled \$399, 440 MHz TV Repeater Duplexer.

Now You Can Receive The Weak Signals With The ALL NEW AMECO PREAMPLIFIER

Model PT-2 is a continuous tuning 6-160 meter Pre-Amp specifically designed for use with a transceiver. The PT-2 combines the features of the well-known PT with new sophisticated control circuitry that permits it to be added to virtually any transceiver with No modification. No serious ham can be without one.

- Improves sensitivity and signal-to-noise ratio.
- Boosts signals up to 26 db.
- For AM or SSB.
- Bypasses itself automatically when the transceiver is transmitting.
- FET amplifier gives superior cross modulation protection.
- Advanced solid-state circuitry.
- Simple to install.
- Improves immunity to transceiver front-end overload by use of its built-in attenuator.
- Provides master power control for station equipment.

MODEL PT-2

\$69.95



TUFTS RADIO CATALOG TUFTS RADIO



**The indispensable  
BIRD model 43  
THRULINE®  
Wattmeter**



MODEL	PRICE
43	\$120
Elements (Table 1) 2-30 MHz	42
Elements (Table 1) 25-1000 MHz	36
Elements (Table 2)	50
80F, 80M	5W 27
8080 QC-N (M)	25W 47
8085 QC-N (M)	50W 75
Minimonitor*	149

**Read RF Watts Directly.**

0.45-2300 MHz, 1-10,000 watts ±5%, Low Insertion VSWR—1.05.

Unequaled economy and flexibility: Buy only the element(s) covering your present frequency and power needs, add extra ranges later if your requirements expand.

**BIRD**

**Table 1**

**STANDARD ELEMENTS (CATALOG NUMBERS)**

Power Range	Frequency Bands (MHz)					
	2-30	25-60	50-125	100-250	200-500	400-1000
5 watts	—	5A	5B	5C	5D	5E
10 watts	—	10A	10B	10C	10D	10E
25 watts	—	25A	25B	25C	25D	25E
50 watts	50H	50A	50B	50C	50D	50E
100 watts	100H	100A	100B	100C	100D	100E
250 watts	250H	250A	250B	250C	250D	250E
500 watts	500H	500A	500B	500C	500D	500E
1000 watts	1000H	1000A	1000B	1000C	1000D	1000E
2500 watts	2500H					
5000 watts	5000H					

**Table 2**

**LOW-POWER ELEMENTS**

1 watt	Cat. No.	2.5 watts	Cat. No.
60-80 MHz	060-1	60-80 MHz	060-2
80-95 MHz	080-1	80-95 MHz	080-2
95-125 MHz	095-1	95-150 MHz	095-2
110-160 MHz	110-1	150-250 MHz	150-2
150-250 MHz	150-1	200-300 MHz	200-2
200-300 MHz	200-1	250-450 MHz	250-2
275-450 MHz	275-1	400-850 MHz	400-2
425-850 MHz	425-1	800-950 MHz	800-2
800-950 MHz	800-1		

**BOMAR Crystal Company**  
Novice Crystals (Specify Band Only)  
**TWO METERS**  
CRYSTALS IN STOCK  
In Stock!

Standard • Icom • Heathkit • Ken • Clegg • Regency • Wilson • VHF Eng • Drake • And Others! \$4.50 @ Lifetime Guarantee

Make/Model	Xmit Freq.	Rec. Freq.

**THE BIG SIGNAL \$12.95**  
**"W2AU" BALUN**

**THE APPROVED LEADING HAM AND COMMERCIAL BALUN IN THE WORLD TODAY.**

**THE PROVEN BALUN**

- HANDLES FULL 2 KW PEP AND THEN SOME. Broad-Banded 3 to 40 Mc.
- HELPS TV PROBLEMS By Reducing Coax Line Radiation.
- NOW ALL STAINLESS STEEL HARDWARE. SO239 Double Silver Plated.
- IMPROVES F/B RATIO By Reducing Coax Line Pick-Up.
- REPLACES CENTER INSULATOR. Withstands Antenna Pull of Over 600 Lbs.
- BUILT-IN LIGHTNING ARRESTER. Helps Protect Balun — Could Also Save Your Valuable Gear.
- BUILT-IN HANG-UP HOOK. Ideal for Inverted Vees, Multi-Band Antennas, Dipoles, Beam and Quads.

NOW BEING USED BY ALL BRANCHES OF THE U.S. ARMED FORCES, FAA, RCA, CIA, CANADIAN DEFENSE DEPT. PLUS THOUSANDS OF HAMS THE WORLD OVER.

**THEY'RE BUILT TO LAST...  
BIG SIGNALS DON'T JUST HAPPEN —  
GIVE YOUR ANTENNA A BREAK**

Comes in 2 models. 1:1 matches 50 or 75 ohm unbalanced (coax line) to 50 or 75 ohm balanced load. 4:1 model matches 50 or 75 ohm unbalanced (coax line) to 250 or 300 ohm balanced load.

AVAILABLE AT ALL LEADING DEALERS. IF NOT, ORDER DIRECT

The big signal W2AU Balun reflects the type of quality that has kept our product out front and number 1 in Baluns the world over for the past 10 years.

The originator of the Balun with a built-in lightning arrester and hang up hook.

**W2AU GUARANTEE**  
no other balun, at any price, has all these features.

**SERIES 31 — BNC CONNECTORS**

Amphenol's BNC connectors are small, lightweight, weatherproof connectors with bayonet action for quick disconnect applications. Shells, coupling rings and male contacts are accurately machined from brass. Springs are made of beryllium copper. All parts in turn are ASTROplated® to give you connectors that can take constant handling, high temperatures and resist abrasion.

**BNC BULKHEAD RECEPTACLE 31-221-385 UG-1094**  
Mates with any BNC plug. Receptacle can be mounted into panels up to 104" thick. \$1.25

**BNC (M) TO UHF (F) ADAPTER 309-2900-385 UG-225**  
Adapts any BNC jack to any UHF plug. \$3.63

**DOUBLE MATE ADAPTER 83-877-385**  
Both coupling rings are free turning. Connects 2 female components. \$2.72

**JACK ADAPTER \$1.95**

**575-102-385**  
Adapts 83-1SP-385 to Motorola type auto antenna jack or pin jack.

**PANEL RECEPTACLE 83-1R-385 SO239**  
Mounts with 4 fasteners in 21/32" diameter hole. \$1.17

**PANEL RECEPTACLE 83-878-385 SO239SH**  
Mounts in single 21/32" diameter hole. Knurled lock nuts prevent turning. \$1.59

**BNC ANGLE ADAPTER 31-009-385 UG-306**  
Adapts any BNC plug for right angle use. \$4.23

**BNC TEE ADAPTER 31-008-385 UG-274**  
Adapts 2 BNC plugs to 31-003-385 or other female BNC type receptable. \$4.56



**BNC(F) TO UHF (M) ADAPTER 31-028-385 UG-273**  
Adapts any BNC plug to any UHF jack. \$2.39

**PUSH-ON 83-1SP-385 83-5SP-385**  
Features an unthreaded, springy shell to push fit on female connectors. \$2.27

**LIGHTNING ARRESTOR 575-105-385**  
Eliminates static build-up from antenna. Protects your valuable equipment against lightning damage. \$4.80

**BNC PLUG 31-002-385 UG-88**  
Commonly used for communications antenna lead cables. For RG 55/U & RG 58/U cables. \$1.59

**BNC STRAIGHT ADAPTER 31-219-385 UG-914**  
1 9/32" long, allows length of cables to be joined. Mates with BNC plugs. \$2.12

**BNC PANEL RECEPTACLE 31-003-385 UG-290**  
Mounts with 4 fasteners in 29/64" diameter hole. \$1.74

**SERIES 581 — PACKAGED CABLE ASSEMBLIES**

All popular lengths are now available in your choice of RG 8/U or RG 58/U type low loss polyfoam dielectric cable. Installed PL-259 connectors are ASTROplated — Amphenol's new non-tarnishing finish — which has all the advantages of precious metal plus more heat, corrosion and abrasion resistors that silver ever had! These cable assemblies are ideal for CB, ham radio and other communications antenna installations and they are ready for immediate use.



**RG 8/U TYPE POLYFOAM COAXIAL CABLE ASSEMBLIES 581-803**  
3-ft. with ASTROplated PL-259's on both ends. \$5.60

**581-820**  
20-ft with ASTROplated PL-259's on both ends. \$11.80

**581-850**  
50-ft with ASTROplated PL-259's on both ends. \$23.10

**581-875**  
75-ft with ASTROplated PL-259's on both ends. \$30.30

**581-8100**  
100-ft. with ASTROplated PL-259's on both ends. \$38.50

**RG 58/U TYPE POLYFOAM COAXIAL CABLE ASSEMBLIES 581-5812**  
12-ft. with ASTROplated PL-259's on both ends. \$6.34

**581-5820**  
20-ft with ASTROplated PL-259's on one end and SPADE LUGS ON OTHER END. \$6.30

**518-5820-2**  
20-ft. with ASTROplated PL-259's on both ends. \$7.36

**581-5850**  
50-ft. with ASTROplated PL-259's on both ends. \$11.20

**581-5875**  
75-ft. with ASTROplated PL-259's on both ends. \$14.00

**581-58100**  
100-ft. with ASTROplated PL-259's on both ends. \$16.10



A new precision clock which tells time anywhere in the world at a glance, has been announced by Yaesu Electronics Corporation. The time in any principal city or time zone can be simultaneously coordinated with local time on a 24 hour basis. After the initial setting, as the clock runs, a Time Zone Hour Disc advances automatically, showing correct time all over the world without further adjustment. The clock is especially designed to withstand shock and may be hung on a wall or placed on its desk mount. The clock will run an entire year on a single 1.5 volt flashlight battery and the mechanism starts as soon as the battery is inserted. It measures six inches in diameter by two and one half inches deep. An excellent item for the business office, ham radio operator, short wave listener, boat owner, and others who want an accurate dependable clock.

Price: \$30.00 Amateur net.

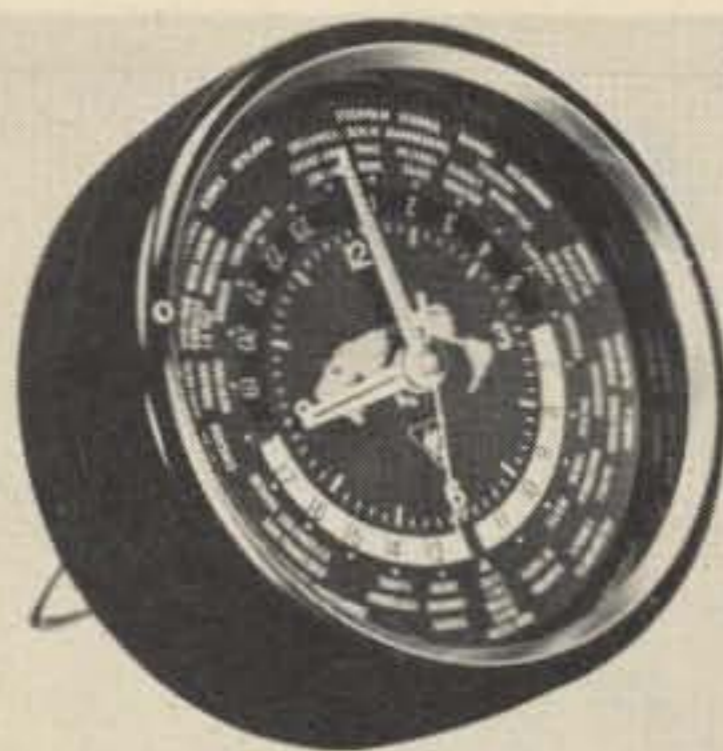

## Now...more than ever--- the TEMPO line means solid value

### Tempo VHF/ONE

the "ONE" you've been waiting for

\$399.00

No need to wait any longer - this is it! Whether you are already on 2-meter and want something better or you've just thinking of getting into it, the VHF/ONE is the way to go.

• Full 2-meter band coverage (144 to 148 MHz for transmit and receive). • Full phase lock synthesized (PLL) so no channel crystals are required. • Compact and lightweight - 9.5" long x 7" wide x 2.25" high. Weight - About 4.5 lbs. • Provisions for an accessory SSB adaptor. • 5-digit LED receive frequency display. • 5 KHz frequency selection for FM operation. • Automatic repeater split - selectable up or down for normal or reverse operation. • Microphone, power cord and mounting bracket included. • Two built-in programmable channels. • All solid state. • 10 watts output. • Super selectivity with a crystal filter at the first IF and E type ceramic filter at the second IF. • 800 Selectable receive frequencies. • Accessory 9-pin socket.



TEMPO SSB/ONE  
\$199.00

SSB adaptor for the Tempo VHF/One  
• Selectable upper or lower sideband. • Plugs directly into the VHF/One with no modification. • Noise blanker built-in. • BIT and VXO for full frequency coverage.

### ● SELECTIVITY CONTROL

This amazing new breakthrough in filter design is truly the filter of the future. Selectivity control on the front panel provides control of bandwidth as well as selection of upper or lower sideband, or double sideband. Continuously variable from 300 to 2700 Hz bandwidth. Shape factor is better than 1.7, with ultimate rejection better than 130 dB. Selectivity for SSB can be set for maximum voice fidelity at 2700 Hz bandwidth, providing transmission and reception of audio from 300 to 3000 Hz, or it can be narrowed down to 2400, 2100 or even 1500 Hz if necessary to reduce adjacent channel QRM. Selectivity can be narrowed gradually to as little as 300 Hz for CW reception.

This amazing new breakthrough in filter design is by Bob Crawford and Eckert Argo of Consulting Engineers. Atlas Radio is privileged to be first to offer this "programmable filter" in the radio communication field and for sometime to come will be the only one.

### ● RECEIVER INCREMENTAL TUNING ● AUDIO FREQUENCY NOTCH FILTER

● PUSH TO TALK  
● VOX OPERATION  
● FULL BREAK-IN CW OPERATION

MODEL 350-XL .....\$995

### ● DIGITAL DIAL READOUT

The Atlas 350-XL has space provided for quick installation of this plug-in accessory. Provides precise frequency readout within 50 Hz. All L.E.D. Dot Matrix 6 digit display.

DD6-XL DIGITAL DIAL .....\$195

### ● PLUG-IN AUXILIARY VFO or CRYSTAL OSCILLATOR

Auxiliary VFO is plugged into the space provided on the front panel of the 350-XL. You have a second tuneable VFO with same tuning ranges as primary VFO for tuning to a separate transmit or receive frequency. LEDs indicate which VFO, primary or secondary, will be used for receive and transmit.

Or instead of the auxiliary VFO a Crystal Oscillator may be plugged into the front panel. Eleven crystal sockets are available with a vernier control for exact frequency setting.

MODEL 305 AUXILIARY VFO .....\$155

MODEL 311 AUXILIARY CRYSTAL OSCILLATOR .....\$135

### ● 350-PS MATCHING AC SUPPLY

Includes front facing speaker and phone jack. Provides 14 volts filtered and regulated D.C. for both low current and high current circuits of the 250-XL. Internal space provided for future installation of accessories such as CW Keyer, Speech Processor, Phone Patch, etc. Operates on 100-130 or 200-260 volts, 50-60 Hz ..\$195

### ● SAME PLUG-IN-AND-GO MOBILE FEATURE AS OUR FAMOUS 210x/215x

The 350-XL has its own optional Mobile Mounting Bracket for quick, easy plug-in or removal from your car. All connections are made automatically .....\$65

### ● ATLAS 210x/215x SSB TRANSCEIVERS

Our famous little compact SSB Transceivers remain a very important part of our product line .....\$679  
With noise blanker installed .....\$719

## ATLAS 350-XL



- ALL SOLID STATE
- 350 WATTS P.E.P. OR CW INPUT
- SSB TRANSCEIVER
- 10 THROUGH 160 METER COVERAGE



Illustrated with optional AC supply, Auxiliary VFO, and Digital Dial.

The all new Atlas 350-XL has all the exciting new features you want, plus superior performance and selectivity control never before possible.

### ● 10-160 METERS

Full coverage of all six amateur bands in 500 kHz segments. Primary frequency control provides highly stable operation. Also included is provision for adding up to 10 additional 500 kHz segments between 2 to 22 MHz by plugging in auxiliary crystals.

### ● 350 WATTS

P.E.P. and CW input. Enough power to work the world barefoot!

### IDEAL FOR DESKTOP OR MOBILE OPERATION

Measuring just 5 in. high x 12 in. wide x 12½ in. deep, and weighing only 13 pounds, the Atlas 350-XL offers more features, performance and value than any other transceiver, regardless of size, on the market today!



No. 114-320-003 - \$9.90  
No. 114-322-003 - Brass - \$10.30

No. 114-320-001 - \$8.30  
No. 114-322-001 - Brass - \$8.65

No. 114-310-003 - \$8.25  
No. 114-312-003 - Brass - \$8.65



No. SSK-1 \$23.95  
No. SSK-1CP-Chrome - \$29.95

### NYE VIKING SPEED-X KEYS

NYE VIKING Standard Speed-X keys feature smooth, adjustable bearings, heavy-duty silver contacts, and are mounted on a heavy oval die cast base with black wrinkle finish. Available with standard, or Navy knob, with, or without switch, and with nickel or brass plated key arm and hardware.

### Pamper yourself with a Gold-Plated NYE VIKING KEY!

Model No. 114-31C-004GP has all the smooth action features of NYE Speed-X keys in a special "presentation" model. All hardware is heavily gold plated and it is mounted on onyx-like jet black plastic sub-base. List price is \$50.00.



### NYE VIKING SQUEEZE KEY

Extra-long, finger-fitting molded paddles with adjustable spring tension, adjustable contact spacing. Knife-edge bearings and extra large, gold plated silver contacts! Nickel plated brass hardware and heavy, die cast base with non-skid feet. Base and dust cover black crackle finished. SSK-1 - \$23.45. SSK-1CP has heavily chrome-plated base and dust cover. List price, \$29.95.

### CODE PRACTICE SET

You get a sure, smooth, Speed-X model 310-001 transmitting key, linear circuit oscillator and amplifier, with a built-in 2" speaker, all mounted on a heavy duty aluminum base with non-skid feet. Operates on standard 9V transistor type battery (not included). List price, \$18.50.

PHONE PATCH Model No. 250-46-1 measures 6-1/2" wide, 2-1/4" high and 2-7/8" deep. List price, \$36.50. Model 250-46-3, designed for use with transceivers having a built-in speaker, has its own built-in 2" x 6" 2 watt speaker. Measures 6-1/2" wide, 2-1/4" high and 2-7/8" deep. List price, \$44.50.

TUFTS RADIO CATALOG



**Mosley**

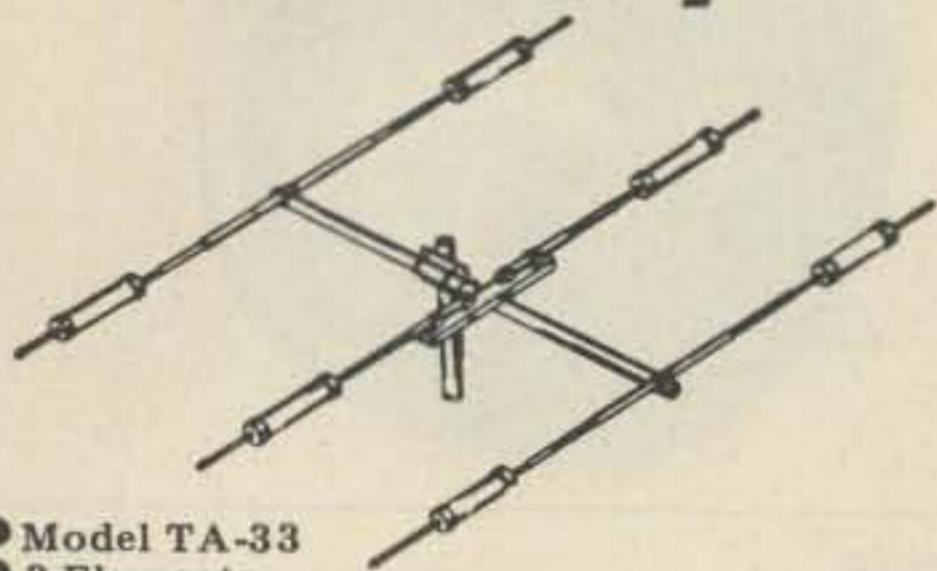

- Model TA-33
- 3 Elements
- 10.1 db Forward Gain (over isotropic source)
- 20 db Front-to-Back Ratio

The Mosley TA-33, 3-element beam provides outstanding 10, 15 and 20 meter performance. Exceptionally broadband — gives excellent results over full Ham bandwidth. Incorporating Mosley Famous Trap-Master traps. Power Rating — 2KW P.E.P. SSB. The TA-33 may also be used on 40 meters with TA-40KR conversion. Complete with hardware. \$206.50

**MULTI-BAND BEAMS**

**TRAP MASTER 33 . . . 10, 15 & 20 Meters**

- Model TA-33Jr.
  - 3 Elements
  - 10.1 db Forward Gain (over isotropic source)
  - 20 db Front-to-Back Ratio
- The TA-33Jr . . . incorporates Mosley Trap-Master Junior traps. This is the low power brother of the TA-33. Power Rating — 1 KW P.E.P. SSB. \$151.85

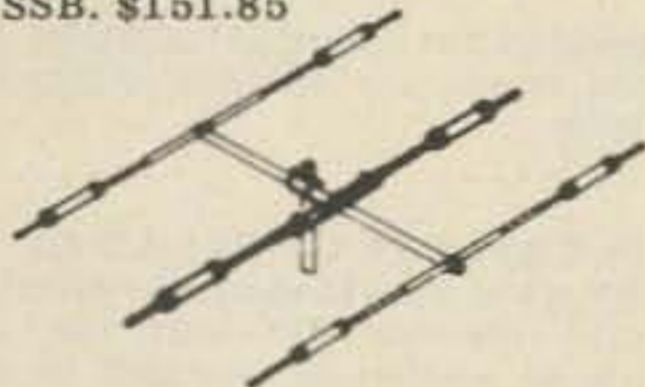

**TA-33JR. POWER CONVERSION KIT MODEL MPK-3**

Owners of the Mosley Trap-Master TA-33Jr. may obtain higher power without buying an entirely new antenna. The addition of the MPK-3 (power conversion kit) converts the TA-33Jr. into essentially a new antenna with 750 watts AM/CW and 2000 watts P.E.P. SSB. \$52.25

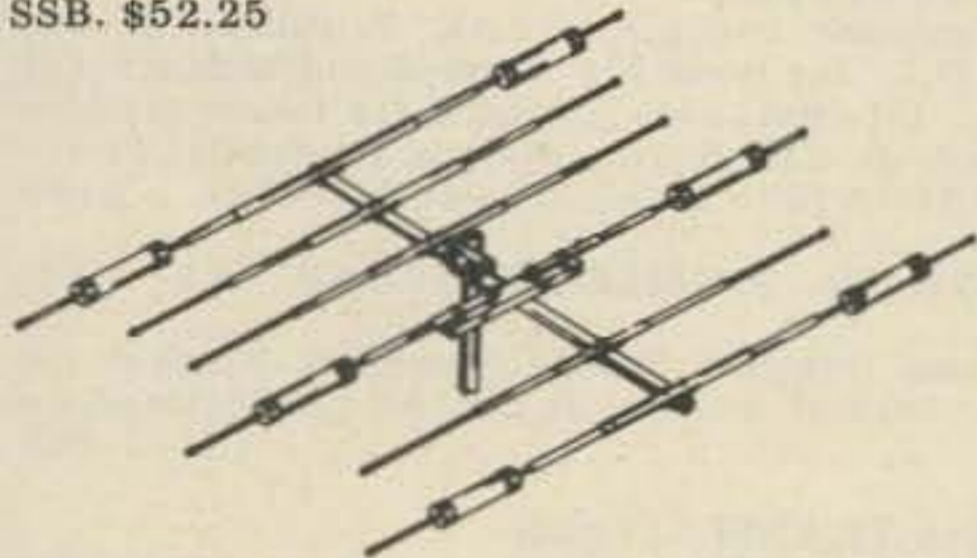

**TRAP MASTER 36 . . . 10, 15 & 20 Meters**

- Model TA-36
- 6 Elements
- Forward Gain (over isotropic source) - 10.1 db on 15 & 20 meters, 11.1 db on 10 meters.

Front-to-Back Ratio on all bands. 20 db. This wide-spaced, six element configuration employs 4 operating elements on 10 meters, 3 operating elements on 15 meters, and 3 operating elements on 20 meters. Automatic bandswitching is accomplished through Mosley exclusively designed high impedance parallel resonant "Trap Circuit." The TA-36 is designed for 1000 watts AM/CW or 2000 watts P.E.P. SSB. Traps are weather and dirt proof, offering frequency stability under all weather conditions. \$335.25



**MOSLEY AK-60 MAST PLATE ADAPTER**  
Mast Plate Adapter for adapting your Mosley 1½" mounted beam to fit 2" OD mast. Complete with angle and hardware. \$11.15

**NATIONAL RADIO COMPANY, INC.**  
**NRCI**



**NCL-2000**

Linear Amplifier. A full 10 Db gain. 20 watts in 2000 watts out. Can be driven with one watt. Continuous duty design utilizes two 8122 ceramic tetrode output tubes, designed for both AM and SSB operation. The industry standard for 12 years. Thousands in use all over the world. Price: \$1,200



**NCX-1000**

The only 1000 watt, "single package" transceiver. Heavy duty design . . . results of 50 years of design leadership in amateur equipment. State of the art speech processing. linear amplifier, power supply, all in one package. Nothing extra to buy. Covers all amateur bands in HF spectrum . . . AM, SSB, CW. Price: \$1,600

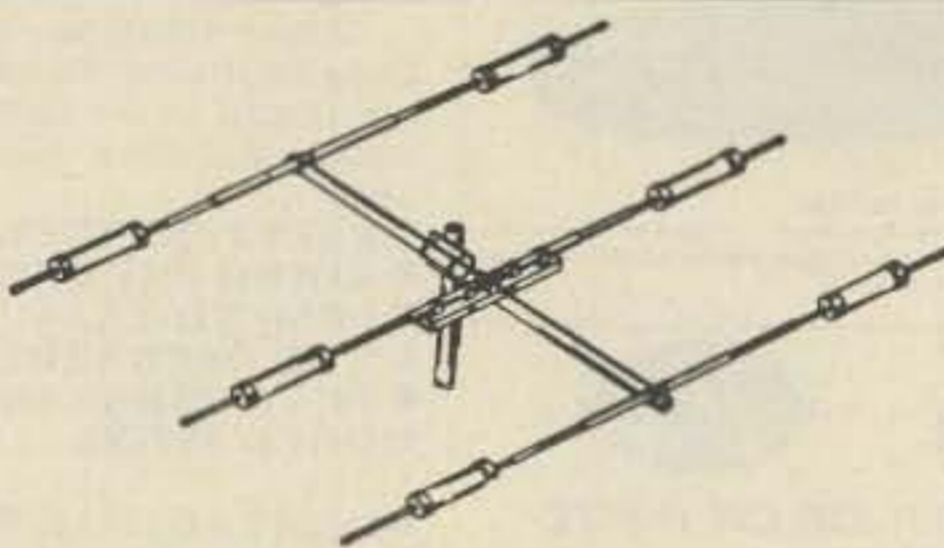

**CLASSIC-33 . . . 10, 15 & 20 Meters**  
Model CL-33

- 3 Elements
- 10.1 db Forward Gain (over isotropic source) on all bands.
- 20 db Front-to-Back Ratio on 15 & 20 meters, 15 db on 10 meters.

**BRIDGING THE GAP . . .** The Classic 33, combines the best of two Mosley systems. Incorporating Mosley Classic Feed System for a "Balanced Capacitive Matching" system with a feed point impedance of 52 ohms at resonance, and the Famous Mosley Trap-Master Traps for "weather-proof" traps with resonant frequency stability. This extra sturdy multi-band beam, Model CL-33, for operation on 10, 15 & 20 meters features improved boom to element clamping, stainless steel hardware, balanced radiation and a longer boom for even wider element spacing. Power Rating — 2 KW P.E.P. SSB. Recommended mast size — 2" OD. Wind Load — 120 lbs. at 80 MPH. Approx. shipping weight — 45 lbs. \$232.50

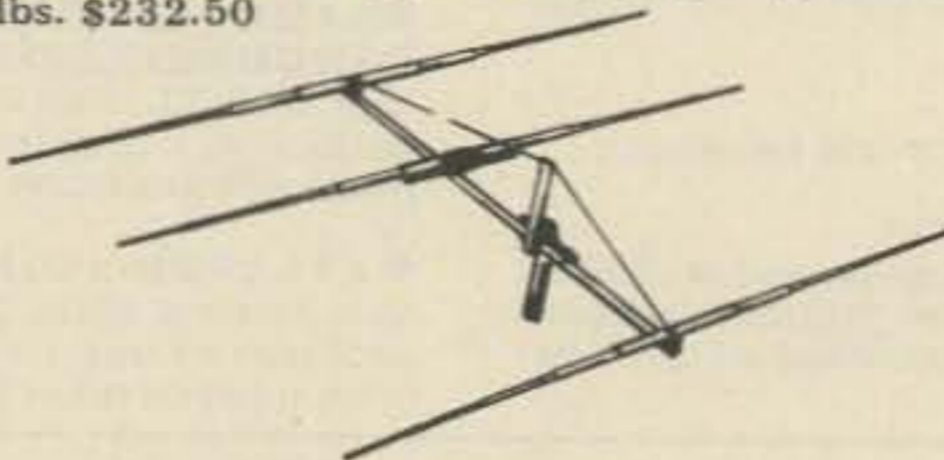

**CLASSIC-203 . . . 20 Meters**  
Model CL-203

- 3 Elements
- 10.1 db Forward Gain (over isotropic source)
- 20 db Front-to-Back Ratio

Incorporating the Mosley patented Classic Feed System, this full size 20 meter single-band beam has 1½" to 3/8" dia. "swaged" elements wide spaced on a 2" dia. 24' boom. Maximum element length—37' 8½". The high standards in quality construction established by Mosley in over a quarter-century of manufacturing is reflected in this mono-band . . . Model CL-203. Boom-to-mast clamping assures stability with a time-tested arrangement of mast plate, cast aluminum clamping blocks and stainless steel U-bolts. The exclusive "Balanced Capacitive Matching" System has a nominal feed point impedance of 52 Ohms at 2 KW P.E.P. SSB. Recommended mast size—2" O.D. Approx. shipping wt: 42 lbs. via truck. \$227.65

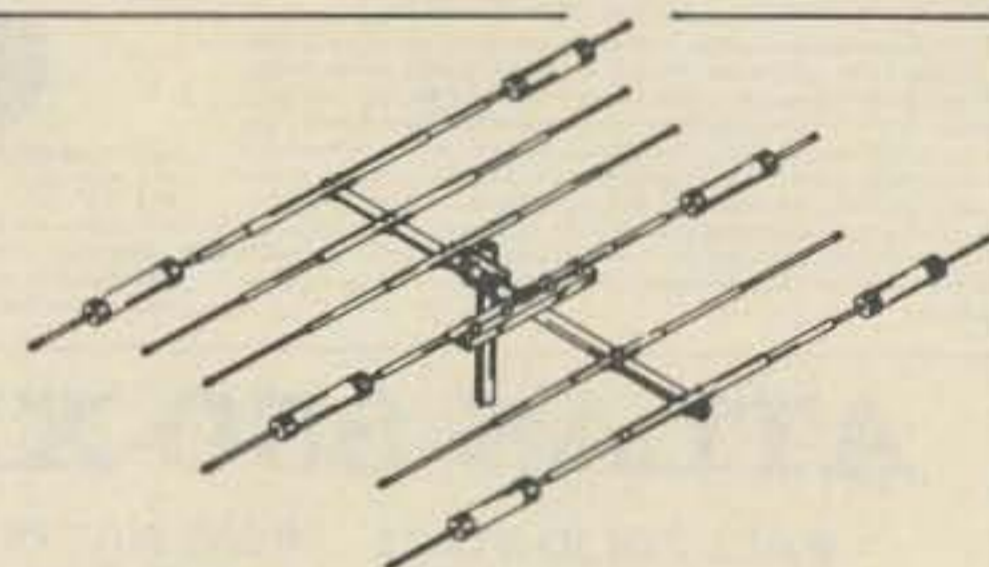

**CLASSIC-36 . . . 10, 15 & 20 Meters**  
Model CL-36

- 6 Elements
- 10.1 db Forward Gain (over isotropic source) on 15 & 20 meters, 11.1 db on 10 meters.
- 20 db Front-to-Back Ratio on all bands.

The Classic 36, like the smaller Classic 33, incorporates both the Mosley World-Famous Trap-Master Traps and the Mosley Classic Feed-System. Designed to operate on 10, 15 & 20 meters, this multi-band beam Model CL-36, employs the high standards of quality construction found in all Mosley products. The boom-to-mast clamping assures stability with a time-tested arrangement of mast plate, cast aluminum clamping blocks and stainless steel U-bolts. The exclusive "Balanced Capacitive Matching" system has a feed point impedance of 52 ohms at resonance. Wind Load — 210.1 lbs. at 80 MPH. Power Rating — 2 KW P.E.P. SSB. Recommended mast size — 2" OD. Approx. shipping weight — 71 lbs. via truck. \$310.65

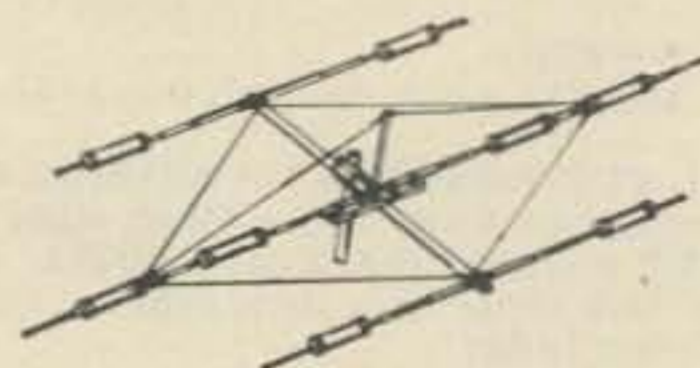

**40 METER CONVERSION KIT MODEL TA-40KR**

Work 40 meters in addition to 10, 15 & 20 meters by using a TA-40KR conversion kit on the radiator element of the TA-33 and TA-36. (Beams with broad band capacitive matching may not be converted!) Convert the TA-33Jr. with the MPK-3 (power conversion kit) before adding the TA-40KR kit. \$92.25

**SIGNAL-MASTER ANTENNA**

Beam Antenna . . . Model S-402 for 40 meters For a top signal needed to push through forty meter QRM, the Mosley Signal Master S-402 will do the trick! This 100% rust-proof 2-element beauty constructed of rugged heavy-wall aluminum is designed and engineered to provide the performance you need for both DX hunting and relaxing in a QRM free rag-chewing session. Beam is fed through link coupling, resulting in an excellent match over the entire bandwidth. \$267.50



## 6 METER BEAMS

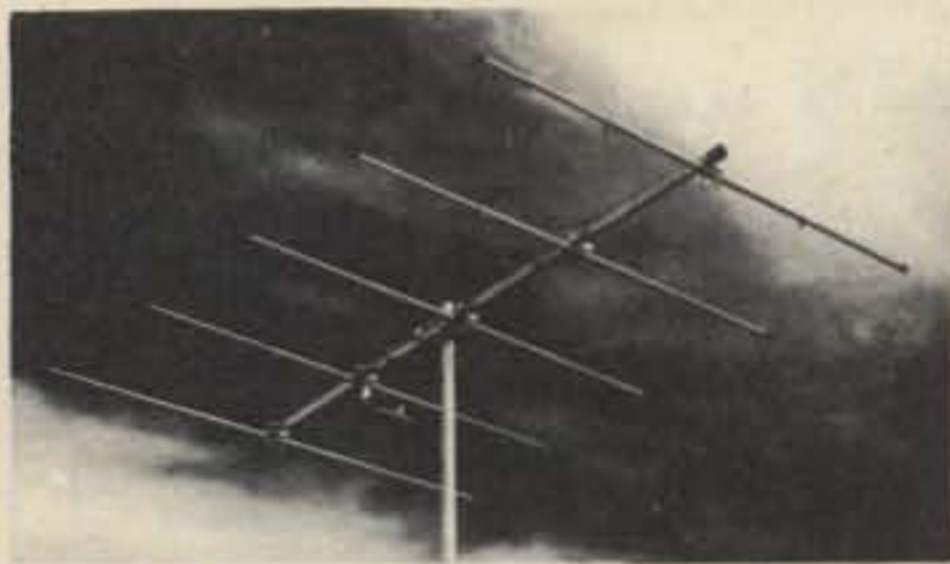

### 3-5-6-10 ELEMENTS

Proven performance from rugged, full size, 6 meter beams. Element spacings and lengths have been carefully engineered to give best pattern, high forward gain, good front to back ratio and broad frequency response.

Booms are .055 wall and elements are 3/4" - 5/8" .049 wall seamless chrome finish aluminum tubing. The 3 and 5 element beams have 1 3/8" - 1 1/4" booms. The 6 and 10 element beams have 1 5/8" - 1 1/2" booms. All brackets are heavy gauge formed aluminum. Bright finish cad plated bolts are adjustable for up to 1 5/8" mast on 3 and 5 element and 2" on 6 and 10 element beams. All models may be mounted for horizontal or vertical polarization.

New features include adjustable length elements, kilowatt Reddi Match and built-in coax fitting for direct 52 ohm feed. These beams are factory marked and supplied with instructions for quick assembly.

Description	3 element	5 element	6 element	10 element
Model No.	A50-3	A50-5	A50-6	A50-10
Boom Length	6"	12"	20"	24"
Longest El.	117"	117"	117"	117"
Turn Radius	6"	7' 6"	11'	13'
Fwd. Gain	7.5 dB	9.5 dB	11.5 dB	13 dB
F/B Ratio	20 dB	24 dB	26 dB	28 dB
Weight	7 lbs.	11 lbs.	18 lbs.	25 lbs.

**new**  
**RINGO**  
**RANGER**  
for FM

4.5 dB\* - 6 dB\*\*

Omnidirectional  
GAIN

BASE STATION  
ANTENNAS

FOR  
MAXIMUM  
PERFORMANCE  
AND  
VALUE

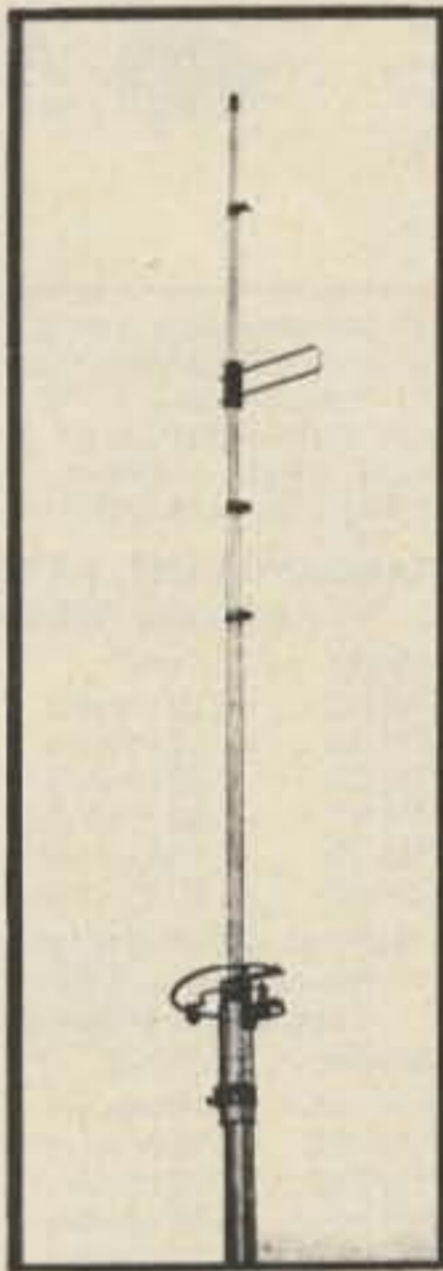

Cush Craft has created another first by making the world's most popular 2 meter antenna twice as good. The new Ringo Ranger is developed from the basic AR-2 with three half waves in phase and a one eighth wave matching stub. Ringo Ranger gives an extremely low angle of radiation for better signal coverage. It is tunable over a broad frequency range and perfectly matched to 52 ohm coax.

ARX-2, 137-160 MHz, 4 lbs., 112"  
ARX-220, 220-225 MHz, 3 lbs., 75"  
ARX-450, 435-450 MHz, 3 lbs., 39"

\* Reference 1/2 wave dipole.  
\*\* Reference 1/4 wave whip used as gain standard by many manufacturers.

Work full quieting into more repeaters and extend the radius of your direct contacts with the new Ringo Ranger.

You can up date your present AR-2 Ringo with the simple addition of this extend. kit. The kit includes the phasing network and necessary element extensions. The only modifications required are easy to make saw slits in the top section of your antenna.

ARX-2K CONVERSION KIT

## 2 METER FM ANTENNAS

A-FM RINGO 3.75 dB Gain (reference 1/4 wave whip). Half wave length antennas with direct dc ground, 52 ohm feed takes PL-259, low angle of radiation with 1-1 SWR. Factory preassembled and ready to install, 6 meter partly preassembled, all but 450 MHz take 1 3/4" mast. There are more Ringos in use than all other FM antennas combined.

Model Number	AR-2	AR-25	AR-6	AR-220	AR-450
Frequency MHz	135-175	135-175	50-54	220-225	440-460
Power-Hdly. Watts	100	500	100	100	250
Wind area sq. ft.	21'	21'	37'	20'	10'

B-4 POLE Up to 9 dB Gain over a 1/2 wave dipole. Overall antenna length 147 MHz - 23' 220 MHz - 15', 435 MHz - 8', pattern 360° - 6 dB gain, 180° - 9 dB gain, 52 ohm feed takes PL-259 connector. Package includes 4 complete dipole assemblies on mounting booms, harness and all hardware. Vertical support mast not supplied.

AFM-4D 144-150 MHz, 1000 watts, wind area 2.58 sq. ft.  
AFM-24D 220-225 MHz, 1000 watts, wind area 1.85 sq. ft.  
AFM-44D 435-450 MHz, 1000 watts, wind area 1.13 sq. ft.

D-POWER PACK The big signal (22 element array) for 2 meter FM, uses two A147-11 yagis with a horizontal mounting boom, coaxial harness and all hardware. Forward gain 16 dB, F/B ratio 24 dB, 1/2 power beamwidth 42°, dimensions 144" x 80" x 40", turn radius 60", weight 15 lbs., 52 ohm feed takes PL-259 fitting.

A147-22 146 - 148 MHz, 1000 Watts, wind area 2.42 sq. ft.

D-YAGI STACKING KITS VPK includes horizontal mounting boom, harness, hardware and instructions for two vertically polarized yagis gives 3 dB gain over the single antenna.

A14-VPK, complete 4 element stacking kit  
A14-SK, 4 element coax harness only  
A147-VPK, complete 11 element stacking kit  
A147-SK, 11 element coax harness only  
A449-SK, 6 + 11 element coax harness only

E-4-6-11 ELEMENT YAGIS The standard of comparison in VHF-UHF communications, now cut for FM and vertical polarization. The four and six element models can be tower side mounted. All are rated at 1000 watts with direct 52 ohm feed and PL-259 connectors.

Model Number	A147-11	A-147-4	A449-11	A449-6	A220-11
Boom/Longest ele.	141"/40"	44"/40"	60"/13"	33"/28"	102"/26"
Wght./Turn radius	6 lbs., 72"	3 lbs., 44"	4 lbs., 60"	3 lbs., 18"	5 lbs., 51"
Gain/F/B ratio dB	13.2/28	9/20	13.2/28	11/23	13.2/28
1/2 Power beam	48°	66°	48°	60°	48°
Wind area sq. ft.	1.21	.43	.39	.50	.50
Frequency MHz	146-148	146-148	440-450	440-450	220-225

F-FM TWIST 12.4 dB Gain: Ten elements horizontal polarization for low end coverage and ten elements vertical polarization for FM coverage. Forward gain 12.4 dB, F/B ratio 22 dB, boom length 130", weight 10 lbs., longest element 40", 52 ohm Reddi Match driven elements take PL-259 connectors, uses two separate Feed lines.

A147-20T 145 - 147 MHz, 1000 watts, wind area 1.42 sq. ft.

## HIGH PERFORMANCE VHF YAGIS

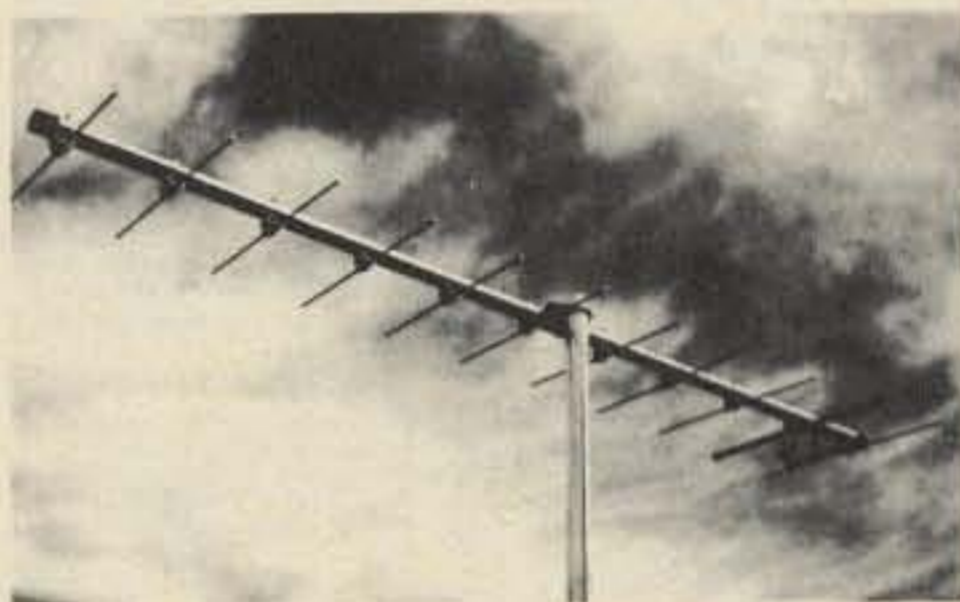

### 3/4, 1-1/4, 2 METER BEAMS

The standard of comparison in amateur VHF/UHF communications Cush Craft yagis combine all out performance and reliability with optimum size for ease of assembly and mounting at your site.

Lightweight yet rugged, the antennas have 3/16" O. D. solid aluminum elements with 5/16" center sections mounted on heavy duty formed brackets. Booms are 1" and 7/8" O. D. aluminum tubing. Mast mounts of 1/8" formed aluminum have adjustable u-bolts for up to 1-1/2" O. D. masts. They can be mounted for horizontal or vertical polarization. Complete instructions include data on 2 meter FM repeater operation.

New features include a kilowatt Reddi Match for direct 52 ohm coaxial feed with a standard PL-259 fitting. All elements are spaced at .2 wavelength and tapered for improved bandwidth.

Model No.	A144-7	A144-11	A220-11	A430-11
Description	2m	2m	1 1/2m	1 1/2m
Elements	7	11	11	11
Boom Length	98"	144"	102"	57"
Weight	4	6	4	3
Fwd. Gain	11 dB	13 dB	13 dB	13 dB
F/B Ratio	26 dB	28 dB	28 dB	28 dB
Fwd. Lobe @				
1/2 pwr. pt.	46	42	42	42
SWR @ Freu.	1 to 1	1 to 1	1 to 1	1 to 1



**Cushcraft**  
CORPORATION



### VHF/UHF BEAMS

A50-3	\$ 32.95	A144-7	21.95
A50-5	49.95	A144-11	32.95
A50-6	69.95	A430-11	24.95
A50-10	99.95		

### AMATEUR FM ANTENNAS

A147-4	\$ 19.95	AFM-44D	54.95
A147-11	29.95	AR-2	21.95
A147-20T	54.95	AR-6	32.95
A147-22	84.95	AR-25	29.95
A220-7	21.95	AR-220	21.95
A220-11	27.95	AR-450	21.95
A449-6	21.95	ARX-2	32.95
A449-11	27.95	ARX-2K	13.95
AFM-4D	59.95	ARX-220	32.95
AFM-24D	57.95	ARX-450	32.95

Description:	144 MHz.		220 MHz.		432 MHz.	
	Model:	Price:	Model:	Price:	Model:	Price:
20 Element DX-Array	DX-120	42.95	DX-220	37.95	DX-420	32.95
Frame & Harness (40 E.)	DXX-140	59.95	DXX-240	54.95	DXX-440	39.95
Frame & Harness (80 E.)	DXX-180	109.95	DXX-280	89.95	DXX-480	79.95
1-1 52-ohm balun	DX-18N	12.95	DX-28N	12.95	DX-48N	12.95
Vert. Pol. Bracket (20 E.)	DX-VPB	9.95	DX-VPB	9.95	DX-VPB	9.95

TUFTS RADIO CATALOG





For all you hams with little cars ...  
We've got the perfect mobile rig for you.



The Atlas 210x or 215x measures only 9 1/2" wide x 9 1/2" deep x only 3 1/2" high, yet the above photograph shows how easily the Atlas transceiver fits into a compact car. And there's plenty of room to spare for VHF gear and other accessory equipment. With the exclusive Atlas plug-in design, you can slip your Atlas in and out of your car in a matter of seconds. All connections are made automatically.

**BUT DON'T LET THE SMALL SIZE FOOL YOU!**  
Even though the Atlas 210x and 215x transceivers are less than half the size and weight of other HF transceivers, the Atlas is truly a giant in performance.

**200 WATTS POWER RATING!**  
This power level in a seven pound transceiver is incredible but true. Atlas transceivers give you all the talk power you need to work the world barefoot. Signal reports

constantly reflect great surprise at the signal strength in relation to the power rating.

**FULL 5 BAND COVERAGE**  
The 210x covers 10-80 meters, while the 215x covers 15-160 meters. Adding the Atlas Model 10x Crystal Oscillator provides greatly increased frequency coverage for MARS and network operation.

**NO TRANSMITTER TUNING OR LOADING CONTROLS**  
With your Atlas you get instant QSY and band change.

**MOST ADVANCED STATE OF THE ART SOLID STATE DESIGN**  
not only accounts for its light weight, but assures you years of top performance and trouble free operating pleasure.

**PLUG-IN CIRCUIT BOARDS**  
and modular design provides for ease of servicing.

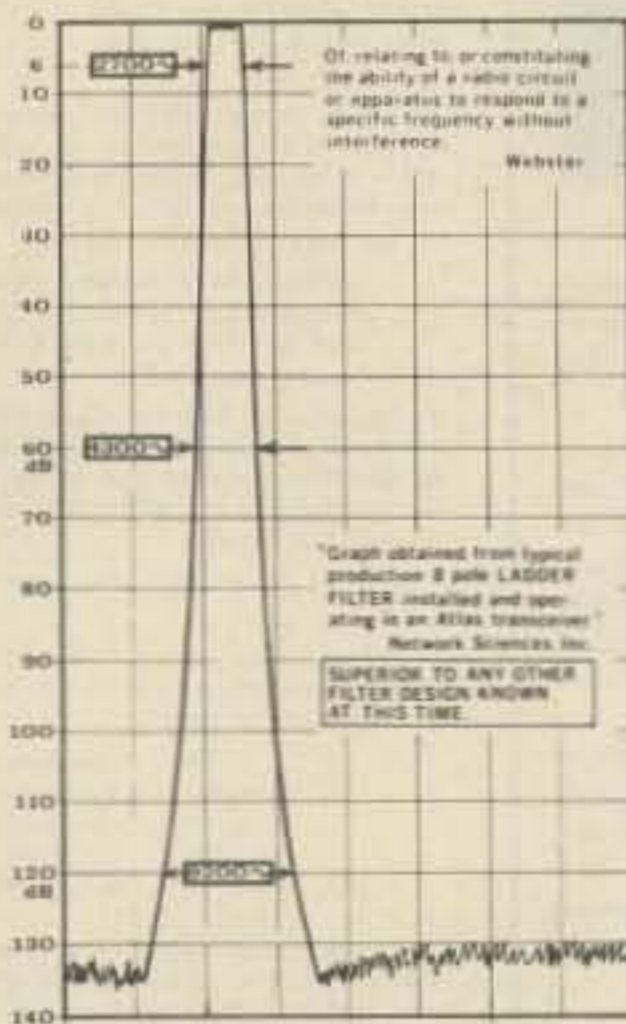

**PHENOMENAL SELECTIVITY**  
The exclusive 8 pole crystal ladder filter used in Atlas transceivers represents a major breakthrough in filter design, with unprecedented skirt selectivity and ultimate rejection. As the above graph shows, this filter provides a 6 db bandwidth of 2700 Hertz, 60 db down of only 4300 Hertz, and a bandwidth of only 9200 Hertz at 120 db down! Ultimate rejection is in excess of 130 db; greater than the measuring limits of most test equipment.

**EXCEPTIONAL IMMUNITY TO STRONG SIGNAL OVERLOAD AND CROSS MODULATION.** The exclusive front end design in the receiver allows you to operate closer in frequency to strong neighboring signals than you have ever experienced before. If you have not yet operated an Atlas transceiver in a crowded band and compared it with any other receiver or transceiver, you have a real thrill coming.



**A WORLD WIDE DEALER NETWORK TO SERVE YOU.**  
Whether you're driving a Honda in Kansas City or a Mercedes Benz in West Germany, there's an Atlas dealer near you.

- Atlas 210x or 215x .....\$675.00
- W/Noise Blanker ..... 719.00
- ACCESSORIES:
- AC Console 110/220 V ..... \$147.00
- Portable AC supply 110/220 V ..... 100.00
- Plug-in Mobile Kit ..... 48.00
- 10x Osc. less crystals ..... 59.00
- Digital Dial DD-6B ..... 229.00

For complete details see your Atlas dealer, or drop us a card and we'll mail you a brochure with dealer list.



# mounts - leads - accessories

## STANDARD GAIN MOBILES

- Two Meters**
- 5/8 wavelength — 34 db gain over 1/4 wave mobile
  - Frequency coverage—143 to 149 MHz
  - Power rating—200 watts FM

**MODEL BBLT-144**  
47" antenna complete with easy to install, no holes to drill, trunk lip mount, impact spring and 17 MIL SPEC RG-58-U and PL-259. Antenna removable from mount.  
Price: \$33.75

**MODEL BBL-144**  
47" antenna mounts on any flat surface, roof, deck or fender in 1/4" hole. Includes impact spring, 17 MIL SPEC RG-58-U and PL-259. Antenna removable from mount.  
Price: \$31.55

**HUSTLER "BUCK-BUSTER"**

**MODEL SF-2**  
51" two meter, 5/8 wavelength, 34 db gain over 1/4 wave mobile. Designed with 3/4" base to fit your mount or a wide selection of Hustler mobile mounts. (Mount or cable not included).  
Price: \$9.00

## DELUXE MOBILE MOUNTS

For medium length, light weight antennas with 3/4" — 24 base.



**MODEL TLM**  
Trunk lip mount for no holes installation on side or edge of trunk lid. Includes 17' RG-58-U connectors attached.  
Price: \$14.85



**MODEL HLM**  
Deluxe trunk lip mount with 180 degree swivel ball for positioning antenna to vertical. Easy — no holes — installation. Includes 17' RG-58-U cable and connectors attached. Price: \$17.20



**MODEL GCM-1**  
Rain gutter mount fits all shapes, angles even latest trim line gutters. Includes 180° swivel ball. Price: \$9.00

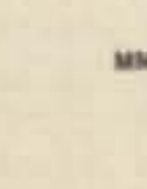

**MODEL MM-1**  
Cowl mount installs in 1" hole. Includes 180° swivel ball and SO-239 connectors. Price: \$7.50



**MODEL TGM-1**  
Trunk groove mount installs in hidden area of groove under trunk lid. Mounting hardware included. Price: \$8.00

## SUPER GAIN MOBILES

- Two Meters**
- 52 db gain over 1/4 wave mobile antenna
  - Frequency coverage—143-149 MHz
  - SWR at resonance—1.1:1 typical
  - Power rating—200 watts FM

**TWO AND SIX METERS—TRUNK LIP MOUNT**  
**MODEL HFT**  
Four section telescopic antenna permits separate adjustment for simultaneous resonance on two and six meters. Operational height: 40". Complete with trunk lip mount, 17 MIL SPEC RG-58-U and factory attached PL-259.  
Price: \$22.55

**VHF/UHF ANTENNA—ROOF MOUNT**  
**MODEL UHT-1**  
Field trimmable radiator for 1/4 wave operation on any frequency from 140 to 500 MHz. Cutting chart included. Mounts on any flat surface, roof, deck, fender in 1/4" hole. Includes 17' RG-58-U.  
Price: \$9.95

**VHF/UHF ANTENNA—TRUNK LIP MOUNT**  
**MODEL THF**  
Field trimmable radiator permits quarter wave operation on any frequency from 140 to 500 MHz. Cutting chart included. Complete with trunk lip mount, 17' RG-58-U and PL-259. Price: \$16.55

**RESONATOR SPRING—STAINLESS STEEL**  
**MODEL RSS-2**  
Installs between Hustler mast and resonator. Absorbs shock when antenna strikes overhanging obstructions. Supplied ready for easy installation.  
Price: \$ 5.85

**QUICK DISCONNECT—100% STAINLESS STEEL**  
**MODEL QD-1**  
Remove antenna from mount with easy press and twist release. Compression spring and all parts 100% stainless steel. 3/4" — 24 threads—female one end, male the other.  
Price: \$16.95

**FEED LINE** **MODEL L-14-240**  
Get known performance, maximum shielding for minimum noise pickup in this MIL SPEC 20 length of RG-58-U cable. Supplied with connectors at each end for use with ball or bumper mount and transceiver.  
Price: \$6.55

**MODEL G6-144A** — Deluxe, Two-Meter Colinear for Repeater or any fixed station operation. 6 db gain over a 1/2 wave dipole. Maximum radiation at the horizon! Shunt fed with D.C. grounding. Radiator, 1/2 wave lower section, 1/4 wave phasing, 1/2 wave upper section. Height: 117". SWR at resonance: 1.2:1 or better. Power rating: 1,000 Watts FM. Wind survival: 100 MPH. Installs on vertical pipe up to 1 1/4" O.D. SO-239 coax connector.  
Price: \$67.55

**MODEL C-32**  
Ball mount complete with mounting hardware.  
Price: \$8.20

**MODEL CGT-144**  
Get big signal performance, superior receiving capability with this 85" colinear antenna. Easy installation on side or edge of trunk lip without drilling — complete with 17 MIL SPEC RG-58-U and PL-259.  
Price: \$41.30

**MODEL CG-144**  
Same characteristics as CGT-144 supplied with 3/4" — 24 base to fit all mobile ball mounts — Length is 85" Mount and cable not included. Price: \$25.50

**VHF/UHF ANTENNA—TRUNK LIP MOUNT**  
**MODEL THF**  
Field trimmable radiator permits quarter wave operation on any frequency from 140 to 500 MHz. Cutting chart included. Complete with trunk lip mount, 17' RG-58-U and PL-259. Price: \$16.55

**MODEL SSM-2**  
Heavy 2" reinforced stainless steel 180° adjustable ball mount easily supports any amateur mobile antenna. Includes cyclic base, steel back-up plate and mounting hardware.  
Price: \$19.20

**STAINLESS STEEL BALL MOUNT FOR DECK, FENDER OR ANY FLAT SURFACE**  
**MODEL GSM-2**  
Heavy 2" reinforced stainless steel 180° adjustable ball mount easily supports any amateur mobile antenna. Includes cyclic base, steel back-up plate and mounting hardware.  
Price: \$19.20

**QUICK DISCONNECT—100% STAINLESS STEEL**  
**MODEL QD-1**  
Remove antenna from mount with easy press and twist release. Compression spring and all parts 100% stainless steel. 3/4" — 24 threads—female one end, male the other.  
Price: \$16.95

**FEED LINE** **MODEL L-14-240**  
Get known performance, maximum shielding for minimum noise pickup in this MIL SPEC 20 length of RG-58-U cable. Supplied with connectors at each end for use with ball or bumper mount and transceiver.  
Price: \$6.55

**MODEL G6-144A** — Deluxe, Two-Meter Colinear for Repeater or any fixed station operation. 6 db gain over a 1/2 wave dipole. Maximum radiation at the horizon! Shunt fed with D.C. grounding. Radiator, 1/2 wave lower section, 1/4 wave phasing, 1/2 wave upper section. Height: 117". SWR at resonance: 1.2:1 or better. Power rating: 1,000 Watts FM. Wind survival: 100 MPH. Installs on vertical pipe up to 1 1/4" O.D. SO-239 coax connector.  
Price: \$67.55

All resonators are precision wound with optimized design for each band. Assembly includes 17-7 PH stainless steel adjustable tip rod for lowest SWR and band edge marker. Choose for medium or high power operation.

## STANDARD HUSTLER RESONATORS

Power Rating: 400 Watts SSB

Model	Band	Price
RM-10	10 meters	\$ 6.50
RM-15	15 meters	6.95
RM-20	20 meters	7.30
RM-40	40 meters	13.20
RM-75	75 meters	15.50
RM-80	80 meters	15.95

## SUPER HUSTLER RESONATORS

Power Rating: Legal Limit SSB  
Supers have widest bandwidth

Model	Band	Price
RM-10S	10 meters	\$11.30
RM-15S	15 meters	12.65
RM-20S	20 meters	13.00
RM-40S	40 meters	15.50
RM-75S	75 meters	30.00
RM-80S	80 meters	30.40

## For 6-10-15-20-40-75-80 Meters

Fold over mast for quick and easy interchange of resonators or entering a garage. When operating, mast is held vertical with shakeproof sleeve clutch. 54" mast also serves as 1/4 wavelength 6 meter antenna. Stainless steel base has 3/4" — 24 threads to fit mobile ball mount or bumper mount.

**MODEL M0-2**  
For bumper mounting—Fold is at roof line 27" above base. Price: \$22.00

**MODEL M0-1**  
For deck or fender mounting—Fold is at roof line 15" above base. Price: \$22.00

Covers 10 - 15 - 20 - 40 Meters  
Only Hustler Gives One Setting for Whole Band Coverage

- MODEL 4-BTV**
- Lowest SWR—PLUS.
  - Bandwidth at its broadest! SWR 1.5 to 1 or better at band edges.
  - Hustler exclusive trap covers "Spritz" extruded to otherwise unattainable close tolerances assuring accurate and permanent trap resonance.
  - Solid one inch fiberglass trap forms for optimum electrical and mechanical stability.
  - Extra heavy duty aluminum mounting bracket with low loss—high strength insulators. Mounting hardware included.
  - All sections 1 1/4" heavy wall, high strength aluminum.
  - Stainless steel clamps permitting adjustment without damage to the aluminum tubing.
  - Guaranteed to be easiest assembly of any multi-band vertical.
  - Antenna has 3/4" — 24 stud at top to accept RM-75 or RM-75-S Hustler resonator for 75 meter operation when desired.
  - Top loading on 75 meters for broader bandwidth and higher radiation efficiency!
  - Feed with any length 50 ohm coax.
  - Power capability—full legal limit on SSB or CW.
  - Mounting: Ground mount with or without radials, or roof mount with radials.
  - Weight: 15 lbs.
  - Price: \$99.95
- Length: 21' 5"  
MODEL 4-BTV





# SUPER AMP

from *DenTron*

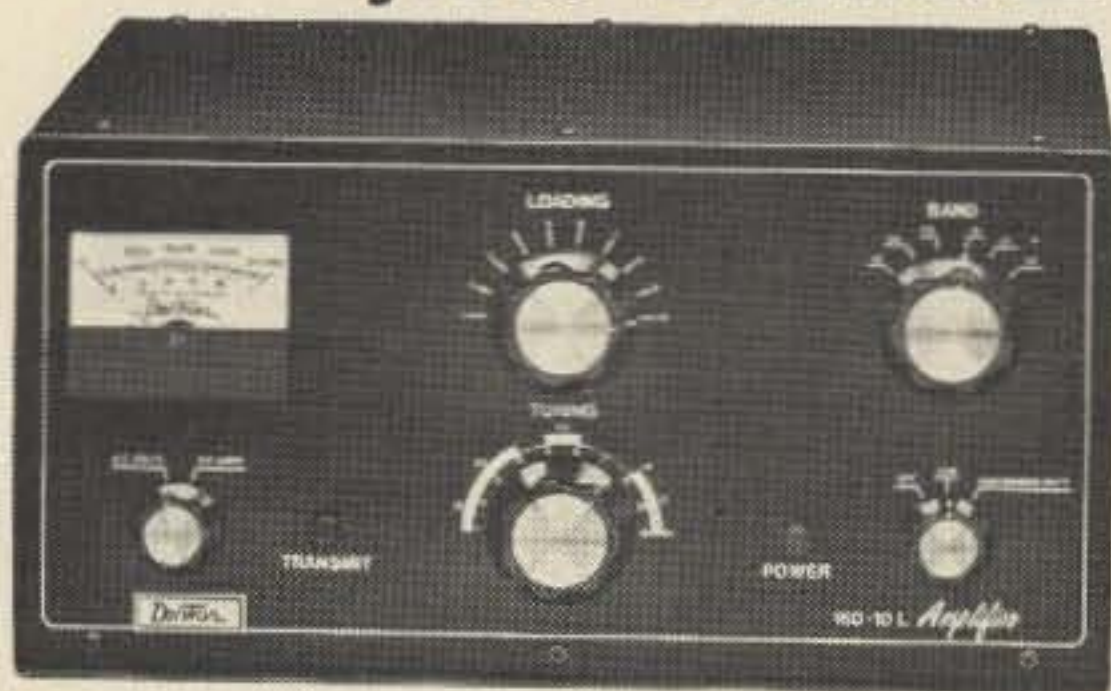

If the amplifier you're thinking of buying doesn't deliver at least 1000 to 1200 watts output, to the antenna, you're buying the wrong amplifier.

Our New Super Amp is sweeping the country because hams have realized that the DenTron Amplifier will deliver to the antenna, (output power), what other manufacturers rate as input power.

The Super Amp runs a full 2000 watts P.E.P. input on SSB, and 1000 watts DC on CW, RTTY or SSTV 160-10 meters, the maximum legal power.

The Super Amp is compact, low profile, has a solid one-piece cabinet assuring maximum TVI shielding.

The heart of our amplifier, the power supply, is a continuous duty, self-contained supply built for contest performance.

We mounted the 4-572B's, industrial workhorse tubes, in a cooling chamber featuring the on-demand variable cooling system.

The hams at DenTron pride themselves on quality work, and we fight to keep prices down. That's why the dynamic DenTron Linear Amplifier beats them all

**\$574.50**

## The 80-10 Skymatcher

Here's an antenna tuner for 80 through 10 meters, handles 500 w P.E.P. and matches your 52 ohm transceiver to a random wire antenna.



- Continuous tuning 3.2 - 30 mc
- "L" network
- Ceramic 12 position rotary switch
- SO-239 receptional to transmitter
- Random wire tuner
- 3000 volt capacitor spacing
- Tapped inductor
- Ceramic antenna feed thru
- 7" W. 5" H. 8" D., Weight: 5 lbs.

**\$59.50**

**Read forward and reflected watts at the same time**

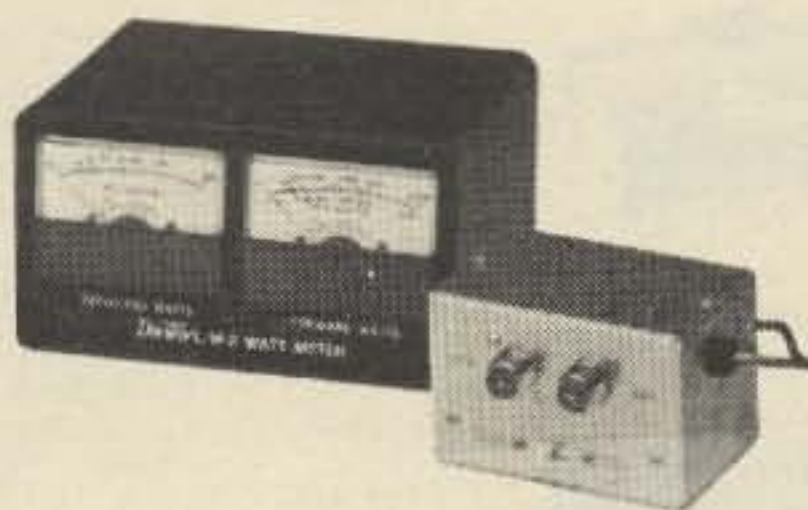

Tired of constant switching and guesswork?

Every serious ham knows he must read both forward and reverse wattage simultaneously for that perfect match. So upgrade with the DenTron W-2 Dual in line Wattmeter.

**\$99.50**

## Match everything from 160 to 10 with the new 160-10 MAT

NEW: The Monitor Tuner was designed because of overwhelming demand. Hams told us they wanted a 3 kilowatt tuner with a built-in wattmeter, a front panel antenna selector for coax, balanced line and random wire. So we engineered the 160-10m Monitor Tuner. It's a lifetime investment at \$299.50.

**\$299.50**

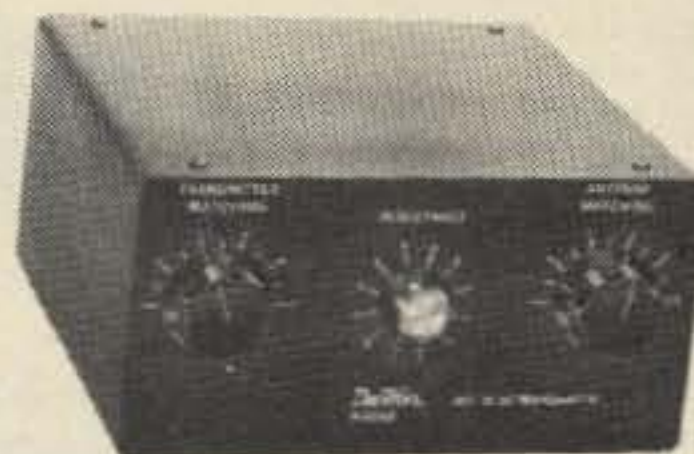

## Meet the SuperTuner

The DenTron Super Tuner tunes everything from 160-10 meters. Whether you have balanced line, coax cable, random or long wire, the Super Tuner will match the antenna impedance to your transmitter. All DenTron tuners give you maximum power transfer from your transmitter to your antenna, and isn't that where it really counts?

1 KW MODEL **\$129.50** 3 KW MODEL **\$229.50**

## The Sky Openers

### SKYMASTER

A fully developed and tested 27 foot vertical antenna covers entire 10, 15, 20, and 40 meter bands using only one cleverly applied wave trap. A full 1/4 wave antenna on 20 meters. Constructed of heavy seamless aluminum with a factory tuned and sealed HQ Trap, SKYMASTER is weatherproof and withstands winds up to 80 mph. Handles 2 KW power level and is for ground, roof or tower mounting. Radials included in our low price of

**\$84.50**

Also 80 m resonator for top mounting on SKYMASTER.

**\$29.50**

### SKYCLAW

A tunable monoband high performance vertical antenna, designed for 40, 80, 160 meter operation. SKYCLAW gives you the following spectrum coverage:

BAND (Meters)	BANDWIDTH (kHz)
160	50
80	200
40	entire band

Tuning is easy and reliable. Rugged construction assures that this self-supporting unit is weatherproof and survives nicely in 100 mph winds.. Handles full legal power limit.

**\$79.50**

### EX-1

The DenTron EX-1 Vertical Antenna is designed for the performance minded antenna experimenter. The EX-1 is a full 40 meter, 1/4 wave, 33', self-supporting vertical. The EX-1 is the ideal vertical for phasing.

**\$59.50**

### TRIM-TENNA

The antenna your neighbors will love. The new DenTron Trim-Tenna with 20 meter beam is designed for the discriminating amateur who wants fantastic performance in an environmentally appealing beam. It's really loaded! Up front there's a 13 foot 6 inch director with precision Hy-Q coils. And, 7 feet behind is a 16 foot driven element fed directly with 52 ohm coax. The Trim-Tenna mounts easily and what a difference in on-the-air performance between the Trim-Tenna and that dipole, long wire or inverted Vee you've been using. 4 & 6 Forward Gain Over Dipole.

**\$129.50**

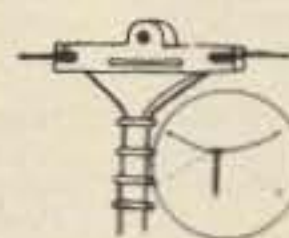

### ALL BAND DOUBLET

This All Band Doublet or inverted Type Antenna covers 160 thru 10 meters. Has total length of 130 feet (14 ga. stranded copper) although it may be made shorter if necessary. This tuned Doublet is center fed through 100 feet of 450 ohm PVC covered balanced transmission line. The assembly is complete. Add rope to the ends and pull up into position. Tune with the DenTron Super Tuner and you're on 10 through 160 meters with one antenna! Now just for the DenTron All Band Doublet.

**\$24.50**

*DenTron*

**DRAKE TVI FILTERS** High Pass Filters for TV Sets provide more than 40 dB attenuation at 52 MHz and lower. Protect the TV set from amateur transmitters 6-160 meters.



**Drake TV-300-HP**  
Model No. 1603  
For 300 ohm twin lead  
Price: \$10.60

**Drake TV-75-HP**  
Model No. 1610  
For 75 ohm TV coaxial cable; TV type connectors installed  
Price: \$13.25



**DRAKE TV-3300-LP**  
1000 watts max. below 30 MHz. Attenuation better than 80 dB above 41 MHz. Helps TV i-f interference, as well as TV front-end problems. Price: \$26.60 Model No. 1608



**DRAKE TV-42-LP** Model No. 1605 is a four section filter designed with 43.2 MHz cut-off and extremely high attenuation in all TV channels for transmitters operating at 30 MHz and lower. Rated 100 watts input. Price: \$14.60

**LOW PASS FILTERS FOR TRANSMITTERS** have four pi sections for sharp cut off below channel 2, and to attenuate transmitter harmonics falling in any TV channel and fm band. 52 ohm. SO-239 connectors built in.

**DRAKE TV-5200-LP**  
200 watts to 52 MHz. Ideal for six meters. For operation below six meters, use TV-3300-LP or TV-42-LP. Model No. 1609 Price: \$26.60

TUFTS RADIO ELECTRONICS RADIO CATALOG



# WORK ALL REPEATERS WITH OUR NEW SYNTHESIZER II



The Synthesizer II is a two meter frequency synthesizer. Frequency is adjustable in 5 kHz steps from 140.00 MHz to 149.995 MHz with its digital readout thumb wheel switching. Transmit offsets are digitally programmed on a diode matrix, and can range from 10 kHz to 10 MHz. No additional components are necessary!  
 Kit ..... \$169.95    Wired and tested \$239.95

- RX28C . . . . . 28-35 MHz FM receiver with 2 pole 10.7 MHz crystal filter . . . \$ 59.95
- RX28C W/T . . . same as above-wired & tested . . . 104.95
- RX50C Kit . . . 30-60 MHz rcvr w/2 pole 10.7 MHz crystal filter . . . . . 59.95
- RX50C W/T . . . same as above-wired & tested . . . 104.95
- RX144C Kit . . . 140-170 MHz rcvr w/2 pole 10.7 MHz crystal filter . . . . . 69.95
- RX144C W/T . . . same as above-wired & tested . . . 114.95
- RX220C Kit . . . 210-240 MHz rcvr w/2 pole 10.7 MHz crystal filter . . . . . 69.95
- RX220C W/T . . . same as above-wired & tested . . . 114.95
- RX432C Kit . . . 432 MHz rcvr w/2 pole 10.7 MHz crystal filter . . . . . 79.95
- RX432C W/T . . . same as above-wired & tested . . . 124.95
- TX50 . . . . . transmitter exciter, 1 watt, 6 mtr. . . 39.95
- TX50 W/T . . . same as above-wired & tested . . . 59.95
- TX144B Kit . . . transmitter exciter-1 watt-2 mtrs . . 29.95
- TX144B W/T . . . same as above-wired & tested. . . 49.95
- TX220B Kit . . . transmitter exciter-1 watt-220 MHz . . . . . 29.95
- PA2501H Kit . . 2 mtr power amp-kit 1w in-25w out with solid state switching, case, connectors . . . . . 59.95
- PA2501H W/T . . same as above-wired & tested . . . 74.95
- PA4010H Kit . . 2 mtr power amp-10w in-40w out-relay switching . . . . . 59.95
- PA4010H W/T . . same as above-wired & tested . . . 74.95
- PA50/25 Kit . . 6 mtr power amp, 1w in, 25w out, less case, connectors & switching . . 49.95
- PA50/25 W/T . . same as above, wired & tested. . . 69.95
- PA144/15 Kit . . 2 mtr power amp-1w in-15w out-less case, connectors and switching . . . . . 39.95
- PA144/15 W/T . . same as PA144/15 kit but 25w . . . 49.95
- PA220/15 Kit . . similar to PA144/15 for 220 MHz . . . 39.95
- PA432/10 Kit . . power amp-similar to PA144/15 except 10w and 432 MHz . . . . . 49.95
- PA140/10 W/T . . 10w in-140w out-2 mtr amp . . . . . 179.95
- PA140/30 W/T . . 30w in-140w out-2 mtr amp . . . . . 159.95
- PS15C Kit . . . 15 amp-12 volt regulated power supply w/case, w/fold-back current limiting and overvoltage protection . . . 79.95
- PS15C W/T . . . same as above-wired & tested . . . 94.95
- PS25C Kit . . . 25 amp-12 volt regulated power supply w/case, w/fold-back current limiting and ovp . . . . . 129.95
- PS25C W/T . . . same as above-wired & tested . . . 149.95
- PS25M Kit . . . same as PS25C with meters . . . . . 149.95
- PS25M W/T . . . same as above-wired & tested . . . 169.95
- RPT50 Kit . . . repeater-6 meter . . . . . 465.95
- RPT50 W/T . . . repeater-6 meter, wired & tested . . . 695.95
- RPT144 Kit . . . repeater-2 mtr-15w-complete (less crystals) . . . . . 465.95
- RPT220 Kit . . . repeater-220 MHz-15w-complete (less crystals) . . . . . 465.95
- RPT432 Kit . . . repeater-10 watt-432 MHz (less crystals) . . . . . 515.95
- RPT144 W/T . . . repeater-15 watt-2 mtr. . . . . 695.95
- RPT220 W/T . . . repeater-15 watt-220 MHz. . . . . 695.95
- RPT432 W/T . . . repeater-10 watt-432 MHz. . . . . 749.95
- DPLA50 . . . . . 6 mtr close spaced duplexer . . . . . 575.00
- TRX50 Kit . . . Complete 6 mtr FM transceiver kit, 20w out, 10 channel scan with case (less mike and crystals). . . . . 249.95
- TRX144 Kit . . . same as above, but 2 mtr & 15w out . . 219.95
- TRX220 Kit . . . same as above except for 220 MHz . . . 219.95
- TRX432 Kit . . . same as above except 10 watt and 432MHz . . . . . 254.95
- TRC-1 . . . . . transceiver case only . . . . . 19.95
- TRC-2 . . . . . transceiver case and accessories . . . 39.95
- SYN II Kit . . . 2 mtr synthesizer, transmitt offsets programmable from 100 KHz-10 MHz, (Mars offsets with optional adapters) . . . . . 169.95
- SYN II W/T . . . same as above-wired & tested . . . 239.95
- MO-1 Kit . . . . . Mars/cap offset optional . . . . . 2.50
- TO-1 Kit . . . . . 18 MHz optional tripler . . . . . 2.50
- HT 144B Kit . . 2 mtr, 2w, 4 channel, hand held receiver with crystals for 146.52 simplex . . . 129.95
- NICAD . . . . . battery pack, 12 VDC, 1/2 amp. . . . . 29.95
- BC12 . . . . . battery charger for above . . . . . 5.95
- Rubber Duck . . 2 mtr, with male BNC connector . . . 8.95

## RECEIVERS



- RXCF . . . . . accessory filter for above receiver kits gives 70 dB adjacent channel rejection . . . . . 8.50
- RF28 Kit . . . . 10 mtr RF front end 10.7 MHz out . . 12.50
- RF50 Kit . . . . 6 mtr RF front end 10.7 MHz out . . 12.50
- RF144D Kit . . . 2 mtr RF front end 10.7 MHz out . . 17.50
- RF220D Kit . . . 220 MHz RF front end 10.7 MHz out . . . . . 17.50
- RF432 Kit . . . . 432 MHz RF front end 10.7 MHz out . . . . . 27.50
- IF 10.7F Kit . . . 10.7 MHz IF module includes 2 pole crystal filter . . . . . 27.50
- FM455 Kit . . . . 455 KHz IF stage plus FM detector . . 17.50
- AS2 Kit . . . . . audio and squelch board . . . . . 15.00

## TRANSMITTERS



- TX220B W/T . . . same as above-wired & tested . . . 49.95
- TX432B Kit . . . transmitter exciter 432 MHz . . . . . 39.95
- TX432B W/T . . . same as above-wired & tested . . . 59.95
- TX150 Kit . . . . 300 milliwatt, 2 mtr transmitter . . . 19.95
- TX150 W/T . . . same as above-wired & tested . . . 29.95

## POWER AMPLIFIERS



Model	Frequency	Power Input	Power Output	
Blue Line . . . .	RF power amp, wired & tested, emission-CW-FM-SSB/AM			
BLB 3/150	45- 55MHz	3W	150W	TBA
BLC 10/70	140-160MHz	10W	70W	139.95
BLC 2/70	140-160MHz	2W	70W	159.95
BLC 10/150	140-160MHz	10W	150W	259.95
BLC 30/150	140-160MHz	30W	150W	239.95
BLD 2/60	220-230MHz	2W	60W	159.95
BLD 10/60	220-230MHz	10W	60W	139.95
BLD 10/120	220-230MHz	10W	120W	259.95
BLE 10/40	420-470MHz	10W	40W	139.95
BLE 2/40	420-470MHz	2W	40W	159.95
BLE 30/80	420-470MHz	30W	80W	259.95
BLE 10/80	420-470MHz	10W	80W	289.95

## POWER SUPPLIES

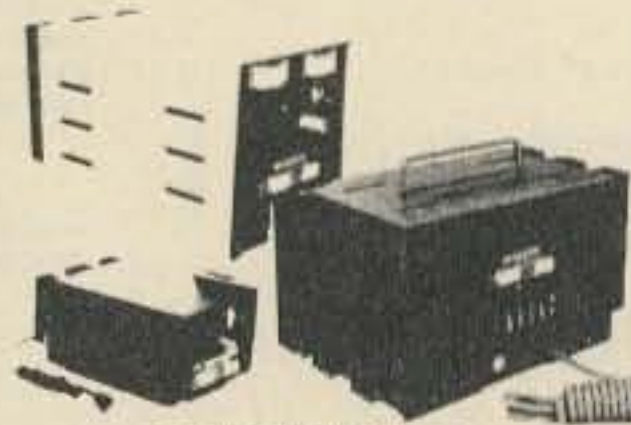

- O.V.P. . . . . adds over voltage protection to your power supplies, 15 VDC max. . . . . 9.95
- PS3A Kit . . . . 12 volt-power supply regulator card with fold-back current limiting . . . . 8.95
- PS3012 W/T . . . new commercial duty 30 amp 12 VDC regulated power supply w/case, w/fold-back current limiting and overvoltage protection . . . . . 239.95

## REPEATERS

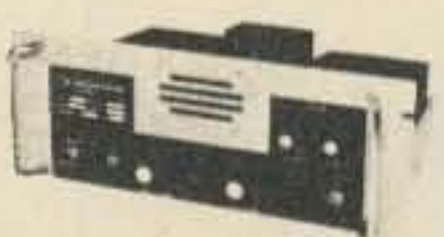

- DPLA144 . . . . 2 mtr, 600 KHz spaced duplexer, wired and tuned to frequency . . . . 379.95
- DPLA220 . . . . 220 MHz duplexer, wired and tuned to frequency . . . . . 379.95
- DPLA432 . . . . rack mount duplexer . . . . . 319.95
- DSC-U . . . . . double shielded duplexer cables with PL259 connectors (pr.) . . . . . 25.00
- DSC-N . . . . . same as above with type N connectors (pr.) . . . . . 25.00

## TRANSCIEVERS



- CD1 Kit . . . . . 10 channel receive xtal deck w/diode switching. . . . . \$ 6.95
- CD2 Kit . . . . . 10 channel xmit deck w/switch and trimmers . . . . . 14.95
- CD3 Kit . . . . . UHF version of CD1 deck, needed for 432 multi-channel operation . . . 12.95
- COR2 Kit . . . . carrier operated relay . . . . . 19.95
- SC3 Kit . . . . . 10 channel auto-scan adapter for RX with priority . . . . . 19.95

## SYNTHESIZERS



- Crystals . . . . . we stock most repeater and simplex pairs from 146.0-147.0 (each). . . . . 5.00
- CWID Kit . . . . 159 bit, field programmable, code identifier with built-in squelch tail and ID timers . . . . . 39.95
- CWID . . . . . wired and tested, not programmed . . 54.95
- CWID . . . . . wired and tested, programmed . . . . 59.95
- MIC 1 . . . . . 2,000 ohm dynamic mike with P.T.T. and coil cord . . . . . 12.95
- TS1 W/T . . . . . tone squelch decoder . . . . . 59.95
- TS1 W/T . . . . installed in repeater, including interface accessories . . . . . 89.95
- TD3 Kit . . . . . 2 tone decoder . . . . . 29.95
- TD3 W/T . . . . same as above-wired & tested . . . . 39.95
- HL144 W/T . . . 4 pole helical resonator, wired & tested, swept tuned to 144 MHz ban . . . . . 24.95
- HL220 W/T . . . same as above tuned to 220 MHz ban . . 24.95
- HL432 W/T . . . same as above tuned to 432 MHz ban . . 24.95

## WALKIE-TALKIES



THE WORLD'S MOST COMPLETE LINE OF VHF-FM KITS AND EQUIPMENT





## Now It's Crystal Clear

Yes, now ICOM helps you steer clear of all the hassles of channel crystals. The new **IC-225** is the same surprising radio you've come to know and love as the **IC-22A**, except that it is totally crystal independent. **Zero crystals.** Solid state engineering enables you to program 23 channels of your choice without waiting. Now the ICOM performance you've demanded comes with the convenience you've wanted, with your new **IC-225**.

Price: \$299.00



### IC-245 Transceiver

The VFO Revolution goes mobile with the unique, ICOM developed LSI synthesizer with 4 digit LED readout. The IC-245 offers the most for mobile on the market. The easy to use tuning knob moves accurately over 50 detent steps and assures excellent control as easily as steering the vehicle. With its optional adapter, the IC-245 puts you into all mode operation on 12V DC power with a compact dash-mounted transceiver. In FM, the synthesizer command frequency is displayed in 5 kHz steps from 146 to 148 MHz, and with the side band adapter the step rate drops to 100 Hz from 144 to 146 MHz. For maximum repeater flexibility, the transmit and receive frequencies are independently programmable on any separation. The IC-245 even comes equipped with a multiple pin Molex connector for remote control. The IC-245 is a product of the revolution in VFO design, from its new style front panel, to its excellent mechanical rigidity and Large Scale Integrated Circuitry. Your IC-245 will give you the most for mobile. \$499.00



### THE NEW ICOM 4 MEG, MULTI-MODE, 2 METER RADIO — IC 211

ICOM introduces the first of a great new wave of amateur radios, with new styling, new versatility, new integration of functions. You've never before laid eyes on a radio like the IC-211, but you'll recognize what you've got when you first turn the single-knob frequency control on this compact new model. The IC-211 is fully synthesized in 100 Hz or 5 kHz steps, with dual tracking, optically coupled VFOs displayed by seven-segment LED readouts, providing any aplit. The IC-211 rolls through 4 megahertz as easily as a breaker through the surf. With its unique ICOM developed LSI synthesizer, the IC-211 is now the best "do everything" radio for 2 meters, with FM, USB, LSB and CW operation. \$749.00

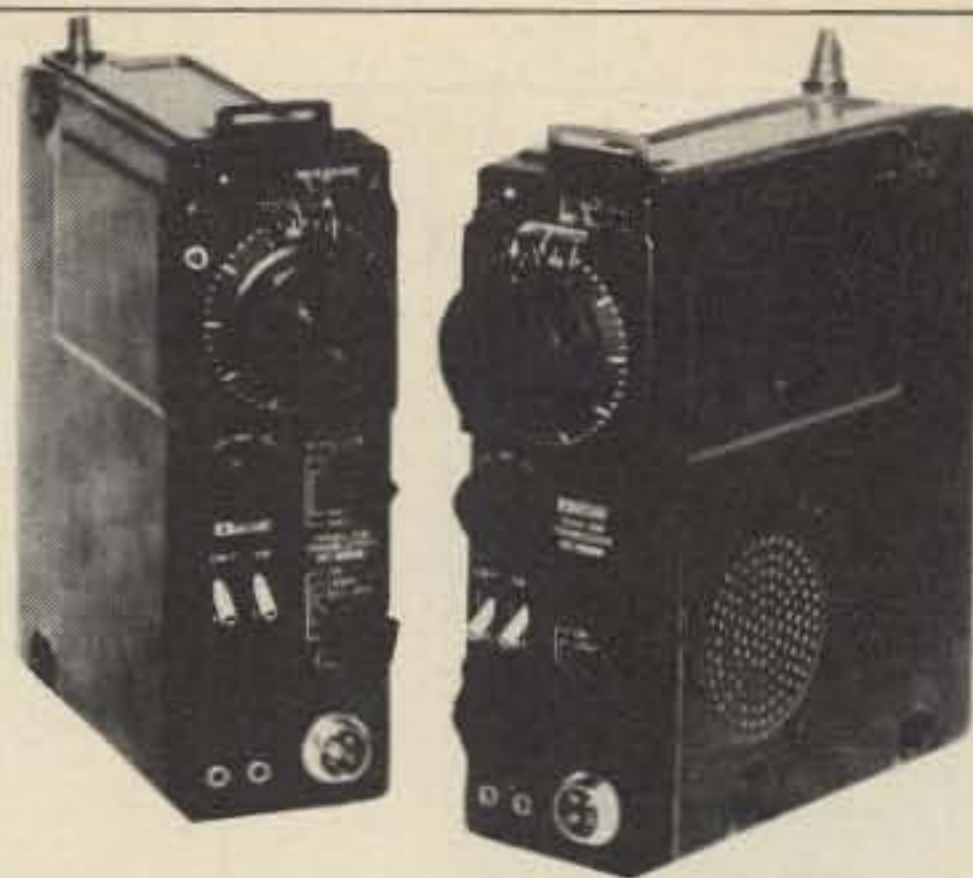

## Hold it!

Take hold of SSB with these two low cost twins. ICOM'S new portable **IC-202** and **IC-502** put it within your reach wherever you are. You can take it with you to the hill top, the highways, or the beach. Three portable watts PEP on two meters or six!

**Hello, DX!** The ICOM quality and excellent receiver characteristics of this pair make bulky converters and low band rigs unnecessary for getting started in SSB-VHF. You just add your linear amp, if you wish, connect to the antenna, and DX! With the **202** you may talk through OSCAR VI and VII! Even transceive with an "up" receiving converter! The **IC-502**, similarly, makes use of six meters in ways that you would have always liked but could never have before. In fact, there are so many things to try, it's like opening a new band.

Take hold of Single Side Band. Take hold of some excitement. Take two.

#### IC-202

2 Meter SSB • 3 Watts PEP • True IF Noise Blanker  
Switched Dial Lights • Internal Batteries • 200KHz  
VXO Tuning • 144.0, 144.2 • 2 More! • RIT!

Price: \$259.00

#### IC-502

6 Meter SSB • 3 Watts PEP • True IF Noise Blanker  
Switched Dial Lights • Internal Batteries • 800KHz  
VFO • RIT!

Price: \$249.00

### Now ICOM Introduces 15 Channels of FM to Go!

## The New IC-215: the FM Grabber

This is ICOM's first FM portable, and it puts good times on the go. Change vehicles, walk through the park, climb a hill, and ICOM quality FM communications go right along with you. Long lasting internal batteries make portable FM really portable, while accessible features make conversion to external power and antenna fast and easy.

Grab for flexibility with the new **IC-215** FM portable.

- Front mounted controls and top mounted antenna
- Narrow filter (15KHz — compatible spacing)
- 15 channels (12 on dial / 3 priority)
- Fully collapsible antenna
- Compatible mount feature for flexible antenna
- Dual power (3 watts high / 400 mw low, nominal)
- External power and antenna easily accessible
- Lighted dial and meter



Price: \$229.00

Your new **IC-215** comes supplied with: 5 popular channels; handheld mic, with protective case; shoulder strap; connectors for external power and speaker; 9 long-life C batteries.



# ICOM

TUFTS RADIO CATALOG TUFTS RADIO





**model 333  
dummy load  
wattmeter**

**Favorite Lightweight Portable—250 WATT RATING—  
Air Cooled**

Ideal field service unit for mobile 2-way radio—CB, marine, business band. Best for QRP amateur use, CB, with zero to 5 watts full scale low power range.

■ specifications

Frequency Range	DC to 300 MHz
VSWR	Less than 1.3:1 to 230 MHz
Power Range	250 watts intermittent
Wattmeter Ranges	0-5, 0-50, 0-125, 0-250
Connector	SO-239
Size	4" x 7" x 8"
Shipping Weight	2 lbs.
Price	\$98.50



**—model 374 dummy load wattmeter—**

**Top of the Line—1500 WATT RATING—Oil Cooled**

Our highest power combination unit. Rated to 1500 watts input (intermittent). Meter ranges are individually calibrated for highest accuracy.

■ specifications

Frequency Range	DC to 300 MHz
VSWR	Less than 1.3:1 to 230 MHz
Power Range	1500 watts DC intermittent. Warning light* signals maximum heat limit.
Wattmeter Ranges	0-15, 0-50, 0-300, 0-1500
Input Connector	SO-239 (hermetically sealed)
Size	4-3/4" x 9" x 10-1/4"
Shipping Weight	12 lbs.
Price	\$215.00

**LITTLE DIPPER**



**model 331A  
transistor dip meter**

Portable RF single generator, signal monitor, or absorption wavemeter. Lightweight (1 pound, 6 ounces with all coils), battery-powered unit is ideal for field use in testing transceivers, tuning antennas, etc. Can also be used to measure capacity, inductance, circuit Q, and other factors. Indispensable for experimenters, it is easily the most versatile instrument in the shop. Continuous coverage from 2 MHz to 230 MHz in seven ranges.

Unit consists of a transistorized RF dip oscillator and 100-microampere meter circuit. Meter circuit uses a single-transistor DC amplifier with a potentiometer in the emitter circuit to control meter sensitivity. A 3-position slide switch connects the meter circuit to the oscillator for dip measurements, to a diode for absorption wavemeter peak measurements, or provides audio modulation of the RF signal.

Frequency dial has a calibrated reference point for Q and bandwidth measurements. Each coil has its own frequency dial: there's no confusion with multiple markings or small, hard-to-read scales near the center of the dial.

■ specifications

Frequency Coverage	2 MHz to 230 MHz in 7 overlapping ranges by plug-in coil assemblies: 2 MHz-4 MHz, 4 MHz-8 MHz, 8 MHz-16 MHz, 16 MHz-32 MHz, 32 MHz-64 MHz, 50 MHz-110 MHz, 110 MHz-230 MHz
Accuracy	±3%
Modulation	1000 Hz, 25% to 40%
Power	9-volt transistor battery, Burgess 2U6 or equivalent
Size	7" x 2-1/4" x 2-1/2"
Shipping Weight	1 lb., 6 oz.
Price	\$120.00



**BARKER & WILLIAMSON, INC.**



**Economy High Power Load—1500 WATT RATING—  
Oil Cooled  
model 384 dummy load**

For high power when all you need is the load.

■ specifications

Frequency Range	DC to 300 MHz
VSWR	Less than 1.3:1 to 230 MHz
Power Range	1500 watts intermittent. Warning light* signals maximum heat limit.
Connector	SO-239 (hermetically sealed)
Size	4-3/4" x 9" x 10-1/2"
Shipping Weight	12 lbs.
Price	\$94.50



**High Power—1000 WATT RATING—Oil Cooled  
model 334A dummy load wattmeter.**

Our most popular combination unit. Handles full amateur power. Meter ranges individually calibrated. Can be panel mounted.

■ specifications

Frequency Range	DC to 300 MHz
VSWR	Less than 1.3:1 to 230 MHz
Power Range	1000 watts CW intermittent. Warning light* signals maximum heat limit.
Wattmeter Ranges	0-10, 0-100, 0-300, 0-1000
Input Connector	SO-239 (hermetically sealed)
Size	4-3/4" x 9" x 10-1/4"
Shipping Weight	12 lbs.
Price	\$174.00

**WIDE RANGE ATTENUATOR**



**Model 371-1**

Protect your receiver or converter from overload, or provide step attenuation of low-level RF signals from signal generators, preamplifiers, or converters. Seven rocker switches provide attenuation from 1 dB to 61 dB in 1-dB steps. Switches are marked in dB, 1-2-3-5-10-20-20. Sum of actuated switches (IN position) gives attenuation. With all switches in OUT position, there is NO insertion loss. Attenuator installs in coaxial line using UHF connectors.

■ specifications

Power Capacity	1/4 watt
VSWR	1.3:1 maximum, DC to 225 MHz
Impedance	50 ohms
Accuracy	1 dB/dB, DC to 60 MHz 0.1 dB/dB ±0.5 dB, DC to 160 MHz 0.1 dB/dB ±1.0 dB, DC to 225 MHz
Size	8-1/2" x 2-1/2" x 2-1/4"
Shipping Weight	1-1/2 lbs.
Price	\$49.50





## Drake R-4C

Solid State Linear permeability-tuned VFO with 1 kHz dial divisions. Gear driven dual circular dials. High mechanical, electrical and temperature stability.

Covers ham bands with crystals furnished. Covers all of 80, 40, 20 and 15 meters, and 28.5-29.0 MHz of 10 meters.

Covers 160 meters with accessory crystal. In addition to the ham bands, tunes any fifteen 500 kHz ranges between 1.5 and 30 MHz, 5.0 to 6.0 MHz not recommended. Can be used for MARS, WWV, CB, Marine and Shortwave broadcasts.

Superior selectivity: 2.4 kHz 8-pole filter provided in ssb positions. 8.0 kHz, 6 pole selectivity for a-m. Optional 8-pole filters of .25, .5, 1.5 and 6.0 kHz bandwidths available.

Tunable notch filter attenuates carriers within passband.

Smooth and precise passband tuning.

Transceive capability; may be used to transceive with the T-4X, T-4XB or T-4XC Transmitters. Illuminated dial shows which PTO is in use.

Usb, lsb, a-m and cw on all bands.

Agc with fast attack and two release times for ssb and a-m or fast release for break-in cw. Agc also may be switched off.

New high efficiency accessory noise blanker that operates in all modes.

Crystal lattice filter in first i-f prevents cross-modulation and desensitization due to strong adjacent channel signals.

Excellent overload and intermodulation characteristics.

25 kHz Calibrator permits working closer to band edges and segments.

Scratch resistant epoxy paint finish.

Price: \$599.00



## Drake T-4XC

Solid State Linear permeability-tuned VFO with 1 kHz dial divisions. Gear driven dual circular dials. High mechanical, electrical and temperature stability.

Covers ham bands with crystals furnished. Covers all of 80, 40, 20 and 15 meters, and 28.5-29.0 MHz of 10 meters.

Covers 160 meters with accessory crystal. Four 500 kHz ranges in addition to the ham bands plus one fixed-frequency range can be switch-selected from the front panel.

Two 8-pole crystal lattice filters for sideband selection.

Transceives with the R-4, R-4A, R-4B, R-4C and SPR-4 Receivers. Switch on the T-4XC selects frequency control by receiver or transmitter PTO or independently. Illuminated dial shows which PTO is in use.

Usb, lsb, a-m and cw on all bands.

Controlled-carrier modulation for a-m is compatible with ssb linear amplifiers.

Automatic transmit-receive switching. Separate VOX time-delay adjustments for phone and cw. VOX gain is independent of microphone gain.

Choice of VOX or PTT. VOX can be disabled by front panel switch.

Adjustable pi network output.

Transmitting agc prevents flat-topping.

Meter reads relative output or plate current with switch on load control.

Built-in cw sidetone.

Spotting function for easy zero-beating.

Easily adaptable to RTTY, either fsk or afsk.

Compact size; rugged construction. Scratch resistant epoxy paint finish.

Price: \$599.00



## Drake SPR-4 - \$629.00

- Programmable to meet specific requirements: SWL, Amateur, Laboratory, Broadcast, Marine Radio, etc.

- Direct frequency dialing: 150-500 kHz plus any 23 500 kHz ranges, 0.5 to 30 MHz

- FET circuitry, all solid state

- Linear dial, 1 kHz readout

- Band-widths for cw, ssb, a-m with built-in LC filter

- Crystals supplied for LW, seven SW, and bc bands

- Notch filter

- Built-in speaker



## Drake DSR-2 - \$2950.00

- Continuous Coverage 10 kHz to 30 MHz

- Digital Synthesizer Frequency Control

- Frequency Displayed to 100 Hz

- All Solid State

- A-m, Ssb, Cw, RTTY, lsb

- Series Balanced Gate Noise Blanker

- Front End Protection

- Optional Features Available on Special Order

## Power Supplies

Power Supplies for T-4, T-4X, T-4XB or T-4XC (The AC-4 can be housed in an MS-4 speaker cabinet).

Model No. 1501 Drake AC-4 \$120.00

Model No. 1505 Drake DC-4 \$135.00



## Drake MS-4

Drake MS-4 Matching Speaker for use with R-4, R-4A, R-4B and R-4C Receivers. (Has space to house AC-3 and AC-4 Power Supplies) Price: \$24.95

## Accessories

### DRAKE MICROPHONES

Wired for use with Drake transmitters and transceivers, for either push-to-talk or VOX. Type of operation is determined by the VOX control setting of the transmitter.



Desk Type Model No. 7075

- Type: Heavy Duty Ceramic Desk Top
- Cable: Four Foot, 3-Conductor, One Shield
- Output Level: Minus 54 dB (0 dB = 1 volt/microbar)
- Frequency Response: 80-7000 Hz
- Switching: Adapts to either push-to-talk or VOX.

Price: \$39.00



Hand-Held Type Model No. 7072

- Type: Ceramic, hand held
- Cable: 11' Retracted, 5' extended, PVC 3 Cord, 1 shielded, Coil Cord
- Case: Cyclac
- Finish: Grey
- Output Level: Minus 65 dB (0 dB = 1 volt/microbar)
- Frequency Response: 300-3000 Hz
- Switching: Adapts to either push-to-talk or VOX.

Price: \$19.00



## Drake FS-4 Digital Synthesizer - \$250.00

The new solid state Drake FS-4 Synthesizer opens the door to a new world of continuous-tuning short wave! Combines synthesized general coverage flexibility with the selectivity, stability, frequency readout and reliability of the Drake R-4C or SPR-4 Receivers.

- Interfaces with all R-4 series receivers and T-4X series transmitters: (R-4, R-4A, R-4B, R-4C, SPR-4, T-4, T-4X, T-4XB and T-4XC), without modification.
- MHz range is set on FS-4, with kHz readout taken from receiver dial.
- Complete general coverage—no range crystals to buy.
- T-4/T-4X series transmitters transceive on any FS-4 frequency, when used with R-4 series receivers.
- Readout 1 kHz with Drake PTO.

Price: \$250.00



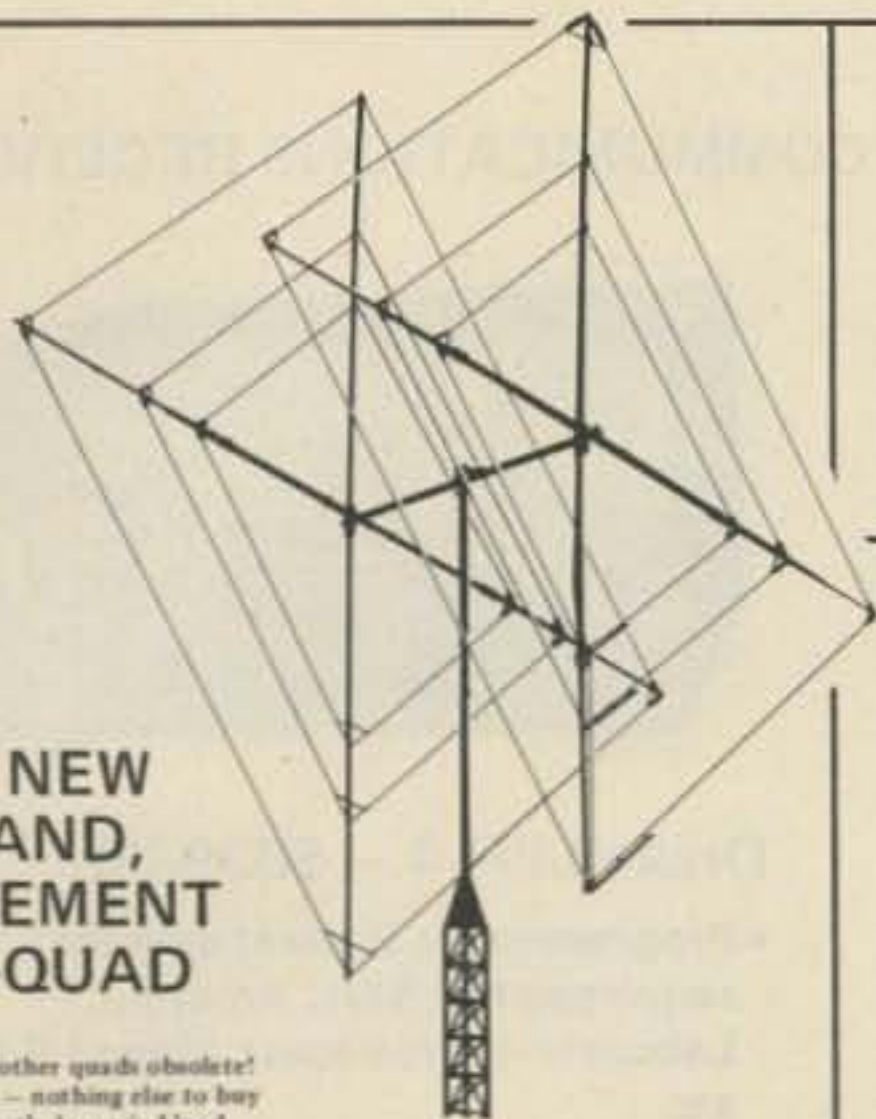

### ALL NEW 3-BAND, 2 ELEMENT HY-QUAD

- Makes all other quads obsolete!
- Complete — nothing else to buy
- High strength, low wind load

The Hy-Quad from Hy-Gain makes all other quads obsolete! Here's why: First, it's the only quad that is complete. There is nothing more to shop for or buy. Secondly, it is uniquely designed so that it overcomes all of the previously undesirable features inherent in quads. The all aluminum structure stays up! The single feed line and diamond shape simplifies feed line routing. Hy-Gain's all new Hy-Quad will outdo all other quads because it's engineered to do just that. The Hy-Quad is new, it's superior, it's complete. It's the first quad to have everything: spreaders are broken up at strategic electrical points with Cyclocar insulators / tri-band 2 element construction with individually resonated elements with no interaction / Hy-Quad requires only one feed line for all three bands / individually tuned gamma matches on each band with Hy-Gain exclusive vertex feed / full wave element loops require no tuning stubs, traps, loading coils or baluns / heavy duty mechanical construction of strong swaged aluminum tubing and die formed spreader-to-boom clamps / extra heavy duty universal boom-to-mast clamp that fits and mounts on any mast 1 1/4" to 2 1/2" in diameter / aluminum stranded wire. You can open and close the bands with this antenna. You'll experience the thrill of real DX.

Order No. 244 Price: \$219.95

#### SPECIFICATIONS

Overall length of spreaders	25'5"	Forward gain	8.5 db
Turning radius	13'6"	Input impedance	52 ohms
Weight	42 lbs.	VSWR	1.2:1 or better at resonance on all bands
Boom diameter	2"	Power	Maximum legal
Boom length	8'	Front-to-back ratio	25-35 db depending upon electrical height
Mast diameter	1 1/4" to 2 1/2"	Polarization	Horizontal
Wind survival	100 mph		
Surface area	6.4 sq. ft.		
Wind load at 100 mph	256.0 lbs.		

### The Versatile Model 18V for 80 thru 10 Meters

The Model 18V is a low-cost, highly efficient vertical antenna that can be tuned to any band .80 thru 10 meters... by a simple adjustment of the feed point on the matching base inductor. Fed with 52 ohm coax, this 18 ft. radiator is amazingly efficient for DX or local contact. Constructed of heavy gauge aluminum tubing, the Model 18V may be installed on a short 1 1/4 inch mast driven into the ground. It is also adaptable to roof or tower mounting. Highly portable, the Model 18V can be quickly knocked down to an overall length of 5 ft. and easily re-assembled for field days and camping trips. Shpg. Wt., 5 lbs. Order No. 193 Price: \$33.00

### WIDE BAND VERTICAL for 80 - 10 Meters Hy-Gain's 18 AVT/WB

Take the wide band, omni-directional performance of Hy-Gain's famous 14AVQ/WB, add 80 meter capability plus extra-heavy duty construction—and you have the unrivalled new 18AVT/WB. In other words, you have quite an antenna.

- Automatic switching, five band capability is accomplished through the use of three beefed-up Hy-Q traps (featuring large diameter coils that develop an exceptionally favorable L/C ratio).
- Top loading coil.
- Across-the-band performance with just one furnished setting for each band (10 through 40).
- True 1/4 wave resonance on all bands.
- SWR of 2:1 or less at band edges.
- Radiation pattern has an outstandingly low angle whether roof top or ground mounted.

**CONSTRUCTION** . . . of extra-heavy duty tapered swaged seamless aluminum tubing with full circumference, corrosion resistant compression clamps at slotted tubing joints... is so rugged and rigid that, although the antenna is 25' in height, it can be mounted without guy wires, using a 12" double grip mast bracket, with recessed coax connector.

Order No. 386 Price: \$97.00



For 10, 15, and 20 Meters  
New Hy-Gain Model 12 AVQ

Completely self-supporting, the Model 12AVQ features Hy-Q traps...12" double-grip mast bracket...taper swaged seamless aluminum construction with full circumference compression clamps at tubing joints. It delivers outstanding low angle radiation. SWR is 2:1 or less on all bands. Overall height is 13'6". Shipping weight 7.2 lbs. Price: \$47.00  
Order No. 384

### New, improved successor to the world's most popular vertical! Hy-Gain Model 14 AVQ/WB for 40-10 Meters.

- Wide band performance with one setting (optimum settings for top performance furnished)
- New Hy-Q Traps • New 12" Double-Grip Mast Bracket • Taper Swaged Seamless Aluminum Construction

The Model 14AVQ/WB, new improved successor to the world famous Model 14AVQ, is a self-supporting, automatic band switching vertical that delivers omni-directional performance on 40 through 10 meters. Three separate Hy-Q traps featuring large diameter coils that develop an exceptionally favorable L/C ratio and a very high Q, provide peak performance by effectively isolating sections of the antenna so that a true 1/4 wave resonance exists on all bands. Outstandingly low angle radiation pattern makes DX and other long haul contacts easy. Superior mechanical features include solid aluminum housing for traps using air dielectric capacitor...heavy gauge taper swaged seamless aluminum radiator...full circumference compression clamps at tubing joints that are resistant to corrosion and wear...and a 12" double-grip mast bracket that insures maximum rigidity whether roof-top or ground mounted. The Model 14AVQ/WB also delivers excellent performance on 80 meters using Hy-Gain Model LC-80Q Loading Coil. Overall height is 18 feet. Shipping weight 9.2 lbs. Unsurpassed portability...outstanding for permanent installations. Price: \$67.00  
Order No. 385

#### TYPICAL 14AVQ/WB VSWR CURVES

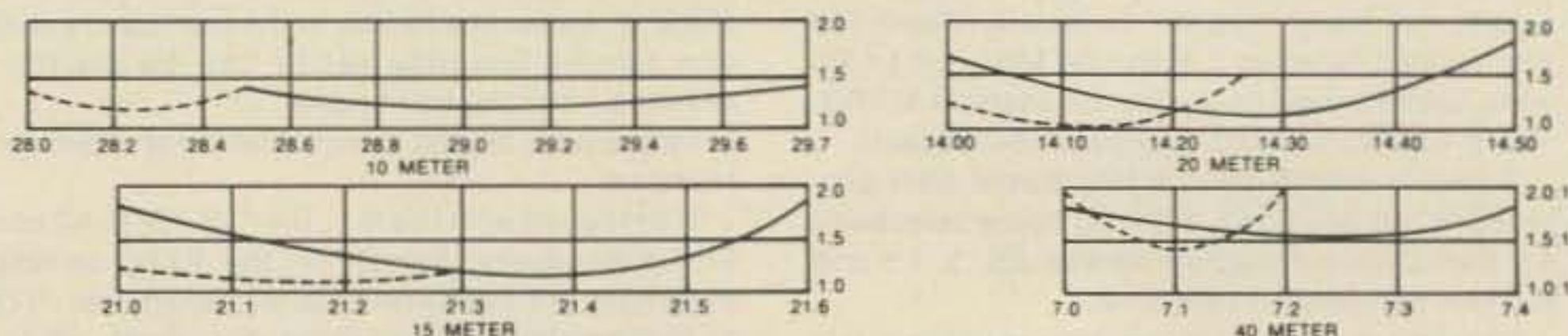

### ROOF MOUNTING KIT—Model 14RMQ provides rugged support for Model 14AVQ/WB. Order No. 184 Price: \$24.95

### Hy-Gain REEL TAPE PORTABLE DIPOLE for 10 thru 80 Meters Model 18TD

The most portable high performance dipole ever...

The Model 18TD is unquestionably the most foolproof high performance portable doublet antenna system ever developed. It has proven invaluable in providing reliable communications in vital military and commercial-applications throughout the world. Two stainless steel tapes, calibrated in meters, extend from either side of the main housing up to a total distance of 132 feet for 3.5 mc operation. 25 ft. lengths of polypropylene rope attached to each tape permits installation to poles, trees, buildings...whatever is available for forming a doublet antenna system. Integrated in the high impact housing is a frequency to length conversion chart calibrated to meter measurements on the tapes...makes installation foolproof. Feeds with 52 ohm coax. Delivers outstanding performance as a portable or permanent installation. Measures 10x5 1/2x2 inches retracted. Wt., 4.1 lbs. Order No. 228 Price: \$94.95

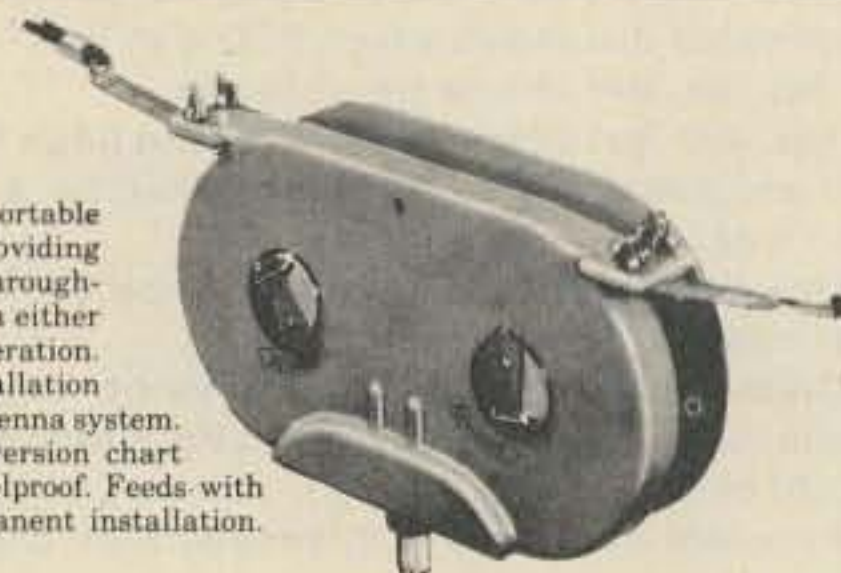

### Dentron MLA-2500 \$799.50

Dentron Radio has packed all the features a linear amplifier should have into their new MLA-2500. Any Ham who works it can tell you the MLA-2500 really was built to make amateur radio more fun.

- ALC circuit to prevent overloading
- 160 thru 10 meters
- 1000 watts DC input on CW, RTTY or SSTV Continuous Duty
- Variable forced air cooling system
- Self-contained continuous duty power supply
- Two EIMAC 8875 external anode ceramic/metal triodes operating in grounded grid
- Covers MARS frequencies without modifications
- 50 ohm input and output impedance
- Built-in RF wattmeter
- 117V or 234V AC 50-60 hz
- Third order distortion down at least 30 db
- Frequency range:
  - 1.8MHz (1.8-2.5) 3.5MHz (3.4-4.6)
  - 7MHz (6.0-9.0) 14MHz (11.0-16.0)
  - 21MHz (16.0-22.0) 28MHz (28.0-30.0)
- 40 watts drive for 1 KW DC input
- Rack mounting kit available (19" rack)
- Size: 5 1/2" H x 14" W x 14" D Wt. 47 lbs.

### Pipo Communications TROUBLE FREE TOUCH-TONE ENCODER



PP-1

POSITIVE TOUCH (KEYS DEPRESS) • MOBILE • HANDHELD  
DESK MOUNT • NO POTTED PARTS (SERVICEABLE)  
MIL. SPEC. COMPONENTS • NO RFI • SELF CONTAINED  
XTAL CONTROLLED • LEVEL ADJUSTABLE FROM FRONT  
Pat. Pend.

M series is for mounting to surfaces inaccessible from the rear; wall, mobile, systems interface panels - test equipment, etc.  
K series is self contained with a relay inside the encoder. When Keys are pressed contact closer depress with a 2 sec. delay, (adjustable). Contacts are rated at 110ma @ 28 Volts switched, 500ma carry. PP-2K contains delay exclusion for the fourth column. However, by jumpering D-5, 4th column delay is restored.

Pipo Communications has developed a trouble free reliable instrument to be free of any defects for years. Unit is constructed with the best components available, without compromise in quality. Unit is operable from 4.5 - 60 Volts at temperatures from below 0 to +140°F. Output level will drive any transmitter at system. Adjustable output level is controlled with an extremely stable multivibrator, with access from the front of the encoder (not behind), saving time for level setting, which amounts to hours when involved with a system.

- PP-1 \$55 12 Keys
- PP-2 \$55 16 Keys
- PP-1A \$55 Lettering Encoder
- PP-2A \$55 Lettering Encoder
- PP-1K \$65 Key 11-01
- PP-2K \$69 Key 11-01
- PP-1A \$65 For Standard Comm. Hand Held

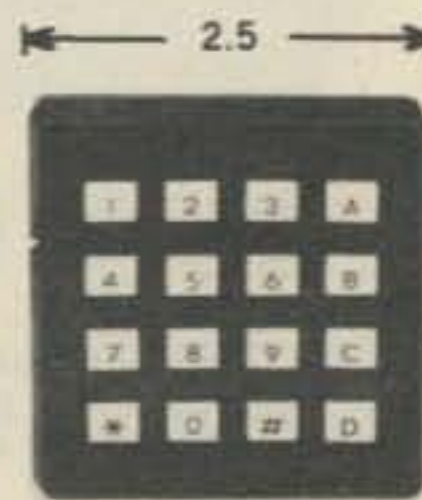

PP-2





# SAVE YOUR RADIO!

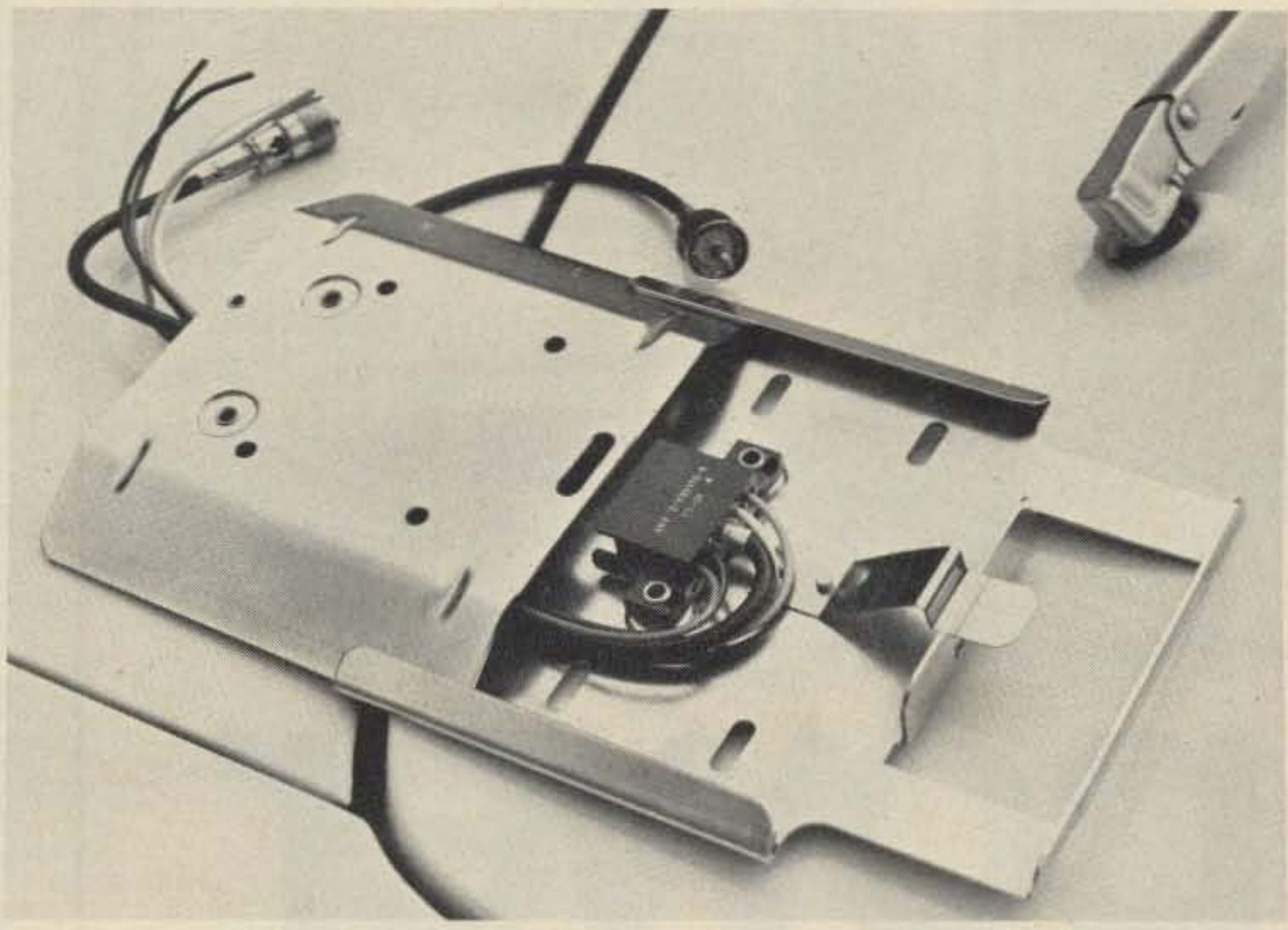

## DESIGNED FOR COMMERCIAL USE UP TO 1000 MHZ.

The **TUFTS SAVE-YOUR-RADIO** bracket can save you a bundle ... and a lot of hassle. Why worry about rig ripoff? The **TUFTS SYR** bracket mounts quickly and easily in your car and makes it possible to snap your rig out of its bracket when you park and put it out of sight.

The connector system has a special coaxial cable connector which will provide you with a lossless connection right up to 1000 MHz! No loss! In addition to the quick coax connector there are also four power and accessory connections which are made automatically when the rig is slid into its bracket ... just what you

need for feeding power and loudspeaker connections to the set.

This is a rugged bracket and connector system ... it'll take a beating. There is a hole on each side of the 16 gauge steel plate for a padlock in case you want to leave the rig for short periods in its bracket. They'll have to rip out the dash to get it ... and it won't be the first time for that.

With two of these brackets you can bring the mobile rig into the house and use it in seconds. On trips you can take an AC supply for the rig and use it in your hotel room. Price: \$29.95

### 400% MORE RF POWER

#### PLUGS BETWEEN YOUR MICROPHONE AND TRANSMITTER



**\$49<sup>95</sup>**

**LSP-520BX.** 30 db dynamic range IC log amp and 3 active filters give clean audio. RF protected. 9 V battery. 3 conductor, 1/4" phone jacks for input and output. 2-3/16 x 3-1/4 x 4 inches.



**\$59<sup>95</sup>**

**LSP-520BX II.** Same as LSP-520BX but in a beautiful 2-1/8 x 3-5/8 x 5-9/16 inch Ten-Tec enclosure with uncommitted 4 pin Mic jack, output cable, rotary function switch.



**\$27<sup>95</sup>**

#### CWF-2BX Super CW Filter

By far the leader. Over 5000 in use. Razor sharp selectivity. 80 Hz bandwidth, extremely steep skirts. No ringing. Plugs between receiver and phones or connect between audio stage for speaker operation.

• Selectable BW: 80, 110, 180 Hz • 60 dB down one octave from center freq. of 750 Hz for 80 Hz BW • Reduces noise 15 dB • 9 V battery • 2-3/16 x 3-1/4 x 4 in. • CWF-2PC, wired PC board, \$18.95 • CWF-2PCK, kit PC board \$15.95



**\$49<sup>95</sup>**

#### CMOS-8043 Electronic Keyer

State of the art design uses CURTIS-8043 Keyer-on-a-chip.

• Built-in Key • Dot memory • Iambic operation with external squeeze key • 8 to 50 WPM • Sidetone and speaker • Speed, volume, tone, weight controls • Ultra reliable solid state keying +300 volts max. • 4 position switch for TUNE, OFF, ON, SIDETONE OFF • Uses 4 pentlight cells • 2-3/16 x 3-1/4 x 4 inches



**\$29<sup>95</sup>**

#### SBF-2BX SSB Filter

Dramatically improves readability.

• Optimizes your audio to reduce sideband splatter, remove low and high pitched QRM, hiss, static crashes, background noise, 60 and 120 Hz hum • Reduces fatigue during contest, DX, and ragchewing • Plugs between phones and receiver or connect between audio stage for speaker operation • Selectable bandwidth IC active audio filter • Uses 9 volt battery • 2-3/16 x 3-1/4 x 4 inches



**\$27<sup>95</sup>**

#### MFJ-200BX Frequency Standard

Provides strong, precise markers every 100, 50, or 25 KHz well into VHF region.

• Exclusive circuitry suppresses all unwanted markers • Markers are gated for positive identification. CMOS IC's with transistor output. • No direct connection necessary • Uses 9 volt battery • Adjustable trimmer for zero beating to WWV • Switch selects 100, 50, 25 KHz or OFF • 2-3/16 x 3-1/4 x 4 inches



**39<sup>95</sup>**

NEW

#### MFJ-16010 Antenna Tuner

Now you can operate all band — 160 thru 10 Meters — with a single random wire and run your full transceiver power output — up to 200 watts RF power OUTPUT.

• Small enough to carry in your hip pocket, 2-3/16 x 3-1/4 x 4 inches • Matches low and high impedances by interchanging input and output • SO-239 coaxial connectors • Unique wide range, high performance, 12 position tapped inductor. Uses two stacked toroid cores



**\$15<sup>95</sup>**

NEW

#### CPO-555 Code Oscillator

For the Newcomer to learn the Morse code. For the Old Timer to polish his list. For the Code Instructor to teach his classes.

• Send crisp clear code with plenty of volume for classroom use • Self contained speaker, volume, tone controls, aluminum cabinet • 9 V battery • Top quality U.S. construction • Uses 555 IC timer • 2-3/16 x 3-1/4 x 4 inches  
TK-555, Optional Telegraph Key ..... \$1.95



**\$49<sup>95</sup>**

#### MFJ-1030BX Receiver Preselector

Clearly copy weak unreadable signals (increases signal 3 to 5 "S" units).

• More than 20 dB low noise gain • Separate input and output tuning controls give maximum gain and RF selectivity to significantly reject out-of-band signals and reduce image responses • Dual gate MOS FET for low noise, strong signal handling abilities • Completely stable • Optimized for 10 thru 30 MHz • 9 V battery • 2-1/8 x 3-5/8 x 5-9/16 inches



**\$27<sup>95</sup>**

#### MFJ-40T QRP Transmitter

Work the world with 5 watts on 40 Meter CW.

• No tuning • Matches 50 ohm load • Clean output with low harmonic content • Power amplifier transistor protected against burnout • Switch selects 3 crystals or VFO input • 12 VDC • 2-3/16 x 3-1/4 x 4 inches  
MFJ-40V, Companion VFO ..... \$27.95  
MFJ-12DC, IC Regulated Power Supply, 1 amp, 12 VDC ..... \$27.95



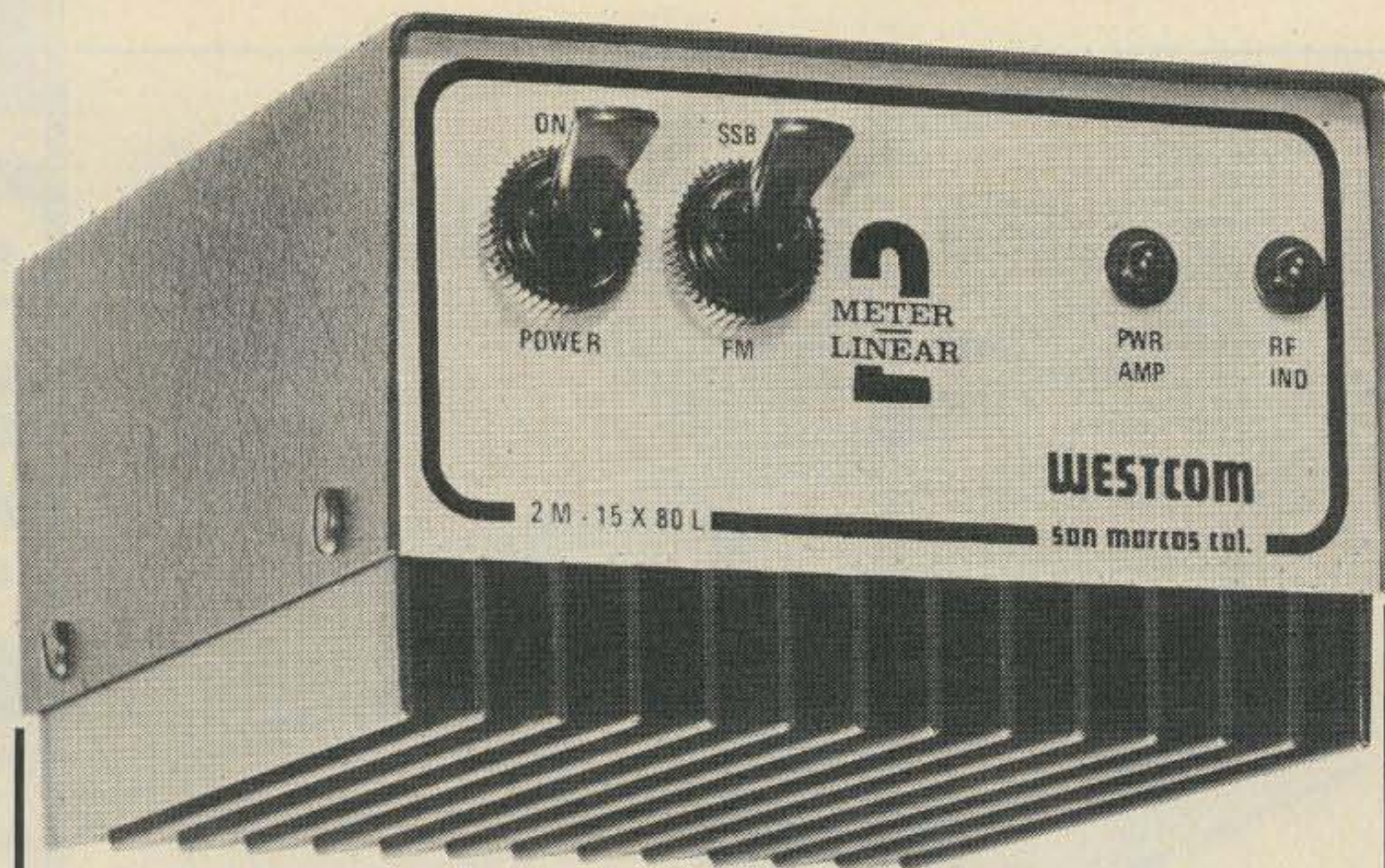

# power up!

## the new 2 meter VHF amplifier from Westcom.

- An add-on unit, no internal connections or adjustments required to associated equipment
- Standard Amplifier Models operate FM. Linear Models operate all modes: SSB, FM, AM, RTTY, CW, etc.
- "Microstrip" design provides high stability and optimum performance over wide bandwidth
- Factory adjusted, no tuning required.
- Mobile mounting bracket included
- RF sensing T/R switching, adjustable dropout delay
- Remote keying capability
- Thermally coupled biasing
- Reverse Voltage protected and fused
- Conservatively rated with oversized heat sink
- Red LED indicators for monitoring DC and RF
- VSWR protected
- Ninety day material and workmanship warranty

MODEL NO.	INPUT POWER (watts)	NOM OUTPUT (watts)	NOM CURRENT 13.8 VDC	PRICE
2M 3X30	1-4	30	4	\$72.95
2M 3X30L*	1-4	30	4	\$82.95
2M 10X40	2-12	40	5	\$77.95
2M 15X50L*	5-15	50	6	\$94.95
2M 15X80	5-15	80	11	\$129.95
2M 15X80L*	5-15	80	11	\$139.95

NOTES: \*Linear; AM, CW, FM, SSB, RTTY  
size: 4 1/8 X 5 1/2 X 2 5/8  
technical specifications and data subject to change without notice

Dealership inquiries are invited;  
available through your local dealer or write:

**WESTCOM ENGINEERING**  
1320 Grand Avenue, San Marcos, California 92069, (714) 744-0700

## DUPLEXERS



\*Patent  
Pending

OUR NEW BANDPASS-  
REJECT DUPLEXERS WITH  
OUR EXCLUSIVE

### BpBr CIRCUIT\*

... provides superior performance, especially at close frequency spacing.

Models available for all Ham bands. Special price for Amateur Repeater Clubs

CALL OR WRITE FOR DETAILS:

**WACOM PRODUCTS, INC.**



Box 7307  
Waco, Texas 76710  
817/776-4444

## CRYSTALS

FOR VHF RECEIVERS

**2 1/4¢ ea.**

ANY FREQUENCY .0005%  
IMMEDIATE DELIVERY

SOUNDS INCREDIBLE, DOESN'T IT? Yet this is the equivalent of all you pay when you order our frequency synthesizer which duplicates crystal frequencies for use from 140-180 MHz in 5 kHz steps, using the crystal formula  $F_c = F_s - 10.7$  divided by 3 (other formulas are also available). There are 8000 separate frequencies instantly selectable from a digital thumbwheel dial and all of them are 10 times more accurate than the standard .005% crystals you've been buying. Why pay \$5.00 or more and wait weeks for delivery every time you need a new frequency when you can have all you'll ever need in our synthesizer which sells for a mere \$179.95. Order by phone and we'll deduct the price of the phone call and ship your order COD in one day. Call us at 212-468-2720 Monday through Friday, 9 AM to 5 PM. For more details and photo of our synthesizer see the January 1977 issue of 73 Magazine.

**VANGUARD LABS**

196-23 Jamaica Ave.,  
Hollis, New York 11423

v1



# TS-1 MICROMINIATURE ENCODER-DECODER

- Available in all EIA standard tones 67.0Hz-203.5Hz
- Microminiature in size, 1.25x2.0x.65" high
- Hi-pass tone rejection filter on board
- Powered by 6-16vdc, unregulated, at 3-9ma.
- Decode sensitivity better than 10mvRMS, bandwidth,  $\pm 2$ Hz max., limited
- Low distortion adjustable sinewave output
- Frequency accuracy,  $\pm 25$ Hz, frequency stability  $\pm 1$ Hz
- Encodes continuously and simultaneously during decode, independent of mike hang-up
- Totally immune to RF

Wired and tested, complete with K-1 element

**\$59.95**

K-1 field replaceable, plug-in, frequency determining elements

**\$3.00 each**

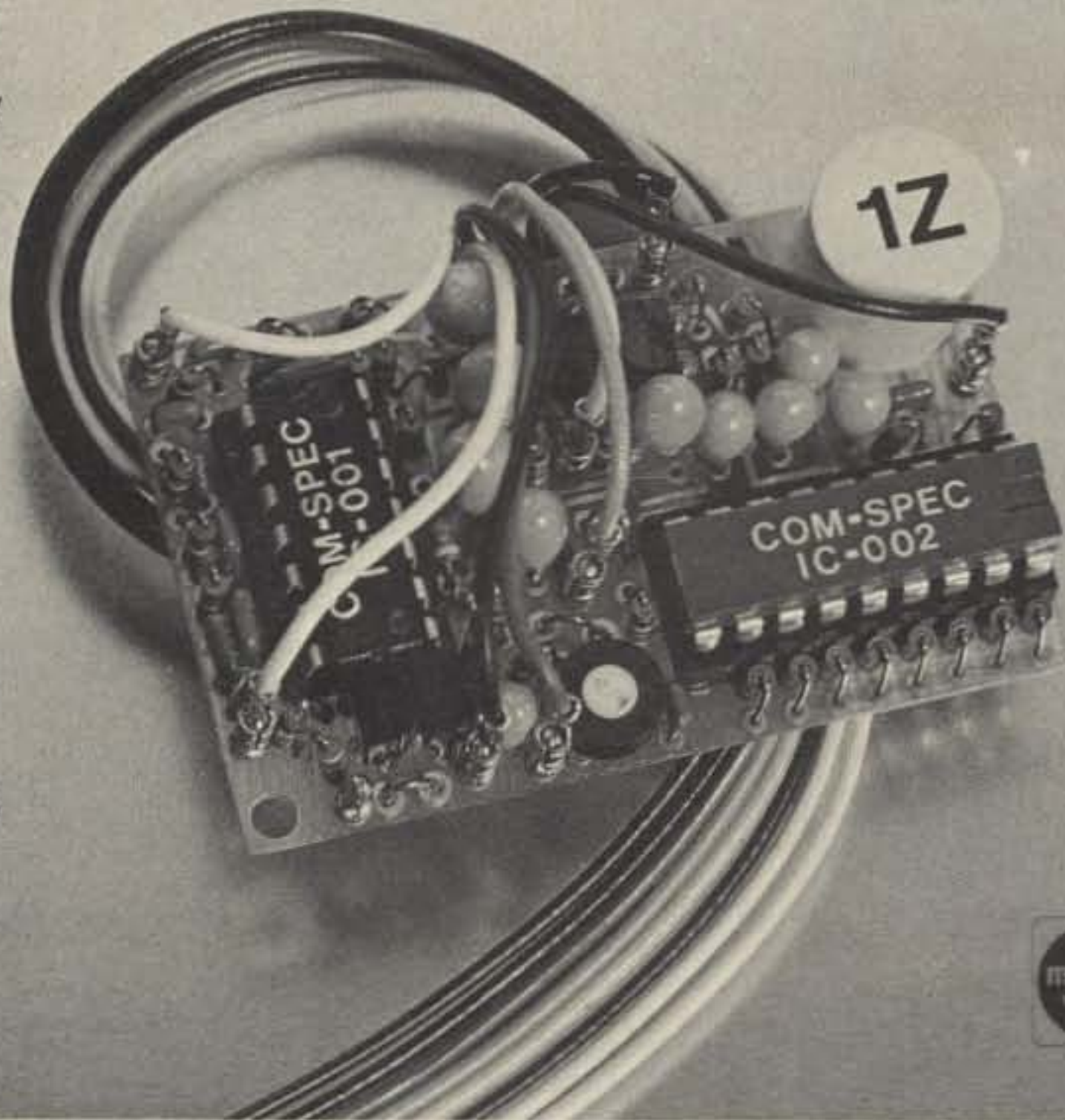

## COMMUNICATIONS SPECIALISTS

P.O. BOX 153  
BREA, CALIFORNIA 92621  
(714) 998-3021



# NEW TOUCHTONE MICROPHONE

STANDARD 12 TONE FREQUENCIES ARE CRYSTAL CONTROLLED  
BUILT-IN MIKE PROVIDES ULTRA CLARITY  
FITS MOST TELEPHONE-TYPE HANDSETS

**\$39<sup>95</sup>**

PLUS SHIPPING AND 6% TAX IN CALIFORNIA

## AUTO-PATCH USERS

INSTANTLY CONVERTS MOST TELEPHONE-TYPE HANDSETS TO AUTO-PATCH OPERATION

HI-FIDELITY CONDENSER TYPE MIKE REPLACES OLD FASHIONED CARBON MICROPHONE

## CONTROL STATIONS

TONE FREQUENCIES ARE 6 TIMES MORE ACCURATE THAN REQUIRED. OPERATES ON 6 to 24 VDC. CAN BE USED WITH MOST ROTARY DIAL PHONES FOR REPEATER CONTROL (Check with your local phone co.)



To Order: Send name, address, city, state, zip to:  
Enclose: Cash, Check or Postal Money Order only.  
Include \$1.50 for Shipping & Handling or use your BankAmericard or Master Charge by filling in the proper boxes.

C & B RADIO & ELECTRONICS  
P.O. BOX 7028  
BURBANK CA 91510



BANKAMERICARD  
MASTER CHARGE  
EXPIRATION DATE

CARD NUMBER

MASTER CHARGE INTERBANK NUMBER

"TOUCHTONE" IS THE REGISTERED TRADEMARK OF AT & T

Call 1-800-555-1212 for Toll Free Number

C38



# SUPER VALUE!

- ICS Socketed
- Push button Switches on Main PC Board
- Open chassis for Easy Assembly

## 2 IN 1 DMM-COUNTER



FCM-8  
8 DIGIT  
250 MHz KIT  
**\$219<sup>95</sup>**

Size 10W x 3-1/2H x 9D

Meter: Auto polarity and overrange indicator, 11 Meg. Ohm input impedance. Four overlapping ranges on AC-DC volts and current to 1KV and 1 AMP and five ranges on ohms to 1 Meg. Ohm. 500% overrange capability, except current. Accuracy:  $\pm 1\%$ ,  $\pm 1$  count DC,  $\pm 1.5\%$ ,  $\pm 1$  count AC and Ohms. Counter: Same as FCC-8.

## CAPACITANCE COUNTER



NOW, IT IS  
A DREAM TO  
MEASURE  
YOUR  
CAPACITORS.  
**\$89<sup>95</sup>**  
KIT

Size 7W x 3H x 8D

$\pm 1\% \pm 1$  count ( $\pm 1$  pfd. below 100 pfd.) Four ranges from pico farads to several thousand microfarads. Features crystal timebase reference for stability. Auto-cycling.

- Deluxe Metal Cabinet
- Complete Step-by-step Instruction & Diagrams
- .3 in. 7-Seg. LED Readouts

## FREQUENCY COUNTER



FC-6  
30 MHz KIT  
**\$89<sup>95</sup>**

Size 7W x 3H x 8D

Perfect for CBers, hams, hobbyists, technicians. Hi Z input, 50MV sensitivity. Frequency 10 Hz to over 30 Mhz. (FC-6) and 100 Hz to over 250 Mhz. (FC-6H). Crystal timebase. 5 ppm.



FCC-8  
8 DIGIT  
250 MHz KIT  
**\$149<sup>95</sup>**

Size 10W x 3-1/2H x 9D

Hi Z input. Sensitivity 50 millivolts at 250 Mhz. Readout Hz., Khz., or Mhz. Resolution 1 Hz. to 10 Mhz. and 10 Hz above Crystal time base - 5 ppm.

Add \$2.50 Shipping/Handling Each  
California Residents Add 6% Sales Tax



Please Allow 3 to 5 Weeks for Delivery

**LIN CORP.** 15311 S. Broadway, Gardena, California 90248 (213) 532-8809

# NEW!

## A \$34.95 Meter Calibrator!

A quality volt-ohm calibrator at a breakthrough price! Why put off calibration of your VOM, VTVM, or digital multimeter?

Here's what you get:

- Check DC volts at 0.100 V, 1.000 V, and 10.000 V
  - Up to 0.02% accuracy on volts
  - Check ohms at 100 $\Omega$ , 1k, 10k, 100k, and 1 meg.
  - Up to 0.1% accuracy on ohms
- Battery powered, uses 2-9 V batteries (not included)  
Uses hybrid IC precision reference

Only \$34.95 each. Please add \$1.50 postage. CA residents add \$2.10 tax.

Gary McClellan and Co. Box 2085  
1001 W. Imperial Hwy.  
La Habra CA 90631

## Programmable Contest Keyer

Build it  
yourself  
and Save!



Among the features of the W7BBX Programmable Memory Keyer 4 x 512 bit memories, paddle programming, protected ps, lambic operation with dot and dash memories, STO, paddle override of message readout, remote operating control, and much more. See April '76 HAM RADIO MAGAZINE. The 50+ p. manual includes step-by-step assembly, testing, and operating instructions, pictorials, schematics, and templates.

Send \$30 for all circuit boards plus manual to

## HFB ENTERPRISES

P.O. Box 667, Herndon, Virginia 22070

"DEALER INQUIRIES INVITED" H18

# 60\* CHANNELS

## DIRECT READOUT / PREPROGRAMMED WITH YOUR IC-22S



\*120 channels with 15 kHz Split Option

You Get These 56 Frequencies Pre-Programmed in the Conversion:

146.01	146.34	146.82	147.15	147.69
146.04	146.37	146.85	147.18	147.72
146.07	146.40	146.88	147.21	147.75
146.10	146.43	146.91	147.24	147.78
146.13	146.46	146.94	147.27	147.81
146.16	146.49	146.97	147.30	147.84
146.19	146.52	147.00	147.33	147.87
146.22	146.55	147.03	147.36	147.90
146.25	146.58	147.06	147.39	147.93
146.28	146.61	147.09	147.42	147.96
146.31	146.64	147.12	147.45	147.99

Install the VIP-60 switch in place of the original 22 channel switch in your IC-22S and you'll have the 56 pre-programmed frequencies listed plus any four additional frequencies you wish to program for yourself. Add 15 kHz splits with split option.

Fast, simple and clean conversion makes a fine transceiver even better



Valley Instrument Products

P.O. BOX 339 - BARTLETT, ILLINOIS 60103 (312) 741-8820



Valley Instrument Products  
P.O. Box 339, Bartlett, IL 60103

BANKAMERICARD

VISA

Ship \_\_\_\_\_ VIP-60 conversion kit(s) at \$25.00 each plus

\$1.00 packing and shipping. Include \_\_\_\_\_ 15 kHz option(s) at \$3.00 each. No C.O.D.'s, PLEASE. Illinois residents add 5% sales tax.

Name \_\_\_\_\_ Call \_\_\_\_\_  
Address \_\_\_\_\_  Check or money order for \$ \_\_\_\_\_ enclosed  
City \_\_\_\_\_  Charge my VISA/BankAmericard # \_\_\_\_\_  
State \_\_\_\_\_ Zip \_\_\_\_\_ Card expires \_\_\_\_\_ Signature \_\_\_\_\_

## GREENE BALUN



Rated 5 Kw pep. Ratio one to one. Hardware SILVER PLATED. AIR wound coil... NO ferrite to saturate at 200 watts... very strong... water tight... Brochure S.A.S.E.

The GREENE center insulator BALUN is without question the very finest unit on the market today. We don't make our unit better - we make it the BEST. THE BIGGEST SIGNAL.

Guaranteed.

Does anyone else give you all this? Or even come close? Design patent applied for

Price \$16.00 ppd USA  
Greene Insulator, 44 Ministerial Branch  
Bedford, New Hampshire 03102  
603-472-3033

G9



# TEE/AX PRESENTS; THE FIRST COAX TOGGLE SWITCH

**\$39<sup>95</sup>**

Patent Pending



Model SW-5000

- 52 ohms
- SPDT, DPDT
- Power 1 KW
- All Brass Construction
- Teflon Insulated
- Captivated Internal Contacts
- Available in UHF, BNC, N, F, all series

**TEE/AX, INC.**

5701 N.W. 31st AVENUE  
FT. LAUDERDALE,  
FLORIDA 33309

*Distributor Inquiries  
Invited*

Mail Orders Accepted — Add 75¢ for Postage



**BARGAIN**

- + 5V @ 7A
- +12V @ 2.5A
- +30V @ 200ma (unregulated)
- 6.2V @ 25ma (no adj. pot)
- 12V @ 2A
- +180 V @ 150 ma

Brand new, made by CDC for microprocessor terminals. 110VAC in, regulated and adjustable DC outputs. Overvoltage protected +5, -12. Power status signal. Fan. Schematic. Original list \$600+. From stock, UPS paid, custom foam box, guaranteed.

**\$50.00**

ELECTRAVALUE INDUSTRIAL  
BOX 464  
Cedar Knolls, NJ 07927  
(201) 267-1117

E18

(the outside looks nice)  
**BUT**  
**IT'S WHAT'S INSIDE THAT COUNTS**

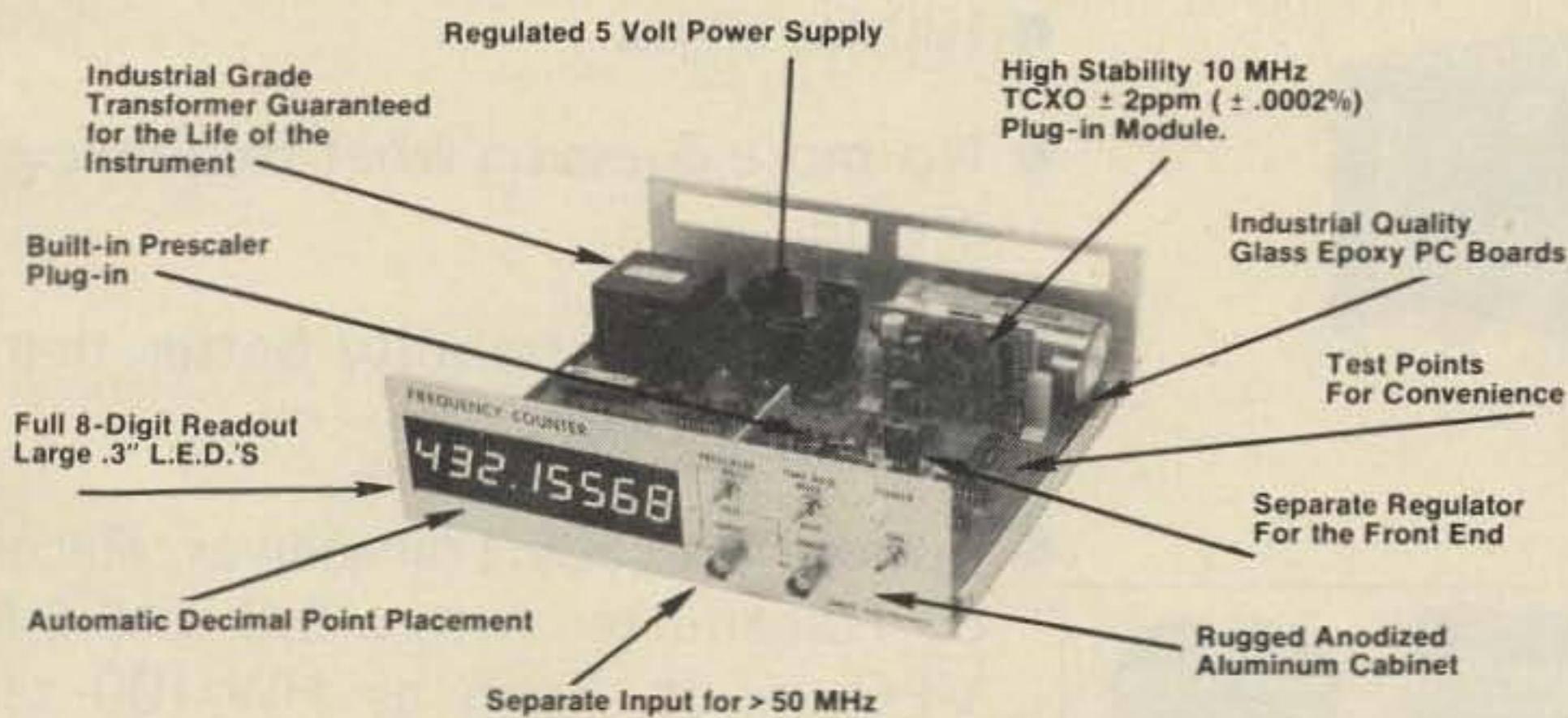

**DAVIS FREQUENCY COUNTER**

- 500 MHz • ±.0002% ACCURACY
- UNBEATABLE LOW COST

500 MHz Kit ..... **\$249.95**  
Kits include all parts, drilled and plated PC boards, cabinet, switches, hardware and a complete instruction manual with calibrating instructions.

All parts are guaranteed for 90 days. Factory service available for \$25.

500 MHz Factory Assembled ... **\$349.95**  
Shipping Charge ..... **\$2.00**

Instruction and Calibrating Manual . **\$3.00**  
(refundable with purchase)

Factory assembled units are tested and calibrated to specifications, and are guaranteed for 1 year.

**DAVIS ELECTRONICS**

Dept. F, 636 Sheridan Drive, Tonawanda, New York 14150

(716) 874-5848

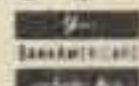

## Armchair Copy



Barlow XCR-30

## Shortwave Listening

Our ONLY occupation is supplying everything you need to tune the mediumwave and shortwave bands—and identify what you hear. Our NEW mini-catalog details Barlow Wadley, Drake and Yaesu receivers, WORLD RADIO TV HANDBOOK, logs, receiving antennas & tuners, calibrators, FM or TV guides, AM pattern maps, QSL albums, ITU publications, RTTY displays, CONFIDENTIAL FREQUENCY LIST, clocks and all SWL books.

**GILFER ASSOCIATES, INC**

P.O. Box 239, Park Ridge, NJ 07656





CL 7402



CL 7401A

The First Really Different Time Piece

### THE **ELECTRONIC EYE** CLOCK by AMELECT

Fascinating to watch as the ELECTRONIC EYE swings around the modern clock face displaying each second, minute, and hour.

- Easy to read, yet mystifying (no hands, springs, moving parts)
- The conversation timepiece for your home or office
- Quality in design, materials and workmanship
- Operates on normal house current (120V 60 Hz)
- Easily reset by miniature, easily accessible push-button switches
- Beautiful, rich-appearing cases are 100% solid woods
- Available in natural walnut, mahogany, maple or cherry
- Covered by a written warranty of one year on material and workmanship

CL7402 Grandpa Wall Mount clock, assembled .. \$95.00  
kit w/o cabinet . . . . 56.25 kit w/cabinet . . . . . 71.50

CL7401A Diagonal Mount Wall clock, assembled . \$75.00  
kit w/o cabinet . . . . 45.00 kit w/cabinet+base . 63.00  
kit w/cabinet . . . . . 55.00 A33

**AMELECT**  
**Incorporated** 106 South Newton Street  
Goodland, Indiana 47948

## 2 METER CRYSTALS IN STOCK

FOR THESE RADIOS ON  
STANDARD ARRL REPEATER  
FREQUENCIES

Clegg HT-146	Regency HR-212
Drake TR-22	Regency HR-2B
Drake TR-33 (rec only)	Regency HR-312
Drake TR-72	Regency HR-2MS
Genave	S.B.E.
Heathkit HW-2021 (rec only)	Sonar 1802-3-4, 3601
Heathkit HW-202	Standard 146/826
Icom/VHF Eng	Standard Horizon
Ken/Wilson	Swan FM 2X
Lafayette HA-146	Tempo FMH
Midland 13-505	Trio/Kenwood
Regency HR-2	Trio/Kenwood TR2200
	Trio/Kenwood TR7200

\$3.50 each — in quantities of  
10 or more, \$3.25 each

Certified check or money order only —  
NO CODs

**ROLIN** DISTRIBUTORS  
P.O. Box 436  
Dunellen NJ 08846

-- LIMITED OFFER -- R15

## MAKE YOUR REMOTE VFO AN **SFO**\* \*SYNTHESIZED FREQUENCY OSCILLATOR



- 100 Hz steps.
- No more guessing what frequency you are on.
- Accuracy and stability better than 10 Hz. [1 Hz Optional].
- For use with any Transceiver, Receiver or Transmitter with a 5.0 to 5.5 MHz VFO input. Such as HW-100 series SB-100 series and TS-520/820.
- Less cost and more stability than remote VFO and counter.
- Price — \$225.00.
- Dimensions: 9 inches wide, 5¼ inches high, and 12 inches deep.

**INTERAD LTD.**  
7808 Cessna Ave.  
Montgomery County Airpark  
Gaithersburg, Maryland U.S.A. 20760



Please Rush my SFO-2020 — Price \$225.00

Check Box For:

Check     Money Order     Master Charge     Bank Americard

Credit Card No.: \_\_\_\_\_ Interbank No.: \_\_\_\_\_

Expiration Date: \_\_\_\_\_ Signature: \_\_\_\_\_

Name: \_\_\_\_\_

Address: \_\_\_\_\_

City: \_\_\_\_\_ State: \_\_\_\_\_ Zip Code: \_\_\_\_\_

Maryland Residents add 4% sales tax.



# Looking West

from page 33

people like Ernie for the time spent updating us, and sincerely hope that this kind of information flow will continue.

As you are aware, part of the trip from here on was spent both SWLing CB and QSOing a "Ham Trucker" into Santa Barbara (on both CB and via two meters). It was not long after that, while listening on .28/.88, that the voice of Larry WA6OBT was heard on the Sulphur Mountain, Ventura County Repeater (WR6AOX). That meant that home was but an hour away. I hope that you enjoyed this trip along with us; maybe soon we can do it again. I can tell you that I will have some updated information this fall, since I intend to accept Ernie's invite and will definitely be at the Santa Maria Convention in October. I've heard that the barbecue is something to behold...

## "73 AND 55"

"WA6ITF clear WR6BAX - 73 and 55, everyone." Something like that is being heard a lot out here these days on both HF and on our VHF repeaters. In fact, 55s are coming from as far to the west as Korea, according to Lenore Jensen W6NAZ. The Los Angeles Council of Radio Clubs, acting in cooperation with the California Highway Patrol, has hit upon a

way in which amateurs can actively participate in a program designed to conserve two of this nation's most important natural resources: fuel and people.

When CHP Officer Dean Hirst came to my place of employment not long ago to speak on the subject of the Highway Patrol's renewed effort to motivate voluntary compliance with the national speed limit of 55 mph, and brought forth incontrovertible proof that the ten mile per hour reduction in the speed limit (from its previous 65 mph) had substantially lowered the number of fatal accidents in this state, it occurred to me that amateur radio might just be the proper vehicle to help spread the word. After all, the life saved might be yours, mine, or that of one of our loved ones.

A subsequent conversation with Officer Hirst led to an introduction to Southern California ARRL P.R.A. Lenore Jensen and to a meeting with the Los Angeles Council of Radio Clubs. Out of the final step has come a pledge that amateur radio operators will do all they can to adhere to the 55 mph limit and to help spread the word of the dual savings by ending QSOs with "73 and 55," thus signifying the individual pledge of voluntary compliance.

Whether you believe that there is a real energy crisis or are one of the



Officer Dean Hirst of the California Highway Patrol and Mary Ed Killitz W6GJF of the San Fernando Valley Amateur Radio Club.

skeptics is not important. The fact that the lower speed limit saves lives has been proven, and that in itself is more than enough reason for my own compliance with it.

How about you? Want to help make this a national movement within amateur radio? It's easy: just watch your speedometer and spread the word by using "73 and 55!"

# Social Events

## SWIFT CURRENT SASKATCHEWAN JULY 2

There will be a hamfest held at Swift Current, Saskatchewan on July 2, 1977. For more info contact H. Bassendowske VE5PZ, 1433 Taylor Drive, Swift Current, Saskatchewan.

## MILTON ONTARIO JULY 8-10

The Ontario Hamfest '77 will be held on July 8, 9 and 10, 1977, at the Milton Fairgrounds in Milton, Ontario. Program includes numerous commercial displays, giant flea market (no space charge), auction late Saturday afternoon, CW bingo, prizes and ham displays. Registration \$4.50 adults; \$3.00 children; children under 3 no charge. Registration after June 15 will be \$5.00 for adults. All activities will be held inside in the event of rain. Talk-in station on 146.520 MHz simplex. For more information write Burlington Amateur Radio Club, PO 836, Burlington, Ont. L7R 3Y6.

## OAK CREEK WI JULY 9

The South Milwaukee Amateur Radio Club Swapfest '77 will be held Saturday, July 9, 1977 at Shepard

Park (American Legion Post #434), 9327 South Shepard Avenue, Oak Creek, Wisconsin. Activities begin at 7 am and will run until about 5 pm. Parking, picnic area, hot and cold sandwiches and liquid refreshments will be available on grounds. Overnight camping is available. Admission is \$1 and includes a "Happy Hour" with free beverages. Prizes will be awarded. Talk-in on 146.94 MHz FM. More details (inc. map) from: South Milwaukee Amateur Radio Club Inc., S. F. Schreiter W9AKF, Sec., 104 Brookdale Drive, South Milwaukee WI 53172.

## CUMMINGTON MA JULY 9-10

The Northern Berkshire Amateur Radio Club Hamfest will be held July 9th and 10th at the Cummington Fairgrounds, Cummington MA. Free overnight camping, tech talks, demos., and dealers. Flea market \$1. Admission \$3 with XYL \$5, advanced \$2 and \$4. For information write Hildy Sheerin WA1ZNE, 79 Greylock Ter., Pittsfield MA 01201.

## CHARLESTON SC JULY 9-10

The Charles Towne Hamfest, Charleston, South Carolina, will be held on July 9 and 10, 1977. Saturday, July

9th, the Charles Towne Hospitality Room will be at the Heart of Charleston Motor Inn starting at 7:30 pm. Sunday, July 10th, the flea market and swapfest will be at the Gaillard Municipal Auditorium starting at 8 am. Complete details by writing to: Charles Towne Hamfest Committee, Box 4555, Charleston Heights SC 29405.

## INDIANAPOLIS IN JULY 10

The Sixth Annual Indianapolis Hamfest will be held on Sunday, July 10, 1977 at the Marion County Fairgrounds. There will be hourly prize drawings, a main prize drawing, a large indoor flea market, and a large outdoor flea market, forums, etc. Over 100 campsites are available. Forty with full hook-ups. Gate admission: \$2. For more information write Indianapolis Hamfest, PO Box 1002, Indianapolis IN 46206.

## BROOKLYN NY JULY 10

The Kings County Repeater Association of Brooklyn, New York, will hold its annual outdoor flea market (if rain - indoors) on Sunday, July 10, 1977, at 9 am to 4 pm. Located at 17 Eastern Parkway (at Grand Army Plaza), Brooklyn, New York. Sellers \$6 per table, \$3 half table, buyers \$1. Refreshments available. Talk-in on 147.43, 146.43 and 52 direct. For further information contact WA2UMY (212) 941-8780.

## SARATOGA UT JULY 16

The Utah Amateur Radio Club will hold its annual Utah hamfest and steak fry on July 16th at Saratoga resort. Bill of fare includes swap tables, CW contest, home brew contest, Oscar demo, women's activities, steak fry and many more ham games. Registration is \$2 for UARC members, \$5 for non-members and \$1 for children under twelve. Registration includes choice steak, discount on rides, hot dog for kids, drawings and all other activities. Events begin at 9 am and run until after dark. Talk-in on repeater 16/76. For more information contact John Dehnel, c/o Utah Amateur Radio Club, 1547 Redondo, Salt Lake City UT 84105.

## CORUNNA MI JULY 16-17

The Shiawassee Amateur Radio Association (SARA) is hosting the Buzzards Roost, Michigan Emergency, and Wolverine Nets picnic and SARA's 3rd Annual FREE Swap and Shop, Saturday and Sunday, July 16 and 17 at McCurdy Park in Corunna, Michigan just east of Owosso. Swap and Shop tables and trunk sale spaces available at \$2.00 for 1 day and \$3.00 for 2 days. Talk-in with W8QQQ on 3930 kHz, 146.52 MHz, 147.63/03 repeater, 449.3/442.1 MHz repeater. For a flier with a map and further information write: SARA, W8QQQ,

Continued on page 197



# Digital Clock Fail-Safe

- - so you won't miss the train

**H**oney, what time is 88:88:88?" "Oh, oh! You pulled the plug. Find out what time it is and I'll reset the clock." "Sorry I'm late, Boss. There must have been a power failure during the night and my electronic digital clock was talking garbage this morning." "Every time I close the transmitter key, that fool clock jumps two hours!" Situations sound familiar? Sure do, but this doesn't have to be. The fact is that of the three basic types of clocks, electrical, mechanical, or electronic, the latter is the one most easily made

fail-safe. The trick is to get a little extra filtering in the normal ac to dc power supply and to provide a standby source of dc voltage and a 60 Hz (50 Hz) signal to keep the clock counting during a power outage.

For a clock built around the CT7001 or similar chip, there's no problem. Beef up the filtering a bit, add a backup battery supply with some diode switching, and let the built-in oscillator provide the counting signal. The ac/dc power supply shown in Fig. 1 should do the job nicely. For

almost any other chip, however, an off chip oscillator has to be provided as well as the battery backup.

One way to generate the reference signal for the counting circuit is to use a precision crystal oscillator coupled with a suitable frequency dividing circuit. There are several ads in this magazine for just such circuits, prebuilt or in kit form. But if your clock is normally operated from the ac mains, the crystal oscillator is only the more expensive, not the best, approach to keeping reasonably accurate time. In the

long run, the 60 Hz (50 Hz) signal provided by the power company should average out to a much more accurate count than will even a well-compensated crystal oscillator. It is possible to synchronize the crystal oscillator to the power company line frequency. However, this generally is not done in the known available kits and, even if it were, it would be an unnecessarily expensive solution.

An alternative technical approach is shown in Fig. 1. It is considerably less expensive than the crystal oscillator/divider circuit and is inherently as accurate as the power company's line frequency whenever ac power is available. As long as the power company keeps furnishing the ac voltage, this oscillator will remain synchronized to the line frequency.

The circuit consists of an ac and backup battery power supply, some switching diodes to automatically engage the battery only when the ac voltage fails, and a phase-shift oscillator that will either synchronize with the line frequency or, during power outage, will provide a reasonably accurate signal to keep the clock counting. The "tickler" coming from the secondary of the power transformer to the base of Q1 serves to lock the oscillator to line frequency, working best when the resonant or free-running oscillator frequency is slightly low, even if ever so slightly. Only during a power outage will the resonant frequency of the oscillator determine clock accuracy.

Will the fact that the free-running oscillator is slightly slow cause much of a problem during power outage? Not really. Let's assume that it runs at 59.9 Hz and also that we have a reasonably long power outage, say four hours. The 0.1 Hz error translates to a 0.167% error, the clock losing 24 seconds during the power outage.

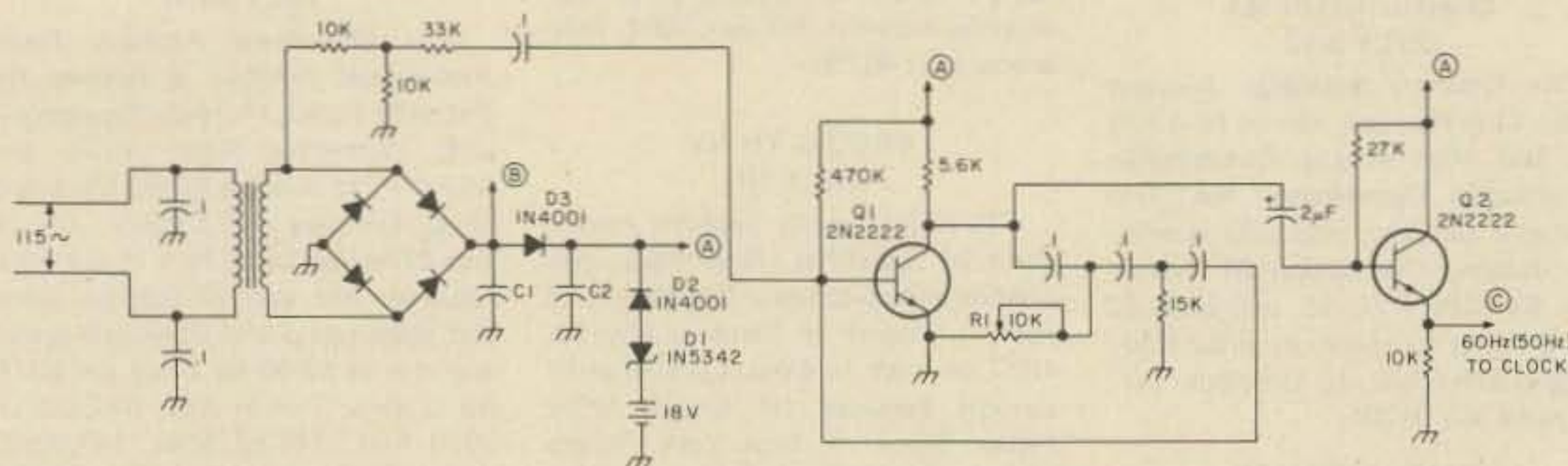

Fig. 1. Fail-safe power supply and clock count generator. Notes: 1.  $C1 = C2 = 200$  to  $300 \mu F$ , 25 volt; 2. D1, D2 — see text; 3. Adjust R1 for 50 or 60 Hz; 4. Point B to LED supply (see Fig. 2); 5. Resistors  $\frac{1}{4}$  or  $\frac{1}{2}$  Watt, as available.



That shouldn't be upsetting in most cases.

Emitter follower, Q2, isolates the oscillator from the clock chip load and provides the necessary current sink. It, like Q1, is shown as a 2N2222. Actually, almost any small silicon NPN transistor will do either job. This looks like a great place to use some of those house-numbered transistors salvaged from a surplus board!

In the typical digital clock circuit, a signal is taken from the secondary of the power transformer, through a current limiting resistor (about 100k Ohms), to one of the clock IC's pins. A signal diode generally goes from that pin to the positive voltage supply. These components should not be removed. Simply cut the existing foil lead near the transformer secondary and solder a lead from the 60 Hz (50 Hz) output of the oscillator to the end of the current limiting resistor that formerly went to the transformer.

Providing a battery backup for the dc voltage to the clock chip may be a little more difficult on a previously assembled board than is coupling in of the timing signal. The actual complexity will vary from board to board, and all that can be said is, "It isn't really tough!" For new construction, whether using a "store bought" PC board or a "home brewed" one, it's probably best to use a separate board for the power supply and phase shift oscillator. If rebuilding an existing clock, it may be best to carefully salvage the power supply associated components from the old board and reuse them on a separate board. By the way, don't forget to remove the clock IC from the board while doing any soldering or unsoldering. It could save you the cost of a new chip!

Fig. 1 shows an 18 volt battery power supply made up of two 9 volt transistor radio batteries in series. The voltage is dropped 6.8 volts

across a 1N5342 zener diode and another 0.6 or 0.7 volts through a 1N4001 before coupling to the ac power supply output (point A on Fig. 1). With the exception of the 1N4001 (or equivalent) diode that provides a switching function, nothing in the combination is critical. It is important only to have the battery-supplied voltage slightly below the normal ac-supplied voltage so as to prevent battery drain during normal operation.

Measure the dc voltage at the filter capacitor in your existing circuit. This will tend to fluctuate as the number of LED elements activated in the display changes. The highest value observed is the one of interest. From that value, subtract about 0.7 volts to account for the drop that will occur across diode D3. The battery voltage to be furnished to point A should be below the resultant figure and above the minimum operating voltage specified by the clock IC manufacturer. Within that range, any combination of batteries and voltage dropping diodes is satisfactory.

For example, the highest measured voltage at point A in the prototype was 12.5 volts. The clock chip specification called for an 11 volt minimum. Thus, any value between 11 and 12.5 volts would be satisfactory. The battery supply could have been made up of a 9 volt cell in series with two 1.5 volt cells with the zener eliminated. The actual circuit used was chosen because the zener was available and for ease in packaging the battery pack. Custom your package to fit your needs. Don't forget, however, that new cell terminal voltage for the 9 volt cell is about 9.4 volts and, for the 1.5 volt cell is 1.55 volts. If you cut your design too close, inadvertent drain of the battery supply during ac operation is possible.

The fail-safe circuit is designed so that, in principle, the LEDs will not display

during battery operation. This is done deliberately to minimize battery drain. In some cases, however, the digits may be faintly displayed. This could occur with the circuit configuration shown in Fig. 2 if the LEDs are particularly efficient. The enabling current is base current flowing through the base of the NPN to the clock IC.

If your digital clock has an alarm clock feature and there happens to be a power outage at the instant the alarm should sound, the fail-safe circuit may or may not cause the alarm to function. It depends upon the design of the alarm feature. If there's an on- or off-chip oscillator, with or without an additional amplifier, driving a small speaker, the alarm buzzer can be made to function even though the time is not being displayed. It's necessary only to insure that power for the alarm circuit is tapped from point A and not from the LED supply bus. Obviously, if the clock functions to enable a radio-alarm, there won't be power available to play the radio, so... This does raise a good point, however. Should you have a radio-alarm, most likely the clock chip is driving a transistor which, in turn, pulls in a relay at the preset time. The relay can be a power hog. In order to protect the batteries, Vcc for the transistor that drives the relay should come from the LED supply bus.

The power supply of Fig. 1 has two filter capacitors, one on each side of diode D3. Capacitor C2 serves to further smooth the ac-supplied voltage against voltage transients. If the batteries are reasonably fresh, this capacitor isn't really necessary. It's most important as the batteries begin to age or are out of the circuit. It, like the zener diode, was a designer choice.

Calibration of the phase shift oscillator is most easily accomplished with the aid of an oscilloscope or frequency counter. With the latter, simply set the frequency to

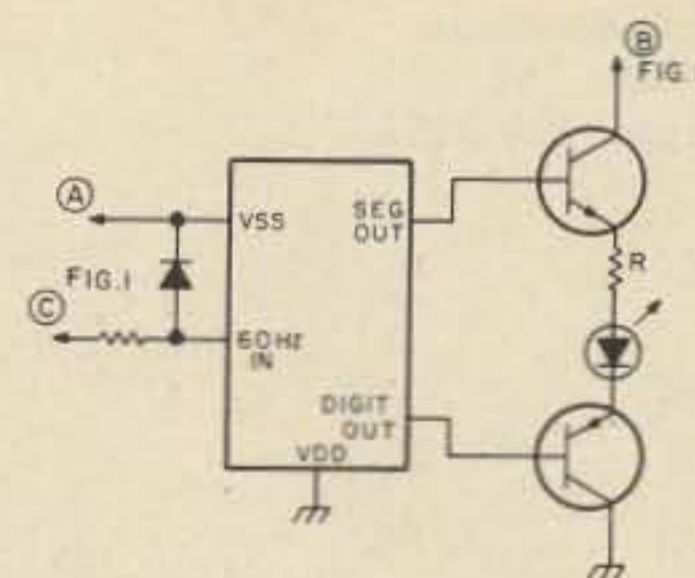

Fig. 2. Isolated LED supply and count in.

59.9 Hz (49.9 Hz). For the scope, connect the vertical probe to the oscillator output, and the horizontal probe to the line frequency terminal on the scope or a similar 50 or 60 Hz source. Adjust R1 until a single ellipse (Lissajous pattern) appears. Then back off ever so slightly so that the pattern appears to be slowly rotating in a clockwise direction about an axis in the plane of the scope.

An alternative technique for calibration is with the sweep second hand of a watch or clock. Rig a temporary switch to enable and disable the ac line to the digital clock. Set the clock, turn power off for a period of 90 seconds, and switch power back on. Adjust R1 until the digital clock advances 90 seconds during the ac power off period. If, after a period of several days, the clock has gained time, tweak R1 to a slightly higher resistance. If the clock is four digit only, switch ac power off just as the minute digit changes. Delay 120 seconds and turn power back on. Adjust R1 so that, at first, the clock is running slow; the minute digit has not quite advanced again when power is re-applied. Gradually adjust R1 to decrease the error.

As the transformer used in the prototype was of the printed circuit board type, a simple PC board was used for the power supply and oscillator. It could otherwise just as well have been assembled on perfboard, vectorboard, or any other of the commonly used assembly techniques.

This simple fail-safe circuit works. Try it, you'll like it! ■



# Interest In Mail Order?

- - an insight into facts and myths

**N**o, this isn't an article about setting up a mail-order business; rather, the subject is how you, as a consumer, can get the most benefit from mail order. As partner in an ad agency, I've had the opportunity to talk with several mail-order companies, and see how they work . . . from announcing a product to shipping out orders. You should know about some of the things I've learned in the process, as this information will help you get the satisfaction you deserve out of mail-order businesses. First of all, let's dispel two myths about the mail-order business:

*Myth #1: Mail Order is Unreliable.* This used to be true, especially in the days of patent medicines and sure cures for gout. Now, however, the competition is tough enough that no business can afford shady operation or unsatisfied customers. Additionally, new federal regulations — plus the severity of postal fraud charges — keep a watchful eye over mail order in gen-

eral; and finally, magazines stop carrying advertising of those companies that inspire complaints to the magazine. A deadbeat company reflects negatively on the magazine that carries the advertising and makes life difficult for the legitimate operators.

How often do you get taken? Over the past eight years I've ordered something from just about every parts company that popped its head up over the horizon. The only problem I had was with a certain company that advertised surplus Switchcraft jacks and ended up sending me Japanese imports (worth far less than the jacks I ordered), and 6 months after I had sent my order, to boot! They cemented my unkind feelings by refusing to answer my letters. Six months later, no magazine was carrying their advertising, which confirmed my opinion was shared by others.

This is not to say you won't have problems; mail-order business employees have bad days, too, and dumb days, and sometimes they

misplace an order or give you the wrong part. But these mistakes are forgivable; after all, we all make them.

*Myth #2: Mail Order Can Sell Cheap Because There Is No Overhead.* True, there is no store. But there are employees, ad budgets, rents on warehouse space, office space, city taxes, state taxes, bookkeeping, repair services, bank charges, insurance, social security payments . . . and the list goes on. But the important point for you to remember is that all of these have to be paid out of the customer's order. We'll see why this is important as we go along, since your actions can make a company operate more efficiently, and help keep costs down for you and other customers.

## Ordering

First, order from *current* ads and catalogs. Prices fluctuate; some items are constantly going up, some are constantly going down (seen any \$350 8080s lately?) Also, terms of sale sometimes change as a company changes,

and there is no set policy on shipping, which varies from company to company. Sending in an order with not enough or too much money slows things down and increases expenses, and guess who ends up paying for it? So it may seem like a small thing, but courtesy dictates that you not send in for a special advertised in April two weeks before Christmas. If you want to find out whether an item is in stock, or if you want to check price, a phone call (remember the new 1 minute rates) or a post card if you're patient will do the job. And, of course, you can always circle the reader service cards in this and other magazines to keep abreast of the latest catalogs.

However, there will be times when you need more information about a product before making an informed buying decision. Again, write or phone the company, but take a few thoughts into account. Keep your questions as specific and to the point as possible; if you waste the time of the people at the company, they will not be able to do what they're paid to do — tend to the orders of paying customers. In fact, if the question you ask is specialized ("I have an antique Atwater Kent and would like to know if your part #45A3 is equivalent to their part #6543"), it is a nice gesture to include a self-addressed, stamped envelope, with your question written out, and a space for the answer. Then the company gets your request, scrawls an answer, and it's back in the mail the same day. Otherwise, the secretary has to be pulled off writing invoices to handle your request, then postage has to be affixed, the address double-checked, and so on. Remember that your requests are being paid for by the customers, so be considerate. Now you know what to order. Next comes . . .

## The Order Blank

First, make sure your



name and address are on the order! It really gets a company bothered to have an order for \$76 worth of parts and no idea of where to send them, or who ordered them in the first place. In a case like that, the only hope is that the customer will write in and ask what happened to the order. Having your address on the check is not good enough, because most companies, when the mail comes in, verify that the amount of the check jibes with the order . . . at which point the check is immediately rushed to the bank to begin the clearing process, while the order moves on to the packing department. It is almost impossible for a large company to go back through a week's worth of checks to weed out one address. For similar reasons, if you have correspondence or questions that don't pertain to the order, put them on a separate piece of paper. That way your question will go to the technical service people, the order will get packed, and the check will get safely put in the bank.

Next, use the order blank the company provides; if that's not available, then type or print up your own, making sure you include 1) the name and/or stock number of the item desired; 2) the quantity you want; 3) a brief description of the item; 4) the subtotal for this item. If applicable, you might put acceptable substitutes on the line below. After you've listed all your items and prices, add the subtotals together and you're in business. If you need to add extra money, for insurance, handling charges, state tax, or whatever, list what it is, clearly. Don't just add on \$2 and expect the company to know what you're doing it for. Is it tax? Or maybe you're ordering two catalogs. Be specific! When a packer is faced with dozens, maybe hundreds, of little pieces of paper in a day, each one of which must be perfectly packed — anything

you can do to help speed things up is greatly appreciated. And that includes neat handwriting, too.

One way to make a company happy is to reference an ad if you're buying from an ad. Now I know people don't like to do this — sort of the "why should I help them, they're taking my money" attitude — but this is poor strategy, and here's why. Advertising is the *only* way a mail-order company can promote itself; there are no walk-in sales. And, advertising is not cheap. The money a company pays for ads has to come out of the profits generated by selling goods. A company with a good, effective, simple advertising program can sell for less and make more money if they know where their ads are doing the most good. This in turn keeps costs down for you. Money wasted on advertising that no one orders from only raises the prices of items you want.

#### The Postage Problem

In the semi-good old days, postage was cheap and the living was easy. Not so any more. The cost of postage, particularly for something heavy like a power supply, can turn a profitable product into a money sucker . . . which gets passed on to you. So, more and more companies are requesting postage or just tack on a straight percentage to cover postage and handling. This brings up a pet peeve of mine: the credit slip. Luckily, these do seem to be dying a slow death, and, unless the amount is very small, most companies will write a refund check if you include too much money for postage. If you get a credit slip, you can always request a check and send back the slip. Xerox your letter and credit slip, though, just in case there are any problems.

More and more companies are relying on UPS to ship their packages. This generally gives better service than the

PO, but remember that UPS goes to your house and needs a street address. They cannot deliver to a post office box, unless, of course, you happen to live in one (cramped quarters, but cheap rent). If you do not include a street address, there will be delays: First UPS has to check with the post office to see if you have a local street address; then they send out a notice that informs you that you need to call UPS and complete arrangements for the delivery of the package. Save time and hassle — include your street address and PO box if you have one (for the mailing list).

There is an easy way to find out exact postage charges. Let's say you're ordering a 10 pound widget from a company in Florida, and you live in Ohio, and the widget is being sent via UPS. Just call up your local UPS and ask them how much it would cost to send a 10 pound widget to Florida from Ohio. It costs the same whether a package goes from point A to point B, or from point B to point A.

#### Minimum Orders

Here is what appears to be a classic example of screwing the little guy, or at least that's what I always thought. But look at it from the company's point of view, and from yours . . . it only takes a little more time to pack a \$200 order than a \$2 order. Let's say it takes 30 minutes total to process a single order. This comes out to at least \$1.50 worth of labor at today's wages. So in the case of the \$200 order, there's enough profit to pay for the cost of the processing. But with a \$2 order, the company may actually lose money. A company that loses money has to make up the difference somewhere, and that difference comes out of the pockets of customers. To help defray this, most companies tack on a service charge for orders under a certain amount. It's a drag, I know;

there have been many times I wanted to buy a single IC, only to find out it would be cheaper to buy ten. But you can't really blame the companies, at least not until people are willing to pack orders for free. Meeting minimum orders keeps the cost down for everybody.

#### Complaints

Eventually you may have to complain about something. But before you do, simmer down for a second and look at the situation objectively. People are only human, and mistakes do occur. Before you assume that a company is out to do you in, give them the benefit of the doubt. Letters do get lost or misplaced; water can spill on an order and make the ink run to the point of illegibility; handwriting can be undecipherable; in short, Murphy's Law is no stranger to the mail-order biz. Or maybe the product that was scheduled to be shipped January 1 is missing two ICs, which were promised by the supplier to arrive in November and finally show up in March. Be sympathetic. The object of a complaint is not to vent your spleen, or to take your aggressions out on some poor clerk, but to get a problem resolved. Don't accuse someone of dishonesty when their only crime may be ignorance or carelessness. It happens to all of us. First time, state your problem clearly and unemotionally; ask for their explanation. But — and this is an important but — although the odds are against it, you may be dealing with a thief. If you make a complaint, make at least two copies of your correspondence in case you need to complain again to the company or the authorities. If you don't get any action after two or three weeks (which should be enough time for the company to answer you), your next letter should be a little less courteous. Mention the date of the previous correspondence, and



show them you've been patient. My father taught me an almost foolproof way of getting answers from people who don't answer the first letter: Take a carbon copy (this is why you make two copies), and write across it, in the biggest letters possible, DON'T YOU ANSWER YOUR MAIL? It gets results.

But if it doesn't . . . the company has two strikes against it. Now comes your "last straw" letter. Document your previous attempts (" . . . there was no reply to my letter of October 2 or November 15 . . . ") and get mad; you've earned it. Send a carbon to the magazine handling their ads, the Better Business Bureau, and possibly someone at consumer affairs in their state government. By the way, you can almost always get a street address for a business from a magazine that carries their advertising; they can't hide behind a PO box anymore. Don't forget the action line of local papers, too; although they may not be able to help in your specific case, they can refer you to the proper authorities.

Postal fraud is a very serious federal offense, and if you can't get satisfaction after all this pressure, it's time to get the government into the act. No doubt some young, hungry bureaucrat would love to sink his or her teeth into a nice fraud conviction. Just make sure you're right before you get heavy.

### Repairs

From time to time you'll get a kit or a finished product that either doesn't work or doesn't come up to spec. The problem may be at your end or the company's; you won't know for sure until they've looked at it. So don't assume the design is lousy, or that the company is putting out a piece of garbage: You could have a cold solder joint, or the company's supplier may have slipped them a bad component, or anything. When dealing with a repair,

first check the unit over thoroughly yourself, preferably on two different days and with a friend who also is familiar with electronics. Sometimes unfamiliarity with a unit prevents getting good results; how can you set up a unit to do something when you aren't quite sure what it's supposed to do? I run into this problem sometimes with the musical modifiers I design; people don't know what it's supposed to sound like, so if there's a bum IC and a distorted sound, they might assume the distortion is part of the effect. Sometimes a phone call to the tech person at the company is all that's needed; sometimes a letter, carefully describing the problem, can save you having to return the unit. So, always write the company before returning something. This isn't just to find out if others have had the same problem — sometimes a company will move and your package can end up in post office limbo; sometimes a company has a separate repair facility, and you could save time by sending your problem child directly to the repair facility. Also, a prior notification alerts the company to watch for your unit.

No company gets rich on repairs; one company I know has yet to charge for any repairs it has done, even those which were the customer's fault. They do enough business, and have a low enough rate of returns, that they can afford to do this. But not all companies can be that generous, especially when asked to repair a problem they didn't cause (bad wiring or soldering, for example). In many of these cases, if the builder, upon receiving the kit, had simply looked at it, recognized it as being beyond his ability, and returned it unbuilt, he could have gotten a full refund. But to botch a kit and then expect the poor company to make good — for free — is too much, and people can expect to pay for their mistakes.

This isn't real good for their pride, maybe, but I have seen some genius computer programmers do lousy soldering jobs. If you're new to kits, start with something simple, then move on to the heavy stuff. Until then, buy your units assembled if you have doubts about your abilities. In many cases, the manufactured units also have more extensive warranties.

When you return the kit, pack it well. You don't want things to go from bad to worse in transit. Also, get a self-stick label and put your name and address on the piece of equipment itself (you won't regret it). Include in the package a thorough description of the problem, along with copies of any pertinent letters (don't say "this is a kludge"; be specific). You can save a repair technician lots of time by relating your experiences with the unit. In your letter, you might also mention that if repair costs are more than a certain amount (whatever you are willing to spend and feel is reasonable), to please notify you by post card. This way, if there is some really bad problem, you won't get any surprises. If it's any consolation, the companies I have seen are conscientious about repairs. Just as word of mouth is the best advertising, a non-working product is the worst. Plus, a company can gain respect by handling repairs in a prompt and intelligent fashion.

### Summing Up

So far we've talked about all the things that can go wrong, and the nightmares that a mail-order operator or customer may confront. Lest you get the wrong idea, just as the majority of companies are ethical, so are the customers. Most are courteous, patient, decent people who trust the companies and have that trust confirmed by a company that acts likewise. Businesses are truly grateful for their customers, and frequently recognize the

names of repeat customers. The point is that even the biggest companies are run by people; you're not dealing with nameless automatons at the other end. So you should know that your patronage is valued, and enjoyed, and they want to keep you as a customer. In this respect, you owe them one favor. If a company does something that leaves you feeling let down — whether it's a part that doesn't meet spec, a delivery commitment that isn't kept, or a kit that doesn't seem to work right — let the company know. Don't just write it off; you may be writing off something whose only problem is a hairline short on a circuit board. If it is a problem at the company's end (like a design flaw that only shows up under certain conditions), they *need* to know about it. Otherwise, they can send out hundreds of the things before someone says something and the error gets corrected. Companies do extensive prototyping, but even then, you can't cover all circumstances of operation. So if you're disappointed, speak up! But remember, you're writing to someone with feelings. Don't just say something is a piece of garbage; be specific, constructive, and objective. You will be doing everybody a favor . . . it's feedback for the company, an elimination of the problem for future buyers, and you've made a contribution.

I hope that all the preceding will help you get the most out of mail-order companies. I buy almost all my parts that way. I've had some bummers, but none that the company wasn't willing to make good (usually with profuse apologies). Treat them like human beings, and you'll be treated likewise. Help them a little bit by following these tips, and you'll simultaneously keep the costs down for yourself and fellow mad scientists . . . and score quite a few bargains in the process. ■





**Adirondack  
has it!**

Amateur Headquarters for the Northeast

**ADIRONDACK Radio  
Supply**

185-191 West Main Street • P.O. Box 88  
Amsterdam, N.Y. 12010 Tel. (518) 842-8350  
Just 5 minutes from N.Y. Thruway - Exit 27

**computer  
depot inc.** T.M.

Parts galore in the Midwest for

PROCESSOR TECHNOLOGY, IMSAI,  
POLYMORPHIC SYSTEMS, DIGITAL  
GROUP, WAVE MATE, CROMEMCO,  
VECTOR GRAPHICS, TDL, SEALS,  
TARBELL, MICRO DESIGNS,  
NORTH STAR, PERIPHERAL  
VISION; INTEL, NATIONAL SEMI-  
CONDUCTOR, FAIRCHILD SEMI-  
CONDUCTOR, MOSTEK, E & L  
INSTRUMENTS, SAMS, TAB,  
HAYDEN, WILEY, MC-GRAW HILL

Catalog Free

Computer Depot Inc.

3515 W. 70th Street

Minneapolis MN 55435

C40

**Portable 500 MHz  
Frequency Counter**

featuring

1 Hz to over 500 MHz. Commercial accuracy — Completely portable (less than 2 pounds) — has rechargeable Nicad batteries — Small - 2"x4"x6" — Recharge operates from 8 to 16 volts DC — limiting circuitry — Less than 50 mV sensitivity — Hi-accuracy international 10MHz crystal — Easy to check calibration — Counts down to 1/10Hz



FULLY GUARANTEED

**\$349<sup>95</sup>** PPD

MasterCharge — BankAmericard

**digitron** Box 8128 Boise, Idaho 83705 (208) 375-4305

**Govt. SURPLUS  
ELECTRONIC  
EQUIPMENT  
CATALOG**

New ITEMS . . . New BARGAINS!

**FREE UPON REQUEST!**

If you haven't received our new Catalog, write for free copy today. Address: Dept. 73

**FAIR RADIO SALES**

1016 E. EUREKA • Box 1105 • LIMA, OHIO • 45802

**Bearcat<sup>®</sup> 210 Scanner**

**\$289.**

The Bearcat 210 super synthesized receiver scans and searches 32-50, 146-174 & 416-512 MHz. without expensive crystals. Order now on our 24 hour toll-free credit card order line 800-521-4414. In Michigan and outside the U.S. call 313-994-4441. Add \$5.00 for shipping in U.S. or \$8.00 for air UPS to west coast. Charge cards or money orders only. Foreign orders invited. For additional information, write: Communications Electronics, P.O. Box 1002, Dept. 21, Ann Arbor, Michigan 48106.



**COMMUNICATIONS ELECTRONICS**  
P.O. BOX 1002 DEPT. 2 D  
ANN ARBOR, MICHIGAN 48106



C5

**NEW!**

**\$32.50**

plus \$1.50 s/h  
NY res. add tax



Features: **CMOS Electronic Keyer**

- State-of-the-art CMOS circuitry
- Self completing dots and dashes
- Dot and dash memory
- Iambic keying with any squeeze paddle
- 5-50 WPM
- Speed, volume, tone controls, side tone and speaker
- Low current drain CMOS-battery operation
- Deluxe quarter-inch jacks for keying and output
- Handsome eggshell white base — woodgrain top
- Compact and portable — 1-7/8 x 4-1/4 x 6-1/4
- Grid block keying
- Wired and tested — fully guaranteed — less battery

**TRAC**

**Electronics, Inc.**  
1106 Rand Bldg. T18  
Buffalo NY 14203





...de W2NSD/I

EDITORIAL BY WAYNE GREEN

from page 4

have a row of LEDs on the rim of the mug spelling out "HOT"?

If I were doing it, I would make up a sample and get it working right, then I'd see about a small firm to make them for me, and I'd start out selling them through the mail-order houses.

Once you get going, you can start distributing them in department stores, discount houses, and you will be a millionaire and have ten times as many problems as you do now ... just different.

The HOT MUGGER will adapt to the car too, plugging into the cigarette lighter. You will have your executive

models for modern desks, a group model for restaurant tables ... it'll hold four cups at a time. It'll work as well for hot chocolate, soups, etc. Then comes the deluxe model with the adjustable thermostat so you can cook the soup right in the cup and then keep it warm, but not boiling, after it is done.

Only one thing ... if you do make it big with the HOT MUGGER, I'd appreciate your building in a 5% royalty for me ... for what's left of my old age.

ELECTRONIC ART

Twice recently, I've seen some good examples of the use of electronic circuits as art forms ... one using

LEDs and the other using NE-2s as part of the art.

For instance, The Electron Art Company is turning out framed and mounted circuits which blink neon lamps. The resistors and capacitors which make up the circuit are part of the art. The battery is built into the back of the picture.

Why not put your imagination to work and see what you can come up with? You have circuit elements to work with ... LEDs of various colors ... neon lamps ... if nothing else you may come up with a winner for a 73 cover. Those electron art "pictures" are selling for around \$18 for an 8 x 10 and \$50 for a 16 x 20, so you might be able to get a small business going. Christmas isn't that far away.

P.O. Box 4430M Santa Clara, CA 95054 (408) 988-1640



Same day shipment. First line parts only. Factory tested. Guaranteed money back. Quality IC's and other components at factory prices.

INTEGRATED CIRCUITS

Table listing various integrated circuits with part numbers and prices.

Table listing various electronic components like crystals, IC sockets, and interface parts with prices.

Advertisement for Swan's, Drake's, Kenwood's, and Yaesu's radio equipment. Includes contact info for Freck Radio & Supply Co., Inc.

Advertisement for COAKIT RF & Audio Connectors & Accessories. Lists various kits and their prices.

Not a Cheap Clock Kit \$17.45. Includes everything except case. 2-PC boards, 6-50" LED Displays, 5314 clock chip, transformer, all components and full instructions. Same clock kit with 80" displays. \$22.75

Function Module Card Kit. Converts any frequency counter into 3 1/2 digit DVM, digital thermometer, pulse & square generator from 10 Hz to 100 kHz. Complete kit minus power supply. \$25.00

Hobbiest Electronics Course. Beginning course in practical electronics, no theory. Lab experiment format. 12 lessons, can be purchased one at a time. \$10.00 per lesson

Plexiglas Cases. Black or white with red bezel in clock sizes. \$5.95

VOLUME SPECIALS. MMS262 2K RAM .90 30, MMS366 Divider 2.10 1.40, 2102-1 500 NS 1K RAM 1.80 1.30, PD411-3 150 NS 4K RAM 8.00 5.75, Momentary Pushbutton Switch .50 .29

60 Hz Crystal Time Base Kit \$4.75. Converts digital clocks from AC line frequency to crystal time base. Outstanding accuracy. Kit includes: PC board, MMS369, crystal, resistors, capacitors and trimmer.

Digital Temperature Meter Kit. Indoor and outdoor. Automatically switches back and forth. Beautiful, 50" LED readouts. Nothing like it available. Needs no additional parts for complete, full operation. Will measure -100° to +200°F, air or liquid. Very accurate. Complete instructions. \$39.95

30 MHz Frequency Counter Kit. Crystal time base. Covers audio, amateur and CB band. 6.5" digits, prescalable with PC board and full instructions. \$55.00 Fully wired and tested. \$75.00

Volt/ohm Probe. Batt. oper. AC/DC to 125 V. 2 pos. volt. and 2 neg. volt. plus continuity. Stainless steel, pocket size, comp. assem. \$34.95

Variable Power Supply Kit. 0-12 VDC @ 1/2 A 7.1% line, load regulation. Remote sense capability. Constant voltage/circuit limit can be modified for other V/I ranges. Complete with board and transformers. \$24.00

Stopwatch Kit \$26.95. Full six digit battery operated. 2-5 volts. 3.2768 MHz crystal accuracy. Times to 59 minutes, 59 seconds, 99 1/100 hrs. Times standard, split and Taylor. 7205 chip, all components minus case. Full instructions. White or black plexiglass case. \$5.00

Digital Thermometer \$65.00. General purpose or medical 32°-230°F. Disposable probe cover ±.2° accuracy. Completely assembled w/compact case.

1977 IC Update Master Manual. Brand new. Complete integrated circuit data selector from all manufacturers. 1234 page master ref guide to the latest IC's including microprocessors and consumer circuits. 17,000 cross references for easier sourcing of hard to get parts. Special pricing: \$24.95, with free update service thru 1977. Domestic postage all \$2.00. Foreign \$6.00.

COSMAC 'ELF' RCA CMOS Microcomputer. CDP1802 CD \$29.50 Users Manual \$7.50. Complete kit of parts to build the "ELF" including CDP1802 and users manual as listed in August '76 Pop. Elect. minus power supply and board. \$92.00

Auto Clock Kit \$15.95. DC clock with 4-50" displays. Uses National MA1012 module with alarm option. Crystal time base PC boards and full instructions. Add \$3.95 for a beautiful dark gray case ready to install. This is the best value available anywhere!

TERMS: \$5.00 min. order U.S. Funds. Calif residents add 6% tax. BankAmericard and Master Charge accepted. Shipping charges will be added. FREE: Send for your copy of our 1977 QUEST CATALOG. Include 13c stamp.

KAUFMAN BALUN. water tight BALUN. 1-1 impedance match. For dipoles, beams, inverted "V", and quads. Includes list of products and prices: Center insulator with BALUN \$13.50, Center insulator without BALUN \$8.50, Dragon Fly antenna construction sheet and drawing \$2.00. Patent No. D219106. 3 Kw PEP, 4 Ounces, Q1 Ferrite. KAUFMAN INDUSTRIES 603-424-2358 3 SHORT ST REEDS FERRY NH 03054 K6



# Radio Hut

Money back guarantee. NO COD'S. Texas residents add 5% sales tax. Add 5% of order for postage and handling. Orders under \$15.00 add 75 cents. Foreign orders add 10% for postage.

For your convenience, call your BankAmericard or Master Charge orders in on our Toll Free Watts Line: 1-800-527-2304. Texas residents call collect: 1-214-271-8423.



P. O. Box 64783  
Dallas, Texas 75206



Memorex computer boards with IC's, diodes, transistor, etc. 5 Boards containing 100 - 200 IC's  
**ONLY \$ 4.25**

## BRIDGE RECTIFIERS

6 Amp	50V	1.10
10 Amp	50V	1.25
25 Amp	50V	1.39

## RESISTORS

Over 50,000,000 in stock

*330 ohm	22K ohm
470 ohm	27K ohm
*680 ohm	33K ohm
1K ohm	39K ohm
1.2K ohm	43K ohm
2.2K ohm	47K ohm
3.3K ohm	82K ohm
4.7K ohm	100K ohm
6.8K ohm	150K ohm
10K ohm	220K ohm
20K ohm	

\*1/8 W only  
\*\*1/2 W only

All resistors are P.C. Lead but are not pull offs.  
100 min. order for each value

NO MIX 100/.99

## MK 5005

4 digit counter/latch decoder; 7 segment output only. 24 pin dip with specs.

**\$ 8.00 EACH**

## UNSCRAMBLER KIT

for all Scanners

- Tunes easily
  - Full instructions included
  - Easy to install
  - 3 1/2" x 3 1/2" x 1 1/2"
- Only \$19.95**

## PLASMA DISPLAY KIT

Kit Includes: 12 digit display .4" Character Power supply for display above Complete specs for hookup.

Line cord Not Included. **ONLY \$ 3.95**



## SPECIAL DEVICES

82S23	2.19
2513	10.00
MK4102-1	.99

## PROJECT CASES

Small	Med.	Large
\$1.50	\$2.00	\$2.75
D-2-1/2"	D-2"	D-2-1/2"
W-4-3/4"	W-4-7/8"	W-7"
H-1-7/8"	H-3-1/2"	H-4"

All cases have a sloped front, white with black wrinkle finish.

## REGULATORS

7805	7818
7806	7824
7808	7905
7812	7912
7815	7915

**Your Choice \$ .95**

## READOUTS

**Best Value!**

FND70 .4"C.C. .59  
FND800 .8"C.C. 1.69  
TI 6 digit array C.C. 3/1.00  
MAN 8 .3"CA Yellow .89  
LT767 .7" C.C. 4 digit stick **\$ 3.95**

## WATERGATE SPECIAL

Telephone Relay automatically starts and stops tape recorder. No batteries required. Kit complete with drilled P.C. Board.

Parts and Case **ONLY \$ 10.95**

## VARIABLE POWER SUPPLY KIT NO. 1

- \*Continuously variable from 5V to 20V
  - \*Excellent regulation up to 500 mil.
  - \*4400 Mfd of filtering
  - \*Drilled fiberglass PC Board
  - \*One hour assembly
  - \*Kit includes all components
  - \*Case Included
- ONLY \$10.95**



## VARIABLE POWER SUPPLY KIT NO. 2

Same as above but with 1 amp output, also with case. **ONLY \$13.95**

## CLOCK KIT

- Kit includes
- LT701 clock module
  - Power Supply
  - Punched Case
  - 12 or 24 hour operation



Complete except for line cord  
LT701E 12 hour clock

**ONLY \$ 14.95**

## BATTERY CLIPS

Standard 9V battery clip with 4-1/2" tinned leads. **25/\$1.00**

\*\*\*

**T T L**

\*\*

7400	.17	7473	.21
7401	.17	7474	.35
7402	.17	7475	.55
7403	.17	7476	.35
74H04	.25	7480	.45
7404	.17	7483	.76
7406	.25	7485	.89
7408	.17	7486	.35
7409	.17	7490	.71
7410	.17	7491	.71
7411	.25	7492	.71
7413	.45	7493	.67
7420	.17	7494	.90
7421	.17	7495	.71
7423	.35	7496	.85
7425	.27	74100	.96
7426	.25	74121	.31
7427	.17	74123	.61
7430	.25	74125	.44
7432	.30	74141	.71
7437	.35	74145	.97
7438	.35	74151	.71
7440	.17	74153	.81
7442	.60	74154	.97
7443	.60	74161	.91
7444	.65	74163	1.05
7446	.85	74164	1.05
7447	.81	74174	.91
7448	.81	74175	1.40
7450	.20	74180	.76
7451	.17	74181	2.25
7453	.17	74191	1.20
7454	.17	74192	1.20
7470	.35	74193	.95
7472	.21	74195	.65

## TRANSISTORS - DIODES

*MJE1103	1/1.00
MJ3001	1.30
2N2222	6/1.00
2N2369	6/1.00
2N2905	4/1.00
*2N2907	15/1.00
2N3906	6/1.00
2N4400	6/1.00
2N4443 SCR	3/1.00
1N4004	15/1.00
1N4007	10/1.00
1N4148 (1N914)	20/1.00
3N201 VHF Pre amp	.50

D40C1 Power Darl - 8/1.00

\*House numbered and P.C. Lead

## PC BOARDS

4 digit PCB for FND800 or 807	2.50
6 digit PCB for FND800 or 807	3.50
4 digit PCB for DL707	1.50
6 digit PCB for DL707	2.00
4 digit PCB for FND503 or 510	2.00
6 digit PCB for FND503 or 510	3.00
4 digit PCB for DL747	2.50
6 digit PCB for DL747	3.00
4 digit PCB for DL727 or 728	2.00
6 digit PCB for DL727 or 728	3.00
4 digit PCB for FND359 or 70	1.75

NOTE: All PC Boards are multiplexed for adding additional digits.

## HARDWARE

New, includes 2-56, 4-40, 6-32 and 8-32 screws and nuts. A very usable selection.

1/2 pound \$1.50  
1 pound \$2.60

## L S

74LS00	.25
74LS02	.25
74LS04	.30
74LS08	.25
74LS10	.25
74LS11	.32
74LS20	.31
74LS21	.33
74LS22	.33
74LS27	.30
74LS30	.31
74LS32	.33
74LS37	.40
74LS38	.35
74LS74	.49
74LS90	.85
74LS132	.90
74LS138	.89
74LS139	.89
74LS155	.90
74LS157	1.00
74LS162	1.39
74LS163	1.39
74LS175	1.09
74LS193	1.09
74LS258	1.09
74LS367	.70
74LS368	.70

## CMOS SALE

4020	.85	4046	.90
CD4000	.16	CD4040	1.00
CD4001	.16	CD4041	.69
CD4002	.16	CD4042	.59
CD4007	.16	CD4043	.60
CD4009	.45	CD4044	.59
CD4010	.45	CD4047	.59
CD4011	.16	CD4049	.35
CD4012	.16	CD4050	.35
CD4013	.29	CD4051	.90
CD4014	.75	CD4053	.90
CD4015	.75	CD4056	1.00
CD4016	.29	CD4058	.90
CD4017	.80	CD4060	1.00
CD4018	.80	CD4066	.69
CD4019	.39	CD4069	.30
CD4021	.90	CD4071	.16
CD4022	.90	CD4076	.99
CD4024	.70	74C04	.29
CD4025	.19	74C107	.29
CD4027	.39	CD4116	.39
CD4028	.75	CD4507	.40
CD4029	.99	CD4512	.50
CD4030	.16	CD4516	.85
CD4034	2.30	CD4518	.85
CD4035	.99	CD4520	.85

ORDER BY PHONE. Charge your order to BankAmericard or Master Charge.

USE OUR TOLL FREE WATTS

**1-800-527-2304**

## 60 Hz L(•)(•)K

**Crystal Time Base Kit** - Kit enables a MOS clock circuit to operate from a DC power source. Ideal for car, camper, van, boat, etc.

60Hz output with an accuracy of .005% (typ.) Low power consumption 2.5 ma (typ.). Small size will fit most any enclosure. Single MOS IC oscillator/divider chip 5-15 volts DC operation.

**ONLY \$ 5.95**  
**2 for \$10.00**

## RADIO HUT GUARANTEE

If you are not satisfied with any of our products **NO MATTER WHAT THE REASON** we offer you a full money back guarantee if the product or products are returned within 14 days after you receive them.



# THINKING ABOUT OSCAR?

Here are some helpful suggestions —

1. Our FM transmitters (shown at the right) can be used very effectively and economically for CW on 2M or 432 uplink. A simple modification allows you to QSY several kHz from xtal frequency.
2. Our famous 2M converters (below) allow you to build up an inexpensive receiving system for mode B. (10 meter i-f recommended.)
3. Popular 10 meter preamps bring new life to your receiver for mode A reception.
4. We have a large stock of the rugged CushCraft beams for immediate delivery, including these popular models recommended for OSCAR. Give us a call; we'll ship yours right away!
5. We stock CDR rotors, low loss cable, etc. Give us a call!

Model	Type	Price
DX-120	20 el 2m Colinear Beam	\$42.95
A147-4	4 el 2m End Mount Beam	19.95
A147-11	11 el 2m Beam	29.95
A147-22	22 el 2m Beam	84.95
A147-20T	10 el FM/10 el SSB	54.95
A144-20T	20 el 2M Twist (linear or circular)	54.95
A449-6	6 el 432/450 End Mount Beam	21.95
A449-11	11 el 432/450 Beam	27.95

- FOR REPEATERS, LINKS, OR JUST A GREAT SOUNDING PERSONAL RIG
- USE ON CW FOR OSCAR!
- RATED FOR CONTINUOUS DUTY
- APPLICATION NOTES AVAILABLE
- SEE FEATURE ARTICLE IN AUG '76 HR
- FULLY SHIELDED PROFESSIONAL DESIGN
- INDIVIDUAL VERNIER FREQ CONTROLS
- COMPANION CABINETS AVAILABLE



T20 Tripler/Driver Module Kit, 150 mW 2M input, 200 mW 450 MHz output \$19.95

## EVER WISH YOUR RECEIVER COULD HEAR THE WEAK ONES ?

Almost every amateur and commercial VHF/UHF receiver can be more sensitive with these popular preamps. Over 7000 in use throughout the world!



P8 KIT \$7.95 P16 W/T \$16.95

MODEL	RANGE
P8-30	20-83 MHz
P8-150	83-190 MHz
P16-	Give exact freq

- Easy-to-tune cascade circuit
- 20-30 dB gain; 2.5 dB noise figure
- Fits in transceivers, only 1/2 x 2-3/8"

P15 KIT \$15.95

P35 W/T \$34.95



- 2 common gate fet's
- 20 dB gain; 4.5 dB noise figure
- Great for atv ssb, fm

Available for any band 380-520 MHz

P9 KIT \$9.95 P14 W/T \$19.95

MODEL	RANGE
P9-30	26-88 MHz
P9-150	88-172 MHz
P9-220	172-230 MHz
P14	Give exact freq.

- 2-stage common gate fet ckt
- 20-30 dB gain; 2 dB noise figure
- Compact — 1 1/2 x 3"
- Coax connectors & diode protection
- Great for OSCAR!



## FM/CW TRANSMITTER KITS

### 200 MW EXCITER MODULE KITS

- T40-11 Eleven Channel Exciter for 2M, 6M, or 220 MHz ..... \$39.95
- T40-1 As Above but only One Channel ..... \$34.95



### RF POWER AMPLIFIER MODULES

- NO TUNING • VSWR PROTECTED • 150 MW DRIVE
- T80-150, 140-175 MHz, 20-25W output, Wired and Tested, simply connect your cables ... \$79.95
- T80-450, 430-470 MHz, 13-15W, W/T \$79.95

## VHF AND UHF CONVERTERS

- Low Noise FET Front End
- All common i-f's
- Coax Connectors
- Low Power Drain
- Crystals Available for any Desired Freq Scheme



- MODEL C25 VHF CONVERTER KIT (shown) \$25.95
- Models for 2M, 6M, 10M, 220 MHz, aircraft, com'l, etc. • Stable cascade rf stage • 0.3-0.5 uv sensitivity • 10-20 dB gain • Compact 2 1/2 x 4 1/2" pcb • Any i-f 10-50 MHz
- MODEL U20-450 UHF CONVERTER \$19.95
- For 432 MHz ssb or atv, 450 MHz fm, aircraft or com'l, etc. • Economy Converter • Use with P15 Preamp for Optimum Performance • Any i-f 10-160 MHz XTAL (either of above)\$5.50

## TEST PROBE KITS



ONLY \$7.95/ea.

- Contain probe, ground clip, cable, and all components except plug to mate with your test equipment.
- TE-3 RF Detector Probe for VTVM, good from 100 kHz to over 500 MHz
- TE-4 Direct probe for ac/ohms, etc.
- TE-5 DC probes w/res for 11 meg input vtvm
- TE-6 Blocking capacitor probe for counter, sig gen
- TE-7 Wideband Detector probe for scopes
- TE-8 High Z/Low Z scope probe

HY-GAIN 3806 2M HT'S IN STOCK!  
Accessories & Crystals, too \$179.95

## VHF/UHF FM RCVR KITS

- MORE FOR YOUR MONEY
- COMMERCIAL TYPE DESIGN
- IDEAL FOR REPEATERS, MONITORS, LINKS, OR RACK MTD RECEIVERS
- MAKE YOUR OWN 2M FM TRUNK MOUNTED TRANSCIEVER



- VHF MODELS FOR ANY BAND 28-240 MHz
- R60-1 1, 0.5-1 uV sens, incl VHF Converter and IF/Audio Boards ..... \$64.95
- R69-1 1, 0.2-0.4uV sens, incl P9 Preamp, VHF Conv, and IF/Audio Boards ..... \$69.95
- R40 10.7 MHz IF/Audio Board alone ..... \$39.95



## ANTENNAS

We have in-depth stocks of CUSHCRAFT, LARSEN, and HY-GAIN antennas & CDR rotors for IMMEDIATE DELIVERY. Popular items like Ringos, Beams, Magnet Mount Whips, Rubber Duckies, 10-80M Verticals, Tribanders, Doublet Insulators, and Lightning Arrestors. Also W2AU baluns & Reyco Traps. CALL or WRITE NOW! We'll be glad to advise you or send you FREE catalogs. No obligation, of course!

- UHF MODELS FOR ANY BAND 380-520 MHz
- R60-450, 5-10uV economy rcvr, incl UHF Conv & IF/Audio Boards only ..... \$59.95
- R80-450, 2-5uV sens monitor rcvr, incl UHF Conv, VHF Conv, and IF/Audio Boards ..... \$84.95
- R95-450, 0.4-1uV sens rcvr, incl P15 Preamp, UHF Conv, VHF Conv, and IF/Audio Boards ..... \$94.95
- CRYSTALS (We stock common freq. and will gladly order others) ..... \$5.50

## Inexpensive DC POWER SUPPLIES



A great new line of power supplies to operate 12vdc gear in the shack or shop! All have low ripple, good regulation, and overload protection. And they are all in STOCK for IMMEDIATE DELIVERY, and they are all WIRED & TESTED.

Model	Price	Intermittent	Cont
12CB4	\$29.95	2.5A	1.5A
103R	39.95	4A	2.5A
104R	49.95	6A	4A
108RA	79.95	12A	8A
108RM*	99.95	12A	8A
109R*	149.95	25A	10A

\* Indicate model which has panel meter(s)

## LARSEN WHIPS

- 5/8 wave 2M or 220 MHz or colinear 450 MHz antennas complete Magnet or Gutter Mount \$38.45
- Trunk Mount 37.90

# hamtronics, inc.

182S BELMONT RD., ROCHESTER NY 14612

- CALL OR WRITE NOW FOR FREE CATALOG OR TO PLACE YOUR ORDER!
- PHONE 716-663-9254, 9AM-9PM EST DAILY.
- Use your credit card or C.O.D.
- Specify operating freq • Add \$1 shipping and handling.



# SCR 1000

State of the Art in

VHF FM Repeaters

Some  
Plain  
Talk  
About  
Repeaters -



SEND  
FOR  
BROCHURE

Let's face it - your repeater group's success or failure hinges on the Quality and Reliability of your "Machine"! That's why the engineers at Spec Comm dedicated themselves to the production of the finest repeater available on the amateur market. The SCR1000 has been conservatively designed for years of trouble-free operation, and every consideration has been given to operator convenience and accessory interfacing. Features like full metering, lighted status indicators, full front panel control of every important repeater operating parameter, and accessory jacks for autopatch, xmtr. remote control, etc. And audio so good and so full, your 30 watts will sound like 100! Think about it, and think about your users. The purchase of a Spec Comm Repeater is a sound investment in your group's future, and they'll be thanking you for years to come. Sold Factory Direct only. \$899.95.

Don't make a mistake - your group deserves the finest!



Custom 'Mods' Available: 'PL', 8 Pole Rcvr. Filter, Hi/Lo Power, Multi-Freq., etc. - Inquire.

#### Specifications

RF Output . . . . . 30 Watts  
Infinite VSWR proof  
Sensitivity . . . . . 0.3uV/20dB Qt.  
Selectivity . . . . . -6dB @ ±6.5 kHz;  
-58dB @ ±15 kHz;  
-90dB @ ±30 kHz.  
(Sharper 8 Pole Fltr. Available)  
Desense/Overload . . . W/1uV de-  
sired signal, desense just begins @  
approx. 50,000uV @ ±600kHz.  
Spurious Response . . . -70dB min.

#### FEATURES

- Full Metering of critical levels.
- Front Panel Controls for timers & AF levels.
- Lighted push-buttons for control/test functions & status indicators
- State of the Art CMOS control logic & timers - No Relays!
- Built-in IDer - field programmable. Fully adjustable speed, pitch, time, etc.
- Exclusive Spec Comm MOSFET/Hot Carrier Diode rcvr. front end - greatly reduces 'desense' & IM problems!
- Built-in AC Supply w/instant btry. switchover for emergency pwr.
- Supplied with .0005% Sentry xtals and a Turner local mic.
- Jacks Provided for Remote Control, Auto-Patch, DC out, AF in/out, COR Switch, etc.
- True FM - For Rpt. Audio so good, it "sounds like direct"!

## SPEC COMM REPEATER BOARDS



#### SCR100 Receiver Board

- Ext. wide dynamic range! Greatly reduces overload, 'desense', and IM.
- Sens. 0.3uV/20dB Qt.
- Sel. -6dB @ ±6.5KHz; -90dB @ ±30KHz, (-110dB w/opt. 8 Pole Fltr.)
- Exc. audio quality! \$115.00 w/xtal, Asmbld. & Tested



#### SCT 100 Xmtr/Exciter Board

- 5-6 Wts. Output
- Infinite VSWR proof
- True FM for exc. audio quality
- Spurious -60dB
- With .0005% xtal. \$115.00 Asmbld. & Tested. BA-10 30 Wt. Amp Board & Heat Sink. 3 sec. LPF & rel. pwr. sensor. \$51.95 Asmbld. & Tested

Call or write today and get the details!

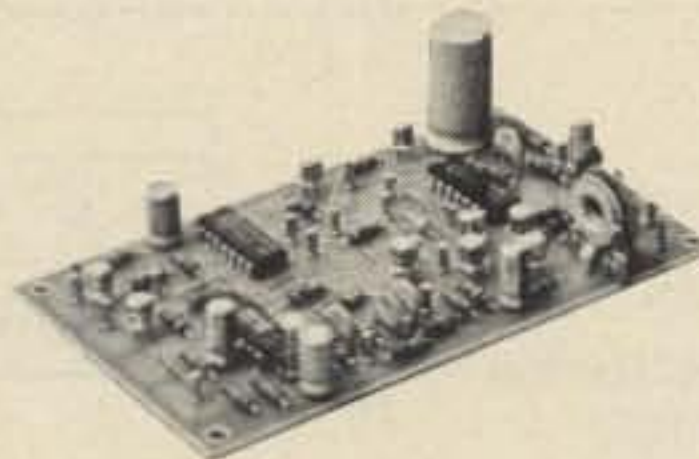

#### CTC100 COR/Timer/Control Board

- Complete COR circuitry
- Carrier 'Hang' & T.O. Timers
- Remote xmtr. control
- 100% Solid State
- Many other features \$32.95 Asmbld. & Tested

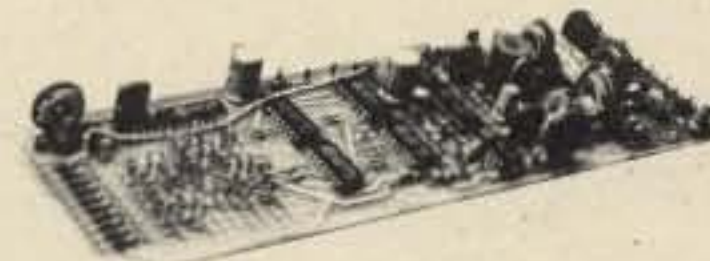

#### ID100 ID & Audio Mixer Board

- 100 bit diode programmable memory
- Adjustable ID tone, speed, level, time
- 4 Input AF Mixer & Local Mic amp
- COR input & xmtr. hold
- All CMOS logic
- Many other features \$59.95 Asmbld. & Tested

Send for Data Sheets!



# SPECTRUM COMMUNICATIONS

1055 W. Germantown Pk., Norristown PA 19401 (215) 631-1710

Formerly of Worcester PA



# GET YOUR NEW RADIO AMATEUR CALLBOOKS

# 1977

The **U.S. Callbook** has over 300,000 W & K listings. It lists calls, license classes, names and addresses plus the many valuable back-up charts and references you come to expect from the **Callbook**.

**\$14.95**  
PLUS SHIPPING

Specialize in DX? Then you're looking for the **Foreign Callbook** with over 250,000 calls, names and addresses of radio amateurs outside the USA plus many valuable, additional features of interest to the DX'r.

**\$13.95**  
PLUS SHIPPING

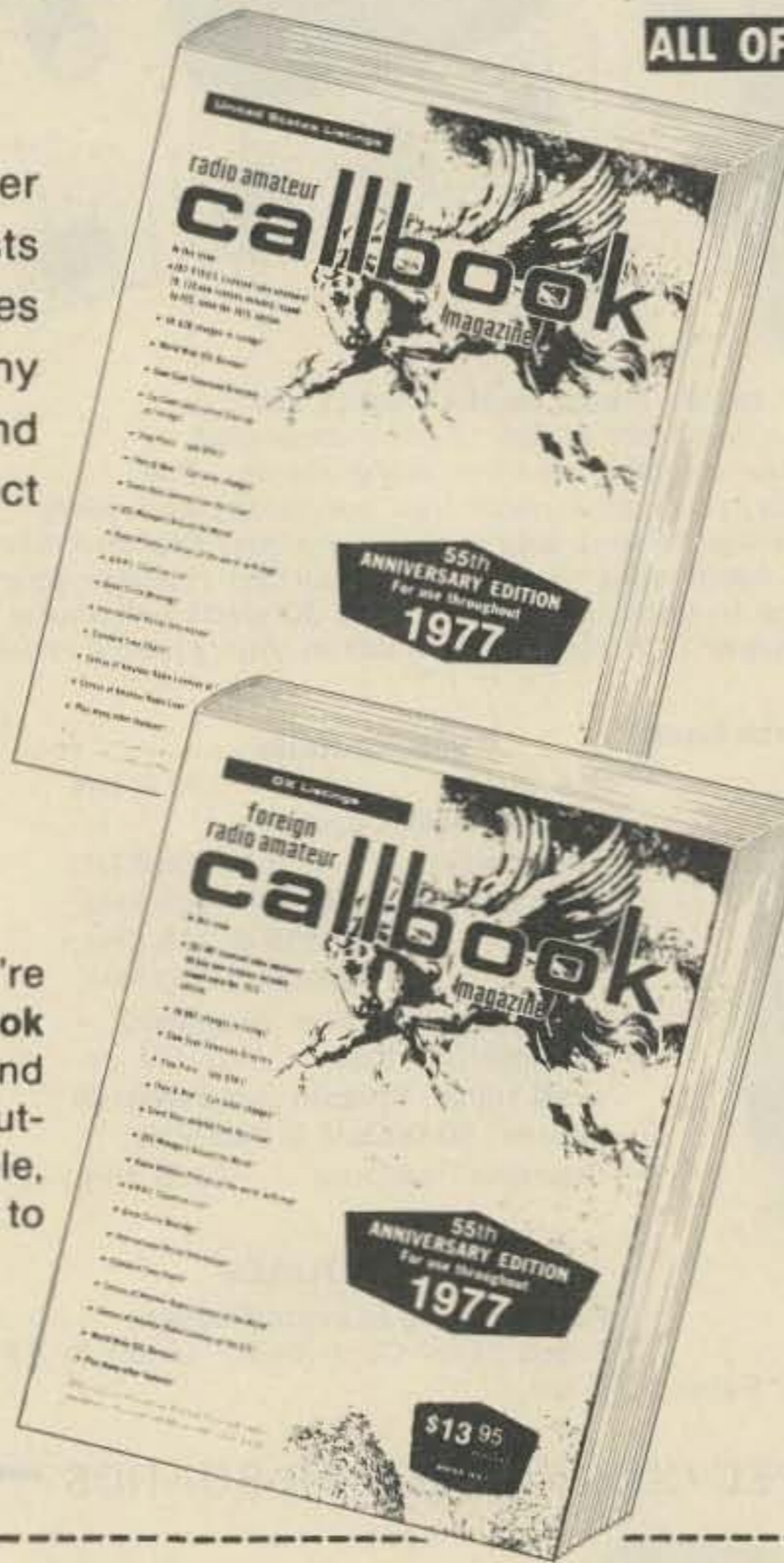

## ALL OF THESE EXTRA FEATURES INCLUDED

- International Radio Amateur Prefixes!
- Radio Amateur Prefixes by Countries!
- A.R.R.L. Phonetic Alphabet!
- Great Circle Bearings and Charts!
- International "Q" and "Z" Signals!
- World Standard Time Charts!
- International Postal Information!
- World Prefix Map!
- F.C.C. Examination Points!
- Where to Buy!
- Telegraphers' Abbreviations!
- DX Operating Code!
- A.R.R.L. Countries List!
- At Your Service — Amateur Radio Dealers!
- QSL Managers Around the World!
- World Wide QSL Bureaus!
- Census of Radio Amateurs of the World!
- Telegraph Codes!
- AMSAT — Oscar Users Directory!
- Slow Scan Television Directory!
- Reciprocal Licenses!
- Hawaii Included!
- Many Other Features!

*Respected worldwide as  
the only complete authority  
for radio amateur  
QSL and QTH information.*

### ORDER FORM

Item	Price Each	Shipping	Total Price
U. S. CALLBOOK	\$14.95	\$1.25	\$ 16.20
FOREIGN CALLBOOK	\$13.95	\$1.25	\$ 15.20

See your favorite electronics dealer or write direct for free catalog to the publisher.

Illinois residents only add 5% sales tax \_\_\_\_\_

Name \_\_\_\_\_ Total \_\_\_\_\_

Address \_\_\_\_\_

City \_\_\_\_\_

State \_\_\_\_\_ Zip \_\_\_\_\_ Total Enclosed \_\_\_\_\_

Master Charge No. \_\_\_\_\_ Interbank # \_\_\_\_\_

Bank \_\_\_\_\_ Expiration Date \_\_\_\_\_

RADIO AMATEUR  
**callbook** INC.  
Dept. B 925 Sherwood Drive  
Lake Bluff, Ill. 60044



# SLEP ELECTRONICS

ACCESSORIES  
and  
ANTENNAS

## ● CUSHCRAFT

A147-4EL, 146-148 MHZ . . . \$19.95  
 A147-11 11EL, 146-148 MHZ . . . 29.95  
 A147-20T 20EL, 144-147 MHZ . . . 54.95  
 A147-22 22EL, 146-148 MHZ . . . 84.95  
 A220-11 11EL 220-225 MHZ . . . 27.95  
 A449-11 11EL 449 MHZ . . . 27.95  
 AFM-4D FOUR J POLE 144-148 . . . 59.95  
 AR-6 RINGO 50-54 MHZ . . . 32.95  
 AR-220 RINGO 220-225 MHZ . . . 21.95  
 AR-450 RINGO 440-460 MHZ . . . 21.95  
 ARX-2 RINGO RANGER 135-170 MHZ . . . 32.95  
 ARX-220 RINGO RANGER 220-225 MHZ . . . 32.95  
 ARX-450 RINGO RANGER 435-450 MHZ . . . 32.95  
 ARX-2K KIT, CONVERTS RINGO TO RINGO RANGER 135-170 MHZ . . . 13.95  
 DX-120 20EL DX ARRAY 144 MHZ . . . 42.95  
 DX-1BN 1-1 BALUN DX-120 . . . 12.95  
 DX-VPB VERT POL BRACKET DX-120 . . . 9.95  
 A14-SK STACKING KIT FOR TWO A147-4 . . . 15.95  
 A14-VPK VERT POLE FOR TWO 147-4 . . . 23.95  
 A21-SK STACKING KIT FOR TWO A220-11 . . . 15.95  
 A220-VPK VERT POLE KIT FOR TWO A220-11 . . . 23.95  
 A147-SK STACKING KIT FOR TWO 147-11 . . . 15.95  
 A147-VPK VERT POLE KIT FOR TWO 147-11 . . . 29.95  
 A449-SK STACK KIT FOR TWO A449-11 . . . 15.95  
 A449-VPK VERT POLE KIT FOR TWO A449-11 . . . 23.95  
 A144-10T 10EL OSCAR 145 MHZ . . . 34.95  
 A144-20T 20EL OSCAR 145 MHZ . . . 54.95  
 A432-20T 20EL OSCAR 430-436 MHZ . . . 49.95  
 A14T-MB TWIST MOUNT BOOM AND BRACKET . . . 15.95  
 A50-5 5 EL BEAM 6 METER . . . 49.95  
 ATB-34 4EL TRI-BAND 10, 15, 20 . . . 239.95  
 AFB-1 BALUN ATB-34 FERRITE 1-1 . . . 14.95  
 CR-1 RINGO CB ANTENNA . . . 29.95  
 MS-2 3 BAND HI, LOW, UHF SCANNER MONITOR ANTENNA . . . 24.50  
 LAC-2 LIGHTNING ARRESTOR SO-239 EACH END . . . 4.50

## ● HY-GAIN

14AVQ/WB VERTICAL 10-THRU-40 . . . 67.00  
 18AVT/WB VERTICAL 10-THRU-80 . . . 97.00  
 14RMQ ROOF MOUNT KIT 14AVQ, 18AVT . . . 24.95  
 18HT HY-TOWER VERTICAL 10 THRU 80 . . . 259.95  
 TH3JR 3EL 10/15/20 BEAM 750 W PEP . . . 144.50

TH3MK3 3EL 10/15/20 BEAM 2KW PEP . . . 199.50  
 TH6DXX 6EL 10/15/20 BEAM, 2KW PEP . . . 239.95  
 203BA 3EL 20 METER . . . 149.95  
 402BA 2EL 40 METER . . . 199.95  
 153BA 3EL 15 METER . . . 79.95  
 64B 4EL 6 METER BEAM . . . 45.00  
 244 HY QUAD, 2EL QUAD 10/15/20 . . . 219.95  
 DB10/15A 2EL 10/15 BEAM . . . 149.95  
 2BDQ TRAP DOUBLET ANTENNA 40/80 . . . 49.95  
 5DBQ TRAP DOUBLET ANTENNA 10 THRU 80 . . . 79.95  
 270 MOBILE 2 MTR 6 DB GAIN FIBERGLASS 3/8 X 24 STUD . . . 39.95  
 271 BASE STATION MOUNTING BRACKET 270 . . . 4.95  
 BN-86 FERRITE BALUN 10-THRU 80 . . . 15.95  
 LA-1 LIGHTNING ARRESTOR, HEAVY DUTY PL-259 CONNECTORS . . . 34.95  
 C1 CENTER INSULATOR FOR DOUBLET . . . 5.95  
 E1 END INSULATOR FOR DOUBLET PAIR . . . 3.95  
 269 2 MTR RUBBER DUCKIE ANTENNA 5/16 X 32 BASE . . . 7.00  
 274 2 MTR RUBBER DUCKIE ANTENNA BNC BASE . . . 9.00  
 275 2 MTR RUBBER DUCKIE ANTENNA PL-259 BASE . . . 7.00

## ● MOSLEY

CL-33 CLASSIC 3EL 10/15/20 BEAM . . . 224.00  
 TA-33 JR 3 EL 10/15/20 BEAM . . . 145.00  
 TA-33 EL 10/15/20 2KW PEP BEAM . . . 198.00  
 TA40KR CONVERSION KIT, ADD 40 MTR TO TA-33 . . . 88.50  
 DI-2 VERTICAL GROUND PLANE 2 MTR 1KW . . . 30.00  
 SWL-7 SHORTWAVE TRAP DIPOLE . . . 41.25

## ● MINI-PRODUCTS

HQ-1 HYBRID QUAD BEAM ANTENNA BANDS 6, 10, 15 & 20 MTRS, ELEMENT LENGTH 11 FT., BOOM 4 1/2 FT. TURNING RADIUS 6'2" 1200W PEP, F/B RATIO 12 TO 17 DB, IDEAL BEAM FOR SMALL AREA, WT. 15 LBS. . . . 119.50  
 C-4 VERTICAL ANTENNA 6, 10, 15, 20 MTR. 1200W PEP . . . 52.50

## ● LARSEN

MM-LM-150 2MTR, 5/8 LOADED 144-174 MHZ MAGNETIC MOUNT ANTENNA WITH RG-58/U COAX . . . 38.50  
 GC-LM-150 2 MTR 5/8 LOADED 144-174 MHZ GUTTER CLAMP MOUNT ANTENNA WITH RG-58/U . . . 38.50  
 AMB-150K 2 MTR 5/8 LOADED 144-147 MHZ TRUNK GUTTER MOUNT ANTENNA WITH RG-58/U . . . 33.00

## ● DENTRON

SKYCLAW VERTICAL, 40/80/160 . . . 79.50

SKYMASTER VERTICAL, 10 THRU 40 . . . 84.50  
 80-4VR RESONATOR 80M FOR SKYMASTER . . . 29.50  
 EX-1 VERTICAL FULL 40 MTR 1/4 WAVE 33 FT, IDEAL VERTICAL FOR PHASING . . . 59.50

## ● NEWTRONICS

4BTV VERTICAL 10-40 MTRS . . . 99.95  
 RM-75 RESONATOR ADD 75 MTRS . . . 15.50  
 RM-75S SUPER RESONATOR 1KW . . . 30.00  
 CG-144 2 MTR COLINEAR 5.2 DB GAIN 3/8" X 24" BASE . . . 25.50  
 CGT-144 2 MTR COLINEAR 5.2 DB GAIN TRUNK LIP MOUNT . . . 41.30  
 DCX DISCONE ANTENNA 40-700 MHZ . . . 13.00  
 G6-144A REPEATER APPROVED 6 DB GAIN COLINEAR 2 MTR . . . 67.50

## ● SWAN

TB2A 2EL BEAM 10/15/20 . . . 129.95  
 TB3HA 3EL BEAM 10/15/20 . . . 189.95  
 TB4HA 3EL BEAM 10/15/20 . . . 249.95  
 742 TRI-BAND 20/40/75 METER MOBILE, ELECTRONICALLY TUNED AUTOMATIC BAND-SWITCHING 500W PEP . . . 79.95  
 SWR-1A POWER/SWR METER 0-1KW 3.5-150 MHZ SO-239 INLINE . . . 25.95  
 SWR-3 MEASURE SWR 1:1 TO 3: SWR AT 500 OHMS 1.7 TO 50 MHZ, SO-239 INLINE . . . 12.95  
 FS-1 MEASURES RADIATED POWER, TELESCOPIC ANTENNA 1.5-200 MHZ . . . 10.95  
 WM-2000 INLINE WATTMETER/SWR THREE SCALES TO 2000W POWER/SWR 3.5-30 MHZ . . . 59.95  
 WM-3000 A TRUE PEP SSB INLINE PEAK RMS WATTMETER/SWR TO 2 KW IN RMS OR PEAK BY SWITCHING . . . 79.95  
 WM-6200 INLINE VHF 50-150 MHZ WATTMETER/SWR TWO SCALES TO 200 WATTS . . . 59.95

## ● CDR ROTORS

HAM II ROTOR WITH CONTROL . . . 139.50  
 CD-44 ROTOR WITH CONTROL . . . 119.50  
 AR-22 ROTOR WITH CONTROL . . . 49.50  
 8 CONDUCTOR ROTOR CABLE PER FOOT . . . 17

## ● COLUMBIA WIRE

50 FT ROLL RG-58/U LOW LOSS FOAM SUPERFLEX COAX WITH PL-259 EACH END . . . 7.50  
 100 FT ROLL RG-58/U SAME AS ABOVE . . . 13.00  
 50 FT ROLL RG-8/U LOW LOSS FOAM SUPERFLEX COAX WITH PL-259 EACH END . . . 14.00  
 100 FT ROLL RG-8/U SAME AS ABOVE . . . 24.00  
 100 FT ANTENNA WIRE NO. 17 BARE COPPERWELD STRANDED 7/25 . . . 3.90

# Slep Electronics Co.

P.O. BOX 100, HWY. 441, DEPT. 73E, OTTO, NORTH CAROLINA 28763

WE PAY SHIPPING via UPS or best way on all advertised items to 50 states and APO/FPO on mailable items. Export orders shipping extra. We accept Master Charge, NC residents add 4% sales tax. Phone Bill Slep (704) 524-7519.



# NEW! FM144-10SXRII



All Solid State-PLL digital synthesized — No Crystals to buy! 5KHz steps — 144-149 MHz-LED digital readout PLUS MARS-CAP.\*

- 5MHz Band Coverage — 1000 Channels (instead of the usual 2MHz to 4MHz — 400 to 800 Channels) • Priority Channel • Audio Output 4 Watts • 15 Watts Output
- Unequaled Receiver Sensitivity and Selectivity — 15 POLE FILTER, MONOLITHIC CRYSTAL FILTER AND AUTOMATIC TUNED RECEIVER FRONT END — COMPARE!!
- Superb Engineering and Superior Commercial Avionics Grade Quality and Construction Second to None at ANY PRICE.

- **FREQUENCY RANGE:** Receive: 144.00 to 148.995 MHz, 5KHz steps (1000 channels). Transmit 144.00 to 148.995 MHz, 5KHz steps (1000 channels) + MARS-CAP.\*
- **FULL DIGITAL READOUT:** Six easy to read LED digits provide direct frequency readout assuring accurate and simple selection of operating frequency.
- **AIRCRAFT TYPE FREQUENCY SELECTOR:** Large and small coaxially mounted knobs select 100KHz and 10KHz steps respectively. Switches click-stopped with a home position facilitate frequency changing without need to view LED'S while driving and provides the sightless amateur with full Braille dial as standard equipment.
- **FULL AUTOMATIC TUNING OF RECEIVER FRONT END:** DC output of PLL fed to varactor diodes in all front end R-F tuned circuits provides full sensitivity and optimum intermodulation rejection over the entire band. **No other amateur unit at any price** has this feature which is found in only the most sophisticated and expensive aircraft and commercial transceivers.
- **TRUE FM:** Not phase modulation — for superb emphasized hi-fi audio quality second to none.
- **FULLY REGULATED INTEGRAL POWER SUPPLIES:** Operating voltage for all circuits, i.e., 12v, 9v and 5v have independently regulated supplies. 12v regulator effective in keeping engine alternator noises out and protects final transistor from overload.
- **MONITOR LAMPS:** 2 LED'S on front panel indicate (1) incoming signal-channel busy, and (2) un-lock condition of phase locked loop.
- **DUPLEX FREQUENCY OFFSET:** 600KHz plus or minus. 5KHz steps. Plus simplex, any frequency.
- **MODULAR COMMERCIAL GRADE CONSTRUCTION:** 6 unitized modules eliminate stray coupling and facilitate ease of maintenance.
- **ACCESSORY SOCKET:** Fully wired for touch-tone, phone patch, and other accessories.
- **RECEIVE:** 25 uv sensitivity 15 pole filter as well as monolithic crystal filter and automatic tuned LC circuits provide superior skirt selectivity.
- **AUDIO OUTPUT: 4 WATTS.** Built in speaker.
- **HIGH/LOW POWER OUTPUT:** 15 watts and 1 watt, switch selected. Low power may be adjusted anywhere between 1 watt and 15 watts, fully protected — short or open SWR.
- **PRIORITY CHANNEL:** Instant selection by front panel switch. Diode matrix may be owner re-programmed to any frequency (146.52 provided).
- **DUAL METER:** Provides "S" reading on receive and power out on transmit.
- **OTHER FEATURES:** Dynamic microphone, mobile mount, external speaker jack, and much, much, more. Size: 2 1/8 x 6 1/2 x 7 1/2. All cords, plugs, fuses, mobile mount, microphone hanger, etc., included. Weight: 5 lbs.



## NEW! 6 METER FM50-10SXRII

Same specifications as above except transmit/receive: 51.00-53.995 MHz. 600 channels  
Introductory Price \$389.00



SUMMER SPECIAL  
FM144-10SXRII  
\$389.00  
VALUE \$599.00  
Regulated AC/PS  
Model FMPS-4R ... \$49.00

NEW!  
TONE ENCODER/DECODER  
SC 12A 12 CHANNELS DUAL TONE  
Introductory Price \$119.00

Touch-Tone Pad  
MODEL FMTP-1  
... \$59.00

Manufactured by one of the world's most distinguished Avionics manufacturers, Kyokuto Denshi Kaisha, Ltd.

First in the world with an all solid state 2 meter FM transceiver.

## AMATEUR-WHOLESALE ELECTRONICS

8817 S.W. 129th Terrace, Miami, Florida 33176  
Telephone (305) 233-3631 • Telex: 51-5628  
U.S. DISTRIBUTOR

PLEASE ORDER FROM YOUR LOCAL  
DEALER OR DIRECT IF UNAVAILABLE.

Regional Sales & Service Centers:  
Northeast: Buzzards Bay Electronics  
Buzzards Bay, Mass.  
East: Sanford Communications, Inc.  
Colonia, N.J.  
West: Consumer Communications, Inc.  
Seattle, Wash.

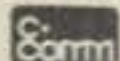



**NEW! FMSC-2 SCANNER FOR KDK FM-144**

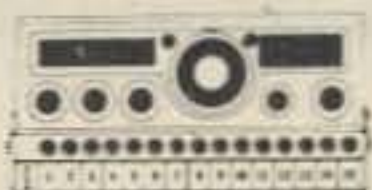

14 CHANNEL PROGRAMABLE  
INTRODUCTORY PRICE \$99

**NEW! 7400 SCANNER**

FOR KENWOOD TR-7400A

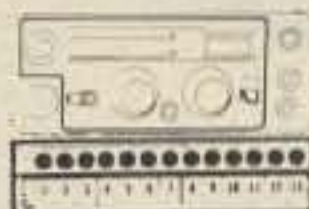

14 CHANNEL PROGRAMABLE  
INTRODUCTORY PRICE \$99

**\*NEW**

\$39.95



NEW! ADD 5 CHANS (TOTAL 10) TO SRC-146A

- Simple 10 min. installation
- Same color and quality as SRC-146A
- Completely WIRED & TESTED
- ALSO usable with most other hand helds \$39.95

ATLAS, COLLINS, REGENCY, DENTRON, BRIMSTONE, CUSH-CRAFT, BIRD, STANDARD, KLM, HYGAIN, KENWOOD, TEMPO, MINI-PRODUCTS, MIDLAND, VHF MARINE, EIMAC, ICOM, AMMCOM, CIR, ETC. — PLEASE WRITE FOR QUOTE.

**\*NEW**

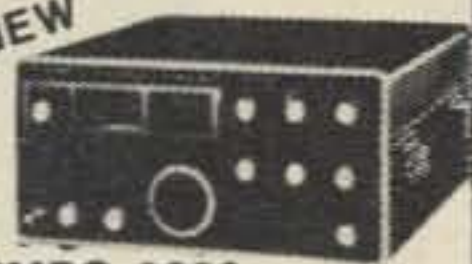

**TEMPO 2020**

A BRILLIANT NEW SSB TRANSCEIVER PROVIDING AN UNBEATABLE COMBINATION OF ADVANCED ENGINEERING AND UNIQUE OPERATING FEATURES. PLEASE WRITE FOR COMPLETE INFORMATION

**STANDARD TRANSCEIVER MODEL SRC-146A**

**\*NEW!**

NEW! TOUCH TONE PAD COMPLETELY WIRED & READY TO PLUG IN \$69.00 COMPLETE BACK ASSEMBLY



**YAESU FT-101E TRANSCEIVER'S**

Please write for special deal.

**NEW AM/FM ANALYZER**

**SIGMA AF-250L**



• INTRODUCTORY PRICE \$199

• DEVIATION/MODULATION METER -

FM: 0-20 KHz, AM: 0-100% • SIZE: 5 1/2" (h) x 10 1/4" (w) x 7 1/4" (d). WEIGHT: 7 lbs.

ALSO MODEL AF-251LW WITH BUILT IN 125 WATT CALIBRATED WATT METER & DUMMY LOAD. PRICE \$289 PLEASE WRITE FOR COMPLETE INFORMATION

**NEW! TWO NEW SCANNERS!**

**FMSC-1 SCANNER FOR KDK FM 144 AND 7400 SCANNER II for Trio-Kenwood TR-7400A**

FMSC-1 SCANNER \$169  
7400 SCANNER II \$189

• Full scan 146 and 147 MHz consecutively or 1 MHz, or any MHz range • Scan rate: 1 MHz/2 seconds (adjustable) • Controls: Scan/Hold, Latch/Delay, 600 KHz offset (off, up, down), program/1 MHz • Simple installation.

NEW— CDR HAM II ROTATORS Reg. \$159.95 \$125.00

**STANDARD NEW 2 METER FM TRANSCEIVERS**

Model SRC-146A  
**SPECIAL SALE!**  
• SRC 146A \$298.00  
• 4 XTALS 34/94 AND 94/94 N/C  
• USA 2 DELUXE BASE CHARGER \$40.00  
• PT3644 LEATHER CASE \$10.00  
• AT 19 RUBBER ANT AND WHIP \$6.00  
• NI CADS \$30.00

NEW! TOUCH TONE PAD COMPLETELY WIRED & READY TO PLUG IN \$69.00  
REGULAR \$384.00  
**OUR PRICE \$279.00**



the indispensable BIRD 43 THRULINE WATTMETER

AUTHORIZED BIRD DISTRIBUTOR

Please write for special deal

**SIGMA RF-2000 SWR & POWER METER**

INTRODUCTORY PRICE \$29  
CAL. PWR SCALES 200W/2000W

• FREQ. RANGE 3.5 - 150 MHz  
• PLEASE DO NOT CONFUSE THE RF 2000 WITH SIMILAR APPEARING LOWER PRICED UNITS  
• RF 2000 IS AN INDIVIDUALLY CALIBRATED PROFESSIONAL QUALITY INSTRUMENT -

SIZE:  
7" (w) x 2 1/2" (h)  
x 2 1/2" (d).

UNEQUALED AT MANY TIMES THE PRICE.



NEW TYPE SWR & POWER METER RF 2000



**ATLAS 210X-215X AND 350-XL**

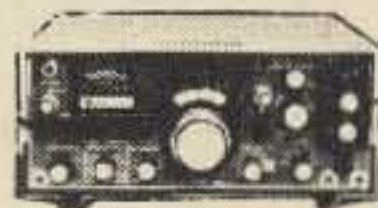

PLEASE WRITE FOR SPECIAL BONUS AND PACKAGE OFFERS.

**NEW!**

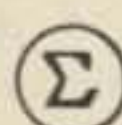

**SIGMA XR-3000D LINEAR AMPLIFIER**



INTRODUCTORY PRICE \$789

2 DAY AIR SHIPMENT ANYWHERE IN U.S. \$35. ALASKA AND HAWAII SLIGHTLY HIGHER.

- FULL BAND COVERAGE 160-10 METERS INCLUDING MARS.
- 2000+ WATTS P.E.P. SSB INPUT. 1000 WATTS INPUT CONTINUOUS DUTY, CW, RTTY AND SSTV.
- TWO EIMAC 3-500Z CONSERVATIVELY RATED FINALS.
- ALL MAJOR HV AND OTHER CIRCUIT COMPONENTS MOUNTED ON SINGLE G-10 GLASS PLUG IN BOARD. HAVE A SERVICE PROBLEM? (VERY UNLIKELY) JUST UNPLUG BOARD AND SEND TO US.
- HEAVY DUTY COMMERCIAL GRADE QUALITY AND CONSTRUCTION SECOND TO NO OTHER UNIT AT ANY PRICE!
- WEIGHT: 90 lbs. SIZE: 9 1/2" (h) x 16" (w) x 15 3/4" (d).

**FEATURES**

CUSTOM COMPUTER GRADE COMMERCIAL COMPONENTS, CAPACITORS, AND TUBE SOCKETS MANUFACTURED ESPECIALLY FOR HIGH POWER USE — HEAVY DUTY 10KW SILVER PLATED CERAMIC BAND SWITCHES • SILVER PLATED COPPER TUBING TANK COIL • HUGH 4" EASY TO READ METERS — MEASURE PLATE CURRENT, HIGH VOLTAGE, GRID CURRENT, AND RELATIVE RF OUTPUT • CONTINUOUS DUTY POWER SUPPLY BUILT IN • STATE OF THE ART ZENER DIODE STANDBY AND OPERATING BIAS PROVIDES REDUCED IDLING CURRENT AND GREATER OUTPUT EFFICIENCY • BUILT IN HUM FREE DC HEAVY DUTY ANTENNA CHANGE-OVER RELAYS • AC INPUT 110V OR 220V AC, 50-60Hz • TUNED INPUT CIRCUITS • ALC-REAR PANEL CONNECTIONS FOR ALC OUTPUT TO EXCITER AND FOR RELAY CONTROL • DOUBLE INTERNAL SHIELDING OF ALL RF ENCLOSURES • HEAVY DUTY CHASSIS AND CABINET CONSTRUCTION AND MUCH, MUCH MORE.

**AMMCOM**

S 2 25 TWO METER SYNTHESIZED VHF-FM TRANCEIVER



- 25 watts output
- 600 kHz and 1 MHz offsets built in
- Please write for complete information and SPECIAL INTRODUCTORY PACKAGE PRICE



**ACCESSORIES FOR KDK FM 144**

FMPS-4R	Regulated AC/PS	\$49
FMT-1	Touch Tone Pad	\$59
FMT-2	Touch Tone Pad with 10 Number Programable Memory	\$99
FMMC-1	Microphone with Built-in Touch Tone Pad	\$59
FMTD-1	Private Call Decoder for use with and Programed by Any Touch Tone Pad	\$129
SC-12A	Audible Tone Encoder Decoder	\$119
FMSC-1	Scanner - Random, Any Range	\$169
FMSC-2	Scanner - Programable, 14 Channels	\$99
MARS-CAP	Option Kit - Any Frequency, Any Split	\$12
FMOF-1	Offset Option Kit - 2 Extra Positions, Crystals Required	\$19
FMOF-2	±1 MHz Offset Option Kit (No Crystals To Buy)	\$19
FMT-1	Sub Audible Tone (100 Hz - Adjustable 67-203 Hz)	\$29
FMAT-1	1/2 Wave Portable Antenna for Hotel, Motel or Apartment	\$7.95
	Extra DC Cord & Plug	\$3.50
	ACC. Socket 5 Pin Din Plug	\$1.50
	Owners Manual (Extra)	\$5.00
	Service Manual	\$2.00
	Mounting Bracket (Extra)	\$6.00

Our crew:  
S. I. GREGORY—WA4KGU  
Owner/Gen. Mgr.  
JIM MAGGIO—MGR W8CXL  
S. E. GLICKMAN—WB4HFJ

**AMATEUR-WHOLESALE ELECTRONICS**

8817 S.W. 129th Terrace, Miami, Florida 33176

COURTEOUS PERSONAL SERVICE—SAME DAY SHIPMENT • Prices subject to change without notice.  
TELEPHONE: (305) 233-3631 • TELEX 51-5628 • STORE HOURS: 10-5 MON.-FRI.



A21





# NEW

## DIGITAL CLOCK

with  
10 MINUTE  
TIMER

6 digits - 12/24 hour

Here's the kit everyone has been asking for!  
Never fail to identify your station again. And

it's easy to use, just tap timer button to start, 9 minutes later the display will flash on and off to alert you. Reset it by simply touching the timer button or it will reset itself automatically after two minutes! Other features are: jumbo .4" LED readouts, durable extruded aluminum case available in 5 colors, plug transformer, Polaroid lens filter, time set buttons, finest quality PC boards and super instructions. You get all parts - no extras are needed, unlike some of the kludges our competitors offer! Colors available: gold, black, silver, bronze, blue (specify). Size: 4.25" x 1.5" x 1.5".

- Clock Kit with 10 min. timer, DC-10 ..... \$25.95
  - Regular 12/24 hr clock kit ..... 22.95
  - Alarm clock, 12 hr only, DC-8 ..... 24.95
- Kits are also available fully assembled and tested, just add \$10 to kit price.

### CAR CLOCK

12/24 HR  
6 DIGIT \$25.95

- High accuracy (1 minute/month)
  - Big .4" LED display
  - Special circuit suppress all voltage spikes and transients
  - Same case as illustrated above
  - Display blanks with ignition off
  - Reverse polarity protected
- Complete Kit, DC-7 ..... \$25.95  
Assembled and calibrated ... 35.95

### CALENDAR ALARM CLOCK

6 Digit LED 12/24 Hour

Has every feature one could ever ask for. Kit includes everything except case, build it into wall, station or even car! **FEATURES:**

- 6 Digits, .5" High LED
  - Calendar shows mo./day
  - True 24 Hour Alarm
  - Battery back up with built in on chip time base
  - 12/24 Hour Format
  - Snooze button
  - 7001 chip does all!!
- Complete Kit, less case, DC-9 ..... \$34.95

### 600 MHz PRESCALER

\$59.95



Assembled and tested. Extend the range of your counter to 600 MHz. Works with all counters. Available in kit form for \$44.95. Specify ÷10 or ÷100 with order.

### 30 WATT

2 Meter  
Power Amp

The famous RE class C power amp now available mail order! Four Watts in for 30 Watts out, 2 in for 15 out, 1 in for 8 out, Incredible value, complete with all parts, instructions and details on T-R relay. Fully stable, output short proof, infinite VSWR protected! Case not included.

Complete Kit ..... \$22.95

## MINI-KITS



### FM Wireless Mike Kit

\$2.95  
FM-1

Transmit up to 300' to any FM broadcast radio. Sensitive mike input requires crystal ceramic or dynamic mike. Runs on 3 to 9 V. Super sensitive model FM-2 ... \$4.95

### TONE DECODER KIT

A complete tone decoder on a single PC Board. Features: 400-5000 Hz adjustable frequency range, voltage regulation, 567 IC. Useful for touch-tone decoding, tone burst detection, FSK demod, signaling, and many other uses. Use 7 for 12 button touchtone decoding. Runs on 5 to 12 volts.

Complete Kit, TD-1 ..... \$4.95

### LED BLINKY KIT

A great attention getter which alternately flashes 2 Jumbo LEDs. Use for name badges, buttons, or warning type panel lights. Runs on 3 to 9 volts.

Complete Kit ..... \$2.95

### SUPER-SNOOP AMPLIFIER

A super-sensitive amplifier which will pick up a pin drop at 15 feet! Great for monitoring baby's room or as a general purpose test amplifier. Full 2 watts of output, runs on 6 to 12 volts, uses any type of mike. Requires 8-45 ohm speaker.

Complete Kit, BN-9 ..... \$4.95

### MUSIC LIGHTS KIT

See music come alive! 3 different lights flicker with music or voice. One light for lows, one for the mid-range and one for the highs. Each channel individually adjustable, and drives up to 300 watts. Great for parties, band music, nite clubs and more.

Complete Kit, ML-1 ..... \$7.95

### SIREN KIT

Produces upward and downward wail characteristic of police siren. 5 Watts audio output, runs on 3-9 volts, uses 8-45 ohm speaker.

Complete Kit, SM-3 ..... \$2.95

### CODE OSCILLATOR KIT

Powerful 1 watt audio oscillator of approx. 1 kHz, good for many uses. Great for warning alarm, battery checker, voltage indicator and code oscillator.

Complete Kit, CPO-1 ..... \$2.50

### POWER SUPPLY KIT

Complete triple regulated power supply provides variable ±15 volts at 200 mA and +5 volts at 1 Amp. 50 mV load regulation good filtering and small size. Kit less transformers. Requires 6-8 V at 1 Amp and 18 to 30 VCT.

Complete Kit, PS-3LT ..... \$6.95

### DECADE COUNTER

#### PARTS KIT

- INCLUDES
- 7490A decade counter
  - 7475 latch
  - 7447 LED driver
  - LED readout
  - Current limit resistors

Complete with instruction and details on how to build an easy, low cost freq. counter. R8

\$3.50

### COMING SOON: VIDEO TERMINAL KIT

SEND FOR DETAILS  
\$149.95

TTL	LINEAR	REGULATOR	TRANSISTORS
74S00 .35	555 .50	309K .99	NPN 2N3904 type 10/\$1.00
74S112 .75	556 .75	309H .99	PNP 2N3906 type 10/\$1.00
7447 .79	567 1.75	340K-12 1.25	NPN Power Tab 40W 3/\$1.00
7473 .35	1458 .50	7805 .99	PNP Power Tab 40W 3/\$1.00
7475 .50	LED DRIVER	7812 .99	FET MPF-102 type 3/\$2.00
7490A .55	75491 .50	7815 .99	UJT 2N2646 type 3/\$2.00
74143 3.50	75492 .50	7818 .99	2N3055 NPN Power .75

DIODES: 1KV,2.5A ..... 5/\$1.00    100V,1A ..... 10/\$1.00    1N914A type ..... 50/\$2.00

#### LED DISPLAYS



- FND 359 ..... .4" C.C. .... .75
- FND 510 ..... .5" C.A. .... 1.25
- DL 707 ..... .33" C.A. .... 1.25
- HP 7730 ..... .27" C.A. .... 1.25
- Red Polaroid Filter ... 4.25" X 1.125" ... .59

#### 741 OP-AMP SPECIAL

Factory prime mini dip with both Xerox and 741 part numbers  
10 for \$2.00

#### SOCKETS

- 14 PIN 5/\$1.00
- 16 PIN 5/\$1.00
- 24 PIN 2/\$1.00
- 40 PIN 3/\$2.00

#### FERRITE BEADS

with info and specs  
15/\$1.00  
6 hole Balun Beads  
5/\$1.00

#### SOCKET KIT

Assortment of 12 most used IC sockets. Good to have around the shop. \$1.95

#### 8080A \$18.95

Factory Prime - includes FREE socket!

21L02-1 \$1.95 Fast 450 ns Low Power

#### 60 Hz XTAL TIME BASE

- Runs on 5-15 VDC
  - Low current (2.5 ma)
  - Operate clocks in car, boat, plane
  - 1 minute/month accuracy
- Kit, TB-7 ... \$5.50  
Assembled & Calibrated ... \$9.95

#### CHEAP CLOCK KIT

- DC-4 Features:
- 6 digit .4" LED
- 12 or 24 format

\$9.95

Does not include board or transformer

PC Board \$2.95

Transformer \$1.49

Dealers Write for our wholesale price list. Hi M'D

# ramsey electronics

P.O. Box 4072 Rochester NY 14610

(716) 271-6487

TELEPHONE ORDERS  
WELCOME

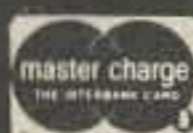

Satisfaction guaranteed or money refunded. COD, add \$1.00. Orders under \$10.00 add \$.75. NY residents add 7% tax.

SEE YOU IN ATLANTA - HAMFESTIVAL JUNE 18 & 19



**ADVA**

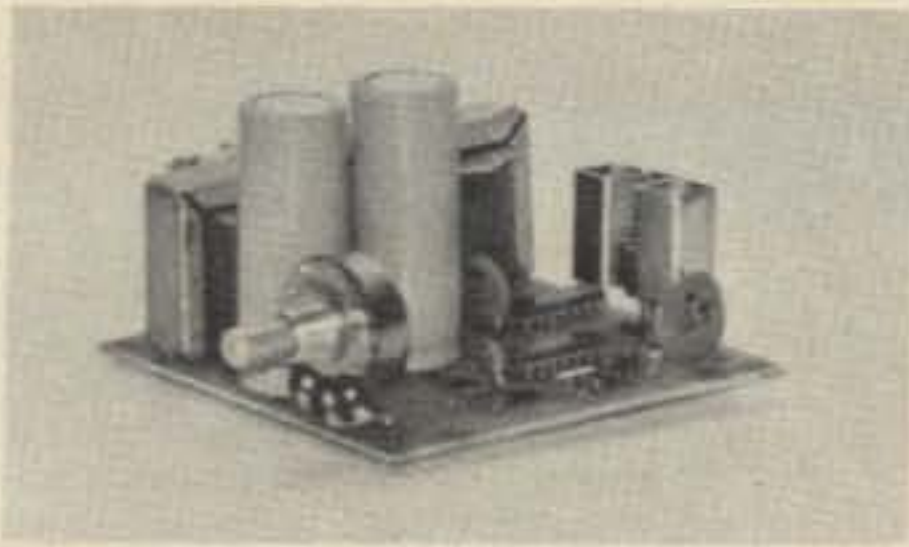

**KIT \$11<sup>95</sup>**

ASSEMBLED \$17.95  
ADD \$1.25 FOR  
POSTAGE/HANDLING

# VARIABLE POWER SUPPLY

- Continuously Variable from 2V to over 15V
- Short-Circuit Proof
- Typical Regulation of 0.1%
- Electronic Current Limiting at 300mA
- Very Low Output Ripple
- Fiberglass PC Board Mounts All Components
- Assemble in about One Hour
- Makes a Great Bench or Lab Power Supply
- Includes All Components except Case and Meters

**OTHER ADVA KITS:**

**LOGIC PROBE KIT**—Use with CMOS, TTL, DTL, RTL, HTL, HINIL and most MOS IC's. Built-in protection against polarity reversal and overvoltage. Draws only a few mA from circuit under test. Dual LED readout. Complete kit includes case and clip leads. **ONLY \$7.85**

**FIXED REGULATED POWER SUPPLY KITS**—Short-circuit proof with thermal current limiting. Compact size and typical regulation of 0.0% make these ideal for most electronic projects. Available for 5V @ 500mA, 6V @ 500mA, 9V @ 500mA, 12V @ 400mA, 15V @ 300mA. Specify voltage when ordering. **\$8.95 ea.**

These easy-to-assemble kits include all components, complete detailed instructions and plated fiberglass PC boards. Power supply kits do not include case or meters. Add \$1.25 per kit for postage and handling.

**MAIL NOW! FREE DATA SHEETS** supplied with many items from this ad. **FREE ON REQUEST**—741 Op Amp with every order of \$5 or more—749 Dual Op Amp or two \$100 FET's with every order of \$10 or more, postmarked prior to 3/31/77. One free item per order. **ORDER TODAY**—All items subject to prior sale and prices subject to change without notice. All items are new surplus parts—100% functionally tested.

**WRITE FOR FREE CATALOG #75** offering over 350 semiconductors carried in stock. Send 13¢ stamp.

**TERMS:** Send check or money order (U.S. funds) with order. We pay 1st Class postage to U.S., Canada and Mexico (except on kits). \$1.00 handling charge on orders under \$10. Calif. residents add 8% sales tax. Foreign orders add postage. COD orders—add \$1.00 service charge.

**MORE SPECIALS:**

**RC4195DN** ±15V @ 50mA VOLTAGE REGULATOR IC. Very easy to use. Makes a neat Highly Regulated ±15V Supply for OP AMP's, etc. Requires only unregulated DC (18-30V) and 2 bypass capacitors. With Data Sheet and Schematics. 8-pin mDIP **\$1.25**

**LM741** FREO COMPENSATED OP AMP, μA741, MC1741, etc. mDIP 5/S1

**MC1458** DUAL 741 OP AMP mDIP **3/S1**

**RC4558** DUAL 741 OP AMP mDIP **3/S1**

**2N3904** NPN TRANSISTOR AMPLIFIER/SWITCH to 50 mA β100 **6/S1**

**ZENERS**—Specify Voltage 3.3, 3.9, 4.3, 5.1, 6.8, 8.2 **400mW 4/\$1.00**  
9.1, 10, 12, 15, 16, 18, 20, 22, 24, 27, or 33V (±10%) **1 Watt 3/\$1.00**

- MONEY-BACK GUARANTEE
- ALL TESTED AND GUARANTEED

**ADVA** ELECTRONICS  
BOX 4181 K, WOODSIDE, CA 94062  
Tel. (415) 851-0455

**FREE**

IC or FET's WITH  
\$5 & \$10 ORDERS.†  
DATA SHEETS  
WITH MANY ITEMS.

DIODES	TRANSISTORS	TRANSISTORS	TRANSISTORS	LINEAR IC's
ZENERS & RECTIFIERS	2N700 \$0.24	2N4001 3/S1	2N5638 2/S1	LM340K 5 \$1.75
1N456 to 8/S1	2N718 .34	2N4002 02.75	2N5640 2/S1	LM340T 5 1.75
1N482 to 6/S1	2N720 .48	2N4121 3/S1	CP643 \$4.00	LM340T-6 1.75
1N485 to 6/S1	2N710 1.51	2N4122 3/S1	CP650* \$5.00	LM340T-12 1.75
1N488 to 6/S1	2N1012 \$0.29	2N4124 5/S1	CP651 \$4.00	LM340T-15 1.75
1N490 to 4/S1	2N1711 .29	2N4248 5/S1	E190 4/S1	LM340T-24 1.75
1N491 to 15/S1	2N1890 .38	2N4249 5/S1	E191 3/S1	LM378N* .55
1N492 to 4/S1	2N1892 .38	2N4250 4/S1	E192 3/S1	LM377N 2.50
1N494 to 4/S1	2N2219 .24	2N4274 5/S1	E175 3/S1	LM380N 1.25
1N497 to 12/S1	2N2222 6/S1	2N4302 5/S1	MPP102 10* 3/S1	NE555V* 2/S1
1N498 to 12/S1	2N2222A* 5/S1	2N4303 .29	MPP104 3/S1	NE556A \$0.90
1N499 to 12/S1	2N2369 5/S1	2N4338 .51	MPP112 4/S1	LM709CN .29
1N500 to 12/S1	2N2606 10 \$2	2N4360M 2/S1	MP56515 3/S1	LM709CN .29
1N501 to 12/S1	2N2609 5/S1	2N4391 .51	SE1001 4/S1	LM723N 2/S1
1N502 to 12/S1	2N2905 50.24	2N4392 50.00	SE1002 4/S1	LM723N* 3/S1
1N503 to 12/S1	2N2906A .24	2N4416 2/S1	SE2001 4/S1	LM739N \$1.00
1N504 to 12/S1	2N2907* 6/S1	2N4416A 30.00	SE2002 4/S1	LM741CN 3/S1
1N505 to 10/S1	2N3553 51.50	2N4856 10 \$1	SE5001 10 3/S1	LM741CN* 4/S1
1N506 to 10/S1	2N3563 6/S1	2N4861 6/S1	SE5003 3/S1	LM741CN14 .34
1N507 to 10/S1	2N3564 4/S1	2N487E 2/S1	SE5020 \$3.00	LM747CN .65
1N508 to 15/S1	2N3565 10 6/S1	2N488E 2/S1	TIS73 10 3/S1	748CJ DIP .35
1N509 to 25/S1	2N3568 6/S1	2N4891 \$2.50	TIS75 3/S1	749CJ DIP 1.00
1N510 to 2/S1	2N3638 6/S1	2N4898 .51	DIGITAL IC's	844CP mDIP .80
1N511 to 2/S1	2N3638A 5/S1	2N4965 3/S1	MM5730N \$2.95	LM1304N 1.15
1N512 to 15/S1	2N3641 5/S1	2N5007 4/S1	SN7400N .16	LM1458N* 3/S1
1N513 to 3/S1	2N3642 5/S1	2N5008 4/S1	SN7410N .16	LM2111N \$1.40
1N514 to 4/S1	2N3643 5/S1	2N5126 10 6/S1	SN7420N .16	KR2550CP 1.55
1N515 to 4/S1	2N3644 4/S1	2N5135 5/S1	SN7440N .16	7748DE 1.95
1N516 to 4/S1	2N3646 4/S1	2N5138 5/S1	SN7451N .18	CA3028A 1.75
1N517 to 3/S1	2N3888 10 3/S1	2N5139 5/S1	SN7473N .36	CA3046 .84
1N518 to 3/S1	2N3891 10 4/S1	2N5197 55.00	SN7475N .48	LM3015N 1.45
1N519 to 3/S1	2N3894 4/S1	2N5199 2.50	SN7479N .35	CA3086* .55
1N520 to 3/S1	2N3821 50.80	2N5210 3/S1	SN7490N .44	LM3900N .55
1N521 to 3/S1	2N3822 .70	2N5208 2/S1	LINEAR IC's	RC4194TK* 2.50
1N522 to 3/S1	2N3823 .40	2N5297 \$1.50	LM100H \$7.50	RC4195DN* 1.25
1N523 to 3/S1	2N3866 .75	2N5432 1.50	LM301AN .27	RC4195TK* 2.25
1N524 to 3/S1	2N3903 10* \$1	2N5457 6/S1	LM307H .27	LM4250CN 2.00
1N525 to 3/S1	2N3906 6/S1	2N5458 50.38	LM308N .88	RC4560N .55
1N526 to 3/S1	2N3919 55.00	2N5484 3/S1	LM309K 1.25	NE556V .95
1N527 to 3/S1	2N3922 5.00	2N5486 2/S1	LM311N .80	NE558V 1.25
1N528 to 3/S1	2N3954 2.20	2N5543 53.00	LM320K 6 1.35	μA7805UC 1.50
1N529 to 3/S1	2N3958 1.15	2N5544 2.50	LM320K-12 1.38	8038 DIP* 1.75
1N530 to 3/S1	2N3970 1.00	2N5561 12.00	LM320K-15 1.35	DM75482 .89

**\*SUPER SPECIALS:**

1N914 100V/10mA Diode	20/S1	MPP102 200MHz RF Amp	3/S1
1N4001 100V/1A Rect.	15/S1	40673 MOSFET RF Amp	\$1.75
1N4154 30V 1N914	25/S1	LM324 Quad 741 Op Amp	.94
BR1 50V 1/2A Bridge Rec	4/S1	LM376 Pos Volt Reg mDIP	.55
2N2222A NPN Transistor	6/S1	NE555 Timer mDIP	2/S1
2N2907 PNP Transistor	6/S1	LM723 2-37V Reg DIP	3/S1
2N3055 Power Xistor 10A	.69	LM741 Comp Op Amp mDIP	4/S1
2N3904 NPN Amp/Sw β100	6/S1	LM1458 Dual 741 mDIP	3/S1
2N3906 PNP Amp/Sw β100	6/S1	CA3086 5 Trans Array DIP	.55
CP650 Power FET 1/2Amp	\$5	RC4195DN ±15V/50mA mDIP	1.25
RF391 RF Power Amp Transistor 10-25W @ 3-30MHz TO-3	\$5.00		
555X Timer 1μs-1hr Different pinout from 555 (w/data)	3/S1		
RC4194TK Dual Tracking Regulator ±0.2 to 30V @ 200mA TO-66	\$2.50		
RC4195TK Dual Tracking Regulator ±15V @ 100mA (TO-66)	\$2.25		
8038 Waveform Generator TTL Wave With Circuits & Data	\$3.75		

# SPECIALS — THIS MONTH ONLY

1N34	Germanium Diode 60V 10mA	10/\$1
1N6263	Hot Carrier Diode (HP2800, etc.)	\$1.00
2N918	UHF Transistor—Osc/Amp up to 1 GHz	4/\$1
2N3866	UHF Transistor—1 Watt at 432 MHz	\$0.75
RCA29	NPN Power Amp/Switch 30W TO-220	.70
LM741	Compensated Op Amp mDIP or DIP	6/\$1
LM1304	FM Multiplex Stereo Demodulator	\$0.99
LM2111	FM IF Amp/Limiter/Detector	.99
CA3028A	RF/IF Amplifier DC to 120 MHz	1.45
RC4136	Quad 741 Op Amp—Low-Noise	.95
LP-10	LOGIC PROBE Kit—TTL, CMOS, etc.	\$7.85

(See Above — "OTHER ADVA KITS")

**ADVA**

ELECTRONICS

BOX 4181 K  
WOODSIDE, CA 94062  
Tel. (415) 851-0455

A24



# BULLET ELECTRONICS

P. O. BOX 19442E  
DALLAS, TEXAS 75219  
(214) 823-3240

WE BET THAT WE CAN SHIP ANYTHING IN THIS AD WITHIN 48 HOURS OF RECEIPT OF YOUR ORDER. If we lose we will still send your order and we will also send you a brand new silver\* dollar for every \$5.00 in merchandise you ordered!

IF WE WIN WE GET TO KEEP YOU AS A SATISFIED CUSTOMER...

WANTA' BET??

\*Silver dollars are new copper clad style. Refunds are calculated on nearest \$5.00 increment. Sundays and holidays are excluded.

## Mini Grandfather Clock Kit



- Completely Electronic
- 100% Solid State
- All CMOS IC Construction
- 2 Quality Plated PC Boards 6.5" x 4.5"
- New, revised easy to follow instructions
- Large 1/2" LED readout with AM/PM & colon indicators
- Simulated LED swinging pendulum with synchronized tick-tock sound.
- Chimes the hour (ie: 3 times for 3 o'clock)
- Adjustable volume tone and sustain on the chime.
- LOW COST
- Complete with all parts including transformer & speaker.

\$39.95 kit

\$59.95 (assembled & checked out)

### SOLID WOOD CLOCK CASE

Handcrafted specifically for the Grandfather Clock (see picture above) MADE FROM SELECT SOLID HARDWOOD. These beautiful cases are custom cut for the Mini Grandfather clock and available in either ASH or WALNUT. Case comes with pre-cut ruby front lens and back panel. The PC boards slide easily into two internal grooves to make installation quick and easy. Choose from the following:

Complete case assembled and finished — \$19.95

Complete case kit. All pieces pre cut and notched, but unstained and unfinished — \$15.95

PLEASE SPECIFY TYPE OF WOOD DESIRED, ASH OR WALNUT

## ULTRASONIC SENDER-RECEIVER KIT

A special buy on a high quality ultrasonic transducer allows us to offer this kit at a super price — but hurry, quantities are limited! You can build intrusion alarms, motion detectors, remote controls, echo ranging or liquid level measurement equipment. We supply the basic transmitter and receiver electronics including a drilled and plated PC board. The units work at 23KHZ with a range of 20 ft. and can be positioned opposite each other or side-by-side and bounced off a solid surface. The output will sink up to 300ma to drive a relay, alarm circuit, etc.

ORDER US-01

\$19.95

### AUTOMATIC TIME-OUT CIRCUIT

Gives a 17 second entry delay, then triggers an alarm, light, etc. with 5-10 minute (selectable) time. Device rearms itself after the cycle. Directly compatible with the US-01 and Warble Alarm. Triggers on a "low" going transition. Requires 12 VDC Will source or sink up to 200MA.

\$3.95

## WARBLE ALARM KIT

Everybody is talking about it! A dual tone ear shattering sound that is impossible to ignore. Resembles the European siren sound. EASY to assemble!

\$2.50

All necessary components & PC board, Less speaker.

5 to 10 watts output depending on speaker impedance. Useable from 3 to 15V (lower voltages gives reduced output). Requires 1 amp for full output.



### OUR CUSTOMERS WRITE ABOUT OUR CDI KIT:

"...great kit."  
"...unbelievable value", "...good design!"  
"...fantastic kit and service. Send three more."

The CDI kit is all these things and more. Get in on a one-time deal. Complete electronics. Requires heatsink (not included) also works for voltage source for high intensity strobe.

\$9.95

B8

### SMILING JACK SPECIAL! CLOCK/TIMER KIT (MK-03)

May we recommend the Aircraft Clock/Timer? Features 24 hour Zulu time and up to 24 hours of elapsed time on the same set of six digit LED readouts. Totally independent operation of both functions. Clock has pre-settable alarm with 10 minute snooze. Timer has reset, hold, and count functions. Full noise and overvoltage protection. 24 hour only. Readouts has dimmer feature or they can be turned off without disturbing the clock or timer. Timebase included (.01% accuracy). Because of the many options and mounting considerations the case and switches are not included. Switches are standard types. Will fit inside standard aircraft instrument case or the medium shadow case (see BF-01).

9-14VDC 150MA W/readouts on  
40MA W/readouts off

\$26.95

TAKE automatic 10% Discount on MDSE orders of \$50.00 or over.

### PS-12 HIGH CURRENT VARIABLE POWER SUPPLY KIT A LOW COST WAY TO HAVE A QUALITY VARIABLE BENCH SUPPLY.

ALL ELECTRONICS SUPPLIED  
LARGE COMPUTER GRADE FILTER  
PLATED PC BOARD  
UNIQUE PRE-REGULATOR ALLOWS COOLER OPERATION AT HIGH CURRENTS.  
3 to 16V & 15 to 30V (two ranges) @  
10A CONTINUOUS (15A with fan cooling)  
ADJUSTABLE CURRENT LIMITING  
SHORT CIRCUIT PROTECTION



\$49.95

Regulation: 240mv Load & Line  
Ripple: Less than .5V @ 30V & 10A.

Add \$3.70 for UPS shipping. Outside continental U.S. Add \$10.00 for Parcel Post & Insurance.

### OVER-VOLTAGE PROTECTION KIT (OVP-1)

\$6.95

The OVP-1 will protect your expensive gear from voltage surges, power supply malfunction or tampering hands on your voltage adjust. Every regulated power supply should have one. Cheap insurance for expensive equipment. Adjustable from 3 to 30 volts DC. Useable on Supplies up to 25 amps. Power supply must be fused. Directly compatible with the PS-12 Power Supply. PC board and all parts supplied, including 25A SCR.

### 6 DIGIT MINI MOBILE ALARM CLOCK KIT

Many of our customers who have bought our other mobile clock kits (MK-03 & MK-04), have requested a small mobile clock for in dash mounting. We put our engineer to work on it and the result is the compact MK-05. Designed to be a mobile clock from the ground up. There has been no compromise on quality. Take a look at the specs, price, size and compare it with any other clock kit on the market. We will be waiting for your order!

- Quartz crystal timebase
- Toroid and zener noise & voltage protection
- Magnified .15 inch, 6 digit LED readout with spacing between hours, minutes, & seconds
- Top Quality epoxy glass PC boards are drilled & plated
- No additional components are required
- Complete with presettable 24 hr. alarm (speaker NOT included)
- Can be used as elapsed timer
- Easy, quick assembly
- 9-14 VDC @ 40 to 50 ma
- Readouts can be turned off & the clock continues to keep time
- PC board Clock: 2.5"x2"
- Readout board: 2 3/8"x.75"

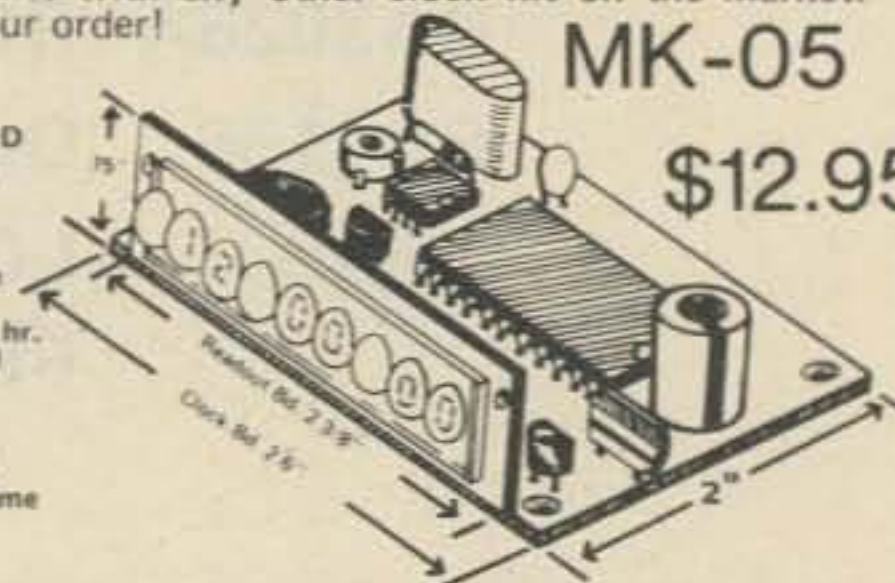

MK-05

\$12.95

TERMS: NO COD's \* Send check or M.O. \* Add 5% postage Tx. Residents add 5% sales tax \* Foreign add 10% (20% airmail) Orders under \$10. add 60c handling \* Repair service available Accepting phone orders on Master Charge and BankAmericard.



# SPECIAL PRICING!

## PRIME - HIGH SPEED RAM

# 21L02-3 400 NS

### LOW POWER - FACTORY FRESH

1-24 \$1.95 ea 100-199 \$1.60 ea  
25-99 1.75 ea 200-499 1.45 ea

OVER 500 PCS. **1.39** ea.

PRINTED CIRCUIT BOARDS for CT-7001 Kits sold separately with assembly info. PC Boards are drilled Fiberglass, solder plated and screened with component layout.

Specify for 7001 B, C or X - \$7.95

# 5-DIGIT LED CLOCK CALENDAR KIT

## DATE-TIME-SNOOZE ALARM & MORE... KIT 7001

FOR THE BUILDER THAT WANTS THE BEST. FEATURING 12 OR 24 HOUR TIME - 29-30-31 DAY CALENDAR. ALARM, SNOOZE AND AUX. TIMER CIRCUITS

Will alternate time (8 seconds) and date (2 seconds) or may be wired for time or date display only, with other functions on demand. Has built-in oscillator for battery back-up. A loud 24 hour alarm with a repeatable 10 minute snooze alarm, alarm set & timer set indicators. Includes 110 VAC/60Hz power pack with cord and top quality components through-out.

KIT-7001B WITH 6 - 5" DIGITS ..... \$39.95  
KIT - 7001C WITH 4 - 6" DIGITS & 2 - 3" DIGITS FOR SECONDS ..... \$42.95  
KIT-7001X WITH 6 - 6" DIGITS ..... \$45.95

KITS ARE COMPLETE (LESS CABINET)  
ALL 7001 KITS FIT CABINET I AND ACCEPT QUARTZ CRYSTAL TIME BASE KIT # TB-1



# 5 DIGIT LED CLOCK KIT #850-4

12/24 HR. OPERATION BIG .4" DIGITS - 50/60 HZ OPERATION.

- KIT INCLUDES**
- INSTRUCTIONS
  - QUALITY COMPONENTS
  - 50 or 60 Hz OPERATION
  - 12 or 24 HR OPERATION
- 6-LED Readouts (FND-359 Red, com. cathode)  
1- MM5314 Clock Chip (24 pin)  
13- Transistors  
3- Switches  
6- Capacitors  
5- Diodes  
9- Resistors  
24- Molex pins

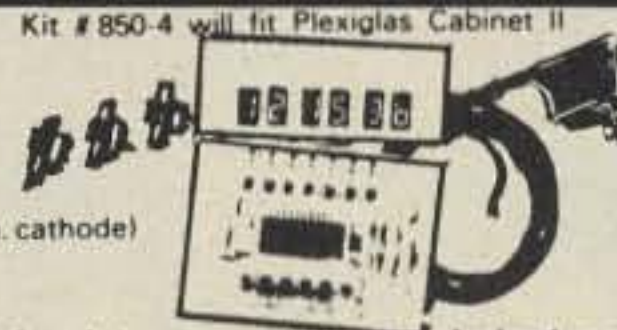

**\$11.95** QTY. 1-5 ea.  
**\$10.95** QTY. 6-11 ea.  
**\$9.95** QTY. 12 OR MORE ea.

"Kit #850-4 will furnish a complete set of clock components as listed. The only additional items required are a 7-12 VAC transformer, a circuit board and a cabinet, if desired."

PRINTED CIRCUIT BOARD FOR KIT #850-4, SCREEN PRINTED DRILLED AND SOLDER PLATED FIBERGLASS ..... \$2.95  
MINI-BRITE RED LED'S (FOR COLON IN CLOCK DISPLAY) .... Pkg. of 5-\$1.00  
MOLDED PLUG TRANSFORMER 115/10 VAC (WITH CORD) ..... \$2.50

NOTE: Entire Clock may be assembled on one PC Board or Board may be cut to remote display.

# MOBILE LED CLOCK

12/24 HR. **.4" DIGITS!**

MODEL 12 VOLT AC or DC POWERED  
#2001



- 8 JUMBO .4" RED LED'S BEHIND RED FILTER LENS WITH CHROME RIM
- SET TIME FROM FRONT VIA HIDDEN SWITCHES • 12/24-Hr. TIME FORMAT
- STYLISH CHARCOAL GRAY CASE OF MOLDED HIGH TEMP. PLASTIC
- BRIDGE POWER INPUT CIRCUITRY - TWO WIRE NO POLARITY HOOK-UP
- OPTIONAL CONNECTION TO BLANK DISPLAY (Use When Key Off In Car, Etc.)
- TOP QUALITY PC BOARDS & COMPONENTS - EXCELLENT INSTRUCTIONS
- MOUNTING BRACKET INCLUDED

KIT #2001 COMPLETE KIT (Less 9V. Battery) **29.95** EA. 3 OR MORE **\$27.95** EA. 115 VAC Power Pack #AC-1 **\$2.50** EA.

ASSEMBLED UNITS WIRED & TESTED (LESS 9V BATTERY) **\$39.95** EA. 3 OR MORE **\$37.95** EA.

WIRING FOR 12 HR. OP. IF NOT SPECIFIED OTHERWISE

**60 HZ. XTAL TIME BASE**  
Will enable Digital Clock Kits or Clock-Calendar Kits to operate from 12V DC. 1"x2" PC Board Power Req: 5-15V (2.5 MA. TYP.) Easy 3 wire hookup Accuracy: ± 2PPM #TB-1 (Adjustable) Complete Kit **\$4.95** ea. Wir & Cal **\$9.95**

# PLEXIGLAS CABINETS

Great for Clocks or any LED Digital project. Clear-Red Chassis serves as Bezel to increase contrast of digital displays.

## CABINET I

3"H, 6 1/4"W, 5 1/2"D Black, White or Clear Cover

## CABINET II

2 1/2"H, 5"W, 4"D **\$6.50** ea.

RED OR GREY PLEXIGLAS FOR DIGITAL BEZELS 3"x6"x1/8" **95c** ea. **4/3**

# SEE THE WORKS Clock Kit

## Clear Plexiglas Stand

- 6 Big .4" digits
- 12 or 24 hr. time
- 3 set switches
- Plug transformer
- all parts included

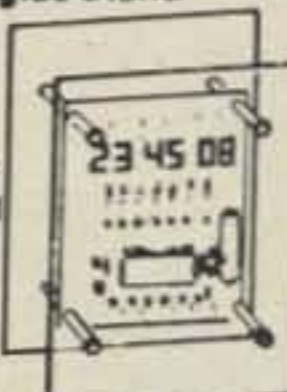

Plexiglas is Pre-cut & drilled  
Kit #850-4 CP

Size: 6"H, 4 1/4"W, 3"D

**\$23.50** ea. **2/45.**

A SUPER CLOCK!

# JUMBO DIGIT CLOCK

A complete Kit (less Cabinet) featuring: six .5" digits, MM5314 IC, 12/24 Hr. time, 50/60 HZ., Plug-Transformer, Line Cord, Switches, and all Parts. (Ideal Fit in Cabinet II) Kit # 5314-5 **\$19.95** 2/38.

WITH PC Board's

JUMBO DIGIT **\$9.95** ea.

CONVERSION KIT

Convert small digit LED clock to large .5" displays. Kit includes 6-LED's, Multiplex PC Board & easy hook-up info. Kit # JD-1CC For common Cathode Kit # JD-1CA for common Anode

# TELEPHONE FORMAT KEYBOARD

## BY Chomerics # EF-21360



**\$4.95** 6/28.

# NEW LSI TECHNOLOGY

# FREQUENCY COUNTER KIT

## 8 LARGE .4" RED LED DIGITS

Kit #FC-50 • 8 IC's • XTAL TIME BASE  
A truly "State of the Art" counter using quality components throughout.  
KIT INCLUDES: DETAILED INSTRUCTIONS, XTAL, TOP QUALITY FIBERGLASS DOUBLE SIDED PC BOARD, IC'S WITH SOCKETS AND ALL PARTS LESS POWER SUPPLY AND CABINET.

50 MHZ COUNTER KIT #FC-50 **\$69.95**

- 5 VOLT REGULATED 1 AMP POWER SUPPLY KIT #PS-02 **\$9.95**
  - 350 MHZ PRESCALER KIT #PSL-350 **23.95**
  - 650 MHZ PRESCALER KIT #PSL-650 **\$29.95**
  - CABINET (& MTG HARDWARE) #CAB III **\$19.95**
- [CABINET WILL HOUSE #FC-50, #PS-02, AND A PRESCALER]

# Fairchild Super Digit FND-359

4" Char. Ht. 7 segment LED RED Com. Cath. Direct pin replacement for popular FND-70. **95c** ea, **10/\$8.50** **100/\$79.00**

SET OF 6 FND-359 WITH MULTIPLEX PC BOARD **\$6.95**

NYLON WIRE TIES  
8" TIE-WRAP 100/\$1.95  
4" TIE-WRAP 100/\$1.75

PLUG TRANSFORMERS  
12 VAC at 150 MA \$ 2.50  
12 VAC at 500 MA 3.50  
7VAC at 1.75 VA \$3.50

# SCHOTTKY TTL

74S00 \$ .35  
74S01 .40  
74S04 .55  
74S05 .60  
74S09 .55  
74S10 .40  
74S20 .50  
74S22 .45  
74S40 .45  
74S50 .45  
74S51 .55  
74S60 .85  
74S64 .55  
74S74 .85  
74S75 1.75  
74S78 1.50  
74S86 .95  
74S107 .95  
74S112 .95  
74S113 1.40  
74S114 .95  
74S133 .75  
74S134 .75  
74S138 1.75  
74S139 1.50  
74S151 1.95  
74S153 1.95  
74S155 1.95  
74S156 1.95  
74S157 1.80  
74S158 2.50  
74S174 2.50  
74S175 2.50  
74S181 2.95  
74S182 1.95  
74S251 2.75

PRESCALE  
11C90DC \$15.95  
95H90 9.95

VOLTAGE REGULATORS  
LM309H TO-5 \$ .95  
LM309K TO-3 1.25  
7805 TAB .95  
7812 TAB 1.25  
7815 TO-3 1.50  
7815 TO-3 1.25  
7815 TAB 1.25  
78L15 TO-5 .75  
7824 TO-3 1.25  
723 DIP .75  
723 TO-5 .75

PROM  
1702 E Prom \$8.95  
5203 E Prom \$8.95

SPECIAL IC'S  
7207A INTERSIL  
7208 INTERSIL  
MC14553 MOT \$ 9.95  
MC14410 MOT \$12.50  
2513 SIG \$ 9.95

IC SOCKETS  
PINS 1-24 25 100  
8 \$ .25 \$ .22 \$ .20  
14 25 22 20  
16 28 25 23  
18 31 28 26  
24 50 45 40  
28 60 55 50  
40 75 70 65

XTAL  
5.242880 MHZ. \$4.95  
3.579545 MHZ. \$1.95

MOLEX PINS  
**\$9.95**  
Reel of 1000  
100 for \$1.25

LED DRIVERS  
7447 \$ .95  
7448 .95  
75491 .65  
75492 .65  
9288 2.50

# TRANSISTORS

2N2222 A TO 18 3/91.00  
2N2712 TO 98 5/91.00  
2N3415 TO 9 5/91.00  
2N3704 TO 92 5/91.00  
2N4400 TO 92 5/91.00  
2N4125 TO 92 5/91.00  
2N4249 TO 92 5/91.00  
2N4437 TO 92 5/91.00  
2N6027 PUT 2/91.00  
2N5457 N J-Fet 2/91.00

DIODES  
IN 4002 1A, 100 PIV 12/91.00  
IN 4005 1A, 600 PIV 11/91.00  
IN 4007 1A, 1000 PIV 10/91.00  
RECTIFIER 2.5A, 1000 PIV 4/91.00  
IN 914 SIL SIGNAL 20/91.00  
IN 4148 SIL SIGNAL 20/91.00  
DYAC 28V 4/91.00

LINEAR  
555 TIMER 2/91.00  
556 DUAL TIMER .95  
565 PLL .95  
566 FUNCTION GEN. 1.75  
567 TONE DECODER 1.75

TRANSISTOR SOCKET TO-5/18 GOLD PINS 5 \$1.00

7-SEG LED

COMMON CATHODE  
COLOR HT DEC PT PREA  
FND 359 RED 4" RHDP \$ 9.95  
FND 503 RED 5" RHDP \$1.35  
DL 750 RED 6" LHDP \$2.95  
XAN 654 GREEN 6" NDP \$1.95  
XAN 664 RED 6" NDP \$1.95

COMMON ANODE  
DL 747 RED 6" LHDP \$1.95  
XAN 72 RED 3" LHDP \$1.25  
MAN 72 RED 3" LHDP \$1.25  
XAN 81 YELLOW 3" RHDP \$1.75  
XAN 351 GREEN 3" RHDP \$1.50  
XAN 362 ORANGE 3" LHDP \$1.50  
XAN 662 RED 6" NDP \$1.95  
XAN 692 RED 6" NDP \$1.95

# OP AMPS

3/91.00  
301 TO-5  
709 DIP  
709 TO 5  
741 DIP  
741 M-DIP  
741 TO-5  
747 TO 5

DISCRETE LED'S  
JUMBO RED  
10 FOR \$1.00  
100 FOR \$9.50

PC TRIM POTS  
25K 6/\$1.00  
4.7K 6/\$1.00

SPECTROL 10K 10 TURN 95c 4/\$3.00

CMOS  
4001 \$ .20  
4002 .20  
4010 .40  
4011 .20  
4013 .40  
4015 .95  
4016 .40  
4023 .20  
4025 .20  
4027 .40  
4028 .85  
4030 .35  
4042 .75  
4044 .60  
4046 1.75  
4049 .40  
4050 .40

# AUTO BURGLAR ALARM KIT

AN EASY TO ASSEMBLE AND EASY TO INSTALL ALARM PROVIDING MANY FEATURES NOT NORMALLY FOUND. KEYLESS ALARM HAS PROVISION FOR POS. & GROUNDING SWITCHES OR SENSORS. WILL PULSE HORN RELAY AT 1HZ RATE OR DRIVE SIREN. KIT PROVIDES PROGRAMMABLE TIME DELAYS FOR EXIT, ENTRY & ALARM PERIOD. UNIT MOUNTS UNDER DASH - REMOTE SWITCH CAN BE MOUNTED WHERE DESIRED. CMOS RELIABILITY RESISTS FALSE ALARMS & PROVIDES FOR ULTRA DEPENDABLE ALARM. DO NOT BE FOOLED BY LOW PRICES! THIS IS A TOP QUALITY COMPLETE KIT WITH ALL PARTS INCLUDING DETAILED DRAWINGS AND INSTRUCTIONS OR AVAILABLE WIRED AND TESTED



KIT #ALR-1 **\$9.95**  
#ALR-1WT WIRED & TESTED **\$19.95**

# VARIABLE REGULATED 1 AMP POWER SUPPLY KIT

- VARIABLE FROM 4 to 14V
  - SHORT CIRCUIT PROOF
  - 723 IC REGULATOR
  - 2N3055 PASS TRANSISTOR
  - CURRENT LIMITING AT 1 Amp
- KIT IS COMPLETE INCLUDING DRILLED & SOLDER PLATED FIBERGLASS PC BOARD AND ALL PARTS (Less TRANSFORMER) KIT #PS-01 **\$8.95**  
TRANSFORMER 24V CT will provide 300MA at 12V and 1 Amp at 5V. **\$3.50**

**OPTOELECTRONICS, INC.**  
BOX 219 • HOLLYWOOD, FLA. 33022 • (305) 921-2056  
STORE: 823 S. 21 AVE.

WE PAY ALL SHIPPING IN CONTINENTAL USA - OTHERS ADD 5% [10% FOR AIRMAIL]  
SEE OUR BOOTHS AT THE ATLANTA HAMFESTIVAL - JUNE 18-19, 1977

ORDER BY PHONE OR MAIL  
COD ORDERS WELCOME  
Orders Under \$15 Add \$1.00 Handling  
Fla. Res. Please Add 4% Sales Tax.



**New!**

# Synthacoder



★ ALL NEW SYNTHESIZER/ENCODER FROM ENGINEERING SPECIALTIES  
THE ULTIMATE IN FREQUENCY CONTROL FOR IC-22S OWNERS!

No more soldering diodes every time you want to try a new repeater!  
Just plug the Synthacoder into the back of your radio, select channel 22, and the Synthacoder takes command of your radio — Giving you fingertip control of ALL frequencies.

- Front Panel Thumbwheel Control of All Channels!
- Fully Automatic Invalid Code Control!
- Small Size: 3 3/4" x 1 1/2" x 6"
- Factory Wired and Tested
- Easy To Install

**SPECIAL**  
only \$87.95  
postpaid  
CA Residents add 6% sales tax

## Engineering Specialties

P.O. BOX 2233  
1247 COMMERCIAL AVENUE  
OXNARD CA 93030  
(805) 486-0817

YES, I would like to purchase a Synthacoder for my IC-22S. Enclosed please find my \$87.95 (Price includes postage and handling). California residents add 6% sales tax.

\$\_\_\_\_\_ enclosed.  Cash  Check  Money Order  
 Please charge my  Master Charge  BankAmericard  
 Credit card # \_\_\_\_\_  
 Interbank # \_\_\_\_\_  
 Expiration date \_\_\_\_\_  
 Signature \_\_\_\_\_

- I'LL BITE! Please send more info.
- I'M HOOKED! Please RUSH my Synthacoder.

Name \_\_\_\_\_ Call \_\_\_\_\_  
 Address \_\_\_\_\_  
 City \_\_\_\_\_ State \_\_\_\_\_ Zip \_\_\_\_\_





# HOBB-Y-TRONIX, INC.

<p><b>BIG-BRIGHT - .5" LED ALARM CLOCK</b> 6 DIGIT AC or DC or ELAPSED TIMER KIT <b>\$19.95 Complete</b></p> <ul style="list-style-type: none"> <li>• PC Board Drilled &amp; Silk Screened (Includes Xtal Time Base Circuitry)</li> <li>• 5375 Nat. Clock Chip &amp; Fairchild Displays</li> <li>• Includes EVERY part required for clock and all options except Cabinet and Crystal Time Base components. If desired, see below.</li> <li>• Brightness Control</li> <li>• Freeze feat. on every mode</li> <li>• Field Tested over 1 Yr.</li> </ul> <p><b>Most Important</b> — Complete Instructions, schematics Pictorials, layouts — everything for trouble free assembly</p> <p>OPTION — XTAL Time Base Components - \$2.95 when purchased w/clock</p>	<p><b>WOOD CLOCK CABINETS</b></p> <p>Includes: Filter &amp; Back Walnut Grain or Black Leatherette Finish <b>\$5.00 ea.</b></p> <p>Dimensions (Inside) A — 1-13/16"H, 5 1/2"W, 4 1/4"D B — 1 1/8"H, 4 1/4"W, 4 1/4"D</p> <p>Extra Filters — Red, Smoke Blue, Amber, &amp; Green — \$ .60</p>	<p><b>AC/DC - ALARM Clock Kit - 12/24 Hr.</b></p> <p><b>\$7.50</b> quantities of 1-5      <b>\$6.50</b> quantities of 6 &amp; up</p> <ul style="list-style-type: none"> <li>• Your choice of Display Colors - Red, Green, Blue, Amber</li> <li>• Displays Hrs. &amp; Min. - Switch to Min. &amp; Secs. on Command.</li> <li>• AM/PM Indication</li> <li>• Field Tested for 6 months</li> </ul> <p>The kit will include a 5316 National Clock Chip, 4 Fluorescent Display tubes, all electronic components, switches, controls &amp; complete instructions, specs, etc. for clock and all optional Features. Other parts required or if desired are as follows:</p> <ul style="list-style-type: none"> <li>• PC Board, Drilled &amp; Silk Screened ..... \$3.00</li> <li>• Xformer (for AC oper.) — \$1.00 App. (SCR output) timer kit — \$2.00</li> <li>• Speaker Alarm Kit — \$2.00 Countdown (turn-off) timer kit — \$2.00</li> </ul>
---	--	---

<p><b>CLOCK CHIPS</b></p> <p>MM5314 ..... \$3.50 MM5316 ..... 3.50 MM5387 (Hi Cur. 5316) ..... 3.95 MM5375 ..... 3.95 CT7001 ..... 7.95 CT7010 ..... 6.95</p>	<p><b>LED DRIVERS</b></p> <p>SN7447 ..... .95 ITT200 ..... .50 ITT201 ..... .50</p>
<p><b>CRYSTALS</b></p> <p>3.579545 MHZ ..... \$1.95</p>	<p><b>TRANSFORMERS</b></p> <p>Plug type-12VAC 250MA. .... 2.50 PC Mnt.-12VAC 250MA ..... 1.50 Bkt Mnt.-5VAC 6 Amp. .... 4.95</p> <p><b>IC SOCKETS</b></p> <p>8 Pin ..... 5 for 1.00 14 Pin ..... 5 for 1.00 16 Pin ..... 4 for 1.00 18 Pin ..... 4 for 1.00 24 Pin ..... 3 for 1.00 28 Pin ..... 3 for 1.00 40 Pin ..... 2 for 1.00</p>

**THE BIG ONE**  
**.8" LED Alarm Clock Kit**

*Big Digits*      *Big Bargain Price*

*simple construction*      **\$17.95 Complete**



Includes:  
Power Supply, Speaker, IC Socket  
PC Board, Clock Chip, Switches  
Fairchild .8" Display Module, resistors, resistors, capitors, Complete Instructions

Features:  
• Hrs. & Min. Switch to Min. & Sec. on Command  
• 12 Hr. - 24 Hr. Alarm  
• 10 Min. Snooze  
• AM/PM Indicators  
• Sleep Output

**7 SEG LED DISPLAYS**

FND359 Common Cathode Red ..... \$ .90  
DL704/707 C.C./C.A. 33" Red ..... 1.00  
FND503/507 C.C./C.A. 50" Red ..... 1.25  
DL747/750 C.C./C.A. 60" Red ..... 1.95  
FND8000 C.C. .80" 4 Digit Mod. Red ..... 4.50

**SWITCHES**

Pushbutton-Mon. On ..... 3 for 1.00  
Mini Toggle-SPDT ..... 1.25  
Mini Toggle-SPDT On-Center Off-Mon On ..... 1.25  
Mini Toggle-DPDT ..... 1.50  
Rocker SPDT ..... 6 for 1.00  
Rocker DPDT ..... 5 for 1.00

**The SUPER COMPACT**  
**\$13.95 Complete**



Includes: All Parts, PC Board Power Supply & Case  
Colors: Black, Silver, or Gold  
Size: 4.75" x 1.8" x 1.4"  
Material: Extruded Alum.

OPTION — Temperature Ind. Front Panel — \$3.00

Features:  
4-large .4" LED Displays  
12/24 hour Format

**60 HZ. CRYSTAL TIME BASE KIT**  
**\$4.95**

Use with Digital Clocks for 12VDC or Portable Operation

**KIT INCLUDES:**  
PC Board, 5369 Divider Chip  
3.5795 MHZ XTAL & All Other Parts  
Complete Instructions

**6 DIGIT LED MOBILE Clock Kit & Elapsed Timer**



4" Digits 12 or 24 Hr.  
Quartz Crystal Controlled  
12 Volt DC or AC operation

**\$27.95 Complete**  
(less 9V battery)

- Protection from noise & High Impulses
- Display Blanking Capability
- Battery Back-Up Capability
- Size 4" x 1 1/4" x 4 1/2"
- Rugged High Impact ABS
- Recessed Front Switches

OPTION — AC Adaptor \$2.50

**MA1003 (National) Mobile Clock Module .. \$24.95**

**Voltage Regulators**

Positive-To 220 Pkg.	Negative-To 220 Pkg.
7805 ..... \$1.00	7905 ..... \$1.25
7806 ..... 1.00	7912 ..... 1.25
7812 ..... 1.00	7915 ..... 1.25
7815 ..... 1.00	
7824 ..... 1.00	LM309K ..... 1.25

**SPECIALS**

Jumbo Red LED's ..... 10 for 1.00 100 for 9.00  
25 Pk. LED's Asstd. Sizes & Colors ..... 2.50  
Bi-Polar LED Red/Green ..... 1.00

Transistors	Bridges
2N2222A ..... 4/1.00	1 1/2 Amp 200 volt ..... 3/1.00
2N3904 type NPN ..... 8/1.00	6 Amp 600 volt ..... 3/2.00
2N3906 type PNP ..... 8/1.00	25 Amp 200 volt ..... 3/5.00
2N3055 (NPN, TO-3) ..... .75	
2N4904 (PNP, TO-3) ..... .85	95H90 ..... 8.95
	11C90 ..... 14.95

**SPRAGUE IC'S**

ULN-3306M Dual Schmitt Trigger ..... \$.75 ea. 5 for \$3.00  
ULN-2285 Audio Amp. 3-5 watts ..... \$1.25 ea. 6 for 5.00

**6 Digit LED Stop-Watch Kit**  
**\$29.95 complete**

Split Time      Taylor Time

**FEATURES:** Reads minutes, seconds, & 100ths of seconds  
6 bright easily readable digits  
Needs only 1.9 volt Xistor battery

**KIT INCLUDES:**

- Hand held case designed for above
- Latest Technology Intersil Mos Chip # 7205
- 3.2768 MHz Crystal
- 2 mini slide & 3 MOM. PB Switches
- 3 pairs (6 digits) Double Digit LED Displays
- P.C. BOARD for above

**Blinky/Flasher/Timing Kit**  
**\$2.50 each      5 for \$10.00**

Kit includes:  
P.C. Board, 555 Timer, all components and a connector for a 9V Battery

**COMPUTER CORNER**

2102 Sig. or Fair ..... \$1.35  
8 for 9.00

Memories: 2102-1 Sig. Hi Speed ..... 1.50 ea.  
8 for 10.00

21102-1 Fair-Hi Speed-Low Pwr. .... 1.95  
8 for 12.00

Prom: 82S23 ..... 3.00  
Microprocessor - 8080A ..... 14.95

Ribbon Cable 28 gauge

	1-10 ft	10-25 ft	25-100 ft
12 to 20 conductor	.25/ft	.20/ft	.15/ft
24 to 36 conductor	.30/ft	.25/ft	.20/ft
40 to 50 conductor	.35/ft	.30/ft	.25/ft

Specify color cable desired-Gray, Blue, & Pink



# GODBOUT

BILL GODBOUT ELECTRONICS  
BOX 2355, OAKLAND AIRPORT, CA 94614

**TERMS:** Please allow up to 5% for shipping; excess refunded. Californians add sales tax. Street address must be included for COD orders. Place BankAmericard® and Mastercharge® orders (\$15 minimum) by calling our 24 hour order desk at (415) 562-0636.

**FREE FLYER:** Just give us the word and we'll send out a copy of our flyer, which describes our complete line of products in greater detail.

## SPECIAL #1

### 12 Volts, 350 mA

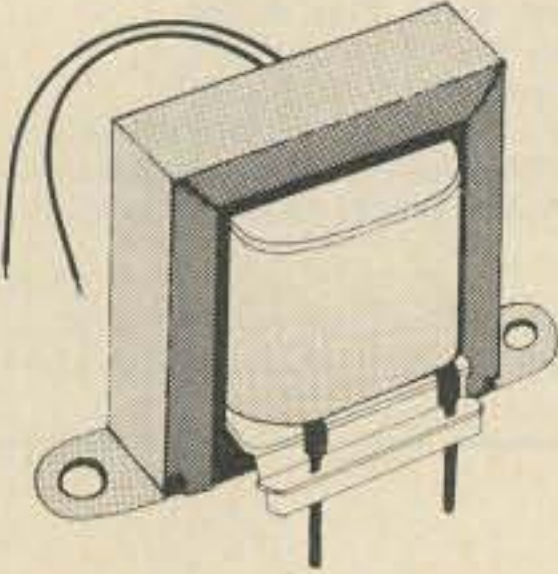

**\$1.50**

Good through 7/31

Regular price \$1.95

## SPECIAL #2

Good through 7/31

### 30A DC RECTIFIER

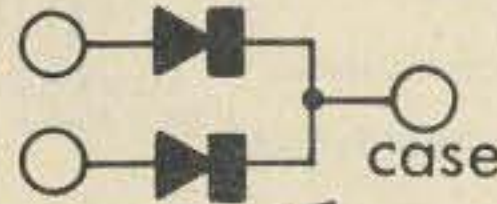

**\$1.95**

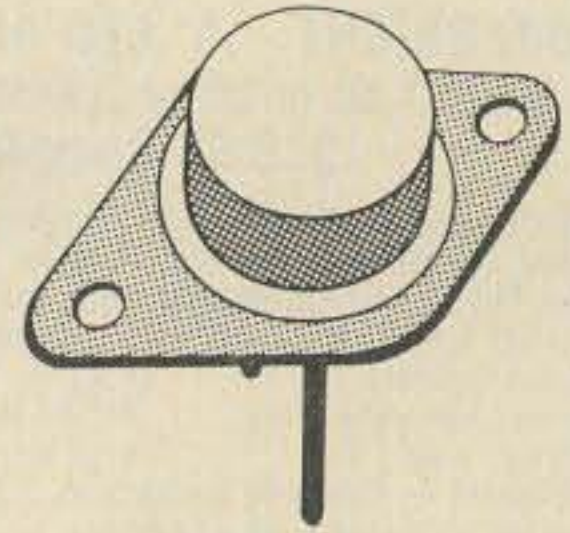

**INCLUDES finned heat sink and socket**

## MOTHERBOARD \$89

Use with the IMSAI microcomputer as an add-on with room for 10 peripherals, or for starting an 11 slot stand-alone system. Comes with 10 edge connectors---lots of places would charge you the cost of our Motherboard for these alone. Active, regulated terminations, included on board, minimize the crosstalk, noise, overshoot, and ringing you can find on improperly terminated busses. And of course, we use an epoxy glass board, with bypass caps and heavy power traces included. Get yourself one of these, a Morrow Sigma-100 Front Panel, some ECONORAM II boards and a power supply, and you're well on your way to a powerful system at a really good price.

**...also 18 SLOTS \$124**

## Small System Power Supply

Finally, a quality, cost-effective supply for small systems. Gives you a full 4 Amps at 5 Volts, with crowbar overvoltage protection, along with half an Amp of +12 and half an Amp of -12...and an additional 10 mA supply, adjustable over 5 to 10V for biasing required by some CPUs. Although intended to be used with computer systems, it's also a dandy little bench supply for digital experiments.

**\$45**

## HI-FI CABLES

**10/\$4.40**

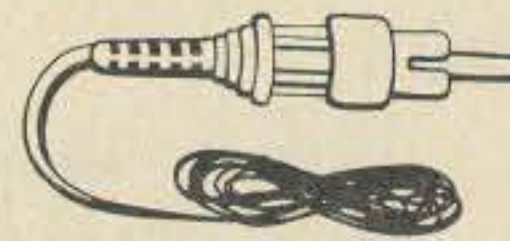

RCA plug at one end; tinned wires at other end. FOURTEEN FEET min. length. Great value for audio!

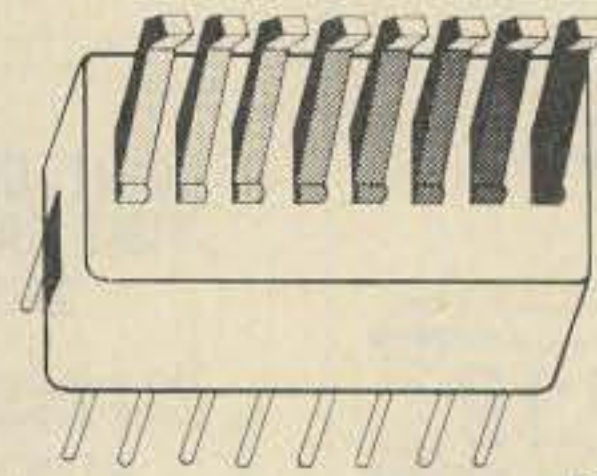

**EIGHT POLE SINGLE THROW**

**\$1.95 TOGGLE ACTION**

## Power Transformer

\$22.50 (+ postage for 6 lbs) brings you a hefty transformer. 117 VAC primary, 16V @ 12A RMS secondary. Custom made to our specifications for high power applications. Order part #G111.

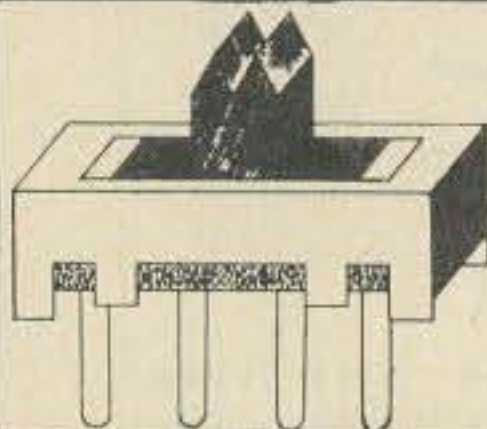

**SUBMINI PC MOUNT SLIDE SWITCH**  
Center off SPDT. Only 5/8" by 1/4" with pins on 1/8" centers. A VERY GOOD BUY.....10/\$2



## CRYSTALS

STATEK 3-lead xtals give .01% accuracy in a TO-5 can; use for fixed freq oscillators or with binary dividers to generate other freqs. Choose from (all freqs in KHz)

10.000	12.800	15.360	16.000	16.384	18.641	19.200	20.480	30.720	31.500
32.768	38.400	40.960	60.000	76.800	100.00	153.60	240.00		

**ALL STATEK CRYSTALS ARE \$5 EACH.**

The following crystals are series mode, fundamental, with wire leads...for hams and computer bugs. Choose from 4, 5, 8, 9, 10, 12, 15, 18, and 20 MHz (all \$5 each). Also available: 500 KHz (\$5), 1 MHz (\$6), and 2 MHz (\$5.50).

**20 uF, 16 Volt axial cap 10/\$1**



**\$5.00**



## OUR FIRST T-SHIRT!

We knew it had to come to this some day, what with CAVE Grafix being T-shirt fanatics: so here it is, our very own T-shirt. It's 100% cotton, fully washable, and made by Haynes...so you know it's good. Specify small, medium, or large.







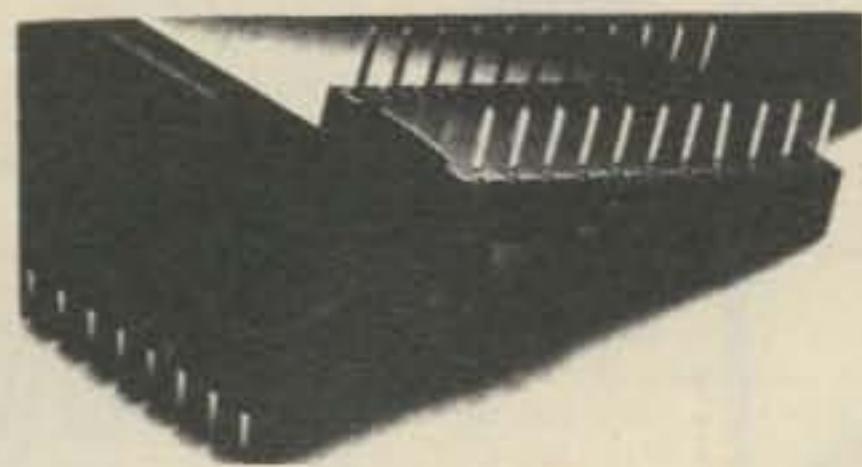

High quality sockets for IC's and PC interconnections. Check our price and quality and you will see why TRI-TEK is fast becoming the leader in IC sockets.

Low Profile DIP Solder Tail (Tin)

	1-9	10-24	25-100
SKT-0802 8 pin	.15	.15	.14
1402 14pin	.18	.17	.16
1602 16pin	.20	.19	.18
1802 18pin	.27	.26	.25
2002 20pin	.29	.28	.27
2202 22pin	.35	.34	.33
2402 24pin	.36	.35	.34
2802 28pin	.42	.41	.40
4002 40pin	.60	.57	.53



3 Level Wire Wrap Gold

	1-9	10-24	25-100
SKT-1400	.38	.37	.36
1600	.42	.41	.40
1800	.73	.65	.59
2400	1.00	.91	.83
4000	1.69	1.51	1.37

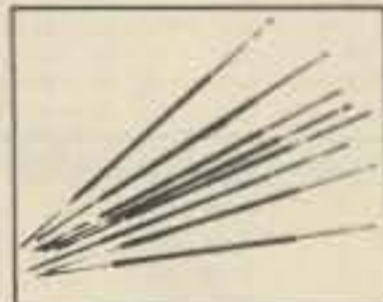

PRESTRIPPED WIRE WRAP WIRE

Highest quality 30 ga. Kynar insulated silver plated wire for wrapping. Stripped 1" on both ends. Indicated lengths are lengths of insulated portion. Packed 100 per sturdy plastic vial or 1000 per poly bag. Compare our prices!!! Available in Black, Red, Yellow and Green. State color desired.

Length	Price per tube of 100	Price per bag of 1000
1"	\$1.48 (WW30VC-1)	\$11.84 (#WW30BK-1)
2"	\$1.60 (WW30VC-2)	\$12.80 (#WW30BK-2)
4"	\$1.85 (WW30VC-4)	\$14.80 (#WW30BK-4)
6"	\$2.20 (WW30VC-6)	\$17.60 (#WW30BK-6)

ROLLS OF WIRE SAME AS ABOVE (30 ga. KYNAR)  
100 ft...\$2.95 500ft...\$8.95 1000ft...\$14.95

IC INTERCONNECT ASSEMBLIES



SINGLE END

No Of Pins	Length					
	6"	12"	18"	24"	36"	48"
14P	1.51	1.62	1.72	1.83	2.05	2.26
16P	1.64	1.76	1.87	1.99	2.21	2.44
24P	2.49	2.69	2.88	3.08	3.48	3.87
DOUBLE END						
14P	2.76	2.87	2.97	3.08	3.30	3.51
16P	3.01	3.13	3.24	3.36	3.58	3.81
24P	4.55	4.75	4.94	5.14	5.54	5.93

AMPLANNY

Says

Everything's coming up bargains at Tri-Tek!



78HGKC 5A VARIABLE REGULATOR

NOW- at last, a high current adjustable regulator. Same simple circuitry as the popular 78GKC. Needs only two external resistors to program to any voltage between +5 and 30V @ 5A output.

78HGKC.....\$13.95  
Spec..... .30

NEW BOOK

NEW 1977 VERSION OF NATIONAL'S CMOS

Greatly expanded now contains 530 pages of data on the 74C series as well as the popular 4000 series. Also has data and applications on the more complex CMOS products for which National has become famous.

CMOS DATA BOOK- 77 Edition by National.....\$3.95



PROFESSIONAL TEMPLATES-LOGIC SYMBOLS-Stand MIL806-B  
3/4 Size.....\$3.50  
1/2 Size.....(Handy shirt pocket size).....\$3.25  
Computer Flow Chart Symbols.....\$3.50

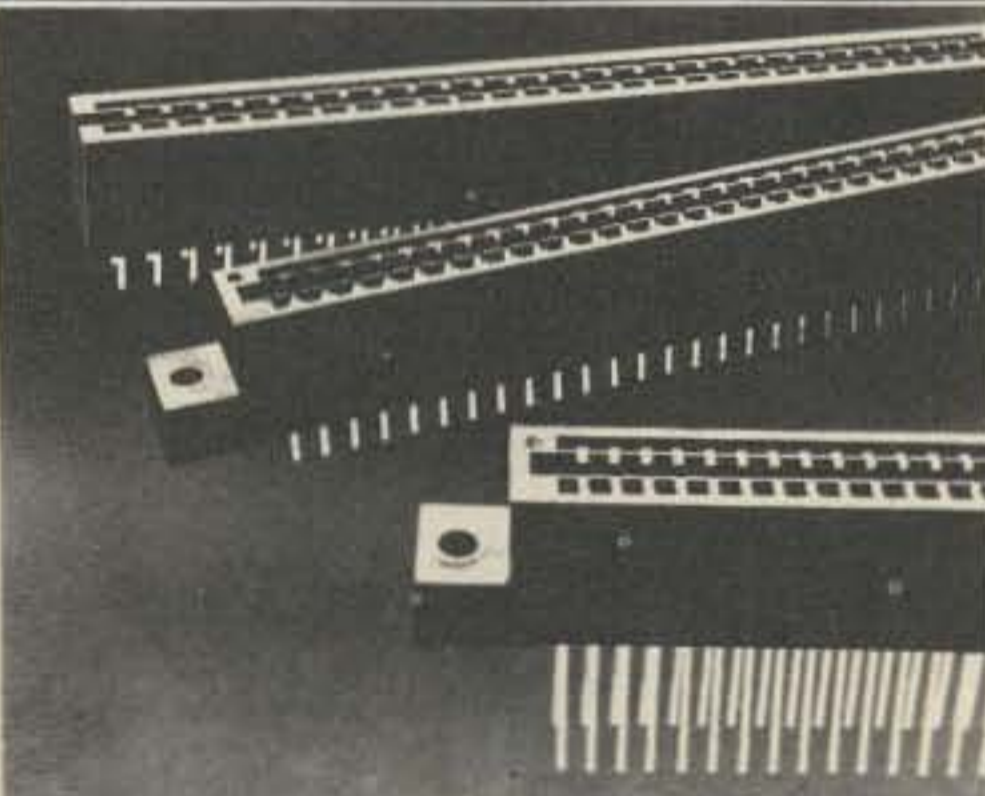

100 PIN MINICOMPUTER PC CONNECTORS

2X50 with .125" spacing. Solder tail or wrap terminals. By TI.  
PCC-100ST (solder)....\$4.99 PCC-100WW....\$4.99 4/\$17.75

SIGNETICS 8000 SERIES TTL LOGIC

These quality units are faster and have greater fan-out capability than standard TTL. From a giant factory change-over you get real bargain prices. All are house numbered, but we provide a reference and pin-out sheet.

N8880A...Quad-2 input NAND gate.....8/\$1.00  
N8822A...Dual J-K master/slave F/F.....4/\$1.00  
N8885A...Quad 2-Input NOR gate.....8/\$1.00  
N8890A...Hex Inverter.....6/\$1.00  
N8202A...10 bit "D" type register..... \$1.25

The following items are available in large quantities Dealer or manufacturer inquiry is invited.

2N3414.. NPN switch on reels.....10/\$1  
1N753A.. 6.2V, 5%, 1/2W Zener..... 5/\$1  
C106F2.. 50V, 4A SCR w/socket..... 3/\$1  
1N967B.. 18V, 5%, 1/2W Zener..... 5/\$1  
42501-1 Quad Ht speed NPN transistor in 14 pin DIP package. Similar to Motorola MPQ3303..... 5/\$1

MCM6571A is an 8192-Bit Horizontal-Scan (Row select) character generator with shifted characters. It contains 128 characters in a 7X9 matrix, and has the capability of shifting certain characters that normally extend below the baseline, such as j,y,g,p and q. A 7-bit address code is used to select one of the characters.

Features:

- .Static operation
- .TTL compatability
- .CMOS compatability (5V)
- .Shifted character compatability
- .Includes Greek alphabet
- .Maximum access time =500ns

(See article in March '77 issue of 73 Magazine for applications including TV-Computer interface)

MCM6571A..... \$9.95  
Specs..... \$1.00

MM5320 TV SYNC GENERATOR I.C.

Generate all the sync pulses necessary for camera or video terminals. Use with MCM6571A in the TV-Computer interface. MM5320N.....\$18.80  
Specs..... 60c

C30-1 400V, 25A Stud SCR..... \$2.25  
SC45E 500V, 10A Stud Triac..... \$1.59  
Insulated Stud 400V, 10A TRIAC assembly with built-in diac. TRI-133..... \$1.85

TIP-30 40V, 1 amp PNP Plastic..... 50c  
TIP-33 40V, 10Amp NPN Plastic..... \$1.00

LM1815 ADAPTIVE SENSE AMP CHIP.

Used with motor control to adapt to variable input and noise levels. Applications include zero crossing switch, motor control, tachometers, motor testing.

LM1815N.....\$5.72  
Specs..... 30c

1N5393 200V, 1.5A Diode. Sturdy replacement for 1N4003 at a good savings.....15/\$1

2N2369 High Speed NPN switching transistor. Marked for a giant computer company with house number. TO-18 metal case. PRIME PARTS!!!!

#2501-12....(2N2369 House Numbered)..... 8/\$1

LM7812KC/LM340-12. Brand new, industrial excess inventory brings you a real bargain in this +12V, 1A regulator. Made by Silicon General for one of those big "puter companies.

LM7812KC/340-12..... \$1.49!!!

2N3902. High voltage NPN. VCEX=700V, VCEO=400V, IC=3.5A, PD=100W.  
2N3902...SUPER SURPLUS BARGAIN!!!!.....\$3.00

1N2071. 600V, 750mA diodes.....15/\$1.00

"COOK BOOKS"

The famous Howard Sams "Cook Book" series tells you what and how in a broad range of subjects. Probably the most widely referenced works in their fields.

Prices quoted include shipping (U.S. only)

TTL Cookbook.....328 pages.....\$9.95  
Active Filter Cookbook.....223 pages..... \$15.95  
CMOS Cookbook.....402 pages..... \$10.95  
IC OP AMP Cookbook.....579 pages..... \$14.25  
TV Typewriter Cookbook.....250 pages..... \$10.95

MC14411 BIT RATE GENERATOR.

Single chip for generating selectable frequencies for equipment in data communications such as TTY, printers, CRT's or microprocessors. Generates 14 different standard bit rates which are multiplied under external control to 1X, 8X, 16X or 64X initial value. Operates from single +5 volt supply. MC14411..... \$11.98

4 pages of data..... .40  
Crystal for the above..... \$4.95

- Accuracy: ±0.05% of Reading ±1 Count
- Two Voltage Ranges: 1.999 V and 198.9 mV
- Up to 25 Conversions/s
- Z<sub>in</sub> > 1000 M ohm
- Auto-Polarity and Auto-Zero
- Single Positive Voltage Reference
- Standard B-Series CMOS Outputs-Drives One Low Power Schottky Load
- Uses On-Chip System Clock, or External Clock
- Low Power Consumption: 8.0 mW typical @ ±5.0 V
- Wide Supply Range: e.g. ±4.5 V to ±8.0 V

MC14433 SINGLE CHIP 3 1/2 DIGIT A/D

Single chip combines linear and CMOS digital to bring you the simplest yet DVM approach. Requiring only 4 external passive parts, this subsystem gives you: Auto polarity, auto zero, single voltage reference, 8 mW operation, overrange, underrange signals, 25 conversions per second and .05% ± 1 count accuracy! 100 uV resolution. 24 Pin DIP.

MC14433P.....with specs.....\$19.55



TRI-TEK, INC.

6522 NORTH 43RD AVENUE,  
GLENDALE, ARIZONA 85301  
phone 602 - 931-6949

We pay surface shipping on all orders over \$10 US, \$15 foreign in US funds. Please add extra for first class or air mail. Excess will be refunded. Orders under \$10, add \$1 handling. Please add 50c insurance. Master charge and Bank America cards welcome, (\$20 minimum). Telephone orders may be placed 10AM to 5:30PM daily, Mon thru Fri. Call 602-931-4528. Check reader service card or send stamp for our latest flyers packed with new and surplus electronic components.



# ALDELCO COMPUTER CENTER NOW OPEN!

Kits, Books, Boards, Magazines. Special 2102LI 8 for \$17.50. 8080A CPU Chip \$19.95. We stock OK Battery Operated Wire Tool \$34.95, OK Hand Wire Wrapped Tool \$5.95. 7400 ICs CMOS, Timers PLL's IC Sockets. All kinds of transistors, rectifiers and diodes. Plus other electronic parts.

HOURS: MONDAY TO SATURDAY, 9:30-5:00 OPEN WEDNESDAY UNTIL 9 PM (516) 378-4555.

We quote on any device at any quantity. Add 5% for shipping. Minimum order \$6.00. Out of USA send certified check or money order, include shipping costs.

BUILD THE W7BBX PROGRAMMABLE KEYS. WE CAN SUPPLY THE FOUR PC BOARDS AND COMPREHENSIVE CONSTRUCTION MANUAL - ALL FOR ONLY \$29.95.

## TTL SPECIALS

74H10 Dual 4 Input Buffer	\$ .20
7490 Decade Counter	.49
74S175 Quad Flip-Flop with clear	.99
74283 4 Bit Binary Adder	.99

2 1/2" round speaker, 8 Ohms	\$1.00
2 1/2" round speaker, 100 Ohms	.75
7 volt AC plug in	XMFR - 1.75 MA .350
Brand New GE Stereo Tape Amplifier Board with all components 4 Watts 12 V ac supply limited	3.50
Mono Amplifier Board 1 control	2.25
6 foot black or brown zip cord and plug	.35
RG174 50' coil	4.50
2 1/4" round speaker, 8 Ohms	.75
VHF Ferrite Beads	15 for 1.00
Ham & CB Slide Mounts with lock & coax connectors	8.95
2 Amp Bridge Rectifier, 200 Volt	.50
2 Amp Bridge Rectifier, 600 Volt	1.25
3 Amp Bridge Rectifier, 200 Volt	.85
Gould AA 500 mA Nicads	1.69
2 Amp 1000 volt rectifier	10 for 1.00
LM 723 14 pin Voltage Reg	.49

## RF DEVICES

2N3375 3W 400 MHz	\$5.50
2N3866 1W 400 MHz	1.15
2N5589 3W 175 MHz	4.75
2N5590 10W 175 MHz	7.80
2N5591 25W 175 MHz	10.95
2SC517	3.95
2SC1226	1.25
2N6080 4W 175 MHz	5.40
2N6081 15W 175 MHz	8.45
2N6082 25W 175 MHz	10.95
2N6083 30W 175 MHz	12.30
2N6084 40W 175 MHz	16.30
2SC1306	4.30
2SC1307	5.25
2N2876	special 10.95

## ZENERS

1N746 to 1N759	400 Mw	ea. .25
1N4728 to 1N4764	1 watt	.28
1N5333 to 1N5378	5 watt	2.10
1N2970 to 1N3005	10 watt	2.40
1N3305 to 1N3340	50 watt	4.75

.01 Disc. CAP 30 Volt	10
50 MFD 150 Volt Mal. TC49A	.30

AL 215 (GE 215)	\$4.50
AL 216 (GE 216)	7.95
2N3055	.99
MPF102 FET	.55
2N3904 or 2N3906	.25
2N5496 or 2N6108	.70
MJE340 (2N5655)	1.10
40673 RCA FET	1.55
741 or 709 14 Pin DIP	.25
555 Timer	.75
556 Dual 555	1.75
200 Volt 25 Amp Bridge	1.50
1N914-1N4148	15 for .99
1N34-1N60-1N64	10 for .99
CA 3028 Dif. Amp	1.50
4060 CMOS	2.00
LM309K Volt Reg	1.10
MJ3055	2.20
5313 Clock Chip	3.95
5314 Clock Chip	4.50
82S23	4.95
2N6103	.89
LM309 or 741 Min DIP Op Amp	.45
LM741CE T05 Op Amp	.45
14 or 16 Pin IC Sockets	.30

1K or 10K 1/4 Watt resistors	100/\$2.50
------------------------------	------------

2N398A	2.50	2N2926Y	.24	2N3646	.27	2N5401	.95	2N3926	6.30
2N2218	.45	2N3053	.50	2N3713	1.35	2N5016	17.60	2N4041	7.80
2N2219	.35	2N3390	.75	2N3725A	1.80	2N5090	7.50	2N4249	.25
2N2222A	.30	2N3439	1.59	2N3771	2.50	2N5129	.40	2N4400	.60
2N2369	.20	2N3440	1.10	2N3772	2.50	2N5179	.90	2N4402	.25
2N2483	.34	2N3512	1.15	2N3773	4.95	2N5306	.50	2N4403	.25
2N2484	.45	2N3553	1.40	2N3819	.35	2N5457	.50	2N4409	.19
2N2905	.35	2N3565	.22	2N3903	.20	2N5458	.50	2N4427	1.35
2N2907	.25	2N3584	2.30	2N3905	.25	2N5913	1.70	2N4429	7.65
2N2926G	.24	2N3638A	.37	2N3924	1.80				

## ALDELCO KITS

**STOPWATCH KIT** Operates on a 9 Volt battery. Includes Crystal, Switches, 7205 MOS Chip & LED Displays and Board \$29.95  
**STOPWATCH HAND CASE** for above \$3.95  
**CLOCK CABINETS** Beautiful wood simulated walnut grain \$4.95  
 Plexiglas in Blue, White, Black or Smoked \$3.95  
**SIX DIGIT AUTO OR BOAT DIGITAL CLOCK KIT** Has a beautiful Charcoal Grey moulded high temperature plastic case with chrome rim. Dimensions are 1 3/4" high x 4" wide x 4 1/2" deep. Large 0.4 LEDs display hours, minutes and seconds. Works on 12 Volt AC or DC as well as automatic switching to a 9 Volt Battery for power failures. Battery (not supplied) fits in case. Provision for blanking display LEDs for out of car or boat use. Adjustable Crystal Time Base included,

as well as Mobile Mounting Bracket.  
**KIT ONLY** \$29.95  
 Three or more kits 27.95  
 Wired and Tested 39.95  
 Power Pack for use on AC 2.95  
**NOW NEW IMPROVED DIGITAL ALARM CLOCK KIT** Hours, Minutes, Seconds displayed on six BIG 0.5 Fairchild 7 Segment Display LEDs 12-hour format 24-hour alarm with snooze feature, plus elapsed time indicator and freeze feature. Eight pages of pictorials and instructions. NEW on-board power transformer and circuitry for optional time base \$19.99  
 60 Cycle time base kit for DC use in automobile or for battery operation \$4.95  
**12 OR 24 HOUR CLOCK KIT.** Comes with Big 0.5 Seven Segment LEDs. Uses National 5314 Clock Chip. Fits our Walnut Grain or Plexiglas Cabinets. ONLY \$18.95

**NOW!**

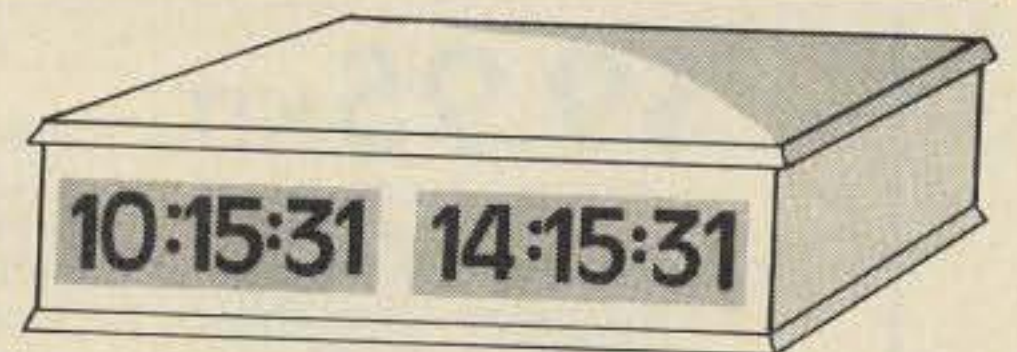

## 2 Dual Digital 12-24 hour clock kits

### MODEL ALD5:

Six big .5 display LEDs in an attractive black plastic cabinet with a red front filter. Great for a ham or broadcast station. Set one clock to GMT the other to local time. Or have a 24 hour format on one clock and 12 hour on the other. Freeze feature lets the clock be set to the second. Each clock is controlled separately. Cabinet measures 2 1/4" x 4 1/4" x 9 1/4". Complete Kit \$44.95.

### MODEL ALD7:

Four bright .3 nixie tube display. Cabinet is an attractive deep blue including front filter. Will display seconds at the push of a button. An asset to any station. Cabinet size is 2 1/4" x 3" x 9 1/4". Complete Kit \$34.95.

**ALDELCO**

2281A BABYLON TURNPIKE, MERRICK NY 11566  
 516-378-4555



# S. D. SALES CO.

P.O. BOX 28810 - A  
DALLAS, TEXAS 75228

## JUMBO LED CAR CLOCK

**\$16.95 KIT**

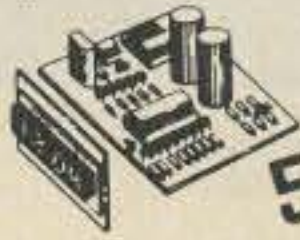

**50,000 Satisfied Clock Kit Customers Can't Be Wrong!**

ALARM OPTION - \$1.50  
AC XFMR - \$1.50

*The Hottest Selling Kit We Ever Produced!*

You requested it! Our first D.C. operated clock kit. Professionally engineered from scratch. Not a makeshift kluge as sold by others.

**Features:**

- A. Bowmar Jumbo .5 inch LED array.
- B. MOSTEK - 50250 - Super Clock Chip
- C. On board precision crystal time base.
- D. 12 or 24 hour Real Time Format.
- E. Perfect for cars, boats, vans, etc.
- F. P.C. Board and all parts (less case) included.

### Specials!

3.579545  
MHZ Time  
Base Crystal  
\$1.25

39 MFD  
16V Mallory  
Electrolytic  
15 for \$1.

28 PIN IC  
Sockets  
3/\$1.00  
11,000 MFD  
50WVDC  
Computer  
Grade  
Cap - \$3.

**60HZ Crystal  
Time Base  
\$5.95**

**FEATURES:**

- A. 60HZ output with accuracy comparable to a digital watch.
  - B. Directly interfaces with all MOS clock chips.
  - C. Super low power consumption (1.5MA typ.)
  - D. Uses latest MOS 17 stage divider IC.
  - E. Eliminates forever the problem of AC line glitches.
  - F. Perfect for cars, boats, campers, or even for portable clocks at ham field days.
  - G. Small size; can be used in existing enclosures.
- Kit includes Crystal, Driver IC, PC board, plus all necessary parts and specs. At last count - over 20,000 sold!

**S.D. Sales Exclusive!**

## 1702A 2K EPROM

We tell it like it is! We could have said these were factory new, but here is the straight scoop. We bought a load of new computer gear that contained a quantity of 1701 A's in sockets. We carefully removed the parts, verified their quality, and are offering them on one heck of a deal. First come, first served. Satisfaction Guaranteed! U. V. Erasable. (2.3 US access time.) **NEW PRICE!**

**\$2.95 each**

2/\$10.

## UP YOUR COMPUTER!

**21L02-1 1K LOW POWER 500 NS STATIC RAM**  
*Time is of the essence!*

And so is power. Not only are our RAM's faster than a speeding bullet but they are now very low power. We are pleased to offer prime new 21L02-1 low power and super fast RAM's. Allows you to **STRETCH** your power supply farther and at the same time keep the wait light off!

**8 for \$12.95**

**\$12.95 S. D. Sales Exclusive! \$12.95**

### MOS 6 DIGIT UP-DOWN COUNTER

40 PIN DIP. Everything you ever wanted in a counter chip. Features: Direct LED segment drive, single power supply (12 VDC TYPE), six decades up/down, pre-loadable counter, separate pre-loadable compare register with compare output, BCD and seven segment outputs, internal scan oscillator, CMOS compatible, leading zero blanking, 1MHZ. count input frequency. Very limited quantity!

### IC's from XEROX

7400 - 9c	7430 - 9c	7493 - 26c	1402A-Shift Regulator-50c
7402 - 9c	7440 - 9c	74121 - 22c	MH0025CN - 55c
7404 - 9c	7437 - 10c	74123 - 32c	
7406 - 11c	7438 - 10c	74151 - 22c	
7407 - 11c	7451 - 9c	74155 - 22c	
7410 - 9c	7474 - 16c	74193 - 35c	
7416 - 13c	7475 - 24c	8233 - 35c	
7420 - 9c	7486 - 16c	Intel - 1302 - 45c	

IC'S REMOVED FROM  
PC BOARDS  
ALL TESTED:  
FULL SPEC.

**1000 MFD**  
Filter Caps  
Rated 35 WVDC Up-  
right style with PC  
leads. Most popular val-  
ue for hobbyists. Compare  
at up to \$1.19 ea.  
from franchise type e-  
lectronic parts stores.

**4/\$1.00**

**SLIDE SWITCH**  
Assortment  
Our best seller. Includes  
miniature and standard  
sizes; single and multi-  
position units. All new,  
first name brand. Try  
one package and you'll  
reorder more! Special!

**12/\$1.00**

**POWER**  
**RESISTOR**  
**15 OHM**  
**25W**  
**BY**  
**CLAROSTAT**

**75¢ ea.**

**RESISTOR**  
**ASSORTMENT**  
¼W 5% & 10% PC  
leads. A good mix of  
values.



**200/\$2.**

**P.C. LEAD**  
**DIODES**  
1N4148/1N914  
100/\$2.00  
1N4002 - 1A  
100 PIV

**40/\$1.**

**Transistor Grab**  
**Bag no. 1**  
Just received a good,  
mixed lot of National  
TO92 plastic transis-  
tors. PNP & NPN, even  
a few FET's. 40 to 50%  
Yield. Untested. Asst.

**500/\$3.**

**DISC CAP**  
**ASSORTMENT**  
PC leads. At least  
10 different val-  
ues. Includes:  
.001, .01, .05  
plus other stan-  
dard values.

**60/\$1.00**

**\$9.95 KIT**

P.C. Board - \$3.00  
AC XFMR - \$1.50  
*Do not confuse with Non-Alarm  
kits sold by our competition!  
Eliminate the hassle -  
avoid the 5314!*

## SIX DIGIT ALARM CLOCK KIT

WE MADE A FANTASTIC KIT EVEN BETTER. REDESIGNED TO TAKE ADVANTAGE OF THE LATEST ADVANCES IN I.C. CLOCK TECHNOLOGY. FEATURES: LITRONIX DUAL ½" DISPLAYS, MOSTEK 50250 SUPER CLOCK CHIP, SINGLE I.C. SEGMENT DRIVER, SCR DIGIT DRIVERS. GREATLY SIMPLIFIED CONSTRUCTION. MORE RELIABLE AND EASIER TO BUILD. KIT INCLUDES ALL NECESSARY PARTS (except case). P.C.B. OR XFMR OPTIONAL. **NEW! WITH JUMBO LED READOUTS!**

**MOTOROLA SCR**  
2N4443. 8 AMP 400 PIV.  
P.C. Leads. \$3/\$1.00  
**FAIRCHILD - TBA 641**  
4W. Audio power. Amp. Just  
out! In special heat sink DIP.  
One super audio IC.  
**\$1.50 with data**  
**AC LINE FILTER**  
Rated 3 AMPS - 115/230V  
50 to 400 HZ.  
Noise Proof Your Computer  
**\$3.00 each**

**GRAB BAG NUMBER 2**  
Mixed Motorola TO-18 case met-  
al transistors. About 60% yield.  
PNP & NPN. Untested. A good  
assortment! **100 for \$3.00**  
**PRICES SHOWN SUBJECT**  
**TO CHANGE WITHOUT**  
**NOTICE.**

*Price Cut!* ~~\$15.95~~  
**\$12.**



## COMPUTER POWER SUPPLY

A very fortunate purchase. One of the best industrial quality REGULATED supplies we have seen. High performance, small size. Input is 120VAC 60HZ. Has the following regulated outputs: -5VDC@800MA; -15VDC@1.25AMP; -25VDC@180MA. Sold at a fraction of original cost. Do yourself a favor and order NOW.

AMD - 1702A

Factory Prime Units - Brand New - 1.5 Micro-seconds Access Time. - \$4.95 each  
**10 FOR \$40.** **HUGE FACTORY DIRECT PURCHASE!**

### TERMS:

**MONEY BACK GUARANTEE.**  
**NO COD'S. TEXAS RESIDENTS**  
**ADD 5% SALES TAX. ADD**  
**5% OF ORDER FOR POSTAGE**  
**& HANDLING. ORDERS**  
**UNDER \$10.00 ADD 75c.**  
**FOREIGN ORDERS: U. S.**  
**FUNDS ONLY!**

Call your BankAmericard or  
Master Charge order in on our  
continental United States toll  
free Watts:

**1-800-527-3460**

Texas Residents Call Collect:

**214/271-0022**

**CHEAP DC SUPPLY**  
Actually an AC adapter for calculators.  
9VDC-no load. 6VDC@200MA.  
4VDC@375MA

**\$2. ea.**

S.D. SALES CO.  
P.O. BOX 28810 - A  
DALLAS, TEXAS 75228

**Orders over \$15. - Choose \$1. FREE MERCHANDISE!**



# HERE'S A HOT NUMBER

# 800-325-3636

(Toll Free)

CALL  
**HAM RADIO CENTER**  
**ST. LOUIS**

FOR NEW AND USED AMATEUR RADIO EQUIPMENT  
 MASTER-CHARGE BANKAMERICARD

TRADE ON NEW OR USED

Hours 9 A.M. - 5 P.M. (Central)

Closed Sun. & Mon.

## THE HAM-KEY

### NOW 5 MODELS

- Iambic circuit for squeeze keying.
- Self completing dots & dashes
- Dot memory.
- Battery operated with provision for external power.
- Built-in side-tone monitor.
- Speed, Volume, tone & weight controls.
- Grid-block or direct keying.
- Use with external paddle such as HK-1.



**NEW**  
**MODEL HK-5**  
**ELECTRONIC KEYS**  
**\$69.95**

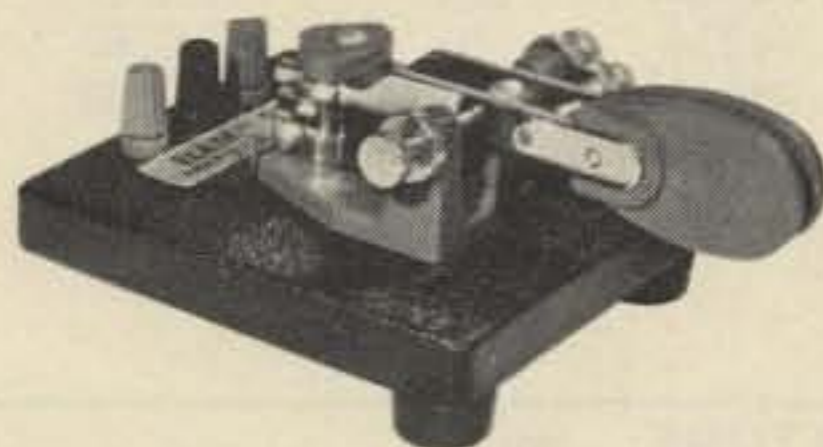

**MODEL HK-1**  
**\$29.95**



**MODEL HK-3**  
**\$16.95**

- Dual lever squeeze paddle.
- Use with HK-5 or any electronic keyer.
- Heavy base with non-slip rubber feet.
- Paddles reversible for wide or close finger spacing.



**MODEL HK-2**  
**\$19.95**

- Deluxe straight key.
- Heavy base, no need to attach to desk.
- Velvet smooth action.

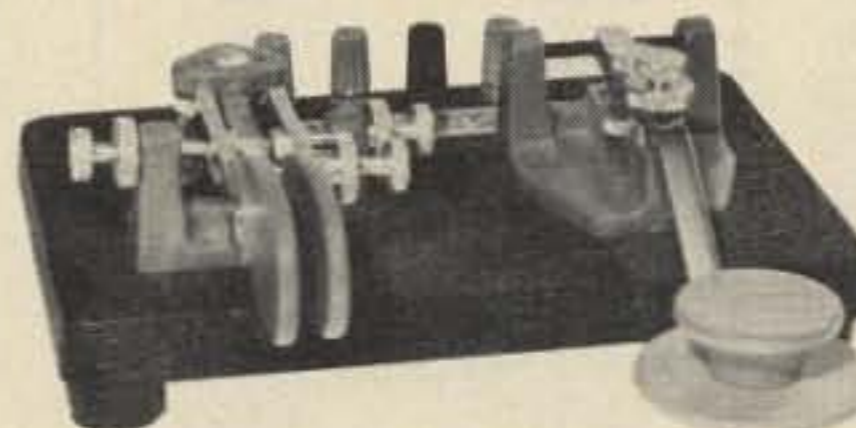

**MODEL HK-4**  
**\$44.95**

- Same as HK-1, less base for those who wish to incorporate in their own Keyer.

- Combination HK-1 & HK-3 on same base.

Available from your local dealer or order direct.

**HAM RADIO CENTER, INC.**

8340-42 OLIVE BLVD. • P. O. BOX 28271 • ST. LOUIS, MO. 63132

H2



DIODES/ZENERS				SOCKETS/BRIDGES				TRANSISTORS, LEDS, etc.				
1N914	100v	10mA	.05	8-pin	pcb	.25	ww	.45	2N2222	NPN		.15
1N4004	400v	1A	.08	14-pin	pcb	.25	ww	.40	2N2907	PNP		.15
1N4005	600v	1A	.08	16-pin	pcb	.25	ww	.40	2N3740	PNP	1A 60v	.25
1N4007	1000v	1A	.15	18-pin	pcb	.25	ww	.75	2N3906	PNP		.10
1N4148	75v	10mA	.03	22-pin	pcb	.45	ww	1.25	2N3054	NPN		.35
1N753A	6.2v	z	.25	24-pin	pcb	.35	ww	1.25	2N3055	NPN	15A 60v	.50
1N758A	10v	z	.25	28-pin	pcb	.35	ww	1.45	T1P125	PNP	Darlington	.35
1N759A	12v	z	.25	40-pin	pcb	.50	ww	1.95	LED Green, Red, Clear			.15
1N4733	5.1v	z	.25	Molex pins .01	To-3 Sockets	.25			D.L.747	7 seg 5/8" high com-anode		1.95
1N5243	13v	z	.25	2 Amp Bridge	100-prv	1.20			XAN72	7 seg com-anode		1.50
1N5244B	14v	z	.25	25 Amp Bridge	200-prv	1.95			FND 359	Red 7 seg com-cathode		1.25
1N5245B	15v	z	.25									

C MOS		- T T L -									
4000	.15	7400	.15	7473	.25	74176	1.25	74H72	.55	74S133	.45
4001	.20	7401	.15	7474	.35	74180	.85	74H101	.75	74S140	.75
4002	.20	7402	.20	7475	.35	74181	2.75	74H103	.75	74S151	.35
4004	3.95	7403	.20	7476	.30	74182	.95	74H106	.95	74S153	.35
4006	1.20	7404	.15	7480	.55	74190	1.75			74S157	.80
4007	.35	7405	.25	7481	.75	74191	1.35			74S158	.35
4008	1.20	7406	.35	7483	.95	74192	1.65	74L00	.35	74S194	1.05
4009	.30	7407	.55	7485	.95	74193	.85	74L02	.35	74S257(8123)	.25
4010	.45	7408	.25	7486	.30	74194	1.25	74L03	.30		
4011	.20	7409	.15	7489	1.35	74195	.95	74L04	.35		
4012	.20	7410	.10	7490	.55	74196	1.25	74L10	.35	74LS00	.45
4013	.40	7411	.25	7491	.95	74197	1.25	74L20	.35	74LS01	.45
4014	1.10	7412	.30	7492	.95	74198	2.35	74L30	.45	74LS02	.45
4015	.95	7413	.45	7493	.40	74221	1.00	74L47	1.95	74LS04	.45
4016	.35	7414	1.10	7494	1.25	74367	.85	74L51	.45	74LS05	.55
4017	1.10	7416	.25	7495	.60			74L55	.65	74LS08	.45
4018	1.10	7417	.40	7496	.80			74L72	.45	74LS09	.45
4019	.70	7420	.15			75108A	.35	74L73	.40	74LS10	.45
4020	.85	7426	.30			75110	.35	74L74	.45	74LS11	.45
4021	1.35	7427	.45	74100	1.85	75491	.50	74L75	.55	74LS20	.40
4022	.95	7430	.15	74107	.35	75492	.50	74L93	.55	74LS21	.25
4023	.25	7432	.30	74121	.35			74L123	.55	74LS22	.25
4024	.75	7437	.35	74122	.55					74LS32	.40
4025	.35	7438	.35	74123	.55	74H00	.25			74LS37	.40
4026	1.95	7440	.25	74125	.45	74H01	.25	74S00	.55	74LS40	.55
4027	.50	7441	1.15	74126	.35	74H04	.25	74S02	.55	74LS42	1.75
4028	.95	7442	.55	74132	1.35	74H05	.25	74S03	.40	74LS51	.65
4030	.35	7443	.85	74141	1.00	74H08	.35	74S04	.35	74LS74	.75
4033	1.95	7444	.45	74150	1.00	74H10	.35	74S05	.35	74LS86	.75
4034	2.45	7445	.80	74151	.75	74H11	.25	74S08	.35	74LS90	1.30
4035	1.25	7446	.95	74153	.95	74H15	.30	74S10	.35	74LS93	1.00
4040	1.35	7447	.95	74154	1.05	74H20	.30	74S11	.35	74LS107	.95
4041	.69	7448	.95	74156	1.15	74H21	.25	74S20	.35	74LS123	1.00
4042	.95	7450	.25	74157	.65	74H22	.40	74S40	.25	74LS151	.75
4043	1.25	7451	.25	74161	.85	74H30	.25	74S50	.25	74LS153	1.20
4044	.95	7453	.20	74163	.95	74H40	.25	74S51	.45	74LS157	.85
4046	1.50	7454	.25	74164	.60	74H50	.25	74S64	.25	74LS164	1.90
4049	.80	7460	.40	74165	1.50	74H51	.25	74S74	.40	74LS367	.85
4050	.60	7470	.45	74166	1.35	74H52	.15	74S112	.90	74LS368	.70
4066	1.35	7472	.45	74175	.80	74H53J	.25	74S114	1.30		
4069	.40					74H55	.25				
4071	.35										
4082	.45										

9000 SERIES		LINEARS, REGULATORS, etc.									
9301	.85	8266	.35	LM320K5 (7905)	1.65	LM340T-24	.95	LM723	.50		
9309	.35	8836	.95	LM320K12	1.65	LM340K-12	2.15	LM725	1.75		
9322	.85	MCT2	.95	LM320T12	1.25	LM340K-15	1.25	LM739	1.50		
95H03	.55	8038	3.95	LM320T15	1.65	LM340K-18	1.25	LM741 8-14	.20		
9601	.75	LM201	.75	LM339	.95	LM340K-24	.95	LM747	1.10		
9602	.50	LM301	.25	7805 (340T-5)	.95	LM373	2.95	LM1307	1.25		
		LM308 (Mini)	.75	LM340T-12	1.00	LM380	.95	LM1458	.95		
		LM309H	.65	LM340T-15	1.00	LM709(8,14 PIN)	.25	LM3900	.50		
		LM309K(340K-5)	.85	LM340T-18	1.00	LM711	.45	LM75451	.65		
		LM310	1.15					NE555	.50		
		LM311D(Mini)	.75					NE556	.95		
		LM318 (Mini)	.65					NE565	.95		
								NE566	1.75		
								NE567	1.35		
								SN72720	1.35		
								SN72820	1.35		

**INTEGRATED CIRCUITS UNLIMITED**  
 7889 Clairemont Mesa Blvd. San Diego, CA 92111 (714) 278-4394  
 All orders shipped prepaid No minimum  
 Open accounts invited COD orders accepted  
 Discounts available at OEM Quantities  
 California Residents add 6% Sales Tax  
**24 Hour Phone (714) 278-4394** **MasterCharge / BankAmericard**



POLY PAK'S IS THE "BARREL KIT KING" OF THE WORLD!



# Poly Pak's EXCLUSIVE

## SURE-FIRE BARREL KITS®

Avg. Ship. Wt. 6-ozs.

Buy 10 BARREL KITS AND CHOOSE THE 11TH KIT Free

Test 'em yourself 'n save! Includes 100% material, too! **INFLATION!** Each kit carries a money-back guarantee!

<b>BARREL KIT #239 SHIELDED CABLE</b> 50-ft. \$1.98 For mikes, stereos; 1-cond. plus shield, 22 ga. vinyl jacket. Wt. 1 lb. 7A3577	<b>BARREL KIT #230 HALF INCH READOUTS</b> 7A3629 15 for \$1.98 From factory to you! Includes Fairchild FND-500 & 507's.	<b>BARREL KIT #225 SOUND TRIGGERS</b> 3 for \$1.98 "Hand clap" sensitizes crystal mike amplifier, triggers SCR. Cat. No. 7A3625	<b>BARREL KIT #221 IC SOCKETS</b> 8 for \$1.98 hobby Mfr unload! Four 14-pin, four 18-pin. Solder tail, in-profile. No. 7A3621	<b>MIXED READOUTS</b> 15 for \$1.98 Barrels of untested .17", .3", .5", 7-segs. Like FND-357, 500, 503, MAN-3's. What a buy! No. 7A3619	<b>BARREL KIT #205 MINI BLOCK CAPACITORS</b> 50 for \$1.98 Unbelievable! Worth \$50. High precision submini caps for all applications. Wt. 3 ozs. Cat. No. 7A3528	<b>BARREL KIT #203 CALCULATOR KEYBOARDS</b> 10 for \$1.98 It's true! 20-key, 4 function keyboards at ridiculous give-away. Wt. 12 ozs. Cat. No. 7A3524
<b>BARREL KIT #210 GLOWIN' PANELS</b> 3 for \$1.98 4" x 1" panels that glow blue-green with 110VAC. Use for nite lites, indicators, etc. Cat. No. 7A3550	<b>100 for \$1.98</b> #202 PLUGS, SOCKETS Distributor unload! Includes AC, DC, RF, audio, 4-9 pin, all kinds. Wt. 1 lb. Cat. No. 7A3527	<b>BARREL KIT #201 6V INDICATORS</b> w/leads 15 for \$1.98 Test lamp manufacturer dumps inventory! Worth 69¢ ea. Like grain-o-wheat. Cat. No. 7A3526 hobby	<b>BARREL KIT #200 9 DIGIT READOUT MODULES</b> 5 for \$1.98 with calculator driver chips beneath epoxy. Cat. No. 7A3515	<b>BARREL KIT #198 TRANSISTORS &amp; DARLINGTONS</b> 50 for \$1.98 Motorola dumps 1,000,000 TO-220 in barrels, NPNs & PNP's. Cat. No. 7A3523	<b>BARREL KIT #191 CARBOFILM RESISTORS</b> 800* for \$1.98 *1/2 pound, approx. 1/8, 1/4 watters. Asst. values. Unmarked. TO-92. Preformed. Cat. No. 7A3445	<b>BARREL KIT #188 400 Parts</b> \$1.98 Includes resistors, caps, transformers, rectifiers, diodes, etc. for p.c. work. Preformed, dumped into barrels by factories, 100%. Cat. No. 7A3401
<b>BARREL KIT #187 AUDIO IC'S</b> 30 for \$1.98 National & Sprague, 2 to 4 watters, LM-350, LM-377, 2277, etc. DIPs, some with heat sinks. Untested. Cat. No. 7A3392	<b>BARREL KIT #185 PC BOARDS</b> 400 parts \$1.98 parts: 50 transformers, 50 s. transformers, 200 s. diodes, etc. Cat. No. 7A3388	<b>BARREL KIT #184 1/4-WATT METAL FILM</b> 150 for \$1.98 100% metal film resistors. Long leads. 7A3413	<b>BARREL KIT #182 JUMBO RED LEDS</b> 15 for \$1.98 100% material, user cancellation from factory dumps, 3V 10 mils. For 100's of projects, red lens. Cat. No. 7A3369	<b>BARREL KIT #163 MINI TRIM POTS</b> 30 for \$1.98 Asst. values 100 to 1 meg. What a buy. Single turn. 1/4 W. Wt. 6 oz. 7A3345	<b>BARREL KIT #161 "POP" PLASTIC TRANSISTORS</b> 25 for \$1.98 2N3904's with some 2N3906's of 100% material. TO-92. Preformed. Cat. No. 7A3343 1 oz.	<b>BARREL KIT #160 V. REGULATORS</b> 10 for \$1.98 No. 7A3330 LM309KC TO-3 V.R.'s barrelled. Not by the pound,
<b>BARREL KIT #159 MODULAR SWITCHES</b> 25 for \$1.98 Centralab switches, TV-makers excess. Dpdt, 6pdt, etc. Brand new. Cat. No. 7A3150	<b>BARREL KIT #158 MAGNIFIED MAN-3's</b> 20 for \$1.98 MAN-3, 7-seg readout, with built-in magnifier. Factory discontinued line. 100% material. Cat. No. 7A3325 1 oz.	<b>BARREL KIT #155 MOLDED CAPACITORS</b> 75 for \$1.98 7A3311 Asst. size voltages, red, green, yellow, blue plastic cases, axial leads. 1 lb.	<b>BARREL KIT #154 CLOCK CHIPS</b> 20 for \$1.98 We gathered an assortment of clock chips, alarm, calendar, beepers, who knows, all mixed. Cat. No. 7A3308	<b>BARREL KIT #145 MINI TRANSFORMER</b> 15 for \$1.98 outputs, inter-stage and audio. Only 1" sq. Wt. 2 lbs. 7A3294	<b>BARREL KIT #144 RCA PHONO PLUGS</b> 40 for \$1.98 1,000,000 RCA phono plugs for this one. You hi-fi-ers know what they are... 100% material. 7A3293	<b>BARREL KIT #138 PANEL SWITCHES</b> 30 for \$1.98 Did you hear of OAK? Another eqpt maker barrelled all types of rotaries, electric, slides, etc. 7A3268
<b>BARREL KIT #135 MICRO MINI LAMPS</b> 20 for \$1.98 Imagine! Micro size (1/4 x 1/4) with wire leads, 3 to 5 VDC, 40 mils. 7A3259	<b>BARREL KIT #128 MINI DIP IC'S</b> 100 for \$1.98 Large mfr dumped 100's of lbs into barrels. Includes 741s, LM-380-S, 703, 567, 555, 558—but who knows? Wt. 1 lb. 7A3245 hobby	<b>BARREL KIT #127 AXIAL ELECTROS</b> 40 for \$1.98 Asst. capacities and voltages. Cat. No. 7A3227	<b>BARREL KIT #126 UPRIGHT ELECTROS</b> 40 for \$1.98 1mf to 300mf in mixture of voltages. 100% marked a good. 7A3226	<b>BARREL KIT #118 MINI SCRS</b> 50 for \$1.98 UNBELIEVABLE! TO-92 plastic SCRS in barrels... rite from factory. Includes all voltages up thru 200 prv. 7A3135	<b>BARREL KIT #117 2 OPTICAL FIBERS</b> 20-MIL 7A3206 200-FT. \$1.98 Fiber optics factory bankruptcy purchase! High quality, most-commonly used size (20-mil). CLEAR.	<b>BARREL KIT #115 MOLEX SOCKETS</b> 200 for \$1.98 100% good Calculator maker dump! We got a zillion of 'em.
<b>BARREL KIT #112 MICRO MINI LEDS</b> 40 for \$1.98 Hobby All the tiny leds, axial, upright of Monsanto, Litronix, variety of colors. Yield 50% or better. 7A3138	<b>BARREL KIT #109 TERMINAL STRIPS</b> 100 for \$1.98 Wide asst. of terminal strip connectors, from 1 contact up. Strip manufacturers barrel dump is your gain. Wt. 1 lb. Cat. No. 7A3136	<b>BARREL KIT #108 TO-5 PLASTIC TRANSISTORS</b> 40 for \$1.98 Includes PNP, NPN, 2N-3638, 2N3641, 2N5000 series, etc. Untested.	<b>BARREL KIT #104 SLIDE VOLUME CONTROLS</b> 10 for \$1.98 Cat. No. 7A1057	<b>BARREL KIT #101 RESISTOR SPECIAL</b> 200 for \$1.98 Includes: 1/8, 1/4, 1/2, 1, 2-watt, carbon, 8 oz, 100% good. 7A3054	<b>BARREL KIT #99 PHOTO ELECTRIC CELLS</b> 10 for \$1.98 Asst. GE types, CDS types. Mixed by factory. Big job for us to separate, 100% good. Cat. No. 7A3052	<b>BARREL KIT #93 HALF WATTERS</b> 200 for \$1.98 Resistor factory tried to fool us by mixing 100% color-coded resistors in barrel. But value is there. 4 oz. 7A3046 Untested
<b>BARREL KIT #91 SILVER MICAS</b> 100 for \$1.98 Axial, red case, variety of physical sizes & values. Cat. No. 7A3018	<b>BARREL KIT #88 LITRONIX LED READOUTS</b> 10 for \$1.98 Hobby single, triplex, etc. 33 to 0.6. Hot from factory. all mixed; have fun! No. 7A2861	<b>BARREL KIT #87 NATIONAL IC BONANZA</b> 100 for \$1.98 Types 5000, 7400 series, DTLs, ROMs, registers, clock & calc. chips, linears, etc. Cat. No. 7A2860 Untested.	<b>BARREL KIT #86 HOBBY LEDS</b> 40 for \$1.98 747's, 727's, singles, triplex, etc. 33 to 0.6. Hot from factory, all mixed; have fun! 7A2859	<b>BARREL KIT #83 LM-340T VOLT REG</b> 15 for \$1.98 Factory rejected them for length of leads. May include 5, 6, 8, 12, 15, 18, 24 volts. Power tab. Cat. No. 7A2635	<b>BARREL KIT #81 SUBMINI RESISTORS</b> 200 for \$1.98 PC, upright type, color coded, 1/4 watt. Asst values. Came to us in a barrel. Cat. No. 7A2746 100% good.	<b>BARREL KIT #76 1-WATT ZENERS</b> 100 for \$1.98 Factory same as 400-mw's. Never-to-see-again offer. 6, 8, 10, 12, 15V. Under glass. Double plug. Cat. No. 7A2741 Untested.

## Digital Clocks BASIC KITS!

Designed for the economy-minded. Includes: all components except for transformer, case & line cord.

### 4 DIGIT FLOURESCENT

□ \$9.95  
.57" Bright Blue Digits

The brightest clock made! Uses 7 segment GE tube readouts. Includes famous MM5316 clock chip and a minimum of components! Easy and fun to build, a minimum of components! 12 hour display, (24 perfect for the new hobbyist! 12 hour display, (24 hour cycle), AM-PM indicator. Options include clock hour cycle, 60 minute sleep timer, and snooze. PC radio timer, not included. Easy to breadboard, with instructions. Requires 12 V transformer, see our 92CU3412. Cat. No. 7A3791 4 Digit Fluorescent Basic Kit \$9.95 Cat. No. 7A3792 Components for Alarm Option 2.95

### 6 DIGIT BEEPER ALARM

□ \$12.95 .35" LED RED DIGITS

Easy and fun to build! 6 digit display time in hours, minutes and seconds, 12 hour format, 24 hour cycle, 7 minute snooze. Uses famous MM5375AB and a minimum of components. Controls for slow and fast set, and reset to zero. Includes all necessary components except for case, line cord, PC board. Requires 12V Transformer, see our Catalog #92CU3412. PC boards available, write or call for information. Wt. 8 oz. Cat. No. 7A3793 6 Digit LED alarm clock basic kit.

COMPLETE KIT: includes case, transformer and line cord. Cat. No. 7E3505..... □ \$19.95

### 4 DIGIT

□ \$12.95

Same as our 6 DIGIT LED ALARM CLOCK BASIC, except with .5" digits, displays hours and minutes, blinking colons indicate seconds. Wt. 8 ozs. Cat. No. 7A3794

COMPLETE KIT: includes case, transformer and line cord. Cat. No. 7A3507..... □ \$19.95

<b>BARREL KIT #73 TRANSISTOR ELECTROS</b> 50 for \$1.98 We don't wish to separate wide asst voltages & values up to 300 mf. Cat. 7A2747	<b>BARREL KIT #71 CAPACITOR SPECIAL</b> 100 pcs. \$1.98 micas, molded, plastics, ceramics, discs, etc. Nifty 100% good. Cat. No. 7A2738	<b>BARREL KIT #68 2 WATTERS</b> 100 for \$1.98 100% good. Suppliers throw 'em in the barrel. It's a hi! gold mine. All marked. Cat. No. 7A2735	<b>BARREL KIT #65 MIXED READOUTS</b> 10 for \$1.98 Factory returns — such numbers as MAN-4's, MAN-7's, MAN-3's, 11 barrels & no time to separate. Hobby Cat. No. 7A2733 Untested.	<b>BARREL KIT #61 POLYSTYRENE CAPS</b> 100 for \$1.98 Finest caps made. As a gamble we bought 10 barrels from factory, mixed values, all good. Cat. No. 7A2729
<b>BARREL KIT #58 SLIDE SWITCHES</b> 30 for \$1.98 All shapes, sizes, spot, opt, momentaries, etc. Tremendous shop pak for 100's of switching projects. Cat. No. 7A2726 100% good	<b>BARREL KIT #56 POWERS! POWERS!</b> 100 for \$1.98 Cat. No. 7A2724 Large distributor cleaned house. Barrels of power resistors 3 to 7 watts.	<b>BARREL KIT #54 8 DIGIT READOUTS</b> 10 for \$1.98 Bargain of a lifetime! All we got was 1 barrel — the "blisdr digit" type. Multiplexed. Cat. No. 7A2722	<b>BARREL KIT #40 PNP HIGH-POWER TRANSISTORS</b> 20 for \$1.98 Hobby Popular germanium TO-3 case 7A2616 100% good	<b>BARREL KIT #39 2N3055 HOBBY TRANSISTORS</b> 15 for \$1.98 Fallouts of the famous 2N3055. 7A2617 100%
<b>BARREL KIT #37 1 AMP "BULLET" RECTIFIERS</b> 100 for \$1.98 Famous style, asst. voltages, silicon, axial includes all types of voltages to 1KV. Cat. No. 7A2615	<b>BARREL KIT #36 GERMANIUM DIODES</b> 200 for \$1.98 Cat. No. 7A2614 Famous maker, pupular item. Never grows old.	<b>BARREL KIT #35 NEON LAMPS</b> 30 for \$1.98 100% good. Famous NE-2's. All prime, but factory made millions and barrel'd 'em. Your advantage. Cat. No. 7A2613	<b>BARREL KIT #31 METALLIC RESISTORS</b> -100 for \$1.98 Made mostly by Corning, the finest resistor made. Mostly 1/2 watters, 1% to .5% tol. & a barrel of values. Cat. No. 7A2609	<b>BARREL KIT #30 PREFORMED RESISTORS</b> 200 for \$1.98 We got barrels of 1/4 and 1/2 watters for pc use. 100 1/4, 100 1/2 watters. No. 7A2608 100% good
<b>BARREL KIT #27 PREFORMED DISCS</b> 150 for \$1.98 Hi-Fi mfr's shelf inventory but he dumped 'em in barrels. Preformed, for PC use. Mixed values too! 7A2605	<b>KIT #26 PLASTIC TRANSISTORS</b> 100 for \$1.98 Hobby Untested. Type TO-92 (TO-18), all manufacturers, variety of 2N 2's. Cat. No. 7A2604	<b>BARREL KIT #25 METAL CAN TRANSISTORS</b> 100 for \$1.98 Includes TO-5, TO-1, TO-18, etc., assorted 2N numbers, unmarked etc. Cat. No. 7A2603 Untested.	<b>BARREL KIT #20 LONG LEAD DISCS</b> 100 for \$1.98 "auction sale". Prime, marked only. Long leads. Cat. No. 7A2598 100% good	<b>BARREL KIT #19 DIPPED MYLARS</b> 60 for \$1.98 Finest capacitors made, shiny finish. Imagine factory dumping 'em in barrels. Cat. No. 7A2597 100% good
<b>BARREL KIT #17 LINEAR &amp; 7400 DIPS</b> 100 for \$1.98 Hobby Untested Marked and unmarked, internal numbers of raw factory stock. Cat. No. 7A2431.	<b>BARREL KIT #15 MOSFET TRANSISTORS</b> 60 for \$1.98 All 4 leaders TO-18 case, includes UHF transistors too! Cat. No. 7A2429	<b>BARREL KIT #14 PRECISION RESISTORS</b> 200 for \$1.98 Marked and unmarked 1/4, 1/2, 2 watts. No. 7A2428	<b>BARREL KIT #11 POWER TAB TRANSISTORS</b> 40 for \$1.98 NPN, plastic TO220 type. Assorted 2N numbers. No. 7A2425 Untested.	<b>BARREL KIT #10 ROMS-REGISTERS</b> 75 for \$1.98 Untested Hobby 28 to 40 pin devices, marked, internal factory numbers, etc. Cat. No. 7A2424
<b>BARREL KIT #8 SUBMINIATURE IF TRANSFORMERS</b> 75 for \$1.98 Amazing. Includes 455kcs, osc. antenna, who knows? Cat. No. 7A2422 100% good	<b>BARREL KIT #7 VOLUME CONTROL</b> 30 for \$1.98 100% good Singles, duals, variety of values, styles, big ones — small ones. Cat. No. 7A2421	<b>BARREL KIT #5 SCRS, TRIACS, QUADRACS</b> 40 for \$1.98 Raw factory stock! All the 10 amp types. Cat. No. 7A2419 Untested.	<b>BARREL KIT #4 "4000" RECTIFIERS</b> 100 for \$1.98 Untested. 1N4000 series. May include 25, 50, 100, 200, 400, 600, 800 and 1000 volters. 7A2417	<b>BARREL KIT #3 1N4148/914 SWITCHING DIODES</b> 100 for \$1.98 Imagine famous switching diodes at these prices! Cat. No. 7A2418 Untested.
<b>BARREL KIT #2 LINEAR OP AMPS, DIPS</b> 75 for \$1.98 Untested May include 709's, 741's, 703's, 560 series. 555 includes 7A2416 hobby	<b>BARREL KIT #1 SN7400 DIP IC'S</b> 75 for \$1.98 Marked 14 and/or with 16 pin dips, may include gates, registers, flip flops, counters. 7A2415 Untest Hobby	<b>Terms: Add postage. Rated: net 30</b> Phone: Wakefield, Mass. (617) 245-3829 Retail: 16-18 Del Carmine St., Wakefield,		

# POLY PAKS

P.O. BOX 942A LYNNFIELD, MA. 01940

SALE! □ Send for FREE SUMMER CATALOG

C.O.D.'s MAY BE PHONED



# NEW

for '77  
Only

# \$145

less batteries  
and crystals



### ECM-5B MK-II fm modulation meter

- 0-6KHz peak reading linear scale, meets commercial standards
- Operates 25MHz to 500MHz
- Crystal controlled for easy operation
- Audio/scope output with earphone
- Options: NICAD power PAK \$34.95

Charger \$29.95

Write or call for complete information. Send check or money order for \$145 plus \$1.75 for shipping. Indiana residents add 4% sales tax. Crystals for 146.94MHz: \$4.95. All other freq: \$7.95.

**ECM** ECM Corporation  
412 N. Weinbach Ave.  
Evansville IN 47711  
812-476-2121 E1

## SST T-I RANDOM WIRE ANTENNA TUNER



Allband operation (160-10 meters) with any random length of wire. 200 watt output power capability - will work with virtually any transceiver. Ideal for portable or home operation. Great for apartments and hotel rooms - simply run a wire inside, out a window, or anyplace available. Toroid inductor for small size: 3X4-1/4X2-3/8. Built-in neon tube-up indicator. SO-239 connector. Guaranteed for 1 yr., 10 day trial. IF NOT SATISFIED RETURN FOR A FULL REFUND! COD OK BY PHONE

THE ORIGINAL RANDOM WIRE ANTENNA TUNER - in use by amateurs for 5 years.

COMPACT EASY TO USE ••• only \$29.95  
POSTPAID (ADD SALES TAX IN CALIF.)  
**SST** Electronics, (213) 376-5887  
P.O. Box 1, Lawndale CA 90260  
\$10

## SUB-AUDIBLE GENERATOR for FM

THE CUBE



- Inexpensive multi tone encoder
- Compatible with PL-CG-QC
- Low distortion sinewave
- Input 8-18 VDC unregulated
- Rugged, plastic encased with leads
- Adjustable frequency (98-250 Hz), Lower available
- Excellent stability

.5 x .6 x .8 in.

Price \$19.95

Freq. set at factory \$5.00 extra

L4

Calif. res. add 6%

Send for more info

**lyle** Products

Dept. 73 P.O. Box 2083 Santa Clara, CA. 95051

# CODE SPEED-BUILDING KIT

## GOOD FOR BEGINNERS, TOO!

## COMPLETE KIT ONLY \$19.95!

Code Practice Oscillator \$13.95

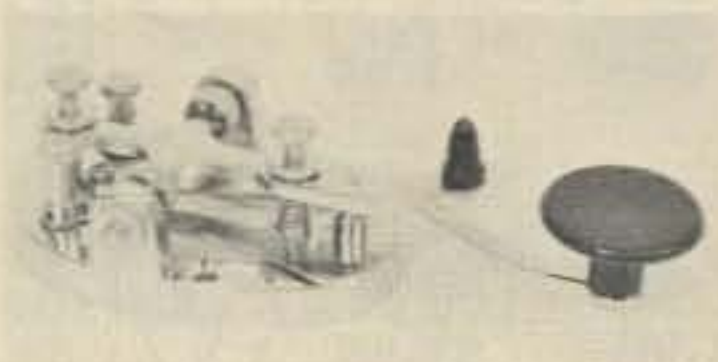

Practice Key \$3.95

Computer-generated Cassette Tape \$3.95



Learn the code or improve your efficiency with Kantronics' cassettes, brass key, and code practice oscillator. All instructional materials accompany the product.

**THE CODE PLACED ON OUR TAPES IS GENERATED BY COMPUTER;** text is entered at a keyboard and then recorded on tape. The code is exact to Morse specifications, and the tone is sharp and crisp at 700 hertz.

You can buy the combination of key, one code cassette, and code practice oscillator, or buy each piece separately. Please specify code speed desired when ordering.

Name \_\_\_\_\_  
PLEASE PRINT

Address \_\_\_\_\_  
STREET OR RFD APT#

\_\_\_\_\_  
CITY STATE ZIP CODE

Card # \_\_\_\_\_ Exp. date \_\_\_\_\_

Signature \_\_\_\_\_

\_\_\_\_\_ Speed-Building Kit - \$19.95

\_\_\_\_\_ Brass Code Key - \$3.95

\_\_\_\_\_ Practice Oscillator - \$13.95

\_\_\_\_\_ Cassette Tape - \$3.95

5wpm  7½wpm  10wpm  13wpm

16wpm  20wpm

\_\_\_\_\_ Custom Tape (include copy) - \$9.95

KS & MO residents add 3% tax  
Please add \$1.00 postage/handling per kit.

\$ \_\_\_\_\_ Total enclosed.

Check  Money order  Master Charge

Bank Americard

NO CASH OR C.O.D. ORDERS, PLEASE! K13

**KANTRONICS, INC.**

1202 East 23rd St Lawrence, Kansas 66044 Telephone 913-842-7745



# Social Events

from page 167

1302 West Main St., Owosso MI 48867.

## CHENEY WA JULY 16-17

The Spokane Amateur Radio Council (SARC) will hold its third annual hamfest July 16 and 17, 1977 in the Pence Union Building at Eastern State College, Cheney, Washington, about 15 miles west of Spokane. Pre-registration is \$9.50, the same as last year, which includes the banquet on campus and many prizes. Numerous seminars, flea market and activities for YLs, XYLs and MYLs. Make pre-reg checks payable to SARC and mail to Jim Johnson WA7BWO, Drawer "A", Cheney WA 99004.

## ALLENTOWN PA JULY 17

The Tri-Club Hamfest will be held July 17, 1977 from 8 am to 5 pm at the Allentown Police Academy Pistol Range in Scenic Lehigh Parkway South at Allentown PA. Admission is \$1.00 to all including sellers. Children are free. Talk-in on .34-.94 and .52.

## EAST MCKEESPORT PA JULY 17

The Two Rivers Amateur Radio Club will hold its 13th Annual Hamfest on Sunday, July 17, 1977 at the Green Valley Fire Department fairgrounds off U.S. Route 30 near East McKeesport. With the expanded parking facilities and the addition of a large flea market area, this event has become one of the largest of its kind in Western Pennsylvania. For more info contact John Roberts WA3SOZ, Secretary, Two Rivers Amateur Radio Club, McKeesport PA 15132.

## BOWLING GREEN OH JULY 17

The Wood County ARC Ham-A-Rama is Sunday, July 17, 1977 from 8:00 am to 5:00 pm, at the County Fairgrounds in Bowling Green, Ohio (about 25 miles south of Toledo). Free parking and admission. Donation \$1.50 advance, \$2.00 at the door. Tables \$2.00. Talk-in on 146.52. Refreshments available. For further info write WCARC, 7929 Rudolph Road, Rudolph, OH 43462.

## EUGENE OR JULY 23-24

The Annual Lane County Ham Fair will be held on July 23-24, 1977 at the Lane County Fairgrounds in Eugene, Oregon. Registration donation will be \$2.00. CW contest - fox hunts on 2 meters - swap and shop - commercial displays - prizes - YL craft table. A Saturday banquet at \$4 per plate with musical entertainment from 7 pm until midnight. Free parking for RVs with limited free hook-ups. Advance registration contact Earl E. Hemenway K7KVV, 2366 Madison

St., Eugene OR 97405.

## SLATER MO JULY 24

Indian Foothills Amateur Radio Club will hold their Hamfest and Communication Show on July 24, 1977 in Slater, Missouri at the city park. Activities include flea market for OM, flea market for XYL, equipment you wish to display, old - new, prize for best home built, KØRWG and wife musical entertainment, kiddie pool, swimming pool, and tennis courts. Talk-in 94, 52, 28-88, 3963 kHz. For information and registration: R. D. Beilsmith WØKNF, Box 74, Slater MO 65349, phone: (816) 529-2173.

## NEENAH WI JULY 24

The 3-F's A.R.C. Northeast Wisconsin Swapfest will be held Sunday, July 24, 1977 in Neenah, Wisconsin, 0900-1500. This annual event features inside tables, food and refreshments, bar and easy access from U.S. Highway 41. (Take Wisconsin Highway 114 exit east, then take first left to the Neenah Labor Temple at 157 South Green Bay Road.) Dealers will be there, an auction at the end of the day has traditionally offered super deals, and there's a special \$3 rate for families. Talk-in on .94/.94. Admission \$1.50, tables \$2. Send advance reservations to 3-F's, Box 1032, Neenah, Wisconsin 54956.

## FLAGSTAFF AZ JULY 29-31

The Ft. Tuthill Hamfest will be held July 29-31, 1977. Ft. Tuthill is the historical name given to the Coconino County Fairgrounds located on Rt. 89A south of Flagstaff AZ. Hamfest activities include a transmitter hunt on 2 meters, exhibits and demonstrations on many facets of amateur radio. Technical sessions, special contests, and many other interesting activities. Talk-in frequencies will be 146.22/82, 146.52, 3.910 MHz. For more information write Ft. Tuthill Hamfest, PO Box 11642, Phoenix AZ 85061.

## OLIVER BC JULY 30-31

The Okanagan International Hamfest will be held July 30 and 31, 1977 at Gallagher Lake, 8 miles north of Oliver, B.C. Family fun, contests, flea market, and gabfest. KOA campsites available. No inflation prices. Prizes galore. Talk-in 34/94. For more information contact Phil Wilkinson VE7ALV, Naramata, B.C.

## FARMINGTON NM JULY 30-31

The Totah Amateur Radio Club, Inc., will hold its club field day on July 30 and 31, 1977, at the Four Corners National Monument (New Mexico, Arizona, Utah and Colorado).

Mode: SSB and CW, bands - 15, 20 and 40. Club station call K5WXI.

## NORTH MANKATO MN JULY 31

The Mankato Area Radio Club will hold its annual picnic, swapfest and auction on July 31, 1977, between 10 am and 4 pm at Spring Lake Park in North Mankato MN. Talk-in 3.93, 146.94 and 146.25/85 MHz. Liquid refreshments will be available; bring your own dinner. For further details write the Mankato Area Radio Club, Box 1961, North Mankato MN 56001 or call Allen Windhorn at (507) 931-1349.

## MACS INN ID AUG 5-7

The 45th Annual WIMU (Wyoming, Idaho, Montana and Utah) Hamfest is scheduled to be held at Macs Inn, Idaho, just south of West Yellowstone about 25 miles. This is one of the Rocky Mountain Northwest's largest hamfeasts and we would like to invite you to attend, and at the same time enjoy a tour through Yellowstone National Park. Advance registration is \$6 (before July 1st). \$7 at the Hamfest. Please send all pre-registrations to WIMU Hamfest, PO Box 30756, Billings, Montana 59107, c/o Ronald Conley, General Chairman, WIMU Hamfest.

## NEWBURGH NY AUG 6

The Mt. Beacon Amateur Radio Club will hold their 4th Annual Hamfest on Saturday, August 6th, 9 am to 5 pm, at Stewart Field, Newburgh NY, inside hangar. Flea market and auction. Talk-in on 37/97 and 16/76. Rain or shine. Plenty of free parking. Admission \$1, Tailgating \$1, under 12 free.

## JACKSONVILLE FL AUG 6-7

The Bold City Hamfest sponsored by the Jacksonville Range Association will be held at the Jacksonville Beach Auditorium August 6-7. Vacation at our Hamfest - Florida's Friendliest. Visit our special "Solar" and "QRPP" forums. Send request for information and tables to Hamfest Coordinator, Jacksonville Range Association, PO Box 10623, Jacksonville FL 32207. For motel reservations call Ramada Inn toll free (800) 228-2828.

## OKLAHOMA CITY OK AUG 6-7

The 1977 Oklahoma Ham-Holiday will be held August 6 and 7, 1977 at the Southgate Inn Best Western, 5245 South Interstate 35, Oklahoma City, (405) 672-5561. Pre-registration \$3.00, at the door \$4.00.

## FORT WAYNE IN AUG 7

The Original FM Hamfest will be held Sunday, August 7, 1977, rain or shine, at the Allen County Police Reserve Center, 3022 Easterday Road, Fort Wayne, Indiana. 5400 square feet of air conditioned exhibit area, hot food and refreshments and prizes.

Sponsored by Fort Wayne Repeater Association, Inc. Advanced registration \$1.50 - call in to WA9EAU on 146.16/146.76, WR9ADI 146.52 or 52.525 MHz. Tickets at door \$2.00. Taped route information available on 146.91 MHz. For more information and advance tickets please write: Fort Wayne Repeater Association, Inc., PO Box 6022, Fort Wayne IN 46806.

## ANGOLA IN AUG 7

The Steuben County Radio Amateurs presents the 19th Annual F.M. Picnic and Hamfest to be held on Sunday, August 7, 1977, at the Steuben County 4-H Park, approximately 2 mi. west and 2 mi. north of Angola, Indiana. Hamfest includes picnic-style B.B.Q. chicken and refreshments, inside tables for exhibitors and vendors, overnight camping permitted in park for those desiring to arrive Saturday, movies Saturday night, as usual. Tickets \$1.00 by donation, advance registration not necessary. Talk-in frequencies 52.525, 146.52, 223.5, 446.0.

## CANTON OH AUGUST 7

The Canton, Ohio, Hall of Fame Hamfest (an official ARRL hamfest) will be held at the Stark County Fairgrounds on Sunday, August 7, 1977. Hamfest includes ARRL, Amateur Electronic Supply, Ken-Mar Industries, Omar Electronics, flea market, YL activities including games and drawings. Admission \$3 at gate, \$2.50 advanced. Under 13 years of age free. For advanced reservations contact: Butch Lebold WA8SHP, Box 3, Sandyville OH 44671. Advanced deadline July 30, 1977. For directions and information call: W8ZX on 146.19/79 (WR8ADE) or W8AL on 146.52/52. Mobile check-in prize!

## PITTSBURGH PA AUG 7

The 40th Annual Hamfest of the South Hills Brass Pounders and Modulators will be held on August 7, 1977 from noon until dusk at St. Clair Beach, Upper St. Clair Township, 5 miles south of Mt. Lebanon, on Rte 19. Swap and shop, picnic space and swimming for the family. Mobile check-in on 29.0 and 146.52. Information and pre-registration at \$1.50 per ticket (\$2 at door) from Rich Eckenrode, 1410 Bellaire Pl., Pittsburgh PA 15226. Vendors must register.

## LEVELLAND TX AUG 7

The 12th annual West Texas Emergency Net Picnic and Swapfest will be held in the city park, Levelland, Texas on Sunday, August 7. Bring your own picnic basket. Registration begins at 8 am. Lunch at 12:30. Swapping all day. Tables are provided. This family event is jointly sponsored by the Hockley County Amateur Radio Club and the West Texas Emergency Net. Mobile talk-in frequency is on 2 meters only, on 28/88, the Levelland Repeater (WR5AFX). Prizes will be given this year and a \$2 donation will



be appreciated, but is not required for registration.

### WASHINGTON MO AUG 7

The Zero-Beaters ARC will hold their annual Hamfest on Sunday, August 7, 1977 at Washington, Missouri city park. Free parking, bingo, and many prizes. No admission fee or fee for parking in the trader's row. For info or tickets contact Marvin Holdmeyer WB0VFP, or Zero-Beaters ARC WA0FYA, Box 24, Dutzow MO 63342.

### AMARILLO TX AUG 12-14

The Panhandle Amateur Radio Club of Amarillo, Texas, is sponsoring the 1977 Edition of the Golden Spread Hamfest at the Holiday Inn West, Amarillo, Texas, August 12, 13 and 14. A grand prize and pre-registration prize worth over \$800 will be given away. Activities include six big

tech and info sessions, commercial exhibitors, flea market, free bingo for all, two hospitality hours, live entertainment, special activities for the ladies, and demonstrations. Pre-registration \$3, at the door \$4. Write Golden Spread Hamfest, PO Box 10221, Amarillo, Texas 79106 for pre-registration packet.

### POLSON MT AUG 13

Western Montana amateurs will sponsor an annual Mini-Hamfest on Flathead Lake, near Polson, Montana, on August 13, 1977.

### CHARLOTTE VT AUG 13-14

Burlington A.R.C. International Field Day will be held on August 13 and 14, 1977, at Charlotte, Vermont. Flea market both days 7 am Saturday to 5 pm Sunday. \$3.00 early bird registration. \$3.50 at door — write P.O. Box 312, Burlington, Vermont.

Talk-in .01-.61.

### PLAIN CITY OH AUG 14

Union County Amateur Radio Club proudly presents Hamfest 77 to be held on Sunday, August 14, 1977 at Plain City Fairground near Columbus OH on St. Rt. 42, 4 miles south of 33. Hamfest includes large flea market, indoor tables for dealers, food available, free parking, and free overnight camping. Admission \$1.50 advance, \$2.00 at gate. Talk-in on 146.16/76. Check in (for prize) on 146.52. For more information write: Union County Amateur Radio Club, 13613 U.S. 36, Marysville OH 43040.

### FORT WASHINGTON PA AUG 14

The Mt. Airy VHF Radio Club (the Packrats) is holding its annual family picnic in the Flourtown Area of the Fort Washington State Park on Sunday, August 14, 1977 (rain date

August 21). Talk-in W3CCX/3 on 52.525, 146.52, and 222.98/224.58 MHz.

### BRISTOL TN-VA AUG 13-14

The Bristol Amateur Radio Club, Inc., will hold the Bristol Hamfest August 13-14 at the Beacon Drive-In Theatre on Blountville Hwy., 9 am to 5 pm, Saturday, 9 am to 3 pm Sunday. Tickets \$1, flea market space \$2. Talk-in on 01-61, 28-88 and 3980. Contact Bristol Amateur Radio Club, Paul E. Booher WA4KAS, 1221 Jonesboro Road, Bristol VA 24201.

### DESOTO IL AUG 22

The SARS Hamfest will be held on August 22, 1977, in Desoto, Illinois. Program includes prizes, food, auction. No charge for flea merchants. For more information write Nick Koenigstein, 2009 Gray Dr., Carbondale IL 62901.

# Are YOU a computer hobbyist



# — yet?

If you are like the rest of us you've been reading about microcomputers ... you're excited about them ... but there is so much to understand and it all seems so complicated that there is no way to understand it. Hogwash.

A brand new magazine is being published for computer hobbyists ... for people who are beginners ... neophytes ... novices ... people who have no idea what a vectored interrupt is, but just the same want to learn about computers and have fun.

A home computer system can cost you a bundle if you don't know what you are doing. Kilobaud could save you a lot of money ... others have learned the hard way. Kilobaud is a sort of giant club newsletter for computer hobbyists ... a place to tell each other about the problems they've had ... and the solutions. It's a magazine filled with great articles ... all written so you'll be able to understand them (for a change).

You want to know about hardware? Read about the new MITS Z-80 CPU in Kilobaud, simply explained by the chap who designed the circuit. Or how about the best-selling TDL Z-80 CPU ... the designer has written about it in Kilobaud too. You're wondering about what cassette system to use? You can go crazy on this one ... but before flipping out, read the Hal Walker article in Kilobaud and find out what the problems are ... and the solutions.

What do you do with the con-founded things after you've gotten them working? The programs are in Kilobaud ... lot's of them.

### MAKE MONEY

Perhaps you've been thinking of the computer hobby as a way to get into a small business. Why not? This is going to be an enormous field in a couple of years and you can bet that those on the ground floor will have the best chance at the gold ring. Kilobaud will help you learn how to get into manufacturing ... to become a dealer ... a manufacturer's representative ... a service bureau ... a writer. Never before has there been an opportunity like this ... so don't miff it ... grab hold and start getting your feet wet. It'll not only pay off well in the long run, you'll have a ball every minute of the way.

### KILOBAUD IS BRAND NEW

The first issue was January 1977 ... and the magazine is the fastest growing and best accepted magazine in the hobby computer field already. You doubt that? Just stop in at any hobby computer store and ask anyone you see. Kilobaud is outselling all other magazines combined ... which says something considering the cover price of \$2. It's full of good articles and has a sense of humor. There are more articles in Kilobaud than you can read in a day ... most readers comment that Kilobaud just has to be read from cover to cover and this takes several days. It's packed.

### CONTROVERSIAL?

You bet! Kilobaud calls a spade a spade, with no pulled punches.

### DO YOU WANT TO LEARN COMPUTERS?

Some magazines emphasize OEM systems ... some are written more for computer scientists ... Kilobaud is written for and by its readers ... the hobbyists. You'll find great articles in there by well known hobbyists such as Don Lancaster ... Don Alexander ... Pete Stark ... Dennis Brown ... Hal Walker ... Art Childs ... Sheila Clark ... and many more. The emphasis is fun.

### TRY A SUBSCRIPTION

The cover price is \$2 (that's \$24 a year), but the subscription rate is only \$15 for the year ... a saving of \$9.00. You can pay for it with your credit card (BankAmericard, Master Charge, American Express) or you can even be billed directly. Send in the below coupon ... a copy of it ... or call the TOLL FREE 800-258-5473 (during office hours) and order by phone.

Your subscription will start with the next published issue, so allow about six weeks for any apparent action. If you would like to be filled in with the back issues they are \$3 each and at last count some were still available.

YES! Start my one year Kilobaud subscription for \$15 with the next published issue.

Name \_\_\_\_\_ Call \_\_\_\_\_

Address \_\_\_\_\_

City \_\_\_\_\_ State \_\_\_\_\_ Zip \_\_\_\_\_

\$15.00 enclosed.  Cash  Check  Money Order

Bill:  Master Charge  BankAmericard  American Express

Card # \_\_\_\_\_ Interbank # \_\_\_\_\_

Signature \_\_\_\_\_ Exp. date \_\_\_\_\_

Bill me direct.

\*Subscription will start with next published issue. Allow six weeks for processing.

Toll Free Subscription Number (800) 258-5473

NH & Nights 800-251-6771

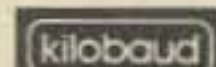

PETERBOROUGH NH 03458

73/7/77



**what do you  
give the man  
who has  
everything?**

**a box  
to put it in.**



73 Magazine, as thick as it is, is more like a floppy when it comes to standing on the bookshelf. Enter the new 73 Magazine Library Shelf Boxes, sturdy corrugated cardboard boxes which will hold your magazines on the shelf and keep them from flopping around.

Yes, we know all about binders . . . we have them too . . . and we sell them, but binders are a drag when you want one copy of a magazine. And they cost like sin (which costs plenty).

Just to be rotten (a talent we are trying to develop, but which comes hard), we have self-sticking labels for the boxes, not only for 73 Magazine, but also for Kilobaud . . . and for Personal Computing, Radio Electronics, Popular Electronics, Interface Age, and . . . yep . . . Byte. Heh, heh! Just ask for whatever stickers you want and we'll throw 'em in with your box order. Hams may want our labels for CQ, QST or Ham Radio, if they get any of those magazines. This is a way you can buy one set of matching boxes and line 'em up on your shelf . . . looks very nice that way.

The boxes are a white color and are particularly resistant to dirt, a real plus for white boxes. There's some kind of funny plastic finish on 'em.

You'll probably do like most people who have tried these so far and order one or two for starters . . . then get a couple dozen. The postage on these is the killer . . . so one box costs \$2.00 postpaid and \$1.50 for each additional box.

Unless the magazine gets whole lot fatter than it is right now these boxes should hold a full year of 73 . . . or Kilobaud.

One side is cut low to permit you to see the binding of the magazine . . . and note that we are now printing the information on the top part of the binding so it will show in these boxes. You can put the boxes on your shelves with the bindings showing or with just the white board showing, there are little marks to help you center your labels on either side.

Your magazine library is your prime reference, so keep it handy and keep it neat with these strong library shelf boxes.

Send me \_\_\_\_\_ boxes for 73 Magazine Shelf Storage at \$2.00 for the first box and \$1.50 for each additional box. Include the following labels: \_\_\_\_\_

\$\_\_\_\_\_ Enclosed  Cash  Check  M.O.  
Bill:  American Express  BankAmericard  
 Master Charge - Interbank # \_\_\_\_\_

Card # \_\_\_\_\_ Expiration date \_\_\_\_\_

Signature \_\_\_\_\_

Name \_\_\_\_\_

Address \_\_\_\_\_

City \_\_\_\_\_ State \_\_\_\_\_ Zip \_\_\_\_\_

**73 MAGAZINE LIBRARY SHELF BOXES**

Peterborough NH 03458

or call Toll Free (800) 258-5473

NH & Evenings (800) 251-6771 73 7/77

**call us**



**...tell us you love us**

Also tell us your credit card number so we can enter a subscription for you. A subscription saves you a bundle of money . . . just figure it out. At \$2 a copy you're spending \$24 a year, yet a subscription costs a lousy \$15. Nine dollars may not be a lot today, but that's no reason to just throw it away because you don't want to bother to pick up the phone.

Three years of 73 . . . if you figured out what that costs you'd send in a subscription instantly. Not having calculators that go out that far (allowing for the usual inflation, increases in postage, rising paper prices, and a new car for Wayne . . . a copy of 73 will probably be \$5 three years from now), no one at 73 has definitely been able to calculate the exact cost of three more years on the newsstand. One thing is for sure, it's going to be a lot more than the current three year \$36 subscription rate, which is an obvious rip-off. Call in your three year subscription and make us rue the day we came up with that low number.

It's toll free:

**800-258-5473**

(NH & nights 800-251-6771) and someone

is usually around during office hours to take your order, credit card number (Master Charge, BankAmericard or American Express). While you're calling what would it hurt to get Kilobaud too? And maybe a few books for the bathroom.

If the line is busy tear out the card bound in the back of the magazine . . . just inside the back cover . . .

While you are tearing out cards it is high time for you to mark up the reader's service card and send that in too. A good response convinces advertisers to run more ads . . . you get more pages of magazine. It's a good investment.

73-peterborough nh 03458



# 73 Radio Bookshop

● **COMPUTER DICTIONARY** by Donald D. Spencer. A compact compendium of computer terms for beginners and professionals alike. The *Computer Dictionary* by Donald D. Spencer defines words and acronyms used by computerists in a clear, easy to understand style. Over 2000 definitions are provided. This reference is a must for the individual getting started in the world of microcomputers. The *Computer Dictionary* by Donald D. Spencer; published by Camelot Press, \$5.95.

● **CHEMISTRY WITH A COMPUTER** by Paul A. Cauchon. An exciting new chemistry book which contains a collection of tutorial, simulation and problem-generation computer programs. Tutorials provide individualization of assignment, immediate evaluation of responses and a new set of problems with each run. Simulations provide models of lengthy laboratory experimentation beyond the limited classroom timeframe and enhancement of course studies by encouraging pre-laboratory research. Problem-generating programs provide individualized sets of questions on a given topic. Can be used with almost any chemistry course at the high school or college level. All programs are written in BASIC, the most popular and easiest to learn educational programming language. \$9.95.

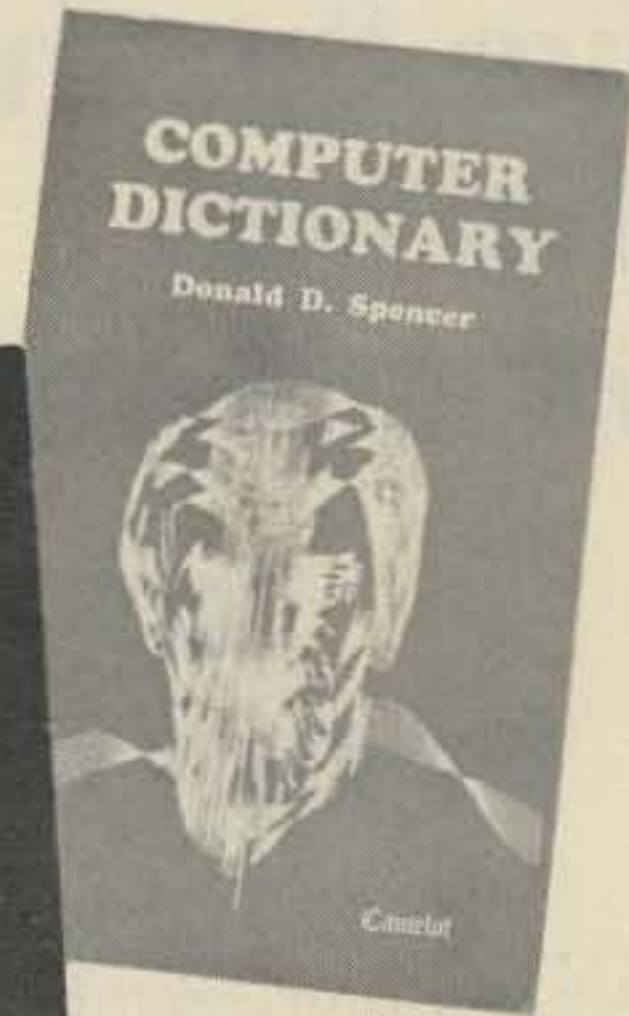
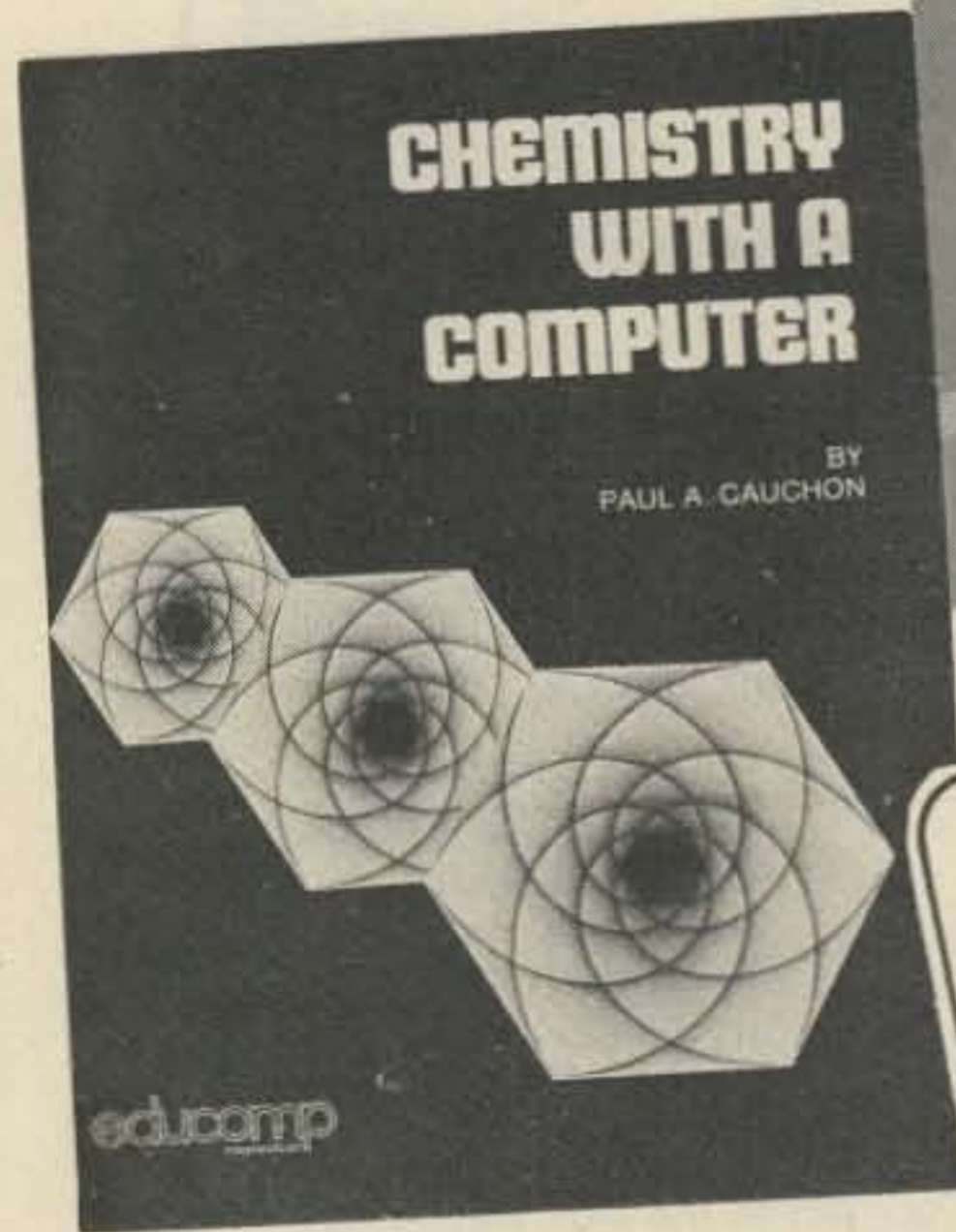

**LAST  
MINUTE  
ADDITIONS**

Use the order card or itemize your order on a separate piece of paper and mail to:  
73 Radio Bookshop • Peterborough NH 03458. Be sure to include check or detailed credit card information.  
Note: Prices subject to change without notice on books not published by 73 Magazine.

## 1977 REPEATER ATLAS of the WORLD

With over 1245 changes since the 1976 Atlas, and over 3000 repeaters listed, you need this Atlas to keep track of repeaters as you travel. Repeaters are listed both by location and by frequency. To help you find repeaters quickly when driving there are state maps showing the locations of the repeaters by output frequency.

The 1977 Atlas also has a chapter on how to use repeaters.

**INCREDIBLE BARGAIN AT \$1.95 POSTPAID**



Send me \_\_\_\_\_ Repeater Atlas(es) @ \$1.95

73/7/77

Please find \$\_\_\_\_\_ enclosed.  Cash  Check  Money order

Bill:  Master Charge  BankAmericard  American Express

**73** MAGAZINE,  
PETERBOROUGH, NH  
03458

Card # \_\_\_\_\_ Interbank # \_\_\_\_\_  
Expiration date \_\_\_\_\_ Signature \_\_\_\_\_  
Name \_\_\_\_\_  
Address \_\_\_\_\_  
City \_\_\_\_\_ State \_\_\_\_\_ Zip \_\_\_\_\_



# COMPUTERMANIA <sup>T.M.</sup>

SEE THE NEW HOBBY COMPUTERS

AUG 25 <sup>THU. 1-10PM</sup> 26 <sup>FRI. 1-10PM</sup> 27 <sup>SAT. 9AM-9PM</sup>



## BOSTON COMMONWEALTH PIER

See dozens of microcomputer systems on display and running... sit down and give them a try... find out why people get hooked on Star Trek... find out why 100,000 computer-geeks have gone nuts over microcomputers. See a couple of hundred exhibits of computers, memory boards, printers, floppy disks - see it all at the Pier this August!

Hear top computerized hams explain about the fun they are having and the fun you can have. This show is worth the trip from anywhere. Charter flights are being organized from the West Coast and Japan.

See the manufacturers show and tell about their systems... and answer your questions - in detail. You don't have to be a computer expert to find out how exciting microcomputers are... and why they are going to be a multi-billion dollar business before long. One look will convince you.

See Morse code translated into print... even into voice... all by microcomputer... and at a price within reasonable hobby limits. See Oscar data computers... repeater control computers... all sorts of fantastic ham applications of microcomputers.

Don't miss the fun at the Pier in Boston... where calculators... TV Games... Microcomputers... Hobby computer systems... ham computer systems... and even small business computers you may be able to use in your business will be on display and running for you to try out.

See a \$250 computer which will beat you at chess... they come in all prices, from under \$100 up to the sky!

### SEE THE NEW CALCULATORS

The NEW calculators do a lot... even have memory... will play lunar landing games... see them at the Pier!

### SEE THE NEW TV GAMES

They've gone way beyond pong... with tank games, blackjack, shooting gallery, and many more fantastic home games you can play on your TV set.

### SEE THE NEW SMALL BUSINESS COMPUTERS

Costing less than the salary of a clerk, these sophisticated business systems may be able to save you thousands of dollars a year. See them at the Pier... try them out... find out... save a bundle.

### SEE THE NEW TUFTS Radio Exhibit

Chuck Martin W1KPS will be there with his loads of ham goodies... don't miss his display. This is your chance to get that ham rig you'll need for fall.

DEMONSTRATIONS\*FORUMS\*TALKS\*OVER 250 EXHIBITS\*PRIZES

**TICKETS AT DOOR: \$12.00**

PREREGISTRATION PRICE - \$10 UNTIL AUGUST 1st

POLL • POLL • POLL • POLL • POLL • POLL

MY INTEREST IS IN:  Calculators  Video Games  
 Microcomputers  Hobby Computing  
 Business Uses  Industrial Control

Occupation \_\_\_\_\_

Equipment now in use (make & model) \_\_\_\_\_

Thinking of buying \_\_\_\_\_

Present investment \$ \_\_\_\_\_

Expect to spend during next year? \$ \_\_\_\_\_

YES! Send me \_\_\_\_\_ admission tickets at \$10 each.  
 Check enclosed  Credit card below  
 BA  AMEX  MC - Interbank # \_\_\_\_\_  
Card # \_\_\_\_\_  
Expir. date \_\_\_\_\_ Signature \_\_\_\_\_  
Name \_\_\_\_\_  
Address \_\_\_\_\_  
City \_\_\_\_\_ State \_\_\_\_\_ Zip \_\_\_\_\_

Computermania Tickets  
Peterborough NH 03458  
or call Toll Free (800) 258-5473



# WHAT HAVE YOU MISSED?

**JUNE 63.** Surplus issue: DMQ-2 Beacon Tx on 220, increasing ARC-2 transceiver selectivity, PE-97A pwr supply conversion, BC-348 bandspread, inductance tester, converting BC-230 tx, beginner's rx using BC-453, recvr motor-tuning, transistor cw monitor, BC-442 ant relay conversion, mobile loading coils, increasing Two-er selectivity, TV with the ART-26 tx, TRC-8 rx on 220, ARC-5 hf rx & tx, ARC-3 tx on 2M.

**AUG 63.** Battery-op 6M stn, diode noise gen, video modulation, magic T-R switch, ant gain, halo mods, cw breaker, VEE beam design, coax losses, RF wattmeter, TX Tube Guide, diode pwr supply, "Lunchbox" squelch, SWR explanation, vertical ant info, info on Windom ant.

**OCT 63.** WBFM transceiver ideas, HF propagation, cheap fone patch, remote-tuned Yagi, construction hints, ant coupler, S5 Vertical, filament xformer construction, 2M nuvistor converter, Lafayette HE-35 mods, Buyer's Guide to Rx & Tx, product detector, novel Hi-C VFO, radio astronomy, panadaptor "if" converter, compact mike amp.

**FEB 64.** 2M multichannel exciter, rx design ideas, magic t/r switch, loudspeaker enclosures, 40M 2W tx, look at test equipment, radio grounds, 40M ZL Special ant, neutralization.

**MAY 67.** Quad Issue. 432 Quad-quad-quad, expanded HF quad, Two el quad, miniquad, 40M quad, quad experiments, half-quad, three el quad, 20M quad, tiltover quad, easy-to-erect quad, Quad Bibliography, FET vfo, tube troubleshooting, HF dummy load, understanding "dB," HF SSB/cw rx, geometric circuit design, GSB-201 transceiver, FET converter for 10-20M, hi-pass rx filters.

**JULY 67.** VE ham radio, VE0 hams, dsb adaptor, home brew tower, transistor design, '39 World's Fair, gnd plane ant, G4ZU beam, SSTV monitor, UHF FET preamps, IC "if" strip, vertical ant, VHF/UHF dipper, tower hints, scope monitoring, operating desk, S-Line crossband, hi-school ham club, Heath HR-10 mods.

**OCT 67.** HF solid state rx, rugged rotator, designing slug-tuned coils, FET converter, SSTV pix gen, VHF log periodics, rotatable dipole, gamma-match cap, old-time dxing, modern dxing.

**JUNE 68.** Surplus issue: Transformer tricks, BC 1206 rx, APS-13 ATV tx, low voltage dc supply, surplus scopes, FM rig commercial xtal types, Wilcox F-3 rx, restoring old equipment, 75A1 rx mods, TRA 19 on 432, freq counter uses, transceiver pwr supply, uses for cheap tape recorders, Surplus Conversion Bibliography, RT-209 walkie on 2M, ARC-1 guard rx, RTTY tx TU.

**JULY 68.** Wooden tower construction, tiltover towers, erecting a telephone pole, IC AF osc, "dB" explained, ham club tips (Part 1).

**SEPT 68.** Mobile vhf, 432 FET preamps, converting TV Tuners, xtal osc stability, parallel Tee design, moonbounce rhombic, 6M xciter (corrections Jan 69), 6M transceiver (corrections Jan 69), 2M dsb amp, ham club tips (Part 3).

**NOV 68.** SSB xtal filters, solid state troubleshooting, IC freq counter (many errors & omissions), "cv" transformers, space comm odyssey, pulsar info, thin-wire ants, 40M transistor cw tx/rx, BC-348M double conversion, multifunction tester, copper wire specs, thermistor applications, hi-voltage transistor list, ham club tips (Part 5).

**JAN 69.** Suppressor compressor, HW-12 on 160, beam tuning, AC voltage control, 2M transistor tx, LC power reducer, spectrum analysis info, 6M transistor rx, operating console, RTTY autostart, calculating osc stability, lppwr 40 cw tx, sequential relay switching, sightless operator's bridge, ham club tips (Part 7).

**FEB 69.** SSTV camera mod for fast-scan, tri-band linear, selective af filter, unijunction transistor info, Nikola Tesla biography, mobile installation hints, extra-class license study (Part 1).

**MAR 69.** Surplus issue: TCS tx mods, cheap compressor/amp, RXZ calculations, transistor keyer, better balanced modulator, transistor oscillators, using blowers, halfwave feedline info, Surplus Conversion Bibliography, extra license study (Part 2).

**APR 69.** 2-channel scope amp, rx preamp, Two-er PTT, variable DC load, SWR bridge, 100 kHz marker gene, some transistor specs, SB-610 monitorscope mods, portable 6M AM tx, 2M converter, extra license study (Part 3).

**MAY 69.** 2M Turnstile, 2M Slot, rx attenuator, generator filter, short VEE, quad tuning, using antennascope, measuring ant gain, phone patch regs, SWR indicator, 160M short verticals, 15M antenna, HF propagation angles, FSK exciter, KW summy load, hi-power linear, extra license study (part 4), all-band curtain array.

**JUNE 69.** Microwave pwr generation, 6M ssb tx, 432-er tx/rx, 6M converter, 2M 5/8 wave whip, UHF tv tuners, ATV video modulator, UHF FET preamps, RTTY monitorscope, extra license study (part 5), building uhf cavities, mini-VEE for 10-20M, vhf vfo.

**JULY 69.** AM modulator, SSTV sig gen, 6M kw linear, 432 KW amp, 432-er tx/rx, 6M IC converter, radio-controlled models, RTTY IC

The back issues of 73 are a gold mine of interesting articles . . . just take a look at what's been covered . . . every possible interest. This is the most important library you can have for hamming.

The supply of these back issues is very limited . . . and when these are gone, that will be it. Don't miss out by procrastinating.

Single issues . . . . . \$1.50 each (before 1976)

Ten back issues (your choice) . . . . \$12 postpaid in US.

Twenty-five back issues (your choice) \$20 postpaid in US.

Twenty-five back issues (our choice) \$10 postpaid in US.

TU, audio notch filter, VRC-19 conversion, tube substitution, 2M transistor xciter, extra license study (part 6), hf FET vfo.

**AUG 69.** FET regen for 3.5 MHz up, FM crystal switching, 5/8 wave vertical, introduction to ICs, RTTY tone gen, good/bad transistor checker, 2M AM tx, measure transistor Ft, 160M propagation, triac applications, simple IF sweep gen, transistor keyer, SB-100 on 6M, xtal freq measurement, extra license study (part 7), FM deviation meter, qrp am 6M tx, circular quads, FM noise figure, transistor parameter tracer.

**SEPT 69.** Tunnel diode theory, magic tee, soldering techniques, wave travel theory, cable shielding, transistor theory, AM noise limiter, AFSK gen, transistor amp debugging, measure meter resistance, diode-stack pwr supply, transistor testing, 2 1/2 W 6M tx, HX-10 neutralizing, capacitor usage, radio propagation, AM mod percentage, extra class license study (part 8), 3-400Z linear, ATV vidicon camera, 2 transistor testers, FET compressor, rf plate choke.

**OCT 69.** Super gain 40M ant, FET chirper, telephone info, scope calibrator, thyrector surge protector, slower tuning rates, identify calibrator harmonics, FM adaptor for AM tx, CB sets on 6M, proportional control xtal oven, xtal filter installation, Q-multiplier, transceiver pwr supply, extra class study (part 9).

**NOV 69.** NCX-3 on 6M, IF notch filters, dial calibration, HW32A external VFO, 6M converter, feedline info, rf z-bridge, fm mobile hints, umbrella ant, 432-er tx (part 1), pwr supply tricks with diodes, transistor keyer, transistor bias design, xtal vhf sign gen, electronic variac, SB33 mods, extra class study (part 10), SB34 linear improvements.

**DEC 69.** Transistor-diode checker, dummy load/attenuator, tuned filter chokes, band-switching Swan 250 & TV-2, 88mh selectivity, match exercises, rti xtal calibrator, transistor pa design, hv mobile p.s., 1-10 GHz frequency, CB rig on 6M, extra license study (part 11), 1970 buyer's guide.

**JAN 70.** Transceiver accessory unit, bench power supply, SSTV color method, base-tuned center-loaded ant, 6M bandpass filter, extra license study (part 12), rectifier diode usage, facsimile info.

**FEB 70.** 18-inch 15M dipole, 6M converter, high-density pc board, camper mobile hints, 2M freq synthesizer, encoding/decoding for repeaters, DX-35 mods, panoramic vhf rx, variable-Z HF mobile mount, extra license study (part 13), linear IC info, qrp 40M tx, IC Q-multiplier.

**MAR 70.** Gdo applications, charger for drycells, FM freq meter, pc board construction, ham fm standards, cheap rf wattmeter, multifreq fm osc, "IF" system modules (part 1), Six-er mods, gdo dip lite, Motorola 41V conversion, cw monitor, buying surplus logic, SSQ-23A sonobuoy conversion, GRC-9 rx/tx conversion, extra class study (part 14), intro to vhf fm.

**APR 70.** Noise blanker, 2M hotcarrier diode converter, repeater controller, understanding COR repeater, 7/8-wave 2M ant, extra class study (part 15), inexpensive semiconductors, removing surplus meters, linear amp bias regulator, hi performance if amp & age system, SSB bfo for shortwave radio, vacuum tube load box, general fm dope & repeater guide, meggering your ant.

**MAY 70.** Comments on "fm docket" #18803, future of cw, fm-am rx aligner, 5/8 wave verticals, using 2M intelligently, auto burglar alarms, pwr supplies from surplus components, "IF" system modules (part 2), vhf FET pre amps, educated "idiot" lites, postage-stamp 6M tx, extra class study (part 16), Bishop IFNL, low-band police monitor, mobile cw tx, Wichita auto patch.

**JUNE 70.** DRRR ant, vfo circuit, remote SWR indicator, indoor hf vertical, two rx on one antenna, environment & coax loss, 2-el trap verticals, buying surplus, two-40M qrp tx, 21dB 2M beam, extra class study (part 17).

**DEC 70.** Solid-state vhf exciter, delta fra control for SSB, 2M transistor FM tx, HW100 offset tuning, "little gate" dipper, 3-500Z hf linear, general class study (part 5), "transi-test"

(no good - errors!), transistor p.s. current limiter.

**JAN 71.** Split fones for dxing, Heath Ten-er mods, cw duty cycle, repeater zero beater, HEP IC projects, 10-15-20M parabolic ideas, lightning protection, IC rx accessory, attic ants, double-balanced mixers, permanent marker tool, ham license study questions.

**FEB 71.** Metal locator, varactor theory, AFSK unit, SSTV patch box, ATV hints, RTTY tuning indicator, tone encoder/decoder, 220 MHz converter, SSTV magnetic deflection, IC code osc, 6M tx beeper, general class study (part 6), RTTY intro, perf-board terminal, low ohmmeter.

**MAR 71.** IC audio filter, IC 6M converter, trap vertical ideas, digi counter info, surplus equipment identification, hf linear, simple fone patch, repeater audio mixer, digi RTTY accessories, coathanger gndplane, general class study (part 7).

**APR 71.** Intro to fm, noise blanker, repeater problems, Motorola HT-22 crowwave repeater linking, digi counter, linear 2M fm rx/tx, rep- . . . fm marketplace, meter ev- . . . sctor modulator, simple sig gen, touch- . . . hookup, hf preselector, 10M 12W tx.

**MAY 71.** 75M mobile whip, 2M preamp, transistor amp design, 10M dsb tx, portable fm transceiver directory, audio compressor clipper, transistor LM frequency, 450 MHz link tx, simple af filter, 1-tube 2M transceiver, surplus 2M power amp, general class study (part 8).

**JUNE 71.** 2M beam experiments, 3-el 2M quad, multi-band dipole patterns, weather balloon vertical, pocket pager squelch, two-er vfo, tuning mobile whips, transistor pwr supply, capacity decade box, 40M gain ant, general class study (part 9).

**JULY 71.** IC audio processor, audio sig gen, cw filter, 2M fm osc, 2M collinear vertical, FM supplier directory, Motorola G-strip conversion, transistor beta tester, general class study (part 10).

**AUG 71.** Ham facsimile (part 1), 500 Watt linear, dimensions for July collinear, 4-tube 80/40 station, vfo digi readout, Jupiter on 15M, general class study (part 11), pink ticket wavemeter.

**SEPT 71.** Transformerless power supplies, solid state tv camera, IC substitution, two rf wattmeters, IC compressor-agg, multichannel HT-200, ham facsimile (part 2), causes of manmade noise, vfo with tracking mixer, general class study (part 12), transistor heat-sinking, IC pulse gen, fone-patch isolation, hcd wattmeters.

**OCT 71.** Emergency repeater cor, transceiver power supply, predicting meteor showers, digi switching, reverse-current battery charger, passive repeaters, earth grounds, audio "tailoring" filters, Swan 350 mods.

**NOV 71.** 3-el 75M beam, motor-tuned gnd-plane, 2M gain vertical, transistor biasing, split-site repeater, fox hunting, audio filter, transistor/diode tester, xtal tester, 6M kw amp, 10-15-20M quad, transistor pi-net final, ant feedline, communications dbs, 2300 MHz exciter.

**AUG 72.** SSTV intro, speech processor, fm repeater info, test probe construction, GE progline ac supply, 432 rf testing, preamp compressor, Six-er mods, fone patch, Two-er info, solar info, SCR regulator for HVPS, "ideal" xtal osc, fm rx adaptor, auto theft alarm.

**SEPT 72.** Plumbicon tv camera, WWVB 60 kHz rx, cigartube sig gen, cw active filter, rf testing at 1296-3500 GHz, balun ant feed, transistor power supply, IC 6M rx, IC fm/am detector (part 2), active filter design (part 3), K20AW freq counter (part 3), 2M freq synthesizer (part 1).

**OCT 72.** Corrections for Aug. fm rx adaptor, 2M freq synthesizer (part 2), 6M transistor vfo, nano-ampere meter, time-freq measurement (part 1), active filter design (part 4), repeater timer, extra-class Q&A (part 3), balloon vertical, ID gen, time delay relay, 432 filter ideas, DC-AC inverter, hc-diode converter, rti decade and nixie driver, plus-minus supply for ICs.

**NOV 72.** Hf transistor power amps, RTTY selcal, IC trf rx, transistor keyer, emergency power, 220 MHz preamp, double-delta ant, simple converter using modules, hf RF tester, "lumped line" osc, 2M freq synthesizer (part 3), K20AW counter errata, 2M preamp, extra class Q&A (part 4), hi Z voltmeter, Nikola Tesla story, vhf swr meter, transistor regen rx, 432 SSB transverter, AC arc welder, intro to computers, hybrid am modulator, HR10 rx mods, 10M transistor am tx, 40M gndplane, IC logic demonstrator, overload protection, if/rf sweep generator, digi freq counter, aural tx tuning.

**DEC 72.** SSTV scope analyzer, 2M fm rx, tone burst encoder and decoder, universal if amp, autopatch hookup, LM380N info, voltage variable cap info, 2M 18 watt amp, SSB modulation monitor, xtal freq/activity meter, 10A vdc supply, transmission line uses, radio astronomy, inductance meter, 75 to 20M transverter, LED info, 40M preamp, transistor vfo, 1972 index, 2M preamp.

**JAN 73.** HT-220 touchtone, 3-el 20M yagi, 50 MHz freq counter, speech processor, 2 tone gen, fm test set, tilt over tower, 6M converter using modules, tuneable af filter, six band linear, 10M IF tuner, diode noise limiter, cw/ssb agg, HW22a transceiver 40M mod, HAL 1D-1 mod.

**FEB 73.** CW id gen, tone operated relay, toroidal quadrature ant, active filter, time freq measurement (part 2), repeater timing control, SSTV circuits (part 1), 2M converter using modules, multifunction metering, FET biasing, freq counter preamp, TR22 hi power mod, transistor rf power amps (part 1), light bulb rf power indicators, 75A4 filters, capacitance measurement, Gonset 201 mod, world time info.

**APR 73.** FM deviation meter, 2M FET preamp, two 2M power amps, repeater control (part 1), repeater licensing, European 2M fm, fm scanner adaptor, RCA CMU15 mods, lightning detector, cb alignment gadget, transistor rf power amps (part 2), repeater economics.

**JUNE 73.** 220 MHz sig gen, uhf power meter, repeater licensing info, RTTY autowatch, 40M hybrid vfo tx, ant polar mount, 10-15-20M quad, K20AW counter mods, double coax ant, ham summer job, tone decoder, field strength meter, nicad battery pack, ohm meter, FCC regs (part 1).

**AUG 73.** Log periodics (part 1), tone burst gen, rf power amp design, transistor radio intercom, 160M ant, SSTV monitor, low cost freq counter, VOM design, qrp 40M tx, 432 MHz exciter, fm audio processing, FCC regs (part 3).

**SEPT 73.** Repeater control system, log periodics (part 2), 2M rx calibrator, PLL ic applications, TT pad hookup, Heath HW7 "s" meter, Oscar-6 doppler, 2M coaxial ant, 2M converter, IC keyer, measure ant Z, FCC regs (part 4).

**OCT 73.** GE Pocketmate mods, microwave freq measurement, CA3102E 2M frontend, 2 kw hf linear, rf wattmeter, meter repair, 60/40 dipole, IC "hi" gen, vhf freq multiplier, FCC regs (part 5).

**NOV 73.** 450 MHz exciter, intro to ATV circuits, nicad voltage monitor, autopatch connections, IC meter amplifier, TR22 ac supply, indoor vertical, IC af filter, momentary power failure protection, 160M ant acoupler, Motorola HT info, SSTV-158, Class B af amp, FCC regs (part 6).

**DEC 73.** Code speed display, 2M kw amp, IC keyer, 8038 waveform gen, helical resonator design, sensitive rf voltmeter, proximity control switch, IC tester, sequential tone decoder, 2M portable beam, electronic calculator math, cw filter design, FCC regs (part 7).

**FEB 74.** SSTV monitor info, IC audio amps, scope sweep gen, 15/20M vertical, telephone line control system, pc board construction, var-Q af filter, blown-fuse indicator, 40m cw stn with Ten-Tec modules, simple preamp compressor, single IC rx, "432 er" final assembly, transistor keying circuit, 7 segment readout with nixie driver.

**APR 74.** Vox for repeaters, tone operated relay, hf transverter, 10 to 2m tx converter, remote control panel for scanner, RCA fm tx tuning, subaudible tone gen, FCC regs (part 9), Repeater Atlas.

**MAY 74.** Cd car ignition, audio compressor info, interference suppression for boats, auto burglar alarms, 2m ic preamp, 10m fat converter.

**JULY 74.** 4-1000A linear, universal freq gen, universal afsk gen, 555 IC timer, 30M phased array, 135 kHz 432 MHz preamps, 10M qrp am tx, 3000 vdc supply, how to read diagrams.

**AUG 74.** Toroidal directional wattmeters, 450 MHz FET preamp, use gdo to find "c", Trimline tt pad hookup, R390 & R392 rx mods, tracking cw filter, aural voltmeter, universal regulated supply, stv scan converter, ttl logic problems, ID timer.

**SEPT 74.** MOSKEY electronic keyer (part 1), ex warning system, Heath 10103 scope mods, qrp 6M am tx, rf speech clipper, audio noise limiter, wx satellite on SSTV monitor, universal IC tester, miniature rig construction, tower construction, infinite rf attenuator, electronic

(More)







# RADIO BOOKSHOP

## The ONLY Complete License Study Guides

- **NOVICE STUDY GUIDE** — Here is a completely new study guide and reference book for the potential ham. This is not a question/answer memorization course. Electronic and radio fundamentals are presented and explained in an easy-to-understand fashion, preparing the beginner for the Novice exam. Includes the latest FCC amateur regulations, as well as application forms. Easily the best path into the exciting world of ham radio! \$4.95.
- **GENERAL CLASS STUDY GUIDE** — A complete theory course for the prospective General or Technician. This reference explains transistor, amplifier, and general radio theory, while preparing the Novice for the "big" ticket. After getting your ticket, you'll use this guide again and again as an electronic reference source. Not a question/answer guide that becomes dated when the FCC updates the amateur exams. \$5.95.
- **ADVANCED CLASS STUDY GUIDE** — Ready to upgrade your license? To prevent retaking the FCC theory exam, you need the 73 Advanced theory guide. SSB, antenna theory, transmitters, and electronic measuring techniques are covered in detail in this easy-to-follow study guide. Special modes and techniques, such as RTTY, are also treated. An engineering degree is *not* necessary to master Advanced theory — try this book before visiting the examiner's office! \$3.95.
- **EXTRA CLASS LICENSE STUDY GUIDE** — Before going for your 1 x 2 call, it pays to be a master of the Extra class electronic theory. This study guide is the logical extension of the 73 theory course. All the theory necessary to pass the exam is presented. Antennas, transmission lines, swr are discussed, as well as noise, propagation, and specialized communication techniques. This book is not a classroom lecture or memorization guide, but rather a logical presentation of the material that must be *understood* before attempting the Extra exam. Save yourself a return trip to the FCC and try the 73 method first! \$5.95.



## novice theory tapes

### Startling Learning Breakthrough

You'll be astounded at how really simple the theory is when you hear it explained on these tapes. Three tapes of theory and one of questions and answers from the latest Novice exams give you the edge you need to breeze through your exam.

73 is interested in helping get more amateurs, so we're giving you the complete set of our tapes for the incredibly low price of ONLY \$15.95.

Scientists have proven that you learn faster by listening than by reading because you can play a cassette tape over and over in your spare time — even while you're driving! You get more and more info each time you hear it.

You can't progress without solid fundamentals. These four hour-long tapes give you all the basics you'll need to pass the Novice exam easily. You'll have an understanding of the basics which will be invaluable to you for the rest of your life! Can you afford to take your Novice exam without first listening to your tapes?

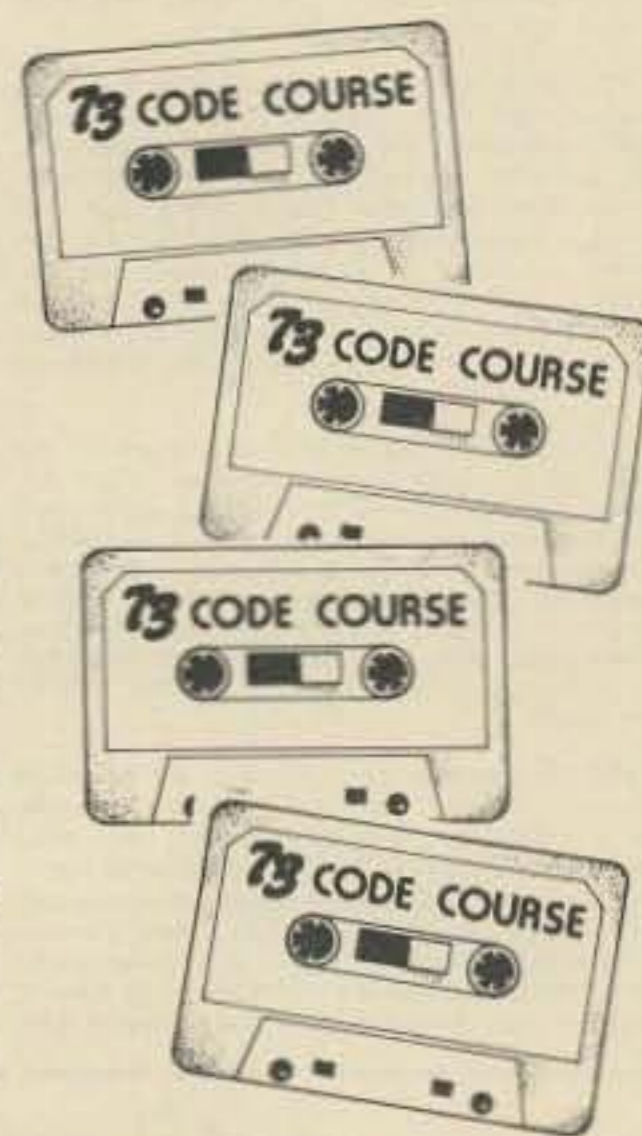

### FOUR TAPES for \$15.95 \$4.95 EACH

**5 WPM** This is the beginning tape for people who do not know the code at all. It takes them through the 26 letters, 10 numbers and necessary punctuation, complete with practice every step of the way using the newest blitz teaching techniques. It is almost miraculous! In one hour many people — including kids of ten — are able to master the code. The ease of learning gives confidence to beginners who might otherwise drop out.

### NEW CODE SYSTEM — Four Speeds Available

**6 WPM** This is the practice tape for the Novice and Technician licenses. It is made up of one solid hour of code, sent at the official FCC standard (no other tape we've heard uses these standards, so many people flunk the code when they are suddenly — under pressure — faced with characters sent at 13 wpm and spaced for 5 wpm). This tape is not memorizable, unlike the zany 5 wpm tape, since the code groups are entirely random characters sent in groups of five. Practice this one during lunch, while in the car,

anywhere, and you'll be more than prepared for the easy FCC exam.

**13 WPM** Code groups again, at a brisk 13 per so you will be at ease when you sit down in front of the steely eyed government inspector and he starts sending you plain language at only 13 per. You need this extra margin to overcome the panic which is universal in the test situations. When you've spent your money and time to take the test you'll thank heavens you had this back-breaking tape.

**20 WPM** Code is what gets you when you go for the Extra Class license. It is so embarrassing to panic out just because you didn't prepare yourself with this tape. Though this is only one word faster, the code groups are so difficult that you'll almost fall asleep copying the FCC stuff by comparison. Users report that they can't believe how easy 20 per really is with this fantastic one hour tape. No one who can copy these tapes can possibly fail the FCC test. Remove all fear of the code forever with these tapes.

ONLY 4 for \$15.95! 73 is in the publishing business, not tapes, so these are priced much lower than anyone else could sell them. Have you ever seen one hour cassettes for under \$6? For 1st class mail add 25¢ per tape ordered.

**RADIO AMATEURS TALK TO THE WORLD!!**  
...ask me about it!

**BUMPER STICKERS:**  
RADIO AMATEURS TALK TO THE WORLD!!  
AUTHORIZED VEHICLE  
SUPPORT YOUR LOCAL POLICE  
50¢ each; any 3 for \$1.00

**BINDERS** — Red Binders with gold lettering keep your 1976 & 1977 73s safe from being lost or damaged. Each binder holds 12 issues. \$6.00 ea., 2 for \$11.00.

**BACK ISSUE BUNDLE!** 73 Magazine Classics, issues containing hundreds of articles & projects. Great for nostalgia buffs. 20 copies (all different) for \$8.00.

**LIBRARY SHELF BOOK BOXES**  
\$2.00 each  
2/\$3.00 • 8/\$10.00

## QSLs!

ONLY \$7.50 for 250,  
\$12.50 for 500,  
\$20.00 for 1000!



How can 73 make such beautiful cards, printed on the best coated stock, available for about half the regular cost?

The world and satellite are printed in blue, your name, address and call are in black. The QSO information is a standard form on the back. DOMESTIC ORDERS ONLY  
**ALLOW 6-8 WEEKS FOR DELIVERY.**

Use the order card or itemize your order on a separate piece of paper and mail to:

73 Radio Bookshop • Peterborough NH 03458 Be sure to include check or detailed credit card information.

Note: Prices subject to change without notice on books not published by 73 Magazine.



# RADIO BOOKSHOP

● **REPEATER ATLAS** Hundreds of new listings . . . by both location and frequency . . . dual listing, invaluable for your car . . . find those repeaters as you travel. This is the **ONLY** complete list of repeaters being published. Almost 3000 repeaters listed in this issue . . . repeaters from all over the entire world. Only \$1.95.

● **VHF ANTENNA HANDBOOK** The **NEW** VHF Antenna Handbook details the theory, design and construction of hundreds of different VHF and UHF antennas . . . A practical book written for the average amateur who takes joy in building, not full of complex formulas for the design engineer. Packed with fabulous antenna projects you can build. \$4.95.

● **WEATHER SATELLITE HANDBOOK** Simple equipment and methods for getting good pictures from the weather satellite. Antennas, receivers, monitors, facsimile you can build, tracking, automatic control (you don't even have to be home). Dr. Taggart WB8DQT \$4.95.

● **COAX HANDBOOK** The world's only handbook devoted exclusively to coax, feedlines and connectors. Special price only \$1.50.



● **VOL. I COMPONENT TESTERS** . . . how to build transistor testers (8), diode testers (3), IC testers (3), voltmeters and VTVMs (9), ohmmeters (8 different kinds), inductance (3), capacity (9), Q measurement, crystal checking (6), temperature (2), aural meters for the blind (3) and all sorts of miscellaneous data on meters . . . using them, making them more versatile, making standards. Invaluable book, \$4.95.

● **VOL. II AUDIO FREQUENCY TESTERS** . . . jam packed full of all kinds of audio frequency test equipment. If you're into SSB, RTTY, SSTV, etc., this book is a must for you . . . a good book for hi-fi addicts and experimenters tool \$4.95.

● **VOL. III RADIO FREQUENCY TESTERS** Radio frequency waves, the common denominator of Amateur Radio. Such items as SWR, antenna impedance, line impedance, rf output and field strength; detailed instructions on testing these items includes sections on signal generators, crystal calibrators, grid dip oscillators, noise generators, dummy loads and much more. \$4.95.

● **THE NEW RTTY HANDBOOK** is a brand new 1977 edition and the only up-to-date RTTY book available. The state of the art has been changing radically and has made all previous RTTY books obsolete. It has the latest circuits, great for the newcomer and the expert alike . . . Only \$5.95.

● **73 VERTICAL, BEAM AND TRIANGLE ANTENNAS** by Edward M. Noll W3FQJ Describes 73 different antennas for amateurs. Each design is the result of the author's own experiments: each has actually been built and air-tested. Includes appendices covering the construction of noise bridges and antenna line tuners, as well as methods for measuring resonant frequency, velocity factor, and standing-wave ratios. 160 pages. \$5.50.

● **IC OP-AMP COOKBOOK** by Walter G. Jung. Covers not only the basic theory of the IC op amp in great detail, but also includes over 250 practical circuit applications, liberally illustrated. 592 pages, 5½ x 8½, softbound \$12.95.

● **73 DIPOLE AND LONG-WIRE ANTENNAS** by Edward M. Noll W3FQJ This is the first collection of virtually every type of wire antenna used by amateurs. Includes dimensions, configurations, and detailed construction data for 73 different antenna types. Appendices describe the construction of noise bridges, line tuners, and data on measuring resonant frequency, velocity factor, and swr. 160 pages. \$5.50.

● **RF AND DIGITAL TEST EQUIPMENT YOU CAN BUILD** Rf burst, function, square wave generators, variable length pulse generators — 100 kHz marker, i-f and rf sweep generators, audio osc, af/rf signal injector, 146 MHz synthesizer, digital readouts for counters, several counters, prescaler, microwavemeter, etc. 252 pages. \$5.95.

● **SSTV HANDBOOK** This excellent book tells all about it, from its history and basics to the present state of the art techniques. Contains chapters on circuits, monitors, cameras, color SSTV, test equipment and much more. Hardbound \$7, softbound \$5.

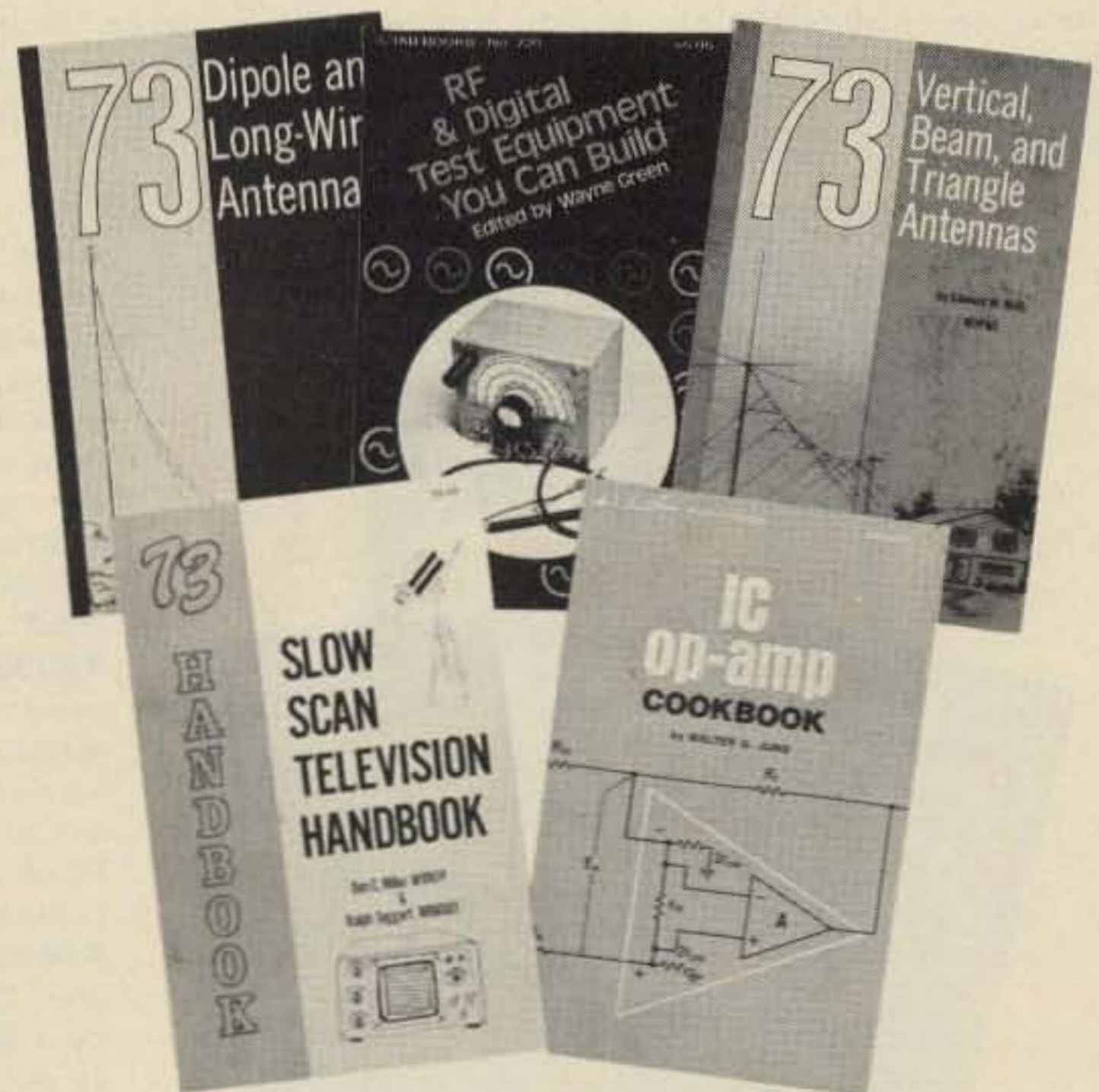

Use the order card or itemize your order on a separate piece of paper and mail to:  
73 Radio Bookshop • Peterborough NH 03458 Be sure to include check or detailed credit card information.  
Note: Prices subject to change without notice on books not published by 73 Magazine.



# RADIO BOOKSHOP

● **RTL COOKBOOK** by Donald Lancaster. Explains the how and why of RTL (Resistor-Transistor Logic) and gives design information that can be put to practical use. Gives a multitude of digital applications ranging from the basic switch to the sophisticated counter. 240 pages; 5½ x 8½; softbound. \$5.50.

● **TTL COOKBOOK** by Donald Lancaster. Explains what TTL is, how it works, and how to use it. Discusses practical applications, such as a digital counter and display system, events counter, electronic stopwatch, digital voltmeter, and a digital tachometer. 336 pages; 5½ x 8½; softbound. \$8.95.

● **TVT COOKBOOK** by Donald Lancaster. Describes the use of a standard television receiver as a microprocessor CRT terminal. Explains and describes character generation, cursor control and interface information in typical, easy-to-understand Lancaster style. This book is a required text for both the microcomputer enthusiast and the amateur RTTY operator who desires a quiet alternative to noisy teletype machines. \$9.95.



● **FASCINATING WORLD OF RADIO COMMUNICATION** Interesting stories in the history of radio pioneering and discovery. Also includes the fundamentals of broadcast band DXing. A must for every radio amateur. \$3.95.

● **PRACTICAL TEST INSTRUMENTS YOU CAN BUILD** 37 simple test instruments you can make — covers VOMs, VTVMs, semiconductor testing units, dip meters, wattmeters, and just about anything else you might need around the test lab and ham shack. \$4.95.

● **1001 PRACTICAL ELECTRONIC CIRCUITS** Tab's new 1001 circuits is available for only \$9.95 ppd. The next time you want a circuit for just about anything, eat your heart out that you didn't send for this book the first time you read about it. You'd better order the book right away, before they run out. \$9.95.

● **HOW TO MAKE BETTER QSLs** Be proud of your QSL cards... have a card which gets front space on every hamshack wall... win prizes at hamfests. The only way to have a truly outstanding card is to make it yourself... which is easy when you have this new book. \$2.00.

● **WHAT TO DO AFTER YOU HIT RETURN** PCC's first book of computer games... 48 different computer games you can play in BASIC... programs, descriptions, muchly illustrated. Lunar Landing, Hammurabi, King, Civil 2, Qubic 5, Taxman, Star Trek, Crash, Market, etc. \$6.95.

● **101 GAMES IN BASIC** Okay, so once you get your computer up and running in BASIC, then what? Then you need some programs in BASIC, that's what. This book has 101 games for you, from very simple to real buggers. You get the games, a description of the games, the listing to put in your computer and a sample run to show you how they work. Fun. Any one game will be worth more than the price of the book for the fun you and your family will have with it. \$7.50.

● **BASIC** by Bob Albrecht, etc. Self-teaching guide to the computer language you will need to know for use with your microcomputer. 324 pages. This is one of the easiest ways to learn computer programming. \$4.95.

● **THE UNDERGROUND BUYING GUIDE** Here is a handy guide for the electronics enthusiast. Over 600 sources of equipment and literature are provided; some are mail-order-only outfits that do not advertise. Sources are listed alphabetically, by service or product, and by state. The guide is cross-referenced for ease of use. Electronic publishing houses are also listed. Published by PMS Publishing Co., \$5.95 each.

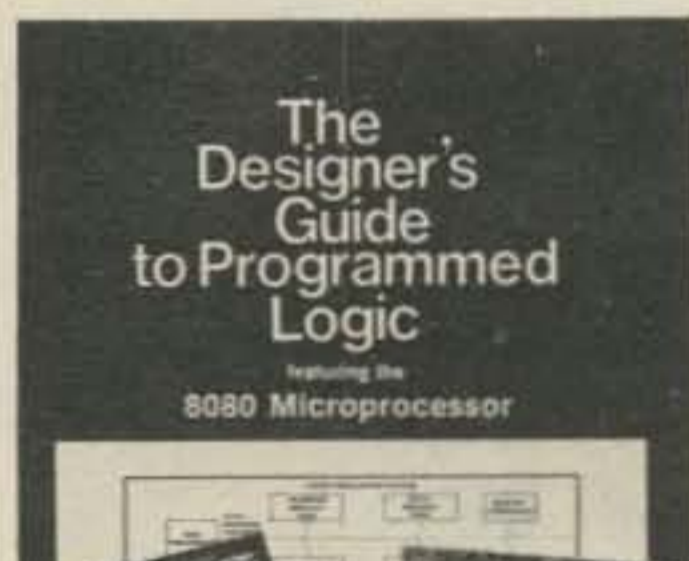

● **AN INTRODUCTION TO MICROCOMPUTERS, VOLS. 1 AND 2** At last! Someone has finally written a book containing hardware details about most of the popular micro chips available to computerists. *An Introduction to Microcomputers*, Volumes 1 and 2, by Adam Osborne Associates, are references dealing with microcomputer architecture in general and specifically with details about most of the common chips. These books are not software-oriented, but are invaluable for the hobbyist who is into building his own interfaces and processors. Volume 1 is dedicated to general hardware theory related to micros, and Volume 2 discusses the practical details of each micro chip. (Detailed review in *Kilobaud* #2) Published by Osborne Associates, \$7.50 each.

● **8080 PROGRAMMING FOR LOGIC DESIGN** Here is an ideal reference for the person desiring an in-depth understanding of the 8080 processor. The work is application-oriented, and the 8080 is discussed in light of replacing conventional, hard-wired logic systems. Both hardware and software is described. Practical design considerations are provided for the individual wishing to implement an 8080-based control system. (Detailed review in *Kilobaud* #1) Published by Osborne Associates, \$7.50.

● **6800 PROGRAMMING FOR LOGIC DESIGN** Oriented toward the industrial user, this book describes the process by which conventional logic can be replaced by a 6800 microprocessor. Both hardware and software techniques are discussed, as well as interface information. This reference, and its companion dedicated to 8080 users, provide practical information that allows an experimenter to design a complete micro control system from the "ground up." An excellent reference! Published by Osborne Associates, \$7.50.

Use the order card or itemize your order on a separate piece of paper and mail to:  
73 Radio Bookshop • Peterborough NH 03458 Be sure to include check or detailed credit card information.  
Note: Prices subject to change without notice on books not published by 73 Magazine.

# RADIO BOOKSHOP



# RADIO BOOKSHOP



● **BRAND NEW DICTIONARY** This new microcomputer dictionary fills the urgent need for all computer people, engineers, scientists, industrialists, communications people — as professionals, amateurs, teachers, or students — to become quickly acquainted with the terminology and nomenclature of a new revolution in computer control capabilities in areas that pervade most of man's daily activities.

Over 5000 definitions and explanations of terms and concepts (704 pages) relating to microprocessors, microcomputers and microcontrollers. There are also separate appendices on: programmable calculators; math and statistics definitions; flowchart symbols and techniques; binary number systems and switching theory; symbol charts and tables; summaries of BASIC, FORTRAN and APL. In addition there is a comprehensive electronics/computer abbreviations and acronyms section. \$15.95.

● **COMPUTER PROGRAMMING HANDBOOK** by Peter Stark. A complete guide to computer programming and data processing. Includes many worked out examples and history of computers. \$8.95.

● **MY COMPUTER LIKES ME . . . WHEN I SPEAK BASIC** An introduction to BASIC . . . simple enough for your kids. If you want to teach BASIC to anyone quickly, this booklet is the way to go. \$2.00.

● **SCELBI'S GALAXY GAME FOR THE "8008"/"8080"** Here's a new twist in computer games by Scelbi Computer Consulting and Robert Findley. The game, "Galaxy," pits the operator of a spaceship against alien craft, as well as variables such as speed, time and ammunition. No two games are the same! This game is described in *Galaxy Game for the 8008/8080*, published by Scelbi Computer Consulting, Inc. \$14.95.

● **SCELBI'S GALAXY GAME FOR THE "6800"** Here's a new twist in computer games by Scelbi Computer Consulting and Robert Findley/Raymond Edwards. The game, "Galaxy," pits the operator of a spaceship against alien craft, as well as such variables as speed, time, and ammunition. No two games are the same! This game is described in *Galaxy Game for the 6800*, published by Scelbi Computer Consulting, Inc. \$14.95.

● **6800 SOFTWARE GOURMET GUIDE & COOKBOOK** If you have been spending too much time developing routines for your 6800 microprocessor, try the new book by Scelbi Computing and Robert Findley. This manual, *6800 Software Gourmet Guide and Cookbook*, describes sorting, searching, and many other routines for the 8080 user. \$9.95.

● **8080 SOFTWARE GOURMET GUIDE AND COOKBOOK** If you have been spending too much time developing simple routines for your 8080, try this new book by Scelbi Computing and Robert Findley. This manual, *8080 Software Gourmet Guide and Cookbook*, describes sorting, searching, and many other routines for the 8080 user. \$9.95.

● **CMOS COOKBOOK** by Don Lancaster, pub. by Howard W. Sams Company. Another winner from Don Lancaster, author of the famous *RTL* and *TTL Cookbooks*. The *CMOS Cookbook* details the application of CMOS, the low power logic family suitable for most applications presently dominated by TTL. The book follows the style of the original Cookbooks. Eight chapters cover all facets of CMOS logic, and the work is prefaced by 100 pages detailing the characteristics of most CMOS circuits. The *CMOS Cookbook* is required reading for every serious digital experimenter. \$9.95.

● **HOBBY COMPUTERS ARE HERE** If you (or a friend) want to come up to speed on how computers work . . . hardware and software . . . this is an excellent book. It starts with the fundamentals and explains the circuits, the basics of programming, along with a couple TVT construction projects, ASCII-Baudot, etc. This book has the highest recommendations as a teaching aid for newcomers. \$4.95.

● **KILOBAUD** The Small Computer Magazine Software & Hardware exposed to the core. Written for the non-PhD computer hobbyist who wants to know what's new. \$2.00 each at the newsstand, \$15.00 for 1 year subscription. Back issues \$3.00 per copy.



● **SCELBI'S FIRST BOOK OF COMPUTER GAMES** Need a game for your 8008 or 8080 microprocessor? Try *Scelbi's First Book of Computer Games for the 8008/8080* which describes three popular games, "Space Capture," "Hexpawn," and "Hangman." Complete flowcharts, logic description, program listing, and instructions are provided. A must for the game freak! \$14.95.

● **THE STORY OF COMPUTERS** by Donald D. Spencer is to computer books what *Dick and Jane* is to novels . . . extremely elementary, gives the non-computerist a fair idea of what the hobbyist is talking about when he speaks computer lingo. Attempts to explain what computers are and can do to a spouse, child or any un-electronics-minded friend. \$4.95.

● **MICROCOMPUTER PRIMER** by Mitchell Waite and Michael Pardee, pub. by Howard W. Sams Company. If you are afraid to get involved with microcomputers for fear of not understanding them, worry no longer! The *Microcomputer Primer* describes basic computer theory, explains numbering systems, and introduces the reader to the world of programming. This book does not elaborate on specific systems or chips, but describes the world of microcomputing in "real world" terminology. There is probably no better way of getting involved with the exciting new hobby of microcomputing. \$7.95.

● **INTRODUCTION TO MICROPROCESSORS** by Charles Rockwell of MICROLOG. Here is an ideal reference for the individual desiring to understand the hardware aspects of microprocessor systems. This book describes the hardware details of computer devices in terms the beginner can understand, instead of treating the micro chip as a "black box." Addressing schemes, registers, control, and memory are all explained, and general information about hardware systems is provided. Specific systems are not described and programming is only briefly discussed. *Introduction To Microprocessors* is a hardware introduction . . . and a good one. \$17.50 US and Canada, \$20 elsewhere.

● **THE NEW HOBBY COMPUTERS!** This book takes it from where "Hobby Computers Are Here" leaves off, with chapters on Large Scale Integration, how to choose a microprocessor chip, an introduction to programming, low cost I/O for a computer, computer arithmetic, checking memory boards, a Baudot monitor/editor system, an audible logic probe for finding those tough problems, a ham's computer, a computer QSO machine . . . and much, much more! Everything of interest is there in one volume, ready to be enjoyed by you. \$4.95.

Use the order card or itemize your order on a separate piece of paper and mail to:

73 Radio Bookshop • Peterborough NH 03458 Be sure to include check or detailed credit card information.

Note: Prices subject to change without notice on books not published by 73 Magazine.



# CUSTOM TRANSFORMERS



## HEAVY DUTY REPLACEMENT TRANSFORMERS\*

Collins 30S-1 Plate Transformer	\$165.00
Collins 516F-2 Power Transformer	95.00
Hunter 2000B Plate Transformer	125.00
ETO A-77D Plate Transformer	125.00
Henry 2K Plate Transformer	140.00
Henry 2K-2 Plate Transformer	165.00
Henry 2K-2A Plate Transformer	135.00
Henry 2K-4 Plate Transformer	165.00
Henry 3K-A Plate Transformer	165.00
Heath Marauder HX-10 Transformer	95.00
Gonset GSB-100 Transformer	95.00
National NCL-2000 Power Transformer	125.00
Gonset GSB-201 Power Transformer	135.00

## SPECIALS

Plate XFMR. 4600 VAC @ 1.5A ICAS 230 VAC 60 Hz primary, Wt. 60 LB	\$195.00
Plate XFMR. 3500 VAC @ 1.0A ICAS 230 VAC 60 Hz primary, Wt. 41 LB	125.00
Plate XFMR. 3000 VAC @ 0.7A ICAS 115/230 VAC 60 Hz pri, Wt. 27 LB	95.00
Plate XFMR. 6000 VCT @ 0.8A CCS 115/230 VAC 60 Hz pri, Wt. 41 LB	135.00
FIL XFMR. 7.5 VCT @ 21A CCS 117 VAC 60 Hz primary Wt. 8 LB	29.95
FIL Choke bifilar wound 30 AMP RF Filament Choke on 1/2x7 rod	8.95
DC Filter Choke 8.0 Hy @ 1.5 ADC	150.00
DC Swinging Choke: 30 Hy @ 0.15A to 5.0 Hy @ 1.0ADC	100.00

\*All heavy duty replacement transformers are electrically superior to original equipment(s). All transformers are manufactured to rigid commercial quality specifications and each carries a 24 month guarantee!

Write today for a free quotation on any transformer, Choke, or saturable reactor.

# Peter W. Dahl Co.

4007 Fort Blvd. • El Paso, Texas 79930  
Telephone (915) 566-5365 or (915) 751-4856 D6

# PROPAGATION

by  
J. H. Nelson

## EASTERN UNITED STATES TO:

	00	02	04	06	08	10	12	14	16	18	20	22
ALASKA	14	14	7	7	7	7	7	7	7	7	7A	14
ARGENTINA	14	14	14	7	7	7	7A	14	14	14	14	14
AUSTRALIA	14	14	14B	7B	7	7	7	7	7B	14	14	14
CANAL ZONE	14	14	7A	7	7	7	7A	14	14	14	14	14
ENGLAND	14	7	7	7	7	7	7A	14	14	14	14	14
HAWAII	14	14	7A	7	7	7	7	7A	14	14	14	14
INDIA	7	7	7B	7B	7B	7B	7B	14	14	14	14	14
JAPAN	14	14	7A	7	7	7	7	7	7A	7A	14	14
MEXICO	14	14	7	7	7	7	7	7	7A	14	14	14
PHILIPPINES	14	14	7	7B	7B	7B	7B	7	7	14B	14B	14
PUERTO RICO	14	7	7	7	7	7	7	7A	14	14	14	14
SOUTH AFRICA	7	7	7	7	7	14	14	14	14	14	7A	7
U. S. S. R.	7A	7	7	7	7	7	14	14	14	14	14	14
WEST COAST	14	14	7A	7	7	7	7	14	14	14	14	14

## CENTRAL UNITED STATES TO:

ALASKA	14	14	14	7	7	7	7	7	7	7	7A	14
ARGENTINA	14	14	14	7	7	7	7	A	14	14	14	14
AUSTRALIA	14	14	14	14B	7	7	7	7	7	7B	14	14
CANAL ZONE	14	14	14	7	7	7	7A	14	14	14	14	14
ENGLAND	7A	7	7	7	7	7	7	7	7A	7A	14	14
HAWAII	14	14	14	7	7	7	7	7	7A	14	14	14
INDIA	14	7A	7B	7B	7B	7B	7B	7A	7A	14	14	14
JAPAN	14	14	14	7	7	7	7	7	7	7	7A	14
MEXICO	14	7	7	7	7	7	7	7	7	7A	14	14
PHILIPPINES	14	14	14	7B	7B	7B	7	7	7	14B	14B	14
PUERTO RICO	14	14	7	7	7	7	7	14	14	14	14	14
SOUTH AFRICA	7	7	7	7	7B	7B	14	14	14	14	7A	7
U. S. S. R.	7A	7	7	7	7	7	7	7A	7A	14	14	14

## WESTERN UNITED STATES TO:

ALASKA	14	14	14	7	7	7	7	7	7	7	7A	7A
ARGENTINA	14	14	14	7A	7	7	7	7A	14	14	14	14
AUSTRALIA	14	14A	14A	14	7A	7	7	7	7	7B	14	14
CANAL ZONE	14	14	7A	7	7	7	7	14	14	14	14	14
ENGLAND	7A	7A	7	7	7	7	7	7	7A	7A	14	14
HAWAII	14	14	14A	14	7A	7	7	7	7A	14	14	14
INDIA	14	14	14	7B	7B	7B	7	7	7A	14	14	14
JAPAN	14	14	14	14	7	7	7	7	7	7A	14	14
MEXICO	14	14	14	7	7	7	7	7A	14	14	14	14
PHILIPPINES	14	14	14	7A	7	7	7	7	7	14B	14B	14
PUERTO RICO	14	14	7A	7	7	7	7	14	14	14	14	14
SOUTH AFRICA	7	7	7	7	7B	7B	7B	14	14	14	7A	7
U. S. S. R.	7A	7A	7	7	7	7	7	7A	7A	14	14	14
EAST COAST	14	14	7A	7	7	7	7	14	14	14	14	14

A = Next higher frequency may also be useful  
B = Difficult circuit this period  
F = Fair  
G = Good  
P = Poor

Let us know 8 weeks in advance so that you won't miss a single issue of 73 Magazine. Attach old label where indicated and print new address in space provided. Also include your mailing label whenever you write concerning your subscription. It helps us serve you promptly.

Write to:

**73 magazine**  
Peterborough NH 03458

Address change only       Payment enclosed  
 Extend subscription      (1 extra BONUS issue)  
 Enter new subscription       Bill me later  
 1 year \$15.00

name \_\_\_\_\_ call \_\_\_\_\_

address \_\_\_\_\_

city \_\_\_\_\_ state \_\_\_\_\_ zip \_\_\_\_\_

*If you have no label handy, print OLD address here.*

AFFIX LABEL

name \_\_\_\_\_ call \_\_\_\_\_

address \_\_\_\_\_

city \_\_\_\_\_ state \_\_\_\_\_ zip \_\_\_\_\_

1977		JULY					1977
SUN	MON	TUE	WED	THU	FRI	SAT	
					<b>1</b>	<b>2</b>	
					F	G	
<b>3</b>	<b>4</b>	<b>5</b>	<b>6</b>	<b>7</b>	<b>8</b>	<b>9</b>	
G	G	G	P	F	F	F	
<b>10</b>	<b>11</b>	<b>12</b>	<b>13</b>	<b>14</b>	<b>15</b>	<b>16</b>	
P	F	P	F	F	F	G	
<b>17</b>	<b>18</b>	<b>19</b>	<b>20</b>	<b>21</b>	<b>22</b>	<b>23</b>	
G	G	G	G	G	G	F	
<b>24</b> <b>31</b>	<b>25</b>	<b>26</b>	<b>27</b>	<b>28</b>	<b>29</b>	<b>30</b>	
F/F	F	F	G	G	G	F	



# YAESU—The “Something For Everyone” Line Of Quality Ham Gear!



**FT-301S or FT-301SD**  
Analog or digital dial, 40 watts PEP  
all solid state, broadbanded output!  
160-10 meters



**FT-301 or FT-301D**  
Analog or digital dial, 240W PEP, all  
solid state, broadbanded output!  
160-10 meters



**FT-221R Transceiver**  
All mode 144-148 MHz, 20 watts  
input, standard repeater shifts + 1  
non-standard shift



**FT-101 Series**  
3 models, 260W PEP, 160-10M + 2  
and 6M with our transverters.



**FT-620B Transceiver**  
SSB, CW, AM, 50-54 MHz  
20 watts input

101 OWNERS: New 226 page service and  
maintenance manual now available. Write for  
information. Soon to come—FT-221 series  
service and maintenance manual!

*Everything Is Stacked In  
Your Favor At Yaesu*

**QRP**  
**BASE KW**  
**RTTY**  
**MOBILE**  
**MARS**  
**CAP**

**160-2 MTRS.**  
**USB-LSB**  
**CW-FM**  
**DIGITAL DIAL**  
**ANALOG DIAL**  
**SWL**



**FR-101 or FR-101D**  
Analog or digital readout receiver, all  
ham bands + SW frequencies with  
accessory crystals



**FL-101 Transmitter**  
160-10 M, 200W PEP, matches the  
FR-101 receiver—“The Yaesu Twins!”

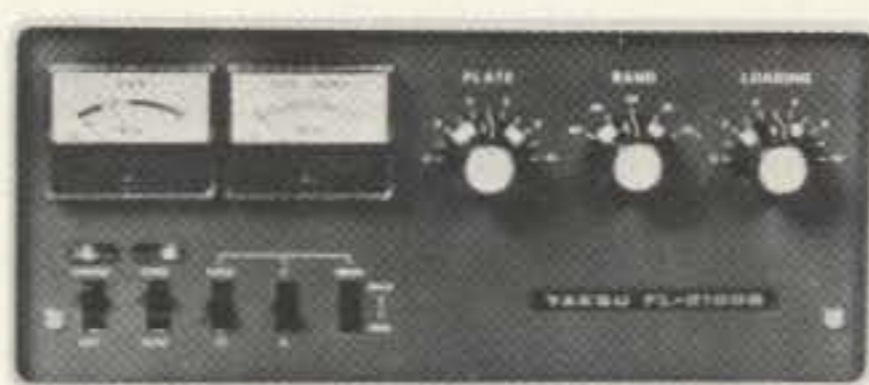

**FL-2100B Linear**  
Matches the 101 series—80-10 me-  
ters, 1200 watts PEP, 1 KW CW.  
Self contained power supply



**FRG-7 Receiver**  
Solid state, triple conversion, 500  
KHz to 29.9 MHz, continuous tuning

... plus a full line of accessories—2 and 6 meter  
transverters, counters, world clock, VFO's, micro-  
phones, phone patch, wattmeters, monitor scopes  
and much more! Send us your name, address and  
ham call for our new 1977 full line catalog.

YAESU  
**The radio.**



777

YAESU ELECTRONICS CORP., 15954 Downey Ave., Paramount, CA 90723 (213) 633-4007  
YAESU ELECTRONICS CORP., Eastern Service Ctr., 613 Redna Ter., Cincinnati, OH 45215



# TR-7500

## KENWOOD'S NEW PLL SYNTHESIZED 2-METER FM TRANSCEIVER

- 146 to 148 MHz
- 100 channels (88 preprogrammed)
- 12 extra diode programmable channels
- $\pm 600$  KHz offset for repeater operation
- 15 KHz split channel offset
- Digital frequency readout
- 10 watts (1 watt lo-power)
- Compact and dependable



TRIO-KENWOOD COMMUNICATIONS INC. 1111 WEST WALNUT/COMPTON, CALIFORNIA 90220

**KENWOOD**  
... *passetter in amateur radio*