

# AMATEUR RADIO

# 73

SEPTEMBER 1976  
\$1.50

Hey, CBers!

Try Hamming -  
It's Fantastic!



*W2NSD/4  
Aerostat Mobile!*



Hobby  
Computer  
Section

Graphics CRT  
PROM Zapper  
Sneaky Baudot  
Counters Are Simple!  
Surprising DDRR Antenna

Are the miles to the next repeater or the next two-meter contact just beyond your equipment capability? Resolve the problem today with a Hustler Super Gain antenna. Get a double measure of improvement with extra signal gain transmitting — additional gain receiving.

**HUSTLER**

IT'S A WHOLE NEW TWO-METER EXPERIENCE!

**G6-144A** \*6 db. colinear with maximum gain at the horizon! D.C. grounded element. Superior mechanical performance. Used extensively on repeaters and fixed station service across the nation. Total height: 117" SO-239 connector. Mounts on vertical pipe up to 1 3/4" O.D.

**CGT-144** 5.2 db. gain, 85" colinear with deluxe swivel ball, no holes to drill trunk lip mount. Includes 17' of RG-58/U, connectors attached, ready to install and operate.

**CG-144** (not illustrated) Same as CGT-144 less mount and cable. 3/8"-24 threaded base fits all standard mobile mounts.

**SF-2** "Buck Buster" 5/8 wave, 3.4 db. gain mobile antenna with 3/8"-24 threaded base to fit your mount or a wide selection of Hustler mounts. (Mount or cable not included).

**BBLT-144** 3.4 db. gain trunk lip mount mobile, stainless steel impact spring, 17' coax, connectors attached, ready for easy no holes installation and operation.

**BBL-144** (not illustrated) Same as BBLT-144 except for roof or deck mounting in a 3/4" hole.

SF-2

BBLT-144

CGT-144

**MASTER GAINER**

G6-144A

\* Gain of G6-144A is compared to a 1/2 wave dipole. Mobile antenna gain compared to 1/4 wave ground plane.

**THE TWO-METER MILE!**

HUSTLER ANTENNA PRODUCTS—for sixteen years—original designs—created and manufactured by American ingenuity, labor and materials—used by communicators throughout the world.

Hustler designs are patented under one or more of the following assigned to New-Tronics Corporation: 3287732, 3513472, 3419869, 3873985, 3327311, 3599214, 3582951

new-tronics corporation

15800 commerce park drive  
brook park, ohio 44142  
(216) 267-3150

Available from all distributors who recognize the best!

# Now...more than ever--- the TEMPO line means solid value

## Tempo VHF/ONE

the "ONE" you've been waiting for

No need to wait any longer — this is it! Whether you are already on 2-meter and want something better or you're just thinking of getting into it, the VHF/ONE is the way to go.

- Full 2-meter band coverage (144 to 148 MHz for transmit and receive).
- Full phase lock synthesized (PLL) so no channel crystals are required.
- Compact and lightweight — 9.5" long x 7" wide x 2.25" high. Weight — About 4.5 lbs.
- Provisions for an accessory SSB adaptor.
- 5-digit LED receive frequency display.
- 5 KHz frequency selection for FM operation.
- Automatic repeater split — selectable up or down for normal or reverse operation.
- Microphone, power cord and mounting bracket included.
- Two built-in programmable channels.
- All solid state.
- 10 watts output.
- Super selectivity with a crystal filter at the first IF and E type ceramic filter at the second IF.
- 800 Selectable receive frequencies.
- Accessory 9-pin socket.

### TEMPO SSB/ONE

SSB adapter for the Tempo VHF/One

- Selectable upper or lower sideband.
- Plugs directly into the VHF/One with no modification.
- Noise blanker built-in.
- RIT and VXO for full frequency coverage.



### TEMPO/fmh

So much for so little! 2 watt VHF/FM hand held 6 Channel capability, solid state, 12 VDC. 144-148 MHz (any two MHz), includes 1 pair of crystals, built-in charging terminals for nicad cells, S-meter, battery level meter, telescoping whip antenna, internal speaker & microphone.

\$199.00

FMH-MC for Marine & Commercial service also available.



### TEMPO/CL146A

...a VHF/FM mobile transceiver for the 2 meter amateur band. It is compact, ruggedly built and completely solid state. One channel supplied plus two channels of your choice FREE

144 to 148 MHz coverage • Multifrequency spread of 2 MHz • 12 channel possible • Metering of output and receive • Internal speaker, dynamic microphone, mounting bracket and power cord supplied. A Tempo "best buy" at \$239.00.

### TEMPO CL220

As new as tomorrow! The superb CL-220 embodies the same general specifications as the CL-146A, but operates in the frequency range of 220-225 MHz (any two MHz without retuning). At \$299.00 it is undoubtedly the best value available today.



TEMPO 100AL10 SOLID STATE VHF LINEAR AMPLIFIER. 144-148 MHz. Power output of 100 watts (nom) with only 10 watts (nom) in. Reliable and compact.

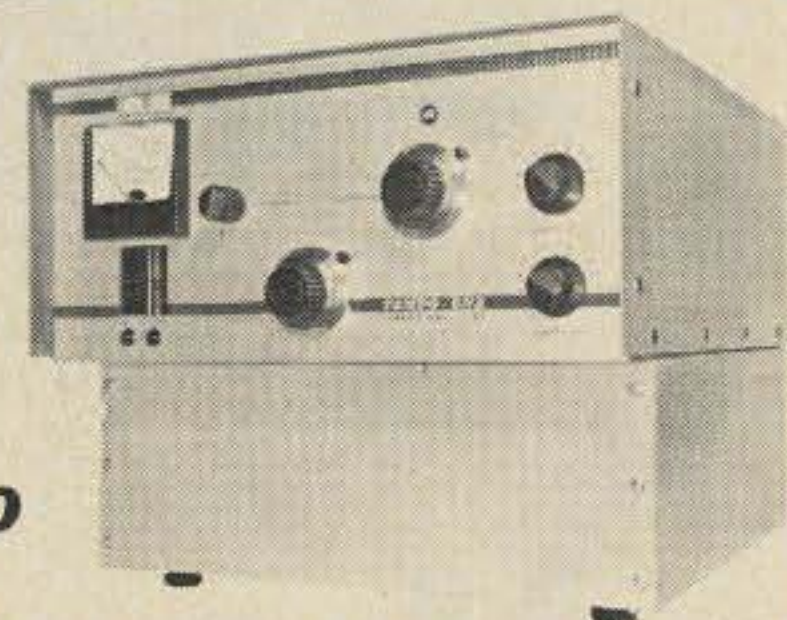

### TEMPO 6N2

The Tempo 6N2 meets the demand for a high power six meter and two meter power amplifier. Using a pair of Eimac 8874 tubes it provides 2000 watts PEP input on SSB and 1000 watts input on CW and FM. Completely self-contained in one small desk mount cabinet with internal solid state power supply, built-in blower and RF relative power indicator.

\$795.00

The Tempo 2002.. 2 meters only \$695.00  
The Tempo 2006.. 6 meters only \$695.00

### TEMPO VHF/UHF AMPLIFIERS

Solid state power amplifiers for use in most land mobile applications. Increase the range, clarity, reliability and speed of two-way communications.

VHF (135 to 175 MHz)				UHF (400 to 512 MHz)					
Drive	Power	Output	Model No.	Price	Drive	Power	Output	Model No.	Price
2W	130W	130A02	\$199		2W	70W	70D02	\$270	
10W	130W	130A10	\$179		10W	70W	70D10	\$250	
30W	130W	130A30	\$189		30W	70W	70D30	\$210	
2W	80W	80A02	\$169		2W	40W	40D02	\$180	
10W	80W	80A10	\$149		10W	40W	40D10	\$145	
30W	80W	80A30	\$159		2W	10W	10D02	\$125	

FCC Type accepted models also available.

Most of the above products are available at dealers throughout the U.S.

# Henry Radio

11240 W. Olympic Blvd., Los Angeles, Calif. 90064 213/477-6701  
931 N. Euclid, Anaheim, Calif. 92801 714/772-9200  
Butler, Missouri 64730 816/679-3127

Prices subject to change without notice.



# Now It's Crystal Clear

Yes, now ICOM helps you steer clear of all the hassles of channel crystals. The new **IC-22S** is the same surprising radio you've come to know and love as the **IC-22A**, except that it is totally crystal independent. **Zero crystals.** Solid state engineering enables you to program 23 channels of your choice without waiting. Now the ICOM performance you've demanded comes with the convenience you've wanted, with your new **IC-22S**.

VHF/UHF AMATEUR AND MARINE COMMUNICATION EQUIPMENT

Distributed by:



# ICOM

ICOM WEST, INC.  
Suite 3  
13256 Northrup Way  
Bellevue, Wash. 98005  
(206) 747-9020

ICOM EAST, INC.  
Suite 307  
3331 Towerwood Drive  
Dallas, Texas 75234  
(214) 620-2780



20  
Balloon to Balloon! — another 73 first  
W2NSD/1



34  
The Surprising DRRR Low Noise Antenna — part II  
Boyer

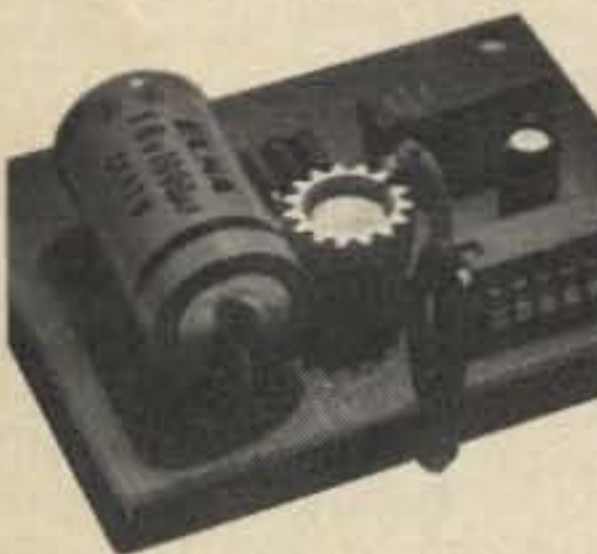

48  
Ultrasimple Regulation with New IC — power supply design greatly simplified  
WBØJLS

56 Can An Indoor Antenna Work? — making the best of a bad bargain  
Staff



60  
12 Inexpensive Volts for Your Base Station — parts right out of your local Radio Shack  
WA8WVF



64  
A Test Lab Bonanza — using a transistor radio  
WA7SCB

68 Protect Your VHF Converter — with a novel antenna relay  
WB2NTP

70 Ridiculously Simple RTTY System — get on the air in one day  
W3KBM

74 How to Catch a CBer — practical hints  
Fields

80  
A 450 MHz Transceiver for Under \$130 — bringing 450 within everyone's reach  
W1HCI, K1ELT



84 Space Age Junque II — updating the 348 by 30 years  
W9CGI

92  
PROM Memory Revisited — getting back to May's CW blockbuster  
WA6VVL

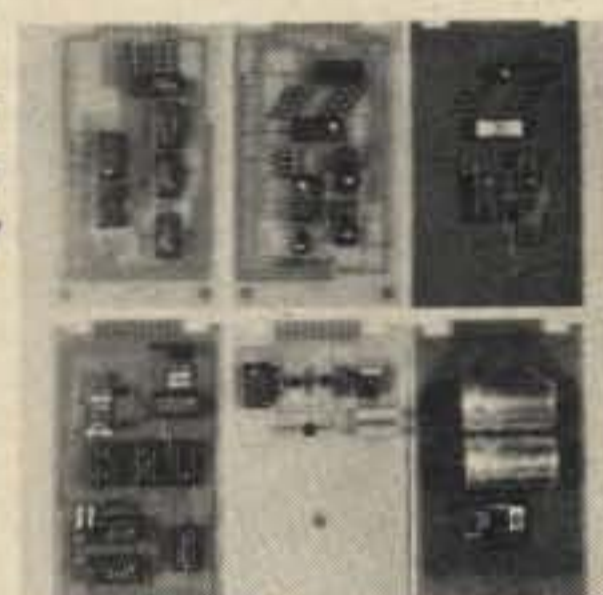

104 What's When — timing diagrams  
Craig

108 Eight Trace Scope Adapter — test accessory for digital timing  
Johnson

112 The PROM Zapper — build this simple PROM programmer  
WA1UFE

115 Sneaky Baudot — with an ASCII keyboard!  
W3KBM

116  
Simple Graphics Terminal — using inexpensive surplus equipment  
K1MRK, Ciarcia

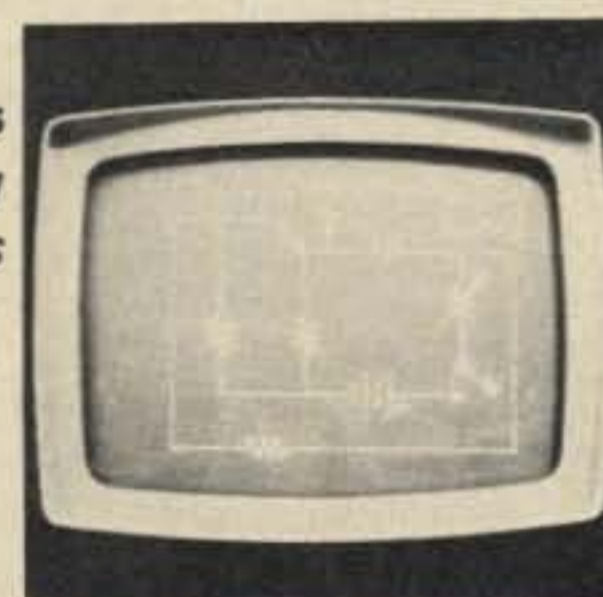

126 Counters Are Not Magic — They're Simple — getting right down to basics  
WB2NEL

# 73

#191 SEPT 1976

4	Never Say Die
7	Be My Guest
8	Letters
12	Contests
15	Ancient Aviator
16	Looking West
18	New Products
90	I/O Editorial
124	I/O Report
130	Social Events
130	Ham Help
131	Oscar Orbits
132	FCC
135	Hamburglar
160	Propagation
160	Reader Service

COVER: Up, up and away (article begins on page 20). Photo by Sherry Smythe.

73 Magazine is published monthly by 73, Inc., Peterborough NH 03458. Subscription rates are \$10 for one year worldwide, and \$20 for three years. Second class postage paid at Peterborough NH 03458 and at additional mailing offices. Phone: 603-924-3873. Microfilm edition — University Microfilms, Ann Arbor MI 48106. Tapes — Science for the Blind, 332 Rock Hill Rd, Bala Cynwyd PA 19904. Entire contents copyright 1976 by 73, Inc. INCLUDE OLD ADDRESS AND ZIP CODE WITH ADDRESS CHANGE NOTIFICATION.



# 73 staff

**EDITOR/PUBLISHER**  
Wayne Green W2NSD/1

**GENERAL MANAGER**  
Biff Mahoney

**MANAGING EDITOR**  
John C. Burnett

**ASSISTANT EDITOR**  
Susan G. Philbrick

**I/O EDITOR**  
John Craig

**PRODUCTION MANAGER**  
Lynn Panciera-Fraser

**ART DEPARTMENT**  
Robin Macrae  
Virginia Mammone  
Michael Murphy  
Bob Sawyer

**PRINTING**  
Brent Lawler  
Michael Potter

**PHOTOGRAPHY**  
Bill Heydolph

**TYPESETTING**  
Barbara J. Latti

**COMPTROLLER**  
Knud E. M. Keller KV4GG/1

**CIRCULATION**  
Barbara Block  
Nancy Chandler  
Carol Dawdy  
Fran Dillon  
Dorothy Gibson  
Florence Goldman  
Marge Nielsen  
Theresa Toussaint  
Judy Waterman

**MARKETING**  
Sherry Smythe

**INVENTORY CONTROL**  
Marshall Raymond  
Gary Slamin

**PLANT MAINTENANCE**  
Bill Barry  
Lorraine Pickering

**ASSOCIATES**  
Robert Baker WA1SCX  
E. H. Barnett WB011X  
Schley Cox WB9LHO  
Tom DiBianco WB8KZD  
Terry Fox WB4JFI  
W. Sanger Green  
Dave Ingram K4TWJ  
Joe Kasser G3ZCZ  
Bill Pasternak WA6ITF  
John Schultz W2EY/K3EZ  
Waller Scott K8D1Z  
Peter A. Stark K2OAW  
Bill Turner WA0ABI

**COMPUTER ENGINEERING**  
James Muehlen  
David E. Wilensky

**DRAFTING**  
Bill Morello  
Lynn Malo  
T. M. Graham Jr. WB6FKW

**ADVERTISING**  
Bill Edwards WB6BED/1  
Nancy Cluff WA1WSU



NEVER SAY DIE

...de W2NSD/1

EDITORIAL BY WAYNE GREEN

## WAYNE AT ATLANTA

About 15 minutes before the time scheduled for my talk, the small room was packed and the hall outside jammed in both directions. The talk was moved to the banquet room. It was estimated that about 350-400 sat in on it. I talked for over an hour and never once at any time mentioned the ARRL! That's not a new record . . . it's just that the League knows some of the things I *could* say and they are willing to suffer a lot of abuse from members to try to prevent that. I say bravo to the Atlanta HamFestival committee for getting me on the program. I think most everyone present had a good time during my talk.

The hamfest came off very well . . . quite an improvement from my last visit there a couple of years ago. I say three cheers for Chaz Cone and the committee for a splendid job. I didn't hear a single beef from anyone about their management.

Atlanta is well worth a visit, even from afar. It is a spectacle . . . and their amusement center, Underground Atlanta, is a lot of fun, too. The big ham dealers came in from all over . . . including a trailerload of ham gear brought down by Chuck Martin of Tufts Radio. The only sour note there was the theft of a Standard HT from the Tufts booth.

Watch out, Dayton!

## FAST SHUFFLE FROM THE FCC

It's odd how long it takes the FCC to get around to acting on our petitions and how fast they seem to go on their own . . . weird. Like the recent 20777 bandwidth deal where the deadline for comments to be filed was way before there was any way for me to get the docket printed in 73 and out where you could read about it.

## SOME THOUGHTS ON BANDWIDTH

Perhaps it was not by design that the FCC set its deadline for comments on the bandwidth docket at such an early date that little amateur dialogue was possible . . . and thus little opportunity for amateurs to help each other understand the ramifications of this docket . . . or to react intelligently to it. Though all of us are at times frustrated by the incredible amounts of time it takes for the FCC to react to our needs, it does seem as if certain functions, such as the time really needed for amateurs to develop a

good reasoned response to a docket, are set too tightly. If the FCC wants to cut us out of the picture as far as our own rules are concerned, this is the way to do it.

I snapped in a petition to extend the deadlines so amateurs would at least have a chance to get their opinions in if they wanted to. They stretched out the comment period a couple of months, so you can put in your say. Read the thing over (see 73, August, 1976, page 160), think about it a lot, and talk it over with your friends on the air . . . and then be sure you drop Uncle Charlie a note.

A few readers have asked me what I think about the docket and, though it may surprise you, I am not wholly without any opinions on the matter.

Now, to get down to some brass tacks on the bandwidth thing. The hot and heavy breath of the old-time CW operator seems to be at work here. I wonder what would have happened to CW if the Novice Class license hadn't been thought up? I also wonder if there is any real justification for the Novice ticket. I wrote a bit about that recently . . . expressing my idea that the Novice license is a cul-de-sac . . . and that it has effectively discouraged more people from continuing as radio amateurs than it has helped.

To repeat briefly . . . a Novice license encourages amateurs to try to learn Morse Code by the worst possible way . . . by gradually speeding up copy. This is fiendish . . . it drags out the learning process by many hours and makes it pathetically difficult to master . . . particularly that 10 wpm hump, which kills off so many who come up against it.

If you start right out learning the sound of each character at 13 wpm, then you never go through that misery of first *translating* each letter . . . then learning to translate them faster and faster . . . until you reach the operating speed of the brain . . . the 10 wpm hump . . . at which time you finally have to do what you should have in the beginning, learn automatic copy of the characters. Well, enough of that . . . it is the basis of the 73 code cassette course and why people using it are able to learn code so quickly. The ARRL code tapes use the time-dishonored slow method and drive people crazy.

If we didn't have the Novice license how much CW would we have in our ham bands? Once you remove the Novices and traffic nets, how much CW do you have? Not a lot . . . and

this is why some of the phone ops have for some time been trying to get across the idea of re-allocating the phone/CW bands a bit.

With the rapid development of television typewriters, I shall be surprised if we don't begin to find RTTY growing substantially on our bands. And with microcomputers to help the RTTY systems, they should get to be very flexible. Since we expect this growth, we should give some thought now to what bandwidths are needed and how much of the band these systems will use.

The old standard of 850 Hz frequency shift, 60 wpm, Baudot (7-level) is on its way out. 170 Hz shift and 100 wpm at 7-level is more popular. And what is the bandwidth of a signal shifting 170 Hz and modulated by a 70 baud signal? (590 Hz, minimum.) Remember that you have to allow for at least third order harmonics if the square waves are to be received . . . possibly 5th order. Or should we go right away to ASCII (11-level) code? Since this is the way most modern equipment works, and we will need clumsy converters to use Baudot, ASCII is difficult to fight. ASCII at 100 wpm is 110 baud (830 Hz).

But why should we stay with 100 words per minute? Most information transfer is now happening at 300 baud or better. I suggest that the practical limit for information exchange is the reading speed of the receiving operator. There will be little use in transferring information at a much faster speed than it can be read for normal radio contacts. Perhaps we should consider this speed as our desired rate of information exchange.

Of course, there might be cases where you would want to send the information at a much higher speed . . . with a wider bandwidth . . . and then leave the transmitter off the air while the material is being read. In this way info could be sent in brief bursts. What we would lose in wider bandwidths, we would gain in time available for transmission.

I view the docket as a transparent device for banning AM from the low bands and ATV from 420 MHz, neither of which seems like a good move to me. If you've read my editorials for very long, you know that there are few amateurs who are less in favor of AM on the low bands. I've been the enemy of the AM kilowatt since sideband appeared in the early 50s. But I don't like to kill off

# KENWOOD GIVES YOU A CHOICE FOR 2-METER SSB



**KENWOOD'S TV-502 TRANSVERTER PUTS YOUR TS-520 OR TS-820 ON THE 2-METER BAND...SSB AND CW. SIMPLY PLUG IT IN AND YOU'RE ON THE AIR**



**OR GO ALL THE WAY WITH THE BEST...THE TS-700A**

Ever tried 2 meter SSB or CW? How about the OSCAR satellite? Tune the band with a VFO instead of fixed channel crystals and experience DX-ing on VHF. In fact, there's a VHF QSO party coming up on September 11 thru 13. FMers improve your scores...beginners try it for the first time. You don't need a big antenna to do it either...anything from a coat hanger to ---? The OSCAR satellites (6 & 7) are waiting for you too! Or go exotic with meteor scatter or tropospheric ducting. The "Sky is the limit" on VHF SSB and CW.

TRIO-KENWOOD COMMUNICATIONS INC.  
116 EAST ALONDRA/GARDENA, CA 90248

 **KENWOOD**  
...pacesetter in amateur radio

everything that would get the axe along with AM by making the rules to kill AM. I firmly believe that amateurs should have the freedom to experiment and pioneer new modes and techniques, so if there is not an awfully good reason for setting limits on experimentation, I think they should be left open.

Just to perhaps enter a slight doubt in the minds of those who are so emotionally upset by AM that they are quite willing to throw out the baby with the bath water (to coin a phrase), let's suppose that some group started working again with double sideband suppressed carrier systems, complete with a relatively simple IC synchronized receiver detector. Suppose this system was demonstrated to enable amateurs to operate on phone with very little interference as close as 500 Hz, thus permitting about seven times as many contacts to take place in a given band as with SSB? Would you want to throw this out just to get rid of a tiny handful of old buzzards who are making trouble on 75m with bad language and arrogant behavior? This is one of the biggest problems with the proposed bandwidth docket.

Do we want to force most RTTY and SSTV to occupy the crowded phone bands while much of the CW channels are going begging? In view of the coming interest in microcomputer-assisted RTTY and SSTV, which could be the biggest interest ever in amateur radio ... even bigger than FM and repeaters ... we might be painting ourselves into a corner (to coin another phrase).

Any precipitous rush into a bandwidth plan for the amateur bands will only give us that much more that we have to undo later on. It seems to me that before we can make any intelligent decisions on such matters we need to open up amateur dialogue about how much of the sub bands we want for CW, how much for phone, how much for other modes such as RTTY, SSTV, FAX, and the coming things which amateurs are pioneering these days.

It has been suggested that perhaps a bandwidth ruling would not be the best solution to the need for room for more modes ... that perhaps it is getting time to pay more than lip service to de-regulation and consider taking off the restrictions to pioneering. We could just open the ham bands in the U.S. as they are in many other countries ... any mode, anywhere. Then we could set up agreements among ourselves if we want to reserve some frequencies for CW DXing ... CW rag chewing ... CW traffic nets. We were able to do this with FM and repeaters on two meters ... without any help from the ARRL or FCC. (The recent attempts by the League to take over FM and repeaters have been rejected by a great many regional repeater groups.)

#### SELF-POLICING?

One of the aspects of amateur radio which has gotten a lot of lip service

from the FCC — and little recognition other than that — has been the self-policing function.

You want proof? Amateurs with any memories at all will recall that much of the activity of the FCC with regard to amateur radio has been in issuing pink slips. If the FCC had contacted the ham magazines and asked them to pass along the word that they would prefer that amateurs do thus and so, amateurs would have gladly done what was expected. But instead, suddenly there is a rash of pink slips for not announcing the call area when mobile. That's how we found out about the FCC wanting that. Phooey.

If you want a child to act like a child, treat him like a child. If you want him to accept responsibility and act more grown up, just treat him accordingly. The same thing holds for amateur radio. I think we can, for the most part, be reasonably adult if we are given the opportunity. If the FCC will give us responsibility, I think we can handle it.

We don't need to go crying to the FCC every time we have a problem. When over-enthusiastic CBers take a turn at trying to use the 10m spot on their dial, we need to let them know immediately that this is a great big no-no. It won't hurt to get the name, address, and as much other data on the offender as possible, complete with some tapes in case you and your fellow local amateurs fail ... but you should exhaust every avenue of approach to the problem before crying to the FCC.

#### CAN AMATEURS ACCEPT RESPONSIBILITY?

We have a lot of nerds in our ranks, I agree. But thank heavens the percentage is miniscule. It is just possible, if you and I assert ourselves, that we can keep things running smoothly.

As proof that we can, we only have to look back at the development of FM repeaters less than 10 years ago. The early days of repeaters were rife with repeater wars and a lot of very bad things that most of the pioneers would prefer to forget. There was little standardization of repeater channels. It was a mess. With the help of a lot of articles in *73*, the *Repeater Bulletin*, and a series of Repeater Symposiums, the field was brought together and repeater groups formed into repeater councils, committees set up to coordinate frequencies and a national agreement made on channels and standards.

By the time the FCC came out with repeater regulations, amateurs had already solved their problems and two meter FM was virtually troublefree. The repeater rules were so far out of line with what was needed that amateurs reacted strongly. The January, 1974, hearing before the FCC, the first of its kind in history, allowed amateurs from all over the country to speak directly to the FCC Commissioners and tell them that we were being over-regulated. This hearing had a tremendous impact on the FCC and

particularly on John Wiley, who was soon to become the Chairman of the Commission.

Wiley felt that the FCC would rule better by ruling less, but he needed a group to use as a demonstration of what could be done. When amateurs went to the trouble to come in and tell the FCC they wanted less regulation, it was at a very fortunate time ... here was just what the FCC needed to show what could be done.

If I may put in a bad word here about the ARRL ... they opposed the hearing and refused to participate in it. I moderated the hearing. After the hearing a League lawyer took us out to lunch and explained that we were naive about how things are done in Washington. Maybe.

Okay, so we did a good job of getting FM organized and working, all without any help from the FCC at all. Does this mean that we can handle our low bands? Frankly, I don't know. FM, by virtue of its short distances, perhaps put more peer pressure on big egos and tantrum throwers than might be possible on 40m. We could be getting into a lot of trouble ... but I think it is worth the gamble. With the support of the ham magazines I think amateurs can go from the small amount of self-policing they have today to almost total self-policing.

Try this on for size ... suppose we throw out docket 20777 entirely and all mode restrictions. This would mean that legally we would no longer have CW bands or phone bands, just ham bands. It would be up to us to set "gentlemen's agreements" on frequency use. I think we could do it. Before you disagree with me, and I know you will, remember back to the beginnings of SSB. There we had an agreement which put SSB stations on the top end of the 20m phone band. Sure, we had a few bad guys who broke the agreement, but 99% of the operators lived by it and it worked. Only the demise of AM ended the agreement.

And don't forget the monumental set of agreements which were put together to allow FM and repeaters to work!

#### CONSTITUTIONAL CONVENTION

We need cooperation between ham magazines ... something that has been sadly missing in the past. I've tried many times to get something going, but the fear of Wayne Green is so strong at ARRL that I sometimes think they would sacrifice the whole hobby rather than cooperate. I shall keep trying. I shan't try to be Mr. Nice Guy with them ... I couldn't be that deceitful. But hopefully our goals are similar ... the betterment of amateur radio. I get a bit depressed when I see what the League has brought about, such as Incentive Licensing, the greatest fiasco in the history of the hobby ... their refusal to accept transistors for years, their refusal to accept FM and repeaters until recently ... etc.

Hopefully the past is the past and

all that bad stuff that has been done can be put aside and we can all work toward a better tomorrow. I'd like to see a national convention of amateurs about every two years where delegates from ham clubs can get together for about a week and change our self-made rules. Committees could be set up as at the ITU in Geneva. The committees would then report their recommendations to the whole convention and a vote would be taken on all rule changes. Amateurs would then live by the new rules until the next convention.

I'd like to see ARRL get into something like this. I sure don't want to have to splinter myself further by trying to organize it or trying to start a new club which could do something like this. I have my hands full trying to run *73*, fighting my little battles with government agencies and phone companies, messing with computers, putting out books, and even getting on the air now and then! I also get out to conventions and hamfests ... a little DXpeditioning ... visits to advertisers ... it keeps me busy, if not out of trouble.

Let's see ... I was writing about bandwidth ... frankly, I'd like to see the lid taken off for a year for a test of our maturity. If we could hack it, I think it would allow the widest possible latitude for pioneering ... and, like it or not, that is one of the ways we pay the freight.

Speaking of pioneering ... every time I've devoted an inordinate part of the magazine to something new as a way of encouraging pioneering in that field, I've had flack from reactionaries. Yes, I know that most hams just sit there and rag chew and don't want to know nothin' about computers. Well, you tell them that it is pioneers and emergency operations that keep them in rag chewing frequencies and that not only shouldn't they sit there and bitch about it, they should darned well see that any magazine which is in there helping them hold onto their hobby is supported to the fullest ... even if they are too lazy to sit down and educate themselves on new techniques. Okay?

Actually, I've had very little griping about I/O ... but I know darned well that a lot of old curmudgeons are out there grumbling ... they think it is clever to try to tear things down and be destructive. They're too dumb to make any creative contributions to amateur radio ... etc.

Every time I get on the air I thank heaven for the amateurs who get out there and do things ... the ones who are the spark plugs for field day outings ... for contests ... who run ham clubs ... who set up training classes for new hams ... who set up and run repeaters ... who build new circuits and then write 'em up for one of the ham magazines ... who see to it that nets meet and work ... who handle traffic ... who are there when an emergency comes and keep at it until all is clear ... who try new

*Continued on page 136*



# be my guest

visiting views from around the world

## Thoughts from the Bull-etin Board

Every school age kid is well aware of the industrial revolution and how it affected our country's growth in the late 1800's. The microprocessor revolution seems to be upon us and it looks like it might last for a while. Motorola believes that the microprocessor revolution has only started. They predict that the total effect will continue to be felt for 200 years. Microprocessors reduce costs to a level which allows them to be used in applications never before considered economically practical.

A quartz crystal watch with LED or liquid crystal display (LCD) is a small version of the microcomputer. They are programmed at the integrated circuit (IC chip) manufacturer's plant rather than being programmed by a person sitting at a keyboard with a CRT display. Some of the more expensive quartz watches are programmed to fit a four year cycle. That is, they are aware of the day of the month, including February, but they automatically take care of leap year when February has 29 days. Then the watch resets itself and it is good for another four years. During that time, the watch has kept track of the fact that it has counted 4 times 10 to the 12th cycles of the quartz crystal. But just once every four years the circuit is activated so that it counts and

displays the time for 29 February! A quartz watch on the wrist is actually more accurate and stable than the broadcast band AM transmitters, a BC transmitter being allowed 20 hertz drift (2 parts in 10 to minus 5th) while the quartz watch has an accuracy of 2 parts in 10 to minus 6th. An added benefit of the LED display is that it can be used to locate keyholes in the dark!

As research continues in the area of the light emitting diode (a truly solid state lamp or light source), they shed more light. I recently received a green LED from Siemens (type LC-57-D) which is able to put out 30 millicandelas at a current of ten milliamperes. When they first came out a few years ago, they put out about .5 millicandelas at 20 mils of current. At a rated 60 mils of current, the green LED is bright enough to cast a cone of light like a prefocused flashlight bulb. And green is at the maximum of the human eye so it appears much brighter. The red LED has maximum output at a frequency where the response of the eye is only 10% of that at green.

Have you thought about what effects a local lightning storm might have on your solid state electronic devices? Consider this. During a lightning storm, voltages in excess of ten

million volts and currents of thousands of Amperes are generated and discharged from cloud to cloud and from cloud to ground. It is at these times that diodes, transistors, and triacs may fail even though the electronic device may not even be turned on. There is not yet much in the technical literature on the subject of lightning-induced electronic failures, but it may well be a design consideration of the future. There has been some data however, in the current issue of *The Electronic Technician* and the *RCA Transistor Manual*. It seems that power line-induced voltage transients may cause transients in the solid state power supply and take out the diodes associated with the power supply. Several instances reported to me concern a sewing machine and a tape recorder. After the last lightning storm (of which there were many in San Antonio in April '76), the sewing machine would operate only at full

speed and not operate at variable speeds as before. Either a diode or triac in the speed control circuits has had its operating voltage exceeded. And thinking back, I noticed that my Radio Shack Timecube (5, 10, 15 MHz) receiver would no longer function. And it is battery operated (9 volts) but I was using an outdoor antenna lying on the ground (an exhausted beverage longwire). I noticed later that if I turned the audio way up and listened closely, I could still hear WWV very weakly. That meant that the transistor in the front end had gone out during one of the recent storms. So go back in your memory to see if your electronic device didn't fail after a lightning storm (even though you may not have noticed it till many days later). Seems like a good article for some electronic magazine!

Cal Graf W5LFM  
San Antonio Radio Club  
Bull-etin

## Touching Minds

Peculiar to amateur radio is its concern with direct and instant communication among people, near and far, of whatever nationality and race. Flying, diving, philately, mountain-climbing and many other hobbies are essentially adventures of private experience, but ours turns on mutual disclosure.

What we have achieved in this free commerce of ideas has not brought peace to the world, but remember that for perhaps only one tenth of one per cent of the time passed since man was a rootless nomad have we known the miracle of wireless contact — international exchange without inter-

mediaries. We have just begun. It was only minutes ago that fires along the hilltops served to signal the approach of an armed host, and that was a top priority message.

Today our technology is a fascinating maze, continually branching in new directions, but still the ultimate goal is to touch another mind, and it always will be. CW or phone, teletype or ATV, even computers — these are but means and the end is communication for the progress of human affairs.

Ken Cole W7IDF  
Vashon WA 98070

## Belt Tightening

The FCC has just released Docket No. 20777, the latest step in the "deregulation" program. Let us examine the immediate effects the proposal would have on amateur operation in the lower frequency bands.

1. Conventional AM, double sideband (reduced or suppressed carrier), and narrow band FM would be prohibited.

2. SSB and SSTV signals would be much more severely restricted in terms of permissible bandwidth than at present. Independent sideband simultaneous transmission of SSTV and voice signals would apparently be precluded.

3. Wide shift RTTY would be forbidden in the present CW bands, but wide and narrow shift forms of FSK would be allowed in the "phone" bands.

4. MCW (A2 emission) would be legal on all frequencies in the HF bands.

The style of reasoning that must

have gone into this proposal reminds me of the "doublethink" which George Orwell describes in *1984*, in which the government insists that "War is Peace; Ignorance is Strength; Freedom is Slavery." Now, outlawing AM, DSB and NBFM and applying strict bandwidth limits to SSB and other modes is deregulation.

Our bands are not critically overloaded by present amateur usage. With the increase in popularity of VHF FM, the HF phone bands have become significantly less crowded in recent years. Of course, we do not know what we will have as frequency allocations after 1979. But today, specified bandwidth limits are neither necessary nor desirable. It would work undue hardships on many amateurs to be forced to abandon their present rigs. We should wait until after the WARC to decide if we need rigid belt tightening.

Donald Chester K4KYV/1  
Cambridge MA

# LETTERS

## OWING

Here's some dough for yet another of your code tapes.

I bought the 5 and 6 wpm tapes when I joined the Novice class being conducted by the 2 meter repeater club here in Beaumont. The 5 wpm tape was being used to drum the blasted code into us.

After missing one of the weekly classes, I arrived at the next class to find a stranger tuning up his beeper and saying something about a test.

I'd gotten pretty much through the 5 wpm tape, but hadn't even tried the 6 wpm and figured there'd be no way I'd pass the test. I took it just for laughs and turned it in on the theory that I might just pass.

Damned if I didn't.

So now I have this mainly unused 6 wpm tape. I'm waiting for the Friendly Candy Company to send my written test now, and I plan to work with that 6 wpm tape while waiting for the ticket so I won't sound like a dummy on the air. I've come by a Heath SB-101 and have put up a 40 meter dipole and am having fun listening.

One thing the other people in my class and I have noticed — these hams helping us get our Novice tickets sure are going to a lot of trouble just to help other people out. They're not getting anything out of it except satisfaction.

"Somebody helped me when I got into it," one of the instructors said. "This is the only way I can pay it back."

It's that attitude that I like the best about ham radio. Already I owe so much to so many people I can't even remember it all.

Richard Stewart  
Beaumont TX

## GETTING THE CALL

The Sterling-Rock Falls (Illinois) Amateur Radio Society was once again called upon by the local United Cerebral Palsy officials to provide communications for their annual WALKATHON EVENT. This event took place on May 15th.

The 20 mile march by grade school and some high school students got off to a start at 9:00 am and finished at 3:30 pm. The following volunteers in mobile units operated in 2 shifts and also helped to supervise the march: Paul Johnson K9BEF, Olli Ikonen

WB9DNA, Bill Peters WB9MCZ, Dick Little K9EEH, Ed Fisher K9APD, and John Ordean WA9BSO. Other members assisting these units were Warren McMurry WB9DNR, Tom Carney WN9RXJ, Ken Weissenburger WN9RVY, and Dan Gryder WN9PSQ.

Several members of the Sterling-Rock Falls Amateur Radio Society and members of the Rock River Amateur Radio Club (Dixon) participated in the Sauk Valley Canoe Association race held May 16th, by providing communications from both land and boats along Rock River. This was a 14 mile stretch starting from Dixon, where the Dixon hams started and took over for a 7 mile stretch and then the Sterling-Rock Falls boys took over for the remaining 7 miles to the finish at the East End of Sterling at the boat marina. The Sterling-Rock Falls members were: Paul Johnson K9BEF and Jim Zeigler WA9NXX. The Dixon members participating were: Chuck Randall W9LDU, Phil Ogan WA9VCN, Darrell Webb K9JBX, Claude Ensinger WB9EBS, Neil Howell WA9OPS, Walter Martin WB4VWH, Sam Berard K9KNV, and Mike Heughes WB9GWU.

John Ordean WA9BSO  
Sterling IL

## HOOKED

Keep up the I/O section. I'm hooked for sure. Since I wrote last, Dave K5WNV has his floppy disk and high speed printer up and flying. With the 24K memory and the disk we are really getting with it. Even running a fairly sophisticated Startrek. We're building both a RTTY and a video link from his shack to mine (25 miles). The video (439.25 MHz) works at short range, but we need more power to clear the hills between us. These hills are over 6000 feet high so you might call them mountains back there. We are running the VHF Engineering rig and modulator on page 28 of the June issue (beat you to it). Need a linear. Again keep it up.

Rod Hallen AA7NEV  
Tombstone AZ

## BACH BEST

Keep up the great work on 73. J. K. Bach is your best writer ("Glass Arm")!

Rick Ferranti WA6NCX  
Menlo Park CA

## WONDERFUL

I recently took advantage of your \$17.76 subscription special, and I am including an order for 250 QSL cards. I first started reading 73 at the local library, and after I got my Novice ticket I decided to get a subscription to your wonderful magazine (even with the new format). I enjoy your magazine tremendously and get more good out of it than the other ham magazines. Keep up the FB on the articles and editorials.

Jeff Ware WN7CIK  
Nampa ID

## SAVING THE SORCERY

I believe you have heard, or soon will, of the sailing sloop *Sorcery* emergency starting Saturday morning, May 8th. The 62 foot sailing vessel *Sorcery* took a 360 degree roll during a storm 1200 miles north of the Hawaiian Islands (42 degrees north, 162 degrees west). She was en route to California from Japan. Mabel W6YLT was aboard. Because of her roll over, she lost all power, masts, commercial radio gear, and life rafts. One crewman was swept overboard and was recovered, but was suffering from shock. Mabel's daughter suffered a compound fracture of the leg, and another crew member had a badly lacerated face. Below decks was a shambles. Mabel rigged an antenna and got a ham radio on 20 meters with battery power.

I thought I would fill you in on the first hour of the emergency:

I was operating on 14.323 in contact with WB9PRZ in Indiana, with my beam pointing east. KL7HAY, Harold (Hal) Berry in Homer, Alaska, heard us and broke in. Hal is a personal friend who winters in Sequim, Washington, and summers in Alaska. He had just moved up there a few weeks ago. His call in Sequim during the winter is WA7SQZ. During the 3 way contact, Hal (I believe his antenna was facing south) heard the distress call from W6YLT/mm region 2. He informed me and the other station. The Indiana station cleared and signed out. I turned my beam west and also picked her up. She was very weak, but between us we were able to get her location and condition. Hal said he would inform the Coast Guard. It turned out that he did not have a phone yet and had to go about a half mile away to reach one. While he was gone for about 20 minutes, I thought my correct job was to maintain communication with Mabel and keep the channel clear, which I did. I told Mabel that I knew KL7HAY had himself spent many years at sea and that I had complete confidence in him to notify the Coast Guard. WA6EAZ, Bill in San Francisco, heard me broadcasting the alert and broke in. He could not hear Mabel, so I asked him, because of his strong signal, to help

keep the channel clear. He did a good job of this, moving above and below the frequency to keep other stations from QRMing. Then he got San Francisco Coast Guard on his phone patch. Hal got back to his rig by this time, and Bill patched both Hal and me into the San Francisco C.G. We filled them in and they notified Juneau, Alaska C.G., which would handle the search. Because Hal did not have a phone in his shack, Juneau Coast Guard called me long distance to confirm that it was no hoax and get further information.

At about the end of the first hour, Kodiak, Ketchikan and Widbey Island, Washington ham stations came on. They were all hearing Mabel somewhat better than we were, so we three, W7SRU, KL7HAY, and WA6EAZ, confined ourselves to a monitoring role and channel guard for the next 25 to 30 hours of the emergency.

I am happy to say that all through the emergency QRM was never a serious problem. All stations were cooperative, and stations whose services were needed at some times bowed out to monitor when they were not needed and remained quiet.

I think Hal KL7HAY should be commended for hearing that first Mayday. Mabel was very weak. We lost her for about 15 or 20 minutes, the boat was taking on water and I thought sure it had sunk. Then Hal's sharp ears heard her again.

Mabel should be commended for her calmness and proficiency during a difficult situation.

Bill WA6EAZ's phone patch for us into San Francisco Coast Guard really helped to get the ball rolling during the first half hour.

Fred A. Boggs W7SRU  
Port Townsend WA

## WILSON GOOD GUYS

Better put the Wilson gang in Las Vegas on your "good guys" list! Perhaps on the top. Ordered a 5 Watt hand-held by phone on Monday, and it was here in Anchorage on Friday, all crystallized up and working "five by."

Air Mail of course! How's that for service!!!

Lt. Col. Herb Rosenthal KL7AE  
Anchorage AK

## MASTERPIECE

Received my July, 1976, 73 Magazine today (May 29). Some service for sure.

Your editorial, "The Good, The Bad, The Ugly," was very interesting. Enjoyed every word. In my opinion, it is a masterpiece. Keep up the good work. I have been a ham 54 years this April and I am proud of it.

W. J. Gentry W5GF  
Amarillo TX

## BOTHERING THE DIEHARDS

I was interested in your I/O Editorial for July 1976 — particularly where you intend to set up cassette computer programs. Whenever you get set up to where you can show some typical simple computer setups where all you have to do is to plug in a TV monitor for readout, or cheap surplus teletype, and a cassette recorder, thousands of guys like me who are not computer hobbyists will buy them — or make them from kits. For what they do, not for what they are — what they do for us.

This will come about only if you get the programs wanted on cassettes. For the home trade, I think games are kid stuff. I'm busy enough — so are you — not to waste time with games. And not many of us run small businesses! Our major bookkeeping is balancing the bank account, and \$5 calculators do that OK.

Program books — take a bunch of books on antennas and program them into an antenna cassette. With graphics if you can, even if the graphics have to be fed into an SSTV monitor.

A cassette on recipes — one for cooking fish, another for vegetarian vegetables, herbs and spices, etc. Microwave ovens — complementary vegs.

One on nutrition — vitamins, minerals, essential amino acids and enzymes — take the McGraw-Hill Nutrition Almanac for a starter. I know of a doctor who updates his computer with nutrition items twice a week from all known sources — and his is a pretty fee, around \$300, to outline your initial program.

Cassettes on hints and kinks — there are so many books that this is endless. Get the writers of technical books together with programmers and you will come out with lots of cassettes — and buyers for lots of minicomputers!

We have a computer at our ATV repeater and any user can feed ASCII into his FM audio input and trigger it. You can get it to give you S-meter readings every few seconds with around 12 readings to a page, and updated as long as you run it — unattended. You can rotate your antenna, change antennas, change powers, and see the results from the computer. There is nothing like it — though the FCC would like to take it away from us. And it bothers no one — but a few diehards in the FCC.

Charles E. Spitz W4API  
Arlington VA

## BRAVE "BRONKO"

I almost applied for a position on your "way out" 73 staff, but decided to have a brain operation instead. (I have Dystonia Musculorum Deformans, a rare disease, and have an appointment at St. Barnabas Hospital, Bronx

NY, for brain surgery. So wish me luck and I'll be looking forward to each and every issue with the same excitement as always.)

I have had the opportunity to get to meet and speak with W2NSD/1 at the 1974 and 1975 Dayton Hamventions. At present, however, I speak and walk like a drunk because of my disability. Since it is progressive at this stage, I'm sure he was only showing his PR side and was certainly not impressed — although I was. Very much so. I certainly wish he knew the tremendous amount of energy it took for me to elbow my way through the crowd from the parking lot to the booth to have the honor to meet and shake hands with such a brave "bronko," although I'm sure he did not understand a third of what I was trying to say. My energy level has gotten so low that I could not make it to this year's Dayton Hamfest. If I could have, Wayne would have had to put up with my persistent effort to be friendly and be understood. **MAYBE IF AND WHEN I HAVE BRAIN SURGERY I'LL BE ABLE TO WALK, TALK AND BE MORE NORMAL, AS OTHER PEOPLE.** Then look out, sir, for I shall be able to be understood and I'll verbally twist your ear off. Thank you for reading this (if you got this far).

Jack E. Foster W8JYE  
Newark OH

## SIGN ME UP

I read your editorial re probable economic coercion exerted by Eimac against your editorializations.

All I have to say is . . .

Sign me up for another three years!  
Henry Gardiner IV WA1GAR  
Waltham MA

## READY

It was a typical heading-home-from-work crowd on WR4ACN, the Chesapeake-Norfolk, Va. repeater, on the afternoon of May 20. Suddenly, at 1645, K4IIV broke in with an emergency request for amateur portable units to coordinate a foot search for two runaway teenage girls who were feared lost in a highly woody and swampy quicksandish area just south of the Norfolk Naval Shipyard in Portsmouth, Va.

WA4MMP mobile, who was about 5 miles from the scene, immediately took charge, and rapidly established an emergency net soliciting operators with 19/79 hand-held equipment. Within 15 minutes, 5 mobile units with hand-held capability were on their way. These included WA4PRU, WB4MBS, WB4AXY, WB2KEA and WB2KLL. Shortly thereafter, WB4OHZ was on his way and W4THN and WB4WSU were en route to the South Norfolk Airport to take up a light plane with a handie-talkie to

assist the foot units. Five other volunteer stations were on the air and waiting at home should they be needed in the field.

By 1815 all units including the aircraft were on the scene, and the search began through the half mile by half mile wooded swamp area. The ground and air units were coordinated by WA4MMP mobile, who had positioned himself with the search organizers midway along the search area frontier. For the next hour and a half an extensive foot/air search was conducted without results, and the operation was secured at 2000 (dusk). The two girls were spotted by police the next day in Hampton, Va., and safely returned to their homes.

Although the operation was unsuccessful in locating the girls (they were not in the searched area), it was an excellent example of how amateur radio operators and their VHF repeater systems can respond quickly and efficiently to their communities in times of need. We know that next time we're called, we're ready!

William R. Shaw WA4MMP  
Chesapeake VA

## SHOCKED

I just received my July issue of 73, and I was shocked when looking through it. On page 46 there was an advertisement for a citizens band radio, which is deplorable to put in a magazine whose readers are hams and expect to find information on amateur matters. This includes both articles and advertisements.

I first subscribed to 73 because of the number and quality (both are high) of your articles, but the reason you guys would stoop so low as to CB ads in a ham magazine is beyond me. Wayne, I hope your desk has been flooded with letters like this, and I think you have some explaining to do.

John Pilson AA1UZK  
Box 27  
Saunderstown RI 02874

*Nope, John . . . it's a flood of just a few letters. I've tried several CB rigs in my car and the Standard Horizon 29 is fantastic . . . substantially better than the others, so I was*

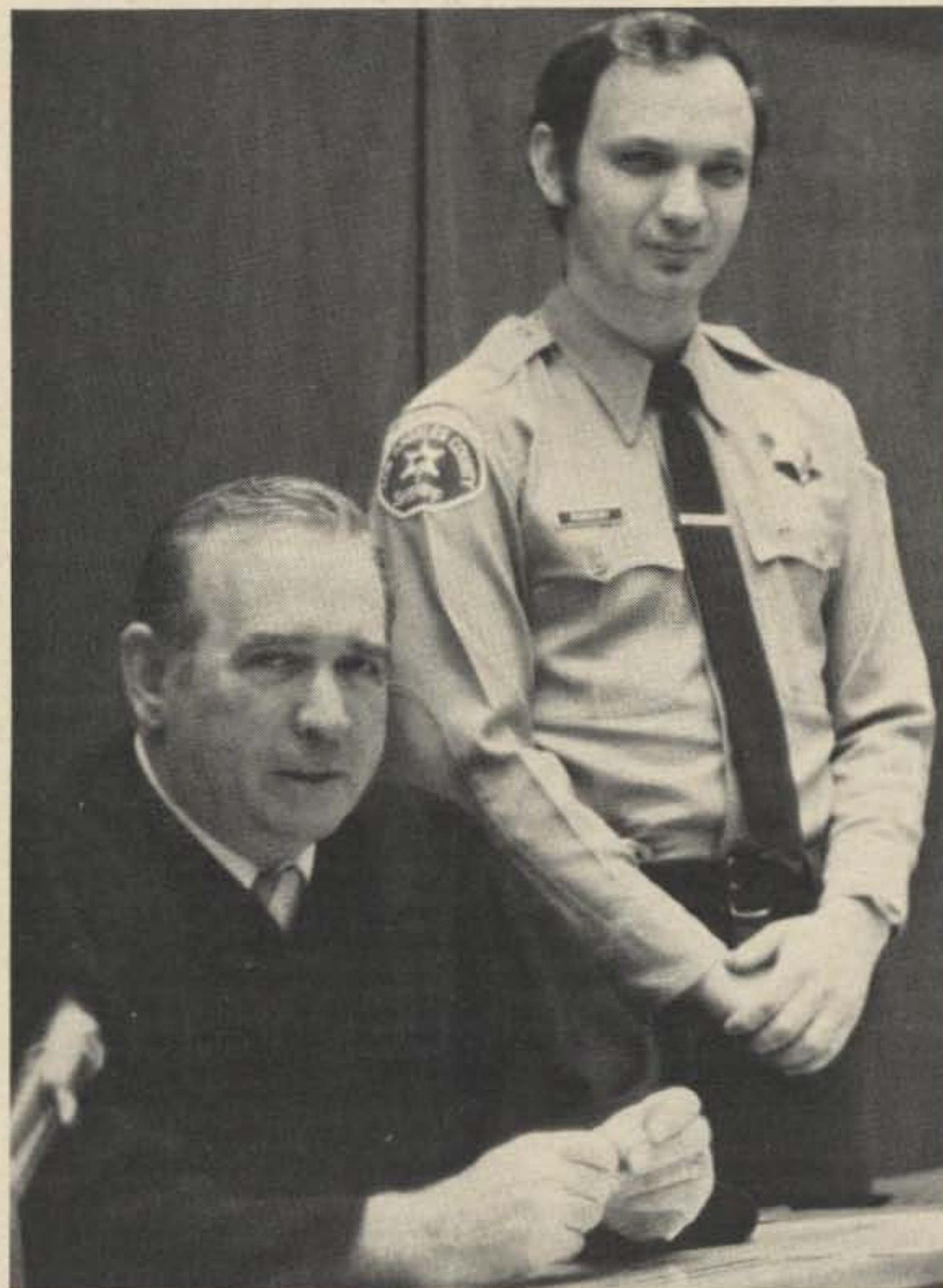

## SMALL WORLD

After months of QSOing each other on 2 meter mobile en route to downtown Los Angeles, Bill W6ONC (left) and Andy WA6WXD (right) dis-

covered, to their amazement, that they were Judge Ritzi and Bailiff Romanisky in the very same Superior courtroom each day! Prior to that, they were unaware that they even worked in the same building.

Lenore Jensen W6NAZ  
Sherman Oaks CA

happy to see it advertised. Apparently you are not one of the first to get the word on how CB has changed in the last couple of years . . . hopefully a reader or two will drop you a letter and bring you up to date. I just wouldn't drive without CB these days, as it is very valuable. I use it to get road directions, say hello to people along the road (including the fuzz), keep track of traffic problems, etc. Further, most of the new hams these days are coming from CB, so a bigoted attitude toward this group is odd, at best. FCC estimates are that we might well hope for over a million CBers to join amateur radio in the next couple of years. I think we need all the hams we can get on the CB bands. That way we can keep bugging them with the "next step" of hamming — Wayne.

#### BYE-BYE TVI

I own a three decker three family house and I had TVI with one of my tenants, and a neighbor, who also lives in a three tenement house, one block away. I thought it very peculiar that one tenant should get it, and others not, but subscribed to the popular thinking of insufficient shielding in the i-f of the TV sets. As it happens, in these three decker houses the 220 V ac is brought in to a main box, then is taken to serve three 110 V ac lines. The only way to do that is 2 on one side and one on the other side. After a lot of fuses renewed at the main box, I investigated the cause, and came to the conclusion that I needed a heavier service line in, plus heavier fuses. Being a cheap guy, I sought another way, and that way was to have my tenant taken off my side of the line, and put with the other tenant. Even then, I did not realize that I had done anything remarkable until my tenant said to me, "I cannot listen to talk any more. I liked to hear gossip over the radio. I could tune you in anytime I wanted — now I can get no more news." I am slow on the uptake, so it took two days for it to sink in that the greatest interference is by the power lines. Anyone using the service from the same side of the power line that you are on is 90% liable for TVI. If the amateur is giving trouble to his neighbors (who are surely using the same pole transformer and the same side of the line as the amateur), then all he has to do is change over to the other side of the 220 V ac line.

Of course one would say then that he would get another crop of TVI neighbors, but it is hardly ever so. The contractors who put up houses, and the electricians, use the same rule of thumb: The front part of the house goes on one side of the line, the back part on the other. I have passed on this information to the local hams, and it works. So now I am sending it to you to pass over to *hamdom* in your magazine.

Cyril Lievesley WA1LET  
Fall River MA

#### MAKING PLANE'S

I've been lookin tru Ben Franklin's May issue & as per usual it's jus loaded with lot's a info. However, last night arnd 9 I was talkin 2 an HRO dn in the Santa Cruz Mtns on 2 M with my Clegg an my 270 Vertical antenna & a HRO broke in saying that when I was tru he'd like a word with K6OPG . . . it turned out that he'd jus flu in fom SINGAPORE 2 days before, & Doc Charan 9V1NR, my ol friend had tol Ed, this HRO, that if he'd ever hrd Kenny K6OPG 2 please say hello 4 him & 2 tell me that it was abt time 4 me 2 come out & pay him a visit 4 a few weeks, as it hasn't been since 1972 since I've visited him & SINGAPORE (the best Country in the World) . . . Well, I haven't hrd Charan 9V1NR on the Ham bands lately, but then I'm jus Not on the air all of the time. Nevertheless, I'm making plane's 4 my visit (& it won't be via a 747 like the last time that I flu into SINGAPORE complements of my MARS ID card in my wallet, but that another story. This time I'll probley take a few years in getting there, as I jus bought a 32' diesel powered sailboat & I'm sholy learning how 2 navigate fr Leanard Davis W6LZA who's a marine engr that jus happens 2 be on the beach at the presant time & over the week-end wer installing some bronz plate's 4 my radio grounding system I'll need 4 my VHF & low-band ATLAS that I plan 2 use aboard. But, I'm out of paper, but will keep U informed.

Kenny Mahoney K6OPG  
San Francisco CA

#### ON TOP

I'd like to bring your attention to the American military amateurs in D-land. You've heard the DA calls on the bands. Through the attentions of DA2BA/WA5LVT, I took my Tech exam and now am waiting for the results to filter back through the federal maze. Activities of this sort, coupled with clubs like the Wiesbaden Amateur Radio Club, with its multi-national membership, make amateur radio in Germany an exciting deal.

In reference to *73 Magazine*, it was the first I read, and none can top it.

Dale LeDoux  
Mainz, Germany

#### LIMARC ATV

LIMARC will shortly put on the air an experimental amateur radio television repeater from the top of the Plainview tower at the Long Island Expressway and Sunnyside Blvd. This repeater will have a center of radiation of 550 feet above sea level and an estimated service radius of forty miles. Its input frequency is 439.25 MHz and it will output at 427.25 MHz,

with an effective radiated power of 500 Watts.

This ATV program is planned to be a pioneer operation in the metropolitan New York area for sociological electronic uses of interactive audio-visual communication (by radio) through simple home terminals and publicly located terminals (such as in schools, library community rooms and the Hall of Science at Flushing Meadow). Conceivably, operations such as this can usher in a completely new dimension in community educational activity and thereby generate a new radio service of undreamed potential and promise.

We in LIMARC are committed to this program and plan to also explore through this repeater operation other experiments utilizing narrow band high definition slow scan frame grabbing techniques and computer access by remote keyboard through radio links.

Ed Piller W2KPO  
Syosset NY

#### HURRICANE WATCH

I wish to inform all concerned that the Hurricane Watch Net will be operating on the frequency of 14325 this year. Also, this frequency will be used for emergency traffic (*only*) if and when it is deemed necessary. Other traffic such as health and welfare will be handled on other frequencies as in previous years (the YLISSB, Intercontinental Traffic Net, and IMRA, to mention a few, as well as other bands).

If any other information is needed, write or phone the manager, Phil J. Craig K4CRU, 115 S. Entrada, Hollywood FL 33021, (305)-983-4536, or myself.

Timmie S. McCraw WB4LQO  
Box 277  
Mountain Home NC 28758  
(704)-692-1042

#### LEMME TELL YOU!

Now just who do you think you're calling a "WN"? I got your 14 wpm tape *months* ago. Do you honestly think that I wouldn't have upgraded by now?

Here's how it happened: I got your tape in the mail and dropped everything to get it on the tape recorder. After about 2 minutes I got very angry at you, Wayne. Please, in the future, try to get the labels on the same side as the code. The code was on the opposite side. Hi, hi.

Well, when I finally found *that* out, the fun first began. The first two groups were okay, but after that — down the drain. Well, to make a short story long, I worked with that tape on the average of one half hour per day for about 6 weeks. Then one day I sat down, and, after being content with copying 5 groups in a row perfectly, I proceeded to copy one half of a

loose-leaf sheet — without a single mistake!!! Lemme tell you, Wayne, that tape was really something.

For the technical part of the exam I used the General Class Study Guide which I got from a friend. Hey, thank the author for me, huh? I couldn't make head nor tail out of the License Manual at first, but after reading your book, I went back to the License Manual, and I actually understood what was there! Great!

I knew this Wednesday was it. (And boy was it ever; it was the first day of the new term and I got stuck with the worst seats in each class. Grrrrr.) Tuesday night I fell asleep saying, "You will not be nervous, you will do fine," over and over again.

Wayne, I woke up so nervous that morning I would have been happy pulling off a Tech. But finally my stomach settled down as I walked into the FCC office in New York. (I still can't figure out if it just settled down or was killed by that subway ride.)

After an incredibly long wait, we were taken in for our code tests. First they send you one minute of 13 wpm as a warm-up. Funny, it sounded more like 10 wpm. Hey, what are they trying to pull here. Ooops, here comes the real thing. Missed one. Missed another one. "Calm down," I tell myself. I reach the end of the page. I go back to fill in. Wayne, I think I filled in 2 letters in over 15 lines. That 13 wpm was nothing. That code tape really did the trick.

The written part of the General was just bordering on difficult, thanks to your book; the Advanced was even easier.

Well that's about it, Wayne. I'll let you (and everybody else, if this ever gets into print, which I seriously doubt) off the hook. Oh, just one more thing, I want to compliment you and your staff on a fine magazine (*73*, remember?). It never fails to mess up my schedule when it comes. I have to read it from cover to cover.

David M. Krumholz WA2YYL  
Rosedale NY

P.S. I like your editorials.

#### A PLEA

This letter is a plea for more peripheral equipment to interface with the new family of microprocessors.

I have been working in data processing for over 20 years and have been following the development of the small processors. I can now pick up *73* or *Popular Electronics* and find pages and pages of advertisements for CPUs and RAMs at reasonable cost. But where is the I/O? I do not consider the TV typewriter display as an I/O device, but simply one for occasional communication by the operator with the processor. Well, what else do we have? Not much. Disk storage units are nice (nice and

*Continued on page 140*

# How do you work a ham when he's not in his shack?

## By telephone.

**It's only 21¢ or less plus tax for a one-minute night or weekend call. If you dial direct.**

You can't work a ham when he's away from his rig, but you *can* set up contact by phone. It's quick and it's reasonable, especially when you dial direct. The Night & Weekend rate is the lowest. Check the chart below for other low dial-direct rates.

NEW RATES FOR COAST-TO-COAST INTERSTATE CALLS			
DIAL-AND-SAVE ONE-MINUTE RATES			OPERATOR-ASSISTED THREE-MINUTE RATES
FULL RATE	35% DISCOUNT	60% DISCOUNT	
<b>WEEKDAYS</b> Monday-Friday 8 a.m.-5 p.m.  First Minute <b>54¢</b>	<b>EVENINGS</b> Sunday-Friday 5 p.m.-11 p.m.  First Minute <b>35¢</b>	<b>NIGHTS &amp; WEEKENDS</b> Every night 11 p.m.-8 a.m. Saturday— day and night Sunday— day and night except 5 p.m. to 11 p.m.  First Minute <b>21¢</b>	<b>STATION-TO-STATION</b> Full rates apply at all times First 3 minutes <b>\$2.25</b>
<b>PERSON-TO-PERSON</b> Full rates apply at all times First 3 minutes <b>\$3.35</b>			

**Additional minutes cost less than the first minute.**

Dial-direct rates apply on all interstate calls completed from a residence or business phone without operator assistance. They also apply on calls placed with an operator from a residence or business phone where dial-direct facilities are not available. For dial-direct rates to Hawaii and Alaska, check your operator. Dial-direct rates do not apply to person-to-person, coin, hotel-guest, credit card or collect calls, or to calls charged to another number, because an operator must assist on such calls. Rates quoted do not include tax.

Additional minutes same as dial rate. Applicable discounts apply to additional minutes during Evening and Night & Weekend periods.

Cut this chart out and put it in your phone book.

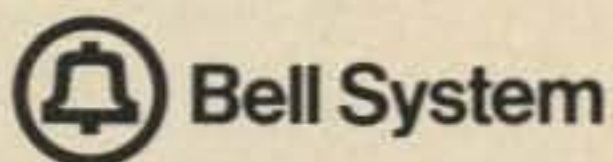

Editor:  
Robert Baker WA1SCX  
34 White Pine Drive  
Littleton MA 01460

# CONTESTS

## NOTE

Just received a note from K5MRU, who says the correct results for the 7th district in the 10-10 Net Winter QSO Party should have been K7PX1 83/207 and WB7AUJ 73/128, and WA7YCO should have been omitted. Also, please note the date change by ARRL for the VHF QSO Party from the slow weekend of Sept 4th to the following weekend, making 4 contests for the weekend of Sept 11th!

## KENTUCKY QSO PARTY

Starts: 000 GMT Aug 28  
Ends: 000 GMT Aug 30  
(full period)

### SPONSOR:

Bluegrass Amateur Radio Club,  
Lexington, Kentucky.

### EXCHANGE:

KY stations send RS(T), county, and consecutive QSO number. Other stations send RS(T), consecutive QSO number, and state, country or province.

### SCORING:

One point per QSO. Multipliers for KY stations are total states, countries

or provinces worked. Multipliers for other stations are total number of KY counties worked. A bonus multiplier of 1.5 may be taken if power input of 250 Watts or less is used.

### ALLOWABLE CONTACTS:

One CW and one other mode per band. 6 and 2 meters to use simplex operation only.

### SUGGESTED FREQUENCIES:

Lower edges of General HF CW and phone bands; also Novice frequencies.

### LOGS:

Send logs by October 1 to Robert H. van Outer WB4YQY, 285 Hillsboro Ave., Lexington KY 40505. Appropriate awards will be presented.

## FOUR LAND QSO PARTY

Starts: 1800 GMT Saturday,  
Sept 4  
Ends: 0200 GMT Monday,  
Sept 6

This is the 7th annual QSO Party and is sponsored by the Fourth Call District Amateur Radio Assn. of the IARS. The same station may be worked on each band and/or mode fixed, and repeated again if operated portable or mobile from another

county. Fourth call district stations may work other stations within the 4th call area.

### EXCHANGE:

4th call area stations will send RS(T), state, and county. All others send RS(T) and state, province, or country.

### FREQUENCIES:

Phone: 3940, 7260, 14340, 21360, 28600.

CW: 3575, 7060, 14070, 21090, 28090 (+/- 10 kHz).

Novice: 3710, 7110, 28110 (+/- 10 kHz).

### SCORING:

4th call area stations score 1 point per W/VE QSO and 3 points per DX QSO (including KH6 and KL7). Final score is total points times total number of states and provinces (regardless of bands). All others score 2 points per QSO times the sum of the number of 4th district states and counties (count each state and county only once). For this bicentennial year, add 2 points for each CHC or FHC member worked. All CHC/FHC members will send their CHC or FHC number along with the report.

### AWARDS:

Certificates to top scorers in each state, VE province, and country. Second and third place awards where scores warrant. High Honor Trophy Award (certificate) to high scorer in 4 Land, high W/K outside 4 Land, and to VE and DX country. Also county awards to 4th call area states and special awards to Novice, SWLer and blind-handicapped.

### ENTRIES:

Mail logs with score within 30 days of end of party to 4th Call District ARA, Attn: Bob Knapp W4OMW, 105 Dupont Circle, Greenville NC 27834. Include an SASE for results.

## ARRL VHF QSO PARTY

Starts: 1900 GMT Sept 11  
Ends: 0600 GMT Sept 12

Rules same as June QSO Party; check August issue of QST for any last minute changes!

Entrants may operate no more than 28 of the 35 hours during the contest period. The seven hours off-time must be taken in increments of 30 minutes or more. Listening time counts as operating time. All contacts must be made on amateur bands above 50 MHz using authorized modes. Fixed, portable, or mobile operation under one call, from one location only is permitted. Any transmitter used to contact a station may not be later used to contact another station during the contest period with any other call sign. Contacts made by retransmitting either or both stations (such as repeaters) do not count for contest purposes. Each contact exchange must

be acknowledged by both operators before either may claim contact points. A one-way confirmed contact does not count.

### EXCHANGE:

Simply exchange your ARRL section.

### SCORING:

On 50 or 144 MHz count 1 point per QSO, on 220 or 420 MHz count 2 points per QSO, and on higher UHF bands count 3 points per QSO. Final score is then the total QSO points multiplied by the number of different bands used.

### ENTRIES:

Usual awards will be issued and the standard disqualification rules will apply. Logs and entry forms are available from ARRL, 225 Main St., Newington CT 06111. All contest entries should then be returned to this same address.

## WASHINGTON STATE QSO PARTY

Starts: 1600 GMT Sept 11  
Ends: 2400 GMT Sept 12

Please note the time change from previous years!

The 11th annual WASH State QSO Party is sponsored by the Boeing Employees' Amateur Radio Society (BEARS) and is open to all amateurs. All bands and modes may be used. Stations may be worked once on each band and each mode for contact points and more than once each band/mode if they are additional multipliers.

### EXCHANGE:

QSO number, RS(T), and WASH county or state/province/country.

### FREQUENCIES:

Phone: 1815, 3935, 7260, 14310, 21380, 28660.

CW: 1805, 3560, 7060, 14060, 21060, 28160.

Novice: 3735, 7125, 21150, 28160.

### SCORING:

WASH stations score 1 point per QSO (including other WASH stations); all others score 2 points for each QSO with a WASH station. WASH stations multiply total contact points by the total of different states, provinces, and countries worked. All others multiply total contact points by the total of different WASH counties worked (39 max). There is an extra multiplier of 1 for each group of eight contacts with the same WASH county for non-WASH stations.

### AWARDS:

Certificates will be awarded to the highest scoring stations (both single and multi-op) in each state, province, country, and WASH county. Additional certificates may be issued if warranted.

The Worked Five BEARS Award is also available to anyone working 5 club members before, during, or after

# CALENDAR

Sept 4 - 5	Albatros SSTV Contest
Sept 4 - 6	Four Land QSO Party
Sept 11 - 12*	European DX Contest - Phone
Sept 11 - 12	ARRL VHF QSO Party
Sept 11 - 12	Washington State QSO Party
Sept 11 - 12	Pennsylvania QSO Party
Sept 16 - 18	YLRL Howdy Days
Sept 18 - 19	Scandinavian Activity Contest - CW
Sept 18 - 20	Maryland/DC QSO Party
Sept 25 - 26	Scandinavian Activity Contest - Phone
Sept 25 - 27	Delta QSO Party
Oct 2 - 3	VK/ZL/Oceania Jubilee DX Contest - Phone
Oct 2 - 4	CARTG Worldwide RTTY DX Contest
Oct 8 - 10	CD Party - Phone
Oct 9 - 10	VK/ZL/Oceania Jubilee DX Contest - CW
Oct 9 - 10	RSGB 21-28 MHz Contest - Phone
Oct 16 - 17	RSGB 7 MHz Contest - CW
Oct 16 - 18	CD Party - CW
Oct 17 - 18	Manitoba QSO Party
Oct 19 - 20	YL Anniversary Party - CW
Oct 30 - 31	CQ Worldwide DX Contest - Phone
Nov 5 - 8	IARS/CHC/FHC/HTH QSO Party
Nov 6 - 7	RSGB 7 MHz Contest - SSB
Nov 6 - 8	ARRL Sweepstakes - CW
Nov 9 - 10	YL Anniversary Party - Phone
Nov 13 - 14*	European DX Contest - RTTY
Nov 14	OK DX Contest
Nov 20 - 22	ARRL Sweepstakes - Phone
Nov 27 - 28	CQ Worldwide DX Contest - CW
Dec 4 - 5	ARRL 160 Meter Contest
Dec 11 - 12	ARRL 10 Meter Contest
Dec 31	Straight Key Night
Feb 19 - 20	YLRL YL-OM Contest - Phone

\* = described in last issue

the QSO Party. All QSO Party entries will be screened by the Contest Committee for possible Worked 5 BEARS Awards. A Worked 3 BEAR Cubs Award is also available for working 3 Novice members.

**ENTRIES:**

Logs must show dates, times in GMT, stations worked, exchanges sent and received, bands, and modes used and scores claimed. Include check sheet for entries with more than 100 QSOs. Each entry must include a signed statement that the decision of the Contest Committee will be accepted as final. No logs can be returned. Results of the QSO party will be mailed to all entries and an SASE is NOT required. Logs must be postmarked no later than October 11, 1976 and sent to Boeing Employees' Amateur Radio Society, c/o Contest Committee, Willis D. Propst K7RSB, 18415 38th Ave. S., Seattle WASH 98188.

**PENNSYLVANIA QSO PARTY**

**Operating Periods:**

1600-0500 GMT Saturday,  
Sept 11  
1300-2400 GMT Sunday,  
Sept 12

The 19th annual PA QSO Party is sponsored by the Nittany ARC and all amateurs are invited to participate. PA stations may work both in-state and out-of-state stations.

**EXCHANGE:**

QSO number, RS(T), and PA county or ARRL section.

**FREQUENCIES:**

Phone: 1815, 3980, 7280, 14315, 21380, 28560.

CW: 1810, 3550, 7050, 14050, 21050, 28050.

Novice: 3715, 7160, 21115, 281115.

Please note changes from last year's frequencies!

**SCORING:**

PA stations score 3 points per non-PA QSO and 1 point per PA QSO. Final score is total number of QSO points times number of ARRL sections worked (including EPA and WPA) plus a multiplier of 1 for any DX. Non-PA stations score 1 point per QSO times the number of PA counties worked (67 max). Stations may be worked once per band and mode.

**AWARDS:**

Certificates to section winners with 10 or more QSOs.

**ENTRIES:**

Logs must show dates/times in GMT, stations worked, exchanges sent/received, bands, modes, number of new section/county as worked. A summary sheet should be included indicating number of QSOs, total counties/sections, QSO points, claimed score, rig description, operating time, and any other gripes, suggestions, etc. Mail by October 15th to Douglas R. Maddox W3HDH, 1187 S. Garner St., State College PA 16801. Do not include an SASE.

**YLRL HOWDY DAYS**

Starts: 1800 GMT Thursday,  
Sept 16

Ends: 1800 GMT Saturday,  
Sept 18

Scores will be based on contacts with licensed women operators ONLY. All bands and modes may be used but crossband operation and net contacts are not permitted. Only one contact with each station will be counted.

**SCORING:**

Score 2 points per YLRL member worked and 1 point for each non-YLRL member YL worked. No multipliers!

**AWARDS:**

Top scoring YLRL member will receive her choice of a YLRL pin, charm, or stationery. Non-YLRL member will receive a one year membership in YLRL.

**ENTRIES:**

Logs should be sent to Mrs. Myrtle Cunningham WA6ISY, 1105 East Acacia Ave., El Segundo CA 90245.

**VE/W CONTEST**

**CW**

Starts: 0001 GMT Saturday,  
Sept 18

Ends: 0000 GMT Sunday  
Sept 19

**Phone**

Starts: 0001 GMT Sunday

Sept 19

Ends: 0000 GMT Monday

Sept 20

The Montreal Amateur Radio Club Inc. invites all W/K and VE/VO amateurs to participate in the 1976 VE/W contest to be held the weekend of September 18-20.

Rules for the 1976 contest include some changes from last year, and therefore should be read carefully by everyone intending to participate. These changes were incorporated at the request of many amateurs participating in last year's contest.

A 10X multiplier is continued for W/K participants in an attempt to equate U.S. and Canadian scores, thus encouraging more competition between the two areas.

Stations should look for each other in the "General" part of the phone and CW bands, and are reminded to check all bands for openings.

Log sheets, regardless of score, will be of definite interest in preparing the contest summary. It will also be of definite interest in preparing "soapbox" comments, unusual occurrences, etc.

**ELIGIBILITY:**

The contest is open to all licensed amateurs located in the ARRL sections listed on page 6 of any QST.

**CLASSES OF ENTRY:**

The contest is divided into two classes: CW and phone. CW and phone scores must be logged, tabulated and submitted separately.

**TYPES OF ENTRY:**

There are two types of entry — single operator and multi-operator. A single operator station is one manned by an individual amateur who receives no assistance from other persons during the contest, such as log keeping or spotting stations.

Stations where two or more ama-

# RESULTS

RESULTS OF THE 1976 YLRL, YL-OM CONTEST

**Overall winners:**

**YL — CW**

WA5VJW 21,532.5 points  
YV5CKR 16,669  
W4VQZ 13,800

**OM — CW**

AC4CHK 1,500 points  
W5WZQ 1,365  
W3ARK 1,282.5

**YL — Phone**

W7JYX 52,345  
W4VQZ 48,240  
I3MWP 40,128

**OM — Phone**

AD4JRB 2,535  
I0DUD 2,430  
W4CHK 2,040

**Other High Scores were:**

**YL — CW**

K1NEI 10,295  
WA2DMK 7,356.25  
WA3SWU 350  
WA4EPM 2,945  
W5QWI 3,135  
WA6TOD 6,500  
K8ONV 12,400  
WA0YNC 11,115  
VE2EDO 2,565

**YL — Phone**

LU1BAR/W3 21,538  
W4LYC 1,770  
WB5LMZ 6,000  
WA6ISY 2,450  
K8ONV 18,176  
W9VNG 24  
WA0YNC 11,115  
VE7DKC 2,626

**OM — CW**

W1PEG 875  
W2RPZ 672  
AD3RFB 238  
K4IEX 800  
K5RRG 797.5  
W6ZT 638  
AC7BKK 300  
W9LNQ 656.25  
WA0FMD 747.5  
VE3EMA 840

**OM — Phone**

W1PEG 80  
K2LFG 522.5  
WA3KSQ 227.5  
W4KFB 625  
WB5GRI 175  
W7AHZ 165  
W9LNQ 906.25  
W0GNX 1,440  
VE2QO 61.25

teurs operate a station, or where a single operator receives assistance in operating the station, must be placed in the multi-operator category.

**CONTEST PERIOD:**

CW Class — All CW contacts must be made during the period 0001 GMT Saturday, September 18 and 0000 Sunday, September 19. Only 18 hours total operating time may be used during this period. Times on and off the air must be shown in the log. Minimum time off period allowed is 15 minutes. Listening time must count as operating time.

Phone Class — All phone contacts must be made during the period 0001 GMT Sunday, September 19, and 0000 GM Monday, September 20. Only 18 hours total operating time may be used during this period. Times on and off the air must be shown in the log. Minimum time off period allowed is 15 minutes. Listening time must count as operating time.

**BANDS:**

All bands and modes for which the participating entry is licensed may be used. A station may be worked once on each band in each contest classification. The use of repeaters for contest exchanges is not permitted.

**EXCHANGE:**

W/Ks will work VE/VO stations and vice versa. W/K to W/K and VE/VO to VE/VO QSOs do not

apply. Valid points can be scored by contacting stations not in the contest if complete exchanges are made. The exchange consists of RS or RST report, a consecutive number beginning with 100 for the first CW contact made at the beginning of the contest, and the number 200 for the first SSB contact, and the ARRL section for W/Ks and geographical areas listed below for VE/VOs.

Newfoundland	VO1	NFLD
Labrador	VO2	LAB
P.E.I.	VE1	PEI
Nova Scotia	VE1	NS
New Brunswick	VE1	NB
Quebec	VE2	QUE
Ontario	VE3	ONT
Manitoba	VE4	MAN
Saskatchewan	VE5	SASK
Alberta	VE6	ALTA
British Columbia	VE7	BC
Yukon	VE8	YUK
Northwest Territories	VE8	NWT

Example CW exchange might be "W9XXX DE VE4YYY 579-165 MAN K"; an example SSB exchange might be "VE1WWW, this is W7ZZZ. Your report 5 and 9 and 296 Oregon go ahead."

**SCORING:**

Each completed contact is 2 points times the number of sections worked on each band, plus a 10 times multiplier for U.S. stations participating,

e.g., 25 contacts in 10 sections on 21 MHz, 10 contacts in 10 sections on 14 MHz, and 20 contacts in 10 sections on 3.7 MHz = 25 + 10 + 20 = 55 contacts x 2 = 110 points x (10 + 10 + 10) 30 = 3300 points for Canada, but 3300 x 10 = 33000 for U.S. stations.

#### CONTEST SUBMISSION:

Log sheets and a summary sheet are required with every submission. The summary page will be submitted as the first page of each entry showing number of contacts, multipliers and total scores. Any 200 plus contact entries are also required to have check sheets (ARRL, op aid #6) for listing or awards. A separate submission for each class (CW and SSB) is mandatory. All entries must be postmarked no later than October 31, 1976, and become the property of the contest committee.

#### OPERATING AIDS:

Check and summary sheets are available from the VE/W Contest Committee, P.O. Box 2206, Dorval Station 780, Quebec, Canada. Include SASE (legal size), IRCs or Canadian stamps with your request. Official sheets are not necessary and reasonable facsimiles are acceptable. No forms will be sent unless sufficient postage accompanies your request.

#### AWARDS:

Plaques will be awarded to the high scoring Canadian and to the high scoring U.S. entry for both classes, CW and SSB, donated by the Montreal Amateur Radio Club. A minimum of 25 QSOs is required to qualify. Entrants operating under reciprocal licensing agreements are not eligible for plaques.

Certificates will be awarded for the high scoring stations in each section for each class and type of entry providing at least three entries in each class and type are received from each section.

#### DISQUALIFICATIONS:

If the claimed score of an entry is reduced by 2% or more, logs may be disqualified. Score reductions may be made for taking credit for unconfirmed QSOs and/or multipliers, duplicate contact, or other scoring discrepancies.

The ruling of the VE/W contest committee will be final in all instances of doubt.

#### SCANDINAVIAN ACTIVITY CONTEST

CW

Starts: 1500 GMT Saturday,  
Sept 18

Ends: 1800 GMT Sunday,  
Sept 19

Phone

Starts: 1500 GMT Saturday,  
Sept 25

Ends: 1800 GMT Sunday,  
Sept 26

Non-Scandinavian stations will try to work as many Scandinavian stations as possible. The same station may be worked once on each band during the contest. Only CW-CW and phone-phone QSOs are valid. Valid Scandinavian prefixes will be: LA, JW, JX, OH, OH0, OX, OY, OZ, and

SM/SK/SL. Use all amateur bands, 80 to 10 meters. General call will be CQ SAC for non-Scandinavian stations or CQ TEST for Scandinavian stations.

#### CLASSES:

Single operator, multi-operator/single transmitter, multi-operator/multi-transmitter. Club stations are in multi-operator class even if operated by a single operator. Multi-op/multi-transmitter stations should use separate series of serial numbers for each band.

#### EXCHANGE:

RS(T) and serial number starting with 001.

#### SCORING:

Score 1 point per completed QSO. Multiplier is number of Scandinavian countries per band, maximum of 10: LA - Norway, OH - Finland, OH0 - Market Reef, OY - Faroe Islands, SM/SK/SL - Sweden, JW - Swalbard, OH0 - Aland Islands, JX - Mayen Islands, OX - Greenland, OZ - Denmark.

Final score is the sum of complete QSOs multiplied by the sum of multipliers.

#### AWARDS:

The two highest scoring stations in all operating classes on CW and phone will receive the Contest Award in each participating country as well as in each participating USA call area. Other certificates may be awarded depending on the activity in each country or call area.

#### LOGS/ENTRIES:

Logs are to be filled in in the following order: date and time in GMT, station worked, sent #, received #, band, note new multiplier. Separate logs for each band are not necessary but a summary sheet showing totals of each band and final score is required. On summary sheet include: callsign, name, full address, and operating class. Separate logs are required for CW and phone. Include any comments on the summary sheet. Also, include a signed statement that you operated according to all rules and regulations and agree to the final decision of the Contest Committee. Logs must be mailed no later than October 15th to SSA Contest Manager SM0DJZ, P.O. Box 3036, S-195 03 Maersta, SWEDEN.

#### MARYLAND/DC QSO PARTY

Starts: 2300 GMT Saturday,  
Sept 18

Ends: 0100 GMT Monday,  
Sept 20

The 10th QSO Party is sponsored again by the Maydale ARS. The same station may be worked on each band and mode for QSO points as well as band multipliers.

#### EXCHANGE:

QSO number, RS(T) and QTH. MD/DC send county (Baltimore City and Washington separate). Others send ARRL section or country.

#### FREQUENCIES:

75 kHz from low end of CW bands on even hours, 25 kHz from top of each phone band on odd hours. Try 10 and 15 on half hours.

#### SCORING:

Score 2 points for each QSO. MD/DC stations multiply QSO points by number of ARRL sections and countries on each band. Others multiply QSO points by number of MD counties and independent cities (24 max) on each band.

#### AWARDS:

Certificates to top scorers in each ARRL section and country with 100 points minimum on each mode, to top MD scorers in each county with 1000 points minimum on each mode.

#### ENTRIES:

Use separate logs for each band and mode as well as a check sheet for each band and mode with over 100 contacts. Include a summary sheet showing scoring, name and address, and a signed declaration that all rules and regulations were observed. Send all entries to Maydale ARS, c/o C.E. Anderson K3JYZ, 14601 Claude Lane, Silver Spring MD 20904.

#### DELTA QSO PARTY

Starts: 2000 GMT

Sept 25

Ends: 0200 GMT

Sept 27

All amateurs are invited to participate in the 7th annual Delta QSO Party which is sponsored by the Delta Division of the ARRL. Contacts must take place during the contest period with no time or power restrictions. Any station disrupting a working Delta Div traffic net or whose log exhibits obvious irregularities will be disqualified from award consideration. General call will be "CQ DELTA QSO PARTY" on SSB and "CQ DELTA" or "CQ TEST" on CW.

#### EXCHANGE:

QSO number, RS(T), and QTH: ARRL section for non-Delta, county and state for Delta. Portables and mobiles may be reworked on the same band/mode if changing counties. Stations may be worked once on each band/mode otherwise. Delta Div stations may work other Delta Div stations.

#### FREQUENCIES:

Novice: 3725, 7125, 21125, 28125.  
SSB: 3990, 7290, 14290, 21390, 28590.

CW: 3550, 7050, 14050, 21050, 28050.

#### SCORING:

Delta stations take number of QSOs times number of ARRL sections (75 max) worked for final score. Outside Delta Div, take number of QSOs times the number of counties worked within the Delta Div (316 max). DX stations may be worked by Delta Div stations but do not count for multipliers.

#### AWARDS:

Delta Achievement Award - All amateurs contacting 5 hams in each of the 4 states comprising the Division will receive this certificate. Certificates will be awarded to the 3 highest scoring stations in each state within the Delta Div; 4th and 5th will also be given if warranted. Certificates will go to the high scoring station in each ARRL section and country; 2nd and 3rd will be given if warranted. A

plaque will be given to the high scoring station both inside and outside of the Division. Plaques will also be awarded to the high scoring portable and mobile stations operating within the Delta Div. A portable or mobile must be operating outside his home county to be eligible. The Lafayette ARC will sponsor the plaques.

#### ENTRIES:

Logs must include date/time, station worked, exchange, band, mode, and multipliers. Logs must be post-marked no later than October 21, 1976 to be eligible for award consideration. Logs will be returned if requested. Send logs to Malcolm P. Keown K5RUB, 213 Moonmist, Vicksburg MS 39180.

#### 1976 CALIFORNIA QSO PARTY

Sponsored by the Northern  
California Contest Club

The 1976 California QSO Party will begin at 1800 UTC (11:00 am PDST) on Saturday, October 2, and end at 2400 UTC (5:00 pm PDST) on Sunday, October 3. Of the thirty hour period, the maximum operating time shall not exceed 24 hours. Times on/off must be clearly marked in the log. Each time off shall not be less than 15 minutes.

#### BANDS:

All amateur bands may be used, and stations may be worked once on phone and once on CW on each band. A California station which changes counties (i.e., a mobile or portable) is considered to be a new station and may be contacted again on each band and mode.

#### SCORING:

California stations will transmit consecutive QSO numbers and county. Non-California stations will send consecutive QSO numbers and state, Canadian province, or country. California stations may work each other, but contacts between stations outside of California have no contest value. Each complete QSO shall count two points; no credit is allowed for partial contacts. The multiplier for California stations shall be the number of different states plus Canadian call districts (VE/VO 1 - 8, maximum of 8). California stations may count the state of California as one multiplier. Also, DX may be worked for QSO points, but does not count for multipliers. Non-California stations will use as their multiplier the number of different California counties worked (58 maximum). The final score equals total QSO points times the multiplier.

#### FREQUENCIES:

CW: 1805, 3560, 7060, 14060, 21060, 28060.

SSB: 1815, 3895, 7230, 14280, 21355, 28560.

Novice: 3725, 7125, 21125, 28125.

Try 10 meters on the hour and 15 meters on the half hour between 1800 and 2200 UTC.

#### LOGS:

Log information should include date, time, band, mode, callsigns

Continued on page 140



## TRAGEDY AT TRENTON

In the early 1930s a popular way for various organizations, such as American Legion posts, service clubs, etc., to raise funds was to sponsor so-called "Air Meets" or "Air Races" at their local airports. One of these was a two day affair at Trenton's Mercer Airport on October 19th and 20th, 1930. It carried the prepossessing title of "All Eastern States Air Meet." I was serving as Judge and Starter in the closing event of the meet, a 25 mile race over a triangular closed course with one pylon on the airport field.

Five planes were lined up ready to start when Mrs. Opal Kunz landed and asked to compete in the race. I asked the pilots of the other five planes if they had any objection to her last minute entry and they all agreed to let her compete.

So I started them off at 50 second intervals and went over to the home pylon to make sure that no one was cutting any corners there. On the last lap three ships were bunched on their approach to my pylon. George Zinn in his Taper Wing Waco was low and on the inside, Mrs. Kunz a little ahead of him and on the outside, and Dick Mackie in his Cessna flying a high, safe race about 150 feet above Mrs. Kunz. Just as they got to the pylon, Mrs. Kunz suddenly cut around directly in front of George, which forced him to pull up sharply to avoid hitting the Kunz machine. Just at that moment, however, Mackie was just above. Zinn's Waco collided with the Cessna and cut its whole tail off. Zinn's Waco lost its flying speed and dove in about 100 feet from where I was standing. Mackie's Cessna seemed to fly along straight and level for a few seconds, but when he throttled back it went straight in. Both were killed instantly. From left to right in the photo are the Kunz plane that cut in front of Zinn, the Cessna with its tail cut off, and Zinn's Waco, with pieces of the Cessna's tail over Zinn's engine and, in

# Autobiography of an Ancient Aviator

W. Sanger Green  
1379 E. 15 Street  
Brooklyn NY 11230

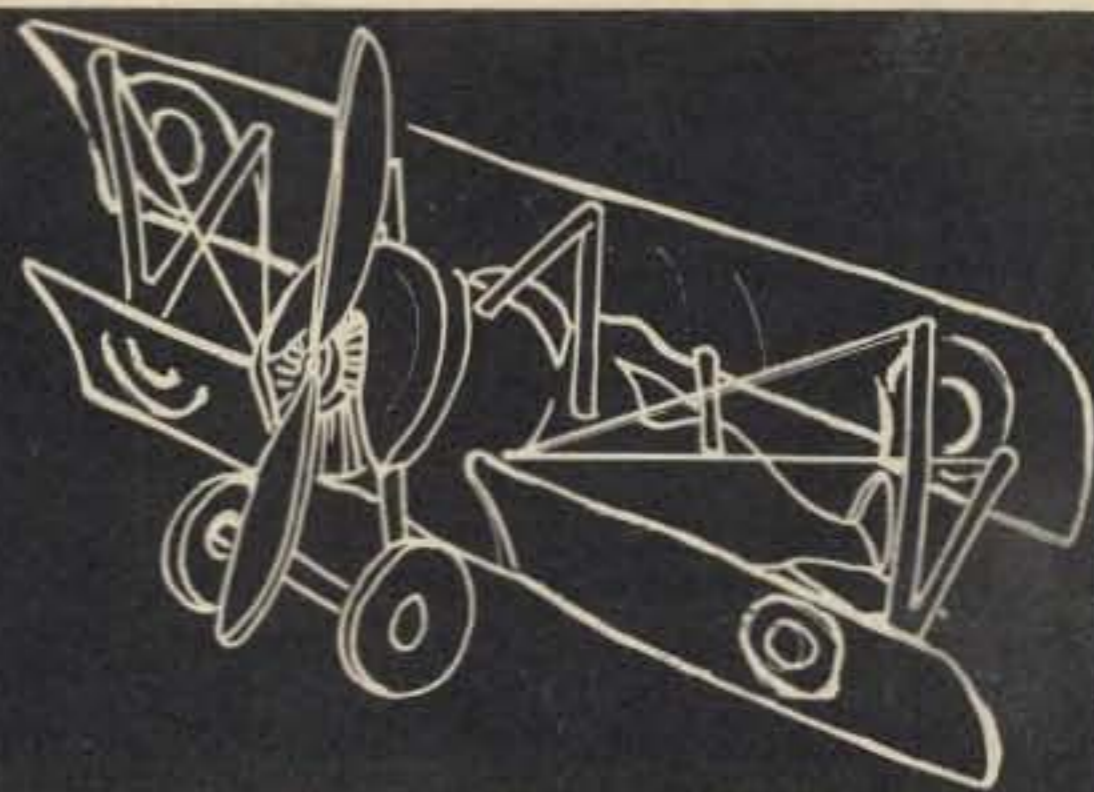

pieces, behind (photo by S. Dennis Welsh). Pieces were also falling all around me. I'll never forget it.

### LUDINGTON LINE, ETC.

In early 1931, the New Jersey legislature passed a bill setting up a State Aviation Commission consisting of a Director and five Commissioners. I was one of the five. This Commission had jurisdiction over all aviation activities in the State. Meetings were twice a month. You got a nice commission signed by the Governor, a gold badge of authority, and special auto license plates. Actually there wasn't much for a State Aviation Commission to do, since the Aeronautics Branch of the U.S. Department of Commerce already had jurisdiction over most aviation activities. I resigned my commission in December, 1933, when I changed my official residence to New York State. Just wanted to let you know that I carried a badge for a while.

During the spring and summer of 1931, Gene Vidal, Paul Collins and Amelia Earhart were quite busy getting the Ludington Line ready to start operations. The idea was to furnish a frequent, low fare service between cities on a highly traveled route — in this case, between New

York, Philadelphia and Washington. The Ludington brothers furnished the bucks and the "know who," Vidal and Collins, the "know how," and Amelia, the visibility. The original officer lineup was as follows: Chairman of the Board — Townsend Ludington; President — Nicholas Ludington; Executive V.P. — Gene Vidal; V.P. Operations — Paul Collins; V.P. Public Relations — Amelia Earhart; Equipment — 12 Stinson 10 passenger trimotors.

Their "Every Hour on the Hour" service from 7 am to 5 pm, to and from New York and Washington, started Sept. 1, 1930. In the first 14 months of its operations, Ludington Lines carried some 85,000 passengers; in 1931, it carried one fourth of the total passengers of all other airlines in the United States.

In the spring of 1931, Nicholas Ludington developed a case of tuberculosis and had to retire to his house in Santa Barbara, California, for a year in bed. That left his brother, Townsend, who was in very poor health, to direct their investment in the airline. So they hired Jim Eaton from Pan American and installed him as President in the fall of 1931. Eaton then tapped me for Assistant to the President and General Traffic Manager of the line. I was glad to shift from the airport to the airline.

The Stinsons had seats for ten passengers and a crew of one — the pilot. The only radio aboard was an airway radio beacon receiver. As an economy measure, the Stinson's center section 20 gallon tank was filled with aviation gasoline, which was used for take-offs. After climbing to about 1000 feet, the pilot switched to the cheaper automobile fuel in the other tanks. This worked very nicely during the winter of 1930-31, but along in April we had a day of unseasonably hot and humid weather. That day Ludington had five forced landings before they knew what had happened. No damage except for some "seized up" engines and a few scared passengers. It seems that they were a bit late in changing from winter auto gas to the summer type.

A more serious thing happened in November, 1931. In the middle of September, the line introduced a new high speed nonstop service of two round trips a day between Washington and Newark Airport, using a new Lockheed Orion. One of these schedules departed Newark at 4:40 pm, and by the time it reached Central Airport (in mid-November) it was dark. On this flight, Capt. Floyd Cox was on his final approach over a golf course when he "ran out of air" and the unforgiving Orion did half a turn of a spin before hitting the ground. Four passengers, the pilot and the Orion became statistics. Townsend Ludington wanted to shut the airline down the next morning. It was the only accident the line had in its two and a half years of operation.

In March, 1932, our airline headquarters was moved from Philadelphia to the Washington-Hoover Airport, so we rented an apartment out on Conn. Ave. By midsummer, 1932, the "Depression" was being felt by everyone. More and more people were finding air travel, or for that matter, travel of any kind, more than they could afford. So our passenger revenue declined somewhat in spite of the many remedies we tried. Then came the Presidential election of 1932 when FDR swept the country except for Vermont and Maine. As a sort of last resort we made a good try at selling the Post Office Department on putting mail on our frequent service. All to no avail. So Nick Ludington

Continued on page 140

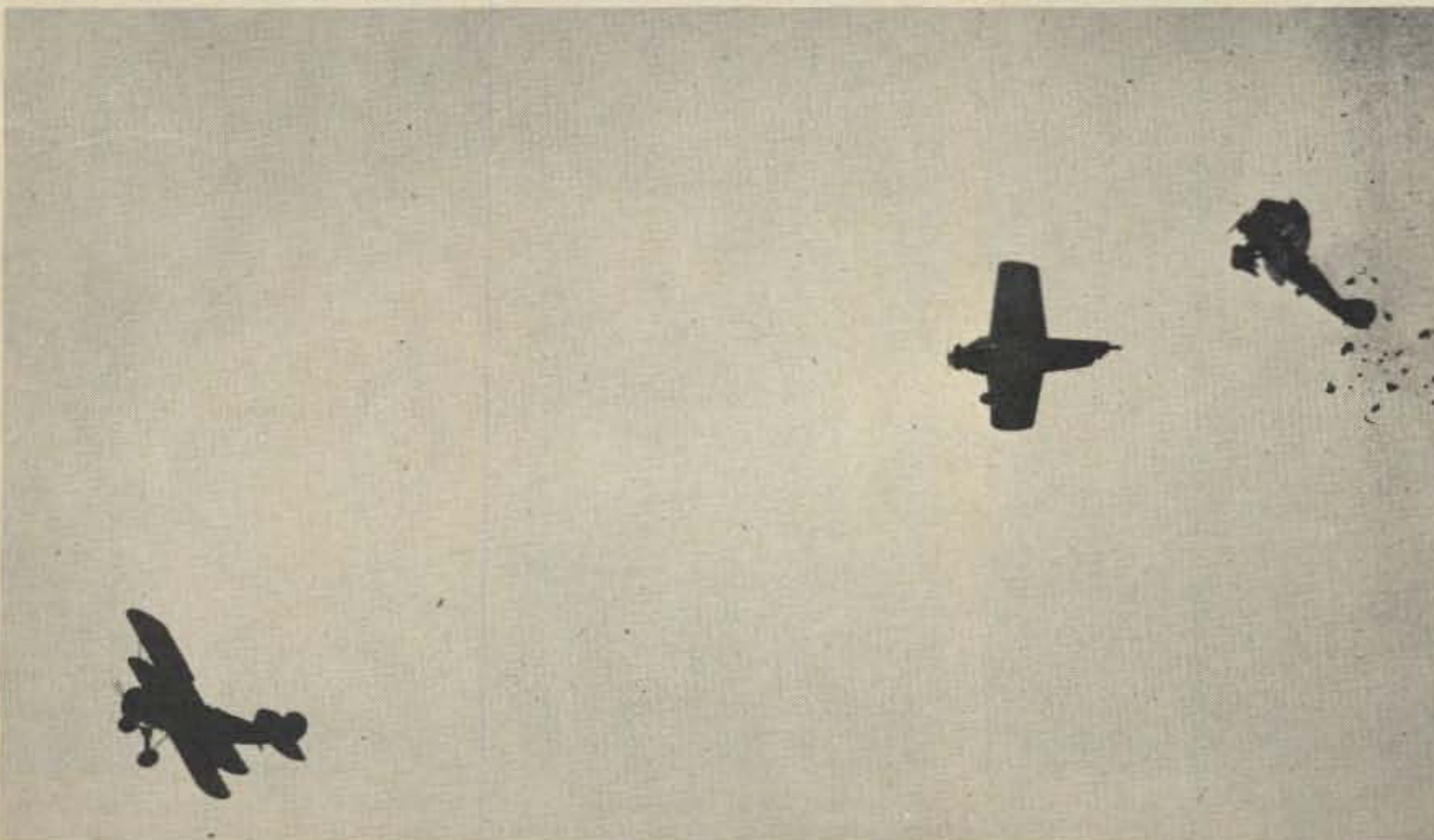

# Looking West

Bill Pasternak WA6ITF  
14725 Titus St. #4  
Panorama City CA 91402

Where were we in the July issue, you ask? Actually, with the July column usually being written in late April and our having to be out of town at the same time, we decided that it would be better to take a vacation for a month than to just write a piece to fill space. Between New York and Dayton we now have a lot to report, and so, on to that wonderful world we love and call amateur radio.

I am beginning to get the impression that I may have opened another can of worms; at least that's the way the mail is running that I am getting about my June "special" on total voluntary coordination (see June 1976 p. 8) and the idea of both offering and/or involving all VHF/UHF oriented amateurs in such a program. There were two specific reasons for my writing that article, plus a third which while left basically unstated is no less important.

First, I, along with many other concerned amateurs, feel that while it would be very nice for the ARRL to officially recognize the work *now being done* by those involved in repeater coordination, it is not for that organization to now, after the majority of the work has already been accomplished, come in and tell the amateur community that they will appoint someone in each area to do this work either in concert with already existing efforts, or by replacing

same. In my opinion, the reason that the majority of coordination efforts have been so successful has been that in most cases the people doing the coordinating work have been asked to take on this job by their peers, their fellow amateurs. To carry this one step further, if the League must get itself involved in this work, then it has a sincere obligation to all amateurs, *both League members and non-members alike*, to elect such people in a like manner to the way that League Directors are elected, since any persons elected to this type of position will hold a heck of a lot of power in their hands. I for one would want to be in a position to cast my ballot and help elect such a person based upon what I know about such a person's qualifications, rather than having such "rammed down my throat." Based upon this, I must for now continue to oppose the concept of a League appointed coordinator until such time as the ARRL publically clarifies exactly how such a person will be chosen and by whom, as well as specifically spelling out what his duties will be in relation to already existing coordinating bodies. How will such a person relate to already operational coordinating efforts and, most important, should a disagreement arise between an existing coordinating body and a League coordinator, whose word will be final? At this moment, June 1, 1976, these are questions yet unanswered. I sincerely hope that before you read this, the answers will be in all our hands.

Secondly, today's existing coordinating efforts grew up as a need for

"government by crisis." FM and repeaters grew up fast, almost too fast in some places. In a matter of but a year or so, some cities found repeaters sitting on repeaters, repeaters encroaching on area simplex channels, and tempers rising. Order was needed from the chaos and out of this need was born the repeater coordinating council. Now while councils are not perfect entities, at least they are representative of the views and voices of the majority of the FMers in any given administration area. Sure, they make mistakes, but because of the very nature that they are entities of more than one individual, they are less likely to repeat such mistakes. By and large you have to admit that most have done a pretty good job in making things work well. Now with the advent of the multi-mode VHF transceiver — you know, that cute package that lets you run CW, AM, FM, SSB plus other various types of emissions from but one radio — there is a growing trend toward operation on these other modes, especially SSB for "DXing." One of the things that I learned I was right about is that in some areas, two meter SSB is growing so fast that local amateurs are making efforts to set aside specific frequencies for such things as DX calling, local rag-chew calling, tune-up, etc. Sound familiar? Even more interesting, the term being given to these frequencies is "channels." If this is then to be a sign of things to come, do we wait once more until we again need "government by crisis," or do we act now and offer the experience we have garnered from repeater coordination to those expanding into new facets of VHF communication to help them avoid any future crisis? At the moment, one might rightly state that, due to the limited amount of activity coupled with the current high price of

such equipment, no such need exists. But, many new amateurs are coming soon into our ranks as a result of the new ARRL training program (many I suspect with eventual VHF interest), and as technology progresses and the market increases, prices may come down on equipment such as this (may I cite the electronic calculator, the digital watch and the under \$100 CB radio as examples of what advanced technology coupled with good marketing practice have done for consumer prices) and bring more amateurs to this and other modes. I for one do not believe in forcing any amateur to do something contrary to his or her belief. However, by the same token, I do feel that if the interest is there, then these and all people have a right to have their views aired. Therefore, if amateurs involved in other modes are interested in involving themselves in some form of coordinated band plan, to formulate among themselves a plan for the future that will insure the sanctity of all amateurs, I for one do not feel that they should be relegated to the sidelines just because they do not own a repeater (as you know, "repeaters are the in thing these days"). Yes, repeaters are "in" right now, but in 10 years, what will be "in" then? I for one am glad to see the advent of the multi-mode transceiver for VHF. Slowly but surely it is taking a bit of the pressure off many very crowded VHF repeaters and at the same time adding diversity to the operating habits of many amateurs. Repeaters are great fun, true, but many VHFers fail to realize that there is a whole world below 146 MHz, and that world is an entity unto itself.

As I said, there are three reasons, and the third is possibly the most important of all. If we are to grow, we must develop lines of communication



All it takes to work EME is a station like that of Bruce Sternstein K2RTH and a little patience.

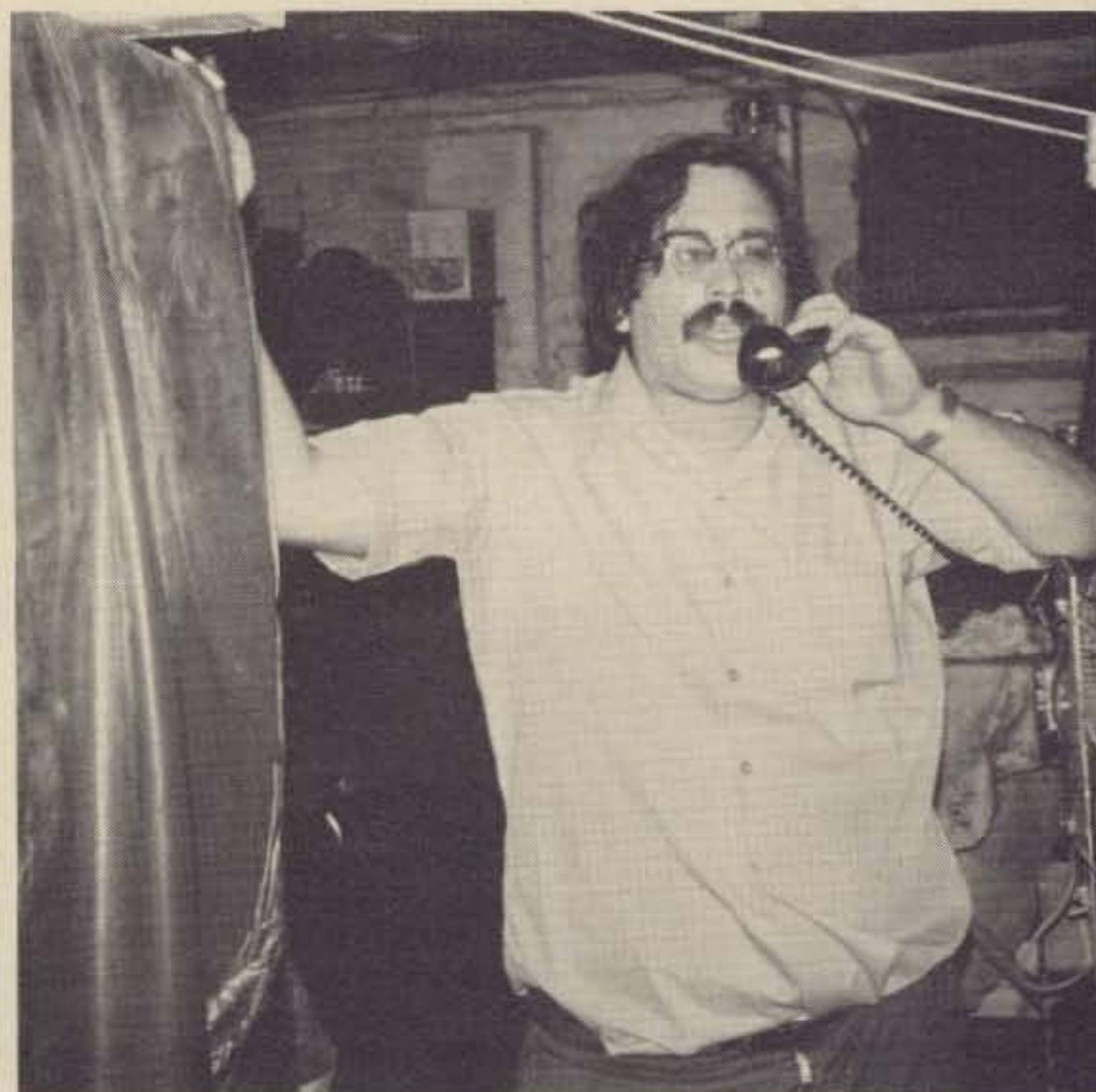

Remember Larry WA2INM who used to write for 73? He is alive, well, on 2 FM, and a champion Siamese cat breeder these days.

that extend far beyond the coverage area of our favorite repeater. We must learn to interact with people whose interests are different than ours and realize that while FM and repeaters are nice, they are but one facet of the overall VHF/UHF picture. If you have never tried working a distant station on 6 meter E or F2, you are missing something. If you have never sat in a round table on two meter AM and been able to talk for 5 or 10 minutes without worrying about timers cutting you off, then you have bypassed a good part of the show. There are people out there, potential friends if you want them. It only takes tuning below 146 MHz to find them.

Now to Southern California and back to that wonderful world of amateur radio. Have you listened to six meters down at the low end lately? Around this part of the country, the DX seems to have started rolling in like in the old days. Most of it is single or double hop E, but as the season progresses there should be some F2 and that will really make it wild. Most of the activity centers around the area of 50.1 to 50.2 SSB, but there is some good stuff on AM as well from around 50.25 up to about .5 or .6. However, the analogy of it being like the "old days" is really not that correct. First, the old days for me were the late 50's and early 60's, but 3000 miles to the east. Therefore, comparisons are a bit hard to make and/or justify. I can tell you that with a ¼ wave ground plane atop the building I am working a bit of the current DX. Since I no longer have my old Swan 250 nor the funds to replace it, I am stuck on medium power AM and CW. For those interested, the six meter station here is nothing more than a Hammarlund HQ110A with an Ameco Nuvistor preamp ahead of it and a choice between an AMECO TX-62 or Knight T-150 transmitter, dependent upon whether I am working the station AM or CW. General band monitoring is done with an old Gonset Comm II. Of note is the fact that most AM users here in Southern California are omnidirectional and vertically polarized, while SSB and CW are horizontal. FM is vertical, with the output of the WA6UJS repeater, 52.525, being the local FM calling channel. Activity here on 6 seems to be on the rise on all modes other than CW, with the majority of CW that I hear being of the MCW variety for code practice.

When you reach a point of "repeater media overload" or more plainly said, the sound of another squelch tale or reset beep will drive you up a wall, six is a real nice place to escape to and lately it seems that more and more people are dusting off their old communicators and 99ers to join the fun. The local people I run into on six are just great, and the best part is that you cannot time out a simplex QSO. After having been wrapped up in repeaters and FM only for a good number of years, getting back on six and back to basics is a real treat. Don't believe me; try it yourself and see.

Last month we mentioned that we would be heading to New York and then on to Dayton for the Hamvention and the festivities there. Next month we will tell you about our impression of the Hamvention, but for now let's all get on board that red and white TWA 707 and go east to the megalopolis of New York. The flight itself must have been good. I am assuming this since I literally slept from Los Angeles to NYC. Sharon told me that around 3 am (we flew the red-eye) we hit a bit of turbulence, but I managed to sleep right through it. I awoke to the sight of the sun coming up over the Atlantic and quickly recorded this event on super 8 movie film. We ate a quick breakfast and then landed at good old JFK International. Right on the numbers for you fellow pilot types.

Sharon's mom and dad were there to meet us and after the customary welcomes and obtaining our baggage (very quickly — one of the advantages of night flying on a medium-sized aircraft), we exited the terminal to be greeted by a blast of 78 degree hot sticky air and the sound of two taxi drivers arguing about who was first in line to pick up a fare. Ah... yes, we were in New York! 6:30 am.

The thing that I wondered about most was how well was the right side up split-split repeater plan that they follow working in comparison to the inverted plan that we here in Southern California use. I unpacked my stock FMH that I had equipped with crystals for .25/.85 (WR2ADM) and .13/.73 (WR2AAA) to see what I could hear and to see who was around. It was now about 11 am Sunday morning. There was a QSO on ADM and I recognized the voices and callsigns, so I tried to break. No luck. I figured that the transmit rock was probably off frequency since I did not have the time to net any crystals before the trip. I flipped over to AAA, but heard nothing. Oh well, will have to run into Brooklyn and use INM's counter later. On .52 simplex (in NYC simplex is called "direct") I managed to get a QSO going with one of the locals; we compared notes about two meter activity for about an hour with a number of other stations breaking in and out of the QSO during that time. Soon the friends and relatives started to arrive, including our 6 month old new nephew, Scott, along with his parents (Sharon's sister and brother-in-law), and this signaled an end to my hamming for the day. It was party time and besides, meeting little Scott was the prime reason for the trip. Away with the HT and out with the cameras.

Around four the next afternoon, after visiting my dad and making his Zenith color TV have color again, I stopped over to see Larry Levy WA2INM. You may remember Larry as he was one of 73's first technical writers in the 60's. After a cold one to wash away the New York City air pollution, which in my mind is far worse smelling than what LA is famed for, we adjourned to his basement



*A sign of things to come? ICOM West representative shows new IC-202 2m SSB portable at SAROC '76. Is it the thing that may replace today's FM hand-held? Who knows?*

workshop to count Hz's. Hm... what's this? Seems as if both my .13 and .25 transmit crystals were stone dead. A few more tests showed that my .73 receive had met the same premature fate. Since FMH rocks are a scarce commodity in NYC, Larry graciously offered to loan me his TR-22. Again, this was a stock unmodified TR-22 purchased in 1971. I stress the point unmodified since such a radio will perform without any problem in and around LA under the inverted split plan. To say that the early TR-22s were somewhat broad in the selectivity department, especially by today's standards, would be a fair assumption. This radio was equipped with four repeater pairs plus .52 and .94 simplex and was set up in my father-in-law's Chrysler using a borrowed ¼ wave gutter clip supplied by "Uncle Lou" K2VMR.

No problem on .25/.85. We were staying with Sharon's mom and dad in Valley Stream and were but a stone's throw from the location of WR6ADM. The welcome we were given on that repeater was the warmest we found anywhere on our trip. ADM is sponsored by LIMARC, the Long Island Mobile Amateur Radio Club, and being with LIMARC people is to me very much like being home on WR6ABB with PARC people. In fact, while it has received no publicity to date, last January LIMARC and PARC became sister clubs on an informal basis as a gesture of goodwill between amateurs separated by the miles as part of our nation's bicentennial celebration. In fact, I believe this is probably the first formal public

announcement of this happening. The two clubs call it "Hands Across A Nation in '76"; however, I was asked while in NYC to bring word back to PARC that LIMARC would like to make this informal tie permanent. I suspect it will be.

Slipping over to .28/.88, I accessed the Staten Island repeater and ran smack dab into a long time friend of mine Andy Feldman WB2FXN. My, how time flies; the last time I had spoken with Andy was just after he and Eileen had gotten married. Now they have a kid of their own and have moved to a new QTH over in Jersey. I listened for a while after signing with Andy and noted that something on an adjacent channel was being heard by the TR-22. Never did identify it though. On .13/.73 I found the worst adjacent channel problem noted. A repeater in Selden, Long Island 15 kHz away was giving AAA a good run for its capture money. AAA, the old WA2SUR system, is located in lower Manhattan and previously I had never heard any problem using my own TR-22, which had come from the same lot number as Larry's. The people on that Selden repeater seemed to be such a nice bunch that I really wished I had some rocks or a synthesized radio with me so that I could have met them. Think I really missed something good. I was not able to either access or hear the Greenbrook, New Jersey repeater on .34/.94, though in the past I had been able to at least hear it in Valley Stream. Later I was told that it had gone "PL" and activity on it was low. This report was never confirmed. I did, however, hear

some .94 simplex activity both on Long Island and while mobile in Brooklyn; I had a number of good QSOs with some old friends. I do think in retrospect that the WA6 callsign and the 10 codes that I have become used to using out here did shake up a number of people.

Anyhow, if I were to judge solely by what I heard on .73 with a five year old radio, I would not be making a really fair analysis. I can tell you that the stock TR-22 that I have here now (that was also purchased in or around 1971) works flawlessly in LA using the inverted split-split plan. However, I would really like someday to see someone take a good synthesized "amateur type" popular radio such as the Icom 230, or the KDK, or a Clegg FM-DX, and channel by channel evaluate both the right side up and the inverted split-split plans. It would require an amateur who happens to own such a radio with both a fat wallet to cover expenses and about a three week vacation. If I had the bread, I probably would make the time, but alas, in my present financial situation that cannot be. In reality though, such a comparison done in the major high activity areas such as NYC and LA where split-split systems exist is the only way we will ever know which method is best. I can tell you what I found, and I can tell you of the success we have had out here with the inverted splits, but until the time that such a channel by channel comparison is actually made, and made from a user standpoint with a fairly modern day user type radio, it is unfair to make any final decisions or recommendations. Any takers out

there for such a project? I guarantee to publish the results. Perhaps this is another good reason for the establishment of a national coordinating council that is technologically and financially able to undertake such a research project.

Two of the people that we were happiest to see were Lou Belsky K2VMR and his lovely wife Linda. It was Lou's guidance as trustee of my old WA2ZWP, now WR2ACV, repeater that brought it back to life and built it into one of the most popular and populous open systems in New York. I discussed doing an article with him about our cross country trip in 1970 just at the time that repeaters were starting to take hold but six meter SSB was still king. From that discussion came the idea for a two or three part article you will be seeing in the near future titled "Lou, Bugsy and Me" or "Can a VW Bug Really Go 3000 Miles Between Gas Stops?" Anyhow, being able to spend time with Lou and Lin were very happy moments for Sharon and myself. Currently, Lou's big amateur radio project is putting together the Amateur Radio Communication Effort for the annual NYC Salute to Israel Parade up Fifth Avenue in June — quite a monumental task in itself.

We also got our first exposure to the art of EME or moonbounce communication thanks to Bruce Sternstein K2RTH. Bruce just happens to live directly across the street from Lou and Lin in Franklin Square, LI, and his antenna array is a bit hard to miss. We meandered across the street to Bruce's place and found out first hand what EME is all about and were

thoroughly impressed. As soon as I have my own home, that's an art form I personally want to involve myself in. EME is not just another way to use amateur radio; the skill required to be really successful at it places EME in the art form class.

We had a chance to talk with Abe Schwartz WB2PQR about a project that he is working toward: a user programmable repeater using a microprocessor. The idea is to program specific needs of a given user into the microprocessor, assign each user a specific identity code and have the user punch up his code to have his specific needs performed automatically. With the amount of information that can be stored and recalled at will, it would be possible to perform tasks such as transferring the system to a directional antenna that would automatically adjust to a predetermined direction, store telephone numbers for autopatch service, and a myriad of other things. While strictly in the planning stage right now, Abe hopes to make the thing a reality in the not too distant future, and I got him to agree to drop me a line from time to time and keep me informed of his progress. The concept, if feasible, really interests me and I suspect it might interest you as well.

#### Southland Hams Win One: California Decides Not To Raise Cost of Ham Plates

Sometimes a letter writing campaign coupled with the proper form of education can win out, as was shown recently in the state of California. For many years only a nominal \$3 fee was necessary in addition to the normal

license plate fee to obtain amateur radio callsign plates. Then recently a re-evaluation was undertaken by the state that would have meant a reclassification of amateur callsign plates to the status of what is termed "vanity plates," i.e., personalized license plates of one form or another. This would have meant a significant increase in both the cost of initially obtaining such plates and in the cost of yearly renewal.

Rather than "flying off the handle," amateurs in California initiated a letter writing campaign specifically aimed at educating the state legislature as to the important part that the state's amateur radio community plays in regard to both public service and as a ready source of trained volunteer communications personnel in case of disaster. It was pointed out that rather than being simply a sign of one's vanity, the amateur callsign appearing on a license plate is an easily identifiable method of determining who the aforementioned emergency communicators are should ever the need arise.

As a result of this effort, the Honorable Michael Wornum, Assemblyman from the Ninth Assembly District and Chairman of the Committee reviewing the standards for issuance of automobile license plates, has amended this bill (California Assembly Bill 4271) so as to exclude amateur radio callsign plates from any increased fees. We at 73 feel that he deserves a thank you for his action on behalf of the California amateur radio community. It is apparent that Assemblyman Wornum is a public servant who listens to his constituency.

## New Products

#### LOW COST GRAPHICS TERMINAL KIT

Southwest Technical's GT-61 Graphics Terminal kit is a low cost graphics unit designed for hobbyists

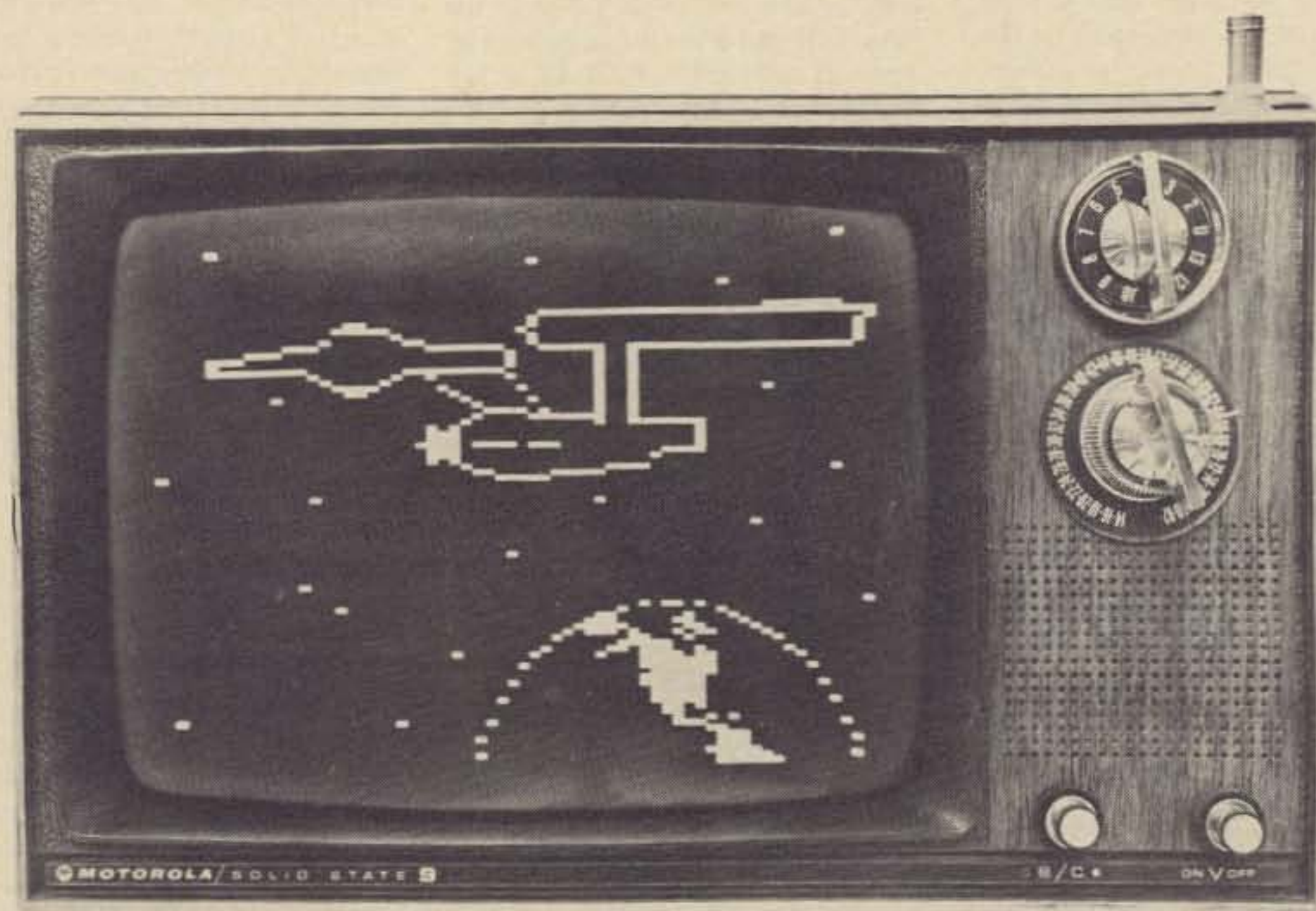

or budget-minded commercial applications. The 9½" x 13" PC board contains all the electronics necessary to display an array of cells 64 wide by 96 high on a standard video monitor or modified television set. The graphics terminal contains its own 6144 bit static memory and thus may be driven by any computer system having a TTL compatible 8 bit parallel interface. The unit is available in kit form only and is sold less power supply, chassis, and monitor for \$98.50 postpaid in the US. Delivery is 30 days. Southwest Technical Products Corporation, 219 W. Rhapsody, San Antonio TX 78216, (512) 344-0241.

#### B&K-PRECISION INTRODUCES NEW LOW COST 3½ DIGIT MULTIMETER

The Model 283, a new 3½ digit multimeter priced at \$170, has been announced by B&K-PRECISION, Dynascan Corporation.

The Model 283 uses high intensity, high reliability LED displays, 0.41" high, that can be easily read in brightly lit rooms at a distance of at least six feet, according to the manufacturers. It measures dc volts, ac volts, dc current, ac current and resistance. A special low voltage circuit permits measuring resistance of tran-

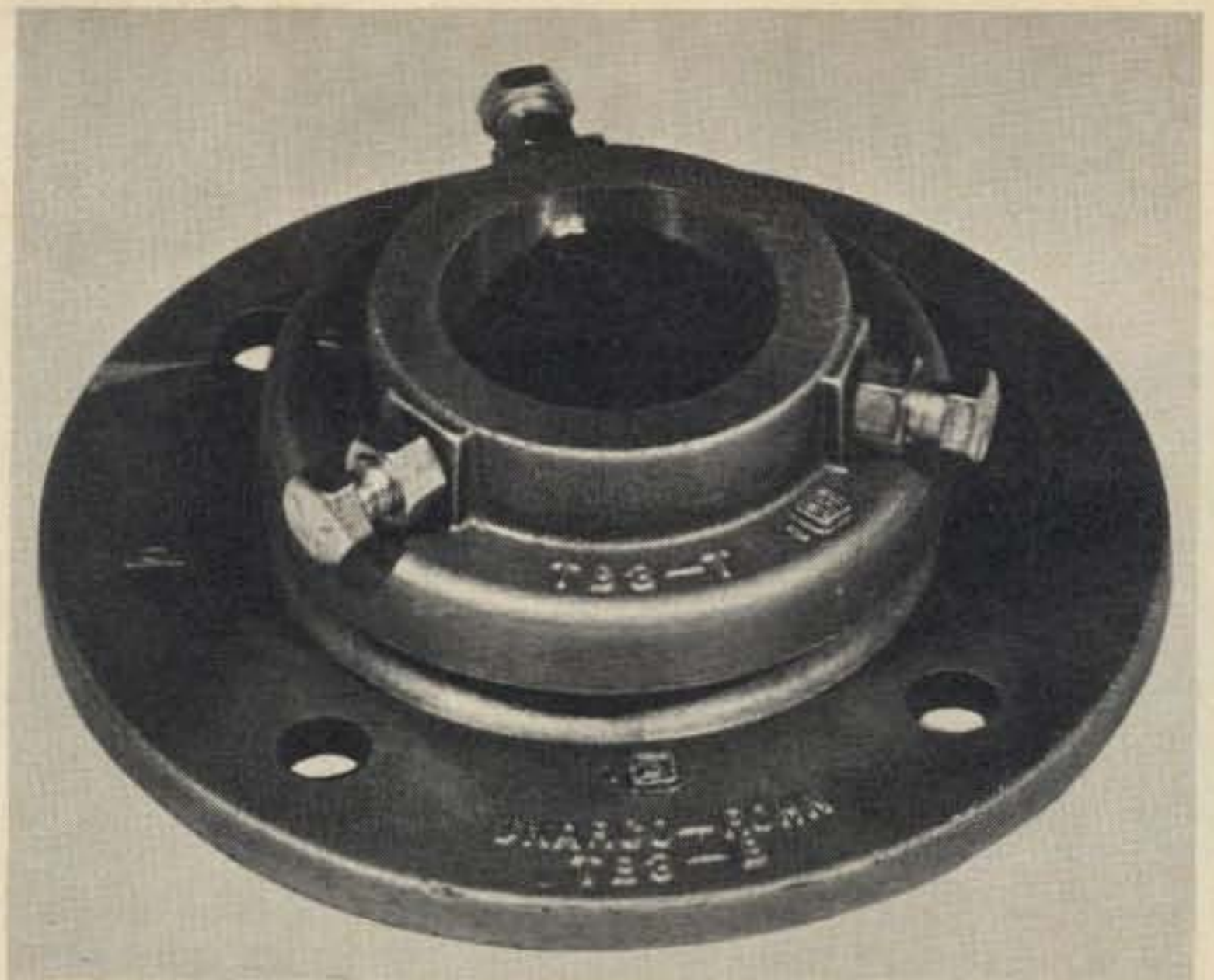

sistor-shunted resistors.

The Model 283 has 100% overrange capability on four ranges, so that one can read to 199.9 on a scale that is normally set for 100.0 maximum. Out-of-range is indicated by a flashing digit and three zeros. All readings have an automatically positioned decimal point.

There are 4 dc voltage ranges, with  $\pm 0.5\%$  accuracy on the 1.000, 10.00 and 100.0 ranges and  $\pm 1.0\%$  on the 1000 V range. Polarity change is

automatic. Four ac voltage ranges have  $\pm 1.0\%$  accuracy on 1.000, 10.00 and 1000.0 ranges and 1.5% accuracy on the 1000 V range. There are four ac current and four dc current ranges ( $\pm 0.1000$ , 10.00, 100.0 mA) with the similar accuracies. The six resistance ranges, 100 Ohms, 1k, 10k, 100k, 1000k, and 10 megohms, have  $\pm 1\%$  accuracy, except top range, which is  $\pm 2\%$ . Input impedance is 10 megohms on all voltage ranges.

Overload protection is provided, up to 1000 V on the Ohms, 1500 V on

the voltage ranges, and 3 A on current shunts.

An optional battery pack provides 8 hours operation on an overnight charging. Batteries also charge when the Model 283 is used on a 110 V ac line.

The B&K-PRECISION multimeter weighs 3 pounds and measures only 9 x 7 x 3.6 inches. With battery pack, its weight is 6 pounds. The Model 283 and accessories are available from B&K-PRECISION distributors.

For additional information, contact Myron Bond, B&K-PRECISION, Dynascan Corporation, 6460 W. Cortland, Chicago IL 60625, (312)-889-9087.

#### NEW THRUST BEARING

Unarco-Rohn, Division of Unarco Industries, Inc., Peoria, Illinois, has just introduced a new thrust bearing (TB-3) for mounting antennas that is superior to anything on the market today. It is of heat-treated cast aluminum, for extra strength. The bearing incorporates 30 stainless steel ball bearings in a race that is protected from the elements, permitting freer movement at all times. Three lock nuts fasten the antenna mast securely in position. This relieves the weight of the antenna on the rotor, and at the same time allows an exceptionally free turning movement.

Unarco-Rohn is one of the country's leading integrated tower manufacturers. Services include tower manufacturing, engineering, fabrication, in-house galvanizing, site construction and supervision.

#### LOW COST ALPHANUMERIC PRINTER KIT

Southwest Technical's PR-40 Alphanumeric Printer Kit is a 5X7 dot matrix impact printer similar in operation to the well known Centronics printers. It prints the 64 character upper case ASCII set with 40 characters/line at a print rate of 75 lines/minute on standard 3-7/8" wide rolls of adding machine paper. One complete line is printed at a time from an internal forty character line buffer memory. Printing takes place either on the receipt of a carriage return or automatically whenever the line buffer memory is filled.

The printer is available in kit form only and includes the assembled print mechanism, chassis, circuit boards, components, 120/240 V ac - 50/60 Hz power supply, assembly instructions, one ribbon and one roll of paper. It sells for \$250.00 ppd. in the US and delivery is 30 days.

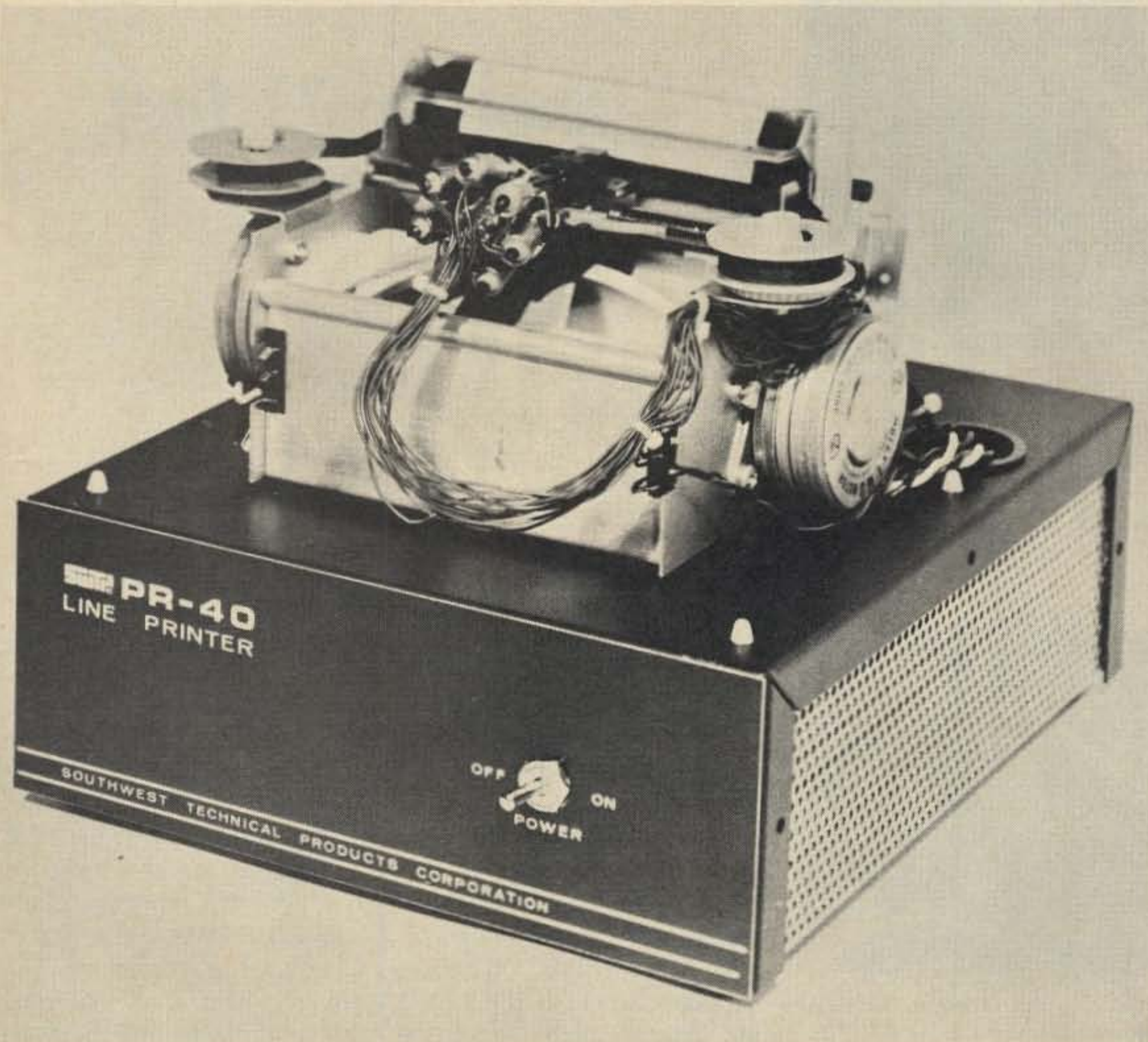

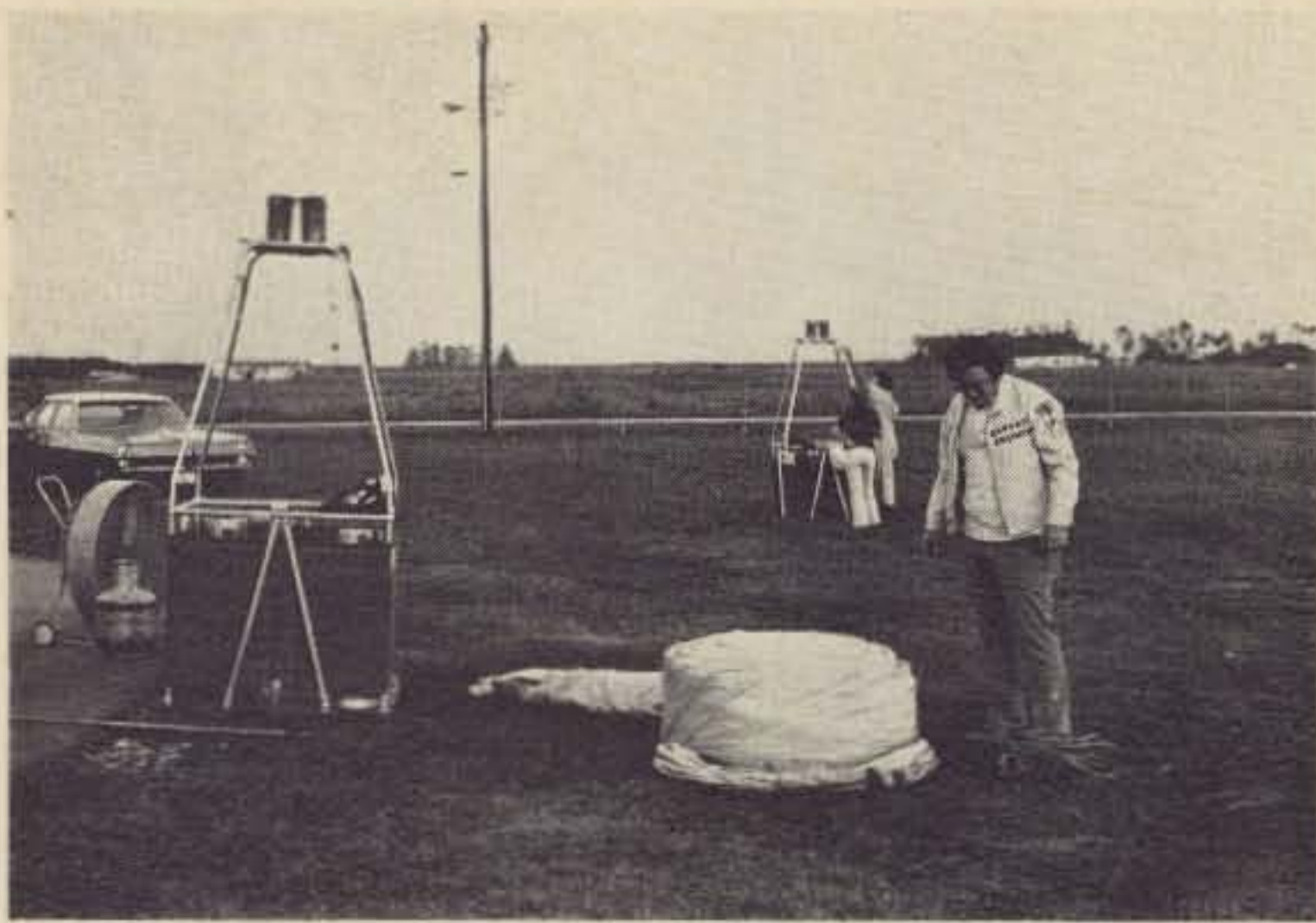

*Captain Crunch gets ready to unwrap his balloon. It's in a long thin bag for protection. At the left is the gondola, which breaks down to two parts for hauling around . . . the gasoline-powered fan for starting the balloon . . . and a spare propane tank. In the background, the second balloon for the First Ham Radio Two Meter FM Two-Way Balloon Contact is being assembled. This is the balloon in which Wayne will go up, manned by John Mickel.*



*Ed Doll W4KLM helps Will Thrasher W4SAC (Captain Crunch) with the balloon, while Bill Otting and Walt Farley K4QE pull the sleeve off the balloon.*



*Laura Thrasher (ex-KN3DHI) fastens wires from balloon to gondola while K4QE holds balloon.*

# Balloon to Balloon!

- - another 73 first

**E**arly on the morning of May 18th, two giant balloons rose from the outskirts of Homestead, Florida, lifting two radio amateurs into the skies so that they could establish a new first . . . aerostat mobile amateur to aerostat mobile amateur two-way communication.

It all started a few weeks earlier when a letter from Will Thrasher W4SAC (Captain Crunch) arrived at the 73 HQ in Peterborough suggesting

the possibility of a new first for amateur radio . . . communications between balloons. Why not! I called Crunch and asked when I should be down for the event . . . cameras and courage in hand.

On the evening of the 17th Sherry Smythe and I headed for Miami, armed with cameras, lenses, HTs, and a CB rig for the rented car. The CB rig helped us to keep track of traffic on the hour



Wayne holds balloon envelope while Will pulls off the sleeve.

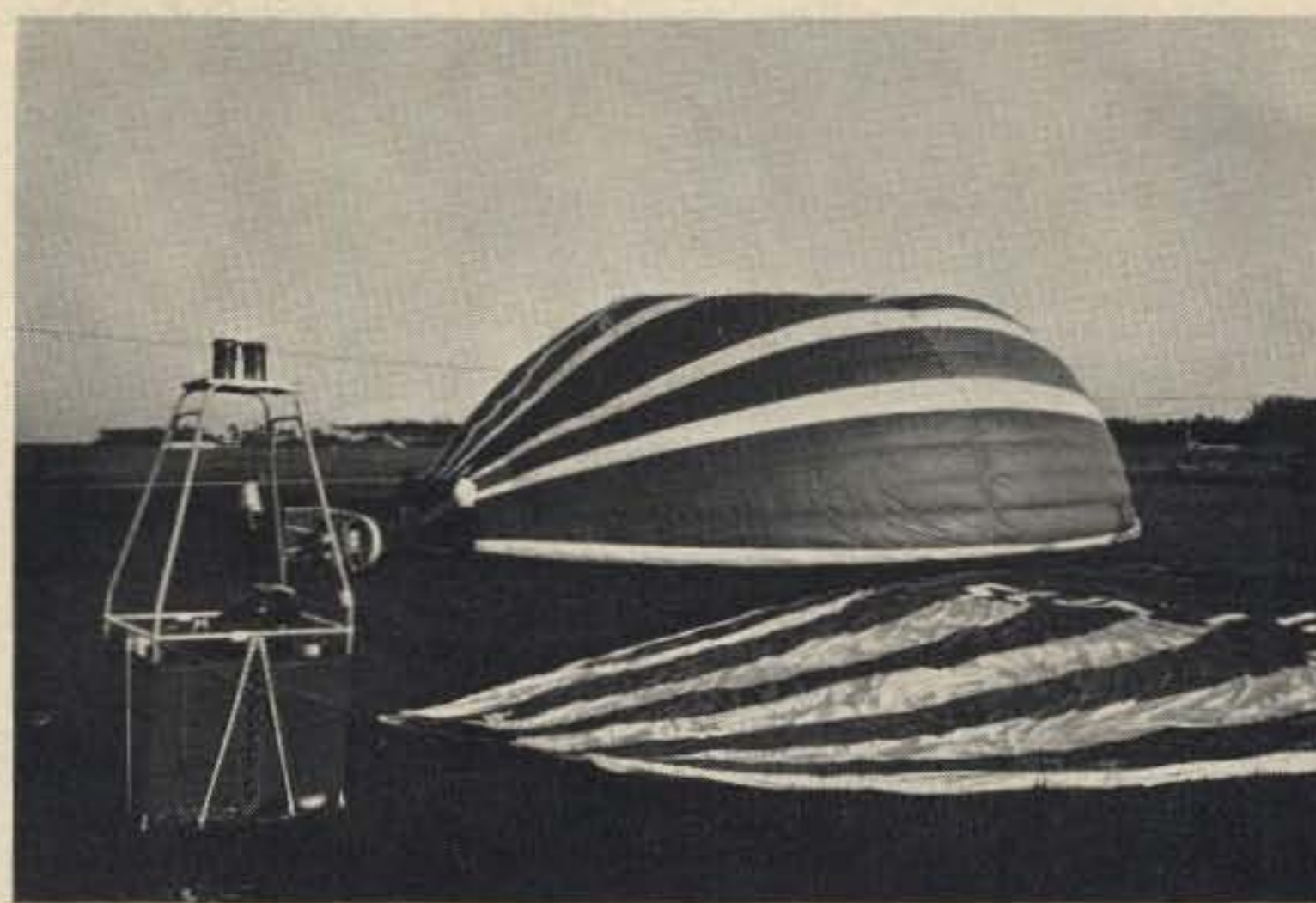

A small gasoline engine-powered fan is used to start inflation of the balloon.



Balloon envelope is spread out and ready to be inflated.

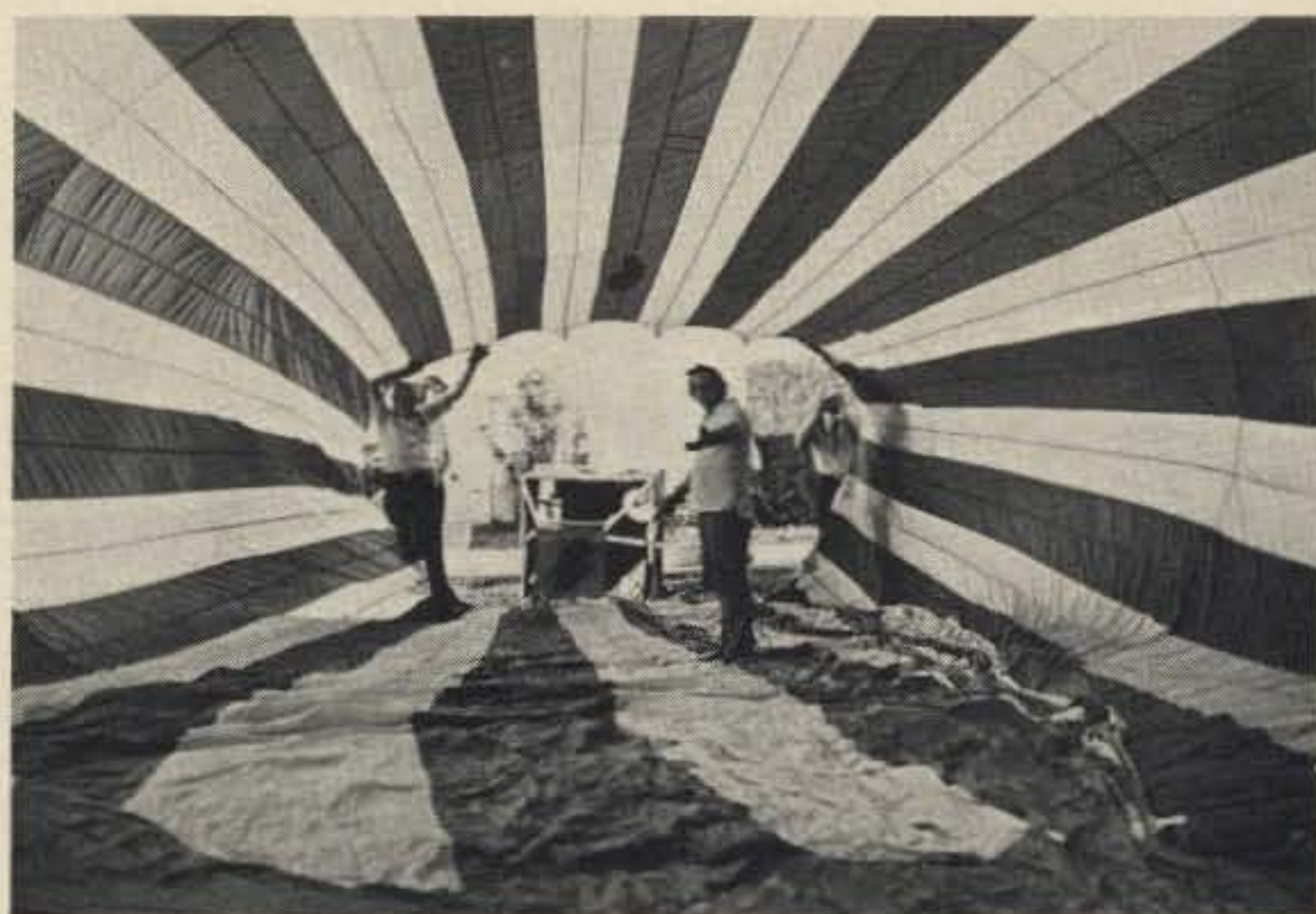

How the balloon looks from inside . . . W4SAC on the right, K4QE on the left.

drive to Homestead . . . and to find the motel when we got there.

We all assembled at Captain Crunch's home the next morning a little after 6:00 am. Present were Will's wife Laura (KN3DHI), the first licensed lady balloonist in Florida . . . Walt Farley K4QE . . . Ed Doll W4KLM (retired from AT&T) . . . Captain Crunch (the second licensed balloonist in Florida) . . . John Mickel, a Florida smokey with a CB handle of Officer Friendly and a car license of FUZZ. John was taught ballooning by Will . . . and he, in turn, taught Laura. John's chase car driver was Nancy Fortier, a Delta Airlines stewardess, who is working on her balloon license. Bill Otting, Will's maintenance man, also helped get the balloons ready.

The balloons were packed in very large hassock-type bags. Once out of the bag and stretched out on the grass, they were amazingly big . . . about 70 feet long. It took three people to pull the protective sheath off the multi-colored nylon material. The gondolas were quickly assembled, despite the multitudes of gnats, which were almost thick enough to drive off the mosquitos . . . but not quite. The two propane tanks were put into each gondola and strapped into place, with a pipe going to the burner located just below the open bottom of the envelope.

A gasoline-powered fan was set up to blow air into the envelopes and they quickly billowed out . . . with the help of my running around inside one pushing the material out to catch the air.

Once the envelope was fairly full of air from the fan, the propane flames were turned on and shot into the envelope. With this the balloon soon righted itself and had to be held down, while we waited for the second balloon to be blown up and heated.

Soon we were ready to go. I stopped taking pictures of the preparations, gave one HT to Sherry for Will to use . . . she was going up with him . . . gave one to W4KLM to coordinate the ground support (they had to follow us as we floated along so they could bring the balloon back after it landed). Sherry also had a camera. John had his balloon about ready to take off so I hopped aboard, camera in one hand, lenses in my pockets, HT in the other

hand, and trying to hold onto the gondola with an elbow as John turned on the propane. The air in the balloon has to be about 100° hotter than outside to get enough lift. It's a little scary with the flames shooting five or six feet up into the nylon balloon, roaring so you can't talk.

We lifted off at 7:22 am, just as smooth as you could ask. John said not to worry about the trees we were dragging through . . . so I didn't . . . it was just the top branches anyway. Soon we were several hundred feet up, with Crunch's balloon just a short way behind us. We'd go up and up . . . then start to settle back down again. As we came down John would give a blast of the propane and we'd slow down . . . then go back

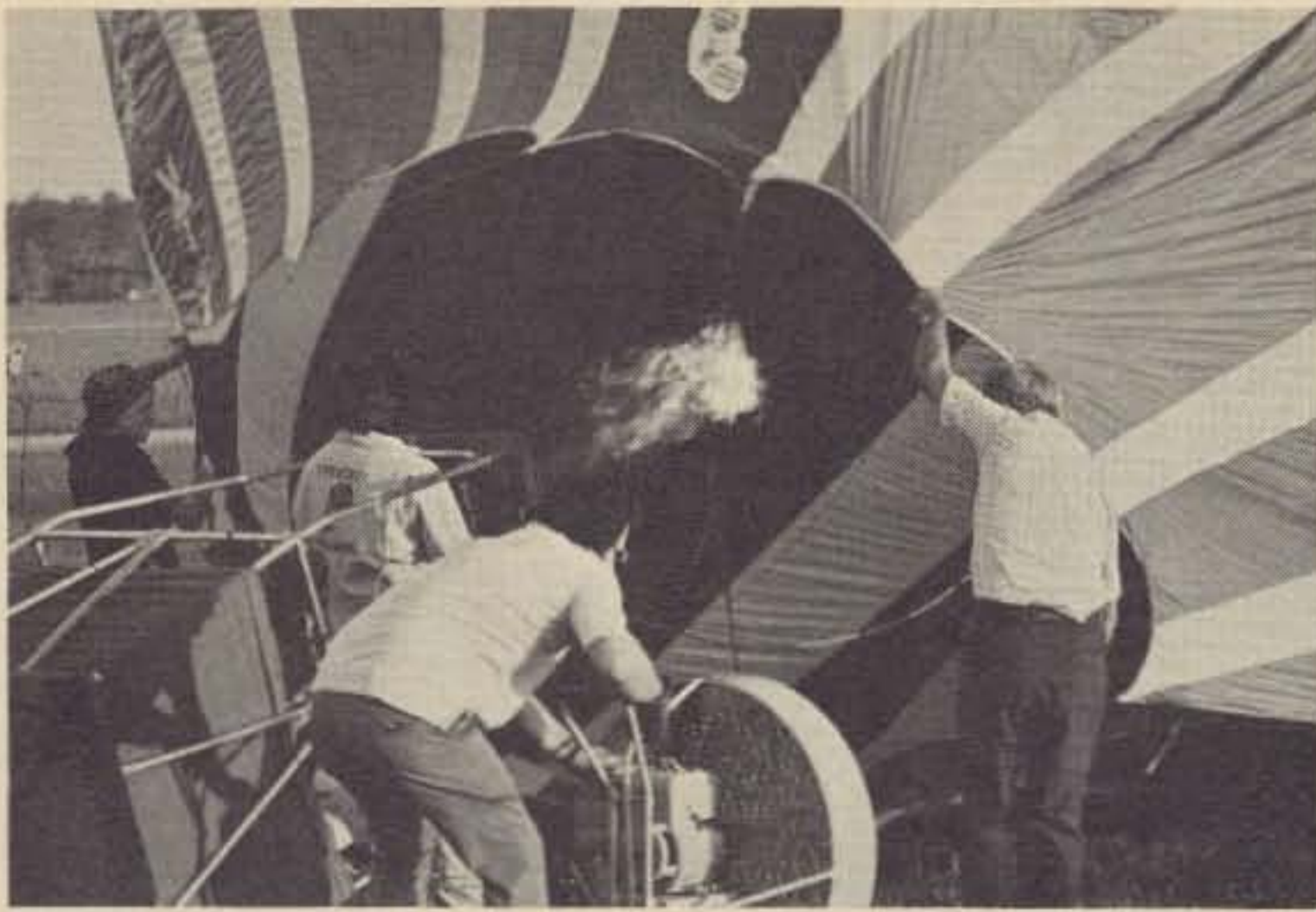

*Once the envelope is inflated, the air has to be heated. On the left is Nancy Fortier, who did the chase car routine for Wayne's balloon.*

up again . . . bobbing across the landscape.

We soon had our two-way amateur radio contact in the bag . . . 146.52 MHz FM . . .

and two-way with the ground to boot. Once that was done, I switched to some of the nearby repeaters and made a few contacts via them as a



*As the air heats up, the balloon rises . . . here is John Mickel (Officer Friendly on CB) getting just the right amount of hot air into the balloon to keep it upright yet not have it take off before everyone is ready.*

bonus.

On one of the descents we came down toward a field where a bunch of women were picking okra. We yelled hello to them and arranged to come down close enough so that they could throw up an okra to us. It was a fairly open field with a road leading into it, so Crunch decided to end his flight there. He touched down gently and that was that. John and I went on a few miles further, with Nancy following in the FUZZ car. We eventually spotted a nice clear field ahead and plopped quietly into the middle of an exercise ring for horses.

Once down you have to collapse the envelope as quickly as you can so it won't be caught in a sudden breeze

and drag you. We took our time . . . gave the balloon a little blast to make it lighter and walked it a couple hundred feet over to the road to deflate it there. You pull a ring and that opens up the whole top of the balloon, letting the hot air out.

The only damage done was when a propane bottle was dropped on the instrument panel as the gondola was being packed for return home. The instruments are an altimeter, a rate of climb indicator, a temperature gauge, and a watch. The thermometer got it good from the propane tank and needed at least a new cover.

Back at Crunch's home we played a tape of the morning's events and ate doughnuts. Laura has a fan-



*The W4SAC balloon about ready to take off, with 73 staffer and Marketing Manager Sherry Smythe just getting into the gondola.*



*Here's the W4SAC home and the second balloon about to take off for the historic ham QSO.*



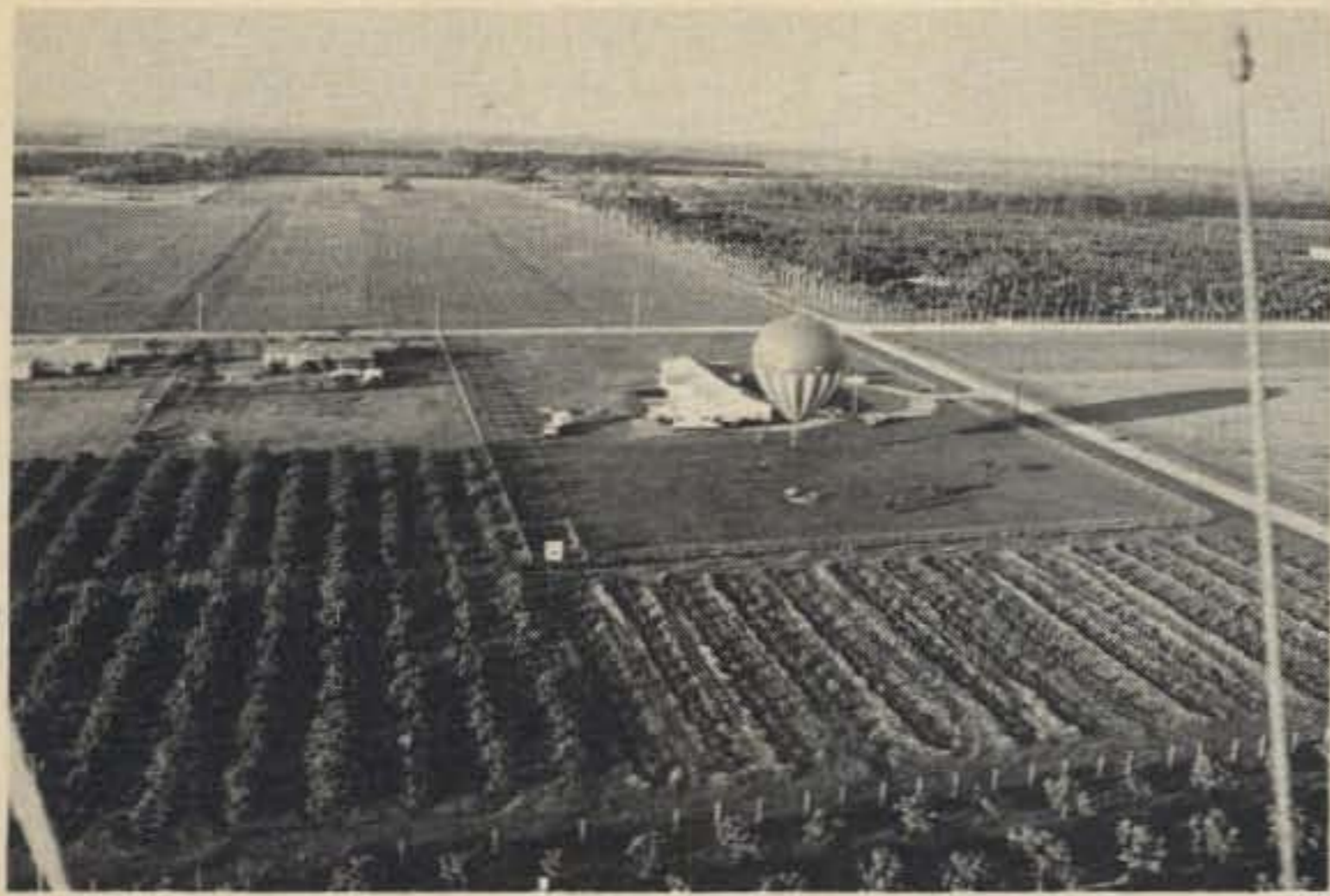

*We're both airborne and the contact is made ... W4SAC aerostat mobile four with W2NSD aerostat mobile four ... roger over and out.*

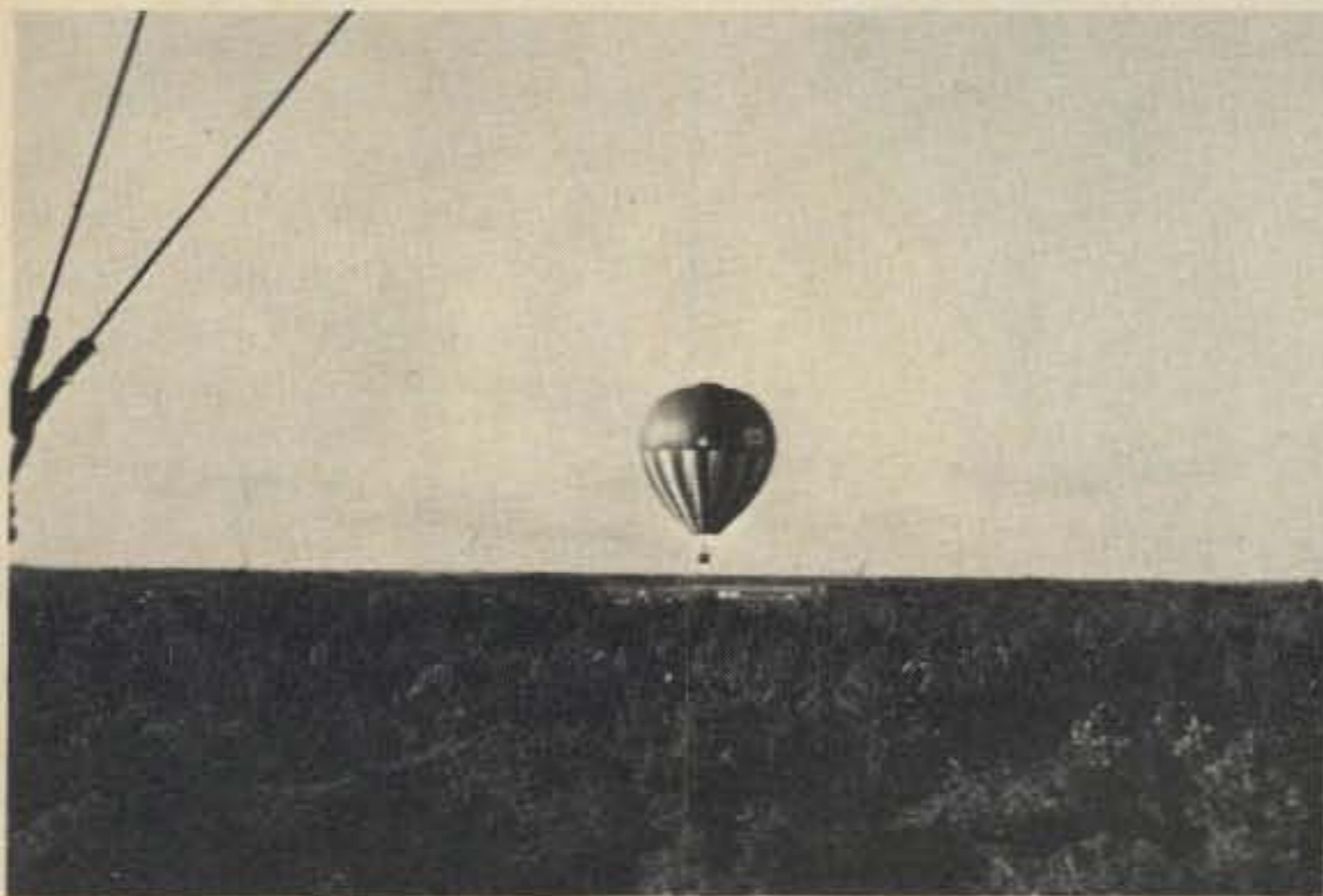

*The two balloons rise and fall with the air currents and propane heating flames, making their way across southern Florida. Will Wayne be blown out to sea and never heard from again? No ... Wayne is busy making contacts via local repeaters with his HT ... keeping in touch with the ground crew ... and talking with the W4SAC/4 balloon. Maybe next time.*



*73 staffer Sherry Smythe helped take the pictures for the article, including the beautiful cover shot. Working at 73 is not all on the level ... sometimes it means odd things like ballooning.*

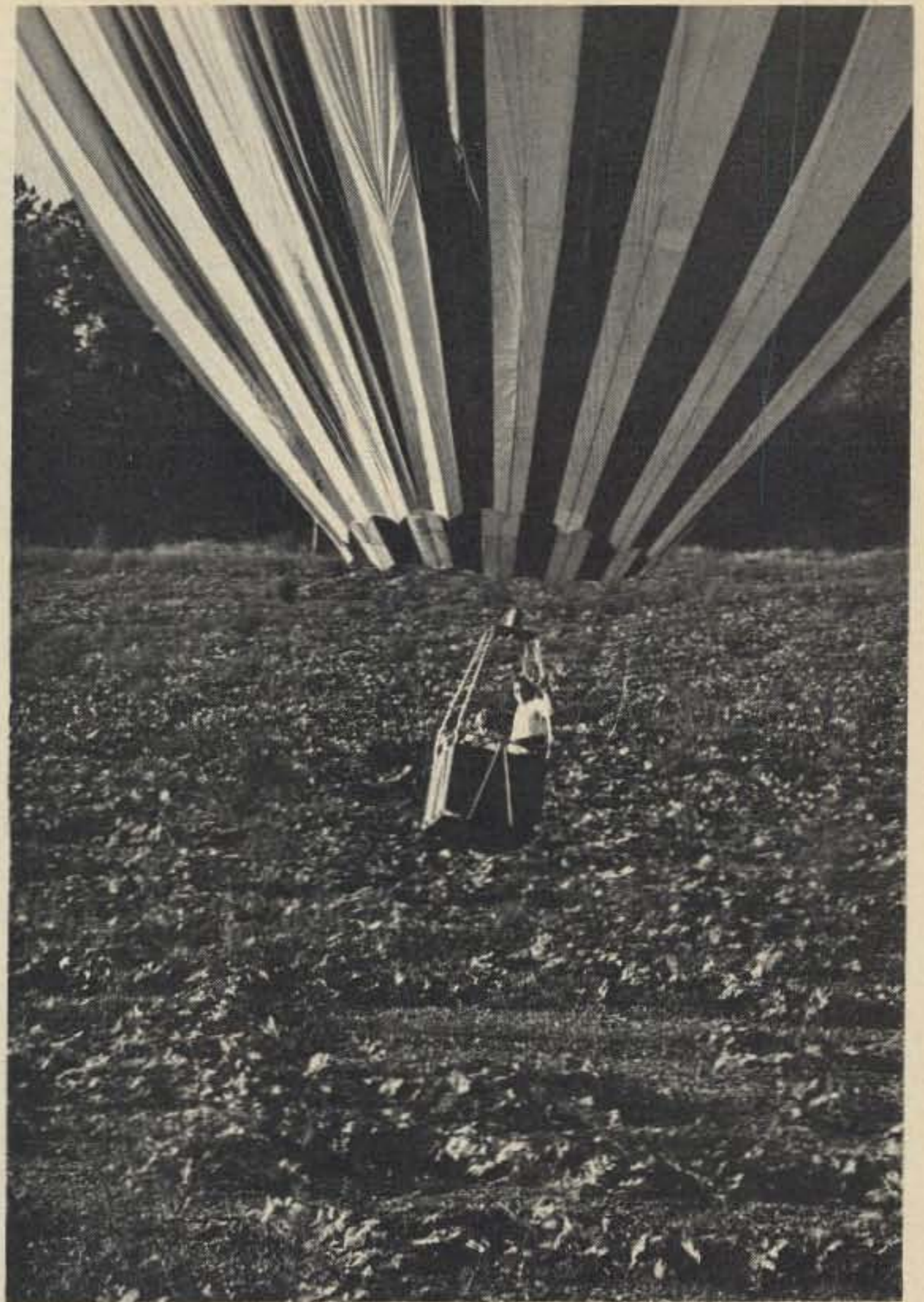

*Crunch lives up to his name by coming down solidly in an okra field a few miles from his home. By using just enough flames to keep the hot air right, it is possible to come down very gently.*

tastic organ setup and she played some music for us ... in all, it was a most successful day.

question about that at all. They run from \$5000 on up, and can stay in the air three to four hours on the two propane tanks. The balloon



*Here's Will with his trailer ... it carries the balloon and gondola for return to home. Will is the chap to see if you are interested in getting into the ballooning hobby ... or maybe in renting a balloon for a hamfest.*

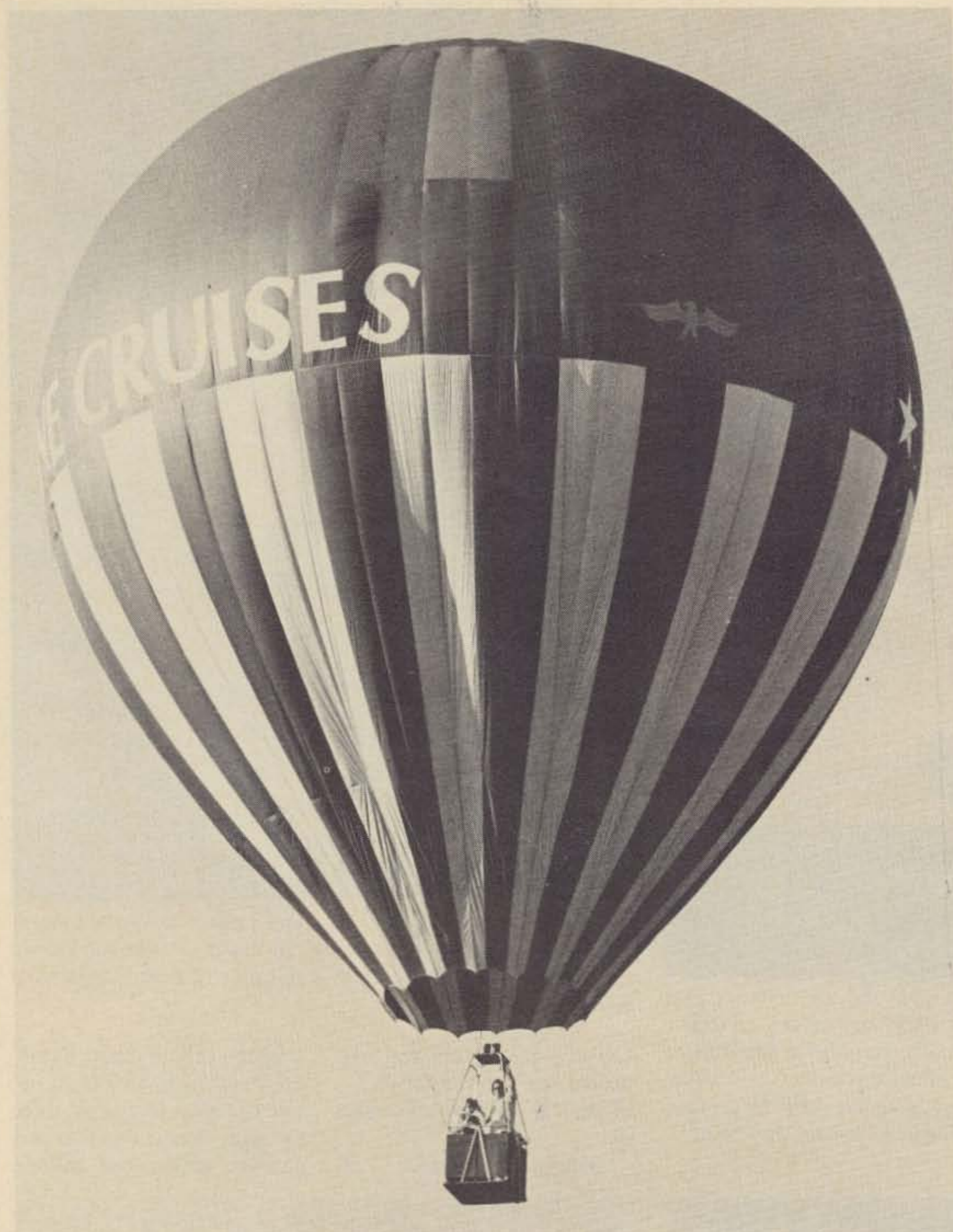

W4SAC and 73's Marketing Manager Smythe wave as the first balloon-to-balloon ham contact is completed.

has a diameter of about 50 feet and goes up about 70 feet. It has a ceiling of about 20,000 feet ... but this is higher than you want to go without oxygen. They'll lift about 400 pounds.

While you don't have a lot of control over which direction you are going to go ... you go with the wind ... you can control your speed quite a bit by picking an elevation which has the winds you want. We were able to slow down and wait for Captain Crunch and Sherry to catch up with us by staying low and waiting for the higher winds to bring them up to us.

I sure want to thank Will for setting up the event. He even brought in a second balloon from Atlanta for it. And I want to thank Laura, Walt, Ed, Nancy and Bill for helping out. Both Sherry and I had a wonderful time. Sherry had the same problems I did ... she had binoculars around her neck, an HT in one hand, a camera in the other ... and then she was told to hold on to the gondola!

What with trying to keep in touch with Captain Crunch in the other balloon, Ed on the ground, hold onto the gondola, and take pictures with various long lenses, I had my hands and knees full ... and pockets. When you're about 500 feet up in the air you have a sort of automatic need to hold onto something. Tight. ■

### DOUBLE BAZOOKA DIPOLE

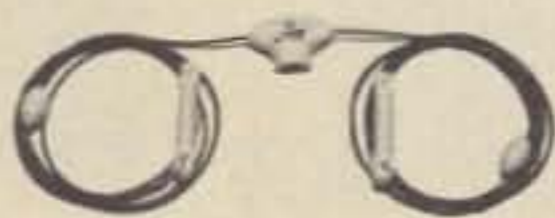

Ready to use broadband dipole complete with central insulator and S0239 connector end insulator completely water proof cap. 1000 watts, specify center frequency. 80 meter - \$29.50, 40/15 meter - \$27.50, 20 meter - \$23.50.

5 band trap dipole KIT complete, includes 80-40 trap central and end insulator antenna wire, 100 feed of RG59, 1-pl259 connector and instruction sheet ... \$35.00  
Fiberglass central insulator similar to photo above. 1000 lbs test ... \$5.95 ppd.

JAC TENNA ELECTRONIC  
13850 Victorin  
Tracy Quebec, Canada

### TELEVISION PICTURE TUBES

NOW: ASE manufactures over 2,000 types of television picture tubes. Full 2 year factory warranty. Write for new list.



**Allied Sales & Engineering, Inc.**  
Dept. 37, Pimento IN 47866  
Telephone 812-495-6555

### SST T-1 RANDOM WIRE ANTENNA TUNER



All band operation (150-10 meters) with most any random length wire. 200 watt power capability. Ideal for portable or home operation. A must for Field Day. Size: 2 x 4 1/2 x 2 3/8. Built-in neon tune-up indicator. Guaranteed for 90 days.

COMPACT - EASY TO USE

●●● only \$29.95

POSTPAID. (ADD SALES TAX IN CALIF.)

SST Electronics, P.O. Box 1, Lawndale CA 90260

### NEW MULTI-BAND ANTENNA



Universal Radio Co. Dept 51  
Box 26041 El Paso, TX 79926  
Telephone (915) 592-1910

# FIRST

Make this comparison:

The GTX-1 gives the high quality performance that compares with Motorola, GE, RCA or any other hand-helds that sell for \$700 or more.

# THEN

Check these features:

**Small:** only 8"x2.6"x1.28" ... **Appearance:** slim silhouette all black metal ... **Serviceable:** easy access to separate receive and transmit circuit boards ... **PLUS:** 6 pole xtal filter for superlative receiver operation ... **and:** trimmers on receive and transmit xtals: standard 10.7 MHz 1st IF.

and specs:

**Rec. Sens.:** .2 $\mu$ v for 12 db SINAD ... **Adjacent channel rejection:**  $\pm$ 30 kHz 55 db ... **Spur. Resp.:** more than 65 db ... **Audio Output:** 500 mw ... **Power output:** Hi 3 w, Lo 1 w ... **Audio Quality:** Distortion free, crisp, clear receive and transmit.



# NOW

Look at the Price:

**GTX-1**  
2 Meter 6 channel  
Hand-Held  
(without encoder)  
**\$249<sup>95</sup>**  
(Bat. Not Incl.)

**GTX-1T**  
with Built-In  
Tone Encoder  
**\$299<sup>95</sup>**  
(Bat. Not Incl.)

GENAVE stocks most common 2-M Xtals for immediate delivery



Use This Handy Order Form

4141 Kingman Dr., Indianapolis, IN 46226  
Phone-in orders accepted (317+546-1111)

NAME \_\_\_\_\_  
ADDRESS \_\_\_\_\_ CITY \_\_\_\_\_  
STATE & ZIP \_\_\_\_\_ AMATEUR CALL \_\_\_\_\_

GTX-200-T

2-meter FM, 100 channel combinations, 30 watts with factory installed tone encoder (Incl. 146.94 MHz)



**\$249<sup>95</sup>**

GTX-200

2-meter FM, 100 channel combinations, 30 watts (Incl. 146.94 MHz)



**\$199<sup>95</sup>**

GTX-10-S

2-meter FM, 10 channels, 10 watts (Xtals not included)

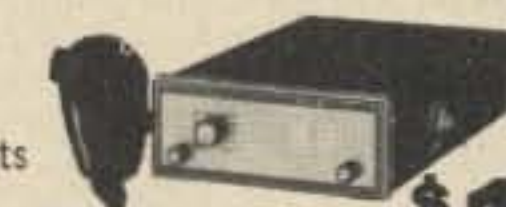

**\$149<sup>95</sup>**

GTX-2

2-meter FM, 10 channels, 30 watts with pushbutton frequency selector (Incl. 146.94 MHz)



**\$189<sup>95</sup>**

GTX-1

2-meter FM, 6-channel, 3.5 watts Hand-Held

**\$249<sup>95</sup>**  
(Bat. not incl.)

GTX-1T

Same as GTX-1, plus Factory Installed Tone Encoder

Operate Auto Patch  
**\$299<sup>95</sup>**  
(Bat. not incl.)



Ringo Ranger ARX-2 6 db 2-M Base Antenna @ \$29.95 \$ \_\_\_\_\_

Lambda/4 2-M and 6-M Trunk Antenna @ \$29.95 \$ \_\_\_\_\_

TE-I Tone Encoder Pad for plug-in installation on most amateur transceivers @ \$59.95 \$ \_\_\_\_\_



TE-II Tone Encoder Pad for installation on most Hand-Helds @ \$49.95 \$ \_\_\_\_\_

PS-1 AC Power Supply for use with all makes of transceivers 14 VDC-6 amps @ \$69.95 \$ \_\_\_\_\_

and the following standard crystals @ \$4.50 each \$ \_\_\_\_\_  
Non-standard crystals @ \$6.50 each: \$ \_\_\_\_\_

### ACCESSORIES FOR GTX-1 and GTX-1T

- PSI-18 Optional Nicad battery pack \$29.95 \$ \_\_\_\_\_
- PS-2 Charger for GTX-1(T) battery pack \$39.95 \$ \_\_\_\_\_
- GLC-1 Leather carrying case .....\$12.95 \$ \_\_\_\_\_
- TE-III Tone Encoder (for use with GTX-1) \$49.95 \$ \_\_\_\_\_

Add \$4 per Radio for Shipping, Handling, and Crystal Netting.

Payment by:

- Certified Check/Money Order  Personal Check
- C.O.D. Include 20% Down

Note: Orders accompanied by personal checks will require about two weeks to process. 20% Down Payment Enclosed. Charge Balance To:

- BankAmericard # \_\_\_\_\_ Expires \_\_\_\_\_
- Master Charge # \_\_\_\_\_ Expires \_\_\_\_\_
- Interbank # \_\_\_\_\_ Expires \_\_\_\_\_

IN residents add 4% sales tax: } \$ \_\_\_\_\_  
CA residents add 6% sales tax: }

All orders shipped post-paid within continental U.S. (allow 8 weeks delivery.)

CLIP OUT AND ORDER NOW

CLIP OUT AND ORDER NOW

## FILTERS

### ELIMINATE INTERFERENCE TO TV SETS WITH AMECO HIGH AND LOW PASS FILTERS

#### LOW PASS FILTER MODEL LN-2

The Ameco low pass filter suppresses the radiation of all spurious signals above 40 Mc. It is designed for Coaxial cable (52 to 72 ohms). Other features include: Negligible Insertion Loss, 35 db, and more attenuation of harmonic and spurious frequencies above 50 MC., will handle up to 200 watts of RF power.

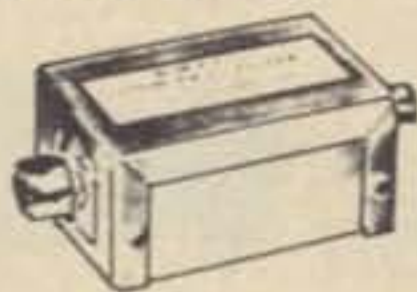

Model LN-2

\$6.95



#### LOW COST HIGH-PASS FILTER MODEL HP-45

Model HP-45 is a single section high-pass filter. All frequencies above 45 MC. are passed through without loss. Other features include: 40 db, and more attenuation at 14 MC. and below; 20 db. attenuation at 10 meters, Negligible insertion loss.

\$1.95

#### MOBILE COMMUNICATIONS FILTERS FOR VEHICULAR AND MARINE ELECTRICAL SYSTEMS

AF-104	Alternator Filter, non-tunable	\$ 4.90
C-20	Feed-thru Coax Filter, .1 mf	2.58
C-40	Feed-thru Coax Filter, .5 mf	4.06
C-70	Same as C-40, except 70 amps.	4.78
CB-330	Generator Filter, 3-30 MHz, Hi-amp.	4.90
G-23	Marine Generator Filter, Tunable	7.64
HF-3060	Generator Filter, Hi-amp., 30-60 MHz	4.90
T-52	Tunable Alt. Filter, 52A, 22-60 MHz	12.59
T-70	Tunable Alt. Filter, 70A, 22-60 MHz	13.14
TH-70	Tunable Alt. Filter, 70A, 100-200 MHz	13.14
TM-49	Tunable Marine Alternator Filter, 49A	13.14
TM-68	Tunable Marine Alternator Filter, 68A	13.69
VF-225	Voltage Regulator Filter	4.90

CES Touch Tone Pads — \$49.95 ea.  
● Model 200 — acoustic coupling ● Model 201 for mounting on walkies or hand-helds



#### MODEL 200

CES Model 220 CES can now offer you a TOUCH-TONE\* back for Standard Communications hand held radios. This is the complete back assembly with the TOUCH-TONE\* encoder mounted and ready to plug into the private channel connector. Also included is an LED tone generation indicator and an external tone deviation adjustment.

MODEL 220

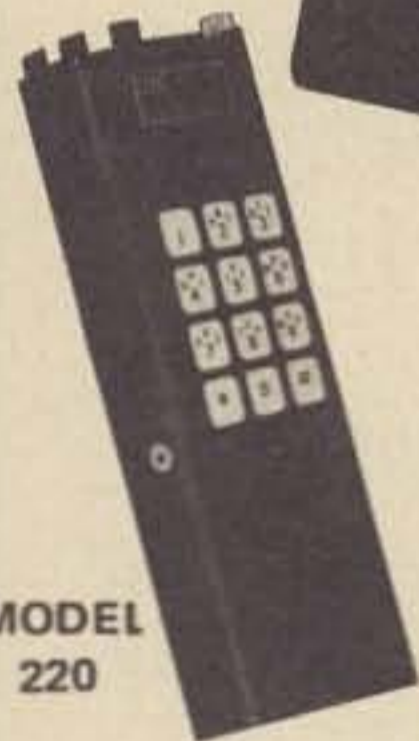

## DENTRON



#### 160-10AT SUPERTUNER™

Want an antenna tuner to match everything between 160 and 10 through balanced line, coax line and random line, pump out the full legal limit and look and sound good doing it? Supertuner™ is the one for you at just

\$129.50

#### 160-10AT-3K SUPER SUPERTUNER™

Designed and engineered to be compatible with the full-power highly efficient modern amplifiers now available to the amateur. In our opinion the finest tuner on the market today.

\$229.50

#### 80-10AT SKYMATCHER™

Here's an antenna tuner for 80 through 10 meters, handles full legal power and matches your 52 ohm transceiver to a random wire antenna. 80-10AT is yours for only

\$59.50

talk power by

## TPL

TPL for an Economy Price? THAT'S RIGHT! introducing the ECONO-LINE

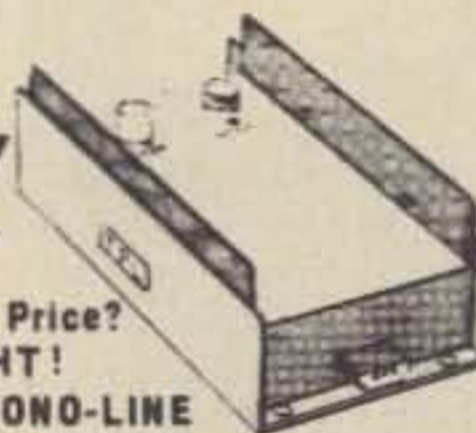

Model	Input	Output	Typical	Frequency	Price
702	5.20W	50.90W	10 in./70 out	143-149 MHz	\$139.00
702B	1.4W	60.80W	1 in./70 out	143-149 MHz	\$169.00

Now get TPL COMMUNICATIONS quality and reliability at an economy price. The new Econo-Line gives you everything that you've come to expect from TPL at a real cost reduction. The latest mechanical and electronic construction techniques combine to make the Econo-Line your best amplifier value. Unique broad-band circuitry requires no tuning throughout the entire 2-Meter band and adjacent MARS channels. See these great new additions to the TPL COMMUNICATIONS product line at your favorite amateur radio dealer.

For prices and specifications please write for our Amateur Products Summary.

FCC type accepted power amplifiers also available. Please call or write for a copy of TPL's Commercial Products Summary.

## TPL

COMMUNICATIONS INC.



AMPHENOL

#### SERIES 581 — PACKAGED CABLE ASSEMBLIES

All popular lengths are now available in your choice of RG 8/U or RG 58/U type low loss polyfoam dielectric cable. Installed PL-259 connectors are ASTROplated® — Amphenol's new non-tarnishing finish — which has all the advantages of precious metal plus more heat, corrosion and abrasion resistors that silver ever had!

#### RG 58/U TYPE POLYFOAM COAXIAL CABLE ASSEMBLIES

581-5803:	3-ft. with ASTROplated PL-259's on both ends.	\$ 3.82
581-5812:	12-ft. with ASTROplated PL-259's on both ends.	\$ 5.08
581-5820-2:	20-ft. with ASTROplated PL-259's on both ends.	\$ 5.88
581-5850:	50-ft. with ASTROplated PL-259's on both ends.	\$ 8.94
581-5875:	75-ft. with ASTROplated PL-259's on both ends.	\$11.22
581-58100:	100-ft. with ASTROplated PL-259's on both ends.	\$12.98

#### RG 8/U TYPE POLYFOAM COAXIAL CABLE ASSEMBLIES

581-803:	3-ft. with ASTROplated PL-259's on both ends.	\$ 4.46
581-820:	20-ft. with ASTROplated PL-259's on both ends.	\$10.36
581-850:	50-ft. with ASTROplated PL-259's on both ends.	\$18.58
581-875:	75-ft. with ASTROplated PL-259's on both ends.	\$25.48
581-8100:	100-ft. with ASTROplated PL-259's on both ends.	\$31.96

#### ALL BAND PREAMPLIFIERS



- 6 THRU 160 METERS
- TWO MODELS AVAILABLE
- RECOMMENDED FOR RECEIVER USE ONLY
- INCLUDES POWER SUPPLY

MODEL PLF employs a dual gate FET providing noise figures of 1.5 to 3.4 db., depending upon the band. The weak signal performance of most receivers as well as image and spurious rejection are greatly improved. Overall gain is in excess of 20 db. Panel contains switching that transfers the antenna directly to the receiver or to the Preamp.

Model PLF 117V AC, 60 Hz. Wired & Tested \$44.00

MODEL PCLP is identical in all respects to the PLF except that two nuvistors are used instead of the FET.

Model PCLP 117V AC, 60 Hz. Wired & tested \$39.00

#### UHF RF CONNECTORS



Low loss R-F connectors for Amateurs, Citizens Band and laboratory use. Silver plated for high RF conductivity.

A	PL-259	Coaxial Plug	\$ .80
B	SO-239	Coaxial Receptacle	.68
C	M-359	Coaxial Right Angle Adapter	2.29
D	PL-258	Coaxial Junction	1.31
E	UG-175/U	Adapter for RG-58/U	.25
DM		Double Male Plug	1.60

## FREE Surprise Gift With Every Order

Mastercharge and BankAmericard accepted on non-discounted orders

Orders over \$1000.00 may deduct 5% Add \$2.00 for shipping and handling on all orders

Mail your order to Distributor: TUFTS RADIO, 386 Main St., Medford, Mass. 02155. Phone (617) 395-8280

PLEASE SEND ME: \_\_\_\_\_

Name \_\_\_\_\_ Address \_\_\_\_\_  
City \_\_\_\_\_ State \_\_\_\_\_ Zip \_\_\_\_\_

(Prices F.O.B. Medford, Mass. All units can be shipped U.P.S. Mass. residents add 5% sales tax.)

# TUFTS

## Radio Electronics

386 Main St., Medford MA 02155  
Phone: 617-395-8280

NEW ENGLAND'S  
FRIENDLIEST HAM  
STORE

Open 9 AM to 9 PM  
Mon. — Sat.



why waste watts?



**SWR-1 guards against power loss for \$21.95**

If you're not pumping out all the power you're paying for, our little SWR-1 combination power meter and SWR bridge will tell you so. You read forward and reflected power simultaneously, up to 1000 watts RF and 1:1 to infinity VSWR at 3.5 to 150 MHz.

Got it all tuned up? Keep it that way with SWR-1. You can leave it right in your antenna circuit.

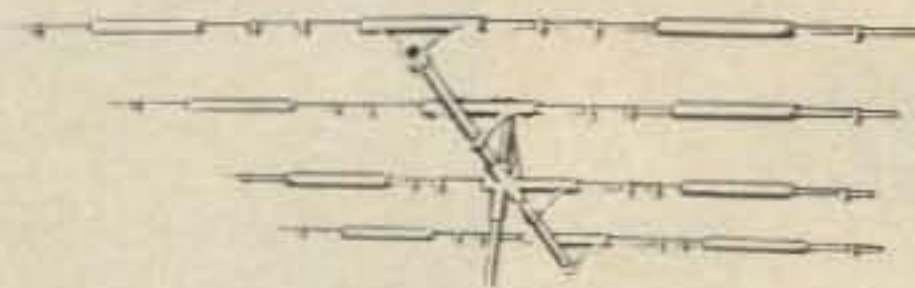

**HEAVY DUTY 4-ELEMENT TRIBAND BEAM.**

Four working elements on each band in 10, 15 and 20 meters. 24 foot boom permits optimum spacing for maximum forward gain and front-to-back ratio. All traps are precision tuned and weather-proofed. Rugged reliability assures ability to withstand winds up to 100 mph. TB-4HA.

**HEAVY DUTY 3-ELEMENT TRIBAND BEAM.**

Three working elements on each band in 10, 15 and 20 meters. 16 foot boom requires a lighter duty rotor and tower than the TB-4HA

but still provides excellent performance characteristics. Precision tuned and weather-proofed traps are combined with rugged construction. TB-3HA.

**ECONOMICAL 2-ELEMENT TRIBAND BEAM.**

Two working elements on each band in 10, 15, and 20 meters. 6.5 foot aluminum boom can easily be raised on an inexpensive mast and operated with a standard TV rotator. Withstands winds up to 80 mph. TB-2A.

**HEAVY DUTY 2-ELEMENT 40-METER BEAM.**

Two working elements on 15.75 foot steel boom. Maximum forward gain and front-to-back ratio in the CW or phone portion of the 40-meter band is easily achieved for optimum performance. Large high-Q loading coils are weather-proofed. Rugged design easily takes 100 mph winds. MB-40H.

**High-Q Fixed Antennas**

All Swan Beam Antennas are Rated for 2000 Watts and Designed to use 52 Ohm Coaxial Feedlines



**SWAN BEAM ANTENNA SPECIFICATIONS**

Antenna Model Number:	Average Forward Gain:	Front to Back Ratio:	Boom Length & Diameter	Longest Element:	Turning Radius:	Maximum Wind Survival:	Wind Load @ 80 mph:	Wind Surface Area:	Net Weight Assembled:	Cost:
TB-4HA	9 dB	24-26 dB	24' x 1.5"	28'-10"	18'-6"	100 mph	148 lbs.	6 sq. ft.	54 lbs.	\$249.95
TB-3HA	8 dB	20-22 dB	16' x 1.5"	28'-2"	16'	100 mph	110 lbs.	4 sq. ft.	44 lbs.	189.95
TB-2A	5 dB	18-18 dB	6.5' x 1.5"	27'-8"	14'-3"	80 mph	60 lbs.	1.8 sq. ft.	18 lbs.	129.95
MB-40H	4 dB	18-18 dB	15.75' x 1.5"	30'-4"	17'-6"	100 mph	80 lbs.	2.5 sq. ft.	40 lbs.	199.95

**SWAN METERS HELP YOU GET IT ALL TOGETHER**

These wattmeters tell you what's going on.

With one of these in-line wattmeters you'll know if you're getting it all together all the time. Need high accuracy? High power handling? Peak

power readings? For whatever purpose we've got the wattmeter for you. Use your Swan credit card. Applications at your dealer or write to us.



**WM2000** In-Line Wattmeter With Muscle. Scales to 2000 watts. New flat-response directional coupler for maximum accuracy. \$49.95



**WM3000** Peak-reading Wattmeter. Reads RMS power, then with the flick of a switch, true peak power of your single-sideband signal. That's what counts on SSB. \$66.95



**WM1500** High-Accuracy In-Line Wattmeter. 10% full scale accuracy on 5, 50, 500 and 1500 watt scales. 2 to 30 MHz. Forward and reflected power. Use it for trouble-shooting, too. \$64.95



**DELUXE 742 TRI-BAND MOBILE ANTENNA**

- Automatically adjusts to proper resonance for 20, 40 and 75 meters.
- Power rated at 500 Watts P.E.P.
- Includes base section, automatic coil and whip top section. 742 Antenna \$79.95



**EXCLUSIVE DELUXE 5-BAND MOBILE 45 ANTENNA**

- All band manual switching antenna for 10, 15, 20, 40 and 75 meters.
- Power rated at 1000 Watts P.E.P.
- Includes base section with mobile coil and six foot whip top section. 45 Antenna \$114.95

Hams the world over value amateur radio products from Swan Electronics. Among the most respected of these are the unique single-sideband rigs with that "special something" extra -- like those illustrated here.

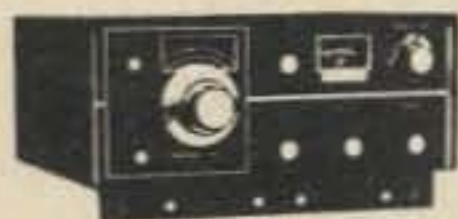

SS-200A

**SWAN SS-200A** Transceiver. Fully solid-state, unique broadband tuning on all five bands, and infinite VSWR protection. Maintains up to 300 watts P.E.P. input on any frequency selected. \$799.95



700 CX

**SWAN 700CX** Champion Transceiver. 700 watts P.E.P. input on the five most popular amateur bands. No other manufacturer gives you this much power and convenience for your money. \$649.95

**SWAN LINEAR AMPLIFIERS** A Mark II 2000 watt P.E.P. full legal input power unit or the 1200X matching Cygnet 1200 watt P.E.P. input powerhouse with built-in power supply. The choice is yours. \$849.95



MARK II

**CYGNET 1200X PORTABLE LINEAR AMPLIFIER**

To quadruple the output of the 300B Cygnet de novo, simply add this matching unit for more than a kilowatt of power. Complete with self-contained power supply and provision for external ALC, this Cygnet offers exceptionally high efficiency and linearity. \$349.95



1200 X

Additional Swan products include: fixed and mobile antennas, VFO's telephone patch, VOX, wattmeter, microphones and mounting kits. As another extra service, only Swan Electronics offers factory-backed financing to the amateur radio community. Visit an authorized Swan Electronics dealer for complete details or, if you prefer, write:



**TUFTS**

Radio Electronics

NEW ENGLAND'S FRIENDLIEST HAM STORE

Open 9 AM to 9 PM Mon. - Sat.

386 Main St., Medford MA 02155

Phone: 617-395-8280



# THE **BIG** SIGNAL \$12.95

## "W2AU" BALUN

THE APPROVED LEADING HAM AND COMMERCIAL BALUN IN THE WORLD TODAY.

### THE PROVEN BALUN



- HANDLES FULL 2 KW PEP AND THEN SOME. Broad-Banded 3 to 40 Mc.
  - HELPS TVI PROBLEMS By Reducing Coax Line Radiation
  - NOW ALL STAINLESS STEEL HARDWARE. SO239 Double Silver Plated
  - IMPROVES F/B RATIO By Reducing Coax Line Pick-Up
  - REPLACES CENTER INSULATOR. Withstands Antenna Pull of Over 500 Lbs.
  - BUILT-IN LIGHTNING ARRESTER. Helps Protect Balun—Could Also Save Your Valuable Gear
  - BUILT-IN HANG-UP HOOK. Ideal for Inverted Yees, Multi-Band Antennas, Dipoles, Beam and Quads
- NOW BEING USED BY ALL BRANCHES OF THE U.S. ARMED FORCES, FAA, RCA, CIA, CANADIAN DEFENSE DEPT. PLUS THOUSANDS OF HAMS THE WORLD OVER
- THEY'RE BUILT TO LAST...  
**BIG SIGNALS DON'T JUST HAPPEN—GIVE YOUR ANTENNA A BREAK**
- Comes in 2 models. 1:1 matches 50 or 75 ohm unbalanced (coax line) to 50 or 75 ohm balanced load. 4:1 model matches 50 or 75 ohm unbalanced (coax line) to 200 or 300 ohm balanced load.
- AVAILABLE AT ALL LEADING DEALERS. IF NOT, ORDER DIRECT
- The big signal W2AU Balun reflects the type of quality that has kept our product out front and number 1 in Baluns the world over for the past 10 years.
- The originator of the Balun with a built-in lightning arrester and hang up hook.

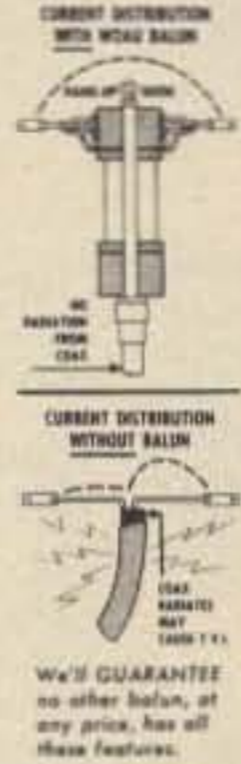

# Now...more than ever--- the TEMPO line means solid value

## Tempo VHF/ONE

the "ONE" you've been waiting for



No need to wait any longer — this is it! Whether you are already on 2-meter and want something better or you're just thinking of getting into it, the VHF/ONE is the way to go.

- Full 2-meter band coverage (144 to 148 MHz for transmit and receive).
- Full phase lock synthesized (PLL) so no channel crystals are required.
- Compact and lightweight — 9.5" long x 7" wide x 2.25" high. Weight — About 4.5 lbs.
- Provisions for an accessory SSB adaptor.
- 5-digit LED receive frequency display.
- 5 KHz frequency selection for FM operation.
- Automatic repeater split — selectable up or down for normal or reverse operation.
- Microphone, power cord and mounting bracket included.
- Two built-in programmable channels.
- All solid state.
- 10 watts output.
- Super selectivity with a crystal filter at the first IF and E type ceramic filter at the second IF.
- 800 Selectable receive frequencies.
- Accessory 9-pin socket.
- \$495.00

TEMPO SSB/ONE. SSB adapter for the Tempo VHF/One. Selectable upper or lower sideband. Plugs directly into the VHF/One with no modification. Noise blanker built-in. SFT and VXO for full frequency coverage. \*\$235.00.

### ASTATIC MICROPHONES



SILVER EAGLE

- T-UG8-D104, transistorized ..... \$48.60
- T-UG9-D104, "Golden Eagle," transistorized . \$95.40
- T-UG9-D104, "Silver Eagle," transistorized ... \$54.60
- UG-D104, ceramic or crystal ..... \$42.60

### TUFTS LIBRARY

- Foreign Radio Amateur Callbook ..... \$12.95
- U.S. Radio Amateur Callbook ..... \$13.95
- A.R.R.L. Radio Amateur Handbook ..... \$ 6.00
- A.R.R.L. Radio Amateur License Manual ..... \$ 1.50
- A.R.R.L. Antenna Book ..... \$ 4.00

### TAB PUBLICATIONS

- Ameco Commercial Operator Theory Course ..... \$ 5.95
- Ameco Amateur Radio Theory Course ..... \$ 4.95
- Amateur Radio Novice Class License Study Guide ..... \$ 5.95
- Amateur Radio General Class License Study Guide . . . \$ 7.95
- Amateur Radio Advanced Class License Study Guide . . \$ 5.95
- Amateur Radio Extra Class License Study Guide ..... \$ 5.95



### 73 PUBLICATIONS

- 1976 FM Repeater Atlas ..... \$ 1.95
  - Weather Satellite Handbook ..... \$ 2.95
  - Code Tapes — 5,6,14&21 wpm ..... \$3.95 ea./4 for \$13.95
- come in and see other 73 publications in stock •

# mounts - leads - accessories

### STANDARD GAIN MOBILES

- Two Meters**
- 5/8 wavelength — 3.4 db gain over 1/4 wave mobile
  - Frequency coverage—143 to 149 MHz
  - Power rating—200 watts FM

#### MODEL BBLT-144

47" antenna complete with easy to install, no holes to drill, trunk lip mount, impact spring and 17" MIL SPEC RG-58-U and PL-259. Antenna removable from mount. \$28.75

#### MODEL BBL-144

47" antenna mounts on any flat surface, roof, deck or fender in 3/4" hole. Includes impact spring, 17" MIL SPEC RG-58-U and PL-259. Antenna removable from mount. \$26.95

### HUSTLER "BUCK-BUSTER"

#### MODEL SF-2

51" two meter, 5/8 wavelength, 3.4 db gain over 1/4 wave mobile. Designed with 3/4" x 24 stud to fit your mount or a wide selection of Hustler mobile mounts. (Mount or cable not included). \$12.75

### DELUXE MOBILE MOUNTS

For medium length, light weight antennas with 3/4" x 24 base.



#### MODEL TLM

Trunk lip mount for no holes installation on side or edge of trunk lid. Includes 17" RG-58-U connectors attached. \$12.05

#### MODEL HLM

Deluxe trunk lip mount with 180 degree swivel ball for positioning antenna to vertical. Easy — no holes — installation. Includes 17" RG-58-U cable and connectors attached. \$14.85

#### MODEL GCM-1

Rain gutter mount fits all shapes, angles even latest trim line gutters. Includes 180° swivel ball. \$7.50

#### MODEL MM-1

Cowl mount installs in 1" hole. Includes 180° swivel ball and SO-239 connectors. \$ 6.45

#### MODEL TGM-1

Trunk groove mount installs in hidden area of groove under trunk lid. Mounting hardware included. \$7.50

#### MODEL C-32

Ball mount complete with mounting hardware. \$5.75

### SUPER GAIN MOBILES

#### Two Meters

- 5.2 db gain over 1/4 wave mobile antenna
- Frequency coverage—143-149 MHz
- SWR at resonance—1.1:1 typical
- Power rating—200 watts FM

#### TWO AND SIX METERS—TRUNK LIP MOUNT

**MODEL HFT**  
Four section telescopic antenna permits separate adjustment for simultaneous resonance on two and six meters. Operational height: 40". Complete with trunk lip mount, 17" MIL SPEC RG-58-U and factory attached PL-259. \$21.45

#### VHF/UHF ANTENNA—ROOF MOUNT

**MODEL UHT-1**  
Field trimmable radiator for 1/4 wave operation on any frequency from 140 to 500 MHz. Cutting chart included. Mounts on any flat surface, roof, deck, fender in 3/4" hole. Includes 15" RG-58-U. \$10.15

#### VHF/UHF ANTENNA—TRUNK LIP MOUNT

**MODEL THF**  
Field trimmable radiator permits quarter wave operation on any frequency from 140 to 500 MHz. Cutting chart included. Complete with trunk lip mount, 17" RG-58-U and PL-259. \$15.95

#### RESONATOR SPRING—STAINLESS STEEL

**MODEL RSS-2**  
Installs between Hustler mast and resonator. Absorbs shock when antenna strikes overhanging obstructions. Supplied ready for easy installation. \$ 9.95

#### QUICK DISCONNECT—100% STAINLESS STEEL

**MODEL QD-1**  
Remove antenna from mount with easy press and twist release. Compression spring and all parts 100% stainless steel. 3/4" x 24 threads—female one end, male the other. \$11.75

#### FEED LINE

**MODEL L-14-240**  
Get lowest performance, maximum shielding for minimum noise pick-up in this MIL SPEC 20 length of RG-58-U cable. Supplied with connectors at each end for use with ball or bumper mount and transceiver. \$ 3.45

#### MODEL G3-144

1/4 wave, two-meter antenna. Includes radials for complete decoupling. SWR at resonance: 1.5:1 or better. Height: 48". Power rating: 200 Watts FM. \$21.95

#### MODEL G6-144A

Deluxe Two-Meter Coaxial Repeater for any fixed station operation. 6 db gain over a 1/4 wave dipole. Maximum radiation at the horizon! Shunt fed with D.C. grounding. Radiator: 3/8 wave lower section, 1/4 wave phasing, 1/2 wave upper section. Height: 117". SWR at resonance: 1.2:1 or better. Power rating: 1,000 Watts FM. Wind survival: 100 MPH. Installs on vertical pipe up to 1 1/2" O.D. SO-239 coax connector. \$52.95

### HUSTLER RESONATORS

STANDARD HUSTLER RESONATORS— Power Rating: 400 watts SSB		
Model	Band	Price
RM-10	10 meters	\$13.75
RM-15	15 meters	\$11.75
RM-20	20 meters	\$12.75
RM-40	40 meters	\$15.95
RM-75	75 meters	\$18.95
RM-80	80 meters	\$18.95

SUPER HUSTLER RESONATORS— Power Rating: Legal Limit SSB Superb low SWR band-width		
Model	Band	Price
RM-10-S	10 meters	\$13.95
RM-15-S	15 meters	\$14.95
RM-20-S	20 meters	\$15.25
RM-40-S	40 meters	\$23.50
RM-75-S	75 meters	\$28.95
RM-80-S	80 meters	\$28.95

Covers 10 - 15 - 20 - 40 Meters  
Only Hustler Gives One Setting for Whole Band Coverage

#### MODEL 4-BTV

- Lowest SWR—PLUS.
  - Bandwidth at its broadest! SWR 1.6 to 1 or better at band edges.
  - Hustler exclusive trap covers "Spritz" extruded to otherwise unobtainable close tolerances assuring accurate and permanent trap resonance.
  - Solid one inch fiberglass trap forms for optimum electrical and mechanical stability.
  - Extra heavy duty aluminum mounting bracket with low loss—high strength insulators. Mounting hardware included.
  - All sections 1 1/4" heavy wall, high strength aluminum.
  - Stainless steel clamps permitting adjustment without damage to the aluminum tubing.
  - Guaranteed to be easiest assembly of any multi-band vertical.
  - Antenna has 3/4" x 24 stud at top to accept RM-75 or RM-75-S Hustler resonator for 75 meter operation when desired.
  - Top loading on 75 meters for broader bandwidth and higher radiation efficiency!
  - Feed with any length 50 ohm coax.
  - Power capability—full legal limit on SSB or CW.
  - Mounting: Ground mount with or without radials, or roof mount with radials.
- Length: 21' 5" Weight: 15 lbs.  
**MODEL 4-BTV \$79.95**

All resonators are precision wound with optimized design for each band. Assembly includes 17-7 PH stainless steel adjustable tip rod for lowest SWR and band edge marker. Choose for medium or high power operation.

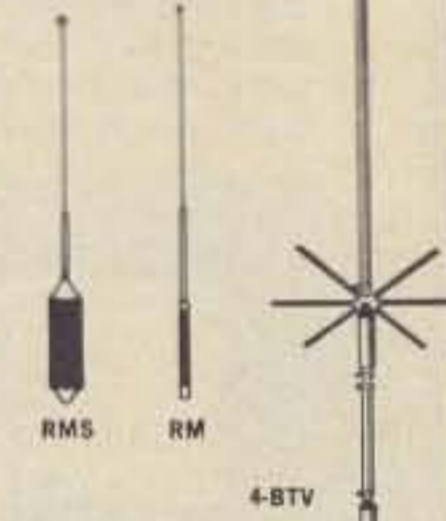

### HUSTLER MASTS

The Majority Choice of Amateurs Throughout the World!

#### MODEL MO-2

For bumper mounting—Fold is at roof line 27" above base. \$15.95

#### MODEL MO-1

For deck or fender mounting—Fold is at roof line 15" above base. \$15.95

# TUFTS

Radio Electronics

300 Main St., Northfield, MA 02155  
 Phone: 617 395-8280



- Remote
- Motor Controlled

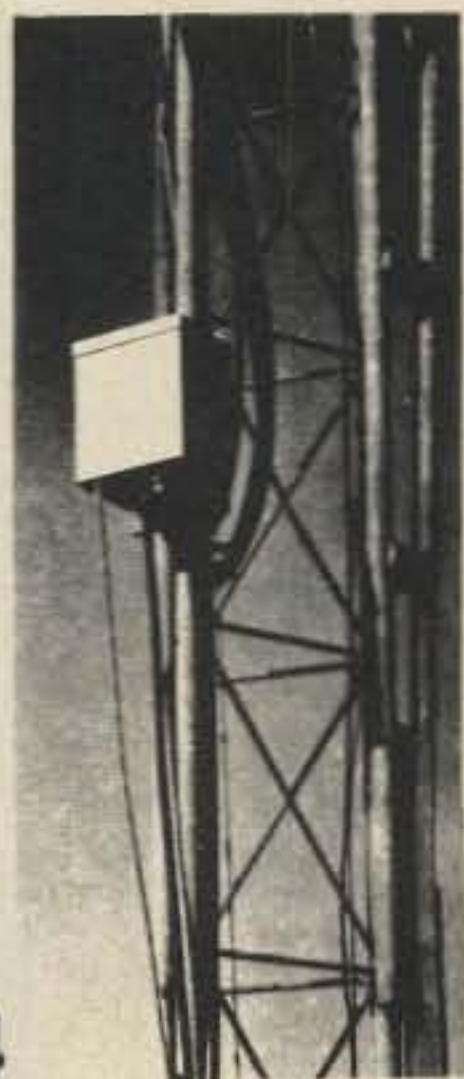

## RCS-4

### COAX ANTENNA SWITCH



- Control unit works on 110/220 VAC, 50/60 Hz, and supplies necessary DC to motor.
- Excellent for single coax feed to multiband quads or arrays of monobanders. The five positions allow a single coax feed to three beams and two dipoles, or other similar combinations.
- Control cable (not supplied) same as for HAM-M rotator.
- Selects antennas remotely, grounds all unused antennas. GND position grounds all antennas when leaving station. "Rain-Hat" construction shields motor and switches.
- Motor: 24 VAC, 2 amp. Lubrication good to -40°F.
- Switch RF Capability: Maximum legal limit. Price: \$120.00

### MATCHING NETWORKS



MN-4  
200 watts

Price: \$110.00



MN-2000  
2000 watts PEP

Price: \$220.00

**General:** • Integral Wattmeter reads forward power in watts and VSWR directly; can be calibrated to read reflected power • Matches 50 ohm transmitter output to coax antenna feedline with VSWR of at least 5:1 • Covers ham bands 80 thru 10 meters • Switches in or out with front panel switch • Size: 5½"H, 10¾"W, 8"D (14.6 x 27.3 x 20.3 cm), MN-2000, 14½"D (36.5 cm).  
• Continuous Duty Output: MN-4, 200 watts; MN-2000, 1000 watts (2000 watts PEP) • MN-2000 only: Up to 3 antenna connectors selected by front panel switch.



### RF WATTMETERS

W-4 1.8-54 MHz Price: \$ 72.00  
WV-4 20-200 MHz Price: \$ 84.00

Reads forward and reflected power directly in watts (VSWR from nomogram). Two scales in each direction. Size: 5½"H, 3¾"W, 4"D (14.0 x 9.5 x 10.2 cm).

Model	Full Scale	Calibration Accuracy
W-4	200 watts	(5% of reading + 2 watts)
	2000 watts	±(5% of reading + 20 watts)
WV-4	100 watts	±(5% of reading + 1 watt)
	1000 watts	±(5% of reading + 10 watts)



## SSR-1 COMMUNICATIONS RECEIVER

**GENERAL:** • All amateur bands 10 thru 80 meters in seven 600 kHz ranges • Solid State VFO with 1 kHz dial divisions • Modes SSB Upper and Lower, CW and AM • Built-in Sidetone and automatic T/R switching on CW • 30 tubes and semi-conductors • Dimensions: 5½"H, 10¾"W, 14¾"D (14.0 x 27.3 x 36.5 cm), Wt.: 16 lbs. (7.3 kg).

**TRANSMIT:** • VOX or PTT on SSB or AM • Input Power: SSB, 300 watts P.E.P.; AM, 260 watts P.E.P. controlled carrier compatible with SSB linears; CW, 260 watts • Adjustable pi-network.

**RECEIVE:** • Sensitivity better than ½ µV for 10 dB S/N • I.F. Selectivity 2.1 kHz @ 6 dB, 3.6 kHz @ 60 dB. • AGC full on receive modes, variable with RF gain control, fast attack and slow release with noise pulse suppression • Diode Detector for AM reception. Price: \$599.00

34-PNB Plug-in Noise Blanker . . . . . 100.00  
FF-1 Crystal Control Unit . . . . . 46.95  
MMK-3 Mobile Mount . . . . . 7.00  
RV-4C Remote VFO . . . . . 120.00

- Synthesized • General Coverage
- Low Cost • All Solid State • Built-in AC Power Supply • Selectable Sidebands
- Excellent Performance

**PRELIMINARY SPECIFICATIONS:** • Coverage: 500 kHz to 30 MHz • Frequency can be read accurately to better than 5 kHz • Sensitivity typically 5 microvolts for 10 dB S+N/N SSB and better than 2 microvolts for 10 dB S+N/N AM • Selectable sidebands • Built-in power supply: 117/234 VAC ± 20% • If the AC power source fails the unit switches automatically to an internal battery pack which uses eight D-cells (not supplied) • For reduced current drain on DC operation the dials do not light up unless a red pushbutton on the front panel is depressed.

The performance, versatility, size and low cost of the SSR-1 make it ideal for use as a stand-by amateur or novice-amateur receiver, short wave receiver, CB monitor receiver, or general purpose laboratory receiver.

Price: \$350.00



## TR-4C SIDEBAND TRANSCEIVER

POWER SUPPLIES  
AC-4 Power Supply . . . . . \$120.00  
DC-4 Power Supply . . . . . 135.00

# Drake C Line



## R-4C RECEIVER

R-4C Receiver . . . . . 599.00

• Linear permeability tuned VFO • Covers ham bands 80, 40, 20, 15 meters completely and 28.5 to 29.0 MHz of 10 meters with crystals furnished • Any fifteen 500 kHz ranges between 1.5 and 30 MHz can be covered with accessory crystals for 160 meters, MARS etc. (5.0-6.0 MHz not recommended) • Electronic Passband tuning • Accessory Noise blanker • Notch filter and 25 kHz crystal calibrator • Product detector for SSB/CW, diode detector for AM • Crystal Lattice Filter • Solid State Permeability Tuned VFO • Three AGC Release Times • Excellent Overload and Cross Modulation characteristics • Dimensions: 5½"H, 10¾"W, 12¾"D. Wt.: 16 lbs.

### ACCESSORIES FOR R-4C RECEIVER

IF Filters: FL-250, FL-500, FL-1500, FL-4000, FL-6000 . . . . . \$52.00  
4-NB Noise Blanker . . . . . 70.00



## T-4XC TRANSMITTER

T-4XC Transmitter . . . . . 599.00

• Covers ham bands 80, 40, 20, 15 meters completely and 28.5 to 29.0 MHz of 10 meters with crystals furnished • Upper and Lower Sideband • Automatic Transmit Receive Switching on CW • Controlled Carrier Modulation for AM • VOX or PTT on SSB and AM • Separate VOX Delay Controls for SSB/AM and CW • Adjustable Pi-Network Output • Two 8-pole Crystals • Lattice Filters • Transmitting AGC • Shaped Grid Block Keying • 200 Watts PEP input on SSB • Meter indicates plate current and relative output • Solid State HF Crystal Oscillator • Dimensions: 5½"H, 10¾"W, 12¾"D. Wt.: 14 lbs.



## LINEAR AMPLIFIER L-4B

L-4B Linear Amplifier . . . . . 895.00

• 2000 Watts PEP-SSB • Class B Grounded-Grid — two 3-500Z Tubes • Broad Band Tuned-Input • RF Negative Feedback • Transmitting AGC • Directional Wattmeter • Two Tauband Suspension Meters • L-4B 13-15/16"W, 7-7/8"H, 14-5/16"D. Wt.: 32 lbs. • Power Supply 6-3/4"W, 7-7/8"H, 11"D. Wt.: 43 lbs.

POWER SUPPLIES  
AC-4 Power Supply . . . . . \$120.00  
DC-4 Power Supply . . . . . 135.00



## TVI MAY BE ELIMINATED WITH THESE DRAKE FILTERS

### Drake Amateur Low Pass Filters

have four pi sections for sharp cut-off and to attenuate xmt harmonics falling in any TV channel and the FM band 52-ohm.

TV-5200-LP (formerly TV-1000-LP)

rated 1000 watts input, 200 watts on 6 meters SO-239 connectors built-in \$19.95

TV-42-LP

is a four-section filter designed with 43.2 MHz cut-off and extremely high attenuation in all TV channels for citizens band and other transmitters 30 MHz and lower. Rated 100 watts input SO-239 connectors built-in \$10.95

TV-3300-LP

1000 watts max. below 30 MHz. Attenuation better than 80 dB above 41 MHz \$19.95

TV-300-HP High Pass Filter

provides more than 40 dB attenuation at 52 MHz and lower. Protects the TV set from amateur transmitters 6 thru 160 meters. \$ 9.95

# TUFTS

## Radio Electronics

386 Main St., Medford MA 02155  
Phone: 617-395-8280

NEW ENGLAND'S  
FRIENDLIEST HAM  
STORE

Open 9 AM to 9 PM  
Mon. — Sat.



## 6 METER BEAMS

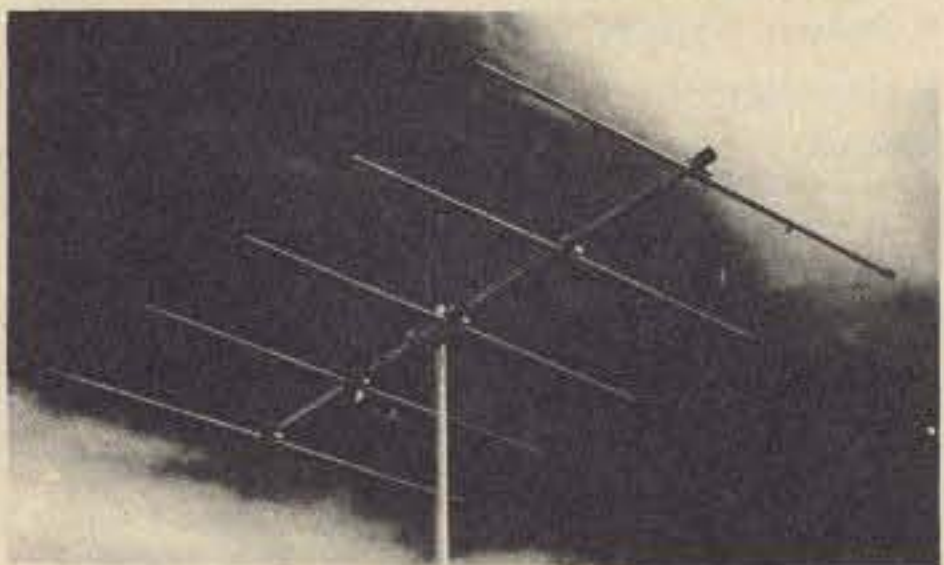

### 3-5-6-10 ELEMENTS

Proven performance from rugged, full size, 6 meter beams. Element spacings and lengths have been carefully engineered to give best pattern, high forward gain, good front to back ratio and broad frequency response.

Booms are .058 wall and elements are 3/4" - 5/8" .049 wall seamless chrome finish aluminum tubing. The 3 and 5 element beams have 1 3/8" - 1 1/4" booms. The 6 and 10 element beams have 1 5/8" - 1 1/2" booms. All brackets are heavy gauge formed aluminum. Bright finish cad plated bolts are adjustable for up to 1 5/8" mast on 3 and 5 element and 2" on 6 and 10 element beams. All models may be mounted for horizontal or vertical polarization.

New features include adjustable length elements, kilowatt Reddi Match and built-in coax fitting for direct 52 ohm feed. These beams are factory marked and supplied with instructions for quick assembly.

Description	3 element	5 element	6 element	10 element
Model No.	A50-3	A50-5	A50-6	A50-10
Boom Length	6'	12'	20'	24'
Longest El.	117"	117"	117"	117"
Turn Radius	6"	7' 6"	11'	13'
Fwd. Gain	7.5 dB	9.5 dB	11.5 dB	13 dB
F/B Ratio	20 dB	24 dB	26 dB	28 dB
Weight	7 lbs.	11 lbs.	18 lbs.	25 lbs.



**4.5 dB\* - 6 dB\*\***  
**Omnidirectional**  
**GAIN**  
**BASE STATION**  
**ANTENNAS**  
**FOR**  
**MAXIMUM**  
**PERFORMANCE**  
**AND**  
**VALUE**

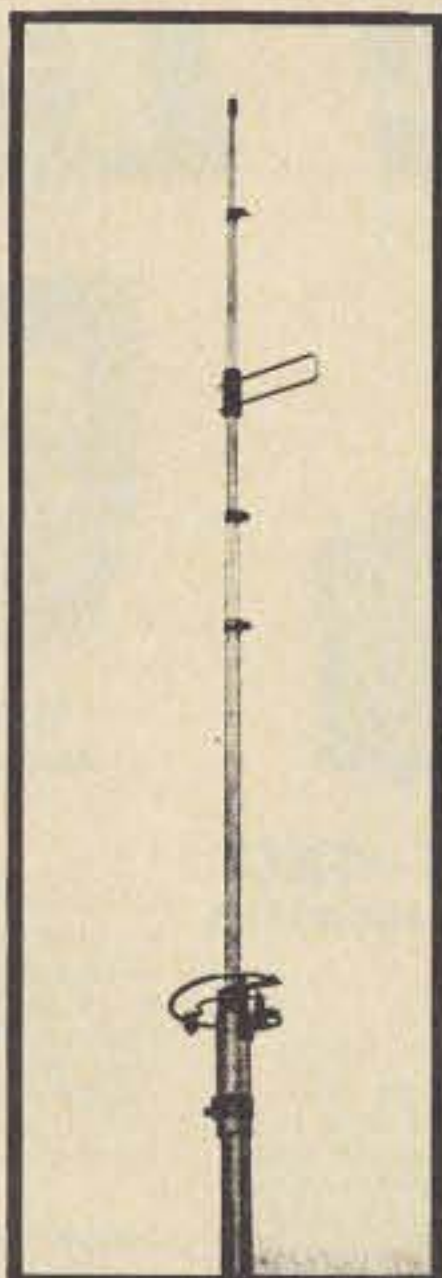

Cush Craft has created another first by making the world's most popular 2 meter antenna twice as good. The new Ringo Ranger is developed from the basic AR-2 with three half waves in phase and a one eighth wave matching stub. Ringo Ranger gives an extremely low angle of radiation for better signal coverage. It is tunable over a broad frequency range and perfectly matched to 52 ohm coax.

- ARX-2, 137-160 MHz, 4 lbs., 112"
- ARX-220, 220-225 MHz, 3 lbs., 75"
- ARX-450, 435-450 MHz, 3 lbs., 39"

\* Reference 1/2 wave dipole.  
 \*\* Reference 1/4 wave whip used as gain standard by many manufacturers.

Work full quieting into more repeaters and extend the radius of your direct contacts with the new Ringo Ranger.

You can up date your present AR-2 Ringo with the simple addition of this extend. kit. The kit includes the phasing network and necessary element extensions. The only modifications required are easy to make saw slits in the top section of your antenna.

**ARX-2K CONVERSION KIT**

## 2 METER FM ANTENNAS

**A-FM RINGO** 3.75 dB Gain (reference 1/4 wave whip). Half wave length antennas with direct dc ground, 52 ohm feed takes PL-259, low angle of radiation with 1-1 SWR. Factory preassembled and ready to install, 6 meter partly preassembled, all but 450 MHz take 1 1/4" mast. There are more Ringos in use than all other FM antennas combined.

Model Number	AR-2	AR-25	AR-6	AR-220	AR-450
Frequency MHz	135-175	135-175	50-54	220-225	440-460
Power-Hdly. Watts	100	500	100	100	250
Wind area sq. ft.	.21'	.21'	.37'	.20'	.10'

**B-4 POLE** Up to 9 dB Gain over a 1/2 wave dipole. Overall antenna length 147 MHz - 23' 220 MHz - 15', 435 MHz - 8', pattern 360° - 6 dB gain, 180° - 9 dB gain, 52 ohm feed takes PL-259 connector. Package includes 4 complete dipole assemblies on mounting booms, harness and all hardware. Vertical support mast not supplied.

- AFM-4D 144 - 150 MHz, 1000 watts, wind area 2.58 sq. ft.
- AFM-24D 220 - 225 MHz, 1000 watts, wind area 1.85 sq. ft.
- AFM-44D 435 - 450 MHz, 1000 watts, wind area 1.13 sq. ft.

**D-POWER PACK** The big signal (22 element array) for 2 meter FM, uses two A147-11 yagis with a horizontal mounting boom, coaxial harness and all hardware. Forward gain 16 dB, F/B ratio 24 dB, 1/2 power beamwidth 42°, dimensions 144" x 80" x 40", turn radius 60", weight 15 lbs., 52 ohm feed takes PL-259 fitting.

- A147-22 146 - 148 MHz, 1000 Watts, wind area 2.42 sq. ft.

**D-YAGI STACKING KITS** VPK includes horizontal mounting boom, harness, hardware and instructions for two vertically polarized yagis gives 3 dB gain over the single antenna.

- A14-VPK, complete 4 element stacking kit
- A14-SK, 4 element coax harness only
- A147-VPK, complete 11 element stacking kit
- A147-SK, 11 element coax harness only
- A449-SK, 6 + 11 element coax harness only

**E-4-6-11 ELEMENT YAGIS** The standard of comparison in VHF-UHF communications, now cut for FM and vertical polarization. The four and six element models can be tower side mounted. All are rated at 1000 watts with direct 52 ohm feed and PL-259 connectors.

Model Number	A147-11	A-147-4	A449-11	A449-6	A220-11
Boom/Longest ele.	144"/40"	44"/40"	60"/13"	35"/26"	102"/26"
Wght./Turn radius	6 lbs., 72"	3 lbs., 44"	4 lbs., 60"	3 lbs., 18"	5 lbs., 51"
Gain/F/B ratio dB	13.2/28	9/20	13.2/28	11/25	13.2/28
1/2 Power beam	48°	66°	48°	60°	48°
Wind area sq. ft.	1.21	.43	.39	.30	.50
Frequency MHz	146-148	146-148	440-450	440-450	220-225

**F-FM TWIST** 12.4 dB Gain: Ten elements horizontal polarization for low end coverage and ten elements vertical polarization for FM coverage. Forward gain 12.4 dB, F/B ratio 22 dB, boom length 130", weight 10 lbs., longest element 40", 52 ohm Reddi Match driven elements take PL-259 connectors, uses two separate feed lines.

- A147-20T 145 - 147 MHz, 1000 watts, wind area 1.42 sq. ft.

## HIGH PERFORMANCE VHF YAGIS

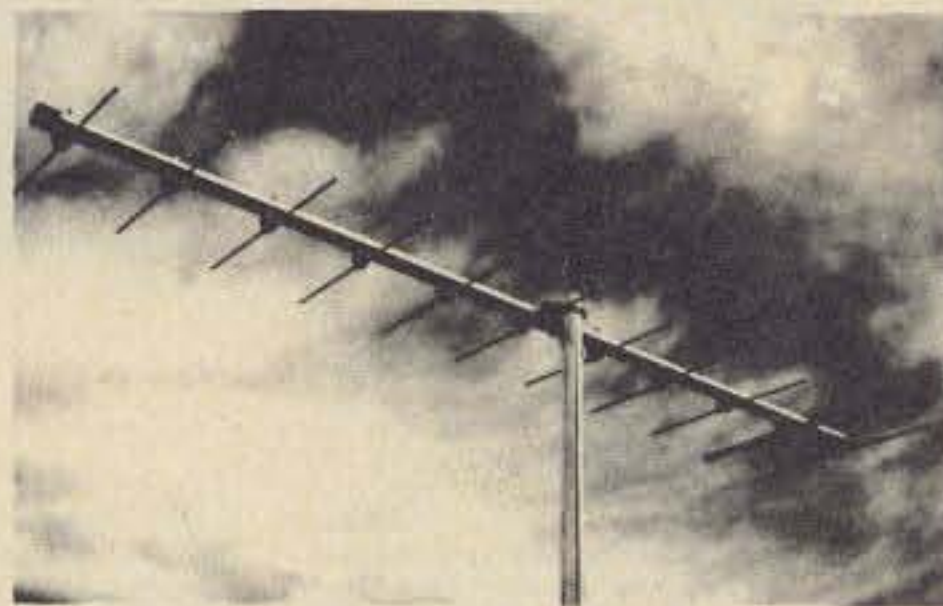

### 3/4, 1-1/4, 2 METER BEAMS

The standard of comparison in amateur VHF/UHF communications Cush Craft yagis combine all out performance and reliability with optimum size for ease of assembly and mounting at your site.

Lightweight yet rugged, the antennas have 3/16" O. D. solid aluminum elements with 5/16" center sections mounted on heavy duty formed brackets. Booms are 1" and 7/8" O. D. aluminum tubing. Mast mounts of 1/8" formed aluminum have adjustable u-bolts for up to 1-1/2" O. D. masts. They can be mounted for horizontal or vertical polarization. Complete instructions include data on 2 meter FM repeater operation.

New features include a kilowatt Reddi Match for direct 52 ohm coaxial feed with a standard PL-259 fitting. All elements are spaced at .2 wavelength and tapered for improved bandwidth.

Model No.	A144-7	A144-11	A220-11	A430-11
Description	2m	2m	1 1/2m	1 1/2m
Elements	7	11	11	11
Boom Length	98"	144"	102"	57"
Weight	4	6	4	3
Fwd. Gain	11 dB	13 dB	13 dB	13 dB
F/B Ratio	26 dB	28 dB	28 dB	28 dB
Fwd. Lobe @ 1/2 pwr. pt.	46°	42°	42°	42°
SWR @ Freq.	1 to 1	1 to 1	1 to 1	1 to 1



VHF/UHF BEAMS			
A50-3	\$ 27.50	A144-7	19.95
A50-5	39.50	A144-11	24.95
A50-6	59.50	A430-11	19.95
A50-10	89.50		

AMATEUR FM ANTENNAS			
A147-4	\$ 15.95	AFM-44D	47.50
A147-11	24.95	AR-2	18.50
A147-20T	47.50	AR-6	24.50
A147-22	69.50	AR-25	21.50
A220-7	18.95	AR-220	18.50
A220-11	22.95	AR-450	18.50
A449-6	15.95	ARX-2	28.50
A449-11	21.95	ARX-2K	11.95
AFM-4D	53.50	ARX-220	28.50
AFM-24D	49.50	ARX-450	28.50

# TUFTS

## Radio Electronics

386 Main St., Medford MA 02155  
 Phone: 617-395-8280



NEW ENGLAND'S  
 FRIENDLIEST HAM  
 STORE  
 Open 9 AM to 9 PM  
 Mon. - Sat.

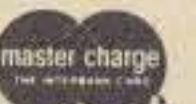



# YAESU The radio.

Model	Description	LIST
FT-101E	160-10M XCVR W/Processor	\$749
FT-101EE	160-10M XCVR W/O Processor	659
FT-101EX	160-10M XCVR W/O Processor	599
FL-2100B	Linear Amplifier	359
FTV-650B	6M Transverter	199
FTV-250	2M Transverter	229
FV-101B	External VFO	99
SP-101B	Speaker	19
SP-101PB	Speaker/Patch	59
YO-100	Monitor Scope	199
YD-844	Dynamic Base Mike	29
FA-9	Cooling Fan	19
MMB-1	Mobile Mount	19
RFP-102	RF Speech Processor	89
XF-30C	600 Hz CW Filter	45
XF-32A	8 Pole SSB Filter for FT-101	49
FR-101S	SOLID STATE, 160-2M/SW RCVR	499
FR-101 Digital	SOLID STATE, 160-2M/SW RCVR	659
Accessories:		
FC-6	6M Converter	30
FC-2	2M Converter	40
FM-1	FM Detector	20
-	Aux/SW Crystals	5
XF-30B	AM-Wide Filter	45
XF-30C	600 Hz CW Filter	45
XF-30D	FM Filter	49
SP-101B	Speaker	19

FL-101	SOLID STATE 160-10M TRANSMITTER	554
Accessories:		
RFP-101	RF Speech Processor	89
MONITOR/TEST EQUIPMENT		
YC-355	30 MHz Counter	229
YC-355D	200 MHz Counter	289
YO-100	Monitor Scope	199
YP-150	Dummy Load/Watt Meter	74
YC-601	Digital Readout (101/401 series)	179
VHF FM & SSB TRANSCEIVERS		
FT-224	24CH, 2M FM	249
FT-2	Auto 8CH/2M FM Scanner	379
200R	Sigmatizer 200CH, 2M FM Synthesizer	449
FT-620B	6M AM/CW/SSB	449
FT-221	2M AM/FM/CW/SSB	679
Accessories:		
MMB-2	Mobile Bracket (FT2A)	19
MMB-3	Mobile Bracket (200R)	19
MMB-4	Mobile Mount (FT-620B, FT-221)	19



FT-101E  
TRANSCEIVER

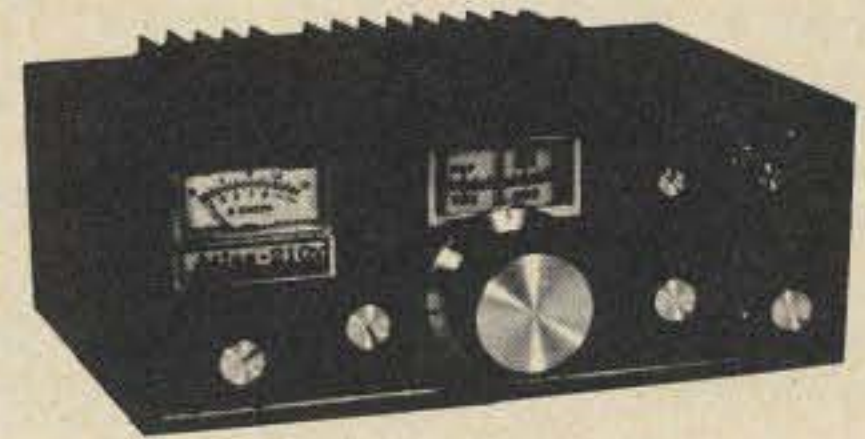

THE ATLAS  
210x/215x

- Solid state SSB/CW transceivers
- 200 watts P.E.P. input
- No transmitter tuning
- The ultimate in sensitivity, selectivity, and overload immunity.
- Plus extended frequency coverage for MARS operation when used with 10x crystal oscillator.

210x or 215x	\$649.
210x or 215x with noise blanker	\$689.
AC Console 110/220V	\$139.
Portable AC Supply 110/220V	\$ 95.
Plug-in Mobile kit	\$ 44.
10x Osc. less crystals	\$ 55.



**ATLAS**  
RADIO INC.

## TUFTS Radio Electronics Vhf engineering

386 Main St., Medford MA 02155  
Phone: 617-395-8280

MINI-CATALOG 1976  
The World's Most Complete Line of  
VHF-FM Kits and Equipment

TX144B Kit . . .	transmitter exciter — 1 watt — 2 meters	\$ 29.95
TX144B W/T . . .	same as above — factory wired and tested	49.95
TX220B Kit . . .	transmitter exciter — 1 watt — 220 MHz	29.95
TX220B W/T . . .	same as above — factory wired and tested	49.95
TX432B Kit . . .	transmitter exciter 432 MHz	39.95
TX432B W/T . . .	same as above — factory wired and tested	59.95
RX50C Kit . . .	30-60 MHz rcvr w/2 pole 10.7 MHz crystal filter	59.95
RX144C Kit . . .	140-170 MHz rcvr w/2 pole 10.7 MHz crystal filter	69.95
RX144C W/T . . .	same as above — factory wired and tested	114.95
RX220C . . . . .	210-240 MHz rcvr w/2 pole 10.7 MHz crystal filter	69.95
RX432C Kit . . .	432 MHz rcvr w/2 pole 10.7 MHz crystal filter	79.95
RXCF . . . . .	accessory filter for above receiver kits gives 70DB adjacent channel rejection	8.50
HT144B Kit . . .	2 meter — 2w — 4 channel — hand held xcvr with crystals for 146.52 simplex	129.95
PA2501H Kit . . .	2 meter power amp — kit 1w in — 25w out with solid state switching, case, connectors	59.95
PA2501H W/T . . .	same as above — factory wired and tested	74.95
PA4010H Kit . . .	2 meter power amp — 10w in — 40w out — relay switching	59.95
PA4010H W/T . . .	same as above — factory wired and tested	74.95
PA144/15 Kit . . .	2 meter power amp — 1w in — 15w out — less case, connectors and switching	39.95
PA144/25 Kit . . .	similar to PA144/15 kit except 25w out	49.95
PA220/15 Kit . . .	similar to PA144/15 for 220 MHz	39.95

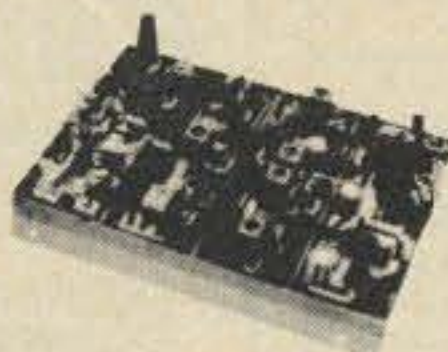
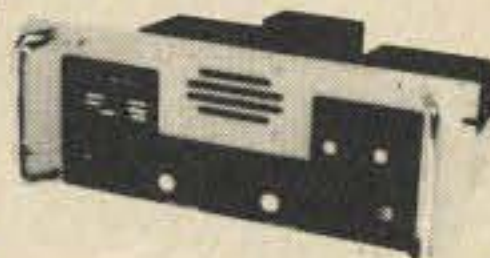

PA432/10 Kit . . .	power amp — similar to PA144/15 except 10w and 432 MHz	49.95
PA140/10 . . . . .	10w in — 140w out — 2 meter amp — factory wired and tested	179.95
PA140/30 . . . . .	30w in — 140w out — 2 meter amp — factory wired and tested	159.95
RPT144 Kit . . . . .	repeater — 2 meter — 15w — complete (less crystals)	465.95
RPT220 Kit . . . . .	repeater — 220 MHz — 15w — complete (less crystals)	465.95
RPT432 Kit . . . . .	repeater — 10 watt — 432 MHz (less crystals)	515.95
RPT144 . . . . .	repeater — 15 watt — 2 meter — factory wired and tested	695.95
RPT220 . . . . .	repeater — 15 watt — 220 MHz — factory wired and tested	695.95
RPT432 . . . . .	repeater — 10 watt — 432 MHz — factory wired and tested	749.95
PS3 Kit . . . . .	12 volt — power supply regulator card	8.95
PS15C Kit . . . . .	NEW — 15 amp — 12 volt regulated power supply w/case, w/fold-back current limiting and overvoltage protection	79.95
PS15C W/T . . . . .	same as above — factory wired and tested	94.95
PS25C Kit . . . . .	NEW — 25 amp — 12 volt regulated power supply w/case, w/fold-back current limiting and overvoltage protection	129.95
PS25C W/T . . . . .	same as above — factory wired and tested	149.95

### OTHER PRODUCTS BY VHF ENGINEERING

CD1 Kit . . . . .	10 channel receive xtal deck w/diode switching	6.95
CD2 Kit . . . . .	10 channel xmit deck w/switch and trimmers	14.95
COR2 Kit . . . . .	complete COR with 3 second and 3 minute timers	19.95
SC3 Kit . . . . .	10 channel auto-scan adapter for RX	19.95
Crystals . . . . .	we stock most repeater & simplex pairs from 146.0-147.0 (each)	5.00

# Get on the air NOW! Let Tufts put you there!

**EL CHEAPO SPECIAL**  
146A Nicad batteries, carrying case, base charger 34/94, 94/94 direct ..... \$300.00



Walkie Talkie 146 A

Penny Pincher 146A all XTALS (Specify three frequencies) ..... \$298.00

SCOTCH TREAT SPECIAL as above includes rubber ducky antenna.

Nicads with base charger ..... \$335.00

SCOTCH DELUXE as above plus Deluxe carrying case ..... \$349.00

THE WORKS: all channels your choice spare Nicad Battery pak ..... \$400.00

Touch Tone mounted on back with plug which will mate to PL deck - \$75 each. Avail. separately or with purchase.



Magnetic Mount or Gutter Clamp 5/8 wave - \$38.50  
Specify, 2 meters, 220, 450. 1/4 wave - \$18.50

## Larsen Antennas

Larsen Antennas to fit Any Mobile Unit

3/8" single hole mount 5/8 wave \$31.50  
1/4 wave 11.50

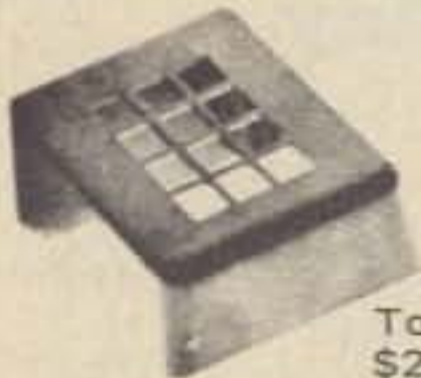

Touch Tone Enclosures  
\$2.95 @. Colors: Beige, Grey, Black



## BOMAR

Novice Crystals  
(Specify Band Only)

Crystal Company

CRYSTALS IN STOCK

Standard Icom Heathkit Ken Clegg  
Regency Wilson VHF Eng Drake And Others

\$4.50 each - LIFETIME GUARANTEE

Make/Model	Xmit Freq.	Rec. Freq.

Please enclose \$2.00 for shipping with your order.

## THE FIRST AND STILL THE LEADER!



**the IC230** \$489.00

Put Over 67 Channels in the Palms of Your Hands

### SPECIAL FEATURES

- No more Crystals - Over 67 fully synthesized channels available.
- All Channel Capability - Travel with confidence that you'll be able to work all repeaters along the way.
- Super Compact - 7.28" high x 6.14" wide x 9.72" deep at a weight of only 5.5 lbs.
- Quick Diamond Mobile Mount - Allows quick car installation.
- Easy Operation - Punch up frequency, select repeater or simplex mode, and you're on the air. (A crystal may be added for a unique repeater frequency.)
- Modular Construction - In case of a problem, modules can easily be removed and sent for repair. A replacement module will be air mailed to minimize down time.
- Super Hot Receiver - Better than Auvi200s sensitivity, helical filters to eliminate "warmot" ... plus a super E filter and a modulator front end.

If There Is A Signal, You'll Hear It On The IC-230!

\$50 Merchandise Credit  
with each IC-230

### HOW TO SAVE \$75.00

#### WHEN YOU BUY YOUR IC-22A FROM TUFTS

With each IC-22A at \$249.00, get your choice of 15 channels of crystals at only \$2.50 per crystal.



### IC-22A

146 MHz FM 10 W Transceiver

- 22 channel capacity
- 10 W nominal power output w/one Watt low power position
- Frequency range 146-148 MHz
- Intermediate Frequencies 10.7 MHz First I.F., 455 kHz second I.F.
- .4 microvolts sensitivity for 20 dB quieting, .3 microvolts for 12 dB SINAD
- Audio power - 1 Watt into 8 Ohms



IC-21A 146 MHz FM 10W transceiver - \$399. DV-21 Digital VFO - \$299.

**IC-21A**  
\* Low intermod. due to MOS-FET RF Amp and 5 helical resonator filter, plus 3 I.F. filters.

\* IDC modulation control provides for minimum bandwidth and channel splatter.

\* Virtually no intermod. Due to MOS FET RF amp and 5 helical cavities in the front end plus FET mixer and 3 I.F. filters.

\* Variable output power. 10 watts output or another output between 500 milliwatts and ten watts may be selected by an external control.

\* S.W.R. bridge, built right into the front panel of the IC-21A, is an accurate meter for VHF

S.W.R. bridge. An invaluable aid in VHF antenna experiments!  
\* The IC-21A contains both the 117 VAC and the 13.6 VDC power supplies.

### DV-21

\* The perfect companion for your IC-21 or IC-21A, the DV-21 is a unique digital synthesizer to complete your ICOM 2 meter station. The DV-21 will operate in 10 kHz steps over the entire 2 meter band. It can also scan frequencies being used. Completely separate selection of the transmit and receive is as simple as touching the keys. Release the mic switch, and the receive frequency is displayed. There are

also two programmable memories for your favorite simplex frequencies. You won't believe the features and versatility of the DV-21 until you've tried it.

\* Advanced feature of the DV-21 - the ability to capture 5 kHz split tertiary with a 10 kHz synthesizer. The 0.5 kHz offset provides the mean to get exactly on the frequency; but even in the scan mode, the channel may be scanned and understood.

\* The DV-21 has its own built-in 117 AC power supply as well as the ability to operate from the 12 VDC line.



Touchtone® Handset (TTH-230) - \$99.95



500 OHM Microphone - \$175.00



Mobile Mount (IC-MM) - \$13.95



Base Microphone - \$39.50



DC Power Cord (IC-DCC) - \$5.00  
Power Connector Only (IC-PC) - \$5.00



Revers & Reading Dial for 22A - \$2.00



ICOM EAST, INC.



IC 3 PA Regulated Power Supply with Speaker - \$89.95



9-Pin Accessory Plugs (9PP) - \$2.00



Burglar Alarm - \$34.95



ARGONAUT, MODEL 509 AMPLIFIER, MODEL 405



TRITON IV

Model 206



**TRITON IV** A new push-pull final amplifier with the latest gold metalized, zener protected transistors, operating at 200 input watts on all hf bands 3.5 through 29.7 MHz. Plus a new crystal heterodyne VFO for improved short and long term frequency stability and uniform 1 kHz readout resolution, even on ten meters. Unsurpassed selectivity is yours with the new eight pole i.f. crystal filter, and improved spurious rejection results from the new IC double balanced mixer.

Many small circuit improvements throughout, taken collectively, add more performance and quality pluses — such things as individual temperature compensated integrated circuit voltage regulators for final bias control and VFO supply. And toroid inductances in the ten and fifteen meter low pass filters, LED indicators for offset tuning and ALC threshold, accessory socket for added flexibility, and sequentially keyed mute, AGC and transmitter

circuits for even better shaped and clickless CW.

**TRITON IV** ..... \$699.00  
12 ac supply, with a built-in speaker and VOX = 262G ..... \$129.00

**ARGONAUT, MODEL 509**

Covers all Amateur bands 10-80 meters. 9 MHz crystal filter. 2.5 kHz bandwidth. 1.7 shape factor @ 6/50 dB points. Power required 12-15 VDC @ 150 mA receive, 800 mA transmit at rated output. Construction: aluminum chassis, top and front panel, molded plastic end panels. Cream front panel, walnut vinyl top and end trim. Size: HWD 4 1/8" x 13" x 7". Weight 6 lbs.

**LINEAR AMPLIFIER, MODEL 405**

Covers all Amateur bands 10-80 meters. 50 watts output power, continuous sine wave, RF wattmeter, SWR meter. Power required 12-15 VDC @ 8 A, max. Construction: aluminum chassis, top and front panel, molded plastic side panels. Cream front

panel, walnut vinyl top and end trim. Size: HWD 4 1/8" x 7" x 8". Weight 2 1/2 lbs.

**Argonaut, Model 509** ..... \$329.00  
**Linear Amplifier, Model 405** ..... 159.00  
**Power Supply, Model 251**  
(Will power both units) ..... 79.00  
**Power Supply, Model 210**  
(Will power Argonaut only) ..... 27.50

**MODEL 206 CRYSTAL CALIBRATOR SPECIFICATIONS**

Power Required: 9 to 12 VDC @ 8 mA.  
Fundamental Frequency 100 kHz  
Circuit Description: Pierce crystal oscillator, followed by Schmitt trigger. Output gated from unijunction oscillator.  
Calibration: Adjustable to WWV with internal variable capacitor.  
Size: HWD 2-1/8" x 4-3/8" x 4-1/8"  
Weight: 1/2 lb.

**Model 206 Crystal Calibrator** ..... \$26.95

**KR20-A ELECTRONIC KEYS**

A fine instrument for all-around high performance electronic keying. Paddle actuation force is factory adjusted for rhythmic smooth keying. Contact adjustments on front. Weighting factor factory set for optimum smoothness and articulation. Over-ride "straight key" conveniently located for emphasis, QRS sending or tune-up. Reed relay output. Side-tone generator with adjustable level. Self-completing characters. Plug-in circuit board. For 117 VAC, 50-60 Hz or 6-14 VDC. Finished in cream and walnut vinyl. **PRICE \$67.50**

**KR5-A ELECTRONIC KEYS**

Similar to KR20-A but without side-tone oscillator or AC power supply. Ideal for portable, mobile or fixed station. A great value that will give years of troublefree service. Housed in an attractive case with cream front, walnut vinyl top. For 6-14 VDC operation. **PRICE \$38.50**

**KR1-A DELUXE DUAL PADDLE**

Paddle assembly is that used in the KR50, housed in an attractive formed aluminum case. **PRICE \$25.00**

**KR2-A SINGLE LEVER PADDLE**

For keying conventional "TO" or discrete

character keyers, as used in the KR20-A.

**PRICE \$15.00**

**KR50 ELECTRONIC KEYS**

A completely automatic electronic keyer fully adjustable to your operating style and preference, speed, touch and weighting, the ratio of the length of dits and dahs to the space between them. Self-controlled keyer to transmit your thoughts clearly, articulately and almost effortlessly. The iambic (squeeze) feature allows the insertion of dits and dahs with perfect timing.

An automatic weighting system provides increased character to space ratio at slower speeds, decreasing as the speed is increased, keeping the balance between smoothness at low speeds and easy to copy higher speed. High intelligibility and rhythmic transmission is maintained at all speeds, automatically.

Memories provided for both dits and dahs but either may be defeated by switches on the rear panel. Thus, the KR50 may be operated as a full iambic (squeeze) keyer, with a single memory or as a conventional type keyer. All characters are self-completing.

**PRICE \$110.00**

**SPECIFICATIONS**

Speed Range: 6-50 w.p.m.  
Weighting Ratio Range: 50% to 150% of classical dit length.

Memories: Dit and dah. Individual defeat switches.

Paddle Actuation Force: 5-50 gms  
Power Source: 117VAC, 50-60 Hz, 6-14 VDC

Finish: Cream front, walnut vinyl top and side panel trim.

Output: Reed relay. Contact rating 15 VA, 400 V, max.

Paddles: Torque drive with ball bearing pivot.

Side-tone: 500 Hz tone.

Adjustable output to 1 volt.

Size HWD: 2 1/2" x 5 1/2" x 8 3/4"

Weight: 1 1/4 lbs.

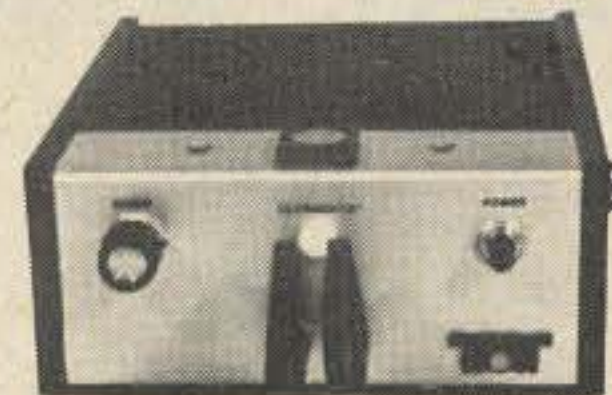

KR50A



Model 310-001: Standard Key, nickel plated hardware, no switch — \$6.65.

Model 310-003: Standard Key, nickel plated hardware, with switch — \$8.25.

Model 320-001: Standard Heavy Duty Key with nickel plated hardware, no switch — \$8.20.

Model 320-003: Same as -001 except with switch — \$9.35.

Model 404-002 SSK-1: Chrome Plated - \$29.95; Black Wrinkle Finish - \$23.95.

Code Practice Set with Key - \$18.50.



310-003



322-001



SSK-1



404-002

**Mobile Amplifiers With Versatility**



- Fully VSWR & reverse voltage protected
- No tuning required across band
- Switchable Class C or AB operation
- Built-in TR switching, w/increased delay for SSB
- Fully compatible with all 1-15W FM/SSB/AM/CW rigs
- All solid-state and microstrip construction

**SPECIALTY COMMUNICATIONS SYSTEMS, INC.**

FREQUENCY MHz	MODEL	INPUT POWER NOM.W	OUTPUT POWER NOM.W	OPERATING CURRENT @13.6VDC	SIZE CM HXWXL	RETAIL PRICE
50-54	6M10-100L	10	100	12	7.1X10.2X22.9	\$169.95
144-148	2M10-70L	10	70	8	7.1X10.2X16.5	139.95
144-148	2M10-140L	10	140	19	7.1X10.2X26.7	219.95
220-225	1.3M10-60L	10	60	7	7.1X10.2X16.5	159.95
420-450	70CM2-10L	2	10	2	7.1X10.2X16.5	109.95
420-450	70CM10-40L	10	35	6	7.1X10.2X16.5	139.95

**TUFTS**

NEW ENGLAND'S FRIENDLIEST HAM STORE

Radio Electronics

386 Main St., Medford MA 02155  
Phone: 617-395-8280

Open 9 AM to 9 PM  
Mon. — Sat.



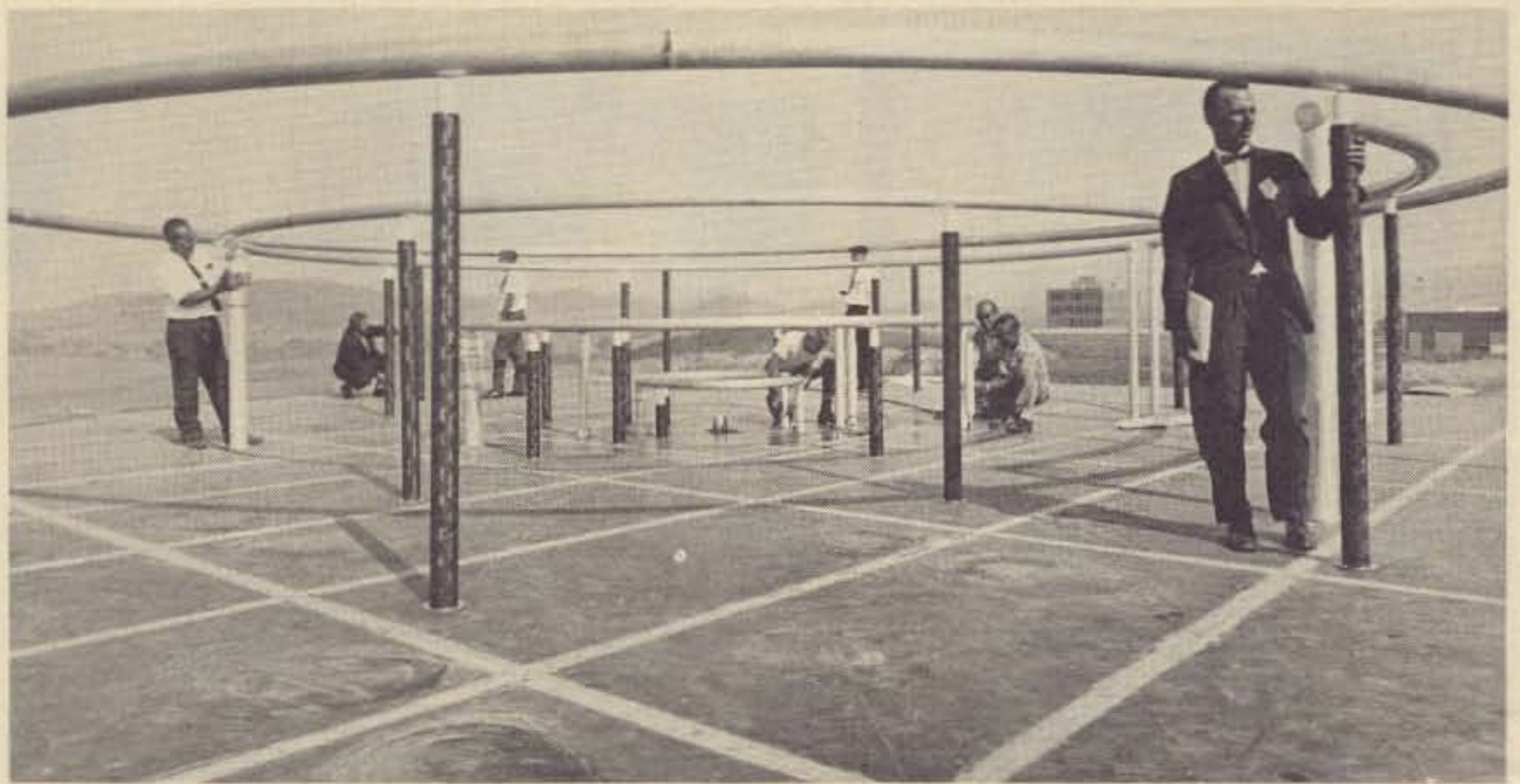

Joseph M. Boyer  
17302 Yukon, Suite 63  
Torrance CA 90504

Northrop Corporation Photo

# The Surprising DDDR

## Low Noise Antenna

-- part II

The intent of this two part article is to describe certain modern transmitting antennas of small electrical size useful to the radio amateur who has limited outdoor space available in which to erect radiators of conventional design. All the antennas discussed, such as the DDDR, LPT, and magnetic transmitting doublet, are forms of radiating rf transmission lines. Each is capable of rapid frequency tuning using very low loss

variable condensers. Most are narrowly banded in frequency response due to small electrical size and low radiation resistance; this seeming limitation, however, turns out to afford a substantial improvement in signal-to-noise ratio during the receiving phase of the two way communications process.

By the end of Part I the reader had been provided with the relations needed to design a DDDR antenna for optimum tuning across any

amateur band (or a bit more), and to match it directly to standard fifty Ohm coaxial feed transmission line to obtain low vswr across an entire ham band. Here the DDDR design will be completed and, in the process, any need for use of space-consuming radial wire ground plane systems will be removed.

### Radiation Resistance of Small Antennas

Radiation resistance  $R_r$

can be defined in terms of the amount of energy an antenna loses per rf cycle to a distant space region occupied by all the other antennas in the universe (as compared to that supplied to its input terminals). The radiation energy loss must be related to a "distant space" region because in its "near space" an antenna also stores input power within a field surrounding its conductors. Such stored field power exists in the form of a standing wave,

the energy merely flowing back and forth between the antenna and near space during each rf cycle; this space standing wave antenna field is very much like that found very close to *open wire, rf transmission lines*.

As the size of an antenna shrinks in comparison to the wavelength  $\lambda$  at which it is operated, less and less of its supplied power is lost as radiation per rf cycle into the far space, and more and more is stored in its near zone standing wave field. By the definition given here, then, the radiation resistance  $R_r$  of electrically short antennas is small in value. Although the exact EM field process which creates antenna radiation is a complex subject, it is possible to give the radiation resistance of monopole antennas whose length  $h^\circ$  is equal to or less than thirty-six electrical degrees quite simply. We will start off by giving two *engineering-type axioms*:

1.0. When an electrically short monopole antenna operating either over ground or its electrical image is brought to electrical resonance *solely* by placing a reactance  $jX_1$  in series between its base and ground to cancel out the antenna's self-reactance, such an antenna possesses a current distribution yielding *minimum* radiation resistance in relation to its conductor length  $h$  in degrees.

2.0. When an electrically short monopole antenna operating either over ground or its electrical image is brought to electrical resonance *solely* by placing a reactance  $jX_2$  in parallel with its top end and ground to cancel out the antenna's self-reactance, such an antenna possesses a current distribution yielding *maximum* radiation resistance in relation to its conductor length  $h$  in degrees.

The term "engineering" is used here in giving the two

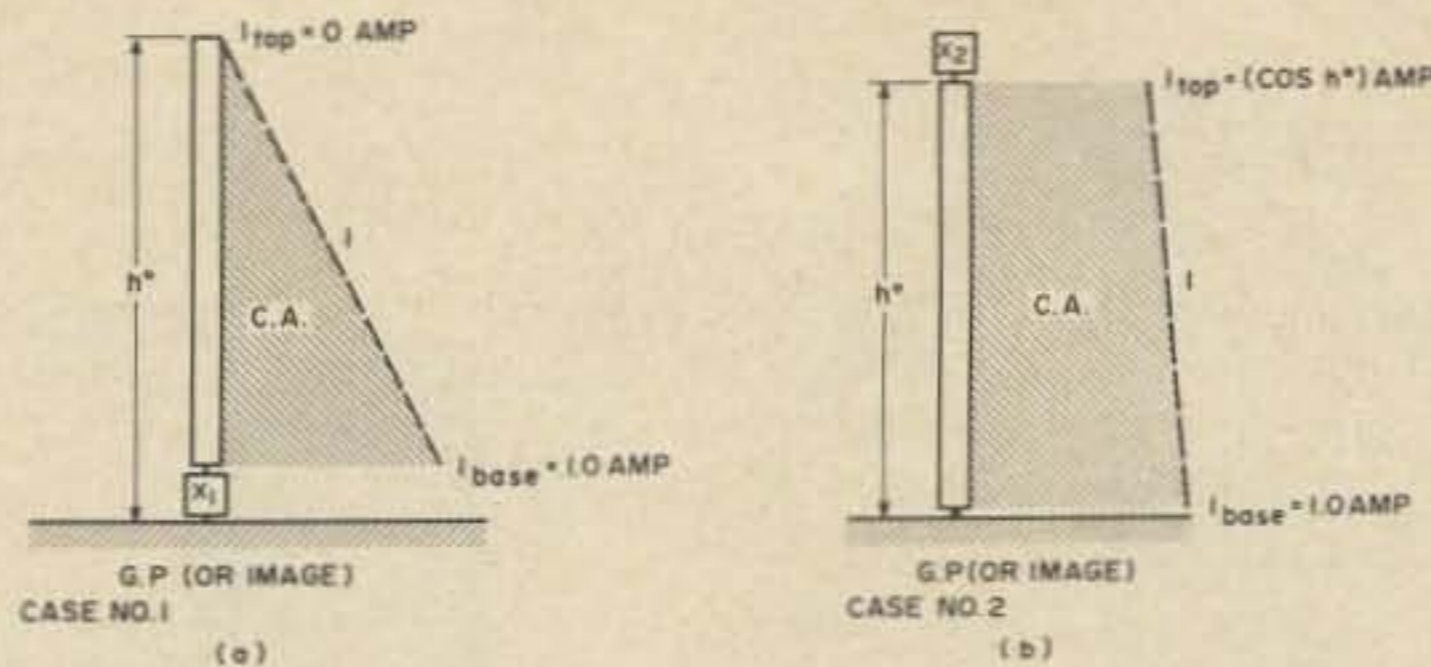

Fig. 1. Limiting cases of current distribution along electrically short, cylindrical monopole antennas resonated solely with (a) base reactance and (b) top reactance. Height  $h^\circ$  is equal to or less than thirty-six electrical degrees.

axioms because they are limited by the following premise: The loading reactances  $jX_1$  or  $jX_2$  are not themselves sources of wave radiation which is in phase opposition to the radiation produced by the short antenna. With such a restriction understood, the current distributions for these two types of reactance loading limits of the small antenna are given in Fig. 1 (a, b). Each antenna's current distribution is assumed to be in the form of a sine wave. However, the shape of the current distribution in each antenna is straight-sided because a plot of the function  $\sin h^\circ$  over a distance less than thirty-six degrees produces a graph which "looks" like a straight line.

In Fig. 1(a) for the short monopole solely base-loaded, the antenna current goes to zero magnitude at its conductor top end because at this point it is "open circuited" into free space. At the base of this monopole the *relative* resonant current amplitude there is assumed to be equal to 1.0 Amperes. Inside the straight-sided current distribution shapes of both antennas, the shaded region is labeled CA. This means current area or, more specifically: *relative current distribution area*. With the antenna height  $h^\circ$  given in degree units and the current relative amplitude given in Amperes, these relative areas CA have the dimen-

sions of *degree-Amperes*. For the solely base-loaded monopole of Fig. 1(a) (case 1.0), the triangularly shaped current distribution area CA is found from plane geometry as

$$CA_{\text{(base loaded)}} = \frac{1}{2} \left[ h^\circ (1.0 \text{ Amp}) \right] \text{ degree-Amperes} \quad (2.1.0)$$

For the solely top-loaded monopole of Fig. 1(b) (case 2.0), the trapezoid-shaped current distribution area CA is

$$CA_{\text{(top loaded)}} = \frac{1}{2} \left[ h^\circ (1.0 \text{ Amp} + \cos h^\circ \text{ Amp}) \right] \text{ degree-Amperes} \quad (2.2.0)$$

In this case the current amplitude at the antenna conductor top is no longer zero Amperes; with resonance produced solely by the top reactance  $jX_2$ , the current  $I_{\text{top}}$  now equals  $(\cos h^\circ)$  Amperes in relative value. The current  $I_{\text{base}}$  is still assumed to be equal to 1.0 relative Amperes. In terms of such *relative*<sup>1</sup> current distribution area CA, the radiation resistance  $R_r$  of short monopole antennas of height  $h^\circ$  equal to or less than thirty-six electrical degrees is just

$$R_r = 0.01215 (CA \text{ degree-Amperes})^2 \text{ Ohms} \quad (2.3.0)$$

Electrically short doublets in free space, of total length  $2h^\circ$ , have a radiation resistance  $R_r$  twice as large as that given by (2-3.0) when each "monopole" half of such doublet is loaded as stated here. Equation (2-3.0) is important in the design of

electrically small antennas because it emphasizes that radiation resistance  $R_r$  is *not a constant* for a given monopole height  $h^\circ$ , but may be increased by *control* of the current distribution along the short antenna.

### Radiation Resistance of the DDRR Antenna

The reader may recall from Part I that the electrical height  $h^\circ$  of the six foot vertical post conductor in the 75 meter band DDRR antenna was 8.78 degrees at 4.0 MHz. Viewed as a monopole antenna, Schelkunoff's equation (1-2.0) gave the average characteristic impedance of the four inch diameter conductor transmission line as  $K_M = 197.57$  Ohms. It is noted that  $K_M$  does not enter into the expression for radiation resistance. If we wished, however, to use just such a post itself as a simple cylindrical monopole over ground,  $K_M$  would come in handy in determining the value of the reactance  $jX_1$  needed to solely bring it to resonance at 4.0 MHz by *base loading*:

$$jX_1 = jX_{\text{coil}} = jK_M \cotan h^\circ = j197.57 \cotan 8.78^\circ = +j1,279.18 \text{ Ohms}$$

For the vertical post, used as a simple monopole antenna, (2-1.0) gives us the CA for this case as

$$CA_{\text{(base loaded)}} = \frac{1}{2} \left[ 8.78^\circ (1.0 \text{ Amp}) \right] = 4.390 \text{ degree-Amperes}$$

The radiation resistance for this case would then be

$$R_r \text{ (base loaded)} = 0.01215 (4.390 \text{ degree-Amperes})^2 = 0.234 \text{ Ohms}$$

Now, if the missing elements of the DDRR antenna system consisting of the horizontal ring transmission line section of  $S^\circ$  and the tuning condenser C were restored and adjusted to resonate the DDRR at 4.0 MHz, we would have case 2.0. As cosine 8.78 degrees equals 0.988, this becomes the relative magnitude of  $I_{\text{top}}$  in Amperes, giving for CA:

$$\begin{aligned} CA_{\text{(DDRR)}} &= 8.728 \text{ degree-Amperes} & (4.0 \text{ MHz}) \\ R_r \text{(DDRR)} &= 0.926 \text{ Ohms} & (4.0 \text{ MHz}) \end{aligned}$$

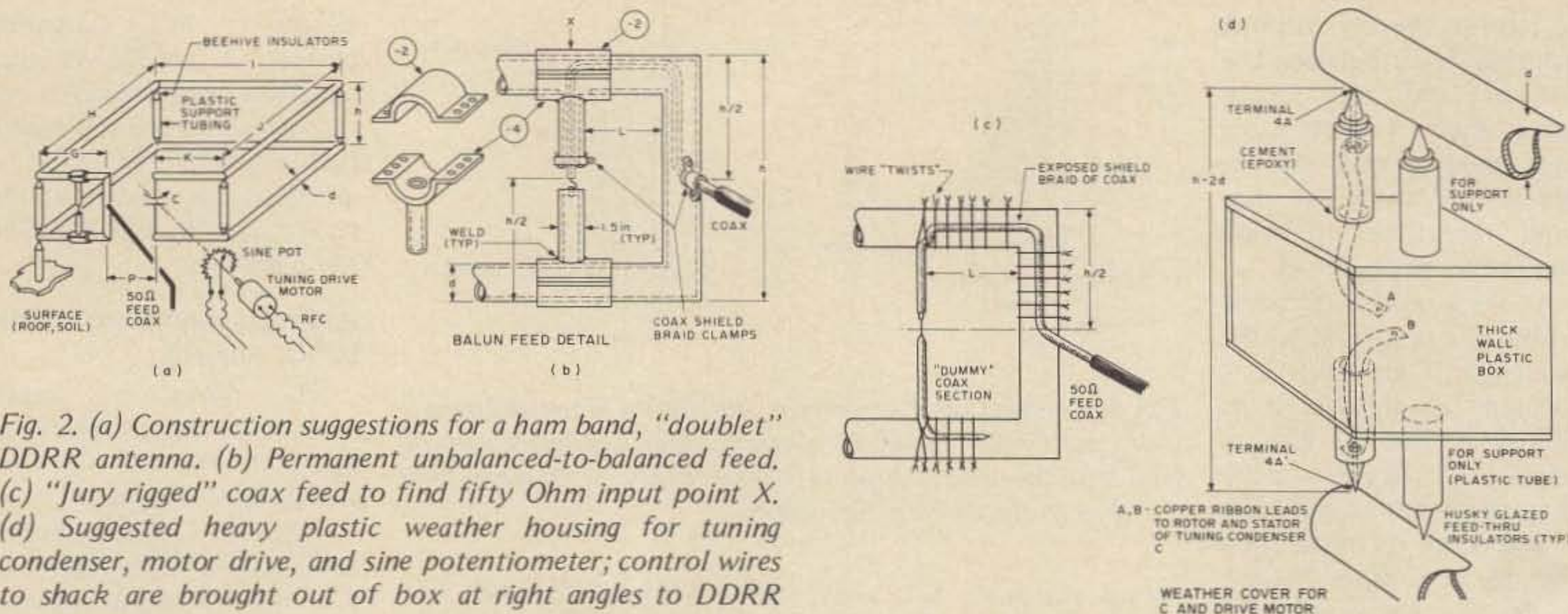

Fig. 2. (a) Construction suggestions for a ham band, "doublet" DDRR antenna. (b) Permanent unbalanced-to-balanced feed. (c) "Jury rigged" coax feed to find fifty Ohm input point X. (d) Suggested heavy plastic weather housing for tuning condenser, motor drive, and sine potentiometer; control wires to shack are brought out of box at right angles to DDRR conductors.

Needless three decimal place accuracy was used here because the current ratio  $I_{top}/I_{base}$  of the DDRR at 4.0 MHz closely approaches unity, giving almost a four-to-one increase in radiation resistance over the same monopole antenna solely base-loaded to resonance. A four-to-one increase in radiation resistance  $R_r$  represents the theoretical upper limit attainable for a short monopole antenna as compared to its  $R_r$  when solely base-loaded. Does that mean that the DDRR antenna actually reaches the theoretical limit of loading for short antennas? Not quite! This is where the limitation placed on the axioms comes in; because the DDRR tuning condenser C has displacement current  $I_{cap}$  flowing through it in proportion to its capacity setting, it represents a concentrated radiation source itself. As the current flow  $I_{cap}$  is in the opposite direction to the conduction current  $I_{base}$  in the vertical post monopole, the total effect is to "drive down" the effective radiation resistance  $R_e$  of the DDRR as a system. This effect is represented by the equation

$$R_e = R_r(DDR) \left[ 1 - \frac{I_{cap}}{I_{base}} \right]^2 \text{ Ohms} \quad (2.4.8)$$

The detrimental effect on

$R_e$  of the DDRR represented by (2-4.0) is negligible at 4.0 MHz due to the high reactance  $-jX_c$  of the tuning condenser set to minimum capacity. Although not serious, it becomes worthy of notice at 3.5 MHz. Hence the warning in Part I related to attempting to make one ring element cover two hf bands.

#### Frequency Bandwidth of Antennas

A practical way to describe the concept of antenna frequency bandwidth is as follows: Assume that at the resonant frequency  $f_0$  of the DDRR the correct feed point X (discussed in Part I) and ground produces an input impedance  $Z_{in} = 50 + j0$  Ohms; a fifty Ohm coaxial line connected to the DDRR there would display a vswr of 1.0:1 at  $f_0$ . Now, *without retuning* the DDRR capacitor C, assume that the transmitter frequency only is increased to some higher frequency  $f_{high}$  where  $Z_{in} = 50 + j50$  Ohms; then assume that the transmitter frequency only is reduced below  $f_0$  to some frequency  $f_{low}$  where  $Z_{in} = 50 - j50$  Ohms. At frequencies  $f_{high}$  and  $f_{low}$  the feed coax vswr would increase to 2.6:1. The total frequency span  $f_{high} - f_{low}$  is the *half power* width of the antenna. In the DDRR antenna case it is the *fixed-*

*tune* half power frequency bandwidth. In the case of non-tunable antennas such as a half wave doublet, quarter wave vertical, yagi, etc., it is the antenna half power frequency bandwidth, period! Another way to describe this term is that at  $f_{high}$  and  $f_{low}$  the reactive part of antenna input impedance  $jX_{in}$  becomes equal to the resistive part  $R_{in}$ .

In Part I we mentioned that a transmission line antenna could be regarded as a highly *mismatched*, open wire transmission line "stub" section and that, due to such mismatch, the line stub possessed high amplitude standing waves along its length (*on* the antenna itself; *not* in the feedline to it). All hf antennas are forms of relatively mismatched rf transmission line stubs. The term "mismatched" is used in relation to a mismatch between the antenna wave impedance and the distant space wave impedance  $Z_0$  equals 377 Ohms. The lower the antenna radiation resistance value  $R_r$  is, (for a fixed value of ohmic environmental loss  $R_\Omega$ ), the higher the vswr on the antenna itself. The vswr on small antennas does not go to infinity to one, however, because a small amount of input power energy is (a) lost in the small but finite  $R_r$  and

(b) lost into  $R_\Omega$  in heating the antenna's near zone EM environment.

This vswr on the antenna itself can be related to the antenna half power frequency width or antenna Q. To get the right answers using conventional methods is very difficult and requires use of higher mathematics. Fortunately, Schelkunoff comes to the rescue in making things easy for us with his very useful expression for the characteristic impedance of an antenna as an rf transmission line. When you know  $K_m$  — and can calculate  $R_r$  from the simple equations (2-1.0), (2-2.0), and (2-3.0) — difficulties evaporate. All you need then are the following relations:<sup>2</sup>

$$m = \frac{K_m R_r}{K_m + R_r} \quad (2.5.0)$$

$$Q = \frac{1+m}{1-m} \quad (2.5.1)$$

$$f_{high} - f_{low} = \frac{f_0}{Q} \quad (2.5.2)$$

As an example, let us take the calculations we just made for the case of the vertical post monopole element of the 75 meter band DDRR. Our  $K_m$  (regardless of loading) was 197.57 Ohms. When solely base-loaded, the DDRR monopole post alone gave us an  $R_r$  equal to 0.234 Ohms at 4.0 MHz. For this case,

**Clegg**  
invites you to  
join us in our...

# 25<sup>th</sup> Anniversary Celebration!!



THE UNEQUALLED  
**FM-DX**  
REGULARLY ~~\$645.00~~

- 35 Watts • 143.5 to 148.5 MHz • Digital Display •
- Fully Synthesized in 5 kHz Steps • .25 uv Receiver •

FACTORY DIRECT  
ANNIVERSARY SPECIAL \$599.00

**ORDER DIRECTLY FROM CLEGG**

THESE TWO UNITS HAVE BEEN OUTSTANDING VALUES AT ~~\$189.50~~



10 Watt FM-76 for 220 MHz

THE *Clegg* ECONOMY LINE

12 Channels • Individual trimmers for Receiver and Transmitter crystal Netting • Big Clear Panel Meter • Superb Receiver • Crisp Clear Audio on Receive and Transmit • Rugged, Compact, Attractive.

## ANNIVERSARY SPECIAL

10 watt FM-76 for 220 MHz only \$165.

15 watt MARK-3 for 146 MHz only \$169.<sup>50</sup>



15 Watt MARK-3 for 146 MHz

Join us in celebrating our 25th Anniversary by calling TOLL FREE today and ordering any of these units at our special limited time prices!  
Phone 1-(800)-233-0250 Mastercharge & BankAmericard orders welcomed.

**Clegg COMMUNICATIONS Corp.**  
208 Centerville Rd., Lancaster, PA 17603



$$m = \frac{197.57 - 0.234}{197.57 + 0.234} = 0.9976 \quad Q = \frac{1 + 0.9976}{1 - 0.9976} = 832.33$$

$$f_{\text{high}} - f_{\text{low}} = \frac{4.0 \times 10^6 \text{ Hz}}{832.33} = 4.80 \times 10^3 \text{ Hz} = 4.80 \text{ kHz}$$

The same height post monopole of  $K_m = 197.57$  Ohms, when solely top-loaded as an element of the DDRR antenna, produced an initial value of  $R_f$  equal to 0.93 Ohms. As  $C$  is set to minimum capacity at 4.0 MHz, its reactance is high and can be calculated. Therefore, let us set  $R_e(\text{DDRR})$  equal to 0.850 Ohms at 4.0 MHz. Then again,

$$m = \frac{197.57 - 0.850}{197.57 + 0.850} = 0.9914 \quad Q = \frac{1 + 0.9914}{1 - 0.9914} = 231.56$$

$$f_{\text{high}} - f_{\text{low}} = \frac{4.0 \times 10^6 \text{ Hz}}{231.56} = 17.27 \times 10^3 \text{ Hz} = 17.27 \text{ kHz}$$

Again here, we have employed needless decimal point accuracy to illustrate the method, using relations which are approximations. Nevertheless, the answers secured are useful. It is seen that using the monopole base-resonated with a *lossless* loading coil, the half power frequency bandwidth obtained is just barely wide enough to pass a 3 kHz SSB signal or CW-type transmission. Conversely, the same monopole — as part of the DDRR — would easily pass "high fidelity" double side-band AM; however, we based our calculations on  $R_f$  alone. As  $R_\Omega$  adds to  $R_f$  in terms of the "dampening" of the vswr on the antenna system, both antennas would actually display a wider bandwidth found by substituting  $R_t$  equals  $R_f + R_\Omega$  in (2-5.0). We don't know what  $R_\Omega$  is in value as yet, but we certainly wish in some way to keep it to a minimum. Securing antenna bandwidth increase due to the "swamping" influence of  $R_\Omega$  is a poor way to go, as it will drop antenna efficiency  $N$  as

$$N = \frac{R_r}{R_r + R_\Omega} \times 100\%$$

(2-4.8)

We will include the environmental ohmic loss resistance  $R_\Omega$  in our discussion a bit later. Here is a critical

point, however: In two-way hf communications, employing a *single antenna*, we wish to secure a total half power antenna bandwidth just wide enough to pass the data information rate to be communicated (CW speed, FM, SSB spectral content) while avoiding excess or redundant antenna bandwidth. During the transmission phase of our communications, an increase in antenna bandwidth of fifty octaves or more greater than we need doesn't count one way or the other. In the reception mode of our two-way communications, however, excess antenna bandwidth permits more random noise to pass and load the front end of the receiver to effectively decrease signal-to-noise ratio. Too wide an antenna bandwidth also increases the QRM we experience on the desired signal we are trying to copy in the presence of strong, just-off channel carriers. Modern communications receivers rely heavily on i-f selectivity. Here, we wish to assist the front end stages of the receiver by placing a narrow, tunable, "bandpass filter" between them and the rf universe — in the form of the antenna.

I said "tunable!" That is a key factor here. When we use antennas which exhibit a narrow but just "wide enough" bandwidth, we must be able to move this filter "slot" quickly in frequency to carry on practical hf communications. If we secured such a narrow frequency width "slot" from an electrically small antenna resonated solely by the lowest possible loss, extremely high  $Q$  loading coil placed very high up in the monopole (to increase CA), the instant we tried to vary the coil inductance (by coil taps, turn sliders, etc.) and change the frequency of resonance, effects from eddy currents and consequent departure from optimum coil

shape factor would immediately run up coil loss — and the antenna radiation efficiency would plunge downward. An air or vacuum condenser is of exceedingly high  $Q$  at a given capacity setting; varying capacity over wide limits to change antenna frequency hardly affects condenser  $Q$  at all.

### An Image for the DDRR (and Other Transmission Line Antennas)

Those among the ham brotherhood who hold calls with only two letters after the area prefix may still remember a device now relegated to moth balls together with the spark gap, galena detector, and super-sensitive regenerative receiver: the *counterpoise* (especially the *tuned counterpoise*). The counterpoise was placed under your linear monopole, "T", or "L" antenna when there was less than  $\lambda/2$  horizontal space area diameter available in which to lay out a radial wire ground system on the soil. You found it very curious: If you did go ahead and lay out  $n$  number of electrically short radial wires on the soil and operated the antenna, you got some value of radiation efficiency  $N_1$  from the total antenna/ground system. But if you (a) lifted the same  $n$  number of short radial wires a bit above the soil, (b) insulated the whole system of  $n$  wires from soil ground, and (c) then tuned *each* short radial wire in the system to resonance at  $f_0$  using individual series *loading coils* — if you did that, you obtained a substantial improvement<sup>2</sup> in total antenna system efficiency.

The old-time professional antenna men who first observed this phenomenon said to themselves, "Wow, this is really weird! For some reason my insulated, tuned wire ground system collects more electric E lines of the antenna near zone field and

returns this energy back to the antenna input terminals with less total ohmic loss  $R_\Omega$  than the same number of short wires just laid on the soil surface!" Unfortunately, space does not permit our having a QSO at this point about the beautiful phenomenon of rf soil and space current (displacement) diffraction which relates to this very effective but now almost forgotten low frequency antenna technique. It can only be noted that such electrically small, insulated and tuned counterpoise systems even permitted erection of monopole antennas on the roofs of tall municipal buildings in the early days of BC radio where the small roof space there didn't offer a prayer's hope for use of a conventional wire "ground" system. The *tuned radial wire counterpoise* worked well. A de-tuned radial wire system, however, was inefficient by comparison. Therefore, the tuned radial wire counterpoise was just fine for use in *one way: fixed frequency* broadcast type transmission. For use in two-way hf communications where frequent and rapid frequency changes are necessary, it is an impractical nightmare! You have to retune *each* of those series loading coils —  $n$  of them! An automated system to do this would not only be a Rube Goldberg mechanical mess, but run into the same efficiency problem in varying coil inductance mentioned a ways back. Now, we said *radial wire ground system!*

In Fig. 3(a) of Part I, you will notice that the image currents flowing in a continuous surface, electrical "mirror" ground plane beneath a DDRR antenna are *not radial* in geometry. Instead, the image currents of the DDRR flow around in circles, going in the opposite direction to the currents flowing in the ring conductor just above them. Very careful



laboratory measurements carried out on a  $5\lambda$  by  $5\lambda$  sheet copper ground plane beneath a DDDR show that these image currents do not begin to turn outward radially until you get at least  $\lambda/8$  distance away from the ring conductor. At such a distance, these image currents are very weak in magnitude; they do not decay by the  $1/r$  rule at all. It was found that DDDR antennas of the purely monopole form did not operate efficiently when placed over a true radial wire ground plane — only over sheet metal mirrors. Of course, in the case of the *U.S.S. Wheeling* DDDR, we had a pretty good approximation to such a sheet metal mirror in the form of the hangar roof, welded ship's structure nearby, and that immense surrounding sea plane, so we used it effectively. But what if the Navy had asked us to erect that 2-30 MHz DDDR on *Old Ironsides* (all wood in spite of her heroic name)? Well, we would have just said, "Aye, aye, Sir. You can have it on the teakwood deck or at the peak of the foremast."

This is the way we would have handled the job on the double:

Under each of those overhead, separate frequency band DDDR ring elements we would have placed a "mirror" image ring conductor — an exact duplicate ring, using the same tubing conductor diameter  $d$ , same circumferential length  $S^\circ$ , and so forth. Instead of each of those tuning condensers  $C$  being connected to the metal roof of the helicopter hangar at terminals 4G, each would have been returned to a duplicate terminal 4A' on the image ring conductor below. In such a conversion to a mirror image DDDR, we would not have increased the vertical height  $h$  at all. Instead of the view of each of those fiberglass posts which

we see in Fig. 1, Part I, supporting the DDDR ring elements in parallel alignment above the hangar roof, we would now see another beehive insulator at each's base end, used to hold the two ring conductors in parallel alignment. Unlike that system of radial wire, tuned images in the old counterpoise system, however, there would be no need for a bull gang of sailors to rush out on deck each time a QSY was needed to start madly grid dipping all those series loading coils to the new operating frequency. Instead the operator, in the comfort of the shack, would merely push the DDDR tuning control button. Because the two ring elements are mirror images of each other, tuning condenser  $C$  would now move the entire DDDR system to the new operating frequency  $f_0$  as before. Of course, the converted Navy DDDR now sitting on the mizzen forepeak of *Old Ironsides* would no longer be a monopole: It would be a DDDR doublet antenna: still vertically polarized, still a low angle, omnipattern antenna. Its radiation resistance  $R_r(\text{doublet})$  would remain unchanged. This is because, although you would use now  $1/2h$  (instead of  $h$ ) to get CA from equation (2-2.0),

you would multiply the answer you get from the monopole radiation resistance equation (2-3.0) by two for the doublet case. Finally, although this is not a "construction" article, Fig. 2 is included to guide the amateur experimenter who desires to complete a compact size DDDR and put it on the air.

From Fig. 2 you see that the minimum size ham band DDDR is a single post model. Also, because it is costly and difficult to form large diameter tubing into circular shape, the ham band model has a square shape: *square*, not rectangular. The total path length  $G + H + I + J + K$  should be equal to the length  $S^\circ$  you obtain from the relations in Part I, with  $H = I = J = G + P + K$ . In an hf band DDDR, the gap  $P$  between the tuning condenser end and the monopole post should be about 1.5 degrees at the high frequency end of frequency coverage. *All ring conductor joints must be welded.* This means heliarc welding, when high conductivity aluminum tubing is used. Please don't use automobile exhaust tubing or cad-plated conductors. Contact resistance and conductor loss spells disaster in electrically small antennas, due to the high magnitude currents in such radiators. Oh

yes — use an absolute minimum diameter of 3 inches for the conductor diameter in antenna elements operating lower than 7.3 MHz. The smaller  $K_m$  (equation 1-2.0) gets, the higher both efficiency and bandwidth (fixed tune) becomes. As the image doublet DDDR requires no other ground plane, most users will probably mount it on a roof of some kind (garage, house, pole). When the height above ground is at least equal to  $h$ , use the formula

$$K_c = 275 \log_{10} \frac{2hl}{d} \text{ Ohms}$$

instead of equation (1-1.0) for the characteristic impedance of the horizontal transmission line section (in getting the needed capacity values for tuning). The change in  $K_c$  of the image DDDR does not impair performance of the antenna when in operation.

Finally, it is seen that if we are dealing with a "doublet" DDDR, the "base" terminals 1A, 1G of the "monopole" are now located at the center of the vertical post. The doublet requires a balanced rather than unbalanced feed, yet we still want to feed it with a coax line to the shack. OK — as seen, the coax line from the shack now enters the vertical

Fig. 3. (a) Low Profile Tunable (LPT) antenna operated in parasitically-coupled, wide passband, single channel mode using  $n$  elements. (b) Typical vswr versus frequency curve; solid line indicates half power frequency bandwidth of total array; broken lines indicate individual vswr response of each coupled element.

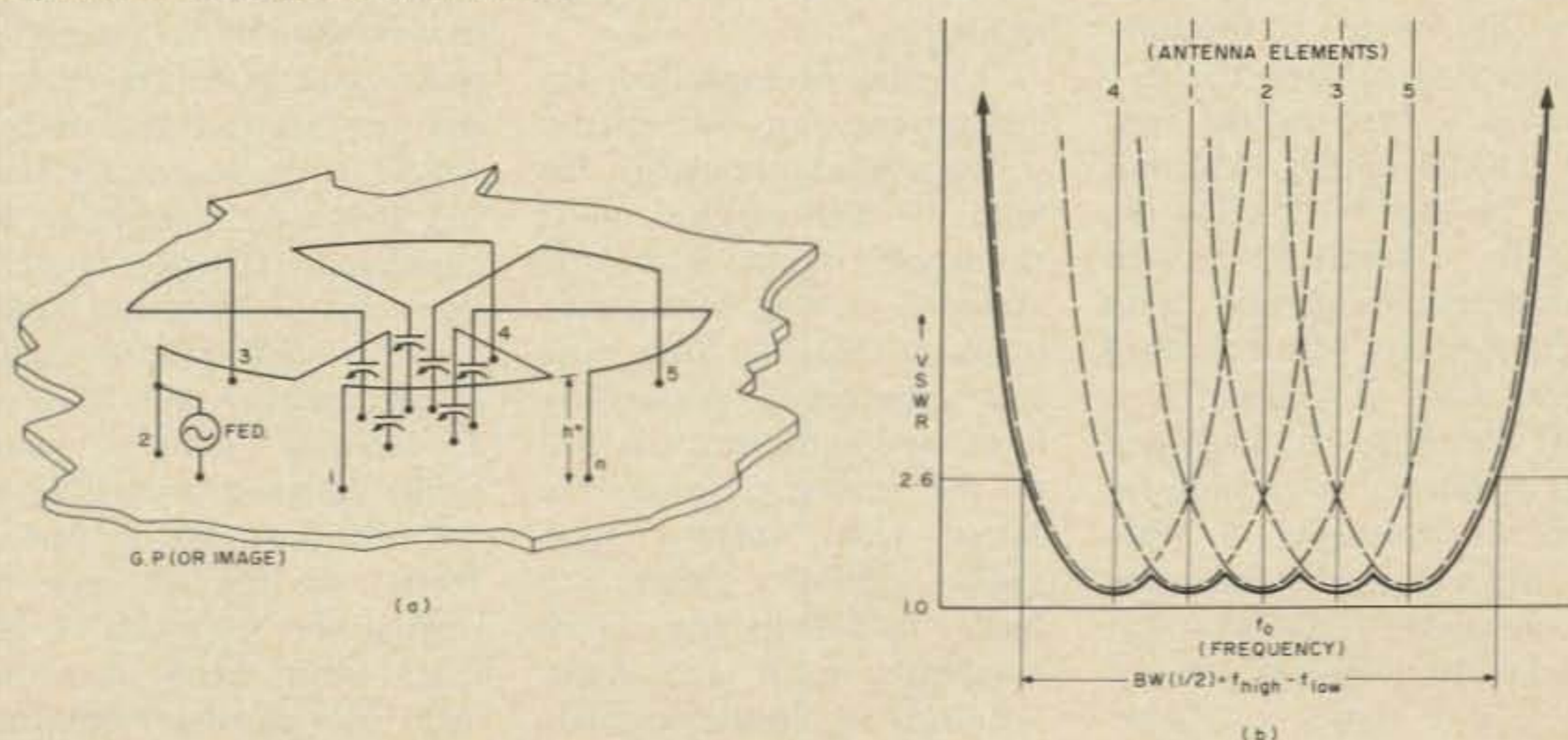

post via a hole through the conductor wall at  $\frac{1}{2}h$ , then is pushed around inside the top horizontal element conductor, passes down through a hole in its *bottom side*, and continues on down the inside of a .5 inch o.d. thin wall tubing section to the  $\frac{1}{2}h$  point.

At this point, the shield of the coax is folded back over the outside of the feed tube and clamped in contact with the metal. The coax inner conductor spans about a one inch gap to connect to the upper end of another 1.5 inch feed tube extending down to the lower "ring" conductor. You need first to determine the location of X for this balanced feed arrangement.

In Fig. 2(c), a suggestion is given for a *temporary* arrangement of coax to locate X and spacing L from the vertical post. The black vinyl coax jacket is stripped back to expose the shield braid over a sufficient length section of coax end. An additional "dummy" length is cut off and the inner conductor and shield shorted together to make a bottom feed section conductor. The aluminum tubing is polished with sandpaper to permit *good* electrical contact, and the coax line section temporarily "jury rigged," as shown, at a trial spacing L. Loops of wire "twists" are used to hold the coax shield in contact with the aluminum ring conductor and post. With the rig tuned to the *center* of the band, vary dimension L carefully until a vswr of close to 1.0:1 can be secured in the feed coax when tuning condenser C is "tweaked" to bring the DDDR to resonance at the transmitter frequency. With the temporary feed tightened down at this X location, now tune the rig up to the desired top frequency of tuning for that band element. If, without relocating the feedpoint X, a vswr of at least 2:1 cannot be attained at the f<sub>high</sub> with tuning condenser

C close to its minimum capacity, a bit of "pruning" is needed. Small, equal length conductor sections must then be removed from the conductor ends 4A, 4A' until a clear minimum vswr dip is observed at the high frequency end of coverage with C close to minimum capacity. The exact minimum vswr is not important, but the "dip" in vswr should be clearly seen. The location procedure for X at the *center of the band* must then be repeated until a 1.0:1 vswr is secured with the DDDR resonated by tuning C. It will then be found that the vswr will be less than 2:1 at both the high and low band limits for a fixed feedpoint X. The "jury rigged" coax feed is then removed and the permanent feed conductor system substituted. When cutting the hole to pass the coaxial line on the underside of the top horizontal tubing conductor, the hole should be elongated about one inch on either side of the X location to permit "inching" the permanent feed in final tests for vswr. An old-fashioned tube "socket" die cutter is handy for this purpose. Warning: *Do not* attempt to make the above described matching rests until (a) the DDDR is mounted at its permanent site and (b) the tuning condenser C is mounted inside its plastic weather housing and connected across the points 4A, 4A', as shown, using beehive or cone feedthrough insulators.

An idea is suggested for cementing up a plastic weatherproof housing for both the high voltage tuning condenser, motor drive, and simple tuning frequency indicator. See Fig. 2(d). Note that although the plastic box is in the intense electric field at the tuning position, the actual leads (copper shim stock ribbons about 1.5 inches wide) to the tuning condenser rotor and stator terminals are insulated solely

by the glazed ceramic insulators on the box. The leads should not be permitted to touch the plastic walls anywhere. Small ceramic button insulators space the condenser off the internal plastic mounting shelf inside the box. The *shaft* of the tuning condenser is also *isolated* from the motor and tuning indicator by means of a high quality rf shaft coupling insulator.

The condenser should be remotely controlled from the shack by a reversible, voltage speed controlled motor. Its shaft speed should be such as to permit "high speed" tuning across the entire band in about one half minute, yet slow enough to "tweak" the DDDR right onto channel center at f<sub>0</sub>. An efficient DDDR is quite sharp in tuning. Once X is set correctly, you will find yourself tuning by means of the sharp receiving "noise peak." Hunting around the band, you will "tweak" this receiving gain point of the DDDR along the dial with the tuning control, as if the antenna were a dog on a long leash. A simple frequency setting indicator is suggested in the form of a sine potentiometer geared 1:1 to the motor shaft. At the shack end a dc meter calibrated in frequency for the current in the sine pot is a help in operating the DDDR. Otherwise, spin the receiver dial until you spot the noise peak — that's where the DDDR is. Small rf chokes should be placed in series with both the motor and sine pot leads at *both* the remote antenna weather box and shack end terminals. In multiband DDDR models, elements for the other bands are mounted concentrically to one another and operated as separate systems, each being designed according to the relations given in Part I. When in the process of finding the feedpoint X for these other band elements, make sure all other band rings

are tuned off from harmonic relationship with the tested ring element. Oh yes, a final word: In a multiband model DDDR, the field coupling isolation between ring elements is very large in value so that even simultaneous working can be carried on in two bands. If, however, you suddenly find it strangely impossible to get low vswr tuning at some spot frequency in a given band, this means the ring element in the *next lower* band is tuned inadvertently to a "subharmonic" relationship. No problem: A touch of the tuning button to the offending band element easily cures this.

We have devoted considerable space here to the DDDR antenna. Fortunately, this detail is not for naught; understanding the DDDR not only permits us to grasp quickly the function of other transmission line antennas, but gives us a deeper appreciation for the small antenna problem in general: both the good and the bad of it.

### The Low Profile, Tunable (LPT) Antenna

The narrow frequency bandpass nature of electrically small antennas of high efficiency has been noted. There are certain modes of transmission, even in amateur service (double sideband AM, FSK teletype), and in commercial and military practice (Loran, hf radar, "data burst"), where a wider fixed frequency bandwidth is desired. If it is also necessary, for various installation or tactical reasons, that an electrically small antenna be employed, a serious problem results. Conventional antenna practice would indicate sacrificing antenna radiation efficiency by letting R<sub>Ω</sub> in the system increase to obtain the necessary bandwidth. Such practice even goes to an extreme called "swamping," where actual ohmic resistors are connected across the

# *“They don't make 'em like they used to...”*

## *(lucky for you, if your next HF transceiver is a TRITON)*

The new ultra-modern fully solid-state TRITON makes operating easier and a lot more fun, without the limitations of vacuum tubes.

For one thing, you can change bands with the flick of a switch and no danger of off-resonance damage. And no deterioration of performance with age.

But that's not all. A superlative 8-pole i-f filter and less than 2% audio distortion, transmitting and receiving, makes it the smoothest and cleanest signal on the air.

The TRITON IV specifications are impeccable. For selectivity, stability and receiver sensitivity. And it has features such as *full* CW break-in, pre-selectable ALC, off-set tuning, separate AC power supply, 12 VDC operation, perfectly shaped CW wave form, built-in SWR bridge and on and on.

For new standards of SSB and CW communication, write for full details or talk it over with your TEN-TEC dealer. We'd like to tell you why “They Don't Make 'Em Like They Used To” makes Ham Radio even more fun.

PRICE \$699.00



# TEN-TEC

## TEN-TEC

SEVIERVILLE, TENNESSEE 37862  
EXPORT: 5715 LINCOLN AVE.  
CHICAGO, ILLINOIS, 60646

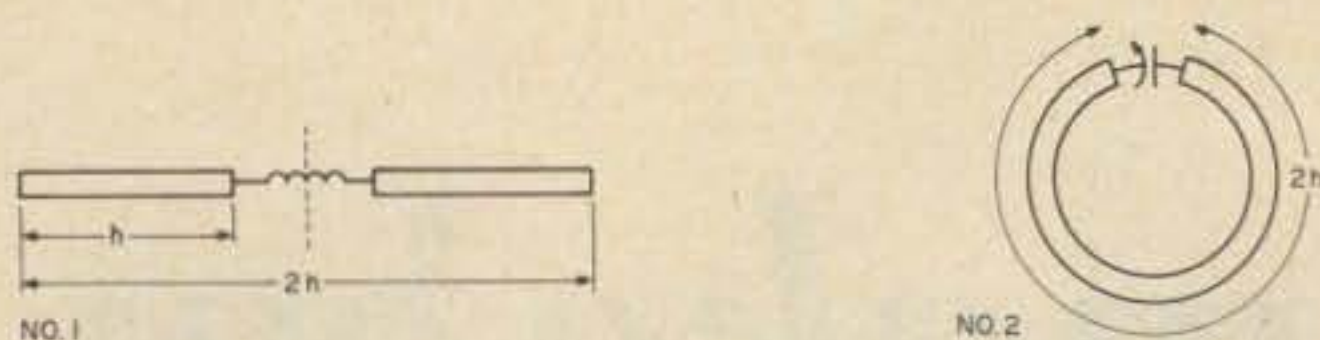

Fig. 4.

small antenna input terminals.

One version of the LPT transmission line antenna<sup>4</sup> answers this need for securing a controllable width frequency bandpass from an electrically small but efficient antenna. Shown in Fig. 3(a), the LPT antenna of this form consists of  $n$  number of radially aligned antenna transmission line elements of small size. Each is tuned at one end by a shunt variable tuning condenser. The "post" at the perimeter end of the short length circumferential conductor section is "grounded" to serve as a monopole antenna. Naturally, a "mirror image" doublet scheme can be used here, as in the DDRR, to improve efficiency. Our familiarity with the DDRR antenna principle would allow us to easily design these LPT elements as well.

However, it is noticed that only *one* of the vertical posts in the array of  $n$  antenna elements is actually fed rf power, as indicated by the "generator" symbol. In Fig. 3(b), the explanation for this strange configuration is made clear. In a manner analogous to the operation of a "stagger tuned" i-f transformer in a wide band receiver, all the other tuned elements in the LPT array are electromagnetically coupled to the driven element as parasites. Each of

the  $n$  parasitic elements is tuned to a slightly different frequency above and below the center  $f_0$  of the radio channel. The staggered, overlapping frequency responses of the  $n$  element array results in a *single* overall frequency passband. The vswr "ripple" across the frequency passband is governed by the number of parasitic elements employed in the same way that the ripple in impedance response of a bandpass filter is governed by the number of network sections used. The analogy is almost exact, except that we deal here with radiators of EM waves. Not shown are small details such as provision for auxiliary reactors to control the coupling coefficient between elements to secure "over-coupling" if desired.

In amateur service where bandwidth increase need is modest, only a few elements would be required, making such an antenna practical, say, for 160 meter application. On the other hand, for such a small antenna to pass the forty microsecond width shaped pulse from a Loran transmitter without distortion, more parasitic elements in the LPT array would be required. There are other forms of the LPT for use in services requiring a large number of  $n$  transmission channels over, say, the 15:1 span of the hf spectrum from

2 to 30 MHz. Others can establish the so-called Bessel function circular array to produce directional beams which can be "slewed" rapidly in direction at hf similar to early German WWII radar systems. These do not find application in amateur service, however, and will not be detailed here.

### The Loop or Magnetic Transmission Line Antenna

Take two equal length sections of aluminum tubing of conductor radius  $a$ . Call their respective equal lengths  $2h$ , where  $2h^\circ$  is only twenty electrical degrees at  $f_0$ ; calculate the  $K_M$  of a section  $h^\circ$  in length. Label one straight section "number 1," and then cut it exactly in half. In a very small gap left at the center of length  $2h$ , connect a *lossless* loading coil whose inductance is

$$2(X_{coil}) = 2(K_M \tan 10^\circ) \text{ Ohms}$$

Bend the other conductor, labeled "number 2," into a circle whose circumference is  $2h^\circ$ , leaving a small gap between the ends of the conductor. In this gap connect a lossless series condenser whose reactance is

$$(X_c) = (X_{loop}) \text{ Ohms}$$

where the reactance  $X_{loop}$  is that of the one turn loop inductor. The two electrically small, reactance loaded antennas will then look like Fig. 4.

Excite both the number 1 and number 2 antennas with rf at  $f_0$ . Now take measurements of the electric  $E$  and magnetic  $H$  parts of the fields produced by each of these two antennas, starting out very close to their conductors and then moving away in steps until a very large distance  $r/\lambda$  is reached. Your results will look like Fig. 5.

Very close to the straight, coil-loaded number 1 antenna, it can be seen that the electric  $E$  field is extremely large in intensity, while the magnetic  $H$  field

part is minute in strength; in this near zone region the field ratio  $E/H$  is immense in value. At increasing distance from the number 1 antenna, however, this  $E/H$  field ratio decreases until at large  $r/\lambda$  distances it approaches a value of 377:1. Over on the right, we see that the result for the case of the loop antenna, however, is just opposite; now it is the magnetic  $H$  field which is tremendously strong near the conductor and the electric  $E$  part of the field which is very weak in intensity. The  $E/H$  ratio, in this case, is close to zero in the near zone. Yet as the distance  $r/\lambda$  from the number 2 loop antenna increases, we see that the  $E/H$  ratio value still ends up at the same magnitude of 377:1. Because of the radically different but "dual" nature of the near zone fields of these two *basic* types of antennas, the number 1 antenna is called an *electric* antenna; number 2 is called a *magnetic* antenna. So far this sounds like boring textbook stuff; who cares about this fancy near zone field phenomenon? We're hams — practical radio communicators. It's that far zone DX field we are really interested in, right? No, wrong! — as you will see in a minute!

Saw number 1 doublet antenna in half, cutting right through the *center of the loading coil*. You now have made it into an electrically small, coil-loaded monopole antenna of length  $h^\circ$ . But it won't work! You must now stick either a flat metal sheet or a set of resonant radial wires under this number 1 antenna to get it oscillating again at  $f_0$  as a resonant monopole over this necessary electrical "mirror": You need a ground plane. However, the little condenser-resonated magnetic loop antenna keeps working nicely with or *without* any ground plane beneath it; it doesn't need one. The

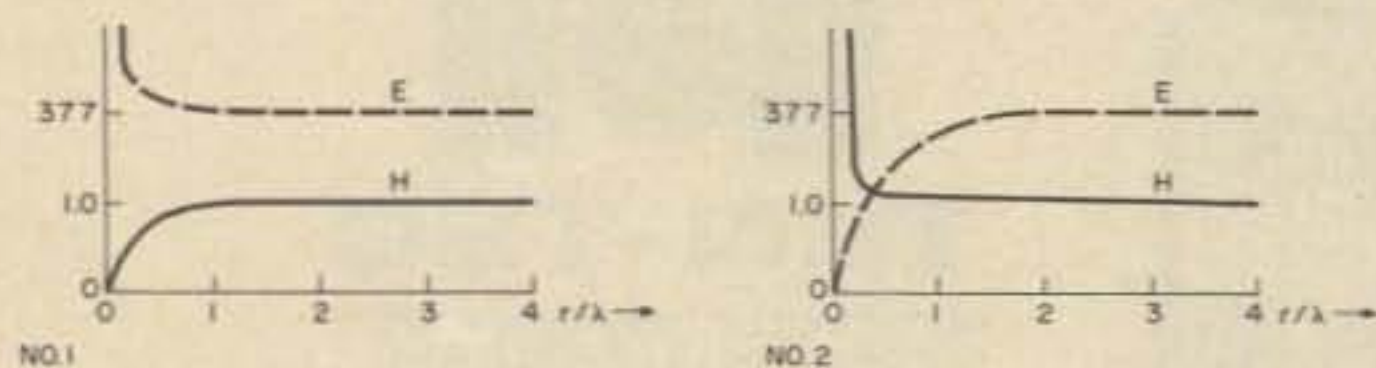
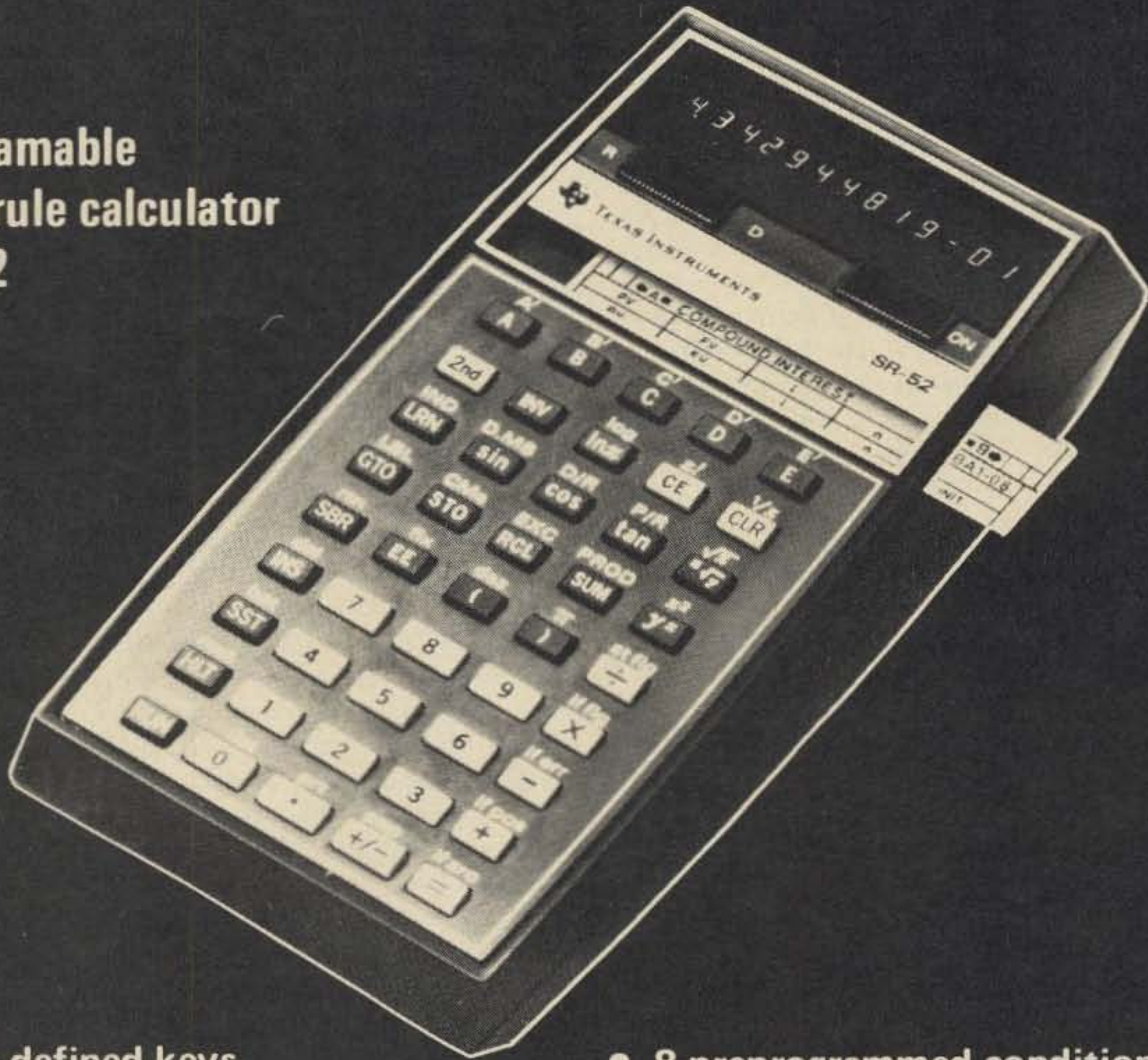

Fig. 5.

# NOW FROM TEXAS INSTRUMENTS . . . three machines in one.

programmable  
slide-rule calculator  
SR-52



- 10 user defined keys
- 224 program storage locations
- 23 preprogrammed key functions
- 8 preprogrammed condition statements
- 20 independent addressable memory registers
- Permanent program storage on magnetic cards

It took TEXAS INSTRUMENTS to invent the SR-52 calculator. It took C & S MARKETING ASSOCIATES to offer it at a price you can afford, now only \$249.95. With such versatility and such an affordable price, you can not afford to be without the problem solving power of card programability. Now solve problems in seconds that would take hours with any ordinary calculator or slideruler if they could be done at all.

For more information or the answer to any question you may have about the SR-52 calculator, call toll free (800-251-6771)\*. Tenn. residents call (800-252-6706). Other TEXAS INSTRUMENT models available from \$49.95.

Each TEXAS INSTRUMENT calculator comes with a 1-year warranty. Should your unit prove defective within 60 days, just return it for a new unit! Finally should you be dissatisfied with your calculator return it within 15 days for a prompt refund.

**C & S MARKETING ASSOC.**  
P.O. BOX 165 ALGOOD, TENN. 38501

QTY. \_\_\_\_\_ PRICE 249.95 ea.  
 CHECK       M.O.       C.O.D.  
 LITERATURE       INFORMATION  
 DIAL (800-251-6771) IN TENN. DIAL  
 (800-252-6706).

loop or magnetic antenna is *always* a doublet. There is also another, very critical, *practical* difference between these two basic kinds of antennas.

Take identical masses of real world dielectric matter such as soil, rock, vegetable tissue, etc., both containing equal amounts of moisture. Set the radial wire "mirror" part of the vertical electric monopole down onto one pile of such matter and the magnetic loop down on the other pile of this real world stuff. Immediately the temperature of the matter beneath the electric antenna will rise; part of the near zone field energy of the electric monopole is being lost into heating the dielectric matter. A check of the same kind of matter beneath the loop, however, shows almost no antenna near zone field energy loss — almost no heating. The tiny amount of heating which *is* taking place is entirely due to the small value of the electric E field in the near zone necessary to make up an *electromagnetic* rf field. The H part of the loop antenna field could care less about the presence of this wet dielectric matter near to it. Theoretically, equal input power fed to ideal electric and magnetic antennas of the same small electrical size in free space, when resonated with reactors of equal ohmic loss, will produce identical amounts of radiated energy at great distance in  $\lambda$ . This is *not the case* when the same electric and magnetic antennas must be erected near to real world, lossy dielectric QTH environments. Under these real world conditions, the electrically small magnetic loop antenna wins the antenna efficiency race over the electrically small electric antenna. By now you are thinking, "Boy, what a neat antenna that loop is!"

You would think, from what has been said up to

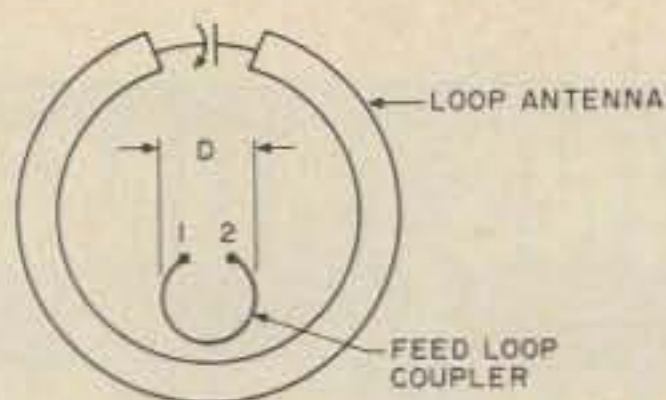

Fig. 6.

here, that communicators would use the magnetic kind of antenna exclusively in at least the hf and lower frequency radio region where antennas must be erected over this lossy, mostly dielectric planet surface of ours. When radio was born in the first spark transmission experiments carried out by Heinrich R. Hertz (1888) in verifying James Clerk Maxwell's prediction of the existence of rf waves, a loop antenna was employed. Since then, however, it is the electric type transmitting antenna which has ruled the ether waves. The loop antenna has been relegated almost completely to receiving service, particularly as a direction finder, where its twin, narrow width pattern nulls give accurate bearings. Why is this? First, the radiation resistance of a small loop is

$$R_r(\text{loop}) = 31,200 \left[ n \frac{A}{\lambda^2} \right]^2 \text{ Ohms} \quad (27.9)$$

where A is the area of space enclosed by the loop conductor in the same units as  $\lambda$ , and n is the number of turns in the loop. This  $R_r(\text{loop})$  comes out to be a very low number value when the area A of the loop is small in terms of wavelength. As mentioned before in relation to the DRRR antenna's "base" impedance, this makes it very difficult to make an impedance match between the resulting small value of  $Z_{in}(\text{loop})$  and the  $Z_0$  of a standard feed transmission line. The always necessary complex network or transformer is inconvenient, invariably gives added ohmic

loss, and must be "track-tuned" in step with the antenna. Some invention is required in the form of a simple, efficient coupler between the loop itself and the transmission line which does not itself need tuning.

Another problem is that, due to the very small value of  $R_r(\text{loop})$  — when the loop inductive reactance is canceled out by use of a *series* tuning condenser at  $f_0$  — the rf current circulating in the electrically small resonant loop at, say, one kW power input can get up to one hundred Amperes or more. Like the DRRR, therefore, you just don't make *transmitting loops* out of wire conductors; you use large cross-sectional diameter, highly conducting tubing. Finally, because the loop inductive reactance  $jX_{loop}$  is quite small in an electrically tiny loop of few turns, the small  $-jX_C$  of the condenser spells lots of capacity in Farads. Although  $-jX_C$  is not large in Ohms, the appreciable current magnitude in the loop produces a respectable magnitude of  $IjX_C$ , so the voltage rating of the tuning condenser is in the high hundreds to a few thousand volt range at one kW peak power.

Loop antennas will work well even when buried in the soil. During WWII, German submarines in "wolf packs" used loop antennas to communicate over relatively short distances while submerged.<sup>5</sup> Knowing all these facts, the U.S. military over the last few years has been field testing a loop transmitting antenna in the 2-30 MHz frequency range at power inputs up to one kW. Needing no ground plane and being of conveniently small physical size, it is well suited to "quickly transportable" two-way radio communications (field day?) applications. However, what makes this new loop transmitting

antenna practical and efficient at long last is the ingenious patented<sup>6</sup> way it is matched in broadband fashion to the feedline. One form of this feed invention looks like Fig. 6.

A balanced two wire feed transmission line is connected to terminals 1,2 of the small feed loop of diameter D. As in the DRRR, all you do is tune the main loop variable condenser for resonance at  $f_0$ , then experimentally change D while "tweaking" the condenser to obtain a minimum vswr reading in the feedline. At the correct diameter D, feedline vswr will fall to 1.0:1. Once D is found, it need not be changed in order to get a good match over a large frequency tuning range. There is no need to actually make electrical contact between the base of the small feed loop and an adjacent point on the main loop conductor; coupling is achieved to the main loop antenna's H field. As expected in a magnetic antenna, even a sheet of varnished plywood can be used to hold the coupling loop in alignment while obtaining negligible dielectric loss. The feed loop can be made of, say, one half inch o.d. copper refrigerator tubing.

For ham band service in the lower hf range, main loops of from eight to sixteen feet in diameter would be practical, made from one or two turns of two inch or larger o.d. thin wall aluminum tubing. Naturally, they can be made square in shape instead of round. All main loop conductor joints must be welded, and husky "ribbon" leads made to the variable tuning condenser. The large total capacity size needed in the condenser for 160/75/40 meter band use could be attained by shunting a smaller size variable air or vacuum condenser with less expensive *fixed* air or vacuum

insulated condenser units. Only the tuning condenser and associated components like a drive motor need be protected by a plastic weather housing.

A little ham ingenuity would result in easy, inexpensive ways to mount and rotate such a transmitting loop antenna and even remotely tune it to resonance from the shack. The very sharp twin nulls in the horizontal pattern plane can be used effectively to slice through QRM by pointing one of the nulls in the direction of the interfering station — sort of like using a 160 meter "beam" antenna. The very broad width maximum lobes of the pattern produce almost omni-response to desired signals. One last but important word: The loop/coupler is a patented concept. No consideration should be given to manufacturing a loop antenna incorporating this excellent idea for sale without legal arrangements being

first made with the listed patent holder. ■

#### Footnotes

<sup>1</sup>Relative amplitude is necessary in such relations because the radiation resistance of an antenna is not dependent upon the actual current magnitude — only its geometric shape of distribution. If this were not so,  $R_r$  would vary with changes in the power input to the antenna.

<sup>2</sup>Edmund A. Laport, "Radio Antenna Engineering," page 240, McGraw-Hill Book Company, Inc., N.Y., 1952. Unfortunately, this unique and invaluable book is out of print, but it may be found in some libraries.

<sup>3</sup>Edmund A. Laport, loc. cit., pp. 139-141.

<sup>4</sup>U.S. patent: J. M. Boyer, #3,680,135.

<sup>5</sup>Long range underwater radio communications is inefficient; this is *not* due, however, to any appreciable loss in the submerged loop antenna. It is due to the conductivity of water "shorting" the radio waves' E field at a large distance in  $\lambda$ , where the E/H ratio becomes appreciable.

<sup>6</sup>U.S. patent: John H. Dunlavy, Jr., #3,588,905, Antenna Research Associates, P.O. Box 196, Beltsville MD 20705.

# MOVING?

Let us know 8 weeks in advance so that you won't miss a single issue of *73 Magazine*.

Attach old label where indicated and print new address in space provided. Also include your mailing label whenever you write concerning your subscription. It helps us serve you promptly.

Write to:

**73 magazine**  
Peterborough NH 03458

- |   |   |
|---|---|
| <input type="checkbox"/> Address change only    | <input type="checkbox"/> Payment enclosed |
| <input type="checkbox"/> Extend subscription    | (1 extra BONUS issue)                     |
| <input type="checkbox"/> Enter new subscription | <input type="checkbox"/> Bill me later    |
| <input type="checkbox"/> 1 year \$10.00         |   |

name \_\_\_\_\_ call \_\_\_\_\_

address \_\_\_\_\_

city \_\_\_\_\_ state \_\_\_\_\_ zip \_\_\_\_\_

*If you have no label handy, print OLD address here.*

name \_\_\_\_\_ call \_\_\_\_\_

address \_\_\_\_\_

city \_\_\_\_\_ state \_\_\_\_\_ zip \_\_\_\_\_

AFFIX LABEL

## ramsey electronics

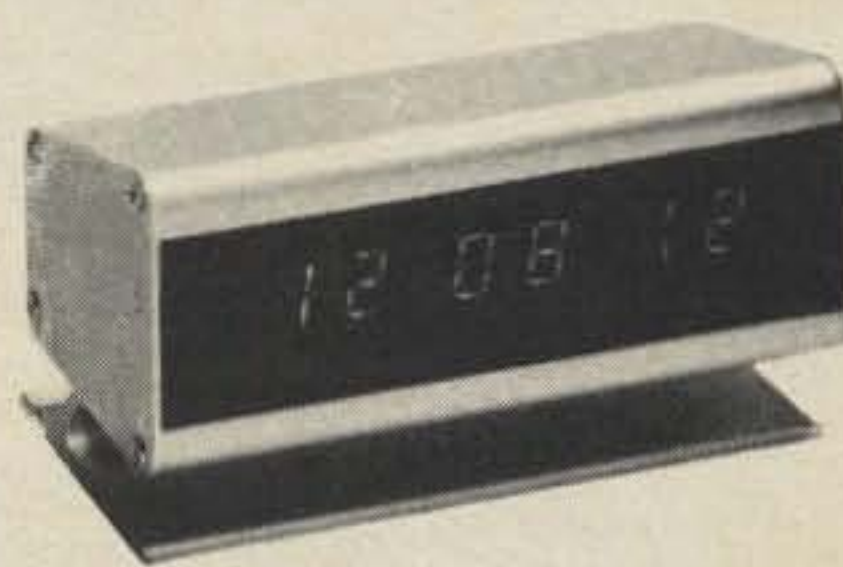

6 DIGIT  
LED CLOCK  
KIT  
**\$22.95**

A SUPER QUALITY kit that features:

- Handsome extruded aluminum case in black, gold, silver, bronze or blue
- Large .33" bright LED display
- 12 or 24 hour readout format
- All parts included — no extras to buy
- Alarm version (12 hour only)

**\$24.95**

### 60 Hz TIME BASE KIT

Run any digital clock in your car, boat or airplane. Features zener regulation, output buffering, CMOS circuitry and small size. Kit includes all parts and instructions to hook up to any clock. **\$4.95 6/\$25.00**

**\$3.95**

\* with clock purchase

### FM WIRELESS MIKE KIT

Transmit up to 300' to any FM broadcast radio. Sensitive mic. input requires crystal, ceramic or dynamic mike. Runs on 3 to 9V. Small one inch square size.

Complete Kit **\$2.95**

### SIREN KIT

Produces police-type wail of siren at toy volume. Runs speaker from 3 — 45 Ohms to 200 mW output. Requires power source of 3 to 6 volts. A neat toy for the kids.

Complete Kit **\$2.95**

### 600 MHz PRESCALER

Extend the range of your counter to 600 MHz. Works with most any counter. Completely assembled and tested. Sensitivity of 100 millivolts. Choice of  $\times 10$  or  $\times 100$ , specify with order. **\$59.95**



### FERRITE BEADS

Beads come with valuable info on uses and specs 15/\$1.00  
6 hole BALUN beads also available . . . . . 5/\$1.00

LED  
DECADE  
COUNTER  
PARTS KIT

**\$2.95**

#### INCLUDES:

- 7490A 33 MHz decade counter
- 7475 latch
- 7447 LED driver
- 7 — 100 Ohm current limit resistors
- 7 segment LED readout

Complete with hook-up instructions on how to build an easy, low-cost frequency counter.

SLIDE POT — 10k linear taper . . . SPECIAL 4/\$1.00

1000 uf 15v FILTER CAP . . . . . 5/\$1.00

## ramsey electronics

P.O. Box 4072E Rochester, NY 14610



48 HOUR  
SERVICE

Satisfaction guaranteed or money refunded. NO COD. Orders under \$10.00 add \$.75. NY residents add 7% tax.

# KENWOOD'S TS-520

*...worth waiting for!*

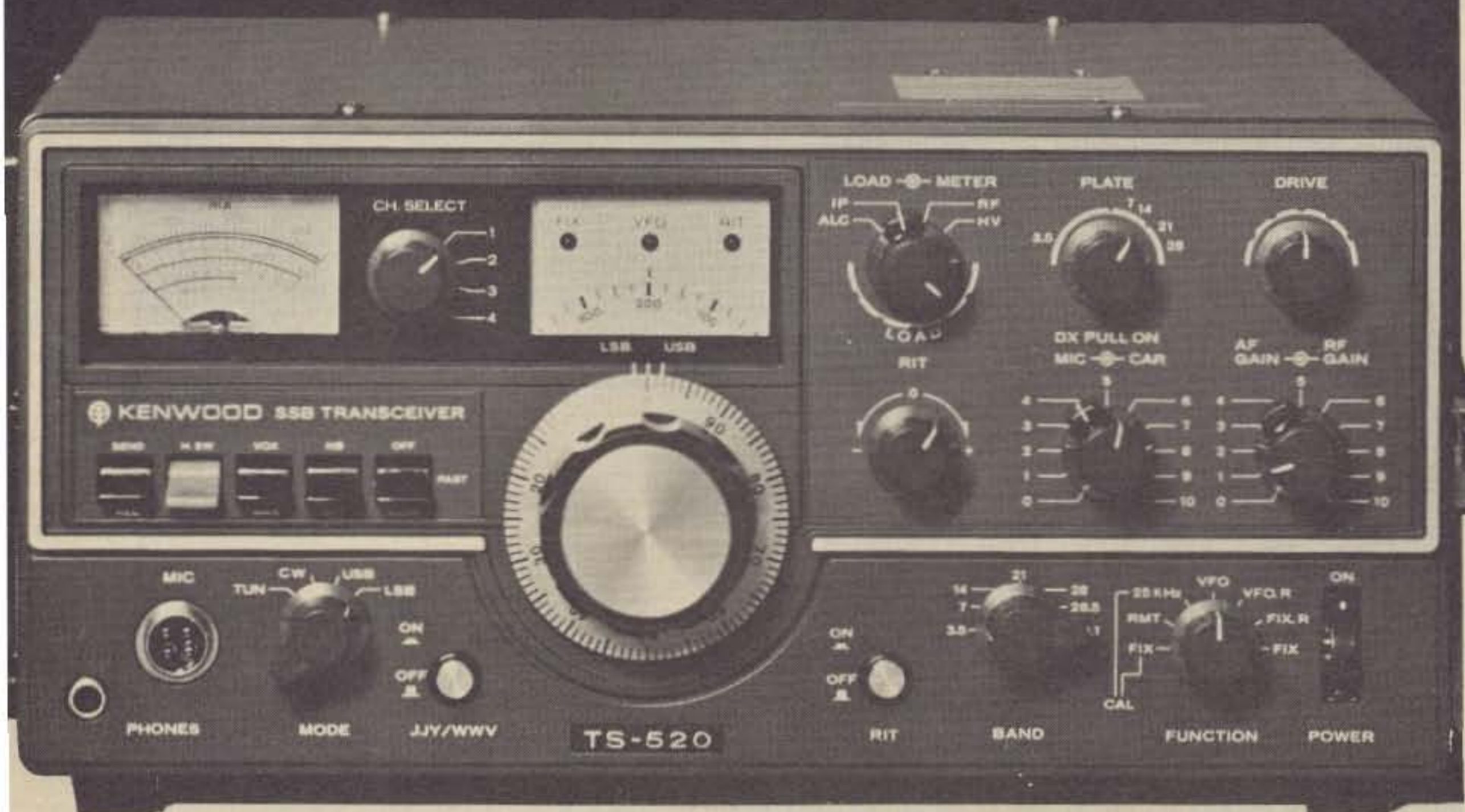

Why wait any longer for a rig that offers top performance, dependability and versatility... the TS-520 has proven itself in the shacks of thousands of discriminating amateurs, in field day sites, in DX and contest stations, and in countless mobile installations.

Superb craftsmanship is evident throughout... in its engineering concepts as well as its construction and styling... craftsmanship that is a Kenwood hallmark.

Maybe the Kenwood TS-520 is the one you have been waiting for.

Kenwood offers accessories guaranteed to add to the pleasure of owning the TS-520. The TV-502 transverter puts you on 2-meters the easy way. (It's completely compatible with the TS-520.) Simply plug it in and you're on the air. Two more units designed to match the TS-520 are the VFO-520 external VFO and the model SP-520 external speaker. All with Kenwood quality built in.



## TS-520 Specifications

MODES: USB, LSB, CW  
POWER: 200 watts PEP input on SSB, 160 watt DC input on CW  
ANTENNA IMPEDANCE: 50-75 Ohms, unbalanced  
CARRIER SUPPRESSION: Better than -45 dB  
UNWANTED SIDEBAND SUPPRESSION: Better than -40 dB  
HARMONIC RADIATION: Better than -40 dB  
AF RESPONSE: 400 to 2600 Hz (-6 dB)  
AUDIO INPUT SENSITIVITY: 0.25 $\mu$ V for 10 dB (S+N)/N  
SELECTIVITY: SSB 2.4 kHz (-6 dB), 4.4 kHz (-60 dB), CW 0.5 kHz (-6 dB), 1.5 kHz (-60 dB) (with accessory filter)  
FREQUENCY STABILITY: 100 Hz per 30 minutes after warmup  
IMAGE RATIO: Better than 50 dB  
IF REJECTION: Better than 50 dB  
TUBE & SEMICONDUCTOR COMPLEMENT: 3 tubes (2 x 6146B, 12BY7A), 1 IC, 18 FET, 44 transistors, 84 diodes  
DIMENSIONS: 13.1" W x 5.9" H x 13.2" D  
WEIGHT: 35.2 lbs.  
SUGGESTED PRICE: \$629.00

### VFO-520

Provides high stability with precision gearing. Function switch provides any combination with the TS-520. Both are equipped with VFO indicators showing at a glance which VFO is being used. Connects with a single cable and obtains its power from the TS-520. Suggested price: \$115.00.

### SP-520

Although the TS-520 has a built-in speaker, the addition of the SP-520 provides improved tonal quality. A perfect match in both design and performance. Suggested price: \$22.95.

### TV-502

TRANSMITTING/RECEIVING FREQUENCY: 144-145.7 MHz, 145.0-146.0 MHz (option)  
INPUT/OUTPUT IF FREQUENCY: 28.0-29.7 MHz  
TYPE OF EMISSION: SSB (A3J), CW (A1)  
RATED OUTPUT: 8W (AC operation)  
ANTENNA INPUT/OUTPUT IMPEDANCE: 50 $\Omega$   
UNWANTED RADIATION: Less than -60 dB  
RECEIVING SENSITIVITY: More than 1 $\mu$ V at S/N 10 dB  
IMAGE RATIO: More than 60 dB  
IF REJECTION: More than 60 dB  
FREQUENCY STABILITY: Less than  $\pm$ 2.5 kHz during 1-60 min after power switch is ON and within 150 Hz (per 30 min) thereafter.  
POWER CONSUMPTION: AC 220/120V, Transmission 50W max., Reception 12W max., DC 13.8V, Transmission 2A max., Reception 0.4A max.  
POWER REQUIREMENT: AC 220/120V, DC 12-16V (standard voltage 13.8V)  
SEMI-CONDUCTOR: FET 5, Transistor 15, Diode 10.  
DIMENSIONS: 6 $\frac{1}{2}$ " W x 6" H x 13 $\frac{1}{4}$ " D  
WEIGHT: 11.5 lbs.  
SUGGESTED PRICE: \$249.00

### CW-520

500 Hz CW Crystal Filter: \$45.00.

Prices subject to change without notice



# When you get tired of compromises...

## TS-700A Specifications

TRANSMIT/RECEIVE FREQUENCY RANGE:  
144-148 MHz  
MODE: SSB, FM, CW, AM  
RF OUTPUT: CW, FM: more than 10W output.  
AM: more than 3W output. SSB: more  
than 20W DC input.  
ANTENNA IMPEDANCE: 50 $\Omega$  (unbalanced)  
CARRIER SUPPRESSION: Better than 40 dB  
SIDE-BAND SUPPRESSION: Better than 40 dB  
SPURIOUS RADIATION: Less than -60 dB



## KENWOOD'S TS-700A finally fulfills the promise of 2-meters...more channels, more versatility, tunable VFO, SSB-CW and, best of all, the type of quality that has placed the Kenwood name out front.

- Operates all modes: SSB (upper & lower), FM, AM, and CW
- Completely solid state circuitry provides stable, long lasting, trouble-free operation
- AC and DC capability. Can operate from your car, boat, or as a base station through its built-in power supply
- 4 MHz band coverage (144 to 148 MHz) instead of the usual 2
- Automatically switches transmit frequency 600 KHz for repeater operation. Just dial in your receive frequency and the radio does the rest... Simplex repeater reverse
- Or do the same thing by plugging a single crystal into one of the 11 crystal positions for

- your favorite channel
- Outstanding frequency stability provided through the use of FET-VFO
- Zero center discriminator meter
- Transmit/Receive capability on 44 channels with 11 crystals
- Complete with microphone and built-in speaker
- The TS-700A has been thoroughly field-tested. Thousands of units are in operation throughout Japan and Europe

The TS-700A is available at select Kenwood dealers throughout the U.S. For the name of your nearest dealer, please write.

MAX. FREQUENCY DEVIATION (FM):  $\pm 5$  kHz  
REPEATER FREQUENCY SHIFT WIDTH:  
600 kHz  
TONE BURST TIME: 0.5-1.0 sec.  
MODULATION: Balanced modulation for SSB.  
Variable reactance frequency shift for FM.  
Low power modulation for AM.  
MICROPHONE: Dynamic microphone, 500 $\Omega$   
AUDIO FREQUENCY RESPONSE: 400-2600 Hz.  
within -9 dB  
RECEIVING SYSTEM: SSB, CW, AM: Single  
superheterodyne. FM: Double-  
superheterodyne.  
INTERMEDIATE FREQUENCY: SSB, CW, AM:  
10.7 MHz. FM: 1st IF: 10.7 MHz. 2nd IF:  
455 kHz  
RECEIVING SENSITIVITY: SSB, CW: S/N = 10  
dB or better at 0.25 $\mu$ V. 20 dB noise  
quieting = Less than 0.4 $\mu$ V. AM: S/N =  
10 dB or better at 1 $\mu$ V.  
IMAGE RATIO: Better than 60 dB  
IF REJECTION: Better than 60dB  
PASS-BANDWIDTH: SSB, CW, AM: More than  
2.4 kHz at -6 dB. FM: More than 12 kHz at  
-6 dB.  
RECEIVER SELECTIVITY: SSB, CW, AM: Less  
than 4.8 kHz at -60 dB. FM: Less than  
24 kHz at -60 dB.  
SQUELCH SENSITIVITY: 0.25 $\mu$ V  
AUDIO OUTPUT: More than 2W at 8 $\Omega$  load  
(10% distortion)  
RECEIVER LOAD IMPEDANCE: 8 $\Omega$   
FREQUENCY STABILITY: Within  $\pm 2$  kHz during  
one hour after one minute of warm-up,  
and within 150 Hz during any 30 minute  
period thereafter.  
POWER CONSUMPTION: Transmit mode: 95W  
(AC 120/220V), 4A (DC 13.8V), max.  
Receive mode (no signal): 45W (AC 120/  
220V), 0.8A (DC 13.8V).  
POWER REQUIREMENTS: AC 120/220V,  
50/60 Hz. DC 12-16V (13.8V as reference).  
DIMENSIONS: 278 (W) x 124 (H) x 320 (D) mm  
WEIGHT: 11 kg  
SUGGESTED PRICE: \$700.00

Prices subject to change without notice

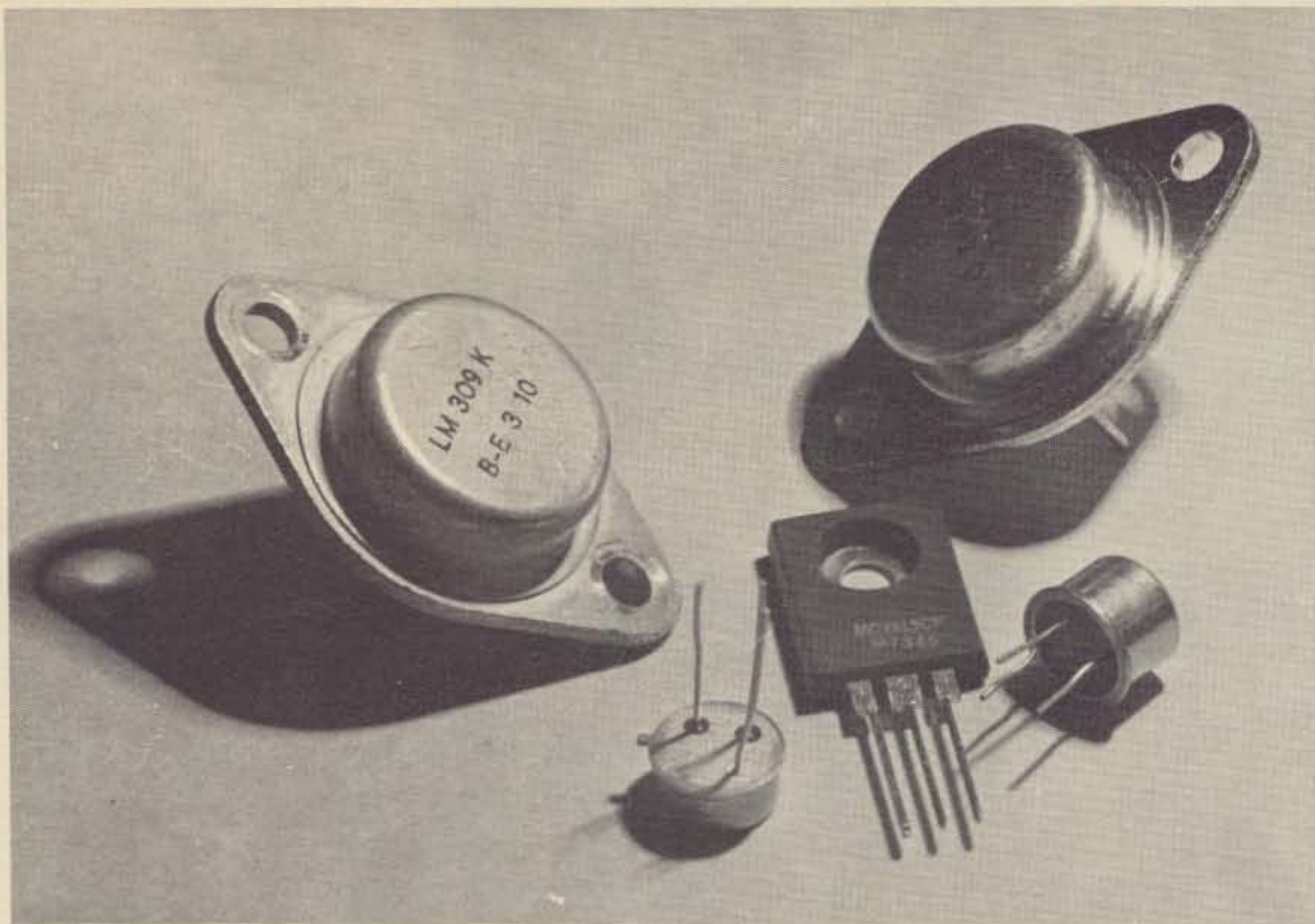

Three terminal IC regulators, available in a wide variety of voltage ratings, current capacities, and package styles, are easily used to make high quality power supplies.

Some time ago there became available to the electronics experimenter a number of three terminal monolithic integrated circuit voltage regulators. With a minimum of external parts, these ICs can be easily and inexpensively used in the design and construction of high quality, low voltage

regulated power supplies.

In this article I am going to explain the basic use of the LM309 and  $\mu$ A7800 series of regulators. They are all fixed voltage units, most exhibiting a continuous duty current capacity of one Ampere. Available through many surplus dealers, they cost under two dollars, and the

price is still going down, *in single unit quantities!*

There are many other regulators available on the surplus market, but I have chosen to describe only the LM309 and  $\mu$ A7800. However, if you spend a little time studying the published data sheets on other units, I think you will find that most of the

circuit design procedures I have outlined here are directly transferable to use with other three terminal regulators.

#### Parts Selection

The specifications for the regulators I am describing are shown in Table 1.

Fig. 1 shows a practical power supply circuit, using any one of the regulators in Table 1. It needs no additional parts. It will work with all of these three terminal devices by simply varying a few component values and ratings.

Fig. 2 is also practical: If you cannot locate a center-tapped transformer, replace T1 and D1-D2 from Fig. 1 with the transformer and bridge rectifier circuit shown in Fig. 2. The full wave rectifier is preferred, because of the smaller diode drop of the two diodes in Fig. 1 than of the four in Fig. 2, but the difference is not that crucial.

Now let's assign some values to the components in those circuits. Use Table 1 to determine what regulator to use for IC1. Make your choice on the basis of voltage rating and current capacity.

# Ultrasimple Regulation with New IC

- - power supply design greatly simplified

James Kucera WB0JLS  
1477 Brenner Ave.  
St. Paul MN 55113

Refer to the graphs in Fig. 3. There are five graphs for use in determining the T1 transformer voltage and C1 filter capacitance for five separate one Amp regulators. The transformer voltage is for a center-tapped transformer with a full wave rectifier, as in Fig. 1. If you use the bridge rectifier configuration from Fig. 2, halve the transformer voltage but remember to *add one volt* to compensate for the voltage drop of the extra diodes. If you use the schematic from Fig. 1, the current capacity of T1 need only be half an Amp — or half of what you want the completed supply to deliver. The lower voltage transformer needed for the less efficient bridge of Fig. 2, however, must be rated the full Amp.

Filter capacitor C1 should be an aluminum computer-grade electrolytic. If you have any question concerning interpolating a capacitance to use with any given transformer, round *up*. This will help to make up for component tolerances and line voltage fluctuations. Since readings off the graph are minimum allowable capacitances, you might want to use a larger value capacitor anyway.

Since the graphs were calculated using one Ampere of drain, if some fraction of an Amp is to be drawn, the C1 value can be reduced by that fraction. For example, if only 100 mA is needed, then only one tenth the capacitance is necessary, or any other such fraction. It works the other

way around, also — if you make a ten Ampere supply (with a pass transistor), you will need ten times the filter size.

Exercise prudence when calculating capacitor voltage ratings. Use at least one and a half times, but preferably twice, the rms transformer voltage across the capacitor.

Do not omit C2. It is an rf bypass capacitor, especially necessary if the power supply is to be used in an area of strong rf such as a ham shack — but still needed even if used elsewhere. C2 helps to absorb the spikes and glitches on the line that are too sharp for C1 to respond to. It can be anywhere from around .10 uF to .33 uF — .22 uF is a happy medium.

Selection of the value of the output capacitor (C3) need not be very exacting. You can use anywhere from around .005 uF to a couple of microfarads. Generally, use larger values for larger currents. A common value for a one Amp supply is about a 1 or 2 uF tantalum. Some of the manufacturers' data sheets insist that it is not needed, but, since the very next phrase in the paragraph is always that its presence "helps to improve transient response," I would not suggest omitting it.

These regulators do not work well at low current drains — around 5 mA and under. Therefore, R1 has been calculated to draw about 5 mA from the supply. A half or quarter watt is sufficient. A pilot light (LED or incandescent) could be

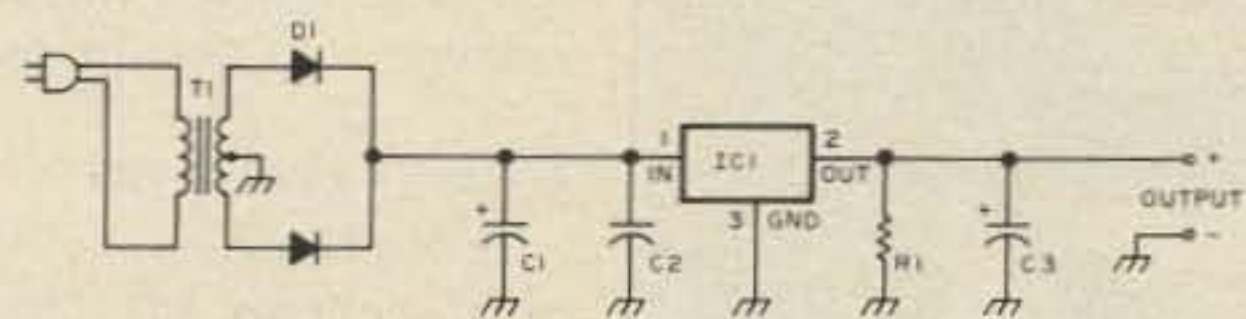

Fig. 1. Here is a practical diagram for a power supply of any voltage, needing no other parts. Use this schematic with center-tapped transformers in a full wave rectifier configuration. Regulator voltage/R1 value: 5/1.0k $\Omega$ , 12/2.2k, 15/2.7k, 18/3.3k, 24/4.7k.

Device	Current	Voltage	Package
LM309H	200 mA	+5 volts	T0-5
LM309K	1.0 Amp	+5 volts	T0-3
uA7805	1.0 Amp	+5 volts	T0-220
uA7812	1.0 Amp	+12 volts	T0-220
uA7815	1.0 Amp	+15 volts	T0-220
uA7818	1.0 Amp	+18 volts	T0-220
uA7824	1.0 Amp	+24 volts	T0-220

Table 1.

wired in to serve the same purpose. If the supply is being built into a project so that the drain is never allowed to go below 5 mA, R1 could be altogether eliminated.

The choice of rectifiers for D1 through D4 is not at all critical. The graphs were compiled using 1.3 volts as the forward diode drop. This figure is based on the 1N4000 series silicon one Amp rectifiers. It should be close enough for interchanging with any of their surplus equivalents or replacements. 1N4002 or 1N4003 diodes would be a good choice for any of the transformer voltages on the graphs. Some of the lower voltage units can even get by with 1N4001s. Just make sure that you don't exceed the diodes' piv ratings.

### Automotive Applications

There are many times when you want to operate a transistorized device in your car that requires a supply voltage different from that of the standard 12 volt automotive electrical system. A higher voltage requirement would take a power convertor exceeding the scope of this article, or a separate battery. But these IC regulators are ideal for obtaining lower voltages from the 12 volt electrical system. Fig. 4 is a supply circuit tailored specifically for use in a car.

An automotive environment is, however, very prone to transience. Special precautions should be exercised to protect the regulator. Positive spikes on the input line can very easily cause that

input terminal to go above the maximum allowable input voltage for the IC. Therefore, the zener diode (Z1) has been put into the circuit to help shunt any higher spikes to ground. You can use whatever zener you have in your junk box in the 24 to 30 volt range.

The rectifiers are absent in this version, but note that the filter capacitor is still there. Keep it there — your car's alternator puts out an awful dc waveform. Filtering is still needed.

All of the other parts are the same as the other circuit diagrams.

### Construction Considerations

The construction considerations you need concern yourself with when using these IC regulators are not very numerous. But those that do exist should be carefully observed.

There are definite reasons for the endpoints of the graphs in Fig. 3. *Do NOT extrapolate transformer voltages from either end of the graphs.*

These regulators will only work when an input voltage between certain limits is present at the input terminal. The dropout voltage, or level below which the unit will not operate properly, is usually two volts greater than the rated output voltage. Thus the LM309 needs an input of at least 7 volts to work correctly. If the input is too low, it will not regulate at the desired voltage and the ripple will be excessive.

The input level to these regulators cannot be too high,

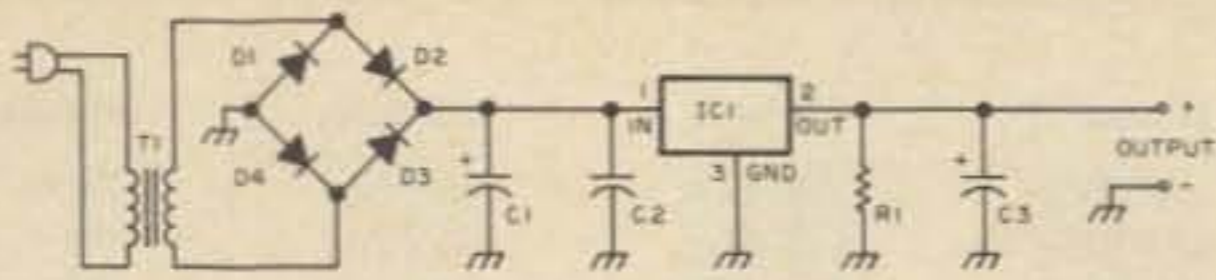

Fig. 2. If you cannot locate a center-tapped transformer, substitute this schematic for that of Fig. 1. Keep in mind the additional design considerations explained in the text necessitated by the extra diodes.

either. The upper limit is almost always 35 volts, except in some of those regulators with a high output voltage. For example, the  $\mu$ A7824 will take an input of up to 40 volts, but the other units in the  $\mu$ A7800 series (and the LM309) are limited to 35 volts. This figure includes *peak* ripple voltage. If the input exceeds the absolute maximum input rating, *permanent damage may result*.

There is another reason for keeping the input voltage as low as possible. The dissipation of the devices in the T0-3 or T0-220 packages

must be limited to around 5 to 10 Watts, depending upon heat sink efficiency. (The LM309H, in its T0-5 metal can package, is limited to around 1 or 2 Watts power dissipation.) In this case, exceeding the junction temperature limit, for whatever reason, will only trigger the internal protective features — thermal shutdown and current limiting — causing no permanent damage. This is especially important if you want to draw a full Ampere from the supply. Although the dissipation capacity is still a function of heat sink

efficiency, 20 Watts is the absolute maximum dissipation regardless of how much heat you remove from the case.

For these reasons I have included points, labeled D (for dissipation limit), on the graphs in Fig. 3. If you want to draw high currents from the IC, use a transformer voltage to the left of (above)

points D and attach the regulator to an adequate heat sink with liberally applied silicone grease. The Signetics LM309 data sheet indicates that a typical commercial heat sink, the Wakefield 680-75, should be sufficient to allow the T0-3 package of the LM309K to dissipate from 5 to 7 Watts at room temperature before thermal shutdown is triggered. Use this as a guideline for determining your own heat sink requirements. Keep in mind that my placement of the dissipation limits in Fig. 3 is in no way absolute. Dissipation capacity is very dependent upon heat sink size and efficiency. Simple experimentation should be used to determine what size is needed for your specific application.

Refer to the base diagrams in Fig. 5 for finding the pin connections of the T0-5 metal can, T0-3 metal power, and the T0-220 plastic power packages. Follow normal wiring procedures, with no other special precautions except to make sure that you use large enough wire for the current you intend to draw.

#### Design Calculations

For those of you who want to apply my design procedures to other three terminal regulators, or just simply want to know a little of the theory behind this shortened design method, here are all the necessary

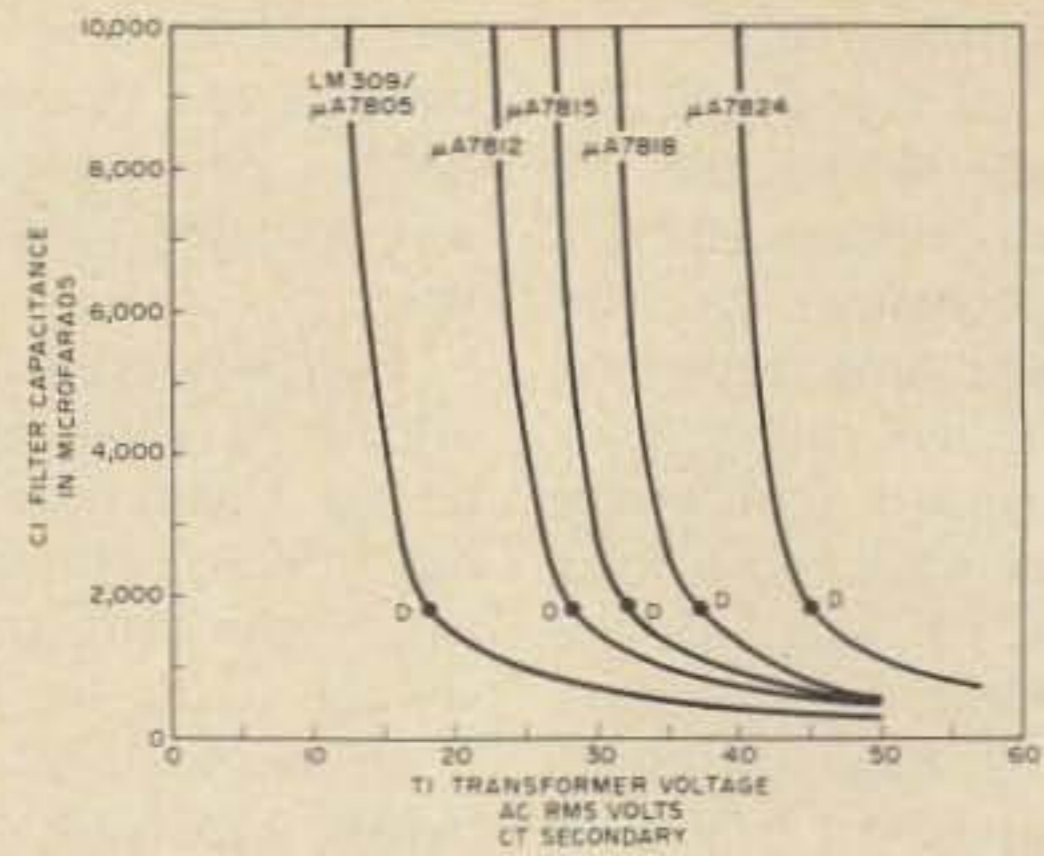
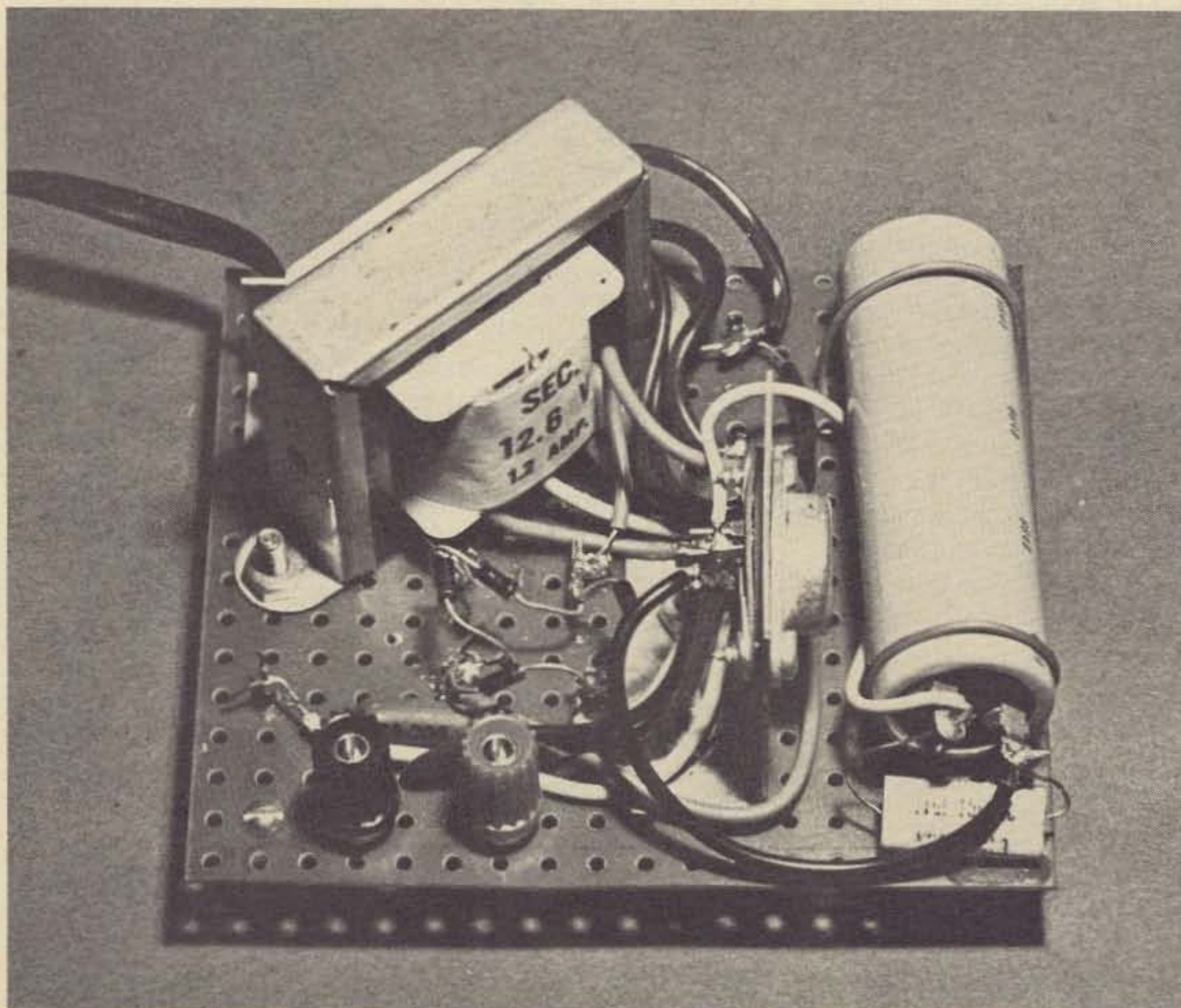

Fig. 3. Use this graph for determining C1 capacitance and T1 voltages. The points labeled "D" are the dissipation limits explained in the text.



This breadboarded supply was assembled with an LM309K for use in testing TTL circuits.



KLM Multi-2000 ... already locked in  
as the greatest feature-per dollar VHF transceiver ...

# Now...both USB & LSB for even greater value...lower, beat-inflation pricing!

The great response to the KLM, Multi-2000 VHF transceiver by amateurs world-wide has now made it possible to manufacture this fine set in quantities substantially larger than the original production runs. Result ... new, value-added features, lowered manufacturing costs.

KLM will now have more sets to sell so, with the Multi-2000A, encourages the buyer by passing along a substantial portion of the production savings. Example: Former price, 795.00. Your inflation-fighting price today is **679.00** ... a **saving of 116.00!** But without extra cost you now get Lower Sideband, making the KLM Multi-2000A **four mode** equipment with NBFM, WBFM, SSB (with both USB and LSB) plus CW. Power output remains at 10 watts.

Here truly is the **complete** full feature VHF station for base or mobile. It has both 12VDC and

115VAC supplies built-in, is actually ready to operate right out of the shipping carton. It offers highest versatility and crystal stability. Any of 200 channels can be selected instantly in 10 kHz steps by three dials controlling the phase lock loop frequency synthesizer setup. Continuous interpolation within the 10 kHz segments (144-148 MHz) is afforded by VXO for trans./rec. and RIT for receive. There are also three FM crystal positions for frequently used channels.

Check the Multi-2000A panel in the photo. Note the convenient, "people engineered" control arrangements, the simple, positive channel setup and the many refinements that contribute to relaxed, enjoyable conversations in any of four different modes.

At your favorite dealer or write direct.

- 144-148MHz. Phase lock loop synthesizer.
- Separate VXO and RIT for full, between-channel tuning.
- Simplex and/or 600kHz repeater capability.
- NBFM/WBFM/SSB (USB & LSB)/CW.
- Built-in AC & DC power supplies.
- Noise blanker • Squelch • RF gain control.
- Selectable 1/10W power output.
- High sensitivity (0.3uV for 12db SINAD).
- Superior immunity to cross mod./inter mod.
- Built-in test (call) tone and touch-tone provisions.

## Economically priced 160W solid-state Linear Amplifier



160W power out from Multi-2000A (or other models/brands) with 5-15W input, SSB, CW, AM, FM. Broad band ... 144-148MHz with out tuning. Automatic RF switching. 13.5 VDC. Also 144, 220, 450MHz models, 12 to 120W out.

# KLM electronics

17025 Laurel Road, Morgan Hill CA 95037  
(408) 226-1780, (408) 779-7363

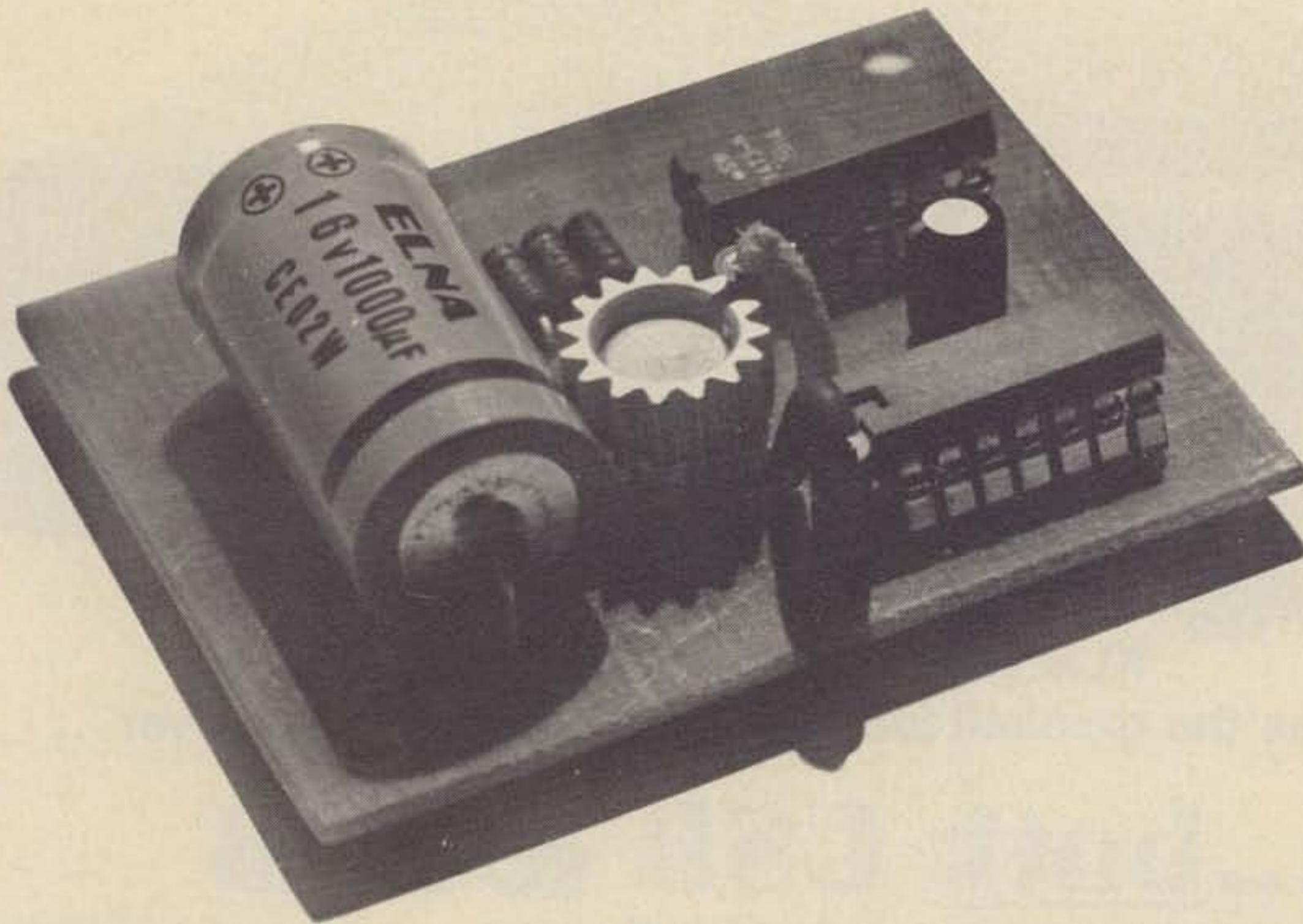

Here is an example of an on-card regulator using the LM309H. The circuit is a TTL heads-tails game, taking its power from a 9 volt battery.

calculations and a little on why they are used:

You do not get exactly 12.6 volts dc from a 12.6 volt transformer. Nor do you get 6.3; in fact, there is no such easy one-to-one relationship. Rather, you get a fluctuating dc waveform whose amplitude varies all the way from zero to a peak value of  $\sqrt{2}$  (or about 1.414) times the transformer voltage.

As you increase the size of the filter capacitor, the ripple stabilizes. The waveform approaches an inverse sawtooth — an almost vertical charge time, followed by a nearly steady linear discharge rate, all repeating every 8.333 milliseconds (cycling at 120 Hertz). The peak value of the waveform remains where it was, but the amount of ripple subtracted from it decreases. Approximating a sawtooth will be close enough for our purposes.

Since specific transformer voltages are a lot easier to come by than are capacitor sizes (especially if you rewind them yourself — but that's another whole story), we will

calculate the necessary transformer size needed with a given capacitor. Let's start by taking that capacitor size and calculating its ripple per given current drain:

$$V_r = \frac{8I}{C}$$

where  $V_r$  = peak-to-peak ripple voltage,  $I$  = current drain in mA, and  $C$  = filter capacitance in uF.

We now have the amount of ripple, the diode drop, and the dropout voltage of our IC regulator. The sum of these voltages equals our minimum necessary peak transformer value. The *minimum* rms voltage that we can use therefore is:

$$V_t = (1.414) (V_d + V_r + 1.3)$$

where  $V_t$  = transformer voltage, volts center-tapped (rms),  $V_d$  = regulator dropout voltage (usually  $2 + V_{out}$ ), and  $V_r$  = the ripple voltage we calculated above.

Since this equation is for use with a center-tapped

transformer and a full wave rectifier, here is a modified formula to use for Fig. 2's bridge. It is not simply half of the full wave value, so use this modified formula instead of trying to work it out of the other one:

$$V_t = (.707) (V_d + V_r + 2.6)$$

where all variable names are the same as before.

If you are using other rectifiers and have more accurate data on them, you can insert your diodes' forward drop in place of the 1.3 and 2.6 that I use for 1N4000 series rectifiers. Remember that, whatever the *average* current, the peak value is much higher at specific instances. Currents above ten

Amperes can be in a one Amp power supply! Keep this in mind if you calculate your own rectifiers' forward drop.

Round up your final answer. This will incorporate a safety margin to allow for component tolerances and line voltage fluctuations. A ten or twenty percent round up margin could safely be used, providing that you do not approach the absolute maximum input ratings of your device. Your final calculation should be a check to make certain that the instantaneous voltage, with the actual component values you have decided to use, never exceeds the capacitor or regulator input ratings. When you round up, all that you in fact are doing is improving the line regulation at only a slight trade-off in size and efficiency.

#### Device Availability

The LM309 regulator (both the H and K package styles) has been designated to be worst case 7400 TTL compatible. Barring thermal shutdown or current limiting, their output voltage will never deviate outside the 4.75 to 5.25 volt range that 7400 TTL logic requires — even counting line, load, and thermal regulation summed worst case.

The LM309H is therefore a prime candidate for on-card regulators for logic circuits needing less than 200 mA — and it is in fact somewhat unique in this respect. The larger package styles, although still small enough for PC board mounting, are more conducive to chassis mounting.

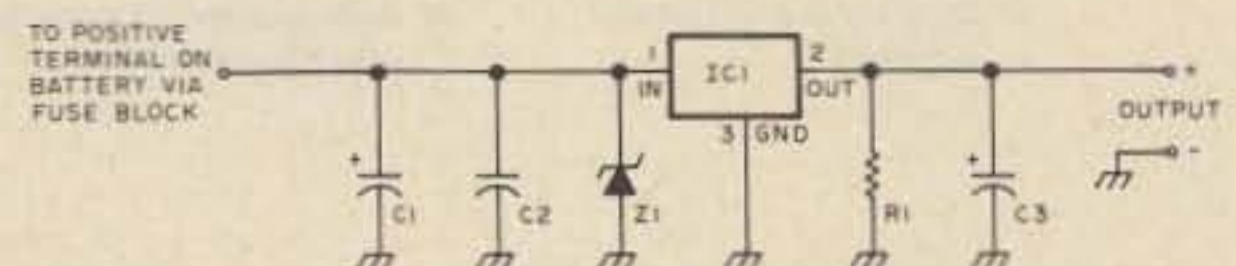

Fig. 4. This is a supply tailored for use in the transient-prone environment of a car. Zener Z1 can be anywhere from around 24 to 30 volts. All other parts are as in Figs. 1 and 2.

The LM309 is by far the most readily available of the many three terminal voltage regulators. For the sake of printing costs, some suppliers have omitted the LM prefix in their magazine advertisements. Others do not make obvious the distinction between the H and K case styles. Nevertheless, a good share of the surplus dealers that advertise in the back of this or any other experimenter-oriented electronics magazine do carry the LM309.

A different story exists concerning the uA7800 series. Even though here again some distributors have dropped the prefix in their advertisements for the sake of brevity, there simply are not as many firms carrying it. Careful reading of advertising, especially the literature sent by suppliers in response to Reader Service inquiries, will show you who sells what. There are some commercial and industrial suppliers who carry the units at prices only slightly higher than mail order surplus dealers. Surplus prices are all about the same, but since slight discrepancies do exist, shop around before you send anyone your money.

There are quite a few regulators available that I have not mentioned here. Don't be afraid to try some of them. However, remember to make sure that you are buying a fixed voltage, three terminal

voltage regulator integrated circuit. Some chips, such as the 723, are not three terminal devices, and they require a number of external components to adjust the output voltage and set the current limiting point. They have to be used with a much larger number of external components, in circuit whose design is much more involved than this. The giveaway should be that no specific output voltage is mentioned. If the device is advertised simply as a "monolithic voltage regulator," you can be pretty sure that it is a multiterminal unit. Some ads do not give a verbal description of the device, but just its number and price. You can cross-reference to other advertisements to figure out what the product is.

A series of regulators that you might be interested in — especially if you want to build a  $\pm 15$  volt op amp supply — is the uA7900 series. They are negative voltage complements to the uA7800s. Availability is still somewhat limited, but hopefully it will improve shortly. Both series are produced in a

wide range of output voltages, including a couple that I have not mentioned here. Again, check through the ads in the back of this magazine.

Make sure that, for any device you buy, you also obtain a set of the manufacturer's specification sheets and also, if possible, application notes. Originally the LM309 was produced by National Semiconductor and the uA7800 series by Fairchild, but quite a number of other manufacturers have since second-sourced them. So don't be too upset if you receive from a single distributor spec sheets and regulators with different manufacturers' names on them. There is enough industry-wide compatibility so that you need not worry about differences between manufacturers. (Actually, a more likely case would be to find no manufacturer's imprint at all on one or the other.) Hopefully, a little bit of reading through those data sheets and application notes will answer most of your questions.

There are external circuits, available from suppliers' and

manufacturers' application notes, that can be used to make these regulators even more versatile. A typical circuit in this category is one enabling the output voltage to be set at different points, or even to be continuously adjustable. But since the main objective of this article is to introduce three terminal regulators in a relatively simple way, I will have to reserve discussion on them for the present time.

Three terminal regulators come into their own for the simple supplies. Usually, by the time you hang on all of the necessary parts to one of these three terminal units to achieve a specialized application, you find that you would have been better off by using a multiterminal device from the start. The 723 that I mentioned before is only one of a large number of these chips available.

I hope, even if you never actually use a three terminal IC regulator, that reading this article has given you a little knowledge about them and their use. If you have any specific questions you would like answered, or would like more explicit information concerning suppliers' names, feel free to write and ask me. (Please include a self-addressed, stamped envelope for my reply.) Maybe I won't know the answers to all of your questions, but hopefully I can at least refer your inquiries to someone who does. ■

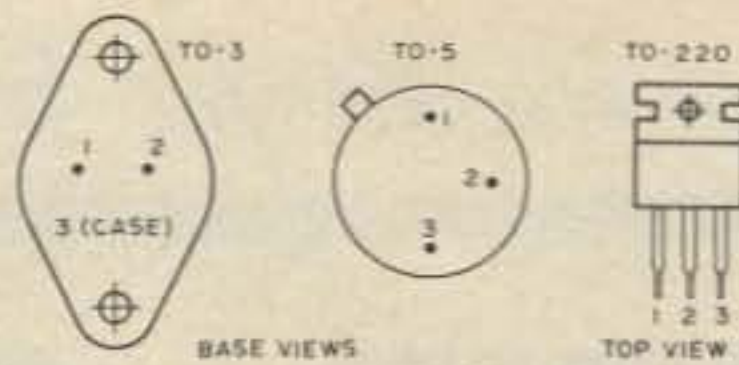

Fig. 5. Here are the pin connections for the TO-5 metal can, TO-3 metal power, and TO-220 plastic power packages.

## FAST SCAN AMATEUR TELEVISION EQUIPMENT

● BROADCAST QUALITY PERFORMANCE ● SOLID STATE



AX-10 TRANSMITTER



AM-1A RCVR MODEM



### Aptron Laboratories

Box 323 Bloomington IN 47401

W

Wilson Electronics Corp. **SUMMER SPECIALS**

# SUPER FINE - 2 METER

## MOBILE . . . 24 CHANNEL • 10 WATT

PRIORITY CHANNEL "CALL BUTTON" • MODULAR CONSTRUCTION

### 10 DAY MONEY BACK GUARANTEE



MODEL WE-224 144 - 148 MHz

Only **\$199<sup>95</sup>**

thru Sept. 30, 1976

- \* LO POWER ADJUSTABLE: 0-5 WATTS
- \* TYPICALLY .3  $\mu$ V SENSITIVITY FOR 20 dB QUIETING
- \* BUILT-IN ADJUSTABLE TONE BURST w/FRONT PANEL SWITCH
- \* TRIMMER CAPS FOR BOTH RECEIVE AND TRANSMIT XTALS
- \* USES SAME XTALS AS THE HAND HELD UNITS
- \* MOSFET FRONT END - HELICAL RESONATOR
- \* HIGH VSWR & REVERSE B+ PROTECTION CIRCUITS
- \* BUILT-IN SPEAKER WITH EXTERNAL MINI PHONE JACK
- \* FILTERS: 10.7 MONOLITHIC & 455 kHz CERAMIC
- \* 10 FEET OF FUSED POWER CABLE WITH LIGHTER ADAPTER
- \* EXTRA FUSES, MOUNTING HARDWARE, BRACKET, 500 OHM MIKE, DIDDLE STICK, & 34 PAGE MANUAL
- \* SIZE: 6.5 x 2.5 x 9.5 in.      \* WEIGHT: 5.5 lbs
- 2.5 x .98 x 3.7 cm              \* WEIGHT: 2.5 kg
- \* CURRENT @ 13.6 VDC      RECEIVE: 45 mA
- TRANSMIT: 750 mA
- @ 1 WATT, 2.6A @ 10 WATTS
- \* 90 DAY WARRANTY & 10 DAY MONEY BACK GUARANTEE
- \* COMES COMPLETE, READY TO OPERATE ON 146.52 SIMPLEX
- \* YOU CAN PURCHASE EXTRA XTALS (TX or RX) FOR \$3.75 ea.
- \* FOR \$7.50 EXTRA, WE'LL PUT ALL THE XTALS ON FREQUENCY!

## 220 and 450 HAND HELDS

- SWITCHABLE 1 - 2.5 WATT (1 & 1.8W ON 450)
- 6 CHANNEL - ALL PLUG-IN XTALS WITH TRIMMERS ON BOTH TX & RX CRYSTALS
- 12 kHz CERAMIC FILTERS • BATTERY INDICATOR
- HAS .3  $\mu$ V SENSITIVITY FOR 20 dB QUIETING
- 10.7 & 455 kHz IF ON 220 (21.4 & 455 kHz ON 450)
- CURRENT: 14 mA RX, 500 mA TX ON BOTH MODELS @ 12.0 VDC
- MICROSWITCH PTT BUTTON
- WEIGHT IS LESS THAN 22 OUNCES (w/o NI-CADS)
- SIZE IS 8.9" x 1.7" x 2.9"
- UNBREAKABLE LEXAN® CASE
- BOTH UNITS USE THE SAME ACCESSORIES AS THE 2-METER 1402 & 1405 HAND HELDS
- OPTIONAL 12 BUTTON TOUCH-TONE PAD AVAILABLE
- COMES COMPLETE w/RUBBER DUCKIE, NI-CAD CASE, (223.50 INSTALLED OR 446.00 ON THE 450)

- \* 220 mHz MODEL 2202SM - \$239.95
- \* 450 mHz MODEL 4502SM - \$279.95



90 DAY WARRANTY

10 DAY MONEY BACK GUARANTEE

### ACCESSORIES AVAILABLE

DESCRIPTION	SPECIAL PRICE
BC1 BATTERY CHARGER	\$34.95
BP1 10 EA. AA GOULD NICAD BATTERIES . . .	14.95
BT1 EXTRA BATTERY TRAY . . . . .	6.00
LC1 LEATHER CASE 1402 . . . . .	9.95
LC2 LEATHER CASE 1405, 2202, 4502 . . . . .	9.95
SM1 SPEAKER MIKE FOR EARLY MODEL 1402 9 PIN CONNECTOR . . . . .	24.95
SM2 SPEAKER MIKE FOR ALL NEW HAND HELDS WITH ROUND 6 PIN CONNECTOR . . . . .	24.95
TE-1 SUB-AUDIBLE TONE ENCODER INSTALLED . . . . .	34.95
TTP TOUCH-TONE PAD . . . . .	49.95
INSTALLATION AT TIME OF RADIO PURCHASE . . . . .	FREE
INSTALLATION AT LATER DATE, ADD . . . . .	15.00
XF-1 10.7 KC MONOLITHIC XTAL FILTER . . . . .	9.95
CRYSTALS TX or RX (Common Frequency Only) . . . . .	3.75

BC-1 BATTERY CHARGER







# 2.5 and 5 WATT 2 METER

6 CHANNEL HAND HELD TRANSCEIVERS

- \* .3  $\mu$ V RECEIVERS - 12 kHz CERAMIC FILTERS
- \* OPTIONAL 12 BUTTON PAD AVAILABLE FOR ANY HAND HELD FACTORY INSTALLED
- \* AVAILABLE FOR MARS OR CAP • 10 DAY MONEY BACK GUARANTEE
- \* 90 DAY WARRANTY • INCLUDES 52 SIMPLEX and "DUCKIE" ANTENNA



2.5 WATT  
MODEL  
1402SM

- TRIMMER CAPS ON RX & TX
- ALL PLUG-IN CRYSTALS (Same as WE-224 Mobile)
- 10.7 and 455 kHz IF
- .3  $\mu$ V SENSITIVITY FOR 20dB QUIETING

CURRENT DRAIN @ 12 VDC

MODEL 1402SM:

RCVR: 14 MA - XMTR: 500 MA

MODEL 1405SM:

RCVR: 14 MA - TX @ 1W: 400 MA

TX @ 5W: 900 MA

- 1402 HAS S METER & BATTERY INDICATOR
- 1405 HAS A SENSITIVE BATTERY INDICATOR
- BOTH MODELS FEATURE MICRO-SWITCH PTT
- THE 1405 CASE IS UNBREAKABLE LEXAN®
- THE 1402 CASE IS HIGH IMPACT ABS PLASTIC
- WEIGHT (w/o NI-CADS) IS LESS THAN 22 OUNCES
- OVERALL MEASURE IS 8.9" x 1.9" x 2.9"
- 10 NI-CADS (ORDER BP-1) ARE EXTRA @ \$14.95



1 or 5 WATT  
MODEL 1405SM

OPTIONAL  
TOUCH-TONE  
PAD  
AVAILABLE  
FACTORY  
INSTALLED  
ON ALL  
HAND  
HELDS

TO: WILSON ELECTRONICS CORP., 4288 S. Polaris Ave., Las Vegas, Nevada 89103, (702) 739-1931, Telex 684-522

## SUMMER SPECIAL DIRECT SALE ORDER BLANK

PLEASE PRINT CLEARLY

- \_\_\_ 1402SM @ \$164.95
- \_\_\_ 1405SM @ \$239.95
- \_\_\_ WE224 @ \$199.95
- \_\_\_ 2202SM @ \$239.95
- \_\_\_ 4502SM @ \$279.95
- \_\_\_ BC1 @ \$34.95
- \_\_\_ BP1 @ \$14.95
- \_\_\_ BT1 @ \$6.00
- \_\_\_ LC1 @ \$9.95
- \_\_\_ LC2 @ \$9.95
- \_\_\_ SM1 @ \$24.95
- \_\_\_ SM2 @ \$24.95
- \_\_\_ TE1 @ \$34.95
- \_\_\_ TTP @ \$49.95
- \_\_\_ XF1 @ \$9.95
- \_\_\_ EXTRA CRYSTALS @ \$3.75 ea.

PLEASE PUT ALL INSTALLED XTALS ON FREQ. (\$7.50 Extra per Radio)

INSTALL THESE CRYSTALS

	TX	RX	TX	RX
	52	52	G.	
A.			H.	
B.			I.	
C.			J.	
D.			K.	
E.			L.	
F.				

Specify Freq. on Tone Encoder TE-1 \_\_\_\_\_ Hz

ENCLOSED IS  CHECK  MONEY ORDER  
 MC  BAC

CARD # \_\_\_\_\_

EXPIRATION DATE \_\_\_\_\_

NAME \_\_\_\_\_

ADDRESS \_\_\_\_\_

CITY \_\_\_\_\_

STATE \_\_\_\_\_ ZIP \_\_\_\_\_ PHONE ( ) \_\_\_\_\_

SIGNATURE \_\_\_\_\_

SHIPPING & HANDLING PREPAID FOR SUMMER SPECIAL  
NEVADA RESIDENTS ADD SALES TAX

SPECIAL PRICES GOOD THRU SEPT. 30, 1976

# Can An Indoor Antenna Work?

-- making the best of a bad bargain

Many amateurs are forced to use indoor antennas on the HF bands either from their home QTH or while traveling. No form of indoor antenna is ever going to be as efficient a radiator as an outdoor antenna but there definitely are a few rules to be observed if one is going to achieve reasonable performance from an indoor antenna. In brief, these rules might be stated as:

1. The fact that an antenna is used indoors does not change basic antenna principles.
2. Choose an indoor location which provides minimum coupling loss to the outside.
3. Use an antenna form which is long enough to get power at least efficiently transferred from the transmitter into the antenna.

This article discusses each of the above rules in some detail and gives a number of examples to illustrate various indoor antenna ideas.

## Radiation Characteristics

Many amateurs feel that, when an antenna is used indoors, its radiation characteristics can no longer follow the typical patterns shown in the various antenna manuals. It is true that, because of increased capacitive effects and coupling to

the building structure, the wavelength formulas given in manuals do not always apply. But, the basic radiation patterns do not change greatly. For instance, a horizontal dipole still has its maximum radiation broadside to the line of the antenna. The same is true for an end feed wire unless it is several wavelengths long at the operating frequency, which normally would not be the case in an indoor location. Fig. 1 shows a bent half-wave antenna, end fed, used in a room. Maximum radiation is broadside to the antenna, or in this case in the direction bisecting the sides of the antenna. Obviously, if one forgets the "basics" and constructs an indoor antenna so it radiates maximum energy in a direction where few stations can be worked, one is wasting power in a situation where every bit of radiated power is precious.

Knowing the directional characteristics of loop antennas is particularly important since they are one of the most useful forms of indoor antenna. A large square loop ( $\frac{1}{4}\lambda$  per side), such as the usual quad antenna element, has its maximum radiation perpendicular to the plane of the loop. If constructed as a closed loop, its terminal impedance is relatively low. For the loop

described, it is about 80 Ohms. If the loop is fed at the bottom, the radiation is horizontally polarized. If fed at the side, the radiation becomes vertically polarized. Fig. 2(a) shows this type of loop. Many variations can be made on a full size loop by shaping it into different forms such as a triangle, by using loading coils to shorten the physical lengths needed and by more exotic shape deformations. One of the most interesting of the latter is shown in Fig. 3. It appeared in *QST* some time

ago and good results were claimed for it. The radiation is vertically polarized and omni-directional. Supposedly, it could be turned around and used horizontally. With dimensions of only  $\frac{1}{10}\lambda$  per side, it becomes feasible to construct it indoors (even on 40 meters) in large rooms.

Although large loops (even the compact version of Fig. 3) look attractive on paper, they become difficult to construct in reality. This is especially true if one wants to set up an antenna indoors for portable operation. A second

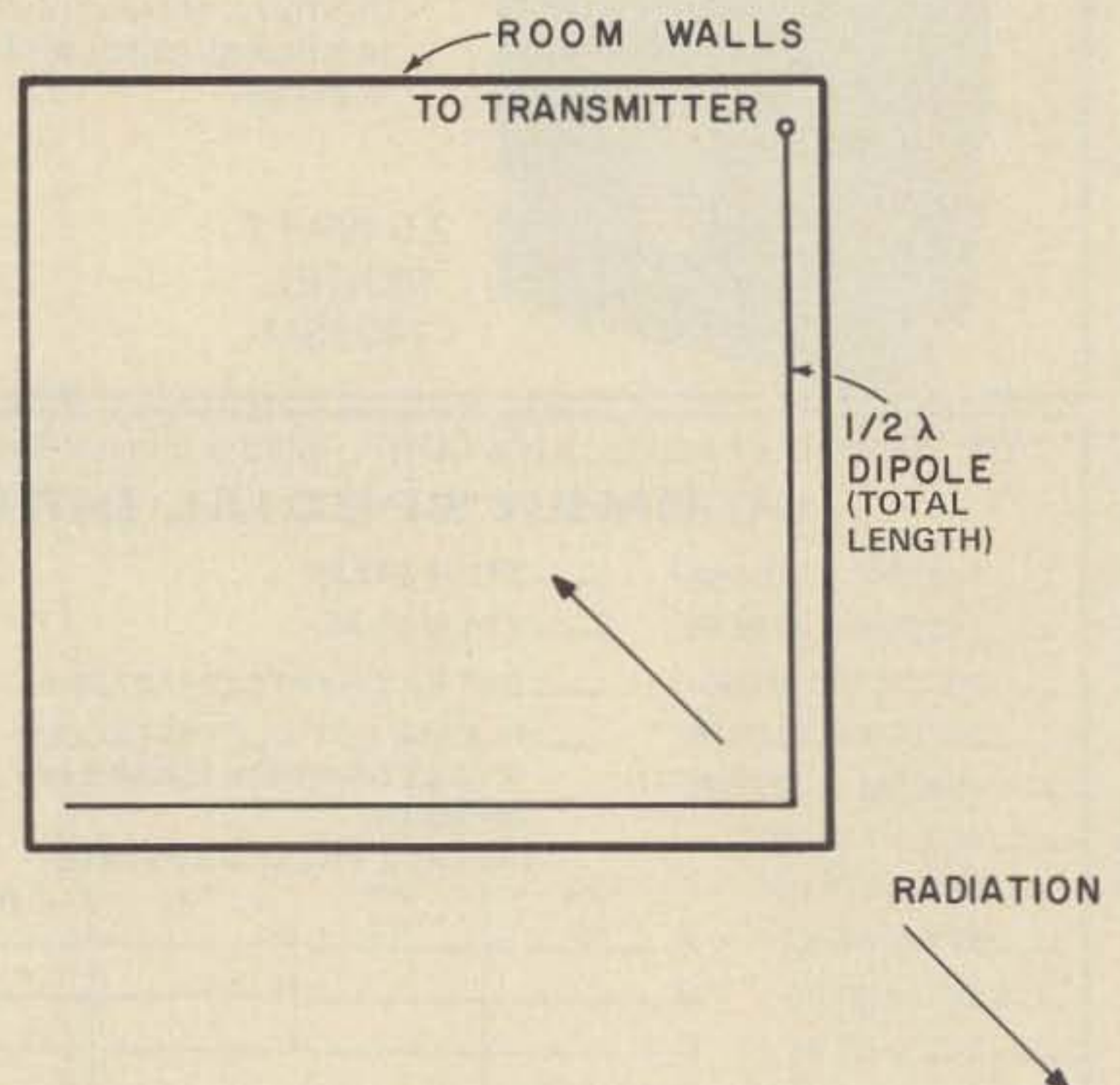

Fig. 1. A dipole antenna ( $\frac{1}{2}\lambda$ ) retains its broadside radiation characteristic inside a room, whether center or end fed.

important class of loop antennas and the one most generally useful for indoor work is the  $1/2\lambda$  loop ( $1/8\lambda$  long per side). Such a loop can be considered as a half wave dipole antenna bent in the form of a loop. An important change in directional characteristics occurs, however. Maximum radiation is now in the plane of the loop and in the direction towards which the antenna is fed. This is shown in Fig. 2(b) for a loop which is "open" at its far end. The reason for "opening" the far end is to reduce the input impedance to about 50 Ohms. Otherwise, it would be in the order of several thousand Ohms and difficult to match. If the antenna is constructed vertically (diagonally across a room), its polarization will be vertical. If constructed horizontally (around the corners of a ceiling), its polarization will be horizontal. The direction of maximum radiation can be controlled by choosing at which end to feed the antenna.

The small loop adapts very well to usage in small to medium size rooms. By noting the dimensions of the room involved, one can quickly determine with a pocket calculator the lowest frequency band on which operation is feasible.

Operation on a second harmonic band is possible by shorting the far end of the loop and using it as a full size loop, but note how the directional properties of the antenna change! If the original  $1/2\lambda$  loop used horizontally is used on a band where it becomes a  $1\lambda$  loop, most of the radiation is straight up and down and useful only for extreme short skip contacts.

The next smaller class of loop is one having a total side length of  $1/4\lambda$ . Such a loop is similar to the loop of Fig. 2(a) except that capacitive loading is required at both the transmitter terminals and

at the "open" terminals to bring the loop into resonance at the operating frequency. The capacitances needed depend upon the operating frequency but are 500-1500 uF at the transmitter end and 50-100 uF at the "open end" for 40/80 meter operation. A BC variable will suffice at the transmitter end but a wide-spaced variable is needed at the "open end." The capacitances are adjusted for minimum swr if a coax feedline is used or for best transmitter loading. The  $1/4\lambda$  loop is a poor radiator — efficiency is only 8-10%. Yet, it may be the only usable antenna form if operation on a low frequency band such as 40 or 80 meters is necessary in a small room. Unlike the other larger loops, antennas where wire size is not critical, the efficiency of the  $1/4\lambda$  loop is very much dependent upon using wire with low ohmic losses.

#### Indoor Locations

The idea of an outdoor antenna being located "as high as possible and as clear as possible" pretty well applies to the indoor antenna as well. Coaxial transmission line loss, even that of miniature coax such as RG-174, is quite low on the HF bands. It would be better to have an indoor antenna located as high as possible within a building, even with a long transmission line, rather than use an indoor antenna at a building level where it is shielded by other nearby buildings. In a private residence this usually means an attic location. In an apartment location one has to examine all the possibilities available since conditions will obviously vary quite widely. A disguised TV transmission line, for instance, might lead instead to a suitable loop antenna located inside or immediately around a roof level housing.

When choosing a portable indoor location one might

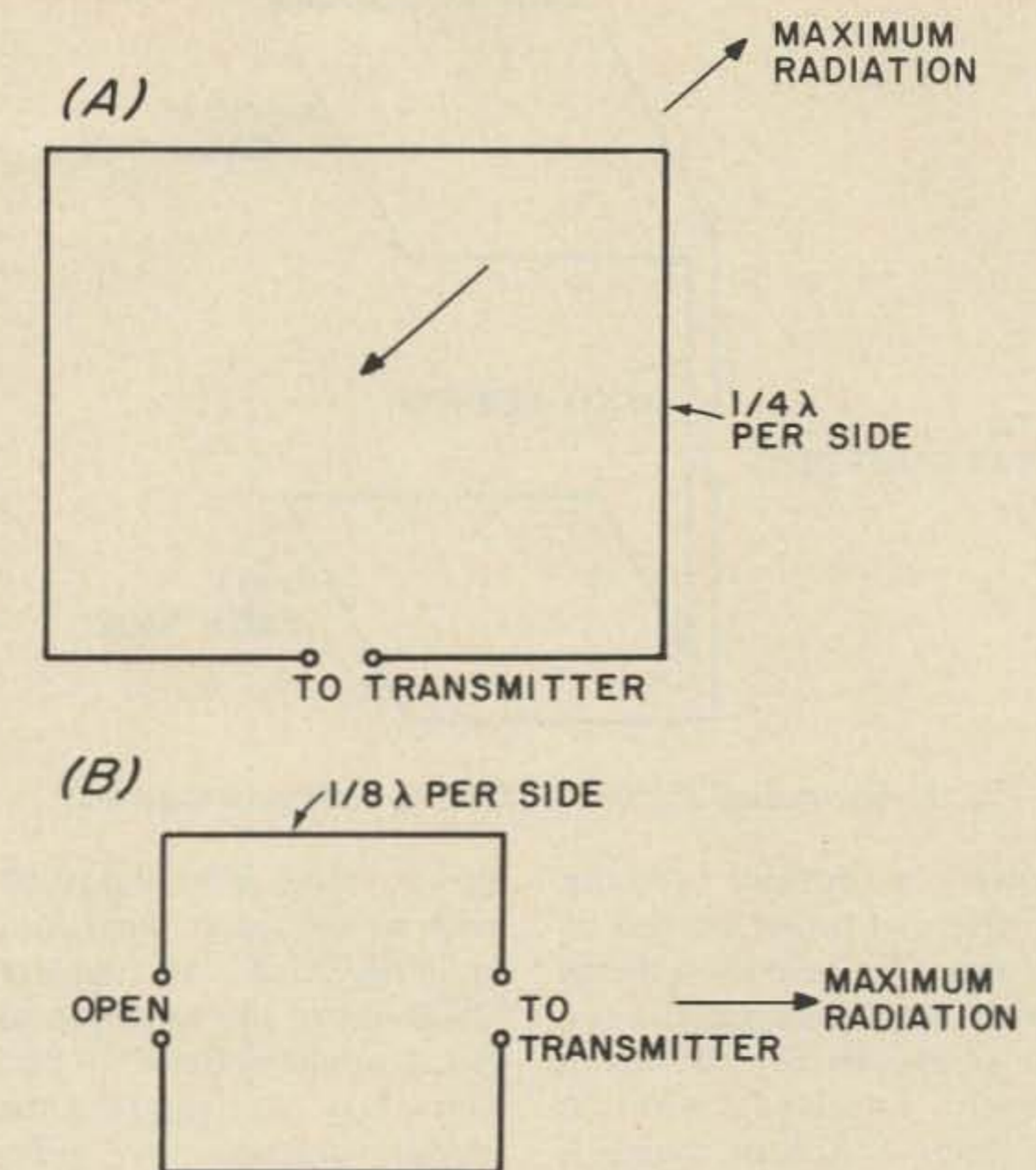

Fig. 2. The  $1\lambda$  and  $1/2\lambda$  loops are the most useful of indoor antenna forms. Both provide a good, direct match to coax line.

have a bit more choice of locations, such as when traveling on vacations. If any choice of building locations is possible, one of the principal rules is to avoid any steel-reinforced building locations. Such buildings will provide the same effect as though one were trying to work out of a screen-shielded room! Buildings can be examined for such construction by a variety of means. For instance, a simple compass can be used to examine walls for metal reinforcements. Sudden deflections at periodic intervals will indicate metal reinforcement as the compass is moved around closely against the wall. Most often, however, the basic nature of the building involved will provide the necessary clues. Any high-rise structure obviously has to be of metal-reinforced construction. Two or three story buildings may or may not be, even those of masonry construction. Wood frame buildings are obviously the most suitable, the only exception being to avoid being immediately under the

roof of such a building if the roof is of tin or other metal. If one must work from a metal-reinforced building, one should try to be as high as possible in the building and in rooms with large glass areas.

Whatever indoor location is chosen, the antenna wire should be held a few inches away from the walls or molding if at all possible. The only exception concerns glass areas. If one is fortunate enough to be in a location with large glass areas, a good antenna construction material to consider is stainless steel tape. The tape can be placed directly on the glass and wires soldered to it, to join sections of an antenna and for connection of a transmission line.

#### Which Antenna Form to Use?

Working from an indoor location is a bad enough handicap, without having to lose transmitter power before it has a chance to be radiated. In other words, an antenna form should be used which will take and radiate as much of the available transmitter

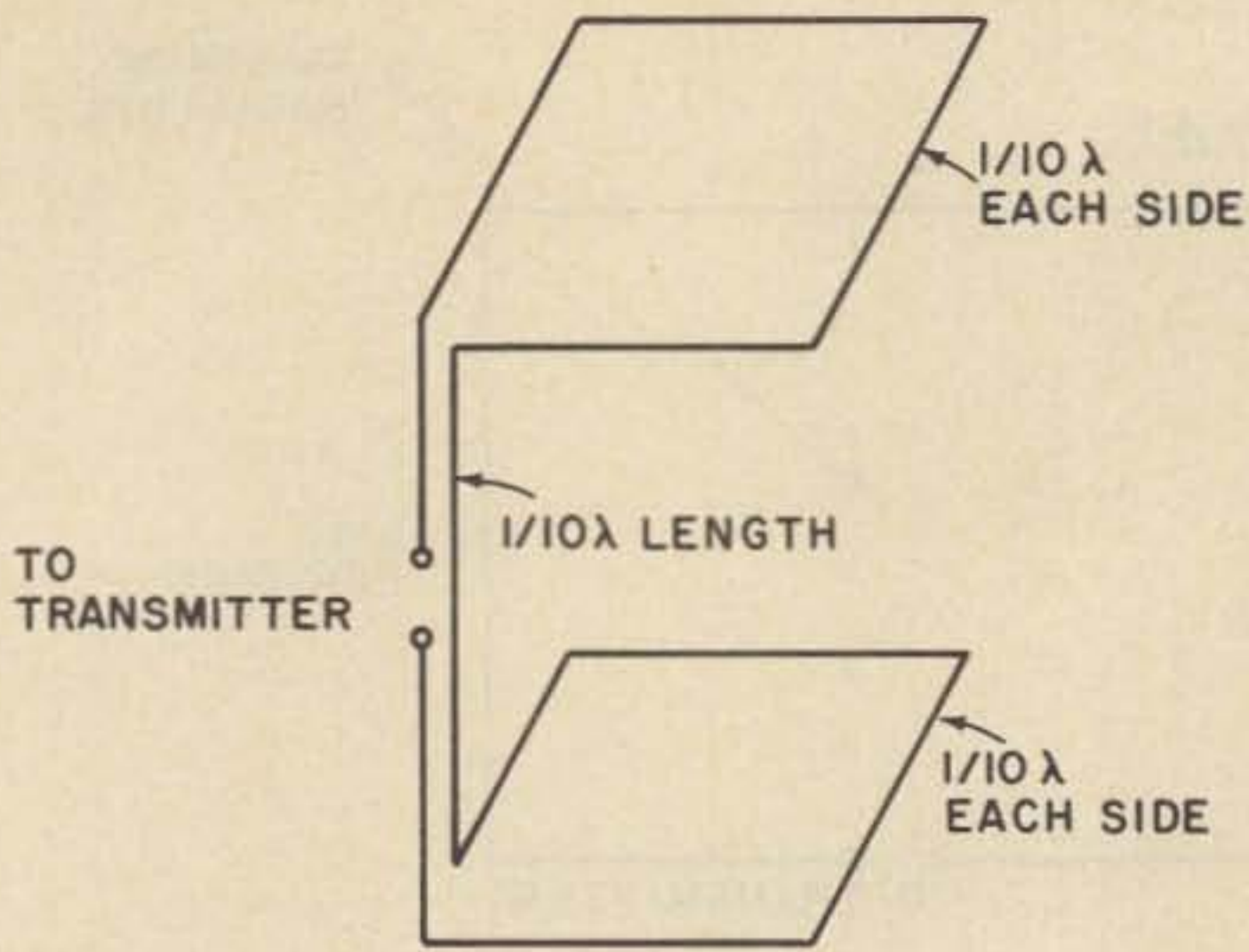

Fig. 3. An unusual method of folding a  $1\lambda$  loop together.

power as possible without having that power burned up in ohmic losses in the antenna or antenna matching devices. In simple terms, put up as much antenna wire as feasible. A rule of thumb is not to use an antenna shorter than about  $1/8\lambda$ . This would mean about 32' on 80 meters and would be a piece of wire which was being worked

against some ground system such as the water pipes in a building. One can squeeze QSOs out of shorter antennas but it would be better to find some way to lengthen the indoor antenna by going through doorways between rooms or utilizing hallways where possible.

Progressing from the  $1/8\lambda$  long wire one can go up to a

$1/4\lambda$  or even  $1/2\lambda$  long wire, all being worked against some ground connection. However, if at all feasible one should try to use a ground-independent antenna. The simplest is a dipole, either stretched out fully or formed into a "V" shape. Such an antenna can usually be used in attics on the higher frequency bands but the only solution in most cases for the lower frequency bands such as 40 and 80 meters is a loop antenna. The form of loop to aim for is the  $1/2\lambda$  open-ended loop. Being a full  $1/2\lambda$  long, its losses are low and it provides a convenient match to a transmission line or directly to a transmitter. Transmitters with adjustable pi-networks or similar networks can usually work into this antenna form without the need of additional antenna tuning devices. Being only about 8 foot on a side for 20 meters, it can be constructed in almost any room on that

band or higher frequency bands. Being about 16 foot on a side for 40 meters means it can be accommodated vertically in only unusually high rooms. But, the diagonal run of many moderate size rooms will accommodate the horizontal legs of such a loop. In that case the vertical legs should be made as long as possible and the extra length made up by having a "U" fold in each vertical leg. Placed horizontally, such an antenna can be accommodated fully stretched out in larger size rooms. On 80 meters, a room would have to have unusual dimensions to accommodate a  $1/2\lambda$  loop placed in any orientation and the only choice here would be the  $1/4\lambda$ , tuned as previously described. Such an antenna has poor efficiency but still it will generally prove to be a better radiator than a  $1/8$  or even  $1/4\lambda$  piece of wire worked against a lossy water pipe ground. ■

Best for beginners . . . preferred by pro's!

### NYE VIKING SPEED-X

Model 114-310-003

**\$8.25**

One of 8 models, all sure-handed . . . smooth operating . . . priced from \$6.65.



### NYE VIKING SUPER SQUEEZE KEY

Fast, comfortable, easy . . . and fun!

Model SSK-1 (shown)

**\$23.95**

Model SSK-3 (has sub-base to hold any SPEED-X Key).

**\$26.95**

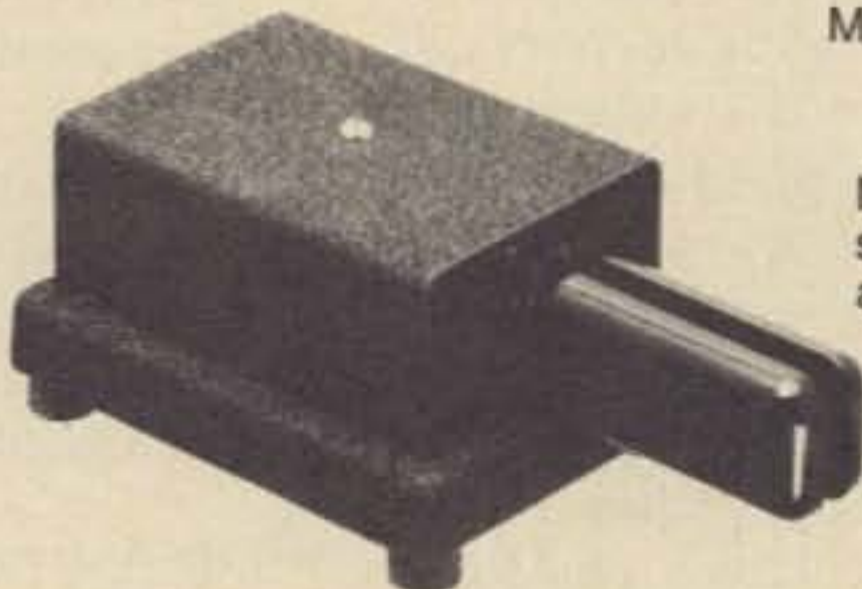

Whether you're a "brass pounder" or a "side swiper" insist on the sure, smooth *feel*, and the long-lasting *quality* that is built into every NYE VIKING KEY.

Prices subject to change.

Available at leading dealers around the world or write for a descriptive catalog.



**WM. M. NYE COMPANY, INC.**

1614 - 130th Ave. N.E., Bellevue, WA 98005

### FREQUENCY STANDARD

Only

**\$37.50**

(less batteries)  
POSTPAID USA  
& CANADA



● Precision crystal.

● Fully guaranteed.

● Markers at 100, 50, 25, 10, or 5 KHz selected by front panel switch.

● Zero adjust sets to WWV. Exclusive circuit suppresses unwanted markers.

● Compact rugged design. Attractive, completely self contained.

● Free brochure on request.

● Order direct. \$37.50 PPD U.S. & Canada. California residents add 6 percent sales tax.

**PALOMAR ENGINEERS**

BOX 455, ESCONDIDO, CA 92025

Phone: (714) 747-3343

## TWO-TONE ENCODER ENCLOSURES

A sharp new vinyl wood-grain covered aluminum enclosure with die punched anodized aluminum front. It will accept all standard twelve button dials except Automatic Electric. The dial is held in place with pre-mounted brackets.



\$8.45 pp  
Universal Model

\$7.95 pp  
Base Model

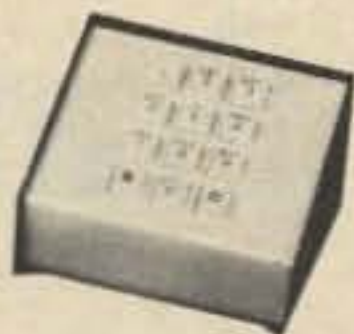

Models M and U have a pivoted anodized gimbal bracket which provides multi-position under-dash panel mounting. All models can be mounted on top of equipment on four rubber feet. Models B and U hold dial at a convenient 30° angle. There is ample room inside for transmitter keying circuitry.



\$8.45 pp  
Mobile Model

WRITE for quantity prices to repeater groups. Prices subject to change without notice. Ohio residents please add 4½% sales tax.

**NORTHWESTERN products**

BOX 5831 DEPT E TOLEDO OH 43613

Now you  
can buy  
Sinclair  
quality at  
professional  
discounts

Sinclair Radio Laboratories has enjoyed a reputation for quality and innovation in the world wide Professional Communications market for over 25 years. Sinclair is the originator of the tunable Mirage antenna and the inventor of the Excaliber mobile antenna. The two meter 100 DB Hybrid Ring duplexer, the Q-circuit<sup>®</sup> duplexer and the popular Q-filter<sup>®</sup> were also developed in Sinclair laboratories. Sinclair builds more quality fixed station duplexers than any manufacturer in the world.

Now, Sinclair offers amateur operators professional quality in:

- Duplexers (Fixed and Mobile)
- Antennas (Fixed and Mobile)
- Filters
- Multicouplers (Tx and Rx)
- Amplifiers
- And more.

Plus, Sinclair makes all this equipment available to individuals and organizations at generous professional discounts. Send for our free brochure today.



**SINCLAIR**  
RADIO LABORATORIES

675 Ensminger Road  
Tonawanda, N.Y. 14150  
(716) 874-3682 Telex: 91-9198

Yes! Send me your free brochure and discount schedule today!

NAME \_\_\_\_\_

ADDRESS \_\_\_\_\_

CITY \_\_\_\_\_

STATE \_\_\_\_\_

ZIP \_\_\_\_\_

NORTH SHORE

**RF TECHNOLOGY**

## DUPLEXER & CAVITY KITS

**NOW** Temperature  
Compensated  
...with Invar<sup>®</sup>!

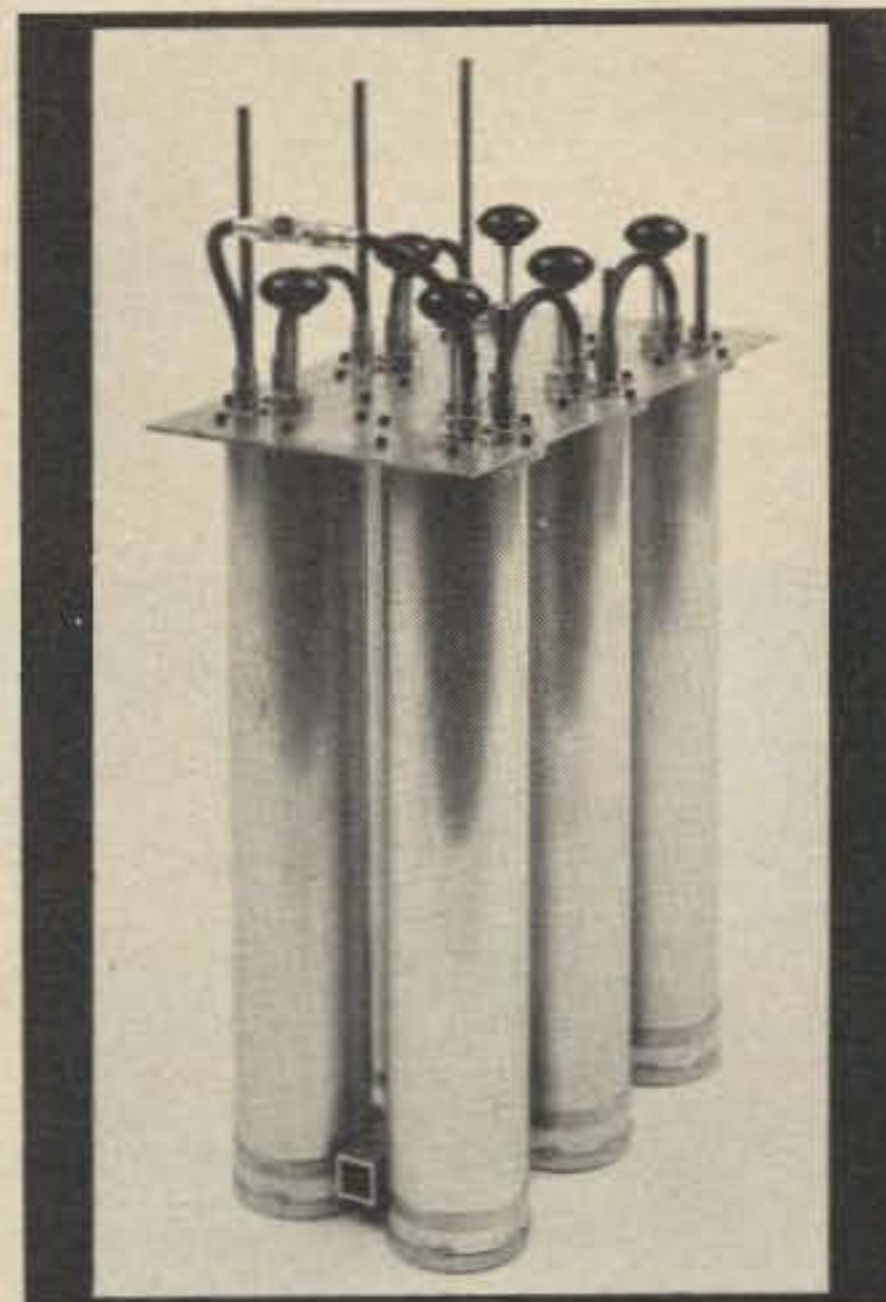

• Easier than ever to assemble and tune • Rugged Construction • Easy maintenance • Low Cost

**Mod. 62-3...6 cav., 2 mtr.,** insertion loss 0.6 db with isolation 100 db typical. pwr. 350 w \$349 ea.

**Mod. 4220-3...4 cav. 220 MHz** insertion loss 0.6 db with 80 db isolation typical. pwr. 350 w \$249 ea.

**Mod. 4440-3...4 cav. 440 MHz,** insertion loss 0.6 db with 80 db isolation typical, pwr. 350 w \$249 ea.

**Mod...30 Cavity Kits 2 mtr. \$65 ea., 220 MHz \$65. ea., 440 MHz \$65 ea.; 6 mtr. \$115 ea.**

Also available: 6 mtr., 4 cav. \$399, 2 mtr. 4 cav. \$249, 440 MHz TV Repeater Duplexer

Only hand tools are necessary to assemble Kits!

All of our Kits are available assembled and tuned. Call or write for prices to Distributor: **TUFTS RADIO**, 386 Main St., Medford, Mass. 02155. Phone (617) 395-8280.

(Prices F.O.B. Medford, Mass. All units can be shipped U.P.S.-C.O.D. orders require \$50 deposit. —Mass. residents add 5% sales tax.)

# 76 callbook

The new 1976 U. S. CALLBOOK has over 300,000 W & K listings. It has calls, license classes, names and addresses plus the many valuable back-up charts and references you have come to expect from the CALLBOOK.

Specialize in DX? Then you're looking for the new, larger than ever 1976 FOREIGN CALLBOOK with over 225,000 calls, names and addresses of amateurs outside of the U.S.A.

On dealer shelves NOW!

Foreign Radio Amateur Callbook  
DX Listings \$12.95

with  
3 Service  
Editions  
\$18.95



United States  
Callbook  
All W & K  
Listings  
\$13.95

with 3 Service Editions \$19.95

RADIO AMATEUR  
**callbook INC.**



Dept. B 925 Sherwood Drive  
Lake Bluff, Ill. 60044

Order from your favorite electronics dealer or direct from the publisher. All direct orders add \$1.00 shipping and handling per Callbook.

# 12 Inexpensive Volts for Your Base Station

-- parts right out of your local Radio Shack

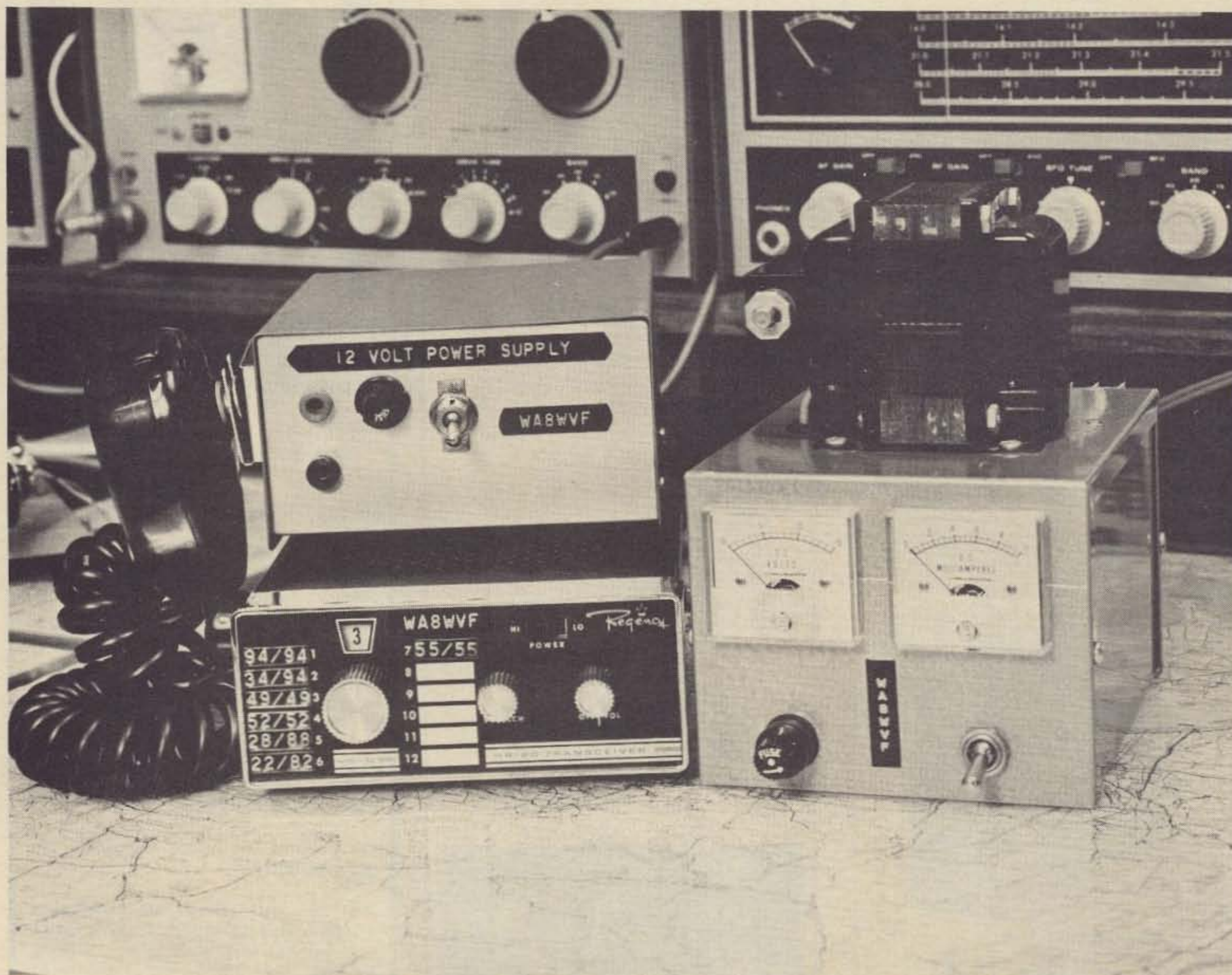

The two 12 volt power supplies use the same circuit. Meters were added to the version on the right to monitor the voltage and current.

The purchase of a new two meter FM rig a few months ago rekindled my interest in ham radio. My ham activity had fallen to an all-time low, but the FM rig helped me rediscover many of my old ham buddies who had already gone the two meter route. It also helped me discover several other things, among them the rapid advancement the state of the art had taken during my absence from the ham bands.

My FM rig worked great mobile; however, base operations were difficult due to the lack of an adequate power supply. The XYL took a dim view of the car battery and charger set up in the living room every time I wanted to monitor the machine from the easy chair. Battery acid and carpet do not a happy home make.

After reading the latest on regulated supplies, I decided to build one. They look simple and are, except for one small item; those nice little IC regulators are about as easy to find in my area as a pocket in a nudist camp. Not wanting a divorce, but desiring to work the rig at home, a solution had to be found. This little power supply was the result.

The circuit is very straightforward and simple. It is by no means original, but is a combination taken from several articles. The great thing about this power supply is that all the parts except the two 10 Watt zener diodes can be obtained from a local Radio Shack store. The entire supply should cost no more than \$24.00 if all the parts are purchased new, and a less expensive cabinet or modest junk box will bring this down considerably.

I have built three of these supplies over the past couple of months and all have worked like a charm. The one on the right in the first photo is the main shack supply now in use. I added the meters to

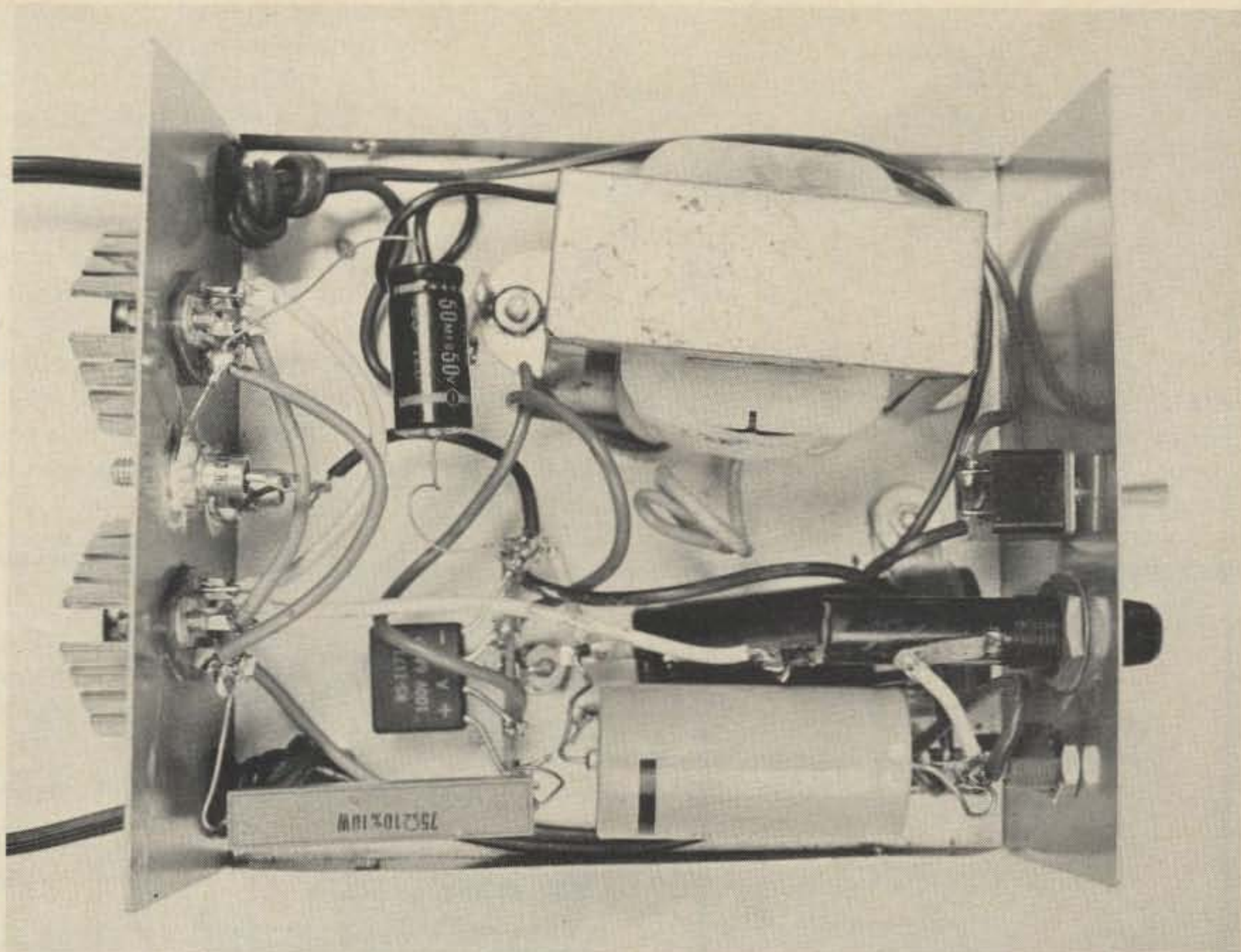

Parts layout is not critical. The cabinet louvers are kept in the rear to aid in cooling Q1 and Q2.

monitor voltage and current so the supply could be used for future projects. The small one on top of the Regency is

the latest version. I wanted to run the rig at work, so this one was built.

Every part in this one was

purchased at Radio Shack, except the 10 Watt zeners. These I bought from a local TV parts store, so they

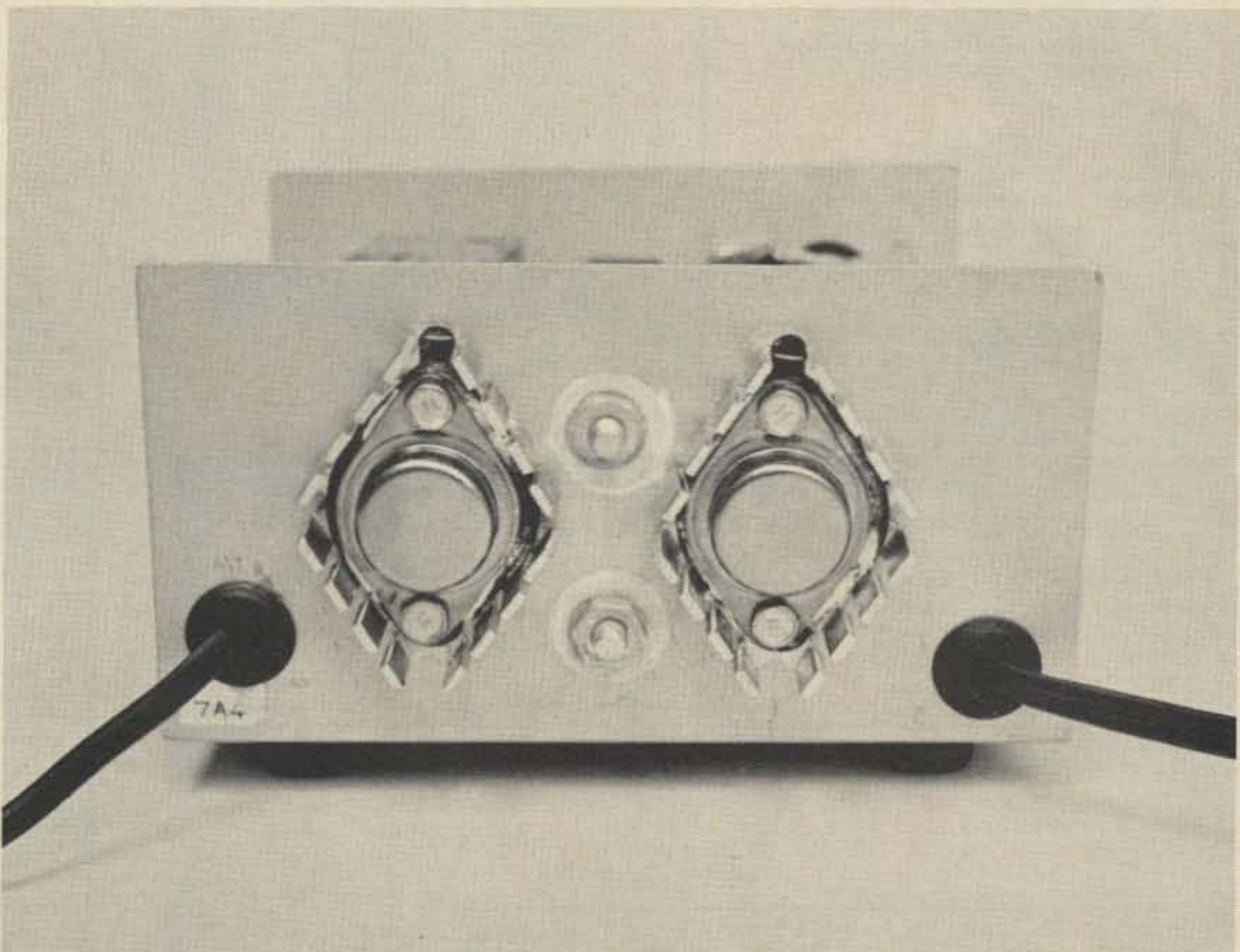

The 10 Watt zener diodes are mounted with insulating mica washers on rear of chassis along with the power transistors. Ac line is on left, 12 volt output on right.

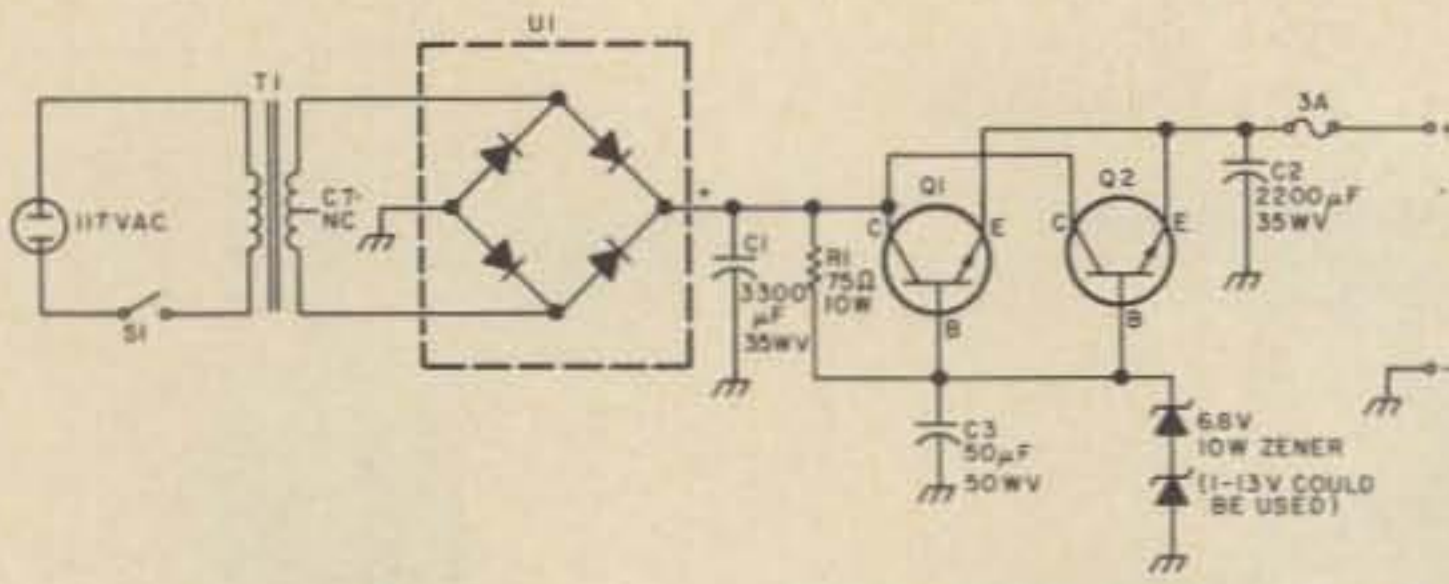

Fig. 1. Super simple 12 volt power supply. Q1, Q2 – 40 Watt power transistors, Radio Shack 276-592; T-1 – 12.6 V, 3 Amps, Radio Shack 273-1510; U1 – full wave bridge rectifier, 100 V, 6 Amps, Radio Shack 276-1171; cabinet – 5¼" x 3" x 5-7/8", Radio Shack 270-253.

should present no problem for anyone wishing to duplicate this supply.

Parts layout is not critical. The only suggestion I would make is to use a bus line for the negative voltage instead of a common chassis ground. This way a stray screwdriver from the case of Q1 or Q2 to the chassis will not short the transistors. The 40 Watt power transistors come 4 to a package. I had to do a bit of experimenting to find a pair that match, but at 30¢ each

this is a minor problem. The rear chassis panel works fine as a heat sink; however, for added cooling I added the small heat sinks shown.

All in all, this little supply works great, looks good and is easy and economical to build. The regulation for the HR2B in the 15 Watt mode is less than ½ volt at 2.8 Amps. I have used this supply with other rigs such as the ICOM IC22A and other ten Watt rigs and the voltage drop has been less than ¼ volt. ■

**YOU ASKED FOR IT!**  
**ecm-5B FM modulation meter**

Only **\$132**  
 less batteries and crystals

- \* 0-7.5 kHz deviation peak reading Meets commercial requirements
- \* Operates 30-500MHz
- \* Crystal controlled for easy operation
- \* Telescopic antenna

**New Options**

- \* NICAD power pak \$20.46
- \* Charger \$29.95
- \* Audio/scope output with earphone \$12.95

Write or call for complete information. Send check or money order for \$132.00 plus \$1.50 for shipping. Indiana residents add 4% sales tax. Crystals for 146.94 MHz: 3.95. All other freq: 7.10.

**ECM**  
 ECM Corporation  
 412 North Weinbach Ave.  
 Evansville, Indiana 47711  
 812-476-2121

**Where are your QSL cards?**

Keep your QSL cards organized and easily accessible. Display them in 3 pocket, crystal clear, vinyl pages. NuAce QSL binders with 23 rings are vinyl covered in blue, black or ginger.

**Only \$5.95**  
 for 10 page binder that holds 60 cards.

Send check or M.O. for immediate delivery or write for information. Add \$1.50 for postage & handling. Satisfaction Guaranteed. Return within 10 days for full refund.

**NUACE**  
 ACE ART COMPANY

Ace Art Company, Inc.  
 24 Gould St., Dept. 73  
 Reading MA 01867

**WYOMING**

Ranch land. Antelope, deer, elk, wild horses – Your "Antenna Ranch." 10 Acres \$30 down, \$30 month. FREE info – maps – photos. Owner:

Dr. Michael Gauthier, K6ICS  
 9550 E. Gallatin Rd., Downey CA 90240

**Shortwave Listening**

1976 World Radio TV Handbook - \$10.95  
 Gated 1000/100/50/25/10 kHz Calibrator - \$54.00  
 Barlow Wadley & R.L. Drake Receivers  
 1976 "Confidential" Frequency List - \$5.45

**GILFER, Box 239, Park Ridge, NJ 07656**

**Triton IV**  
 by **TEN-TEC, INC.**

**"Terrific"**

Send for specs & other great products too.

Serving amateurs since 1928

Master Charge BankAmericard

**FRECK radio & supply co., inc.**  
 252 Patton Ave., Asheville, N.C. 28801  
 PHONE: (704) 254-9551

**ANTENNA SUPERMARKET** PO Box 338, Dept. A, Chambersburg PA 17201

**DIPOLE AND WIRE ANTENNA KITS**, complete with HI-Q BALUN, 100' rope, copper antenna wire and insulators.

80/40/15 parallel dipole	\$36.95	160 short, 130' length	\$36.95
40/20/15 parallel dipole	\$30.95	80 short, 63' length	\$31.95
80/40 trap dipole	\$41.95	40 short, 33' length	\$28.95
40/20 trap dipole	\$36.95	Single band models from	\$24.95

**VERTICALS** – complete with Universal Mounting Base, Folds to 5' for Easy Transport, Hvy. Duty Aluminum Tubing.

20/15 trap, 13' hgt.	\$29.95	160 compact 23' hgt.	\$44.95
40/20/15 trap 22' hgt.	44.95	80 compact 20' hgt.	39.95
80/40/20 trap 30' hgt.	69.95	40 compact 15' hgt.	34.95
80/40/15 trap 20' hgt.	59.95	20/15/10 full size vertical	29.95
10 meter cov. for above	add 9.95		

**NEW Apartment/Portable** apt. roof or patio, camper, trailer, motor home. All bands 80-10, folds to 5' easily. 13' height.

80-40-20-15-10	\$49.95
----------------	---------

TO ORDER — Include \$1.95 shipping (\$2.95 West Coast) 24 hour shipment. 30 day guarantee. For info: SASE or 1st Class Stamp.

Include Interbank # and Expiration date on Credit Card orders.

**IRON POWDER TOROIDS**

Chart showing uH per 100 turns

CORE SIZE	MIX 2 5-30MHz u=10	MIX 6 10-90MHz u=8.5	MIX 12 60-200MHz u=4	SIZE OD (in.)	PRICE USA \$
T-200	120			2.00	3.25
T-106	135			1.06	1.50
T-80	55			.80	.80
T-68	57	47		.68	.65
T-50	51	40		.50	.55
T-25	34	27	12	.25	.40

Ferrite beads 20-500 MHz \$2.00 Doz.  
 Wideband chokes 20-500MHz 95¢ Ea.

Specify core size and mix. Pack and ship 50¢ USA & Canada. Air parcel post delivery worldwide \$2.00. 6 percent tax in Calif. Send for free brochure.

**PALOMAR ENGINEERS**  
 BOX 455 ESCONDIDO CA 92025



# IF YOU ARE ON 144, 220 OR 432 AND HAVE WORKED A REPEATER...

It was probably this one.

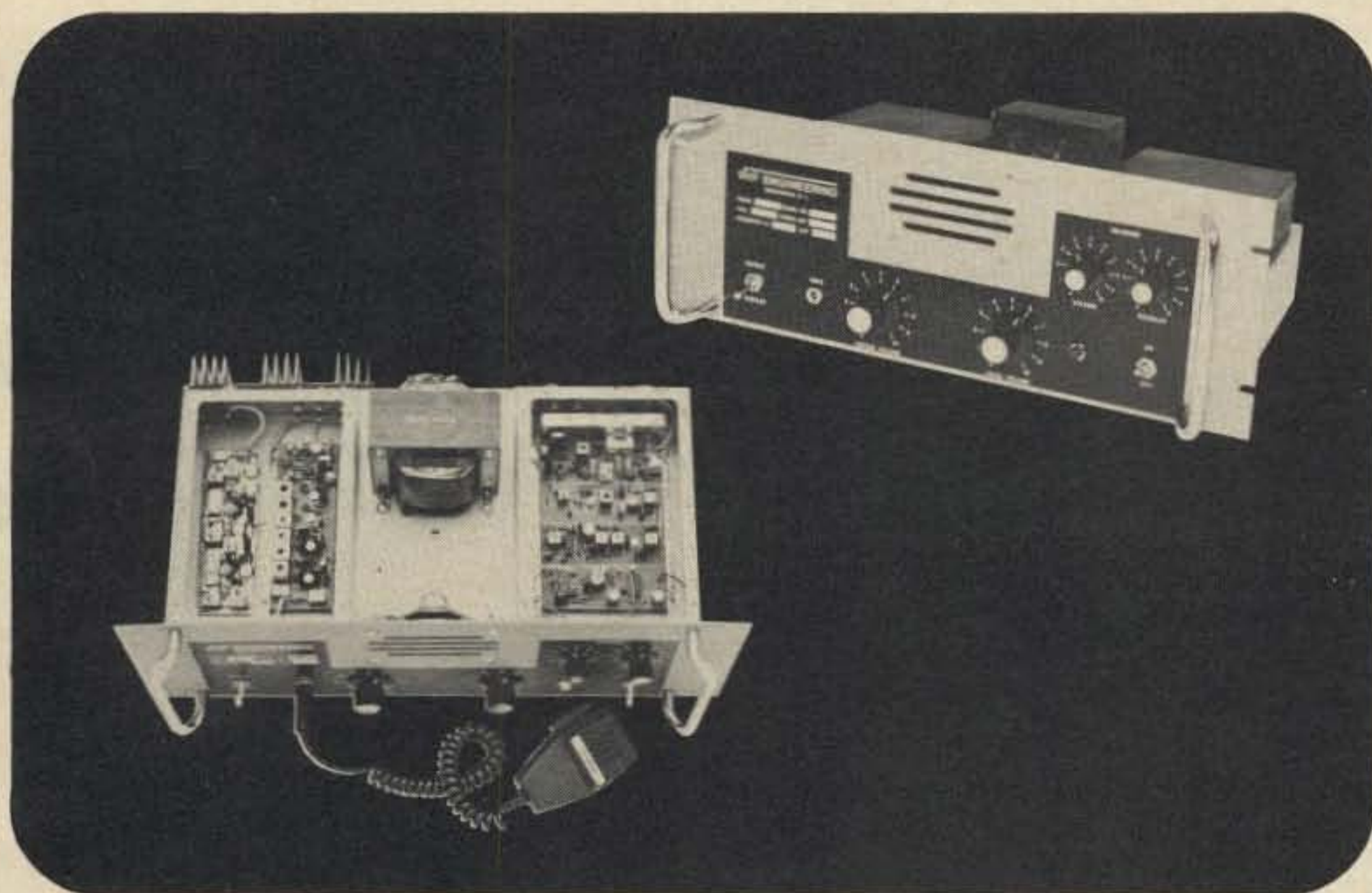

The RPT 144B, RPT 220B and RPT 432 are self-contained — all solid state machines. Conservatively rated, high quality components, assures EXCELLENT RELIABILITY. Careful consideration has been given to both interfacing and control flexibility.

RPT 144B or RPT 220B Kit .....	\$465.96
RPT 432B Kit .....	515.95
RPT 144B or RPT 220B factory wired and tested .....	695.95
RPT 432B factory wired and tested .....	795.95
RPT 50B soon to be announced .....	N.A.
RPT 28B soon to be announced .....	N.A.

## WORK ALL REPEATERS WITH OUR NEW SYNTHESIZER II



The Synthesizer II is a two meter frequency synthesizer. Frequency is adjustable in 5 KHz steps from 140.00 MHz to 149.995 MHz with its digital readout thumb wheel switching. Transmit offsets are digitally programmed on a diode matrix, and can range from 10 KHz to 10 MHz. No additional components are necessary!

Kit ..... \$169.95    Wired and tested ..... \$239.95

*Export prices slightly higher.*

### Available at these dealers:

- A-B-C Communications  
Seattle, WA 98155
- A-B-C Communications  
Everett, WA
- Alpha Electronic Labs  
Columbia, Missouri 65201
- Amateur Electronic Supply  
Milwaukee, Wisc. 53216
- Amateur Wholesale Electronics  
Miami, FL 33156
- Amateur Wholesale Electronics  
Ashland, KY 41101
- Ayre's Ltd.  
St. John's, Newfoundland
- Barry Electronics Corp.  
New York, NY 10012
- Frank L. Beier Radio, Inc.  
New Orleans, LA 70118
- Burghardt Amateur Center, Inc.  
Watertown, SD 57201
- C & A Electronic Enterprises  
Carson, CA 90745
- CDS Electronics & Hobbies Unltd.  
Emerado, ND 58228
- CFP Enterprises  
Horseheads, NY 14845
- Communications Electronics  
Fond du Lac, WI 54935
- Communication Specialties Co.  
Aurora, CO 80012
- Communication Systems  
Bourbon, IN 46504
- Communication Unlimited  
Whitmore Lake, MI 48189
- COSYSCO, Inc.  
Sodus, NY 14551 (Export only)
- Harry G. Crofts  
Northville, Mich. 48167
- Delmar Electronics, Inc.  
West Babylon, L.I., NY 11704
- Derrick Electronics, Inc.  
Broken Arrow, OK 74012
- Edison Electronics, Inc.  
Santurce, P.R.
- Electronic Enterprises  
Rio Linda, CA 95673
- GFL Electronics Co.  
Pickering, Ontario Canada
- Klaus Radio, Inc.  
Peoria, IL 61614
- Loffler Electronics  
Ogdensburg, NY 13669
- Radio Communications Co., Inc.  
Roanoke, VA 24106
- Radio Store, Inc.  
Oklahoma City, OK 73100
- Radio Supply & Engineering Co., Inc.  
Detroit, Mich. 48200
- SON Electric  
Fresno, CA 93727
- Soundcom (VHF-UHF Outlet)  
Akron, OH 44314
- Spectronics, Inc.  
Oak Park, IL 60304
- W. Spindler Electronic Service  
Rome, NY 13440
- Teco Electronics  
Garland, TX 75040
- Tele-Com Electronics  
San Jose, CA 95100
- Tufts Radio Electronics  
Medford, Mass. 02155
- Vegas Radio  
Las Vegas, NV 89106
- VHF Communications  
Jamestown, NY 14701
- Vickers Electronics  
Durham, NC 27702
- Westcom  
San Marcos, CA 92069
- West Indies Sales Co., Ltd.  
Miami, FL 33166

**Vhf engineering**

DIVISION OF BROWNIAN ELECTRONICS CORP.

320 WATER ST. • P.O. BOX 1921  
BINGHAMTON, N.Y. 13902 • 607-723-9574



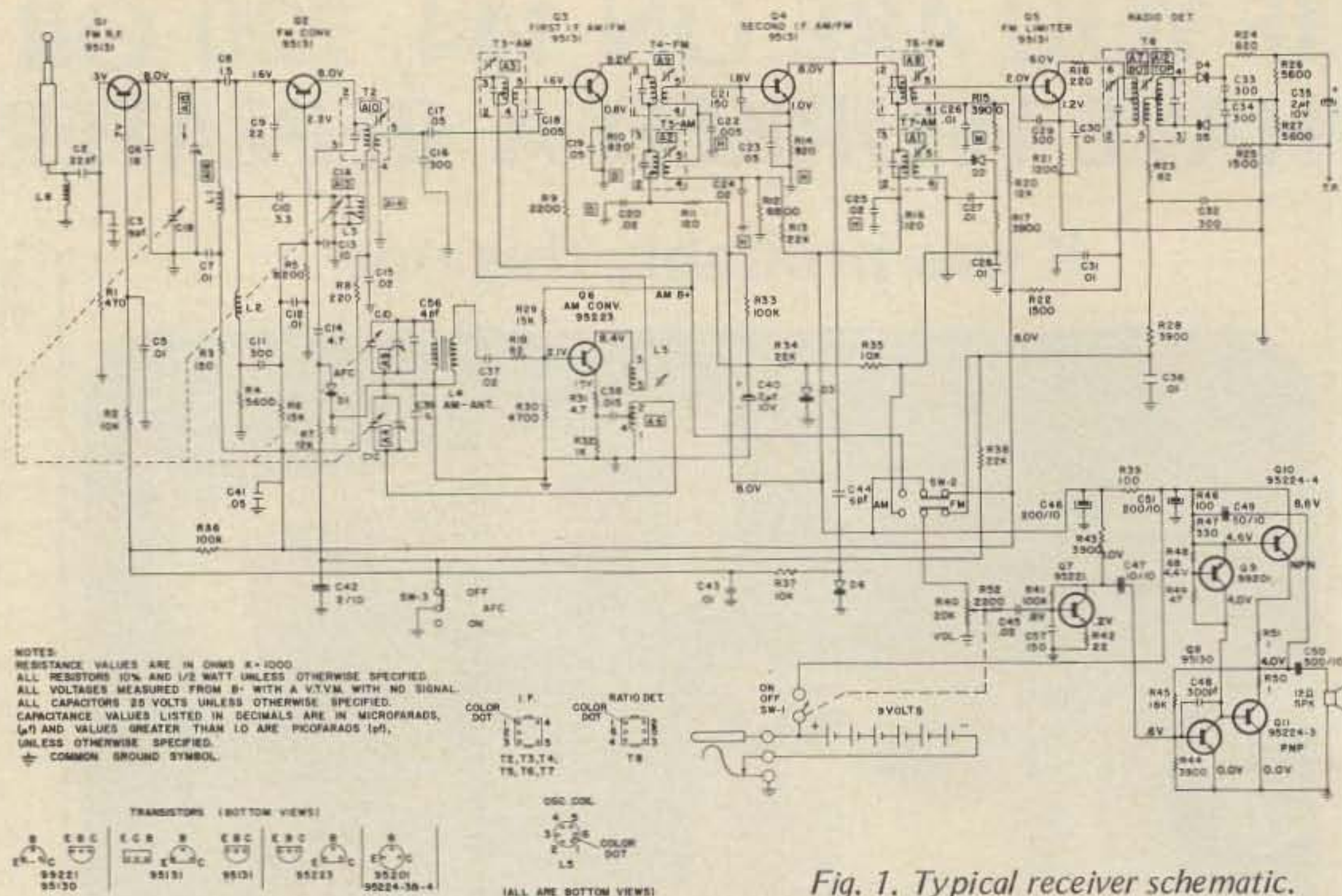

Fig. 1. Typical receiver schematic.

Jim Huffman WA7SCB  
 PO Box 357  
 Provo UT 84601

# A Test Lab Bonanza - - Free!

- - using a transistor radio

Just about everyone needs more test equipment, or easier ways to use the test equipment he already has. Just about everyone has an old radio sitting around and this can provide the needed test equipment. You merely need to make the proper modifications to the radio, then know how to apply the resultant piece of test gear.

Here are some modifications which will allow you to add a mess of handy test equipment to your shop, and still leave your old transistor radio in working order. The finished device will be everything from a speaker subber to a transistor checker, and will still provide your favorite news or music while just sitting on the bench.

The first consideration is what to do about packaging the radio. You may decide to leave the radio intact and add plugs and jacks of your choice in the radio cabinet. You could run leads out from the radio cabinet and put the plugs, jacks, and switches on a minibox. Or you could package the radio complete with modifications in the box

of your choice. No matter what the package you choose, be sure to decide on plugs and jacks that you already have around so you don't make all your test leads obsolete. The diagrams in this article show the use of phone jacks, but you could just as well use banana jacks or whatever. Fig. 1 shows a typical radio schematic. Some

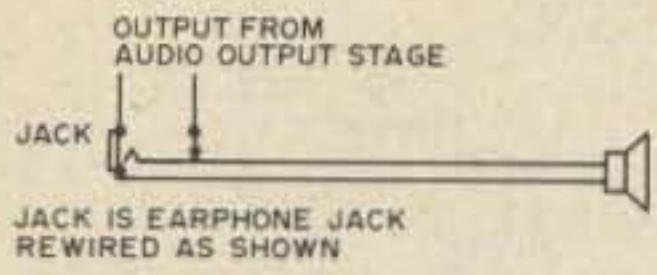

Fig. 2. Using the radio as a substitute speaker. You may wish to add a jack as shown while retaining the original earphone jack on the unit.

will differ, especially in part values, but the stages are essentially the same as the one shown. At least this diagram is helpful in locating where to put the modifications in your particular radio. You may add any or all the modifications to make a speaker subber, power supply, audio oscillator, signal injector, transistor checker, alignment generator, or weather receiver.

### Speaker Subber

This is the simplest modification. You may add a plug as shown in Fig. 2 or you may modify the earphone jack already on many radios. When a phone plug is plugged in, the speaker is automatically disconnected. A pair of alligator clips on the end of the leads will allow you to connect to almost any source.

### Power Supply

Whether your radio is battery or ac power, it will give you an easy source of 9-12 volts dc depending on the radio. All this without tying up the main power supply in your shop. When you are using the other radio circuits to check out a radio or experimenting with a circuit on the bench, the radio power supply will run both the test equipment and the radio or circuit under test. Fig. 3 shows some of the suggested modifications for both battery and ac power supplies. In Fig. 3(c) a transistor is used as a voltage source to provide variable voltage outputs from the

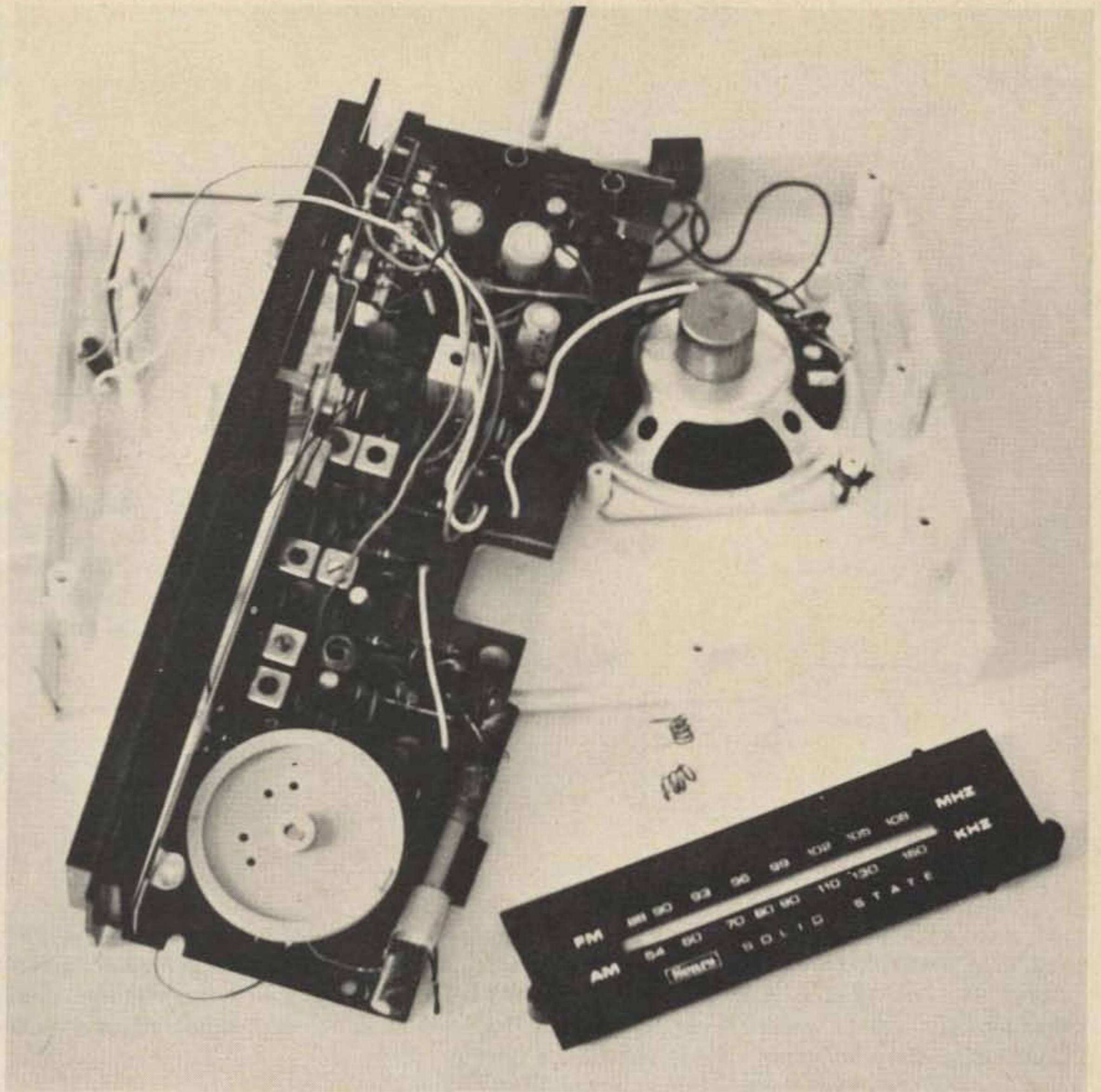

Here is a typical small radio undergoing transformation into a VHF receiver, one of the many applications described in the text. Add any or all to make your radio a handy piece of test equipment and still use it for a radio when it is not working for you. Note the coils in photo; these are the original FM coils removed for the frequency conversion described in the text.

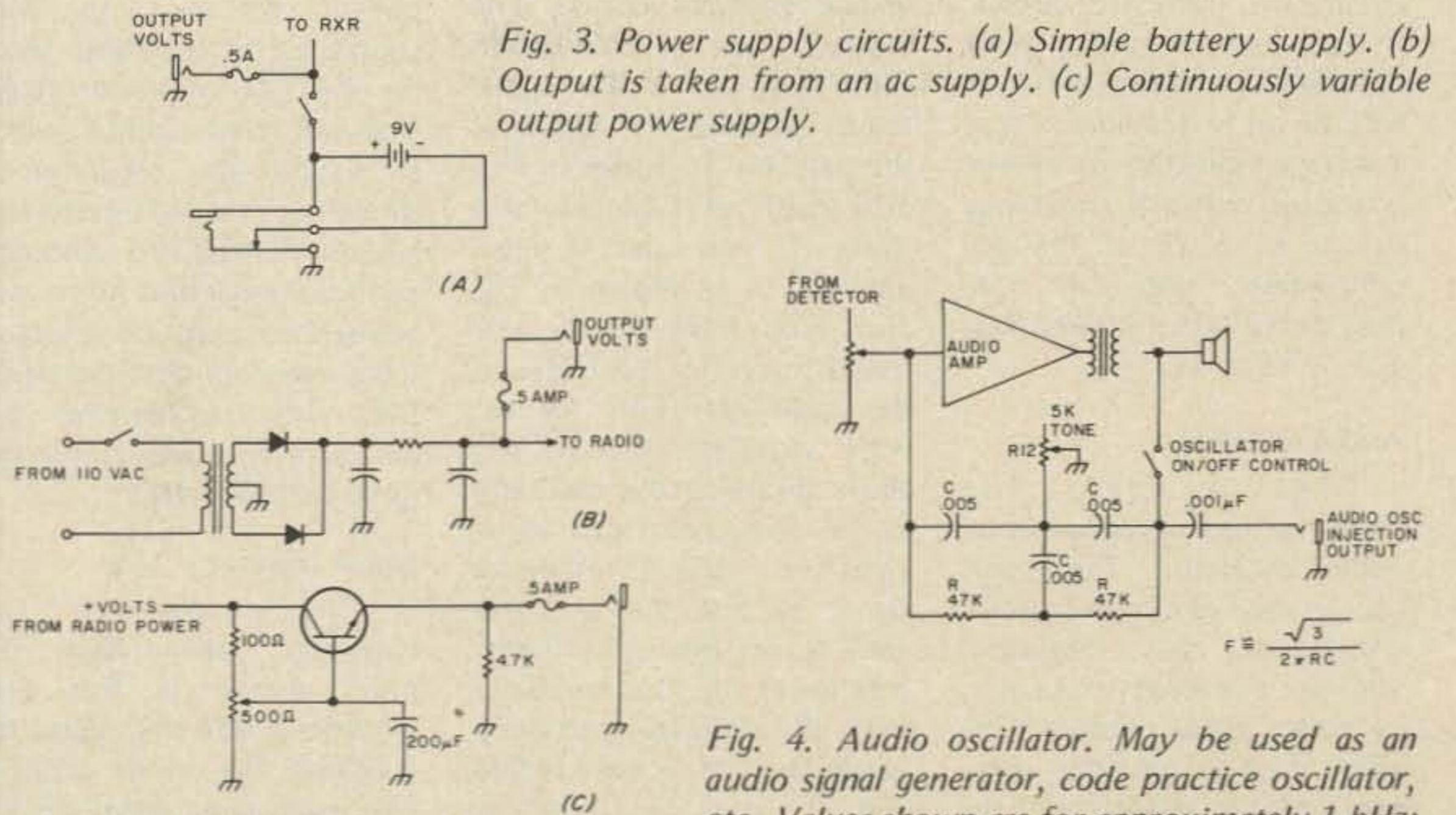

Fig. 3. Power supply circuits. (a) Simple battery supply. (b) Output is taken from an ac supply. (c) Continuously variable output power supply.

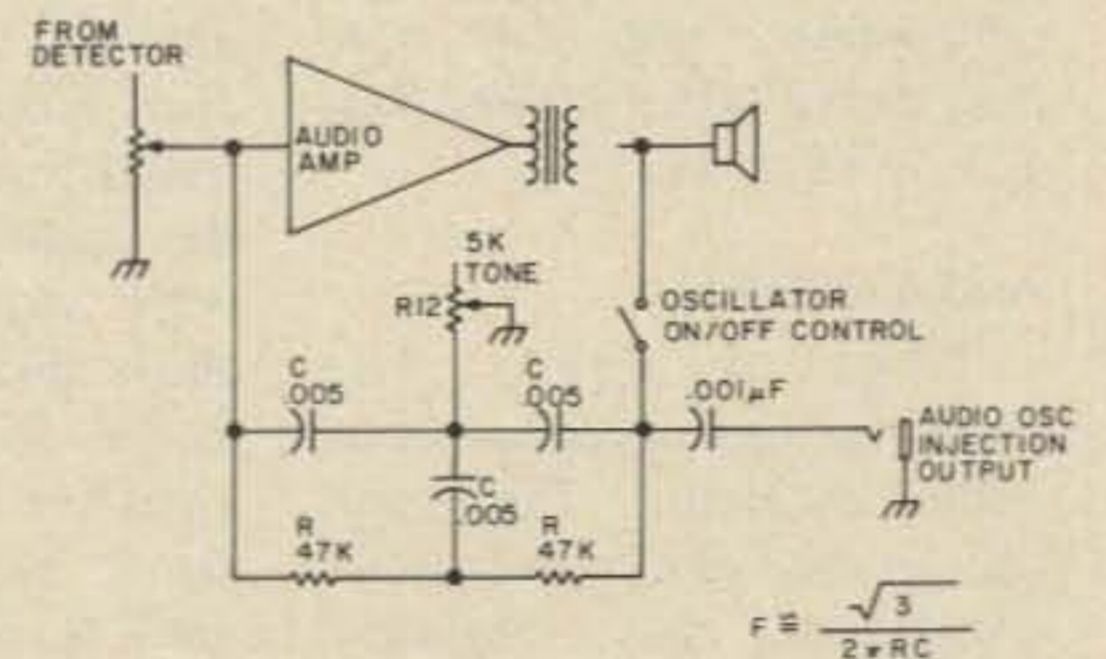

Fig. 4. Audio oscillator. May be used as an audio signal generator, code practice oscillator, etc. Values shown are for approximately 1 kHz; use formula for other frequencies.

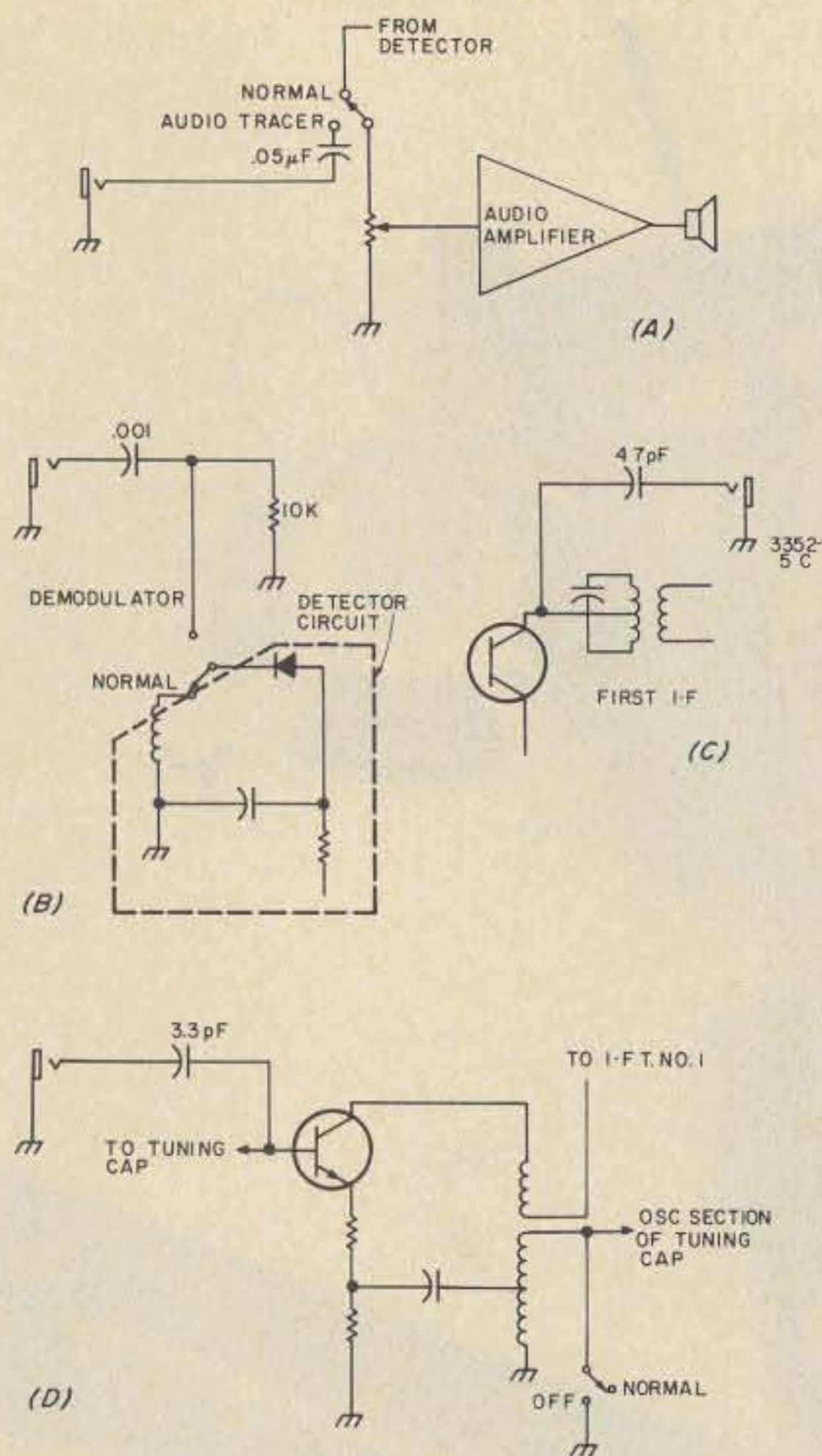

Fig. 5. Signal tracers. (a) Switch permits use as audio signal tracer. (b) The input is applied to the detector for use as a demodulator. (c) I-f injection for 455 kHz. (d) Oscillator is disabled to allow injection of oscillator from another set to test its operation. With switch at normal, radio can be tuned to detect 1600 kHz i-fs.

radio supply. You cannot ruin the pass transistor because you cannot short circuit the transistor circuit. If you have a battery level indicator on your radio, it may be calibrated and used as a voltage indicator. By adding a resistor network and range switch in place of the potentiometer, you can have discrete voltage outputs such as 1.5, 5.9, etc.

#### Audio Oscillator

Fig. 4 gives the modifications which make an audio oscillator. The result can be used as a code practice oscillator, test oscillator, audible continuity checker, or audio signal injector. The tone control provides some measure of control of the basic oscillator frequency.

#### Signal Tracer

The radio will work as several different tracers. The most obvious use is shown in Fig. 5(a), an audio signal tracer. Injecting a signal at the detector as shown in Fig. 5(b) yields an rf demodulator tracer. If you inject a signal into the i-f as shown in Fig. 5(c), you have a 455 kHz tuned tracer (or 10.7 MHz if the radio has FM) for use with standard i-fs. If you allow disabling the oscillator as in 5(d), you can inject another radio's oscillator signal to test the oscillator section of the other radio. Just inject the local oscillator from the radio being serviced, juggle the dial on both radios, and if you can pick up signals, the oscillator in the

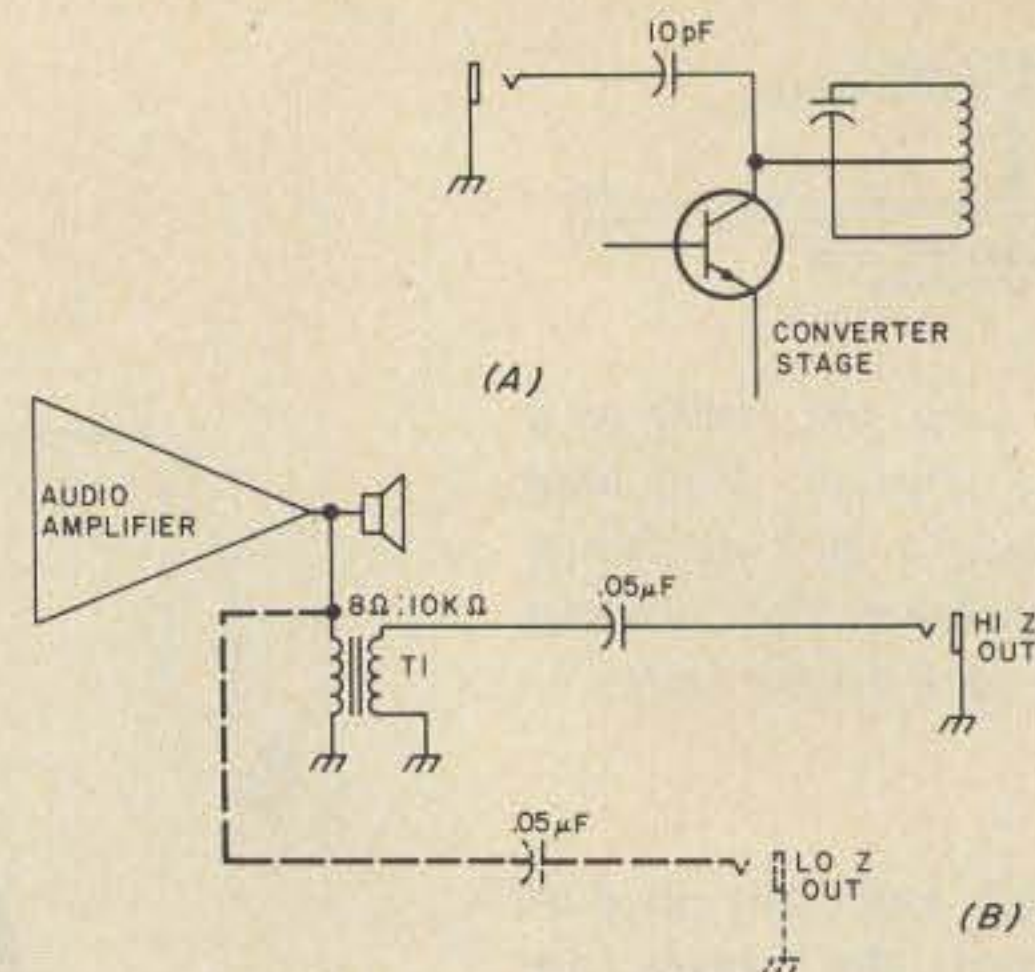

Fig. 6. Signal injectors. (a) The 455 kHz output from the converter can be injected in various i-f stages to check out their operation. (b) Addition of an impedance matching transformer for an audio signal injector with high output impedance. Dotted lines show alternate connection.

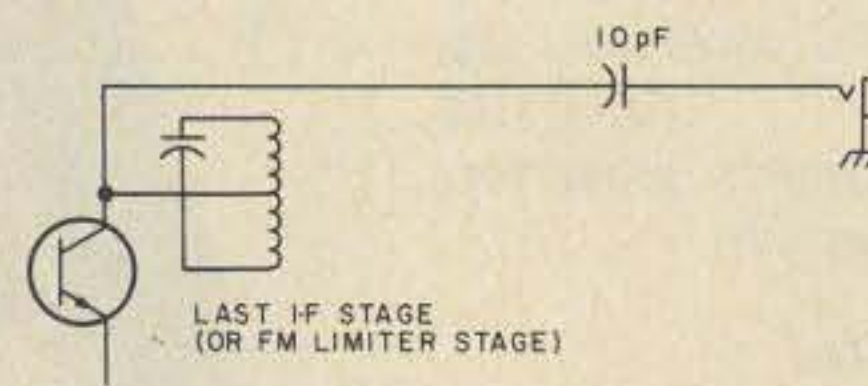

Fig. 7. This configuration will act as a fairly accurate i-f alignment generator. Since the output is from the last stage at the i-f, you have the advantage of the narrowing from all the tuned circuits at the intermediate frequency.

other radio is working. The same method could be used for FM systems; in that case, couple the oscillator signal to the FM converter stage through a gimmick of about 7 twists of hookup wire connected in the same place on the FM converter stage. You will have to add a switch to disable the oscillator as shown on the AM converter circuit. For the AM radio, the oscillator injection point also serves as a point to inject rf from a system that uses 1600 kHz i-fs by letting the oscillator run and tuning the radio to 1600 kHz.

#### Signal Injector

The output of the converter taken from the point shown in Fig. 6(a) provides a 455 kHz signal for checking the i-f of a radio. (An equivalent point on the FM converter provides 10.7

MHz signals.) Tune the radio to a station and the 455 kHz output will be the signal transmitted from that station. Fig. 6(b) shows the connection for injecting audio signals; just tune in a station and use its audio to check out the audio circuits under test.

#### Alignment Generator

In Fig. 7 the output from the i-f is taken after it has gone through several stages of i-f amplification. Since this signal has the benefit of the several stages of selectivity, the i-f output signal can be used as a source of accurate 455 kHz (or 10.7 MHz) assuming the radio has been accurately aligned. Merely align the radio as one of the steps to making it into a piece of test equipment. Signals tuned in on the radio will be translated to their equivalent

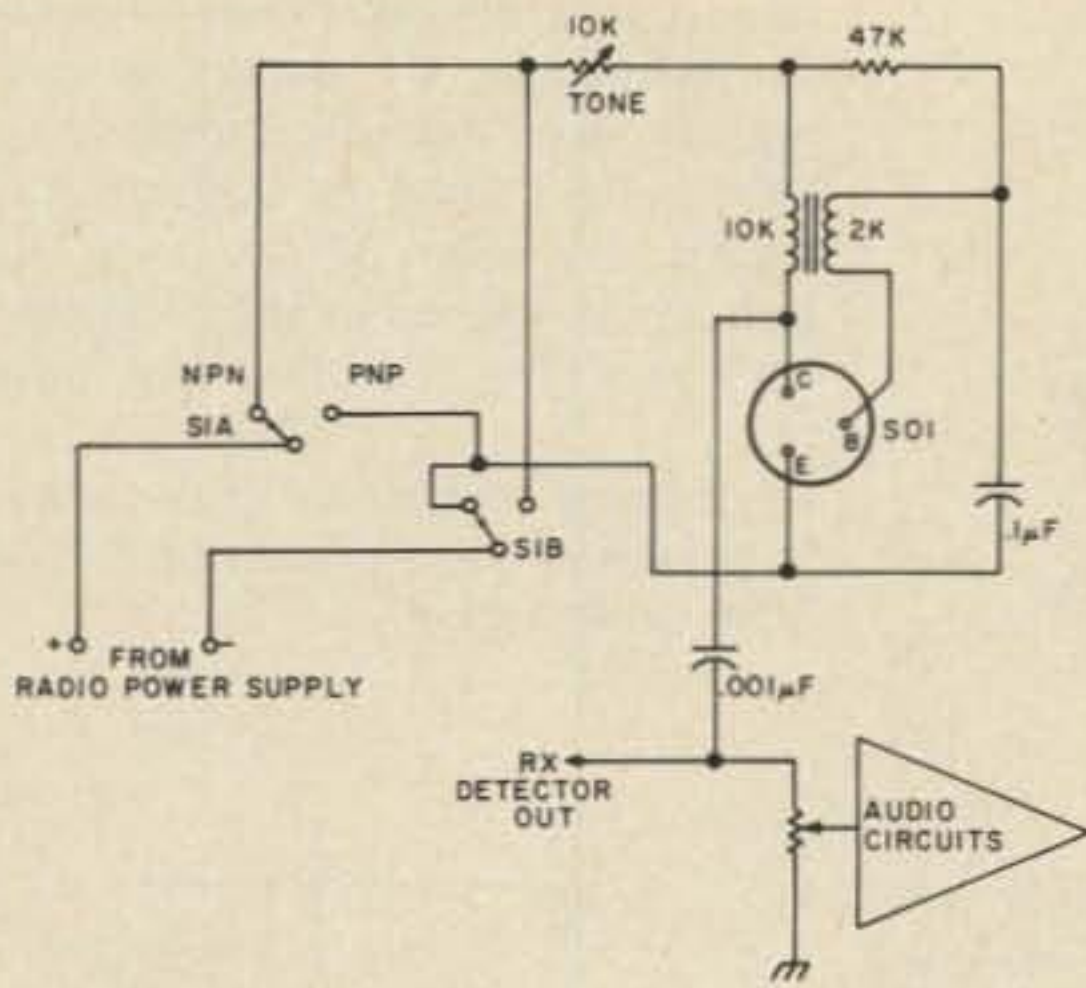

Fig. 8. Go-No Go transistor checker will work with silicon or germanium types with reasonable HFEs. Use a good unit for checkout; if circuit fails to oscillate, reverse either the primary or secondary connections. A good transistor will produce a tone in the speaker. You may wish to use clip leads in place of a socket.

i-f frequency and can be used as alignment signals.

#### Transistor Checker

Fig. 8 shows an outboard circuit added to the radio to allow in or out of circuit transistor checking. If the transistor under test will oscillate, it is generally good. This is a fairly accurate check in or out of circuit. Another simpler tester can be fabricated by merely replacing one of the transistors in the radio with a socket. When a transistor close to the type you are replacing it with is put in the socket, the radio should work. This test is only accurate for the NPN or PNP transistor type being replaced, and will only work with silicon or germanium

types depending on what the radio has originally. This simple tester will not allow in-circuit checks at all, but the radio will operate normally as soon as the original transistor is placed in its socket.

#### Band Opening Monitor

Fig. 9 shows the schematic of a citizens band converter that works into the 455 kHz i-f of an AM radio. You may shudder at the thought of listening to the citizens band, but it sure is a good band opening monitoring device. Just buy a crystal for channel 10 and you will rejoice when the DX comes rolling in. Crystals are available at your handy Radio Shack store for a few pennies. Just don't let 'em worry you with that stuff

about what model transceiver the crystal is for . . . any one will do.

#### Commercial FM Receiver

If your radio has FM, it can be modified to make a receiver that will pick up commercial business-band FM signals such as police, fire, public service, weather, etc. Some find the idea of listening to these signals more appealing than music when the radio is resting on the bench. Begin the modification by changing the oscillator coil. Reduce the number of turns by 1/3, then bring it on frequency by adjusting the spacing of the turns and the trimmer capacitor on the radio. If you can't measure the oscillator frequency with a grid-dip meter or equivalent, use a TV tuned to channel 7. Watch the TV as you tune the oscillator; when you can see and hear a signal on the TV,

the oscillator is set around 175 MHz. The radio will now tune around 185 MHz or 165 MHz, depending on the resonant frequency of the circuits in the rf amp and mixer stages. Reduce the number of turns in the rf stage and the mixer by the same factor as the oscillator coil. Tune them in by adjusting the spacing and by resetting the trimmers on the tuning capacitor. Final tuneup should come while listening to a signal.

Now that the radio is completely modified, it will serve you well as a radio as well as a handy test jig ideal for servicing transistor radios. The unit is also perfect for the experimenter who may need to use one or all its functions in checking out breadboard circuits. Once you master use of all its possibilities, it will prove as handy on your bench as your VOM. ■

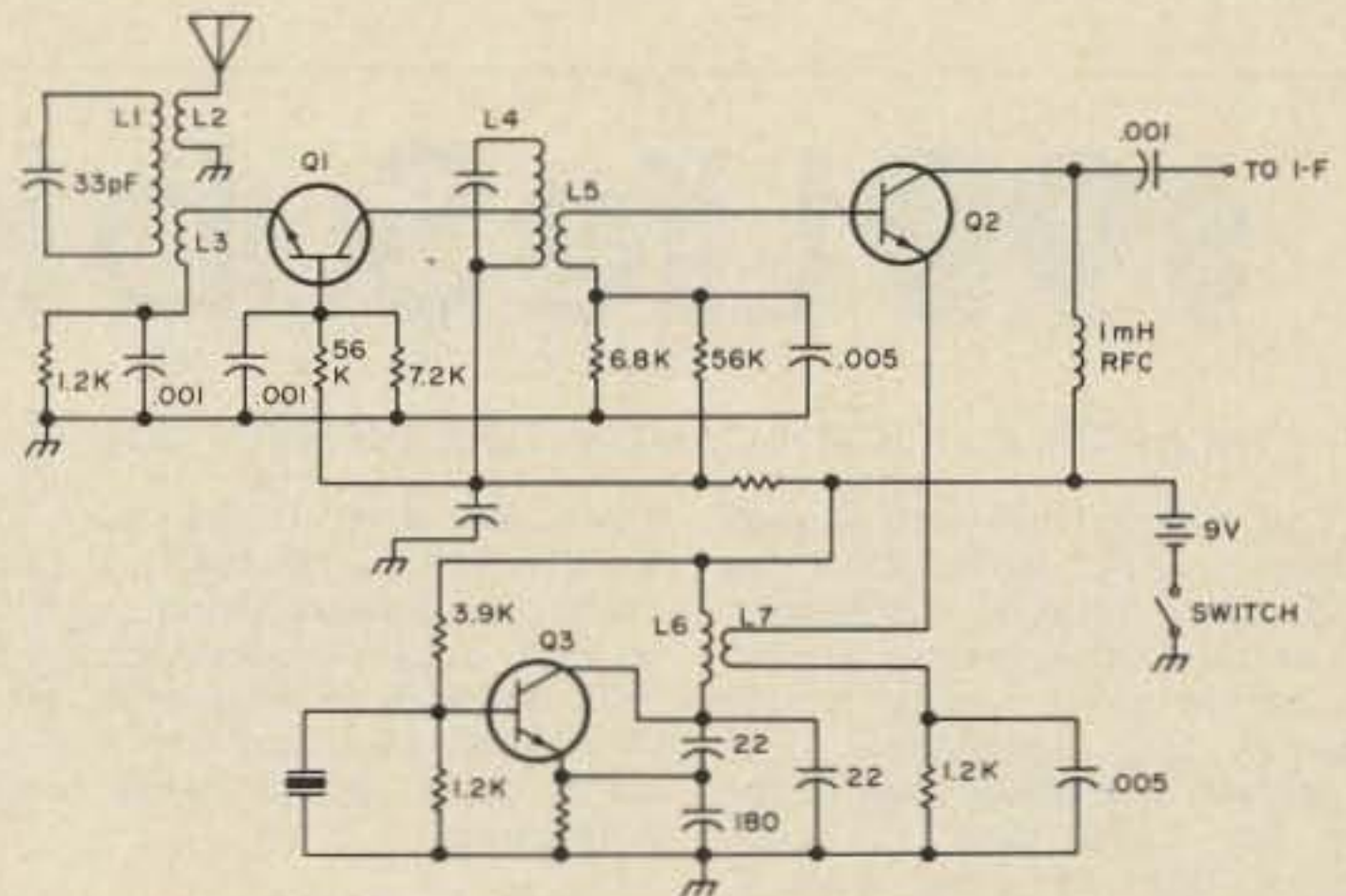

Fig. 9. CB converter for band opening monitor.

### TELEVISION AND FM ANTENNAS

QUALITY ANTENNAS for television & FM at unbelievable prices. Snap out construction — aluminum + cadmium-plated steel, molded plastic insulators. Write today for more information.



**Allied Sales & Engineering, Inc.**  
Dept. 39, Pimento IN 47866  
Telephone 812-495-6555

### PRINTED CIRCUIT

Positive Acting Photo Resist; Carbide Bits; Bubble Etchers; W. H. Brady PC Drafting Aids; Epoxy Glass Boards

Send stamp & address label for flyer

**TRUMBULL**

833 Balra Dr., El Cerrito, CA 94530

### 500 MHz FREQUENCY SCALER

Designed by K2OAW. P.C. board with instructions \$7. Still available — K2OAW Counter boards \$15, SWR Computer boards \$10. NYS residents add tax.

STAR-KITS, GPO Box 545,  
Staten Island NY 10314.

DAYTON HAMVENTION  
PATCHES, limited quantity, \$2.00  
each while quantity lasts.

LePhCo, 2860 Pinkerton Road,  
Zanesville, Ohio 43701

Isolated — Pad — Drill — Mill

Duplicate any etched board without etching. Professional — compact — useable breadboards. Sizes: .20, .15, .10 in dia — \$7.95 ea. See: 73, Nov 73, p-19. QST, May 73, p-44, Dec 73, p-14. Hints & Kinks, p-82.



**A F STAHLER Co**

PO BOX 354 CUPERTINO, CALIF 95014 408-252-4219

# Protect Your VHF Converter

-- with a novel antenna relay

Today's modern VHF receiving converters are superior in many respects to their older tube counterparts. Their noise figures are lower, gain is usually higher, power consumption is down, and because they are solid state, they lend themselves easily to portable operation.

They have one shortcoming: They must be protected against transients from the transmitter. This is especially true of converters with MOSFET front ends.

The standard antenna changeover relay may not be fast enough. The transmitter should be turned on after the antenna has been switched and should be turned off before the antenna has been switched back for maximum protection. Of course, the changeover relay should provide a high degree of isolation between transmitter and receiver ports.

Fig. 1 illustrates such a system. The theory of operation for the system follows (refer to Fig. 1).

When the push-to-talk switch S1 is closed, relay RY1 is energized. This energizes relay RY2 and partially completes the circuit that will allow relay RY3 to be energized. This allows the antenna to be switched and the receiver muted. Closure of RY2 completes the circuit for RY3, energizing it and allowing the transmitter to be keyed.

When switch S1 is opened, RY1 opens, opening the circuit for RY2 and RY3. Relay RY3 opens, turning off transmitter power, but RY2 is held in by the charged capacitor C1. This keeps the antenna connected to the transmitter until all output from the transmitter has ceased.

The relay RY2 can be a Dow Key 12 V relay with outboard DPDT contacts. If this

relay is used, the other relays should be 12 V also. Capacitor C1 should be selected to operate with the coil impedance of RY2. (My system used a 300 uF capacitor.) Diodes D1 and D2 serve to short the transient developed by the collapsing field of RY1 and RY2 after they have been turned off.

Although the circuit may look involved, it does offer good protection for solid state VHF converters. ■

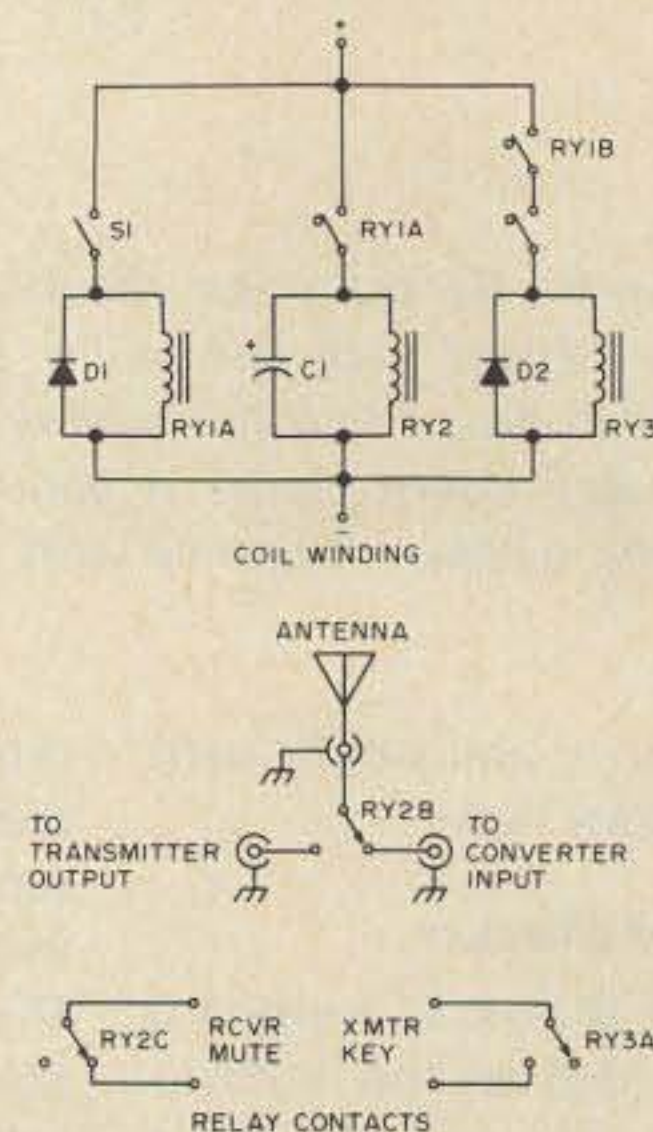

Fig. 1.

## \$99 Life Sub Is A BUMMER!

REASONS FOR NOT BUYING A LIFE SUBSCRIPTION AT THIS TIME:

1. You may not live long enough to have a LIFE subscription pay off for you. Look at it this way, at the rate subscriptions are increasing in price yearly it will probably take almost five years before you will break even at the \$99 for LIFE rate ... now suppose there is a big WAR in 1980 and you get zonked ... you'll have wasted some money.

2. You want 73 to be the biggest and best of the ham magazines, right? Okay, if you take advantage of a little slipup of the publisher in not increasing the LIFE subscription rate several years ago when the other maga-

zines increased theirs, you are hurting only yourself. If you really are serious about wanting to buy a LIFE subscription you will do best to wait until after September 15th and buy it at the \$149 price. It's a much better investment.

3. Another big disadvantage to a LIFE subscription is that you will no longer get those clever renewal letters every year. You don't want to miss those, do you?

4. Other amateurs will hate you. The handful of amateurs who took advantage of the earlier LIFE rates (they started at \$37 in

1960) are just plain impossible with their damned smugness. Don't take a chance on such a thing happening to you.

5. Heck, you probably bought a three year sub at \$17.76 recently and your stingy nature won't let you buy a LIFE subscription until the three years are up. We're with you. Please do not request a LIFE plus three year sub just because you sent us a Buy Centennial \$17.76. We urge you to be penny-wise and pound foolish and pass up this LIFE offer.

6. Read #2 again, we couldn't think of anything else.

A Much Better Deal  
 At \$149<sup>00</sup>  
 WAIT!

If you are heartless enough to take advantage of us and insist on your right to subscribe for LIFE for \$99 ... send a check, BankAmericard or Mastercharge to LIFER, 73 Magazine, Peterborough NH 03458. Please add \$2 each for any questions if you don't understand the above.

\$99 LIFE Subscription — offer expires Sept. 15, 1976

Check enclosed

Bill me

Name \_\_\_\_\_

Call \_\_\_\_\_

Bill BankAmericard # \_\_\_\_\_

Address \_\_\_\_\_

Bill Mastercharge # \_\_\_\_\_

City \_\_\_\_\_

State \_\_\_\_\_

Zip \_\_\_\_\_

Interbank # \_\_\_\_\_

Signature \_\_\_\_\_

Card expiration date \_\_\_\_\_

### 7400N TTL

SN7400N*	16	SN7453N	27	SN74150N	1.00
SN7401N	16	SN7454N	20	SN74151N	.79
SN7402N	21	SN7459A	25	SN74153N	.89
SN7403N	16	SN7460N	22	SN74154N*	1.25
SN7404N	18	SN7470N	45	SN74155N	.99
SN7405N	24	SN7471N*	69	SN74156N	.99
SN7406N	20	SN7472N	39	SN74157N	.99
SN7407N	29	SN7473N*	37	SN74160N	1.25
SN7408N	25	SN7474N*	32	SN74161N	.99
SN7409N	25	SN7475N*	50	SN74163N*	.99
SN7410N*	18	SN7476N*	32	SN74164N	1.10
SN7411N	30	SN7479N*	5.00	SN74165N	1.10
SN7412N	33	SN7480N	50	SN74166N	1.25
SN7413N	45	SN7482N	98	SN74167N	5.50
SN7414N	70	SN7483N	70	SN74170N	2.10
SN7415N	35	SN7485N	89	SN74172N	18.00
SN7417N	35	SN7486N	39	SN74173N	1.50
SN7420N	21	SN7488N	3.50	SN74174N	1.25
SN7421N	33	SN7489N	2.25	SN74175N	.99
SN7422N*	49	SN7490N*	45	SN74176N	.90
SN7423N	37	SN7491N	75	SN74177N	.90
SN7425N	29	SN7492N	49	SN74180N	.99
SN7426N	29	SN7493N*	49	SN74181N	2.49
SN7427N	37	SN7494N	79	SN74182N	.95
SN7429N	42	SN7495N	79	SN74184N	1.95
SN7430N	26	SN7496N	89	SN74185N	2.20
SN7432N	31	SN7497N*	4.00	SN74186N*	5.00
SN7437N	27	SN74100N*	1.00	SN74187N	6.00
SN7438N	27	SN74107N	39	SN74190N	1.19
SN7439N	25	SN74121N*	39	SN74191N	1.25
SN7440N	15	SN74122N	39	SN74192N*	.89
SN7441N	89	SN74123N*	70	SN74193N*	.89
SN7442N	59	SN74125N	60	SN74194N	1.25
SN7443N	75	SN74126N	60	SN74195N	.75
SN7444N	75	SN74132N	1.09	SN74196N	1.25
SN7445N	75	SN74136N	95	SN74197N	.75
SN7446N	.81	SN74141N	1.15	SN74198N	1.75
SN7447N*	69	SN74142N*	4.00	SN74199N	1.75
SN7448N	79	SN74143N*	4.50	SN74200N	5.59
SN7450N	26	SN74144N*	4.50	SN74279N*	.90
SN7451N	27	SN74145N	1.15	SN74251N	1.79
SN7452N	27	SN74147N	2.35	SN74284N	6.00
SN7453N	27	SN74148N	2.00	SN74285N	6.00

MANY OTHERS AVAILABLE ON REQUEST  
20% Discount for 100 Combined 7400's

### CMOS

CD4000	25	74C04N	.75
CD4001	25	74C10N	.65
CD4002	25	74C20N	.65
CD4006	2.50	74C30N	.65
CD4007	25	74C42N	2.15
CD4009	59	74C73N	1.50
CD4010	59	74C74	1.15
CD4011	25	74C90N	3.00
CD4012	25	74C95N	2.00
CD4013	47	74C107N	1.25
CD4016	56	74C151	2.90
CD4017	1.35	74C154	3.00
CD4019	55	74C157	2.15
CD4020	1.49	74C160	3.25
CD4022	25	74C161	3.25
CD4023	1.25	74C163	3.00
CD4024	1.50	74C164	3.25
CD4025	25	74C173	2.60
CD4027	69	74C193	2.75
CD4028	1.65	74C195	2.75
CD4029	2.90	74C00N	.39
CD4030	65	74C02N	.55
74C04N	.75	74C10N	.65
74C20N	.65	74C30N	.65
74C42N	2.15	74C73N	1.50
74C74	1.15	74C90N	3.00
74C95N	2.00	74C107N	1.25
74C151	2.90	74C154	3.00
74C157	2.15	74C160	3.25
74C161	3.25	74C163	3.00
74C164	3.25	74C173	2.60
74C193	2.75	74C195	2.75
MC4044*	4.50	MC14016*	.56

### LINEAR

LM300H	.80	LM1351N	1.65
LM301H	.35	LM1414N	1.75
LM301CN	.75	LM1458C	.65
LM302H	.35	LM380N	.95
LM304H	1.00	LM380CN	1.05
LM305H	.95	LM381N	1.79
LM307CN	.35	LM382N	1.79
LM308H	1.00	NE501K	8.00
LM308CN	1.00	NE510A	6.00
LM309H	1.10	NE531H	3.00
LM309K	.99	NE538T	6.00
LM310CN	1.15	NE540L	6.00
LM311H	.90	NE550N	.79
LM311N	.90	NE553	2.50
LM318CN	1.50	NE555V*	.45
LM319N	1.30	NE560B*	5.00
LM319D	9.00	NE561B*	5.00
LM320K-5	1.35	NE562B*	5.00
LM320K-5.2	1.35	NE565H*	.99
LM320K-12	1.35	NE565N*	1.25
LM320K-15	1.35	NE566CN*	1.95
LM320T-5*	1.75	NE567H*	1.25
LM320T-8*	1.75	NE567V*	1.50
LM320T-12*	1.75	LM703CN	.45
LM320T-15*	1.75	LM709H	.29
LM323K-5*	9.95	LM709N	.29
LM324N	1.80	LM710N	.79
LM339N	1.70	LM711N	.39
LM340K-5	1.95	LM723N	.55
LM340K-12	1.95	LM723H	.55
LM340K-15	1.95	LM733N	1.00
LM340K-24	1.95	LM739N	1.29
LM340T-5	1.75	LM741CH	.35
LM340T-8*	1.75	LM741CN	.35
LM340T-12*	1.75	LM741 14N	.39
LM340T-15*	1.75	LM747H	.79
LM340T-24	1.75	LM747N	.79
LM350N	1.00	LM748H	.39
LM351CN	.65	LM748N	.39
LM370N	1.15	LM1303N	.90
LM370H	1.15	LM1304N	1.19
LM373N	3.25	LM1305N	1.40
		LM1307N	.85
		RC4194	5.95
		RC4195	3.25

### KITS EXAR ICS

**XR-2206KA SPECIAL \$17.95**  
Includes monolithic function generator IC, PC board, and assembly instruction manual.

**XR-2206KB SPECIAL \$27.95**  
Same as XR 2206KA above and includes external components for PC board.

<b>TIMERS</b>		<b>STEREO DECODERS</b>	
XR-555CP	\$ .69	XR-1310P	\$3.20
XR-320P	1.55	XR-1310EP	3.20
XR-556CP	1.85	XR-1800P	3.20
XR-2556CP	3.20		
XR-2240CP	3.25	<b>WAVEFORM GENERATOR</b>	
		XR-205	8.40
		XR-2206CP	4.49
		XR-2207CP	3.85
<b>PHASE LOCKED LOOPS</b>		<b>MISCELLANEOUS</b>	
XR-210	5.20	XR-2211CP	6.70
XR-215	6.60	XR-2261	3.79
XR-567CP	1.95	XR-2261	3.79
XR-2567CP	2.99	XR4136	2.00

**DATA HANDBOOKS**  
7400 Pin-out & Description of 5400/7400 ICS \$2.95  
CMOS Pin-out & Description of 4000 Series ICS \$2.95  
LINEAR Pin-out & Functional Description \$2.95  
ALL THREE HANDBOOKS \$6.95

## CONSUMER ELECTRONICS

### exelar



**DIGITAL WATCH**  
This watch is manufactured by National Semiconductor. It provides 5 functions; hours, minutes, seconds, date, A.M. indicator dot. Accuracy is assured to .5 seconds per month by precision quartz crystal. If something should go wrong with the watch, repair is assured within 48 hours after it is received. Complete with steel black leather band.

**ES4-YS**  
**3 MICRON GOLD PLATE BEZEL**  
**\$29.95**  
NOT A KIT

### Novus



**DIGITAL ALARM CLOCK**  
This 4 digit Novus Alarm Clock is a very reliable and smartly styled unit. It provides such features as an alarm settable to any minute of the day, a 7 minutes snooze alarm, a power failure indicator, and even an A.M. / P.M. indicator.

**\$19.95**  
NOT A KIT

## XCITON OPTO ELECTRONICS

### LITRONIX MONSANTO DISCRETE LEDS

R - RED  
G - GREEN  
Y - YELLOW  
O - ORANGE

XC209R	5/S1	XC526R	5/S1	XC111R	5/S1
XC209G	4/S1	XC526G	4/S1	XC111G	4/S1
XC209Y	4/S1	XC526Y	4/S1	XC111Y	4/S1
XC209O	4/S1	XC526O	4/S1	XC111O	4/S1

125" dia. .185" dia. .190" dia.  
.200" dia. .200" dia. .085" dia.

### DISPLAY LEDS

FND503 FND70 DL707 MAN 2 MAN 3 MAN 4 MAN 7 DL747 DL338

TYPE	POLARITY	HT	TYPE	POLARITY	HT
MAN 1	COMMON ANODE	270 \$3.25	MAN 74	COMMON CATHODE	300 \$1.50
MAN 2	5 x 7 DOT MATRIX	300 4.95	DL707	COMMON ANODE	300 \$1.50
MAN 3	COMMON CATHODE	125 .39	DL747	COMMON ANODE	600 2.25
MAN 4	COMMON CATHODE	187 1.95	DL750	COMMON CATHODE	600 2.49
MAN 7	COMMON ANODE	300 1.50	DL338	COMMON CATHODE	110 1.25
MAN 7G	COMMON ANODE-GREEN	300 1.95	FND70	COMMON CATHODE	250 .50
MAN 7Y	COMMON ANODE-YELLOW	300 1.95	FND503	COMMON CATHODE	500 1.75
MAN 7Z	COMMON ANODE	300 1.50	FND507	COMMON ANODE	500 1.75

### IC SOLDERTAIL — LOW PROFILE (TIN) SOCKETS

6 pin	\$ .17	15	24 pin	\$ .38	37	.36
14 pin	.20	19	28 pin	.45	44	.43
22 pin	.22	21	36 pin	.60	59	.58
18 pin	.29	28	40 pin	.63	62	.61
22 pin	.37	36				

### WIRE WRAP SOCKETS (GOLD) LEVEL #3

10 pin	\$ .45	41	37	24 pin	\$1.05	.95	.85
14 pin	.39	38	37	28 pin	1.40	1.25	1.10
16 pin	.43	42	41	36 pin	1.59	1.45	1.30
18 pin	.75	68	62	40 pin	1.75	1.55	1.40

### 50 PCS. RESISTOR ASSORTMENTS \$1.25 PER ASST.

ASST. 1	5 ea.	10 OHM	12 OHM	15 OHM	18 OHM	22 OHM	1/4 WATT 5% — 50 PCS.
ASST. 2	5 ea.	27 OHM	33 OHM	39 OHM	47 OHM	56 OHM	1/4 WATT 5% — 50 PCS.
ASST. 3	5 ea.	68 OHM	82 OHM	100 OHM	120 OHM	150 OHM	1/4 WATT 5% — 50 PCS.
ASST. 4	5 ea.	180 OHM	220 OHM	270 OHM	330 OHM	390 OHM	1/4 WATT 5% — 50 PCS.
ASST. 5	5 ea.	470 OHM	560 OHM	680 OHM	820 OHM	1K	1/4 WATT 5% — 50 PCS.
ASST. 6	5 ea.	1.2K	1.5K	1.8K	2.2K	2.7K	1/4 WATT 5% — 50 PCS.
ASST. 7	5 ea.	3.3K	3.9K	4.7K	5.6K	6.8K	1/4 WATT 5% — 50 PCS.
ASST. 8	5 ea.	8.2K	10K	12K	15K	18K	1/4 WATT 5% — 50 PCS.
ASST. 9	5 ea.	22K	27K	33K	39K	47K	1/4 WATT 5% — 50 PCS.
ASST. 10	5 ea.	56K	68K	82K	100K	120K	1/4 WATT 5% — 50 PCS.
ASST. 11	5 ea.	150K	180K	220K	270K	330K	1/4 WATT 5% — 50 PCS.
ASST. 12	5 ea.	390K	470K	560K	680K	820K	1/4 WATT 5% — 50 PCS.
ASST. 13	5 ea.	1M	1.2M	1.5M	1.8M	2.2M	1/4 WATT 5% — 50 PCS.
ASST. 14	5 ea.	2.7M	3.3M	3.9M	4.7M	5.6M	1/4 WATT 5% — 50 PCS.

ALL OTHER RESISTORS FROM 2.2 OHMS 5.6M AVAILABLE IN MULTIPLES OF 5 ea

### 14 PCS. POTENTIOMETER ASSORTMENTS

ASST. A 2 ea: 10 OHM-20 OHM-50 OHM-100 OHM-200 OHM-250 OHM-500 OHM

ASST. B 2 ea: 1K, 2K, 5K, 10K, 20K, 20K, 50K

ASST. C 2 ea: 50K, 100K, 200K, 250K, 500K, 1M, 2M

**\$9.95 Per Asst.**

Each assortment contains 14 pcs of 10 turn pots. All pots are available in single unit quantities. \$9.95 ea.

\*Astrisk Denotes Items On Special For This Month\*  
Satisfaction Guaranteed. \$5.00 Min. Order. U.S. Funds.  
California Residents — Add 6% Sales Tax — Data Sheets 25c each  
Send a 13c Stamp (postage) for a FREE 1976 Catalog

# JAMES

1021 HOWARD AVE., SAN CARLOS, CA. 94070  
PHONE ORDERS — (415) 592-8097

### 74LS00 TTL

74LS00	39	74LS55	.39	74LS151	1.55
74LS02	39	74LS73	.65	74LS153	1.89
74LS03	39	74LS74	.65	74LS157	1.55
74LS04	45	74LS75	.79	74LS162	2.25
74LS05	45	74LS76	.65	74LS163	2.25
74LS08	39	74LS83	2.19	74LS164	2.25
74LS10	39	74LS86	.65	74LS181	3.69
74LS13	79	74LS90	1.25	74LS190	2.85
74LS14	2.19	74LS92	1.25	74LS191	2.85
74LS20	39	74LS93	1.25	74LS192	2.85
74LS26	49	74LS95	2.19	74LS193	2.85
74LS27	45	74LS96	1.89	74LS194	2.25
74LS28	49	74LS107	.65	74LS195	2.25
74LS30	39	74LS112	.65	74LS257	1.89
74LS32	45	74LS132	1.55	74LS260	.55
74LS40	49	74LS136	.65	74LS279	.79
74LS51	39	74LS138	1.89	74LS270	5.95

**THIS MONTH ONLY!!! DL728**  
The DL728 is a dual 0.5" common cathode red display. It is ideal for use with clock chips, as segments are already multiplexed.  
**\$1.95**

### MINIATURE TOGGLE

DPDT	ON	OFF	ON	221	3.05	2.65	1.97	1.78
	ON	NONE	ON	223	2.65	2.25	1.68	1.51
	ON	OFF	ON	121	2.35	1.95	1.43	1.30
	ON	NONE	ON	123	2.05	1.65	1.21	1.10

### P

**I**t all started through the courtesy of K3CPG. He had heard that some teletype page printers were to become available through the time-honored grapevine. With the expenditure of a bit of physical energy, our home was adorned with a large black box nicely mounted on its own pedestal. Having never worked with teletype, I was given the short course by WA3RMA.

The first order of business was not too tough: Build a loop supply. The result is diagrammed in Fig. 1. Do not omit the 1.0 uF capacitor and do not significantly increase its value. The teletype machine seems to be the home of some rather nasty electrical noises, when running, and the function of this capacitor is to keep those electrical disturbances from getting into your receiver and your terminal unit.

When I first completed the loop supply, I put a key in series with it. With the machine running I was able, by keying, to generate letters and numbers in random fashion. This did nothing but prove to me that the loop

supply and the machine were functioning in some fashion.

The next step, again taken with the help of WA3RMA, was to test the machine using his TD or tape distributor. The RTTY magnet is plugged into J1 of the loop supply and J2 accepted the TD output. The sights and sounds of good copy coming from the punched tape of the TD let me know that the machine was in proper adjustment.

This led to the next step, namely building a TU or terminal unit that would take the output of my receiver or tape recorder and let the machine do its stuff.

I had purchased copies of two books: *Teletype from A to Z* by Durward J. Tucker and the *RTTY Handbook* by Wayne Green. These volumes are excellent, and while they do have some duplication of material, they are complementary and well worth having in your technical library.

Having enough printed matter to completely avoid re-inventing the wheel, I was, however, determined to try my hand at designing a TU.



The requirements were narrow shift. Early in the low cost, simplicity, solid design I decided to try copying on one tone only, copying wide shift and choosing the space tone. Fig.

# Ridiculously Simple RTTY System

- - get on the air in one day

Allan S. Joffe W3KBM  
1005 Twining Road  
Dresher PA 19025



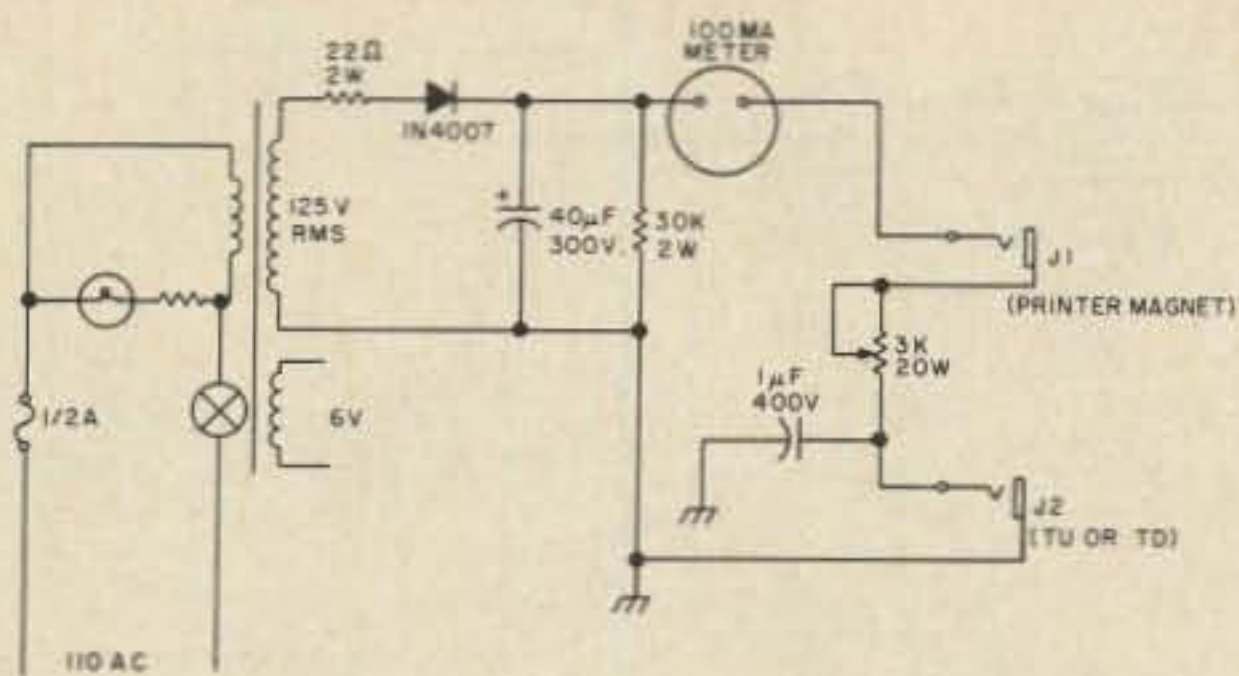

Fig. 1. RTTY loop supply. Transformer: Stancor PA-8421. Adjust 3k resistor so loop current runs about 60 mA, steady state. Note: If you use a metal panel, J-1 must be insulated from the panel.

2 shows the schematic of the finished product.

The input sensitivity is such that about 150 millivolts will produce RTTY copy. However, it is best to use enough input to take advantage of the clipping effect of the diodes shown as part of the input circuit to counter the effects of fading on the low frequency bands.

The next element in line is the audio filter that selects the space tone from the RTTY signal and also insulates the unit from QRN and other interference. This filter owes most of its form to an excellent article by Courtney Hall (September 1975 *Ham Radio*).

In his article, he indicated trouble with oscillation at certain filter settings and boy, he was right. I managed to cure the problem with the 0.001 capacitor that goes from the junction of the 1500 Ohm resistor and one end of the tuning pot. This capacitor to ground made the filter circuit stable at all settings. The unstable portion of the tuning range was the low frequency end, and I did do enough playing with different values of capacity to determine that significantly more than the 0.001 made other troubles, so stay close to this value.

The tuning pot is a 5k linear which will allow the filter to tune from 1500 Hz at the low end to just a bit over 3000 Hz at the high end.

The 1500 Ohm resistor connected to one end of the pot has the greatest effect on tuning range. The 150k resistor connected to the other end of the pot mainly affects the sharpness of the filter peak. Here again these values were diddled with enough to know that they are "on the money."

The filter is connected in the feedback loop of IC1 which is an 8 pin minidip 741. Curiosity impelled me to see if various ICs of the same type would significantly vary the filter tuning. The average of five different ICs showed no significant shift in either frequency or peak as the case may be.

The output of this IC is rectified by the diode, and the rectified voltage is developed across the 15k resistor from diode to ground. Notice that the polarity is negative. In passing, I will note that in the finished unit I have tried bypassing this resistor with a small capacitor ranging up to 0.05 uF with indifferent results. You can try this yourself with the understanding that as you approach 0.05 uF, the circuit starts to lose its immunity to QRN of the static random impulse variety.

Before we leave this area of the circuit, let's examine the meter which is connected across the 15k diode load. This is a very useful item as it serves as a tuning meter for the TU. The meter is multiplied (50 microamp basic scale) so that it becomes a three volt full scale dc meter. With a RTTY signal applied to the TU, the tuning pot is varied until the meter indicates that the filter is tuned to the desired tone. In normal operation, the meter will show about 1½ to two volts. The reading will vary with the incoming transmission char-

acters, with fading of signals, etc. Do not omit this feature unless you enjoy headaches with your RTTY.

Up to this point, we have selectively filtered the RTTY signal, limited it to take care of input level variations, within reason, and supplied a tuning indicator. The next step concerns IC2, which is another 8 pin minidip 741 op amp.

This stage is used as a dc comparator. A negative polarity reference voltage of about 0.75 volts is provided by the voltage divider which goes between the minus terminal of the split voltage power supply and ground. When this voltage is applied to the designated input of the comparator, the output is highly positive on pin 6 of the IC. The other input of the IC is connected to the rectified signal output of the previous stage which, as has been stated before, is also negative in polarity.

When a RTTY signal that can pass through the filter is present, and if its value causes the voltage applied to IC2 input to exceed the reference voltage from the divider, the output of IC2 will imme-

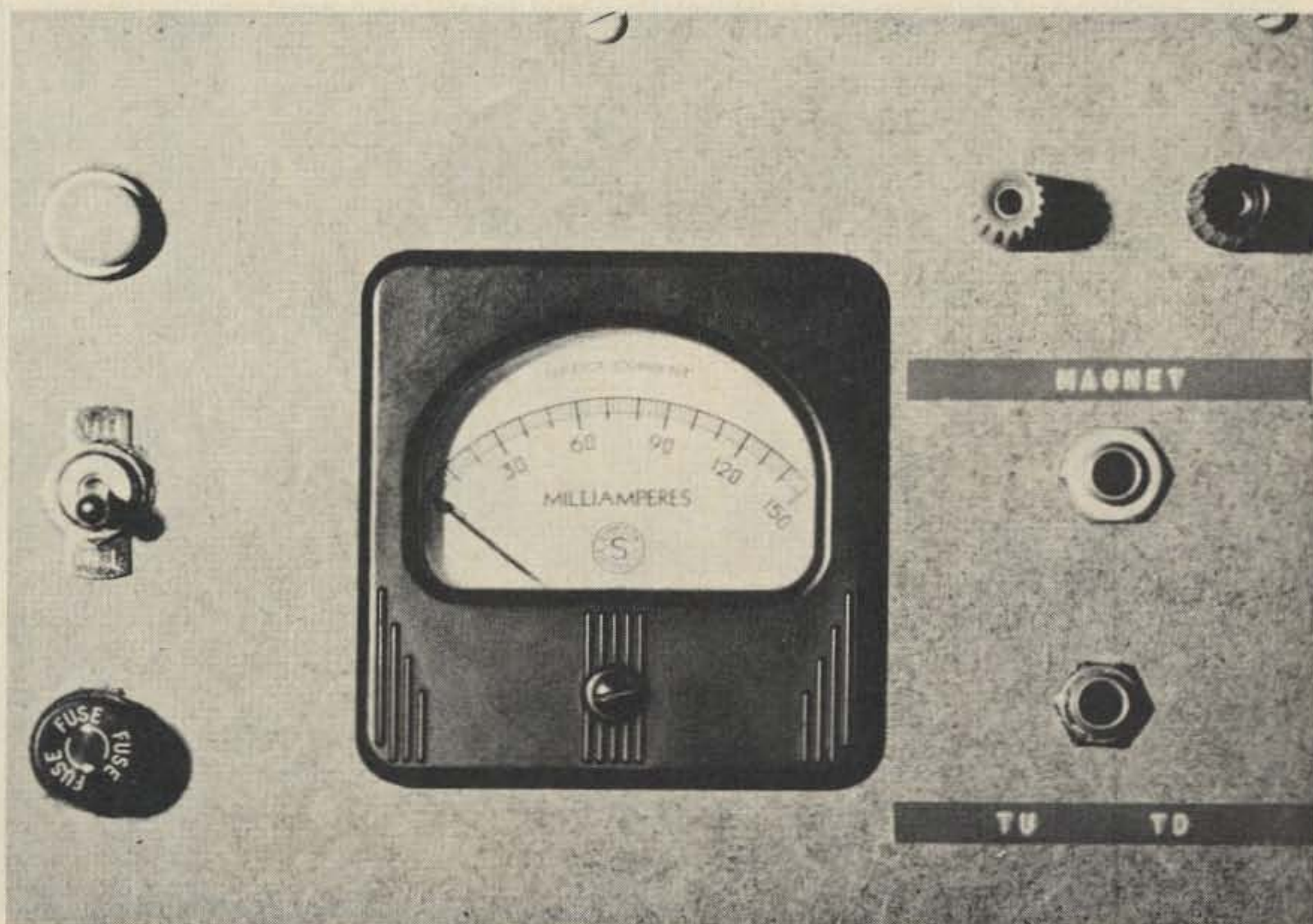

diately swing to ground or even a small amount negative.

The output of IC2 is directly coupled to the base of Q1. When IC2 output is positive, Q1 is biased full on and current will flow in the printer magnet. When the output of IC2 is at ground or slightly negative, Q1 has no base drive and no current flows in the printer magnet. Thus Q1 acts as a switch turning the printer magnet current on and off with the incoming RTTY signal, hopefully creating our objective of solid RTTY copy.

Q1 deserves a bit of special attention. It is an MJE-340 which is rated at some 300 volts and was obtained from SD sales through an ad in this magazine. Notice that there is a diode in series with the collector. This serves to protect the transistor from high voltage negative transients that may be present when the current in the printer magnet decays upon opening. To heat sink or not to heat sink is an open question. When the unit was under development, I had it running for some 20 minutes with RTTY going through it, and the MJE-340 remained

quite comfortable, thermally speaking. In the final version, I chickened out and attached a symbolic heat sink of thin sheet copper approximately 6 cm square in area.

That about wraps up the unit but still leaves some explaining to do. For wide shift RTTY, the space tone which we are using to produce copy is 2975 Hz. The other tone you hear is the mark tone, and for wide shift it is 850 Hz below the space tone, or 2125 Hz. When the RTTY signal is applied to the TU, we tune the frequency so that the space tone is accepted by the system. The effect of the mark tone is acquired by indirection. Hopefully, since the RTTY signal is composed of mark and space tones, our TU will respond faithfully to the presence of space tones and by doing essentially nothing will indicate to the RTTY machine where the mark tones are in the transmitted characters. This is what I mean by "mark by indirection." This has one added plus. When no signal at all is present, the machine will run "closed." This is the equivalent of a simple "mark hold"

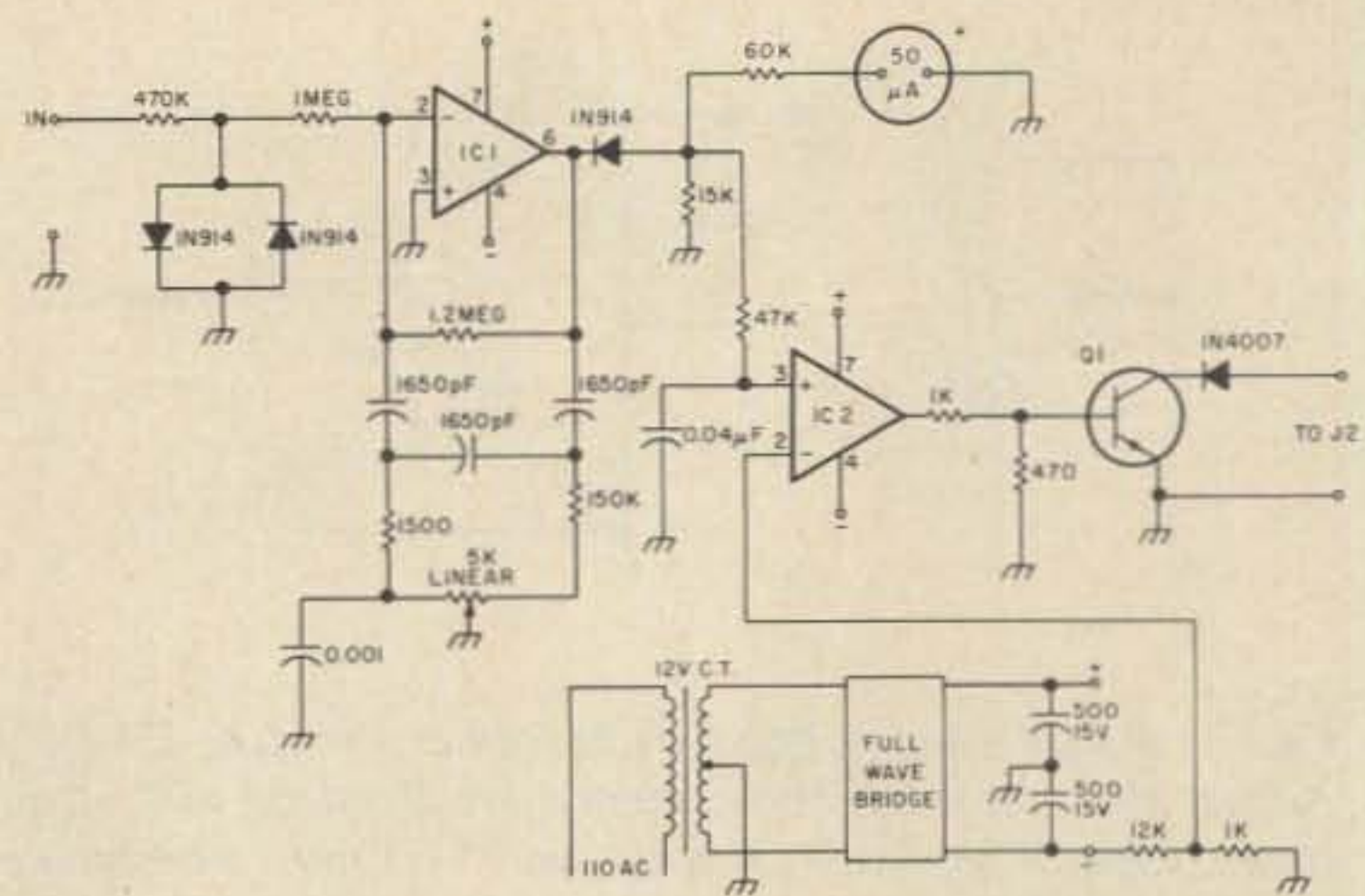

Fig. 2. RTTY TU. IC1, IC2 — 741 op amps; Q1 — MJE-340. All resistors 1/4 W if wattage not indicated.

circuit. Its additional virtue derives from the fact that when the machine is running "closed" it makes a lot less noise than when running "open," strictly because there is much less mechanical activity going on within its innards.

When receiving narrow shift RTTY, the mark tone is not changed, but the space tone usually becomes 2295 Hz which is only a 170 Hz separation. It is under narrow shift conditions that you can begin to appreciate just how good the simple audio filter really is (Table 1).

You are going to run into two different RTTY transmission types on the ham bands, FSK and AFSK. AFSK is the simpler mode to receive and will be found on six meters and two meters and possibly higher.

Basically, in AFSK, the RTTY machine at the sending end keys an audio oscillator to produce the two tones usually transmitted. This varying frequency audio signal is used to modulate the transmitter. At the receiving end you merely tune in the signal in the same manner as a voice transmission, apply it to the TU, and sit back and let the machine do its thing.

I said that AFSK is by far the simpler mode to receive for the following reasons. Most of us, as I am, are burdened with super selective receivers for the low bands where FSK is used. My receiver has a selectivity of about 2.1 kHz and there's no way in the world that I am going to be able to get a decent 2975 Hz audio signal through it. This is the reason that the audio filter has been designed to function effectively down to 1500 Hz. What you do is receive the signal just like any CW signal. In FSK, the transmitted carrier is actually shifted in frequency and arrives at your receiver just like a CW signal as far as sound coming out of

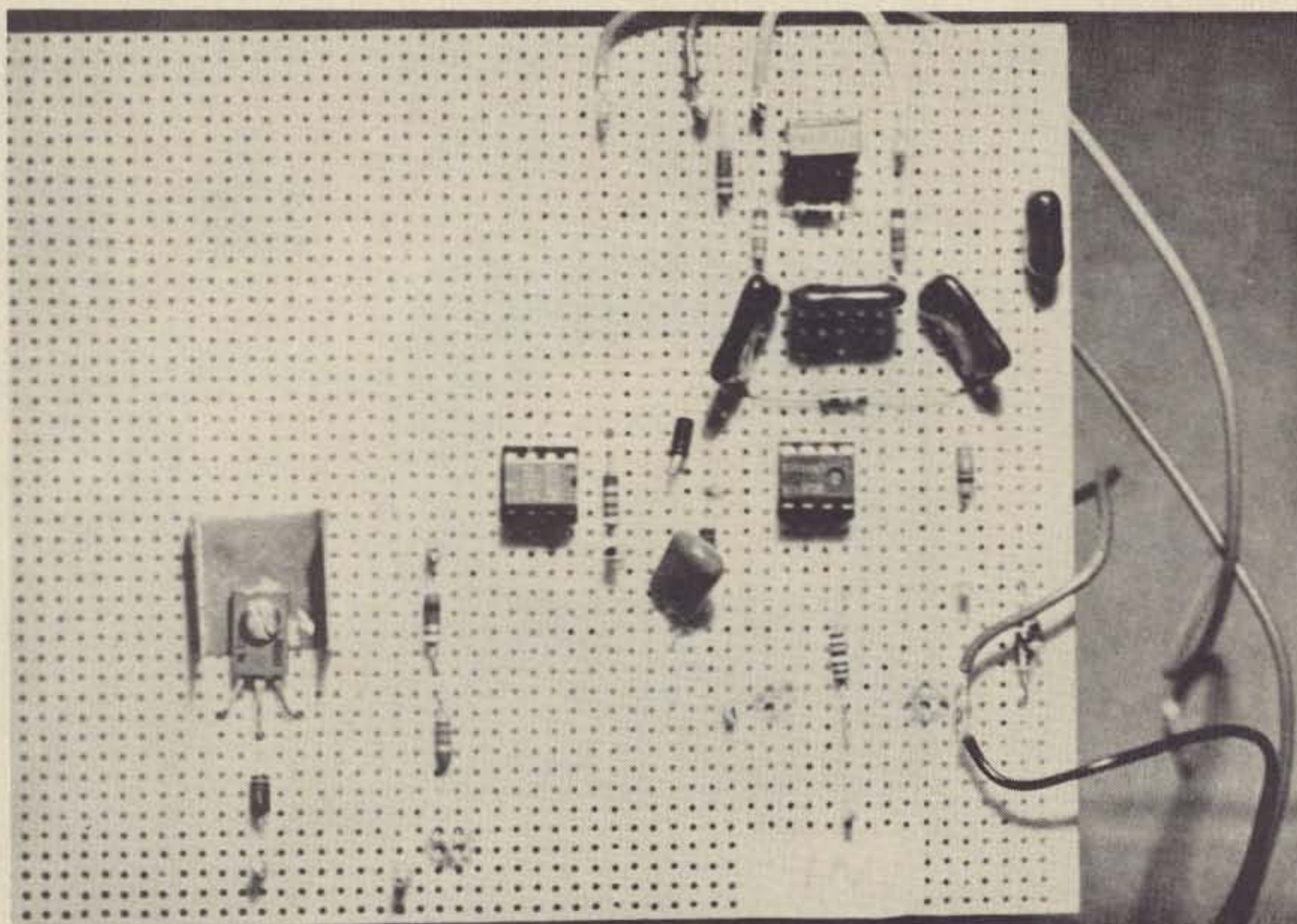

the audio system goes. Without the BFO on, it is just a series of clicks. Now, how do we solve the dilemma of getting a signal out of the receiver when I said that my receiver won't pass the signal, audiowise, due to the tight bandpass? Simple ... you just vary the tuning or the BFO until the generated audio beat tone is down within the tuning range of the audio filter in the TU.

The tuning meter greatly facilitates this process, and after several tries you readily get the feel of what sounds right. The procedure for wide shift or for narrow shift is the same. If your receiver is a wide band job, it will make the translation process unnecessary, but you will pay the penalty for lack of a narrow pass band, namely more interference from adjacent signals.

Using this TU, I have gotten very good copy from WIAW on their satellite trans-

missions which let one and all know what "Oscar" is up to. The transmissions I copied were aired on Sundays at 5 pm on a frequency of 3620 kHz. The first transmission used wide shift, and the same information was repeated after this using narrow shift. This is an excellent transmission to use for test copy as the signal is strong, clean and uses both shifts.

It is practical to copy a signal on a reasonably good reel to reel tape recorder. During the test period of the TU, I would feed the receiver both to the TU and the tape machine. The taped copy gave me a known signal to pump into the TU while changing parts values during the design. From experience, I can freely and sadly state that all tape machines running at a given speed, say 7½ IPS, really do not. Play the RTTY tape back on the same machine that it was made on, to avoid real grief.

Decibels	Frequency Hz	Voltage shown on tuning meter
±0	2295	1.50 volts
-3	2285	1.25 volts
-6	2275	0.75 volts
-11	2265	0.40 volts
-23	2255	0.10 volts
	2245	
	2235	

For these two frequencies, voltage was too low for accurate reading.

Conditions of measurement: Enough voltage was applied at 2295 Hz to make tuning meter read 1.50 volts with filter peaked. Frequency was monitored by counter and varied in 10 Hz steps.

Table 1. Values showing effectiveness of filter when tuned for narrow shift. Space frequency is 2295 Hz.

If you enjoy suffering, try using a run of the mill cassette recorder.

For those inclined to put a scope on things they build, you should see nothing but nice clean square waves bouncing merrily at the base of Q1. It is the function of the 0.04 capacitor at the non-inverting input of IC2 to clean up any RTTY signal ripple. Do not increase the value of this capacitor. However, you can drop it down to an 0.03 with very little difference in effect.

You will notice after a bit that the rhythm and sound of your printer will tell you if all is well with the printing process. This is particularly true if the transmission is coming in from a punched tape. You will soon learn that any radical departure from that nice steady mechanical chuga chuga chuga means that something is amiss. Of course, if the transmission is manual, this is not true, particularly if a hunt and peck artist is at the other end of the circuit. ■

# Faster and easier is what we're all about.

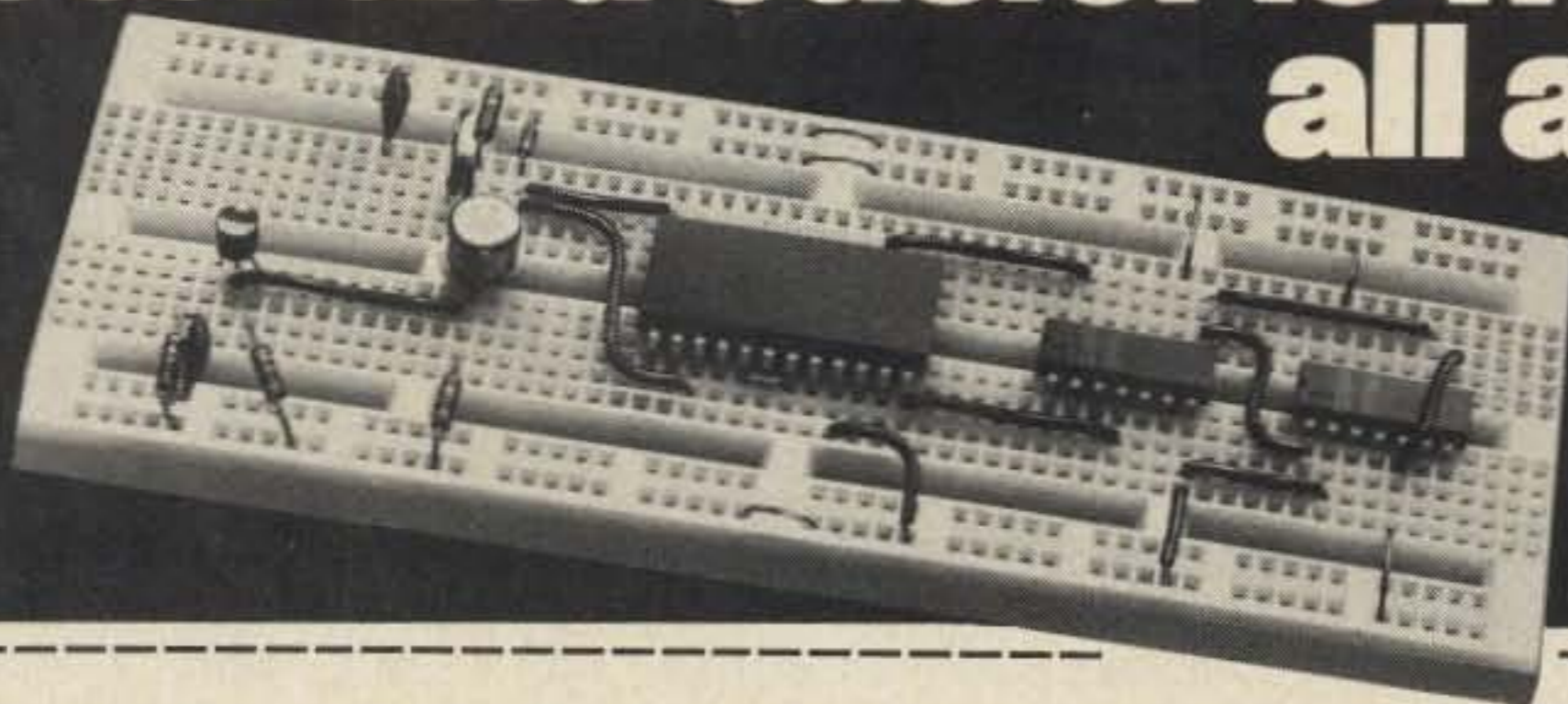

As little as  
**\$17**

Now, whenever you'd like to give a circuit a try, you can build it up nearly as fast as you can dream it up with Super-Strips™, the faster, easier and less expensive solderless breadboards from A P Products. When you build your circuit on a Super-Strip, everything stays as good as new. Once you're through, you can use everything again and again. Instantly. Put a Super-Strip to work for you. Eight distribution lines handle signal and power, and 128 five-tie-point terminals can handle 9 ICs and then some. It's a whole lot easier than printing a circuit and a whole lot handier than haywire. Better send for a Super-Strip before the urge to build strikes again. After all, the time you save may be your own.



**A P PRODUCTS INCORPORATED**

Box 110- Z Painesville, OH 44077 (216) 354-2101 TWX: 810-425-2250

Part Number	Model Number	Terminal Type	Price Each	Quantity	Total
923252	SS-2	nickel-silver	\$17.00		
923748	SS-1	gold-plated	\$18.90		

\_\_\_\_\_

Credit Card Number

\_\_\_\_\_

4 Numbers Above Name (MC) Good Thru

\_\_\_\_\_

Signature

\_\_\_\_\_

Print Name

\_\_\_\_\_

Address

\_\_\_\_\_

City State Zip

- Check or M.O. enclosed
- Charge BAC
- Charge MC
- Send catalog

Total for merchandise	
Sales Tax (OH and CA)	
Shipping (see table)	
<b>TOTAL ENCLOSED</b>	

**Shipping/Handling**

Up to \$10.00	<b>\$1.00</b>
10.01 to 25.00	<b>1.50</b>
25.01 to 50.00	<b>2.00</b>
50.01 to 100.00	<b>2.50</b>
100.01 to 200.00	<b>3.00</b>

Company PO's FOB Painesville  
No COD orders

Orders subject to acceptance at factory.

**DEALER INQUIRIES INVITED.**



Robert Lee Fields  
 Box 884  
 El Sobrante CA 94803

# How to Catch a CBer

-- practical hints

Judging from the title of this article, your first thoughts were that someone finally wrote "An Elementary Guide to Catching and Prosecuting Your Local Bootleg Citizen Band Operator." He's that "good buddy" that is wiping out all your neighbors' boob-tubes with his 1 kilowatt linear and spreading hate and discontent throughout the whole area. I'm sorry to disappoint you, but this article is intended to help you catch those CBers who are just about ready to turn in their skip handles because they have had enough of the CB retailers' "big bonanza."

This article is from an ex-CBer, ex-Novice, and almost a General Class ham's point of view on what to do to catch a new ham — or if you prefer, a CBer.

My background in CB runs the whole interest spectrum. I started as a legal call letters CBer, progressed through the "track down those law-breakers" period, and finally ended up joining their ranks as the "Spook." After attending their social gatherings for a few months, I met the girl of my dreams and had the traditional CB wedding. One guest remarked that the church parking lot looked as

if the fishing fleet had come in because of all the cars with CB antennas on them. Luckily, my marriage has lasted longer than my interest in CB. And that is why I turned to ham radio and away from the "good buddy" part of my life in 1972.

Somewhere in the scads of CB articles in the *Pop Electronics* magazines, I have read that the average life expectancy of a "good buddy" is 3 or 4 years. That's from when he first gets excited about CB until he no longer has any interest in it as a hobby or way of life.

During this time the average CBer buys a SSB base radio, 2 mobile AM rigs, a groundplane, tower, rotor, and beam antenna, plus a linear and all the extra goodies to make his station the talk of the town. This means the fellow can spend a couple of hundred or a couple of thousand dollars, but spend they do in a big way. Through this period of second mortgaging his house to buy CB equipment, the "good buddy" can usually be found at coffee breaks shooting the bull and trading QSL cards, going to CB jamborees hundreds or thousands

of miles away, and making himself known for miles around by yakking on the radio day and night. Then along comes about the fourth year and the CBer realizes that it's just no fun trying to fight the local "channel hog" for a break or trying to compete with the thousands of new CBers on his channel just to attempt to talk 15 miles. Even skip shooting is becoming impossible with these new fellows and their new linears in the local area. So the "good buddy" decides to sell his station for that camera equipment that he has always longed for, and his CB way of life ends.

Now this is the chance that ham radio clubs have been waiting for to pick up some new recruits. Hundreds of these "good buddies" have gotten to the point of selling out because of a general lack of interest and the enormous crowds since the CB boom of 1976 came along.

Of course, I am speaking of C. W. McCall's hit record "Convoy" (about the CBing truck drivers), television's "Movin' On" with those CB truckers Sonny and Will, and the country western and rock stations across the country that are giving CB rigs away by the bushel to promote the song. And then there are all the clubs: CB, custom vans, custom 4 wheelers, custom pickups, custom VWs, custom skateboards, custom motorcycles, custom 18 wheelers, custom motorhomes; and don't forget airplanes, hot air balloons, hang gliders, and the ever popular U.S.S. Enterprise "Star Trek" Space Communicators with twin warp sound for the kiddies. A quick analysis of the situation leads me to ask these vital questions: Is everybody in this country a "good buddy"? Does everyone drive a semi and say "negatory" and "10-4"? Is everybody from Oklahoma and what is bodacious?

Millions of people are "turning off" CB after long and illustrious careers (to buy camera equipment) because of the CB boom. With something like 500,000 CBers a month seeking FCC licenses, there just isn't any place for the old timers to go to have room to talk. Even the high channels above channel 23 are filling up with sidebanders and their funny Donald Duck talking. So the "good buddies" with their Yaesus, Trams, and Tempos try to use off channels, ham bands, or just give up and finally sell out completely. The reason always seems the same: all their friends are gone and the channels are too crowded to use.

So how do the hams attract all these CBers into their clubs? Let's find out how the average guy gets interested in CB in the first place.

#### The Neighborhood CBer

Most CBers are drawn in by the advertisements in the media, or by a friend or relative who shows the prospective CBer what fun it is to talk on his cute little radio, get these nifty QSL cards, and use a catchy little handle like "Spook" or "Li'l Goober." The neighborhood CBer takes him to a CB coffee break to meet other CBers, and later helps the new guy buy a rig, put up antennas, check swr, fill out applications and give him all the help he needs to get into the CB groove.

#### CB Coffee Breaks

Coffee breaks are family style get-togethers usually held at pizza parlors with food, beverage, a live country western band for dancing, drawings, and a meeting thrown in. The drawings and prizes are what bring the crowds to the breaks — the better the prizes, the bigger the crowd. Most of the money goes to buy more

prizes, but any left over goes to the club to sponsor picnics, dances, or campouts. Family participation is really stressed with all sorts of kids' prizes, food or appliances for the wife, and lots of radio gear for the hubby. An awards ceremony usually follows with presentations such as Channel Hog Award, Ratchet Jaw Award, Bucket Mouth Award, and the coveted All Mouth No Ears Alligator Awards. The CB family comes home with a full stomach after a fun evening with friends, and with a little luck, all sorts of prizes just for buying a few bucks worth of tickets. My wife and I have furnished our kitchen in this manner for years — sure saved us a bundle.

#### CB Jamborees

Jamborees are the big brothers of coffee breaks and are usually held at county or state fairgrounds. An individual or club rents the fairgrounds, then rents out

sales space for business and controls the food concessions. The club has printed thousands of flyers which are carried or sent to other jamborees all over the country hoping to bring droves of CBers to this jamboree. And not wanting to be left out of the "big one," a typical "good buddy" packs up the family camper, and family and friends caravan a thousand miles for a weekend jamboree.

Jamborees are like big fairs with something for everyone. Activities at most jamborees are dealer displays, carnival, flea market, kids' games and rides, bed racing, country western dances, liquid refreshment, and the thrill of meeting all those other skip talkers eyeball to eyeball. Two full days of excitement with your friends in a party atmosphere for only the cost of parking your camper on the grounds with hookups and buying tickets for the thousands of dollars of prizes the jamboree has put up to

**ANNUAL SAN FRANCISCO BAY AREA JAMBOREE**  
CITY FAIRGROUNDS, CALIFORNIA  
Sept. 26-28, 1975

**BIG 4 JAMBOREE**  
Sept. 5-7, 1975  
GLENN COUNTY FAIRGROUNDS, CALIFORNIA

**Mendocino Modulators 1976 Jamboree**  
February 6-7, 1976  
Ukiah Fairgrounds, Ukiah, Calif.  
Over 2000 Radio Gear, Reduced Fares  
**MAIN PRIZE \$1000 CASH**

**2nd Annual LAS VEGAS JAMBOREE**  
Oct. 31, Nov. 1 & 2, 1975  
Flamingo Las Vegas  
Prize Pool \$7500.00  
Free Admission

**Double-O Buddy International  
1ST JAMBOREE**  
LODI, CALIF.  
Grape & Wine Pavilion  
OLD HIGHWAY 99 AND LAKESHORE STREET  
**MAY 7, 8, 9, 1976**  
Main Prizes: 1st \$500, 2nd \$300, 3rd \$200  
Secondaries: Calture - Radios & Electronic Equipment  
Roller Skating & Park on Grounds for Children  
Registration Fee \$1.00 each - Under 16 free  
This includes ticket at special price plus mandatory ticket  
**Free Dance Saturday Evening**  
\$2.00 per night staying in - Limited alcohol beverages  
Beer & Food available  
Book information write:  
Double-O Buddy International Jamboree  
P.O. Box 9170, Stockton, Ca 95204

**BAKERSFIELD**  
A.M.A.S.R.  
**6th ANNUAL  
C.B. JAMBOREE**  
Kern County Fairgrounds  
All Buildings Air Conditioned  
1976-JUNE 16th thru 20th-1976

FOR INFORMATION  
HOTEL RESERVATIONS  
WRITE TO:  
MAYFAIR FAIRGROUNDS  
DEKON, CALIF. 92423

Checklist - Other Items:  
Registration Fee  
General Admission  
Prizes and Soups  
Appointments "etc."

OFFICE OF CHAIRMAN  
BUREAU BAKERSFIELD  
P.O. BOX 1400  
BAKERSFIELD, CALIF. 93301

**1st ANNUAL  
GOLD COAST  
1975  
JAMBOREE**

MAYFAIR FAIRGROUNDS  
DEKON, CALIFORNIA  
ROOM 21-22-23

PROCEEDS  
WILL BE USED TO  
SUPPORT THE  
M.C.'S  
BUREAU

**MAY 14-15-16 1976**

PLAN EARLY  
BRING THE WHOLE  
FAMILY

**5th ANNUAL  
SUNNY BAY C.B.  
CAMP**

CELEBRATE  
"50th ANNIVERSARY"  
LILAC ORNS CAMPGROUNDS - ESCONDIDO, CAL.  
SAT. NIGHT DANCE  
JAMES BANTS, HAYRINEZ  
AVAILABLE  
\$10.00 PER PIC. FROM 8 AM  
\$5.00 PER CARLOAD FOR PICNICING  
DEALER DISPLAYS  
FOR BIRTH RESERVATIONS P.O. BOX 3013, CHULA VISTA, CAL.

MISS BOBBY CONTEST  
GAMES FOR THE KIDS  
FIRST-COME, FIRST-SERVED

WE WILL SEE YOU  
where the action is  
**2nd Annual  
BOOTLEGGERS  
JAMBOREE** SSB

KATEER DOME  
NATIONAL ORANGE SHOW  
GROUNDS  
SAN BERNARDINO, CALIF.  
C.B.'s are urged to attend this great event and bring your friends

**JUNE 11 12 13 1976**  
Friday, Saturday & Sunday,  
Many Dealer Displays

Free Western Shows with Country Music, Sat. Night  
Master of Ceremonies  
ARKANSAS BOY  
KING PIN

**PRIZES**  
ROBET  
SPECIAL DRAWING SAT.  
TROPHIES

FOR INFO OR DISPLAY CONTACT  
P.O. BOX 1111  
EL MODO, CALIF. 91731  
PHONE 771-1111

**MON. 5**

bring in the crowds. The family has a great time and the "good buddy" comes home with a prize or two if he buys enough tickets. No admissions price, no banquet, no expensive hotel room - just the cost of getting there with the family and tent or camper.

I once had the pleasure of writing to the ARRL to tell them of the CB jamboree in Southern California at Bakersfield. This is the largest one in California and last year brought in around 12,000+ people. It cost nothing to park the car and go take a look see, only to camp and buy raffle tickets. The CBers put on these free jamborees to bring in the crowds (and make money), but the ham conventions charge for the same privilege.

A case in point: At the recent ARRL Pacific Convention held at the Royal Coach Motor Inn at San Mateo,

California, I telephoned to find out about just going over to see the exhibits. The fellow on the phone told me that I couldn't get in without either buying the banquet dinner or paying ten bucks to see the exhibits. "Outrageous!" I said. Why should I drive a hundred miles to pay and see the exhibits when I can look in a ham magazine and see the same thing? And how is a young person going to scrape up the money to pay for the privilege of trying to get interested in ham radio as a hobby? No wonder there are so many new CBers if this is ham radio's attitude towards new members.

This convention was held in one of the most expensive hotels in the bay area. It would only draw in people with the big money to pay for it, and how many of us are rich these days? I'm sure there are plenty of hams who either cannot afford the

fancy convention or are not willing to part with 10 hard earned bucks just to look at radio displays. My letter to the ARRL convinced me that they are not interested in the family aspect of ham radio and neither are those who put on conventions. It is the family activity that has made CB so popular and with that idea in mind here are some suggestions to catch a new ham:

1. Don't charge admission to get into an event for those who just want to browse around. This discourages the people who aren't sure they are that interested and who would leave rather than spend the money. Charge only for the lectures and banquet if you have to make money, but give these people a chance to see what it's all about.

2. Get your ham club to advertise classes for Novices and Generals at places where CBs are sold with the selling

point being "Tired of CB? Get into the exciting world of ham radio with its wide open and uncrowded spaces!" When they call to find out more information, invite them over to see your station. Sell them so hard that they will trade the CB gear for ham gear and not cameras.

3. Don't ever have a Novice class without a General class scheduled back-to-back. I attended a class with 7 disgusted fellow CBers who were eager to get into ham radio. After we all worked hard to get the Novice there was no one there to help them set up their stations and no hope of doing what these CBers had really set out to do - TALK. CBers are talkers and they want to get to the talking stage as fast as possible or find something better to do with their time. Get them through that grand canyon between Novice and General quickly so they don't become discouraged and quit too soon.

4. Get the whole family interested in your ham radio club. Have picnics, parties, dances, and get the young blood interested in social activities. It is the young men and women who will be the future hams if there is something to spark their interest. Friendship with other young people is a great start towards sharing the ham experience. Get your wife or lover involved in social parts of the meetings; wives love to get involved with other wives at social gatherings and yak while you're yakking with the men. Here's your chance to sell her on ham radio as something other than the hobby you waste all your time and money on. Save the dull activities for regular meetings and the fun things for the family get-togethers.

I'm certainly not advocating the complete overthrow of ham radio as we know it today. I'd just like to

see interest generated from within the clubs rather than having the FCC constantly tell us "Use it or lose it." There may be a future in their Communicator class license, but it could also lead us right into the mess that CB is in today. Then how do we stop it in our bands?

Wouldn't it be better to get your family and friends participating in your hobby and also become socially active rather than be hiding in the shack all the time? This is a great way to meet the fellow hams you have spoken to but never met. The CBers have done this for years with obvious success, and even the square dancers make a family event out of their hobby. It's time to get rid of the stuffy, antisocial attitude that most hams have about CBers and show them we are friendly types who are interested in bringing new members into our hobby. A typical CBER

feels that hams talk like computers in 26 syllable words that scare them away before they can learn what those big words mean. And you'd be surprised the number of hams that I've met through CB because they crave the social family excitement that CB has to offer.

But most of all, don't lose the Novices before they become Generals. They have worked hard and you've wasted your time and turned them off completely if the Novice license expires and no one has come forward to show them how to get into the big leagues. New hams are out there for the asking; it's just a case of showing them that you are real people and are interested in them personally. With a little effort in the right direction those clicks you hear will be energetic new Novices rather than ex-CBERs with their Japanese cameras. ■

## We're Fighting Inflation... No Price Rise for '76

### FOR FREQUENCY STABILITY

Depend on JAN Crystals. Our large stock of quartz crystal materials and components assures Fast Delivery from us!

Two CRYSTALS FOR  
Meter Citizens Band Monitor  
Band Marine Receivers  
Radio

### CRYSTAL SPECIALS

Frequency Standards

100 KHz (HC 13/U) .....	\$4.50
1000 KHz (HC 6/U) .....	4.50
Almost all CB sets, TR or Rec .....	\$2.50
(CB Synthesizer Crystal on request)	
Amateur Band in FT-243 .....	ea. \$1.50
.....	4/\$5.00
80-Meter .....	\$3.00 (160-meter not avail.)

For 1st class mail, add 20¢ per crystal. For Airmail, add 25¢. Send check or money order. No dealers, please.

**JAN**  
CRYSTALS

Div. of Bob Whan & Son Electronics, Inc.  
2400 Crystal Dr., Ft. Myers, Fla. 33901  
All Phones: (813) 936-2397  
Send 10¢ for new catalog

## ME-3 microminiature tone encoder

Compatible with all sub-audible tone systems such as: Private Line, Channel Guard, Quiet Channel, etc.

- Powered by 6-16vdc, unregulated
- Microminiature in size to fit inside all mobile units and most portable units
- Field replaceable, plug-in, frequency determining elements
- Excellent frequency accuracy and temperature stability
- Output level adjustment potentiometer
- Low distortion sinewave output
- Available in all EIA tone frequencies, 67.0 Hz-203.5 Hz
- Complete immunity to RF
- Reverse polarity protection built-in



\$29.95 each

Wired and tested, complete with K-1 element

communications specialists

P. O. BOX 153  
BREA, CALIFORNIA 92621  
(714) 998-3021

K-1 FIELD REPLACEABLE,  
PLUG-IN, FREQUENCY  
DETERMINING ELEMENTS  
\$3.00 each

## K-ENTERPRISES

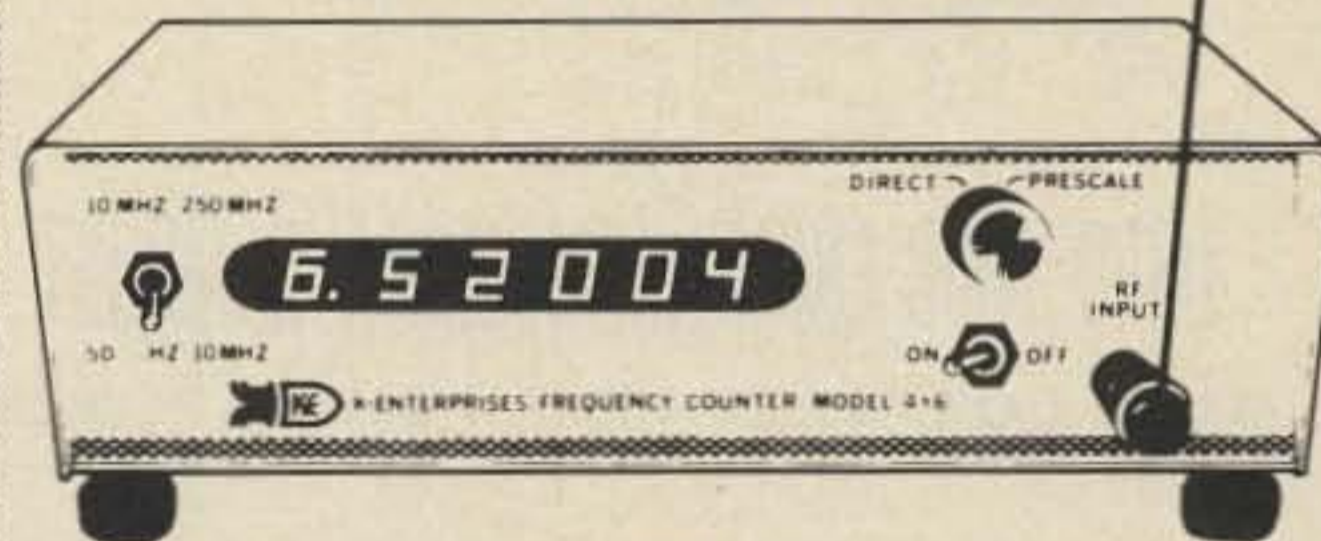

MODEL 4X6C

50 HZ—250 MHZ ..... \$270.00

300 and 500 MHZ PRESCALERS

FREQUENCY STANDARDS

MARKER and PEAKING GENERATORS

POWER SUPPLIES AMPLIFIERS

WRITE FOR FREE CATALOG



Phone:  
405-273-9024



K-ENTERPRISES

1401 N. Tucker

Shawnee, Okla. 74801



YOUR BEST  
THEFT  
PROTECTION!

# FOILER

PATENT APPLIED FOR <sup>TM</sup>

## Quick Release Adapter for Trunk Lip Antennas

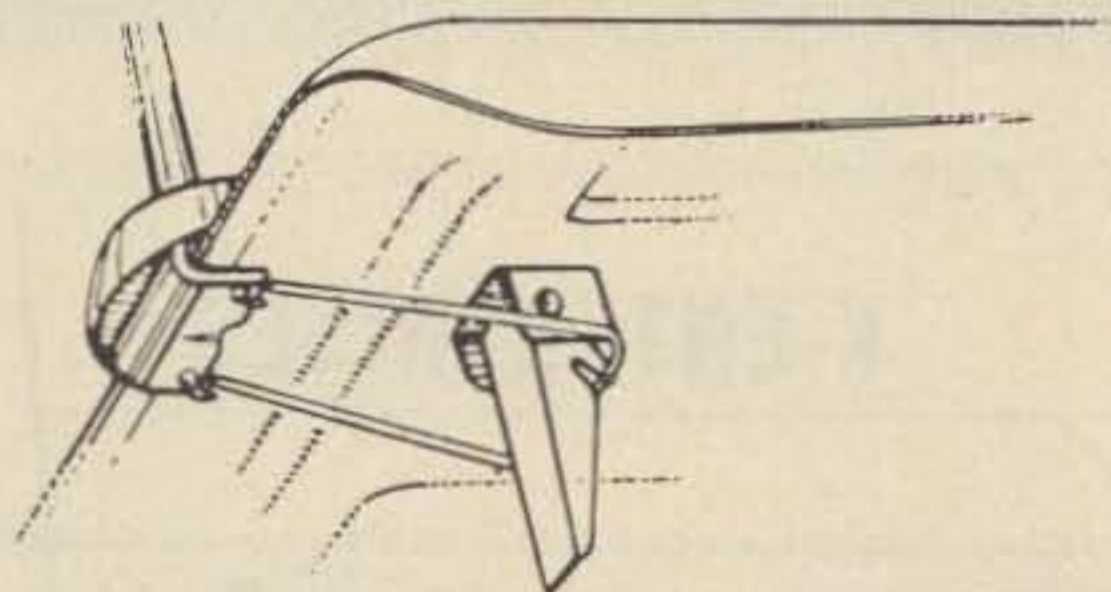

USES YOUR EXISTING ANTENNA & MOUNT

MOUNTS EASILY INSIDE TRUNK WITH ONLY 2 SCREWS

DON'T ADVERTISE YOUR RADIO INSTALLATION  
TO THE RADIO THIEF

# \$4.95

IF YOUR DEALER DOESN'T HAVE THE FOILER  
IN STOCK, ORDER DIRECT. ADD 50¢ POSTAGE  
& HANDLING. TEXAS RESIDENTS ADD 5% SALES  
TAX. SEND CASHIER'S CHECK OR MONEY ORDER  
FOR PROMPT SHIPMENT.

- DEALER INQUIRIES INVITED -

### South Com, Inc.

P. O. BOX 11212 FORT WORTH, TEXAS 76109



## Tired of "CB-Quality" Cables?

### INEXPENSIVE ASSURANCE OF THE MOST CRITICAL LINK IN YOUR 2-WAY SYSTEM!

Regardless of how much you spend on your radio and antenna system, they can't do their best job unless all of your output power gets from the radio to the antenna, and all of the weak signals get from antenna back to radio. The road both power and signals use for this trip is your coaxial cable. Obviously, then, if the cable is broken or contains losses, you won't get the performance you paid for, yet, very few radio operators pay any attention to the quality of the cable they buy, nor do they replace it periodically. Even the best of cable weathers, ages, and develops losses. The coax cable is the least expensive part of your system. The difference in the best and the cheapest you can buy is only a couple of dollars at worst and yet it can literally "make or break" your performance.

Most cable available today in ready-made lengths, and most cable furnished with new antennas, has three less-than-desirable characteristics.

First, most such cables have a single center wire, which breaks with bending, twisting, and day-to-day handling. SouthCom's cables have a 19-strand center wire, so all 19 strands must break before the cable loses connection.

Second, most cable does not have full shielding. You can peel back a small section of the outer black insulation, and you can see the inner insulation through "holes" in the braid. SouthCom's cable is fully shielded!

Third, most cable uses bare copper conductors, and you know how quickly bare copper can corrode. SouthCom's cables use tinned copper to resist corrosion.

Connectors vary widely. Solder-on types are the most common, yet they require a lot of heat which can partially melt the inner insulation, and distort the shape of the cable. In addition, you can't tell how much of the braid has actually been soldered through the four tiny holes in the fitting. SouthCom uses AMP, Inc. air-cripped connectors, which require no heat, and assure a solid bond to all of the braid. Because of the inner construction of the connector, it is almost impossible for a SouthCom cable to short.

In seven months of production, we have had only one report of a defective cable! Quite a record. Part of this record can be attributed to our quality control which checks every cable for SWR and power loss, not just continuity. We think the quality we build in, and the care with which we put our cables together makes them worth a little bit more. Since you're surely entitled to the performance you paid for when you bought your radio and antenna, you should insist on SouthCom cables. If your dealer won't get them for you, we will ship to you from the factory. Add \$1.00 postage and handling, Texas residents add also 5% sales tax. Send cashier's check or money order for immediate shipment.

58-3	3-ft. cable/PL-259's . . . . .	\$3.98
58-6	6-ft. cable/PL-259's . . . . .	4.85
58-12	12-ft. cable/PL-259's . . . . .	5.65
58-20	20-ft. cable/PL-259's . . . . .	6.50
58-20L	20-ft. cable, PL-259-solder lugs . . . . .	5.95
58-50	50-ft. cable/PL-259's . . . . .	9.95

REPLACE WITH SOUTHCOM CABLES TODAY...  
GET THE PERFORMANCE YOU PAID FOR!

### South Com, Inc.

P. O. BOX 11212 FORT WORTH, TEXAS 76109



# NEW! FM144-10SXR-II



All Solid State-PLL digital synthesized — No Crystals to buy! 5KHz steps — 144-148 MHz-LED digital readout.

Introducing the standard of comparison for years to come. No other unit begins to compare with the superb engineering and superior commercial avionics grade quality and construction of the FM144-10SXR-II

- **FREQUENCY RANGE:** Receive: 144.00 to 148.995 MHz, 5KHz steps (1000 channels). Transmit: 146.00 to 147.995 MHz, 5KHz steps (400 channels).
- **FULL DIGITAL READOUT:** Six easy to read LED digits provide direct frequency readout assuring accurate and simple selection of operating frequency.
- **AIRCRAFT TYPE FREQUENCY SELECTOR:** Large and small coaxially mounted knobs select 100KHz and 10KHz steps respectively. Switches click-stopped with a home position facilitate frequency changing without need to view LED'S while driving and provides the sightless amateur with full Braille dial as standard equipment.
- **FULL AUTOMATIC TUNING OF RECEIVER FRONT END:** DC output of PLL fed to varactor diodes in all front end R-F tuned circuits provides full sensitivity and optimum intermodulation rejection over the entire band. **No other amateur unit at any price** has this feature which is found in only the most sophisticated and expensive aircraft and commercial transceivers.
- **TRUE FM:** Not phase modulation — for superb emphasized hi-fi audio quality second to none.
- **FULLY REGULATED INTEGRAL POWER SUPPLIES:** Operating voltage for all circuits, i.e., 12v, 9v and 5v have independently regulated supplies. 12v regulator effective in keeping engine alternator noises out and protects final transistor from overload.

- **MONITOR LAMPS:** 2 LED'S on front panel indicate (1) incoming signal-channel busy, and (2) un-lock condition of phase locked loop.
- **DUPLEX FREQUENCY OFFSET:** 600KHz plus or minus, 5KHz steps. Plus simplex, any frequency.
- **MODULAR COMMERCIAL GRADE CONSTRUCTION:** 6 unitized modules eliminate stray coupling and facilitate ease of maintenance.
- **ACCESSORY SOCKET:** Fully wired for touch-tone, phone patch, and other accessories.
- **RECEIVE:** .25 uv sensitivity, 9 pole filter as well as monolithic crystal filter and automatic tuned LC circuits provide superior skirt selectivity.
- **AUDIO OUTPUT: 4 WATTS**
- **HIGH/LOW POWER OUTPUT:** 15 watts and 1 watt, switch selected. Low power may be adjusted anywhere between 1 watt and 15 watts.
- **PRIORITY CHANNEL:** Instant selection by front panel switch. Diode matrix may be owner re-programmed to any frequency (146.52 provided).
- **DUAL METER:** Provides "S" reading on receive and power out on transmit.
- **OTHER FEATURES:** Dynamic microphone, mobile mount, external speaker jack, and much, much, more. Size: 2½ x 6½ x 7½. All cords, plugs, fuses, mobile mount, microphone hanger, etc., included. Built in speaker.

FM144-10SXR-11

**\$439<sup>00</sup>**

VALUE \$599<sup>00</sup>

Price subject to change without notice

Regulated AC/PS  
MODEL FMPS-4R . . . \$49<sup>00</sup>  
NEW! Touch-Tone Pad \$59<sup>00</sup>

Manufactured by one of the world's most distinguished Avionics manufacturers, Kyokuto Denshi Kaisha, Ltd.

## AMATEUR-WHOLESALE ELECTRONICS

8817 S.W. 129th Terrace, Miami, Florida 33176

Telephone (305) 233-3631

U.S. DISTRIBUTOR PLEASE WRITE FOR FURTHER INFORMATION



G. R. Allen W1HCl  
80 Farmstead Lane  
Windsor CT 06095

Alexander J. Joseph K1ELT  
202 Dix Ave.  
Newington CT 06111

# A 450 MHz Transceiver for Under \$130?

-- bringing 450 within everyone's reach

**A** UHF 450 MHz FM transceiver may be built for less than \$130 by following the details given in this article. This basic transceiver is a single channel unit, developing better than 1 Watt of output, and has a receiver

sensitivity of at least .3  $\mu$ V. The unit is totally modular and may be expanded upon at a later date to include a 10 W amplifier, multi-channel operation and scanning capability. All components are readily available and the unit

may be constructed by the average amateur in 16 hours or less.

## The Basic Transceiver

In a previous article<sup>1</sup>, a complete modular two meter transceiver was described

using VHF Engineering kits. Because of the success of this approach and because of the large amount of interest and favorable comments received, we decided to use the same approach for a 450 MHz transceiver. Thus, this transceiver uses the transmitter and receiver kits manufactured by VHF Engineering of Binghamton, N.Y. These kits are a good choice since they are inexpensive, reliable, easy to build and perform well.

## The Receiver

The receiver used for this transceiver is the VHF Engineering RX 432C. It consists of 4 basic modules: an audio module, a 455 kHz module, a 10.7 MHz module and a 450 MHz converter. The first three modules are the same modules as used in the 2 meter receiver. The converter module is different. The converter module will tune any 2 MHz range between 420 and 470 MHz without retuning and features a varicap controlled AFC circuit.



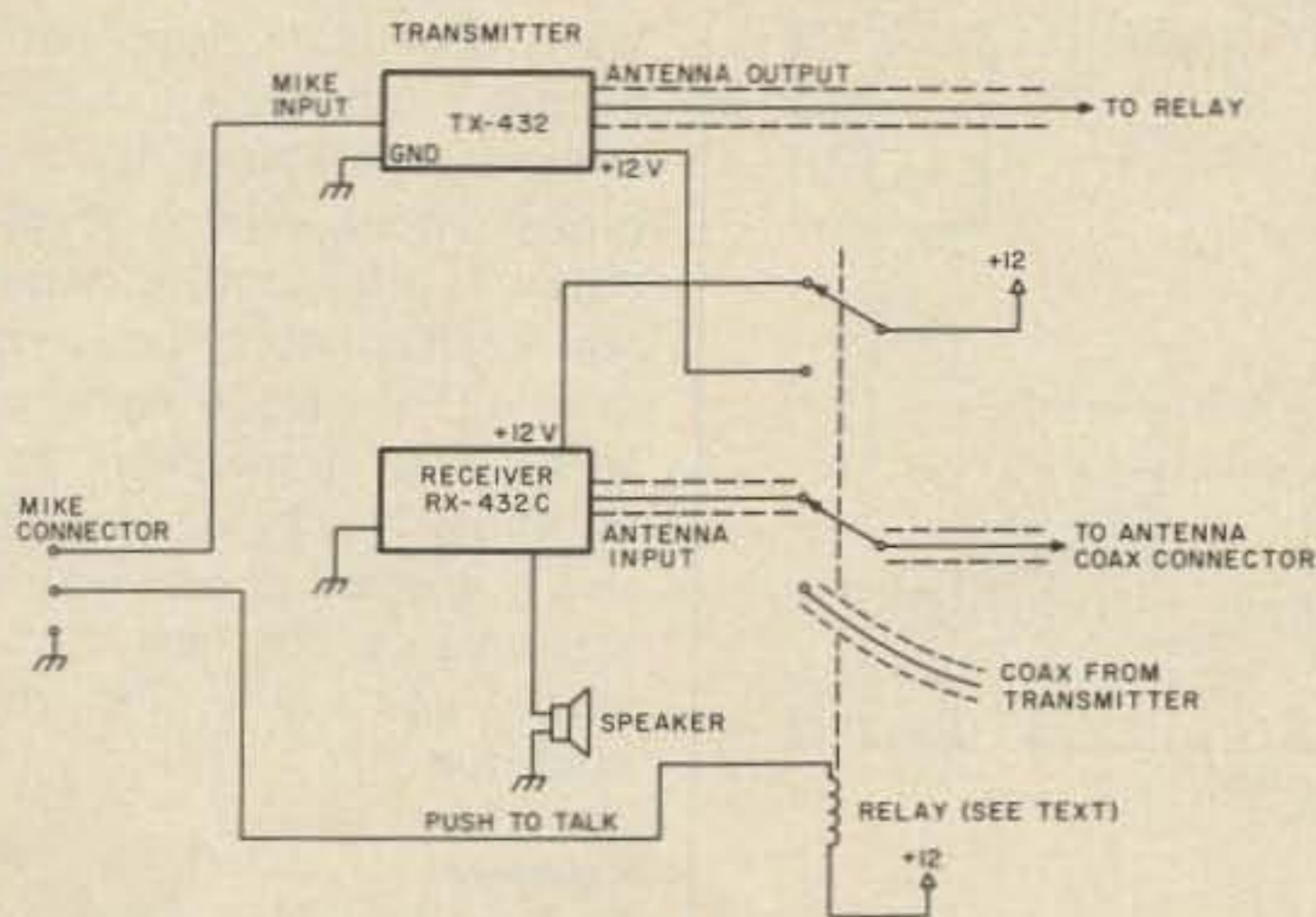

Fig. 1. Basic transceiver connections.

The AFC circuit is designed to control the receiver crystal oscillator and serves to keep it on frequency. It has a maximum control or pull in range of approximately 3 kHz.

Since the receiver, with the exception of the rf converter module, is the same as the VHF Engineering 2 meter receiver, owners of the 2 meter receiver need not purchase a complete 450 MHz receiver in order to receive 450. Only the 450 MHz converter need be purchased and substituted for the 2 meter rf converter board. If the builder wishes, he may use both converters and connect a switch to select one or the other front ends.

#### Receiver Multi-Channel Option

The basic 450 MHz transceiver as shown in the photographs did not include the multi-channel option since this option did not arrive in time to be incorporated into this article. The 450 MHz receiver multi-channel option differs from the 2 meter option in that a separate oscillator is provided on the multi-channel deck. This option may be incorporated into the basic unit or it may be added at a later date. The option adds 10 receiver channels to the transceiver.

#### Scanner Option

The latest version of the channel scanner from VHF Engineering scans 10 channels and incorporates a priority channel feature. The priority channel feature causes the scanner to periodically check a designated priority channel for activity when the scanner is locked on another channel. If activity is detected on the priority channel, the scanner will switch to the priority channel until the channel becomes quiet. It then will

return to the channel that it was previously locked onto.

#### The Transmitter

The 450 MHz transmitter uses the same basic circuitry as the 2 meter and 220 MHz transmitters, but contains an additional doubler stage to drive the final directly at 450 MHz. It is rated at a nominal 1 Watt output; however, the units which we have built have given outputs in the 2 to 3 Watt range as measured on the Bird Wattmeter.

The basic transceiver did not incorporate an amplifier in order to keep the cost of the basic unit to a minimum and to keep the current drain down to a point where portable operation using battery power would be feasible. An amplifier may be added later if desired by using the VHF Engineering PA 432/10 10 Watt power amplifier.

#### Transmitter Multi-Channel Option

The transmitter multi-channel option expands the basic transmitter to 10 channel transmit capability. It is the same option as used on the 144 and 220 MHz transmitters.

#### Construction

The 450 MHz transceiver as shown in the photographs was built into a standard Calectro cabinet and measures 9" x 5 1/4" x 4 1/2". This cabinet was used because its size and construction would facilitate easy assembly of the transceiver without undue crowding. The receiver was mounted on the bottom panel of the cabinet and the transmitter was mounted on the rear panel as shown. The speaker was mounted on the top panel projecting upwards, but will be moved to a side panel location if an amplifier is eventually used. The top panel would then be used for the 10 Watt amplifier module.

VHF Engineering is now offering a cabinet specifically designed for this transceiver. The builder may wish to purchase the cabinet specifically designed for these units.

#### Hookup

The hookup for the 450 MHz transceiver is the same as for the 2 meter transceiver as shown in Fig. 1, except that the high pass filter used

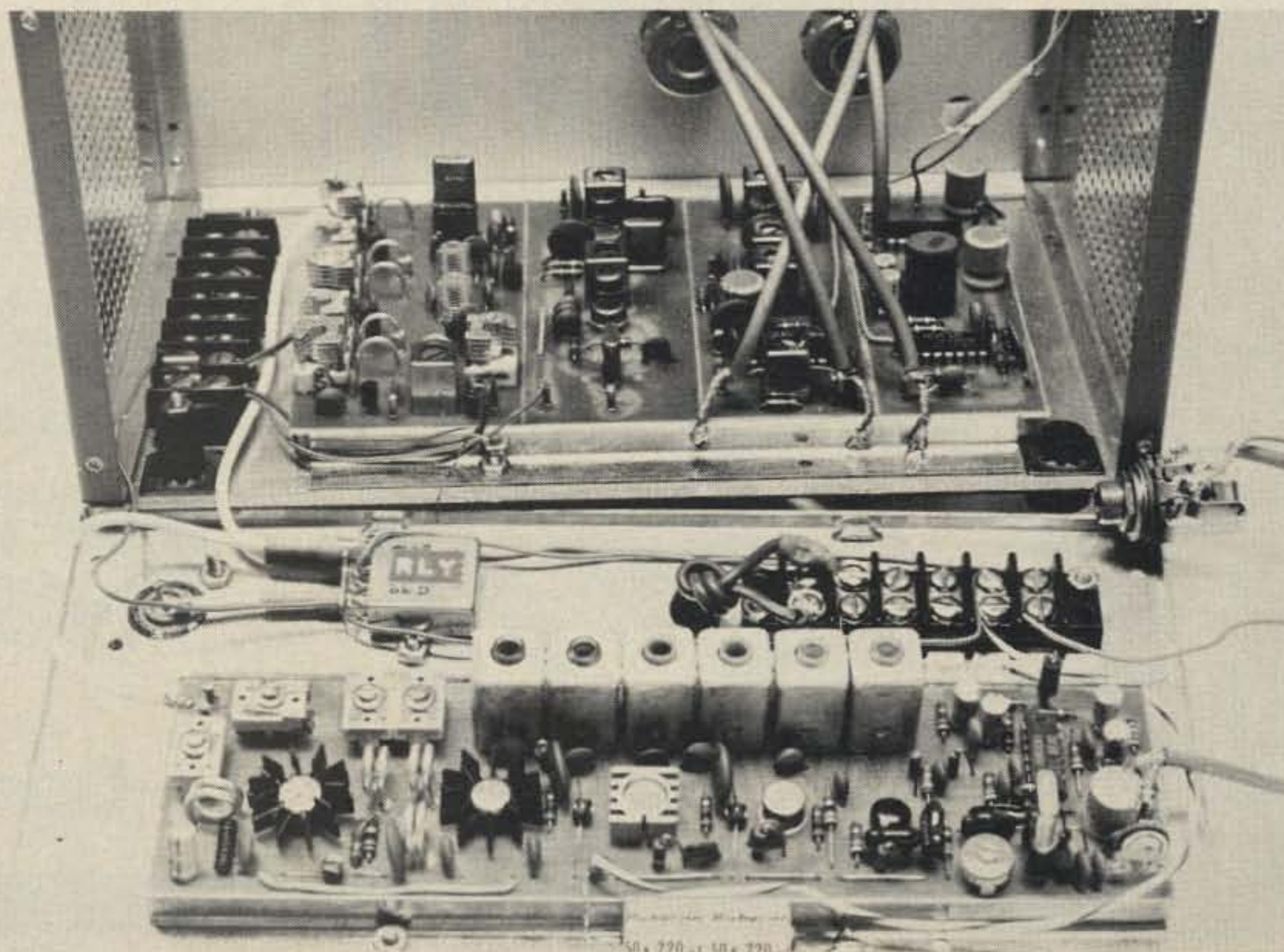

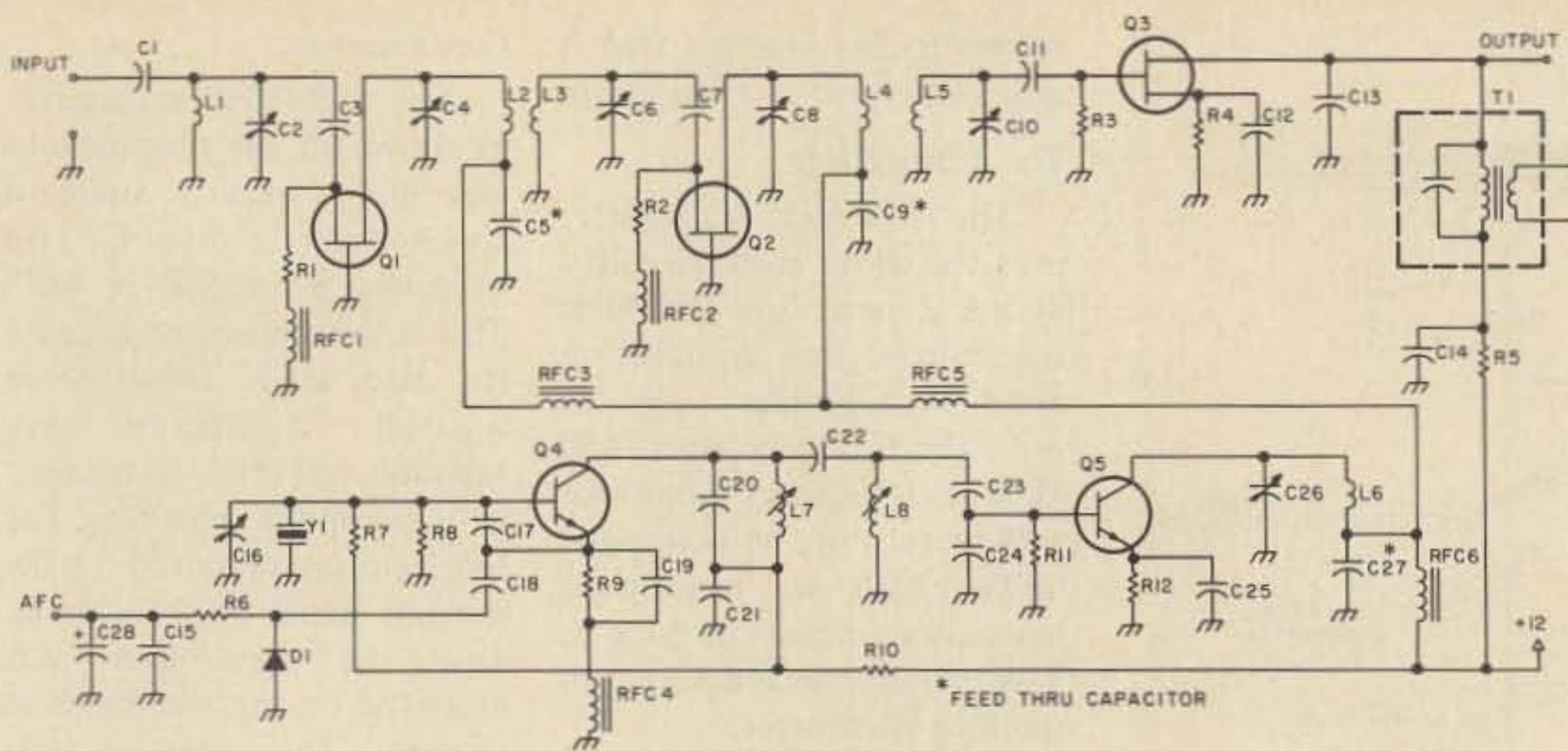

Fig. 2. 432 MHz converter portion of receiver.

in the microphone circuit for the 2 meter transmitter is not needed for the 450 MHz unit. This high pass filter is included on the 450 MHz transmitter board. (Note: All current VHF Engineering transmitters now have the high pass filter included on the PC boards.)

It is important to use a

good quality transmit/receive relay to avoid excessive losses at the UHF frequencies. Further, it is important to use coaxial cable (52Ω) from the transmitter and receiver to the relay. VHF Engineering can furnish a T/R relay if you wish.

For a microphone, a medium impedance dynamic

unit (also available from VHF Engineering) may be used.

#### Operation and Performance

The units that we have assembled for use into the WR1ABM 450 MHz repeater have been performing far beyond all expectations. Receiver sensitivity as measured in the lab has been better than .15 uV, while

transmitter output power has been running from 2 to 3 Watts. Operation, from both mobile and base station environments, shows that the power output from the transmitter is sufficient to maintain a full quieting signal over most of the repeater coverage area. This transceiver has shown itself to be very rugged and it appears to be equal in performance to any solid state unit now on the market. ■

#### Reference

<sup>1</sup>G. R. Allen, R. Brown, 73 Magazine, Jan. 1976, p. 144, "Module Kits, A Low Cost Home Brewing Breakthrough."

#### Parts Lists and Board Layouts

Space does not permit the printing of complete parts lists, board layouts, and detailed assembly instruction. To obtain these, send \$5.95 to

VHF Engineering  
320 Water Street  
Binghamton NY 13902

The microphone and T/R relay are also available from VHF Engineering.

**FORUMS**  
with **JOHN JOHNSTON**, Chief  
Amateur & Citizens Div.,  
FCC and many others.

**DISPLAYS**  
by major manufacturers.

**\$5000** in door prizes.

Luncheon. Ladies' programs.

**CAMP AREA** open Friday  
for set-up.

**QCWA**

**Chicago's**  
**6th annual**  
**RADIO**  
**EXPO**

**SEPT.**  
**18-19** '76

**Don't miss it!**

For information and tickets write: EXPO, Box 1014, Arlington Heights IL 60006

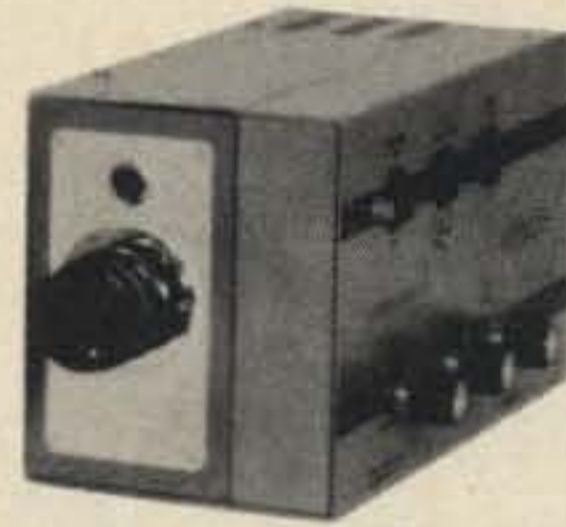
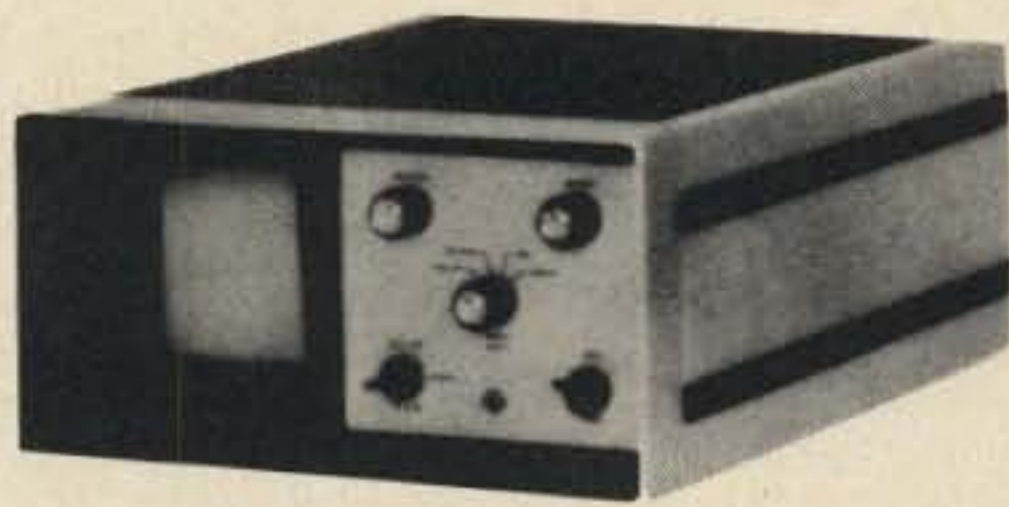

# Start YOUR slow-scan TV with a



**SS2K KIT \$235**  
or  
**SS2 WIRED \$285**

**C1 FAST/SLO SCAN  
CAMERA \$385**

#### MONITOR FEATURES:

Oscilloscope display of SSTV signal  
Rugged industrial grade construction  
Modular Construction

#### CAMERA FEATURES:

Use C1 camera with your home TV set  
Has both long distance and close-up features  
Adjustable frame size  
Built-in slo-scan bar gen for transmit  
Focus on a postage stamp

#### ACCESSORIES:

P1 Polaroid adapter for hard copy photos \$34.50  
V1 viewing hood \$14.50  
T1 tripod \$24.95  
CK256 line conversion kit available

*AVAILABLE NOW: Order factory direct or from our stocking distributors. See Below*

A-G Co., Inc.  
Imperial, Pa.

Amateur Electronics Supply  
Milwaukee, Wisc.  
Cleveland, Ohio  
Orlando, Fla.

Argon Electronics  
Miami Springs, Fla.

A and W Electronics  
Medford, Mass.

Barry Electronics  
New York, N.Y.

CFP Enterprises  
Lansing, N.Y.

Electronic Distributors  
Muskegon, Michigan

Goldstein's  
Pensacola, Fla.

Harrison Electronics  
Farmingdale, N.Y.

Henry Radio  
Los Angeles, Calif.

Hobby Industry  
Council Bluffs, Iowa

# Venus Scientific Inc.

*The company that put high voltage on the moon, now brings you expanding amateur radio technology.*

399 SMITH STREET  
FARMINGDALE, N.Y. 11735  
PHONE 516-293-4100  
TWX 510-224-6492

If I may make reference to the first paragraphs of Part I of this article (73 Magazine, March, 1976, p. 34), it should be easy for you to see why my 12 years of designing, adapting, and modifying around the basic BC-348 receiver package could not be covered in a single article, even if all the failures and quasi-successes were left out — and I assure you that they will be!

It is my purpose in Part II to add one more modification, AFC, that we have found very useful in copying both Oscar and EME signals. In addition, since alignment is required for this modification, and in general for a properly operating receiver, I'll throw in a few tips I have found very handy in securing top performance from any receiver — even if the AFC doesn't interest you. I have the sometimes envied position of having electronics as both my career and hobby, and because of this all of my ideas and modifications have been checked and evaluated both in amateur-equipped shops and in those using more sophisticated lab grade equipment.

My modifications are kept straight by my use of the letter M (modification) and a number (you did M-1, the

David Brown W9CGI  
RR 5 Box 39  
Noblesville IN 46060

# Space Age Junque II

## -- updating the 348 by 30 years

power supply, and M-2, the audio module, from the March 73 article). Since all modifications are not in all of our receivers at any one time, and the M-# described the order in which I tried things, don't let any missing numbers in these articles bother you. The AFC part to be described in this article, for instance, is

M-3A (M-3B was a transistor version).

The M-3A AFC unit is an adaptation from an article by W4EPL (QST, March, 1966) for the low i-f mixer scheme, and another by K7DEP (73, October, 1973) for the rf discriminator. Whether the overall unit is run "open loop," and only the tuning meter is used for manually tuning and correcting frequency, or you later use another of my modifications (M-4) to change the HFO portion of the BC-348 to a varactor oscillator to run full "closed loop" AFC, this modification makes itself well worthwhile.

When you get your receiver up to full AFC capability, you will wonder how you ever worked some modes without it (e.g., Oscar, EME, RTTY, SSTV, FAX, etc.). At least I don't remember Wayne ever having any articles on growing a third and fourth hand, and, with one on the elevation controls and one

on azimuth, I find that both of mine are full — without having to tune a receiver drifting with Doppler, etc.

The AFC is a simple tube-type, with a circuit board layout to remove the pains of punching the chassis, wiring terminal boards, and so forth. The board is laid out so that you can run my 28 V dc filament scheme or use your 6.3 V ac filament line in a present receiver, if that is how you did your BC series rig. The components are all common parts, and within reason I left pad sizes large enough to allow for substitutions (i-f transformers, etc.). The mixer-oscillator alone is worth the time it takes to bring the odd 915 kHz i-f frequency of the BC-348 down to 455 kHz for other uses (panadapters, Q multipliers, etc.). The overall board size was chosen to fit over the dynamotor well where many BC-348 modifications placed the power supply. I have found the external power supply (along with its cable)

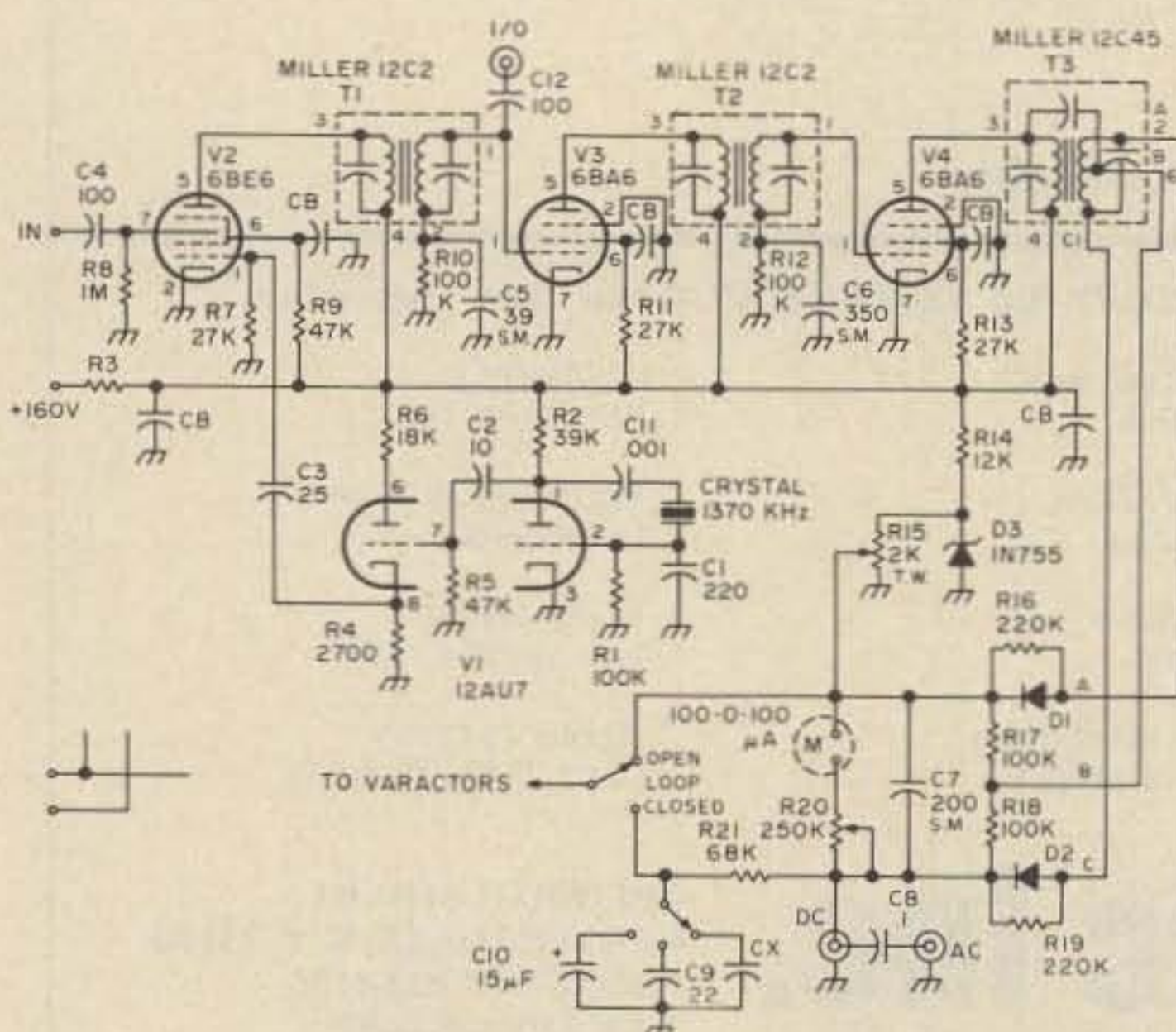

Fig. 1. Schematic.

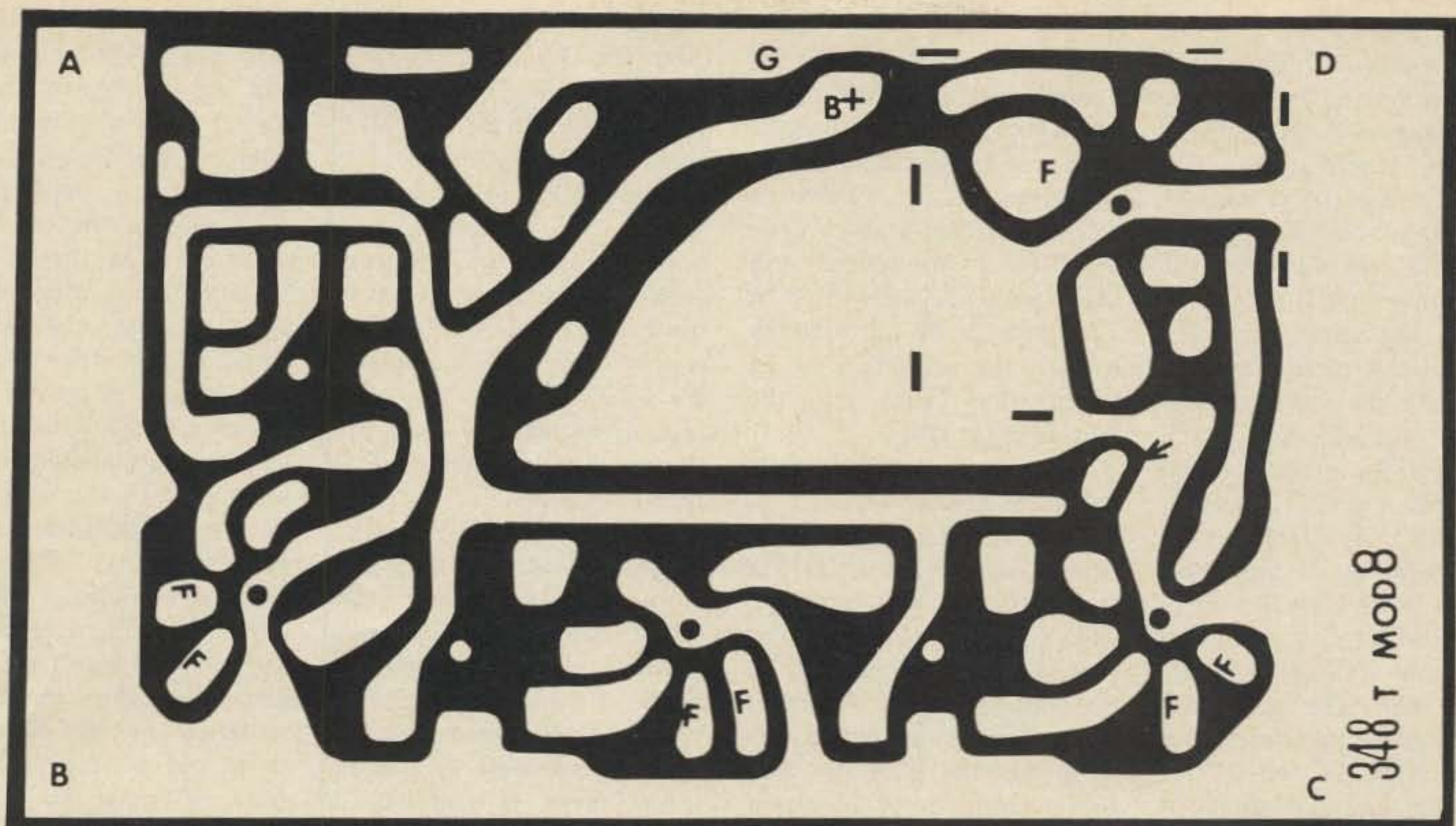

Fig. 2. PC Board (full size).

to be of no special disadvantage, since an external speaker was already called for (meaning at least a two piece rig anyway). If nothing else, a decent size speaker can be used in this layout, versus a pip-squeak tinny type if you tried building it in.

As with all circuit board projects, a minimum of part by part construction help will be written out. Follow the parts list, board layout, and schematic carefully, and you should encounter no problems. A tuned input circuit was intentionally omitted, so you can put a crystal into the unit that is 455 kHz *above* the i-f frequency you are going to feed in and get an AFC action the same as or comparable to mine.

I will make some brief notes on a few of the parts and their action, if for no other reason than to convince the way that they *can* build projects, substitute parts reasonably, and get the projects to work.

Say your junk (sorry — junque) box contains a crystal on 1375 instead of 1370 kHz as called out —

fine, the transformers T1 to T3 do have *some* tuning range — try it! R15 is a TW (thumb-wheel), small, printed circuit pot of 2k. I made a nice spot for it on the board. If you have a place in the BC-348 (and there are lots of them) to put a full size pot or slider resistor of 2 to 4k for R15 — and you have one — use it! The same goes for R20. A bit harder to adjust a slider? Sure, but time — not money — should control what you try to do in your hobby, shouldn't it? Often you are scared off by a project because you don't have the exact parts, and on this one you shouldn't be. That is one reason (of many) I chose the BC-348 as a starting point. You need not have dreams of dollars with wings (your trade-in value) or crying spells every time I tell you to take drill in hand. The switch for AFC time constants (C9, C10, Cx), and the switch for the loop (open, closed), should be put on the BC-348 front panel, obviously, but the other things coming to the outside world can go where *you* want them. The meter can go in the panel, a

box, with the speaker and power supply in that panel, etc. My S-meter (another modification), speaker, power supply, AFC meter, etc., are all in a box separate from the receiver and are at the operating position (my receivers are rack-mounted and remote-tuned).

The parts list describes the parts I used and should be pretty well self-explanatory. One incidental I should mention, however, is that the dc output jack can be used with a pen recorder — or to drive a VCO like the 566 IC, to produce a tone that can go onto any inexpensive tape recorder. I have used the tone to track Doppler shifts on many of the satellites. It (the dc) can also be used as a point that gives demodulated FSK signals (RTTY fans?). Also, the ac output just happens to be the FM (desired or undesired) of the incoming carrier (FM anyone?). The capacitors shown unmarked in T1, T2, and T3 come in the transformers that are specified, the CB are bypasses as called out in the parts list, and R3 is not needed if the unit is run off

the +160 V dc (replace it with a jumper wire). The B+ at the connection to the board should be +160 V dc regardless.

If your present i-f is already 455 kHz, or you want a 455 kHz take-off point for other projects, include C12 and the jack. If you have 455 kHz, all of V1 and V2 and components can be deleted; feed 455 kHz into the AFC unit through the jack. If you don't, include C12 and the jack, and use it in the future as a 455 kHz take-off point.

It's built — now what?

Now, as promised, the run-down on noise, alignment, etc., for all receivers. Most of it we have learned the hard way, having either evaluated it with lab grade equipment and then duplicated it using somewhat more crude instruments, or vice versa. Either way, the ideas work and have been proven out *both* ways, so you can have some faith in the premise that they are worth your time and trouble.

First, the AFC unit, since it is the simplest and its initial alignment can even be done while it's completely out of the receiver. Hook +160 V dc

to the +160 point (B+) of the circuit board, and the +28 V dc or 6.3 V ac to the filament point, depending on how you put the jumpers into the board. M, the meter, should be a zero center type; a 100-0-100  $\mu$ A was used. If new transformers are used, feed in the same frequency unmodulated carrier as that of the i-f you intend to connect to (BC-348, 915 kHz), and place the proper crystal into the socket (BC-348, 1370 kHz). A VTVM set for minus (-) dc at V1 pin 2 will tell you if V1 is oscillating as the grid bias varies when you place the crystal into the socket. With the new LFO running and a moderate signal fed in, align T1 and T2 for maximum negative voltage at pin 1 of V3 and V4, respectively. Remove generator input. Set R15 for about 6 V dc at the open loop terminal of the loop switch (may have

to be varied later with varactors chosen). Set R2 for a zero reading on the meter for now. Connect the signal generator again and, using the rf probe on a VTVM or scope, tune the primary *only* of T3 for a maximum of 455 kHz across the secondary of T3 (A to C). Do not attempt to zero the secondary of T3 at this time. That's it for the AFC unit for now.

The basic receiver alignment and noise:

The receiver referred to here is our BC-348 series, but the ideas and methods used work equally well with any receiver. First, alignment. To do a good job of alignment using ham grade test equipment, let the generator stay on a *minimum* of 24 hours, and the receiver at *least* one hour. Our receiver runs a whole day, and the generator, a not too shaggy military item, is *always* running!) Pick

the tuning range of interest. I used the 15 to 15.7 MHz region for my 2 meter converters, such that 145 MHz equalled 15 MHz, 145.1 MHz equalled 15.1 MHz, and so forth. If you want a top-notch tunable i-f for converters, give up the idea of using the same receiver as a general coverage instrument. We aren't going to "kill" the rest of the receiver — just put its best kind of performance where it counts.

Use 15 MHz WWV to very accurately set your oscillator trimmer, and allow one minute after each adjustment to be sure it stays put! Compression trimmers sometimes "relax" after your mechanical pressure, as well as torque, leaves them. If you have a counter, put its probe "near" the grid of the mixer and not down the oscillator's "throat," as that would pull the oscillator off frequency

from where it will be when you remove the counter. If you are going to use the crystal filter or some other i-f filter, have it in and running at this point. Monitor the AGC line in the receiver — don't use your ears to judge alignment or improvement! More negative AGC is more signal. Keep the generator low enough in output to let the meter vary with i-f transformer adjustments. You want the 915 kHz i-f lined up on the crystal filter or filter you are using, so rock the generator around slightly and look for improvement — output. You won't get such a gain drop when the filter is switched in this way, and those old crystals do age in (one of mine is at 913.8 kHz). Align slowly and carefully, getting every tenth of a volt more negative AGC that you can. Work from the audio end toward the rf in

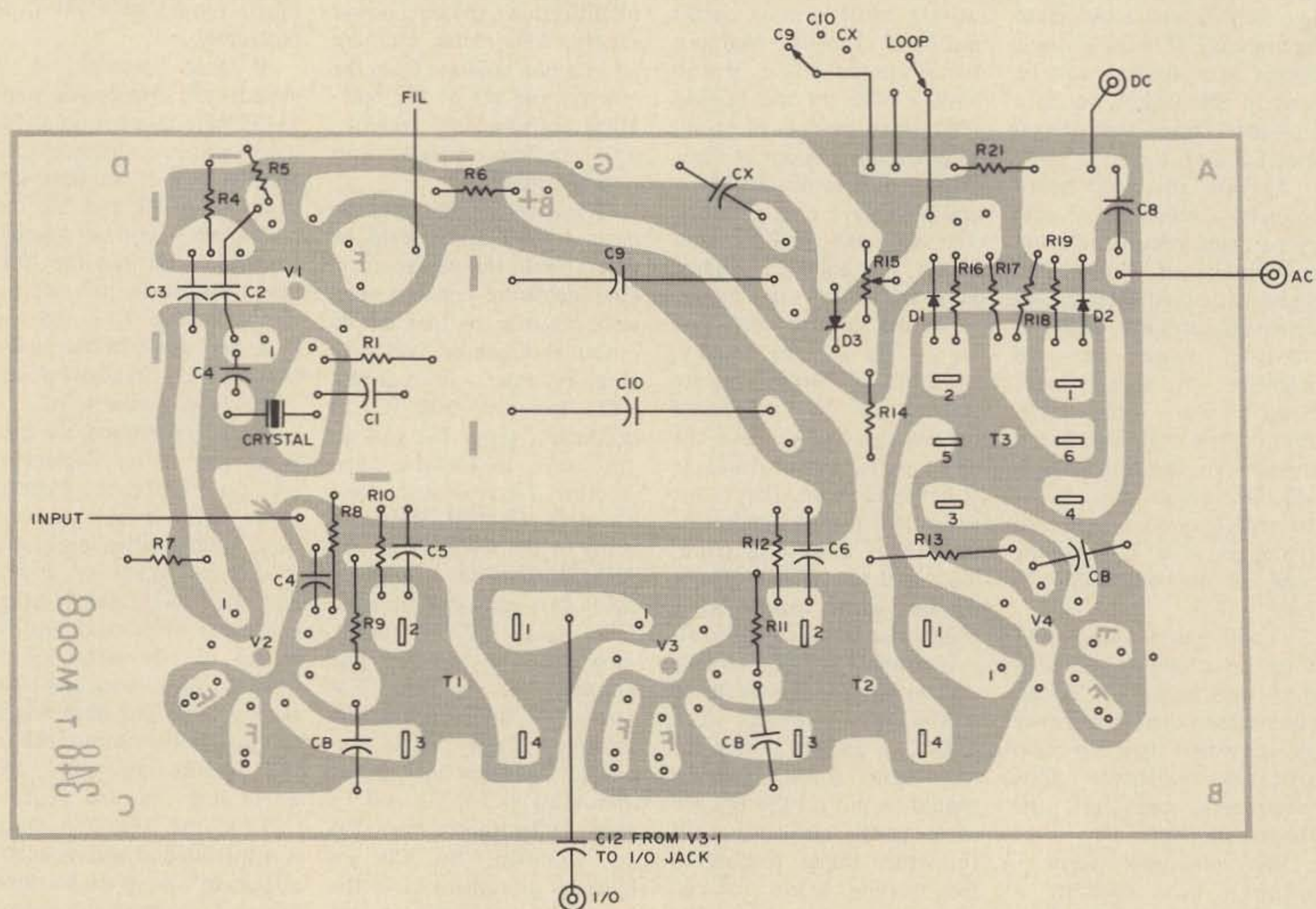

Fig. 3. Component layout. Some resistors are mounted standing up (e.g., R5). R2 is on copper side (B+ to pin 1 of V1).



and do it several times, as each time may gain a bit more. Remember, a volt of AGC increase is a lot of signal gain carried to the detector.

On my BC-348, a good AGC reading to maintain seems to be about -3 V dc on a 0-10 V scale. Adjust a slug or trimmer to get maximum negative AGC, then reduce the generator to return to the -3 V dc reading, then do another slug or trimmer, then return to -3 V dc, etc. This seems to maintain a good rf level at the detector, without saturating or "cramming" it. The result is a meter that gives good smooth changes that are easy to see and follow as you are adjusting. Follow this procedure throughout the low i-f (915 kHz), and then tune the generator and receiver to the upper limit of interest (15.7 MHz).

At this point, align the trimmer capacitors on the rf tank circuits. You will wreck the 13 to 18 MHz tracking and gain ability doing so, but the 15 to 15.7 MHz region will be set up at its best, as we wanted. Also, the rest of the bands remain unchanged (for those who care). You are setting up the maximum gain L-C condition for your tunable i-f, and not trying for a general wideband receiver.

With the alignment done, change the front panel rf connector to a BNC or UHF type to mate your convertor cable. Remove the 100k or 470k resistor from the center of

the old antenna input to ground, and discard it. You are no longer going to have this point tied directly to an antenna, much less to a static noisy aircraft antenna, and the resistors change value — sometimes going down to 1k. Replace the wire from that connector to the first rf can, and replace it with a short piece of coax (RG-174 is fine), with the ground tied at the panel end only. While in this region of the receiver, short the wires on the pot mounted to the end of the main tuning capacitors (this pot helped keep gain variations down from band end to band end — by reducing gain!). Another improvement, if only small, will be noticed.

As for the noise cures, several noted here apply to all receivers. Mass produced goods just can't get hand-built care — another reason for rolling your own — even if you start with the hard mechanical part already done.

The 991 gas voltage regulator used to regulate the B+ to the oscillator is the best little rf "hash" generator you can find, and there it sits, right next to the rf and 1st mixer grids. (Nobody said the BC-348 was perfect as purchased!) The 991 or a suitable zener diode replacement must be moved to your power supply, but be sure to remove the 991 at all costs. Clip one of its supply resistors so you don't ever accidentally replace it. Use another wire of the power

supply cable to bring this oscillator B+ up to the receiver. A .1 mF capacitor to ground should be added to the point where this B+ line enters the oscillator can, where it enters the receiver, and where it leaves the power supply. Now the oscillator should be running on dc at least, and the ton of hash stays "canned" at the power supply.

The improvement to the whole receiver (other bands, too) in the noise and racket department should be dramatic (and include the lack of hum, if you used the +28 V dc on the filaments as suggested). While on the subject of the +28 V dc, you can now try our most noticeable improvement for the amount of effort! Tune in a fairly weak but steady station, preferably voice (so you don't need to concentrate on CW). Put your dc voltmeter on the +28 V dc line and begin to reduce the +28 V dc by turning the pot down on the regulator board. The gain available in the audio module will go down, as well as the thermionic emission from each tube. The oscillator *may* move frequency slightly, and the overall noise goes down. Correct any frequency shift, and turn up the volume control only. Hear the difference?

An SASE has become mandatory since Uncle Sam went to his unlucky "13," but I *will* try to help anyone with problems. ■

#### Parts List

Printed circuit board (per 1:1 template)  
 Assorted jacks to suit builder (outputs/inputs)  
 V1 — 12AU7 — osc.-buffer  
 V2 — 6BE6 — mixer  
 V3 — 6BA6 — low i-f  
 V4 — 6BA6 — low i-f  
 T1-T2 — Miller 12C2  
 T3 — Miller 12C45  
 D1-D2 — 1N914  
 D3 — 1N755 — zener  
 R1 — 100k ½ W  
 R2 — 39k ½ W  
 R3 — as req.  
 R4 — 2700 ½ W  
 R5 — 47k ½ W  
 R6 — 18k ½ W  
 R7 — 27k ½ W  
 R8 — 1 meg ½ W  
 R9 — 47k ½ W  
 R10 — 100k ½ W  
 R11 — 27k ½ W  
 R12 — 100k ½ W  
 R13 — 27k ½ W  
 R14 — 12k ½ W  
 R15 — 2k lin. pot  
 R16 — 220k ½ W  
 R17 — 100k ½ W  
 R18 — 100k ½ W  
 R19 — 220k ½ W  
 R20 — 250k lin. pot  
 R21 — 68k ½ W  
 C1 — 220 pF s.m.  
 C2 — 10 pF disc  
 C3 — 25 pF disc  
 C4 — 100 pF disc  
 C5 — 39 pF s.m.  
 C6 — 350 pF s.m.  
 C7 — 200 pF s.m.  
 C8 — 0.1 uF mylar or paper, 100 V  
 C9 — .22 uF mylar or paper, 100 V  
 C10 — 15 uF elect., 25 to 50 V  
 C11 — .001 uF disc  
 CB — .1 to .33 uF mylar or paper, 200 V  
 C12 — 100 pF disc  
 Assorted switches to suit location and builder  
 Loop (open/closed) — DPDT — second half to lamp indicator  
 Loop (capacitor) — SP3T — slide or rotary  
 Meter — 100-0-100 uA — size and shape to fit builder req.

## KAUFMAN BALUN

KAUFMAN  
water tight  
BALUN

new and improved  
molded plastic



1:1 impedance  
match

with or  
without  
BALUN

Patent No. For dipoles,  
D219106 beams, inverted "V", and quads

KAUFMAN Center Insulator with BALUN \$13.50  
 KAUFMAN Center Insulator without BALUN \$ 8.50  
 Dragon Fly antenna construction sheet and drawing

postpaid USA \$ 2.00

3 Kw PEP  
4 Ounces  
Q1 Ferrite

KAUFMAN INDUSTRIES  
BOX 817  
REEDS FERRY, NH 03054

## LITE BULBS

BUY DIRECT & save money. Everything from flashlight to fluorescent for home, auto and business. Over 700 types. Buy direct and sell, make \$\$\$ moonlighting. Descriptive catalog \$1.00. (Refundable with purchase).



Allied Sales & Engineering, Inc.  
Dept. 38, Pimento IN 47866  
Telephone 812-495-6555

## A.R.R.L. DAKOTA DIVISION CONVENTION

OCTOBER 1, 2, 3  
ST. PAUL CIVIC CENTER

Write for information and  
reservation form

St. Paul Radio Club  
P.O. Box 30313  
St. Paul MN 55175

# Now we're on TV!

MORSE CODE BUZZS — WATCH FOR SUPER ANNOUNCEMENT

Wave Mate introduces Jupiter IIC, a complete computer system incorporating a monitor quality TV interface. This system provides everything you need to create and run application programs. Jupiter IIC includes a CPU with 8K dynamic RAM and 3K ROM memory, video terminal interface and keyboard, and dual audio cassette interface. The TV interface features upper and lower case and



Greek character sets, and dot graphics. The dual audio cassette interface provides start/stop operation and operates at 300, 600, or 1200 baud. And of course we still provide these high-quality features: burn-in tested IC's, socketed IC's, complete documentation, and more.

## ATTENTION: ORIGINAL EQUIPMENT MANUFACTURERS

Jupiter IIC provides OEMs with the tools to get systems into the field faster and at lower cost. (1) Use Jupiter IIC as your development system. Perfect for development of software and special hardware. (2) Use Jupiter IIC for prototype systems. Only Wave Mate provides the tools — wire wrap modules, universal modules, complete documentation — to easily tailor system logic and add customized interfaces within the basic Jupiter IIC package.

## SOFTWARE

All Jupiter IIC systems feature a sophisticated monitor/debugger package including a versatile interrupt system and I/O monitor call instructions. A programmable macro editor and expanded assembler are also provided. Proposed ANSI standard BASIC is included with Jupiter IIC.

## THE JUPITER IIC KIT: \$2200

The kit includes the CPU, software debugger and monitor module, 8K dynamic memory, module cage, power supply, front panel, video interface, cassette interface, and all the documentation required to assemble, run, and understand the system as well as modification instructions for a black and white TV set.

## THE JUPITER IIC ASSEMBLED SYSTEM: \$3200

All components of the Jupiter IIC kit plus two audio cassette units and a 12-inch black and white TV set. The complete system is shipped with all components assembled and tested.

## SPECIFICATIONS

### CPU

MC 6800; eight-level interrupt, prioritized and maskable by level; single-cycle and block DMA

### DUAL AUDIO CASSETTE

Complete paper tape replacement; start/stop motor control; 300, 600, or 1200 baud (crystal controlled); error correction

### VIDEO TERMINAL INTERFACE

64 x 16 lines (32 lines optional); Upper and lower case, plus Greek alphabet; 7 x 12 format, 128 dot (hor.) x 48 dot (vert.) graphics (96 dot optional)

### MEMORY

8K dynamic RAM; 3K ROM; 1K dual-port static RAM

### KEYBOARD

Generates full 128-character ASCII set



Send details on Jupiter II systems

Have salesman call

Name \_\_\_\_\_

Title \_\_\_\_\_

Company \_\_\_\_\_

Address \_\_\_\_\_

City \_\_\_\_\_ State \_\_\_\_\_ Zip \_\_\_\_\_

Phone \_\_\_\_\_

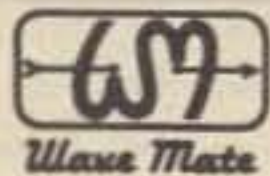

WAVE MATE 1015 West 190th Street, Gardena, California 90248  
Dept. 203

Telephone (213) 329-8941

# DIGITAL DATA RECORDER

## for Computer or Teletype Use

### Up to 4800 Baud

Uses the industry standard tape saturation method (NRZ) to beat all FSK systems ten to one. No modems or FSK decoders required. Loads 8K of memory in 17 seconds. This recorder enables you to back up your computer by loading and dumping programs and data fast as you go, thus enabling you to get by with less memory. Great for small business bookkeeping. Imagine! A year's books on one cassette.

Can be software controlled. Comes complete with a software program used to test the units in production (8080). Manual includes software control hook up data and programs for 8080 and 6800.

#### NEW - 8080 I/O BOARD with ROM Permanent Relief from "Bootstrap Chafing"

This is our new "turnkey" board. Turn on your Altair or Imsai and go (No Bootstrapping). Controls one terminal (CRT or TTY) and one or two cassettes with all programs in ROM. Enables you to turn on and just type in what you want done. Loads, Dumps, Examines, Modifies from the keyboard in Hex. Loads Octal. For the cassettes, it is a fully software controlled Load and Dump at the touch of a key. Even loads MITS Basic. Ends "Bootstrap Chafe" forever. Uses 512 bytes of ROM, one UART for the terminal and one USART for the Cassettes. Our orders are backed up on this one. #2SIO (R) Kit form \$140. Fully assembled and tested \$170.00.



#### SPECIFICATIONS: Model CC7 \$149.95

A. Recording Mode: Tape Saturation binary (NRZ). This is not a FSK or Home type recorder. No voice capability. No Modem. Runs at 2400 baud or less Asynchronous and 4800 baud Synchronous. Runs at 3.1"/sec. Speed mechanically regulated  $\pm 0.5\%$  or better.

B. Two channels (1) Clock, (2) Data. Or two data channels providing four (4) tracks on the cassette. Can also be used for Bi-Phase, Manchester, etc.

C. Inputs: Two (2). Will accept TTY, TTL or RS 232 digital.

D. Outputs: Two (2). Board changeable from TTY, RS232 or TTL digital.

E. Erase: Erases while recording one track at a time. Record new data on one track and preserve three or record on two and preserve two.

F. Compatibility: Will interface any computer using a UART or ACIA board. (Altair, Sphere, IMSAI, M6800, etc.)

G. Other Data: 110-220 V - (50-60) Hz; 3 Watts total: UL listed; three wire line cord; on/off switch; audio, meter and light operation monitors. Remote control of motor optional. Four foot, seven conductor remoting cable provided.

H. Warrantee: 90 days. All units tested at 300 and 2400 baud before shipment. Test cassette with 8080 software program included.

Also available - MODEL CC7A with variable motor speed which is electronically regulated. Runs 4800 baud Synchronous or Asynchronous. Recommended for quantity users who require tape interchangeability. Comes with speed calibration tape to set exact speed against 60 cycle line. \$169.95.

#### NATIONAL MULTIPLEX CORPORATION

3474 Rand Avenue, Box 288

South Plainfield, New Jersey 07080

(201) 561-3600

SHIP TO:

\_\_\_\_\_  
 \_\_\_\_\_  
 \_\_\_\_\_

.... Data Recorder CC-7 @ \$149.95 Please enclose \$2.00 Shipping & Handling

.... Data Recorder CC-7A @ \$169.95 on each Recorder or I/O Board.

.... Operating & Technical Manual (Schematics) includes Software & Hookups for 8080, 6800, and I/O. @ \$2.00

N.J. Residents add 5% Sales Tax

Cash  Check  BankAmericard  Master Charge

Card No. \_\_\_\_\_ Expiration date \_\_\_\_\_

Signature \_\_\_\_\_

Total enclosed \$ \_\_\_\_\_



# EDITORIAL

## uP IN OSCAR

The next Oscar is being designed and built in Germany with help from Canada, and they're putting in a microprocessor ... RCA COSMAC CDP1801 ... to help sort out the input stations running more power than they should ... one of the more serious problems which have been bothering Oscar 7 on the 432 MHz uplink.

The uP will also control the attitude of the satellite with magnetic torquing, spin rate and boost motor control, transponder times on and off, format of the telemetry beacons plus analog to digital conversion of signals and commands.

By the time Oscar 8 is up there, a good many ground stations should be running with uP control and probably a number of automatic contacts between uP operated stations. Even a simple microprocessor will let you know exactly when Oscar is accessible ... and exactly where ... even what Doppler shift to expect. It will control your antennas and keep them aimed exactly at the satellite. Hmmm ... one hundred countries worked in one hundred seconds? Maybe we should offer a certificate.

## OPPORTUNITIES

Hardly a day goes by when I don't get a phone call from someone wanting me to answer some questions in the microprocessor field. As more and more businessmen become aware of the possibilities of these computer systems, anyone with a good knowledge of them will be able to do very well.

I get calls from microcomputer manufacturers asking if I know people who might be able to work for them in developing their equipment and software. Other manufacturers are looking for people with enough uP background to open computer stores and sell their systems. And about once a day I get a call from a businessman who would like to have a uP system put together and programmed for a particular application ... can I suggest what equipment would be best and how he would get the programs? Other manufacturers are desperately looking for people who can write and help them put together ads, instruction books, articles and brochures.

My answer to them is the obvious one: get in touch with some of the authors of articles which appear in 73.

About the *only* way to establish a reputation in a brand new field is by writing articles and books ... publish and prosper. It's nice not only to be paid for the article, but also to have manufacturers and businesses fall all over you with job offers and consulting assignments.

Okay, you'd like to make some money writing ... and it wouldn't look bad on your resume ... or perhaps you'd like to get out there and really get going in the uP field and be in the line for the big money that is going to be here ... and that means you want to build your reputation ... so you wonder what to write about.

Once you get started writing you'll find it impossible to stop. There is so much to cover that it is endless. If you've gotten an Altair up and working you've managed to solve a dozen or a hundred problems. Hopefully you've kept a day-to-day diary of your progress (or lack of it). This didn't work at first and you found the problem ... a whole lot of other people are desperate to know how you got that solved. Like all the time I wasted with my Altair trying to get it to interface with the Southwest Tech TVT-II ... what a hassle! It turned out that the TVT was sending out lower case letters to the Altair, but was printing upper case on its screen. Once someone suggested using the shift key on letters, there was no further problem. Little problem, big deal.

Sphere system users have had their share of miseries and there are a lot of us who would like to learn from them. Ditto Imsai and all the other systems. Like how many of you have been able to get a teletype working right off with your system? Or a cassette recorder? We still don't have the ability to put a program on a tape without dumping everything, but we'll get it solved one of these days.

Maybe you've tried the Ohio Scientific learning system ... what was your experience? How about terminals ... all of us need some perspective on the various terminals available ... HAL, SWTPC, Interactive Systems, etc. How about using some surplus terminals such as the Sanders, Burroughs?

Software ... readers are gradually getting used to the idea that they are going to have to program their systems, but they don't know much as

yet about where they will get the programs or how to learn to use them. Where can the reader get all of the free programs that are available? What books are best to learn to use FORTRAN ... BASIC ... etc?

## BEST uP YET?

We've had several letters from readers all excited about the Levy microprocessor in the June issue (page 106), saying that this is by far the best microcomputer design yet and the *first* how-to-build-it uP article in *any* ham magazine. A letter from Pete Stark K2OAW, who is an expert in this field since he teaches it in college and has several books out on computers and programming, was particularly welcome.

## FACTORY RECALLS

A call came from Bill Godbout with a request that all purchasers of his Econoram kits (before June 15th) drop a card to Godbout with the invoice number of their order. It appears that the kit was too good, in a way. It works a bit too fast for some of the systems and Bill has a retrofit kit which will fix up any problems purchasers may have been having or might eventually have. How about *that* for an advertiser?

## WORD PROCESSING

You'll be seeing a lot of the term "word processing," so it will help if you understand just what this means. Good luck ... for in the computer field it has a wide range of meanings and when you bring up word processing (can we shorten that to WP for now?) you still have to make sure that you and your friend are talking about similar things.

One person will think of WP in the context of setting type for a book or magazine. It is being used for this, and such uses will be growing rapidly. In this case you set your words on a video terminal and then, when you are satisfied, you can put them on tape to be set by a photo typesetting unit.

The use of a video terminal allows a lot of flexibility. With a good WP program and some "intelligence" to use the program, you can move characters, words, sentences or even paragraphs around as you please. Once you are done, you can have the finished work printed or put on some memory medium for later printing. This is one very good application for low cost microprocessors.

Your WP program can be made to justify lines or to have them fit around illustrations, as in magazine pages. Some magazines and newspapers are using such systems to set and arrange whole pages at a time. These systems are not inexpensive ... yet.

Perhaps you can see why a secretary or a businessman would go for a WP system ... the savings in typing letters can be enormous. One error on a letter ... or a change in a shipping date ... does not force the whole letter to be retyped. Sentences or even paragraphs can be held in memory and put in letters easily. It is the invention that could do away with the typewriter.

Suppose you want to send essentially the same letter to fifty firms (or congressmen). A typist had to type out the fifty letters before ... now the WP system will turn them out quickly with but one typing. You can even have the mailing list in memory and tell the processor to send one letter to each on the list. A system along this line is used to generate those letters which appear to be typed directly to you ... *Reader's Digest* is big on this idea. Blanks are left in the letter form to be filled in by the processor with your name and address.

How much stock would you buy in a typewriter company when you can see word processing on the way? We're looking at possible video terminal prices on the order of \$500 (eventually half that) and line printer ones of \$1000, which can handle dozens of terminals for all but large scale production of form letters.

## CREDIT DUE

Several readers have asked about the Biorhythm computer program I mentioned as being available in my review of the MITS Altair Convention. I got my copy from In-Touch Systems of El Paso and my thanks to Richard Bandat for his consideration. I also got three business programs, but haven't been able to use them as yet. The 73 uP lab is just now being finished ... once it is in shape we'll have a lot of equipment up and running and be able to start testing out programs for possible distribution.

Recent equipment received for the lab includes two Imsai computers, a MITS disc system, a Burroughs video terminal, and a Wavemate Jupiter II computer. The Jupiter is on test by John Craig.

# HIT THE BEACH ...

 Personal  
Computing  
**76** Consumer Trade Fair

Atlantic City, N.J.  
August 28th-29th

**What its all about!**  
Software Development  
Micro Computers  
Hardware Development  
Disc Memories  
Computer Comparisons  
Interfacing  
Program Implementation  
AMSAT  
Computerized Music  
Video Terminals  
Kit Construction  
Printers  
Computer Games  
Digital Tapes

- Seminars and Technical talks by leading electronic equipment manufacturers
- Major Exhibits from all over the country
- Demonstrations in many areas including Home and Personal Computing
- Door Prizes, Free Literature and Free Mementos
- All this plus Sun and Surf - Fun and Excitement - Relaxation and Leisure

Weekend Fair admission \$5.00 advanced. \$7.50 at door  
Admission includes Exhibits, Seminars

Write for FREE TRIP-KIT to Personal Computing 76 Fair Headquarters Shelburne Hotel-Motel  
Box 1138 Boardwalk and Michigan Ave. Atlantic City, New Jersey 08404  
EXHIBITION BOOTHS STILL AVAILABLE - CALL (609) 927-6950

# PROM Memory Revisited

-- getting back to May's CW blockbuster

The thought of using a CW memory did not occur to me until Greg Kordes WA6EEB demonstrated his keyer/memory at the local radio club (Newport Amateur Radio Society, NARS). Greg's keyer/memory utilized a 512-bit random access memory (RAM) which was easy to operate and

program, and generated considerable interest.

Here was a piece of equipment which would complement my keyer, be fun to operate, and store those often repeated parts of the QSO.

During the following weeks, I sent for

some specification sheets and resurrected old ham magazines looking for related articles. When I first started, I had no idea what exactly I wanted or where I was going. All I knew is that I wanted a keyer with a CW memory and that I had several articles I could use for reference.

My first attempt at building a keyer/memory was a 2560-bit keyer/RAM memory which utilized ten 256-bit RAMs. Memory retrieval was either automatic, using a decade counter and decoder to select the appropriate chip, or manual, using a ten position thumbwheel switch. An LED read-out let me see which RAM was being programmed or read. My first attempt was about 90% completed and operating before I found that I was programming the same information into the RAM memory every time I turned on the power.

At this point, I determined that *my* CW operating habits did not require the versatility of the RAM and that my memory requirements could be satisfied with one or more programmable read only memories (PROMs). Although the control logic for the read modes are similar for RAMs and PROMs, PROMs offer a non-destructible memory (within their recommended operating parameters) after their initial programming, without the need to frequently refresh the memory as is necessary with RAMs.

My next CW memory was a self-contained 1024-bit PROM memory utilizing four 256-bit Intersil PROMs<sup>1</sup>. This was so successful that I decided to integrate the PROM memory with the WB4VVF accu-keyer<sup>2</sup>.

The memory was increased an additional 1280 bits for an effective memory capacity

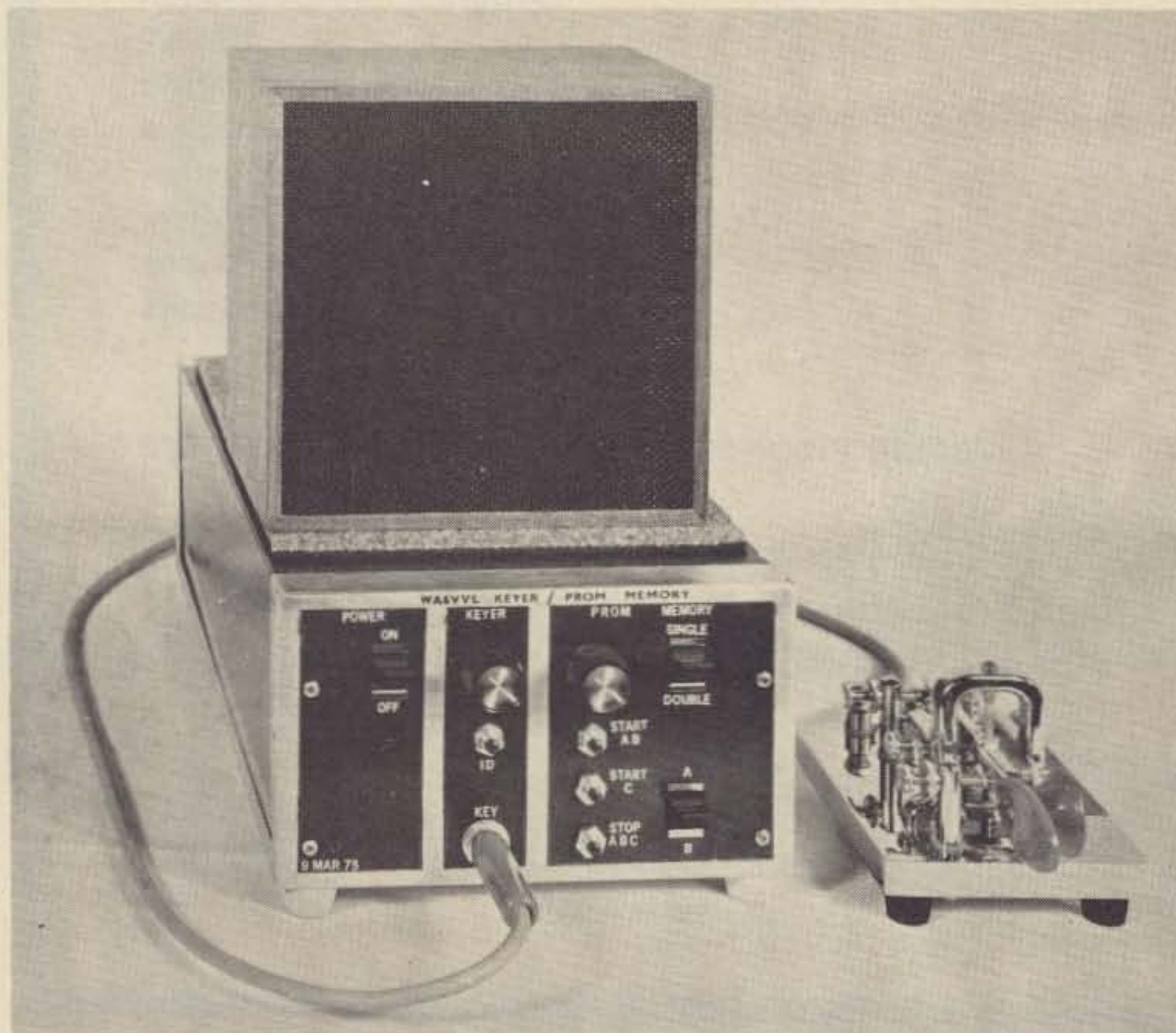

Photos by Alan Burgstahler WA6AWD

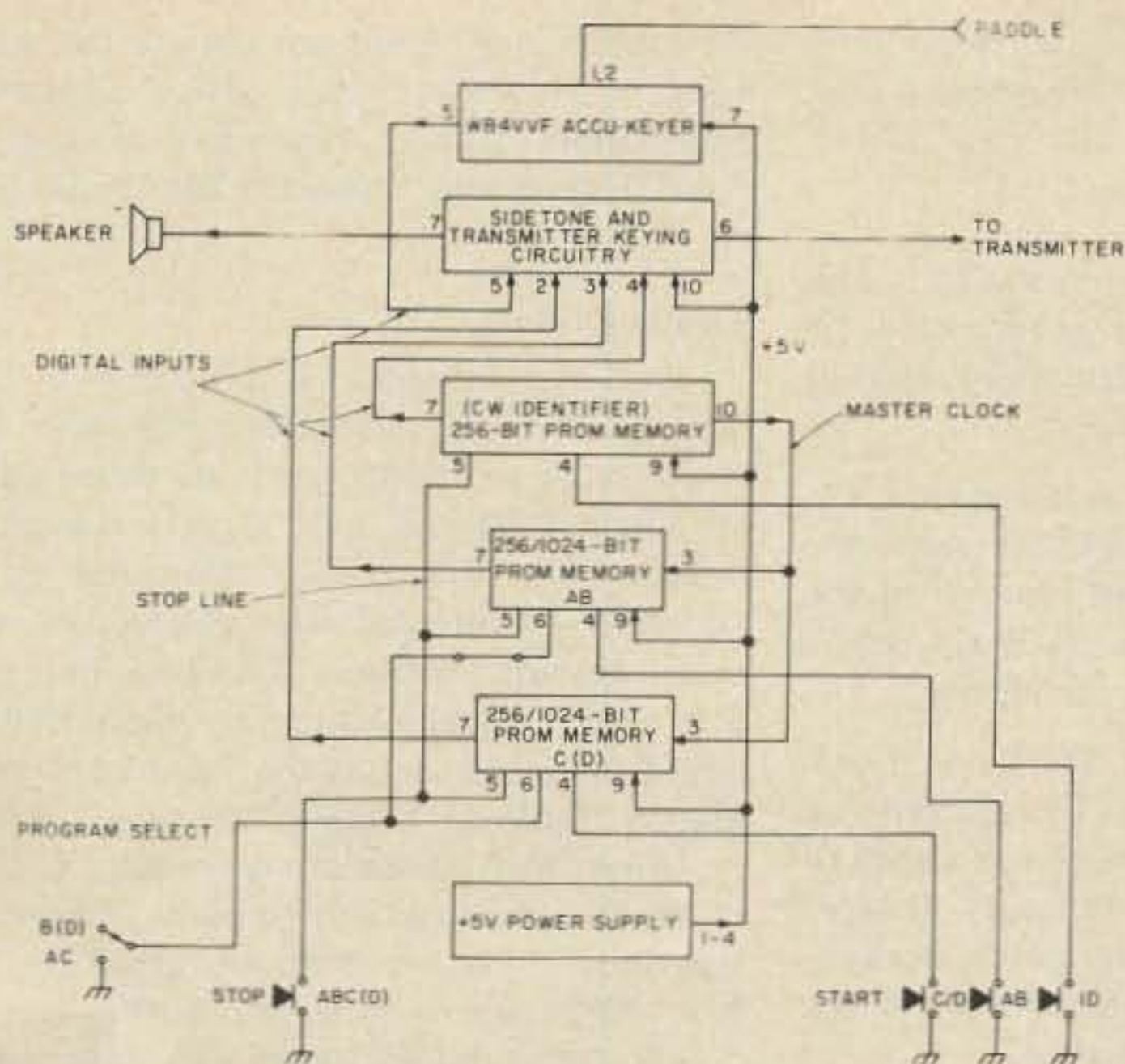

Fig. 1. Block diagram, keyer/memory.

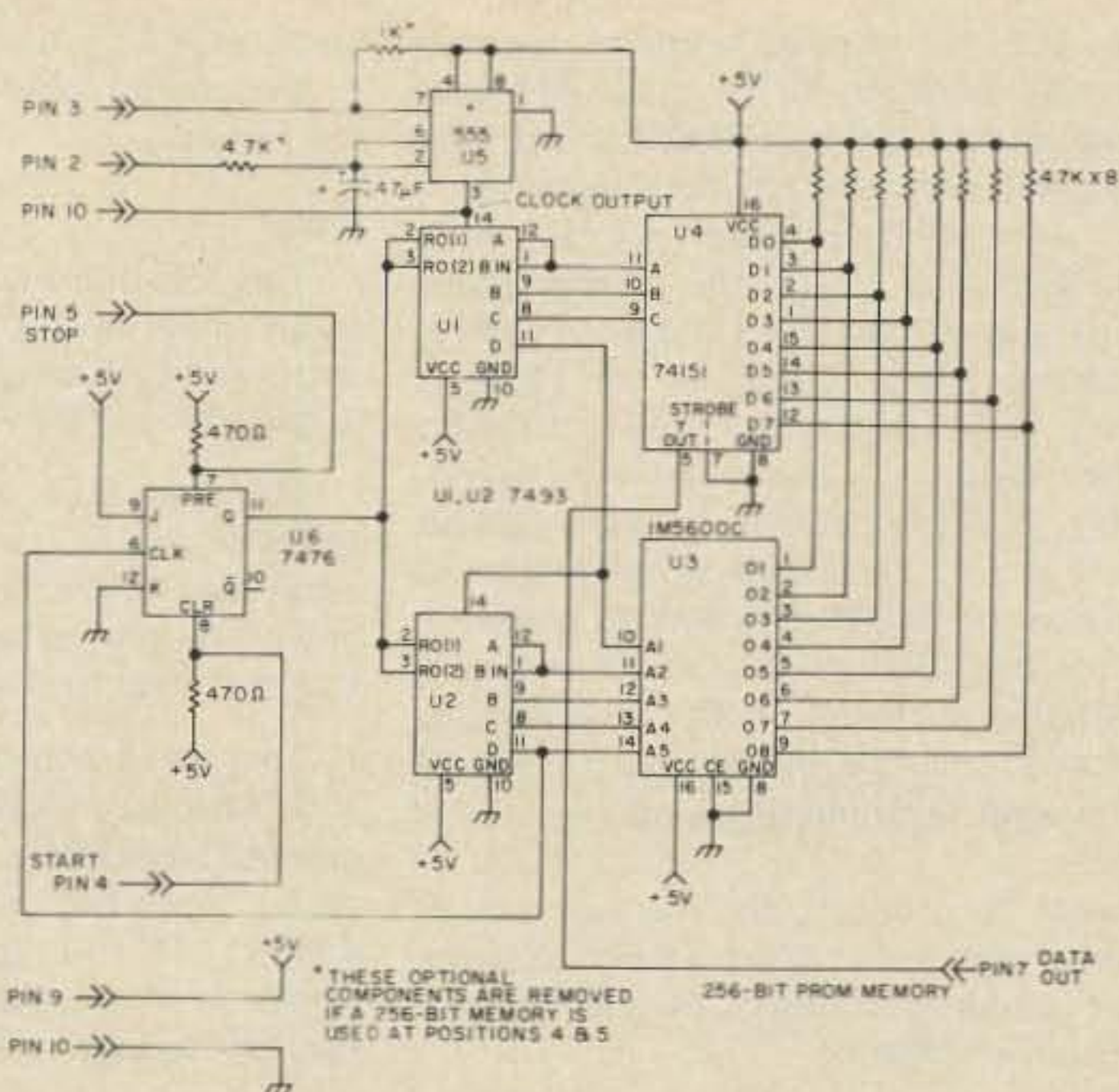

Fig. 2. 256-bit PROM memory.

of 2304 bits (2304 bits = 2 x 1024 bits + 256 bits). Memory expansion is simplified by adding additional memories as the reader's memory requirements, space and pocketbook allow.

The keyer/memory described is completely self-contained and is designed to drive grid-block keyed transmitters with key-up voltages not exceeding -100 volts.

Fig. 1 shows a simplified block diagram of the keyer/memory.

#### Memory

The PROM memory section (boards 4-6) contains one to three memory boards using two Intersil PROMs, an IM5600C (256-bit, 32 words by 8 bits) and/or an IM5603A (1024-bit, 256 words by 4 bits) as memory elements.

A 256-bit memory, used as a CW identifier, contains a "master clock" for the memories. Both memory boards are laid out for a clock, but the components are not installed on boards 4 and 5. The schematic of the 256-bit memory, Fig. 2, shows the similarities in logic between this and my May article. 256-bit PROMs programmed for the previous memories can be used.

# SAVE \$80,000.00 IN CRYSTALS

## LISTEN TO 16,000 DIFFERENT FREQUENCIES WITH NO CRYSTALS UP TO \$60.00 OFF MANUFACTURER'S PRICE



### BEARCAT 101

16 channels  
30-50 MHz  
146-174 MHz  
416-512 MHz  
CE's Price - \$296.95

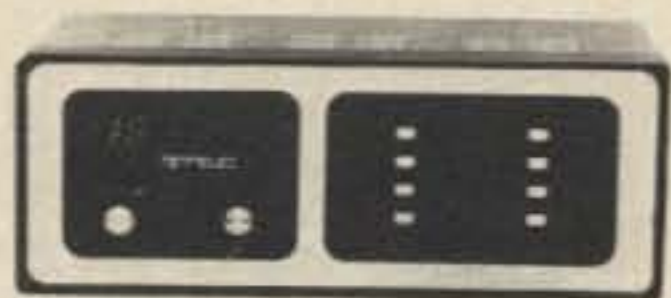

### TENNELEC

MCP 1  
16 channels  
31.18-51.655  
151.18-171.655  
451.18-471.655  
CE's Price - \$399.95



### Regency

WHAMO-10  
10 channels  
30-50 MHz  
146-174  
440-512  
CE's Price - \$278.95

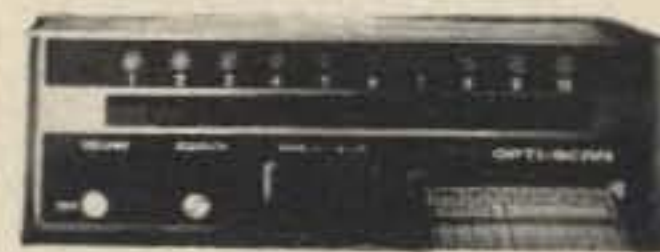

### SBE

OPTISCAN  
10 channels  
30-50 MHz  
150-170 or 140-160  
450-470  
490-510  
CE's Price - \$339.95



We now carry a complete stock of CB equipment available at discount prices. 24 hour Mastercharge-BankAmericard order & information line 616-775-0881. Certified check or charge card on mail orders for Immediate Shipment. Dealer inquiries invited. Michigan Residents add tax. Foreign orders invited. Write or call for free catalog & specifications.

**CE**™  
Communications Engineering  
P.O. Box 473, Ypsilanti, MI 48197  
Cable Address: COMENG

Call 313-971-0888

The 1024-bit memory contains approximately 90 characters of memory. The control logic for the 1024-bit PROM is such that two 512-bit programs can be selected by a front panel SPST program select switch (A/B). Removing W5 on the mother board (Fig. 6) and W3 on the 1024-bit memory, and adding W2 and W4 on the 1024-bit memory will enable the entire 1024-bit program instead of two 512-bit programs. Looking at the schematic of the 1024-bit memory in Fig. 3, notice that the method of addressing the PROM (U3) and U4 is slightly different than that of the 256-bit memory, necessitating a change in the programming format for the PROM. The larger PROM requires eight programming cards.

Except for a clock, the memory boards are completely self-contained with start/stop circuitry, address counters, parallel to serial conversion and PROM.

Memory retrieval for all memories is initiated with the appropriate program select push-button switch. The program(s) can be stopped at any point with the stop push-button switch.

#### Sidetone/Transmitter Keying Circuitry

The keying circuitry in Fig. 4 is essentially the same as that of my May article, with the addition of U2, an NE555 timer IC which is used as a sidetone oscillator,<sup>3</sup> and its control transistor Q2. A small speaker may be mounted on the board or the chassis, or connected through the external speaker jack (as illustrated).

Unused digital inputs (pins 2-5) must be grounded to prevent the transmitter from being keyed. Since no provisions have been made on the board or mother board for grounding the unused inputs, the output

pin(s) of U1 (3, 6, 8 and 11) corresponding to the unused input(s) are not inserted into the socket.

#### Keyer

This position is "up for grabs." The reader may use his favorite keyer circuit or the accu-keyer which is adequately covered in the 1974 ARRL *Handbook*.<sup>4</sup>

My adaptation of the accu-keyer is virtually identical to the original with the exception of the board and removal of the power supply components (C3, C6, CR2, R13 and VR1 in the ARRL *Handbook*).

The speed controls for the keyer clock and memory clock can be ganged or mounted separately. I chose to use an SPDT switch and use both techniques (single/double). If your keyer utilizes a nonsynchronous clock, the memory master clock may be used for your keyer also.

#### Power Supply

The 5 volt supply illustrated in Fig. 5 satisfies the power supply requirements of the keyer/memory, supplying 600-900 mA with all boards in place.

As can be seen in the photograph, I used a 6.3 V filament transformer for the 5 volt supply. These transformers, when used with 5 volt three-terminal regulators, do not provide enough unregulated voltage at the input of the regulator to work satisfactorily at nominal line at high supply currents. There also seem to be large variations between similar transformers. The previous PROM memory was marginal at low line while the keyer/memory did not begin to regulate until 125 V ac line voltage. No problems with the keyer/memory have been experienced operating at 95 V ac with this transformer. For this reason and to keep U1's

dissipation low, I did not replace the transformer. However, good design dictates a transformer with a secondary voltage of 7.5-8.0 Vrms and I would recommend using it.

#### Construction

The keyer/memory is housed in a BUD 12" x 7" x 4" aluminum minibox. The majority of the components are mounted on six single-sided 5½" x 3" glass-epoxy circuit boards. The boards are fabricated to fit standard 10-pin card edge connectors with .156" spacing. The boards, in turn, plug into a 6" x 3½" single-sided glass-epoxy mother board mounted against the front panel with mating 10-pin card edge connectors.

Using this modular approach, I have changed individual circuit boards and revised the mother board without affecting the front panel wiring. Also, the boards may be quickly removed for repair or inspection in just a few seconds.

The boards, in order of their appearance, are as follows:

1. WB4VVF accu-keyer.
2. +5 volt logic power supply.
3. Sidetone/transmitter keying circuitry.
4. 256/1024-bit PROM memory.
5. 256/1024-bit PROM memory.
6. 256-bit PROM memory/CW identifier (includes the master clock for boards 4, 5 and 6).

The power transformer, fuse holders, ac connector, panel switches and controls are mounted on the aluminum minibox.

There are 27 integrated circuits and approximately 68 discrete components.

Again, sockets are advisable due to the cost of the integrated circuits and PROMs. They not only speed troubleshooting when

Fig. 3. 1024-bit PROM memory.

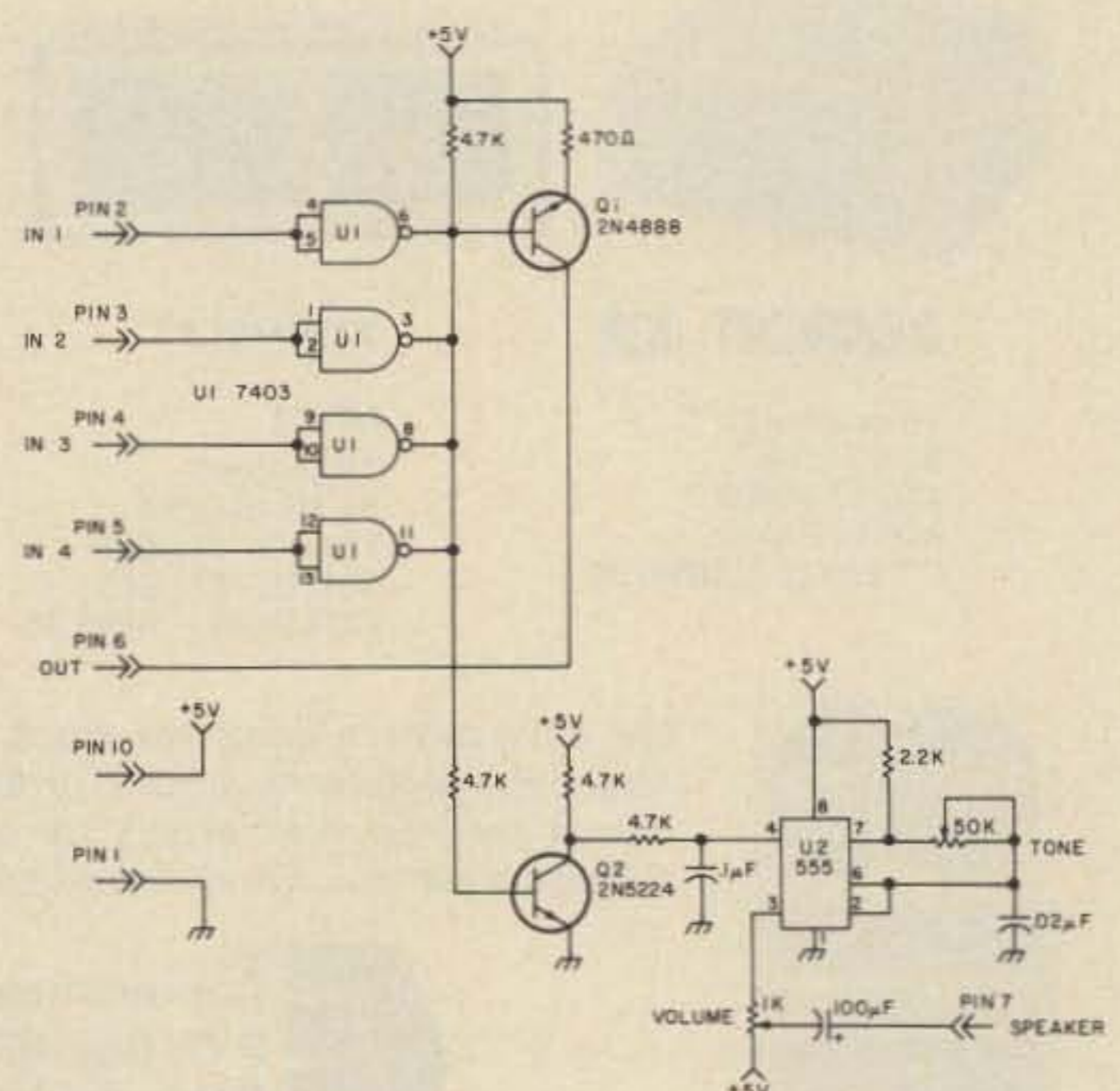
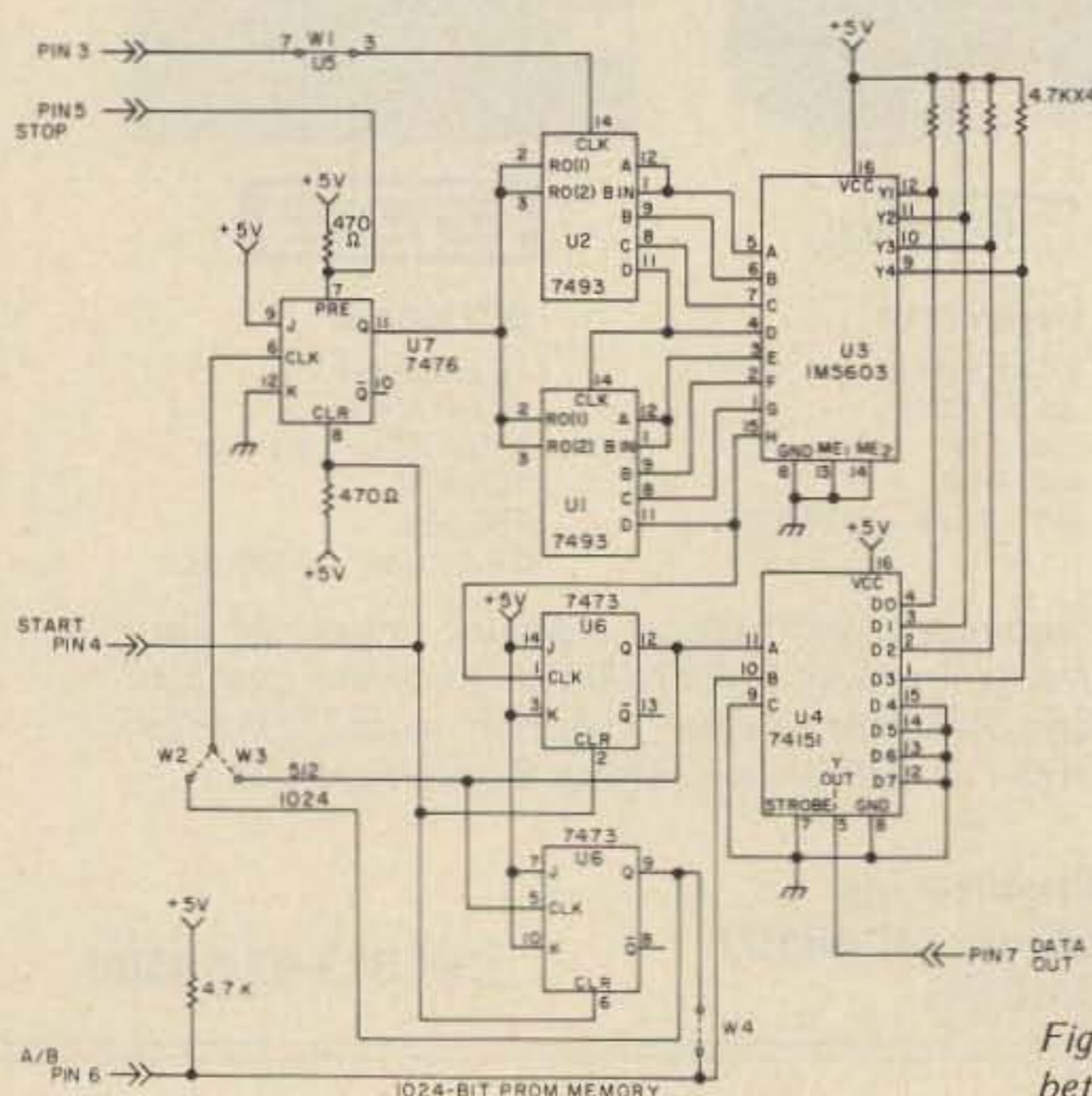

Fig. 4. Sidetone/transmitter keying circuitry. Note: Speaker is connected between +5 V and speaker out.



## NEED HARDCOPY?

If you are one of the many computer users who wants hardcopy printouts, but can't afford any of the available machines, your troubles are over. Our PR-40 is a universal printer that gives you clear easy to read hardcopy like the sample on the right with almost any computer. Our printer operates from any eight bit parallel I/O port. The printer has its own character generator and memory buffer. This means that the computers only job is to feed data when the printer is ready. No special program is needed in the computer to convert the data to a form that the printer can use as each character is printed. The PR-40 is easy to use, easy to interface and easy to afford.

- \* SWTPC PR-40 ALPHANUMERIC PRINTER \*
- \* 40 CHARACTERS / LINE
- \* 5 X 7 DOT MATRIX IMPACT PRINT
- \* USES STANDARD 3 7/8" CALCULATOR PAPER
- \* 75 LINE / MINUTE PRINT RATE
- \* AUTOMATIC RIBBON REVERSE
- \* 64 CHARACTER ASCII CHARACTER SET
- \* 40 CHARACTER LINE MEMORY
- \* TTL, SWTPC 6800, MITS COMPATIBLE

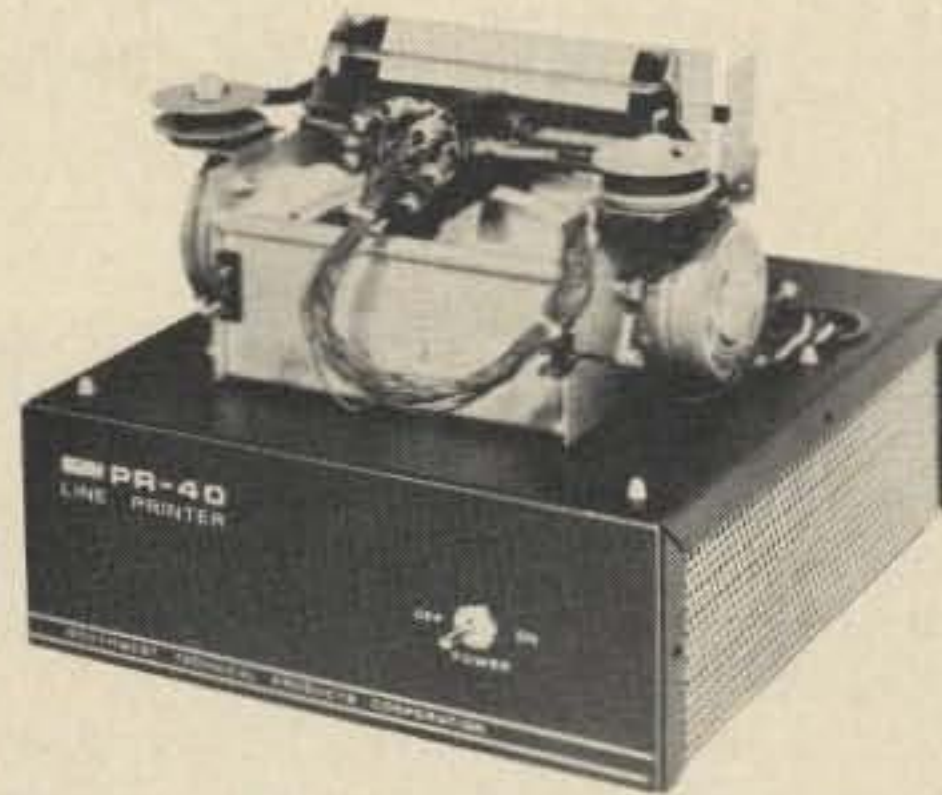

PR-40 LINE PRINTER KIT.....\$250.00 PPd

## HOW ABOUT PICTURES?

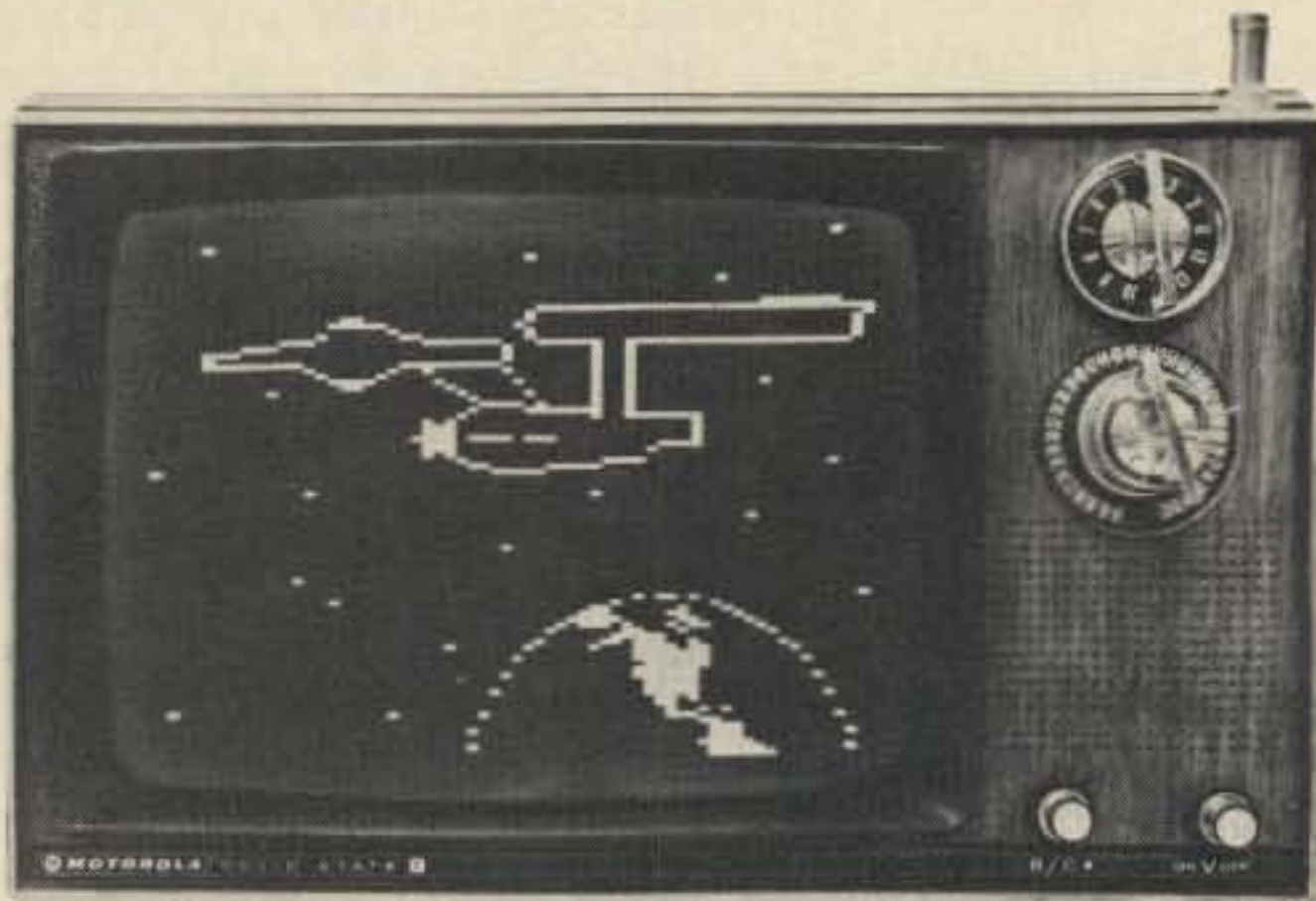

Games are more fun with pictures. Now you can add graphics displays to your game programs and on any type computer. Our GT-6144 operates from any eight bit parallel I/O port. It has its own self contained memory, so memory space for the display is not robbed from your computer. The 9½ x 13 circuit board contains all you need to produce a graphic display like the one of the starship "Enterprise" shown on the left. Kit is less power supply, or chassis.

GT-6144 GRAPHICS TERMINAL KIT . \$ 98.50 PPd



I know a bargain when I see it. Send the following:

- |  |          |   |          |
|--|----------|---|----------|
| <input type="checkbox"/> 6800 Computer             | \$395.00 | <input type="checkbox"/> PR-40 Printer    | \$250.00 |
| <input type="checkbox"/> GT-6144 Graphics Terminal | \$ 98.50 | <input type="checkbox"/> Just data (free) |          |

NAME \_\_\_\_\_

ADDRESS \_\_\_\_\_

CITY \_\_\_\_\_

STATE \_\_\_\_\_

ZIP \_\_\_\_\_

Southwest Technical Products Corp.  
Box 32040, San Antonio, Texas 78284

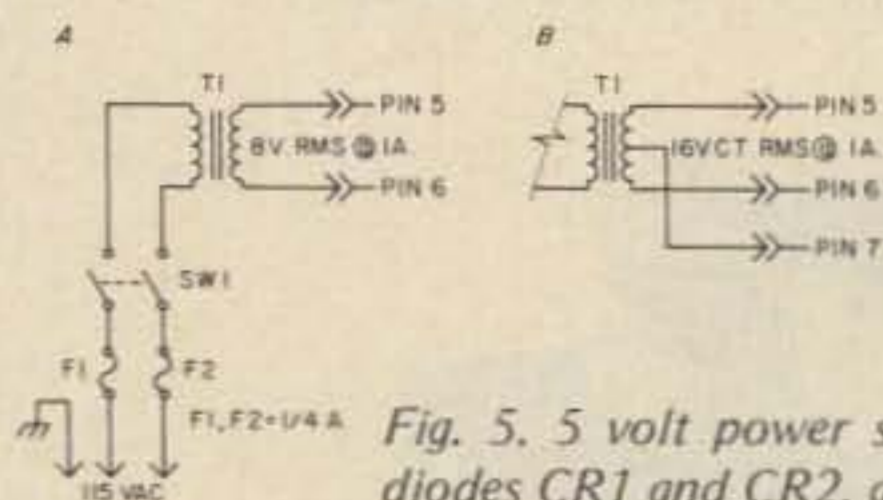
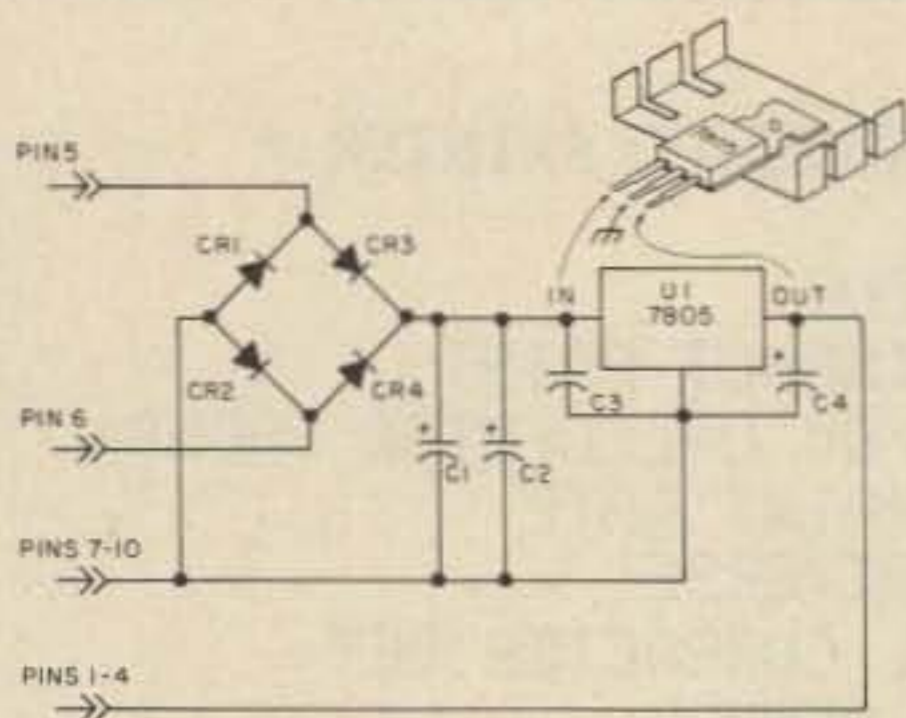

Fig. 5. 5 volt power supply. If a center-tapped transformer is used, remove diodes CR1 and CR2, and connect accordingly.

the need arises but also avoid overheating during the soldering operation.

After assembly, check the power supply voltage *before* plugging in the remaining boards.

If all parts were purchased new (based on the Cramer, Newark, and/or Allied industrial electronics catalogs) and you built your own printed circuit boards averaging \$6 apiece, the total cost would approach \$225. My total investment, purchasing most of the parts at electronic discount/surplus stores in the Costa Mesa area, was \$100. It could have been lower but I made some mistakes along the way and changed design in midstream more than once.

#### Printed Circuit Boards

The artworks for all boards were prepared at home using commercially available artwork aids. They were taped 2:1 and

photographically reduced at a local photo shop. The artworks were small enough to reduce two on one positive, cutting costs a bit.

Using direct positive photoresist-coated boards available from the Vector Electronic Co. (CU70/45WE-1R, 7" x 4½" 1/16" single-sided glass-epoxy), the boards were exposed in my darkroom (bathroom) using a positive. Following the instructions that came with the boards, I was able to make some very outstanding circuit boards.

After cutting and drilling, I tin-plate the finished board with Shipley LT-25 chemical plating solution<sup>5</sup>.

I usually get better results etching with ferric chloride than with ammonium persulfate.

With careful planning and the above materials, I can produce a production quality board for approximately \$6, which

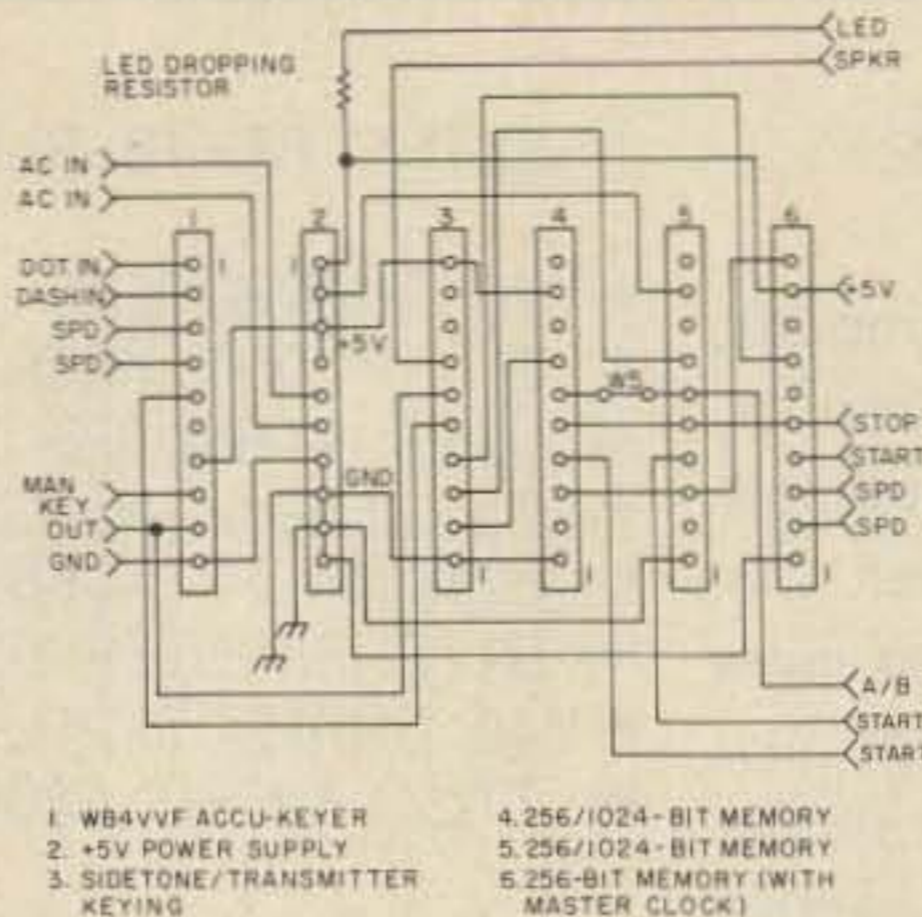

1. WB4VVF AGCU-KEYER
2. +5V POWER SUPPLY
3. SIDETONE/TRANSMITTER KEYING
4. 256/1024-BIT MEMORY
5. 256/1024-BIT MEMORY
6. 256-BIT MEMORY (WITH MASTER CLOCK)

Fig. 6. Mother board.

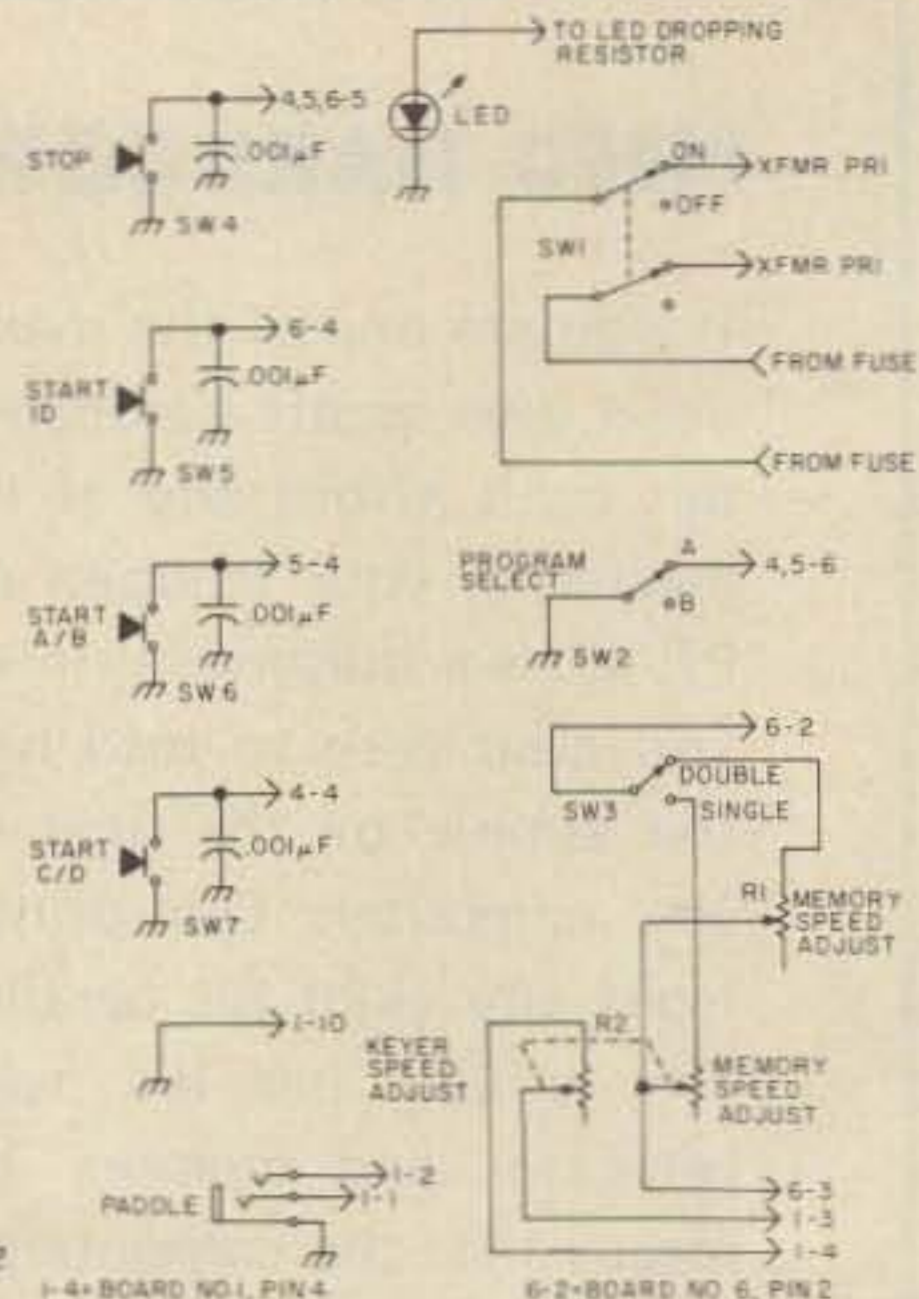
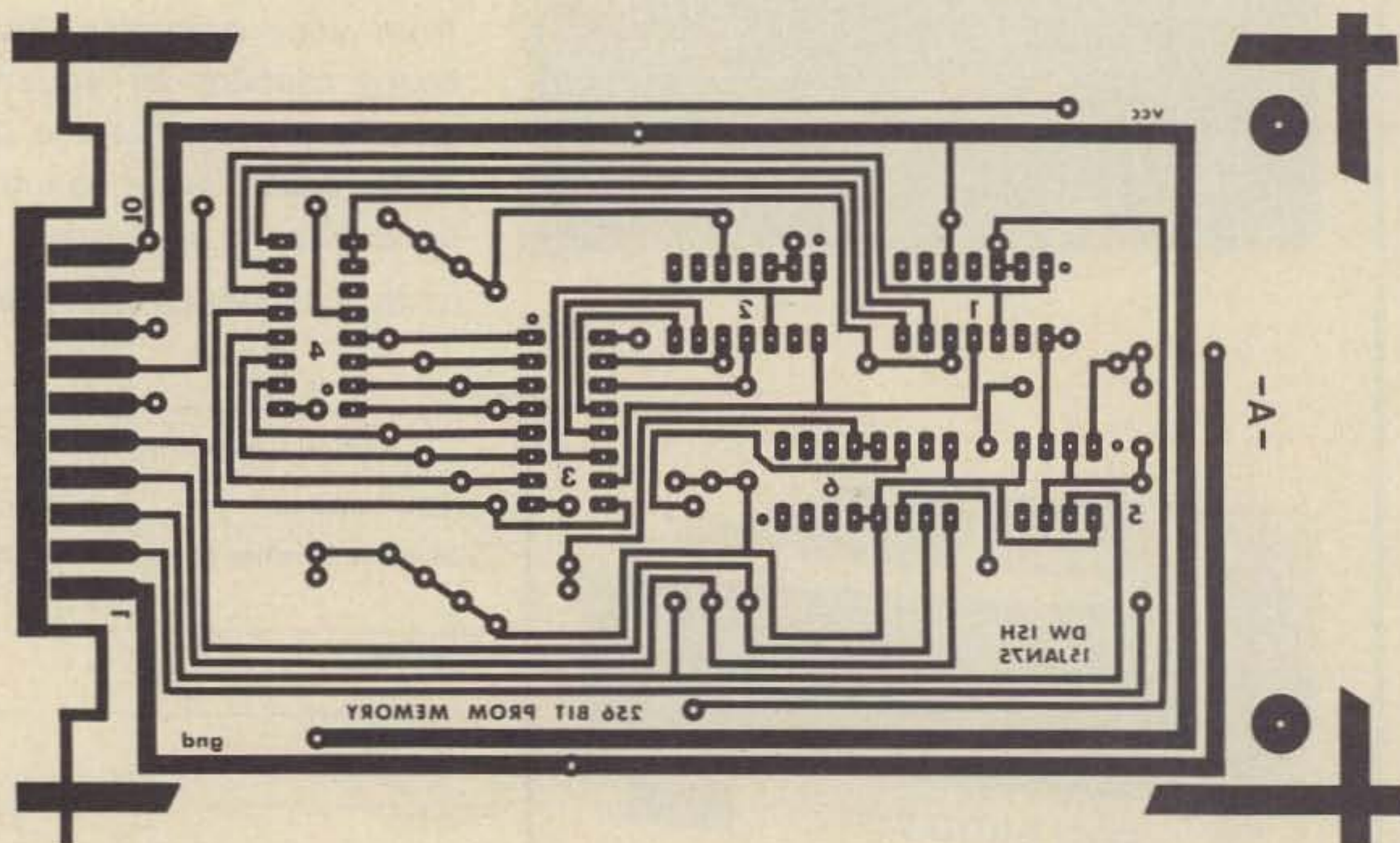

Fig. 7. Front panel wiring.

Fig. 8(a). PC board, 256-bit PROM memory (full size).



Note: PC boards are top views, or as viewed from the component side. Component layouts are bottom views, or as viewed from the circuit side.

includes the photographic reduction of my artworks.

#### Programming

All of my PROM memories have utilized Intersil bipolar PROMs whose programming procedure forces a resistive shaft through the junction of one diode in the memory cell, resulting in a logic 1 at selected locations in the memory as determined from the user's program. Once the memory cell has been programmed to a logic 1, that bit cannot be altered (reprogrammed).

Although design data sheets and application notes are available from the manufacturer and distributors which describe the programming procedures (electrical) in detail, the reader will probably take advantage of the custom programming services offered through the manufacturer or distributor. Programming methods vary from

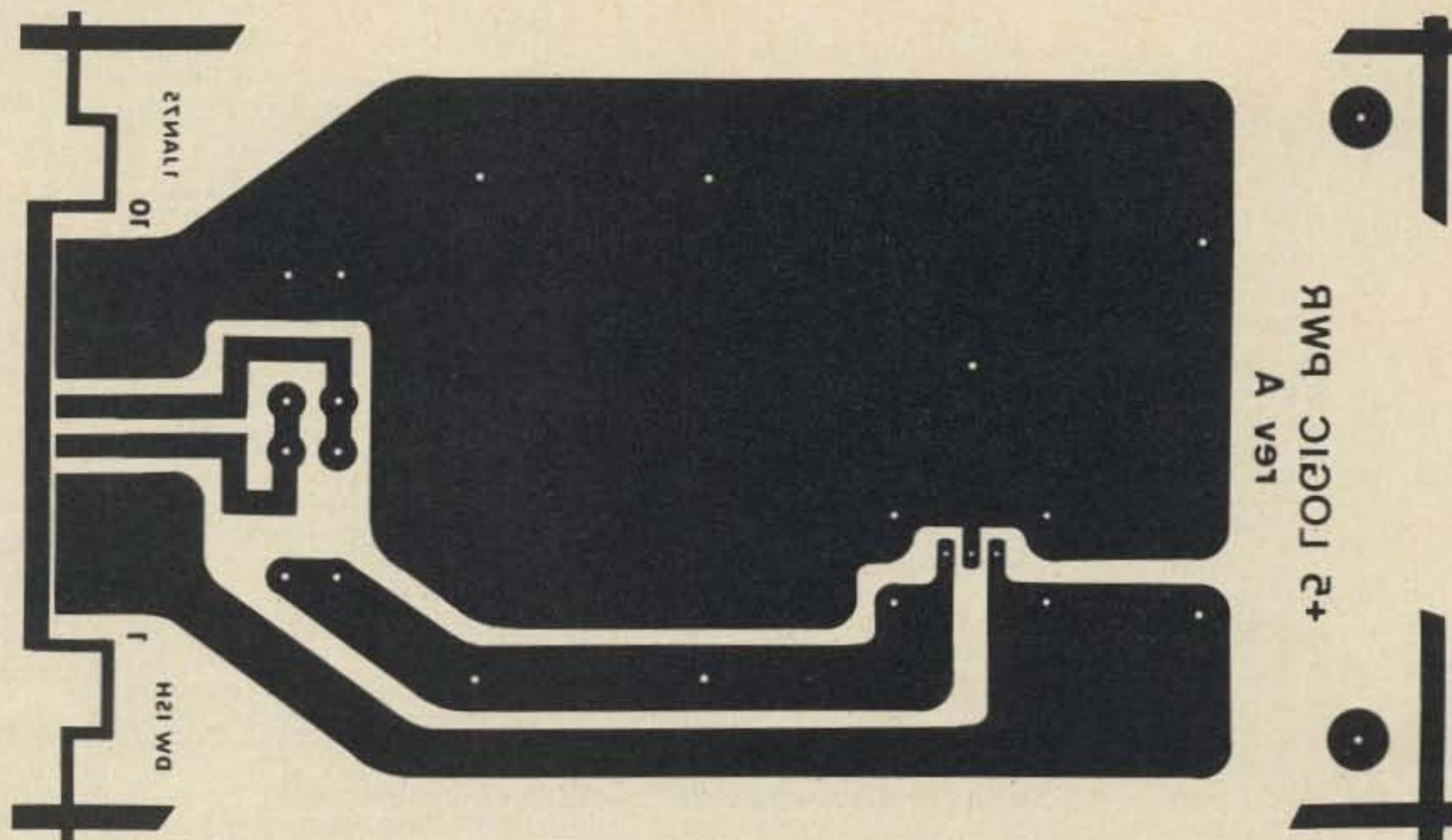

Fig. 10(a). PC board, +5 volt power supply (full size).

manufacturer to manufacturer and from type to type so that the reader will have to do some homework and some independent research in selecting PROMs. Send for the design data sheets and application notes corresponding to the PROMs selected. READ THESE PROGRAMMING INSTRUC-

TIONS CAREFULLY AND FULLY UNDERSTAND THE ADDRESS METHODS AS PROGRAMMING ERRORS CAN BE COSTLY. The quoted prices from R. V. Weatherford included programming costs and they supplied the programming cards and instructions.

Standard spacing should be used in writing your program: 7 bits for a word space, 3 bits for a letter space, 3 bits for a dash, and 1 bit for a dot.

#### Conclusion

The size of the memory and the PROM(s) used depend entirely upon how complicated your memory access is, your pocketbook, and your CW operating habits. PROM memories, because of their nature, are not versatile. For the CW operator requiring a versatile memory, PROMs are not the way to go unless a large memory is used which can be easily accessed. The more complicated your access scheme, the more complicated the memory manipulations during a QSO. Memory access in my case is through push-button switches, making it fast and fairly foolproof.

There have been about a dozen "good" articles on keyers with memories which have appeared during the last three to four years, and yet none of them has really satisfied my memory requirements. They were, however, invaluable as food for thought. The keyer/memory described in this article is the result of reading and partially building many of these articles which have appeared in 73, *Ham Radio* and *QST*.

My primary purpose in writing this article was to demonstrate another method of building a CW memory so that, if one was interested, he could use this and other articles to build his own, tailored to his operating habits. The keyer/memory described has been designed specifically for my CW operating habits and is not meant to be a "better mousetrap."

There is little difference when switching from "fist" to memory other than character and letter spacing. No one has noticed a difference to date, or commented on it if he has.

No RFI problems have been encountered

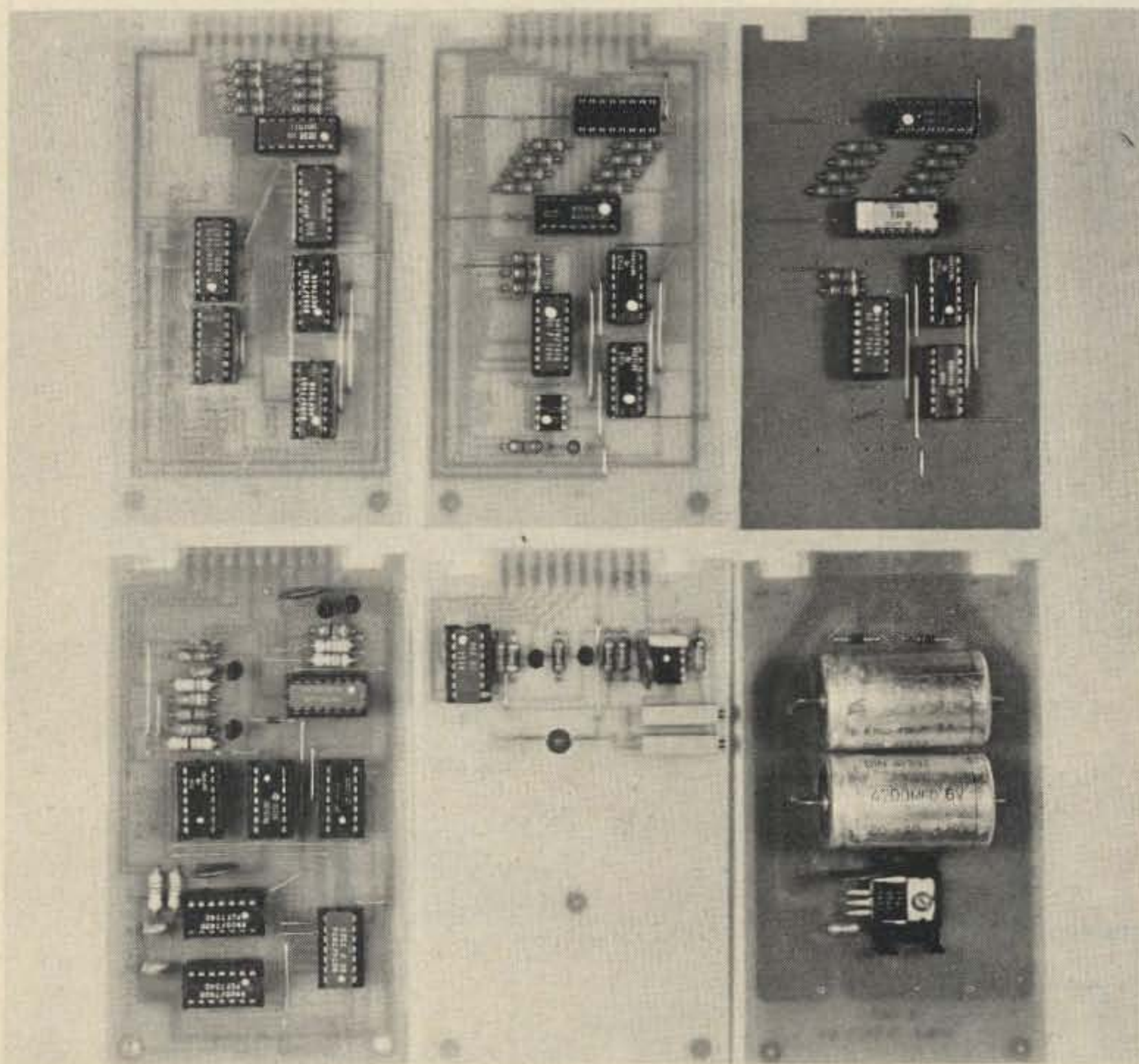

Circuit boards. Clockwise, from upper left: 1024-bit PROM memory, 256-bit PROM memory w/clock, 256-bit PROM memory w/o clock, +5 V power supply, sidetone/transmitter, Accu-keyer.

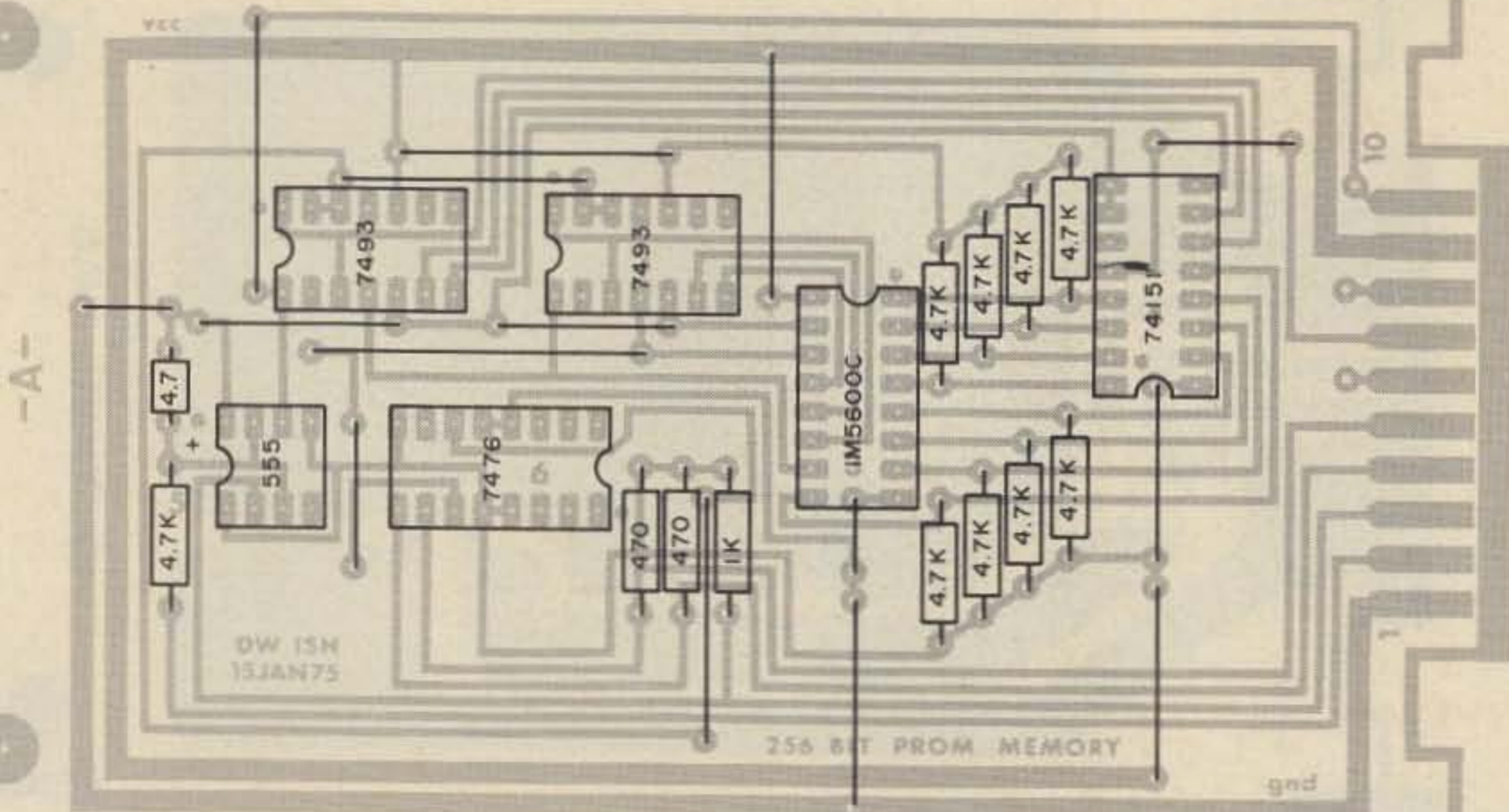

Fig. 8(b). Component layout, 256-bit PROM memory.

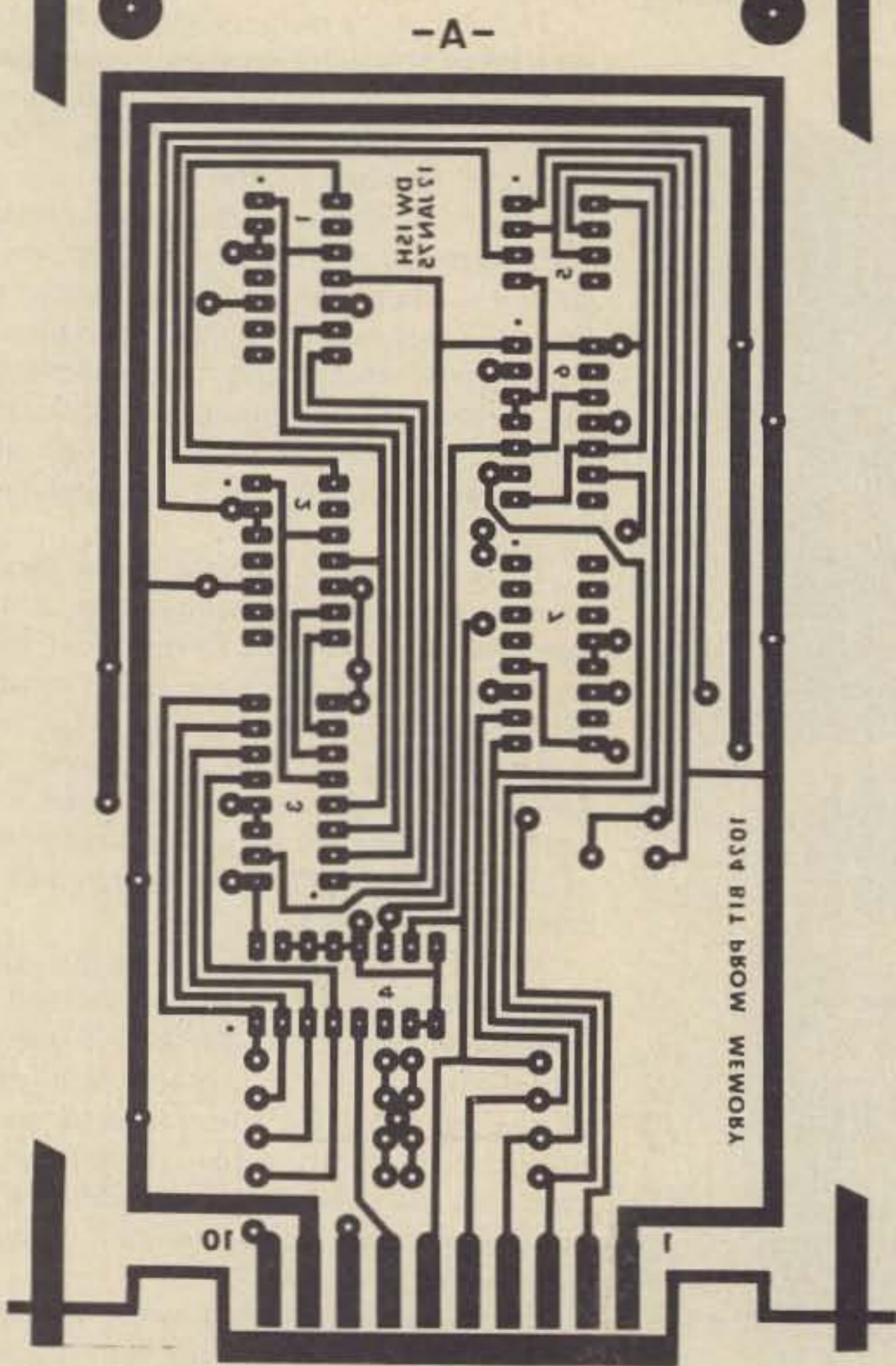

Fig. 9(a). PC board, 1024-bit PROM memory (full size).

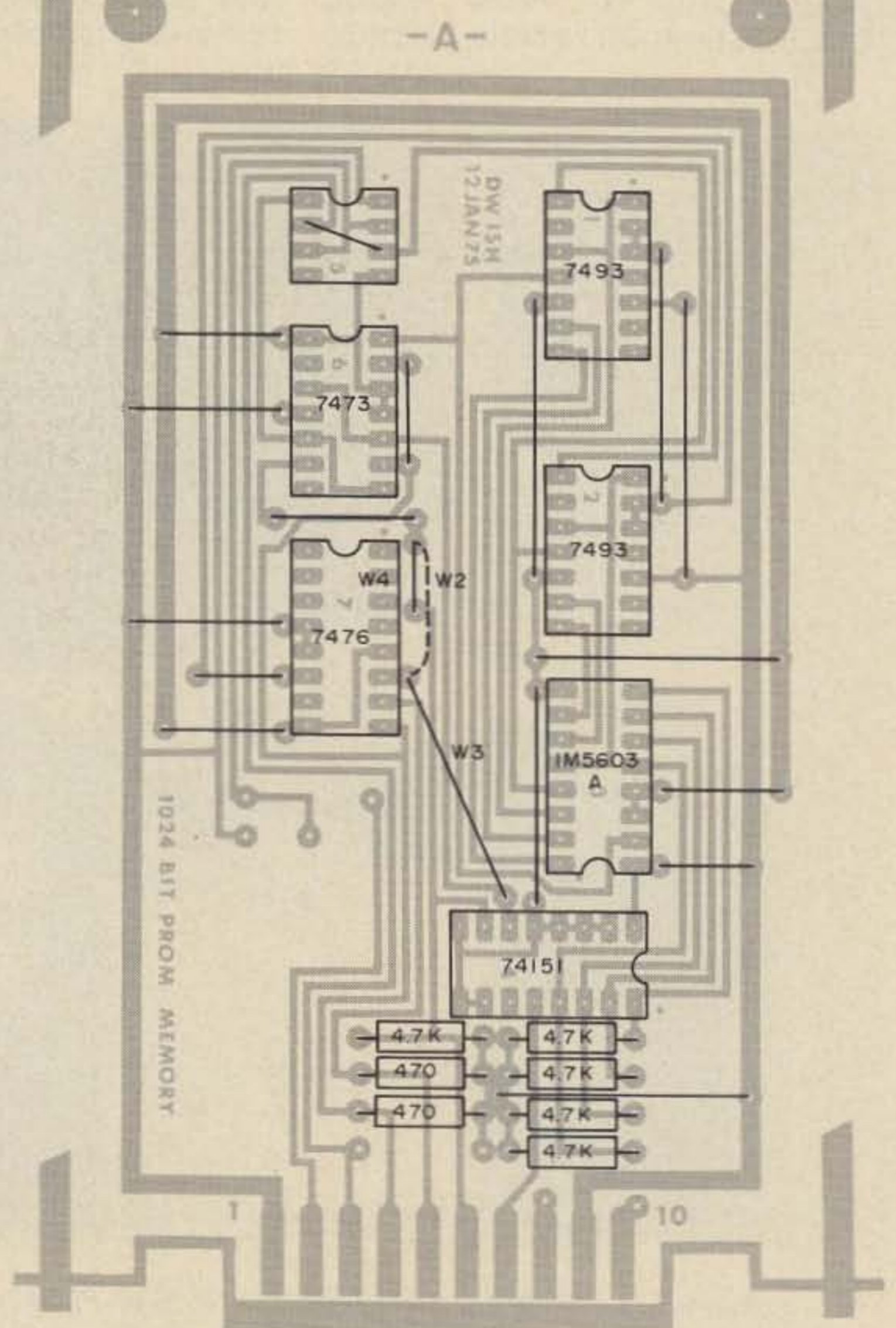

Fig. 9(b). Component layout, 1024-bit PROM memory.

+5 LOGIC PWR  
rev A

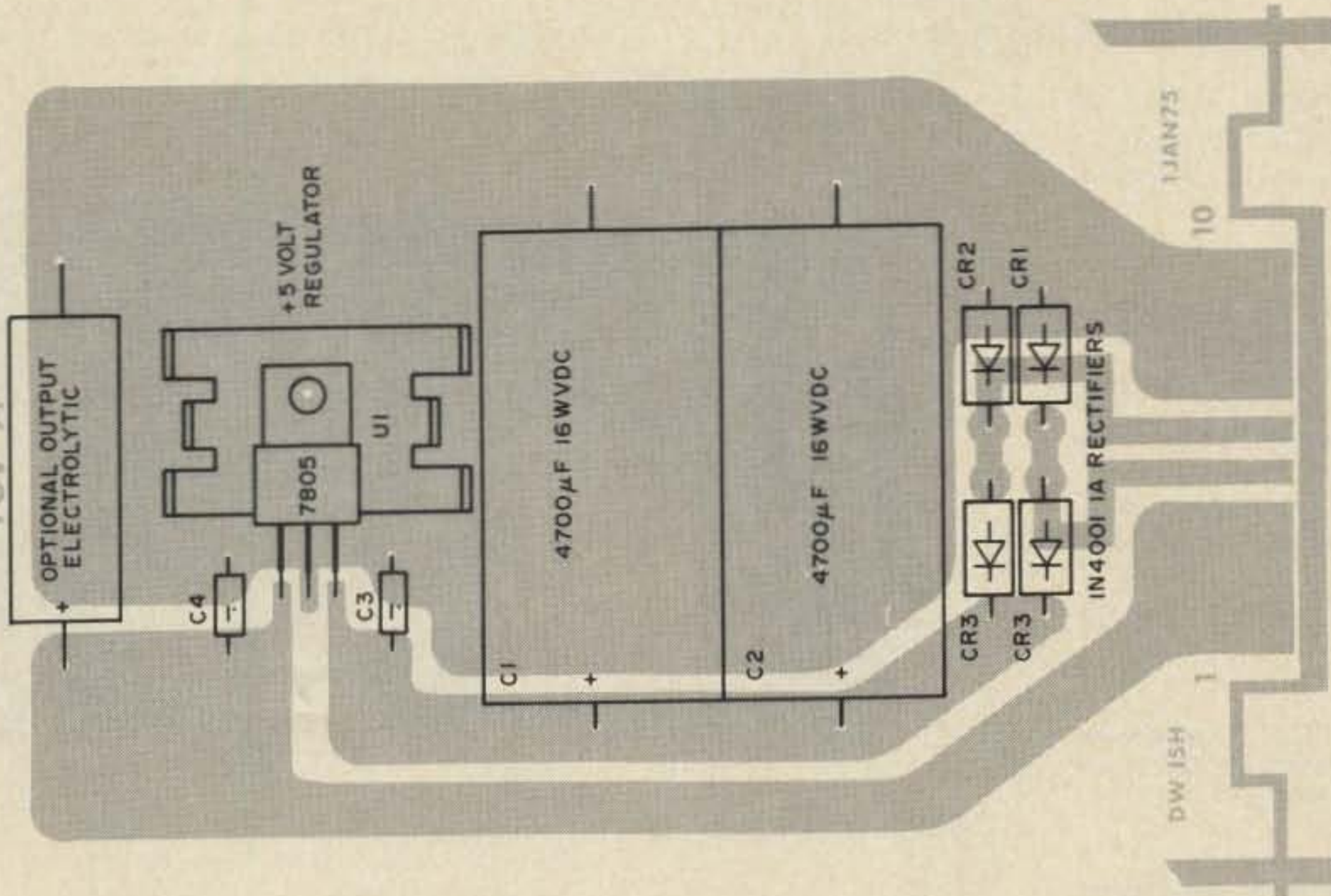

Fig. 10(b). Component layout, +5 volt power supply.

OPTIONAL LOCATION FOR BOARD MOUNTED SPEAKER

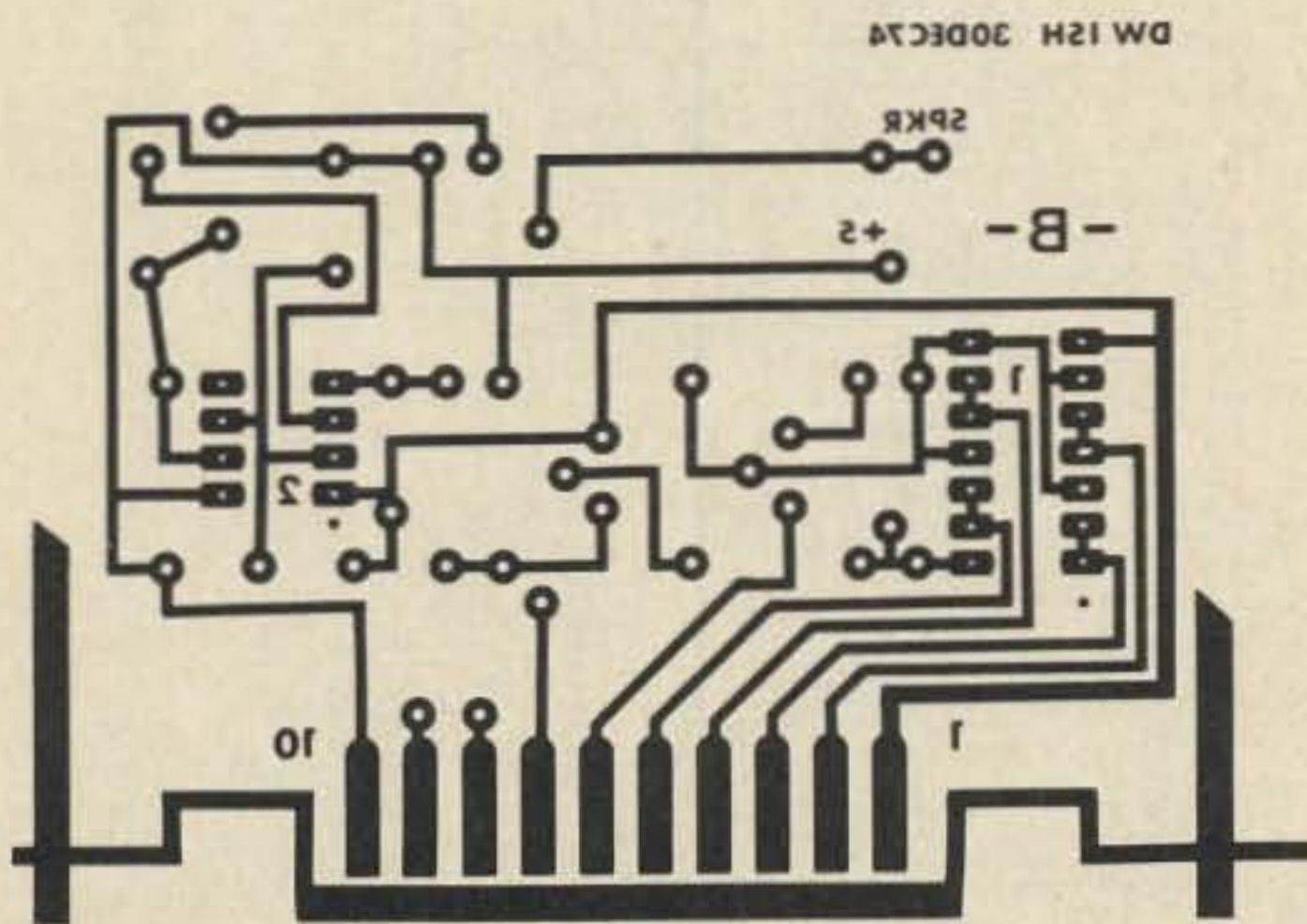

Fig. 11(a). PC board, sidetone/transmitter keying circuitry (full size).

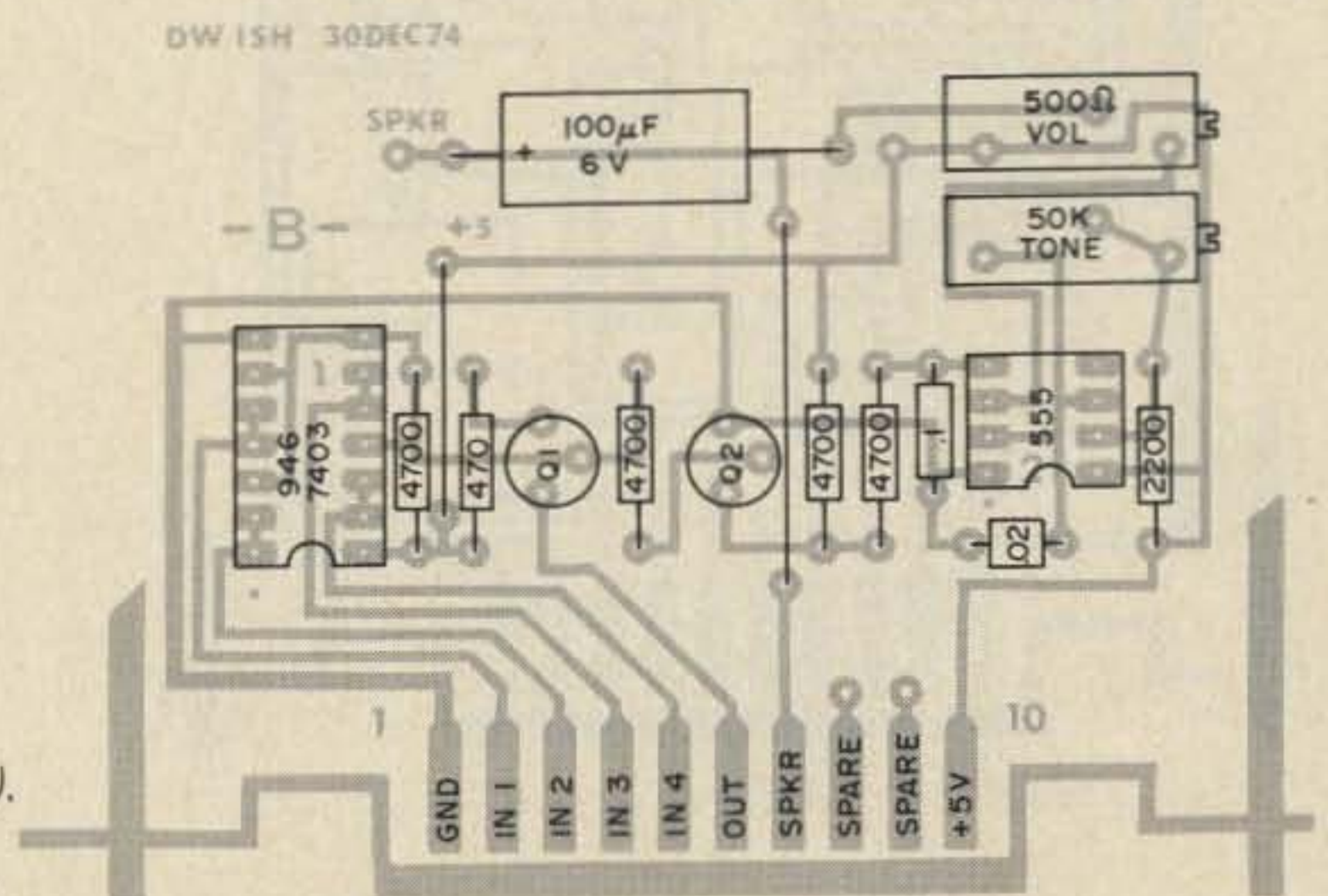

Fig. 11(b). Component layout, sidetone/transmitter keying circuitry.

to date keying a Kenwood TS-511S to 350 Watts (input). Additional bypassing may be required at higher inputs.

Whether the reader chooses RAMs or PROMs for his CW memory, anything which can be sent with a key can be put into memory. Try it, you'll like it. ■

**References**

- <sup>1</sup> D.W. Ishmael WA6VVL, "Building a CW PROM Memory," *73*, May, 1976, pages 102-108.
- <sup>2</sup> James Garrett WB4VVF, "The WB4VVF Accu-Keyer," *QST*, August, 1973, pages 19-23.
- <sup>3</sup> Signetics, *Digital/Linear/MOS Applications*, "555 Timer," pages 6-78 through 6-90.
- <sup>4</sup> "Deluxe All-Solid-State Keyer," *The Radio Amateur's Handbook*, ARRL, pages 362-366, 1974 edition.
- <sup>5</sup> Shipley Co. Inc., 2300 Washington St., Newton MA 02162.

**Additional References**

- The Weatherford Universal P/ROM Programming Center, Bulletin W-2123. Weatherford, 6921 San Fernando Rd., Glendale CA 91201.  
 Intersil IM5600C Data Sheet.  
 Intersil IM5603A Data Sheet.  
 Intersil IM5600 Reliability Evaluation Data Sheet.  
 The TTL Data Book For Design Engineers, Texas Instruments, Inc.

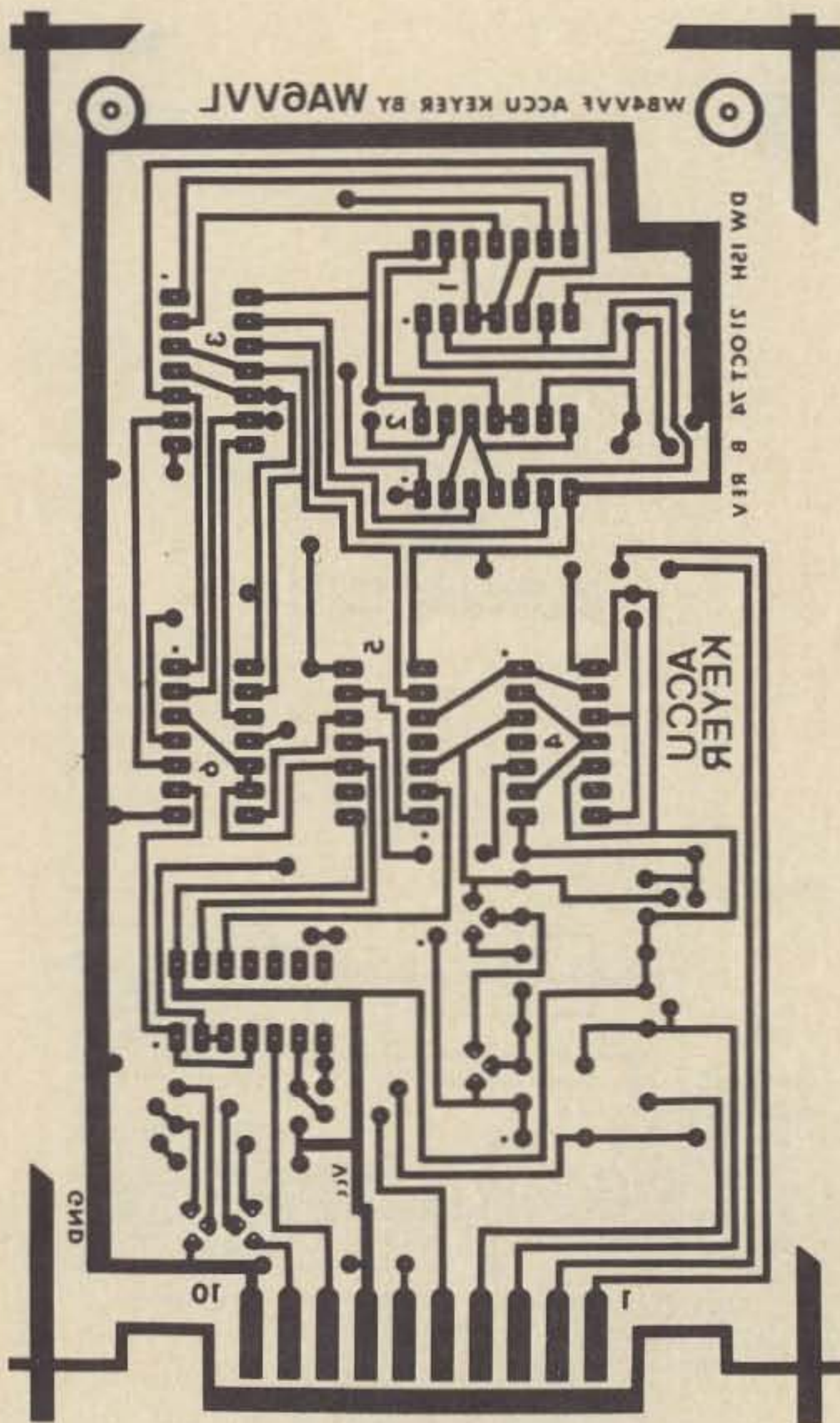
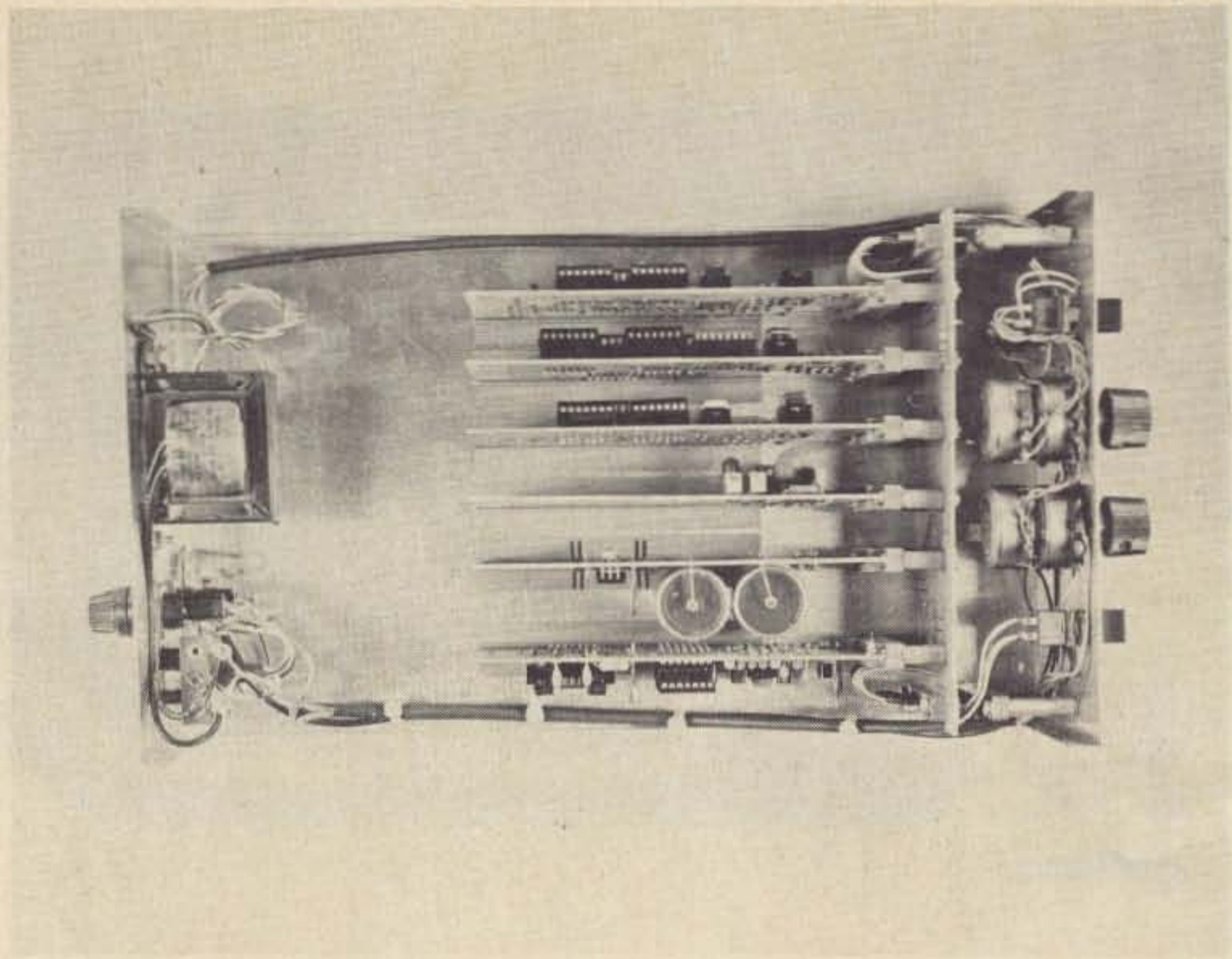

Fig. 12(a). PCB board, WB4VVF Accu-keyer (full size).

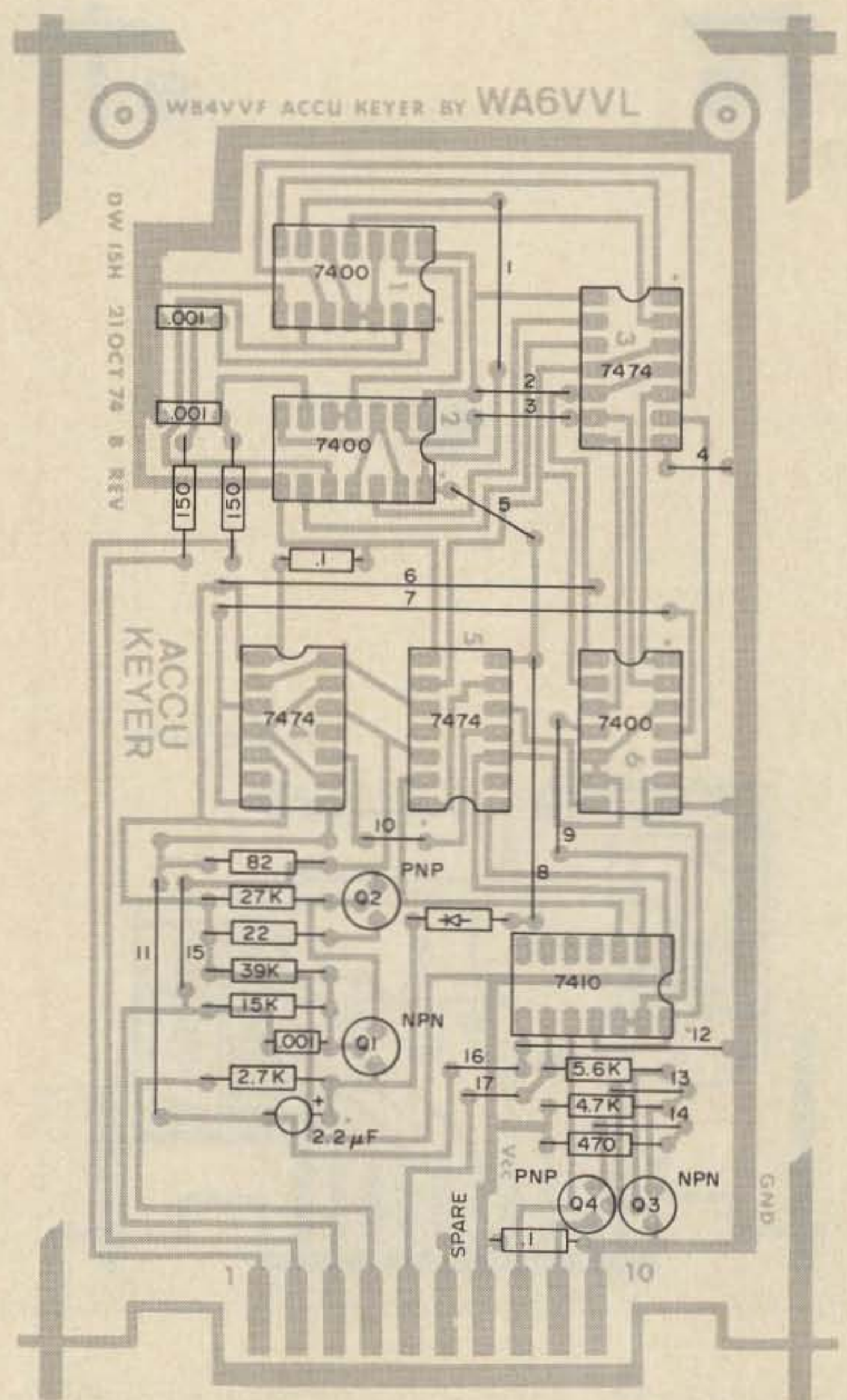



Fig. 12(b). Component layout, WB4VVF Accu-keyer.





# BURROUGHS model D8565 computer display terminal

THE TERMINALS WE OFFER ARE NEW AND UNUSED, IN ORIGINAL CARTONS.

*This display terminal has an integral controller, B/W cathode ray tube and keyboard. The system has a serial I/O interface for communication and an I/O interface for a printer. These units employ standard Motorola RTL Technology.*

-  **DISPLAY (P/N 4802-1095-501) FEATURES:**
- 17" B/W CRT
  - 41 lines of data
  - 52 characters per line
  - Characters are generated by a diode matrix "graphic" technique
  - 21 special push-buttons wired for a program call up
  - Brightness Control
  - Self-contained power supply

-  **KEYBOARD (P/N 4802-1115-501) FEATURES:**
- Reed switch technology
  - 54 data keys
  - 28 special keys detachable with cable

-  **LOGIC UNIT (P/N 4802-1157-502) FEATURES:**
- 1024 by 6 bit core memory
  - Printer I/O interface
  - Communication I/O interface

-  **POWER: 115V, 50/60 Hz, 500 Watts**

**WEIGHT: 210 lbs. (including logic unit, keyboard, display and cables.)**

**SHIPPING WEIGHT: 238 lbs. F.O.B. our warehouse.**

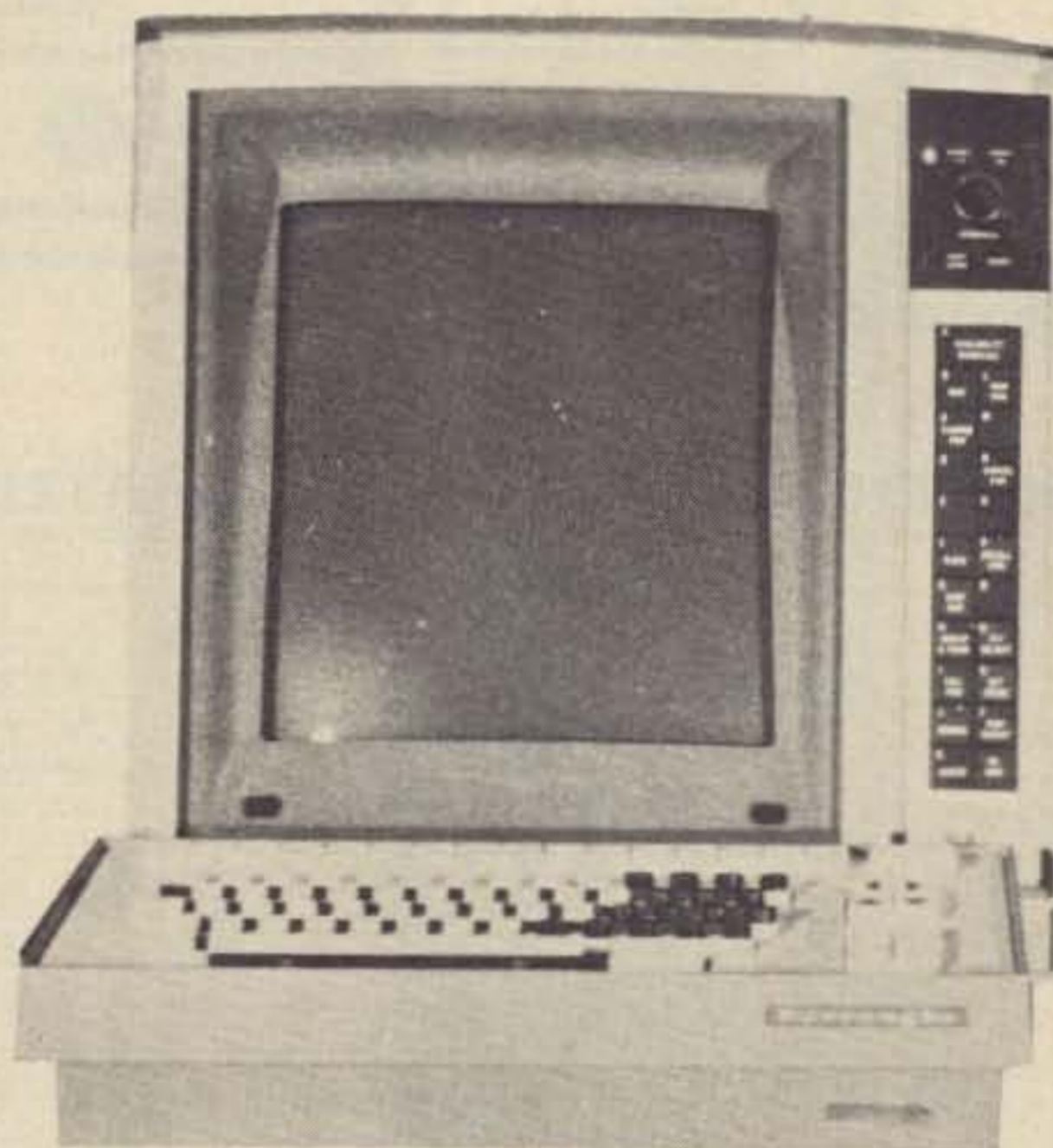

## SPECIAL PRICE:

ORIGINAL, UNOPENED CARTONS - NO CHECKOUT OR WARRANTY (DUE TO STORAGE, YOU MAY ENCOUNTER LOOSE BOARDS, LOOSE OR TARNISHED CONNECTORS, ETC., WHICH MAY REQUIRE ADJUSTMENT)

**\$495.00**

COMPLETELY CHECKED AND OPERATIONAL WITH 30 DAY WARRANTY AND DOCUMENTATION

**\$795.00**

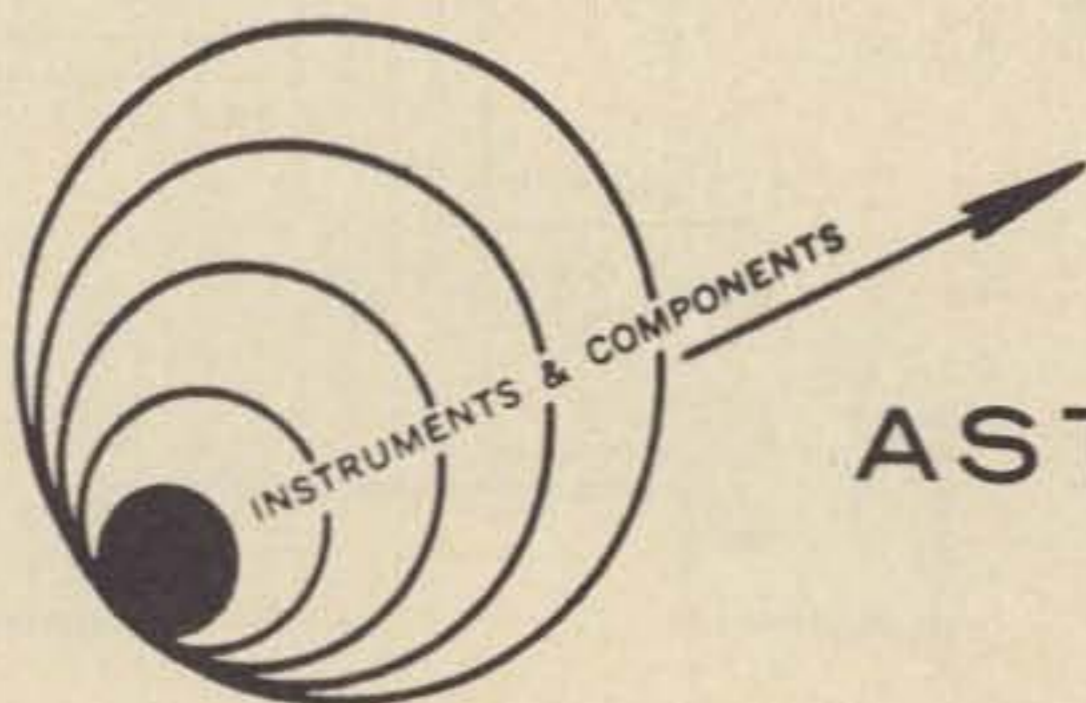

## AST/SERVO SYSTEMS, INC.

20 REPUBLIC ROAD, NORTH BILLERICA, MASS. 01862  
617-667-8541



# The first 8-K that NEVER\* FORGETS!

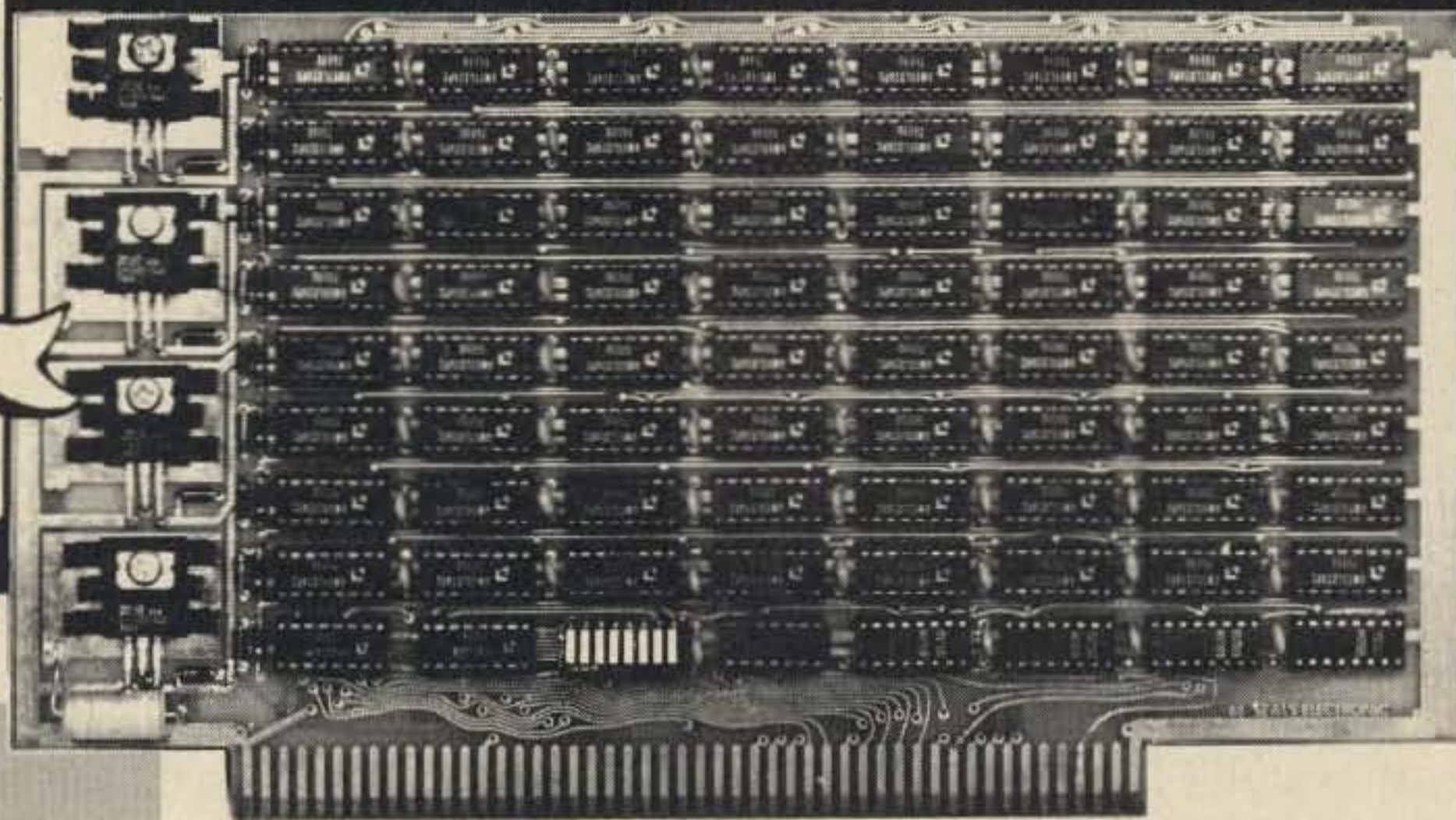
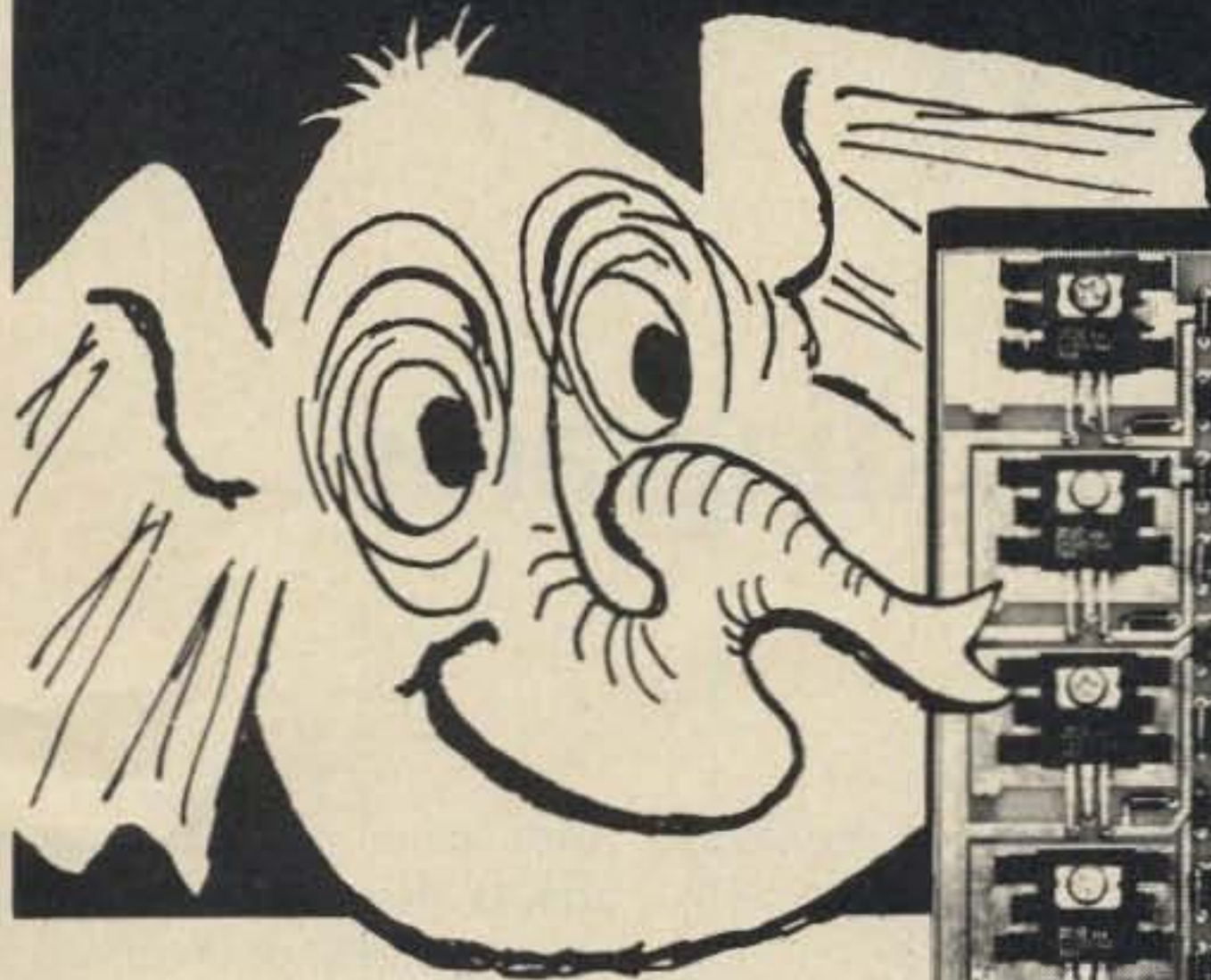

## SPECIFICATIONS:

### 8K SC - 8 Specifications:

- Access Time: 500 ns Max. (225 max on request)
- Current Req: Less than 200 ma per 1024 words maximum
- Memory Chip: AMD 91L02 APC (low power 1K x 1)
- Voltage Supply: +5 to +10 volts
- Battery Standby: 1.5 to 2 Volt, Automatic power loss sensing circuit. Eliminates need for switches.
- Address Select: 8 ea. Spst. switches in a Dip IC package. (No longer any need for a soldering iron to change address.)
- +5 Volt regulated: 4 ea. 7805 regulators with individual heat sinks to run cooler.
- Wait States: NONE! Your wait light will not burn because of a memory wait state.

ALL ADDRESS, CONTROL, AND DATA OUT LINES FULLY BUFFERED

### Circuit Board

Double sided, G10 glass epoxy board  
Plated through holes. 5 mil. tin minimum  
Solder reflow processed  
Solder mask on both sides of PC board  
Component lay out silk screened on component side of PC board  
Gold plated edge contacts  
No jumper wires used  
Professional layout techniques used

ALL ADDRESS, CONTROL, AND DATA OUT LINES FULLY BUFFERED

QUANTITY, DEALER, AND CLUB INQUIRIES INVITED

PLUG IN-COMPATIBLE WITH ALTAIR® AND IMSAI® IC SOCKETS INCLUDED

\$295.00 Kit - \$394.00 Assembled - \$2.00 Shipping and handling

\*LIMITED TO CAPACITY OF STANDBY BATTERY

SEALS  
ELECTRONICS



BOX 11651, KNOXVILLE, TN. 37919

Enclosed is \$ \_\_\_\_\_  FULL AMOUNT  25%; BALANCE C.O.D.  
 BANK AMERICARD/MASTER CHARGE # \_\_\_\_\_

PLEASE SHIP THE FOLLOWING:

- 8KSC KITS .....@ \$295.00 each  
 8KSC ASSEMBLED .....@ \$349.00 each  
 MORE INFORMATION AND SPECIFICATIONS

TO \_\_\_\_\_

STREET \_\_\_\_\_

CITY \_\_\_\_\_ STATE \_\_\_\_\_ ZIP \_\_\_\_\_

ADD \$2.00 SHIPPING AND HANDLING

# What's When

## -- timing diagrams

A timing diagram is one of several "road maps" for digital circuits. Aside from providing us with a "picture" of what a waveform should look like at the output of a circuit, it can also tell us the exact conditions which exist within a circuit for any particular instant in time. The latter can be very helpful information when troubleshooting a circuit. Being able to generate a timing diagram to the point of determining what the output waveform looks like is a useful tool in analyzing and learning digital circuits.

We're going to be discussing timing diagrams from two different angles. First, we're going to take a look at some of the fundamentals and techniques involved in generating a timing diagram.

Secondly, we're going to examine a couple of manufacturers' diagrams and discuss the *interpretation* of same.

### A Basic Timing Diagram

Fig. 1 illustrates the fundamentals of a simple timing diagram. Perhaps one of the first things worth pointing out is the desirability of using *graph paper*. This will help you establish a time reference (by assigning a time period for each division) and certainly help in keeping events lined up vertically, which is one of the objectives.

The arrow at the bottom of the diagram indicates *time* is going from left to right. It's the only way to go . . . there aren't many things as confusing as trying to use a timing diagram drawn the other way. (Keep in mind

that an oscilloscope display is also from left to right with respect to time.)

The diagram illustrates the inputs and outputs of a 3-input NAND gate. Assuming we had the three input signals down on paper our next step would be to generate the output. Remembering the rules for a NAND gate (that is, the output will go low only when all of the inputs are high), we begin examining the input signals from the left. As long as any of the inputs are low, the output will remain high. And, as you can see, the output drops low when all three are high. Signal OPUT ("OUTPUT") is high, indicating an output function is to be performed.  $\overline{\text{INPT}}$  ("INPUT" NOT) is high, indicating an input function is not currently being done. And, XFER ("Transfer") goes high to enable the data transfer. The output signal,  $\overline{\text{GATB}}$ , ("Gate to Bus" NOT) is low when we're gating data to the bus.

One more point before leaving this basic diagram. Notice the comments. Now, it doesn't matter if you put comments with the signal mnemonic or with the waveform, as shown. But, it's a good idea to do it . . . and for a very good reason. This timing diagram is to the hard-

ware man what a program and/or flowchart is to a software man. All of them will be easier to read and understand by others (and yourself, a year from now) if there are comments included. (By the way, the reference to "hardware" and "software" shouldn't imply that this discussion is aimed toward computers. We're dealing with *digital electronics*, and that covers a wide range of equipment and applications.)

### Timing Diagram Generation

It was evident from Fig. 1 that we needed to know what the input signals were before we could start. This will, of course, hold true for any timing diagram we wish to generate (i.e., the inputs will be our "known" values, and the other signals — including the output — will be our variables, or "unknowns").

We have three signals coming into the circuit shown in Fig. 2. These are  $\Theta 1$  (Phase 1),  $\Theta 2$  (Phase 2), and  $\overline{\text{RST}}$  (RESET NOT). As you can see, this circuit has a flip flop, and it is very important that you establish in the beginning the state of that flip flop (either set or reset). Note that  $\overline{\text{RST}}$  goes true (low) in the beginning to put the flip flop in a reset condition. (And, as part of the "comments" in this diagram, the arrow illus-

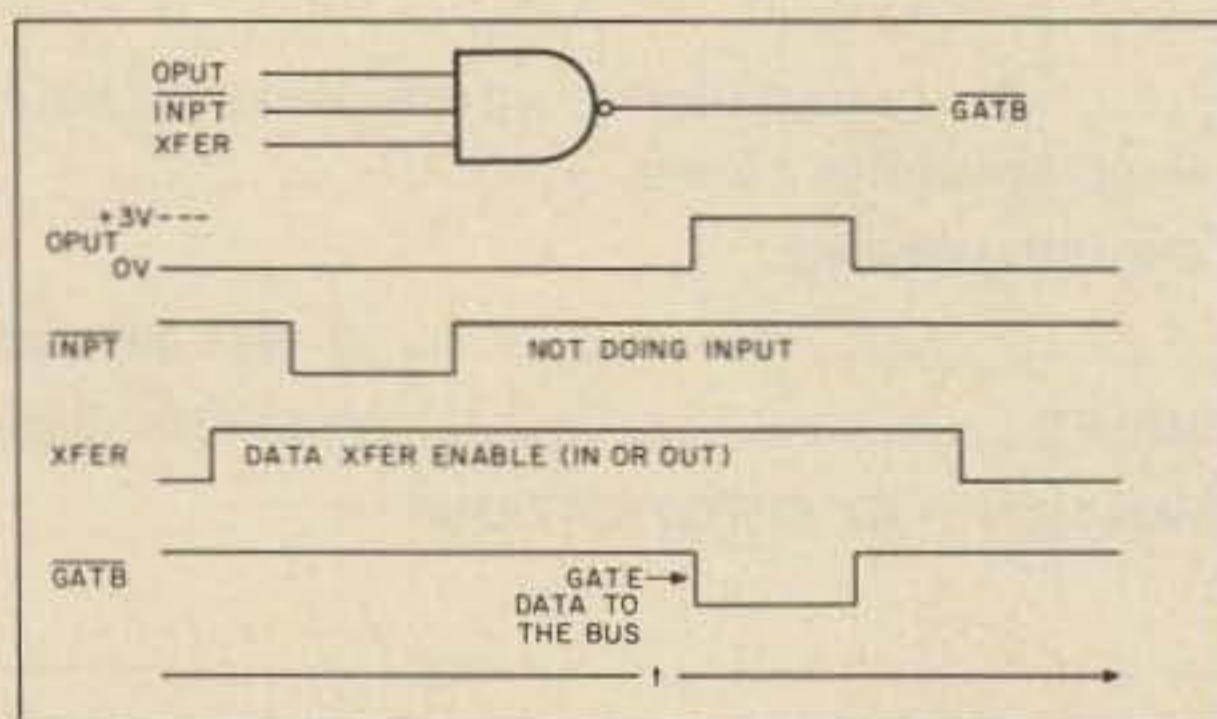

Fig. 1. A simple timing diagram illustrating the output of a 3-input NAND gate.

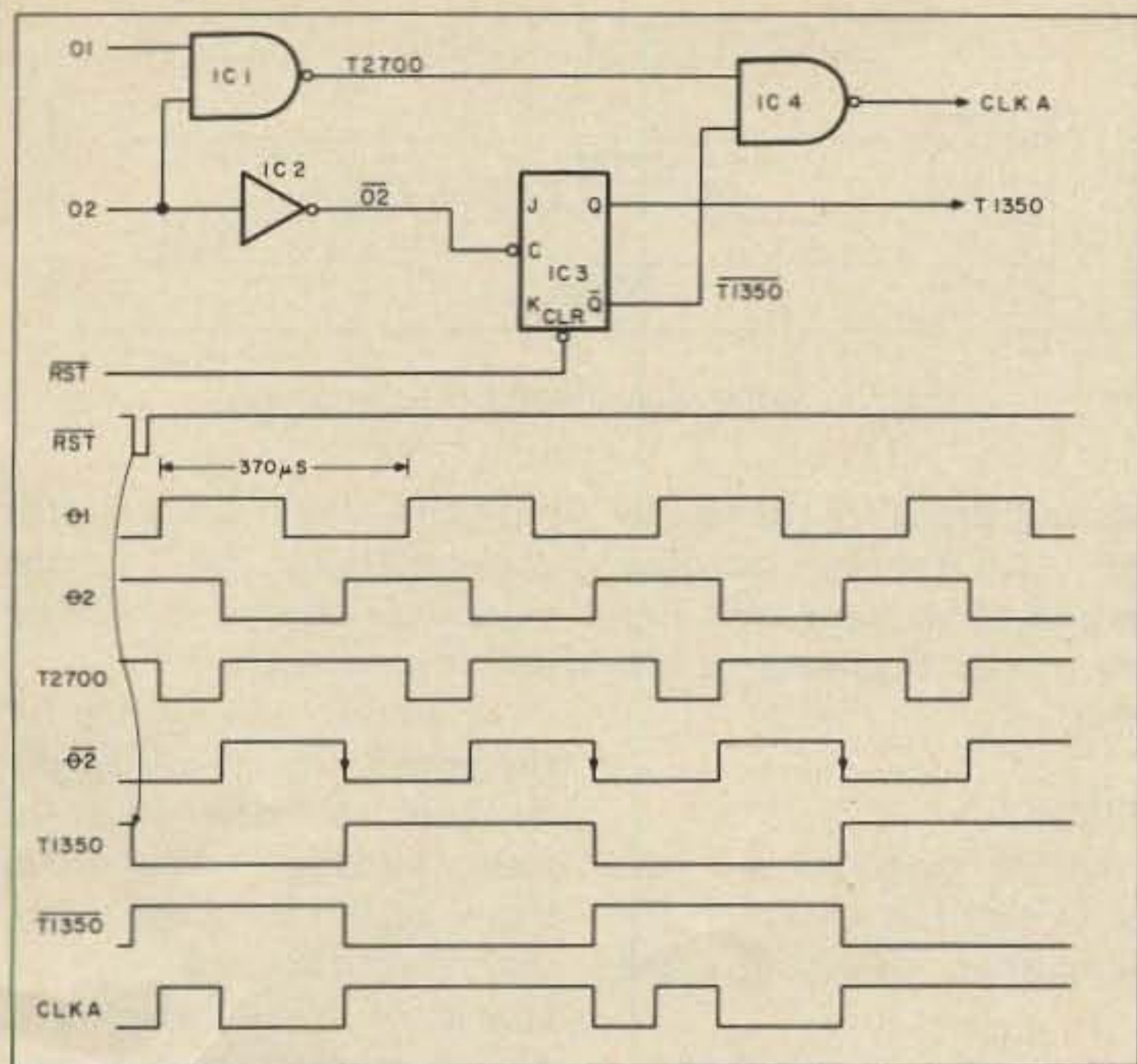

Fig. 2. Generation of a nonsymmetrical clock.

trates this.)

As a suggestion, why don't you take a piece of paper and cover the waveforms below the three inputs, and we'll see if you can anticipate the outputs as we go along (or better yet, draw them on the paper).

O1 has a period of 370 microseconds. If you grab your handy-dandy little calculator and take the reciprocal of that, you should come up with a frequency of 2700 Hz. The ANDing of O1 and O2 (through NAND gate IC1) produces the signal T2700. So much for IC1 ... and doing it first was strictly arbitrary. Now, let's take the

inversion of O2 (through IC2) and generate the clock for the JK flip flop. On the trailing edge (or "down-clock" or "one-to-zero transition") of O2 the flip flop will change state. It started off in the reset condition (because of RST) and is clocked set (i.e., Q output high, and Q-bar low) on the first trailing edge of O2. And, as you can see, it is toggled (change of state) two more times during the duration of the diagram. The outputs of the flip flop are labeled T1350 and T1350-bar. The signal names in this case are derived from the frequency of the output, which is 1350 Hz. (The flip flop

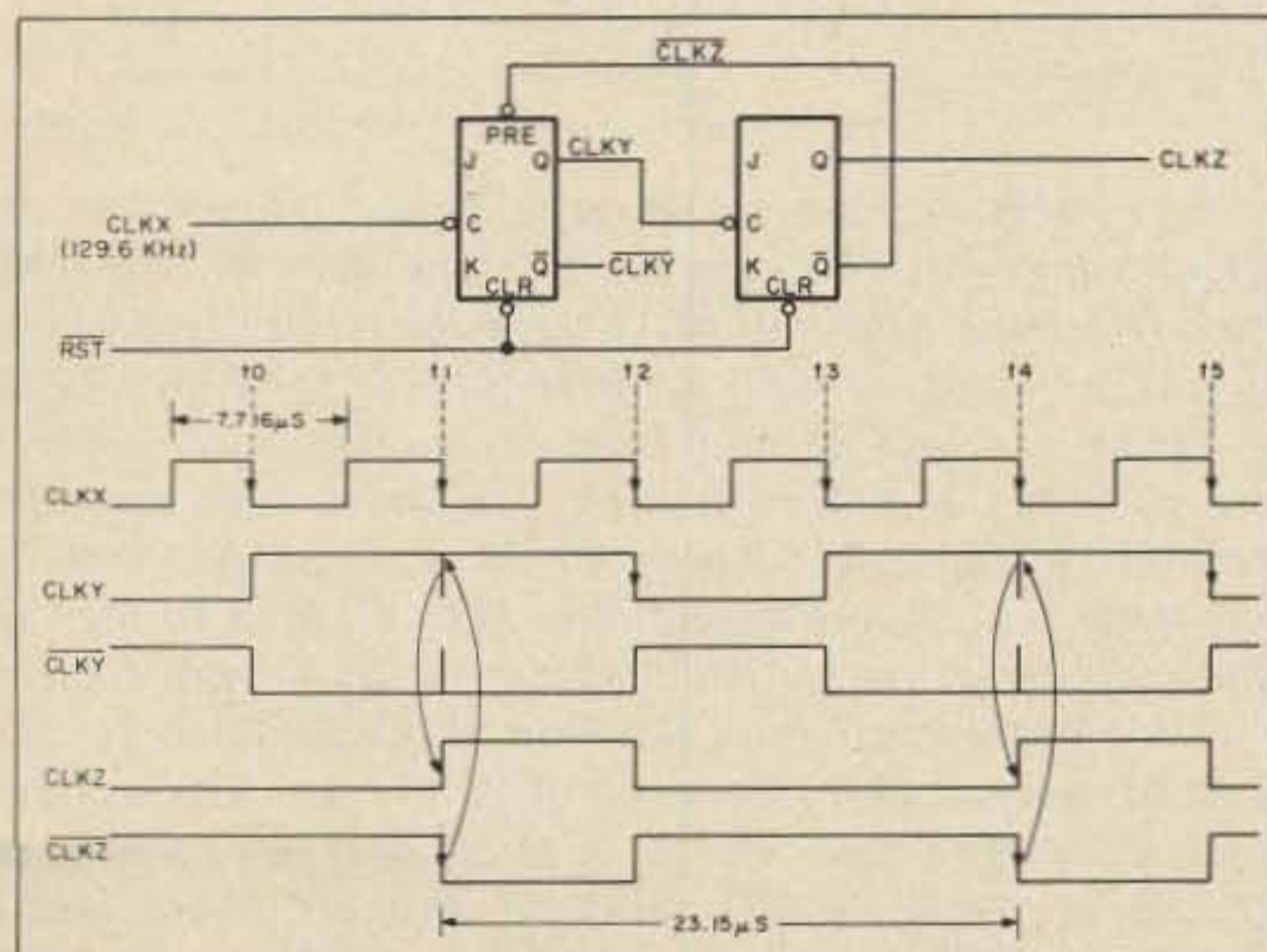

Fig. 3. A divide-by-three circuit.

divided the input frequency of 2700 Hz by two.)

In order to complete the timing diagram for this circuit, we need to AND together (through NAND gate IC4) the signals T2700 and T1350. Once again, remembering the rule that the output goes low only when the inputs are both high, we generate the signal CLKA (which is, of course, a non-symmetrical clock, or signal).

Fig. 3 is an interesting circuit, a divide-by-three. Note that in this case we didn't show the reset signal (RST) in the timing diagram. Regardless, it's very important that you establish the starting conditions for the flip flops (either set or reset). The labeling of various timing points ( $t_0, t_1 \dots t_5$ ) can be very useful for reference when discussing the diagram. Also notice the "comments," the period of the input waveform (7.716 usec), the period of the output waveform (23.15 usec), and the arrows indicating which transition caused which change of state. The divide-by-three function of the circuit is evident when you see that it took three cycles at the input to develop one full cycle at the output. (If you haven't seen this circuit before, and you find it interesting, it's suggested that you examine it more closely, because it is definitely a tricky little devil!)

Fig. 4 is an "exercise" circuit for those of you who would like to try your hand at generating a diagram from scratch. The "answer" (timing diagram) is shown in Fig. 6. Assume that all three

flip flops are in a reset condition initially, and the input frequency of 10.8 kHz is a symmetrical square wave. (NOTE: Have at least ten full cycles of the input signal across the page.)

### Interpretation

There are several techniques regarding timing diagrams which haven't been mentioned (but are very common) and will help you in interpreting others. For example, we've been using the bar (or vinculum) over the signal mnemonic to indicate the not term (e.g., INPT = "INPUT NOT"). There are several methods in use today for representing the true and false terms in signal notation. Most of them are listed in Table 1.

Fig. 5 illustrates several techniques used to indicate various conditions or states. The first line (DAL 0-7) represents the data and address lines of an eight bit computer. The crossing over of the lines simply indicates that the data and address will be either ones or zeros. This is especially true for multiple lines (as per the example) but can also be used for a single line. The signal called SYNC in the second example is depicted with a broken line, which means that the signal may or may not occur at that particular point. The third line (ADDR) illustrates the "settling time" for a signal. (Settling time is the time it takes for a signal to become stable after being applied to a line or bus.) This is of primary concern when the signal is initially applied to a

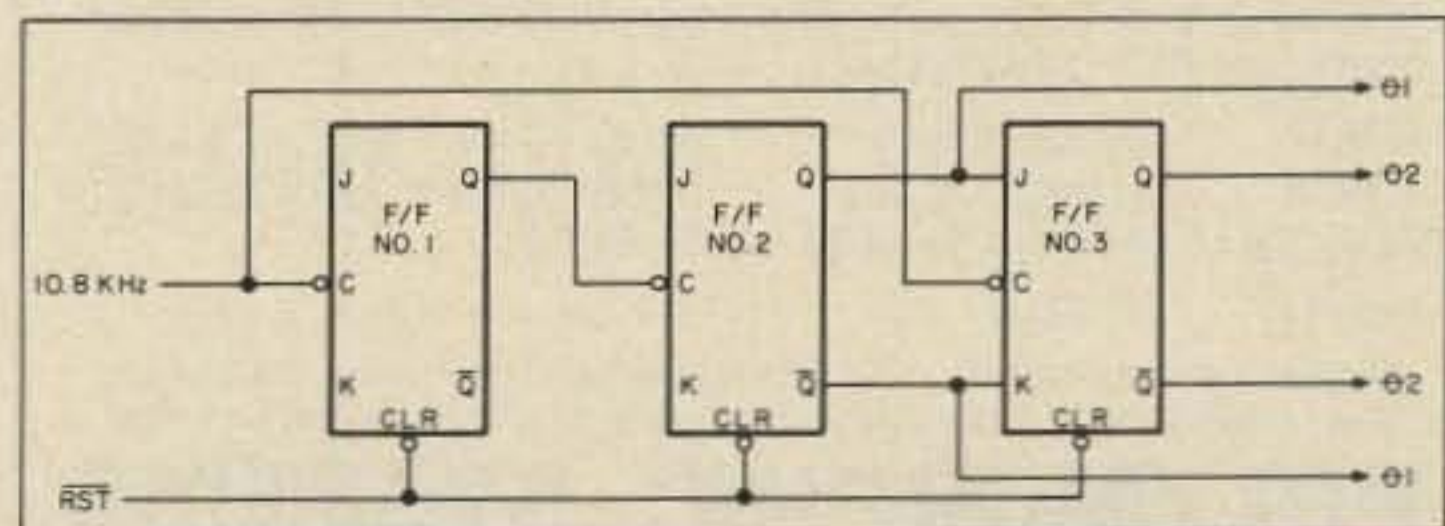
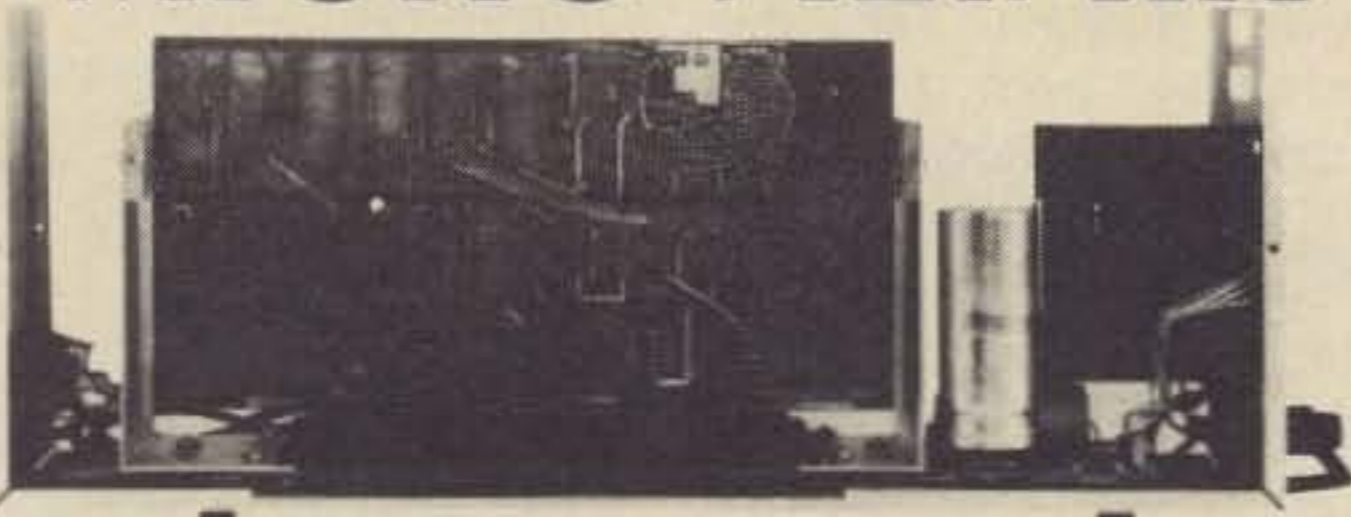

Fig. 4. Exercise circuit.

# INTRODUCING THE MICRO-ALTAIR



**The complete Computer System that requires just a keyboard and TV monitor for use.**

The MICRO-ALTAIR is:

**The hardware** — video terminal interface board, CPU/ROM/RAM board, backplane, power supply and cabinet;

**The software** — video driver, debugger, operating kernel supplied on ROM;

**The personal computer system** — complete, expandable, no loose ends — a complete and powerful tool;

### THE SOLUTION BOX FROM POLYMORPHIC SYSTEMS.

Applications include smart terminals, data acquisition systems, games, accounting, front-end for a larger computer-anywhere a little processing is required.

**COMPLETE SYSTEM [EXCEPT FOR MONITOR AND ASCII KEYBOARD] \$575.00 KIT. DELIVERY 60 DAYS — SERIAL I/O AND CASSETTE OPTIONS AVAILABLE.**



Go to your local computer store and compare

**Video Terminal Interface** — characters are stored in on-board memory. Entire screen may be read or written in 20 milliseconds. Software includes a text editing system with scrolling and insert and delete by character or line.

VTI/32	32 character line	\$160.00 kit	\$230.00 assd.
VTI/64	64 character line	\$185.00 kit	\$260.00 assd.
VTI/SK	Socket kit for VTI kit	\$ 15.00	

Delivery — 30 days

**Analog Interface** — 1 or 2 channels of analog output with 10 bits of resolutions (0-10V or  $\pm 5V$  with bipolar option), 6 bits of latched digital output and 8 analog comparators for software controlled A/D conversions.

ADA/1	1 analog output	\$135.00 kit	\$175.00 assd.
ADA/2	2 analog outputs	\$185.00 kit	\$235.00 assd.
ADA/SK	Socket kit for ADA kit	\$ 10.00	

Delivery — 30 days

BankAmericard and Master Charge Accepted

All prices and specifications subject to change without notice. Prices are USA only. Calif. residents add 6% sales tax. Add 5% shipping, handling, and insurance.

## POLYMORPHIC SYSTEMS

737 S. Kellogg, Goleta, CA 93017

(805) 967-2351

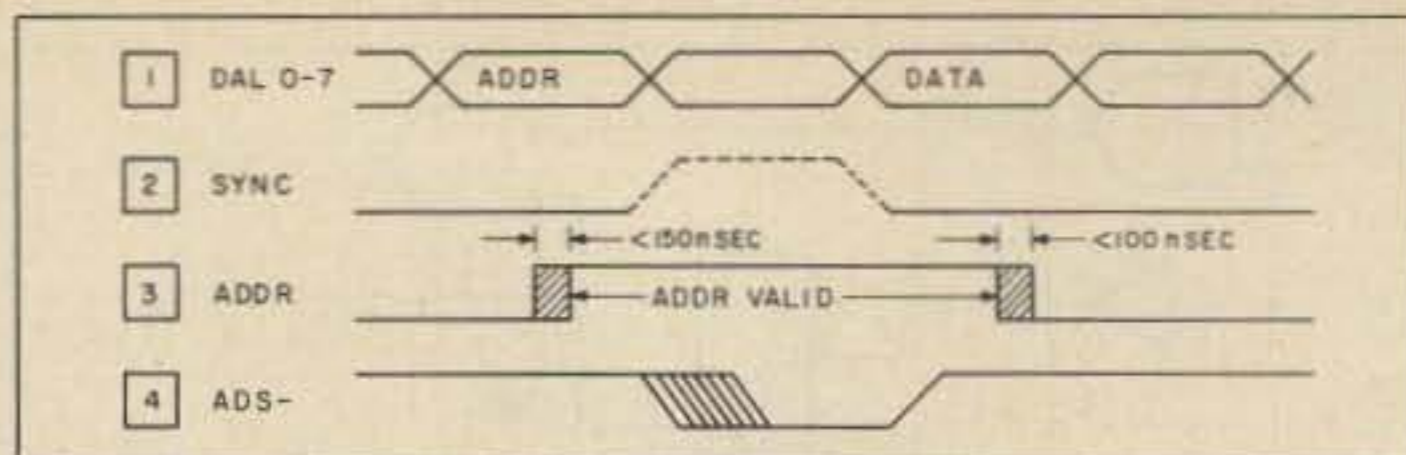

Fig. 5. Some miscellaneous techniques.

line, and therefore the fourth line illustrates another method of showing this, but only at the beginning of the signal.

### Summary

Timing diagrams are just one of several useful tools for evaluating, designing, and

analyzing logic circuits. It's like anything else ... the more you use it, the better tool it becomes.

If you've been waiting for the punch line regarding "the illogical characteristics of logic circuits," I'm afraid there really isn't one. But, there are times during the course of troubleshooting a digital monster that I (and others) have been known to throw up their hands and scream, "Is there really anything *logical* about this mess!?" Usually, after sitting down and analyzing the "mess" (with a timing diagram, or other means), we find that there is. ■

High True Condition	Low True Condition
STRB+	STRB-
STEP	STEP
EADR	NEADR
CRST	CRST'
INTF	INTF L
INIT	*INIT

Table 1. Examples of signal notation.

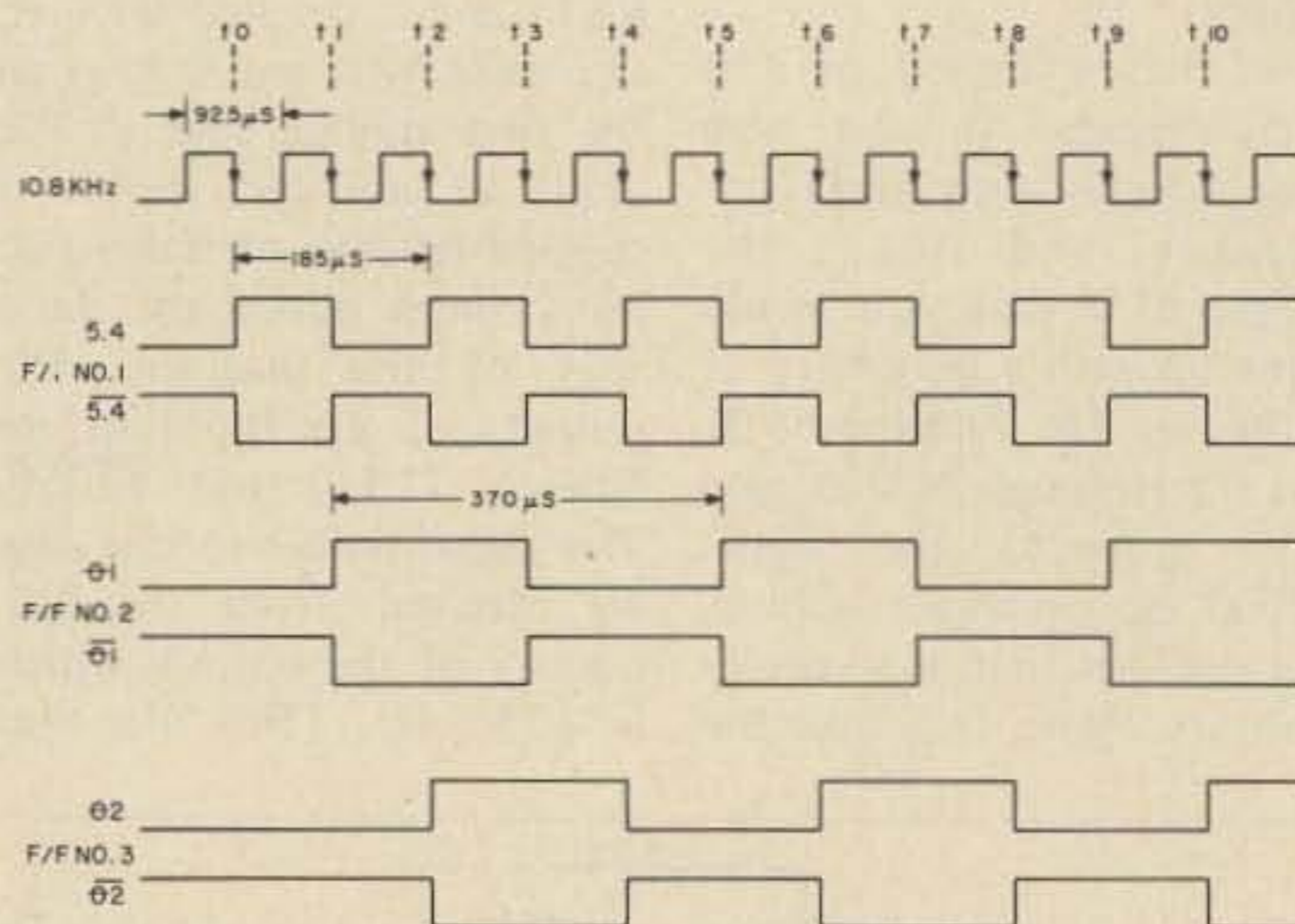
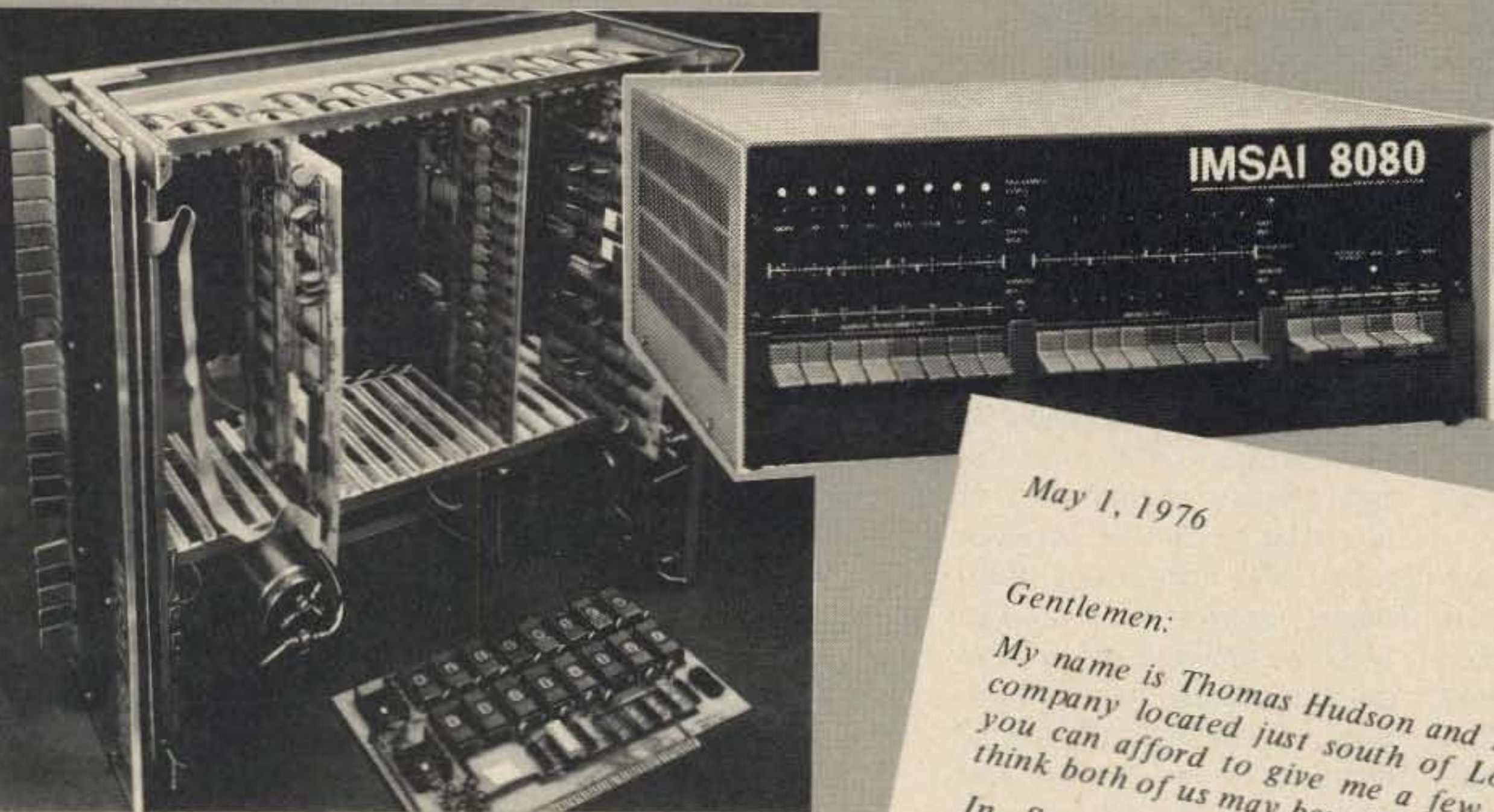

Fig. 6. Timing diagram for exercise circuit. Hopefully your diagram came out the same as the one shown here. Let's discuss it briefly. Flip flop #1 divided the input frequency by two, and we came up with 5.4 kHz. Flip flop #2 divided the 5.4 kHz by two and we now have a frequency of 2700 Hz. In order to make this circuit work you must take the input conditions to flip flop #3 prior to the trailing edge of the  $t_1$  clock pulse (i.e., a low should have been clocked to the "Q" output, as shown here). The high output ( $\ominus 1$ ) from flip flop #2 won't be clocked into flip flop #3 until clock  $t_2$ . This circuit has generated a frequency of 2700 Hz at four different phases. Consider signal " $\ominus 1$ " as  $0^\circ$  Phase, and " $\ominus 1$ " will be the  $180^\circ$  Phase. " $\ominus 2$ " is  $90^\circ$  removed from  $0^\circ$  Phase (and is therefore the  $90^\circ$  Phase). Signal " $\ominus 2$ " is  $180^\circ$  removed from  $90^\circ$ , and must therefore be the  $270^\circ$  Phase.



- IMSAI 8080 Kit, \$540.00
- IMSAI 8080 Assembled, \$829.00
- IMSAI 4K Low Power Memory Board, \$125.00

## OTHER PRODUCTS OF EXCEPTIONAL MERIT

*The I/O board and printer were developed for our in-house commercial products. They are extremely well-built, of high quality and are excellent for the discriminating hobbyist.*

### MMI Model **I/O PENER**

- 6 PORTS of parallel which can be any combination of in and out (software control)
- 5 PORTS in and 1 out, 2 in and 4 out, etc.
- 2 PORTS serial interface, or 20 mil current loop and one RS 232 or both PORTS either type.
- Board select 110 to 9600 baud.
- Kit price ..... \$219.95/each
- DECWRITER LA 36 II 30 CPS printer brand new in box from factory, air shipped to your door ..... \$1776.00

### MMI Model 40P

- 5 x 7 dot matrix impact type
- 40 column alphanumeric printer w/PS, case and interface to IMSAI/MITS
- Double size print under software control - 1.25 lines per second.
- Assembled price ..... \$599.00/each
- Introductory price ..... \$519.00/each

*TERMS: Cash, check, or money order. We cannot accept any charge cards; however your bank will advance you the cash - your payments are the same. Make out your check and mail to:*

# MICROPROCESSOR MARKETING, INC.

28120 PEACOCK RIDGE DRIVE, SUITE 806, RANCHO PALOS VERDES CA 90274

*Inquire as to quantity club discounts - IMSAI products only.*

May 1, 1976

Gentlemen:

My name is Thomas Hudson and I am President of a small company located just south of Los Angeles, California. If you can afford to give me a few minutes of your time, I think both of us may benefit.

In September of 1975 I decided to attempt to sell microprocessor-based computing systems to the commercial market. I visited every microprocessor-based kit manufacturer in the United States, and questioned numerous people in the industry. For many reasons, all of which hold true today, I decided on the Intel 8080 family of microprocessors as the best hardware choice. In November of 1975 we decided on a product offered by a company in San Leandro, California, IMS ASSOCIATES INC. Before Christmas we had 3 IMSAI 8080 kits on the way, and they have operated flawlessly ever since we turned on the power. We still use these original kits as development tools and for some really neat games. The IMSAI 8080 microprocessor kit is of the highest quality available. Company management is excellent, the engineers are first-class, deliveries are almost on time (within days, not months), and the ability to run DEC derived BASIC and FOCAL is a powerful not to be overlooked advantage. Once over the usual arguments for and against various chips, assuming you decide (wisely) on the 8080, the obvious best choice is IMSAI. I feel from experience that you cannot buy a better microprocessor-based kit.

Probably the most frustrating problem faced when designing digital circuitry is control of timing. After working out a design on paper, one usually breadboards the circuit to prove it out. In accordance with Murphy's well-known laws, there will be several logic errors which will then be apparent but very elusive. Depending upon the complexity of the design, the errors may be (but usually are not) easily located and corrected.

A number of tools are helpful in tracking down these problems — the logic probe and oscilloscope probably being the most helpful. A logic probe establishes the steady-state status of various points in the circuit, but tells nothing about pulse widths or repetition rates. The oscilloscope is used to visually illustrate these waveshapes, pulse widths, and repetition rates. What most scopes do not show is the time relationship between pulses at different locations in the circuit. Sometimes this relationship is crucial in searching out a problem that may be caused by "glitches" (extremely short pulses caused by unexpected and unwanted time overlaps). Well-equipped laboratories use special multi-channel logic scopes for this sort of work, but most of us are not equipped with the kilobuck pocketbook required to manage this. Even a

dual channel high speed scope requires a considerable investment.

While such a scope would be most welcome in any experimenter's laboratory, most of us must settle for a relatively inexpensive general purpose scope. Fortunately, it is neither difficult nor expensive to build an adapter to display multi-channel logic signals. The adapter permits viewing up to 8 channels of logic signals simultaneously, and thereby examination of the relative timing between them. Although analog waveshapes cannot be displayed (you can use your scope without the adapter for this function), it will show the low or high states, in precise time positions, of any signals present in TTL or DTL circuits.

Almost any general purpose scope should work with this adapter, but it is recommended that it be equipped with a triggered sweep. The viewing of simple repetitive signals without a triggered sweep can be frustrating enough, but attempting to lock onto one of eight channels being displayed may be virtually impossible. If you are using a scope without this feature, I highly recommend that you consider adding a new triggered sweep, even if you do not build this adapter. The attractive scope described by WØACR in 73 (November/December, 1975) includes such a circuit, which could be easily added to any

Robert A. Johnson  
5707 - 101A Ave.  
Edmonton, Alberta  
Canada T6A 0L9

# Eight Trace Scope Adapter

-- test accessory  
for digital timing

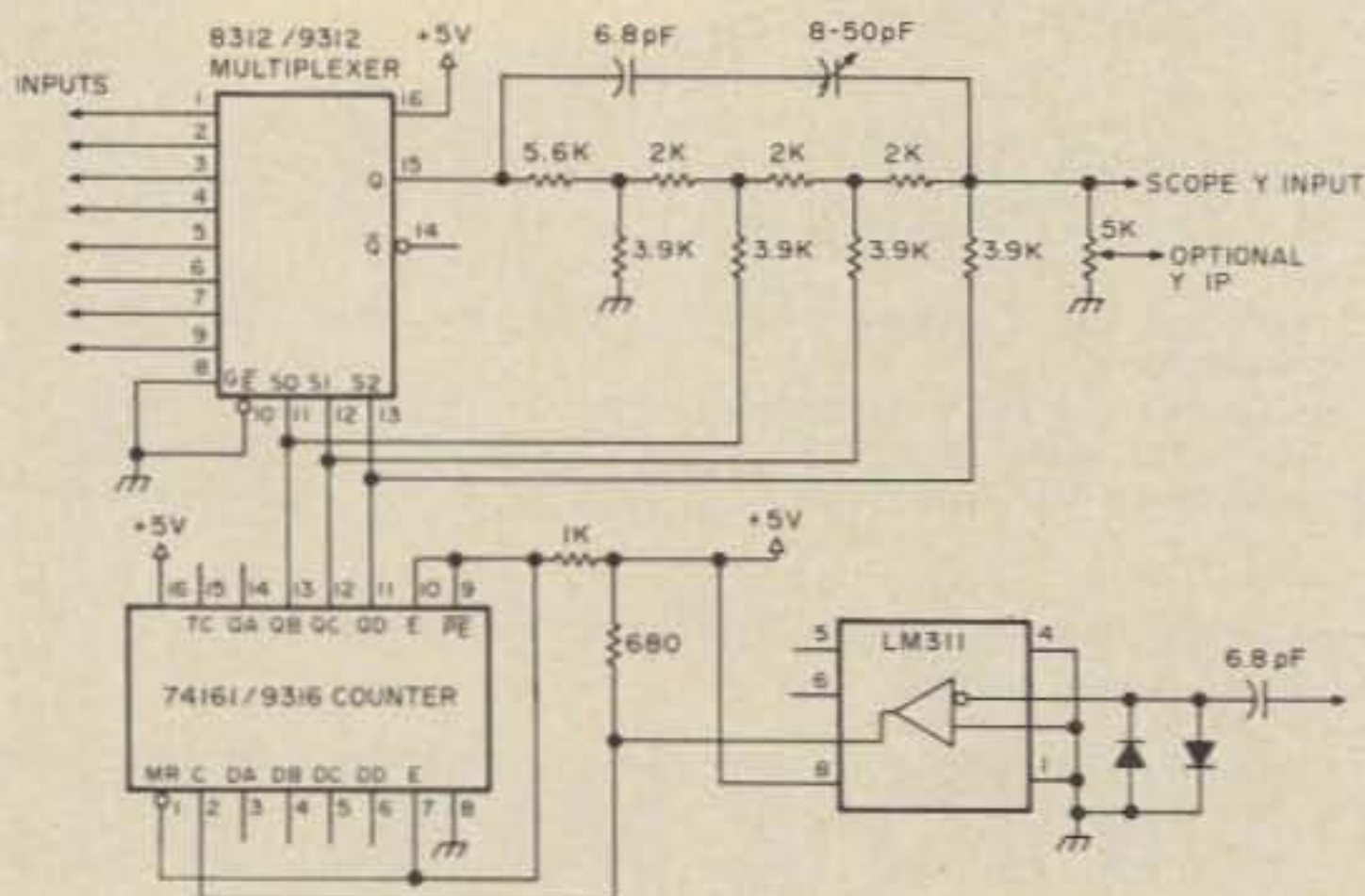

Fig. 1. Schematic.

scope. *Radio Electronics* for February, 1975 (p. 143), has another simple 2 IC sweep circuit. Scope bandwidth is not critical unless you are working with really high speed stuff, and a 4 MHz bandwidth will let you examine almost all you need to see. You must have a way to externally trigger the scope sweep, and you will have to find the sweep signal or blanking pulse to permit changing the input channels during the retrace interval.

The circuit itself is very simple: A small capacitor couples the scope sweep circuit to a voltage comparator (you may find it necessary to adjust the size of the capacitor for reliable trace switching). The sweep retrace causes a negative excursion at pin 3 of the LM311, forcing its output to go high. Each time this occurs, a 16 stage counter advances one count. Three output bits of the counter are connected to an eight-to-one 9312 multiplexer, which selects each input in turn, and outputs to pin 15. If most of your work is at the lower frequencies, use the low order 3 bits of the counter, instead of the 3 high order bits shown. When using the 3 high order bits, you may use the adapter with a dual channel scope operating in the "alternate" mode.

A ladder network commonly used for digital to analog conversion is used to position each channel on the screen. The resistors should be well matched (i.e., 1%), but satisfactory results have been experienced with 5% units. If your display is not evenly spaced vertically, try swapping resistors in this network for best spacing. The variable capacitor is used to compensate for the scope input capacitance, and should be adjusted for best wave-shapes. The output potentiometer will not be required in most instances, and should not be used unless essential.

Fig. 2(a). PC board (full size).

Note that a 74161 or 9316 synchronous counter is recommended, rather than a 7493 or similar asynchronous type. It is unlikely that propagation delays in an asynchronous counter would result in viewable glitches on the scope in this application, but it is good design practice to always use a synchronous counter where the output states are decoded and fed back to the counter.

The adapter may be built on a small printed circuit board (note the IC polarity!) and installed inside your scope. However, it may be very conveniently enclosed in a small box which can be located near and powered from the digital project, and coupled to the scope via cables. You will need the usual vertical input cable and a sweep-out signal. Many scopes have an "Ext" jack for horizontal input, which is permanently connected to the input of the horizontal amplifier. When the sweep is running, this also happens to be the output of the sweep generator!

Should you experience difficulty in obtaining a stable trace, the sweep circuit may not be advancing the counter properly. Try a

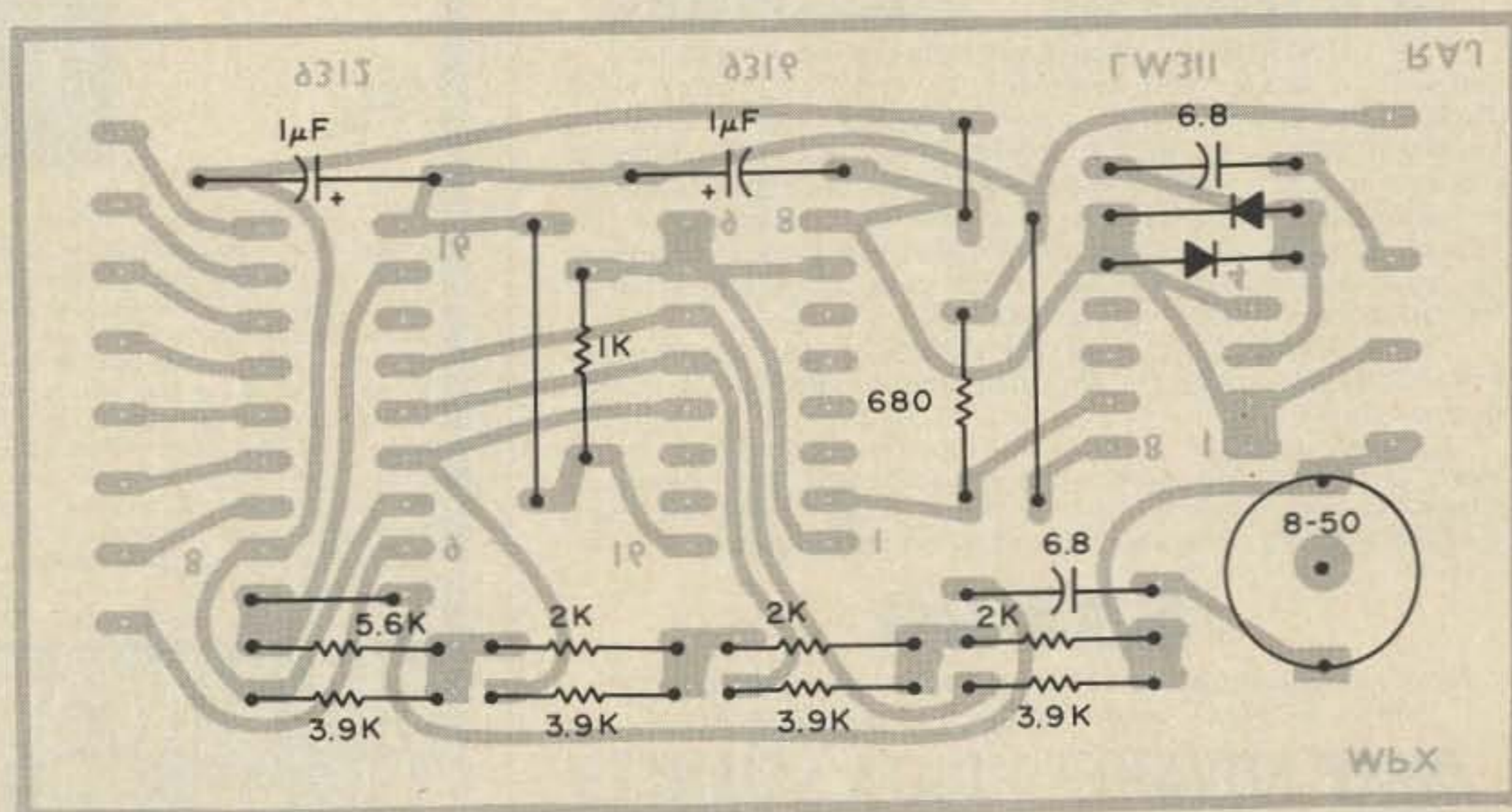
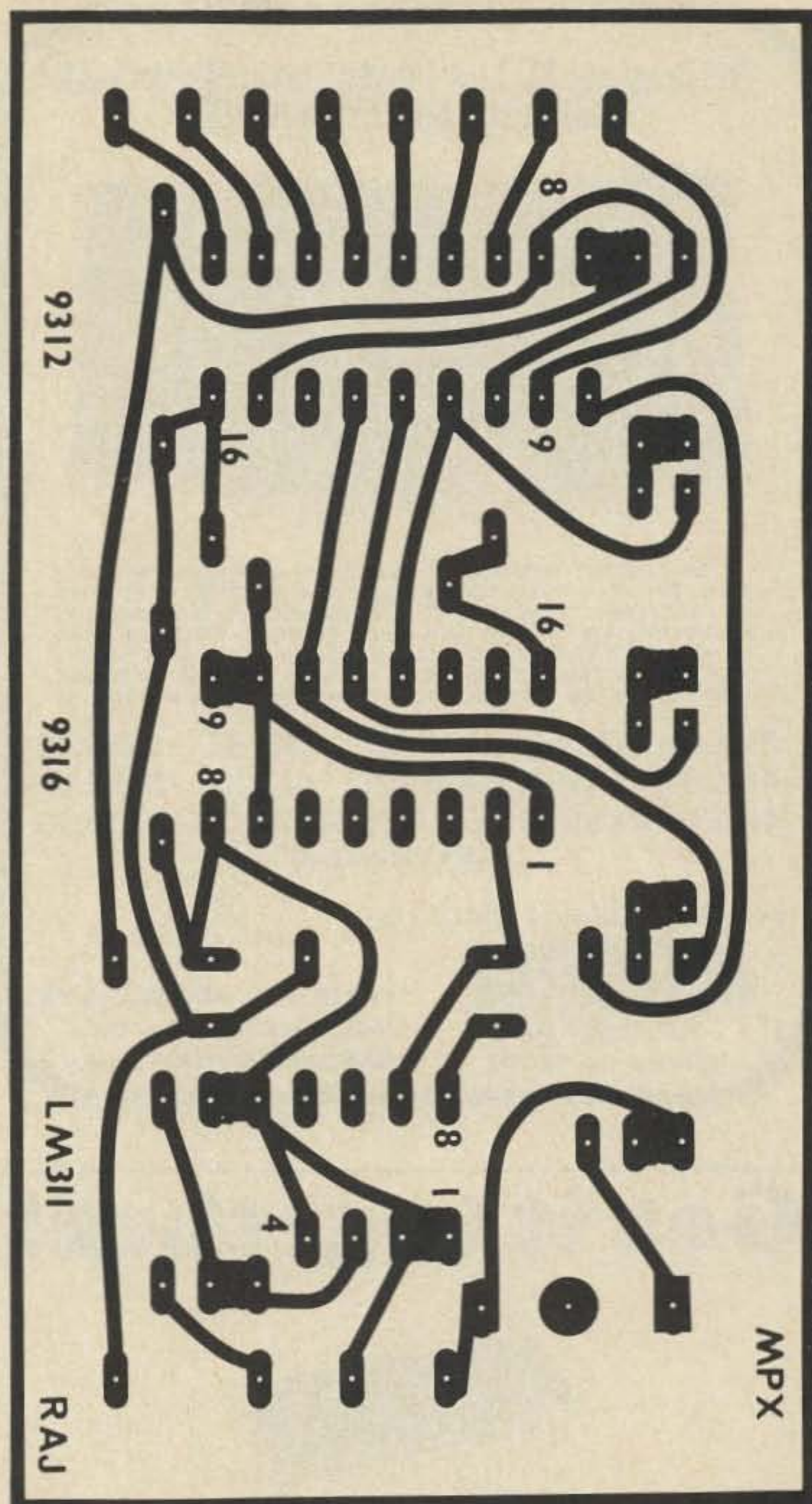
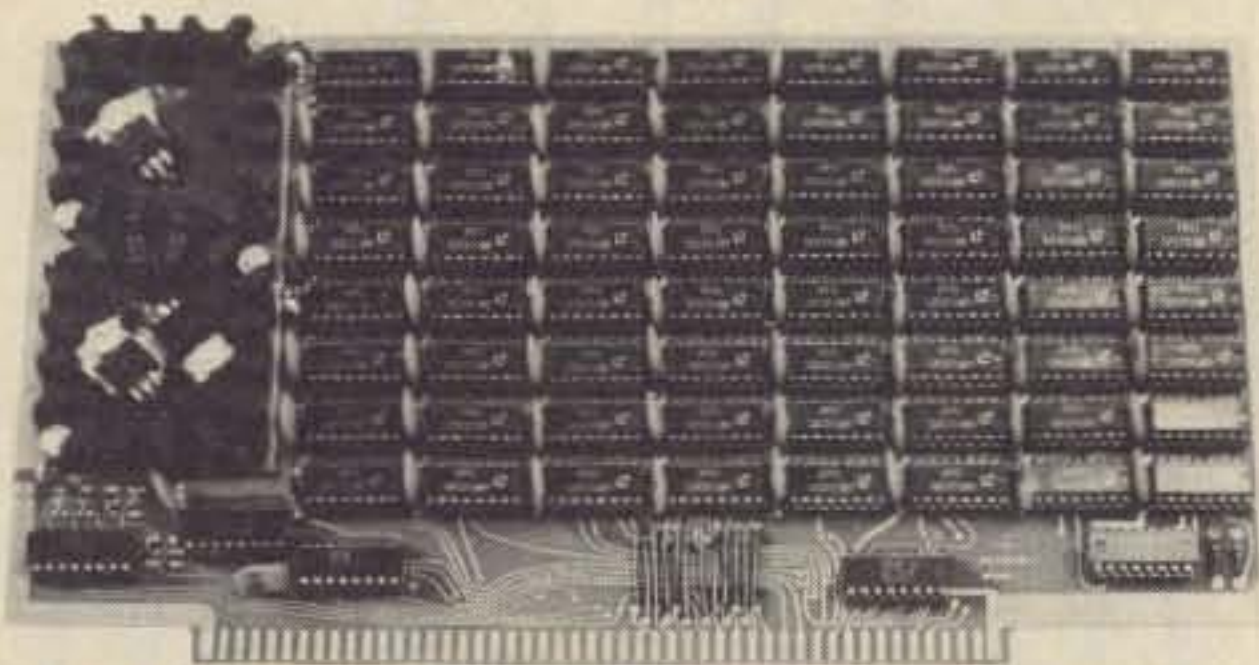

Fig. 2(b). Component layout.

**The Original 8K Low Power Static Memory Kit  
Still at the Low Price of \$285.**



• PLUG DIRECTLY INTO 8800 or 8800 BOARD COMPATIBLE SYSTEM • TURNS OFF YOUR WAIT LED (8080 RUNS AT FULL SPEED) • LESS THAN 520 nS ACCESS AND CYCLE TIME • LOW POWER (LESS THAN 225 mA/1K at 5 VOLTS) • 100% NEW INDUSTRIAL COMPONENTS • EASY INTERFACE TO HOME BREW • 50/50 GOLD PLATED EDGE CONTACTS • EPOXY BOARD WITH PLATED THRU HOLES • 8K or 4K WITH EXPANSION • SOCKET PROGRAM 4K or 8K ADDRESS SLOT • DETAILED ASSEMBLY AND THEORY

**8K LOW POWER RAM KIT: 8KLST \$285.00**  
**4K LOW POWER RAM KIT: 4KLST \$159.00**  
**4K EXPANSION FOR 4KLST:4KXST \$139.00**  
 PLUS SHIPPING

WRITE TO DAVE (K6LKL) at

**DUTRONICS**

P.O. Box 9160,  
Stockton CA 95208

ON DISPLAY AT  
BYTE SHOP  
MT. VIEW CA  
MARSH DATA SYSTEMS  
TAMPA FL

\*CALIF. RES. ADD SALES TAX  
\*MASTER CHARGE - OK  
\*BANKAMERICARD - OK

different spot in the sweep circuit first. You may find it necessary to invert the signal by using pin 2 of the LM311 (grounding pin 3) if the signal is reversed in polarity. The 74161 counts on a rising edge, and reverse polarity will cause the channel change to occur in mid-sweep, with obvious visible distortion. You may find experimenting with the size of the sweep input capacitor to be helpful, but be careful to avoid distorting the sweep. The scope will not be as bright as usual, as the trace is being time-shared among 8 signals. A slight adjustment of the brightness control compensates for this. The variable capacitor is adjusted for best waveform using a 10 kHz or higher digital pulse. A 74151 multiplexer is functionally identical, but not pin compatible, with the 9312 unit. The LM311 comes in either a mini-dip or T0-5 package. As

the pin-outs are identical, either may be used with the circuit board shown.

Using your multi-trace scope is a delightful experience: You see all of those signals at the same time, and can really tell what is going on. Remember that you must trigger the sweep from the slowest signal you are viewing; otherwise, you will not be able to sync the slower signals. Also, be aware that the inputs are not protected in any way, and connection to potentials outside of the proper logic levels will destroy the multiplexer IC. Protective diodes may be added on the input lines to give marginal security, but care, plus a socket for the 9312, are probably adequate.

The small investment required to construct this unit will be quickly repaid the first time you use it to track down a problem.

Happy hunting! ■

**Get it together!**

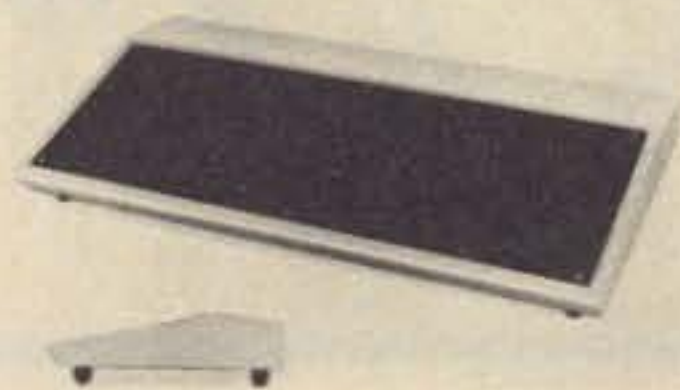

**In a Univue™ enclosure**

The UNIVUE keyboard/instrumentation enclosure is designed to house your keyboard, keypad, low profile video display generator, or small micro-processing system. Great for keyboard Morse or RTTY applications, too! Special design features include a 1/16" welded steel body of rugged two piece construction, and an outside removable flush mounting aluminum front panel. Over 200 cubic inches of rear space is available for your self-contained power supply and support electronics. Overall size (excluding feet) is 24x12x3".

The UNIVUE body is coated with light gray lacquer type primer/surfacer, ready for the color co-ordinated custom finish of your choice.

Shipped complete with 23x8" mill finish aluminum panel, heavy duty non-skid rubber feet, all necessary panel mounting hardware, and finishing tips. Shipping weight is 17 lbs., with FAST delivery from stock. Absolutely no back orders!

**\$32.95**

plus \$4.50 postage and handling. Ohio res. add 4% sales tax  
Sorry: no C.O.D. Send check or money order today to:



**ADVANCED DATA SCIENCES**

P.O. DRAWER 1147 - MARION, OH 43302 - (614) 382-7917

**Your basic 4k RAM**

**\$88**

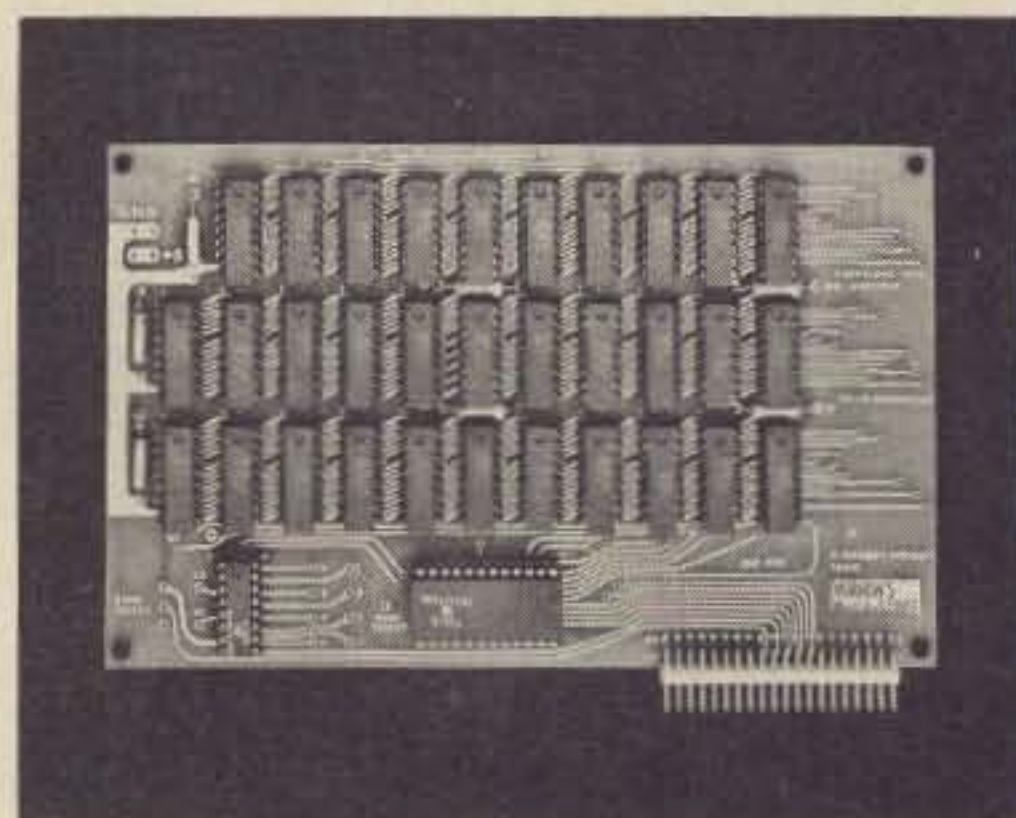

"This is a very easy to use 4Kx8 memory board. It uses an 8 bit, tri-state data buss, making it a natural for adding on to your SC/MP, 6800, 6502, 2650, and other microprocessors. In this manner, experimenters can evaluate different uPs using a single, general purpose memory block. The kit uses 2112s and runs from a single +5V supply, typically drawing 750 ma. The board can occupy any 4K boundary in your system. As an extra feature, these boards may be easily stacked on top of each other using plastic standoffs (4 included with kit). This RAM also comes with a 40 pin flat cable connector, which is compatible with the popular, low-cost JOLT microcomputer system.

"I feel this is a specially good deal for either JOLT owners who wish to add inexpensive memory, or for experimenters who need some memory to help turn a solo processor into a useful system. It's also ideal for SC/MP uPs; in fact, order two 4Kx8 boards and we'll throw in a SC/MP microprocessor for \$10 extra."

---- George Morrow

**MORROW'S** BOX 6194  
ALBANY, CA 94706  
**Micro-STUFF**

WE PAY POSTAGE, but Californians pay sales tax. No CODs. BankAmericard® welcome.

SEND FOR OUR FLYER!





ACOUSTICAL MODEMS –  
 ORIGINATE ONLY  
 USED–UNTESTED  
 \$20.00 ea./2 for \$35  
 By various manufacturers  
 – three types shown. No  
 user selection except when  
 two or more ordered and  
 requested to be of same  
 type.

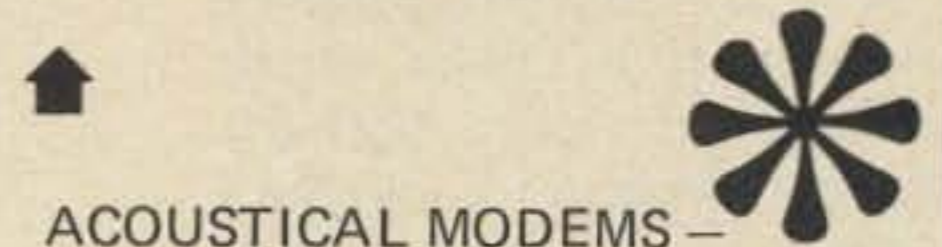

ACOUSTICAL MODEMS –  
 ORIGINATE ONLY  
 USED–UNTESTED  
 IN WOOD ENCLOSURE  
 \$20.00 ea. 2 for \$35

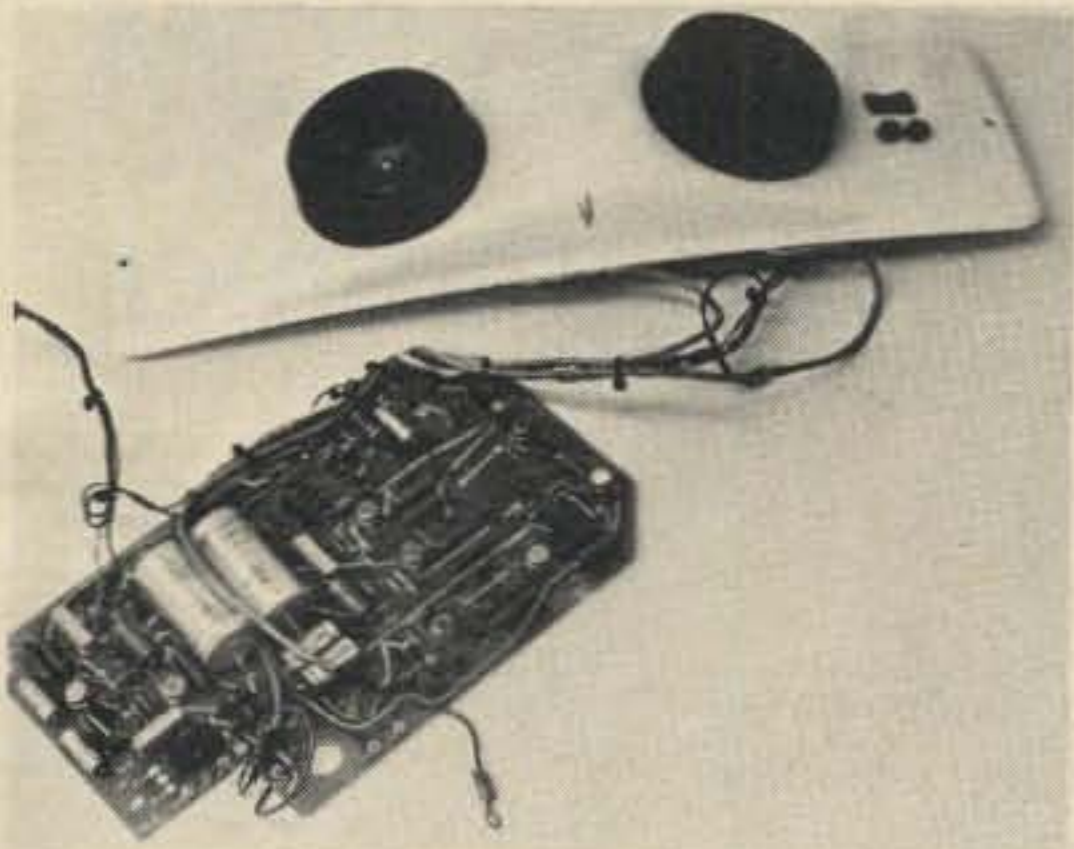

ACOUSTICAL MODEMS –  
 ORIGINATE ONLY  
 USED–UNTESTED  
 \$15.00 ea. 2 for \$25  
 Physically fit into Model 33  
 Teletype.  
 Manufactured by Paragon.

None of the above includes prints, documentation, connecting cords, connectors. Equipment is shipped on an as is – where is basis.

**\* CARTERFONE MODEL 318 ASYNCH MODEM**

- Hard wire
- TTY or RS-232B interface
- Originate only
- Up to 300 BPS

USED–UNTESTED ..... \$25.00  
 USED–TESTED ..... \$80.00

**\* PENRIL TTY-300 ASYNCH MODEM TTY BUILT-IN**

- Up to 300 BPS
- Half or full duplex
- Auto answer-manual originate
- Bell system 101C compatible

USED–UNTESTED ..... \$35.00  
 2 for \$60

TERMS: Cash, Check, Money Order. Add \$2.00 for shipping and handling. Texas residents add 5% sales tax.

\* These come with prints.

**WE ALSO HAVE:**

1. 30CPS hard-copy terminals (Univac, Beta, Gulton, etc.) \$200.00+up.
2. Teletypes model 33 \$400.00+up
3. Line printers \$795.00+up
4. Card readers \$200.00+up
5. Paper tape readers and punches
6. Digital tape cassette drives
7. IBM selectric terminals

**WE SELL THE FOLLOWING EQUIPMENT**

- \* Mini-Computers and Micro-Computers  
 DEC/PDP  
 DG/NOVA  
 DATAPOINT
- \* Computer Peripherals  
 Printers, Readers, Punches  
 Tape Drives, Disk Drives
- \* Computer Terminals  
 Teletypes  
 CRT'S  
 Selectrics
- \* Computer Support Equipment  
 Card Files, Tape Racks  
 Disk Pak Cabinets, Raised  
 Flooring
- \* Forms Handling Equipment  
 Bursters, Deleavers, Joggers  
 Inserters, Imprinters
- \* Data Processing Supplies  
 Continuous Forms, Cards,  
 Tapes, Disk Paks
- \* Computer Hobby Equipment

**ONDURE COMPANY**

1224 SECURITY DRIVE • DALLAS, TEXAS 75247 (214) 630-4621 TWX-910 - 861-4985

Quite a few articles have been published recently in 73 and other magazines wherein a PROM has been required. Usually a schematic like the one in this article is supplied along with instructions for programming, but not the construction of the programmer. This is the one I built for programming the 8223 PROM used in my CW ID. (See 73, July 1976, page 58.) The 8223 PROM is a 32 word by 8 bit memory element. It is similar to the circuit in the Signetics *Bipolar Memories* book, but I added a built-in 5 volt regulator and a low current LED to verify the output programming. The switches are also somewhat different. The only power needed is a regulated 12.5 volt supply or auto battery.

### Construction

The programmer is built in a 4" x 6" x 2" aluminum chassis. A parts layout is given, but may be altered to suit your own taste, depending on the enclosure used. All wiring is point-to-point, with only one PC board used. The PC board has a socket for the 8223 and also provides solder pads for wiring.

First, lay out the top panel. Then drill the holes for the switches and LM309K. Drill two 7/16" holes and file

Geoffrey W. Kufchak WA1UFE  
15 Fourth Ave.  
Westover AFB MA 01022

to a rectangular shape for the IC socket to fit snug. Using the PC board as a template, mark and drill the two mounting holes. Drill a hole somewhere on the panel for the LED and two holes on a side panel for the power connections. Deburr all holes and cutouts. Apply lettering if desired.

Mount all the parts on the chassis with appropriate hardware, using insulated washers where necessary. A few ground lugs will also help. Install the resistors, capacitors and LED first, then wire the output selector switch, using color-coded wire to avoid confusion. Then wire the address and program switches, the Vcc and ground

# The PROM Zapper

## -- build this simple PROM programmer

lines.

### Operation

Recheck all your wiring and then program according to the following instructions:

1. Connect programmer to a regulated 12.5 volt source.
2. Set the PROGRAM-VERIFY switch to OFF.
3. Insert the 8223 to be programmed in the socket, paying attention to the location of pin 1.
4. Set the ADDRESS switches to the proper word to be programmed.
5. Set the OUTPUT switch to the output to be programmed for the corresponding word.
6. Set the PROGRAM-

VERIFY switch to PROGRAM.

7. Momentarily depress the PUSH-TO-PROGRAM switch to program a logic 1. (Do not exceed 1 second.)

8. Set the PROGRAM-VERIFY switch to VERIFY. The LED will light indicating a logic 1 has been programmed. Set switch to OFF.

9. Repeat steps 4 through 8 to program the rest of the chip.

Only logic 1s need be programmed as the chip comes with all outputs at a logic 0. Also, by using the VERIFY position, pre-programmed chips may be tested and a truth table made up. ■

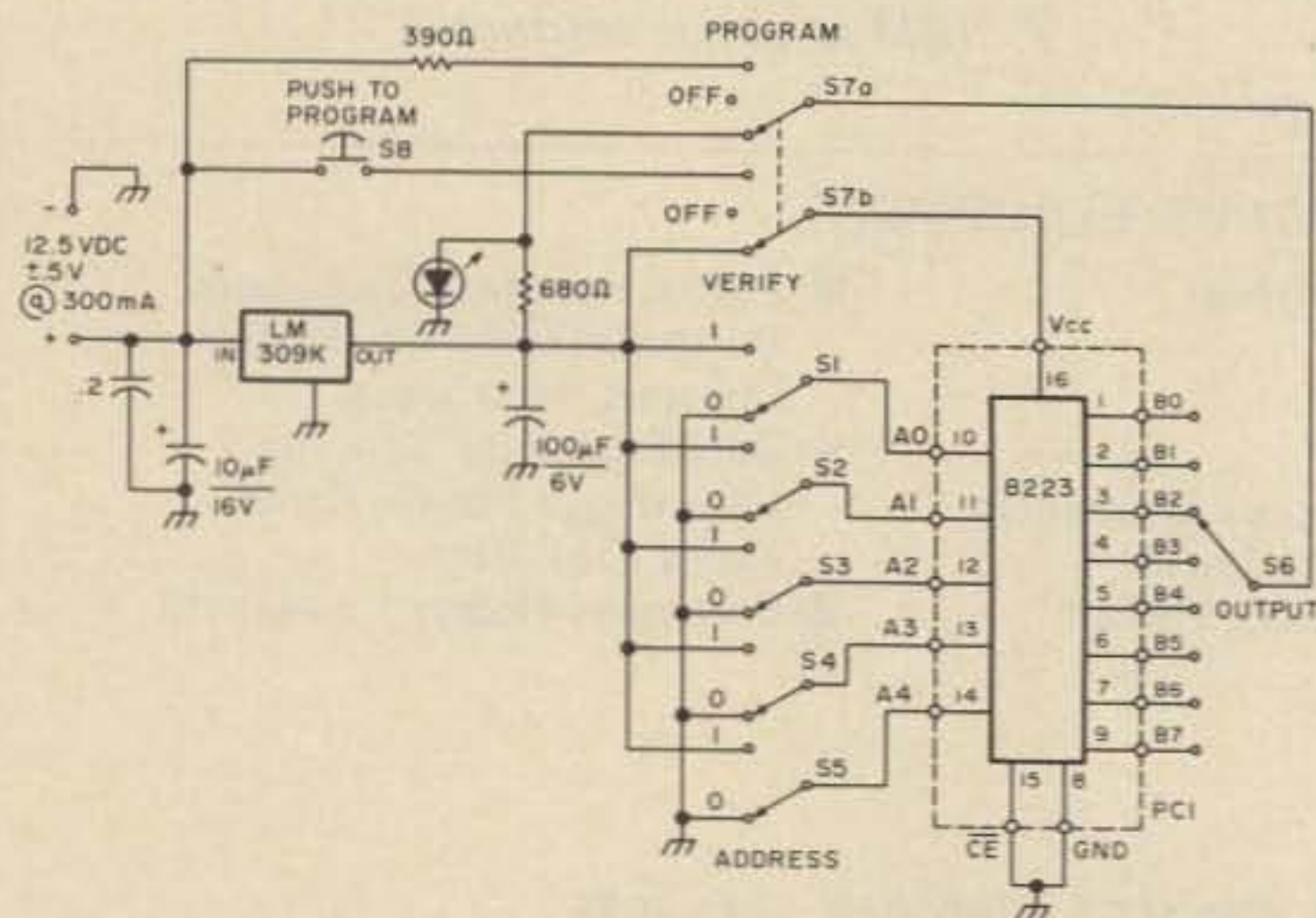

Fig. 1. 8223 PROM programmer schematic diagram.

### Parts List

(Most parts available at Radio Shack)

- |       |                                    |
|-------|------------------------------------|
| 1     | LM309K                             |
| 1     | 390 Ohm 1/2 W                      |
| 1     | 680 Ohm 1/2 W                      |
| 1     | LED                                |
| 1     | .2 uF disc                         |
| 1     | 10 uF 16 V                         |
| 1     | 100 uF 6 V                         |
| 1     | Chassis RS#270-245                 |
| 2     | Banana jacks                       |
| 1     | 16 pin DIP socket                  |
| PC1   | Printed Circuit-RS#276-024         |
| S1-S5 | SPDT RS#275-326                    |
| S6    | 8-position rotary or thumbwheel    |
| S7    | DPDT Neutral Center RS#275-1545    |
| S8    | SPST Momentary Contact push-button |

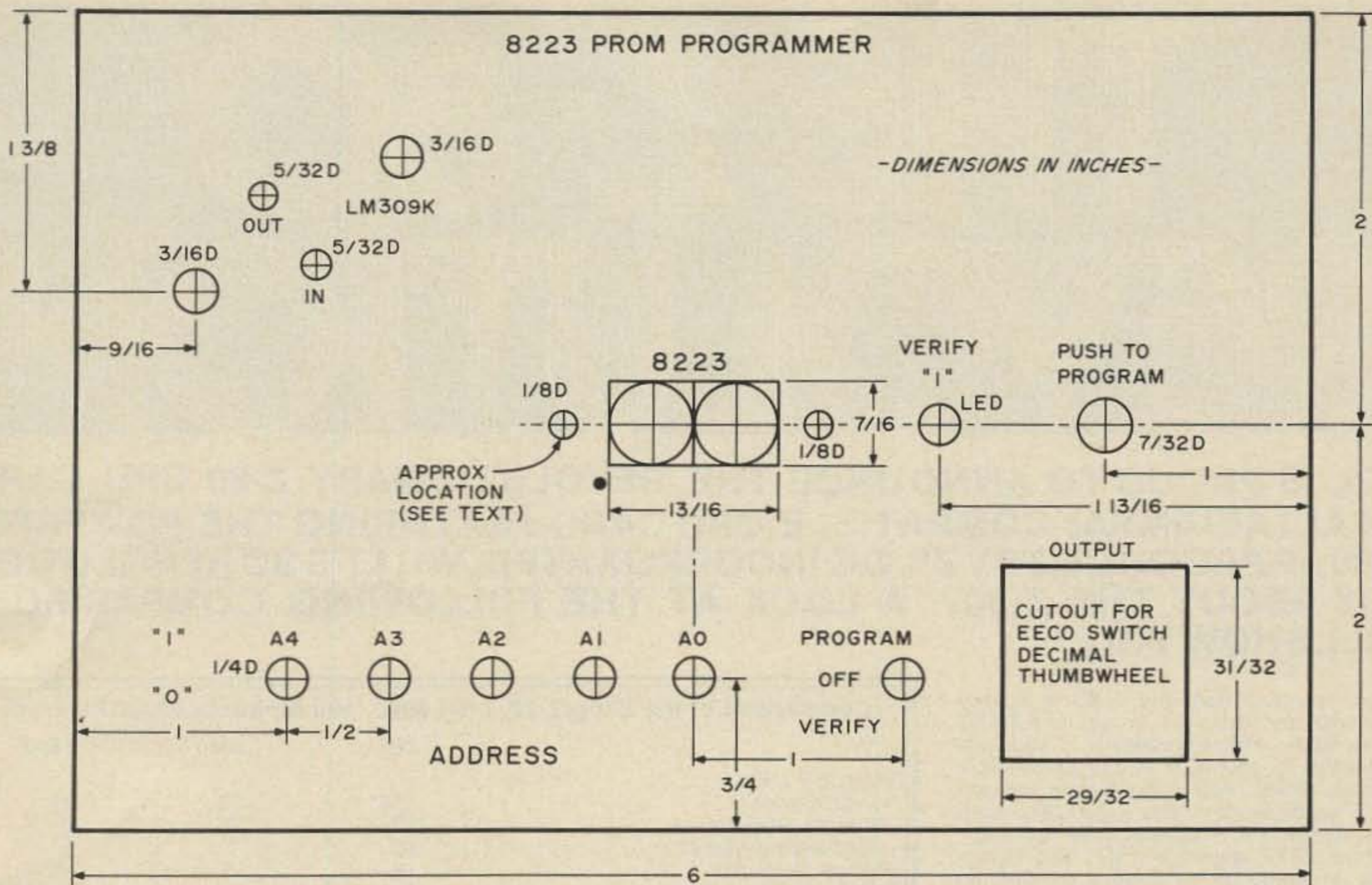

Fig. 2. Parts layout of top panel (full size) with suggested labeling. Hole for LED should ensure tight press-fit.

### ECONOMY KITS

- SUPER-PONG™ TV GAME BY "VISULEX" (AS FEATURED IN JUNE 76 RADIO ELECTRONICS) COMPLETE KIT (P.S. & CASES) .. \$150.00
- TVT-II W/2K MEM. CAPABILITY (TVT-III) ..... \$114.75
- AUDIO CASSETTE INTERFACE ..... \$28.50
- MOTION DETECTOR (ULTRASONIC); ASSEMBLED ..... \$18.75
- 4K MEM. CARD (2102) FOR ALTAIR & IMSAI ..... \$75.00

### MORE BARGAINS

- NSL 4944; AC/DC UNIV. LED .. \$ .95
- LM 3909 LED FLASHER ..... \$ .99
- PWR. XFORM, 115v PRI; 3EA SEC: 9v, 2A; 15v, 2.7A; 20v, .7A; (4LB) ..... 9.50
- MINI XFORM, PRI: 115v; SEC: 7V, 1.5A (9 oz.) ..... 1.25
- COMPUT. CAPS: 11,500 MFD, 25WV: \$.75; 12,000 MFD, 35WV .85
- SELF-GRIP MINI TEST PROD ..... .50

FREE CATALOG  
SEE OUR JULY AD

**ELECTRONIC DISCOUNT**  
sales  
138 N. 81 STREET  
MESA AZ 85207

### ALDELCO SEMI-CONDUCTOR SUPERMARKET

#### RF DEVICES

2N3375 3W 400 MHz ... 5.50	2N6080 4W 175 MHz ... 5.40
2N3866 1W 400 MHz ... .99	2N6081 15W 175 MHz ... 8.45
2N5589 3W 175 MHz ... 4.75	2N6082 25W 175 MHz ... 10.95
2N5590 10W 175 MHz ... 7.80	2N6083 30W 175 MHz ... 11.85
2N5591 25W 175 MHz ... 10.95	2N6084 40W 175 MHz ... 16.30

#### HEAVY DUTY RECTIFIERS

200 Volt 100 Amp D08 .....	8.50
200 Volt 250 Amp D09 .....	12.50
400 Volt 2 Amp Silicon Rectifier RCA .....	15 for .99
1000 Volt 2 Amp Silicon Rectifier RCA .....	10 for .99
10,000 Volt Silicon Rectifier Erie 65 mA .....	2.95

#### ALDELCO KITS

Digital Clock Kit. Hours Minutes & Seconds. Large half inch LED readouts. Elapsed time indicator, 12 hour format with 24 hour alarm. Snooze feature, AM PM indicator, power supply, power failure indicator. Complete with wood grain cabinet. \$23.95

LOGIC PROBE KIT, LED indicators \$14.95

#### LEDS

Jumbo Reds, long or short bulb .....	6 for \$1.00
Jumbo Orange, Grn, Clear Red or Grn .....	5 for \$1.00
209 Series, Green, Orange, Yellow or Red .....	5 for \$1.00
RL2 or Macro Red .....	5 for \$1.00

#### ZENERS

1N746 to 1N759 400 Mw ea .25	1N4728 to 1N4764 1 w .....	.35
10 assorted zener diodes unmarked .....		1.98

#### TC106B SCR .....

MPSA14 .....	.90
2N3055 .....	.99
2N2926 NPN .....	10/.99
2N3904 or 2N3906 .....	10/.99
2N5496 or 2N6108 .....	.35
FT0601 FET .....	.99
40673 .....	1.55
741 or 709 14 Pin DIP .....	.25
555 Timer .....	.75
556 Dual 555 .....	1.75
200 Volt 25 Amp Bridge .....	1.00
1N914 - 1N4148 10 for .99	
1N34 - 1N60 - 1N64 10 for .99	

#### TTL's

7400 .....	.20	7475 .....	.80
7401 .....	.20	7490 .....	.80
7403 .....	.20	7492 .....	.80
7404 .....	.25	74121 .....	.60
7405 .....	.25	74123 .....	1.10
7406 .....	.45	74162 .....	1.25
7407 .....	.45	74165 .....	2.00
7411 .....	.30	74166 .....	1.75
7413 .....	.85	74177 .....	1.35
7430 .....	.20	74181 .....	3.90
7437 .....	.50	74192 .....	1.50
7442 .....	1.10	74193 .....	1.45

We quote on any device at any quantity. All items postpaid. \$5.00 min. order. Send stamp for catalog. NYS add tax.

**ALDELCO**

P.O. Box 341 A, Lynbrook NY 11563

### Computer Hobbyists!

Bargain hunt and sell via ON\_LINE  
18 issues/year — \$3.75  
Free sample issue

ON\_LINE, 24695 Santa Cruz Hwy.  
Los Gatos CA 95030

### QSL FORWARDING

To US (all K,W)-5c per card, to other hams or ISWLs-4c. 10 percent discount to members of participating clubs - just send me a list of members' calls & a single address.

W7IZH QSL SERVICE  
Box 17987-S  
Tucson, AZ 85731

### LOGIC PROBE KIT



**\$14.95**

(plus shipping)

Now! A Digital Logic Probe kit at a realistic price. Red, Green, and Yellow light emitting diodes signal the presence of logic levels encountered in digital circuitry. Utilization of transistor and integrated circuit switching techniques permit the DIGAPEAKE-A to indicate logic 1, logic 0, and pulsing circuit conditions. Complete kit including easy instructions is available now from ...

Chesapeake Digital Devices Inc.  
P.O. BOX 341  
Havre de Grace, Md. 21078

# THE Z-80 REVOLUTION

**TDL IS PROUD TO ANNOUNCE THE REVOLUTIONARY Z-80 CPU CARD, AN ALTAIR/IMSAI COMPATIBLE CPU CARD FEATURING THE POWERFUL Z-80 uP PRODUCED BY ZILOG INCORPORATED. WHAT'S SO REVOLUTIONARY ABOUT THE Z-80? A LOOK AT THE FOLLOWING COMPARISONS WILL SHOW YOU:**

As you can see, the Z-80 is a very powerful and fast uP - in fact its a NEXT generation microprocessor. And its available to you in a totally compatible format, NOW. Just unplug your current CPU card, plug in the Z-80 CPU, load a program, and you're up and running - with a NEXT generation uP. The power and versatility of the Z-80 is unequalled in the uP field, and it opens the door to tremendous developments in the state of the art. More powerful, faster, and less memory consuming versions of your current 8080 software are just a part of the possibilities the Z-80 provides. (TDL's own 8-K BASIC for the Z-80 will be available in September.)

**Each Z-80 CPU kit comes complete with:**

- Prime commercial quality boards, IC sockets etc.
- easy to follow instructions
- Zilog's Z-80 Manual
- Schematics
- An easy to understand and apply user's guide
- TDL's Z-MONITOR on paper tape (soon to be available in deluxe PROM version)
- And membership in the Z-80 user's group.

**Move up to the Z-80. Only \$269.**

**THE FASTEST RAM?** The high speed capability of the Z-80 demands an extra-fast RAM to back it up, and TDL's new Z8K RAM board fills the bill. The Z8K is an 8K by 8 static RAM with the fastest access time in personal computing - 215ns. Its the only RAM in personal computing fast enough to let the Z-80 run at full speed with no wait states. If that isn't enough, it also happens to be one of the lowest powered RAMs around as well. Only 150 ma typical current load on the 5V supply. That makes the Z8K run cool -and perfect for battery standby operation as well. Other so-called "low power" 4K RAM boards can't compete with these specs. Its the perfect match for the Z-80, and its features and low cost make it a perfect match for ANY uP. (It's fully Altair bus compatible of course...) Price: Only \$295

**WHAT ABOUT QUALITY?** All TDL products share one thing in common - exceptionally high quality. The quality starts with engineering that is dedicated to keep your system state of the art at the lowest possible cost. Consider also the "Qual Division" whose ONLY purpose is

Comparison of the Zilog Z-80, Intel 8080, and Motorola 6800CPU chips			
	Z80	8080	6800
<b>NUMBER OF:</b>			
Instructions	158*	78	72
Internal Registers	17	7	6
Addressing Modes	10	7	8
Voltage Required	+5	+5,-5,+12	+5
Standard Clock Rate	DC-3MHz	0.5-2MHz	0.1-1MHz
Clock Phases	1	2	2
Clock Voltage	4.2	8.4	4.8
DynamicRAM refresh and timing signals without slowing down CPU or requiring additional circuitry	Yes	No	No
Single instruction memory to memory and memory to I/O BLOCK TRANSFERS	Yes	No	No
Single instruction SET, RESET, or TEST of any bit in accumulator, any general purpose register, or any external memory location	Yes	No	No
Single instruction BLOCK SEARCH of any desired length of external memory for any 8-bit character	Yes	No	No
Non-Maskable Interrupt and TTL compatible inputs	Yes	No	Yes
Internal sync of inputs and direct strobe of outputs	Yes	No	No

\* Includes all 78 machine code instructions of the 8080A and is therefore capable of running any standard 8080A software without modification.

**ADDITIONAL FEATURES OF THE Z-80:**

- Up to 500% more throughput than the 8080A
- Requires 25% to 50% less memory space than the 8080A CPU
- Three modes of fast interrupt response plus a non-maskable interrupt
- Outperforms any other microcomputer in 4-, 8-, 16-bit applications

to keep TDL's products the best in the industry. And our products use only the finest boards available, prime components, sockets for all ICs, gold plated edge contacts and other earmarks of a commercial grade product. And its backed by a solid 90 day guarantee on parts and materials.

**SAVE MONEY NOW** Order both a Z-80 CPU card, and one or more Z8K RAM boards before September 1st, 1976, and you can deduct 10% on the total cost. Act now while this special offer lasts. (Does

not apply to COD orders.)

**HOW TO ORDER** Just send check or money order, or use your BankAmericard or Mastercharge, and your orders will be shipped to you postpaid within 30 days. COD orders must be accompanied by a 25% deposit. Your credit card order must include the serial # of the card, expiration date, and your order must be signed. New Jersey residents add 5% state sales tax. For more information, send for our free catalog.

Dealer Inquiries Invited

**TDL**

(609) 392-7070

TECHNICAL DESIGN LABS INC.  
342 COLUMBUS AVENUE  
TRENTON, NEW JERSEY 08629

Character or Function	ASCII character to match Baudot code
A	C or #
B	Y or 9
C	N or period
D	I or )
E	A or !
F	M or carriage return
G	Z or :
H	T or 4
I	& or F
J	K or +
K	Letter O or /
L	R or 2
M	\ or <
N	L or ,
O	X or 8
P	6 or V
Q	W or 7
R	J or line feed
S	E or %
T	P or Zero
U	G or ' or Bell
V	Λ or >
W	S or 3
X	= or ]
Y	U or 5
Z	Q or 1
CR	H or (
LF	B or "
Letters	- or ?
Figures	; or [
Space	D or \$

Table 1. ASCII keyboard characters which will produce corresponding Baudot characters. Only bits one through five of the ASCII character are used.

# Sneaky Baudot

-- with an ASCII keyboard!

Here are some apparently unrelated items to fit together.

1. From what I have heard and copied RTTY-wise, most of us hams are not the world's greatest typists; hunt and peck sounds like the order of the day.

2. The April '76 issue of *73 Magazine* has a great idea article on a RTTY generator by WA6JMM.

3. There are lots of keyboards around but they mostly spit out their dope in ASCII whilst we ply our trade with Baudot.

4. There are splendid circuits for getting Baudot from an ASCII keyboard, but they tend to be exotic and mildly expensive.

compromise our aesthetic sensibilities just a smidgin, accept hunt and peck as a legitimate life style, we can take the ASCII keyboard, rearrange the key caps a bit, throw away bits 6 and 7 of the ASCII code, and feed the result into the versatile TTY generator of WA6JMM.

The accompanying table shows the cross referencing of Baudot to the first five bits of the ASCII code. Naturally you will have a lot of keys on the standard ASCII keyboard that you will have no use for as the entire Baudot budget uses but 31 keys. Notice that at least two of the ASCII keys will produce the same Baudot code group character, which gives you some choice as to how to lay out your revised keyboard. ■

If we are willing to

Type	Description	Price	THIS MONTH'S Specials			
11C01FC	High Speed Dual 5-4 Input	OR/NOR \$15.40	<b>NEW</b> Fairchild VHF Prescaler Chips			
11C05DC	1 GHZ Counter Divide By 4	\$74.35				
11C05DM	1 GHZ Counter Divide By 4	\$110.50	New			
11C06DC	UHF Prescaler 750 MHz Flip/Flop	D Type \$12.30				
11C24DC	Dual TTL VCM	\$2.60	RF TRANSISTORS			
11C44DC	Phase Freq. Detector	\$2.60				
11C58DC	ECL VCM	\$4.53	RCA 40290 12.5v. Ft. Typ. 500MHz 2 watts min. at p. in 0.5 watts \$2.48			
11C70DC	600 MHz Flip/Flop With Reset	\$12.30				
11C83DC	1 GHZ 248/256 Prescaler	\$29.90	TUBES			
11C90DC	650 MHz ECL/TTL Prescaler	\$16.00				
11C90DM	650 MHz ECL/TTL Prescaler	\$24.60	7289/2C39A 10 for \$12.50			
11C91DC	650 MHz ECL/TTL Prescaler	\$16.00				
11C91DM	650 MHz ECL/TTL Prescaler	\$24.60	MHZ electronics			
95H90DC	250 MHz Prescaler	\$9.50				
95H90DM	250 MHz Prescaler	\$16.55	2543 N. 32ND STREET PHOENIX, ARIZONA 85008 PH. 602-957-0786			
95H91DC	250 MHz Prescaler	\$9.50				
95H91DM	250 MHz Prescaler	\$16.50	MMCM918 \$2.50			

C. L. Robertson K1MRK  
6 King Richard Drive  
Londonderry NH 03053

Steve Ciarcia  
124 Hebron Ave.  
Glastonbury CT 06033

# Simple Graphics Terminal

-- using inexpensive surplus equipment

Several designs have been presented in the past that would, in one way or another, allow the display of graphical data on a CRT. Although these several

approaches will accomplish the stated objective, each has the shortcomings of requiring the builder to fend for himself when it comes to the actual output device to be

used. The graphics display described in this article takes advantage of a group of ready-made subassemblies, which when interconnected and properly interfaced with the graphics driver portion of this project, will result in a first class graphics display with capabilities far in excess of those attainable with a simple oscilloscope adaptation or a raster-scan television readout device.

To illustrate that point, consider the following. The raster-scan home television type display, such as that used in several popular alphanumeric displays, can be used. But, the display is overly complicated and will appear as a connection of blocks rather than as pure line segments. Consequently, since graphics display implies a random display, a single memory cell is required for every defined location on the screen, with the block size determining the maximum number of locations and hence, the resolution. The finer the detail required, the

smaller the blocks and the more memory cells required. If the complete screen is to have 256 elements or blocks, these individual units could be defined by four bit X and Y addresses and 32 bytes of 8 bit memory. The resolution in a display with these few points would be terrible.

An 8 bit microprocessor works best with multiples of 8 bits. If we, therefore, made a display incorporating an 8 bit X address and an 8 bit Y address, it would fit nicely and be easy to work with. This display would be of fairly high resolution since it now has 65,000 discrete locations. The only complication is that it will require 8K bytes of memory to store, regardless of the picture being displayed. This will always be the case in any digital storage system. The computer must account for every dot on the screen (65K) and, depending on whether there is a one or a zero stored in the memory location defining that spot, it will make it either black or white. Additional information is

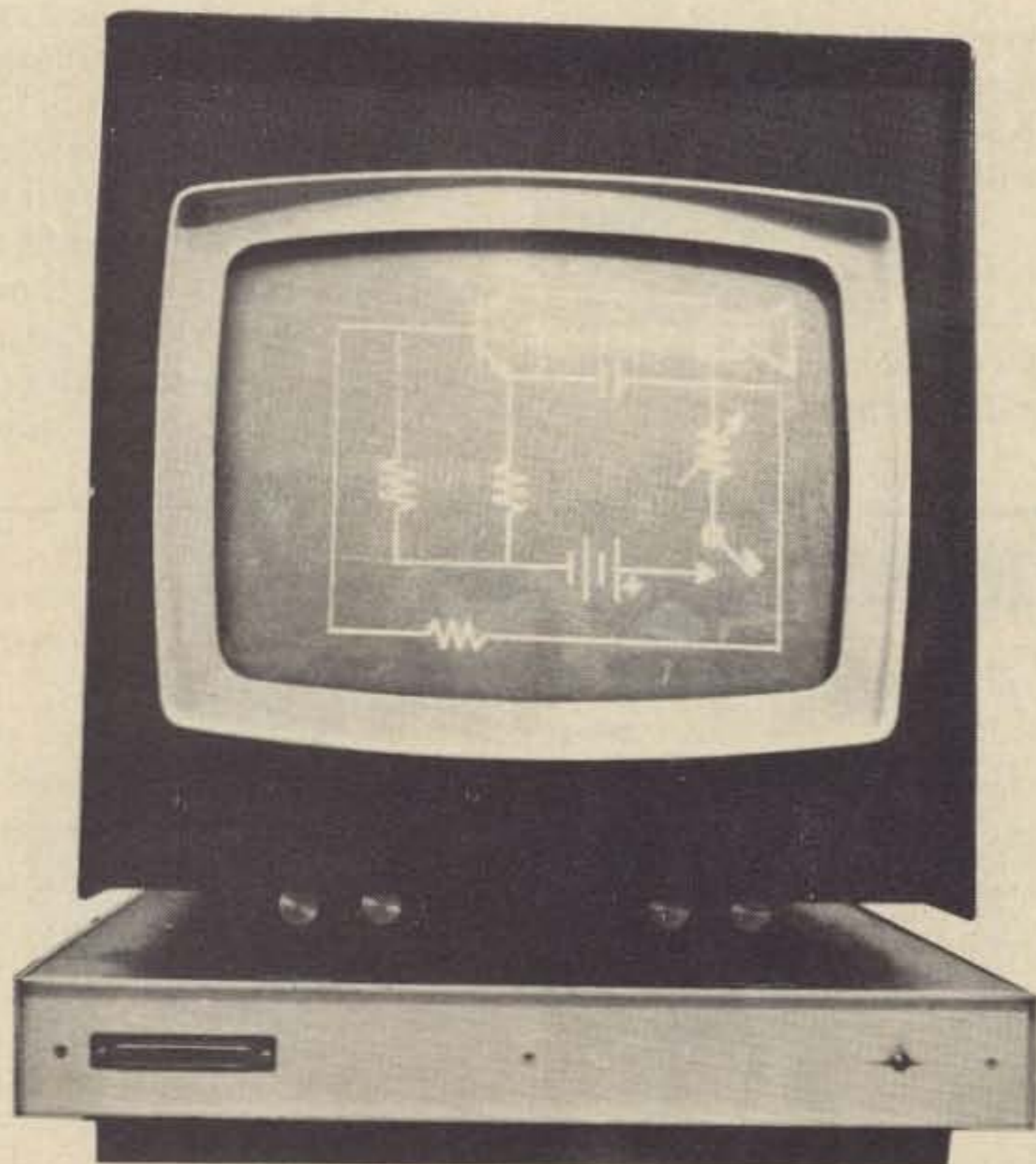

required if gray tones are involved.

A much better system is one which incorporates this same high resolution but does not have to provide storage for anything other than the actual displayed points. The one described here is just such a system.

### What Is Graphics Display?

Everybody knows what a graphics display is, right? We all know that a graphics display will allow us to observe phenomena in that familiar Etch-A-Sketch format drilled into us since kindergarten days. Using appropriate input signal conditioning, a graphics display can be just about anything we want it to be... from a simple tic-tac-toe pattern to a very complex schematic or logic diagram. We can even play games such as Space War and tennis, display a graph of the current stock market trends, plot temperature and humidity, and on and on.

That's terrific. Everyone should have one, you say? Agreed. The following paragraphs will describe, in sufficient detail, a method whereby the average experimenter can acquire all of the parts and subassemblies needed to construct just such a device. Basically, this graphics display consists of a group of ready-made subassemblies which, when modified per the instructions contained herein, will result in a very high performance X-Y display. The readout device is a 12" diagonal TV-like CRT with a very bright green-blue trace. This CRT has a medium persistence, which is desirable in the interests of flicker reduction. Additional electronics are described to transform the output instructions from any microprocessor into the analog voltages and positioning signals used to actually produce the various

line segments that will make up the desired display of information.

It should be noted that this article and the graphics display described are the result of the joint efforts of the authors to pull together the many bits and pieces of pertinent information and ideas which abound in the field today. We've drawn on ideas, and in some cases used portions, of previously described circuits to arrive at the final configuration presented here. Our only claim to originality is that we have integrated these various data into a workable, practicable and AVAILABLE piece of equipment intended to do a specific task well, but also have a degree of expandability for new techniques of the future.

So much for the commercial. Now it's time to get on with the description of the project. We'll start with the basic CRT display, since that is the easiest portion. What could be easier than simply sending off an order for a couple of boxes full of already constructed gear and waiting patiently for the order to arrive? Well, there's a wee bit more to it than that, but not much. Suntronix Company (Londonderry, N.H. and Lawrence, Mass.) is once again selling a package

of electronic subassemblies that include all of the basic electronic items needed to construct the X-Y display portion of this project. These subassemblies include all of the power supplies, both high and low voltage, the vertical and horizontal deflection amplifiers, a special yoke for the magnetically deflected 12" CRT, four PC cards, a chassis and base to hold these subassemblies and a neat enclosure to hide all of the above. Also included in the package price is a keyboard, ASCII encoded, with an enclosure that fits nicely with the rest of the equipment. Complete data in the form of schematic diagrams for each subassembly is included. As received from Suntronix, these subassemblies will interconnect without major modification to provide the basic X-Y display. So, first thing to do is fire off an order to Suntronix for the complete package of subassemblies.

Now the hard part. You must decide whether you want to build the CRT driver from scratch or order one from Suntronix. Whichever route you choose, you should read the following technical description anyhow, so put off the hard part (the decision-making) and continue to read.

### CRT Graphics Driver

The graphics driver is the interface between the actual display and the microprocessor. It translates the binary coded coordinates presented to it through software routines to analog voltages which position the CRT beam appropriately. This driver is a fairly simple system designed to draw line segments with a very high degree of resolution, yet requires only beginning and ending cartesian coordinates to define that line segment. For example, a line running diagonally across the CRT screen from upper left to lower right (-X, +Y to +X, -Y) requires only four eight bit bytes to define the line. Beam position is proportional to the analog voltages applied to the inputs of the deflection amplifiers. The digital to analog converters (DACs) in the graphics driver convert the eight bit coordinates to the analog voltages they represent. Continuous scanning of a series of these values connects many individual line segments to produce the desired figures or pictures or whatever. Additional circuitry is included to assure a relatively uniform beam intensity regardless of where the beam is commanded to go. Also, blanking of unwanted beam

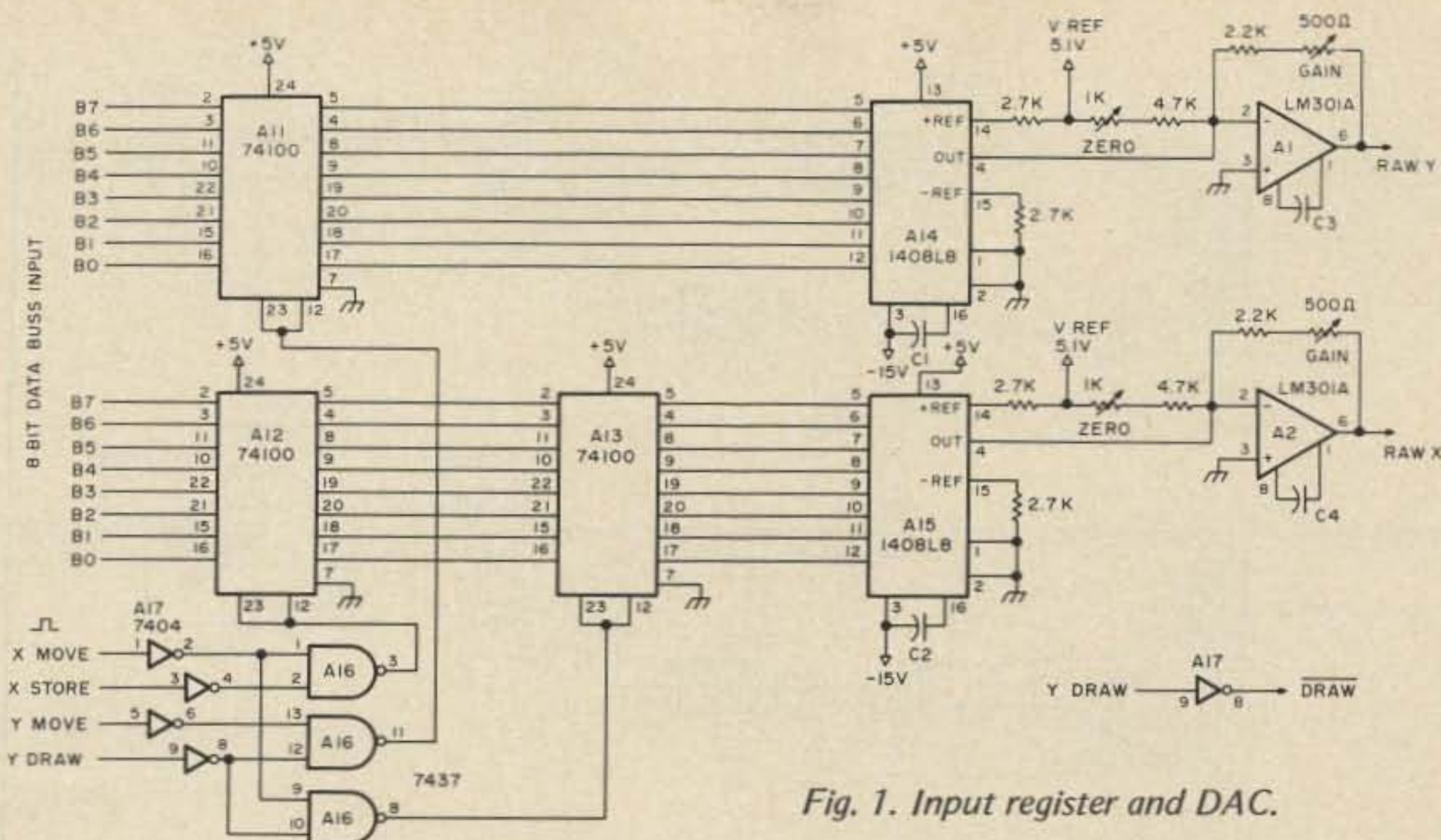

Fig. 1. Input register and DAC.

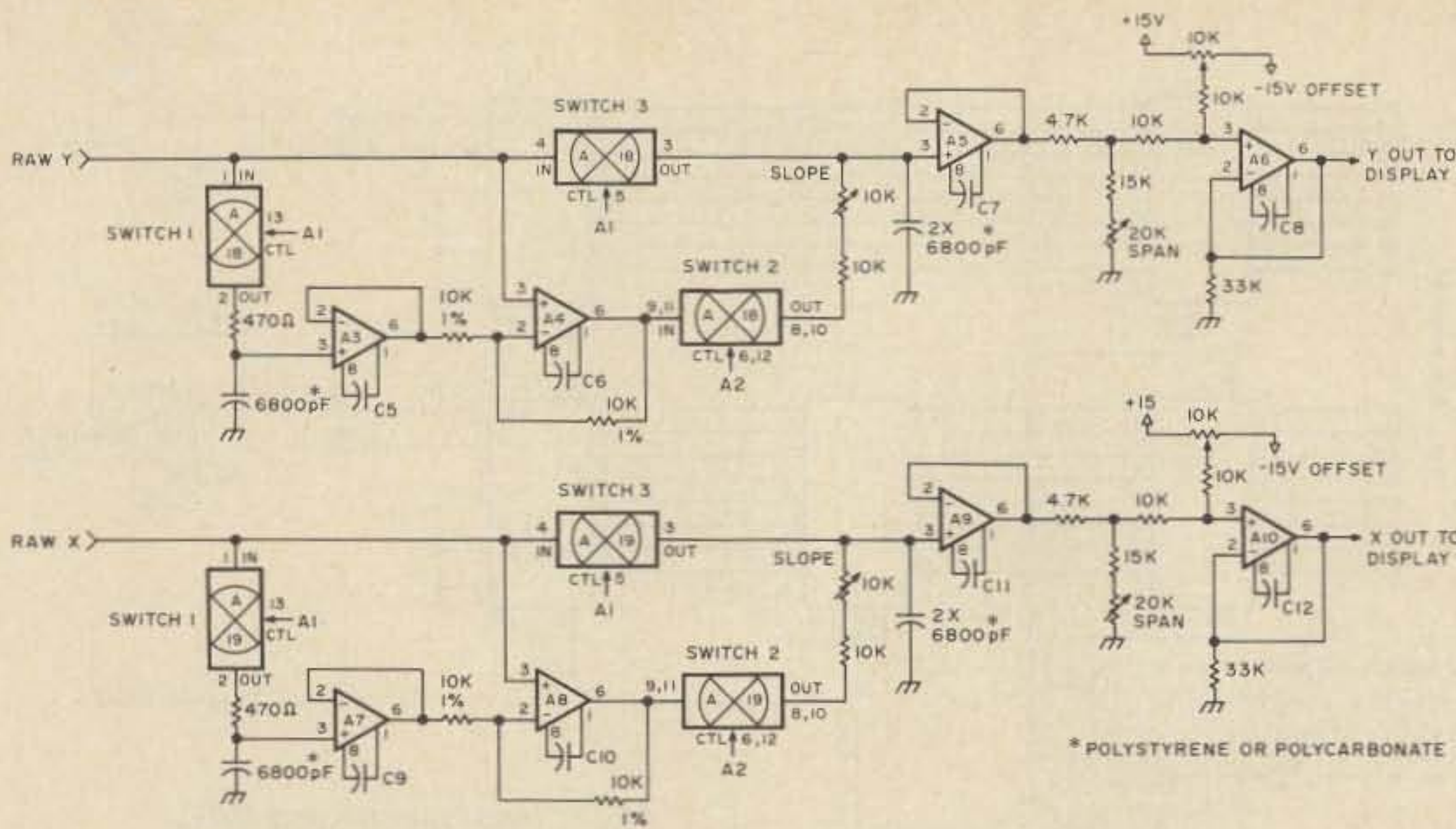

Fig. 2. Vector generator. Note: A1-A10 — pin 7 to +5 V, pin 4 to -15 V; A16-A17, A21, A22 — pin 14 to +5 V, pin 7 to ground; A20 — pin 16 to +5 V, pin 8 to ground.

movements is included.

### Input Registers and DACs

The graphics driver has been designed to be driven by any eight bit microprocessor such as the 8008, 8008-1. It is compatible with any faster eight bit machine so long as the software scanning routines do not exceed the processing and analog conversion time of the driver. Though somewhat modified, this circuit is based upon a similar design by Hal Chamberlin and presented in the first three issues of *TCH*. Basically, the design is a software graphics driver. Computer instructions are

used to output the binary position coordinates to the driver eight bits at a time; first an X position, then a Y position. Together, these sixteen bits represent the X,Y beginning position of a line segment. Next, the computer outputs the X,Y values of the ending position of that line segment and the driver unblanks the CRT beam to allow display of this motion between the start and end positions. Since this display is software driven, the total number of displayed lines is a function of the computer's speed. Refresh of the display is accomplished by having the computer scan the co-

ordinates continuously. If there are too many points, the display will appear to blink or jitter. The CRT's P31 phosphor helps to correct this condition by allowing more time between refresh cycles. This will be helpful to people with slow computers!

Four instructions are used: Xmove, Ymove, Xstore and Ydraw. They are actually four output strobes from the computer which are enabled by the transfer of position data to the graphics driver storage registers. When Xmove (the I/O instruction outputting data to whatever output port is chosen) is executed, the contents of the

microprocessor's accumulator are transferred via the eight bit data bus to an eight bit register, A13. Next a Ymove is executed and the accumulator contents are transferred to A11. Connected to these registers are two eight bit DACs, A14 and A15. The converters free run and will follow any change in value of the input registers. Within a few microseconds of data input, the respective raw X and raw Y voltages will have settled out and now represent, in analog form, the digital X and Y coordinates from the computer. As the instructions implied (Xmove and Ymove), the beam position changes to follow this new input but is not displayed since the beam is blanked during this period.

The actual analog voltage is a function of the 1408L8 DAC. This device behaves like a programmable current source set by the reference current at pin 14. In this particular design, the reference current is approximately 2.0 mA. Binary inputs to the DAC provide the equivalent fraction of the reference current at the output. For example, if the input to the DAC were 00100000, the output current would be 32/256 of the reference current. This signal is more useful and manageable in voltage form. That's the job of op amps A1 and A2. These op amps are configured as current to voltage converters with adjustable gain and offset. With an input of 00000000 binary, the output should be adjusted to a value of -2.5 volts. Adjusting the gain and offset trimmers alternately will produce the desired results. Conversely, an input of 10000000 should produce an output of +2.5 volts. This voltage range is not compatible with the display deflection amplifiers as received, and will be scaled by additional circuitry in the display driver electronics.

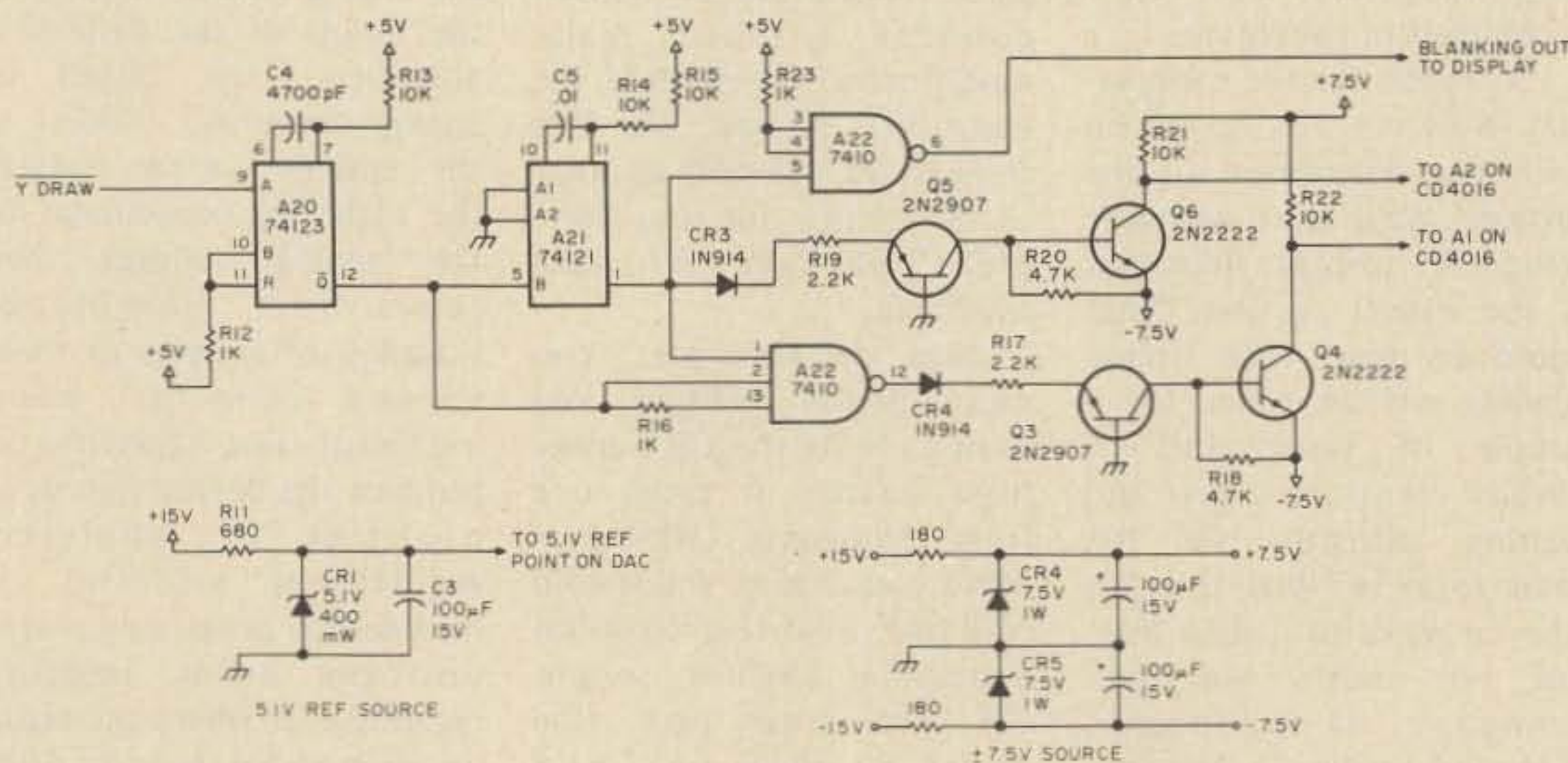
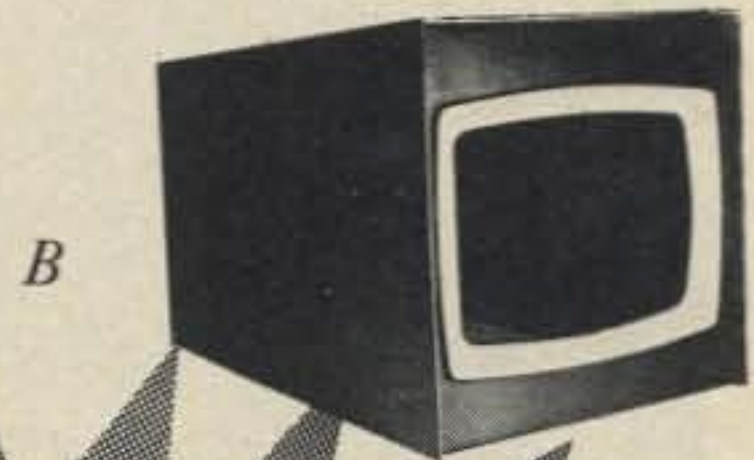

Fig. 3.



We're pleased to announce the availability of a limited quantity of various subassemblies which can be readily utilized to construct a fantastic visual read-out monitor. Each subassembly is removed from functioning systems and can be used alone or in combination with other devices to produce a SSTV Monitor, a big screen oscilloscope, a visual RTTY Monitor or even a video monitor for use with a computer. Construction articles using these subassemblies have been published in 73 with more coming in future issues. Don't miss out this time around — order one or several, but please don't delay — the supply is limited. Please call for further information.

**A. ASCII KEYBOARD** — This is a 7 bit parallel ASCII encoded keyboard. Plugs into the front of the chassis mounting base. Makes a very professional Video Readout Terminal combination. These keyboards are in like new condition, have interconnection data etched on the IC-Diode matrix PC board. They can be readily used for any ASCII encoded requirement. Similar keyboards, when available, sell for almost two times the very low SUNTRONIX price of \$39.95 FOB.



A

B

**B. ENCLOSURE AND BEZEL FOR 12" CRT** — This is the frosting on the cake. All components A thru G fit perfectly inside this enclosure. It is hinged and can be lifted for easy access to the electronics. It will really dress up any project. Measures approx. 22"L x 18"W x 20"H and weighs approx. 10 lbs. Made of steel with a handsome blue crackle finish. Get 'em while they last, for \$7.95 FOB.

**C. BASIC CHASSIS AND MOUNTING BASE for 12" big-screen CRT.** Tube can be mounted either vertically or horizontally by rotating front plate 90 degrees. Comes with base, on-off sw. and intensity control, four controls for vert. and horiz. Has plenty of room for most any electronics needed for your pet project. All subassemblies offered will perfectly fit in spaces provided. Why try to cut the metal yourself? This chassis will let you concentrate on the electronics instead of the metalwork!! Order now for only \$29.95 FOB, less CRT.

**D. FOUR PC BOARDS CHOCK-FULL OF GOODIES** — Two D/A converters, one IC-loaded logic board, and one multipurpose board. We have no schematic data for these boards at present. We will supply any data we obtain to purchasers as we get it. Of course when we finally figure out what these boards are good for, the price will change accordingly. Take the gamble now and we'll provide any data we get free of charge. Set of 4 \$19.95 FOB.

**E. VERTICAL AND HORIZONTAL AMPLIFIER Subassemblies** — Good for a conservative 150W complementary DC coupled output. Freq. resp. beyond 2.0 MHz. Parts alone worth many times the low, low price of \$24.95 ea., or both for \$39.95 FOB.

**F. CRT HIGH VOLTAGE POWER SUPPLY** — This is a real super CRT High Voltage Power supply, providing all voltages needed for any CRT. Outputs 10-14KV DC, plus 850 Vdc, minus 150 Vdc. Needs inputs of plus 5.0 Vdc, plus 15.0 Vdc and a drive signal of approx 8.4 kHz @ 1.0 vrms or more. All inputs/outputs via plug/jack cables and even has a socket/cable assy for the CRT. A very fine buy at only \$29.95 FOB.

**G. LOW VOLTAGE POWER SUPPLY** — A real brute used to supply all low voltages needed by the typical monitor. Input, 117Vac, outputs: plus 15.0 Vdc @ 10.0 A; minus 15.0 Vdc @ 10.0A; plus 5.0Vdc @ more than 2.0A, all regulated. Mounts on the rear of the Basic Chassis. Weighs approx 45 lbs. Only \$29.95 FOB.

**FLASH — FLASH — FLASH**

We have the Graphics Driver Units as described on page 116 of this issue. Production units will fit the 44 pin connector in the chassis requiring only slight rewiring. Comes completely assembled on one PC card fully tested and adjusted. Complete instructions with diagrams included for easy hookup. We will also make available a kit which includes all parts and PC card with instructions; you need only supply the solder and the labor. These Graphics Drivers are made with new factory components; no surplus or reject parts. The design is excellent and the unit operates as described in the article. Can also be interfaced to ANY X-Y Display such as an Oscilloscope or Video Display. Order now.

Fully Assembled and tested — \$119.95  
Kit, complete parts & PC — \$99.95  
PC Card w/instruct. — \$19.95

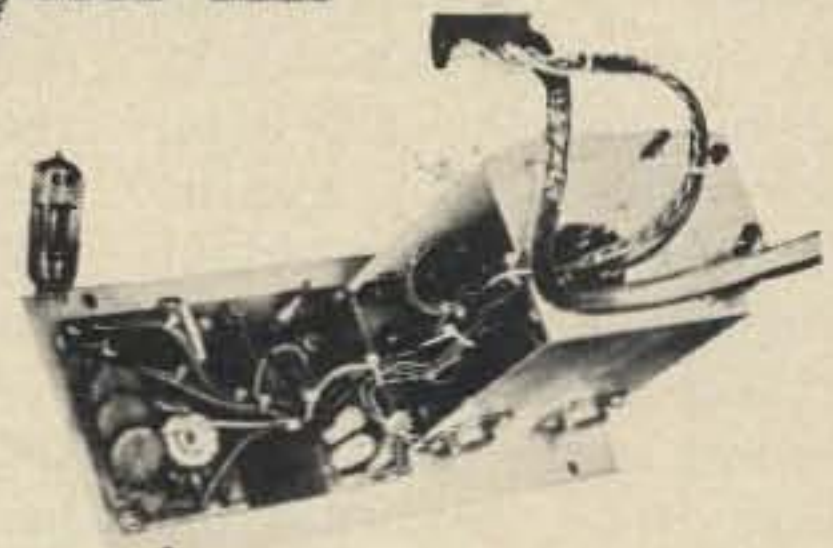
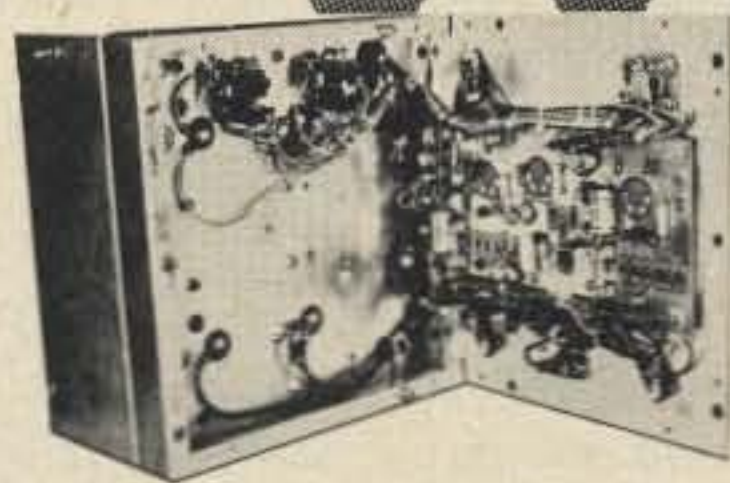

G

F

**PACKAGE DEAL** — For the really serious experimenter we'll make a very special offer — you can buy all of the sub-assemblies listed above plus a good 12" CRT, a muffin fan for cooling. DON'T miss out on this real money-saving buy. The individual prices for the sub-assemblies add up to \$207.60. You can buy the entire package for the very low price of \$175.00 FOB. Shipped only to areas served by UPS. (Does not include Graphics Driver)



**SUNTRONIX COMPANY**

360 Merrimack Street, Lawrence MA 01843 617-688-0751  
Hours: 8:00 am to 5:00 pm

Terms: Full price plus shipping cost must accompany order. No CODs. All prices subject to change without notice. Price includes data package of schematics of applicable subassemblies. Previous purchasers can obtain this data package free of charge by sending LARGE manila envelope (9 x 12) plus 50¢ in stamps or coin along with a copy of original invoice as proof of purchase.

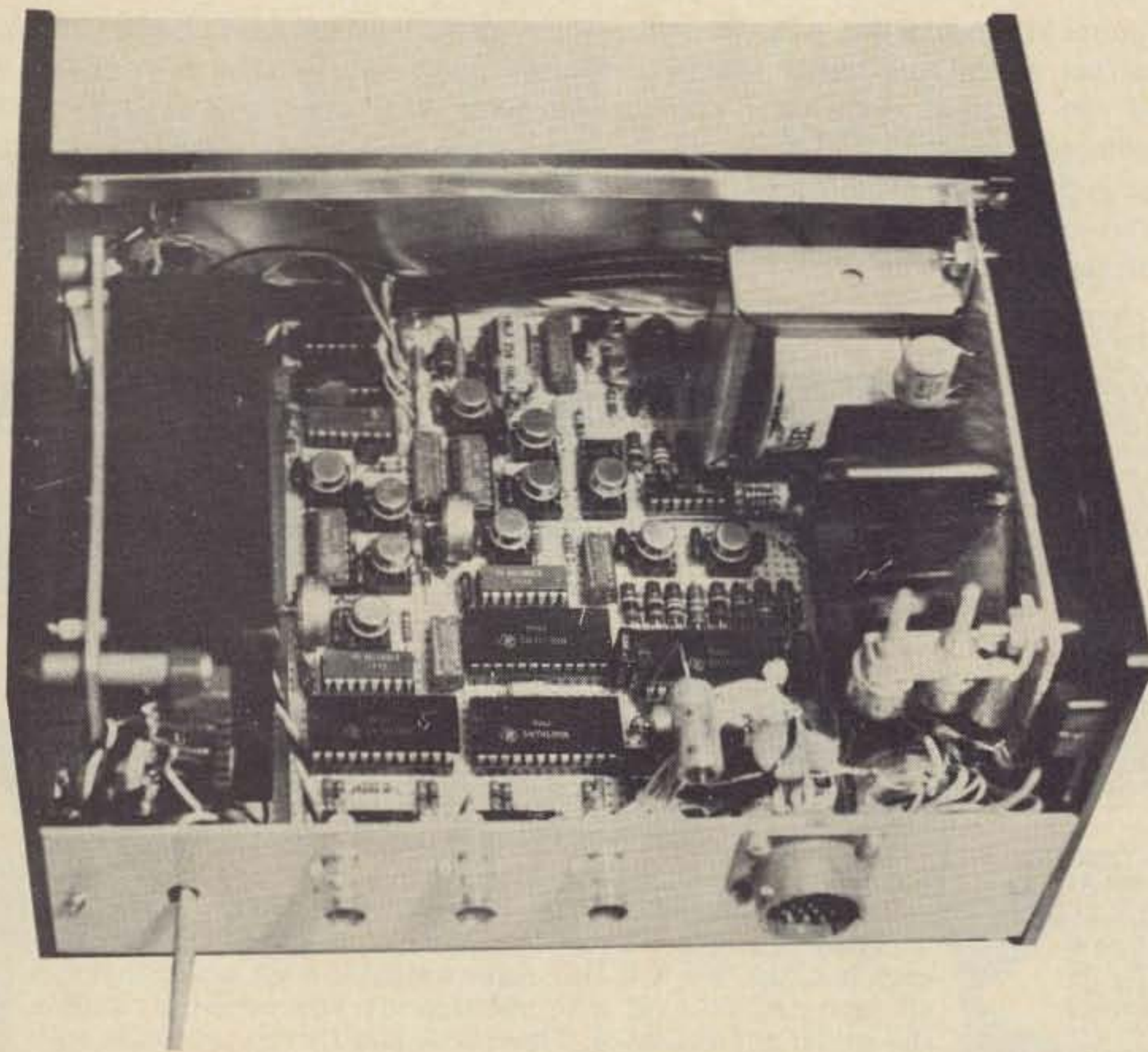

### Vector Generator

The raw X and raw Y voltages from the DACs go to the vector generator which uses CD4016 quad analog switches. These switches are controlled by Q1, Q2, Q3, and Q4, a level shifter that changes the voltages from TTL levels to MOS levels, required by the CD4016s. Each switch section consists of a signal input and output terminal and a switch control terminal. When this control terminal is at +7.5 volts, the switch is on, and when the control terminal is at -7.5 volts, it is off. A DM8800 level shifter could be used in place of the four transistors and associated components if you can find it. The Suntronix graphics driver uses the transistor version in the interest of simply being able to obtain the parts readily.

In the quiescent state, switches 1 and 3 are on, 2 is off, and the output of the vector generator is equal to the raw input voltage. When a Ydraw is executed, A20 fires for approximately 20 microseconds and turns off

switches 1 and 3. During this one shot period, raw X and raw Y voltages are settling toward the new input values loaded into the registers. These values correspond to the end point of the line segment. The display is still in a blanked state, and with switches 1 and 3 off, the vector generator is acting as a sample and hold circuit in a hold condition with the output constant.

When the first one shot times out, it fires A21 which has a period of approximately 100 microseconds. While A21 is on, the beam is unblanked, switch 2 turns on, and switches 1 and 3 remain off. In this state, the integrating capacitor at A9 starts charging through switch 2 along an exponential curve. Even though this voltage is actually 2 times the new raw value minus the original raw value, the one shot's period is adjusted to time out at the correct end point voltage and provide the appearance of a straight line. The fact that the output voltage changes along an exponential curve is

irrelevant as long as both axes are identical. At the conclusion of this one shot period, switch 2 turns off, switches 1 and 3 turn on, and the display blanks again. The output voltage readjusts itself to exactly the new voltage through switch 3.

The driver electronics, to this point, have been set to produce minus and plus 2.5 volt signals for octal inputs of 000 and 377 respectively. This five volt magnitude is incompatible with the deflection amplifiers as purchased. The purpose of A6 and A10 is to scale and offset the vector generator outputs so they are within 0 to -3 volts as required. Each op amp is configured as a non-inverting summing amplifier. The span adjustment alternates the 5 volt absolute magnitude from the vector generator to 3 volts (plus 1.5 volts to -1.5 volts). The offset pot is then set to produce an offset of -1.5 volts with no signal in. The resulting signal level will be minus 3 volts for an octal 000 input and 0 volts for an octal 377 input. These

two settings, as well as the gain and offset adjustments of the D to A converters, are best done by loading single values in the registers and not trying to program an actual display.

The vector generators will need slope and end match calibration. It is easiest to adjust the vector generator if a square with diagonals from corner to corner is displayed. The worst case for the driver, and hence the optimum case for calibration, is the display of a square with full scale coordinates. A square with two diagonals can be drawn with 6 line segments and is illustrated with full scale octal coordinate numbers in Fig. 5. The brute force display method is to write a program which treats each line segment as a separate entity and outputs the display coordinates to the driver sequentially. For this particular square, the program would do successive outputs from the accumulator of Xmove, Ymove, Xstore, and Ydraw, respectively, for the following series of octal coordinates: 000,000,000,377 (line segment 1); 000,377,377,377 (line segment 2); 377,377,377,000 (line segment 3); 377,000,000,000 (line segment 4); 000,000,377,377 (diagonal line segment 5); and 000,377,377,000 (diagonal line segment 6). Repeat continually for a constant display.

This again is the worst case display and requires optimum performance from the driver. End point timing problems will appear either as under- or over-shoot of line segment length and can be compensated by adjusting the end match pot on A21. Slope problems will result in the diagonals of the square not meeting in the corners. Slope adjustments are made with the appropriate pots at A5 and A9. It is important not to

A1-A10	LM301A Op amp
A11-A13	74100 8 bit Reg.
A14-A15	1408L8 8 bit D to A converter — Motorola
A16	7437 Quad NAND
A17	7404 Hex inverter
A18-A19	4016 CMOS quad analog switch
A20	74123 One shot
A21	74121 One shot
A22	7410 3 input NAND

All resistors 1/4 W 5% unless otherwise noted.  
All variable resistors are trim pots or equivalent.

Fig. 4. Parts list for graphics driver.

substitute any operational amplifiers which may have a slower frequency response than the LM301A's because this will compromise the driver's ability to track large changes in input coordinates and will attenuate full scale response. An additional area of concern is power supply bypassing and grounding. The largest ground plane and thickest wire appropriate for connecting grounds will result in the least noise and the cleanest display. Bypass capacitors (.1 microfarad/25 volt) should be placed between supply voltage points and the ground plane at a number of locations on the display driver board. Too many is always better than too few when it comes to bypass capacitors. Make the layout orderly and neat to reduce crosstalk and avoid ground loops. If separate power supplies for the +5 volts, +15 volts and -15 volts are built and connected by a cable, it is a good idea to put extra filter capacitors (100 microfarad or higher/25 volts) on these power lines where they enter the display board. Tantalum capacitors are the best choice but aluminum foil capacitors are adequate.

Now that you know how it works, it has once again come to the hard part; a decision must be made whether to "build or buy." Obviously, the quickest and easiest way to get this fascinating and useful instrument up and running is to purchase the graphics driver and the set of subassemblies

being offered by Suntronix Company. Certainly that is not the only way. You may choose to build the graphics driver from scratch. With the printed circuit card available from Suntronix it should be a relatively simple and even enjoyable task. Merely follow the instructions in the following paragraphs and those that come with the PC card.

If you want to build the driver and elect not to purchase the driver PC card, some additional comments are in order.

Much of the electronics on the four PC cards that come with the subassemblies is superfluous when used as an X,Y display. The two 6 bit digital to analog converters previously used for character placement can be eliminated, as well as the actual starburst pattern generator. The only other alteration is to isolate the blanking signal. When these few tasks are completed and external voltages applied where the DAC inputs had been previously, one will have an operational 12" X,Y input CRT all ready for graphics.

#### Testing the Unmodified CRT Subassemblies

Before any modifications can be made, the operational integrity of the terminal must be established. Even though the refrigerator sized controller necessary for alphanumeric is missing, the unit is capable of self-scanning through a combination of positions and blanking control with the D to A cards as they are. To test

the unit, install the four cards. The card closest to the screen is the horizontal DAC and the next card behind it is the vertical DAC. Both cards are identical. The third card in from the tube end is the integrator, clock conditioner, and starburst generator card. Behind it is the digital position and unblanking card. On the back connector, labeled J103, it will be necessary to put in a 1 MHz clock signal and an unblanking signal. The 1 MHz clock, which is required both for the high voltage generation and character position, is applied to pins 8 and 9 (8 ground and 9 high). A suitable TTL circuit to feed the 50 Ohm load presented by the CRT is illustrated in Fig. 6. It is not necessary that it be crystal controlled, but a clock input is required at all times to operate this unit. The unblanking signal is applied to pins 10 and 11 (10 ground and 11 signal in). With the clock signal applied, and -5 volts from pin 11 to ground, turn on the display. A fairly noticeable high pitched tone should be heard. This is the high voltage oscillator. Slowly rotate the intensity control (same shaft with the on/off control), and a pattern should appear. This pattern will appear as though one were looking at ten layers of chicken wire, but it is actually all starburst locations

unblanked and displayed. Removing the -5 volts from the blanking input will leave one starburst pattern displayed on the screen in a random location. Repeated applications of the blanking input will make this single pattern appear to jump around the screen.

At this point, initial check-out is complete and modifications can begin. Although not absolutely necessary, it was determined that all of the modifications to this terminal could be carried out on the four PC cards. The easiest approach is always the preferred method when dealing with surplus electronics because of the numerous design revisions such equipment has had over the years. The latest schematics are always hard to find.

#### TTL Level Blanking Input

One of the first modifications necessary is to change the blanking level input from the previous level of -5 volts into 50Ω which is inconvenient to use. This negative voltage is an external requirement only. From there it feeds a level translator on the integrator card which converts it to a +4.5 volt blanking level compatible for use in the digital logic of the position and unblanking board. After transferring through all the logic, this

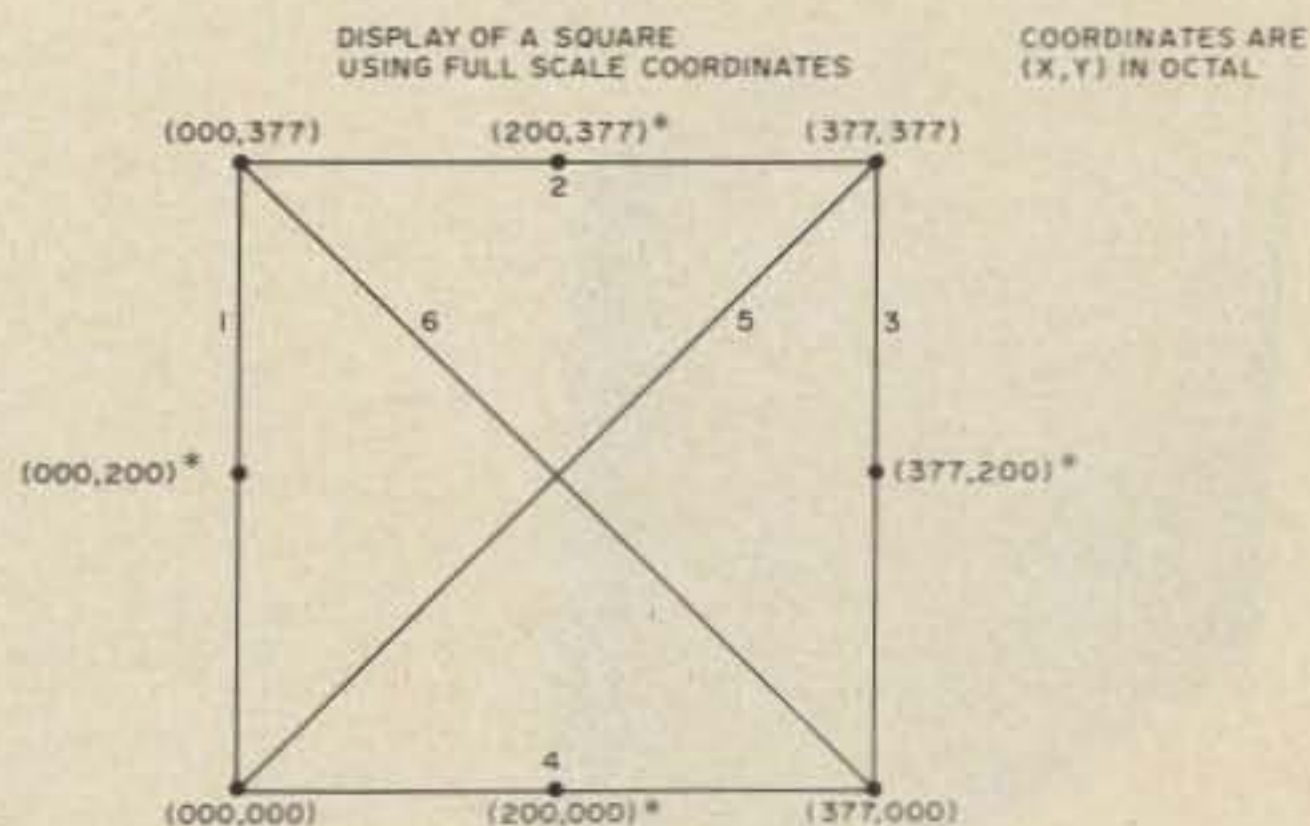

Fig. 5. Example of a square for calibration. Note: Reference numbers refer to line segments. \*Locations given for example only.

signal leaves the board as an unblank to video amp signal on pin 3 of connector J107 on the base of the card. Between terminal E31 (connected to pin 3) and E30 is a jumper. By removing this jumper and attaching a separate TTL level input to terminal E31, this unblanking option can be externally controlled. The card itself cannot be discarded and has to be inserted for the unit to be operational. There is additional logic on this card necessary to generate the high voltage for the CRT. This concludes the modifications necessary to allow external blanking.

### Eliminating the Starburst Generator

The starburst generator is located on the integrator and clock conditioner card. The output of this generator feeds directly to the video amplifier and must be disabled or a moving starburst will be displayed rather than a line segment when the beam is moved. This simple modification can be accomplished by removing a transistor, Q9, and cutting a tape between pin 15 and the junction of

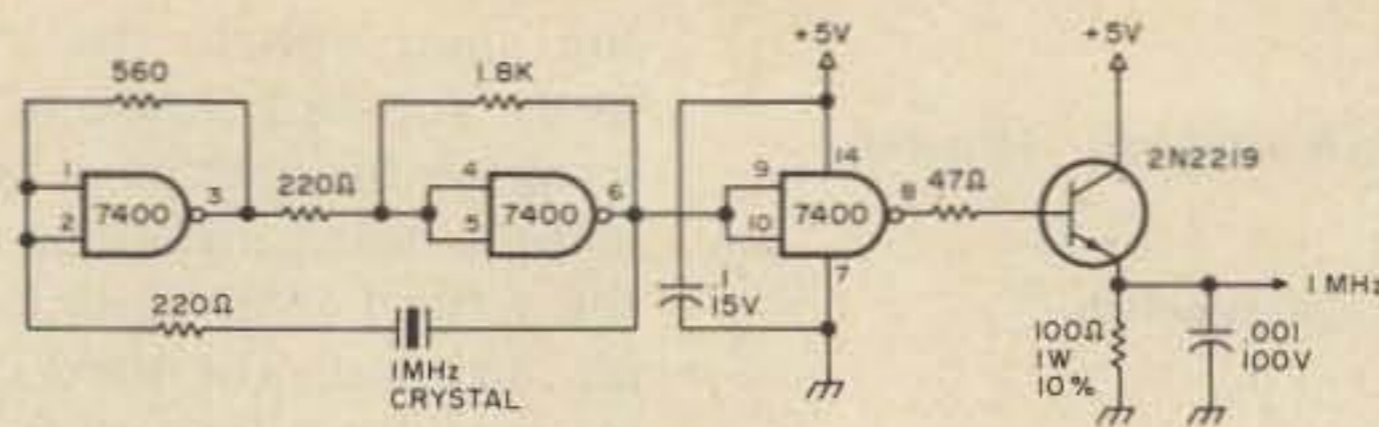

Fig. 6. 1 MHz oscillator. All resistors  $\frac{1}{4}$  W 5% unless otherwise noted.

R21 and the emitter of Q8. By cutting these two signals to the video amp, we are eliminating a 2 bit D to A converter which continually causes the beam to trace a starburst pattern. What is left is a single dot on the screen whose position is completely controlled by the vertical and horizontal deflection voltages generated on the vertical and horizontal D to A cards. As in the previous case, there is other circuitry on this card, such as the clock conditioner, which requires that the card be inserted for the display to be used. This concludes the integrator card modifications.

### Vertical and Horizontal Deflection Inputs

The modification to the deflection amplifiers to allow external deflection voltage input is indeed simple. It

essentially means throwing away the two D to A converter cards and applying the external input voltages directly to the connector pins. Unfortunately, getting at these pins is difficult and requires removing the high voltage section. An easier method is to disconnect the DAC outputs on each card and attach the external input on the card in its place. The two cards are identical and require the same modification. Each of these boards is a 6 bit digital to analog converter card. The output of the converter is jumpered from terminal E1 to terminal E2. Terminal E2 is also the output pin M on the base of the card. By removing this jumper, the card electronics is disconnected. A coaxial cable can then be attached to terminal E2 on each board to

provide the external input. There is plenty of foil grounding area on the cards to which to solder the coax shield directly, and this serves to reduce input noise considerably.

Warning! With all these modifications, the automatic blanking and sweep circuits of the unit have been defeated. This is of no real consequence, but extreme care must be taken not to damage the CRT. The blue-green phosphor is exceedingly bright, and has to be protected from over-intensity which would otherwise burn a permanent mark on the screen. The graphics driver is designed to prevent this occurrence, but at this stage of the checkout process, none of those protective circuits is involved.

It is important to check the display terminal as it stands now. For all practical purposes, it is a 12" oscilloscope at this point and can be checked out as such. The deflection voltage which must be externally applied to both horizontal and vertical inputs is in the range of 0 to -3 volts. It is of the gravest importance that the polarity not be reversed or the magnitude exceeded on these inputs. Schematically, it would appear quite acceptable to do this, but in actuality it is disastrous. The deflection yoke resistance is less than .1 Ohm and demands considerable current to drive it. This deflection current is directly proportional to the input voltage. When a 0 to -3 volt signal is applied, the deflection current sweeps from -2 Amps to +2 Amps approximately. The low voltage power supply is a real brute capable of better than 10 Amps. When voltages of other than the optimum are applied, the deflection will try to follow. The unfortunate problem is that the manufacturer didn't build the deflection amplifiers to handle this much current and

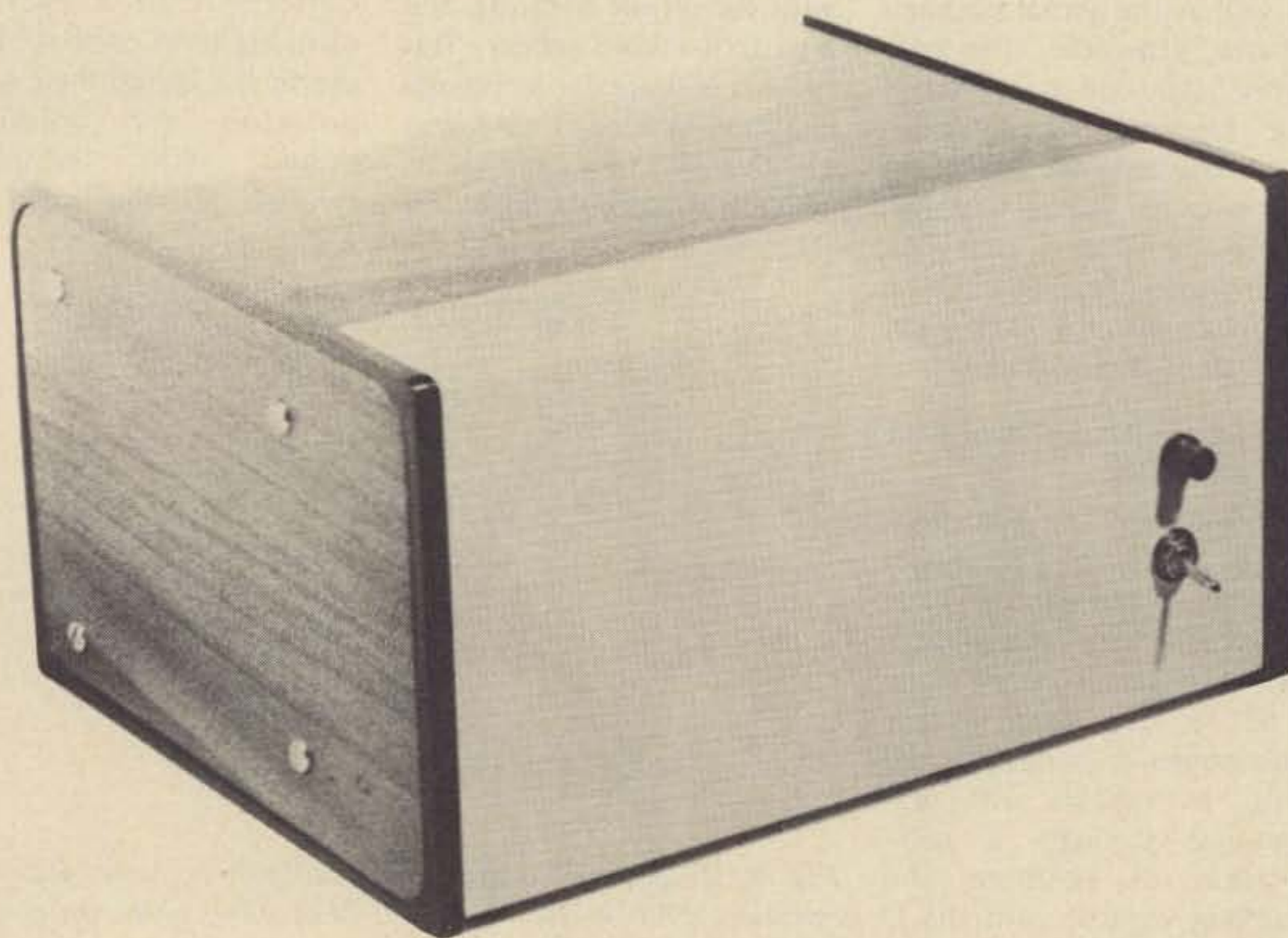

they go poof! They, of course, never were concerned with this problem because the D to A converter cards could not have produced these voltages. It is a wise idea, if this display is not going to be permanently attached to a driver of some sort, to put some clamping and voltage limiting circuitry on these inputs. It wasn't without hard reality that these facts were determined.

To continue the deflection checkout, it is necessary to have two 3 volt supplies. Two pair of "C" cells in series are quite adequate and safest. Fig. 7 is a sketch of these checkout requirements. Each 3 volt supply should be placed across a 10k Ohm pot with the positive side of the battery connected to the display chassis ground. The output voltage at the wiper of the pot will go from 0 to -3 volts with respect to chassis ground. When this fact is agreed upon, one can feel

fairly safe in attaching this variable voltage to the horizontal and vertical inputs as described previously.

Now comes the acid test. Using a meter, set each input to -1.5 volts. This will correspond to a null or no deflection condition and should place the beam position directly in the center of the screen. The blanking input should be ungrounded and open and the 1 MHz oscillator turned on. Very carefully turn on the display, but don't immediately rotate the intensity adjustment. After allowing about 30 seconds warmup, and taking note the high voltage is on, slowly increase the intensity. Eventually there will appear a single dot near the center of the screen. Do not make it too bright because it will burn the screen. When this phase is accomplished, increase the voltage applied from the battery sources and notice that the beam moves

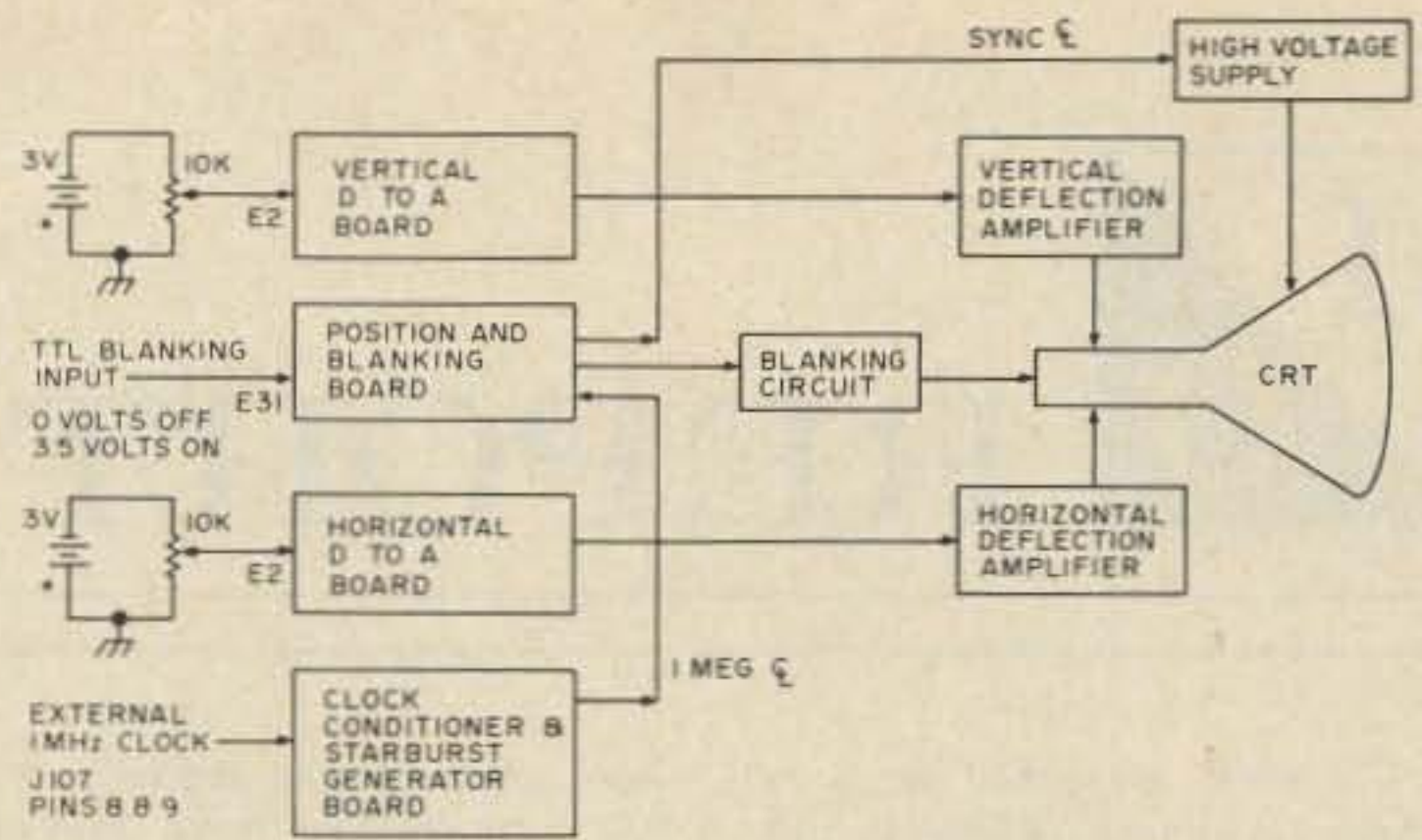

Fig. 7. Deflection amp subassembly checkout.

proportionally with the voltage change. The horizontal input obviously is driving the beam in an X direction from left to right and back, while the vertical is driving it in the Y direction which is up and down. If both pots are turned simultaneously, the beam will move at an angle.

That's all there is to it. Be sure to use coax between the driver and the horizontal and vertical inputs and watch the

ground loops. Properly adjusted and imaginatively programmed, this graphic display will very quickly become your favorite form of entertainment as well as an extremely useful tool.

The authors will be happy to hear from any who build this unit. We'll try to answer your questions as quickly as possible as fully as possible, but please, enclose an SASE when requesting answers. That will insure a reply. ■

## TS-1 MICROMINIATURE ENCODER-DECODER

- Available in all EIA standard tones 67.0Hz-203.5Hz
- Microminiature in size, 1.25x2.0x.65" high
- Hi-pass tone rejection filter on board
- Powered by 6-16vdc, unregulated, at 3-9ma.
- Decode sensitivity better than 10mvRMS, bandwidth,  $\pm 2$ Hz max., limited
- Low distortion adjustable sinewave output
- Frequency accuracy,  $\pm 25$ Hz, frequency stability  $\pm 1$ Hz
- Encodes continuously and simultaneously during decode, independent of mike hang-up
- Totally immune to RF

Wired and tested, complete with K-1 element

**\$59.95**

K-1 field replaceable, plug-in, frequency determining elements

**\$3.00 each**

### COMMUNICATIONS SPECIALISTS

P.O. BOX 153  
BREA, CALIFORNIA 92621  
(714) 998-3021

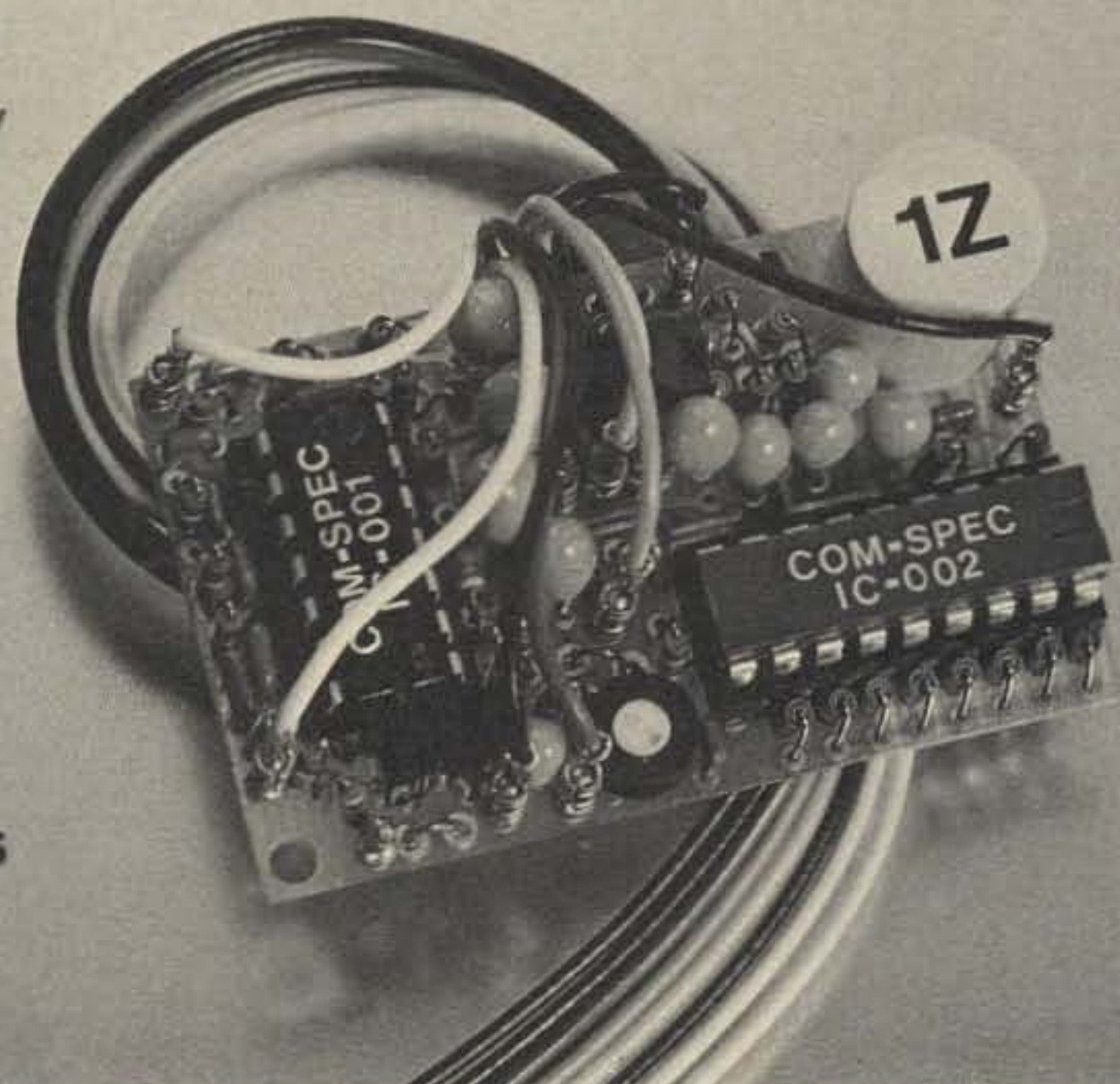



# REPORT

"73 West" is located on a hill outside of Lompoc, California, overlooking the beautiful Valley of the Flowers and in the "backyard" of Vandenberg Air Force Base. Because of this vantage point, we're treated to two beautiful sights not found in many spots around the country. One is the panorama of flower fields laid out below us during the summer; the other is the spectacular launching of spacecraft from Vandenberg. Another benefit derived from living here is that the weather never demands snow chains on our cars or galoshes on our feet ... as you might find in other parts of the country (e.g., New Hampshire).

I couldn't have picked a better "in between" location for keeping track of the computer field here in California. San Francisco, and the "Silicon Valley," is about 4½ hours away and the tremendous amount of activity in the Los Angeles area is only 3 hours away.

We've set up a computer center here for evaluating and testing all the new microcomputer systems and peripherals coming on the market. The objective is to be able to better serve you, the reader, and manufacturers, by having additional facilities for checking out these units. I'm going to be generating both articles and new product reports on systems, options, and peripherals. And, not incidentally, the editorial functions for "I/O" are being taken care of here.

Aside from the systems which have



been passing through regularly, I have my own personal home computer, which is of the wall-mounted variety. It's a Varian Data Machines model V-73 which, as I'm sure you're all aware, is fast becoming one of the most popular home computer systems among hobbyists. (Actually, I recently formed a user's group of privately-owned Varian computers and it turns out that there are only two other V-73s owned by individuals in the entire country ... that I know of, anyway.) It may not be the most practical home system (because of the cost), but you can rest assured that it is *the* machine for 73 Magazine! Varian was undoubtedly thinking of us when they gave it the 73 model number, right?

The V-73 is a microprogrammed computer. Through the use of ROMs, as a control memory, it is set up to emulate an earlier Varian computer ... and through the use of a Writable Control Store board (which is equivalent to Erasable Programmable Read Only Memory ... EPROMS), the machine can be programmed to emulate *any* computer. I'm in the process of developing the firmware (microprograms) to emulate the 8080 ... so I can run all that software being developed out there.

If you haven't already discovered the "thrill" of getting your kids turned on to your computer, then maybe you should consider yourself lucky! Actually, I'm just kidding ... one of the reasons I have a home computer is to introduce my kids to the fun. (They do have a habit of tying the machine up, and we may be seeing the beginning of a problem in home systems — a problem which will very likely be resolved by developing time-share systems for the home computer of the future.) One of the most popular programs run on the Craig system is a game called Qubic, and here you see my daughter Sheri tying up the machine playing it.

#### User Groups

As I mentioned earlier, I own a Varian Data Machines computer, and I have formed a user's group (of about ten people). By doing so, I've definitely increased the potential of my machine. We swap parts, software, and quite often some very good ideas. Regardless of what type of computer you have, you can reap the same benefits by checking around and seeing if a group has been formed for your particular machine. And, if one

hasn't been formed, give some thought to starting one. This can be done by looking through some of the computer hobbyist newsletters and finding people with the same computer as yours. Be prepared for a little work if you decide to start one. But, once it's going ... no problem ... you just become another member.

If you know of any user groups which have been formed, drop me a line and we'll publish them in upcoming issues of 73. Also, if you have word on any new computer clubs which have started up, let us know about them. We'll be publishing a list of clubs soon, too.

#### Dr. Dobb's Journal of Computer Calisthenics

This could be a big one! Jim Warren, who went to work for the People's Computer Company (PCC) part-time to crank out three newsletters on Tiny BASIC, is now the editor of *another* hobbyist magazine! All of the programs they publish (Tiny BASIC, interpreters, compilers, assemblers, cassette and floppy disc file systems, TV Dazzler software, graphics, music, and on and on) will go into the public domain ... i.e., it's gonna be free! If you're interested, drop him a line: *Dr. Dobb's Journal of Computer Calisthenics & Orthodontia*, P.O. Box 310, Menlo Park CA 94025.

#### Baudot — Hardware or Software?

If you've got a Model 15 or Model 19 and it isn't hooked up to a computer, it should be. One of the things which would make me hesitate

(if I were in your shoes) would be the interfacing and conversion from ASCII to Baudot and vice versa. Well, the interfacing isn't that much of a problem (see the article by Dick Whipple and John Arnold in the May 73) ... and, if you're hung up on the *hardware* for accomplishing the ASCII/Baudot conversion, don't be. There's no need to do it with hardware! The conversion in both directions can be accomplished very easily using two small *software* routines. Once again, I refer you to the above article. Software is really the only way to go for something like code conversion. Keep your eyes open for the articles by Don Alexander (the winner of the Grand Prize at the Altair Convention in March). He has a Model 19 for hard copy ... and does the conversion via software. But you'll really want to catch his article on the home brew TVT he built. It has split-screen, multiple cursors, scrolling, and several other features. And ... almost all of it is done with software! Stay tuned ... it's all coming up in 73.

#### The Sinister Microprocessor

If we're blessed with many more TV script writers like the guy who wrote a recent "Six Million Dollar Man," our kids are really going to have some warped ideas. (Incidentally, my family hates it when I occasionally join them to watch the program because of my running comments, such as, "How stupid!!", "They must

*Continued on page 139*



### RTTY/COMPUTER DISPLAY

A 25 line X 40 character display unit which can be used with any tv monitor or modified tv set. Complete system on one board including provision for power supply.

See construction article by Jeff Roloff in July issue of 73 Magazine

TVT-2540-100 Board only	39.95
TVT-2540-200 Board with all components less power supply comps.	119.95
TVT-2540-300 Board with all components including power supply comps	139.95
TVT-2540-BSI Baudot serial input board kit	34.95
TVT-2540-ASI ASCII serial input board kit	27.95

Add \$1.50 shipping, handling, insurance.

### TV TERMINAL III

Displays 16 X 32 lines on tv monitor or modified tv set from ASCII code input. Two pages of memory with provision for adding two additional pages.

TVT III Complete kit	134.95
-------------------------	--------

Add \$1.50 shipping, handling, insurance

RM and C-MOD 6800 and 8080 systems available. Complete systems starting at \$279.95

Surplus keyboards, power supplies, and fans available from stock

ALTAIR - complete line of Altair compatible boards available.

Lowest prices and most complete line of computer kits in the industry.

Send stamped, self-addressed envelope for prompt response.

## MiniMicroMart

1618 James Street  
Syracuse, New York 13203  
(315) 422-4467



# Regency

the first name in solid state

## INTRODUCES THE VERSATILE NEW



# HR-312

- **More Channels...at the flip of a switch**  
Unlock the unique mode switch and 12 channels become 144
- **More Sensitivity, Less Interference**  
.25  $\mu$ V Sensitivity plus 75 db adjacent channel selectivity and 70 db image rejection
- **More Power Out**  
35 watts nominal with a minimum of 30 watts across the band

... for a lot less

## \$269<sup>00</sup>

Amateur Net

© 1976  **Regency** ELECTRONICS, INC.  
the first name in solid state

7707 Records Street  
Indianapolis, Indiana 46226

## THE FM LEADER



2 METER 

220 MHz 

6 METER 

440 MHz 

# Counters Are Not Magic -- They're Simple

-- getting right down to basics

There are plenty of counter projects about. You can easily build one of them and it will work fine, first try, too. But how do they actually operate? It was hinted at in "Flip Flops Exposed," Nov/Dec 75, but many readers demanded more details.

My pleasure.

The basic counting circuit

has four elements: a decade counter, a latch, a BCD-to-7 segment decoder/driver and a 7 segment LED. One of each will allow us to count from 0 to 9. To count higher we cascade, or add, more elements. Fig. 1 shows the block diagram of a counter circuit.

Let's work backwards. Believe me, it's easier.

## A Short Course in 7 Segment LEDs

The 7 segment LED is composed of 7 segments, each of which is one light emitting diode. When a current flows through, in the correct direction (it's a diode, after all), it lights. By placing the segments in the proper configuration we can form all the numbers (Fig. 2). Each segment is identified by a letter from a-g.

7 segment LEDs come in two varieties, common anode and common cathode. In the common anode case, all the anodes are connected to-

gether internally and we light each segment by touching it to ground. In the common cathode configuration, the negatives are connected together and we light the segments by connecting them to a positive potential. Fig. 2a shows the pin designations.

## The Decoder/Driver

Operation of the decoder/driver requires a back-step to discuss binary numbers. You probably never thought about it, but our number system is based on tens (most likely because we have ten fingers or digits). We count like this: 1, 2, 3 ... 7, 8 9; when we get to what we call ten, we are actually starting all over. Ten is really one-zero. Eleven is really one-one. But, because we use these numbers so often, we gave them special names.

Computers lend themselves to systems or bases other than our base ten. Base two, or binary numbers, are easily comprehended by these infernal machines because they use only two digits, 0 and 1. It takes a lot more room to count great numbers because we only have 0 and 1 to use, but computers digest them readily as 0 and 1 can be ON and OFF, an easy concept for the machine's limited intelligence.

Let's count in binary: 00,01,10,11. That's 0,1,2 and 3 in our decade system. From right to left, our system has columns of units (or ones), tens, hundreds, etc. In binary, we have units (or ones), twos, fours, eights, etc. The chart makes it easy.

The 7446 chip is a BCD (binary coded decimal)-to-7 segment decoder/driver. Internally, it is a maze of AND, NAND and NOT gates, but we don't have to go into that. For decoding purposes, it takes binary coded decimals, the binary numbers we talked about, and converts them to our base ten system for readout on a 7 segment

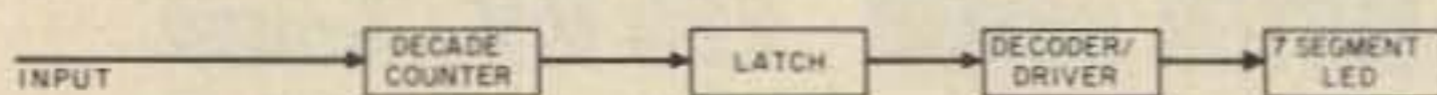

Fig. 1. Block diagram of counter.





Fig. 2. 7 segment LED.

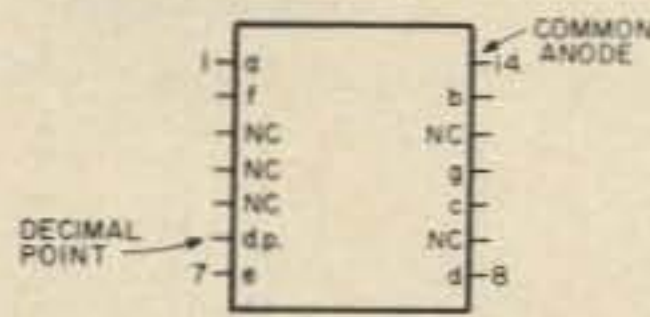

Fig. 2a. Pin configuration. Important note: Not all LEDs use this exact configuration. In some cases the NC pins may be the common anode connection. Check the specs for your LED and use Fig. 4 to connect it correctly.

LED. As shown in Fig. 4 it has four inputs: DCBA (the backward notation will be explained), and 7 outputs. Disregard the lamp test, RB input and RB output for now.

The input can be any binary number from 0000 to 1111. In our system that would be 0 to 15. Since we are dealing with only one 7 segment display, we are only concerned with 0000 to 1001, or 0 to 9.

Look at Fig. 5. If we put a low at inputs D, B and A, and a high at C, we make the number 0100 (see the reason for the DCBA order). In our decimal system, that is the number 4. The outputs corresponding to that input are highs at a, d and e, and lows at b, c, f and g. Looking at the LED chart, we see that the segments will be blank at a, d and e forming the number 4. Hasn't he got it backwards? Nope. This chip is for common anode LEDs. Thus, any segment assigned a zero, or low, will light. The 7448 chip is available for common cathode LEDs and works in a similar manner, only "negatively."

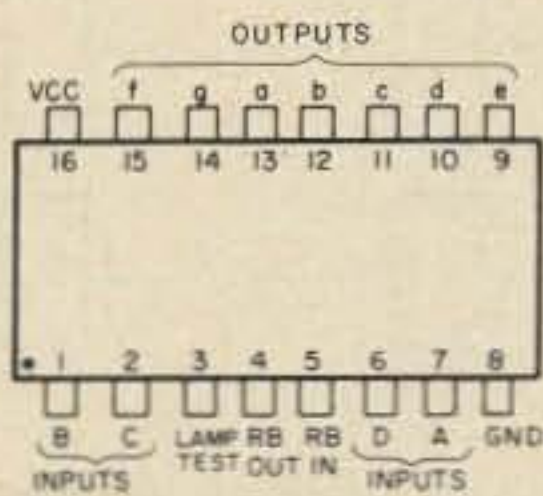

Fig. 4. 7446 decoder/driver (same as 7447).

Let's try another one. The number 8 in binary is 1000. We impose a high on D and a low on B, C and A. The output is then 0000000. All segments are grounded and they light. The number 8!

### The Decade Counter

Except in ringalevio we all count by ones. We need something that will count by ones and convert it to binary for our decoder/driver. Not only does it have to count, but it must reset at ten. The 7490 chip was made for this purpose. Every time a pulse from our clock is triggered into the decade counter, it is noted and the output responds with a binary notation.

Fig. 6 shows the 7490 configuration. The outputs DCBA will respond to every clock pulse.

Pulse 1 will give us an output of 0001. The second pulse will yield an output of 0010; the third pulse gives an output of 0011. The chart is known as the BCD count sequence. Very simple.

The 7490 is versatile. The unused R inputs allow many options. By keeping pins 2 and 3 high, our LED will always read 0. Keeping pins 6 and 7 high will give us a constant 9 on the readout. A reset/count chart provided by the manufacturer shows the many choices that are available.

We even have choices for the counter to work properly. Any configuration in lines 4-7 is permissible. It's fun to experiment with all the possi-

Binary eights	fours	twos	ones	Decimal hundreds	tens	ones
0	0	0	0	0	0	0
0	0	0	1			1
0	0	1	0			2
0	0	1	1			3
0	1	0	0			4
0	1	0	1			5
0	1	1	0			6
0	1	1	1			7
1	0	0	0			8
1	0	0	1			9

Fig. 3.

bilities, then check back to the chart and see that you were correct in your choices and outcomes.

The 7490 can also be used for other jobs besides decade counting. It can be used for divide-by-ten counting, divide-by-two counting and divide-by-five counting. All require different external connections. In our decade counting application, the output at pin 12 must be connected to pin 1 for correct operation.

### The Latch

We are almost done. The 7475 chip is a quadruple bistable latch. Four flip flops, that's all (Fig. 7).

It acts as temporary storage between the decade counter and the decoder/driver. It does have an important function which may be of value in some cases. If the pins 4 and 13 are kept high, the pulses going through will be counted normally. If they are low, the number on the LED is held stationary. To restore normal counting, make it high again. This feature makes it easy to stop the count at any time

without doing so at the input. If a situation arises where we are counting and we want to know at what count a certain transaction occurred, all we do is have that event cause pins 4 and 13 to go high.

Not only will we know at what number the event happened, but it will stay visible until we manually reset it to continue its count.

### Putting It All Together

All three chips are inexpensive TTLs. They should cost no more than two dollars all together. The price of the LED will be determined by its size. The bigger the segments, the more costly it will be. And, it will also be nicer to look at. That's your choice. There are good 7 segment LEDs available for a dollar. They can be gotten as cosmetic rejects as one segment may be slightly dimmer than the rest. Sometimes you have to look closely to notice it at all. I bought some dollar LEDs of that type and the difference is only evident when all segments are lit and carefully compared.

The schematic is straight-

	Inputs				Outputs						
	D	C	B	A	a	b	c	d	e	f	g
0	0	0	0	0	0	0	0	0	0	0	1
1	0	0	0	1	1	0	0	1	1	1	1
2	0	0	1	0	0	0	1	0	0	1	0
3	0	0	1	1	0	0	0	0	1	1	0
4	0	1	0	0	1	0	0	1	1	0	0
5	0	1	0	1	0	1	0	0	1	0	0
6	0	1	1	0	1	1	1	0	0	0	0
7	0	1	1	1	0	0	0	1	1	1	1
8	1	0	0	0	0	0	0	0	0	0	0
9	1	0	0	1	0	0	0	1	1	0	0

Fig. 5. 7446 inputs and outputs.

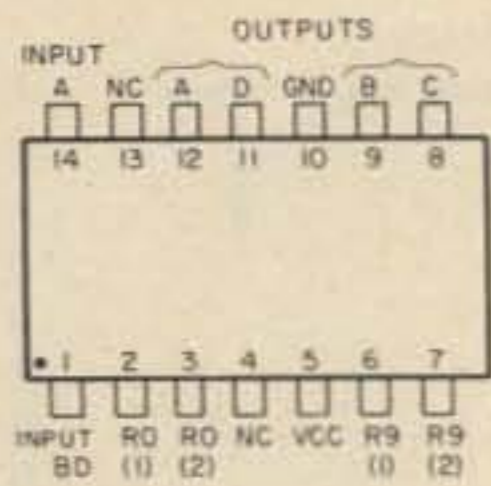

Fig. 6. 7490 decade counter.

**BCD count sequence**

count	D	C	B	A
0	0	0	0	0
1	0	0	0	1
2	0	0	1	0
3	0	0	1	1
4	0	1	0	0
5	0	1	0	1
6	0	1	1	0
7	0	1	1	1
8	1	0	0	0
9	1	0	0	1

Reset/count reset inputs				output			
Ro(1)	Ro(2)	R9(1)	R9(2)	D	C	B	A
1	1	0	x	0	0	0	0
1	1	x	0	0	0	0	0
x	x	1	1	1	0	0	1
x	0	x	0	count	count	count	count
0	x	0	x	count	count	count	count
0	x	x	0	count	count	count	count
x	0	0	x	count	count	count	count

x denotes either 0 or 1.

Fig. 6a. Charts for the 7490 decade counter.

forward. The pulses from our clock (which we all have by now) are the input. You can try to pulse it by hand, but you won't be able to do it. Your hand is just not sure enough to pulse it once, and only once. Try it. You will see the numbers jump a few no matter how carefully you attempt to give it just one shot. This phenomena is known as switch "bounce." Now you'll understand why flip flops are used as switching devices; mechanical means just CAN'T touch only one time.

Now, back to the other 7446 controls: lamp test, RB input and RB output. Lamp test means just that. If we put it low, all segments light giving us an indication of our LED's condition. When a low is applied to RB output, all segments go blank. It will continue counting though. Going back to a high will light them again wherever it is in the counting sequence. If, while you are counting, you desire to skip 0, put RB input to low. Every time zero comes around nothing is seen.

**Cascading Counters**

Our counter works fine,

but it only counts to 9. For higher numbers we need more counters. And, we have to add them in such a way that the first counter triggers the second after the number 9. And, the third counter must be triggered such that it will work when the second counter goes over 9. This is called cascading.

If you check the operation of the counter, on a slow speed, with a VTVM, you will see that the numbers change on the 1 to 0 change. This is known as "trailing edge triggering." That's important to know. Looking at Fig. 6a,

we see that the numbers 8 and 9 have very distinct characteristics. They are the only numbers to have 1 in the D column. If we have a second counter waiting at count zero, it will trigger upon a 1 to 0 change. By taking output D of our first counter and connecting it to the input pin 14 of our second counter, it will count "one" when our first counter passes 9. The first counter will return to 0 and the second counter has a 1. By placing the counters in the proper position we have one-zero, the number 10.

The schematic shows how

easy it is to cascade counters. You might also like to make the reset controls a permanent fixture. This assures that the counters all start at zero.

Start counting.

Special thanks are extended to Isaac WN2ALK, who, without regard for his personal safety, came over late one night to supply me with some much needed data. ■

**References**

- Signetics Handbook*, 1972, Signetics Corp.
- Huffman, Jim, "What Do You Want to Count?", *73 Magazine*, Feb. 1976.

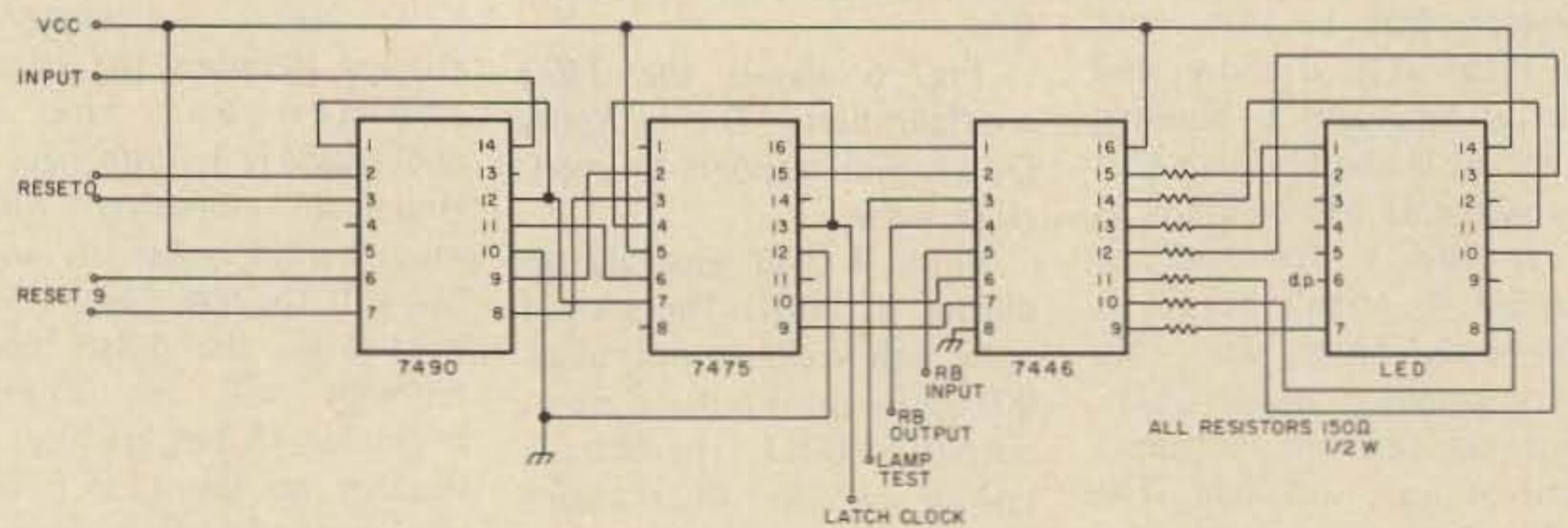

Fig. 8. Counter.

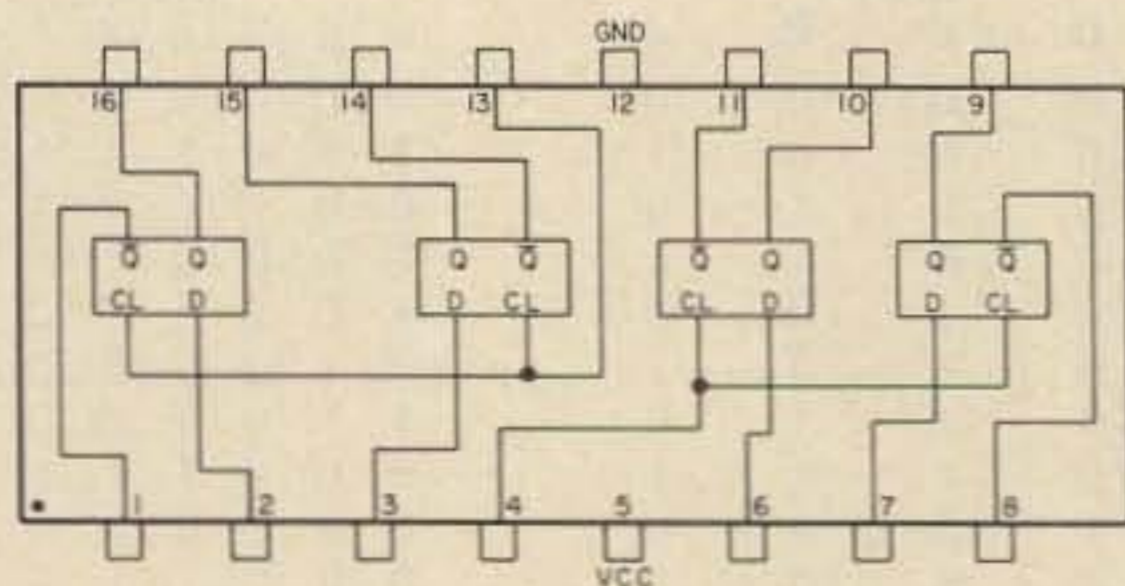

Fig. 7. 7475 quadruple bistable latch.

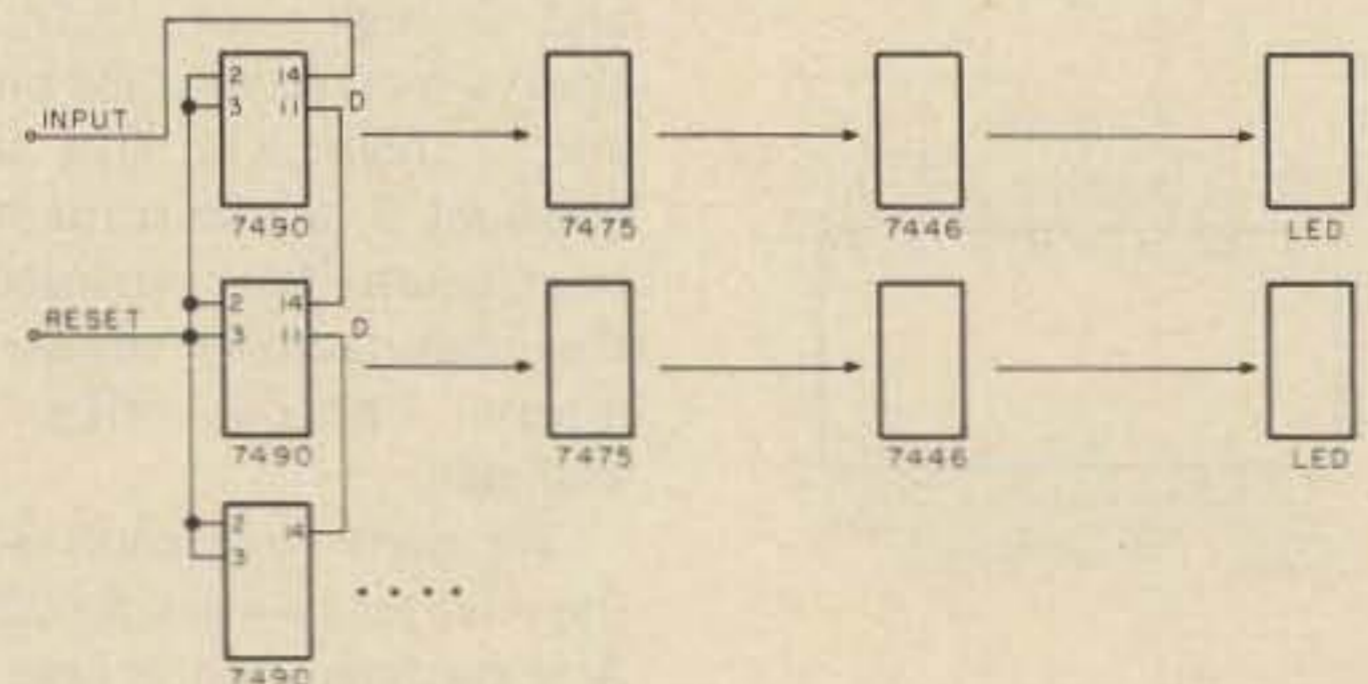

Fig. 9. Cascaded counters.

"IF YOU COULD HAVE ANYTHING YOU WANTED IN A 4Kx8 MEMORY BOARD KIT, WHAT WOULD YOU WANT?"

"I'd want it to be plug-in compatible with my Altair 8800 or IMSAI, have zero wait states guaranteed over the full temp range of 0° to 55°C, and current drain of no more than .75A; .6A is more like it. And I'd like buffers on the addresses, data lines, and outputs... enough regulators to give some headroom for my supply, lots of bypass caps, and the latest low power Schottky support ICs. And I want sockets for all ICs, a really nice PC board, some decent instructions...and a warranty against defective parts. Oh yes, and I'd like all this for under \$100."

"YOU'VE GOT IT."

**ECONORAM™**

**\$99.95**

This board was selected at random from stock. After 30 minutes running with an 8 volt supply, it drew 592 ma.

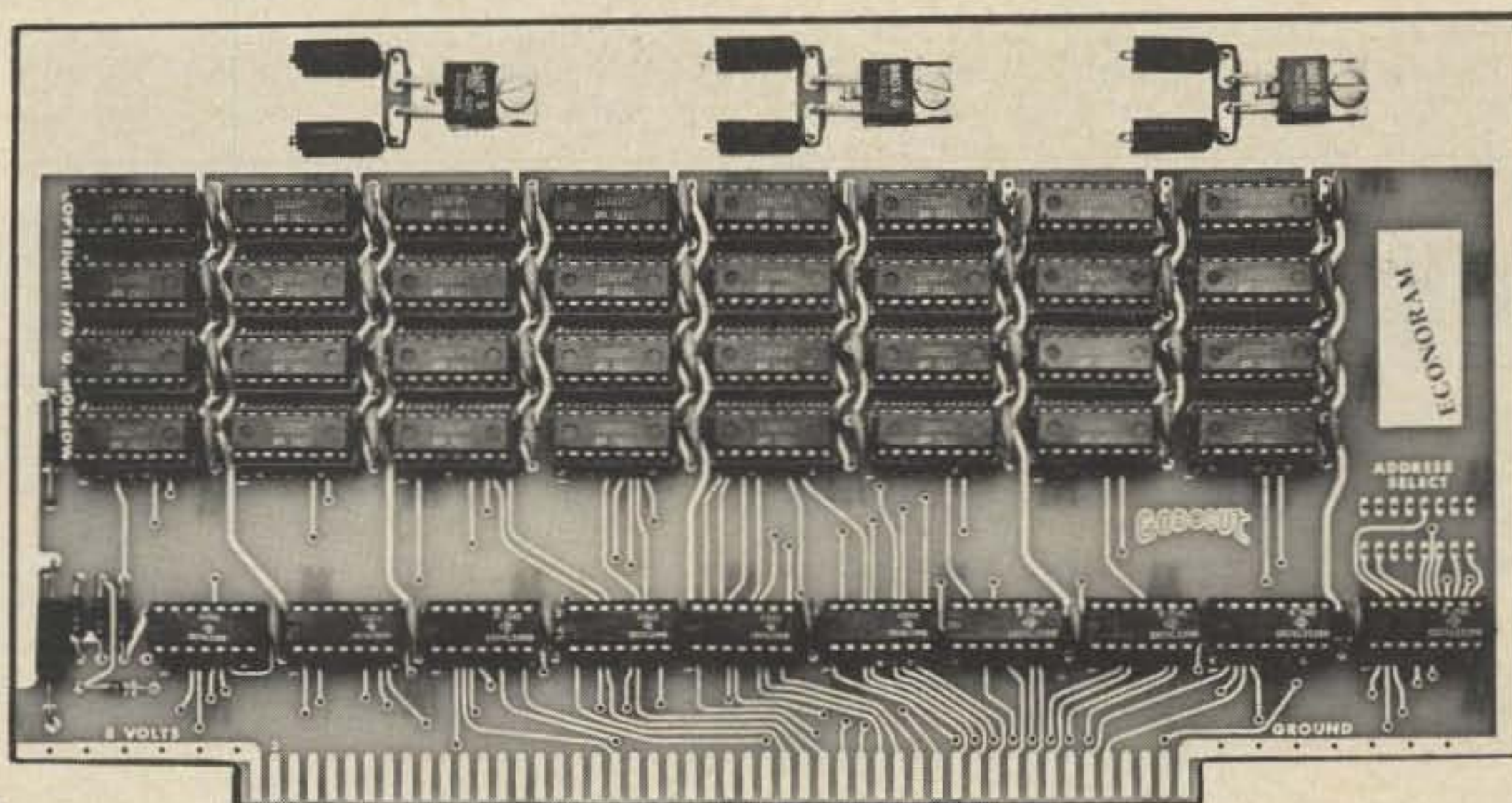

**CAVE**  
grafix

**GODBOUT**

BILL GODBOUT ELECTRONICS  
BOX 2355, OAKLAND AIRPORT, CA 94614

TERMS: For BankAmericard and Mastercharge orders, call our 24 hour answering service at (415) 357-7007...or write to us. Please be sure to include your street address so that UPS can find you. No COD orders---too much paperwork. Californians add applicable sales tax. GROUP DISCOUNTS: Buy 10 ECONORAMS, take 10%; buy 100, take 15%. Please note: prices are subject to change without notice.

# Social Events

## MACK'S INN ID AUG 6-8

The Wyoming - Idaho - Montana - Utah Ham Club would like to announce that the 44th Annual WIMU Hamfest will be held August 6-8 at Mack's Inn, Idaho just 20 miles west of Yellowstone National Park. There will be a full line of activities including our famous breakfast under the pines. Camping on the grounds is available plus motels, cabins and restaurants. Pre-registration is \$6 per person, \$1 for children under twelve. For registration or more info contact: WIMU, c/o Larry Jacobs WA7ZBO, 5655 So., 4060 West, Salt Lake City, Utah 84118.

## OKLAHOMA CITY OK AUG 7-8

The Oklahoma Ham Holiday and State ARRL Convention will be held Saturday and Sunday, August 7 and 8 in Oklahoma City, Oklahoma. The meeting will feature the largest flea market in the Southwest, special programs, technical seminars, equipment displays, and unique activities for the ladies. For information and advance registration write Oklahoma Ham Holiday, Post Office Box 20567, Oklahoma City, Oklahoma 73120.

## CONCORDIA KS AUG 8

Hamfest - Cloud County Community College, Concordia, Kansas, August 8, 1976. Swimming, tennis, and radio-controlled model airplanes for the kids. Events for the XYLs.

Prizes, meetings: 2 meter, ARRL, MARS, satellite. W0FNS Award, ham auction. Lew McCoy will speak at August 7 banquet.

## FT. WASHINGTON STATE PARK PA AUG 8

The Mt. Airy VHF Radio Club (the Packrats) are holding their annual family picnic in the Flourtown Area of the Fort Washington State Park on Sunday, August 8, 1976 (rain date 15 August). Talk-in via W3CCX/3 on 52.525, 146.52, and 222.98/224.58 MHz.

## SAUK RAPIDS MN AUG 8

The St. Cloud Radio Club Annual Hamfest will be held on Sunday, August 8, 1976, from 10 am till closing, at the Sauk Rapids Municipal Park. Free parking and overnight parking, hot dogs and pop available. Swapfest and ham gear sale. Talk-in on 34/94 and 3925. Hope to see you all there. For further info, contact Bill Zins WA0OTO, St. Cloud Radio Club, PO Box 752, St. Cloud MN 56301.

## PETOSKEY MI AUG 14

Straits Area Radio Club Swap and Shop will be held August 14 from 8 am to 4 pm at Emmet County Fairgrounds on US 31, 1/2 mile west of southern junction of US 31 and US 131, in Petoskey, Michigan. All amateurs, CBers, SWLs, \$1 admission, 50¢ per table, door prizes, lunch counter,

free parking. Talk-in on 3.920 MHz, channel 1, 146.52 MHz.

## EAST RUTHERFORD NJ AUG 14

The Knight Raiders VHF Club's auction and flea market will be held on Saturday, August 14th, at St. Joseph's Church of East Rutherford, Hoboken Road, East Rutherford. Free admission, free parking, refreshments available. Talk-in will be on 146.52. Doors will open 10 am. Flea market tables: \$6 for a full table, \$3.50 for half a table. Reserve your tables in advance by writing to The Knight Raiders VHF Club, K2DEL, PO Box 1054, Passaic NJ 07055.

## HUNTSVILLE AL AUG 15

The North Alabama Hamfest will be held on Sunday, August 15 at The Mall in Huntsville, Alabama. A hamfest supper will be held on Saturday night. Events include prize drawing, flea market, ARRL forum, MARS meetings, displays, and XYL programs. Talk-in on 146.94 and 3965. For more information contact N.A.H.A., PO Box 423, Huntsville AL 35804.

## NEW CASTLE DE AUG 15

Delmarva's new annual hamfest will be held August 15, 1976 at Wilmington College, New Castle, Delaware - U.S. Route 13 just north of Delaware Route 141 in New Castle, New Castle County. Tail-gating \$2.50 per space. Rummage and display tables \$5 per table. Food and camping available. Ladies' Bingo. Admission \$1.75 advance - \$2.50 at gate. Children are free. Make all checks payable to

Delmarva Hamfest Inc. Mail all requests for reservations and information to John Low K3YHR, 11 Scottfield Drive, Newark DE 19713.

## PUYALLUP WA AUG 21-22

The Radio Club of Tacoma (W7DK) presents HAMFAIR-76, Saturday and Sunday, August 21st and 22nd, at the Pierce County Fairgrounds, 11 miles South of Puyallup Washington. This ARRL sanctioned event features technical seminars women's and children's activities, contests, flea market, Saturday evening dinner and entertainment, Sunday morning loggers breakfast, and free camping with electrical hookups. First prize is an ICOM IC-230. Contact: W7GPR, 3421 E. 138th St., Tacoma WA 98446, phone 531-3821.

## SPRINGFIELD MO AUG 22

The Southwest Missouri Amateur Radio Club will hold its annual hamfest, swap meet and family picnic on August 22, 1976, at Lake Springfield Park. This picnic attracts over two hundred radio amateurs and their families from southwest Missouri, northwest Arkansas, southeast Kansas, and northeast Oklahoma each year. For more information write: James A. Crooke, Secretary, Southwest Missouri Amateur Radio Club, 1601 South Kimbrough Avenue, Springfield MO 65807.

## AURORA IL AUG 22

The Fox River Radio League W9CEQ Hamfest will be held August 22, 1976 at beautiful Phillips Park, east edge of Aurora, U.S. Hwy. Rt.

# Ham Help

Would appreciate plans for SIMPLE Novice band receiver.

C. E. Moore  
1112 W. Tucker  
Arlington TX 76013

Please place my name in your Ham Help column. I am willing to help people in the NYC-Long Island area get their licenses, or to help Novices upgrade.

David M. Krumholz WA2YYL  
148-10 Huxley St.  
Rosedale NY 11422

Since I first become a ham, I subscribed to QST first, then Ham Radio. Both left a lot to be desired. QST is the better of the two, however; Ham Radio was just plain over my head. Then a friend and fellow ham straightened me out and I subscribed to 73. At first glance I knew I had found the right mag for me. I must say some of the best and most interesting material is found in your

editorials and letters from other hams. If you'd like you can use this one for a sales pitch. Also, please enter my name into your "Ham Help" column for anyone who needs help. I started a ham club here in Hoosick Falls and have gotten 5 guys their Novices. Three new members are about ready for theirs. That is why I am sending for code tapes. Six of us are boning up for our General tests. Also, I would like to add my coupon to extend my subscription for three years. Keep up the good work for your fellow hams.

Dave Kessler WN2SSR  
Hoosick Falls NY

Please add my name to your list of helpers. I'd be glad to lend assistance to any aspiring hams-to-be in the Pittsburgh vicinity.

Peter Wilson WB3ALS  
1260 Fox Chapel Rd.  
Pittsburgh PA 15238  
(412)-963-9138

I am not an amateur radio operator

at this moment, but I really want to become one. I get a copy of 73 monthly at the newsstand. I love reading it. Could you please list me in your "Ham Help" column? Thank you very much.

Edward Best  
26-A Duke Manor Apts.  
311 S. LaSalle St.  
Durham NC 27705  
(919)-383-1223

In your person I should like to ask your outstanding magazine to give me help. I would like to get in touch with a ham whose profession is linguistics - more concretely, applied linguistics, terminology, linguistics. My ex-call was UA6LMX; my new call has not been received yet. Languages are English and Russian. I'm sorry for the trouble I'm giving you.

Serge P. Kushneruk  
Box 34, GPO, Tyumen  
USSR

First, to the Ham Help column - Help!!! I'm a CBER, KNK2337, who has been interested in amateur radio for almost sixteen years but never had the free time necessary for more than

superficial learning. I've also been studying electronics by home study for three months, so I'm not a complete ignoramus about electronics, just close. Am very interested in FM, SSB and 2 meter operations. I'd greatly appreciate help in making the transition.

Do you guys personally know of any ham shops in the area? CB seems to be all over the place, but the only other radios I've seen so far are scanning monitors. I've gotten three issues of your magazine now and I think it's great. I am interested in computers and think you should keep those articles in. I may understand in general only every fourth word, but it's a joy to struggle for the rest. Thanks for your help.

Gregory W. Lincavage  
23 Kingsland St.  
Nutley NJ 07110

I would like to know if anyone can obtain a matching speaker for an Allied AX-190 receiver. I would be very interested in purchasing this.

Mike Evans  
Box 985  
Ft. Smith AR 72901

#30. All day family fun, picnic, zoo, lake and flowers. Same old price — \$1.00 advanced with SASE to FRRL, PO Box 443 Aurora IL 60507. Talk-in on 146.94.

**RENO NV  
AUG 28**

Nevada Amateur Radio Association will again host the Sierra Nevada Hamfest, August 28, 1976, at the California Building, Idlewild Park, Reno, Nevada. Pre-registration \$10, until August 21. For further details, write P.O. Box 2534, Reno, Nevada 89505.

**ATLANTIC CITY NJ  
AUG 28-29**

The Personal Computing '76 Consumer Trade Fair will be held August 28-29, 1976 in Atlantic City, New Jersey. Seminars and technical talks, major exhibits, demonstrations, door prizes, and free literature all about software and hardware development, microcomputers, memories, comparisons, interfacing, implementation, AMSAT, computerized music, video terminals, construction, printers, games, and tapes. Admission \$5 advanced, \$7.50 at door (includes exhibits and seminars). Exhibition booths — call (609) 927-6950.

**LA PORTE IN  
AUG 29**

The combined La Porte County Amateur Radio Clubs will hold their Fall Hamfest on Sunday, August 29th, 1976 at the La Porte County Fairgrounds in La Porte, beginning at 7 am Chicago time. Overnight camping available. Indoors in case of rain. No table or set-up charge. Paved midway, good food and drink. \$2 donation at the gate. For more information write: PO Box 30, La Porte IN 46350. Talk-in on 01-61 and 94 simplex.

**SO DARTMOUTH MA  
AUG 29**

The Southeastern Amateur Radio Club is having a Flea Market and Picnic on August 29, 1976 at the Stackhouse Fairgrounds in So. Dartmouth MA. Space will be \$2 and table an additional \$2. Homemade food, magic show for the children, and many raffles. For a flier write: Arthur Sylvia, 317 Nemasket St., New Bedford MA 02740.

**EL PASO TX  
SEPT 4-5**

The ARRL Hamfest will be held September 4-5 at the elegant Vista Motor Inn. Seminars, solar power, exotic modes, OSCAR and flea-market. Write PO Box 24050, El Paso TX 79914. Visit us on Labor Day weekend!

**MENA AR  
SEPT 4-5**

The Queen Wilhelmina Hamfest 1976 is Saturday and Sunday, September 4 and 5, at Queen Wil-

helmina State Park, Rich Mountain, Mena, Arkansas. Excellent accommodations and food at the newly restored historic Queen Wilhelmina Castle. Door prizes hourly, grand prize, new equipment displays, flea market, camping area with utilities and rest rooms, amusements for harmonics. Talk-in 146.52. For more information write WB5CXX, P.O. Box 5191, Texarkana TX or phone (214) 838-0625.

**DANVILLE IL  
SEPT 5**

The Danville Hamfest will be held at Douglas Park, Danville, Illinois September 5. Downstate Illinois' largest. Great prizes. Advance tickets \$1.75 ea., 3/\$5 with an SASE to Jim Wilson, 308 First, Ridgeway IL 61870. Talk-in 22/82 and 3910.

**YORK PA  
SEPT 5**

The 21st Annual York County Hamfest will be held September 5th, rain or shine, 10 miles west of York PA; ½ mile west of York Airport, turn south off Rt 30 to Elickers Grove. Registration begins at 9 am — fee \$3.00. All adults and amateurs are expected to register, XYs and children free. A limited number of flea market tables are available inside by advance reservations *only*. Contact hamfest committee. There will be a \$5.00 charge for using electric power. Talk-in 146.04-64; 28-88; 52-52. For more information write or phone Leroy Frey K3POR, 170 S. Albemarle St., York PA 17402, phone 854-1203.

**BEREA OH  
SEPT 11**

The '76 Cleveland Hamfest presented by the Cleveland Hamfest Association will be held Saturday, September 11 at 8 am to 6 pm at the Cuyahoga County Fairgrounds, Berea, Ohio. Eastland Road entrance only to County Fairgrounds with easy access from Hopkins Airport, Interstate I-71, I-90 or Ohio Turnpike. Tickets \$1.50 before August 31; \$2.00 at 0800 for all 12 or over when gates open. Asphalt quad flea market parking \$1 additional per space at 0700. Bring your own tables and shade. Registration: \$1.50 tickets by mail before August 31 with check or money order to: Cleveland Hamfest Association, P.O. Box 43413, Cleveland, Ohio 44143.

**MELBOURNE FL  
SEPT 11-12**

The 11th annual Melbourne, Florida hamfest will be held Saturday and Sunday, September 11-12, 1976, from 9 am to 5 pm each day in the air-conditioned Melbourne Civic Auditorium located on Hibiscus Boulevard. Donation is \$2.50 per adult. Full program includes forums, meetings, auction, swap tables, commercial exhibits, awards, prizes, etc. Talk-in on 25/85 and 52/52. Sponsored by Platinum Coast Amateur

Radio Society. For more info write PO Box 1004, Melbourne FL 32901. FCC exams in Ramada Inn Saturday at 8 am for General, Advanced, and Extra. Form 610 and \$4 fee must be filed with FCC, Room 919, 51 S.W. First Avenue, Miami, no later than August 31, 1976.

**FINDLAY OH  
SEPT 12**

The 34th Annual Findlay Hamfest will be held on Sept. 12 at Riverside Park, Findlay, Ohio. Talk-in 146.52. For advanced tickets and/or info write: Clark Foltz W8UN, 122 W. Hobart St., Findlay, Ohio 45840 (SASE please for under 5 tickets).

**MALAGA NJ  
SEPT 12**

The South Jersey Radio Assn. 28th Annual Hamfest will be held September 12, 1976, 10 to 5 pm, at Molia Farms, Malaga, New Jersey. Lake, picnic grounds and food available. Tailgate sales, swap shop and door prizes. Family tickets: advance sales — \$2.50, gate sales — \$3.50. Advance sales send SASE to Jack Koch, Box 103, Cherry Hill NJ 08002. Talk-in 146.52.

**HAMBURG NY  
SEPT 18**

The Hamburg International Hamfest will be held September 18, 1976 at the Erie County Fairgrounds in Hamburg, New York. Directions: Take the New York State Thruway to the Blasdell Exit (Exit 56). Recreational vehicles will turn right on Mile Strip Road and turn left on Route 62

South (first major intersection). Follow the signs to the Erie County Fairgrounds entrance. All other vehicles turn left on Mile Strip Road and turn right on McKinley Parkway (first major intersection). Hamfest will include giant flea market, technical forums, picnic facilities, excellent programs, non-amateur displays, code contest, women's programs, organization meetings, equipment displays and FM hospitality room, and thousands of dollars in awards. Admission: \$3 at gate, \$2.50 in advance. \$1 for flea market parking. Children under 12 admitted free. Talk-in stations will be on the WR2ABU repeater (146.31 in, 146.91 out), 146.52 simplex, 7.255 (ECARS), and 3.925. For more information contact Bert Jones W2CUU, 143 Orchard Drive, Kenmore NY 14223, tel. 716-873-3984.

**NEW KENSINGTON PA  
SEPT 19**

The Skyview Radio Society's Swap & Shop will be held on Sept. 19, 1976 at the Skyview Radio Club, New Kensington PA. Registration \$1. Talk-in 52-52 and 04-64.

**NEW BERLIN IL  
SEPT 26**

The Sangamon Valley Radio Club Hamfest will be held September 26 at the Sangamon County Fairgrounds, New Berlin, Illinois, twelve miles west of Springfield (Illinois state capitol) on Route 36. There will be food, programs, covered pavilion, and nearby camping. See Lincoln shrines. Talk-in 28/88 AF9AFA. Tickets \$1.00. Write: K9HDZ, 622 Magnolia, Rochester, Illinois.

# Oscar Orbits

Oscar 6 Orbital Information					Oscar 7 Orbital Information			
Orbit	Date (Sept)	Time (GMT)	Longitude of Eq.	Mode	Orbit	Date (Sept)	Time (GMT)	Longitude of Eq.
			Crossing W					Crossing W
17736	1	0052:31	69.9	AX	8210	1	0038:10	59.3
17749	2	0147:27	83.7	B	8223	2	0132:27	72.9
17761	3	0047:23	68.7	A	8235	3	0031:47	57.7
17774	4	0142:19	82.4	B	8248	4	0126:04	71.3
17786	5	0042:15	67.4	A	8260	5	0025:24	56.1
17799	6	0137:10	81.2	B	8273	6	0119:41	69.7
17811	7	0037:06	66.2	A	8285	7	0019:02	54.6
17824	8	0132:02	79.9	BX	8298	8	0113:18	68.1
17836	9	0031:58	64.9	A	8310	9	0012:39	53.0
17849	10	0126:54	78.7	B	8323	10	0106:56	66.5
17861	11	0026:50	63.7	A	8335	11	0006:16	51.4
17874	12	0121:45	77.4	B	8348	12	0100:33	64.9
17886	13	0021:41	62.4	A	8361	13	0154:58	78.5
17899	14	0116:37	76.1	B	8373	14	0054:10	63.3
17911	15	0016:33	61.1	AX	8386	15	0148:27	76.9
17924	16	0111:29	74.9	B	8398	16	0047:47	61.7
17936	17	0011:25	59.9	A	8411	17	0142:04	75.3
17949	18	0106:20	73.6	B	8423	18	0041:25	60.1
17961	19	0006:16	58.6	A	8436	19	0135:42	73.7
17974	20	0101:12	72.4	B	8448	20	0035:02	58.6
17986	21	0001:08	57.4	A	8461	21	0129:19	72.1
17999	22	0056:04	71.1	BX	8473	22	0028:39	57.0
18012	23	0150:59	84.9	A	8486	23	0122:56	70.5
18024	24	0050:55	69.9	B	8498	24	0022:16	55.4
18037	25	0145:51	83.6	A	8511	25	0116:33	68.9
18049	26	0045:47	68.6	B	8523	26	0015:54	53.8
18062	27	0140:43	82.4	A	8536	27	0110:11	67.3
18074	28	0040:39	67.4	B	8548	28	0009:31	52.2
18087	29	0135:55	81.1	AX	8561	29	0103:48	65.7
18099	30	0035:31	66.1	B	8573	30	0003:08	50.6

Before the  
**FEDERAL COMMUNICATIONS  
 COMMISSION**  
 Washington, D.C. 20554  
 FCC 76-537  
 41127

In the Matter of  
 Amendment of Part 97 of the  
 Commission's Rules concerning operator  
 classes, privileges,  
 and requirements in the  
 Amateur Radio Service.

Docket 20282

RM-1016 1363, 1454  
 1456, 1516, 1521, 1526,  
 1535, 1568, 1572, 1602,  
 1615, 1629, 1633, 1656,  
 1724, 1793, 1805, 1841,  
 1920, 1947, 1976, 1991,  
 2030, 2043, 2053, 2149,  
 2150, 2162, 2166, 2216,  
 2219, 2256, 2284, 2449

FIRST REPORT AND ORDER

Adopted: June 9, 1976;  
 Released: June 15, 1976

By the Commission:

1. On December 16, 1974, the Commission released a Notice of Proposed Rule Making in this proceeding which was published in the Federal Register on December 20, 1975 (39-FR44042). Comments were due by June 16, 1975, and reply comments by July 16, 1975. The due dates for both comments and reply comments were extended, and the final cutoff dates were set at July 16, 1975, and September 1, 1975, respectively.

2. The purpose of the Notice was to consolidate into one rulemaking proceeding the many petitions we had received which dealt one way or another with changing the structure of the Amateur Radio Service. We recognized that the requests found in the petitions were often interrelated, and should not be handled on a piecemeal basis. For this reason, we undertook a fundamental review of the entire structure of the Amateur service and proposed various changes in that structure.

3. The major proposed rule changes contained in the Notice were the following:

- a) Creation of a "dual ladder" licensing structure;
- b) Creation of a Communicator Class license having no telegraphy privileges or examination requirement;
- c) Establishment of new power limits based on transmitter peak envelope power output;
- d) New restrictions on licenses obtained by means of volunteer-administered mail examinations;
- e) Issuance of lifetime Amateur Extra Class operator licenses; and
- f) Modification of the frequencies and modes available to certain license classes.

4. An estimated 4000 comments and reply comments were filed in this Docket. They ranged from postcards to multipage typewritten statements, often with very detailed analyses of our proposals coupled with suggested revisions thereto. All of these comments have been read and carefully considered. Also, in addition to these documents, we have closely examined the results of a poll taken by the American Radio Relay League (ARRL) which elicited responses from many thousands of that organization's members.

5. Because of severe manpower and time restrictions brought about by the recent surge in Citizens Radio Service applications, we are unable at this time to undertake the preparation of a comprehensive Report and Order which would address all of the issues raised in the Notice. We are therefore releasing this First Report and Order in which several matters of importance will be addressed, and we plan to prepare additional Reports and Orders in the future as our workload permits.

6. Firstly, we will address the matter of examinations administered by volunteer examiners. Under the system put forth in the Notice, all licenses obtained in this way, except Novice licenses and licenses granted in those instances where the applicant qualified for a volunteer-administered examination on the basis of a protracted disability which prevented travel to a Commission examination point, were to be non-renewable. Such licenses were to be temporary, and the licensees would have been required to successfully complete a regular Commission-supervised examination in order to remain licensed. This arrangement would have required all presently licensed Technician (C) and Conditional licensees to undergo reexamination by the Commission. Failure to successfully complete the Commission-supervised examination would have

## 2 METER CRYSTALS IN STOCK

We can ship C.O.D. first class mail. Orders can be paid by: check, money order, Master Charge, or BankAmericard. Orders prepaid are shipped postage paid. Phone orders accepted. Crystals are guaranteed for life. Crystals are all \$5.00 each (Mass. residents add 25¢ tax per crystal). *U.S. Funds Only*

We are authorized distributors for: Icom and Standard Communications Equipment. (2 meter)

Note: If you do not know type of radio, or if your radio is not listed, give fundamental frequency, formula and loading capacitance.

### LIST OF TWO METER CRYSTALS CURRENTLY STOCKED FOR RADIOS LISTED BELOW:

- |  |                     |
|--|---------------------|
| 1. Drake TR-22                         | 6. Regency HR-2B    |
| 2. Genave                              | 7. S.B.E.           |
| 3. Icom/VHF Eng.                       | 8. Standard 146/826 |
| 4. Ken/Wilson /Tempo FMH               | 9. Standard Horizon |
| 5. Regency HR-2A/HR212/Heathkit HW-202 | 10. Clegg HT-146    |

The first two numbers of the frequency are deleted for the sake of being non-repetitive. Example: 146.67 receive would be listed as - 6.67R

- |          |            |           |           |           |           |           |           |
|----------|------------|-----------|-----------|-----------|-----------|-----------|-----------|
| 1. 6.01T | 9. 6.13T   | 17. 6.19T | 25. 6.31T | 33. 6.52T | 41. 7.03R | 49. 7.15R | 57. 7.27R |
| 2. 6.61R | 10. 6.73R  | 18. 6.79R | 26. 6.91R | 34. 6.52R | 42. 7.66T | 50. 7.78T | 58. 7.90T |
| 3. 6.04T | 11. 6.145T | 19. 6.22T | 27. 6.34T | 35. 6.55T | 43. 7.06R | 51. 7.18R | 59. 7.30R |
| 4. 6.64R | 12. 6.745R | 20. 6.82R | 28. 6.94R | 36. 6.55R | 44. 7.69T | 52. 7.81T | 60. 7.93T |
| 5. 6.07T | 13. 6.16T  | 21. 6.25T | 29. 6.37T | 37. 6.94T | 45. 7.09R | 53. 7.21R | 61. 7.33R |
| 6. 6.67R | 14. 6.76R  | 22. 6.85R | 30. 6.97R | 38. 7.60T | 46. 7.72T | 54. 7.84T | 62. 7.96T |
| 7. 6.10T | 15. 6.175T | 23. 6.28T | 31. 6.40T | 39. 7.00R | 47. 7.12R | 55. 7.24R | 63. 7.36R |
| 8. 6.70R | 16. 6.775R | 24. 6.88R | 32. 6.46T | 40. 7.63T | 48. 7.75T | 56. 7.87T | 64. 7.99T |
|          |            |           |           |           |           |           | 65. 7.39R |

CRYSTALS FOR THE IC-230 SPLITS IN STOCK: 13.851111 MHz;  
 13.884444 MHz; 13.917778 MHz. \$6.50 ea.

**BACK IN  
 STOCK!**

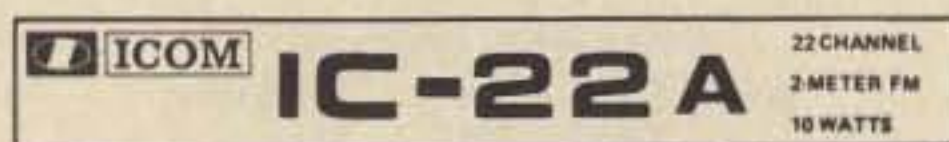

Special! Only \$249.95. Get 8 crystals of your choice for only \$2.50 more with purchase of IC-22A.

### READY TO GO ON:

- |   |       |   |       |   |       |
|---|-------|---|-------|---|-------|
| 1 | 94/94 | 3 | 22/82 | 5 | 52/52 |
| 2 | 34/94 | 4 | 28/88 |   |       |

### VHF FM

#### RECEIVER:

Reception Frequencies	22 channels for 144 MHz band. Built-in crystal units for 5 channels.	144.00 to 148.00 MHz using 22 channels
Reception System	Double Superheterodyne	Transistors .....23
Intermediate Frequencies	1st intermediate: 10.7 MHz 2nd intermediate: 455 kHz	FET .....3
Sensitivity	a. Better than 0.4 u v 20db quieting	IC .....3
		Diodes .....16

STORE HOURS: MON-FRI: 9 A.M. - 9 P.M. SAT: 9 A.M. - 6 P.M.

**Kensco** Box 469  
 Dept. 4976, Quincy MA 02169  
 617-471-6427

**Communications** INC.



meant that the licensee could not have continued to renew his license upon expiration.

7. As one of the broad objectives in this proceeding, we stated in the Notice that we desired to preclude, or at least minimize, any adverse impact upon presently licensed amateurs. The sentiments in the comments overwhelmingly supported this posture, and we continue to believe it to be the only reasonable course of action. Many comments objected to our "non-renewability" proposal for volunteer-administered examinations as being detrimental to amateur radio in general and excessively burdensome to thousands of licensees who, for valid reasons, did not undertake Commission-supervised examinations. Moreover, inasmuch as the Technician Class license program has always been, by Commission intent, based primarily on volunteer-administered examinations, a mass recall of these persons does not now appear equitable. We are in basic agreement with these objections, and have modified our proposal to blunt any ill effects on present licensees. We believe the limited resources available to us can be best utilized elsewhere.

8. However, our experience with the volunteer examination program has shown that it has been abused. Our routine call-in program of Technician(C) and Conditional Class licensees has shown that over 90% of such persons either fail to appear for re-examination, or if they do appear, fail the examination. Such results tend to confirm the suspicion that some such licensees obtained their licenses fraudulently. We have therefore determined to limit the availability of volunteer-administered examinations to the following categories of applicants:

a) Applicants for the Novice license; and

b) Applicants who show by physician's certification that they are unable to appear at a Commission examination point because of a protracted disability preventing travel.

All applications for mail examinations on the basis of a protracted disability should now be sent to the FCC field office nearest the applicant, rather than to the Commission's offices in Gettysburg, Pennsylvania. Such examinations will be conducted by a volunteer examiner selected by the Commission, or by Commission personnel.

9. Persons now holding licenses obtained on the basis of a mail examination will not be adversely affected by this rule change. All such licenses may continue to be renewed, and Rule Section 97.25 is being modified to indicate that examination credit will be given for those elements which were passed without Commission supervision. For instance, a Technician(C) licensee will automatically be given credit for Element 3 should he attempt to obtain a General Class license. He would be required only to pass Element 1(B), the 13 wpm telegraphy test. We believe that this "grandfather" provision penalizes no one, and will encourage such licensees to upgrade. Upon application for license modification or renewal, all present Conditional Class licensees will be issued General Class licenses, and all Technician(C) licensees will be issued Technician licenses. Henceforth, all applicants passing Elements 1(B) and 3 on a volunteer-administered examination will be issued a General Class license. The Conditional Class will no longer be issued.

10. The elimination of the 175 mile distance eligibility criteria for the Conditional Class (now General Class) license will not, in our view, impose an undue hardship on those persons sincerely interested in obtaining an amateur license. The number of such applications received is now slight, and the enlargement of the Commission's examination schedule for remote points all but eliminates the usefulness of the 175 mile criterion. With respect to the Technician(C) Class license, we do not foresee any significant adverse impact resulting from its elimin-

ation. The vast majority of persons seeking that license live within convenient travel distance of a Commission examination point, and our examination policy with respect to the Technician Class is now consistent with our policy governing all license classes except Novice. As proposed, we are also deleting the availability of mail examinations on the basis of eligibility criteria set out in §97.27(c) and (d).

11. A related issue we will address at this time involves the Novice Class license. Many thousands of Novice examinations are given each year, and this has been the gateway to

Amateur radio for over half of all present licensees. We believe the experience of taking the Novice test to be very worthwhile, inasmuch as there is no overlap in the Novice examination questions and the questions found on more advanced examinations. We are therefore amending the Rules to require that all persons entering Amateur Radio Service, at any level, successfully complete examination element in addition to the other examination elements presently required for the license examination being undertaken. We are also at this time deleting the provision in Section 97.9(f) which pro-

hibits the issuance of a Novice Class license to a person who has held within the prior 12 month period any class of Amateur radio license. We believe this provision serves no useful purpose and has prohibited otherwise qualified persons from remaining in Amateur radio.

12. The final matter we will touch on in this First Report and Order involves the privileges available to Technician and Novice Class licensees. Until several years ago, it was permissible for a licensee to hold both the Novice and Technician Classes of license at the same time. Such dual licensing was

### PHONE PAD \$6.50

New, packaged by Automatic Electric. Preferred by many over the tactile pads. Great for repeaters, auto-dialers, etc.

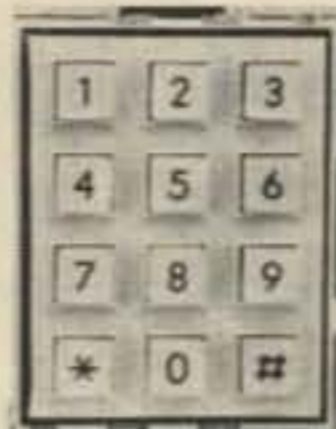

SP-213A \$6.50 ea 3/\$16.00

### SPEED CONTROL

New solid state SCR speed control for AC/DC devices or resistive loads, lights, etc. Good for a whopping 1.2 KW. Ideal soldering iron control.



SP-189A \$4.50 ea 3/\$12.00

5 VOLT 1 AMP REGULATED power supply kit for logic work. All parts including LM 309K #PK-7 \$7.50

DUMMY LOAD resistor, non-inductive, 50 ohm 5 watts \$1.00

AA NICAD CELLS brand new, fine biz for handy talkies. \$1.25 ea 9/\$9.00

ASCII KEYBOARD brand new w/ROM chip, data package \$45.00

### POWER SUPPLY MODULE

New, plug-in module. Plugs into AC outlet provides 12 volts AC at 1/2 amp by two screw terminals. Great for various clocks, chargers, adding machines, etc. New \$2.50 ea. 5/\$10.00

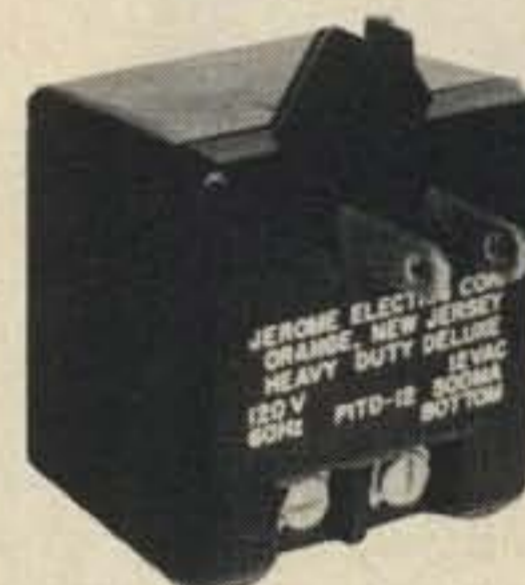

### LASER DISCHARGE CAP

Sangamo, new, 40 mfd 3,000 volts, 180 Joules. May be used for filtering, linears, etc., by derating to 2,000 volts. Shipping wgt. 10 lbs. Measures 3 3/4 x 4 1/2 x 9 1/2 inches. \$25.00 each 5/\$110.00

### TELEPHONE TOUCH PADS

New, by Chromerics, standard telephone format. Measure 2 1/4 x 3 inches. Great for repeaters, phones, computers, etc. \$4.50 each 6/\$25.00



### VIDEO TAPE HEADS

Brand new from Cartavision home video equipment. Made for 1/2 inch tape, includes erase, play, record. We include 3 different, made by Vikron, Bogen. 3 different for the \$5.00. A \$60 value. SP 240A 3/\$5.00

Please add shipping cost on above.

*Meshna*

P.O. Box 62  
E. Lynn, Massachusetts 01904

FREE CATALOG  
SP-8 NOW READY

subsequently prohibited in Section 97.9(f), which states that the Novice Class license may not be concurrently held with any other class of license. We have received several petitions to lift this restriction, and in our Notice we proposed to include Novice Class privileges in the Technician Class license. We are herein adopting that proposal, which was widely supported in the comments. We are also modifying the maximum permissible transmitter power input which Novices, and all other license classes, may utilize when operating on Novice frequencies. We are limiting to 250 Watts the

maximum power input which may be used by any class of operator transmitting in Novice sub-bands. We are adopting this change for two reasons; firstly, it will mean that a Novice can buy equipment which will be readily useable and practical when he upgrades to General Class and above. Presently, in order to conform to the 75 Watt power limit, Novices oftentimes are forced to buy low power transmitters which they find have limited usefulness outside Novice sub-bands; and secondly, we see no reason to permit non-Novices to utilize high power in a sub-band where such power gives

them a significant advantage over a license class which is restricted to that sub-band.

13. In view of the foregoing, we are of the opinion that the amended rules as discussed above are in the public interest, convenience, and necessity. Accordingly, pursuant to authority contained in Section 4(i) and 303 of the Communications Act of 1934, as amended, IT IS ORDERED, that Part 97 of the Commission's Rules IS AMENDED as set forth in the Appendix attached hereto. These amendments become effective July 23, 1976.

FEDERAL  
COMMUNICATIONS  
COMMISSION  
Vincent J. Mullins  
Secretary

#### APPENDIX

Chapter 1, Part 97 of Title 47 of the Code of Federal Regulations is amended as follows:

1. In Section 97.7, paragraphs (b), (c) and (d) are amended and (e) is added to read as follows:

§97.7 Privileges of operator licenses.

(b) *General Class.* All authorized amateur privileges except those exclusive operating privileges which are reserved to the Advanced Class and/or Amateur Extra Class.

(c) *Conditional Class.* Same privileges as General Class. New Conditional Class licenses will not be issued. Present Conditional Class licensees will be issued General Class licenses at time of renewal or modification.

(d) *Technician Class.* All authorized amateur privileges on the frequencies 50.1-54 MHz and 145-148 MHz and in the Amateur bands above 220 MHz. Such licenses also carry the full privileges of the *Novice Class* license.

(e) *Novice Class.* Radiotelegraphy in the frequency bands 3700-3750 kHz, 7100-7150 kHz (7050-7075 kHz when the terrestrial station location is not within Region 2), 21,100-21,200 kHz, and 28,100-28,200 kHz, using only Type A1 emission.

2. Section 97.9 is amended to read as follows:

§97.9 Eligibility for new operator license.

Anyone except a representative of a foreign government is eligible for an amateur operator license.

3. Section 97.11(b) is amended to read as follows:

§97.11 Application for operator license.

(b) An application (FCC Form 610) for a new operator license, including an application for change in operating privileges, which requests an examination supervised by a volunteer examiner under the provisions of §97.27, shall be submitted to the FCC field office nearest the applicant. Applications for the Novice Class license should be sent to the Commission's offices in Gettysburg, PA 17325. All applications should be accompanied by any necessary filing fee.

4. Section 97.23 is amended to read as follows:

§97.23 Examination requirements.

Applicants for operator licenses will be required to pass the following examination elements:

(a) Amateur Extra Class: Elements 1(C), 2, 3, 4(A) and 4(B);

(b) Advanced Class: Elements 1(B), 2, 3, and 4(A);

(c) General Class: Elements 1(B), 2, and 3;

(d) Technician Class: Elements 1(A), 2, and 3;

(e) Novice Class: Elements 1(A) and 2.

5. Section 97.25(a) is amended to read as follows:

§97.25 Examination credit.

(a) An applicant for a higher class of amateur operator license who holds any valid amateur license will be required to pass only those elements of the higher class examination that are not included in the examination for the amateur license held.

6. Section 97.27 is retitled and amended to read as follows:

§97.27 Mail examinations for applicants unable to travel.

The Commission may permit the examinations for an Amateur Extra, Advanced, General, or Technician Class license to be administered at a location other than a Commission examination point by an examiner chosen by the Commission when it is shown by physician's certification that the applicant is unable to appear at a regular

# G.R. WHITEHOUSE & CO.

17 Newbury Drive, Amherst, N.H. 03031

## TRANSMITTING VARIABLES

Millen 16250 dual 255pF 3kV . . . . . \$43.25  
Millen 16520A single 200pF 3kV . . . . . 24.75  
Johnson 154-10 single 347pF 3 kV . . . . . 34.60

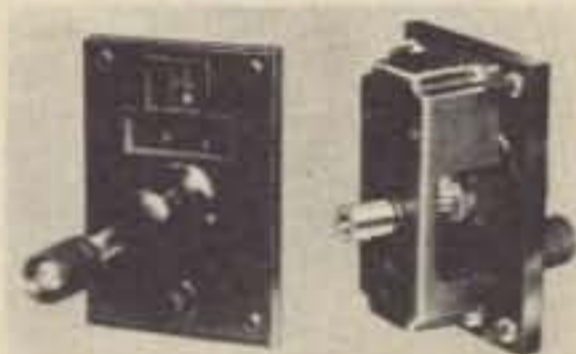

## COUNTER DIAL

Millen 10031, 0-99 turns readout with 0-100 vernier dial, ideal for transmatch, fits 1/4" shaft . . . . . \$25.50



## PANEL DIAL

Millen 10039, 4" x 3-9/32", 7 1/2 to 1 ratio, mounts on front panel . . . . . \$12.30

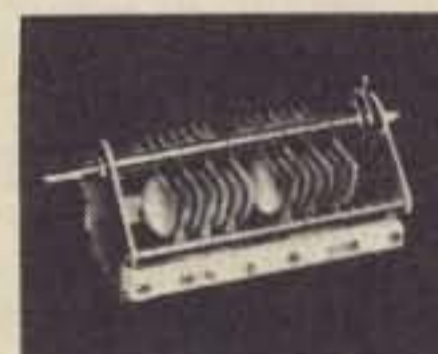

## TOROIDAL CORES

(specify material)  
T-200 . . . \$1.60  
T-80 . . . \$ .40  
T-68 . . . \$ .35  
T-50 . . . \$ .30  
T-37 . . . \$ .25  
T-25 . . . \$ .15

## BARKER & WILLIAMSON

MODEL 375 PROTAX™ 6-position coaxial switch, rear contacts . . . . . \$18.50  
MODEL 376 same as above, with side connectors . . . . . 18.50  
MODEL 425 TVI Filter, 1000 W . . . . . 32.50  
MODEL 350/2Q4 Audio Phase Shift Network . . . . . 15.00  
MODEL CC50 Dipole Antenna center coaxial connector . . . . . 8.25



## RF Switch

Millen 51001, 1 pole, 2 to 6 pos, 13kV flashover, 20 Amps \$21.20

## JOHNSON MINIATURE VARIABLES

160-102 1.5 to 5 pF . . . . . \$3.00  
160-104 1.8 to 8 pF . . . . . 3.05  
160-107 2.3 to 14 pF . . . . . 3.15  
160-110 2.7 to 19 pF . . . . . 3.20  
160-130 3.0 to 32 pF . . . . . 3.45

## ROTARY INDUCTOR

Johnson style 229-203, 28 mH . . . . . \$32.00

## MILLEN

92200 2kW Antenna Tuner . . . . . \$199  
92201 300W Antenna Tuner . . . . . \$138  
90652 Solid State Grid Dip Osc . . . . . \$138

## NOW IN STOCK

Transmitting Variables — Roller Inductors — Counter Dials  
Air Wound Coils — Couplings — Knobs — Receiving Variables  
Toroids — R.F. Chokes — Coil Forms and more

From

Millen - E. F. Johnson - Barker & Williamson - JW Miller - Hammarlund  
Send First Class Stamp for Flyer

Add \$1.50 to each order for shipping and handling. Prices subject to change.



Commission examination point because of a protracted disability preventing travel.

7. Section 97.28 is retitled and amended to read as follows:

§97.28 Manner of conducting examinations.

(a) Except as provided by §97.27, all examinations for Amateur, Extra, Advanced, General, and Technician Class operator licenses will be conducted by authorized Commission personnel or representatives at locations and times specified by the Commission. Examination elements given under the provisions of §97.27 will be administered by an examiner selected by the Commission. All applications for consideration of eligibility under §97.27 should be filed on FCC Form 610, and should be sent to the FCC field office nearest the applicant. (A list of these offices appears in §0.121 of the Commission's Rules and can be obtained from the Regional Services Division, Field Operations Bureau, FCC, Washington, D.C. 20554, or any field office.)

(b) Unless otherwise prescribed by the Commission, examinations for the Novice Class license will be conducted and supervised by a volunteer examiner selected by the applicant. The volunteer examiner shall be at least 21 years of age, shall be unrelated to the applicant, and shall be the holder of an Amateur Extra, Advanced, or General Class operator license. The written portion of the Novice examination, Element 2, shall be obtained, administered, and submitted in accordance with the following procedure:

(1) Within 10 days after successfully completing telegraphy examination element 1(A), an applicant shall submit an application (FCC Form 610) to the Commission's office in Gettysburg, Pennsylvania 17325. The application shall include a written request from the volunteer examiner for the examination papers for Element 2. The examiner's written request shall include (i) the names and permanent addresses of the examiner and the applicant, (ii) a description of the examiner's qualifications to administer the examination, (iii) the examiner's statement that the applicant has passed telegraphy element 1(A) under his supervision within the 10 days prior to submission of the request, and (iv) the examiner's written signature. Examination papers will be forwarded only to the volunteer examiner.

(2) The volunteer examiner shall be responsible for the proper conduct and necessary supervision of the examination. Administration of the examination shall be in accordance with the instructions included with the examination papers.

(3) The examination papers, either completed or unopened in the event the examination is not taken, shall be returned by the volunteer examiner to the Commission's offices in Gettysburg, Pa., no later than 30 days after the date the papers are mailed by the Commission (the date of mailing is normally stamped by the Commission on the outside of the examination envelope).

(c) The code test required of an applicant for an amateur radio operator license, in accordance with the provisions of §§97.21 and 97.23 shall determine the applicant's ability to transmit by hand key (straight key or, if supplied by the applicant, any other type of hand operated key such as a semi-automatic or electronic key, but not a keyboard keyer) and to receive by ear, in plain language, messages in the International Morse Code at not less than the prescribed speed during a five minute test period. Each five characters shall be counted as one word. Each punctuation mark and numeral shall be counted as two characters.

(d) All written portions of the examinations for amateur operator privileges shall be completed by the applicant in legible handwriting or hand printing. Whenever the applicant's signature is required, his normal signature shall be used. Applicants unable to comply with these requirements, because of physical disability, may dictate their answers to the examination questions and the receiving code test. If the examination or any

# Tracking the Hamburglar

ABDUCTED: Drake ML2 no. 11512. Xtals for 10 channels, green sub min. coax connected for T/T pad to coax conn BNC on rear, 1 coax sub min. connected to dev. terminals. Stolen March 26, 1976 in Andover, Massachusetts. Contact Frank S. Minas WA1MJI, 16 Cottage Street, Exeter NH 03833.

LIFTED: Genave GTX-1T handheld transceiver, s/n 13-07 stolen from our booth at the Dayton Hamfest. Contact Claude L. Henderson, Vice President, General Aviation Electronics, 4141 Kingman Drive, Indianapolis IN 46226, phone (317)-546-1111.

GONZO: Icom IC-230 2m FM transceiver, s/n 2406312, with all 5 West Coast split-split crystals. Inscribed on rear chassis: "CA DL #G516583" and "K6ICS". Contact Dr. Michael K. Gauthier, 9550 Gallatin Road,

Downey CA 90240, (213)-923-0131.

RUSTLED: Icom IC230 two meter fm transceiver with mount and B2 xtal, s/n 2835. TPL Model 1002 two meter power amplifier, s/n 0426. Regency 10 channel scanner model ACTR 10HLU with all crystals and antenna junction box, s/n 185A88279. Stolen from the Mission Valley area of San Diego on May 17, 1976. If located, advise San Diego Police Dept, Burglary Div. at 236-6281 (case #76-33350), or contact Zane Sprague K6WK (714) 481-0594.

TAKEN: Unimetrics Ultra-Com 25, s/n 080213, stolen from locked auto parked in residence driveway, about 5 am, May 12, 1976. Unit encribed in two places with N.C. driver's license number, 2067134. Contact Greensboro N.C. Police Dept., or W4DWR.

STOLEN: GTX-2 s/n 29-63 and ID no. 020-34-2737. GLH-100 and same ID no. Taken from my car on June 12, 1976. I am offering \$100 for the recovery and conviction of the persons responsible for the theft. Paul F. Kelley K1UXD, 165 Garfield Avenue, Hyde Park MA 02136.

REMOVED: Icom IC-22A transceiver, s/n 1216, 16/76, 31/91, 01/61 xtals also in radio besides standard xtals from Icom. The radio also had a Motorola type microphone, instead of the standard Icom mike. Realistic PRO-11 Scanner, s/n 08370930, xtals for 155.79 and 155.685 MHz. Sanyo FT-867 AM/FM/8 trk in dash car radio, s/n 87661611. Realistic MPA-10 PA amplifier, manufacturer did not put s/n on unit, also non-stock microphone with it. These items were stolen from my auto parked outside my home on the night of August 21, 1975. I also had my name and SSN (214-68-9618) engraved on each unit. Please contact Stephen E. Martin WA3SAD, 12115 Northwood Drive, Upper Marlboro MD 20870 or at this phone number: 301-627-4933, or contact the Prince Georges County Police, Bowie, MD, case number 75-233-163.

## ATTENTION METRUM II OWNERS

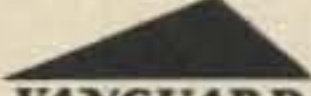
 **VANGUARD** has a high quality synthesizer made for your rig. You get 2,000 thumbwheel selected channels from 140.000 to 149.995 MHz in 5 kHz steps at .0005% accuracy over the temperature range of -10 to +60 C and your cost is only \$159.95. With the Metrum, one Vanguard synthesizer covers both transmit and receive frequencies.

*For complete details and photo see our half page ad in the May issue of this magazine.*

## VANGUARD LABS

196-23 Jamaica Ave., Hollis, New York 11423

## CS<sub>dc</sub> Silicon Rectifier Modules



### FEATURING:

- Voltage ratings up to 20,000 volts
- Current ratings up to 6.0 amps
- Fully glassivated diode building blocks by—  
**GENERAL ELECTRIC**
- Wide variety of standard assemblies available in configurations such as half wave, center-tap, doublers, and bridges (1 & 3 phase)
- Avalanche types
- Both standard power line frequency and fast switching types
- Capable of replacing many other manufacturers' types which are no longer available such as silicon retro-fits for tube types 866, 872, 8020, etc.
- Custom designs and engineering services
- Applicable to higher reliability applications such as industrial control systems, communication equipment, ham radio gear, smoke stack precipitators, etc.

### FOR MORE INFORMATION CONTACT:

**CONDITIONING SEMICONDUCTOR DEVICES CORP.**  
Post Office Box No. 816 Wayne, N. J. 07470  
Telephone: 201-227-2539

part thereof is dictated, the examiner shall certify the nature of the applicant's disability and the name and address of the person(s) taking and transcribing the applicant's dictation.

8. Section 97.29 is deleted and redesignated as reserved.

9. Section 97.31(a) is amended to read as follows:

§97.31 Grading of examinations.

(a) Code tests for sending and receiving are graded separately.

10. Section 97.33 is amended to read as follows:

§97.33 Eligibility for re-examination.

An applicant who fails a written examination for an amateur radio operator license may not take another written examination for the same or higher class license within 30 days.

11. Section 97.35 is deleted.

12. In Section 97.67 paragraph (a) is amended and (d) is added to read as follows:

§97.67 Maximum authorized power.

(a) Except for power restrictions as set forth in §97.61 and paragraph (d) below each amateur transmitter may be operated with a power input not exceeding one kilowatt to the plate circuit of the final

amplifier stage of an amplifier oscillator transmitter or to the plate circuit of an oscillator transmitter. An amateur transmitter operating with a power input exceeding 900 Watts to the plate circuit shall provide means for accurately measuring the plate power input to the vacuum tube or tubes supplying power to the antenna.

(d) In the frequency bands 3700-3750 kHz, 7100-7150 kHz (7050-7075 kHz when the terrestrial location of the station is not within Region 2) 21,100-21,200 kHz, and 28,100-28,200 kHz, the maximum plate input power which may be utilized is 250 Watts.



...de W2NSD/I

EDITORIAL BY WAYNE GREEN

from page 6

techniques and modes ... who are on Oscar ... the moonbounce groups ... there are a whole lot of heros in amateur radio and I take my hat off to them.

If we must for some reason have limits on bandwidth, I don't think they should be written to kill off those old buggers on AM or the television pioneers on 420 MHz ... they should be written to encourage amateur development and pioneering. Do you agree?

If we are going to let the door open for new RTTY and RTTY/computer communications systems, we need to set things up with plenty of latitude for experimentation.

In docket 20777 the proposal was for 350 Hz bandwidth for the CW parts of the band. This would force all of the special modes such as RTTY, high speed CW, and FAX to be in the phone bands. Is this what we want to do?

Are we so jammed up on our bands that we have to set the phone band bandwidths at 3500 Hz? This would eliminate any experimenting with new systems which might allow for greater savings in terms of bandwidth/time. It would prohibit work with a synchronous detecting system of communications. It would prohibit work with double sideband systems where picture info is on one sideband and voice on the other.

Yes, there are times when every Hz of band is needed ... Saturday and Sunday afternoons can be difficult. There are also many hours when even the most crowded of bands are virtually empty. Should we set the rules to meet the problems of Saturday afternoon and forget about the other times? Should we have our rules so they are designed to limit us for our own sake during the peak of the sunspot cycles ... or should we ask for rules which allow us to work within the limitations of the bands in which we are working? A chap with a 25 kHz wide signal on 10m these days is not much of a problem to anyone ... so why make a rule to stop him? It just might be that this idiot is working on a super narrow band television system.

The use of the bands is self-limiting. As they become more crowded, wider band signals will have to wait. This is something that sort of takes care of itself. We don't need stifling rules to force us to do these things.

Okay ... again let us suppose that the FCC takes the lid off and says go ahead and use any width signals you want on any frequencies you want. What may happen? I suspect that

without guidelines we would be in a pickle. Anarchy is not good either. Perhaps the FCC could say that we would no longer be bound by FCC regulations on bandwidths and sub-bands, but that they recommend we keep our present system until we are able to come up with a plan that we agree is better.

#### DUMP BANDWIDTH

I'm hoping you'll agree with me and write to the FCC asking that they not put through docket 20777. I'm hoping you'll ask them to get rid of limitations to experimenting and modes ... even sub-bands. Oh, I guess we'd better keep the Novice bands, since the FCC is about to virtually throw them open to anyone who wants to give hamming a try.

Send your comments to the FCC, Washington DC 20554, and mention 20777. If you have a copier send the 15 copies ... if not, send at least one ... but send.

#### CONDITIONAL LICENSES DELETED

Johnny Johnston announced at Atlanta that on July 23rd the Conditional Class of license would be eliminated. Conditional Techs would be grandfathered into the regular Tech license and all other Conditionals would be grandfathered into the regular class of license.

Johnny admitted that only about 10% of the Conditionals called up are able to pass their test, but the prospect of trying to re-examine over 82,000 Conditionals was not pleasant. The FCC is just barely getting out of the mess caused by the flood of CB licenses and one thing they don't need is another big hassle.

To give an idea of what the Commission was up against with the CB licenses, Johnny showed some slides of their Gettysburg facility. About a year ago they would get one thin mailbag of license applications a day for all the services they handled. This has increased a bit and now runs over 80 mailbags a day on busy Mondays. They've been able to get permission to add a few temporary employees to help, but the whole thing is a madhouse.

To me this change means that all of us have to accept that we are now on equal terms with some chaps who have paid \$100 for a General license or \$10 for a Tech license and who don't even know the code. Okay, we have absolutely nothing to gain by bitching about it or making these chaps uncomfortable ... they have enough of a problem living with their cheating, without our rubbing their noses in it. What we have to do is

make sure that our clubs have darned good technical sessions and code classes so everyone in the hobby will learn and have more fun with amateur radio. The more you know about hamming, the more fun it is.

There is no indication that the code is going to be relaxed for the General Class and above tickets, so we can certainly do all we can to get every ham to pass the 13 wpm exam. It is now recognized that probably the worst possible way to try to get code speed is to start slow and gradually try and build up speed ... say on the air. Johnny mentioned that this never worked for him either and that he got his code speed up by using tapes.

The 73 tape is only \$3.95, so it isn't a big deal and can be used whenever the time permits. But it is more fun to get together with the club and have a short code copying session ... probably about 20 minutes is right ... as part of each meeting. It is vitally important to remember to keep code fun. As soon as you find yourself getting bored or fidgety, do something else. Keep the pressure off ... take it easy ... and have fun copying.

I'll try to get as many articles for 73 as I can which will help newcomers get the hang of radio theory. Authors please take note. If you've any experience in teaching at clubs, you'll reach a lot more people via articles in 73 ... and the prestige of being published may make your audience listen a little more carefully.

My petition to permit Techs to use the Novice bands was part of this docket on the Conditional licenses. It is about time! And they made one other *big* change ... Novices will be able to use 250 Watts input instead of 75. The reasoning was that Novices need to have good equipment to operate in their crowded bands, and this means buying a regular ham transceiver. Most of these have sweep tube finals and run in the 150-250 Watt range. So why not make that the power limit? And just to make it a bit more fair, *any* operator using the Novice band must keep his power to the 250 Watt limit.

#### COMMUNICATOR LICENSES

The FCC is still thinking seriously about the Communicator license, and they are now talking in terms of perhaps millions of them. They are not about to open this can of worms until they have a lot of other parts of their act going ... like being able to handle the license applications.

The FCC is all tied up with problems on opening new channels for CB. There is a general agreement that CB needs more channels. I'm not convinced of this yet. I'd like to see a study of channel use. I think it would refute the more channel idea. They were just about to okay the channel increase when tests showed that two CBers 450 kHz apart in channels generated a good deal of intermod on the i-f and raised miseries on all channels of sets within several miles! Further tests indicated that signals on

half the i-f frequency were also generating substantial intermod and that this might be responsible for quite a bit of the interference many CBers were getting. The FCC found that some CB sets were particularly dirty and it is certain that the Commission will be reviewing their type acceptance of several sets.

The FCC is well aware of the problems that sunspots and increased skip are going to make for them. The impact is going to be really serious when about seven million CBers discover that 23 over-powered stations in the midwest can wipe out much of the country. This means that the FCC has to get something going on a higher frequency band pretty soon. With the licensing mess they've had little time to do much else ... except sweat. They know what is going to happen and they are so understaffed they are almost powerless to cope.

The Communicator license could be one thing to help get them off the spot. They can answer millions of screaming furious CBers with a simple ham ticket which will allow them to keep hamming away ... on a band without skip ... and legally. No code, darned little other exam ... perhaps a short course with a local ham club which then can hand out the license.

I just wanted you to see what is happening and why. If you have any better ideas on what to do, let the FCC know ... and me. The FCC hasn't time or people to read your letter, and neither do I ... but I'll try ... and they may too. Hey! Why not write to the ARRL ... they have the time.

#### NO FUELING

Put on your blue sky thinking cap with me for a moment.

There has been a lot of PR given to a need for saving fuel. I don't think any of us really disagree with the fact that there is a problem ... it's just that few of us are willing to voluntarily make big sacrifices in the name of fuel saving without some evidence that everyone else is hurting, too.

Now what do we spend a lot of gas on that could be saved? Well, I don't know about you, but trips to stores put a lot of mileage on my car. There are three or four trips to the supermarket a week, a couple to the hardware store, one or two to a department or discount store ... several to the book/stationery store ... things like that.

Add to my trips those of deliveries to my home ... cleaning, UPS, mail ... things like that.

Suppose some firm ... perhaps UPS ... got involved with a super delivery service which would bring mail, groceries, cleaning, hardware, Sears stuff, and everything else all at one time? Right there we could save over 50 million gallons of gasoline a day. Let's suppose that the delivery trucks, since they wouldn't have very far to drive, could be battery-powered ... charged up overnight. Think of the pollution that would be eliminated ... how much longer cars

**Introducing  
the new concept  
in ham antennas...**

# **The STAR SERIES**

The STAR series introduces a new dimension of antenna size, shape, and flexibility for today's amateur radio operator. Many hams operate from apartments or urban locations where space is at a premium or other restrictions prohibit installation of large beams or quads. Even verticals can present obstacles due to the space required for radials. COMSTAR recognized the need for an effective small antenna for such locations as well as for portable or field operation. The resulting antennas are also unique alternatives for those with no antenna restrictions.

The STAR series are not miniaturized conventional antennas but the optimum size dictated by the design concepts employed. The freedom of the STAR design from losses in baluns or loading coils produces wider bandwidth and higher radiation efficiency.

The antenna elements and coax feedline are contained within a rugged dielectric frame for protection and the entire antenna can be painted for display or to blend in with the surroundings. The small size and weight permit use of low cost standard TV masts and rotator, if desired. No radials or matching devices are required. Additional STAR features include:

- 52 ohm impedance (matching any length of 52 ohm coax)
- Broadbanded to maintain low VSWR over entire band. VSWR typically less than 1.2:1 at resonance.
- High attenuation of harmonics
- Choice of vertical or horizontal polarization
- Capable of handling legal power on SSB and CW
- Turning radius: STAR 20, 23 inches; STAR 40, 45 inches
- Price: STAR 20 (20 meters) - \$39.95; STAR 40 (40 meters) - \$49.95

To introduce the STAR antennas at the lowest cost, they are available factory direct only from the address below. Complete instructions are provided for assembly and tuning for optimum performance at your QTH. State whether the STAR 20, STAR 40, or both are desired. Send money order or check to the address below. Include \$3.00 per antenna for shipping charges. California residents add 6% sales tax.

**The COM ★ STAR Corporation**

**AMATEUR RADIO DIVISION**

**1926 S. Pacific Coast Highway • Suite 233 • Redondo Beach, CA 90277**

would last without these unending short trips to the store . . . how much would be saved on insurance by keeping cars out of parking lot accidents.

Older folk will remember the time when most grocery shopping was done by telephone and the grocer delivered. Supermarkets killed this nice way of doing things . . . substituting a whole lot of your time in exchange for that of the delivery boy and the grocery clerk . . . plus your gas. Remember that most delivery boys used bicycles.

We can go back to the phone again . . . perhaps this time by way of the microcomputer which will give us pricing and buying information on all products and permit us to order them and pay at the same time via something like Master Charge.

Perhaps the time will come when most of our stuff will come by way of a daily (or twice daily) van . . . groceries, cleaning, mail, packages, drugs, Sears, hardware, liquor . . . ? The plan would seem to have enough economies in it to make it worthwhile to set up. And it would help in the energy crunch . . . and pollution problem . . . if the non-use of about 435 million barrels of gas a year is of any importance.

Until such time as small computers are in widespread use, it is unlikely that any serious computer-to-computer via phone lines system can be set up to get around our deteriorating and increasingly costly mail "service." But the one thing the post office has that has kept them in business despite their problems and cost has been a delivery service that reaches everywhere.

Suppose that my suggested delivery service were to get going . . . and were to catch on widely. It might be that it could be used by a "Western Union" type of outfit to deliver messages. On the other hand, with all those microcomputers out there for ordering merchandise and groceries . . . it might be that electronic mail would develop. Either way, such a system could serve that additional benefit . . . a fast and inexpensive mail service.

#### CBers

A letter from J. Henry Felton, who lists his calls as AA4HXZ-WR4AKX, says, "Wayne, what is that I see on page 46 of the July 73? Bad news! Is 73 going 'CB'? If it takes ads like that to get 176 pages, then cut down to 120 pages. 73 has been the best since day one, you don't need CB ads. Let CQ have them!"

I expected a bit of flack on the CB ad, but really I expected a bit more than one letter . . . thanks J. Henry, for writing and giving me a chance to say something.

No, 73 is not going "CB." And while I would accept ads from Fredricks of Hollywood or Idaho potatoes to help pay for more space to print articles . . . every additional page of ads makes it possible to print about two or three pages of articles

. . . I still won't permit ads from ham manufacturers selling bum products or providing lousy service. Not that CB ads are all that far out anyway.

If you have been reading my editorials for very long, you are quite aware that as situations change, my opinions change with them. I try to keep up to date and get all the input I can. A case in point is CB. A couple years ago you found me pretty sarcastic and negative about CB. I think that was appropriate at the time. Since then the situation has changed.

Two things happened. One was the sunspot minimum, which allowed 11m to settle down to a local band for a few years. The second was the national 55 mph speed limit. This combo got the truckers into CB and that got CB into the newspapers . . . and that got CB into the cars of several million people. Note that the CBers of today are rarely the CBers of two or five years ago. In most areas of the country bad language is a rare exception.

A great many amateurs are putting CB rigs in their cars and every one I've talked with is very enthusiastic about it. During my talk at Atlanta I asked for a show of hands of amateurs who were also using CB. Over a hundred hands went up. I then asked how many of them would be without it . . . only one hand went up. I know I wouldn't be without it. When I fly anywhere I take along both a ham rig for the repeaters and a CB rig for road information.

If you run up against a seriously anti-CB amateur, ask him the same question I would . . . has he used CB during the last year? You will never get a yes to that.

Before I go on with this, I'd like to just mention this 55 mph speed limit a bit. Unfortunately, most readers are not getting *Car and Driver*. I think that is a great magazine . . . not as great as it was a few years ago, but still great. I can't go into the details they do to show what a farce the whole 55 mph thing is . . . how much lower the accident rate is on the German Autobahns where there is *no* speed limit as compared to our interstates . . . etc. You probably find, as I do, that on the interstates most of the traffic moves along at 65 mph or so. Police, who might do better to follow up on CB reports of drunk or wild drivers, are manning radar speed traps . . . and drivers are countering with more CB and radar detectors.

*Car and Driver* figures that the next step will be radar jammers. Hmmm. I'm still hoping some enterprising ham will come along with a nice mobile rig for the 10 GHz ham band . . . a tenth Watt will do. That may make the radar people have to put in sharp filters to prevent adjacent band QRM from our rigs. A ham rig like that might sell like crazy.

Letters from ham clubs all around the country confirm that about 80% of the newcomers to amateur radio

start out with CB. Wouldn't you, if you were getting going these days? Thus it ill behooves us to sneer at CBers. The chaps who are attracted to CB these days shouldn't be held responsible for the crimes of that bunch of clowns who terrorized the channels a few years ago. Now that the FCC is catching up with licenses and has an instant CB licensing scheme you'll even hear quite a lot of CBers using legitimate calls.

#### YOU CAN HELP

A few years back I wrote a column for *Electronics Illustrated*. It was a lot of work, but my mail showed that it was accomplishing what I wanted . . . attracting new blood to amateur radio.

In order to get my oar in the main stream . . . and for the same basic reason . . . I am now writing a syndicated CB column for newspapers. The column, called "CB Today," is aimed at educating the CBER and making him aware of amateur radio. I answer the questions CBers have, help them understand about antennas, car noise, the rules and things like that . . . but the end thrust is always to gently encourage them towards an amateur license.

The column has been accepted in 16 cities so far. If you see it in your local paper please send me a copy for my scrap book. If you don't, maybe you could call the editor and suggest that the column would be popular. I'll send samples and other info on it to anyone you suggest. My policy is that the column appear in only one paper in each area, so it is first come first served. If you happen to know the editor personally . . . lean on him.

The papers that are running the column report that it has helped them sell a lot of CB ads. Radio Shack stores in particular jump at the chance. The column is inexpensive and the ad revenue it brings papers pays for the column many times over.

Getting back to 73. Perhaps you can understand why I was quite enthusiastic about the Standard ad for their Horizon 29 CB rig. I think that any amateur who is not on CB is missing fun . . . missing grand opportunities to talk up amateur radio and get a lot more newcomers to our hobby . . . and certainly is at a disadvantage in driving when he gets no warning of traffic tieups and accidents. Amateurs with FM rigs can report accidents, but they have to go some to beat CBers at this these days. And if you see a drunken driver you aren't going to be in direct touch with a police car unless you have CB. More and more smokeys are wearing ears these days . . . and the results have been good.

Yes, I know some CBers speed . . . so do non-CBers. But since the whole 55 mph thing involved gasoline problems . . . and I see that Detroit is again going more and more into floating boats for our highways which get

half the mileage of my little bomb, even if I'm running it at 80 mph . . . perhaps it is time for reason to rule over emotions.

To recap . . . I welcome CB ads in 73 . . . CB is fun . . . write for copies of my "CB Today" column for your local paper . . . inventors, we need a radar detector test device . . . mercy me, how about that good buddy?

In case you are still hung up . . . we are getting about four times as many new hams today as a year ago . . . and almost 80% of these are CBers. Can I make it any clearer? Remember back to when you started as an amateur . . . where you met as a friend and buddy or as a lowly, to be sneered at, bum? I've found CBers today to be great people and very enthusiastic amateur newcomers. Extend your hand in friendship and help.

#### POLITICS AGAIN!

All you President Ford supporters out there should get your letter writing arm oiled up and working, for the White House is again mixing into our rain barrel. The Nixon White House was the big pressure which was pushing for the 220 MHz CB band, for those of you with short memories. Now the Ford White House is hot at it again and 220 is being pushed hard by the Ford group.

A few hundred letters from hams, friends of hams, families of hams, and anyone else you can get to write the Ford we may not like to have in our future can't hurt. If a few hundred letters come in showing Ford that he is losing votes by trying to force the FCC to take away part of a ham band for CB growth, it could have an effect.

Remember, please, that this was the origin of pressure which almost tipped the scales just before Nixon resigned. It would appear that EIA has an incredibly good friend on the White House staff somewhere high up. The FCC, under Chairman Wiley, has been dead set against taking ham frequencies for CB . . . so someone higher up than the FCC had to be bought or convinced.

There is no question that CB *must* have some UHF band if utter chaos (and that's the very best kind of chaos) is to be avoided in a couple of years. Even the White House can't stall off sunspots for much longer. Once those little rascals start burping out ions it will be bedlamsville on CB.

The FCC has been thinking more and more of something nice around 800 MHz. With synthesizers and the new module rf packages, this might be a good idea. It remains to be seen whether the FCC can get moving faster than the White House bunch.

#### THE SUPPORTING CAST

In response to rather persistent demands that we uncover the anonymity of our fearless crew, we present the first installment of our Kodak renditions of the troops. You asked for it.



*Big Bill Edwards WB6BED/1, the ad manager of 73, has been with us for over two years and shows no sign of giving up one of the toughest jobs in the place. Note Bill hard at work. He must be doing something right since 73 has more pages of ads than any other ham magazine.*



*Meet Dotty Gibson, who has been managing the subscription department for over ten years. If you've called 73 at any time, the chances are you've talked with Dotty and she's helped you with your problem. Dotty is the one who undoes the screwups of our friendly computer down in Massachusetts.*

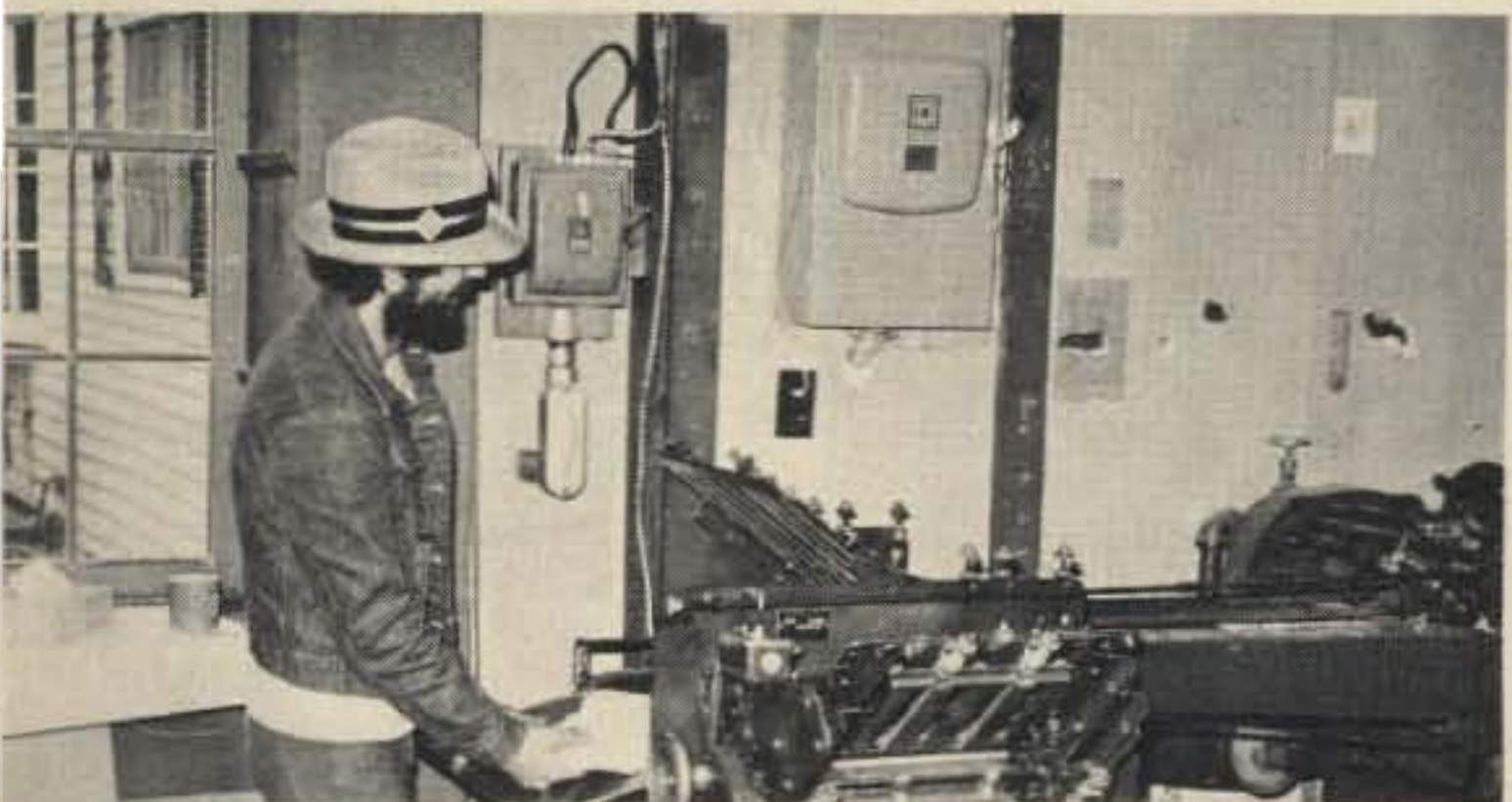

*Brent Lawler runs the printing department at 73. The magazine is printed out in Wisconsin, but many of the books are printed in the 73 print shop . . . as are the subscription letters, forms, QSL cards, and things like that. It is enough to keep two men busy full time and then some.*



*Here is Bob Sawyer, who works in the 73 Magazine art department. Bob lays out most of the QSL card orders and a good many of the nice ads which 73 makes up for manufacturers who do not have advertising agencies.*



*Here's Judy Waterman, the lovely gal who runs the bulk sales end of things. The office used to be Wayne's a few years back and it was wall papered for his daughter Tully. Some things don't change too fast around the magazine.*



*Susan Philbrick does the layouts of the articles in 73 whenever she is not taking care of and supporting a bunch of horses and dogs.*

# I/O REPORT

from page 124

really think we're ignorant!", and "How can you guys stand this?"

Anyway, the other night our hero Steve Austin's mission was to intercept a shipment of sinister *micro-processors*!! As Oscar (his boss) explained it, "If these microprocessors

are allowed into the country, they can be used to drain all of our defense computers." Luckily, the country was saved because Austin did get the can (coconut oil can) filled with those crafty, devious little devices and prevented them from falling into the wrong hands. Foreign microprocessors being smuggled into the country in

coconut oil cans . . . my gosh, they must have been made on some subversive south sea island!

## Miscellaneous

I was cleaning out my desk the other day and came across my old, and yet perfectly good, Post slide rule (in its nice leather case, even). I used to be able to do *everything* with this beauty. I think the fact that it is such a beautiful instrument is what bothered me the most . . . because I just couldn't bring myself to throw it away. I put it back in the desk (in the bottom drawer, way in the back) and I'll probably bring it out some day and show my grandchildren what we used before the hand-held computers came along.

We certainly want to encourage an exchange of ideas (no matter how far out) regarding computer applications in ham radio. So drop me a line if you come up with any . . . and we'll spread the word through the editorial pages or perhaps start a "Letters to the I/O Editor" section. Also, if anyone wants to set up a net to discuss computer applications, hardware, software, etc., send me the frequency and time and we'll be happy to publish them.

We're looking for good articles for the I/O section . . . and writing for 73 can not only be profitable, but quite gratifying. Earn a few extra dollars and at the same time share your ideas and efforts with others. If you have any ideas for articles, drop me a line and we'll talk about them.

ou soon don't ever proof  
lousy manuscripts from bat  
LETTERS  
I insist that you print ev  
tell Ma Bell that she shou

from page 10

expensive), but you still need mag tape for data input/output and back up disk dumps. How do we get data printed? Programs loaded/bumped? Sure, some of these units are available to do our I/O, but at present they are 3 times the cost of the CPU and memory. I realize that I/O units are electro-mechanical devices and are expensive to make, but I feel the makers could do much better. Don't you?

Leon Howe WB0LIY  
Sashiki-Son, Okinawa

Well, Leon, I just don't see what is wrong with an old (and cheap) Model 15 teletype for hard copy and one of the TVTs for soft copy. I find precious little that I want in hard copy ... most RTTY contacts via computer and games don't require much of a permanent record. You will be encouraged to know that there are some fairly inexpensive hard copy devices coming, so hold tight — Wayne.

## Ancient Aviator

from page 15

sold the line to Eastern Air Transport. Eastern asked me to stay on for two or three months to set up a new passenger ticketing and accounting procedure. This took almost three months, after which I joined Jim Eaton in New York to form an aeronautical consulting firm.

### BOSTON AND MAINE AIRWAYS

One of our early jobs was for the Ludingtons in an attempt to interest

### EGO INFLATION

Just a short note of praise to inflate your ego.

Last year with my subscription I got one of your 21+ wpm tapes and decided to go for the Extra when I got the time. I finished medical school two months ago and decided that it would be now or never with the Extra because I would not have the time during my internship. I ordered one of your Extra Class Study Guides and used it in conjunction with the ARRL License Manual and many other references. Your guide was so simple to comprehend that for the first time in my twelve years as a ham I feel I know some of the theory that I had heretofore memorized just for the sake of passing a test.

To make a long story short, I studied daily for one month using your 21+ wpm tape and Study Guide and passed the Extra on the first try last week.

I can't argue with success and

sincerely thank the 73 staff for their study materials. Keep up the work.

Larry Smith, M.D. WA4YYU  
Ellabell GA

### OUT OF HARM'S WAY

Looks like the burglar has a lot of relatives. Business has been on the upswing for the last few weeks, but I am really saddened to say that it has been because of the increased activities of the burglar. We now receive calls every day we are open, from hams who have had their equipment stolen from their cars and homes. Today we had three cases, and yesterday two. As you know, I have had many losses myself, the most recent about two weeks ago while in a local restaurant. The police have arrested three suspects with one of the rigs stolen in that break, and although the suspects admitted having the other two rigs, they are out on the streets, will probably not be convicted of the break, and I will probably not have my equipment returned. My insurance agent did not seem too awfully surprised at all this, and it seems to be that the courts are just too busy with larger problems to bother with these cases.

I try to tell every customer who buys a rig not to leave it in his car; far too many come back the very next day to get a serial number for the police (never thought it could happen in a nice town like ...).

I hope everyone who reads this will try to keep his rig out of harm's way. We need the business, but I sure hate to get it this way. By the way, Wayne, we will keep an eye out for your CB radio along with all the others.

Chuck Martin WA1KPS  
Tufts Radio, Medford MA

### KENWOOD GROUP

I wonder if I might have the temerity to request that something of interest to the HF bands be included in your mag, which I enjoy reading very much. I have recently formed a TS520 group here in ZL. It is primarily aimed at TS520 owners, with the idea of producing a monthly newsletter containing details of mods, accessories and general interest articles. However, the whole range of the Kenwood products can be included if enough interest is generated.

Anyway, I would be much obliged if you could either publish this letter, or a short notice somewhere in the 73 mag, bringing the attention of any Kenwood owners to the formation of the group, correspondence to be addressed to the address below.

George Halligan ZL2BJW  
3 Petersens Road  
Aokautere  
R.D.1  
Palmerston North  
New Zealand

per mile. This grew into Northeast Airlines, which was eventually sold to Eastern Airlines.

### MARINE AIRLINES

The next project Jim Eaton and I worked on was an airline between New York and Boston, using amphibian airplanes. We proposed to land in the East River in New York and use a ramp that was already constructed at the Skyport at the foot of Wall Street. In Boston, we'd land at a city-owned South Boston pier or the Boston Airport. Equipment was to be two Sikorsky S-40 38 place amphibians.

We had the S-40s on order, I had passed \$5000 under the table to get a

pier lease from the city, and we had a public offering of our stock ready to hit the market, when Sikorsky advised us that Pan Am had "exercised an option" on the two S-40s and that no more would be available for eight months. I guess it only took a phone call from the President of the airline we would be competing with to the President of Pan Am to do the trick. This was in October, 1936. While Eaton and I were tearing up those nice new stock certificates of Marine Airlines, a phone call came in from Tommy Hitchcock, a partner in Lehman Bros. He said he had a new proposition that he wanted to see us about. Next month I'll tell you about it.

## CONTESTS

from page 14

worked, and exchanges sent and received. Please number each new multiplier as worked. A summary sheet should be included showing your call-sign, name, address, number of QSOs on each band and mode, total number of QSOs, total multiplier (maximum of 58), claimed score, and whether the entry is single or multi-operator.

### AWARDS:

Certificates will be awarded to the

highest scoring station in each California county, state, province, and country. Second and third place awards may be made where justified. In addition, certificates also will be awarded to the highest scoring mobile station, portable station, multi-single, and multi-multi entries. A certificate will be awarded to the club submitting the highest aggregate score.

### ENTRIES:

All entries must be sent to the NCCC, c/o Doug Docherty WA6DQM,

2306 Monserat Ave., Belmont CA 94002, and must be postmarked not later than October 31, 1976. A large, business size SASE is requested with each entry. All comments and suggestions will be appreciated.

### FIRST CALL DISTRICT HAM OF THE YEAR AWARD 1976

The Federation of Eastern Massachusetts Amateur Radio Associations is now requesting nominations for the "Ham of the Year" award for 1976. Only amateurs in the first call district are eligible and the amateur selected will be the top "good neighbor" among hams, the one who has performed an outstanding public service.

Anyone may nominate an amateur

radio operator for the honor. The winner of the award will be chosen for the amateur activity which brings the greatest benefit to an individual or group and for the amount of ingenuity and personal sacrifice displayed in performing the service.

Nominating letters should include the candidate's name, address, call letters, and a complete description of the service performed. Letters should be sent to the Chairman of the FEMARA Awards Committee, 28 Forest Ave., Swampscott MA 01907.

The winner will be presented with a plaque and a cash award at the ARRL New England Convention, Statler-Hilton Hotel, Boston MA, on September 11, 1976.

**NEW 500/50 MHz COUNTER**



The CTR-2 will put you on frequency. Measure transmitters, hand held transceivers, tone pads, repeaters, etc. Built-in TCXO insures an accuracy of  $\pm 2\text{ppm}$  ( $\pm .0002\%$ ). You can't afford to be without this versatile counter. Order yours today.

8 Digit L.E.D. Display 50 MHz Basic  
10 MHz TCXO  $\pm 2\text{ppm}$  500 MHz with built-in prescaler  
Input sensitivity 30 mv @ 50 MHz, 150 mv @ 500 MHz.

CTR-2-50 MHz Kit \$199.95 — CTR-2-500 MHz Kit \$249.95

**DAVIS ELECTRONICS**

636 Sheridan Drive, Tonawanda, N. Y. 14150, Dept. K  
(716) 874-5848

**Govt. SURPLUS  
ELECTRONIC  
EQUIPMENT  
CATALOG**

New ITEMS . . . New BARGAINS!

**FREE UPON REQUEST!**

If you haven't received our new Catalog, write for free copy today. Address: Dept. 73

**FAIR RADIO SALES**

1016 E. EUREKA • Box 1105 • LIMA, OHIO • 45802

have you ever  
sent perfect code?



you can.

The ETK (Electronic Touch Keyer) processes inputs and sends perfect dots, dashes, and spaces at speeds of 7 to 55 wpm. The LED indicators displaying dots, dashes, and spaces serve as a visual training aid for the less proficient CW operator. 17 IC's, relay output, side tone speaker, 120 VAC. Inquiries invited.

for only **145.00**  
(includes instruction book)



**Order direct from:**

P.O. Box 1125  
Kent, Washington 98031

Instruction Book 1.00



**Digital Multimeter Kit  
Model 75 AK**

Siliconix dual chip AD converter. Basic DC accuracy is .05% of rdg.  $\pm 1$  digit. FET Input for  $Z_{in}$  of more than 1000 Meg. on 200 mV and 2 V DC. Automatic Zero Automatic polarity Solid state reference voltage. Large  $\frac{1}{2}$ " Litronix LED readouts. Measures DCV, ACV, K-Ohms, Megohms, and DC Ma.

**\$99.95**

SEND FOR FREE FLYER

**ROTO-KIT INC.**

BOX 301, 415 KAY AVE.  
ADDISON IL 60101

**Portable • Commercial Standard  
FREQUENCY  
COUNTER**



FEATURING

1 Hz to over 300 MHz • Commercial Accuracy  $3.10^8$  • Completely Portable — has Nicad batteries • Small — 2"x4"x6" • Recharge/operates from ext. 12V or 110V ac • Internal charge-limiting circuitry • Less than 50mV sensitivity • Hi-accuracy international 10 MHz crystal • Easy to check calibration • Counts down to 1/10 Hz

Fully Guaranteed

**\$349<sup>95</sup>** PPD

Master Charge — BankAmericard

**digi-tech**

P.O. Box 2214, Salem, Oregon 97308 (503) 399-1370

**MC14412 UNIVERSAL MODEM CHIP**

MC14412 contains a complete FSK modulator and de-modulator compatible with foreign and USA communications. (0-600 BPS)

**FEATURES:**

- .On chip crystal oscillator
- .Echo suppressor disable tone generator
- .Originate and answer modes
- .Simplex, half-duplex, and full duplex operation
- .On chip sine wave
- .Modem self test mode
- .Selectable data rates: 0-200  
0-300  
0-600

.Single supply  
VDD=4.75 to 15VDC - FL suffix  
VDD=4.75 to 6 VDC - VL suffix

**TYPICAL APPLICATIONS:**

- .Stand alone - low speed modems
- .Built - in low speed modems
- .Remote terminals, acoustic couplers

MC14412FL.....	\$28.99
MC14412VL.....	\$21.74
6 pages of data.....	.60
Crystal for the above.....	\$4.95

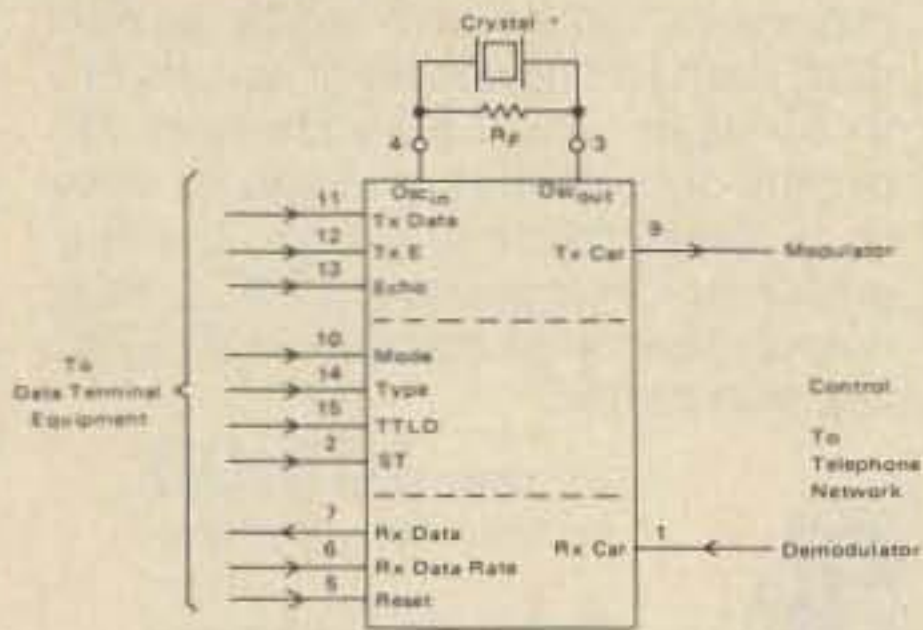

**MC14411 BIT RATE GENERATOR.**

Single chip for generating selectable frequencies for equipment in data communications such as TTY, printers, CRT's or microprocessors. Generates 14 different standard bit rates which are multiplied under external control to 1X, 8X, 16X or 64X initial value. Operates from single +5 volt supply. MC14411..... \$11.98  
4 pages of data..... .40  
Crystal for the above..... \$4.95

**7 WATT AUDIO AMP** Fairchild TBA 810S Monolithic I.C. Class B audio Amp works over wide range of power supply voltages. 1 watt at 6V, 7 watts at 16V. TBA - 810S.....\$2.75  
Data for the above......60

**4 DIGIT COUNTER.** MM74C926 is a 4 digit counter with 7 segment output. Carry output for cascading and internal display select allows outputting of counter or set of internal latches. 3 to 6V operation. Great for clocks, event and frequency counters. MM74C926 - with spec sheet.....\$12.00

**FOUR QUADRANT MULTIPLIER.** MC1495L provides output as a linear product of two analog input. Use for frequency doubler, balanced modulator/demodulator, electronics gains control. MC1495L.....\$5.50  
6 pages of specs......60  
9 pages of applications......90

**TELETYPE CODE CONVERSION CHIP**  
MM5220BL converts 5 level Baudot into 8 level ASCII. Use this chip to make your old TTY talk to your new computer. MM5220BL..... \$18.00  
Specs for the above..... .30

**MOS TIME BASE KIT.**  
Only 1" X 1.5". Input 5 to 15 VDC, output is 60HZ square wave for portable or mobile clocks. PC board is drilled! MTBK-60HZ..... \$5.88



# AMPL'ANNY

## Says

GET YOUR HIGHER EDUCATION AT GOOD OLD TTI\* WITH THE LATEST IN DATA BOOKS AND MANUALS  
\*Tri-Tek, Inc.



### GOLD CHIP Linear Integrated Circuits

Brand new process by RCA in which the aluminum metalization has been replaced by gold. The chip is then hermetically sealed. What this means to you is unprecedented reliability and uniformity. Plastic parts that meet mil specs!!  
Tri-Tek is proud to be the first to bring this new level of performance to you at SURPLUS PRICES. Why buy regrades??

- CA301A..Improved,general purpose op-amp,8 pin dip..59c
- CA307...Super 741 op-amp. 8 pin dip.....52c
- CA324...Compensated quad op-amp, 14 pin dip.....\$1.80
- CA339A.. Low offset quad comparator. 14 pin dip...\$1.59
- CA741C..Famous general purpose op-amp, 8 pin dip.. 45c
- CA747C..General purpose dual op-amp, 14 pin dip... 82c
- CA748C..Externally compensated 741, 8 pin dip.....49c
- CA1458..General purpose dual op-amp. 8 pin dip.....69c
- CA3401..Quad single supply (5-18V) op amp. 14 pin..89c

Another super buy from RCA. CA555 timer. 8 pin dip. 59c

**NEW NATIONAL BOOKS!**

- AUDIO HANDBOOK contains detailed discussions, including complete design particulars, covering many areas of audio with real world design examples...\$3.25
- SPECIAL FUNCTIONS DATA BOOK contains detailed information for specifying and applying special amplifiers, buffers, clock drivers, analog switches and D/A-A/D converter products.....\$3.25

**CD4059 IS BACK.** Now, again in stock is the popular CMOS divide by "N" down counter. Programmable to divide by any number from 3 to 15,999. CD 4059 AE.....\$6.50  
Specs for the above......50

**DC to DC CONVERTER MODULE.** Tiny potted module is a complete regulated output up-converter. 4.5V D.C. input provides approximately 14V @ 12 mA. Will operate down to 2.5V with reduced output. Size only 1" X 1/2" X 1/4". With connection diagram.....\$1.25

**NSL4944 LED.** Current regulated, universal diffused-lens red LED lamp. A GaAsP solid-state high intensity LED encapsulated in a plastic package containing a current regulating IC that provides constant intensity over a wide voltage range. 2 to 18V, AC or DC. Use for indicator lamps, optical coupling, battery charging circuits, logic probes, almost any place you need a lamp. Long life, wide angle. No series resistor needed. Typical 13mA forward current. NSL4944..... 89c

**D-A CONVERTER BY ZELTEX**  
8 bit precision hybrid circuit for use in controllers, timers, volt meters, etc. Molded plastic package with P.C. pins. Super buy on this better than usual subsystem. ZELTEX model ZD430. DAC-430.....\$4.95

**NEW BOOK!!! "An Introduction to Microcomputers"**  
This is the book which Fairchild Semiconductor Company called ".....the best darned introduction to the industry to date." Covers everything from basic concepts to a review of real microcomputers. IMC-001.....\$8.00

**78H05 Voltage regulator.** Fairchild 5V, 5A, TO-3 regulator. Take care of those heavy current requirements without separate regulator/pass transistor combinations. Use it with the same ease of installation as the 309K(same pin arrangement.).....with specs..... \$11.25



**LM317 Voltage Regulator.** 1.5A, 3 terminal adjustable regulator in TO-3 case. Adjusts from +1.2V to +37V. Complete overload protection. .1% load regulation, .01%/V line regulation. No need to stock assorted regulators - just stock resistors.....\$4.99  
Specs for the above..... .70

**DATA BOOKS BY NATIONAL SEMICONDUCTOR**  
**DIGITAL.** Covers TTL, DTL, Tri-State, etc. .... \$3.95  
**LINEAR.** Covers amplifiers, pre-amps, op-amps, .. \$3.95  
**LINEAR APPLICATIONS.** Dozens of application notes and technical briefs covering the use of op-amps, regulators, phase locked loops and audio amps..... \$3.25  
**CMOS Gates, Flip Flops, registers, functional blocks** \$3  
**VOLTAGE REGULATORS.** A must for anyone making a power supply. Complete theory including transformers, filters, heat sinks, regulators, etc..... \$3.00  
**MEMORY.** Information on MOS and Bipolar memories: RAMS, ROMS, PROMS and decoders/encoders... \$3.95  
**INTERFACE.** Covers peripheral drivers, level translators, line driver/receivers, memory and clock drivers, sense amps display driver and opto-couplers..... \$3.95  
(Outside U.S., add postage for 1.5lbs)

**HIGH VOLTAGE RF TRANSISTOR**  
MRF-427 is an NPN RF part designed for SSB service from 2-30MHz at 25W output. VCC up to 50V. Higher voltage allows circuit and power supply simplification. MRF-427.....\$19.00  
4 pages of specs for the above..... .40



## tri-tek, inc.

6522 NORTH 43RD AVENUE.  
GLENDALE, ARIZONA 85301  
phone 602 - 931-6949

We pay shipping on all orders over \$10 US, \$15 foreign in US funds. Orders under \$10, please add \$1 handling. Please add insurance. Master Charge and Bank America cards welcome, (\$20 minimum) Telephone orders may be placed 11AM to 5PM daily, Mon thru Fri. Call 602-931-4528. Check reader service card or send stamp for our latest flyers packed with new and surplus electronic components.



# Poly Pak's EXCLUSIVE

Avg. Ship. Wt. 6 ozs.

# \$1.98

YOUR CHOICE OF ANY KIT



100'S OF BARRELS PURCHASED! TEST 'EM YOURSELF 'N SAVE!

For the first time anywhere, Poly Pak merchandisers introduce a new way in buying the economical way. Raw stock from the "barrel". Remember the "good ole days"? They're back again. The same way merchandisers

throughout the United States buy from various factories... their overruns in barrels. Poly Pak has done the same. Therefore you are getting the same type of material as the RE-TESTERS DO!

Every kit carries a money back guarantee!

<b>BARREL KIT #1</b> SN7400 DIP IC'S <b>75 for \$1.98</b> Marked 14 and/or with 18 pin dips, may include gates, registers, flip flops, counters. Who knows! GUARANTEED SATISFACTION! Cat.No. 9A2415 Untested.	<b>BARREL KIT #2</b> LINEAR OP AMPS, DIPS <b>75 for \$1.98</b> Un tested May include 700's, 741's, 703's, 560 series, 555 includes marked and unmarked. Cat.No. 9A2416	<b>BARREL KIT #3</b> 1N4148/914 SWITCHING DIODES <b>100 for \$1.98</b> You never saw this before. Imagine famous switching diodes at these prices! Cat.No. 9A2418 Untested.	<b>BARREL KIT #4</b> "4000" RECTIFIERS <b>100 for \$1.98</b> Un tested. These are the famous micro miniature rectifiers of the 1N4000 series. May include 25, 50, 100, 200, 400, 600, 800 and 1000 volters. Cat.No. 9A2417	<b>BARREL KIT #5</b> SCRS, TRIACS, QUADRACS <b>40 for \$1.98</b> All the famous plastic power tab type. Raw factory stock! All the 10 amp types. Cat.No. 9A2419 Untested.	<b>BARREL KIT #145</b> MINI TRANSFORMER <b>15 for \$1.98</b> Miniature transformer back again. Asst. outputs, inter-stage and audio. Only 1" sq. Wt. 2 lbs. 9A3294	<b>BARREL KIT #147</b> OVER-FLO FLUORESCENT NIXIES <b>5 for \$1.98</b> Used originally in table top calculators. Brand new. Gas discharge type, color: Blue. Cat. No. 9A3288
<b>BARREL KIT #7</b> VOLUME CONTROL BONANZA! <b>40 for \$1.98</b> 100% good Singles, duals, variety of values, styles, big ones — small ones. Cat.No. 9A2421	<b>BARREL KIT #8</b> SUBMINIATURE IF TRANSFORMERS <b>100 for \$1.98</b> 100% good. Amazing, includes 455kcs, osc, antenna, who knows? From transistor radio manufacturers. Cat.No. 9A2422	<b>BARREL KIT #10</b> ROMS-REGISTERS <b>50 for \$1.98</b> Un tested. 28 to 40 pin devices, marked, internal factory numbers, etc. Cat.No. 9A2424	<b>BARREL KIT #12</b> POWER TAB TRANSISTORS <b>40 for \$1.98</b> PNP, plastic TO220 type. Assorted 2N numbers. Cat.No. 9A2426 Untested.	<b>BARREL KIT #13</b> RESISTOR NETWORKS <b>60 for \$1.98</b> Un tested. By Corning Glass, in 14-pin dip paks. Cat.No. 9A2427	<b>BARREL KIT #151</b> INCANDESCENT <b>15 for \$1.98</b> Importer sez, "Name your price". Hard to find 7-seg. 5V readouts. How good, asst sizes, we don't know. Can't test 'em. 9A3365	<b>BARREL KIT #154</b> CLOCK CHIPS <b>20 for \$1.98</b> We gathered an assortment of clock chip, alarm, calendar, beepers, who knows, all mixed. At these prices? Cat. No. 9A3308
<b>BARREL KIT #14</b> PRECISION RESISTORS <b>200 for \$1.98</b> Marked and unmarked 1/4, 1/2, 2 watts. No. 9A2428	<b>BARREL KIT #15</b> MOSFET TRANSISTORS <b>60 for \$1.98</b> All 4 leaders TO-18 case, includes UHF transistors too! Cat.No. 9A2429	<b>BARREL KIT #17</b> LINEAR & 7400 DIPS <b>100 for \$1.98</b> Un tested. Marked and unmarked, internal numbers of raw factory stock. Cat.No. 9A2431	<b>BARREL KIT #19</b> DIPPED MYLARS <b>60 for \$1.98</b> Finest capacitors made, shiny finish. Imagine factory dumping 'em in barrels. Cat.No. 9A2597 100% good.	<b>BARREL KIT #20</b> LONG LEAD DISCS <b>150 for \$1.98</b> Factory distributor stock "auction sale". Prime, marked only. Long leads. Cat.No. 9A2598 100% good	<b>BARREL KIT #155</b> MOLDED CAPACITORS <b>75 for \$1.98</b> Asst. size voltages, red, green, yellow, blue plastic cases, axial leads. No. 9A3311	<b>BARREL KIT #159</b> MODULAR SWITCHES <b>24 for \$1.98</b> Centralab "push-ON" switches. TV-makers excess. Dpdt, 6pdt, etc. Brand new. Cat. No. 9A3150
<b>BARREL KIT #30</b> PREFORMED RESISTORS <b>250 for \$1.98</b> We got barrels of 1/4 and 1/2 watters for pc use. You'll get even amount, 100 1/4, 100 1/2 watters. Cat.No. 9A2608 100% good	<b>BARREL KIT #31</b> METALLIC RESISTORS <b>100 for \$1.98</b> Made mostly by Corning, the finest resistor made. Mostly 1/2 watters, 1% to 5% tol., & a barrel of values. Cat. No. 9A2609	<b>BARREL KIT #32</b> TRANSISTORS WITH A HOLE IN IT <b>50 for \$1.98</b> Un tested. Can't name factory but we bought barrels of 25 watters with mtg. hole in middle. PNP's and NPN's. Cat.No. 9A2610	<b>BARREL KIT #35</b> NEON LAMPS <b>30 for \$1.98</b> 100% good. Famous NE-2's. All prime, but factory made millions and barrel'ed 'em. Your advantage. Cat.No. 9A2613	<b>BARREL KIT #36</b> GERMANIUM DIODES <b>200 for \$1.98</b> Un tested. Famous maker, popular item. Never grows old. But this is the way the RE-TESTERS buy 'em from the factories. Cat.No. 9A2614	<b>BARREL KIT #25</b> METAL CAN TRANSISTORS <b>100 for \$1.98</b> Un tested. Includes TO-5, TO-1, TO-18, etc., assorted 2N numbers, unmarked etc. Cat.No. 9A2603	<b>BARREL KIT #26</b> PLASTIC TRANSISTORS <b>100 for \$1.98</b> Un tested. Type TO-92 (TO-18), all manufacturers, variety of 2N #'s. Cat.No. 9A2604
<b>BARREL KIT #40</b> PNP HIGH-POWER TRANSISTORS <b>20 for \$1.98</b> Popular germanium TO-3 case units, now available at "good ole barrel" prices. Cat.No. 9A2618 100% good.	<b>BARREL KIT #46</b> G.E. 3.5 WATT AMPLIFIERS <b>25 for \$1.98</b> Un tested. Hobby type, factory fall-outs, we purchased them in barrels. These are unknowns. Cat.No. 9A2624	<b>BARREL KIT #50</b> SIGNAL SILICON DIODES <b>200 for \$1.98</b> Includes many, many types of switching, signal silicon types, all axial leads. Some may be zeners. Cat.No. 9A2628 Untested.	<b>BARREL KIT #53</b> JUMBO RESISTOR PAK <b>100-pc. \$1.98</b> Un tested. Assortm metal films, precisions, carbons, metal oxide powers, from 1/2 watt to 7 watts. Color coded & 100% good. Worth \$10. Cat.No. 9A2721	<b>BARREL KIT #54</b> 8 DIGIT READOUTS <b>7 for \$1.98</b> Bargain of a lifetime! All we got was 1 barrel — the "blisder digit" types, Multi-plexed. Cat. No. 9A2722	<b>BARREL KIT #37</b> 1 AMP "BULLET" RECTIFIERS <b>100 for \$1.98</b> Un tested. Famous style, asstd. voltages, silicon, axial includes all types of voltages to 1KV. Cat.No. 9A2615	<b>BARREL KIT #39</b> 2N3055 HOBBY TRANSISTORS <b>15 for \$1.98</b> 100% good. From factory to you, these fallouts of the famous 2N3055. We have 10 barrels. Cat.No. 9A2617
<b>BARREL KIT #61</b> POLYSTYRENE CAPS <b>100 for \$1.98</b> Finest caps made. As a gamble we bought 10 barrels from factory, mixed values; all good. Cat.No. 9A2729	<b>BARREL KIT #65</b> MIXED READOUTS <b>15 for \$1.98</b> Un tested. Factory returns — such numbers as MAN-4's, MAN-7's, MAN-3's, 11 barrels & no time to separate. Cat.No. 9A2733 Untested.	<b>BARREL KIT #68</b> 2 WATERS <b>100 for \$1.98</b> 100% good. Nobody seems to want 'em! So many suppliers don't count, but throw 'em in the barrel. It's a li'l gold mine. All marked. Cat.No. 9A2735	<b>BARREL KIT #71</b> CAPACITOR SPECIAL <b>100 pcs. \$1.98</b> Un tested. Emptied stockrooms into barrels of mylars, poly's, mica's, molded's, plastics, ceramics, discs, etc. Nifty 100% good. Cat.No. 9A2738	<b>BARREL KIT #73</b> TRANSISTOR ELECTROS <b>50 for \$1.98</b> Un tested. It "bugs" us why the factories dump 'em in barrels. We don't wish to separate wide asst voltages & values up to 300 mf. Cat.No. 9A2747	<b>BARREL KIT #75</b> 400MW ZENERS <b>150 for \$1.98</b> Un tested. Factory out of biz! Amazing offer: 6, 8, 10, 12 to 15V. You test. Hermetically sealed glass pak, Double plug. Cat.No. 9A2740	<b>BARREL KIT #76</b> 1-WATT ZENERS <b>100 for \$1.98</b> Un tested. Factory same as 400-mw's. Never-to-see-again offer, 6, 8, 10, 12, 15V. under glass. Double plug. Cat.No. 9A2741
<b>BARREL KIT #77</b> "BROWN" BODY TRANSISTORS <b>40 for \$1.98</b> Un tested. G-E D-40 series has hi-voltage. Darlington's, hi-current, npn's. Factory line discontinued. Power tabs. Cat.No. 9A2742 Untested.	<b>BARREL KIT #81</b> SUBMINI RESISTORS <b>200 for \$1.98</b> 100% good. PC, upright type, color coded, 1/4 watt. Asst values. Came to us in a barrel. Cat.No. 9A2746	<b>BARREL KIT #83</b> LM-340T UNTESTED VOLTAGE REGULATORS <b>15 for \$1.98</b> Un tested. Factory rejected them for length of leads. May include 5, 6, 8, 12, 15, 18, 24 volts. Power tab. Cat.No. 9A2635	<b>BARREL KIT #86</b> HOBBY LEDS <b>40 for \$1.98</b> Un tested. Wow! A Litronics dump of all kinds of mixed discrete LEDS, shapes, colors, good, poor, etc. 9A2859	<b>BARREL KIT #87</b> NATIONAL IC BONANZA <b>100 for \$1.98</b> Un tested. Factory dumps into barrels. Types: 8000, 7400 series, DTLs, ROMs, registers, clock & calc. chips, linears, etc. Cat.No. 9A2860 Untested.	<b>BARREL KIT #88</b> LITRONICS LED READOUTS <b>10 for \$1.98</b> Un tested. 747's, 727's, singles, triples, etc., .33 to 0.6. Bot from factory, all mixed; have fun! No. 9A2861	<b>BARREL #91</b> SILVER MICAS <b>100 for \$1.98</b> Cat.No. 9A3018 For the first time silver mica's so low in price! Axial, red case, variety of physical sizes & values. Big savings from distributor prices. Wt. 1 lb.
<b>BARREL KIT #93</b> HALF WATERS <b>200 for \$1.98</b> Un tested. Resistor factory tried to fool us by mixing 100% color-coded resistors in barrel. But value is there. 4 oz. Cat. No. 9A3046	<b>BARREL KIT #99</b> PHOTO ELECTRIC CELLS <b>10 for \$1.98</b> Un tested. Asst. GE types, CDS types. Mixed by factory. Big job for us to separate. 100% good. Cat.No. 9A3052	<b>BARREL KIT #101</b> RESISTOR SPECIAL <b>200 for \$1.98</b> Un tested. Includes: 1/4, 1/2, 1, 2-watt, carbon, 8 oz. 100% good. 9A3054	<b>BARREL KIT #104</b> SLIDE VOLUME CONTROLS <b>10 for \$1.98</b> Un tested. Used in hi-fi, volume control maker unloads. Asst. values, what a buy. Worth \$1 ea. We've got barrels of 100% material. Cat.No. 9A3057	<b>BARREL KIT #105</b> MINI VOLUME CONTROLS <b>25 for \$1.98</b> Un tested. 1-Million pcs of 100%, 50K mini pots, ceramic case, long shaft. Eqnt maker unloads. 9A3058	<b>BARREL KIT #108</b> TO-5 PLASTIC TRANSISTORS <b>40 for \$1.98</b> Un tested. Includes PNP, NPN, 2N-3638, 2N3641, 2N5000 series, etc. Un tested, but guaranteed to a 60% yield. Cat.No. 9A3101	<b>BARREL KIT #109</b> TERMINAL STRIPS <b>150 for \$1.98</b> Un tested. Wide asst. of terminal strip connectors, from 1 contact up. Strip manufacturers barrel dump in your gain. Wt. 1 lb. Cat.No. 9A3136
<b>BARREL KIT #112</b> MICRO MINI LEDS <b>40 for \$1.98</b> Un tested. All the tiny leds, axial, upright of Monsanto, Litronics, variety of colors. Yield 50% or better. Cat.No. 9A3139	<b>BARREL KIT #115</b> MOLEX SOCKETS <b>200 for \$1.98</b> 100% good. Calculator maker dump! We got a million of 'em. Used for IC sockets, etc. Cat.No. 9A3144	<b>BARREL KIT #116</b> BUTTONS 'N FEEDTHRU'S <b>100 for \$1.98</b> 100% good. Truthfully worth a small fortune. Wide asst. of button-feedthru caps! HAMS TAKE NOTE! RF, UHF, etc. Wt. 1 lb. Cat.No. 9A3141	<b>BARREL KIT #118</b> MINI SCRS <b>50 for \$1.98</b> Un tested. UNBELIEVABLE! TO-92 plastic SCRS in barrels... rite from factory. Includes all voltages up thru 200 pv. 9A3135	<b>BARREL KIT #119</b> PRECISION RESISTORS <b>100 for \$1.98</b> 100% good. 2 ozs. PREFORMED! Designed for printed circuit work. 1/4, 1/2 w. Marked values, 1 and 2% values. 9A3205	<b>BARREL KIT #126</b> UPRIGHT ELECTROS <b>40 for \$1.98</b> Un tested. Wide asst. of values from 1mf to 300mf in mixture of voltages. 100% marked 'n good. Why barreled? U-got-a-buy! Cat. No. 9A3226	<b>BARREL KIT #127</b> AXIAL ELECTROS <b>40 for \$1.98</b> Un tested. Truthfully the factories (by mixing 'em in barrels) do all of us a favor. WUT A BUY! Asst. capacities and voltages. Cat. No. 9A3227
<b>BARREL KIT #128</b> MINI DIP IC'S <b>75 for \$1.98</b> Un tested. Large mfr dumped 100's of lbs into barrels. Includes 741s, LM-380-8, 703, 567, 555, 558—but who knows? Factory to you. All mixed, you test. Wt. 1 lb. Cat. No. 9A3245	<b>BARREL KIT #130</b> CRYSTALS! <b>12 for \$1.98</b> Un tested. Large U.S. maker dumped frequency marked H/6U crystals in barrels. Some worth \$5. Precision. Many in 8 mc. areas. 9A3250	<b>BARREL KIT #131</b> TANTALUM ELECTROS <b>30 for \$1.98</b> Un tested. Mixed, marked prime, top grade asst. values, voltages, GE, Centralab, etc. Cat. No. 9A3255	<b>BARREL KIT #133</b> C-MOS IC'S <b>60 for \$1.98</b> Un tested. Deliberately thrown in barrels, so we can't test 'em! The famous CD4000 series. How good? Who knows? Who cares? It's only 3c ea. Cat. No. 9A3257	<b>BARREL KIT #134</b> CALCULATOR CHIPS <b>15 for \$1.98</b> Un tested. National type. Can be MM5736, 38, etc. They have discontinued these chips. FIND A USE. Un tested. Cat. No. 9A3258	<b>BARREL KIT #136</b> KLIP IN DIODES <b>50 for \$1.98</b> Un tested. 2 ozs. 100% good. Snaps into fuse type clip holder, 1N82 diodes. Metal ferrule type. No. 9A3261	<b>BARREL KIT #137</b> OPTO SPECIAL <b>25 for \$1.98</b> Un tested. "Skinny C-Thru's". New, Monsanto, infra-red led, photo darlington's, photo transistors. 9A3262
<b>BARREL KIT #138</b> PANEL SWITCHES <b>30 for \$1.98</b> Un tested. Did you hear of OAK? Another eqpt maker barreled all types of rotaries, electric, slides, etc. 9A3268	<b>BARREL KIT #142</b> DARLINGTON TRANSISTORS <b>40 for \$1.98</b> Un tested. TO-92, a Motorola dump, unknown numbers, but high yield to good darlington's. Retesters didn't get 'em! You will. 9A3285	<b>BARREL KIT #143</b> 75-PC TRANSISTORS <b>\$1.98</b> Un tested. 100% material, TO-92, factory discontinued lines, pap's mixed with npns, 2N4400-1-2-3-4. Wut do you care, it's gud stuff. Cat. No. 9A3290	<b>BARREL KIT #144</b> RCA PHONO PLUGS <b>40 for \$1.98</b> Un tested. 1,000,000 RCA phono plugs for this one. You hi-ere know wut they are... 100% material. Look at the price. 9A3293	<p>Terms: Add postage. Rated: net 30 Phone: Wakefield, Mass. (617) 245-3829 Retail: 16-18 Del Carmine St., Wakefield, MINIMUM ORDER — \$6.00</p>		<p>C.O.D.'s MAY BE PHONED</p>
<h1>POLY PAKS</h1>						<p>Send for FREE Fall-Winter CATALOG</p>
<p>P.O. BOX 942A LYNNFIELD, MASS. 01940</p>						

# VERADA 214

## Summer / Fall SURPLUS SPECIALS

### PANEL METERS

Brand new, factory boxed, 2 1/2 inch square Hickok. Dual range 0-3-15 dc voltmeter. 0-1 amp dc ammeter. Modern design. Perfect combination for bench power supplies. While they last. \$4.50 ea., \$6.75/pair. Order #OU3A (voltmeter), #OU3B (ammeter). Shipping Wt. 8 oz. ea.

### GEL CELLS 6 VOLT

RECHARGEABLE solid gel battery. LEAK-PROOF. A lot of power in a small package (6x2x3 3/4, 7.5 amp hrs). Removed from equipment, but checked for chargeability. Diagram for charger included. Perfect for alarm systems, remote installations. Order #OU4A \$3.00 ea., 4/\$10.00, 10/\$22.00, Sh. Wt. 4 lb.



### CHIP PRICES CHIPPED

National MM5316 clock chip with data, 12 or 24 hr, am-pm, brightness control, snooze alarm. \$2.95 ea., 3/\$7.50.

Analog Devices AD505 High speed op amp with data. \$15.00 value. \$1.95, 3/\$5.00

SG711CN Dual voltage comparator \$.25 ea., 5/\$1.00.

AMS 6002 1024 bit RAM with data \$2.95 ea., 3/\$8.00.

741 "old faithful" op amp. Super deal \$.39 ea., 4/\$1.00.

Intel 3101 High speed, fully decoded 64 bit Ram. With data. \$3.75 ea.

ALL CHIPS ARE 100% TESTED AND GUARANTEED

### SOCKET TO 'EM

#### Dip Sockets

16 pin wirewrap, gold plate, low profile (\$.46 ea.) (10 to 100, \$.41 ea.) (100 and up, \$.38 ea.)

14 pin wire wrap, gold plate, low profile (\$.39 ea.) (10 to 100, \$.37 ea.) (100 and up, \$.34 ea.)

16 pin soldertail (tinplate) (\$.35 ea.) (10 to 100, \$.31 ea.) (100 and up, \$.28 ea.)

#### Clock-Calculator-MSI Sockets

Gold plated G-10 board

24 pin for MSI, MM5314, 5312 etc. Width 5/8 in.

28 pin for CT5005, 5311, 5313 ICs. Width 5/8 in.

40 pin for MOS, MSI ICs width 1-1/16 in. \$.35 ea., 10 for \$2.75, 100 for \$20.00.

### ELECTRONIC HARDWARE ASSORTMENT

Approx. 1 lb. package of SMALL NUTS, BOLTS, WASHERS, ETC. Buy several, they're inexpensive and handy to have around. Order #OU5A \$.075 ea., 3/\$1.50.

### SPEAKERS BY THE TRUCKLOAD

These fine QUALITY SPEAKERS are brand new, FACTORY FRESH. We are offering them at these low prices because we were able to purchase a huge factory overrun. All perfect and guaranteed. The five and eight inch units are just right for good sounding bookshelf systems. The ten inch makes an excellent woofer in medium priced floor standing enclosures. Both the ten and the twelve inch can be used to full advantage in P.A. sound systems for both voice and music. All are eight ohms.

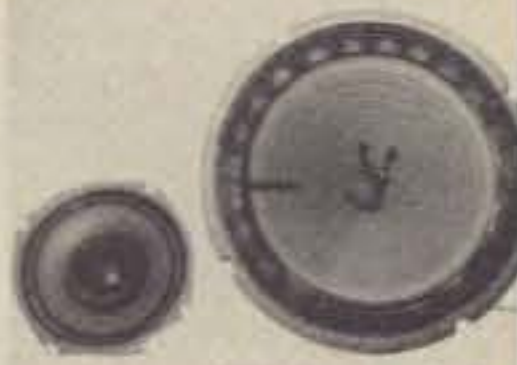

Order #	Diam.	Function	Power(rms)	Magnet	Price	Sh.Wt.
5FR5	5 in.	Full range	5 watt	5 oz. ceramic	\$2.75 ea., 2/\$5.00	2 lb.
8FR8	8 in.	Full range	15 watt	Alnico V	\$4.00 ea., 2/\$7.50	2 lb.
10W10	10 in.	Woofer/Mid	30 watt	10 oz. ceramic	\$10.75 ea., 2/\$20.	4 lb.
12W12	12 in.	Woofer/Mid	10 watt	Alnico V	\$6.50 ea., 2/\$12	5 lb.

### LOW VOLTAGE TRANSFORMERS AT LOW BUDGET PRICES

Our most popular units. Perfect for bench supplies, power amps, etc. DON'T MISS OUT. At these prices, they won't last. All are 115 volt, 60 cycle primary. NEW SURPLUS, FIRST QUALITY.

Secondary	Size	Sh. Wt.	Price	Order #
50 vct @ 1.5 a.	4-1/4H x 3-5/8 x 3-3/8	4 lb.	\$3.00 ea., 3/\$7.50	OT9E
50 v @ 2.5 a.	3-1/8H x 3-3/4 x 2-1/2	3 lb.	\$3.75 ea., 3/\$9.00	OT2F
50 v @ 4.5 a.	3-3/4H x 4-1/2 x 3-1/4	4 lb.	\$5.25 ea., 3/\$11.25	OT2E
50 v @ 8.5 a.	3-3/4H x 4-1/2 x 4-1/4	6 lb.	\$6.75 ea., 3/\$15.75	OT2D
2.2 v @ 3.0 a.	2H x 2-3/8 x 1-3/4	2 lb.	\$2.75 ea., 3/\$7.25	OT9F
34 vct @ .5 a.	1-3/4H x 2 x 2	1 lb.	\$3.50 ea., 3/\$8.50	OT2A
6.3 v @ .5 a.				
20 vct @ .5 a.	1-3/4H x 2 x 2	1 lb.	\$2.75 ea., 5/\$10.00	OT2B
22 vct @ 1.0 a.	2H x 2-1/2 x 2-1/4	2 lb.	\$4.50 ea., 3/\$11.50	OT2C
18 vct @ 1.0 a.				
40 vct @ 1.0 a.	2-1/2H x 3-1/8 x 2-1/2	2 lb.	\$4.50 ea., 3/\$11.50	OT9B
30 v @ 1.0 a.				

### PC BOARD EDGE CONNECTORS

For single or double sided board. Shipping Wt. 3 oz. ea.

Order #	Mfr.	# of pins	Per side	Spacing	Bd.Th.	Desc.	Price ea.	10 up ea.
OU2A	Amp	56	28	.125	1/16	Gold WW.	\$1.65	\$1.25
OU2B	Burndy	86	43	.156	.065	H.D. Gold WW	\$2.25	\$1.90
						5 amp contacts		
OU2C	Litton	80	40	.125	1/16	Gold WW	\$1.85	\$1.45
OU2D	CCC	50	25	.156	1/16	Gold solder	\$1.90	\$0.90
OU2E	Winchester	86	43	.156	1/16	Gold solder	\$1.65	\$1.25

VIATRON 2111 DATA MANAGEMENT SYSTEM. We sell them, service them, and supply parts for them. For Viatron, Call Verada.

BURROUGHS D830INFORMATION PROCESSING SYSTEM. We are pleased to announce the addition of this fine terminal to our line of computer hardware. Units are brand new surplus. Call or write for further info.

### VIATRON USERS ORGANIZATION

Verada 214 is seriously considering the organization of a Viatron Users Society for the purpose of providing an information exchange between owners of Viatron machines. This would be accomplished by a series of newsletters, worked up from information sent to us by members of the society (or other sources when available). We would appreciate getting some reader response on the subject.



verada 214  
38 french st. p.o. box 438  
lowell, mass. 01852 617-458-3077

# BULLET<sup>®</sup> ELECTRONICS

PO BOX 1465E, LAKE WORTH, FLORIDA 33460

20% REFUND ON ALL ORDERS NOT SHIPPED IN 48HRS!  
QUALITY PARTS AND KITS

POSTAGE PAID ON ALL ORDERS OVER \$10.00 (unless noted)

\*\*\* ORDERS UNDER \$10.00 ADD 60c HANDLING.

\*\*\* NO COD- check or MO  
\*\*\* ALL ORDERS SHIPPED P.P.  
\*\*\* ADD 5¢ For Air Mail

FOREIGN ORDERS ADD 10% 20% for Air Mail  
FLORIDA RESIDENTS ADD 4%

## PS 01 POWER SUPPLY KIT

COMPARE THIS UNIT WITH ANY OTHER KIT AVAILABLE.

THIS SUPPLY OFFERS THREE VOLTAGES AT THE

SAME PRICE MOST OTHERS OFFER ONLY ONE!

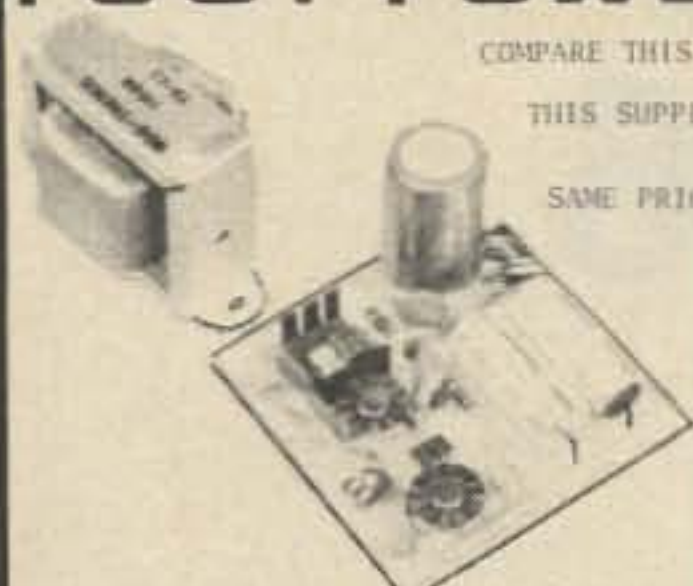

YOU GET:

- All components, hardware, heatsinks and transformer
- G10 plated and drilled PC Board
- Complete instructions

The PS-01 uses the highly effective 78L series of 3 terminal voltage regulators and a series pass transistor for each voltage.

+5 @ 1.5A

+15 @ 150 MA

\$14.95

MURATA 10.7 MHZ CERAMIC FILTERS

\$1.69 with specs and circuit tips



- MINIATURE SIZE
- Superior selectivity
- No-tuning required - ever!

3db Bandwidth: 220 ±db KHZ  
50db Bandwidth: 700 KHz Max  
Ripple: 1 dB Max  
Insertion Loss: 10 dB Max  
Temp Coefficient: less than 120ppm/°C  
Impedance: 330 Ohms

The bandwidth can be narrowed by loading filter with a higher impedance



FACTORY NEW!!!

### nude

DRILLED FOR 4 TO-3 TRANSISTORS

12" LONG APPROX. 120WATTS \$3.50

DRILLED FOR 2 TO-3 TRANSISTORS

6" LONG APPROX. 60WATTS \$1.80

CURRENT LIMIT RESISTORS  
HARD TO FIND VALUES:

.1 OHM @ 10W

.032 OHM @ 10W 3/\$1

2 OHM @ 10W

## TIMEBASE KIT TB03/50

Want 24-hour time from your Mostek 50252 clock kit? This chip requires 50 Hz for a 24-hour format.

6 to 20 volts  
.01% accuracy

- Ultra-small, low current
- Stable ceramic resonator
- Works directly with 50252, 5314, 5316, etc., chips
- Buffered output
- Adjustable



Complete Kit \$5.50 3/\$15.00

SEND A STAMP for an illustrated catalog of low priced, quality kits and components. WE HAVE: alarm clock kits, mobile clock kits, 50 & 60 Hz timebases, touchtone encoders, high current power supplies, capacitor discharge ignitions and many other items. FREE WITH AN ORDER!

## HEATSHRINK TUBING SPECIAL

#1 assorted one foot lengths of 3/64, 1/16, 1/8, & 1/4" 10 pieces .49

#2 assorted one foot lengths of 3/8, & 1/2" .59

## "POWER SUPPLY HANDBOOK"

by J. Kevin Lynn

The hows and whys of various types of regulated power supplies with schematics & circuit description on series pass, shunt, switching and floating regulators. This informative booklet develops several novel and unique power supplies. Learn about transformer ratings, heatsink ratings, IC regulators, high current supplies, dual tracking supplies and more. 89¢ AVAILABLE ONLY from BULLET!

WOULD YOU BELIEVE-

50 OHMS @ 100WATTS ?!

### Whats?

FOUR OF OUR CERAMIC, NON-INDUCTIVE RESISTORS WILL DISSIPATE THAT MUCH WHEN CONNECTED IN SERIES/PARALLEL AND MOUNTED IN A GOOD HEATSINK.

### 4/99¢

We can't think of a thing to do with these.... so you can have them cheap

Everybody we told about this kit said it was "too cheap - you should sell it for more" ... but we think the buyer can recognize a super deal SO HERE IT IS!!

## Capacitor Discharge Ignition KIT



### \$9.95

CONTAINS:

- PC BOARD
- SPECIAL TOROID TRANSFORMER
- 2 100W Power Transistors
- 8A SCR
- 4 800 Volt Diodes
- All resistors & caps
- COMPLETE INSTRUCTIONS

Double the output of your cars' ignition system

CASES ARE AVAILABLE!

\$5.95 includes Heatsink & Hardware

Does not need a special coil Easy to install

2N2222 Unmarked but tested good!

12/\$1



### LOUDI 10 WATT WARBLE ALARM KIT

All the components you need to build a dual tone warble alarm but the speaker.

Complete with PC Board

6-15VDC \$2.50 complete

## GREEN PHOSPHOR READOUT



1.4 V Filament  
24 V segment  
Low Current  
(40 mA per readout)  
DG8F  
79¢ each  
(works on 12volts)  
10 for \$7.00

## 1101 MEMORIES

RAM



256 11

\$1.25

LIMITED QUANTITY

DRILLED AND PLATED PC BOARD WITH PARTS LAYOUT. Mounts the Clock Chip, Transistors, Caps and resistors. You build the Readout Board 1.75

## ORDERS OVER \$50 TAKE 10% DISC

SEND 25¢ FOR COMPLETE CATALOG...FREE WITH AN ORDER

# HAVE I GOT A NUMBER FOR YOU!

toll free

## 800-325-3636

call

**HAM RADIO CENTER  
ST. LOUIS  
FOR NEW AND USED  
AMATEUR RADIO EQUIPMENT**

*We Trade on New or Used  
Charge it on Master-Charge or BankAmericard*



HK-1

**THE HAM-KEY  
Now 4 Models**

**MODEL HK-1 \$29.95 DELIVERED**

- \*DUAL LEVER SQUEEZE PADDLE
- \*FOR USE WITH ALL ELECTRONIC KEYS
- \*HEAVY BASE WITH NON-SLIP RUBBER FEET
- \*PADDLES REVERSIBLE FOR WIDE OR CLOSE FINGER SPACING

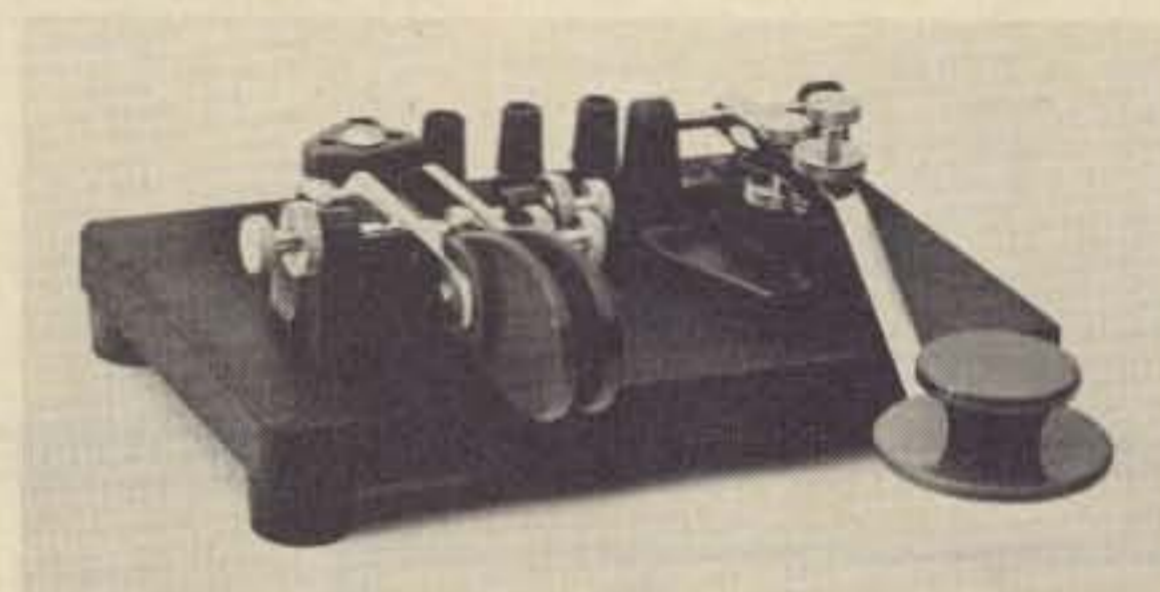

HK-4

**MODEL HK-4 \$44.95 DELIVERED**

- \*COMBINATION DUAL LEVER PADDLE AND STRAIGHT KEY ON SAME BASE
- \*STRAIGHT KEY MAY BE USED CONVENTIONALLY OR AS A SWITCH TO TRIGGER A MEMORY



HK-2

**MODEL HK-2 \$19.95 DELIVERED**

- \*SAME AS HK-1, BUT LESS BASE FOR THOSE WHO WISH TO INCORPORATE IN THEIR OWN KEYS

- ALL KEYS ARE COMPLETELY ADJUSTABLE
- ALL PLASTIC PARTS HI-IMPACT STYRENE
- ALL HAVE COLOR CODED BINDING POSTS



HK-3

**MODEL HK-3 \$16.95 DELIVERED**

- \*DE LUXE STRAIGHT KEY
- \*VELVET SMOOTH ACTION
- \*HEAVY BASE WITH NON-SLIP RUBBER FEET
- \*NO NEED TO ATTACH TO DESK

## HAM RADIO CENTER INC.

8342 Olive BL.

P.O. Box 28271

St. Louis, MO 63132

# 6 Digit LED Clock Kit - 12/24 hr.

**\$950**  
ea.

IN QUANTITIES  
OF 1 TO 5

**\$850**  
ea.

IN QUANTITIES  
OF 6 OR MORE

**KIT INCLUDES**

- INSTRUCTIONS
- QUALITY COMPONENTS
- MONEY BACK GUARANTEE
- 50 or 60 Hz OPERATION
- 12 or 24 HR OPERATION

- 6 - LED Readouts (FND-70 .25 in. Red, com. cathode)
- 1 - MM5314 Clock Chip (24 pin)
- 13 - Transistors
- 3 - Switches
- 5 - Capacitors
- 5 - Diodes
- 9 - Resistors
- 24 - Molex pins for IC socket

**ORDER KIT #850**  
**AN INCREDIBLE VALUE!**

"Kit #850 will furnish a complete set of clock components as listed. The only additional items required are a 7-11 VAC transformer, a circuit board and a cabinet, if desired."

- Printed Circuit Board for kit #850 or #850-4 (etched & drilled fiberglass) ..... \$2.95
- Standard Transformer 115 VAC/8 VAC ..... 1.50
- Molded Plug Transformer 115 VAC/10 VAC (with cord) ..... 2.50
- Plexiglas Cabinet II red chassis, white case (see below) ..... 5.95

**KIT #850-4 same as #850 except larger .4" LEDs ..... \$11.95**

**60 Hz Xtal Timebase Kit #TB-1**  
Power: 5-16 VDC/2.5 mA @ 12 VDC  
Size: PC board approx 1"x2"  
Accuracy: ±2 ppm (adjustable)

Will free IC digital clock from ac timebase and allow 12 VDC operation. Use in car, van, boat, camper, etc.  
**6/28.95, 5.95 each.**  
(4.95 when purchased with any clock kit.)

This is a complete - single IC kit with info for easy hookup to most IC clocks.

**Jumbo Digit Conversion Kit** for LED clocks. Kit provides a multiplex display board and six .5" LED digits (FND-503 or FND-510). LEDs require only 5 mA/seg and can be driven by most any LED clock circuit. Data for displays and hookup included. (Connections from this board will line up point to point with kit #850 PC board). Specify common anode or cathode displays ..... **\$9.95**

**Jumbo Digit Clock Kit Complete** - Kit features six .5" red digits. All components, PC boards, plug transformer, line cord, etc. Uses mm5314 IC, 50/60 Hz op., 12 or 24 hr. (will fit cab. I) Kit #5314-5 complete less case ..... **\$19.95**

## 6 Digit LED Clock-Calendar-Alarm Kit

• 12/24 HR TIME • JUMBO DIGITS (MAN-64) • 28-30-31 DAY CALENDAR • AC FAILURE/BATTERY BACK-UP • 24 HR ALARM - 10 MIN. SNOOZE • ALTERNATES TIME (8 SEC) AND DATE (2 SEC) OR DISPLAYS TIME ONLY AND DATE ON DEMAND • THIS KIT USES THE FANTASTIC CT-7001 CHIP. FOR THE PERSON THAT WANTS A SUPER CLOCK KIT (TOO MANY FEATURES TO LIST)!

**39.95** ORDER KIT #7001B  
(CASE NOT INCLUDED)  
COMPLETE KIT, including Power Supply, Line Cord, Drilled PC Boards, etc.

Kit #7001-C same as #7001-B but has different LEDs. Uses 4 DL-747 .63" digits & 2 MAN-7 .3" digits for seconds. Complete kit, less case. **\$42.95**

**CABINET I**

3" HIGH  
6 1/4" WIDE  
5 1/2" DEEP



GREAT FOR CLOCK & CLOCK CALENDAR KITS  
White Plexiglas Case  
Specify RED or GRAY  
Plexiglas Chassis

Chassis Serves As Bezel To Increase Contrast of Digital Displays. Use Gray With Any Color - Red With Red Displays Only (Red LED's with Red Chassis Brightest) **\$6.95 ea.**

**CABINET II**

2 1/2" HIGH  
4 1/2" WIDE  
5 1/2" DEEP



GREAT FOR SMALLER CLOCK KITS

**NEW!**

(Ideal for Kit #850 above.)  
All Plexiglas Red Chassis, White Case.  
Red Chassis Serves As Bezel To Increase Contrast of LED Displays. **\$5.95 ea.**

**PLEXIGLAS FOR DIGITAL BEZELS**

Gray or Red Filter **95¢ ea**  
3" x 6" x 1/8" Approx. Size  
**4 for \$3.00**

25k or 4.7k PC Trimmers  
**6 for \$1.00**

LM-309K 5V. Reg ..... **\$1.25**

555 Timer ..... **2 for 1.00**

565 PLL ..... **.95**

TELEX (one ear) HEADSET  
2kΩ Impedance **\$2.95ea.**

**NEW FND-359 NEW**  
Jumbo .4" 7-Seg LEDs  
Red Common Cathode  
\$.95 ea. 10/\$8.50 100/\$79.00  
(Direct Plug Replacement for FND-70)

**PRINTED CIRCUIT BOARDS** for clock-calendar-alarm kit (CT-7001 IC), sold separately with instructions and parts list.  
Set of 2 - \$7.95 specify #7001B or #7001C.  
PC boards are drilled, etched, fiberglass with solder plating and screened component layout.

## 7-SEG LED

Common Anode			
MAN-64 AL	RED	.4"	\$1.25 ea
MAN-8	YELLOW	.3"	.95
MAN-7	RED	.3"	.95
DL-707	RED	.3"	.95
FND-510	RED	.5"	1.35
Common Cathode			
HP5082-7702	RED	.3"	1.25
FND-70	RED	.25"	.50
FND-71	±1	.25"	.50
FND-503	RED	.5"	1.35
DL-33MMB	RED	.3 x .1"	.49
FND 359	RED	.4"	.95
FND 803	RED	.8"	3.50



**JUMBO RED LED's**

12/\$1.00      100 for \$7.50

Bi-Polar LED's Lights Red One Polarity Green Rev. \$1.25

**25 AMP FULL WAVE BRIDGE 100 PIV**



**\$1.95 ea.**    1N4148    25/\$1.00  
1N914    25/\$1.00  
**3/\$5.00**    1N4005    12/\$1.00

**CLOCK ICs**

CT-7001 clock-cal-alm	\$7.95
MM5314 clock	\$3.95
MM5316 alarm clock	\$4.95
MM5369 xtal TB IC	\$2.95
MM5375AB 6 digit alarm clock	\$3.95

Motorola 2N2501 High Speed Switch Silicon NPN 350 MHz hFE 50  
8/\$1.00      100/\$9.00      1000/\$55.00

**2N2554 PNP Power Amplifier**

Stud Mount Case      2 for \$1.00  
80V. 3A.

**Burroughs Panaplex II Display**

11 Digit .25" char. gas discharge  
\$2.95 each      2/\$5.00

Mini Slide Switch SPDT	6/\$1.00
Reg Slide Switch DPDT	8/\$1.00
Push-button Switch N.O.	7/\$2.00
Rocker Switch SPDT	6/\$1.00

**10 Turn Spectrol 10K Pot**

3/8"x3/8"x1/4" high ..... 2 for \$1.00

**CMOS Micropower PLL**

RCA CD4046 AE ..... \$1.50 5/\$5.

**IC SOCKETS SOLDER TAIL LP**

14 pin - 9/\$2	50/\$9.95
16 pin - 4/\$1	50/\$11.50
18 pin - 3/\$1	50/\$14.50
40 pin - \$.95	4/\$3.00

**Opto Isolator**      House #  
By Monsanto      2 for \$1.00

**Transistors 5 for \$1.00**

2N1991	PNP	T0-5
2N2222A	NPN	T0-18
2N2369	NPN	T0-92
2N3394	NPN	T0-92
2N3704	NPN	T0-92
2N4125	PNP	T0-92
2N4249	PNP	T0-92
2N4437	NPN	T0-92

**OPTOELECTRONICS, inc.**

BOX 219 • HOLLYWOOD, FLA. 33022 • (305) 921-2056

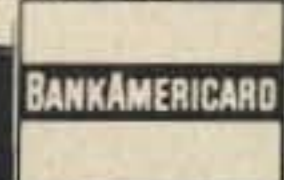
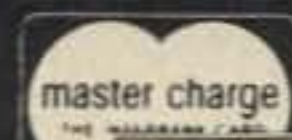

BankAmericard, Mastercharge or C.O.D. order accepted by phone day or evening.  
We Pay All Shipping in Continental U.S.A. Orders under \$15 add \$1 handling. Fla. res. add 4%.

# S. D. SALES

P. O. BOX 28810 • DALLAS, TEXAS 75228

<p><b>PLASTIC READOUT FILTERS</b> Originally used in desk top calculators. Perfect for use with LED and other type readouts. <b>RED - 4 for \$1.00</b> <b>AMBER - 6 for \$1.00</b></p>	<p><b>FLOURESCENT READOUTS</b> No. DG8F, Seven segments, blue-green in color. Can be directly driven by many MOS IC's. .3 inch character. <b>SPECIAL - 89¢ each</b> <b>LIMITED QUANTITY</b></p>		<p><b>TRIMMER POTS</b> 10K OHM, MINI, FOR P.C. BOARDS <b>10 for \$1.00</b></p>
<p><b>CLOCK TRANSFORMER</b> PRI: 115 VAC 60 HZ SEC: 20 VAC C.T. @ 200 MA AND 150 VAC @ 15 MA Miniature Size. <b>\$1.25 ea.</b></p>	<p><b>NATIONAL MM5204 4K EPROM</b> Brand new parts. 512 x 8 Bits. EQUIV. to two 1702A's in one package. <b>LIMITED QTY. - \$12. each</b></p>		<p><b>PHOTOCELL ASSORTMENT</b> We bought almost 200K from a big US Mfg. Three product families; small, medium and dual photocells. Perfect for all light sensitive applications. <b>12 for \$1.00</b></p>
<p><b>IC SOCKETS BACK IN STOCK!</b> 14 PIN - 5 for \$1.00 16 PIN - 4 for \$1.00 18 PIN - 3 for \$1.00 28 PIN - 69¢ each</p>	<p><b>LM 380 AUDIO AMP</b> 14 Pin DIP. 2 Watts. <b>99¢</b></p>	<p><b>NE567V by SIGNETICS</b> Phased locked loop. <b>\$1.25</b></p>	<p><b>MOTOROLA MJE 3055</b> NPN SILICON. 15A. 90 W. 75¢ PLASTIC 2N3055</p>
<p><b>MOTOROLA MJE2370</b> PNP SILICON. 3A. 40 W. General Purpose PNP plastic power transistor. Regular catalog is \$1.25 <b>3 for \$1.00</b></p>	<p><b>PROM's 20¢ EACH?</b> We bought a load from a very large US computer firm. Includes 8223, 82S23, Intel 3601, 82S126, etc. Most are programmed, but may have some useful codes and data. Lot is mixed, sorry no choice of numbers. No data. Perfect for experiments. <b>LIMITED QUANTITY - 5 for \$1.00</b></p>		<p><b>TI POWER TRANSISTORS</b> TIP29 (EP967) NPN TIP30 (EP929) PNP PLASTIC CASE TO - 220 <b>YOUR CHOICE:</b> <b>4 for \$1.00</b></p>

## QUAD 741 OP AMPS

LM324 BY NATIONAL. IMAGINE, 4 741C OP AMPS IN ONE 14 PIN DIP.

LIMITED QTY. 99¢

## DUAL 741 (5558)

ANOTHER S. D. "SPECIAL" - 2 - 741V IN ONE MINI DIP PACKAGE. THESE UNITS WERE BOUGHT FROM XEROX CORPORATION ON ANOTHER OF OUR SUPER BUYS. THEY ARE HOUSE NUMBERED, BUT GUARANTEED PRIME. THEY FEATURE: NO FREQUENCY COMPENSATION REQUIRED. SHORT CIRCUIT PROTECTION. LOW POWER CONSUMPTION. NO LATCH-UP.

S. D. SPECIAL INTRODUCTORY PRICE 4/\$1.00



## INTERSIL 8038 VCO IC

THIS IS A PRECISION FUNCTION GENERATOR IN A 14 PIN DIP. PRODUCES SINE, SQUARE, AND TRIANGULAR WAVEFORMS. LOW DISTORTION, HIGH LINEARITY. USEFUL OVER A WIDE FREQUENCY RANGE. WITH SPEC. SHEETS. **\$4.99 EACH**

## S. D. SLASHES LINEAR PRICES

TIRED OF GETTING RIPPED OFF? TIRED OF PAYING HIGH PRICES FOR LINEAR IC'S OF QUESTIONABLE QUALITY? THEN YOU SHOULD BE BUYING YOUR LINEARS FROM S. D. BELOW DEVICES ARE ALL FACTORY PRIME, FULL SPEC OF ALL PARAMETERS. COMPARE THESE PRICES!

741C	MINI DIP OP AMP	4/\$1
741CH	TO - 5 CAN OP AMP	3/\$1
555V	TIMER IC	2/\$1
565A	PHASE LOCKED LOOP	2/\$1
LM 380-8	MINI DIP AUDIO AMP	2/\$1



## LM309K

5 VDC 1 AMP VOLTAGE REGULATORS. PRIME UNITS. NOT RETESTS OR OFF SPEC.

\$1.49

## LM340T - 5 (7805)

SAME AS LM309K EXCEPT IN A TO-220 CASE BY NATIONAL

99¢



# S. D. SALES

P. O. BOX 28810 • DALLAS, TEXAS 75228

**MK50252 ALARM CLOCK CHIP.** THE EASIEST TO USE CHIP ON THE MARKET. FEATURES: SIMPLE TIME SET, 24 HOUR ALARM, 10 MINUTE SNOOZE, 4 OR 6 DIGITS, AM-PM INDICATION. THIS IS THE ONLY CHIP THAT GENERATES THE ALARM TONE INTERNALLY, THUS ELIMINATING MANY EXTERNAL COMPONENTS. VASTLY OUT PERFORMS OLDER STYLE CHIPS LIKE THE MM5316. WITH SPECS. 28 PIN PACKAGE  
 CPMPARE THIS PRICE! -- \$4.99 EACH

## CALCULATOR CHIP WITH SQUARE ROOT

10 DIGITS, SIX FUNCTIONS (+ - x ÷ % AND SQUARE ROOT) FEATURES DIRECT SEGMENT DRIVE FOR LED READOUTS, INTERNAL CLOCK OSCILLATOR, FLOATING DECIMAL POINT. DOES NOT REQUIRE MANY EXTERNAL COMPONENTS AS DO OLDER TYPES LIKE CT5001, 5002 OR 5005. YOU GET A FULL TEN DIGITS AND SIX FUNCTIONS AT THIS LOW PRICE. WITH SPECS.  
 \$2.50 EACH

## REPEAT OF A SELLOUT

**5082 - 7740** BY HEWLETT - PACKARD. .30 INCH CHARACTER. COMMON CATHODE. RIGHT DECIMAL POINT. ONE OF THE BRIGHTEST UNITS WE HAVE SEEN. PRIME FACTORY NEW UNITS, NOT RE-TESTED REJECTS AS SOLD BY OTHERS. SPECIAL \$1.25 EACH  
 6 FOR \$6.00



## DL747 JUMBO LED READOUTS

BY LITRONIX. .65 INCH CHARACTER. COMMON ANODE. OUT PERFORMS SLA - 3. PERFECT FOR GIANT DIGITAL CLOCKS. ONLY 20 MA. PER SEGMENT. NOT CLASS II  
 SPECIAL - \$2.50 EACH



## LARGE SIZE LED LAMPS

SIMILAR TO MV5024. PRIME FACTORY TESTED UNITS. WE INCLUDE PLASTIC MOUNTING CLIPS WHICH ARE VERY HARD TO COME BY. SPECIAL 5 FOR \$1.00



### NATIONAL MM5375AA ALARM CLOCK CHIP

Second generation alarm chip. Six digits, internally generates alarm tone, snooze, power failure indicator, etc. Very easy to use. Outperforms older types like 5316, 5370, etc. Perfect for use with our HP 5082-7740 LED readouts. S.D. SPECIAL PRICE: \$3.50  
 WITH DATA

### MOSTEK MK50380 DIRECT DRIVE ALARM CHIP

Drives LED readouts direct, eliminates transistor or IC interface circuitry. 4 digit output is non-multiplexed to eliminate RFI in clock radio applications. Has sleep and snooze features. 40 pin DIP. Makes a JUMBO alarm clock by using our FND 503 readouts. We show you how.  
 INTRODUCTORY PRICE: \$3.95

### CT-5005 WITH FOUR- FUNCTION MEMORY!

CALCULATOR CHIP  
 By CalTex. 12 Digits.  
 With Specs.  
 Factory prime. \$1.25 ea.

## TRANSISTORS

TYPE	MAT.	POL.	V <sub>CEO</sub>	I <sub>C</sub>	HFE	CASE	PRICE
2N3904	S	N	40	100MA	200	TO- 92	8/\$1.00
2N3906	S	P	40	100MA	200	TO- 92	8/\$1.00
2N3638	S	P	25	150MA	60	TO-105	8/\$1.00
2N2905	S	P	40	350MA	200	TO- 5	4/\$1.00
2N4249	S	P	60				10/\$1.00

## RCA HIGH VOLTAGE POWER TRANSISTOR

100 WATTS, 5 AMPS. V<sub>CEO</sub>-300 SILICON NPN TO-3 CASE. THESE ARE MANUFACTURERS HOUSE NUMBERED 2N5240. PERFECT FOR HIGH VOLTAGE POWER SUPPLIES OR FOR USE IN VERTICAL AND HORIZONTAL TV CIRCUITS. REGULAR CAT. PRICE IS \$6.00  
 OUR PRICE - 99¢ EACH



# S. D. SALES CO.

P. O. BOX 28810 DALLAS, TEXAS 75228

## ALARM CLOCK KIT SIX DIGIT LED

Thousands of hobbyists have bought and built our original clock kit and were completely satisfied. But we have received many requests for an alarm clock kit with the same value and quality that you have come to expect from S.D. So, here it is!

### THE KIT INCLUDES:

- 1 Mostek 50252 Alarm Clock Chip
- 6 Hewlett Packard .30 in. common cathode readouts.
- 15 NPN Driver Transistors
- 2 Switches for time set
- 2 Slide Switches for alarm set and enable
- 1 Filter Cap
- 4 IN4002 Rectifiers
- 1 IN914 Diode
- 1 .01 Disc Cap
- 15 Resistors
- 1 Speaker for alarm
- 1 LED lamp for PM indicator.

# \$9.95

PCB - 3.00

XFMR - 1.50

## 60 Hz. Crystal Time Base

FOR DIGITAL CLOCKS  
S. D. SALES EXCLUSIVE!  
**\$5.95**

### KIT FEATURES:

- A. 60 Hz output with accuracy comparable to a digital watch.
- B. Directly interfaces with all MOS clock chips.
- C. Super low power consumption (1.5 Ma typ.)
- D. Uses latest MOS 17 stage divider IC.
- E. Eliminates forever the problem of AC line glitches.
- F. Perfect for cars, boats, campers, or even for portable clocks at ham field days.
- G. Small size, can be used in existing enclosures.

Kit includes crystal, divider IC, P.C. Board plus all other necessary parts and specs.

### MOS 4 DIGIT COUNTER I C

All in one 28 PIN DIP. 4 Decade counters, latches, MUX circuits, display decoders, etc. Features: 5VDC operation, 25 MW power consumption, BOTH 7 segment and BCD outputs. Perfect for DVM's, frequency meters, tach's, etc. Can be cascaded for more digits. #5002 - \$8.95.

### 8008-1 MICRO PROCESSOR

New Units. High speed 8008. Almost twice as fast as units sold by others. Still a very versatile and widely used MPU. No data book, only pinout data included at this price. \$12.50 LIMITED QTY.

### 1101 A RAM IC

256 X 1 BITS. Perfect for 8008 or small systems such as telephone dials that do not require a lot of memory. Special 59c. 8 FOR \$4.

### C & K MINI TOGGLE SWITCH

#7103 SUB MINI SPDT Center OFF. Special - 99c.

### TTL INTEGRATED CIRCUITS

7400 - 19c	7430 - 19c	7476 - 35c	74153 - 75c
7402 - 19c	7432 - 34c	7480 - 49c	74154 - 1.00
74L04 - 29c	7437 - 39c	7483 - 95c	74157 - 75c
74S04 - 44c	7438 - 39c	7485 - 95c	74161 - 95c
7404 - 19c	7440 - 19c	7486 - 45c	74164 - 1.10
7406 - 29c	7447 - 85c	7490 - 65c	74165 - 1.10
7408 - 19c	7448 - 85c	7492 - 75c	74174 - 95c
7410 - 19c	7451 - 19c	7495 - 75c	74181 - 2.50
7411 - 29c	7453 - 19c	7496 - 89c	74191 - 1.25
7413 - 50c	7473 - 39c	74121 - 38c	74192 - 1.25
7420 - 19c	7474 - 35c	74123 - 65c	74193 - 1.00
	7475 - 69c	74141 - 75c	74195 - 69c



### MOTOROLA POWER DARLINGTON - \$1.99

BACK IN STOCK!  
Like MJ3001. NPN 80 V., 10A., HFE 6000 TYP. TO-3 case. We include a free 723C volt. reg. with schematic for a power supply. SPECIAL - \$1.99

### MOTOROLA RTL IC'S

Brand new, factory prime. Hard to find, but still used in a variety of projects. (See the RTL Cookbook by Howard W. Sams.)

MC724P-59c	MC780P-89c	MC791P-69c
MC725P-59c	MC785P-49c	MC792P-59c
MC764P-49c	MC787P-89c	MC799P-59c
MC767P-69c	MC788P-49c	MC9704P-89c
MC771P-49c	MC789P-59c	MC9709P-69c
MC775P-89c	MC790P-89c	MC9760P-69c

### MV-50 TYPE LED's

by LITRONIX  
10 for \$1  
Factory Prime!

### 3 DIGIT LED ARRAY - 75c

by LITRONIX  
DL33MMB. 3 MAN-3 Size Readouts in one package. These are factory prime, not retested rejects as sold by others. compare this price! 75c 3 for \$2.

### SALE ON CUT LEAD SEMICONDUCTORS

Leads were cut for PCB insertion. Still very useable.

1N914/1N4148	100/\$2
1N4002 1 Amp 100 PIV	40/\$1
1N4745A 16V 1W Zener	20/\$1
EN2222 NPN Transistor	25/\$1
EN2907 PNP Transistor	25/\$1
2N3904 NPN Driver Xstr.	25/\$1
2N3392 GE Pre-amp Xstr.	25/\$1
C103Y SCR. 800MA. 60V.	10/\$1

ALL NEW.  
UNUSED.  
SOME ARE  
HOUSE #

### SLIDE SWITCH ASSORTMENT

Our best seller. Includes miniatures and standard sizes, single and multi-position units. All new, first quality, name brand switches. Try one package and you'll reorder more. Special - 12 for \$1 (Assortment)



### DISC CAP ASSORTMENT

PC leads. At least 10 different values. Includes .001, .01, .05, plus other standard values.  
**60 FOR \$1**



### UPRIGHT ELECTROLYTIC CAPS

47 mfd 35 V-10/\$1 68 mfd 25V-8/\$1  
Brand new by Sprague. PC leads.

### RESISTOR ASSORTMENT

1/4 W 5% and 10%. PC leads.  
A good mix of values. 200/\$2

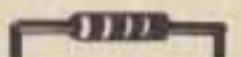

### 1000 MFD FILTER CAPS

Rated 35 WVDC. Upright style with P.C. leads. Most popular value for hobbyists. Compare at up to \$1.19 each from franchise type electronic parts stores. S.D. Special 4 for \$1



### FAIRCHILD BIG LED READOUTS

A big .50 inch easy to read character. Now available in either common anode or common cathode. Take your pick. Super low current drain, only 5 MA per segment typical.

		YOUR CHOICE	
FND - 510	Common Anode		
FND - 503	Common Cathode	\$1.50 ea.	6 for \$7.50

### DUAL 741C (5558) OP AMPS

Mini dip. New house numbered units by RAYTHEON.  
**4 FOR \$1**

### FET'S BY TEXAS INSTRUMENTS - SPECIAL 5 for \$1

#TIS-75 but with an internal house number. TO-92 plastic case. N. Channel, Junction type FET.

We do not sell junk. Money back guarantee on every item. No C.O.D. Texas Res. add 5% tax. Postage rates went up 30%! Please add 5% of your total order to help cover shipping.

### S. D. SALES CO.

P.O. BOX 28810  
DALLAS, TEXAS 75228

T \_ \_ \_ K \_ \_ \_  
\_ \_ \_ \_ \_

ORDERS UNDER \$10  
ADD 75c HANDLING.

## ORDERS OVER \$15 CHOOSE \$1 FREE MERCHANDISE

FOREIGN ORDERS MUST BE PAID IN U.S. FUNDS



# S. D. SALES CO.

P. O. BOX 28810  
DALLAS, TEXAS 75228

## UP YOUR COMPUTER!

21L02-1 1K LOW POWER

500NS STATIC RAM

### TIME IS OF THE ESSENCE

And so is power. Not only are our RAM's faster than a speeding bullet but they are now very low power. We are pleased to offer prime, new 21L02-1 low power and super fast RAM's. Allows you to **STRETCH** your power supply farther and at the same time keep the **WAIT** light off.

**8 for \$17.50**

## TOUCHTONE KEYBOARD SWITCH SET

By Controls Research. High quality long life switches with keytops. For encoders, combination locks, etc.

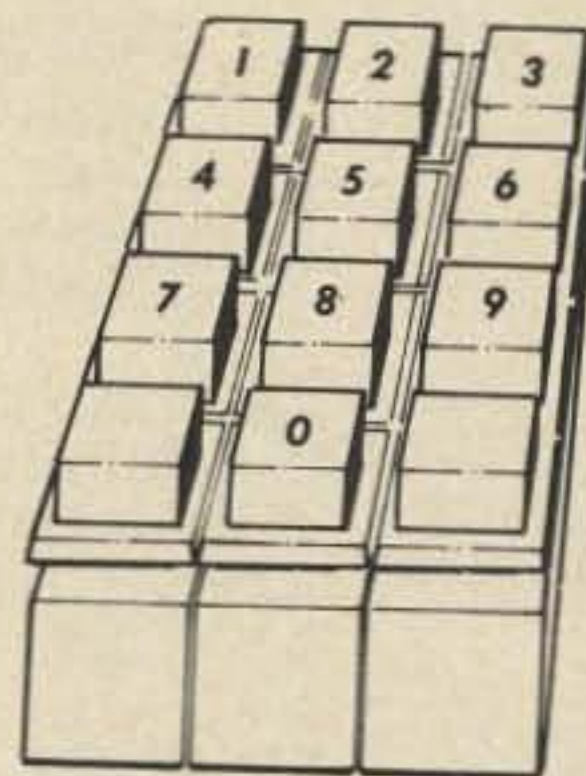

12 switches and tops, including 0 thru 9. Switch contacts are independent, allows hook-up to any matrix. Keytops easily removed.

**\$2.95 Set**  
**2 for \$5.00**

## 4K LOW POWER RAM BOARD KIT

Imsai and Altair 8080 plug in compatible. Uses low power static 21L02-1 500 ns. RAM's. Fully buffered, drastically reduced power consumption, on board regulated, all sockets and parts included. Premium quality plated thru PC Board.

THE WHOLE WORKS

**\$89.95**

Call your **BANK AMERICARD** or **MASTER CHARGE**  
order in on our  
**CONTINENTAL UNITED STATES TOLL FREE WATTS:**

*Exclusively  
Yours*



**1-800-527-3460**

TEXAS RESIDENTS CALL COLLECT:

**214/271-0022**

**1 MORE TIME**

Please call between 8:30 AM and 6:00 PM C.S.T. — Monday through Friday. You may also call to check stock or just ask a question. However, only B.A.C. and M.C. orders will be accepted. We do not ship C.O.D. (See terms of sale on other page.)

# WHAT HAVE YOU MISSED?

**JUNE 63.** Surplus issue: DMQ-2 Beacon Tx on 220, increasing ARC-2 transceiver selectivity, PE-97A pwr supply conversion, BC-348 bandspread, inductance tester, converting BC-230 tx, beginner's rx using BC-453, recvr motor-tuning, transistor cw monitor, BC-442 ant relay conversion, mobile loading coils, increasing Two-er selectivity, TV with the ART-26 tx, TRC-8 rx on 220, ARC-5 hf rx & tx, ARC-3 tx on 2M.

**AUG 63.** Battery-op 6M stn, diode noise gen, video modulation, magic T-R switch, ant gain, halo mods, cw breakin, VEE beam design, coax losses, RF wattmeter, TX Tube Guide, diode pwr supply, "Lunchbox" squelch, SWR explanation, vertical ant info, info on Window ant.

**OCT 63.** WBFM transceiver ideas, HF propagation, cheap tone patch, remote-tuned Yagi, construction hints, ant coupler, S5 Vertical, filament xformer construction, 2M nuvistor converter, Lafayette HE-35 mods, Buyer's Guide to Rx & Tx, product detector, novel Hi-C VFO, radio astronomy, paraadaptor "if" converter, compact mike amp.

**FEB 64.** 2M multichannel exciter, rx design ideas, magic t/r switch, loudspeaker enclosures, 40M 2W tx, look at test equipment, radio grounds, 40M ZL Special ant, neutralization.

**MAY 67.** Quad Issue: 432 Quad-quad-quad, expanded HF quad, Two el quad, miniquad, 40M quad, quad experiments, half-quad, three el quad, 20M quad, tiltover quad, easy-to-erect quad, Quad Bibliography, FET vfo, tube troubleshooting, HF dummy load, understanding "dB," HF SSB/cw rx, geometric circuit design, GSB-201 transceiver, FET converter for 10-20M, hi-pass rx filters.

**JULY 67.** VE ham radio, VEO hams, dsb adaptor, home brew tuner, transistor design, '39 World's Fair, gnd plane ant, G4ZU beam, SSTV monitor, UHF FET preamps, IC "if" strip, vertical ant, VHF/UHF dipper, tower hints, scope monitoring, operating desk, S-Line crossband, hi-school ham club, Heath HR-10 mods.

**OCT 67.** HF solid state rx, rugged rotor, designing slug-tuned coils, FET converter, SSTV pix gen, VHF log-periodics, rotatable dipole, gamma-match cap, old-time dxing, modern dxing.

**JUNE 68.** Surplus issue: Transformer tricks, BC-1206 rx, APS-13 ATV tx, low voltage dc supply, surplus scopes, FM rig commercial xtal types, Wilcox F-3 rx, restoring old equipment, 75A1 rx mods, TRA-19 on 432, freq counter uses, transceiver pwr supply, uses for cheap tape recorders, Surplus Conversion Bibliography, RT-209 walkie on 2M, ARC-1 guard rx, RTTY tx TU.

**JULY 68.** Wooden tower construction, tiltover towers, erecting a telephone pole, IC AF osc, "dB" explained, ham club tips (Part 1).

**SEPT 68.** Mobile vhf, 432 FET preamps, converting TV Tuners, xtal osc stability, parallel-Tee design, moonbounce rhombic, 6M xciter (corrections Jan 69), 6M transceiver (corrections Jan 69), 2M dsb amp, ham club tips (Part 3).

**NOV 68.** SSB xtal filters, solid state troubleshooting, IC freq counter (many errors & omissions), "cv" transformers, space comm odyssey, pulsar info, thin-wire ants, 40M transistor cw tx/rx, BC-348M double conversion, multifunction tester, copper wire specs, thermostat applications, hi-voltage transistor list, ham club tips (Part 5).

**JAN 69.** Suppressor compressor, HW-12 on 160, beam tuning, AC voltage control, 2M transistor tx, LC power reducer, spectrum analysis info, 6M transistor rx, operating console, RTTY autostart, calculating osc stability, lo-pwr 40 cw tx, sequential relay switching, sightless operator's bridge, ham club tips (Part 7).

**FEB 69.** SSTV camera mod for fast-scan, tri-band linear, selective af filter, unijunction transistor info, Nikola Tesla biography, mobile installation hints, extra-class license study (Part 1).

**MAR 69.** Surplus issue: TCS tx mods, cheap compressor/amp, RXZ calculations, transistor keyer, better balanced modulator, transistor oscillators, using blowers, half-wave feedline info, Surplus Conversion Bibliography, extra license study (Part 2).

**APR 69.** 2-channel scope amp, rx preamp, Two-er PTT, variable DC load, SWR bridge, 100 kHz marker gene, some transistor specs, SB-610 monitorscope mods, portable 6M AM tx, 2M converter, extra license study (Part 3).

**MAY 69.** 2M Turnstile, 2M Slot, rx attenuator, generator filter, short VEE, quad tuning, using antennascope, measuring ant gain, phone patch regs, SWR indicator, 160M short verticals, 15M antenna, HF propagation angles, FSK exciter, KW summy load, hi-power linear, extra license study (part 4), all-band curtain array.

**JUNE 69.** Microwave pwr generation, 6M ssb tx, 432-er tx/rx, 6M converter, 2M 5/8 wave whip, UHF tv tuners, ATV video modulator, UHF FET preamps, RTTY monitorscope, extra license study (part 5), building uhf cavities, mini-VEE for 10-20M, vhf vfo.

**JULY 69.** AM modulator, SSTV sig gen, 6M kw linear, 432 KW amp, 432-er tx/rx, 6M IC converter, radio-controlled models, RTTY IC

The back issues of 73 are a gold mine of interesting articles . . . just take a look at what's been covered . . . every possible interest. This is the most important library you can have for hamming.

The supply of these back issues is very limited . . . and when these are gone, that will be it. Don't miss out by procrastinating.

Single issues . . . . . \$1 each (before 1976)

Ten back issues (your choice) . . . . \$12 postpaid in US.

Twenty-five back issues (your choice) \$20 postpaid in US.

Twenty-five back issues (our choice) \$10 postpaid in US.

TU, audio notch filter, VRC-19 conversion, tube substitution, 2M transistor xciter, extra license study (part 6), hf FET vfo.

**AUG 69.** FET regen for 3.5 MHz up, FM crystal switching, 5/8 wave vertical, introduction to ICs, RTTY tone gen, good/bad transistor checker, 2M AM tx, measure transistor Ft, 160M propagation, triac applications, simple IF sweep gen, transistor keyer, SB-100 on 6M, xtal freq measurement, extra license study (part 7), FM deviation meter, qrp am 6M tx, circular quads, FM noise figure, transistor parameter tracer.

**SEPT 69.** Tunnel diode theory, magic tee, soldering techniques, wave travel theory, cable shielding, transistor theory, AM noise limiter, AFSK gen, transistor amp debugging, measure meter resistance, diode-stack pwr supply, transistor testing, 2 1/2W 6M tx, HX-10 neutralizing, capacitor usage, radio propagation, AM mod percentage, extra class license study (part 8), 3-400Z linear, ATV vidicon camera, 2 transistor testers, FET compressor, rf plate choke.

**OCT 69.** Super gain 40M ant, FET chirper, telephone info, scope calibrator, thyrector surge protector, slower tuning rates, identify calibrator harmonics, FM adaptor for AM tx, CB sets on 6M, proportional control xtal oven, xtal filter installation, Q-multiplier, transceiver pwr supply, extra class study (part 9).

**NOV 69.** NCX-3 on 6M, IF notch filters, dial calibration, HW32A external VFO, 6M converter, feedline info, rf z-bridge, fm mobile hints, umbrella ant, 432-er tx (part 1), pwr supply tricks with diodes, transistor keyer, transistor bias design, xtal vhf sign gen, electronic variac, SB33 mods, extra class study (part 10), SB34 linear improvements.

**DEC 69.** Transistor-diode checker, dummy load/attenuator, tuned filter chokes, band-switching Swan 250 & TV-2, 88mh selectivity, match exercises, rtl xtal calibrator, transistor pa design, hv mobile p.s., 1-10 GHz freqmeter, CB rig on 6M, extra license study (part 11), 1970 buyer's guide.

**JAN 70.** Transceiver accessory unit, bench power supply, SSTV color method, base-tuned center-loaded ant, 6M bandpass filter, extra license study (part 12), rectifier diode usage, facsimile info.

**FEB 70.** 18-inch 15M dipole, 6M converter, high-density pc board, camper-mobile hints, 2M freq synthesizer, encoding/decoding for repeaters, DX-35 mods, panoramic vhf rx, variable-Z HF mobile mount, extra license study (part 13), linear IC info, qrp 40M tx, IC Q-multiplier.

**MAR 70.** Gdo applications, charger for drycells, FM freq meter, pc board construction, ham fm standards, cheap rf wattmeter, multifreq fm osc, "IF" system modules (part 1), Six-er mods, gdo dip lite, Motorola 41V conversion, cw monitor, buying surplus logic, SSO-23A sonobuoy conversion, GRC-9 rx/tx conversion, extra class study (part 14), intro to vhf fm.

**APR 70.** Noise blanker, 2M hotcarrier diode converter, repeater controller, understanding COR repeater, 7/8-wave 2M ant, extra class study (part 15), inexpensive semiconductors, removing surplus meters, linear amp bias regulator, hi performance if amp & agc system, SSB bfo for shortwave radio, vacuum tube load box, general fm dope & repeater guide, meggering your ant.

**MAY 70.** Comments on "fm docket" #18803, future of cw, fm-am rx aligner, 5/8 wave verticals, using 2M intelligently, auto burglar alarms, pwr supplies from surplus components, "IF" system modules (part 2), vhf FET preamps, educated "idiot" lites, postage-stamp 6M tx, extra class study (part 16), Bishop (FNL), low-band police monitor, mobile cw tx, Wichita auto-patch.

**JUNE 70.** ODRR ant, vfo circuit, remote SWR indicator, indoor hf vertical, two rx on one antenna, environment & coax loss, 2-el trap verticals, buying surplus, two 40M qrp tx, 21dB 2M beam, extra class study (part 17).

**DEC 70.** Solid-state vhf exciter, delta-fre control for SSB, 2M transistor FM tx, HW100 offset tuning, "little gate" dipper, 3-500Z hf linear, general class study (part 5), "transi-test"

(no good - errors!), transistor p.s. current limiter.

**JAN 71.** Split tones for dxing, Heath Ten-er mods, cw duty cycle, repeater zero-beater, HEP IC projects, 10-15-20M parabolic ideas, lightning protection, IC rx accessory, attic ants, double-balanced mixers, permanent marker tool, ham license study questions.

**FEB 71.** Metal locator, varactor theory, AFSK unit, SSTV patch box, ATV hints, RTTY tuning indicator, tone encoder/decoder, 220 MHz converter, SSTV magnetic deflection, IC code osc, 6M tx beeper, general class study (part 6), RTTY intro, perf-board terminal, low-ohmmeter.

**MAR 71.** IC audio filter, IC 6M converter, trap vertical ideas, digi counter info, surplus equipment identification, hf linear, simple tone patch, repeater audio mixer, digi RTTY accessories, coathanger gndplane, general class study (part 7).

**APR 71.** Intro to fm, noise blanker, repeater problems, Motorola HT mods, microwave repeater linking, digital ID unit, tuneable 2M fm rx/tx, repeater directory, fm marketplace, meter evaluator, varactor modulator, simple sig gen, touchtone hookup, hf preselector, 10M 12W tx.

**MAY 71.** 75M mobile whip, 2M preamp, transistor amp design, 10M dsb tx, portable fm transceiver directory, audio compressor-clipper, transistor LM freqmeter, 450 MHz link tx, simple af filter, 1-tube 2M transceiver, surplus 2M power amp, general class study (part 8).

**JUNE 71.** 2M beam experiments, 3-el 2M quad, multi-band dipole patterns, weather balloon vertical, pocket-pager squelch, two-er vfo, tuning mobile whips, transistor pwr supply, capacity decade box, 40M gain ant, general class study (part 9).

**JULY 71.** IC audio processor, audio sig gen, cw filter, 2M fm osc, 2M collinear vertical, FM supplier directory, Motorola G-strip conversion, transistor beta tester, general class study (part 10).

**AUG 71.** Ham facsimile (part 1), 500 Watt linear, dimensions for July collinear, 4-tube 80/40 station, vfo digi readout, Jupiter on 15M, general class study (part 11), pink ticket wave-meter.

**SEPT 71.** Transformerless power supplies, solid state tv camera, IC substitution, two rf wattmeters, IC compressor-agc, multichannel HT-200, ham facsimile (part 2), causes of manmade noise, vfo with tracking mixer, general class study (part 12), transistor heat-sinking, IC pulse gen, fone-patch isolation, hcd wattmeters.

**OCT 71.** Emergency repeater cor, transceiver power supply, predicting meteor showers, digi switching, reverse-current battery charger, passive repeaters, earth grounds, audio "tailoring" filters, Swan 350 mods.

**NOV 71.** 3-el 75M beam, motor-tuned gnd-plane, 2M gain vertical, transistor biasing, split-site repeater, fox-hunting, audio filter, transistor/diode tester, xtal tester, 6M kw amp, 10-15-20M quad, transistor pi-net final, ant feedline, communications db's, 2300 MHz exciter.

**AUG 72.** SSTV intro, speech processor, fm repeater info, test probe construction, GE progline ac supply, 432 rf testing, preamp-compressor, Six-er mods, fone patch, Two-er info, solar info, SCR regulator for HVPS, "ideal" xtal osc, fm rx adaptor, auto theft alarm.

**SEPT 72.** Plumbicon tv camera, WWVB 60 kHz rx, cigartube sig gen, cw active filter, rf testing at 1296-3500 GHz, balun ant feed, transistor power supply, IC 6M rx, IC fm/am detector (part 2), active filter design (part 3), K20AW freq counter (part 3), 2M freq synthesizer (part 1).

**OCT 72.** Corrections for Aug. fm rx adaptor, 2M freq synthesizer (part 2), 6M transistor vfo, nano-ampere meter, time-freq measurement (part 1), active filter design (part 4), repeater timer, extra-class Q&A (part 3), balloon vertical, ID gen, time delay relay, 432 filter ideas, DC-AC inverter, hc-diode converter, rtl decade and nixie driver, plus-minus supply for ICs.

**NOV 72.** Hf transistor power amps, RTTY selcal, IC trf rx, transistor keyer, emergency power, 220 MHz preamp, double-delta ant, simple converter using modules, hf RF tester, "lumped line" osc, 2M freq synthesizer (part 3), K20AW counter errata, 2M preamp, extra class Q&A (part 4), hi-Z voltmeter, Nikola Tesla story, vhf swr meter, transistor regen rx, 432 SSB transverter, AC arc welder, intro to computers, hybrid am modulator, HR10 rx mods, 10M transistor am tx, 40M gndplane, IC logic demonstrator, overload protection, if/rf sweep generator, digi freq counter, aural tx tuning.

**DEC 72.** SSTV scope analyzer, 2M fm rx, tone burst encoder and decoder, universal if amp, autopatch hookup, LM380N info, voltage variable cap info, 2M 18 watt amp, SSB modulation monitor, xtal freq/activity meter, 10A var. dc supply, transmission line uses, radio astronomy, inductance meter, 75 to 20M transverter, LED info, 40M preamp, transistor vfo, 1972 index, 2M preamp.

**JAN 73.** HT-220 touchtone, 3-el 20M yagi, 50 MHz freq counter, speech processor, 2-tone gen, fm test set, tilt-over tower, 6M converter using modules, tuneable af filter, six band linear, 10M IF tuner, diode noise limiter, cw/ssb agc, HW22a transceiver 40M mod, HAL ID-1 mod.

**FEB 73.** CW id gen, tone operated relay toroidal quadrature ant, active filter, time freq measurement (part 2), repeater timing control, SSTV circuits (part 1), 2M converter using modules, multifunction metering, FET biasing, freq counter preamp, TR22 hi-power mod, transistor rf power amps (part 1), light bulb rf power indicators, 75A4 filters, capacitance measurement, Gonset 201 mod, world time info.

**APR 73.** FM deviation meter, 2M FET preamp, two 2M power amps, repeater control (part 1), repeater licensing, European 2M fm, fm scanner adaptor, RCA CMU15 mods, lightning detector, cb alignment gadget, transistor rf power amps (part 2), repeater economics.

**JUNE 73.** 220 MHz sig gen, uhf power meter, repeater licensing info, RTTY autoswitch, 40M hybrid vfo tx, ant polar mount, 10-15-20M quad, K20AW counter mods, double coax ant, ham summer job, tone decoder, field strength meter, nicad battery pack, ohm meter, FCC regs (part 1).

**AUG 73.** Log-periodics (part 1), tone burst gen, rf power amp design, transistor radio intercom, 160M ant, SSTV monitor, low cost freq counter, VOM design, qrp 40M tx, 432 MHz exciter, fm audio processing, FCC regs (part 3).

**SEPT 73.** Repeater control system, log-periodics (part 2), 2M rx calibrator, PLL ic applications, TT pad hookup, Heath HW7 "s" meter, Oscar-6 doppler, 2M coaxial ant, 2M converter, IC keyer, measure ant Z, FCC regs (part 4).

**OCT 73.** GE Pocketmate mods, microwave freq measurement, CA3102E 2M frontend, 2 kw hf linear, rf wattmeter, meter repair, 60/40 dipole, IC "hi" gen, vhf freq multiplier, FCC regs (part 5).

**NOV 73.** 450 MHz exciter, intro to ATV circuits, nicad voltage monitor, autopatch connections, IC meter amplifier, TR22 ac supply, indoor vertical, IC af filter, momentary power failure protection, 160M ant coupler, Motorola HT info, SSTV ISB, Class-B af amp, FCC regs (part 6).

**DEC 73.** Code speed display, 2M kw amp, IC keyer, 803B waveform gen, helical resonator design, sensitive rf voltmeter, proximity control switch, IC tester, sequential tone decoder, 2M portable beam, electronic calculator math, cv filter design, FCC regs (part 7).

**FEB 74.** SSTV monitor info, IC audio amps, scope sweep gen, 15/20M vertical, telephone line control system, pc board construction, var-Q af filter, blown-fuse indicator, 40m cv stn with Ten-Tec modules, simple preamp-compressor, single-IC rx, "432-er" final assembly, transistor keying circuit, 7-segment readout with nixie driver.

**APR 74.** Vox for repeaters, tone-operated relay, hf transverter, 10-to-2m tx converter, remote control panel for scanner, RCA fm tx tuning, subaudible tone gen, FCC regs (part 9), Repeater Atlas.

**MAY 74.** Cd car ignition, audio compressor info, interference suppression for boats, auto burglar alarms, 2m ic preamp, 10m fet converter.

**JULY 74.** 4-1000A linear, universal freq gen, universal afsk gen, 555 IC timer, 80M phased array, 135 kHz-432 MHz preamps, 10M qrp-am tx, 3000 vdc supply, how to read diagrams.

**AUG 74.** Toroidal directional wattmeters, 450 MHz FET preamp, use gdo to find "c", Trimline II pad hookup, R390 & R392 rx mods, tracking cw filter, aural voltmeter, universal regulated supply, sstv scan converter, rtl logic problems, ID timer.

**SEPT 74.** MOSKEY electronic keyer (part 1), ex warning system, Heath 10-103 scope mods, qrp 6M am tx, rf speech clipper, audio noise limiter, wx satellite on SSTV monitor, universal IC tester, miniature rig construction, tower construction, infinite rf attenuator, electronic

(More)

photo-flash ideas, IC "select-o-ject."

**OCT 74.** Microtransistor circuits, synthesized HT-220 (part 1), repeater government, regulated 5 vdc supply, fm selcal, removable mobile ants, Motorola metering, 2M vertical collinear, Motorola model code, 2M coaxial dipole, 1.6 MHz if strip, MOSKEY electronic keyer (part 2), carbon mike circuit, hi-power lo-pass filter, 6M preamp, 3-wire dipole, ATV sync gen, NCX-5 mods, mobile whip for apartment dwellers, sstv auto vertical trig.

**NOV 74.** K2OAW counter update, regulated 5 vdc supply, wind direction indicator, synthesized HT-220 (part 2), 20M 3-el beam, auto-patch pad hookups, double-stub ant match, novice class instruction, digi swr meter (part 1), 6M converter (1.6 MHz if), "C-bridge," MOSKEY electronic keyer (part 3), Aug. sstv scan converter errata, repeater off-freq indicator.

**DEC 74.** Care of nicads, wind speed/direction indicator, wx satellite video converter, electronic keyer, hints for novices, unknown meter scales, SSTV tape ideas, TTL logic probe, public service band converter, tuned-diode test receivers, digi swr meter (part 2), telephone

Since there's little to get stale in back issues of 73 (our magazine is not padded ... like others ... with reams of activity reports), you'll have a fantastic time reading them. Most of the articles are still exciting to read ... and old editorials are even more fun for most of the dire predictions by Green have now come to pass. Incentive licensing was every bit the debacle he predicted ... and more. You'll really get a kick out of the back issues.

pole beam support, rhombic antennas, 1974 Index

**FEB 75.** Heath HO-10 scope mod for SSTV, electronic keyer, digital satellite orbital timer, Oscar-7 operation, satellite orbital prediction, Heath SB-102 mods, comparing FM & AM, repeater engineering, Robot 80-A sstv camera

mod, neutralizing Heath SB-110A, "Bounceless" IC switch, tape keyer for cw tx.

**APR 75.** \$50 walky for 2M, 2M scanning synthesizer, 88 mH toroid info, 8-function repeater controller, nicad battery precautions, TR22C preamp, telephone attachment regs, Guide to 2M Hand-held Transceivers, 2M 7-el

beam, basic telephone systems (part 1), 10 min ID timer, modified hf Hustler mobile ant for 2M, 15M quad modified for 20M, 2M collinear beam, R-11A surplus rx conversion, 5/16-wave 2M ant, Hallicrafters SX-111 rx mods, 160M cw tx.

**AUG 75.** 146/432 MHz Helical ants (part 2), 10 min ID timer, digi swr computer (part 1), debugging rf feedback, DVM byer's guide, wx satellite monitor, cmos "accu-keyer," pc board method, sweep-tube final precautions, compact multiband dipoles, small digital clock, accessory vfo for hf transceiver, modern non-Morse codes, multi-function gen, 2M scanning synthesizer errata, KP-202 walky charger, 10M multi-element beam.

**SEPT 75.** Calculating freq counter, wx satellite FAX system (part 1), IC millivoltmeter, three-button TT decoder, troubleshooting sstv pix, 40M dx ants, 146/432 MHz helical ants (conclusion), digi swr computer (conclusion), reed relay for cw bk-in, NE555 preset timer, power-failure alarm, portable grp rig power unit, precision 10 vdc reference standard, 135 kHz if strip, telephone handsets with fm transceivers, Motorola T-44 tx mod for ATV, 0-60 MHz synthesizer (part 10, ham radio PR).

# BACK ISSUES

## 73 MAGAZINE CLASSICS

issues containing hundreds of articles & projects  
GREAT FOR NOSTALGIA BUFFS

SEND TO 73 BACK ISSUES - PETERBOROUGH, N.H. 03458

9-76

- |                                  |                                  |                                  |
|----------------------------------|----------------------------------|----------------------------------|
| <input type="checkbox"/> JUNE 63 | <input type="checkbox"/> JAN 70  | <input type="checkbox"/> JAN 73  |
| <input type="checkbox"/> AUG 63  | <input type="checkbox"/> FEB 70  | <input type="checkbox"/> FEB 73  |
| <input type="checkbox"/> OCT 63  | <input type="checkbox"/> MAR 70  | <input type="checkbox"/> APR 73  |
| <input type="checkbox"/> FEB 64  | <input type="checkbox"/> APR 70  | <input type="checkbox"/> JUNE 73 |
| <input type="checkbox"/> MAY 67  | <input type="checkbox"/> MAY 70  | <input type="checkbox"/> AUG 73  |
| <input type="checkbox"/> JULY 67 | <input type="checkbox"/> JUNE 70 | <input type="checkbox"/> SEPT 73 |
| <input type="checkbox"/> OCT 67  | <input type="checkbox"/> DEC 70  | <input type="checkbox"/> OCT 73  |
| <input type="checkbox"/> JUNE 68 | <input type="checkbox"/> JAN 71  | <input type="checkbox"/> NOV 73  |
| <input type="checkbox"/> JULY 68 | <input type="checkbox"/> FEB 71  | <input type="checkbox"/> DEC 73  |
| <input type="checkbox"/> SEPT 68 | <input type="checkbox"/> MAR 71  | <input type="checkbox"/> FEB 74  |
| <input type="checkbox"/> NOV 68  | <input type="checkbox"/> APR 71  | <input type="checkbox"/> APR 74  |
| <input type="checkbox"/> JAN 69  | <input type="checkbox"/> MAY 71  | <input type="checkbox"/> MAY 74  |
| <input type="checkbox"/> FEB 69  | <input type="checkbox"/> JUNE 71 | <input type="checkbox"/> JULY 74 |
| <input type="checkbox"/> MAR 69  | <input type="checkbox"/> JULY 71 | <input type="checkbox"/> AUG 74  |
| <input type="checkbox"/> APR 69  | <input type="checkbox"/> AUG 71  | <input type="checkbox"/> SEPT 74 |
| <input type="checkbox"/> MAY 69  | <input type="checkbox"/> SEPT 71 | <input type="checkbox"/> OCT 74  |
| <input type="checkbox"/> JUNE 69 | <input type="checkbox"/> OCT 71  | <input type="checkbox"/> NOV 74  |
| <input type="checkbox"/> JULY 69 | <input type="checkbox"/> NOV 71  | <input type="checkbox"/> DEC 74  |
| <input type="checkbox"/> AUG 69  | <input type="checkbox"/> AUG 72  | <input type="checkbox"/> FEB 75  |
| <input type="checkbox"/> SEPT 69 | <input type="checkbox"/> SEPT 72 | <input type="checkbox"/> APR 75  |
| <input type="checkbox"/> OCT 69  | <input type="checkbox"/> OCT 72  | <input type="checkbox"/> AUG 75  |
| <input type="checkbox"/> NOV 69  | <input type="checkbox"/> NOV 72  | <input type="checkbox"/> SEPT 75 |
| <input type="checkbox"/> DEC 69  | <input type="checkbox"/> DEC 72  |                                  |

\$1 - single issues (indicate your choice at left) \_\_\_\_\_ issues @ \$1

\$12 - ten issues (indicate your choice at left)

\$20 - 25 issues (indicate your choice at left)

\$10 - 25 issues, our choice  60-65  66-70  71-75

Cash, check, money order enclosed.

Name \_\_\_\_\_ Call \_\_\_\_\_

Address \_\_\_\_\_

City \_\_\_\_\_ State \_\_\_\_\_ Zip \_\_\_\_\_

Charge:  BankAmericard # \_\_\_\_\_

Master Charge # \_\_\_\_\_

Master Charge Interbank # \_\_\_\_\_ Expiration date \_\_\_\_\_

Date \_\_\_\_\_ Signature \_\_\_\_\_

**HAM  
DIES  
OF  
BURST  
BLADDER**

Word has just reached the 73 offices of the recent departure for that great DXpedition in the sky of a very avid 73 reader. Upon investigation it was ascertained that said ex-ham had, shortly before his demise, received delivery of a bundle of back issues of 73. Apparently these so captured his attention that other functions were totally forgotten.

**BE WARNED.** Back issues of 73 should be taken in moderation. Even though they arrive in bundles of twenty, no more than two should be read at any one sitting.

Back issues are available in three different assortments — vintage, mid-years and recent. These are packed by the mentally handicapped (73 is an equal opportunity employer), so no specific issues can be requested . . . you take what you get . . . the only guarantee is that all will be different and some will be musty, particularly the VINTAGE BEAUTIES.

The supply of these FANTASTIC GEMS is very limited so run do not walk to your checkbook and flip the \$8.00 per bundle to us right now.

20 Back Issues of 73 . . . . . \$8.00

**BRAND NEW! DICTIONARY**

This new microcomputer dictionary fills the urgent need for all computer people, engineers, scientists, industrialists, communications people — as professionals, amateurs, teachers, or students — to become quickly acquainted with the terminology and nomenclature of a new revolution in computer control capabilities in areas that pervade most of man's daily activities.

Over 5000 definitions and explanations of terms and concepts (704 pages) relating to microprocessors, microcomputers and microcontrollers. There are also separate appendices on: programmable calculators; math and statistics definitions; flowchart symbols and techniques; binary number systems and switching theory; symbol charts and tables; summaries of BASIC FORTRAN and APL. In addition there is a comprehensive electronics/computer abbreviations and acronyms section.

DICTIONARY . . . . . \$15.95



**new REPEATER ATLAS**

Hundreds of new listings . . . listed by both location and frequency . . . dual listing. Invaluable for your car . . . find those repeaters as you travel. This is the ONLY complete list of repeaters being published. Almost 3000 repeaters listed in this issue . . . repeaters from all over the entire world.

FM Atlas . . . . . only \$1.95

**BIGGEST  
BARGAIN  
YET**

Tab's new 1001 circuits is available for only \$9.95 ppd. The next time you want a circuit for just about anything eat your heart out that you didn't send for this book the first time you read about it. You'd better order the book right away, before they run out. 1001 Electronic Circuits . . . \$9.95



**The ONLY Complete License Study Guides**



**NOVICE  
\$4.95**

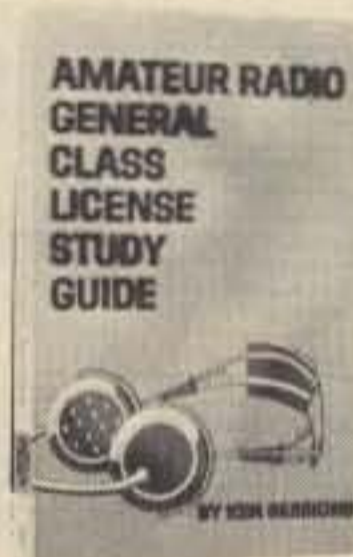

**GENERAL  
\$5.95**



**ADVANCED  
\$3.95**



**EXTRA  
CLASS  
\$4.95**

FCC exams got you scared? Frustrated by theory fundamentals? There's no need to worry. 73's four License Study Guides will help you breeze through any of the four tough exams! They are the ONLY guides which cover ALL the material you will have to know. Many amateurs find that one quick reading through our guides is enough to get them through with no sweat.

**Startling Learning Breakthrough**



NOVICE THEORY TAPES  
Set of 4 Tapes only \$13.95

You'll be astounded at how really simple the theory is when you hear it explained on these tapes. Three tapes of theory and one of questions and answers from the latest Novice exams give you the edge you need to breeze through your exam.

73 is interested in helping get more amateurs, so we're giving you the complete set of four tapes for the incredibly low price of ONLY \$13.95.

Scientists have proven that you learn faster by listening than by reading because you can play a cassette tape over and over in your spare time — even while you're driving! You get more and more into each time you hear it.

You can't progress without solid fundamentals. These four hour-long tapes give you all the basics you'll need to pass the Novice exam easily. You'll have an understanding of the basics which will be invaluable to you for the rest of your life! Can you afford to take your Novice exam without first listening to your tapes?

**VHF PROJECTS FOR AMATEUR AND EXPERIMENTER**

A must for the VHF op. Opening chapters on operating practices and getting started in VHF, both AM and FM, followed by 58 chapters on building useful test equipment, modifying existing and surplus gear. \$4.95



**SSTV HANDBOOK**



This excellent book tells all about it, from its history and basics to the present state-of-the-art techniques. Contains chapters on circuits, monitors, cameras, color SSTV, test equipment and much more. Hardbound \$7, Softbound \$5.

**VHF PROJECTS FOR AMATEUR AND EXPERIMENTER**

A must for the VHF op. Opening chapters on operating practices and getting started in VHF, both AM and FM, followed by 58 chapters on building useful test equipment, modifying existing and surplus gear. \$4.95



**2M FM HANDBOOK**

Contains almost every conceivable circuit that might be needed for use with a repeater. All circuits explained in detail. All aspects covered, from the operator to the antenna. \$5.95



**PRACTICAL TEST INSTRUMENTS YOU CAN BUILD**

37 simple test instruments you can make — covers VOMs, VTVMs, semiconductor testing units, dip meters, watt meters, and just about anything else you might need around the test lab and ham shack. \$4.95



**RF and DIGITAL TEST EQUIPMENT YOU CAN BUILD**

RF burst, function, square wave generators, variable length pulse generators — 100 kHz marker, i-f and rf sweep generators, audio osc, af/rf signal injector, 146 MHz synthesizer, digital readouts for counters, several counters, prescaler, micro-wavemeter, etc. 252 pages. \$5.95



4  
for  
\$13.95



# NEW CODE SYSTEM

FOUR SPEEDS AVAILABLE

**5 WPM** This is the beginning tape for people who do not know the code at all. It takes them through the 26 letters, 10 numbers and necessary punctuation, complete with practice every step of the way using the newest blitz teaching techniques. It is almost miraculous! In one hour many people — including kids of ten — are able to master the code. The ease of learning gives confidence to beginners who might otherwise drop out.

**6 WPM** This is the practice tape for the Novice and Technician licenses. It is made up of one solid hour of code, sent at the official FCC standard (no other tape we've heard uses these standards, so many people flunk the code when they are suddenly — under pressure — faced with characters sent at 13 wpm and spaced for 5 wpm). This tape is not memorizable, unlike the zany 5 wpm tape, since the code groups are entirely random characters sent in groups of five. Practice this one during lunch, while in the car,

anywhere and you'll be more than prepared for the easy FCC exam.

**14 WPM** Code groups again, at a brisk 14 per so you will be at ease when you sit down in front of the steely eyed government inspector and he starts sending you plain language at only 13 per. You need this extra margin to overcome the panic which is universal in the test situations. When you've spent your money and time to take the test you'll thank heavens you had this back breaking tape.

**21 WPM** Code is what gets you when you go for the Extra Class license. It is so embarrassing to panic out just because you didn't prepare yourself with this tape. Though this is only one word faster, the code groups are so difficult that you'll almost fall asleep copying the FCC stuff by comparison. Users report that they can't believe how easy 20 per really is with this fantastic one hour tape. No one who can copy these tapes can possibly fail the FCC test. Remove all fear of the code forever with these tapes.

**ONLY \$3.95!** 73 is in the publishing business, not tapes, so these are priced much lower than anyone else could sell them. Have you ever seen one hour cassettes for under \$6? For 1<sup>st</sup> class mail add 25¢ per tape ordered.



Hot off the press, the NEW VHF Antenna Handbook details the theory, design and construction of hundreds of different VHF and UHF antennas . . . antennas for FM, for DXing, for repeaters, for mobiles, for emergencies, for contests, quickies, mammoth arrays . . . **EVERYTHING IS RIGHT HERE!**

A practical book written for the average amateur who takes joy in building, not full of complex formulas for the design engineer. Packed with fabulous antenna projects you can build.

This quality reference book would normally sell for as much as \$5 or \$6, but the publishers have agreed to keep the price at an inflation fighting price of \$2.95. Send cash, check or money order . . . or give your Master Charge or BankAmericard number . . . **ORDER TODAY!**

Dealer inquiries invited

**SPREAD  
the  
WORD!**



Ham radio is too great a hobby for us to keep it to ourselves. Let's tell the whole world about it! And what better way than by sporting this attractive lime-green bumper sticker on your car! It's only 50¢ — and it's phosphorescent so you can see it even at night. Go ahead . . . **SPREAD THE WORD! Order yours TODAY!**

**QSLs!** Get some you can be proud of... and—save money!

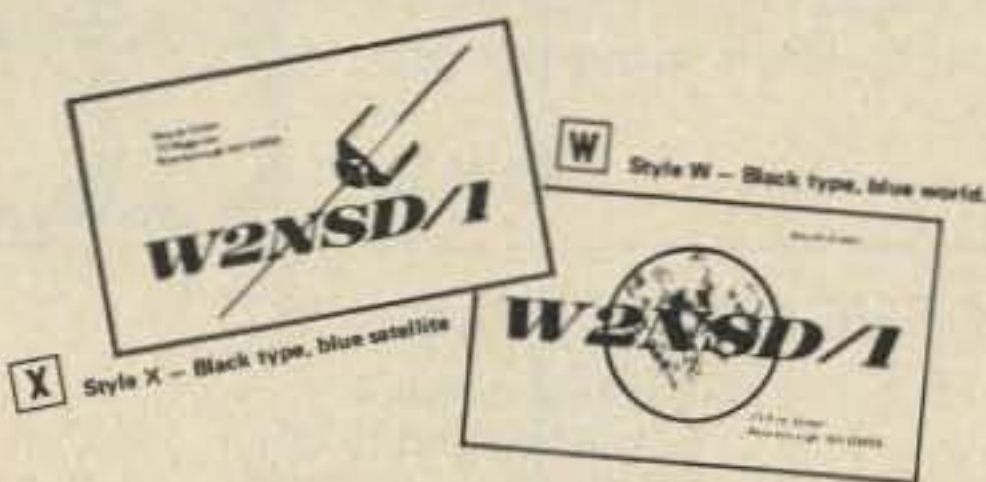

**ONLY \$6 for 250, \$10 for 500, \$15 for 1,000, and \$20 for 2,000.**

How can 73 make such beautiful cards, printed on the best coated stock, available for about half the regular cost? Our business is 73 Magazine and QSLs just help keep things going during slack days of the month. We do this at cost just to keep busy — you get the benefit. How many shacks have your QSL card proudly on display?

The world and satellite are printed in blue, your name, address and call are in black. The QSO information is a standard form on the back.

DOMESTIC ORDERS ONLY

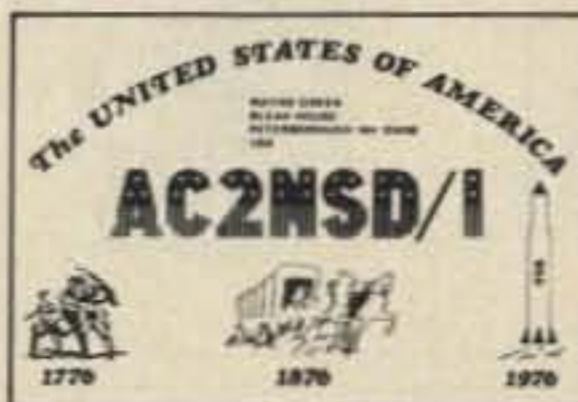

**BICENTENNIAL  
QSL CARDS**

**LAST CHANCE TO ORDER!**

Be the first in your area with a special BICENTENNIAL QSL card. These cards are gorgeous — red, white and blue (you were expecting fuchsia and mauve?). And they are 100% custom made . . . with the exception of the bicentennial design and contact report form on the back . . . you can have your own call letters (unless you'd rather be AC2NSD/1 for a year (which is no bargain, believe it)).

You also get your own name and address on the card (unless you happen to be another Wayne Green, which happens).

These cards are ganged up into large batches and run off the 73 presses in between other work, so you don't get overnight delivery, but you do end up with a fantastic QSL at a ridiculously low price (and there are a lot of fans for that sort of service these days).

Suggestion: order today, right now, not later, not next week. Send cash, check, money order, IRCs, Master Charge or BankAmericard numbers . . . send something negotiable.

DOMESTIC ORDERS ONLY

Allow 4 weeks for delivery.



## RTTY HANDBOOK

A comprehensive book covering all areas of radio teletype, from getting started with the basic principles, what equipment to procure and how to make it work.

RTTY Hdbk . . . . . \$5.95

## 73 VERTICAL, BEAM AND TRIANGLE ANTENNAS

by Edward M. Noll W3FQJ

Describes 73 different antennas for amateurs. Each design is the result of the author's own experiments: each has actually been built and air-tested. Includes appendices covering the construction of noise bridges and antenna line tuners, as well as methods for measuring resonant frequency, velocity factor, and standing-wave ratios. 160 pages.

Just \$4.95

## 73 DIPOLE AND LONG-WIRE ANTENNAS

by Edward M. Noll W3FQJ

This is the first collection of virtually every type of wire antenna used by amateurs. Includes dimensions, configurations, and detailed construction data for 73 different antenna types. Appendices describe the construction of noise bridges, line tuners, and data on measuring resonant frequency, velocity factor, and swr. 160 pages.

Just \$4.95

TAPES from 73 MAGAZINE

# 73 Computer Library

## COMPUTER PROGRAMMING HANDBOOK

... Peter Stark K2OAW

A complete guide to computer programming and data processing. Includes many worked out examples and history of computers. **\$8.95**



## IC OP-AMP COOKBOOK

by Walter G. Jung. Covers not only the basic theory of the IC op amp in great detail, but also includes over 250 practical circuit applications, liberally illustrated. Organized into three basic parts: introduction to the IC op amp and general considerations, practical circuit applications, and appendices of manufacturers' reference material. 592 pages; 5 1/2 x 8 1/2; softbound. **\$12.95**

## TTL COOKBOOK

by Donald Lancaster. Explains what TTL is, how it works, and how to use it. Discusses practical applications, such as a digital counter and display system, events counter, electronic stopwatch, digital voltmeter, and a digital tachometer. 336 pages; 5 1/2 x 8 1/2; softbound. **\$8.95**

## RTL COOKBOOK

by Don Lancaster. Explains the how and why of RTL (Resistor-Transistor Logic) and gives design information that can be put to practical use. Gives a multitude of digital applications ranging from the basic switch to the sophisticated counter. 240 pages; 5 1/2 x 8 1/2; softbound. **\$5.50**

## WHAT TO DO AFTER YOU HIT RETURN

or

P.C.C.'s First Book of Computer Games



## What To Do After You Hit Return

PCC's first book of computer games ... 48 different computer games you can play in Basic ... programs, descriptions, muchly illustrated. Lunar landing, Hammurabi, King, Civil 2, Qubic 5, Taxman, Startrek, Crash, Market ... etc.

WHAT TO DO ..... **\$6.95 pp.**

## MY COMPUTER LIKES ME

... when I speak Basic

... Albrecht

An introduction to Basic ... simple enough for your kids. If you want to teach Basic to anyone quickly, this booklet is the way to go.

MY COMPUTER ..... **\$2.00 pp.**



## BASIC ... by Bob Albrecht, etc.

Self-teaching guide to the computer language you will need to know for use with your microcomputer. 324 pages. This is one of the easiest ways to learn computer programming.

BASIC ..... **\$3.95 pp.**



### TO ORDER, CHECK DESIRED ITEMS FROM THE FOLLOWING LIST:

- |  |  |   |
|--|--|---|
| <input type="checkbox"/> Back Issues (8.00)          | <input type="checkbox"/> Bicentennial                      | <input type="checkbox"/> SSTV Handbook                    |
| <input type="checkbox"/> Recent                      | <input type="checkbox"/> 250 (7.50)                        | <input type="checkbox"/> Softbound (5.00)                 |
| <input type="checkbox"/> Midyears                    | <input type="checkbox"/> 500 (12.50)                       | <input type="checkbox"/> Hardbound (7.00)                 |
| <input type="checkbox"/> Vintage                     | <input type="checkbox"/> 1000 (20.00)                      |   |
| <input type="checkbox"/> Novice Theory Tapes (13.95) | <input type="checkbox"/> Microcomputer Dictionary (15.95)  | <input type="checkbox"/> VHF Antenna Handbook (2.95)      |
| <input type="checkbox"/> Code Tapes                  | <input type="checkbox"/> Repeater Atlas (1.95)             | <input type="checkbox"/> RTTY Handbook (5.95)             |
| <input type="checkbox"/> 5 WPM (3.95)                | <input type="checkbox"/> Novice Study Guide (4.95)         | <input type="checkbox"/> 73 Vertical Beam Antennas (4.95) |
| <input type="checkbox"/> 6 WPM (3.95)                | <input type="checkbox"/> General Study Guide (5.95)        | <input type="checkbox"/> 73 Dipole Antennas (4.95),       |
| <input type="checkbox"/> 14 WPM (3.95)               | <input type="checkbox"/> Advanced Study Guide (3.95)       | <input type="checkbox"/> 73 Binders (6.00)                |
| <input type="checkbox"/> 21 WPM (3.95)               | <input type="checkbox"/> Extra Class Study Guide (4.95)    | <input type="checkbox"/> Computer Programming (8.95)      |
| <input type="checkbox"/> All four for \$13.95        | <input type="checkbox"/> 1001 Circuits (9.95)              | <input type="checkbox"/> What To Do (6.95)                |
| <input type="checkbox"/> Bumper Stickers (.50)       | <input type="checkbox"/> VHF Projects (4.95)               | <input type="checkbox"/> My Computer Likes Me (2.00)      |
| <input type="checkbox"/> QSLs                        | <input type="checkbox"/> 2M FM Handbook (5.95)             | <input type="checkbox"/> Basic (3.95)                     |
| <input type="checkbox"/> Style W                     | <input type="checkbox"/> RF and Digital Test Equip (5.95)  | <input type="checkbox"/> IC Op Amp Cookbook (12.95)       |
| <input type="checkbox"/> Style X                     | <input type="checkbox"/> Practical Test Instruments (4.95) | <input type="checkbox"/> TTL Cookbook (8.95)              |
| <input type="checkbox"/> 250 (6.00)                  |  | <input type="checkbox"/> RTL Cookbook (5.50)              |
| <input type="checkbox"/> 500 (10.00)                 |  |   |
| <input type="checkbox"/> 1000 (15.00)                |  |   |
| <input type="checkbox"/> 2000 (20.00)                |  |   |

Name \_\_\_\_\_ Call \_\_\_\_\_  Cash       Mastercharge

Address \_\_\_\_\_  Check       BankAmericard

City \_\_\_\_\_ State \_\_\_\_\_ Zip \_\_\_\_\_ Mastercharge # \_\_\_\_\_

Awards to be listed (W and X QSLs only) \_\_\_\_\_ BankAmericard # \_\_\_\_\_

Bicentennial Call (Bicentennial QSLs) \_\_\_\_\_ Expiration date \_\_\_\_\_

Mail to: 73 MAGAZINE, Peterborough, New Hampshire 03458

Signature \_\_\_\_\_ Coupon expires in 60 days. 9/76



# Weather Satellite Handbook

Simple equipment and methods for getting good pictures from the weather satellite. Antennas, receivers, monitors, facsimile you can build, tracking, automatic control (you don't even have to be home). By Dr. Taggart WB8DQT.

**\$2.95**



Weather Satellite Handbook  
73 Magazine, Peterborough NH 03458

Name \_\_\_\_\_ Call \_\_\_\_\_

Address \_\_\_\_\_

City \_\_\_\_\_ State \_\_\_\_\_ Zip \_\_\_\_\_

Send me \_\_\_\_\_ Weather Satellite Handbook(s) @ \$2.95.

Cash    Check    BankAmericard    Master Charge



Interbank No. \_\_\_\_\_

Card No. \_\_\_\_\_ Expiration date \_\_\_\_\_

Signature \_\_\_\_\_

DOMESTIC ORDERS ONLY

# NEW

## QSL FOTOKARD

NOW - a QSL card with your photo, a picture of your shack, your home - make your card truly personalized. Send a good clear picture, and preferably black & white, at least 2 1/4" x 2 1/4" (square format). **PHOTOS WILL NOT BE RETURNED.** Include your name, call, address and zip code. Go first class with your QSL - one you can really be proud of! And go for less than you would pay anywhere else. Cards are large international mail size with complete QSO info on the back.

250 Cards .....	\$12.00
500 Cards .....	\$18.00
1000 Cards .....	\$25.00

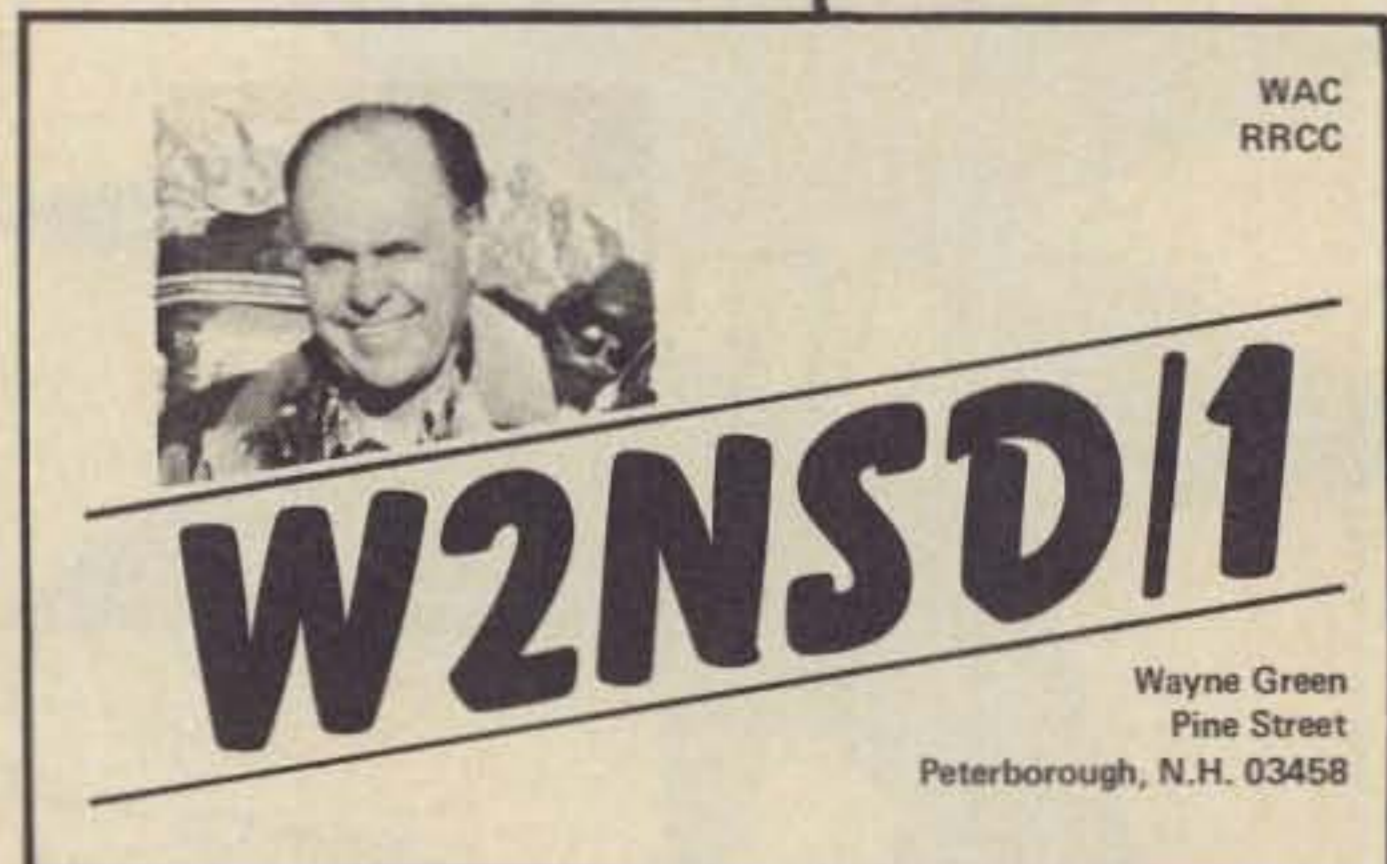

ACTUAL SIZE: 3 1/2 x 5 1/2

# LAST CHANCE

## BICENTENNIAL QSL

This is your last chance to order special Bicentennial QSL cards. No more orders will be accepted after September 15th. You'll kick yourself for years to come if you don't get in on the bicentennial fun and get your special bicentennial QSL cards. These are special prefixes that aren't going to be around again, so don't miss out on them. These cards are *only* available with your special bicentennial prefix ... so just send your regular call and we'll make sure you get the right prefix to go with it.

250 Bicentennial QSLs .....	\$7.50
500 .....	\$12.50
1000 .....	\$20.00



ACTUAL SIZE: 3 1/2 x 5 1/2

Name \_\_\_\_\_ Call \_\_\_\_\_

Awards (FotoKard Only) \_\_\_\_\_

Address \_\_\_\_\_

City \_\_\_\_\_ State \_\_\_\_\_ Zip \_\_\_\_\_

Cash  
 Check Enclosed  
 BankAmericard # \_\_\_\_\_

Master Charge # \_\_\_\_\_  
 Expiration date \_\_\_\_\_  
 Signature \_\_\_\_\_

QSL FotoKards _____	Bicentennial QSLs _____
<input type="checkbox"/> 250 ..... \$12.00	<input type="checkbox"/> 250 ..... \$7.50
<input type="checkbox"/> 500 ..... \$18.00	<input type="checkbox"/> 500 ..... \$12.50
<input type="checkbox"/> 1000 ..... \$25.00	<input type="checkbox"/> 1000 ..... \$20.00

9-76





# REGULAR NEWSSTAND PRICE!

When you subscribe **NOW** to 73 Magazine for 3 years – for only \$18.00 (that's what you'd pay for one year at the newsstand – a savings of \$36.00 hard cash!)

73 for only \$.50 a copy – incredible! The best amateur radio magazine for the price of an ice-cream cone. 73 is the biggest amateur radio publication available, loaded with more interesting articles (covering more subjects), more projects, more ads and bargains than any other ham magazine.

To insure your place on our mailing list, do not turn the page or stop by the refrigerator. Simply fill out the subscription blank below and let 73 do the rest.

**EXTRA OFFER . . .** If you prepay (include your check with subscription order), we'll send you an additional issue of 73 as a bonus. Offer expires 12/31/76.

## THREE YEARS OF 73 MAGAZINE . . . \$18.00 WOW!

Name \_\_\_\_\_ Call \_\_\_\_\_

Address \_\_\_\_\_

City \_\_\_\_\_ State \_\_\_\_\_ Zip \_\_\_\_\_

- |   |  |  |
|---|--|--|
| <input type="checkbox"/> New Sub          | <input type="checkbox"/> Start with next Issue | <input type="checkbox"/> BankAmericard |
| <input type="checkbox"/> \$18.00 Enclosed | <input type="checkbox"/> Renewal or Extension  | <input type="checkbox"/> Master Charge |
|   |  | <input type="checkbox"/> Bill Me       |

Card Number \_\_\_\_\_ Expiration Date \_\_\_\_\_

Signature \_\_\_\_\_

73 MAGAZINE – PETERBOROUGH NH 03458

9/76

# 73 READER SERVICE

Circle appropriate Reader Service # for desired company brochures, data sheets or catalogs and mail in to 73. Include your zip code, please. Send money directly to advertisers. \* Reader Service inquiries not honored. **LIMIT: 25 requests.**

## ADVERTISER INDEX

- |                              |                            |
|------------------------------|----------------------------|
| A19 Ace Art Co 62            | M6 Mini Micro Mart 125     |
| A20 Advanced Data 110        | M7 Morrow's 110            |
| A2 Aldelco 113               | N1 National Multiplex 89   |
| A4 Allied Sales 24, 67, 87   | N2 New-tronics CII         |
| A21 Amateur Wholesale 79     | N5 Northshore 59           |
| A14 Antenna Supermarket 62   | N6 Northwestern 59         |
| A22 A P Products 73          | N4 Nye 58                  |
| A6 Aptron 53                 | O2 ON_LINE 113             |
| A7 ARRL-MN 87                | O3 Optoelectronics 147     |
| A18 AST/Servo 102            | P1 Palomar 58, 62          |
| * A. T. & T. 11              | P5 Parrot 43               |
| B8 Bullet 143                | P6 Personal Comp. 91       |
| C13 Chesapeake Dig. 113      | P4 Polymorphic 106         |
| C3 Clegg 37                  | P2 Poly Paks 143           |
| C5 Comm. Eng. 93             | R1 Radio Am. Cllbk. 59     |
| C6 Comm. Specialists 77, 123 | R6 Radio Expo 82           |
| C19 Com*Star 137             | R8 Ramsey 45               |
| C14 CRS 141                  | R2 Regency 125             |
| C11 CSdc 135                 | R7 Rondure 111             |
| D10 Davis 141                | R5 Roto Kit 141            |
| D9 Digi-Tech 141             | S2 S. D. Sales 148-151     |
| D5 Dutronics 110             | S22 Seals 103              |
| E1 ECM 62                    | S23 Sinclair Radio Labs 59 |
| E9 Electronic Disc. 113      | S19 Southcom 78            |
| F1 Fair 141                  | S6 Southwest Tech 95       |
| F3 Freck 62                  | S10 SST 24                 |
| G2 Gauthier 62               | S11 Stahler 67             |
| G3 GENAVE 25                 | S15 Star Kits 67           |
| G6 Gilfer 62                 | S12 Suntronix 119          |
| G4 Godbout 129               | T8 Technical Design 114    |
| H2 Ham Radio Ctr. 146        | * Ten Tec 41               |
| H3 Henry 1                   | T1 Tri Tek 142             |
| I1 ICOM 2                    | T2 Trumbull 67             |
| J3 Jac Tenna 24              | T3 Tufts 26-33             |
| J1 James 69                  | U1 Universal Radio 24      |
| J2 Jan 77                    | V1 Vanguard 135            |
| K6 Kaufman 87                | V3 Venus Sc. 83            |
| K1 Kensco 132                | V4 Verada 144              |
| K2 K-Ent 77                  | V5 VHF Eng. 63             |
| * Kenwood 5, 46, 47          | W5 Wave Mate 88            |
| K4 KLM CIV, 51               | W7 White House 134         |
| L2 LePhCo 67                 | W2 Wilson 54, 55           |
| M2 Meshna 133                | W8 W7IZH 113               |
| M8 MHz 115                   | Y1 Yaesu CIII              |
| M9 Microprocessor Mktg. 107  |                            |

From 73...

- |                       |                       |
|-----------------------|-----------------------|
| 73 Moving 45          | Weather Satellite 157 |
| Back issues 152 & 153 | QSLs 158              |
| 73 Books 154-156      | 73 Subs 159           |

NEWSSTAND  SUBSCRIPTION

## READER SERVICE

73 Inc., Peterborough NH 03458  
SEPTEMBER 1976

Please print or type.

Name \_\_\_\_\_ Call \_\_\_\_\_  
Address \_\_\_\_\_  
City \_\_\_\_\_  
State \_\_\_\_\_ Zip \_\_\_\_\_

Coupon expires in 60 days...

# propagation

by  
J. H. Nelson

## EASTERN UNITED STATES TO:

	GMT:	00	02	04	06	08	10	12	14	16	18	20	22
ALASKA	7A	7	7	7	3	3	3	7	7	7A	14	14	
ARGENTINA	14	7A	7B	7	7	7	14	14	14	14	14A	14A	
AUSTRALIA	14	7B	7B	7	7	3A	7	7	7	7B	14	14	
CANAL ZONE	14	7	7	7	7	7	7A	14	14	14	14A	14	
ENGLAND	7	7	7	7	7	7	7A	14	14	14	14	7	
HAWAII	14	7B	7B	7	7	3B	7	7	14	14	14	14	
INDIA	7	7	7B	7B	7B	7B	14	14	14	7	7	7	
JAPAN	14	7B	7B	7	3B	3B	7	7	7	7	7	14	
MEXICO	14	7	7	7	7	3	7	14	14	14	14	14	
PHILIPPINES	14	7B	7B	7B	3B	3B	7	7	7A	7A	7B	14	
PUERTO RICO	7	7	7	7	3	3	14	14	14	14	14	14	
SOUTH AFRICA	7	7	7	7	7B	7A	14	14	14A	14A	14	14	
U. S. S. R.	7	3	3	3A	3A	7	7	14	14	14	7	7	
WEST COAST	14	7	7	7	7	3	7	7A	14	14	14	14	

## CENTRAL UNITED STATES TO:

	GMT:	00	02	04	06	08	10	12	14	16	18	20	22
ALASKA	14	14	7	7	3	3	3	7	7	7A	14	14	
ARGENTINA	14	14	7B	7	7	7	7	14	14	14	14A	14A	
AUSTRALIA	14	14	7B	7B	7	7	7	7	7	7B	14	14	
CANAL ZONE	14	7A	7	7	7	7	7A	14	14	14	14A	14A	
ENGLAND	7	7	7	7	7	3A	7	14	14	14	14	7	
HAWAII	14	14	7B	7	7	7	7	7	14	14	14	14	
INDIA	7	7	7B	7B	3B	3B	7B	7	7A	7A	7	7	
JAPAN	14	7B	7B	7	3B	3B	3B	7	7	7	7	14	
MEXICO	14	7	7	7	7	3	7	7	14	14	14	14	
PHILIPPINES	14	14	7B	7B	3B	3B	3B	7	7	7	7B	14	
PUERTO RICO	14	7	7	7	7	3	7A	14	14	14	14	14A	
SOUTH AFRICA	7	7	7	7	7B	7B	7A	14	14	14	14	14	
U. S. S. R.	7	3	3	3	3	3B	7	7	14	14	7	7	

## WESTERN UNITED STATES TO:

	GMT:	00	02	04	06	08	10	12	14	16	18	20	22
ALASKA	14	14	7	7	3	3	3	7	7	7	7A	7A	
ARGENTINA	14	14	7B	7	7	7	7B	14	14	14	14A	14A	
AUSTRALIA	14A	14A	14	7B	7	7	7	7	7	7B	14	14	
CANAL ZONE	14	14	7	7	7	7	7	14	14	14	14	14A	
ENGLAND	7	7	7	7	7	3B	3B	7	14	14	14B	7	
HAWAII	14A	14	14	7	7	7	7	7	14	14	14	14	
INDIA	7	14	7B	7B	3B	3B	3B	7	7	7	7	7	
JAPAN	14	14	7A	7	3A	3A	3	7	7	7	7A	14	
MEXICO	14	14	7	7	7	7	7	7	14	14	14	14	
PHILIPPINES	14	14	14	7B	7B	7B	3B	7	7	7	7B	14	
PUERTO RICO	14	7	7	7	7	3	7	14	14	14	14	14A	
SOUTH AFRICA	7	7	7	7	7	3B	7B	7A	14	14	14	14	
U. S. S. R.	7	3B	3	3	3	3B	3B	7	7A	7A	7	7	
EAST COAST	14	7	7	7	7	3	7	7A	14	14	14	14	

A = Next higher frequency also may be useful  
B = Difficult circuit this period  
N = Normal  
U = Unsettled  
D = Disturbed  
F = Chance of solar flares

1976		SEPTEMBER					1976	
SUN	MON	TUE	WED	THU	FRI	SAT		
			<b>1</b>	<b>2</b>	<b>3</b>	<b>4</b>		
			N	N	N	N		
<b>5</b>	<b>6</b>	<b>7</b>	<b>8</b>	<b>9</b>	<b>10</b>	<b>11</b>		
U	U	U	U	N	N	N		
<b>12</b>	<b>13</b>	<b>14</b>	<b>15</b>	<b>16</b>	<b>17</b>	<b>18</b>		
U	U	D	U	N	N	U		
<b>19</b>	<b>20</b>	<b>21</b>	<b>22</b>	<b>23</b>	<b>24</b>	<b>25</b>		
N	N	N	U	U	D	N		
<b>26</b>	<b>27</b>	<b>28</b>	<b>29</b>	<b>30</b>				
N	N	N/F	D/F	D/F				

# From YAESU The Outstanding New **GOLD LINE** FT-301D



**ALL SOLID STATE**

**200W PEP**

**DIGITAL DIAL TRANSCEIVER**



- 6 - Digit Readout
- All Modes – SSB/CW/AM/FSK
- 160 thru 10 Meters
- TX & RX Clarifier
- RF Feedback
- 3 - Position AGC
- Rejection Tuning (Tuneable IF Crystal Filter)
- Built-in DC Power Supply
- Optional AC Power Supply & Speaker Unit with 12 or 24 Hr. Digital Clock
- Noise Blanker
- RF Speech Processor
- Computer Type Plug-In Module Construction
- Size: 11 in. (w) × 5 in. (h) × 13½ in. (d)
- Light Weight: 22 lbs.

The Model FT-301D is a precision-built, all solid-state, compact high performance transceiver of advanced design. All circuits are fully transistorized with ICs and FETs for reliability. A wide-band tuning system with preset pass band tuning combined with wide-band amplifier eliminates final amplifier tuning for band change. Also available as an option is an automatic CW identifier (programmable).

*Whether you judge it on price, performance or operational features, the FT-301D comes out a winner!*

YAESU  
**The radio.**

Yaesu Musen USA Inc., 7625 E. Rosecrans, No. 29, Paramount, California 90723

Yaesu Musen USA Inc., Eastern Service Center • 613 Redna Terrace, Cincinnati, OH 45215

*KLM exclusive*

# 2-way channel scan

*plus 23 fixed channels*



Now ... continuous, sequential monitoring of your favorite four repeaters or fixed/mobile stations ... safely conveniently ... eyes on the road.

Four channel scanning **both** receive **and** transmit. A transmit control crystal, selected for simplex or repeater duplex as required, switches with each electronically-scanned position. Just flip the

"manual" toggle and break in.

In **addition** ... both **Multi-11** and **U-11** also give you 23 switchable, crystal controlled transmit and receive channels.

Compare prices, operating features (many exclusive) of either transceiver with any other available. You'll find the KLM feature-per-dollar ratio very hard to beat.

- All solid-state ... no tubes.
- Double conversion receiver.
- Two stage crystal filter.
- Two RF stages w/ dual gate MOS FET.
- Fractional microvolt sensitivity.
- Sensitive squelch w/ 0.5uV threshold.
- RIT for receiver, ±5 kHz.
- Multi-function metering: Power out/"S" units. Also switchable to FM centering.

#### MULTI-11 TRANSCEIVER

Freq.: 144-146MHz (or 146-148MHz)  
Channels: 23, manually switchable, 4, auto-scan.  
Freq. control: Quartz crystals. External VFO or synthesizer input.

**\$325**

- Auto or manual scan (Four channels), transmitter and receiver.
- NBFM, 10W output (switchable to 1W)
- Protective circuit for output transistor.
- Available solid-state amplifiers boost output 70-160 watts.
- Tone osc. w/ sw. For test, control, etc.
- 13.5VDC negative ground.
- Compact: 2.2"(56mm)H, 6.41"(163mm)W, 9"(230 mm) D. Wgt: Approx. 4.4 lbs(2KG).

#### MULTI-U-11

Freq.: 420-450MHz (any 4MHz segment).  
Channels: 23, manually switchable, 4, auto-scan.  
Freq. control: Quartz crystals. External VFO or synthesizer input.

**\$379**

#### MULTI-7, FULL-FEATURED COMPACT, LOW PRICE, 2-METER TRANSCEIVER



23 xtl chans. (external VFO). NBFM. 10W power out. Sensitive, double-conversion receiver. Mobile. 13.5VDC

**\$239**

# KLM electronics

17025 Laurel Road, Morgan Hill CA 95037 (408) 226-1780, (408) 779-7363