

# 73

# AMATEUR RADIO

HOLIDAY 1976  
\$2.00

[REDACTED] DK1=S\*  
U [REDACTED] 31  
C

# 55 ARTICLES!



# KLM 2700

presents the



## A brilliant new 2 meter transceiver with every in-demand operating feature and convenience

- ★ Synthesizer and VFO.
- ★ All modes: NBFM, WBFM, AM, SSB w/ USB/LSB and CW.
  - Frequency synthesizer (PLL) 3 Knob, 600 channels. 10kHz steps.
  - VXO, plus or minus 7kHz.
- ★ LED readout on synthesizer.
  - Standard 600 kHz splits plus...
  - Two "oddball" splits.
- ★ OSCAR transceiver 2 to 10 meter operation.
  - OSCAR receiver built-in.
  - Connectors on rear for separate 2 meter and 10 meter antennas.
- Built-in VFO (continuous coverage, 144-148MHz in 1.3MHz segments. 1kHz readout).
- 8 pole SSB filter plus two FM filters.
- 100kHz crystal calibrator.
- Voice operated relay (VOX) or p-t-t.
- ★ Audio speech compression.
  - Noise blanker.
  - RIT, plus or minus 5kHz.
  - Power out/"S" meter.
  - FM center deviation meter.
  - 10W minimum output power. NO TUNING!
- Hi-Lo power provision.
- Built-in AC/DC power supply.
- Double conversion receiver. 16.9MHz and 455kHz I-F's.
- Receiver sensitivity:
  - FM: 0.5 $\mu$ V for 28db S/N.
  - SSB/CW: 0.25 $\mu$ V for 14db S/N.
  - AM: 2 $\mu$ V for 10db S/N.
- 50MHz or 432MHz converters will be available. Interior space and terminals are provided.
- Size: Inches: 5H, 14.88W, 12D. MM: 128H, 378W 305D
- Weight: 28 lbs. (13KG).

At your favorite dealer. Write for catalog.

**KLM** electronics, inc.

17025 Laurel Road, Morgan Hill, CA 95037 (408) 779-7363

# Vhf engineering

THE WORLD'S MOST COMPLETE LINE OF VHF-FM KITS AND EQUIPMENT

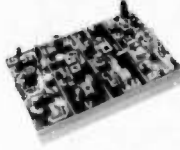
		RECEIVERS	
RX28C	28-35 MHz FM receiver with 2 pole 10.7 MHz crystal filter	59.95	
RX50C Kit	30-60 MHz rcvr w/2 pole 10.7 MHz crystal filter	59.95	
RX144C Kit	140-170 MHz rcvr w/2 pole 10.7 MHz crystal filter	69.95	
RX144C W/T	same as above - factory wired and tested	114.95	
RX220C Kit	210-240 MHz rcvr w/2 pole 10.7 MHz crystal filter	69.95	
RX220C W/T	same as above - factory wired and tested	114.95	
RX432C Kit	432 MHz rcvr w/2 pole 10.7 MHz crystal filter	79.95	
RXCF	accessory filter for above receiver kits gives 70 dB adjacent channel rejection	8.50	
RF28 Kit	10 meter RF front end 10.7 MHz output	12.50	
RF50 Kit	6 meter RF front end 10.7 MHz output	12.50	
RF144D Kit	2 meter RF front end 10.7 MHz output	17.50	
RF220D Kit	220 MHz RF front end 10.7 MHz output	17.50	
RF432 Kit	432 MHz RF front end 10.7 MHz output	27.50	
IF 10.7F Kit	10.7 MHz IF module includes 2 pole crystal filter	27.50	
FM455 Kit	455 KHz IF stage plus FM detector	17.50	
AS2 Kit	audio and squelch board	15.00	

		TRANSMITTERS	
TX144B Kit	transmitter exciter - 1 watt - 2 meters	29.95	
TX144B W/T	same as above - factory wired and tested	49.95	
TX220B Kit	transmitter exciter - 1 watt - 220 MHz	29.95	
TX220B W/T	same as above - factory wired and tested	49.95	
TX432B Kit	transmitter exciter 432 MHz	39.95	
TX432B W/T	same as above - factory wired and tested	59.95	
TX150 Kit	300 milliwatt, complete 2 meter transmitter, less crystal and mike	19.95	

		POWER AMPLIFIERS	
PA2501H Kit	2 meter power amp - kit 1 w in - 25w out with solid state switching, case, connectors	59.95	
PA2501H W/T	same as above - factory wired and tested	74.95	
PA4010H Kit	2 meter power amp - 10w in - 40w out - relay switching	59.95	
PA4010H W/T	same as above - factory wired and tested	74.95	
PA144/15 Kit	2 meter power amp - 1w in - 15w out - less case, connectors and switching	39.95	
PA144/25 Kit	similar to PA144/15 kit except 25w out	49.95	
PA220/15 Kit	similar to PA144/15 for 220 MHz power amp - similar to PA144/15 except 10w and 432 MHz	39.95	
PA432/10 Kit	10w in - 140w out - 2 meter amp - factory wired and tested	49.95	
PA140/10	30w in - 140w out - 2 meter amp - factory wired and tested	179.95	
PA140/30	30w in - 140w out - 2 meter amp - factory wired and tested	159.95	

		POWER SUPPLIES	
PS15C Kit	15 amp - 12 volt regulated power supply w/case, w/fold-back current limiting and overvoltage protection	79.95	
PS15C W/T	same as above - factory wired and tested	94.95	
PS25C Kit	25 amp - 12 volt regulated power supply w/case, w/fold-back current limiting and overvoltage protection	129.95	
PS25C W/T	same as above - factory wired and tested	149.95	
O.V.P.	adds over voltage protection to your power supplies, 15 VDC max	9.95	
PS3A Kit	12 volt - power supply regulator card with fold back current limiting	8.95	
PS3012	new commercial duty 30 amp 12 VDC regulated power supply w/case, w/foldback current limiting and over voltage protection, wired and tested	239.95	

		REPEATERS	
RPT28 Kit	repeater - 10 meter	TBA	
RPT28	repeater - 10 meter, wired & tested	TBA	
RPT50 Kit	repeater - 6 meter	TBA	
RPT50	repeater - 6 meter, wired & tested	TBA	
RPT144 Kit	repeater - 2 meter - 15w - complete (less crystals)	465.95	
RPT220 Kit	repeater - 220 MHz - 15w - complete (less crystals)	465.95	
RPT432 Kit	repeater - 10 watt - 432 MHz (less crystals)	515.95	
RPT144	repeater - 15 watt - 2 meter - factory wired and tested	695.95	
RPT220	repeater - 15 watt - 220 MHz - factory wired and tested	695.95	
RPT432	repeater - 10 watt - 432 MHz - factory wired and tested	749.95	
DPLX144	2 meter, 600 KHz spaced duplexer, wired and tuned to frequency	399.95	
DPLX220	220 MHz duplexer, wired and tuned to frequency	399.95	

		TRANSCIVERS	
TRX 144 Kit	case and all components to build 15 watt 10 channel scanning 2 meter transceiver (less mike and crystals)	219.95	
TRX 220 Kit	same as above except for 220 MHz	219.95	
TRX 432 Kit	same as above except 10 watt and 432MHz	254.95	

		SYNTHESIZERS	
SYN II Kit	2 meter synthesizer, transmit offsets programmable from 100 KHz - 10 MHz, (Mars offsets with optional adapters)	169.95	
SYN II	same as above, wired and tested	239.95	

		WALKIE TALKIES	
HT 144B Kit	2 meter, 2w, 4 channel, hand held receiver with crystals for 146.52 simplex	129.95	
NICAD	battery pack, 12 VDC, 1/2 amp	29.95	
NICAD	battery charger	5.95	
Rubber Duck	2 meter, with male BNC connector	8.95	

		OTHER PRODUCTS BY VHF ENGINEERING	
CD1 Kit	10 channel receive xtal deck w/ diode switching	6.95	
CD2 Kit	10 channel xmit deck w/switch and trimmers	14.95	
CD-3 Kit	UHF version of CD-1 deck, needed for 432 multi-channel operations	12.95	
COR2 Kit	complete COR with 3 second and 3 minute timers	19.95	
SC3 Kit	10 channel auto-scan adapter for RX with priority	19.95	
Crystals	we stock most repeater and simplex pairs from 146.0-147.0 (each)	5.00	
CWID Kit	159 bit, field programmable, code identifier with built-in squelch tail and ID timers	39.95	
CWID	wired and tested, not programmed	54.95	
CWID	wired and tested, programmed	59.95	
Microphone	2,000 ohm dynamic mike with P.T.T. and coil cord	9.95	



VHF ENGINEERING  
 DIVISION OF BROWNIAN ELECTRONICS CORP.  
 320 WATER ST. / BINGHAMTON, N.Y. 13901 / Phone 607-723-9574



# ANNOUNCING AN EXCITING NEW 2-METER TRANSCEIVER FROM KENWOOD

## TR-7400A Specifications

Range: 144.00 MHz to 147.995 MHz  
 Mode: FM  
 800 Channels: 5 KHz spaced  
 Sensitivity: Better than 0.4  $\mu$ V for 20 dB quieting  
 Better than 1  $\mu$ V for 30 dB S/N  
 Squelch Sensitivity: Better than 0.25  $\mu$ V  
 Selectivity: 12 KHz at -6 dB down  
 40 KHz at -70 dB down  
 Image Rejection: Better than -70 dB



# the TR-7400A

Featuring Kenwood's New and Unique  
**CONTINUOUS TONE CODED SQUELCH SYSTEM**  
**4 MHz BAND COVERAGE**  
**25 WATT OUTPUT**  
**FULLY SYNTHESIZED**

#### UNIQUE SQUELCH SYSTEM

The TR-7400A may be used on your favorite repeater, no matter what type of squelch system is used. The continuous tone coded squelch (CTCS) may be used for both transmit and receive or for transmit only. Tone burst operation may also be used.

#### SYNTHESIZED, 800 CHANNELS

The phase-locked loop (PLL) frequency synthesizer in the TR-7400A divides the 4 MHz bandwidth into 400 channels at intervals of 10 KHz. The frequency may be offset 5 KHz higher with the push of a button, thus providing 800 discrete channels.

#### REPEATER OFFSET

A convenient front panel switch offsets the transmit frequency of the TR-7400A up OR down 600 KHz for standard repeater operation. This offset circuit uses digital technology to provide a highly stable offset frequency without spurious response. A dual color LED

indicates the direction of offset from the displayed receive frequency.

#### OUTSTANDING RECEIVER PERFORMANCE

Large-sized helical resonators with high Q minimize undesirable interference from outside the 2-meter band. The large helical resonators, 2-pole 10.7 MHz monolithic crystal filter, and MOSFET front-end circuitry combine to give outstanding receiver performance.

#### TONE PAD CAPABILITY

A jack is provided to allow convenient connection of a tone pad to the TR-7400A.

#### FINAL PROTECTION CIRCUIT

The final transistor in the TR-7400A is protected from antenna impedance mismatch. Excessive reflected power reduces the amount of drive to the final transistor rather than turning off the final stage. This practical feature allows continued safe operation at a reduced power level whether the antenna system becomes opened or shorted.

Spurious Interference: Better than -60 dB

Intermodulation: Better than 66 dB

Receive System: Double conversion

First IF: 10.7 MHz

Second IF: 455 KHz

Audio Output: More than 1.5 Watts (8 ohm load)

RF Output Power: 25 Watts (High)  
 5-15 Watts (Low-adjustable)

Antenna Impedance: 50 ohms

Frequency Deviation:  $\pm$  5 KHz

Spurious Response: Better than -60 dB

Tone Pad Input Impedance: 600 ohms

Tone Burst Duration: 0.5 to 1.0 sec.

CTCS Range: 88.5 Hz to 156.7 Hz

Microphone: Dynamic, with PTT switch, 500 ohms

Voltage: 11.5 to 16.0V DC (13.8V DC nominal)

Current Drain: Less than 1A in receive (no input signal)

Current Drain: Less than 8A in transmit

Polarity: Negative ground

Temperature Range: -20 to +50 degrees C

Dimensions: 182 mm (7-3/16") wide  
 270 mm (10-5/8") deep  
 74 mm (2-7/8") high

Net Weight: Approximately 2.8 kg (6.2 lbs.)

TRIO-KENWOOD COMMUNICATIONS INC.  
 116 EAST ALONDRA/GARDENA, CA 90248

 **KENWOOD**  
 ...pacesetter in amateur radio

- 22 Build This Inexpensive 400 Watt Amplifier — a pair of shoes never hurts  
W7SCD
- 24 How Do You Use ICs? — part V  
WA2SUT/NNN0ZVB
- 32 Mobile Smokey Detector — 10.5 GHz: use it or lose it  
W1SNN
- 35 Get a Kid Off the Streets — and into ham radio  
WA1GFJ
- 36 Add RIT to Your Transceiver — a must for CW operators  
Staff
- 38 Coronaries for Burglars — with this cheapo car alarm  
WB6QDS
- 40 Power Supply — versatile  
WB4EHG
- 44 DXpedition: Memories for a Lifetime — reflections of HK1TL  
K3JJZ
- 46 Secret PC Layout Method — simple and inexpensive artwork  
WA9VFG
- 48 Design Your Own QRP Dummy Load — useful beginner's project  
WA1SNG
- 49 Failsafe Super Charger — multi-rate, too!  
WA3KKM
- 52 The Amazing 18" Antenna for 160m — get on topband simply  
W2NYU/WA1JJV
- 53 A Great Way to Lay Out PC Boards — new use for shirt cardboards  
WB4TTY
- 54 Replacing the Knife Switch — simple TR system for the Novice  
WA1SNG
- 56 \$25 for a Connector? You're Crazy! — do-it-yourself 7/8" coax connectors  
W9DOR
- 58 Now You Can Synthesize — the VHF Engineering approach to 2m happiness  
WB8STQ
- 61 IC Audio Frequency Meter — another use for the 555  
WA5KPG
- 62 Hutchinson's Remedy — the chirpless CW machine  
VE3CWY
- 66 The Mod Squad Does the Pocket Scanner — Radio Shack PRO-4 updated  
WB0KZV
- 69 TR-22 Mod Squad — king of the modifieds?  
WA2AJQ
- 80 What Computers Can and Can't Do — a look at amateur radio's future possibilities  
WB6OBS
- 82 A Ham Shack File Handler — program in BASIC for OSLs, repeaters, etc.  
W4BQ
- 84 Print Your Own Log Book — on your nearest computer  
W0TBL
- 86 The Bit Explosion — 8 vs. 12 vs. 16 vs. ?  
WB2GFE
- 90 Backward Branch the Easy Way — for the 6800 Hunter  
Hunter
- 92 Superprobe — modern replacement for the scope  
WA6JMM
- 94 The Frumious Hexadecimal — for 16-fingered folk  
W3KBM

- 97 V-V-V LF Generator — the lowdown  
Hileman
- 100 Shoeing Your HT — semi-ideal mobile setup  
WB5HSK
- 103 \$22 for a Regulator? Never! — a simple car voltage regulator  
WB9JSE
- 104 Cash In on the CB — installation for fun and profit  
WA4WOC
- 107 Surplus Headset Mod — no tanks needed  
K2EE
- 108 Am I Really Transmitting? — red and green LEDs for the TR-22  
WB8IMY
- 109 Dear Gabby — exasperation explained  
W7IDF
- 110 The Smart Charger — auto shutoff and all that  
WA5KPG
- 111 Simple Remote Ammeter — using a bus-bar shunt  
W7RXV
- 112 Micrometers for Microwaves — the art of delicate measurement  
Kehl
- 127 Tuning Those Big Antenna Coils — permeability  
W6AGX
- 128 The 2m Mod Squad Tackles the Weatherradio — and wins!  
W2OSW/W2UJR
- 130 Design Your Own PC Boards — the styrofoam solution  
Adsit
- 134 Hamming by Laser — modulating them isn't easy  
WA7NMO
- 138 A 60 Foot Antenna on a 20 Foot Lot — solving a 40m Novice problem  
Collector and Emitter
- 146 Dual Voltage Power Supply — about as simple as they come  
W6WQC
- 147 Kints and Hinks — for money savers  
VE3FEZ
- 148 An Autopatch Busy Signal — when the phone's already in use  
WA1RTD
- 151 Catch Standing Waves — with a tunable trap  
W6AGX
- 154 Inside the GLB — a gutsy look at a synthesizer  
WA6CPP
- 160 Three for Two — antenna forum  
K4TWJ
- 162 How to Bug an Automatic Keyer — putting new life in an old bug  
WB9BNF
- 164 A 450 Duplexer — that fits in your car!  
W7JSW
- 166 Turn Signal Reminder — setting things straight  
K5AR/7
- 168 Do-It-Yourself Ceramics — for tube sockets, insulators, etc.  
WA9VFG
- 172 Tubes ... ? — VFO project for nostalgia buffs  
W5JJ
- 192 The Hellbox All-Purpose Keyer — keys, mutes, T/R ... the works  
W5JJ
- 204 Will Silver-Zinc Replace the Nicad? — portable power with a punch  
W6JTT

# 73

#195 HOLIDAY 1976

4	Never Say Die
8	Letters
12	Looking West
14	Be My Guest
19	Review
19	Hamburglar
20	Novice Q & A
74	I/O Editorial
76	I/O Report
143	Social Events
170	Circuits <sup>2</sup>
182	Briefs
194	Corrections
195	AMSAT
200	New Products
205	1976 Index

COVER: 208 element moon-bounce antenna used by Mt. Airy VHF Club DXpedition to Colombia. See page 44.

73 Magazine is published monthly by 73, Inc., Peterborough NH 03458. Subscription rates in the U.S. and Canada are \$15 for one year and \$25 for three years. Outside the U.S. and Canada, add \$2. Second class postage paid at Peterborough NH 03458 and at additional mailing offices. Phone: 603-924-3873. Microfilm edition — University Microfilms, Ann Arbor MI 48106. Tapes — Science for the Blind, 332 Rock Hill Rd, Bala Cynwyd PA 19004. Entire contents copyright 1976 by 73, Inc. INCLUDE OLD ADDRESS AND ZIP CODE WITH ADDRESS CHANGE NOTIFICATION.

# 73 STAFF

EDITOR/PUBLISHER  
Wayne Green W2NSD/1

GENERAL MANAGER  
Biff Mahoney

MANAGING EDITOR  
John C. Burnett

ASSISTANT EDITOR  
Susan G. Philbrick

FOO EDITOR  
John Craig

ASSOCIATE EDITORS  
Ruth Brown W1LUT  
Warren Elty WA1GUD/1  
Rich Force WB2QYV/1  
S. Miestkowski WA1UMV

PRODUCTION MANAGER  
Lynn Panciera-Fraser

ART DEPARTMENT  
Craig Brown  
Virginia Mammone  
Michael Murphy  
Bob Sawyer  
Roban M. Sloan  
Jody Wright

PRINTING  
John Bianchi  
William Cerling  
Brent Lawler  
Michael Potter  
Noel R. Self  
Gary Steinbach

PHOTOGRAPHY  
Bill Heydolph

TYPESETTING  
Barbara J. Latti  
Sandy White

COMPTROLLER  
Knut E. M. Kaller KV4GG/1

#### CIRCULATION

Dorothy Gibson  
Leslie Bailey  
Barbara Block  
Judi Brumaghim  
Susan Brumaghim  
Nancy Chandler  
Susan Chandler  
Fran Dillon  
Florence Goldman  
Pat Hogan  
Lois Ireland  
Marge Nielsen  
Peggy Syryn  
Theresa Toussaint  
Judy Waterman

#### MARKETING

Sherry Smythe  
Cher Dean  
Lisa Healey  
Karen McDonough  
Mary McDonough

#### INVENTORY CONTROL

Marshall Raymond  
Larry Ames  
Gary Slamin

#### PLANT MAINTENANCE

Bill Barry  
Lorraine Pickering

#### ASSOCIATES

Robert Baker WB2GFE  
E. H. Barnett WB0HIX  
Schley Cox WB9LHO  
Tom DiBise WB9KZD  
Terry Fox WB4JF1  
W. Sanger Green  
Dave Ingram K4TJWJ  
Joe Kasser G3CZC  
Bill Pasternak WA6ITF  
John Schultz W2EEV/K3EZ  
Walter Scott KB0IZ  
Peter Stark K2OAW  
Bill Turner WA0AB1

#### COMPUTER ENGINEERING

James Muehlen  
Glenn Lefebvre  
David E. Wilensky

#### DRAFTING

Bill Morelio  
Lynn Maio  
T. M. Graham, Jr. WBFKW

#### ADVERTISING

Bill Edwards WB6BED/1  
Nancy Cluff WA1WSU



NEVER SAY DIE

...de W2NSD/1

EDITORIAL BY WAYNE GREEN

### ASPEN CONFERENCE

With the amateur radio industry in a turmoil as a result of the high input of CBers into the Novice ranks, the low band Novice privileges of the Techs, the possible loss of 220 to the CB industry (CBers don't want it), the even worse disaster possible to the low band frequencies if ARRL continues to do its best to prevent preparation for the WARC, manufacturers going direct in sales as dealers fold up, and dealers caught between low markups, price cutting, high advertising costs and shortages of supply, it is time for everyone to get together for a few days and see if anything can be done which will work out better for the long range benefit of the hobby and bring more business to everyone involved.

Such a meeting has been arranged for the week of January 8-15th in Aspen, Colorado. Here, with over 100 restaurants to pick from, there will be a series of extended dinner meetings so the ham industry can discuss its problems and work out some possible solutions. Manufacturers, dealers, and just plain interested hams are invited to join the group in Aspen for some skiing, some relaxation, and a lot of serious business.

I'll be there to help as a catalyst and perhaps bring some perspective to things like the coming Communicator Class license (my proposal, in case you've forgotten), the state of the CB industry at present (I write a CB newspaper column), and things like that. Chuck Martin WA1KPS (Tufts Radio), the largest New England ham distributor, will be there to discuss the viewpoint of the ham dealer. It should be a very valuable meeting ... and fun.

We'll be staying at the Continental Inn, which is near the center of town. You can probably get rooms if you get right at it by calling Aspen Reservations. Look for a place with a sauna and heated pool, if you can get it ... that eases the aching muscles after skiing and makes dinner a lot more pleasant.

If you're a good skier, you'll probably be lurching with us on top of the Aspen mountains. If your skiing needs some repair, they have the best ski instructors in the world at Aspen. I went from a rank beginner to a high intermediate in one week at Aspen.

If you are going to join us at Aspen, please let me know as soon as possible

so I can arrange for you (and anyone with you) at the dinner meetings.

### FOOTNOTE IN MOUTH DISEASE

If you are a League member who gets hot under the collar every time I mention the ARRL, rather than get mad every time I go negative on 'em, why not check out the facts and correct me if I'm wrong ... and correct the ARRL if I'm right? The newpages of 73 are wide open for anything like that.

Now, to the matter at hand ... or foot, in this case. I've mentioned before about the long standing policy of QST to delete footnotes in articles referencing 73. This is a bit hard on readers because 73 publishes about four times as many articles as QST and thus it is almost impossible to write any technical articles for QST without having some 73 references ... often a raft of them. Is the value of the QST articles degraded by these deletions?

The recent QST series on microprocessors gave no reference to any of the 70 articles so far published in 73 on the subject. Was that honest? By far the biggest laugh on this was the October QST cover article by Tilton on the planets and radio propagation ... with all sorts of talk about the originator of the idea, John Nelson, but without a single mention that he has for many years been the Propagation editor of 73 and has had many articles in 73. I'll bet they get a hard time over that!

Many of you recall the little incident of the "Lifted Counter" where K2OAW'S counter circuit was lifted almost intact and published two years later in QST as an original construction project ... with not one mention of Stark or 73. Since the K2OAW counter has been extremely popular and built by more hams than all other types of counters combined, it was hardly an oversight.

Well, never mind ... 73 will continue to reference any and all ham magazines in articles ... even CQ, should the occasion ever arise.

### INSTANT DVM

It is not a very well kept secret that Motorola is getting ready to deliver their digital voltmeter chip (14433) which will sell for around \$20 in single lots and probably be available via Godbout and others for much less than that.

This little dandy requires a small

power supply, a two volt reference, and a 3½ digit display. It may require a display buffer. It has a 1000 megohm input and auto polarity, and all that sort of good thing. The result is going to be very low priced DVMs and perhaps DVMs being built into the newer rigs, since they will be cheaper than a panel meter.

In steps the microprocessor again (sorry about that, tubers). With a very simple processor the DVM circuit can check out just about every circuit of a transmitter or receiver (or anything else) and report deviant behavior. The DVM can use the real time clock readout (you might as well use the processor as a clock, too) to report on any voltage you want to monitor ... or current, or to tell you when something is out of spec.

### HIJACKING PLANES

After a few trips by air I've gotten the hang of what I can or cannot get through the baggage inspection stations. Since I need a small knife to open packages shipped for use at hamfests, I always used to pop my little Swiss Army knife in my camera bag. It was handy, with a built-in scissors, screwdriver, file and things like that.

The first time I tried to get that through the inspection team they viewed it with the same reaction you might expect if they found an automatic gun in my bag. They rushed me into a room and I was grilled for a half hour by an idiot with a Kojak haircut and a breath that could only have resulted from a raw onions and cigar sandwich. I managed to convince them that it was just a blunder on my part, so they sent my knife along in a sealed bag for the captain to take along and have delivered to me at my destination ... after I was safely off the plane.

Okay ... no pocketknives. The next serious brush with the paranoiacs came when I attempted to get through the gauntlet with a pair of scissors. In packing up after the Dayton Hamvention I'd ended up with the scissors used to cut the packing tape. They went into my camera bag. Bad news. As they were trying to get me into the Dayton grilling room I offered to settle out of court and bribed them with the scissors. I figured it was cheaper to buy another pair than miss my plane.

Okay ... no pocketknives or scissors.

## Now ICOM Introduces 15 Channels of FM to Go!

# The New IC-215: the FM Grabber

This is ICOM's first FM portable, and it puts good times on the go. Change vehicles, walk through the park, climb a hill, and ICOM quality FM communications go right along with you. Long lasting internal batteries make portable FM really portable, while accessible features make conversion to external power and antenna fast and easy.

Grab for flexibility with the new **IC-215** FM portable.

- Front mounted controls and top mounted antenna
- Narrow filter (15KHz — compatible spacing)
- 15 channels (12 on dial / 3 priority)
- Fully collapsible antenna
- Compatible mount feature for flexible antenna
- Dual power (3 watts high / 400 mw low, nominal)
- External power and antenna easily accessible
- Lighted dial and meter

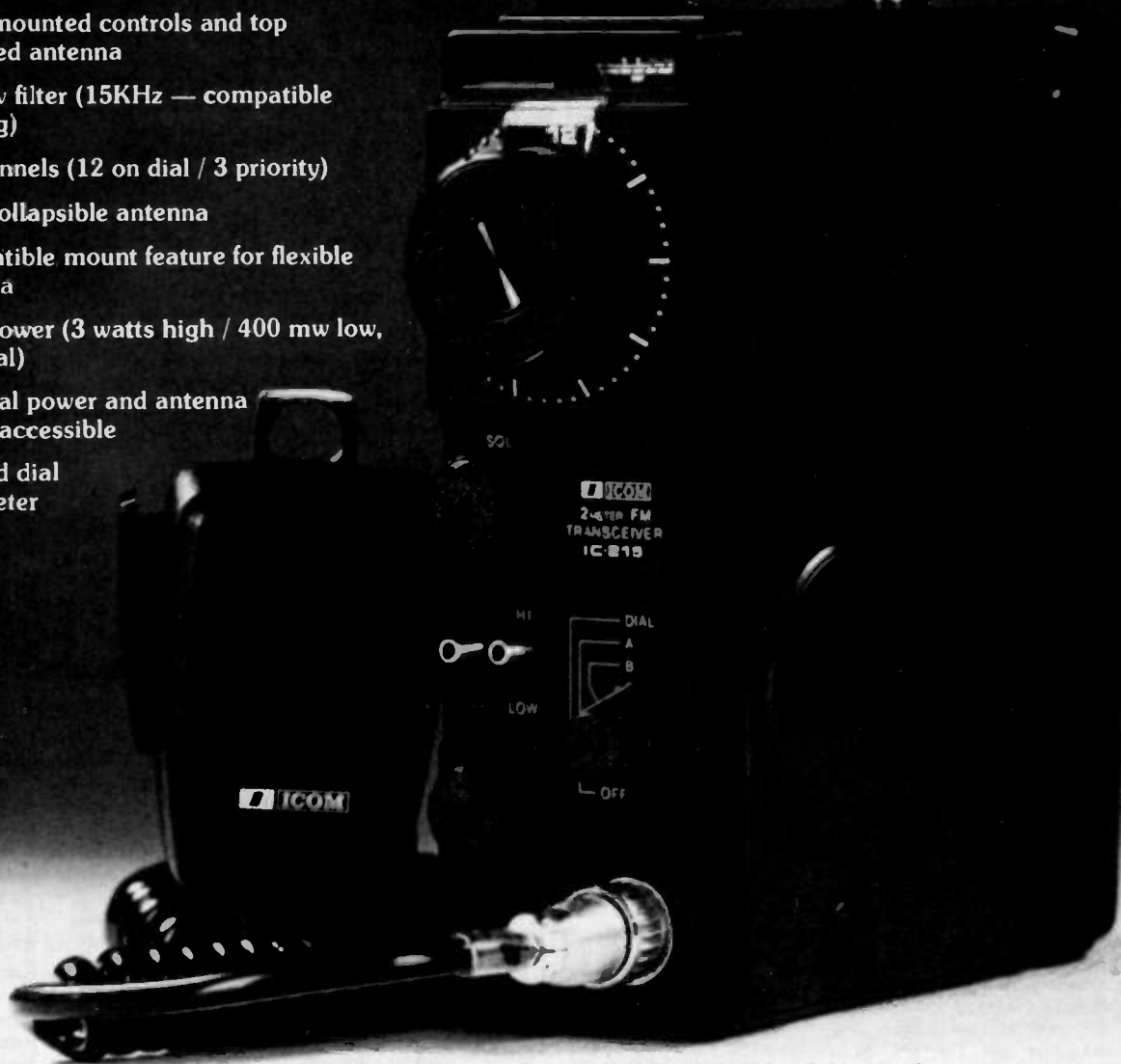

Your new **IC-215** comes supplied with: 5 popular channels; handheld mic, with protective case; shoulder strap; connectors for external power and speaker; 9 long-life C batteries.

VHF/UHF AMATEUR AND MARINE COMMUNICATION EQUIPMENT

Distributed by:



# ICOM

**ICOM WEST, INC.**  
Suite 3  
13256 Northrup Way  
Bellevue, Wash. 98005  
(206) 747-9020

**ICOM EAST, INC.**  
Suite 307  
3331 Towerwood Drive  
Dallas, Texas 75234  
(214) 620-2780

The next time the lights started flashing and bells ringing it was a dental pick in my camera bag. I had a tooth that was trying to die and my dentist had given me an emergency kit to stave off the inevitable. Did these clowns figure that I was going to hold the passengers and crew of a DC-10 at bay with a lousy dental pick? Yes... that's what they thought. The captain gave it to me when I reached my destination.

I must admit to reading with just a twinge of satisfaction about the chap who went aboard a plane with a bunch of plastic explosives on his belt.

### CB DEBACLE PROFITS HAMS

CB rigs are going for a "dime a dozen" these days, figuratively speaking, and this is a great opportunity for hams to take advantage and get some gear cheap — good gear.

Many, if not most, of the CB rigs can be moved up 2 MHz so they will perk away on 10 meters.

Most of you are aware of what happened to the CB market... it bombed. I attended a meeting of CB manufacturers and dealers recently (73 was the *only* ham magazine present, by the way). I was more interested in what schemes they had going for them for 220 MHz than in their miseries with price cutting and dealer dumping, etc.

Here's what happened. Back last spring when CB was in all the papers and appearing on TV shows, the public went ape over CB and just about anything made to look like a CB set was selling. The FCC was getting 500,000 license applications a day. Dealers were being badgered by customers for sets and dealers in turn were driving manufacturers up the wall with orders and demands for delivery. New factories were built as fast as they could be built, hi-fi factories in Japan were turned into CB plants, customers went from dealer to dealer trying to place orders, and the dealers, in turn, passed the orders along to the manufacturers.

By summer the heat was dying down a bit. Millions of CB sets were being turned out in the U.S. and every ship available was loaded to the Plimsol line coming from Japan, Taiwan and Singapore. FCC license applications dropped off to 100,000 a day and dealers began to find that their "customers" had ordered from five or ten other dealers and had long since bought a rig. Shelves began to droop with the unsold sets... then storage areas filled up... then warehouses. And still the sets came, pouring off ships, filling rented emergency warehouses, stuffing trailer trucks.

By August first, the FCC was down to 90,000 applications a day and then they dropped the big bomb... 40 channel sets can be sold in January! Panic! "How in the hell are we going to sell obsolete 23 channel sets when the public is waiting for 40 channels?"

In one move the FCC had killed the whole Christmas season for the CB industry — it could lose them billions of dollars.

To make matters worse, a couple of petitions were filed to prevent the expansion to 40 channels — filed by TV groups who wanted to try and prevent interference to channel 6 like that being suffered by channel 5. The third harmonic of the present sets raises the devil with channel 5 and the new higher channels would probably do the same to channel 6. The FCC has to decide soon whether to throw out the expansion or not... and the decision could go either way.

If the FCC decides against the TV groups, then it could still go to court and take months to years for a decision.

By September, just to help out, the FCC announced that CB applications had dropped to about 75,000 a month. This is big as far as hamming is concerned, where we have maybe 150,000 hams who could be considered active, but by CB standards it is a disaster.

This is going to be a great time to get some incredible buys on 11m rigs. If we can get some good conversions to ham channels, we have an opportunity to get good ham gear at perhaps 30% of what it might otherwise cost. I'll be most interested in simple conversions of popular CB rigs to 10m and some sort of plan for setting up standard channels on 10m so we can all intercommunicate. Who knows, perhaps we can get started on some 10 meter repeaters while the band is still suffering from sunspotlessness. How about some articles?

### COMPLAINT AGAINST YOU

Mary is pretty upset — and she has a right to be — for you've been letting her down. Mary is the incredibly gorgeous girl who handles the reader's service requests. We have to keep her locked up in a secret inside room if we want any of the fellows here to get any work done; otherwise they hang around and keep Mary busy talking — and Mary is a talker.

Her complaint is that after all of the trouble and expense of having a reader's service card bound into the magazine so you can send for information without tearing a page out of your magazine, there are still thousands of readers who are *not* sending in the cards. Poor Mary — she's in tears some days when only a couple hundred cards come in.

You can keep Mary a lot happier if you tear out that card, circle the info you want and send it in. This will also make the advertisers happy, and you have a strong vested interest in this too, for the more ads there are in 73, the more pages of articles you'll get. Simple as that. To keep the cornucopia pouring out every month, you have to encourage the advertisers with reader's service requests... and you have to let them know it when you buy something that has been adver-

tised in 73.

### MORE DELOGGING REQUESTED

Though most of the logging requirements for amateur stations were deleted some months back, the requirement to keep a log of all third party traffic hung in there, much to the irritation of repeater groups, who had to keep making tapes of all autopatch contacts and saving them.

T-MARC, The Middle Atlantic FM and Repeater Council, has petitioned the FCC to delete this requirement, pointing out that the Commission has not in fact made much (if any) use of these tapes.

It will be interesting to see how the Commission reacts to this request for further deregulation.

### YAESU GIVES \$29

Yaesu Electronics Corp. has announced that they will pay anyone who gets his first ham ticket between November 1, 1976 and June 30, 1977 a bonus of \$25 plus \$4 reimbursement for the cost of the ham license. To qualify, you must have purchased a Yaesu FT-221 (the 2m SSB-FM-AM-CW transceiver) from an authorized Yaesu dealer. A copy of the license and the bill of sale will bring the bonus.

Big deal, you say? When you consider that there are several million CBers out there who are candidates for ham tickets and that the Yaesu nationwide publicity and advertising program for the above bonus will undoubtedly stimulate interest in amateur radio, it is indeed a big deal.

### APPLYING FOR EMPLOYMENT

My recent plea for help at 73 brought in quite a bunch of resumes, most of them very poorly done.

Look, fellows, when you are looking for a job, you are selling yourself, so make an effort to do just that. For instance, you'll find that few prospective employers are interested in why you want the job. Fellows who write to me and tell me that they would like to live in New Hampshire so they can climb mountains are not convincing me that I really need them with 73. Fellows who are unhappy with their present jobs and are looking for something else... anything else... are not very persuasive.

The chap who sends a letter to me giving me the reasons why he will be of value to 73... telling me what he can do and what he would like to learn to do... heck, I wouldn't even need an opening for him, I'd make one. What employer will turn down someone who shows how he can increase the income of the firm substantially? Or cut expenses?

Some employers put a lot of stock in schooling... I tend more to want to know what a chap has done for his previous employers... how much interest he has in learning... how much he is into working... how well he gets along with others. And the chap who shows that he has enough interest in working for 73 to do some

research has a big advantage.

A fellow might visit a few ham stores and get opinions from dealers about ways for us to do better in selling 73 bulk copies to them... or in selling the 73 books to them... and then write to me and mention that among the things he'd like to do is help with increasing sales through dealers... for instance... etc. That shows interest, resourcefulness, and imagination... and almost any employer will sign you on immediately.

### ARRL TO SPEND \$800,000

Did the directors vote this enormous sum to help amateur radio prepare for the 1979 ITU conference? No... well, perhaps it will be spent on a nationwide publicity and advertising campaign to help amateur radio grow? No... the fact is that that half million dollar building everyone pitched in to pay for a few years ago is a bit cramped and rather than either streamline operations or double up a bit, they feel that they really must add to the building. \$800,000 worth of addition!

Will we have another building fund drive?

Youngsters may not have heard about the last building fund drive. Let me tell you about it briefly. For many years the League was operating out of West Hartford and putting aside money for a new building. They had about a half million stashed away for this. Then came a new director... a shrewd one. Why spend all that money when you can get the members to donate enough for the new building? Sure enough, he was right, and the League ended up with money in both pockets. The part that I enjoyed the most was when they sold the old building for a half million! Who says non-profit organizations can't make money... millions of dollars? Since very few members make the effort to get the yearly ARRL report... or to read it, hardly any members are aware of what is really going on.

I suggest that the League *should* have another building fund drive to build on the new wing... and take the \$800,000 and use it to field a couple of ham ambassadors to the smaller countries of the world who will swing the votes in a couple of years... the votes which could make that new wing unnecessary.

A "bravo" for ARRL director Griggs, the only one with the guts to stand up against Baldwin on this utter waste of membership funds.

### NOTE

The Ancient Aviator has not flown the coop — he is merely on vacation. His column will be resumed soon. Also, our Contests, Oscar Orbits, and Propagation columns will continue on a regular basis beginning with the January issue.



There is no substitute for quality, performance,  
or the satisfaction of owning the very best.

Hence, the incomparable Hy-Gain 3750 Amateur  
transceiver. The 3750 covers all amateur bands  
1.8-30 MHz (160-10 meters). It utilizes advanced  
Phase-Lock-Loop circuitry with dual gate MOS  
FET's at all critical RF amplifier and mixer stages.  
There's a rotating dial for easy band-scanning and an  
electronic frequency counter with digital readout  
and a memory display that remembers frequencies at  
the flip of a switch. And that's just the beginning.

Matching speaker unit (3854) and complete  
external VFO (3855) also available.

See the incomparable Hy-Gain 3750 at your radio  
dealer or write Department MM. There is no substitute.



3854

3750

3855

# There is no substitute.

**hy-gain**<sup>®</sup>  
We keep people talking.

Hy-Gain Electronics Corporation  
8601 Northeast Highway Six; Lincoln, NE 68505

© 1976 Hy-Gain

ou goons don't ever proof  
lousy manuscripts from bat  
bush...  
you...  
I insist that you print ev  
tell Ma Bell that she shou

# LETTERS

## GUAM: A WINNER

Just a few lines to let you know that the reprogrammable ID described in your April '76 issue is a winner. My compliments to Bob Glaser WA3MSW and you for publishing a good workable and easily reproducible construction article (my copy of the IDer works great). Myself and some of the others here on Guam are making good headway on setting up a 16/76 machine. Right now, the only circuit I haven't been able to come up with is one which would take the output of a touchtone decoder (NE567s, 7402s, et. al.) and convert it to Ma Bell compatible dial pulsing. If you or any of your readers happen across such a circuit I sure would appreciate it.

More on the 16/76 repeater: Hoped to have it operational about 1 Oct 76, but with the inevitable wait for licensing it could take much longer (ordered my own KG6 secondary call in June with no results so far). At present there are no active repeaters on the island, although members of the Marianas ARC are diligently working (especially K7IRC/KG6) to restore their 34/94 machine. It seems they have a combination of duplexer, control circuit, and site problems at the moment, which don't lend to a speedy solution.

Visitors to Guam should find a welcome reception on 94 simplex in the meantime, and later on (hopefully) both the 34/94 and 16/76 open machines.

Bill Howard K1LNJ/KG6  
Guam

So who visits Guam? — Wayne.

## TOO GOOD?

I must register my frustration with the quality of 73. It's too good. I take a large number of diversified magazines, but most of them have enough uninteresting material that I can skim them in short order. However, when my monthly 73 arrives, I get nothing else done for days, because 73 is so interesting that I find I must devour every word. Seriously, keep up the fine work. It's really amazing how you consistently maintain such high quality, month after month.

Stan Tippin W4VMR  
Niceville FL

Baloney, Stan, it isn't that good. — Wayne.

## MULESHOER

Since CB radio has become so popular, many of my customers have gotten rid of their telephones and gone exclusively to the CB radio in order to communicate with their friends. That was the reason I got CB for my truck... I can't confirm appointments by carrier pigeon or smoke signal. And Wayne is right... it's darned handy. I have found another side benefit of it. I'll tell it by the example of last Saturday night: I was shoeing horses in the Milwaukee area all day Saturday. It was 9:30 or 10:00 pm when I started home, which meant I'd get home sometime around midnight. 70 or 80 of those miles are interstate highway. I put the (ham radio) bug into the ears of a lot of those truckers... my "handle" is Muleshoer ("horseshoer" tends to come out of the radio sounding like "whore-shoer" and we don't want that!). After the truckers get over the first shock of finding out that there is a female professional horseshoer in the world, they ask a lot of questions. I try real hard to evangelize in the name of hamming, and Saturday night alone there were at least 6 different voices that kept interrupting and asking me for the name of "that magazine with the friendly name." They were all really intrigued by the prospect of being able to talk legally with someone several states away. One of them wondered about getting "Smokey reports" from Europe (maybe he drives an amphibious semi?). I keep telling them that "anything 6- and 10-year-old kids can do, they can do, right?" It gets to them, apparently. Even though neither of us has been able to scare up the time to go and take our license exams, we have spent a lot of time passing on the word about amateur radio. If any of it "takes," it will have been well worth it. I was wondering about the likelihood of getting new blood into amateur radio before Wayne started pushing it in his column(s). Keep it up, Wayne. Just because a lot of those CBers are interested only in "broadcasting" doesn't mean they all are. There is a lot of talent out there that will be wasted as far as ham radio is concerned if we don't all get out there and evangelize. What you don't use, you lose, and if we don't get more bodies into ham radio's ranks, we'll lose a lot of our space. It may well be that many CBers will get involved in ham radio because of the crush on the

CB channels — as well as out of curiosity about the workings of "that box" under the dash. If we are to keep what we have in the way of air space, we have to welcome them with open arms, and this is truer if we hope to expand our air space. One of the biggest "selling points" of CB radio is its family atmosphere. CB breaks are family affairs. Hamfests don't seem to be. I've never been to a break, but I hear a lot about them because of the antenna on my truck. And they emphasize "friendly" and "inexpensive" entertainment. Hamfests are friendly, but they are expensive and tend to be overwhelming to the newcomer. Even 73 tends to err slightly in this direction... those ads for gear have terrific price tags. The equipment is probably worth it, but even a kit sends too many potential hams racing back to their CBs. Let's face it: To a guy with a non-working spouse and 2 or (ugh!) more children, \$400 to \$700 for a transceiver is frightening. And then there's all that "other equipment." We need more articles on good quality stuff that a person could put together "as the money becomes available." Besides, those how-to articles and the attitude that goes with them are among the best selling points of amateur radio.

Well, enough haranguing. As someone who intends to get my Advanced ham ticket soon, I have a vested interest in seeing to it that there will be plenty of space in which to "do my thing" after all that effort. Besides, knowledge should be used and passed on — and our fund of it expanded. We can't do that without getting more people involved in hamming.

Thanks for the forum.

Carol G. Sakowski  
Mt. Horeb WI

So what ham can afford a non-working wife? — Wayne.

## NAVASSA, AGAIN

Would you please publish the QSL address for YB0ABV, as via K0DX/4, 11104 Seaglade Drive, Pensacola FL 32507. QSLs for 1971 W0EXD/KC4 Navassa Island operation should go to the same address.

Dr. Richard J. Brown K0DX  
Pensacola FL

## 300 MILE ATV!

On Oct. 3, three Ohio stations, W4BRMC, WA9ZIG/8, and W8DMR, received standard scan pictures from W9ZIH. Bill W8DMR, Columbus OH, estimates the path to Ron W9ZIH, Hickory Hills IL, to be 300 miles. Ron runs 500 W to 4-24 el. yagi array. Bill runs 50 W to a 48 el. collinear array at 40 feet. Art, Dale and Bill report that this ATV contact may be a new record.

Bill Parker W8DMR  
Columbus OH

## HITCH A RIDE

The letter from John Halliwell prompted this writing. As I read it my mind wandered back the 20+ years to the days when I was trying to first grasp electronics. Remember "CARL & JERRY" and the CK722 (I still have my first one).

To all young electronics enthusiasts, may I suggest they contact a local ham (hang around a Radio Shack, hams are in and out all day) and hitch a ride to a hamfest where ham and electronics magazines can often be found for less than a dime each, then READ READ READ! It's amazing how the pieces will fall into place.

How many times have you seen a young person with a parts list being given a hard time by some power crazed clerk? I am slow to anger, but this enrages me. I jump all over the clerk with both feet and have ended up donating parts from my junk box. Next time you see this happening, remember when you were young. Jump in and reach out — it feels great!

Richard Wright  
Tiffin OH

## DARTS AND LAURELS

First the praise: 73 is a fantastic magazine. Between myself and my friends, we get about all the popular ham radio magazines currently being published and we all agree that 73 is TOPS. The ratio of technical articles to ads is excellent and the class of those articles is also very good. Your policy in allowing only reputable firms to advertise in 73 is also much appreciated; I have purchased several items from firms listed and can only say that I have had the best of service.

Now the criticism: Judging by the fact that in almost every country that I have visited (I am in the airline business), 73 can be found on newsstands throughout the world, it can be assumed that you have a substantial export mailing list and it is on behalf of your many overseas readers that I make these points.

1. We can do without the "historical interest" stuff — by this I mean that, due to the time factor involved in mailing to countries out of the USA, some of the data and ads are of historical interest only by the time the magazine reaches the subscriber. Propagation charts and some ads which offer Specials valid during the month of publication only are examples of what I mean. While it is realized that the great majority of your readers are in the US, please give a thought to those keen readers in the far-flung outposts of the empire who, after all, do pay the same money in subs and who would certainly appreciate this consideration.

2. These new-fangled names, and especially the abbreviations, for the latest generation of ICs are most confusing to the casual reader. Would

it not be possible to include an abbreviation list so that we can decipher Naked RAMs, ROMs, PROMs, MOS, CMOS, AND, NAND and the suchlike? Street names and signs are for people who *don't* know the way!! A permanent abbreviation list and perhaps explanatory notes would be most helpful.

Thanks for a really great magazine; may your shadow never diminish.

Rob McGrath ZL1BFF  
Auckland, New Zealand

Advertisers, please note! — Wayne.

### USE IT OR LOSE IT

I have just tonight had the opportunity to speak with FCC Chairman Richard E. Wiley on a listener-response radio program aired over KRRLD-AM in Dallas. The two hour program included Chairman Wiley, Commissioner Benjamin L. Hooks, and several FCC bureau chiefs. After a wide-ranging interview and discussion of broadcasting policies, political fairness considerations, and CB problems, telephone lines were opened for listeners to call in and discuss any subject with these FCC executives. Though several questions touched upon amateur radio and CB expansion, I believe I was the only ham to call in and confront the Commission representatives with what I consider an important, and so far unresolved, question in the minds of radio amateurs: the potential loss of spectrum now allocated to the amateur service for the provision of a "citizen's band" available to auto makers and radio manufacturers, so that they may sell to a new market factory option two-way radios in new automobiles.

The following is a literal transcript (from my tape recording of the broadcast) of my question and the Chairman's reply...

WA5RON: "Good evening, gentlemen. I am a radio amateur calling from Austin, Texas, and I wanted to ask Chairman Wiley about rumors and allegations we've been hearing for about three years now that major automobile manufacturers and other electronic industries and associations thereof have been putting pressure on the FCC through the Office of Telecommunications Policy, and perhaps the White House itself, to take away from radio amateurs certain frequencies, particularly in the 220 to 225 MHz band, to provide a Citizen's Band, a new Citizen's Band for them, so that auto manufacturers can install factory two-way radios in automobiles. I wonder if Chairman Wiley could assure the radio amateurs tonight that frequencies will not be taken from their service to provide this new Citizen's Band."

FCC Chairman Richard E. Wiley: "Well, the Commission hasn't made a final decision on that. Let me say that there are a lot of problems in the 224-225 band, technical problems as well as policy questions, and I have

some personal reservations and doubts that we will ever make that decision, but the Commission has not yet made a final determination in this regard. I happen to think the next expansion of CB might well be at 900 MHz, but that's a decision down the, down the trail a bit."

I thought that you would be interested, as I am, in the FCC's current thought over the "224-225 band" proposal, and the possible pressures that are being brought to bear on this question. I feel somewhat heartened by Chairman Wiley's apparent personal resistance to re-allocate these amateur frequencies, but I wish that he had denied outright the rumors of strong political and industrial lobby pressures that I alluded to. I would feel so much better about our chances to preserve our amateur frequencies.

J. R. Johnson WA5RON  
Austin TX

### DX TKS

Greetings to all at 73 Magazine. Keep the good work going, it is the day of the month when 73 arrives. Please ask your advertisers to mention if they sell overseas. Hi.

S. K. Mogensen OZ6SM  
Aabybro, Denmark

### KEEPING UP

I want to report outstanding service from one of your advertisers — James Electronics, 1021 Howard Avenue, San Carlos CA 94070.

Please keep the digital stuff rolling. I didn't like it, but have realized it is a necessity, especially as I do some TV repair and new sets use more and more. If I don't keep up, using 73, I might as well retire. Thanks for the best mag in the field.

John P. Dieringer W6RVP  
Los Angeles CA

Here, here. — Wayne.

### ROLLING BILLBOARD

I thought I would drop you a picture of my second hobby. My rolling billboard is actually a 1961 Chrysler. The idea for the message came from you and your mag. The parking lot at the local asphalt oval looks like a 27 MHz antenna farm. I would say I have a pretty good "radio" audience.

I was going to run some 2m mobile on the track, but it gets awful crowded and everyone seems to be in such a hurry. Besides, the QRM is terrible!

Shown in the pic is my body (still in one piece), my trophy (amateur division), and my checkered flag. It is one of many wins (actually it's one of three).

The old asphalt oval is a lot of fun. I get into a lot of DX pileups on the ham gear on Saturdays and a lot of retaining wall (and misc. autos) on Sunday. I've never been hurt on the track, but I have gone through a few pair of skivvies.

Oh well, the racing is over for this weekend and this year. The "billboard" is safely tucked away until next year. I guess till then it's DX pileups all weekend. Ham radio is my #1 hobby: Richard Petty, eat your heart out.

Richard A. Zidonis WB8VBS  
Cleveland OH

### 13 DOWN, 21 TO GO

I just thought you would like to know that your code tapes are just great. I started with the six wpm, and had it down pat in about three weeks. Then I bought the thirteen wpm tape and in about one month I just could not copy it. I just couldn't get past the ten wpm hump. Then I bought the 21 wpm tape.

I drive around a lot and I took the tape with me. Instead of listening to the radio, I listened to that tape. About 3 weeks later I had the 13 wpm tape down pat. I have been listening to the 21 wpm tape every time I get a chance. I can almost copy it perfectly, but every once in a while I hit a bump, especially on the Zs, Gs and 4s, as they sound so much like 7s, Bs and Vs. Hi, hi!

I would like to know if you make or have a 25 wpm tape; if so, I would like to get one. I know if I listen to it, I will get the 21 wpm tape down pat.

My way of thinking is, if you can't copy 13 wpm, go to a 21 wpm tape. I got my Novice call on May 18, 1976, in less than five months, and your tapes have helped me so much I wanted to let you know about it.

Frederick J. Feddersen WN1YDC  
Londonderry NH

Sure, Fred, we have a 25 wpm tape, \$3.95 postpaid. Have fun. — Wayne.

### CQ DX, CQ DX

Please pass this information to all DXers.

We are once again on the YASME trail. This time our Worldwide YASME DXpedition is literally following in the footsteps of Danny Weil, the first radio amateur in the world to go forth on a sustained full-time DXpedition.

Like Danny, we are starting this episode of our DXpedition from the American Virgin Islands and under the guidance and help of Dick Spenceley KV4AA. Dick, who is now 71 years old, spends several hours on the air every day. Dick and his wife, Anna, are both very active and look and act much the same as they did when we visited the Virgin Islands 20 years ago.

We will remain here one month, operate all bands, phone and CW, signing W6KG/AJ3.

From here we plan to visit and operate from all nine of the VP countries. Watch for us and work us, but only one QSO per band per mode please.

Lloyd Colvin W6KG  
Iris Colvin W6QL  
American Virgin Islands

I'm jealous as all heck. — Wayne.

### SYMPATHY

After reading WB8SWD's letter and your response in November's 73, I could not resist getting into the act.

As one who has been an active amateur for almost 25 years, and who has been a close and concerned observer of the amateur scene even longer, I cannot but sympathize with OM Torossian's view.

What we really need is not large numbers of new licensees but more efficient frequency utilization by those presently licensed. I realize, of course, that getting amateurs to make more logical and effective use of the



amateur bands is probably a lost cause, but feel it worth the effort to try, rather than expend our energies recruiting more licensees who will probably follow the example of their peers and cluster in the same spots, compounding the problem instead of solving it.

And why must all newcomers "come into amateur radio via the lowband S800 transceiver route"? With home brew or kit-based equipment, a person can get started in amateur radio for a helluva lot less than \$800.

There are no easy solutions, but let's spend a little time and effort solving our present problems rather than rushing to create new ones.

Morgan W. Godwin W4WFL  
New York NY

*Trying to start a new trend, Morgan?*  
— Wayne.

### STILL WAITING

I just thought I would let you know that 73 is the best amateur radio magazine in the world! Yes — the world! I've had them from all over: Australia, U.K., Germany, U.S.A., Hong Kong. None comes close to 73.

The mail from Peterborough is good, too. I got May's issue in May, July's issue in July, and September's in September. I'm still waiting for June's issue of QST, and July's, and August's, etc.

Keep up the good work, and you can put my name on the list for the next 3 years.

Baden J. Melhuish ZL3THO  
Christchurch, New Zealand

### IMPRESSED

I have just received your November issue of 73 and wanted to say I was very impressed with it. Your articles on different computer and IC projects are very helpful to me as a beginner. Yours is the first magazine I have read that has a full catalog for another company. With that and your limit of just a few pages instead of half a book on the contest winners, I think I will have good reading for the next three years. Keep up the good work.

Les Sullins WB0KFK  
Kansas City KS

### BE CAREFUL

The audio of the TR2200A can be improved by a field modification — two 1/16 inch holes drilled in the back of the microphone.

I recommend that you take the back off the mike and drill the holes just above the "h" and "m" in the word "Dynamic," and then reset audio gain and deviation for a vastly improved radio.

Circuit boards, schematic diagrams, beautiful photos, and detailed instructions are not available. Just be careful — the microphone element itself does not need two 1/16th inch holes! Only the back of the case!

I enjoy reading your magazine.

Robert Behar WA4HCL  
Columbus GA

*Holy mike-ral. — Wayne.*

### DRAKE SCORES

What with all the publicity about the rip-offs by Trigger Electronics, I thought I would add my bit about a company that offers excellent service after the sale — R. L. Drake. I had occasion to utilize their service on my T4XC, which had developed a recurring problem with the balanced modulator, and I would like to reassure your readers that R. L. Drake Company certainly stands behind their products and really practices excellent customer service relations. Mr. Bill Frost of the Drake Service Department was most helpful and cooperative. I find it quite refreshing to find this attitude in a company in this day and age.

Mark Witmer WA6FXM/9  
Great Lakes IL

### THE VLF CAPER

I (and others) would like to see an article or two in 73 on construction of simple VLF (very low frequency) antennas and receivers or converters. And what, exactly, is propagation like at VLF? Believe it or not, it is very difficult to find anything on this subject, although I've found a few incomplete hints here and there. I'm certain that many 73 readers would be interested, provided they would be told as much as possible about the interesting, weird, secret and sometimes totally inexplicable things going on down at VLF.

It is theoretically and in fact possible to radiate any frequency above zero Hz as rf and to receive it — no matter how low. During WW II the sly Germans wrapped a one turn loop antenna around a mountain and keyed the 50 Hz power line into it through a transformer to send secret CW messages! This was transmitted as rf, not merely hum. It was quite some time before our agents learned of this, because almost no one (except the Germans!) had receivers capable of tuning down that low. The mountain happened to contain magnetic ores which improved the system gain.

Large VLF antennas can operate quite efficiently when buried and thus invisible (how many don't we see?).

Now the US government is equipped with VLF receivers and transmitters for certain special (and often secret) purposes. The Navy recently began using the 30-300 Hz band for communication with its

submarines, as this band penetrates water quite well. The Navy also uses other VLF bands. (And I meant 30-300 Hz, not kHz.)

A few years ago a US secret (CIA) agent was caught in Cuba sending secret messages by a complete VLF outfit in a briefcase. Obviously, these frequencies are still considered "safe" because of the general lack of VLF receivers.

Various natural objects in space occasionally generate weird VLF signals that sound like the sound track of a science fiction movie. Lightning also generates weird VLF signals, and the mechanism isn't completely understood.

WWV has an experimental outlet at 19 kHz and a permanent one at 60 kHz. Complex and comprehensive time codes are sent digitally, which should interest computer freaks. VLF is more reliable and provides higher accuracy than is possible with WWV's other frequencies.

Perhaps you have read some of John A. Keel's books and articles on UFOs and other paranormal phenomena. Keel knows one or two hams who have ancient WW One receivers capable of tuning down to about 3 kHz. Keel doesn't say if tubes (audions) were used in these particular receivers. However, tubes did exist during WW I, though they were very new. VLF was used extensively during the early days of radio communications. Some transmitters used mechanical ac generators putting out rf at below 100 kHz. This was not a spark gap system.

The fortunate hams with these ancient VLF receivers have received and recorded voice transmissions speaking no known Earth language! They are not Earth languages in code or Earth-language sounds in code. Occasionally it sounds like dogs barking to each other, but usually it is a definite but unidentifiable language. Expert linguists have listened to the tapes and have been unable to identify the languages used. Keel suspects that these transmissions are precisely what they appear to be — unearthly — that these are UFO communications, that the UFO entities know that we have very few VLF receivers.

Maybe our government knows much, much more about UFOs than they admit.

Designing a reasonably simple but reasonably sensitive and selective VLF antenna and receiver or converter would not be without problems. For example, it would be difficult to physically realize the tuning circuits with standard, readily available components. The coils would require far more inductance than is usually used in receivers and converters. (Early receivers often had huge coils.) This problem wouldn't be so bad if you want a single frequency receiver or converter, but I want one capable of covering the whole VLF range, so that I could tune around and perhaps discover something interesting. Neither would standard tuning capacitors be optimum for VLF. The solu-

tion might lie in one of the new techniques to synthesize inductance or capacitance.

Clyde E. Wade, Jr.  
Little Rock AR

*Sounds like a bunch of bat guano to me, Wade. And as far as tuning in audio frequencies is concerned, it doesn't take huge coils, only some audio transformers. Once you've received the audio signals from an antenna, they are audio signals. If you transmit them by ether via an antenna, then they travel at the speed of light ... if you put them in a loud-speaker, they travel at the speed of sound. If you detect the sound waves, you get audio ... and if you detect radio waves at audio frequencies, it should be audio. Is there something I don't understand? — Wayne.*

### HATS OFF!

Just a short note to let you know I appreciate and am wholly in favor of your attitude towards your advertisers. I'm particularly in favor of having your readers applaud the specially good ones.

In that category, here's some applause for Tufts. I recently made a couple of crystal orders to them, which were both delivered with what I considered amazing speed. On the second order I had a crystal which wouldn't net quite right so I returned it to them. I mailed it back from Arizona on a Monday and was absolutely amazed to have the replacement crystal back in the Thursday mail. My hat is off to Tufts — they have one satisfied customer.

Bill Hosking W7JSW  
Scottsdale AZ

### WARBLE, WARBLE

You can put Bullet Electronics back on your list of great people. Apparently the biggest problem I had with them was due to the mail system, as I got a refund check and a Warble Alarm for all the problems. It turns out they were out of stock on the product I ordered. Enclosed is a subscription request for *Kilobaud Magazine*.

Martin Peck WB0JMO/KG6  
Guam

*What do you do with a Warble Alarm on Guam? — Wayne.*

### COUNT YOUR BLESSINGS

Thought you might like to know what amateur radio in Okinawa, Japan, is like. I can speak only for American hams who are servicemen and women stationed here, but our brothers and sisters in the states have

*Continued on page 140*

# Another\* Christmas present for you

**SAVE  
with a**

**VENUS**

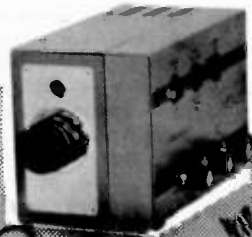
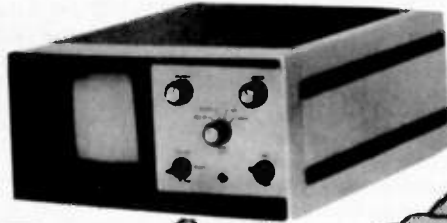

SS2K KIT ~~\$235~~ \$189  
or  
SS2 WIRED ~~\$285~~ \$225

C1 FAST/SLO'SCAN  
CAMERA \$385

**MONITOR**

**FEATURES:**

Oscilloscope display of SSTV signal  
Rugged — modular — industrial grade  
Modular Construction  
Independent easy to use controls

**CAMERA**

**FEATURES:**

Use C1 camera with your home TV set  
Has both long distance and close-up features  
Adjustable frame size  
Built-in slo-scan bar gen for transmit  
Focus on a postage stamp

**ACCESSORIES:**

P1 Polaroid adapter for hard copy photos \$34.50  
V1 viewing hood \$14.50  
T1 tripod \$24.95  
CK256 line conversion kit available

A-G Co., Inc.  
Imperial, Pa.

Amateur Electronics Supply  
Milwaukee, Wisc.  
Cleveland, Ohio  
Orlando, Fla.

Argon Electronics  
Miami Springs, Fla.

**AVAILABLE NOW:**

*Order factory direct or from our distributors. See Below*

A and W Electronics  
Medford, Mass.

Barry Electronics  
New York, N.Y.

CFP Enterprises  
Lansing, N.Y.

Electronic Distributors  
Muskegon, Michigan

Goldstein's  
Pensacola, Fla.

Harrison Electronics  
Farmingdale, N.Y.

Henry Radio  
Los Angeles, Calif.

Hobby Industry  
Council Bluffs, Iowa

Mr. Keith Roberts  
P.O. Box 677

Bedford, N.S.  
Canada B0N 1B0

## Venus Scientific Inc.

*The company that put high voltage on the moon, now brings you expanding amateur radio technology.*

399 SMITH STREET  
FARMINGDALE, N.Y. 11735  
PHONE 516-293-4100  
TWX 510-224-6492



\*THIS OFFER GOOD FROM NOV. 1 THRU DEC. 31, '76

# Looking West

Bill Pasternak WA6ITF  
14725 Titus St. #4  
Panorama City CA 91402

Those of you who happened to read my special article on total coordinated band planning last June may remember that I stated therein something to the effect that the multi-mode VHF transceiver would have a rather large effect on the operating habits of many an amateur. This innovation would not only put a bit of diversity into the aforementioned "operating habits," but would also call for a revision in our thinking in matters of VHF coordination so as to protect the integrity of all VHF special interests, not just VHF repeaters. Perhaps a better term than coordination would be band planning, total voluntary band planning from within the amateur community.

While the mail response to this article was about evenly divided, it seems that the greatest flack was received from "repeater people," both owners and users who felt that while coordination was important for their mode, the same did not hold true for other modes. On the surface, and most importantly by today's operating standards, a good part of their reasoning may hold merit. The opponents cite the fact that repeaters are coordinated to specific channel pairs, while other modes have the ability of a VFO to scamper about the band. Fine, but what these repeater people fail to understand (due mainly, I suspect, to lack of knowledge on the way these other modes operate) is that in many areas SSB is beginning to channelize itself in a similar way to the way FM and FM repeaters channelize. If you are involved in VHF modes other than FM, you will probably understand what I mean by "protected calling channels," "DX monitoring channels," "local rag chew channels," etc. In different parts of the country the terminology differs,

but the object remains the same: the setting aside of specific frequencies, mainly on two meters around 145 MHz, for a given specific use on a gentleman's agreement basis. Does all this sound a lot like both channelization and coordination? Are the similarities now a bit more evident?

I suspect that as more amateurs get their hands on these little gems, some form of "coordination" will take place, whether it's national in nature or just on a local level. However, we have a rather special opportunity right now, an opportunity to get those lines of communication built and to work together on a level not limited to the coverage area of our favorite repeater. We have an opportunity to plan for the future in a manner not normally within our reach. Getting to know one another on a local level is the first step, learning a bit about the other guy's favorite mode of operation is the second, and learning to interact with one another is by far the most important.

Call it band planning, coordination or what have you. For each mode and each special interest to assure itself of longevity and viability, "coordination" on some level will happen. Wouldn't it be nice, though, if we all got our act together and were the same nationally? To that small minority of "FM repeaters only" people who seem critical of the ideas of others, remember that those band planning other modes learned their act from what you have accomplished. You were the ones who succeeded in doing the impossible when virtually everyone thought it could not be done. You provided the leadership for yourselves, and whether you realize it or not, you seem to have done so for others. Your obligation is clear: to offer guidance to others when they request it, regardless of what mode they may operate. It's the unwritten obligation of the brotherhood upon which amateur radio is built. It's also

part of the challenge of amateur radio's future, and the official statistics seem to tell us that we're growing in number. Amateur radio going public through a rather well-coordinated public relations effort seems to have turned the tide. This means more amateurs and this in turn means more individuals involved in each mode. To VHF and UHF this means more repeater operators, more repeaters, more RTTY, SSB and probably even more AM among other modes. Even more ATV. Each group will indeed need spectrum and, by carefully planning now, we can make sure that it's there in the future. Think about it!

While on the topic of modes other than FM, and specifically speaking about two meter SSB operation, let me introduce you to a rather interesting group out of Fort Worth, Texas known as "Side Winders on Two" or, as they call themselves, simply "SWOT." Len Hoops W5JTA, SWOT Secretary, was kind enough to send me a press release about the DX accomplishments of his group and also put "LW" on their newsletter mailing list.

More about the DX in a moment, but first a bit about the group itself. These are a group of amateurs interested in seeing what can be accomplished without the use of a radio relay device on the two meter band: to see how far one can talk using other modes and operating procedures that can't be found on FM repeaters. They see this as an exciting challenge to their individual and collective skill, and this summer the perseverance of a number of their members paid off. On July 29, 1976, four of their number had the opportunity to make DX contact with a number of California stations. On the Texas end there were WB5MEV, WB5NLB, WB5ACO and Len W5JTA. The stations that they worked were WA6OOC, WB6HDB and WA6DVX in LA, as well as W6DPD in Fresno. In addition, the report continues that another SWOT member, WA5SMA, in Vernon, Texas also QSOed with WB6HDB, and K5UGM while mobile near San Antonio also worked a 6-lander. Bill Brady WB6HDB happens to be a friend of mine, and when I caught him on one of our local FM systems, confirmed his contacts.

In a rather beautiful letter from Len at a later date, he gives credit to the advent of the multi-mode VHF transceiver for providing more diversity to his operating habits and giving him the chance to get involved in SSB and two meter DX chasing. I have said many times before that a whole different world exists below 146 MHz and SWOT is another example of this. Just tune down there, or to six, or to the low end of 420 to see for yourself. Now ... part two of K3BNS in Los Angeles.

Even "Looking West" got its chance now and then to pose a few questions to John. Among them was one that I feel is rather important, because in my opinion John's answer

gives a bit of a hint as to what future reports on restructuring and deregulation might hold and, moreover, who will help him in formulating same.

My question was as follows: "10 meter repeaters are now legal; cross-band repeaters are legal; Technician class operators are coming out on 10 meters. Is anything going to be done about this and where does a Technician class operator sit if he happens to be on a repeater that is being repeated to 10?"

John's response was this: "We have an outstanding decision to make on 20282. You know that was very carefully labeled 'First Report and Order' (virtually everyone in attendance laughs at this comment) and that business of the 10 meters would solve a problem if we went ahead as proposed. (I must assume that this is a reference back to my question as asked and the content therein.) But I think there is another issue we've been kind of waiting to hear people start talking about, and that's with this newest change and the new structure we have, which I guess everybody's reasonably happy with. The only difference now between Technician and General is that code test ... telegraphy ... that's the only difference in the requirements. So what should be the difference in privileges? The communications act says that the FCC is responsible for establishing qualifications for radio operators and making sure the license (possibly licensee ... a case of tape drop-out muffled one word here) and the qualifications as established are consistent with the duties they have to perform."

Questioning John continues: "Maybe they should be given all the General phone frequencies ...? We thought that might be something that amateurs might want to cogitate."

Now back to some questions posed by others present: "There have been some bills in the Communications Sub-Committee (referring to Congress); one in particular is there right now about forcing the entertainment (electronic) industry to improve their designs so that they wouldn't be so subject to interference. I understand that the Commission has been asked a number of times in the past to present an opinion on these bills, either pro or con, and they failed to do so, and this has happened now for a couple of years. Do you know what's happening now on that?"

John: "Yes, they're waiting for the Congress to ask them what it is; they've been asked by everybody other than Congress, and it would be inappropriate or presumptive to comment on anything that is still in sub-committee. The Commission has not taken a position; I've heard it discussed both ways. The problem of susceptibility goes far beyond just television receivers and radio receivers and so forth. You know we have some unplanned receivers; I'm sure you've heard the stories about the public address systems, organs and stereo amplifiers in churches that pick up



Among the attendees was KTLA-TV personality Johnny Grant WA6MJV, here being greeted by Jim Hendershot WA6VQP of the SCRA.

some things at inappropriate times. Whether the Federal Government should be getting into regulatory matters to that detail in the present climate — well, I am sure you appreciate how that might be."

Question (same questioner pursuing the point): "Well, with all the RFI complaints I am sure are down at the office there in Washington, it would seem it would present a pretty good argument in favor of some more regulation on the (electronic) entertainment industry; at least someone should be made aware that this is available for Congress to look at."

John: "There would have to be a great deal of funds, of course, to make that system work. Our labs would have to be enlarged, for instance, and the staff enlarged, and standards set on all this equipment; they would have to be brought into the labs to make sure they meet all these standards and it sort of elevates that whole area maybe beyond what a lot of people think it should be; that's where the dilemma occurs."

For some reason, the subject of CB radio and the CB service was on many minds. A number of questions were asked about CB and CB expansion. Among them was this one: "I've read in the newspapers that 40 more CB channels (note the questioner's error in stating 40 more rather than 17 more for a total of 40) are being opened as of the first of next year. In view of the well-publicized chaotic conditions which have prevailed on the CB bands, and the amounts of illegal activity and the inability of the regulatory agencies to control this, what is the reason for giving CB even more channels than they have now. Can you answer that, please?"

John (his answer very concise and to the point): "Yes, that's what the public wanted and of course the Commission is there to serve the public."

Question: "Back on the subject of licenses: For instance, you have a mail-order license. As of the 23rd of July, you have grandfathered all Conditional Technicians to be as normal Technicians, is that right?" John responds affirmatively and questioner continues: "Since you are already a Technician, you've passed 5 wpm; do you have to retake the written examination when you go in front of the FCC examiner for your General?"

John: "No, you just come in and take your 13 wpm and then you get the General." Questioner thanks John and then John kiddingly adds: "Hope to see you there shortly." This brings a chuckle from the crowd and John continues: "I think we have come more than halfway; I think you ought to come a little bit too. The Techs I've talked to have all expressed their desire to move forward."

Question: "John, I'd like to compliment you on getting that Technician and Novice thing together; you know, the idea that the Technician now can also use code. I think we're all anticipating when the second shoe

will drop with regard to the other things that are in the cooker. Do you have any idea when we'll be getting some further information on some of the other proposals that have actually been sent forth?"

John: "Yes, you know we got that through. I had to literally stand up in front of the Commission and swear that absolutely nobody would be unhappy with those changes we made and I think that my credibility is still good, so maybe we can move on to some additional things. One I get asked about a lot is the additional phone privileges for Technicians; I think there are some sub-bands in there we propose to eliminate, maybe move down to HF and so forth. I know that all the Techs are interested in that, but I don't see all the hurry. I really think the Techs have made out pretty good in this; it's even easier to move up to General and so forth. I'm sure we don't want to have everybody take the Novice license, move on to Tech and then just stop. We want to leave a little bit of reason to move on up."

One particular questioner became involved in a rather interesting two-way Q&A period with John on the subject of willful and malicious jamming and what could be done by both amateurs and the Commission. Earlier, during the seminar, John had described working with the local FCC engineer in charge as a starting point, but the information garnered from this particular Q&A sub-section is particularly interesting. Here is part of it:

Questioner: "Many of your local police agencies have reserve programs; you have reserve officers and deputies. Is it conceivable, since you are a regulatory agency, to appoint Field Engineers (I assume that the questioner refers to appointment on a voluntary non-remunerative basis), either electronic engineers with many years amateur experience or perhaps people in the Department of Justice who can prosecute, or sworn officers of local police agencies who are also amateurs? Is there any such thing possible?"

John: "I don't know. That was brought up by several police officers on occasion to me and I've checked it out with our attorneys and they're not quite sure if the 'Act' does permit that or not. We've also thought about the creation of, for lack of a better term, the FCC Auxiliary. For instance, if we could set up a good system for giving examinations, then the field people wouldn't have to tie up the manpower; about half the manpower is tied up in giving examinations and answering questions for the public and so forth. That money could be reprogrammed toward straight hard enforcement work."

"I have heard the Chief of the Enforcement Bureau talk about this and ask what it would take: FCC, just tell us, how much would it take to clean out all of it? (I suspect this means all violators in both CB and amateur services). That's sort of a staggering thought. Maybe that's not

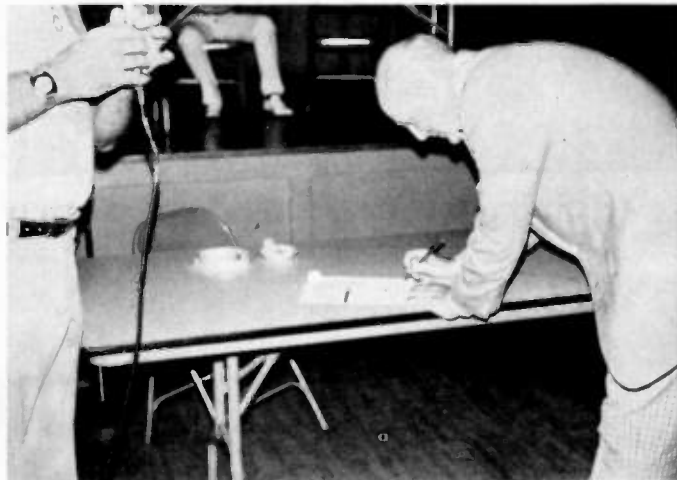

The S.F. Valley A.R.C. honored John by awarding him "honorary membership." Here John places his "Hancock" on the bottom line to accept this honor.

the way to do it. The best example I can think of is how amateurs do it; it's got to be a self-enforcement system if it's ever going to work. If you can't get people to realize that this is for their own benefit, then you can write all the rules you want, you can put all the policemen out there you want, and it's still not going to work. There are still going to be those bananas who cause trouble; and get on our repeaters and act out the writing on the wall's graffiti and all this other junk they do these days. So they are looking at other ways, particularly in CB, to try to convince them of more self-enforcement; they point at the amateur service as one example of how this works.

"One of the things they (I suspect this refers to questions asked by CBers) ask is 'What can we do?' Well, I think a lot of it has to do with the callsign. In the CB service it sort of grew up that you didn't use your callsign. You didn't identify to the world who you were. You became some mysterious stranger. You were anonymous and this raised the inclination to make mischief. Now, that has never prevailed in the amateur service. Amateurs have always been extremely proud of their callsigns and we probably do more arguing with amateurs about callsigns than any other thing. They're very, very proud; they listen to the 10 minute identification rule; some guys give their callsign 10 times in one minute (chuckle from the audience). And when you have a situation like that, where people are saying who they are and they're willing to stand up and identify themselves, they behave themselves. They're responsible people. And that's one of the things we always try to point out to the CBers: use their callsigns."

Questioner interrupts John and asks: "I would agree with you that amateurs don't want to be over-regulated; I probably could speak for everybody in the room for that. As you very well know, it doesn't take an amateur license to steal an amateur radio; they look in the car just like

those other radios. (John interjects the fact that his two meter radio had been purloined, then questioner continues.) They also got mine once, but the point is, that once he has got it and he can't sell it, he plays with it. This is mushrooming. The callsign means nothing; you have people who are amateurs, qualified for their license, who don't know enough not to talk to that individual and they create ten times the problem that would normally be."

John asks: "Is that really right? We've had that problem in our area and in just about every case the amateurs have been able to solve it."

Questioner continues: "We have a problem here in the Los Angeles area; it's been going on about 3 to 4 weeks now with two particular individuals who jump from frequency to frequency. We are just now, because of this situation, organizing a cross-frequency coordination which should have been done a long time ago. The problem is getting severe, in that the amateurs are adding to it with their own illegal comments." (Note: For those among you who are unaware, it is a direct and major violation of the rules and regulations to enter into QSO with or converse via the radio with a non-licensed/non-identified station.)

John interjects emphatically: "That does not work!"

Questioner: "Yes, but it's being done!"

John: "That's what they want; they want attention. If you let them do it; they'll just keep doing it." (Note: Remember that I have written in the past about never giving any form of recognition to one who willfully plays havoc with you on your favorite repeater? Ignore them; T-Hunt them down, what have you. But again — no matter how much it hurts, never give recognition and thereby an audience to a jammer — never.)

Questioner: "If we can't solve the problem, it will grow."

Continued on page 132

# BE MY GUEST

visiting views from around the globe

## In Pursuit of the HFers

Here at 73 we receive dozens of ham club bulletins and other publications each month. One of the newer ones we're getting is called *SSB News*, published in Daytona Beach FL. It's not for hams operating SSB... the 20 page magazine is aimed at people running SSB (and kW's) between the CB band and 10 meter amateur band.

*SSB News* is filled with advertising (ham transceivers, linear amplifiers) and advice to the so-called "HFers." "Your signals are heard in foreign countries... and when a ham reports a violation... heads will roll and tails will be busted!" warns an article entitled "Trouble Ahead." The author goes on to urge HFers to stick to the decision of the HF Regional Advisors meeting at Colorado Springs... that all HFers use 27.425 MHz and 27.325 MHz as calling frequencies, with 27.315 to 27.585 MHz set as the "HF band." There's even a VHFers organization, with calls and numbers... but, of course, no last names.

What does the FCC think of all this? Richard Smith, Chief of FCC's Field Operations Bureau (FOB), put it this way: "I've been given the task of

stopping the Atlantic Ocean from reaching the beach; I've been assigned one man with a broom... and he's sweeping as fast as he can." Smith says FOB has 4 teams of agents, five men to a team. That's twenty agents against more than 30 thousand illegal SSB HFers! What's more, the FOB now has less personnel than it did 28 years ago, before the communications boom!

Despite the odds, FOB has managed to make arrests and get convictions from federal judges. According to Smith, recent operations in Birmingham AL, Newark NJ, and Des Moines IA have nailed 23 HFers with fines and confiscated equipment in the thousands of dollars. As you read this, FOB agents, US marshals and federal search warrants are coming down on another group of illegal SSB operators. (More on the latest raids coming up.)

The FCC is concentrating on individual users, hoping to prosecute enough of the HFers to discourage growth of outlaw SSB. Normal practice is to send an FOB team into an area, monitor for several nights,

and pick out the worst of the bunch. Then the agents visit a local federal judge, obtain search warrants and US marshals, and make their raids about a week after setting up.

As Smith put it in our 73 interview, "We don't expect to ever have the resources to put a cop on every beat... a monitoring van in every city... but we do plan to use education and voluntary compliance along with the federal courts when necessary." Education and peer pressure turn out to be the FCC's best weapons, due to the extreme shortage of enforcement staff. Smith admits he is hard pressed, and agrees FCC can only concentrate on the "hard core" HFers, CBers and amateurs.

The amateur service has not been a major problem, according to Smith. Deliberate interference is probably the biggest amateur hang-up, with extreme difficulties in proving cases in court. Smith says FOB monitoring vans have spent weeks listening to suspected amateurs, only to come up empty-handed. The agents must be able to prove where the transmissions came from in a court of law. That

takes what Smith calls "close-in monitoring," and the record shows it's been a pretty hit or miss operation. (During the WESTCARS mess, several stations were "close-in monitored" for weeks, with only one license revocation resulting, and that violation was not directly related to the net interference problem!)

Net interference poses a special dilemma. Smith says there are really two sides to the story. The net feels that they have more right to the frequency, even in non-emergency situations, while the interfering stations view the net as an unofficial theft of frequency. Smith says it's a ticklish situation, which has to do with the nature of net operations and the difficulty of proving interference complaints. "Amateurs as a group must put their heads together and deal with it," says Smith, who admitted he did not have a solution. (Smith himself is an amateur.)

What can the amateur do about net interference and the HF bootleggers? Apparently not much. Despite published reports that amateurs played a role in the New Jersey busts, Smith says reports from hams can only provide an indication of the extent of illegal activity. Actual "close-in monitoring" is the only answer in Smith's view, although FCC is not about to turn down ham help. To the contrary, they are interested in any information they can get. The key is self-policing, and field enforcement against the "hard core" violator. Fortunately the amateur service has not required the kind of effort FCC is mounting against the HFers.

Incidentally, anyone wondering how the monitoring stations are going to tell Novices from the rest, now that WN calls are no more, can be assured FCC knows... each monitoring station has direct 24 hour access to the Gettysburg computer.

Warren Elly WA1GUD/1  
Associate Editor

## The 75m Follies

It's getting so that I am almost ashamed to tune across 75 meters in the evenings when demonstrating ham radio to a visitor. In case you weren't aware of it, there seems to be a group of individuals down there who feel they must use amateur radio as a platform to spew forth their personal political and sociological ideals, while using the guise of an "amateur net" as a cover.

I am even more angered by the "Priscilla Goodbody" brand of ham, who feels it is his duty to uphold

"motherhood and apple pie" by bending the law to his own means, and using his station to jam and harass the others. Frankly, I find the jammer even more disgusting than the rhetorician.

How, then, do you handle such a situation? First, we must realize that whether we like what is being said or not, there are laws that must be obeyed to protect all of us. We might not like what they are saying, but they are apparently operating within the limitations of their licenses and

therefore are legal.

There is a rather simple and obvious solution, one we have seen work on VHF repeaters time and time again. Obviously, for these people to keep it up night after night, they must assume that they have an audience. Thus, the attention rendered in the form of malicious jamming is like a "Linus security blanket." As long as there is jamming, the aforementioned hams will know that there are people listening, and will do their best to entertain the audience.

Take away the audience, and what do they have other than each other? Nothing... no reason at all to exist. Many repeater systems now instruct their users to ignore and boycott jammers. Why not apply the same logic to the 75 meter problem? We should exert peer pressure and create a no-hams-land at least 10 kHz either side of them... give them a clear berth to spew forth their rhetoric and hope that in doing so one of them will

make a slip and give the FCC monitoring facilities what they need to handle the matter.

Remember, no one is perfect, and though it may take some time, they eventually will make that slip. In the interim, the best thing we can do is make sure the rest of the world is made aware these people do not in any way reflect the feelings of the vast majority, and indeed that they in no way represent the true scope of interest and values held by American hams. If there is one tragic aspect, it is that those involved are amateurs. Both the rhetoric peddlers and jammers are the kind that will hurt us at the 1979 WARC, the kind of harm that might well spell an end to ham radio as we have all come to know and love it. We all agree that a way must be found to stop them, and taking away their audience, their very reason to exist, is the best alternative. It's in your hands.

Bill Pasternak WA6ITF  
Panorama City CA



In Los Angeles the emphasis may soon be shifting from counterfeiting to grand larceny and dealing in stolen merchandise, as the investigation of crime in the electronics industry mounts. The Los Angeles County District Attorney's office, already heavily involved in checking the affairs of Pacific Semiconductor in Inglewood, has launched a separate probe into the theft of computer circuit boards valued at 8.7 million dollars from Xerox Corp., El Segundo.

Other electronics companies, particularly in northern and southern California, are expected to aid in the investigation by revealing previously suppressed burglary information.

Early information indicates that US electronics companies have been plagued for the last five years by unsolved "inside jobs," many of which have been carefully shielded from publicity by the companies involved.

Although the investigation of possible crimes committed at Pacific is focusing on counterfeiting, a diary kept by private investigator Gary Williams also contains references to the marketing of stolen goods. Under-

In Chicago, at the Attorney General's office, Assistant Attorney General Howard Kaufman and his assistant John McPhee are swamped with mail. Kaufman heads the Illinois Consumer Fraud Division, and he's suing Israel Treger W91VJ. Treger owns Trigger Electronics, the target of scores of ham complaints. The fraud division has processed more than 200 from hams in all 50 states. The prime complaint is non-delivery of ordered items, despite receipt of cancelled checks from the buyer. The AG's office has asked the court to permanently stop Treger from doing business, and distribute his assets. McPhee says Treger used FCC listings of new licensees to ship catalogs, promising quick delivery and availability of several lines of amateur equipment. (A look at past letters to the editor column will indicate the results.) Trigger orders, when they were filled, took months. And more often than not they went unfilled.

McPhee told 73 his files show at least 3 years of mail order problems at

cover agent Williams was hired by Fairchild, Intel, Motorola, and National to infiltrate Pacific. (Signetics joined the group later.)

Williams started work on March 3. He delivered approximately 120 pages of commentary on the PSI operation to Robert Ewen, an investigator for the LA County District Attorney's office, on May 25. (Ewen has also been assigned to the Xerox case.) Search warrants were issued and PSI and two related companies were raided on June 3-4. According to Mitchell Harris, Deputy District Attorney for major frauds, the raiding marshals seized "equipment for the alteration or remarking of manu-

Trigger, and in early October his office filed an amended complaint, charging Trigger with false practices. It seems that Treger had agreed to pay off his creditors through a verbal arrangement with McPhee's predecessor, but failed to comply. As McPhee put it, "I saw a lack of action... and now it's time to go after him." On October 8th, the State of Illinois took that action.

The Federal Government may get into the act as well, on grounds Trigger may have violated section 5 of the Federal Trade Act. That is the so-called "Truth in Advertising" provision, which requires advertisements crossing state borders to live up to their claims. Trigger was reportedly given three weeks to comply, but legal observers say a Federal suit can be expected. The Post Office also conducted an investigation into Trigger, but reportedly decided not to prosecute, because they could not prove intent to violate the postal laws.

Hams who have lost money in the Trigger mess do have some hope to

factorer's markings on electronic components including grinders, buffers, die stamps, markers, scrapers, paint, paint removers, labels, insignia and logos." Reportedly, branding equipment for virtually every semiconductor manufacturer was found.

Williams claims that PSI upgraded low cost parts in addition to changing brands. He cites, in one case, the purchase of 12,000 inexpensive Solitron transistors, which were remarked and sold as RCA 2N3055 devices. Williams says that PSI also bought a portion of an estimated 100,000 Intel 1702 integrated circuits stolen by an Intel employee. He also claims PSI came into possession of an

Intel microprocessor development system that disappeared while en route from Mountain View to Culver City CA. The unit was seized by US customs officials as it was being reshipped to its Sao Paulo, Brazil destination.

PSI also had trouble with stealing by its own employees. In April it put on four armed guards for after hour patrol, following theft of 1702 ICs and other devices.

Richard Berger, the attorney for PSI president Jerome Friedman, says his client denies all of the allegations. Reprinted from Squelch Tales (from Electronic Engineering Times), August, 1976.

# Stealing and Dealing

## Targeted

collect, but they may not get a full refund. If Trigger filed for bankruptcy, for example, creditors could only expect to collect about ten cents on the dollar. (Legal sources in Chicago told 73 they fully expect bankruptcy.) Most of the Trigger victims are newly licensed hams, because of Trigger's use of FCC mailing lists. FCC spokesman Greg Jones told 73 the mailing lists are public information under the Freedom of Information Act, and are sold by an outside contractor.

73 tried to contact Treger, but was told he no longer worked for Trigger.

Attempts to reach him through other channels have failed. The man who answered the phone at Trigger refused to answer any questions about the situation, and referred us to "the legal department" at the company's River Forest address. We are still waiting for their reply.

Hams who have had problems with Trigger are advised to send copies of correspondence, cancelled checks, or any other relevant material to Howard Kaufman, Chief Attorney, Consumer Fraud Division, Attorney General of Illinois, 134 North LaSalle Street, Chicago IL 60602.

## Okino Tori Shima

The question of the Okino Tori Shima approval for the JARL 50th anniversary and the actions of the ARRL headquarters staff in bending the criteria to approve the "new" country status for this mostly submerged reef have been with us all through the spring of 1976. Bitterly

opposed not only within the JARL but by amateurs and amateur groups in other countries as well as within the U.S., many were waiting to see what the ARRL Board of Directors would do with the problem at their July Board of Directors meeting at Denver. If you are to read the official minutes,

you are going to be as much in the dark after finishing as when you started.

Using the now-familiar ploy of a "Committee of the Whole" to screen their actions, the official minutes give the following information.

15. On motion of Mr.

Price, VOTED at 10:25 pm, that the Board does now resolve itself into a Committee of the Whole to discuss DX matters, and that the Headquarters staff, exclusive of the General Manager and the Communications Manager, be excused. The designated people departed from the meeting. The Committee rose at 11:35 pm and reported to the Board.

That's it! All of it!

If you search the official minutes, a

Continued on page 18

## SPECIAL INTRODUCTORY OFFER

..... at a price YOU can afford!

# SCOTT COMMUNICATIONS SYSTEMS



**TOUCH TONE ENCODER** (Shown) Complete .... **\$52.95**

**RF ACTUATED CW MONITOR** –  
for the best in CW operating ..... **\$24.95**

**CRYSTAL CALIBRATOR** – 100, 50, 25 kHz ..... **\$19.95**  
range extended to 10, 5, 1 kHz ..... **\$24.95**

### RTTY OPERATORS

Digital Date-Time-Message Generator, UARTS.  
Quick Brown Fox Generator, many others.

### MICROPROCESSOR BUFFS

CPU, Backplane, I/O Memory, Timing,  
many others – boards, kits and assemblies.

### VHF-FM TRANSCEIVER

TT Pad Programmable, PROM selected Channels.  
Hi/Lo Power, PLL-5 kHz resolution.

Above available early '77, write for details.

Send 13¢ Stamp for latest catalog.

## SCOTT COMMUNICATIONS SYSTEMS

Box 2117, Dept. 7, Stamford, Ct. 06906 or  
Call (203) 357-1667

WHAT'S A

# Synthacoder



**ANNOUNCING: "Synthacoder 22"**

All New Synthesizer/Encoder from Engineering  
Specialties. The Ultimate in Frequency Control  
for ICOM 22-S Owners

- Front Panel Thumbwheel Control of All Channels!
- Fully Automatic Invalid Code Control!
- Small Size 3¾" x 1½" x 6"
- Factory Wired and Tested
- Brushed and Anodized Aluminum Case
- Highest Quality
- Easy to Install

Send check or Money Order To:  
**Engineering Specialties**

**ONLY \$74.95**

\$2.00 Postage & Handling.  
CA Res Add 6% Sales Tax.

P. O. Box 2233  
1247 Commercial Avenue  
Oxnard, California 93030  
(805) 486-0817

## TS-1 MICROMINIATURE ENCODER-DECODER

- Available in all EIA standard tones 67.0Hz-203.5Hz
- Microminiature in size, 1.25x2.0x.65" high
- Hi-pass tone rejection filter on board
- Powered by 6-16vdc, unregulated, at 3-9ma.
- Decode sensitivity better than 10mvRMS, bandwidth, ±2Hz max., limited
- Low distortion adjustable sinewave output
- Frequency accuracy, ±.25Hz, frequency stability ±.1Hz
- Encodes continuously and simultaneously during decode, independent of mike hang-up
- Totally immune to RF

Wired and tested, complete with  
K-1 element

**\$59.95**

K-1 field replaceable, plug-in, frequency  
determining elements

**\$3.00 each**

### COMMUNICATIONS SPECIALISTS

P.O. BOX 153  
BREA, CALIFORNIA 92621  
(714) 998-3021

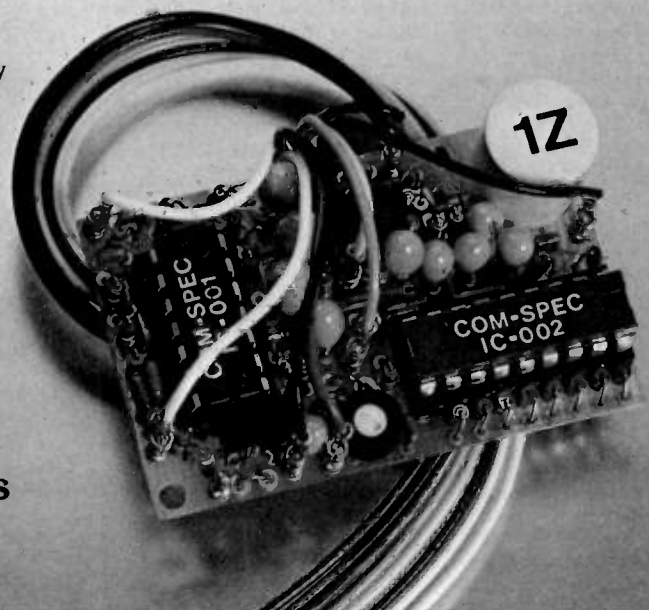

# SSTV BREAKTHROUGH



## Robot Model 400

All solid state—digital  
random access memory \$ **695**  
SSTV Scan Converter

- All solid state Random Access Memory.
- Slow-to-fast and fast-to-slow conversion capability.
- SSTV picture display on any standard CCTV monitor.
- Frame freeze from any standard CCTV camera, broadcast video or video tape source.
- Permanent picture storage.
- Automatic or manual TV frame snatch.
- Internal grey scale generator precision adjustment standard.
- Capable of real time display of digitally processed fast scan video.

The new Robot Model 400 Scan Converter eliminates the problems, the mystery, and the high price from SSTV, and makes operating SSTV fun and inexpensive for everyone.

Our new solid state design and random access memory make operating SSTV simpler than ever before. You send and receive sharp, clear, complete pictures that are easily seen on a conventional TV monitor under normal room lighting conditions, and can be stored indefinitely for later viewing or photographing.

Slow-to-fast conversion capability lets you view a received or taped

image as a whole picture on a conventional television monitor, while the fast-to-slow conversion enables you to use standard fast scan video (such as CCTV or television receiver) as a source for SSTV transmission.

Operation is easy to understand, simple to work. If you can operate a camera and adjust a TV set, you can operate the new Robot Model 400 SSTV Scan Converter.

Our new price is really a breakthrough! Now you can get into the fast growing SSTV activity for just \$695! (Plus CCTV camera and monitor.)

For the complete story on our new Model 400 all solid state-digital-RAM Scan Converter, write or call today for our new brochure.



**ROBOT RESEARCH, INC.**  
7591 Convo Court  
San Diego, California 92111  
Phone 714-279-9430

Please send me complete information on your new Solid State SSTV Scan Converter.

Name \_\_\_\_\_ Call \_\_\_\_\_  
Address \_\_\_\_\_  
City \_\_\_\_\_  
State \_\_\_\_\_ Zip \_\_\_\_\_

## BE MY GUEST

visiting views from around the globe

from page 15

bit further along you will find a minute which could be intriguing. This is Minute 40.

40. On motion of Mr. Price, seconded by Mr. Cotterell, unanimously voted that the Secretary is directed to prepare a comprehensive indexed list of standing instructions of the Board now in effect. The list shall be accompanied by

his recommendation for additions, deletions or changes as appropriate.

The report from the Committee of the Whole is not included with the minutes. It is presumed that as a committee report it will be available to the membership. However, if you are going to write for it, you will have to be specific, as there were a lot of "Committee of the Whole" actions.

Minute 7. Committee of the Whole to discuss staff mat-

ters.

Minute 15. Committee of the Whole to discuss DX matters.

Minute 17. Committee of the Whole to discuss Docket 20777.

Minute 43. Committee of the Whole to consider report of a committee appointed to prepare draft of League's position on FCC Docket 20777.

If one tries to analyze what took place, there seem to be indicators that more time was spent in trying to determine if the actions were procedurally correct rather than were the actions in themselves correct. The feeling is that the headquarters people were able to cite authority and

precedents for the actions taken and this is perhaps the basis for Minute 40. It appears that the Board wants to know just what actions, decision-making authority and policy decisions it has delegated to the headquarters staff on an open-ended basis.

As far as the question of Okino Tori Shima itself, the bending of the criteria to take care of another International Society, the twisted logic whereby an operation from the rocks at one time counts for Ogasawara but at another time for a "new" country has not been clarified. Certainly the plight of many concerned DXers is summed up in the quotation: "I call ... but no one hears ... no one answers."

Reprinted from West Coast DX Bulletin.

# Red Cross Emergencies

WCARS is participating in a series of meetings with representatives of Disaster Services in the Western Area Office of the American National Red Cross, the Military Affiliated Radio Services and the American Radio Relay League. These meetings are being held to clarify the ARC emergency communications needs during major disasters in the US and to set up effective coordination of the various radio services. Primary results of these meetings to date are as follows:

1. The territory of ARC, WA covers from the eastern border of

Montana to Guam on the west and from Alaska on the north to Palou Island in the south.

2. Based on availability, ARC uses communications systems in the following order:

- a. Commercial communications.
- b. Military Affiliated Radio Services through an understanding with the Department of Defense.
- c. Amateur radio communications.

3. The order of priorities for

Red Cross communications needs are:

- a. Communications between the ARC job administrative units in the disaster area and also with government agencies in the area to meet immediate life saving and life supporting needs of victims (short range usually).

- b. Communications between the disaster job headquarters and a Division or Area Headquarters to get essential outside support and to let the job know when support is coming in (usually long range).

- c. Communications between the job headquarters and the ARC Disaster Welfare Inquiry Center to procure and provide information on the location and welfare of victims in order to answer inquiries from immediate family members in or outside of the affected area (short or long range).

4. ARC plans to immediately assign a communications expert on major disasters to determine the needs and make arrangements for use of the appropriate services.

5. A joint committee will explore the feasibility of setting up an emergency communications team with readily transportable equipment and availability for immediate response in areas where adequate communication services are not available.

6. Discussions of disaster welfare inquiries (DWIs) from immediate

family members outside of the disaster areas brought out the following information on the Red Cross system:

- a. A DWI team is immediately assigned to set up a separate teletype equipped center, adjacent to the disaster area for collection of all information about the affected area and disaster victims, as this information becomes available.

- b. A moratorium on traffic is declared and remains in effect until the collection and communications systems are operable. This moratorium information is distributed by a teletype Disaster Welfare Inquiry Bulletin (DWIB) to all 72 ARC divisions, over 3,000 ARC chapters in the U.S. and all military installations with ARC field services (SMI). When the system is operable, the entire system is notified by DWIB of the location and terminal TWX.

- c. Inquiring immediate family members provide the local chapter or SMI office with the essential information on ANRC form 2079. The inquiry is forwarded through the system to the job DWI Center after the moratorium is lifted. The answer goes back through the same channel.

- d. Information concerning the moratorium time period, geographic areas affected and job terminal numbers can be obtained by contacting the local Red Cross. This essential DWIB information will be rebroadcasted by WCARS and other systems as soon as possible.

WCARS hasn't been called to bat yet. The major disasters so far have occurred outside the WCARS zone of operation. BUT, let's stay ready.

C. J. Weber  
Director WCARS

## Tough Break(er)

Clyde "Blue Rover" Rice was convicted of manslaughter Friday in the death of another Citizens Band radio operator after the two had argued over use of a CB channel.

Rice, 31, of Lincoln, Neb., was charged with first degree murder but the jury convicted him of a lesser charge of manslaughter.

Rice was charged with running down Donald "Bear Tracks" Edelman with his pickup truck in the parking lot of the Veterans of Foreign Wars hall April 10. Edelman died three days

later.

The two men, authorities said, had battled verbally over the air waves for several months over the use of CB channel 23. Rice was known by his nickname or "handle" of Blue Rover on the CB radio band and Edelman was called Bear Tracks.

Judge William Blue set bond for Rice at \$15,000 and continued the proceedings pending a presentence investigation.

Reprinted from the Pacific Stars and Stripes, July 27, 1976.

# Review

## NOVICE CLASS STUDY GUIDE

With the publication of the new *Amateur Radio Novice Class Study Guide*, 73 has again been able to maintain its lead in the amateur training field by keeping the content of its materials for prospective hams well ahead of the rest of the market. The new guide is the most up-to-date aid available to all those seeking a ham ticket. Right from the very beginning the materials are presented in a clear concise manner, making the complete understanding of Novice theory and the FCC rules and regulations as easy to the neophyte radio enthusiast as any learning experience could be.

In keeping with the FCC's move to include more advanced material on

the Novice exam, the new *Novice Class Study Guide* has been updated and expanded to include more detailed sections on radio wave propagation, filters, receivers and rectifiers.

The subject matter is arranged in such a way that one chapter feeds on the preceding and is a necessity for a complete understanding of the next. Starting off with a thorough description of the terminology one is to encounter in ham radio, the book proceeds through basic definitions of electricity, resistance, capacitance and inductance to simple circuits and applications of Ohm's law. The text then continues on through amplifiers, vacuum tubes and transistors to receivers, filters, rectifiers and transmitters. A thorough discussion of

radio wave propagation follows. The entire last section of the book is devoted to rules and regulations and includes the latest update from the FCC. Study questions and the essay tape are included and the book ends with one of those hard to obtain FCC 610 forms for license application.

The *Novice Class Study Guide* follows the philosophy of all 73 publications which are geared for license advancement, to teach the material and not run a series of vague questions and answers which is more conducive to memorization than to learning. It is a logical conclusion that much more enjoyment can be obtained from a hobby if the fundamentals of the hobby are thoroughly understood. A mere memorization of questions to pass the test is not enough for a long term enjoyment of the hobby and can become very sticky if the FCC pulls a "no-no" by rephrasing their questions.

A good understanding of the Novice test matter also provides an

excellent foundation on which to build for the General and Advanced class exams which will come later.

This guide is used in conjunction with the Novice code tapes, which are also produced by 73. There is no better teaching aid for the prospective Novice. The code tapes, which consist of a 5 word per minute learning tape and a 6 wpm practice tape, are the best on the market. The characters are sent at 13 wpm and the spacing between characters is at 5 wpm. This allows the beginner to learn the code only once and to accelerate progress toward General or Advanced (just close up those spaces).

As a package, the *Novice Class Study Guide* and tapes would make an excellent Christmas present. 73 also has special deals for clubs which are offering Novice classes. When it comes to studying for the Novice class amateur radio license, the materials offered by 73 can't be beat with currently available materials.

# Tracking the Hamburglar

**TAKEN:** One GTX-1T handie-talkie, s/n 10-59 with .13T/.73R, .25T/.85R, .52T/.52R, .72T/.12R. Taken from Genave Radio Expo '76 booth in Chicago, Sept. 18-19, 1976. Anyone with information on this radio is requested to contact the Genave factory. General Aviation Electronics, Inc., 4141 Kingman Drive, Indianapolis IN 46226, (317) 546-1111.

**RIPPED OFF:** Icom 22S, s/n 0017, channeled for: #1 16-76, 2 34-94, 3 22-82, 4 28-88, 5 52-52, 6 37-97, 7 07-67, 9 19-79, 12 25-85, 15 7.63-03, 17 7.87-27. Has total of nineteen channels programmed in first 20 positions, no channel 19. All above 15 are 147 meg. Ken Keyte W0TGL, 3812 Windsor Ave., Colorado Springs CO 80907.

**HIJACKED:** Icom 230 2 meter radio, s/n 240-2915, forcibly removed from vehicle in Fort Wayne, Indiana on September 4, 1976. Report filed with Fort Wayne police. Kenneth C. DeGroff WB9OCW, 62322 Oak Road, South Bend, Indiana 46614.

**RIPPED OFF:** Kyokuto FM-144 2m transceiver, s/n 6215. Stolen from vehicle at Los Angeles Coliseum on July 24, 1976. Contact Abel J. Tapia WA6FSZ, PO Box 414, Montclair CA 91763.

**TAKEN:** Wilson T1402 S/M 2 meter handie-talkie, s/n OR6427. Crystals for 52/52, 22/82, 25/85, 16/76, 34/94, 69/09. Stolen from James Hettle, PSC #1, PO Box 2493, Peterson AFB CO 80914.

**RIFLED:** Heathkit HW-202 with installed Tone Burst Encoder, TTPAD, six (6) sets xtals 34/94, 94/ , 25/85, 115/715, 28/88, 16/76 (switch indicates 04/64 but xtals are 16/76). My ssn 125-32-5960 on various parts internally including underside of trans and rec boards. Also stolen: Courier Comet 23 CB, s/n 12300643. Stolen from my parked auto in Garden City NY on August 30, 1976. If found, please contact heart-broken owner, David K. Gordon WB2YUJ, 155 Nimbus Road, Holbrook, NY 11741.

**STOLEN:** Drake TR-22 2 meter transceiver, s/n 640139, beige Trimline TT Handset, magnet mount quarter wave antennae. Crystals for 52/52, 16/76, 37/97, 87/27, 63/03, 34/94. Stolen from Rick Simpson K0UZP, 2723 Rigel Drive, Colorado Springs CO 80906, 303-471-2059.

**PURLOINED:** TR22-C s/n 850278; Swan 350 s/n C847975. These were taken from my automobile at the Northwest Plaza shopping center in

St. Ann, Missouri on June 24, 1976. Please contact W2ZKE, 1150 Staffler Road, Bridgewater NJ 08807.

**ROBBED:** One Tempo VHF/ONE 2 meter transceiver, s/n 5728. Also Western Electric touchtone pad. Stolen from car on August 20, 1976 in a San Francisco parking lot. Reward. Contact: Shel Kurtzman K6RMM, 19436 Topham Street, Tarzana CA 91356, or phone (213) 344-0878.

**RUSTLED:** Drake MN-2000 matching network, s/n 6485. Heath SB-650 frequency counter. Stolen on August 29, 1976 from auto in Rockland County. Please contact Cliff Cooley, Jr. WN2GHL, 4 Camp Hill Road, Pomona NY 10970.

**ROBBED:** Yaesu FR-101SD1G HF digital receiver, s/n 6C31339. Yaesu FL101 HF digital transmitter, s/n GE306276. Stolen from Associated Electronic Service, 404 Arrawana, Colorado Springs CO 80909.

# Ham Help

Does anyone have any plans or info for a good noise blanker circuit which will work effectively on SSB in a National NC300 receiver?

I would really appreciate any help on such.

Joe Demke W7KCF  
PO Box 182  
Vernonia OR 97064

I am in need of a service manual and/or schematic for a Lafayette HE45A 6 meter transceiver. A copy of same will do fine. Thank you.

W. A. Carl WA3YUB  
643 River St.  
Scranton PA 18505

I would like help getting my Tech license and info on 2m and above equipment. I'm familiar with computers. I have a 6800, 6502 and a TM9900, although I've had a 8080 system. I would like to hear from any ham who needs help with computers and could help me. Phone: (201) 343-8072. Thank you for your help.

Bruce Lill  
Apt. 17-A  
399 Prospect Avenue  
Hackensack NJ 07601

It was suggested I write to you on the subject of obtaining my Novice class amateur radio license.

Any help would be greatly appreciated. Thank you.

Ron Sklaver  
200 S. Middle Neck Rd  
Great Neck NY 11021

I am interested in putting an ATV repeater on the air and would like a group of 3 to 4 people interested in the same.

Earl Clark  
550 Fiske Drive  
Detroit MI 48214

We are in the process of adding autopatch to our new repeater. We have a good touchtone decoder which has a digital output in either decimal 1 through 10, or BCD weighted 1-2-4-8.

The problem? The dialer portion. We need the part that first will store

the seven digits as fast as they are entered and then pulse out the numbers at the proper rate and digit spacing for General Tel system. It should also not accept long distance numbers, by possibly storing a maximum of 7 numbers. Any schematics or other information that would help in the construction of this pulser (dialer) would be greatly appreciated. Thank you.

Jim Wagner WB8HFJ  
R #2 Box 49A  
Scottville MI 49454

I'd be glad to help anyone in the Pittsburgh area in their amateur studies - up to and including the Advanced Class.

Gregg Corsello WN3LDK  
226 Waldorf St.  
Pittsburgh PA 15214

# Novice Q&A

This column will be a monthly feature of 73 Magazine. It is hoped that it will be of assistance to beginners and old-timers alike. We only ask that your questions be kept as general as possible. We will try to answer all queries received. Please mail your questions to Technical Editor, 73 Magazine, Peterborough NH 03458.

**Q.** What is the best way to measure frequency drift on a transceiver?

**A.** The best way is with a good, commercial-type frequency counter. Be sure not to confine your drift measurements to one band or only one or two frequencies within a band — drift will usually vary according to frequency.

If a counter is not available, a good stable heterodyne frequency meter is needed. With both the receiver and meter warmed up (24 hours or more), put the meter and set on the same frequency and let both alone for a couple of hours. Then re-zero the meter to the receiver frequency. If your dial can be read closely, plot the difference frequency on a chart. Repeat with different frequencies.

**Q.** How can more uniform response be obtained from a pair of magnetic headphones having a dc resistance of around 4000Ω? At around 1000 to 1350 Hz they seem to be rather resonant.

**A.** Refer to the figure. Both treble and bass will be boosted some 16 dB with this circuit. Adjust the 750Ω pot to suit your individual listening pleasure. When the total resistance is in, the boost mentioned will occur.

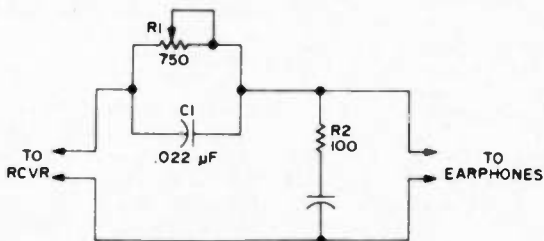

**Q.** Is there a practical circuit diagram for a simple SSB-CW noise limiter which is easy to install in a receiver which has a good product detector?

**A.** Semiconductor diodes may be used (see the figure) instead of a dual-diode tube, but they must have a high front-to-back ratio.

**Q.** What could cause TVI from a good-working communications receiver?

**A.** The high frequency oscillator has too much second harmonic radiation. To prevent this, tighten up the front panel screws; add external lockwashers under each of the rear chassis screw heads to insure a good metal-to-metal contact. Next, install a piece of heavy aluminum foil around the receiver chassis edges.

If these measures do not solve the problem, on some receivers you can solder a 1000Ω, 1/2 W resistor from the 10.30 MHz HF oscillator coil tap to the B-plus bus.

**Q.** How can coax cable be checked for moisture or leakage?

**A.** If a "megger" — an instrument that reads in the thousands of megohms — is not available, use a scope. If a scope is not available, a VTVM on the highest resistance range may work. With dry, well-insulated coax an infinite reading should be obtained with the VTVM. With a megger, the higher the reading the better. Connect any of the instruments mentioned between inner conductor and the shield to check for moisture. Make sure the inside of any connector used is clean and dry.

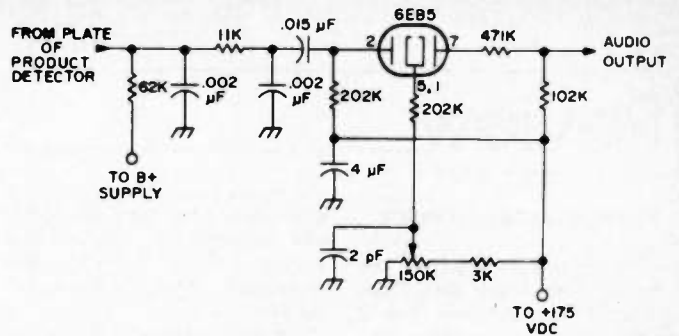

**Q.** When using an inexpensive vertical antenna, can radials be installed?

**A.** Yes, six or eight wires twice the length of the vertical can be installed in shallow trenches, and improved performance will be noted.

**Q.** What would cause the final plate current meter in a small transmitter to burn out, if it was not overloaded?

**A.** Switch connections should be checked for a possible short. In some sets, having no clamp tube, momentary loss or rf excitation can cause large current surges that can burn out a meter. If possible, replace the regular meter with an 0-500 dc milliammeter for reading total final plate current and watch for surges — especially when set is turned off and then turned back on while tubes are still hot.

**Q.** What is a good study guide for the Novice class amateur license?

**A.** The Novice Class License Study Guide, available from 73, is a very good reference, as it is by far the most up-to-date publication available on this subject. Other manuals and guides have not been revised nor sufficiently updated to include the latest changes in the FCC exams. The advantages of this type of guide are retention and complete understanding of the electrical theory, rather than hasty memorization of questions and

answers. There are similarly good books for the General, Advanced and Extra class licenses from the same source.

**Q.** How can spurious signal responses be attenuated at 21 MHz?

**A.** First, check receiver alignment. If this is correct (and frequently it isn't), connect a National R60-4 coil in parallel with a 51 pF variable capacitor. Now wire this combination in series with your antenna. This should provide up to 78 dB suppression of unwanted signals between 13 and 36 MHz.

Of course, you must adjust this circuit from time to time — depending upon the frequency you're listening to.

**Q.** Is there a simple circuit for a good rf output indicator?

**A.** To provide external control of the circuit shown in the figure, the pot is placed next to the meter and is used to adjust for maximum desired indication on the band used. If operation is mainly on the lower bands (80-40 meters), use a 7 or 12 pF in place of the 6 pF unit shown. The 6 pF is adequate for use on 20 through 10 meters. In some transmitters the "driver current" position of the meter switch can be used, inasmuch as it is not often used on SSB.

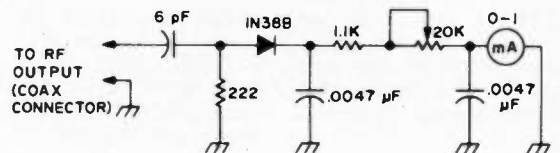

## FAST SCAN AMATEUR TELEVISION EQUIPMENT

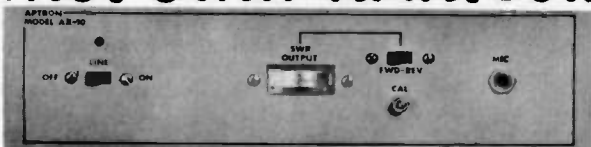

AX-10 TRANSMITTER



AM-1A RCVR MODEM

**BROADCAST  
QUALITY  
PERFORMANCE**

**Aptron Laboratories**

Box 323 Bloomington IN 47401

**SOLID  
STATE**

# ONLY HENRY RADIO OFFERS THE WORLD'S MOST COMPLETE LINE OF AMPLIFIERS



**30 MODELS! THE WORLD'S FINEST LINE OF AMATEUR AMPLIFIERS. BOTH VACUUM TUBE AND SOLID STATE...FOR HF, VHF AND UHF...FIXED STATION AND MOBILE ...LOW POWER AND HIGH POWER. NEVER BEFORE HAS ONE COMPANY MANUFACTURED SUCH A BROAD LINE OF AMATEUR AMPLIFIERS**

## 2K-4...THE "WORKHORSE"

The 2K-4 linear amplifier offers engineering, construction and features second to none, and at a price that makes it the best amplifier value ever offered to the amateur. Constructed with a ruggedness guaranteed to provide a long life of reliable service, its heavy duty components allow it to loaf along even at full legal power. If you want to put that strong clear signal on the air that you've probably heard from other 2K users, now is the time. Operates on all amateur bands, 80 thru 10 meters. Move up to the 2K-4. Floor console...\$995.00

## 3K-A COMMERCIAL/MILITARY AMPLIFIER

A high quality linear amplifier designed for commercial and military uses. The 3K-A employs two rugged Eimac 3-500Z grounded grid triodes for superior linearity and provides a conservative three kilowatts PEP input on SSB with efficiencies in the range of 60%. This results in PEP output in excess of 2000 watts. It provides a heavy duty power supply capable of furnishing 2000 watts of continuous duty input for either RTTY or CW with 1200 watts output 3.5-30 MHz.....\$1395.

## 4K-ULTRA

Specifically designed for the most demanding commercial and military operation for SSB, CW, FSK or AM. Features general coverage operation from 3.0 to 30 MHz. Using the magnificent new Eimac 8877 grounded grid triodes, vacuum tune and load condensers, and a vacuum antenna relay, the 4K-ULTRA represents the last word in rugged, reliable, linear high power RF amplification. 100 watts drive delivers 4000 watts PEP input. Can be supplied modified for operation on frequencies up to about 100 MHz. ...\$2950.00

## TEMPO 6N2

The Tempo 6N2 brings the same high standards to the 6 meter and 2 meter bands. A pair of advanced design Eimac 8874 tubes provide 2,000 watts PEP input on SSB or 1,000 watts on FM or CW. The 6N2 is complete with self-contained solid state power supply, built-in blower and RF relative power indicator. ...\$895.00

## TEMPO 2002

The same fine specs and features as the 6N2, but for 2 meter operation only. ...\$745.00

## TEMPO 2006

Like the 2002, but for 6 meter operation. ...\$795.00

## TEMPO VHF/UHF AMPLIFIERS

Solid state power amplifiers for use in most land mobile applications. Increases the range, clarity, reliability and speed of two-way communications. FCC type accepted also.

Model	Drive Power	Output Power	Price	Model	Drive Power	Output Power	Price
<b>LOW BAND VHF AMPLIFIERS (35 to 75 MHz)</b>							
Tempo 100C30	30W	100W	\$159.	Tempo 100C10	10W	100W	\$149.
Tempo 100C02	2W	100W	\$179.				
<b>HIGH BAND VHF AMPLIFIERS (135 to 175 MHz)</b>							
Tempo 130A30	30W	130W	\$189.	Tempo 80A02	2W	80W	\$159.
Tempo 130A10	10W	130W	\$179.	Tempo 50A10	10W	50W	\$ 99.
Tempo 130A02	2W	130W	\$199.	Tempo 50A02	2W	50W	\$119.
Tempo 80A30	30W	80W	\$149.	Tempo 30A10	10W	30W	\$ 69.
Tempo 80A10	10W	80W	\$139.	Tempo 30A02	2W	30W	\$ 89.
<b>UHF AMPLIFIERS (400 to 512 MHz)</b>							
Tempo 70D30	30W	70W	\$210.	Tempo 40D01	1W	40W	\$185.
Tempo 70D10	10W	70W	\$240.	Tempo 25D02	2W	25W	\$125.
Tempo 70D02	2W	70W	\$270.	Tempo 10D02	2W	10W	\$ 85.
Tempo 40D10	10W	40W	\$145.	Tempo 10D01	1W	10W	\$125.
Tempo 40D02	2W	40W	\$165.				

## TEMPO 100AL10 VHF LINEAR AMPLIFIER

Completely solid state, 144-148 MHz. Power output of 100 watts (nom.) with only 10 watts (nom.) in. Reliable and compact ...\$199.00

TEMPO 100AL10/B BASE AMPLIFIER ...\$349.00

please call or write for complete information.

# Henry Radio

11240 W. Olympic Blvd., Los Angeles, Calif. 90064 213/477-6701  
931 N. Euclid, Anaheim, Calif. 92801 714/772-9200  
Butler, Missouri 64730 816/679-3127

Prices subject to change, without notice.

The popularity of push pull circuits in rf amplifiers dropped off shortly after World War II. The use of the pi network pretty well solved the harmonic problem, worked well with a single tube or two tubes in parallel, lent itself to bandswitching, and used a few less components. However, with the advent of TV, everybody started putting low pass filters in the output line anyway, so we are just about back to where we started from. So let's take a look at push pull again.

The number one objection to push pull seems to be the necessity of an input tuned circuit to get the grids 180° out of phase. As will be seen later, this problem has been eliminated. Secondly, the push pull circuit does not lend itself to bandswitching. This is true, but there are people who are interested in one band only. Also, with a small compromise in L/C ratio, you can cover two bands with one coil. This is especially true if the two bands happen to be 15 and 20 or 10 and 15. You can even cover 10, 15 and 20 if you prune very carefully and use a fairly sizable maximum capacity tuning capacitor. Another possibility, the one used in this article, is the National all band tuner,

Bob Baird W7CSD  
3740 Summers Lane  
Klamath Falls OR 97601

# Build This Inexpensive 400 Watt Amplifier

## -- a pair of shoes never hurts

Photos by Gary Gray

which does away with bandswitching entirely.

Of recent date the grounded grid circuit has come to the forefront. It requires no neutralizing and is ideal for the exciter that already has considerable power output. How about a push pull grounded grid? It ought to work fine, but we have all of that circuitry mentioned above. It ain't necessarily so! It occurred to

me that since this is a low impedance circuit to the input, a 4:1 balun could be used to get the push pull excitation. Accordingly a two inch toroid core was ordered from Amidon. Upon receipt of same, we wound 8 turns of 72 Ohm ribbon (receiving type) on it, as per page 162, 1975 *ARRL Handbook*, and discovered that the drive to the grids was about the same as that derived from a tuned

circuit. And it works on all bands.

The circuit in Fig. 1 will work at any power level but in this design three restraints were imposed. First of all, the all band tuner is rated at about 1500 volts, and it was desired to voltage double an old TV power transformer for the dc supply which also comes out about 1500 volts. Secondly, the box to be used was of limited size, so the number and size of components had to be kept at a minimum. Last but not least, operation without a fan was desired.

Grounded grid with a filamentary cathode is a headache because you need to have big, bulky, hard to mount, filament rf chokes which are expensive if you buy them ready-made. An indirectly heated cathode is much to be desired. A pair of 7094s was on hand. These were ideal except at 1500 volts they don't operate at maximum ratings. Several power tubes with indirectly heated cathodes and higher dissipation ratings have come out recently. Obviously many of the TV tubes could be







used in the circuit, operated at lower voltage and power levels.

Fig. 1, using the all band tuner, was selected. Trial one did not include the ferrite beads and trouble with parasitics was experienced. Beads were added to the grid circuit primarily because the grids were easy to get at. Beads in the plate circuit might be better. Ordinary parasitic chokes with shunt resistors will do the same thing. Beads seem to be the cheap and easy way to do it. At any rate, the parasitic problem was solved. The plate circuit-pickup coil was tapped and the taps connected to a rotary switch. This gives adjustable loading ability. If you have a set of BC 610 plug-in coils with a swinging link, you get the same effect, only it is continuously variable.

The unit shown in the photos uses a box left over from some former project. It is in the vertical position shown because of the National all band tuner which fitted best this way. All of the power supply is in the bottom. The rectifiers are actually 5 1000 V piv diodes on each side, without any

voltage dividing resistors or capacitors.

At 10¢ each, it's too much trouble to add resistors and capacitors. Just put in twice as many diodes as required for the voltage. It saves space. The front panel is a piece of aluminum sheet from an off-set printing system common to many newspapers. You can buy these sheets for 25¢ each and they yield nearly two square feet of aluminum. They are pretty thin but, as in this case, will cover an old panel with the holes in the

wrong places. The switches are ordinary toggle switches mounted on the grounded front panel. There has been no voltage breakdown to date. You could mount them insulated but then touching them might be an electrical hazard.

If you use the all band tuner, you should carefully check the output frequency with a wave meter (grid dipper on diode position). Make sure you have the right band and mark same on the dial. For example, the 40

meter and the 15 meter points are close together. You could be tuned to 15 when you think you are on 40 if you are not careful.

## Results

With the restraints listed, we were able to get about 400 Watts dc input (800 Watts PEP if you like that definition). This would be a very effective setup for an SB 33 or SB 34 or other transmitter in that size range. The Argonaut is a little small, but it yielded about 50 Watts out. This corresponded to about 150 Watts input – practically class A.

An SB 10 was also tried, and yielded about 300 W dc input. An FT 101 is actually a bit too large for a driver; you can't run it full bore. The output of the linear is only about 2½ times the full output of an FT 101. You need to have at least a 4 to 1 step up to make a linear worthwhile. If the same linear were built with a 2000 volt supply and 2000 volt components, the FT 101 or similar would be about right.

If you are not limited by space or circuit considerations, a linear of this kind would easily run full legal power when driven by a standard transceiver.

Try a push pull grounded grid. ■

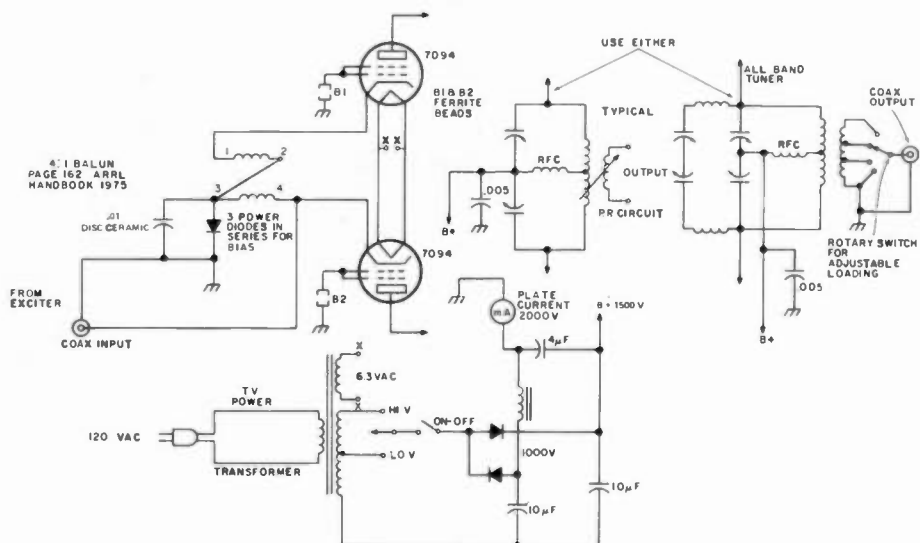

Fig. 1. Push pull grounded grid linear.

Just for sheer bulk and apparent circuit complexity, the actual counting and digital readout circuit of a frequency counter is enough to turn most amateurs off on sight.

As this often is the largest single part of a counter or most other equipment using such a readout, when you get scared off by this you don't bother with the rest of the equipment either.

This is a shame, because once you understand this part of the circuit, almost half of the piece of equipment will fall into place in your mind.

Just as with the timing chain, the readout chain can be broken into bite-sized pieces which will put the whole thing into simple perspective.

When you understand one

digit in the readout, you just about understand them all. When you are looking at this mammoth wad of ICs, you are really just looking at the same thing repeated over and over again. It really is that simple.

To understand what this circuit is, we will concentrate on just one digit with a simple circuit that is very easy to duplicate if you have an IC test setup.

While there is a whole fund of complex information available on how the ICs involved perform their task electronically, this is unnecessary for your purposes.

You don't have to know how the ICs do the job — that's their problem. What you want to know is how to make them do the job for you.

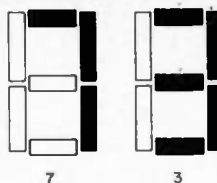

Fig. 1.

To do this, it helps to think of a digit of readout as consisting of three parts. Whenever you need a digit you will think of these three parts automatically.

We will start with the end result, the numerical readout itself. Since the IC field changes so fast, what is available has changed rapidly in just a few years.

Some of the older circuits relied upon two types of readout devices, individual indicator lamps (ten per digit)

and the "Nixie," which was a neon type of tube. These were both clumsy to use and are no longer in common use.

The thing that made the difference was the sudden availability of LED readouts at a cheap surplus price.

The name LED stands for Light Emitting Diode. It does just what its name implies. It is a diode that lights up when current flows through it. The higher the current, the brighter the light, up to the point where it gets damaged by too much current.

These are also known as seven segment readouts. This is because there are seven individual segments made from LEDs that form the number. The various digits are formed from selected combinations of the LEDs, giving the numbers that distinctive computer look.

Fig. 1 shows two numbers as they would look when lit. This is the simplest recognizable method to get all of the numbers.

As we are talking about diodes, they have many characteristics in common with all other diodes. They have an anode and a cathode.

In operation, the readout is either of the common anode or common cathode type. This means all of one or the other are returned to the same point. This is important to keep in mind when coming to part two of the hookup.

Fig. 2 shows the block diagram of the three parts of the circuit. The middle part is the driver for the readout IC. This and the readout are sort of a matched pair.

While there are a number of readouts available, there seems to be a favoring of the MAN-1 type. This is also similar and interchangeable with the SLA-1 and the Data Lite 707. They are all of the common anode type.

These are usually driven by the SN7446 (or just 7446) driver IC which is designed for this service. The generic name for this type of IC is the BCD to seven segment decoder/driver. The BCD part

# How Do You Use ICs?

- - part V

will be explained shortly, but let's start with the driver part.

It is the job of the middle IC to take information supplied to it and light up the correct segments to form the required number. This is why it is called a decoder/driver.

Fig. 3 shows its hookup to the readout IC. This seems quite complicated but it really isn't once you understand about those resistors.

The diodes require a certain amount of current to light up, but with too much they will be destroyed. The one in the test unit was rated at fifteen mA per segment (or a total of 105 mA for full brilliance).

One of the things that increases the value of a readout is that it requires less current than another. Five of these is half an Ampere. There are ways around this.

The primary purpose of the resistor is to limit the current to each segment to a safe value. Notice that all of the resistors are the same value. In a multi-digit display all of the other resistors in this position will be of the same value.

This usually will not be critical, within reason. Typical values range between 220 and 1000 Ohms at a quarter Watt. The higher the value, the dimmer the display (but the less the current).

These resistors are cheap (in quantity) when you go to put together a full display, so don't worry about the number. Once you realize that you are just repeating the same thing, it makes wiring easier, too.

The readout does what it is told. It gets its orders from the decoder/driver. The driver is told what to do by the third element of the circuit, which is the counter IC.

(While it is not part of the counting circuit, most LED readouts have at least one decimal point either to the left of the digit or to the right. Some have one on each side.

This is fed from the same Vcc source as the readout,

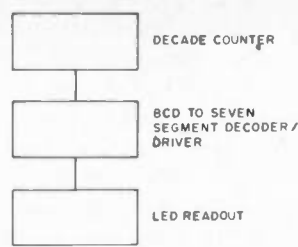

Fig. 2.

and commonly has the same value of limiting resistor in series with the Vcc voltage. The pins may be located by applying the voltage through a resistor to the "extra" pins and seeing what lights up.

The decimal point has nothing at all to do with the counting circuit. It is arbitrarily selected by switch action.

The position is chosen at a certain point on the display by the requirements of the value the display is showing. Thus a four digit display showing Hz would display 2100 and the same display set to show kHz would display 2.100.

This is usually done by a multi-gang range switch. While other sections are selecting the electronics for the given range, one gang is used to select the required decimal point position on the display and illuminate the correct decimal point for the range.

This action is completely independent of the other electronics of the counter. It is all done by the switch.)

Most of the counters use the 7490 decade counter IC. This has been shown previously in its application as a frequency divider, but its main purpose in life is to count.

The internal process is highly complex, but for our purposes there are only a few things to keep in mind about what it does.

It counts. That is, every time it is pulsed it produces an output to identify that pulse as part of a sequence from one to ten.

At the tenth pulse it performs two functions. It starts in at the beginning of

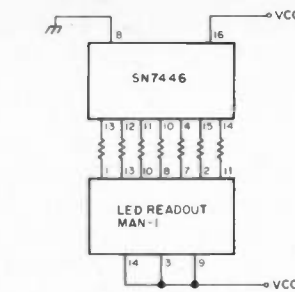

Fig. 3.

the ten count sequence and it produces a pulse to go on to the next link in the counting chain.

So for every ten pulses, it produces counting information for the decoder to use and one output pulse for the next stage.

And now a word about BCD. The decoder/driver was listed as a BCD to seven segment decoder/driver. As a previous article mentioned, many of the pins have letter names relating to their computer function. The particular outputs of the 7490 that go to the decoder/driver are labeled A, B, C and D.

Putting the whole thing together will give you the electronic capability to count and display pulses. Fig. 4 shows a very simple circuit which can duplicate the action of the larger equipment.

This circuit will actually show the numbers in order on the readout. It is a simplified circuit and not quite what you will get in an actual counter. There are some fancy improvements built into the ICs that were disabled for simplicity. They will be discussed later.

First, the counting action. Notice pin fourteen in the schematic. This is the 7490 input pin. The pulse input to here is what gets "counted" by the IC.

The purpose of the pulse is to key the IC and make it work. To work, the IC must be turned on and off. It does this by being switched between a high state and a low state.

Usually the 7490 is

switched by an IC gate in a counter circuit. In this circuit a 7400 gate is hooked up as a "bounceless switch" to pulse the counter IC.

The reason for the bounceless switch is to produce a clean pulse for the 7490. If an ordinary switch were used, it would have a slight amount of contact bounce (that is, the switch contact would not just make one clean contact but would mechanically make and break slightly before coming to final rest). For many purposes this would not even be noticed by the circuit, but the IC counter is a very high speed sensing device and will actually count these extra pulses.

So the 7400 is used to switch the 7490 cleanly. An SPDT switch can be used to control the 7400. This can be the momentary contact push-button type or the ordinary type. The push-button will perform the reset operation of the 7400 automatically. Otherwise, the operation will have to be done manually.

The 7400 switch is actually a form of flip flop circuit. When it is pulsed it goes from its original state to the new state and remains that way until switched back. Thus, to continue to pulse the 7490, the 7400 will have to be reset to its original state for each new output pulse.

The test circuit didn't even use a mechanical switch for the 7400 — just a clip lead which was switched between the correct IC terminals to affect the 7400 switch action.

When you change to nine, the next number will be a return to zero. Then the counting cycle begins all over again. These are the basic mechanics of the numbering system. You next have to learn to count with it.

With a little practice you will be able to pulse the 7490 quite quickly, particularly if you use a switch rather than a piece of wire. For the sake of example, let's assume that you can get only three pulses per minute.

With this circuit, in the first minute you would reach the count of three. In the second minute you would reach a count of six and in the third a count of nine.

This circuit can be thought of as a basic event counter. It will go on counting how many times something pulses it until it runs out of numbers.

Even with just a simple event counter, there comes a time when you want to be able to reset the circuit to zero to start counting from that point again.

With this simple circuit, this can be done by turning off the Vcc voltage and turning it back on again. This will return the readout to zero, but it would be impractical to do this with many actual working devices. It would upset too many other internal circuits.

What is needed is a reset circuit. Fortunately, such a problem was thought of by the designers of the device, and there is a built-in answer. There is a reset circuit within the 7490 that does the very thing needed.

Actually there are two built-in reset circuits, but the one we want is called the zero reset. There are two pins for this, pins two and three.

The operation of the circuit is easy to duplicate in simplified form with the modification shown in Fig. 5; however, it may not appear exactly the same in actual use

because it will not be performed in this manner. The principle is the same, though.

The only thing changed is that pin two, which was grounded, now has a switch in the circuit. Pin three is unconnected and left floating. Only one pin is needed here to control the reset action.

Assume that you are still pulsing the counter at the rate of three counts per minute. At the end of the minute you push the push-to-break switch at pin two and release it before the next counting pulse. This will cause the readout to return to zero before the next pulse, so that the count will again pick up with one and count on from there.

In a real frequency counter circuit, there will be a pulse supplied from the timing chain to perform this task. It will also "gate" the counter (in other words, apply the signal to be counted to the counter for a specified amount of time and reset the circuit to provide a continuously updated count).

As this must be done in microseconds or so, it sounds like it would take some doing, but the circuit is usually just a few IC sections.

Using the push-button at any time will return the readout to zero. This is how things like elapsed time circuits are reset.

There is one other reset circuit built in which you should know about, although

it has yet to find common use in any amateur application.

Just as pins two and three control a return to zero circuit, pins six and seven comprise the same reset feature to return to nine. It works the same way and the effect can be shown by grounding two and three, leaving either six or seven floating and switching the remaining pin from ground as was done with the zero reset pin.

That's it for the basic operation of the counter part of the circuit. There is another feature of the decoder/driver that is commonly used and should be understood.

Left to its own when properly hooked up, all of the digits in the display would light up as zeros. This would be OK if the frequency was 1000 Hz, for example, but could be confusing to the eye if 20 Hz registered as 0020.

Considering how much the 7490 does for you, it would be unfair to expect it to attend to all the little details, so the feature that deals with the zeros is built into the 7446 decoder/driver.

It is called zero blanking. It's not necessary to go into detail about how it is done, but it is important to know which pins are used and how to make them do the job.

Fig. 6<sup>1</sup> shows part of a larger digital readout. This is virtually identical to the one digit circuit already shown. The basic differences are just the mechanical ones caused by the physical hookup of the circuit and the additional built-in features to be used.

Notice in Fig. 4 that pin five is connected to pin 16, the Vcc source pin. This is one of the pins in the zero blanking circuit that was disabled for the test circuit.

In Fig. 6 it is connected to pin four of the following IC package in order to do its job. The circuit starts with the highest significant figure (extreme left of the decimal point) and works towards the

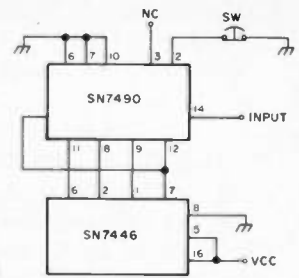

Fig. 5.

right (decimal point).

If the most significant digit is a zero, the circuit will blank it out and continue until a decimal position shows a number other than zero. It will not blank out the zero in a number like 101, but 001 would read as 1.

For several reasons, you probably will not see an actual circuit just like this one. It is not normal to blank out digits on such a small readout, and the least significant digits of a larger readout would not use the feature. They would be connected to read normally.

These are minor circuit considerations which can easily be seen by inspection of the schematic. Once you know what you are looking for, or at, it is easy to understand.

The least important digit is very important to the circuit operation. This is the one immediately to the left of the decimal point. Even though it may only be tens or hundreds of cycles per second, it has a major effect on the operation of the whole circuit.

The frequency to be read is fed to the least significant decimal place first and works its way up the chain. This is very important.

It does not go from the most significant figure and work its way down. From a practical viewpoint this means several things must be taken into account.

Even though it reads out to a lowly place on the scale, this first IC may determine the highest frequency that the counter can count. It will be operating at that frequency and dividing it down from there.

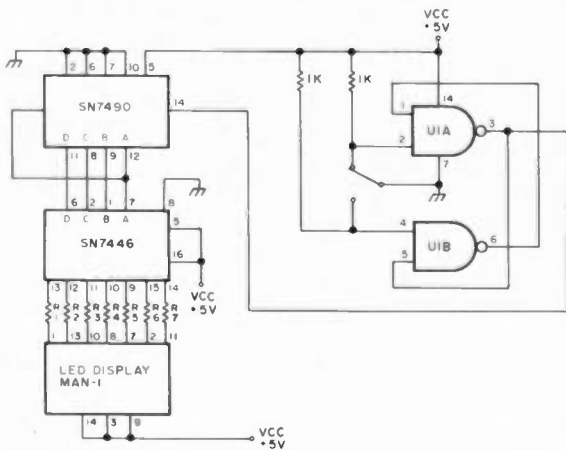

Fig. 4. R1-7: 220 to 1000Ω ¼ W. U1: SN7400.

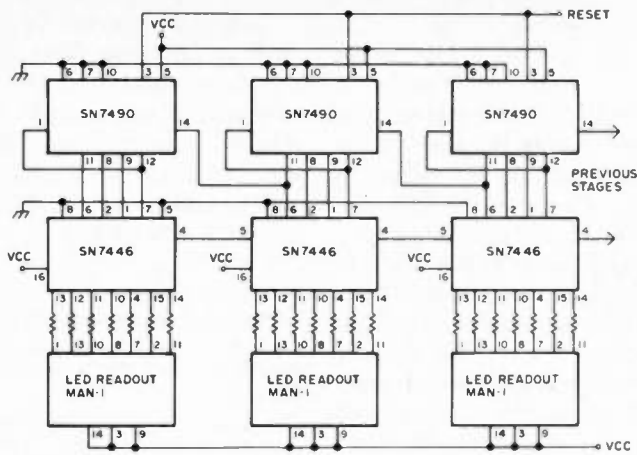

Fig. 6.

It is not common to see a counter using the 7490 in this position. It's too slow. It is only expected to work at around 20 MHz. While a selected IC might be able to go higher, the usual thing that is done is to use a high speed decade counter in this position.

As this may not be the same thing electronically, it will spoil the symmetry of the circuit visually and you will have to watch the wiring carefully. That is all it will be, though, and when you watch for it there should be little trouble understanding the differences from this simple circuit.

It is time to go a little more deeply into what is happening around the readout section and controlling it from the outside.

There are two important things going on outside the readout strip that are essential to the operation of the counter. One has been explained, the reset function. The other is the "gating" of the input signal.

Both of these functions are controlled by the timing chain. It is a pulse time signal from there that acts upon the readout section.

In order to count a rate of speed of an incoming signal, you have to be able to admit it to the counting and readout section for a known specific period of time.

This is called gating, which is also quite literally how it is

done. Often a two input NAND gate IC is used for the purpose, as shown in Fig. 7.

Basically, the input signal is sent to one of the inputs. A NAND gate will not have an output when there is a signal applied to both gate inputs at the same time. This is the timing pulse which turns this gate on and then off for a specific time period.

Hence the name gating. The readout displays the count that has been established by the circuit during the time the signal is admitted to the counting circuit.

When it comes time for the next count to begin, the same timing chain supplies a pulse signal to the reset pins to reset the readout in time for the next counting period to come through the gate.

This function is usually handled by a single section or so of an IC and is done with high and low logic.

There is one other usual action performed on the readout, and there are two ways it can be done. Only one is used commonly in simple circuits, so it will be described first.

Each section of the readout IC can draw about 15 mA. That's over 100 mA per digit, or over half an Ampere for the whole readout section (just the LED ICs, not the 7490s or 7446s).

To help lessen the load on the power supply, it is common practice to strobe the readout ICs. This means that they are not running full

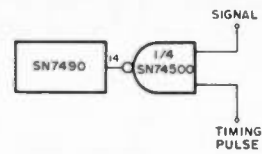

Fig. 7.

time, but are turned on and off at a high rate of speed so that the eye is fooled into thinking they are running continuously.

This is almost easier done than said. Fig. 8<sup>2</sup> shows a basic circuit. It is in the common line of the readout ICs. A switching transistor with suitable power rating is switched on and off by the same timing pulses that work the reset and gating ICs.

Thus the readouts draw an average current that is quite a bit less than the total current they would draw running full time — and the power supply runs cooler.

It is not hard to include this action in the timing sequence so that the display is blanked during the actual counting period when the digits are changing and a blur. Then when the counter has arrived at its count, the numbers are displayed and can be read. Then the display blanks out during reset and the whole cycle begins again.

This is done so fast that to the eye it looks like the display is steady. In fact, it is recounting the frequency a number of times and redisplaying the answer. Unless there is a change in the frequency, the readout will be the same. If there is a change, the counter will display an updated reading.

There is another method of strobing the display, but being more complex, it is not so common in simple equip-

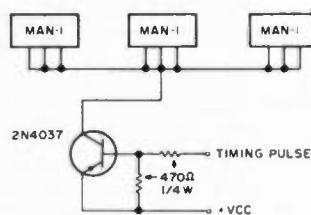

Fig. 8.

ment and will only be briefly described.

A timing pulse is given to a decade counter and the output signal is sent to a decoder/driver as with the readout circuit. However, instead of the decoder/driver feeding a readout IC, each output would go to a separate digit of the display, turning each on in sequence.

Thus, instead of turning the whole display on and off at a high rate of speed, each individual digit is turned on and off in sequence.

To the eye, the effect is the same. The display looks lit at all times, but since only one digit is actually on at any given time, the average current is less than with the other method. However, it is more complex.

While the basic readout circuit has three parts, there is a slightly more complex form of readout circuit which has four sections.

Several circuits have appeared recently using this configuration. The fourth section is a temporary memory which goes between the counter and the driver/decoder.

This is a latch type IC. It involves no new problems in understanding — only the mechanical problem of wiring.

One digit of a recent

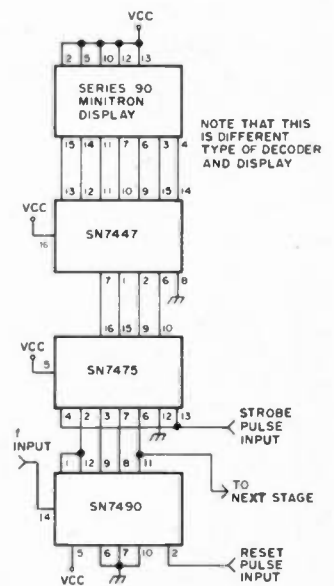

Fig. 9.

schematic is shown in Fig. 9.<sup>3</sup> As can be seen, it is quite simple and should not be any problem if you wish to construct a circuit using this feature.

Notice in this circuit that the strobing function is done by this latch IC. The rest of the counter did not conform to the guidelines given. It used the 7490s all the way through the readout section. In this case a high speed IC was used to prescale the count so that the frequency

limit of the 7490 was not a factor.

The gating function of the counter took place just before the prescaler and used a different type of two input gate (a NOR) than described in the simple circuit.

This is still basically similar to the simple counter readout. If you understand the general operation of the simple one, you should be able to recognize the variations for what they are: just slightly different ways of

doing the job.

As the IC scene keeps changing, it can be expected that any given circuit will not look exactly the same as the simple test circuits shown. In the near future though, the readouts will probably bear a strong family resemblance to what has been presented here. Once you know what you are looking for in the way of differences, the whole readout section should stand out as an easily comprehensible unit.

Since this and the timing chain comprise the most part of the usual frequency counting circuit, you will be able to concentrate on the other sections and should be able to understand and duplicate what you want. ■

#### References

<sup>1,2</sup>"Six Digit 50 MHz Frequency Counter," Pollock, James W., WB2DFA, *Ham Radio*, January, 1976, p. 18.

<sup>3</sup>"A Fun Counter Project," Plavcan, Al, *73 Magazine*, July, 1976, p. 36.

### ANTENNA SUPERMARKET Dept A P.O. Box 1682, Largo, Florida 33540

**DIPOLE AND WIRE ANTENNA KITS**, complete with HI-Q BALUN, 100' rope, copper antenna wire and insulators.

80/40/15 parallel dipole .....	\$36.95	160 short, 130' length .....	\$36.95
40/20/15 parallel dipole .....	\$30.95	80 short, 63' length .....	\$31.95
80/40 trap dipole .....	\$41.95	40 short, 33' length .....	\$28.95
40/20 trap dipole .....	\$36.95	Single band models from .....	\$24.95

**VERTICALS** — complete with Universal Mounting Base, Folds to 5' for Easy Transport, Hvy. Duty Aluminum Tubing.

20/15 trap, 13' hgt. ....	\$29.95	160 compact 23' hgt. ....	\$44.95
40/20/15 trap 22' hgt. ....	44.95	80 compact 20' hgt. ....	39.95
80/40/20 trap 30' hgt. ....	69.95	40 compact 15' hgt. ....	34.95
80/40/15 trap 20' hgt. ....	59.95	20/15/10 full size vertical	29.95

**NEW Apartment/Portable** apt. roof or patio, camper, trailer, motor home. All bands 80-10, folds to 5' easily. 13' height.  
80-40-20-15-10 \$49.95

TO ORDER — Include Shipping — Dipoles \$2.50, verticals \$3.00  
24 hour shipment. 30 day guarantee.  
For info: SASE or 1st Class Stamp.

Include Interbank # and Expiration date on Credit Card orders.

### YOUR PERSONALIZED GREAT CIRCLE MAP CENTERED ON YOUR QTH



Provides you with instant and accurate bearing and distance to any other location in the world. Each map is a multicolored original. It is available in 10, 20, and 30 inch sizes for \$13.95, \$18.95 and \$23.95 from Computer Drawing Corporation, P.O. Box 88559 Seattle, Washington 98188 (Add 75¢ for mailing).

# Incredible counter! Incomparable price!

A 500mHz (6-Digit) FREQUENCY COUNTER for under 40 cents per mHz! Figure it out. It adds up to unheard-of savings! With guaranteed quality to match and exceed overpriced brands. Let us prove it to you now!

# 169<sup>95</sup>

\$199.95 assembled

Perfect for: Cbers, Hams, Service Techs, & Experimenters!

- HAM, CB, & COMMERCIAL BANDS • WIRED & TESTED AVAILABLE • 100HZ READOUT • 6 DIGITS
- CRYSTAL TIME-BASE • 1HZ OPTIONAL • MASTER CHG. / B. AMERICARD OK • ADD \$2 SHIPPING

(6-DIGIT/500mHz KIT) FREQUENCY COUNTER



# Hufco

Incredible counters starting at \$45.95 are also available! All counters can be factory wired and tested. Write or call today!  
Box 357, Dept. 60, Provo, UT 84601 (801) 375-8566

## PRINTED CIRCUIT

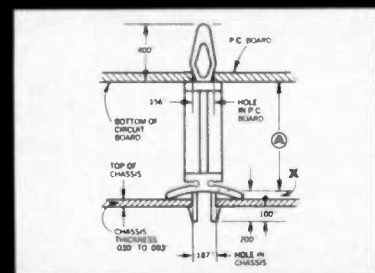

**NYLON CIRCUIT BOARD SUPPORTS**  
Avoid spacers, nuts, bolts and fits of temper with this amazing problem solver.

**BYTESIZE CIRCUIT BOARD BLANKS**  
Epoxy glass boards computer routed to fit IMSAI & ALTAIR computers. Available in single and double clad 1 oz. copper. Do your own thing!

Positive acting photo resist, positive acting Diazo film, W. H. Brady & Datak drafting aids, carbide bits.

Send for our flyer  
**TRUMBULL CO.**

833 Balra Dr., El Cerrito CA 94530

# WILSON AMATEUR ANTENNAS

## MODEL 204 MONOBANDER PLUS DB33

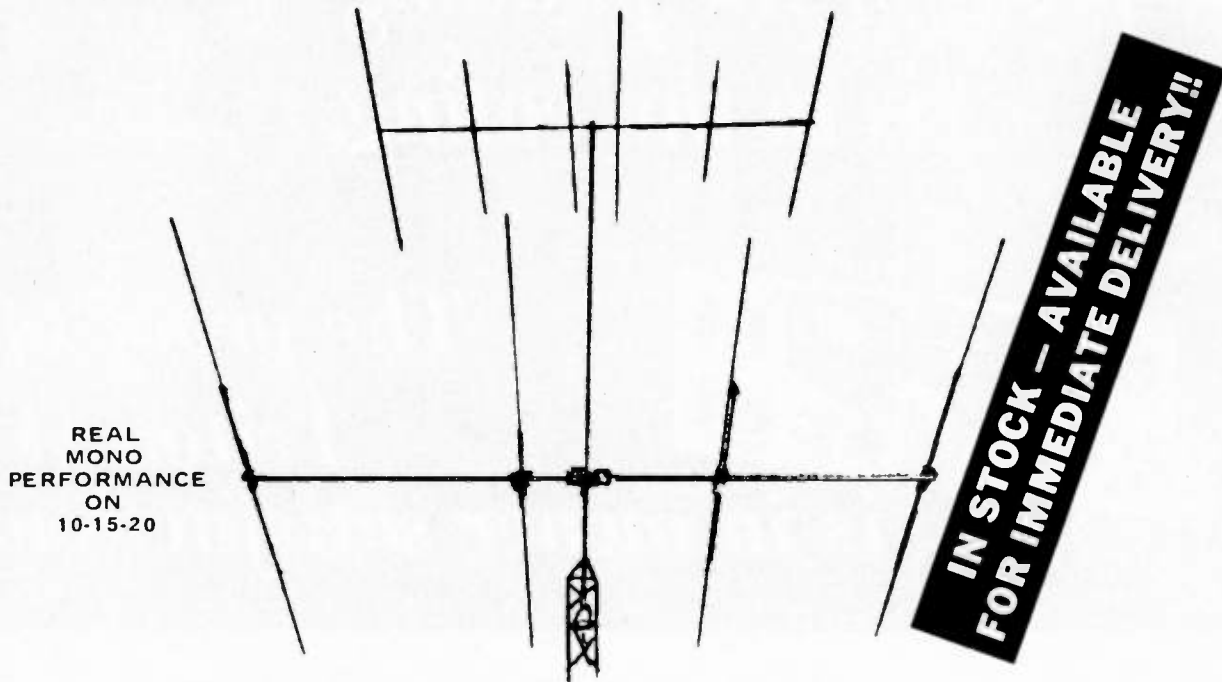

The Wilson 204 is the best and most economical antenna of its type on the market. Four elements on a 26' boom plus a Gamma Match (no balun required) make for high performance on CW & phone across the entire 20 meter band. The 204 Monobander is built rugged at the high stress points. Using taper swaged slotted tubing permits larger diameter tubing where it counts, for maximum strength with minimum wind loading.

The DB33 is the newest addition to the Wilson line of antennas. Designed for the amateur who wants a lightweight, economical antenna package, the DB33 compliments the M204 for an excellent DXers combination.

All Wilson Monoband and Duoband beams have the following common features:

- Taper Swaged Tubing
- Full Compression Clamps
- No Holes Drilled in Elements
- 2" or 3" Aluminum Booms
- Adjustable 52  $\Omega$  Gamma Match
- Quality Aluminum
- Handle 4kw
- Heavy Extruded Element to Boom Mounts

### WILSON AMATEUR ANTENNA SPECIFICATIONS

	Forward Gain (dB)	Front-to-Back Ratio (dB)	Front-to-Side Ratio (dB)	Boom Length (ft)	Number Elements	Longest Element (ft)	Turning Radius (ft)	Surface Area (sq ft)	Wind load at 80 MPH (lbs)	Assembled Weight (lbs)	Shipping Weight (lbs)	Price
M520	12.0	26	30	40	5	36'4"	27'0"	5.0	125	90	96	\$269.00
M204	10.0	25	30	26	4	36'4"	22'6"	3.9	100	46	49	139.00
M155	12.0	26	30	26	5	24'3"	18'0"	3.7	93	41	44	139.00
M154	10.0	25	30	20	4	24'3"	15'9"	3.0	75	30	32	89.00
M106	13.0	26	30	31	6	19'0"	16'1"	2.9	73	34	36	99.00
DB54(20)	12.0	26	30	40	5	36'4"	27'0"	7.9	198	105	119	299.00
(15)	10.0	25	30		4	24'3"						
DB43(15)	8.5	20	30	26	4	24'3"	15'8"	4.3	108	36	38	119.00
(10)	10.0	25	30		3	18'0"						
DB33(15)	8.5	20	30	17	3	24'3"	12'2"	3.8	95	31	33	89.00
(10)	8.5	20	30		3	18'0"						

The above Antennas are FACTORY DIRECT ONLY!

Most antennas in stock. If you order any antenna, you may purchase a CDR Ham II for \$144.45 or a CDR CD44 for \$117.45. Send check or money order, or phone in BankAmericard or Master Charge. All 2" Boom antennas shipped UPS, 3" by truck.

# Wilson Electronics Corp.

4288 S. Polaris Avenue, Las Vegas, Nevada 89103 702-739-1931 TELEX 684-522

*The proof of the pudding  
is in the eating.*



*The proof of  
Triton IV  
is in owner satisfaction.*

*Here's some of the proof . . .*

**K4EME** — This is my second TRITON IV. They are excellent xceivers! **WA1JCK** — Luv it. Dynamite! **W9NXU** — I am very thrilled with this unit, it is great. I think you have scooped the field. **WADAYA** — I like CW and full break-in. (Beautiful) **K3TFU** — I love the unit. **WA3VEZ** — Rig is just great. Combined with your service makes a super transceiver. **WN0SED** — Beautiful radio to use. Magnificent CW filter! Just a pure joy. **W8IIT** — I have had my TRITON IV for two months and am delighted with it. **YN1MBV** — It is a very nice rig. **W3GTX** — New features very welcome. **W0BYC** — Bought one of the first TRITON II, like it so well I updated it with a TRITON IV. **W2TBK** — It is absolutely fantastic. **W800PI** — I am pleased with the rig. **WA3GJA** — Very-very-nice. Good audio quality. **W5ZBC** — The most outstanding rig I have ever used. **K8CJA** — Excellent rig. Good filters. **W7BKK** — Very happy . . . getting excellent quality reports. **W2CET** — Power-signal reports good. **WB2UEH** — I like the compactness and appearance. **VE3IBK** — An excellent rig with superior receiving quality. **K4IVM** — I think it is tops. **WA4LDG** — I've become so used to dip, peak and adjust, this TRITON is a beautiful new experience. **KL7IHW** — Easy to set up—works great. **K4JXD** — Seems to be very FB rig. **WA7KHE** — Fantastic performance. Thanks for a fine rig. **WB4BPG** — No problems—fine rig. **VE1BZ** — Good work. **W9HQT** — Receiver better than expected, CW break-in is super. **WOAP** — Tremendous transceiver. I appreciate your engineering. **WA2ZRO** — Wonderful. **K0SFV** — Real nice rig. You thought of almost every feature and built it in. **KQ9DQ** — Beautiful. **W80J1Q** — Beautiful radio; however, your ads do not do justice to the radio. **WN550H** — Very sophisticated—Easiest tuning rig ever. Very glad I bought it. **K30JV** — Very impressed. **W4LZP** — Very good results. Put out 100 watts as good as 300 watt rigs. **WA4DQY** — I think the TRITON IV is great. **W6QXN** — Appreciate full CW break-in. **W0INH** — Enjoy light weight. **VE3CYK** — I am extremely pleased with the clarity of receiver and after putting rig on the air, received unsolicited compliments on the audio quality of the transmitter. **K4PHY** — Was 3rd in USA, first in fourth district in WWCQ contest. **W8RYU** — Own Argonaut. Both fine rigs. **W4CDA** — Compact, light weight, good engineering. **WB2WZG** — TRITON IV is the most versatile CW/SSB radio I have ever used. **WB2FMV** — Outstanding. Highly pleased with performance. **W8ACZ** — A real nice rig. I have owned about every other make. **W5EGK** — Works nicely. **WB4ECO** — I tried this rig, a pleasure to operate. **W4YRK** — Excellent reports on audio. **WB8NKB** — Wonderful. **W9QPQ** — An excellent rig. Love it. **W8SDP** — Makes running SSB nets a real breeze. Also good on CW nets. **WL7IRT** — Fantastic rig. **W4MDB** — Has rekindled my interest and enthusiasm in Amateur Radio to an extent I hadn't thought possible. It far out distances any competitive product at any price. **W6EYR** — Very nice. Been a ham for 45 years and now solid state perfection. **W2RPH** — Excellent rig. **WN0TDK** — TRITON IV is a fabulous piece of equipment. **W5VIW** — Very nice rig. **WB2LQF** — Wow! **W9JCV** — Tnx for giving us a FB piece of equipment made in the USA. **W8GHD** — Very pleased. **K4KXB** — Seems to have everything desired. **W4SZ** — A pleasure to operate. **W2FKF** — Greatest rig I ever had. So far in a month 34 QSO's without one miss. Been a ham since 1922. **W4GVC** — Nothing but complements. **WB9EZE** — Well pleased with performance and simplicity of operation. **K4ETI** — Rig is great. **W8CNV** — Man! what a rig. I've had this call since 1929. Never saw anything like it and I've seen them all! **WB2MZU** — Seems like everything the S----- O--- was supposed to be at one third the price. **WN0VHE** — I think it is a very good rig. **WB9FTD** — Break-in CW is very impressive. **K0CBA** — I believe it is one of the finest HF transceivers on the market. I can't tell you how pleased I am with the noise blander. I can get on the air from my home station again for the first time in a few years. Other rigs with noise blankers just didn't hack it. **WA7YHW** — I am very pleased with this equipment. It is certainly of high quality. **W7IA** — Excellent equipment. **WBORWA** — Couldn't be more pleased with it. It certainly has performed beautifully and is all I expected and more. **WB4QJT** — Like it very much — keep up the good work. **WN1YVX** — Really impressed with looks and performance. **W0NC** — Very FB rig. Performs up to specifications. an excellent design. **K8PBZ** — Already have TRITON II and IV. **W7KD** — This little "T-4" is smooth as silk . . . I've received some very flattering reports about transmitter voice quality and the CW operation is the greatest. **WN8TDD** — I found that the TRITON IV was the best rig on the market for around \$800. I love it! **W2JBK** — It is absolutely fantastic. **W8FEI** — Am amazed at receiver performance. I thought I had a top notch receiver with the R-----! **W1FYM** — Your guarantee is refreshingly proper. **W8MOK** — Sure makes a guy look twice at his old tube type gear. **W1TFS** — Finest CW ever, CW selectivity very good. **WB6IVR** — Very satisfied with TRITON IV. Just what I was looking for to use on my yacht. Thanks. **W80NP** — Also have a TRITON II. I am pleased that Al Kahn and the good guys at TEN-TEC thought of the CW operator! **W2EMX** — Excellent Amateur gear meets and exceeds advertised claims. **W0AMJ** — It looks like there is nothing left to be desired. It is beautiful. **W6SE** — The receive function is outstanding. It is superb in transmit. **W1BYV** — In love with this fantastic gem. It's so easy and a pleasure to operate. **W6ASH** — Very happy with performance. Particularly impressed with full break-in and light weight. **W0AIMS** — By far the best rig I have ever operated. I am glad I decided on the TRITON IV and not one of the other transceivers on the market. **W8HQO** — Thank you gentlemen.

Add your name to the growing list. See your TEN-TEC dealer or write for full details.

**TEN-TEC**, INC.  
SEVIERVILLE, TENNESSEE 37862  
EXPORT: 5715 LINCOLN AVE., CHICAGO, ILL. 60646



**ALDELCO SEMI-CONDUCTOR SUPERMARKET**

**NOW OPEN** ALDELCO HOBBY COMPUTER CENTER  
KITS-BOARDS-BDDKS-ACCESSORIES  
Write for catalog

Brand New GE Stereo Tape Amplifier Board with all components 4 Watts 12 Vac	\$3.50
Mono Amplifier Board 1 control	2.25
6 foot black zip cord and plug	.35
RG174 100 foot coil	6.50
2 1/2" round speaker, 8 Dhms	.75
2 1/2" round speaker, 100 Dhms	1.10
Speco miniature replacement speakers from 1" to 3 1/2", SASE for list.	
Speco weatherproof trumpet speaker, 15 Watts, 5" horn, 8 Dhms	
SPC-8	12.95
Speco Ham & CB extension speaker, 8 Dhms, 4" speaker, 10' cord.	
CBS-4	12.75
Hobby Motor 6 Volt Super Challenger	1.77
Shur-Lok Disappearing Antenna Trunk Mount	10.95
Ham & CB Slide Mounts with lock and coax connectors	12.95
2 Amp Bridge Rectifier, 200 Volt	.50
2 Amp Bridge Rectifier, 600 Volt	1.25

**RF DEVICES**

2N3375 3W 400 MHz	\$5.50	2N6080 4W 175 MHz	\$5.40
2N3866 1W 400 MHz	.99	2N6081 15W 175 MHz	8.45
2N5589 3W 175 MHz	4.75	2N6082 25W 175 MHz	10.95
2N5590 10W 175 MHz	7.80	2N6083 30W 175 MHz	12.30
2N5591 25W 175 MHz	10.95	2N6084 40W 175 MHz	16.30
2SC517	3.95	2SC1306	4.30
2SC1226	1.25	2SC1307	5.25

**HEAVY DUTY RECTIFIERS**

200 Volt 100 Amp D08	\$8.50
200 Volt 250 Amp D09	12.50
1000 Volt 2 Amp Silicon Rectifier RCA	10 for .99
10,000 Volt Silicon Rectifier Erie 65 mA	2.95

**ALDELCO KITS**

Digital Clock Kit, Hours Minutes & Seconds. Large half inch LED readouts. Elapsed time indicator. 12 hour format with 24 hour alarm. Snooze feature, AM PM indicator, power supply, power failure indicator. Complete with wood grain cabinet. \$23.95  
MOS Time Base Kit 50/60 Hz 5.95

**DISPLAY LEDS**

FND503 Common Cathode	.500	\$1.75
FND 507 Common Anode	.500	1.75
FND 359	.3	1.35
MAN 5 Green	.27	1.45
DL 747 Common Anode	.6	2.25

**DISCRETE LEDS**

Jumbo Reds, long or short bulb	6 for \$1.00
Jumbo Orange, Green, Clear Red or Green	5 for \$1.00
209 Series, Green, Orange, Yellow or Red	5 for \$1.00
RL2 or Micro Red	5 for \$1.00

**ZENERS**

1N746 to 1N759 400 Mw ea.	25	1N4728 to 1N4764 1 w	28
C1068 SCR	5.65	CA 3028A Dif. Amp	\$1.50
MPSA14	.90	LM301 Op Amp	.55
2N3055	.95	LM309K Volt Reg.	1.10
MPF102 FET	45	LM380N Audio Amp	1.75
2N3904 or 2N3906	10 for .99	NE540L Power Driver	5.95
2N5496 or 2N6108	.35	NE561B PLL	4.95
MJE340 (2N5655)	1.10	NE562B PLL	4.95
40673 RCA FET	1.55	NE565A PLL	2.50
741 or 709 14 Pin DIP	.75	LM709 Min DIP Op Amp	.45
555 Timer	.75	LM741CE T05 Op Amp	.45
556 Dual 555	1.75	14 or 16 Pin IC Sockets	.30
200 Volt 25 Amp Bridge	1.50	We have 7400 series ICs; send stamp for catalog	
1N914 - 1N4148	15 for .99		
1N34 - 1N60 - 1N64	10 for .99		
2N918	.95	2N3772	2.25
2N2218	.55	2N3773	4.95
2N2219A	.40	2N3859	.29
2N2222A	.20	2N3903	.20
2N2369	.20	2N3905	.25
2N2483	.45	2N3924	1.80
2N2484	.25	2N3926	6.30
2N2905	.15	2N4041	5.50
2N2907	.30	2N4249	.15
2N2926G	.30	2N4401	.16
2N2926Y	.30	2N4402	.60
2N3053	.50	2N4403	.15
2N3390	.75	2N4409	.19
2N3439	1.20	2N4427	1.35
2N3440	.60	2N4429	7.65
2N3512	1.15	2N4888	.50
2N3553	1.40	2N5016	17.60
2N3563	.30	2N5090	7.50
2N3584	2.35	2N5129	.20
2N3638	.15	2N5179	.90
2N3646	.15	2N5641	5.40
2N3713	.50	2N5642	10.25
2N3725A	.50	2N5643	14.35
2N3771	2.50	2N5913	1.70

We quote on any device at any quantity. All items shipped in USA. Min order \$6.00. Out of USA send certified check or money order. Include postage.

**ALDELCO**

2281A Babylon TnPk Merrick, N.Y. 11566  
(516) 378-4555

**YOU ASKED FOR IT!**  
**ecm-5B FM modulation meter**

Only **\$132** less batteries and crystals



- \* 0.75 kHz deviation peak reading Meets commercial requirements
- \* Operates 30-500MHz
- \* Crystal controlled for easy operation
- \* Telescopic antenna

**New Options**

- \* NICAD power pak \$20.46
- \* Charger \$29.95
- \* Audio/scope output with earphone \$12.95

Write or call for complete information. Send check or money order for \$132.00 plus \$1.50 for shipping. Indiana residents add 4% sales tax. Crystals for 146.94 MHz: 3.95. All other freq 7.10.

ECM Corporation  
412 North Weinbach Ave.  
Evansville, Indiana 47711  
812-476-2121

**ECM**

**NEW** from *Yaesu*

**FT-301D ALL SOLID STATE DIGITAL 160-10 M TRANSCEIVER. 40 OR 200 PEP.**  
**PRICES START AT \$535.00**

Serving amateurs since 1928

Master Charge Bank Americard

**FRECK radio & supply co., inc.**

252 Patton Ave., Asheville, N.C. 28801  
PHONE: (704) 254-9551

**UNIVERSAL TOWERS**

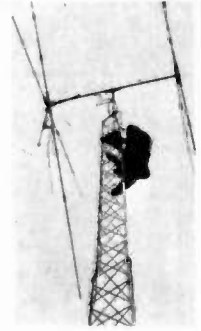

Free standing aluminum tower 10' to 100'. Prices from \$110 (30').

**MOST POPULAR HAM TOWER EVER MADE**

REQUEST NEW CATALOG OF TOWERS & ANTENNAS  
**Midwest Ham Headquarters**

For over 38 years

HAMS! Write for Free Catalog and Wholesale Prices!

**ELECTRONIC DISTRIBUTORS, INC.**  
1960 Peck Muskegon, MI 49441  
Tel. (616)726-3196 TELEX 22-8411

**SAVE IC-230**

VHF FM PHASE LOCKED LOOP SYNTHESIZED TRANSCEIVER

**SPECIAL SALE!**

**\$359**



REGULAR \$489

IC 22S's • KDK FM 144's  
ALL YOUR 2 METER FM NEEDS  
**W. B. COMMUNICATIONS**

16401 S.W. 142nd Ave. • Miami, Fla. 33177  
TELEPHONE (305) 253-7440

**Sensational price! Superb quality!**

**69<sup>95</sup> 119<sup>95</sup>**  
(30mHz Kit) (25D mHz Kit)

**6-DIGIT FREQUENCY COUNTERS**



A counter-offer you can't refuse! It's rock-bottom price and sky-high quality make it your best buy! We've proved it to thousands. Let us prove it to you!

- 100mHz Readout
- 1Hz Optional
- Crystal Time-Base
- Ham, CB, & Commercial Bands
- Master Chg./B. Americard OK
- Add \$2 Shipping

All counters can be factory wired and tested.

**Hufco**

Write or call today!  
P.O. Box 357, Dept. 55,  
Provo, UT 84601 (801) 375-8566

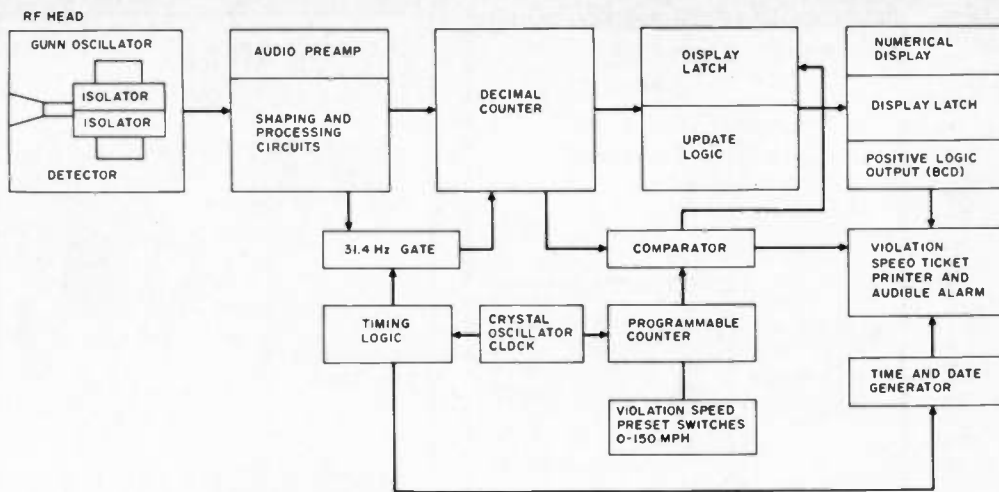

Fig. 1. Block diagram.

Stirling M. Olberg W1SNN  
19 Loretta Road  
Waltham MA 02154

# Mobile Smokey Detector

## -- 10.5 GHz: use it or lose it

While a few readers may want to build this unit which is described as a smoke detector, the main reason for publishing this article is that it is an example of applying ham techniques to make commercial products. Note that, by the simple addition of a small 10.5 GHz oscillator,

this unit can be used in the 10.5 GHz ham band for communications with other cars using the detector. Since power levels below 100 mW could perform well, it might not even be necessary to have a ham ticket to use this transceiver. The article certainly opens up all sorts of inter-

esting experimental opportunities. As a detector of police radar — one which returns a strong echo modulated to indicate whatever speed you wish — it is possible that a lot of these could be sold. It could be marketed for under \$50 and homemade for perhaps \$10. — Ed.

Many times when I've been rolling merrily on the highway, I've come upon road signs indicating that the road was "Radar Patrolled," which I've paid little or no attention to. One day I got bagged. I saw the radar too late and, of course, it had me before I could slow down.

I was to become very closely associated with traffic radars, but at that time all I could do was pay the fine and slow down. I thought of installing one of the gadgets that detects radars, and tried one. It was a disappointment.

Some time later I was to become associated with a firm which sold and serviced police equipment, including traffic radars. I became very intimate with the workings of the beasts. Also, the methods of detecting them at reasonable distances became of greater interest to me.

Building a fairly sensitive radar detector requires an understanding of how a traffic radar works. Here is a rundown on several of the units which are in common use by traffic safety officers.

For the most part, traffic radars throughout the USA are CW Doppler radars operating in the X band region at 10.525 GHz. There are other frequencies in use, but we will confine this description to X band versions.

If a microwave oscillator producing a CW signal coupled to an appropriate antenna is pointed at a target, which is moving toward or away from the antenna, the target will reflect part of the radiated signal back to the antenna and that signal will be modulated by the motion of the target, producing a Doppler signal which is in the audio range. A detector, also connected to the same microwave antenna, will rectify the reflected signal and, when amplified by an appropriate audio amplifier, can be processed to determine the speed at which the target is moving.

Most people have experienced the Doppler effect and perhaps have not realized it. Perhaps you remember that the pitch of a railroad train horn appears to sound higher when approaching, and then seems to go to a lower pitch after it has passed. It is this audio component, produced by microwave reflection, which can be processed to tell the exact speed of a vehicle.

Since it is an audio signal, it is quite simple to calculate the frequency of the Doppler for a given speed. To calculate the Doppler frequency, we use the following formula:

$$F_r = \frac{C+V}{C-V} \times F_t$$

where

- $F_r$  = the received frequency
- $F_t$  = the transmitted frequency
- $C$  = the speed of light
- $V$  = the speed of the target
- $F_d$  = the Doppler frequency

Since we are interested in the difference between  $F_t$  and  $F_r$  or  $F_d$ , and we know that our radar transmitting frequency is 10.525 GHz or 10,525,000,000 Hzps, and that  $C$  is equal to 186,000 miles per second or 186,000 x 3600 mph, we equate as follows:

$$F_d = \frac{2V \times 10,525,000,000 \text{ (Hzps)}}{186,000 \times 3600 \text{ (mph)}}$$

$$F_d = \frac{2V \times 10,525 \times 10^9}{6696 \times 10^5}$$

$$F_d = \frac{2V \times 10,525 \times 10^4}{6696}$$

$$F_d = 2.986V \times 10.525$$

$$F_d = 31.4V$$

All this means that a target speed of one mile per hour has radio Doppler of 31.4 Hz per second. Therefore, if the speed of the vehicle is multiplied by 31.4 Hz, the Doppler frequency will be the answer (example: 31.4 x 60 mph = 1884 Hz).

The traffic radars use a diode rate counter and an integrator circuit coupled to an appropriate dc amplifier to operate a direct reading meter calibrated in mph. A digital

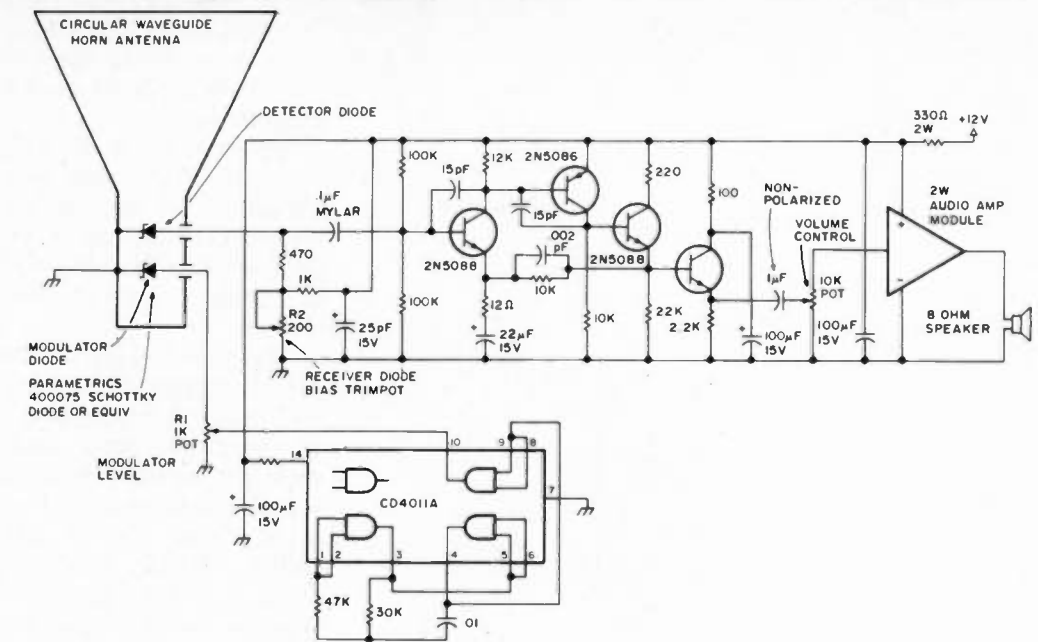

Fig. 2.

frequency counter which is gated at 31.4 Hz will give a direct reading in miles per hour.

These radars are calibrated internally from a quartz crystal oscillator and associated dividers to produce, usually, a 60 or 65 mph direct calibration. The calibrators are checked against laboratory standards which are related to NBS accuracy. Certification is required in writing for court use and must be done at least twice a year in most states.

A look at the block diagram Fig. 1 will assist the reader in following the operation of a digital radar. The compare circuits are controlled by a programmable speed alarm which is preset by the operator to the value which has been determined to be the violation speed. The comparator digitally looks at the target speed and the preset speed and, of course, an alarm goes off if the two values are equal. The alarm sounds as an audio beep and the speed is indicated on a numerical display.

In many of the older radars, a tuning fork vibrating at 1884 Hz held in front of the antenna provided the calibration for 60 mph. Radar patrolmen were instructed

not to set up near moving objects such as rotating signs or motor driven rotating devices — and there is the clue to a good radar detector.

In the older radars, two pieces of wave guide were fitted in a manner that allowed one of them to be the transmitting guide and the other to be a receiving one. A Klystron or Gunn oscillator served as the transmitter, and a detector was mounted at the end of the second guide; both sections of guide were mounted to excite a small parabolic reflector having a gain in the vicinity of 22 dB and a beamwidth in excess of eight degrees.

The more up-to-date digital units use a circular wave guide, and the antenna is a circularly polarized horn. A circular mode transducer is used to decouple the detector from the transmitter. In the conventional wave guide configuration, the two sections of the guides had a shield between them to allow only a small amount of rf from the transmitter to bias the receiving diode. Very poor control of the level was maintained; often vehicles reflected excess bias and destroyed the diode. In the circular mode, this effect is

greatly reduced by the mode transducer, although destruction of the diode can still occur (from almost direct occlusion of the horn).

The output of the detector is connected to a very high gain audio preamplifier, which has a low cut at three hundred cycles and upper response at four kilocycles, allowing speeds of ten miles per hour to 130 mph to be detected. The output of the amplifier is usually shaped to a square wave and then further prepared into digital form for alarm and display. We will not concern ourselves with any of the signal processing beyond the amplifier, since all we want is an indication that a radar is present.

Recall that the tuning fork or a vehicle, or anything which is moving in the beam of the antenna, produces a Doppler at an audio rate. Suppose we construct an antenna with a detector mounted at the correct position to produce a good match, and then feed the output of the detector which has been biased by dc; instead of a Klystron to produce the best match to the input of a good low noise preamplifier, shouldn't we hear the radar? "Negatory," as the CBER says, "there ain't no Moji there."

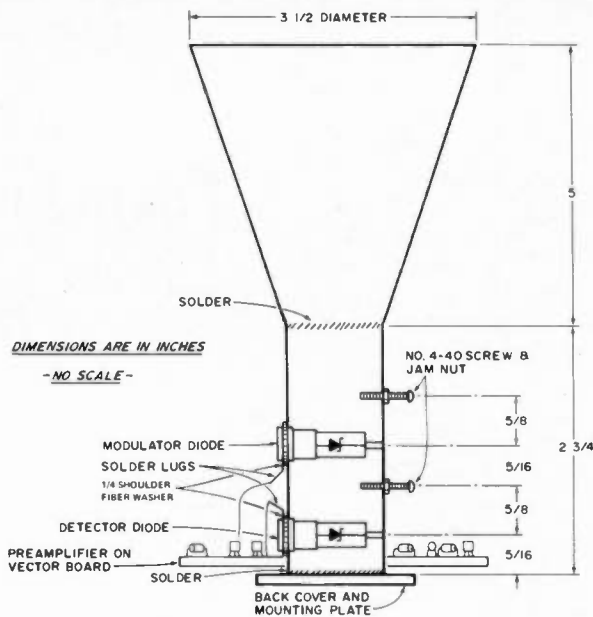

Fig. 3.

If some modulation is applied to the received signal, much greater detection range can be realized. Modulation must be applied at low levels, and at a low frequency, for two reasons. First, if the level is too high, it will leak into the audio amplifier and be a nuisance sound. And second, the rf picked up by the detector antenna reflects back to the radar when you are close to it, and a high frequency modulation rate will indicate strange things to the policeman operating the radar! So keep the modulation rate at 300 Hz, which is 9 miles per hour. Oh yes, there are laws which cover interfering with the performance of a peace officer doing his thing. You say you're not transmitting anything, of course not, but try convincing the judge!

The receiver we will construct is not new to amateurs. It's the old crystal video receiver trick or zero i-f receiver QRP fans are using. The microwave antenna, detector and modulator are simple to construct and can be made with tin shears and a soldering iron. This construction project is a guide for those who'd like to copy my unit or try to come up with a better one.

The horn is a 23 degree cone shaped from flashing

copper. To make the cone mandrel, I used a four inch piece of heavy card. By rolling one end tighter than the other, a cone is formed and adjusted until it is 3-3/4 inches in diameter at the large end, and 7/8 of an inch in diameter at the other. The hole at the small end is taped over with Scotch tape, and the cone is filled with wet sand or patching plaster. Next, smooth a piece of copper flashing and roll it around the paper cone. Trim the edges so that they butt against one another. Now solder the edges together, slide the copper cone off of the mandrel, and you have a horn.

Next, provide a three inch disc of vector board. In the center of the disc bore a 7/8 inch diameter hole. This hole should be as close as possible to the outside diameter of the 3/4 inch copper pipe, to provide a tight fit.

Construct the audio amplifier on part of this board, observing all of the procedures which a high gain hi-fi preamp requires.

The audio oscillator which is used as the 300 Hz source for the modulated diode is also built upon the same disc.

All components are mounted on vector clips for both sections. Care in part

orientation must be taken, to insure no coupling between the 300 Hz oscillator and the amplifier input.

The preamplifier circuit is composed of three low noise transistors. The output of the preamplifier is fed into a two Watt amplifier module which will drive a small 8 Ohm speaker.

The overall gain of the preamp/amplifier combination is great enough to have a 10 microvolt signal really make the speaker move. All wiring to externals, such as the volume control and switch, should be shielded to avoid picking up undesired radiation. This allows the detector to be absolutely silent unless it is the field of a radar or X band signal at 10.525 GHz. Voltage from the automobile cigarette lighter can be used to operate the detector.

When the amplifier has been completed and tested, lay it aside and finish the construction of the diode detector and modulator. Be very careful to position the diode mountings and the two tuning screws as shown in the drawing.

The diodes used are sold by Parametrics in Winchester, Mass. They are Schottky diodes and are very sensitive. Do not handle them unnecessarily, since they can be damaged easily. 1N23E diodes will also work fairly well, but at reduced range.

Construct the mountings for the diodes from 7/8 inch diameter brass tubing (which can be obtained from hobby shops) or use a piece of 3/4 inch water pipe. The rest of the mounting is easily constructed from shoulder washers and solder lugs. Solder the lugs to the wire connections before the diodes are installed.

The two tuning screws should be made of brass. The gain nuts can be steel. The positioning of these two screw holes should be accurate. Tap the two holes for 4-40 threads.

Next, mount the audio

amplifier/modulator on the copper pipe directly behind the receiver diode. Use epoxy glue to hold it in place. Locate the amplifier input as close to the detector diode as possible to reduce its lead length. The volume control can be brought out through the rear of the coffee can, as can the power and speaker cord. Solder the two inch square of 1/16 thick brass over the end of the pipe.

Prior to final assembly, the tune-up procedure for maximizing the sensitivity of the "smoke" detector should be done as follows:

An X band signal generator and an ac voltmeter are required. The signal generator should be connected to a gain standard horn which is located about 5 feet away from the radar detector horn. Clamp this horn so that it is stationary and directed into the radar detector horn.

Next, connect a VOM in an ac mode to the speaker terminals; set the meter to read 8-10 volts full scale.

Turn the pot modulator trimpot R1 to 50 percent of its rotation, turn the volume control full on, and turn R2 to full counterclockwise. Be sure R2 is at the ground end. This pot sets the dc bias on the receiving diode.

Turn on the signal generator and set it to 10.525 GHz; turn the output attenuator to allow full output to feed the gain standard horn.

Now turn on the radar detector. A 300 cycle tone should be heard loudly. Adjust the volume control to produce 1 volt on the VOM. Check the orientation of the antennas to be sure that they are aligned for maximum signal, and rotate the circular horn about its axis to be sure of maximum signal.

Secure the radar detector so that it will not move while being further adjusted. Be sure you have access to the two tuning screws.

Next, adjust R2 until +.125 millivolts dc appears at the output of the detector diode. A slight increase in

output signal will be noted on the VOM. Carefully adjust R2 in very small increments, until no further increase in signal output is noted on the VOM. Now adjust tuning screw A until an increase in signal is indicated on the VOM. This screw will adjust through a peak and will be erratic if the gain nut is loose. Make it tight to allow the screw to move with a heavy drag on it. Once the peak is reached, move to the second screw B and adjust it in the

same manner as screw A was adjusted. Further adjustment alternately of the A and B screws can be made until no further improvement is noted. The last adjustment is touching up R2 to see if a slight increase can be observed.

Decrease the signal level by turning the attenuator to 70-75 dBm and then change the VOM scale to read 1 volt full scale. Approximately 800 millivolts of signal will be indicated. This is about the

maximum sensitivity with this receiver, and should allow detection of radars within a range of at least 2500 feet when in a straight line with the radar antenna. Radars can be heard at distances of one mile or greater, which should give adequate forewarning. The unit can now be assembled into the coffee can. The two inch square brass plate serves as a mounting, which is fastened to the rear of the coffee can. The plastic cover

which comes with the can acts as a cover radome.

Now that you can easily detect radars, don't push your luck; use the detector to help stay within the legal speed limit. Radar is used to help keep you alive. The mobile smoke detector will help, and not cheat, "Smokey the Bear" when you keep this in mind. Those who choose to notify other "ears" that "Smokey" is around may find that it makes the old bear happy when they do. ■

**S**uggestions for ways that we hams can keep ham radio alive have appeared from time to time in this magazine. There is one way, however, that I don't remember seeing in print. That is *giving ham radio books to your local library.*

I realized how important this could be a few years ago when I gave a few of my old ham radio books to the North Haven, Conn., library. The librarian called me to thank me, and said that *they get a lot of requests for this type of book, mostly by young people.* Since that time I have lost count of the number of books I have given to the libraries in Hartford, East Hartford and North Haven.

Look around your ham shack. Aren't there at least a few books of yours that you don't read anymore, that you haven't needed in years? Don't you have an old call-book, ARRL license guide or 73 study guide?

Honestly, do you think you really need these books? Have you ever lent them to anyone? Probably not. So all these years these perfectly good books have been doing no one any good. What a shame! Some high school student might have picked up the book and gotten started in ham radio.

What's your objection? You think you might need the book some day? That's possible. Then you can go down to the library and

borrow it back. Can't afford it? I think you can't afford not to do it. Your few dollars are an investment in the future of ham radio. The more people there are in ham radio, the more chance there is we won't be clobbered in the next WARC.

If you don't have any books gathering dust, then why not buy a few? 73 puts out some excellent books and

study guides. The *ARRL Handbook* isn't too bad either. Spend a few dollars to get some kid off the streets and into ham radio.

And now for the ultimate — an absolutely terrific way to get people interested in ham radio. Buy a subscription to 73 for your local library! Far out? Not at all. The Hartford Library already carries *QST*. 73 is by far more

exciting. Put 73 on the shelves of your library. I'll bet it will be worn out and dog-eared in a week.

I'm going to practice what I preach. As I'm writing this, I am taking down a copy of the ARRL VHF manual and will drop it off at the North Haven Library in an hour or two. Let's see, there are a couple of boxes of books in the attic. I wonder if . . . ■

Gabe Gargiulo WA1GFJ  
17 Whitney St.  
East Hartford CT 06118

# Get a Kid Off the Streets

## -- and into ham radio

# Add RIT to Your Transceiver

-- a must for CW operators

It is quite interesting to note that many new transceivers are still coming on the market without incorporating RIT, or receiver incremental tuning. Of course, if you purchase the accessory vfo most transceiver manufacturers make, you don't need RIT and will have more tuning flexibility than with just RIT.

But for many portable and mobile applications, the idea of adding another box to the basic transceiver is awkward.

What is RIT? Most amateurs are familiar with RIT, so just a brief background summary for newcomers. Transceivers which transmit and receive on exactly the same frequency (because of a common master

oscillator) work fine with each other as long as one does not change the receiver tuning once contact is established to get a better audio response, different CW note, etc. If this is done, the transmitter frequency is changed and the other party will retune his transceiver when you transmit, etc. The cycle is repeated each time one party transmits and the overall result is so-called "leap-frogging" up or down a band and in some cases may be straight out of a legal band segment for the mode being used! The cure is simple: Provide a means for tuning the transceiver in the receive mode over a small (incremental) range of a few kHz without affecting the output frequency of the

transceiver in the transmit mode. One also has to (or should) provide some means to disable the RIT so receive and transmit frequencies correspond exactly when desired to initiate a contact.

## Basic RIT Circuit

The basic RIT circuit is shown in Fig. 1. This was the usual way incremental tuning was added to transceivers for several years until solid state devices came on the market. But it shouldn't be dismissed too easily. It still has applications and may be the best way to add incremental tuning even to solid state transceivers! Besides simplicity, it also has an outstanding feature in that air variable capacitors are used and only one silver mica. They have excellent temperature stability and produce a minimum effect on the basic temperature and mechanical stability of the transceiver's vfo.

The circuit functions by switching one of the two added variable capacitors across the tank circuit of the vfo. In the transmit mode a capacitor is switched in, which is set at about  $\frac{1}{2}$  its capacitance range and which is not panel mounted. In the receive mode, another capacitor of the same type which is panel mounted is switched. When this capacitor is set to exactly the same value as the other capacitor, receive and transmit frequencies correspond. When it is varied, the receive frequency can be varied plus or minus a few kHz without changing the transmit frequency. The first capacitor is made variable instead of fixed because small differences in wiring capacitance will invariably exist and having it variable allows the second panel mounted capacitor to be set at exactly mid-range to achieve equal receive/transmit frequencies. A switch can be provided in the relay coil

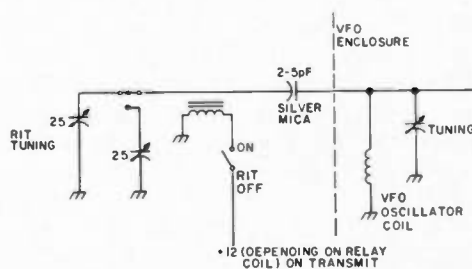

Fig. 1. RIT circuit using regular air variable capacitors.

circuit to disable the relay and then, of course, the receive/transmit frequencies will have to remain the same.

The variable capacitor values shown in Fig. 1 are typical for use with most HF vfo circuits. A good clue as to what value to use is to check the size of the variable capacitor used for the usual "frequency adjustment" or "dial set" capacitor on the vfo. Use about the same value. Some readjustment of the vfo calibration is necessary after adding RIT, but since this is true for the solid state circuits also, it is discussed at the end of the article.

### Solid State Variations

The action shown in Fig. 1 can be duplicated by a variety of transistor and diode circuits. They have great value when mechanical considerations do not allow the placing of the capacitors necessary for RIT right next to the transceiver vfo. Only the transistors or diodes providing the variable capacitance effect, plus their isolating resistor or rf choke, need be placed right at the vfo tank circuit. Their dc control leads can be run to a tuning potentiometer located at any convenient point on the transceiver panel. One good method to "free" a pot location on the front panel and avoid drilling holes is to gang-up two existing separate front panel controls (such as af and rf gain) into one dual pot with concentric shafts. Many TV replacement pots are usable for this purpose.

Fig. 2 shows an almost completely solid state RIT arrangement. A relay is still used to switch control potentials to the varactor diode, but since the relay only carries low voltage dc instead of rf, almost any simple relay will suffice. If a transmit/receive relay in a transceiver should have a set of unused contacts, they can be used to do the necessary

switching. Of course, then there would be no possibility of disabling the relay to provide for exact coincidence of receive and transmit frequencies. The varactor tuning pot would have to be set at the point of zero frequency offset to accomplish this.

In the receive position of the relay, a fixed bias is applied to the varactor diode by means of the 10k Ohm divider network. In the transmit position, a variable bias is applied by the 10k tuning pot. Only one pot (the 10k tuning pot) is front panel mounted, but a number of adjustment pots are provided in the circuit for flexibility in adjustment. To start, adjust the 10k pot R1 so the voltage on the diode is about half of the supply voltage. Adjust R3, R5 and R6 to maximum resistance. Place the control knob on R4 at its mid-point (12 o'clock). Adjust R3 and R5 in the receive mode so the voltage on the diode is exactly the same as in the transmit mode. Rotate R4 both sides of its center position and check that the frequency excursion is about the same on both sides. If not, "linearizing" pot R6 is adjusted so it comes as close as possible.

The total frequency excursion of the RIT depends on a number of factors but is controlled to a large degree by the settings of R3 and R5. If these pots are set at their maximum values, the voltage excursion possible by R4 is limited and the RIT range

restricted. The opposite is true with these pots at their minimum values. In a typical case, the RIT can be set for excursion of from  $\pm 1.5$  kHz to  $\pm 10$  kHz. Which setting to use depends on one's taste. Try the minimum range first (procedure as described) and work up to a wider range if it is found necessary in actual operation. There may seem to be a lot of pots in the circuit but they are there because of adjustment flexibility and because of price. R4 is a standard single-turn, linear-taper, panel mounted pot. All other pots are 15 turn trimmer pots. These pots are highly recommended because they provide very fine adjustment and can be obtained from Poly Paks, Lynn MA (see almost any 73 issue for ad and address) at a bargain price of 2/\$1.00.

A word about the other components. The varactor diodes can be obtained for about \$1.00 each from Circuit Specialists, Box 3047, Scottsdale AZ 85257. Their free catalog has a nice graph

of the capacitance range of the various diodes they offer. Some transistors can also be substituted for varactor diodes and work quite well by utilizing their collector-base capacitance change with applied voltage. Try 2N697, 2N2053 and 2N3053. The emitter is left floating. Base goes to ground and the collector is the other end of the "diode." R1 should provide sufficient isolation for the diode. If, however, the circuit should seem to be "touchy" and not rf isolated, try a few ferrite beads over the diode end of R1. The only leads that must be kept short and well dressed are those for the diode, C1, and the end of R1 going to the diode.

Fig. 3 shows a few variations for solid state RIT circuits. In Fig. 3a, the relay has been omitted since many transceivers provide low voltages in the receive or transmit modes already switched on or off by the transceiver circuitry. The power diodes are used for

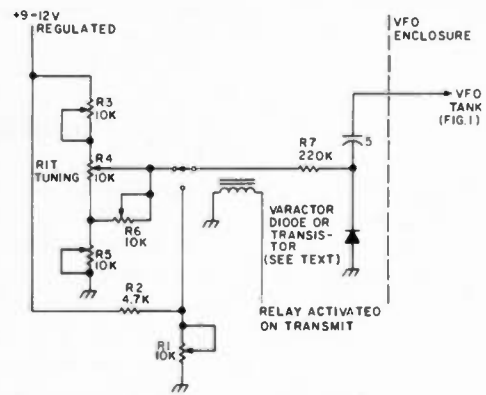

Fig. 2. Solid state version of RIT.

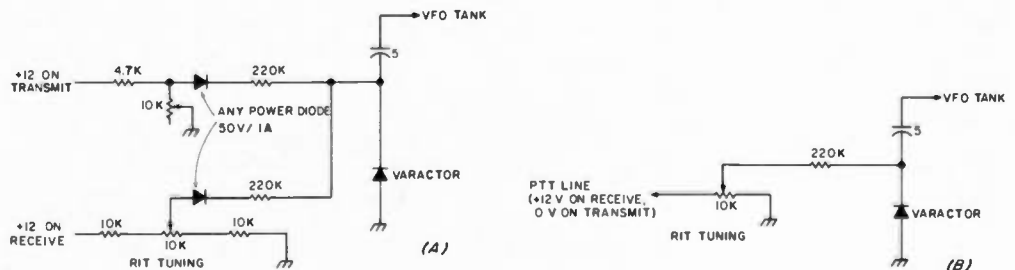

Fig. 3. Simpler RIT circuits. (a) Shows circuit particularly suited to solid state transceiver. (b) Shows a crude but usable RIT.

isolation so that the inactive voltage circuit does not interfere with the active one. Fig. 3b shows about as simple a RIT circuit as one can develop, but it does have disadvantages. The zero frequency offset position on the tuning potentiometer cannot be adjusted and the frequency offset will be non-linear as the tuning pot is varied. Nonetheless, just to give a quick and inexpensive try to RIT, it is worthwhile remembering.

### VFO Realignment

Adding RIT to a vfo places some additional capacitance across the tank circuit of the vfo which must be compensated for. One may be inclined to compensate for the added capacitance by readjustment of the "dial adjust" or "frequency adjust" control on a transceiver in conjunction with a calibrator. Doing this would, however, destroy the usefulness of this control since it would have to

be set at the extreme end of its adjustment range and probably will not have sufficient range left to perform its normal function.

One has to adjust the slug in the oscillator coil or internal padding capacitor to bring the oscillator frequency and dial calibration back into alignment. Disconnect the RIT circuitry and note where calibration zero beat occurred on the dial. Reconnect the RIT circuitry and tune the coil slug or padder capacitor

until zero beat is re-established. The amount by which the slug or capacitor has to be turned should be very small — usually a fraction of a turn. This small adjustment should not effect the linearity of any oscillator. Check this by being sure that the calibration zero beat at each extreme of the tuning dial is still achievable within the range of the "dial set" or "frequency adjustment" capacitor on the vfo. ■

**VIDEO RECORDERS Like New!**  
 Norelco Model #LDL1000  
 1/2" Helical Scan  
 \$195.00 F.O.B. Chicago  
 Programming Technologies  
 6666 Lincoln Ave.  
 Lincolnwood IL 60645  
 (312) 676-9400

**PRINTED CIRCUIT BOARDS**  
 Epoxy G-10 used exclusively  
 As seen in 73 Magazine Nov 1976  
 Page 32 - Lab scope, both boards ..... \$5.00  
 Page 98 - Battery charger ..... \$2.50  
 Page 150 - ASCII/Baudot converter, both boards ..... \$10.00  
 Other boards made - send artwork for free estimate  
 MAKE PAYMENT TO: R. L. Carillo or  
 H. Miller  
 1 Banner 3rd Terrace  
 Brooklyn NY 11235

**DX Ops**  
 We export electronic & scientific components & equipment. All manufacturers. Tubes • Transistors • ICs • uPs •  
 Send your list of requirements for quote. **ICS ELECTRONICS COMPANY**  
 9550 E. Gallatin Rd.  
 Downey CA 90240 U.S.A.

David Johnson WB6QDS  
 621 Parra Grande Lane  
 Santa Barbara CA 93108

# Coronaries for Burglars

-- with this cheapo car alarm

Theft of radio gear from parked cars is on the increase nationwide. While there have been no local reports of such losses lately, the threat is always there. One way of protecting yourself against such misdeeds is to install a car burglar alarm.

To be sure, alarms aren't foolproof, and at best can only be expected to frighten off a would-be thief. Still,

some protection is better than none, and the burglar alarm approach is probably the most cost-effective.

While commercial alarms are available, they generally

aren't cheap, and besides deprive the true experimenter of his bent to improvise. An amateur's solution to the need for a burglar alarm is shown in Fig. 1. This simple

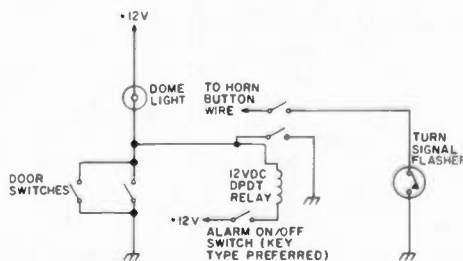

Fig. 1.

circuit requires only three parts and some wire, but does its job extremely well. The alarm is activated whenever one of the car doors is opened, and is effected by intermittent blasts of the car horn which continue until the alarm is manually reset.

The alarm basically consists of a 12 volt relay which is connected to latch in the closed position whenever the dome light circuit is completed (by opening a door). Closing the relay also returns the horn relay line to ground through a turn signal flasher, which will alternately make and break the circuit, providing repeated blasts on the horn. Once the relay has latched, blowing of the horn will continue until power is removed by opening the alarm switch. Note: The alarm switch must be located *outside* the car in order to set the circuit when parking. If a toggle switch is used, it should be placed in a hidden location. Otherwise, use a key switch. ■

Reprinted from the March, 1975, *Key-Klix*, Journal of the Santa Barbara Amateur Radio Club.



# We have the perfect mobile/portable HF SSB Transceiver for you.



## The Atlas 210x/215x

The Atlas 210x or 215x measures only 9½" wide x 9½" deep x only 3½" high, yet the above photograph shows how easily the Atlas transceiver fits into a compact car. And there's plenty of room to spare for VHF gear and other accessory equipment. With the exclusive Atlas plug-in design, you can slip your Atlas in and out of your car in a matter of seconds. All connections are made automatically.

### BUT DON'T LET THE SMALL SIZE FOOL YOU!

Even though the Atlas 210x and 215x transceivers are less than half the size and weight of other HF transceivers, the Atlas is truly a giant in performance.

### 200 WATTS POWER RATING!

This power level in a seven pound transceiver is incredible but true. Atlas transceivers give you all the talk power you need to work the world barefoot. Signal reports constantly reflect great surprise at the signal strength in relation to the power rating.

### FULL 5 BAND COVERAGE

The 210x covers 10-80 meters, while the 215x covers 15-160 meters. Adding the Atlas Model 10x Crystal Oscillator provides greatly increased frequency coverage for MARS and network operation.

### HELP WANTED

Technicians with Solid State and SSB experience. If you are a really sharp technician who would enjoy working in the amateur radio field, we have excellent opportunities with a bright future. Send your resume to Atlas Radio. No phone calls please.

**NO TRANSMITTER TUNING OR LOADING CONTROLS** with Atlas' total broadbanding. With your Atlas you get instant QSY and band change.

### MOST ADVANCED STATE OF THE ART SOLID STATE DESIGN

not only accounts for its light weight, but assures you years of top performance and trouble free operating pleasure.

### PLUG-IN CIRCUIT BOARDS

and modular design provides for ease of servicing.

### PHENOMENAL SELECTIVITY

The exclusive 8 pole crystal ladder filter used in Atlas transceivers represents a major breakthrough in filter design, with unprecedented skirt selectivity and ultimate rejection. This filter provides a 6 db bandwidth of 2700 Hertz, 60 db down of only 4300 Hertz, and a bandwidth of only 9200 Hertz at 120 db down! Ultimate rejection is in excess of 130 db; greater than the measuring limits of most test equipment.

**EXCEPTIONAL IMMUNITY TO STRONG SIGNAL OVERLOAD AND CROSS MODULATION.** The exclusive front end design in the receiver allows you to operate closer in frequency to strong neighboring signals than you have ever experienced before. If you have not yet operated an Atlas transceiver in a crowded band and compared it with any other receiver or transceiver, you have a real thrill coming.

### ATLAS TRANSCEIVERS

Model 210x or 215x Transceiver . . . . \$679  
With noise blanker installed \$719

### ACCESSORIES

AC Console 110/220V . . . . . \$149  
With VOX \$195  
Portable AC Supply 110/220V . . . . . \$100  
Plug-in Mobile Kit . . . . . \$48  
Auxiliary VFO Model 206  
Includes Digital Dial . . . . . \$299  
Model DD6-B Digital Dial only . . . . . \$229  
10x Osc. less crystals . . . . . \$59  
Matching Transformer MT-1 . . . . . \$27  
Model VX-5M Self-contained VOX . . . . \$55

### NEW FROM ATLAS

DL 200 Dummy Load  
200 watt intermittent or 60 watt continuous power rating. Housed in a compact one quart can. . . . . \$9

Same Dummy Load as above, but with dual range Wattmeter reading 0 to 50, and 0 to 200 watts. . . . . \$24

For complete details see your Atlas dealer, or drop us a card and we'll mail you a brochure with dealer list.



417 Via Del Monte • Oceanside, CA 92054 Phone (714) 433-1983  
Special Customer Service Direct Line (714) 433-9591

*Season's Greetings from the gang at Atlas*

This article describes what I call a versatile regulated power supply. Versatile because of its many uses: a 12 volt version powers my Drake TR22, another powers my Regency HR220. A 5 volt version runs the logic in the WR4AKK repeater, while one with plus and minus 15 volts powers all my op amp projects.

All in all, I've built nine power supplies of different voltage and current ratings using this circuit.

Whether you need a supply to charge batteries, run a portable tape recorder or radio, operate relays, run your mobile FM rig in the house, or power op amps or logic, this circuit definitely deserves a try. It's simple, uses a minimum of easily obtainable parts and, best yet, it works.

The basic circuit (Fig. 1) is a simple two transistor regulated supply. One transistor, Q1, acts as a reference voltage source and the other, Q2, acts as a series pass regulating element.

The circuit is the same no matter what the output voltage. Only the transformer, zener diode, resistor R2, and possibly Q1 and Q2 have different values.

#### Circuit Theory

The circuit consists of three sections — the transformer, rectifier and filter being one, the voltage reference another and the series pass regulator transistor the third.

Pick your transformer for a slightly higher voltage than you wish to regulate. For example: for 12 volts regulated output, use a 16 to 19 volt transformer (a 6 volt and a 12 volt filament transformer in series). For 5 volts regulated output, a 6 V filament transformer is used. And for 15 volts output, use a 24 volt transformer.

If you use a transformer capable of high current output, you may need to put a resistor in series with the out-

put of the rectifier. This prevents the surge current, generated when the supply is turned on, from destroying the rectifier diodes.

Of all the different rectifier circuits in use today, I prefer to use the full wave bridge. The bridge circuit has a higher output voltage than the standard full wave rectifier and a higher frequency ripple than the half wave, making it easier to filter. However, any type rectifier, as well as the conventional voltage doublers and triplers, can be used with no circuit degradation.

For output filtering, I have found that using a 1000 uF capacitor for C1 provides adequate filtering. The more capacitance, the more filtering, so you can increase this value if you wish. The regulator also acts as a capacitance multiplier so that the total capacitance is the capacitance of C1 plus the

capacitance of C2 multiplied by the gain,  $h_{fe}$ , of Q2:

$$C_T = C_2 (h_{fe}) + C_1$$

Resistor R2, the zener diode and Q1 form a voltage reference circuit. Set the reference voltage to about 1.5 V above the desired output voltage. The reference voltage is higher because there are two diode voltage drops between this point and the output. To determine the value of the zener current limiting resistor, R2, you must first know the gain of transistors Q1 and Q2.

The dc gain of Q1 and Q2 can be found in a transistor specification manual. Gain, sometimes called Beta or  $h_{fe}$ , is the ratio of the collector current to the base current that caused it. For example: for a transistor with a gain of 20, 1 mA of base current causes 20 mA of collector current.

Now, knowing the transistor gains and the desired output current, you pick a value for R2 by calculating how much current must flow from the base of Q1 to make a corresponding amount of current flow from the base of

R. B. Joerger WR4EHG  
1330 W 54 St. C-112  
Hialeah FL 33012

# Power Supply

-- versatile

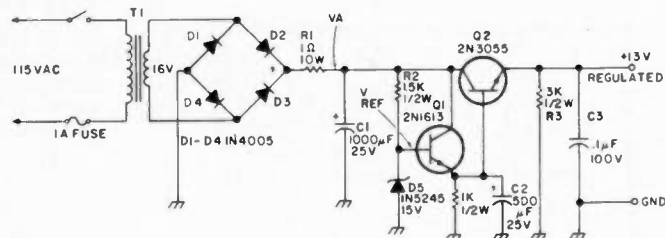

Fig. 1. Regulated +13 volts at 2 Amps using NPN transistors.

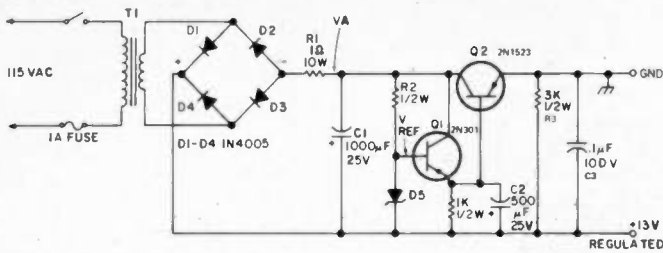

Fig. 2. Regulated +13 volts at 2 Amps using PNP transistors.

Q2, to cause the desired output current flow into Q2. Simple. Right?

For example, we wish to have a regulated output voltage of 13 V at 2.0 Amps. The gain of Q1 is 70 and the gain of Q2 is 20. The voltage at point A is 20 V. To cause 2.0 Amps of current to flow into Q2, the current flow from the base of Q2 must be 100 mA.

$$I_b = \frac{I_{out}}{gain} = \frac{2.0 A}{20} = 100 \text{ mA}$$

And similarly, to cause 100 mA of current flow into Q1, the base current must be

$$I_b = \frac{100 \text{ mA}}{70} = 1.4 \text{ mA}$$

If you use a 15 V zener diode, the voltage drop across R2 is 5 V, so from Ohm's Law:

$$R = \frac{E}{I} = 5 \text{ V} / 1.4 \text{ mA} = 3.7 \text{ k}$$

Let R2 be 3.3k. The reason for this lower resistance is that most transistors have less gain than that listed in the specification book, so by using a smaller resistor more current will be available, making up for possible low transistor gain. This also gives you a safety margin, in case you need just a bit more current than you thought.

In picking transistors for Q1 and Q2, not only must you pick a transistor with suitable gain but you must also choose it for its type (NPN or PNP), emitter-collector breakdown voltage ( $BV_{ceo}$ ), collector current ( $I_c$ ), and power dissipation.

All of these circuits use NPN transistors. If you wish to use PNPs, reverse the

polarity of the rectifier output, the filter capacitors and the zener diode. Isolate everything from ground. If you require that the negative lead be grounded, ground the emitter of Q2 (see Fig. 2).

$BV_{ceo}$  is the voltage at which the collector to emitter junction breaks down. For Q1 this voltage rating must be high enough to stand the difference in voltage between the rectifier output and ground, and for Q2 the rectifier output and the regulated output.

The collector current ( $I_c$ ) rating of each transistor is the maximum continuous collector current that the collector to emitter junction can safely pass. For Q2, this is the total output current which you require from the supply.

Power dissipation is the maximum amount of power that the transistor can dissipate before it is destroyed. The power dissipation rating is usually given for an ambient case temperature of +25° C. If you heat sink the transistor (which I recommend for Q2), you can exceed this dissipation by an amount which depends upon how well your heat sink dissipates the power.

The output circuit consists of R3, a bleeder resistor chosen to allow a couple of milliamps of current to flow, and capacitor C3, which acts as a high frequency filter to keep any zener noise or voltage spikes out of solid state equipment.

#### Construction

The circuit layout is not critical and almost any type of configuration can be used. I have built the supply

both on a piece of pegboard with the device leads serving as hookup wire, and on a printed circuit board. With the circuit board shown in Fig. 3, the electrolytic capacitors are mounted external to the board due to their large physical size. This figure also shows Q2 mounted on the board. While this will work for low power applications (one example is the supply running my TR22), I would suggest that you heat sink this transistor, as it does pass the total load current and can get warm.

You will notice that there is a break in the land coming from the positive output of the bridge. This is where R1, which must be heat sunk externally from the board, is connected. If you do not use R1, connect a jumper in its place.

I used a resist marking pen to draw the circuit on a PC board. You can do the same or make a photographic negative and use the photoresist method of making a board. The board in Fig. 3 is shown full size. I have mounted all of my supplies inside Bud boxes, and, as there are quite a variety of Bud boxes, no two supplies look alike. The only precaution is to mount the heat sunk transistor, Q2, where its case cannot be accidentally shorted to ground. If possible, mounting it on an attachable heat sink and mounting the heat sink inside the box (with a few ventilation holes) will work fine. I have not included any pictures of box layouts, as that is a matter of personal choice and the requirements of the equipment you need the supply for. ■

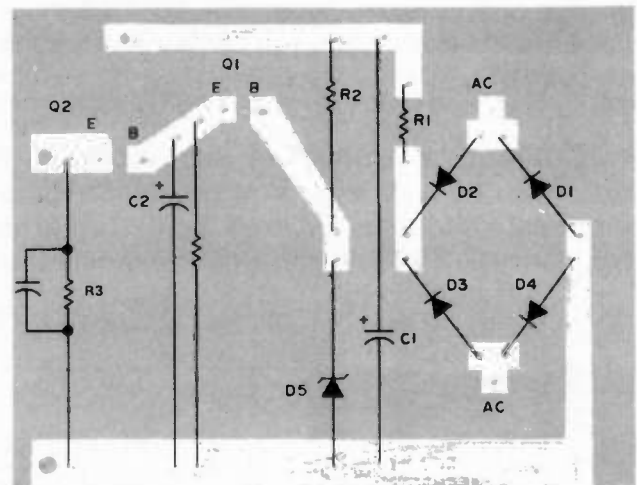
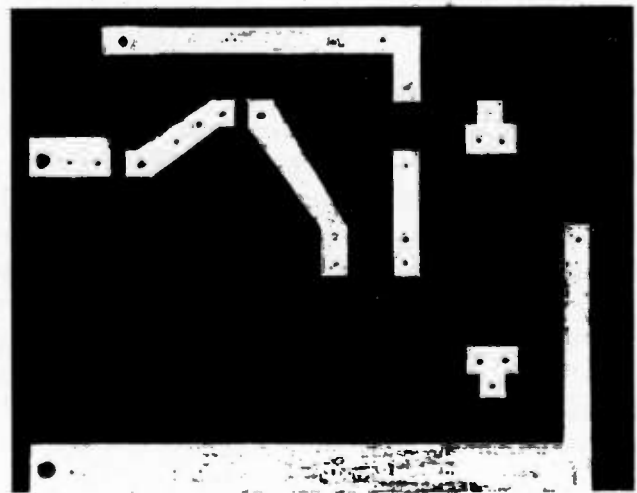

Fig. 3. Foil side view.

# ICOM INTRODUCES THE REVOLUTION IN VFO TECHNOLOGY



## Introducing the IC-245, 144-148 MHz FM Transceiver

The VFO Revolution goes mobile with the unique, ICOM developed LSI synthesizer with 4 digit LED readout. The **IC-245** offers the most for mobile on the market. The easy to use tuning knob moves accurately over 50 detent steps and assures excellent control as easily as steering the vehicle. With its optional adapter, the **IC-245** puts you into all mode operation on 12V DC power with a compact dash-mounted transceiver. In FM, the synthesizer command frequency is displayed in 5 KHz steps from 146 to 148 MHz, and with the side band adapter the step rate drops to 100Hz from 144 to 146 MHz. For maximum repeater flexibility, the transmit and receive frequencies are independently programmable on any separation. The **IC-245** even comes equipped with a multiple pin Molex connector for remote control.

The **IC-245** is a product of the revolution in VFO design, from its new style front panel, to its excellent mechanical rigidity and Large Scale Integrated Circuitry. Your **IC-245** will give you the most for mobile.

### SPECIFICATIONS

#### GENERAL

Frequency Coverage	*144.00 to 148.00 MHz
Modes	FM (F3) *SSB (A3J), CW (A1)
Supply Voltage	DC 13.8V ±15%
Size (mm)	90H x 155W x 235D
Weight (kg)	2.7

#### TRANSMITTER

TX Output	F3 10W *A3J 10W (PEP), A1 10W
Carrier Suppression	40 dB or better
Spurious Radiation	-60 dB or less below carrier
Maximum Frequency Deviation	±5 KHz
Microphone Impedance	600 ohms

#### RECEIVER:

Sensitivity	*A3J, A1 0.5 microvolt input gives 10 dB S+N/N or better F3 0.6 microvolt or less for 20 dB quieting S+N+D/N at 1 microvolt input, 30 dB
Squeich Threshold	-8 dB or less (F3)
Spurious Response	-60 dB or better

#### SYNTHESIZER:

Frequency Range	144 MHz to 148 MHz
Step Size	5 KHz for FM *100 Hz or 5 KHz for SSB
Stability	per C in the range of -10 to +60 C, ±0.0000145% per C

\* Valid with SSB Adapter only



**ALL MODE MOBILE!** Optional equipment for your **IC-245** includes a Side Band Adapter which attaches as an integral part of the transceiver. With this easy to make conversion, your **IC-245** operates in FM, SSB or CW. Depressing the adapter's tuning speed button produces a frequency change of 5 KHz steps in SSB mode, and furnishes fine tuning in 100 Hz steps in FM. The adapter's RIT function changes the receive frequency ±1 KHz without changing the transmit frequency. (See footnoted specifications for the **IC-245**.)



## DIGITAL PERFECTION NOW

ICOM recently introduced the revolutionary new **IC-211** 4 MEG All Mode transceiver with dual tracking, optically coupled VFO's: just the first of a great new wave of ICOM LSI synthesized radios. And now the **IC-211** is joined by the amazing **IC-245** mobile transceiver. Together they herald the beginning of the ICOM VFO Revolution.

### ICOM DEVELOPED PHASE LOCKED LOOP CMOS LSI

To facilitate the advancement of the phase locked loop concept which has been nurtured by ICOM's forward looking engineers, ICOM has designed an IC to provide these functions in a single LSI integrated circuit.

The circuitry of this chip contains all of the command registers and up down counters and the divide-by-n counter needed to make the ICOM "digital perfection" a reality.

This chip also contains the phase detector and memory system which provides the dual VFO function. In addition, there are provi-

sions to cause the step rate to increase to 5KHz or 10KHz from 100 Hz and another which causes the reading to "freeze" and not change with the dial setting. And yet another provides pulses to both sets of counters to allow them to track while staying offset by the set amount.

Also, included is the circuitry which makes the 100 Hz steps possible with a 10 KHz reference. This circuitry is so unique ICOM has a Japanese patent pending.



THE BEGINNING OF THE ICOM VFO REVOLUTION!

VHF/UHF AMATEUR AND MARINE COMMUNICATION EQUIPMENT

Distributed by:



# ICOM

**ICOM WEST, INC.**  
Suite 3  
13256 Northrup Way  
Bellevue, Wash. 98005  
(206) 747-9020

**ICOM EAST, INC.**  
Suite 307  
3331 Towerwood Drive  
Dallas, Texas 75234  
(214) 620-2780

**ICOM CANADA**  
7087 Victoria Drive  
Vancouver B.C. V5P 3Y9  
Canada  
(604) 321-1833

# DXpedition: Memories for a Lifetime

## - - reflections of HK1TL

**T**o those of you who have never been a part of a "FIRST," I must tell you that the feeling is one beyond description.

Maybe you could compare it with the thrill of your first amateur contact. Do you remember it? Do you remember the adrenalin flow? If you made the first contact on CW as a Novice, did your mind go blank when it was your turn to transmit?

Well, that is an inadequate description, but it is the best that I can do. HK1TL was the callsign of the Pack Rat Colombian Moonbounce Expedition, an expedition designed to accomplish the first 432 MHz EME contact from the continent of South America. It was, as you no doubt have already read in the press releases, a complete success.

Who are we? How did we get there? Why did we do it? Would we do it again? What did we learn? What were the people like? How long did it take to plan?

It is now two months since the history-making event. I have been asked to put together reflections of the expedition.

Well, let us start with basic definitions that may help you understand what the Pack Rats are and what motivates them.

The Pack Rats are offi-

cially the Mount Airy VHF Radio Club. We are now 20 years old. Our main purpose is to promote interest and activity on the VHF bands, and improvement in operation and equipment. All club members are expected to participate in the club-sponsored activities: club nets, meetings, January VHF sweepstakes, June VHF QSO party, and our annual flea market "Hamarama."

We are not what one would call a "DXpedition Club." As a matter of fact, prior to HK1TL, there were only two other expeditions that I know of. An attempt to break the 1296 MHz record over water from Rodantha, N.C., in the summer of 1970 failed. A 1296 MHz expedition to the state of Delaware was a success.

HK1TL, our third expedition-type operation, entered the planning stages in January, 1976. We discovered a potential new member who was originally from Colombia. He made contacts with his friends in Barranquilla, Colombia, and we started through the red tape necessary to get all the approvals. My correspondence file is more than 2 inches thick but that is the nature of dealing with governments.

Why did we do it?

Because it needed doing, because we had the opportu-

nity, because we had the expertise to do it, and because we were assured of complete cooperation from the Colombians.

Would we do it again?

Well, obviously if something was a success, you have no reservations about doing it again. However, knowing what we know now, we would have been better prepared for power outages. We would have insisted on a 4 kW generator with adequate regulation.

We learned that you can always count on amateur radio cooperation: from the equipment handling of Russ Wicker W4ZXI through the Miami Airport, the Area 2 Radio Club in Barranquilla, the 20 meter liaison work of W3KKN and W3TNP Ernie and Bertha Kenas, as well as the operation of the Pack Rat Moonbounce station W3CCX/3 by Dave Mascara WA3JUF. Everybody wanted it to work.

We also learned quite a bit about the effect of Faraday shift. That is to be the subject of a separate article.

We learned that the pressure of six months of intense preparation ran us to the breaking point, that at times we would have petty arguments among ourselves. Fortunately, there was always someone wise enough to sit back and analyze the situa-

tion. Tempers were getting short; pressure was building. "Hey, you guys, let's not let the situation get out of control."

Finally, what were the people like?

"Super" is the best description I can offer. They couldn't do enough to help us. Not only the Colombian hams, but the farm people and the civil defense organization. I would not have thought it possible in two short weeks to establish such deep personal relationships, but we did.

What kind of problems did we have?

In addition to sporadic, if any, line voltage, we discovered on unpacking that a filter capacitor in the power supply had broken loose from its mounting. That is not so bad, but it rubbed against a chassis corner and tore a hole in it. We requested another from the states and in the meantime set about to effect repairs.

Some solder closed up the hole and we were lucky it worked. We were also unfortunate enough to blow our 2 meter transistorized converter during the second OSCAR run. More field repairs required.

Any idea how you solder with the electricity off? Use a mini-torch (we brought one with us).

Since this was only to be an article on reflections, I'll not go into the technical decisions that were made as we prepared for the project. That will be the subject of a separate article.

Suffice it to say that if you ever have the chance to become part of a "DXpedition," do it.

Don't worry about the fact that (a) you can't afford it, (b) your XYL might go to divorce court, (c) the expedition might not be successful, or (d) that there will be a lot of work that must be done before you leave.

Do it; do it because it is a once in a lifetime experience that you will never forget. ■

**PREASSEMBLED**

**COMPLETE KIT**



# Crescent Frequency Counters Features:

- 1** High Sensitivity VHF pre-scaler (built-in). 100mv RMS @ 50Ω @ 300MHZ. Frequency range DC through 600MHZ Model 600, DC through 300MHZ Model 300.
- 2** Excellent temperature compensation crystal controlled time base, yielding  $\pm 1$  part/  $10^6$  stability per hour after 10 min warm-up,  $\pm 10$ PPM worst case, from 0° to + 55°C!, at 100Hz @ 450MHZ is attainable, typically if calibrated to WWVL. This is approximately 2 parts in  $10^7$ !
- 3** 7 digit display, resolution 100Hz with 10m Sec. gate interval, pre-scaled! 10Hz resolution with 1 Sec. pre-scaled, 1Hz resolution with 10 Sec. gate interval pre-scaled!
- 4** Built-in 5VDC regulator; input to 3-terminal regulator is accessible for use with 12VDC out-board PS. You can use this counter mobile.

- 5** Easy 6 hour assembly; all circuit broad tracks are pre-tinned, have drilled holes and are plated through! All I.C. socks included -- Makes trouble shooting a breeze.
- 6** Cabinet, plexy window and all necessary components included for easy, trouble-free assembly.
- 7** 90-Day full coverage warranty.

Optional accessories TCXO time base yielding ½ PPM stability. \$79.95

Optional 10 Sec. time gate resolution to 1Hz. \$15.00. (Free with purchase of above TCXO)

Optional 12VDC power receptacle and cord assembly \$15.00 (on preassembled counter only)

**"HAVE IT YOUR WAY"**

Complete kit or preassembled, burned in, and environmental chamber tested unit available for the commercial shop or modern ham shack.

KIT	Model 300K	\$139.00 ea.	PREASSEMBLED & TESTED	Model 300AT	\$199.00
	Model 600K	179.00 ea.		Model 600 AT	249.00

NAME \_\_\_\_\_

STREET \_\_\_\_\_

CITY \_\_\_\_\_ STATE \_\_\_\_\_ ZIP \_\_\_\_\_

CALL SIGN \_\_\_\_\_

SEND CHECK OR MONEY ORDER TO:

**Crescent** *... for all your wire & cable needs*  
**Wire & Cable Inc.**

Bldg. 13 Euclid Ave., Newark N.J. 07105 (201) 589-4647

# Secret PC Layout Method

- - simple and inexpensive artwork

**T**he most desired state of the art method of making a printed circuit board is the photo-etching process. I will attempt to describe an inexpensive method of artwork that can be used to obtain professional results.

A modest supply of circles, squares, pads, fillets, line tapes, etc., can consume a large portion of a limited

budget. Like many other experimenters, I would like to use these artwork aids; however, I have more time than money.

The general layout of the artwork is the most difficult portion of any etching process. If there are any simple secret methods of doing this, they certainly have remained a secret.

I suppose that most of us have a preferred way to lay out the artwork. For those who don't, I will share my secret method and a general description of my preferred way of doing the artwork. The circuit is made in its neatest form, all parts numbered, and generally reading from left to right. Of course,

check and recheck.

I have developed this method for the laying out of the artwork. For the lack of a better title, let us call it the quad method. Fig. 1(a) shows a 14 pin IC laid out in a quad pattern. In Fig. 1(b), the quad sections are labeled.

Inside 1-7 means that the lead will terminate on a pin from 1 to 7 and will run

between the two rows of pins of the IC. Outside means that the leads will run on the outside of the 2 rows of pins of the IC.

Figs. 2(a), (b), and (c) demonstrate the basic idea. A typical quad method of layout is shown in Fig. 2(a). Leads must follow three general rules. One, the number of inside leads must be limited. Two, there must not be leads between two adjacent pins, although I have seen this done. Three, the leads must not cross each other; use jumpers where necessary.

It can be seen in Fig. 2(b) that pin 14 is fenced in. This resulted by not following the quad method for lead "D." Fig. 2(c) is correct, as lead "D" approaches from the inside of pin 13 and exits to the outside of pin 13, going down and entering pin 6 from the inside. Following the quad method, the result is that both pin 7 and pin 14 are unobstructed as laid out in Fig. 2(a).

When wiring more than one IC, the vertical leads on the left side of the drawing will normally be the top leads, and those on the right will be run across the bottom. Whatever the case as the leads enter the quad zone of the proper IC, the leads should then run within the quad arrangement. See Figs. 3(a), (b), and (c), and note that in the finished layout the outside lead was rearranged. I might add that Figs. 3(a), (b), and (c) are actual working drawings of another project. The PC board is to be double-sided. The jumpers will be printed on the top

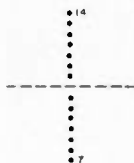

Fig. 1(a).

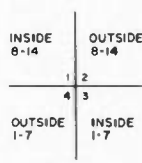

Fig. 1(b).

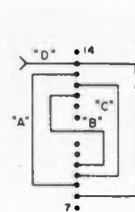

Fig. 2(a).

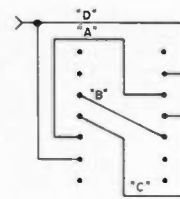

Fig. 2(b). Incorrect.

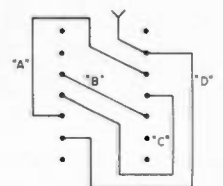

Fig. 2(c). Correct.



side, along with the power leads.

The use of a #2 pencil and a good eraser is most important, as it will be necessary to change the routing of the leads to get the best result.

After transferring the quad information to the layout on a grid paper, and finding yourself happy with the layout, place a piece of carbon paper upside down under the grid paper. The leads are now traced, leaving a carbon copy on the back side of the grid paper. This is the foil side view. On the top of a piece of corrugated cardboard or a piece of foam plastic, place a good grade sheet of white paper and tape the corners. The grid sheet is placed over the white paper foil side up, and taped at the corners to maintain registration. A hat pin or some other sharp pointed object is pressed through each place where we intend to drill the PC board. These pin holes become the centers of our dots.

The white paper is removed and put on a flat surface. A circle template of the desired size of our dot is centered over each hole, one at a time. A black felt tip pen is used to trace the circle of the template, and filled in while the template is in place. Most templates are for pencil use, so to prevent fuzzy edges the template is slightly raised above the paper by placing a couple strips of masking tape

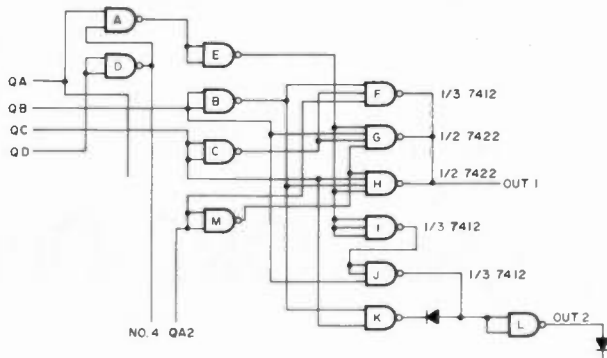

Fig. 3(a). All 2 input NAND gates are 7400s.

across the bottom side of the template. After all of the dots are made, the lines are drawn in either freehand or with a guide. A light blue pencil can be used to sketch in the lines first (if desired); this will help to prevent errors. The blue will not photograph, so if you would like to make notes on the artwork, go ahead.

For appearance, sharp corners and abrupt intersections should be avoided. This is why I prefer a sweeping freehand line. The dots can now be made into tear drops, fillets added to intersections, dots combined into double dot configurations, etc.

Check and recheck the artwork. A mistake can easily be corrected by the use of self-sticking address labels cut to fit over the area to be changed and then redrawn. After reassuring yourself that everything is correct, use the hat pin again to make sure that all holes are open.

A somewhat simpler

method is the use of a light blue lined grid paper and a light blue pencil. The drawing of the foil side is drawn with the blue pencil on the blue grid paper. The final results are traced with a black felt tip pen. The hat pin is used as before to make the center of the dots.

A final personal touch is the adding of your monogram.

The artwork is now ready for the photographer, and should be copied against a white background.

Although I have always made my design double scale, it can be done 1:1 with good results. For an extremely complex drawing, perhaps a 4:1 scale would be used.

I was quite shocked when I saw a student press the pins of an IC through a piece of blue lined notebook paper. He proceeded to circle the resulting holes and to draw in the connecting lines with a black felt tip pen. To my surprise, the PC board was

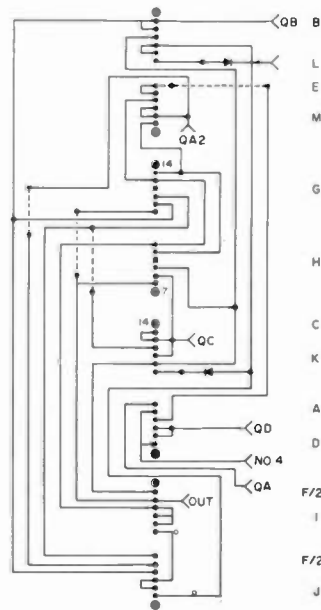

Fig. 3(b). Quad layout.

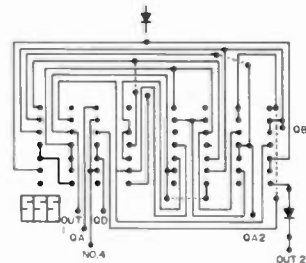

Fig. 3(c). Foil work sheet (top view, bottom foil).

amazingly nice.

The artwork may perhaps be copied with a camera as simple as the "pin hole" camera, but a high contrast type of film should be used (such as a process film and high contrast D11 developer).

Good luck on your next PC board. ■

## YOU CAN COUNT ON THE DAVIS FREQUENCY COUNTER FOR:

- 500 MHz
- ± .0002% ACCURACY
- UNBEATABLE LOW COST

Kits include all parts, drilled and plated PC boards, cabinet, switches, hardware and a complete instruction manual including calibrating instructions.

All parts guaranteed for 90 days. Factory Service available for \$25.

Factory assembled units are tested and calibrated to specifications, and are fully guaranteed for 1 year.



**PRICES:**  
 500 MHz kit ..... \$249.95  
 500 MHz factory assembled ..... \$349.95  
 Instruction & Calibration Manual ..... \$3.00  
 (refundable with purchase)

### FEATURES:

- 8 Digit Display
- Large .3" LED Readouts
- Automatic Dp. Placement
- Resolution to 1 Hz
- High Input Sensitivity
- Automatic Input Limiting
- Input Diode Protected
- Selectable Gate Times, 1 ms. and 1 sec. Provision for 10 sec.
- High Stability 10 MHz Crystal Time Base
- Plug-in Time Base
- Plug-in Prescaler
- All Metal Cabinet with High Quality Components

**DAVIS ELECTRONICS**

636 SHERIDAN DRIVE, TONAWANDA, NEW YORK 14150  
 (716) 874-5848

# Design Your Own QRP Dummy Load

-- useful beginner's project

A dummy load can prove to be a handy little gadget when it comes time to tweak-up the final in your handie talkie, QRP rig, or even (egad!) CB set. Unfortunately, there doesn't seem to be anything on the market that lends itself to the task,

unless you're willing to invest in an expensive kilowatt model. The only way to get around it is to build your own, an easy accomplishment with a little forethought and a handful of components.

## Choosing the Resistors

Ideally, the resistors in a dummy load should act purely resistive (no reactance) over the frequency range they are going to be used. The only inexpensive resistors that come close to meeting this requirement are the carbon (composition) type. Wirewound resistors, although cheaper and available in higher wattage values, exhibit too much inductance and are bothered by the skin effect. By contrast, carbon resistors are less subject to skin effect problems, so their resistance stays fairly constant as the operating frequency increases. In carbon resistors, reactance is mainly due to inductive effects in the leads and stray capacitance between the leads and nearby metal. These effects remain negligible up to around 100 MHz providing that the resistors are properly mounted and have values greater than 25 Ohms.

Proper mounting dictates that leads should be kept as short as practical, and that there should be some separation between adjacent resistors.

## Design

Because carbon resistors capable of handling more than two Watts are expensive and difficult to locate, the only convenient way to achieve high power dissipation is to use several resistors in parallel. This increases reactive effects, but it offers greater power dissipation as an acceptable trade-off, unless you need an extremely accurate dummy load. Also, it should be remembered that the power rating of resistors is a continuous "free air" rating, so for short duty cycles, a dummy load can easily stand more. For example, with the 33% duty cycle of SSB the power rating may safely be increased by three, while the 50% CW duty cycle will allow an increase of two. A good rule to follow is to touch the resistors occasionally. If they are too hot to handle then they are dissipating too much.

The actual design of the dummy load is accomplished by starting with two parameters, the desired total power dissipation and the desired characteristic resistance. Assuming that all resistors have the same values and power ratings, the following equations may be used for designing a multiple-resistor dummy load: Number of resistors needed = Desired power dissipation of dummy load / Power rating of each

resistor, and Value of each resistor = Total resistance of dummy load x Number of resistors needed. All too often the calculated value for each resistor will not be a standard resistance, a factor that will complicate matters. Table 1 helps to sneak around this problem by offering values based on the standard two Watt resistors.

## Construction

The actual construction depends upon the number of resistors that the above equation tells you are needed. If you can get away with just one, whether it be a 1/8 or 2 Watt, then the design in Fig. 1(a) should do the job. Here, the resistor is soldered inside a PL-259 connect, with a small metal plate soldered to the end as a shield.

For higher power operation, the circuit in Fig. 1(b) allows compact mounting for twenty resistors or more. In this circuit, two copper or brass plates are used for mounting to eliminate capacitive coupling between adjacent leads. After the SO-239 connector has been mounted, a series of small holes are drilled in both plates for the resistors. A hole is also drilled in the center of the back plate and a wire soldered between the center conductor of the coax connector and the back plate itself. As always, leads should be kept

Dummy Loads Using  
 Standard 5%, 2 W Resistors

Watts	R <sub>char</sub>	R <sub>each</sub>	N
4	50.0	100	2
4	75.0	150	2
6	50.0	150	3
6	73.3	220	3
8	50.0	200	4
8	75.0	300	4
10	48.0	240	5
12	50.0	300	6
12	73.3	430	6
14	51.4	360	7
14	72.8	510	7
16	48.7	390	8
16	77.5	620	8
18	52.2	470	9
18	75.5	680	9
20	51.0	510	10
20	75.0	750	10
22	74.5	820	11
24	51.6	620	12
24	75.8	910	12
26	52.3	680	13
26	73.3	1100	13
30	50.0	750	15
32	51.2	820	16
32	75.0	1200	16
34	76.4	1300	17
36	50.5	910	18
40	50.0	1000	20
40	75.0	1500	20

Table 1. The above design values will not result in a mismatch greater than 1.1:1, even when the tolerance is worst case.

as short as possible.

If shielding is what you need, and even higher power dissipation, then the circuit in Fig. 1(c) may be installed inside a pint or one half pint paint can. Transformer oil can be added to increase the short duration power handling capacity by a factor of three or four. A note of caution however: Don't use motor oil — because of its lower boiling point, it has a nasty habit of blowing off can lids, and sending hot oil

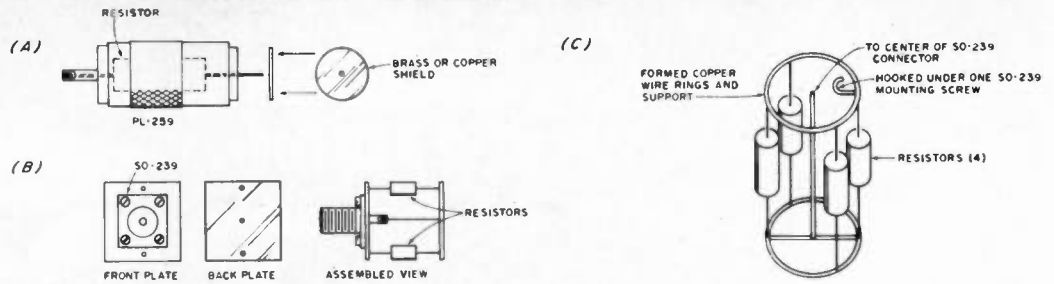

Fig. 1. At (c), the S-239 connector is mounted in the can lid. Make sure that the bottom ring does not make contact with the can.

all over the place.

In the interest of accuracy, it's worth the extra money to

invest in 5% resistors for the above circuits. This will give a tolerance of  $\pm 2.5$  Ohms for a

50 Ohm dummy load, which results in a mismatch of only 1.05:1. ■

Francis J. Piraino WA3KMM  
Box 86  
Pocono Summit PA 18346

# Failsafe Super Charger

-- multi-rate, too!

At my QTH, many systems operate from a 12 volt dc automobile battery. The old saying "close the barn door after the horse runs away" applies to me. My QTH was burglarized; now I have a burglar alarm system.

My system is simple yet quite adequate and it operates from 117 V ac and, in case of power failure, it switches to 12 V dc.

An automobile battery supplies the power, but keeping the battery at its

peak was quite a problem and it was time-consuming. This is the reason for building the charger. It keeps the battery at full charge and never needs to be disconnected. In fact, since building this charger, I have added a power failure alarm. I have installed a 12 volt automobile FM stereo and tape player in my den. I operate my ham antenna switching system from this battery, and also my 2 meter FM transceiver when I remove it from the car. There were a few places I needed a light, and using a dome lamp assembly from an old auto worked perfectly.

This charger is rather simple and doesn't require any expensive parts. Any

transformer with a voltage between 14-24 volts and rated at a few Amps can be used. Mine was from an old battery charger.

A two gang rotary switch and two 9 Ohm 30 Watt resistors are used to give me three charging rates when wired as shown in the schematic. Any charging combinations can be used provided the transformer and bridge rectifier can handle the current. The SCR listed is rated at 7 Amps with a heat sink.

Only one meter is used to read voltage or current. The meter shunt is in series with the positive lead to the battery and connecting the switch as shown will give you voltage or current. The meter face was reprinted to read 0-15 V dc and 0-4 Amps.

The pulse transformer was a small audio transformer which was rewound to give a 1:1 turns ratio at approximately 20 Ohms resistance. Since then I have seen them listed as SCR trigger transformers.

The unijunction is used as a relaxation oscillator, and the potentiometer controls the upper voltage limit for the battery. When this limit is reached, the oscillator stops oscillating, which in turn stops triggering the SCR. The battery must be connected for the circuit to operate. If the oscillator circuit fails to operate, reverse one of the pulse transformer windings. The SCR needs a positive spike at the gate to fire. ■

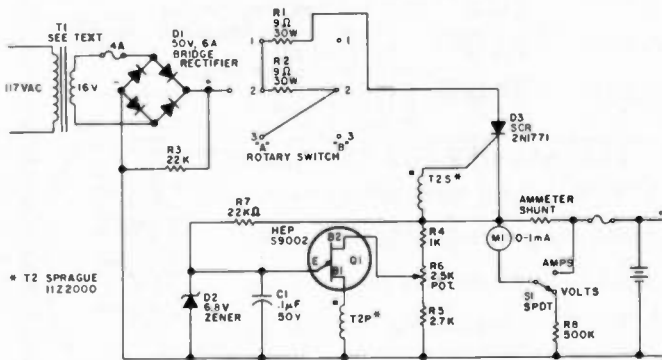

Fig. 1. Electronic battery charger.

# Whatever Santa Says . . . Will be Sharper, Clearer and VALUE PACKED! With the Incredible

This  
Holiday  
Season  
look for value,  
look for performance.  
Then buy the  
Worlds Finest  
Amateur Transceiver.  
GENAVE!



**GTX-1 or  
GTX-1T  
HAND-HELD  
2-Meter FM  
Transceiver**

**CHECK THESE FEATURES:**

- All Metal Case
- American Made
- Accepts standard plug-in crystals
- Features 10.7 MHz crystal filter
- Trimmer caps on TX and RX crystals
- 2.5 watts output
- Battery holder accepts AA regular, alkaline or nicad cells
- Mini Handheld measures 8" high x 2.625" wide x 1.281" deep
- Rubber ducky antenna. Wrist safety-carrying strap included
- 6 Channels
- Factory-direct to You

**Accessories Available:**

- Nicad Battery Pack
- Charger for GTX-1 battery pack
- Leather carrying case
- TE III Tone Encoder for auto patch

**GTX-200-T**



2-meter FM, 100 channel combinations, 30 watts with factory installed tone encoder (Incl. 146.94 MHz)

**\$249<sup>95</sup>**

**GTX-200**



2-meter FM, 100 channel combinations, 30 watts (Incl. 146.94 MHz)

**\$199<sup>95</sup>**

**GTX-10-S**



2-meter FM, 10 channels, 10 watts (Xtals not included)

**\$149<sup>95</sup>**

**GTX-2**



2-meter FM, 10 channels, 30 watts with pushbutton frequency selector (Incl. 146.94 MHz)

**\$189<sup>95</sup>**

2-meter FM, 6-channel, 3.5 watts Hand-Held

**\$249<sup>95</sup>**



**PLUG IN TONE ENCODER PAD**  
Plug in installation on most amateur transceivers

Same as GTX-1, plus factory installed Tone Encoder \*(Bat. not incl.)

**\$299<sup>95</sup>**

**TE-II \$49<sup>95</sup> TE-I \$59<sup>95</sup>**

**GTX-I  
GTX-IT**

**HURRY!**

Use This Handy Order Form



4141 Kingman Dr., Indianapolis, IN 46226  
Phone-in orders accepted (317+546-1111)

NAME \_\_\_\_\_  
ADDRESS \_\_\_\_\_ CITY \_\_\_\_\_  
STATE & ZIP \_\_\_\_\_ AMATEUR CALL \_\_\_\_\_

Payment by:  
 Certified Check / Money Order     Personal Check  
 C.C.D. Include 20% Down

Note: Orders accompanied by personal checks will require about two weeks to process.  
20% Down Payment Enclosed. Charge Balance To:

BankAmericard # \_\_\_\_\_ Expires \_\_\_\_\_  
 Master Charge # \_\_\_\_\_ Expires \_\_\_\_\_  
 Interbank # \_\_\_\_\_ Expires \_\_\_\_\_

IN residents add 4% sales tax: } \$ \_\_\_\_\_  
CA residents add 6% sales tax: }

73 All orders shipped post-paid within continental U.S.

- GTX-200-T **\$249<sup>95</sup>**     Ringo Ranger ARX-2 6db 2-M Base Antenna **\$299<sup>95</sup>**
- GTX-200 **\$199<sup>95</sup>**     Lambda/4 2-M and 6-M Trunk Antenna **\$299<sup>95</sup>**
- GTX-10-S **\$149<sup>95</sup>**     TE-I Tone Encoder Pad **\$59<sup>95</sup>**
- GTX-2 **\$189<sup>95</sup>**     TE-II Tone Encoder Pad **\$49<sup>95</sup>**
- GTX-1 **\$249<sup>95</sup>**     PS-I AC Power Supply for use with all makes of transceivers 14 VDC—6 amp and the following standard crystals @ \$4.50 each    **\$69<sup>95</sup>**  
Non-standard crystals @ \$6.50 each: \$ \_\_\_\_\_
- GTX-IT **\$299<sup>95</sup>**

**ACCESSORIES FOR GTX-1 and GTX-1T**

- PSI-18 Optional Nicad battery pack ..... **\$29<sup>95</sup>**
- PS-2 Charger for GTX-1(T) battery pack ..... **\$39<sup>95</sup>**
- GLC-1 Leather carrying case ..... **\$12<sup>95</sup>**
- TE-III Tone Encoder (for use with GTX-1) .... **\$49<sup>95</sup>**

Add \$4 per Radio for Shipping, Handling, and Crystal Netting.

# SPECIFICATIONS:

## GENERAL:

Front Panel Size: 6 1/2" X 2 1/2"  
 Over-all Dimensions: 10 1/2" deep X 6 1/2" wide X 2 1/2" high  
 Components: 13 Transistors, 10 Diodes, 6 FETS, 4 ICs  
 Frequency Range: 144 to 148 MHz  
 Number of Channels: 20 plus 2  
 Weight: Approximately 6 lbs.  
 Power Supply: 13.75v DC system, negative ground

## RECEIVER:

Sensitivity: 12 db SINAD: .25 Microvolt  
 Selectivity: ±7.5 KHz, @ 6 db or less  
 Squelch Threshold: 0.1 Microvolt  
 Modulation Acceptance: More than 5 KH  
 Adjacent Channel Rejection: More than 85 db (±30KHz)  
 Intermod response: More than 70 db  
 Image Responses: More than 70 db  
 Spurious Response: More than 70 db  
 Audio Output Power: 4 Watts at less than 15% distortion (5 Watts Max)  
 Frequency Stability: ±.001%  
 Circuit Type: Double conversion, Superheterodyne, Crystal Controlled, 8 Pole Crystal Filter  
 Intermediate Frequencies: 10.7 mHz 1st IF; 455 KHz 2nd IF  
 Current Drain: (Squelched) .2 Amps.  
 FCC Certified: Part 15, subpart C

## TRANSMITTER:

Power Output: Hi: 30 Watts nom., 25 Watts min., @ 14v DC input  
 Lo: 1 Watt @ 14v DC input  
 Output Impedance: Matches standard 50 Ohm amateur antennas  
 Frequency Stability: ±.001%  
 Audio Modulation Deviation: Adjustable to 10 KHz max.  
 (Factory set to ±5 KHz)  
 Current Drain: Hi. 6.0 Amps. Lo 1.7 Amps.

# Just Unpack the GTX-202 and Channel in for the Holidays . . .

The GTX-202 is adaptable anywhere—at half the price of Synthesis—So, buy at low acquisition cost, and add crystals later as you want or need them.



## USE THIS HANDY ORDER FORM

GTX-202 22 Channels **\$239.95**

- Ringo Ranger ARX-2 6 db 2-M Base Antenna @ \$29.95 \$ \_\_\_\_\_
- Lambda/4 2-M and 6-M Trunk Antenna @ \$29.95 \$ \_\_\_\_\_

TE-I Tone Encoder Pad for plug-in installation on most amateur transceivers @ \$59.95 \$ \_\_\_\_\_

TE-II Tone Encoder Pad for installation on most Hand-Helds @ \$49.95 \$ \_\_\_\_\_

PS-1 AC Power Supply for use with all makes of transceivers 14 VDC-6 amps @ \$69.95 \$ \_\_\_\_\_

and the following  
 Standard crystals @ \$4.50 each \$ \_\_\_\_\_  
 Non-Standard crystals @ \$6.50 each \$ \_\_\_\_\_

Payment by:  
 Certified Check/Money Order  Personal Check  
 C.O.D. Include 20% Down

Note: Orders accompanied by personal checks will require about two weeks to process.  
 20% Down Payment Enclosed. Charge Balance To:

- BankAmericard # \_\_\_\_\_ Expires \_\_\_\_\_
- Master Charge # \_\_\_\_\_ Expires \_\_\_\_\_
- Interbank # \_\_\_\_\_ Expires \_\_\_\_\_

IN residents add 4% sales tax: } \$ \_\_\_\_\_  
 CA residents add 6% sales tax: } \$ \_\_\_\_\_

All orders shipped post-paid within Continental U.S.  
 Add \$4 per Radio for Shipping, Handling, and Crystal Netting.

Check these outstanding features:

- Massive heat sink to maintain power over prolonged transmissions
- 30 watts (nom.) output
- 8-pole crystal filter
- 15-pin accessory jack
- Dual-gate MOSFET front end

Same Circuitry as used in Genave's famous Land Mobile transceivers . . . Manufactured in America by the same Government-Inspected facility that produces high quality reliable communications and navigations for marine and aircraft industries.

Be sure to look for the **MADE IN U.S.** tag.



4141 Kingman Dr., Indianapolis, IN 46226  
 Phone-in orders accepted (317-546-1111)

NAME \_\_\_\_\_

ADDRESS \_\_\_\_\_ CITY \_\_\_\_\_

STATE & ZIP \_\_\_\_\_ AMATEUR CALL \_\_\_\_\_

CLIP OUT AND ORDER NOW

# The Amazing 18" Antenna for 160m

-- get on topband simply

**M**any hams are interested in the low bands, but shy away from 160 meters because of the size of the antenna needed. Many of these same hams have the makings of an excellent antenna for this band, in the form of their tower and beam installation. With an easily added modification,

they could be on "topband." The required additional space? About 18 inches!

A tower can be used as the grounded leg of a short unipole. (A unipole is half of a dipole, with the missing half replaced by a ground plane.) An added download makes the antenna a folded unipole (half of a folded dipole) and

does some nice things for us — not the least of which is enabling us to more easily secure a good match to 50 or 75 Ohm feedline. Let's see why this happens.

At 2 MHz, a 50 foot tower is a short (.1 wavelength) antenna, and an antenna this short is highly reactive. If it were fed as a conventional vertical (as you might feed a short vertical mobile antenna on another band), it would require a large, lossy, and physically awkward inductance to cancel the reactance, and would be difficult to adjust properly. It would also display a very low radiation resistance, on the order of .5 Ohms, and be a very inefficient system.

Adding a download to form a folded unipole has the effect of raising the impedance by a factor of 4 (as does a folded dipole compared to a dipole), and therefore the radiation

resistance is raised and the ground losses reduced by the same factor.

The download acts in the same manner as the gamma rod on a beam assembly, and changes the sign of the reactance. The required matching network is now a capacitive one, and is therefore a more easily adjusted device. If we take a page from the beam designers and add an additional shunt capacitor, we form an omegamatch, a network which has even more flexibility and will match a wide range of antenna/feedline impedances with ease.

The folded unipole is a broadbanded system, and will tolerate greater excursions from tune-up frequency before swr becomes excessive. Any 25 kHz segment may be covered, with no retuning necessary and swr remaining below 1.5/1.

My tower installation is composed of a Rohn foldover 50 foot, with a TH3 tribander and a couple of inverted vees for other bands, and a two meter beam. To add the download, I used a 30 inch piece of 1/2 inch aluminum tubing, clamped to the tower with stainless steel hose clamps. The download, a piece of #16 stranded, is attached to the tubing at a point 18 inches away from the tower, using a lug and a self-tapping screw. A short wire is attached to the tubing in the same manner, and the free end is secured to the tower under a structure bolt. This gives a solid, low resistance connection to the tower — without requiring any holes to be drilled in the structure. The download is secured to the base of the tower using another 30 inch tubing and clamp arrangement. An insulator and short lead to the omegamatch assembly complete the installation.

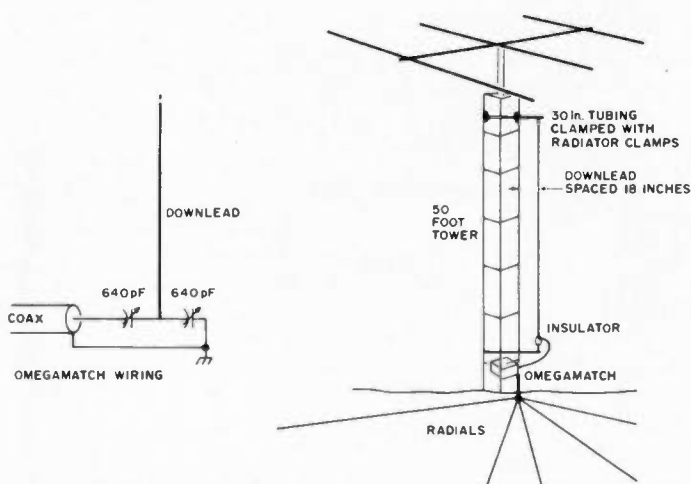

Fig. 1. The "hairpin" on top.

The omegamatch assembly is built using a couple of old dual 360 pF variables salvaged from an old radio. I would recommend wider spacing if possible, especially if higher power is authorized in your area, but running the legal (nighttime) power of 100 Watts input has not caused any arcover. Use heavy wire to make the various connections, as the current is high. I enclosed the omegamatch unit in a plastic Tupperware refrigerator box

with a tight-fitting lid, and have had no problems due to moisture. There is rf present on the rotor of the series capacitor, so use adequate knobs.

Tune-up is accomplished using a grid dipper and antenna scope (or just feed low power to the system and adjust for best swr). A 1/1 match at tune-up frequency is easily obtained, and my installation enabled me to go 20 kHz above or below this frequency with less than

1.4/1 swr. Signal reports have compared favorably with other stations running comparable power with full-sized antennas.

This, like all verticals, requires a good ground system — not just a pipe a few feet in the ground. Radials, as long as possible (up to a quarter wave) and as many as practical, will assure a good system. They may either be laid on top of the ground with spikes to secure them, or buried an inch or so

in the ground. I used an electric edger, and installed 25 radials in a short time. All wires should be soldered to a common ground bus, and this is attached to the tower with a large lug. Shield from a piece of scrap coax makes a good source of copper bus strap.

I hope this approach to the antenna problem will encourage others to try topband. It's a challenge, and fun. See you on the low end? ■

Dennis J. Sommers WB4TTY  
Route 2 Box 68-A9  
Central SC 29630

**M**ost projects hams try to build start with a schematic, and most circuit board kits tell you to draw the layout on the board and etch. The trouble is getting from one step to the other.

The method I use requires the simplest of tools and provides a template layout of the foil side of the board, a template for drilling the board, and a component layout.

The materials required are as follows: a hat pin, medium weight cardboard, a fine point pen, scissors, and some components (resistors, capacitors, etc.).

First cut the cardboard to the size of the required PC board, and mark all mounting holes with the pen. Next, bend the component leads to the proper length for use on a board. Place the lead ends of the component on cardboard and mark by pushing the pin through the cardboard, as shown in Fig. 1.

Next, using the pen, draw a line between the pin marks and indicate the component number or value as shown in Fig. 2. This will work as your component placement guide during assembly.

As you locate more parts

on the cardboard, turn it over and draw in foil areas as shown in Fig. 3. This will serve as your layout for the project. Also, when the cardboard is placed over the

circuit board, the pin holes can be used to lay out the location of holes in the board.

By doing your design this way you can get the best

layout, and if it flops, all you lose is a piece of cardboard. ■

# A Great Way to Lay Out PC Boards

## -- new use for shirt cardboards

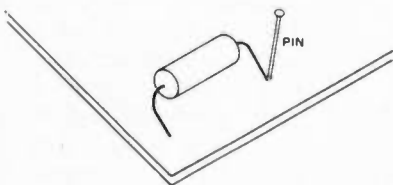

Fig. 1.

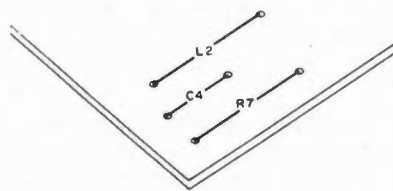

Fig. 2.

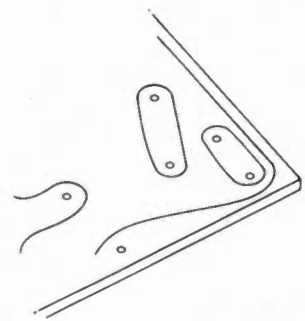

Fig. 3.

# Replacing the Knife Switch

-- simple TR system for the Novice

**H**ow many of us start our first ham station with manual transmit-receive switching? You know, "real" manual switching. First the other guy turns it over to you, then you throw the receiver into standby, then you throw the transmitter out of standby, and finally you frantically flip that little knife switch that does all the antenna changeover work. Maybe you've even forgotten all about it by now, but chances are that many of the Novices who are reading this are pretty familiar with how it feels to wonder if the other fellow gave up on you during the intermission. It's not an impossible situation to remedy, though. For about

two thirds the cost of the popular Dow Key "60" coaxial relay, you can build a 1000 W capacity transceive switch that gives you convenient one switch operation.

The heart of this little gadget is a Kurman 115 V rf power relay, available from Lafayette Radio Electronics. This may be expensive, but compared to virtually any similar rf relay, the cost is a really solid investment. It has quite impressive specs.

The relay coil itself draws about a Watt at 115 V, but if you prefer odd coil voltages, models are available with 6, 12, and 110 V dc coils. The DPDT, self-wiping contacts

are capable of handling 1.5 kW at frequencies up to 450 MHz. Standard G-7 insulating bridges provide excellent rf isolation between contacts. The relay can be easily mounted on one side of your enclosure by using the four tapped #6-32 mounting holes provided.

## Construction

A four pole, three position telephone lever switch is used for the front panel transceive switching. The middle position provides a standby condition for both transmitter and receiver. Two of the DPDT contacts are used to switch the transmitter and receiver standby circuits, while the third energizes the

relay. On my model, the fourth contact was used to short the receiver antenna terminals during transmit, thus providing extra protection from front end burnout.

Three SO-239 female coax connectors were mounted on the rear panel to provide standard interconnection to any rig. The power cord is also mounted on the back of the Radio Shack 5-1/4" x 3" x 5-7/8" cabinet, being passed through a grommet for safety's sake. Additionally, a four pin socket is mounted below the coax connectors for hookup to the receiver and transmitter standby circuits. Since transmitter standby is often just a switching of the primary of the plate transformer, the socket pins must be capable of handling 2 A or so. An optional power switch can be installed, as indicated on the schematic, but it's not really necessary because the relay will be turned off anyway when the lever switch is in the center position.

For most applications, the .001 uF bypass capacitors will adequately prevent rf from riding out on the incoming power leads. However, leads should be kept short on the capacitors bypassing the relay coil since such coils tend to pick up a lot of rf at high frequencies and subsequently put it right into the power line. Also, if the transceive switch is intended to be operated into a constant impedance, then coax is suggested for all rf carrying leads within the box.

This switching system allows considerable versatility at nearly any power level and with virtually any equipment. I experienced only one difficulty. It may be necessary to weight down the entire assembly to prevent it from moving all over the place when the lever is thrown.

Otherwise, you should have a reliable switch that will serve your needs for many years to come, no matter how much your other equipment changes. ■

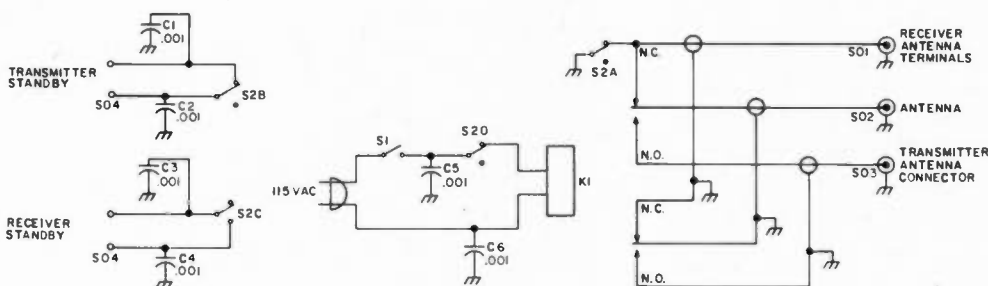

Fig. 1. Optional switch S1 (SPDT toggle) is shown in the off position, while S2 (4PDT telephone lever switch) is shown in the transmit position. C1-6: .001 uF, 1 kV, disc ceramic. K1: DPDT rf power relay (Lafayette #30E22217). SO1-3: SO-239 female coax connectors. SO4: 4 pin socket, all pins well isolated from chassis, capable of 2 A. Enclosure: Radio Shack 5-1/4" x 3" x 5-7/8" metal cabinet.





# Hold it!

Take hold of SSB with these two low cost twins. ICOM'S new portable IC-202 and IC-502 put it within your reach wherever you are. You can take it with you to the hill top, the highways, or the beach. Three portable watts PEP on two meters or six!

**Hello, DX!** The ICOM quality and excellent receiver characteristics of this pair make bulky converters and low band rigs unnecessary for getting started in SSB-VHF. You just add your linear amp, if you wish, connect to the antenna, and DX! With the 202 you may talk through OSCAR VI and VII! Even transceive with an "up" receiving converter! The IC-502, similarly, makes use of six meters in ways that you would have always liked but could never have before. In fact, there are so many things to try, it's like opening a new band.

Take hold of Single Side Band. Take hold of some excitement. Take two.

#### IC-202

2 Meter SSB • 3 Watts PEP • True IF Noise Blanker  
Switched Dial Lights • Internal Batteries • 200KHz  
VXO Tuning • 144.0, 144.2 + 2 More! • RIT!

#### IC-502

6 Meter SSB • 3 Watts PEP • True IF Noise Blanker  
Switched Dial Lights • Internal Batteries • 800KHz  
VFO • RIT!

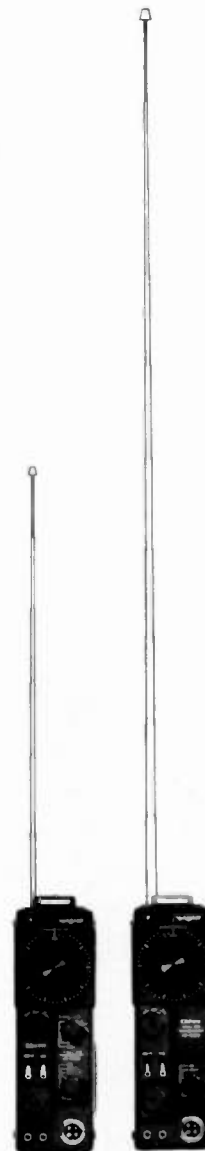

VHF/UHF AMATEUR AND MARINE COMMUNICATION EQUIPMENT

Distributed by:



# ICOM

**ICOM WEST, INC.**  
Suite 3  
13256 Northrup Way  
Bellevue, Wash. 98005  
(206) 747-9020

**ICOM EAST, INC.**  
Suite 307  
3331 Towerwood Drive  
Dallas, Texas 75234  
(214) 620-2780

# \$25 for a Connector? You're Crazy!

## -- do-it-yourself 7/8" coax connectors

Kenneth R. Leiser W9DOR  
364 Normandy Lane  
Grayslake IL 60030

**M**easurement of output power at the transmitter, in comparison to output power at the antenna end of a transmission line, will show how much power is lost in the transmission line. You may be shocked at how high

this loss really is, especially if you are using conventional coax for your transmission line. Power lost is power wasted and remember that transmission line loss affects your received signals as well. Loss in received signal

strength is usually of more concern than loss affecting transmitted signals.

Loss in a transmission line becomes greater as the frequency is increased. Therefore, loss is of considerable importance for the 420 MHz band which is becoming quite popular due to satellite, ATV, EME and other types of communications. "Put your antenna up as high as possible, but keep your transmission line as short as possible" may be good advice, but it is not an easy thing to do. The longer your transmission line, the greater the loss.

One way to reduce transmission line loss is to use 7/8" helical wound cable. This type of cable is available and often can be found at hamfests, usually at very reasonable prices. Sometimes it is "used" cable, still in excellent condition after being retired from a commercial installation. The price of helical cable may be considerably less than conventional coax.

The 7/8" helical wound

Photos courtesy of Lynn Finch WN0NYC

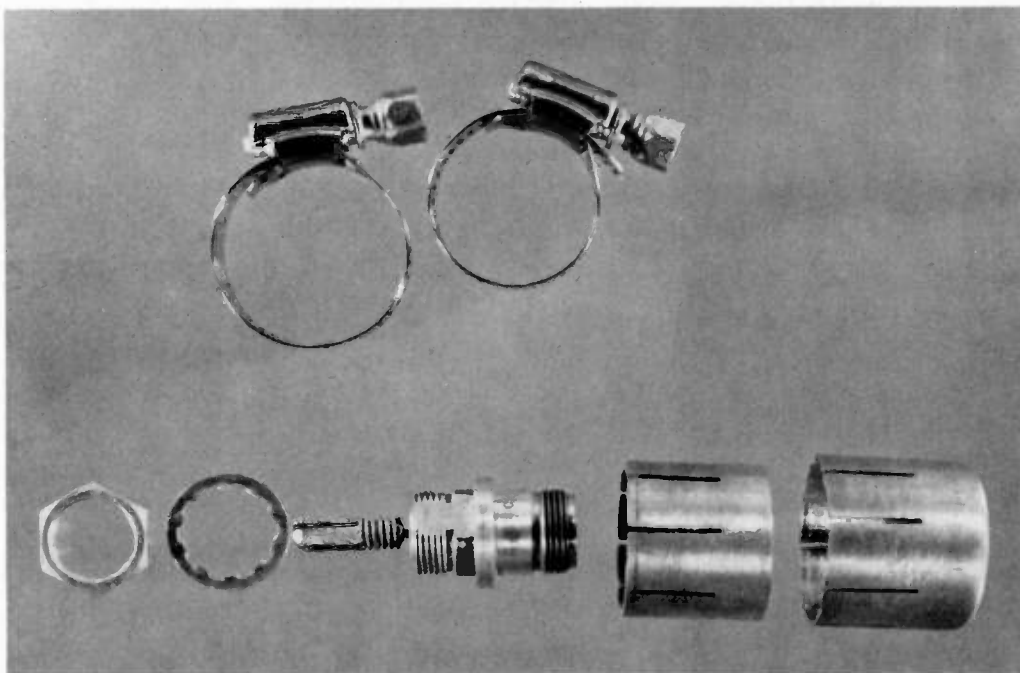

Component parts of connector unit prepared for assembling. Connector pin is soldered in place.

cable is semi-rigid and measures about 1" in diameter, including the protective outer jacket. It has a hollow 1/4" diameter copper center conductor and 7/8" helical wound copper outer conductor with teflon dielectric between the two. This high quality, 52 Ohm impedance cable has much lower loss than conventional coax and should provide many years of excellent service in an amateur installation.

So, what about connectors? They are necessary when using 7/8" helical wound cable, but many amateurs have been discouraged from buying or using it when they learn the connectors would cost several times more than the cable itself. These connectors are difficult to obtain, and they are very expensive. Also, they are not normally available on the surplus market. So how can you use quality cable without spending a small fortune on

accessories? Why not make your own connectors? This is how I solved the problem of using 7/8" helical wound cable.

Common tools are used, and the few parts required should be easily obtained at low cost. The parts list for one cable connector assembly consists of one UG-680/U "N" type connector, one 1" length of standard 1" copper pipe, one standard 1" copper pipe cap, two size 12 stainless steel hose clamps, and one 3/4" length of 1/4" diameter brass rod (copper rod should work equally well).

Using a hacksaw, make eight 5/8" long slots in one end of the 1" length of pipe. Saw similar slots in the open end of the pipe cap. With a chassis punch make a 5/8" hole in the center of the closed end of the pipe cap.

Unsolder and remove the wire terminal lug from the center pin of the connector, saw two 1/2" long right angle slots in one end of the brass

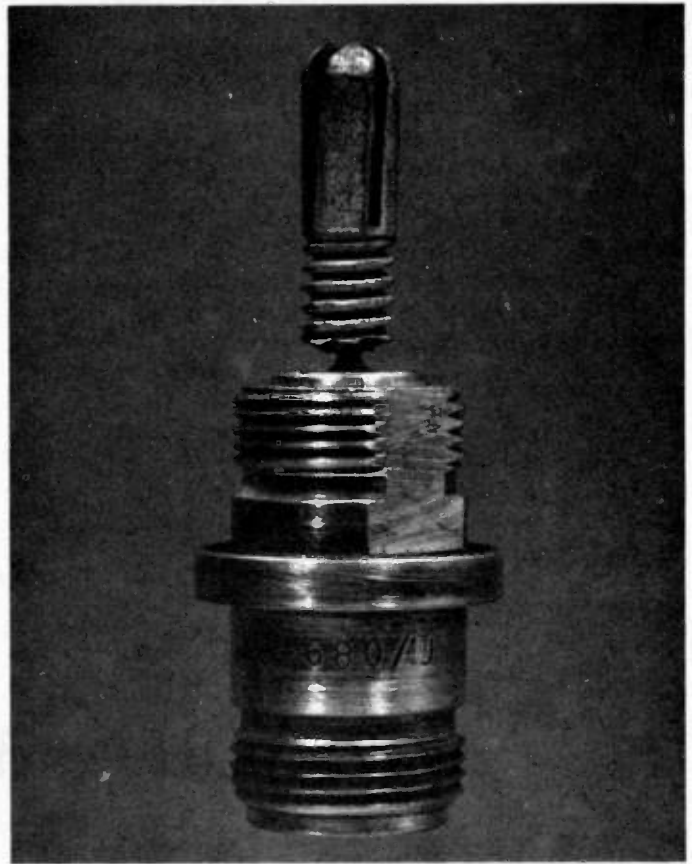

*Close-up of "N" type connector with fabricated center pin. The threaded portion of the pin is immaterial.*



*Expanded end of connector pin shown provides snug fit into center conductor of cable.*

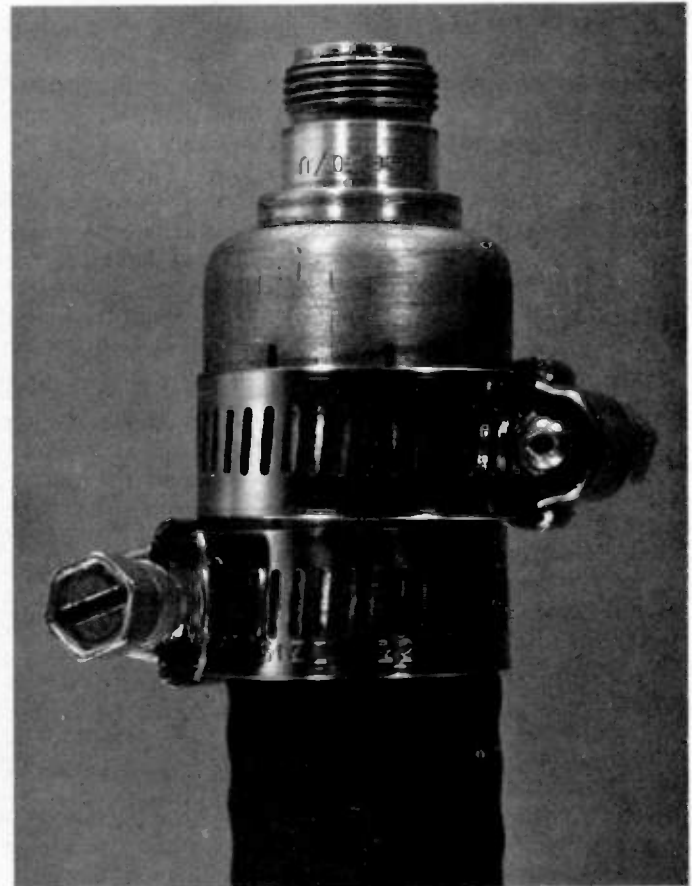

*The completely assembled product ready for weatherproofing and final installation.*

rod, and round the end off slightly with a file. The four pieces from sawing the slots should be spread enough to provide a good snug fit when inserted into the 1/4" center conductor of the cable. Center and drill a small hole in the other end of the rod, to slip over the end pin of the connector. Using a small torch, solder the connector pin in place.

Remove a 1" length of the protective outer jacket from the end of the cable. Then slip the slotted end of the

pipe over the outer conductor of the cable, and secure with a hose clamp at the slotted end. Be sure that the other end of the pipe is flush with the end of the cable, then tighten the hose clamp.

Mount the connector in the pipe cap with lock washer and nut and tighten securely. Assemble by sliding the expanded end of the connector pin into the center conductor of the cable. The slotted end of the pipe cap should slide 1/2" over the pipe previously secured in place. Secure the

pipe cap in place by placing a second hose clamp at the slotted end and tightening the clamp.

For long term stability, it is desirable that all connector parts be silver plated before assembly. This is not absolutely necessary, however, since the cable conductors themselves are bare copper. Be sure to thoroughly weatherproof the entire connector assembly. I use a silicone rubber sealer and it works fine. "N" connectors are supposedly "weather-

proof," but I use sealer to be sure.

If you remembered that there are two ends on your cable, then you probably doubled the quantity of each item required. If so, you are ready to make a connector assembly for the other end of your cable. Install it, and start enjoying the advantages of using a low loss transmission line without the headache of special (and expensive) connectors. I think you will agree the results are well worth the effort. ■

Donald L. Upp WB8STQ  
52 East Sherry Drive  
Trotwood OH 45426

# Now You Can Synthesize

## -- the VHF Engineering approach to 2m happiness

**A**fter nearly two years of active crystal buying, otherwise known as 2 meter operating, I finally broke down and started shopping for a synthesizer. Being known as one so tight that I squeak when I walk, cost effectiveness was a prime requirement. My attention was captured by the VHF Engineering Synthesizer II ad in the Dayton Hamvention program and then by their exhibit, when they introduced the unit, in April. This unit also met requirement number two — I could assemble it myself.

So I ordered one. I was told it would be about six weeks for delivery. It came July 12th (Monday), which comes out to eleven weeks, not too far off my own guess of ten weeks, as this was a new product. In my later conversations with VHF, they said they did not get satisfactory boards until the first of July. So they were very prompt in sending out the kits once they got going.

The wait for good boards was worth it. I didn't start on assembly until Wednesday night about nine pm, and quit at eleven-thirty, and did the same on Thursday and Friday, then played golf Saturday. Sunday morning I worked DX on the low bands, and still put the synthesizer on the air about four pm Sunday. With no snags.

Well, almost none. I made one error at eleven pm on Saturday that was my own fault — I wired the thumbwheel switch multi-wire ribbon conductor *THROUGH* the switch mounting hole instead of *OVER* the front panel, so I had fourteen wires to remove and redo. Judging from the manual (which is very well done), the author was left-handed. The whole thing was much easier in reversed sequence.

Also, I broke two tuning slugs working on the VCO coil, as the coil form tightens down on the slug due to the pressure of the grommet

against the plastic form. This is not a serious problem, just an aggravation. But be sure you have clean-running, lubricated threads when you do this part of the assembly, and put the slug in long after the can is bead-soldered to the board.

Since this was one of their first production units, I expected to find several board or instruction errors. There were none on the board (which is a good quality, double-sided board with all components on one side). No parts were missing or bad, and I only caught two instruction errors, one very minor. The major one is obvious — in the section on receiver output alignment, the chokes L-2 and L-3 are being adjusted, and in one line it says "realign L-1 and L-2" where it means L-2 and L-3, as L-1 is the VCO coil.

The minor error is omission of the holes for the LM309K and the transistor leads in the chassis drawing

on page 16. And there was one minor sheet metal problem with the alignment hole for the offset selector switch being too small. I just used an ice pick to "persuade" it open slightly.

The unit works well, with nothing but good reports on audio quality and frequency stability. Construction was clean and simple, everything worked. I did add an LED pilot light (LED and 330 Ohm resistor from the thumbwheel switch five volt common to ground) to let me know the unit is energized. There is one minor drawback. Since the Synthesizer II programs offsets up to 10 MHz in 100 kHz steps, I can't program the 146.115-146.70 pair used in Cincinnati. But with five other positions on my HW-202, I don't really feel too bad about that.

All in all, the \$169.50 kit price was an excellent cost effective purchase, and is a real help to the construction ego by working the first time. ■

# EBC 144 JR

## THE ULTIMATE in Versatility.



*ONLY THE EBC-144 JR. HAS:*

- \* *All repeater offsets*
- \* *More than 20 Watts of rf*
- \* *Better than .35 uV sensitivity*
- \* *Dynamic microphone*
- \* *Full coverage 143.5 to 148.5 MHz*
- \* *Two frequency monitoring*
- \* *More than 4 Watts of audio*
- \* *Lighted front panel*
- \* *Selectivity with 10 poles of crystal filtering*

AVAILABLE NOW FOR ONLY ...

**\$529.95**

For your EBC-144 Jr. send \$529.95  
... we'll pay the shipping.

*Need to be Convinced? ...*

*Write:*

15 River Street New Rochelle NY 10801  
(914) 235-9400

  
**emergency  
beacon corp.**

(A Public Corporation)

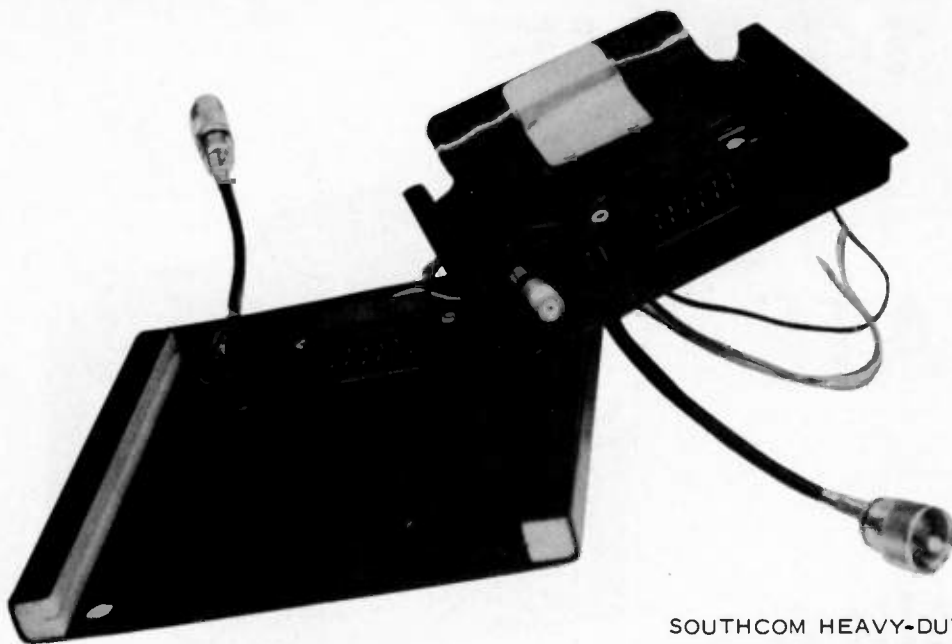

SOUTHCOM HEAVY-DUTY SLIDE MOUNTS ARE DIFFERENT. HEAVY-GAUGE STEEL SLIDES ON PLASTIC GUIDES FOR SMOOTH OPERATION. POWER AND SPEAKER CONNECTIONS ARE SECURE THROUGH COMPUTERTYPE CONNECTORS. A STAINLESS STEEL LATCH HOLDS THOSE CONNECTIONS UNTIL YOU REMOVE YOUR UNIT. PROVISION IS MADE FOR LOCK BY A USER-PROVIDED PADLOCK.

FOR TWO-WAY RADIO USERS, THE MB-3 PROVIDES A NEW MINIATURE COAX CONNECTOR DESIGNED FOR DEMANDING UHF APPLICATIONS. OTHERS MAY CLAIM NO SWR OR LOSS. . .WE CAN GUARANTEE IT!

WHETHER YOUR UNIT IS A "MICRO" OR A HEAVYWEIGHT. . .MOUNTED IN CAR, TRUCK OR BOAT, A SOUTHCOM SLIDE MOUNT INSURES "PERMANENT INSTALLATION" OPERATION WITH INSTANT IN/OUT SAFETY AND CONVENIENCE. ASK YOUR DEALER FOR A SOUTHCOM SLIDE MOUNT TODAY.

MB-3 (ILLUSTRATED) FOR 2-WAY RADIO	\$19.95
MB-2 (NO ANTENNA CONNECTIONS) FOR TAPE DECKS	\$14.95
MB-1 MOUNT ONLY, WITH NO WIRING	\$ 7.25

**SOUTHCOM, INC.**  
P. O. Box 11212  
Ft. Worth, Tex. 76109



The 555 timer integrated circuit can easily be made into an inexpensive linear frequency meter covering the audio spectrum. The 555 is used in a monostable multivibrator circuit. The monostable puts out a fixed time-width pulse, which is triggered by the unknown input frequency.

Referring to Fig. 1, transistors Q1 and Q2 are used as an input Schmitt trigger. The unknown frequency input is clipped between 9 volts and ground by these transistors. Positive feedback is used to insure the waveforms have fast, clean edges. The output of Q2 is a square pulse with the same frequency as the input signal. The output of Q2 is differentiated by C2 and R2 to provide a short pulse for the 555. A small signal diode is connected across the differentiator to insure that the 555 input never exceeds 9 volts. The 555 is connected in the standard monostable circuit. Since a Schmitt is used to trigger the monostable, square, sine and ramp type waveforms may be used at the input to the frequency meter. A nominal voltage of 1 volt rms is required to trigger the Schmitt circuit.

The range scale timing resistors R3, which determine the monostable pulsewidth, are small potentiometers mounted directly on the circuit board. These pots are used to calibrate each frequency scale.

Gene Hinkle WA5KPG  
9503 Gambel's Quail Trail  
Austin TX 78758

# IC Audio Frequency Meter

-- another use for the 555

The output of the monostable is a fixed width pulse. Every time a zero crossing of the unknown frequency occurs, the monostable is triggered. Thus, as the frequency of the trigger pulse increases, the monostable output has a greater and greater duty cycle. The frequency limit on any one range is determined by the R3C3 time constant chosen. As the input frequency becomes too great, the monostable output will never return to zero, because of constant re-triggering, and a constant 9 volts will appear at the output.

The monostable output is a pulse with a duty cycle dependent upon the input frequency. Thus, by integrating or averaging the output waveform, a dc voltage is developed. This voltage is directly related to

frequency. Resistor and capacitor R4C4 is used as a pulse averager, important on the lower range setting. As the input frequency increases, the panel meter itself can act as a waveform averager. Input frequencies greater than 50 Hz will be averaged by the meter fairly well; however, at lower frequencies the meter will respond to each cycle of the unknown frequency input. The meter is used as a high impedance voltmeter. A 1 mA meter could be substituted with a change of resistor R5. For a 1 mA meter, R5 should be about 9.1k and R4C4 should be changed appropriately. R4 should be a factor of ten less than R5, and the same R4C4 time constant should be kept. This would make C4 a very large value, so R4C4 could be left out if the lower frequencies are of little interest

(less than 50 Hz).

The range scales are set up in decades. To calibrate each scale, a standard input frequency is connected to the input. About 1 volt rms is needed to trigger the first stage. The monostable output pulse period must be less than the maximum input frequency to be measured on each scale. With the maximum input frequency applied, each range potentiometer should be adjusted until the value of the input frequency corresponds to the full scale meter reading. The duty cycle of the monostable should be roughly 90% at the maximum frequency input for each scale. This will give the maximum dynamic range on each scale setting. If, for a 90% duty cycle, the meter will not read full scale, meter resistor R5 should be lowered accordingly. Each scale setting should be calibrated by adjusting the respective R3 potentiometer.

During operation, when the scale reads off scale on any range, the scale should be changed to the next higher setting. Once calibrated, this frequency meter should read within 5% of full scale. The useful frequency range of the meter is from tens of Hertz to well over 50 kHz. Although decade ranges are shown, the ranges between the decades can easily be added to give as many frequency ranges as deemed necessary. ■

Fig. 1. 555 timer frequency meter.

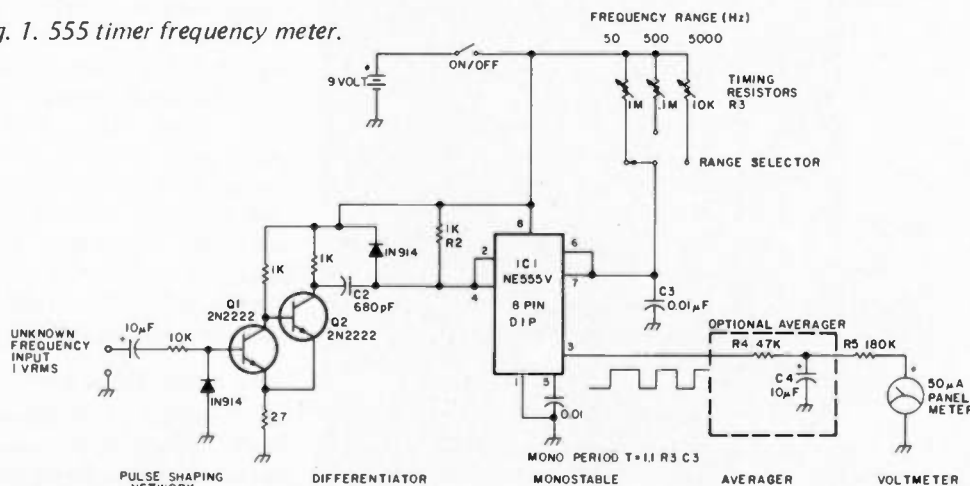

# Hutchinson's Remedy

## -- the chirpless CW machine

If you have ever built your own rig with vfo control, you will know that it is nearly impossible to key the vfo and maintain a chirpfree note. You can often get away with keying the oscillator when operating on 3.5 MHz or 7 MHz, but at 14, 21 or 28 MHz small changes in the vfo

frequency caused by keying become magnified many times. The resulting "note," if not embarrassing, is not easy to copy.

There have been two common remedies that I know of to achieve chirpfree operation. The first is differential keying, described in the

*Radio Amateur's Handbook*. The idea here is to build a circuit which turns the vfo and the final amplifier on and off at different times. When the key is pressed, the vfo turns on immediately, and after a delay of, say, 3 ms, the final amplifier turns on. In this 3 ms interval most of

the chirp will have occurred and will not be amplified. Similarly, when the key is released, the final amplifier turns off immediately, but the vfo turns off about 3 ms later. Again, any chirp at the end of the character is not amplified.

Well, this all sounds good and it does work to some extent, but my experience is that with my vfo, which is the series-tuned Colpitts one described in the chapter on oscillators in the *Handbook*, the chirp at 28 MHz is so bad that it extends over the length of an entire dash or dot when I'm sending at 20 wpm. No amount of differential keying is going to cure that!

The second standard remedy works better, but it costs more, too. This is to have your vfo run all the time and mix its output with the output of a crystal oscillator. The beat frequency of 3.5 MHz, or whatever, is then amplified. Here you key the crystal oscillator and the final amplifier together. The crystal oscillator is so stable that it can be keyed with very little chirp. This method works well, I should think; I've never tried it but often read about it. It's too expensive, and if you're inexperienced you might have trouble getting the mixer circuitry properly tuned.

### Hutchinson's Remedy

My circuit is moderately simple, requires no adjustments, is adaptable to any

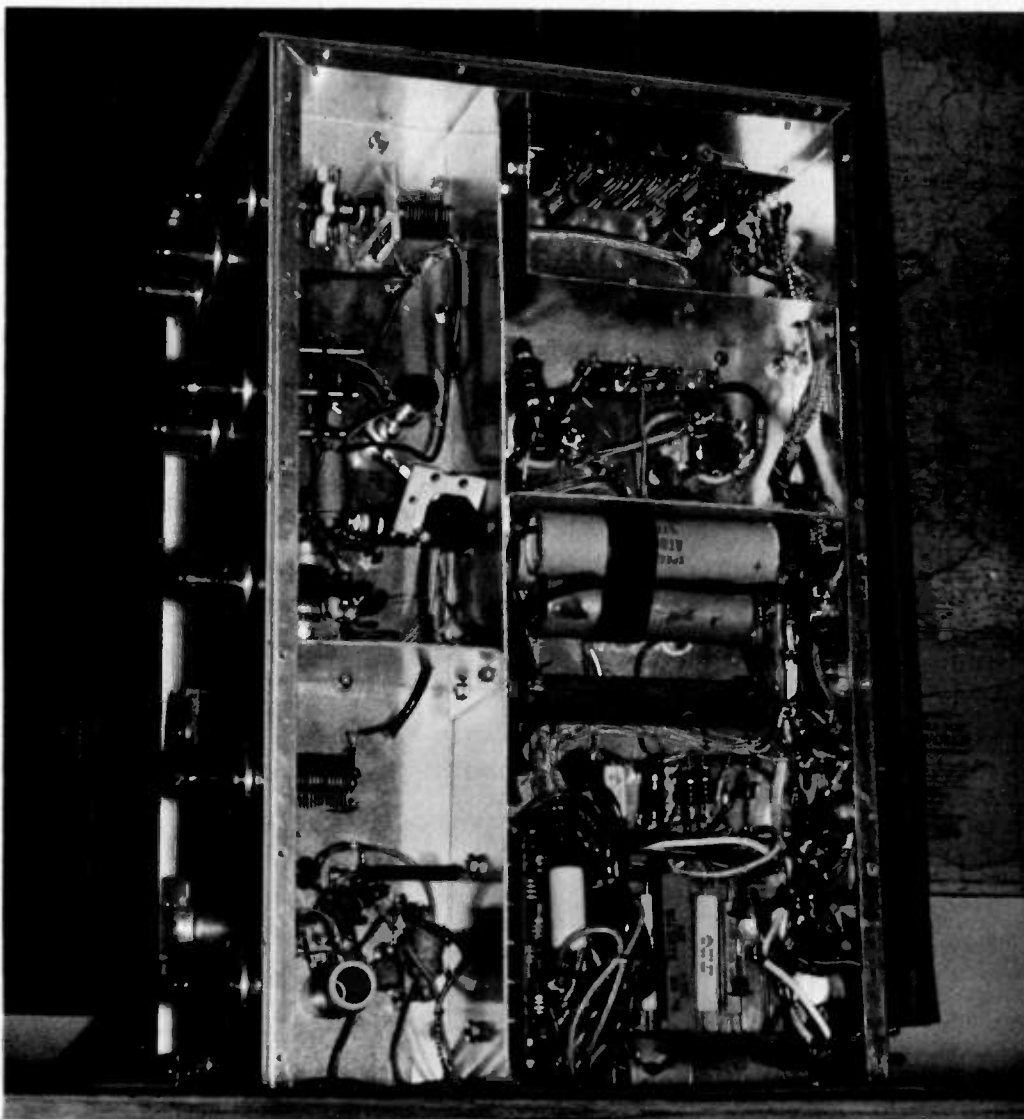



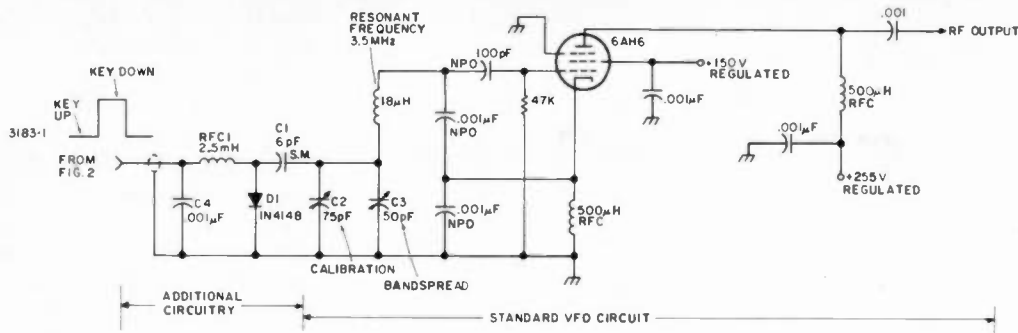

Fig. 1.

vfo, and gives unsurpassed chirpfree break-in operation. The principle here is that of allowing the vfo to run continuously at a frequency slightly higher than the frequency on which you wish to operate. When you press the key, a small capacitor is electronically switched in parallel with the main tuning capacitor in the vfo to lower its frequency to the operating frequency. When the key is released, the vfo frequency snaps back up to where it was before. This allows you to listen on the operating frequency between dots and dashes without the vfo interfering. Since the vfo runs all the time, there can be no chirp. I have incorporated a differential keying circuit which delays the turn-on of the final amplifier at the "make" of each character and delays the upward switching of the vfo frequency at the "break" of each character. This is needed so that you do not amplify and transmit those frequencies being generated while the vfo frequency is in transition from high to low or from low to high.

You must make sure, of course, that there is sufficient isolation between your vfo and your final amplifier so that the vfo frequency is not "pulled" by the final amplifier. The test for this is to allow your vfo to run continuously and key only the final amplifier while listening for any chirp that would indicate pulling. The circuit to be described cannot cure chirp caused by pulling.

### Circuit Details

Fig. 1 shows the series-tuned Colpitts oscillator operating at 3.5 MHz. D1 becomes forward-biased when the key is pressed, effectively placing C1 in parallel with C2 and lowering the frequency of the vfo by approximately 50 kHz. C1 is purposely very small so that if you are installing this in a vfo whose dial is already calibrated, you can maintain this calibration by reducing C2 by 6 pF. Also, such a small capacitor is not likely to upset the Q or temperature stability of your resonant circuit. D1, RFC1 and C4 are placed as close as possible to C1 and within the same enclosure as C2.

Referring next to Fig. 2, a Schmitt trigger conditions the contacts of the key so that dirty contacts still give good operation. U2 is a monostable

multivibrator that delivers a pulse about 3 ms wide when the key is pressed. The negative going pulse from pin 1 goes to flip flop U3A which toggles on the leading negative going edge of the waveform. At the same time pin 6 of U2 delivers a positive going pulse to U3B, but since the SN7473 flip flop triggers only on negative going transitions, U3B toggles later, on the trailing edge of the 3 ms pulse. Assuming U3 was cleared beforehand (Q3A = Q3B = 0), this means that the output of U4B goes to zero the instant the key is pressed, while the output of U4C goes to one 3 ms later. The output of U4B is inverted by U1D and used to control the frequency of the vfo. By closing S1 you can spot your operating frequency. The output of U4C is inverted by U4D. When pin 1 of U4D goes to 0,

Q2 becomes forward-biased and turns on the final amplifier.

When Q3B of U3B goes to 0 at the end of the 3 ms pulse, pin 12 of U4A and hence pins 3 and 5 of U2 go to 0 also. This sets up U2 to send out a second 3 ms pulse at the moment the key is released. Again U3A toggles before U3B and this time U4C switches immediately while U4B switches 3 ms later. So the final amplifier turns off the instant the key is released and 3 ms later the frequency of the vfo switches upward by 50 kHz. The circuit is now back in its initial state ready for the key to be depressed again.

Q2 is set up for grid blocked keying and with the values of R1 and R2 shown it will operate properly with grid currents up to at least 6 mA, which is what the pair of 6146Bs in my final requires. At higher currents the grid current flowing through R1 becomes comparable to the current set up in R1 and R2 by the 5 V source. This disturbs the biasing of Q2 and, once turned on, it may not shut off. To operate with higher grid currents you may have to reduce R1 and R2, keeping their ratio still about 1:1. This, of course, would increase the base current to

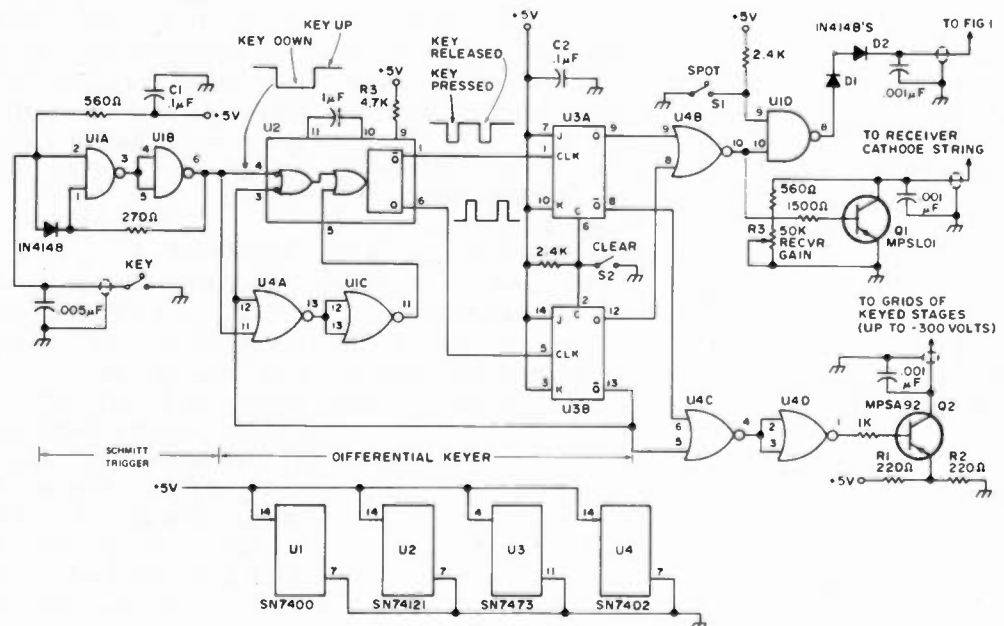

Fig. 2.

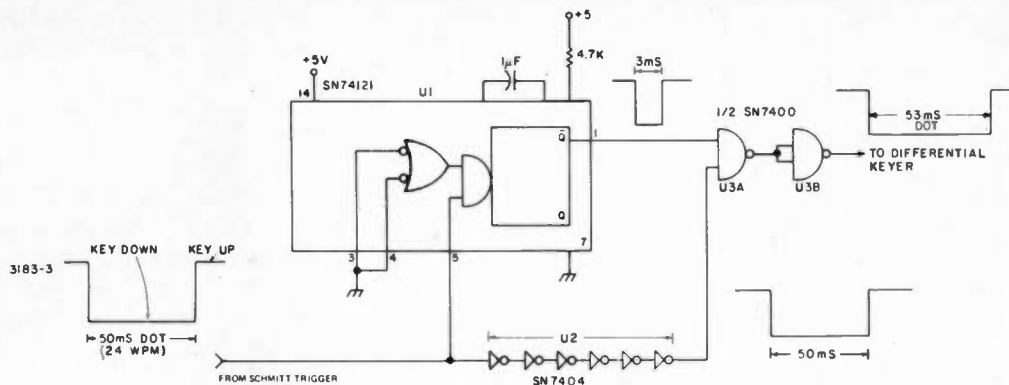

Fig. 3. Optional character stretcher.

Q2. You'll find the MPSA92 Motorola transistor (Q2) very inexpensive (about \$1) and it will handle the highest grid blocking voltages in my experience.

A bonus feature of this differential keyer circuit is that the output of U4B can be used to key your receiver for full break-in operation. A low output from U4B turns down the gain of the receiver, while a high output from U4B restores the gain to normal listening level. The beauty of it is that the gain goes down *before* the final amplifier turns on and the gain is restored only *after* the final amplifier turns off. The result is smooth operation without clicking or popping sounds from your receiver.

In my particular receiver, a Hallicrafters SX-96, the gain is controlled by a potentiometer connected between the cathodes of the various stages and ground. Provision is made through a power plug at the back of the receiver for connecting an external resistor or switch in series with this potentiometer to alter the gain. Q1 in Fig. 2 acts as a switch in this regard. When Q1 conducts, the gain is high; when Q1 shuts off, the gain is low and depends on the setting of R3, an external

control, which you adjust for a comfortable level to monitor your transmissions. Although your receiver may differ from mine in these details, there will be some way to key it and you may have to alter this part of the circuit to meet your needs.

You may be wondering about the function of diodes D1 and D2 in Fig. 2. They insure that when the output of U1D is low there will be no current through D1 of Fig. 1. Even a slight current in D1 of Fig. 1 effectively places C1 across C2 and lowers the frequency of the vfo.

In Fig. 2, S1 and S2 are shown as separate switches, both normally open. In practice you may wish to use an SPDT switch with center off. Always remember to close S2 momentarily when you first turn on your rig in order to clear the flip flops. Further clearing should not be necessary, providing your key does not have excessive contact bounce. Contact bounce up to 3 ms long is acceptable, but any bounce after that will retrigger U2 prematurely and give unpredictable operation. Even the worst key shouldn't bounce that long! Of course, you can always lengthen the 3 ms pulse by increasing R3 at pin 9 of U2, but you can't

do this forever because each dot and dash gets shortened by an amount equal to this pulsewidth. At 24 wpm, a dot is about 50 ms long, and if you chop off, say, 10 ms from this, you start to notice.

For the CW perfectionist who objects to losing 3 ms or so of each dot and dash (that could add up to a few minutes after many QSOs!), there is a solution. The circuit in Fig. 3 can be connected between the Schmitt trigger and the differential keyer to artificially lengthen each character by 3 ms so that the transmitted characters end up precisely the right length! In Fig. 3, a 3 ms pulse is generated by U1 upon each release of the key; NAND gate U3A adds this on to the end of the character just sent. U2 serves as a delay line, insuring that the falling edge of the 3 ms pulse reaches U3A before the rising edge of the waveform from the Schmitt trigger does. The circuit works, but as I said, it's only for the very fussy operator.

#### Construction

I constructed the circuit on a 7.2 cm x 12 cm piece of veroboard, with the 2.54 mm hole spacing that is compatible with the IC pin spacing. Since the circuit will be used in the presence of rf fields, you must bypass each lead to the board with a .001 or .005 uF ceramic capacitor. If rf fields are very strong, you are advised to use properly bypassed shielded wires leading to and from the

circuit board. Failure to take precautions in preventing the influx of rf energy to the circuit will result in the flip flops triggering unpredictably, and you will be constantly pressing the clear button S2 to get things working again. Under some circumstances, I've found it necessary to place a .005 uF ceramic capacitor directly across the terminals of the key. Also the 5 V line is bypassed with low voltage ceramics C1 and C2 in two separate places to reduce switching transients.

The ground connections in Fig. 1 and Fig. 2 must be connected to your receiver ground, and transmitter ground also, so that Q1 and Q2 will key them properly.

The power supply shown in Fig. 4 is suitable for running the circuits in Fig. 1, but you will likely have to lower the value of R1 if you also want to operate those in Fig. 3. Although the power supply could have been designed to work from 6.3 V ac, I often encounter low line voltage situations and decided to borrow another 2.5 V from a spare filament winding in the rig just to be on the safe side. That's how you get that odd value of 8.8 V shown. The measured current requirement of Fig. 2 was 95 mA with key down (maximum current condition).

In Fig. 1, make sure you keep the leads of C1 and D1 short so that your vfo remains mechanically stable. I used silvered mica for C1 and it seemed to be adequate. If your vfo is of a different type, there should still be no problem as long as one side of your tuning capacitor is grounded. Just connect C1 to the ungrounded side as shown.

#### Conclusion

I have had this circuit in use for some time now and am pleased to report that on all bands (80m-10m) the many amateurs I have worked report that there is no detectable chirp on my note. ■

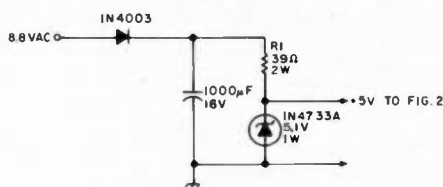

Fig. 4. Power supply.

# The one you've been waiting for!



Shown with optional Micoder™

## HEATHKIT SYNTHESIZED 2-METER TRANSCEIVER!

**\$269<sup>95</sup>**

With Standard PTT Microphone

### The new Heathkit 2-meter frequency-synthesized transceiver...

combines state-of-the-art technology with operating ease, convenience and versatility in an easy-to-build kit that's about HALF THE COST of comparable synthesized transceivers. It's the one to buy and build for real 2-meter PERFORMANCE!

Operation is easier than ever! The front panel lever switches select any frequency in any 2 MHz segment of the 143.5 to 148.5 operating bands. You select the last four digits, three with lever switches which display the frequency directly and the last with a 5 kHz toggle switch which makes ALL 2-meter frequencies in the band available. If you inadvertently dial up an out-of-band frequency, the transmitter simply will not key.

And the signal is solid! The HW-2036 puts out a minimum 10 watts at 25° C and 13.8 VDC. And it operates into an infinite VSWR without failure. The transmitter output is extremely clean (see spectrum analyzer photos above). True FM circuitry means you transmit and receive with excellent audio quality too.

The receiver is hot! Sensitivity is an outstanding 0.5  $\mu$ V for 12 dB SINAD. An 8-pole IF crystal filter provides an ideally shaped bandpass for excellent adjacent channel rejection and its superb selectivity characteristics make it the one to have for crowded signal areas.

Prices & specifications subject to change without notice

Heath Company, Dept. 11-241  
Benton Harbor, Michigan 49022

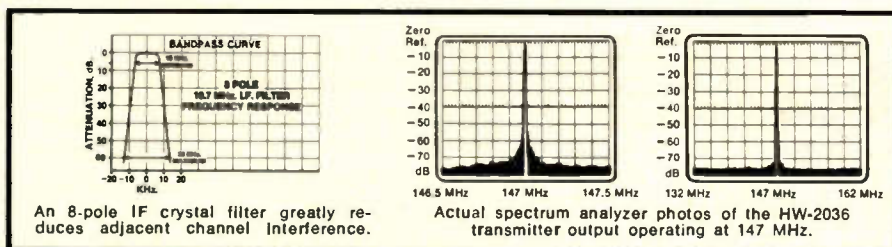

An 8-pole IF crystal filter greatly reduces adjacent channel interference.

Actual spectrum analyzer photos of the HW-2036 transmitter output operating at 147 MHz.

Complete operating versatility! A built-in continuous tone encoder — with three tones selectable on the front panel accesses most repeaters. Built-in simplex, + and - 600 kHz offsets, and an Aux. position that lets you add a crystal for any other frequency gives you all the offset capability you'll ever need. And, if you order the HW-2036 with the Heathkit Micoder combination microphone/auto patch encoder, you'll be able to make phone calls through repeaters equipped with auto patch input!

The HW-2036 operates from its built-in 12 VDC power supply, or you can use the optional HWA-2036-3 AC power supply, and operate it from a fixed station.

The HW-2036 is our best 2-meter transceiver. Check it out for yourself and you'll see it's one to have for years of reliable 2-meter communications. Read more about the HW-2036 and all the other superb Amateur radio products in new Heathkit catalog. Mail card or send coupon today!



Nearly 400 fun-to-build, practical and money-saving electronic kits! Send coupon today!

## FREE Heathkit Catalog Send coupon today!

HEATH  
Schlumberger Heath Company, Dept. 11-241  
Benton Harbor, Michigan 49022

Please send me my FREE Heathkit Catalog.  
I am not on your mailing list.

Name \_\_\_\_\_  
Address \_\_\_\_\_  
City \_\_\_\_\_ State \_\_\_\_\_  
AM-340 Zip \_\_\_\_\_

# The Mod Squad Does the Pocket Scanner

## -- Radio Shack PRO-4 updated

Last year, my wife gave me a Pocket-Scan for my birthday. This little receiver has proven to be a great monitor receiver on 2 meters. The only real drawback was that it required two 9 volt batteries, wired in

parallel, to power it.

After a while, it became rather expensive replacing these batteries and I have been unable to find a nicad replacement.

In November, 1974, Radio Shack came out with their PRO-6 model Pocket-Scan which is powered by four "AA" batteries. I managed to obtain a copy of the schematic and compared it with the schematic of the PRO-4. I found the circuits to be very similar, so I proceeded to compare resistance values.

Table 1 is a list of the resistors and capacitors I changed and their nomenclature as indicated on the PRO-4 schematic. If possible, use 1/4 Watt resistors due to space limitations on the PC board.

I found that leaving the series resistors for the LEDs (R51-54) alone had no appreciable effect on their operation. If anything, they

reduced the current drain on the nicads.

Speaking of current drain, my Pocket-Scan now draws 21 mA while scanning and approximately 30 mA while receiving a signal with the volume set at a comfortable level. With this in mind, the batteries should last about 15 to 21 hours on one charge. In actual practice, the receiver operates for about 16 hours on one charge, or about one hour of operation per one hour of charge time. Plenty of time for the average ham-fest or just day-to-day use.

Getting back to the parts replacement, there were two problems. One was the audio section. When I first "completed" the conversion, the best I could get was distorted, hard to understand audio. Also, the amplifier tended to oscillate. I discovered that I had too much bias on the base of Q19; thus the insertion of the 100 Ohm resistor in series with R47. The voltage on the base should be about 2.6 volts. Also, the replacement of C61 is critical or the amplifier will oscillate. Use as small a 470 pF as possible. Finally, use the capacitor from C39 to replace C52. This also adds to the amplifier's stability.

As referred to in the parts list, R44 is removed. Take a razor blade and cut the circuit foil between C47 and R44. Next take a 10k (preferably a 1/4 Watt unit) resistor and bridge this gap (note the photo). Replace R44 with an 82k resistor.

The second problem was the 1st mixer transistor (Q2). The receiver worked well for about 2 weeks, then all of a sudden the transistor blew. I believe this to be the result of too much  $V_{be}$ . It should be about .6 volts. The replacement of R4 should remedy the problem.

Anyway, I also replaced Q2 with an RS 2015 from Radio Shack. This is the replacement for the 2SC784(0) as indicated on the schematic of the PRO-6. The RS 2015 is really a 2N4996. This tran-

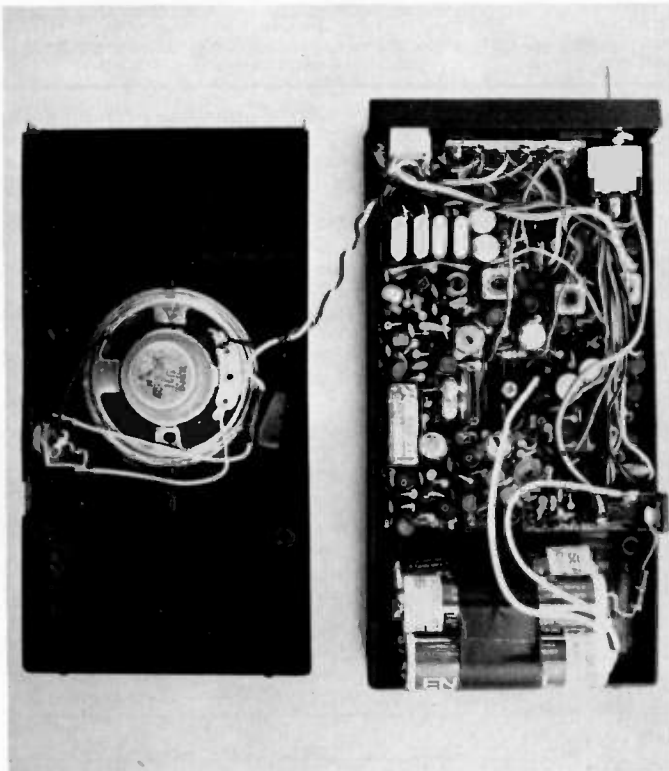

# KENWOOD

*...the Pacesetter in Amateur Radio*



**Discover  
the luxury  
of 4 MHz**

## TS-700A

Kenwood's TS-700A offers the ultimate promise of 2-meters... more channels, more versatility, tunable VFO, SSB-CW... and Kenwood quality.

Operates all modes: SSB (upper & lower), FM, AM and CW • Completely solid state circuitry provides stable, long lasting, trouble-free operation • AC and DC capability (operate from your car, boat, or as a base station through its built-in power supply) • 4 MHz band coverage (144 to 148 MHz) • Automatically switches transmit frequency 600 KHz for repeater operation. Simply dial in your receive frequency and the radio does the rest... simplex repeater reverse • Or accomplish the same by plugging a single crystal into one of the 11 crystal positions for your favorite channel • Transmit/Receive capability on 44 channels with 11 crystals.



## TR-7400A NEW...AVAILABLE IN DECEMBER

**KENWOOD'S EXCITING NEW 2-METER MOBILE TRANSCEIVER •**  
All solid state • Synthesized phase lock loop (PLL) • Power output: 25 or 10 watts (high or low selectable) • 6 digit LED frequency display • Full coverage 144-148 MHz, 800 channels in 5 KHz steps • 600 KHz repeater offset • Continuous tone-coded squelch (CTCS) for transmit and receive or transmit only with tone elements optional • Tone burst (tone elements optional) • Kenwood dependability and value built in.

## TR-2200A

Kenwood's high performance portable 2-meter FM transceiver... completely transistorized, rugged and compact. 12 channel capacity • Telescoping removable antenna • External 12 VDC or internal ni-cad batteries • 146-148 MHz frequency coverage • 6 channels supplied • Battery saving "light off" position • Hi-Lo power switch (2 watts-400mW).

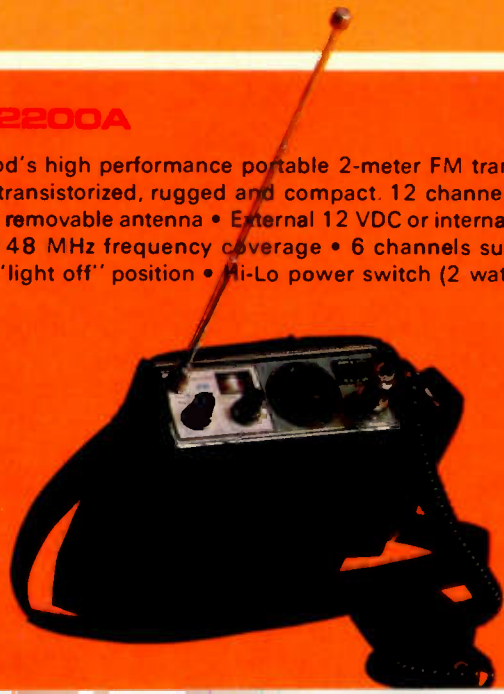

## TR-7200A

Kenwood's superb 2-meter FM mobile transceiver. Designed to withstand the most severe punishment while providing consistently excellent performance. Packed with features like the PRIORITY function... Put your favorite crystals in channel 7, and the 7200A switches there with the push of a button... no matter what channel you are on. 146-148 MHz coverage, 22 channels, 6 supplied. Completely solid state.

The perfect companion to the TR-7200A is the PS-5 AC/DC power supply. Together they provide an efficient and handsome base station. Complete with a digital clock and automatic time control feature built in.

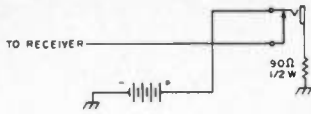

Fig. 1.

sistor greatly improved the sensitivity. A word of caution, though: If Q2 does blow, turn off the receiver immediately; otherwise, T4 will blow, also. I was able to repair mine, but you may not be so lucky.

As shown in the photos, the nicads are soldered together. There is not enough room for any kind of battery holder. Since the batteries cannot be removed, I installed a 90 Ohm 1/2 Watt series resistor for charging. I am using the 9 V dc supply I received with the Pocket-Scan as the charger. Since the radio operates so long on one charge, I did not provide for ac operation. Fig. 1 is the schematic of how I wired the built-in power connector.

Note the other miniature connector in the photo. I used this for another ear-phone jack because the one in the top panel is a sub-miniature.

Now, you ask, when do I charge the batteries? I have found that when the audio quality deteriorates and the volume goes down, it is time to recharge.

The Pocket-Scan is now converted to nicad operation (5 V); we now need to tune up the receiver to operate on 2 meters.

The front end (consisting of T1, T2, T3 and T5) is tuned for minimum noise on a signal on 146.94. Use a pair of headphones for the best results. I found that the best way is to turn the slugs down into the transformer and then bring them out for minimum noise. When you reach the minimum noise point, STOP. Going farther will do no good.

There are three more transformers. T4 is the 10.7 i-f and should not require retuning. T6 and T7 are the discriminator coils. Note that



there are two test points. Use TP-2 and an 11 megohm VOM/VTVM to peak T6 and dip (that is to 0 volts) T7. Of course, in order to peak and dip these coils, you must be receiving a signal.

I have found that TR-22C crystals work just fine or you may wish to have crystals made for the PRO-4. With my PRO-4 tuned up on 146.94

and some playing with T7, the discriminator voltage is + or - .1 volts with my crystals and they include: 146.67, 146.76, 146.88 and 146.94.

This completes the tune-up on the PRO-4. I have found it to be quite sensitive on 2 meters and I can still hear KEC 76 on 162.55 for local weather. Of course the sensitivity is somewhat de-

graded but acceptable for the weather station.

Since I do not have any test equipment other than my VOM, I can only judge by ear, but the Pocket-Scan seems to exhibit the same sensitivity as my TR-22C as both can hear WRØAEK (16/76) in Colorado Springs (70 miles) with about the same amount of noise. ■

CHANGE ...	FROM ...	TO ...
R2/C5	100/.001	Remove & short.
R3	1k	100
R4	470k	1 meg, see text.
R17	100	Remove & short.
R19, 21, 22, 25, 27	470k	330k
R31	470k	100k
C38	.01	.005
C39	.01	Remove.
R42	4.7k	2.2k
R43	100	Remove & short.
R44	62k	Remove & see text.
R47	68	Add 100 Ohms in series, see text.
R48, 49	3.3	Add a 10 Ohm resistor in parallel with each 3.3 Ohm resistor. See photo.
R50	3.3k	Remove & short.
C52	.0015	.01
R56	1k	47
R57	10k	3.3k
R58	22k	Remove
R60	22k	10k
R61	10k	3.3k
C61	330 pF	470 pF (see text)
R62, 63	22k	10k
R66	33k	10k

Table. 1.

# TR-22 Mod Squad

## -- king of the modifieds ?

In the February, 1973, 73 *Magazine*, Jerry Copeland W8FJA wrote an article about increasing the power output of a TR-22. Since then, Peter Stark K2OAW has written an article on revising previously printed articles so that you can write your own article, have your name in print and become a famous author (May, 1975). Therefore, credit goes to the above.

In this article, I use the terms TR-22 and TR-22C. TR-22C specifically refers to a TR-22C. These modifications can be made to both.

Several months ago I made a trip to VHF Engineering to purchase a PA-2501 amplifier. My concern was whether the PA-2501 could handle the power of my Standard SRC-146A, which I alternate as a mobile rig with the TR-22C. Bob Brown gave me a Motorola MRF-237 transistor with the spec sheets and said that perhaps I could use this transistor in my TR-22C. Hospitality at VHF Engineering makes it well worth the trip.

After returning home and spending three hours assembling the PA-2501, it was installed in the car and I went off to see if the MRF-237 would work in the TR-22C.

A phone call was made to William Frost, service manager of R. L. Drake. I found that he had had experience with W8FJA's modification, and that he had seen some failures of the TR-22's output transistor because of the fact that the unit was operated without a load. In one sentence, W8FJA's modification to the TR-22 was to change the driver transistor to a Motorola HEP-75, to increase the power to 2.7 Watts. Higher power output was thus achieved by driving the original transistor harder.

I might mention at this time that you should go out and dig up W8FJA's article, in the February, 1973, 73 *Magazine* (page 91), and read it for more insight into what I am going to do. As you can see, he borrowed the idea from Jack Lemon WB6CTA. I knew there was a 6 looking for more power.

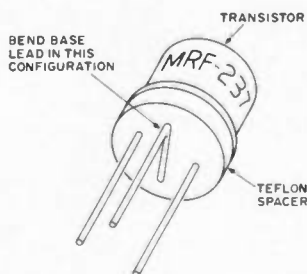

Fig. 1.

Now that you have returned from his article, go down to your local Motorola dealer and order an MRF-237. I paid \$1.80 for one to modify a friend's TR-22C. Get out the manual, the TR-22 or TR-22C, a wattmeter or swr bridge, soldering pencil, solder sucker, needle nose, screwdrivers, and wire cutters.

Remove the TR-22 case. Remove the telescoping antenna and then remove the receiver board by unscrewing the four phillips screws and turning the board over and over and away from the aluminum chassis. This exposes the bottom side of the TR-22 transmitter board. My first modification was simply to locate and remove the power output transistor. It's the one with the big square heat sink. You can't miss it. Now comes the trick. The MRF-237 uses a grounded emitter (TO-39) and the lead configuration is reversed from the original transistor leads. Therefore, you must place a teflon transistor pad between the collector and emitter leads. Rebend it again to obtain the triangular lead pattern — only reversed from what it was. See Fig. 1. Be sure to use a teflon spacer. They are plentiful on surplus computer

boards. Do not use a cardboard spacer. It will attract moisture and degrade performance. Remove the original output transistor and remove the heat sink by expanding it with a screwdriver. Install the prepared MRF-237 and teflon pad onto the transmitter PC board. Liberally goop the MRF-237 with a heat sink compound. Tune the input and output capacitors, Tct2 and Tct1, for maximum power output on the wattmeter. This can be done with the unit apart, observing caution that nothing is shorting. If you have the TR-22C face pointing at you and use the power output transistor as a center of a clock, Tct1 is located at 2 o'clock and Tct2 is located at 8 o'clock. This modification netted a power output increase from 1.3 to 2.2 Watts at 12 V dc. This output transistor change increased transmit current drain from 450 mA to 500 mA.

What can be done with the perfectly good power output transistor you have just removed? Very simple — exchange it with the driver transistor. Simply remove the driver transistor, Q18, located at 1 o'clock from the power output transistor. It might be a little difficult to remove the driver transistor because of the speaker bracket, but it can be done by prying gently on the transistor and using a hot soldering pencil on the bottom of the board. Install the old power output transistor into the printed circuit board where the driver transistor was removed. Tune Tct1, Tct2 and Lt10 for maximum output. Current drain increased to 580 mA. Button up the radio, check the tuning and off you go. Power output now was 3.4 Watts.

What about the batteries? First off you are not going to decrease battery life that much. The Standard SRC-146A draws 630 mA on transmit versus the 580 mA my TR-22C now uses. If you have ever used a TR-22C any

# KENWOOD TS-700A



THE PROMISE  
OF 2-METER TRANSCEIVING  
BEAUTIFULLY FULFILLED BY THE TS-700A •  
SUPERB SPECIFICATIONS, EXCELLENT FEAT-  
URES AND KENWOOD'S REPUTATION FOR  
UNSURPASSED QUALITY AND PERFORM-  
ANCE, PLACE THIS UNIT A CUT ABOVE  
ALL OTHERS.

TRIO-KENWOOD COMMUNICATIONS INC. 116 EAST ALONDRA/GARDENA, CA 90248

 **KENWOOD**  
*...pacesetter in amateur radio*



length of time, you know that they don't last forever on batteries. Besides, we all know that the battery pack was designed to run the radio in an emergency when external power is not available. In emergency operation we keep our transmissions short. We don't ragchew, right? Justification enough for power increase. Increased power also makes a better reason to buy a rubber duckie and save the telescoping antenna.

To help you make it easier to use the TR-22 in mobile, base and portable operation, install a PL-259 to BNC female adapter, and buy the BNC connectors for your coax. I also use a rubber duck antenna with a BNC connector on it which is available from various manufacturers. This makes it easier to move the rig from mobile to base to portable operation. I also use a right angle BNC, so I can set the rig flat and the rubber duckie vertical. It is also nice

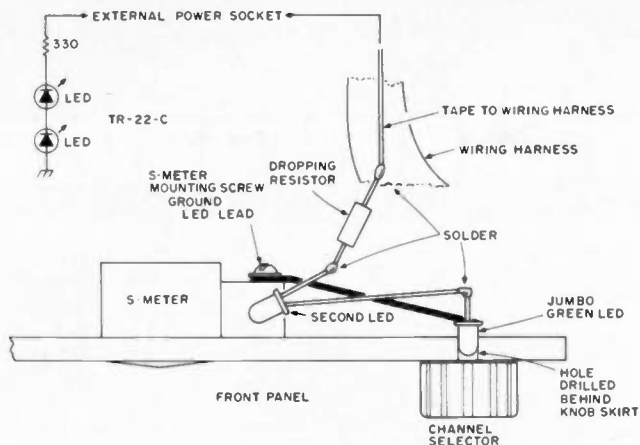

Fig. 2.

when using the rig over the shoulder. The antenna is horizontal but away from the body and the body acts as a ground plane.

My final modification was to backlight the dial on my TR-22C. I drilled a hole in the face plate behind the channel selector knob after it was removed and mounted a jumbo green LED. Be sure the LED does not touch the skirt of the channel selector

knob, as it will scratch the channel numbers off the skirt. The LED was suspended by one lead grounded to the S-meter mounting screws. See Fig. 2. A second LED was installed in series with the first, and pointed into the S-meter face from the inside. The primary reason for this was to dissipate some of the voltage drop required so that a 1/2 Watt current limiting resistor

could be used. "This draws more power," you say? Right you are. But if you go to the external power jack you will find that the back terminal on the jack is hot only when external power is applied — and when external power is applied, who cares? Use a voltmeter to find the terminal on the external power jack.

The R. L. Drake Company does not recommend any modifications to its radios; if yours is under warranty, these modifications will void it! After 90 days, it's your radio and you can do what you want. The LED readout is very nice while mobile during night operation. The MRF-237 transistor has passed the "let's kerchunk the repeater to see if it's up" test many times without an antenna. In my experiments, the transistor has withstood the ten second keydown test with no antenna. Probably the collapsed antenna presents some kind of load that saves the device. ■

"It's the first book I've ever read about computers that I can understand . . ."

## Hobby Computers Are Here!

BEST SELLING BOOK AT 1976 BOSTON HAMVENTION

This book is for the beginner. It will help get you into the world of microcomputers, a world of enormous fun (and one which all amateurs are going to have to get used to, like it or not). It is a complicated world and you need all of the really fundamental help you can get . . . like this book. Some chapters . . . What's a Computer?, History of Numbering Systems, Is Digital New?, How Computers Figure, What's That in Binary?, Computers are for Hams, How Gates Work, TTL — Best Logic Yet, Ins and Outs of TTL, Flip Flops Exposed, Memory Chips, Computer Languages, New Cassette System Standard, Build this TVT, Using Surplus Keyboards, Morse to RTTY Converter, ASCII to Baudot via a PROM, ASCII/Baudot via PROMs, A Second Way . . . plus reprints of some of the 73 editorials on computers such as Computermania, The Great Computer Peril, Yes, But Which Kit?, Computer Publications, Ham Computing, Postal Disaster, Programs for Sale? These are reprints from 73, gathered in one place to tie the whole works together for you. Don't miss out any longer on the fun of hobby computing and the fantastic ham applications of these incredible devices.

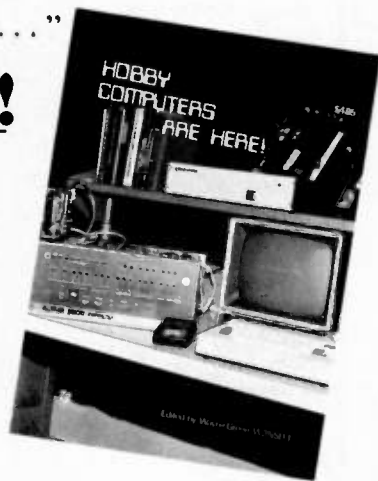

Hobby Computers Are Here! . . . \$4.95

Send me  Hobby Computers are Here! — \$4.95

Cash enclosed  Bill BankAmericard # \_\_\_\_\_

Name \_\_\_\_\_

Check enclosed  Bill American Express # \_\_\_\_\_

Address \_\_\_\_\_

Bill Mastercharge # \_\_\_\_\_ Interbank # \_\_\_\_\_

City \_\_\_\_\_

Expiration date \_\_\_\_\_ Signature \_\_\_\_\_

State \_\_\_\_\_ Zip \_\_\_\_\_

TOLL FREE call (800) 258-5473

**73** magazine • Peterborough NH 03458

H/76

OR  
(800) 251-6771

# Wilson Electronics Corp.

# HAND HELDS

# 450

FREQUENCY RANGE 420 - 450 MHz

- 6 Channel Operation
- Individual Trimmers on all TX/RX Crystals
- All Crystals Plug In
- 12 KHz Ceramic Filter
- 21.4 and 455 KC IF
- .3 Microvolt Sensitivity for 20 dB Quieting
- Weight: 1 lb. 14 oz. less Battery
- Battery Indicator
- Size: 8 7/8 x 1 3/4 x 2 7/8
- Switchable 1 & 1.8 Watts Output
- 12 VDC
- Current Drain: RX 14 MA, TX 500 MA
- Microswitch Mike Button
- Unbreakable Lexan® Case

USES SAME ACCESSORIES AS 1405

INCLUDES

1. 4502 SM
2. Flex Antenna
3. 446.00 Simplex Installed

~~\$279<sup>95</sup>~~

XMAS SPECIAL

\$269<sup>95</sup>

## ACCESSORY SPECIALS

DESCRIPTION	SPECIAL PRICE
BC1 BATTERY CHARGER	\$34.95
BP1 10 EA. AA GOULD NICAD BATTERIES	14.95
BT1 EXTRA BATTERY TRAY	6.00
LC1 LEATHER CASE 1402	12.95
LC2 LEATHER CASE 1405, 2202, 4502	12.95
SM1 SPEAKER MIKE FDR EARLY MODEL 1402 9 PIN CONNECTOR	24.95
SM2 SPEAKER MIKE FOR ALL NEW HAND HELDS WITH ROUND 6 PIN CONNNECTOR	24.95
TE-1 SUB-AUDIBLE TONE ENCODER INSTALLED	34.95
TTP TOUCH-TONE PAD	49.95
INSTALLATION AT TIME OF RADIO PURCHASE	FREE
INSTALLATION AT LATER DATE, ADD	15.00
XF-1 10.7 KC MONOLITHIC XTAL FILTER	9.95
CRYSTALS TX or RX (Common Frequency Only)	3.75



BC-1 BATTERY CHARGER

# 220

FREQUENCY RANGE 220 - 225 MHz

- 6 Channel Operation
- Individual Trimmers on all TX/RX Crystals
- All Crystals Plug In
- 12 KHz Ceramic Filter
- 10.7 and 455 KC IF
- .3 Microvolt Sensitivity for 20 dB Quieting
- Weight: 1 lb. 14 oz. less Battery
- Battery Indicator
- Size: 8 7/8 x 1 3/4 x 2 7/8
- Switchable 1 & 2.5 Watts Output
- 12 VDC
- Current Drain: RX 14 MA, TX 500 MA
- Microswitch Mike Button
- Unbreakable Lexan® Case

USES SAME ACCESSORIES AS 1405

INCLUDES

1. 2202 SM
2. Flex Antenna
3. 223.50 Simplex Installed

~~\$239<sup>95</sup>~~

XMAS SPECIAL

\$219<sup>95</sup>

# XMAS SPECIAL

Wilson

**"FACTORY  
DIRECT  
ONLY"**

**XMAS SPECIAL**



**1402SM HAND HELD  
2.5 WATT  
TRANSCEIVER**

144-148 MHz

~~\$164.95~~

XMAS SPECIAL

**\$159.95**

**FEATURES**

**1402 SM**

- 6 Channel Operation
- Individual Trimmers on all TX/RX Crystals
- All Crystals Plug In
- 12 KHz Ceramic Filter
- 10.7 IF and 455 KC IF
- .3 Microvolt Sensitivity for 20 dB Quieting
- Weight: 1 lb. 14 oz. less Battery
- 5-Meter/Battery Indicator
- Size: 8 7/8 x 1 7/8 x 2 7/8
- 2.5 Watts Minimum Output @ 12 VDC
- Current Drain RX 14 MA TX 500 MA
- Microswitch Mike Button
- High Impact Plastic Case

**1405 SM**

- 6 Channel Operation
- Individual Trimmers on all TX/RX Crystals
- All Crystals Plug In
- 12 KHz Ceramic Filter
- 10.7 and 455 KC IF
- .3 Microvolt Sensitivity for 20 dB Quieting
- Weight: 1 lb. 14 oz. less Battery
- Battery Indicator
- Size: 8 7/8 x 1 3/4 x 2 7/8
- Switchable 1 & 5 Watts Minimum Output @ 12 VDC
- Current Drain: RX 14 MA TX 400 MA (Iw) 900 MA (5W)
- Microswitch Mike Button
- Unbreakable Lexan® Case

Shown With  
Optional  
Touch-Tone Pad

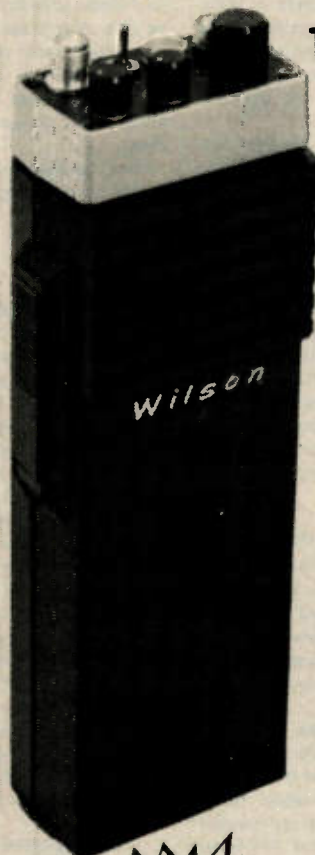

**1405SM HAND HELD  
5 WATT  
TRANSCEIVER**

144-148 MHz

~~\$239.95~~

XMAS SPECIAL

**\$229.95**

**SPECIAL  
ON EACH RADIO  
INCLUDES:**

Flex Antenna  
52/52 Simplex Xtal

90 Day Warranty      10 Day Money Back Guarantee

Can be Modified for MARS or CAP

**OVER 35,000  
XTALS  
IN STOCK**

**OVER 2000  
UNITS IN STOCK  
FOR XMAS SALE**

**XMAS SPECIAL DIRECT SALE ORDER BLANK**

TO: WILSON ELECTRONICS CORP., 4288 S. POLARIS AVE., LAS VEGAS, NEVADA 89103  
(702) 739-1931

- TTP @ \$49.95
- XF1 @ \$9.95
- TX or RX XTALS @ \$3.75 ea. Common Frequencies Only.
- FACTORY XTAL INSTALLATION/NETTING @ \$7.50/Radio
- MARS or CAP XTALS @ \$10.00 ea.

**EQUIP TRANSCEIVER AS FOLLOWS:**

XTALS TX	RX	XTALS TX	RX
A. 52	52	G.	
B.		H.	
C.		I.	
D.		J.	
E.		K.	
F.		L.	

- 1402SM @ \$159.95
- 1405SM @ \$229.95
- 2202SM @ \$219.95
- 4502SM @ \$269.95
- BC1 @ \$34.95
- BP1 @ \$14.95
- BT1 @ \$6.00
- LC1 @ \$12.95
- LC2 @ \$12.95
- SM1 @ \$24.95
- SM2 @ \$24.95
- TE1 @ \$34.95

(SPECIFY FREQUENCY \_\_\_\_\_)

- CHECK    MONEY ORDER
- MASTER CHARGE
- BANKAMERICARD

ENCLOSED IS \_\_\_\_\_

CARD # \_\_\_\_\_

EXPIRATION DATE \_\_\_\_\_

NAME \_\_\_\_\_

ADDRESS \_\_\_\_\_

CITY \_\_\_\_\_

STATE \_\_\_\_\_ ZIP \_\_\_\_\_

SIGNATURE \_\_\_\_\_

SHIPPING & HANDLING PREPAID FOR XMAS SPECIAL  
NEVADA RESIDENTS ADD SALES TAX  
73      VALID ONLY NOV. 1 THRU DEC. 31, 1976



# EDITORIAL

## KILOBAUD?

We've decided on a last minute name change from *Kilobyte* to *Kilobaud*. A high capacity data channel is rated in kilobauds, and the purpose of the new computer hobby magazine is to provide a maximum of data per unit of time. It's a natural.

We did like the name *Kilobyte*, but when a suit was entered by *Byte* we decided that we would prefer to put the money, time and effort into a better magazine rather than a court battle, even though we could see no way to lose. Our business is publishing, not fighting lawsuits. We consider this a frivolous suit, but since the magazine has yet to be published the name is not worth a big hassle.

*Kilobaud* has no connection with *Byte* or any other computer magazine. If anyone subscribed thinking he was getting *Byte*, the subscription may be canceled.

## COMPUTERIZED MORSE

One of the computer mags recently devoted an entire issue to stuff on Morse code via computers . . . and I'd like to have my say on this subject. As usual, opposing opinions are welcome and will be printed if they seem to warrant it.

Just to get off on the right foot with you, I'll say it plainly and simply . . . I think Morse code via computer is a fad and of little real value. Yes, I know the arguments. I am quite aware that there are no speed limits on Morse, nor any bandwidth limits (as yet). I also know that one way to get them is to start spraying the ham bands with 1000 wpm Morse which covers X kHz or so. You figure out how wide it would be and put in a number.

No, take it easy . . . relax a little and see what I have to say before getting all upset. Let me take you back twenty years or so to when a small group of us were battling the ARRL to get the FCC to okay FSK (frequency shift keying) for our Teletypes on the low bands. Sure, we could send make-break RTTY if we wanted . . . and a few of us experimented with it extensively. I used to have a wicked signal on 3620 with make-break, and made many contacts using it in those long-ago days. I still have that old kilowatt rig down under the cellar stairs.

So, having spent a couple years with make-break RTTY and then many more with FSK RTTY, let me tell you that you can work through a whole lot more garbage with FSK than you can with make-break (CW). How long do you think it is going to

be before a whole raft of spoil sports will be geared up to chop computerized Morse code to bits? And they will be able to do it easily. The fact is that it is much more difficult to clobber FSK, particularly if you use some of the better circuits which will run off either mark or space during interference.

Sure, we have to convert to Baudot before transmitting at present, but I'll bet that we can get the FCC to authorize ASCII if we only make an effort, and then we'll have much clearer sailing. Do I hear any serious arguments for CW vs. FSK? I doubt it.

So, to put our money where our typewriter is, I'll say that I am much more interested in Baudot circuits and programs than in Morse for publication in 73. But please don't let this stop you from peppering the FCC with petitions and letters telling them you want ASCII. I tried to get them to give us a Christmas present a year ago of ASCII and was brought up short by the news that *no one* had been pushing for it. Come on.

One more item — it is my plan to keep ham-oriented computer material in 73 and non-ham in *Kilobaud*. Any arguments on that? I figure that hams will be reading it in 73 and non-hams won't care that much. This is not to say that *Kilobaud* readers won't get a lot of propaganda about how great computers are over the air.

## WHITHER I/O?

With *Kilobaud* scheduled out in early December, a lot of readers want to know what is going to happen to the I/O section of 73. For those of you who missed my answer to that last month: not much. We'll be having a good deal of hardware in I/O for you, while *Kilobaud* will tend more toward software. Reactionaries who have been wishing that computers would just go away are going to be as frustrated about them as the previous generation was over transistors, which just wouldn't go away.

## AND KILOBAUD?

Though editor Craig suffered a lot from doubts about our getting enough articles to keep *Kilobaud* going, the fact is that we already have more than enough for the first three issues and articles are coming in two or three a day — good articles! These are articles that are simple enough so even I can understand them!

Well, you can't really tell that much about a new magazine until it has been going for about six months, so we'll see how my ideas hold up and if we can deliver what I've promised.

Promises: fun, fundamentals, the opportunity to make money with your hobby, equipment reviews galore, the best communications we can muster for readers and an ongoing library of programs and algorithms.

Like 73, *Kilobaud* will not be taking itself too seriously. No ego trips or PhD pretensions. We'll try hard to tell it like it is — tell you what we think — and give you a place to argue about it. That's the fun part of it.

Since hardware people need fundamental articles on software and softies need ditto on hardware, we'll try to keep a good part of *Kilobaud* simply written. One measure of this is whether I can understand the material or not. There are a lot of things in *Byte* and *Interface* which I don't understand, and so far the feedback is that most of you have found the same thing. An awful lot of us want a magazine we can understand.

Money: Hal! I'll not be satisfied until every hobbyist out there is making plenty of money . . . and it won't be that difficult. I may be able to get you some business programs you can run on your system and handle things for local merchants (a nearby drug store is after us to get our Altair rigged up to keep track of his customer list and prescription numbers — and he'll pay well for the service). Or how about a simple system for printing out portraits at fairs, shows, etc? They sell for \$2 or so each and are a snap to make with relatively inexpensive equipment. There are plenty of ways to make money with small computers and we'll be pushing hard to bring you this info.

Well, you get the picture. We think *Kilobaud* is going to be by far the best of the computer magazines — and the widest read. Any magazine that can help you make a few extra bucks (or a few thou) is one you can't refuse.

How many hobbies can you find which will pay off like that?

## VISITING AROUND

In August 1975, I made a quick trip around the country visiting the few microcomputer manufacturers . . . Sphere, MITS and Southwest Tech. In August 1976, Sherry Smythe (73's Marketing Manager) and I repeated the trip, this time including Apple, Jolt, M&R, Wave Mate, the Computer Mart, the Byte Shops, and Intelligent Systems, as well as a revisit to the three of the previous year.

Last month I briefly covered our visits to the California and Utah manufacturers. The next stop was Albuquerque and MITS, which is just around the corner from the airport.

Ed Roberts is usually busier than a one-armed paper hanger, so I expected at best to get a quick hello as he dashed past. It turned out that we spent the whole day talking and almost missed the plane to San Antonio that evening!

Ed is getting very much involved with ham radio, as are quite a few other computer hobbyists (about 25%). It had not escaped him that a great many hobby computer applications were for ham projects. We talked hamming and hobby computers for hours. I think we are pretty much in agreement about the future possibilities for small computer systems and there is no question Ed is thinking way, way ahead with a lot of the projects he has going.

MITs has settled into the new plant they got this year — quite a difference from the string of small rooms they had last year. The place is very busy, with programmers programming, engineers designing and testing, and the production lines going full blast.

## AHA, SAN ANTONIO

The next morning Sherry and I visited Southwest Technical Products in San Antonio where Dan Meyer had his new printer up and running. It has the same internal mechanism as the MPI (\$450) printer, but comes in kit form for \$250. The 40 character line width is a bit limiting, but should be fine for program dumps, label printing, short invoices, etc. I understand that a couple of fellows have already worked up an 80 character modification of the system — this would take a bit of machine work, but should not be too difficult.

The SWT graphics system was up and running, too, and should prove very popular. This is the first step toward being able to run programs like the tank battles you find in the quarter arcades. We also got to see the SWT cassette system in action (uses the Kansas City Standard — I don't feel much like calling it the *Byte* standard). Southwest Tech sure has their act together.

My Chronex watch dimmed and then went out while I was in San Antonio. I didn't realize how much I depended on it. The batteries were supposed to last a full year . . . hey, come to think of it, it was just a year ago I stopped off at the Chronex factory near Dallas and had the batteries put in . . . not bad. We stopped at a shopping center and they had the tiny batteries for sale . . . my watch was running again.

*Continued on page 200*



# SWTP 6800

- ★ COMPLETE WITH 2K OF MEMORY
- ★ SERIAL INTERFACE
- ★ STANDARD ROM MONITOR (Motorola MC 6830L7)
- ★ 4K AND 8K BASIC AVAILABLE

Always the best value in hardware and now an outstanding selection of software too. What more could you want in a computer system? For less than four hundred dollars you get everything you need—ready to connect to a terminal and go to work. No surprises no funny business, just good reliable hardware in a very practical system that may be expanded to meet almost any later need.

Memory and interfaces are not extra cost items in our system. A standard Motorola MIKBUG® ROM monitor makes the system completely compatible with Motorola

© Motorola

software and eliminates any need for console switches and light. Data may be entered from the terminal in convenient hexadecimal form. The power supply is adequate to operate a fully expanded system with up to 24K of memory and up to eight (8) interfaces—simultaneously.

See the 6800 and our peripheral equipment at your nearest dealer, or write for a complete description.

**MP-68 COMPUTER KIT—with serial interface,  
2k of memory and ROM monitor** **\$395.00 ppd**



Southwest Technical Products Corporation, 219 W. Rhapsody, San Antonio, Texas 78216

# I/O REPORT

The I/O section of *73* is alive and well! (And will continue to be... for a long time.) I thought I should mention that, because in my traveling around to clubs, stores and manufacturers, it seems that one of the questions thrown at me the most has been, "Now that you and Wayne are starting *Kilobaud*, what's going to happen to the I/O section in *73*?" The answer is quite simple. *73* is going to continue providing you with over 160 pages each month of the most interesting, most up-to-date, and most invigorating material you're going to find in any ham or electronic hobbyist magazine. And, you can bet that the I/O section will continue making its contribution. There are two reasons why the I/O section will continue (in style, I might add). First and foremost is the fact that Wayne Green would never be satisfied with having *73* in any position other than *number one*. Needless to say, one of the things that keeps us out in front is the fact that we're usually a couple of years ahead of the other ham magazines... and the I/O section with its coverage of amateur microcomputer systems is one of the things giving us the two year jump right now.

The other reason why the I/O section will stick around is because I've got an unending stack of manuscripts for it! Once again, there are two reasons to explain the situation: A lot of hams (and non-hams) will continue to write for I/O because they know they're getting to a large readership (which is something most authors want... and is why they'll be writing for *Kilobaud*, too). The second reason is the one which really strikes home... *money*. Do you realize that we pay so well? That in most cases you could make enough with one or two articles to *buy a microcomputer*? A lot of the people whose articles you're reading know it. Think about it.

Another question which comes up is, "If I have a subscription to *73* and *Kilobaud* am I going to be reading the same material in both?" We don't have any intention of reprinting articles from one magazine in the other. But, in rare cases, if it's felt that a particularly good article belongs in both, we'll probably run it in both.

## MICROSYSTEMS SERVICE ENGINEERS/TECHNICIANS

You know, with over 300 computer stores around the country and the possibility of this whole thing busting wide open in the near future (with small business and/or home systems), the opportunities for getting into the service field *are there*. The parallels between this situation and what

happened with the television industry are too close to be ignored. I keep thinking back to 1949 and the TV repair business my dad (ex-W5WVA) started in his garage. He had more business than he could handle, and he was only doing it on a part-time basis to pick up extra cash. (Of course, that isn't too unusual... you can do the same thing today if you open a garage TV repair business!) The point is, if he had decided that TV repair was what he wanted to pursue, he would probably have a *chain* of repair shops today. Very soon there will be enough microcomputer systems around to enable a lot of enterprising individuals to get into part-time (and eventually full-time) businesses repairing and maintaining these systems.

Perhaps you're wondering how you could get into something like this? I've got some suggestions. If you want to build up your expertise in this area, you're going to need to get as much experience in troubleshooting as many different kinds of systems as possible. One way to accomplish this would be to let the word out at your local computer club meeting that you would like to get in on the troubleshooting of any problems which crop up among the members. People appreciate help when they're troubleshooting... two heads are usually better than one. If you own a good oscilloscope, the chances are that people will occasionally ask to borrow it. Simply go with it.

It certainly isn't going to do to become a "specialist" with the 8080 (for example), and ignore the 6800 and others. As I said before, it will be important to get to know them all as well as you can. Being able to write short little troubleshooting routines to check out (or troubleshoot) a peripheral will be a good thing to concentrate on. Most of the problems of the future very likely will be with peripherals. I'm not too sure that's the case right now, because I've spent some long hours lately troubleshooting the processors of several microcomputers.

Another method for getting a variety of troubleshooting experience under your belt would be to ask the owner of your local computer store if he would mind you getting in on the troubleshooting problems he encounters. Needless to say, you could fall into a part-time job working there after becoming good at it.

I would be willing to bet we're talking about more than just a little part-time cash, though. If this thing takes off and flies in the next few years, there's going to be as much of a need for computer repair shops as there ever was for TV repair shops.

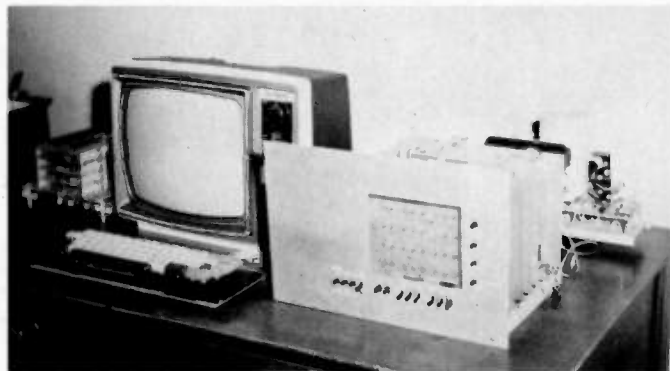

Kind of a side note to this whole thing is the fact that there are quite a few MARK-8 computers out there which don't work, and a lot of people would like to take them down off that shelf and get them running. I'm not too sure you could make a lot of money by getting into the MARK-8 repair business, but if you're interested, drop me a line and I'll tell you how to get in touch with the "MARK-8 world." (For you newcomers, the MARK-8 is the little 8008-based microcomputer that got this whole thing going 2½ years ago.)

## SPEAKING OF THE MARK-8...

I have tried (unsuccessfully, until now) to get several MARK-8 owners I know to send me pictures of their systems so that we could include them in the I/O section... and satisfy the history buffs among us. Grant Runyan came through. This year Grant retired after teaching high school math for over twenty years. One of the things he did in his last two years was to get quite a few kids turned on to computers (via his MARK-8).

Not only is he making good use of the first hobbyist microcomputer, but he's also using the first hobbyist TV typewriter: the TVT I. The processor is running with 12K of 21202s. He has plans to interface a Flexowriter for hard copy (also as a terminal, I would

assume), and the Mathematical Function Unit (calculator chip interface) as described in the September and October '76 *Byte*. The system is a paper tape system, in that he has a Friden punch (not shown) and a home built high speed paper tape reader (shown in the lower photograph).

(A friend of Grant's, Doug Hogg, has an identical system and has written a comprehensive construction article for that reader which will be in an early issue of *Kilobaud*. He'll also be doing a future article concerning that Flexowriter interface. Both of which will interface with *any* system.)

Now you might be asking the question, "What good is an 8008-based system? There isn't a good BASIC around to run on it, and there is very little software that has been developed for it." There is a good 8008 "BASIC" around... and it's the Scelbi language called SCELBAL. I say it's "good," but I don't really know... I'm just going by what I've heard. Why doesn't someone write an article which would be a critique of Scelbi's SCELBAL? We review new products and books, don't we? Why not new software? Let's find out how it stacks up against other BASICs (by the way, there's an 8008 and an 8080

*Continued on page 144*

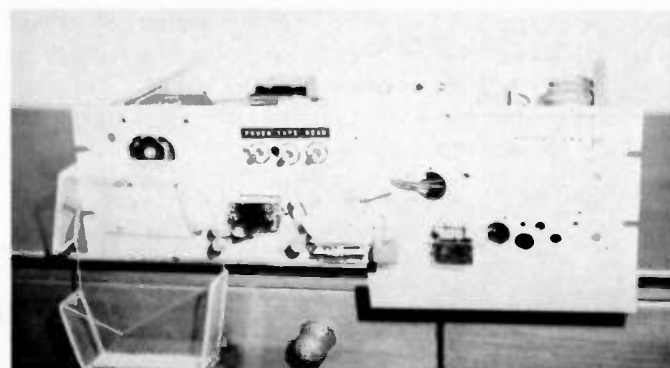

# Now we're on TV!

Wave Mate introduces Jupiter IIC, a complete computer system incorporating a monitor quality TV interface. This system provides everything you need to create and run application programs. Jupiter IIC includes a CPU with 8K dynamic RAM and 3K ROM memory, video terminal interface and keyboard, and dual audio cassette tape interface. The TV interface features upper and lower case and



Greek character sets, and dot graphics. The dual audio cassette interface provides start/stop operation and operates at 300, 600, or 1200 baud. And of course we still provide these high-quality features: burn-in tested IC's, socketed IC's, complete documentation, and more.

## ATTENTION: ORIGINAL EQUIPMENT MANUFACTURERS

Jupiter IIC provides OEMs with the tools to get systems into the field faster and at lower cost. (1) Use Jupiter IIC as your development system. Perfect for development of software and special hardware. (2) Use Jupiter IIC for prototype systems. Only Wave Mate provides the tools — wire wrap modules, universal modules, complete documentation — to easily tailor system logic and add customized interfaces within the basic Jupiter IIC package.

### SOFTWARE

All Jupiter IIC systems feature a sophisticated monitor/debugger package including a versatile interrupt system and I/O monitor call instructions. A programmable macro editor and expanded assembler are also provided. Proposed ANSI standard BASIC is included with Jupiter IIC.

### THE JUPITER IIC KIT: \$2850

The kit includes the CPU, software debugger and monitor module, 8K dynamic memory, module cage, power supply, front panel, video interface, cassette interface, and all the documentation required to assemble, run, and understand the system as well as modification instructions for a black and white TV set.

### THE JUPITER IIC ASSEMBLED SYSTEM: \$3800

All components of the Jupiter IIC kit plus two audio cassette units and a 12-inch black and white TV set. The complete system is shipped with all components assembled and tested.

### SPECIFICATIONS

**CPU**  
MC 6800; eight-level interrupt, prioritized and maskable by level; single-cycle and block DMA

**DUAL AUDIO CASSETTE**  
Complete paper tape replacement; start/stop motor control; 300, 600, or 1200 baud (crystal controlled); error correction

**VIDEO TERMINAL INTERFACE**  
64 x 32 lines  
Upper and lower case, plus Greek alphabet; 7 x 12 format, 128 dot (hor.) x 96 dot (vert.) graphics

**MEMORY**  
8K dynamic RAM; 3K ROM; 1K dual-port static RAM  
**KEYBOARD**  
Generates full 128-character ASCII set



Send details on Jupiter II systems  
 Have salesman call

Name \_\_\_\_\_  
Title \_\_\_\_\_  
Company \_\_\_\_\_  
Address \_\_\_\_\_  
City \_\_\_\_\_ State \_\_\_\_\_ Zip \_\_\_\_\_  
Phone \_\_\_\_\_



WAVE MATE 1015 West 190th Street, Gardena, California 90248  
Dept. 203

Telephone (213) 329-8941

# Twenty Reasons Why There Is a



# In Your Future

- 1 *Kilobaud Magazine* is going to be as much fun for the computer hobbyist as 73 is for the ham.
- 2 It will help you in many ways to take advantage of the coming bonanza for hobbyists. The \$50 million computer hobbyist market of today will be the \$500 million small business market of two years from now and the \$5 billion market of ten years from now (or a lot less). *Kilobaud* will help you make money.
- 3 You'll continue to get I/O hardware articles in 73. *Kilobaud* will be more software oriented, and you'll be needing this info.
- 4 Computing and hamming go together. There will be a microprocessor in much of your ham gear in another year, so learn about them right now . . . be a pioneer. Were you among the last to change to SSB? How about FM? Did you fight it or did you get in there and pioneer it with your own repeater? Here is another pioneering opportunity for you . . . don't muff it.
- 5 *Kilobaud* will tell you as much as possible about the hardware being put out. Other magazines have had little about it. Get to know all of the major systems and their plusses and minuses.
- 6 *Kilobaud* will have a continuing program library. When you want to write a program, it will be duck soup to sit down and take part of this one and perhaps that algorithm . . . and end up with a program that might even work the first time.
- 7 *Kilobaud* will be the first magazine to bring you detailed letters from hobbyists telling you of the problems they've had with their systems and how they managed to overcome them – invaluable unless you are a big fan of wheel reinventing.
- 8 The *Kilobaud* lab will have most of the common hobby systems up and running. This means the staff will be able to test new gadgets, programs and systems and let you know their reactions. No other magazine has such a lab.
- 9 *Kilobaud* is going to be aimed at helping newcomers to computers, so you'll find it easy to come up to speed in this new field.
- 10 Just as 73 has the top writers of the ham field, *Kilobaud* will be publishing the top computer hobbyist writers. If you know your beans, you will find *Kilobaud* pays about double what most other magazines do for articles (this is one of the reasons why the very best are going to be in *Kilobaud*).
- 11-20 . . . even better reasons for subscribing to *Kilobaud* . . . wish we had the room here to give them in detail.
- 21 The Charter Subscription price for *Kilobaud* is only \$12 for one year and \$25 for three years. Individual copies will be \$2. The Charter Subscription is good until December 31, 1976.
- 22 Note that first copies of *Byte* are selling for more than a year's subscription . . . take heed. A limited number of *Kilobaud*'s first issue will be printed and when they are gone, they will be gone.
- 23 Better fill out the subscription blank. Charge it.

Yes, send me a  Charter Subscription

\$12.00/one year  \$25.00/three years

Toll Free subscription numbers 800-258-5473/800-251-6771



Name \_\_\_\_\_

Address \_\_\_\_\_

City \_\_\_\_\_ State \_\_\_\_\_ Zip \_\_\_\_\_

Cash enclosed  Check  Money Order  Bill me

Bill my credit card  American Express  Bank Americard  Master Charge

Credit card # \_\_\_\_\_ Interbank # \_\_\_\_\_

Expiration date \_\_\_\_\_ Signature \_\_\_\_\_

Kilobaud • Peterborough NH 03458

H/76



# UNBELIEVABLE!!!!!!

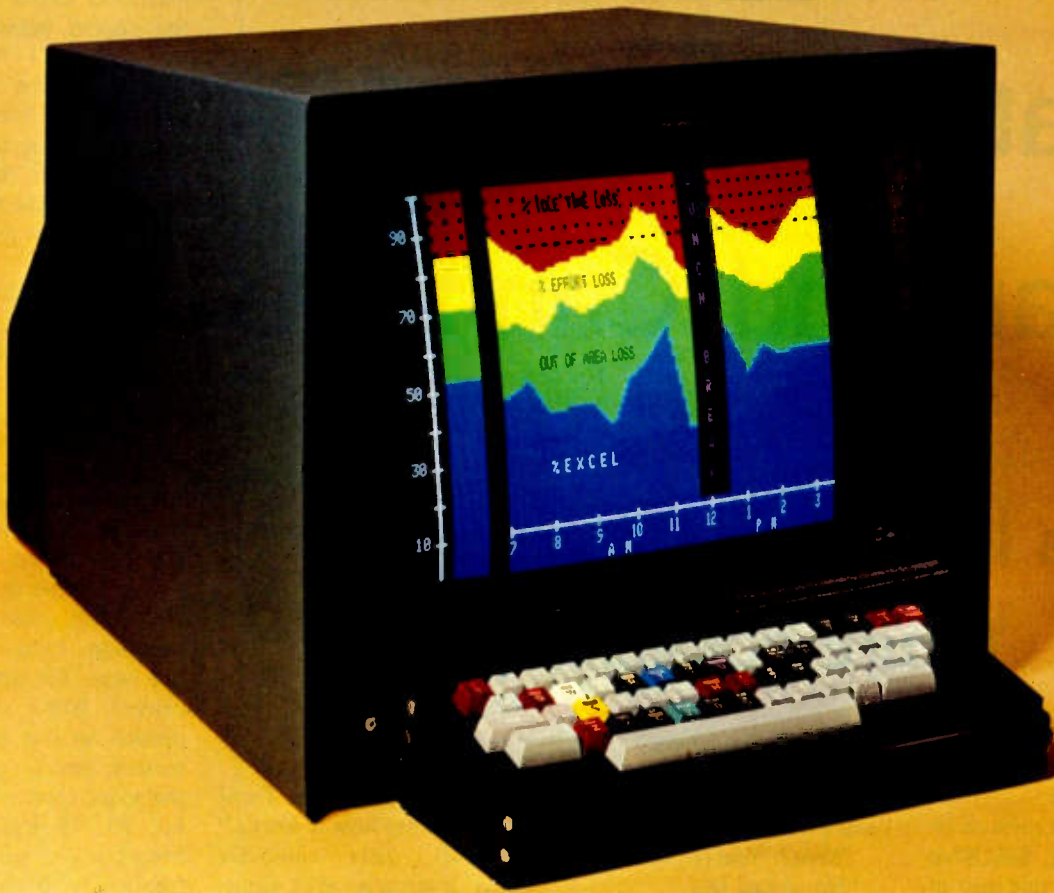

## The Intecolor<sup>®</sup> 8001 Kit

A Complete 8 COLOR Intelligent CRT Terminal Kit

# \$1,395\*

**"Complete" Means:**

- 8080 CPU • 25 Line x 80 Characters/Line • 4Kx8 RAM • PROM Software • Space for UV Erasable PROM • 19" Shadow Mask Color CR Tube • RS232 I/O • Selectable Baud Rates to 9600 Baud • Single Package • 8 Color Monitor • ASCII Set • Keyboard • Bell • Manual

And you also get the Intecolor<sup>®</sup> 8001 9 Sector Convergence System for ease of set up (3-5 minutes) and stability.

**Additional Options Available:**

- Roll • Additional RAM to 32K • 48 Line x 80 Characters/Line • Light Pen • Limited Graphics Mode • Background Color • Special Graphics Characters • Games

Delivery 30-60 days ARO.

\*Domestic USA price

*ISC WILL MAKE A BELIEVER OUT OF YOU.*

Send me \_\_\_\_\_ (No.) Intecolor<sup>®</sup> 8001 kits at \$1,395 plus \$15.00 shipping charges each.

Enclosed is my  cashier's check,  money order,

personal check\*  \$350 deposit/kit for C.O.D.

Shipment for \$\_\_\_\_\_.

NAME \_\_\_\_\_

ADDRESS \_\_\_\_\_

CITY \_\_\_\_\_

STATE \_\_\_\_\_ ZIP \_\_\_\_\_

\*Allow 8 weeks clearance on personal checks.



**Intelligent Systems Corp.** <sup>®</sup>

4376 Ridgeway Drive, Duluth, Georgia 30136  
Telephone (404) 449-5961

# What Computers Can and Can't Do

-- a look at amateur radio's  
future possibilities

**K**nock. Knock.  
"It's open. Come on in.  
Oh, good evening, Bill. What  
are you doing in this part of  
town?"

"Evening, Tom. I just, uh,  
happened to be in the neigh-  
borhood and thought I'd  
drop by and see how you did  
in the Sweepstakes."

"Oh, I can't complain. I'm  
a little tired from staying up  
most of last night, but I had a  
lot of fun. How about your-  
self?"

"I had a great time. I got  
me an automatic CQ sender  
just for the contest, and it  
really helped. I made, get this  
now, 142,730 points."

"Hey, that's real good.  
That's the best you've ever  
done, isn't it?"

"Yes it is, Tom. It's the  
CQ sender that did it. What  
kind of score did you make?"

"Oh, a pretty good one."

"How good?"

"Well . . ."

"Aaaaw, don't be embar-  
rased. I won't tell the boys."

"Oh, I'm not embarrassed.  
I made 387,540 points."

"What? You're kidding!"

"No, actual fact."

"That's more than twice  
the highest score I ever heard  
of. You must have figured it  
wrong."

"No, I didn't, Bill. I just  
made a few modifications to  
the station. Would you like to  
see what I've done?"

"Would I ever!"

"In here. Let me get the  
light."

"Hey, what are all these  
funny looking boxes? Are  
you running 10 kW or some-  
thing?"

"No, this is just my latest  
interest, a computerized ham  
station."

"A what?"

"The price of computers  
has been dropping and a lot  
of hams have been getting  
interested in them. I built a  
few things and programmed  
this little computer to make  
my Sweepstakes operation  
more efficient."

"How do you mean, Tom?  
I still can't see how it works."

"Well, this computer  
works internally with some-  
thing called ASCII Code. So  
first I built a Morse code to  
ASCII converter so that the  
computer can understand  
Morse. Then I wrote a micro-  
program so that the com-  
puter could lock on to any  
code speed by comparing the  
relative spacing of the dots  
and dashes. Now I have a  
computer that I can hook up  
to my receiver and it can  
understand any CW signal it  
hears. Does that make  
sense?"

"Yeah, I guess so."

"Next I took this old TV  
set and modified it to use as a  
display. Now the computer  
can read CW and print the  
results on the TV screen for  
me to read. Then I built two  
digital sweep circuits, one for  
my main receiver and one for  
my spare receiver. Now the  
computer can automatically  
sweep through the band, and

I've programmed it to copy  
and store the call, frequency,  
code speed, and other infor-  
mation such as section, etc.,  
of everyone it hears. And  
when I'm sending, the com-  
puter tunes the receiver to  
the other end of the band and  
listens to who's there during  
the spaces between charac-  
ters. When I finish trans-  
mitting, it zips the receiver  
back to the transmitter fre-  
quency, listens to the other  
guy's part of the exchange  
and displays the result on the  
TV screen. Got that?"

"Wow!"

"Of course, the computer  
also keeps the log and main-  
tains a check list to make sure  
that I'm not working the  
same guy twice. It also  
retunes the transmitter for  
the part of the band I'm in,  
and, of course, it points the  
beam in the direction of the  
guy I'm talking to. Oh, and  
you remember that I said that  
I'd built two frequency  
sweeping circuits and that  
one was for the spare re-  
ceiver? While I'm working  
people on one band, say 40  
meters, the computer is using  
the spare receiver to listen to  
80, 20, 15 and 10 and to  
keep track of who's on, what  
frequency they're on, their  
section, and approximate  
code speed. It also keeps  
track of band conditions so  
that if 20 gets real good, for  
example, I don't waste my  
time on another band that  
isn't as active."

"Wow!"

"Of course, I programmed  
the computer with all of the  
sections. For the first 3 hours  
of the contest I just worked  
as many stations as I could.  
After that, the computer kept  
a special watch for the sec-  
tions that were missing."

"Wow!"

"But let me describe a  
typical QSO for you, Bill.  
The computer would print on  
the screen: 'W1XYZ 7033.28  
KHZ 16 WPM CT SEC.' From  
the way I had programmed  
the machine, I knew that  
W1XYZ had just called CQ  
SS, that he was on 7033.28  
kHz, that he was sending at

about 16 wpm, and that the computer had previously copied his section as CT. I also knew that I hadn't worked him before or the computer wouldn't have printed his call on the screen. I'd hit this button on the console labeled GET HIM, the computer would zip the transmitter to 7033.28 kHz, switch to the dummy antenna and retune, and a few milliseconds later, while aiming the beam at Connecticut, send at 16 wpm: 'W1XYZ DE WB6OBS K'. If he came back to me, the computer would print his response on the screen while I listened to it for verification: 'WB6OBS DE W1XYZ NR 1 A W1XYZ 55 CT BK'. The computer would print on the screen and start sending: 'BK QSL NR 50 A WB6OBS 64 SD BK'. The computer would print W1XYZ's response while I listened: 'BK QSL GL CQ SS ...'. As soon as I saw and heard that, I hit this other button here labeled LOG IT, and the computer would log the call, time, frequency, exchange, etc., as required. If the other guy missed anything, the computer is programmed to respond to requests for a repeat of CALL, PRECEDENCE, NR, CK, or SEC. If anything else was needed or if the computer didn't understand what was missed, it would print a line of question marks on the screen: '?????????????' and turn control to manual. That meant that I would have to take over and complete the

exchange and log it manually. Then I would turn control back to the computer. Of course, I could hit the MANUAL button any time I wanted to make changes or corrections to the exchange or to the log entry. Interesting little system, eh Bill?"

"Fantastic! Unbelievable! I feel like I'm in the year 2077 rather than 1977 like I know I am. I see how you made that high score now. Wow! ... A couple of things do bother me, though."

"Yeah, like what?"

"Well, I don't see how anybody can compete with a computerized station like yours unless he's got one like it. Does this mean we all have to computerize or give up contests?"

"No, Bill, I figure that within a year or two there will either be a separate category and computerized stations will only compete with each other, or there will be a multiplier for non-computerized stations, like one for low power, to give everybody an equal chance. Anything else?"

"Well, it looks like the computer did everything. It looks like you could have turned it on and gone to bed. It doesn't seem much like ham radio to me. Do we all computerize our stations and then sit back on our hands while the computers talk to each other?"

"I thought about that too, Bill, but I don't think so. First, all of the things the computer did were things

that I wish I could do myself. I wish that I could listen to and remember all the calls and frequencies and sections from one end of every band to the other, but I can't. This computer can, so why not use it? I wish that I could generate rf in my brain and send and receive it with no additional equipment. I can't, so I use a transmitter and a receiver and an antenna. They do the things I can't do, just like you use your new CQ sender to call CQ while you're logging, because you can't do both things at once without it."

"But it doesn't seem quite human somehow, and I like the human touch in my QSOs."

"I like the human touch in my QSOs too. When I'm not using the computer here for contests, I use it to make my QSOs more satisfying. I keep a more detailed log with it than I ever could with pencil and paper. If a guy tells me that he's a retired mailman and that he now builds model airplanes and lives on a houseboat, I record all of those things in my computer log. If I work the same guy again in three months or three years, I wish that I could remember all of those things. I can't, but my computer log can, and all I have to do is type in the guy's call and a question mark and hit the ENTER key, and if I ever talked to him before, I know it in about 2 seconds and I know everything I ever logged about him because the com-

puter prints the log entry and information on the screen."

"I think I see what you mean, Tom. Use the computer to do things you can't do and to make your operating more enjoyable. It would be great to keep a watch for those rare DX stations, and it could keep watch day and night, on all bands."

"Yeah, that's the kind of thing I mean. You could even have it keep watch for specific calls, so that if an old friend of yours got on the air you would know it immediately. Or it could automatically aim your antenna at a satellite and follow it across the sky. The possibilities are almost unlimited."

"It sounds great, Tom. You've sure sold me. All of this gear must have cost a fortune though."

"I told you that the price of computers and computer memory was dropping fast, right?"

"Right."

"All of the computer gear you see here cost me about \$400. It's mostly used gear and surplus, and some of the interface stuff is home brew. I probably spent six months getting everything together and getting it working, though."

"That's not too bad. I have just one last question, Tom."

"What's that?"

"Do you know anybody who wants to buy a slightly used automatic CQ sender?" ■

Manufactured & Guaranteed by

**MOR-GAIN**  
2200T South 4th Street  
Leavenworth, Kansas 66048



Overseas Sales (except Canada)

E. D. Magnus & Associates  
5715 North Lincoln Ave.  
Chicago, Illinois 60659

Fully Air Tested - Thousands Already in Use

**#16 40% Copper Weld wire annealed to handle like soft Copper wire - Rated for better than full legal power AM/CW or SSB Coaxial or Balanced 50 to 75 ohm feedline - VSWR under 1.5 to 1 at most heights - Stainless Steel hardware - Drop Proof Insulators - Terrific Performance - No coils or traps to break down or change under weather conditions - Completely Assembled ready to put up - Guaranteed 1 year - ONE DESIGN DOES IT ALL.**

**EXCLUSIVE 66 FOOT,  
75 THRU 10 METER DIPOLES**

NOTES

- Models prefaced '\*\*\*' will be available 1/77.
- All models above are furnished with crimp/solder lugs.
- All models can be furnished with a SO-239 female coaxial connector at additional cost. The SO-239 mates with the standard PL-259 male coaxial cable connector. To order this factory installed option, add the letter 'A' after the model number. Example: 40-20 HD/A.
- 75 meter models are factory tuned to resonate at 3950 kHz. (SP) models are factory tuned to resonate at 3800 kHz. 80 meter models are factory tuned to resonate at 3650 kHz. See VSWR curves for other resonance data.

(Canadian customers - please contact your favorite Canadian dealer of MOR-GAIN direct.)

**NO TRAPS—NO COILS—  
NO STUBS—NO CAPACITORS**

MOR-GAIN HD DIPOLES ... • One half the length of conventional half-wave dipoles. • Multi-band, Multi-frequency. • Maximum efficiency - no traps, loading coils, or stubs. • Fully assembled and pre-tuned - no measuring, no cutting. • All weather rated - 1 KW AM, 2.5 KW CW or PEP SSB. • Proven performance - more than 15,000 have been delivered. • Permit use of the full capabilities of today's 5-band xcvrs. • One feedline for operation on all bands. • Lowest cost/benefit antenna on the market today. • Fast OSY - no feedline switching. • Highest performance for the Novice as well as the Extra Class Op.

MODEL	BANDS (Meters)	PRICE	WEIGHT (Oz./Kg)	LENGTH (Ft./Mtrs)
40-20 HD	40/20	\$49.50	26/73	36/10.9
40-10 HD	40/20/15/10	59.50	36/101	36/10.9
80-40 HD	80/40 • 15	57.50	41/115	69/21.0
75-40 HD	75/40	55.00	40/112	66/20.1
75-40 HD (SP)	75/40	57.50	40/112	66/20.1
75-20 HD	75/40/20	66.50	44/123	66/20.1
75-20 HD (SP)	75/40/20	66.50	44/123	66/20.1
75-10 HD	75/40/20/15/10	74.50	48/134	66/20.1
75-10 HD (SP)	75/40/20/15/10	74.50	48/134	66/20.1
80-10 HD	80/40/20/15/10	76.50	50/140	69/21.0

# A Ham Shack File Handler

-- program in BASIC for QSLs, repeaters, etc.

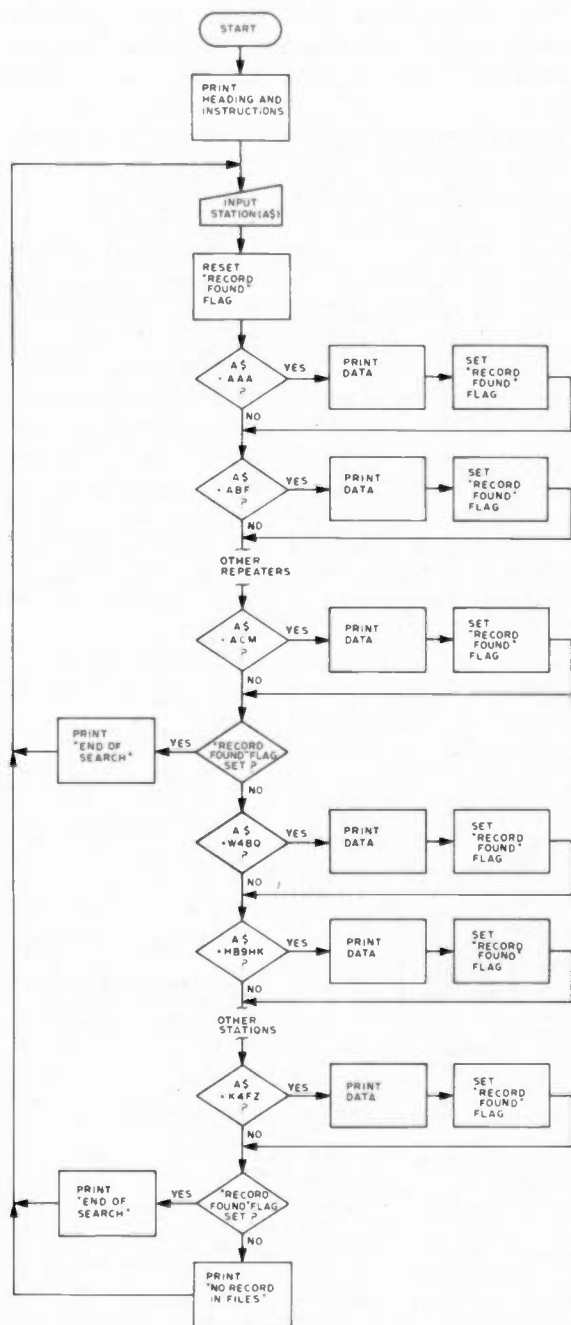

Program flow chart.

This article describes a simple program in BASIC which will keep track of your QSLs and also give you information on the repeaters that you may wish to use. The program may also be extended to provide other functions in logkeeping, but it was kept simple to give the hams who are new computer freaks a chance to get acquainted with their new toy. It is written in Altair BASIC version 3.2, but could be easily modified to any other BASIC.

## A SAMPLE RUN OF THE HAM FILE

RUN

REPEATER AND QSL FILE

FOR REPEATERS USE LAST THREE LETTERS OR FREQUENCY AS 13/73 OR CITY NAME, FOR AMATEUR STATIONS USE COMPLETE CALL.

STATION ? AAA  
 WR4AAA, 13/73, 190, SALISBURY, NC.

END OF SEARCH

STATION ? 28/88  
 WR4ABF, 28/88, 195, SHELBY, NC

END OF SEARCH

STATION ? HICKORY  
 WR4ACM, 25/85, 195, HICKORY, NC

END OF SEARCH

STATION ? ABQ

NO RECORD IN FILES

STATION ? CR6CA  
 5/26/71, 0015Z, 14MHZ, RTTY, JOE

END OF SEARCH

STATION ? K4GV  
 11/6/75, 0710P, 2M-FM, TED  
 12/5/75, 0655P, 2M-FM, TED

END OF SEARCH

STATION ? W2ABC

NO RECORD IN FILES

STATION ? W4BQ  
 THAT'S YOU, STUPID!

END OF SEARCH

STATION ?

OK

## Station Operation

A sample readout shows that information about a repeater can be obtained by replying to the initial question of the computer ("STATION?") with the last three letters of the repeater call, such as "AAA" or by typing in the frequency pair as "37/97", or even by typing in the location city as "SHELBY." If your input is a city name, all the repeaters in that city will be printed and the same goes for the repeater frequency pairs, but only one repeater will be printed for each call. If you should be working in an area which crosses district boundaries, and the same last three letters have been assigned to repeaters that you work, then the identifier should be expanded to include the district number (e.g., "3AAA" and "4AAA").

For information from the log on amateur QSLs, the "STATION?" request is followed by typing in the full call of the amateur station.

After the computer prints the information on repeaters or amateur stations, it will print "END OF SEARCH" and then return to "STA-



TION?" for the next request. If the requested information is not in the file, the computer will print "NO RECORD IN FILES" and go back to "STATION?"

### The Program

Additions or deletions to the file are accomplished by using the Altair BASIC command "CLOAD," which brings the program into the computer from cassette. A

new entry is made by simply adding a new line for each new station, repeater, or even additional QSLs with a previously logged station. After the updating has been performed, the program is then put back on cassette using the "CSAVE" command.

The memory required for the listing shown takes about 1250 bytes and a typical entry takes about 45 bytes. The program could be ex-

panded to provide readouts for summaries of QSLs by districts or foreign countries. This could be done by adding an "OR" phrase as was done in the repeater section of the program, but as mentioned at the start, this program has been kept simple. However, it is a practical operating program and is in use at my station. The listing as shown shows only a small portion of my log files. ■

```

LIST
5 REM HAM FILE IN ALTAIR BASIC BY GEORGE L. HALLER
10 PRINT:PRINT
20 PRINT "REPEATER AND QSL FILE"
30 PRINT
40 PRINT "FOR REPEATERS USE LAST THREE LETTERS OR FREQUENCY AS 13/73"
50 PRINT "OR CITY NAME, FOR AMATEUR STATIONS USE COMPLETE CALL."
60 PRINT:PRINT
70 INPUT "STATION ";AS
80 F=0:REM RESET "RECORD FOUND" FLAG
100 IF AS="AAA" OR AS="13/73" OR AS="SALISBURY" THEN GOSUB 300
110 IF AS="ABF" OR AS="28/88" OR AS="SHELBY" THEN GOSUB 310
130 IF AS="ACM" OR AS="25/85" OR AS="HICKORY" THEN GOSUB 330
280 IF F>0 THEN 1000:REM IF REPEATER IS FOUND
290 GOTO 400 :REM JUMPS REPEATER SUBROUTINES
300 PRINT "WR4AAA, 13/73, 190, SALISBURY, NC":F=1:RETURN
310 PRINT "WR4ABF, 28/88, 195, SHELBY, NC":F=1:RETURN
330 PRINT "WR4ACM, 25/85, 195, HICKORY, NC":F=1:RETURN
400 IF AS="W4BQ" THEN PRINT "THAT'S YOU, STUPID!":F=1
410 IF AS="HB9HK" THEN PRINT "7/20/73, 2030Z, 14MHZ, RTTY, WILLY":F=1
420 IF AS="CR6CA" THEN PRINT "5/26/71, 0015Z, 14MHZ, RTTY, JOE":F=1
430 IF AS="OA4BR" THEN PRINT "7/3/74, 0915Z, 14MHZ, RTTY, ZIP":F=1
440 IF AS="JH1TF" THEN PRINT "5/27/74, 1150Z, 14MHZ, RTTY, DOC":F=1
450 IF AS="KJ6BZ" THEN PRINT "7/6/73, 0200Z, 14MHZ, RTTY, GEORGE":F=1
460 IF AS="K4GV" THEN PRINT "11/6/75, 0710P, 2M-FM, TED":F=1
470 IF AS="W4MYG" THEN PRINT "11/3/75, 0725P, 2M-FM, RAY":F=1
480 IF AS="K4GV" THEN PRINT "12/5/75, 0655P, 2M-FM, TED":F=1
490 IF AS="K4FZ" THEN PRINT "2/17/76, 0430P, 14MHZ, SSTV, BOB":F=1
1000 PRINT
1010 IF F>0 THEN PRINT"END OF SEARCH":GOTO 60
1020 PRINT "NO RECORD IN FILES":GOTO 60
OK
    
```

Heading  
&  
Instructions

Input Station Request &  
Reset "Record Found" Flag

Repeater Recognition  
Symbols

Repeater Subroutines  
(The number after the frequency pair is the  
antenna direction bearing from my station)

Station QSL Compare  
Routines

Robert S. Hatch, Jr. W0TBL  
Route 10  
Columbia MO 65201

Several days ago, we stopped in at the local ham store to purchase a log book. And, to our amazement, the ARRL Log Books were priced at \$2.00 each. We felt that something had to be done to help combat this inflation, so we decided we could print our own logs on the computer at work. Agreed, not everyone has access to an IBM 370 Model 165 and 155 back to back. However, there are a lot of computers around, and who knows, the guy down the block just might run the program for you.

The program was written in Fortran IV because of simplicity, and can be compiled by a large number of computers.

The computer program is punched into IBM cards on an IBM 029 Key punch. The JCL (Job Control Language) was not included because each computer installation has its own unique JCL. And, you will need to know the JCL at the particular computer site you use.

So why not punch up the program, find a computer, and run off several thousand log sheets on that idle computer? ■

Editor's note: The author is selling this program deck for \$4.00 postpaid.

# Print Your Own Log Book

-- on your nearest computer

```

1 $JOB
2 DD 9 M=1.15
3 WRITE(6.1)
4 1 FORMAT('1')
5 WRITE(6.2)
6 2 FORMAT(' ',130('--'))
7 WRITE(6.3)
8 3 FORMAT(' ',1 AMATEUR RADIO STATION LOG OF WAYNE GREEN
9 1 CALL W2NSD/1 TIME IN GMT,.33X,.1')
10 WRITE(6.2)
11 WRITE(6.4)
12 4 FORMAT(' ',1 DATE P | STATION | CALLED | HIS | MY | FR
13 1EQ. | MODE | POWER | TIME | COMMENTS*.22X,.1 QSL |)
14 WRITE(6.5)
15 5 FORMAT(' ',1 TIME | CALLED | BY | RST | RST |
16 1 | WATTS | ENDED | *.31X,.1 S|R |)
17 WRITE(6.2)
18 DD 7 K=1.24
19 WRITE(6.6)
20 6 FORMAT(' ',1 | | | | | | | | | |)
21 7 WRITE(6.2)
22 9 WRITE(6.3)M
23 8 FORMAT(/' ',1 PAGE*.15)
24 WRITE(6.1)
25 STOP
26 END

```

SENTRY

The staff (both of us) at ON\_LINE wish to acknowledge our readers and advertisers as being the true cause of our successful first year. Our thanks and wishes for a 1977 full of events, satisfaction and peace.

**COMPUTER HOBBYISTS!**  
Nationwide Classified Ad Newsletter  
Buy & Sell Hardware & Software  
new/used/unique/low-cost  
\$3.75 for 18 issues.  
Free sample issue on request.  
**ON\_LINE NEWSLETTER**  
24695 Santa Cruz Hwy., Los Gatos  
CA 95030

## KAUFMAN BALUN

KAUFMAN  
water tight  
BALUN

new and improved  
molded plastic



1:1 Impedance  
match

with or  
without  
BALUN

Patent No. D219106 For dipoles, beams, inverted "Y", and quads

KAUFMAN Center Insulator with BALUN \$13.50  
KAUFMAN Center Insulator without BALUN \$ 8.50  
Dragon Fly antenna construction sheet and drawing

postpaid USA \$ 2.00

3 Kw PEP  
4 Ounces  
Q1 Ferrite

**KAUFMAN INDUSTRIES**  
3 Short St.  
REEDS FERRY, N.H. 03054

## SUB-AUDIBLE GENERATOR for FM

THE CUBE

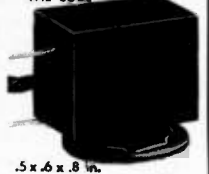

.5 x .6 x .8 in.

- Inexpensive multi tone encoder
- Compatible with PL-CG-QC
- Low distortion sinewave
- Input 8-18 VDC unregulated
- Rugged, plastic encased with leads
- Adjustable frequency (98-250 Hz), Lower available
- Excellent stability

Price \$19.95

Freq. set at  
factory  
\$5.00 extra

Calif. res. add 6%

Send for more info

lyle  
Products

Dept. 73 P.O. Box 2083 Santa Clara, CA 95051

# Meet the Challenger.™

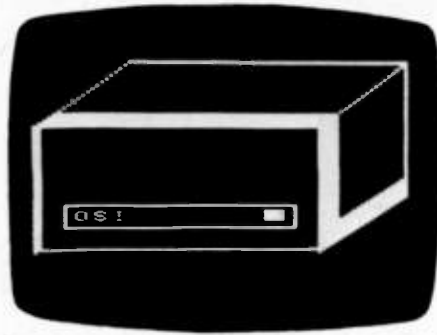

The Challenger  
Self Portrait

## The new price and performance champ from OSI.

### He's got his act together!

Even our lowest-cost Challenger comes fully assembled, complete with a 500 ns 6502A, serial interface, 1,024 words of memory and a UL-approved power supply, all for \$439. Every Challenger comes ready for easy expansion with an 8-slot mother board, backplane expansion capability, and a power supply heavy enough to handle a full complement of system boards. Our 4K Challenger comes ready to run BASIC minutes after you unpack it. And there's more.

### He packs some heavy hardware.

You've never seen memory and interface options like these—not at our prices, fully assembled! 4K RAM memory boards \$139! (see below). Single drive OSI Challenger Floppy Disk \$990! Dual drive Floppy \$1490! Plus 8K PROM boards! A Video Graphics board, including alphabetics, graphics, and color! An audio cassette, A/D, D/A and parallel I/O board! A backplane extender board! A prototyping board! And our extraordinary **CPU Expander Board**—it lets you run a Z-80, and 6100 (PDP-8 equivalent) **concurrently** with The Challenger's 6502, or under its control.

### There's nothing soft about his software!

OSI has full software support for our Challengers. Including extended BASIC, extended Video Monitor, a Disk Operating System, some very Hollywood real time programs for Video Graphics, Animation, Sound Processing and so forth, plus PROM firmware, with more to come.

### He's fast!

You can order The Challenger with a 6502C for a 250 ns cycle time, with a standard 6502A for 500 ns cycle time, or with a 6800 for 1 microsecond cycle time. And with

our CPU Expander Board, you can always update to any new CPU to be as fast as fast can be.

### And he isn't just good!

He's better! By design. The OSI Challenger is the only completely-assembled, ultra-high-performance, fully-expandable mainframe computer that does this much for this little. Get your hands on one now. Send for your Challenger today.

### You can't beat The Challenger!

The OSI Challenger 65-1K. Fully assembled. Features 6502A CPU, serial interface, 1,024 words of memory. **\$439.**

The OSI Challenger 65-4K. Same as 65-1K but with 4,096 words of memory. Will run Tiny BASIC without expansion. **\$529.**

The OSI Challenger 65V-4K. NO NEED for an expensive terminal. Connects to your ASCII keyboard and video monitor through included OSI 440 Video Board. Features software utility that simulates a deluxe CRT terminal. **\$675.**

The OSI Challenger 68-1K. Based on 6800 CPU. For the casual hobbyist, smaller systems. The Challenger 68 series comes only in serial interface forms and is compatible with MIKBUG software through an included OSI software utilities package. **\$459.**

The OSI Challenger 68-4K. With OSI 4K BASIC on paper tape. **\$529**  
**SPECIAL! ADDITIONAL 4K MEMORY BOARDS.** Ordered with your Challenger, limit 3 more at this special Low Price, (total 16K, including 4K already on-board in mainframe). **\$139**  
Buy 12K or larger Challenger 65 system and we include Extended BASIC FREE!

OSI Challenger Floppy Disk System. Fully assembled, for use with OSI Computers only. **\$990** Single drive **\$1490** Dual drive.

OSI Audio Cassette Interface. Comes assembled, but with room for you to populate with A/D and D/A chips later. (OSI 430 based) **\$89**  
And all the baseboards and kits of the powerful OSI 400 System.

### OK, OSI, I'm ready to buy!

To order your Challenger System, send the total amount of your purchase plus \$4.00 for shipping and insurance (plus sales tax for Ohio orders) by personal money order or check. Or indicate all numbers on your BankAmericard or Master Charge to charge your order. Or send a 20% (non-refundable) deposit to receive your order C.O.D. Delivery is typically 60 days (except when payment is by check, which must clear before shipment can be made). Deliveries are scheduled on a first ordered, first shipped basis.

Name \_\_\_\_\_

Address \_\_\_\_\_

City \_\_\_\_\_ State \_\_\_\_\_ Zip \_\_\_\_\_

Telephone \_\_\_\_\_

Bank card info Inter Bank # \_\_\_\_\_

Expiration Date \_\_\_\_\_

Account # \_\_\_\_\_

Check  M. O.  BAC  MC   
20%, bal. C.O.D.

Order attached.

Send additional information on The OSI Challenger.

Send additional information on OSI 400 Kits.

\$1.00 enclosed for complete OSI Catalog.

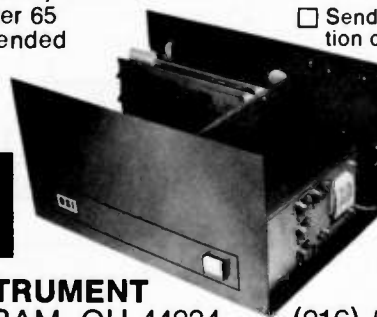

# OSI

OHIO SCIENTIFIC INSTRUMENT

Dept. H 11679 HAYDEN STREET, HIRAM, OH 44234

(216) 569-7945

# The Bit Explosion

-- 8 vs. 12 vs. 16 vs. ?

**W**hy settle for eight bits? If you're thinking of building your own microcomputer, take a quick look at what's available before plunging in. For slightly more than what you would expect to pay for an 80-bit CPU chip, you can now get a 12- or 16-bit microprocessor with many more capabilities and features. Those

currently available include the 12-bit CMOS chip from Intersil (IM-6100) and Harris Semiconductor (HM-6100) which executes the same instruction set as the Digital Equipment PDP-8/E minicomputer and the 16-bit CPUs from Texas Instruments (TMS-9900), National Semiconductor (PACE), and General Instruments

(CP-1600). If you think you're not ready to design your own custom system, several of these companies offer various boards and systems all ready to go.

## The 12-Bit 6100

The IM-6100 from Intersil and the HM-6100 from Harris Semiconductor are pin-for-pin compatible 12-bit microprocessors in 40 pin dual-inline packages. Both recognize the standard instruction set of the Digital Equipment PDP-8/E minicomputer but cannot accept the Extended Arithmetic Element (EAE) or User Flag (UF) options. Normal memory addressing capacity is only 4K but may be extended to 32K via an Extended Memory Control element. The bus structure of the 6100 can be adapted to provide a subset of the PDP-8/E OMNIBUS signals allowing all PDP-8/E programmed I/O interfaces to operate with the 6100 without hardware or software modifications.

The CMOS processor chip requires only a single voltage supply between 4 and 11 volts and is TTL compatible with a 5 V supply. There is a built-in crystal controlled oscillator, for system timing, with a maximum frequency of 8 MHz with selected ver-

sions of the chip. All control signals are produced by the CPU chip and can interface with up to 64 separate I/O devices with PDP-8/E compatible interfaces. Other features include single clock/single instruction capabilities, Direct Memory Access (which is not PDP-8 compatible), interrupts, and dedicated control panel features.

The 6100 does require slightly more support hardware than the simpler 8-bit microprocessors, but its software compatibility with the PDP-8 should make the extra effort well worthwhile. Over a thousand fully developed and documented programs are available from Digital Equipment Corporation, Software Distribution Center, 146 Main Street, Maynard MA 01754. Other user generated programs are available from the DEC User's Society (DECUS) at Parker Street, Mail Stop PK-3/E55, Maynard MA 01754. Besides the usual loaders, assemblers, editors, and other utility programs, you can also get various versions of BASIC and FOCAL or even a complete PDP-8 operating system software package. For added troubleshooting convenience, the complete set of processor, memory, and terminal diagnostic programs for the DEC PDP-8 can also be used with the 6100. This last feature, the ability to run various diagnostic programs, is lacking in most microprocessors/microcomputers currently available.

## The 16-Bit Offerings

The TMS-9900 from Texas Instruments provides a unique approach in micro-system design using a memory to memory architecture with multiple register files resident in memory, similar to some large scale computers. It's available as a single chip, a complete board (similar to the DEC LSI-11), or a complete system; each has hardware multiply and divide as a standard feature. The rather large 64 pin dual-

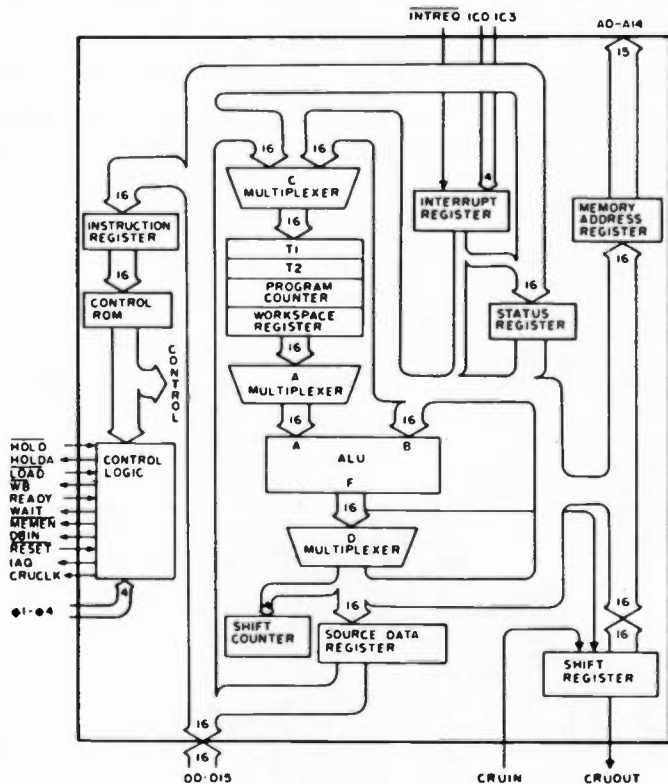

Fig. 1. TMS-9900 block diagram.



in-line package requires  $\pm 5$  V and +12 V supplies along with a four-phase 3 MHz clock. Fig. 1 gives a block diagram of the internal architecture of the TMS-9900.

The maximum addressable memory space is 64K 8-bit bytes or 32K 16-bit words. The first 64 words of memory are reserved for interrupt and trap vectors while the last two memory words are used for the LOAD signal trap vector. The remaining memory space may be used for programs, data, or workspace registers as desired.

The only three internal hardware registers accessible to the user are the program counter (PC), the status register (ST), and the workspace pointer (WP). The workspace pointer points to the starting address of a 16 register workspace resident anywhere in the external memory space. Each workspace register is addressed by an offset from the current workspace pointer, and the various registers may be used as desired except for a few that have fixed uses as part of subroutine and interrupt linkage conventions.

The CPU provides up to 16 different interrupt levels with level 0 reserved for the RESET function. A built-in Communications Register Unit (CRU) allows up to 4096 I/O bits in fields of 1 to 16 bits in a unique command-driven I/O interface. This interface allows implementing interfaces with exactly the right number of data bits required for a particular application. Other timing and control signals provide capabilities for ROM loaders, front panel service, CPU hold, slow memory cycles and DMA transfers. Of the 66 general instructions, 5 provide a means of initiating user implemented external functions for special applications.

Fig. 2 shows a block diagram of the PACE microprocessor from National Semiconductor, a 16-bit microprocessor in a 40 pin

dual-in-line package. The PACE provides four 16-bit general purpose working registers along with a 16-bit status and control flag register that automatically preserves the system status. Return addresses for subroutines and interrupt servicing are automatically saved on a ten word last-in, first-out stack which may be expanded through software via stack full/stack empty interrupt routines. There is a six level, vectored priority interrupt system with individual interrupt enables in the status register for each level as well as a master interrupt enable for the five lower levels as a group. For direct processor status and control functions, there are four sense inputs and four control flag outputs to the CPU chip itself.

The instruction set consists of 45 instructions in eight classes. Memory reference instructions utilize an addressing scheme that provides three floating memory pages and one fixed memory page of 256 words (16-bit) each. The maximum addressable memory size is 64K words of 16 bits each.

Several support chips are available for PACE which are designed to interface directly with the microprocessor chip and thus simplify system design. The System Timing Element (STE) provides the required MOS clock signals as well as an optional TTL clock. The Bi-directional Transceiver Element (BTE) provides single chip, 8-bit I/O buffering between TTL devices and the PACE MOS I/O lines. The remaining support chips include an Address Latch Element (ALE) and an Interface Latch Element (ILE) that may be needed for more complex systems.

For more complete information, sample system diagrams, and applications, refer to the PACE Technical Description available from National Semiconductor (publication #4200078A).

The CP-1600 from General

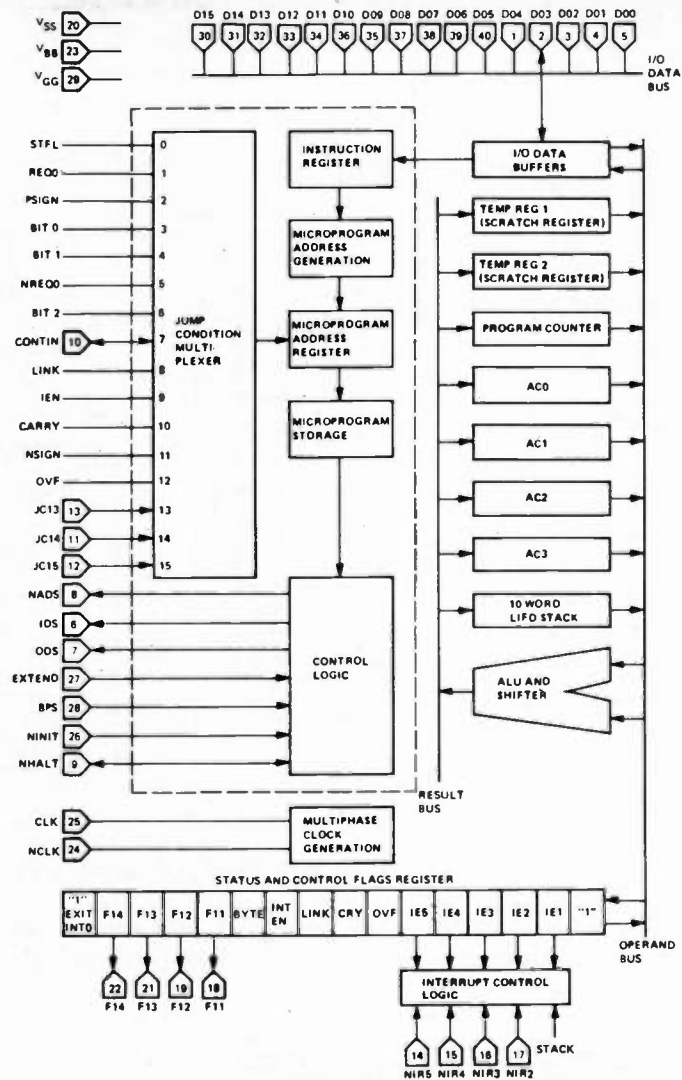

Fig. 2. PACE microprocessor functional block diagram.

Instruments is a single 40 pin chip, 16-bit MOS LSI microprocessor that closely resembles a Digital Equipment PDP-11 in architecture (see Fig. 3). There are eight general purpose, 16-bit registers with R6 reserved as the stack pointer (SP) and R7 as the program counter (PC) just as in the PDP-11. Unlimited stack depth and self-identifying nested interrupt and subroutine capabilities are provided by the stack pointer in conjunction with external RAM memory.

Instruction execution times range from 1.6 to 4.8 microseconds with a 2-phase, 5 MHz clock. Four addressing modes combined with a 16-bit word length allow direct addressing of 64K bytes or 32K words of memory or peripheral

devices. Memory and peripheral interfaces are intermixed in the same address space as desired, and all I/O operations may use any of the 87 available general purpose instructions. For special applications, the Branch on External Condition (BEXT) instruction allows direct testing of up to 16 external digital signals.

The main difference between the CP-1600 and the PDP-11 is that the CP-1600 instruction word format is only 10 bits long in the lower order bit positions of a 16-bit processor word. The higher order 6 bits are ignored; thus only 10-bit wide ROM memory is needed where ultimate ROM bit efficiency is desired for particular applications.

For complete information

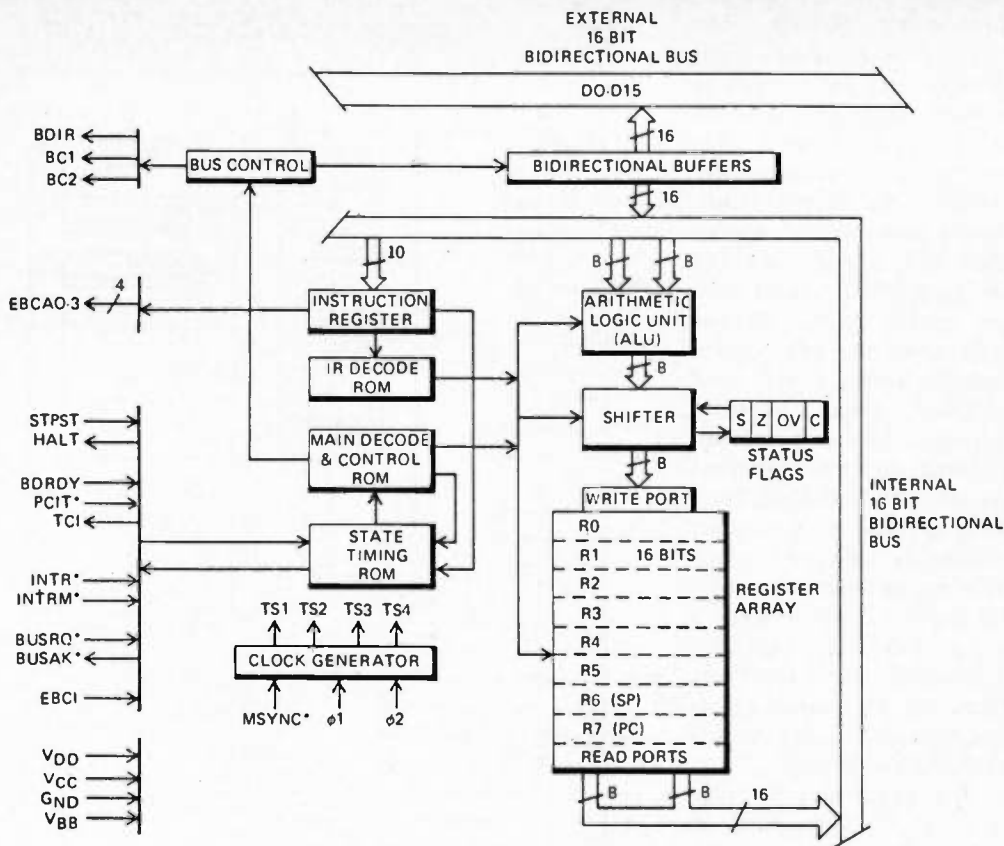

Fig. 3. CP-1600 internal block diagram.

available from General Instruments for \$20.

### Conclusion

In closing then, you can readily see that the microprocessor world is not limited to simple 8-bit systems and that some of the larger chips are very attractive from the hobbyist point of view in building a new system from the ground up. The prices currently range from about \$30 to over \$100 in small quantities, but should continue to drop as more interest develops and second-sourcing becomes more common.

So why build an 8-bit machine and wish you could do more, when 12 or 16-bit CPUs are currently available at reasonable prices with many expanded features? Keep in mind that the larger word size machines make higher-level languages more powerful and easier to implement if you don't intend to write all your programs in machine language — and who in their right mind would? ■

on the CP-1600 CPU chip showing timing diagrams, programming information, and Series 1600 Microprocessor system configurations, the System Documentation is

**ECONOMY KITS**

SUPER-PONG TV<sup>®</sup> game by "Visulex" (as featured in June '76 Radio Electronics) complete kit (p.s. & cases) . . . . . \$150.00  
 TVT-III (2k mem. bd.) . . . . . 114.75  
 Screen read . . . . . 11.65  
 Manual cursor . . . . . 9.50  
 U.A.R.T. (TVT-III plug-in) . . . . . 32.50  
 Cassette-computer interface dual recorder, 1000 baud . . . . . 28.50  
 Motion det. (ult. son.) . . . . . 18.75  
 TVT-III pwr. supply, 5 V, 2.7 A; 7A; 5 V, 20 mA . . . . . 25.00

*Boards available separately for above kits except for pwr. sup. & motion det; pwr. sup. & cases not included in above kits except as noted.*

**MSI-LSI**

8008, 8 bit CPU . . . . . \$15.50  
 AY5-1013 U.A.R.T. . . . . 8.50  
 COM 2502 U.A.R.T. . . . . 7.95  
 C1702A, 2k EPROM, static . . . . . 7.50  
 2102, 1k RAM, 500Ns . . . . . 1.45  
 8212, 8 bit I/O port . . . . . 5.75  
 MM5330, 4 1/2 digit DVM . . . . . 8.95

**MISC. BARGAINS**

NSL 4944, ac/dc univ. led . . . . . \$ .95  
 LM 3909, LED flasher . . . . . .99  
 6 position DIP switch . . . . . 1.95  
 4 position DIP switch . . . . . 1.75  
 Woven nylon adhes. tape 1/2" x 600 ft., 45¢ per roll; nylon adhesive cable clamps . .08

**ELECTRONIC DISCOUNT**  
**sales**  
 138 N. 81 STREET  
 MESA AZ 85207

## MICROCOMPUTER PROGRAMMING COURSE

Free description and outline of Modu-Learn™ Home Study Course in microcomputer programming. Hundreds of pages of text with examples, problems, and solutions. Prepared by professional design engineers using the best software design techniques from structured programming and practical experience with microcomputers. Presented in a modular sequence of 10 lessons oriented for the new programmer. Extensive reference material you will use long after you become an accomplished microcomputer software designer. Much of the information in the course has been available only through costly seminars. Now you can purchase this complete home study course for under \$50.00. Send for free descriptive brochure now.

### LOGICAL SERVICES INCORPORATED

711 Stierlin Rd, Mountain View, CA 94043 (415) 965-8365



only \$9.95 ppd

## Now you can cook-up hot programs on your "8080"

A gourmet's delight of practical "how to" facts, including description of "8080" instruction set. How to manipulate "8080" stack. Flow charts. Source listings. Routines for multiple precision operation. Programming time delays for real time applications. Random number generators. Completely assembled floating point math program. Input/output processing for basic I/O programming through interrupt processing. Code, numeric conversion routines. Real time programming. Search/sort routines. Plus many more finger-lickin' goodies.

Order your copy of Scelbi's "8080" Software Gourmet Guide & Cook Book today! Only \$9.95 ppd. Bon appetite!

SCELBI COMPUTER CONSULTING INC.

1322 Rear Boston Post Road  
 Milford, CT 06460 • (203) 874-1573

# DIGITAL DATA RECORDERS



Model 3M3 - \$199.95

## USING 3M DATA CARTRIDGES



Model 3M1 - \$169.95

### BRAND NEW DESIGN!

Featuring the radically new "UNIBOARD" method of construction for data cartridge drives. The major computer manufacturers are changing from cassettes to cartridges at a rapid pace because of freedom from binding and greater data reliability. Now, these professional type units are priced within the range of all data users. Being made primarily as OEM data storage units for the world's major manufacturers, these units, together with controller board and software ROM, are being made available to the individual user as well.

\*Appearance and specifications may be changed slightly following acceptance tests now being conducted by OEM users.

**MODEL 3M3** Uses the 3M Data Cartridge, model DC300. This cartridge contains 300 feet of .250 tape in a sealed container. Records and plays at 9600 baud NRZ, 4800 baud P.E. Nominal speed 8" per second. Max. recommended flux density 1200 fcpi. Using four tracks, you can store nearly 2 megabytes of data on a cartridge. Cartridge measures 4" by 6". Turns counter indicates tape position. Inter-record gap light gives more accurate position 2SIO(R) is NOT required for use but is highly recommended for 8080 and Z80 systems.

**COMMON SPECIFICATIONS** FULL SOFTWARE CONTROL of record, play, fast forward and rewind. LED indicates inter-record gaps. EOT and BOT are sensed and automatically shut down recorder. Can also be manually operated using the switches on top which parallel the software control signals when not under software control. Signal feedback makes it possible to software search for inter-record gaps at high speed. 117V - 60 Hz - 5 watts.

**TWO I/O PORT CONTROLLER WITH ROM** Controls your terminal and one or two cassettes or cartridge units. On board ROM (for 8080 and Z80) has terminal and cassette software for turn on and go operation. NO MORE BOOTSTRAPPING. Plug in compatible with Altair and IMSAI. Loads and dumps memory in Hex from the keyboard, formats tape files, punches tape, functions as a word processor and searches for files and four letter strings within files. Keyboard controls the cartridge units above on rewind and fast forward. Special keyboard codes enable you to dump and read Phase Encoded tapes as well as NRZ tapes. (Including K.C. Std.) Call routines give access to these from your software.

**MODEL 2SIO(R)** - With 1 ROM for NRZ Cassettes \$169.95 (Assembled & Tested) (Half of above Program)  
 With 2 ROMs for Data Cartridges and P.E. cassettes. \$189.95 (Full Program)  
 Kits available for \$30 off above prices.

**OVERSEAS:** EXPORT VERSION - 220 V - 50 Hz. Write Factory or - Datameg, 8011 Putzbrunn, Munchen, Germany; Nippon Automation 5-16-7 Shiba, Minato-Ku, Tokyo; EBASA, Enrique Barges, 17 Barcelona, Spain; Hobby Data, Spirea Vagen 5, Malmö, Sweden; G. Ashbee, 172 Ifield Road, London SW 10-9AG.

For U.P.S. delivery, add \$2.00 each item. Overseas and air shipments charges collect. N.J. Residents add 5% Sales Tax. WRITE or CALL for further information. Phone Orders on Master Charge and BankAmericard accepted.

**MODEL 3M1** - Uses the 3M Data Cartridge type DC100A. This cartridge contains 150 feet of .150 tape and is the same cartridge used by H.P. and others. Runs at 4800 baud NRZ, 2400 baud P.E. Tape speed adjustable but nominally set at 5"/second. Maximum recommended flux density 1200 fcpi. Cartridge measures 2-1/8" by 3-1/4". This model is ultra compact, yet extremely capable. It is intended for word processing, mailing list use and other applications requiring the compact storage of data. Data location is by inter-record gaps and automatic file search. See Common Specs and 2SIO(R) below. 2SIO(R) is NOT required for use, but is highly recommended for 8080 and Z80 users.

**For 8080 and Z80 users:** Comes complete with software program listings for the programs on the 2SIO(R) ROM below. 6800 software is being written but not yet completed. These programs give FULL SOFTWARE CONTROL.

**CARTRIDGE AVAILABILITY** Cartridges are made by 3M, ITC, Wabash and others. They are available at all computer supply houses and most major computer service centers. We can also supply them at normal current list prices.

**NEW AUDIO CASSETTE INTERFACE\*** Phase Encoding interface for use with audio cassettes or NRZ recorders. Runs 2400 baud phase encoded on good quality audio cassette recorders. May also be used with 2SIO(R) above to use the 2SIO(R) cassette programs with your audio cassette player. Can also accommodate "Tarbell" tapes and K.C. Std. tapes. \$50.00, Wired & Tested. \$35.00, Kit Form.

\*NOTE: You do not require an interface with the 3M1 and 3M3 unless you Phase Encode. But, you do need an interface to use the 2SIO(R) with your own audio cassette.

"COMPUTER AID" and "UNIBOARD" are trademarks of the NATIONAL MULTIPLEX CORPORATION. The 3M Data Cartridges are covered by 3M Patents and Marks. "UNIBOARD" Patents Pending.

NATIONAL MULTIPLEX CORPORATION

3474 Rand Avenue, South Plainfield NJ 07080, Box 288. Phone (201) 561-3600 TWX 710-997-9530.



ADDRESS INSTRUCTION COMMENTS

A04A	CE	LOAD INDEX REGISTER IMMEDIATE
A04B	00	
A04C	00	
A04D	6F	CLEAR MEMORY (INDEXED)
A04E	00	
A04F	08	INCREMENT INDEX REGISTER
A050	20	BRANCH ALWAYS
A051	??	RELATIVE ADDRESS TO BRANCH BACK TO A04D

Thomas H. Hunter  
8991 Knoll Street  
Allison Park PA 15101

Fig. 1. Sample program containing a backward branch.

# Backward Branch the Easy Way

- - for the 6800

**I** have this 6800 machine language down pretty well, but I keep getting software bugs and it's always because of a lousy *backward branch!*

Sound familiar? I don't know of anyone with a 6800 system who doesn't have this problem. Machine language programming the 6800 can be quite simple ... until you have to calculate a backward branch!

The book says to add 2 to the present location (in hex), then subtract from that the destination address (in hex), and then take two's complement of the result as the address to use. If you have trouble with that, don't feel bad. I can't get it to come out right, either. What I have done is make up the accompanying chart which is now nailed to the wall over my desk.

It is simple to use. Consider the example given in Fig. 1, a program to clear all memory. In order to branch from A050 back to A04D, count (in decimal) from the address of the branch instruction (A050) to the target address. In this case you

would count A04F, A04E, A04D — three addresses. Examine Fig. 2 and appreciate the "rain dance" necessary to calculate the address on paper. Look up 3 in the "Count" column of the table (Fig. 3), and then find the corresponding number in the "Use" column (in this case, FB). Quite a difference in

effort, huh?

The situation is enough to make a person appreciate an

assembler ... which would take care of calculations such as this. ■

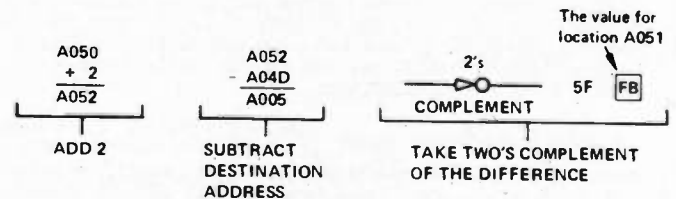
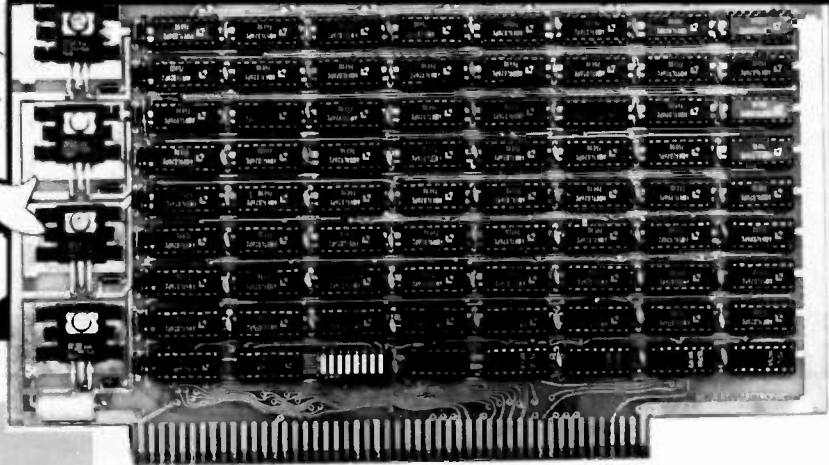

Fig. 2. The "not-so-easy algorithm" worked out on paper.

COUNT USE	COUNT USE	COUNT USE	COUNT USE	COUNT USE
1 - FD	26 - E4	51 - CB	76 - B2	101 - 99
2 - FC	27 - E3	52 - CA	77 - B1	102 - 98
3 - FB	28 - E2	53 - C9	78 - B0	103 - 97
4 - FA	29 - E1	54 - C8	79 - AF	104 - 96
5 - F9	30 - E0	55 - C7	80 - AE	105 - 95
6 - F8	31 - DF	56 - C6	81 - AD	106 - 94
7 - F7	32 - DE	57 - C5	82 - AC	107 - 93
8 - F6	33 - DD	58 - C4	83 - AB	108 - 92
9 - F5	34 - DC	59 - C3	84 - AA	109 - 91
10 - F4	35 - DB	60 - C2	85 - A9	110 - 90
11 - F3	36 - DA	61 - C1	86 - A8	111 - 8F
12 - F2	37 - D9	62 - C0	87 - A7	112 - 8E
13 - F1	38 - D8	63 - BF	88 - A6	113 - 8D
14 - F0	39 - D7	64 - BE	89 - A5	114 - 8C
15 - EF	40 - D6	65 - BD	90 - A4	115 - 8B
16 - EE	41 - D5	66 - BC	91 - A3	116 - 8A
17 - ED	42 - D4	67 - BB	92 - A2	117 - 89
18 - EC	43 - D3	68 - BA	93 - A1	118 - 88
19 - EB	44 - D2	69 - B9	94 - A0	119 - 87
20 - EA	45 - D1	70 - B8	95 - 9F	120 - 86
21 - E9	46 - D0	71 - B7	96 - 9E	121 - 85
22 - E8	47 - CF	72 - B6	97 - 9D	122 - 84
23 - E7	48 - CE	73 - B5	98 - 9C	123 - 83
24 - E6	49 - CD	74 - B4	99 - 9B	124 - 82
25 - E5	50 - CC	75 - B3	100 - 9A	125 - 81

Fig. 3. The 6800 machine language branch chart.

# The first 8-K that NEVER\* FORGETS!



## SPECIFICATIONS:

### 8K SC - 8 Specifications:

Access Time:	500 ns Max. (225 max on request)
Current Req:	Less than 200 ma per 1024 words maximum
Memory Chip:	AMD 91L02 APC (low power 1K x 1)
Voltage Supply:	+5 to +10 volts
Battery Standby:	1.5 to 2 Volt, Automatic power loss sensing circuit. Eliminates need for switches.
Address Select:	8 ea. Spst. switches in a Dip IC package. (No longer any need for a soldering iron to change address.)
+5 Volt regulated:	4 ea. 7805 regulators with individual heat sinks to run cooler.
Wait States:	NONE! Your wait light will not burn because of a memory wait state.

ALL ADDRESS, CONTROL, AND DATA OUT LINES FULLY BUFFERED

### Circuit Board

Double sided, G10 glass epoxy board  
Plated through holes. 5 mil. tin minimum  
Solder reflow processed  
Solder mask on both sides of PC board  
Component lay out silk screened on component side of PC board  
Gold plated edge contacts  
No jumper wires used  
Professional layout techniques used

ALL ADDRESS, CONTROL, AND DATA OUT LINES FULLY BUFFERED

QUANTITY, DEALER, AND CLUB INQUIRIES INVITED

PLUG IN-COMPATIBLE WITH ALTAIR® AND IMSAI® IC SOCKETS INCLUDED

\$295.00 Kit - \$394.00 Assembled - \$2.00 Shipping and handling

\*LIMITED TO CAPACITY OF STANDBY BATTERY

...SEALS...  
ELECTRONICS

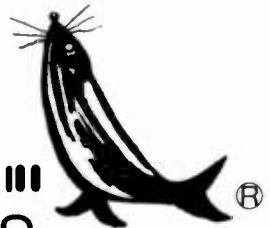

BOX 11651, KNOXVILLE, TN. 37919

**Special** FOR **73** READERS ONLY

WITH EVERY PRE-PAID ORDER OF \$500 OR MORE, WE'LL GIVE A TI 1200 CALCULATOR ABSOLUTELY FREE.

ORDERS IN BY THE 10TH OF DECEMBER WILL ARRIVE IN TIME FOR CHRISTMAS.

TWX #810-583-0075

If the modern technician is going to be successful when working with digital logic, he must have means of "looking" inside the circuit. The most common way in the industry is with the use of an oscilloscope or logic analyzer. Both of these instruments are great, but the cost puts them out of reach for most experimenters.

The Superprobe was designed to be an inexpensive piece of test gear which will provide the necessary insight into the digital circuit under test. This probe is not a toy, and will provide the user with almost as much information as a \$3,000 oscilloscope, when dealing with TTL or DTL logic.

The probe has several desirable features, aside from the expected "1" and "0" indication. The first is a pulse stretcher, and pulse memory.

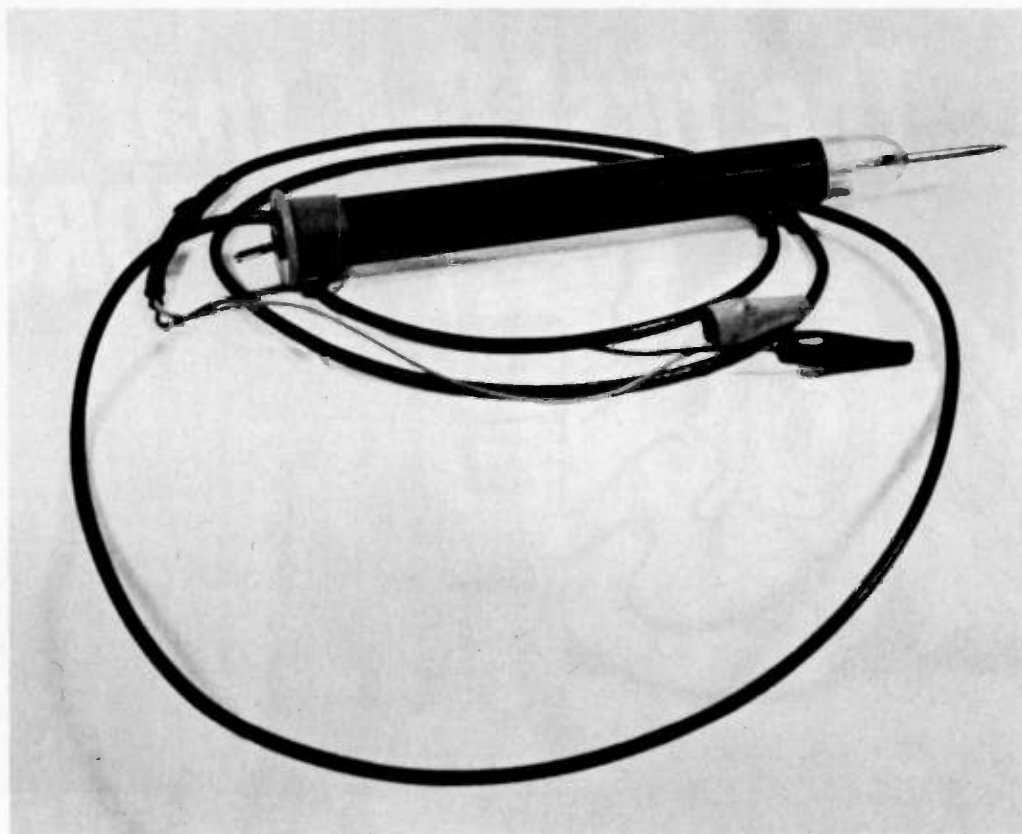

# Superprobe

- - modern replacement for the scope



# The Frumious Hexadecimal! Beware!

-- for 16-fingered folk

**B**y this time words like octal, binary, and decimal, plus phrases like base two or base ten have liberally penetrated the consciousness of any 73 reader. The sign of the I/O stands a good chance of becoming the thirteenth sign of the zodiac for many hams.\*

For those so afflicted, here is one more number base family to shake hands with. Hexadecimal or base 16 (hexa meaning six and decimal meaning ten ... the sum thereof being 16) has a unique quality in that its symbology uses both numbers and letters.

The first ten states are conventional, using the number symbols 0 through 9. The

next six symbols in order are A, B, C, D, E, F. These six alpha characters represent number symbols for values 10, 11, 12, 13, 14, 15.

If you encounter this number family in computer literature, you will generally find that hexadecimal is indicated in one of two general ways. H '10' might be one general form. The alternate form drops the H but keeps the single quote before and after the number, '10'.

The place values for hexadecimal, as might be expected, rise rather rapidly due to the fact that we are dealing with base 16.

Confining our discussion to whole numbers, the value of the rightmost figure of any

hexadecimal expression ranges from 0 to 15, this compared to 0 and 1 for binary, 0 to 9 for decimal, and 0 to 7 for octal notation.

In a two digit hexadecimal expression, we can see the rapid escalation of values. Any digit in the column to the left of the first digit is multiplied by 16 to get its absolute value.

As an example, H '3A' is numerically the sum of A which equals 10, plus 3 times 16 or 48. Thus H '3A' equals decimal 58.

H 'FF' would similarly be computed as the sum of 15 added to 15 times 16. This would equal decimal 255.

If we consider four place values of hexadecimal in the

same mathematical fashion as we consider decimal, binary or octal, they would form the usual series:

$$16^3 \quad 16^2 \quad 16^1 \quad 16^0$$

Thus by the time we got something like this, H '3A7B', its decimal value, computed as follows, really climbs.

The value of 'B' is decimal 11.

The value of '7' is 7 times 16 or decimal 112.

The value of 'A' is 10 times 16<sup>2</sup> or decimal 2560.

The value of '3' is 3 times 16<sup>3</sup> or decimal 12,288.

The value of the entire expression is 14,971. If you want some exercise you can compute the value of H 'FFFF'.

You may well ask, "Is there a justification for hexadecimal?" The answer most definitely is, yes. It is the same reason that octal is of value. You can enter large numbers in a system much faster (fewer key strokes) with octal than you can with binary, and the same is true of hexadecimal by several orders of magnitude. Try expressing the numerical value 14,971 in binary to get the idea of just how time/cost effective the higher valued base systems are.

You can perform basic manipulations with hexadecimal just as you can with any other number family. Take the simple example of adding two numbers such as H '13' and H 'A1':

$$\begin{array}{r} \text{H '13'} \\ \text{H 'A1'} \\ \hline \text{'B 4'} \end{array}$$

How do we arrive at this conclusion? The sum of the rightmost column is fairly obvious, 3 plus one = 4. The sum of the next column becomes equally clear if we remember we are really adding 1 plus 10 which equals 11 which equals B in hex notation.



# Hi! We're PAIA®

A lot of you already know us. We're the ones who keep getting better!

Most of our kits are musically related; but that doesn't mean that you have to be a pro-musician - or a musician at all to enjoy them. For instance:

## Surf Synthesizer

Imagine the roar of the surf electronically synthesized and played through your hi-fi.  
#3711K \$12.95 + \$1.00 shipping chg.



### CHORD EGG

The EGG\* plugs into any stereo amp to create soothing, flowing environmental sound textures - and through headphones it's incredible. The chords and notes EXIST in your mind. They pan and swell and phase their way through your psyche in unpredictable patterns never repeating.

The combination of LSI organ technology with synthesizer-type processing and digital randomizing/control elements make the EGG an altogether intriguing package from either technological or metaphysical viewpoints.

#3790 \$24.95 + \$1.00 shipping

\*EGG - Encephalo-Gratification Generator

## OZ & GNOME



### THE GNOME MICRO-SYNTHESIZER KIT

The GNOME can make outer space sounds for rock musicians, demonstrate principles of music and acoustics for educators, provide rhythmic pulses and tones for modern dance groups, create sound effects for theatre companies and is one of the neatest toys in the world for an audiophile.

#3740 - \$48.95 - + shipping for 4 lbs.

### OZ - MINI-ORGAN

OZ is polytonic with over 6-1/2 octaves total range from its 1-1/2 octave keyboard. Large scale integration & CMOS technology allow battery powered portability. Output jack and switch selectable step or multiple pulse trigger provides simple synthesizer interface. OZ has a unique pressure-sensitive pitch bender that chromatically transposes single notes or whole chords, and a built in speaker and amplifier.

#3760 - \$84.95 - + shipping for 12 lbs.

And don't forget... these two were designed to operate together in one of the most synergistic relationships imaginable. Just think, a completely portable polytonic synthesizer-like instrument for less than you'd expect to pay for a guitar. Terrific!

Now, if it happens that you are a Pro musician, you really owe it to yourself to check out our electronic music synthesizer packages. Like our 4700/S for example. It costs about 50% of what "mini" packages from other manufacturers do - and you can judge for yourself whether it's a mini or not.

## 4700/S



### Synthesizer

When you combine all of the modules that are part of this package including keyboard, 12-event sequencer and a four input stereo mixer, it's almost like having 2 synthesizers in a single package. Wrap them all in sturdy road cases and you have an instrument that goes anywhere and does any job.

#4700/S Kit - \$499.00  
shipped air freight col.

Send TODAY for your FREE catalog with details on these and dozens of other fascinating PAIA kits.

**PAIA** ELECTRONICS DEPT. H  
1020 WEST WILSHIRE BLVD  
OKLAHOMA CITY, OK 73116

To prove the answer we get the decimal value of H '13' which is 16 plus 3 or decimal 19. H 'A1' is equal to 10 times 16 plus 1 or 161. The result of the addition is decimal 180. Our answer H 'B4' is the sum of 11 times 16 plus 4, or 176 + 4 which is the same decimal number, 180.

Now let's introduce the element of the "carry" into another simple addition problem, adding H '1A' to H '27':

H '1A'  
H '27'  
H '41'

How did we arrive at this? The sum of 'A' plus '7' is decimal 17. We deduct the number of sixteens we can get out of this first column addition, and the remainder becomes the right hand figure in the answer. The integral number of sixteens is then added to the next column as a carry. This next column

now looks like this...

H '1' (the carry)  
H '1'  
H '2'  
H '4'

Checking as before, in the original problem H '1A' equals decimal 26. H '27' equals decimal 39 and the sum of 26 + 39 = 65. Our addition answer H '41' equals 4x16 + 1 = 65. This introduction to hexadecimal should allow you to understand the reference you will bump into as you wander down the I/O trail. ■

\*There are many heavenly bodies directly connected with amateur endeavors. If you will locate the zodiac group Aquarius spilling star-studded water across the firmament, you will notice the water falls near the base of the little known constellation of Antennae. Obviously the grand design is to have Aquarius improve ground conductivity in the region of Antennae. Also not to be overlooked is the original I/O star, Altair.



K-W Manufacturing Company  
P.O. Box 508  
Prague, Oklahoma 74864  
Telephone: 405-567-2285

## CRYSTALS

### 2 meter 220 MHz

\*For most standard FM sets - Genave - Regency - Clegg - Drake - Wilson - Swan - Sonar - Telecomm - Yaesu - Tempo - Varitronics - IC-21 - SB144 - Johnson - Ross & White. Standard - G.E. - Motorola & Gladding.

Dealers! Write for our special Distribution Price Program.

DELIVERY - 10 DAYS

FREE CATALOG



Manufacturing  
| Inc. |

K-W Manufacturing, Inc.  
P.O. Box 508  
Prague, Oklahoma 74864  
Phone: 405-567-2285

Name \_\_\_\_\_

Address \_\_\_\_\_

City \_\_\_\_\_ State \_\_\_\_\_ Zip \_\_\_\_\_



# altair<sup>T.M.</sup>

**Number One in low-cost computing.**

Altair, from Mits, is the number one name in microcomputers for home, business, personal and industrial applications. Because the Altair was first, it has set the standard in the industry. More Altair 8800's are now operational than all other microcomputers combined.

Whether you buy a \$395 complete computer kit\* or a multi-disk system for under \$10,000; Mits will provide you with thorough and lasting support. Satisfied Altair users include schools, corporations, small businesses, students, engineers, and hobbyists.

Altair hardware includes three microcomputers; the Altair 8800a, 8800b, and 680b. Mits has a complete selection of Altair plug-compatible memory and interface options, including the new Altair 16K Static board and Altair multi-port serial and parallel I/O boards. Also available is a complete line of Altair peripherals including line printers, CRT's, and multiple disk systems.

Altair software is by far the most complete and best for any microcomputer. Our Extended BASIC and Disk BASIC have received industry wide acclaim for programming power and efficiency. Application packages are available at many Altair Computer Centers.\*\*

The Altair computer is a revolution in low cost computing. Shouldn't you write for more information including our free, color catalogue.

\*The Altair 680b turnkey model.

\*\*Retail Altair computer outlets now opened in many large cities.



**mits**

MITS, Inc. 2450 Alamo S.E. / Albuquerque, New Mexico 87106

Dale and Laverne Hileman  
Hileman's Mineral Maps  
1132 Roseta Drive  
Topanga CA 90290

A major deficiency of the older or less expensive sine wave generator is that its output frequency doesn't go low enough for many vital purposes, the dial typically bottoming out at 20 Hz. A principal reason is the unwieldy values of resistance and capacitance required by the oscillator to tune sub-audio frequencies. The instrument described here was designed specifically to complement the workshop sine wave generator by filling in at the low end of the spectrum. It circumvents the tuning problem by providing a number of discrete switch-selected output frequencies.

The frequencies I chose are 1 Hz and 2 to 20 Hz in 2 Hz steps (see Fig. 1). Given different circuit values, however, the instrument is capable of a much wider range, as we will indicate. Maximum output amplitude is 3 volts rms or 8.5 volts peak-to-peak. A pot-and-switch attenuator allows the output level to be set, with a fair degree of precision, to any value within a range of 5 decades. The unit is powered by two 9 volt batteries of any type. Performance does not suffer until either battery potential drops below 6 volts.

#### How it Works

As shown in the circuit diagram, the sine wave generator employs a common IC, the popular type 741, in a Wien bridge oscillator. This kind of circuit is characterized by a four-element r-c network connected in the feedback path of an amplifier. The four elements are R6 in parallel with the capacitor selected by S2A, and R7 in series with the capacitor selected by S2B. This network is connected in the positive feedback path of IC1, so oscillation occurs at the frequency where zero phase shift occurs. The two selected capacitors are always equal in value, to keep the reactance of the parallel combination the same as the series, so that the voltage-

# V-V-V LF Generator

## -- the lowdown

dividing action of the network gives the same amount of feedback at any frequency. The selection of these capacitors is discussed under "Choice of Parts."

The gain of the amplifier, and hence the amount of

positive feedback necessary to sustain oscillation, is determined mainly by the setting of output adjustment R3 in the negative feedback path. However, feedback in a sine wave oscillator is very critical; too little and the oscillator

quits, too much and it saturates, generating a square wave instead of a sine wave. Non-linear elements are usually introduced to deal with this problem. One system uses a lamp or thermistor where we have connected R3. Current sensitive elements such as these, however, introduce perturbations due to thermal inertia. Another method uses a voltage sensitive element like a zener diode, connected in the positive feedback path.

Zener diodes, though not suffering thermal undulations, have a deleterious effect on oscillator waveform, tending to flatten the peaks. So we have introduced a variation of the zener idea; ordinary silicon diodes CR1 and CR2 constitute the required nonlinear load, but waveform distortion is minimized by the mitigating effect of series resistor R8. This scheme yields a good sine wave without making the adjustment of R3 terribly critical.

A small dc offset results from the constraint offered by higher resistance in the positive input of the op amp than in its negative input. Hence offset adjustment R2 is provided to set the average output level of the op amp to



zero, as described later under "Adjustment."

Due to the shunting action of the network R8, CR1, and CR2, the formula normally used to find the frequency of a Wien bridge oscillator does not apply to our instrument. Furthermore, since this is a nonlinear network, frequency depends somewhat on the amplitude of the sine wave appearing across it. As a practical matter, with R3 adjusted to give a signal of 8.5 volts peak-to-peak at pin 6 of IC1, the oscillator frequency is  $f = 0.6/C$ , where C is the value selected by S2A or S2B, in  $\mu\text{F}$ .

It is important to keep in mind that the setting of R3 does have an effect on frequency. Also, be advised that R2 and R3 interact slightly.

#### Choice of Parts

Frequency is determined by the two capacitances selected and by R6, R7 and R8. Precision resistors are recommended for use in these latter three circuit locations to give you the best chance of achieving the same output frequencies as mine. Also, a precision resistor gives better long-term stability than an ordinary carbon composition type.

Likewise, stability is best served by using high quality film capacitors. Ceramics would be a dubious choice due to reports of frequent problems with stability, leakage, temperature sensitivity, tolerance, power factor and just plain open circuits (especially when capacitors of this type are obtained on the surplus market). Electrolytics or other types that polarize should not be considered.

If you want the output amplitude of the generator to be exactly the same for every setting of FREQ switch S2, the two capacitance values selected in each position must be matched exactly. Note that most of the values in the table were obtained by connecting two capacitors in parallel. For example, C1 and C12 are each 0.6  $\mu\text{F}$ , achieved

by paralleling 0.5  $\mu\text{F}$  and 0.1  $\mu\text{F}$ . The two 0.5s should be matched and so should the two 0.1s. I used a capacitance bridge for this selection job. Of course, the closer the actual value of the capacitors to the figures given in the table, the more accurate will be the frequency settings.

If you don't have a capacitance bridge, you can match the capacitors in-circuit. Two capacitors are matched if the output level remains the same when they are interchanged. However, this cut-and-try method is tedious and tricky at best. Therefore, to keep the adjustment procedure reasonably short, we will proceed on the assumption that you have somehow managed to match the capacitors or else don't care if the output level varies slightly from one frequency setting to the next.

You may wish to extend the frequency range of your instrument. There is no lower limit, but the upper is dictated by the op amp itself, output amplitude suffering beyond about 5 kHz. Using a high frequency op amp (such as the 741S) will extend the frequency range to about 20 kHz. Also, it helps to connect a small capacitor from pin 2 of the op amp to common; the value is best determined experimentally but 250 pF would be typical.

Position 12 of S2 was left unused to permit the addition of jacks for external capacitors, if test signals outside the present frequency range of the device are required.

#### Construction

There are no special precautions to be observed in construction. My instrument is built in a 5-1/4" x 3" x 2-1/8" LMB box chassis No. 136. This box is admittedly a bit small to comfortably accommodate all those capacitors, and you would be smart to use a bigger one.

In my unit, the IC and a few other small parts are wired onto a perboard, which is mounted to the chassis box by a spacer.

The batteries are mounted inside the cover with double stick tape.

#### Adjustment

If you are using precision resistors for R6, R7 and R8, and have carefully selected the capacitors, the probability is very great that your output frequencies will be right on the money, and all you need for testing and adjustment is a VOM. If you wish to check output frequency, you will of course need suitable test equipment such as an oscilloscope with accurate timebase. To adjust the sine wave generator, pro-

ceed as follows:

1. Set offset adjustment R2 to its minimum voltage, or ground, position, MULT switch S3 to the 1 position, VAR control R13 to its maximum output position, and FREQ switch S2 to 20 Hz.

2. Connect a VOM to output terminals J1. Set the VOM to measure ac voltage and adjust R3 to obtain 3 volts rms. (Don't use the "output" feature if your VOM has one, because its coupling capacitor may not be big enough to pass 20 Hz without some attenuation).

3. Set the VOM to measure dc voltage on its lowest range, and adjust R2 to obtain zero volts.

4. Repeat steps 2 and 3 until no further adjustment is necessary.

You may now calibrate the VAR control if desired. I calibrated my instrument in terms of peak-to-peak voltage, but you may prefer to use rms instead. An oscilloscope is more convenient to obtain values in the former units, a VOM in the latter.

If you have access to an oscilloscope, check frequency and amplitude of the sine wave at various switch positions. Variations in amplitude are caused by imperfect matching of the capacitor values. Errors in frequency at some switch positions but not

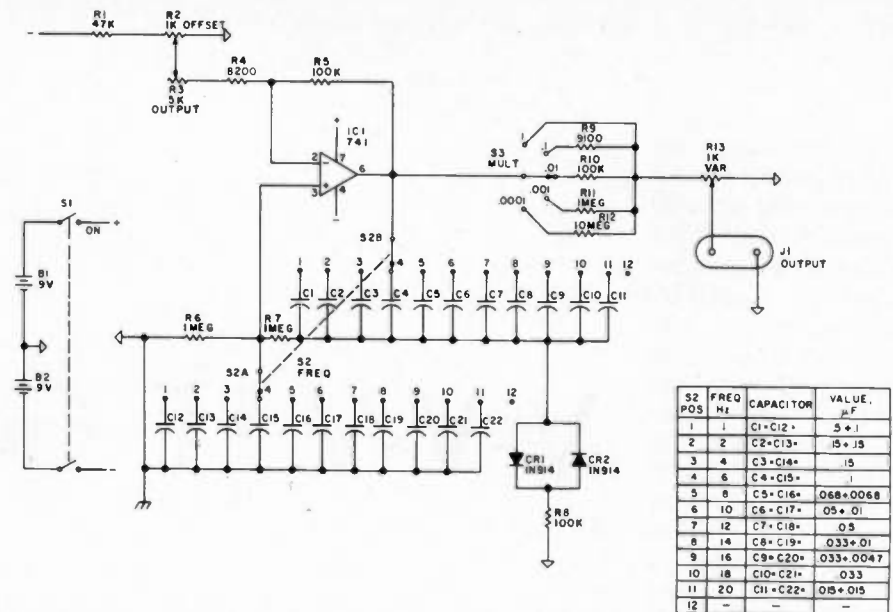
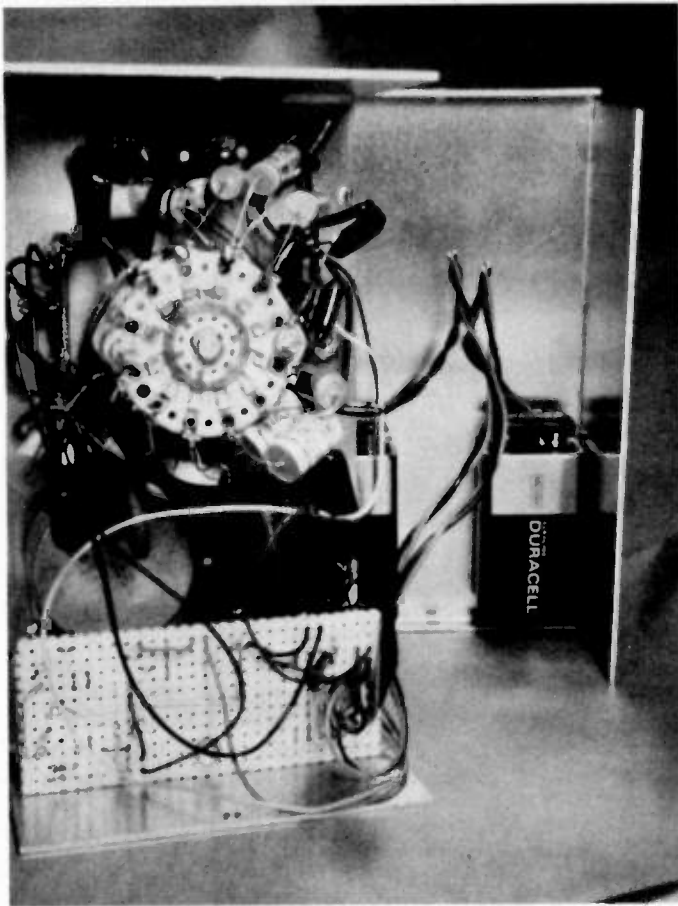

Fig. 1. LF sine wave generator, using Wien bridge oscillator.



others means inaccurately selected values.

If all frequencies should prove to be off by about the

same percentage and in the same direction, the problem is easily solved by changing the value of R8 as required, to make the output frequencies exactly correspond to the dial markings. Raising or lowering R8 by 20 per cent lowers or raises the frequency by about 8 per cent. However, varying R8 changes feedback, so you should repeat the adjustment procedure each time you try a different value.

There are no special tricks to operating the instrument, but remember that the output is dc coupled and a suitably large capacitor or some other means of dc translation is needed if you wish to drive any conductor on which dc is present.

A small dc offset appearing in the output as the minus battery runs down can be balanced out, if necessary, by touching up offset adjustment R2. ■

#### Parts List

B1, B2 — 9 volt battery

C1-C22 — Film capacitors (values given in table, see text for discussion of matching)

CR1, CR2 — 1N914 diode

IC1 — Op amp, Fairchild Type FU5B7741393 or equivalent

J1 — Dual binding post, red and black, H H Smith Type 269RB

R1 — 47,000 Ohm, ¼ Watt resistor, 10%

R2 — 1000 Ohm miniature potentiometer, Mallory MTC-13-L1

R3 — 5000 Ohm miniature potentiometer, Mallory MTC-53-L1

R4 — 8200 Ohm, ¼ Watt resistor, 5%

R5, R10 — 100,000 Ohm, ¼ Watt resistor, 5%

R6, R7 — 1 megohm, ¼ Watt precision resistor, 1%

R8 — 100,000 Ohm, ¼ Watt precision resistor, 1%

R9 — 9100 Ohm, ¼ Watt resistor, 5%

R11 — 1 megohm, ¼ Watt resistor, 5%

R12 — 10 megohm, ¼ Watt resistor, 5%

R13 — 1000 Ohm linear potentiometer

S1 — Toggle switch, double pole single throw

S2 — Rotary switch, 2 pole, 12 position

Misc. parts — Battery connectors (2), perfboard, knobs with indices (3), suitable chassis, mounting hardware, etc.

# ZILOG Z-80 CPU CHIP IN STOCK! \$75.00 (MANUAL INCLUDED)

The "last word" in 8 bit CPU's. You've read and heard about this fantastic chip with its tremendous power and versatility. 158 different instructions including all 78 of the 8080A. Superior software features include relative addressing, block data transfer and search, BCD digit rotate, etc. Superior hardware features include single phase TTL compatible clock, high clock frequency, no expensive support chips (like 8212, 8224) are required, on chip dynamic memory refresh circuitry. If you are thinking about building your own computer from scratch then this is the chip to use.

*LIMITED QUANTITY — FIRST COME FIRST SERVED*

## Z-80 TECHNICAL MANUAL

The whole story, inside and out, on the Zilog Z-80. Includes complete explanation of the Z-80's expanded instruction set.

**\$7.50**

*PS: If you are thinking about buying an IMSAI or ALTAIR compatible Z-80 CPU Board then WAIT! At least until next month when S. D. Sales will announce its next kit. It's worth waiting for!*

**S.D. SALES CO.**

P. O. BOX 28810 A

DALLAS, TEXAS 75228

Bob Blaylock WB5HSK  
 11322 Sagecreek Dr.  
 Houston TX 77034



# Shoeing Your HT

-- semi-ideal mobile setup

Get the most out of your HT by building this inexpensive mobile amplifier. I must confess to begin with that this idea was taken from Motorola's "Converta-Com" consoles. I realize that my unit in no way compares with the Motorola unit, which was designed along with their fine HT220, but, not having an overabundance of money and already owning a Wilson 1402SM HT, I decided that mobilizing my present HT was the only way to go.

Like most amateurs, I have accumulated over the years many pieces of treasure (junk); going through this treasure, I came across a CB radio chassis and case which I decided would make a good housing for the unit.

I started by stripping the components from the chassis. When I finished the chassis it was a pretty sad sight, and I thought to myself, "Do you really want to put your beloved HT into this mess?" But I had already spent the time removing the old components, so I proceeded. The face plate had a large hole previously occupied by the speaker. I slid my HT through the hole and it rested on the flat surface of the chassis. I installed two side rails on the chassis and a tension band to the back of the chassis to secure the HT once inserted. I lined these contact surfaces with suede leather to prevent marring the exterior of the HT.

Having completed this step, I installed a terminal strip on the chassis where connections for the external plug of the HT would terminate. I then checked the owner's manual for pin connections on the HT, secured a male plug, heated up the trusty old soldering iron, and started soldering a multi-cable to the plug. Although there were nine pins on the external plug, it was necessary to use only five. The pins and their uses are: pin #1 — + voltage; pin #2 — receive-transmit switch; pin #3 — ground; pin #4 — external

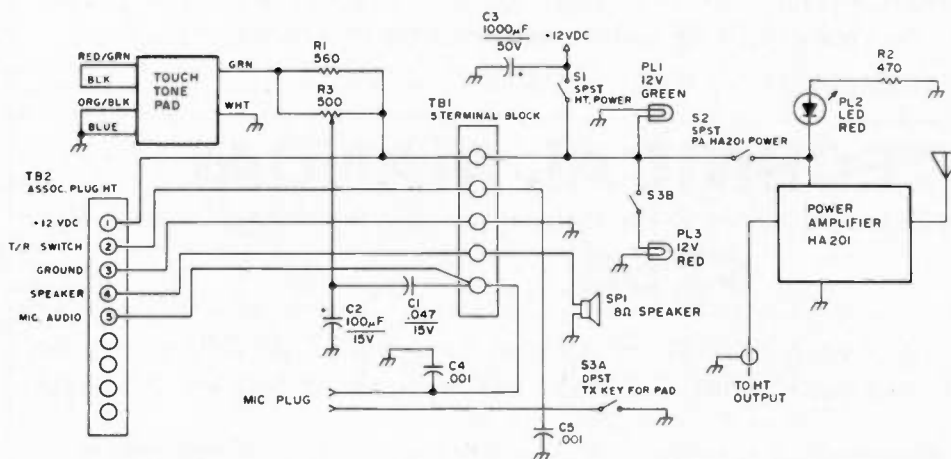
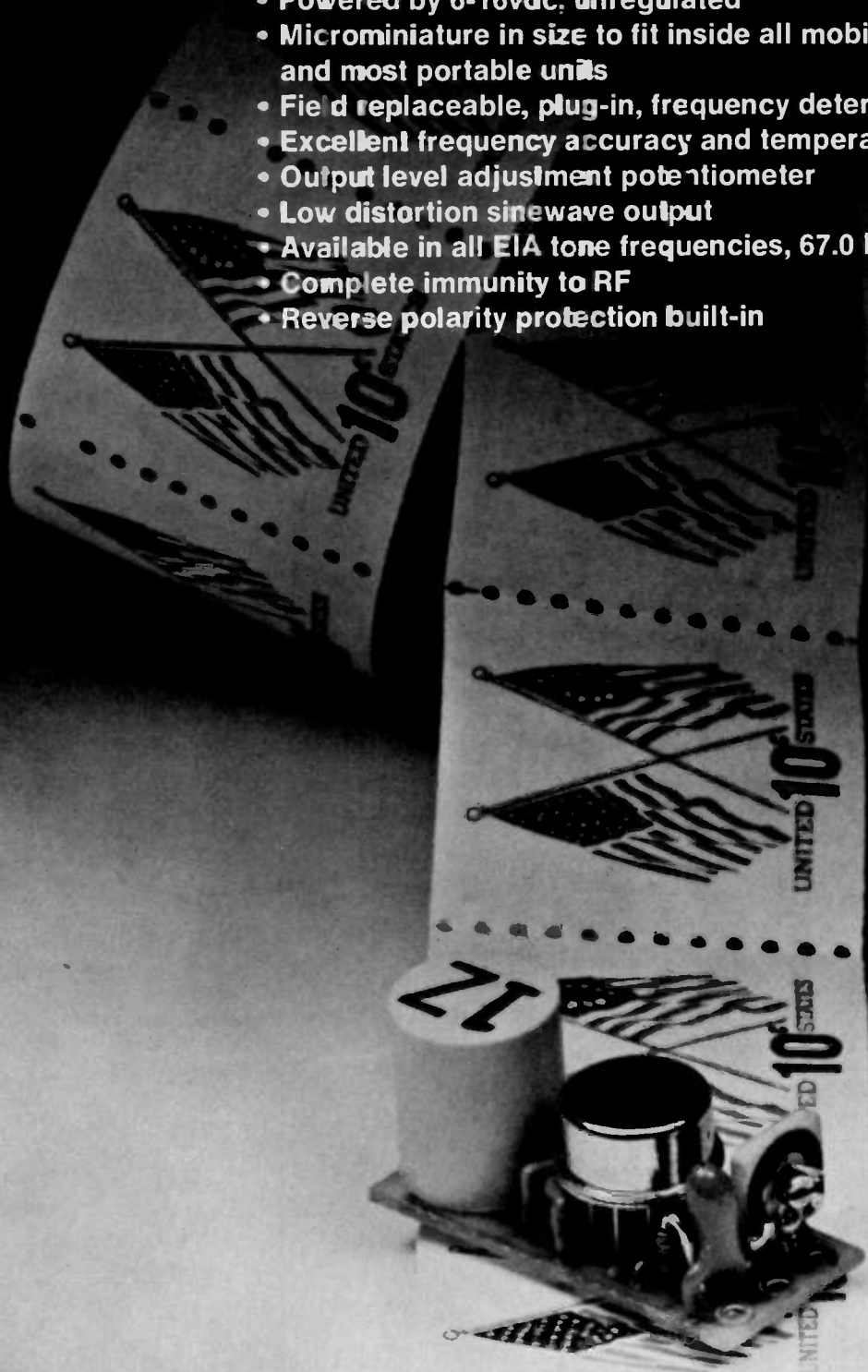

Fig. 1.

# ME-3 microminiature tone encoder

Compatible with all sub-audible tone systems such as: Private Line, Channel Guard, Quiet Channel, etc.

- Powered by 6-16vdc, unregulated
- Microminiature in size to fit inside all mobile units and most portable units
- Field replaceable, plug-in, frequency determining elements
- Excellent frequency accuracy and temperature stability
- Output level adjustment potentiometer
- Low distortion sinewave output
- Available in all EIA tone frequencies, 67.0 Hz-203.5 Hz
- Complete immunity to RF
- Reverse polarity protection built-in



**\$29.95 each**

Wired and tested, complete with K-1 element

**communications specialists**

P. O. BOX 153  
BREA, CALIFORNIA 92621

(714) 998-3021

K-1 FIELD REPLACEABLE,  
PLUG-IN, FREQUENCY  
DETERMINING ELEMENTS

**\$3.00 each**

speaker; pin #5 — mike audio. After having soldered the cable to the plug, I routed the cable through a hole drilled in the face plate to the terminal strip previously mounted in the chassis. Terminal connectors were installed and connected to the terminal strip.

I then cut a hole in the face plate, installed a touch-tone pad, and wired it to the terminal strip.

My next step was to install a speaker and connect it to the terminal strip. Having completed this, I then mounted a mike jack to the face plate and routed the shielded cable to the terminal strip.

Looking over my labors and noting all the empty space inside the chassis, I said to myself, "Why settle for 2 Watts output?" So I began to consider installing an rf amplifier in the chassis.

After much inner debate, I decided to purchase the Heathkit HA-201 10 Watt amplifier. The deciding factor in this decision was the reasonable price of the unit.

I hastily made a trip to the local Heathkit Center and purchased the kit. As with most Heathkits, I had no problem with assembly and was finished in a couple of hours. I did have a problem placing the circuit board in the chassis. When I had removed all the old components from the chassis, it was left with many holes. I had decided to discard Heathkit's chassis and mount the circuit board to the CB chassis, but the transistor was left with no heat sink due to one of the large holes. I made a trip to a local electronics store and picked up an aluminum heat sink to install under the chassis, thus providing much better heat dissipation than that provided by the Heathkit chassis.

I connected the coax supplied by Heathkit from the HT to the amplifier and from the amplifier to the SO-239 connector which was spared in the stripping opera-

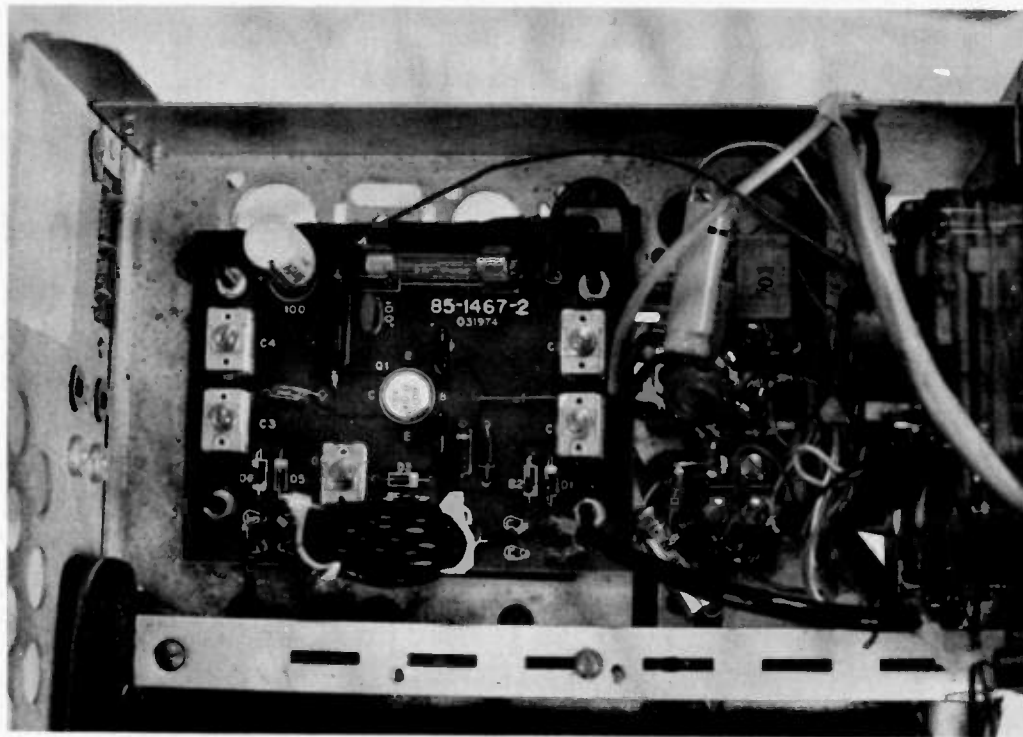

tion; the plus voltage lead was terminated at the terminal strip. Placing the HT in the unit, I carefully checked over my work, not wanting to watch it all go up in smoke. I placed a Bird in-line wattmeter at the output and a dummy load in place. I carefully placed +12.5 volts to terminal #1 and negative to ground, and turned on the

power supply. Observing no smoke or loud crackling noises, I turned on the HT, keyed the hand mike, and observed 5 Watts on the meter. Being brilliant enough to realize that the HT only put out 2 Watts, I said to myself, "It's working!" While keeping a close watch on the meter, I tuned the rf amplifier. After I completed the

alignment, the Bird wattmeter indicated 12.5 Watts. Listening to a nearby receiver, the transmission was loud and clear, and the touch-tone was adjusted to what appeared to be a proper level.

Upon removing the 50 Ohm dummy load and installing a quarter wave antenna, I easily brought up the local repeater, but I

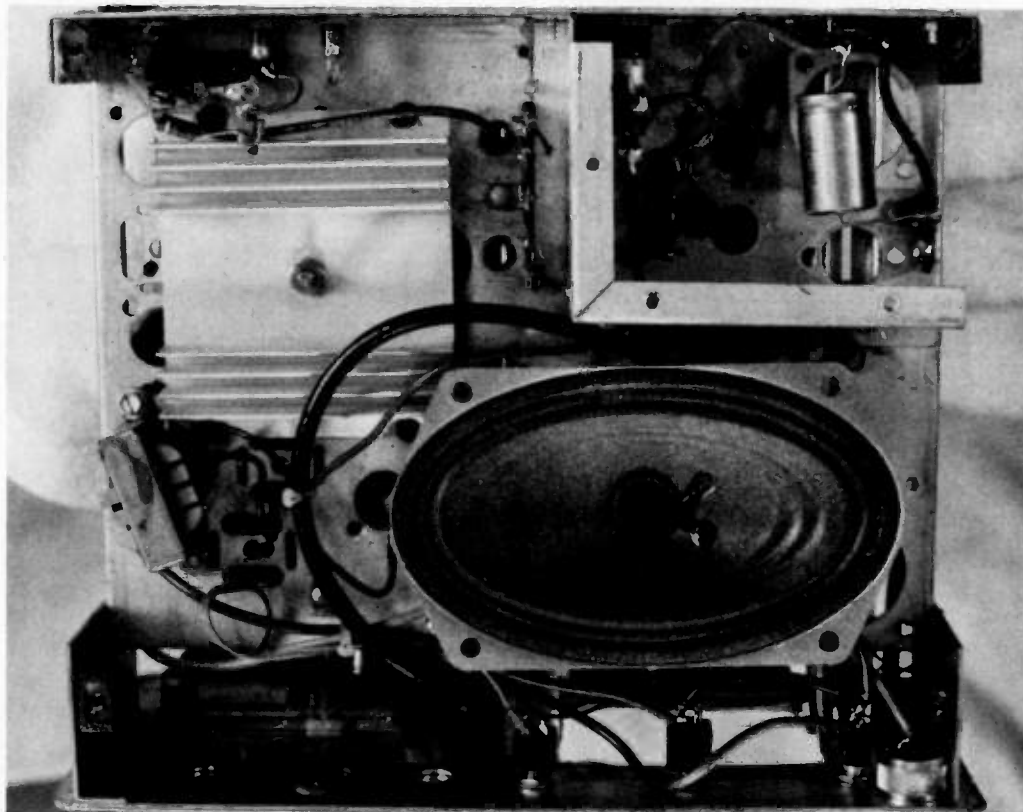



noticed that the wattmeter had dropped to 7.5 Watts. I realigned the amplifier, thus regaining the lost power. I used the TT pad and had no problem.

Finishing up, I mounted control switches on the face plate and a power plug to the unit. I was now ready to try it in my truck.

With the engine off and the wattmeter in line, the output once again was down to 7.5 Watts. I realigned the amplifier, bringing the power

up. Checking reflected power, I discovered that the 5/8 wave antenna showed flat. Upon cranking the engine, I saw that there was no problem with reception — but transmission was another story. Every arc, spark, and whine under the hood was present in the signal. Through a process of elimination, I determined that the noise was entering the mike audio input; this problem was quickly solved with a 100 uF electrolytic capacitor from

the wiper of the 50k pot on the pad circuit to ground.

Now, back to the unexplained problem of power loss from the Heathkit rf amplifier. I determined that the output circuit was very sensitive to changes in load, however slight. I decided to install the rf detector circuit supplied by Heathkit for alignment of the amplifier. I connected this circuit to the SO-239 connector inside the chassis (terminated to the female meter pins at the back

of the chassis) and, with a Simpson 260 VOM, aligned the amplifier while connected directly to feedline and antenna.

A big advantage to this unit is that in no way does it resemble a Citizens Band radio and, therefore, it is perhaps less likely to be ripped off. The HT itself can be easily removed for safe-keeping. I can just see a would-be thief gaping at the large hole where the HT had been. ■

P. Scott Smith WB9JSE  
7723 West Bender Ave., Apt. 1  
Milwaukee WI 53218

# \$22 for a Regulator? Never!

## -- a simple car voltage regulator

**A** price of \$22 for a new voltage regulator in my automobile gave birth to this simple yet very effective solid state replacement. The circuit should be usable in almost any negative ground system using an alternator.

A few words about the automotive battery charging system will help in understanding the operation of this circuit. An alternator's output voltage, and thus its charging current, is controlled by varying the field current in the alternator. Full voltage on the field winding will give full output from the alternator, and reducing the field voltage

will result in reduced output. The output capacity of any alternator is limited by its design, primarily the wire size used. In fact, loading an alternator heavily will rarely damage it, as it will put out just so much current, and beyond that its output voltage will drop, limiting the total power available.

In the usual electro-mechanical type regulator, a resistor is switched in series with the field winding to reduce the alternator output. When the battery voltage drops due to a heavy load, the resistor is shunted by a pair of contacts on the relay,

which is voltage sensitive. Under normal conditions, with the engine running, battery voltage should be approximately 13.6 to 13.8 volts, indicating the battery is receiving a charge.

In order to best understand the electronic circuit, it can be looked at as a switch, either supplying no or full voltage to the field winding. Start with a low battery voltage. Diode D1, a 13.0 volt zener, does not conduct as long as the battery is below 13.0 volts. If D1 is not conducting, no bias is applied to Q1 base, keeping Q1 turned off. If Q1 is off, Q2 is on fully, being biased by R2, 120 Ohms. It then applies full battery voltage to the field winding on the alternator. This of course means the alternator will put out full voltage to the battery, causing it to charge.

Now, as soon as the

battery voltage increases to 13 volts, a small amount of bias is applied to Q1 base as the diode begins to conduct. If the battery reaches 13.6 volts, the zener diode will conduct fully, dropping 13.0 volts and leaving .6 volts to bias Q1. When this happens, Q1 turns on fully, reducing the voltage on Q2 base to very close to zero. Q2 turns off, removing all voltage from the field. Now the alternator output is reduced to zero, so the battery receives no charging current.

In actual use, this entire process happens very rapidly, and the constantly changing alternator is in effect smoothed out by the battery. Battery voltage will always be the zener diode voltage plus the drop across the base-emitter junction of Q1, about .6 to .7 volts. Resistor R3 limits the base current to a safe value.

My unit was built on a large heat sink with all parts being supported by the transistor leads. This is not really necessary, as both transistors are operating as switches and consume very little power. The circuit has survived the past winter in my car, and has always kept the battery properly charged, and at a fraction of the cost of a new regulator. It might be a handy circuit to keep in mind the next time you are left with a dead battery due to a faulty regulator, or if you are doing any experimentation with windmill power and surplus auto alternators. ■

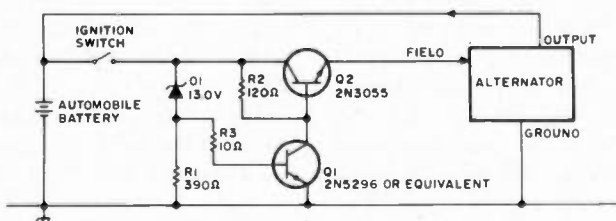

# Cash In on the CB

## -- installation for fun and profit

In the last two years, the demand for technicians to install and repair Citizens Band radios has skyrocketed. With the expansion to 40 channels expected to increase the number of units in use, it doesn't look like the supply of technicians will catch the demand in the near future. Your ham background may be all you need to turn this shortage into a lucrative part-time venture. With the determination not to offer your services free of charge, you can support your ham habit entirely from working for CBers — at your convenience. Whether you decide to cash in on installations, repair, or both, the business opportunity is there. The rest is up to you.

If you have installed a two meter rig in your own vehicle, you've got the practical experience necessary to start into "installation for hire." If not, you're sure to find neighbors or relatives eager to let you practice until you feel confident that you can successfully complete an installation in profitable time. Two or three will tell you whether you've got the knack for it. After you've done a hundred, you can do it in your sleep.

Complete step-by-step instructions for doing installations are beyond the scope of this article. If you feel you need them, you should consider mowing lawns or shoveling snow to earn extra

cash. Mostly, this article is intended to steer you away from the disasters that can befall even the simplest of installations.

The typical CB installation (a dash-mounted unit with a trunk lip antenna) takes a guy who's handy with a wrench about an hour. The going rate to perform such a service in this part of the country is a flat thirty bucks. The tools required are a screwdriver, a small crescent wrench, a soldering iron and a 3/8" drill with bits. A \$15 swr bridge completes a professional installation. You can do two on Saturday and still have time left over to mow the lawn, watch the ball game, and work a little DX before supper.

No commercial license is required to do installations, and a classified ad in the local newspaper will net you plenty of part-time business. Have some business cards printed and leave them with the salesmen in the local stores that sell CB equipment. Having someone to refer his customers to for installation is a strong selling point for the CB retailer. Very few places that sell CB equipment do their own installation work. Word-of-mouth advertising may be all you need in more rural areas.

Before you rush out to make your fortune in the installation business, there is one pitfall to consider.

Always remember that people who pay someone else to install their CB sets have no knowledge of electronics whatsoever and are liable to blame you for malfunctions or operator error that is not your fault.

Ask your customers a few questions before you agree to do a job at a certain price. What kind of vehicle does he own? What kind of antenna does he want? Where does he want the antenna mounted? A roof-mounted antenna on a station wagon takes a lot longer than one hour. The skill required to do a neat, professional looking job of running the coax is greater, and the risk of doing expensive damage to the vehicle is multiplied. Don't be ashamed to refuse a job for these reasons. If you decide to do it, don't be afraid to charge more for the extra work and risk involved.

You should make certain that the customer understands that alternator whine and ignition noise are the fault of the vehicle, not necessarily the fault of the radio and *absolutely* not the fault of the installation. Usually these noises can be eliminated or reduced to an acceptable level by methods discussed later, but if you can't get it out it's his problem. If you spend an extensive period of time eliminating noise problems, the customer should be

required to pay a reasonable fee for this service — above and beyond the cost of the installation.

Be sure that you and the customer are in complete agreement as to the location of all components before you drill any holes. There are a lot of special installation tools on the market, but a hole remover isn't one of them. While you are discussing the location of components with the customer, be as observant as possible of detail. Always be on the alert for snags in the installation itself. When you see a good reason why a particular component should not be put in a particular location, explain why and suggest a location more suitable. This not only makes the job easier for you, but also increases the customer's confidence in your ability, which is an asset you can't afford to be without. Greater love hath no man than an American for his automobile.

Take ten minutes to go over every motion involved in the actual installation. Look closely at what you are going to do before you lift the first tool. This will cut the installation time in half, because you won't have to change your strategy in midstream.

It is probably easiest to run the antenna cable first. This way, when you are ready to run the cable under the front of the carpet, the unit isn't in your way. On a trunk lip or deck-mounted antenna, feeding the cable through the trunk to the back seat is where you are going to cut your hands. Get yourself a broken antenna rod or similar stiff fish wire to do your poking and probing. Once the fish wire is run, tape the coax to it and pull it through. Always try to run the coax under the carpet on the passenger side. It's a real pain working under the steering wheel.

The carpet in all sedans has a split under the front seat. You can pull the cable by hand straight from the back to this split, and then

# C & S

## marketing

### introduces out-of-sight CB that's ready for 40 when you are!



## \$239.95

Hy-Gain 9 (model 2679) sells for \$239.95 with Hy-Gain 426 AM/FM/CB antenna. Deduct \$20.00 if you don't want antenna.

The following Hy-Gain 23-channel radios can be remanufactured to FCC 40-channel specifications after January 1, 1977 and FCC type acceptance.

681, 682, 2680, 2681, 2682, 2683, 2679, 3084

If you currently own one of these radios, a 40-channel certificate may be obtained from your Hy-Gain dealer.

Now! Get the Hy-Gain CB system that's ready for 40 channels when you are. Our out-of-sight Hy-Gain 9 (Model 2679) citizens two-way transceiver and Hy-Gain 426 AM/FM/CB 40-channel antenna.

The great Hy-Gain 9 transceiver goes out of sight in the trunk or under the seat. All that's visible is the hand-held MSR (microphone, speaker and radio) Control Unit with built-in mic and speaker. Disconnects easily. So you can take it with you. Or store it away. Superb performance includes TVI filter to help prevent TV interference.

After January 1 and FCC acceptance, just send Hy-Gain the certificate that comes with the Hy-Gain 9. And \$25 for remanufacture. Hy-Gain will remanufacture your radio for all 40 channels! Offer expires June 30, 1977.

The high performance Hy-Gain 426 40-channel AM/FM/CB antenna goes great with the Hy-Gain 9. Replaces standard auto antenna. Looks like original equipment. So you know it's CB. But rip-off artists don't!

  
We keep people talking.

Hy-Gain 426 AM/FM/CB 40-channel antenna



**C & S MARKETING ASSOCIATES**

P.O. Box 165

Algood TN 38501

Call Toll Free 800-251-6771

In Tennessee call 800-262-6706

reach from the front to the split and pull the cable through next to the transmission hump. This is much quicker than removing the metal strip that holds the carpet down and running the coax along the side. If the car has electric seats, remove the strip; you will never be able to get your hand under the front seat. The biggest problem in running the cable is placing it too near the clip that holds the back seat down. The cable gets pinched when there is extra weight on the rear seat and you'll have an intermittent radio. You have a tendency to look sideways at a CBer when he tells you the radio won't work when the wife and kids are in the car with him, but the joke is on you when you find the problem.

If the cable comes with one of those solderless PL-259 connectors, take it and heave it as far as you can. When you get good at distance, practice for accuracy. Buy a good connector and solder it on. It's a dollar well spent. The cable that comes from the factory with the connector attached is usually OK, but inspect it before relying upon it. When you check the swr, wiggle it to make sure it isn't intermittent.

The installation of the antenna mount is up to you and the instructions. Follow them and you should encounter no great difficulties. Roof-mounted antennas are easier to install if you remove the dome light and center punch a dent upwards a little behind the light itself. Headliners vary greatly from vehicle to vehicle. The only advice offered is *be careful*. Very few cars have headliners designed so that it is possible to run the cable without showing, and it is really easy to leave wrinkles. The slightest mistake sticks out like a sore thumb. Never pull any more of the headliner loose from the roof than is necessary to pull the fish wire through. When drilling a 3/8"

hole in the roof, slip a piece of 1/2" conduit over the drill bit so that only about 1/2" of the bit protrudes. This prevents you from drilling through the roof and into the headliner. Don't trust your reflexes to stop in time — it will never happen.

Antennas are easiest to install on pickup trucks. There are three basic types of headliners. One has a double wall steel roof, one has a foam-backed headliner glued to the roof, and the third has a cardboard headliner. When removing the cardboard type headliner to run the coax, take out only half the screws. The headliner will hang out of your way. If you make the mistake of removing the headliner completely, it will take you twenty or thirty minutes to put it back — and you are going to look like a scene out of a Marx Brothers movie fighting to get it back in place. On the other two types, mount the antenna about two inches in from the back edge of the roof. You can then fish the cable over to the sidewall and down. On some trucks you will have to drill a hole in the sidewall to bring the cable out.

Mounting the unit itself will present no problem on dashes that are made of metal. On plastic dashes, you have to use bolts with nuts and lockwashers instead of sheet metal screws. A little forethought and you are home free. On most CBs, the mike hangup bracket bolts right to the unit. The only warning in mounting the unit is to look behind where you plan to drill on the dashboard. Many autos run a power lead in the lip where it is most convenient to drill the holes for the bracket. A hole through this cable creates an unbelievable amount of smoke.

On units that have two power leads (one red and one black), it is sometimes difficult to find a place to secure the ground lead. This is especially true on late model cars where the dash is all

plastic. If this is the case, you can cut the ground wire short and fasten it under one of the screws that holds the case on the unit. The unit will be grounded through the antenna, even if bolted to a plastic dash. The hot lead should go through the firewall directly to the battery. You will probably have to use some zip cord to make it long enough. Use butt splices or solder the wires together — don't just twist and tape. Splicing in under the dash or connecting the unit to the fuseblock is OK, but when you are finished and there is considerable alternator whine, you are going to have to run the wire to the battery anyway.

If the customer has purchased a hump mount for his unit, there is one precaution you should take. Never, never drill a hole through the carpet without cutting a plug out of it first. If you do, the pile catches on the bit and it takes about a quarter of a second to put a two foot run in the carpet. Get an ice pick and punch a hole through the carpet and the floorboard. A sheet metal screw will start right in the hole without the need to use a drill at all. Also, make sure the screws you use aren't too long, or they will hit the transmission housing.

Assuming the unit is functioning and there are no great noise problems, you are ready to tune the antenna. Check the swr on channel 1 and check it again on channel 23. If the swr is higher on channel 1, the antenna is too short. If it is higher on channel 23, it is too long. Adjust until it is the same or as near the same as you can get it on both channels and tell the customer it is flat.

The biggest headache in mobile installations is engine and electrical system noise. It ranges from the pop of the firing spark plugs to the grind of electrical windshield wipers. Some cases are for all practical purposes impossible to defeat. Most are at least

reducible.

Engine noise is a lot like lightning. It generates rf throughout the spectrum and is picked up by the antenna. It is then detected just like any signal on the band. Since it is an amplitude modulated signal, it gives the CB receiver a fit. Very few noise blankers or noise limiters in CB receivers are effective against this noise, so the cure lies in eliminating or reducing the radiation of this noise from the engine compartment. Grounding straps on the hood, with good metal-to-metal contact to the car frame, is a good place to start. If this isn't effective, take a pocket size AM radio and snoop around under the hood until you find the source of the noise. If you are lucky, it may only be a bad plug wire, but listen around the distributor and ignition coil just the same. Fabricate some sort of metal shield to go around the culprit and ground it good to the car frame. Sometimes a poor connection on the coaxial shield will allow engine noise to run rampant, but this condition will show up when you check the swr. If the customer says he has no engine noise at low speeds, but it is terrible on the highway, check to see that the little ball on the antenna rod has not been removed. Corona discharge is often a source of noise, so remember when you have to trim an antenna rod to trim it from the bottom.

If you have tried everything you know to eliminate the noise and the customer is still not satisfied, tell him the only solution left is to spend about thirty bucks for a noise blanker. There is one on the market, manufactured by TEST, called (appropriately enough) an Ignition Noise Eliminator. It works like the extender circuit in a Motorola. There are four wires to connect: one goes to the ignition coil, one to ground and the other two in series with the speaker leads.

When the coil fires, it opens the speaker. There is plenty of junk on the market for CBers to waste their money on, but this thing really works.

Alternator whine is the next biggest noise problem, but it is far easier to defeat. Running the hot lead directly to the battery will eliminate alternator whine almost every time. If it doesn't, try an LC filter right where the hot lead goes into the radio. If neither of these things work, it's a

good bet that there is a ground loop somewhere. Ground the chassis of the radio and the ground lead (if it has one) to the same point on the car body. Check to make sure that the antenna mount is securely grounded. Save buying an expensive alternator filter as a last resort, because it probably isn't going to help anyway.

The smallest number of noise problems comes from accessory motors and defective equipment. The latter

refers to bad alternator bearings or a shot water pump. The cure for these is obvious. Fan motors, windshield wiper motors and the like are sometimes the source of irritating noise. The worst offenders in this category seem to be Japanese vehicles. Feedthrough capacitors are the best weapons against these motors. On multi-speed motors, you will need one capacitor for each speed, plus one for the power lead.

At this point, if any noises

discussed so far are still in the unit, you'll just have to remind the customer that you warned him this might happen and hope you are the wiser. You are going to find noise problems that you can't beat if you do many installations, but the stubborn cases are few.

Installing CB radios can become a lucrative pastime for any amateur with the attitude and patience required to do a respectable job. ■

John A. Houser K2EE  
23 Washington St.  
Rensselaer NY 12144

**A**s supplied, the headset from the WW II Tank Transmitter/Receiver Mark II (Photo 1) was about the most uncomfortable thing one could think of using. (It may have been good bumping around in the tanks.) But it can be easily adapted for ham use, and as it sells on the surplus market for \$2.50 up, it's actually a real bargain when adapted.

Photo 2 shows how to adapt it for comfortable usage.

The steps are as follows:

- 1) Remove (snap out) both springs secured by the web (former) headband. Remove the web strap.
- 2) Carefully cut 2 cords on each earpiece which secure a rubber protector. Remove the rubber protector and the cords from the 2 terminals on each ear-

piece. Be careful in removing the nuts as some of the machine screws are not secured inside the headpiece.

- 3) Remove the steel strap (it snaps off each bracket). Remove the brackets from the ear-

pieces. Break off the outside spring piece from each bracket (this formerly held the neck steel strap to bracket). 4) Braze (preferably) or firmly solder the steel former neckpiece to each of the springs

removed from the web. 5) Secure a standard headset cord and attach it to each phone. Reassemble the extensible steel headband and brackets to each earphone, as shown in Photo 2. ■

# Surplus Headset Mod

-- no tanks needed



Photo 1.

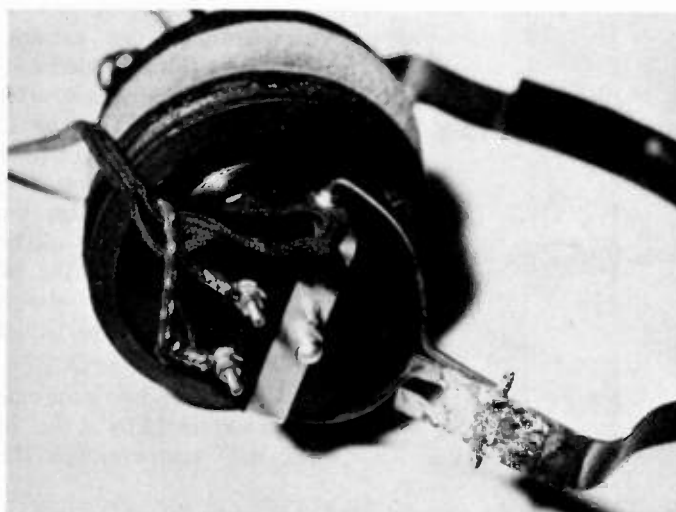

Photo 2.

# Am I Really Transmitting?

## -- red and green LEDs for the TR-22

**A**h, the Drake TR-22! It's an extremely versatile rig at a sensible price. This is a rig that has everything for most FMers. Well, almost everything.

Let's say that you happen to be cruising down a poorly lighted thoroughfare at night and you'd like a little company. Why not call WB8XYZ? You grab the mike and press the switch, but you can't seem to key up the local machine. Is your rig on the blink? Has your super mobile gain goody fallen off the

roof? Maybe you've been sitting on the mike for the last few miles and the repeater has timed out. Well, it's anybody's guess because it is just too dark to see if the relative power meter is moving or not. Your next step will probably be to turn on the local AM radio and mutter to yourself about why you don't have any indicator lights on your TR-22.

If you've read this far, you are probably nodding your head and smiling bitterly. Well, cheer up, because a solution is just paragraphs away. Read on!

Installing the LED indicators in the TR-22 is a fairly simple project that can be completed in one evening. The result will be added convenience as well as a smarter look for your rig. There are as many varieties of the LEDs as there are ways of installing them, so, even though my steps in this project will be detailed, it is up to the individual ham to design around his own particular situation.

I started by acquiring some surplus LEDs at the '74 Dayton Hamvention. The

conical shaped diodes (3/8 inch long) were picked since they would be easier to work with. These surplus LEDs can be purchased cheaply and are quite sturdy. I was lucky to be able to get them in green as well as red, so it was decided that the green LED would be used as the power indicator and the red LED as the transmit indicator. It would be wise to choose low current LEDs since they will draw less battery power when the rig is portable.

Most LEDs are low voltage devices and will require dropping resistors in series with them. I used 2 volt LEDs and found that a 300 Ohm 1/2 Watt resistor in series worked best. As mentioned before, however, LEDs differ, so the proper resistor value for your particular choice of diode should be determined by the circuit shown in Fig. 1. Before applying the supply voltage (12 V dc) to the circuit, make certain that the potentiometer is set in the position of maximum resistance and that the diode is properly polarized with the supply voltage. (The negative side of the conical LEDs is often marked by a flattened edge on the diode itself.)

The next step is to apply the voltage and slowly de-

crease the potentiometer resistance until the voltmeter across the diode reads 2 volts (or whatever voltage your LED requires). Now just measure the pot's resistance at that point and let that determine the value of the dropping resistor.

With the resistors out of the way for now, the time has come to get down to the nitty-gritty of the installation. I began by drilling two 3/16 inch diameter holes into the front of the TR-22 (see Fig. 2) through which the tips of the LEDs would protrude. (Hole size will differ with other LEDs.) The internal circuitry was carefully covered with cellophane before drilling to prevent metal shavings from causing electrical chaos. After filing off the rough edges of the holes on the inside of the rig, I touched up the outside with flat black paint where some of the original paint had flaked off during drilling.

I decided to mount and wire the transmit (red) LED first. The dropping resistor was connected to the positive lead of the diode and an insulated wire was routed from the other end of the resistor to a nearby post on the transmitter board labeled BT. It is located just behind the crystal deck section that holds the receive crystals, near the 4th channel crystal. It is clearly labeled. The 12 volt source is present here only when the transmitter is keyed. Remember: Always be careful to observe the polarity of the diodes. I ran an insulated lead from the negative side of the diode to the closest ground point. This happened to be the bottom terminal of the squelch pot, that is, the pot terminal closest to you when the bottom of the TR-22 (the transmitter board) is facing up. Of course, any other ground point can be utilized.

The power (green) indicator was mounted near the top of the rig (as shown) near the receiver board. After connecting the dropping resistor

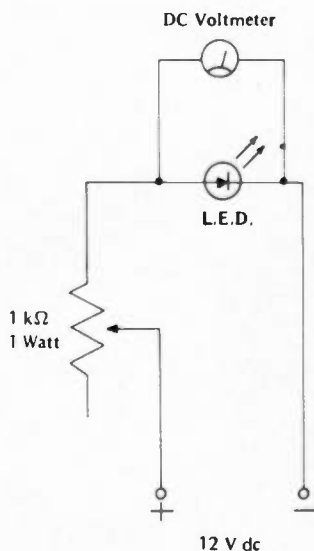

Fig. 1. Circuit for determining the value of the LED dropping resistors.

to the hot side of the diode, I again routed an insulated wire from the other side of the resistor to the bottom side of the TR-22 and found a 12 volt source at one of the switch terminals on the volume pot. I used the terminal closest to the side of the rig (when bottom is facing up) so that the LED would be switched on and off with the transceiver supply voltage. I found a ground point for the diode on the meter terminal that is nearest

to the built-in antenna.

After all the wiring was completed, I set the LEDs into the holes. Using a toothpick, I carefully dabbed some quick drying epoxy cement on the *inside* of the rig where the diodes made contact with the edges of the holes.

The end product still draws curious comments at ham gatherings and I often take for granted that it has saved me from a lot of guesswork and maybe from a little potential embarrassment,

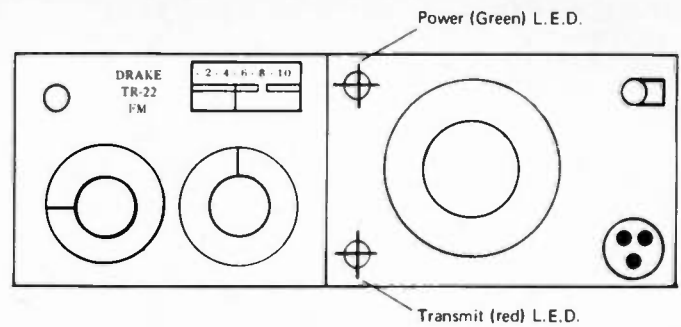

Fig. 2. Location of LEDs on the TR-22.

too! The results were quite gratifying from such a simple project.

A special thanks to Chuck Bair WB8NTY for his technical assistance. ■

# Dear Gabby

## - - exasperation explained

Ken Cole W7IDF  
PO Box 3  
Vashon WA 98070

**Y**ou won't remember, but last year I wrote to you about my husband (!) John who was wasting what could have been the best years of our marriage (the children are grown and out in Oregon, making belts and candles) fooling with radios down in the basement and having DX contests, whatever they are. Needless to say, I was never invited. He said they use code and I wouldn't understand. I don't want to understand why they use code — I can guess. Anyway, you didn't exactly sprain a leg helping me, but you printed my letter and John said they read it at his radio

club. He was furious, but at least he spoke to me and got my name right.

Now I've got a new problem and this is your last chance, Miss Know-It-All. John met someone named Oscar and now our TV antenna is pointed up in the sky and seems to creep around. He says it's on account of ghosts, but we don't believe in them. And if it's such a hot idea, how come we still have rabbit ears on the TV set and get wiggly pictures when he goes downstairs? You can imagine the queer looks I get from the neighbors when they ask me about our funny TV antenna. That smart-aleck bachelor next door (nearly forty and unmarried!) grinned and said John is probably trying to improve the vertical sink! He

works for a television station and has a beard. Can you imagine washing dishes in a vertical sink? Help!

Exasperated

Dear Exasperated:

Your problem is not as uncommon as you may think.

*Many husbands tend to relax and fade into the basement or the workshop when the children leave. And sometimes when they don't leave. Instead of helping with the housework, they go ape with Oscar, EME, microprocessors (there goes the Christmas money) and other weirdo stuff. Then we have to use some kind of shock therapy to break the spell and re-establish our authority. Melanie, the wife of WA7KYI, came up with an ingenious gambit she calls the Glossary Game, and I recommend it. Just read the left-hand column and challenge John to come up with the matching definitions. The results may surprise you.*

*Okay, sweetie? After this I think he'll look at you a little differently. Tell him that the rule of the game is that if he missed more than five he has to go back to eleven meters and start over. Try it; the results may surprise you. ■*

- |                        |                                      |
|------------------------|--------------------------------------|
| 1. R.F. processor      | A receiver                           |
| 2. Noise blanker       | Volume control                       |
| 3. Broadband           | All-girl orchestra                   |
| 4. Spurious response   | I gave at the office                 |
| 5. Digital readout     | Braille                              |
| 6. Ultra short wave    | Mini-ripple                          |
| 7. Perfect match       | Solid gold zippo                     |
| 8. Gamma match         | Gampa                                |
| 9. Disc cap            | Beret                                |
| 10. Image ratio        | Count the mirrors                    |
| 11. Traffic net        | Spaced smokeys                       |
| 12. Touch pad          | Massage parlor                       |
| 13. Phase distortion   | An ugly look                         |
| 14. Logic probe        | A debate                             |
| 15. Noise bridge       | Part of a violin                     |
| 16. Delta tune         | Slap yo' feet on the Mississippi mud |
| 17. Terminal strip     | Last act of the floor show           |
| 18. Integrated circuit | School bus route                     |

# The Smart Charger

-- auto shutoff and all that

While operating mobile on occasion, I have found it necessary to recharge a run-down battery. This is particularly true when the ham rig was left on inadvertently all night. Contemplating the need for a battery charger, but not wanting to pay the price for a new one, I decided the junk box could be put to good use. I already had a 12.6 V ac, 10 Amp transformer available and I thought a simple rectifier circuit would make a real simple battery charger. However, as long as I was going to be the trouble of making a battery charger from scratch, I decided to add another dimension to the typical battery charger circuit design. An automatic turn-off feature was designed into the charger so a maximum charge voltage could be obtained. After the predetermined battery voltage level was reached, the charger circuit would auto-

matically turn itself off. Thus, overvoltage protection would be inherent in this design. Since I had already thought of other applications for the hefty dc power source in the ham shack, I put in an override circuit to the overvoltage sense circuit. By using a Variac at the input of the transformer, an adjustable dc voltage was possible at the output when the manual override was enabled. Fig. 1 shows the basic block diagram of the power supply

with the automatic cut-off feature. The trip voltage for the cut-off is adjustable with a variable resistor. Under normal circumstances, the trip point is pre-set with a good, fully-charged battery connected across the output terminals.

Fig. 2 shows the schematic diagram of the battery charger. With the output voltage below the trip point level, transistor Q2 is turned on and the relay RL1 is closed, applying full output

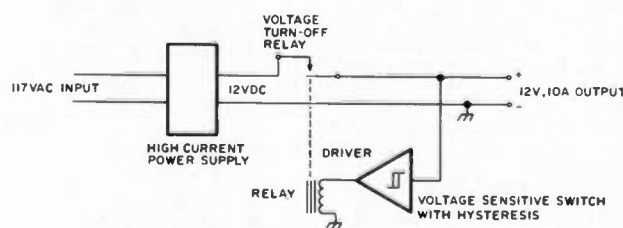

Fig. 1. Block diagram of the battery charger with auto-turn-off feature. Power supply can stand alone for general use. High current power supply is a standard design. Relay interrupts output when the battery voltage reaches the pre-set threshold.

voltage to the charger's terminal. As the battery is charging, its voltage increases. When the battery voltage reaches the pre-set level, zener diode D1 conducts, turning on transistor Q2 and the relay. The charger's dc power source is then disconnected from the battery, preventing overcharging. If the battery voltage goes below the threshold voltage by a small amount, the relay will automatically connect across the battery, again charging it. Thus, the charger may be left connected to the battery without fear of overcharging. Resistor  $R_f$  is used to provide some hysteresis so the relay does not chatter when the threshold voltage is reached.  $R_f$  is chosen for about 0.5 volt hysteresis. A 12 volt lamp is used to show when the charger is charging the battery.

To furnish the power source at all times across the charger's terminals, switch S2 grounds the threshold potentiometer so the output voltage does not have any effect on the operation of the relay.

If the ripple is too great, a full wave bridge rectifier may be substituted for the 15 Amp diode. The meter may be left out if it is not necessary to monitor the charging current from the charger.

This charging technique may also be used to charge nicad batteries. A resistor should be connected in series with the batteries however, to prevent excessive currents during the initial charge process. The resistor should have a value to correspond to the maximum charging current permitted. As the nicad batteries come up to voltage, the charging current will drop accordingly. When the predetermined battery voltage is reached, the current will go to zero as the circuit is automatically disconnected. The batteries will be thus protected from excess currents and destruction.

All of the part values are not critical, and should be



Fig. 2. Schematic diagram of the battery charger and high current power supply with the automatic cut-off feature. A manual override permits use of the power supply by itself for general bench use.

changed accordingly to agree with one's requirements and junk box. Substitutions should be made to keep the cost to a minimum. The transistors should be NPN types with reasonable current gains. Most general purpose types will work. The 3.9 volt zener diode can be replaced with a zener diode in the range of 2 to 6 volts. Its only purpose is

to furnish a relatively sharp voltage threshold. The value of the potentiometer may have to be adjusted if the zener voltage is changed drastically. The relay was a 24 volt dc surplus type capable of 15 Amps of current, but other types should work equally well. Most 24 volt relays will work in a 12 volt circuit. ■

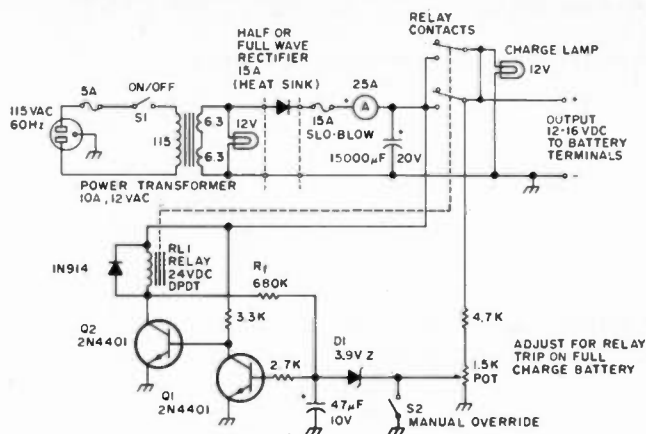

Evert Fruitman W7RXV  
2808 W. Rancho Drive  
Phoenix AZ 85017

This is really a simplified method for cutting ammeter shunts. There are two things that will not happen. It will not be necessary to do any real deep math, and the meter will not get pinned during the cutting process.

The voltage drop along a piece of wire is proportional to its length and the current through it. If a piece of heavy wire is hooked up as shown in Fig. 1, all of the sport is taken out of making meter shunts.

A power supply, ammeter, resistor, and the bus bar that is about to become a shunt are all connected in series. Long thin flexible leads from the 0-5 mA meter may be used. After all, they are going to carry no more than 5 mA. The negative lead is tied to the power supply and bus minus. The power is turned on and adjusted to give the required current. This is shown on the standard VOM. The plus lead of the 5 mA meter is touched to the bus near the minus lead. There should be a small deflection seen on the meter. The lead is then slid along the wire until full scale deflection is obtained. That point on the wire is marked.

If a single range is all that is required, it only remains to solder the leads in place. The resistance change at the point of soldering will be small in comparison to the resistance of the meter. Therefore, the soldering operation will not upset the calibration.

Leave a little more bus at each end than is needed. If the shunt is rather long, then slide insulation over it before the final soldering. The wire may be wound on a convenient coil form in order to make it somewhat more compact.

If a 0-20 Amp range is needed and there aren't more than 2 Amps available, or the shack VOM doesn't have a high Amp range, all is not lost. Set things up as shown

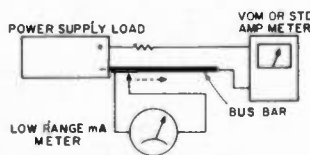

Fig. 1. Setup for shunting meter.

# Simple Remote Ammeter

- - using a bus-bar shunt

above and adjust the power supply for, say, 2 Amps. Then slide the plus lead for 20 divided by 2 or 1/10 of full scale. This will generally prove to be adequate calibration if the standard is reasonably close. Later, when the high current supply is finished and a higher range standard is available, it will take almost no effort to touch up the calibration.

If the shunt turns out to be 10 inches long for 500 mA, then halfway there, or 5 inches up from the cold end,

will give a 1000 mA or 1 Amp shunt.

A multi-range ammeter was constructed with this method in less time than it used to take to make a single shunt. Again, since the meter and its leads are carrying only 50 uA or 5 mA (whatever the basic movement is), then a cheap multi-position switch and light hook-up wire will do the job. Number 22 wire may be used for shunts up to about 1 A.

This should get some of those low range mA meters out of the junk box and into circulation. And isn't that like getting a new meter for an old one? Although a 5 mA meter was used in this example, other meters may be used. ■

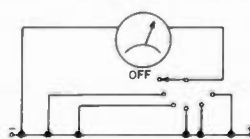

Fig. 2. Multi-range ammeter.

THE 64ths SCALE  
(4X SIZE)

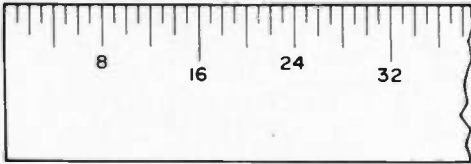

Fig. 1.

Dennis Kehl  
3205 Conrad Dr.  
Racine WI 53404

Often, during the construction of UHF equipment, the amateur radio operator may be slightly hindered by his unfamiliarity with precision measuring tools. Due to the need for precise measurements of lengths and diameters of components used at UHF frequencies, a brief discussion of some common measuring tools might be appropriate.

The first measuring tool and the most common is the scale, more commonly known as a ruler. A scale may not seem to be a very accurate measuring tool but, with the proper scale, lengths to 5/1000 of an inch can be measured. The best type of scale for general use is made of steel for lasting accuracy, short, between 6 and 12 inches long, so as not to be awkward, relatively narrow, and thin, approximately 1/32 of an inch thick, to help prevent parallax. A precision scale is usually graduated in sixty-fourths, as shown in Fig. 1, or hundredths, as shown in Fig. 2, of an inch. A common precision metric scale is usually graduated in half millimeters. The fine divisions on these scales are not designed to wreck the reader's eyes but are necessary to achieve the highest possible accuracy.

Now, with the proper scale selected, some tips for using it properly are appropriate.

THE 100ths SCALE  
(4X SIZE)

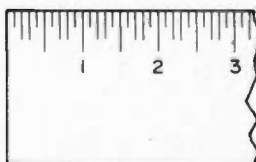

Fig. 2.

Usually a scale's graduations start at the end of the scale; however, if the scale is old, its ends are rounded from use, making it difficult to start at zero. For greatest accuracy, align the first inch mark on the scale with the edge of the stock or starting point. Another tip is not to measure with the scale flat on the work piece, but with it tipped up on its edge to minimize parallax.

The other common measuring tool that will be discussed is the micrometer. A micrometer is a very handy tool to have around when building UHF equipment. All micrometers that read in inches are graduated in thousandths of an inch and have a range starting from 0-1 inch up to and beyond 60 inches. A good micrometer that will last indefinitely can usually be purchased for approximately 20 dollars. Care must be exercised when using a micrometer, because it is a precision measuring tool. It must not be dropped and must be kept clean at all times.

Before using the micrometer, the measuring surfaces of the tool must be cleaned. Do this by lightly closing the

micrometer's anvils over a clean piece of paper and sliding it off the paper.

To use the micrometer, first close the tool down gently onto the work to be measured. Then, to read the micrometer, as shown in Fig. 3, first count the number of tenths of an inch on the sleeve, then count the number of quarter tenths of an inch on the sleeve, then count the number of divisions or thousandths of an inch from the zero mark on the thimble to the reference line on the sleeve, and then add these three numbers together to obtain the reading.

4, is to be read, the same principle is used. First, the millimeters are read above the reference line on the sleeve, and finally the hundredths of a millimeter are read on the thimble. Add these three numbers together to obtain the reading.

This article was not intended to thoroughly cover all the aspects of precision measuring, but it should serve as a refresher on the basics of measuring with a scale and micrometer, to speed work on projects and to help increase the quality of projects. ■

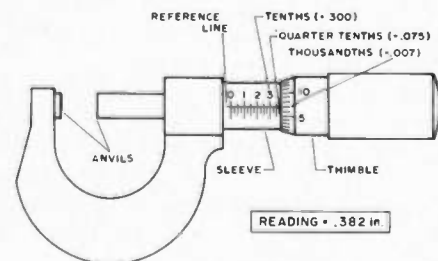

Fig. 3. The micrometer.

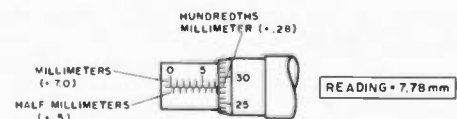

Fig. 4. The metric micrometer.

**SST T-1 RANDOM WIRE ANTENNA TUNER**



All band operation (160-10 meters) with most any random length wire. 200 Watt power capability. Ideal for portable or home operation. A must for Field Day. Size: 2 x

4-1/4 x 2-3/8. Built-in neon tune-up indicator. Guaranteed for 90 days. Compact — easy to use. Only \$29.95 postpaid (add sales tax in CA).



Larsen Antennas  
to fit Any Mobile Unit

**Larsen Antennas**

Magnetic Mount or Gutter Clamp 5/8 wave — \$38.50  
Specify, 2 meters, 220, 450. 1/4 wave — \$18.50  
.....  
3/8" single hole mount 5/8 wave \$31.50  
1/4 wave 11.50

CES Touch Tone Pads — \$49.95 ea.  
• Model 200 — acoustic coupling  
• Model 210 for mounting on walkies or hand-helds



MODEL 200

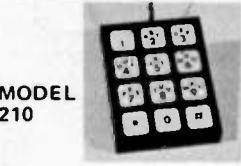

MODEL 210

**CES Model 220**  
CES can now offer you a TOUCH-TONE\* back for Standard Communications hand held radios. This is the complete back assembly with the TOUCH-TONE\* encoder mounted and ready to plug into the private channel connector. Also included is an LED tone generation Indicator and an external tone deviation adjustment.

talk power by **TPL**



**TPL** for an Economy Price? THAT'S RIGHT!  
introducing the **ECONO-LINE**

Model	Input	Output	Typical	Frequency	Price
702	5.20W	50-90W	10 in/70 out	143-149 MHz	\$139.00
702B	1.4W	60-80W	1 in/70 out	143-149 MHz	\$169.00

Now get TPL COMMUNICATIONS quality and reliability at an economy price. The new Econo-Line gives you everything that you've come to expect from TPL at a real cost reduction. The latest mechanical and electronic construction techniques combine to make the Econo-Line your best amplifier value. Unique broad-band circuitry requires no tuning throughout the entire 2-meter band and adjacent MARS channels. See these great new additions to the TPL COMMUNICATIONS product line at your favorite amateur radio dealer. For prices and specifications please write for our Amateur Products Summary! FCC type accepted power amplifiers also available. Please call or write for a copy of TPL's Commercial Products Summary.

**SLINKY!** \$39.95 kit  
A LOT of antenna in a LITTLE space  
New Slinky® dipole\* with helical loading radiates a good signal at 1/10 wavelength long!

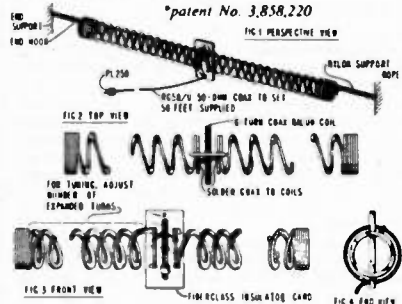

\*patent No. 3,858,220  
• This electrically small 80/75, 40, & 20 meter antenna operates at any length from 24 to 70 feet • no extra balun or transmatch needed • portable—erects & stores in minutes • small enough to fit in attic or apartment • full legal power • low SWR over complete 80/75, 40, & 20 meter bands • much lower atmospheric noise pickup than a vertical and needs no radials • kit includes a pair of specially-made 4-inch dia. by 4-inch long coils, containing 335 feet of radiating conductor, balun, 50 ft RG58/U coax, PL259 connector, nylon rope & instruction manual • now in use by US Dept. of State, US Army, radio schools, plus thousands of hams the world over.

**Get on the air NOW!  
Let Tufts put you there!**

- 146A
  - NICAD Batteries
  - Base charger
  - Touch Tone pad — installed & working
  - 4 Channels of crystals — 34-94/94-94 plus 2 channels of your choice
  - Deluxe leather case
  - Rubber antenna
- ONLY \$399.00

**COMMERCIAL QUALITY  
AT AMATEUR PRICES!**

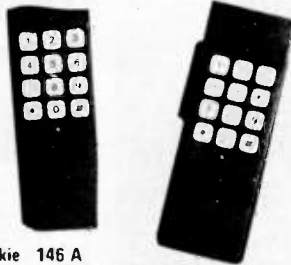

Walkie Talkie 146 A

**Standard Communications**



**BOMAR**

**TWO METER**

CRYSTALS IN STOCK

- Standard • Icom • Heathkit • Ken • Clegg • Regency • Wilson • VHF Eng • Drake • And Others!

\$4.50 @ Lifetime Guarantee

Novice Crystals  
(Specify Band Only)

*Crystal Company*

**NOW!  
Motorola HT 220 Crystals  
In Stock!**

Make/Model	Xmit Freq.	Rec. Freq.



Name \_\_\_\_\_ Call \_\_\_\_\_  
Address \_\_\_\_\_  
City \_\_\_\_\_ State \_\_\_\_\_ Zip \_\_\_\_\_  
Order: \_\_\_\_\_

MasterCharge  
American Express  
BankAmericard  
accepted on  
MOST items!

Radio Electronics  
386 Main Street  
Medford MA 02155  
(617) 395-8280

Check enclosed  
 BankAmericard  MasterCharge  American Express  
Credit card # \_\_\_\_\_ Interbank # \_\_\_\_\_  
Signature \_\_\_\_\_ Card expiration date \_\_\_\_\_

Prices FOB Medford MA. All units can be shipped UPS. MA residents add 5% sales tax. Orders over \$1000 deduct 5%. Add \$3.00 for shipping & handling on all orders.

**FREE Gift With Every Order!**

**ALL SALES FINAL!**

**TUFTS RADIO CATALOG TUFTS RADIO**

## 6 METER BEAMS

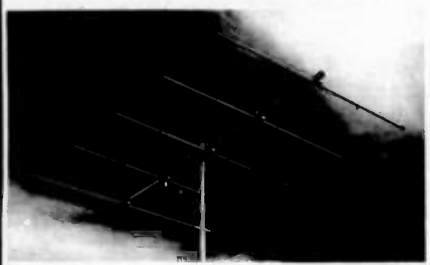

### 3-5-6-10 ELEMENTS

Proven performance from rugged, full size, 6 meter beams. Element spacings and lengths have been carefully engineered to give best pattern, high forward gain, good front to back ratio and broad frequency response.

Booms are .058 wall and elements are 3/4" - 5/8" .049 wall seamless chrome finish aluminum tubing. The 3 and 5 element beams have 1 3/8" - 1 1/4" booms. The 6 and 10 element beams have 1 5/8" - 1 1/2" booms. All brackets are heavy gauge formed aluminum. Bright finish cad plated bolts are adjustable for up to 1 5/8" mast on 3 and 5 element and 2" on 6 and 10 element beams. All models may be mounted for horizontal or vertical polarization.

New features include adjustable length elements, kilowatt Redd Match and built-in coax fitting for direct 52 ohm feed. These beams are factory marked and supplied with instructions for quick assembly.

Description	3 element	5 element	6 element	10 element
Model No.	A503	A505	A506	A5010
Boom Length	6"	12"	20"	24"
Longest El.	117"	117"	117"	117"
Turn Radius	6"	7 5/8"	11"	13"
Fwd. Gain	7.5 dB	9.5 dB	11.5 dB	13 dB
F/B Ratio	20 dB	24 dB	26 dB	28 dB
Weight	7 lbs.	11 lbs.	18 lbs.	25 lbs.



**4.5 dB\* - 6 dB\*\***  
**Omnidirectional GAIN**  
**BASE STATION ANTENNAS**  
**FOR MAXIMUM PERFORMANCE AND VALUE**



Cush Craft has created another first by making the world's most popular 2 meter antenna twice as good. The new Ringo Ranger is developed from the basic AR-2 with three half waves in phase and a one eighth wave matching stub. Ringo Ranger gives an extremely low angle of radiation for better signal coverage. It is tunable over a broad frequency range and perfectly matched to 52 ohm coax.

- ARX-2, 137-160 MHz, 4 lbs., 112"
- ARX-220, 220-225 MHz, 3 lbs., 75"
- ARX-450, 435-450 MHz, 3 lbs., 39"

\* Reference 1/2 wave dipole.  
 \*\* Reference 1/4 wave whip used as gain standard by many manufacturers.

Work full quieting into more repeaters and extend the radius of your direct contacts with the new Ringo Ranger.

You can update your present AR-2 Ringo with the simple addition of this extend. kit. The kit includes the phasing network and necessary element extensions. The only modifications required are easy to make saw slits in the top section of your antenna.

#### ARX-2K CONVERSION KIT

## 2 METER FM ANTENNAS

**A-FM RINGO** 3.75 dB Gain (reference 1/4 wave whip). Half wave length antennas with direct dc ground. 52 ohm feed takes PL-259, low angle of radiation with 1:1 SWR. Factory preassembled and ready to install, 6 meter partly preassembled all but 450 MHz take 1 1/4" mast. There are more Ringos in use than all other FM antennas combined.

Model Number	AR-2	AR-25	AR-6	AR-220	AR-450
Frequency MHz	135-175	135-175	50-54	220-225	440-460
Power-High, Watts	100	500	100	100	250
Wind area sq. ft.	.21'	.21'	.37'	.20'	.10'

**B-4 POLE** Up to 9 dB Gain over a 1/2 wave dipole. Overall antenna length 147 MHz - 23' 220 MHz - 15', 435 MHz - 8', pattern 360° - 6 dB gain, 180° - 9 dB gain, 52 ohm feed takes PL-259 connector. Package includes 4 complete dipole assemblies on mounting booms, harness and all hardware. Vertical support mast not supplied.

AFM-4D	144 - 150 MHz, 1000 watts, wind area 2.58 sq. ft.
AFM-24D	220 - 225 MHz, 1000 watts, wind area 1.85 sq. ft.
AFM-44D	435 - 450 MHz, 1000 watts, wind area 1.13 sq. ft.

**D-POWER PACK** The big signal (22 element array) for 2 meter FM, uses two A147-11 yagis with a horizontal mounting boom, coaxial harness and all hardware. Forward gain 18 dB, F/B ratio 24 dB, 1/2 power beamwidth 42°, dimensions 144" x 80" x 40", turn radius 60", weight 18 lbs., 52 ohm feed takes PL-259 fitting.

A147-22 146 - 148 MHz, 1000 Watts, wind area 2.42 sq. ft.

**D-YAGI STACKING KITS** VPK includes horizontal mounting boom, harness, hardware and instructions for two vertically polarized yagis gives 3 dB gain over the single antenna.

- A11-VPK, complete 4 element stacking kit
- A11-SK, 4 element coax harness only
- A147-VPK, complete 11 element stacking kit
- A147-SK, 11 element coax harness only
- A449-SK, 6 + 11 element coax harness only

**E-4-8-11 ELEMENT YAGIS** The standard of comparison in VHF/UHF communications, now cut for FM and vertical polarization. The four and six element models can be lower side mounted. All are rated at 1000 watts with direct 52 ohm feed and PL-259 connectors.

Model Number	A147-11	A-147-4	A449-11	A449-6	A220-11
Boom/Longest ele	144"/40"	44"/40"	80"/13"	33"/36"	102"/28"
Wght./Turn radius	4 lbs. 72"	3 lbs. 44"	4 lbs. 60"	3 lbs. 18"	5 lbs. 51"
Gain/F/B ratio dB	13.2/28	9/20	13.2/28	11/25	13.2/28
1/2 Power beam	48°	66°	48°	60°	48°
Wind area sq. ft.	1.21	.43	.39	.30	.50
Frequency MHz	146-148	146-148	440-450	440-450	220-225

**F-FM TWIST** 12.4 dB Gain: Ten elements horizontal polarization for low end coverage and ten elements vertical polarization for FM coverage. Forward gain 12.4 dB, F/B ratio 22 dB, boom length 130", weight 10 lbs., longest element 40", 52 ohm Redd Match driven elements take PL-259 connectors, uses two separate feed lines.

A147-20T 145 - 147 MHz, 1000 watts, wind area 1.42 sq. ft.

## HIGH PERFORMANCE VHF YAGIS

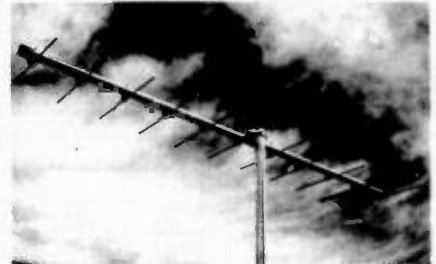

### 3/4, 1-1/4, 2 METER BEAMS

The standard of comparison in amateur VHF/UHF communications Cush Craft yagis combine all out performance and reliability with optimum size for ease of assembly and mounting at your site.

Lightweight yet rugged, the antennas have 3/16" O. D. solid aluminum elements with 5/16" center sections mounted on heavy duty formed brackets. Booms are 1" and 7/8" O. D. aluminum tubing. Most mounts of 1/8" formed aluminum have adjustable u-bolts for up to 1-1/2" O. D. masts. They can be mounted for horizontal or vertical polarization. Complete instructions include data on 2 meter FM repeater operation.

New features include a kilowatt Redd Match for direct 52 ohm coaxial feed with a standard PL-259 fitting. All elements are spaced at .2 wavelength and tapered for improved bandwidth.

Model No.	A144 7	A144 11	A220 11	A430 11
Description	2m	2m	1 1/2m	1 1/2m
Elements	7	11	11	11
Boom Length	98"	144"	102"	57"
Weight	4	6	4	3
Fwd. Gain	11 dB	13 dB	13 dB	13 dB
F/B Ratio	26 dB	28 dB	28 dB	28 dB
Fwd. Lobe @ 1/2 pwr. pt.	46°	42°	42°	42°
SWR @ Freq.	1 to 1	1 to 1	1 to 1	1 to 1

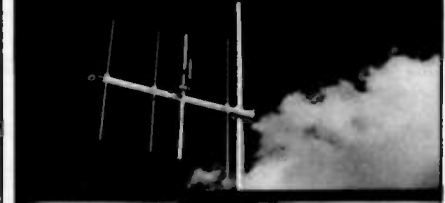
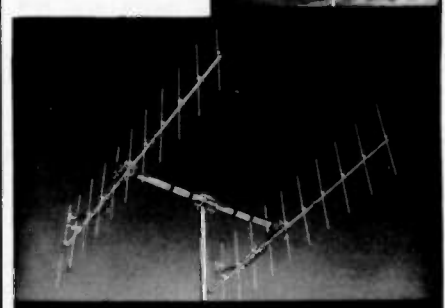
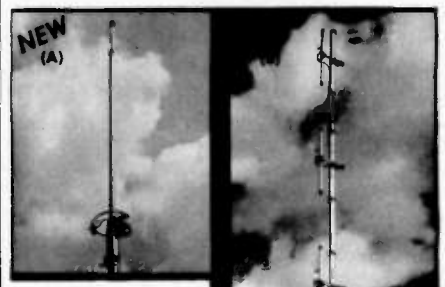

VHF/UHF BEAMS			
A50-3	\$ 27.50	A144-7	19.95
A50-5	39.50	A144-11	24.95
A50-6	59.50	A430-11	19.95
A50-10	89.50		

AMATEUR FM ANTENNAS			
A147-4	\$ 15.95	AFM-44D	47.50
A147-11	24.95	AR-2	18.50
A147-20T	47.50	AR-6	24.50
A147-22	69.50	AR-25	21.50
A220-7	18.95	AR-220	18.50
A220-11	22.95	AR-450	18.50
A449-6	15.95	ARX-2	28.50
A449-11	21.95	ARX-2K	11.95
AFM-4D	53.50	ARX-220	28.50
AFM-24D	49.50	ARX-450	28.50

Send SASE for a reprint of this catalog!



## Now It's Crystal Clear

Yes, now ICOM helps you steer clear of all the hassles of channel crystals. The new **IC-225** is the same surprising radio you've come to know and love as the **IC-22A**, except that it is totally crystal independent. **Zero crystals.** Solid state engineering enables you to program **23 channels** of your choice without waiting. Now the ICOM performance you've demanded comes with the convenience you've wanted, with your new **IC-225**. Price: \$289.00



**IC-21A 146 MHz FM 10W transceiver — \$399**

**DV-21 Digital VFO — \$299.**

### IC-21A

- Low intermod, due to MOS-FET RF Amp and 5 helical resonator filter, plus 3 I.F. filters.
- IDC modulation control provides for minimum bandwidth and channel splatter.
- Virtually no intermod, due to MOS-FET RF amp and 5 helical cavities in the front end plus FET mixer and 3 I.F. filters.
- Variable output power. 10 watts output or another output between 500 milliwatts and ten watts may be selected by an external control.
- S.W.R. bridge, built right into the front panel of the IC-21A, is an accurate meter for VHF S.W.R. bridge. An invaluable aid in VHF antenna experiments!
- The IC-21A contains both the 117 V ac and the 13.6 V dc power supplies.

### DV-21

- The perfect companion for your IC-21 or IC-21A, the DV-21 is a unique digital synthesizer to complete your ICOM 2 meter station. The DV-21 will operate in 10 kHz steps over the entire 2 meter band. It can also scan frequencies being used. Completely separate selection of the transmit and receive is as simple as touching the keys. Release the mic switch, and the receive frequency is displayed. There are also two programmable memories for your favorite simplex-frequencies. You won't believe the features and versatility of the DV-21 until you've tried it.
- Advanced feature of the DV-21 — the ability to capture 5 kHz split tertiary with a 10 kHz synthesizer. The 0.5 kHz offset provides the mean to get exactly on the frequency; but even in the scan mode, the channel may be scanned and understood.
- The DV-21 has its own built-in 117 ac power supply as well as the ability to operate from the 12 V dc line.



## Hold it!

Take hold of SSB with these two low cost twins. ICOM'S new portable **IC-202** and **IC-502** put it within your reach wherever you are. You can take it with you to the hill top, the highways, or the beach. Three portable watts PEP on two meters or six!

**Hello, DX!** The ICOM quality and excellent receiver characteristics of this pair make bulky converters and low band rigs unnecessary for getting started in SSB-VHF. You just add your linear amp, if you wish, connect to the antenna, and DX! With the **202** you may talk through OSCAR VI and VII! Even transceive with an "up" receiving converter! The **IC-502**, similarly, makes use of six meters in ways that you would have always liked but could never have before. In fact, there are so many things to try, it's like opening a new band.

Take hold of Single Side Band. Take hold of some excitement. Take two.

**IC-202**  
2 Meter SSB - 3 Watts PEP - True IF Noise Blanker  
Switched Dial Lights - Internal Batteries - 200KHz  
VFO Tuning - 144.0, 144.2 - 2 Morel - RIT  
Price: \$259.00

**IC-502**  
5 Meter SSB - 3 Watts PEP - True IF Noise Blanker  
Switched Dial Lights - Internal Batteries - 600KHz  
VFO - RIT  
Price: \$249.00

## Now ICOM Introduces 15 Channels of FM to Go! The New IC-215: the FM Grabber

This is ICOM's first FM portable, and it puts good times on the go. Change vehicles, walk through the park, climb a hill, and ICOM quality FM communications go right along with you. Long lasting internal batteries make portable FM really portable, while accessible features make conversion to external power and antenna fast and easy.

Grab for flexibility with the new **IC-215 FM** portable.

- Front mounted controls and top mounted antenna
- Narrow filter (15KHz — compatible spacing)
- 15 channels (12 on dial / 3 priority)
- Fully collapsible antenna
- Compatible mount feature for flexible antenna
- Dual power (3 watts high / 400 mw low, nominal)
- External power and antenna easily accessible
- Lighted dial and meter



Price: \$229.00

Your new **IC-215** comes supplied with 5 popular channels, handheld mic. with protective case, shoulder strap, connectors for external power and speaker, 9 long-life C batteries.



**ICOM**

There is no substitute for quality, performance, or the satisfaction of owning the very best.

Hence, the incomparable Hy-Gain 3750 Amateur transceiver. The 3750 covers all amateur bands 1.8-30 MHz (160-10 meters). It utilizes advanced Phase-Lock-Loop circuitry with dual gate MOS FET's at all critical RF amplifier and mixer stages. There's a rotating dial for easy band-scanning and an electronic frequency counter with digital readout and a memory display that remembers frequencies at the flip of a switch. And that's just the beginning.

Matching speaker unit (3854) and complete external VFO (3855) also available.

See the incomparable Hy-Gain 3750 at your radio dealer or write Department MM. There is no substitute.



3854 - \$59.95      3750 - \$1895.00      3855 - \$495.00

# There is no substitute.

**hy-gain**  
Amateur Radio Systems.

## Hy-Quad 10-15-20 Meter Antenna 3-bands, 2 elements, 1 package

## Complete from Hy-Gain.

Now Hy-Gain wraps total 3-band quad performance into one tidy package. The Hy-Quad. Specially engineered to maximize unique quad advantages while minimizing inherent disadvantages. Exceptional Hy-Quad features include all-aluminum diamond element structure and single feed line that simplify line routing. Cyclocac insulators break spreaders at strategic electrical points with each element individually resonated to prevent interaction.

All Hy-Quad designs are thoroughly tested at Hy-Gain's 35-acre test site to insure continuous peak performance.

Hy-Quad. The unbeatable package deal. Complete from Hy-Gain.

- Individually tuned gamma matches on each band.
- Exclusive vertex feed.
- Full wave element loops require no tuning stubs, traps, loading coils or baluns.
- Horizontally polarized.
- VSWR less than 1.5:1 at resonance on all bands.
- Mounts on any mast 1-1/4" to 2-1/2" diameter.
- 52 ohms impedance.
- Accepts maximum legal power with ease.
- Boom length 8'.
- Spreaders 25.5" overall.
- Turning radius 13.6'.
- Weighs just 42 lbs. complete.

Order No. 244

**hy-gain**  
Amateur Radio Systems.

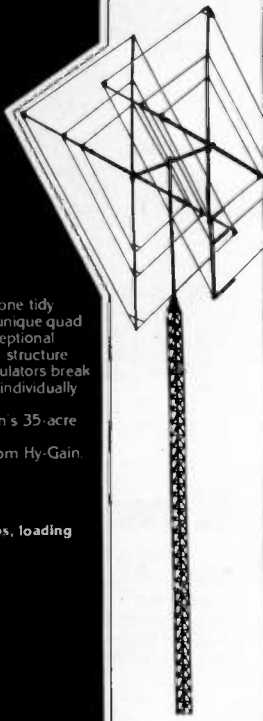

**\$219.95**

### MULTI-BAND HY-Q TRAP DOUBLETS

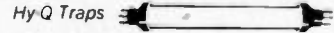

- Install Horizontally or as Inverted V
- Super-Strength Aluminum Clad Wire
- Weatherproof Center and End Insulators

Installed horizontally or as an inverted V, Hy-Gain doublets with Hy-Q traps deliver true half wavelength performance on every design frequency. Matched traps, individually pretuned for each band feature large diameter coils that develop an exceptionally favorable L/C ratio and very high Q performance. Mechanically superior solid aluminum trap housings provide maximum protection and support to the loading coil. Fed with 52 ohm coax, Hy-Gain doublets employ super-strength aluminum clad single strand steel wire elements that defy deterioration from salt water and smoke... will not stretch... withstand hurricane-like winds. SWR less than 1.5:1 on all bands. Strong, lightweight, weatherproof center insulators are molded from high impact cyclocac. Hardware is iridite treated to MIL spec. Heavily serrated 7-inch end insulators molded from high impact cyclocac increase leakage path to approximately 12 inches.



### CENTER INSULATOR for Multi-Band Doublets Model CI

Strong, lightweight weatherproof Model CI is molded from high impact cyclocac. Hardware is iridite treated to MIL spec. Accepts 1/4" or 3/8" coaxial cable. Shpg. Wt., 0.6 lbs. \$5.95  
Order No. 155

### PORTABLE ANTENNAS

Rugged, durable, continuously loaded antennas designed for portable applications. Constructed to withstand rough handling. Completely insulated with vinyl coating. Can be bent at all angles without destroying or cracking protective finish. Cannot be accidentally shorted out.

Frequency 136-470 MHz (specify model)  
VSWR 2.0 to 1 or less  
Loading Coil Plated wire, silver solder, cad. plated brass base

Model 274 - \$9.00    Model 275 - \$7.00    Model 269 - \$7.00

MODEL 280Q for 40 and 80 meters. 100' 10 1/2" overall. Takes maximum legal power. Shpg. Wt., 7.5 lbs. \$49.95  
Order No. 380

MODEL 58DQ for 10, 15, 20, 40 and 30 meters. 94' overall. Takes maximum legal power. Shpg. Wt., 12.2 lbs. \$79.95  
Order No. 383

### BROAD BAND DOUBLET BALUN for 10 thru 80 Meters Model BN-86

The model BN-86 balun provides optimum balance of power to both sides of any doublet and vastly improves the transfer of energy from feedline to antenna. Power capacity is 1 KW DC. Features weatherproof construction and built-in mounting brackets. \$15.95  
Shpg. Wt. 1 lb. Order No. 242



### Hy-Gain SINGLE BAND DOUBLET Model HD-4

High performance single band doublet installs horizontally or as inverted V. Takes 500 watts P.E.P. Supplied with cutting instructions for 10, 15, 20, 40 or 80 meter operation. Complete with miniature center and end insulators, 50' RG58/U and necessary copper clad stranded steel wire. Shpg. Wt. 3.3 lbs.  
Order No. 214

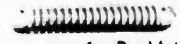

### END INSULATORS for Doublets Model EI

Rugged 7-inch end insulators are molded from high impact cyclocac that is heavily serrated to increase leakage path to approximately 12 inches. Available in pairs only. Shpg. Wt., 0.4 lbs. \$3.95      Order No. 156

### Super 3-Element Thunderbird for 10, 15 and 20 Meters Model TH3Mk3

Price: \$119.95

Hy-Gain's Super 3-element Thunderbird delivers outstanding performance on 10, 15 and 20 meters. The TH3Mk3 features separate and matched Hy-Q traps for each band, and feeds with 52 ohm coax. Hy-Gain Beta Match presents tapered impedance for most efficient 3 band matching, and provides DC ground to eliminate precipitation static. The TH3Mk3 delivers maximum F/B ratio, and SWR less than 1.5:1 at resonance on all bands. Its mechanically superior construction features taper swaged slotted tubing for easy adjustment and larger diameter. Comes equipped with heavy tiltable boom-to-mast clamp. Hy-Gain ferrite balun BN-86 is recommended for use with the TH3Mk3.

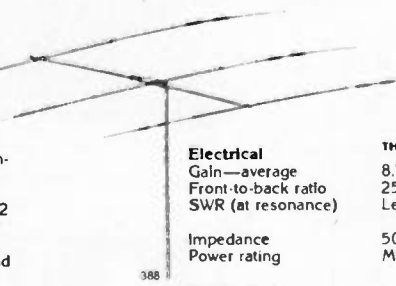

**Electrical**  
Gain—average 8.7dB  
Front-to-back ratio 25dB  
SWR (at resonance) Less than 1.5:1

**Impedance**  
Power rating 50 ohms  
Max legal

**Mechanical**  
Longest element 31.1'  
Boom length 24'  
Turning radius 20'  
Wind load at 80 MPH 156 lbs.  
Maximum wind survival 100 MPH  
Net weight 57 lbs.  
Mast diameter accepted 1 1/4" to 2 1/2"  
Surface area 6.1 sq. ft.

	TH6DXX	TH3Mk3
Gain—average	8.7dB	8dB
Front-to-back ratio	25dB	25dB
SWR (at resonance)	Less than 1.5:1	Less than 1.5:1
Impedance	50 ohms	50 ohms
Power rating	Max legal	Max legal

Longest element	31.1'	27'
Boom length	24'	14'
Turning radius	20'	15.7'
Wind load at 80 MPH	156 lbs.	103.2 lbs.
Maximum wind survival	100 MPH	100 MPH
Net weight	57 lbs.	36 lbs.
Mast diameter accepted	1 1/4" to 2 1/2"	1 1/4" to 2 1/2"
Surface area	6.1 sq. ft.	4.03 sq. ft.

### 6-Element Super Thunderbird DX for 10, 15 and 20 Meters Model TH6DXX Price: \$239.95

The Super Thunderbird TH6DXX offers the ultimate in tribander performance and mechanical reliability for 10, 15 and 20 meters. Separate Hy-Q traps, featuring large diameter coils that develop an exceptionally favorable L/C ratio and very high Q, provide peak performance on each band whether working phone or CW. Exclusive Hy-Gain beta match, factory pretuned, insures maximum gain and F/B ratio without compromise. The TH6DXX feeds with 52 ohm coaxial cable and delivers less than 1.5:1 SWR on all bands. Mechanically superior construction features taper swaged, slotted tubing for easy adjustment and readjustment, and for larger diameter and less wind loading. Full circumference compression clamps replace self-tapping sheet metal screws. Includes large diameter, heavy gauge aluminum boom, heavy cast aluminum boom-to-mast clamp, and heavy gauge machine formed element-to-boom brackets. Hy-Gain's ferrite balun BN-86 is recommended for use with the TH6DXX.

- Remote
- Motor Controlled

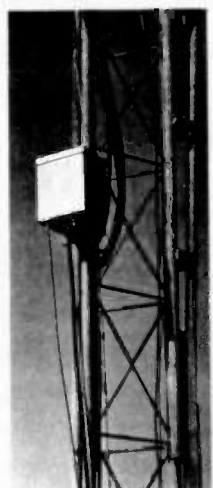

### RCS-4

### COAX ANTENNA SWITCH



- Control unit works on 110/220 VAC, 50/60 Hz. and supplies necessary DC to motor.
- Excellent for single coax feed to multiband quads or arrays of monobanders. The five positions allow a single coax feed to three beams and two dipoles, or other similar combinations.
- Control cable (not supplied) same as for HAM-M rotator.
- Selects antennas remotely, grounds all unused antennas. GND position grounds all antennas when leaving station. "Rain-Hat" construction shields motor and switches.
- Motor: 24 VAC, 2 amp. Lubrication good to -40°F.
- Switch RF Capability: Maximum legal limit. Price: \$120.00

### MATCHING NETWORKS



**MN-4**  
200 watts  
Price: \$110.00



**MN-2000**  
2000 watts PEP  
Price: \$220.00

**General:** • Integral Wattmeter reads forward power in watts and VSWR directly, can be calibrated to read reflected power • Matches 50 ohm transmitter output to coax antenna feedline with VSWR of at least 5:1 • Covers ham bands 80 thru 10 meters • Switches in or out with front panel switch • Size: 5 1/2" H, 10 1/4" W, 8" D (14.0 x 27.3 x 20.3 cm). MN-2000, 14 1/4" D (36.5 cm).  
**Continuous Duty Output:** MN-4, 200 watts; MN-2000, 1000 watts (2000 watts PEP) • MN-2000 only: Up to 3 antenna connectors selected by front panel switch.



### RF WATTMETERS

- W-4** 1.8-54 MHz Price: \$ 72.00
- WV-4** 20-200 MHz Price: \$ 84.00

Reads forward and reflected power directly in watts (VSWR from nomogram). Two scales in each direction. Size: 5 1/2" H, 3 3/4" W, 4" D (14.0 x 9.5 x 10.2 cm).

Model	Full Scale	Calibration Accuracy
W-4	200 watts	±(5% of reading + 2 watts)
	2000 watts	±(5% of reading + 20 watts)
WV-4	100 watts	±(5% of reading + 1 watt)
	1000 watts	±(5% of reading + 10 watts)

## **DRAKE**



### SSR-1 COMMUNICATIONS RECEIVER

**GENERAL:** • All amateur bands 10 thru 80 meters in seven 600 kHz ranges • Solid State VFO with 1 kHz dial divisions • Modes SSB Upper and Lower, CW and AM • Built-in Sidetone and automatic T/R switching on CW • 30 tubes and semi-conductors • Dimensions: 5 1/2" H, 10 1/4" W, 14 1/4" D (14.0 x 27.3 x 36.5 cm), Wt.: 16 lbs. (7.3 kg).

**TRANSMIT:** • VOX or PTT on SSB or AM • Input Power: SSB, 300 watts P.E.P.; AM, 260 watts P.E.P. controlled carrier compatible with SSB linears; CW, 260 watts • Adjustable pi-network.

**RECEIVE:** • Sensitivity better than 1/2 µV for 10 dB S/N • I.F. Selectivity 2.1 kHz @ 6 dB, 3.6 kHz @ 60 dB. • AGC full on receive modes, variable with RF gain control, fast attack and slow release with noise pulse suppression • Diode Detector for AM reception. Price: \$599.00

- 34-PNB Plug-in Noise Blanker . . . . . 100.00
- FF-1 Crystal Control Unit . . . . . 46.95
- MMK-3 Mobile Mount . . . . . 7.00
- RV-4C Remote VFO . . . . . 120.00

- Synthesized • General Coverage
- Low Cost • All Solid State • Built-in AC Power Supply • Selectable Sidebands
- Excellent Performance

**PRELIMINARY SPECIFICATIONS:** • Coverage: 500 kHz to 30 MHz • Frequency can be read accurately to better than 5 kHz • Sensitivity typically 5 microvolts for 10 dB S+N/N SSB and better than 2 microvolts for 10 dB S+N/N AM • Selectable sidebands • Built-in power supply: 117/234 VAC ± 20% • If the AC power source fails the unit switches automatically to an internal battery pack which uses eight D-cells (not supplied) • For reduced current drain on DC operation the dials do not light up unless a red pushbutton on the front panel is depressed.

The performance, versatility, size and low cost of the SSR-1 make it ideal for use as a stand-by amateur or novice-amateur receiver, short wave receiver, CB monitor receiver, or general purpose laboratory receiver.

Price: \$350.00



### TR-4C SIDEBAND TRANSCEIVER

- POWER SUPPLIES**
- AC-4 Power Supply . . . . . \$120.00
  - DC-4 Power Supply . . . . . 135.00

## 2 Meter FM Portable Transceiver

### Model TR-33C

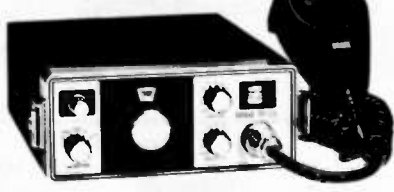

#### Amateur Net \$229.95

- SCPC\* Frequency Control
- 12 Channels with Selectable Xmtr Offsets.
- All FET Front-end and Crystal Filter for Superb Receiver Intermod Rejection.
- Expanded Antenna Choice.
- Low Receiver Battery Drain.
- Traditional R. L. Drake Service Backup.
- Single Crystal Per Channel.

### Linear Amplifier L-4B



- L-4B Linear Amplifier . . . . . 895.00**
- 2000 Watts PEP-SSB • Class B Grounded-Grid — two 3-500Z Tubes • Broad Band Tuned-Input • RF Negative Feedback • Transmitting AGC • Directional Wattmeter • Two Tauband Suspension Meters • L-4B 13-15/16" W, 7-7/8" H, 14-5/16" D. Wt.: 32 lbs. • Power Supply 6-3/4" W, 7-7/8" H, 11" D, Wt.: 43 lbs.
- POWER SUPPLIES**
- AC 4 Power Supply . . . . . \$120.00
  - DC 4 Power Supply . . . . . 135.00

## Drake TVI Filters

### High Pass Filters for TV Sets

provide more than 40 dB attenuation at 52 MHz and lower. Protect the TV set from amateur transmitters 6-160 meters.



Model No. 1603  
**Drake TV-300-HP**  
For 300 ohm twin lead  
Price: \$ 7.95



Model No. 1610  
**Drake TV-75-HP**  
For 75 ohm TV coaxial cable; TV type connectors installed  
Price: \$ 9.95

**LOW PASS FILTERS FOR TRANSMITTERS** have four pi sections for sharp cut off below channel 2, and to attenuate transmitter harmonics falling in any TV channel and fm band. 52 ohm, SO-239 connectors built in.



Model No. 1608 **Drake TV-3300-LP**  
1000 watts max. below 30 MHz. Attenuation better than 80 dB above 41 MHz. Helps TV I-interference, as well as TV front-end problems.  
Price: \$19.95



Model No. 1609 **Drake TV-5200-LP**  
200 watts to 52 MHz. Ideal for six meters. For operation below six meters, use TV-3300-LP or TV-42-LP.  
Price: \$19.95

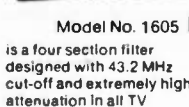

Model No. 1605 **Drake TV-42-LP**  
is a four section filter designed with 43.2 MHz cut-off and extremely high attenuation in all TV channels for transmitters operating at 30 MHz and lower. Rated 100 watts input.  
Price: \$10.95

# Vhf engineering

THE WORLD'S MOST COMPLETE LINE OF VHF-FM KITS AND EQUIPMENT

RX28C	28-35 MHz FM receiver with 2 pole 10.7 MHz crystal filter	59.95
RX50C Kit	30-60 MHz rcvr w/2 pole 10.7 MHz crystal filter	59.95
RX144C Kit	140-170 MHz rcvr w/2 pole 10.7 MHz crystal filter	69.95
RX144C W/T	same as above - factory wired and tested	114.95
RX220C Kit	210-240 MHz rcvr w/2 pole 10.7 MHz crystal filter	69.95
RX220C W/T	same as above - factory wired and tested	114.95
RX432C Kit	432 MHz rcvr w/2 pole 10.7 MHz crystal filter	79.95
RXCF	accessory filter for above receiver kits gives 70 dB adjacent channel rejection	8.50



### RECEIVERS

RF28 Kit	10 meter RF front end 10.7 MHz output	12.50
RF50 Kit	6 meter RF front end 10.7 MHz output	12.50
RF144D Kit	2 meter RF front end 10.7 MHz output	17.50
RF220D Kit	220 MHz RF front end 10.7 MHz output	17.50
RF432 Kit	432 MHz RF front end 10.7 MHz output	27.50
IF 10.7F Kit	10.7 MHz IF module includes 2 pole crystal filter	27.50
FM455 Kit	455 KHz IF stage plus FM detector	17.50
AS2 Kit	audio and squelch board	15.00

TX144B Kit	transmitter exciter - 1 watt - 2 meters	29.95
TX144B W/T	same as above - factory wired and tested	49.95
TX220B Kit	transmitter exciter - 1 watt - 220 MHz	29.95
TX220B W/T	same as above - factory wired and tested	49.95



### TRANSMITTERS

TX432B Kit	transmitter exciter 432 MHz	39.95
TX432B W/T	same as above - factory wired and tested	59.95
TX150 Kit	300 milliwatt, complete 2 meter transmitter, less crystal and mike	19.95

PA2501H Kit	2 meter power amp - kit 1 w in - 25w out with solid state switching, case, connectors	59.95
PA2501H W/T	same as above - factory wired and tested	74.95
PA4010H Kit	2 meter power amp - 10w in - 40w out - relay switching	59.95
PA4010H W/T	same as above - factory wired and tested	74.95
PA144/15 Kit	2 meter power amp - 1w in - 15w out - less case, connectors and switching	39.95

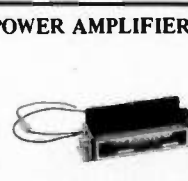

### POWER AMPLIFIERS

PA144/25 Kit	similar to PA144/15 kit except 25w out	49.95
PA220/15 Kit	similar to PA144/15 for 220 MHz	39.95
PA432/10 Kit	power amp - similar to PA144/15 except 10w and 432 MHz	49.95
PA140/10	10w in - 140w out - 2 meter amp - factory wired and tested	179.95
PA140/30	30w in - 140w out - 2 meter amp - factory wired and tested	159.95

PS15C Kit	15 amp - 12 volt regulated power supply w/case, w/fold-back current limiting and overvoltage protection	79.95
PS15C W/T	same as above - factory wired and tested	94.95
PS25C Kit	25 amp - 12 volt regulated power supply w/case, w/fold-back current limiting and overvoltage protection	129.95
PS25C W/T	same as above - factory wired and tested	149.95



### POWER SUPPLIES

O.V.P.	adds over voltage protection to your power supplies, 15 VDC max	9.95
PS3A Kit	12 volt - power supply regulator card with fold back current limiting	8.95
PS3012	new commercial duty 30 amp 12 VDC regulated power supply w/case, w/foldback current limiting and over voltage protection, wired and tested	239.95

RPT28 Kit	repeater - 10 meter	TBA
RPT28	repeater - 10 meter, wired & tested	TBA
RPT50 Kit	repeater - 6 meter	TBA
RPT50	repeater - 6 meter, wired & tested	TBA
RPT144 Kit	repeater - 2 meter - 15w - complete (less crystals)	465.95
RPT220 Kit	repeater - 220 MHz - 15w - complete (less crystals)	465.95
RPT432 Kit	repeater - 10 watt - 432 MHz (less crystals)	515.95



### REPEATERS

RPT144	repeater - 15 watt - 2 meter - factory wired and tested	695.95
RPT220	repeater - 15 watt - 220 MHz - factory wired and tested	695.95
RPT432	repeater - 10 watt - 432 MHz - factory wired and tested	749.95
DPLX144	2 meter, 600 KHz spaced duplexer, wired and tuned to frequency	399.95
DPLX220	220 MHz duplexer, wired and tuned to frequency	399.95

TRX 144 Kit	case and all components to build 15 watt 10 channel scanning 2 meter transceiver (less mike and crystals)	219.95
TRX 220 Kit	same as above except for 220 MHz	219.95
TRX 432 Kit	same as above except 10 watt and 432MHz	254.95



### TRANSCEIVERS

### OTHER PRODUCTS BY VHF ENGINEERING

CD1 Kit	10 channel receive xtal deck w/ diode switching	6.95
CD2 Kit	10 channel xmit deck w/switch and trimmers	14.95
CD-3 Kit	UHF version of CD-1 deck, needed for 432 multi-channel operations	12.95
COR2 Kit	complete COR with 3 second and 3 minute timers	19.95
SC3 Kit	10 channel auto-scan adapter for RX with priority	19.95
Crystals	we stock most repeater and simplex pairs from 146.0-147.0 (each)	5.00
CWID Kit	159 bit, field programmable, code identifier with built-in squelch tail and ID timers	39.95
CWID	wired and tested, not programmed	54.95
CWID	wired and tested, programmed	59.95
Microphone	2,000 ohm dynamic mike with P.T.T. and coil cord	9.95

SYN II Kit	2 meter synthesizer, transmit offsets programmable from 100 KHz - 10 MHz, (Mars offsets with optional adapters)	169.95
SYN II	same as above, wired and tested	239.95



### SYNTHESIZERS

HT 144B Kit	2 meter, 2w, 4 channel, hand held receiver with crystals for 146.52 simplex	129.95
NICAD	battery pack, 12 VDC, 1/2 amp	29.95
NICAD	battery charger	5.95
Rubber Duck	2 meter, with male BNC connector	8.95



### WALKIE TALKIES



# Build a 2 meter or 220 MHz Transceiver

10 Channel Scanning . . . 15 Watt

You can put it all together for only \$219.95

RX144C or RX220C Receiver Kit

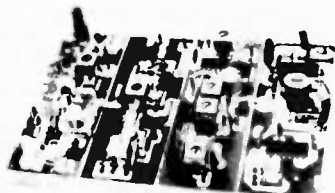

SENSITIVITY .3uV for 20db quieting. SQUELCH THRESHOLD .2uV. AUDIO OUTPUT 2 watts. STABILITY better than .002. IMAGE REJECTION 60db. SPURIOUS REJECTION greater than 60db. IF REJECTION 80db. FIRST IF 10.7 Mhz. SECOND IF 455 KHz. BANDWIDTH 15 KHz at 3db, 60 KHz at 30db (40 KHz with optional 4 pole filter). CRYSTAL 45 Mhz parallel at 20pf (HC/25U holder).

PA144/15 - 15 Watt Power Amplifier



POWER GAIN; 12 db nominal, INPUT POWER; 2 watts max., INPUT VOLTAGE; 12 to 14 volts DC negative ground, INPUT CURRENT; 4 amps max., STANDBY CURRENT; virtually insignificant, INSERTION LOSS; less than 1 db on receive, DUTY CYCLE; 50% or less. Consists of drilled glass PC Board, heat sink and all components.

TX 144B or TX220B Transmitter Kit

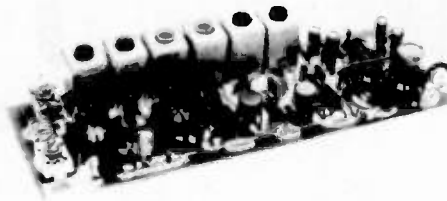

A one watt exciter using four RF transistors, two diodes, and one integrated circuit. The RF transistors are operating well below their ratings allowing long keying periods without damage. • Nominal output 1½ watts • Deviation adjusted to 10KHz • IC audio with clipping and active filter • All spurious outputs down 30db or more • Temperature compensation crystal trimmer • Zener regulated oscillator • Uses readily available 12 or 18 MHz crystals (18MHz for 220) • All tuning coils prewound • Pre drilled and tinned G-10 Circuit board

SC-3 Scanner



Capable of scanning up to 10 channels. Scan delay allows both sides of a conversation to be monitored without the scan starting each time the carrier drops. The priority feature allows the user to program the scanner to return to his favorite channel whenever it is active.

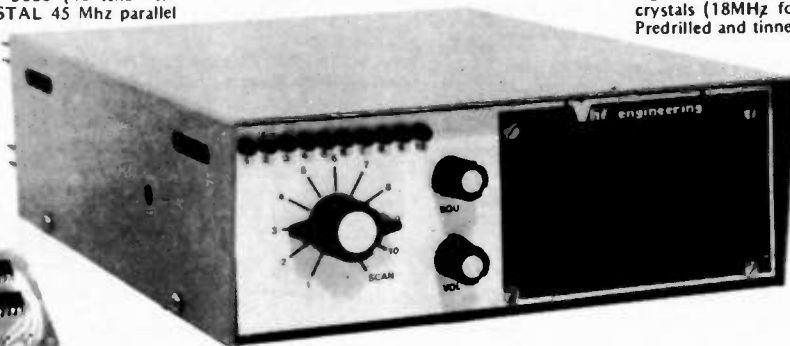

CD-1 Crystal Deck



A ten channel receiver crystal deck which utilizes diode switching to select the crystal position required.

CD-2 Crystal Deck

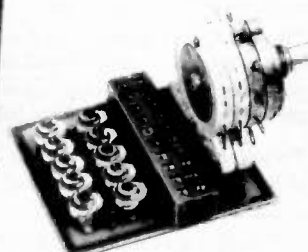

Designed to provide multi-channel operation for the TX-series transmitters. It features an extra set of contacts that may be wired to the CD-1 crystal deck for 10 channel transceiver. The extra contacts may also be used to switch L.E.D. indicators. The switch has 11 positions.

Complete with cabinet, speaker, hardware, L.E.D.'s, all accessories and full assembly instructions.

*(Crystals and microphone not included.)*

IF YOU ARE  
ON 144, 220  
OR 432

AND HAVE WORKED A REPEATER...

It was probably  
this one.

The RPT 144B, RPT 220B and RPT 432 are self-contained — all solid state machines. Conservatively rated, high quality components, assures EXCELLENT RELIABILITY. Careful consideration has been given to both interfacing and control flexibility.

RPT 144B or RPT 220B Kit . . . . . \$465.96  
RPT 432B Kit . . . . . 515.95  
RPT 144B or RPT 220B  
factory wired and tested . . . . . 695.95  
RPT 432B factory wired and tested . . . . . 795.95

## WORK ALL REPEATERS WITH OUR NEW SYNTHESIZER II



The Synthesizer II is a two meter frequency synthesizer. Frequency is adjustable in 5 KHz steps from 140.00 MHz to 149.995 MHz with its digital readout thumb wheel switching. Transmit offsets are digitally programmed on a diode matrix, and can range from 10 KHz to 10 MHz. No additional components are necessary!

Kit . . . . . \$169.95    Wired and tested . . . . . \$239.95

WUPPTS RADIO CATALOG WUPPTS RADIO

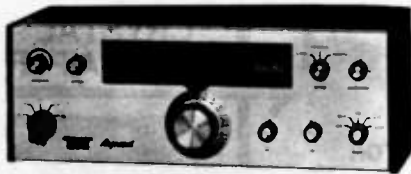

ARGONAUT #509

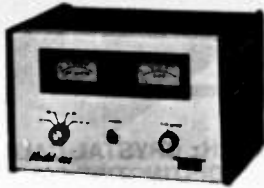

AMPLIFIER #405

# TRITON TEN-TEC

## ARGONAUT, MODEL 509

Covers all Amateur bands 10-80 meters. 9 MHz crystal filter. 2.5 kHz bandwidth. 1.7 shape factor @ 6/50 dB points. Power required 12-15 VDC @ 150 mA receive, 800 mA transmit at rated output. Construction: aluminum chassis, top and front panel, molded plastic end panels. Cream front panel, walnut vinyl top and end trim. Size: HWD 4 1/2" x 7" x 8". Weight 2 1/2 lbs.

## LINEAR AMPLIFIER, MODEL 405

Covers all Amateur bands 10-80 meters. 50 watts output power, continuous sine

wave. RF wattmeter. SWR meter. Power required 12-15 VDC @ 8 A, max. Construction: aluminum chassis, top and front panel, molded plastic side panels. Cream front panel, walnut vinyl top and end trim. Size: HWD 4 1/2" x 7" x 8". Weight 2 1/2 lbs.

Argonaut, Model 509 ..... \$329.00  
 Linear Amplifier, Model 405 ..... 159.00  
 Power Supply, Model 251 (Will power both units) ..... 79.00  
 Power Supply, Model 210 (Will power Argonaut only) ..... 27.50

The new ultra-modern fully solid-state TRITON makes operating easier and a lot more fun, without the limitations of vacuum tubes.

For one thing, you can change bands with the flick of a switch and no danger of off-resonance damage. And no deterioration of performance with age.

But that's not all. A superlative 8-pole i-f filter and less than 2% audio distortion, transmitting and receiving, makes it the smoothest and cleanest signal on the air.

The TRITON IV specifications are impeccable. For selectivity, stability and receiver sensitivity. And it has features such as full CW break-in, pre-selectable ALC, off-set tuning, separate AC power supply, 12 VDC operation, perfectly shaped CW wave form, built-in SWR bridge and on and on.

For new standards of SSB and CW communication, write for full details or talk it over with your TEN-TEC dealer. We'd like to tell you why "They

Don't Make 'Em Like They Used To" makes Ham Radio even more fun.

TRITON IV \$699.00

### ACCESSORIES:

Model 240 One-Sixty Converter... \$ 97.00  
 Model 244 Digital Readout ..... 197.00

Model 245 CW Filter ..... \$ 25.00  
 Model 249 Noise Blanker ..... 29.00  
 Model 252G Power Supply ..... 99.00  
 Model 262G Power Supply/VOX.. 129.00



## KR20-A ELECTRONIC KEYS

A fine instrument for all-around high performance electronic keying. Paddle actuation force is factory adjusted for rhythmic smooth keying. Contact adjustments on front. Weighting factor factory set for optimum smoothness and articulation. Over-ride "straight key" conveniently located for emphasis, QRS sending or tune-up. Reed relay output. Side-tone generator with adjustable level. Self-completing characters. Plug-in circuit board. For 117 VAC, 50-60 Hz or 6-14 VDC. Finished in cream and walnut vinyl. **PRICE \$67.50**

## KR5-A ELECTRONIC KEYS

Similar to KR20-A but without side-tone oscillator or AC power supply. Ideal for portable, mobile or fixed station. A great value that will give years of troublefree service. Housed in an attractive case with cream front, walnut vinyl top. For 6-14 VDC operation. **PRICE \$38.50**

## KR1-A DELUXE DUAL PADDLE

Paddle assembly is that used in the KR50, housed in an attractive formed aluminum case. **PRICE \$25.00**

## KR2-A SINGLE LEVER PADDLE

For keying conventional "TO" or discrete

character keys, as used in the KR20-A. **PRICE \$15.00**

## KR50 ELECTRONIC KEYS

A completely automatic electronic keyer fully adjustable to your operating style and preference, speed, touch and weighting, the ratio of the length of dits and dahs to the space between them. Self-controlled keyer to transmit your thoughts clearly, articulately and almost effortlessly. The iambic (squeeze) feature allows the insertion of dits and dahs with perfect timing.

An automatic weighting system provides increased character to space ratio at slower speeds, decreasing as the speed is increased, keeping the balance between smoothness at low speeds and easy to copy higher speed. High intelligibility and rhythmic transmission is maintained at all speeds, automatically.

Memories provided for both dits and dahs but either may be defeated by switches on the rear panel. Thus, the KR50 may be operated as a full iambic (squeeze) keyer, with a single memory or as a conventional type keyer. All characters are self-completing. **PRICE \$110.00**

### SPECIFICATIONS

Speed Range: 6-50 w.p.m.  
 Weighting Ratio Range: 50% to 150% of classical dit length.

Memories: Dit and dah. Individual defeat switches.

Paddle Actuation Force: 5-50 gms  
 Power Source: 117VAC, 50-60 Hz, 6-14 VDC

Finish: Cream front, walnut vinyl top and side panel trim.

Output: Reed relay. Contact rating 15 VA, 400 V. max.

Paddles: Torque drive with ball bearing pivot.

Side-tone: 500 Hz tone.

Adjustable output to 1 volt.

Size HWD: 2 1/2" x 5 1/2" x 8 1/4"

Weight: 1 1/4 lbs.

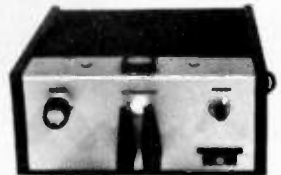

KR50A



Model 310-001: Standard Key, nickel plated hardware, no switch — \$6.65.

Model 310-003: Standard Key, nickel plated hardware, with switch — \$8.25.

Model 320-001: Standard Heavy Duty Key with nickel plated hardware, no switch — \$8.20.

Model 320-003: Same as -001 except with switch — \$9.35.

322-001



Code Practice Set with Key — \$18.50.



SSK-1: Chrome plated — \$29.95; Black Wrinkle Finish — \$23.95.

- Fully VSWR & reverse voltage protected
- No tuning required across band

- Switchable Class C or AB operation
- Built-in TR switching, w/increased delay for SSB

- Fully compatible with all 1-15W FM/SSB/AM/CW rigs
- All solid-state and microstrip construction

Mobile Amplifiers  
 With  
 Versatility



## SPECIALTY COMMUNICATIONS SYSTEMS, INC.

FREQUENCY MHz	MODEL	INPUT POWER NOM.W	OUTPUT POWER NOM.W	OPERATING CURRENT @13.6VDC	SIZE CM HXWXL	RETAIL PRICE
220-225	1.3M10-60L	10	60	7	7.1X10.2X16.5	159.95
144-148	2M10-70L	10	70	8	7.1X10.2X16.5	139.95

# SUPER AMP

from *DenTron*



**\$499.50**

If the amplifier you're thinking of buying doesn't deliver at least 1000 to 1200 watts output, to the antenna, you're buying the wrong amplifier.

Our New Super Amp is sweeping the country because hams have realized that the DenTron Amplifier will deliver to the antenna, (output power), what other manufacturers rate as input power.

The Super Amp runs a full 2000 watts P.E.P. input on SSB, and 1000 watts DC on CW, RTTY or SSTV 160-10 meters, the maximum legal power.

The Super Amp is compact, low profile, has a solid one-piece cabinet assuring maximum TVI shielding.

The heart of our amplifier, the power supply, is a continuous duty, self-contained supply built for contest performance.

We mounted the 4 - 811 A's, industrial workhorse tubes, in a cooling chamber featuring the on demand variable cooling system.

The hams at DenTron pride themselves on quality work, and we fight to keep prices down. That's why the dynamic DenTron Linear Amplifier beats them all at \$499.50.

NOW AVAILABLE WITH 572 B<sup>3</sup> FOR **\$574.50**

*DenTron*

## Match everything from 160 to 10 with the new 160-10 MAT

NEW: The Monitor Tuner was designed because of overwhelming demand. Hams told us they wanted a 3 kilowatt tuner with a built-in wattmeter, a front panel antenna selector for coax, balanced line and random wire. So we engineered the 160-10m Monitor Tuner. It's a lifetime investment at \$299.50.

**\$299.50**



## Meet the SuperTuner

The DenTron Super Tuner tunes everything from 160-10 meters. Whether you have balanced line, coax cable, random or long wire, the Super Tuner will match the antenna impedance to your transmitter. All DenTron tuners give you maximum power transfer from your transmitter to your antenna, and isn't that where it really counts?

1 KW MODEL **\$129.50** 3 KW MODEL **\$229.50**

*DenTron*

## The 80-10 Skymatcher

Here's an antenna tuner for 80 through 10 meters, handles 500 w P.E.P., and matches your 52 ohm transceiver to a random wire antenna.



- Continuous tuning 3.2 - 30 mc
- "L" network
- Ceramic 12 position rotary switch
- SO-239 receptional to transmitter
- Random wire tuner
- 3000 volt capacitor spacing
- Tapped inductor
- Ceramic antenna feed thru
- 7" W. 5" H. 8" D., Weight: 5 lbs.

**\$59.50**

## Read forward and reflected watts at the same time

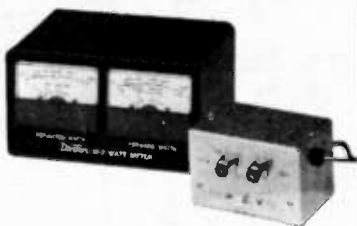

Tired of constant switching and guesswork?

Every serious ham knows he must read both forward and reverse wattage simultaneously for that perfect match. So upgrade with the DenTron W-2 Dual in Line Wattmeter.

**\$99.50**

*DenTron*

## The Sky Openers



### SKYMASTER

A fully developed and tested 27 foot vertical antenna covers entire 10, 15, 20, and 40 meter bands using only one cleverly applied wave trap. A full 1/4 wave antenna on 20 meters. Constructed of heavy seamless aluminum with a factory tuned and sealed HQ Trap, SKYMASTER is weatherproof and withstands winds up to 80 mph. Handles 2 KW power level and is for ground, roof or tower mounting. Radials included in our low price of

**\$84.50**

Also 80 m resonator for top mounting on SKYMASTER.

**\$29.50**

### SKYCLAW

A tunable monoband high performance vertical antenna, designed for 40, 80, 160 meter operation. SKYCLAW gives you the following spectrum coverage:

BAND (Meters)	BANDWIDTH (kHz)
160	50
80	200
40	entire band

Tuning is easy and reliable. Rugged construction assures that this self-supporting unit is weatherproof and survives nicely in 100 mph winds. Handles full legal power limit.

**\$79.50**

### EX-1

The DenTron EX-1 Vertical Antenna is designed for the performance minded antenna experimenter. The EX-1 is a full 40 meter, 1/4 wave, 33', self-supporting vertical. The EX-1 is the ideal vertical for phasing.

**\$59.50**

### TRIM-TENNA

The antenna your neighbors will love. The new DenTron Trim-Tenna with 20 meter beam is designed for the discriminating amateur who wants fantastic performance in an environmentally appealing beam. It's really loaded! Up front there's a 13 foot 8 inch director with precision Hy-Q coils. And, 7 feet behind is a 16 foot driven element fed directly with 52 ohm coax. The Trim-Tenna mounts easily and what a difference in on-the-air performance between the Trim-Tenna and that dipole, long wire or inverted Vee you've been using. 4 & 6 Forward Gain Deer Dipole.

**\$129.50**



### ALL BAND DOUBLET

This All Band Doubler or inverted Type Antenna covers 160 thru 10 meters. Has total length of 130 feet (14 ga. stranded copper) although it may be made shorter if necessary. This tuned Doubler is center fed through 100 feet of 450 ohm PVC covered balanced transmission line. The assembly is complete. Add rope to the ends and pull up into position. Tune with the DenTron Super Tuner and you're on 10 through 160 meters with one antenna! Now just for the DenTron All Band Doubler.

**\$24.50**

*DenTron*

# For all you hams with little cars ... We've got the perfect mobile rig for you.



The Atlas 210x or 215x measures only 9 1/4" wide x 9 1/4" deep x only 3 1/4" high, yet the above photograph shows how easily the Atlas transceiver fits into a compact car. And there's plenty of room to spare for VHF gear and other accessory equipment. With the exclusive Atlas plug-in design, you can slip your Atlas in and out of your car in a matter of seconds. All connections are made automatically.

**BUT DON'T LET THE SMALL SIZE FOOL YOU!**

Even though the Atlas 210x and 215x transceivers are less than half the size and weight of other HF transceivers, the Atlas is truly a giant in performance.

**200 WATTS POWER RATING!**

This power level in a seven pound transceiver is incredible but true. Atlas transceivers give you all the talk power you need to work the world barefoot. Signal reports

constantly reflect great surprise at the signal strength in relation to the power rating.

**FULL 5 BAND COVERAGE**

The 210x covers 10-80 meters, while the 215x covers 15-160 meters. Adding the Atlas Model 10x Crystal Oscillator provides greatly increased frequency coverage for MARS and network operation.

**NO TRANSMITTER TUNING OR LOADING CONTROLS**

with Atlas' total broadbanding. With your Atlas you get instant QSY and band change.

**MOST ADVANCED STATE OF THE ART SOLID STATE DESIGN**

not only accounts for its light weight, but assures you years of top performance and trouble free operating pleasure.

**PLUG-IN CIRCUIT BOARDS**

and modular design provides for ease of servicing.

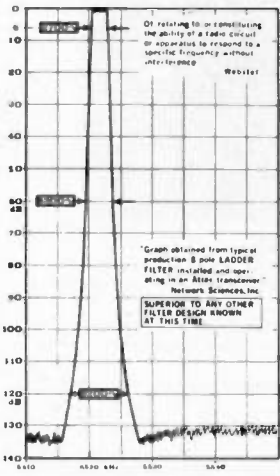

**PHENOMENAL SELECTIVITY**

The exclusive 8 pole crystal ladder filter used in Atlas transceivers represents a major breakthrough in filter design, with unprecedented skirt selectivity and ultimate rejection. As the above graph shows, this filter provides a 6 db bandwidth of 2700 Hertz, 60 db down of only 4300 Hertz, and a bandwidth of only 9200 Hertz at 120 db down! Ultimate rejection is in excess of 130 db; greater than the measuring limits of most test equipment.

**EXCEPTIONAL IMMUNITY TO STRONG SIGNAL OVERLOAD AND CROSS MODULATION.** The exclusive front end design in the receiver allows you to operate closer in frequency to strong neighboring signals than you have ever experienced before. If you have not yet operated an Atlas transceiver in a crowded band and compared it with any other receiver or transceiver, you have a real thrill coming.



**A WORLD WIDE DEALER NETWORK TO SERVE YOU.**

Whether you're driving a Honda in Kansas City or a Mercedes Benz in West Germany, there's an Atlas dealer near you.

Atlas 210x or 215x	.....	\$675.00
W/Noise Blanker	.....	719.00
<b>ACCESSORIES:</b>		
AC Console 110/220 V	.....	\$147.00
Portable AC supply 110/220 V	.....	100.00
Plug-in Mobile Kit	.....	48.00
10x Osc. less crystals	.....	59.00
Digital Dial DD-6B	.....	229.00

For complete details see your Atlas dealer, or drop us a card and we'll mail you a brochure with dealer list.



## mounts - leads - accessories

**STANDARD GAIN MOBILES**

**Two Meters**

- 5/8 wavelength — 34 db gain over 1/4 wave mobile
- Frequency coverage—143 to 149 MHz
- Power rating—200 watts FM

**MODEL BBLT-144**

47" antenna complete with easy to install, no holes to drill, trunk lip mount, impact spring and 17 MIL SPEC RG-58-U and PL-259. Antenna removable from mount. **\$28.75**

**MODEL BBL-144**

47" antenna mounts on any flat surface, roof, deck or fender in 3/8" hole. Includes impact spring, 17 MIL SPEC RG-58-U and PL-259. Antenna removable from mount. **\$26.95**

**HUSTLER "BUCK-BUSTER" MODEL SF-2**

51" two meter, 5/8 wavelength, 34 db gain over 1/4 wave mobile. Designed with 3/8" 24 base to fit your mount or a wide selection of Hustler mobile mounts. (Mount or cable not included). **\$12.75**

**SUPER GAIN MOBILES**

**Two Meters**

- 5.2 db gain over 1/4 wave mobile antenna
- Frequency coverage—143-149 MHz
- SWR at resonance—1:1 typical
- Power rating—200 watts FM

**TWO AND SIX METERS—TRUNK LIP MOUNT**

**MODEL MFT**

Four section telescopic antenna permits separate adjustment for simultaneous resonance on two and six meters. Operational height, 40". Complete with trunk lip mount, 17 MIL SPEC RG-58-U and factory attached PL-259. **\$21.45**

**VHF/UHF ANTENNA—ROOF MOUNT**

**MODEL UHT-1**

Field trimmable radiator for 1/4 wave operation on any frequency from 140 to 500 MHz. Cutting chart included. Mounts on any flat surface, roof, deck, fender in 3/8" hole. Includes 15' RG-58-U. **\$10.15**

**VHF/UHF ANTENNA—TRUNK LIP MOUNT**

**MODEL THF**

Field trimmable radiator permits quarter wave operation on any frequency from 140 to 500 MHz. Cutting chart included. Complete with trunk lip mount, 17' RG-58-U and PL-259. **\$15.95**

**MODEL CGT-144**

Get big signal performance, superior receiving capability with this 85" collinear antenna. Easy installation on side or edge of trunk lip without drilling—Complete with 17 MIL SPEC RG-58-U and PL-259. **\$39.95**

**MODEL CG-144**

Same characteristics as CGT-144 supplied with 3/8" 24 base to fit all mobile ball mounts—Length is 85". Mount and cable not included. **\$26.75**

**SSM-2**

**GO-1**

**DELUXE MOBILE MOUNTS**

For medium length, light weight antennas with 3/8" 24 base.

**MODEL TLM**

Deluxe trunk lip mount for no holes installation on side or edge of trunk lid. Includes 17' RG-58-U connectors attached. **\$12.05**

**MODEL HLM**

Deluxe trunk lip mount with 180 degree swivel (least trim line gutters) to vertical. Easy — no holes — installation. Includes 17' RG-58-U cable and connectors attached. **\$14.85**

**MODEL GCM-1**

Rain gutter mount fits all shapes, angles even (least trim line gutters) to vertical. Easy — no holes — installation. Includes 180° swivel ball. **\$7.50**

**MODEL MM-1**

Cowl mount installs in 1" hole. Includes 180° swivel ball and 50-229 connectors. **\$ 6.45**

**MODEL TGM-1**

Trunk groove mount installs in hidden area of groove under trunk lid. Mounting hardware included. **\$7.50**

**RESONATOR SPRING—STAINLESS STEEL**

**MODEL RSS-2**

Inserts between Hustler mast and resonator. Absorbs shock when antenna strikes, overbearing obstacles. Supplied ready for easy installation. **\$ 5.00**

**QUICK DISCONNECT—100% STAINLESS STEEL**

**MODEL QD-1**

Removes antenna from mount with easy press and twist release. Compression spring and all parts 100% stainless steel 3/8" 24 threads—torque one end, mate the other. **\$11.75**

**FEED LINE**

**MODEL L14-240**

Get known performance, maximum shielding for minimum noise pickup in this MIL SPEC 20 length of RG-58-U cable. Supplied with connectors attached for use with ball or bumper mount and transceiver. **\$ 7.45**

**MODEL G6-144A**

Deluxe, Two-Meter Collinear for Repeater or any fixed station operation. 6 db gain over a 1/2 wave dipole. Maximum radiation at the horizon! Shunt fed with D.C. grounding. Radiator 3/4 wave lower section, 3/8 wave phasing 3/4 wave upper section. Height: 117" SWR at resonator: 1.2:1 or better. Power rating: 1,000 Watts P.M. Wind survival: 100 MPH. Installs on vertical pipe up to 1 1/2". Q.D. 50-239 coax connector. **\$52.95**

### HUSTLER RESONATORS

**STANDARD HUSTLER RESONATORS—Power Rating: 400 watts SSB**

Model	Band	Price
RM 10	10 meters	\$10.75
RM 15	15 meters	\$11.75
RM 20	20 meters	\$12.75
RM 30	30 meters	\$13.75
RM 40	40 meters	\$14.75
RM 50	50 meters	\$15.75
RM 60	60 meters	\$16.75
RM 80	80 meters	\$18.75

**SUPER HUSTLER RESONATORS—Power Rating: Legal Limit SSB. Super's have widest band width**

Model	Band	Price
RM 10 S	10 meters	\$13.95
RM 15 S	15 meters	\$14.95
RM 20 S	20 meters	\$15.95
RM 30 S	30 meters	\$16.95
RM 40 S	40 meters	\$17.95
RM 50 S	50 meters	\$18.95
RM 60 S	60 meters	\$19.95

Covers 10 - 15 - 20 - 40 Meters  
Only Hustler Gives One Setting for  
Whole Band Coverage

**MODEL 4-BTV**

- Lowest SWR—PLUS.
- Bandwidth at its broadest! SWR 1.6 to 1 or better at band edges.
- Hustler exclusive trap covers "Spritz" extruded to otherwise unattainable close tolerances assuring accurate and permanent trap resonance.
- Solid one inch fiberglass trap forms for optimum electrical and mechanical stability.
- Extra heavy duty aluminum mounting bracket with low loss—high strength insulators. Mounting hardware included.
- All sections 1 1/4" heavy wall, high strength aluminum.
- Stainless steel clamps permitting adjustment without damage to the aluminum tubing.
- Guaranteed to be easiest assembly of any multi-band vertical.
- Antenna has 3/8" 24 stud at top to accept RM-75 or RM-75S Hustler resonator for 75 meter operation when desired.
- Top loading on 75 meters for broader bandwidth and higher radiation efficiency!
- Feed with any length 50 ohm coax.
- Power capability—full legal limit on SSB or CW.
- Mounting: Ground mount with or without radials, or roof mount with radials.

Length: 21' 5"  
MODEL 4-BTV  
Weight: 15 lbs.  
**\$79.95**

For 6 - 10 - 15 - 20 - 40 - 75 - 80 Meters

Fold over mast for quick and easy interchange of resonators or entering a garage. When operating, mast is held vertical with shaperproof sleeve clutch. 58" mast also serves as 1/4 wavelength 6 meter antenna. Stainless steel base has 3/8" 24 threads to fit mobile ball mount or bumper mount.

**HUSTLER MASTS**

The Majority Choice of Amateurs Throughout the World

**MODEL MO-2**

For bumper mounting—Fold is at roof line 27" above base. **\$15.95**

**MODEL MO-1**

For deck or fender mounting—Fold is at roof line 15" above base. **\$15.95**



why waste watts?

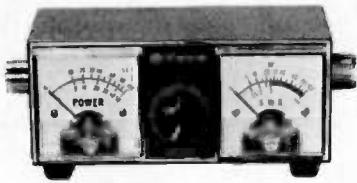

**SWR-1 guards against power loss for \$21.95**

If you're not pumping out all the power you're paying for, our little SWR-1 combination power meter and SWR bridge will tell you so. You read forward and reflected power simultaneously, up to 1000 watts RF and 1:1 to infinity VSWR at 3.5 to 150 MHz.

Got it all tuned up? Keep it that way with SWR-1. You can leave it right in your antenna circuit.



**DELUXE 742 TRI-BAND MOBILE ANTENNA**  
 • Automatically adjusts to proper resonance for 20, 40 and 75 meters.  
 • Power rated at 500 Watts P.E.P.  
 • Includes base section, automatic coil and whip top section. 742 Antenna \$79.95

**EXCLUSIVE DELUXE 5-BAND MOBILE 45 ANTENNA**  
 • All band manual switching antenna for 10, 15, 20, 40 and 75 meters.  
 • Power rated at 1000 Watts P.E.P.  
 • Includes base section with mobile coil and six foot whip top section. 45 Antenna \$114.95



NORTH SHORE

**RF TECHNOLOGY**

**DUPLEXER & CAVITY KITS...**

**Now**

**available for you fully assembled and tuned!**



• UPGRADE YOUR REPEATER WITH A RF TECHNOLOGY DUPLEXER.

• ALL DUPLEXERS AND CAVITIES ARE TEMPERATURE COMPENSATED WITH INVAR® AND MEET ALL COMMERCIAL STANDARDS

• ONLY TOP QUALITY MATERIALS GO INTO OUR PRODUCTS.

• BOTH KITS & ASSEMBLED DUPLEXERS AND CAVITIES ARE AVAILABLE TO YOU AT A SAVINGS TO YOU.

Mod. 62-3...6 cav., 2 mtr., insertion loss 0.6 db with isolation 100 db typical; pwr. 350 w. Kit \$349 ea.-Assembled \$439.

Mod. 4220-3...4 cav. 220 MHz insertion loss 0.6 db with 80 db isolation typical; pwr. 350 w. Kit \$249 ea. - Assembled \$329.

Mod. 4440-3...4 cav. 440 MHz, insertion loss 0.6 db with 80 db isolation typical; pwr. 350 w. Kits \$249 ea. - Assembled \$329.

Mod. 30 Cavity Kits: 2 mtr. \$65 ea., 220 MHz \$65 ea., 440 MHz \$65 ea.; 6 mtr. \$115 ea. Add \$15 for Assembled Kit.

Also available: 6 mtr., 4 cav. Kit \$399-Assembled \$499, 2 mtr. 4 cav. Kit \$249-Assembled \$329, 440 MHz TV Repeater Duplexer

Only hand tools are necessary to assemble Kits!

Send your order to: Distributor: TUFTS RADIO, 386 Main St., Medford, Mass. 02155. Phone (617) 395-8280.

(Prices F.O.B. Medford, Mass. All units can be shipped U.P.S.-C.O.O. orders require \$50 deposit. —Mass. residents add 5% sales tax.)

**SWAN METERS HELP YOU GET IT ALL TOGETHER**

These wattmeters tell you what's going on.

With one of these in-line wattmeters you'll know if you're getting it all together all the time. Need high accuracy? High power handling? Peak

power readings? For whatever purpose we've got the wattmeter for you. Use your Swan credit card. Applications at your dealer or write to us.



**WM2000 In-Line Wattmeter With Muscle.** Scales to 2000 watts. New flat-response directional coupler for maximum accuracy. \$49.95



**WM3000 Peak-reading Wattmeter.** Reads RMS power then with the flick of a switch, true peak power of your single-sideband signal. That's what counts on SSB. \$66.95



**WM1500 High-Accuracy In-Line Wattmeter.** 10% full scale accuracy on 5, 50, 500 and 1500 watt scales, 2 to 30 MHz. Forward and reflected power. Use it for trouble-shooting, too. \$64.95



Hams the world over value amateur radio products from Swan Electronics. Among the most respected of these are the unique

single-sideband rigs with that "special something" extra — like those illustrated here.



**SWAN 55-200A Transceiver.** Fully solid-state, unique broadband tuning on all five bands, and infinite VSWR protection. Maintains up to 300 watts P.E.P. input on any frequency selected. \$799.95

**SWAN LINEAR AMPLIFIERS** A Mark II 2000 watt P.E.P. full legal input power unit or the 1200X matching Cygnet 1200 watt P.E.P. input power-house with built-in power supply. The choice is yours. \$849.95



MARK II

Additional Swan products include: fixed and mobile antennas, VFO's telephone patch, VOX, wattmeter, microphones and mounting kits. As another extra service, only Swan Electronics offers factory-backed financing to the amateur radio community. Visit an authorized Swan Electronics dealer for complete details, or, if you prefer, write:



**CYGNET 1200X PORTABLE LINEAR AMPLIFIER**

To quadruple the output of the 300B Cygnet de novo, simply add this matching unit for more than a kilowatt of power. Complete with self-contained power supply and provision for external ALC, this Cygnet offers exceptionally high efficiency and linearity. \$349.95



1200 X

TUFTS RADIO CATALOG TUFTS RADIO

# THE BIG SIGNAL \$129.95

## "W2AU" BALUN

THE APPROVED LEADING HAM AND COMMERCIAL BALUN IN THE WORLD TODAY.

### THE PROVEN BALUN



1. HANDLES FULL 2 KW PEP AND THEN SOME. Broad Banded 3 to 40 Mc.
2. HELPS TVI PROBLEMS By Reducing Coax Line Radiation.
3. NOW ALL STAINLESS STEEL HARDWARE. SO239 Double Silver Plated.
4. IMPROVES F/B RATIO By Reducing Coax Line Pick-Up.
5. REPLACES CENTER INSULATOR. Withstands Antenna Pull of Over 600 Lbs.
6. BUILT-IN LIGHTNING ARRESTER. Helps Protect Balun—Could Also Save Your Valuable Gear!
7. BUILT-IN WIND UP HOOD. Ideal for inverted Vees, Multi-Band Antennas, Dipoles, Beams and Quads.

NOW BEING USED BY ALL BRANCHES OF THE U.S. ARMED FORCES, FAA, RCA, CIA, CANADIAN DEFENSE DEPT. PLUS THOUSANDS OF HAMS THE WORLD OVER.

**THEY'RE BUILT TO LAST...  
BIG SIGNALS DON'T JUST HAPPEN—  
GIVE YOUR ANTENNA A BREAK**

Comes in 2 models. 1:1 matches 50 or 75 ohm unbalanced coax line to 50 or 75 ohm balanced load. 4:1 model matches 50 or 75 ohm unbalanced coax line to 200 or 300 ohm balanced load.

**AVAILABLE AT ALL LEADING DEALERS. IF NOT, ORDER DIRECT**

The big signal W2AU Balun reflects the type of quality that has kept our product out front and number 1 in Baluns the world over for the past 10 years.

The originator of the Balun with a built-in lightning arrester and hang up hook.

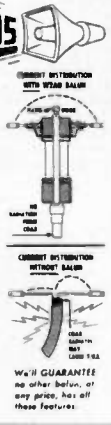

## Now...more than ever--- the TEMPO line means solid value

### Tempo VHF/ONE

the "ONE" you've been waiting for



No need to wait any longer — this is it! Whether you are already on 2-meter and want something better or you're just thinking of getting into it, the VHF/ONE is the way to go.

- Full 2 meter band coverage (144 to 148 MHz for transmit and receive).
- Full phase lock synthesized (PLL) so no channel crystals are required.
- Compact and lightweight — 9.5" long x 7" wide x 2.25" high. Weight — About 4.5 lbs.
- Provisions for an accessory SSB adaptor.
- 5-digit LED receive frequency display.
- 5 KHz frequency selection for FM operation.
- Automatic repeater split — selectable up or down for normal or reverse operation.
- Microphone, power cord and mounting bracket included.
- Two built-in programmable channels.
- All solid state.
- 10 watts output.
- Super selectivity with a crystal filter at the first IF and E type ceramic filter at the second IF.
- 800 Selectable receive frequencies.
- Accessory 9-pin socket. • \$495.00

TEMPO SSB/ONE SSB adapter for the Tempo VHF/One. • Selectable upper or lower side-band. • Plugs directly into the VHF/One with no modification. • Noise blanker built-in. • RT and VXO for full frequency coverage. • \$225.00.

# YAESU

FT 301	160M-10M Transceiver — 200 WPEP	\$769
FP 301 DIG	160M-10M Transceiver — 200 WPEP	935
FP 301	AC Power Supply	125
FP 301 CID	AC P.S. w/Clock and CW ID	199
FRG-7	General Cov. Synthesized Receiver	299
QTR-24	Yaesu World Clock	30
FT-101-E		
160-10M	XCVR W/Processor	749
FT-101EE		
160-10M	XCVR W/O Processor	659
FT-101EX		
160-10M	XCVR W/O Processor	
	AC Only, Less Mike	599
FL-2100B	Linear Amplifier	399
FTV-650B	6M Transverter	189
FTV-250	2M Transverter	219
FV-101B	External VFO	99
SP-101B	Speaker	19
SP-101PB	Speaker/Patch	59
YO-100	Monitor Scope	199
YD-844	Dynamic Base Mike	29
FA-9	Cooling Fan	19
MMB-1	Mobile Mount	19
RFP-102	RF Speech Processor	89
XF-30C	600 Hz CW Filter	45
XF-32A	8 Pole SSB Filter for FT-101	49
FR-101S		
SOLID STATE	160-2M/SW RCVR	489
FR 101 DIG		
SOLID STATE	160-2M/SW RCVR	629

Accessories:		
FC-6	6M Converter	30
FC-2	2M Converter	40
FM-1	FM Detector	20
	Aux/SW Crystals	5
X F-30B	AM-Wide Filter	45
X F-30C	600 Hz CW Filter	45
X F-30D	FM Filter	49
SP-101 B	Speaker	19
FL-101		
SOLID STATE	160-10M	
TRANSMITTER		545
Accessories:		
RFP-101	RF Speech Processor	89
MONITOR/TEST EQUIPMENT		
YC-355D	200 MHz Counter	229
YO-100	Monitor Scope	199
YP-150	Dummy Load/Watt Meter	74
YC-601	Digital Readout (101/401 series)	179
VHF FM & SSB TRANSCEIVERS		
FT-224	24CH, 2M FM	249
FT-620B	6M AM/CW/SSB	449
FT-221	2M AM/FM/CW/SSB	629
Accessories:		
MMB-4	Mobile Mount (FT-620B, FT-221)	19



FT-101E TRANSCEIVER

## Now You Can Receive The Weak Signals With The

Model PT-2 is a continuous tuning 6-160 meter Pre-Amp specifically designed for use with a transceiver. The PT-2 combines the features of the well-known PT with new sophisticated control circuitry

that permits it to be added to virtually any transceiver with No modification. No serious ham can be without one.

**ALL NEW**

## AMECO PREAMPLIFIER

- Improves sensitivity and signal-to-noise ratio.
- Boosts signals up to 26 db.
- For AM or SSB.
- Bypasses itself automatically when the transceiver is transmitting.
- FET amplifier gives superior cross modulation protection.
- Advanced solid-state circuitry.
- Simple to install.
- Improves immunity to transceiver front-end overload by use of its built-in attenuator.
- Provides master power control for station equipment.



MODEL PT-2

**\$69.95**

# HAM RADIO / MOBILE COMMUNICATIONS



MODEL	NET PRICE	103R	\$39.95
12V4	\$19.95	*13CB4	\$41.95
600	\$20.50	104R	\$49.95
102	\$24.95	12/115	\$69.95
612	\$27.95	108R	\$79.95
107	\$28.95	108RM	\$99.95
12CB4	\$29.95	109R	\$149.95

## MODEL 12HM4

NPC 2.5 Amp Regulated Power Supply. Solid State. Short Circuit Protected.



ALSO! Available as 13 HM 4 with built-in loudspeaker.

	TYPICAL	MAXIMUM
Output Voltage	13.5 ± 5VDC	14VDC
Continuous Current	1.5 Amp	
Regulation	2.5 Amp	
Ripple/Noise	5 mV RMS	10 mV RMS

Case: 3" (H) x 4" (W) x 5 1/2" (D). Shipping Weight: 3 lbs.

Low cost regulated power supply quietly converts 115 volts AC to 13.5 volts DC ± 200 millivolts. 1.5 amps continuous, 2.5 amps reg. Ideally suited for operating mobile CB transceivers in your home or office base station.



## MODEL 107

NPC 4 Amp Power Supply, 6 Amp Max. Solid State. Overload Protected



Functions silently in converting 115 volts AC to 12 volts DC. 4 amps continuous, 6 amps max. Enables anyone to enjoy CB radio, car 8-track cartridge, cassette player or car radio in a home or office.

	4 Amp
Continuous Current (Full Load)	4 Amp
Output Voltage (No Load)	16 V max
Output Voltage (Full Load)	12 V min
Filtering Capacitor	10,000 uF
Ripple (Full Load)	5 V RMS
Short Circuit Protection	Thermal Breaker

Case: 3" (H) x 4 1/4" (W) x 5 1/4" (D). Shipping Weight: 5 lbs.

## MODEL 103R

NPC 4 Amp Regulated Power Supply. Solid State. Dual Overload Protection.



Converts 115 volts AC to 13.6 volts DC ± 200 millivolts. Handles 2.5 amps continuous and 4 amps max. Ideally suited for applications where no hum and DC stability are important such as CB transmission, small Ham radio transmitter, and high quality eight-track car stereos. Can also be used to trickle-charge 12 volt car batteries.

	TYPICAL	MAXIMUM
Output Voltage	13.6 ± 2 VDC	13.6 ± 3 VDC
Line/Load Regulation	20 mV	50 mV
Ripple/Noise	2 mV RMS	5 mV RMS
Transient Response	20 uSec	
Current Continuous	2.5 Amp	
Current Limit	4 Amp	
Current Foldback	1 Amp	

Case: 3" (H) x 4 1/4" (W) x 5 1/4" (D). Shipping Weight: 4 lbs.



## MODEL 108RM

NPC 12 Amp Regulated Power Supply. Solid State. 3-Way Protected. Current Meter.



This heavy duty unit quietly converts 115 volts AC to 13.6 volts DC ± 200 millivolts. 8 amps continuous, 12 amps max. All solid state. Features dual current overload and overvoltage protection. Ideally suited for operating mobile Ham radio 2 meter AM-FM-SSB transceivers in your home or office. Can also be used to trickle-charge 12 volt car batteries.

	TYPICAL	MAXIMUM
Output Voltage	13.6 ± 2VDC	13.6 ± 3VDC
Line/Load Regulation	20 mV	50 mV
Ripple/Noise	2 mV RMS	5 mV RMS
Transient Response	20 uSec	
Current Continuous	8 Amp	
Current Limit	12 Amp	
Current Foldback	2.5 Amp	
Overvoltage Protection	14.5 V	15 V

Case: 4 1/4" (H) x 7 1/2" (W) x 5 1/2" (D). Shipping Weight: 9.5 lbs.

ALSO AVAILABLE AS MODEL 108RA WITHOUT METER AND OVERVOLTAGE PROTECTION.

## MODEL 109R

NPC 25 Amp Regulated Power Supply. 4-Way Protected. Output Voltage and Current Meters.

Extra heavy-duty unit quietly converts 115 volts AC to 13.6 volts DC ± 200 millivolts. 10 amps continuous, 25 amps max. All solid state. Features dual current overload, overvoltage and thermal protection. Ideally suited for operating mobile Ham radio and linear amplifier in your home or office. Excellent bench power supply for testing and servicing of mobile communications equipment.

	TYPICAL	MAXIMUM
Output Voltage	13.6 ± 2VDC	13.6 ± 3VDC
Line/Load Regulation	50 mV	100 mV
Ripple/Noise	5 mV RMS	10 mV RMS
Transient Response	20 uSec	
Current Continuous	10 Amp	
Current Limit	26 Amp	
Overvoltage Protection	14.5 V	15 V
Thermal Overload	180°F	

Case: 4 1/4" (H) x 9" (W) x 8 1/2" (D). Shipping Weight: 15 lbs.

## MODEL 12V4

NPC 1.75 Amp Power Supply. 3 Amp Max.



Functions silently in converting 115 volts AC to 12 volts DC. Ideally suited for most applications including 8-track stereo, burglar alarm, car radio and cassette tape player within power rating.

	1.75 Amp
Continuous Current (Full Load)	1.75 Amp
Output Voltage (No Load)	16 V max
Output Voltage (Full Load)	12 V min
Filtering Capacitor	5,000 uF
Ripple (Full Load)	.4 V RMS
Short Circuit Protection	Thermal Breaker

Case: 3" (H) x 4" (W) x 5 1/4" (D). Shipping Weight: 3 lbs.

## MODEL 104R

NPC 6 Amp Power Supply Regulated. Solid State. Dual Overload Protection.



Converts 115 volts AC to 13.6 volts DC ± 200 millivolts. Handles 4 amps continuous and 6 amps max. Ideally suited for applications where excellent DC stability is important, such as CB transmission, small Ham radio transmitter, and high quality eight-track car stereos. Can be used to trickle-charge 12 volt car batteries.

	MAXIMUM	TYPICAL
Output Voltage	13.6 ± 2 VDC	13.6 ± 3 VDC
Line/Load Regulation	20 mV	50 mV
Ripple/Noise	2 mV RMS	5 mV RMS
Transient Response	20 uSec	
Current Continuous	4 Amp	
Current Limit	6 Amp	
Current Foldback	2 Amp	

Case: 3 1/2" (H) x 5 1/2" (W) x 6 1/2" (D). Shipping Weight: 6 lbs.



## MODEL 102

NPC 2.5 Amp Power Supply. 4 Amp Max. Solid State. Overload Protected.

Functions silently in converting 115 volts AC to 12-volts DC. 2.5 amps continuous, 4 amps max. Enables anyone to enjoy CB radio, car 8-track cartridge, cassette tape player or car radio in a home or office.

	2.5 Amp
Continuous Current (Full Load)	2.5 Amp
Output Voltage (No Load)	16 V max
Output Voltage (Full Load)	12 V min
Filtering Capacitor	5,000 uF
Ripple (Full Load)	.6 V RMS
Short Circuit Protection	Thermal Breaker

Case: 3" (H) x 4 1/4" (W) x 5 1/4" (D). Shipping Weight: 4 lbs.

# MARINE & RV

## MODEL 12-115

NPC 12-115 Solid State Inverter. 200 W. Parallel Connection for Higher Power up to 350 W.

Converts 12 volts DC to 115 volts AC @ 60 Hz output. 200 watts continuous operation with peak power up to 240 watts. All silicon semiconductors assure high reliability at excessive ambient temperatures. The output voltage is a square wave. The inverter is not recommended where high transients are not tolerable.

The 12-115 allows you to have AC house current in your boat, car, truck, camper, house trailer, or houseboat. Will operate small household appliances, T.V., hand tools, electric shaver, AC radios, and lights within power rating. Built-in overload protection.

Case: 4 1/4" (H) x 7 1/2" (W) x 5 1/2" (D). Shipping Weight: 7 lbs.

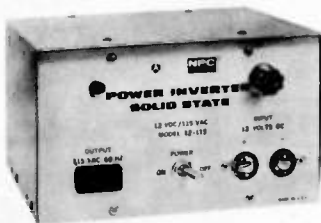

Output Voltage (No Load)	12 VDC 1N	14 VDC 1N
Output Voltage (Full Load)	115 V RMS	130 V RMS
Frequency (No Load)	100 V RMS	115 V RMS
Frequency (Full Load)	58 Hz	66 Hz
Power Continuous	54 Hz	62 Hz
Power Peak		200W
Parallel Connection		240W
		350W

All Values Are Typical

## MODEL 612

Model 612 Power Converter

NPC 612 converts 6 volt negative ground or 12 volt positive ground electrical systems to 12 volt negative ground operation. Provides full 3 amp continuous power. The inexpensive solution for installing car radios, stereo and cassette tape players, in vehicles with 6 volt negative ground or 12 volt positive ground systems. Case: 2 1/4" (H) x 3" (W) x 5" (D). Shipping Weight: 1 lb.



MURPHY'S RADIO CATALOG MURPHY'S RADIO



# BARKER & WILLIAMSON



Model 372 - \$27.50

### model 372 CLIPREAMP

Get maximum legal modulation without danger of splatter. Solid-state speech preamplifier and clipper for transmitters, public-address systems, and tape recorders needs no external power.

- specifications
- Input Impedance 100,000 ohms
- Input Levels 5 millivolts to 20 millivolts
- Voltage Gain 10 dB
- Output Level 80 millivolts
- Output Impedance 50,000 ohms
- Power 9-watt transistor battery, Burgess 2U6 or equivalent
- Size 2 3/4" x 3" x 4 1/2"
- Shipping Weight 7 oz.
- Connectors Terminal strip

### COAXIAL ANTENNA CHANGEOVER RELAY

model 377



Model 377 - \$17.95

Economical and reliable. Can be operated from VOX circuit for completely automatic operation or from PTT or manual T/R switch. Receiver input is automatically grounded when the relay is in the Transmit position. Wide AC operating voltage range and low operating current.

- specifications
- Power Rating 1000 watts CW (2000 watts SSB)
- VSWR Less than 1.15:1, DC to 150 MHz
- Power Requirements 0.815 Ampere, 68 to 130 volts AC
- Connectors UHF Type SO-238
- Dimensions 3-1/2" x 1-1/2"
- Shipping Weight 1 lb.

### UNIVERSAL HYBRID COUPLER II PHONE PATCH

model 3002W and model 3001W



Model 300 2W with *Compreamp*  
- \$125.00

Model 300 1W without *Compreamp*  
- \$85.00

Connect your station to the telephone lines. Five switch-selectable modes give complete flexibility for patching the station to the line and for tape recording and playback to or from the line or the station. The hybrid circuit provides for effortless VOX operation of the phone patch. A built-in *Compreamp* speech preamplifier/limiter (in Model 3002W) increases the level of weak phone signals and also prevents overmodulation when the local telephone is used as the station microphone. (The *Compreamp* also functions as a preamplifier/limiter with the station microphone, if desired.)

- specifications
- Inputs from:
  - Line 600 ohms
  - Receiver 4 ohms
  - Microphone High impedance (50,000 ohm crystal or dynamic)
  - Tape Recorder 4 ohms
- Outputs to:
  - Transmitter 50,000 ohms
  - Receiver Speaker 4 ohms
  - Tape Recorder 0.5 megohm
- Size 8-1/2" x 7-1/2" x 3"
- Shipping Weight 3-1/2 lbs.
- Power 8-watt battery, Burgess 2U6 or equivalent
- Connectors Phone

**BARKER & WILLIAMSON, INC.**

Model 359 - \$37.50



Increase your transmitter's effective speech power up to four times. Or use it with your tape recorder or public address system for improved performance. This two-stage, transistorized Audio Preamplifier/Limiter can be used with all types of transmitters. Powered by a long-lasting dry-cell battery—no external power needed. Installs without any wiring changes in your transmitter. Just connect the *Compreamp* between your microphone (50,000-ohm dynamic or high-impedance dynamic) and your transmitter's microphone input connector. Front-panel rocker switch lets you bypass the *Compreamp* when you want to. Compression level is adjustable, too.

- specifications
- Input Impedance 100,000 ohms
- Input Level 5 millivolts to 20 millivolts
- Voltage Gain 10 dB
- Output Level 60 millivolts
- Output Impedance 50,000 ohms
- Power 9-watt transistor battery, Burgess 2U6 or equivalent
- Size 2 3/4" x 3" x 4 1/2"
- Shipping Weight 8-1/2 oz.
- Connectors Terminal strip

### COAXIAL SWITCHES AND ACCESSORIES

for antenna selection and RF switching

These high-quality switches have set the standard for the industry for years. Ceramic switches with silver-alloy contacts and silver-plated conductors give unmatched performance and reliability from audio frequencies to 150 MHz.

B&W coaxial switches are designed for use with 52- to 75-ohm non-reactive loads, and are power rated at 1000 watts AM, 2000 watts SSB. Connectors are UHF type. Insertion loss is negligible, and VSWR is less than 1.2:1 up to 150 MHz.

Crosstalk (measured at 30 MHz) is 45 dB between adjacent outlets and 60 dB between alternate outlets.

Models are available for desk, wall, or panel mounting, and with or without protective grounding of inactive outputs. Radial (side-mounted) connector models can be either wall or panel mounted; axial (backplate-mounted) connector models are for panel mounting only, save panel space.

Use the selector chart below to choose the models you need.



### COAXIAL SWITCH SELECTOR CHART

Model	PRICE	Outputs	Connector Placement	Mounting			Automatic Grounding	Dial Plate	Remarks
				Panel	Wall	Desk			
375	18.95	6	Axial	x			x	Supplied	PROTAX switch. Grounds all except selected output circuit.
376	18.95	5	Radial	x	x		x	Supplied	PROTAX switch. Grounds all except selected output circuit. Sixth switch position grounds all outputs.
550A	14.00	5	Radial	x	x			DP 5	
550A-2	12.50	2	Radial	x	x			DP 2	
551A	17.50	2	Radial	x	x			DP-2	Special 2 pole, 2-position switch used to switch any RF device in or out of series connection in a coaxial line. See figure (over).
556	.95	-	-		x				Bracket only, for wall mounting of radial connector switches.
590	17.95	5	Axial	x				DP 5	
590G	17.95	5	Axial	x			x	Supplied	Grounds all except selected output circuit.
592	16.50	2	Axial	x				DP-2	
595	18.50	6	In-line		x	x	x		Grounds all except selected output circuit.

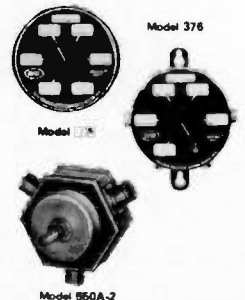
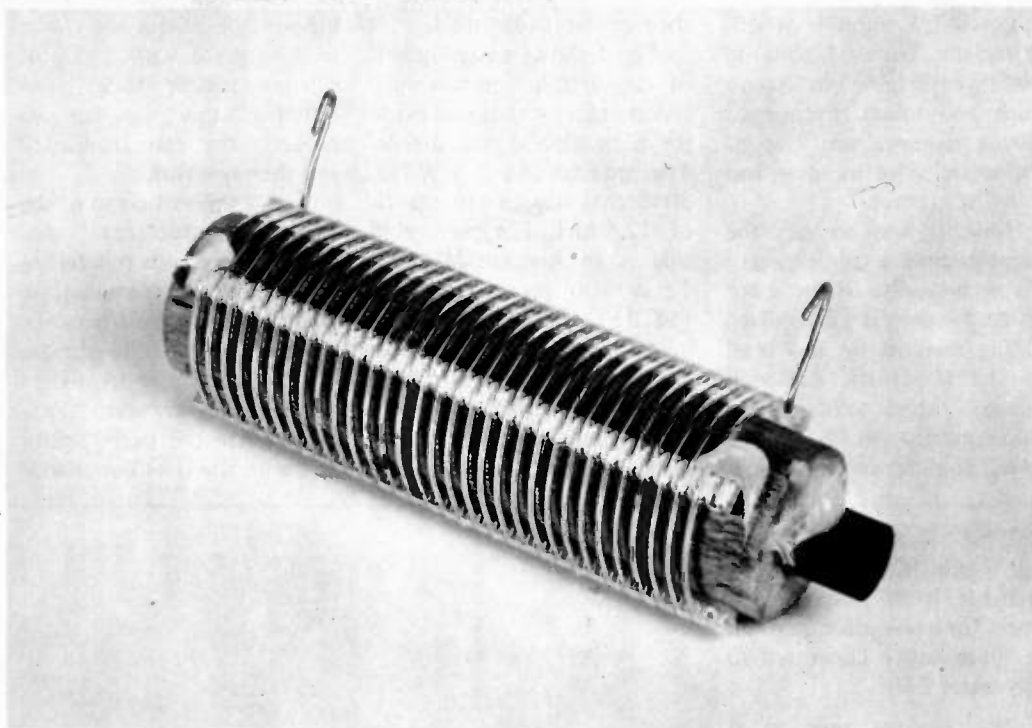



Fig. 1. B & W coil with adjustable permeable tuning slug.



Alfred F. Stahler W6AGX  
5521 Big Oak Dr.  
San Jose CA 95129

# Tuning Those Big Antenna Coils

## -- permeability

Recent articles have prompted me to experiment with various antenna configurations. My QTH is restricted in size, so my attention has been directed to physically-shortened antennas. Since a shortened antenna presents a capacitive reactance, an equivalent inductive reactance is required to achieve resonance. These inductors are usually large, to minimize  $I^2R$  losses, and, if resonant, have high rf potentials. The standard design solution is to use an air-wound coil (B & W, etc.) and to tune to the desired

inductance or resonant frequency, either by trial and error pruning or by shunting with a transmitting type variable capacitor.

This solution is fine, but transmitting variables are rare and expensive and operation during a rainstorm is, at best, unpredictable. One alternate solution is to shunt the inductor with a capacitor made of a length of coaxial cable which yields 15-30 pF per foot, withstands high rf voltage, and can easily be made immune to weather. The problem with this technique is that tuning is

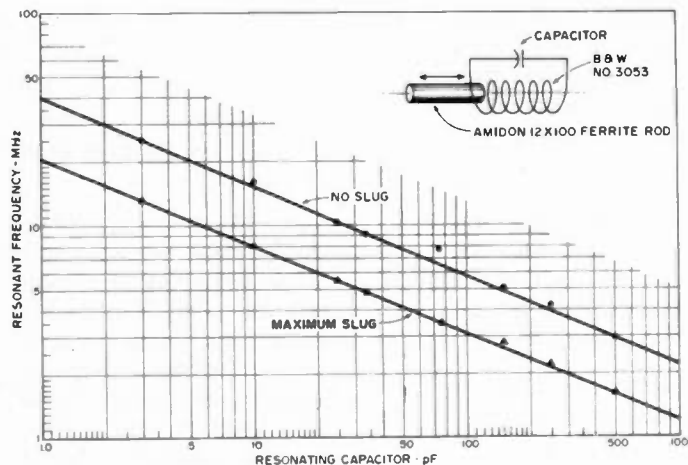

Fig. 2. Comparison of resonant frequencies, with and without permeable slug.

achieved by snipping length from the coax — and in finding resonance one *always* snips too much. Frequency change requires repetition of the capacitance building and snipping process.

Another way to vary the inductance of a coil is to vary the permeability of the space inside the coil; it's a standard tuning method for low level i-f and rf signals. Although variable tuned coils are not commercially available for large, high power inductors,

they can be readily made.

Fig. 1 shows a photograph of a variable permeability tuned inductor that was made for a multiband trap dipole. The inductor is a B & W No. 3053 that has an inductance of 12.5 uH. The permeable slug is an Amidon MV-125, 12 x 100 mm ferrite rod (\$1.25). The supporting material is a 1-1/8" diameter closet pole with a 1/2" diameter hole drilled through. Once tuned, by sliding the ferrite rod in or out of the

hole in the wood, the rod is held in place with a dab of silicone rubber sealer. For retuning, this seal can be broken, the rod readjusted and then resealed.

Fig. 2 shows a curve of the measured inductance variation possible with this ferrite rod and coil combination. Note that over the frequency range tested the ratio of maximum to minimum frequency is essentially constant, indicating that the permeability of the ferrite does not change

over this range (it probably decreases at higher frequencies).

I have used this construction technique on several antenna projects for traps, loading coils and for a high power, plate tank circuit. The Q of the coils remains very high and there is negligible loss in the ferrite, even at high power levels. If the wooden ferrite rod guide is boiled in wax or replaced by plastic, the unit will be impervious to weather. ■

**T**he Realistic Weather-radio (Cat #12-162) is available from Radio Shack stores for a low price, and can be quite easily converted to two meter FM.

The receiver uses an rf stage and a combination mixer/oscillator. It has positive ground, and either nine or twelve volts may be used, with better sensitivity from 12.

Remove the back cover, battery, and two Phillips screws. Remove the antenna, hold the board at the rear near the speaker hole, and lift up and out. There are two slotted tabs at the front of the case near the thumbwheel controls; the cement on these breaks easily while removing the board.

View the printed circuit side and solder a 10 pF capacitor across L1, L2, and L4. The radio is supplied with a complete schematic which may be helpful. Any good 10 pF capacitors should work as long as they fit with short leads, preferably less than a quarter inch. Either a ceramic or small mica should do. L1 is the tuned rf stage input coil, L2 the rf stage output, and L4 is the oscillator coil. The latter requires the most care in adjustment.

Remove the beeswax from the coils and replace the

Reprinted from *The Link*, Bulletin of the Buffalo Amateur Radio Repeater Association, Inc.

board into the case. Compress the coils to increase their inductance.

The circuit tunes with a varactor diode. Set the tuning pot to midpoint and compress the coils. You should expect to hear aircraft images. When properly adjusted, the tuning should cover approximately 2 MHz, from 146 to 148 MHz. Adjust L1 and L2 for maximum sensitivity after the oscillator has been set. ■

Casey Pustelnik W2OSW  
1133 Center Rd.  
Buffalo NY 14224

Richard Haungs W2UJR  
11315 Cary Rd.  
Alden NY 14004

# The 2m Mod Squad Tackles the Weatherradio

-- and wins!

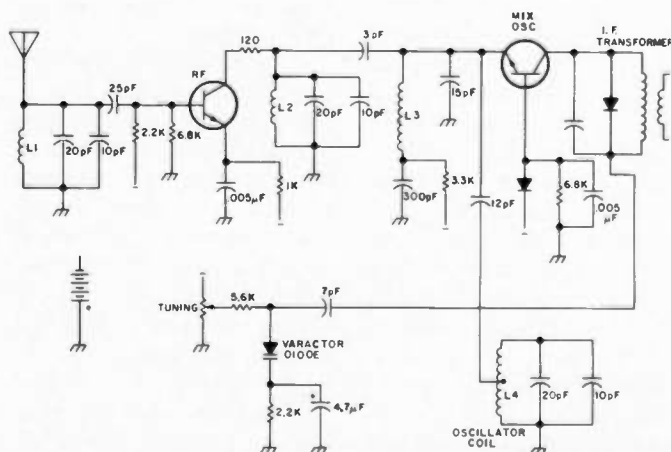

# 5 KW PEP INPUT

WITH THIS NEW BALUN



On all bands 160 to 10 meters.

Runs cool as a cucumber at its CCS rating of 2 KW (Continuous output power through the balun at matched load).

4" dia. Wt. 24 oz. \$32.50 PPD.

AND FOR FULL LEGAL POWER

the time tested Model 1K balun is still available. Rated at 1 KW CCS (3 KW PEP input).

2 1/4" dia. Wt. 9 oz. \$16.95 PPD.

ONLY PALOMAR BALUNS  
HAVE ALL THESE FEATURES

- Toroidal core for highest efficiency.
- Teflon insulated wire to prevent arc-over. OK for tuned feeders.
- Stainless steel eyebolts take antenna tension. Won't rust, won't pull apart.
- Epoxy filled case. Absolutely waterproof.
- Lightning protection built-in.
- Wideband 1.7 to 30 MHz.
- Hang-up hook provided.
- Now available in either 1:1 or 4:1 ratio. 1:1 ratio matches 50 or 75 ohm coax to 50 or 75 ohm balanced load (dipoles and inverted Vees). 4:1 ratio matches 50 or 75 ohm coax to 200 to 300 ohm balanced load.

Free descriptive brochure on request.

Order direct.

Model 2K \$32.50 Model 1K \$16.95

Center insulator without balun \$7.95

Postpaid U.S. & Canada.

Specify ratio 1:1 or 4:1

California residents add 6% tax.

Send check or money order to:

## PALOMAR ENGINEERS

BOX 455, ESCONDIDO, CA 92025

Phone: (714) 747-3343

the first name in solid state®

## THE FM LEADER

2 METER 220 MHz   
6 METER 440 MHz

FEATURING THE ...

### HR-2B



12 Channels  
15 Watts  
\$229<sup>00</sup> Amateur Net

### The Master in 2 Meter FM

Positive performance at a practical price makes our HR-2B tops on 2 meters. Individual trimmer capacitors give bull's-eye accuracy for working repeaters or point-to-point. The .35 $\mu$ V sensitivity and Hi/Lo power switch insure your hearing and being heard . . . clearly and reliably . . . the Regency way.

... AND THE

### HR-440



12 Channels  
10 Watts  
\$349<sup>00</sup> Amateur Net

### UHF—The Ultimate in FM

440 is fresh . . . it's new . . . and with our HR 440 you can use UHF without using-up your budget. So, pioneer some new ground! Put a compact HR 440 under your dash or at your desk. It's the best way to usher yourself into UHF.

1976 the first name in solid state®

ELECTRONICS, INC. 7707 Records Street  
Indianapolis, Indiana 46226

# Design Your Own PC Boards

## -- the styrofoam solution

**W**hether you are an old hand at the design of original PC boards, or you are about to embark upon your first masterpiece of copper and phenolic, the method of PC board design and construction described here will show you how to go from schematic diagram to etched board with a minimum of headaches.

You don't have to be a genius to design PC boards; all it takes is a little time, logic and common sense. In this article I'll try to show how to cut down on the time it takes to design PC boards and make it easier to visualize the routing of foil connections between components.

If you've got a schematic of that great project you've been drooling over for months, but have balked at the idea of making PC boards for it, welcome to the club. A schematic diagram is one thing, but turning that mass of criss-cross connections on paper into a PC board with winding foil patterns is another.

Have no fear ... after reading this article, you will be a veritable master of PC board design. A few easy to get household items will turn you into a seasoned veteran in the war against point-to-point wiring. Put away your vectorboard and take up your copper laminate and etching

solution!

With the method usually used for PC board construction, four main steps are used.

1. Layout and design work on paper.
2. Transfer of paper design to a suitable template.
3. Application of resist to the board in conjunction with the template.
4. Etching the board.

Using the method described here, the first two steps are combined, the third is eliminated and the fourth is carried out in the normal manner.

The biggest problem I had was the design layout of components and the routing of the foil connections between them. One day while trying to create a layout for a 10/15 meter preamp, I noticed a vase of artificial flowers. The ends of the flowers were stuck in a piece of styrofoam sitting at the bottom of the vase to hold them upright and in place. In my frustration of trying to design the preamp layout I mumbled to myself, "I wish I could just stick components on the board like that" .... grumble, grumble ... one nanosecond later lights started flashing around my head and sirens began to wail. "EUREKA!" I shouted, "I HAVE IT!"

Thundering my way up

the stairs, past the frightened and cowering dog, I ran into my room and dug out a small piece of styrofoam. I cradled it carefully in my hands and placed it reverently on my work table, for it was the salvation of my patience and sanity.

After thanking the gods for my redemption from mental anguish and after banging my head three times on the floor in the general direction of Mecca, I began to perfect a method for simple and inexpensive PC board design and construction.

The idea was this: Why spend hours measuring the distance between component leads, drawing diagrams and layouts on paper, carefully cutting out templates and then applying etch-resist when there is an easier way?

All you need to make a PC board of any complexity and of any size are the following easy to get items:

1. One piece of styrofoam.
2. One roll of wide masking tape.
3. A few felt tip pens.
4. One used razor blade.

The styrofoam can be of any size but a piece about 6" by 12" can be used for all your projects. The felt pens must be able to write on masking tape and should be of different widths.

If you have all the items mentioned, you are ready to

design your PC board layout.

The first step is to take the PC board you are planning to use and place it on top of the styrofoam. Mark around the edges of the board with a felt tip pen so you have an outline of the board on the styrofoam.

Next take the masking tape and put it right on top of the styrofoam to fill in the outline of the board completely. Now stick the leads of all your major components through the tape and into the foam in the positions you want them to be on the board. This will hold them in place and now you can find convenient locations for your capacitors, resistors, etc.

With all the components sitting there in front of you just as they would be on the actual PC board, draw the foil connection patterns with your felt tip pens from component to component as you wish them to be on the actual PC board. Make sure you draw the foil connections the exact width you want them to be on the actual PC board; this is important because it eliminates making a template, as we'll see later.

With this method you can even make those fancy little round foil lands with the hole in the center that professional PC board designers use. Just whirl your felt pen around

# C & S MARKETING ASSOCIATES



If you are PLANNING TO PURCHASE A NEW TRANSCEIVER, why not GET THE BEST? You should give serious consideration to the new Hy-Gain 3750 Transceiver. With it you can expect superior performance that will surpass the demands of even the most experienced amateur.

The advantages of the new 3750 are many. For starters, more operating frequencies to choose from means more operating fun for the serious radio amateur. With 160 meters fast becoming the favorite of more operators each day, the addition of this band to your shack can only add to your enjoyment of your favorite hobby. Not only more frequencies, but also the greater accuracy of the digital readout make operating the 3750 a real pleasure. With readout to 100 Hz and WWV receive for calibration, you always know exactly where you are. As an added bonus, there is also a memory circuit which will allow you to return to an interesting spot on the band without writing down the frequency. With the optional 3855 VFO you can split TX/RX frequencies for operating DX. The 3855 also has provision for adding up to seven crystal controlled channels.

The 3750 is a pleasure to operate, but it is a dream to listen to. You will never again be annoyed by the roar of a cooling fan. The three tubes are cooled by a fan that is not only whisper quiet, but is also standard equipment. And, you can forget about image and spurious response problems thanks to the narrow band SSB crystal filter in the first i-f. Intermodulation and cross modulation performance are enhanced through the use of dual-gate MOS FETs at all critical rf amplifier and mixer stages. To help cut down the strength of the OM using the California kW, a handy rf attenuator is included. For CW operators, the selectivity is -6 dB @ 400 Hz and -66 dB @ 1.8 kHz.

The same high standard of performance is found in the Transmitter section! Average power output is kept at a high level through the use of an audio compression circuit and automatic level control. The microphone compression circuit gives 20 dB of audio compression and the ALC provides an additional 20 dB to prevent "flat topping" and transmitted adjacent channel splatter. To help reduce the QRN from the neighbors over the subject of TVI, a low pass filter is included in the output stage. Speaking of the output stage, it uses two specially developed S-2002 tubes for high peak power output with maximum plate dissipation characteristics. The VFO section of the 3750 delivers an exceptionally stable signal. Drift is less than 500 Hz from turn-on to 10 minutes and less than 100 Hz after a 30 minute warm-up.

Other features include a noise blanker, VOX, and side-tone circuits. All stages have been by-passed and tightly sealed to improve performance and reduce internally generated "birdies" to the minimum possible.

The advanced features of the HY-GAIN 3750 make it quite a bargain at only \$1895.00. For more information, or to place an order, call TOLL FREE 800-251-6771. In Tennessee, call 800-262-6706. Master Charge and BankAmericard are welcome.

## C & S MARKETING ASSOCIATES

*P.O. Box 165*

*Algood TN 38501*

*Call Toll Free 800-251-6771*

*In Tennessee call 800-262-6706*

the component lead where it meets the tape. This creates a circle around the lead and leaves a portion in the center that is unmarked which you can use as a guide for your drill bit when you drill the holes in the board. If you wish, you may make extra wide patterns for the common or ground connection on the board, or extra wide bus bar connections simply by using a felt pen with a wider tip.

If you goof someplace in the process of making the foil patterns on the tape, either remove the tape and parts from the foam and put down fresh tape exactly as you did earlier or remove the parts from the tape and then use a damp cloth to wipe off the ink from the tape and start over.

Once you have finished your layout on the foam and the foil patterns on the tape are as you wish them to be, remove all the parts you had

put into the foam and carefully peel off the masking tape. Now place this strip of tape on the foil side of your PC board. If some small pieces of styrofoam stick to the tape when you peel it off, just use your fingernail or razor blade to remove them.

Now use the razor blade to cut away all portions of the tape which are *not* colored. These portions will be etched away when you put the board in the etching solution. The tape that is left on the board is your foil pattern. This tape will function the same as the etch-resist coating you normally would use.

Remember, there are no templates to make. Just cut away the portions of the tape you wish to be etched. Simple, isn't it?

If everything has gone according to schedule, you have before your very eyes the semi-finished product of your labors. All that remains to be done is to put the board

in the etching solution and drill the holes for the components in the usual manner.

As I am sure you will realize, this method of design and construction has some very appealing points in its favor:

#### *Inexpensive*

There is no need to spend hard-earned money on etch-resist or preformed stick-on lands and connections.

#### *Easy*

The layout of components and connections is right in front of you to better visualize exactly how foil connections *should* be made.

#### *Flexible*

This method can be used for all your projects no matter how complex or simple they may be. If you decide to modify or delete any portions of your circuit, the changes can be made more quickly and easily using this method than the normal

design and construction method.

#### *Availability of Parts*

Every piece of material needed should be lying around your house someplace. If you find you don't have a needed item and you must buy it, it can be found at a drug store, hobby shop or department store for a cheap price. Perhaps you don't have any styrofoam — well, try digging through the boxes and crates lying around outside in the back of any drug store or department store. The foam is used as a packing filler and shock absorber for goods during shipment. If you work it right, the cash outlay for all the things needed will be exactly zero.

After reading this article you've got *no* excuse to moan and complain about the supposed complexity and cost of making PC boards. So go and dig out your favorite schematic and get to work! ■

## Looking West

from page 13

John: "That's unfortunate. We've been able to pretty much stem that in

my area. In fact, I don't think we have any bananas on any of our repeaters at the present time. We have had some pretty good cases and in one in



"Big Jim" Davis WBQSP/6 of KHJ radio listens intently to John's program.

particular they were able to break up a whole ring. We got the local police in on it; the guy's basement was loaded with all kinds of land mobiles, CBs, amateur and everything else. But the amateurs have pretty much done the investigatory work and have been very successful at it. This story that I heard at dinner tonight, about the Happy Fliers, now there's a real contribution that amateurs are making to technology, so maybe the solution lies right within the amateur community." (Note: The Happy Fliers, a group of flying amateurs, have developed some rather interesting DF equipment and techniques for its use. More on this in future LW.)

We could go on for pages and pages, but as usual we are well past the normal length of this column. I sincerely hope though that through our coverage these past two months, you all have gained a bit of insight into John, his ideas, and his feelings about the service he administers. There is no doubt in my mind, after getting a chance to meet him and hear first hand what he has to say, that he not only genuinely loves amateur radio, but also has a heck of a lot of respect for each of us within the amateur service. He trusts us, trusts in our integrity as individuals to abide by the rules and regulations and to use that special inner respect that seems to be the intangible aspect of bearing an amateur call sign to influence others properly in that same direction. Above all, he feels, as I do, that your

individual and collective obligation to be "thinking forward-looking amateurs" never ends; looking toward the future and planning for it is just as important an obligation for you and me as properly maintaining and operating our stations.

In the end, it comes down to this: If we as amateurs sincerely want fewer regulations, then we must each be prepared to assume the burden of responsibility that this entails. We must each work toward being model citizens within the amateur community and provide, on an organized level, a constant flow of ongoing feedback to the Commission and John so that he can thereby know exactly what's happening where, how well things are going, and what can be done to improve things. One suggestion I might make is to put John on your radio club newsletter mailing list, as this is a vital source of local level information. Another is to always offer alternative ideas when commenting on pending dockets. Saying you do not like something is all well and good; but from where in heaven are John and his associates within the Amateur and Citizens Division supposed to find the proper answer unless it comes from you? For indeed, it is you who are the true future of amateur radio. It's a responsibility that goes far beyond that piece of paper you proudly exhibit on the wall. Your license is more than just a badge of pride, it's a badge of responsibility!



**TS-820**  
*Specifications*

FREQUENCY RANGE: 1.8-29.7 MHz  
(160 - 10 meters)  
MODES: USB, LSB, CW, FSK  
INPUT POWER: 200W PEP on SSB  
160 W DC on CW  
100 W DC on FSK  
ANTENNA IMPEDANCE: 50-75 ohms, unbalanced  
CARRIER SUPPRESSION: Better than 40 dB  
SIDE BAND SUPPRESSION: Better than 50 dB  
SPURIOUS RADIATION: Greater than -60 dB  
(Harmonics more than -40 dB)  
RECEIVER SENSITIVITY: Better than 0.25uV  
RECEIVER SELECTIVITY:  
SSB 2.4 kHz (-6 dB)  
4.4 kHz (-60 dB)  
CW\* 0.5 kHz (-6 dB)  
1.8 kHz (-60 dB)  
\*(with optional CW filter installed)  
IMAGE RATIO: 160-15 meters: Better than 60 dB  
10 meters: Better than 50 dB  
IF REJECTION: Better than 80 dB  
POWER REQUIREMENTS: 120/220 VAC,  
50/60 Hz, 13.8 VDC (with optional  
DS-1A DC-DC converter)  
POWER CONSUMPTION: Transmit: 280 Watts  
Receive: 26 Watts (heaters off)  
DIMENSIONS: 13-1/8" W x 5" H  
x 13-3/16" D  
WEIGHT: 35.2 lbs (16 kg)

Kenwood's TS-520 has sold itself to thousands of amateurs the world over.

The value of its features and specifications are obvious. But just as important is the kind of quality that Kenwood builds in. Hundreds of testimonials on the air attest to its performance and dependability. You probably have heard of some of the same glowing praise.

The TS-520 operates SSB and CW on 80 through 10 meters and features built-in AC and 12VDC power supply.



**TS-520**  
*Specifications*

MODES: USB, LSB, CW  
POWER: 200 watts PEP input on SSB, 160 watts DC input on CW  
ANTENNA IMPEDANCE: 50-75 Ohms, unbalanced  
CARRIER SUPPRESSION: Better than -45 dB  
UNWANTED SIDE BAND SUPPRESSION: Better than -40 dB

HARMONIC RADIATION: Better than -40 dB  
AF RESPONSE: 400 to 2600 Hz (-6 dB)  
AUDIO INPUT SENSITIVITY: 0.25µV for 10 dB (S+N)/N  
SELECTIVITY: SSB 2.4 kHz (-6 dB), 4.4 kHz (-60 dB) CW 0.5 kHz (-6 dB), 1.5 kHz (-60 dB) (with accessory filter)  
FREQUENCY STABILITY: 100 Hz per 30 minutes after warmup

IMAGE RATIO: Better than 50 dB  
IF REJECTION: Better than 50 dB  
TUBE & SEMICONDUCTOR COMPLEMENT: 3 tubes (2 x 6146B, 12BY7A), 1 IC, 18 FET, 44 transistors, 84 diodes  
DIMENSIONS: 13.1" W x 5.9" H x 13.2" D  
WEIGHT: 35.2 lbs.



**KENWOOD'S TS-700A** finally fulfills the promise of 2-meters... more channels, more versatility, tunable VFO, SSB-CW and, best of all, the type of quality that has placed the Kenwood name out front.

**KLAUS RADIO Inc.**  
8400 N. Pioneer Parkway, Peoria IL 61614, Phone 309-691-4840

# Hamming by Laser

-- modulating them isn't easy

**T**hrough a stroke of luck, my professor loaned me a Spectra Physics helium-neon one milliwatt laser for two weeks — an ideal opportunity for a ham to get hands-on experience with the old-fashioned but up-and-coming communication medium, "optics."

Lasers have found many applications in science and industry, from measuring stress, to 3D imaging, to distance measuring. It is not novel to send voice (or other messages) over a laser or other light beam, but my two week experiment might provide food for thought for other ham projects.

## Fundamentals

Helium-neon lasers, for all practical purposes, put out only a single color of light (6328 Angstroms). It is this monochromaticity (single color) which allows differential measurement of small distances, by additive or destructive addition of light waves, as well as 3D imaging (holography). They also put out an extremely narrow beam of light, in comparison to that of a flashlight. So narrow, in fact, that even this inexpensive unit diverges to only 6" in diameter at 400 feet, or 6.4' at 1 mile. That is a beamwidth of  $.069^\circ$  (4.1

minutes). That is a much narrower beamwidth than my 16 element 2 meter collinear. In fact, it is so narrow that you cannot possibly hold it steady enough in hand to use it to communicate 1 mile. You must use a tripod or other adjustable rigid mount to perform almost any experiment with it.

One milliwatt does not seem like much power output. Compare that with a flashlamp: 6 volts x .25 Amps x .10 efficiency = 150 mW output. Yet at 400 feet (the length of my street), the laser appears much brighter because of its narrow beam. The laser incident energy is  $1 \text{ mW}/182 \text{ cm}^2 = .0055 \text{ mW}/\text{cm}^2$ , while the flashlight energy (a very good one) is  $150 \text{ mW}/291863 \text{ cm}^2 = .0055 \text{ mW}/\text{cm}^2$ . The laser is 10 times brighter at 400 feet. Danger? Well, 1 milliwatt is completely safe impinging on your hands or fingers. But don't look directly into the beam from closer than  $\frac{1}{2}$  mile. Concentrated laser light can and will destroy the visual acuity of the retina. Also, be careful to avoid looking accidentally at reflections off mirrors.

## Modulation

Now for the ham radio application. There are several ways to modulate a laser: 1)

amplitude modulation; 2) pulsedwidth modulation; 3) polarization modulation;<sup>1</sup> and 4) spatial modulation (angular deflection). Let's examine each.

Amplitude modulation of the laser is possible by varying the current through the laser tube. Modulation is adequately linear over a current range of 1 mA to 5 mA.<sup>2</sup> This current modulation is accomplished by modulating the 6000 V supply<sup>2</sup> with a high voltage tube.

Pulsedwidth modulation of the laser may be accomplished by switching the supply voltage to the laser tube on and off. If done at a constant frequency, with the "on time" duration varied proportionally to the modulating voltage, 100% linear modulation is possible. In addition, for long distance communication, an i-f strip amplifier tuned to the repetition rate of the on/off switching can be used to amplify the output of a photomultiplier<sup>3</sup> to usable levels. You might cleverly choose 455 kHz as a pulse repetition rate, thus making an old transistor radio a practical i-f amplifier. Commercially available 100% modulated lasers only have an upper repetition rate limit of 100 kHz,<sup>1</sup> so 455 kHz would require customization.

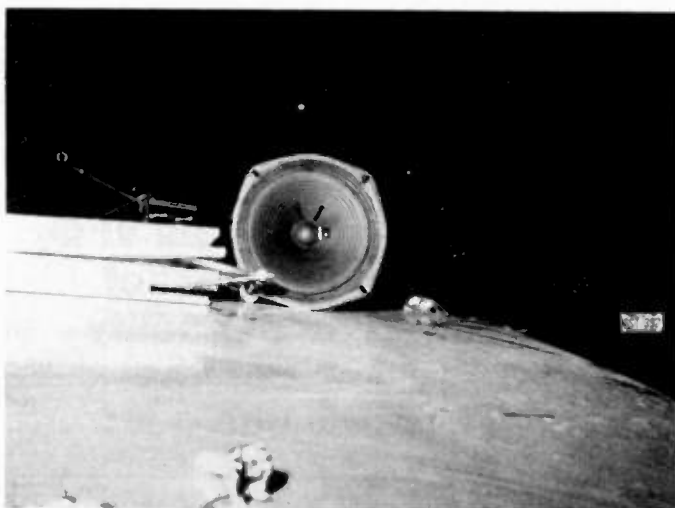

Close-up of mirror and C-clamp mounted on speaker at transmitting end. 73 Magazines are used to shim elevation of reflected light beam, which may be seen in center of mirror.



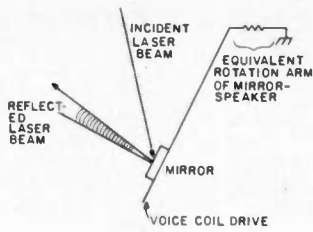

Fig. 1.

Polarization modulation can be likened to changing antenna polarization from horizontal to vertical and back, based on microphone voltage. It is accomplished with a laser by first polarizing the laser output to horizontal by a polaroid filter, and then passing the light through a Kerr cell or Pockels cell (a nitro benzene mixture between very high voltage plates). The Pockels cell rotates the light polarization through an angle proportional to the voltage applied. At the receiving end, the light is passed through a second polaroid filter, and thus becomes amplitude modulated proportional to the speech input. Differential reception is possible to cancel stray light noise by using two polaroid filters at the receiver, one horizontal and one vertical, and subtracting the light energy of one from the other. Note that differential reception is desirable to cancel the effects of lights run from 60 Hz power, many

of which exhibit nearly 100% 120 Hz modulation. The differential signal recovered is nearly constant across the beamwidth.

Spatial modulation, or angular deflection, means simply to deflect the beam through an angle proportional to the modulating voltage, preferably in the horizontal plane. For deflection angles less than the beamwidth (in this case, less than  $.069^\circ$ ), the light energy at the left and right edges of the beam is amplitude modulated. Again, differential reception is possible by subtracting left edge light energy from right edge light energy. The signal recovered is proportional to detector separation relative to the edges of the undeflected beam, and to the ratio of modulated laser light energy to ambient illumination.

#### Practical Application

Tearing into the university's laser to modulate the 6000 V supply was undesirable. This ruled out internal AM and PWM. External modulation by Pockels

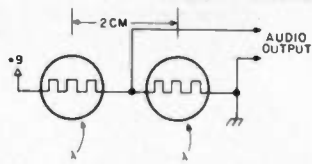
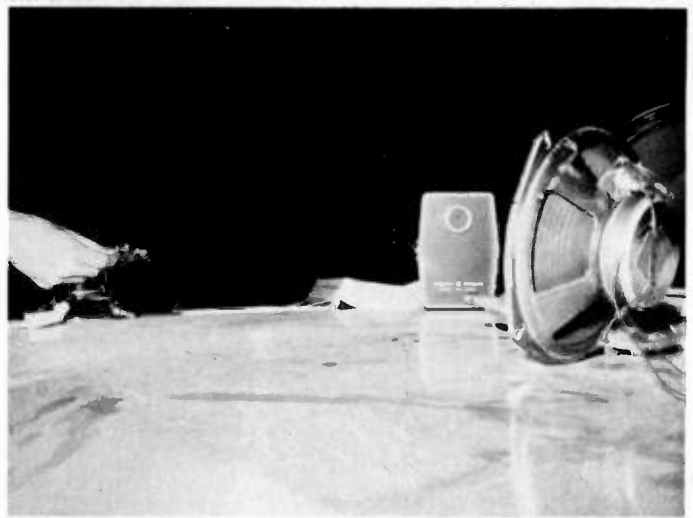

Fig. 2.



Close-up of laser, mirrored speaker, and receiver system.

cells and Kerr cells, in addition to costing more, requires upwards of 1000 volts for  $90^\circ$  polarity rotation. That left spatial modulation. Commercial mirrors with magnetic drives were available. But, with ham radio zeal, I decided to glue a small 1 cm by 1 cm mirror near the voice coil of a 6" 5 Watt speaker with a 20 ounce ceramic magnet, thus ensuring minimal spectral distortion due to the additional mass of the mirror. This arrangement (Fig. 1) provided an angular rotation of the mirror surface which was small — but appropriate for reasonable audio power levels (50 mW).

Thus the mirror undergoes a small rotation for voice coil displacement. The audio

power applied is adjusted to deflect the beam approximately half the beamwidth on maximum excursions.

At the receiver I utilized two matched  $\frac{1}{4}$ " cadmium sulfide photocells in series with 2 cm horizontal displacement to achieve a differential (hum canceling) photodetector (Fig. 2). Thus, if the detector connected to the +V receives more light, output voltage rises. If the grounded detector receives more light, output voltage falls. If both receive increasing or decreasing amounts of light, output remains constant.

This detector pair was soldered to a handy 4 transistor high impedance input audio amplifier (see Fig. 3). A similar one was used to drive

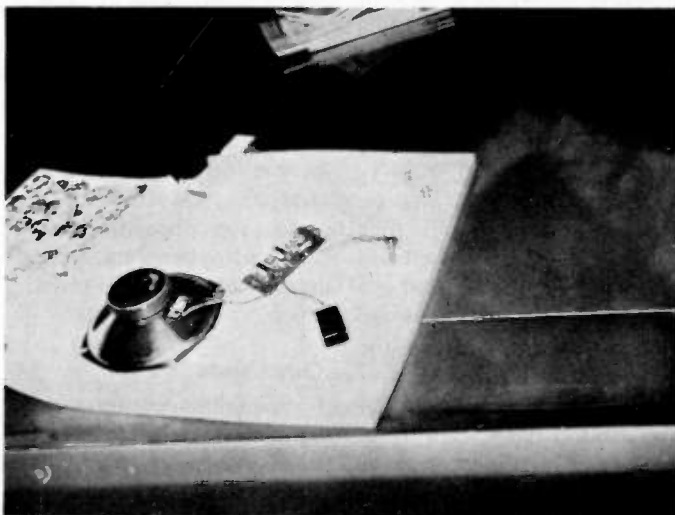
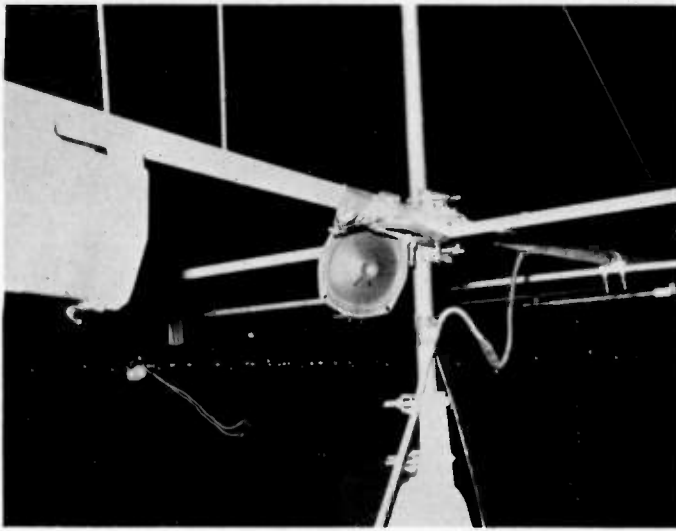

Photo of receiver showing four transistor audio amplifier, and cadmium sulphide photocells at input end. Loudspeaker, battery, and volume control may also be seen.



Laser light viewed at night from 400 feet down the street. Other lights are street lights.



Close-up of laser, speaker, and C-clamp mounted on 6m yagi.

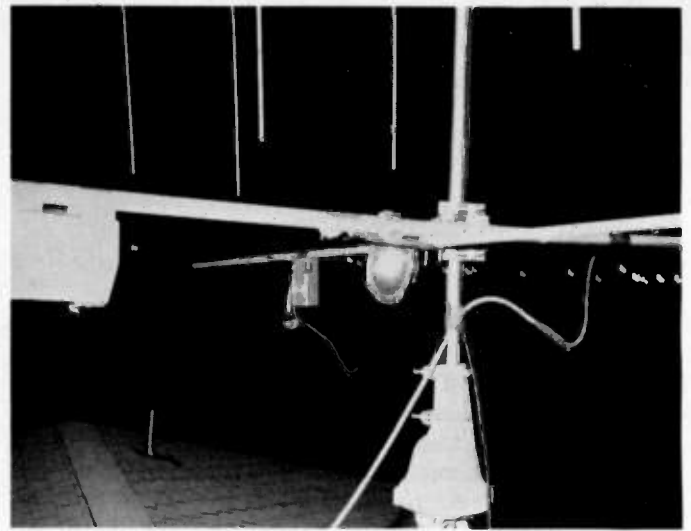

Laser and speaker mounted on 6m yagi, with reflected laser light showing clearly in center of speaker.

the mirror loudspeaker, with microphone input.

Aiming the laser to bounce off the mirror and go where you intend is the most difficult and time-consuming aspect of the project. A chemistry lab flask holder would be most helpful for holding the speaker, but a series of C-clamps and magazines served to shim it into position. A tripod would be quite useful for the laser, but some 73 Magazines were adequate to shim it into position for a 400' test. Having carefully aligned the beam down the sidewalk (at night) with constant elevation, a QSO was conducted between a 2m

HT and the laser. The recovered audio was excellent beyond the distance where the beamwidth fully covered both detector cells, out to the full length of the street (410 feet).

I next attempted to transmit the laser light to a nearby friend's home 1 mile away. This was accomplished by taping the laser, speaker and clamp to my 6 meter yagi, and rotating the antenna until the reflected beam pointed in the correct direction. Then, by standing on the roof and pushing up/down/back and forth on the element to which the C-clamp was taped, and listening to .94 feedback,

I was able to position the reflected laser beam in my friend's direction. Generally speaking, 1/4" of movement on the end of the yagi element moved the laser 50 feet at his end. Unfortunately, he was completely unable to detect audio on the laser beam with the photocell arrangement. There were clearly two problems: 1) the laser needed a hard mount, with the ability to move the receiving photocells to the beam center; and 2) the laser light needed to be reconcentrated for the cadmium sulfide photocells to be adequately responsive.

In order to reconcentrate the laser light, I purchased 2 Fresnel lenses with a 1000:1 concentration ratio, and mounted them in a cardboard frame. The cardboard frame also mounts the cadmium sulfide photocells at the focus of the concentration lenses, the audio amplifier and the loudspeaker.

We made special arrangements to use the 1/2 mile taxiway at the Falcon Field airport one night, so that the laser could be hardmounted and left pointing down the taxiway, while the receiver was moved to the center of the beam. Again, .94 feedback was used to achieve approximate aiming of the light beam. Elevation control of the light beam was most critical in this instance, since 5 feet too high would be

unreachable with the receiver, and 5 feet too low would move the beam halfway down the taxiway. To achieve this critical elevation adjustment, a 3" x 5" card was slowly slid between the pages of the phone book supporting the speaker and C-clamp, until the correct elevation was reported from the receiving end. Now the receiving system with Fresnel concentrators was moved into position in the beam. The audio was awful. Examination of the beam, viewed upon my tee shirt, revealed considerable fluctuation in the beam due to air currents rising from the pavement. Apparently, the rising air currents created rarefactions of small enough diameter to effect one side of the differential detector, but not both simultaneously. Unaccountably, the audio quality of the output was best, and adequate, when one or the other of the photodetectors was covered, thus using the photodetector in the photo-voltaic mode instead of the photo-resistive mode.

### Conclusions

Spatial modulation of laser light must be considered the least expensive modulation technique through atmosphere. The apparent upper range limit with unsophisticated reception techniques is one mile at night, and con-

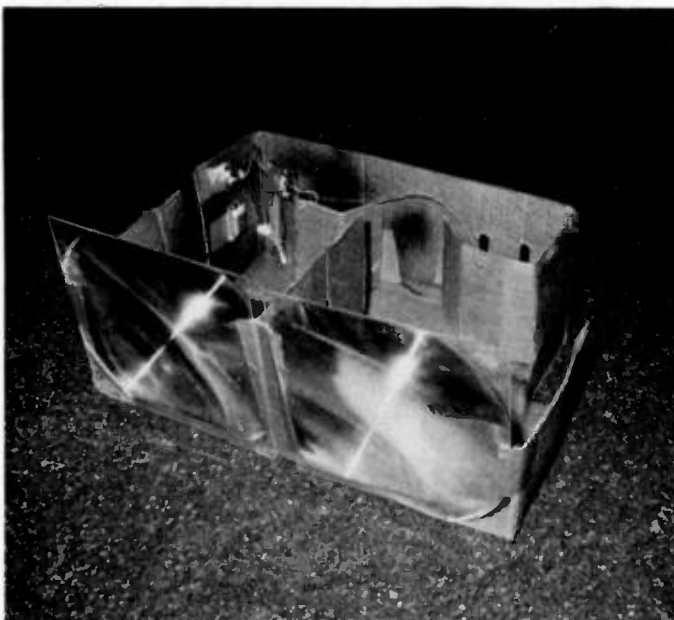

Fresnel concentrator in cardboard frame, showing photocells, audio amp, and loudspeaker.

# SOLVE YOUR TEST CONNECTION PROBLEMS WITH EZ-HOOK

E-Z Hooks have been designed and field tested throughout the industry to save time and money in commercial electronic production and servicing. The spring-loaded hook attaches firmly, yet so gently it will not damage component — frees hands while testing. Durably constructed and fully insulated to a single contact point assuring true readings. Meets exacting laboratory and space age computer technology requirements. **AVAILABLE IN 10 RETNA COLORS:** Red, black, blue, green, orange, yellow, white, violet, brown or gray.

**Jumper with X-100W Mini Hooks**

Order No.	Length	Price
204-12W*	12"	\$1.60
204-24W*	24"	1.60

Specify color.

**EXTRA LONG MINI HOOK**

ORDER XL-1

XL-1 Mini Hook (5.0" long) combines all the proven features of the X100W with an extra long body. It will make safe, short-free test connections in card racks and through deep wiring nest up to 4". \$1.25 ea.

**Jumper with X-Micro Hook to Banana Plug**

Order No.	Length	Price
201XM*	32"	\$1.40

Specify color.

**MINI HOOK**

X100W Mini Hook (2.25" long) combines rugged construction, miniature size and Finger-safe Hypo Action for all the best test connections. Hook is large enough for component leads, yet small enough to get into tight places. . . . \$1.75 ea.

Specify color. ORDER X100W

**JUMPER WITH XL-1 MINI HOOKS**

Order No.	Length	Price
204XL1-12	12"	\$2.80
204XL1-24	24"	2.80

Specify color.

**JUMPER, XL-1 MINI HOOK TO STACKING BANANA PLUG**

Order No.	Length	Price
201XL1*	32"	\$1.95

Specify color. \*Square hole tip for hooking laterally to leads or vertically over square wire-wrap pins.

**COMPLETE SET \$7.95**  
**ORDER YOUR XMS MICRO HOOK SET TODAY!** (Includes 1 ea. red, black, blue, green, orange, yellow, white, brown, violet and gray Micro Hook) At this low price you can afford more than one set.

### CONTINENTAL SPECIALTIES

#### PROTO BOARDS

Build & test circuits as fast as you think!

PB6	6 IC cap breadboard kit	\$16.95
PB100	10 IC cap breadboard kit	19.95
PB101	10 14-DIP cap, 5-way post, 940 solderless tie points, 8.8 x 4.5"	29.95
PB102	12 14-DIP cap, like PB101 with 1,240 tie points, 7.0 x 4.5"	39.95
PB103	24 14-DIP cap, 4.5-way post, 2,250 tie points, 6.0 x 9.0"	59.95
PB104	32 14-DIP cap., 3,060 solderless tie points, 8.0 x 9.76"	79.95

#### LOGIC MONITOR 1

Simultaneously displays static and dynamic logic states of DTL, TTL, HTL or CMOS DIP ICs. Pocket size. \$74.95

#### LOGIC MONITOR 2

Displays static and dynamic states of digital ICs such as C-MOS, HTL, TTL, DTL & RTL. Selectable threshold control. \$124.95

#### LOGIC PROBE LP-1

Compact, circuit-powered multifunction logic probe. Multi-family compatibility. DTL/TTL/HTL/CMOS. Traces logic levels and outputs through digital circuitry. \$44.95

#### SOCKETS & BUS STRIPS

Plug-in, wire, test, modify or expand without patch cords or solder. Snap together to form breadboard needed.

PN/Description	Term's	Price
QT596 Socket	118	\$12.50
QT598 Bus	20	2.80
QT475 Socket	94	10.00
QT478 Bus	16	2.26
QT355 Socket	70	8.50
QT358 Bus	12	2.00
QT185 Socket	36	4.75
QT128 Socket	24	3.75
QT85 Socket	16	3.25
QT75 Socket	14	3.00

#### PROTO BOARDS

With built-in regulated short-proof power supplies

PB203	5V, 1 amp regulated power supply	\$ 75.00
PB203A	5V, 1 amp and ±15V, ½ amp regulated power supply	120.00

#### DESIGN MATES

**DESIGN MATE 1 . . . . . CIRCUIT DESIGNER**  
 With built-in, regulated, metered power supply to design unusual circuits fast. . . . . \$54.95

**DESIGN MATE 2 . . . . . FUNCTION GENERATOR**  
 Complements Design Mate 1. Produces clean, accurate wave forms with variable amplitude and frequency controls. \$69.95

**DESIGN MATE 3 . . . . . R/C BRIDGE**  
 Saves design time by measuring and selecting capacitors and resistors to better than 5% instantly! . . . . . \$59.95

**DESIGN MATE 4 . . . . . MULTIPURPOSE PULSE GENERATOR**  
 With the precision and versatility of a laboratory instrument, ideal wherever a source of clean, fast output pulses compatible with virtually all logic families and discrete circuits is needed. . . . . \$124.95

#### BREADBOARD JUMPER WIRE KIT

Each kit contains 360 wires cut to 14 different lengths from 0.1" to 5.0". Each wire is stripped and leads are bent 90° for easy insertion. Wire length is classified by color coding. All wire is solid tinned 22 gauge with PVC insulation. The wires come packed in a convenient plastic box. BK-1 . . . . . \$9.95

#### CARBON FILM RESISTORS (5%)

Only in Multiples of 100 pcs per value (ohms)  
 %W. . . \$1.69 per 100 • %W. . . \$1.79 per 100

10	33	100	330	1.0K	3.3K	10K	33K	100K	330K	1.0M	3.3M
11	36	110	360	1.1K	3.6K	11K	36K	110K	360K	1.1M	3.6M
12	39	120	390	1.2K	3.9K	12K	39K	120K	390K	1.2M	3.9M
13	43	130	430	1.3K	4.3K	13K	43K	130K	430K	1.3M	4.3M
15	47	150	470	1.5K	4.7K	15K	47K	150K	470K	1.5M	4.7M
16	51	160	510	1.6K	5.1K	16K	51K	160K	510K	1.6M	5.1M
18	56	180	560	1.8K	5.6K	18K	56K	180K	560K	1.8M	5.6M
20	62	200	620	2.0K	6.2K	20K	62K	200K	620K	2.0M	6.2M
22	68	220	680	2.2K	6.8K	22K	68K	220K	680K	2.2M	6.8M
24	75	240	750	2.4K	7.5K	24K	75K	240K	750K	2.4M	7.5M
27	82	270	820	2.7K	8.2K	27K	82K	270K	820K	2.7M	8.2M
30	91	300	910	3.0K	9.1K	30K	91K	300K	910K	3.0M	9.1M

## NEW IN STOCK PLESSEY

LOW COST INTEGRATED CIRCUITS FOR RADIO COMMUNICATIONS

Plessey SL1600 Radio Communications Circuits are used in all types of military, commercial and amateur radio systems. These same devices are now available in economical, easy-to-use plastic minidip packages. Now you can afford to make extensive use of Plessey circuits in the design of synchrodyne, superhet, SSB and multimode receivers, transmitters and transceivers.

114 PAGE APPLICATIONS MANUAL  
 Contains Circuit Data, System Design and Technical Data for SL 1600 series integrated circuits . . . \$1.95

**A TYPICAL TRANSCEIVER SYSTEM**

SSB transmitters and receivers of the same type contain many identical components. Therefore, by a little signal switching, it is possible to make one set of filters and SL1600 devices perform alternately as a transmitter and as a receiver — i.e. as a transceiver. This, of course, results in a real cost savings, both on SL1600 devices (which in any case are relatively inexpensive) and on filters (which are not!). These points are illustrated by the Figure below, a typical SSB transceiver, and also in Applications Manual Appendices B and D.

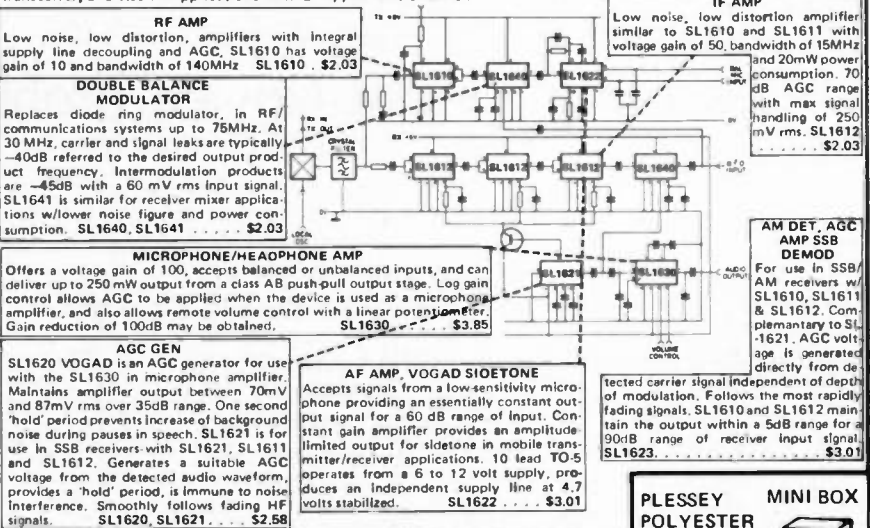

#### Digital Auto Clock Build-It-Yourself Kit

A brand new solid state Technology Kit from FAIRCHILD

AVAILABLE NOW — \$40.00 COMPLETE

IC SOCKETS		TO-5 SOCKETS	
SOLDERTIN DIP		TEFLON	
1-24 25 100		1-24 25 100	
WIRE-WRAP GOLD DIP			
PIN	1-24 25 100	14 25 22 20	3 PIN .55 EA
14	45 41 37	16 28 25 23	8 PIN 1.10 EA
16	54 49 44	18 34 31 28	10 PIN 1.40 EA
		22 37 34 35	8 PIN 1.10 EA
		24 47 43 40	10 PIN 1.40 EA
		28 88 80 70	
		14 .34 .31 .28	36 1.09 .98 .89
		16 .37 .34 .31	40 1.24 1.12 .90
			PLASTIC TO-5
			8 PIN 40 EA

#### POWER SUPPLIES AOTECH

Model No.	Vdc	Amps	
APS5-3	5	3.0	
APS12-1.6	12	1.6	
APS15-1.5	15	1.5	\$30.95
APS24-1	24	1.0	
APS28-0.8	28	0.8	
APS5-6	5	6	
APS12-4	12	4	
APS15-3	15	3	\$50.40
APS24-2.2	24	2.2	
APS28-2	28	2	
APS10-8	10	8	
APS12-7	12	7	
APS15-6	15	6	\$71.20
APS24-5	24	5	
APS28-4	28	4	

#### PLESSEY MINI BOX POLYESTER (CAPACITOR)

MF	V	\$	MF	V	\$
.001	1000	.14	.039	280	.16
.0012	1000	.14	.047	280	.16
.0016	1000	.14	.068	280	.16
.0018	1000	.14	.068	280	.15
.0022	1000	.14	.082	280	.17
.0023	1000	.14	.1	100	.17
.0023	1000	.14	.12	100	.18
.0029	630	.14	.18	100	.20
.0047	630	.14	.18	100	.21
.0056	830	.14	.22	100	.23
.0058	630	.14	.27	100	.26
.0062	630	.14	.33	100	.30
.01	630	.14	.39	100	.33
.012	630	.14	.47	100	.38
.015	400	.18	.66	100	.44
.018	400	.18	.68	100	.47
.022	400	.18	.82	100	.54
.027	400	.15	1.0	100	.64
.033	250	.18			

## ANCRONA

Minimum order \$10.00. Add \$1.00 to cover postage and handling. California residents add 6% sales tax. Mail Order — Send Check or money order to: P.O. Box 2208M Culver City, CA 90230 • Phone Order — Call: (213) 641-4064. COD, Master Charge and BankAmericard welcomed. (Stores do not accept mail or phone orders.)

CALIFORNIA ANCRONA 11080 Jefferson Blvd. Culver City, CA 90230 (213) 390-3595	CALIFORNIA ANCRONA 1300 E. Edinger Ave. Santa Ana, CA 92705 (714) 547-8424	ARIZONA ANCRONA 4518 E. Broadway Tucson, AZ 85711 (602) 881-2348	OREGON ANCRONA 1125 N.E. 82nd Ave. Portland, OR 97220 (503) 254-5541	GEORGIA ANCRONA 3330 Piedmont Rd. NE Atlanta, GA 30305 (404) 261-7100	CANADA, B.C. ANCRONA 5656 Fraser St. Vancouver, BC V5W 2Z4 (604) 324-0505
--	---	---	---	--	--



# RF POWER TRANSISTORS

PRICE FIG P<sub>D</sub> MAX POUTMIN PIN EFFICIENCY REMARKS  
@ 250C @ 2 GHz @ 2 GHz

\$4.95	A	3.5W	1.0W	310mW	30%	Sim. to RCA 2N5470
\$5.95	B	8.7W	2.5W	300mW	33%	Sim. to RCA TA8407
\$6.95	B	21W	5.5W	1.25W	33%	Sim. to RCA 2N6269
\$7.95	B	29W	7.5W	1.5W	33%	Factory selected part---2N6269

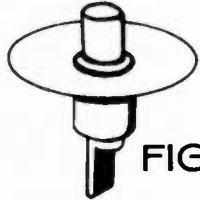

FIG A

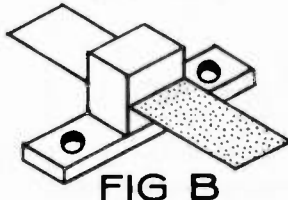

FIG B

For operation at lower frequencies gain and efficiency are higher, giving higher output power.

EIGHT POLE  
SINGLE  
THROW

TOGGLE  
ACTION

\$1.95

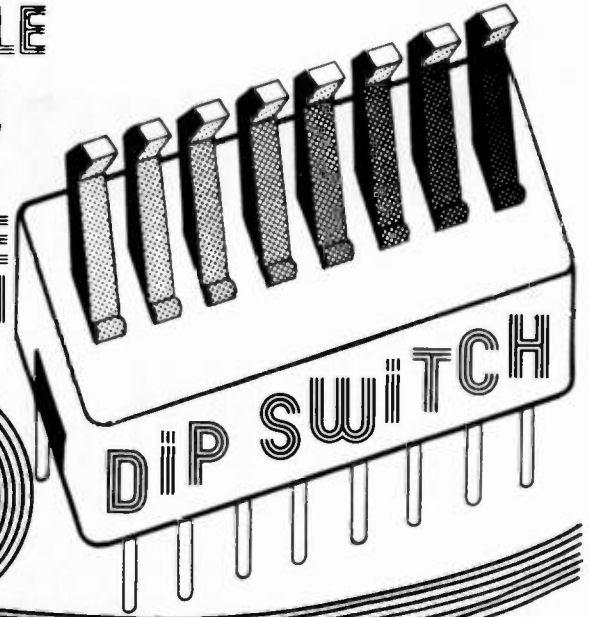

**CAPACITOR**  
10μF 450V  
**3 FOR \$1**

Now you have a choice--specify wire wrap pins (illustrated) or solder-tail with .250" row spacing. For IMSAI and Altair peripherals. Wire wrap part # S-100WW. Solder-tail part # S-100ST. COME AND GET 'EM...



100  
PIN  
EDGE  
CONNECTOR

\$5 EACH--\$22 FOR 5

factory fresh:

709 OP AMP 4/\$1

74109 flipflop 4/\$1



**SPECIAL  
SPECIAL  
SPECIAL**

**12V 8A  
POWER  
SUPPLY  
CLOSE-OUT**

One of our most popular kits is now making way for a new model. This is the last time you'll see this quality supply for \$22.50 (also include postage for 24 pounds). Better than .05V regulation; current limited at 13A; adjustable output 11-14V; short protection; RF bypassing. NOTE: LIMITED QUANTITIES.

**MINIATURE TOGGLE  
SWITCHES!  
\$1.10 EACH-  
OR 5 FOR \$5**



New, with mounting hardware. Contacts rated up to 5 Amps at 120 VAC. MADE IN U.S.A.; similar to C&K #7101.

Switches of this quality seldom show up as surplus...here's your chance.

TERMS: Orders under \$10 add 50¢ handling. No COD orders. Place Mastercharge® and BankAmericard® orders by calling 415-562-0636, 24 hours. California residents add appropriate sales tax.

**GODBOUT**  
BILL GODBOUT ELECTRONICS  
BOX 2355, OAKLAND AIRPORT, CA 94614

While you're here...circle the reader service card. Our flyer will make it worth your while!

ou goons don't ever proof  
lously manuscripts from bat  
burh or rock on  
you liard in  
I insist that you print ev  
tell Ma Bell that she shou

# LETTERS

from page 10

it a lot easier ... so count your blessings. No mobile operation is permitted here. No operation outside of a military installation. And no communication by radio with Japanese amateurs. To an avid 2m FMer like myself, it is very frustrating. (Don't know how true it is, but I'm told that the reason we can't work Japanese

stations is a story like this: It seems that some time in the '50s or '60s an American ham insulted a Japanese amateur on the air. Well, the Japanese ham happened to be the equivalent of our FCC Chief of the Amateur and Citizen's Division, and a Japanese law came into being shortly after that Japanese hams will not communicate with US hams stationed within Japan. In the spirit of cooperation, American military hams are told they will not work Japanese stations. There are no other operating restrictions on what country you work, other than the ones all American hams follow.) Incidentally, CB operation is prohibited here, so if you are coming over ... leave it home.

So it appears the only way I can get on the air here is through OSCAR. That is, just using the equipment I already have. I brought my TR-22 with me, and my friend Steve KA6XX has a Kenwood TS-520 he had already set up in the MARS station on post. If we can hear the satellites, I'm going to modify my TR-22 for CW, and have at it. It'll be my first time working OSCAR.

MARS is very active here, and a warm thank you to all the hams who ever helped MARS anywhere. I remember what I used to think of MARS in the states ... and it has taken on a new importance and vitality for me here.

I'm a Tech, and hoped to get my Conditional over here. However, with the Conditional dead, I'd have to get to Guam to take my test ... so I guess I'm stuck ... it's not all that bad - Techs have all General CW privileges here.

There are two good things ... equipment is inexpensive, and you can pick your own callsign, due to the scarcity of US hams here.

Thanks, and see to it that 73 is always around.

Mark R. Wheeler WB2ULR  
APO San Francisco

## A LOVELY COVER

Mr. Harry Goldman has managed to tell us a number of new facts about Tesla, which is quite a feat. Most of what we get is a capsule subluxation of H. Gernsback, who knew him best. Goldman's research and understanding make his article a landmark.

I have been told, long ago, that TESS-la is not the proper pronunciation, that TESH-la is. I don't know any Croatian, so I don't know this for sure.

One thing I do know: Tesla invented the roller coil tuning inductance. He shows it on a patent drawing for a wireless invention. He doesn't mention it in the patent papers, other than to say that the inductance was "variable," but the handle on the end could have turned nothing else but the cylinder itself. The lower frequency Command transmitters used this coil for antenna tuning. The WE D-156000 SSB trans-

# G.R. WHITEHOUSE & CO.

17 Newbury Drive, Amherst, N.H. 03031

## TRANSMITTING VARIABLES

- Millen 16250 dual 255pF 3kV ..... \$43.25
- Millen 16520A single 200pF 3kV ... 24.75
- Johnson 154-10 single 347pF 3 kV .. 34.60
- Johnson 154-507 Dual 200 pF k V ..46.20

## COUNTER DIAL

- Millen 10031, 0-99 turns readout with 0-100 vernier dial, ideal for transmatch, fits 1/4" shaft \$25.50

## ROTARY INDUCTORS

- Johnson Style 229-203, 28 mH ..... \$32.00

## 2KW ANTENNA TUNERS

- Millen 92200 ..... 199.00

## DUMMY LOAD WATTMETER

- B&W Model 374 1.5 kW 0-300 MHz ..... 215.00

## MINIINDUCTORS

- 3003 \$1.85
- 3011 1.90
- 3012 2.05
- 3014 1.85
- 3015 1.95
- 3016 \$2.10
- 3021 2.20
- 3025 4.45
- 3029/3905-1 5.05

## GROUNDING-GRID FILAMENT CHOKES

- B&W FC15A dual winding 15 A ..... \$24.50

- B&W FC30A twin dual winding 30 A ..... 29.00

## R-F PLATE CHOKES

- B&W 800 90 mH 2.5 kV 500 mA ..... \$8.75

- National R175A 145 mH 3 kV 800 mA ..... 10.60

We offer the identical product as the other house

at about ONE HALF THE COST  
IRON POWDER TOROIDAL CORES

Size	Price	Size	Price
T200-2	\$1.60	T50-6	\$.30
T130-2	1.15	T50-10	.30
T106-2	.75	T50-12	.30
T106-3	.75	T44-2	.25
T94-2	.50	T37-2	.25
T94-6	.50	T37-6	.25
T80-2	.40	T37-10	.25
T80-3	.40	T37-12	.25
T68-2	.35	T25-2	.20
T68-3	.35	T25-12	.20
T68-6	.35	T12-2	.15
T50-2	.30	T12-2	.15
T50-3	.30		

Ferrite Toroidal Cores	Price
FT-50-61	.35
FT-50-72	.35
FT-82-61	.40

Ferrite Shielding Beads	Price
FB-73-101	\$1.00 Doz.
FB-43-101	1.00 Doz.
FB-73-801	1.50 Doz.
FB-43-801	1.50 Doz.

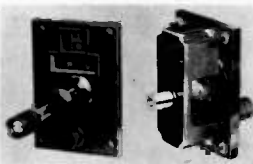
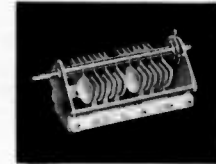

LOWEST PRICES

## JOHNSON SINGLE SECTION 800 V

- 160-102 1.5-.5 pF \$3.00
- 160-104 1.8-.8 pF 3.05
- 160-107 2.3-.14 pF 3.15
- 160-110 2.7-.19 pF 3.20
- 160-130 3.0-.32 pF 3.45

## BUTTERFLY

- 160-203 1.5-3 pF \$3.10
- 160-205 1.8-5 pF 3.30
- 160-208 2.2-8 pF 3.50
- 160-211 2.7-10 pF 4.50

## DIFFERENTIAL

- 160-303 1.5-5 pF \$3.20
- 160-305 1.8-8 pF 3.60
- 160-308 2.3-14 pF 4.00
- 160-311 2.7-19 pF 4.50

## HAMMARLUND SINGLE SECTION 1200 V

- MC 20S 3.5-.20 pF \$8.40
- MC 35S 6.0-.35 pF 8.50
- MC 50S 6.5-.50 pF 8.60
- MC 75S 8.0-.80 pF 8.80
- MC100s 8.3-100 pF 9.30
- MC140S 10-.140 pF 9.40

## MILLEN SINGLE SECTION 800 V

- 19100 8-.100 pF \$11.40
- 19140 9.7-148 pF 12.00
- 19335 15-.339 pF 17.15

## J. W. MILLER

- 1460-1 3gang 6-21 pF \$6.48
- 2101 1gang 11-105 pF 18.00

Many other values from these designs in stock.

NOW IN STOCK

Transmitting Variables - Roller Inductors - Counter Dials - Air Wound Coils - Couplings - Knobs - Receiving Variables - Toroids - R.F. Chokes - Coil Forms and more from Millen - E. F. Johnson - Barker & Williamson - JW Miller - Hammarlund. Send First Class Stamp for Flyer. Add \$2.00 to each order for shipping and handling. Prices subject to change.

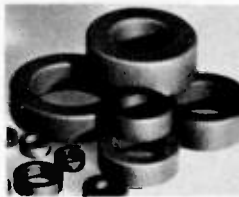

mitter used a number of them. I have seen at least five different designs in all.

What's more, the November issue has a lovely cover.

Jake Bach  
Walden NY

**TERRIBLE!**

Please pass along congratulations to Ken Cole W7IDF, for his vvy FB story "Paolo" in the November 1976 73. His prose was a delight to read, his description of wartime action fantastic! Please, more!

Contrast that with "See the World and Get Paid" by Hargett in the same issue. What a thudding bore. That article would definitely keep me from looking into the Merchant Marine. Terrible.

Joe Koziol W1FLX  
Pittsfield MA

Maybe we'll make a regular column for the Merchant Marine. — Wayne.

**KUOOS TO MESHNA**

I built the Keycoder I described in the July '76 issue of 73 and it works as advertised. Kudos to John Meshna & Co. for his excellent service in providing key components.

Wonder if any other builders have experienced EMI problems on 20 meters and above with the unit. Flawless operation on 40m; however, on 20m and above, keyer latches up on most alphanumeric due to proximity of keyer to rf from my Swan 500CX.

Short of shielding the entire keyer with aluminum foil or the like, wonder if other builders have suggestions on EMI protection for the timer and/or keying ICs.

Keep up the good work.

E.V. Shaparenko W6LQP  
255 S. Rengstorff  
Mountain View CA 94040

**THE GRIPER**

In May 1976, I subscribed to 73 Magazine because of your I/O section and the basic, easy to understand computer articles it contains.

Now in your Nov '76 I/O Editorial you say you are going to have less computer articles in 73 Magazine, and are going to publish a new computer-oriented magazine.

I feel this is unfair to the people who subscribed to 73 because of the I/O section.

There are some of us who would like to see more computer-oriented articles in 73.

F. M. Gamer  
Salina KS

It won't be much less, so stop griping. — Wayne.

**WORTH THE MONEY**

Enclosed with this letter you'll find a subscription to 73 and Kilobaud. I've been buying 73 for the past year at a local ham store, and you've convinced me. If Kilobaud is anywhere near the quality of 73, it's well worth the money.

Two months ago I passed my Technician test and I'm still waiting for my call letters. Seems like a burn. When a CBER sends his four bucks in he can go on the air, and a commercial operator can talk as soon as he passes his test, but not a ham! We pass our test and give our four bucks and get a pat on the back. It's not fair!

Your code tapes were a real help. I tried for the longest time to learn

code from other tapes and records, but your tapes are wonderful.

Your reply to WB8SWD's letter (pg. 19, Nov. 73) is one of the main reasons that I support 73. I'm convinced that we must use our VHF and microwave bands or they won't be ours for long. I disagree with you only on the discontinuance of the "mail order Tech license."

I found that local amateurs openly

**FAX MACHINE BY DATAFAX**

We have transmitters and receivers. Used for weather charts, hi speed teletype recording. Normally used over the phone lines. Operational when removed due to upgrading of equipment. Only a few on hand and sold "AS IS." When used over the phone lines from weather data system, will draw full map of the US with cloud cover and also pressure gradients. Due to the weight of these machines they must be shipped via truck as they are around 60 lbs. Made for desk top use. Made by Steward Warner Elect. Picture is typical unit. When ordering state receiver or transmitter. #FAX \$125.00 FOB Lynn Mass.



**PARITY DETECTOR**

New packaged, made for RCA, detects even or odd parity, baud rate 110, 150 or 134.46. Built-in logic supply for the ICs, operates from standard 115 Vac. Control panel allows manual or automatic reset mode of operation. Aluminum enclosure (not shown) covers the electronics. TTY compatible. Ship wt. 10 lbs. ~~\$18.50~~ \$12.50

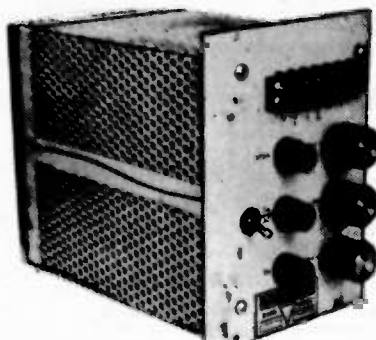
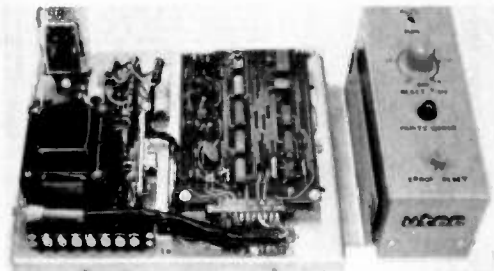

**GENERAL PURPOSE POWER SUPPLY**

A well designed transistorized regulated power supply with many uses. Each voltage adjustable by a pot. Each voltage fused. 115 volts AC 60 cycle input. Output (minus) 12 volts at 1/3 Amp, 12 volts (plus) at 3 Amps, 6 volts at 1 Amp . . . three output voltages. Many uses . . . as battery charger, op amp, 5 volt logic supply, operate your car radio or tape player, CB set, in the house, etc. A commercially built regulated supply for far less the price of a kit. Shipping wgt. 10 lb. #SP-152-L \$17.50

**SOLAR CELLS**

Designed for the space program, these are the highly efficient silicon high output cells. Used for powering equipment, charging batteries. Made by Ion Physics Corp. Each with spec sheet.  
Size .394 x .788" 65 mA, .43 V \$1.25 12/\$12.00  
Size .788 x .788" 125 mA, .43 V \$1.60 12/\$15.00



**SILICON SOLAR CELL**  
shown actual size

ZENER 15V 63 Watt \$1.00  
2.5 Amp 1,000 piv diode . . . . . 4/\$1.00, 25/\$5  
Motorola 1N4001 diode 1A, 50 piv . . . . . 20/\$1.00

RT 70/GRC as written up in 73 Magazine, November, 1976. Only \$20.00.

Please add shipping cost on above.

**FREE CATALOG SP-9 NOW READY**  
P.O. Box 62 E. Lynn, Massachusetts 01904

*Meshna*

refused to give the test for Technician when it was mail order. They claimed that no one would practice code with a Tech license, so Novice was the only way to go. Now with the opening of the Novice code bands to Technicians, there's no excuse for discouraging Techs!

I'm an experimenter, not an appliance man. I consider 73 to be a

real learning tool, a chance to increase our knowledge of electronics and communication, a far cry from the dull lists of call letters and contests in QST!

Howard Gerber  
Houston TX

Hey, don't discourage QST from long lists of call letters — I like 'em. — Wayne.

### OBVIOUS GROWTH

Having recently re-subscribed to 73 after a lapse of 7 years or so during which I was not active in hamming other than radio control on 6 meters, I would like to compliment you on the obvious growth of your magazine. I am fully in favor of the I/O articles and have just sent in a subscription for

Kilbaud. I work for Aeronutronic-Ford Corp. on an Air Force contract operating tracking stations. I have just been transferred to Thule AFB, Greenland, for an 18 month tour, and would like to set up an OSCAR station here.

Can you recommend any books that can give me info on the operation of these satellites or perhaps the address of the group responsible for their development and operation? With my location (400 miles from the pole), I am in a position to work the vehicles on almost every orbit. I have equipment but have to decide on antennas. I am in the final phases of assembling my uP system based on the MOS Technology KIM-1 module, with expanded memory from Godbout and UART/TVT III from Mini Micro Mart. Per your editorial comment in the Nov '76 issue of 73, I will detail in a later letter all the problems involved with the various mail order houses.

In closing, would appreciate any help in info on OSCAR. Keep up the info on new technology even though people scream. After 12 years in the satellite business, I know that you have to stay on top of the new developments or you are lost. In just 12 years, my job has progressed from tubes and 200 MHz to uP and 2.2 GHz — and it involves constant schooling and study just to keep up.

E. A. Zeitler KG6JCO  
Box 1337 AFSCF OLA  
APO New York 09023

Your best source of info is AMSAT, the Radio Amateur Satellite Corporation down in Washington, DC. Their address is AMSAT, PO Box 27, Washington DC 20044. They publish a quarterly newsletter and provide the orbit information which appears each month in 73. Speaking of 73, one of our most popular past issues covering OSCAR was back in July, 1975. More recent articles have covered ways to program calculators to plot OSCAR orbits. — Ed.

### TROUBLE AHEAD

It looks like the NBS people changed their minds that the turning point of this sunspot cycle would have been this summer. A notice I got from them yesterday gave a forecast of sunspot numbers from August to next May, and they are forecasting even lower sunspot numbers for this winter than we had last winter. This agrees with what I told you.

I had a two day visit in June from the chairman of their forecasting committee to discuss my forecasting technique. I showed him how I do it. He also asked me for my opinion on this sunspot low and I told him the same thing that I told you ... a long deep low followed by a low high.

John H. Nelson  
Whiting NJ

John Nelson prepares our monthly propagation forecasts. — Ed.

# 2 METER CRYSTALS

FREQUENCIES IN STOCK

- 146.01T
- 6.61R
- 6.04T
- 6.64R
- 6.07T
- 6.67R
- 6.10T
- 6.70R
- 6.115T
- 6.715R
- 6.13T
- 6.73R
- 6.145T
- 6.745R
- 6.616T
- 6.76R
- 6.175T
- 6.775R
- 6.19T
- 6.79R
- 6.22T
- 6.82R
- 6.25T
- 6.85R
- 6.28T
- 6.88R
- 6.31T
- 6.91R
- 6.34T
- 6.94R
- 6.37T
- 6.97R
- 6.40T
- 6.46T
- 6.46R
- 6.52T
- 6.52R
- 6.55T
- 6.55R
- 6.58T
- 6.58R
- 6.94T
- 7.60T
- 7.00R
- 7.63T
- 7.03R
- 7.66T
- 7.06R
- 7.69T
- 7.09R
- 7.72T
- 7.12R
- 7.75T
- 7.15R
- 7.78T
- 7.18R
- 7.81T
- 7.21R
- 7.84T
- 7.24R
- 7.87T
- 7.27R
- 7.90T
- 7.30R
- 7.93T
- 7.33R
- 7.96T
- 7.36R
- 7.99T
- 7.39R

FOR THESE RADIOS

Clegg HT-146  
Drake TR-22  
Drake TR-33 rec only  
Drake TR-72  
Genave

Heathkit HW-201 rec only  
Heathkit HW-202  
Icom/VHF Eng  
Ken/Wilson  
Lafayette HA-146  
Midland 13-505  
Regency HR-2  
Regency HR-212  
Regency HR-2B

Regency HR-312  
Regency HR-2MS S.B.E.  
Sonar 1802-3-4, 3601  
Standard 146/826  
Standard Horizon  
Swan FM 2X  
Tempo FMH  
Trio/Kenwood TR2200  
Trio/Kenwood TR7200

Note: If you do not know type of radio, or if your radio is not listed, give fundamental frequency, formula and loading capacitance.

CRYSTALS FOR THE IC-230 SPLITS IN STOCK: 13.851111 MHz; 13.884444 MHz; 13.917778 MHz; HEATHKIT HW2021 600 KHz. OFFSET 11.3 MHz; \$6.50 ea.

## MASTER GAINER

MODEL G6-144A — Deluxe. Two Meter Colinear for Repeater or any fixed station operation. 6 db gain over a 1/4 wave dipole. Maximum radiation at the horizon. Shunt fed with D.C. grounding. Radiator: 1/2 wave lower section, 1/2 wave phasing, 1/2 wave upper section. Height: 117". SWR at resonance: 1.2:1 or better. Power rating: 1,000 Watts FM. Wind survival: 100 MPH. Installs on vertical pipe up to 1 1/2" O.D. SO-239 coax connector. **\$52.95**



## SUPER GAIN MOBILES

Two Meters

- 5.2 db gain over 1/4 wave mobile antenna
- Frequency coverage—143-149 MHz
- SWR at resonance—1.1:1 typical
- Power rating—200 watts FM

MODEL CG-144

Same characteristics as CGT-144 supplied with 1/2" base to fit all mobile ball mounts—Length is 85". Mount and cable not included. **\$26.75**

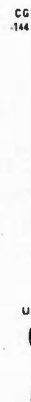

## HUSTLER

VHF/UHF ANTENNA—ROOF MOUNT

MODEL UHT-1

Field trimmable radiator for 1/4 wave operation on any frequency from 140 to 500 MHz. Cutting chart included. Mounts on any flat surface, roof, deck, fender in 1/2" hole. Includes 15' RG-58-U. **\$10.15**

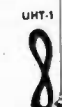

## STANDARD GAIN MOBILES

Two Meters

- 5/8 wavelength—3.4 db gain over 1/4 wave mobile
- Frequency coverage—143 to 149 MHz
- Power rating—50 watts FM

MODEL BBLT-144

47" antenna complete with easy to install, no holes to drill, trunk lip mount, impact spring and 17 MIL SPEC RG-58-U and PL-259. Antenna removable from mount. **\$28.75**

MODEL BBL-144

47" antenna mounts on any flat surface, roof, deck or fender in 1/2" hole. Includes impact spring, 17 MIL SPEC RG-58-U and PL-259. Antenna removable from mount. **\$26.95**



## HUSTLER "BUCK-BUSTER"

MODEL SF-2

51 two meter, 5/8 wavelength, 3.4 db gain over 1/4 wave mobile. Designed with 1/2" base to fit your mount or a wide selection of Hustler mobile mounts (Mount or cable not included). **\$12.75**

## DELUXE MOBILE MOUNTS

For medium length, light weight antennas with 1/2" base

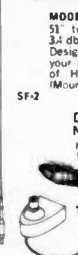

MODEL TLM

Trunk lip mount for no holes installation on side or edge of trunk lid. Includes 17' RG-58-U connectors attached. **\$12.05**



MODEL MLM

Deluxe trunk lip mount with 180 degree swivel ball for positioning antenna to vertical. Easy—no holes—installation. Includes 17' RG-58-U cable and connectors attached. **\$14.85**

MODEL GCM-1

Rain gutter mount fits all shapes, angles even latest trim line gutters. Includes 180° swivel ball. **\$7.50**

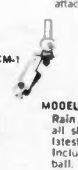

## HF VHF UHF AMATEUR ANTENNAS

Each Hustler antenna design is specifically optimized for amateur band performance. Every assembly is manufactured from the best available materials under carefully controlled quality standards to give you superior mechanical and electrical performance. For more than a decade, reliability has been our foremost desire!

### SHIPPING

We can ship C.O.O. first class mail. Orders can be paid by: check, money order, Master Charge, or BankAmericard. Orders prepaid are shipped postage paid. Phone orders accepted. Crystals are guaranteed for life. Crystals are all \$5.00 each (Mass. residents add 25¢ tax per crystal). U.S. FUNDS ONLY

# KENSCO COMMUNICATIONS

PRICES SUBJECT TO CHANGE WITHOUT NOTICE

Box 469  
Dept. 976  
Quincy, MA 02169  
(617)471-6427

Store Hours:  
Daily 9-9  
Sat. 9-6

We are authorized distributors for:  
Icom and Standard Communications Equipment. (2 meter)



John H. Nelson  
Whiting NJ

John Nelson prepares our monthly propagation forecasts. — Ed.



**LIVINGSTON NJ  
DEC 3**

The Livingston Amateur Radio Club will hold its second annual electronic flea market on Friday, December 3, at 7:30 pm at the Livingston Memorial Recreation Building. For further info, contact Jeff Gehl WN2AXL, (201)-267-0280.

**BROOKLYN NY  
DEC 19**

The Kings County Repeater Association will hold an indoor flea market on Sunday, December 19, 1976, from 9 am to 4 pm. Located at 910 Union Street, Brooklyn NY (at Grand Army Plaza). Sellers \$3.00, buyers \$1, children free. Refreshments available. Talk-in on 146.43 and 146.52.

**FORT WAYNE IN  
JAN 23**

The annual Fort Wayne Winter Hamfest will be held at Shiloh Hall north of Fort Wayne, Indiana on January 23, 1977. Hours are from 9 pm to 4 pm local time, and early parking is available. This yearly event is sponsored by the Allen County Amateur Radio Technical Society (AC-ARTS). Admission is \$1.50 by advanced ticket, or \$2.00 at the door. Table space is available for vendors at \$1.00 per half-table (about four feet). For more information or advanced tickets and table reservations (held until 9:30 am), write to Hamfest Chairman, AC-ARTS, Inc., P.O. Box 342, Fort Wayne, Indiana 46801.

**CORPUS CHRISTI TX  
FEB 4-6**

The Texas VHF-FM Society will hold its winter meeting at the Holiday Inn, Emerald Beach, 1102 S. Shoreline, Corpus Christi, Texas, on February 4, 5, 6, 1977. For further information contact: James Linthcum W5LCN, 1802 Daly, Corpus Christi, Texas 78412.

**MANSFIELD OH  
FEB 6**

The Mansfield Ohio Mid Winter Hamfest Auction will be held February 6, 1977 at the Richland County Fairgrounds, Mansfield, Ohio. Prizes, flea market, auction - large heated building. Doors open 8 am. Talk-in 146.34/.94 and .52/.52. Tickets \$1.50 in advance, \$2.00 at the door. Contact Harry Frierhen K8JPF, 120 Homewood, Mansfield, Ohio 44906 or phone (419) 529-2801 or (419) 524-1441.

**GRIFFITH IN  
FEB 19**

The Lake County Amateur Radio Club's 24th annual banquet is Saturday, February 19 at 6 pm, at the Griffith Knights of Columbus Hall, 1400 South Broad Street, Griffith, Indiana. All the delicious home-cooked food you can eat, wine fountain, entertainment, guest speakers, special awards, door prizes, cash

raffles and a dance band after. Tickets are \$7.50 each: no door purchase. Write (prior to Feb. 3) to Herbert S. Brier W9AD (W9EGQ), 409 S. 14th Street, Chesterton IN 46304.

**DAVENPORT IA  
FEB 27**

The annual Davenport Radio Amateur Club Hamfest will be held Sunday, February 27, 1977 at the

# Social Events

Masonic Temple in Davenport, Iowa. Admission is \$1.50 advance - \$2.00 at the door. Talk-in on 28/88 and 52. Refreshments and tables are available. For info and tickets send SASE to Dick Lane WA0GXC, 116 Park Avenue, So. Eldridge IA 52748.

**FORT WALTON BEACH FL  
MAR 20**

The Fort Walton Beach Swapfest will be held Sunday, March 20, 1977. For further information contact Playground Amateur Radio Club, PO Box 873, Fort Walton Beach FL 32548.

★ 'ORLANDO HAMCATION 77' 'ORLANDO HAMCATION 77' 'ORLANDO HAMCATION 77' ★

**The Orlando Hamcation Committee Presents**

**The GREATEST ORLANDO HAMFEST EVER!**

**& The Southeastern ARRL Convention**

AT THE SHERATON'S TWIN TOWER HOTEL & CONVENTION COMPLEX, NEAR THE CROSSROADS OF THE FLORIDA TURNPIKE AND I-4 INTERCHANGE, IN ORLANDO FLORIDA.

★ **FEBRUARY 11\*-12-13, 1977** ★

*Plan a family vacation in Central Florida around our Hamfest, Visit Walt Disney World, Circus World, Sea World, famous beaches on both the East and West coast, Cape Kennedy's launch complex and many more entertainment spots of interest for the whole family.*

*Main Ballroom Exhibit & Hamfest Area Opens Daily At 9AM  
Swapfest Area Opens At 7AM Daily, And Friday Nite At 6PM.*

★ <b>TECHNICAL FORUMS</b> FOR THE BEGINNERS AND UP	★ <b>ARRL FORUMS</b> THREE PLANNED FOR SATURDAY PM
★ <b>MANY DOOR PRIZES</b> TOO MANY TO MENTION !	★ <b>GIGANTIC SWAPFEST AREA</b> 24,000 SQ.FT., All inside and Air Conditioned
★ <b>MAJOR COMMERCIAL EXHIBITS</b> PLUSH ATMOSPHERE	
★ <b>LADIES' ACTIVITIES</b> PLANNED DAY LONG	★ <b>SATURDAY NIGHT BANQUET</b> TICKETS AVAILABLE AT DOOR

Advance registration \$3, at the door \$4, per adult. Swapfest tables \$5 per day.

FOR A COMPLETE HAMFEST INFORMATION PACKAGE INCLUDING OTHER NEAR BY HOTEL/MOTEL RATES SEND A SASE TO:

Hamfest Secretary, Georgia Denman K4ZXS, 405 Enka Way, Orlando Fla. 32811

MAKE ALL CHECKS FOR ADVANCED REGISTRATION AND SWAPFEST TABLES, PAYABLE TO 'THE ORLANDO AMATEUR RADIO CLUB INC,' AN INFO PACKAGE WILL BE RETURNED WITH ALL REQUESTS.

---

FOR SHERATON TWIN TOWERS HOTEL RESERVATIONS, WRITE DIRECTLY TO:  
The Sheraton Towers, 5780 Major Blvd. Orlando, Fla. 32805  
Rooms, Single \$28, Double \$36, per day. CALL TOLL FREE 800-325-3535

\*SWAP FEST AREA WILL BE OPEN FRIDAY NIGHT FEB. 11 FROM 6PM, no additional charge other than registration or a Saturday swap table ticket.

★ 'ORLANDO HAMCATION 77' 'ORLANDO HAMCATION 77' 'ORLANDO HAMCATION 77' ★



# REPORT

from page 76

version of SCELBAL). Will it do the

trick for writing game programs, business programs? Does it have string capability? Etc. Anyway, with the 8008 SCELBAL coming on the scene, it would seem that we have even another good reason to get those "down" MARK-8s up and running.

### AGAIN... WHERE'S ALL THAT SOFTWARE?

We've seen programmers (both amateur and professional) sit down

and develop Tiny BASIC interpreters in a matter of weeks. I have the feeling that there has been a lot of applications software developed, too ... it's just not being marketed like some of the language processors (Tiny BASIC, in particular). We all would like to have some useful and practical programs for our home systems (education, entertainment, etc.), and the need for small business software is acute, to say the least. Those who could use it are surely willing to pay for it. Those who have developed it would surely like to sell it. The 73/Kilobaud Software Library would surely like to market it ... at a reasonable price ... and pay the programmer/author a hefty 15% royalty.

We're going to have articles in 73 and Kilobaud discussing this library, and how we can all benefit from it. The main objective is to get as much software out to the small computer community as possible via national distribution media (73 and Kilobaud). To encourage and help along the development of small business systems is another objective, and I don't feel anyone has to worry about helping the "competition" ... for crying out loud, there's more than enough out there for everyone. Along this same line, if you have some business applications software to sell, there's no reason why you can't go ahead and advertise and sell what you can through your own efforts, and submit it to the 73/Kilobaud Software Library, also. Just that much more additional income from the program, right?

It's kind of interesting how a reaction is almost automatic when mention is made of small business systems. When I'm speaking to a group and the subject comes up, I almost invariably have several people come up afterward to get more information. My references to small business applications in previous I/O Reports have generated a variety of responses from interested people around the country, too.

### A BIG ONE!

It's finally all coming "home." The first major personal and home computer conference and exhibition to be held in the San Francisco area (where most microprocessors are "born") will be coming along on April 15-17, 1977. The First West Coast Computer Faire is being put together by Jim Warren, Editor of Dr. Dobb's Journal, and Bob Reiling, Editor of the Homebrew Computer Club Newsletter. It's being sponsored by a number of local and regional hobbyist clubs, educational organizations, and professional groups ... and supported by 73 and Kilobaud. One of the areas of big interest will be ham radio applications with microcomputer systems. For more information, contact: Jim Warren (415) 85107664 or (415) 323-3111, or Bob Reiling (415) 967-6754 (evenings) ... or stay tuned for complete details in next month's I/O Report.

## ATTENTION USERS OF VHF SCANNING RECEIVERS



VANGUARD has a frequency synthesizer that will save you time and money. It will give you 8000 thumb-wheel selected channels from 140.000 to 179.995 MHz in 5 kHz steps at .0005% accuracy and your cost is only \$179.95. Our standard model is for receivers with the crystal formula  $F_c = F_s - 10.7 \text{ MHz}$  divided by 3. However, we can make it for almost any other formula.

For complete details of this synthesizer and others priced as low as \$139.95, see our half page ad in the May 1976 issue of this magazine.

### VANGUARD LABS

196-23 Jamaica Ave., Hollis, New York 11423

## YOUR HAM TUBE HEADQUARTERS!

TUBES BOUGHT, SOLD AND TRADED  
SAVE \$\$\$ - HIGH \$\$\$ FOR YOUR TUBES

### MONTHLY SPECIALS

3CX1000A7/8283	\$245.00	811A	8.50
3CX1500A7/8877	230.00	813	18.00
3-500Z	48.00	6146B	4.60
3-1000Z	135.00	6360	3.75
4-125A	42.00	6883B	4.95
4-400A	48.00	8122	39.00
4-1000A	180.00	8236	22.00
4CX250B	27.50	8908	5.25
572B	22.00	8950	4.75

Imac Tubes & Accessories In Stock  
Write or phone for types not listed

### BRAND NEW\*\*\*\*FACTORY GUARANTEED

TOP BRAND Popular Receiving Tube Types.  
BRAND NEW 75%+ Off List\* Factory Boxed.  
FREE LIST Available - Includes full line of RF Power Transistors. Minimum Order \$25.



COMMUNICATIONS, Inc.  
2115 Avenue X  
Brooklyn, NY 11235  
Phone (212) 646-6300

SERVING THE INDUSTRY SINCE 1922

## VANGUARD NOW HAS A "HOT" 2 METER CONVERTER at a price you can afford



MODEL C-144-A  
ONLY \$39.95

Read the specifications and see why it's the best converter value available anywhere.

- Dual-gate MOSFET r.f. stage with diode protected input.
- Dual-gate MOSFET mixer for minimum cross modulation. Every converter tested for noise figure (2.5 - 3.0 dB max.) with Hewlett Packard noise measuring equipment.
- 6 tuned circuits.
- More than 20 dB gain. .1 microvolt sensitivity guarantee when used with receivers having 1 microvolt or better sensitivity.
- Complete with one .005% plug-in crystal to cover 144-146 or 146-148 MHz (be sure to specify which, or get both for only \$5.00 more). Standard output is for 28-30 MHz.
- 16 gauge aluminum case with BNC receptacles and antenna/power switch. Measures 3-1/2" x 2-3/4" x 1-1/4".

IN STOCK NOW FOR IMMEDIATE C.O.D. SHIPMENT. Call Monday through Friday 9 AM to 4 PM (212) 468-2720.

### VANGUARD LABS

196-23 Jamaica Ave., Hollis, New York 11423

## CS<sub>dc</sub> Silicon Retro-fit Rectifiers

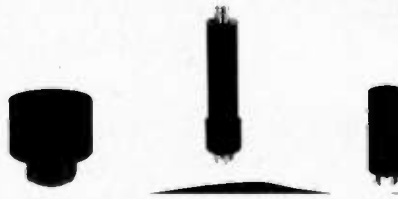

### FEATURING:

- Voltage ratings up to 65,000 volts
- Current ratings up to 1.25 amps
- Fully glassivated diode building blocks by —

### GENERAL ELECTRIC

- Replacement types including —

Type No.	\$	Type No.	\$	Type No.	\$
dc3B24	17.00	dc5Z3	3.65	dc371A	31.50
dc3B28	12.00	dc5Z4	3.65	dc575	50.50
dc3R29	16.00	dc6AX5	3.65	dc576	39.00
dc5R4	5.10	dc6X4	4.85	dc673	50.50
dc5U4	3.65	dc25Z6	4.00	dc866	12.00
dc5V4	3.65	dc80	4.35	dc872	19.50
dc5Y3	3.50	dc250R	75.00	dc8008	19.50
				dc8020	41.00

NOTE—Unit pricing in 1-24 Qt.

Minimum Order: \$10.00 (with 'HAM' call letters)

### FOR MORE INFORMATION CONTACT:

Post Office Box No. 816 Wayne, N. J. 07470

CONDITIONING SEMICONDUCTOR DEVICES CORP.

Telephone: 201-227-2539



junk box, you are already ahead of the game, but later on you will see how all of the parts may be obtained from a source near you to make it as easy as possible for you to get started experimenting. When all parts are on hand, you can assemble and package them in any way you like.

The power supply schematic may look a little strange to you, but do not be alarmed. This is a solid state version of the so-called "economy" power supply, more popular several years ago than it is today. It is a combination of the well known bridge and full wave rectifier circuit configurations. One regulator is connected to the transformer secondary winding center tap to yield five volts at the output for TTL circuits, and makes use of two of the diodes in the bridge rectifier to work as a standard full wave rectifier circuit. The other regulator is connected to the output of the bridge rectifier to yield about 14 volts at the output for CMOS and linear circuits. This regulator is biased up from ground by the two resistor divider network across the output. The regulated output voltage is adjustable by virtue of the variable resistor. The regulator requires a minimum voltage differential of about two volts between the regulated output and the dc voltage at input pin 1 from the output of the rectifier diodes and filter capacitor.

Most CMOS integrated circuits are rated by the manufacturer at 15 volts maximum, and it is wise to limit the output voltage of the power supply to not over, say, 14 volts. A voltage between 12 and 14 is good in order to take full advantage of the exceptionally high noise immunity of CMOS integrated circuits, and is also a good operating voltage for linear IC projects. The variable resistor may be replaced with a fixed resistor of equal in-circuit value, if it is not desired to vary the

# Dual Voltage Power Supply

-- about as simple as they come

Certainly one of the more enjoyable, educational, and fascinating aspects of amateur radio is experimenting and home brewing with low cost readily available digital and linear integrated circuits. This regulated dual voltage power supply can start you off experimenting with the more common TTL integrated circuits and the increasingly popular CMOS integrated circuits. In addition, the higher voltage available from the power supply is good for a vast number of linear IC projects.

The power supply uses two type 309K three terminal regulator integrated circuits. These consist of an in, out and common pin connection

and thus this IC is the simplest possible device to work with. The K suffix designates the type TO-3 package. This regulator is also available in the type TO-5 package, but we will use the higher power package to obtain output currents in excess of one Ampere. This is a particularly fine power regulator specifically built for five volt output for TTL use but a simple connection allows the regulator to furnish higher output voltages with equally excellent regulation.

The 309K three terminal regulator is rated by the manufacturer at output currents in excess of one Ampere and employs internal current limiting, thermal shutdown

and safe-area compensation. All of this means that it is essentially indestructible. It also does not require a lot of external components, unlike most other regulator circuits. It requires only two resistors to provide a higher output voltage. All told, this is one of the easiest to build fully regulated and self-protected power supplies around.

There are no critical layout precautions. If the supply should exhibit a tendency to oscillate as evidenced by erratic operation, simply connect a 0.22  $\mu$ F capacitor directly from input pin one to ground as close as possible to the regulator.

If you can scrounge up some of the parts from your

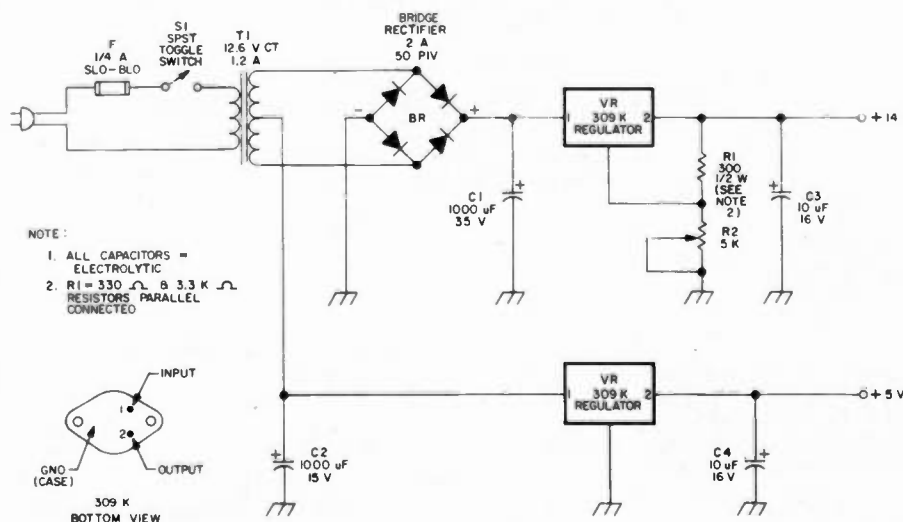

Fig. 1.

output voltage. Temporarily connect a variable resistor and adjust it to set the regulator output voltage as read by a voltmeter. Shut off the power supply, remove and measure the value of the resistor and solder in a fixed ½ Watt resistor of the nearest standard value.

Notice that the common terminal of the 309K is also the case of the regulator, so it is necessary to insulate the higher voltage regulator from the heat sink. For this pur-

pose use the insulator found in the power transistor mounting hardware kit. Spread a very thin coat of heat sink compound (silicone grease) on each side of the insulator before mounting the regulator to the heat sink. Use the power transistor sockets to save soldering directly onto the pins of the regulator. This usually results in a messy-looking job. Perhaps a more important reason for using the sockets is that they have self-aligning

insulated hubs that center the pins as they pass through the holes in the heat sink. The socket also insulates the mounting screws from the heat sink and prevent shorts from this cause.

If you yearn to try many of the wonderful devices described in ham magazine construction articles but are disillusioned, as I am, by the difficulty in obtaining all of the necessary parts, take heed — all is not lost. Building this power supply is about as

simple as can be. All of the parts are available from Radio Shack. Surely one of these stores is conveniently near if not actually within walking distance of your shack. There is nothing wrong with mail order purchases when that is the best way to obtain specific parts, but buying direct does save time and postage. Any equally rated part can be substituted to build the power supply. So have fun and start experimenting. ■

Peter Walton VE3FEZ  
421 Lodor St.  
Ancaster, Ontario  
Canada L9G 2Z9

# Kints and Hinks

- - for money savers

**H**ave you ever been faced with the situation of wanting to rescale an old junk box meter to suit a particular application or project?

Most hams have a few old meters kicking around deep in the bowels of the junk box that could be easily rescaled to suit present needs or interests.

I have found a relatively simple method of accomplishing this objective with a minimum of skill and artistic ability. The answer lies in the local stationery store, or perhaps even as close as your secretary's desk. It is in the form of a product called "liquid paper."

Liquid paper is basically a very fast drying white paint that is used by just about all secretaries to obliterate typing errors. You can use it

to obliterate the old meter scale. Just paint a new white surface right over the old scale; it dries in a matter of seconds.

Now that you have the old scale painted out, you can easily add your own new one by means of dry transfer lettering which is readily available at any engineering or drafting supply store.

Using a bit of patience and some good old-fashioned pride in your work, you can come up with a really professional-looking meter face.

At today's prices, it really pays off to rescale an old meter.

**E**veryone knows how difficult it can be to find a small knob that's just

right for the end of an adjustable coil or capacitor. Next time you see your wife tossing out an empty aerosol can, grab it.

Pull off the little push-button on the top of the can and put it in your junk box for future consideration. These little knobs can be drilled and epoxy glued to fit just about any small shaft you can think of.

You can also drill them and use them as insulating spacers, or even glue them to the bottom of a small cabinet and use the little devils as feet.

I have one stuck on the end of a home brew two meter whip antenna that I use on my portable. It saves me from getting my eyes poked out.

The XYL might think you're crazy, but these little

buttons have lots of uses in the shack.

**H**ave you ever attempted to locate a source for that nice springy stainless steel wire that is used in the makeup of two meter quarter wave whips?

Would you believe that it can be obtained in three foot lengths at just about any hobby shop?

The model aircraft hobbyists use this material for the construction of landing gear struts. Any hobby store that deals in model aircraft supplies will have plenty in stock.

When cut into 19 inch lengths, this good stuff makes excellent two meter whips at a very reasonable cost. ■

# An Autopatch Busy Signal

-- when the phone's  
 already in use

While many repeaters are located at choice mountaintop locations, others are in more convenient locations such as the home of the "highest ham in town." If the repeater has an autopatch, then the desire to use the telephone line that services the house is very strong — not only is it easily accessible but it also saves the repeater users from having to rent a separate telephone line. There are, however, two disadvantages:

1. There is a fundamental contention problem, namely that when the occupant is

using the phone, it isn't available to the autopatch users and vice versa.

2. If special provisions aren't made, a potential autopatch user will attach to the phone line when it is already in use by the occupant and cause an interruption. The interruption is generally followed by the occupant having to explain to the telephone party what the "funny tones" were all about.

The contention problem and related need to share the

phone line is the price you pay for not renting a separate line for the exclusive use of the autopatch circuitry. The interruption problem, however, can be solved by incorporating a circuit in the autopatch to lock out access to the phone line when it is already in use by the occupant. The

fundamental characteristics of such a circuit are shown in Fig. 1. The general idea is to implement the following logic: "If the phone is in use then connect a busy signal generator else connect the phone line." The actual circuit isn't quite that simple, because if the phone is not in use and you connect the autopatch, then it is in use. The circuit must thus be able to differentiate between the occupant's use of the phone line and the autopatch's use of the line, so that it doesn't cycle between connecting and then immediately disconnecting the patch.

Fig. 2 provides additional circuit details. When the telephone line is not in use, the voltage between the red and green wires is approximately 48 volts dc. When the phone is off the hook, the voltage drops to about 6 volts. It is therefore possible to monitor the voltage across the line to determine whether or not the phone is in use (off hook). Resistors R1, R2 and R3 form a voltage divider circuit. When the line is not in use, the voltage across R2 is approximately 1.5 volts. This voltage is used to provide base current for Q1 through a 3900 Ohm base resistor. Thus Q1 and its associated relay RL2 are turned on when the

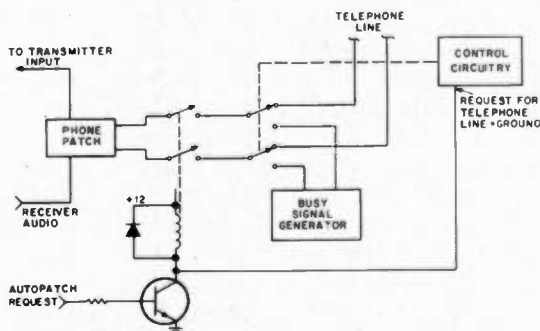

Fig. 1. Block diagram of telephone line status indicator.

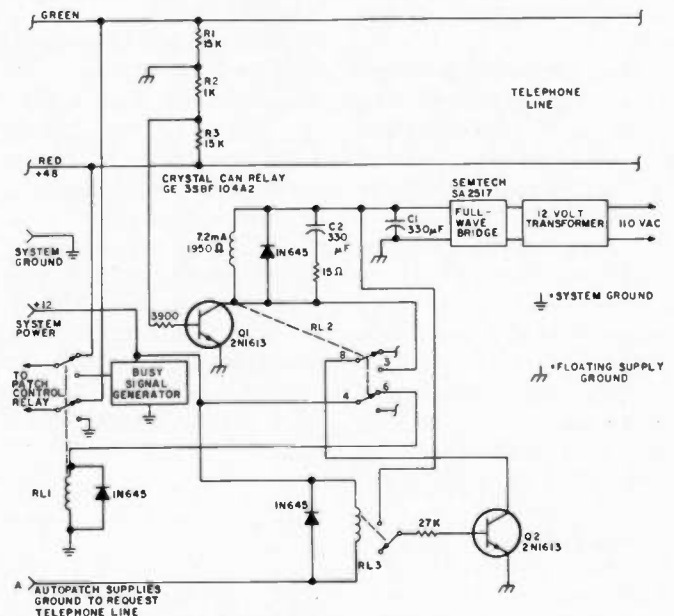

Fig. 2. Circuit diagram of status indicator.

**HERE'S A  
HOT NUMBER:**

**800 - 325 - 3636  
TOLL FREE**

**for new & used  
amateur  
radio equipment.**

**HAM RADIO CENTER INC.**

8340-42 OLIVE BLVD.

P.O. BOX #28271

ST. LOUIS, MO 63132





# Catch Standing Waves

-- with a tunable trap

I'd like to describe the construction and measured performance of a simple but effective means to eliminate

feedline-antenna interaction. The device, a T<sup>2</sup>LT, or tunable-transmission-line-trap, is a resonant L-C circuit

that is connected, between the feedline and the antenna, at the antenna. This resonant circuit is made from the feed-

line itself; the coil is made from a length of the feedline wound about a cylinder, with the capacitor connected across the extremities of this coil. See Figs. 1, 2(a).

The coil is wound on a length of 2½" PVC water pipe. The PVC is transparent to rf at this or even higher frequencies (still cold after a ten minute "cook" in a radar range). The coax is RG-8U, and the variable capacitor is a surplus ARC-5 transmitter unit. This capacitor has a built-in 96:1 gearbox. The coil, made of the coax shield, has an inductance of 3.4 H.

Since the coil-capacitor combination is made of, and located on, the shield conductor of the antenna feedline, its presence cannot affect the transmission line currents that exist inside the coaxial feedline. However, when resonated, this L-C circuit acts as a trap, preventing the flow of current over the shield of the coaxial transmission line.

Current flowing on the shield of a transmission line implies that the transmission line radiates energy in just the same manner as an antenna. When a transmission line, with current on its shield, is used to feed an antenna, the radiated fields of the antenna and the transmission line interact, and marked changes in the radiation pattern of the antenna-feedline system can occur. Current flowing on the feedline shield does not necessarily imply loss, but just a redistribution of the total input power into that radiated by the antenna and that radiated by the feedline. This redistribution of power can drastically affect the horizontal and vertical radiation patterns.

Fig. 3 shows the measured, field strength performance of this antenna, with and without the T<sup>2</sup>LT. Note the increased field strength associated with the T<sup>2</sup>LT and its sensitivity to very small changes in the resonating capacitor, indicating a high Q resonant circuit and a very

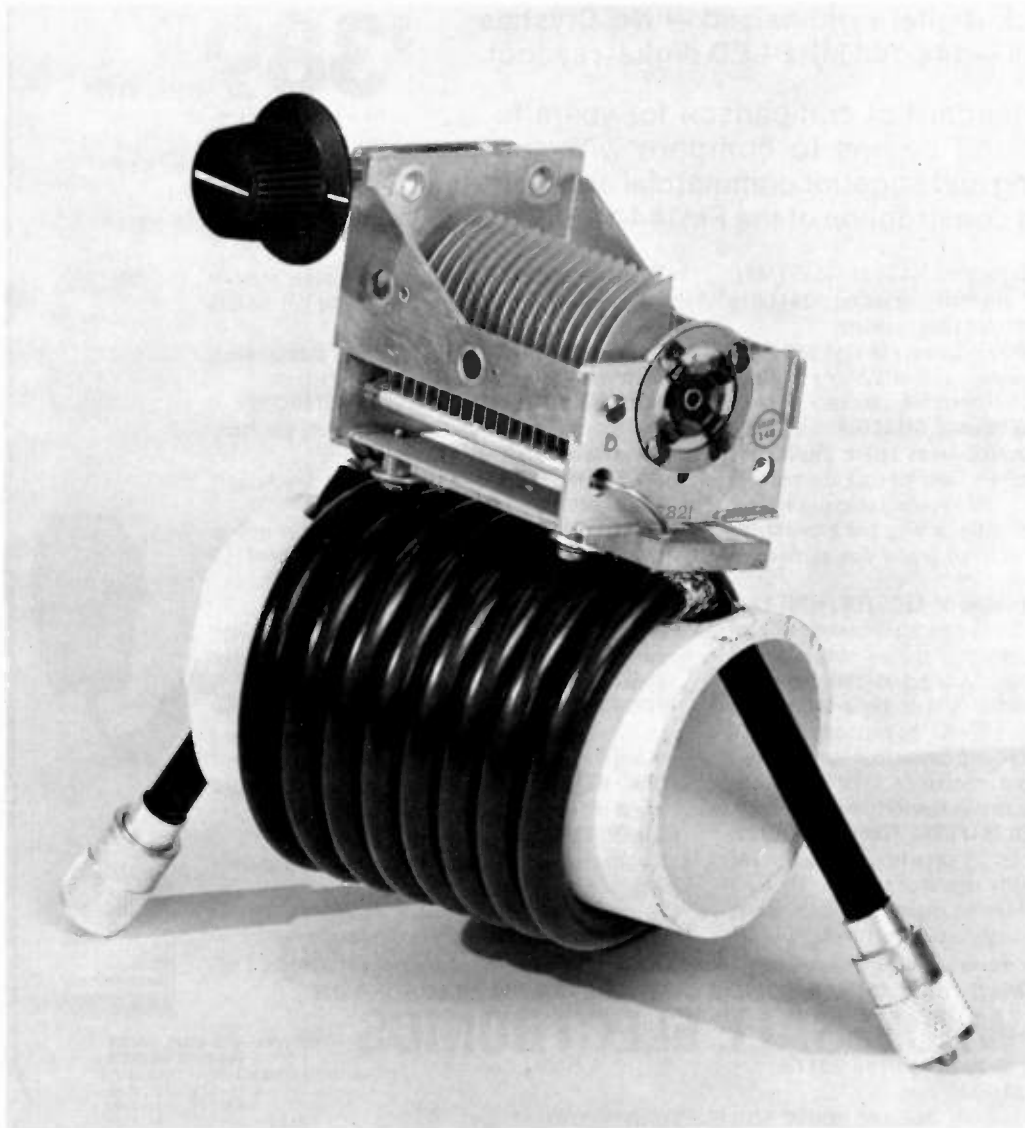

Fig. 1. The T<sup>2</sup>LT.

# NEW! FM144-10SXRII



# NEW! 6 METER FM50-10SXRII



Same specifications as below except transmit/receive:  
51.000-53.995 MHz. 600 channels  
Introductory Price **\$389.00**

Price subject to change without notice



NEW!

**TONE ENCODER/DECODER**  
SC-10 . . . 10 CHANNELS . . . DUAL TONE  
Introductory Price **\$119.00**

Price subject to change without notice

**All Solid State-PLL digital synthesized — No Crystals to buy! 5KHz steps — 144-148 MHz-LED digital readout.**

Introducing the standard of comparison for years to come. No other unit begins to compare with the superb engineering and superior commercial avionics grade quality and construction of the FM144-10SXRII

- **FREQUENCY RANGE:** Receive: 144.00 to 148.995 MHz, 5KHz steps (1000 channels). Transmit: 144.00 to 147.995 MHz, 5KHz steps (800 channels).
- **FULL DIGITAL READOUT:** Six easy to read LED digits provide direct frequency readout assuring accurate and simple selection of operating frequency.
- **AIRCRAFT TYPE FREQUENCY SELECTOR:** Large and small coaxially mounted knobs select 100KHz and 10KHz steps respectively. Switches click-stopped with a home position facilitate frequency changing without need to view LED'S while driving and provides the sightless amateur with full Braille dial as standard equipment.
- **FULL AUTOMATIC TUNING OF RECEIVER FRONT END:** DC output of PLL fed to varactor diodes in all front end R-F tuned circuits provides full sensitivity and optimum intermodulation rejection over the entire band. No other amateur unit at any price has this feature which is found in only the most sophisticated and expensive aircraft and commercial transceivers.
- **TRUE FM:** Not phase modulation — for superb emphasized hi-fi audio quality second to none.
- **FULLY REGULATED INTEGRAL POWER SUPPLIES:** Operating voltage for all circuits, i.e., 12v, 9v and 5v have independently regulated supplies. 12v regulator effective in keeping engine alternator noises out and protects final transistor from overload.

- **MONITOR LAMPS:** 2 LED'S on front panel indicate (1) incoming signal-channel busy, and (2) un-lock condition of phase locked loop.
- **DUPLEX FREQUENCY OFFSET:** 600KHz plus or minus, 5KHz steps. Plus simplex, any frequency.
- **MODULAR COMMERCIAL GRADE CONSTRUCTION:** 6 unitized modules eliminate stray coupling and facilitate ease of maintenance.
- **ACCESSORY SOCKET:** Fully wired for touch-tone, phone patch, and other accessories.
- **RECEIVE:** 25 uv sensitivity. 15 pole filter as well as monolithic crystal filter and automatic tuned LC circuits provide superior skirt selectivity.
- **AUDIO OUTPUT: 4 WATTS**
- **HIGH/LOW POWER OUTPUT:** 15 watts and 1 watt, switch selected. Low power may be adjusted anywhere between 1 watt and 15 watts.
- **PRIORITY CHANNEL:** Instant selection by front panel switch. Diode matrix may be owner re-programmed to any frequency (146.52 provided).
- **DUAL METER:** Provides "S" reading on receive and power out on transmit.
- **OTHER FEATURES:** Dynamic microphone, mobile mount, external speaker jack, and much, much, more. Size: 2½ x 6½ x 7½. All cords, plugs, fuses, mobile mount, microphone hanger, etc., included. Built in speaker.



**HOLIDAY SPECIAL**  
**FM144-10SXRII**  
**\$389.00** VALUE \$599.00

Price subject to change without notice

Regulated AC/PS  
MODEL FMPS-4R . . . \$49.00

Touch-Tone Pad  
MODEL FMTP-1 . . . . . \$59.00

Manufactured by one of the world's most distinguished Avionics manufacturers, *Kyokuto Denshi Kaisha, Ltd.*  
**FIRST IN THE WORLD WITH AN ALL SOLID STATE 2 METER FM TRANSCEIVER.**

## AMATEUR-WHOLESALE ELECTRONICS

8817 S.W. 129th Terrace, Miami, Florida 33176  
Telephone (305) 233-3631  
U.S. DISTRIBUTOR

PLEASE WRITE FOR FURTHER INFORMATION

WESTERN REGIONAL SALES  
& SERVICE CENTER  
CONSUMER COMMUNICATIONS, INC.  
6115-15TH AVE., N.W.  
SEATTLE, WA 98107  
TELEPHONE (206) 784-7337

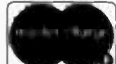

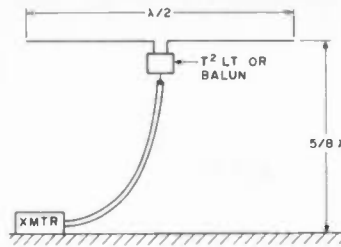
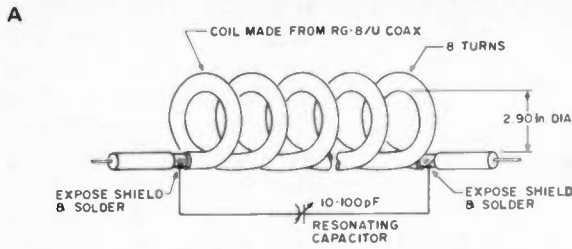

Fig. 2. (a) Schematic representation of T<sup>2</sup>LT. (b) Elevation view of antenna.

effective trap. Fig. 3 also shows the field strength level for the antenna operated without the T<sup>2</sup>LT; the reduction in field strength at the measuring point is obvious. Some of the data points were repeated with a conventional balun<sup>1</sup> installed at the antenna feedpoint between the antenna and the transmission line on the T<sup>2</sup>LT. It is apparent that the presence or absence of this transformer-type balun had little effect on the radiation characteristics of the antenna-feedline system. Because the T<sup>2</sup>LT forbids current flow on the coax shield, it also can be used as an effective

trap, ground independent, means for a 1:1 transformation from a balanced to an unbalanced transmission line.

The data presented in this article can represent only the performance of this particular configuration. However, the implications are clear: The T<sup>2</sup>LT introduces essentially no loss into the feedline system, and it forbids current from flowing on the feedline shield (which must eliminate antenna-feedline interaction) and thereby allows the antenna to perform correctly.

The T<sup>2</sup>LT is simple to build and install. Build it, install it, and try it. If you find, as you tune the T<sup>2</sup>LT

through resonance, any changes in resonant frequency measured at the trans-

mitter, swr, loading, dial settings of the transmitter, maximum forward power, field strength, and so forth — any change at all — then you need a T<sup>2</sup>LT, because the T<sup>2</sup>LT can make changes if and only if there are antenna currents on the feedline. ■

**References**

- <sup>1</sup> *The Radio Amateur's Handbook*, 1975 Edition, Fig. 20-16, A, p. 581.
- <sup>2</sup> *Ibid.*, Fig. 17-46, p. 532.

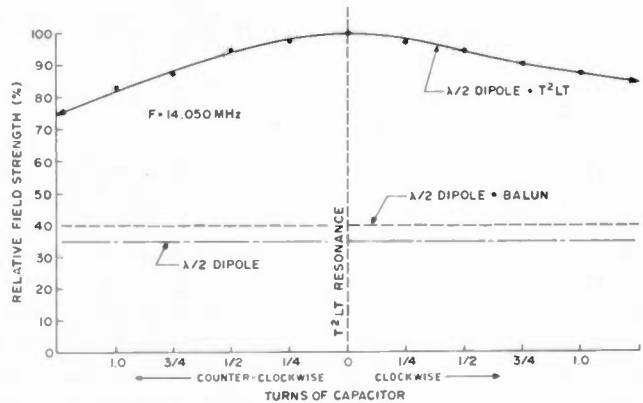

Fig. 3. Relative field strength versus capacitor turns (field strength measured at 10λ, broadside).

**25 WATTS OUTPUT**  
• PRECISION PROFESSIONAL QUALITY • 2 YEAR WARRANTY

**SPECIAL \* SALE!**

**\$479**

WITH 12 AMP FULLY REGULATED AND PROTECTED AC/PS..... \$569

REG \$650.00

**BRIMSTONE 144**

- COMPLETE BAND COVERAGE, plus MARS 143.000 to 149.99 Mhz digitally dialed 5 khz steps. ANY FREQUENCY, ANY SPLIT • NO CRYSTALS TO BUY!
- COMPLETELY INDEPENDENT TRANSMIT AND RECEIVE FREQUENCY CONTROL, YET SIMPLEX OR REPEAT MODE WITH THE FLIP OF A SINGLE SWITCH!
- 25 UV SENSITIVITY • OPTIONAL PLUG-IN MODULES FOR TOUCH TONE, DIAL TONE BURST (selectable), AND SUBAUDIBLE TONE • TRUE FM—NOT PHASE MODULATION • HI FI EMPHASIZED EFFECTIVE AUDIO QUALITY • GID GLASS PLUG IN BOARDS • GOLD CONTACT SOCKETS AND RELAYS • 100% AMERICAN MADE • AUDIO OUTPUT 2 WATTS • TWO TRANSCEIVERS IN ONE AND MUCH, MUCH, MORE

PLEASE WRITE FOR COMPLETELY DETAILED BROCHURE.

**OPTIONAL PLUG IN ACCESSORY MODULES**

Touch-Tone™ interface ..... \$28.95  
Dial Tone (specify frequency) ..... \$39.95

\* SPECIAL SALE NO OPTION UNITS ONLY EXCEPT FOR ABOVE.

**NEW**

**TEMPO 2020**  
A BRILLIANT NEW SSB TRANSCEIVER PROVIDING AN UNBEATABLE COMBINATION OF ADVANCED ENGINEERING AND UNIQUE OPERATING FEATURES. PLEASE WRITE FOR COMPLETE INFORMATION.

**STANDARD TRANSCEIVER MODEL SRC-146A**

**NEW!**

**NEW!! TOUCH-TONE PAD**  
COMPLETELY WIRED & READY TO PLUG IN \$69.00  
COMPLETE BACK ASSEMBLY

**\$39.95**

**NEW!! ADD 5 CHANS (TOTAL 10) TO SRC-146A**

- Simple 10 min. installation
- Same color and quality as SRC 146A
- Completely WIRED & TESTED
- ALSO usable with most other hand helds \$39.95

**BEST WISHES FOR THE HOLIDAY SEASON FROM ALL THE GANG AT AMATEUR WHOLESALE ELECTRONICS**

We wish to thank all of our customers for their support during the past year. Many new and exciting products will be introduced during the coming year and your continued suggestions and support will be deeply appreciated. Thank you.

**NEW— CDR HAM II ROTATORS** Reg. \$159.95 \$125.00

**STANDARD NEW 2 METER FM TRANSCEIVERS Model SRC 146A**

**SPECIAL SALE!**

- SRC 146A \$298.00
- 4 XTALS 34.94
- ANO 94/94 N/C
- USA 2 DELUXE BASE CHARGER \$40.00
- PT 3644 LEATHER CASE \$10.00
- AT 19 RUBBER ANT AND WHIP \$6.00
- NI-CAOS \$30.00

**NEW! TOUCH TONE PAD** REGULAR \$384.00  
COMPLETELY WIRED & READY TO PLUG IN \$69.00 OUR PRICE **\$275.00**  
Quantities Limited

**REGULATED DUAL PROTECTED POWER SUPPLIES**

**108RM 12 AMPS — DC AMP METER TYPICAL**

Output Voltage 13.6 ± 2VOC  
Line/Load Regulation 20 mV  
Ripple/Noise 2 mV RMS  
Transient Response 20 uSec  
Current Limit 12 Amp  
Current Foldback 2.5 Amp

CASE: 4 1/2" (h) x 7 1/2" (w) x 5 1/2" (d)  
WEIGHT: 9.5 lbs. OUR PRICE: \$82.00

**109R 25 AMPS — DUAL METERS TYPICAL**

Output Voltage 13.6 ± 2VOC  
Line/Load Regulation 20 mV  
Ripple/Noise 2 mV RMS  
Transient Response 20 uSec  
Current Output 25 Amps Max REGULATED  
Current Foldback 5 Amps

Over-Voltage and Over-Temperature Protected  
SIZE: 4 1/2" (h) x 9" (w) x 8 1/2" (d)  
WEIGHT 15 lbs. OUR PRICE \$119.00

All power supplies feature short circuit, current overload, over voltage and thermal overload protection circuitry.

ATLAS, COLLINS, REGENCY, DENTRON, BRIMSTONE, CUSH-CRAFT, BIRD, STANDARD, KLM, HYGAIN, KENWOOD, TEMPO, MINI PRODUCTS, MIDLAND, VHF MARINE, ETC.—PLEASE WRITE FOR QUOTE

**Atlas 210X**

PLEASE WRITE FOR SPECIAL BONUS AND PACKAGE OFFERS.

All power supplies feature short circuit, current overload, over voltage and thermal overload protection circuitry.

**AMATEUR-WHOLESALE ELECTRONICS**

OUR CREW  
CAL SMITH-WAALK, Mgr.  
S. L. GREGORY-WAALKU, Owner/Gen. Mgr.

8817 S.W. 129th Terrace, Miami, Florida 33176  
COURTEOUS PERSONAL SERVICE—SAME DAY SHIPMENT • Prices subject to change without notice.  
Telephone: (305) 233-3631 STORE HOURS: 10-5 MON-FRI.

Master Charge, American Express, Discover

# Inside the GLB

## - - a gutsy look at a synthesizer

The use of synthesizers instead of crystals is getting to be quite popular by 2 meter operators. It makes good sense to use such a device for the serious operator, since in the long run it is much cheaper to have this gadget instead of a handful of crystals. In a busy area most 2 meter transceivers won't take all the crystals you want it to due to the limitation imposed by the channel switch.

The GLB Channelizer has attracted considerable interest by many people. The firm runs a small ad in *QST*

which is easy to miss and doesn't say much. On writing for the literature, one learns little more than the ad says, getting a price list without much supplementary information. An equipment review appeared in *QST* some time ago which described the unit in glowing terms, but who has seen an equipment review that has spoken of the item in pejorative terms? The GLB is a good unit, but it is not without its drawbacks and problems. I saw one in use at WA6FKM and found it to be most useful and efficient, so I bought one and it is pretty

much living up to its expectations.

Much in GLB's favor is their speedy delivery service. The unit arrived in just over a week after it was ordered. There was a small shortage in the resistors with some of the needed ones missing and some extra ones enclosed, but the company promptly supplied the missing components. The problem in supply was the receive offset crystal — it took just over six weeks for the offset crystal to arrive which was a rather frustrating experience. I had the unit assembled except for

the crystal, so the equipment rested on my desk, then in a box, mostly assembled, for this time. Of course, ordering crystals from the manufacturers often incurs such a delay. Bernie Sanders of GLB advised me by letter when I inquired when I could expect the crystal,

"... any business is facing [problems] today with regards to obtaining any kind of mfg. component. We order, get a delivery date, and then keep calling our vendors who are late as much as 6 to 8 weeks."

I was quite pleased with how helpful they were when he advised me:

"You can always get a xtal from some other manufacturer and we will refund the amount you pay for it ... There are very few vendors that can make a .0005% xtal these days."

Considering that I would have to wait as long as they for anything, I maintained my patience and the crystal did arrive.

Alignment of the instrument is quite simple with clear information in the instruction book for use with a frequency counter or with a communications receiver tuned to WWV. Since WA6FKM had experience with the unit and a good counter, I dropped by one Sunday afternoon to get the Channelizer calibrated.

Constructing the unit is not without an occasional problem. In one or two places it is not absolutely clear just what is to be done, but a quick check with the diagram will explain the problem. In one place one must construct a coil on the supplied coil form with the supplied #32 wire. This is enameled wire which should have the enamel scraped away where the wire will be soldered. The instructions say nothing about

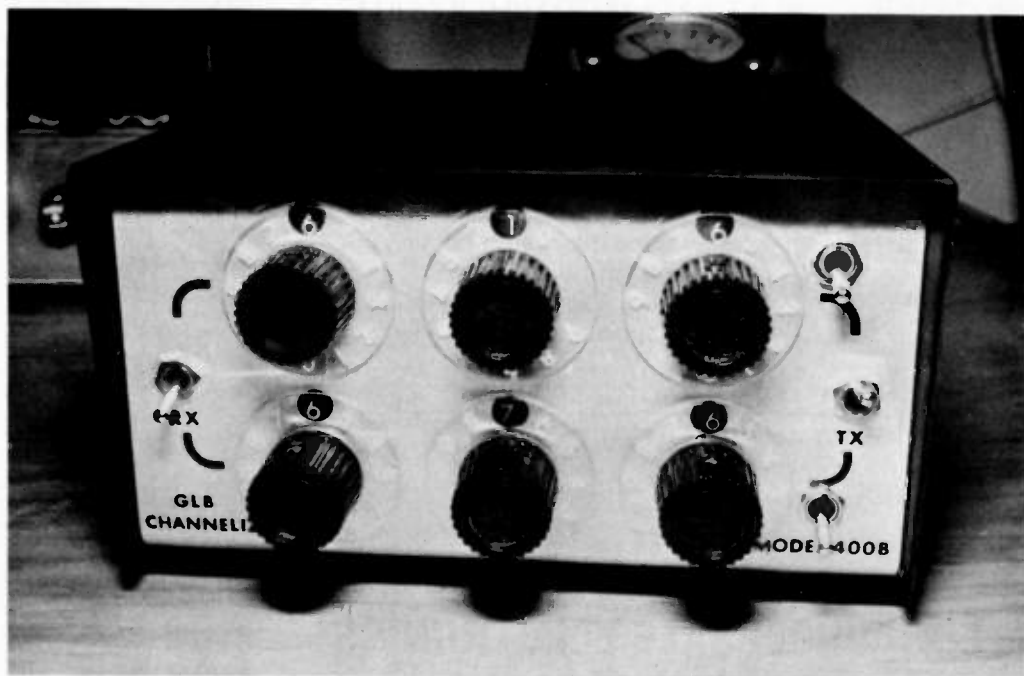

Front view of the GLB Channelizer.

# 73 magazine



## Very last chance ...

The subscription rate for 73 goes up January 1st — Happy New Year! What will 73 cost you next year? Dearly ... \$2 a copy at your dealer. That's \$24 for a year ... more than a dinner for two in most restaurants.

Now you can subscribe for HALF PRICE — \$12 for one year — until New Year's Eve.

In addition to saving \$12 right off the top (it'll buy a few crystals), you'll be sure of getting every issue of 73 and keeping your library intact. You never know when you are going to need a back issue. In a few months this stuff about microcomputers may get to you and you'll go crazy trying to find a missing issue.

If you are trying to decide between 73 and some other ham rag, consider this: 73 has more articles, more pages, more ads, and 73 tells it like it is. You just get a lot more with 73. The higher pay for articles gives 73 first choice of writers. Is 73 really bigger or is that baloney? Look at the numbers — the last six months of the magazines stacked up like this: 1168 pages for 73, 964-752-500 for the other three.

What about ads? If you want to know what is available at the best prices, you want plenty of ads — particularly when the magazine keeps out the crooks. 73 ran 520 pages of ads in the last six issues vs. 434-369-135 for the other three.

One thing you won't get any place else: the other side of the coin as far as the ARRL is concerned. 73 tries to bring you a rounded picture of what is actually going on, without pulling punches.

## buy a second subscription for a friend ...

Your first subscription is \$12 for one year (U.S. and Canada only — all others add \$2.00 per year foreign postage). Buy as many gift subscriptions for friends for \$10 each at the same time\* ... just send their name, call and address ... we'll see that they get a nice gift card telling them of your thoughtfulness and rush the first issue of their subscription to them in time for Christmas (if possible). Then, every month for the next year, they will be reminded of your consideration. It makes a great Christmas gift.

\*If you're already a subscriber, make that first gift subscription \$12.00. Subsequent subscriptions will be only \$10.00 each.

### SUBSCRIPTION BLANK:

YES, I WANT A ONE YEAR SUBSCRIPTION TO **73** @ \$12.00

New     Renew or extend     It's a gift!

Name \_\_\_\_\_ Call \_\_\_\_\_

Address \_\_\_\_\_

City \_\_\_\_\_ State \_\_\_\_\_ Zip \_\_\_\_\_

Send a one year gift subscription @ \$10.00 to:

New     Renew or extend     Don't know, please check

Name \_\_\_\_\_ Call \_\_\_\_\_

Address \_\_\_\_\_

City \_\_\_\_\_ State \_\_\_\_\_ Zip \_\_\_\_\_

Enclosed \_\_\_\_\_  Cash     Check     Money Order     Bill me

Charge my credit card     American Express     BankAmericard     MasterCard

Credit Card # \_\_\_\_\_ Interbank # \_\_\_\_\_

Expiration date \_\_\_\_\_ Signature \_\_\_\_\_

H/76

**73 magazine** • Peterborough NH 03458

Toll Free subscription numbers 800-258-5473 / 800-251-6771

scraping the enamel; an inexperienced builder might not know about this. Location of parts on the supplementary frequency doubler board are not indicated on the board, nor is it easy to make determination from the instruction sheet. It isn't impossible but it takes some studying.

No sockets are provided for the transistors — I would have preferred this (I could have purchased some) since I am always afraid of damaging these items when soldering. Sockets are provided for the integrated circuits.

The unit uses these RCA-type pin plugs for the rf outputs; I would have preferred to use a more sophisticated rf connector. Of course, I could have done something about this, but I didn't.

My friend had two problems with his unit — he



thought the power transistor was running a bit warm, solvable by using a larger heat sink; and the unit would get out of lock, causing all sorts of problems, solved by interchanging two of the ICs.

My unit had some interface problems with my

Regency HR2B. It worked fine between 144 MHz and 146 MHz, but in the 147 range the output dropped off to less than one Watt on the high power (15 Watt) position. The voltage in the Regency circuit was less than that obtained with use of a 147.54 crystal. However, the output voltage from the

Channelizer was constant. This problem was solved by disconnecting the output filter on the transmit line — evidently the frequency of the low pass filter was too low. On the receive side there were a number of spurious responses, receiving repeater outputs in funny places, along with a couple birdies.

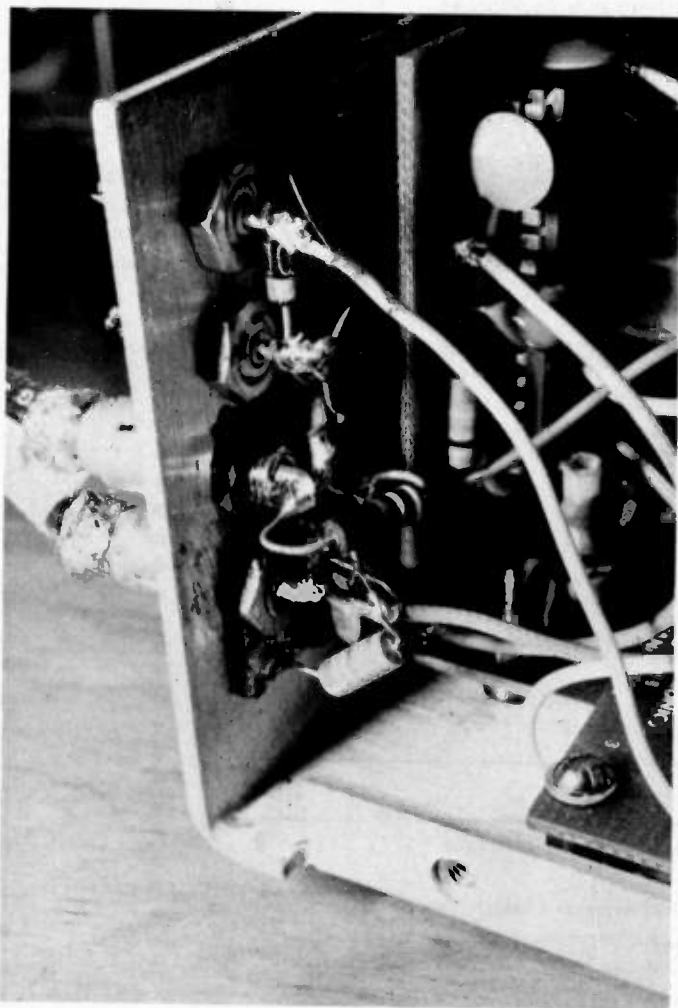

*Inside view of connections showing the diode between +12 and PTT to absorb voltage glitches caused by rig's relay releasing and special resistor installed on output of receive frequency to pad it down a bit (3rd one down).*

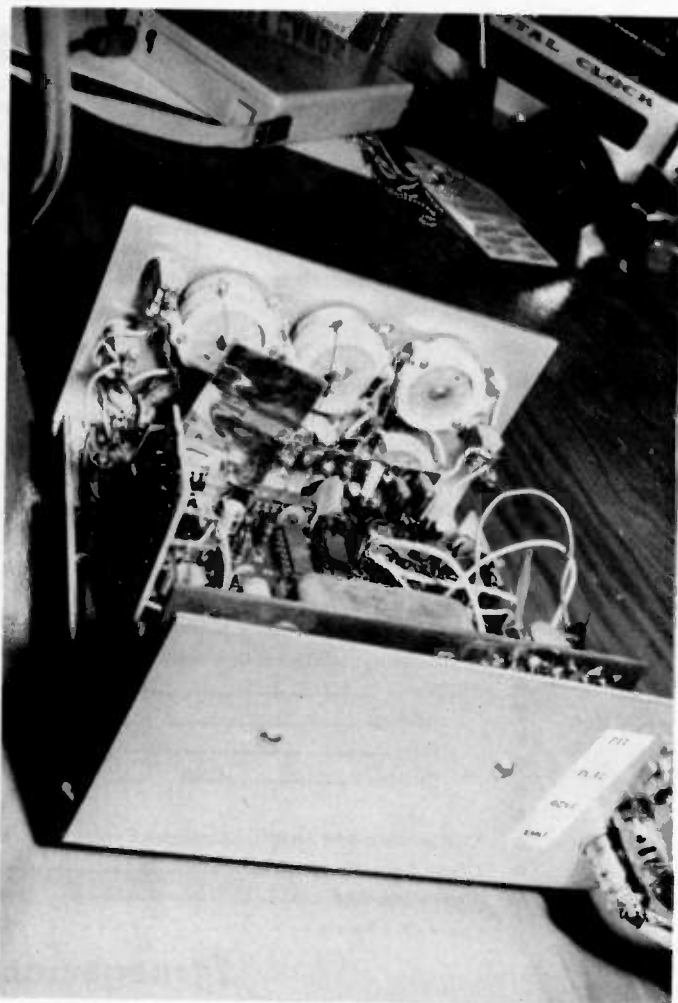

*View from the back showing the heat sink, connections, crystals, and diode switching.*

# 6 Digit LED Clock Kit - 12/24 hr.

**\$9<sup>95</sup>** QTY. 12  
ea. OR MORE

**\$10<sup>95</sup>** QTY.  
ea. 6-11

**\$11<sup>95</sup>** QTY.  
ea. 1-5

- KIT INCLUDES**
- INSTRUCTIONS
  - QUALITY COMPONENTS
  - 50 or 60 Hz OPERATION
  - 12 or 24 HR OPERATION

6-LED Readouts (FND-359 Red, com. cathode)  
1-MM5314 Clock Chip (24 pin)  
13-Transistors  
3-Switches  
6-Capacitors  
5-Diodes  
9-Resistors  
24-Molex pins for IC socket

**LARGE .4" DIGITS!**  
ORDER KIT #850-4  
AN INCREDIBLE VALUE!

"Kit #850-4 will furnish a complete set of clock components as listed. The only additional items required are a 7-12 VAC transformer, a circuit board and a cabinet, if desired."

Printed Circuit Board for kit # 850-4 (etched & drilled fiberglass) ..... \$2.95  
Mini-Brite Red LED's (for color in clock display) pkg. of 5 ..... 1.00  
Molded Plug Transformer 115/10 VAC (with cord) ..... 2.50  
NOTE: Entire Clock may be assembled on one PC Board or Board may be cut to remote display.  
Kit # 850-4 will fit Plexiglas Cabinet II.

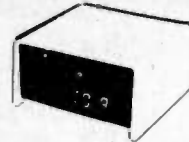

## PLEXIGLAS CABINETS

Great for Clocks or any LED Digital project. Clear-Red Chassis serves as Bezel to increase contrast of digital displays.

**Black, White or Clear Cover**

**CABINET I**  
3"H, 6 1/4"W, 5 1/2"D

**CABINET II**  
2 1/2"H, 5"W, 4"D

ANY SIZE/COLOR **\$6.50 ea.** 2/**\$12.**

RED OR GREY PLEXIGLAS FOR DIGITAL BEZELS

3"x6"x1/8" **95¢ ea.** 4/**\$3**

## MOBILE LED CLOCK

12 OR 24-HOUR OPERATION

12 VOLT AC or DC POWERED FOR FIXED OR MOBILE OPERATION.

SIX JUMBO .4" DIGITS!

KIT OR ASSEMBLED

MODEL 2001

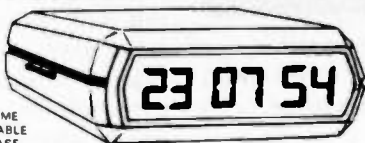

ACCURATE TIME WITH ADJUSTABLE XTAL TIME BASE

BATTERY BACK-UP FOR POWER FAILURE OR TRANSPORTING FROM HOUSE TO CAR, ETC.

Approx. Size:  
1 1/4"H x 4"W x 4 1/2"D

- 6 JUMBO .4" RED LED'S BEHIND RED FILTER LENS WITH CHROME RIM.
- SET TIME FROM FRONT VIA HIDDEN SWITCHES / 12/24 H. TIME FORMAT
- STYLISH CHARCOAL GRAY CASE OF MOLDED HIGH TEMP. PLASTIC
- BRIDGE POWER INPUT CIRCUITRY - TWO WIRE NO POLARITY HOOK-UP
- OPTIONAL CONNECTION TO BLANK DISPLAY (Use When Key Off in Car, Etc.)
- TOP QUALITY PC BOARDS & COMPONENTS - EXCELLENT INSTRUCTIONS

KIT # 2001 COMPLETE KIT (Less 9V. Battery) **29<sup>95</sup>** 3 OR MORE **\$27<sup>95</sup>** EA. 115 VAC Power Pack #AC-1 **\$2<sup>95</sup>** EA.

ASSEMBLED UNITS WIRE & TESTED ORDER # 2001 WT (LESS 9V. BATTERY) **\$39<sup>95</sup>** EA. 3 OR MORE **\$37<sup>95</sup>** EA. Assembled Units May Be Mixed With Kits for Qty. Price

**JUMBO RED LED'S 12/\$1.00 50/\$3.95**

## 6 Digit-LED Clock-Calendar-Alarm Kit

This is a complete, top of the line, Kit for the person that wants the best. Some of the many features and options are: 12/24 time, 28-30-31 day calendar, alternates time (8 sec) and date (2 sec) or can display time only and date on demand, 24 hr alarm - 10 minute snooze, alarm set indicator, 50/60 HZ. line operation or use with Xtal time base (#TB-1), built in OSC for battery back-up / AC failure, Aux. timer. Large digits.

Kit # 7001B 6-.4" Digits Man-64 **\$39.95**  
Kit # 7001C 4-.6" Digits & 2-.3" (seconds) **\$42.95**

Kits are complete (less cabinet) including PC boards, power supply, IC socket, 9 switches, 16 transistors and all parts required for above features and options (Ideal fit in Cabinet I above).

### 60 HZ.

XTAL TIME BASE KIT

Will enable Digital Clock or Clock-Cal. Kits to operate from 12VDC. Uses MM5369 and 3.58MHZ. XTAL. Req. 5-15VDC/2.5 MA. 1"x2" PC Board. Easy 3 wire hookup Accuracy: +- 2 PPM

#TB-1 [adjustable] Complete kit \$4.95 ea  
Wired & Cal. \$9.95 ea

PRINTED CIRCUIT BOARDS for CT-7001 Kits sold separately with assembly info. PC Boards are drilled Fiberglass, solder plated and screened with component layout. Specify for # 7001B or # 7001C (Set of 2) \$7.95

### JUMBO DIGIT CLOCK KIT

A complete Kit (less Cabinet) featuring: six .5" digits, MM5314 IC, 12/24 Hr. time, 50/60 HZ., Plug-Transformer, Line Cord, Switches, and all Parts.

[Ideal Fit in Cabinet II] **\$19<sup>95</sup>** 2/**\$38.**  
Kit #5314-5

### JUMBO DIGIT CONVERSION KIT

Convert small digit LED clock to large .5" displays. Kit includes 6-.5" LED's, Multiplex PC Board & easy hook-up info.

Kit # JD-1CC For common Cathode **\$9<sup>95</sup>** 2/**\$19.**  
Kit # JD-1CA For common Anode

### SCHOTTKY TTL

74500 \$ .35	930 \$ .09
74501 .40	932 .08
74504 .55	937 .08
74505 .60	
74509 .55	
74510 .40	7447 \$ .95
74515 .50	7448 .95
74520 .50	75491 .65
74522 .45	75492 .65
74540 .45	
74550 .45	
74551 .55	
74560 .85	
74564 .55	LM 309 H TO-5 \$ .95
74573 1.25	LM 309 K TO-3 1.25
74574 .85	
74575 1.75	7805 TAB .95
74578 1.50	7812 TAB 1.25
74586 .95	7815 TO-3 1.25
745107 .95	7815 TAB 1.25
745112 .95	7815 TO-5 .75
745113 1.40	7824 TO-3 1.25
745114 .95	723 DIP .75
745121 .95	723 TO-5 .75
745133 .75	
745134 .75	
745138 1.75	
745139 1.50	
745151 1.95	MM 5312 \$ 4.95
745153 1.95	MM 5314 3.95
745155 1.95	MM 5375 AB 3.95
745156 1.95	CT-7001 7.95
745157 1.80	CT-7002 13.95
745158 2.50	50380 3.95
745174 2.50	MM 5369 2.50
745175 2.50	
745181 2.95	
745182 1.95	
745251 2.75	3.579545 MHZ \$ 1.95

### UART

AY5-1013 \$ 6.95	
<b>DIODES</b>	
IN 4002 1A, 100 PIV 12/\$1.00	
IN 4003 1A, 200 PIV 12/\$1.00	
IN 4005 1A, 600 PIV 11/\$1.00	
IN 4007 1A, 1000 PIV 10/\$1.00	
RECTIFIER 2.5A, 1000 PIV 4/\$1.00	
RECTIFIER 3A, 1000 PIV 3/\$1.00	
IN 5400 3A, 50 PIV 5/\$1.00	
IN 914 SIL. SIGNAL 20/\$1.00	
IN 4148 SIL. SIGNAL 20/\$1.00	
DIAC 28V. 4/\$1.00	
<b>PLUG TRANSFORMERS</b>	
12 VAC at 150 MA \$ 2.50	
12 VAC at 500 MA 3.50	
<b>LINEAR</b>	
555 TIMER 2/\$1.00	
556 DUAL TIMER .95	
565 PLL .95	
566 FLUNCTION GEN. 1.75	
567 TONE DECODER 1.75	
<b>IC SOCKETS</b>	
PINS 1.24 25 100	
14 \$ .25 \$ .22 \$ .20	
16 .28 .25 .23	
18 .31 .28 .26	
24 .50 .45 .40	
28 .60 .55 .50	
40 .75 .70 .65	
<b>MEMORY</b>	
2102 1 IK RAM \$1.95	
2102 \$2.35	

### EXAR

XR 2556 \$ 1.75	
XR 2567 \$ 1.95	
<b>TRANSISTORS</b>	
2N2222A TO-18 5/\$1.00	
2N3415 TO-92 5/\$1.00	
2N3704 TO-92 5/\$1.00	
2N4249 TO-92 5/\$1.00	
2N4400 TO-92 5/\$1.00	
2N4437 TO-92 5/\$1.00	
2N5089 TO-92 5/\$1.00	
<b>SWITCHES</b>	
ROCKER SPDT 6/\$1.	
MINI SLIDE SPDT 5/\$1.	
REG. SLIDE DPDT 6/\$1.	
PUSH BUTTON N.O. 3/\$1.	
<b>TRANSISTOR SOCKET</b>	
TO-5/18 GOLD PINS 5/\$1.00	
<b>NYLON WIRE TIES</b>	
8" TIE-WRAP 100/\$1.95	
4" TIE-WRAP 100/\$1.75	
<b>MOLEX PINS</b>	
REEL OF 1000 \$ 8.50	
STRIP OF 100 1.25	
<b>MISC. PRIME IC's</b>	
FAIRCHILD 9316 (74161) \$ .95	
75234 DUAL CORE SENSE AMP 1.50	
MM 502H TO 5 SHIFT REG .95	

### OP AMPS

301 DIP 3/\$1.00	
301 TO-5 301 TO-5 709 DIP 741 DIP 741 M-DIP 741 TO-5 747 DIP 748 TO-5	
<b>DISCRETE LED'S</b>	
JUMBED RED 12/\$1.00 50/\$3.95 100/\$7.50	
<b>PC TRIM POTS</b>	
25K 6/\$1.00 4.7K 6/\$1.00	
<b>SPECTROL TORX TORQUE</b>	
95c 4/\$3.00	
<b>TELEPHONE FORMAT KEYBOARD</b>	
BY Chometrics 2-1/4"x3" 5/32" thick <b>\$4.95</b> 6/ <b>\$28.</b>	

### Fairchild Super Digit FND-359

4 1/2 Char. H.L. 7 segment LED RED Com. Cath. Direct pin replacement for popular FND-70

**95¢ ea, 10/\$8.50 100/\$79.00**

SET OF 6 FND-359 WITH MULTIPLEX PC BOARD \$6.95

25 AMP BRIDGE \$1.95 ea. 3/\$5.00 100 PIV

TELEPHONE FORMAT KEYBOARD BY Chometrics

2-1/4"x3" 5/32" thick **\$4.95** 6/**\$28.**

### SEE THE WORKS Clock Kit Clear Plexiglas Stand

- 6 Big .4" digits
  - 12 or 24 hr. time
  - 3 set switches (back)
  - Plug transformer
  - All parts included
- Plexiglas Is Pre-cut & drilled Size: 6"H, 4 1/2"W, 3"D

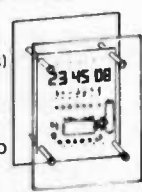

A SUPER LOOKING CLOCK!

Kit #850-4 CP **\$23<sup>50</sup>** ea. 2/**\$45.**

### 7-SEG LED COMMON CATHODE

COLOR	HT. DEC.PT. P.R.A.	
FND-359 RED	4" RHDP	\$ .95
FND-503 RED	5" RHDP	\$1.35
DL-750 RED	6" LHDP	\$2.95
XAN-654 GREEN	6" NDP	\$2.95
XAN-664 RED	6" NDP	\$2.95

COMMON ANODE		
DL-747 RED	6" LHDP	\$2.95
XAN-72 RED	3" LHDP	\$1.25
XAN-81 YELLOW	3" RHDP	\$1.75
XAN-351 GREEN	3" RHDP	\$1.50
XAN-361 RED	3" RHDP	\$1.50
XAN-362 RED	3" LHDP	\$1.50
XAN-662 RED	6" NDP	\$2.50
XAN-692 RED	6" NDP	\$2.50

Form Inexpensive Sockets 100 for \$1.25 Reel of 1000 - \$8.50

# OPTOELECTRONICS, inc.

BOX 219 • HOLLYWOOD, FLA. 33022 • (305) 921-2056



ORDER BY PHONE OR MAIL  
COD ORDERS WELCOME  
\$1.00 CHG.  
Orders Under \$15 Add \$1.00 Handling  
Fla. Res. Please Add 4% Sales Tax.

WE PAY ALL SHIPPING IN CONTINENTAL USA — OTHERS ADD 5% | 10% FOR AIRMAIL |

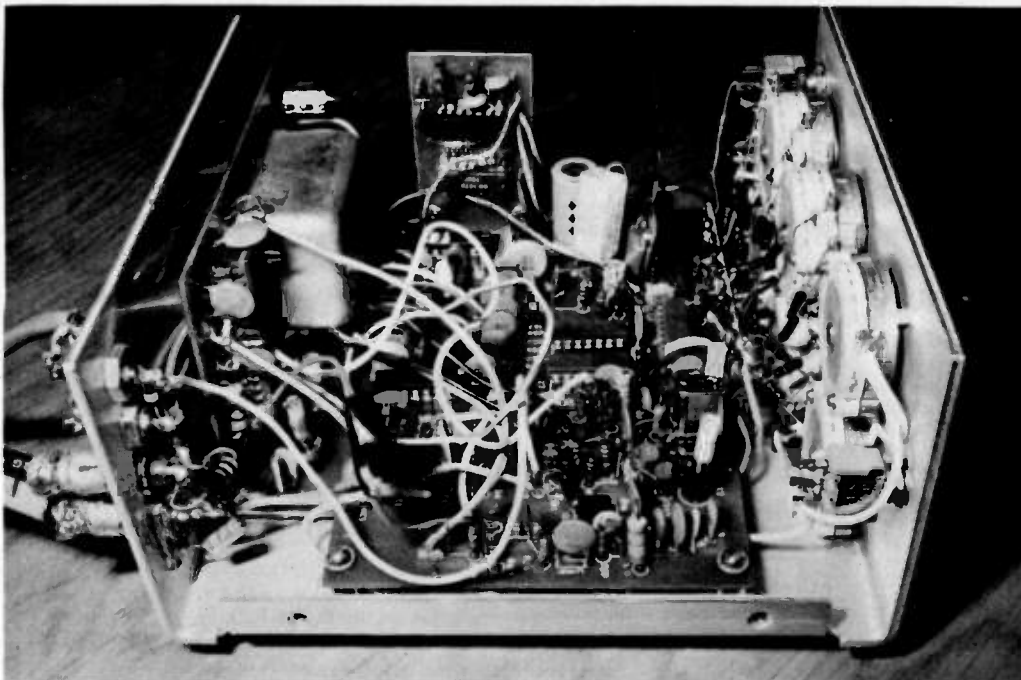

General view of inside of unit. 5 kHz board is vertical one in background with the two ICs. Top board mounted on the back is the VCO board with the shield over the critical components. Below this is the frequency doubler board (almost out of sight, it has the 2 coils mounted on it).

This problem was solved by inserting a 470 Ohm resistor in series with the receiver output. Apparently the signal

injection was at a bit too high level and caused this problem.

These were the only things on the negative side. On the

positive side, the unit is ultra stable, quite versatile, simple and functional. It is nice to be able to use the entire 2

meter band, even with 5 kHz steps, rather than be restricted to 12 channels. (After all, one wouldn't get on 20 meters and use only a few frequencies!) The unit will also function as a rough frequency checker — it is quite easy to tell if the other person is on or near the proper frequency by moving in 5 kHz steps and noting the fuzziness of the response. At the same time, your station can move up and down in 5 kHz increments and he can check his bandwidth or whatever.

The GLB people are most helpful in their correspondence over the telephone. I would honestly recommend this unit to the serious 2 meter operator, with the provision that anyone should be prepared for the delays, which aren't really GLB's problem, and the minor construction difficulties, which would creep up in almost anything. Once it works, it works just great. ■

## ADVA

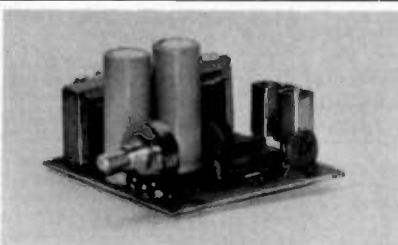

# KIT \$11<sup>95</sup>

ASSEMBLED \$17.95  
ADD \$1.25 FOR  
POSTAGE/HANDLING

## VARIABLE POWER SUPPLY

- Continuously Variable from 2V to over 15V
- Short-Circuit Proof
- Typical Regulation of 0.1%
- Electronic Current Limiting at 300mA
- Very Low Output Ripple
- Fiberglass PC Board Mounts All Components
- Assemble in about One Hour
- Makes a Great Bench or Lab Power Supply
- Includes All Components except Case and Meters

### OTHER ADVA KITS:

**LOGIC PROBE KIT**—Use with CMOS, TTL, DTL, HTL, HPL, and most MOS IC's. Built in protection against polarity reversal and over-voltage. Drawn only a few mA from circuit under test. Dual LED readout. Complete kit includes case and clip leads. **ONLY \$3.85**

**FIXED REGULATED POWER SUPPLY KITS**—Short-circuit proof with thermal current limiting. Compact size and typical regulation of 0.5% make these ideal for most electronic projects. Available for 5V @ 500mA, 6V @ 500mA, 9V @ 500mA, 12V @ 400mA, 15V @ 300mA. Specify voltage when ordering. **\$8.95 ea.**

These easy to assemble kits include all components, complete detailed instructions and plated fiberglass PC boards. Power supply kits do not include case or meters. Add \$1.25 per kit for postage and handling.

**1 MAIL NOW! FREE DATA SHEETS** included with many items from this ad. **FREE ON REQUEST**—741 Op Amp with every order of \$5 or more; 743 Dual Op Amp or two E100 FET's with every order of \$10 or more, postmarked prior to 3/31/77. One free item per order. **ORDER TODAY**—All items subject to prior sale and prices subject to change without notice. All items are new surplus parts—100% functionally tested.

**WRITE FOR FREE CATALOG #76** offering over 350 semiconductors carried in stock. Send 13¢ stamp.

**TERMS:** Send check or money order (U.S. funds) with order. We pay 1st Class postage to U.S., Canada and Mexico (except on kits). \$1.00 handling charge on orders under \$10. Calif. residents add 6% sales tax. Foreign orders add postage. COD orders add \$1.00 service charge.

### MORE SPECIALS:

**RC4195DN ±15V @ 50mA VOLTAGE REGULATOR IC.** Very easy to use. Makes a neat Highly Regulated ±15V Supply for Op AMP's, etc. Requires only unregulated DC (18-30V) and 2 bypass capacitors. With Data Sheet and Schematics. 8-pin MDIP **\$1.25**

**LM741 FREED COMPENSATED OP AMP.** μA741, MC1741, etc. mDIP 5/S1 **3/51**

**MC1458 DUAL 741 OP AMP mDIP 3/51**

**RC4558 DUAL 741 OP AMP mDIP 3/51**

**2N3904 NPN TRANSISTOR AMPLIFIER/SWITCH** to 50 mA β100 **6/51**

**ZENERS**—Specify Voltage 2.3, 3.9, 4.3, 5.1, 6.8, 8.2 400mW 4/S1,00 9-1, 10, 12, 15, 18, 20, 22, 24, 27, or 33V (±10%) 1 Watt 3/S1,00

- MONEY-BACK GUARANTEE
- ALL TESTED AND GUARANTEED

**ADVA ELECTRONICS**  
BOX 4181 H, WOODSIDE, CA 94062  
Tel. (415) 851-0455

# FREE

IC or FET's WITH  
\$5 & \$10 ORDERS.†  
DATA SHEETS  
WITH MANY ITEMS.

DIODES & RECTIFIERS	TRANSISTORS	TRANSISTORS	TRANSISTORS	LINEAR IC's
2N706 50 74	2N4091 3/51	2N4533 2/51	LM340K-6 1.70	
2N718 24	2N4092 50 74	2N4540 2/51	LM340K-15 1.70	
1N454 to 0/51	2N720 40	2N4121 3/51	LM340K-3 1.70	
1N458 0/51	2N718 40	2N4122 3/51	LM340T-12 1.70	
1N483 to 0/51	2N1813 50 74	2N4124 3/51	LM340T-16 1.70	
1N488 0/51	2N1711 20	2N4248 5/51	LM340T-24 1.70	
1N746 to 0/51	2N1850 30	2N4249 5/51	LM378M- 50	
1N759 0/51	2N1893 30	2N4250 4/51	LM377N 2.50	
1N801-4 1/51	2N2219 24	2N4274 5/51	E170 3/51	LM330N 1.20
1N812 to 0/51	2N2222 4/51	2N4302 50 74	MPF102 1.40	NE555M* 2/51
1N974 4/51	2N2222A 5/51	2N4303 20	MPF104 3/51	NE555A 20.00
1N3064 0/51	2N7269 5/51	2N4338 50	MPF112 4/51	LM705CH 30.00
1N3068 0/51	2N7269 to 50	2N4350M 2/51	MP5551B 3/51	LM705CN 20.00
2N9011* 0/51	2N7905 50 74	2N4351 50 74	MP5552 3/51	LM723M 3/51
1N4002 12/51	2N7905 50 24	2N4352 50 80	SE1007 4/51	LM723M* 3/51
1N4003 12/51	2N7906A 30	2N4418 2/51	SE2001 4/51	LM733N 50.00
1N4004 12/51	2N7907 5/51	2N4419A 50 80	SE2002 4/51	LM741CN 3/51
1N4005 10/51	2N2553 51-50	2N4456 to 50	SE5001 to 50	LM741CN* 4/51
1N4006 10/51	2N3542 0/51	2N4461 50	SE5003 3/51	LM741CN14 3/51
1N4007 10/51	2N3564 4/51	2N4467E 3/51	SE5020 53.00	LM747CN 2.5
1N4148 15/51	2N3565 to 0/51	2N4488E 2/51	TS173 to 3/51	7482C DIP 1.25
1N4154* 25/51	2N3568 0/51	2N4481 52-50	TS175 3/51	7482C DIP 1.00
1N4370 to 2/51	2N3638 0/51	2N4488 50		DIGITAL IC's
1N4372 2/51	2N3638A 5/51	2N4495 3/51		844C mDIP 30.00
1N4656 15/51	2N3641 5/51	2N4507 4/51	MM5738N 52.95	LM1304N 1.10
1N4729 to 3/51	2N3642 5/51	2N5089 4/51	SN7400N 16	LM1458M- 3/51
1N4753 3/51	2N3643 0/51	2N5126 to 0/51	SN7410N 16	LM2119N 14.00
1N5223 to 0/51	2N3644 4/51	2N5135 5/51	SN7420N 16	XR2556CP 1.66
1N5236 4/51	2N3646 4/51	2N5136 5/51	SN7440N 16	2N700E 1.95
	2N3680 to 3/51	2N5138 5/51	SN7451N 16	CA3028A 1.70
	2N3690 3/51	2N5183 3/51	SN7451N 16	CA3046 84
	2N3691 3/51	2N5187 55.00	SN7473N 26	LM3075N1 1.66
	2N3694 4/51	2N5199 2.50	SN7478N 35	CA3086* 50
	2N3721 50 80	2N5216 3/51	SN7489N 64	LM3000N 55
	2N3722 70	2N5308 2/51	LINEAR IC's	RC4194D 1.60
	2N3823 40	2N5397 51.50	LM100H 27.50	RC4194K* 2.80
	2N3866 75	2N5432 1.00	LM101AN 27.50	RC4194M* 1.25
	2N3903* 0/51	2N5457 3/51	LM103H 27	RC4195K* 2.25
	2N3906 55.00	2N5458 3/51	LM103H 27	LM2500CN 2.00
	2N3907 55.00	2N5464 3/51	LM103H 27	RC4550N 8.00
	2N3922 5.00	2N5466 2/51	LM111N 90	NE555V 1.25
	2N3934 3.20	2N5543 53.00	LM120K-6 1.35	NE555V 50.00
	2N3935 1.10	2N5544 2.50	LM120K-12 1.35	RC4195K 2.25
	2N3939 1.00	2N5545 12.00	LM120K-15 1.35	RC4195T 3/51

### \*SUPER SPECIALS:

1N914 100V/10mA Diode	20/S1	MPF102 200MHz RF Amp	3/51
1N4001 100V/1A Rect.	15/S1	40673 MOSFET RF Amp	\$1.75
1N4154 30V 1N914	25/S1	LM324 Quad 741 Op Amp	.94
BRT 50V 1/8A Bridge Rec	4/51	LM376 Pos Volt Reg mDIP	.55
2N2222A NPN Transistor	6/51	NE555 Timer mDIP	2/51
2N2907 PNP Transistor	6/51	LM723 2.37V Reg Dip	3/51
2N3055 Power Xistor 10A	6/51	LM741 Comp Op Amp mDIP	4/51
2N3904 NPN Amp/Sw β100	6/51	LM1458 Dual 741 mDIP	3/51
2N3906 PNP Amp/Sw β100	6/51	CA3086 5 Trans Array DIP	.55
CP650 Power FET 7Amp	55	RC4195DN ±15V/50mA mDIP	1.25

RF-391 RF Power Amp Transistor 10-25W @ 3-30MHz TO 3 **\$5.00**  
555X Timer 1.5-1hr Off-Reset pinout from 555 (w/dial) **2.25**  
RC4194TK Dual Tracking Regulator 0-2 to 30V @ 200mA TO 66 **\$2.50**  
RC4195TK Dual Tracking Regulator ±15V @ 100mA (TO 66) **\$2.25**  
8038 Waveform Generator ~□△ Wave With Circuits & Data **\$3.75**



# Radio Hut

P. O. BOX 64783 DALLAS, TEXAS 75206

TERMS: NO COD's. Cash or money orders only. Texas Residents add 5% Sales Tax. Add 5% of total order for postage and handling. Foreign orders add 10%. Overseas orders - US funds only! Phone orders welcome! - 214/271-8423 in Dallas. Dallas customers: We offer 1 day pick up service. Call 271-8423. If you have to pay for the call - DON'T! - Use our toll free no. Orders must be called in one day in advance. Pick-up between 12-5PM on weekdays and 12-3 PM on Saturday.



CALL OUR TOLL FREE NUMBER  
1-800-527-2304



## READOUTS

FND 503-CA  
FND 510-CC  
\$1.50 each  
or 6 for \$7.50

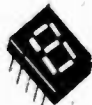

Ideal for large  
readout application.

FND 800-CC

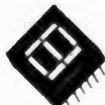

RED., 5 in. char.  
10ma per segment.

FND. 359  
.95 each



FCS. 8000 CC.

\$6.25 each

LOOK!

RED. .25 in. char.  
15ma per segment.  
Common Cathode.

100%  
PRIME!

### TRANSISTORS

2N4400	5/\$1.
2N5401	5/\$1.
2N2907	6/\$1.
2N3904	6/\$1.
2N3906	6/\$1.
2N3055	.90
3N201	.75
MJE3001	.45
MJE1103	.45

100% PRIME!

### LINEARS

LM340-6	\$1.10	LM3900	.39
LM340-8	1.10	LM309-K	1.50
LM340-12	1.10	LM324	.39
LM340-15	1.10	NE555	.45
LM340-18	1.10	NE556	1.10
LM340-24	1.10	NE565	1.00
LM709	.39	NE566	1.10
LM723	.55	NE567	1.25
LM741	.35	NE5558	.75

BEST  
VALUE!

GUARANTEED!

## CMOS

100% PRIME!

CD4001	.23	CD4017	1.00	CD4030	.40	CD4056	1.80
CD4002	.23	CD4018	1.20	CD4035	1.24	CD4060	1.45
CD4007	.23	CD4019	.40	CD4040	1.35	CD4066	.85
CD4009	.53	CD4021	1.20	CD4041	.85	CD4071	.23
CD4010	.49	CD4022	.95	CD4043	.73	CD4076	1.25
CD4011	.23	CD4023	.23	CD4044	.50	CD4098	1.65
CD4012	.23	CD4024	.87	CD4049	.55	CD4512	1.30
CD4013	.45	CD4025	.23	CD4050	.50	CD4516	1.75
CD4014	1.30	CD4027	.53	CD4051	1.45	CD4518	1.60
CD4015	1.10	CD4028	.90	CD4052	1.25	CD4520	1.60
CD4016	.49	CD4029	1.20	CD4053	2.25	CD4911	.30

CALL OUR TOLL FREE NUMBER 1-800-527-2304  
FOR QUANTITY DISCOUNT INFORMATION

LIMITED QUANTITY! CAPS

1000UF	35VDC	.90 each (upright)
4700UF	25VDC	.90 each
4100UF	15VDC	.90 each
1300UF	15VDC	.80 each
600UF	15VDC	.75 each

DON'T MISS  
THIS ONE!

LIMITED QUANTITY

Caps listed are Electrolytic and have axial leads.  
BRAND NEW - NEVER USED!

## ALUMINUM PROJECT CASES

(Order by number)

### CASE 1

H-1 1/2"  
W-3"  
L-4 3/8"

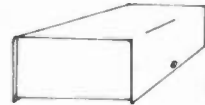

\$1.40

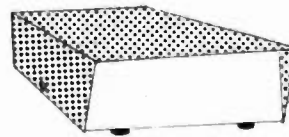

### CASE 2

H-2" \$3.00  
W-4 7/8"  
L-3 1/2"  
Slope Front - 3/4"

### CASE 3

H-2 1/2" \$3.40  
W-7"  
L-4"  
Slope Front - 1/2"

### CASE 5

H-1 1/2" \$.99  
W-2 7/8"  
L-2 3/4"

FOR CUSTOM BUILT  
CASES, CALL OUR  
TOLL FREE NUMBER.  
Also ask about our  
liberal quantity discounts.

### CASE 4

H-1 7/8"  
W-4 3/8"  
L-3"



\$2.50

Ask about our TRANSFORMERS QTY. DISCOUNTS

ALL TRANSFORMERS ARE SHIELDED AND HAVE 2 3/8"  
MTG. CENTERS EXCEPT NUMBER 7 WHICH HAS A 1 1/4"  
MTG. CENTER. 120V PRIMARYS.

TRANSFORMER 1  
25.5V at 1 AMP SEC.  
\$2.00

TRANSFORMER 2  
15V at 500ma SEC.  
\$1.30

TRANSFORMER 3  
24V at 300ma  
150V at 20ma  
Dual SEC.  
\$1.60

TRANSFORMER 4  
12V at 35ma  
150V at 25ma  
Dual SEC.  
\$1.60

TRANSFORMER 5  
18V at 500ma  
24V at 300ma  
Dual SEC.  
\$1.30

TRANSFORMER 6  
9V at 200ma  
60V at 150ma  
Dual SEC.  
\$1.30

7400	.19	7411	.29	7496	.89
7401	.19	7413	.50	74100	\$1.
7402	.19	7420	.19	74174	.95
7403	.19	7430	.19	74175	
		7421	.19	7422	.25
		7422	.39	7443	.65
		7423	.39	7444	.65
		7424	.30	7445	.69
		7425	.30	7446	.69
		7426	.27	7447	.89
		7427	.27	7448	.89
		7428	.19	7449	.85
		7429	.19	7450	.24
		7430	.34	7451	.19
		7431	.34	7452	.19
		7432	.34	7453	.19
		7433	.39	7454	.19
		7434	.39	7455	.19
		7435	.39	7456	.19
		7436	.39	7457	.19
		7437	.39	7458	.19
		7438	.39	7459	.19
		7439	.39	7460	.19
		7440	.19	7461	.19
		7441	.19	7462	.19
		7442	.19	7463	.19
		7443	.19	7464	.19
		7444	.19	7465	.19
		7445	.19	7466	.19
		7446	.19	7467	.19
		7447	.19	7468	.19
		7448	.19	7469	.19
		7449	.19	7470	.19
		7450	.19	7471	.19
		7451	.19	7472	.19
		7452	.19	7473	.19
		7453	.19	7474	.19
		7454	.19	7475	.19
		7455	.19	7476	.19
		7456	.19	7477	.19
		7457	.19	7478	.19
		7458	.19	7479	.19
		7459	.19	7480	.19
		7460	.19	7481	.19
		7461	.19	7482	.19
		7462	.19	7483	.19
		7463	.19	7484	.19
		7464	.19	7485	.19
		7465	.19	7486	.19
		7466	.19	7487	.19
		7467	.19	7488	.19
		7468	.19	7489	.19
		7469	.19	7490	.19
		7470	.19	7491	.19
		7471	.19	7492	.19
		7472	.19	7493	.19
		7473	.19	7494	.19
		7474	.19	7495	.19
		7475	.19	7496	.19
		7476	.19	7497	.19
		7477	.19	7498	.19
		7478	.19	7499	.19
		7479	.19	7500	.19

100%  
GUARANTEED!  
OR YOUR MONEY BACK

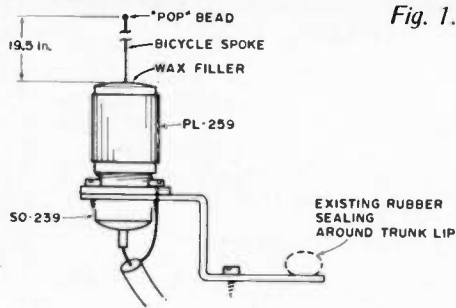
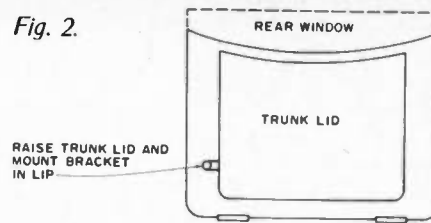

Fig. 1.

Fig. 2.



The wide array of available 2 meter mobile antennas can make it rather difficult to settle on a particular style. Often one doesn't care to invest a large sum of money in the mobile antenna because of low funds or fear of being ripped off. Thus the following three suggestions are offered, each of which can be assembled in a very short time (I built one in 10 minutes).

These antennas, when carefully assembled and properly cut to the desired frequency, will perform as well as their commercial counterparts.

#### Trunk Mount Antenna

First cut a bicycle spoke, welding rod or piece of bus bar approximately 21½ inches long. Fit this into the center conductor of a PL-259

rf plug and solder. Fill the connector with candle wax or epoxy and smooth off the excess. The wax will act as a sealer and insulator. The antenna length from top of connector to antenna tip should now be trimmed to your favorite frequency.

Next, a thin piece of metal approximately 1½ inches by 3 inches is bent as in Fig. 1 and painted. This will act as a mounting bracket. One end is drilled and fitted with an SO-239 rf chassis connector. The other end of the bracket

is drilled to clear two sheet metal screws.

Now connect RG-58 transmission line to the SO-239, slipping the braid under a mounting screw. Mount this assembly in your trunk lid lip, shown in Fig. 2, using two sheet metal screws. All autos have a little extra space here, so the screws will fit nicely. These screws are covered when the trunk is closed, thus preventing leaks and displaying a neat assembly.

Finally, run the transmission line to the front of the car and connect the rig. If you need a quick portable whip, just unscrew the top section, connect it to an 831J right angle adapter and plug it into the back of your rig. A home brew 5/8 wave antenna could also be used with this mounting system.

#### Gutter Clip Antenna

First, build the antenna whip assembly as described previously. Now secure an 831J double female rf connector and large, battery-type alligator clip. (The aluminum type are relatively inexpensive.) Tightly wire the 831J connector to the alligator clip and plug the whip assembly into one end.

Plug the transmission line from your rig into the other end of the 831J, and then clip the assembly on your auto's gutter. Finally, tape the transmission line in position for a few days to "train" it. Fig. 3 shows details of this super quick, but very effective, antenna.

#### Luggage Rack Antenna

If your auto has a luggage rack, a quick mount can be fabricated quite inexpensively.

Shop the hardware store for a U bolt which fits snugly over a flat bar on the rack. Mount the U bolt securely in the desired position, with the threaded ends up. Later you will slip a mount and a second nut on one side.

Now find a piece of metal approximately 1 inch by 3

# Three for Two

-- antenna forum

Dave Ingram K4TWJ  
Eastwood Village #604 N.  
Rt. 11, Box 499  
Birmingham AL 35210

# NOT JUST A PRETTY FACE.....



## *Novice Class Beginner's Bargain A Great Gift \* \* \* Help A Beginner*

If you know anyone who would like to get a Novice license the easiest possible way, turn them on to this special bargain Novice Study Package. This is great for club study courses . . . or for home study for the Novice ticket.

**NOVICE CLASS STUDY GUIDE.** This is a brand new book, just published, which includes the very latest FCC materials . . . things that are not in any other study guides, but which will be on the test. The FCC has sneakily been putting some of the General Class material in the Novice test lately. The book also includes the latest FCC rules and regulations . . . try to find them anywhere else. You will have a tough time getting them from the FCC.

Use of this book will prepare you not only for the Novice test, but also lay the groundwork for the General Class study course. This is the difference between a real study guide which teaches you the theory simply and progressively and one of those darned question and answer manuals which teach you nothing and make it so difficult when the FCC rewrites the questions . . . which they do.

**NOVICE CLASS THEORY TAPES.** Since most people get only about 20% comprehension with a reading of a book, we also have some great theory tapes which cover the same material, but which can be listened to anywhere you use a cassette tape player . . . in your car, at lunch, etc. This is the most painless way yet to learn the theory. The material is discussed by Wayne Green, not just read by an announcer. You'll not find an easier or more fun way to learn. There are four one hour cassettes in the set.

**MORSE CODE CASSETTE.** The beginner's cassette has Wayne telling you the letters, numbers and punctuation you'll need for the test. This tape uses the latest scientific breakthrough in teaching . . . sending each character at 13 wpm, but spacing the characters for 5 wpm. And you'll start off in the first minute or so copying words in code . . . you'll see. This is a one hour cassette.

**6 WPM CASSETTE.** This is for practice once you know the letters and numbers. It is a mixture of letters, numbers and punctuation and is very difficult. When you have mastered this (about four or five hours of work) you'll be able to breeze through the FCC test. This is a one hour cassette.

The book, four theory tapes and two one hour code cassettes normally sell for about \$31. As a test we are offering this complete set for the Package Price of \$22.95 postpaid in the U.S. Please add \$3 outside of the U.S.

If you have Master Charge, BankAmericard or American Express, you can call one of our special 800 numbers (toll free) - 800-258-5473 or 800-251-6771 - and place your order for immediate shipment. Otherwise, fill out the below coupon and send in your order. This will be a fantastic Christmas gift for a youngster.

\*\*\*\*\*

Please send \_\_\_\_\_ Beginner's Bargain(s) including Novice Class License Code Tapes, Theory Tapes and Study Guide @ \$22.95 (ppd. USA). Foreign orders add \$3.00 postage and handling; First Class mail USA - add \$2.00.

TOLL FREE CALL (800) 258-5473 or (800) 251-6771

\$ \_\_\_\_\_ enclosed.     Cash     Check     Money Order  
 Charge my credit card:     American Express     Master Charge     BankAmericard  
 Credit card # \_\_\_\_\_ Interbank # \_\_\_\_\_  
 Expiration date \_\_\_\_\_ Signature \_\_\_\_\_



Name \_\_\_\_\_ Call \_\_\_\_\_

Address \_\_\_\_\_

City \_\_\_\_\_ State \_\_\_\_\_ Zip \_\_\_\_\_

If a gift, print name and address of receiver. Send to: \_\_\_\_\_

\_\_\_\_\_

\_\_\_\_\_

Gift card to read: \_\_\_\_\_

\_\_\_\_\_

inches and drill a hole in each end. Mount an SO-239 connector (antenna mount) in one end and bolt the other end to one side of the U bolt on the luggage rack, as shown in Fig. 4. (If you purchase two U bolts, this piece of metal may be salvaged from one.) Now plug in the whip assembly mentioned previously, and run the transmission line inside the auto. I might add this method works beautifully with roof mount type whips like the Antenna Specialist M7A, and sure

**A**fter unsuccessfully trying to trade my Vibroplex semiautomatic key "bug," I decided to try to modify it to work with my new electronic keyer.

The modification takes just a few simple steps. Remove the connections to the "dit" post on the bottom of the bug and spread them out as shown in Fig. 1. Place a piece of plastic tape between the 4-40 screw and bug bottom to prevent a short circuit between "dah" connection and ground.

Next, advance the dit post screw forward, so that the vibrator always makes contact with the dit post when the paddle is pressed to the right side. See Fig. 2. The weights can then be adjusted for the desired "feel" even though their position has no effect on the dit speed, which is now controlled by the electronic keyer.

Last, connect the dit and dah connections of the keyer as shown in Fig. 2.

You now have a key to use with your automatic keyer. This key can easily be changed back into a regular bug by reversing the above procedure. ■

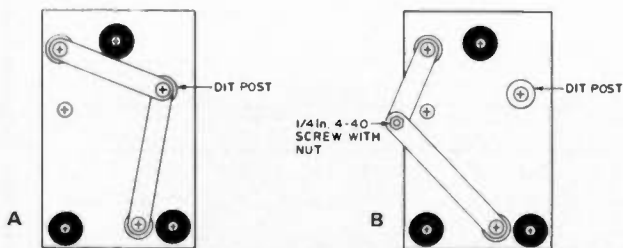

Fig. 1. Bottom view of bug (a) before modification and (b) after modification.

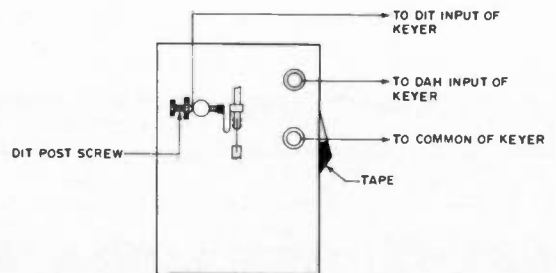
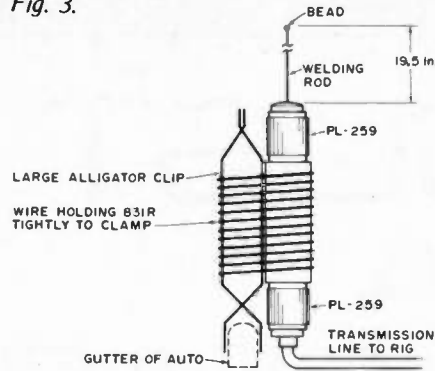

Fig. 2. Partial top view of bug showing keyer connections.

Fig. 3.



beats drilling a hole in the roof.

While the three antennas

previously mentioned were designed as an inexpensive answer to 2 meter mobile

Fig. 4.

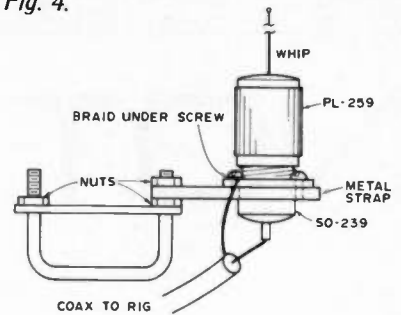

applications, they also contain some unique ideas. Why not give one or two of them a try? They go together nicely and work very well. ■

James C. Nordgren WB9BNF  
1100 N. LaSalle, Apt. 1106  
Chicago IL 60610

# How to Bug an Automatic Keyer

## - - putting new life in an old bug

# S. D. SALES CO.

P. O. BOX 28810- A  
DALLAS, TEXAS 75228

## 4K LOW POWER RAM BOARD KIT THE WHOLE WORKS \$89.95

Imesai and Altair 8080 plug in compatible. Uses low power static 21L02-1 500 ns. RAM's, which are included. Fully buffered, drastically reduced power consumption, on board regulated, all sockets and parts included. Premium quality plated thru PC Board.

## Stick It!

IN YOUR CLOCK!  
IN YOUR DVM, etc.

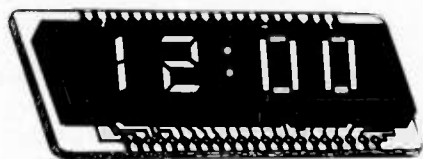

4 JUMBO .50 INCH DIGITS  
ON ONE "STICK"!  
(with colons and AM/PM Indicator)

**\$3.95**

BUY 3 FOR \$10.00

BOWMAR

### 4 DIGIT LED READOUT ARRAY

The Bowmar Opto-Stick. The best readout bargain we have ever offered. Has four common cathode jumbo digits with all segments and cathodes brought out. Increased versatility since any of the digits may be used independently to fit your applications. Perfect for any clock chip, especially direct drive units like 50380 or 7010. Also use in freq. counters, DVM's, etc. For 12 or 24 hour format.

HUGE SPECIAL PURCHASE!  
NOT FACTORY SECONDS  
AS SOLD BY OTHERS

## MICROPROCESSORS AND THINGS

8080A	By AMD. Outperforms INTEL	\$24.00
8008-1	High Speed 8008	6.95
8212	I/O PORT	3.50
8224	Clock Generator	4.95
8820	Dual Line RCVR	1.75
8830	Dual Line Driver	1.75
8838	Quad Bus Transceiver	2.00
MC1488	RS232 to TTL	1.50
MC1489	TTL to RS232	1.50
2513	Character Gen.	10.00
MM5204	4K E Prom	12.00

LOW COST  
HIGH VALUE

### TTL INTEGRATED CIRCUITS

7400 - 19c	7430 - 19c	7476 - 35c	74153 - 75c
7402 - 19c	7432 - 34c	7480 - 49c	74154 - 1.00
74L04 - 29c	7437 - 39c	7483 - 95c	74157 - 75c
74S04 - 44c	7438 - 39c	7485 - 95c	74161 - 95c
7404 - 19c	7440 - 19c	7586 - 45c	74164 - 1.10
7406 - 29c	7447 - 85c	7490 - 65c	74165 - 1.10
7408 - 19c	7448 - 85c	7492 - 75c	74174 - 95c
7410 - 19c	7451 - 19c	7495 - 75c	74181 - 2.50
7411 - 29c	7453 - 19c	7496 - 89c	74191 - 1.25
7413 - 50c	7473 - 39c	74121 - 38c	74192 - 1.25
7420 - 19c	7474 - 35c	74123 - 65c	74193 - 1.00
	7575 - 35c	74141 - 75c	74195 - 69c

## 60HZ CRYSTAL TIME BASE 2/\$10. FOR DIGITAL CLOCKS S.D. SALES EXCLUSIVE! \$5.95

### KIT FEATURES:

- A. 60hz output with accuracy comparable to a digital watch
- B. Directly interfaces with all MOS Clock Chips
- C. Super low power consumption (1.5 Ma typ.)
- D. Uses latest MOS 17 stage divider IC
- E. Eliminates forever the problem of AC line glitches
- F. Perfect for cars, boats, campers, or even for portable clocks at ham field days.
- G. Small size, can be used in existing enclosures.

KIT INCLUDES CRYSTAL, DIVIDER IC, PC BOARD PLUS ALL OTHER NECESSARY PARTS & SPECS.

## JUMBO LED CAR CLOCK

**\$16.95  
KIT**

You requested it! Our first DC operated clock kit. Professionally engineered from scratch to be a DC operated clock. Not a makeshift kluge as sold by others. Features: Bowmar 4 digit .5 inch LED array, Mostek 50252 super clock chip, on board precision time base, 12 or 24 hour real time format, perfect for cars, boats, vans, etc. Kit contains PC Board and all other parts needed (except case). 50,000 satisfied clock kit customers cannot be wrong!

FOR ALARM OPTION ADD \$1.50  
FOR XFMR FOR AC OPERATION ADD \$1.50

## 50 HZ CRYSTAL TIME BASE KIT - \$6.95

All the features of our 60HZ kit but has 50HZ output. For use with clock chips like the 50252 that require 50HZ to give 24 hour time format.

## UP YOUR COMPUTER! 21L02-1 1K LOW POWER 500 NS STATIC RAM TIME IS OF THE ESSENCE

And so is power. Not only are our RAM's faster than a speeding bullet but they are now very low power. We are pleased to offer prime new 21L02 - 1 low power and super fast RAM's. Allows you to STRETCH your power supply farther and at the same time keep the wait light off.

8 for \$12.95

## 1000 MFD FILTER CAPS

Rated 35 WVDC. Up-right style with PC leads. Most popular value for hobbyists. Compare at up to \$1.19 each from franchise type electronic parts stores.

S.D. Special  
4 for \$1.00

## WESTERN DIGITAL UART No. TR1602B, 40 pin DIP

This is a very powerful and popular part.

NEW-\$6.95 with data  
LIMITED QUANTITY

## C&K MINI TOGGLE SWITCH No. 7103 SUB MINI SPDT Center OFF.

SPECIAL - 99c

## SLIDE SWITCH ASSORTMENT

Our best seller. Includes miniature and standard sizes, single and multi-position units. All new, first quality, name brand. Try one package and you'll reorder more. SPECIAL 12/\$1.

## RESISTOR ASSORTMENT

1/4 W 5% and 10%. PC leads. A good mix of values. 200/\$2.

## 74S200

256 Bit High Speed RAM  
Same as 82S16  
\$3.95

## 1K PROM BACK IN STOCK!

82S129. 256x4. Bipolar, 50NS.  
FAST. WITH SPECS.  
\$3.95

## FAIRCHILD BIG LED READOUTS

A big .50 inch easy to read character. Now available in either common anode or common cathode. Take your pick. Super low current drain, only 5MA per segment typical. FND-510 Common Anode FND-503 Common Cathode  
PRICE SLASHED! 59c each

### TERMS:

Money Back Guarantee. No COD. Texas Residents add 5% tax. Add 5% of order for postage and handling. Orders under \$10, add 75c. Foreign orders: US Funds ONLY!

## MOTOROLA POWER DARLINGTON

Back In Stock!  
Like MJ3001. NPN 80V. 10A. HFE 6000 TYP. TO-3 case. We include a free 723 C volt reg. with schematic for power supply. SPECIAL - \$1.99

## SALE ON CUT LEAD SEMICONDUCTORS

Leads were cut for PCB insertion. Still very useable. All new, unused. Some House no.

## IN914/1N4148

100/\$2.  
1N4002 1 Amp 100 PIV 40/\$1.  
1N4745A 16V 1W Zener 20/\$1  
EN2222 NPN Transistor 25/\$1  
2N3392 GE Pre-amp Xstr 25/\$1  
C103Y SCR, 800MA 60V 10/\$1.

CALL YOUR BANK  
AMERICARD OR MASTER  
CHARGE ORDER IN ON  
OUR CONTINENTAL  
UNITED STATES TOLL  
FREE WATTS:

1-800-527-3460

Texas Residents Call Collect  
214/271-0022

S.D. SALES CO.  
P. O. BOX 28810 - A  
Dallas, Texas 75228

William Hosking W7JSW  
8626 E. Clarendon  
Scottsdale AZ 85251

*Great radios come and go . . . and the SB-450 is no longer available. But the duplex mods will work with virtually any 450 transceiver, adding a whole new dimension to UHF operation. — Ed.*

# A 450 Duplexer

- - that fits in your car!

**I** have owned an SBE SB-450 for almost a year now and like the radio pretty well. I have never had any problems and it operates quite well, but, like many members of the ham community, I can't leave well enough alone. I wanted a full duplex radio on 450 as well as the size and convenience of the SB-450, so naturally I attacked the problem of duplexing it.

Duplexing *any* radio takes two basic steps no matter how complex the actual operation gets. They are: Fix the receiver so it has power all the time, even when transmitting, and fix the receiver shielding up so that the transmitter doesn't desense the receiver. Oh, yes, I should have said three, because you also have to add a separate antenna connection for the receiver. Digging out the SBE manual yielded a good schematic and also PC board layouts.

## Receiver dc

Receiver dc is supplied through a regulator which is turned off by the PTT switch. After much looking back and forth between the radio and the manual, I discovered that I could remove an orange wire from point A on the R-2 circuit board and that would eliminate the PTT connection. Since this was a push-on connector, I put some heat shrink tubing over it and left it lying loose. Nothing is ever as easy as it first seems. When I tried the receiver, I still had no audio from the speaker when transmitting. Further tracing showed that the audio input to the audio amplifier

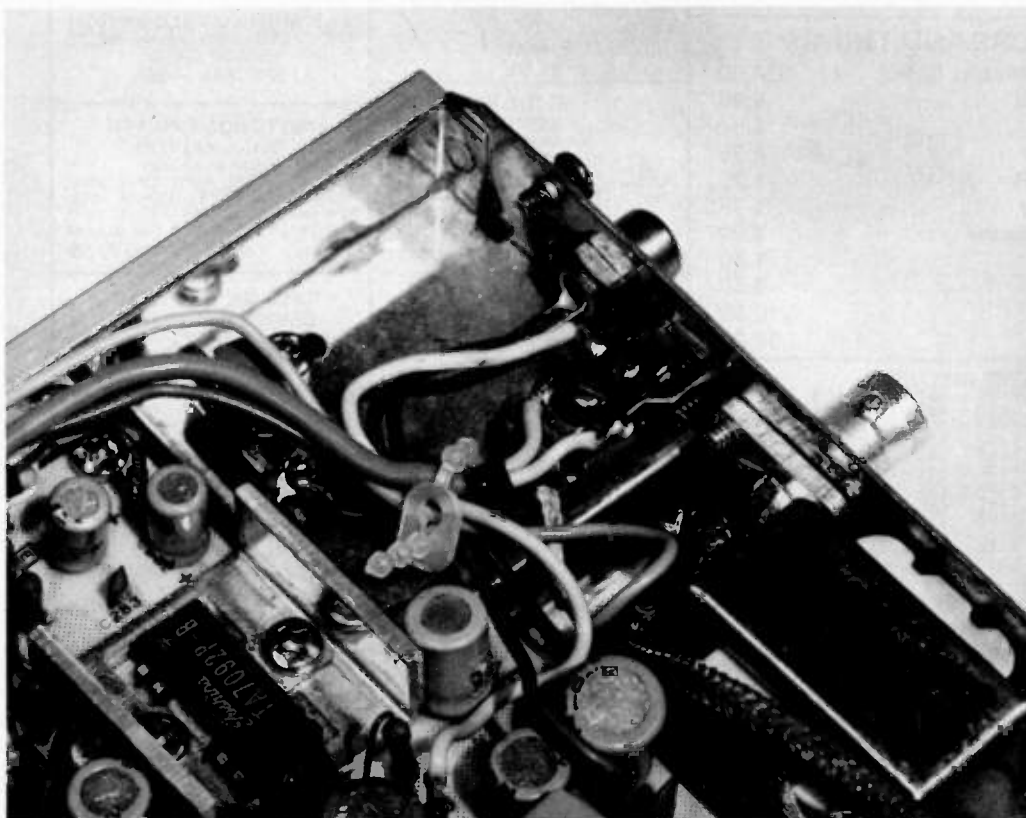

*Rear view of the added BNC antenna connector. Although it cannot be seen here, the outer shield of the coax is soldered to the shell of the connector.*

was shorted by the PTT line during transmit. That problem was easily eliminated by removing a purple wire from point H on the R-2 board and covering the end in the same way I did for the orange wire. Now the receiver was operating and audio was coming out while the PTT switch was closed.

#### Receiver Antenna

There is a place in the back of the radio, on the top, between the transformer and the power plug, where a BNC connector can be installed. I installed a connector and, being lazy, simply cut the receiver antenna coax where it ran past the connector, and soldered it to the new connector with the existing coax.

Well, I figured I was ready to test it out. I hooked the transmitter to a dummy load, the receiver to my signal generator, and powered up. The receiver looked OK and still checked out at about 0.5 uV. When I keyed up the transmitter, however, all I got was noise. I started cranking up the output of the signal generator but I couldn't get a signal through until I got above one millivolt. Gloom and despair!

#### Receiver Desensitization

After almost a day of zero success trying to reduce the desense with copper tape and bypassing, I called a friend who works in the EMI (Electromagnetic Interference) field. He suggested I make sure the antenna input was properly shielded, and preferably double shielded. With his advice in mind, I went back to the rig.

The antenna connection leading into the rf section on the receiver is nothing but an unshielded feedthrough with the coax connected on the outside and a coupling capacitor on the inside. The neatest approach would be to put a coax connector (miniature) on the rf section, but the crystal trimmers prevented that. A couple of cups of



*Front right view of the transceiver with the top cover removed, showing the receive coax cable entry into the rf compartment. Note that the outer braid is soldered to the outer wall of the compartment.*

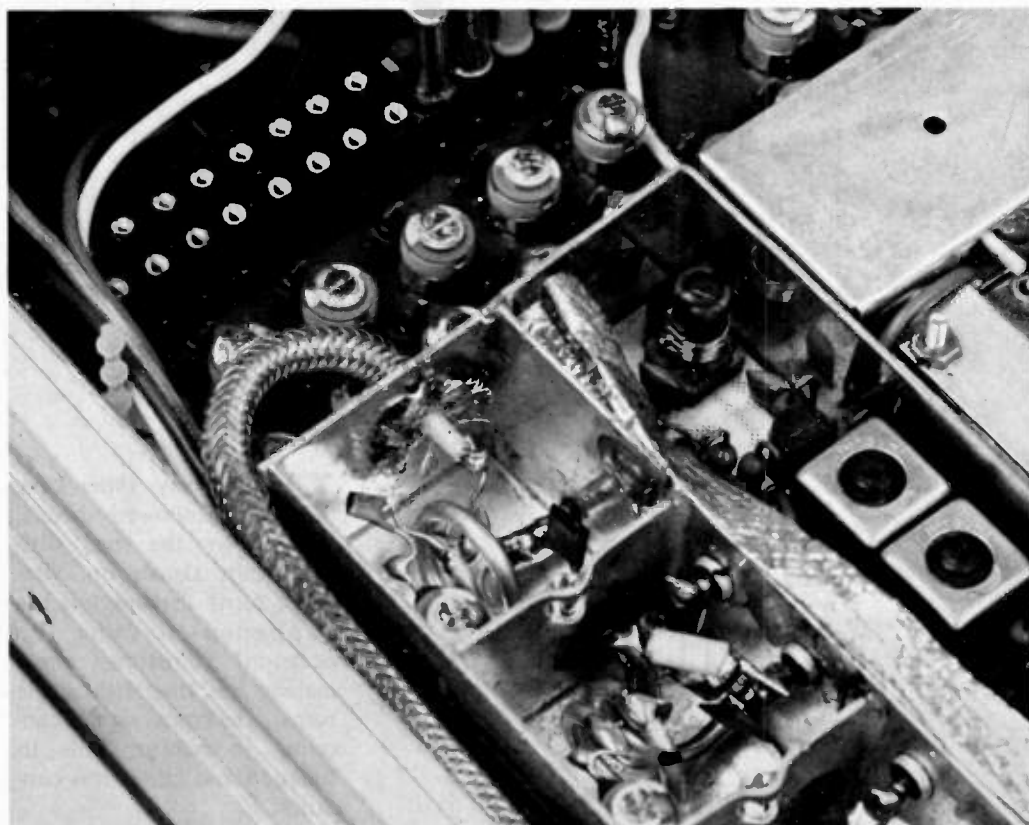

*Inside of rf shield in the top of the radio. The receive coax cable with its inner shield is coming through the hole left by removal of the original feedthrough. Depending on the size cable you use, you may have to enlarge the original hole. The inner braid is soldered to the inside of the compartment. The center conductor of the coax is then soldered to the small coupling capacitor originally connected to the feedthrough. Copper tape can be seen folded back along the right side of the shield compartment.*

coffee and a few swear words later, I decided to replace the entire receiver antenna connection.

The first thing I did was remove the existing coax and the antenna feedthrough. (That takes a heavy duty soldering iron.) Then, not having double shielded coax, I took some better quality regular 50 Ohm coax, stripped it, and fed the shield and inner conductor through the hole left by the feedthrough. I soldered the inner

braid to the inside wall of the rf section housing, and the inner conductor to the capacitor lead previously removed from the feedthrough. Then I slipped a piece of braid taken from another coax cable over the outside of the new cable and soldered it to the outside of the rf section housing.

The problem of maintaining shield integrity to the chassis was solved by removing the threaded chassis BNC connector that I had put

in earlier, and replacing it with one having a shielded back. This all sounds much easier than it actually was. In order to install the flange mount BNC connector, I had to remove the mounting screws from a transformer and move it aside until the connector was in place. Then I could only get one screw back into the transformer mount. I routed the coax, closed up the receiver section, and added some copper tape. I haven't taken measurements

to see if the tape is necessary.

### Conclusion

Well, to end a long story, it worked. I still have a very small amount of desense, but all in all, it works very well and the appearance of the radio is virtually unchanged. Additionally, it would only take a few moments to convert the radio back to simplex operation. I'm even happier with the radio now than I was before it underwent surgery. ■

Ace Goodwin K5AR/7  
1215 Las Vegas Blvd. N. #26  
Las Vegas NV 89101

# Turn Signal Reminder

- - setting things straight

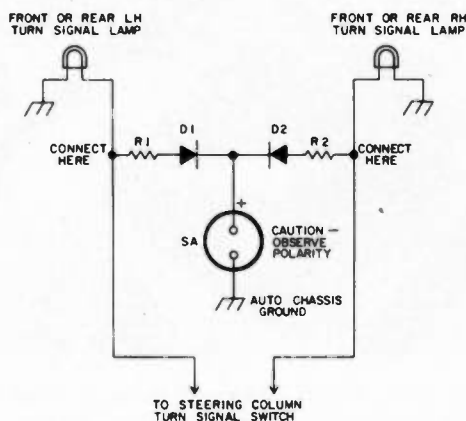

Fig. 1. R1, R2: 2.7k $\Omega$ , 1/2 W  $\pm$ 10%. D1, D2: any general purpose small current silicon diode. SA: Sonalert, Mallory catalogue number SC1.5.

The SC1.5 3500 Hz tone, along with its optimum sound volume, is just annoying enough that you cannot ignore it.

Simply mount the Sonalert at any convenient place near the driver's position; the other parts may be mounted anywhere. Silicon diodes are used because they will function better (higher reliability than germanium types) in the high heat environments encountered in automobiles.

The schematic shown is for 12 V negative ground systems. For 6 V negative ground systems change R1 and R2 to approximately 1/2 the resistance values. For positive ground systems reverse the diodes and the Sonalert. Less than 4 mA current (intermittent) is drawn by the Sonalert, so there is no significant loading of the automobile's electrical system.

The sound is produced by a piezoelectronic transducer, and the frequency is generated by a transistorized circuit which is an integral part of the Sonalert and cannot be altered by external means. Any attempt to alter the output frequency or volume may damage the device.

Sonalert is a registered trademark of P.R. Mallory and Company of Indianapolis IN. These units are available in radio supply stores, or they may be ordered directly from Burstein Applebee, 3199 Mercier, Kansas City MO 64111. ■

**H**ow many times have you followed drivers, going down the road with their turn signals on, who don't turn? Perhaps this has happened to you on occasion? Sometimes, when making less than right angle turns, the turn signal canceling mechanism fails to function and causes this condition.

Here is a schematic for an accessory for your automobile which will give an audible tone for each turn signal light duration period and thus will let you know when your turn signal is on.



# CALL TOLL FREE 800-521-4414

## MOBILE DIGITAL NEW CLOCK

AVAILABLE NOW —

- In-Dash
- On-Dash
- Black/Chrome
- Brown/Chrome



ENLARGED  
TO SHOW  
DETAIL

The DC101A digital clock sets the trend in digital automotive electronics which will be offered in the upcoming years. Its small size (1¼ x 2¼ x 5/8) and coordinated leather texture and chrome exterior make it an attractive addition to any car. Solid state electronics and a quartz crystal produce a clock that is the most modern timekeeping device for automobiles. It can be easily mounted in minutes in its compact ABS plastic case. Installation is accomplished by drilling an eighth inch hole in the dash, passing the power wires through it, and connecting them to the power with quick-connect wire clamps. Bright light emitting diodes (LED) allow for easy reading in all conditions. Since the clock is all solid state, it is inherently long life. A one year guarantee is offered on the clock.

- Quartz Crystal Accuracy
- Light Emitting Diodes
- All Solid State Electronics
- Unit is Protected by Fusistor
- Black or Brown Case
- Installs in Minutes
- One Minute/Month Accuracy
- One Year Guarantee

LIST  
PRICE

~~\$59.00~~

INTRODUCTORY  
PRICE

**\$49.95**

\*\*\*\*\*

**COMMUNICATIONS ELECTRONICS**  
P.O. Box 1002 Dept. 5  
Ann Arbor, Michigan 48106

Toll free U.S.A. 24 hour order & information line 800-521-4414. Outside U.S.A. & Michigan 24 hour phone 313-994-4441. Certified check or charge card on mail orders for immediate shipment. Dealer inquiries invited. Michigan residents add tax. Foreign orders invited. Call toll free or write for your free complete catalog & specifications. Satisfaction guaranteed or your money back. For engineering advice, call after 6:00 PM EST.

NAME \_\_\_\_\_  
 ADDRESS \_\_\_\_\_  
 CITY \_\_\_\_\_ STATE \_\_\_\_\_ ZIP \_\_\_\_\_  
 CHARGE —  BANKAMERICARD  MASTERCHARGE  
 CARD # \_\_\_\_\_ INTERBANK # \_\_\_\_\_  
 SIGNATURE \_\_\_\_\_ EXPIRATION DATE \_\_\_\_\_



- IN-DASH
- ON-DASH
- BLACK/CHROME
- BROWN/CHROME



Silas S. Smith WA9VFG  
2308 McCord  
Murphysboro IL 62966

**M**ost of us builders have at one time or another run up against a problem with only one solution — do it yourself. Suppose someone should give us a gold nugget, a 416B tube, for a high frequency project. What are we to do for a socket? The answer is to make one. Let us then borrow an idea or so from the hobby of ceramics in much the same way we have borrowed printed circuits and silk screening from other hobbies. Most of us will find ceramics an ideal way to construct a socket for the 416B tube, as well as insulators in any shape or size.

The raw material for ceramics comes in the form of clay or as a thinner mixture called slip. The clay



# Do-It-Yourself Ceramics

- - for tube sockets, insulators, etc.



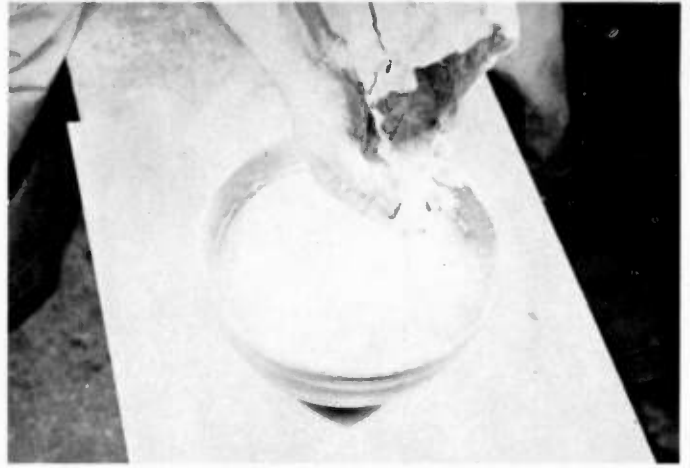

can be rolled out flat using a piece of wax paper above and below and rolling it out with a rolling pin or a dead 807. This clay can be cut, squeezed, fingered, or what have you, to almost any shape. After we pat it into the desired shape, we then let it dry. The dry clay can then be drilled, sandpapered and tapped. Taps for fine threads and small size (under 3/16) do not do as good a job as the larger taps. Clay at this stage is very brittle until it is fired in a kiln to about 1800 degrees. Some shrinkage is to be expected, so whatever we build should be slightly oversized.

Using slip requires a mold made of casting plaster or of plaster of paris. The mold has two functions — it gives the desired shape to the object to be cast and also absorbs the moisture out of the slip, leaving only the clay along the inside surface of the mold. As the thickness of this clay builds up to the desired thickness for the object, the

remaining slip can then be poured out. This will leave a hollow object. When the walls of the object become leather-like, the object can then be removed from the mold. When dry, this is called greenware. It is very brittle until fired to a high degree of temperature in a kiln. Objects can also be made solid by leaving the slip in the mold and adding a little slip now and then to compensate for the moisture that the mold is removing.

To make a simple mold, the pattern is placed on a surface and clay is built up around the pattern until the clay reaches the center line of the pattern. A dam is placed around the pattern and clay. The whole works is then brushed with liquid soap, sometimes called green soap (a detergent will not work). Remove the surplus soap with a sponge that has been pre-moistened with the liquid soap. You are now ready to prepare your casting plaster. Casting plaster, or plaster of

paris if casting plaster cannot be found, is mixed well with water in a large bowl. The plaster should be mixed to a consistency of pancake batter. This mixture is then poured rapidly into the mold from. It is good to tap the table with a hammer to move any trapped air bubbles to the surface. We can now have a cup of coffee as we must wait about 20 minutes before proceeding.

As the plaster sets, it will get very wet-looking; then it begins to look dry, and a good deal of heat will be radiated. Soon after the heat buildup, the mold form and the clay can be removed. At this point do not remove the pattern. A pocket knife can now be used to shave the half mold down smoothly or dress it up.

To align the two halves, dimples are now put in the part of the half mold around our pattern. Usually only 3 or 4 are enough. This is done with the tip of a spoon. The dimple is gouged out by

turning the tip of a spoon in a 360 degree circle and applying pressure down. The half mold is now ready to be dammed up and brushed with soap as before. A good job of soaping is required to insure the separation of the two halves of the mold. Mix and pour the plaster as before. Another cup of coffee, or maybe two, and then the heat should be pretty well up. The dam, or form, can now be removed. A knife is used to trim the outside of the mold. Cut the corners at a 45 degree angle to prevent chipping of the finished mold. If any plaster got past the form to the first half of the mold, now is the time to trim it off. After too much coffee already, let us just wait for 15 or 20 minutes. The two halves of the mold should then be ready to separate. The two halves should come apart easily by just tapping the mold lightly on all sides and pulling gently apart. Barring any undercuts, the pattern can now be removed. Trim

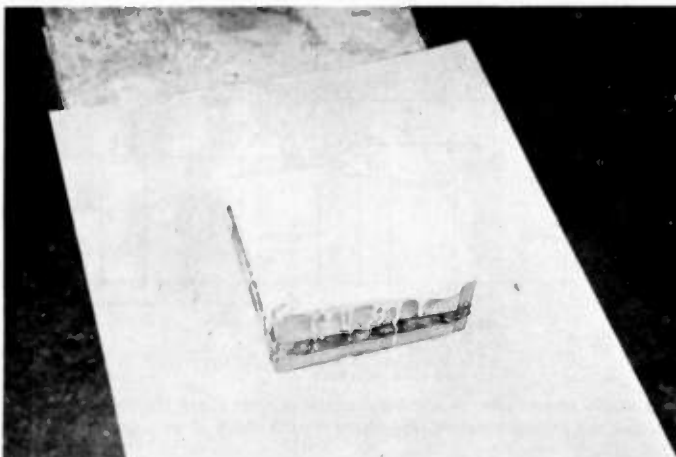



out a funnel-shaped hole, half on each mold section for a pouring spout. The mold will be finished when it is thoroughly dry.

The two pieces are joined together while in a leather-like state. An ordinary art brush is used to brush fresh slip on the parts to be joined and then they are put together.

To make sockets for the aforementioned 416B, find a 7 or 9 pin ceramic socket and observe how the pins are

mounted. Then create a socket for the 416B constructing it along the same lines as the 7 or 9 pin socket. (Pins can be removed from the sockets.) Some of the sockets we made here had tie points added. The tie points were constructed by adding a standoff to the sockets and drilling small holes around the top. Such use of ceramics need not be limited to the 416B or coil forms, of course, but may also be used for many other projects. ■

## Circuits<sup>2</sup>

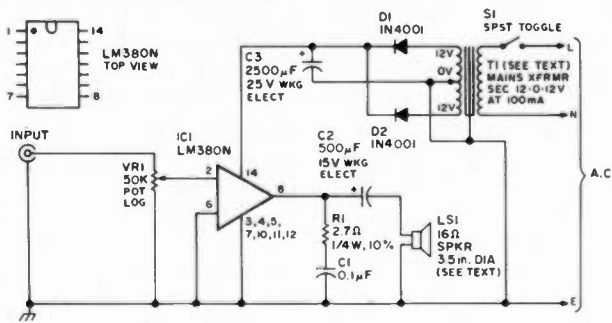

A general purpose amplifier using a few simple parts. Reprinted from Radio & Electronics Constructor, July, 1976.

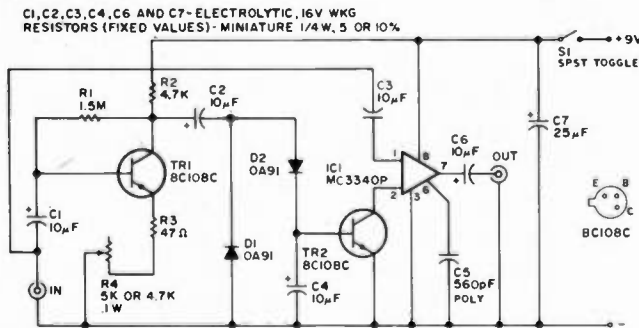

Simple audio squelch unit which suppresses all input signals below a preset threshold. Reprinted from Radio & Electronics Constructor, July, 1976.

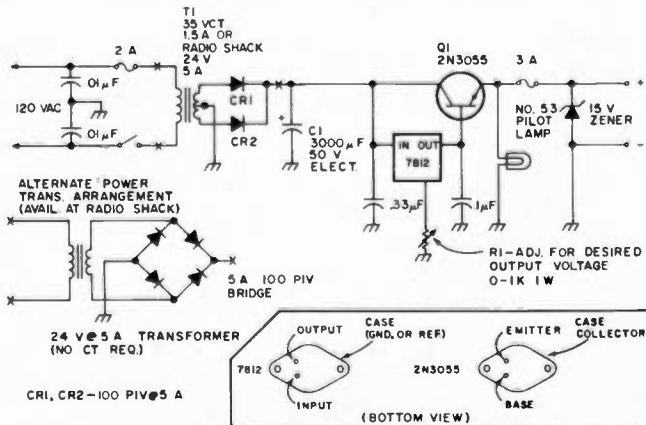

A 510 12-14 V regulated 3 A power supply. Reprinted from The State of the Arts, August, 1976.

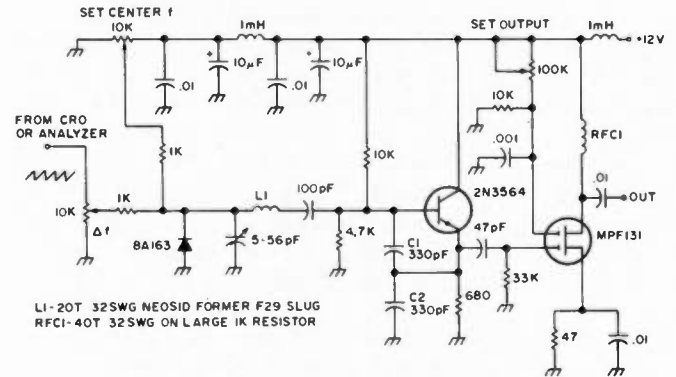

A 10.7 MHz sweep generator for looking at the response of an i-f amp or a filter. Can be used with an oscilloscope or, for more dynamic range, with a spectrum analyzer. Reprinted from Amateur Radio, May, 1976.

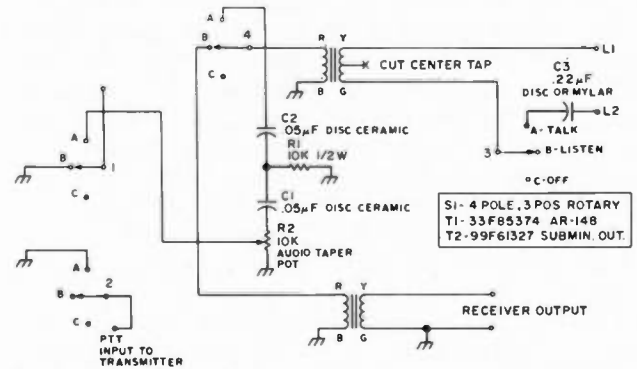

A poor ham's phone patch. L1 and L2 are the red and green wires of your phone line. Reprinted from the Hall of Science Radio Club Bulletin, September, 1976.

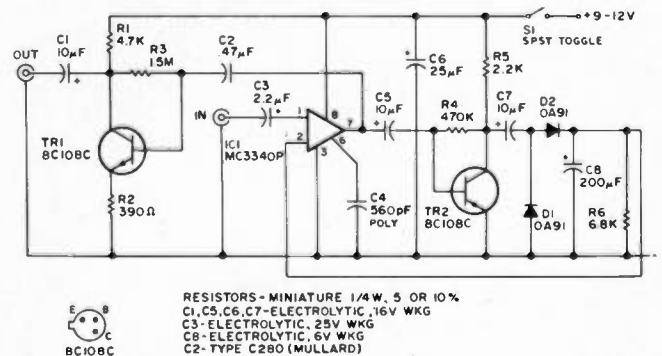

An audio compressor. If the input signal is kept above the threshold level, output will remain constant. Reprinted from Radio & Electronics Constructor, July, 1976.

# GET YOUR NEW RADIO AMATEUR CALLBOOKS

# 1977

### ALL OF THESE EXTRA FEATURES INCLUDED

The **U.S. Callbook** has over 300,000 W & K listings. It lists calls, license classes, names and addresses plus the many valuable back-up charts and references you come to expect from the **Callbook**.

**\$14.95**  
PLUS SHIPPING

Specialize in DX? Then you're looking for the **Foreign Callbook** with over 250,000 calls, names and addresses of radio amateurs outside the USA plus many valuable, additional features of interest to the DX'r.

**\$13.95**  
PLUS SHIPPING

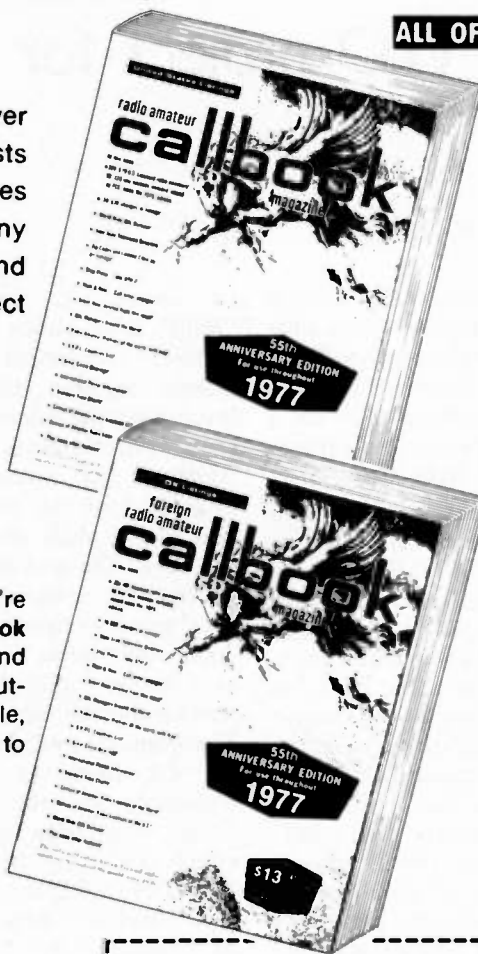

- International Radio Amateur Prefixes!
- Radio Amateur Prefixes by Countries!
- A.R.R.L. Phonetic Alphabet!
- Great Circle Bearings and Charts!
- International "Q" and "Z" Signals!
- World Standard Time Charts!
- International Postal Information!
- World Prefix Map!
- F.C.C. Examination Points!
- Where to Buy!
- Telegraphers' Abbreviations!
- DX Operating Code!
- A.R.R.L. Countries List!
- At Your Service — Amateur Radio Dealers!
- QSL Managers Around the World!
- World Wide QSL Bureaus!
- Census of Radio Amateurs of the World!
- Telegraph Codes!
- AMSAT — Oscar Users Directory!
- Slow Scan Television Directory!
- Reciprocal Licenses!
- Hawaii Included!
- Many Other Features!

*Respected worldwide as  
the only complete authority  
for radio amateur  
QSL and QTH information.*

See your favorite electronics dealer or write direct for free catalog to the publisher.

**RADIO AMATEUR callbook INC.**  
Dept. B 925 Sherwood Drive  
Lake Bluff, Ill. 60044

#### ORDER FORM

Item	Price Each	Shipping	Total Price
<b>U. S. CALLBOOK</b>	<b>\$14.95</b>	<b>\$1.25</b>	<b>\$ 16.20</b>
<b>FOREIGN CALLBOOK</b>	<b>\$13.95</b>	<b>\$1.25</b>	<b>\$ 15.20</b>

Illinois residents only add 5% sales tax \_\_\_\_\_

Name \_\_\_\_\_ Total \_\_\_\_\_

Address \_\_\_\_\_

City \_\_\_\_\_

State \_\_\_\_\_ Zip \_\_\_\_\_ Total Enclosed \_\_\_\_\_

Master Charge No. \_\_\_\_\_ Interbank # \_\_\_\_\_

Bank \_\_\_\_\_ Expiration Date \_\_\_\_\_

The crystal-controlled oscillator just won't cut it for today's operating practices. You just have to possess the ability to move around in a band if you want to make contacts. And you do want to make contacts. That puts the would-be builder in a tough spot. It's easy to put together a crystal-controlled rig that'll produce a clean signal, one that's a compliment to its builder. But getting such a signal from a variable-frequency oscillator is quite another matter!

This article concerns building a self-excited oscillator. It's written for the radio amateur who has wanted to build a transmitter but has hesitated because of the known difficulty of making a VFO that sounds right. The second purpose of this article is to encourage prospective builders to use parts that may be at hand or that can be mooched from some other amateur's junk box. Therefore, I'll talk a bit about some design considerations.

If you're not an experienced and highly-talented builder, it's best to start with a single-band rig. Its simplicity helps much to avoid the pitfalls that await the builder of a multi-band rig.

Decide what band holds your greatest interest. Consider such factors as antenna requirements, band activity at the time of day and season you operate, and that harsh truth of oscillators being more difficult to build as frequency goes up. Many builders conclude that the 7 MHz band represents a reasonable compromise among the many (and sometimes conflicting) considerations. We'll talk about an oscillator for that band. Unless you're firmly dedicated to "state of the art" solid state techniques, it's recommended that you use vacuum tubes for your first building projects. There are many and quite sound reasons. Vacuum tubes abound in junk boxes. Those from old TV receivers and

Carl C. Drumeller W5JJ  
5824 N.W. 58 Street  
Warr Acres OK 73122

# Tubes...?

## - - VFO project for nostalgia buffs

military surplus radio or radar sets lend themselves to amateur projects nicely. Then, too, I've found it's just one heck of a lot easier to get a decent note out of a vacuum tube than from a transistor.

The next decision concerns the oscillator circuit to be used. Just about any can be made to work well. Some can be coaxed to give a good note more easily than others. I've tried just about every one that's shown up in amateur radio publications over the past half-century, and have found one that seems just a bit more nearly "foolproof" than others. Note, though, that this is purely a personal choice and does not imply that other persons may not find another circuit more to their liking.

Why did I select this one circuit from among many? Because it offers easy means of adjusting the feedback to just the precise amount needed to ensure stable oscillation and yet deliver a note that's free from the harshness characteristic of an oscillator being "pushed" too strongly. Its schematic diagram appears in Fig. 1.

A prototype was built up

to check its operation. "Built" is too strong a word. Rather, components were tacked together by their leads. Then the values of certain components were "diddled" to discover just what it took to make the note clean. Many will affect the note. The grid capacitor C1 has little effect upon the note, but does have a bearing upon the effect of tube capacitances upon the frequency-determining "tank." The output coupling capacitor C4, being in a low-impedance portion of the circuit, has only a minor effect upon its oscillation. The value of R2, the cathode bias resistor, does affect oscillation. It, however, should be of a value selected to place the tube's quiescent operating point at about the midpoint of the straight portion of its  $E_{c1b}$  curve. (Read that as saying the tube should be biased as though you were using it in a Class A amplifier circuit.) That leaves two parts, R4 and C2, that strongly affect feedback and which can be safely altered.

Roughly speaking, C2 should be as small as you can make it and still have reliable oscillation. Its value will vary

depending upon many factors, such as tube type, value of R4, plate voltage, etc.

There's no reason why you can't vary R4 over whatever range it takes to give an acceptable note. I'm assuming, of course, that you're listening to the oscillator on a receiver with its antenna disconnected, so as to prevent signal overloading.

Now, let's talk about tubes. Almost any dual triode or even two discrete triodes with their cathodes strapped together can be used. There's little choice. I used a 6J6 just because I had a potful on hand.

Perhaps the matter of second importance in an oscillator is that of short-term frequency stability, that of not creeping during a transmission. Rigid long-term stability can be a hairy problem, but short-term stability usually can be achieved by mounting components solidly. It helps, too, if the resonant circuit has high Q. Fortunately, there's a simultaneous solution to these two problems: Use a ferrite-core toroid coil for the inductor. This type of coil

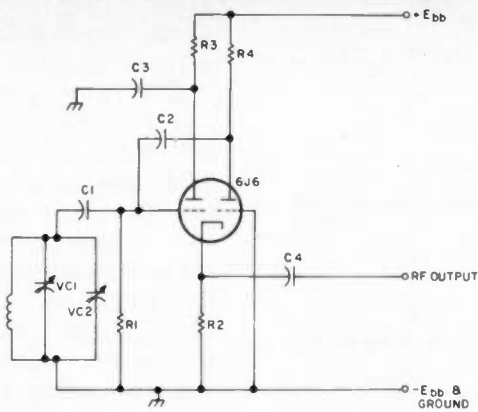

Fig. 1. Basic oscillator circuit. In this circuit, feedback is through C2, encouraged by R4. C3 and R3 serve only to ensure having the plate of the first triode at ground potential. The second triode acts as a grounded grid non-inverting amplifier. Low impedance rf output is taken from across the common cathode bias resistor.

can be mounted solidly, and, with the proper kind of core material, the Q can be high indeed. But be sure you use a core material known to be suited for the high frequency band! Also, it's important to use plenty of capacitance in the resonant circuit. For 7 MHz, 100 pF is not too much. If you try to get this amount in one capacitor, the rate of tuning will be too rapid, so it's best to use two variable capacitors, one of high capacitance (about 100 pF maximum) for setting the frequency at one edge of the band, and another (much smaller) to vary the frequency over the band. Ideally, the 180° rotation of the bandspread capacitor should just cover the desired frequency range. You can compromise, though, on something far less than this ideal! But if you're a purist, you can achieve the ideal by judicious juggling of the magnitude of inductance, bandset capacitance, and bandspread capacitance.

A third matter of importance in an oscillator is that of isolating the oscillator's frequency-determining circuit from external disturbances. You can start by ensuring a stable plate voltage supply, which is easily accomplished by use of VR tubes or any of the several other means of obtaining a steady voltage

source. Less easy, though, is the task of isolating it from a changing load. If that load is keyed, as it will be if the oscillator excites a radiotelegraph transmitter, the load change is abrupt and violent. So you'll need rather elaborate and highly effective isolation. The simplest way of getting that isolation is by adding Class A buffer stages.

We've talked about what can be done. Now let's talk about one way of doing the building job, not forgetting that there are innumerable other ways of arriving at the same goal just as effectively.

I told you about tacking together components to make a prototype and about experimenting to ascertain the proper values of certain parts

in order to get stable operation and a pure-sounding note. The next logical step is to build up the circuit in a practical form, a configuration that'll permit it to excite another stage. It was with considerable trepidation that I approached that task, for years of experience had taught me the truth of that old adage: "If it looks like hell, it'll work swell. If it looks swell, it'll work — like hell!" Because of having been constructed entirely from parts rooted out of my junk box, the finished product certainly would take no beauty prize. Perhaps because of that, it worked quite well!

The exciter's schematic diagram is shown in Fig. 2. Although it shows 6AC7 tubes being used in the Class A isolation (buffer) stages, again let it be emphasized that there are dozens of other types of tubes that could have been used. I selected 6AC7s because I had about a gallon on hand, plus a few quarts of octal sockets. Many of the newer and hotter TV tubes probably would work even better. There's no need to be concerned about getting a tube that's too hot; the resistance coupling between stages insures unconditional stability. Just remember to use a suitable value of cathode biasing resistor and the recommended value of plate and screen grid voltages; with these precautions in

mind, you can toss in just about any tube that turns up in your (or your friend's) junk box.

My exciter is built in a box measuring 3" wide, 4" high, and 5" deep. Tube sockets are mounted on the top surface, the bandset and bandspread variable capacitors on the front, and all other components within, either on socket terminals or tag strips. The toroid coil is cemented to a plastic mount which, in turn, is bolted to the inside top surface. This permits short leads to the variable capacitor and to the oscillator tube. Filament, screen grid and plate supply leads are brought out in a cable.

Only one construction feature might be thought of as unorthodox: The "cold" side of the rf output is brought back through an insulated feedthrough to the cathode of the output tube. It may not be important, but some experienced builders consider it wise not to cause rf to flow *through* a shield. The "hot" side of the rf output, of course, is brought out through another feedthrough insulator.

This rf output, which is isolated from all dc potentials, may be used to excite a larger tube. Or, you may want to run it into a pi net and couple it to an antenna. The power may seem to be insignificant, but I've worked into Hawaii with

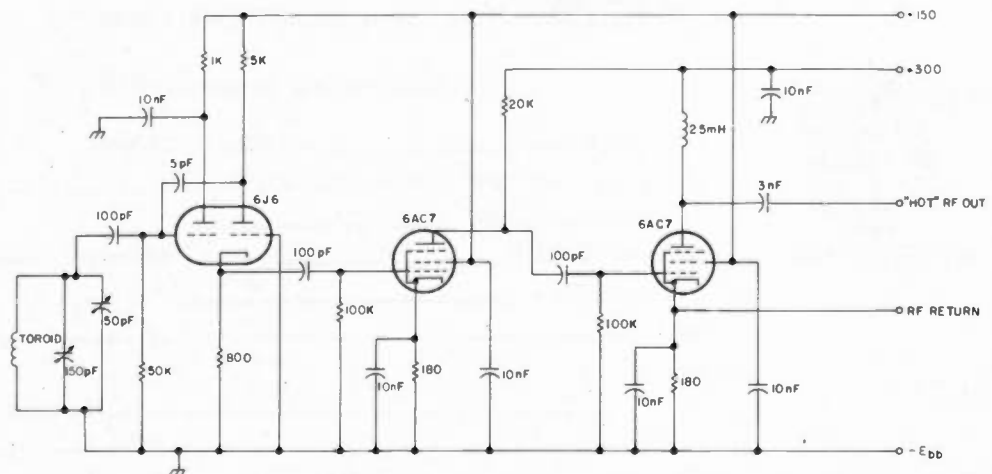

Fig. 2. VFO exciter for 7 MHz. Number of turns on toroid depends upon its physical size and electrical permeability.

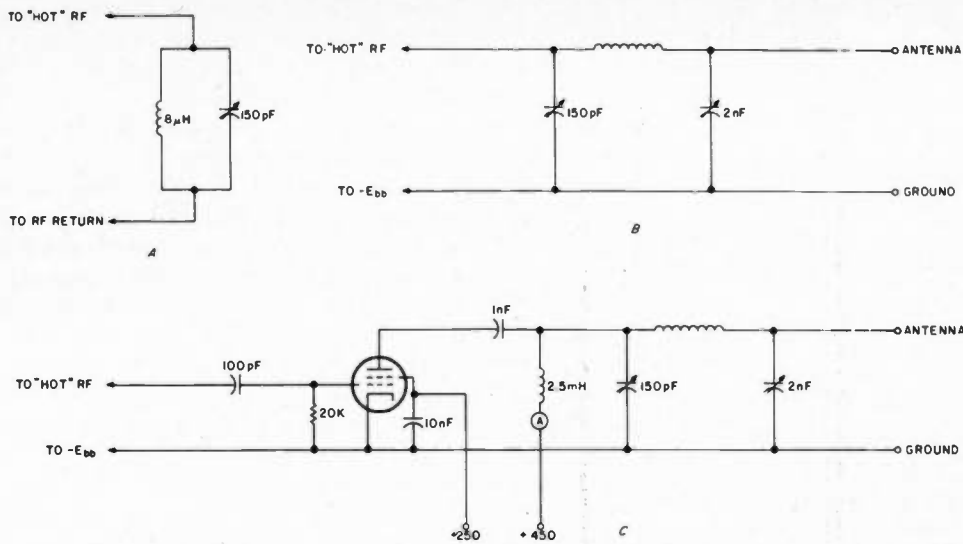

Fig. 3. a) Test termination for checking for rf output. b) Pi net for coupling to antenna; requires provision for keying. c) Rf amplifier using 807, 6146, etc.; suggest use of grid-block keying.

no greater power! An additional stage is advisable, however, if only to permit convenient keying.

You'll note that I've not mentioned power supplies other than to say that the one for the oscillator should have good voltage regulation. Most radio amateurs have power

supplies on hand. If you don't, every handbook tells you how to build one.

You may have noticed that I've avoided saying much about the inductor used. Its core started life as the tuning slug in the plate tank circuit of a BC-457 HF transmitter. Many years ago I read that

one could make a good core for a toroid coil from this slug by sawing off a piece, drilling a hole through it, and rounding off the sharp edges with a file. This I did. Then the core lived in a cabinet drawer until I ran across it while excavating for parts for this oscillator. I'm happy to

say the long-forgotten author was quite correct!

This rambling article has been written in hope that it will encourage persons to build, using parts on hand or ones that can be mooched. It was triggered by two pleasant memories. One was the period of the early thirties, when I built many transmitters and receivers from parts salvaged from old battery-operated broadcast receivers that one could get for little or nothing. The other pleasant memory relates to the period just after the Hitler war, when one could take a few dollars to a junk dealer and come back with treasures far beyond one's (pre-war) imagination. Those were heavenly days for the builder! There're still parts remaining from WWII surplus, but when these parts are gone there'll be no more. None are being manufactured. So be wise — build now before you have to pay antique-parts prices for even the simplest components! ■

# 1976 Binders

Keep your 1976 73s safe from being lost or damaged in these handsomely appointed binders with rich red covers and gold lettering. Each binder holds 12 issues, making an EXCELLENT REFERENCE HANDBOOK. Several binders form a quality library you can be proud of.

Order yours today . . . only \$6.00 each . . . SEND IN YOUR ORDER RIGHT NOW! FILL OUT THE COUPON BELOW.

**yes** — I want to keep my 1976 73s in a binder!

Send me  binder(s) @ \$6.00.

TOTAL enclosed \$   Cash  Check

Charge my credit card:  BankAmericard #

American Express #

Master Charge #  Interbank #

Expiration Date

Signature

Send to:

Name

Address

City  State  Zip



**73**  
magazine

Send order to 73 Magazine — Peterborough NH 03458 or phone TOLL FREE 800-258-5473 or 800-251-6771.



## This Month's Specials

### NEW

### Fairchild VHF Prescaler Chips

Type	Description	Price
11CQ1FC	High Speed Dual 5-4 Input OR/NOR	\$15.40
11C05DC	1 GHZ Counter Divide By 4	\$74.35
11C05DM	1 GHZ Counter Divide By 4	\$110.50
11C06DC	UHF Prescaler 750 MHz D Type Flip/Flop	\$12.30
11C24DC	Dual TTL VCM	\$2.60
11C44DC	Phase Freq. Detector	\$2.60
11C58DC	ECL VCM	\$4.53
11C70DC	600 MHz Flip/Flop With Reset	\$12.30
11C83DC	1 GHZ 24B/256 Prescaler	\$29.90
11C90DC	650 MHz ECL/TTL Prescaler	\$16.00
11C90DM	650 MHz ECL/TTL Prescaler	\$24.60
11C91DC	650 MHz ECL/TTL Prescaler	\$16.00
11C91DM	650 MHz ECL/TTL Prescaler	\$24.60
95H90DC	250 MHz Prescaler	\$9.50
95H90DM	250 MHz Prescaler	\$16.55
95H91DC	250 MHz Prescaler	\$9.50
95H91DM	250 MHz Prescaler	\$16.50

### RF TRANSISTORS

New			
RCA 40290	12.5v, Ft. Typ. 500MHz 2 watts min. at p. in 0.5 watts		\$2.48
2N2857	\$1.85	2N6080	\$5.45
2N3375	\$7.00	2N6081	\$8.60
2N3866	\$1.08	2N6082	\$11.25
2N4072	\$1.50	2N6083	\$12.95
2N4427	\$1.20	2N6084	\$14.95
2N5179	\$6.8	2N6166	\$85.00
2N5589	\$4.60	MRF511	\$8.60
2N5590	\$6.30	MMCM918	\$2.50
2N5591	\$10.35	MMT2857	\$2.50
2N5637	\$20.70		

### TUBES

IP21	\$19.95	6146B/8298A	\$5.75
2E26	\$4.00	6661	\$1.00
4X150C	\$18.00	6680	\$1.00
4X150A	\$15.00	6681	\$1.00
4CX250B	\$24.00	7984	\$3.95
4X250F	\$22.00	8072	\$32.00
DX415	\$25.00	8106	\$1.95
572B/T160L	\$25.00	8156	\$3.95
811A	\$7.95	8950	\$5.50
813	\$19.00	6LQ6	\$3.95
931A	\$9.95	7289/2C39A	\$4.50 ea.
4652/8042	\$6.95		
5894	\$32.00		
6146A	\$4.75		

**JUST ARRIVED!** These radios have just been pulled out of service. Set up for approx. 150 MHz. Clean. All tubes included. No accessories. Prices FOB Phoenix.

Motorola U43 GGT	\$49.95
GE TPL	\$99.95
GE MT-33	\$39.95

NICAD Batteries, AA, 1.25 volts	49¢ ea.
GEL/CELL #GC1215, 12 volts, 1.5 amp hrs	\$19.95

We have all types of test equipment. Call or write today!

# MHz electronics

2543 N. 32ND STREET  
PHOENIX, ARIZONA 85008  
PH. 602-957-0786

# PRESTO!

## Your counter becomes a digital display!

Like magic, Hufco's Digi-Dial Adaptor turns any frequency counter into an absolutely accurate digital display! Inexpensively! With continual display of both transmit and receive frequencies — as fast as you turn your transceiver dial!

With the Digi-Dial Adaptor your counter easily adapts to Yaesu, Tempo, Drake C Line, Collins, Kenwood and other transceivers. (Tell us which other brand you have. We'll tell you if the adaptor fits.)

Operation requires only a connecting cable to the transceiver VFO plug. Translates VFO output to 2 through 2.5 MHz. No internal connection or modifications necessary! Complete instructions included.

No frequency counter? Get both the Digi-Dial Adaptor and a frequency counter from Hufco. We have counters starting as low as \$45.95!

### DIGI-DIAL ADAPTOR

# 39.95

kit form

\$49.95 assembled

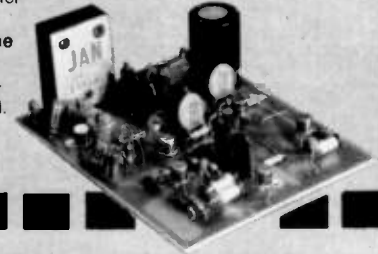

**Quick!**  
**Order yours today!**

Please rush me:

- Digi-Dial Adaptor  
\$39.95 kit form - \$49.95 assembled

Check or money order enclosed.

- Complete data on Hufco frequency counters

Name \_\_\_\_\_

Address \_\_\_\_\_

City/State/Zip \_\_\_\_\_

## Hufco

Box 357, Dept. 73,  
Provo, Utah 84601 801/375-8566

# If it's for Communications... Adirondack has it!

including the  
Yaesu FT101E

# \$749.00



**Largest selling  
amateur transceiver in the world**

- Built-in AC & DC power supplies
- 260 watts PEP; 180W-CW; 80W-AM
- RF Speech processor (E model)

**Complete  
inventory all  
major brands**

- Atlas
- Collins
- Dentrion
- Drake
- Icom
- Kenwood
- TenTec

# ADIRONDACK

Radio Supply, Inc.

185-191 WEST MAIN STREET • P. O. Box 88 • AMSTERDAM, N.Y. 12010  
TEL. (518) 842-8350

**Just 5 minutes from N.Y. Thruway — EXIT 27**

# SLEP ELECTRONICS

# IS NOW SHIPPING ANTENNAS & ACCESSORIES

## CUSHCRAFT

A147-4 BEAM 4EL 146-148MHZ . . . \$15.95  
 A147-11 BEAM 11EL 146-148MHZ . . . 24.95  
 A147-20T BEAM TWIST 20EL 144-147  
 MHZ . . . 47.50  
 A147-22 BEAM 22EL 146-148MHZ . . . 69.50  
 ARX-2 RINGO RANGER 135-170  
 MHZ . . . 28.50  
 ARX-220 RINGO RANGER 220-225  
 MHZ . . . 28.50  
 ARX-450 RINGO RANGER 435-450  
 MHZ . . . 28.50  
 A220-7 BEAM 7EL 220-225MHZ . . . 18.95  
 A220-11 BEAM 11EL 220-225MHZ . . . 22.95  
 A449-11 BEAM 11EL 449MHZ . . . 21.95  
 AFM-4 D FOUR POLE 144-148MHZ . . . 53.50  
 AR-6 RINGO 50-54MHZ . . . 24.50  
 CR-1 RINGO CITIZEN BAND . . . 28.50  
 A50-5 6 METER 5EL BEAM . . . 39.50  
 A144-10T OSCAR 145.9 BEAM 10EL 32.50  
 A144-20T OSCAR 145.9 BEAM 20EL 47.50  
 A147-MB MOUNTING BOOM . . . 13.95  
 A432-20T BEAM 432 20EL . . . 45.00

## HY-GAIN

14A VQ/WB VERTICAL 10 THRU 40  
 METERS . . . 67.00  
 18 AVT/WB - VERTICAL 10 THRU 80  
 METERS . . . 97.00  
 18HT HY TOWER 10 THRU 80  
 METERS . . . 259.95  
 TH3JR 10/15/20 BEAM 750W PEP . . . 144.50  
 203BA 3EL 20M BEAM 2KW . . . 149.95  
 TH3MK3 10/15/20 BEAM 2KW, 3EL 199.95  
 TH6DXX SUPER THUNDERBIRD 6EL  
 10/15/20 BEAM . . . 239.95  
 204BA 4EL 20 METER BEAM . . . 179.95  
 402BA 2EL 40 METER BEAM . . . 199.95  
 244 HY QUAD, 2EL QUAD 10/15/20  
 METER . . . 219.95  
 2 BDQ TRAP DOUBLET 40 AND 80  
 METER . . . 49.95  
 270 MOBILE 2 METER 6DB GAIN FIBER-  
 GLASS 2 METER . . . 39.95  
 MODEL 28 TWO METER 8EL YAGI  
 BEAM . . . 37.00  
 269 RUBBER DUCKIE PORTABLE  
 ANTENNA 2 METER 5/16 X 32 BASE 7.00  
 274 RUBBER DUCKIE PORTABLE  
 ANTENNA 2 METER BNC BASE . . . 9.00  
 275 RUBBER DUCKIE PORTABLE AN-  
 TENNA 2 METER PL-259 BASE . . . 7.00  
 C1 CENTER INSULATOR FOR  
 DOUBLET . . . 5.95  
 E1 END INSULATOR FOR DOUBLET  
 PAIR . . . 3.95  
 14RMQ ROOF MOUNT KIT 14AVQ, 18AVT  
 VERTICAL . . . 24.95  
 271 BASE STATION MOUNTING  
 BRACKET FOR 270 . . . 4.95  
 BN-86 FERRITE BALUN 10 THRU 80  
 METERS . . . 15.95

## LARSEN ANTENNAS

JM150 WITH MM/LM MAGNETIC MOUNT  
 2 METER FM ANTENNA 5/8 LOADED  
 144-174 MHZ WITH RG-58/U COAX . . . 37.00  
 JM150 WITH GC/LM GUTTER CLAMP  
 MOUNT, 2 METER FM 5/8 LOADED  
 144-174MHZ WITH RG-58/U COAX . . . 37.00

## MINI-PRODUCTS

HQ-1 HYBRID QUAD, ELEMENT LENGTH  
 11 FT., BOOM 4 1/2 FT., TURNING RADIUS  
 6'2" WT. 15 LBS - BANDS 6, 10, 15 & 20  
 METERS, 1200 PEP F/B RATIO 12 TO  
 17DB, 52 OHM . . . 109.50

## MOSLEY

CL-33 CLASSIC BEAM 3EL 10/15/20  
 METER 1KW . . . 224.00  
 TA-33 JR 3EL BEAM 10/15/20 METERS  
 300 WATTS . . . 145.00  
 TA-33 3EL BEAM 10/15/20 1KW . . . 198.00  
 TA-40KR CONVERSION KIT, ADD 40  
 METER TO TA-33 . . . 88.50  
 SWL-7 SHORTWAVE LISTENING DIPOLE,  
 11 THRU 49 METERS . . . 41.25  
 DI-2 DIPLOMAT VERTICAL GROUND  
 PLANE 2 METERS . . . 30.00  
 62SC WALL THRU & COAX OUTLET . . . 7.50  
 C2-PK - WALL PLATE WITH DUAL COAX  
 OUTLETS . . . 10.50  
 CRS-PK WALL PLATE WITH SINGLE  
 COAX AND 8 WIRE ROTOR OUTLET 12.00

## NEWTRONICS

4BTV VERTICAL 10-40 METER . . . 79.95  
 RM-75 ADD ON 75 METER RESONA-  
 TOR . . . 16.95  
 RM-75S ADD ON 75 METER SUPER  
 RESONATOR . . . 28.95  
 BBLT-144 5/8 MOBILE WITH TRUNK LIP  
 MOUNT 143-149MHZ . . . 28.75  
 CG-144 TWO METER COLINEAR 5.2DB  
 GAIN 3/8" X 24 BASE . . . 26.75  
 CGT-144 TWO METER COLINEAR 5.2DB  
 GAIN WITH TRUNK LIP MOUNT . . . 39.95  
 G6-144A REPEATER APPROVED 60B  
 GAIN COLINEAR . . . 52.95  
 MO-1 54" MAST FOR MOBILE DECK OR  
 FENDER MOUNT . . . 15.95  
 MO-2 54" MAST FOR MOBILE BUMPER  
 MOUNT . . . 15.95  
 RM-10 RESONATOR 10 METER . . . 10.75  
 RM-10S SUPER RESONATOR 10  
 METER . . . 13.95  
 RM-15 RESONATOR 15 METER . . . 11.75  
 RM-15S SUPER RESONATOR 15  
 METER . . . 16.95  
 RM-20 RESONATOR 20 METER . . . 12.75

RM-20S SUPER RESONATOR 20  
 METER . . . 19.25  
 RM-40 RESONATOR 40 METER . . . 15.95  
 RM-40S SUPER RESONATOR 40  
 METER . . . 23.50  
 RM-75 RESONATOR 75 METER . . . 16.95  
 RM-75S SUPER RESONATOR 75  
 METER . . . 28.95  
 RM-80 RESONATOR 80 METER . . . 16.95  
 RM-80S SUPER RESONATOR . . . 28.95  
 RSS-2 RESONATOR SPRING . . . 5.65  
 QD-1 QUICK DISCONNECT . . . 11.75  
 BM-1 BUMPER MOUNT STAINLESS STEEL  
 STRAP . . . 11.95  
 MM-1 COWL MOUNT WITH SO-239 AND  
 3/8" - 24" BASE . . . 6.45  
 GCM-1 RAIN GUTTER MOUNT 3/8" - 24"  
 THREAD . . . 7.50  
 SSM-2 COMMERCIAL BALL MOUNT  
 ONLY . . . 13.50  
 SSM-3 COMMERCIAL STAINLESS STEEL  
 SPRING . . . 11.95

## CDR ROTORS

HAM II ROTOR WITH CONTROL . . . 139.50  
 CD 44 ROTOR WITH CONTROL . . . 119.50  
 ROTOR CABLE 8 CONDUCTOR 2/18, 6/22  
 GAGE . . . 16 FT.  
 RG-8/U LOW LOSS FOAM COLUMBIA  
 SUPERFLEX COAX WITH PL-259 EACH  
 END, 50 FEET . . . 12.50  
 100 FEET . . . 23.00  
 ANTENNA WIRE #17 BARE COPPERWELD  
 STRANDED 7/25 100 FEET . . . 3.60  
 PL-259 COAX CONNECTORS . . . 60  
 RG-8/U LOW LOSS COLUMBIA SUPER-  
 FLEX CABLE 500FT REEL . . . 120.00  
 RG-58/U LOW LOSS FOAM COLUMBIA  
 SUPERFLEX WITH PL-259 EACH END, 50  
 FEET . . . 7.00  
 100 FEET . . . 12.00

## BARKER & WILLIAMSON

MODEL 3002W UNIVERSAL HYBRID  
 COUPLER PHONE PATCH WITH BUILT-IN  
 COMPREAMP. THE BEST OF PHONE  
 PATCHES . . . 125.00  
 MODEL 375 PROTAX ANTENNA SWITCH  
 WITH AUTOMATIC GROUNDING, 6 POSI-  
 TION REAR MOUNTED SO-239 . . . 18.95  
 MODEL 376 SAME AS ABOVE ONLY 5  
 POSITION SIDE MOUNTED SO-239 . . . 18.95  
 CC-50 DIPOLE ANTENNA CENTER,  
 WEATHER PROOFED . . . 7.50  
 MODEL 377 ANTENNA COAXIAL  
 CHANGEOVER RELAY, DC TO 150MHZ  
 115V/60HZ. SWITCHES ANTENNA FROM  
 TRANSMIT TO RECEIVE, SO-239  
 CONNECTORS . . . 16.50

# Slep Electronics Co.

P.O. BOX 100, HWY. 441, DEPT. 73, OTTO, NORTH CAROLINA 28763

WE PAY SHIPPING VIA U.P.S. OR BEST  
 WAY ON ALL ADVERTISED ITEMS;  
 TRADES TAKEN ON NEW EQUIPMENT.  
 WRITE FOR SPECIAL PACKAGE PRICE  
 ON COMPLETE STATIONS. SATISFAC-  
 TION GUARANTEED. WE ACCEPT  
 MASTER CHARGE, N.C. RESIDENTS ADD  
 4% SALES TAX. PHONE BILL SLEP  
 704-524-7519 MONDAY THRU FRIDAY  
 8:30 - 6:00 PM.

# SLEP ELECTRONICS

# IS NOW SHIPPING

**ATLAS**  
210X 80 THRU 10M ..... \$679.00  
215X160 THRU 15M ..... 679.00  
210X OR 215X WITH NOISE  
BLANKER ..... 719.00  
AC CONSOLE 220CS WITH VOX/SEMI  
BREAK-IN CW ..... 194.00  
AC CONSOLE 220CS ..... 147.00  
PORTABLE AC SUPPLY 200PS ..... 100.00  
DMK PLUG-IN MOBILE MOUNT, WITH DC  
CABLE ..... 48.00  
DCC BATTERY CABLE ..... 12.00  
DD-6B DIGITAL DIAL ..... 229.00  
MT-1 MOBILE ANTENNA MATCHING  
TRANSFORMER ..... 27.00  
PC-120 NOISE BLANKER CONVERSION  
KIT ..... 52.00  
VX-5 VOX CONVERSION KIT FOR AC  
CONSOLE ..... 49.00  
206 AUXILIARY VFO WITH EXTENDER  
FREQUENCY COVERAGE FOR ALL  
ATLAS TRANSCEIVERS ..... 299.00

**DRAKE**  
R-4C RECEIVER 160-10M ..... 599.00  
4-NB NOISE BLANKER R-4C ..... 70.00  
FILTERS 250HZ, 500HZ, 1.5HZ ea. 42.00  
SPR-4 RECEIVER ..... 629.00  
5-NB NOISE BLANKER SPR-4 ..... 70.00  
DC-PC 12V POWER CORD ..... 5.00  
SCC-4 100HZ CALIBRATOR ..... 20.00  
CRYSTAL KIT AMATEUR BANDS ..... 31.20  
SSR-1 GENERAL COVERAGE RECEIVER  
.5 TO 30MHZ ..... 350.00  
DC-PC SSR-1 DC POWER CORD ..... 5.00  
T-4XC TRANSMITTER 160-10M ..... 599.00  
TR-4C TRANSCEIVER 80-10M ..... 599.95  
34PNB NOISE BLANKER TR-4C ..... 100.00  
MMK-3 MOBILE MOUNT ..... 7.00  
RV-4C REMOTE VEO TR-4C ..... 120.00  
AC-4 POWER SUPPLY FOR ALL DRAKE  
TRANSMITTER TRANSCEIVERS ..... 120.00  
DC-4 12V DC MOBILE POWER  
SUPPLY ..... 135.00  
TR-33C 2 METER FM TRANSCEIVER 12  
CHANNELS ..... 229.95  
AA-10 10 WATT 2 METER AMPLI-  
FIER ..... 49.95  
AC-10 POWER SUPPLY TR-22, TR-33,  
TR-72 ..... 49.95  
MN-4 ANTENNA MATCH BOX ..... 110.00  
MN-2000 ANTENNA MATCHBOX ..... 220.00  
MS-4 SPEAKER ..... 24.95  
W-4 WATTMETER 1.8 TO 54MHZ ..... 72.00  
7072 HAND-HELD MIKE ..... 19.00  
7075 DESK TOP MIKE WITH VOX  
SWITCH ..... 39.00  
RCS-4 REMOTE CONTROL ANTENNA  
SWITCH ..... 120.00  
HS-1 HEADPHONES ..... 10.00  
TV-3300LP LOW PASS FILTER ..... 19.95  
DSR-2 VLF-HF DIGITAL  
RECEIVER ..... 2,950.00

**TEMPO**  
TEMPO ONE, 5 BAND SSB TRANS-  
CEIVER ..... 399.00  
TEMPO ONE AC POWER SUPPLY ..... 99.00  
TEMPO VF/ONE EXTERNAL VFO ..... 109.00  
TEMPO DFD/ONE DIGITAL DISPLAY  
TEMPO ONE ..... 189.00  
TEMPO 2020 SSB/AM TRANSCEIVER 80  
TO 10M 115V/12VDC P/S ..... 759.00  
TEMPO FMH 2 METER, 6CH HAND-HELD  
FM TRANSCEIVER ..... 199.00  
TEMPO VHF/ONE SYNTHESIZED  
DIGITAL READ-OUT 2 METER 10 WATT  
TRANSCEIVER, NO CRYSTALS TO  
BUY ..... 495.00  
TEMPO SSB/ONE SSB ADAPTOR FOR  
UHF/ONE ..... 225.00  
TEMPO 130A10 130 WATTS OUT 10W  
DRIVE ..... 179.00  
TEMPO 80A10 80 WATTS OUT 10W  
DRIVE ..... 139.00  
TEMPO 50A10 50 WATTS OUT 10W  
DRIVE ..... 99.00

**TEN TEC**  
TRITON IV MODEL 540 TRANS-  
CEIVER ..... 699.00  
252G POWER SUPPLY ..... 99.00  
252G POWER SUPPLY/VOX ..... 129.00  
207 AMMETER ..... 14.00  
245 CW FILTER ..... 25.00  
ARGONAUT MODEL 509 ..... 329.00  
405 LINEAR AMPLIFIER ..... 159.00  
210 POWER SUPPLY 1 AMP ..... 27.50  
251 POWER SUPPLY 9 AMP ..... 79.00  
206 CRYSTAL CALIBRATOR ..... 26.95  
208 CW FILTER ..... 29.00  
HR5A KEYS ..... 38.50  
KR20A KEYS ..... 67.50  
KR50 KEYS ..... 110.00

**BRIMSTONE**  
MODEL 144 2 METER FM TRANSCEIVER  
25 WATT 143 TO 149.99MHZ DIGITAL  
DIALED 5KHZ STEPS, NO CRYSTALS TO  
BUY 142MHZ MARS COVERAGE  
OPTIONAL ..... 650.00

**COMCRAFT**  
CST-50 VHF TWO BAND TRANSCEIVER 2  
AND 1 1/2 METERS, DIGITAL FREQUENCY  
SYNTHESIS 142 TO 149.995MHZ AND 220  
TO 225 MHZ 25 WATTS ..... 869.00

**SHURE**  
526T DESK TOP MICROPHONE WITH  
PRE-AMP ..... 36.50  
444 SSB DESK TOP MICROPHONE WITH  
OFF-ON VOX SWITCH PTT ..... 34.50  
404C HIGH IMPEDANCE MAGNETIC  
HAND-HELD MICROPHONE FOR SSB PTT,  
IDEAL FOR SWAN, ATLAS ..... 27.00

**MILLEN**  
92200 ANTENNA MATCHBOX ALL BAND  
2KW ..... 199.00  
92201 JR ANTENNA MATCHBOX ALL  
BAND 300 WATTS ..... 138.00  
90652 SOLID STATE GRID DIP OSCIL-  
LATOR 9 VOLT BATTERY OPERATED  
WITH COILS 1.7 THRU 300MHZ  
SUPPLIED ..... 138.00

**SWAN**  
700CX TRANSCEIVER ..... 649.95  
117XC CONSOLE SPKR/PS ..... 159.95  
14-117 DC MOBILE P/S ..... 189.95  
510X CRYSTAL OSCILLATOR ..... 67.95  
VX-2 VOX ..... 44.95  
FP-1 PHONE PATCH ..... 64.95  
SWR-1 POWER/SWR METER 0-1 KW, 3.5 -  
150 MHZ SO-239 CONNECTORS ..... 21.95  
WM-2000 IN LINE WATTMETER SCALES  
TO 2KW ..... 49.95  
1200X LINEAR AMPLIFIER 1200  
WATTS ..... 349.95  
MARK II LINEAR AMPLIFIER 2KW ..... 849.95  
SS-16B KIT ..... 99.95  
45 ALL BAND MANUAL SWITCHING 1KW  
PEP MOBILE ANTENNA ..... 114.95  
742 TRI-BAND 20-40-75 METER ELEC-  
TRONICALLY TUNED AUTOMATIC  
BAND-SWITCHING, 500 W.PEP ..... 79.95

**REGENCY TRANSCEIVERS**  
HR-312 FM 2 METER 30W ..... 269.00  
HR-6 FM 6 METER 15W ..... 229.00  
HR-220 FM 220MHZ 10W ..... 239.00  
HR-440 FM 440 MHZ 10W ..... 349.00  
P-110 AC P/S 117V/12VDC REGULATED 5  
AMP ..... 49.95

**NYE-VIKING**  
CODE KEYS SPEED-X MODEL 114-310-003  
STANDARD KEY, NICKEL PLATED  
HARDWARE WITH SWITCH ..... 8.25  
MODEL 114-310-004 STANDARD KEY,  
NICKEL PLATE HARDWARE WITH  
SWITCH AND NAVY KNOB ..... 9.10  
SSK-1 DUAL PADDLE SQUEEZE KEY  
NICKEL PLATED ..... 23.95  
MODEL 114-404-002 CODE PRACTICE SET  
WITH KEY, OSCILLATOR, AMPLIFIER 2"  
BUILT-IN SPEAKER, HEAVY DUTY BASE,  
TAKE 9V BATTERY, NOT  
INCLUDED ..... 18.50

**BEARCAT**  
MODEL 101, 16 CHANNEL SCANNER,  
30-50MHZ 146-174MHZ, 416-512MHZ, NO  
CRYSTALS TO BUY ..... 290.00  
W2AU BALUN, 2KW PEP, 3 TO 40 MHZ 1:1  
MATCHES 50 OR 75 OHM UNBALANCED  
COAX LINE TO 50 OR 75 OHM BAL-  
ANCED LOAD, BUILT-IN LIGHTNING  
ARRESTOR ..... 12.95

# Slep Electronics Co.

P.O. BOX 100, HWY. 441, DEPT. 73, OTTO, NORTH CAROLINA 28763

WE PAY SHIPPING VIA U.P.S. OR BEST  
WAY ON ALL ADVERTISED ITEMS;  
TRADES TAKEN ON NEW EQUIPMENT.  
WRITE FOR SPECIAL PACKAGE PRICE  
ON COMPLETE STATIONS. SATISFA-  
CTION GUARANTEED. WE ACCEPT  
MASTER CHARGE, N.C. RESIDENTS ADD  
4% SALES TAX. PHONE BILL SLEP  
704-524-7519 MONDAY THRU FRIDAY  
8:30 - 6:00 PM.

# BULLET

(214)823-3240

# ELECTRONICS

PO BOX 19442E  
DALLAS TX 75219

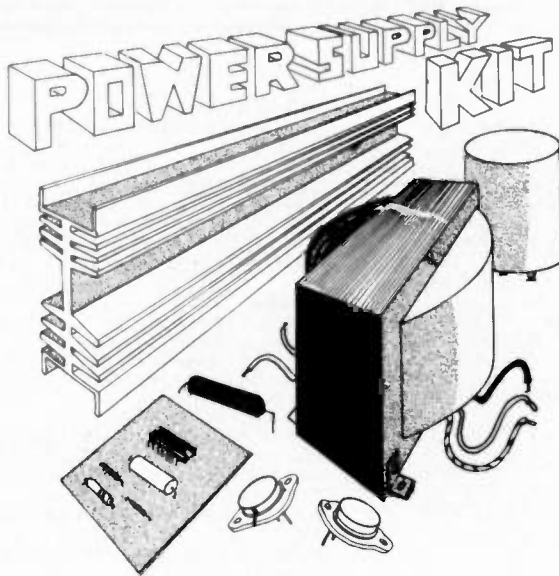

- FEATURES:**
- Output adjustable from 3 to 30 Volts DC
  - Adjustable Current Limiting to 15 Amps
  - Special Pre-Regulator Circuit eliminates need for massive heatsinks
  - Better than 1% Load & Line Regulation from 0 to 15 Amps
  - Low Ripple Output
  - Heavy Duty 10 lb. transformer

- KIT INCLUDES:**
- Transformer
  - Heatsink (drilled)
  - Semiconductors (diodes, transistors, etc.)
  - All Components (resistors, caps)
  - Transistor mounting hardware and insulators
  - Drilled & Plated P.C. Board
  - Wire

Not only is the PS-12 able to supply a continuous 15 AMPS of low ripple, regulated DC Voltage, but it is also variable from 3 to 30 volts! Use it as a building block for a fantastic bench supply. The chassis work is up to you - go fancy with meters and lights; or plain with a metal plate. Either way we get you out with a quality kit at a super low price and we guarantee your satisfaction.

**PS-12 \$49.95** INCLUDE  
3.70 FOR SHIPPING

## MINI GRANDFATHER CLOCK KIT

- 4 Digit LED Readout
- Simulated Swinging Pendulum
- Tick-Tock sound matches pendulum swing
- Electronic Tone Chimes the Hour (ie: 3 times for 3 o'clock)
- Quality Components & P.C. Boards
- Transformer for 115 VAC included.

*The most novel and fascinating kit we have ever offered*

**\$44.<sup>00</sup>**

**POSTPAID**

NO CASE INCLUDED, LET YOUR IMAGINATION RUN WILD AND DESIGN YOUR OWN. WE SUPPLY ALL THE ELECTRONICS.

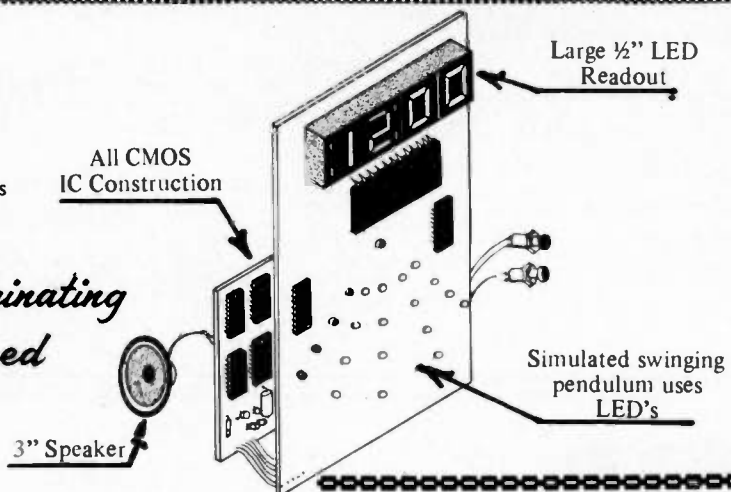

Tex. Res.  
add 5% tax.

**NO CODS  
SEND CHECK  
MO, BAC, MC**



# BULLET ELECTRONICS

P. O. BOX 19442 E  
DALLAS, TEXAS 75219  
(214) 823-3240

- NO COD's
- SEND CHECK or M.O.
- BANKAMERICARD OR M.C.#
- ADD 5% FOR FIRST CLASS
- FOREIGN ORDERS ADD 10% (20% FOR AIRMAIL)
- TEXAS RESIDENTS ADD 5% SALES TAX
- ADD 60c FOR HANDLING ON ORDERS UNDER \$10.00

BUILD A COMPLETE CDI IGNITION KIT AT A FRACTION OF THE COST OF OTHER UNITS. A special buy allows us to sell the complete kit at this low price! Up to 40,000 volts from your present ignition without changing the coil. Simple connections.

INCLUDES: Special toroid transformer  
Drilled and Plated board  
Complete instructions  
All resistors and caps  
All semiconductors

**\$9.95**

(Does not include heatsink or case.) For 12V negative ground systems.

## PS-01 POWER SUPPLY KIT

IMAGINE! A power supply with a well filtered, regulated output in three voltages. The PS-01A has quality IC regulators, semiconductors and components. The transformer is custom designed and well made. Features 10mv load regulation.

YOU GET:

Drilled and Plated board  
Complete kit of components  
Heatsinks +5V @ 1.5A  
Complete Instructions ±15V @ 200MA

**\$14.95**

NOTE: +5 and ±12VDC supply is available at same price. Order PS-01/B.

## AIRCRAFT/MOBILE CLOCK TIMER KIT

MK-03

A FULL 6 DIGIT LED READOUT CLOCK THAT GIVES 24 HOUR (ZULU) REALTIME AND ELAPSED TIME IN SECONDS, MINUTES AND HOURS UP TO 24 HOURS. READOUTS CAN BE TURNED OFF OR DIMMED. PC BOARDS ARE SMALL TO FIT INSIDE A STANDARD INSTRUMENT CASE (2 1/4" Dia.)

FEATURES:

.3" LED Readouts Real Time (24 hr.)  
Special Noise Filter Elapsed Time  
Quality plated boards 2 MOS Chips 12V NEG GND

**\$26.95**

KIT IS SUPPLIED WITHOUT SWITCHES OR CASE

## ULTRASONIC SENDER-RECEIVER KIT

A special buy on a high quality ultrasonic transducer allows us to offer this kit at a super price — but hurry, quantities are limited! You can build intrusion alarms, motion detectors, remote controls, echo ranging or liquid level measurement equipment. We supply the basic transmitter and receiver electronics including a drilled and plated PC board. The units work at 23KHZ with a range of 20 ft. and can be positioned opposite each other or side-by-side and bounced off a solid surface. The output will sink up to 300ma to drive a relay, alarm circuit, etc.

ORDER US-01

\$19.95

1 HY TOROID POT  
CORE COILS  
ULTRA STABLE  
FOR LOW  
FREQUENCY  
OSCILLATORS,  
FILTERS, etc.

**.49**



**\$25.00**

COMPLETE!

**MK-04**

- \* 6 DIGIT LED
- \* 4" READOUT
- \* TIMEBASE INCLUDED

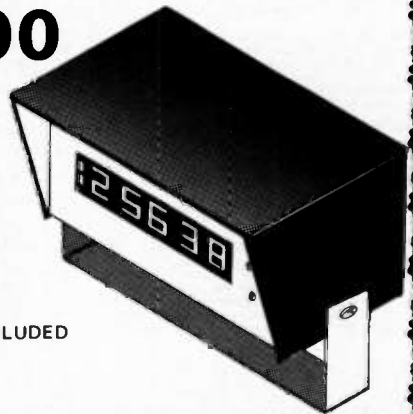

**WARBLE ALARM Kit** A piercing 10 WATTS of dual tone noise that can't be ignored. Perfect for burglar alarms, warning devices, or to call your kids home for supper! Complete with PC Board. Less speaker or switch. Requires 6 to 15 VDC. \$2.50 COMPLETE

## METAL PROJECT CASES

CASES ARE HEAVY GAUGE ALUMINUM WITH BAKED WHITE FINISH & BLACK WRINKLE TOPS.

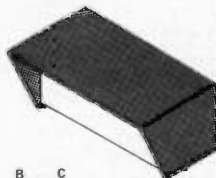
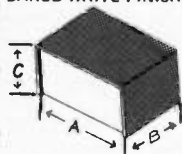

	A	B	C	
Small:	2 7/8"	2 3/4"	1 1/2"	\$1.60
Medium:	4 1/4"	2 1/2"	1 7/8"	2.15
	SHADOW FRONT			
Medium:	4 13/16"	3 3/4"	2"	3.50
Large:	7"	4"	2 3/8"	4.35

## GUARANTEED!



POSITIVE REGULATOR 500ma  
VARIABLE FROM 3 to 30 VDC  
7560 - 50c

NEG. REGULATOR (same as 7560 but for negative)  
7563 - 40c

DUAL REGULATORS +/- 500ma  
7568 - 69c

RETESTED  
UNMARKED  
FUNCTIONAL  
DEVICES

## AUDIBLE CONTINUITY TESTER

Code Practice Oscillator  
Continuity Checker  
Transistor, diode or LED checker  
Tone varies with resistance

**\$1.95** (kit)

MEASURE CONTINUITY & RESISTANCE TO 2K TEST LED's, DIODES, AND TRANSISTORS. LESS SPEAKER.

Requires 3 to 6 volt batteries (not included)

PHONE ORDERS ACCEPTED ON BAC OR MC CARDS

48 HOUR FAST SERVICE

CATALOG INCLUDED WITH EACH ORDER, OR SEND A STAMP

ALL COMPONENTS AND KITS GUARANTEED.

ORDERS OVER \$50.00 TAKE 10% DISCOUNT

# WHAT HAVE YOU MISSED?

The back issues of 73 are a gold mine of interesting articles . . . just take a look at what's been covered . . . every possible interest. This is the most important library you can have for hamming.

The supply of these back issues is very limited . . . and when these are gone, that will be it. Don't miss out by procrastinating.

Single issues . . . \$1.50 each (before 1976)  
Ten back issues (your choice) . . . \$12 postpaid in US.  
Twenty-five back issues (your choice) \$20 postpaid in US.  
Twenty-five back issues (our choice) \$10 postpaid in US.

**JUNE 63.** Surplus Issue: DMO-2 Beacon Tx on 220, increasing ARC-2 transceiver selectivity, PE-97A pwr supply conversion, BC-348 bandspread, inductance tester, converting BC230 tx, beginner's rx using BC-453, rcv'y motor-tuning, transistor cw motor, BC-442 ant relay conversion, mobile loading coils, increasing Two-er selectivity, TV with the ART-26 tx, TRC-8 rx on 220, ARC-5 hf rx & tx, ARC-3 rx on 2M.

**AUG 63.** Battery-op 6M stn, diode noise gen, video modulation, magic T-R switch, ant gain, halo mods, cw breakin, VEE beam design, coax losses, RF wattmeter, TX Tube SWR, diode pwr supply, "Lunchbox" squelch, GWR explanation, vertical ant info, info on Windom ant.

**OCT 63.** WBFM transceiver ideas, HF propagation, cheap fone patch, remote-tuned Yagi, construction hints, ant coupler, S5 Vertical, filament xformer construction, 2M navistor converter, Lafayette HE-35 mods, Buyer's Guide to Hi-C VFO, radio astronomy, panadaptor "H" converter, compact mike amp.

**FEB 64.** 2M multichannel exciter, rx design ideas, majic T-R switch, loudspeaker enclosures, 40M 2L tx, look at test equipment, radio grounds, 40M 2L Special ant, neutralization.

**MAY 67.** Quad Issue: 432 Quad-quad quad, expanded HF quad, Two el quad, miniquad, 40M quad, quad experiments, half-quad, three el quad, 20M quad, filter quad, easy-to-erect quad, Quad Bibliography, FET vfo, tube troubleshooting, HF dummy load, understanding "dB", HF SSB/cw rx, geometric circuit design, GSB-201 transceiver, FET converter for 10 20M, hi-pass rx filters.

**JULY 67.** VE ham radio, VEB hams, dsb adaptor, home brew tower, transistor design, '39 World's Fair, gnd plane ant, G4ZU beam, SSTV monitor, UHF FET preamps, IC "H" strip, vertical ant, VHF/UHF dipper, tower hints, scope monitoring, operating dc, S-Line crossband, hi-school ham club, Heath HR-10 mods.

**OCT 67.** HF solid state rx, rugged rotor, designing slug-tuned coils, FET converter, SSTV pix gen, VHF log-periodics, rotatable dipole, gamma-match cap, old-time dxing, modern dxing.

**JUNE 68.** Surplus Issue: Transformer tricks, BC-1206 rx, APS-13 ATV tx, low voltage dc supply, surplus scopes, FM rig commercial kit types, Wilcox F-3 rx, restoring old equipment, 75A1 rx mods, TRA-19 on 432, freq counter uses, transceiver pwr supply, uses for cheap tape recorders, Surplus Conversion Bibliography, RT-209 walkie on 2M, ARC-1 guard rx, RTTY tx TU.

**JULY 68.** Wooden tower construction, tiltover towers, erecting a telephone pole, IC AF osc, "dB" explained, ham club tips (Part 1).

**SEPT 68.** Mobile vhf, 432 FET preamps, converting TV Tuners, xtal osc stability, parallel-TE design, moonbounce rhombic, 6M xciter (corrections Jan 69), 6M transceiver (corrections Jan 69), 2M dsb amp, ham club tips (Part 3).

**NOV 68.** SSB xtal filters, solid state troubleshooting, IC freq counter (many errors & omissions), "cv" transformers, space comm odyssey, pulsar info, thin wire ants, 40M transmitter cw tx/rx, BC-38M double conversion, multifunction tester, copper wire specs, thermistor applications, hi-voltage transistor list, ham club tips (Part 5).

**JAN 69.** Suppressor compressor, HW12 on 160, beam tuning, AC voltage control, 2M transistor tx, LC power reducer, spectrum analysis info, 6M transistor rx, operating console, RTTY autostart, calculating osc stability, lo-pwr 40 cw tx, sequential relay switching, sightless operator's bridge, ham club tips (Part 7).

**FEB 69.** SSTV camera mod for fastscan, tri-band linear, selective af filter, unijunction transistor info, Nikola Tesla biography, mobile installation hints, extra-class license study (Part 1).

**MAR 69.** Surplus Issue: TCS tx mods, cheap compressor/amp, RXZ calculations, transistor keyer, better balanced modulator, transistor oscillators, using blowers, half-wave feedline info, Surplus Conversion Bibliography, extra license study (Part 2).

**APR 69.** 2-channel scope amp, rx preamp, Two-er PTT, variable DC load, SWR bridge, 100 kHz marker gen, some transistor specs, SB 610 monitor scope mods, portable 6M AM tx, 2M converter, extra license study (Part 3).

**MAY 69.** 2M Turnstile, 2M Slot, rx attenuator, generator filter, short VEE, quad tuning, using antenna scope, measuring ant gain, phone patch reg, SWR indicator, 160M short verticals, 15M antenna, HF propagation hints, FSK exciter, KW sunny load, hi-power linear, extra license study (part 4), all-band curtain array.

**JUNE 69.** Microwave pwr generation, 6M ssb tx, 432-er tx/rx, 6M converter, 2M 5/8 wave whip, UHF tv tuners, ATV video modulator, UHF FET preamps, RTTY videoscope, extra license study (part 5), building uhf cavities, mini-VEE for 10-20M, vhf vfo.

**JULY 69.** AM modulator, SSTV sig gen, 6M kw linear, 432 kw amp, 432-er tx/rx, 6M IC converter, radio-controlled models, RTTY IC

TU, audio notch filter, VRC-19 conversion, tube substitution, 2M transistor xciter, extra license study (part 6), HF FET vfo.

**AUG 69.** FET regen for 3.5 MHz up, FM crystal switching, 5/8 wave vertical, introduction to ICs, RTTY tone gen, good/bad transistor checker, 2M AM tx, measure transistor Ft, 160M propagation, tric applications, simple HF sweep gen, transistor keyer, SB-100 on 6M, xtal freq measurement, extra license study (part 7), FM deviation meter, qrp am 6M tx, circular quads, FM noise figure, transistor parameter tracer.

**SEPT 69.** Tunnel diode theory, majic tee, soldering techniques, wave travel theory, cable shielding, transistor theory, AM noise limiter, AFSK gen, transistor amp debugging, measure meter resistance, diode-stack pwr supply, transistor testing, 2 1/2W 6M tx, HX-100 neutralizing, capacitor usage, radio propagation, AM mod percentage, extra class license keyer (part 8), 3-402 linear, ATV vidicon camera, 2 transistor testers, FET compressor, rf plate choke.

**OCT 69.** Super gain 40M ant, FET clipper, telephone info, scope calibrator, thyristor surge protector, slower tuning rates, identify calibrator harmonics, FM adaptor for AM tx, CB sets on 6M, proportional control xtal oven, xtal filter installation, Q-multiplier, transceiver pwr supply, extra class study (part 9).

**NOV 69.** NCX-3 on 6M, IF notch filters, dial calibration, HW32A external VFO, 6M converter, feedline info, rf z-bridge, fm mobile hints, umbrella ant, 432-er tx (part 1), pwr supply tricks with diodes, transistor keyer, transistor bias design, xtal vhf sig gen, electronic varac, SB33 mods, extra class study (part 10), SB34 linear improvements.

**DEC 69.** Transistor-diode checker, dummy load/attenuator, tuned filter chokes, band-switching, Swan 250 & TV-2, 8mhz selectivity, match exarites, rf xtal calibrator, transistor packaging, hv mobile p.s., 1-10 GHz freemeter, CB rig on 6M, extra license study (part 11), 1970 buyer's guide.

**JAN 70.** Transceiver accessory unit, bench power supply, SSTV color method, base-tuned center-loaded ant, 6M bandpass filter, extra license study (part 12), rectifier diode usage, facsimile info.

**FEB 70.** 18-inch 15M dipole, 6M converter, high-density pc board, camper mobile hints, 2M freq synthesizer, encoding/decoding for repeaters, DX-35 mods, panoramic vhf rx, variable-Z HF mobile mount, extra license study (part 13), linear IC info, qrp 40M tx, IC Q-multiplier.

**MAR 70.** Gdo applications, charger for drycells, FM freq meter, pc board construction, ham fm standards, cheap rf wattmeter, multireg fm osc, "IF" system modules (part 1), Six-er mods, gdo dip lite, Motorola 41V conversion, cw monitor, buying surplus, log, SSO-23A conversion, GRC-9 rx/tx converter, extra class study (part 14), Intro to vhf fm.

**APR 70.** Noise blanker, 2M hotcarrier diode converter, repeater controller, understanding COR repeater, 7/8 wave 2M ant, extra class study (part 15), inexpensive semiconductors, removing surplus meters, linear amp bias regulator, hi-performance HF amp & agc system, SSB info for shortwave radio, vacuum tube-based fm dop, general fm dop & repeater guide, meggering your ant.

**MAY 70.** Comments on "fm docket" #18803, future of cw, fm-am rx aligner, 5/8-wave verticals, using 2M intelligent, auto burglar alarms, pwr supplies from surplus components, "IF" system modules (part 2), vhf FET preamps, educated "idiot" lites, postage stamp 6M tx, extra class study (part 16), Blom IFNL, low-band police monitor, mobile cw tx, Wichita auto patch.

**JUNE 70.** DRR ant, vfo circuit, remote SWR indicator, indoor hi vertical, mobile rx bne antenna, environment & coax loss, 2-el pad verticals, buying surplus, two 40M qrp tx, 21dB 2M beam, extra class study (part 17).

**DEC 70.** Solid-state vhf exciter, diode-free control for SSB, 2M transistor FM tx, HW100 offset tuning, "little gear" dipcut, 3-5002 hf linear, general class study (part 5), "transi-test"

(no good — errors!), transistor p.s. current limiter.

**JAN 71.** Split tones for dxing, Heath Ten-er mods, cw duty cycle, repeater zero-beater, HEP IC projects, 10 15-20M parabolic ideas, light ning protection, IC rx accessory, attic ants, double-balanced mixers, permanent marker tool, ham license study questions.

**FEB 71.** Metal locator, varactor theory, AFSK intro, SSTV patch box, ATV hints, RTTY tuning indicator, tone encoder/decoder, 220 MHz converter, SSTV magnetic deflection, IC code osc, 6M tx beeper, general class study (part 6), RTTY intro, perf-board terminal, low-ohmmeter.

**MAR 71.** IC audio filter, IC 6M converter, trap vertical ideas, digi counter info, surplus equipment identification, hf linear, simple fone patch, repeater audio mixer, digi RTTY accessories, coat-hanger gndplane, general class study (part 7).

**APR 71.** Intro to fm, noise blanker, repeater problems, Motorola HT mods, microwave repeater linking, digital ID unit, tuneable 2M fm rx/tx, repeater directory, fm marketplace, meter evaluator, varactor modulator, simple sig gen, touchtone hookup, hf preselector, 10M 12W tx.

**MAY 71.** 75M mobile whip, 2M preamp, transistor amp design, 10M dsb tx, portable fm transceiver directory, audio compressor-clipper, transistor LM freemeter, 450 MHz link tx, simple af filter, 1-tube 2M transceiver, surplus 2M power amp, general class study (part 8).

**JUNE 71.** 2M beam experiments, 3 el 2M quad, multi-band dipole patterns, weather balloon vertical, pocket-paper squelch, two-er vfo, tuning mobile-whips, transistor pwr supply, capacity decade box, 40M gain ant, general class study (part 9).

**JULY 71.** IC audio processor, audio sig gen, cw filter, 2M fm osc, 2M collinear vertical, FM supplier directory, Motorola G-strip conversion, transistor beta tester, general class study (part 10).

**AUG 71.** Ham facsimile (part 1), 500 Watt linear, dimensions for July collinear, 4-tube 80/40 station, vfo digi readout, Jupiter on 15M, general class study (part 11), pink ticket wave meter.

**SEPT 71.** Transformerless power supplies, solid state tv camera, IC substitution, two rf wattmeters, IC compressor-agc, multichannel HT-200, ham facsimile (part 2), causes of manmade noise, vfo with tracking mixer, general class study (part 12), transistor heat-sinking, IC pulse gen, fone-patch isolation, hcd wattmeters.

**OCT 71.** Emergency repeater cor, transceiver power supply, predicting meteor showers, digi switching, reverse-current battery charger, passive repeaters, earth grounds, audio "tailoring" filters, Swan 350 mods.

**NOV 71.** 3-el 75M beam, motor-tuned gndplane, 2M gain vertical, transistor biasing, split-state repeater, fox-hunting, audio filter, transistor/diode tester, xtal tester, 6M kw amp, 10 15-20M quad, transistor pin-test final ant feedline, communications dbt, 2300 MHz xciter.

**AUG 72.** SSTV intro, speech processor, fm repeater info, test probe construction, GE propline ac supply, 432 rf testing, preamp compressor, Six-er mods, fone patch, two-er info, solar info, SCR regulator for RVPS, "ideal" xtal osc, fm rx adaptor, auto theft alarm.

**SEPT 72.** Plumbicon tv camera, WWVB 60 kHz rc, clartube sig gen, cw active filter, rf testing at 1295-3500 GHz, balun ant feed, transistor power supply, IC 6M rx, IC fm/am detector (part 2), active filter design (part 3), K20AW freq counter (part 3), 2M freq synthesizer (part 1).

**OCT 72.** Corrections for Aug, fm rx adaptor, 2M freq synthesizer (part 2), 6M transistor vfo, nano-ampere meter, time-freq measurement (part 1), active filter design (part 4), repeater timer, extra-class G&A (part 3), balloon vertical ID gen, time delay relay, 432 filter idea, DC-AC inverter, hc-diode converter, rf decade and nixie driver, plus-minus supply for ICs.

**NOV 72.** HF transistor power amps, RTTY seical, IC triode, transistor keyer, emergency power, 220 MHz preamp, double-delta ant, simple converter using modules, hf RF tester, "lumped line" osc, 2M freq synthesizer (part 3), K20AW counter errata, 2M preamp, extra class G&A (part 4), hi-Z voltmeter, Nikola Tesla story, vhf swr meter, transistor regen rx, 432 SSB transceiver, AC arc welder, Intro to computers, hybrid am modulator, HR10 rx mods, 10M transistor am tx, 40M gndplane, IC logic demonstrator, overload protection, H/F sweep generator, digi freq counter, aural tx tuning.

**DEC 72.** SSTV scope analyzer, 2M fm rx, tone burst encoder and decoder, universal hf amp, autopatch hookup, LM380N info, voltage variable cap info, 2M 18 watt amp, SSB modulation monitor, xtal freq/activity meter, 10A var dc supply, transmission line uses, radio astronomy, inductance meter, 75 to 20M transceiver, LED info, 40M preamp, transistor vfo, 1972 index, 2M preamp.

**JAN 73.** HT-220 touchtone, 3 el 20M vfo, 50 MHz freq counter, speech processor, 2-tone gen, fm test set, tilt-over tower, 6M converter using modules, tuneable af filter, six band linear, 10M IF tuner, diode noise limiter, cw/ssh agc, HW22a transceiver 40M mod, HAL ID-1 mod.

**FEB 73.** CW id gen, tone operated relay, toroidal quadrature ant, active filter, time freq measurement (part 2), repeater timing control, SSTV circuits (part 1), 2M converter using modules, multifunction meter, FET biasing, freq counter preamp, TR22 hi-power mod, transistor rf power amps (part 1), light bulb rf power indicators, 75A.4 filters, capacitance measurement, Gonset 201 mod, world time info.

**APR 73.** FM deviation meter, 2M FET preamp, two 2M power amps, repeater control (part 1), repeater licensing, European 2M fm, fm scanner adapter, RCA CMU15 mods, lightning detector, cb alignment gadget, transistor rf power amps (part 2), repeater economics.

**JUNE 73.** 220 MHz sig gen, uhf power meter, remote licensing info, RTTY auto-tune, 40M hybrid vfo tx ant polar mount, 10 16 20M quad, K20AW counter mods, double coax ant, ham summer job, tone decoder, field strength meter, nicad battery pack, ohm meter, FCC regs (part 1).

**AUG 73.** Log-periodics (part 1), tone burst gen, rf power amp design, transistor radio intercom, 160M ant, SSTV monitor, low cost freq counter, VOM design, qrp 40M tx, 432 MHz exciter, fm audio processing, FCC regs (part 3).

**SEPT 73.** Repeater control system, log-periodics (part 2), 2M rx calibrator, PLL IC applications, TT pad hookup, Heath HW7 "y" meter, Oscar-6 doppler, 2M coaxial ant, 2M converter, IC keyer, measure ant 2, FCC regs (part 4).

**OCT 73.** GE Pocketmate mods, microwave freq measurement, CA3102E 2M frontend, 2 kw hf linear, rf wattmeter, meter repair, 60/40 dipole, IC "hi" gen, vhf freq multiplier, FCC regs (part 5).

**NOV 73.** 450 MHz exciter, Intro to ATV circuits, nicad voltage monitor, autopatch connections, IC meter amplifier, TR22 ac supply, indoor vertical, IC af filter, momentary power failure protector, 150M ant, acupler, Motorola HT info, SSTV-ISB, Class B of amp, FCC regs (part 6).

**DEC 73.** Code speed display, 2M kw amp, IC keyer, 8038 wavform gen, helical resonator design, sensitive hf voltmeter, proximity control switch, IC tester, sequential tone decoder, 2M portable beam, electronic calculator math, cw filter design, FCC regs (part 7).

**FEB 74.** SSTV monitor info, IC audio amps, scope sweep gen, 15/20M vertical, telephone line controls system, pc board construction, var-Q af filter, blown-fuse indicator, 40m cw stn with Ten-Tec modules, simple preamp-compressor, single-IC rx, "432-er" final assembly, transistor keying circuit, 7-segment readout with nixie driver.

**APR 74.** Vox for repeaters, tone operated relay, hf transverter, 10 to 2m tx converter, remote control panel for scanner, RCA fm tx tuning, subaudible tone gen, FCC regs (part 9), Repeater Atlas.

**MAY 74.** Cd ar ignition, audio compressor info, interference suppression for boats, auto burglar alarms, 2m ic preamp, 10m test converter.

**JULY 74.** 4 1000A linear, universal freq gen, universal afsk gen, 555 IC timer, 80M phased array, 135 kHz 432 MHz preamps, 10M qrp am tx, 3000 vdc supply, how to read diagrams.

**AUG 74.** Toroidal directional wattmeters, 450 MHz FET preamp, use gdo to find "c", Trimline tt pad hookup, R390 & R392 rx mods, tracking cw filter, aural voltmeter, universal regulated supply, sstv scan converter, ttl logic problems, ID timer.

**SEPT 74.** MOSKEY electronic keyer (part 1), exc warning system, Heath 10 103 scope mods, qrp 6M am tx, rf speech clipper, audio noise generator, miniature rig construction, tower construction, infinite rf attenuator, electronic

(More)

photo-flash ideas, IC "select-o-ject."

OCT 74. Microtransistor circuits, synthesized HT-220 (part 1), repeater government, regulated 5 vdc supply, fm seical, removable mobile ants, Motorola metering, 2M vertical collinear, Motorola model code, 2M coaxial dipole, 1.6 MHz lf strip, MOSKEY electronic keyer (part 2), carbon mike circuit, hi-power lo pass filter, 6M preamp, 3-wire dipole, ATV sync gen, NCX-5 mods, mobile whip for apartment dwellers, sstv auto vertical trig.

NOV 74. K20AW counter update, regulated 5 vdc supply, wind direction indicator, synthesized HT-220 (part 2), 20M 3 el beam, auto-patch pad hookups, double-stub ant match, novice class instruction, digi swr meter (part 1), 6M converter (1.6 MHz 'H), "C-bridge", MOSKEY electronic keyer (part 3), Aug. sstv scan converter errata, repeater off-freq indicator.

OEC 74. Care of nicads, wind speed/direction indicator, wx satellite video converter, electronic keyer, hints for novices, unknown meter scales, SSTV tape ideas, TTL logic probe, public service band converter, tuned diode test receivers, digi swr meter (part 2), telephone

Since there's little to get stale in back issues of 73 (our magazine is not padded ... like others ... with reams of activity reports), you'll have a fantastic time reading them. Most of the articles are still exciting to read ... and old editorials are even more fun for most of the dire predictions by Green have now come to pass. Incentive licensing was every bit the debacle he predicted ... and more. You'll really get a kick out of the back issues.

pole beam support, rhombic antennas, 1974 Index.

FEB 75. Heath HD-10 scope mod for SSTV, electronic keyer, digital satellite orbital timer, Oscar 7 operation, satellite orbital prediction, Heath SB-102 mods, comparing FM & AM, repeater engineering, Robot 80 A sstv camera

mod, neutralizing Heath SB-110A, "Bounceless" IC switch, tape keyer for cw tx.

APR 75. S50 walky for 2M, 2M scanning synthesizer, 88 mH toroid info, 8-function repeater controller, nicad battery precautions, TR22C preamp, telephone attachment regs, Guide to 2M Hand-held Transceivers, 2M 7-el

beam, basic telephone systems (part 1), 10 min ID timer, modified hf Hustler mobile ant for 2M, 15M quad modified for 20M, 2M collinear beam, R-11A surplus rx conversion, 5/16 wave 2M ant, Hallicrafters SX 111 rx mods, 160M cw tx.

AUG 75. 146/432 MHz Helical ants (part 2), 10 min ID timer, digi swr computer (part 1), debugging rf feedback, DVM byer's guide, wx satellite monitor, cmos "accu-keyer," pc board method, sweep-tube final precautions, compact multiband dipoles, small digital clock, accessory vfo for hf transceiver, modern non-Morse codes, multi-function gen, 2M scanning synthesizer errata, KP-202 walky charger, 10M multi-element beam.

SEPT 75. Calculating freq counter, wx satellite FAX system (part 1), IC millivoltmeter, three button TT decoder, troubleshooting sstv plx, 40M dx ants, 146/432 MHz helical ants (conclusion), digi swr computer (conclusion), read relay for cw bk-in, NE555 preset timer, power-failure alarm, portable grd rig power unit, precision 10 vdc reference standard, 135 khz lf strip, telephone bandsets with fm transceivers, Motorola T-44 tx mod for ATV, 060 MHz synthesizer (part 10, ham radio PR).

# BACK ISSUES

## 73 MAGAZINE CLASSICS

### issues containing hundreds of articles & projects GREAT FOR NOSTALGIA BUFFS

SEND TO 73 BACK ISSUES - PETERBOROUGH, N.H. 03458

H-76

- JUNE 63
- AUG 63
- OCT 63
- FEB 64
- MAY 67
- JULY 67
- OCT 67
- JUNE 68
- JULY 68
- SEPT 68
- NOV 68
- JAN 69
- FEB 69
- MAR 69
- APR 69
- MAY 69
- JUNE 69
- JULY 69
- AUG 69
- SEPT 69
- OCT 69
- NOV 69
- DEC 69
- JAN 70
- FEB 70
- MAR 70
- APR 70
- MAY 70
- JUNE 70
- DEC 70
- JAN 71
- FEB 71
- MAR 71
- APR 71
- MAY 71
- JUNE 71
- JULY 71
- AUG 71
- SEPT 71
- OCT 71
- NOV 71
- AUG 72
- SEPT 72
- OCT 72
- NOV 72
- DEC 72
- JAN 73
- FEB 73
- APR 73
- JUNE 73
- AUG 73
- SEPT 73
- OCT 73
- NOV 73
- DEC 73
- FEB 74
- APR 74
- MAY 74
- JULY 74
- AUG 74
- SEPT 74
- OCT 74
- NOV 74
- DEC 74
- FEB 75
- APR 75
- AUG 75
- SEPT 75

\$1.50 - single issues (indicate your choice at left) issues @ \$1.50

\$12 - ten issues (indicate your choice at left)

\$20 - 25 issues (indicate your choice at left)

\$10 - 25 issues, our choice  60-65  66-70  71-75

Cash, check, money order enclosed.

Name \_\_\_\_\_ Call \_\_\_\_\_

Address \_\_\_\_\_

City \_\_\_\_\_ State \_\_\_\_\_ Zip \_\_\_\_\_

Charge  American Express  BankAmericard  MasterCard

Credit card # \_\_\_\_\_ Interbank # \_\_\_\_\_

Signature \_\_\_\_\_ Expiration date \_\_\_\_\_

# Briefs

Business use of repeater autopatches continues to be a topic of debate nationally. For example, a note from K2CFG: "Due to what can only be described as a gross oversight by our technical committee, repeater trustee, and board of directors, it would seem that WR2ADM is not only on the wrong frequency but actually licensed in the wrong radio service. Everyone concerned with filing the applications for 25-85 acted on the obviously incorrect assumption that this was to be an amateur repeater, operating under FCC rule 97.3 (b), which defines amateur radio communication as, 'radio communication by or among amateur radio stations solely with a personal aim and without pecuniary or business interest.'

"The steadily increasing amount of distinctly business-related conversation on our repeater puts the licenses of all concerned in jeopardy. While it is perfectly legal to mention in conversation the nature of your job and where you work, it is equally *illegal* to exchange names of customers on whom you call or might call, prices and availability of products or services you buy or sell, or itineraries of planned or completed business trips. Even more serious is the use of the repeater for the taking of orders for amateur radio, photographic or any other equipment, or an announcement of the availability of same at bargain prices.

"Please — support your local telephone company — let's keep our repeater in the amateur radio service." Reprinted from the LIMARC LOG, bulletin of the Long Island Mobile Amateur Radio Club, October, 1976.

On October 15, AMSAT/OSCAR 6 celebrated its fourth anniversary. Launched in 1972 from Vandenberg Air Force Base as ballast for the ITOS-D weather satellite, OSCAR 6 had an expected life of one year. More than three years after its expected demise, it shows no signs of giving up.

November 15 was another birthday. AMSAT/OSCAR 7 was two years old. In the hopes of further conservation of battery power, Mode B orbits that fall on GMT Mondays have been designated QRP, with a recommended power limit of ten Watts ERP. AMSAT officials have asked all OSCAR users to limit their power to 100 Watts ERP, in an effort to extend the life of both satellites.

It appears that the reported sale of General Class licenses in the US is a hoax. An article published August 15 in the *Indianapolis Star*, and subsequently reported in *HR Reports*, said a government employee with access to FCC computers had allegedly offered to have licenses issued by

feeding the information to the computers. Groups of amateurs were reportedly selling the tickets for \$200 by telling prospective recipients that they could circumvent the usual testing procedures.

O. Franklin Lowry, the FBI agent-in-charge in Indianapolis, told 73 that although the investigation is continuing, it appears that the report is a hoax. Lowry said the bureau has been unable to uncover any evidence of the alleged sale. Citing the fact that he has received numerous queries from members of the press, Lowry theorized that the same person who reported the attempted sale to the FBI also called in the press.

On a higher level, the situation was much the same. A well-placed FCC source, when queried by 73, said he hadn't even heard of the investigation.

Two major manufacturers of ham equipment have announced an end to field warranty service stations. Drake and Icom have opted for centralized facilities, which means the dealer who sold the radio can no longer repair it! The rig must be sent to a regional repair center, and thus the amateur may face substantial delay. The only other option is for the amateur to forget the warranty and pay for his own repairs. Factory authorized service (non-warranty) will still be available at many dealers. Drake, meanwhile, has set up a western service center in Las Vegas, apparently to take the load off their Miamisburg OH factory.

Word form Down Under has it that ZL stations have been authorized an additional 10 kHz segment of 160 meters. Just in time for winter DXing — look for ZLs between 1803 and 1813 kHz.

Harry Boyle, an air traffic controller at the Tucson International Airport, might have felt a little funny. There he was, guiding a light plane into the approach pattern, talking to the pilot about altitude and wind vectors and such . . . on the telephone. It was the first landing by phone in the airport's history, although it wasn't planned that way.

Fred Chitwood W0YJX/AM7, a Phoenix engineer, was en route to Tucson in his light twin-engine plane when the radio quit. "Around Picacho peak, I realized I was talking to myself," Chitwood said. "Kind of a warm and comfy feeling, you know."

But Chitwood had his trusty 2m HT handy, and called for help via WR7AIM. Bart Paine K7CC was monitoring the repeater at the salt mines, and quickly dialed up the airport tower via autopatch. In all, it took only 14 minutes from Chit-

wood's call for help until he touched down on the Tucson landing strip.

Reprinted from the Tucson Daily Citizen, with thanks to K7QYN.

Low band openings may have been few and far between this summer, but VHF-UHF activity was a different story. WAS on 2 meters, and WAC on EME were among the summer season standouts. What records will fall next only time will tell, but it seems that 432 WAS and DXCC may not be far away.

EME, tropospheric ducting, and meteor scatter were among the simple tools used by K0MQS in his 10 year quest for 2 meter WAS. The last contact was K6YNB/KL7 via moon-bounce, with Idaho, W7UBI, number 49. Dick ran a full gallon in racking up the first WAS, 2 meter style.

EME was also the focus of the Mt. Airy VHF Club DXpedition to Colombia, South America, in late July. The Pack Rats hauled more than 1200 pounds of gear into Santa Veronica July 25th. Using a 208 element antenna for 432 and a full gallon, the crew provided K2UYH number six for the first ever WAC on 432. Signing HK1TL, the Pack Rats made 16 contacts in 8 different countries, operating a total of nine days, including 20 meter liaison with stateside and OSCAR. (See article this issue.)

The new 10,000 MHz DX record stands at 323 miles, after G4BRS and GM30XX completed a two-way QSO between Cornwall and Edinborough. On 2 meters, the first USA-Bermuda contact was achieved between W1NU/VP9 and K1HTV, September 14th. If you're after Bermuda, try 144.09 around 0100Z.

Following is the text of a telegram sent to President Ford by the ARRL on July 9:

"We are concerned about persistent reports that a special committee, said to be acting upon instructions from the White House, might recommend withdrawal of vital frequencies actively used by the amateur service in order to create a new general radio service apparently desired by certain commercial interests. The more than one quarter million licensed, qualified, and law abiding radio amateurs of the United States request your assurance that frequencies now assigned to the amateur radio service will be respected and protected by the United States Government. (s) Harry J. Dannels, President, ARRL."

Reprinted from the *Lockheed Employees Recreation Club Bulletin*, September, 1976.

No more portable or mobile designations when IDing after November 26th . . . that's the latest from the FCC. Docket 20686 was approved in mid-October, after the Commission decided there really wasn't any need

for amateurs to indicate their operating status. In conjunction with 20686, amateurs will no longer have to notify the FCC in advance when operating away from their permanent station addresses for extended periods. Keep in mind that it is still a prime requirement for all licensees to keep the FCC informed of their mailing addresses, especially if mail won't be forwarded during extended portable operation. The new ruling does not prohibit use of portable or mobile designations, and most contest operation will probably still require it. The one exception to all this is foreign amateurs operating in the states. They will have to continue signing portable or mobile and location, in accordance with Part 97.313.

A new plan for slowing up the hambuglar . . . hams who have lost their Icom radios should send driver's license number, name, address, model and serial number, plus any distinguishable mods or markings, to their nearest distributor. The idea is actually the brainchild of K5CYB, a US Treasury agent based in Dallas. Icom will supply the data mailed to them from amateurs, and Dave will plug it into a data bank to be used as a supplement to the national NCIC (National Crime Information Center) in Washington.

It is apparent that the old music playing days on 75 meters may have spread to the CB band. K4AWS reports an article published in an Orlando FL newspaper:

"Religion took to the CB airways Sunday in Kissimmee. An unidentified church choir group took to channel 19, and sang hymns for several minutes. A spokesman for the FCC office in Miami said there had been no complaints and no investigation had been launched."

Reports have reached 73 that Kentucky police are enforcing the state's anti-scanner law. Under the statute, it is illegal for anyone to use a scanner on the public service bands, while in motion. The law has been loosely interpreted to cover stationary mobile as well! Kentucky law agents are reportedly confiscating scanners and handing out stiff fines to drivers.

SSTV enthusiasts can still receive pictures relayed from the Viking spacecraft on Mars. James Lumsven of the Jet Propulsion Laboratory Amateur Radio Club in Pasadena, California, says that members of the club relay the Viking pictures via SSTV on an average of three days a week. Pictures are transmitted on 14.250 MHz between 2330 and 2630 GMT. Nearly one hundred members of the club are involved in the relay, which commenced in late June and is expected to continue until the end of the year and possibly beyond.



# NEW 73 BOOKS

## TEST EQUIPMENT LIBRARY Vol. III, Radio Frequency Testers

Radio frequency waves are the common denominator of Amateur Radio so here is a book for all hams. No matter what your specific interest, such items as SWR, antenna impedance, line impedance, RF output and field strength should interest you. This book not only gives detailed instructions on testing these items but includes sections on signal generators, crystal calibrators grid dip oscillators, noise generators, dummy loads and much more. It's a must for all up-to-date shacks.

Test Equipment Library  
Vol. III, Radio Frequency Testers ..... \$4.95

Available November, 1976

## TEST EQUIPMENT LIBRARY VOL. II, Audio Frequency Testers

HOW'S YOUR SPEECH POWER? YOUR SHIFT? YOUR SYNC?

You can find out easily with a little time and a junk box full of parts. It's all right there in the new Volume II of the 73 Test Equipment Library... Audio Frequency Testers... jam packed full of all kinds of audio frequency test equipment. So if you're into SSB, RTTY, SSTV, etc., this book is a must for you... good book for hi-fi addicts and experimenters too!

Test Equipment Library  
Vol. II, Audio Frequency Testers ..... \$4.95

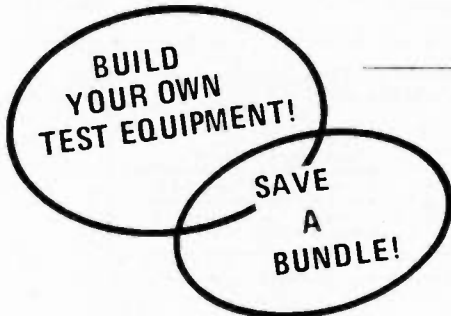

## TEST EQUIPMENT LIBRARY VOL. I, Component Testers

Just out is Volume I of the 73 Test Equipment Library... how to build transistor testers (eight of 'em), diode testers (3), IC testers (3), voltmeters and VTVMs (9), ohmmeters (8 different kinds), inductance (3), capacity (9), Q measurement, crystal checking (6), temperature (2), aural meters for the blind (3) and all sorts of miscellaneous data on meters... using them, making them more versatile, making standards, things like that. Invaluable book, ridiculously low priced.

Test Equipment Library, Vol. I, Component Testers ..... \$4.95

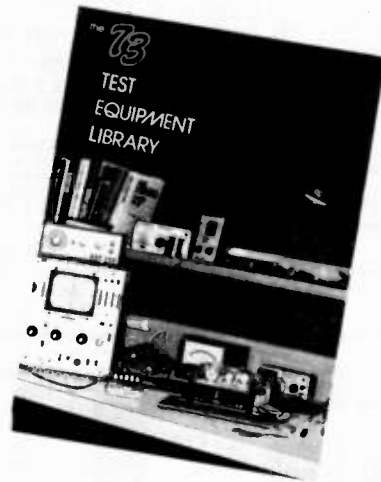

Send me:

- Vol. 1.....Component Testers
- Vol. II... Audio Frequency Testers
- Vol. III...Radio Frequency Testers

Cash enclosed     Check enclosed     Bill me

BankAmericard     Master Charge     American Express

Card # \_\_\_\_\_ Interbank # \_\_\_\_\_ Expiration date \_\_\_\_\_

Name \_\_\_\_\_ Signature \_\_\_\_\_

Address \_\_\_\_\_

City \_\_\_\_\_ State \_\_\_\_\_ Zip \_\_\_\_\_

# The easy \$25 counter kit!

An easy-to-build 50MHz (6-digit) Frequency Counter for a measly \$25! Standard easy-to-find parts, too! (Unlike other kits.) Any Radio Shack has them. Uses 7 segment LED readouts — no scarce Nixie® tubes! No tricky crystal ovens, either! Kit includes a classy cabinet with front panel, PC boards, hardware, instructions, and diagrams. A proven design! An unbeatable offer!

6-DIGIT (50 MHz Kit)  
FREQUENCY COUNTERS



**Hufco** Write or call today!  
P.O. Box 357, Dept. 57,  
Provo, UT 84601 (801) 375-8566

WYOMING RANCH LAND  
Antelope, deer, elk, wild horses. Your "Antenna Ranch," 20 miles Northwest of Rawlins. 10 acres — \$30 down, \$30 a month. Will trade equity for ham gear, test equipment, etc.

FREE info — maps — photos  
FOR SALE by owner —  
Dr. Michael K. Gauthier K6ICS  
9550E Gallatin Road  
Downey CA 90240

7400 SERIES TTL			
SN 7400N	\$ .17		
SN 7401N	.17		
SN 7402N	.17		
SN 7403N	.17		
SN 7404N	.17		
SN 7405N	.23	SN 7401N	\$ .69
SN 7406N	.20	SN 7402N	.49
SN 7407N	.24	SN 7403N	.46
SN 7408N	.22	SN 7404N	.69
SN 7409N	.22	SN 7405N	.69
SN 7410N	.17	SN 7406N	.84
SN 7411N	.30	SN 7407N	2.25
SN 7412N	.28	SN 7408N	.95
SN 7413N	.42	SN 7409N	.35
SN 7414N	.60	SN 7410N	.49
SN 7415N	.30	SN 7411N	.39
SN 7416N	.30	SN 7412N	1.47
SN 7417N	.30	SN 7413N	.35
SN 7418N	.33	SN 7414N	.35
SN 7419N	.39	SN 7415N	.65
SN 7420N	.20	SN 7416N	2.00
SN 7421N	.30	SN 7417N	1.70
SN 7422N	.39	SN 7418N	.88
SN 7423N	.33	SN 7419N	.89
SN 7424N	.26	SN 7420N	.88
SN 7425N	.36	SN 7421N	.88
SN 7426N	.26	SN 7422N	.88
SN 7427N	.33	SN 7423N	.89
SN 7428N	.26	SN 7424N	.89
SN 7429N	.31	SN 7425N	.89
SN 7430N	.26	SN 7426N	.89
SN 7431N	.29	SN 7427N	.89
SN 7432N	.31	SN 7428N	.89
SN 7433N	.26	SN 7429N	.89
SN 7434N	.26	SN 7430N	.89
SN 7435N	.26	SN 7431N	.89
SN 7436N	.26	SN 7432N	.89
SN 7437N	.26	SN 7433N	.89
SN 7438N	.26	SN 7434N	.89
SN 7439N	.17	SN 7435N	.89
SN 7440N	.54	SN 7436N	.89
SN 7441N	.82	SN 7437N	.89
SN 7442N	.82	SN 7438N	.89
SN 7443N	.74	SN 7439N	.89
SN 7444N	.74	SN 7440N	.89
SN 7445N	.75	SN 7441N	.89
SN 7446N	.87	SN 7442N	.89
SN 7447N	.87	SN 7443N	.89
SN 7448N	.75	SN 7444N	.89
SN 7449N	.24	SN 7445N	.89
SN 7450N	.25	SN 7446N	.89
SN 7451N	.18	SN 7447N	.89
SN 7452N	.19	SN 7448N	.89
SN 7453N	.40	SN 7449N	.89
SN 7454N	.35	SN 7450N	.89
SN 7455N	.35	SN 7451N	.89
SN 7456N	.30	SN 7452N	.89
SN 7457N	.48	SN 7453N	.89
SN 7458N	.30	SN 7454N	.89
SN 7459N	.69	SN 7455N	.89
SN 7460N	.37	SN 7456N	.89
SN 7461N	.200	SN 7457N	.89
SN 7462N	.47	SN 7458N	.89

All TTL components are original factory product. We do not sell fall-out material.

10% discount on 40 pieces or more.

# WINKLER ELECTRONICS, INC.

P.O. Box 2067, Oceanside, New Jersey 07712  
(201) 938-2211 Telex 132491

## ORDERING INSTRUCTIONS:

\$5.00 minimum order.

Check or Money Order. COD orders accepted.

No credit cards accepted.

Postage: Add 5% of total order for postage. Excess will be refunded.

New Jersey residents add 5% Sales Tax.

Foreign order (excluding Canada or Mexico): \$20.00 minimum prepaid only per International money order plus 15% of value for postage.

For large quantities or parts not on list, please send us your request.

**SPECIAL**

**SN7522 DUAL CHANNEL SENSE AMPLIFIERS**

1-49 \$1.10 ea.  
50 up \$ .90 ea.

Electrical characteristics:  
VCC+ = 5 V, VCC- = -5 V,  
TA = 0° C to 70° C

**SPECIAL**

**VOLTAGE REGULATORS NATIONAL SEMICONDUCTOR**

L M 340 T 12

QTY	\$1.50
1-49	\$1.50
50-99	1.26
100-999	1.00

**FEATURES:**

- Output current in excess of 1A
- Internal Thermal overload protection
- No external components required
- Output transistor safe area protection
- Internal short circuit current limit
- Available in plastic TO-220

**74L's**

SN 74LS00N	\$ .37	SN 74LS02N	\$ 1.19
SN 74LS01N	.37	SN 74LS03N	2.00
SN 74LS02N	.37	SN 74LS04N	1.79
SN 74LS03N	.37	SN 74LS05N	.61
SN 74LS04N	.37	SN 74LS06N	.61
SN 74LS05N	.37	SN 74LS07N	1.49
SN 74LS06N	.37	SN 74LS08N	.61
SN 74LS07N	.37	SN 74LS09N	1.49
SN 74LS08N	.37	SN 74LS10N	.61
SN 74LS09N	.37	SN 74LS11N	.61
SN 74LS10N	.37	SN 74LS12N	1.49
SN 74LS11N	.37	SN 74LS13N	.61
SN 74LS12N	.37	SN 74LS14N	1.79
SN 74LS13N	.37	SN 74LS15N	1.49
SN 74LS14N	.37	SN 74LS16N	1.49
SN 74LS15N	.37	SN 74LS17N	1.49
SN 74LS16N	.37	SN 74LS18N	2.14
SN 74LS17N	.37	SN 74LS19N	2.14
SN 74LS18N	.37	SN 74LS20N	2.14
SN 74LS19N	.37	SN 74LS21N	2.14
SN 74LS20N	.37	SN 74LS22N	2.14
SN 74LS21N	.37	SN 74LS23N	2.14
SN 74LS22N	.37	SN 74LS24N	2.14
SN 74LS23N	.37	SN 74LS25N	2.14
SN 74LS24N	.37	SN 74LS26N	2.14
SN 74LS25N	.37	SN 74LS27N	2.14
SN 74LS26N	.37	SN 74LS28N	2.14
SN 74LS27N	.37	SN 74LS29N	2.14
SN 74LS28N	.37	SN 74LS30N	2.14
SN 74LS29N	.37	SN 74LS31N	2.14
SN 74LS30N	.37	SN 74LS32N	2.14
SN 74LS31N	.37	SN 74LS33N	2.14
SN 74LS32N	.37	SN 74LS34N	2.14
SN 74LS33N	.37	SN 74LS35N	2.14
SN 74LS34N	.37	SN 74LS36N	2.14
SN 74LS35N	.37	SN 74LS37N	2.14
SN 74LS36N	.37	SN 74LS38N	2.14
SN 74LS37N	.37	SN 74LS39N	2.14
SN 74LS38N	.37	SN 74LS40N	2.14
SN 74LS39N	.37	SN 74LS41N	2.14
SN 74LS40N	.37	SN 74LS42N	2.14
SN 74LS41N	.37	SN 74LS43N	2.14
SN 74LS42N	.37	SN 74LS44N	2.14
SN 74LS43N	.37	SN 74LS45N	2.14
SN 74LS44N	.37	SN 74LS46N	2.14
SN 74LS45N	.37	SN 74LS47N	2.14
SN 74LS46N	.37	SN 74LS48N	2.14
SN 74LS47N	.37	SN 74LS49N	2.14
SN 74LS48N	.37	SN 74LS50N	2.14
SN 74LS49N	.37	SN 74LS51N	2.14
SN 74LS50N	.37	SN 74LS52N	2.14
SN 74LS51N	.37	SN 74LS53N	2.14
SN 74LS52N	.37	SN 74LS54N	2.14
SN 74LS53N	.37	SN 74LS55N	2.14
SN 74LS54N	.37	SN 74LS56N	2.14
SN 74LS55N	.37	SN 74LS57N	2.14
SN 74LS56N	.37	SN 74LS58N	2.14
SN 74LS57N	.37	SN 74LS59N	2.14
SN 74LS58N	.37	SN 74LS60N	2.14
SN 74LS59N	.37	SN 74LS61N	2.14
SN 74LS60N	.37	SN 74LS62N	2.14
SN 74LS61N	.37	SN 74LS63N	2.14
SN 74LS62N	.37	SN 74LS64N	2.14
SN 74LS63N	.37	SN 74LS65N	2.14
SN 74LS64N	.37	SN 74LS66N	2.14
SN 74LS65N	.37	SN 74LS67N	2.14
SN 74LS66N	.37	SN 74LS68N	2.14
SN 74LS67N	.37	SN 74LS69N	2.14
SN 74LS68N	.37	SN 74LS70N	2.14
SN 74LS69N	.37	SN 74LS71N	2.14
SN 74LS70N	.37	SN 74LS72N	2.14
SN 74LS71N	.37	SN 74LS73N	2.14
SN 74LS72N	.37	SN 74LS74N	2.14
SN 74LS73N	.37	SN 74LS75N	2.14
SN 74LS74N	.37	SN 74LS76N	2.14
SN 74LS75N	.37	SN 74LS77N	2.14
SN 74LS76N	.37	SN 74LS78N	2.14
SN 74LS77N	.37	SN 74LS79N	2.14
SN 74LS78N	.37	SN 74LS80N	2.14
SN 74LS79N	.37	SN 74LS81N	2.14
SN 74LS80N	.37	SN 74LS82N	2.14
SN 74LS81N	.37	SN 74LS83N	2.14
SN 74LS82N	.37	SN 74LS84N	2.14
SN 74LS83N	.37	SN 74LS85N	2.14
SN 74LS84N	.37	SN 74LS86N	2.14
SN 74LS85N	.37	SN 74LS87N	2.14
SN 74LS86N	.37	SN 74LS88N	2.14
SN 74LS87N	.37	SN 74LS89N	2.14
SN 74LS88N	.37	SN 74LS90N	2.14
SN 74LS89N	.37	SN 74LS91N	2.14
SN 74LS90N	.37	SN 74LS92N	2.14
SN 74LS91N	.37	SN 74LS93N	2.14
SN 74LS92N	.37	SN 74LS94N	2.14
SN 74LS93N	.37	SN 74LS95N	2.14
SN 74LS94N	.37	SN 74LS96N	2.14
SN 74LS95N	.37	SN 74LS97N	2.14
SN 74LS96N	.37	SN 74LS98N	2.14
SN 74LS97N	.37	SN 74LS99N	2.14
SN 74LS98N	.37	SN 74LS00N	2.14
SN 74LS99N	.37	SN 74LS01N	2.14

**SPECIAL**

**C-MOS MOTOROLA**

MC14071CP \$ .29  
MC14501CP .29  
MC14543CP 1.85  
MC14516CP 1.45  
MC14583CP .95

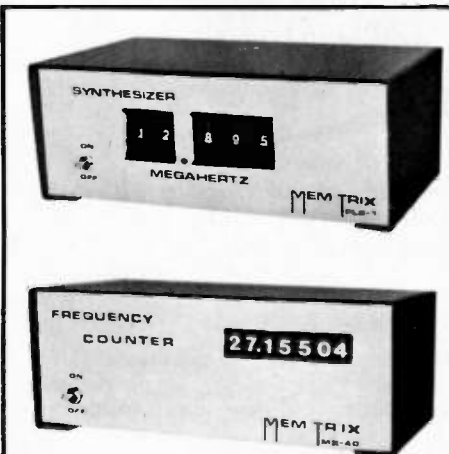

**SYNTHESIZER PLS-1**  
Single quartz crystal digital PLL provides sine output from 10 MHz to 15 MHz. ROM translates panel selection frequency if required. 115 V ac or 12 V dc power. \$169.95

**FIRST TIME**



**SOLID STATE ELECTRONIC QUASI-LOG ARITHMIC SPEECH PROCESSOR Model SP-21**  
Assures 99% modulation. Includes a patented background suppression of noise. VOX capabilities and includes batteries and cable. \$119.95

**FREQUENCY COUNTER Model MX-40**  
7 digit, 7 segment LED Display. Range: 10 Hz to 40 MHz. Input sensitivity: 10 mV RMS-protected. Input impedance: 1000 Ohms. Display Interval: 4 Sec. Timebase = quartz ±.001%. \$99.95

QUANT.	ITEM	UNIT PRICE	TOTAL PRICE
	PLS - 1	169.95	
	SP - 21	119.95	
	MX - 40	99.95	
	" W/AC Adapter	7.95	
	" W/DC Adapter	7.95	
	Conn. Residents Add Tax		
	ADD \$2 for shipping/handling		
	ADD \$1 for COD-20% DEP. REQ'D		
	<b>TOTAL</b>		

Check enclosed  Money Order  C.O.D.  
 Master Charge # \_\_\_\_\_  
Interbank # \_\_\_\_\_

Exp. date \_\_\_\_\_ Signature \_\_\_\_\_  
Name \_\_\_\_\_  
Address \_\_\_\_\_  
City \_\_\_\_\_ State \_\_\_\_\_ Zip \_\_\_\_\_

MEMTRIX, 350-11 South Main St.,  
Div. of E.D.C., Cheshire CT 06410  
DIST., DLRS, REPS, inquiries invited

a lot of antenna in a little space

new Slinky® dipole\* with helical loading radiates a good signal at 1/10 wavelength long!

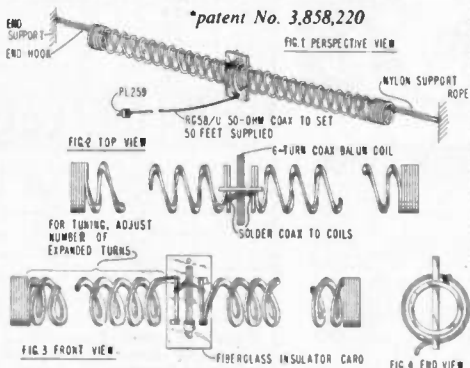

\*patent No. 3,858,220

- This electrically small 80/75, 40, & 20 meter antenna operates at any length from 24 to 70 feet
- no extra balun or transmatch needed
- portable—erects & stores in minutes
- small enough to fit in attic or apartment
- full legal power
- low SWR over complete 80/75, 40, & 20 meter bands
- much lower atmospheric noise pickup than a vertical and needs no radials
- kit includes a pair of specially-made 4-inch dia. by 4-inch long coils, containing 335 feet of radiating conductor, balun, 50 ft. RG58/U coax, PL259 connector, nylon rope & instruction manual
- now in use by US Dept. of State, US Army, radio schools, plus thousands of hams the world over.

TELETRON CORP. AVAILABLE AT ALL LEADING DEALERS. IF NOT, ORDER DIRECT

Suite 500  
Box 84  
Kings Park NY 11754

Kit or 80-40-20 \$39.95 postpaid  
 Coils only (pair of 4" dia. special coils) \$23.95 postpaid  
(N. Y. residents add sales tax)

name.....  
street.....  
town.....zip.....  
enclose check with order - we ship UPS upon receipt of order - CDD: \$1 extra

2 Week  
Money-Back  
Guarantee

S  
L  
I  
N  
K  
Y

Best for beginners . . . preferred by pro's!

## NYE VIKING SPEED-X

Model 114-310-003

**\$8.25**

One of 8 models, all sure-handed . . . smooth operating . . . priced from \$6.65.



## NYE VIKING SUPER SQUEEZE KEY

Fast, comfortable, easy . . . and fun!

Model SSK-1 (shown)

**\$23.95**

Model SSK-3 (has sub-base to hold any SPEED-X Key).

**\$26.95**

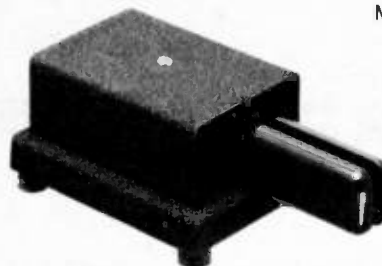

Whether you're a "brass pounder" or a "side swiper" insist on the sure, smooth feel, and the long-lasting quality that is built into every NYE VIKING KEY.

Prices subject to change.

Available at leading dealers around the world or write for a descriptive catalog.



**WM. M. NYE COMPANY, INC.**

1614 - 130th Ave. N.E., Bellevue, WA 98005

# MOVING?

Let us know 8 weeks in advance so that you won't miss a single issue of 73 Magazine.

Attach old label where indicated and print new address in space provided. Also include your mailing label whenever you write concerning your subscription. It helps us serve you promptly.

Write to:

**73** magazine  
Peterborough NH 03458

- Address change only       Payment enclosed  
 Extend subscription      (1 extra BONUS issue)  
 Enter new subscription     Bill me later  
 1 year \$10.00

name \_\_\_\_\_ call \_\_\_\_\_

address \_\_\_\_\_

city \_\_\_\_\_ state \_\_\_\_\_ zip \_\_\_\_\_

If you have no label handy, print OLD address here.

name \_\_\_\_\_ call \_\_\_\_\_

address \_\_\_\_\_

city \_\_\_\_\_ state \_\_\_\_\_ zip \_\_\_\_\_

AFFIX LABEL

## CUSTOM TRANSFORMERS

### HEAVY DUTY REPLACEMENT TRANSFORMERS\*

Collins 30S-1 Plate Transformer . . . . . \$150.00  
Collins 516F-2 Power Transformer . . . . . 85.00  
Hunter 2000B Plate Transformer . . . . . 125.00  
ETO A-77D Plate Transformer . . . . . 125.00  
Henry 2K Plate Transformer . . . . . 125.00  
Henry 2K-4 Plate Transformer . . . . . 135.00  
Henry 3K-A Plate Transformer . . . . . 150.00  
Heath Marauder HX-10 Transformer . . . . . 75.00

\*All Heavy Duty Replacement Transformers are positively guaranteed to run cooler and last longer than the original units.



### SPECIALS

Plate xfmr. 4600 Vac at 1.5A ICAS 230 Vac 60 Hz primary, wt. 60 lbs. . . . . \$175.00  
Plate xfmr. 3500 Vac at 1.0A ICAS 230 Vac 60 Hz primary, wt. 41 lb. . . . . \$125.00  
Plate xfmr. 3000 Vac at 0.7A ICAS 115/230 Vac 60 Hz pri., wt. 27 lb. . . . . \$95.00  
Plate xfmr. 6000 Vct at 0.8A CCS 115/230 Vac 60 Hz Pri., wt. 41 lb. . . . . \$135.00  
Fil xfmr. 7.5 Vct at 21A CCS 117 Vac 60 Hz primary wt. 8 lb. . . . . \$24.95  
Fil Choke bifilar wound 30 Amp rf filament choke on 1/2x7 rod . . . . . \$8.95

All transformers are manufactured to rigid commercial quality specifications and each carries a 24 month guarantee! Write today for a free quotation on any transformer. Choke, or saturable reactor.

## Peter W. Dahl Co.

5325 Annette · El Paso, Texas 79924  
Telephone (915) 568-9702 or (915) 751-4856

## What is Your Gear Really Worth

Consumer Pricing Service will be glad to tell you. Wholesale, retail, trades and insurance appraisals, by an independent service with *your* interests in mind.

Send us a list of your gear showing options, age and condition of each item, an SASE and \$5.00 for an immediate quote.

You will also receive at no additional cost our brochure on how to get the most for your gear, along with some tips on buying new and used ham gear.

**DON'T SETTLE FOR LESS THAN YOUR GEARS ACTUAL VALUE. ACT TODAY AND SAVE A BUNDLE.**

Consumer Pricing Service  
P.O. Box 454  
Somerville MA 02143

It Pay\$ To

# Advertise in 73

### UR TRIPOLE MULTI-BAND



Guaranteed. 80 to 6 Meters plus 160! 45 S.M.L. Bands. Built-in balun.....1 KM ICAS rating. No retuning, tap or trap changes. 80 to 120 Ft. Inverted-V or horizontal. Available in kit form or assembled. Kit 180-K.....\$54.95 cash PPD in USA. Texas residents add 5% sales tax. Send stamped envelope for information on TRIPOLE antennas and feedline kits.

Universal Radio Co. Dept 51  
Box 26041 El Paso, TX 79926  
Telephone (915) 592-1910

### LOGIC PROBE KIT



**\$14.95**  
(plus shipping)

Now! A Digital Logic Probe Kit at a realistic price. Red, Green, and Yellow light emitting diodes signal the presence of logic levels encountered in digital circuitry. Utilization of transistor and integrated circuit switching techniques permit the DIGAPEAKE-A to indicate logic 1, logic 0, and pulsing circuit conditions. Complete kit including easy instructions is available now from...

Chesapeake Digital Devices Inc.  
P.O. Box 341  
Havre de Grace, Md. 21078

### DOUBLE BAZOOKA DIPOLE



Ready to use broadband dipole complete with central insulator and SO239 connector end insulator completely water proof cap. 1000 watts, specify center frequency. 80 meter — \$29.50, 40/15 meter — \$27.50, 20 meter — \$23.50.

5 band trap dipole KIT complete. Includes 80-40 trap central and end insulator antenna wire, 100 feed of RG59, 1-pl259 connector and instruction sheet...\$35.00  
Fiberglass central insulator similar to photo above, 1000 lbs test...\$5.95 ppd.

JAC TENNA ELECTRONIC  
13850 Victorin  
Tracy Quebec, Canada

### IRON POWDER TOROIDS

CORE SIZE	MIX 2 5-30MHz u = 10	MIX 6 10-90MHz u = 8.5	MIX 12 60-200MHz u = 4	SIZE OD (in.)	PRICE USA \$
T-200	120			2.00	3.25
T-106	135			1.06	1.50
T-80	55	45		.80	.80
T-68	57	47	21	.68	.66
T-50	51	40	18	.50	.55
T-25	34	27	12	.25	.40

### RF FERRITE TOROIDS

CORE SIZE	MIX Q1 u = 125	MIX Q2 u = 40	SIZE OD (in.)	PRICE USA \$
F-240	1300	400	2.40	6.00
F-125	900	300	1.25	3.00
F-87	600	190	.87	2.05
F-50	500	190	.50	1.25
F-37	400	140	.37	1.25
F-23	190	60	.23	1.10

Charts above show uH per 100 turns. Use iron powder toroids for tuned circuits. Use ferrite toroids for broadband transformers. Q1 for .1-70 MHz, Q2 for 10-150 MHz.

Ferrite beads 20-500 MHz (fit #18 wire) \$2.00 Doz. Wideband chokes 20-500 MHz (Z=850 ohms) 95¢ Ea. Specify core size and mix. Pack and ship 50¢ USA and Canada. Air parcel post delivery worldwide \$2.00; 6% tax in Calif.; Fast service; Cores shipped from stock via first class mail or air. Send for free brochure.

### PALOMAR ENGINEERS

BOX 455, ESCONDIDO, CA 92025

### QSL FORWARDING

To US (all K,W)-5c per card, to other hams or ISWLs-4c. 10 percent discount to members of participating clubs - just send me a list of members' calls & a single address.

W7IZH QSL SERVICE  
Box 17987-S  
Tucson, AZ 85731

PL-259

Either Plugs OR Sockets

5 for \$3.50

SO-239

POST-PAID  
N.J. residents add 18c Sales Tax

COAKIT

Send SASE for other Connectors.  
P.O. Box 101-A, Dumont, N.J. 07628

### SST T-1 RANDOM WIRE ANTENNA TUNER

The SST T-1 Antenna Tuner gets you on 160-10 meters with a random length of wire. In use by amateurs for 4 years. See other ad this issue. COD OK by phone: (213) 376-5887 or order by mail. SST Electronics, P.O. Box 1, Lawndale, CA 90260.

SST Electronics, PO Box 1, Lawndale CA 90260  
(213) 376-5887

## Station Identifier

\$110



CWID-51 provides automatic ID for repeater stations in perfect Morse code. Has factory-programmed IC memory. Brochure describes CWID-51 and CWID-50 (\$75).

**control signal co** 5964 W. COLUMBIA PLACE  
DENVER, COLORADO 80227

have you ever sent perfect code?



you can.

The ETK (Electronic Touch Keyer) processes inputs and sends perfect dots, dashes, and spaces at speeds of 7 to 55 wpm. The LED indicators displaying dots, dashes, and spaces serve as a visual training aid for the less proficient CW operator. 17 IC's, relay output, side tone speaker, 120 VAC. Inquiries invited.

for only **145.00**  
(includes instruction book)



Order direct from:  
P.O. Box 1125  
Kent, Washington 98031

Instruction Book 1.00

# Babylon-Pac super SALE! \$1.98

Each pac only

All pac's are first quality (no fallout), tested and guaranteed.

## Memory pac

4 MM5016 MOS T0-5 512 BIT shift registers from NATIONAL - with data \$1.98

## Flip-Flop pac

10 assorted Flip-Flops, Dual JK's, ST's, and Low power FF's, with data \$1.98

## Comparator pac

5 assorted DIP's--LM311, 710, 711, with data \$1.98

## TTL Gates

15 assorted DIP's 7400 series-7420, 7430, 7440, etc...All prime, marked parts, with data \$1.98

## LED pac

10 assorted discrete LED's-green, red, and infra-red, with data \$1.98

## Regulators

LM723 DIP variable regulators, 2-40V, with data \$1.98

## TIP31A pac

5 TIP31A NPN Power Transistor: HFE-30; IC-3A; VCE0-60V; 40W. Power tab w/ formed leads \$1.98

## Silicon Diode pac

40 Silicon Signal Diodes PRV better than 200V!! Leads trimmed for PCB mounting \$1.98

## Resistors

100 1/4 watt 5% resistors of any single standard value from 2.7 ohm to 1M ohm \$1.98

## Linear pac

8 assorted linears in mini-DIP or TO-5\*741 op amp, LM307 op amp, LM703 RF-IF amp, with data and circuits \$1.98

## Capacitors

20 25mfd 6V tantalum Capacitors-5/16"x1/4"x1/8"-Long leads, PCB mount. Some unmarked. Ideal for TTL logic \$1.98

## Diodes

100 Germanium computer signal diodes with leads trimmed for PCB mounting \$1.98

## LED Display pac

2 DL33 - 3 digits each, approximately .1" magnified digits in a 12 pin DIP, with data \$1.98

## DIP RC Network

50 assorted 14 and 16 pin IC packages containing precision resistors and capacitors-no data available \$1.98

## TTL

7400	.16	74L72	.60
74H00	.18	7473	.25
7401	.16	74L73	.75
7402	.21	7474	.30
7404	.18	74H74	.75
74H04	.30	7475	.50
7405	.24	7476	.30
7406	.25	74L78	.70
7408	.25	7480	.50
74H08	.30	7483	.50
7410	.18	7490	.50
74H10	.30	7492	.35
7413	.45	7493	.55
7417	.35	7495	.65
7420	.16	74L95	1.00
74L20	.25	74107	.25
74H20	.18	74L110	1.00
74H22	.30	74L23	.75
7426	.29	74L25	1.00
7430	.16	74L45	1.10
74H30	.30	74L54	1.00
74L30	.30	74L55	.90
7440	.15	74L57	.90
7441	.89	74L63	.90
7442	.50	74L64	1.20
7447	.80	74L65	1.00
7448	.80	74L66	1.40
7450	.16	74L74	1.00
74H50	.30	74L77	.80
7451	.16	74L78	1.00
74H51	.25	74L80	1.00
7453	.16	74L92	.90
74L54	.25	74L93	1.00
74L55	.25	74L97	.80
7460	.16	75L91	1.00
74L71	.20	75L92	1.00
7472	.40		

## UNTESTED PACS

CMOS pac 30 Untested CMOS ICs. All factory marked-- \$1.98

Axial Rectifiers 30 Axial Rectifiers, untested, 1 Amp--1200V. Cosmetic rejects due to poor plating \$1.98

## Transistors

40 assorted GE power tab series--NPN, PNP and some Darlington. Untested, pin connections supplied. \$1.98

IC Assortment 100 Untested ICs, all DIP, mostly TTL--some marked, housemarked, or unmarked. \$1.98

Buy 5 pac's for \$9.90 and pic-a-pac for

10¢

# Specials

## Diode Array

10-11914 SILICON SIGNAL DIODES IN ONE PACKAGE. 20 LEADS ALTERNATELY SPACED .1"; NO COMMON CONNECTIONS. \$2.25

## 25K Trimmer

Printed Circuit Board Type

Each \$ .20  
10 for \$1.50

## DIP Trimmer

-12 turn trim pots which plug into a DIP socket  
-5K and 200K  
-1/4" x 1/4" x 1/4"  
-4 leads spaced .3" x .2"  
Each \$ .65 10 for \$4.95

## MEMORIES

### 2102-2 MOS 1024 BIT MEMORY

14 PIN OIP ON CARRIERS  
ONLY \$1.60 TEN for \$15.00

93410 - 256x4 RAM (256 word x 1 bit)  
Fully Decoded, High Speed (40 ns),  
Open Collector Output. 16 Pin DIP  
with data. ONLY \$1.50 10/\$12.95

## High Quality PCB Mounting IC Sockets

8 pin	.19
14 pin	.21
16 pin	.21
24 pin	.55
28 pin	.70
40 pin	1.10

14 pin wire wrap sockets--gold inlay, long leads, by Texas Instruments.  
Each \$ .35 10 for \$3.00

## POTTER BRUMFIELD

Type KHP Relay  
4 PDT 3A Contacts

24V DC . \$1.50  
(650 coil)  
120V AC . \$1.75  
(10.5 MA coil)

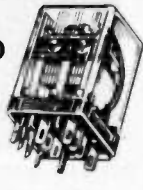

PCB vertical mount electrolytic capacitors.  
2" long, 3/4" dia.  
59¢ ea. 10 for \$5.00

## Capacitors

PCB vertical mount tantalum capacitors--shown 1/2 actual size.

25¢ each

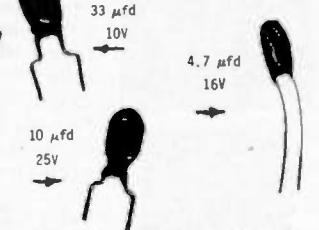

## 12V DC Relay

OPDT - 1A Contacts

Dimensions:  
1 1/16" x 1 3/16" x 1 5/16"

Prime, with PCB pins & 500 ohm coil. Rated 12V, and works well at 6V.  
EACH \$1.35  
TEN for \$12.50



## 1 Amp OP AMP



Similar to National LM0021.  
General purpose operational amplifier in an 8-pin TO-3 package. Capable of large output currents. Complete data included.  
\$4.50 each 5 for \$20.00

## NPN TO3 POWER TRANSISTORS

2N3055: PD-115W; VCE-60V; HFE-50; Ft-30K.

EACH \$ .90 10 for \$6.95

410 (RCA) 200V-10A  
EACH \$1.75 10 for \$15.00

## CD-2 COUNTER KIT

This kit provides a highly sophisticated display section module for clocks, counters, or other numerical displays. Unit is .8" x 4 3/8", and requires a 5V power source. Kit includes 2-sided PC board with plated-through holes, 7490, 7475, 7447, RCA DR2010, complete instructions, and Molex. When ordering please specify single digits or panels of up to 10 digits (with all interconnects.)

COMPLETE KIT \$7.95 per digit

## CD-3 COUNTER KIT

This kit can be programmed to count to any modulus: 2-9 for one kit, 2-99 for two kits, etc. Includes all as in CD-2, 2 resistors, 3 diodes, but without the 7475 quad latch. Perfect for displays of seconds, minutes, hours, etc. Full instructions included.  
When ordering please specify single digits or panels of up to 10 digits (with all interconnects.)

COMPLETE KIT \$6.25 per digit

## LINEARS

NE555	PRECISION TIMER MINI DIP	.70
NE560	PHASE LOCK LOOP DIP	2.95
NE565	PHASE LOCK LOOP DIP	2.95
5558	DUAL 741 OP AMP MINI DIP	1.00
709	POPULAR OP AMP TO-5	.30
710	VOLTAGE COMPARATOR DIP	.30
711	DUAL VOLTAGE COMP. DIP	.24
739	STEREO AMPLIFIER DIP	.50
741	OP AMP MINI DIP - TO-5	.35
748	OP AMP TO-5	.80
HA2500	HARRIS OP AMP TO-5	.80
LM300	POSITIVE DC REGULATOR TO-5	.75
LM301	HI PERF. AMPL. MINI-DIP	.50
LM302	VOLTAGE FOLLOWER TO-5	1.25
LM305	PRECISION VOLT. REGULATOR TO-5	1.00
LM307	OP AMP TO-5 - MINI-DIP	.35
LM308A	PRECISION OP AMP TO-5	1.00
LM311	VOLTAGE COMPARATOR MINI-DIP	1.25
LM370	AGC AUDIO AMP DIP - TO-5	1.75
LM380	2 WATT AUDIO AMP DIP	1.35
LM381	LOW NOISE STEREO AMP DIP	1.75
9601	MONOSTABLE MULTIVIBRATOR DIP	.55
9602	DUAL 9601	.95
MC1536	HI VOLTAGE OP AMP TO-5	1.35
CA3018	2 TRANSISTORS AND A DARLINGTON CONNECTED PAIR TO-5	1.00
CA3026	TRANSISTOR ARRAY W/ 2 INDEPENDENT DIFFERENTIAL AMPLIFIERS	1.00
CA3036	LOW NOISE DUAL DARL. ARRAY	1.00
CA3081	7 NPN TRANSISTORS WITH COMMON EMITTER CONN. DIP	1.00
75491	QUAD SEGMENT DRIVER	1.00
75492	HEX DIGIT DRIVER	1.00

## SPACE AGE CLOCK KIT

Instructions & parts - 12 or 24 hour format.

Four digit clock kit includes all parts for complete clock: 3 1/2" x 2".  
-FND 70 readouts  
-MM5314 clock chip & all transistors, etc.  
-extruded aluminum case  
-cord with transformer plug  
**\$16.95**

## CMOS

CD4001	QUAD 2 IN NOR	.29
CD4002	DUAL 4 IN NOR	.29
CD4009	HEX BUFFER INVERTER	.59
CD4010	HEX BUFFER NON-INVERTING	.59
CD4011	QUAD 2 IN NAND	.29
CD4012	DUAL 4 INPUT NAND	.29
CD4013	DUAL 4 FLIP FLOP	.69
CD4015	DUAL 4 STAGE SR WITH S1/PO	1.98
CD4016	QUAD BILATERAL SWITCH	.69
CD4019	QUAD AND-OR SELECT	.69
CD4023	TRIPLE 3 IN NAND	.29
CD4024	7 STAGE RIPPLE COUNTER	1.50
CD4025	TRIPLE 3 IN NOR	.34
CD4029	PRESETTABLE UP/DOWN BINARY/DECADE COUNTER	2.25
CD4030	QUAD EXCLUSIVE OR	.65
CD4042	QUAD CLOCKED D LATCH	1.50
74C20	DUAL 4 IN NAND GATE	.65
74C42	ONE OF TEN DECODER	2.00

## Money back guarantee!

Send a stamp for our flyer listing more money-saving bargains!

Mail orders to:  
P.O. Box 41778 4811 Myrtle Ave.  
Sacramento, CA Sacramento, CA  
95841  
Phone (916)334-2161

Orders under \$7.00 add \$1.00 postage and handling. Residents of Cal. add sales tax. Orders shipped promptly. \$10 minimum on C.O.O.s.

# BABYLON ELECTRONICS



## Transistor Sale!



2N5964 - HEPS0005, NPN, 150V  
Each 15¢ 10 for \$1.00

2N4248 - HEP715, PNP, 40V.  
Each 15¢ 10 for \$1.00

2N2222 - NPN, 1.8W, 40V  
Each 20¢ 10 for \$1.75

2N4400 NPN Transistor: TO-92  
VCE-40V; HFE-50; Ft-200M.  
EACH \$ .15 10 FOR \$1.35

# 73 LIBRARY

## NEW REPEATER ATLAS

Hundreds of new listings . . . listed by both location and frequency . . . dual listing, invaluable for your car . . . find those repeaters as you travel. This is the **ONLY** complete list of repeaters being published. Almost 3000 repeaters listed in this issue . . . repeaters from all over the entire world. only \$1.95



## RF AND DIGITAL TEST EQUIPMENT YOU CAN BUILD

RF burst, function, square wave generators, variable length pulse generators — 100 kHz marker, i-f and rf sweep generators, audio osc, af/rf signal injector, 146 MHz synthesizer, digital readouts for counters, several counters, prescaler, microwavemeter, etc. 252 pages. \$5.95.



## VHF ANTENNA HANDBOOK

The **NEW** VHF Antenna Handbook details the theory, design and construction of hundreds of different VHF and UHF antennas . . .

A practical book written for the average amateur who takes joy in building, not full of complex formulas for the design engineer. Packed with fabulous antenna projects you can build. \$4.95

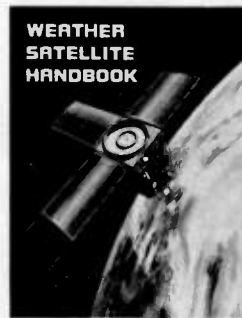

## WEATHER SATELLITE HANDBOOK

Simple equipment and methods for getting good pictures from the weather satellite. Antennas, receivers, monitors, facsimile you can build, tracking, automatic control (you don't even have to be home). Dr. Taggart WB8DQT \$4.95.

## 73 VERTICAL, BEAM AND TRIANGLE ANTENNAS

by Edward M. NoII W3FQJ  
Describes 73 different antennas for amateurs. Each design is the result of the author's own experiments: each has actually been built and air-tested. Includes appendices covering the construction of noise bridges and antenna line tuners, as well as methods for measuring resonant frequency, velocity factor, and standing-wave ratios. 160 pages. \$5.50

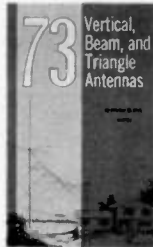

## SSTV HANDBOOK

This excellent book tells all about it, from its history and basics to the present state of the art techniques. Contains chapters on circuits, monitors, cameras, color SSTV, test equipment and much more.

Hardbound \$7 Softbound \$5

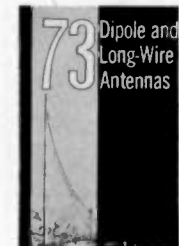

## 73 DIPOLE AND LONG-WIRE ANTENNAS

by Edward M. NoII W3FQJ  
This is the first collection of virtually every type of wire antenna used by amateurs. Includes dimensions, configurations, and detailed construction data for 73 different antenna types. Appendices describe the construction of noise bridges, line tuners, and data on measuring resonant frequency, velocity factor, and swr. 160 pages. \$4.95



## FASCINATING WORLD OF RADIO COMMUNICATION

Interesting stories of the history of radio pioneering and discovery. Also includes the fundamentals of broadcast band DXing. A must for every radio amateur. \$3.95.

## TEST EQUIPMENT LIBRARY

A four volume anthology that you won't find anywhere for three times the price! The editors of 73 present a complete guide to testing that is both basic and complete and aimed at everyone from beginners to amateur Extras. Everything from how to test diodes to frequency counters. Plus a cumulative index . . . all in 73's all new **TEST EQUIPMENT LIBRARY** Vol. I — Vol. IV.

- Vol. I — Component Testers — \$4.95
- Vol. II — Audio Frequency Testers — \$4.95
- Vol. III — Radio Frequency Testers — \$4.95
- Vol. IV — IC Test Equipment — \$4.95



## 2M FM HANDBOOK

Contains almost every conceivable circuit that might be needed for use with a repeater. All circuits explained in detail. All aspects covered, from the operator to the antenna. \$5.95



**Practical Test Instruments You Can Build**  
37 simple test instruments you can make — covers VOMs, VTVMs, semiconductor testing units, dip meters, wattmeters, and just about anything else you might need around the test lab and ham shack. \$4.95



## 1001 PRACTICAL ELECTRONIC CIRCUITS

Tab's new 1001 circuits is available for only \$9.95 ppd. The next time you want a circuit for just about anything, eat your heart out that you didn't send for this book the first time you read about it. You'd better order the book right away, before they run out. \$9.95



## IC OP-AMP COOKBOOK

by Walter G. Jung. Covers not only the basic theory of the IC op amp is great detail, but also includes over 250 practical circuit applications, liberally illustrated. 592 pages, 5 1/2 x 8 1/2, soft bound. \$12.95



## VHF PROJECTS FOR AMATEUR AND EXPERIMENTER

A must for the VHF op. Opening chapters on operating practices and getting started in VHF, both AM and FM, followed by 58 chapters on building useful test equipment, modifying existing and surplus gear. \$4.95

# 73 COMPUTER BOOKS & stuff

## BRAND NEW! DICTIONARY \$15.95

This new microcomputer dictionary fills the urgent need for all computer people, engineers, scientists, industrialists, communications people — as professionals, amateurs, teachers, or students — to become quickly acquainted with the terminology and nomenclature of a new revolution in computer control capabilities in areas that pervade most of man's daily activities.

Over 5000 definitions and explanations of terms and concepts (704 pages) relating to microprocessors, microcomputers and microcontrollers. There are also separate appendices on: program-

mable calculators; math and statistics definitions; flowchart symbols and techniques; binary number systems and switching theory; symbol charts and tables; summaries of BASIC FORTRAN and APL. In addition there is a comprehensive electronics/computer abbreviations and acronyms section.

MICROCOMPUTER

Dictionary & Guide



## BASIC . . . by Bob Albrecht, etc.

Self-teaching guide to the computer language you will need to know for use with your microcomputer. 324 pages. This is one of the easiest ways to learn computer programming. \$4.95 pp.

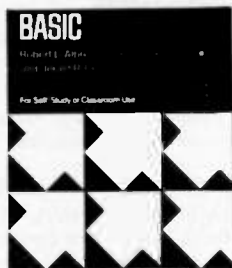

## What To Do After You Hit Return

PCC's first book of computer games . . . 48 different computer games you can play in BASIC . . . programs, descriptions, muchly illustrated. Lunar landing, Hamurabi, King, Civil 2, Qubic 5, Taxman, Star Trek, Crash, Market, etc. \$6.95 pp.

## WHAT TO DO AFTER YOU HIT RETURN

or  
P.C.C.'s First Book of Computer Games



## 101 GAMES IN BASIC

Okay so once you get your computer up and running in BASIC, then what? Then you need some programs in BASIC, that's what. This book has 101 games for you, from very simple to real buggers. You get the games, a description of the games, the listing to put in your computer and a sample run to show you how they work. Fun. Any one game will be worth more than the price of the book for the fun you and your family will have with it. \$7.50 postpaid.

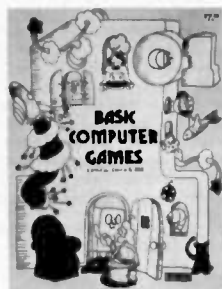

**1976 BINDERS** — Red Binders with gold lettering keep your 1976 73's safe from being lost or damaged. Each binder holds 12 issues. \$6.00

**BACK ISSUE BUNDLE!** 73 Magazine Classics, issues containing hundreds of articles & projects. Great for nostalgia buffs. 20 copies (all different) for \$8.00.

**kilobaud**

IS HERE!

Software & Hardware exposed to the core. Written for the non-PhD computer hobbyist who wants to know what's new. \$2.00 each at newsstand, \$15.00 for 1 year subscription.



## Computer Programming Handbook . . . Peter Stark K2OAW

A complete guide to computer programming and data processing. Includes many worked out examples and history of computers. \$8.95

## HOBBY COMPUTERS ARE HERE

An anthology of computer articles from 73 — a must if you loan articles to friends. This keeps the easy to read basic information all in one place for quick reference. Only \$4.95

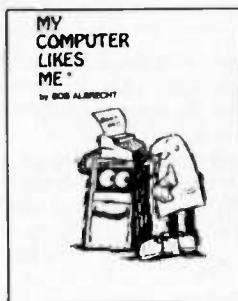

## MY COMPUTER LIKES ME

. . . when I speak Basic . . . Albrecht

An introduction to Basic . . . simple enough for your kids. If you want to teach Basic to anyone quickly, this booklet is the way to go. \$2.00 pp.

## RTL COOKBOOK

by Don Lancaster. Explains the how and why of RTL (Resistor-Transistor Logic) and gives design information that can be put to practical use. Gives a multitude of digital applications ranging from the basic switch to the sophisticated counter. 240 pages; 5 1/2 x 8 1/2; softbound. \$5.50

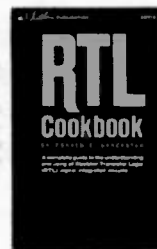

## TTL COOKBOOK

by Donald Lancaster. Explains what TTL is, how it works, and how to use it. Discusses practical applications, such as a digital counter and display system, events counter, electronic stopwatch, digital voltmeter, and a digital tachometer. 336 pages; 5 1/2 x 8 1/2; softbound. \$8.95

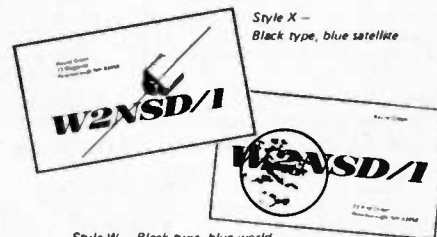

# QSLs!

Get some you can be proud of... and—save money!

ONLY \$6 for 250, \$10 for 500, \$15 for 1,000, and \$20 for 2,000.

How can 73 make such beautiful cards, printed on the best coated stock, available for about half the regular cost?

The world and satellite are printed in blue, your name, address and call are in black. The QSO information is a standard form on the back. DOMESTIC ORDERS ONLY

Allow 4 to 6 weeks for delivery.

# 73 STUDY GUIDES



**NOVICE**  
\$4.95

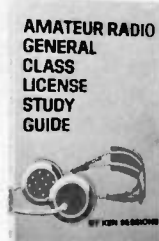

**GENERAL**  
\$5.95



**ADVANCED**  
\$3.95



**EXTRA CLASS**  
\$4.95

## The ONLY Complete License Study Guides

FCC exams got you scared? Frustrated by theory fundamentals? There's no need to worry. 73's four License Study Guides will help you breeze through any of the four tough exams! They are the ONLY guides which cover ALL the material you will have to know. Many amateurs find that one quick reading through our guides is enough to get them through with no sweat.

## novice theory tapes

### Startling Learning Breakthrough

You'll be astounded at how really simple the theory is when you hear it explained on these tapes. Three tapes of theory and one of questions and answers from the latest Novice exams give you the edge you need to breeze through your exam.

73 is interested in helping get more amateurs, so we're giving you the complete set of four tapes for the incredibly low price of ONLY \$15.95.

Scientists have proven that you learn faster by listening than by reading because you can play a cassette tape over and over in your spare time — even while you're driving! You get more and more info each time you hear it.

You can't progress without solid fundamentals. These four hour-long tapes give you all the basics you'll need to pass the Novice exam easily. You'll have an understanding of the basics which will be invaluable to you for the rest of your life! Can you afford to take your Novice exam without first listening to your tapes?



NOVICE THEORY TAPES

**SET OF FOUR TAPES**  
only \$15.95

### FOUR TAPES for \$15.95 \$4.95 EACH

**5 WPM** This is the beginning tape for people who do not know the code at all. It takes them through the 26 letters, 10 numbers and necessary punctuation, complete with practice every step of the way using the newest blitz teaching techniques. It is almost miraculous! In one hour many people — including kids of ten — are able to master the code. The ease of learning gives confidence to beginners who might otherwise drop out.

### NEW CODE SYSTEM — Four Speeds Available

**6 WPM** This is the practice tape for the Novice and Technician licenses. It is made up of one solid hour of code, sent at the official FCC standard (no other tape we've heard uses these standards, so many people flunk the code when they are suddenly — under pressure — faced with characters sent at 13 wpm and spaced for 5 wpm). This tape is not memorizable, unlike the zany 5 wpm tape, since the code groups are entirely random characters sent in groups of five. Practice this one during lunch, while in the car,

anywhere and you'll be more than prepared for the easy FCC exam.

**14 WPM** Code groups again, at a brisk 14 per so you will be at ease when you sit down in front of the steely eyed government inspector and he starts sending you plain language at only 13 per. You need this extra margin to overcome the panic which is universal in the test situations. When you've spent your money and time to take the test you'll thank heavens you had this back breaking tape.

**21 WPM** Code is what gets you when you go for the Extra Class license. It is so embarrassing to panic out just because you didn't prepare yourself with this tape. Though this is only one word faster, the code groups are so difficult that you'll almost fall asleep copying the FCC stuff by comparison. Users report that they can't believe how easy 20 per really is with this fantastic one hour tape. No one who can copy these tapes can possibly fail the FCC test. Remove all fear of the code forever with these tapes.

ONLY 4 for \$15.95! 73 is in the publishing business, not tapes, so these are priced much lower than anyone else could sell them. Have you ever seen one hour cassettes for under \$6? For 1st class mail add 25¢ per tape ordered.

#### TO ORDER, CHECK DESIRED ITEMS FROM THE FOLLOWING LIST:

- |   |   |   |  |  |
|---|---|---|--|--|
| <input type="checkbox"/> Back Issues (\$8.00)<br><input type="checkbox"/> Recent<br><input type="checkbox"/> Mid-years<br><input type="checkbox"/> Vintage<br><input type="checkbox"/> Novice Theory Tapes (\$15.95)<br><input type="checkbox"/> Code Tapes<br><input type="checkbox"/> 5 WPM (\$4.95)<br><input type="checkbox"/> 6 WPM (\$4.95)<br><input type="checkbox"/> 14 WPM (\$4.95)<br><input type="checkbox"/> 21 WPM (\$4.95)<br><input type="checkbox"/> All four for \$15.95<br><input type="checkbox"/> Bumper Stickers — 50¢<br><input type="checkbox"/> 1976 73 Binders — \$6.00 | <input type="checkbox"/> OSLS<br><input type="checkbox"/> Style W<br><input type="checkbox"/> Style X<br><input type="checkbox"/> 250 (\$6.00)<br><input type="checkbox"/> 500 (\$10.00)<br><input type="checkbox"/> 1000 (\$15.00)<br><input type="checkbox"/> 2000 (\$20.00)<br><input type="checkbox"/> IC Op-Amp Cookbook — \$12.95<br><input type="checkbox"/> 2M FM Handbook — \$5.95<br><input type="checkbox"/> 73 Dipole Antennas — \$5.50<br><input type="checkbox"/> 73 Vertical Beam Antennas — \$4.95<br><input type="checkbox"/> 1001 Circuits — \$9.95 | <input type="checkbox"/> Practical Test Instruments — \$4.95<br><input type="checkbox"/> Repeater Atlas — \$1.95<br><input type="checkbox"/> RF and Digital Test Equipment — \$5.95<br><input type="checkbox"/> Fascinating World of Radio Communication — \$3.95<br><input type="checkbox"/> SSTV Handbook<br><input type="checkbox"/> Soft (\$5.00)<br><input type="checkbox"/> Hard (\$7.00)<br><input type="checkbox"/> Study Guides:<br><input type="checkbox"/> Novice — \$4.95<br><input type="checkbox"/> General — \$5.95<br><input type="checkbox"/> Advanced — \$3.95<br><input type="checkbox"/> Extra — \$4.95 | <input type="checkbox"/> Test Equipment Library:<br><input type="checkbox"/> Vol. I — Component Testers — \$4.95<br><input type="checkbox"/> Vol. II — Audio Frequency Testers — \$4.95<br><input type="checkbox"/> Vol. III — Radio Frequency Testers — \$4.95<br><input type="checkbox"/> Vol. IV — IC Test Equipment — \$4.95<br><input type="checkbox"/> VHF Antenna Handbook — \$4.95<br><input type="checkbox"/> VHF Projects — \$4.95<br><input type="checkbox"/> Weather Satellite Handbook — \$4.95<br><input type="checkbox"/> KILOBAUD — 1 year subscription — \$15.00<br><input type="checkbox"/> BASIC — \$4.95<br><input type="checkbox"/> Computer Programming Handbook — \$8.95<br><input type="checkbox"/> Hobby Computers Are Here! — \$4.95 | <input type="checkbox"/> Microcomputer Dictionary — \$15.95<br><input type="checkbox"/> My Computer Likes Me — \$2.00<br><input type="checkbox"/> RTL Cookbook — \$5.50<br><input type="checkbox"/> TTL Cookbook — \$8.95<br><input type="checkbox"/> What To Do After You Hit Return — \$6.95<br><input type="checkbox"/> 101 BASIC Computer Games — \$7.50 |
|---|---|---|--|--|

H/76

TOLL FREE Call (800) 258-5473 or (800) 251-6771

Name \_\_\_\_\_

Address \_\_\_\_\_

City \_\_\_\_\_ State \_\_\_\_\_ Zip \_\_\_\_\_

Cash enclosed     Check enclosed     Money Order  
 Bill:  American Express     Bank Americard  
 Master Charge

Credit Card # \_\_\_\_\_ Interbank # \_\_\_\_\_

Expiration Date \_\_\_\_\_ Signature \_\_\_\_\_





**TOUCH TONE GENERATOR BY MOSTEK.** MK5086N produces the dual-tone multi-frequency telephone dialing signals as used in TT phones and auto patches. Uses inexpensive crystal, 1 resistor and 1 capacitor. Both tones are internally mixed and buffered to a single output - simple! Two additional output switches can control timers, transmitter, mute receiver, enable audio amp, etc. Uses

our Chamerics keyboard. Comes in 16 pin plastic DIP.  
 MK5086N.....\$8.95...Crystal for MK5086N..... \$1.90  
 Specs for MK5086N 80c.  
 Kit of parts including etched and drilled P.C. board and one of our Chamerics keyboards.....\$19.95

**MC14412 UNIVERSAL MODEM CHIP**

MC14412 contains a complete FSK modulator and de-modulator compatible with foreign and USA communications. (0-600 BPS)

**FEATURES:**

- .On chip crystal oscillator
- .Echo suppressor disable tone generator
- .Originate and answer modes
- .Simplex, half-duplex, and full duplex operation
- .On chip sine wave
- .Modem self test mode
- .Selectable data rates: 0-200  
0-300  
0-600

- .Single supply  
VDD=4.75 to 15VDC - FL suffix  
VDD=4.75 to 6 VDC - VL suffix

**TYPICAL APPLICATIONS:**

- .Stand alone - low speed modems
- .Built - in low speed modems
- .Remote terminals, acoustic couplers

MC14412FL..... \$28.99  
 MC14412VL..... \$21.74  
 6 pages of data..... .60

Crystal for the above.....\$4.95

**MC14411 BIT RATE GENERATOR.**

Single chip for generating selectable frequencies for equipment in data communications such as TTY, printers, CRTs or microprocessors. Generates 14 different standard bit rates which are multiplied under external control to 1X, 8X, 16X or 64X initial value. Operates from single +5 volt supply. MC14411..... \$11.98  
 4 pages of data..... .40  
 Crystal for the above..... \$4.95

**REMOTE CONTROL TRANSMITTER. MC14422P**

is a 22 channel ultra-sonic remote control transmitter I.C. CMOS uses little power and only a few external passive components. Applications include TV receivers, security controls, toys, industrial controls and locks. 16 pin DIP plastic pkg. MC14422P..... with specs.....\$11.10

**PRECISION REFERENCE AMP**

LH0070-1H provides a precise 10.0 volts for use in BCD A to D converters or meter calibrators. Typical initial accuracy is .3% (% .03V). Comes in TO-5 can. LH0070-1H.....with specs.....\$5.35

**4 DIGIT COUNTER. MM74C926**

is a 4 digit counter with 7 segment output. Carry output for cascading and internal display select allows outputting of counter or set of internal latches. 3 to 6V operation. Great for clocks, event and frequency counters. MM74C926 - with spec sheet.....\$12.00

**3 DECADE (BCD) COUNTER CHIP**

MC145538CP consists of 3 negative edge triggered synchronous counters, 3 quad latches and self scan multiplexed, TTL compatible outputs. MC145538CP.....\$8.72  
 Spec sheets.....\$.60

**TELETYPE CODE CONVERSION CHIP**

MM52208L converts 5 level Baudot into 8 level ASCII. Use this chip to make your old TTY talk to your new computer. MM52208L.....\$18.00  
 Specs for the above......30

**MOS TIME BASE KIT.**

Only 1" X 1.5". Input 5 to 15 VDC, output is 60HZ square wave for portable or mobile clocks. PC board is drilled! MTBK-60HZ.....\$5.88



# AMPLANNY

## Says

PROJECT OFF TO A SHAKY START?  
 GET GOING IN THE RIGHT DIRECTION  
 WITH HELP FROM.....TRI-TEK



### GOLD CHIP

Linear Integrated Circuits

Brand new process by RCA in which the aluminum metalization has been replaced by gold. The chip is then hermetically sealed. What this means to you is unprecedented reliability and uniformity. Plastic parts that meet mil specs!! Tri-Tek is proud to be the first to bring this new level of performance to you at SURPLUS PRICES. Why buy regrades??

- CA301A..Improved, general purpose op-amp, 8 pin dip...59c
- CA307...Super 741 op-amp, 8 pin dip.....52c
- CA324...Compensated quad op-amp, 14 pin dip.....\$1.80
- CA339A.. Low offset quad comparator, 14 pin dip...\$1.59
- CA741C..Famous general purpose op-amp, 8 pin dip... 45c
- CA747C..General purpose dual op-amp, 14 pin dip... 82c
- CA748C..Externally compensated 741, 8 pin dip.....49c
- CA1458..General purpose dual op-amp, 8 pin dip.....69c
- CA3401..Quad single supply (5-18V) op amp, 14 pin..89c

Another super buy from RCA. CA555 timer, 8 pin dip. 59c

**CLASS B AUDIO DRIVERS**

MC3320P and MC3321P are pre amps and drivers for class B complementary output transistors. Self balancing allows for no special HFE matching of output transistors. MC3320P operates up to 30V, 89db gain.....\$2.25  
 MC3321P operates up to 14V, 32db gain.....\$1.98  
 Specs for both......40c

**POWER FET**

VMPT is an N channel MOS FET capable of switching 1 Amp in 5nSeconds. Can be used as RF power Amplifier with power gain of 40 db! VMPT1.....TO-3.....\$9.75  
 Specs......60c

RCA 40673 dual gate MOS FET.....\$1.01  
 2N 5485 N channel J FET......69c  
 2N 5486 N channel J FET......69c

**DATA BOOKS BY NATIONAL SEMICONDUCTOR**

**DIGITAL.** Covers TTL, DTL, Tri-State, etc. .... \$3.95  
**LINEAR.** Covers amplifiers, pre-amps, op-amps, .. \$3.95  
**LINEAR APPLICATIONS.** Dozens of application notes and technical briefs covering the use of op-amps, regulators, phase locked loops and audio amps..... Vol I..... \$3.25  
**CMOS Gates, Flip Flops, registers, functional blocks \$3**  
**VOLTAGE REGULATORS.** A must for anyone making a power supply. Complete theory including transformers, filters, heat sinks, regulators, etc..... \$3.00  
**MEMORY.** Information on MOS and Bipolar memories  
**RAMS, ROMS, PROMS and decoders/encoders..... \$3.95**  
**INTERFACE.** Covers peripheral drivers, level translators, line driver/receivers, memory and clock drivers, sense amps display driver and opto-couplers..... \$3.95  
 (Outside U.S., add postage for 1.5lbs)

**SPECIAL FUNCTIONS DATA BOOK** contains detailed information for specifying and applying special amplifiers, buffers, clock drivers, analog switches and D/A-A/D converter products.....\$3.25

**AUDIO HANDBOOK** contains detailed discussions, including complete design particulars, covering many areas of audio with real world design examples...\$3.25

**5 DECADE COUNTER**

MC145348CP is a 5 decade real time counter with multiplexed BCD outputs. Can be cascaded for longer counts. Typically 5MHZ operation at 15 Volts. CMOS structure for low power consumption. MC145348CP.....\$11.25

**10 AMP VOLTAGE REGULATOR**

MPC1000 is a 10 Amp positive voltage regulator adjustable from 2 to 35 VDC. 0.1% line and load regulation with 0.005% per °C temperature stability. Can be fold-back limited. Here is high current, high power with minimum bother. MPC-1000.....\$16.85  
 Specs for above......60c

**NEW NATIONAL BOOK---LINEAR APPLICATIONS VOL II**

Takes up where Vol I left you--All the latest linear devices. Along with Vol I you have a great source of application data on the most widely used devices as well as new types just appearing.....\$3.25

**INTRODUCTION TO MICRO COMPUTERS**

New book from OSBORNE.  
 The first edition of this classic was a huge success. Now, due to the growth of information on the subject Osborne has expanded the work into 2 volumes. Vol I covers basic concepts, Vol II discusses real world micro computers. IMC-002 Vol I.....\$8.00  
 IMC-002 Vol II.....\$8.00

**ANOTHER NEW BOOK FROM OSBORNE.**

"8080 PROGRAMMING FOR LOGIC DESIGN" explains how an assembly language program within a microcomputer system can replace combinatorial logic ---- for logic designers, programmers or anyone who is interested in real and powerful applications of the ubiquitous 8080. PLD-4001.....\$8.00



## tri-tek, inc.

6522 NORTH 43RD AVENUE,  
 GLENDALE, ARIZONA 85301  
 phone 602 - 931-6949

We pay shipping on all orders over \$10 US, \$15 foreign in US funds. Orders under \$10, please add \$1 handling. Please add insurance. Master Charge and Bank America cards welcome, (\$20 minimum) Telephone orders may be placed 11AM to 5PM daily, Mon thru Fri. Call 602-931-4528. Check reader service card or send stamp for our latest flyers packed with new and surplus electronic components.

# The Hellbox All-Purpose Keyer

--keys, mutes, T/R... the works

There's a revival of interest in constructing low power CW transmitters. Low power does not necessarily have to equate with crude or inconvenient to operate. Most operators desire automatic antenna changeover, and most would like a form of keying that'll silence the receiver while transmitting, yet quickly and automatically restore the receiver when there's a pause in keying. As a bonus, it's pleasing to have the oscillator stay on continuously while the receiver's silenced, and turn off when you've sent that dah-dit-dah and started listening.

All these desirable characteristics can be

incorporated into your transmitter with little work and very, very little expense. In fact, most of the needed parts probably are collecting dust in your "hellbox" right now.

Here's what you'll need. Five diodes that'll handle 20 or 30 volts and a couple hundred milliamperes. A pair of electrolytic capacitors, at least 15 or 20 volts and the more microfarads the better. Two more capacitors, these 35 or 40 volts, one of moderate capacitance and the other very large indeed. A dc relay (maybe you'll need several in parallel to switch all the circuits you're planning) of the 24 volt "buck a bushel" variety that clutters

up every hellbox; check it out to confirm that it'll follow the usual pattern of pulling in at about 15 volts and not dropping out until the voltage is reduced to around ten volts. You might have to buy that one big capacitor, but all the other items should be available from your collection or mooched from a friend, one who'll thank you for reducing his inventory.

Take a look at the schematic wiring diagram. Note that it uses 6.3 volts from a filament transformer, jacking it up with a rectifier-tripler. The multi-contact relay can be used to key the oscillator ON and hold it in that state as long as you're transmitting, to

transfer the antenna from receiver to transmitter, and to silence the receiver. Don't try to add an additional function of a sidetone keyer. Better use an rf-powered tone generator for that! The hold-in time of the relay is determined by the capacitance of the output capacitor working in conjunction with the dc resistance of the relay. Because of this latter variable, it's not feasible to assign a value to the capacitor. You'll have to experiment until you find what it takes to hold the relay in the brief period that is compatible with your operating habits. To eliminate sparking at the key contacts (originating from the keyer and not the transmitter), a low-value resistor (15-30 Ohms) is used in series with the output rectifier. (The rectifier serves to isolate the keyer from the keyed stage.) Another diode isolates the keyed stage from the keyer's voltage supply.

The keyer can be built on a small piece of perfboard, small enough to be tucked away in most any transmitter.

The use of this keyer will make operation of a simple transmitter almost as convenient as using a sophisticated transceiver. It'll richly repay the small effort of building it. And, besides, building is fun! ■

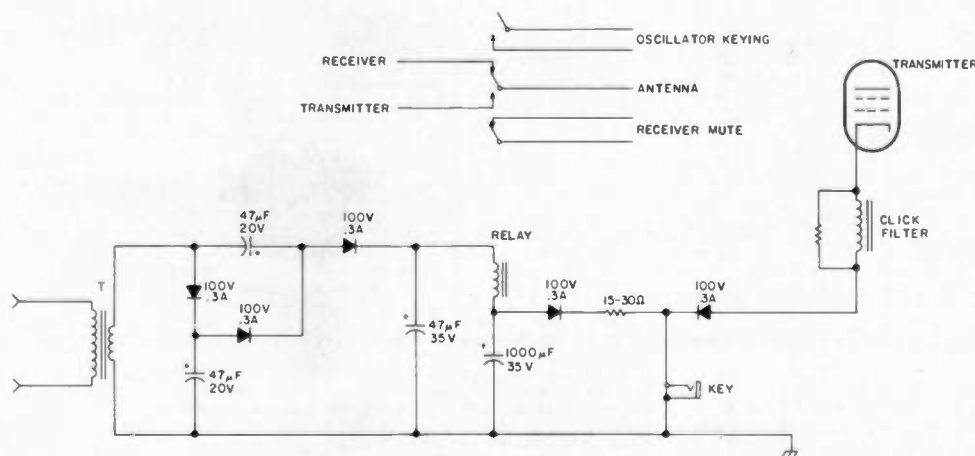

Fig. 1. Relay, multi-pole, double throw, with a coil that pulls in the armature at 15 volts and has a 10 volt armature dropout point.



# CLOCK KIT

## \$22.95

6 Digit .33" LED  
12 or 24 Hour

*The nicest looking, most durable, most RFI proof clock on the market. Features include: extruded aluminum case in 5 colors, Polaroid lens filter, quality PC boards, and line cord transformer. A complete kit - no extras required. Colors available: black, gold, silver, blue, bronze (specify).*

Mobile Version, .01% accuracy, 12 V dc ..... \$25.95  
Alarm Version, 12 hr. only ..... \$24.95  
Time base kit, use with any 60 Hz clock ..... \$4.95

# LOW COST CLOCK

## \$10<sup>95</sup> DC-4

12/24 HOUR 6 DIGIT  
LARGE .4" DIGITS

DC-4 includes all parts and switches, does not include PC board, case or transformer. DC-4 will not fit in case as shown above. Case size required, 3" x 5" x 4".

PC Board, drilled and etched, 3" x 4" ..... \$2.95  
Transformer, line cord type, 12 V ac ..... 1.98  
Transformer, lug mount type, 12 V ac ..... 1.49

# CALENDAR-ALARM-CLOCK, 6 DIGIT

Features:

- 6 Digits .5" high LED
- 12/24 hour format
- Calendar, keeps track of days in each month
- 7001 chip, does it all!
- Time displayed 8 sec., date for 2 sec or time only, date upon request
- True 24 hr. alarm with snooze
- Radio timer, to 9 min, 59 sec.
- Battery back-up, on chip time base

Kit includes all parts, switches, PC board, transformer less case, size required, approx. 3" x 6" x 5" \$34.95

## 30 WATT

2 Meter Power Amp

The famous RE class C power amp now available mail order! Four Watts in for 30 Watts out, 2 in for 15 out, 1 in for 8 out, Incredible value, complete with all parts, instructions and details on T-R relay. Fully stable, output short proof, infinite VSWR protected! Case not included.  
**Complete Kit \$22.95**

## 600 MHz PRESCALER

### \$44.95 KIT

assembled . . \$59.95

Extend the range of your counter to 600 MHz. Works with most any counter. Available with most any counter. Available kit or assembled and tested. Specify +10 or +100 with order.



## 741 OP-AMP SPECIAL 10 for \$2.00

Take advantage of a special one time deal on factory prime mini-dip op-amps. These were house numbered for Xerox Corp., but also have the 741 number printed on them. This is the **LOWEST** price in the USA!

FERRITE BEADS with info and specs	15/\$1.00
6 Hole Balun Beads	5/\$1.00
SLIDE-POT - 10k linear taper	4/\$1.00
1000uf 15V FILTER CAP	5/\$1.00
1000V, 2.5A DIODE	5/\$1.00

## IC SOCKETS

14 PIN	.25	50/10.00
16 PIN	.30	50/12.50
24 PIN	.50	10/ 4.50
40 PIN	.75	10/ 7.00

# MINI-KITS



FM Wireless Mike Kit  
\$2.95

Transmit up to 300' to any FM broadcast radio. Sensitive mike input requires crystal ceramic or dynamic mike. Runs on 3 to 9 V.

## LED Blinky Kit

A great attention getter which alternately flashes 2 Jumbo LEDs. Use for name badges, buttons, or warning type panel lights. Runs on 3 to 9 volts.  
**Complete Kit \$2.95**

## SIREN KIT

### \$2.95

200 mW audio output. 3-6V operation. Uses 3-45 Ohm speaker.



## TONE DECODER KIT

A complete tone decoder on a single pc board. Features - 400 to 5000 Hz adjustable frequency range, voltage regulation, 567 IC. Useful for Touchtone decoding, tone burst detection, FZK demod, signaling, etc. Use 7 units for 12 button touchtone decoding.  
**Complete Kit, TD-1 \$4.95**

## POWER SUPPLY KIT ±15 V, +5 V

A complete bench supply! Dual tracking regulator provides adjustable ±6 to 15 Volts at 100 mA, while a stable 3 terminal regulator produces 5 V at 1 Amp. Novel 2 transformer design permits 110/220 V operation. Complete with all parts except case and cord.  
**PS-3 Power Supply Kit \$14.95**

## DECADE COUNTER

### PARTS KIT

- INCLUDES ● 7490A decade counter  
● 7475 latch  
● 7447 LED driver  
● LED readout  
● Current limit resistors

\$2.95

Complete with instruction and details on how to build an easy, low cost freq. counter.

## INTEGRATED CIRCUITS

LM567	1.75	MC1458	1.75
LM565	.75	MC4024	1.95
555	.50	74107	.35
556	.85	74143	3.50
7490A	.59	7805	.99
7447	.85	309K	1.19

# ramsey electronics

P.O. Box 4072A, Rochester NY 14610



SEND 25¢ FOR CATALOGUE  
FREE WITH ORDER

Satisfaction guaranteed or money refunded, COD, add \$1.00. Orders under \$10.00 add \$.75. NY residents add 7% tax.

# Corrections

"SIMPLE GRAPHICS TERMINAL"  
(September, 1976)

caption for Fig. 2 should read  
"A1-A10 — pin 7 to +15 V..."

Please note the corrections to my article as shown in bold on the accompanying schematics. In addition, the

Steve Ciarcia  
Glastonbury CT

## "PROGRAMMABLE CW ID UNIT" (October, 1976)

Some suggestions in conjunction with the "Programmable CW ID Unit" published in the October issue of *73 Magazine* on page 52: It has been found that for some unknown reason, the switch debouncer circuit will not prevent bounce when the clock is fed from IC1-11 as shown. The fix, if the unit you build has this problem, is to remove the wire from IC1-11 and move it to IC4-10. As an electronics engineer, I must confess I don't fully understand why the debouncer doesn't debounce at that point, or why it does at the other point, which is (logic-wise) the same, but if you find you have the problem, that's the fix.

Another suggestion is to change the values of C1 and R2. As shown, nothing is wrong, but the .47 uF capacitor is an awkward value forcing a large capacitor or an electrolytic capacitor. A better choice is to replace C1 with a .05 uF disc ceramic, and replace R2 with a 1 meg variable resistor. These value changes give the same range and in no other way affect the operation of the circuit.

There are no other known errors or problems with the circuit other than that my mail tells me that many people are having trouble getting the MC14562CP shift register. This IC may be obtained from me for \$10.00 including shipping, or a complete set of all ICs required may be obtained for \$13.50.

C. Warren Andreasen WA6JMM  
Post Office Box 8306  
Van Nuys CA 91406

## "BAUDOT TO ASCII" (November, 1976)

I just received my November 73, which includes my Baudot to ASCII conversion program. And, of course, I immediately noticed that I let a few errors slip by when I reviewed the proof you sent me. The only error likely to cause any problems occurs in line 440 of the program. This line should be corrected to read:

00440 0831 B5 80 BITA = \$80 test  
bit 7 set?

Of course, I corrected the error when I first ran the program — but forgot about it when running off the copy to send to you. Naturally, a programmer with several months experience and a thorough knowledge of the program would immediately spot the error.

My check for a charter subscription to *Kilobaud* is enclosed. Sounds like a good place for me to share some of my happy experiences with my SWTPC system (and maybe a few of the frustrating moments too!).

Mark Borgerson  
Corvallis OR

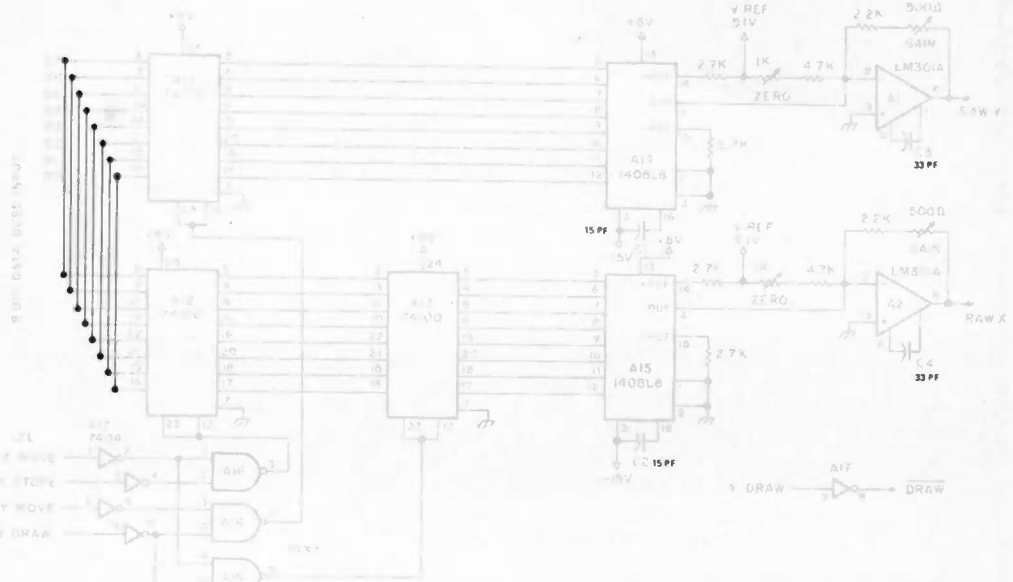

Fig. 1. (page 117)

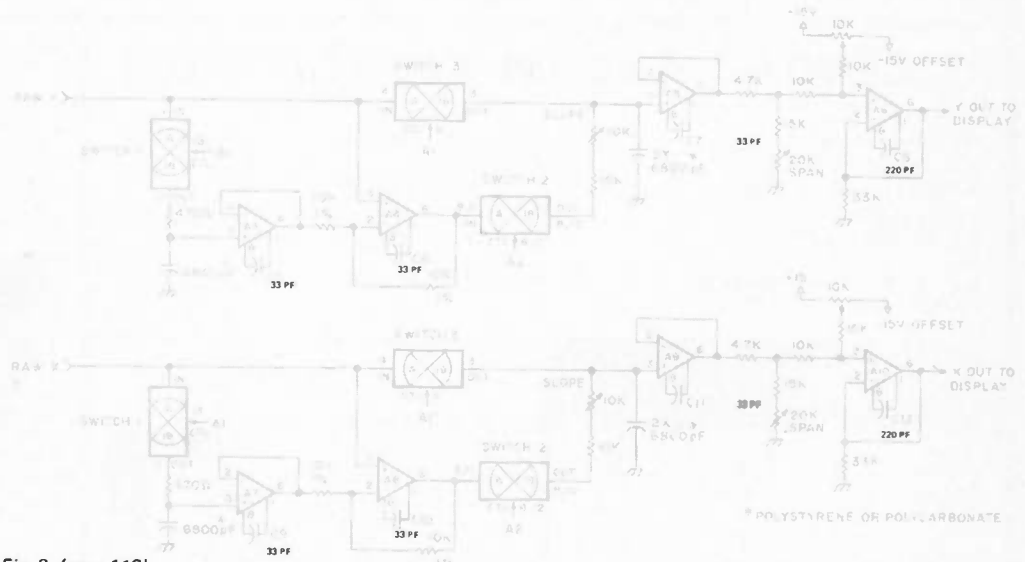

Fig. 2. (page 118)

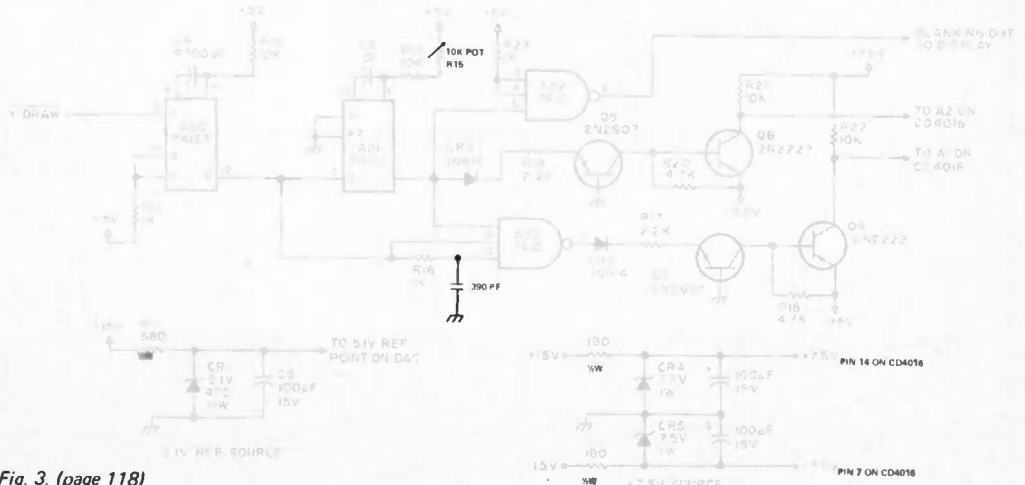

Fig. 3. (page 118)

**"THE S38 IS NOT DEAD!"**  
(November, 1976)

There's apparently an error in one of my circuits ("The S38 Is Not Dead!", November, 1976, Fig. 1, page 88). A dropping resistor (18k  $\Omega$ , 1W) was left out, between the +100 V bus and the cathode of the 33 volt zener diode.

Hank Olson W6GXN  
Menlo Park CA

**"ASCII/BAUDOT WITH A PROM"**  
(June, 1976)

To builders of the BAC-2 Baudot-ASCII converter: The purpose of this letter is to document all the known "bugs."

1. Pin 1 of U8 goes to pin 10 rather than pin 14. This sets up a start bit by pre-clearing the 7474 to a zero. This was a bug in the *TTL Cookbook* by Lancaster that I garbled in drawing my diagram (I had found it in my original unit).

2. B4, B5, and B6 go to pins 5, 6, 7 on U6 (8223), rather than pins 4, 5, and 6.

3. In Fig. 4, B5 goes to pin 12 (not 11) and B6 goes to pin 11 (not 12).

Since the article was published, an outfit came out with a board to convert the CT-1024 (TVT-2) to a 64 character line (still 16 lines down the page). It really works well on my unit and improves the performance tremendously. They want \$5 for a small board and you supply a 74193, 7485, 7404, and 7400, and a .1  $\mu$ F cap. It takes about 2 hours to install the modification. The address is: Digital Designs, Box 4241, Victoria TX 77901.

They also have the circuitry worked out to add scrolling, but stated they were not sure if people were interested. The board for this would sell for about \$16. If you are interested, please let them know so that they decide to go into production (I want

one too!!).

Hope this is of some help and that your unit is working for you. Please send an SASE, which I'll keep on file if any other developments come up.

Dave Guthrie W8LNY  
2956 London Way  
Bloomfield MI 48013

**NEW PRODUCTS: EICO DLP-6**  
(December, 1976)

My apologies for having neglected to include the accompanying Interpretation of Indicators table with my review of the EICO DLP-6.

Dr. Jack W. Crenshaw  
Huntsville AL

Indicators			Meaning
High	Low	Pulse	
Off	Off	Off	Open Circuit
Off	On	Off	Dc Logic Low
On	Off	Off	Dc Logic High
Off	On	On	Low with short, regular high pulses (more frequent than 4 Hz)
On	Off	On	High with short low pulses
On	On	On	Square or rectangular waves (Relative brightness of high and low indicators gives a rough measure of duty cycle)
On	Flashing	Flashing	Logic high with intermittent low pulses (If pulses are less than about 1 ms, flashing of low indicator will be invisible)
Flashing	On	Flashing	Logic low with intermittent high pulses

# AMSAT

**AMSAT-OSCAR 6 AND 7  
ORBITAL DATA CALENDAR**

In cooperation with AMSAT, Skip Reymann W6PAJ has published an improved AMSAT-OSCAR orbital data calendar containing all orbits for 1977 for both AMSAT-OSCAR 6 and AMSAT-OSCAR 7. Designed so that it may be hung on the wall, the calendar includes information on the operating schedules and frequencies for both spacecraft, and also the telemetry decoding equations. Also included is step-by-step information on how to determine times of passage of the two satellites.

The orbital calendar is available postpaid for \$5.00 U.S. funds or 30 IRCs (\$3.00 to AMSAT members, and free to AMSAT Life Members). Overseas orders will be airmailed. Orders and payments should be made to Skip Reymann W6PAJ, P.O. Box 374, San Dimas CA 91773. Please include a gummed, self-addressed label with

your order to speed up processing. Proceeds from the orbital calendar benefit AMSAT.

**SCHEDULE CHANGE**

Effective October 3, 1976, all GMT Sunday descending node (south-bound) passes of AMSAT-OSCAR 6 have been considered as *on* passes. The transponder will be turned on by AMSAT telecommand stations whenever possible so these orbits can be used for two-way communications. The reason for adding these additional passes is because the satellite's orbit is such that AO-6 is in total sunlight according to NORAD tracking data. Our telemetry from AO-6 indicates that the temperature on board is still rising and is almost at a peak which would confirm the NORAD data. Because of this, it is necessary to keep the transponder on for additional orbits to help keep the battery from overcharging and thus overheating. Even though the satellite will be in

total sunlight for a number of months to come, it can't be left on all the time since the solar arrays can't provide all the power required to run the transponder. The battery must provide the balance of the power required, and can't do this if it is not allowed to be recharged on a regular basis. This is the reason for the scheduled *off* days.

The new schedule for AMSAT-OSCAR 6 is: The transponder will be

turned *on* for two-way communications by users on all ascending node passes on Mondays, Thursdays and Saturdays and for all descending node passes on Sundays, GMT. This schedule of *on* orbits will remain in effect until further notice. If the battery voltage drops below a certain point (a telemetry channel 3A count of 52), the AMSAT telecommand stations have been instructed to turn the transponder *off* immediately.



14SN (left) and DJ4ZC (right) inspect a model of the frame for the Phase III spacecraft at a recent AMSAT meeting held at Greenbelt, Maryland.

P.O. Box 4430M Santa Clara, CA 95054  
(408) 988-1640

**Same day shipment**  
First line parts only. Factory tested. Guaranteed money back. Quality IC's and other components at factory prices.

**TERMS: \$5.00 min. order U.S. funds**  
Calif. residents add 6% tax.  
**FREE: Send for your copy of our 1976 QUEST CATALOG.**



INTEGRATED CIRCUITS		MICROPROCESSOR KIT	
7400TTL	17	KEYER 8043	14.95
SN7400N	17	CLOCKS	
SN7402N	17	MS3509	4.00
SN7404N	19	MS3111	3.80
SN7410N	17	MS3112	4.80
SN7414N	63	MS3133	3.80
SN7416N	34	MS3134	4.20
SN7417N	39	MS3135	4.00
SN7420N	17	MS3136	4.20
SN7430N	20	MS3137	5.00
SN7432N	25	MS3138	9.00
SN7434N	25	MS3139	4.00
SN7436N	17	MS3140	4.00
SN7438N	60	MS3141	4.20
SN7440N	17	MS3142	4.00
SN7442N	60	MS3143	4.20
SN7444N	32	MS3144	4.20
SN7446N	46	MS3145	4.00
SN7448N	32	MS3146	4.20
SN7449N	40	MS3147	4.00
SN7450N	17	MS3148	4.00
SN7451N	60	MS3149	4.20
SN7452N	20	MS3150	4.00
SN7453N	36	MS3151	4.20
SN7454N	32	MS3152	4.00
SN7455N	46	MS3153	4.20
SN7456N	40	MS3154	4.00
SN7457N	32	MS3155	4.20
SN7458N	46	MS3156	4.00
SN7459N	40	MS3157	4.20
SN7460N	40	MS3158	4.00
SN7461N	40	MS3159	4.20
SN7462N	40	MS3160	4.00
SN7463N	40	MS3161	4.20
SN7464N	40	MS3162	4.00
SN7465N	40	MS3163	4.20
SN7466N	40	MS3164	4.00
SN7467N	40	MS3165	4.20
SN7468N	40	MS3166	4.00
SN7469N	40	MS3167	4.20
SN7470N	40	MS3168	4.00
SN7471N	40	MS3169	4.20
SN7472N	40	MS3170	4.00
SN7473N	40	MS3171	4.20
SN7474N	40	MS3172	4.00
SN7475N	40	MS3173	4.20
SN7476N	40	MS3174	4.00
SN7477N	40	MS3175	4.20
SN7478N	40	MS3176	4.00
SN7479N	40	MS3177	4.20
SN7480N	40	MS3178	4.00
SN7481N	40	MS3179	4.20
SN7482N	40	MS3180	4.00
SN7483N	40	MS3181	4.20
SN7484N	40	MS3182	4.00
SN7485N	40	MS3183	4.20
SN7486N	40	MS3184	4.00
SN7487N	40	MS3185	4.20
SN7488N	40	MS3186	4.00
SN7489N	40	MS3187	4.20
SN7490N	40	MS3188	4.00
SN7491N	40	MS3189	4.20
SN7492N	40	MS3190	4.00
SN7493N	40	MS3191	4.20
SN7494N	40	MS3192	4.00
SN7495N	40	MS3193	4.20
SN7496N	40	MS3194	4.00
SN7497N	40	MS3195	4.20
SN7498N	40	MS3196	4.00
SN7499N	40	MS3197	4.20
SN7500N	40	MS3198	4.00
SN7501N	40	MS3199	4.20
SN7502N	40	MS3200	4.00
SN7503N	40	MS3201	4.20
SN7504N	40	MS3202	4.00
SN7505N	40	MS3203	4.20
SN7506N	40	MS3204	4.00
SN7507N	40	MS3205	4.20
SN7508N	40	MS3206	4.00
SN7509N	40	MS3207	4.20
SN7510N	40	MS3208	4.00
SN7511N	40	MS3209	4.20
SN7512N	40	MS3210	4.00
SN7513N	40	MS3211	4.20
SN7514N	40	MS3212	4.00
SN7515N	40	MS3213	4.20
SN7516N	40	MS3214	4.00
SN7517N	40	MS3215	4.20
SN7518N	40	MS3216	4.00
SN7519N	40	MS3217	4.20
SN7520N	40	MS3218	4.00
SN7521N	40	MS3219	4.20
SN7522N	40	MS3220	4.00
SN7523N	40	MS3221	4.20
SN7524N	40	MS3222	4.00
SN7525N	40	MS3223	4.20
SN7526N	40	MS3224	4.00
SN7527N	40	MS3225	4.20
SN7528N	40	MS3226	4.00
SN7529N	40	MS3227	4.20
SN7530N	40	MS3228	4.00
SN7531N	40	MS3229	4.20
SN7532N	40	MS3230	4.00
SN7533N	40	MS3231	4.20
SN7534N	40	MS3232	4.00
SN7535N	40	MS3233	4.20
SN7536N	40	MS3234	4.00
SN7537N	40	MS3235	4.20
SN7538N	40	MS3236	4.00
SN7539N	40	MS3237	4.20
SN7540N	40	MS3238	4.00
SN7541N	40	MS3239	4.20
SN7542N	40	MS3240	4.00
SN7543N	40	MS3241	4.20
SN7544N	40	MS3242	4.00
SN7545N	40	MS3243	4.20
SN7546N	40	MS3244	4.00
SN7547N	40	MS3245	4.20
SN7548N	40	MS3246	4.00
SN7549N	40	MS3247	4.20
SN7550N	40	MS3248	4.00
SN7551N	40	MS3249	4.20
SN7552N	40	MS3250	4.00
SN7553N	40	MS3251	4.20
SN7554N	40	MS3252	4.00
SN7555N	40	MS3253	4.20
SN7556N	40	MS3254	4.00
SN7557N	40	MS3255	4.20
SN7558N	40	MS3256	4.00
SN7559N	40	MS3257	4.20
SN7560N	40	MS3258	4.00
SN7561N	40	MS3259	4.20
SN7562N	40	MS3260	4.00
SN7563N	40	MS3261	4.20
SN7564N	40	MS3262	4.00
SN7565N	40	MS3263	4.20
SN7566N	40	MS3264	4.00
SN7567N	40	MS3265	4.20
SN7568N	40	MS3266	4.00
SN7569N	40	MS3267	4.20
SN7570N	40	MS3268	4.00
SN7571N	40	MS3269	4.20
SN7572N	40	MS3270	4.00
SN7573N	40	MS3271	4.20
SN7574N	40	MS3272	4.00
SN7575N	40	MS3273	4.20
SN7576N	40	MS3274	4.00
SN7577N	40	MS3275	4.20
SN7578N	40	MS3276	4.00
SN7579N	40	MS3277	4.20
SN7580N	40	MS3278	4.00
SN7581N	40	MS3279	4.20
SN7582N	40	MS3280	4.00
SN7583N	40	MS3281	4.20
SN7584N	40	MS3282	4.00
SN7585N	40	MS3283	4.20
SN7586N	40	MS3284	4.00
SN7587N	40	MS3285	4.20
SN7588N	40	MS3286	4.00
SN7589N	40	MS3287	4.20
SN7590N	40	MS3288	4.00
SN7591N	40	MS3289	4.20
SN7592N	40	MS3290	4.00
SN7593N	40	MS3291	4.20
SN7594N	40	MS3292	4.00
SN7595N	40	MS3293	4.20
SN7596N	40	MS3294	4.00
SN7597N	40	MS3295	4.20
SN7598N	40	MS3296	4.00
SN7599N	40	MS3297	4.20
SN7600N	40	MS3298	4.00
SN7601N	40	MS3299	4.20
SN7602N	40	MS3300	4.00
SN7603N	40	MS3301	4.20
SN7604N	40	MS3302	4.00
SN7605N	40	MS3303	4.20
SN7606N	40	MS3304	4.00
SN7607N	40	MS3305	4.20
SN7608N	40	MS3306	4.00
SN7609N	40	MS3307	4.20
SN7610N	40	MS3308	4.00
SN7611N	40	MS3309	4.20
SN7612N	40	MS3310	4.00
SN7613N	40	MS3311	4.20
SN7614N	40	MS3312	4.00
SN7615N	40	MS3313	4.20
SN7616N	40	MS3314	4.00
SN7617N	40	MS3315	4.20
SN7618N	40	MS3316	4.00
SN7619N	40	MS3317	4.20
SN7620N	40	MS3318	4.00
SN7621N			

**FAIRCHILD**

ANNOUNCES THE

**FAIRCHILD**

SOLID STATE

**TECHNOLOGY KIT**

- FOR THE EXPERIMENTER WITH TASTE FOR "STATE OF THE ART" PRODUCTS
- COMPLETE SPECIFICATIONS ARE PRINTED ON THE BACK OF EACH TECHNOLOGY KIT

FTK0020



CARD FRONT

FTK0020

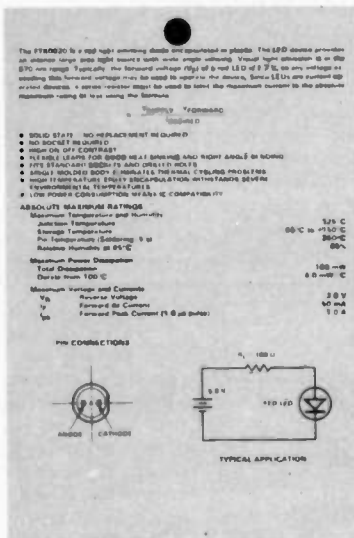

CARD BACK

FTK0106

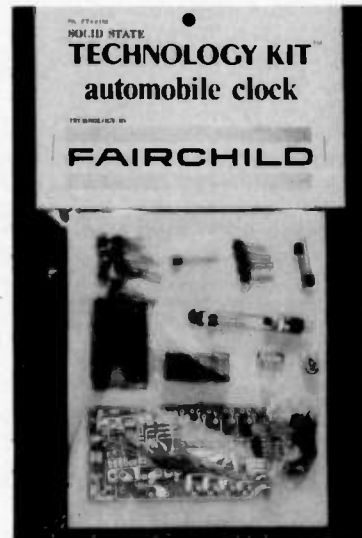

CARD FRONT

**DIGITS**

FTK0001	0.5" High Common Cathode Digit	\$1.00
FTK0002	0.5" High Common Anode Digit	1.00
FTK0003	.357" High Common Cathode Digit	.75
FTK0004	0.8" High Common Cathode Digit	2.00
FTK0005	0.8" High Common Anode Digit	2.00

**0.8" HIGH DISPLAY ARRAYS**

FTK0010	12 Hour, 3½ Digit Clock Display	7.00
FTK0011	24 Hour, 4 Digit Clock Display	8.00

**LED LAMPS**

FTK0020	10 Red LED Lamps	1.00
FTK0021	5 Mixed Colored LED Lamps	1.00
FTK0022	10 LED Mounting Clips	1.00
FTK0023	5 Three Piece LED Mounting Adapters	1.00

**PHOTO TRANSISTORS**

FTK0030	5 Flat Lens Photo Transistors	1.00
FTK0031	5 Round Lens Photo Transistors	1.00
FTK0032	3 Flat Lens Photo Darlington	1.00
FTK0033	3 Round Lens Photo Darlington	1.00

**PHOTO ARRAYS**

FTK0040	9-Element Tape Reader Array	16.00
FTK0041	12-Element Card Reader Array	24.00
FTK0042	Reflective Opto Coupler	4.00

**COUPLERS**

FTK0050	3 General Purpose Opto Couplers	1.00
FTK0051	Darlington Opto Coupler	1.00

**MOS CLOCK CIRCUITS**

FTK0400	Digital Clock/Calendar Circuit (FCM7001)	7.00
FTK0401	Digital Clock/Calendar with BCD Outputs (FCM7002)	7.00
FTK0402	Direct Drive Digital Clock Circuit with AC Output (FCM3817A)	5.00
FTK0403	Direct Drive Digital Clock Circuit with DC Output (FCM3817D)	5.00
FTK0405	Direct Drive Digital Clock/Calendar Circuit (FCM7015)	6.00

**KITS**

FTK0106	Automobile Clock Kit	40.00
---------	----------------------	-------

- THESE PRODUCTS ARE PACKAGED FOR OUTSTANDING WALL DISPLAY APPEARANCE

- FULL **FAIRCHILD** PRODUCT LINE TO FOLLOW

Satisfaction Guaranteed. \$5.00 Min. Order. U.S. Funds.  
California Residents — Add 6% Sales Tax  
Send a 24¢ Stamp (postage) for a Free 1977 Catalog

**NOW OPEN SATURDAYS**

**JAMES**

1021-A HOWARD AVE., SAN CARLOS, CA. 94070  
PHONE ORDERS WELCOME — (415) 592-8097

- DEALER'S AND WHOLE-SALER'S INQUIRIES INVITED — PRICE LIST AVAILABLE.

- BUY WITH PRIDE THE PRODUCTS BUILT BY THE INDUSTRY'S LEADER — **FAIRCHILD**

### 7400N TTL

SN7400N	16	SN7400A	25	SN74154N	1.00
SN7401N	16	SN7401A	22	SN74155N	0.99
SN7402N	16	SN7402A	45	SN74156N	0.99
SN7403N	16	SN7403A	37	SN74157N	0.99
SN7404N	18	SN7404A	32	SN74160N	1.25
SN7405N	24	SN7405A	30	SN74161N	0.99
SN7406N	20	SN7406A	32	SN74162N	0.99
SN7407N	20	SN7407A	50	SN74163N	1.10
SN7408N	20	SN7408A	50	SN74164N	1.10
SN7409N	25	SN7409A	90	SN74165N	1.10
SN7410N	18	SN7410A	90	SN74166A	1.25
SN7411N	30	SN7411A	90	SN74167N	5.50
SN7412N	30	SN7412A	89	SN74168N	2.10
SN7413N	45	SN7413A	39	SN74172N	0.95
SN7414N	70	SN7414A	3.50	SN74173N	1.50
SN7415N	36	SN7415A	2.50	SN74174N	1.25
SN7416N	35	SN7416A	45	SN74175N	0.99
SN7420N	21	SN7420A	75	SN74176N	0.90
SN7421N	33	SN7421A	49	SN74177N	0.90
SN7422N	49	SN7422A	79	SN74180N	0.99
SN7423N	37	SN7423A	49	SN74181N	2.49
SN7425N	29	SN7425A	79	SN74182N	2.20
SN7426N	29	SN7426A	89	SN74184A	1.95
SN7427N	37	SN7427A	4.00	SN74185N	2.20
SN7429N	42	SN7429A	1.00	SN74186N	15.00
SN7430N	26	SN7430A	39	SN74187N	6.00
SN7431N	31	SN7431A	89	SN74188N	1.25
SN7432N	27	SN7432A	70	SN74190N	1.15
SN7433N	27	SN7433A	70	SN74191N	1.25
SN7434N	27	SN7434A	70	SN74192N	1.25
SN7435N	27	SN7435A	70	SN74193N	1.25
SN7436N	27	SN7436A	70	SN74194N	1.25
SN7437N	27	SN7437A	70	SN74195N	1.25
SN7438N	27	SN7438A	70	SN74196N	1.25
SN7439N	25	SN7439A	60	SN74197N	1.75
SN7440N	15	SN7440A	50	SN74198N	1.75
SN7441N	89	SN7441A	1.00	SN74199N	1.75
SN7442N	59	SN7442A	95	SN74200N	5.50
SN7443N	75	SN7443A	1.15	SN74201N	3.90
SN7444N	75	SN7444A	4.00	SN74202N	6.00
SN7445N	75	SN7445A	4.00	SN74203N	6.00
SN7446N	81	SN7446A	4.50	SN74204N	6.00
SN7447N	69	SN7447A	1.15	SN74205N	5.90
SN7448N	79	SN7448A	2.35	SN74206N	5.90
SN7449N	20	SN7449A	2.00	SN74207N	6.00
SN7451N	27	SN7451A	1.00	SN74208N	6.00
SN7453N	27	SN7453A	79	SN74209N	6.00
SN7454N	20	SN7454A	89	SN74367N	7.5

### CMOS

20% Discount for 100 Combined 7400's

CD4000	25	74C04N	75
CD4001	25	74C01N	65
CD4002	25	74C02N	65
CD4003	25	74C03N	65
CD4004	25	74C04N	65
CD4005	25	74C05N	65
CD4006	25	74C06N	65
CD4007	25	74C07N	65
CD4008	25	74C08N	65
CD4009	25	74C09N	65
CD4010	25	74C10N	65
CD4011	25	74C11N	65
CD4012	25	74C12N	65
CD4013	25	74C13N	65
CD4014	25	74C14N	65
CD4015	25	74C15N	65
CD4016	25	74C16N	65
CD4017	25	74C17N	65
CD4018	25	74C18N	65
CD4019	25	74C19N	65
CD4020	25	74C20N	65
CD4021	25	74C21N	65
CD4022	25	74C22N	65
CD4023	25	74C23N	65
CD4024	25	74C24N	65
CD4025	25	74C25N	65
CD4026	25	74C26N	65
CD4027	25	74C27N	65
CD4028	25	74C28N	65
CD4029	25	74C29N	65
CD4030	25	74C30N	65

### LINEAR

LM3001	80	LM317N	2.95
LM3001N	35	LM318N	1.75
LM3002	35	LM319N	1.75
LM3002N	75	LM320N	1.75
LM3004	1.00	LM320N	1.75
LM3005	95	LM321N	1.85
LM3007	35	LM322N	1.85
LM3008	1.00	LM323N	2.95
LM3009	1.10	LM324N	6.9
LM3009N	99	LM325N	5.5
LM3010	1.15	LM326N	5.5
LM3011	90	LM327N	1.85
LM3011N	90	LM328N	1.85
LM318CN	1.50	LM329N	1.85
LM319N	1.30	LM330N	1.25
LM320K	1.35	LM331N	4.95
LM320K-12	1.35	LM332N	4.9
LM320K-15	1.35	LM333N	4.9
LM320K-18	1.35	LM334N	4.9
LM320K-22	1.35	LM335N	4.9
LM320K-25	1.35	LM336N	4.9
LM320K-30	1.35	LM337N	4.9
LM320K-35	1.35	LM338N	4.9
LM320K-40	1.35	LM339N	4.9
LM320K-45	1.35	LM340N	4.9
LM320K-50	1.35	LM341N	4.9
LM320K-55	1.35	LM342N	4.9
LM320K-60	1.35	LM343N	4.9
LM320K-65	1.35	LM344N	4.9
LM320K-70	1.35	LM345N	4.9
LM320K-75	1.35	LM346N	4.9
LM320K-80	1.35	LM347N	4.9
LM320K-85	1.35	LM348N	4.9
LM320K-90	1.35	LM349N	4.9
LM320K-95	1.35	LM350N	4.9
LM320K-100	1.35	LM351N	4.9
LM320K-105	1.35	LM352N	4.9
LM320K-110	1.35	LM353N	4.9
LM320K-115	1.35	LM354N	4.9
LM320K-120	1.35	LM355N	4.9
LM320K-125	1.35	LM356N	4.9
LM320K-130	1.35	LM357N	4.9
LM320K-135	1.35	LM358N	4.9
LM320K-140	1.35	LM359N	4.9
LM320K-145	1.35	LM360N	4.9
LM320K-150	1.35	LM361N	4.9
LM320K-155	1.35	LM362N	4.9
LM320K-160	1.35	LM363N	4.9
LM320K-165	1.35	LM364N	4.9
LM320K-170	1.35	LM365N	4.9
LM320K-175	1.35	LM366N	4.9
LM320K-180	1.35	LM367N	4.9
LM320K-185	1.35	LM368N	4.9
LM320K-190	1.35	LM369N	4.9
LM320K-195	1.35	LM370N	4.9
LM320K-200	1.35	LM371N	4.9
LM320K-205	1.35	LM372N	4.9
LM320K-210	1.35	LM373N	4.9
LM320K-215	1.35	LM374N	4.9
LM320K-220	1.35	LM375N	4.9
LM320K-225	1.35	LM376N	4.9
LM320K-230	1.35	LM377N	4.9
LM320K-235	1.35	LM378N	4.9
LM320K-240	1.35	LM379N	4.9
LM320K-245	1.35	LM380N	4.9
LM320K-250	1.35	LM381N	4.9
LM320K-255	1.35	LM382N	4.9
LM320K-260	1.35	LM383N	4.9
LM320K-265	1.35	LM384N	4.9
LM320K-270	1.35	LM385N	4.9
LM320K-275	1.35	LM386N	4.9
LM320K-280	1.35	LM387N	4.9
LM320K-285	1.35	LM388N	4.9
LM320K-290	1.35	LM389N	4.9
LM320K-295	1.35	LM390N	4.9
LM320K-300	1.35	LM391N	4.9
LM320K-305	1.35	LM392N	4.9
LM320K-310	1.35	LM393N	4.9
LM320K-315	1.35	LM394N	4.9
LM320K-320	1.35	LM395N	4.9
LM320K-325	1.35	LM396N	4.9
LM320K-330	1.35	LM397N	4.9
LM320K-335	1.35	LM398N	4.9
LM320K-340	1.35	LM399N	4.9
LM320K-345	1.35	LM400N	4.9
LM320K-350	1.35	LM401N	4.9
LM320K-355	1.35	LM402N	4.9
LM320K-360	1.35	LM403N	4.9
LM320K-365	1.35	LM404N	4.9
LM320K-370	1.35	LM405N	4.9
LM320K-375	1.35	LM406N	4.9
LM320K-380	1.35	LM407N	4.9
LM320K-385	1.35	LM408N	4.9
LM320K-390	1.35	LM409N	4.9
LM320K-395	1.35	LM410N	4.9
LM320K-400	1.35	LM411N	4.9
LM320K-405	1.35	LM412N	4.9
LM320K-410	1.35	LM413N	4.9
LM320K-415	1.35	LM414N	4.9
LM320K-420	1.35	LM415N	4.9
LM320K-425	1.35	LM416N	4.9
LM320K-430	1.35	LM417N	4.9
LM320K-435	1.35	LM418N	4.9
LM320K-440	1.35	LM419N	4.9
LM320K-445	1.35	LM420N	4.9
LM320K-450	1.35	LM421N	4.9
LM320K-455	1.35	LM422N	4.9
LM320K-460	1.35	LM423N	4.9
LM320K-465	1.35	LM424N	4.9
LM320K-470	1.35	LM425N	4.9
LM320K-475	1.35	LM426N	4.9
LM320K-480	1.35	LM427N	4.9
LM320K-485	1.35	LM428N	4.9
LM320K-490	1.35	LM429N	4.9
LM320K-495	1.35	LM430N	4.9
LM320K-500	1.35	LM431N	4.9
LM320K-505	1.35	LM432N	4.9
LM320K-510	1.35	LM433N	4.9
LM320K-515	1.35	LM434N	4.9
LM320K-520	1.35	LM435N	4.9
LM320K-525	1.35	LM436N	4.9
LM320K-530	1.35	LM437N	4.9
LM320K-535	1.35	LM438N	4.9
LM320K-540	1.35	LM439N	4.9
LM320K-545	1.35	LM440N	4.9
LM320K-550	1.35	LM441N	4.9
LM320K-555	1.35	LM442N	4.9
LM320K-560	1.35	LM443N	4.9
LM320K-565	1.35	LM444N	4.9
LM320K-570	1.35	LM445N	4.9
LM320K-575	1.35	LM446N	4.9
LM320K-580	1.35	LM447N	4.9
LM320K-585	1.35	LM448N	4.9
LM320K-590	1.35	LM449N	4.9
LM320K-595	1.35	LM450N	4.9
LM320K-600	1.35	LM451N	4.9
LM320K-605	1.35	LM452N	4.9
LM320K-610	1.35	LM453N	4.9
LM320K-615	1.35	LM454N	4.9
LM320K-620	1.35	LM455N	4.9
LM320K-625	1.35	LM456N	4.9
LM320K-630	1.35	LM457N	4.9
LM320K-635	1.35	LM458N	4.9
LM320K-640	1.35	LM459N	4.9
LM320K-645	1.35	LM460N	4.9
LM320K-650	1.35	LM461N	4.9
LM320K-655	1.35	LM462N	4.9
LM320K-660	1.35	LM463N	4.9
LM320K-665	1.35	LM464N	4.9
LM320K-670	1.35	LM465N	4.9
LM320K-675	1.35	LM466N	4.9
LM320K-680	1.35	LM467N	4.9
LM320K-685	1.35	LM468N	4.9
LM320K-690	1.35	LM469N	4.9
LM320K-695	1.35	LM470N	4.9
LM320K-700	1.35	LM471N	4.9
LM320K-705	1.35	LM472N	4.9
LM320K-710	1.35	LM473N	4.9
LM320K-715	1.35	LM474N	4.9
LM320K-720	1.35	LM475N	4.9
LM320K-725	1.35	LM476N	4.9
LM320K-730	1.35	LM477N	4.9
LM320K-735	1.35	LM478N	4.9
LM320K-740	1.35	LM479N	4.9
LM320K-745	1.35	LM480N	4.9
LM320K-750	1.35	LM481N	4.9
LM320K-755	1.35	LM482N	4.9
LM320K-760	1.35	LM483N	4.9
LM320K-765	1.35	LM484N	4.9
LM320K-770	1.35	LM485N	4.9
LM320K-775	1.35	LM486N	4.9
LM320K-780	1.35	LM487N	4.9
LM320K-785	1.35	LM488N	4.9
LM320K-790	1.35	LM489N	4.9
LM320K-795	1.35	LM490N	4.9
LM			

# The STAR SERIES

**NOTICE**  
 PRICE INCREASES EFFECTIVE JAN. 31, 1977  
 STAR 15 : \$39.95  
 STAR 20 : \$44.95  
 STAR 40 : \$54.95

The STAR Series provides a new dimension of antenna size, shape and versatility for today's ham. The success of these antennas is based on their combination of performance and small physical size. Ideal for apartments and urban installations having limited space, the STAR is an antenna even a neighbor can appreciate. □ The STAR antennas are modified magnetic loops\* (not halos or electrical loops) with the benefits resulting from this design. The extremely low E/H ratio in the near field eliminates the need for a ground plane or radials and greatly reduces absorptions and ground losses. A shaped RF current distribution along the driven element produces resonance and a nominal 52 ohm input impedance directly, without the use of lossy matching networks or loading coils. A low angle of radiation results and sharp nulls are formed which can be oriented to minimize QRM. No antenna resonances occur at harmonics of the fundamental, suppressing TVI radiation. The above factors combine to produce a horizontally polarized signal with gain over a vertical or dipole, wide bandwidth, and low noise pickup. STAR antennas can be phased to provide gain and directivity comparable to a two element beam. The antennas are circular in cross section with spokes radiating from the mast hub to provide rigid support. The antenna elements are protected within a rugged polyvinyl chloride frame which can be painted. When horizontally polarized, wind survival is in excess of 100 mph. The STAR series of antennas are capable of handling legal power and can be mounted for either horizontal or vertical polarization. The STAR 20 and the STAR 40 can be stacked vertically on a single mast if desired.

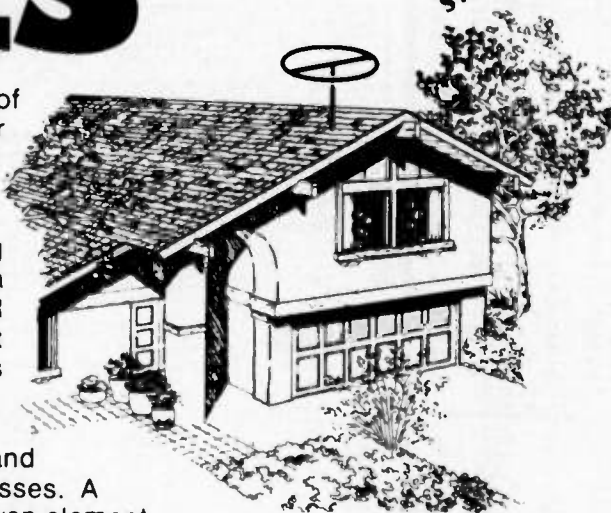

Star 20 shown (mast not included)

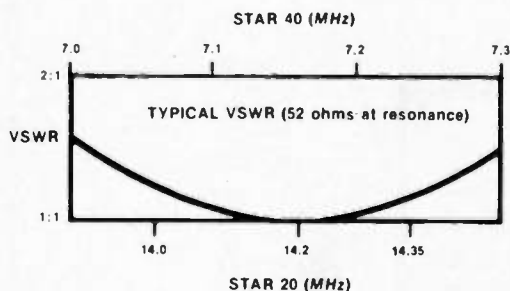

To introduce the STAR antennas at the lowest cost, they are available factory direct only from the address below. Complete instructions are provided for assembly and tuning for optimum performance at your QTH. State whether the STAR 20, STAR 40, or both are desired. Send check or money order to the address below. California residents add 6% sales tax. Antennas will be shipped by UPS.

\*J.M. Boyer, "The Surprising DRRR Low Noise Antenna," 73 Magazine, September 1976, pp. 42-45.

STAR 20 (20 meters): \$39.95

Weight: 10 pounds

Dimensions: 46" diameter x 2.5" depth

STAR 40 (40 meters): \$49.95

Weight: 20 pounds

dimensions: 90" diameter x 2.5" depth

## The COM ★ STAR Corporation

AMATEUR RADIO DIVISION

1926 S. Pacific Coast Highway • Suite 233 • Redondo Beach, CA 90277



# Poly Pak's EXCLUSIVE Avg. Ship. Wt. 6 oz. \$1.98

## BARREL KITS

YOUR CHOICE OF ANY KIT

Every kit carries a money back guarantee!

Buy 10 BARREL KITS and get the 11th Free

100'S OF BARRELS PURCHASED!

For the first time anywhere, Poly Pak merchandisers introduce a new way in buying the economical way. Raw stock from the "barrel". Remember the "good old days"? They're back again. The same way merchandisers throughout the United States buy from various factories... their overruns in barrels. Poly Pak has done the same. Therefore you are getting the same type of material as the RE-TESTERS DO!

TEST 'EM YOURSELF 'N SAVE!

**BARREL KIT #200**  
9 DIGIT READOUT MODULES  
5 for \$1.98 with calculator & beneath epoxy driver chips per p.d. work. How good? Who knows! Cat. No. 1A3518

**BARREL KIT #188**  
400 Parts \$1.98  
Includes: Resistors, caps, transformers, capacitors, diodes, etc. for p.d. work. Preformed, dumped into barrels by factories. 100% good. Cat. No. 1A3401

**BARREL KIT #200**  
CALCULATOR KEYBOARDS  
10 for \$1.98  
It's true! 20-key, 4 function keyboards at ridiculous prices give-away. Wt. 12 oz. Cat. No. 1A3524

**BARREL KIT #188**  
KEYBOARD CHIPS  
10 for \$1.98  
Truly good! 20-key keyboard encoder chips. How good they are we don't know. Cat. No. 1A3414

**BARREL KIT #184**  
1/4-WATT METAL FILM  
150 for \$1.98  
100% metal film resistors. Long leads. 1A3413

**BARREL KIT #160**  
V. REGULATORS  
15 for \$1.98  
LM309KC TO-3 V.R.'s barreled. Bot. by the pound. No. 1A3330

**BARREL KIT #182**  
JUMBO RED LEDS  
15 for \$1.98  
200% material, use count. radiation from factory dumps, 3V 10 mils. For 100's of projects, red lens. Cat. No. 1A3369

**BARREL KIT #159**  
MODULAR SWITCHES  
25 for \$1.98  
Centralab switches, TV-made. Opdnt. Opdnt. Brand new. Cat. No. 1A3150

**BARREL KIT #170**  
TERMINAL STRIPS  
1-lb. \$1.98  
Bot 5 tons! Factory mixed, but nicely asstd 280 pcs approx. Quite a saving. Cat. No. 1A3064

**BARREL KIT #157**  
MOLEX CONNECTORS  
100 for \$1.98  
Nylon, white cable connectors. NO PICKER! Mixed in barrels. Cat. No. 1A3324

**BARREL KIT #107**  
ROMS-RAMS-REGISTERS  
1-lb. \$1.98  
With approx count of 80 pcs. You get more. Mostly marked, mostly National. Some 40 pins. 1A3064

**BARREL KIT #154**  
CLOCK CHIPS  
20 for \$1.98  
We gathered an assortment of clock chip, alarm, calendar, beepers, who knows, all mixed. Cat. No. 1A3308

**BARREL KIT #166**  
LONG LEAD DISCS  
4 ozs. \$1.98  
No counting makes it so you get 150-pc kits (approx). All marked, 100%. Cat. No. 1A3089

**BARREL KIT #151**  
INCANDESCENT  
15 for \$1.98  
Importer sez. "Name your price." Hard to find 7-agg. 5V readouts. How good, can't say, we don't know. Can't test 'em. 1A3368

**BARREL KIT #162**  
MINI TRIM POTS  
30 for \$1.98  
Asst. values 100 to 1 meg. em. What a buy. Single turn. 1/4 W. Wt. 0.5 oz. Cat. No. 1A3345

**BARREL KIT #148**  
ROCKER SWITCHES  
25 for \$1.98  
Barrels in barrels, so many, our customers should get the deal. No. 1A3303,

**BARREL KIT #161**  
POP PLASTIC TRANSISTORS  
25 for \$1.98  
2N3904's with some 2N3906's. Precision. Many in 8 pc. areas. 1A3320

**BARREL KIT #149**  
MINI TRANSFORMER  
15 for \$1.98  
Miniature transformer back again. Asst. outputs, interstage and audio. Only 1/2 sq. Wt. 2 lbs. 1A3294

**BARREL KIT #144**  
RCA PHONO PLUGS  
40 for \$1.98  
1,000,000 RCA phono plugs for this one. You'll never know what they are. 100% material. 1A3293

**BARREL KIT #128**  
MINI DIP IC'S  
75 for \$1.98  
Large mfg dumped 100's of lbs into barrels. Includes 7414, LM-380-8, 703, 587, 556, 558—but who knows! Wt. 1 lb. 1A3248

**BARREL KIT #143**  
75-PC TRANSISTORS  
\$1.98  
100% material, TO-92, factory discontinued lines, pop's mixed with opns. 2N4400-1-2-3-4. 1A3290

**BARREL KIT #127**  
AXIAL ELECTROS  
40 for \$1.98  
Asst. cap. capacities all voltages. Cat. No. 1A3227

**BARREL KIT #140**  
LAMPS, INDICATORS  
20 for \$1.98  
Precision mini lamp axial metal, panel, with mtg hardware. Lamp maker's overstock. No. 1A3287

**BARREL KIT #126**  
UPRIGHT ELECTROS  
40 for \$1.98  
1ml to 300ml in mixture of voltages. 100% marked a good. 1A3226

**BARREL KIT #138**  
PANEL SWITCHES  
30 for \$1.98  
Did you hear of OAKY Antennae eqpt maker Barreled all types of rotary electric, slider, etc. 1A3256

**BARREL KIT #118**  
PRECISION RESISTORS  
100 for \$1.98  
PREFORMED! Designed for printed circuit work. 1/4, 1/2 W. Marked values, 1 and 2% values 2 orn. 1A3205

**BARREL KIT #134**  
CALCULATOR CHIPS  
15 for \$1.98  
National type. Can MM6736. 88. etc. Un-tested. Cat. No. 1A3258

**BARREL KIT #118**  
MINI SCRS  
50 for \$1.98  
UNBELIEVABLE! TO-92 plastic SCRS in barrels... fite from factory. Includes all voltages up thru 200 prv. 1A3126

**BARREL KIT #131**  
TANTALUM ELECTROS  
30 for \$1.98  
Mixed, marked primes, top grade asst. values. voltage. Cat. No. 1A3258

**BARREL KIT #117**  
OPTICAL FIBERS  
200 FT. \$1.98  
Fiber optic factory bank-rupty purchase! High quality, most-commonly used size (20-mil) CLEAR.

**BARREL KIT #130**  
CRYSTALS  
12 for \$1.98  
Large U.S. maker dumped frequency marked H/6U crystals in barrels. Some work. Precision. Many in 8 pc. areas. 1A3250

**BARREL KIT #118**  
MOLEX 100% SOCKETS  
200 for \$1.98  
Calculator maker dumped! Use a zillion of 'em. Used for IC sockets, etc.

**BARREL KIT #112**  
MICRO MINI LEDS  
40 for \$1.98  
All the tiny leds, axial, weight of Monsanto, Litronic, variety of colors. Yield 50% or better. 1A3126

**BARREL KIT #92**  
AMP EPOXY RECTIFIERS  
100 for \$1.98  
Cosmetic rejects, electrically fine business! You check 'em, it's not for asst. voltages. Un-tested. 1A3264

**BARREL KIT #109**  
TERMINAL STRIPS  
100 for \$1.98  
Wide asst. of terminal strip connectors, from 1 contact up. Strip manufacturers barrel dump in your rain. 1 lb Cat. No. 1A3136

**BARREL KIT #91**  
SILVER MICAS  
100 for \$1.98  
Axial, red case, variety of physical sizes & values. Cat. No. 1A3018

**BARREL KIT #105**  
MINI VOLUME CONTROLS  
25 for \$1.98  
1-Million pcs of 100%, 50% mini pot, ceramic case, long shaft. Eqpt maker's overstock. No. 1A3058

**BARREL KIT #104**  
SLIDE VOLUME CONTROLS  
10 for \$1.98  
747's, 727's, singles, tri-ples, etc. 33 to 0.6. Bot from factory, all mixed; have fun! No. 1A2661

**BARREL KIT #103**  
RESISTOR SPECIAL  
200 for \$1.98  
Includes: 1/4, 1/2, 1, 2-watt; carbon, 8 oz, 100% good. 1A3054

**BARREL KIT #87**  
NATIONAL IC BONANZA  
100 for \$1.98  
Types 8000, 7400 series, DTLs, ROMs, registers, clock & calc. chips, linear, etc. Cat. No. 1A2900 Un-tested.

**BARREL KIT #86**  
HOBBY LEDS  
40 for \$1.98  
Wow! A Litronic dump of all kinds of mixed discrete LEDs, white, color, good, poor, etc. 1A2889

**BARREL KIT #83**  
VOLT REO  
15 for \$1.98  
Factory rejected them for length of leads. May include 8 W, 12, 15, 18, 24 volt. Power tab Cat. 1A2833

**BARREL KIT #82**  
MIXED READOUT  
10 for \$1.98  
Factory returns—such numbers as MAN-4's, MAN-7's, MAN-8's, 11 barrels & more. Cat. No. 1A2733 Un-tested.

**BARREL KIT #81**  
SUBMINI RESISTORS  
200 for \$1.98  
PC upright type, color coded, 1/4 watt. Asst. values. All good. Cat. No. 1A2746 100% good.

**BARREL KIT #80**  
POLYSTYRENE CAPS  
100 for \$1.98  
Finest caps made. As a gamble we bought 10 barrels from factory, mixed values; all good. Cat. No. 1A2729

**BARREL KIT #77**  
RECTIFIERS  
100 for \$1.98  
Famous axial asst. voltages, silicon, axial included all types of voltages to 1KV. Cat. No. 1A2615

**BARREL KIT #76**  
1-WATT ZENERS  
100 for \$1.98  
Factory same as 400-mw's. Never-to-see again offer. 6, 8, 10, 12, 15V, under glass. Double plug. Cat. No. 1A2741 Un-tested.

**BARREL KIT #75**  
400MW ZENERS  
150 for \$1.98  
Factory out of Biol Amazing offer. 6, 8, 10, 12 to 15V. You test. Hermetically sealed glass pak. Double plug. Cat. No. 1A2740

**BARREL KIT #73**  
TRANSISTOR ELECTROS  
50 for \$1.98  
We don't wish to separate wide asst. voltages & values up to 300 mV. Cat. 1A2747

**BARREL KIT #72**  
CAPACITOR SPECIAL  
100 pcs. \$1.98  
mica, maldens, plastics, ceramics, discs, etc. Nifty 100% good. Cat. No. 1A2738

**BARREL KIT #71**  
CAPACITOR SPECIAL  
100 pcs. \$1.98  
mica, maldens, plastics, ceramics, discs, etc. Nifty 100% good. Cat. No. 1A2738

**BARREL KIT #68**  
2 WATERS  
100 for \$1.98  
All marked. Cat. No. 1A2735

**BARREL KIT #67**  
PLASTIC TRANSISTORS  
100 for \$1.98  
Type TO-92 (TO-18), all manufacturers, variety of 2N's. Cat. No. 1A2604

**BARREL KIT #66**  
METAL CAN TRANSISTORS  
100 for \$1.98  
Includes: TO-5, TO-1, TO-18, etc., assorted 2N numbers, unmarked etc. Cat. No. 1A2603 Un-tested.

**BARREL KIT #65**  
MIXED READOUT  
10 for \$1.98  
Factory returns—such numbers as MAN-4's, MAN-7's, MAN-8's, 11 barrels & more. Cat. No. 1A2733 Un-tested.

**BARREL KIT #64**  
DIGIT READOUTS  
10 for \$1.98  
Bargain of a lifetime! All the numbers of the "bladder digit" types. Multi-plexed. Cat. No. 1A2722

**BARREL KIT #63**  
LONG LEAD DISCS  
100 for \$1.98  
"auction sale". Prime, marked only. Long leads. Cat. 1A2598 100% good

**BARREL KIT #62**  
LONG LEAD DISCS  
100 for \$1.98  
"auction sale". Prime, marked only. Long leads. Cat. 1A2598 100% good

**BARREL KIT #61**  
DIPPED MYLARS  
60 for \$1.98  
Finest capacitors made, shiny finish. Imagine factory dumping 'em in barrels. Cat. No. 1A2597 100% good

**BARREL KIT #59**  
SLIDE SWITCHES  
30 for \$1.98  
All shapes, sizes, spst, apdt, momentaries, etc. Tremendous shop pak for 100's of switching projects. Cat. No. 1A2721 100% good

**BARREL KIT #58**  
SLIDE SWITCHES  
30 for \$1.98  
All shapes, sizes, spst, apdt, momentaries, etc. Tremendous shop pak for 100's of switching projects. Cat. No. 1A2721 100% good

**BARREL KIT #57**  
NEON LAMPS  
30 for \$1.98  
Famous NE-2's. All prime, but factory made millions and barreled 'em. Your advantage. Cat. No. 1A2613

**BARREL KIT #56**  
METALLIC RESISTORS  
100 for \$1.98  
Made mostly by Corning, the finest resistors made. Mostly 1/2 watters. 1% to 5% tol. & a barrel of values. Cat. No. 1A2609

**BARREL KIT #55**  
PREFORMED RESISTORS  
200 for \$1.98  
We got barrels of 1/4 and 1/2 watters for pc use. 100% 1/4, 100% 1/2 watters. No 1A2608 100% good

**BARREL KIT #54**  
DIGIT READOUTS  
10 for \$1.98  
Bargain of a lifetime! All the numbers of the "bladder digit" types. Multi-plexed. Cat. No. 1A2722

**BARREL KIT #53**  
PLASTIC TRANSISTORS  
100 for \$1.98  
Type TO-92 (TO-18), all manufacturers, variety of 2N's. Cat. No. 1A2604

**BARREL KIT #52**  
METAL CAN TRANSISTORS  
100 for \$1.98  
Includes: TO-5, TO-1, TO-18, etc., assorted 2N numbers, unmarked etc. Cat. No. 1A2603 Un-tested.

**BARREL KIT #51**  
MOSFET TRANSISTORS  
60 for \$1.98  
All 4 leadeers TO-18 case, include ULIF transistors too! Cat. No. 1A2429

**BARREL KIT #50**  
ROMS-REGISTERS  
75 for \$1.98  
28 to 40 pin devices, marked, internal factory numbers. etc. 1A2424 Un-tested.

**BARREL KIT #49**  
"4000" RECTIFIERS  
100 for \$1.98  
1N4000 series. May include 25, 50, 100, 200, 400, 600, 800 and 1000 volters 1A2417

**BARREL KIT #48**  
PRECISION RESISTORS  
200 for \$1.98  
Marked and unmarked 1/4, 1/2, 2 watts. No. 1A2429

**BARREL KIT #47**  
SUBMINIATURE TRANSISTORS  
100 for \$1.98  
Amazing, includes 455k's, osc, antenna, who knows! From transistor radio manufacturers. 100% 1A2416

**BARREL KIT #46**  
POWER TAB TRANSISTORS  
40 for \$1.98  
PNP, plastic TO220 type. Includes 2N numbers. Un-tested. Cat. No. 1A2426

**BARREL KIT #45**  
VOLUME CONTROL BONANZA  
30 for \$1.98  
Singles, duals, variety of values, styles, big ones—small ones. Cat. No. 1A2427

**Wow! INCREDIBLE PRICES**

**BUY ANY 10 TAKE 15%**

**BUY 100 TAKE 25%**

**TYPE SALE**

SNT7400N	16	SNT7442N	53	SNT7494N	78	SNT74180N	88
SNT7401N	16	SNT7443N	59	SNT7495N	78	SNT74181N	88
SNT7402N	16	SNT7444N	69	SNT7496N	72	SNT74182N	79
SNT7403N	16	SNT7445N	79	SNT7497N	98	SNT74183N	99
SNT7404N	16	SNT7446N	78	SNT7498N	85	SNT74184N	97
SNT7405N	18	SNT7447N	78	SNT7499N	85	SNT74185N	89
SNT7406N	20	SNT7448N	78	SNT7500N	85	SNT74186N	79
SNT7407N	25	SNT7449N	18	SNT7501N	85	SNT74187N	79
SNT7408N	25	SNT7450N	18	SNT7502N	85	SNT74188N	2.05
SNT7409N	18	SNT7451N	16	SNT7503N	85	SNT74189N	1.75
SNT7410N	18	SNT7452N	16	SNT7504N	85	SNT74190N	1.5
SNT7411N	18	SNT7453N	16	SNT7505N	85	SNT74191N	1.05
SNT7412N	25	SNT7454N	16	SNT7506N	85	SNT74192N	1.75
SNT7413N	25	SNT7455N	16	SNT7507N	85	SNT74193N	83
SNT7414N	25	SNT7456N	31	SNT7508N	85	SNT74194N	83
SNT7415N	32	SNT7457N	31	SNT7509N	85	SNT74195N	88
SNT7416N	32	SNT7458N	31	SNT7510N	85	SNT74196N	88
SNT7417N	32	SNT7459N	31	SNT7511N	85	SNT74197N	88
SNT7418N	32	SNT7460N	31	SNT7512N	85	SNT74198N	88
SNT7419N	32	SNT7461N	31	SNT7513N	85	SNT74199N	88
SNT7420N	32	SNT7462N	31	SNT7514N	85	SNT74200N	88
SNT7421N	32	SNT7463N	31	SNT7515N	85	SNT74201N	88
SNT7422N	32	SNT7464N	31	SNT7516N	85	SNT74202N	88
SNT7423N	32	SNT7465N	31	SNT7517N	85	SNT74203N	88
SNT7424N	32	SNT7466N	31	SNT7518N	85	SNT74204N	88
SNT7425N	32	SNT7467N	31	SNT7519N	85	SNT74205N	88
SNT7426N	32	SNT7468N	31	SNT7520N	85	SNT74206N	88
SNT7427N	32	SNT7469N	31	SNT7521N	85	SNT74207N	88
SNT7428N	32	SNT7470N	31	SNT7522N	85	SNT74208N	88
SNT7429N	32	SNT7471N	31	SNT7523N	85	SNT74209N	88
SNT7430N	32	SNT7472N	31	SNT7524N	85	SNT74210N	88
SNT7431N	32	SNT7473N	31	SNT7525N	85	SNT74211N	88
SNT7432N	32	SNT7474N	31	SNT7526N	85	SNT74212N	88
SNT7433N	32	SNT7475N	31	SNT7527N	85	SNT74213N	88
SNT7434N	32	SNT7476N	31	SNT7528N	85	SNT74214N	88
SNT7435N	32	SNT7477N	31	SNT7529N	85	SNT74215N	88
SNT7436N	32	SNT7478N	31	SNT7530N	85	SNT74216N	88
SNT7437N	32	SNT7479N	31	SNT7531N	85	SNT74217N	88
SNT7438N	32	SNT7480N	31	SNT7532N	85	SNT74218N	88
SNT7439N	32	SNT7481N	31	SNT7533N	85	SNT74219N	88
SNT7440N	32	SNT7482N	31	SNT7534N	85	SNT74220N	88
SNT7441N	32	SNT7483N	31	SNT7535N	85	SNT74221N	88
SNT7442N	32	SNT7484N	31	SNT7536N	85	SNT74222N	88
SNT7443N	32	SNT7485N	31	SNT7537N	85	SNT74223N	88
SNT7444N	32	SNT7486N	31	SNT7538N	85	SNT74224N	88
SNT7445N	32	SNT7487N	31	SNT7539N	85	SNT74225N	88
SNT7446N	32	SNT7488N	31	SNT7540N	85	SNT74226N	88
SNT7447N	32	SNT7489N	31	SNT7541N	85	SNT74227N	88
SNT7448N	32	SNT7490N	31	SNT7542N	85	SNT74228N	88
SNT7449N	32	SNT7491N	31	SNT7543N	85	SNT74229N	88
SNT7450N	32	SNT7492N	31	SNT7544N	85	SNT74230N	88
SNT7451N	32	SNT7493N	31	SNT7545N	85	SNT74231N	88
SNT7452N	32	SNT7494N	31	SNT7546N	85	SNT74232N	88
SNT7453N	32	SNT7495N	31	SNT7547N	85	SNT74233N	88
SNT7454N	32	SNT7496N	31	SNT7548N	85	SNT74234N	88
SNT7455N	32	SNT7497N	31	SNT7549N	85	SNT74235N	88
SNT7456N	32	SNT7498N	31	SNT7550N	85	SNT74236N	88
SNT7457N	32	SNT7499N	31	SNT7551N	85	SNT74237N	88
SNT7458N	32	SNT7500N	31	SNT7552N	85	SNT74238N	88
SNT7459N	32	SNT7501N	31	SNT7553N	85	SNT74239N	88
SNT7460N	32	SNT7502N	31	SNT7554N	85	SNT74240N	88
SNT7461N	32	SNT7503N	31	SNT7555N	85	SNT74241N	88
SNT7462N	32	SNT7504N	31	SNT7556N	85	SNT74242N	88
SNT7463N	32	SNT7505N	31	SNT7557N	85	SNT74243N	88
SNT7464N	32	SNT7506N	31	SNT7558N	85	SNT74244N	88
SNT7465N	32	SNT7507N	31	SNT7559N	85	SNT74245N	88
SNT7466N	32	SNT7508N	31	SNT7560N	85	SNT74246N	88
SNT7467N	32	SNT7509N	31	SNT7561N	85	SNT74247N	88
SNT7468N	32	SNT7510N	31	SNT7562N	85	SNT74248N	88
SNT7469N	32	SNT7511N	31	SNT			



# EDITORIAL

from page 74

That afternoon Sherry and I drove out to visit her folks in nearby Seguin, Texas. I hadn't seen them but once since I'd visited them in Ft. Worth back in 1949 while I was working at a television station in Dallas, so we had a great reunion ... capped by a fantastic veal curry dinner (my best curry recipe came from Sherry's mother Alma). Sherry's father, Snuffy Smythe, had worked with my father back in the early 40's, so we'd all known each other for almost 35 years.

The next day we flew up to Austin and visited the Motorola plant there, where they make memory chips and 6800s. We were taken through the plant and watched them make the chips - a process that is largely automated. The silicon bars are grown, turned down on a lathe, sawed into thin slices about 3" in diameter, and then the building up of the layers of circuits is started, going from one bay of the building to the next for each layer, carried on cushions of air along an intricate production line ... with microscope checkpoints after each operation.

We had a great time talking with the Motorola gang, including Mike Wiles (the Mike of MIKBUG), Joe Magee (who will be writing for us), Irwin Carroll, John Beyer, George Foote, Mike Hadley, Joel Boney ... several were active hams. The Austin Motorola plant is their LSI center. Only one sour note: no free samples! How frustrating to see those thou-

sands of great chips just on the other side of a window.

## SUBMARINE REUNION

Next we flew into Mobile, Alabama, where we joined a reunion of members of the crew of the *USS Drum* (SS-228). Eighteen of us turned up for the get together aboard our old World War II home, which is anchored beside the battleship *Alabama* as a memorial to the war. The last time I'd seen my old boat was around 1956 during a convention in Washington when it was included as one of the attractions for visiting. It was used as a school boat at that time.

I hadn't seen anyone from the crew since 1946 - thirty years. What a bunch of *old men!*

We reminded each other of the funny things that had happened during our year or so together ... the time Skinny Guinea, the cook, was discovered trying to put the stew back in the pot after the boat had taken a tremendous lurch and spilled it all over the galley deck. Or the time Skillet (another cook) found his food storage lockers filled up and kicked the remaining supplies overboard one night rather than bother to return them. The missing supplies turned out to be mostly sugar, so we made a 60-day war patrol without sugar ... until we managed to flag a passing submarine (one of ours) and swap some of our hydraulic oil for sugar. Picture two submarines off the coast of Japan (not very far off) passing oil and sugar across between them in the

middle of the night.

I've got enough good sea stories from my five war patrols on the *Drum* to fill half a book - I think I'll see if the other members of the old crew can come up with enough more to make a complete book. I've never heard of a book written by the crew of a ship before.

## ATLANTA

The Computer Systems Center opened up specially for us on Sunday and we had an opportunity to rap for quite a long time without interruptions. Richard Stafford, Ron Roberts, Steve Mann and Jim Dunion are making good headway toward developing small business operating systems for use on microcomputers such as the Altair and the Intelligent Systems unit. They have programs developed for an accounting system (general ledger, invoicing, accounts receivable, accounts payable, payroll), a word processing system and an inventory system. These are the first business systems I've seen and they give us a good idea of what is coming.

We wanted to see the Intelligent Systems plant (where they make those full color video terminals), so we drove out to their new factory and met Terry Hughey, the president. He has a small assembly system going there and was shipping both kits (with enormous instruction manuals) and assembled units. This terminal has an 8080A built in, so it has rather impressive possibilities. I got the impression that not much software was yet available. I think most of the programs so far written were done by the Computer Systems Center. There was no question that I really had to have one of those gorgeous full color terminals.

The prices of the systems were a bit

confusing. In single lots I think they were going for around \$2500 ... in bulk for \$1995. They had a special coming up for \$1775, but I later got the impression that this was a bare bones system ... this was further impressed on me when our unit arrived along with a bill for \$4550 (we wanted some accessories). We were hoping that we could furnish color terminals with our Publishers Data computer system which we hope to sell soon, but we may have to go with the Lear-Siegler terminals in glorious black and white.

We are in the final stages of programming our computer system at 73 ... it will take care of subscriptions, renewal notices, billing for subs, prospective subscribers, bulk accounts for radio stores and newsstand wholesalers, space advertising records and billing, payroll, general ledger, reader's service, profit and loss, an article index, repeater list, and a dozen more functions. Everything is on line at all times and the system is handling eight terminals.

Since our system is far less expensive than anything else I've seen anywhere, I think we'll have quite a few publishers interested in it. We'll be selling it complete with all hardware and programs. We're expecting to have several hundred customers for the system since it does just about everything and costs so little.

It was a most interesting trip. We had a chance not only to see how the firms I visited last year have progressed, but to talk with them and get their perspective on how the industry is doing and where they think it is going. A lot of this is influencing the thrust of *Kilobaud* magazine.

As time permits, we'll try to get out and contact newer firms in the field and let you know what's going on.

## New Products

### THE HAL SYSTEM

It hardly takes any time at all using a Teletype machine for I/O before you are ready to put in some sort of

video terminal ... any type of video terminal. Practically speaking, this means a choice between a Southwest Technical Products CT-1024, the HAL



Communications system, or the Lear-Siegler. Let's, for the time being, take a good close look at the HAL system.

What are we looking for in a terminal? We don't want to spend any more money than we have to, yet we want something which will do a professional job. The HAL AKB-1005 keyboard and RVD-1005A TV driver come assembled and tested (a big plus for many hobbyists) and are nicely packaged in good looking boxes ... nothing Mickey Mouse about it.

We want a keyboard that is well laid out - with the return key easy to use, not where you have to move your hand to touch it (for this usually means you have to check the keyboard visually to get back typing again). The HAL keyboard is very easy to use. One great feature (which you generally find in only the more expensive keyboards) is the "n-key rollover." This allows you to hold down as many keys as you want and have the characters sent out when you release them. This feature makes the keyboard a lot faster to use.

Only a couple of things were missing ... a "repeat" key which

permits a character to be repeated when both it and the character are held down at the same time ... and a bell or some audio tone. A tone is nice as a signal when a cassette file is found. There is a connection for a bell or tone, if you want to put it in yourself.

Hobbyists will want to know how difficult it is to interface the HAL system. It should virtually plug into most computers, since it has a standard RS-232C interface, 110 baud, 11 bit word, no parity and local echo. Changing baud rates is a bit complicated, requiring a clock crystal change.

Other options which are changeable by jumper are:

- Local echo (normal)
- No local echo
- No parity check (normal)
- Even parity check
- Odd parity check
- Variable baud rate (normal)
- High speed clock
- Negative true input (parallel) (normal)
- Positive true input (parallel)
- Ten unit output (1 stop bit) (normal)
- Eleven unit output (2 stop bits)

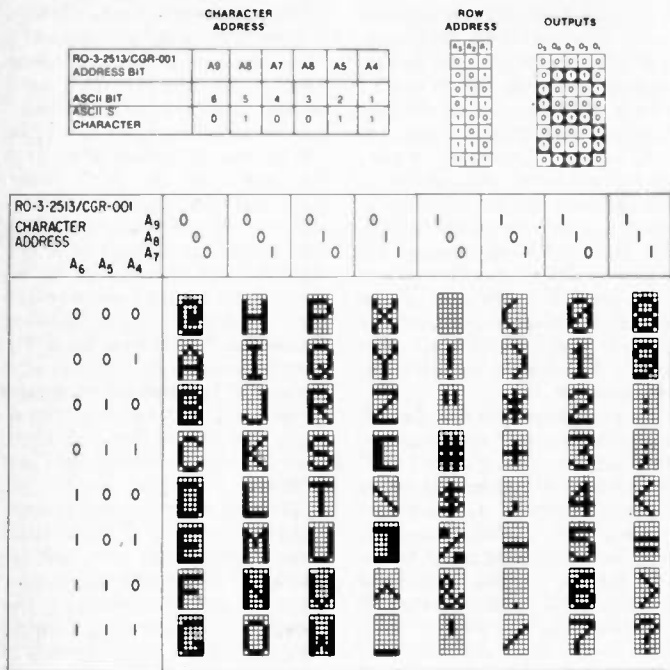

Fig. 1. RO-3-2513-001 standard pattern character format. The RO-3-2513/CGR-001 is a preprogrammed version of the RO-3-2513 series with ASCII encoding and the character font shown above. A logic "1" represents an input or output voltage nominally equal to Vcc (+5 V) and a logic "0" represents a voltage nominally equal to GND (0 V). An example demonstrating the correspondence of device outputs and addressing sequence to the 5 x 7 dot matrix font is shown.

This strapping flexibility offers an easy method of changing the characteristics of the communications device as you improve your mainframe. Although the chips are well marked on the PC boards, the jumpers are not. With no UART as a landmark, it will take just a little looking to find the applicable jumper. The lands for these jumpers are on the bottom side of the board. This prevents the movement of jumpers without first removing the board. At first this looks like a disadvantage, but actually it is not. If the lands are on the top surface of the PC, there is a great temptation to make modifications to a board mounted in its chassis. Working in a confined space is difficult and conducive to solder splashes and other solder errors which may go undetected. The HAL board must be removed in order to make jumper changes. There are 3 nylon stakes, 2 screws and 2 dip sockets holding the board in the chassis. It takes less than a minute to get the board out and in the open, where it can be worked on with plenty of room and good lighting.

The RVD-1005A is designed to plug into a TV monitor with a BNC connector. Most solid state TVs and many tube-type TVs can be connected if coupled through a capacitor to the base or grid of the first video amplifier. This should be attempted on ac isolated sets only. If you are a customer of HAL, and you send them a schematic of the TV you are using, they will sketch out the details.

The clarity of the display is a function of the TV of monitor size, focus, contrast, and the character

generator chip that HAL has chosen for their device. The HAL format is 25 lines per page, 40 characters per line, and each character is formed by a 5 x 7 dot matrix. The character generator chip is a 2513 made by National Semiconductor and General Instruments. Fig. 1 shows the correlation of the ASCII binary to the character as displayed. This character set in the HAL format produces a very legible display on any size screen.

The character set encoded by the keyboard is a product of another LSI chip, this time found on the keyboard PC in the AKB-1005. The MMS740AAE by National Semiconductor encodes the depression of the key by row and column. This chip is a 90 character device and generates normal, shift, control and shift control mode characters. There are no deficiencies in this character set for standard applications.

The hobbyist who is going to be getting into it and changing the baud rate and word size will find that the PC boards are orderly and clean, with the parts well numbered. The boards do not have a solder mask, so extra care should be taken when working with a soldering iron. The instruction manual contains all the prints and theory necessary to get you around the boards.

And now for the bottom line. The AKB-1005 keyboard is priced at \$100; the RVD-1005A at \$375. If you plan to rack mount the TV driver, be sure to specify RVD-1005AR.

In a market that is so sorely hurting for good yet inexpensive CRT devices, HAL Communications Corporation makes well-packaged, well-engineered

equipment at affordable prices. HAL Communications Corp., Box 365, Urbana CA 91801.

James Muehlen  
Computer Lab Director

### ICOM IC-202 AND IC-502 PORTABLE SSB TRANSCEIVERS

The first vestiges of winter come early to southern New Hampshire. Only the week before, the countryside had been ablaze with crimson and yellow hues. But now, the situation was completely different. Sitting on top of Pack Monadnock mountain, a fierce wind gusting to over fifty miles per hour buffeted the car and bent trees and metal road signs. All this for the middle of October.

Who, you may ask, would spend the afternoon in a place like that on such a blustery day? A ham, of course! By my side sat two new rigs from Icom. If you're one of those amateurs who is sick and tired of the crowded conditions on repeaters and the low bands, you need simmer no longer. These rigs are for you.

Sideband activity on six and two meters is increasing every day. There's still plenty of time to get into these wide open areas. The IC-202 covers 144.0-144.4 MHz, the IC-502 50.0-51.0 MHz. Both units operate USB and CW, with 3 Watt output feeding quarter wave whips. The 502 is a hair larger than the 202, with both approximating the size of the well-

known 22A. Nine batteries add to the weight, but both weigh in at a reasonable 4½ pounds. Padded shoulder straps make the carrying job a little easier.

The lack of a suitable winter coat and the associated gear necessitated the rigs be tested by putting the whip antennas through a partially open car window. On two meters, a bit of tuning and a few CQs brought a QSO with a station in the Boston area, some 80 miles away. Later, on six meters, a station in the Springfield MA area answered my call, also about 80 miles away as the buzzard flies. Both stations reported crisp and easily readable signals. With the pleasurable QSOs, the freezing of toes and bones was soon forgotten. Both rigs were extremely easy to tune and drifted not at all during the half hour contacts.

Activity on these bands is still not very heavy. But enough stations are around to find contacts anytime without the worry of being QRMed out of the shack. Reports from the west coast confirm an even greater interest in this hassle-free part of the spectrum. These new radios should be responsible for a big increase in sideband use.

There are several minor nit-picking points on the minus side. The one Watt audio output to the two inch speaker makes it a bit difficult to read in a mobile that's underway. If you



lack an extension speaker, the earphone included with the units makes for much better copy. Another minor inconvenience is CW operation: On every go around, the CW transmit switch must be returned to the receive position. Finally, the aforementioned problem of weight. Although 4½ pounds may not seem like much, after a day of climbing the rocks and hills, it begins to feel much heavier. I found it easier to carry under the arm like a book.

Regardless of those minor inconveniences, these units have been ready-made for the ham on the go, be it in the hills of New England or the city. The VHF twins are made to the usual high standards of Icom gear and have no troubles standing up to the rigors of portable operation. They seem to be built like the rocks that they were inadvertently bumped against, without any adverse effect. The owner's manuals are complete down to every last detail. A fold-out schematic with indicated voltages makes for easy troubleshooting without a magnifying glass or strained eyes.

Included with both rigs are batteries, mike, earphone, strap and mike carrying case, as well as miniature plugs for power supplies, external speaker and CW key.

Turning to specs, both the IC-202 and IC-502 receivers have sensitivity of better than .5 uV for 10 dB S+N/N. Intermod rejection is better than 60 dB. The i-f is 10.7 MHz. The transmitters feature a filter type SSB producing system with spurious suppression of over 40 dB.

There's still plenty of room on two and six meters, and these units from Icom are just the radios to create new interest. Just looking at them sitting on a table gives you the urge to go out and climb a mountain. If you're not in the mood to do that, a power supply, linear, and external antenna make them perfect base stations. The 202 even has two empty crystal positions and can be used for the OSCAR uplink.

The 202 retails for \$259.00, the 502 for \$249.00. *Icom East, Inc., Suite 307, 3331 Towerwood Dr., Dallas TX 75234; Icom West, Inc., Suite 3, 13256 Northrup Way, Bellevue WA 98005.*

Stan Miastkowski WA1UMV  
Associate Editor

#### KENWOOD TS-820

With the latest changes in the amateur rules, equipment manufacturers are working hard on new gear. Low band privileges for Technicians and higher power for Novices mean a bigger market for the manufacturers. After the first of the year there will be several surprises from companies that until now have stayed away from low band gear. Chances are that they will be trying to equal the latest high water mark in amateur transceivers ... the Kenwood TS-820.

The Kenwood is not cheap. After adding up all the accessories, the

buyer faces a tab somewhere around \$1200. But for his money the owner gets a high quality piece of gear, not to mention the tremendous incentive to upgrade, with SSB and the rest of the bands sitting there waiting for him.

Sure, you can buy less expensive transceivers, but you're going to be hard pressed to find a better value than the 820. It represents the state of the art, and quite frankly it's a fun machine. Look at the 820 as an investment, and consider the years of troublefree operation and pleasure you'll get out of it. As they say, it does pay to go first class. Now, let's take a closer look.

Before long every low band transceiver will probably have digital readout. Once you've used it you'll never want to use the old dial format again. Instantly you know what frequency you're on and, wrapped in a package like the 820, you'll wonder how you got along all these years without it. It's great fun.

The digital readout is a \$170 option, but we doubt Kenwood is selling many units without it. It's calibrated down to 100 Hz with 6 bright Kenwood Blue LEDs. Installing the three piece digital option is easy. All the cables are there, and it just takes a few self-tapping screws to complete the job. All connections are failsafe computer type, making it impossible to plug in upside down.

Right out of the box our 820 was within 100 Hz of WWV on 15 MHz. What's more, the 820 has a digital hold (DH) control which allows the operator to lock the LEDs and tune off frequency. To get back to the original frequency all you do is release the hold control (after noting the locked frequency) and tune back to the starting point. A handy device for taking a station off frequency without a remote vfo. There is, however, no magic ... the DH switch will not whisk you back to the original frequency when released (as some on-air QSOs have speculated).

Tuning the 820 is smooth, with no sign of backlash. The standard SSB filter provides good selectivity, with signal separation better than most transceivers. The Kenwood has good sensitivity, and can handle adjacent

signals quite well. With the passband tuning, the circuit shifts the i-f passband without changing your receiver frequency and, while it works well, no radio is going to magically clear the QRM; you can only hope to reduce it.

A single conversion system, although new in low band transceivers, gives the Kenwood real immunity to images, overload, and cross modulation. There is a 20 dB front end pad to take care of any serious problems, if you are one of the unlucky ones with another ham living down the street. It seems the 820 will be a popular field day rig, considering its rugged receiver.

On the transmitting end the 820 sets the same kind of pace. Incoming signal reports were fantastic! QSO after QSO brought gratifying reports and much reaction to the radio's excellent audio quality. Several stations even volunteered praise for the 820, without knowing what I was running. DX stations reported substantial improvement in audio punch when using the built-in rf speech processor. Local stations didn't even find the processor objectionable when I switched it in for comparison purposes. A compression level scale is included on the 820's multimeter for proper adjustment, and Kenwood built in an air monitor which allows you to hear yourself. Comforting.

In fact, Kenwood has left practically nothing out. The 820 has front panel controls for VOX, compression level, FSK, a 20 dB front end attenuator, three position AGC switching (slow for SSB, fast for CW, and off for receiving very weak signals), four fixed channels (for MARS or net frequencies), and RIT (for offsetting receive frequency in nets or on CW).

All controls are in a sensible, easy-to-use format. Aside from adding a finger hole for the main tuning knob, I wouldn't change a thing. Ac power supply, speaker and PA blower are built-in. Mobile work requires an accessory adapter, but the 820 isn't too large for most family cars — and would make a fine mobile rig.

Band coverage is complete ... no accessory crystals to buy. 16-10 meters are included, along with 15 MHz for WWV reception, and the rest of the 19 meter SW band as a bonus.

The transmitter is a breeze to tune. I found it to be fairly broadbanded, requiring touch-up only after excursions of over 100 kHz using our 3 element CushCraft 20 meter beam. The PA contains the rig's only tubes, two Japanese equivalents of the 6146 for finals and a 12BY7 driver. Kenwood has provided separate switching for the heater circuitry, a nice feature for portable or mobile operation. I'm sure one of the big reasons why the 820 tunes so easily is the introduction of rf feedback between the PA and driver stages. The Kenwood runs super cool, with a PA fan so quiet I checked twice to be sure it was running. Power output on all bands was greater than 120 Watts, more than enough to drive most linear amplifiers.

Kenwood offers a variety of accessories: remote vfo, 2 meter transverter, 500 Hz CW filter, and (of course) the digital frequency display. Since the standard package includes enough features to put the Kenwood high on any ham's list, it's not hard to understand why dealers are deluged with orders.

Most important, the flexibility is there, and so is the operating pleasure. Without a remote vfo the TS-820 will do just about anything separates can do. With the second vfo it's hard to argue that the rig won't satisfy even the most demanding DX chaser. *Trio-Kenwood Communications, 116 E. Alondra Blvd., Gardena CA 90248.*

Warren Eilly WA1GUD/1  
Associate Editor

#### THE ICOM 22S

Cries of "the computers are coming, the computers are coming" will be heard, as more hams get their hands on the new IC-22S. This is, essentially, the best parts of the old IC-22 (which was a darned good rig) plus a synthesizer — a programmable synthesizer.

Up to 22 channels can be set up in the IC-22S by soldering in diodes on a matrix board. This is very handy if you are going from one area to another and want to change the channels so that you don't break any wires going to the matrix or break off the diode leads when you are soldering.

The rig seems to beg for connection to a computer-managed switching unit — just the thing for even the simplest of microprocessors to handle. A little software program to let you select the channel via a touch pad, or perhaps a scanning program. We'll bet that Tom Gentry, one of the bigwigs of Icom East, comes up with something. Tom is deeply into computers these days.

The fact is that we had a tough job getting a 22S to test (without buying one). Dealers are swamped with orders and Icom East is up to here trying to keep up with them. One of the last things they need right now is more people putting pressure on them for radios. In spite of all this, we did manage to get a unit (which had been used for demo at hamfests) and wring it out.

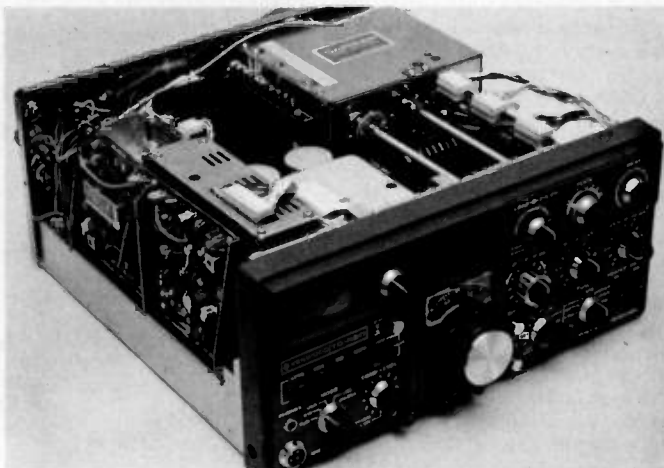



#### It works.

The larger speaker (than the 22A) results in better fidelity and more audio than most of us can use. The reports on voice quality are definitely better than we get with the IC-230. We ran the 22S and 230 side by side with separate antennas and could see no difference between the receivers — both excellent.

A matrix system for switching is about the same thing as the Read Only Memory (ROM) units in computers. By defining the frequency as a binary number and using diodes as switches, the synthesizer in the 22S is programmable. This means you don't have to buy any crystals. The IC-22S comes with a chart which tells you where to solder in the diodes to get the receive frequency you desire — the transmitter channel (600 kHz split) is then taken care of.

Considering the small size, the 22 channels, and the flexibility of the IC-22S, it is no wonder that dealers are raising Cain with Icom to get deliveries for customers. I think we'll be having a lot of good articles on modifications of this rig — first with an outboard switch for remote programming the synthesizer, and then later software control via a microprocessor. We'll see. *Icom East, Inc., Suite 307, 3331 Towerwood Dr., Dallas TX 75234; Icom West, Inc., Suite 3, 13256 Northrup Way, Bellevue WA 98005.*

Warren Ely WA1GUD/1  
Associate Editor

#### LOW COST ACTIVE FILTERS INTRODUCED BY NATIONAL

A new series of low cost active filters designed for use at frequencies up to 10 kHz has been developed by National Semiconductor Corp., according to Brent Welling, marketing manager for hybrid products.

Called the AF100 series, the new integrated circuits are intended for use in low frequency analog systems, including medical, geophysical, sonar, audio, tone signaling, modem, and feedback control systems where specific filter functions are required.

The AF100 series filters are basic building blocks that can be used to construct any filter response, such as Butterworth, Bessel, Caer,

and Tschebycheff. With the addition of only four external resistors, the AF100 can be programmed for second order functions.

Lowpass, highpass, and bandpass functions are available simultaneously at separate outputs, and notch and allpass functions are available by combining these outputs in an internal summing amplifier. If higher order systems are required, several AF100s can be cascaded. In all configurations, the Q, gain, and center frequency adjustments are independent, requiring no iterative trimming.

Other features of the new active filter series include a Q range of up to 500 and a frequency accuracy of either  $\pm 1\%$  or  $\pm 2.5\%$ . Operating power supply range is from  $\pm 5$  V to  $\pm 18$  V and supply current is 4.5 mA max.

The new active filter series is available in either a 16 pin plastic dual in-line package or a 12 pin TO-8 can for operation over the commercial temperature range of from  $-25^\circ$  C to  $+85^\circ$  C, and in the TO-8 can for operation over the military temperature range of from  $-55^\circ$  C to  $+125^\circ$  C. In quantities of 100, the commercial plastic DIP active filters with a frequency tolerance of  $\pm 2.5\%$  (the AF100-1CJ) sell for \$4.95 each. Delivery is from stock. *National Semiconductor, 2900 Semiconductor Drive, Santa Clara CA 95051.*

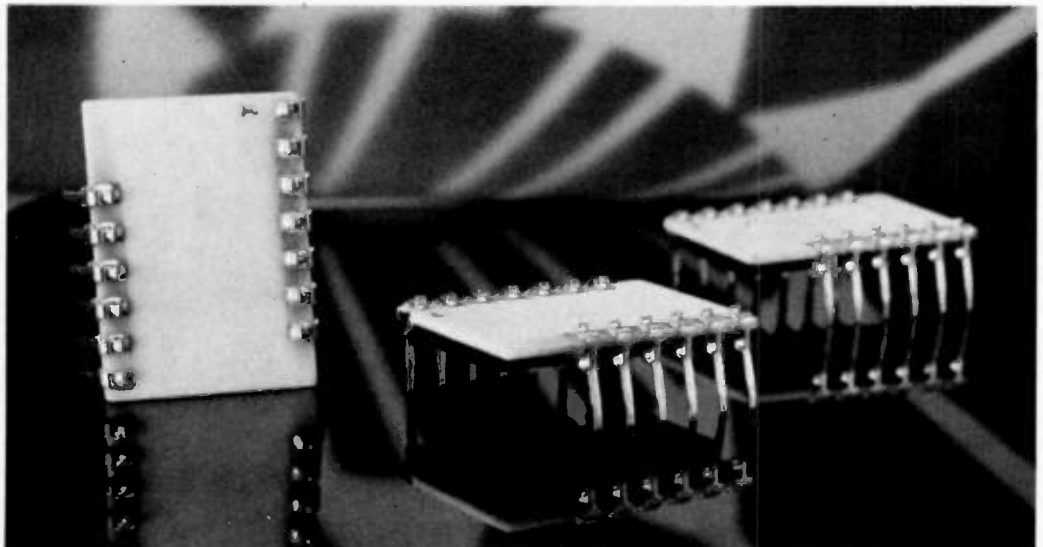

#### SECURITY PRODUCTS KIK-CO "KEEPS IT" SECURITY KIT SOUTHCORP INC. SLIDE MOUNTS AND FOILER (see ad, page 50, December, 1976)

An ever-increasing complaint among amateurs is the "missing rig syndrome." It's brought about by the realization that the rig that was innocently sitting in your car a few minutes ago is no longer there. In all probability, that 2 meter rig will end up in a trash can in some back alley after the thief realizes that it's not a CB unit after all.

In an effort to discourage the "rig-ripper-offers," a number of security products are hitting the market. The key point here is the word discourage. No security device makes a rig entirely theftproof, unless you want to lock it away in some underground vault. Many devices on the market capitalize on the assumption that most thieves who filch rigs are in a big hurry. Therefore, anything that extends the time required to remove the rig will supposedly discourage the would-be filcher. The concept is called "controlled access" and it's been used with great success in jails, banks, and other areas that require any great degree of security.

One of the neatest security devices on the market is the "Keeps It"™ security kit made by Kik-Co of Fort Worth, Texas (\$14.95). This patented product consists of two panels made of what's called "space age aircraft material stronger than steel." Included in the kit is all necessary hardware for installation. Most radios using standard type brackets can easily be protected by the kit. Two notable exceptions are Icom and Heathkit. Installation of the kit is an easy half hour project using only a standard screwdriver and a special wrench supplied with the kit.

The two panels limit access to the bolts holding the unit by covering them. Also featured are one way head bolts to hold the bracket to the dash, further discouraging the would-be

thief.

Some brackets might require a bit of modification.

The massive bracket of my FM-DX required that a couple of holes be drilled in order to fit the protective plates. Removal of the rig is no problem. The special wrench and a screwdriver are required. The whole process takes about a minute.

Another method of discouraging theft is to remove the radio entirely. One of the quickest ways to do this is a slide bracket. Most brackets have been plagued with the problem of interconnecting pins not lining up after a few removals. This problem has been solved by SouthCom. Their heavy duty slide mounts are constructed using heavy steel on plastic guides for smoother operation. This, coupled with the use of computer-type connectors, assures positive connection every time.

Another problem has been power loss and increased swr through inferior connectors. SouthCom's bracket uses a new miniature coax connector. 73 tested the unit with a wattmeter and found zero loss of power.

The mount is available in three configurations: the MB-3 for 2-way radios, the MB-2 for tape decks, and the MB-1, which requires wiring. All three include provision for a padlock (not supplied). Prices range from \$7.25 to \$19.95.

Another SouthCom product is something called the "Foiler." This five dollar unit is used in conjunction with a trunk mount antenna. Two screws mount it to one of the braces under the trunk lid. A latch and stainless steel spring hold the antenna securely to the trunk lid while operating. When stopped, a flip of the latch disengages the antenna and it stows neatly in the trunk. Voila! ... no telltale antenna to announce the presence of an expensive unit within.

*Kik-Co, P.O. Box 13249, Fort Worth, Texas 76118.*

*SouthCom, P.O. Box 11212, Fort Worth, Texas 76109.*

Stan Miastkowski WA1UMV  
Associate Editor

The advent of all solid state equipment has resulted in a renaissance for the battery industry. Nickel-cadmium, "alkaline," carbon-zinc and lead-acid batteries are all in widespread use by amateurs. Due to its cost, the silver-zinc cell has seldom been encountered, although it is highly desirable for really portable operations. This type of cell has been extensively used in torpedoes, missiles and space applications.

Recently one of my favorite surplus haunts received a shipment of dry charged Yardney "Silvercell" batteries. The cells were new,

sealed and dry charged. Their small size was ideal for one of my portable applications, so I invested in a set not knowing what a bargain I had stumbled on.

The silver-zinc cell has an extremely high ratio of stored energy to weight, a flat discharge curve and an ability to discharge at a high rate without damage. The cell consists of a silver oxide positive electrode and a zinc negative electrode. The electrolyte is potassium hydroxide. A 40% to 45% concentration should be used. Do not use "standard" battery electrolyte, which is sulphuric acid. This would immediately destroy

the zinc electrode, giving off hydrogen gas.

To place the cell in operation, the electrolyte is introduced through the vent plug. This can be a tricky and hazardous task. For the small size cells normally encountered, the process is best done in the kitchen sink. Remove the small porous filter from under the vent cap. Make a pipette from a piece of glass tubing, or use an old eyedropper that will fit into the cell.

Simply pouring the electrolyte into the vent tube will result in splashing when the cell burps. The cell should be set in the sink or in a glass

bowl to prevent damage from the electrolyte. Remember that the electrolyte is highly basic. It can be neutralized with household vinegar.

After filling, let the cell sit for a while, and then top off with more electrolyte to replace that absorbed by the separators. Carefully wipe any spilled electrolyte from the polystyrene case. Charging of the small size cells, with a less than 25 Amp maximum discharge rate, can be readily done with the dc power supply and battery charger shown in Fig. 1. If the supply is to be used only for battery charging, the filter capacitor can be omitted. Batteries can readily be assembled from individual cells by placing them in series. Room temperature open circuit voltage for charged cells is typically 1.86 volts. The normal voltage spread is such that six cells are used for a 9 volt battery, and 8 or 9 for a 12 volt battery. Charging current should be limited to between 7% and 10% of the rated cell discharge capacity. This value is generally found as part of the identification number printed on the cell. For example, a Yardney HR-5 series means that the cell is designed for a high rate of discharge, and that the design discharge rate is 5 Amps. In this case, charging current should be kept between 350 and 500 mA. Charging should be stopped when the cell voltage rises sharply and reaches 2.05 volts (see Fig. 2). Do not overcharge, as this will greatly reduce the cycle life.

Manufacturers' specifications showed a dry storage life of up to five years. Packing dates on the surplus cells revealed that the cells were 12 years old, yet they charged right up and have performed satisfactorily.

When selecting surplus cells, avoid any that have been in service. Remember, these might pay off for scrap as the silver oxide electrode has a sizeable percentage of

# Will Silver - Zinc Replace the Nicad?

- - portable power with a punch

Sam Kelly W6JTT  
12811 Owen Street  
Garden Grove CA 92645

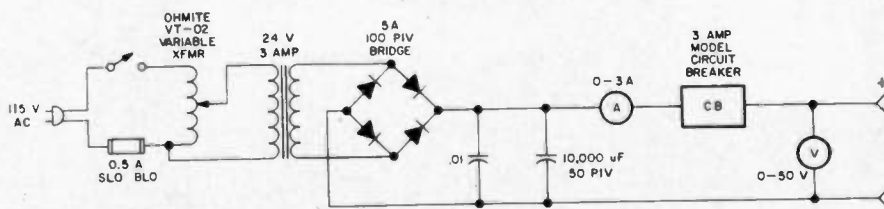

Fig. 1. Dc supply and battery charger.

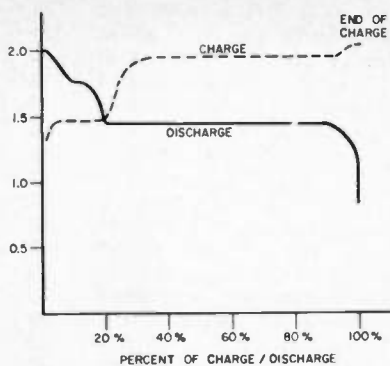

Fig. 2.

recoverable silver when the cell is discharged! Buy only dry charged cells that are unused, and preferably ones that are still sealed from the atmosphere. Once electrolyte

has been added, the life span of the cell ranges from six months to two years, with the high discharge cells having the least life span.

My main application for the cells is to power an RF Communications MARS issue RF-403 VHF transceiver. Using 9 Yardney HR-5DC-8 cells results in a handy-pack that could run the set on full transmit (20 Amps) for about 15 minutes of continuous transmission! Since the set draws only 150 mA on

receive and about 3 Amps on reduced power transmit, I typically get 10 to 12 operating hours between charges from a package that measures only 2.9 x 1 x 5.3 inches, and weighs only a little over 3 pounds! Obviously, the operating time would depend heavily upon the transmit to receive duty cycle. The size to energy ratio of these little jewels makes it worthwhile to search through your favorite surplus mart and invest in them. ■

# 1976 Index

Compiled by  
Warren Eilly WA1GUD/1

<b>AMPLIFIERS</b> (see SURPLUS)			
Run The Legal Limit with One Shoe	WA7IEO	226	Jan
The Mighty TR-22/15	WB4MYL	60	Apr
Build This Inexpensive 400 Watt Amplifier	W7CSD	22	Hol
<b>ANTENNAS</b>			
De-Strain Your Ham-M	K6BW	26	Jan
Why Fight It?	WA0KKC	173	Jan
Save Money on Coax	W8HXR	181	Jan
The "Little Log" for 40 to 20m	VE4GS	211	Jan
A Transmission Line Matcher	W5JJ	46	Feb
Catch Big Ones - fishpole mobile	W4RHZ	100	Feb
Alarm Foil Antennas	WB2NEL	136	Feb
A \$5 100 Watt Amplifier	VE6OB	38	Apr
The Tuna-Two Traveler	W1RHN	56	Apr
The Magnificent Sevens Microhelix	Jacoby	16	May
An Allband Inverted Vee	WA5FGC	22	May
Squaring the Conical	Staff	24	May
Secret Antennas for Cliff Dwellers	WA6PXY	26	May
The Novice Inverted Vee	W8HXR	30	May
Closed Loop Antenna Tuning	WA5KPG	32	May
The 75-80m Broadbander	K2VGD	34	May
The Magic of a Matchmaker	W1CEJ	38	May
How to Coax Your Antenna	W6AGX	40	May
40m DXing - city style	K8ANG	42	May
The Secret 2m Mobile Antenna	Staff	44	May
An Inverted Vee for 160/80m	K8ANG	46	May
The Dipole Dangler	PY8ZAC/W8VOH	48	May
5/8 Wave Power for Your HT	W8KUT	118	May
Aim Your Beam Right	WB4GVE	122	Jun
Don't Build This Project (field strength meter)	W8LWS	79	Jul
Gain for Your HT	K3VNR	149	Jul
The Super Transmatch	Staff	150	Jul
Surprising Miniature Low Band Antennas - part I	Boyer	28	Aug
The Surprising DRRR Low Noise Antenna - part II	Boyer	34	Sept
Can An Indoor Antenna Work?	Staff	56	Sept
The Hybrid Quad	WB8VCS/5	48	Oct
Quickie Collinears for 15 and 10	K8ANG	58	Oct
The Beam Saver	W6YUY	46	Nov
The Amazing Inverted L	K8ANG	94	Nov
The ZF Special Antenna	ZF1MA	51	Dec
Exploding the Power Myth	W9IK/XE1ZX	120	Dec

Exploding the SWR Myth	G3OGR	122	Dec
The Amazing 18" Antenna for 160m	W2NYU/WA1JJV	52	Hol
\$25 for a Connector? You're Crazy!	W9DOR	56	Hol
Tuning Those Big Antenna Coils	W6AGX	127	Hol
60' Antenna on a 20' Lot	Collector and Emitter	138	Hol
Kints and Hinks (2m Quarter Wave)	VE3FEZ	147	Hol
Catch Standing Waves	W6AGX	151	Hol
Three for Two	K4TWJ	160	Hol

<b>ATV</b>			
Simple Amateur TV Transmitter	WB4YTU/WA9GVK	26	Jun
Amateur TV Receiving System	WB4YTU/WA9GVK	33	Jun
Super Simple 450 MHz Rig	WB4YTU/WA9GVK	72	Aug
Ham Time-Sharing is Here for You	WB4YTU/WA9GVK	134	Nov

<b>AUDIO</b>			
How's Your Speech Quality?	Staff	44	Feb

<b>CB</b>			
How to Catch a CBer	Fields	74	Sept
Saving a CBer	WA2KBZ/JY9KS	62	Dec
Cash In on the CB	WA4WOC	104	Hol

<b>CLOCKS</b>			
Clocks... Really Simplified!	WB2NEL	22	Jan
Build This S5 Timer	VE2FEZ	129	Jan
The Two Timer	Deeds	106	Apr
Behold the Giant Nixie Clock	W4LLR	70	Jul
Dependable Timer	W1HCI	84	Jul
Oops! There Goes the Power	W4CUG	92	Jul
CT7001 Clockbuster	WB5DEP	52	Dec

<b>COMMERCIAL EQUIPMENT</b>			
Module Kits - A Low Cost Breakthrough	W1HCI, W2EDN	144	Jan
Improving the FT-101	K8ANG	112	Feb
Put Your SB-10 on 160m	WA2ECI	121	Feb
Carrier Indicator for Your Regency	WA1SNI	42	Apr
The Mighty TR-22/15	WB4MYL	60	Apr
TR-22 Tips	K9POX	126	Apr
Scan Your HR212	K9EEH	66	May
TT Pad for the Wilson HT	WA1LOU	94	Jul
FSK with the SB-401	WA3AJR	150	Aug
The S38 Is Not Dead!	W6GXN	88	Nov
Add RIT To Your Transceiver	Staff	36	Hol
The Mod Squad Does the Pocket Scanner	WB0KZV	66	Hol
The TR-22 Mod Squad	WA9AJQ	69	Hol
Red and Green LEDs for the TR-22	WB8IMY	108	Hol
Mod Squad Tackles the Weatheradio	W2OSW/W2UJR	128	Hol
Inside the GLB Synthesizer	WA6CPP	154	Hol
A 450 Duplexer (SBE SB-450 Mods)	W7JSW	164	Hol

<b>CONSTRUCTION</b>			
The Solder Master	K6JM	92	Jan
Capacitors Unmasked	K6HKB/1	172	Jan
You Can Make Photo IC Boards	Harrington	30	Feb
Copper Clad	W6HGX	134	Apr

Gone in a Flash (strobing)	W9CGI	120	May	The Mighty TR22/15	WB4MYL	60	Apr
Handy Dandy Soldering Iron Cooler Offer	WB4FDQ	18	Jul	A New Fashion in Hats for the Fun Mode?	WB8FJA	130	Apr
The Skinflint's Delight Breadboard	K7YGP/7	52	Aug	The Secret 2m Mobile Antenna	Staff	44	Apr
Blowtorch Your ICs	VE3FEZ	101	Oct	5/8 Wave Power for Your HT	W8KUT	118	May
Cordless Iron Tips	K9POX	26	Nov	Super COR — digital . . . of course!	WA0BMP, WB0JHS	16	Jun
What's All This Wire-Wrap Stuff?	K2STV	116	Dec	Touchtone Decoder — using a calculator readout	W2A00	26	Jun
Secret PC Layout Method	WA9VFG	46	Hol	Mobile Autodialer	WB9LTA	44	Jun
A Great Way to Layout PC Boards	WB4TTY	53	Hol	Autocall '76	WA6JMM	52	Jun
Micrometers for Microwaves	Kehl	112	Hol	Phone Patching '76	WA1RTD	67	Jun
Design Your Own PC Boards	Adsit	130	Hol	Der Repeatermeister	WA1UFE	58	Jul
Do-It-Yourself Ceramics	WA9VFG	168	Hol	Gain for Your HT	K3VNR	149	Jul

### CONTROL

Long Distance Call Eliminator	W7JSW	44	Apr
Simple New TT Decoder	W7JSW	52	Apr
One IC Tone Burster	WB6ZUA	55	Apr
Dandy Digital Dial Decoder	W9CGI	116	Nov
Toward a More Perfect Touchtone Decoder	WA3VXH	178	Nov
Go Tone for Ten	WB6GON	22	Dec

### COUNTERS

A \$50 Self-Powered Counter	WA7SCB	130	Jan
What Do You Want To Count?	WA7SCB	66	Feb
Counters Are Not Magic	WB2NEL	126	Sept
Build a Counter for Your Receiver	WA3YGJ	28	Oct
Frequency Detector for Your Counter	W2A00	50	Oct
500 MHz Scaler	K2OAW	62	Oct
The Latest in Counters	WA1UFE/8	140	Dec

### CW

"We Must Abandon Ship . . . Help . . ."	WB4SNC	230	Jan
Stereo — A New Type of CW Filter	WBKZM	48	Mar
Build a CW Memory	WA6VVL	102	May
Glass Arm — the dreaded CW disease	Bach	38	Jan
A Morse to RTTY Converter			
— using a microprocessor	WB6SQU	106	Jun
Perfect CW	WA9VGS	21	Jul
CW Regenerator/Processor	W6GXN	80	Jul
Your Computer Can Talk Morse	Whitfield	133	Jul
PROM Memory Revisited	WA6VVL	92	Sept
Another CW Keyboard Keyer	WA9VGS	78	Oct
A Ham's Computer — CW/RTTY the easy way	K7YZZ	78	Dec
Hutchinson's Remedy — Chirpless CW	VE3CWY	62	Hol

### DIGITAL

Is Digital All That New?	WA9VFG	94	May
Power Supply Testing	Tenny	112	Jul
How Do You Use ICs? — part I	WA2SUT/NNN0ZVB	24	Aug
What's When — timing diagrams	Craig	104	Sept
How Do You Use ICs? — part II	WA2SUT/NNN0ZVB	38	Oct
How Do You Use ICs? — part III	WA2SUT/NNN0ZVB	106	Nov
Dandy Digital Dial Decoder	W9CGI	116	Nov
How Do You Use ICs? — part IV	WA2SUT/NNN0ZVB	36	Dec
How Do You Use ICs? — part V	WA2SUT/NNN0ZVB	24	Hol
Superprobe	WA6JMM	92	Hol

### DX

Global Calculations for the DXer	W2IAT	66	Aug
Watch DX with a Spectrum Analyzer	Dewey	162	Dec
DXing with a Weather Map	W9CGI	166	Dec
DXpedition: Memories for a Lifetime	K3JJZ	44	Hol

### FAX

Amateur Weather Satellite Reception	WB8DQT	52	May
Build a FAX from Scratch	W4NK	44	Jul
Weather Satellite Display Control	WB8DQT	122	Nov

### FM

An Automatic Dialer for Deluxe Mobile	WA4SAM	49	Jan
Module Kits — A Low Cost Breakthrough	W1HCl, W2EDN	144	Jan
Really Soup Up Your 2m Receiver	W9ZTK	40	Feb
Tunable FM Receiver Strips	W1SNN	24	Mar
Yes, You Can Build This 2m Receiver	WA7SCB	18	Apr
Put That AM Rig on FM	WB6FVW	34	Apr
A Carrier Operated Relay (COR)	W7JSW	36	Apr
Build A 220 MHz Repeater	WA1UFE	40	Apr
Long Distance Call Eliminator	W7JSW	44	Apr
Repeaters in Paradise	W3EAG	48	Apr
Simple New TT Decoder	W7JSW	52	Apr
One IC Tone Burster	WB6ZUA	55	Apr
The Tuna-Two Traveler	W1RHN	56	Apr

Staff	44	Apr
W8KUT	118	May
WA0BMP, WB0JHS	16	Jun
W2A00	26	Jun
WB9LTA	44	Jun
WA6JMM	52	Jun
WA1RTD	67	Jun
WA1UFE	58	Jul
K3VNR	149	Jul
W2NSD/1	20	Sept
WA8WVF	60	Sept
W1HCl, K1ELT	80	Sept
WA6JMM	52	Oct
W7JSW	90	Nov
WB6GON	22	Dec
K4EEU	46	Dec
WA5RON	106	Dec
WA3SWS	152	Dec
WA1UQC	126	Dec
WB6QDS	38	Hol
WB8STQ	58	Hol
WB5HSK	100	Hol
WA1RTD	148	Hol
K4TWJ	160	Hol

### GADGETS

Trekkies, Build this Starfleet Communicator!	WA3AJR	18	Feb
The Sound of Random Numbers	WA1GSF	60	Feb
Hey, Look What My Daddy Built!	Ciavcia	104	Oct
Put Your Name in Lights	W4LLR	60	Nov
The Wind Counter	W9CGI	84	Nov
Big Noise Burglar Alarm	WA3SWS	114	Nov
The Coffee Flipper	WA3VXH	162	Nov
Using a Wireless Broadcaster	WA9VGS	184	Nov

### HISTORY

"We Must Abandon Ship . . . Help . . ."	WB4SNC	230	Jan
Hot Carbon	W1BNN	28	Jan
Thirty Years of Ham RTTY	W2NSD/1	110	Nov
The Man Who Invented AC	Goldman	164	Nov
The Quiet Spy	Matlack	188	Nov
Paolo	W7IDF	258	Nov

### HUMOR

60 Hurts Per Second	WA8GDW	98	Feb
Glitchgate	WA8WTE	102	Feb
Chariots of the Hams?	WB0FKZ	98	Apr
Bicentennial Seconds	WA1DFL	136	Apr
It Happened to Me	WB2HJD	132	May
A Failure to Communicate	WB4YDX	143	May
Dear Gabby	W7IDF	109	Hol

### ICs

Stack Your ICs and Pot 'Em	W4CUG	95	Jan
99¢ IC BFO	WB5MJT	201	Jan
The Experimenter's Dream Card	K9AIY	222	Jan
The IC See-er	WB4FDQ	72	Mar
The Ins and Outs of TTL	W1EWL	96	May
A TTL Tester	WA9VFG	110	Oct
How Do You Use ICs? — part I	WA2SUT/NNN0ZVB	24	Aug
How Do You Use ICs? — part II	WA2SUT/NNN0ZVB	38	Oct
How Do You Use ICs? — part III	WA2SUT/NNN0ZVB	106	Nov
How Do You Use ICs? — part IV	WA2SUT/NNN0ZVB	36	Dec
How Do You Use ICs? — part V	WA2SUT/NNN0ZVB	24	Hol
IC Audio Frequency Meter — the 555	WA5KPG	61	Hol

### ID

A Reprogrammable ID	WA3MSW	28	Apr
Programmable CW ID Unit	WA6JMM	52	Oct
ID with a PROM	W7JSW	90	Nov
A Super Cheapo CW IDer	K4EEY	46	Dec

### I/O

The Computer QSO Machine	W1HAB	80	Jan
Using A Bargain Surplus Keyboard	W60XP	212	Jan
Believe Me — I'm No Expert!	W2NSD/1	86	Feb
What's That In Binary?	W3KBM	92	Mar
Computers Are Ridiculously Simple!	Wadsworth	68	Apr
Computer Languages — simplified	WB8TUR	70	May



A Very Cheap I/O — the Model 15 . . . . .	W5CUD, Whipple	77	May
A Nifty Cassette-Computer System . . . . .	Staff	88	May
Is Digital All That New? . . . . .	WA9VFG	94	May
The Ins and Outs of TTL . . . . .	W1EWL	96	May
Two Finger Arithmetic . . . . .	W1HCI	84	Jun
Those Exciting Memory Chips . . . . .	Fowler	96	Jun
Number Systems . . . . .	W6PZV	112	Jun
Inexpensive Paper Tape System . . . . .	W5CUD, Whipple	145	Jul
The First Computer-Controlled Ham Station . . . . .	WABVNP	82	Aug
The Which Chip Dilemma! . . . . .	Pittman	90	Aug
Meaningful Conversations with your Computer . . . . .	WB2ZCF	98	Aug
A Baudot Monitor/Editor System . . . . .	W5CUD, Whipple	102	Aug
How Computer Arithmetic Works . . . . .	W1HCI	108	Aug
The Death of Negative (IBM) Logic . . . . .	W6KYP	116	Aug
And on the Other Side			
— binary octalization of decimals . . . . .	W3KBM	120	Aug
PROM Memory Revisited . . . . .	WA6VVL	92	Sept
What's When — timing diagrams . . . . .	Craig	104	Sept
Eight Trace Scope Adapter . . . . .	Johnson	108	Sept
The PROM Zapper . . . . .	WA1UFE	112	Sept
Sneaky Baudot — with an ASCII Keyboard . . . . .	W3KBM	115	Sept
Simple Graphics Terminal . . . . .	KIMRK, Ciarcia	116	Sept
How to Interface a Clock Chip . . . . .	GBKWR/DC0GK	102	Oct
How to Check Memory Boards . . . . .	VE3OWC	114	Oct
The New Ham Programmer . . . . .	W2HBY	118	Oct
The Soft Art of Programming — part I . . . . .	Didday	124	Oct
BASIC? What's That? . . . . .	WA1GFJ	128	Oct
Ham Time-Sharing is Here for You! . . . . .	WB4YTU/WA9GVK	134	Nov
The Soft Art of Programming — part II . . . . .	Didday	140	Nov
OSCAR Orbits on Your Altair . . . . .	G3ZCZ	146	Nov
ASCII/Baudot Converter for Your TVT . . . . .	Roloff	150	Nov
Baudot to ASCII . . . . .	Borgerson	172	Nov
Baudot and BASIC . . . . .	W5CUD, Whipple	174	Nov
A Ham's Computer . . . . .	K7YZZ	78	Dec
What's All This LSI Bunk . . . . .	Leventhal	84	Dec
The Soft Art of Programming — part III . . . . .	Didday	92	Dec
Getting By the Friden B800 Communications Gap . . . . .	VE3DWC	100	Dec
What Computers Can and Can't Do . . . . .	WB6OBS	80	Hol
A Ham Shack File Handler . . . . .	W4BQ	82	Hol
Print Your Own Log Book . . . . .	W0TBL	84	Hol
The Bit Explosion . . . . .	WB2GFE	86	Hol
Backward Branch the Easy Way . . . . .	Hunter	90	Hol
The Frumious Hexadecimal — Beware! . . . . .	W3KBM	94	Hol

**KEYERS**

MINI-MOS — The Best Keyer Yet? . . . . .	WA6EGY	38	Aug
How to Bug an Automatic Keyer . . . . .	WB9BNF	162	Hol
The Hellbox All-Purpose Keyer . . . . .	W5JJ	192	Hol

**LICENSING**

Greetings, You Have Been Selected . . . . .	K0CBA	176	Jan
How to Pass Exams . . . . .	WBHXR	182	Jan
Docket 206B6 (IDing) . . . . .	FCC	148	May
A Representative Democratic Republic? . . . . .	WA6ITF	8	Jun
Docket 19723 (RACES) . . . . .	FCC	143	Jun
Docket 20147 (HIRAN) . . . . .	FCC	155	Jul
Docket 20777 (Bandwidth) . . . . .	FCC	160	Aug
Docket 20092 (Extra class calls) . . . . .	FCC	163	Aug
Docket 202B2 (Restructuring) . . . . .	FCC	132	Sept
FCC (Novice Class Callsigns) . . . . .	FCC	180	Dec

**MISC**

Ham Q Quiz . . . . .	W5UOJ	156	Jan
Saving Ham Radio . . . . .	WA4BDW	162	Jan
County Hunting . . . . .	W2SDU	192	Jan
Switch It Off First . . . . .	VK3IQ	108	Feb
Maintenance Musts . . . . .	WA6CPP	132	Feb
Adventure . . . . .	Bach	16	Mar
Inherit the Wind . . . . .	W2A00	44	Mar
AM is not Dead . . . . .	WA1WDS	110	May
Is Extraterrestrial Communication Possible? . . . . .	K6BW	114	May
Lightning and Thunder and Other Stuff . . . . .	Bach	64	Jul
Balloon to Balloon . . . . .	W2NSD/1	20	Sept
Who, me? A Pioneer? . . . . .	W5WGF	54	Nov
See the World and Get Paid! — part I . . . . .	Hargett	75	Nov
Battery Chargers Exposed . . . . .	W6GXN	98	Nov
Hamming 101 . . . . .	Inman	40	Dec
See the World and Get Paid! — part II . . . . .	Hargett	154	Dec
Get a Kid Off the Streets . . . . .	WA1GFJ	35	Hol
Hamming by Laser . . . . .	WA7NMO	134	Hol
Kints and Hinks . . . . .	VE3FEZ	147	Hol

**MOBILE**

Adding An Ammeter to Your Car . . . . .	WB5DEP	34	Feb
Alarm! Alarm! Alarm! . . . . .	WB4MYL	138	Feb
Put a Pin Hole in Your Cadillac's Roof . . . . .	Staff	60	Mar
The Secret 2m Mobile Antenna . . . . .	Staff	44	May
Build a Weird 2 Band Mobile Antenna . . . . .	W6AAQ	20	Oct
Bicycle Mobile . . . . .	WB4SNC	30	Nov
Mobile Smokey Detector . . . . .	W1SNN	32	Hol
Coronaries for Burglars . . . . .	WB6QDS	38	Hol
\$22 for a Regulator? Never! . . . . .	WB9JSE	103	Hol
Simple Remote Ammeter . . . . .	W7RXV	111	Hol
Turn Signal Reminder . . . . .	K5AR/7	166	Hol

**NEW PRODUCTS**

Vector Plugboard Model 4350 . . . . .	Staff	14	Feb
Hufco TWS-300 TWS-600 Frequency Counters . . . . .	Staff	15	Feb
D-D's Magnifier/Lamp . . . . .	Staff	15	Feb
The Cromemco Bytesaver™ . . . . .	Staff	8	Mar
Lab Science's ECONOTRACE . . . . .	Staff	115	Apr
Inline Instruments 100H Inline Coupler . . . . .	Staff	124	May
Inline Instruments 101 PRH Inline Relay . . . . .	Staff	124	May
MFJ CMOS-B043 Electronic Keyer . . . . .	Staff	124	May
AP Products Flat Ribbon Jumpers . . . . .	Staff	125	May
Kenwood TS-700A 2m Transceiver . . . . .	WA1WDS	125	May
Wilson 1405SM . . . . .	W2NSD/1	141	Jun
VHF Engineering PS-15C, PS-25C Power Supplies . . . . .	W1HCI	141	Jun
Nexus PC Boards for Two-Timer Clock . . . . .	Staff	141	Jun
ICOM IC-202 . . . . .	WB6JNN	41	Jul
Yaesu FT-221 2m Transceiver . . . . .	WA1WDS	16	Aug
Ham Radio Center HK4			
Straight Key/Dual Lever Paddle . . . . .	Staff	16	Aug
Standard Horizon 29 . . . . .	W2NSD/1	16	Aug
Alphanumeric Transfer Sheet (AN1X) . . . . .	Staff	17	Aug
Palomar Electronic Keyer . . . . .	Staff	17	Aug
<i>Machine Language Programming for the 8008 and Similar Microcomputers</i> . . . . .	Staff	17	Aug
Southwest Technical Products GT-61			
Graphics Terminal Unit . . . . .	Staff	18	Sept
B&K-Precision Model 2B3 3½ Digit Multimeter . . . . .	Staff	18	Sept
Unarco-Rohn TB-3 Thrust Bearing . . . . .	Staff	19	Sept
Southwest Technical PR-40 Alphanumeric Printer Kit . . . . .	Staff	19	Sept
AP Products ACE Solderless Breadboards . . . . .	Staff	27	Oct
Drake RCS-4 Remote Control Antenna Switch . . . . .	Staff	27	Oct
Hewlett-Packard 3455A Digital Voltmeter . . . . .	Staff	20	Nov
Sencore TF40 Transistor/FET Checker . . . . .	Staff	20	Nov
UC 1800 Microcomputer . . . . .	Staff	21	Nov
National Semiconductor "Adversary" TV Game . . . . .	Staff	21	Nov
Lectronix DC-101A Automotive Digital Clock . . . . .	Staff	21	Nov
Infinite FS 20 Field Strength Meter . . . . .	Staff	23	Nov
Hewlett-Packard Low Power Large Monolithic LED Displays . . . . .	Staff	23	Nov
Eico DLP-6 Logic Probe . . . . .	Crenshaw	20	Dec
KLM Multi-2700 All Mode Transceiver . . . . .	Staff	20	Dec
VIZ WD-752A Frequency Counter . . . . .	Staff	21	Dec
Sencore F-14 Field Effect Meter . . . . .	W6AJZ	21	Dec
Now You Can Synthesize (VHF Engineering II) . . . . .	WB8STQ	58	Hol

**NOVICE**

Work a Novice . . . . .	W2OLU	171	Jan
Night DXing on 10 and 15 . . . . .	WN2UGO	95	Feb
WH6DBF-K10XK-W6LZJ . . . . .	W6LZJ	124	Feb
The Magnificent Sevens Microhelix . . . . .	Jacoby	16	May
The Novice Inverted Vee . . . . .	WBHXR	30	May
Get a Kid Off the Streets . . . . .	WA1GFJ	35	Hol
Design Your Own QRP Dummy Load . . . . .	WA1SNG	48	Hol
Replacing the Knife Switch . . . . .	WA1SNG	54	Hol
60' Antenna on a 20' Lot . . . . .	<i>Collector and Emitter</i>	138	Hol

**OSCAR**

OSCAR Orbits on Your Altair . . . . .	G3ZCZ	146	Nov
---------------------------------------	-------	-----	-----

**POWER SUPPLY**

Zapping Dead Nicads to Life . . . . .	K2OAW	62	Jan
The Smart Power Supply . . . . .	WA4SAM	96	Mar
Power Supply Testing . . . . .	Tenny	112	Jul
Ultrasimple Regulation with New IC . . . . .	WB0JLS	48	Sept
12 Inexpensive Volts for Your Base Station . . . . .	WA8WVF	60	Sept
Battery Chargers Exposed . . . . .	W6GXN	98	Nov
Power Supply — Versatile . . . . .	WB4EHG	40	Hol
Failsafe Super Charger . . . . .	WA3KKM	49	Hol
The Smart Charger . . . . .	WA5KPG	110	Hol
Dual Voltage Power Supply . . . . .	W6WQC	140	Hol

Will Silver-Zinc Replace the Nicad? . . . . .	W6JTT	204	Hol	Instant Counter Calibration . . . . .	K9POX	70	Aug
<b>PUBLIC SERVICE</b>				A Logic Probe You Can Hear . . . . .	WA6HWJ	106	Aug
Patching Tales . . . . .	W8HXR	166	Jan	El Cheapo Signal Tracer . . . . .	WB8EQQ	148	Aug
<b>RECEIVERS</b>				A Test Lab Bonanza — Free! . . . . .	WA7SCB	64	Sept
What's All the Noise? . . . . .	W2DNY	154	Jan	Build a Counter for Your Receiver . . . . .	WA3YGJ	28	Oct
Really Soup Up Your 2m Receiver . . . . .	W9ZTK	40	Feb	Frequency Detector for Your Counter . . . . .	W2A00	50	Oct
Tunable FM Receiver Strips . . . . .	W1SNN	24	Mar	Is My Rig Working or Not? . . . . .	K8VIR	56	Oct
160m Solid State Receiver . . . . .	VK3ANY	52	Mar	500 MHz Scaler . . . . .	K2OAW	62	Oct
Yes, You Can Build This 2m Receiver! . . . . .	WA7SCB	18	Apr	Build a Super Standard . . . . .	WA7VVC	66	Oct
Is It The Band or My Receiver? . . . . .	Staff	132	Oct	Is It the Band or My Receiver? . . . . .	Staff	132	Oct
The S38 Is Not Dead! . . . . .	W6GXN	88	Nov	Build a Simple "Lab" Scope . . . . .	K8JWR	32	Nov
World's Simplest Five Band Receiver . . . . .	K3QKO	28	Dec	Updated Universal Frequency Generator . . . . .	K3EZ	50	Nov
Build a Counter for Your Receiver . . . . .	WA3YGJ	28	Oct	The Smoke Tester . . . . .	W7RXV	159	Nov
<b>RTTY</b>				The Latest in Counters . . . . .	WA1UFE/8	140	Dec
ASCII to Baudot Converter . . . . .	W60XP	52	Feb	Design Your Own QRP Dummy Load . . . . .	WA1SNG	48	Hol
RTTY Autocall — the digital way . . . . .	VE6BV	76	Feb	Superprobe . . . . .	WA6JMM	92	Hol
Build This Exciting New TVT . . . . .	K7YZZ	76	Mar	V-V-V LF Generator . . . . .	Hileman	97	Hol
Magic Fingers for RTTY . . . . .	W9CGI	86	Mar	<b>THEORY</b>			
A Versatile TTY Generator . . . . .	WA6JMM	90	Apr	The PLL — Exposed! . . . . .	WB2NEL	102	Apr
Code Converter Using PROMs . . . . .	K7YZZ	84	May	How Those Triangle Things Work . . . . .	K7YGP/7	60	Jun
A Morse to RTTY Converter . . . . .				More PLL Magic . . . . .	W9ZTK	56	Aug
— using a microprocessor . . . . .	WB6SQU	106	Jun	Never Underestimate the NAND . . . . .	WB0JHS	128	Aug
ASCII/Baudot with a PROM . . . . .	W8LNY	114	Jun	The Incredible Lambda Diode . . . . .	WB5DEP	70	Oct
A RTTY/Computer Display Unit . . . . .	Roloff	118	Jul	Have You Used a Triac Yet? . . . . .	WB9JSE	76	Oct
More PLL Magic . . . . .				Liquid Crystal Display Guide . . . . .	WB5DEP	62	Nov
— like low frequencies for RTTY . . . . .	W9ZTK	56	Aug	Battery Chargers Exposed . . . . .	W6GXN	98	Nov
The First Computer-Controlled Ham Station . . . . .	WA8VNP	82	Aug	Exploding the Power Myth . . . . .	W9IK/XE1ZX	120	Dec
Build the Safari RTTY Terminal . . . . .	DL2SX/ZS6JR	122	Aug	Exploding the SWR Myth . . . . .	G3OGR	122	Dec
FSK with the SB-401 . . . . .	WA3AJR	150	Aug	<b>TOUCHTONE</b>			
Ridiculously Simple RTTY System . . . . .	W3KBM	70	Sept	Simple New TT Decoder . . . . .	W7JSW	52	Apr
Sneaky Baudot — with an ASCII keyboard . . . . .	W3KBM	115	Sept	The Shirt Pocket Touchtone . . . . .	K4TWJ	58	Nov
Mechanical RTTY Buffer . . . . .	K5UAR	74	Oct	Toward a More Perfect Touchtone Decoder . . . . .	WA3VXH	178	Nov
RTTY/uP Flexibility . . . . .	Roloff	96	Oct	<b>TRANSCEIVERS</b>			
Thirty Years of Ham RTTY . . . . .	W2NSD/1	110	Nov	A 450 MHz Transceiver for Under \$130 . . . . .	W1HCl, K1ELT	80	Sept
A Ham's Computer . . . . .	K7YZZ	78	Dec	Get on Six with Surplus . . . . .	WA5HLE	40	Nov
<b>SATELLITE</b>				The Benefits of Sidetone Monitoring . . . . .	Staff	191	Nov
Amateur Weather Satellite Reception . . . . .	WB8DQT	52	May	Add RIT To Your Transceiver . . . . .	Staff	36	Hol
Satellite Orbit Predicting . . . . .				<b>TRANSMITTERS</b>			
— using a pocket calculator . . . . .	W1ODI	113	Aug	Put That AM Rig on FM . . . . .	WB6FVW	34	Apr
Weather Satellite Display Control . . . . .	WB8DQT	122	Nov	The Mini-Mite Allband QRP Rig . . . . .	WA7SCB	30	Jul
<b>SSTV</b>				QRP Fun on 40 and 80 . . . . .	K5JRN	44	Oct
Improve Your SSTV with The Framer . . . . .	W2FJT	218	Jan	Hamming by Laser . . . . .	WA7NMO	134	Hol
Gray Matters . . . . .	W9CGI	122	Apr	Tubes . . . ? — VFO Project for Nostalgia Buffs . . . . .	W5JJ	172	Hol
555 Timer Sweep Circuit for SSTV . . . . .	W8KZM	134	May	<b>VACUUM TUBES</b>			
Creative SSTV Programming . . . . .	WB8DQT	76	Jul	Empty State . . . . .	Bach	202	Jan
Put Snap in Your SSTV Picture . . . . .	W2FJT	112	Dec	Tubes Are Not Dead! . . . . .	WA6ITF	56	Mar
<b>SURPLUS</b>				<b>VHF</b>			
Surplus Circuit Boards . . . . .	W0FEV	28	Mar	Module Kits — A Low Cost Breakthrough . . . . .	W1HCl, W2EDN	144	Jan
The Perils and Pleasures of Surplus Shopping . . . . .	Thompson	30	Mar	Really Soup Up Your 2m Receiver . . . . .	W9ZTK	40	Feb
Space Age Junque . . . . .	W9CGI	34	Mar	Tunable FM Receiver Strips . . . . .	W1SNN	24	Mar
A PC Board Bonanza . . . . .	WA4LAM/W5SAY	38	Mar	Yes, You Can Build This 2m Receiver! . . . . .	WA7SCB	18	Apr
Government Surplus: Is It All Gone? . . . . .	WN5NBE	40	Mar	Put That AM Rig on FM . . . . .	WB6FVW	34	Apr
How to Use Surplus Pots . . . . .	WB0NPN	108	Mar	A Carrier Operated Relay (COR) . . . . .	W7JSW	36	Apr
Tech Manuals . . . . .	K4ORT	140	May	A \$5 100 Watt Amplifier . . . . .	VE6OB	38	Apr
Space Age Junque II . . . . .	W9CGI	84	Sept	Build A 220 MHz Repeater . . . . .	WA1UFE	40	Apr
Simple Graphics Terminal — using inexpensive surplus equipment . . . . .	K1MRK, Ciarcia	116	Sept	Repeaters in Paradise . . . . .	W3EAG	48	Apr
Blowtorch Your ICs . . . . .	VE3FEZ	101	Oct	Simple New TT Decoder . . . . .	W7JSW	52	Apr
Get on Six with Surplus . . . . .	WA5HLE	40	Nov	One IC Tone Burster . . . . .	WB6ZUA	55	Apr
\$25 for a Connector? You're Crazy! . . . . .	W9DOR	56	Hol	The Tuna-Two Traveler . . . . .	W1RHN	56	Apr
Surplus Headset Mod . . . . .	K2EE	107	Hol	The Mighty TR22/15 . . . . .	WB4MYL	60	Apr
<b>TEST EQUIPMENT</b>				The Secret 2m Mobile Antenna . . . . .	Staff	44	May
Plugboard Extender for Under \$3.00 . . . . .	W3WTO	65	Jan	Super COR — digital . . . of course! . . . . .	WA0BMP, WB0JHS	16	Jun
Eyes for Your Shack (scope) — conclusion . . . . .	W0ACR	66	Jan	Touchtone Decoder — using a calculator readout . . . . .	W2A00	26	Jun
Build This Digital Capacity Meter . . . . .	Chladek	70	Jan	Mobile Autodialer . . . . .	WB9LTA	44	Jun
How to Become a Troubleshooting Wizard . . . . .	K4IPV	138	Jan	Autocall '76 . . . . .	WA6JMM	52	Jun
A Synthesized IC Frequency Standard . . . . .	Plavcan	22	Feb	Phone Patching '76 . . . . .	WA1RTD	67	Jun
Adrift Over your C's? . . . . .	G3OGR	106	Mar	Der Repeatermeister . . . . .	WA1UFE	58	Jul
Inexpensive HF-VHF Frequency Standard . . . . .	WA5KPG, WA5QZM	62	Apr	What's Up on 156 MHz? . . . . .	K3RXK	88	Jul
How Accurate Is Your Counter — Really? . . . . .	W6YUY	110	Apr	Simple VHF Monitor . . . . .	W6JTT	160	Jul
RF and Mod Monitor . . . . .	K5JRN	142	May	Protect Your VHF Converter . . . . .	WB2NTP	68	Sept
Build This Lab Type Bridge . . . . .	WB4FDQ	56	Jun	A 450 MHz Transceiver for Under \$130? . . . . .	W1HCl, K1ELT	80	Sept
A Fun Counter Project . . . . .	Plavcan	36	Jul	Bring a Dead Band to Life . . . . .	WB8BEL	125	Dec
The Logic Grabber . . . . .	WA3TCO	60	Aug	DXpedition: Memories for a Lifetime . . . . .	K3JJZ	44	Hol
				Micrometers for Microwaves . . . . .	Kehl	112	Hol
				A 450 Duplexer . . . . .	W7JSW	164	Hol

# 73 READER SERVICE

Circle appropriate Reader Service # for desired company brochures, data sheets or catalogs and mail to 73 Include your zip code, please. Send money directly to advertisers. LIMIT: 25 requests.

A1	C20	C25	G2	I6	M10	P9	S1	V1	73
A24	C24	C14	G3	J3	M2	P1	S25	V3	
A2	C1	C11	G4	J1	M8	P2	S22	V5	
A21	C13	D6	H2	K6	M4	P10	S4	W8	
A12	C21	D10	H5	K1	M11	Q3	S19	W5	
A14	C5	E1	H3	K3	N1	R1	S6	W12	
A6	C6	E9	H11	K7	N4	R11	S10	W7	
A16	C22	E3	H10	K4	O1	R8	T1	W2	
B9	C19	E11	H4	K10	O2	R2	T2	W11	
B10	C26	E12	I1	L3	O3	R9	T3	Y1	
B8	C16	F3	I8	L4	O4	S2	U1		

Subscriber      please print or type       Newsstand Buyer

Name \_\_\_\_\_ Call \_\_\_\_\_

Address \_\_\_\_\_

City \_\_\_\_\_ State \_\_\_\_\_ Zip \_\_\_\_\_

Coupon Expires in 60 Days

H/76

PLACE  
STAMP  
HERE

## 73 magazine peterborough, n.h. 03458

Att: Mail Order

### I WANT TO subscribe!

Send me 73 for:

1 year - \$12.00\*      \$20.00\*       Life Subscription - \$149.00

3 years - ~~\$25.00\*~~ SPECIAL!       Renewal

New Sub.

Enclosed \$ \_\_\_\_\_  Cash       Check       Money order

American Express       BankAmericard       Master Charge

Credit Card # \_\_\_\_\_ Interbank # \_\_\_\_\_

Expiration date \_\_\_\_\_ Signature \_\_\_\_\_

Bill me      Signature \_\_\_\_\_

Name \_\_\_\_\_ Call \_\_\_\_\_

Address \_\_\_\_\_

City \_\_\_\_\_ State \_\_\_\_\_ Zip \_\_\_\_\_

\*U.S. & Canada only! All others please add \$2/year Foreign postage. H/76

# 73 magazine ADVERTISER INDEX

- A1 Adirondack 175
- A24 ADVA Electronics 158
- A2 Aldelco 31
- A21 Amateur Wholesale 152, 153
- A12 Ancrona 137
- A14 Antenna Supermarket 28
- A6 Apron Labs 20
- A16 Arifa 39
- B9 Babylon 187
- B10 Bird Electronic Corporation 93
- B8 Bullet 178, 179
- C20 C & S Marketing 105, 131
- C24 Carialto 38
- C1 CeCo 144
- C13 Chesapeake Digital 186
- C21 Coakit 186
- C5 Communications Electronics 150, 167
- C6 Communications Specialists 16, 101
- C22 Computer Drawing 28
- C19 COM\*STAR 198
- C26 Consumer Pricing Service 186
- C16 Control Signal 186
- C25 Crescent Wire 45
- C14 CRS Co. 186
- C11 CScd 144
- D6 Dahl Co. 185
- D10 Davis 47
- E1 ECM Corporation 31
- E9 Electronic Discount 88
- E3 Electronic Distributors 31
- E11 Emergency Beacon 59
- E12 Engineering Specialists 16
- F3 Freck Radio 31
- G2 Gaurther 184
- G3 GENAVE 50, 51
- G4 Godbout 139
- H2 Ham Radio Center 149
- H5 Heath Company 65
- H3 Henry 21
- M11 Hobb-V-Tronix 145
- M10 Hulco 28, 31, 175, 184
- H4 Hy-Gain 7
- I1 ICOM 5, 42, 43, 55
- I8 ICS Electronics 38
- I6 Intelligent Systems 79
- J3 Jac Tenna Electronics 186
- J1 James 196, 197
- K8 Kaufman 84
- K1 Kensco 142
- K3 Kenwood CIV, 2, 67, 70
- K7 Klaus Radio 133
- K4 KLM CII
- K10 K.W. Manufacturing 95
- L3 Logical Services 88
- L4 Lyle Products 84
- M10 Memtrix 184
- M2 Meshna 141
- M8 MHz Electronics 175
- M4 MITS 96
- M11 MOR-GAIN 81
- N1 National Multiplex 89
- N4 Nye Co. 185
- O1 Ohio Scientific Instrument 85
- O2 ON LINE 84
- O3 Optoelectronics 157
- O4 Orlando Hamcation 77, 143
- P9 Paia 95
- P1 Palomar 129, 186
- P2 Poly Paks 199
- P10 Programming Technologies 38
- Q3 Quast 195
- R1 Radio Amateur Callbook 171
- R11 Radio Mut 159
- R8 Ramsey 193
- R2 Regency 129
- R9 Robot 17
- S2 S. D. Sales 99, 163
- S1 Scalbi 88
- S25 Scott Communications Systems 16
- S22 Seals Electronics 91
- S4 Sep 176, 177
- S19 SouthCom 60
- S5 Southwest Tech. 75
- S10 SST Electronics 186
- Telexon Corp. 185
- TEN-TEC 30
- T1 Tri-Tek 191
- T2 Trumbull 28
- T3 Tutts Radio 113-126
- U1 Universal Radio 186
- V1 Vanguard Labs 144
- V3 Venus Scientific 11
- V5 VHF Engineering 1
- W8 W7124 186
- W5 Wave Mate 77
- W12 W. B. Associates 31
- W7 Whitehouse 140
- W2 Wilson 29, 72, 73
- W11 Winkler Electronics Inc. 184
- V1 Yassu Mussen CIII

- From 73 ...
- Hobby Computers 171
- Kilobaud 78
- 73 Subs 155
- Novice Bargain 161
- Binders 174
- Back Issues 180, 181
- New Books 183
- Mowing? 185
- 73 Stuff 188, 190

\*Reader Service inquiries not honored.

**73 magazine**  
Peterborough NH 03458

FIRST CLASS  
Permit No. 73  
Peterborough NH

BUSINESS REPLY MAIL  
NO POSTAGE NECESSARY IF MAILED IN UNITED STATES

POSTAGE WILL BE PAID BY

**73** magazine  
peterborough, n.h.  
03458

Att: Reader Service

PLEASE SEND ME THE FOLLOWING **73** PRODUCTS:

Quantity	Description	Unit Price	Total

Total for Order

Enclosed \$  Cash  Check  Money order  
Bill:  American Express  BankAmericard  Master Charge  
Credit Card # \_\_\_\_\_ Interbank # \_\_\_\_\_  
Expiration date \_\_\_\_\_ Signature \_\_\_\_\_

Name \_\_\_\_\_ Call \_\_\_\_\_  
Address \_\_\_\_\_  
City \_\_\_\_\_ State \_\_\_\_\_ Zip \_\_\_\_\_

please print or type

H/76

PLACE  
STAMP  
HERE

**73** magazine  
peterborough, n.h.  
03458

Att: Subscriptions

FROM **73**

**73 BOOKS:**

- 2M FM Handbook - \$5.95
- 73 Dipole Antennas - \$5.50
- 73 Vertical Beam Antennas - \$4.95
- 1001 Circuits - \$9.95
- Practical Test Instruments - \$4.95
- Repeater Atlas - \$1.95
- RF and Digital Test Equipment - \$5.95
- Fascinating World of Radio Communication - \$3.95
- SSTV Handbook - \$5.00 (Soft); \$7.00 (Hard)
- Study Guides:
  - Novice - \$4.95
  - General - \$5.95
  - Advanced - \$3.95
  - Extra - \$4.95
- Test Equipment Library: \$4.95 each
  - Volume I - Component Testers
  - Volume II - Audio Frequency Testers
  - Volume III - Radio Frequency Testers
- VHF Antenna Handbook - \$4.95
- VHF Projects - \$4.95
- Weather Satellite Handbook - \$4.95

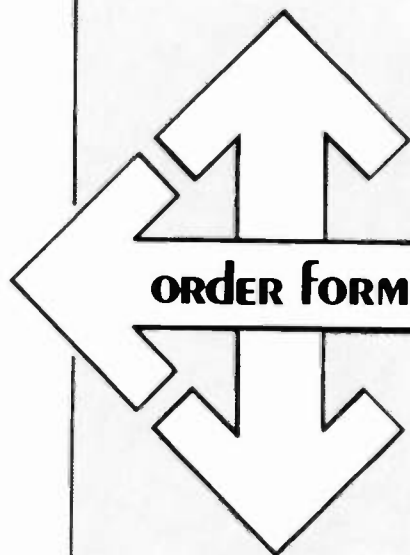

**73 COMPUTER LIBRARY:**

- BASIC - \$4.95
- Computer Programming Handbook - \$8.95
- Hobby Computers Are Here! - \$4.95
- IC Op-Amp Cookbook - \$12.95
- Microcomputer Dictionary - \$15.95
- My Computer Likes Me - \$2.00
- RTL Cookbook - \$5.50
- TTL Cookbook - \$8.95
- What To Do After You Hit Return - \$6.95

For more detailed information see pages 71, 183, 188-90.

- Back Issue Bundles - \$8.00
- 73 Binders - \$6.00
- Bumper Stickers - 50¢
- OSLs - \$6 and up
- 73 Tapes:
  - Code - \$4.95 each; \$15.95 set
  - Novice Theory - \$15.95 set

For more detailed information see pages 161, 174, 180-81, 188-90.

**73** magazine  
Peterborough NH 03458

# YAESU Deluxe "101" Series

## The Ultimate Station Combination



**FL-101 Transmitter**



**FR-101 Digital Readout Receiver**

- 160 thru 10 Meter coverage with two auxiliary bands
- All mode operation: SSB, CW, AM, and FSK
- 240 Watts PEP
- Reliable, plug-in circuit boards
- Built-in AC supply
- Built-in, fully adjustable VOX
- Automatic break-in CW operation with sidetone
- Indicator light for internal VFO operation
- Provision for optional RF speech processor
- Built-in final cooling fan

- Total Coverage: 160 thru 2 Meters with optional 6 and 2 Meter converters
- Provision for all mode reception; SSB, CW, AM, RTTY, and FM with optional filters and FM detector
- Complete transceive capability with all 101 series equipment
- Reliable, plug-in circuit boards
- Selectable fast or slow AGC
- Built-in, threshold adjustable, noise blanker
- Better than 1 KHz readout on all bands
- Fixed channel, crystal-controlled operation
- $\pm 5$  KHz clarifier
- Built-in calibrator 25 or 100 KHz (selectable)
- Indicator lights for internal VFO and clarifier
- Built-in AC and 12V DC power supply

## And . . . For General Coverage - Our New FRG-7 !

- Synthesized all solid state hi-performance
- Triple conversion
- Continuous coverage: 500 KHz to 29.99 MHz
- AC or internal battery with automatic switching in case of power failure
- USB/LSB/AM/CW
- Drift canceling circuit
- Ceramic IF filters
- 5 KHz direct dial readout
- Many, many more super features found only in receivers at three times its price! See at your dealer, or write us for brochure



**FRG-7 Receiver**



**YAESU**  
**The radio.**

Yaesu Electronics Corp., 15954 Downey Ave., Paramount, CA 90723 ● (213) 633-4007  
Yaesu Electronics Corp., Eastern Service Ctr., 613 Redna Ter., Cincinnati, OH 45215 ● (513) 772-1500

# TR-7400A



## KENWOOD'S EXCITING NEW 2-METER TRANSCEIVER

Features Kenwood's brand new and totally unique continuous tone coded squelch system • 4 MHz band coverage (instead of the usual 2)  
• 25 watt output • 800 channels provided by the TR-7400A's phase-locked loop frequency synthesizer • outstanding receiver performance

 **KENWOOD**  
...pacesetter in amateur radio