

73

amateur radio

# BIG DOUBLE ISSUE

*Flip Flops Exposed*  
*Transmission Lines Made Simple*  
*ATV Breakthrough*  
*Interview with Hitler*  
*Eyes for Your Shack*

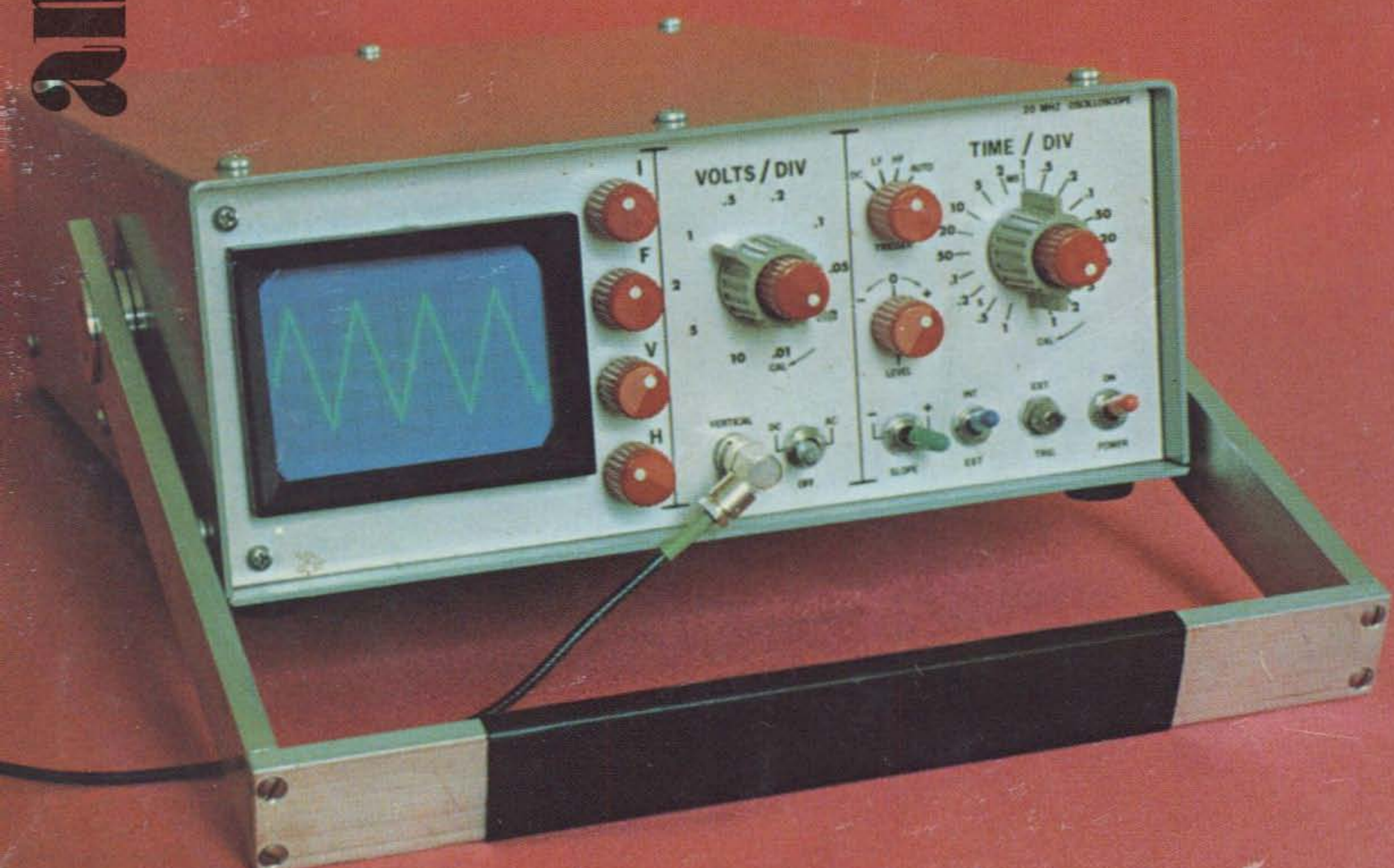

**new**



# the real performer! specifically for repeater

...or any TWO-METER FIXED STATION OPERATION

With **6** db—  
db—

- Gain compared to 1/2 wave dipole
- FCC accepted for repeater application

### mechanical

- Vertical element—117" long, 1-1/8" telescopic to 3/8" OD high strength aluminum
- Radials—four, 21" x 3/16" OD aluminum rod
- Connector—SO-239
- Wind load—26 pounds at 100 mph.
- Wind survival—100 mph.
- Completely self-supporting
- Mounting—fits vertical pipe up to 1-3/4" OD

### electrical

- 6 db. gain over 1/2 wave dipole
- Omnidirectional radiation pattern
- Maximum radiation—at horizon
- 50 ohm feed impedance
- Field adjustable—140-150 MHz
- SWR at resonance—1.2:1 measured at antenna
- Bandwidth—6 MHz for 2:1 or better SWR
- Power—one kilowatt FM
- Feed—Shunt with D.C. grounding
- Radiator—5/8 wave lower section, 1/4 wave phasing, 5/8 wave upper section

The gain you gain—you gain transmitting and receiving—get both with Hustler!

Available from all distributors who recognize the best!

THE HUSTLER MASTER GAINER  
MODEL G6-144-A

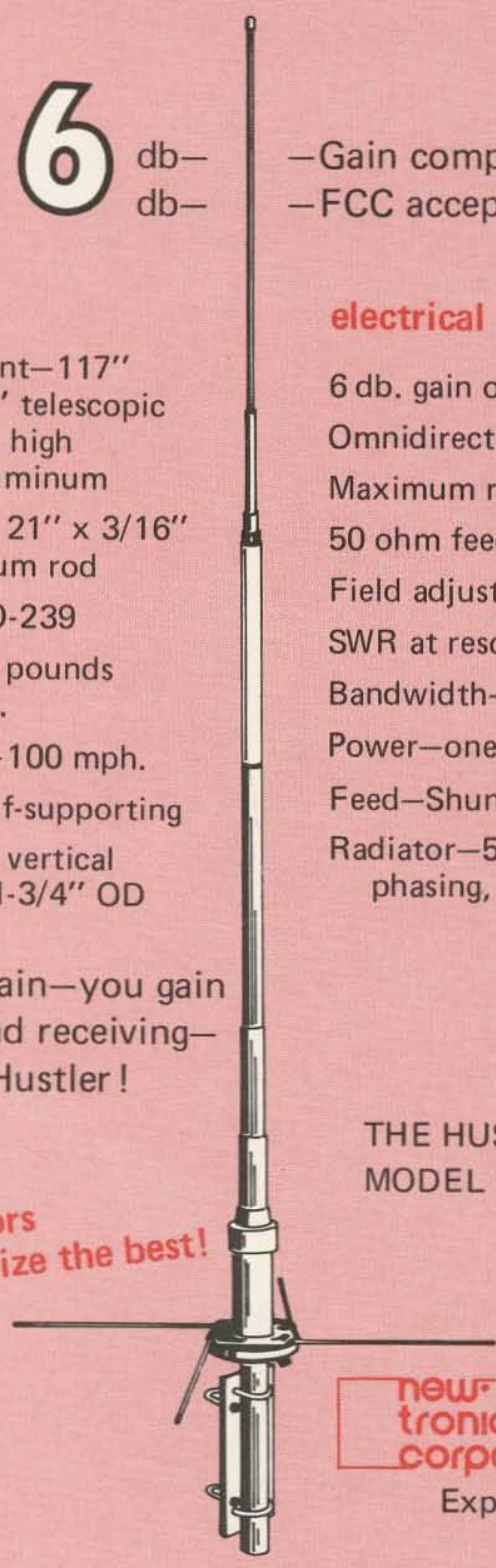

**newtronics corporation**  
15800 commerce park drive,  
brook park, ohio 44142

Exporter: Roburn Agencies, Inc.,  
New York, N.Y.

WB2NEL	30	Flip Flops Exposed
WB4YTU	37	Breakthrough in Fast Scan ATV
WB4DCV	49	Strobing Displays is Cool
W2FEZ	52	The Sensuous Tuned Lunch Box
WØSYK	57	Loudest Signal in the World?
K7YGP/7	63	Build a Deluxe TTY Keyboard
WØACR	74	Eyes for Your Shack
WA2OKZ	95	Predicting Third Order Intermod
WA1SNG	103	Feedline Primer
W1BNN	117	Caught "Spying" by the Gestapo
WA5RON	125	Why Tubes Haven't Died
WB5DEP	133	Instant Circuits
W7JSW	138	K2OAW Synthesizer PROM-oted
WA1PAZ	145	Computers are for Hams!
WB5DEP	151	The Unzapper
W6NLB/7	157	A \$1.00 Strip Chart Recorder!
W4LLR	186	Display Yourself in a Big Way
BACH	191	Fun City's Surplus Scene
WA6ITF	199	Looking Back — Looking Ahead
WA5OKA	214	Updating the Heathkit IB-1101

# 73 amateur radio

#182 NOV/DEC 1975

2	Never Say Die	14	Looking West
3	For Your Eyes Only	21	Social Events
4	Be My Guest	162	New Products
6	Letters	204	Hamburglar
10	Contests	208	Caveat Emptor
12	Ancient Aviator	218	Ham Help
12	Networks	256	Advertiser Index
13	AMSAT	256	Propagation

COVER: WØACR's "Eyes for Your Shack." Article begins on page 74.

73 Magazine is published monthly by 73, Inc., Peterborough, New Hampshire 03458. Subscription rates are \$8 for one year in North American and U.S. Zip Code areas overseas, \$9 per year elsewhere. Three years, \$16 and \$17 overseas. Second class postage paid at Peterborough, New Hampshire 03458 and at additional mailing offices. Phone: 603-924-3873. Microfilm edition of 73 available from University Microfilms, Ann Arbor MI 48106. Magnetic tapes available from Science for the Blind, 332 Rock Hill Rd., Bala Cynwyd PA 19904. Entire contents copyright 1975 by 73 Inc. Peterborough, NH 03458.



# 73 staff

**EDITOR/PUBLISHER**

Wayne Green W2NSD/1

**MANAGER**

Virginia Londner Green

**MANAGING EDITOR**

John C. Burnett

**ASSISTANT EDITORS**

Beth Alpaugh WA1VMZ/1

Alex Barvicks WB4RVH

Fred R. Goldstein WB2ZJQ/1

Susan G. Philbrick

**PRODUCTION MANAGER**

Lynn Panciera-Fraser

**ART DEPARTMENT**

Nancy Estle

Neal Kandel

Peri Mahoney

Bob Sawyer

**PRINTER**

Biff Mahoney

**PRINTER'S DEVIL**

Brent Lawler

**PHOTOGRAPHY**

Bill Heydolph

**TYPESETTING**

Barbara J. Latti

**ADVERTISING**

Bill Edwards WB6BED/1

Nancy Cluff

**COMPTROLLER**

Knud E. M. Keller KV4GG/1

**CIRCULATION**

Barbara Block

Susan Chandler

Pat Geilenberg

Dorothy Gibson

Pearl Lahey

Charlene Lawler

Marge McCarthy

Judy Waterman

**INVENTORY CONTROL**

Kim Johansson

Marshall Raymond

**PLANT MAINTENANCE**

Bill Barry

Elaine Mercier

**ASSOCIATES**

Robert Baker WA1SCX

E. H. Barnett WB0IIX

Schley Cox WB9LHO

Tom DiBiase WB8KZD

Terry Fox WB4JFI

W. Sanger Green

Dave Ingram K4TWJ

Joe Kasser G3ZCZ

Bill Pasternak WA6ITF

John Schultz W2EEY

Waller Scott K8DIZ

Peter A. Stark K2OAW

Bill Turner WA0ABI

**DRAFTING**

Bill Morello

Lynn Malo

T.M. Graham Jr. W8FKW

Caro Kandel



NEVER SAY DIE

*...de W2NSD/1*

EDITORIAL BY WAYNE GREEN

Johnny Johnston as Chief of the Amateur Division ... there could hardly be better news for amateurs.

### THINGS ARE NOT ALL BAD DEPARTMENT

As a matter of fact, things could hardly be better as far as the latest FCC news is concerned. There has been a serious problem with the amateur division of the FCC ... Johnny Johnston had been transferred to another branch in order to give him an increase in rank, losing amateurs one of the most dedicated and fair licensed hams in the FCC from the amateur division. Then came the "resignation" of Prose Walker, leaving the division with no one in residence to make decisions. This almost totally constipated all actions pending.

The first breakthrough was the appointment of Joe Johnson to fill Johnny's old spot. Then came fantastic news ... Johnny Johnston was back as Chief of the Amateur Division, filling the Walker chair! There could hardly be better news for amateurs. Johnny is well known for being seriously interested in following the concepts of Chairman Wiley toward a minimum of regulation ... and he is also known to be very accessible and open to new ideas. No rigid ideas ... no arrogance ... an ideal choice.

One more hot news flash ... Charlie Higginbotham, the head of the Safety and Special Services ... Johnny's boss ... who is also well known for his accessibility and belief in a minimum of regulation ... just got his ham ticket, W3CAH, and will be getting on the air. Having talked a bit with Charlie I think I can say that you won't have to watch yourself ... he's into hamming for the fun of it, not to be an FCC monitoring post. Anytime you run into someone special you can louse up ham radio for him by making a big deal of his specialness ... you'll do best if you let him know that you know who he is (we all have egos), but other than that treat him as just another ham ...

and that goes for King Hussein, Arthur Godfrey, on down. One of the worst possible things you can do is frantically call him for a "contact." Lay off!

### THE REPEATER HOBBY— AN EGO EXERCISE

Common sense, as it has a way of doing when either money or egos are involved, has taken a nose dive in the repeater field. The plain fact is that there are a lot more repeaters in many areas of the country than are needed.

Despite those lovely numbers in the Callbook showing over 250,000 licensed amateurs, there are more like 120,000 actually active. Of that number about 50% are involved with FM and repeaters. Thus, with an average of about 30 users per repeater, it is no wonder that most of the repeaters are silent 95% of the time — there just aren't enough FMers to support all that mountain hardware and keep it in use.

Perhaps we can look forward to ... 60,000 "active" repeaters, each with its own control operator waiting hopefully for a user to come along.

It used to be that a group of fellows would get together and decide to put a repeater on the air — now it only takes one. Perhaps we can look forward to the time when we have 60,000 "active" repeaters, each with its own control operator waiting hopefully for a user to come along.

Put it this way — if you're into FM you've talked over several repeaters by now — how many times have you heard a repeater owner ever using anyone else's repeater? Rare indeed.

My recent visits to Salt Lake, Phoenix, Albuquerque, San Antonio, Dallas and New York have done a lot to convince me that we have a whole lot more repeaters than we really need. We just don't have enough FMers to keep even half of them active.

To understand how this all comes

*Continued on page 18*

# FOR YOUR EYES ONLY

*Required reading —  
by Dr. Thomas A. Reilly W3GAT/2  
and Calvin McCarthy.*

*There has been a tremendous proliferation of integrated circuit devices in the past few years. Take a look at the ads in this magazine. You will see numerous columns of numbers designating the many types of integrated circuits available to the amateur. There was once a time when these ads included a brief description with each circuit, but now this is infrequent. There is a great deal of information available on ICs, much of which has recently been appearing in this magazine. As of early 1975, there were over 16,000 devices available from about 80 manufacturers. A major problem for the amateur further frustrating his desire to obtain information is that these companies are frequently reluctant to send materials to people who are neither engineers nor work for an engineering company.*

*I found myself beginning to want a single source of integrated circuit data. Having such a data source would make it easy to become familiar with the available ICs as well as to identify those in the ads. It would be possible to determine those which could simplify a project in order to make it easier to complete. Because there is no single source of information that contains all of the varied digital and linear circuit data, I've attempted to develop a bibliography of readily available books which will provide most of the required information.*

*I did not attempt to review everything I have found. Rather, I hoped to present a useful summary of IC information readily available to the amateur user and yet not so expensive that he wouldn't be able to afford to buy the circuits.*

**THE TTL DATA BOOK**  
LCC4111, 640 pages, \$3.95.

**SUPPLEMENT TO THE TTL  
DATA BOOK**  
LCC4161, 400 pages, \$1.95.

Texas Instruments, PO Box 3640 M/S  
84M, Dallas TX 75285.

These two books are by far the most useful to the experimenter who uses this common family of digital integrated circuits. There is a functional index and selection guide so that it is possible to select a device having a particular speed, power and logic function. Also included is a cross reference between Texas Instruments and other IC manufacturers such as National Semiconductor. These books include an excellent description of the TTL family, including circuit ratings, unused inputs, and driving and input current requirements. There are 75 small scale and 175 medium and large scale devices in the first volume and

171 in the supplement, including Schottky limited ICs. This represents 54 logic classes of ICs. These volumes are also particularly useful because of both the clear truth tables for many circuits and the liberal application notes.

**LINEAR AND INTERFACE  
CIRCUITS DATA BOOK**

Texas Instruments, LCC4151, 688  
pages, \$3.95.

This book includes data on eight classes of integrated circuits, including operational amplifiers, voltage regulators, voltage comparators, video amplifiers, and special functions such as line drivers. It contains data on 242 devices.

Incidentally, Texas Instruments does provide a number of other books on optoelectronics, transistors, diodes and power semiconductors for about the same cost.

**COS/MOS DIGITAL  
INTEGRATED CIRCUITS**

SSD 203B, 527 pages, \$2.00.

RCA Solid State Division, Box 3200,  
Somerville NJ 08876.

This book contains complete data and related application notes on all CMOS circuits (CD4000 series) currently manufactured by RCA. It has data on 60 ICs and 18 application notes. Information is provided on voltages, unused inputs, and interfacing with other circuit families. A very useful section describes how to handle this type of circuit so as not to blow it out with static charges. The 1975 volume is said to contain data on about 90 circuits. This book is the most complete CMOS data source that I've been able to find.

**LINEAR INTEGRATED  
CIRCUIT BOOK**

800 pages, \$3.00.

Motorola Semiconductor Products,  
Inc., PO Box 20924, Phoenix AZ  
85036.

For the curious, Motorola offers this fun type of book. It includes data on about 200 circuits, but each circuit is so different. There are op amps, voltage regulators, analog multipliers, modulators, detectors, DA and AD converters, TV and hi-fi circuits, and many others. Many of these can be readily adapted to IC hobby and amateur radio use. Some of these are fantastic devices but I've unfortunately seen too few amateur ads offering these circuits.

**MCMOS DATA BOOK**

Motorola, 372 pages, \$2.50.

Also for the CMOS hobbyist, this book contains data for 69 devices in the MC14000 family of ICs. Design information on power supplies, interfacing and thermal and static charge precautions is also included. Much of the information is contained in the RCA data book, although some of these circuits are different.

**PHASE LOCKED LOOP SYSTEMS**

Motorola, 180 pages, \$2.00.

Those interested in two meter FM already know something about crystal synthesizers. This book tells everything you ever wanted to know about phase locked loops. If you can manage simple algebra you will be able to

*Continued on page 22*



# BE MY GUEST

*Visiting views from around the globe.*

## A Hobby That Helps

Ham radio operators come in two categories. Some like to tinker. Others like to talk.

Those who tinker build their own equipment from kits. They talk to other amateur radio operators about how certain receivers work in thunderstorms or which way the antenna should point. Studies show that 49 percent of the conversations on ham radio bands deal with the technical aspects of radio.

Talkers, however, usually buy their equipment ready to go. They become ham radio operators to "meet" people by dialing through the available frequencies until they find someone to talk to. They find excitement in striking up a conversation with a businessman in Japan, a teacher in South America, or a salesman from Topeka.

Bruce Frederickson, Pastor of First Lutheran Church at Mount Ayr, Iowa, and ham operator number WAØCAE, is a talker.

"All ham radio operators are amateurs," he says. "That means each of us has another interest in life. Our mutual interest in radio is the starting point. Then the conversation can go into any direction — depending on the person I happen to meet."

Pastor Frederickson frequently has regular conversations with commuters who have installed equipment in their car to make a profitable use of time spent on the road. (The Iowa pastor also has car equipment as well as a "radio shack" in the parsonage.) He has regular conversations with lawyers, sales representatives, and other ministers.

Invalids often become ham operators to have communication beyond the sick room. For them a call to WAØCAE is like a visit from the pastor.

"Not long ago I met a man from Rhode Island who was recovering from a serious operation," says the

pastor. "As we got acquainted he told me he had no faith, and to him the Bible was nothing but garbage.

"But we made an appointment to meet again," he continues. "As we continued to visit, he asked me to pray for him. Later he told me he was going back to his church."

The Lutheran pastor's hobby has also added to his ministry in the congregation. He regularly visits with Walter Schramm, a support person for Lutheran Bible Translators in Monrovia, Liberia, West Africa. The Schramms are originally from Red Wing, Minn., and have a daughter, Robin, who attends St. Paul's College at Concordia, Mo.

Since West Africa is one of the countries that allows phone patches (others are all Central and South American countries, Jordan, Israel, and Canada), the Schramms can contact Pastor Frederickson on the radio. He then calls Robin on the telephone, and the family can talk via a combination of phone and radio for only the cost of a phone call from Mount Ayr to Concordia, Mo.

The phone patch helps both the missionary family and members of First Lutheran Congregation. Church members have become more aware of mission work in Africa.

They also have had contact with Larry Johnson, a Lutheran missionary in Goya, Liberia. Using the ham radio with a phone from the parsonage to the church, the women of First Lutheran heard Mrs. Johnson explain the activities of a missionary family in Africa.

Robin Schramm once visited the congregation in Iowa and talked about her life as a teenager in Africa. During their furlough later this year, the entire Schramm family plans to spend a week at Mount Ayr.

"Because our congregation is a new mission — we just dedicated our church in October 1974 after worship-

## you betcha!

The Old Timer was by last week and one of the Legion of Hand-Wringers cornered him. "Tell me," this one said to the Old Timer, "what possible pleasure is there in working DX? Why, I listened to some DXers a couple of weeks back and it was absolute bedlam! Absolutely!"

The Wringer paused in anticipation of a comment, and, when none came, proceeded onward on the path of righteousness. "Why, it seemed that there was hardly a gentleman in the whole group, and if there was one, he certainly was submerged. Tell me! Tell me why supposedly mature and rational people would engage in such tumultuous battles just to work a new country. There must be a reason that you can explain to me. Just why do

they do it?"

The Old Timer was silent for a bit, and, when the Wringer showed signs of starting again, he raised his hand to forestall further questioning. "Maybe they enjoy it," he said, and that was it.

There will always be questions when one applies his own standards of behaviour to others, and one of the eternal truths is that only a true-blue DXer can understand another DXer. There is always joy in battle and pride in the scars of battles past, but the best thing of all is to get through that pile-up and work that station. Rollerball all the way!!! You betcha!!

*Reprinted from the West Coast DX Bulletin, August 26, 1975.*

ing in a chapel in the parsonage for many years — we need this contact with a mission program overseas," says Pastor Frederickson.

"We have a lot of evangelism to do here. Talking to people like the Schramms and Johnsons helps us see the need in our area," he continues, "and I hope we are also encouraging our missionary friends."

The Iowa pastor is glad to make phone patch connections with missionaries for their families. However, the connections can be made only in those countries that allow "third party" contacts.

Pastor Frederickson also reminds those who would like to contact someone via ham radio that the system is not like making a phone call. He cannot call someone unless the person is expecting the call and has a receiver set at the right frequency and the right time. All conversations on ham radio must be either by accident (talk to anyone you happen to bump into) or by appointment.

Special interest groups can form "networks" by agreeing to tune in an established frequency at an appointed time. Several missionary groups have networks; so they can depend on ham radio for regular communication.

Ham radio messages may not be used for business — to make sales, place orders, or compete with professional radio. Music may not be played on frequencies reserved for amateur use.

Like all ham operators the minister feels a responsibility to be at his radio during natural disasters anywhere in the world. During the December 1973 earthquake in Managua, Nicaragua, he handled over a dozen calls from people in Central America who wanted to assure relatives in the U.S. that they were not hurt.

"Generally we accept phone patches only for our own area since that keeps down the price of long distance phone calls. But in a crisis like that I took every call I picked up. Of course the conversations were always in Spanish; so I didn't get any firsthand reports of the quake."

Pastor Frederickson received his Novice license and bought his first equipment when he was in junior high school.

"It's still a hobby," he says. "Even though I have found ways to use it in parish ministry, I'm not suggesting that every seminarian apply for a ham license.

"But there are ham operators in every community. (In the U.S. there



*WA0CAE conducts another one of his many phone patches for overseas missionaries.*

are almost 300,000 hams.) A contact with a ham could add to the mission education program in any congregation."

*Reprinted from The Lutheran Witness, The Lutheran Church-Missouri Synod, 500 N. Broadway, St. Louis MO 63105, August 3, 1975.*

## PL: A Good Idea

15 kHz splits are not the only solution to overcrowded channels. Bill Mengel WA8PIA, president of the Ohio Amateur Repeater Council, presented a plan that would make more efficient use of at least our underutilized channels, if not every two meter repeater channel.

Very simply, the plan calls for every repeater to go to tone-coded squelch (it's called "PL" around here), with two PL decoders. One of the PL decoders would respond to a specific frequency designated for that area (and all the repeaters in that area would use the same PL frequency). The other decoder in those repeaters, and every repeater in the country, would respond to a "universal" frequency (Ohio recommends 100 Hz, 1z). All the repeaters in an adjacent area would respond to 100 Hz and some different code.

In practice it would work like this:

**Base stations.** A base station working a local repeater would select the local PL code; thus, he would not key the nearby repeater sharing the channel, only the local machine. If he wanted to use the other nearby repeater he would select that

repeater's local code, and he would not key his local repeater. This would require multi-frequency PL for base stations wishing to work more than their local repeaters.

**Mobiles.** When a mobile is near its local repeater it uses the local PL code. In other areas the mobile switches to the "universal" 100 Hz code. The mobile would need only a 2 freq PL board.

**Portables.** Portables would all use the "universal" 100 Hz tone since their low power would usually not key up more than the local repeater.

This plan would allow much closer spacing of repeaters than is possible with carrier or tone burst access, but the "universal" PL code would not shut out transient mobiles from repeaters outside their local area. It would work well for the less busy repeaters, though wide area, highly active systems would probably still need clear channels for some distance.

"Universal" tone squelch is worth considering as an alternative to 15 kHz channels.

*Reprinted from Squelch Tale, Chicago FM Club, Chicago IL.*

ou goons don't ever proofr  
easy man... from tab  
bunch of trocks pre...  
you ignored my comments in  
I insist that you print ev

---

### ANONYMITY ANSWERED

---

In reference to an anonymous letter printed in your September issue by a fellow seeking help in studying for his amateur radio license, I would like to offer a few points of interest. First off, I would like to offer my services personally to anyone who lives in my area (or wants to call me from Timbuktu if he likes) to give all the help they need to study for their exams.

I am Advanced class operator WB2TBC. My home phone is 427-7385; my work phone is 246-2310. I belong to the Hall of Science Amateur Radio Club in Flushing, New York (WB2JSM and WB2ZZO). The Hall of Science (as do many other clubs throughout the country) offers classes to hundreds of people every year in Novice, General, Advanced and Extra (both theory and code practice).

The club has programs whereby anyone who wants private instruction and help, in addition to the courses, can get someone from the club to work with him. I believe we have been very successful, having initiated nearly one thousand new hams in only three (3) years.

If the gentleman who wrote the anonymous letter will contact me,

Fred Kahn  
305 E. 93 St.

New York NY 10028,

I will find a ham to help him — no matter what part of the country he lives in. I think (I know) there are many hams willing to help him; he just has not found them. By the way, I read your help wanted column every month and have offered my help to a few. Please print this letter so the gentleman who wrote the anonymous letter can see we really are a brotherhood.

Fred Kahn WB2TBC  
New York NY

*We are also happy to note the response of another Hall of Science'er, Bob Reiley WB2FHN, who wrote:*

*"This is directed to the author of your item in the September, 1975 issue. If you live in the Metropolitan New York area, we are the ones you are looking for. Call Bob, 699-9400, days." What a club! — Ed.*

I read in your September 73, in the "Be My Guest" section, the letters from the two non-hams. I agree much with their statements of the plight of getting into ham radio. I am a ham, hold the Advanced class ticket, but haven't been able to be on the air much over the last four years.

I did not and do not have a technical background. When I first started in ham radio I thought a "plate" was something one ate off of and a "tube" was what toothpaste came from. I had little help with the theory... a good memory and the ability to "associate" and help with the code when I went for General was how I finally did get those tickets. I got in on the Advanced when it first came into being and still retained some of the theory from the other tests.

Although at this time I'm not actively on the air, I have helped a few, mostly kids, to get their Novice tickets on a 1:1 basis. I do not begin to understand all the theory, but by association, memory, and understanding what I could, I did get my tickets.

I live in an isolated section of the country now, but in December will be moving to Reno, Nevada. If anyone would like help by correspondence or lives in the Reno area, I will be more than glad to assist them in obtaining their Novice ticket.

M. K. Houston WA7LBQ  
PO Box 177  
Owyhee NV 89832

I sit here writing what is my second letter to a ham magazine ever. First I would like to thank you for printing my first letter in the August issue. I hope you can find room for this letter in an upcoming issue: I find myself

needing to answer the comments made in the *Be My Guest* part of the magazine. I refer to the letter sent in by Glenn B. Knight and the one sent in anonymously. There are hams willing to help, I am forced to agree — not that many, but there are some. I, for one, want people to know that, if they are a non-ham and have a problem with finding help, that if they write to me and tell me the problem I will do my best to answer it or get one of the hams I know to do it. As long as they include an SASE.

I would also like to let people know the names of other hams willing to help, who have helped me: Eric Falkof K1NUN, Alan Burke W1RM, Irving Geller WA1CDW. I would like to draw special attention to Bill Sidell WA1HXQ, who took me in his ham shack and taught me how to work his receiver, allowed me to talk on his rig, and helped me learn code. Also Richard Metro W1NEX, who even now is helping to teach me how to build from scratch a transceiver and how to read schematics, so that I can understand theory better.

And last but not least, Bob Bello, President of the Middlesex Amateur Radio Club, who is helping the Ham Post 510 to obtain the knowledge it needs to help others earn their licenses. I think that it's radio operators like these who have the right to think of themselves as the elite group of hams.

Wayne S. Gateman WN1UXS  
36 Madoc Street  
Newton Centre MA 02159

---

### TOP OF THE HEAP

---

Mr. Bob Brown  
VHF Engineering  
Binghamton, New York 13902

*Friend Bob:*

Yes, you are indeed a real friend even though I've only met you via the twisted pair. I want to compliment and thank you and the rest of the people at VHF for the outstanding way you have backed me up on the Repeater and Duplexer.

I know it's unusual for so many things: 1. Duplexer tuned backward. 2. One cavity with loose internals. 3. Receiver front-end and alignment problems. 4. Dud XMT crystal. 5. Ground loop troubles in the COR/Squelch circuits. 6. And finally,



shield cans acting as Diodes in the Transmitter.

WRØAFW is behaving beautifully and is drawing excellent reports — such as 50 miles with one watt — 15 mile HT-220 range, etc. — this with the antenna at only 80 feet. We are looking forward to the permanent site of some 200.

In my business, I deal with many broadcast supply companies and your performance in backing your products, by supplying all of the parts including a replacement Transmitter Strip so promptly, is certainly at the very top of the heap.

H. C. Snyder WØNVE  
Fremont NE

---

### YOU CAN'T MAKE THEM DRINK

---

Regarding *Be My Guest*, "How to Generate Your Own Interference", W2EUP, August, 1975:

Perhaps you would be interested in the experiences of our Radio Club, W3YXE, which followed the words of wisdom of W2EUP a year ago.

At that time a local CB club requested code and theory classes, estimating attendance of 50 people out of an approximate 500. We encouraged them to attend our annual classes which were about to begin. Our club offers complete help (besides code and theory), including repair of equipment, putting up antennas, etc. The first evening 8 people of the CB club attended. Drop-outs were high, with excuses of not being able to learn code, the XYL would not permit, weather was bad, etc. Not one completed the classes or was willing to try for the Novice exam. Their class was our one and only failure at gaining new operators. You are correct W2EUP, the CBers do want ham tickets, at least a few of them, but not enough to put forth the necessary effort. You can lead a horse to water but you can't make him drink.

Norma Vanderhoff WA3KKT  
Corry PA

---

### FINE BUSINESS

---

After an absence of quite a few years, I'm seriously considering getting back into ham radio. I'm not at all sure how I'm going to be able to operate a rig in a Manhattan tenement, surrounded on all sides by

taller buildings, on a very low budget, but I hope to find a way.

I had a Technician class license, acquired in 1957. It appears that theory requirements are now more stringent than they were then, and I've forgotten nearly all the theory I ever knew!

Yesterday I picked up a copy of 73 in an electronics store — the first time I've seen the magazine. I must say, "Fine business!" I read the magazine from cover to cover — something I've never done with any magazine before! Many of the articles were above my level of technical understanding, but I learned something from all of them and, most important, they helped me to understand what kinds of questions I need to be asking. The entire staff seems to be doing an excellent job!

Paul Busby  
ex-K5QJL, K9ZEM  
New York NY

*For your antenna problems, we suggest a look at our special antenna issue (March, 1975) and at "Antennas for Oscar — What Really Works?", July, 1975. — Ed.*

---

### REPEATER AND THE WOLF

---

We had a bit of excitement the other day on WR8ACG here in Akron. I thought you might get a kick out of it so I have enclosed a cassette tape for you to play. The incident is about a chap who had a stolen 2 meter FM rig and decided to use it on the repeater, feeling 100% he was on a CB channel.

It all started when one of the fellas on the repeater had his rig stolen from his car on Sunday morning, September 7th. That same night at about 10:10 pm an unfamiliar voice calling himself "Timberwolf" came on the repeater wanting to know if anyone had a copy on him.

The hams on the repeater at the time were aware of the theft and when they heard this fella, everyone dropped their call letters and started using assumed handles. The tape enclosed is only a small portion of the entire goings on, but is enough for you to get an idea of what went on.

"Timberwolf" was convinced that he was on a CB set and thought that the timer reset beep was someone running a Browning. He was so convinced that he was on CB that he gave one of our guys his phone number, and when he finally signed with his

Timberwolf howl, Akron Police had already been contacted and were in the process of tracking down the phone number in their criss-cross. As it turned out, the number was unlisted so they had to wait till morning, when they contacted Ohio Bell for the info.

First thing Monday morning, Akron Police and detectives paid a visit to "Timberwolf's" house. Even though they had no warrant, "Timberwolf" let them inside. Akron Police then found the stolen radio, along with 10 pounds of marijuana and 3 other radios. They then returned to the station and then — armed with a search warrant — returned to "Timberwolf's" house to recover miscellaneous drugs, six firearms, stolen driver's licenses, stolen credit cards and a stolen tape player. "Timberwolf" was charged with several felony charges that day, and as a result of further investigation has ended up with the following charges against him:

- Possession of Amphetamines
- Possession of Heroin
- Possession of LSD
- Possession of Marijuana
- Possession of Marijuana for sale
- Possession of an Hallucinogen
- Possession of Narcotics
- Felon in possession of firearms
- 6 counts of receiving stolen property

So Wayne, needless to say, it appears that "Timberwolf" might be sent up the river for quite awhile. At any rate, his 10-4 good buddy days on the 04-64 Akron repeater are over for awhile.

Tom Weiss WA8VSY  
Cuyahoga Falls OH

---

### SLICING THE PIE

---

I was going over the August issue last night and reread Gilbert Boelke's "How to Generate Your Own Interference." He brings out many good points, to which I'd like to add a few.

I'd like to begin by saying that I almost went the CB route before I was convinced that the extra effort put out in obtaining a ham license would be worthwhile. I haven't regretted it yet.

While what I'm about to suggest may have been said before, I haven't yet heard or read of it. The animosity between hams and CBers can be done away with. As Mr. Boelke mentioned, CBers are a potential source of new

blood for us. I'm sure that many of them were at the same crossroads as I was six years ago, and for various reasons chose CB over ham radio.

What can we do? Well, first we can talk it up at a club meeting. It's not a forbidden topic, as some may think. From there the club could contact a local CB organization and arrange to send a small delegation to one of their meetings to give them a rundown on what ham radio is really about. Follow up with an invitation for a few of the CBers to give their side of the story at a ham meeting. Not only may you learn something, but it saves the program chairman from the agony of having to come up with something new and interesting when none of the members volunteer. If you really want to build on this, why not check into the possibility of a joint meeting. It never hurt anybody to meet the other guy half way, and understanding the other guy a little better never did any harm. They're people just like you and me — responsive to somebody else who moves to know them just a little better. We all know that we can always learn something from the other guy. (When you heard your first SB-104, didn't you chew the other guy's ear off with questions about it?)

Maybe getting ahead of myself, but certainly not being unreasonable, is the possibility of getting the CBers into public service. Invite one of the local REACT groups to help provide communications for a parade, walkathon, etc. Cooperation and coordination such as this could prove invaluable should disaster strike. Think about it. We may be giving up a slice of the public service "pie," but then everybody stands to benefit. When you come down to it, isn't that what it's all about?

Think about it. Talk about it. Above all, give it a try. There's nothing to lose, everything to gain, and it won't hurt a bit.

Scott Liebling WA3OXG  
Pittsburgh PA

---

XU4XA

---

Enclosed is a copy of a letter from W6CLB, ex-XU4XA, a result of your publication of my article, "Odd Problems with an Old Antenna", which appeared in the September, 1975 issue of 73.

OM Lower's letter brought back a flood of memories to me, and I feel sure it will do the same to many who read it.

You undoubtedly know that all those calls mentioned in my article were for real — at that time. It has always bugged me that QST has carried very little about the war-time and later activity of the people who operated those DX stations. I had to go to the library to find out what happened to Reg Fox (AC4YN) after he had to flee Tibet!

Byron H. Kretzman W2JTP  
Huntington NY

Dear OM,

Read your article on page 100 of the September issue of 73 Magazine, and was quite pleased with it — especially since you mentioned one of my old China calls — XU4XA!!

I guess we must have been QSO with that call at one time — I don't know. That was a station I had in the American Embassy in Chungking, which was up the Yangtze River about 1500 miles in West China (Szechuan Province).

I lived in various parts of the Far East with the US Navy from 1930 to 1940. I had ham stations in Shanghai, Tsingtao in North China, and the XU4XA in Chungking. Also used to work from Hong Kong using a rig that belonged to a British Navy man — VS6AQ. In the Philippines I used to work from KA1BH and KA1CM.

I think I have worked old W8CRA from just about every place I ever ran a ham rig out there — he sure had a signal and knew how to dig out the DX! Wonder if he is still alive and kicking?

I went from Shanghai to Chungking in 1938 and the Chinese and Japanese were having one of their wars. I built a transmitter in Shanghai, scrounged an HRO receiver, had a Japanese friend make me a big auto-transformer (on account of the line voltage fluctuations in the interior cities of China) and packed up my ham rig (which had an 803 in the final). My receiver was an RME-69 with a preselector. I gathered up what spare parts I could, packed it all up and went to Hong Kong on an old Navy coastal gunboat.

In Hong Kong, I got passage on what proved to be the last train to run from there to Hankow. It was usually about a 24 hour run, but this time it took us about five days, because the Japanese were bombing the railway and we had to hide and wait until the Chinese repaired the tracks so we could proceed — that was some ride!!

When we got to Hankow, the Japanese were bombing the railway

station, so we made a dash for the Yangtze River and managed to get the attention of the flagship of the US Navy Yangtze patrol about a mile across the river. They sent a boat for us, and we figured that our radio gear was gone in the bombing of the railway station. It was all smoking and on fire, but when we went back early the next morning, the baggage car that contained our stuff was OK, so we hired a few coolies and carried it down to the river and then across to the USS Luzon.

The Japanese were on the verge of taking Hankow (lots of bombing of the city and fires), and the Chinese government decided to move out to Chungking. The American Embassy staff was there, including the ambassador, and I was attached to his crew to set up and operate a radio station for him so he could keep in touch with the flagship of the Asiatic fleet and move his traffic. Anyway, we left that afternoon and ran up the Yangtze. We had to go through the Yangtze Gorges to get to Chungking. I think it was about 400 or so miles, a very interesting ride with spectacular scenery; we could only run during daylight, since it was too dangerous at night.

Another smaller Yangtze River patrol gunboat, the USS Tutuilla, went with us. She was to remain in Chungking as station ship. We carried all the embassy staff on the two gunboats. When we finally reached Chungking, we went ashore and set up our radio station in the top floor of the old Standard Oil Company Building, which was to be the American Embassy.

There were three of us Navy operators assigned to detached duty with the embassy. I had to do all the maintenance, as well as operate — the other two guys were mainly operators. The three of us maintained a continuous 7 day weekly watch and we handled two or three hundred messages each way every day — a lot of them three and four page encoded messages, so you can see we kept busy! When there were air raids (of which we had over 400 in two years), the local power went off and we had to hightail it down the hill and set up a watch on the gunboat there until the all clear sounded (but they were down on the river and conditions were pretty poor — we were up the side of the river bank a way and it was better). Incidentally, we maintained a

Continued on page 26

# the hottest pair on the air



## The Tempo ONE *DIGITAL* SSB TRANSCEIVER

The Tempo ONE has been the "best value" in SSB transceivers for several years. Now Tempo has outdone itself. The brand new Tempo ONE DIGITAL offers all of the proven features of the "ONE" combined with the advantages of a digital readout. Actual transmit and receive frequencies are displayed as fast as the transceiver is tuned. There is no chance of confusion, no chance of operating out of the band. The Tempo ONE DIGITAL, at only \$498, is the most inexpensive digital transceiver available.

The famous Tempo ONE, without digital readout, is still available at only \$399.00 AC/ONE power supply \$99.00. DC/1-A power supply \$120.00

*The Tempo ONE and T-2000 are available at Tempo dealers throughout the U.S. Specifications available upon request.*

*Also available is the Tempo 2002, 2006, 6N2, CL-146A, CL-220, DFD/ONE, DFD/K, FMH, RBF-1 and TDC.*

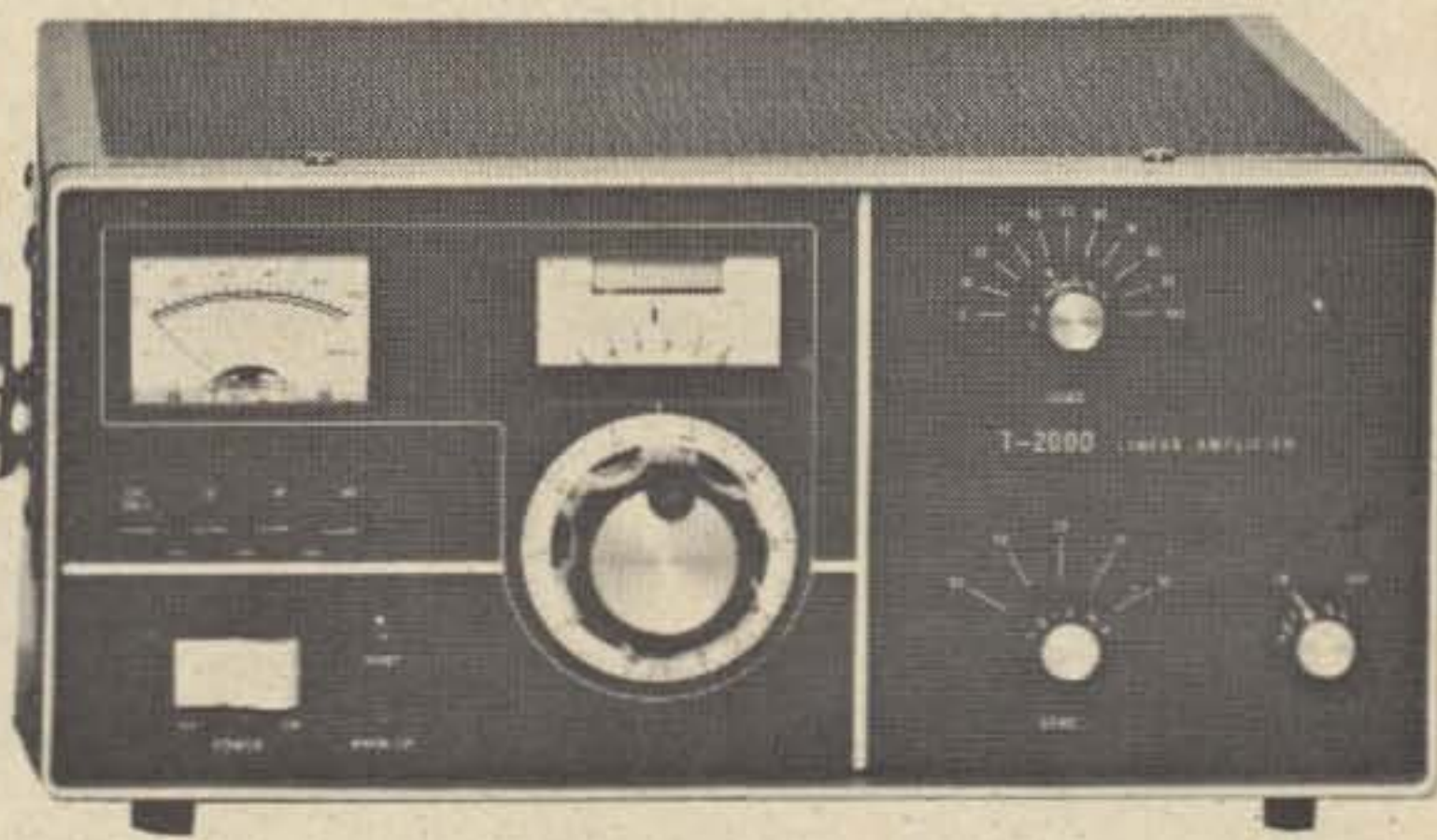

## The Tempo T-2000 LINEAR AMPLIFIER

The brand new T-2000 linear is the perfect companion for the Tempo ONE. It is compact, reliable, and priced right. Uses two Eimac 8873 grounded grid triodes cooled through a large heat sink. The T-2000 offers a full 2 KW PEP input for SSB operation and provides amateur band coverage from 80—10 meters. Provides a built-in solid state power supply, built-in antenna relay, a relative RF power indicator, and built-in quality to match much more expensive amplifiers. Completely wired and ready for operation . . . only \$795.00

# *Henry Radio*

11240 W. Olympic Blvd., Los Angeles, Calif. 90064

213/477-6701

931 N. Euclid, Anaheim, Calif. 92801

714/772-9200

Butler, Missouri 64730

816/679-3127

# CONTESTS

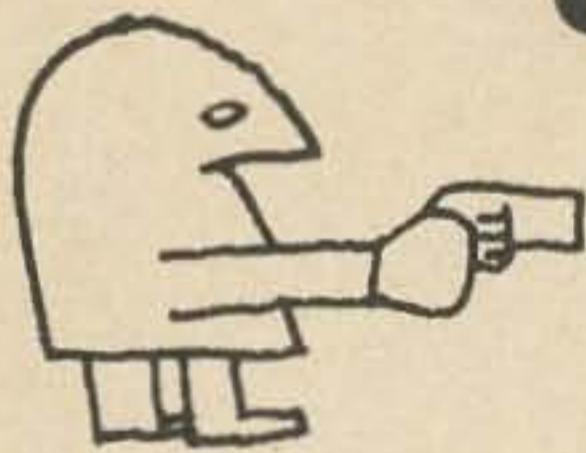

Editor:  
Robert Baker WA1SCX  
34 White Pine Drive  
Littleton MA 01460

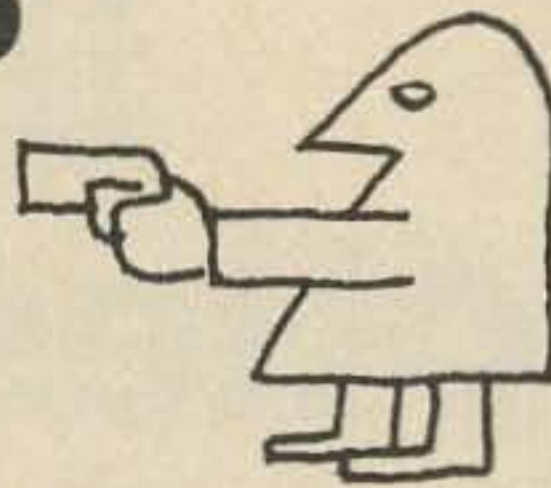

## 1976 SUMMER OLYMPICS AWARD

A certificate to honor the 1976 Summer Olympics will be awarded by the Westminster Amateur Radio School to licensed amateurs who comply with the following requirements:

1. Canadian amateurs must work 10 Montreal *Island* stations. (Montreal Island stations must work 20 Montreal Island stations.) VHF/UHF repeater contacts disallowed.
2. Foreign amateurs must work 5 Montreal *Island* stations.
3. Contacts must be made between August 1, 1975 and July 31, 1976, and contacts may be made on any mode.
4. Send \$1.00 or 5 IRCs, and a copy of your log containing: date, time, station worked and operator, mode, frequency, received signal report, and sent signal report. **NO QSLs ARE REQUIRED !!!!!**

Send applications to:

Secretary  
Westminster Amateur Radio School  
Box 323  
Montreal Int'l Airport, A.M.F.  
P.Q., Canada

## RSGB 7 MHZ DX CONTEST PHONE

Starts: 1800 GMT Saturday,  
November 1  
Ends: 1800 GMT Sunday,  
November 2

### EXCHANGE:

Report and serial number, starting with 001.

### SCORING:

Non-British Isles stations score 5 points for each contact with the British Isles; those outside Europe score 50 points. All may claim a bonus of 20 points for each British Isles numerical prefix worked (G, GC, GD, GI, GM, GW — 2, 3, 4, 5, 6). Contacts with stations using GB prefixes will not count for bonus points.

### AWARDS:

Non-European stations must make at least 10 QSOs to qualify for an award.

### LOGS:

Logs and entries must be addressed to the HF Contests Committee, c/o J.

Bazley G3HCT, Brooklands, Ullenhall, Solihull, West Midlands, England, to arrive no later than December 29th.

## EUROPEAN DX CONTEST RTTY

Starts: 0000 GMT Saturday,  
November 8  
Ends: 2400 GMT Sunday,  
November 9

Rules for the contest are the same as for the Phone section, with one exception:

In the RTTY section, contacts with one's own continent are permitted and count 1 point per QSO. Multipliers will be counted as before.

Complete rules appeared in the September issue on pages 14 and 15. Briefly, the basic rules are as follows:

Use all bands 3.5 through 28 MHz, with only 36 hours of operation out of the 48 hour contest period for single operator stations. The 12 hour rest period may be taken in up to 3 periods. Classes include single operator (all band), and multi-operator with single transmitter.

### EXCHANGE:

RST and progressive QSO number starting with 001.

### SCORING:

Each QSO will count 1 point. A station may be worked once per band. Each QTC (given or received) counts 1 point — see September issue. The multiplier for non-European stations is the number of European countries worked on each band. Europeans will use the ARRL countries list. In addition, each call area in the following countries will be considered a multiplier: JA, PY, VE, VO, VK, W/K, ZL, ZS, UA9/UA0. The multiplier on 3.5 MHz may be multiplied by 4; the multiplier on 7 MHz may be multiplied by 3; the multiplier on 14/21/28 MHz may be multiplied by 2. The final score is the total QSO points plus QTC points, multiplied by the sum total multipliers from all bands.

### AWARDS:

Certificates to highest scorer in each country, reasonable score provided.

Continental leaders will be honored. Certificates will also be given to stations with at least half the score of the continental leader.

### LOGS:

Use a separate log sheet for each band. Logs for the RTTY section should be mailed no later than December 1st. North American stations may send their contest logs to: H. E. Weiss WA3KWD, 762 Cheuch St., Millersburg PA 17061, USA. All others should send their logs to: WAEDC — Committee, D-895 Kaufbeuren, Post-box 262, Germany.

## ARRL SWEEPSTAKES CW

Starts: 2100 GMT Saturday,  
November 8  
Ends: 0300 GMT Sunday,  
November 10  
Phone  
Starts: 2100 GMT Saturday,  
November 22  
Ends: 0300 GMT Sunday,  
November 24

Sweepstakes is sponsored by the ARRL and is open to all amateurs in the US, US possessions, and Canada. No more than 24 hours of operation are permitted during the 30 hour contest period. Time spent listening counts as operating time and OFF periods may not be less than 15 minutes. Times on and off as well as QSO times must be entered in the log. Each station may be worked only once, regardless of band.

### CLASSES:

All entries will be classified as either single or multiple operator stations. Single operator stations will be further classified by input power; Class A = 200 Watts dc or less, Class B for above 200 Watts. All ARRL affiliated clubs may also participate in the club competition.

### EXCHANGE:

Number, precedence, your call, CK and ARRL section. Send A for precedence if power is 200 Watts dc or less; otherwise send B. For CK, send the last 2 digits of the year you were first licensed.

### SCORING:

Score 2 points for each completed QSO. Final score is sum of QSO points multiplied by the total number of ARRL sections plus VE8 (max. 75).

### AWARDS:

Certificates will be awarded to the highest scoring class A entry and the highest scoring class B entry in each section, provided there are at least 3 single operator entries or the score is

10,000 points or more. Certificates will also be awarded for high scoring Novices and Technicians. Multi-operator entries are not eligible for certificate awards and will be listed separately in the results.

**FORMS:**

It is suggested that contest forms be obtained from ARRL, 225 Main St., Newington CT 06111. All entries with 200 or more QSOs must have a cross-check sheet to check for duplicate QSOs. Each log must show date, QSO time, times on/off, exchanges sent and received, band and mode.

*These rules were taken from last year's contest. For complete rules, see the October issue of QST.*

**MISSOURI QSO PARTY**

**Starts: 1800 GMT Saturday,  
November 15**  
**Ends: 2300 GMT Sunday,  
November 16**

The St. Louis Amateur Radio Club will sponsor the 12th Annual Party with an effort to activate some of the hard-to-get Missouri counties. The same station may be worked once on each band/mode. Missouri mobiles will count separate from each different county.

**EXCHANGE:**

QSO Number, RS(T), and QTH — county for Missouri stations, state, province or country for others. Missouri mobiles will start with number 1 from each county activated. Frequencies on most bands will be 60 to 70 kHz up from the low end of the band.

**SCORING:**

One point per QSO. Missouri use states, provinces, and countries for multiplier; others use Missouri counties (maximum 115). Missouri mobiles total separate score from each county activated.

**AWARDS:**

Certificates to top scores in each state, province, and country, top ten Missouri entries, and top three Missouri mobiles.

**MAILING DEADLINE:**

December 15th, to The St. Louis Amateur Radio Club, KØLIR, 842 Tuxedo Blvd., Webster Groves MO 63119. Include an SASE for a copy of the results.

**CQ WW DX CONTEST — CW**

**Starts: 0000 GMT Saturday,  
November 29**  
**Ends: 2400 GMT Sunday,  
November 30**

The contest is open to all amateurs and all bands. 160 to 10 meters may

be used. Stations are permitted to contact their own country and zone for multiplier credit. The CQ Zone map, DXCC and WAE country lists, and WAC boundaries are standards.

**CLASSES:**

Single Operator — single or all band; Multi-Operator — single or multi-transmitter (all band only). Also, club competition.

**EXCHANGE:**

RST and Zone.

**SCORING:**

Contacts between stations on different continents count 3 points. Contacts between stations on the same continent but different countries count 1 point. For North America stations only, contacts between stations within NA count 2 points. Contacts between stations in the same country are permitted for multipliers but do not count for QSO points. The multiplier is the total number of different zones and countries worked on each band. Final score is the sum of QSO points times the total multiplier.

**AWARDS:**

First place certificates will be awarded in each class in every participating country and in each call area of the US, Canada, Australia, and Asiatic USSR. Final results will be published in CQ. To be eligible for an award a

single operator station must show a minimum of 12 hours of operation. Multi-operator stations must operate a minimum of 24 hours. A single band log is eligible for a single band award only. Second and third places will be awarded if warranted. There is also a long list of trophies that will be awarded.

**LOGS:**

All times in GMT. Indicate zone and country multipliers only the first time worked on each band. Check for duplicate QSOs and correct QSO points and multipliers. Use a separate log sheet for each band. For official logs, summary sheet, and zone maps, send a large SASE to: CQ WW Contest Committee, 14 Vanderventer Ave., Port Washington, L.I. NY 11050.

Logs should be postmarked no later than one month after the contest and should be sent to the address above. Indicate phone or CW on the envelope.

*These rules were taken from last year's contest. Check the September issue of CQ for complete rules.*

**ARRL 160 METER CONTEST**

**Starts: 2200 GMT Friday,  
December 5**  
**Ends: 1600 GMT Sunday,  
December 7**

*Continued on page 23*

# CONTEST CALENDAR

Nov 1 - 2	RSGB 7 MHz DX Contest
Nov 1 - 2	Worked All El Paso Contest
Nov 1 - 3	North Carolina QSO Party*
Nov 6 - 7	YL Anniversary Party — PHONE*
Nov 7 - 8	Trillium Weekend Contest (TOT)
Nov 7 - 10	IARS/CHC/FHC/SWL-CHC/HTH QSO Party*
Nov 8 - 9	European RTTY DX Contest
Nov 8 - 10	ARRL Sweepstakes — CW
Nov 9	International OK DX Contest*
Nov 15 - 16	Missouri QSO Party
Nov 15 - 16	All Austria Contest
Nov 22 - 24	ARRL Sweepstakes — PHONE
Nov 29 - 30	CQ WW DX Contest — CW
Dec 5 - 7	ARRL 160 Meter Contest
Dec 6 - 7	Delaware QSO Party
Dec 6 - 7	Telephone Pioneer QSO Party
Dec 6 - 7	TOPS CW Contest
Dec 7	TU2 Competition
Dec 13 - 14	ARRL 10 Meter Contest
Dec 13 - 14	EA Contest — CW
Dec 28	HA5 — WW Contest
Dec 31	Straight Key Night
Apr 3 - 4	Florida QSO Party

\* = described in previous issue.

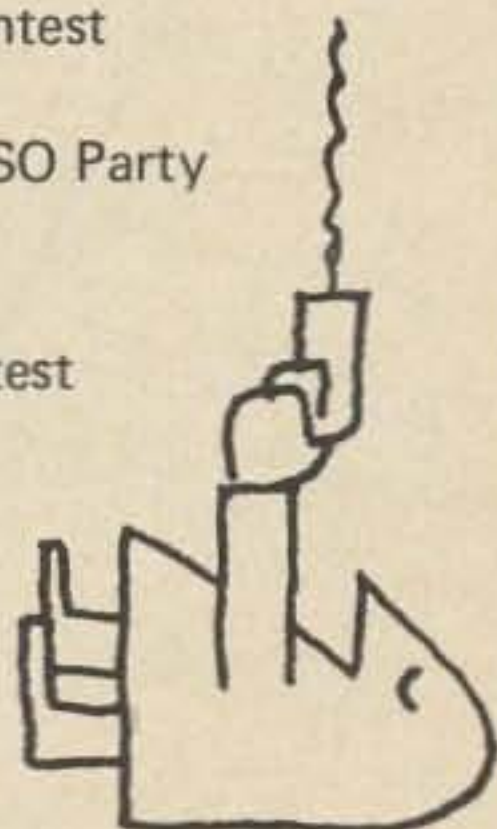
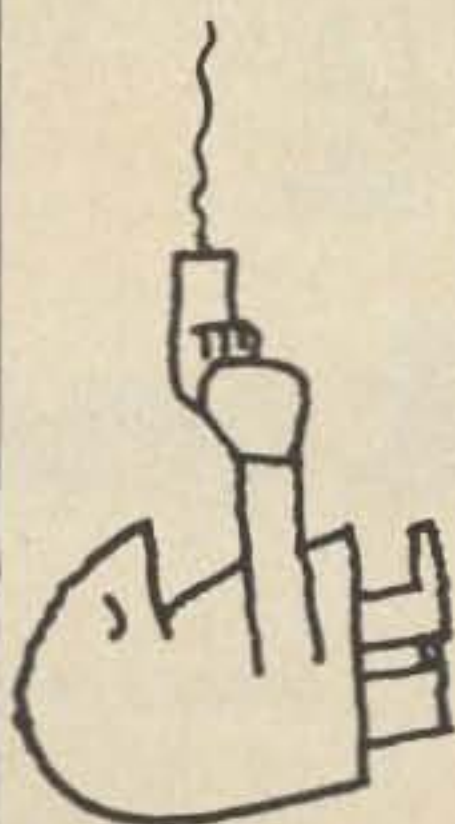

# Autobiography of an Ancient Aviator

W. Sanger Green  
1379 E. 15 Street  
Brooklyn NY 11230

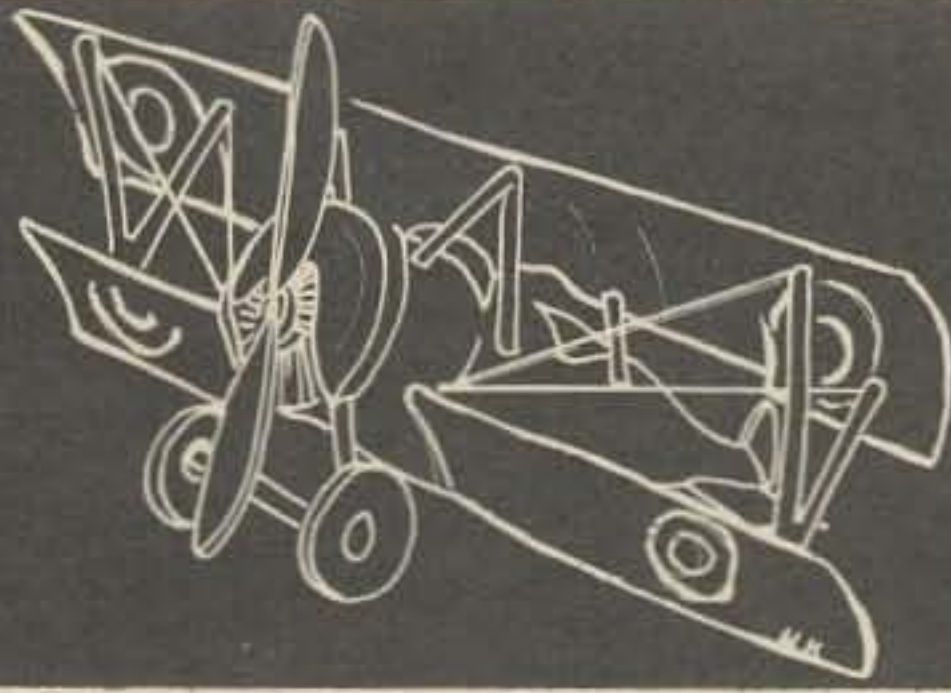

## Two Lucky Ones

Doyle had plans to start working our way south from Elkins, West Virginia about the middle of October, with his "Flying Circus". On Saturday, October 6, the local high school football team was entertaining its biggest rival, and they asked us to fly over the field and drop a football to start the game. Dice Harper, who owned the field we were operating from, volunteered to go along and toss out the ball. All went well as I throttled back and came in low over the football field. Harper dropped the football on the button but when I gave the engine the gun to climb out of there it picked that moment to "pack up". I only had enough flying speed to allow me to turn and get over some high tension wires into a very small field with woods at its end. Not even enough room for a ground loop

So I aimed our nose between the two largest trees, took off my goggles, and ducked.

before hitting the trees. So I aimed our nose right in between the two largest trees, took off my goggles, and ducked. Dice Harper and I escaped with only a few superficial scratches, but the R4 was totaled except for the undependable engine.

My pay automatically stopped when the R4 did, so I came back to Brooklyn. When I got there I found a letter from the Mitchel Field operations officer saying that they were putting on a carnival from November 6th to 10th and asking me if I would lead a formation of five jennies piloted by reserve officers. I phoned him at once and gave him a

list of the reserve pilots I thought might be best for close formation work. We had two weekends to practice together, and so were able to put on a pretty good show.

That ended my flying for 1923. I got a lot of experience that was to be a great deal of help in later years. Then back to the Van Alstyne Huppmobile Company and the beautiful new 1924 Hupps.

Just after the first of 1924, Gillespie of Federal Aviation Co. in Newark phoned me to say he had sold another LWF and that the owner wanted a pilot to fly the ship on a few advertising missions over Newark. He was willing to pay \$30 a flight, so I took the LWF out of Heller Field and based it at Hasbrouck Heights (now Teterboro Airport). The missions turned out to call for flying very low over Broad Street, Newark, with my passenger throwing out a large load of advertising leaflets. I flew ten of these missions, changing landing fields several times, before the police caught up with the plane's owner. Fortunately, I was not around when the axe fell.

The next call from Gillespie came around the first of July. He had sold an LWF to a David Morris of Youngstown, Ohio, who wanted a pilot to fly passengers from a field he had rented near Amityville, Long Island. By that time my price for taking an LWF out of Heller Field had gone up to \$50. My log book says that I took the ship out of Heller on July 1st, picked up gas and Morris at Hasbrouck Heights, and flew him to his field at Amityville. From then to

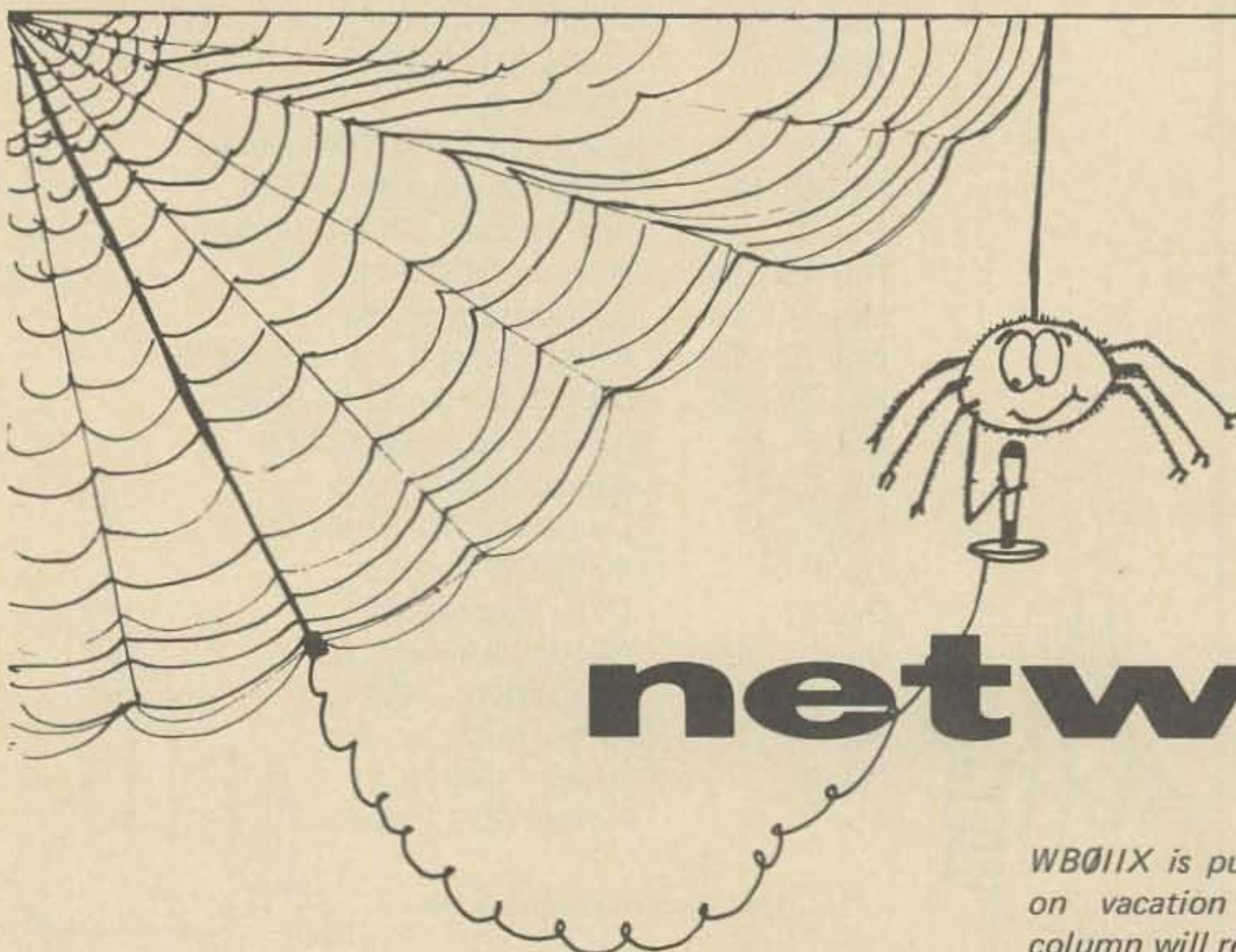

E. H. Barnett WBØIIX  
Route 1  
Ashland, Missouri 65010

You can only get out of amateur radio what you are willing to give. Check into a net. You will make new friends who will be there when you need them! (Ever tried to raise a tower by yourself??) If you don't want to wait for a long roll call, most nets have a "Short Timer's" check-in before roll call. If you do check into a net, tell me about it so I can include it here.

## networks

WBØIIX is purported to be checking out nets while on vacation in Yellowstone National Park. His column will return next month. — Ed.





Bill Pasternak WA6ITF  
14725 Titus St. #4  
Panorama City CA 91402

### ALL QUIET ON THE WESTERN FRONT

My goodness. I get the feeling I may have created a monster, though a good "monster" in the eyes of the amateur radio community. A few months ago, we suggested in this column that amateurs as individuals and collectively take on the task of educating the general public as to who we were and what we could do. It was suggested at that time, and still is, to make use of what the mass communications media calls the Public Service Announcement, or simply PSA (not to be confused with the airline of the same initials). The reason that I personally favor the PSA over other methods of reaching the public at large is that it has the possibility of reaching them at the most opportune moment — the time when they are relaxed and enjoying a program on the "one-eyed monster". Can you imagine the numbers of amateurs that might come to our ranks if such an announcement was run in the middle of a well promoted network movie or, even better, in the middle of the Johnny Carson Tonight Show?

I would be willing to "bet my sweet bippie" that such a sales campaign for amateur radio would do more to stimulate interest in our hobby than 20282 or anything else in the way of restructuring. Sure, restructuring in some form is necessary; most of us agree on this point. However, who outside the amateur community itself will ever hear about it? I doubt if the *New York Times* is going to run a headline "Amateur Restructuring Passes" on the day when the Commission releases its Report and Order on the subject. Heck, I doubt if even the *L.A. Free Press* or *Village Voice* will give it a mention. Simply, the media won't know — much less care. Except to the amateur

community itself, what goes on within our ranks is rarely deemed newsworthy.

As a viable and worthwhile minority community within the structure of international society, we have a right to public recognition of our achievements and to the respect that is accorded all other minority communities. While many other minority groups are held together along ethnic or socio-economic lines, our bond comes from our mutual interest in interrelation with one another through the use of radio. The very nature of our ability to communicate on an international basis, freely and openly, does indeed make us a sub-culture of international proportion. As such, we can no longer permit the public to look upon us as "tinkerers" or "electronic freaks".

The image of the "hermit" hidden away in the attic, surrounded by racks of equipment, tons of wire and the like must be laid to rest for eternity. We must draw the dividing line between amateur radio and citizen's band radio — doing so in a way that is in no way derogatory to either. However, it must be made clear that there is a difference between the two services, and this must be made crystal clear to the media and the public. I for one am tired of hearing and reading news articles in which the amateur community is confused with the citizen's radio service, and I suspect that they too feel the same way when they are confused with us.

The key to this is obvious: education through the media, through the public school systems, and through fraternal organizations. Recently I had the opportunity — no, honor — of speaking to a group of "young people" who were busy working toward their amateur licenses under the guidance of Mr. Ted Ryan WB6JQX. Ted is a teacher at John Burrows Junior High School in Los Angeles, and during the summer session runs a class geared toward helping those young people who are interested to obtain their amateur license. Ted had asked if I could drop by and explain a bit about VHF and repeaters to his two classes. So, armed with a Bell and Howell Super 8 Sound Projector, one of the PARC films, and a loving wife for support, we made the 25 minute trek down the Hollywood Freeway.

What met me was a surprise that I will always remember. There in the Electrical Shop bungalow were

gathered a true cross-section of our nation's future! Young people aged 10 to 14 were there, male and female, representing almost every nationality and ethnic background, all intent on one goal: becoming members of the sub-culture we call amateur radio. No one had forced these "little people" to spend their vacation in school; they were doing so because they wanted to, because getting their amateur ticket was important to them — and to their future.

There was a feeling of mutual love between Ted and his class that you could actually feel, though you could never adequately describe it in words. Here, in Ted, I saw a thing of beauty. Here was a man with a love of amateur radio and the ability to share this love, and the knowledge contained therein, with those who are truly the future of this nation and maybe the world: the children, the "little people" who were on their way toward becoming the "big people". In my eyes, they're better than half way there! As I said, education in all its forms and via every avenue available is the key to our survival and prosperity. We must all work together so that we will not fall together.

As an initial step in developing dialogue between the amateur radio community and the mass media, ARRL Southwestern Director John Griggs W6KW has appointed Lenore Kingston Jensen W6NAZ as liaison between the broadcast media and the amateur radio service.

Her job and that of her committee will be twofold: First, to educate the media as to what the amateur service is, provide technical assistance at times when amateur radio is being dealt with by the broadcast media, and generally make sure we are treated in a favorable light. And second, the other facet of this committee's work will be to work toward getting specific "PR" via the media for amateur radio. This might include producing news documentaries and the like dealing with us, as well as providing interested groups with speakers well versed in the many diverse aspects of our hobby. In having Lenore in this position, you have probably one of the most qualified people possible taking on this task. She is a person well versed in the subject, having been involved within the broadcast media for many years, and a person respected with much admiration in both the media and amateur radio.



She has both the experience and talent necessary and not only do I wish her "good luck", but also my personal support and that of this column. There is a long road ahead, but the seeds of the future have now been planted and are starting to take root. If you have any suggestions as to how this formidable task can be accomplished, or if you are involved in any phase of the broadcast media (anyplace in the nation) and feel you can be of help on this project, either contact Lenore W6NAZ or yours truly and I will forward your letters to Lenore. The leadership is now here; the ideas and help must come from you!

Bill Orenstein KH6IAF and myself are both what Jean Shepherd K2ORS terms "night people". (How I miss Jean's radio show out here, since KPFK decided to no longer carry it last year!) That is to say, Bill and I tend to function much better after the sun goes down. So it was the other evening when we collectively wrote the following on SAROC Hawaii. As I said last month, though a native Angelino, Bill is a transplant to the Hawaiian Islands, returned to LA for business reasons. Therefore, whenever a reasonable excuse arises, Bill is not against spending five hours aboard a 747 so that he can spend a few weeks in his adopted home state: Hawaii. SAROC Hawaii was just such a happening.

Bill had but one major complaint about the convention, in that everything — speakers and exhibitors — was in one room, with no form of partition in between. In his estimation, this made it more than a bit difficult to direct one's concentration toward either. (Leonard Norman, take note for next time.) Even a simple folding partition to separate the two would have done wonders to eliminate the confusion.



Turnout was lighter than expected and Bill estimates that about 250 would be a fairly accurate figure, with about 70 to 80 coming from the mainland. This was far below expectations. Perhaps a less expensive travel package on the part of Del Webb Enterprises, the promoters of SAROC Hawaii, would be something to consider for such events in the future. Hawaii is not exactly around the corner for most mainlanders and, with the economy in its present state, most people think twice before shelling out a bundle for airline and hotel reservations. Putting a travel package for such an event within the

# WANTED

## FOR JAMMING

ANY MISGUIDED RADIO OPERATOR,  
ON ANY HAMBAND!

## REWARD

 \$100.00 

FOR INFORMATION LEADING TO LICENSE  
SUSPENSION, REVOCATION, OR CRIMINAL CONVICTION.

CONTACT ED PECK, ATTY., 405 14TH ST., SUITE 800,  
OAKLAND, CA. 94612

*This offer is a legitimate one from friends of WCARS.*

price range of the average ham could do wonders for attendance.

The highlight of the convention was a talk given by Mr. Charles Higginbotham of the FCC concerning restructuring, in which Mr. Higginbotham was not only very open and candid about the whole subject, but quite willing to field any questions put before him. Bill got the feeling that Mr. Higginbotham was quite sincere in his feelings toward amateur radio and that he is a person to be looked to for support for our service. Bill taped this talk and I hope to be able to transcribe it and bring it to you in the near future; I for one was impressed with what I heard.

As you may have noted during the past few months, I have been quite hard on those we call "jammers". "Malicious malcontents," I term

them: people with warped minds who have no place in amateur radio or on our bands . . . licensed or otherwise. I feel that the best way to stop the jamming of our VHF Repeaters and HF Nets is to publicly expose those who would do us dirt, and shame them in front of their peers as well as the rest of society. The longer we wait, the worse the situation will get, unless some form of strong leadership arises in that direction. If one would-be num-num sees person "A" getting away with it, then chances are that num-num "B" will join in to get his share of the kicks.

The problems being incurred by WCARS are well known, and for that very reason they started collecting donations for what is termed the

*Continued on page 21*

**Get on the air NOW!**  
**Let Tufts put you**  
**there!**

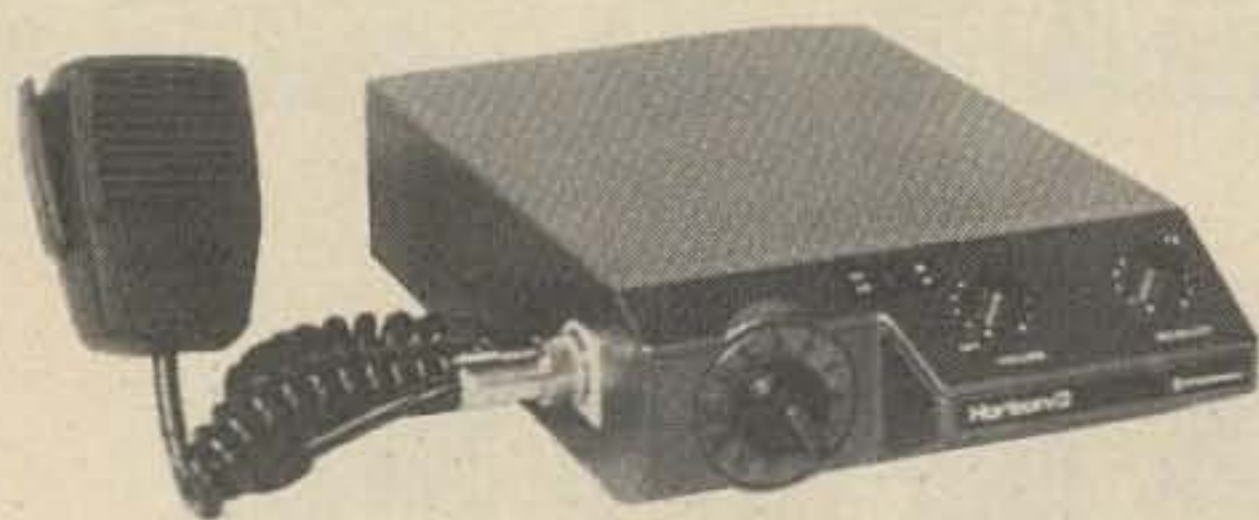

*by*



**Standard  
 Communications**



**Horizon 2**  
**25 Watts, 12 Channels**

**Walkie Talkie**  
**146 A**

**NEW ENGLAND'S FRIENDLIEST HAM DEALER**

**TUFTS** Radio Electronics

386 Main St., Medford MA 02155  
 Phone: 617-395-8280

*Open Monday through Saturday until 9 pm*

Penny Pincher 146A all XTALS (Specify three frequencies) .....\$298.00

34/94	94/94			
-------	-------	--	--	--

SCOTCH TREAT SPECIAL as above includes rubber ducky antenna.

Nicads with charger .....\$335.00

--	--	--	--	--

SCOTCH DELUXE as above plus Deluxe carrying case .....\$349.00

THE WORKS: all channels your choice spare Nicad Battery pak .....\$400.00

--	--	--	--	--

MOBILE DELIGHT                      HORIZON 2

6 channels your choice                      5/8 wave gain antenna

Trunk lip or roof mount your choice .....\$295.00

--	--	--	--	--	--

MOBILE DELIGHT DELUXE as above but all channels your choice ....\$325.00

Send Check with order — Shipping postpaid

Mass. residents add 3% sales tax.

Name \_\_\_\_\_

Address \_\_\_\_\_

City \_\_\_\_\_ State \_\_\_\_\_ Zip \_\_\_\_\_

**\$25.00 Free Gift Certificate if orders not shipped in 48 hours!**  
*(excepting some XTALS — we have most all of 'em but...)*

---

# the **ONLY** **DESENSE** thing to do!

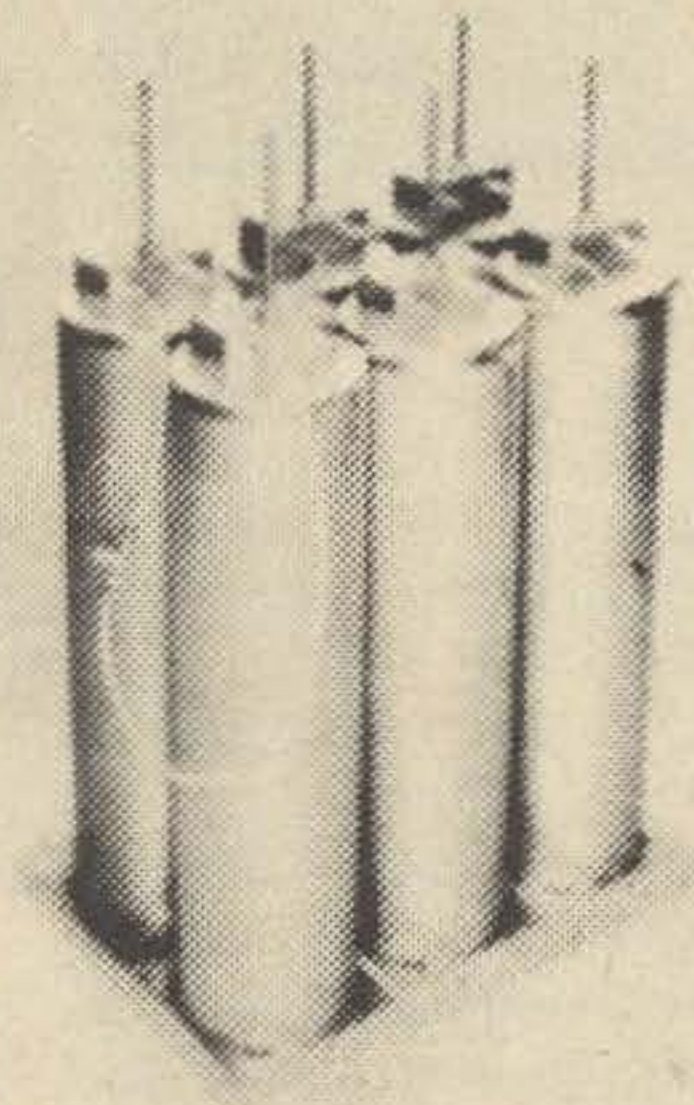

Why do all repeaters eventually go to a DUPLEXER? For exactly the same reason you will for your repeater . . . it makes the repeater work a whole lot better. You can repeat much weaker stations because a duplexer (a good duplexer) greatly reduces desense . . . helps get rid of ugly intermod . . . evens up the coverage of your transmitter and receiver by virtue of using one single antenna for everything.

There are other advantages to you in using a duplexer (a good duplexer) such as the need for one and only one antenna . . . one feedline . . . and when you figure the cost of a real good gain collinear that is not to be ignored.

There are good duplexers and there are el cheapo duplexers. The main difference is that good ones (guess which?) have substantially lower loss, which increases the range of the repeater . . . less intermod . . . and considerably less zapping of the receiver front end or the transmitter final . . . ask some sorry repeater groups about that!

## **Two Models to Choose From**

The four cavity NoRF is designed to work with tube type gear where the degree of rejection is not as critical as it is with that solid state stuff. If you're running tubes and are going to keep it that way, this is all you need, so why buy more? MOD. 62-1 6 cavity, 135-165 MHz. Power 250W. Isolation greater than 100dB 600 kHz. Insertion loss 9dB min. Temp stable over wide range.

FOB Boston . . . . . PRICE \$349.00

The six banger is all you need or will ever need for the most delicate of transistors. MOD. 42-1 4 cavity, same as 6 cavity, except isolation greater than 80dB 600 kHz, insertion loss .6dB max. FOB Boston . . . . . PRICE \$249.00

Proven design. Over 150 sold in U.S., Canada and Europe. Construction — welded aluminum iridite and silver plated. All parts professional quality. Everything supplied. Can be assembled & tuned in one evening. No special tools. Receiver & transmitter can be used for tuneup.

ORDER FROM

# **TUFTS** Radio Electronics

386 Main St., Medford MA 02155  
Phone: 617-395-8280

**NEW ENGLAND'S EXCLUSIVE DEALER**

*Open Monday through Saturday until 9 pm*

---



from page 2

about I only have to look at a couple of the nearby repeater groups and project the situation. Let's take the Boston 19-79 repeater as a horrible example.

The New England coordinators have coordinated this pair to a repeater at the Crotched Mountain Rehabilitation Center in Franconia NH. There are a number of crippled children there with ham tickets who would like to operate with small rigs from their wheelchairs and be able to communicate with people outside. A 90 foot tower and a complete repeater have been donated to the Center. The tower is up, but the repeater has not been put on the air because no local amateur has been found with enough time to help in the installation of the repeater.

A Boston amateur, who had not made himself popular by deciding that his hobby was DXing on repeaters, complete with a powerful base station and beam (aided by a Clegg 27B which put him on every channel he wanted to DX), got the idea to put up his own repeater. Other repeater owners breathed a sigh of relief.

To hell with the crippled children and their channel — Boston soon had a powerful 19-79 autopatch repeater, complete with day and night dialing up of weather, time and every other phone company service. Despite the discouragement of anything but phoning on the repeater, a small collection of groupies collected and spelled the owner in this work.

Then came a bright idea — how about a 34-94 repeater in Boston to give out Bicentennial information? Fantastic — and to hell with the frequency coordinators who were still trying to get that 19-79 machine off the air. And to hell, too, with the Concord NH repeater on the channel about 70 miles away, even though it could be used easily all through the area by most mobiles.

A great many of the ops using the new 34-94 Boston machine also came in just fine on the NH repeater, causing some hard feelings. Despite severe criticism and every effort of the frequency coordinators, the new repeater has remained on.

With two pirate repeaters going, why not more? The next choice was

13-73. This pair had been tried in Boston in the past, but interference with nearby Maine, Cape Cod, Rhode Island and Western Massachusetts 73 repeaters had been too severe and the pair had been abandoned in Boston. The channel was essentially in full use by another Boston group on 145-745, just 15 kHz off the 13-73 channel. A 13-73 repeater would clobber them. So they quickly bought new crystals and moved to the 13-73 pair to hold the channel. The interference to the other four repeaters, all about 75 miles or so away, was as predicted.

Once the plans for a new 13-73 machine were positively scrapped, the 145 group moved their repeater back where it had been and everything quieted down. But not for long. DL2AA/WR1, the first reciprocally licensed repeater in the country, on 81-21, decided to quit (very, very little activity). The 19-79 chap grabbed it and added that to his growing collection of repeaters. The uproar over this further ignoring of the coordinators has been

---

Every FMer should make it his own personal business to resist uncoordinated repeaters...

---

considerable. The old 81-21 location was low and plans had been well along for a repeater on that channel in Western NH, but this would not work with the newly located 81 site.

And so it goes. This same story, with other channels and other casts of characters, is being replayed all over the country. This will continue as long as FMers don't insist on repeater owners being coordinated. Every FMer should make it his own personal business to resist uncoordinated repeaters in every way he can. He should refuse to use these pirates for contacts, he should take every opportunity to tell the owner how he feels about this pirate action, and he should try in every way to convince the people using the pirate repeaters to stop encouraging the setup.

Keep it legal. No kerchunking, no bad language ... just call in, state your message, sign your call, and ask other users to join you on a coordinated repeater to discuss the situation. Try not to get into arguments on the pirate repeater — make them go to a coordinated repeater for discussions. The future of FM and repeaters lies in your hands. Are they to be an instrument of ego for a few or a service for all of us?

## TENNESSEE DEVELOPMENT

The Eddy Palmer K4LSP situation has changed a bit. Encouraged by a few local amateurs, the Kingsport repeater has been causing serious troubles to the Mt. Pisgah repeater. The latest word is that the FCC has stepped into the picture (and this is what many of us had hoped would not have to happen). Eddy has been accused of deliberate and malicious interference to the Mt. Pisgah repeater ... and the tapes I've heard leave little doubt about this accusation. It is reported that Eddy, a Conditional licensee, has been recalled for a new exam by the FCC and that both repeaters may be moved to separate splinter channels to stop the jamming. Since there appear to be several quite acceptable standard channels available for the Kingsport repeater, it is expected that it will be moved to one of them instead of to a splinter, thus leaving Mt. Pisgah on the 16-76 pair.

One factor that had bad consequences in this case was that in some way Palmer managed to be accepted as the frequency coordinator for Tennessee! Somebody goofed. The whole situation would take a book to cover thoroughly — and the file on it is a thick one here at 73 — if you have a few hours you are welcome to go over it and listen to the hours of tapes of the jamming. However, once the repeater council acted and demanded that Palmer move his repeater, the onus of further developments was on those amateurs who refused to force Palmer to follow through. Those who continued to use the Kingsport repeater backed up Palmer in his flaunting of the council. Here is where individual responsibility lies. These amateurs knew about the council action, yet they behaved contrary to it.

We can keep amateur radio a top notch hobby if we really do use peer pressure to keep it clean. But when we go along with things we know are not right we are no better than the worst of the CBers.

With the seemingly inevitable influx of CBers through the coming Communicator ticket, we'd better shape up. These chaps will conform to whatever mode of operation they find when they join us. If we continue to flaunt our own self-imposed rules about frequency coordination, they will compound the problem for us. If we keep bringing out the worst in ourselves over the air — discouraging interesting contacts — encouraging long winded boring ops — encouraging

old timers who repeat everything they say at least five times — we will suffer the consequences.

Proposal: Since it is almost impossible to get on the air on a repeater and read off a list of your interests other than amateur radio, how about the editors of the club papers making a survey of these interests and publishing them so members can have them at hand for use during a contact? This might help get things moving and cut down on the number of blah contacts. Let's be reasonable about this — what is the use of our fantastic communications system if we hardly ever have anything to communicate? We can't sit there for months on end waiting for emergencies.

Another proposal: One possible use for ham computers would be to operate a synthesizer to check all nearby repeater channels, listening for some coded call. Perhaps we could decide on a two or three Touch-tone sequence that would be used for calling a particular station. The computer would then constantly check all available channels looking for the first of these tones, perhaps sweeping them all several times a second. The first tone would stop the computer and it would then wait for the second and/or third tone before alerting the op that a call was waiting. This could all be done without a computer, but it would take some hardware . . . and a computer could do most of it with a program and little hardware. Any articles coming on this?

End of proposals for this month.

#### FCC — HURRY UP!

It's difficult enough to get new blood interested in amateur radio without having to contend with interminable waits on the FCC. Recent club newsletters mention waits of three to four weeks for license exams for Novice and Tech tests. Then, once the test has been administered, comes the real test of patience, with three to four months getting to be the usual wait. This just isn't fair and Friendly should get on the stick and fix the problem.

Another *big* hangup is in the acceptance of ASCII code for RTTY uses. It was bad enough having to wait out the years it takes the Commission to make a simple decision like this, but it was recently aggravated by permission to use ASCII for Oscar work on a special temporary basis.

This is just one more case where the FCC is blocking amateurs who want to keep up with the state of the art, forcing them to use antique communications methods.

Not that amateurs will put up with such nonsensical restrictions forever. Word is seeping out that several amateurs are working on a clever system of upping the Baud rate for RTTY communications. One way is to take advantage of the lack of any restrictions on Morse code speed or bandwidth and convert high speed Teletype (usually in ASCII code) into Morse, send it at about 200 words per minute, and then convert it back to ASCII again at the receiving end. This can be done on either end via some ICs or with a programmed microprocessor system . . . hardware or software, if you prefer. Computers talking to computers.

Suggestion: If you have a little spare time, why not spend it writing a petition to the FCC asking them to expedite ASCII on the ham bands. You might ask them to take off the restrictions on Baudot too, permitting any speed. Look over the regulations and where you find restrictions that are not really needed, petition for them to be removed so we can work

---

Look for an FCC investigation of financial records and public service records of closed repeater groups.

---

on new ideas and communications systems without forever having to worry about breaking this or that totally unnecessary rule.

#### CLOSING CLOSED REPEATERS?

The feelings of the FCC with regard to using the amateur bands for commercial purposes are not any secret. It thus should not come as any surprise that there is growing unhappiness in Washington over the closed repeater situation.

For starters, the question is asked: With all the open repeaters on the bands, is there any proven need for closed repeaters? Then they want to know if it is really consistent with amateur regulations for any public amateur frequencies to be closed off by a small group for their personal use.

With fees as high as \$500 per person per year (a very, very closed New Hampshire group, reportedly), isn't that gross commercialism? The closed repeaters have been aggravating

the situation by telling visitors to get the hell off the closed repeater, by just ignoring nonpaying call-ins, or even by turning off the repeater for cashless customers.

Now that channels are getting difficult to find for free and open repeaters, many repeater groups are getting irritated by the high-handed actions of closed repeaters. Perhaps some accommodation for closed repeaters can be worked out whereby they are assigned channels by the frequency coordinators on a secondary use basis, with the open repeater on channel having the use of the frequency on a priority basis. An interim solution would be for closed repeaters to move to splinter channels, but this certainly won't simplify the FCC's growing interest in the play for pay aspect.

Look for an FCC investigation of the financial records and public service records of closed repeater groups.

Readers who have reports on closed repeaters, pro or con, can send them to 73. A lot more light needs to be shed on this problem.

#### COMPUTERS AGAIN

I see where an outfit in Phoenix is building an alarm system into their cable TV setup which polls the individual houses to make sure everything is okay. Once every six seconds the minicomputer system checks each house — there are sensors for fire detection, burglary, etc. If any troubles are found the computer prints out the situation in the appropriate place: fire, police, medical, etc.

W4API sent in the clipping with a note that amateurs could set up a similar arrangement via repeaters with a microcomputer system to poll the repeater group members. He's right — we could get something like that working . . . any takers?

#### RTTY ARTICLES NEEDED

Digital ICs have brought on some new RTTY circuits and I'd like to see more of them in 73. The door is open. Let's have some simple terminals, some complex ones, some autocall circuits, more Baudot to ASCII and back converters, Morse to ASCII and back, television typewriter terminals, end of line indicators, cassette storage of forms, and so forth.

The development of the TV

*Continued on page 220*

# The most versatile transceivers...

- Solid state SSB / CW
- 200 watts P.E.P. input
- No transmitter tuning
- The ultimate in sensitivity selectivity and overload immunity



## ATLAS 210x/215x

PLUS EXTENDED FREQUENCY COVERAGE FOR MARS OPERATION WHEN USED WITH 10X CRYSTAL OSCILLATOR

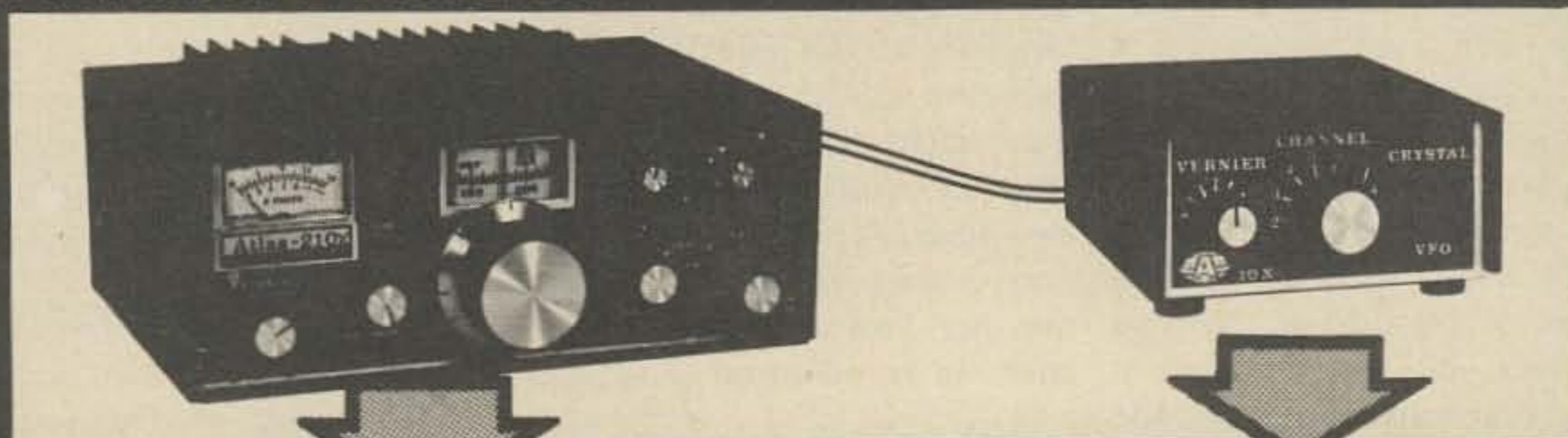

BAND	VFO RANGE	CRYSTAL CONTROLLED RANGE
160M Model 215x only	1,800-2,100 KHz	1,700-3,000 KHz
80M	3,500-4,000	3,000-5,200
40M	7,000-7,500	5,800-10,000
20M	14,000-14,500	13,900-14,900
15M	21,000-21,500	20,600-21,600
10M Model 210x only	28,400-29,400 Adjustable for any 1,000 KHz segment	27,500-30,000

210x/215x \$649.  
AC Console 110/220V \$139.  
Portable AC Supply, 110/22V \$95.

Plug-in Mobile Kit \$44.  
10x Osc. Less Crystals \$55.



417 Via Del Monte, Oceanside, CA 92054  
Phone (714) 433-1983

For complete details see your Atlas dealer, or drop us a card and we'll mail you a brochure with dealer list

**"SEE YOU AT SAROC '76!"**

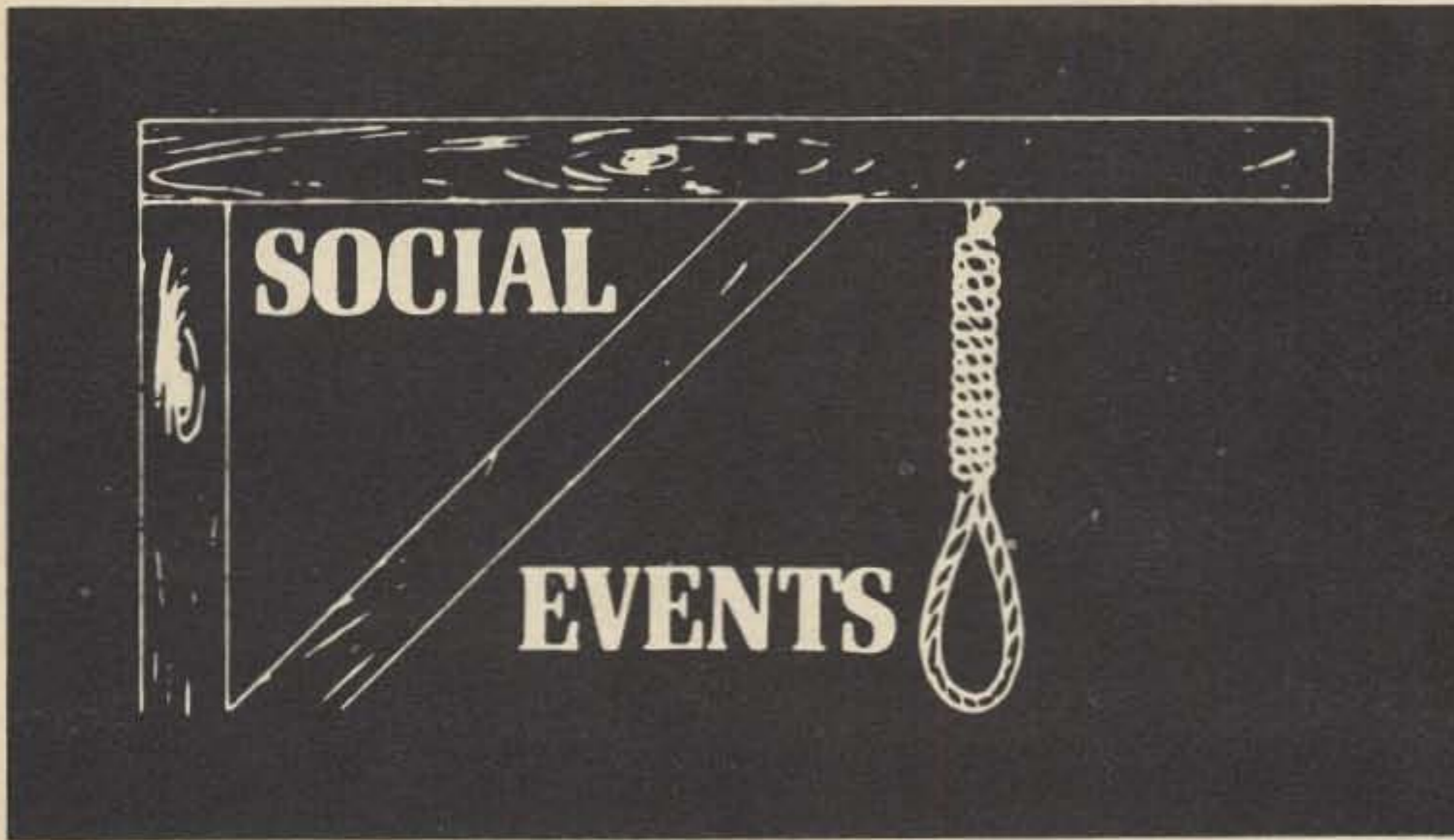

**HARTFORD CT  
NOV 1-2**

The 1975 New England Division ARRL Convention will be held at the Hartford (CT) Sheraton and Civic Center, November 1-2. For exhibit space contact Carleton Dane W1FXK, PO Box 431, Canton CT 06019.

**MASSILLON OH  
NOV 21**

The Massillon Amateur Radio Club presents the 14th annual flea market and auction on Friday, November 21,

1975 at the Amherst Park Civic Center (Amherst Park Shopping Center Complex), corner of Lake Avenue and Amherst, Massillon, Ohio. Flea market opens at 6:30 pm. Auction and all drawings — 7:30 until 11 pm. Donation at door: \$1.00. No charge for flea market tables. Refreshments available: coffee, cider and donuts. Auction rules: no minimums; bid your item back w/no penalty. Commission 10%. Electronics items only and no children under 12. For more information write MARC, Box 8711, Canton OH 44711.

**NEWTON MA  
NOV 28**

The Middlesex ARC's annual auction is Friday, November 28, at 8 pm at the Mason-Rice School, 149 Pleasant Street in Newton, Massachusetts. Club share is 15%. For more information contact WA1JWQ, 16 Beals Street, Brookline MA 02146.

**SANDUSKY OH  
NOV 30**

The Erie Amateur Radio Society's fourth annual Thanksgiving auction will be held on Sunday afternoon, November 30, 1975 at the Laborers Union Hall, 2109 West Perkins Avenue, Sandusky, Ohio, across from the New Departure plant. Doors will open at 11 am with the auction starting at 1:30 pm. Admission \$1 per person, no commission charged for auctioned items. Simplex call in on .52. Free coffee while it lasts. Plenty of parking, good restaurants in the area. Bring your extra gear that you couldn't pedal in the summer flea markets, and it will sell at the auction. Door prizes will be cash. It's a go — rain, shine, snow or earthquake. Auction only, no swapshop.

*Looking*  
**West**

from page 15

WCARS War Chest. The purpose of this is to have the funds necessary to bring one of these sickies into court and cost the jammer where it hurts most: in the wallet. While they are still soliciting financial support, the time has come that action can be taken.

As the reprint of the poster says, there is now a price on the head of every jammer anyplace. It can be a HF or VHF jammer, they don't care; all they want is one that they can prosecute. Therefore, the reward — a quick hundred bucks for turning in a rat and either getting his license suspended or revoked or getting a criminal conviction against him. There is the incentive, though it is indeed a pity that such is necessary. While others are content to procrastinate, at least WCARS is taking the bull by the horns.

Finally, in closing this month, a final comment on .16/.76 vs. .76 simplex. I had hoped that by this time I would have heard from SANDRA, the sponsors of the ill-fated .16/.76 system on Mt. Laguna. WR6AJL is

still in operation, but has moved to 147.75/.15, though at this time it is still considered uncoordinated by the SCRA. I do believe it is the responsibility of anyone writing a column such as this to present all sides in a matter such as this, since in the long run it can effect an entire nation. Therefore, my offer still stands to publish their side of the story if they wish. To that end, I add the

following extension to my offer. Send me a letter on your official organizational stationery, signed by your board of directors and expressing your viewpoint on the matter, and it will be printed in this column without editing or comment by me, period. A free, open format for your stand. Your side of the story has a right to be heard!

... WA6ITF



Some of WB6JQX's students get a demo of 2m FM from WA6ITF. Photo by Sharon Pasternak.

# FOR YOUR EYES ONLY

from page 3

construct a PLL without much trouble. There is a good discussion of all the basic elements of PLLs: phase detectors, voltage controlled oscillators, mixers and counters. Much of the book is adaptable for using such circuits as the 561 PLL.

The newest item in the hobby IC scene is the microprocessor. The Intel 8008 can now be purchased for about \$30 and the 8080 for about \$200. There is not yet an extended literature on these devices. However, Motorola now has two manuals for their M6800 microprocessor. These books are specifically for this microprocessor, yet they are quite useful because the information can be adapted to almost any other microprocessor (if the difference of the instruction set is taken into consideration).

## M6800 MICROPROCESSOR APPLICATIONS MANUAL Motorola, 714 pages, \$25.00.

This book is expensive but worth it to anyone who seriously considers building a microcomputer. There are descriptions of microprocessor systems and wiring, as well as of each microprocessor instruction and its interrupt system. The book is a good learning tool for those interested in microcomputers (both hardware and software), and contains routines for doing arithmetic operations. The major sections of the book include input/output techniques, programming techniques, peripheral control of cassettes, floppy disks, keyboards, etc., and system design. This is probably the best book available for persons interested in this area of electronics.

## M6800 PROGRAMMING MANUAL Motorola, \$10.00.

This manual supplies detailed instructions for the construction and

use of a microcomputer using the 6800, including a description of the interfaces to teletype and phone. Unfortunately, this book assumes some knowledge of computer technology, such as knowing the uses and meanings of busses, registers, masking, etc. This book does not have the general usefulness of the preceding, but if you plan to use a 6800 it will be indispensable.

For the professionally dedicated amateur, hobby clubs, or an available technical library, there are two additional encyclopedic IC information sources.

## IC MASTER UPDATE

645 Stewart Ave., Garden City NY 11530, \$30.00.

This book is on the expensive side, but it is the size of a Manhattan phone book and is updated annually. It provides a listing of the names and addresses of 73 manufacturers (and their distributors) of digital, interface, linear and memory integrated circuits. An extremely useful table is an index to all ICs, making it possible to identify almost any linear or digital circuit. A master function index is provided, which lists all of the various ICs by function and class; for example: Digital, CMOS, Dual JK flip flop. There is a manufacturer's catalog data section which samples about 26 companies and about 500 different circuit types. These appear to be very new devices, although I have seen a few in surplus ads. I found it interesting just to see what kind of circuits are being made beyond the simple logic of the common TTL circuits. The catalog section also serves as a kind of text, showing what these specialized devices can do should you build something like an asynchronous receiver-transmitter in connecting your microcomputer to a teletype

machine and to a phone. This book is very useful for identification of a device and its ratings. Its only fault is that it does not include circuit details such as pin connections, inputs and outputs.

## DIGITAL INTEGRATED CIRCUIT D.A.T.A. BOOK

DATA, Inc., 32 Lincoln Ave., Orange NJ 07050, \$40.00 (two issues annually).

This is another comprehensive book on about 16,000 digital integrated circuits. It provides a cross index of all digital integrated circuits, classified into the following groups: flip flops, clocks, counters, decoders, gates, time delay, ADC, DAC, line drivers, multipliers, arithmetic logic units, and microprocessors. For most, logic diagrams and pin diagrams are included; generally, though, insufficient information is provided, so that it would be difficult to use one of the more complicated circuits without additional data. This book is good for the purpose of identifying circuits, but suffers because it does not include memories and linear integrated circuits. This company does have other issues on linear and MSI-LSI memories, but they are equally expensive.

... W3GAT/2

\*\*\*\*\*

## ELECTRONICS BENCH MANUAL

Technical Documentation, Box 340, Centreville VA 22020, \$19.95.

The amateur radio hobby is well served by many books devoted to the electronic circuitry of equipment and construction articles of specific transmitters, receivers and accessories. Most books assume that the reader will trust that the components specified are the best to use in this application. What happens where there is a problem to solve but no schematic with the solution? Where can one start selecting components to do the job? How must values be chosen? The ELECTRONICS BENCH MANUAL starts where the other standard works only give one or two chapters.

The ELECTRONICS BENCH MANUAL is component-centered, introducing the amateur engineer to many new ideas. To begin, there is a



guide to setting up an electronics workshop. I was impressed by the unpretentious approach taken here. The workshop described as practical is within the resources of anyone able to take up electronics as a hobby, yet hints taken from professional labs make it very versatile. It continues with a section on soldering, printed circuits, chassis layout and construction, which will allow the builder to produce professional looking equipment instead of equipment which is only "cheap and nasty".

The semiconductor section is an answer to the plea of many amateurs, "What do those numbers in the advertisements describe when they say 741, 555, 7490 or 74199?" General transistor theory is presented clearly, as well as listings with pinout diagrams for the TTL MSI series and the National linear IC line. Five pages of text and twelve schematics for application of the NE 723 cover power supply regulation. There are twenty-four pages of diode, transistor, operational amplifier, and digital circuits, and a four page description of the fascinating NE 555 timer.

Following the semiconductor section are sections on tubes, resistors, capacitors, inductors, transformers, switches and relays, wire and cable, meters and displays, energy sources, mechanical devices, and hardware. The exciting characteristic of each section is the simplicity in detail. Assuming that the user's resources are limited, it does not embarrass the reader with ideas which belong only in the Hewlett-Packard laboratories, yet it encourages him to utilize the many components available to most efficiently do his job.

The manual is rugged and easy to use as well. Solid polyethylene covers take rough handling right at the work bench, while the three ring binder format makes additions to the manual or removal of pages a "snap". If you can use much practical information you can use this manual in your library.

... McCarthy

73 solicits reviews of current titles having to do with amateur radio and its periphery. While payment varies according to the size and quality of manuscripts, it is nonetheless uniformly generous. Contact Book Reviews, 73, Peterborough NH 03458.

## CONTESTS

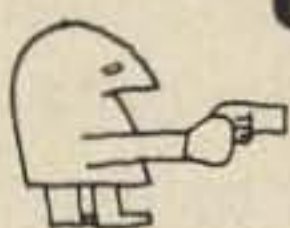

from page 11

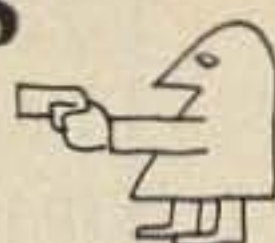

The 6th annual ARRL 160 Meter Contest is open to all amateurs on CW only. Multi-operator work is permitted and scores will be listed separately in the results, but they will not be eligible for certificates.

### EXCHANGE:

RST and ARRL section or country.

### SCORING:

QSOs with amateurs in an ARRL section count 2 points; QSOs with amateurs not in an ARRL section are worth 5 points. DX to DX QSOs do not count. Multiplier is the total number of ARRL sections (74), VE8, and foreign countries worked.

### AWARDS:

Certificates will be awarded for section and non W/VE country high scores. Division high scores will have their section award endorsed with an appropriate seal.

### FORMS:

It is suggested that contest forms be obtained from ARRL, 225 Main St., Newington CT 06111. Check sheets are not required but a penalty of 3 additional contacts will be made for each duplicate contact.

*These rules were taken from last year's contest. For complete rules, see the November issue of QST.*

### RESULTS OF 1975 HELVETIA 22 (H22) CONTEST

#### European Scores:

##### Country Leaders

DK5EZ	11,070 pts.
DM3GF	11,808
EA5BS	11,610
F80Q	3,087
FC9VN	6,138
G3ESF	12,600
GW3INW	2,678
HA2RM	8,424
I3ZDN	2,508
LA9GN	756
LZ2KSB	5,616
OE2RIL	1,428
OH2DW	4,788
OK3ØKFF	11,952
OZ3WG	9,702
PAØALS	4,089
SM2DMU	2,244
SQ9ABE	11,970
UA2FAW	924
UA3AFQ	1,620
UY5LO	8,103
UK2PAF	2,775

UR2QD	11,040
UK2GAN	2,232
YO2BLO	75
YU2HDE	10,680

#### Non-European Scores:

##### Country Leaders

JE1HJJ	12 pts.
KP4DPN	216
W1CNU	702
LU2AHI/W2	1,218
WA2HZR	1,218
W3GFB	1,734
WA5VDH	450
W8VSK	897
W9OHH	702
OA4ZP	612
UA9CBM	429
UL7NAA	288
VE3UOT	1,092

### RESULTS OF 1975 FLORIDA QSO PARTY

#### Top Florida Club Score:

W. Palm Beach ARC . . .  
197,531 points

#### Top Florida Scores:

##### Phone

WA4LZR	85,157 pts.
WA4IMC	66,240
W4OZF/M4	36,051
K4ELK	33,096
WB4YLG	28,448
WA4UFW	24,035
WB4PQB	19,551
WB4NXR	16,555

##### CW

K4VFY/4	45,792 pts.
K4VW	44,064
WB4AEX	41,202
W4BRB	30,256
K4HWW	29,698
WB4TAF	27,720
K4AIZ	21,831
WB4SKI	21,252

#### Top Out of State Scores:

##### Phone

CG3GCO	7,072 pts.
WØIUB	2,132
W8WT	1,386
WA1QNF	1,344
K9KKX	644
WA9MGY	507
W1LQQ	504
VE3EJK	468

##### CW

WB8FUO	4,448 pts.
WØPRY	2,548
W9NII	2,300
K9DDA	2,280
WA1QNF	2,250
W5WG	2,184
W7GHT/7	2,054
W1AQE	2,047

**NEW!**

from



*This New Unit meets the best spec of all: Its Low Price! The GTX-1 is NOT a "cheap" import. It IS identical to Genave's Land Mobile and Aircraft units for high quality and reliability. Compare performance to Motorola, GE, RCA or any other hand-helds that sell for \$700 or more . . .*

# GTX-1 HAND-HELD 2-Meter FM Transceiver

## NOW CHECK THESE FEATURES:

- All Metal Case
- American Made
- Accepts standard plug-in crystals
- Features 10.7 MHz crystal filter
- Trimmer caps on TX and RX crystals
- 2.5 watts output
- Battery holder accepts AA regular, alkaline or nicad cells
- Mini Handheld measures 8" high x 2.625" wide x 1.281" deep
- Rubber ducky antenna, Wrist safety-carrying-strap included
- 6 Channels
- Factory-direct to You

### Accessories Available:

- Nicad Battery Pack
- Charger for GTX-1 battery pack
- Leather carrying case
- TE III Tone Encoder for auto patch

**SPECIAL  
INTRODUCTORY  
OFFER**



**GTX-1**  
2 Meter 6 channel  
Hand-Held  
(without encoder)  
**\$279<sup>95</sup>**  
(Reg. \$299.95)

**GTX-1T**  
with Built-In  
Tone Encoder  
**\$329<sup>95</sup>**  
(Reg. \$349.95)

**ORDER NOW FOR  
BEFORE-CHRISTMAS DELIVERY**

**Use This  
Handy Order Form**

**USUAL IMMEDIATE SERVICE  
ON ALL OTHER GENAVE FACTORY-TO-YOU EQUIPMENT**

CLIP OUT AND ORDER NOW

# THIS PAGE IS YOUR ORDER BLANK! ORDER NOW AND SAVE!

## Specials at Unbeatable Prices



GENAVE, 4141 Kingman Dr., Indianapolis, IN 46226 (317+546-1111)

HEY, GENAVE! Thanks for the nice prices! Please send me:

Operate Auto-Patch



**GTX-200-T**  
2-meter FM, 100 channels, 30 watts (incl. 146.94 MHz)

Special Price  
**\$259<sup>95</sup>**

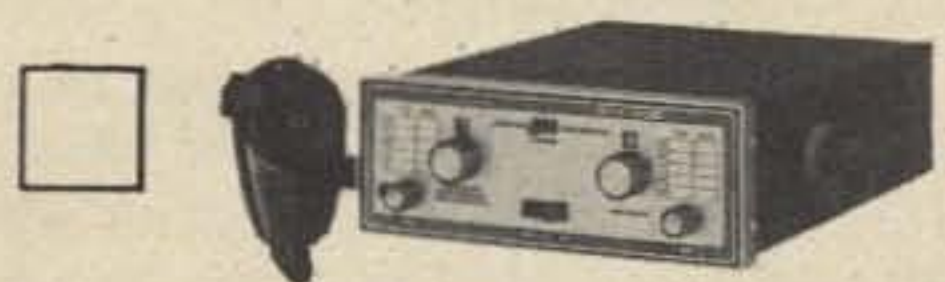

**GTX-200**  
2-meter FM, 100 channels, 30 watts was \$299.95 (Incl. 146.94 MHz)

NOW  
**\$219<sup>95</sup>**

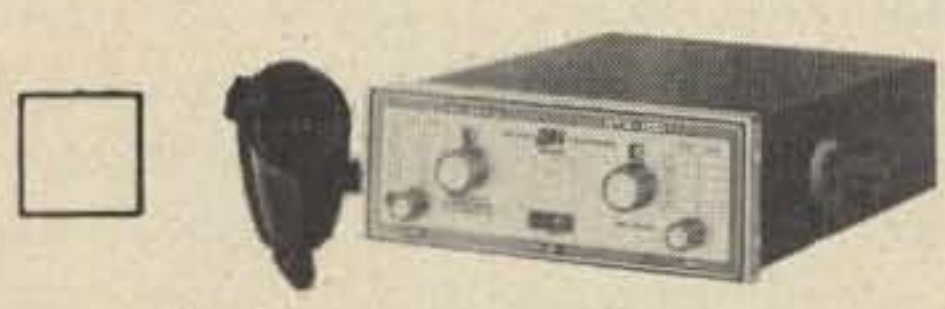

**GTX-100**  
1 1/4-meter FM, 100 channels, 12 watts was \$309.95 (Incl. 223.5 MHz)

VERY SPECIAL  
**\$199<sup>95</sup>**

**GTX-10**  
2-meter FM, 10 channels, 10 watts

~~\$169<sup>95</sup>~~  
**WOW! \$139<sup>95</sup>**



**GTX-2**  
2-meter FM, 10 channels, 30 watts was \$299.95 (Incl. 146.94 MHz)

NOW  
**\$199<sup>95</sup>**

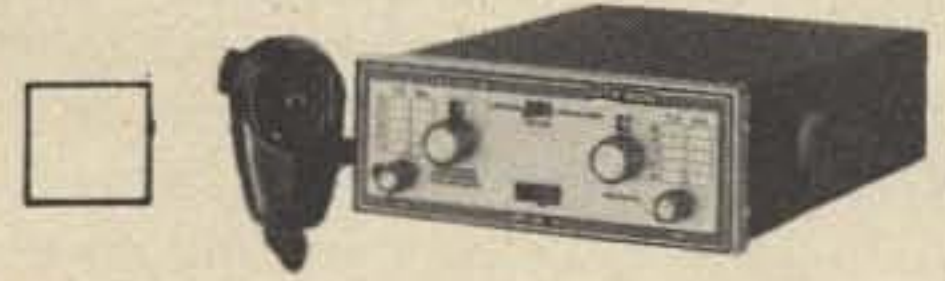

**GTX-600**  
6-meter FM, 100 channels, 35 watts was \$309.95 (Incl. 52.525 MHz)

SPECIAL NOW  
**\$199<sup>95</sup>**

**NEW!**  
*For Christmas Delivery*

**GTX-I**  
Special Price **\$279<sup>95</sup>**

**GTX-IT**  
Operate Auto Patch  
Special Price **\$329<sup>95</sup>**

- PSI-11 Battery Pack** (with charger) @ \$109.95 \$ \_\_\_\_\_
- ARX-2 2-M Base Antenna** @ \$29.95 \$ \_\_\_\_\_
- Lambda/4 2-M Trunk Antenna** @ \$29.95 \$ \_\_\_\_\_
- TE-I Tone Encoder Pad** @ \$59.95 \$ \_\_\_\_\_
- TE-II Tone Encoder Pad** @ \$49.95 \$ \_\_\_\_\_
- PSI-9 Port. Power Package** (less batteries) @ \$29.95 \$ \_\_\_\_\_
- PS-1 AC Power Supply** @ \$69.95 \$ \_\_\_\_\_

and the following **standard** crystals @ \$4.50 each: \_\_\_\_\_ \$ \_\_\_\_\_

**Non-standard** crystals @ \$6.50 each: \_\_\_\_\_ \$ \_\_\_\_\_

(allow 8 weeks delivery.)  
For factory crystal installation add \$8.50 per transceiver.

Sub-Total: \$ \_\_\_\_\_

IN residents add 4% sales tax:

**TOTAL:** \$ \_\_\_\_\_

CA residents add 6% sales tax:

(minimum order \$12.00)

All orders shipped post-paid within continental U.S.

PHONE \_\_\_\_\_

NAME \_\_\_\_\_ AMATEUR CALL \_\_\_\_\_

ADDRESS \_\_\_\_\_ CITY \_\_\_\_\_ STATE & ZIP \_\_\_\_\_

Payment by:  Certified Check/Money Order  Personal Check  C.O.D. Include 20% Down.

Note: Orders accompanied by personal checks will require about two weeks to process.

20% Down Payment Enclosed. Charge Balance To:

BankAmericard # \_\_\_\_\_ Expires \_\_\_\_\_

Master Charge # \_\_\_\_\_ Expires \_\_\_\_\_ Interbank # \_\_\_\_\_

Prices and specifications subject to change without notice.

ou goons don't ever print  
loosy man...  
**LETTERS**  
you ignored my comments in  
I insist that you print ev

from page 8

24 hour a day watch also! Just three men made the watches come around pretty often — all for \$79.20 a month, plus \$1.95 a day for being on detached duty! The \$1.95 a day was commuted rations, and we had to feed ourselves. We ate in a big Chinese restaurant — mighty fine food!

Anyway, I set up my ham rig after I got the Navy station working, and I had a windom (single wire, off center fed antenna) cut for 20 meters. Also had one cut for 40 meters but ran into too much QRM on 40 to be able to do much good. Although the west coast came in pretty well on 40, 20 was the best.

I was rather surprised to find that from Chungking on 20 meters my signals were apparently going the long way around via Europe and that I was doing really good into the east coast of the US. Used to get on there around 6:00 am, which was around 6:00 pm on the east coast, and man, did I work the boys back there! For the majority of them I was the first XU station any of them had ever heard, let alone work!

Had a sked with W2CMY and worked W2GT and W3EMM very often also. I worked a whole bunch of the members of the Frankfort Radio Club around Philadelphia. I worked them in order and sent the QSL cards to their communications manager — and he doled them out. I could send my cards out with US postage via the diplomatic pouch, with a better than average chance of their getting through. Mail took about 40 days from Chungking to the east coast. It went out via air to Hong Kong, and later out over the Burma Road to Rangoon.

Also had a weekly sked with AC4YN in Tibet. I fixed up a couple of guys in the USA with a QSO and at that time there were only about three guys in the US who had worked him. They formed a little club called "TWA" — for Tibet Workers of America! I remember seeing a little squib in *QST* about it — somebody sent me a copy. I also got chewed out by a couple of hams in the US for being some kind of phony in Europe using an XU callsign! There was one guy who wrote a very indignant letter to the ARRL about this phony in

Europe! At the time I didn't dare be too specific as to my location — ham radio was *verbotten* in China, and since I was in the wartime capitol of China, and living in the American Embassy, I was pretty cautious for some time about telling people where I really was. It took a couple of months before the word got around in the States that I was legitimate — and where I was.

Later on, I got chummy with the Chinese Vice Minister of Communications and he told me it was OK for me to operate on the ham bands unofficially. He couldn't really give me a Chinese ham license, but I was not to worry — and be sure I didn't say anything much about the Chinese-Japanese war then in progress. I thus managed to stay on the air with no worries. I only operated about 16 months, but I sent out over 5000 QSL cards all over the world in that time.

I could make WAC from XU4XA in 15 to 20 minutes any evening — signals were something else! All I had to do was make one short CQ and, from then on, everyone seemed to be calling me! On the mid watch (1:00 am to 8:00 am), there seldom was much traffic, so I used to shift over to 20m CW and work all over. Europe, South American and Africa were always in there; the US started coming in around 5:30 am and stayed in until around 10:00 am. I didn't have a vfo in those days, but I had about ten 40m xtals that did a pretty good job of spreading my frequencies around. I had to change frequencies a lot of times because of the pile-ups, but we managed!

Anyway, we had to move to a new embassy up on top of a hill, and, as I only had a few months left to do on the job (I wanted to go back to the States, having been in Asia for over ten years), I decided to sell my rig. The Chinese government bought it, lock, stock and barrel — including my spare parts (which were almost impossible to get in wartime China) — for about six times the price the rig had originally cost me! I understand they used it as a guerrilla station with Chinese operatives behind the Japanese lines. Wonder what ever became of it??

I left Chungking in August of 1940. We had to fly out and were limited to 30 pounds of baggage, so I packed up about 4000 of my QSL cards, all my logs, my old bug that I had used for about 10 years as a Navy operator, and, together with a few odds and ends I had accumulated, had it

shipped out over the Burma Road, to Hong Kong. When a Navy transport came in, it was supposed to be sent on to me in the States.

However, it took several months to get to Hong Kong, and before it could be forwarded to me, the World War Two business broke out and that's the last I ever heard of my little foot locker! I would rather have lost a left leg than 10 years' accumulation of QSL cards and all my ham logs, but that's the way it went! I have no idea who I worked from my various QTHs out there, with a few exceptions. I don't even have a single one of my old XU QSL cards! Met a guy once after the war who had one, but he wasn't about to part with it! He was a radio engineer with the Voice of America here in California, and I had worked him when he was a W3 back east. Boy!! Most of those cards I had would be a real curiosity these days! AC4YN, all kinds of Europeans, Africans, South Americans — plus all the ones I got from the Ws over the years!

Well, I finally got back to the States around September, 1940. I visited my family, then went to Philadelphia and put a new seaplane tender in commission. We went through the Panama Canal and to Honolulu, and I was there on Pearl Harbor Day. The ship was kamikazed and bombed; I lost all my transmitters due to fire and explosion, plus five of my radiomen. I was the maintenance chief, and finally got out of the operating after about 12 years. I spent the whole war in the Pacific, and finally caught another kamikaze in Okinawa that put us out of commission until the war was over — and also killed a few more of my radiomen.

After the war was over I got sent to a 6 month advanced teletype maintenance school. Then, after over 18 years of continuous sea and overseas duty, I got sent to the Navy's first teletype operator school on the east coast, at Bainbridge, Maryland, as chief instructor. When that base closed, I went to Norfolk, Virginia, in the same job. Norfolk decided me to retire, which I did.

Came out to California and went into the dry cleaning business here in Sacramento, with my brother-in-law. Then, when the Korean War started, I was recalled to active duty and was sent to Guam as chief in charge of the teletype maintenance shop there. Busy? We had over 200 teletypes on the line at all times!

Then I was sent back to the States

and was chief in charge of the Navy's high power, high frequency transmitter station at Dixon, near Sacramento. That was NPG and we had another station in Mare Island with about 200 transmitters of all types on the floor there. It has now been shut down for many years and all the west coast Navy transmitters are at Dixon — we had 1280 acres there and more antennas than you would believe!

After the Korean War I worked as an expeditor for a big electrical contractor here for awhile, but lots of strikes and labor troubles occurred, so I went to work for the US Army at the signal depot here as an electronic technician. Worked for them for 19 years, and about 3-1/2 years ago I finally retired for good with over 42 years service with the federal government.

I like this seven day weekend deal (with pay) — but I get less done now than when I was working a 40 hour week! I get just a shade over \$12,000 a year in pension, so do pretty well. Manage to buy a bottle of good scotch now and then! Hi!!

I have a ham rig here, and some old Navy receivers that pre-date WW-2. Also have a Collins 75S1, a Heathkit SB-401 transmitter and one of their 2 kW linears (which I have never used) — plus several xmtrs I built. I don't do too much hamming, but am quite active in Army MARS. I work about 4 skeds a day and handle around 200 or more messages a month — the "morale" type messages from troops overseas to their people in the States.

Had to go SSB to keep in the swim — not too many good CW operators left anymore — but I do work about 8 CW nets a week in Army MARS. Also have a Collins 51S1 receiver (general coverage job).

Well, I've run on at some length, but thought you might like to know what happened to XU4XA in the past 37 or 38 years! Guess you are still active on the bands. I enjoyed your article in 73 and it got my mind running way back when, so I thought I'd drop you a line. Hope it is of interest to you.

Al Lower W6CLB, ex-XU4XA  
3916 Arden Way  
Sacramento CA 95825

---

#### NUMBER ONE

---

Dear Wayne,

In your May issue, you published my letter regarding my problems

contacting a local club and the "boorish" behavior of the 2 "hams" I tried to contact on my own.

I received no less than 1 dozen replies, and thanks to WA3IFY (Jay Kuperman) I will be starting classes at the end of September in a local club he put me in contact with.

I personally want to thank you, Wayne, for the copy of *Novice Class License Study Guide*, which you were so kind to send me. I have also sent for and received your 5 wpm code cassette, which has already helped me get a head start on that code.

As far as I am concerned, 73 means #1 in amateur radio magazines. Thanks again and 73.

Charles F. Super Jr.  
Philadelphia PA

---

#### COLLUSION?

---

Regarding "There's Always Hope", *Be My Guest*, September, 1975:

This goes to prove at what end FCC will go to make them look like the good guys. I'd say collusion! I once tuned across the 40 MHz band and heard one of the kid wonders, called CQ for nearly three 3 minutes then a long pause — then came loud and clear what do I say now dad? What price publicity?

G. B. Post W6BYP  
Nice CA

---

#### SUPER SPECTRUM

---

I guess I am one of the original subscribers to the magazine, as I caught you at the Dayton Hamvention many years ago and subscribed on the spot. I think it was 37¢ per issue then and I've never regretted it a bit. It's still the finest on the market and I still enjoy browsing through the back issues to pick up bits of info that can still be used today. I seldom if ever have too much to say about your advertisers and if I get stung I usually take my beating and don't go back for seconds.

I think you should know about Spectrum Communications, as your review of their product caught my eye and I purchased one of their repeater receiver boards a month or so ago. I still don't believe it!

This Spectrum board surpasses anything I've ever seen. The sensitivity and lack of intermod is something to be seen and appreciated. I can't say too much for Joe deCourcelle and his fine group, as they have taken a

personal interest in my new repeater (using their equipment) that is above and beyond the interest usually shown to any customer. I expect to have the transmitter board this month, as well as one of their 12 channel units for my mobile. In both the old repeater and the new one, I am using Peter Stark's excellent digital control system and IDer that appeared in the February and March 1973 issues. It works like a dream and he too has been of help in getting us over the rough spots.

As of September 1, the receiver and control circuits were complete, and in shakedown testing on a 24 hours a day, 7 days a week basis I've had no problems with either of them. The new repeater is a desk top, rack and panel, set up with individual power supplies for each unit and set up for either dual antennas or duplexer use. It has the Data Signal 12 tone decoder board which I built from their excellent kit and will be set up for autopatch using a control circuit designed and built by one of the local hams and now in use by the Wyandotte, Michigan repeater group.

Keep up the good work. You and your fine group are responsible for many of the improvements in 2 meter FM — and are a real credit to ham radio.

Lee Pennington K8OVJ  
Lincoln Park MI

---

#### BEDSIDE CHAT

---

Here is a hint I use when printed circuit parts are removed and I want to enlarge or make a hole in the solder.

I take a piece of element wire (chrome plated) and push it through when I heat the solder. The solder doesn't stick to chrome. I have even used a short piece cut slanted on the end for a drill to drill small holes. It's slow but sure, especially if you have a variable speed drill.

I use it to make shunts in series with a milliammeter to get correct charging current for my nicads.

I use a light bulb in series with my small ac fan to slow it down to half speed. (I use the same wattage bulb as the fan.) It puts out almost as much air and will last a lot longer. An added feature at night is that it makes a good night light, too.

I use neon (NE-2) bulbs with a 22k resistor in series in my pencil soldering gun and solder sucker. This way I can tell if it's on without burning my

hand. I also use a light bulb in series with them, but I have a shorting switch so I can get full power in minutes by just shorting the bulb out. The iron won't burn up nearly as quickly this way and it's hot when I need it to solder small jobs (with the bulb still in series with the iron). This comes with many years of experience like using the piece of braid off shielded wire to soak up solder.

I'm bedfast, so I keep a lot of "junque" on the bed. A 2' x 3' sheet of 1/4" plywood with about #10 copper wire, masking taped to the top edge all the way around, makes a good workbench and things won't roll off with the wire there. The masking tape also covers the edge and splinters.

I built the voltage regulated power supply in the May, 1975 issue (pages 85-87) and it worked a few minutes and then quit. I found the 723 V.R. had blown. I put in a new one and it gets hot. I haven't found the trouble yet.

S. D. Sales has a special on the 723 free, if you buy the MJ-3001 at \$1.99, as advertised in 73 mag. They are sure a fine company to deal with. If any of their parts go bad, I write them and they replace them free, postage and all, and sometimes throw in some free parts, too. They don't ask for the bad parts, either.

I have a large ash tray, so I used some #16 copper and went clear around it with some indentations in the top to lay my soldering pencils in. Now no more burned wires and bed sheets. Just don't touch the wire while it's hot.

If I stick tapewriter labels on something like xtal markings on the 2 meter rig, I clean it first with lighter fluid. If it comes loose, I use some Scotch tape over it.

On the children's band (CB) radio one night I heard a fellow tell another one about 2 girls spending the night with him — and he even told their names and where they were from. I guess it pays to advertise. Hi!

I've heard about everything on CB possible, from little kids singing a complete song, tapes, and fights over whose channel it was. I listen for fun when I don't feel like working on something or building — and sometimes when I am. Maybe that's why some things don't work. Hi! I picked up big mama on Ch. 6 TV one night clear across town from here. She said someone was griping about hearing her on an adjacent CB channel, so I checked and I could hear her 3 up and 3 down and more —

except they were being used. I've heard she has a linear and an amplified mike. Thanks for listening . . .

Lee Lanterman  
Frederick OK

---

#### PROMPT RESPONSE

---

I want to thank you for the prompt response to my orders for books and tapes in the past. I would also like to say that I think *73 Magazine* is the best ham publication around. Wayne Green is to be commended for his time and effort to help struggling future amateurs like myself with the code and theory. Keep up the good work!

John Wingard  
Columbus GA

---

#### NO CHALK

---

Observed, written in chalk, on a Union Pacific boxcar passing through Salt Lake City on August 30, 1975: "W2NSD QSL". Thought you would be interested.

Dallas Barrett WA7MEL  
Salt Lake City UT

*Interested, and perplexed. I visited Salt Lake City in early August, but didn't have any chalk. — Wayne.*

---

#### DIRECTIONS

---

I took advantage of your subscription and code tape offer just a few months ago and have already found that the benefits have been worth the price.

Listening to W1AW was fine to a point, but it was the tape that put me over the hump. I passed the General code test with ease. Your *General Class License Study Guide* was invaluable in helping me put all the required technical knowledge together on the written exam. I'm sure that the *Advanced Class Study Guide*, that I purchased personally from you in Rochester in May, will help me obtain the Advanced class ticket on the first try.

As far as the magazine is concerned, I've enjoyed the mixture of technical and narrative articles. I found the article by Paul Rudolph WB6OMT in the September 1975 issue entitled, "Full Break-in at 60 wpm?" to be very timely. I'm now keying my transmitter, activating a sidetone and muting my receiver very simply and

reliably. Prior to the article's appearance I had concocted some wild schemes to do the same thing!

So keep those comments, articles and projects coming, Wayne!

One favor — please give directions on how to reach your offices once in Peterborough. On my vacation in July my XYL and I drove around town quite a while without finding your location.

Steve Zahas  
Williamsville NY

*Get on U.S. 101, east of town, and look for towers. — Ed.*

---

#### KAPUT

---

I've been an inactive ham for over 3 years (my wife says I was born a ham and am never inactive), and just got back on the air by putting a 2m FM rig in the car. I now find that all my hard-won theory is kaput because some wise/guy got tired of writing about grids, plates and filaments, and got people thinking about little bitty plastic things with something called emitters and collectors inside!

Now, as if that wasn't bad enough, some other clown took a bunch of the above plastic doohickeys and mixed them up with a lot of ———'s and ———|———'s. He must have then rolled them out flat and stuck about 16 (yes, sixteen) little wires onto it and called it an IC.

Now I ask you, is that any way for an otherwise nice bunch of guys to act while I wasn't looking? Where in the hell do I plug in a spare 6LQ6 in one of those little boxes? And where, oh where, do I attach the +250 V from my trusty supply with the 141b transformer?

And worst of all, what do I tell my 11 year old son (whom I encouraged to study for his Novice exam) when he asks me, "What's the difference between a common cathode and a common anode LED, Daddy??"

I would also like to start building accessory items for 2m FM using those plastic thingamajigs, but I can't decide which would be a more suitable how-to-do-it book, *The 2m FM Handbook* or *VHF Projects For Amateur and Experimenter*. So, I'm tossing it in your lap. Pick one and send it.

Bear in mind that a dummy like me needs more than just a schematic to make it work. As an example, do my chassis punches still work on that plastic stuff with the copper on one side?

Seriously, thanks for writing *How To Use FM*. It was a big help in avoiding the major errors when I first fired up the 2m FM rig. The XYL here has a question, though: When the girl on the cover finally puts on her blouse, does the carry strap go over it or under it?

Jeff Combs WA2ASO  
Turnersville NJ

*If Judy Repeater ever puts on her blouse we could be in a lot of trouble — it can't be just the listings of repeaters that are selling all those Repeater Atlas's. About that +250... how about a big red switch on the front panel, mount it insulated with a "self-destruct" sign and hook that to the 250? — Wayne.*

---

### GOOD GUYS

---

Please send the 14 wpm cassette and put my name on your subscription list for at least the next three years. I've got the last couple issues from one of my local amateur dealers and have been quite impressed with your articles and construction projects.

I hold a 1st class FCC phone ticket and make my living maintaining and doing system design on a business band communication system and, as a result of this, I am probably more critical of construction projects than most readers. I've read a few issues of *QST* and find myself wondering if the authors have an insatiable need to see their name in print or if they're deluding themselves into thinking that real people build things like that! They seem to see just how many odd-ball parts they can get in a project and it couldn't be any good unless it costs two hundred bucks.

Keep up the quality of your magazine and be assured that your subscriptions will multiply and be happy. The good guys always win in the end!

William E. Adams  
Columbus OH

8-33?

---

It is not that I admire the "code phrases" or ten-codes on citizen's band, but there may be some need for abbreviated phone signals for rapid, or more rapid, communication, or for more concise meanings, such as the following (now being used to some degree in this area):

- 8-01... You've got to be kidding!!!
- 8-02... Get off my back.
- 8-03... He shut down an hour ago, so you can quit calling him!!!
- 8-04... I hear you 5 by 9, but I don't want to talk to you!!!
- 8-05... You're sure beautiful when you're mad.
- 8-06... What do you expect, the W(8) — only got a 3 by 4 report.
- 8-07... Use a dummy load, stupid!!
- 8-08... Big deal, so what???
- 8-09... Beautiful signal, simply beautiful.
- 8-10... I give up, see you in the next pile-up.
- 8-11... I've been had!!
- 8-12... Sorry about that.
- 8-14... May the great kahuna befoul your rf clipper.
- 8-15... Great scott! Are you paid by the word??
- 8-16... How about telling it to someone who really cares??
- 8-17... I just hope the FCC catches up with you.
- 8-18... Same to you, fella!!!
- 8-19... What was his call???
- 8-20... Where's he at???
- 8-21... I did not design the stupid rig!!!
- 8-22... This has to be the worst contact I've ever had!!!
- 8-23... Bug off, stupid.
- 8-24... He is listening up ten kHz, so you can quit calling him on this one!!!
- 8-25... He is working the DX by call area, so quit calling and wait your turn.
- 8-26... He is working the DX from a list.
- 8-27... The net on this frequency terminated half an hour ago, so how about you stopping the effort to check in???
- 8-28... The frequency is already in use.
- 8-29... How about getting on the right frequency for a change???
- 8-30... Get on my frequency, stupid!!!
- 8-31... You are only 5 kHz out of the band.
- 8-32... Come on over for a cup of brew.
- 8-33... Are you crooked to the eyebrows??
- 8-34... Pardon me, sir, but I believe you think you are talking to someone who cares!!
- 8-35... What's wrong, have you no antenna?
- 8-36... Your deviation is only about

four times too wide for the repeater.

- 8-37... See you tomorrow, 73s.
- 8-38... Terminating operations here.
- 8-39... Who is calling me???
- 8-40... What time do you think you have???
- 8-41... You are too weak to understand.
- 8-42... You are as strong as horse-radish, here.
- 8-43... Let's change frequency.
- 8-44... Listen for you up ten.
- 8-45... Listen down ten for you.
- 8-46... Why do you want to know???
- 8-47... So and so covered you up, so try again.

There may be other phrases, but these are the ones known here.

M. L. Braun K8IOB  
Bellevue OH

---

### SORRY

---

A few months ago I entered a "first" subscription to *73* as a trial. I like your style. The technical articles, the editorials, Amsat information, and your ads are excellent. I am only sorry that I did not subscribe for 3 years.

R. C. Cunningham W3UJD  
Pittsburgh PA

---

### GIVING UP ELEVEN

---

Re "0-60 MHz Synthesizer", September issue, please note with interest the frequency pictured in the snapshot. It's heartwarming to know that there are still gallant stalwarts around who'd rather die than give up eleven meters. My hat's off to Mr. Calvin... 10-4?

Nelson Roberts WB6JFS  
Westlake Village CA

---

### THE 10-0 DECODER

---

Mr. Biddle (August, 1975, page 136) asked about a "descrambler"... our local PD uses a scrambler from time to time. 10-0 is their code for going to the device. The unit is very simple for this particular type of encoding. Anyone with reasonable ability in electronics should be able to build the device. I don't want to make an article about this... I feel that the police departments have enough trouble with the cons and crooks having monitors to listen in with.

*Continued on page 221*

# Flip Flops Exposed

The purpose of this article is not only to teach the basics of flip flops, but also to help the ham builder understand the circuits which he sees every day in magazines and construction project books.

All of us try to follow the builder's explanation of operation but may fall short of full understanding due to ignorance in certain shorthand notations or unfamiliar phrases such as "the flip flop is now set," or "it operates in a master-slave configuration," or more common, "the device will be allowed to toggle."

We decide to skip the explanation and build it anyway. It works, but we miss the joy of knowing how it works. Hopefully, these intermittent knowledge gaps now can be filled once and for all.

The flip flop has an amazing talent: a memory.

This may not seem like much to you, but for a chunk of silicon it's quite an accomplishment.

This memory is the basis of all computers and counters. After all, what is counting but remembering what you had last? And the beauty of learning about flip flops is that there is no new background material with which to grapple. All that is needed is an understanding of the TTL primer in the July issue.

Take a minute and review the four basic gates and the action of the clocking input.

There are four basic types of flip flops. They are the R-S, D,T and J-K. All have two stable states, either 0 or 1. This is known as bistable. Sometimes flip flops are referred to as bistable multivibrators. Another name you might have seen is bistable latch. They are all the same thing, a form of the flip flop.

## R-S Type

Fig. 1 shows the simple R-S flip flop or latch. The S means SET and the R means RESET. Other terms used are PRESET and CLEAR, respectively.

By convention, the outputs Q and  $\bar{Q}$  cannot be equal. In fact, the bar over any letter means "not".  $\bar{Q}$  is called "not Q".

To show the action, let's *assume* that Q = 1 and  $\bar{Q}$  = 0. Because of the feedback loops

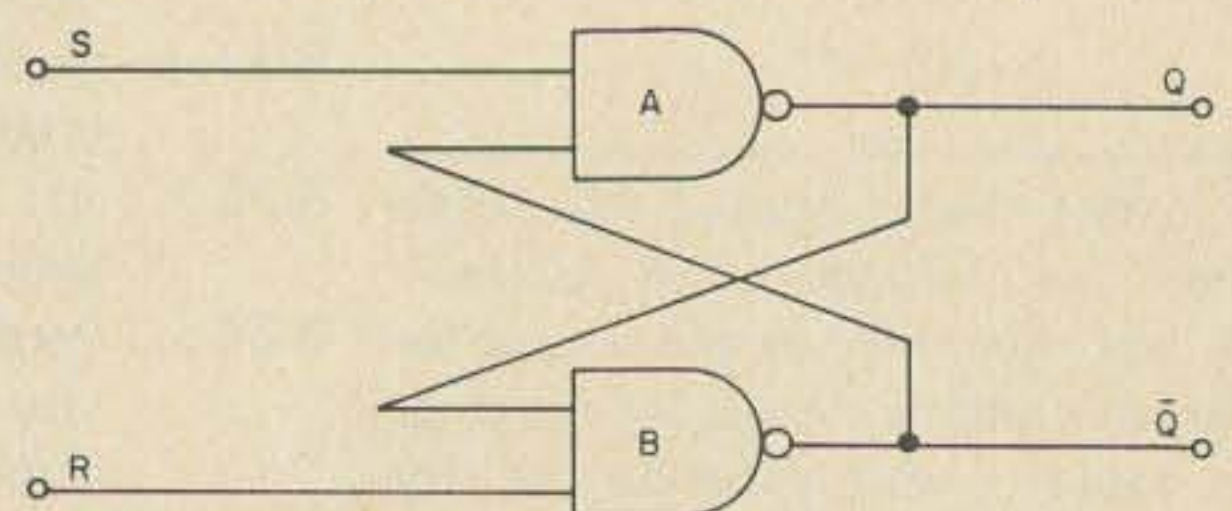

Fig. 1. R-S flip flop.



the B input is 1 and the A input is 0. For the initial state in the NAND flip flop (NOR gates can also be used) R and S are always 1. So we have the initial condition, as shown in Fig. 2(a).

If you recall the NAND truth table, only inputs of 1,1 yield 0; all other combinations give 1.

If we drive R to 0 the following chain takes place. The R input of 0 combines with the 1 input at B to make the output at  $\bar{Q} = 1$ . This 1 feeds back to the A input and combines with the  $S = 1$  input to make a 0 output at Q. This 0 feeds back to the input at B, as seen in Fig. 2(b).

Whew! But look what happened! Our outputs are reversed! Even if we return R to its initial state of 1, the output will still remain, as we see in Fig. 2(c).

That momentary driving of R to 0 could be a push-button or a clock pulse.

Now if we take our final condition of 2(c) and impress S to 0, the outputs will flip around again. And they will stay, even if S is returned to 1. See Figs. 2(d) and 2(e).

The name flip flop is thus shown to be quite appropriate.

A flip flop is said to be in the SET condition if the Q output is 1. The RESET condition exists if the  $\bar{Q}$  is 1.

Fig. 2(a) is a SET state and 2(c) is a RESET condition. The rule: If a flip flop is SET, driving RESET to 0 will change the output. If it is RESET, driving SET to 0 will change the output.

The symmetry is beautiful. If it's SET, reset it. If it's RESET, set it.

But what happens if both R and S are impressed to 0? Well, that is the problem with the R-S latch. The answer is ambiguous. Since you never know which 0 came first, the output is unpredictable. Try it, and you'll see the fun.

A schematic diagram of a flip flop may show the actual gates or it may show a configuration such as Fig. 3(a). A personal favorite is shown in Fig. 3(b).

Either way, it indicates that something like what is shown in Fig. 3(c) may have been done with (for instance) the 7400 chip.

Not all flip flops will be made from chips containing *only* simple gates. Some ICs have

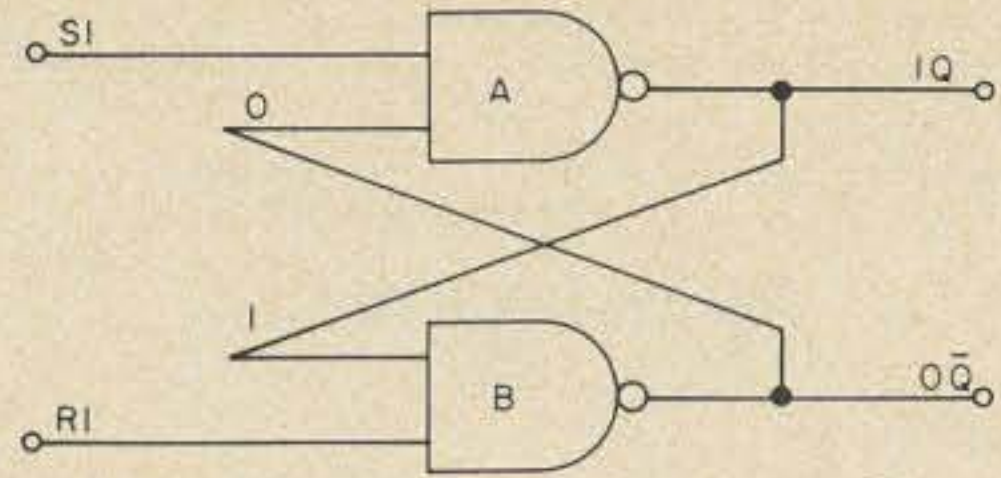

Fig. 2(a). Initial condition.

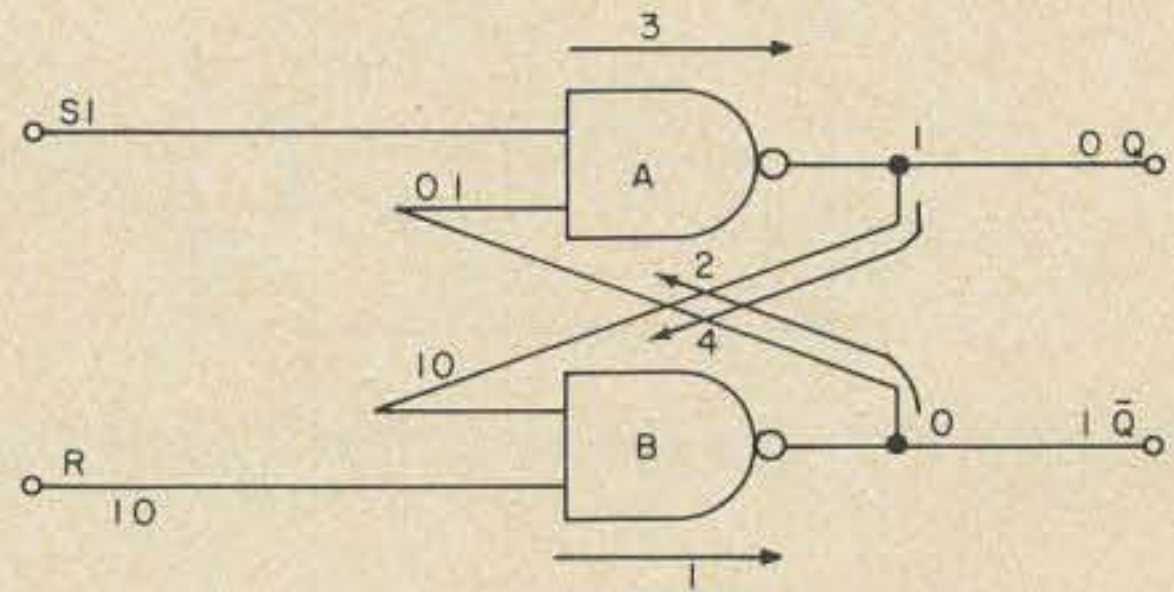

Fig. 2(b). Follow the action!

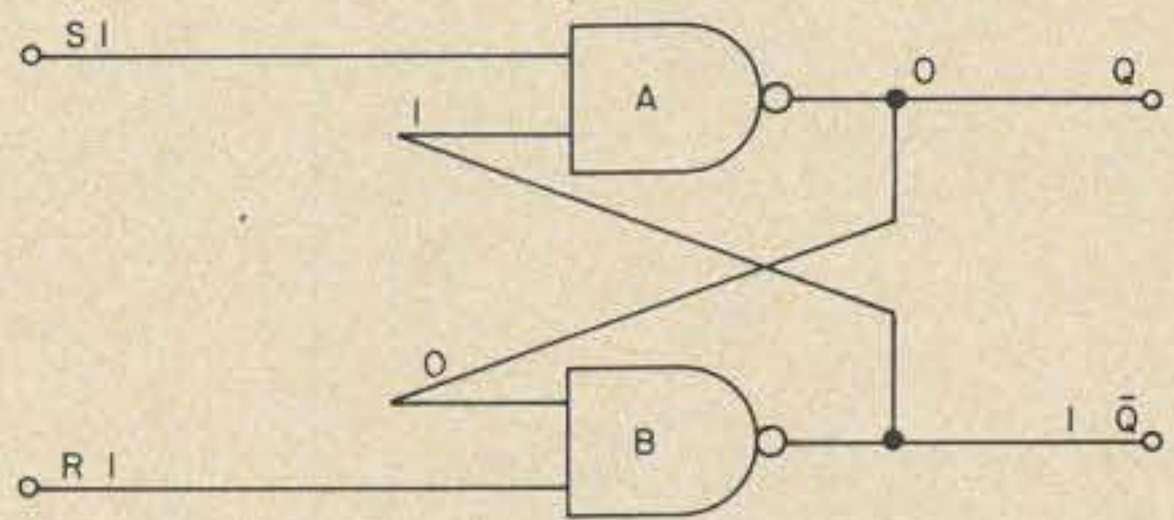

Fig. 2(c). Outputs reverse and stay, even though R is returned to 1.

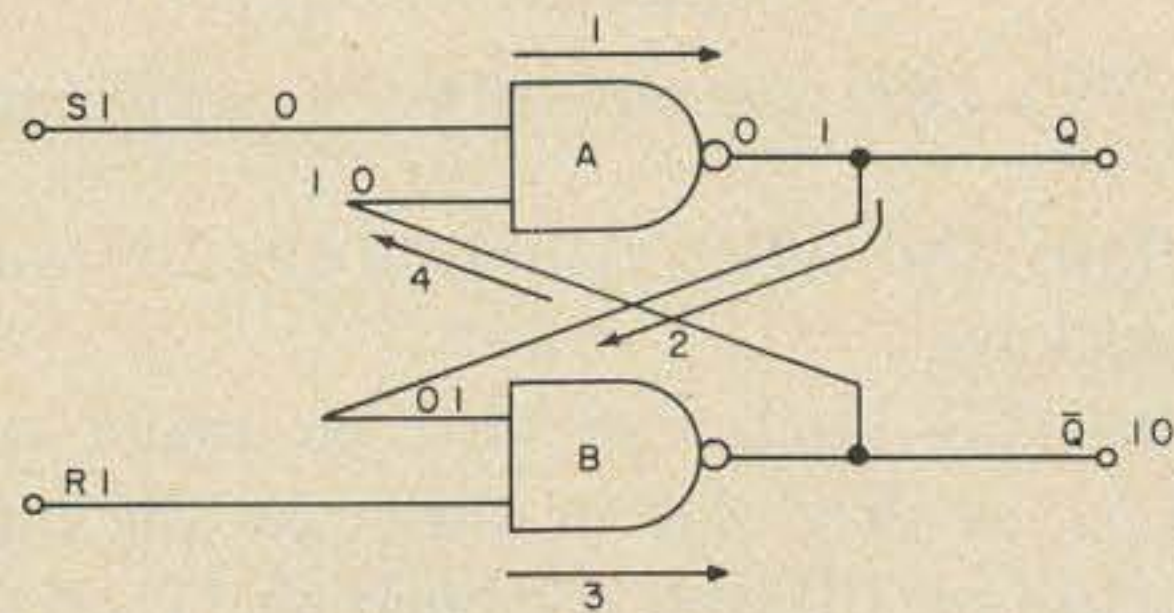

Fig. 2(d). S goes to 0 and outputs reverse.

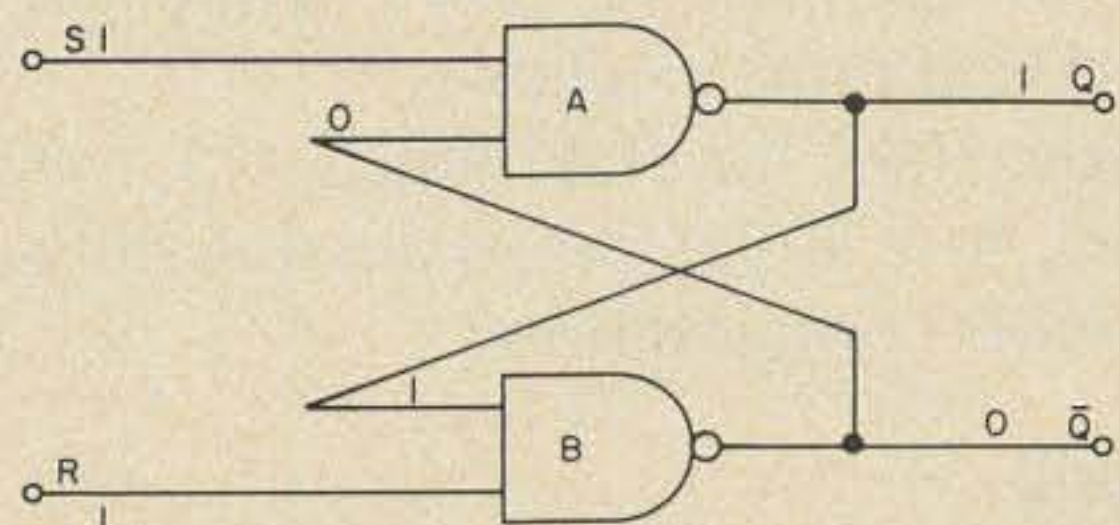

Fig. 2(e). Outputs stay reversed, even if S is returned to 1.

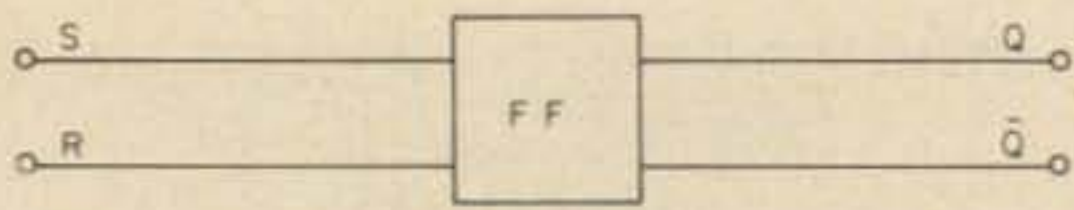

Fig. 3(a). R-S flip flop.

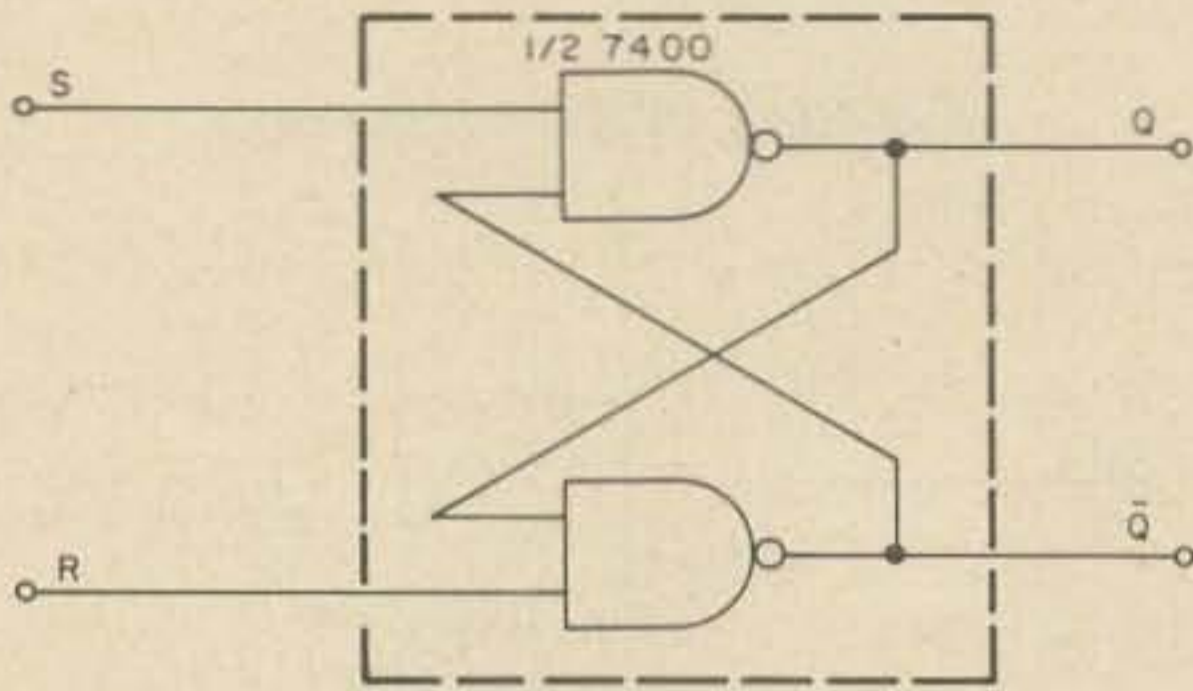

Fig. 3(b). Flip flop showing chip it came from.

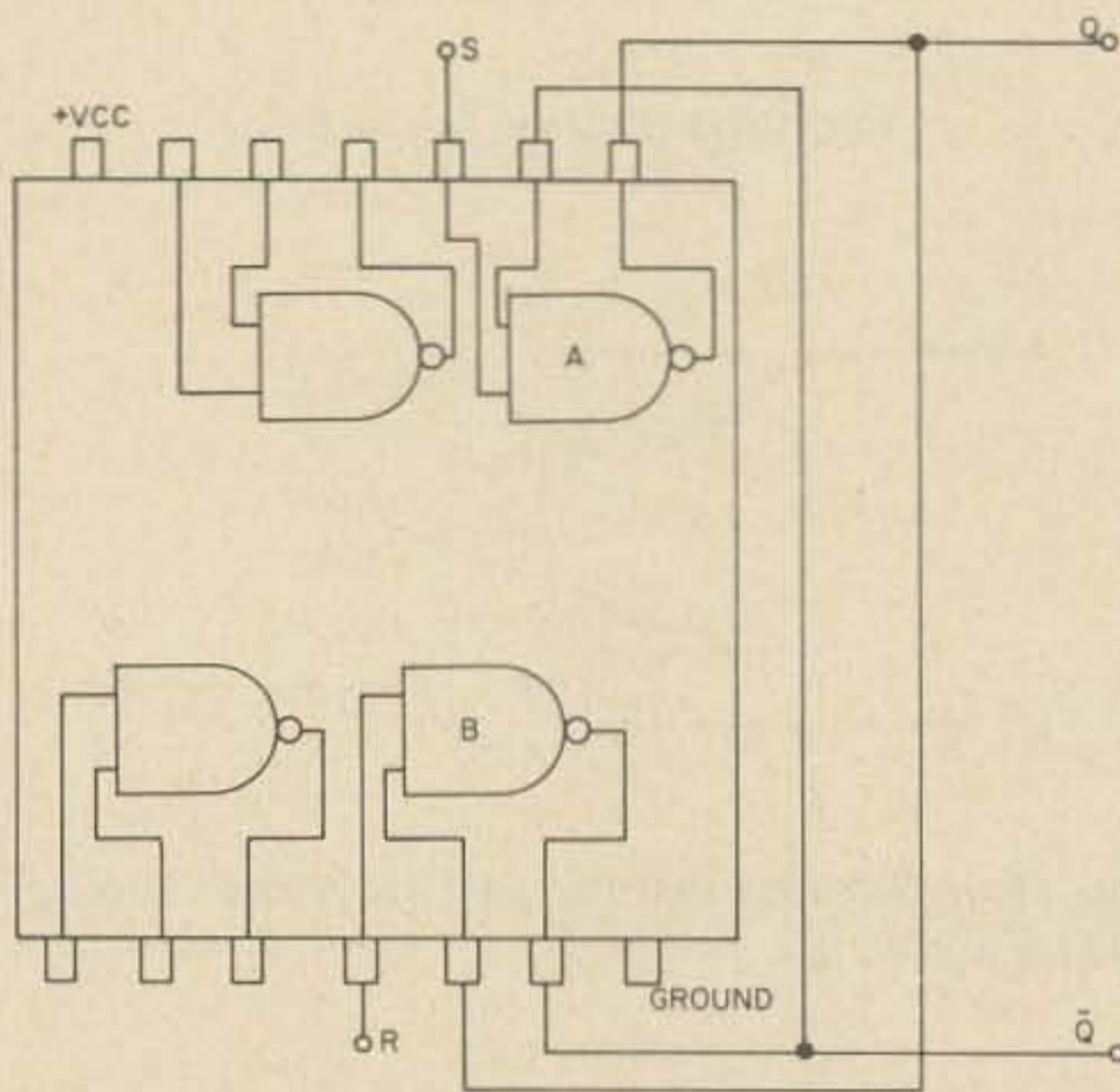

Fig. 3(c). 7400 wired in R-S latch configuration.

flip flops and *other* elaborate circuits within one package.

The R-S latch can also be made using NOR gates (Fig. 4). In this case the inputs are held low (0) and driven high (1) to start the flip flop function. It's just the opposite of the NAND gate flip flop, where inputs are held high (1) and driven low (0) to activate.

The NOR flip flop is not used much. It is easier to use NAND gates. They are also cheaper and more available.

In the NOR flip flop inputs of 1,1 are not allowed, just as 0,0 inputs are not allowed in the NAND configuration.

### Clocking

Two types of logic circuits are used. One is synchronous and the other is non-synchronous or asynchronous.

Asynchronous operation exists when circuits are operating independently of each other. Each individual circuit has its own input and it responds to these inputs.

Synchronous operation relies on a common input such as a clock to feed all the circuits in the system. All functions rely on the clock.

If we add a clocking input to our R-S flip flop, two additional NAND gates are used. These gates insure that the latch works only when the clock pulse (1) is present. In Fig. 5 the input of C will be 0 only if the A input is 1 and the clock pulse is 1. Remember that the R-S configuration latches only on the 0 drive — and we have supplied it.

### D Type

The second type of flip flop is the D or delay type. Since we still have the problem of the SET and RESET inputs being the same (causing an unpredictable output), the best we can do is to insure that we don't have the same inputs at the same time.

In Fig. 6 the inverter (E) negates all inputs; 0 becomes 1 and 1 becomes 0. We employ it to feed the B input. By placing it there while feeding it *and* A from the same input, we can be certain that the signals reaching the gates will be different.

Any signal going to A will remain the same and those passing through the inverter to B will change.

The D type can also have PRESET and CLEAR controls. They are superior or overriding functions. No matter what is going on, commands on these controls have priority. When either of these inputs is present (0), the output will go to 0 or 1 depending upon which function is employed.

In schematic diagrams, the letter "D" is the only indication of the flip flop type.

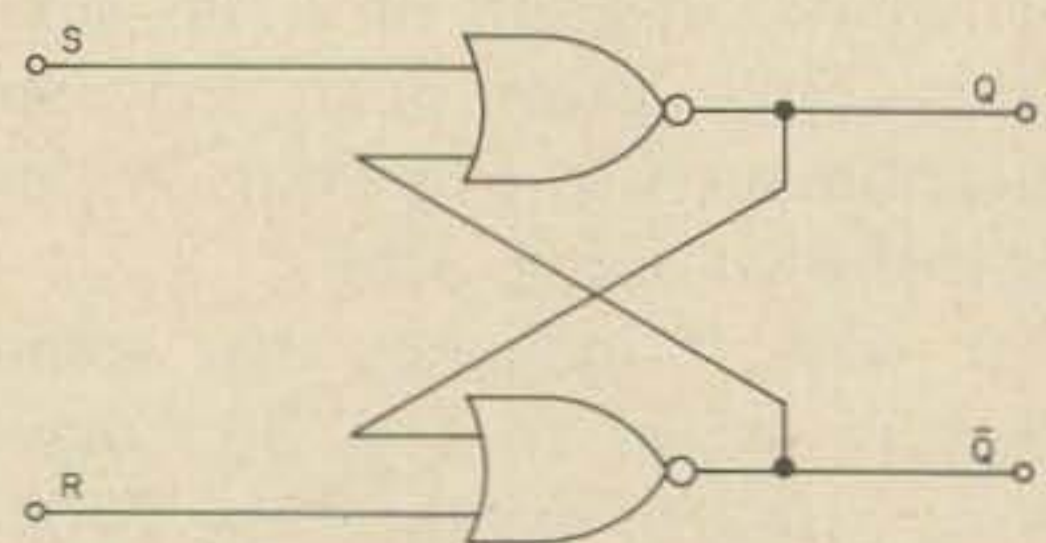

Fig. 4. NOR gated flip flop.

IC types which are D flip flops are 7474 (contains 2 flip flops with PRESET and CLEAR) and 7475 (contains 4 flip flops without PRESET and CLEAR).

### T Type

The toggle or T type does what its picturesque name implies — it toggles.

The logic is such that the output will change regardless of what it was prior to clocking. But this only happens if the clock is fast enough. If it is not rapid, the output will change state and then return. It will forever change and change back again.

Toggle flip flops have been assigned mixed jobs. When a clock pulse is applied, the output will change once every input cycle. Therefore, it completes one output cycle (not just change) for every two input cycles. This gives a divide-by-two property which is used in counters and calculators.

Another use is in random output devices like "electronic dice" and "heads-tails" circuits, which electronics magazines are so fond of printing once a year. Since it is unknown where the circuit is toggling at the moment, a stop-toggling command will produce a random output.

### J-K Type

The J-K flip flop is very widely used. The inputs J and K correspond to S and R. The gates 1-4 are the master section and 5-8 the slave section. Gate 9 is used as an inverter. (Although not shown, a constant input of 1 is kept on the other input. It will combine with the other input to invert it. 1 and 1 yield 0; 1 and 0 yield 1.)

Both sections are synchronous (use the same clock pulse) and are activated by a pulse of 1.

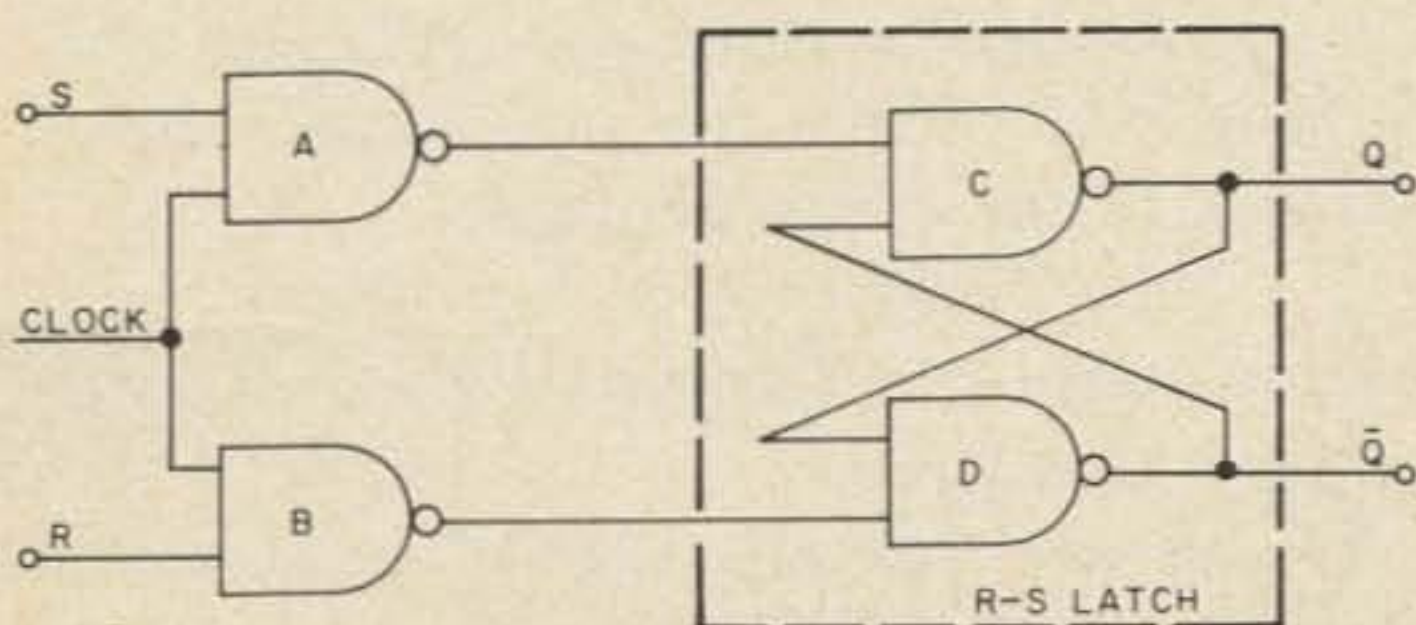

Fig. 5. Synchronous clocking of R-S latch.

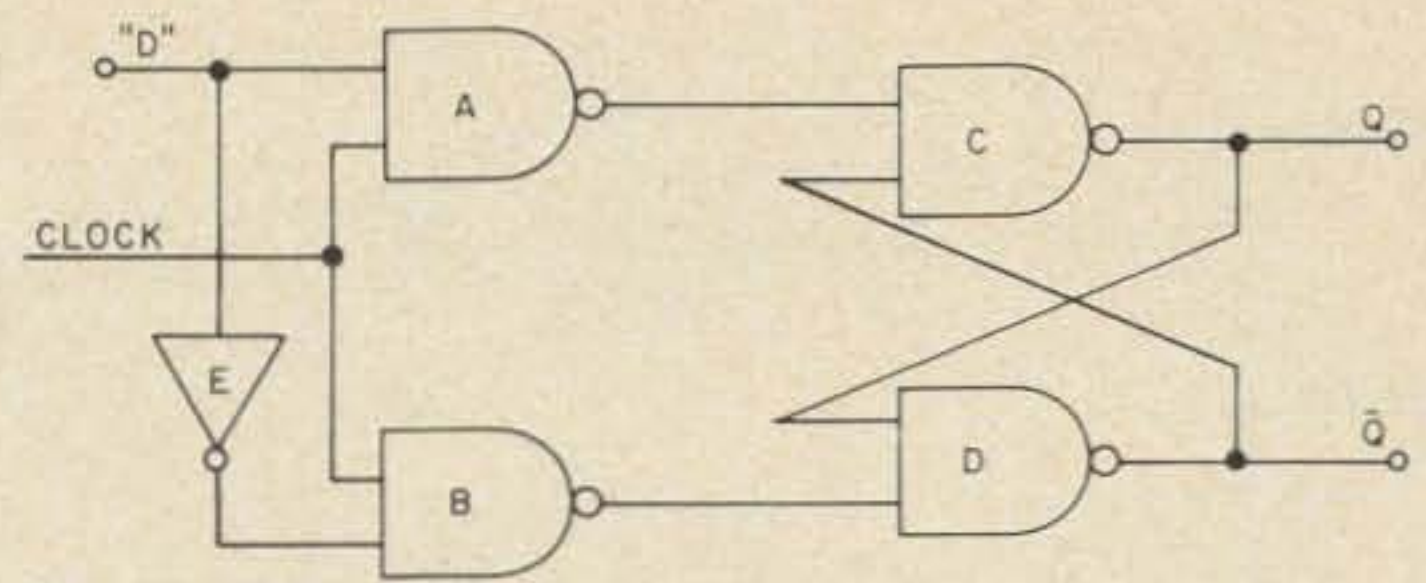

Fig. 6(a). D type flip flop.

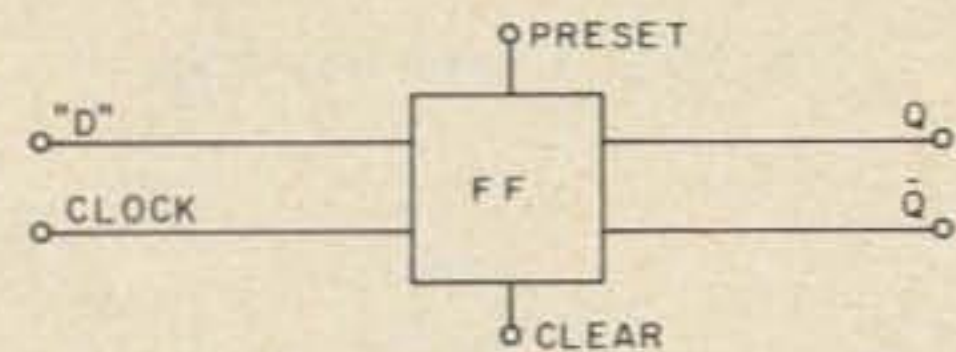

Fig. 6(b). D type with PRESET and CLEAR.

If the clock is 1, the master will see this and activate. However, the slave will see the inversion of this (0) because of gate 9, and not activate.

The feedback via lines a and b from slave to master will be valid until the clock pulse is 0. Then the slave will energize due to the inversion of this pulse from 0 to 1. But now the master is disabled because it sees the 0 straight from the clock.

The information is passed from master to slave. The next pulse will feed the output of the slave back to the master and so on.

A sequence of four steps takes place.

1. Isolate slave from master.
2. Enter information to master.
3. Disable master.
4. Transfer information from master to slave.

All this takes time. That is a useful property. A J-K can be used for storage of information while another circuit is doing something else. The two informations can then rendezvous at the proper time. The J-K also solves the same ambiguous input problem of the simple R-S. It's pretty good as a toggle, too.

Some examples of J-K flip flops are the 7470, 7473 and 7476. Each has a unique property such as number of flip flops, different voltage and frequency ratings, and different controls.

### How the Flip Flop Counts (or, Here's the Part We've All Been Waiting For)

We have seen that it takes two pulses to return a flip flop to its initial state. If we

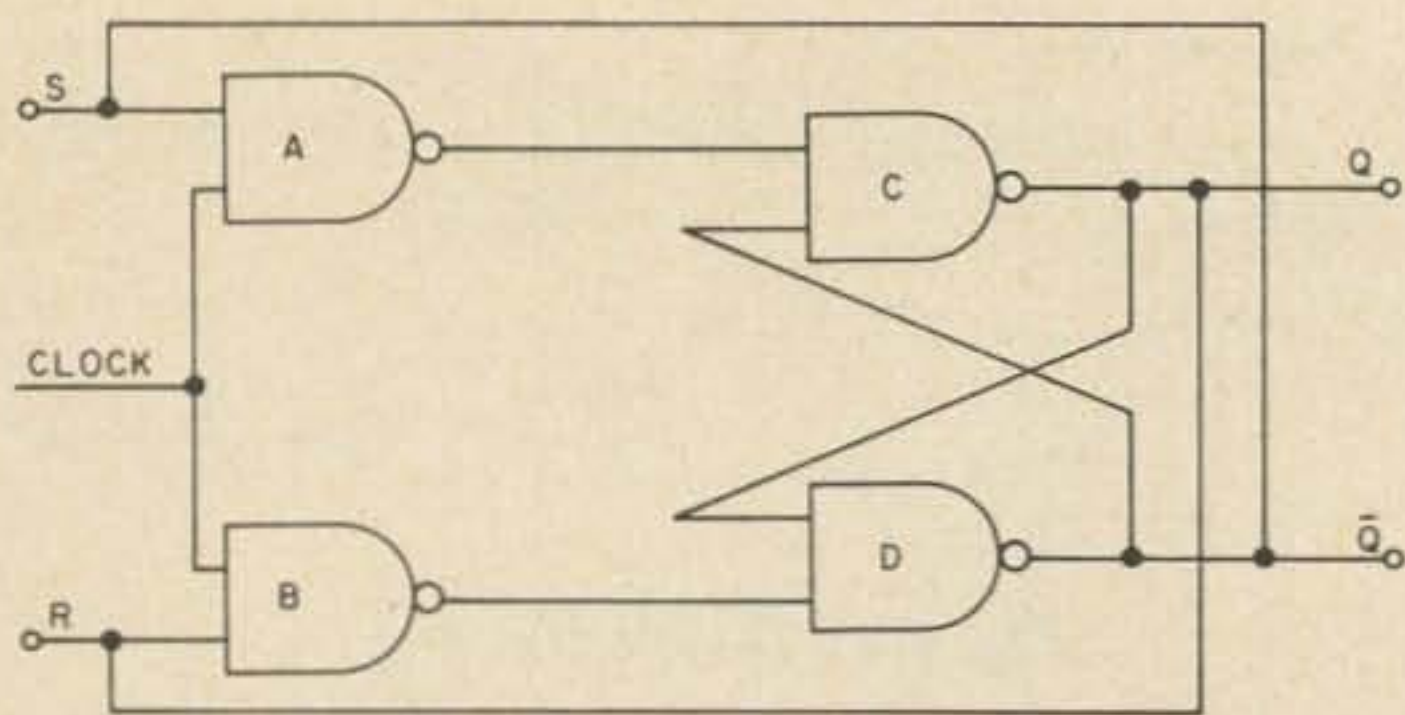

Fig. 7(a). T type flip flop.

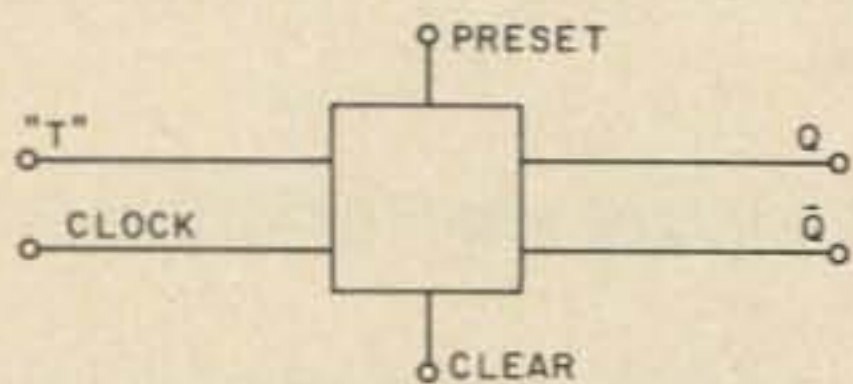

Fig. 7(b). T type with PRESET and CLEAR.

start with Q as 1, it will take two pulses to make it 1 again. The memory remembers the first pulse and waits for the next.

Therefore, if we monitor the output of Q we can tell when the input has completed two pulses. Since each flip flop counts by "twos", placing them together will allow the first to count by two, the second by four, the third by eight, and so on (Fig. 9).

Think of each flip flop as having two stages. Initially, all inputs and outputs are 0. Pulse 1 will energize a<sub>1</sub>. Pulse 2 will return the first flip flop to its initial condition and store a pulse at b<sub>1</sub>. Pulse 3 activates a<sub>1</sub>

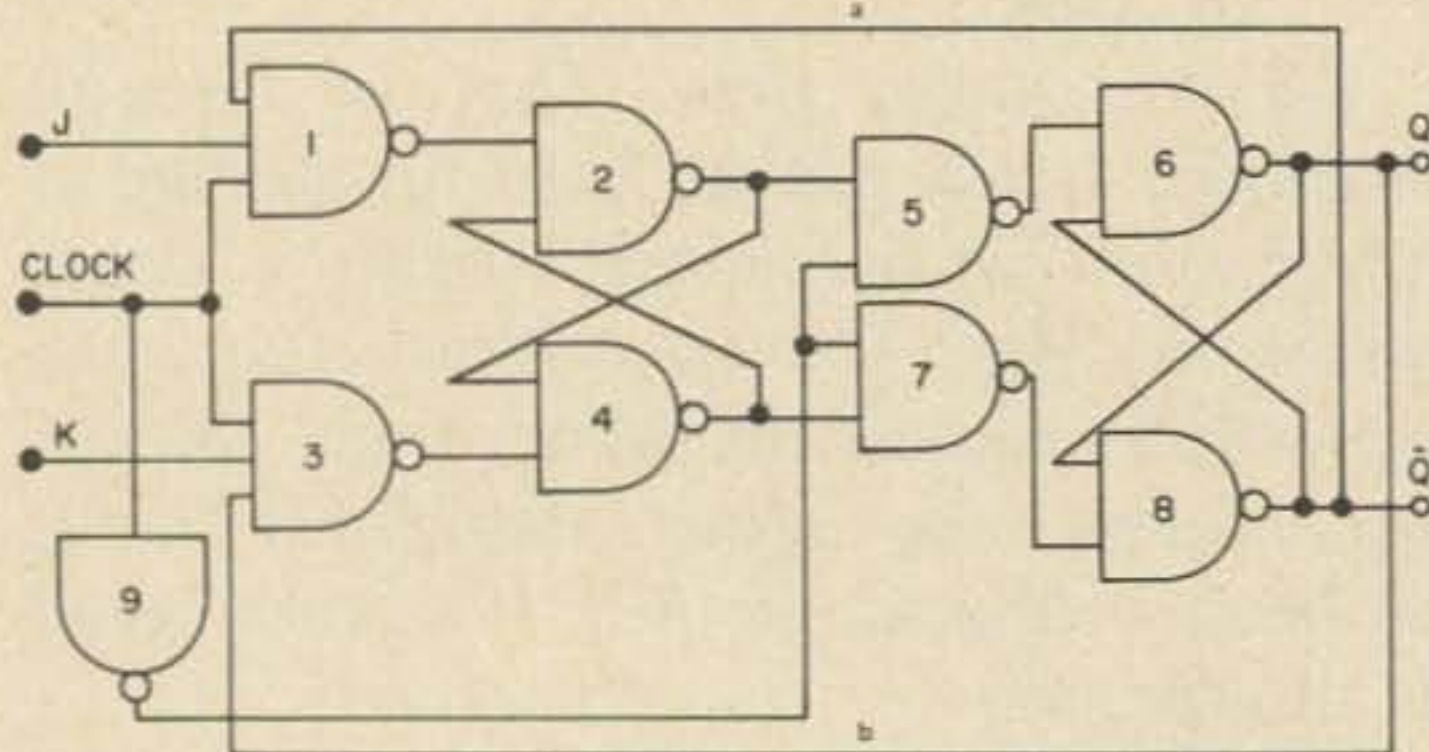

Fig. 8(a). J-K flip flop made from R-S latches.

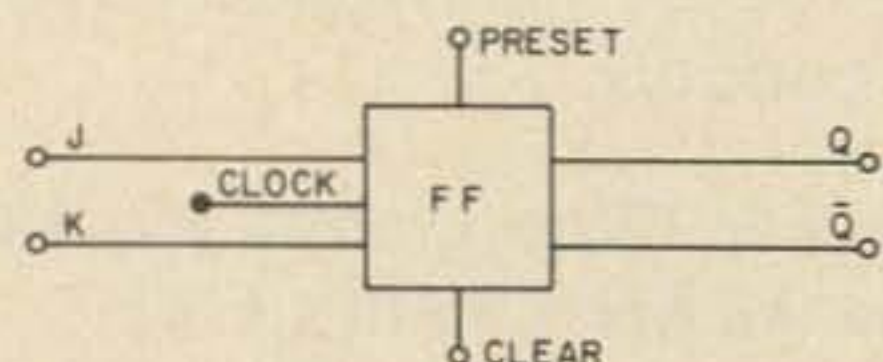

Fig. 8(b). J-K type with PRESET and CLEAR.

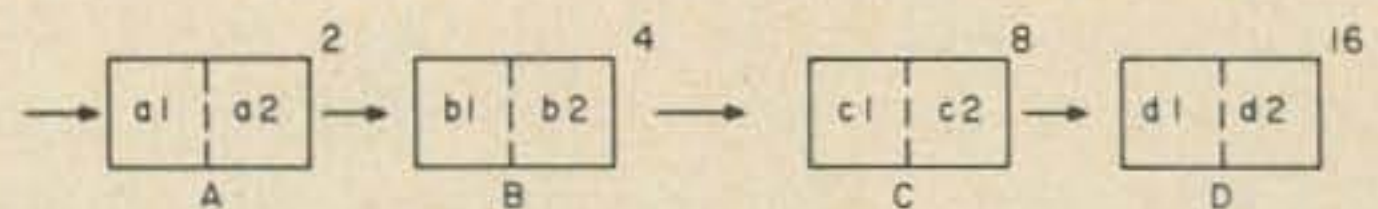

Fig. 9. Flip flop counter.

again. Pulse 4 flips section A and passes a pulse to b, where it combines with the pulse already there to flip section B. Our monitor at the output of B rings, buzzes or lights, and we know we have counted to 4.

After 16 pulses the entire counter is returned to 0. We have counted to 16!

### Experimentation

Many readers have asked how to convert this type of "pure" knowledge into practical application. The IC mystique still lives! Just experiment. Buy some ICs and hook them up. See what happens when you do "this" or "that". There is no great mystery. They will work — really!

Here are some suggestions to help you play around.

1) Get a 5 volt power supply. It's cheap if you build one. The October, 1974 issue of 73 has a fine one. If you like printed circuits, Radio Shack has a board which is almost the same (except for part values). Parts are very cheap from the advertisers in 73.

2) Monitor the output with some light emitting diodes (LEDs). They tell you if the output is high (1) or low (0).

3) Get data sheets on ICs that you wish to work with. They have the circuit diagrams of the internal gates so you know how to hook them up. They also give 0 and 1 values.

4) Never be embarrassed to return non-working chips. The same mass production techniques which brought down the price also brought down the quality. Don't get worried, though: *Most ICs will function properly*, but if they don't, return them. I have *never* had a store *not* replace a non-working chip. Even the mail order houses exchange them without a hassle.

5) New breadboard kits have been arriving on the markets. I haven't tried them, but they look good.

6) ICs are rugged. Don't be afraid of them.

... WB2NEL

# YAESU - the radio company.

See the complete line of radios at these authorized dealers . . .

ABC Communications  
17541 15th Ave. NE  
Seattle WA 98155  
206-364-6410

Adirondack Radio Supply  
185 W. Main St.  
Amsterdam NY 12010  
518-842-8350

Amateur Electronic Supply  
4828 W. Fond Du Lac Ave.  
Milwaukee WI 53216  
414-442-4200

Amateur Electronic Supply  
621 Commonwealth Ave.  
Orlando FL 32003  
305-894-3238

Amateur Electronic Supply  
17929 Euclid Avenue  
Cleveland OH 44112  
216-486-7330

Burghardt Amateur Center  
124 First Ave. NW  
Watertown SD 57201  
605-886-7314

Conley Radio Supply  
101 S. 31st St.  
Billings MT 59101  
406-259-9554

C W Electronics  
1401 Blake St.  
Denver CO 80202  
303-244-5523

Ed Juge Electronics  
3850 S. Freeway  
Fort Worth TX 76110  
817-926-5221

Electronic International  
Service Corp.  
11305 Elkin St.  
Wheaton MD 20902  
301-946-1088

Freck Radio Supply  
38 Biltmore Ave.  
Ashville NC 28807  
704-254-9551

Gary Radio  
8199 Clairemont Mesa  
Boulevard  
San Diego CA 92111  
714-292-1440

Graham Electronics  
133 S. Pennsylvania St.  
Indianapolis IN 46204  
317-634-8486

Ham Radio Center  
8342 Olive Blvd.  
St. Louis MO 63732  
800-325-3636

Ham Radio Outlet  
999 Howard Ave.  
Burlingame CA 94010  
415-342-5757

Hamtronics  
4033 Brownsville Rd.  
Trevose PA 19047  
215-357-1400

Harrison Radio  
20 Smith St.  
Farmingdale, LI, NY 11735  
516-293-7990

Henry Radio  
11240 W. Olympic Blvd.  
Los Angeles CA 90064  
213-272-0861

Honolulu Electronics  
819 Keeaumoku St.  
Honolulu HI 96814  
808-949-5564

Klaus Radio Inc.  
8400 N. Pioneer Pkwy.  
Peoria IL 61614  
309-691-4840

Oregon Ham Sales  
409 W. First Ave.  
Albany OR 97321  
503-926-4591

Quement Electronics  
1000 S. Bascom Ave.  
San Jose CA 95128  
408-998-5900

Racom Electronics  
15051 S.E. 128th St.  
Renton WA 98055  
206-255-6656

Radio Inc.  
1000 S. Main  
Tulsa OK 74119  
918-587-9123

Teco  
1717 S. Jupiter Rd.  
Garland TX 75042  
800-527-4642  
(214-348-8800 in  
Texas)

Vickers Electronics  
500 E. Main St.  
Durham NC 27702  
919-683-1597

Webster Radio  
2602 Ashlan  
Fresno CA 97326  
209-224-5111

Wilson Electronics  
4288 S. Polaris Ave.  
Las Vegas NV 89103  
702-739-1931

YAESU  
***The radio.***

Yaesu Musen USA, Inc., 7625 E. Rosecrans, No. 29,  
Paramount, CA 90723

# **NOW you can REALLY CARRY it with you!**



Our Touch tone encoder comes encased in a beautiful pocket secretary and features —

- *A built-in speaker for acoustic coupling*
- *Miniature phone jack with cord for plug-in use*
- *Self-contained 9 volt power source*

**\$69.95**

**Telecommunication Control SYSTEMS**

*Div. of Communications, Inc.  
Haverhill and York Sts.  
Andover, Mass. 01810*

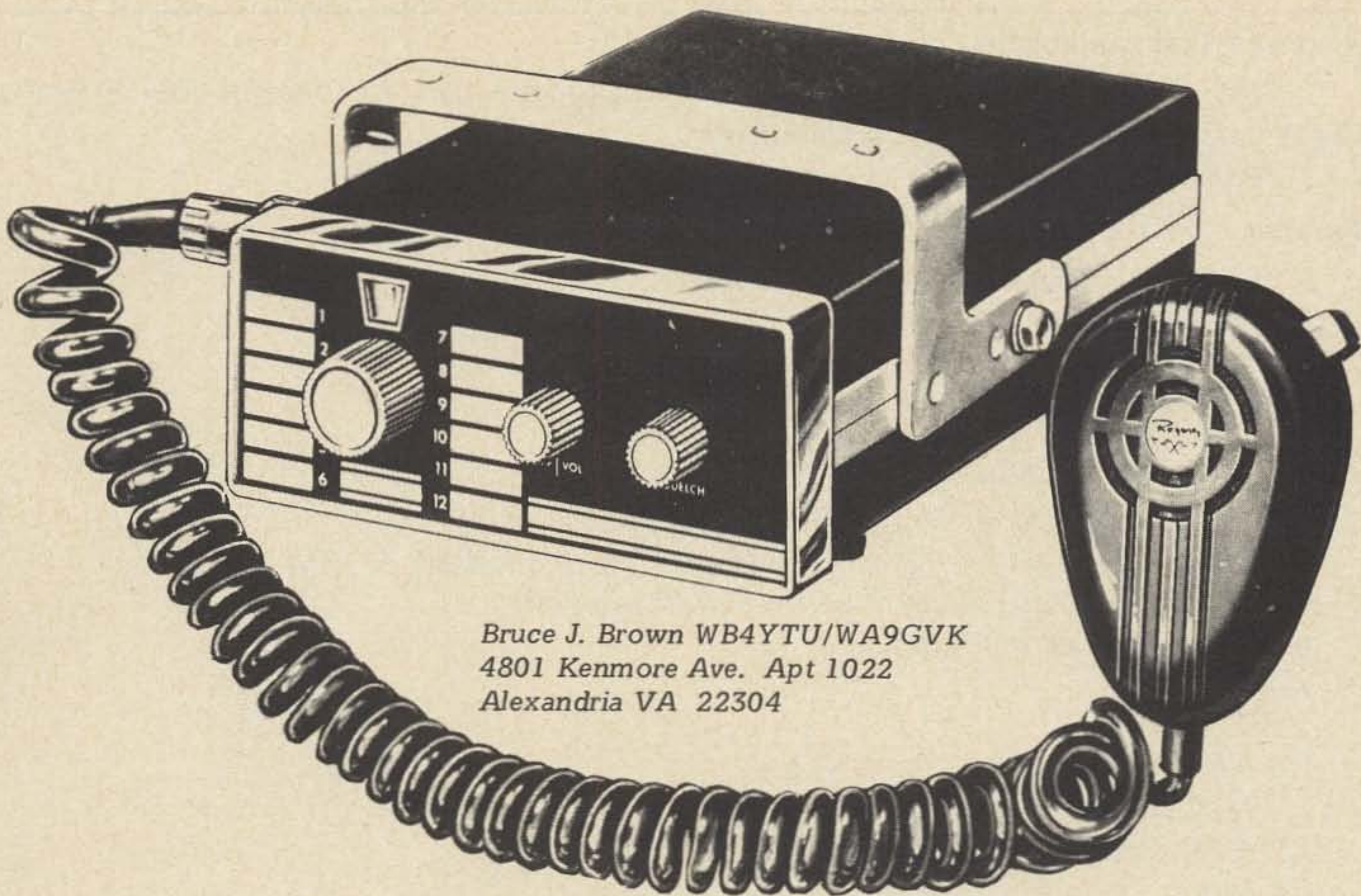

Bruce J. Brown WB4YTU/WA9GVK  
 4801 Kenmore Ave. Apt 1022  
 Alexandria VA 22304

# Breakthrough in Fast Scan ATV

**A**re you tired of using your tube ATV rig as an auxiliary room heater? Is

your rig taking up valuable space that could be better used for storage of your porno magazine collection? Does everyone think your rig looks like a booby prize won at a hamfest raffle? Are you tired of searching through surplus store garbage cans for final amplifier tubes? Have you been afraid to get into amateur television because of the above? If your answer to any or all of the above is yes, then the ATV Modified Regency HR-440 is for you!

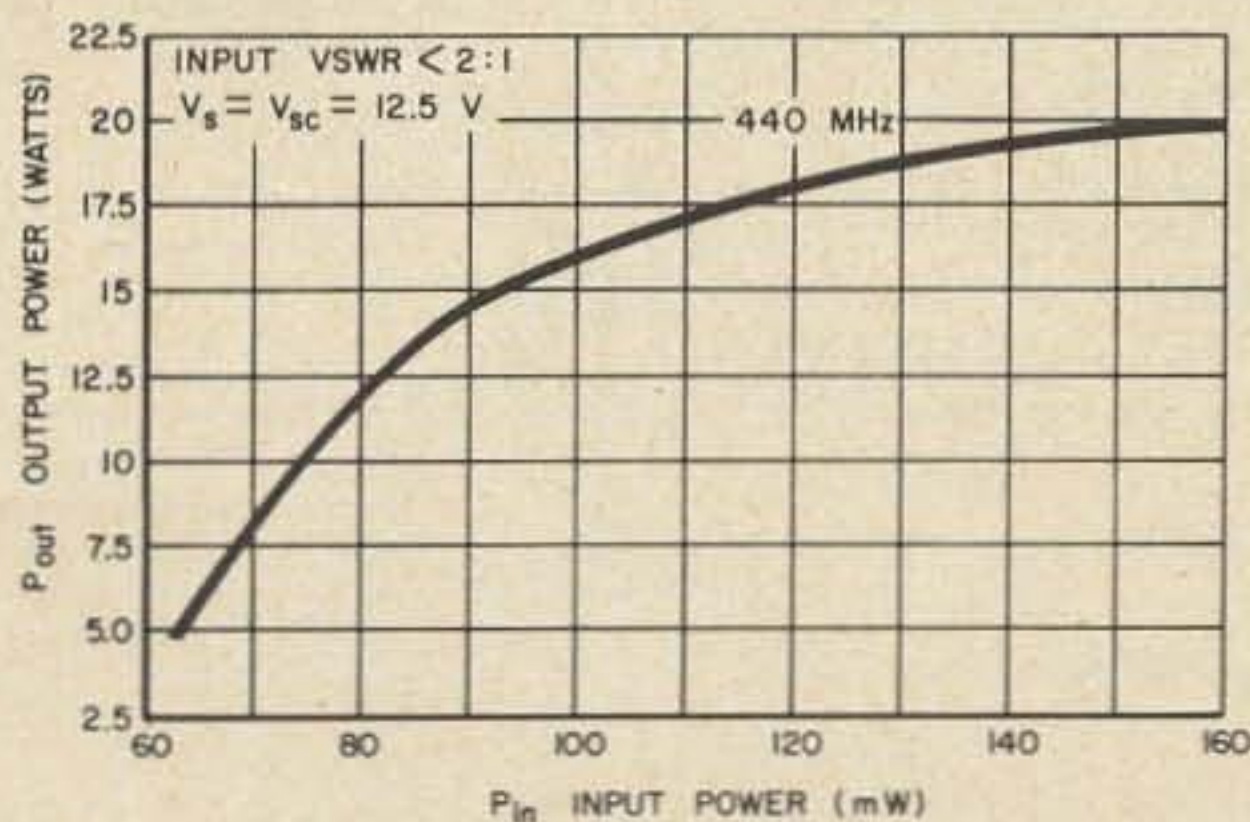

Fig. 1. MHW-710 output vs input power.

It is not only a compact, solid state, 10 Watt average TV transmitter, but has a

### Required Test Equipment

1. UHF wattmeter (Bird 43) with 50 Ohm dummy load. (50 feet of RG-58 into a Heath Antenna results in a good UHF load.)
2. 20,000 Ohms per volt (or greater) VOM.

### Required Modification Tools

1. 30 Watt soldering iron and 60/40 solder.
2. Diagonal cutters.
3. Needlenose pliers.
4. Wirestrippers.
5. Screwdriver (to tighten #4-40 screws).
6. Jeweler's screwdriver.
7. Nutdriver set (Radio Shack 64-1800; \$3.29).
8. Desoldering tool or remover wick (Radio Shack 64-2090; \$1.49).
9. Variable speed electric drill with the following bits:
  - a. 3/32" (optional hole starter)
  - b. 1/4"
  - c. 3/8"
10. File (to clean burrs from holes).
11. 1/2" wrench (for tightening UG-1094 nuts).
12. RTV or nut-tightening solution.
13. Ruler.

### Required Tune-Up Tools

1. 0.075 plastic hex alignment tool.
2. Thin tipped insulated screwdriver. Both available in single tool, GC #9304 (\$.55).

### Required Reference

Regency Owner's Manual Model HR-440 440 MHz Amateur FM Transceiver (supplied with rig; \$5.00 otherwise). Regency Electronics, 7707 Records Street, Indianapolis IN 46226.

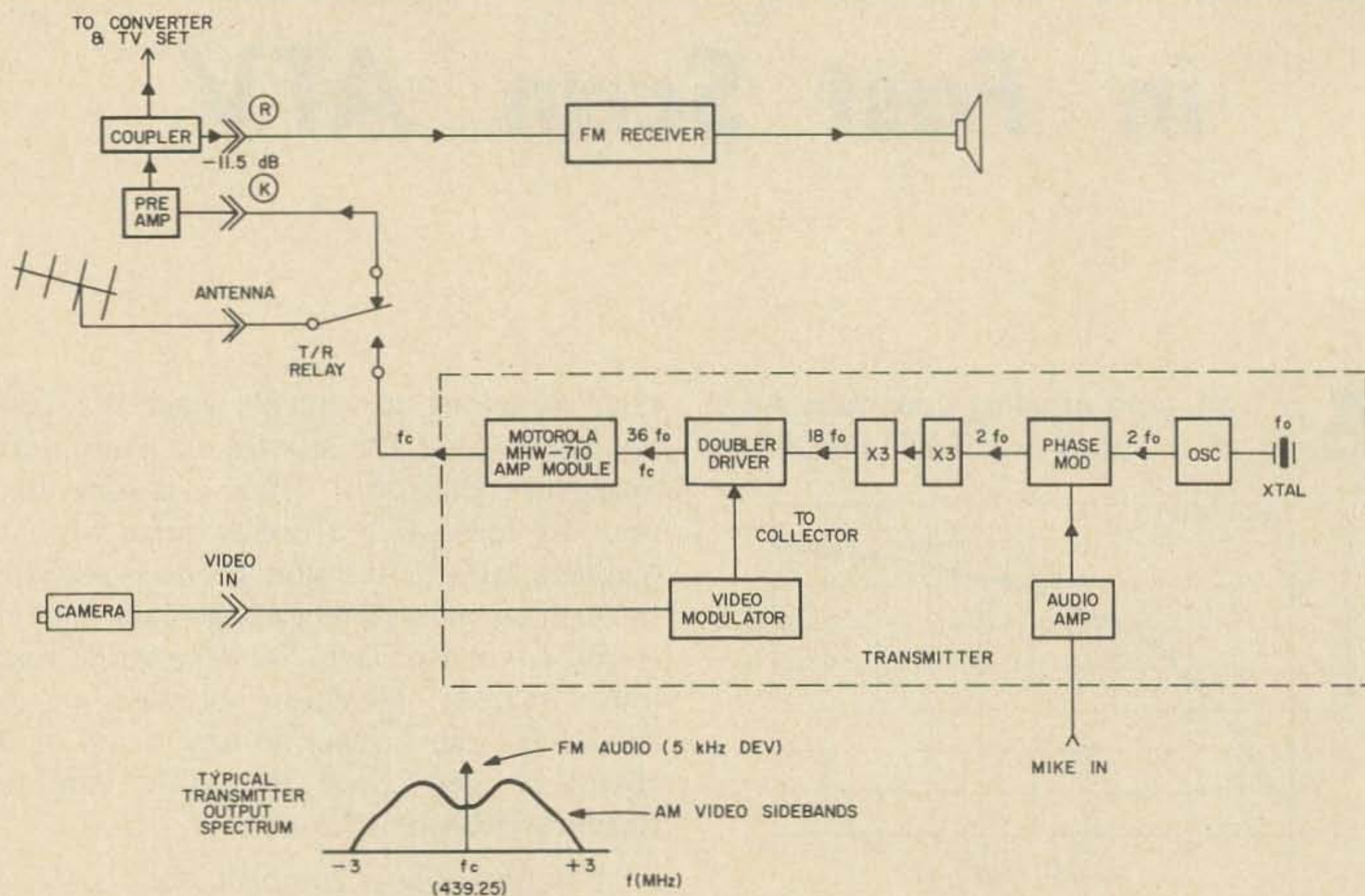

Fig. 2. HR-440 Mod ATV transceiver block diagram.



squelched audio receiver, to boot. It's adaptable for simplex and/or repeater operation and is compatible with the popular "audio on the video carrier" format. You can even operate ATV from your car or in the field with a rechargeable battery.

This paper details the modification procedure necessary to use an HR-440 for fast scan amateur television use. Approximately \$25 in parts and 5 hours of labor, using proper tools, are required to implement the conversion.

### Transmitter Modification (Figs. 1, 2 and 3)

Video amplitude modulation of the carrier is achieved through collector modulation of the driver stage immediately preceding the Motorola MHW-710 power amplifier module. This is accomplished using a video modulator board added internally in the rig. A somewhat linear output signal is possible due to the output vs. input performance characteristics of the module operating in the 7 to 10 Watt region as shown in Fig. 1.

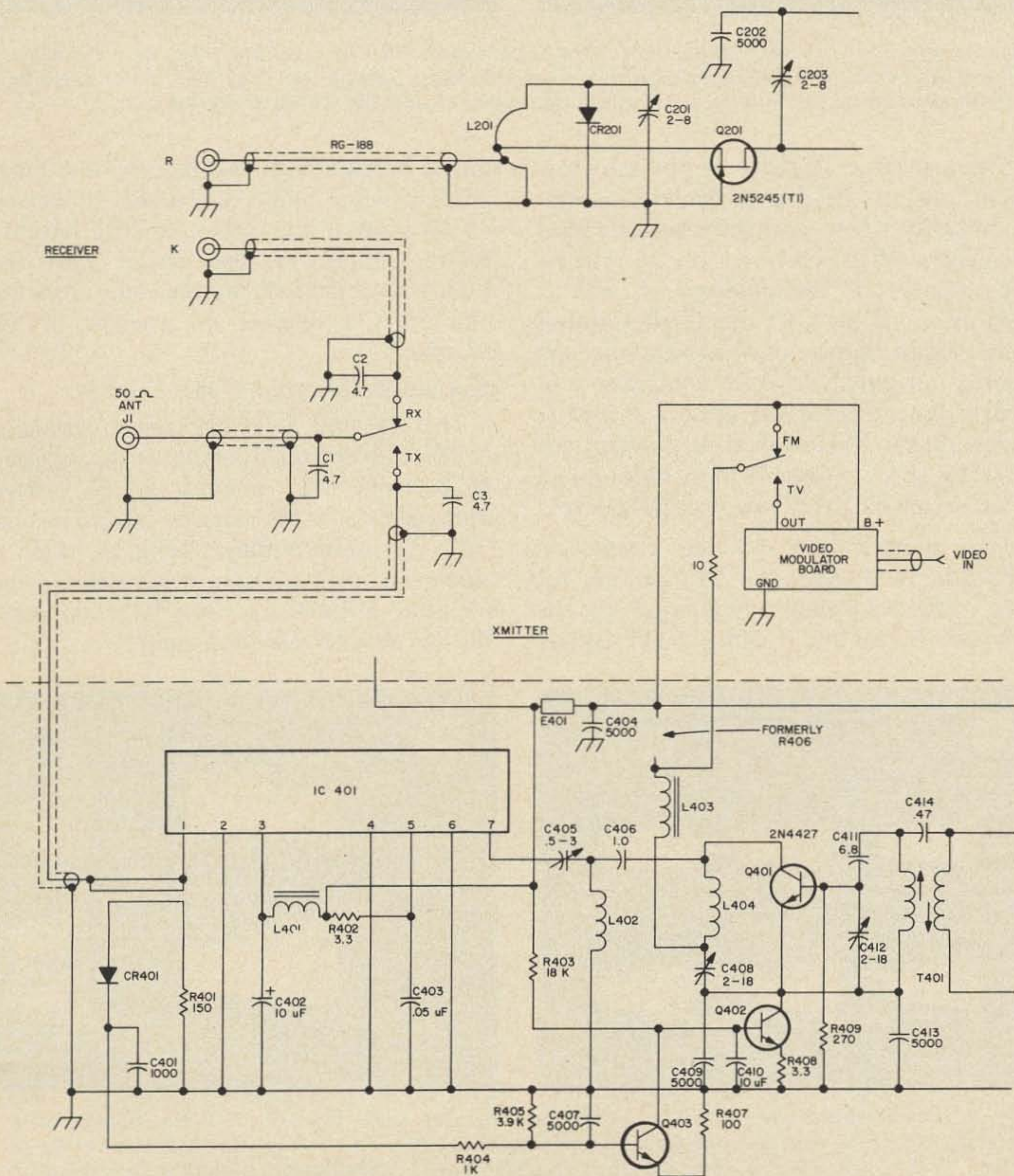

Fig. 3. Modification schematic.

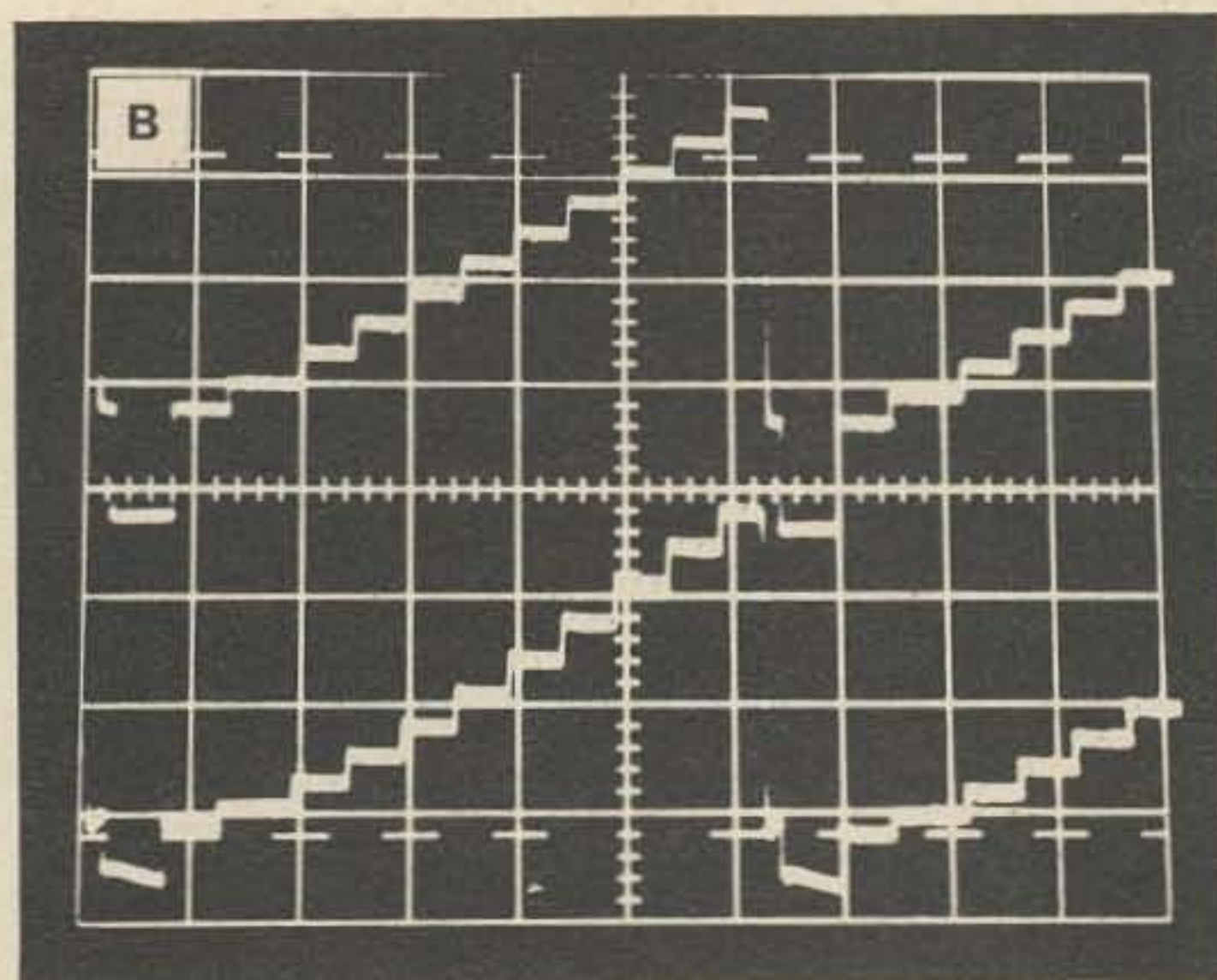
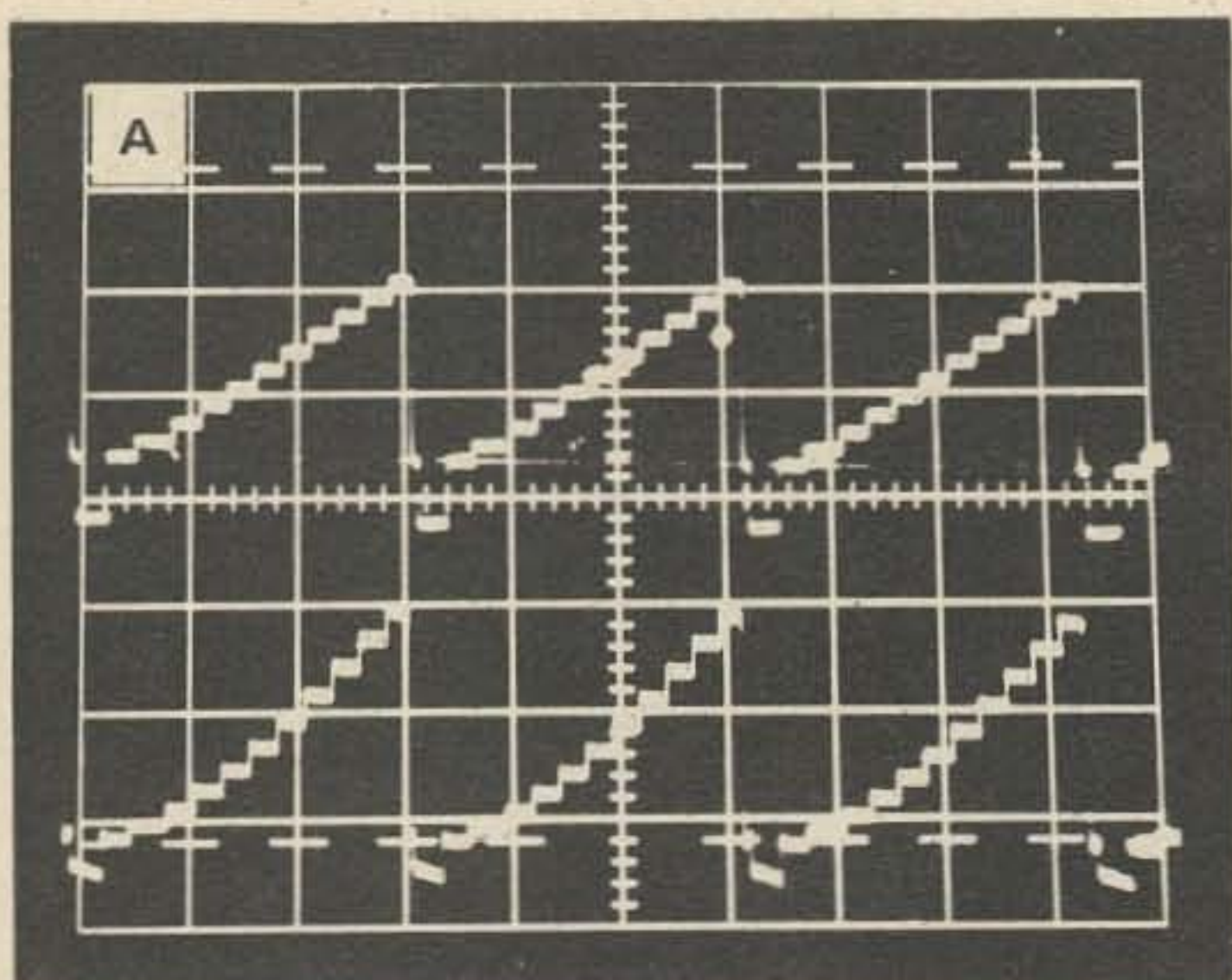

Fig. 4. Performance curves — linearity. (a) Top scale: video in .5 V/div.; bottom scale: detected rf out 10 mV/div.; axis = 0; 20 usec/div. horizontal; 10 Watts average out. (b) Top scale: video in uncalibrated; bottom scale: detected rf out uncalibrated; 10 usec/div. 10 Watts average out.

Although true linearity is not achieved, few, if any, will be able to detect the slight non-linearity when viewing the picture. Most noticeable, when observed on an oscilloscope display of the detected rf, will be compression of the sync tips (highest power levels). Again, this is not a problem since the majority of amateurs use compressed or clipped sync anyway to achieve a greater average power level from their transmitters. (Most TV sets are capable of locking up to a picture exhibiting very low sync pulse level.)

This modification scheme results in amplitude modulation of the carrier, for video, and frequency modulation of the same carrier, for audio. Since a TV receiver

cannot receive both the picture and audio simultaneously unless the audio is located 4.5 MHz above the video carrier, a separate receiver tuned to the carrier must be employed to demodulate the audio from the 440. Such a receiver is available in the HR-440.

#### Receiver Modification (Figs. 2 and 3)

The HR-440 relay-to-receiver wiring is modified to permit the bulk of the received signal from the antenna to be routed ultimately to a TV receiver (via connector "K") for video display. Using an external coupler, a small portion of the signal is fed into the HR-440 receiver (via connector "R") to provide television audio.

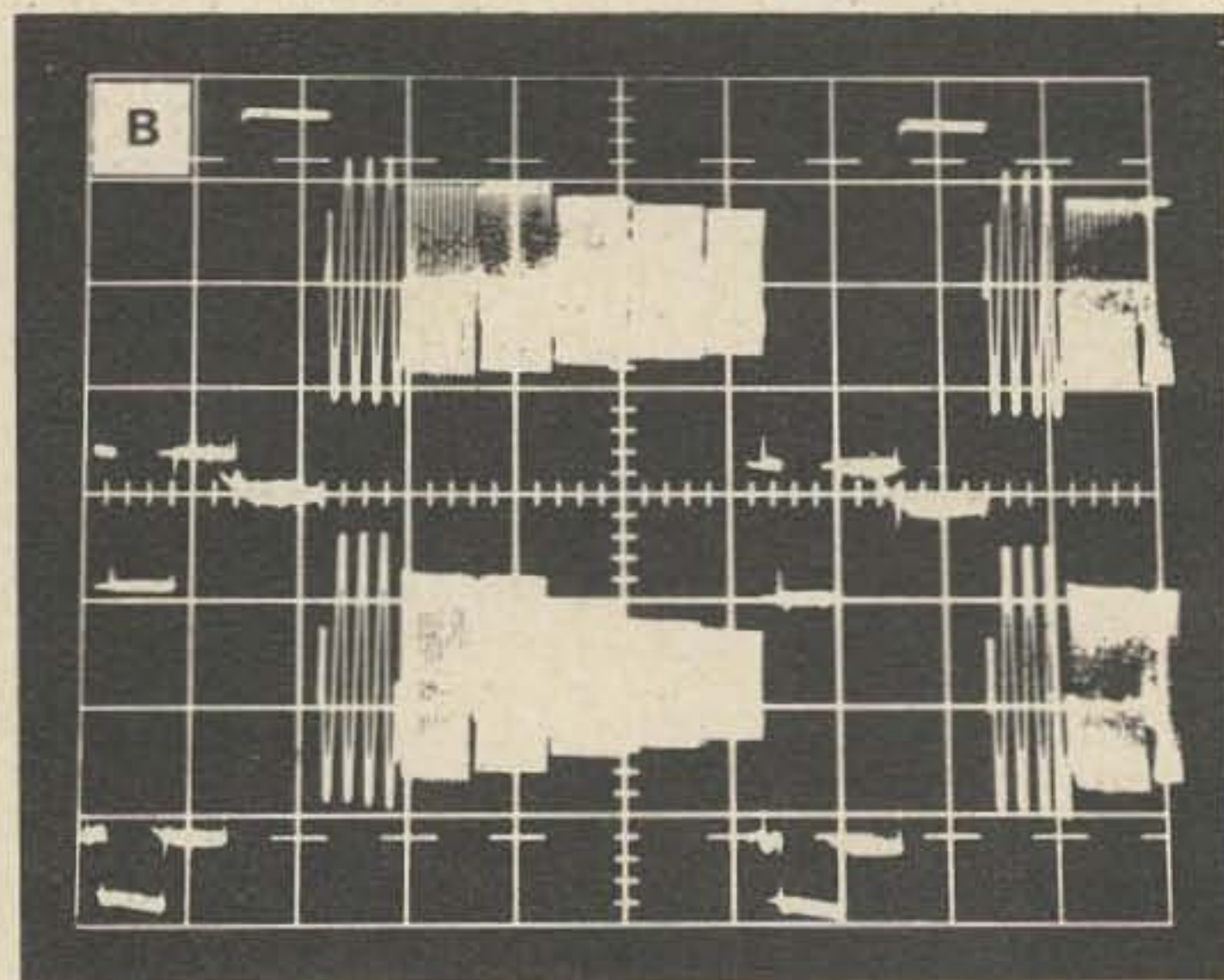
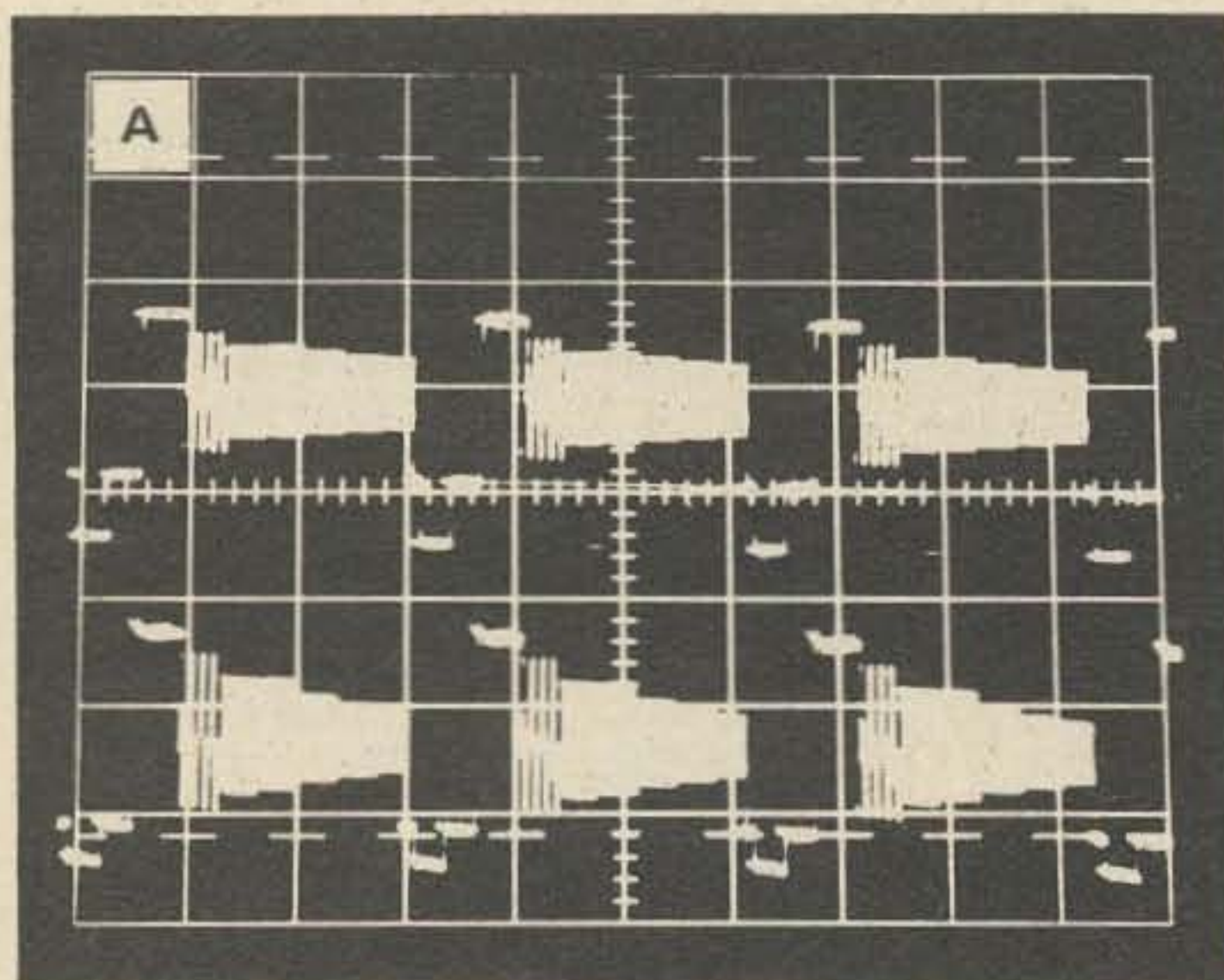

Fig. 5. Performance curves — frequency response. (a) Top scale: video in .5 V/div.; bottom scale: detected rf out 10 mV/div.; axis = 0; 20 usec/div. horizontal; 10 Watts average out; burst order (in MHz): .5, 1.5, 2.0, 3.0, 3.58, and 4.2. (b) Top scale: video in uncalibrated; bottom scale: detected rf out uncalibrated; 10 usec/div.; 10 Watts out average; burst order (in MHz): .5, 1.5, 2.0, 3.0, 3.58, and 4.2.

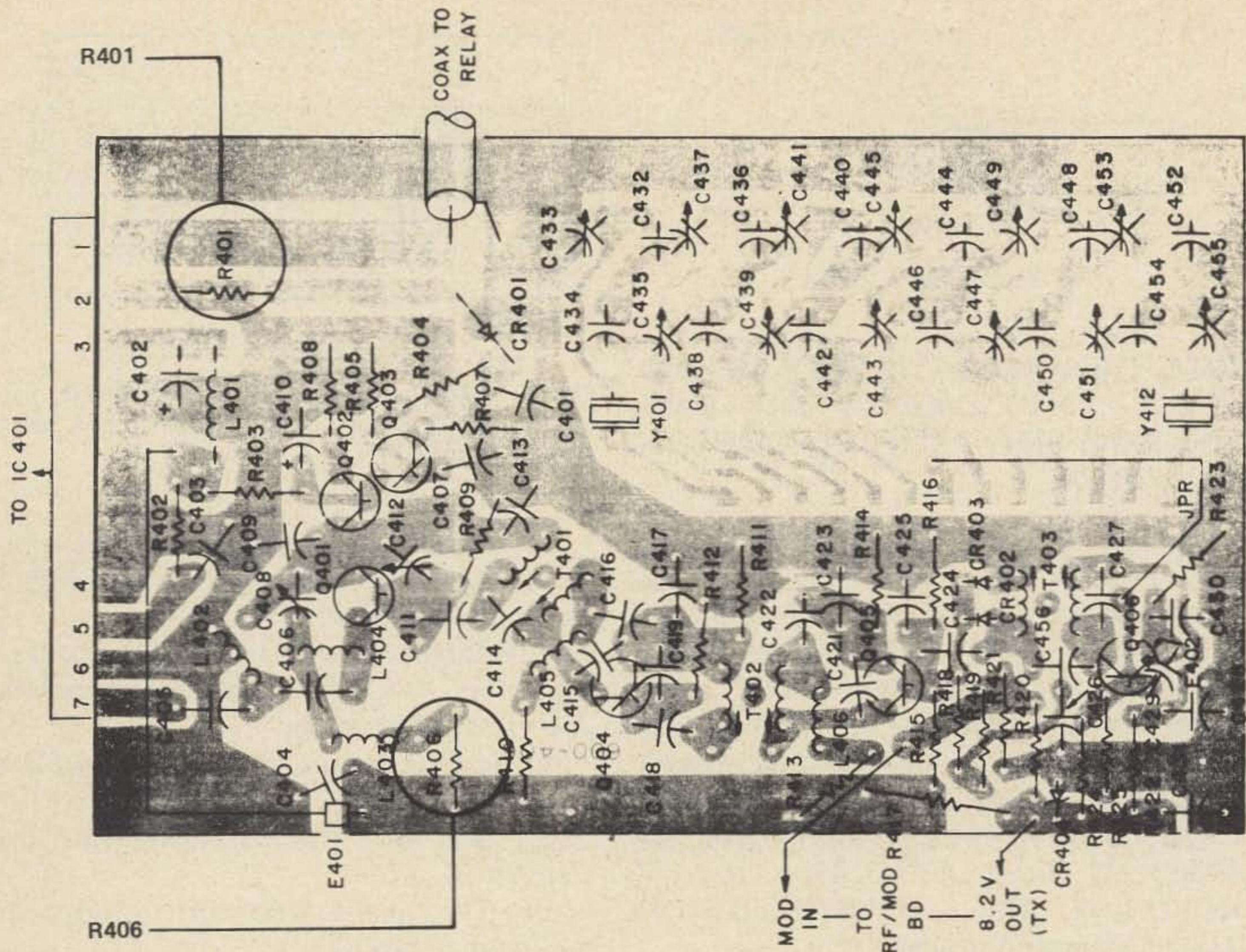

Fig. 6. Transmitter board 600-406, foil side.

### Modification Procedure

Before proceeding, make sure the rig is operating properly using the 446.0 MHz crystals supplied. Immediately order the crystals for amateur television operation in your local area. Delivery is approximately 1 month; see parts list.

1. Remove transceiver cover by unscrewing the two large bolts located at the sides.

2. To remove speaker, unscrew the two small metal screws (one on each side) holding the speaker bracket. Carefully place the speaker assembly along side of the unit.

3. Locate R401 on the transmitter board; see Fig. 6. Check its value. If it is 150 Ohms, as was installed in the first factory production run, replace it with an 82 Ohm, 1/4 Watt resistor. This factory authorized modification desenses the Vswr limiting circuit to improve output power levels into slightly mismatched antenna systems. Re-install speaker.

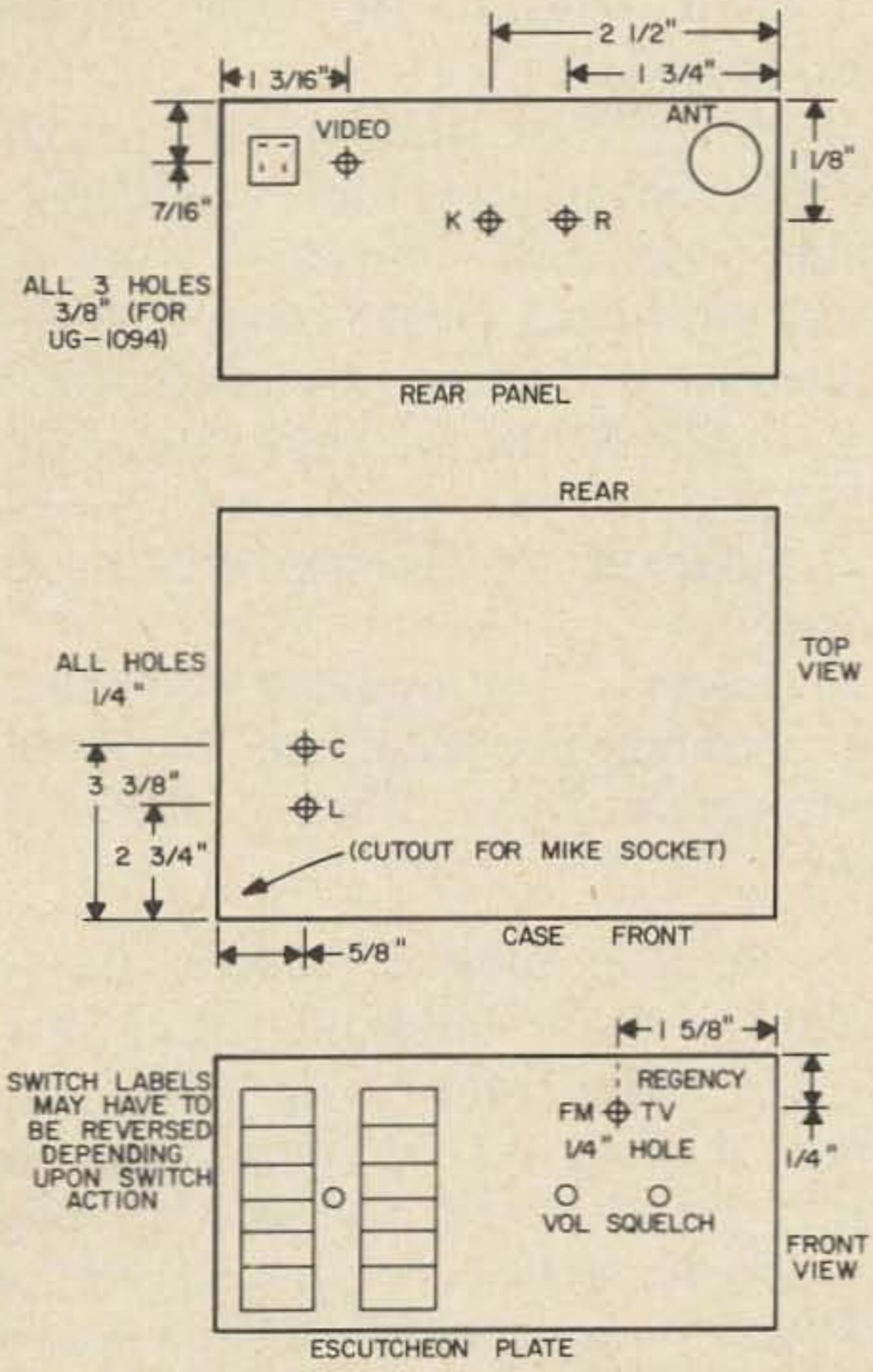

Fig. 7. Drill and label guides (not drawn to scale).

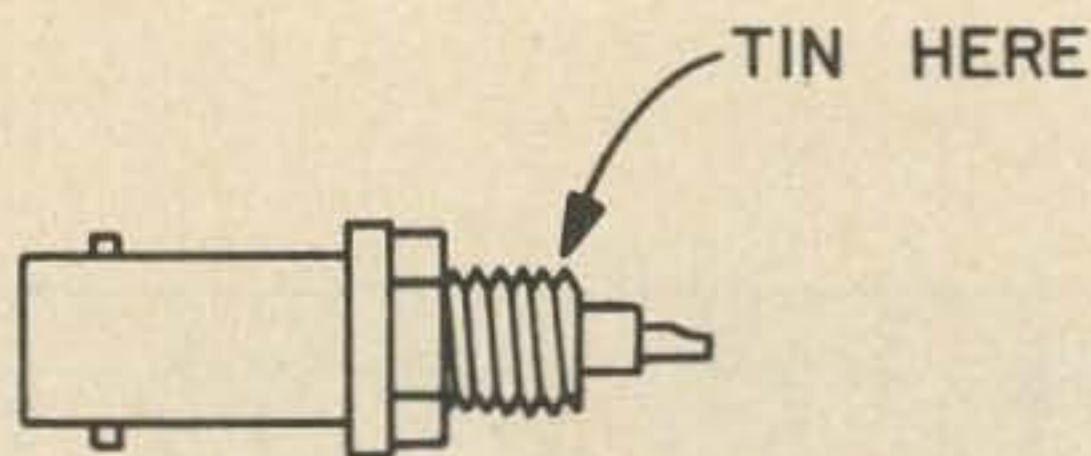

Fig. 8. Tinning UG-1094.

**NOTE: THE WARRANTY WILL BE VOID UPON IMPLEMENTING THE FOLLOWING MODIFICATION PROCEDURE.**

4. Turn rig over so that foil side is facing you. Locate R406 (10 Ohms) on the transmitter board referring to Fig. 6. Using a soldering iron with a desoldering device, remove solder around both R406 leads. Alternately apply pressure to each lead using the soldering iron tip to release the resistor from the PC board. You can use a lead from a spare 1/4 Watt resistor to help push the R406 leads through. SAVE R406. You will use it later. Make sure both holes are completely clear of solder.

*Approximate Time, Steps 1-4 = 1/4 hour*

5. Using Fig. 7, very carefully drill three 3/8" holes in the rear chassis. A smaller drill size, such as 3/32", may be helpful to initially start the hole. When drilling, hold chassis securely and with foil side up to prevent metal particles from falling into the electronics. Clean burrs from holes with a file and apply labels "Video," "K" and "R" as shown in the figure.

6. Insert three UG-1094 connectors into the holes. Loosely mount them with the lockwashers and nuts supplied. Do not tighten. Tin, with a soldering iron and solder, a portion of the grounded edge of the UG-1094 "K" and "R" connectors. See Fig. 8.

It will probably take several minutes to develop enough heat to permit a good solder flow. (The tinning operation will permit RG-188 shields, described later, to be properly terminated to ground.) Tighten all three connectors with a 1/2" wrench, making sure that the tinned regions are facing up.

*Approximate Time, Steps 5 and 6 = 1 hour*

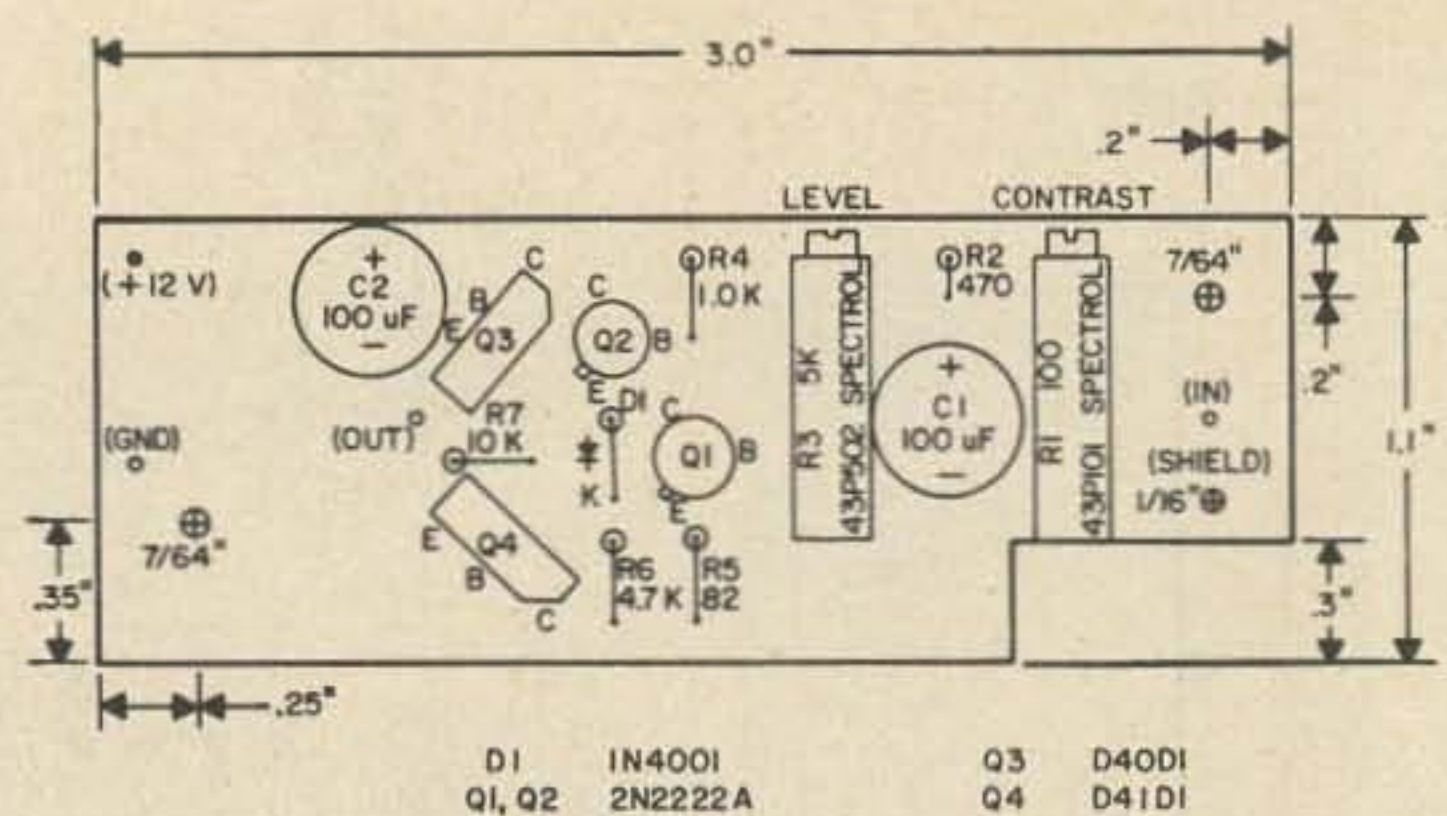

Fig. 9. Video modulator - component side. Tabs cut off of D40 and D41. Resistors and diode mounted vertically.

7. Mount all components to the video modulator PC board as shown in Fig. 9, noting the following:

- Double-check polarities of the 100 uF capacitors, D40D1 and D41D1 transistors and the 1N4001 diode.
- Seat both pots as close as possible to PC board.
- Clip off tabs of D40 and D41 transistors.
- The diode and all resistors are mounted vertically.
- Keep leads short and solder globs small on the foil side of the board.

8. Add wires to the video modulator board as follows:

- Strip 1/2" insulation of a 10" length of RG-188. Separate center conductor and shield. Strip 1/8" insulation from center conductor. Solder center conductor to "IN" on board and shield to adjacent ground hole.
- Solder 8" of insulated #24 solid wire to "OUT."
- Solder 8" of insulated #24 solid wire to "B+."
- Solder 1" of insulated #24 solid wire to ground hole provided near "B+" hole.

*Approximate Time, Steps 7 and 8 = 1 1/2 hours*

9. Remove speaker. Mount the video modulator board inside the rig on the left side wall (with front of rig facing you), as shown in Fig. 12. Existing holes in the chassis wall are used. Use two 1/2" long flat head #4-40 screws, #4 spacers 1/8" long, lockwashers and nuts. Video modulator board foil faces the chassis wall; pot adjustments facing up. Put a dab of RTV (or

Fig. 10. Regency HR-440 Video Modulator (similar in structure to W0MZL T44 modulator described in QST, Feb 73). All resistors 1/4 Watt, 10%.

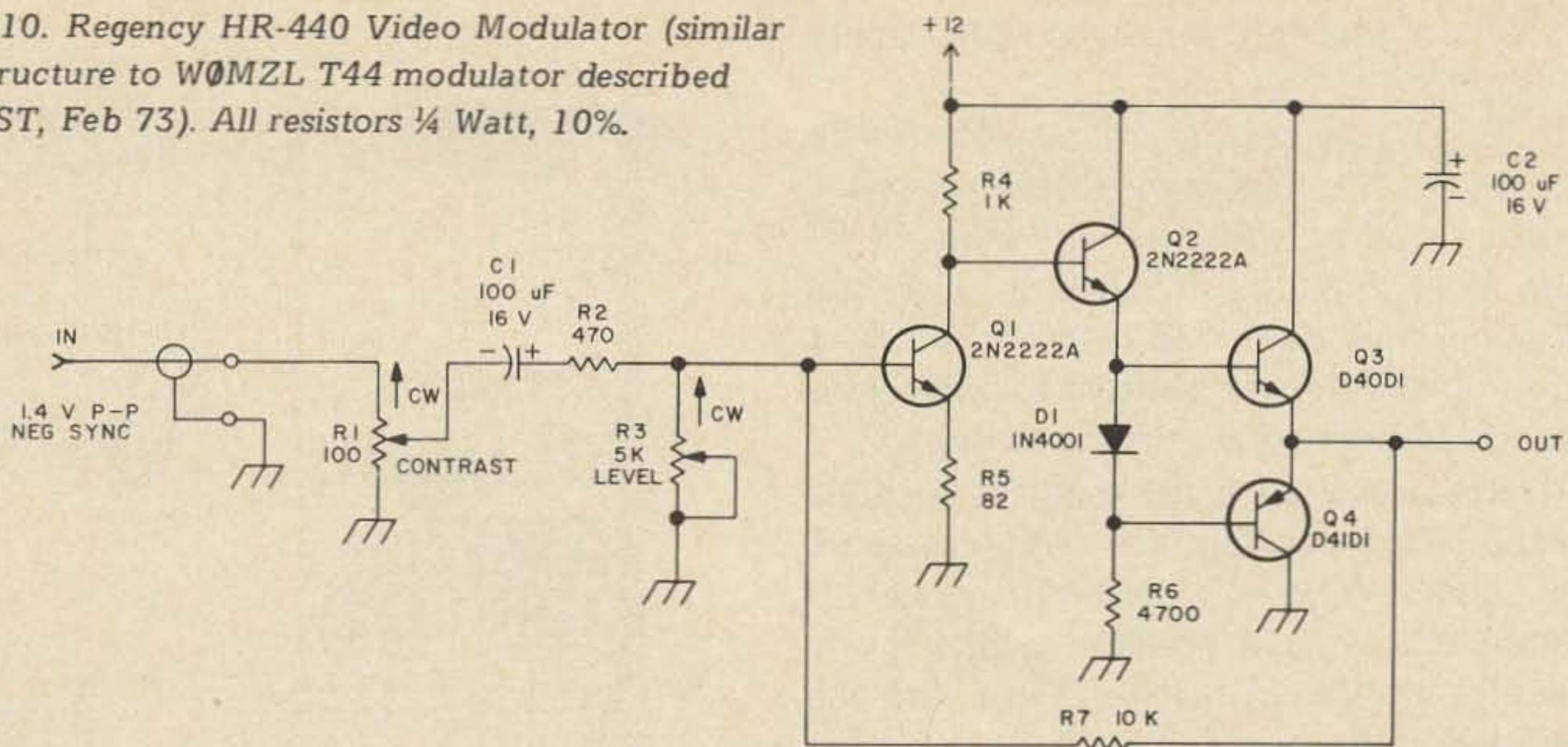

similar solution) on the nuts after they are tightened to prevent them from loosening and falling into the rig under severe vibration.

10. Connect the RG-188 cable from the video modulator board to the "Video" BNC connector on the rear. Shield is soldered to the ground of the adjacent power connector. Route cable along the side and rear walls.

11. Solder the 1" wire from the video modulator board (ground) to the grounded terminal of the nearby microphone connector.

*Approximate Time, Steps 9, 10 and 11 = 1/4 hour*

12. In order to mount the front panel mode selector switch, pull off the three knobs on the front panel. Using a jeweler's screwdriver, pry off black escutcheon plate which is glued to the chrome-plated bezel. As shown in Fig. 7, drill a 1/4" hole and mount a miniature SPDT toggle switch.

13. Route wire from "OUT" on video modulator board along the upper, inside

edge of the front wall. Direct the wire-end through the hole located above and between the volume and squelch pots so that it protrudes through the front of the rig. Place a 1/2" piece of spaghetti over this wire and solder it to the miniature switch as shown in Fig. 12. Push spaghetti over contact.

14. Solder one end of a 10 Ohm resistor, namely R406 removed in Step 4, to the center terminal of the switch. Solder the other end to a 4" piece of insulated #24 wire. Use a large piece of spaghetti to completely cover the resistor and solder joints. The other end of the wire is soldered to the plated-through hole in the transmitter board, formerly occupied by R406, that is electrically connected to L403. It is the hole furthest away from the wall. See Figs. 6 and 12. The resistor and wire should also have

Fig. 11. Video modulator - foil side. Board available from Stu Mitchell WA0DYJ. See parts list.

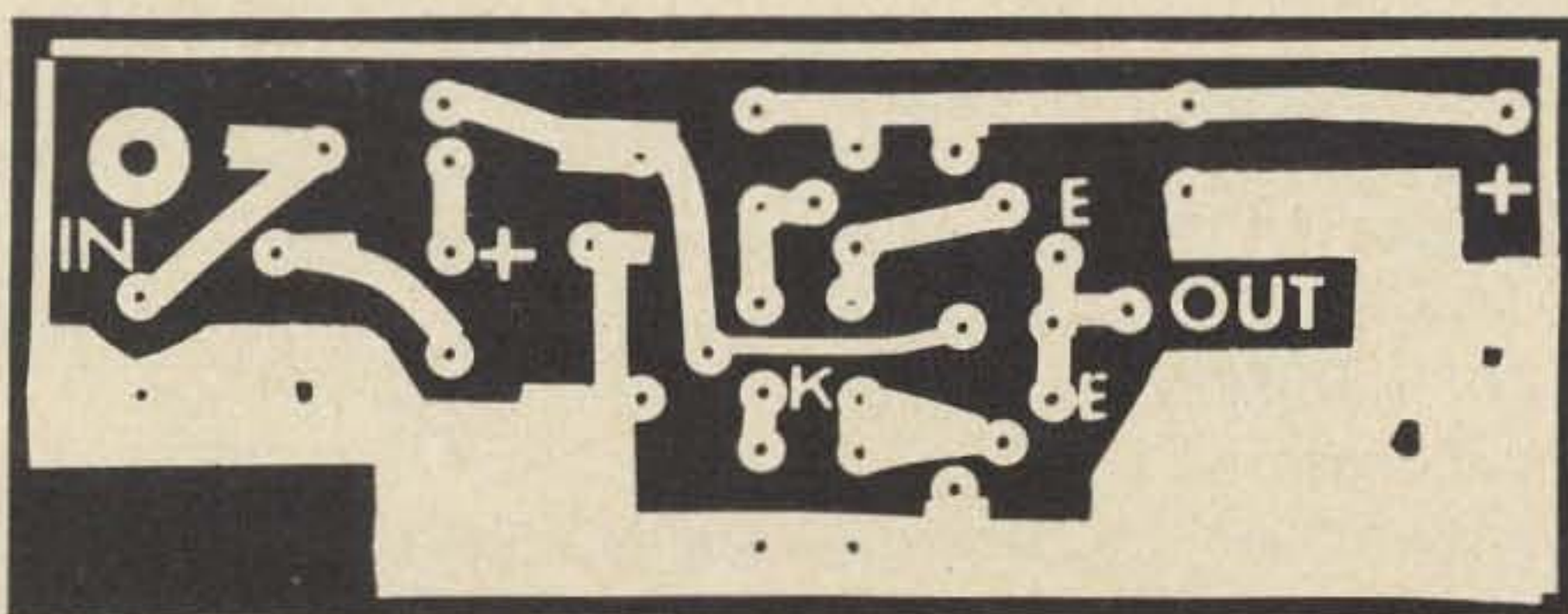
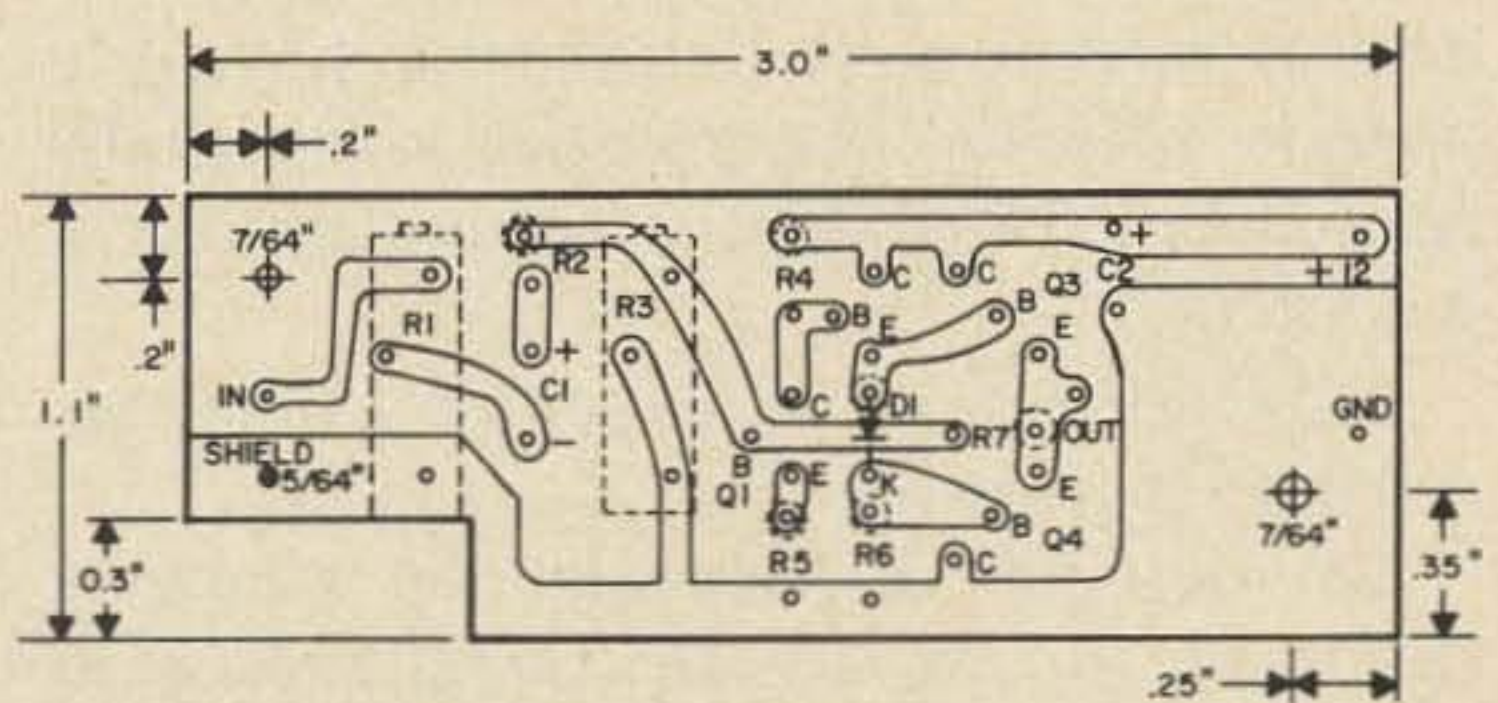

been routed through the same front panel hole described in Step 13.

15. Solder one end of a 4" insulated #24 solid wire to the remaining R406 hole (B+) and route it along with the wire from "B+" on the video modulator board through the front panel hole described in Step 13. Slip a piece of spaghetti over both wires and solder to the remaining contact on the switch.

16. Replace front panel escutcheon plate onto the chrome-plated bezel and replace all knobs. Use a VOM as a continuity tester to determine the switch position which shorts the center switch contact to "OUT" on the video modulator board. Label this position "TV" on the front plate and the other position "FM".

*Approximate Time, Steps 12 through 16 = 3/4 hour*

17. Using a solder removal device, remove the center conductor and shield of the white coax cable terminated on the receiver board near the antenna connector. Do not unsolder this cable at the relay end. Re-solder this cable to the BNC connector "K" installed in Step 6. Solder the shield to the tinned portion of the BNC. You may have to keep the soldering iron touching the connector for a considerable period to develop enough heat to solder the shield.

18. Connect a 3" length of RG-188 between the receiver board holes emptied by Step 17 and BNC connector "R" installed in Step 6. Connect shield as described in Step 17.

19. Bend both speaker terminals 90 degrees inward using needlenose pliers (to provide sufficient clearance for video modulator board components after the speaker is mounted).

20. Drill two 1/4" holes on top of the case and label as shown in Fig. 7.

21. Carefully loosen relay by removing two screws on chassis side. Completely wrap relay in copper foil and ground to relay support bar. Re-install screws and secure relay in original position.

*Approximate Time, Steps 17 through 21 = 1 1/4 hours. Except for final tune-up, the modification is complete. Total Approximate Time = 5 hours*

22. Follow procedure in the tune-up section.

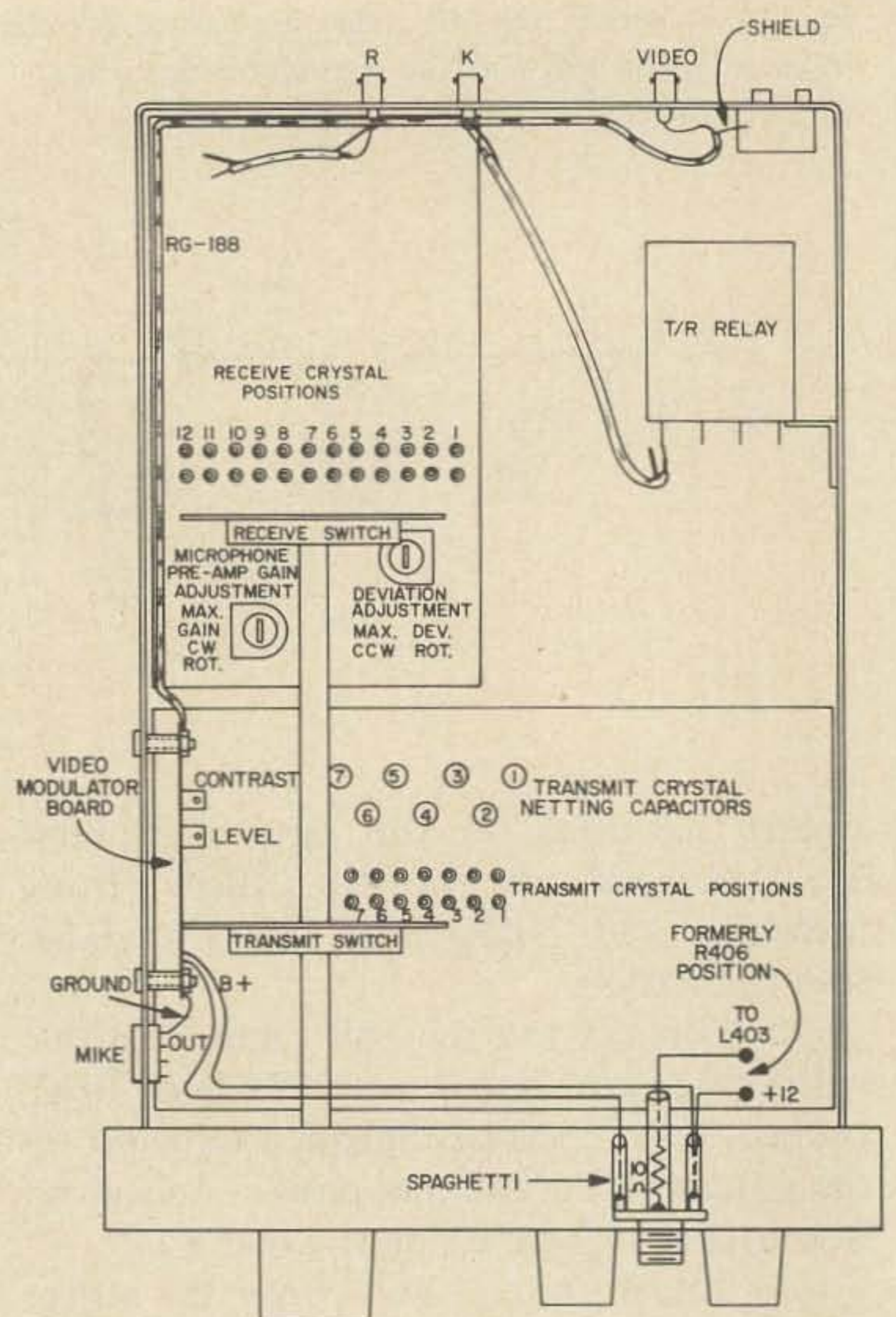

Fig. 12. Modification components layout - top view.

23. Re-install speaker. The large cut-off end is adjacent to the relay.

24. Re-install case on rig.

### Tune-Up Procedure

Install crystals for television frequencies in your local area (typically 439.25 MHz transmit, 439.25 MHz simplex receive, and 427.25 MHz repeater receive). Follow installation instructions detailed on page 9 of the HR-440 Owner's Manual.

#### A. Transmitter

1. Retune transmitter as described on pages 12 and 13 of the Owner's Manual using a UHF wattmeter with dummy load. A 20,000 Ohms/volt VOM may be used in lieu of the VTVM specified. **IMPORTANT:** Both leads of the VOM or VTVM must be floating with respect to ground. The front panel mode switch should be in the "FM" position for this initial tune-up.

2. Set the "C" or contrast control (accessible from the top of the case) fully counterclockwise (CCW).

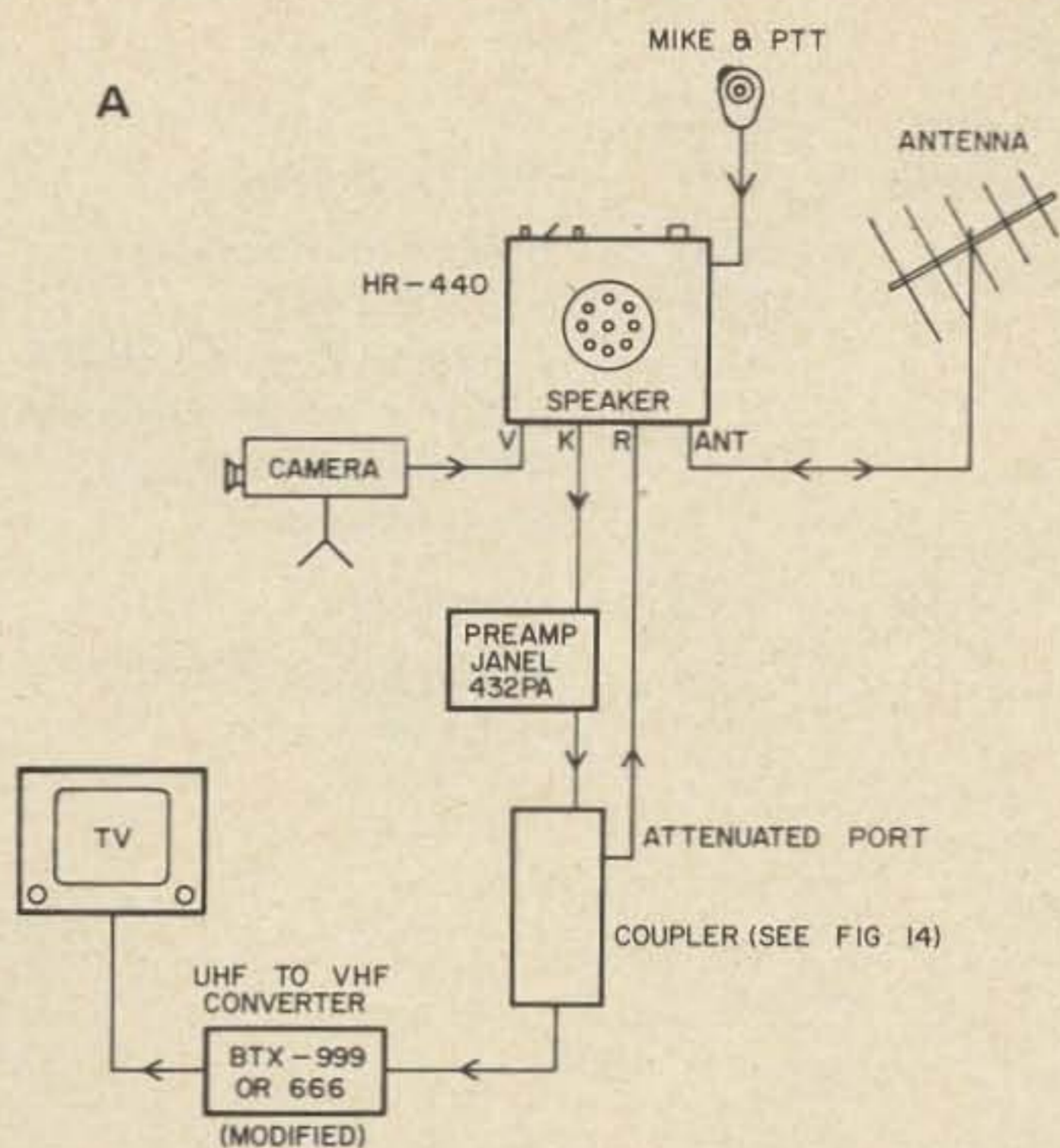

3. Set the "L" or power level control fully clockwise (CW).

4. Set the mode selector switch on the front panel to the "TV" position. The rig should now operate as it did in the "FM" position (or as it did before modification); i.e., about 15 Watts out from a cold start into a matched 50 Ohm load.

5. Connect the video output of a TV camera producing a 0.5 to 2.0 volt peak-to-peak signal to the "Video" connector on the back of the rig.

6. Using the wattmeter, turn the "L" control *counterclockwise* (CCW) until 10 Watts is read. IMPORTANT: 10 Watts is possible only when a properly matched antenna system is used.

7. Viewing the picture on a converted TV set, turn the contrast control "C" clockwise (CW) until a picture starts to appear on the

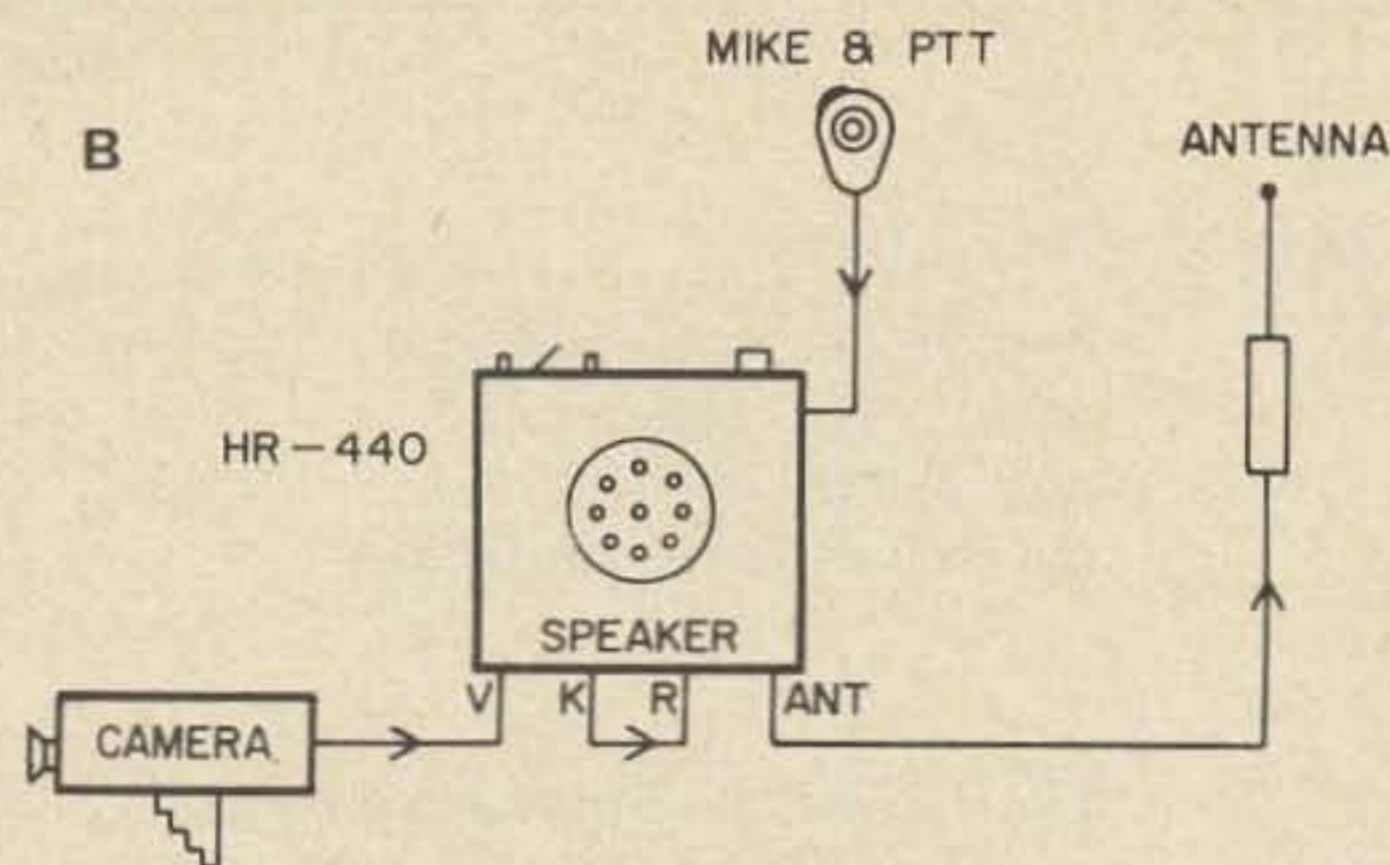
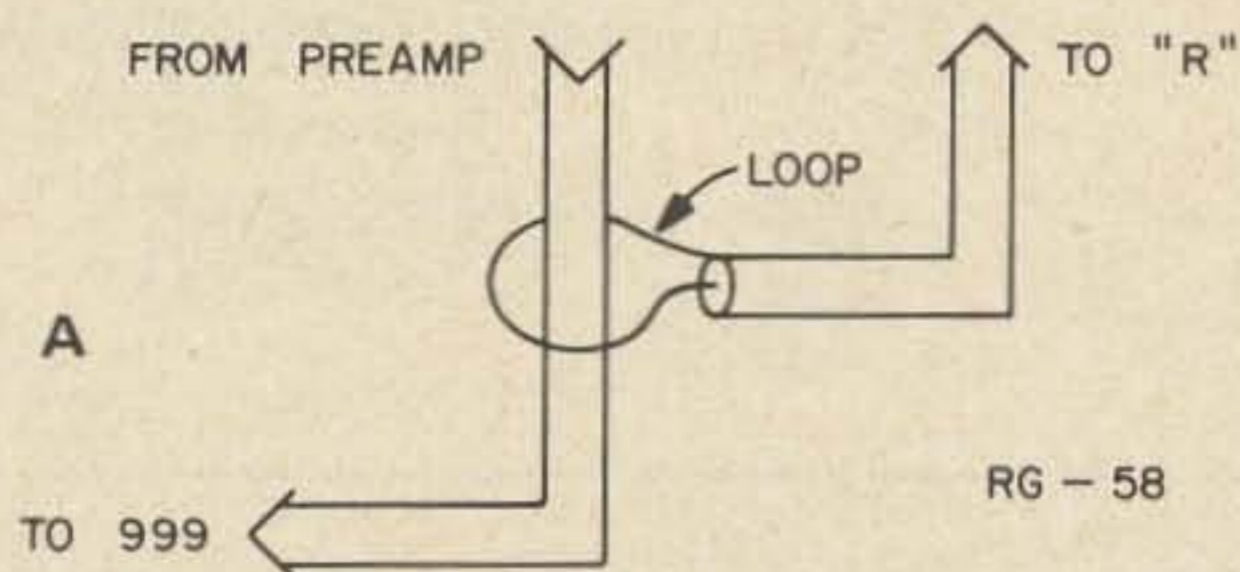

Fig. 13. Operational configurations. (a) Home use — video and audio transmit; video and audio receive. (b) Mobile/field use — video and audio transmit; audio receive.

screen. Recheck the output power and if necessary readjust "L" for 10 Watts. Keep turning "C" clockwise until a good picture appears. Readjust "L" for 10 Watts.

8. Re-peak C405, C408, C412 and the top of T401 for maximum output power. Set C408 slightly *counterclockwise* (CCW) past its peak and the top core of T401 slightly clockwise (CW) past its peak.

9. Repeat Step 7 if necessary.

10. Once on the air, using an antenna with a through-line wattmeter and a remote receiving station to watch your picture, the rig can be properly fine-tuned to provide an excellent quality picture. NOTE: Do not set "C" too high or you will cause cut-off or buzzing on the audio channel.

B. Receiver — Follow procedure on page 11 of the Owner's Manual with the signal generator connected to "R" on the rig.

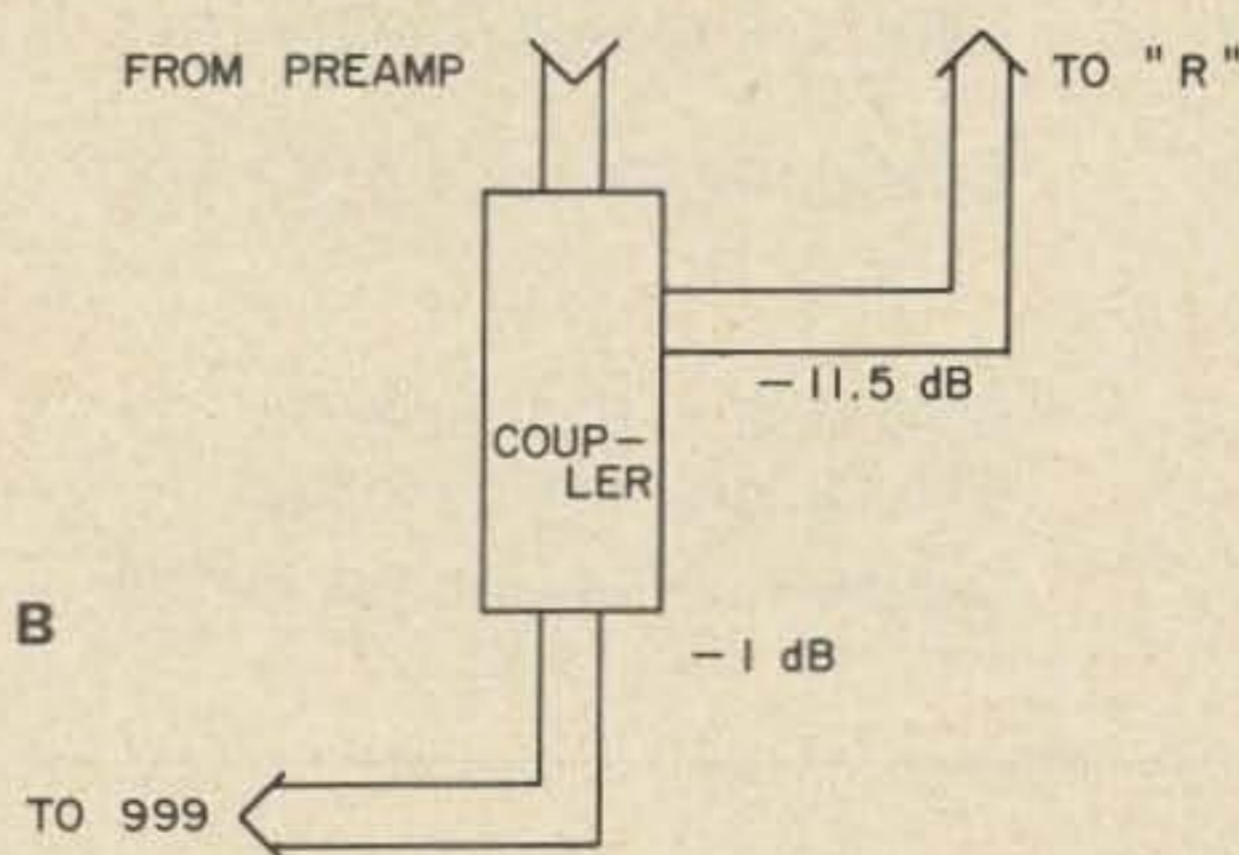

Fig. 14. Coupler implementation. Method (a) — simple, inexpensive; results in large drop of audio receiver (HR-440) sensitivity but is adequate for most applications. Method (b) — more expensive but provides greater audio channel sensitivity. Low cost coupler available from Minicircuits Lab, 837-843 Utica Ave., Brooklyn NY 11203, 212-342-2500. #PDC10-1, \$11.95 (qty 5-49), does not come with connectors but could fit into Janel Pre-amp; or #ZDC10-1, \$26.95 (qty 4-24), with BNC connectors in case.

### PARTS LIST

Part #	Description	Qty.	Unit Cost	Total Cost	Source of Supply
1	439.25 HR-440 xmit xtal	1		6.50	Shepherd Industries P.O. Box 4279 Overland Park KS 66204 \$15 min. order; Delivery about 30 days. Prices are postpaid.
	439.25 HR-440 rcv xtal	1		4.95	
	427.25 HR-440 rcv xtal (for TV repeater reception)	1		4.95	
2	UG-1094 BNC Bulkhead connect	3	1.10	3.30	Numerous
3	Subminiature SPDT Toggle Sw 7/32 or 1/4" mounting hole	1		1.39	Radio Shack 275-613 or equal
4	Dry transfer or stick-on lettering kit				
5	#24 solid insulated wire	30"			
6	Spaghetti; 1/8" OD	3"			
7	1/2" long #4-40 flathead screws. Head length not greater than 1/16". File down if necessary.	2			
8	4-40 nuts	2			
9	#4 lockwashers	2			
10	#4 hole, 1/8" long spacer, metal or plastic	2			
11	RG-188 cable	13"			Cable & Board Stu Mitchell WAØDYJ/4 14761 Dodson Woodbridge VA 22193 Postpaid
12	Video Modulator PC board, etched, cut and drilled	1		\$3.00	
D1	1N4001 Diode	1		.09	
R1	100 Ohm pot #43P101 Spectrol	1		1.35	James Electronics
R2	470 Ohm, ¼ Watt, 10%	1		.05	P.O. Box 822
R3	5k pot, #43P502 Spectrol	1		1.35	Belmont CA 94002
R4	1.0k, ¼ Watt, 10%	1		.05	(415) 592-8097
R5	82 Ohm, ¼ Watt, 10%	1		.05	Add 5% for postage &
R6	4.7k, ¼ Watt, 10%	1		.05	handling; 8 day delivery
R7	10k, ¼ Watt, 10%	1		.05	\$5.00 min. order.
C1, 2	100 uF, 16 V dc Radial	2	.19	.38	
Q1, 2	2N2222A	2	.20	.40	
Q3	D40D1, D40D4 or D40D7 (GE)	1		1.00	Schweber (Nationwide) or Spectronics, 1009 Garfield St., Oak Park Illinois 60304 (\$2.35 ppd for D41D7 & D40D7)
Q4	D41D1, D41D4, or D41D7 (GE)	1		1.00	
	BNC Male to BNC Male 4 to 12" (for recvr hookup)	1		4.85	Pomona or equal
	Copper Foil, Circuit Stik #9252	1 sheet		1.29	

### Acknowledgements

The author is grateful to Metrovision Amateur Television Club for purchasing the HR-440 used to develop this modification procedure. Terry Fox WB4JFI provided valuable test equipment to optimize the

modification design and Tom Ohara W6ORG provided useful comments concerning the MHW-710 power module. The video modulator printed circuit board was fabricated by Stu Mitchell WAØDYJ/4.

... WB4YTU/WA9GVK



When Kenwood entered the amateur market, we did it with the finest technology and craftsmanship available. Thousands of discerning amateurs have selected Kenwood... after comparing specifications, features and prices ... and finally, comparing its performance against all competition. The result has been Kenwood's phenomenal acceptance by the amateur world. And with this acceptance we pledge to constantly improve our products as technology advances and to bring forth new products that will meet tomorrow's needs. That is why we are the "pacesetter in amateur radio."

# KENWOOD

The "Twins" have  
a new look!



The R-599D and the T-599D is the most versatile solid state receiver and transmitter combination on the ham bands. Thousands of "Twins" have proven themselves through daily use. Everything that made them the best remain... only their appearance has changed.

Available at select Kenwood dealers throughout the U.S.

*Kenwood... pacesetter in amateur radio*

Distributed by



**TRIO-KENWOOD  
COMMUNICATIONS INC.**

116 East Alondra / Gardena, California 90248



# ATLAS RADIO INC.



417 Via Del Monte  
Oceanside CA 92054  
Phone (714) 433-1983

# Strobing Displays is Cool

**W**ell, I'd managed to build my own home brew frequency meter, mostly from the K5DUS article in the March, 1973 issue of 73, only to discover that the most lightly covered subject, the regulated power supply, was insufficient to power *my* version of the instrument. I not only had ac hum on the Vcc line, but I had little samples of everything that was going on inside the timing circuits also appearing on the +5 volt "regulated" Vcc line. As everybody knows (but doesn't take into account), transistor devices are current eating little monsters and must be fed properly or else! Something in there was using up mils like mad.

I checked the Vcc line with my voltmeter and sure enough, the regulated Vcc lines were down to about 4.6 volts and "hairy," even though I had split up the loads between two LM309 IC voltage regulators (which should each have handled a full Amp). In fact, the LMs were so hot you could fry eggs on the heat sink. The thing was drawing upwards of three Amps and the LEDs were doing the worst drawing.

Having recently been involved in trying to solve a problem with an IC digital clock, I remembered the unique way that the clock displays were strobed to decode the numerals into only seven lines. Strobing is just another way of saying that the power was being applied to first one segment and then another, so fast that the eye couldn't detect the flicker. This also resulted in power being applied to only one segment at a time, and the power supply was never "seeing" more than about a 20 mA load at any time. Wonderful!

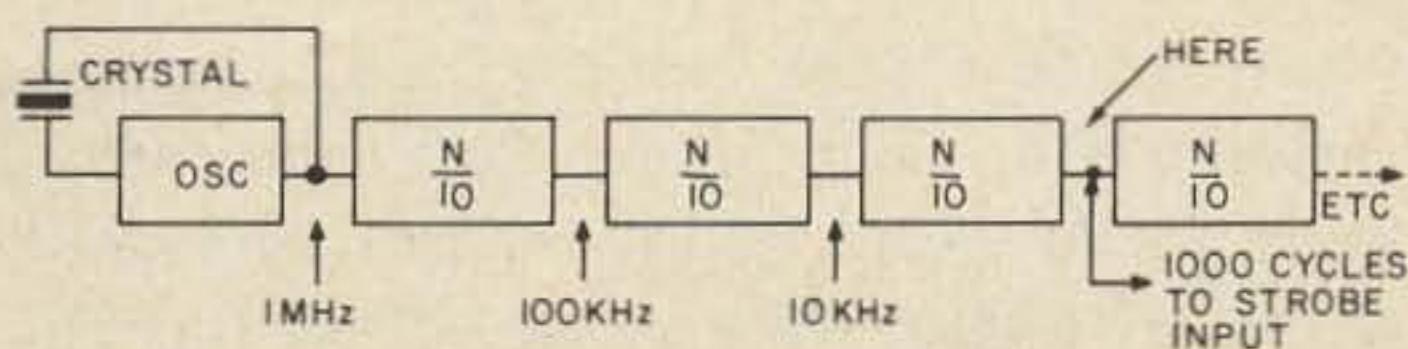

Fig. 1. All  $n/10 = 7490$ .

Before I could work it all out (I'm a slow thinker), W5NPD's article appeared in the July, 1975 *Ham Radio* about multiplexing (strobing) LED surplus calculator displays for ham use. These multi-digit, one piece LED displays are out of those little hand held calculators which have become so plentiful and are absolutely useless unless they are strobed.

Anyway, this saved me a lot of trouble trying to design something new. I would strobe the display anodes and reduce the amount of power they used to about a sixth and still have adequate brightness. It would also save me from re-engineering the whole power supply, which I had neatly tucked into the leftover space at the back of the cabinet.

We start with 1000 Hz borrowed from the timing chain. If you are using a 1 MHz crystal for your standard, the takeoff point would be at the output of the third 7490 IC from the 1 MHz oscillator. See Fig. 1. From this point the 1 kHz goes into the strobe circuit and into the 7492 divide-by-twelve countdown IC. In W5NPD's schematic he used a 7490 divide-by-ten IC, which gives a scan frequency of 100 Hz, but I figured that by going to the 7492 I would get about 83.3 Hz scan (which gives a longer duty cycle with consequent brighter display). The binary output of the 7492 is then presented to a 7441 IC, which converts it to a one-in-ten output. The 7441 was designed to drive numeral elements in a Nixie tube by grounding whichever element it wanted to light up. Very nice! Since the IC couldn't handle the current being used by the LED displays, we use a cheap pass transistor to do the dirty work. All that is needed is a 5600 Ohm "pull up" resistor on each of the ten output leads and a 470 Ohm resistor to limit base current. Ha! Now we're getting somewhere! See Fig. 2.

In order to get the highest brightness to the displays, I hooked the pass transistor Vcc line to the power supply right where the rectified dc goes into the first filter capacitor. There's a high 120 Hz ripple there (as might be expected), but there are also about 8 volts pulsating dc (and the LEDs aren't bothered a bit by that).

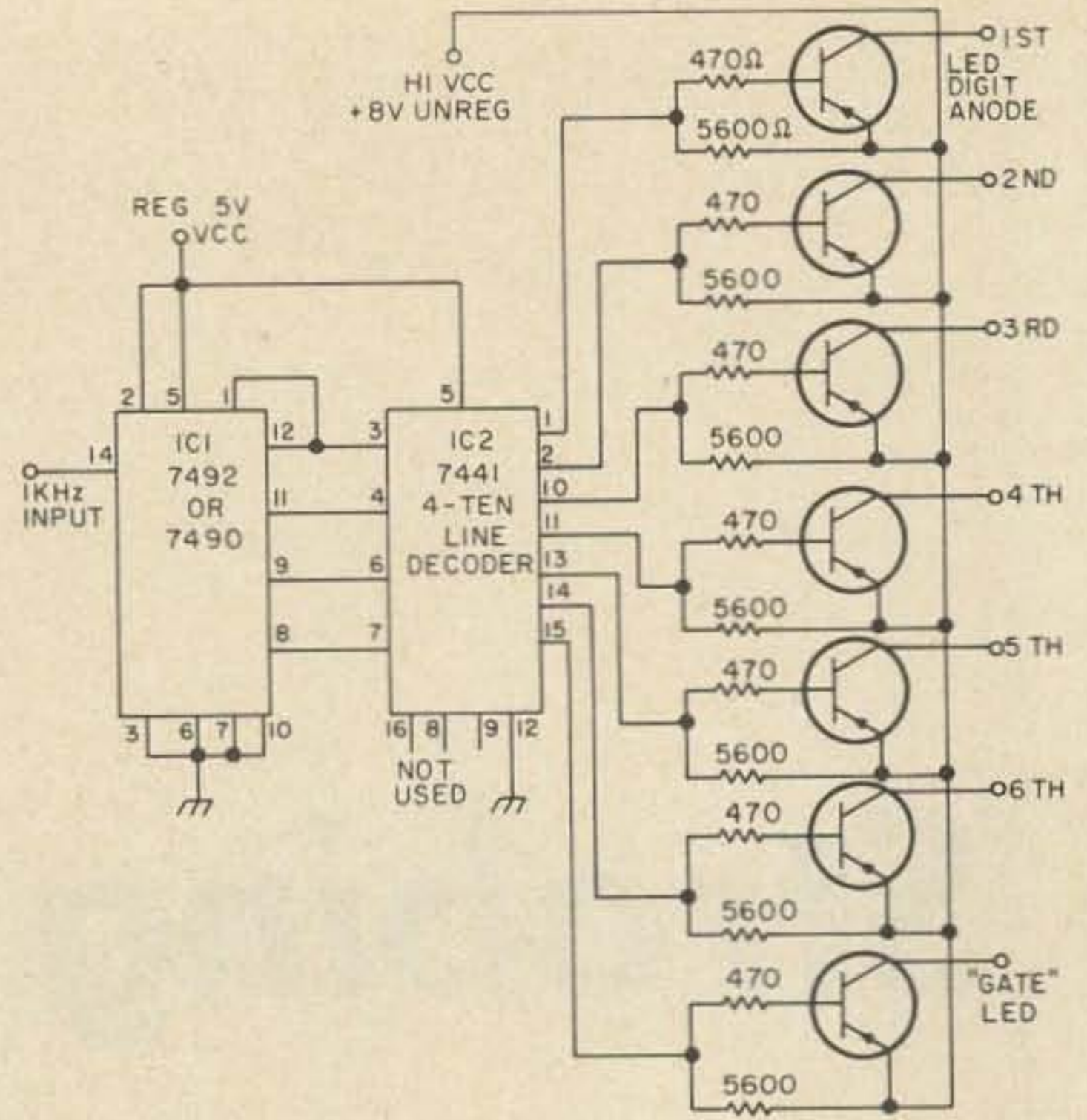

Fig. 2. All transistors are 2N3904 PNP. All resistors are 1/4 Watt.

I built the strobe circuitry on a plug-in card and eased it into a spare slot which I had provided to cover Murphy's Law on homebuilt equipment.

I then removed the jumper wire which connected all the display anodes and brought a wire from each anode in turn to one of the pass transistor leads. I included a separate wire for the little LED that shows the gate is "open". This used up seven of the possible ten outputs and left three "spares" in case something else turned up.

Back into the socket went the old line cord and again I checked the Vcc lines. This time the Vcc lines were pure. I was getting a good solid 5 volts on each of the VRs and the strobe circuitry was drawing only about 90 mils. The power supply assembly fit nicely back into the rear of the case with the heat sink only mildly warm to the touch.

At 83.3 Hz/sec the display appears solidly lit to the eye and the count is not a bit affected by what is being used to power the displays.

I've since wondered whether I couldn't have put the whole thing, more or less, on a synchronized strobe and reduced the power consumption even more, but that would mean more brain work — and everybody knows that hams like to do things the easy way. Any ideas, anyone?

... WB4DCV

# The TEMPO line . . . commercial quality at amateur prices

Compare this equipment with any other available. Compare their performance, their quality of construction, their ease of maintenance, and then compare prices. Your choice will have to be TEMPO.

**new!**



## TEMPO/CL 146A

. . . a VHF/FM mobile transceiver for the 2 meter amateur band. It is compact, ruggedly built and completely solid state. One channel supplied plus two channels of your choice

**FREE**

144 to 148 MHz coverage  Multifrequency spread of 2 MHz  12 channel possible  Metering of output and receive  Internal speaker, dynamic microphone, mounting bracket and power cord supplied. A Tempo "best buy" at \$239.00.



## TEMPO CL 220

As new as tomorrow! The superb CL-220 embodies the same general specifications as the CL-146A, but operates in the frequency range of 220-225 MHz (any two MHz without retuning). At \$299.00 it is undoubtedly the best value available today.



## TEMPO VHF/UHF AMPLIFIERS

Solid state power amplifiers for use in most land mobile applications. Increase the range, clarity, reliability and speed of two-way communications.

VHF (135 to 175 MHz)			
Drive Power	Output	Model No.	Price
2W	130W	130A02	\$199
10W	130W	130A10	\$179
30W	130W	130A30	\$189
2W	80W	80A02	\$169
10W	80W	80A10	\$149
30W	80W	80A30	\$159

UHF (400 to 512 MHz)			
Drive Power	Output	Model No.	Price
2W	70W	70D02	\$270
10W	70W	70D10	\$250
30W	70W	70D30	\$210
2W	40W	40D02	\$180
10W	40W	40D10	\$145
2W	10W	10D02	\$125

FCC Type accepted models also available.

## TEMPO/fmh

So much for so little! 2 watt VHF/FM hand held 6 Channel capability, solid state, 12 VDC. 144-148 MHz (any two MHz), includes 1 pair of crystals, built-in charging terminals for nicad cells, S-meter, battery level meter, telescoping whip antenna, internal speaker & microphone.

\$199.00



FMH-MC for Marine & Commercial service also available.

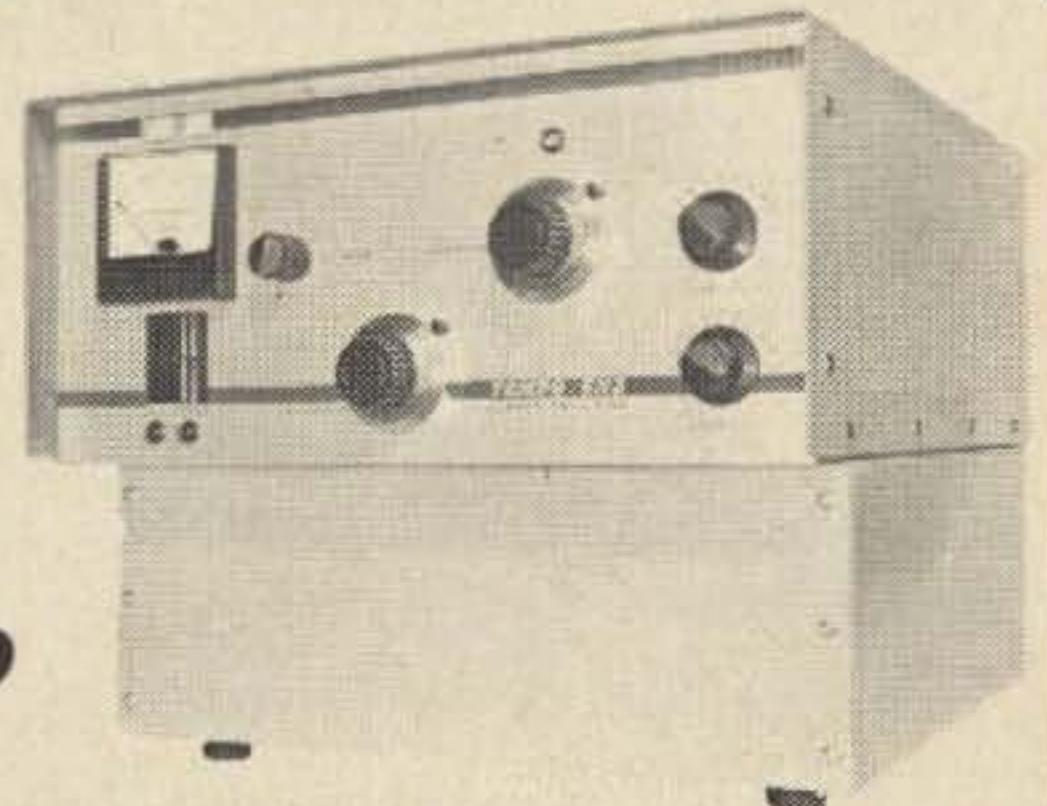

## TEMPO 6N2

The Tempo 6N2 meets the demand for a high power six meter and two meter power amplifier. Using a pair of Eimac 8874 tubes it provides 2000 watts PEP input on SSB and 1000 watts input on CW and FM. Completely self-contained in one small desk mount cabinet with internal solid state power supply, built-in blower and RF relative power indicator.

\$795.00

The Tempo 2002.. 2 meters only \$695.00

The Tempo 2006.. 6 meters only \$695.00

Available at select dealers throughout the U.S.

# Henry Radio

11240 W. Olympic Blvd., Los Angeles, Calif. 90064 213/477-6701  
931 N. Euclid, Anaheim, Calif. 92801 714/772-9200  
Butler, Missouri 64730 816/679-3127

W. Edmund Hood W2FEZ  
116 W. Park St.  
Albion NY 14411

# The Sensuous Tuned Lunch Box

**E**nd-fed antennas seem to have lost their popularity about the time coax came into ready supply in the ham world. The reasons are quite obvious: A center-fed dipole is easy to match with coax, you don't have rf floating all around your shack, and finally, most of today's transmitters have low impedance output. From the standpoint of convenience, however, they are hard to beat, especially when you take your rig with you on vacation.

As I mentioned, most transmitters have a low impedance output. The end of a half wave antenna is very high in impedance. Consequently, if an end-fed antenna is to be used, some kind of impedance-transforming device is needed — hence the antenna tuner.

I picked up the lunch box for 50¢ at the local junk shop. The rest of the parts came either from my junk box or from the trash can at work. For the ham without the convenient access to discarded electronic goodies that I enjoy, the inductor would probably be the most expensive component, and even that is no big deal.

The circuit used is called an "L-network," and is a favorite wherever a low-to-high impedance transformation is used. Perhaps it is over-simplification, but I find it easiest to understand by rearranging it to look like the classical parallel-tuned circuit with the signal source in series. A parallel-tuned circuit, which is what the antenna sees, is a high impedance device. On the other hand, circulating currents within the circuit are quite high, and very little voltage exists between the "low" end of the coil and ground. Low voltage and high current defines a low impedance. Thus the transmitter sees a low impedance load.

The latch and handle were taken off the box long enough to paint it. If you want a "cool" looking tuner, leave the original design intact. After drilling the mounting holes for the connectors, strip the paint from around each hole on the inside of the box to provide a good ground connection. Just to be on the safe side, I ran a wire to join the ground points of all parts. You might not want to do that.

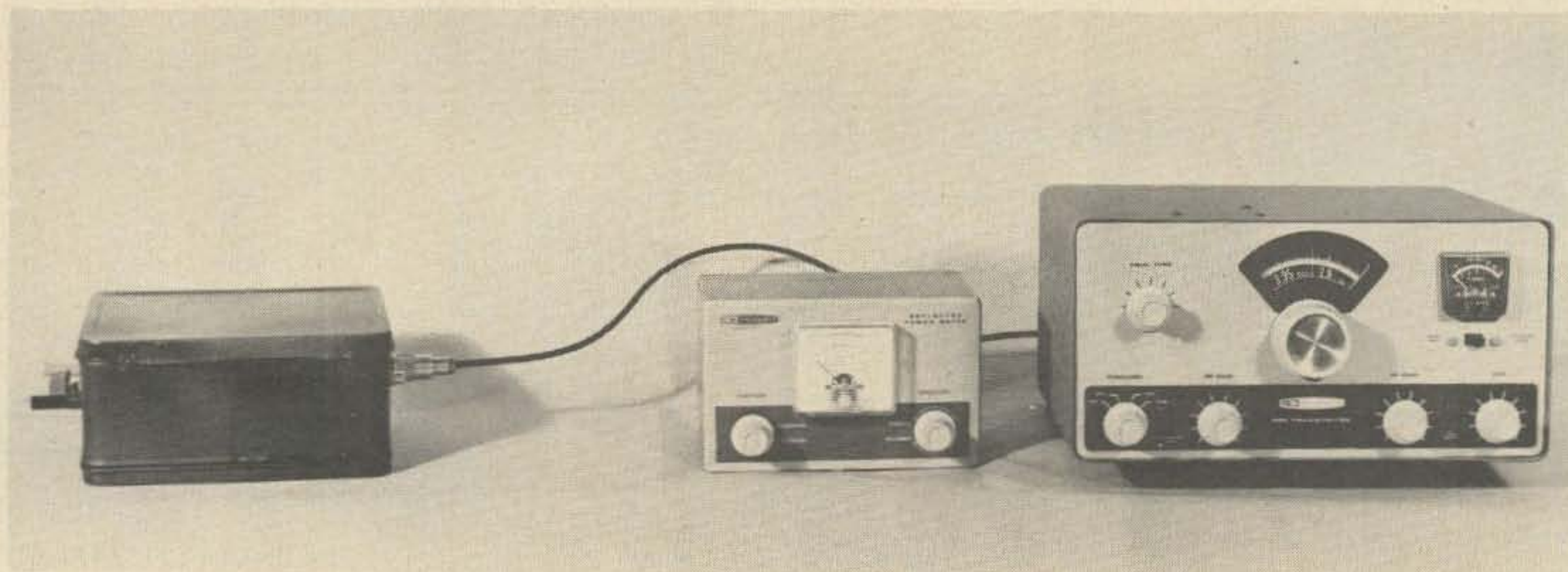

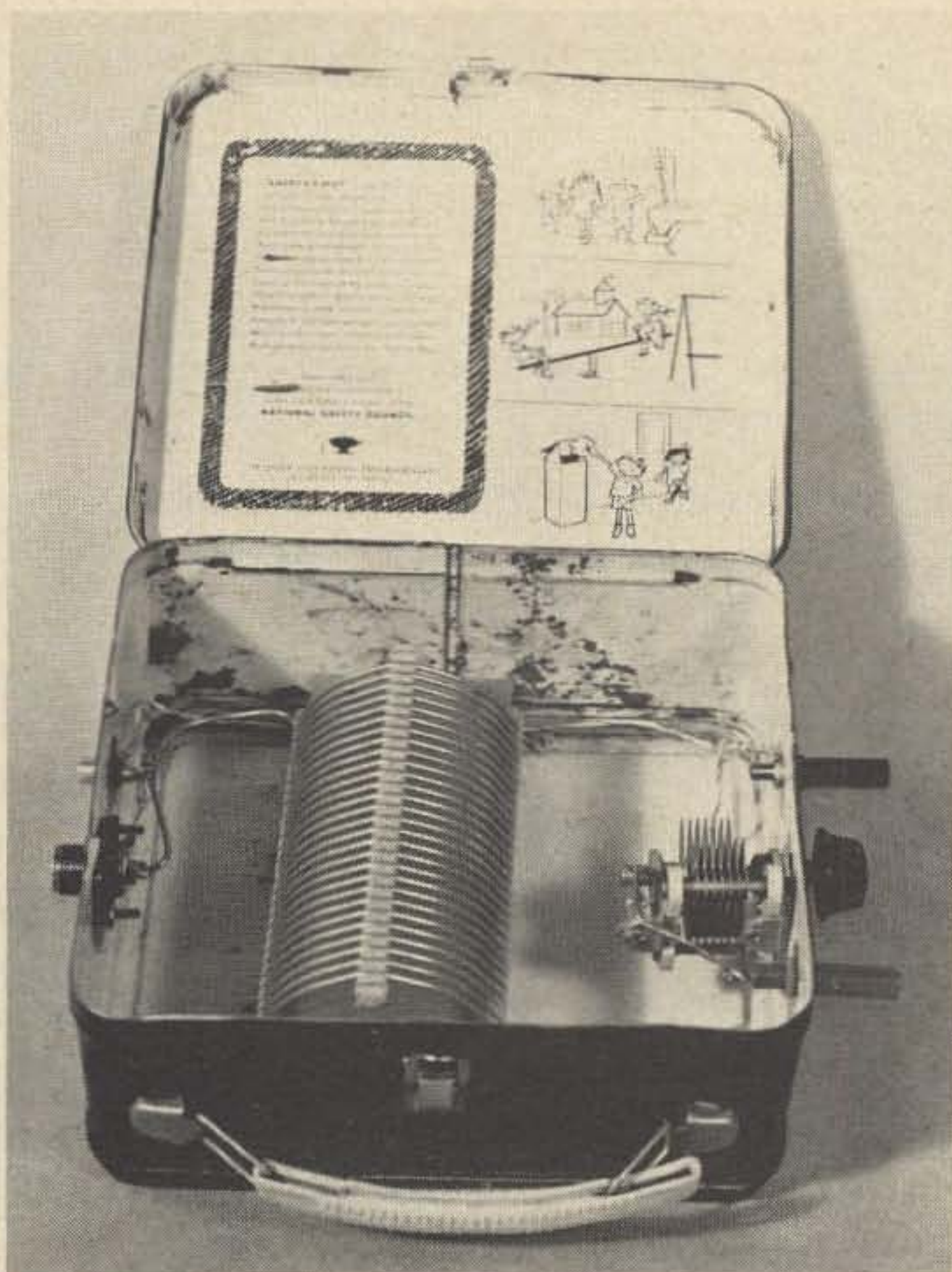

Note that there are two input connectors. Heath transmitters often use an RCA phono connector for the antenna, while most others use the SO-239. Banana jacks receive the end of the antenna wire, and a lead to an external ground, if needed.

You will need a reflected-power indicator to tune it up. Generally speaking, the point of maximum forward power does not correspond exactly with the point of minimum swr. You want the lowest possible swr, because it is only in that condition that such things as low-pass filters work exactly as designed.

Tuning up this thing for the first time can be a headache, but it need not be. Troubles come only if you are working with more than one variable. However, if you know the approximate setting where your transmitter matches into fifty Ohms, set it there and leave it alone while you work with the tuner. With the antenna in place, set your station to the receive mode and tune the capacitor for maximum receive sensitivity. If your tuner seems to approach but not pass that point, you may need to change the inductance. Remove turns if it approaches peak at minimum C; add turns if it approaches peak at maximum C. This operation gets you into

the right ball park. No change of inductance was needed in my unit. Now key your transmitter with reduced drive, and tune for maximum forward power. (CAUTION: Do this with your transmitter drive reduced to give about 50% of its normal output.) Next switch your reflected power meter to read swr and adjust the tuner for a dip in swr. Now you're ready to set your transmitter for full output and fine-adjust the tuner if necessary.

Once tuned up, you will find you have an almost immeasurably small swr. The tuner has a fairly wide tolerance to small changes in frequency. For larger changes, simply readjust for minimum swr. Experience with this type of tuner indicates that the needed inductance is inversely proportional to fre-

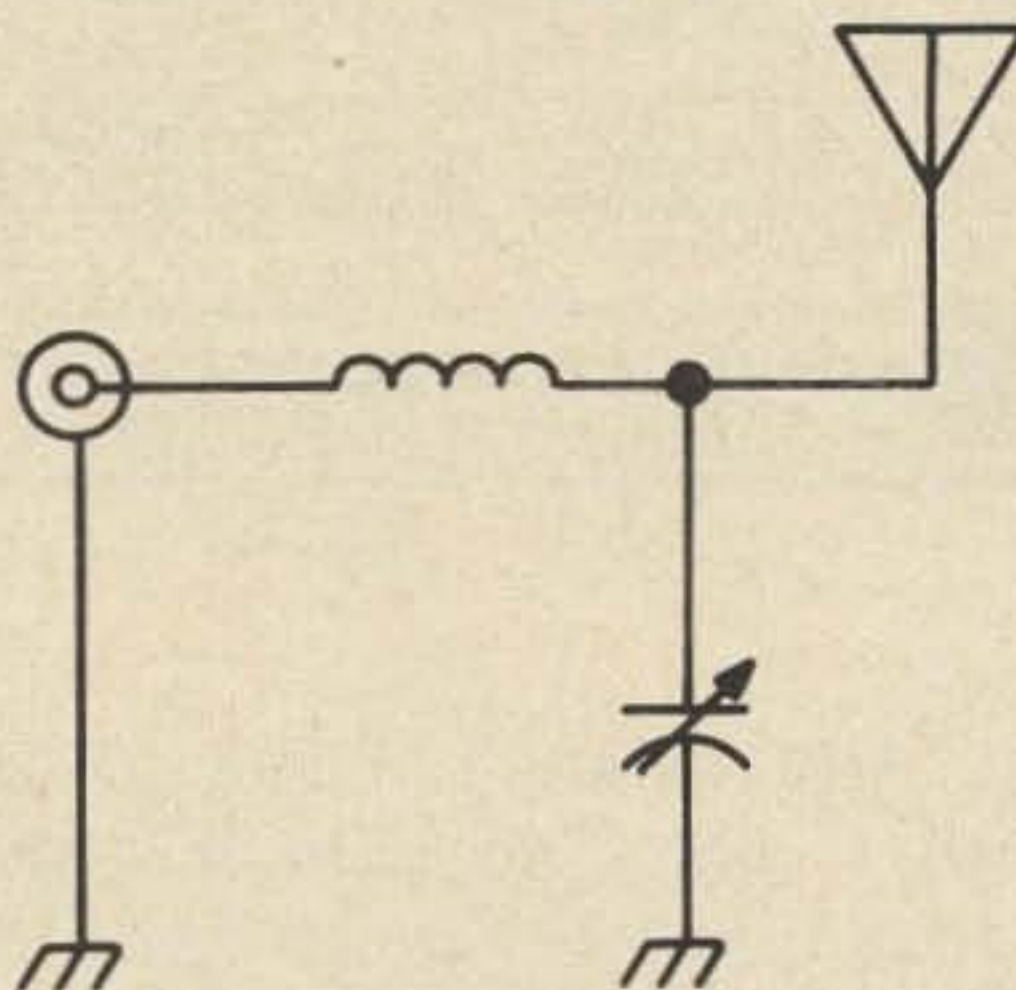

Fig. 1(a). The basic L-network.

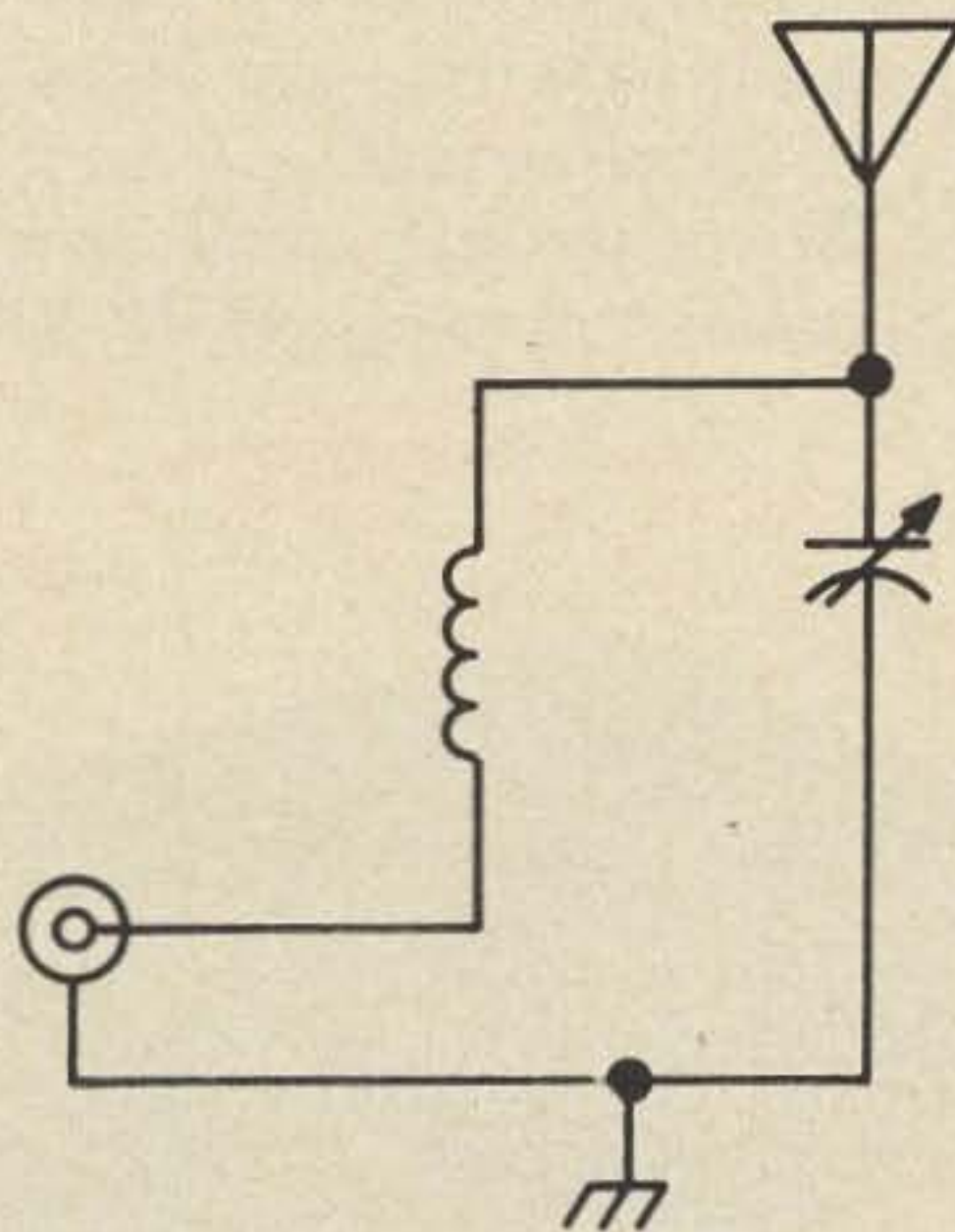

Fig. 1(b). Rearranging (a), we see the antenna at the top of a parallel-tuned circuit, while the transmitter output is in series with the circuit components, therefore seeing a low impedance.

**In a hurry?**  
try these high-performance  
**A·C·E All-Circuit Evaluators**

7 models for fast building and testing of circuits

All solderless plug-in tie-points



photo ACE 227

On all models... simply plug in your components and interconnect with 22-ga. solid wire. All models accept all DIP's, TO-5's and discretes with leads up to .032" diameter.

obsoletes ordinary breadboards

Multiple buses can easily be linked for power and ground distribution, reset and clock lines, shift command, etc. Bases: gold-anodized aluminum. Terminals: non-corrosive nickel-silver. Four rubber feet included.

Order No.	ACE Model No.	Tie Points	DIP Capacity	No. Buses	No. Posts	Board Size (inches)	Price Each
923333	200-K (kit)	728	8 (16's)	2	2	4-9/16 x 5-9/16	\$18.95
923332	208 (assem.)	872	8 (16's)	8	2	4-9/16 x 5-9/16	28.95
923334	201-K (kit)	1032	12 (14's)	2	2	4-9/16 x 7	24.95
923331	212 (assem.)	1224	12 (14's)	8	2	4-9/16 x 7	34.95
923326	218 (assem.)	1760	18 (14's)	10	2	6-1/2 x 7-1/8	46.95
923325	227 (assem.)	2712	27 (14's)	28	4	8 x 9-1/4	59.95
923324	236 (assem.)	3648	36 (14's)	36	4	10-1/4 x 9-1/4	79.95

We honor M.C. and B.A.C. charges. Add sales tax on OH and CA orders. (F.O.B. Painesville on company P.O.'s.) Dealer inquiries invited

Add → fees from this chart.

SHIPPING/HANDLING	C.O.D.
Up to \$10.00	\$1.00
\$10.01 to \$25.00	1.50
25.01 to 50.00	2.00

**AP PRODUCTS INCORPORATED**  
Box 110-Z • Painesville, OH 44077 • 216/354-2101

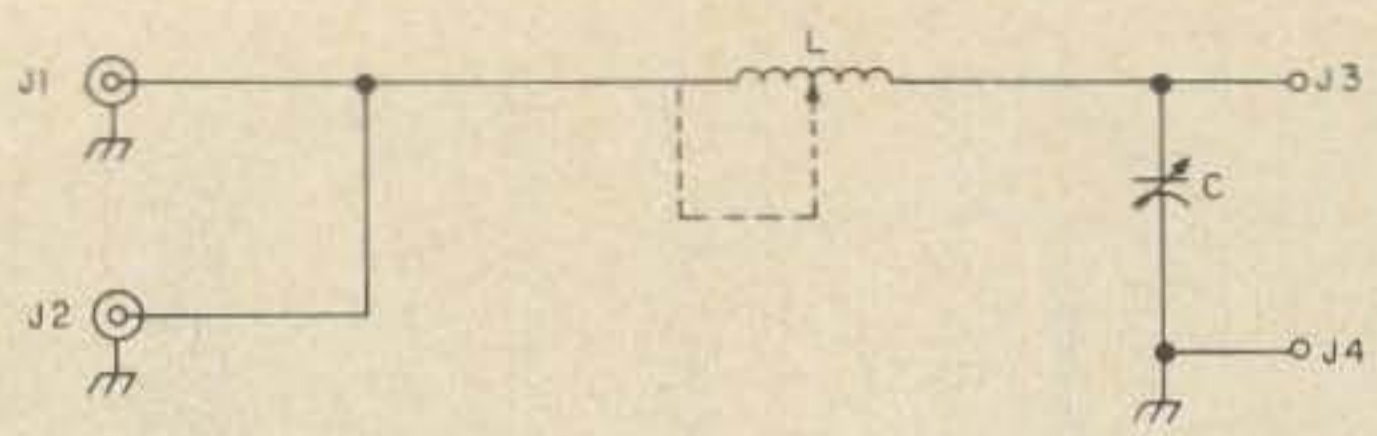

Fig. 2. The lunch box schematic (see Parts List for component values).

longwire on 20, and a 3 wave longwire on 15, all of which have similar end-feed impedance.

For those who may doubt that this thing works, it was fired up on 75 phone at 9:15 am, August 10, 1975. The transmitter was a Heath SB401. Signal report was S9+ in Cleveland, about 200 miles away. Swr was measured at 1.15 to 1 into a 125 foot wire. Later that day, when I checked into the Western New York Emergency Net, with the lunch box still in the system, I was reported as having "one of the best signals you've ever put into the net."

**Parts List**

- J1 - SO-239
- J2 - RCA phono connector
- J3, J4 - Single banana jacks
- C - 100 pF air variable
- L - 80m: 27 mH B&W 3059, or equivalent; 40m: 13 mH B&W 3053, or equivalent; 20m: 6 mH B&W 3052, or equivalent; 15m: 4 mH B&W 3048, minus 3 turns; 10m: Experiment!

Above values are for half wave antennas. By tapping off turns in the 80 meter unit, you can feed an 80 meter antenna on 40, 20 and 15 with an excellent swr. Power limits depend mostly on wire size in the coil and plate spacing in the capacitor. This unit should be OK up to 400 Watts or so. For higher power, use a bread box and make your coil from a B&W 3064.

... W2FEZ

quency, with about 123 feet of antenna. Although I didn't do it in this particular tuner, I have, in other tuners using the same circuit, operated multiband by simply tapping the coil. You may need to experiment a bit, but if you tap it about midway for 40 meters, 25% from the input end for 20, and about 16% from the input end for 15, very satisfactory swr can be achieved using an 80 meter half wave antenna. It simply becomes full wave on 40, a 2 wave





# ### *hy-gain* TH3Mk 3

## 10-15-20 Meter Tri-Band Antenna

No matter how you stack 'em,  
Hy-Gain is still the best.

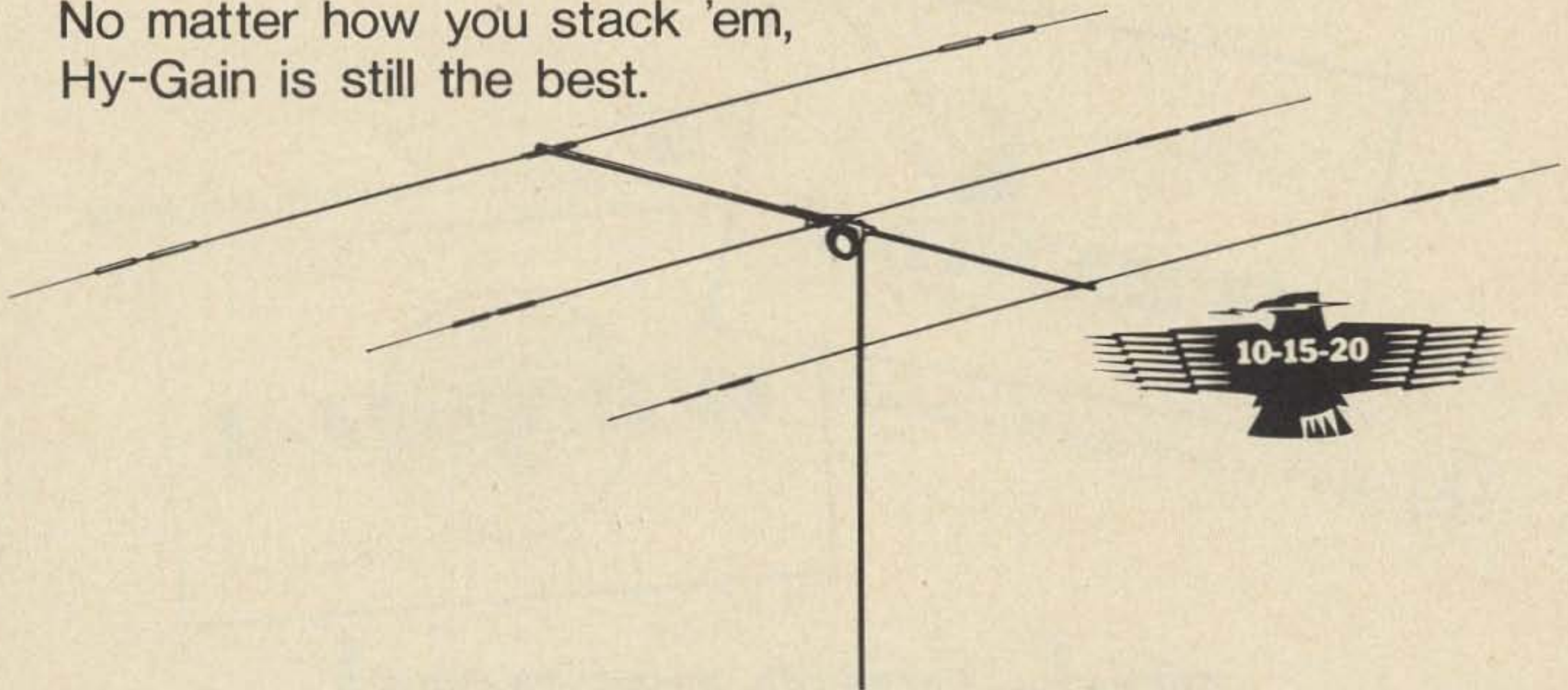

Outstanding performance makes the difference in Hy-Gain's popular 3 element TH3Mk3 tri-band beam. Superior construction makes it the best. The Hy-Gain TH3Mk3 superior construction includes a cast aluminum, tilt head, universal boom-to-mast bracket that accommodates masts from 1 1/4" to 2 1/2". Allows easy tilting for installation, maintenance and tuning, and provides mast feedthru for beam stacking.

Taper swaged slotted tubing on all elements. Taper swaged for larger diameter tubing at the element root where it counts, and less wind loading at the element tip. Slotted for easy adjustment and readjustment.

Full circumference compression clamps at all joints are mechanically and electrically superior to self-tapping metal screws.

Extra heavy gauge machine-formed, element-to-boom brackets with plastic sleeves used only for insulation. Bracket design allows full support.

"Hy-Q" traps for each band are tuned at the factory. You can tune the antenna, using charts supplied in the manual, for optimum performance on your preferred mode, phone or CW.

Hy-Gain's exclusive Beta Match for optimum matching, balanced input on all 3 bands and DC ground to eliminate precipitation static.

For best results, use with Hy-Gain BN-86 balun is recommended.

- Up to 8 db gain.
- 20-25 db front-to-back.
- VSWR less than 1.5:1 at resonance.
- 1 KW AM, 2 KW PEP power capability.
- Turning radius... 15.7'.
- Net weight... 36 lbs.
- Boom length... 14'.
- Longest element... 27'.
- Surface area... 5.1 sq. ft.
- Nominal 50 ohm input.

### Other great Hy-Gain Tri-Band beams...

TH6DXX	6-element Super Thunderbird	Order No. 389
TH3JR	3-element Thunderbird Jr.	Order No. 221
TH2Mk3	Inexpensive 2-element	Order No. 390

For prices and information, contact your local  
Hy-Gain distributor or write Hy-Gain.

### *hy-gain*

Hy-Gain Electronics Corporation; 8601 Northeast Highway Six; Lincoln, NE 68507; 402/464-9151; Telex 48-6424.  
Branch Office and Warehouse; 6100 Sepulveda Blvd., #322; Van Nuys, CA 91401; 213/785-4532; Telex 65-1359.  
Distributed in Canada by Lectron Radio Sales, Ltd.; 211 Hunter Street West; Peterborough, Ontario.



**You KNOW you need QSLs!**

**Get some you can be proud of...**

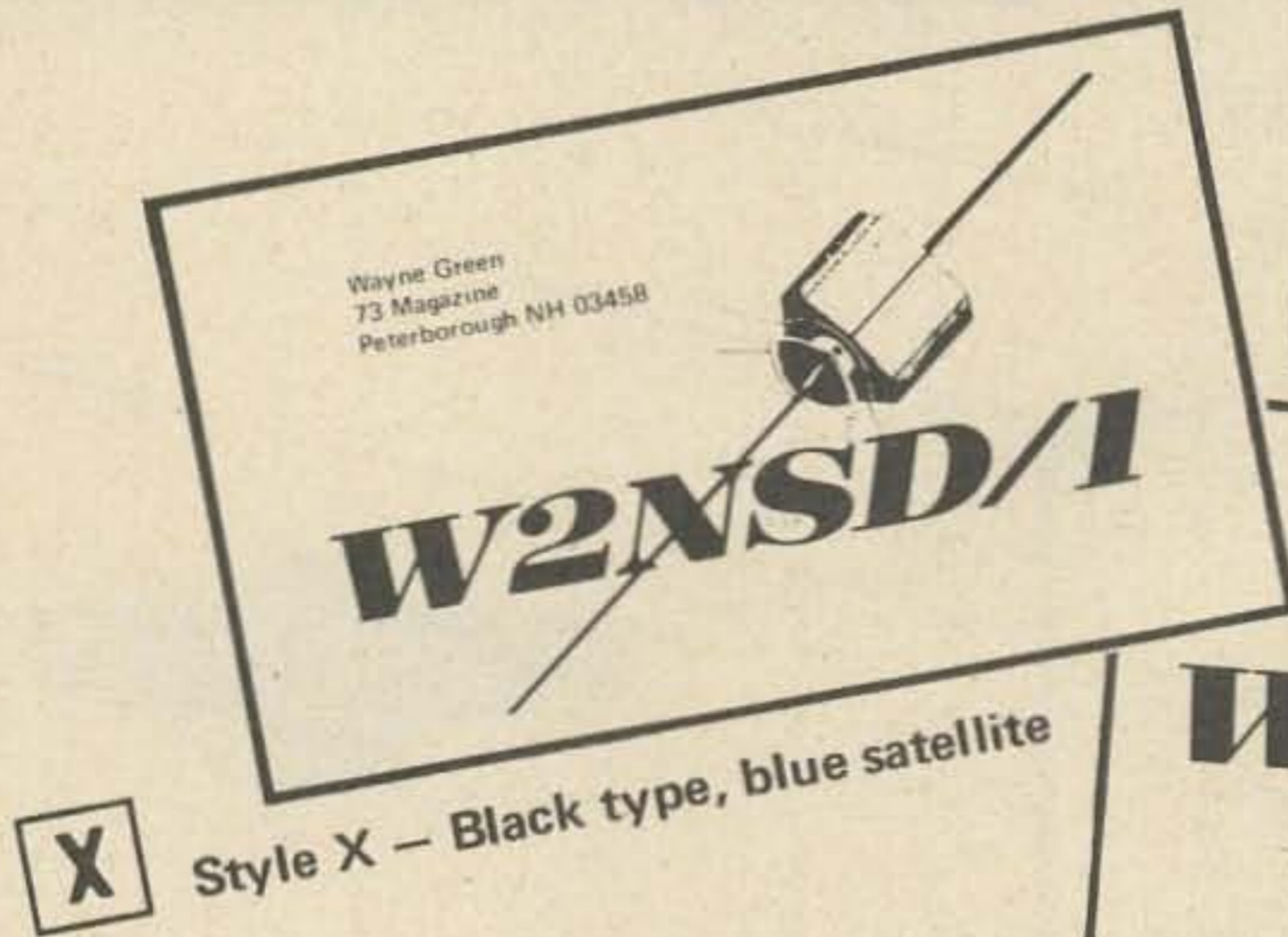

**X** Style X – Black type, blue satellite

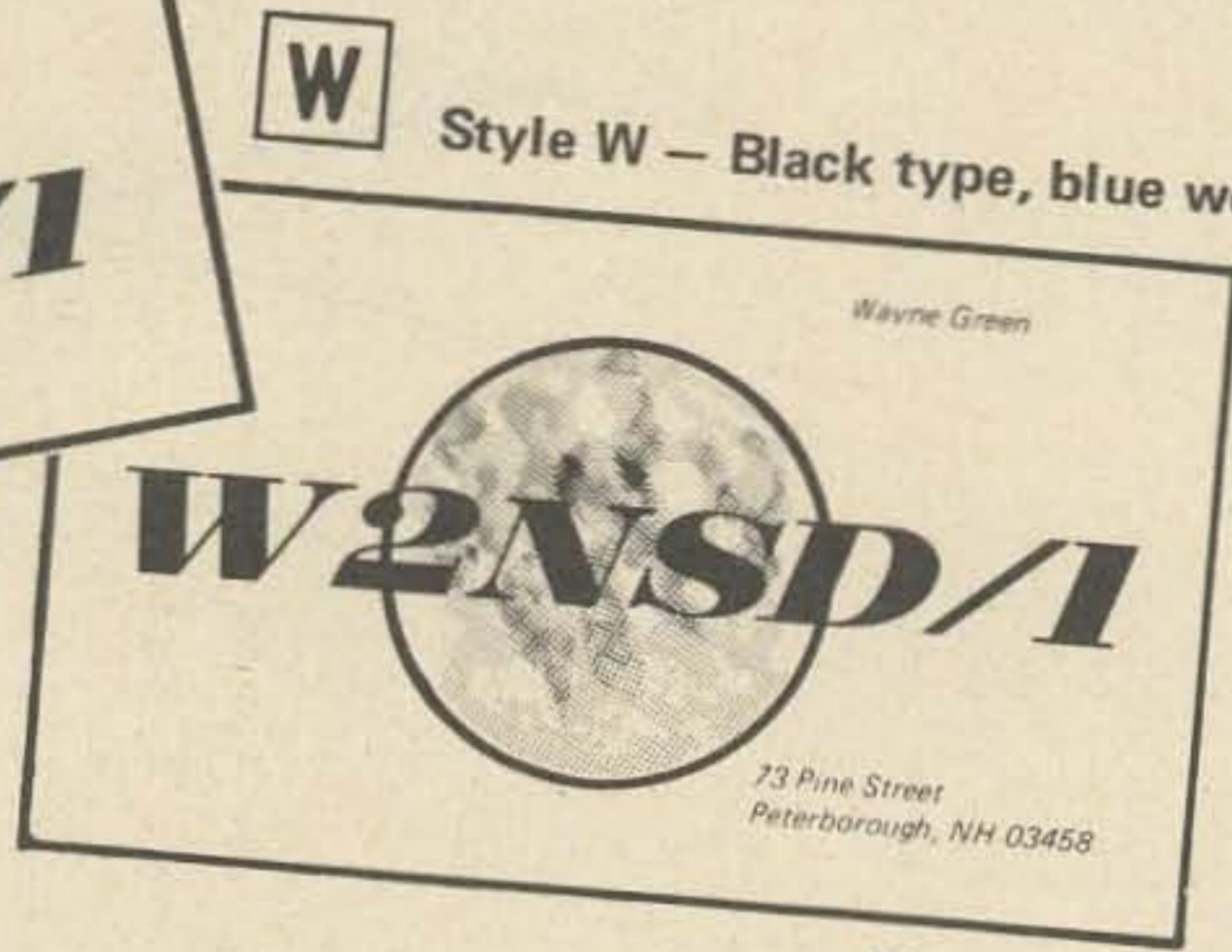

**W** Style W – Black type, blue world.

**and—save money!**

**ONLY \$6 for 250, \$10 for 500, \$15 for 1,000, and \$20 for 2,000.**

How can 73 make such beautiful cards, printed on the best coated stock, available for about half the regular cost? Our business is 73 Magazine and QSLs just help keep things going during slack days of the month. We do this at cost just to keep busy — you get the benefit. How many shacks have your QSL card proudly on display?

The world and satellite are printed in blue, your name, address and call are in black. The QSO information is a standard form on the back.

DOMESTIC ORDERS ONLY

**QSL Dept. • 73 MAGAZINE • Peterborough NH 03458**

Name \_\_\_\_\_ Call \_\_\_\_\_

Address \_\_\_\_\_

City \_\_\_\_\_ State \_\_\_\_\_ Zip \_\_\_\_\_

Awards to be listed: \_\_\_\_\_

Cash     Check



BankAmericard



MasterCharge

Style

- |                            |                                      |
|----------------------------|--------------------------------------|
| <input type="checkbox"/> W | <input type="checkbox"/> \$6 – 250   |
| World                      | <input type="checkbox"/> \$10 – 500  |
| <input type="checkbox"/> X | <input type="checkbox"/> \$15 – 1000 |
| Satellite                  | <input type="checkbox"/> \$20 – 2000 |

Card No. \_\_\_\_\_

Expiration Date \_\_\_\_\_

Signature \_\_\_\_\_

# Loudest Signal in the World?

*The Saga of the Brown Bomber.*

**A**fter many years of viewing the ads of Telrex Laboratories, showing their "Big Bertha," I finally got to see one in the flesh. In 1963 I visited Dr. Megebow K2HLB and enjoyed operating his station to his stacked yagis. Since I was of modest means, this antenna system was far from my reach. Seven years later, after the death of K2HLB, this antenna system was purchased and delivered to Memphis, Tennessee.

Before the erection of this mast (with the 4 sections on the ground and with the permission of the owner), I checked the size of the pipes as to wall thickness, length and diameter size. I found out that all pipes were of regular wall thickness starting with a #2 and increasing to the bottom section of 14", which is a #14 pipe.

I started getting prices and soon ordered the top two sections, which are 2-7/8" and 3-1/2" outside diameter. At this point I had less than \$10.00 invested, but I was on my way. My next step was to purchase a Lincoln 225 A ac welder. The complete outfit sells for \$99.00. Not being a welder, it took me a week or two to pick up this skill. Using the new drag rods, nice looking welds can be

made by the novice welder. After welding the first two sections together, I purchased 3 more pieces to make up the first section. They were of 3-1/2" std, 4" std and 5" o.d., all of .250" (approx.) wall thickness common black steel pipe.

My garage is 25' x 40', so sections were welded up less than 40' in length. The first section was 26' and its total weight was 310 pounds.

After these five pieces were welded and painted, they were laid aside and progress started on section two. Total cost at this point was \$43.00, which, divided by 26 feet, equals \$1.65 per foot. Section two was made up of four pieces (5" std, 6" std, 7" std, and 8" std). All were .3125" wall thickness; total length was 29', with total weight about 800 pounds. Concrete blocks were used as horses to support the pipe during the welding operation. Up to this point no mechanical means had been used to raise and lower the pipes as all the sections weighed less than 200 pounds.

The third section, 34' in length, was made of 4 pieces which were 9", 10", 11", and 12" std. A 5 ton hydraulic jack was used to

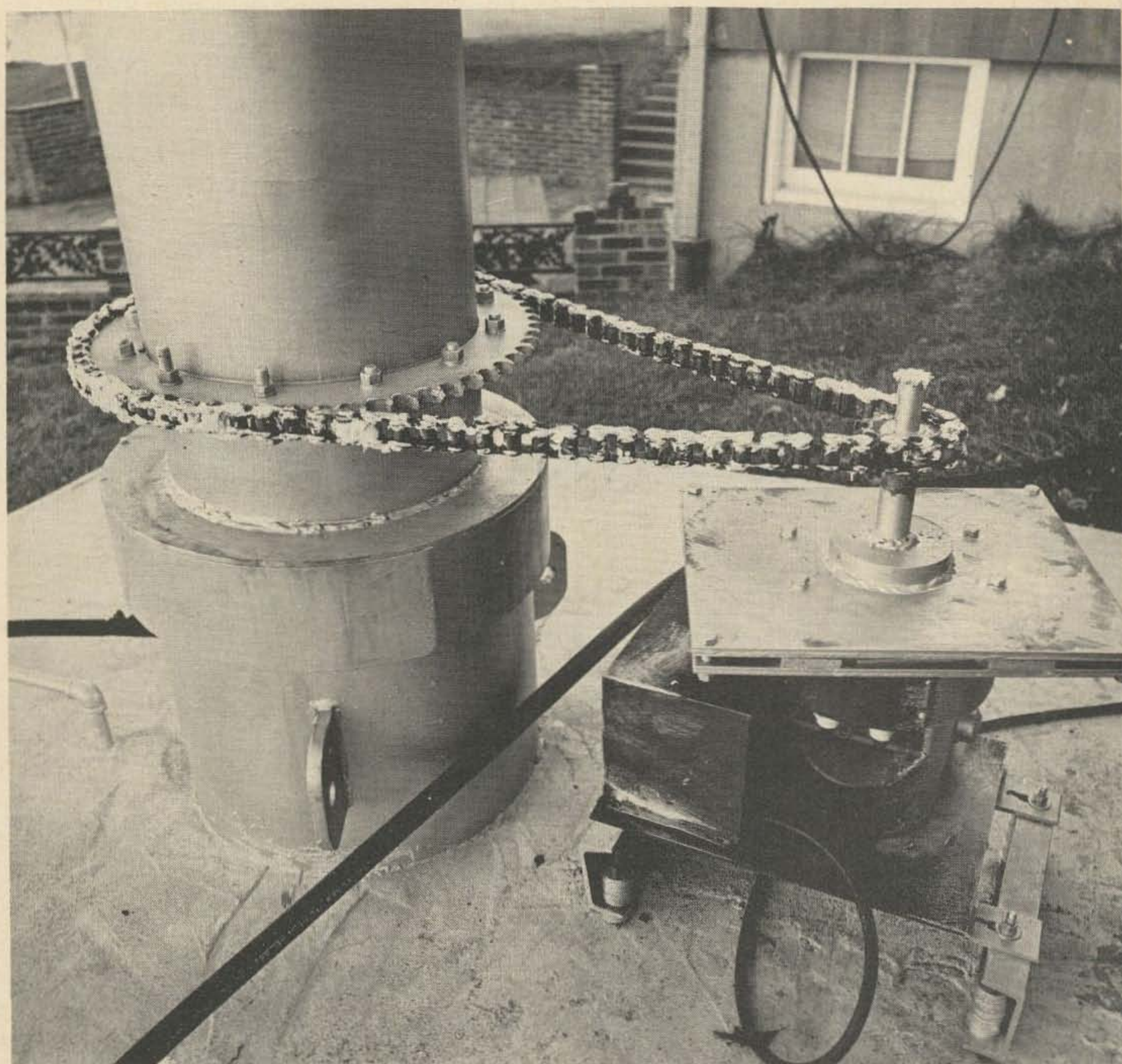

engage these sections together, as well as was a 16' long 4 x 4, used as a lever.

Section four was made of one 40 foot long piece of 14" o.d. pipe (.375" wall thickness). This section weighed 2137 pounds, but was easily raised and lowered with the 5 ton jack. To keep the pipe sections concentric, steel spacers 1/2" wide, spot-welded at 120 degrees, did the job. These pieces were ground down on a grinding wheel to a clearance of .010". Overlap between pipe sections varied from 14" at the top to 24" at the bottom of mast.

Climbing steps were made from 3/4" steel rod 7" long, threaded on one end to screw into a 3/4" nut which was welded to the mast. Eight boom mounting plates were welded at the following levels above the ground: 41', 47', 53', 65', 85', 96', 103', and

110'. The total length of the mast was 127', of which 10 feet is below the ground. The top mounting plate is 7' below the top of the mast, for a boom strut for larger beams.

After the location for the mast was determined, concrete forms were erected and leveled, forming a square 7' x 7'. Hand digging was then begun and continued to a depth of 11'. This was done a little at a time and, after a depth of 7' was reached, dirt was hauled out with the help of five gallon buckets.

A 12' section of 18" pipe (with a wall thickness of .500") was used for the concrete tube. At the bottom end of this tube, a steel plate 36" x 36" was welded, to keep the tube plumb in the concrete. Before welding the tube to the plate, a bearing race was held in place by using 3 angle clips 120

1 pc 2-7/8" o.d. tubing 5/16" wall x 5' 2"	\$	4.78	
1 pc 3-1/2" o.d. tubing 5/16" wall x 4' 11"		5.08	
1 pc 3-1/2" std .226" wall x 7' 2"		7.80	
1 pc 4" std .237" wall x 7' 10"		10.19	
1 pc 5" o.d. .300" wall x 8' 0"		16.50	
1 pc 5" std .258" wall x 8' 2"		16.18	
1 pc 6" std .280" wall x 8' 0"		19.80	
1 pc 7" std .301" wall x 9' 1"		29.10	
1 pc 8" std .375" wall 11' 0"		38.40	
1 pc 9" std .312" wall x 10' 0"		46.80	
1 pc 10" std .307" wall x 10' 0"		48.20	
1 pc 11" (11.750" o.d.) .400" wall x 10' 0"		85.40	
1 pc 12" std .330" wall x 10' 0"		63.10	
1 pc 14" std 375" wall x 40' 0"		399.36	
1 pc 18" o.d. .500" wall x 11' 6"		213.93	
		<u>\$1,004.62</u>	\$1,004.62
Concrete 7' x 7' x 11' (19 yards)	\$	301.00	
Mach. work (tubing)		60.00	
Misc. steel		75.00	
Paint (3 coats)		20.00	
1 PKSE60 & 1 PKSE10 Boston Gear Sprockets		36.70	
2 side bearings (stock from 17" o.d. x 1.5000" wall)		60.20	
Mach. work		25.00	
1 rain shield		20.00	
		<u>\$597.90</u>	597.90
			<u><u>\$1,602.52</u></u>

Table 1. Parts List. 117' at a total cost of \$1602.52 = \$13.69 per foot.

degrees apart. Adjustment of the race was made by 1/2" bolts threaded into clips.

A large roller bearing was given to me; it had been taken from the main axle of a



The main roller bearing.

diesel locomotive, designed to support 100 tons at a speed of 120 mph. The bearing was used, but in perfect condition. With my total weight of 3 tons and one third of a revolution per minute, my safety factor was very good. I knew that, if the array did not work DX-wise using this bearing, at least I could have the fastest beam in the west. This particular bearing was made by Timken (model # 560650-561251 TS); many similar bearings are used in industry.

Eight gallons of #20 motor oil was poured in the bottom of the tube for lubrication of roller bearing. Note the 1/2" pipe running from the top of concrete to the bottom of the bearing, to remove any water mixed in the oil because of condensation.

A bronze bearing was machined to fit the top and inside of the 18" tube. This bearing is 4" wide and just under 2" thick, giving a clearance of .063". Rotation of the mast is so easy that my wife can turn it with one hand. A rain shield is welded to the mast just above the concrete tube to prevent rain running down into the oil. A step down ratio of 6 to 1 is made by having a Boston gear sprocket of 60 teeth reduced to 10 teeth on



Aha, the SECRET of PC Board success finally revealed. A perfectly balanced lighting tool combining magnification with cool fluorescence. Excellent for fine detail, component assembly, etc. Lens is precision ground and polished.

Regularly \$65.00. Now, over 30% discount (only \$46.00) to all licensed Hams, verified in Call-Book. Uses 22 watt fluorescent tube 8 inch diameter circle (not supplied).

Include \$3.00 U.S. postage, or \$4.00 in Canada, \$5.00 elsewhere. California residents include 6% sales tax. Or send stamped envelope for free brochure of other incandescent or fluorescent lamps suitable for all engineers, architects, students, etc.

\$46.00 price assured until Jan. 1, 1976

## D-D ENTERPRISES



Dept. B-4, P.O. Box 7776  
San Francisco CA 94119

the rotator. The chain is of standard 5/8" roller type. With this gear ratio, any type of rotator will handle this job; at present I am using a Johnson rotator (which is more than ample).

A small 3" steel block using 3/8" steel cable is mounted at the very top of the mast for hoisting beams, as well as a bosun's chair (for ease when working, painting, etc.). A breakdown of costs can be seen in Table 1.

After finishing the welding and painting (2 coats) of the four sections, I borrowed a wrecking tow truck and carried the four sections to the erection site. The four sections were then put together on top of concrete blocks, so that the mast was several feet off of the ground. Wooden forms were constructed at each end of the mast and piano wire was stretched on the top and one side. With the use of the jack, shims were placed at various points to make the 127' mast as straight as possible; at this time tack welds were made on the top side. The mast was then rotated 180 degrees and the same operation repeated. After tack welding every 90 degrees and again checking for straight-



*The Brown Bomber — ready for action.*

ness, the complete welding of each joint was accomplished. The welds were wire brushed and painted.

Erection time for the mast was here. A large truck crane with a 65' boom and a capacity of 30 tons was hired for the job. By trial and error we found the balance point to be 40' from the bottom end. A steel cable sling was placed 10' higher, in order to keep the bottom of the mast heavy. As the top of the mast climbed to about 30 degrees above the ground, the mast looked as if it were a giant fishing pole with a large catch on the end. My mind was wondering whether the welds would hold. In a few seconds the mast was at about 60 degrees and the bending was decreased. In short time, the mast was vertical and the crane engineer started to swing it toward the concrete tube. Needless to say, there was quite a feeling of relief when the mast started into the tube. This turned out to be quite a show for my neighbors and DX friends.

Incidentally, considerable cost may be saved by using used pipe, so I'll see you at the junkyard.

... WØSYK

## LINEAR I.C. s

LM300H	Positive Voltage Regulator (metal can)	.69
LM301AH	Hi Performance Op Amp (metal can)	.35
LM304H	Negative Voltage Regulator (metal can)	.75
LM305H	Positive Voltage Regulator (metal can)	.78
LM307H	Op Amp (Super 741) (metal can)	.28
LM307 mini	Op Amp (Super 741) (mini dip)	.28
LM309H	5V 1 Amp Voltage Regulator (metal can)	.99
LM309K	5V 1 Amp Voltage Regulator (TO-3)	1.39
LM310H	Voltage Follower Op Amp (metal can)	1.09
LM324	Quad Op Amp (DIL)	1.75
LM339	Quad Comparator (DIL)	1.75
LM555	Timer (mini dip)	.54
LM556N	Dual Timer (DIL)	.99

LM709CH	Op Amp (metal can)	.29
LM709 mini	Op Amp (mini dip)	.29
LM709CN	Op Amp (DIL)	.29
LM711CH	Dual Difference Comparator (metal can)	.50
LM723CH	Voltage Regulator (metal can)	.54
LM723CN	Voltage Regulator (14 pin DIL)	.54
LM741CH	Op Amp (metal can)	.29
LM741 mini	Op Amp (mini dip)	.28
LM741CN	Op Amp (14 pin DIL)	.29
LM747CH	Dual 741 Op Amp (metal can)	.65
LM747CN	Dual 741 Op Amp (14 pin DIL)	.75
LM748 mini	Dual 741 Op Amp (mini dip)	.29
LM1458H	Dual Op Amp (metal can)	.65
LM3046	Transistor Array	.85
LM3900	Quad Amplifier	.79

## PLASTIC TRANSISTORS

2N3415	\$ .17
2N3563	.15
2N3564	.15
2N3565	.15
2N3566	.15
2N3567	.15
2N3568	.15
2N3569	.15
2N3640	.15
2N3641	.15
2N3643	.15
2N3702	.17
2N3703	.17
2N3704	.17
2N3705	.17
2N3706	.17
2N3707	.17
2N3708	.17
2N3709	.17
2N3710	.17
2N3711	.17
2N3819	.29
2N3820	.35
2N3903	.15
2N3904	.15
2N3905	.15
2N3906	.15
2N4058	.17
2N4059	.17
2N4060	.17
2N4061	.17
2N4062	.17
2N4123	.15
2N4124	.15
2N4125	.15
2N4126	.15
2N4250	.15
2N4275	.15
2N4401	.15
2N4403	.15
2N5400	.22
2N5447	.16
2N5449	.16
2N5525	.39
TIS43	.39

## METAL TRANSISTORS

2N696	\$ .39	2N2222A	.19
2N697	.39	2N2369A	.19
2N706	.25	2N2484	.24
2N708	.28	2N2857	.95
2N709	.26	2N2904A	.28
2N718	.25	2N2905	.27
2N910	.27	2N2907A	.24
2N1131	.39	2N3054	.49
2N1303	.29	2N3055	.69
2N1304	.29	2N3137	1.50
2N1305	.29	2N3250	.29
2N1420	.19	2N3253	.40
2N1613	.30	2N3375	4.95
2N1711	.35	2N3866	.98
2N1890	.39	2N4036	.55
2N1893	.39	2N4234	.55
2N2060	2.75	2N4237	.55
2N2102	.35	2N5415	1.25
2N2218A	.29	2N5416	1.50

## PLASTIC POWER TRANSISTORS

TIP29A	NPN 1A 60V	\$ .45
TIP30A	PNP 1A 60V	.49
TIP31A	NPN 3A 60V	.52
TIP32A	PNP 3A 60V	.55
TIP34	PNP 10A 40V	.99
TIP35	NPN 25A 40V	1.99
TIP36	PNP 25A 40V	2.25
TIP41A	NPN 6A 60V	.65
TIP42A	PNP 6A 60V	.75
TIP47	NPN 1A 250V	.88
TIP48	NPN 1A 300V	.96
TIP49	NPN 1A 350V	.99
TIP110	NPN 2A 60V	.92
TIP121	NPN 5A 80V	1.64
TIP127	PNP 5A 100V	2.02
TIP2955	PNP 15A 60V	.89
TIP3055	NPN 15A 60V	.85

## C/MOS

CD 4000	\$ .24	CD 4033	1.95
4001	.24	4035	1.50
4002	.24	4040	1.24
4006	1.50	4041	.89
4007	.24	4042	.79
4008	.99	4043	.79
4009	.49	4044	.79
4010	.49	4049	.49
4011	.24	4050	.49
4012	.24	4051	1.50
4013	.49	4052	1.50
4014	1.24	4053	1.50
4015	1.24	4055	1.99
4016	.49	4056	1.99
4017	1.24	4060	1.99
4018	1.24	4066	.79
4019	.49	4069	.35
4020	1.24	4071	.35
4021	1.24	4076	1.24
4022	1.24	4081	.35
4023	.24	4507	1.25
4024	.99	4510	1.24
4025	.24	4511	2.50
4026	1.95	4512	2.95
4027	.59	4516	1.75
4028	.99	4518	1.95
4029	1.24	4520	1.95
4030	.49	4528	1.50

## SCR s

C106B1	\$ .55	2N5063	.32
C106D1	.85	2N5064	.34
2N5061	.28	TIC47	.38
2N5062	.30		

## I.C. SOCKETS

8 Pin DIL	\$ .18	16 Pin DIL	.24
14 Pin DIL	.22	24 Pin DIL	.59

## MEMORIES

AY5-1013P	UART	\$ 9.00
AY5-2376	Keyboard Encoder ROM	19.95
1101AP	256 Bit Static RAM MOS	3.95
1403AT	Dual 512 Bit Dyn MOS S/R	3.75
1404AT	Single 1024 Bit Dyn MOS S/R	3.50
1702A	2048 Bit Erasable Elect. Reprogrammable Static MOS RAM	23.95
2102P	1024 Bit Static RAM MOS	3.95
8008R	8 Bit Central Processing Unit	44.00
8080	8 Bit Parallel CPU	195.00
TMS4030NL	4K RAM 4096 Bit	19.95

## TTL

SN 7400	\$ .15	SN 74121	.38
7401	.15	74122	.44
7402	.15	74123	.74
7403	.15	74125	.54
7404	.18	74126	.54
7405	.18	74128	.84
7406	.34	74132	1.45
7407	.34	74136	.64
7408	.18	74141	.94
7409	.18	74142	3.70
7410	.15	74143	3.98
7411	.25	74144	3.98
7412	.30	74145	.98
7413	.45	74147	2.30
7414	1.49	74148	1.90
7416	.33	74150	.94
7417	.33	74151	.69
7420	.15	74153	.79
7421	.32	74154	1.09
7423	.27	74155	.79
7425	.27	74156	.79
7426	.24	74157	.69
7427	.27	74159	3.50
7428	.39	74160	.99
7430	.15	74161	.99
7432	.24	74162	.99
7433	.37	74163	.99
7437	.29	74164	1.10
7438	.29	74165	1.10
7440	.15	74166	1.35
7442	.59	74170	2.25
7443	.85	74172	8.75
7444	.85	74173	1.35
7445	.79	74174	1.15
7446	.87	74175	.99
7447	.87	74176	.79
7448	.85	74177	.79
7450	.15	74178	1.95
7451	.15	74179	1.95
7453	.15	74180	.79
7454	.15	74181	2.40
7460	.15	74182	.69
7470	.28	74184	1.95
7472	.28	74185	1.85
7473	.34	74186	13.95
7474	.34	74188	4.75
7475	.49	74190	1.33
7476	.35	74191	1.33
7480	.48	74192	1.10
7481	.99	74193	1.10
7482	.69	74194	1.05
7483A	.78	74195	.74
7484	1.95	74196	.99
7485	1.08	74197	.89
7486	.34	74198	1.69
7489	2.35	74199	1.69
7490	.49	74221	1.50
7491	.79	74246	1.95
7492	.49	74247	1.85
7493	.49	74248	1.75
7494	.79	74249	1.75
7495	.74	74251	1.40
7496	.79	74265	.85
74100	1.25	74273	2.75
74104	.43	74278	2.45
74105	.43	74279	.95
74107	.34	74283	1.75
74109	.74	74284	4.50
74110	.54	74285	4.50
74111	.74	74290	.85
74116	1.98	74293	.85
74118	1.35	74298	1.98
74120	1.40	74367	.95

## LED s & OPTO ISOLATORS

DL707	7 Seg 0.3"	\$ 1.70
DL747	7 Seg 0.63"	2.45
RL2	Red Led .19"	.23
TIL209	Red Led .125"	.19
TIL111	Opto-Coupler	1.20
TIL220	Red Led .20"	.24
IL15	Opto-Isolator	1.25
IL16	Opto-Isolator	1.40
TIL312	7 Seg. 0.3"	1.70
TIL313	7 Seg. 0.3"	1.70

## LOW POWER SCHOTTKY

SN74LS00	\$ .42	SN74LS114	.68
74LS01	.42	74LS122	.68
74LS02	.42	74LS123	.84
74LS03	.42	74LS125	.68
74LS04	.47	74LS126	.68
74LS05	.47	74LS132	1.58
74LS08	.42	74LS136	.68
74LS09	.42	74LS138	1.94
74LS10	.42	74LS139	1.94
74LS11	.42	74LS145	1.58
74LS12	.42	74LS151	1.58
74LS13	.84	74LS153	1.94
74LS14	2.22	74LS155	1.94
74LS15	.42	74LS156	1.94
74LS20	.42	74LS157	1.58
74LS21	.42	74LS158	1.58
74LS22	.42	74LS164	2.27
74LS26	.54	74LS170	5.36
74LS27	.47	74LS174	2.27
74LS28	.54	74LS175	2.27
74LS30	.42	74LS181	6.30
74LS32	.47	74LS190	2.87
74LS33	.54	74LS191	2.87
74LS37	.54	74LS192	2.87
74LS38	.54	74LS193	2.87
74LS40	.54	74LS194A	2.27
74LS42	1.25	74LS195A	2.27
74LS48	1.25	74LS196	2.27
74LS49	1.25	74LS197	2.27
74LS51	.42	74LS221	1.41
74LS54	.42	74LS247	1.25
74LS55	.42	74LS248	1.25
74LS73	.68	74LS249	1.25
74LS74	.68	74LS251	1.94
74LS75	.84	74LS253	2.27
74LS76	.68	74LS257	1.94
74LS78	.68	74LS258	1.94
74LS83A	2.27	74LS261	5.36
74LS85	2.88	74LS266	.68
74LS85	.68	74LS279	.84
74LS90	1.25	74LS283	2.27
74LS91	1.25	74LS290	1.25
74LS92	1.25	74LS293	1.25
74LS93	1.25	74LS295A	2.27
74LS95A	2.27	74LS365	.68
74LS96	1.94	74LS367	.68
74LS107	.68	74LS368	.68
74LS109	.68	74LS375	.84
74LS112	.68	74LS386	.68
74LS113	.68	74LS670	6.30

# Active Electronic Sales Corp.

P.O. BOX 1035 FRAMINGHAM, MASSACHUSETTS 01701

Telephone Orders (617) 879-0077

MINIMUM ORDER \$10.00

ADD \$1.00 TO COVER POSTAGE & HANDLING



# You Win Again!

You've been bugging us to modify the IC-22A for use with the DV-21, and we did it! We're giving you what you've been wanting in a new field modification package simple enough for anyone experienced in kit building or home brewing. You can now use our unique scanning digital synthesizer to complete your ICOM two meter station.

The DV-21 is the LED readout synthesizer that operates in 5KHz steps over the 146-148MHz FM section of the two meter band, and even scans frequencies being used. Completely separate selection of the transmit or receive is as simple as touching the keys. When you transmit, the bright, easy to read LED's display your TX frequency. Release the mic switch, and the receive frequency is displayed. There are even two programable memories for your favorite simplex frequencies. You won't believe the features and versatility the DV-21 will add to your station.

We'll send you everything you need to make your modification: wire, coax cable, an extension/adaptor cable with seven to nine pin capacity, and the active components. If you have neither the time nor the inclination to make your own connections, we will modify your radio for you at a nominal fee of \$30.00 with prepaid return.

To get your mod kit send \$10.00 to ICOM EAST, Inc. or ICOM WEST, Inc., and you will receive yours by return mail, prepaid.

Distributed by:



# ICOM

**ICOM WEST, INC.**  
Suite 3  
13256 Northrup Way  
Bellevue, Wash. 98005  
(206) 747-9020

**ICOM EAST, INC.**  
Suite 307  
3331 Towerwood Drive  
Dallas, Texas 75234  
(214) 620-2780



# Build a Deluxe TTY Keyboard

## Conclusion

The last time under this heading, a TTY keyboard was described that performed about as well as your old model 15; about the only positive feature of that keyboard was that it didn't make as much noise. Well, don't give up yet. Described in the following paragraphs are the features that make the keyboard truly deluxe. These features are in some cases mutually optional and their circuitry differs slightly whether used alone

or with a complete system. If that is the case, both circuits are shown. The options described here are divided into three assemblies: 1) character counter; 2) auto function module (AFM); and 3) TTY signal generator.

### Character Counter

The first addition to the basic keyboard is the character counter. This is a handy device

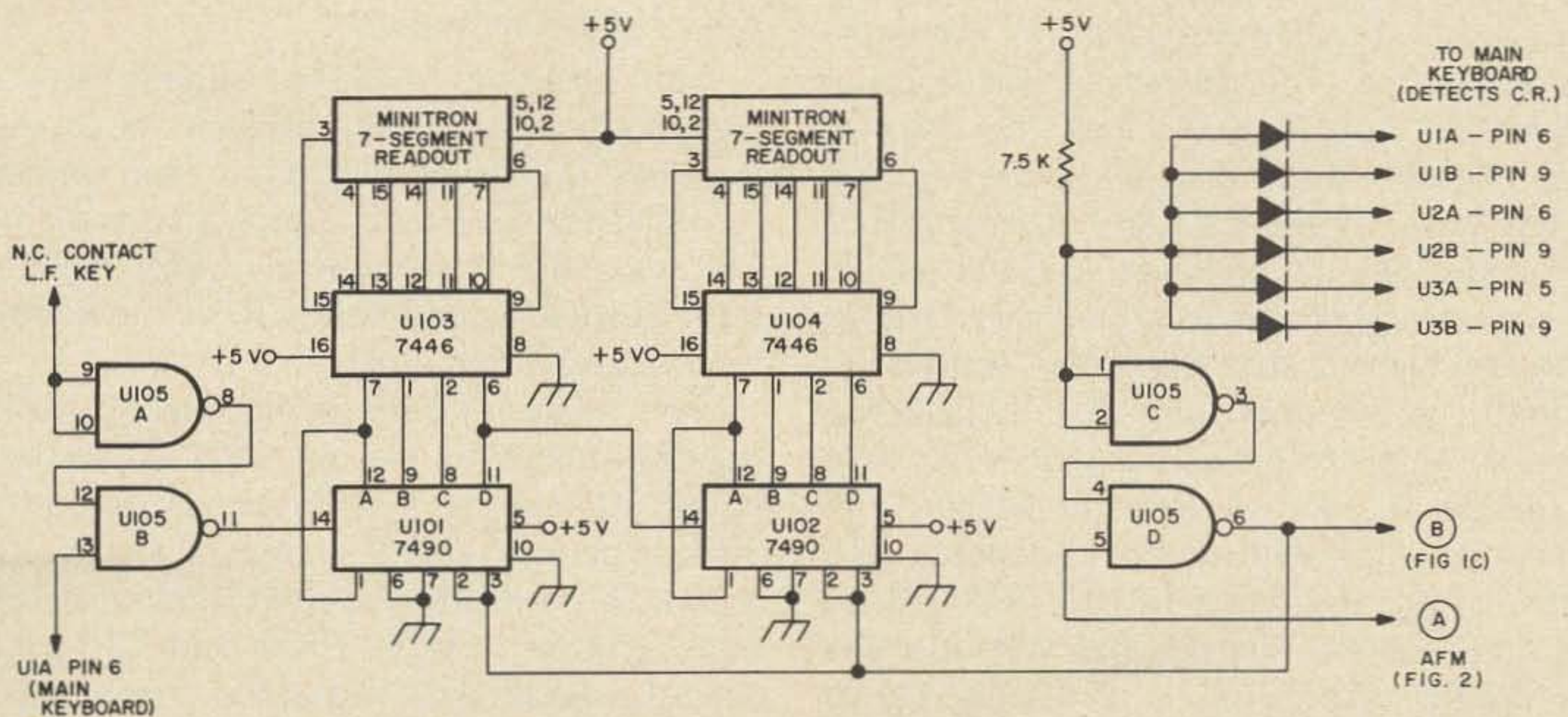

Fig. 1(a). Character counter.

if you are typing into an unseen page printer. In addition to providing an indication of the number of characters transmitted since the last line feed, a "beep" sounds to indicate that a line is nearly full. The circuit, shown in Fig. 1, is a straight BCD counter with decoders to drive a pair of 7-segment indicators. In the prototype, the indicators are the incandescent Minitron type, although LED displays could have been used.

The input to the counter is connected to the Q of U1A (in the keyboard) and toggles every time a stop pulse is entered into the keyboard shift register. The extra gating at the input inhibits the count whenever a machine function is transmitted, since those result in no carriage travel in a page printer. In order to inhibit count during the transmission of these functions, double pole key switches are required for the LF (line feed), LTRS, and FIGS keys. If the AFM is used, a double throw switch is needed only for the LF key, since the LTRS and the FIGS keys are not connected to the keyboard register in this case. The count gate circuitry shown in Fig. 1(b) is used when the AFM is not included.

The character counter should obviously be reset by the transmission of CR (carriage return). This is accomplished by using a diode gate that detects the presence of CR in the keyboard shift register. The extra reset input (terminal A) is provided for the eventual use of the automatic CR/LF circuit.

The diodes connected to the outputs of U101 and U102 decode, in this case, 62 or some other number designated as approaching a full line. The output of this decoder drives the auto CR/LF and the warning beep. Another diode decoder detects a count of ten more. By the way, any number can be decoded from the character counter simply by connecting diodes to all counter outputs that are high at that particular count. For example, a full line could be 56 characters long, so that 46 (giving ten spaces warning) would be decoded to drive the beeper. This would be done with diodes connected to B and C of the units stage (U101) and C of the ten stage. While this decoder will also give true (high) outputs at counts 47, 56, 57, 66, 67, 76 and 77, the counter reaches 46 first so all subsequent outputs can be ignored.

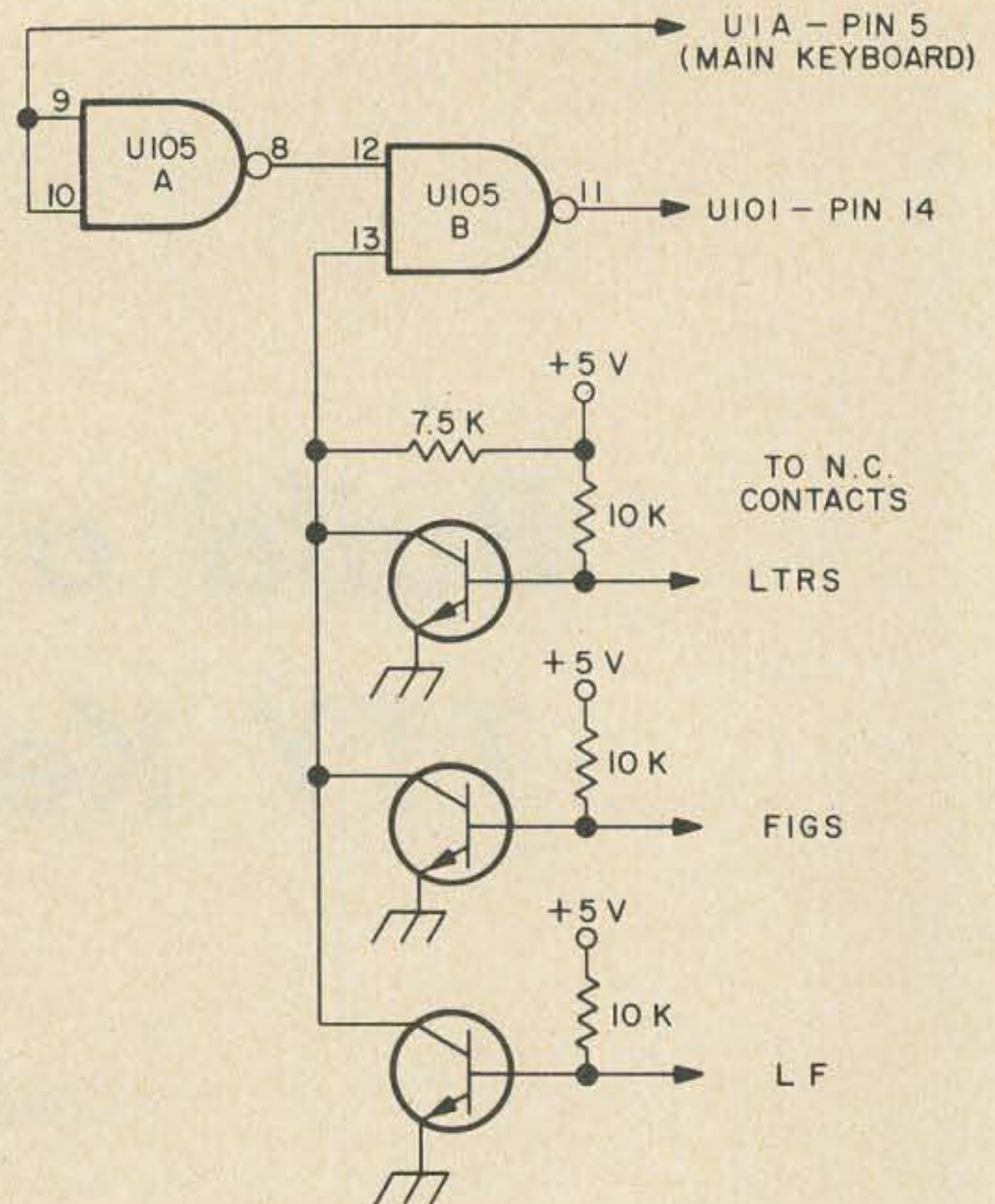

Fig. 1(b). Alternate count gate circuitry for use without AFM. Transistors are NPN silicon switches. U105 and U107 are 7400. Vcc - pin 14. GND - pin 7.

The function of the warning beep is similar to the warning bell on a typewriter or some teleprinters. The high output of the decoder drives a 74121 one-shot with a period of .5 seconds. The output of the one-shot drives a NE555 connected as an oscillator driving a small speaker. When the one-shot triggers, a latch is set to inhibit further triggering of the beeper until the next line.

### Auto Function Module

This addition, while of slightly greater complexity than the original keyboard, increases operating ease more than enough to offset the increased complexity and cost. The auto function module (AFM) includes both auto/shift and auto CR/LF since both involve similar circuitry.

The heart of both operations is a shift register similar to the one used in the basic keyboard. The main difference between this TTY generator and the keyboard generator is that this one produces only three different code groups: LTRS, FIGS and CR. Note that the AFM shift register is connected in series with the keyboard register by gates U202A, B only when there is data in the

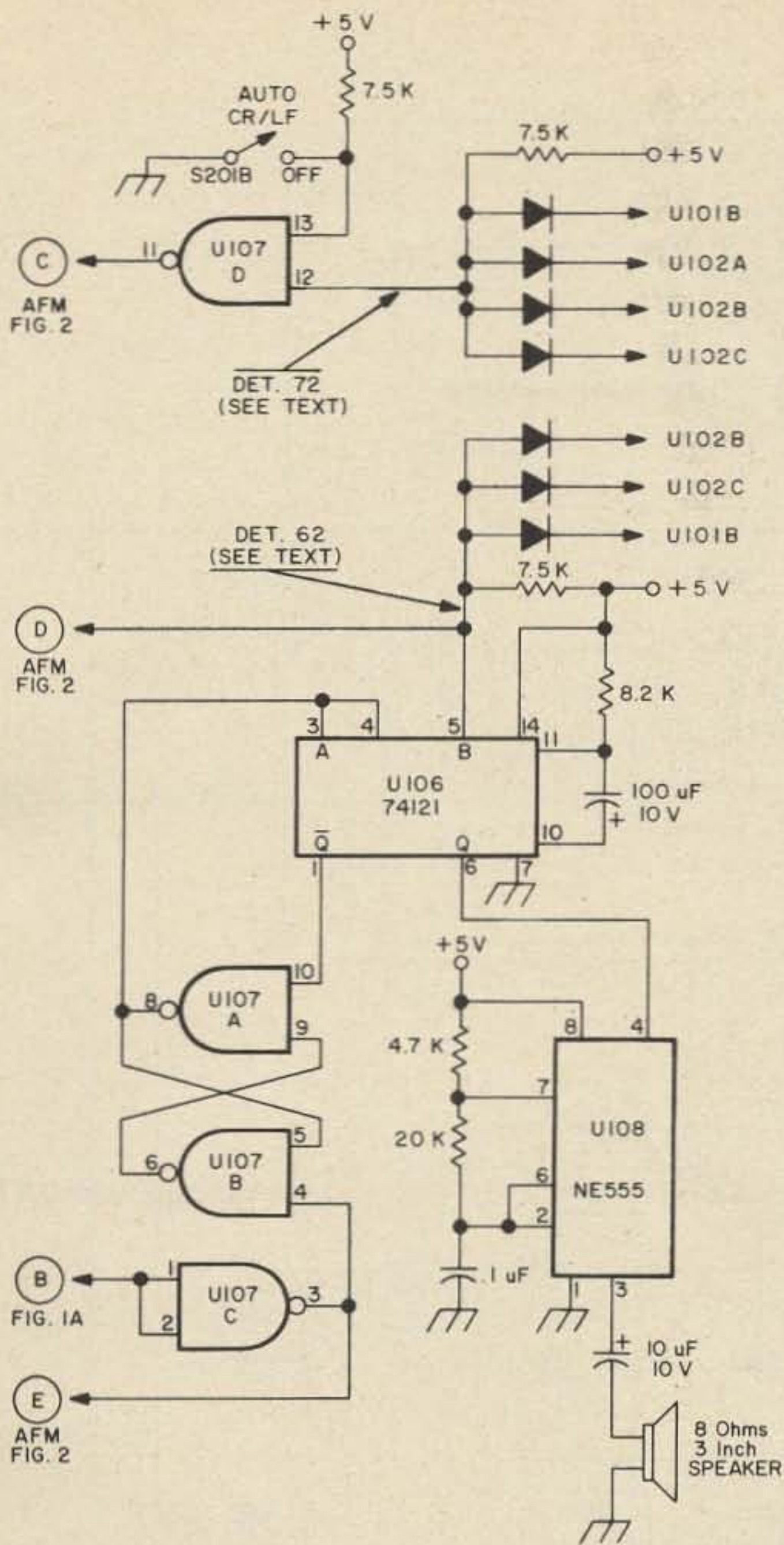

Fig. 1(c). End-of-line warning beeper and character count decode.

AFM register. At all other times, it is effectively out of the circuit.

The auto shift function uses most of the components in this module (see Fig. 2). The two extra toroids in the keyboard matrix are now used. The matrix should be wired so that wires from lower case keys pass through the LTRS core while wires from upper case keys go through the FIGS core. Not every upper case character should have a key of its own. Some of the characters are used so seldom that a separate key switch would not be worth the space it takes. In the original unit, only the numbers, period, question mark and slash have separate keys. Of course, the choice of upper case keys is up to the individual.

The auto shift circuit not only encodes and inserts shift functions, it also determines

when they should be added. While it would be workable to include a shift function before every character transmitted, the effective speed of communication would be halved. Thus, circuitry is included to insert a shift function only when required. For example, when transmitting a call (K7YGP/7), the symbols are typed as written. The circuitry then inserts FIGS only before the first 7 and the / and inserts LTRS only before the K and Y. What it boils down to is that the circuit generates a shift function only at the beginning of a series of like cased characters. Operationally, this results in the generation of alternate shifts: FIGS then LTRS then FIGS — never two of the same in a row.

The auto shift circuitry derives its commands from the two shift toroids in the matrix and two shift keys (FIGS and LTRS). Assume that the U204A, U204B latch is set so the output of U204A is low and that of U204B is high (FIGS was the last shift command). The low applied to U205B pin 9 keeps its output high so no pulses from the FIGS toroid reach the output. Assuming pin 2 of U205A is also high, a pulse from the LTRS toroid will appear as a low going pulse at the output of U205A. This pulse is applied to U204A, causing that latch to change state, inhibiting the LTRS input and releasing the FIGS input. The LTRS pulse is also applied to U205C and U210A, B, C, setting the shift register to LTRS coding. If an upper case key is next pressed, the U204A, B latch will be driven to its original state and FIGS coding will be set into the register through U205C and U210A, C. The LED indicators at the output of the latch show the last shift function sent. Differentiated pulses from the manual shift keys trigger their associated one-shots (U206A, B). The outputs of the one-shot performed the same function as the pulses from the auto shift toroids except that the input gates (U205A, B) are bypassed allowing one shift function to be generated with each push of the key. The U204C, D latch is set when the manual FIGS key is pressed. When set, the latch lights the FIGS LOCK light and applies a low signal to U205A, inhibiting the auto LTRS signal. This permits transmitting upper case characters that have no separate

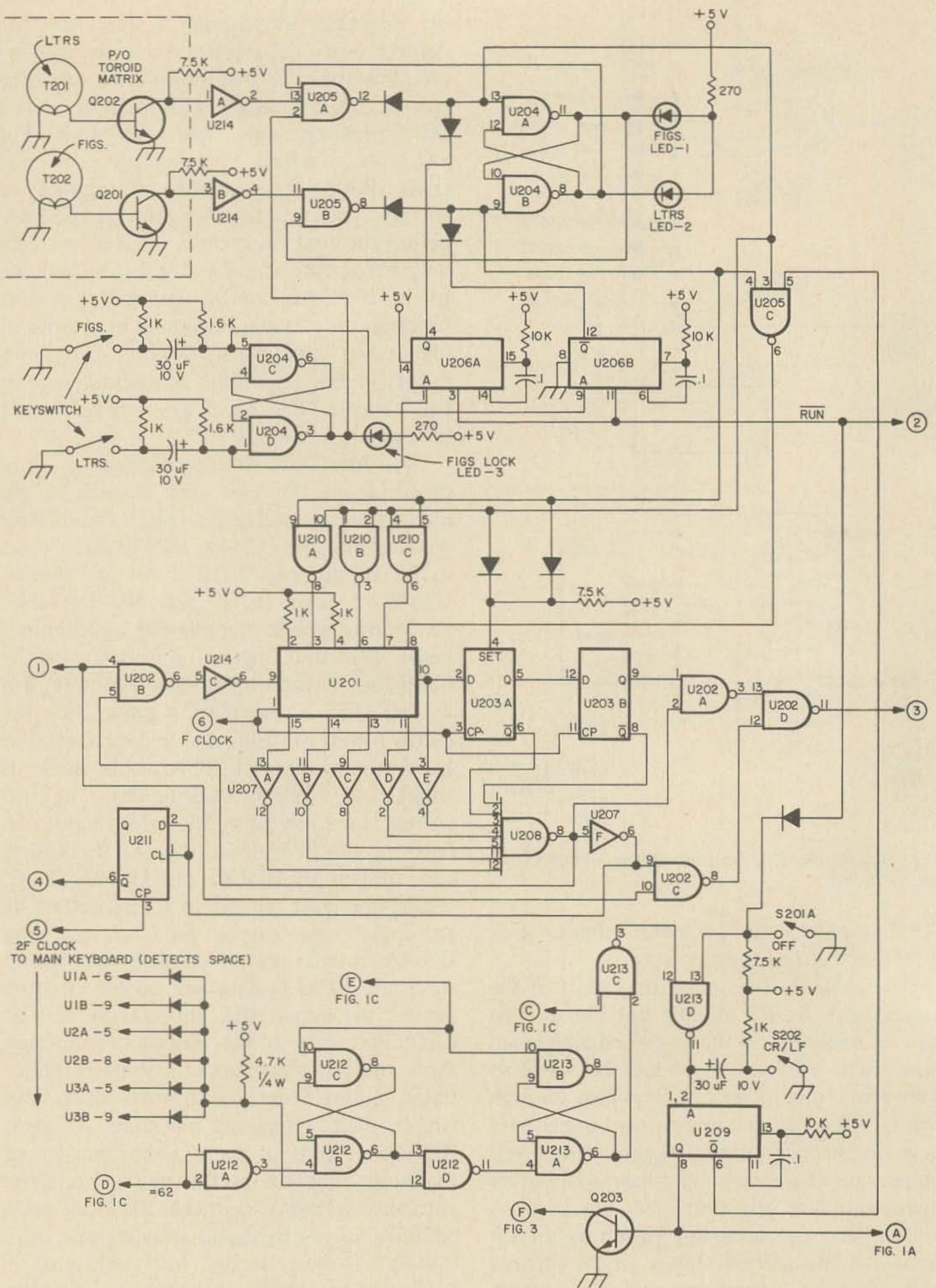

Fig. 2. Automatic function module (AFM). Vcc on pin 14 and ground on pin 7 of all ICs but U201: Vcc - pin 5, GND - pin 12. AFM terminal connections to the basic keyboard: 1 - connects to output of "output gate;" 2 - connects to line that goes low when clock is running; 3 - connects to base resistor of loop keyer; 4 - connects to temporarily grounded input of NOR gate (UGA?); 5 - connects to 2F clock; 6 - connects to 1F clock buffer (the one that goes nowhere).

# Reliability.



That's what you get from Sentry.  
The most reliable crystals you'll find anywhere. Because Sentry crystals are made of the finest quartz to the latest state-of-the-art specifications. And our manufacturing methods are the most precise available. Since Sentry has the largest semi-processed crystal bank in the world, we can custom-make crystals for any rig. Any frequency. Faster than anyone else in the business.

And talk about frequency stability. You've got it with Sentry.

So place your next order with us. It's easy. Our processing is quick, accurate, efficient. Our guarantees are solid. And we'll send you our complete 1975 Catalog. Absolutely free.

Sentry. You can depend on us.  
Sentry Manufacturing Company.  
Crystal Park, Chickasha, Oklahoma 73018.  
Phone: (405) 224-6780,  
TWX-910-830-6425.

**Sentry**  
Manufacturing Company  
**Tuned-In to Quality.**

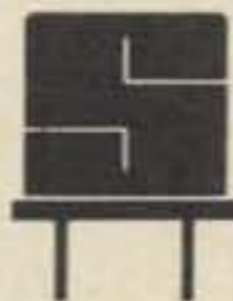
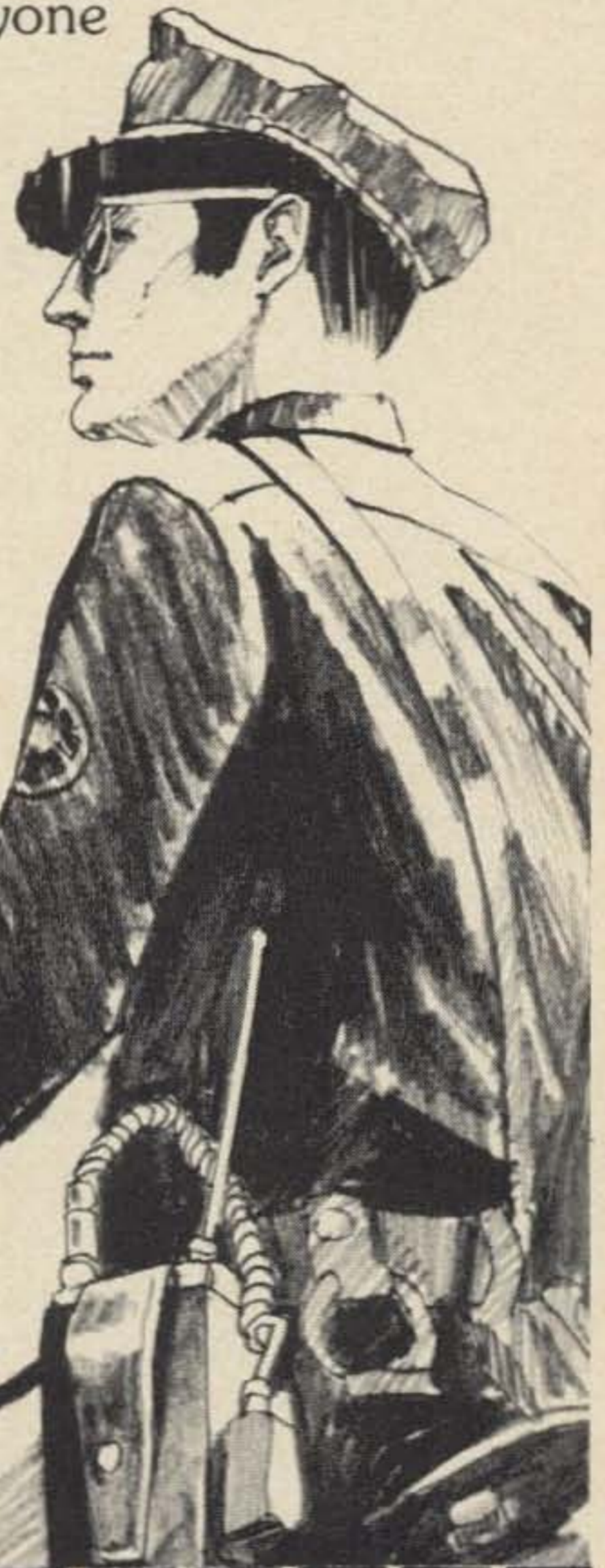

Sentry Manufacturing Co.  
Crystal Park  
Chickasha, Okla. 73018

**Please send me your Free 1975 Sentry Catalog.  
RIGHT AWAY!**

Name \_\_\_\_\_

Street \_\_\_\_\_

City \_\_\_\_\_ State \_\_\_\_\_ Zip \_\_\_\_\_

**Send for  
Sentry's  
FREE 1975  
Catalog!**

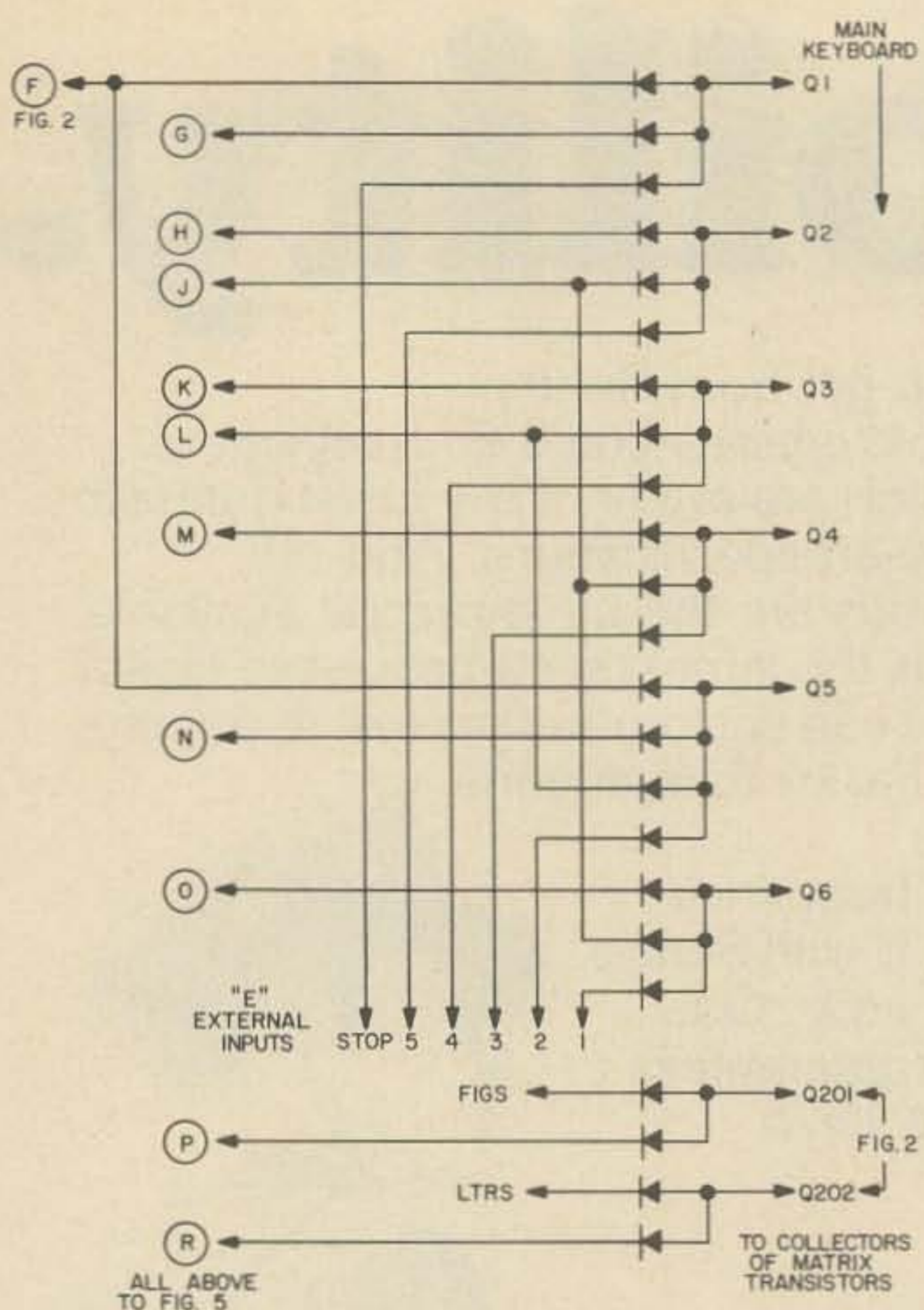

Fig. 3. Auxiliary encoding matrix — all diodes germanium.

key. The latch is reset by pressing the manual LTRS key, returning the circuitry to auto shift operation.

The shift register, composed of U201 and U203A, B, while different componentwise from the keyboard register, is logically the same. When the register is empty (full of space coding), all the low outputs of U201 are inverted by U207A through E and applied to U208 along with the high signals from U203A and U203B. The output of U208 controls clocking the same way as its counterpart in the keyboard register. The only difference is that the U208 output also controls gates U202A, B, C. These place the AFM register in the circuit, in series with the keyboard register, when it (AFM) contains data, and bypasses it when empty.

The other function of the AFM is to insert CR/LF when the end of a line approaches. The same signal that drives the end of line warning also initiates the operation of the auto CR/LF. In case you are in the middle of a word, the circuitry is set up so that CR/LF is inserted only after the first space sent after end of line warning. As a failsafe feature, CR/LF insertion is actuated

by an end of line signal (warning plus 10 more characters), whether or not the last word is completed. Originally, CR/LF was initiated only at the end of a line. This got the job done but seemed always to occur in the middle of a word — which tended to be a little distracting. The present circuit gives CR/LF somewhere during the last ten positions of the line at the end of a word (as long as the word is not over ten letters long).

Since several of the functions to be described require encoding access to the main keyboard shift register, a method of auxiliary encoding is necessary (see Fig. 3). In spite of what was said about diode matrices in the last part ("Where do you find room for all those diodes?" or something like that), that is exactly what is used here. Different methods were tried to electronically actuate the toroid matrix but none worked. This was probably due to the fast rising, high current pulse required on the matrix primaries. Anyway, this group of diodes is connected to the collectors of the matrix switching transistors. Grounding the cathode end of the diode sets the associated register stage(s). You will notice three sets of diode matrix inputs. The first set goes to the AFM for setting LF. The second set connects to the signal generator (may be omitted if the signal generator is). The last set, labeled external, goes nowhere at the moment. Its eventual use will be for inputting externally generated parallel data from a tape reader or a video terminal or something else I haven't thought of, but you might. Of course, those diodes can be omitted without effecting the operation of the keyboard or its accessories. All the matrix diodes in the prototype were mounted on the same board as the toroid matrix. But that is enough about a bunch of diodes — let's get back to the AFM and its auto CR/LF function.

This function is accomplished by the circuitry in the lower part of Fig. 2. When an end of line warning signal (end of a line minus ten) is received, the U212B, C latch is set. This places a high on one input of U212D. When sometime later a space is set into the main shift register, this event is detected by D1 through 6 and a brief high pulse appears on the other input of U212D. This sets the U213A, B latch output low.

The low is inverted and applied to one input U213D. Since the keyboard is transmitting a space, the  $\overline{RUN}$  is low, preventing the output of U213D from going high. As soon as the  $\overline{RUN}$  line goes high, the U213D goes high and triggers the U209 one-shot. The pulse does several things: 1) The AFM shift register is loaded with coding for carriage return; 2) a set of diodes at the auxiliary coding matrix is grounded by Q203, loading the main keyboard register with coding for line feed; and 3) the character counter is reset. Resetting of the character counter also rests the two latches in the auto CR/LF circuitry. After a carriage return and a line feed are shifted out of the keyboard, the  $\overline{RUN}$  line goes high and the keyboard is free to start transmitting a new line.

The failsafe CR/LF is initiated by an end of line count which places a low at the input of U213C. Just like the low from U213A, this produces a high output from U213C. From here failsafe operation is the same as for a normally initiated CR/LF.

### Signal Generators

While the inclusion of TTY signal generators in the keyboard does not improve ease of operation, there are instances where a source of low distortion signals proves useful. The signal generator included here generates either RY signals or a modified binary sequence of all characters (binary QBF). A source of continuous RYs is handy in making range adjustments to printers. Since one character has all odd pulses mark and the other has all even pulses mark, the sequence produces the maximum amount of movement within a mechanical printer. So if

anything is going to go wrong it will do so with RYs. The latter signal is a cheap and dirty method of producing all possible TTY characters as a Quick Brown Fox generator does. While the sequence appears random, it will become familiar after a few repetitions (see Fig. 4). If a true Quick Brown Fox is desired, a custom ROM (read only memory, such as the 8223) could be designed into the circuit. This is not done since the benefits are not worth the added expense.

Now a little about how it works. Since we already have a set of shift registers capable of producing properly timed pulses, we only need a means of automatically programming the registers. That's what the circuit of Fig. 5 does. Most of the circuitry is common to both the RY and binary QBF generators, but since the RY generator is simpler we will start the explanation with the signal generator in that mode.

With S301 in the off position the binary counter (U305, U304) is reset and the output of U301B is held low, keeping the circuit inactive. S302 in the RY position keeps the QBF output gates (U302, U303) inactive no matter what (a high output is inactive). Assuming there is no other activity in the keyboard ( $\overline{RUN}$  high, =  $\overline{72}$  high), opening S301 removes the reset signal from the counter and permits the output of U301B to go high. Through U303D a stop pulse and through U301D the coding for R is set into the main keyboard shift register. With data in the register, the  $\overline{RUN}$  line goes low and the output of U301B goes low, causing all data gates to become inactive and toggling U304B. When the keyboard register clears, the output of U301B goes high once

#### Output from binary QBF:

Blank, Space, Carriage Return, N, Line Feed, I, R, C, E, S, D, F, A, U, J, K, T, H, O, M, L, P, G, V, Z, Y, B, X, W, Q, FIGS, LTRS (and repeat in upper case);

Its appearance on a page printer is:

```

N
,IRCESDFAUJKTHOMLPGVZYBXWQ
N84:3$!-7'(5#9.)0&:"6?/21
IRCESDFAUJKTHOMLPGVZYBXWQ ... etc.

```

Fig. 4. Binary QBF output.

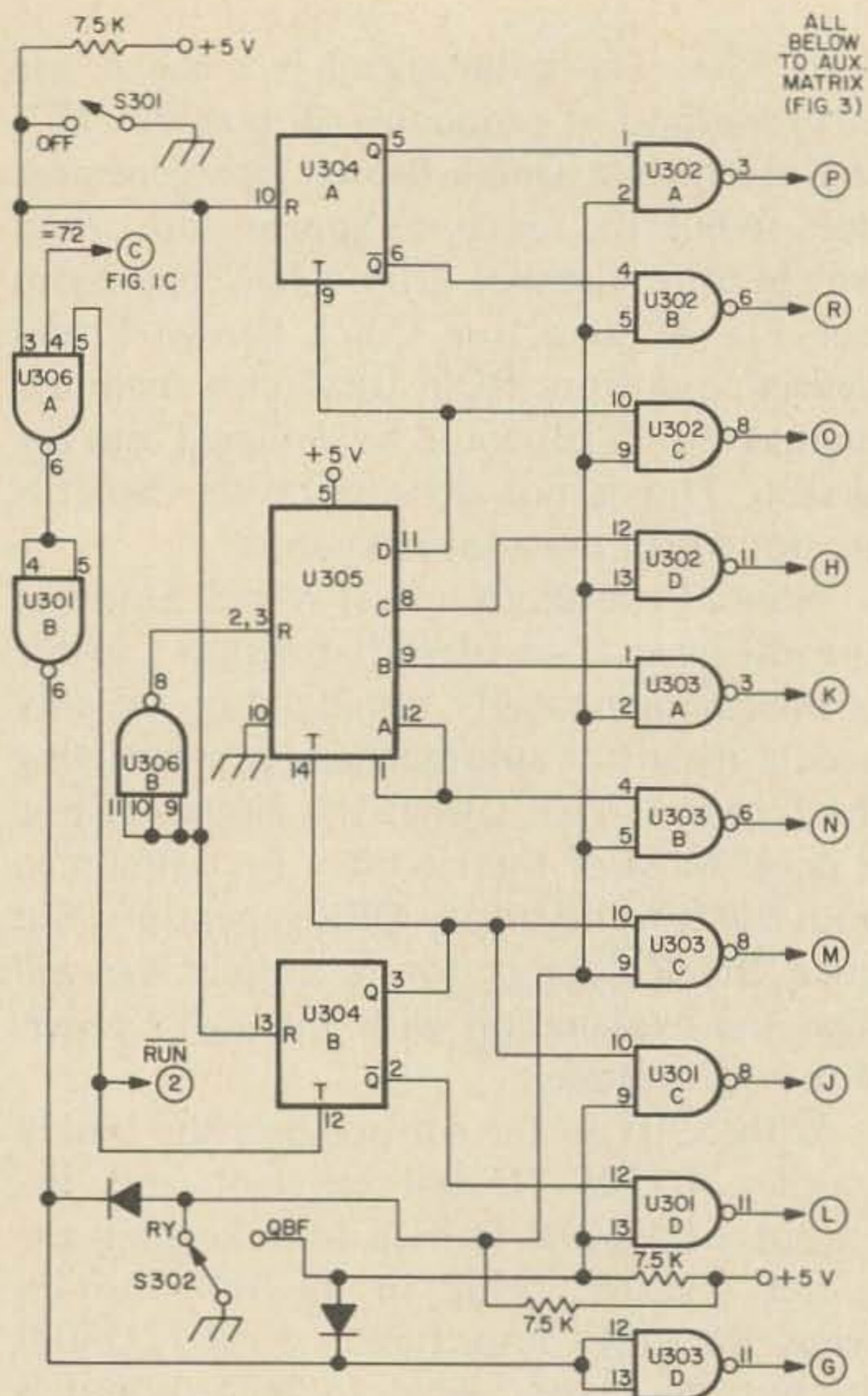

Fig. 5. Signal generator. Vcc on pin 14 and GND on pin 7 of all ICs except U305: Vcc - pin 5, GND - pin 10. All resistors 1/4 W, all diodes germanium.

again. This time the keyboard register is set through U303D and U301C (Y coding). This process repeats itself forever until shut off or an auto CR/LF is initiated. The latter interrupts the generator only long enough to insert coding for CR/LF. This is kind of handy if your printer doesn't have some means of overprint prevention built into it. If you're not watching and the printer is stuck at the end of a line, it won't take long until the machine has beat a hole through the paper (sure makes that last letter illegible).

The operation of the binary QBF is much the same except the entire counter and the U303 and U302 output gate are used. After each character is entered into the shift register, the counter changes state in preparation for the next character. The gates controlled by U304A insert shift information into the auto shift circuitry so that alternate lines of printout are in alternate case. When the signal generator is in this mode, auto

CR/LF is inactive since the character counter never reaches a full line count. So it makes no difference whether the auto CR/LF is on or off.

Now that we have a signal generator capable of transmitting both RY and a binary QBF you may wonder what to do with it. Using RY for setting the range on a mechanical printer has already been mentioned. Using the signal to measure the bias of a system (demodulator, loop keyer, etc.) has been covered in another article.<sup>1</sup> It should be noted that the mark duty cycle of this generator is 53.3% rather than the usual 50% duty cycle used to measure distortion. Compensation has to be made for this when taking loop bias measurements by setting 53.3% of full scale as 0 bias and slightly compressing the mark bias calibration, while slightly expanding the space bias calibration.

The primary use of the binary QBF is in checking that old printer you picked up out of Western Union's discard pile. If you run out of things to say during a QSO, you can always turn the generator on. It may take the guy on the other end a while to figure out why his machine keeps printing the same garble over and over again.

### Can There Be More?

After building these goodies into your keyboard and using them for awhile, you realize that digital electronics and TTY complement each other better than a set of BNC connectors. Other operating aids and gimmicks come to mind quite readily. Admittedly, some are impractical and others are not within the financial range of most amateurs. But things like automatic identifiers (both TTY and Morse), magnetic tape data storage, readout and control of your tape reader from the keyboard, automatic speed conversion, and even a video display with selective readout (sort of an electronic ASR) are possible with a little effort and imagination.

Anyway, the field of digital communications has always been one of the most interesting to me. The idea of pushing a button here and making something happen

<sup>1</sup>Shinsel, "RTTY Signal Generator," *Ham Radio*, March, 1971, p. 23.



there is fascinating. The appeal is even greater when the result of that button pushing is unique and due to your own design. Some of the above mentioned gadgets are in the breadboard stage and may see publication if my soldering iron, pen and XYL hold up under the strain.

Finally, if there are any points I failed to cover well enough or missed completely, or if anyone has ideas to discuss, please write and I will respond as well as I can (SASE, please — I too am poor and unable to afford sugar).

### IC Parts List

Counter: Fig. 1.

- U101, U102 — 7490
- U103, U104 — 7446 or 7447
- U105, U107 — 7400
- U106 — 74121
- U108 — NE555

AFM: Fig. 2.

- U201 — 7496
- U202, U204, U210, U212, U213 — 7400
- U203, U211 — 7474
- U205 — 7410
- U206 — 74123
- U207, U214 — 7404
- U208 — 7430

Sig. Gen: Fig. 5.

- U301, U302, U303 — 7400
- U304 — 74107 (May use 7473 with different pinout)
- U305 — 7493
- U306 — 7410

### Other Parts List

Counter: Fig. 2.

- All diodes: Low leakage germanium (13 of them)
- All transistors: NPN switching 2N2222 OR = (3)
- All resistors: 10% 1/4 W.
- Capacitors: As shown, low voltage

AFM: Fig. 2.

- All diodes: Low leakage germanium (13 of them)
- Q201, Q202, Q203: NPN switches
- Resistors and capacitors: as above S201 — DPST, S202 — min. toggle SPST

Sig. Gen: Fig. 5.

- All diodes (1 of 'em), resistors as above.
- S301 — SPST toggle
- S302 — SPDT toggle

AEM Fig. 3.

All diodes: As above (23 this time)

All assemblies: A few .1 uF disc capacitors for Vcc buss bypasses.

**AUTHOR'S NOTE:** *There may be some confusion as to how the automatic function module (Fig. 2, Part II) connects to the basic keyboard (Fig. 5, Part I). Following is a list of necessary interconnections:*

BASIC KEYBOARD  
(Fig. 5, Part I)

AFM  
(Fig. 2, Part II)

- |                   |   |                   |
|-------------------|---|-------------------|
| A — U7A, pin 3    | → | 1 — U202B, pin 4  |
| B — 1.5k resistor | → | 3 — U202D, pin 11 |
| C — U6A, pin 3    | → | 4 — U211, pin 6   |
| D — U9C, pin 8    | → | 6 — U201, pin 1   |
| U9D, pin 12       | → | 2 — U206B, pin 11 |
| U9A, pin 3        | → | 5 — U211, pin 3   |

*I certainly hope this information may alleviate any possible problems with interconnection.*

...K7YGP/7

### ALDELCO SEMI-CONDUCTOR SUPERMARKET

Silicon Rect. Direct Tube Replacements	
1N2637 replaces 866,866A,3B28	\$ 9.80
1N2389 replaces 5U4,5Y4,etc.	5.25
S872 replaces 872A	28.50
RF Devices	
2N6081 15 watt 175 MHz 12.5 volt	8.45
2N6082 25 watt 175 MHz 12.5 volt	10.95
2N6083 30 watt 175 MHz 12.5 volt	12.30
2N6084 40 watt 175 MHz 12.5 volt	16.30
2102 1024 bit Static RAM	5.50
8008 CPU Chip	30.95
8038 Function Generator	5.25
555 Timer	.95
309K Voltage Regulator	1.75
MM5314 Clock Chip \$5.50 MM5316	7.50

Postpaid \$5.00 Min. SEND FOR FLYER. NYS Residents add Sales Tax.

**ALDELCO** P.O. Box 341, Dept. 7  
Lynbrook, New York 11563

Inflation-Fighting

**DISCOUNTS**  
**DISCOUNTS**

**WEIRNU** P.O. Box 942  
Colton, CA 92324

\$10+ orders take 5%; \$30+ orders take 10%;  
\$60+ orders take 15%; \$100+ orders take 20%

— While They Last! —

MM Series		5320N	12.50
451H	6.75 2524CN 3.95 5040H 1.95	5220N	5.00 5341N 10.00 AH
502H	1.95 2528N 8.50 5053H 3.00	5221N	5.00 5342N 10.00 0014D 9.00
550H	5.50 2602N 8.00 5054N 4.60	5227N	4.50 5365N 10.00 0014CD 4.00
551H	5.50 3505N 5.00 5055N 3.80	5230N	4.50 5554N 1.10 0151CD 4.50
555H	5.50 3705N 5.00 5056N 3.80	5232N	9.50 5555N 4.40 0126CD 4.50
571AY/N	4.95 5001H 3.85 5057N 3.80	5233N	9.50 5556N 4.50
582H	6.00 5006H 1.95 5058N 5.50	5240N	4.95 5561N 4.50 DH
1101N	2.10 5007H 3.00 5060N 4.75	5260N	3.85 5725N 3.95 0008CH 3.50
1103N	4.00 5010AH 3.40 5081N 14.00	5261N	6.00 5736N 4.95 0011H 7.00
1402N	5.40 5013N 3.50 5100H 4.75	5262N	5.50 5738N 4.25 0016CN 2.75
1403N	5.00 5016N 2.00 5104H 5.00	5311N	5.95 4739N 3.95 0017N 2.50
1404N	5.00 5017N 2.95 5203Q 20.00	5314N	5.95 4741N 4.75 0028CN 2.95
2102N	7.75 5036N 2.95 5213N 11.00	5316N	6.95 5804N 4.75
2501N	4.50	Check back in last month's Ad — Those parts are also still available.	

1. Add 50¢ for postage & handling on orders under \$10.
2. Send your order along with check or money order to: WEIRNU, P.O. Box 942, Colton, CA 92324.
3. A list of our complete stock will accompany all orders, but if you are not ordering right now but would like the list sent to you, send a stamped envelope with your request.
4. Calif. residents include 6% tax. 5. All parts guaranteed.

# Specializing in VHF-UHF FM & SSB Equipment



IC-22A \$249.00

Supplied with  
Seven channels  
94/94 34/94  
22/82 28/88  
52/52

Plus TWO channels  
of your choice.  
Additional channels  
\$9.95 installed

## THE PREMIUM 2 METER FM TRANSCEIVER

IC-230 \$489.00

### SAVE \$75.00

Purchase an ICOM for \$489 with no-trade, and you may apply \$75 credit towards the purchase of accessories below.



IC-230

#### For the Mobile —

KLM PA10-70B 70W 2M Ampl	\$129.95
KLM PA10-140B 140W 2M Ampl	\$189.95
KLM PA10-70BL 70W 2M FM/SSB lin.	\$139.95
KLM PA10-140BL 140W 2M FM/SSB lin.	199.95
Hustler CGT-144 5.2dB Colin, tnk lip mt	\$39.95
Hustler CG-144 5.2dB Colinear, 3/8 thread	26.75
Larsen LM-150K 3dB 5/8 wave	\$28.35
Larsen LM-150 on Magnetic Mount	\$35.00

#### For the Ham Shack —

KLM 144-148-12 12el DX Beam	\$43.95
KLM 144-148-16 16el DX Beam	\$54.95
KLM Baluns (optional, recommended)	\$13.95
KLM 2 Antenna Combiner	\$19.95
KLM 144-150-12C 12el Circ. Pol. (Oscar)	\$54.95
Cushcraft ARX-2 Ringo Ranger	\$26.50
Cushcraft A147-11 11el Beam	\$23.95
Cushcraft A147-22 Stacked 11's	\$68.50

Hustler G6-144A 6dB Colinear \$52.95

**We Ship!**

Allow \$3.00 shipping per antenna or amplifier.

Our in-depth stock assures filling orders the same day received. We ship UPS or best way. For fast shipment we suggest 1. Cashier's check or MO., 2. C.O.D., 3. BankAmericard, 5. Master Charge. California residents add 6% sales tax.

# Westcom

831 GRAND AVE. • SAN MARCOS • CAL • 92069 • (714) 744-0700

# Thinkin' about Oscar?

Well . . . . .

**Westcom** puts it all together —

In depth stocking of KLM products makes it easy to get on Oscar.

*ECHO II 2 meter SSB/CW frequency synthesized separate VXO and RIT. Includes crystals for 145.00–145.23 & 145.77–146.00 MHz. Microphone and mobile bracket \$389.00*

- Optional 2dB NF preamp, installed . . . . . 25.00
- LSB option . . . . . 25.00
- 144 MHz Band XTAL . . . . . 10.00



*NEW! ECHO 70 432 MHz SSB/CW similar to ECHO II USB/LSB 10 watts. Ideal for Oscar 7 mode B uplink \$489.00*

*KLM Multi 2000 FM/SSB/CW frequency synthesized, 10 watt output 144.0 – 148.0 MHz deviation and signal level meters separate VXO and RIT \$795.00*



*NEW! KLM LINEAR POWER AMPS designed for CW, FM, and SSB, mobile or base operation. 10 watts input, 13.6 VDC  
PA 10-80 BL 80 w output  
PA 10-160 BL 160 w output*



**POWER SUPPLIES AVAILABLE**

# Westcom

831 GRAND AVE. • SAN MARCOS • CAL • 92069 • (714) 744-0700

G. E. Friton W0ACR  
628 Marshall Ave.  
Webster Groves MO 63119

# Eyes For Your Shack

*A project with scope.*

## *Part One*

**A**s the complexity of our equipment has markedly increased during the last couple of years, especially along digital lines, there springs upon the ham a more and more

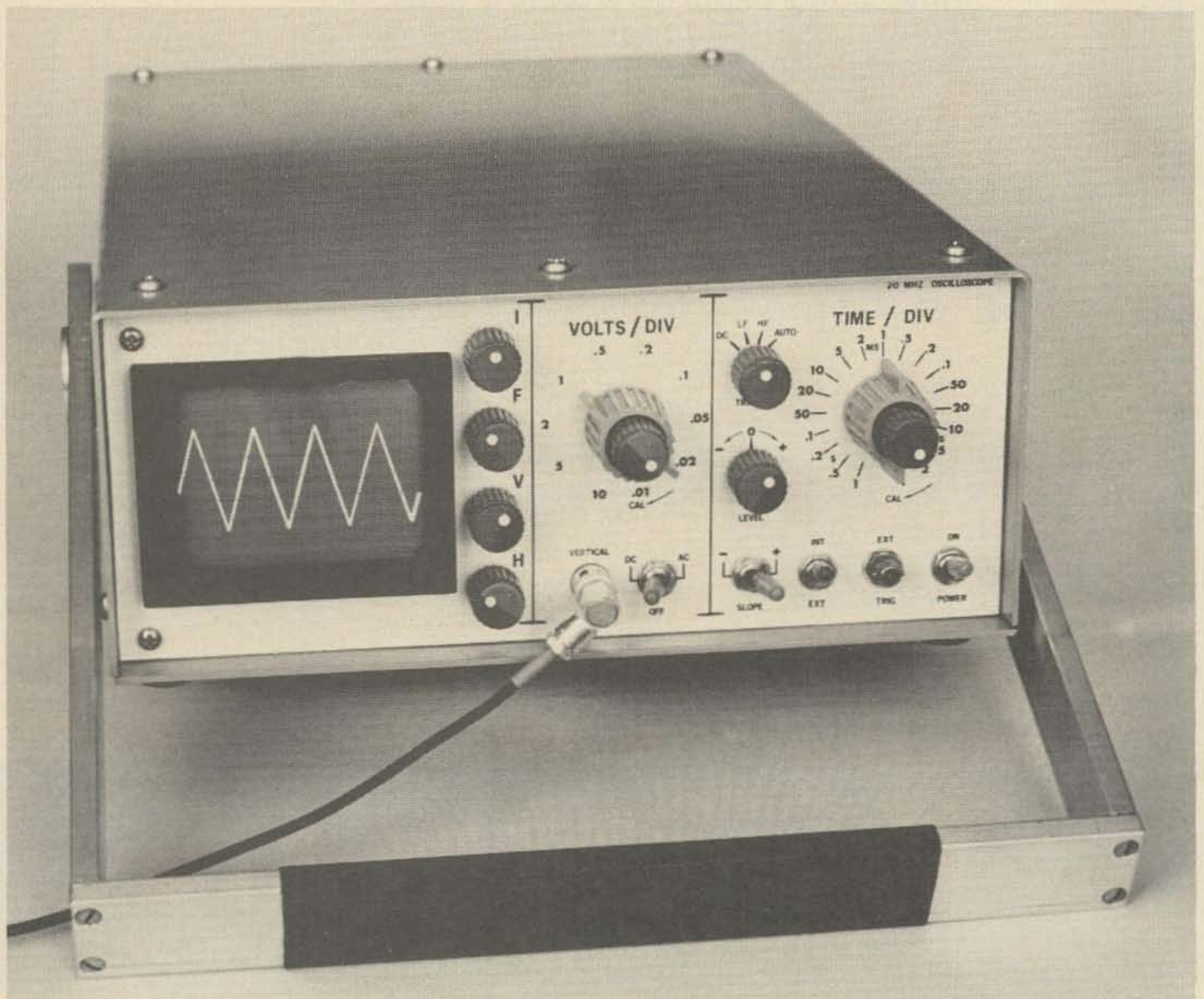

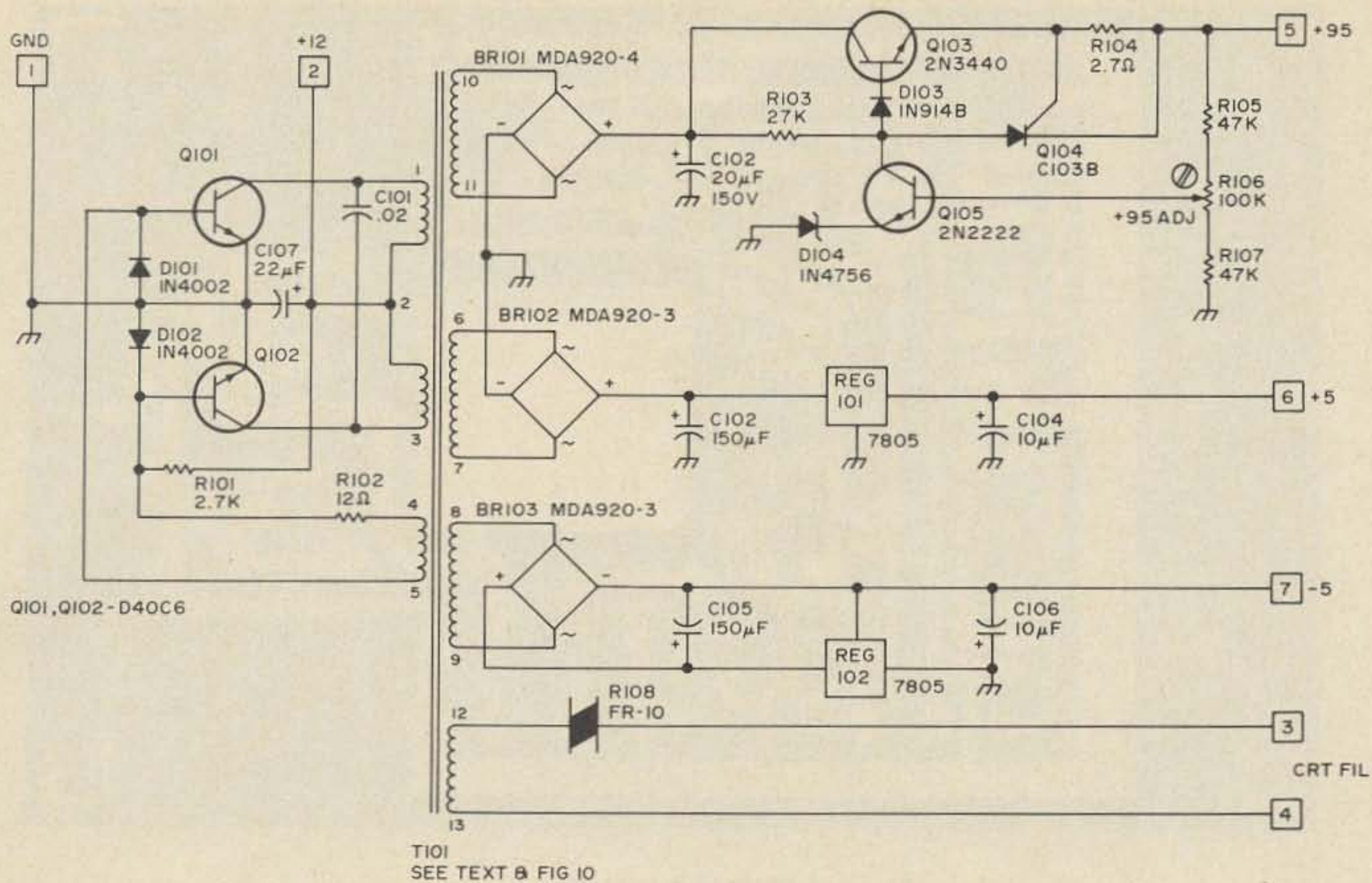

Fig. 1. LVPS schematic.

pressing need for a decent oscilloscope. Since a goodly portion of us work with limited funds, most of us are forced to put off purchasing a really good one.

Let's define a "decent ham oscilloscope": Must be inexpensive for sure . . . less than \$100; medium to wide bandwidth, say dc to 10 MHz minimum; calibrated, triggered timebase, 1 sec/div to 1  $\mu$ s/div; relatively light, small (8½ x 3½ x 13) and portable; maybe even battery and ac; good to look at and easy to operate.

Armed with this outline, we can now design and build our own — and do an admirable job for less than \$100. Don't believe it? Read on!

Since this article's primary purpose is to help you make a scope, I'm going to squeeze most of the circuit's operational description into a few paragraphs now, so you won't have to wade through it later on searching for construction details.

Most of the electronics is rather mundane, so let's concentrate on the more interesting circuitry.

### Low Voltage Power Supply

One thing interesting about the power supply is the slightly strange inverter, using D101 and D102 (Fig. 1) as commutating

switches for the untapped feedback winding. This arrangement allows R102 to determine drive, while R101 produces a definitely unbalanced starting bias. Net effect is an exceptionally efficient inverter, quite a bit better than the usual tapped winding kind, in this type of service.

The 95 V regulator's pass transistor Q103 is protected against accidental shorts (Murphy screwdriver) by Q104, R104 and D103, which form an overcurrent shutdown. When more than 220 mA is drawn through R104, Q104 fires, depriving Q103 of base bias. D103 ensures that Q103 shuts down fully. After the short is removed, Q104 resets, and the regulator returns to normal.

The CRT filament is nearly a dead short when cold, and since inverters get rather balky under such loads, a thermistor (R108) is placed in series with the filament. R108 starts out at 10 Ohms cold, progressing to about 1 Ohm in about 20 seconds, through self-heating. By that time, the CRT filament is warm and higher in resistance. The inverter, in effect, sees a nearly constant load during the transition.

### High Voltage Power Supply

The high voltage power supply (Fig. 4) is a controlled-inverter type, feeding positive

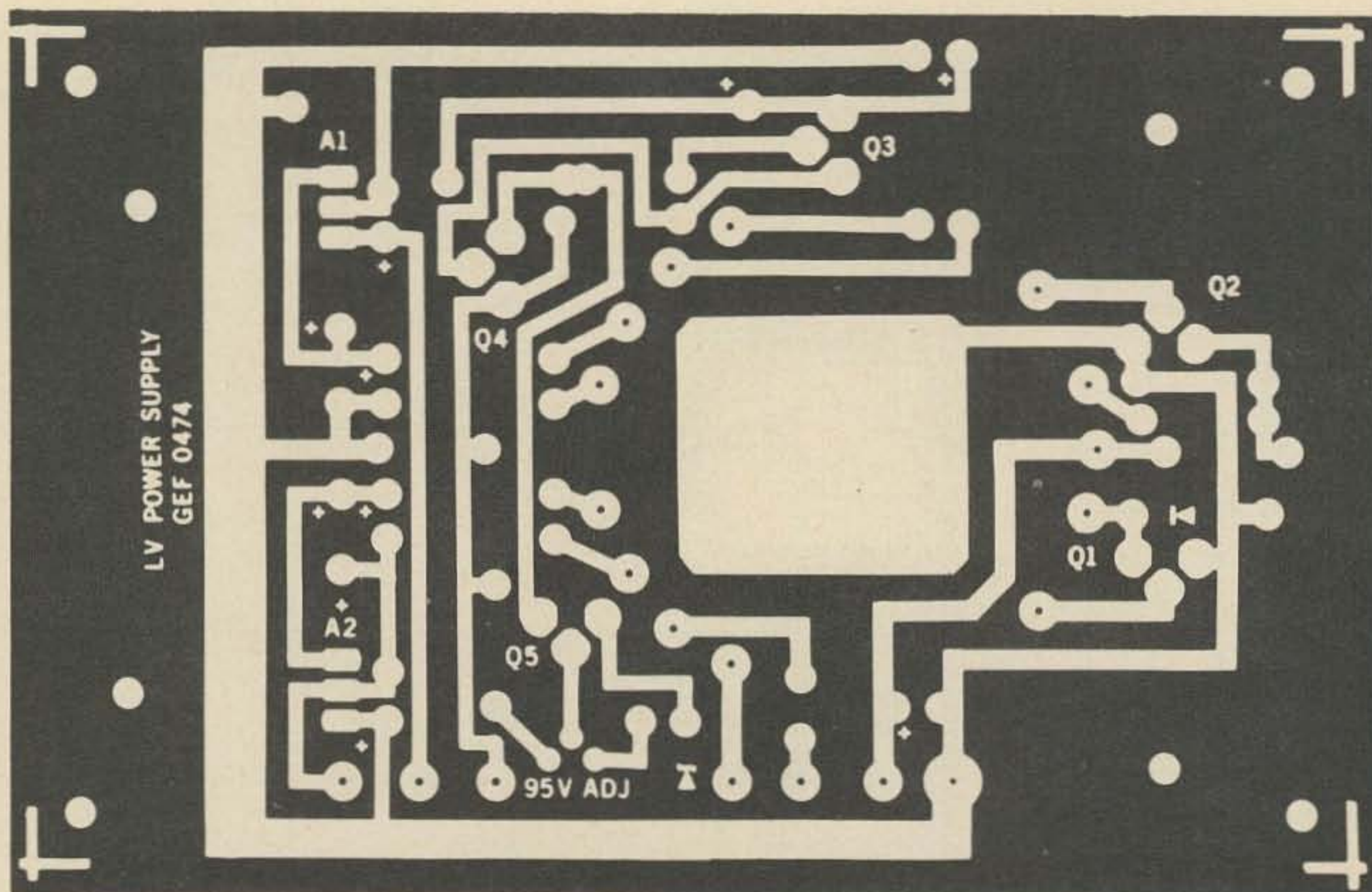

Fig. 2. LVPS PC board (full size).

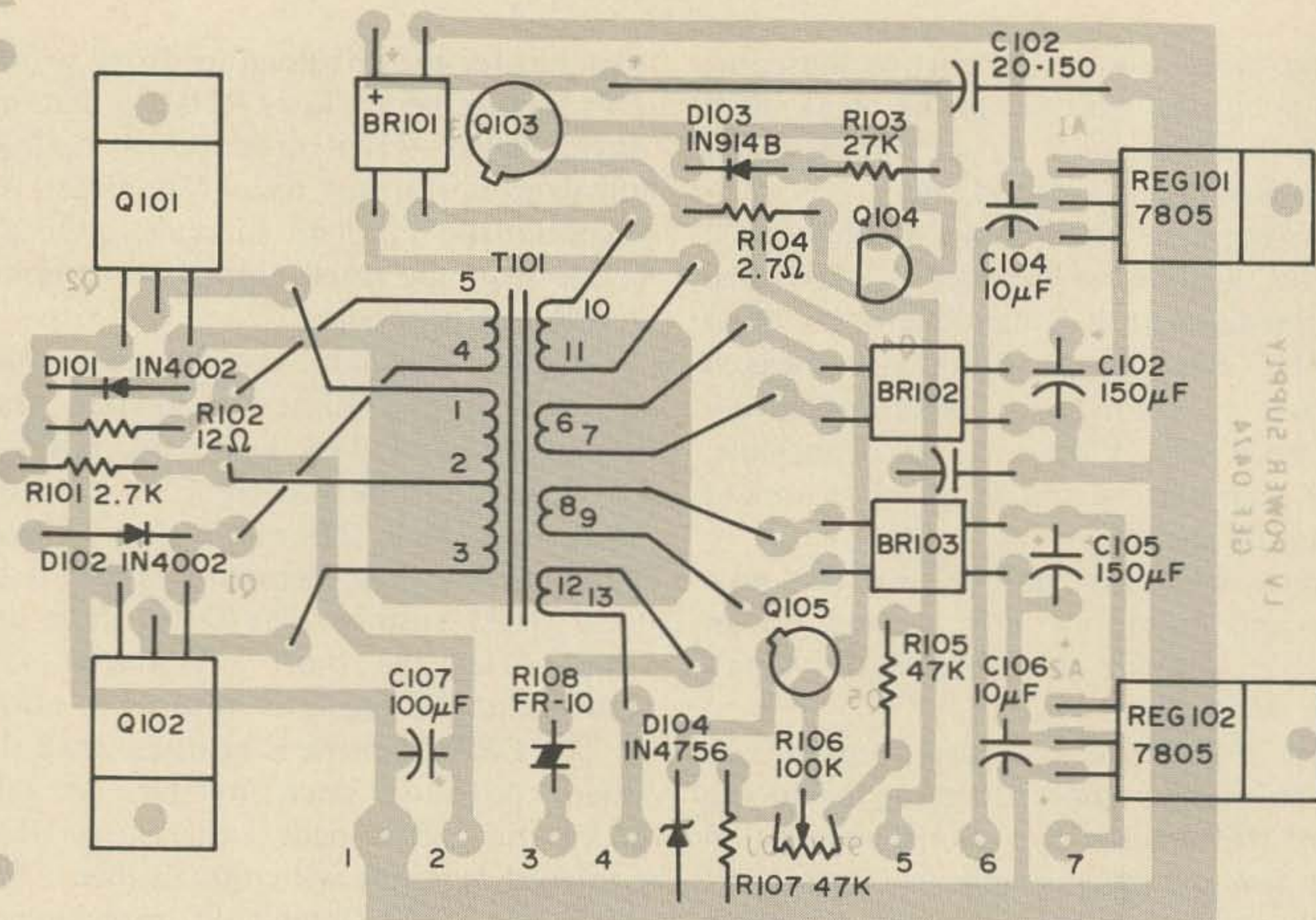

Fig. 3. LVPS component layout.

and negative triplers. A sample of inverter output, taken at the first stage of the negative tripler, is fed to Q203 and Q204. Q204 in turn controls input to the inverter, thus regulating the negative high voltage. By heavily coupling the positive multiplier,

demands on the positive supply are reflected through the transformer to the negative side, causing regulation of the positive output.

#### Vertical Amplifier

The vertical preamp (Fig. 7) is a fully

# ME-3 microminiature tone encoder

Compatible with all sub-audible tone systems such as: Private Line, Channel Guard, Quiet Channel, etc.

- Powered by 6-16vdc, unregulated
- Microminiature in size to fit inside all mobile units and most portable units
- Field replaceable, plug-in, frequency determining elements
- Excellent frequency accuracy and temperature stability
- Output level adjustment potentiometer
- Low distortion sinewave output
- Available in all EIA tone frequencies, 67.0 Hz-203.5 Hz
- Complete immunity to RF
- Reverse polarity protection built-in

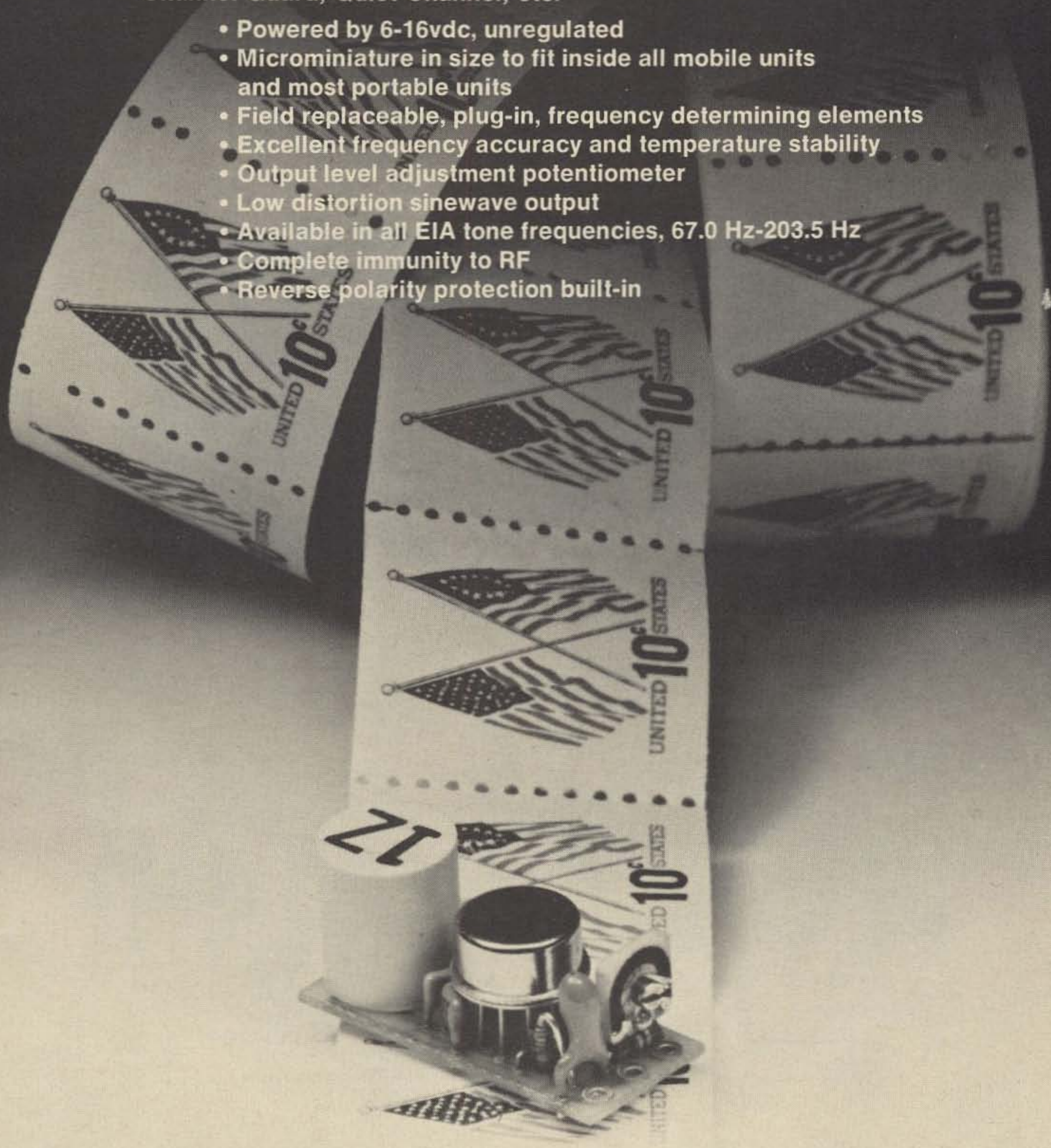

**\$29.95 each**

Wired and tested, complete with K-1 element

**communications specialists**

P. O. BOX 153  
BREA, CALIFORNIA 92621  
(714) 998-3021

K-1 FIELD REPLACEABLE,  
PLUG-IN, FREQUENCY  
DETERMINING ELEMENTS

**\$3.00 each**

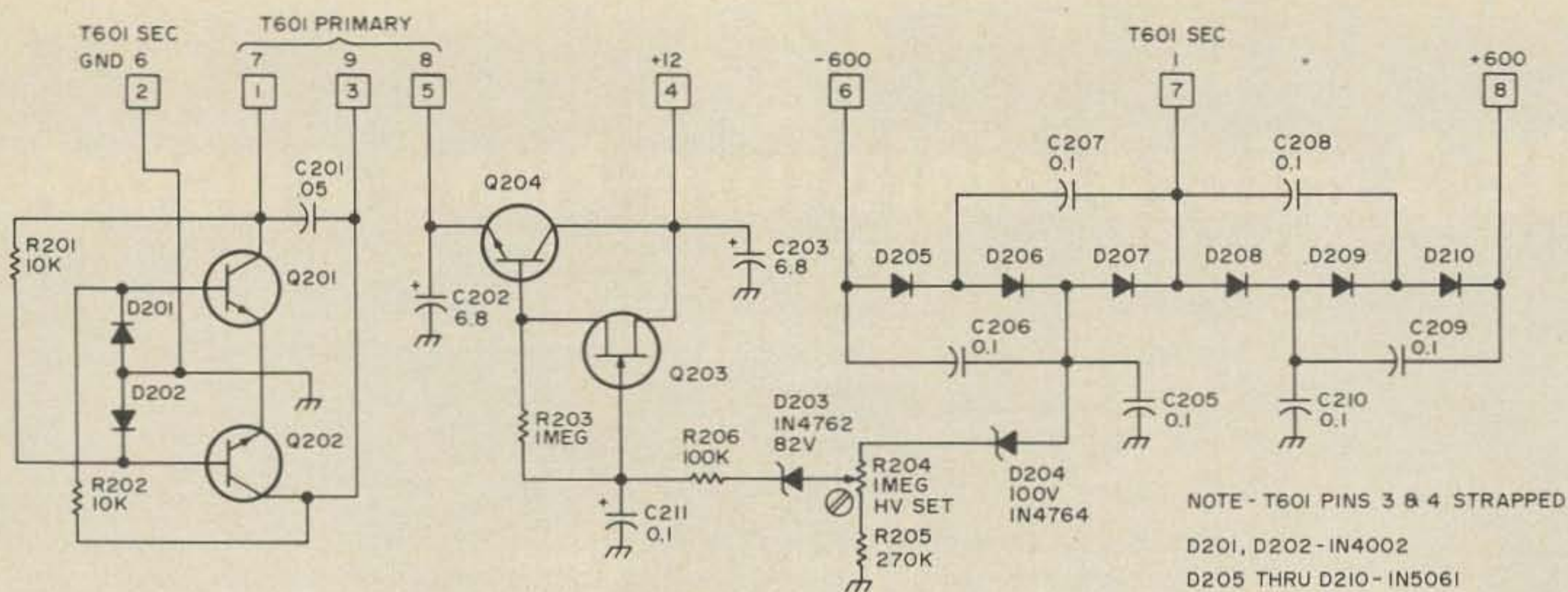

Fig. 4. HVPS schematic.

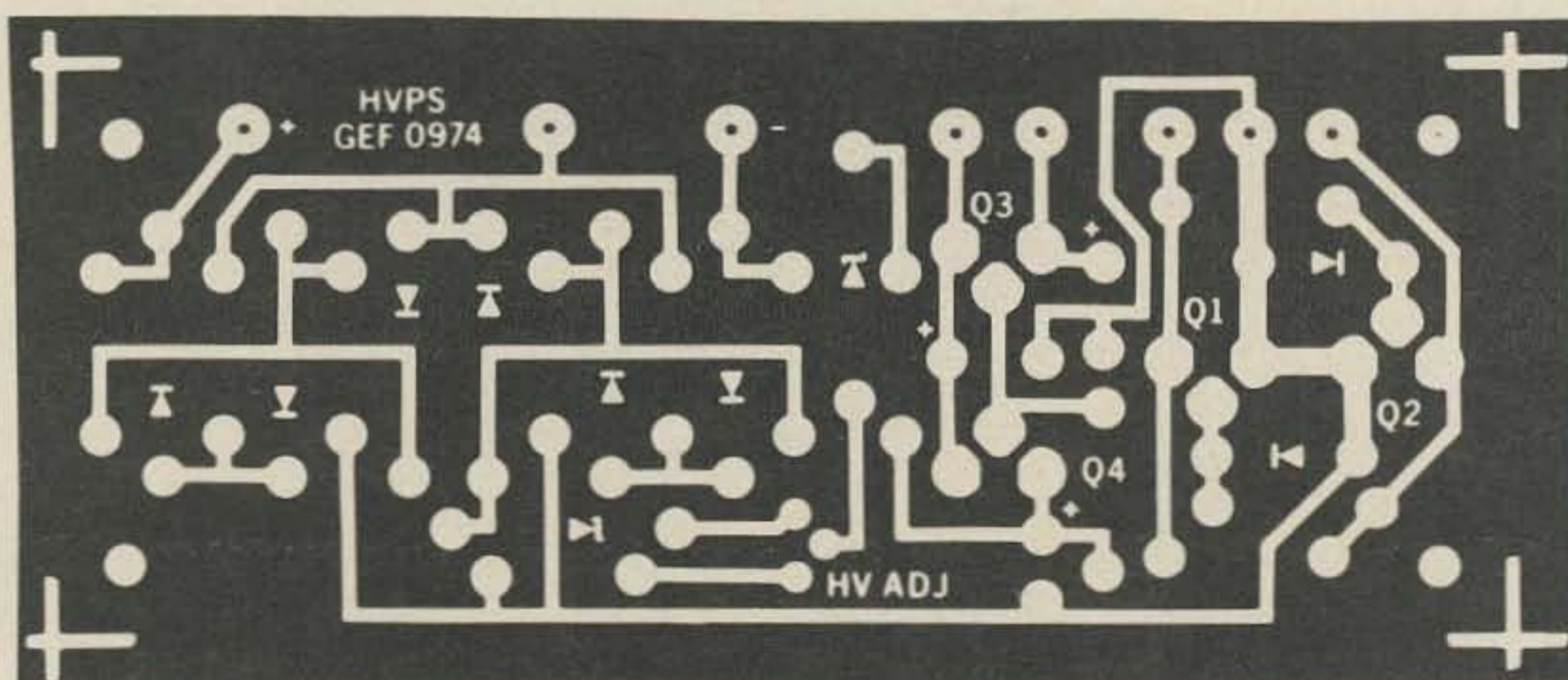

Fig. 5. HVPS PC board (full size).

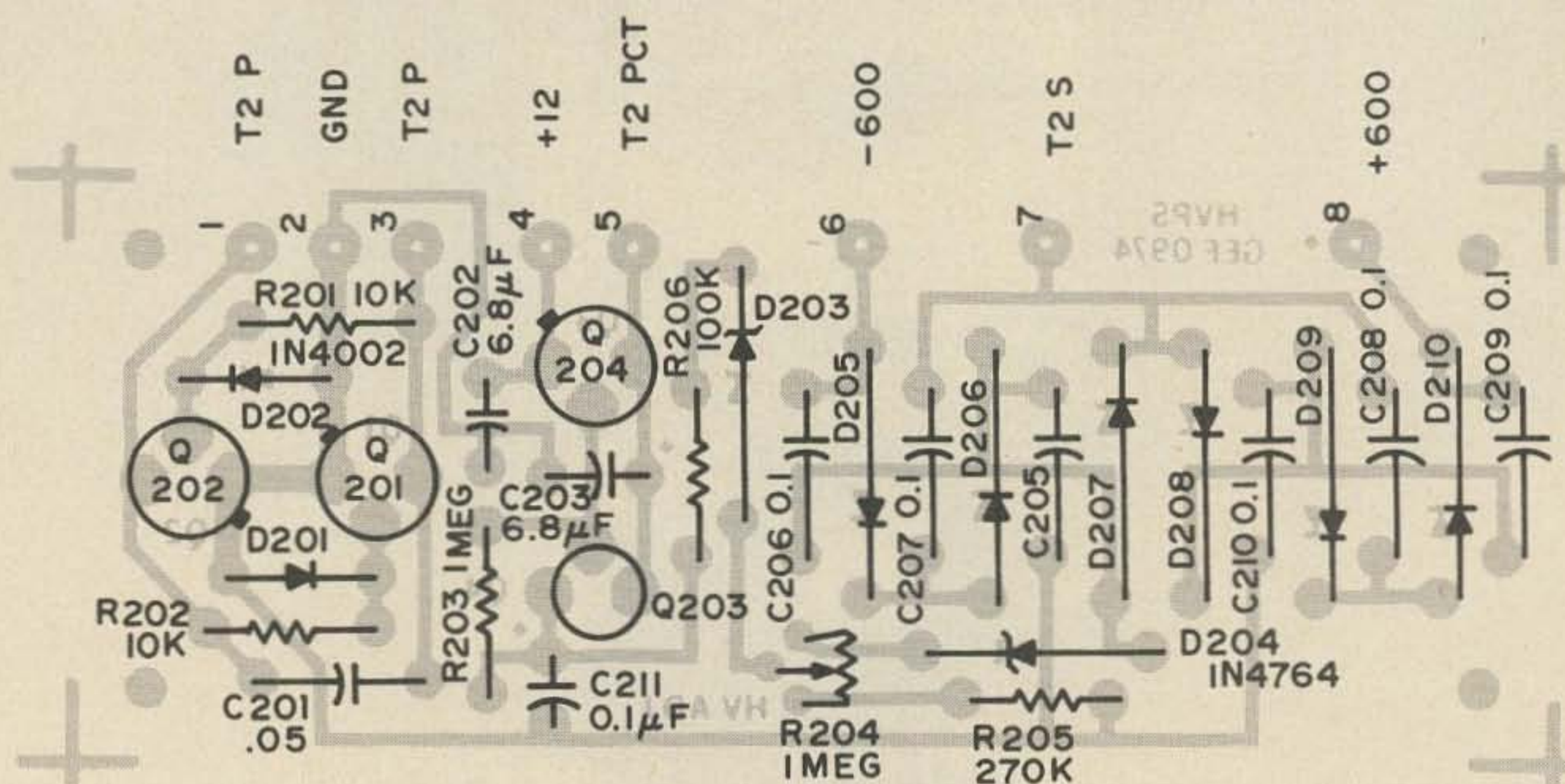

Fig. 6. HVPS component layout.

differential, monolithic FET input type. Q301 is set up as a tracking dual source follower, one side for signal impedance conversion, the other for thermal balance. Output of Q301 feeds A301 for amplification, controlled by the variable gain control

and Cal pot. Dc balance of the preamp is set with R305.

Q302 through Q309 form a dual operational amplifier, working differentially with a total gain of 30. Due to feedback, Q302 (Q306)'s base is at virtual ground, allowing



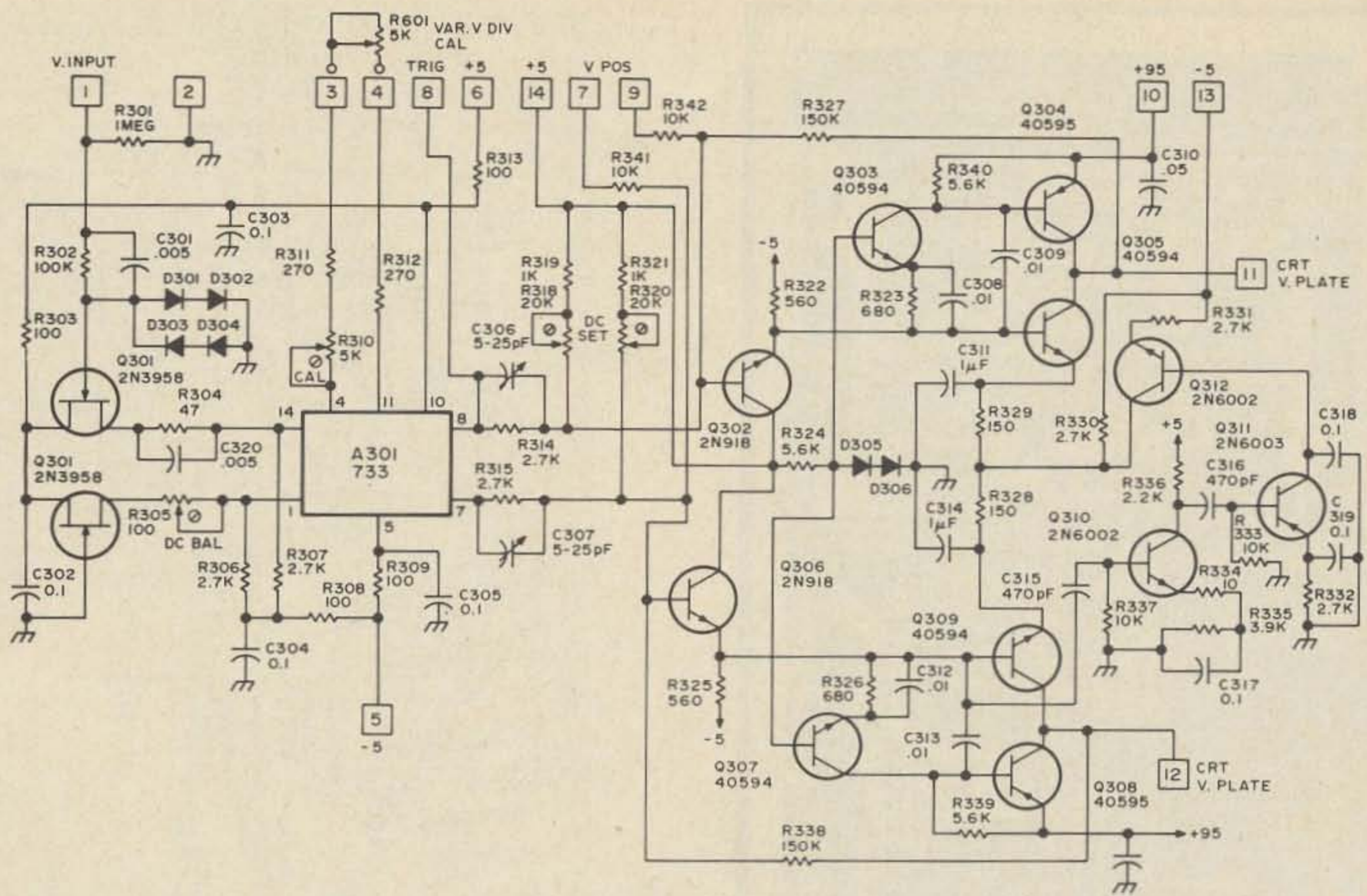
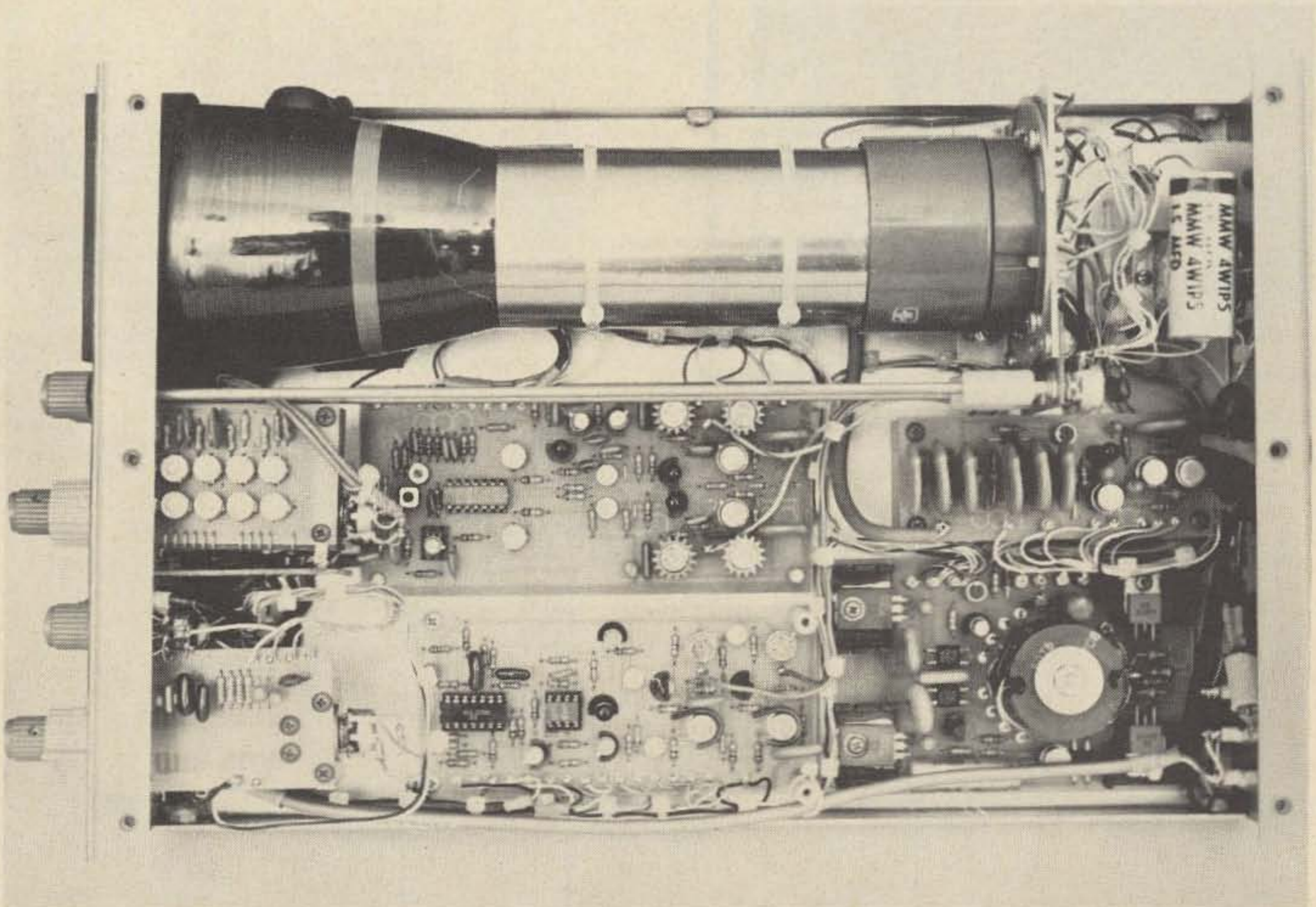

Fig. 7. Vertical amplifier schematic.



Top view of scope's interior. Center of chassis, left to right: vertical attenuator, vertical amplifier, HVPS, and, just visible under the HVPS, the blanking board. Lower portion of the chassis: timebase switch, horizontal board, and LVPS. Note intensity and focus controls mounted on CRT socket bracket; T601 and the astigmatism control are to the rear of the CRT. Battery pack not installed in this picture.

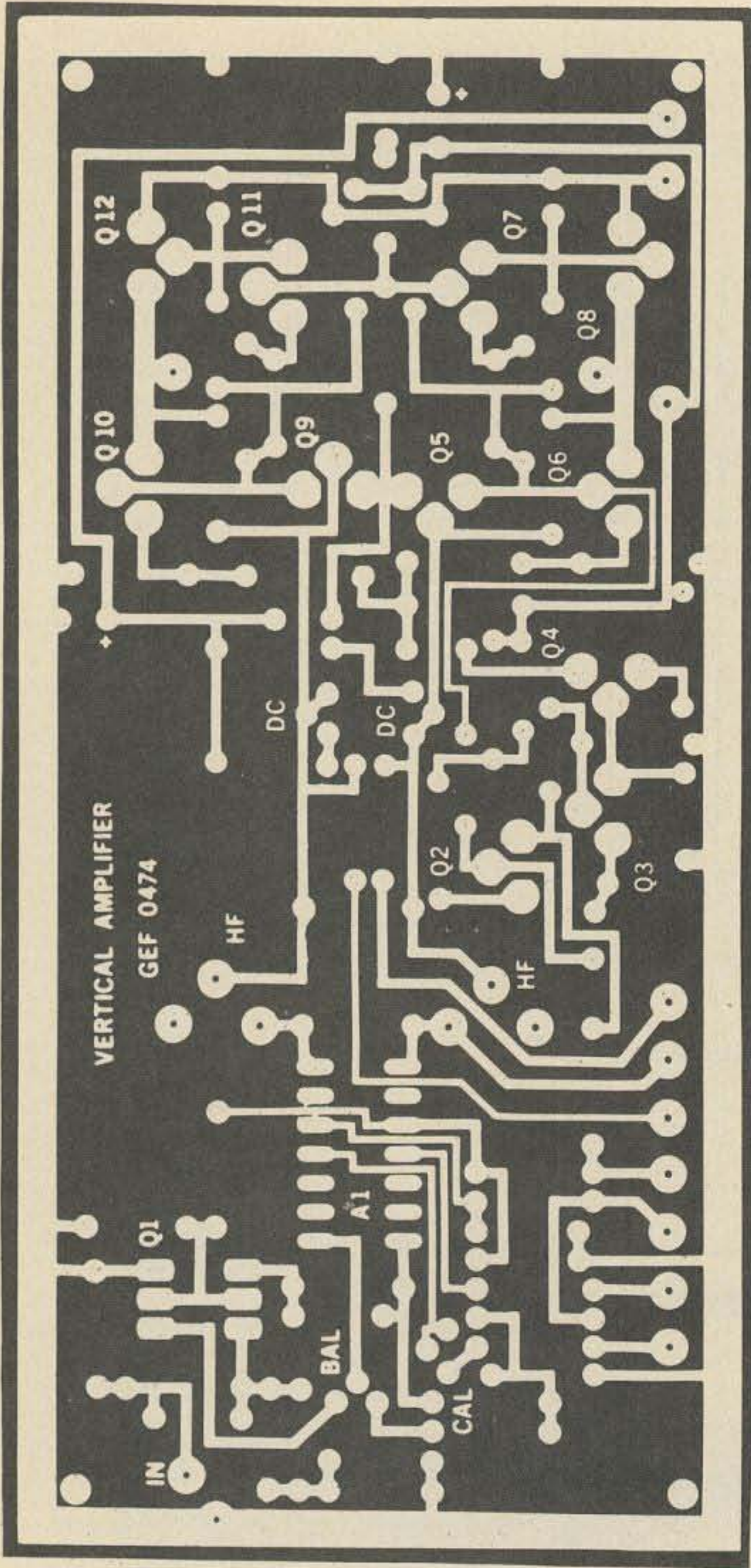

Fig. 8. Vertical amplifier PC board (full size).

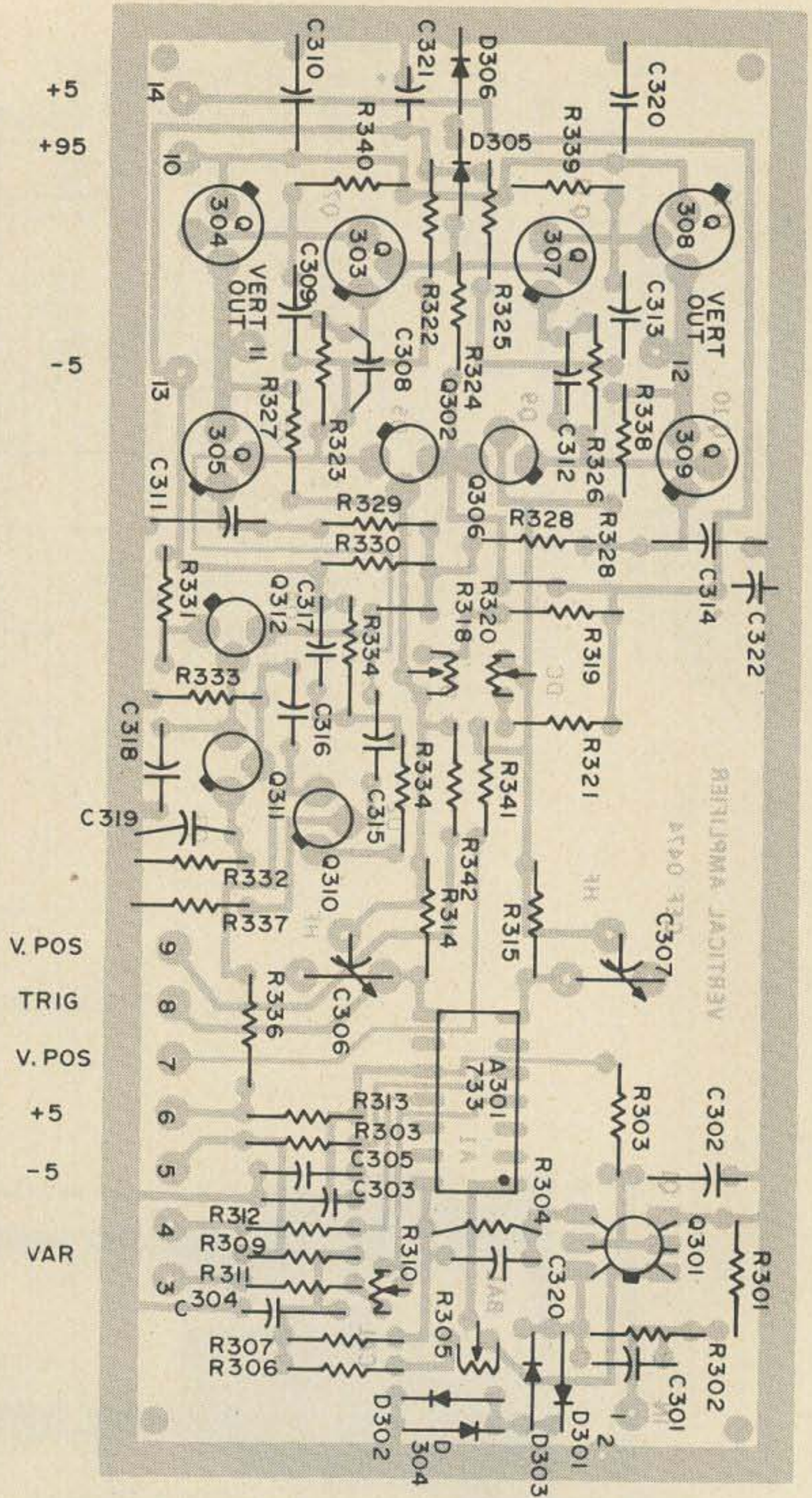

Fig. 9. Vertical amplifier component layout.

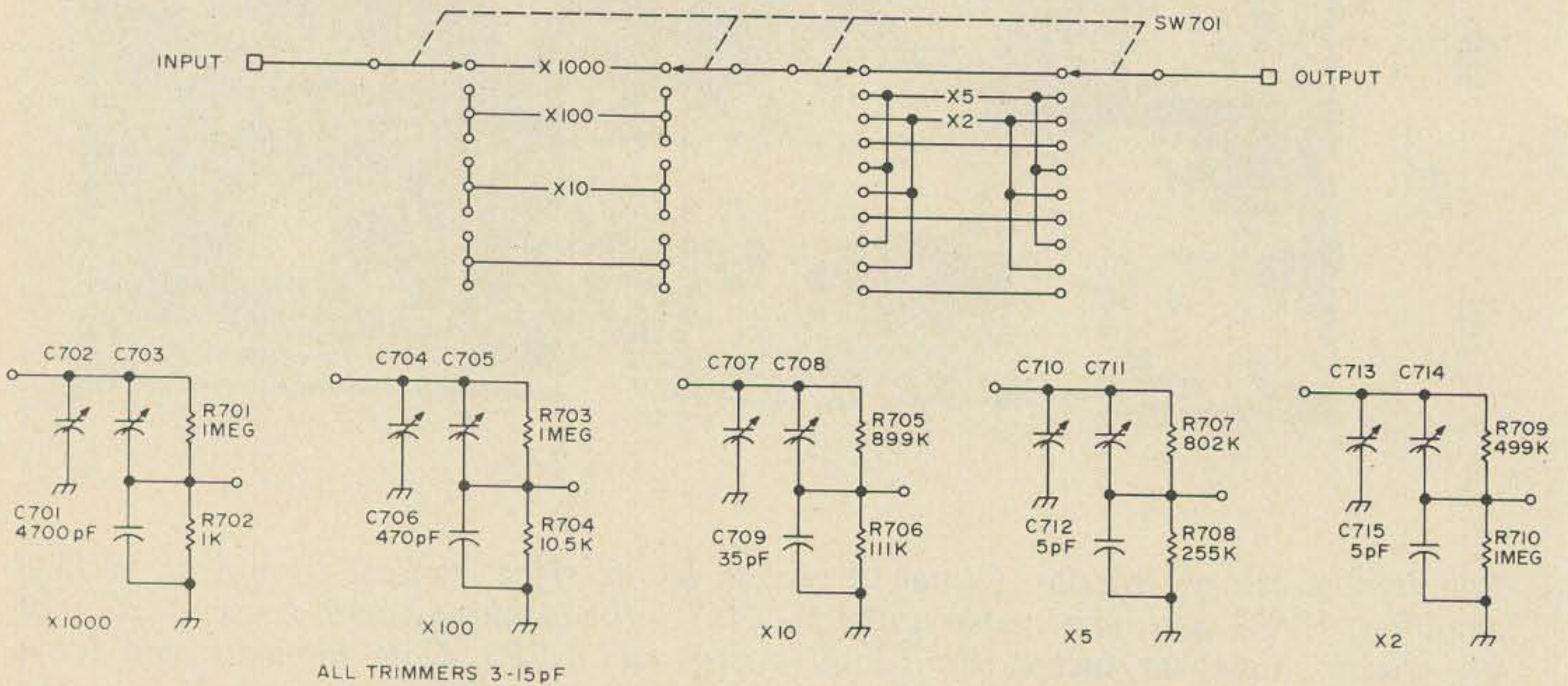

Fig. 10. Vertical attenuator schematic.

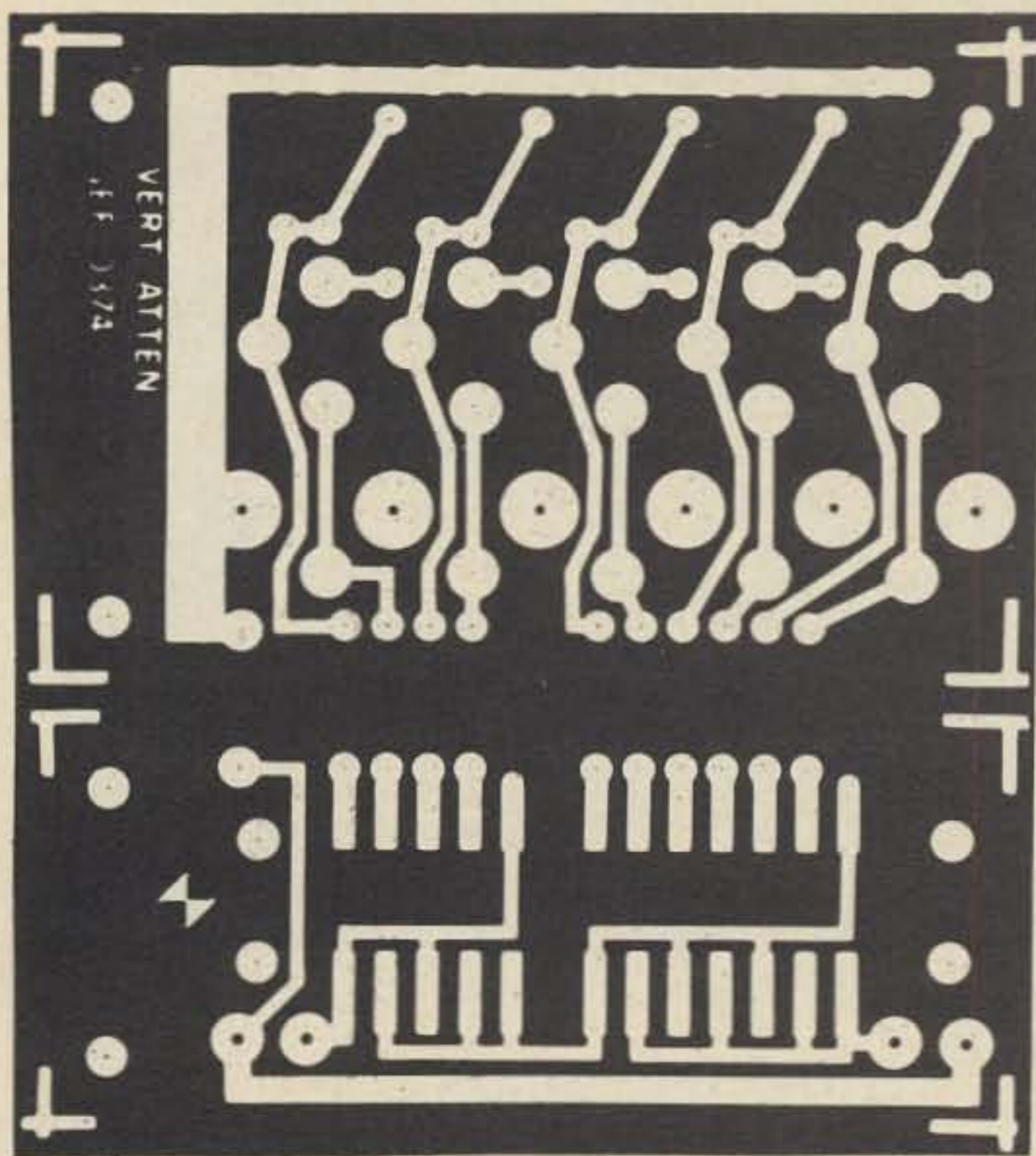

Fig. 11. Vertical attenuator PC board (full size).

easy summing of operating point, position, and signal currents. Q303 (Q307) is an active dc coupler; Q304 (Q308) and Q305 (Q309) supply deflection voltages to the vertical plates.

Low frequency signals require much less current than high, due to the capacitive nature of the CRT load. At low frequencies (to conserve power) the output stacks are

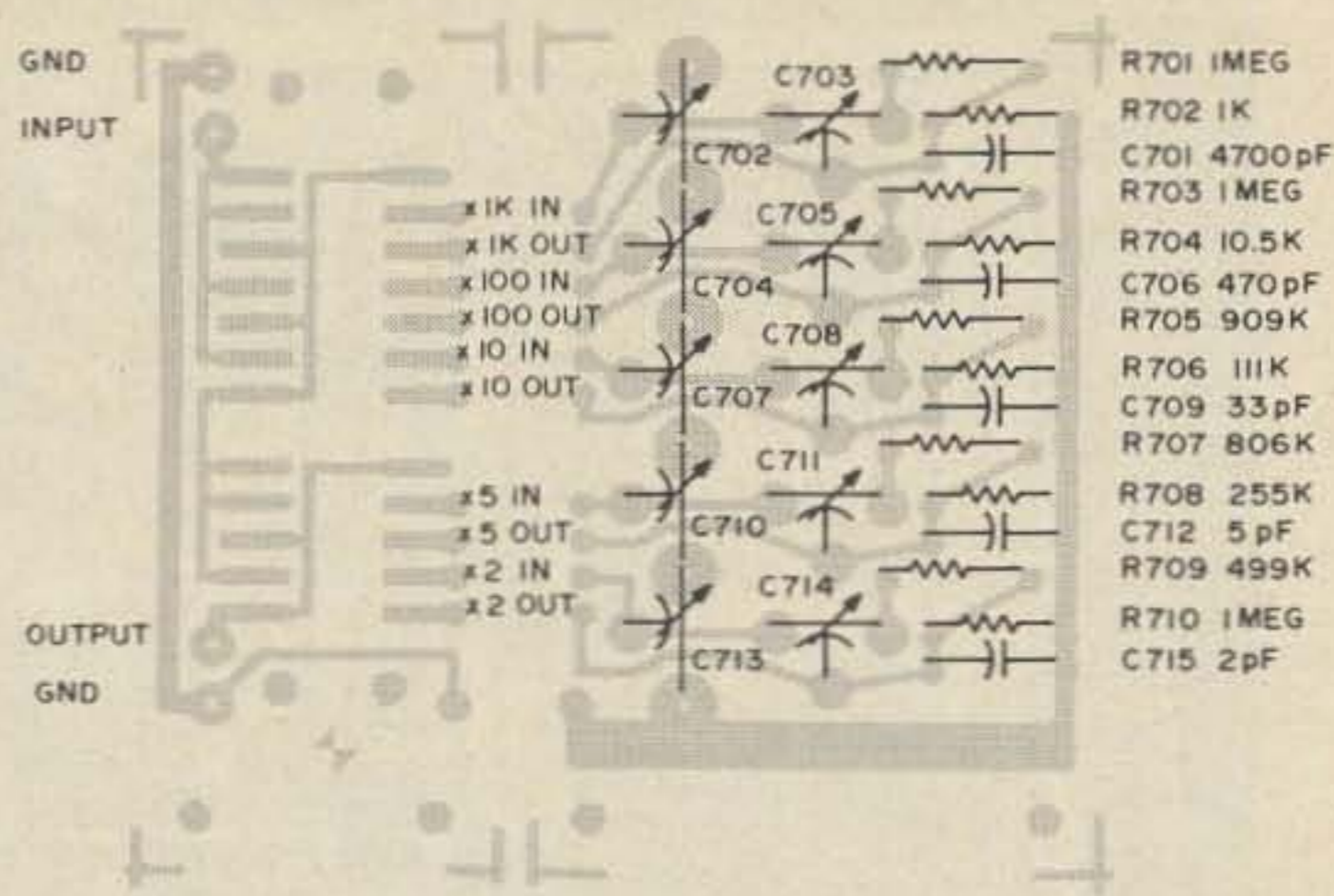

Fig. 12. Vertical attenuator component layout.

run at minimum current levels, primarily controlled by common emitter resistor R330; as the signal frequency increases, the output stacks begin to lose their ability to supply sufficient charge current, negative feedback is reduced, and signal swing at Q305 and Q309's bases increase, as it is no longer at virtual ground. Augmenting this, increased HF coupling through C315 and C316 causes Q312 to conduct, decreasing the output stack's source impedance, and thus enabling higher output currents to be developed. Although appearing to be open-ended, this HF boost circuit is operational in nature, since, in correcting the stack's

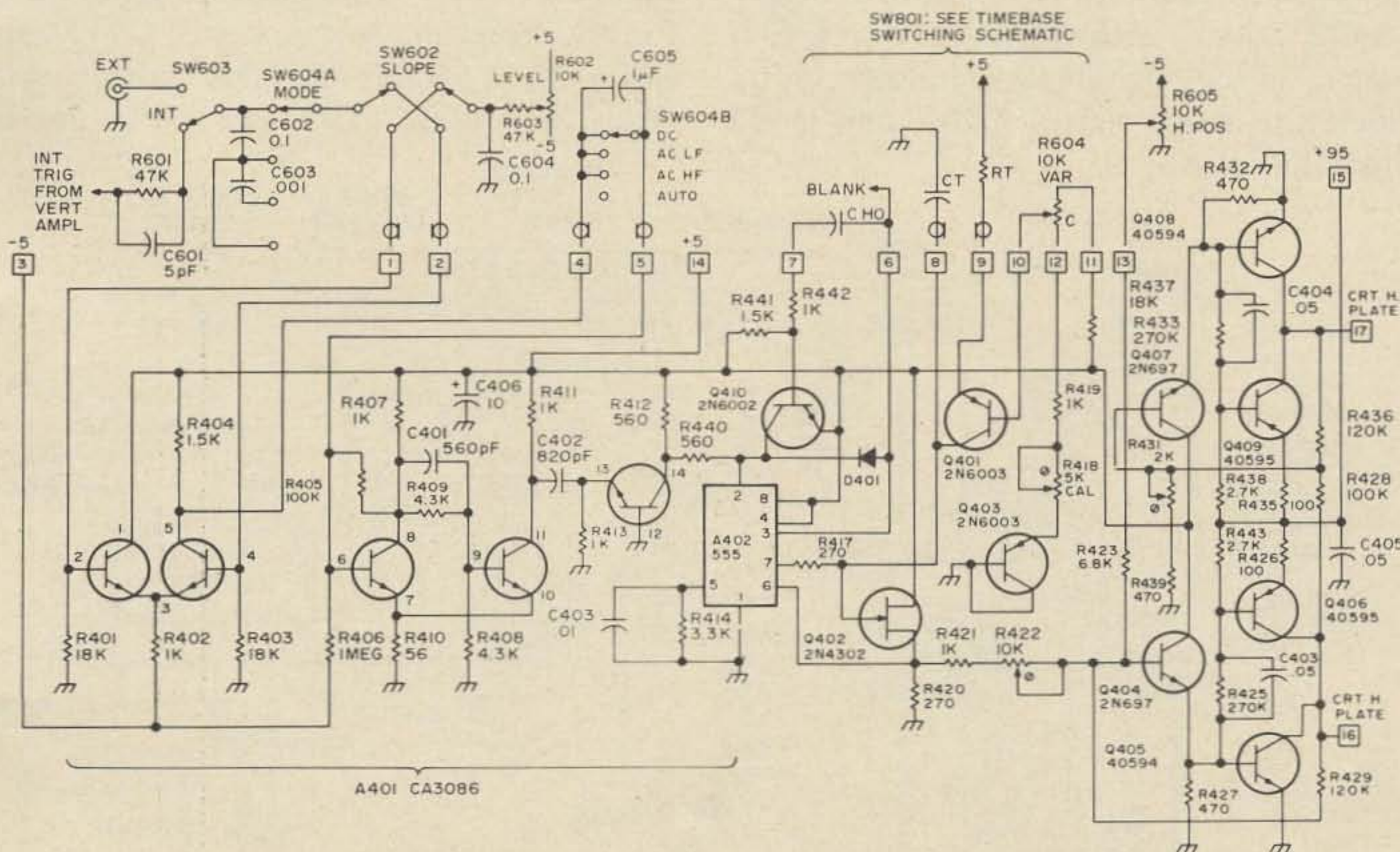

Fig. 13. Timebase schematic.

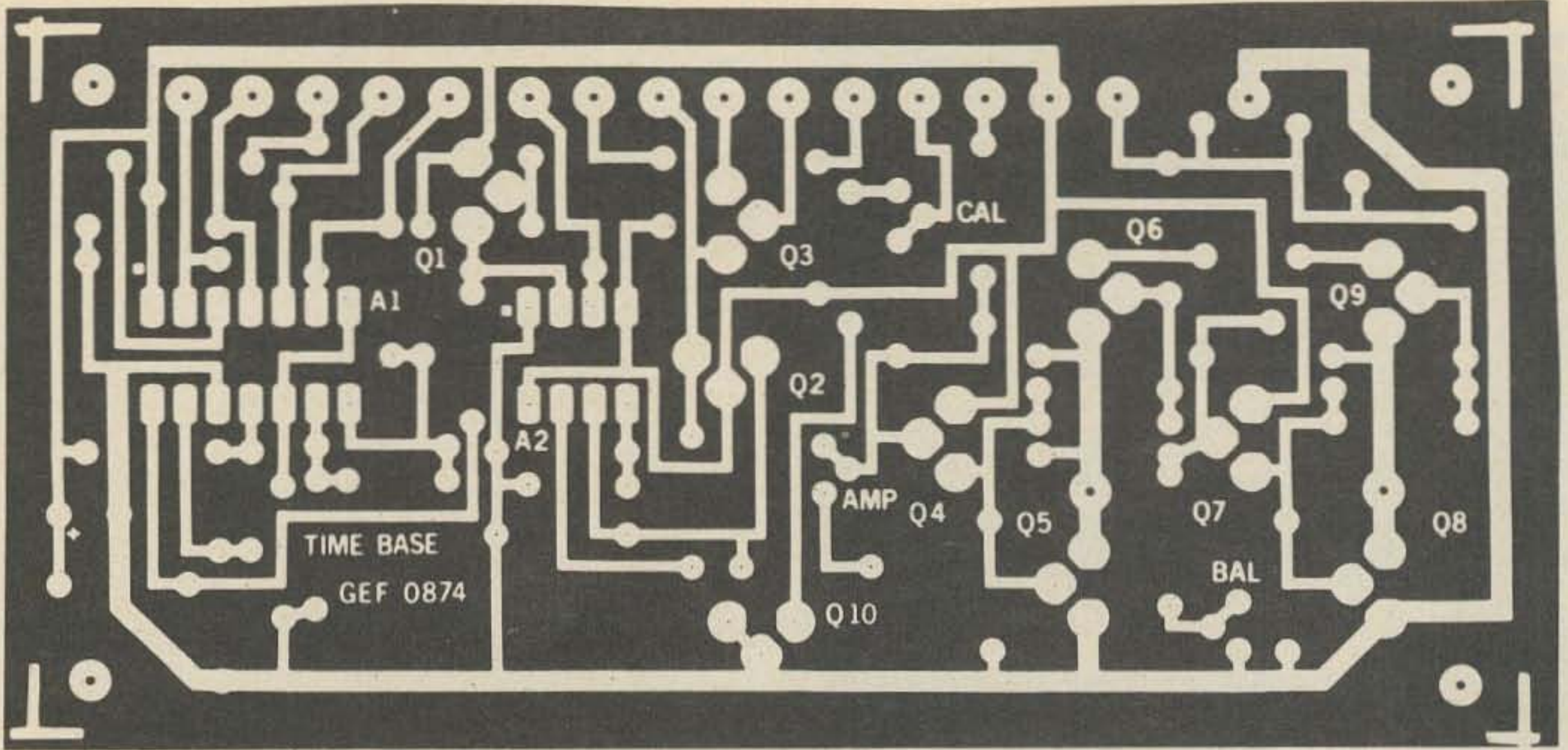

Fig. 14. Timebase PC board (full size).

deficiency, it tends to balance out its own input signal simultaneously.

### Timebase Generator

Timebase trigger processing is accomplished within A401, a five transistor array (Fig. 13). The first two transistors are set up as a differential amplifier, for signal inversion. The second two transistors form a bistable Schmitt Trigger with 2.2 V threshold, which squares up the incoming waveform. Automode causes this Schmitt to freerun at about 50 Hz, syncable to the signal. The last transistor in A401 works as a pulse shaper, feeding a 50 ns negative trigger to A402, which, with current source Q401, produces sweep, blanking and holdoff. A403 temperature compensates Q401, and Q402 buffers the ramp.

### Horizontal Amplifier

The buffered ramp is amplified by two similar op amps connected in series to give differential drive to the CRT plates. The first op amp performs at a gain of about 80; the second is a high level voltage follower. Balance of the output amps is set with R431. Note the use of gimmicks for HF stability.

### Blanking

The blanking board (Fig. 19) must process a fast risetime signal, so the same type amplifier as in both vertical and horizontal outputs is used with a few slight changes. R505 is the collector load for Q503 for low frequency components; C502 causes Q504 to conduct on fast positive-going edges, supplying extra current to preserve

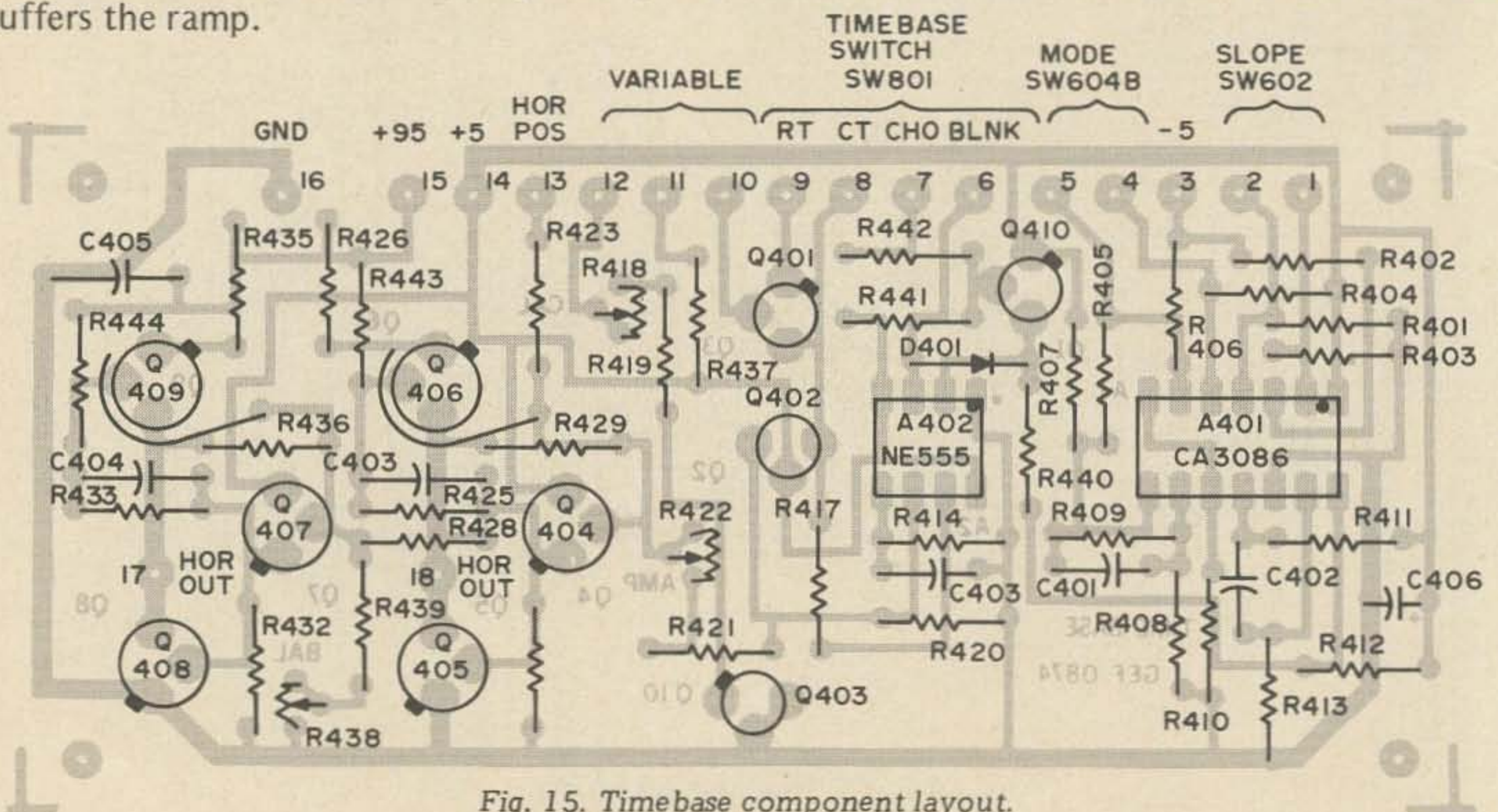

Fig. 15. Timebase component layout.

## OPTIONS TO ADAPT SCOPE TO A PARTICULAR CRT

### Option 1. Mono-accelerator CRT.

HVPS: Place a jumper in place of D210; don't put in C209. Cut land from D204 (anode) to D207 (anode); connect D204 (anode) to D208 (cathode). Connect normally-grounded end of C205 to junction of C210 and D209. T601 (sec) now goes to terminal 8, rather than 7. Disregard terminal 7; terminal 6 is negative 1250 V output.

BLANKING: Replace D501 with a 1N5061 rectifier *in the same direction*; it serves as an 850 V zener (no kidding). The 1N5061 is stable, but for proper blanking you may need to prune the zener stack due to variances in the 1N5061. Proper zener stack drop is indicated by 5 to 10 V across R506 with the HVPS adjusted to midrange, and no sweep.

### Option 2. Higher acceleration voltage for PDA type tubes (2.5 kV).

HVPS: Use two T601 transformers; connect primaries in parallel, secondaries in series-aiding. Insulate from ground and each other. Connect to the HVPS PC board as if it were one transformer. D204 is a 1N5281 (200 V zener), and D203 is a 1N4764 (100 V).

BLANKING: Same as in option 1.

risetime. D501, D502 and D503 dc couple the blanking amplifier to the CRT grid, while C503 couples the high frequency components of the blanking signal to the CRT. D504 and D506, with R509 and R510, clamp the unblanking level at 50 V below negative HV; D505 is the recharge path for C503, and D507 prevents the CRT grid from going more positive than its cathode.

## CONSTRUCTION DETAILS

### Picking Your CRT

Nearly all major parameters of your scope are in some way a function of the CRT you

choose. On the following page is a list of some relatively common tubes; my ratings are based on adaptability to the scope, and price. The list is by no means complete. Even if your junk box has a nice bottle that's not listed, though, be sure to look for high deflection sensitivity and/or post deflection accelerator (PDA). We can trade accelerator potential for higher sensitivity (while retaining adequate brilliance) only with the PDA type tube. My 3ACP1 required this tradeoff. Mono-accelerator tubes will have a softer, less bright trace in general. Flat face types generally give superior performance, as well as look better.

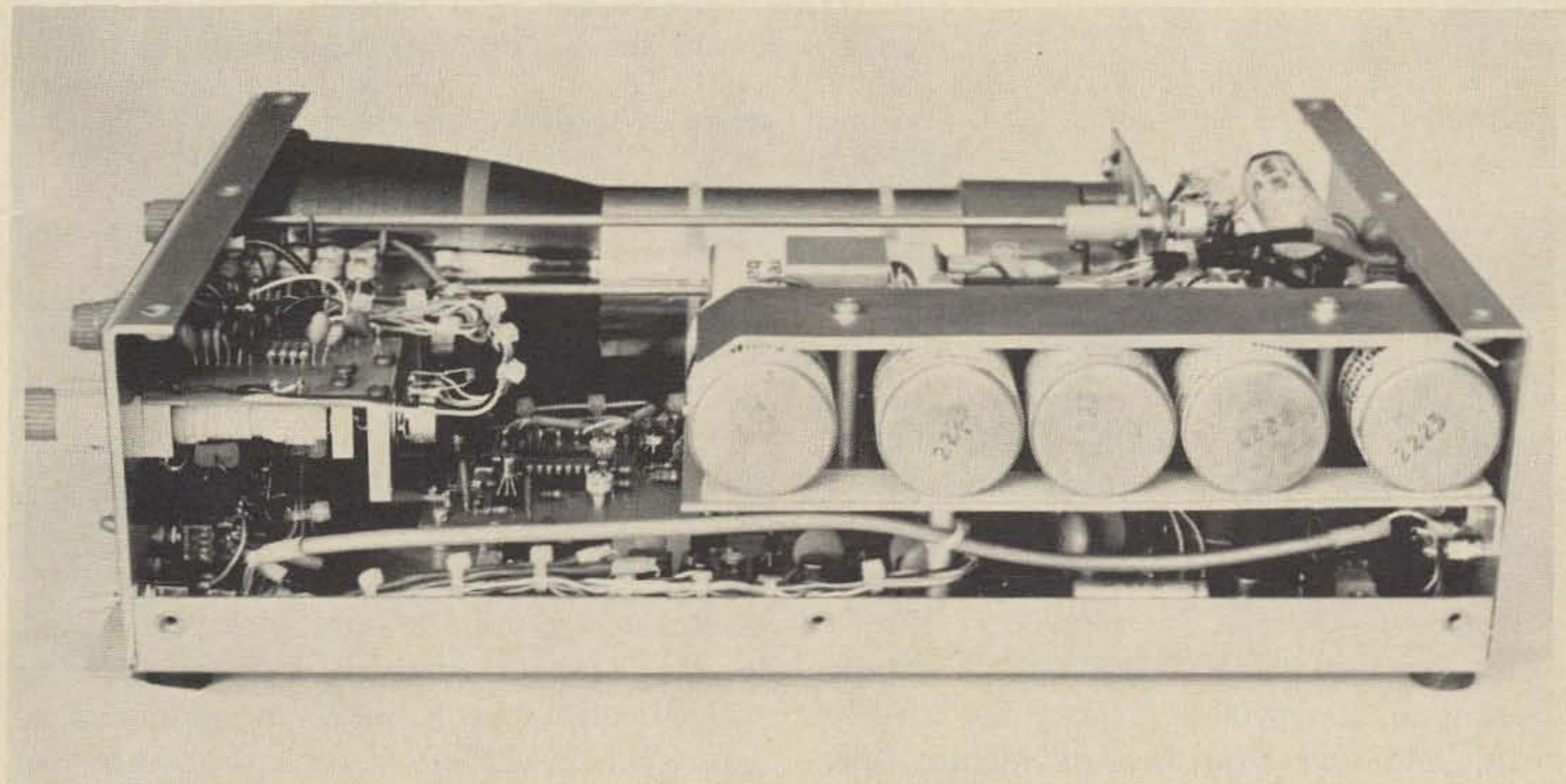

*The scope with battery pack installed.*

### CRT RATING CHART

Tube Type	Rating	Remarks
1EP-	Poor	Batteries necessary to support the filament dwarf the CRT. About \$30 new.
3AP-, 3BP-, 3GP-, 3EP-	Fair	Curved face, mono-accelerator types. Most exhibit trace shift with intensity change . . . very annoying. Use option 1. Price, \$4 up in general.
3ACP-, 3ADP-	Good	Flat face, PDA type, capable of good trace brilliance; use of reduced accelerator potentials gives 20 V/in deflection sensitivity. Can be had for \$4 surplus to \$40 new, in P1, P7, P11; P1 (green) is best, P7 (short blue, long yellow) is OK, P11 (blue) is passable.
3AYP-, 3XP-	Good	Interchangeable tubes; 3AYP- is almost flat face version. Mono-accelerator types with good deflection sensitivity. Option 1 for this one. Price (3XP-) \$5 surplus to \$60 for a new 3AYP-. Suggestion: Buy a cheap 3XP- first, then upgrade to a 3AYP- later.
3BQP-	Fair	Excellent performer, mono-accelerator type. Option 1. High price holds my rating down (\$60 new).
5ABP-, 5ADP-	Good	Flat face, good sensitivity, PDA types. Length (17") makes scope rather long. Use option 2.
5BP-, 5CP-	Poor	Curved face, old design. Has trace shift with intensity change. Option 1.
5BTP-	Good	Very short tube (12"), making it ideal for a "mini" 5" scope. You'll need option 2 for this tube.
5UP-	Fair	Almost flat face, mono-accelerator tube. Not too bright. Use option 1.
D7-190	Good	Flat face, mono-accelerator, P31 tube. Drawing 300 mA, it will give better battery life. \$55 new from Amperex.
D7-191	Good	Like D7-190, except even lower filament current, 95 mA. Batteries will really last with this one! \$55 new. Option 1.
D13-480	Good	Five inch version of D7-190. Very short tube (12.5"); use option 1.
D13-481	Good	Five incher with 95 mA filament; otherwise identical to D13-480.

When making your CRT choice, temper your decision with just how large you intend your scope to be (try fitting a 5ABP1 into an 8½ x 3½ x 13 case!), availability, which varies widely, and cost, since this is probably the most expensive single item of the entire project.

By the way, don't pass up a P7 type (short blue, long yellow). They are usually cheap, and give you Instant Memoscope, simply by changing a blue plexiglas graticule to yellow!

### Picking Your Power

You also will need a 12 volt power source, namely 2 to 5 A-H rechargeable batteries.

Regarding your choice of battery type, let me interject a very biased opinion: The sealed lead-acid cells presently produced by Gates Energy Products Inc. are far superior to equivalent capacity nicads in this usage. (No, I don't work for Gates.) Several reasons

prompt this rather strong statement: The Gates batteries do not exhibit the definite limits sealed nicads are well known for, such as memory, cell reversal, and thermal runaway problems. Also, the Gates cells may be fully charged in 3 to 4 hours without harm, adding to the convenience of your scope. And according to Gates, moderate overcharge will not destroy the cells.

On the other hand, nicads are, within their limitations, excellent batteries, so if you have a bunch, you can certainly use them with the nicad network to be explained later.

Another good choice for your oscilloscope is the Gel-Cell, basically a lead-acid type, and in essence, sealed (if you don't charge 'em too fast). Use the nicad network for these batteries, also.

By the way, if you feel you must put the charger within the scope, mount the power transformer *with tape* directly behind the CRT, and be prepared to turn it for minimum beam disturbance. Then and only then, bolt it down.

### Basic Case Layout

Sounds a little out of order, but now's the time to make a rough sketch of your case. Just use the PC board sizes (parts list) as a guide; if you intend to build on vectorboard, increase these dimensions 50%. A few pointers: This is only intended to be a "first fitting," so just sketch it! Also, avoid cramming it in — leave yourself some room, and construction will be almost as enjoyable as showing the finished scope to your friends.

Try to follow the general layout philosophy of my scope as much as possible (see photos). Things to consider: Keep the vertical and horizontal boards as close to their respective front panel controls as possible (cuts down on shielding requirements). Power supplies should be as far from the front ends of the vertical and horizontal boards as possible. Leave a little space around the boards to enable possible shield installation later (Edsel Murphy); plan enough space for a CRT shield; front panel controls should be arranged with an eye to functionality, symmetry, and cabling ease. Enough work on the case for now.

# THE LM-3 VOLKSMETER

World's lowest priced precision digital multimeter  
-- more accurate and rugged than the old pointer meter -- ideal for field service.

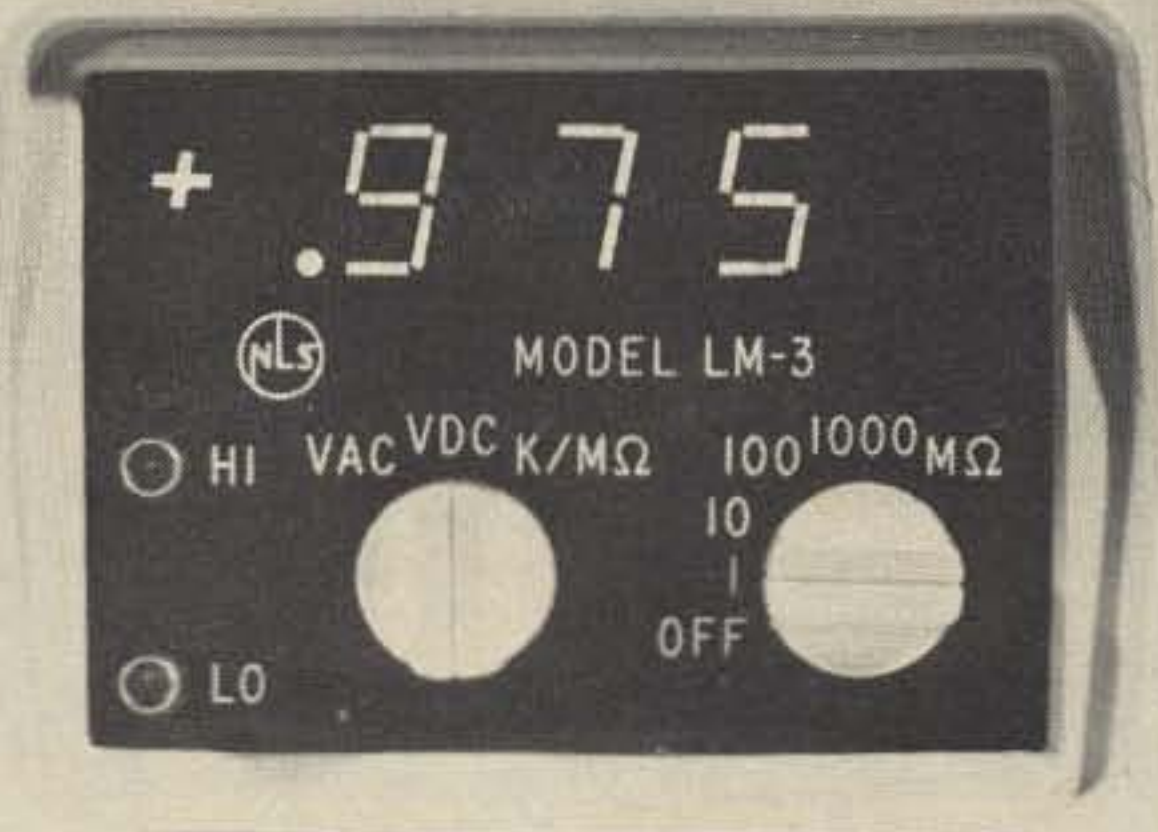

With rechargeable  
batteries and charger unit

## \$125

Now a multimeter with truly outstanding features.

- Super Rugged: Ideal for field service use - you don't have to recalibrate or replace if dropped.
- High Input Impedance: 10 megohms on all ranges; no more circuit loading.
- Automatic Polarity: No more test lead reversing or switching.
- Automatic Zero: No more adjustment of the zero when you change range, function or position; no more full scale ohms adjust.
- Full three digits without parallax or required interpolation; a 0.33" high LED display. A true one percent meter.
- 13 ranges: 4 vdc, 4 vac and 5 ohms.
- Measurements: Up to 700 vdc or 500 vac and up to 10 megohms.
- Small Size: 1.9" H x 2.7" W x 3.9" D.
- Versatile: Operates from standard 115V outlets or on self-contained rechargeable batteries.
- Fully Protected: No damage from overload on volts and ohms measurements.

#### Optional Features:

- Leather Case.
- High Voltage Probe: For measuring up to 30 KV.
- Current Shunts: One percent accuracy from 1 $\mu$ A to 1A.

LM-3 basic meter also available in four digits with 0.02% accuracy. Ask for LM-4.

See your local distributor!

Distributor inquiries invited.



**Non-Linear Systems, Inc.**

Originator of the digital voltmeter.

Box N, Del Mar, California 92014

Telephone (714) 755-1134 TWX 910-322-1132

**NOW**  
is the time to order  
**YOUR**  
**76**  
**callbook**

Don't wait until 1976 is half over. Get your new **Callbooks** now and have a full year of the most up-to-date QSL information available anywhere.

The new 1976 **U. S. Callbook** will have over 300,000 W & K listings. It will have calls, license classes, names and addresses plus the many valuable back-up charts and references you have come to expect from the **Callbook**.

Specialize in DX? Then you're looking for the new, larger than ever 1976 **Foreign Callbook** with over 225,000 calls, names and addresses of amateurs outside of the USA.

On dealer shelves Dec. 1, 1975



**Foreign Radio Amateur Callbook DX Listings**  
**\$12.95**  
with  
**3 Service Editions**  
**\$18.95**



**United States Callbook All W & K Listings**  
**\$13.95**  
with  
**3 Service Editions**  
**\$19.95**

RADIO AMATEUR  
**callbook** INC.  
Dept. B 925 Sherwood Drive  
Lake Bluff, Ill. 60044

Order from your favorite electronics dealer or direct from the publisher. All direct orders add \$1.00 shipping and handling per Callbook.

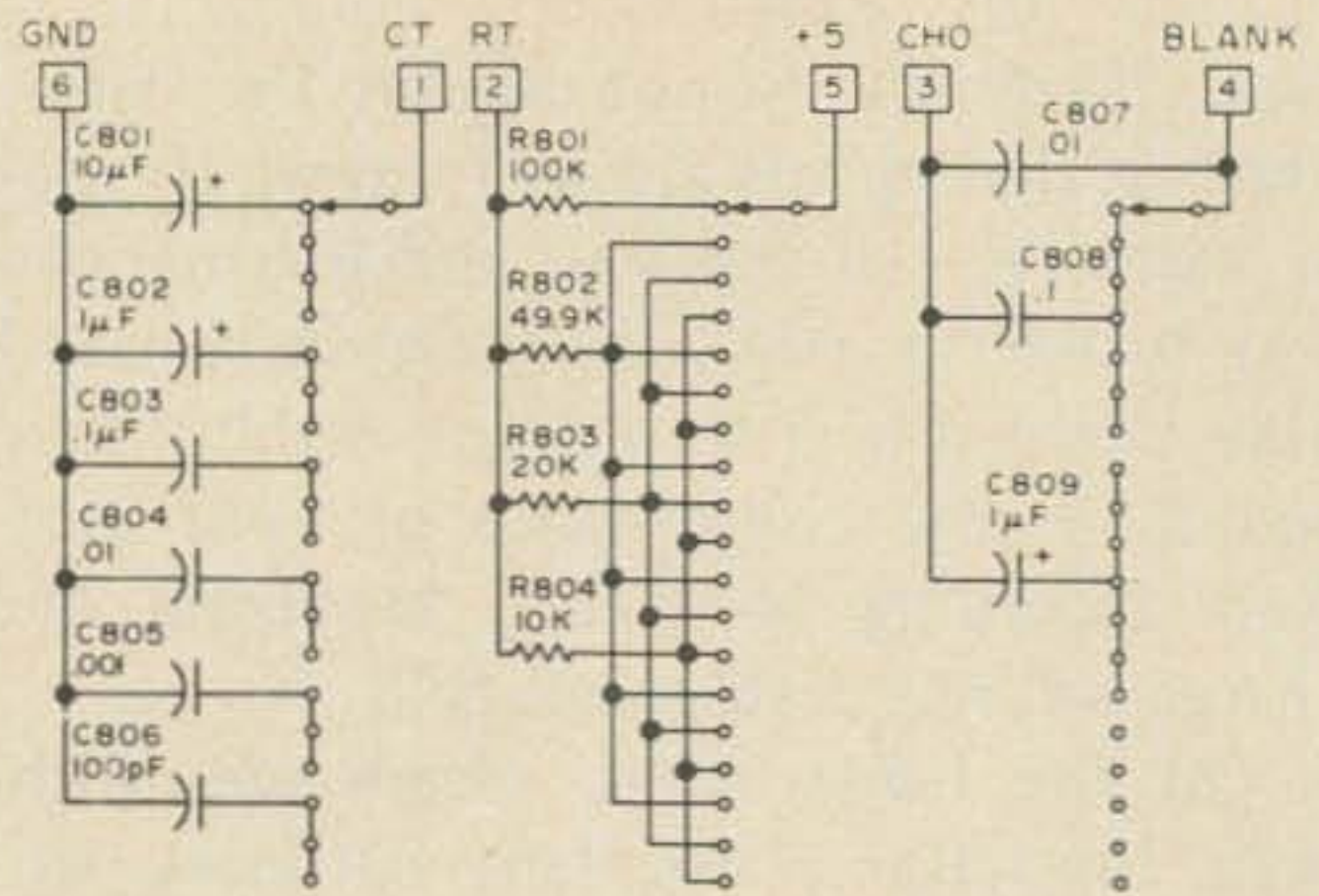

Fig. 16. Timebase switch schematic.

### Winding the LVPS Transformer

Oh! oh! . . . (you knew there was a catch in this project somewhere). Not really — it's easy to wind this one! First off, you'll need a core. Best choice is a ferrite cupcore: It's easy to wind, and efficient. Pick one that's about 1¼" diameter x 1¼" high, with a bobbin. Winding area cross section of at least 3/8" x 3/4" is necessary. Best efficiency is attained with either T-26 or N-22 type cores (usually stamped right on 'em).

If you can't find a cupcore, a tapewound toroid is as efficient, although just a bit more difficult to wind. I've found that 1-3/8" o.d., 3/4" i.d. is ideal. Ferrite toroids generally don't work too well, but if you want to test one, wind a quick primary and feedback, hook it up, and try it. If you get a good square wave . . . come to think of it, you need the scope to see that . . . so simply monitor the transistor temperature for a minute or so; if they get more than lukewarm, the core is not suitable.

Bottom of the pile, but still adequate is the lowly E-I laminated audio transformer. Pick a 2 x 2¼ x ½ core (or larger), and test it as described for the toroid.

After selecting the core, cut strips of plastic bag (cupcore and E-I), or vinyl electrical type (toroid) for insulation between layers. Also cut 10 to 15 one inch pieces of Scotch tape, and 4 three inch pieces of small spaghetti. Use a hand drill to wind the bobbins, or a popsicle stick for the toroid.

Wind the HV secondary first (Fig. 23), insulating between layers. If you're using the cupcore or E-Is, leave a 1/16" space on each end of the layers. Spaghetti the flyleads, and



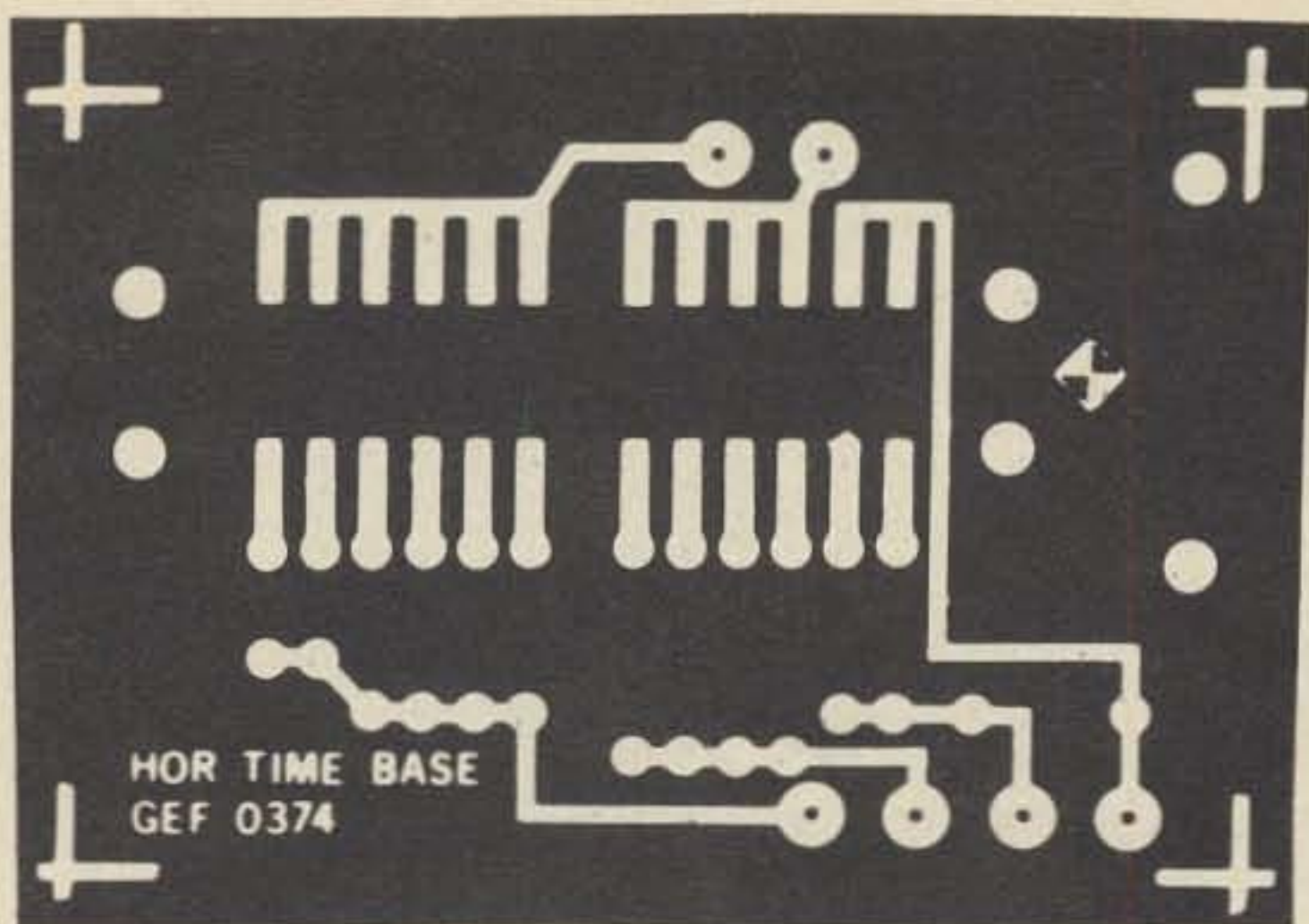

Fig. 17. Timebase switch PC board (full size).

cover the HV winding with a double layer of poly-bag strip, securing with Scotch tape.

Next comes the CRT filament winding. This one's got to have a good insulation, so run the spaghetti into the layer and secure with tape. Cover the winding with 2 layers of insulation, secured with tape.

Wind on the two remaining secondaries (bifilar saves time), insulate and secure. Mark each flylead. Finish up with the primary (bifilar wound) and feedback windings. Mark *start* ends of each, and wind both in the *same* direction. Secure, and finish up with a layer of vinyl tape. Assemble the bobbin and core (cupcore and E-I types), and set aside. Sounds tedious, but it'll only take an hour or so. That's one of those jobs you'll get wound up in, right to the core.

### Selecting Primary Electronic Parts

On to more interesting tasks. You now have enough information to select the larger electronic parts, such as switches, pots and the HV transformer. Remember that most all parts of your scope are quite non-critical (exceptions are marked), so some thoughtful

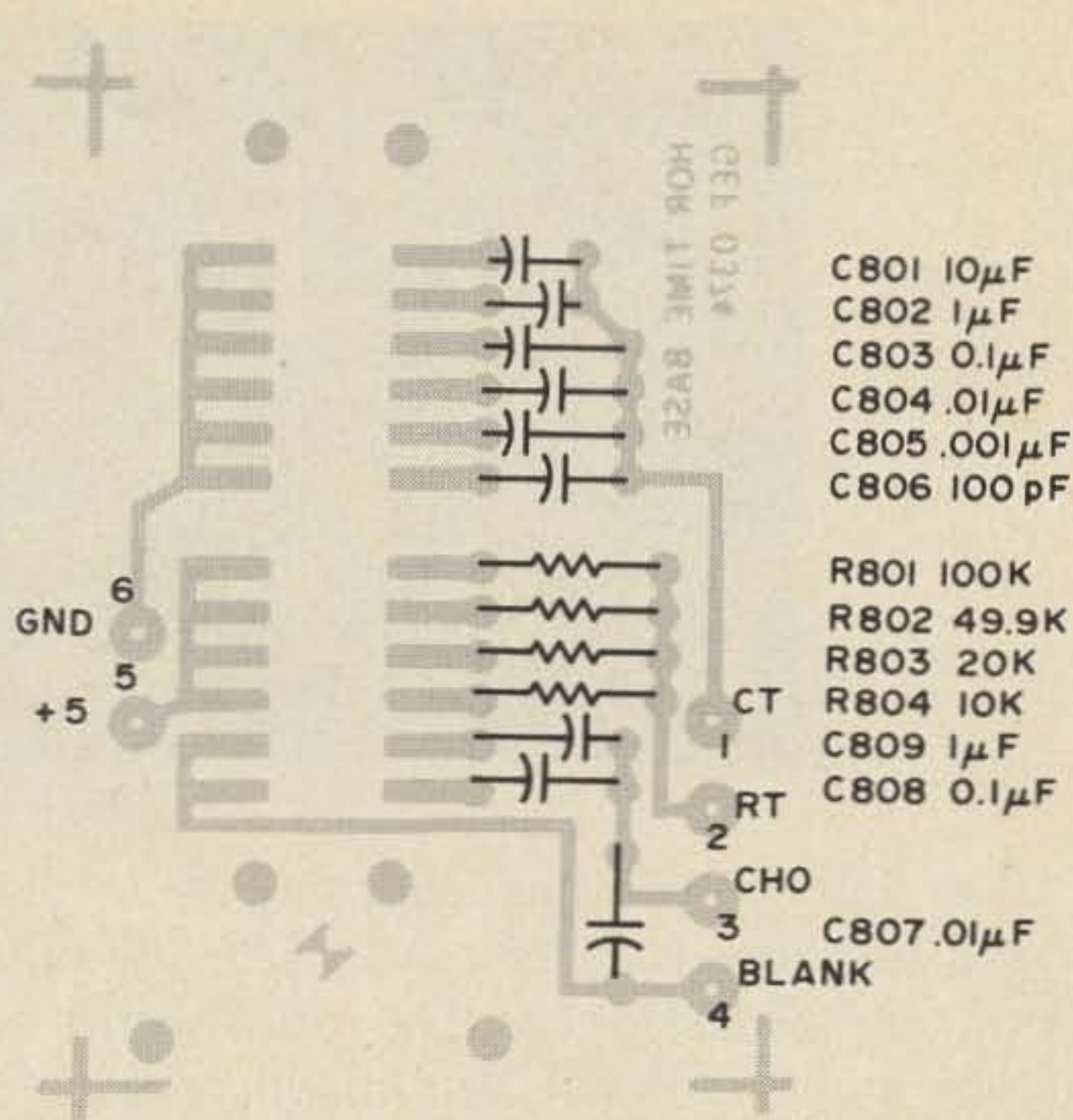

Fig. 18. Timebase switch component layout.

scrounging here can save you money! Use the services of the many surplus houses, some junk box parts, etc., and you'll be amazed at the savings!

All parts of your scope may be standard items, or you may want to try some of your own design. My scope makes use of a home brew cam-type switch for vertical attenuator and timebase, primarily to save space. The photo illustrates the basic construction of this type of switch. However, there are several alternate approaches.

Use standard switches with a similar number of positions, if you have the space. Note that by slightly changing the timing resistors, you can come up with a 1-3-10 sequence, which saves many switch positions, making for a smaller switch. Values for the 1-3-10 resistors are listed under switch options in the parts list.

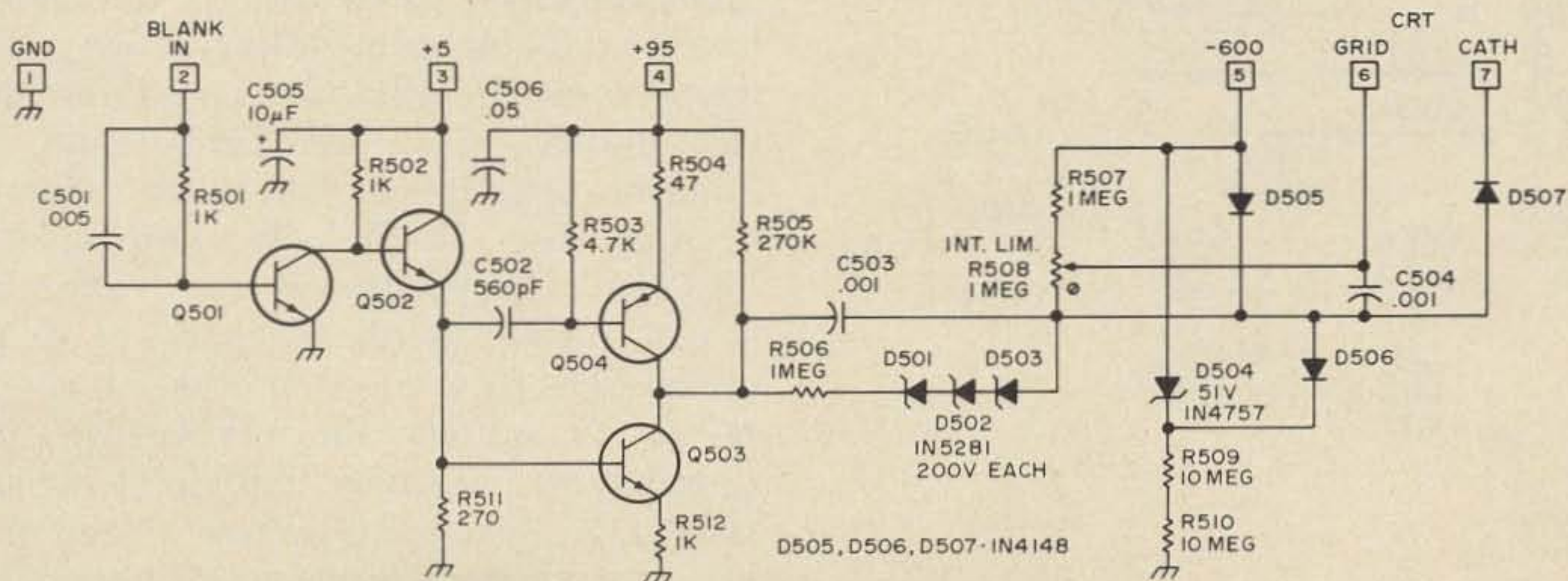

Fig. 19. Blanking schematic.

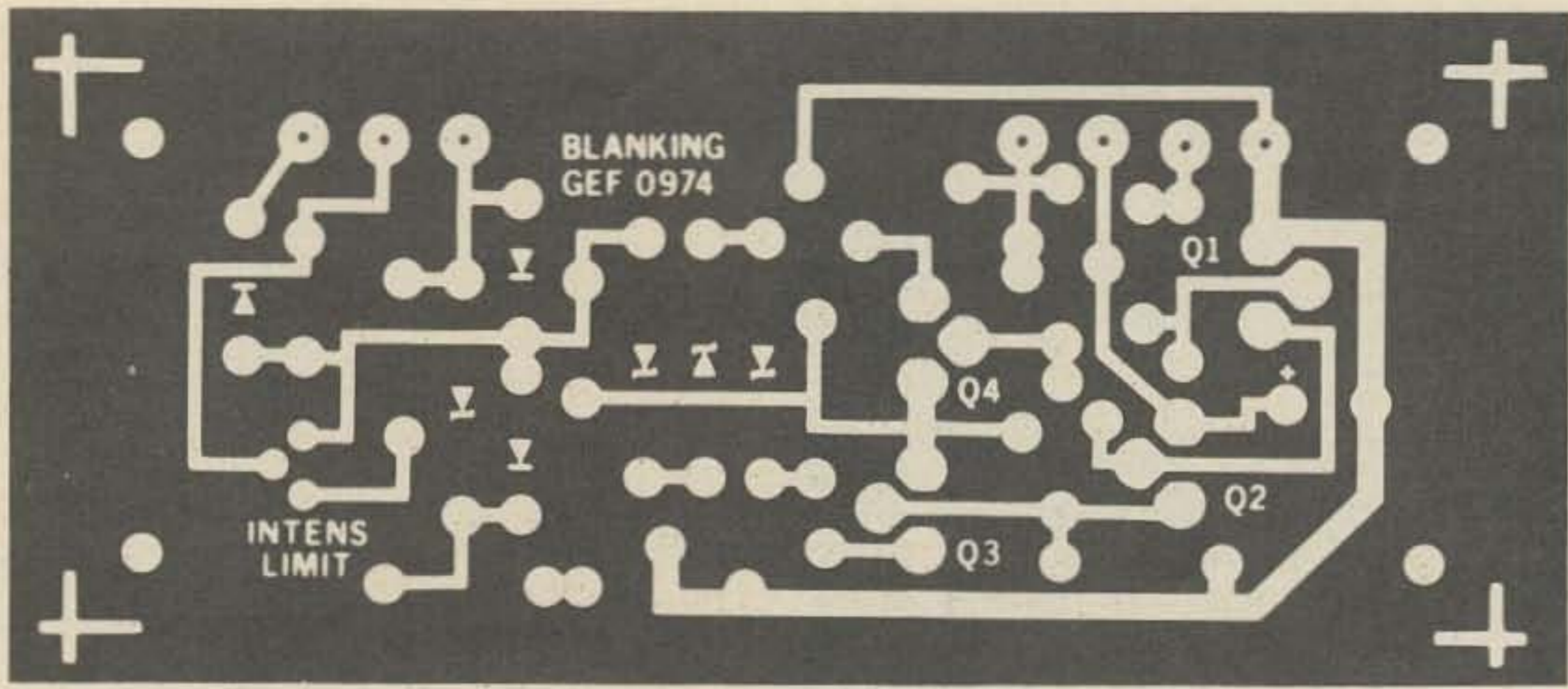

Fig. 20. Blanking PC board (full size).

The HV transformer specified is an old friend to phone-patchers, 22k, 5.2k and 600 Ohm, all centertapped. The transformer is usually under a dollar, and readily available surplus. Note you'll need 2 for options 1 or 2. Making this little feller withstand 250 to

500 V constantly may seem a bit risky, but I've used more than 20 of them in various direct (no multiplication) supplies for up to 1.8 kV with only one failure. That's a whale of a lot more voltage than your scope's transformer will ever see!

### Electronic Construction

The heart of your scope is, of course, the electronics. Best, and by far the easiest, construction is afforded by PC boards; however, you may use vector, or any other suitable method. Whatever way you do it, remember that most of the circuitry operates from dc to at least 10 MHz, so use good layouts and plenty of bypasses! You may tape from the PC layouts in this article, or get full size negative prints (for photo-etching) for an SASE. Should you make your PC board by photoetch, don't strip the KPR off after etching. Solder through it, cleaning the board of rosin with isopropyl or denatured alcohol. The KPR will keep the copper bright during construction.

All components are readily available, most surplus. Even though E. Murphy says interchangeable parts won't, you should have no difficulty substituting. A few recommendations: Use solid tantalums rather than electrolytics. Use low temperature coefficient ceramics or micas in calibrated circuits. Use 1/4 W, 5% film resistors "R-Ohm". (They have only one disadvantage — you can only get them in packs of 50. But at 2¢ each, they are a far better buy than regular 1/4 watters and the leftovers will certainly be a welcome addition to the junk box.) Use sockets everywhere — they make life much more enjoyable during testing later on.

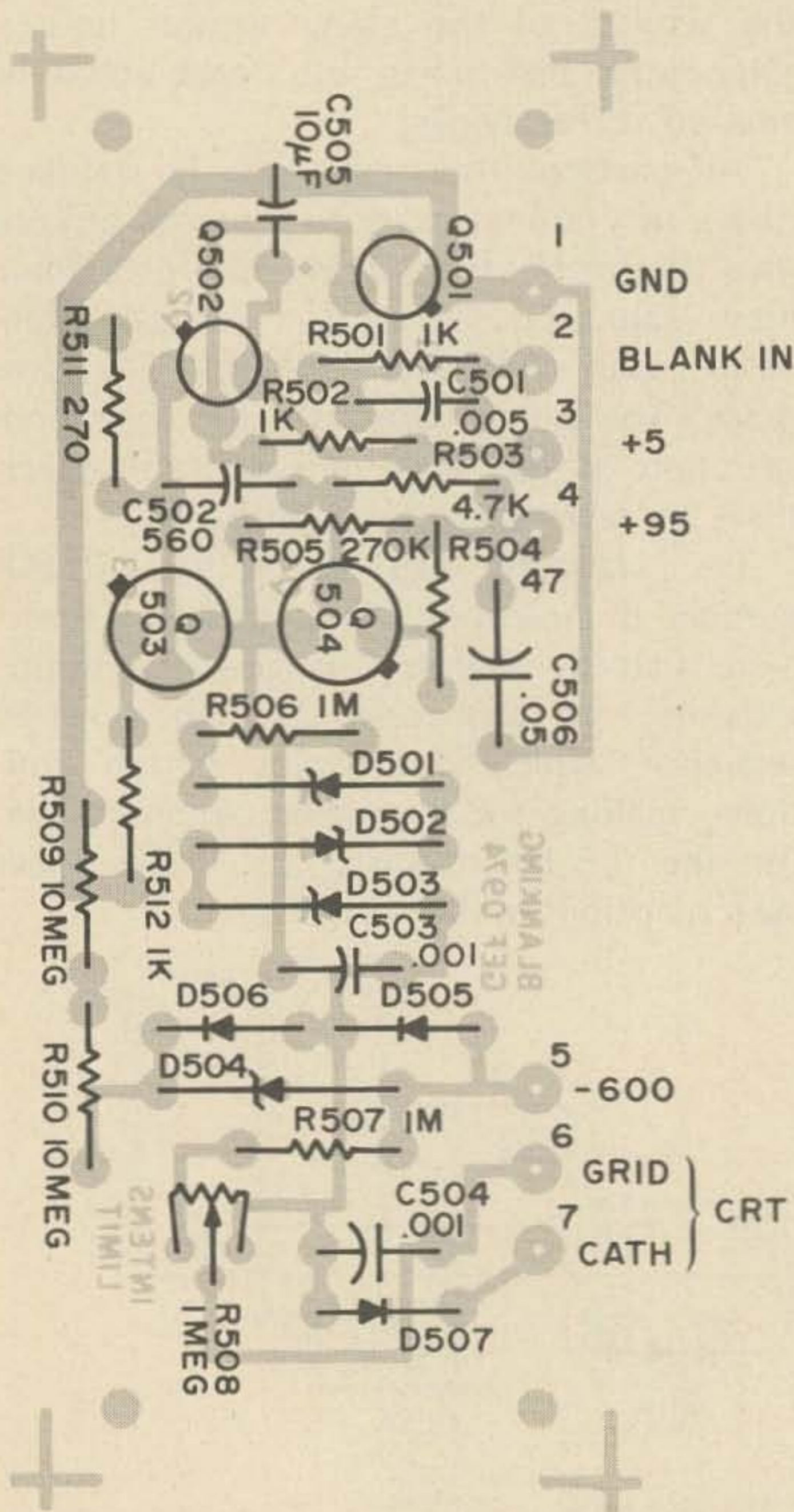
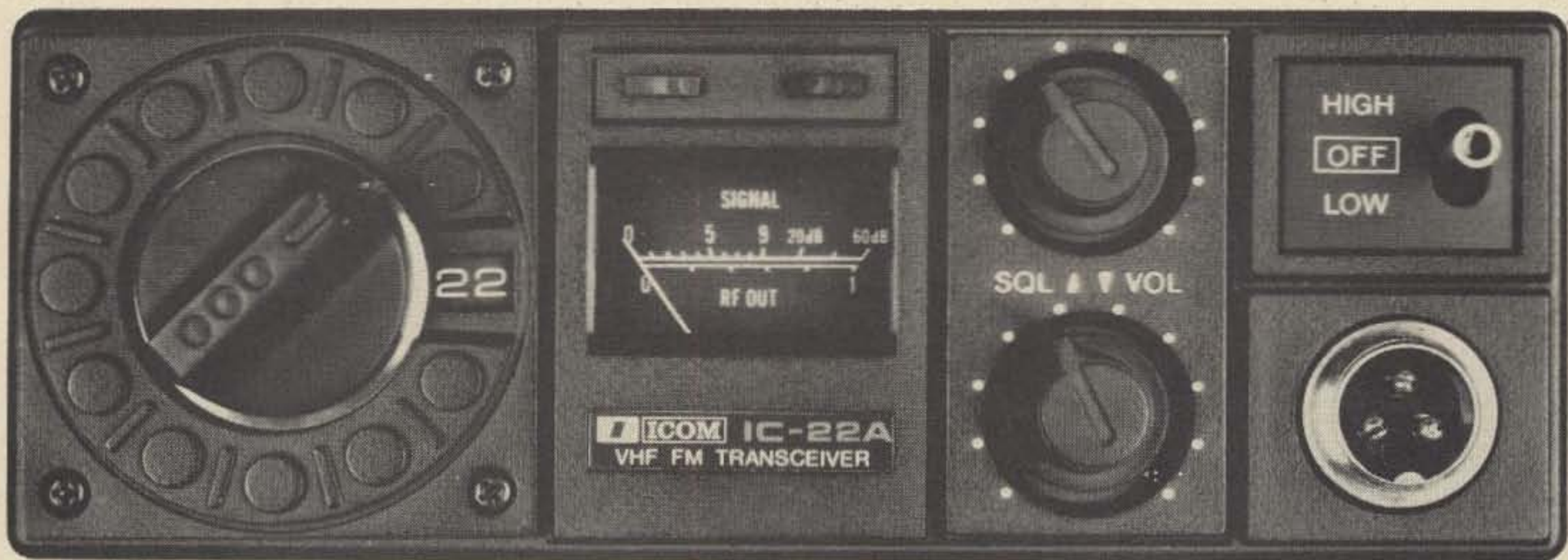

Fig. 21. Blanking component layout.

# WE'VE GIVEN IT A NEW LOOK!



## IC-22A

The front panel and control locations have been changed to make the IC-22A even better looking and easier to operate. The new design allows the use of larger channel numbers which may be

viewed from the left side or right side by reversing the window position and installing a new dial. (optional at nominal cost)

Inside is the same high quality radio construction and engineering that has made the IC-22 the most reliable, most popular two meter crystal controlled set on the market.

When you join 22 channels of capacity (five supplied) with the unexcelled performance of helical RF filtering in the receiver front end then add solid state T-R switching you get one great radio for your money. All the great features that made the IC-22 so desired are still there. Including, 1 watt/10 watt switch option, trimmer capacitors on both receiver and transmitter crystals plus a 9 pin accessory jack with the discriminator already wired for frequency calibration.

SEE ONE !! BUY ONE !! AT YOUR ICOM DEALER TODAY.

Distributed by:



# ICOM

ICOM WEST, INC.  
Suite 3  
13256 Northrup Way  
Bellevue WA 98005

ICOM EAST, INC.  
Suite 307  
3331 Towerwood Drive  
Dallas TX 75234

## PC Boards

PC board layout is such that all off-board leads terminate on one edge of the board. This makes it easy to flip the board over after cabling. Wires may be simply poked and soldered, or turret terminals may be used. The latter method is much nicer looking. By the way, there is no need to buy expensive setting dies: Simply drill a small hole  $\frac{1}{4}$ " deep into a  $\frac{1}{4}$ " diameter rod for the anvil. Use a centerpunch to set the terminals. Stuff and solder all components. Clean the rosin off with alcohol, and give the finished boards a light coat of clear Krylon.

## Preliminary Testing

By now, you're feeling the unscratchable itch to see some of your handiwork do something. OK, fire up (what terminology!) the LVPS, using either a regulated power supply or the scope's batteries. Be sure to fuse the line, unless you want to really fire it up!

Upon connecting the 12 V dc, you'll hear

the inverter, and can check +5 and -5, and set the +95. To check the CRT filament supply, cliplead your CRT across it, watching for normal filament glow after about 20 to 30 seconds. (Some VOMs dislike square waves, and won't read correctly.) Check current drain with the CRT connected — it should be 500 to 600 mA. That completes checkout of the LVPS.

The HVPS may be tested by tacking in the transformer and applying 12 V dc. A low buzz indicates normal operations. Check the high voltage carefully. An easy way to check regulation is to change VOM ranges, causing different loads; voltage reading should remain substantially constant. Remember to bleed both outputs down after testing, unless you like surprises.

The remainder of the boards are best tested after cabling is complete, so let's get at it.

## Case Work

Returning to the case, arrange all your finished boards and other parts, and mark

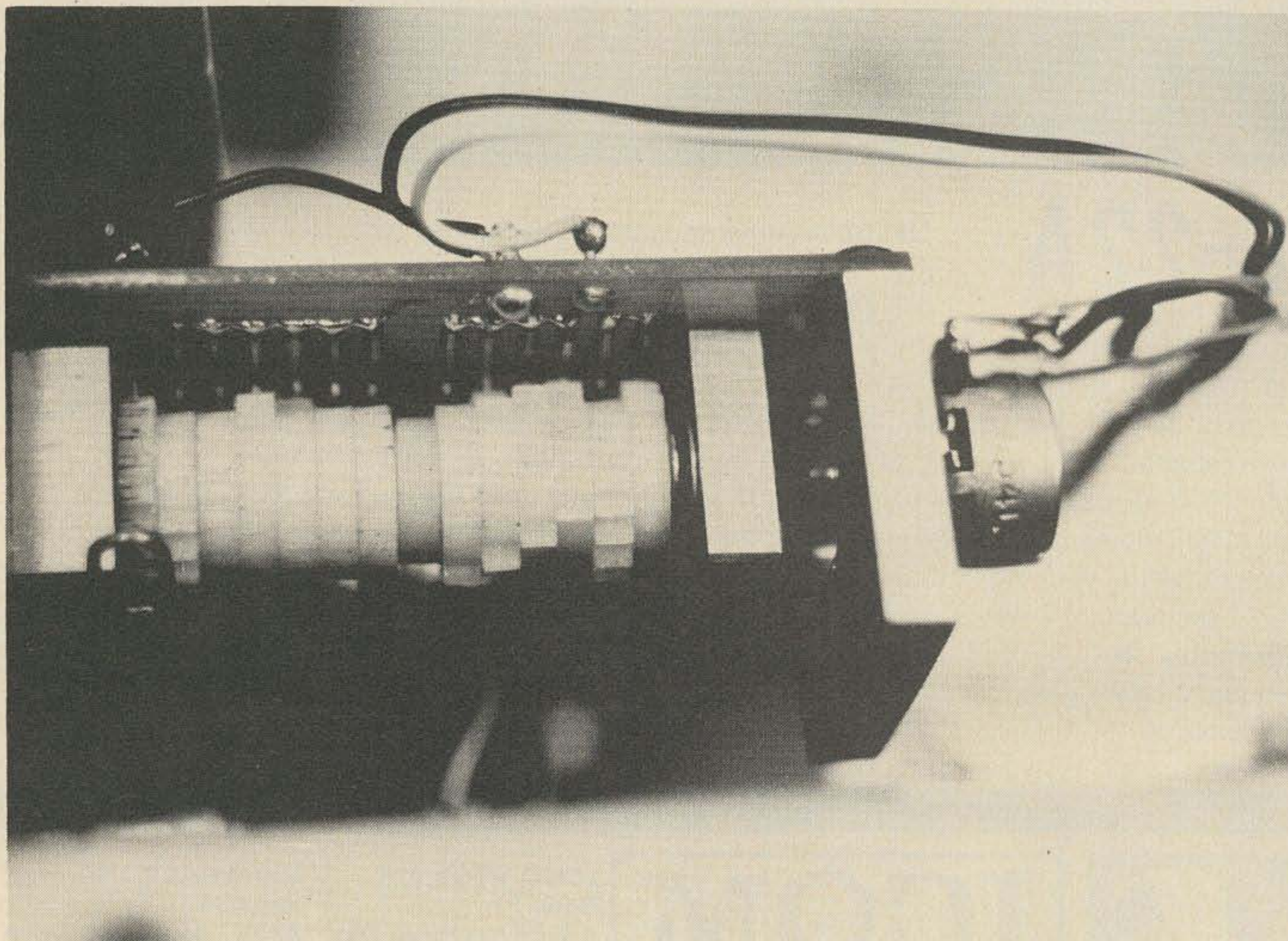

*Closeup of timebase switch. The cams are made from TV tuner gears, which press spring contact arms onto pads on the PC board. Detent spring on left end is a paper clip.*

and drill all mounting holes. Make an exact template of the drilled front panel for later. Mount the boards, controls and all other parts.

Cable up your entire scope, using #24 PVC color coded or equivalent, and RG 174/U or similar well-shielded coax for all sensitive leads. Use shrink tubing to finish off the coax ends. At this point, don't tiwrap the cables. I strongly recommend the usage of three large turret terminals near the power supply section: +12, -12, and clean ground. These facilitate making neat, loop-free grounding and power connections. All board grounds should be run separately to the clean ground point. Be sure to use shielded cable for the lines to the power switch, and ground the shield to the *clean* ground.

Install your CRT and its shield carefully. Make a quick check of primary power wiring, and check for any dead shorts with a VOM.

### Graticule

We will shortly need graticule, so now's the time to make one. Choose a piece of blue or green 1/16" transparent plexiglas. Get a piece large enough for two graticules, in case you make a mistake. Cut the plexiglas to size, smooth the edges, and tape it (squarely) to a piece of linear graph paper. Take a ruler, and carefully scribe lines into the plexiglas with the back edge of an X-acto

knife. Scribe 10 horizontal divisions, and 5 vertical. Mount this graticule on the scope with screws or cement, whichever is appropriate.

### PARTS LIST

This list should be used as a guide. As I mentioned before, the scope is insensitive to any reasonable subbing, except for the calibrated circuits. For this reason, I've supplied you with a lot of parameter data, allowing more freedom in parts choice. Hopefully this will help hold the cost to a minimum.

**CRT** — See the table on page 83, and the text.

**Batteries** — Use sealed, rechargeable cells that will supply a solid 12 V at 2 to 5 A-H.

**Case** — To fit. Consider such oddballs as a large chassis, the bottom plate supporting everything. Cut the ends off the chassis, trim them to fit within the chassis, and fasten to the bottom plate to form the front and rear panels. Cost about \$10; not bad for a custom case!

**PC Boards** — Use G 10 epoxy board, and buy a square foot surplus. The local printer might give you enough KPR for the job (2 ounces). Vertical amplifier is 5½ x 2½; horizontal board, 5 x 2¼; LVPS, 4½ x 3; HVPS and blanking, 4 x 1½; vertical attenuator and timebase switches, 2¼ x 1½.

**Rotary Switches** — All may be phenolic wafer type, or better. One 4 pole, 10 position; one 3 pole, 20 position; and one 3 pole, 4 position.

**Toggle Switches** — Miniature type, available surplus for 50¢. Two DPDT, one SPDT, and an odd one that may be hard to find: C&K type 7211, with 3

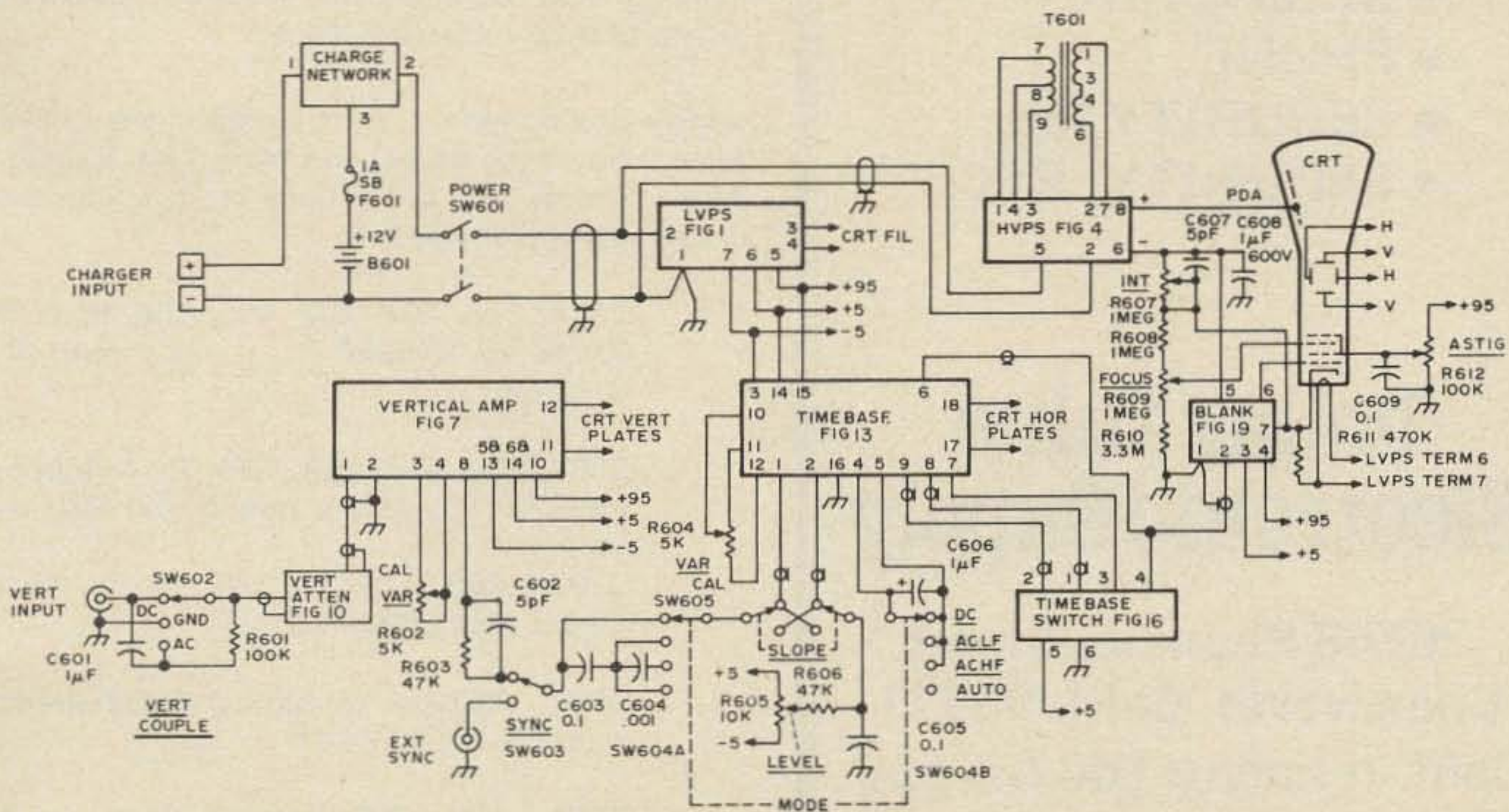
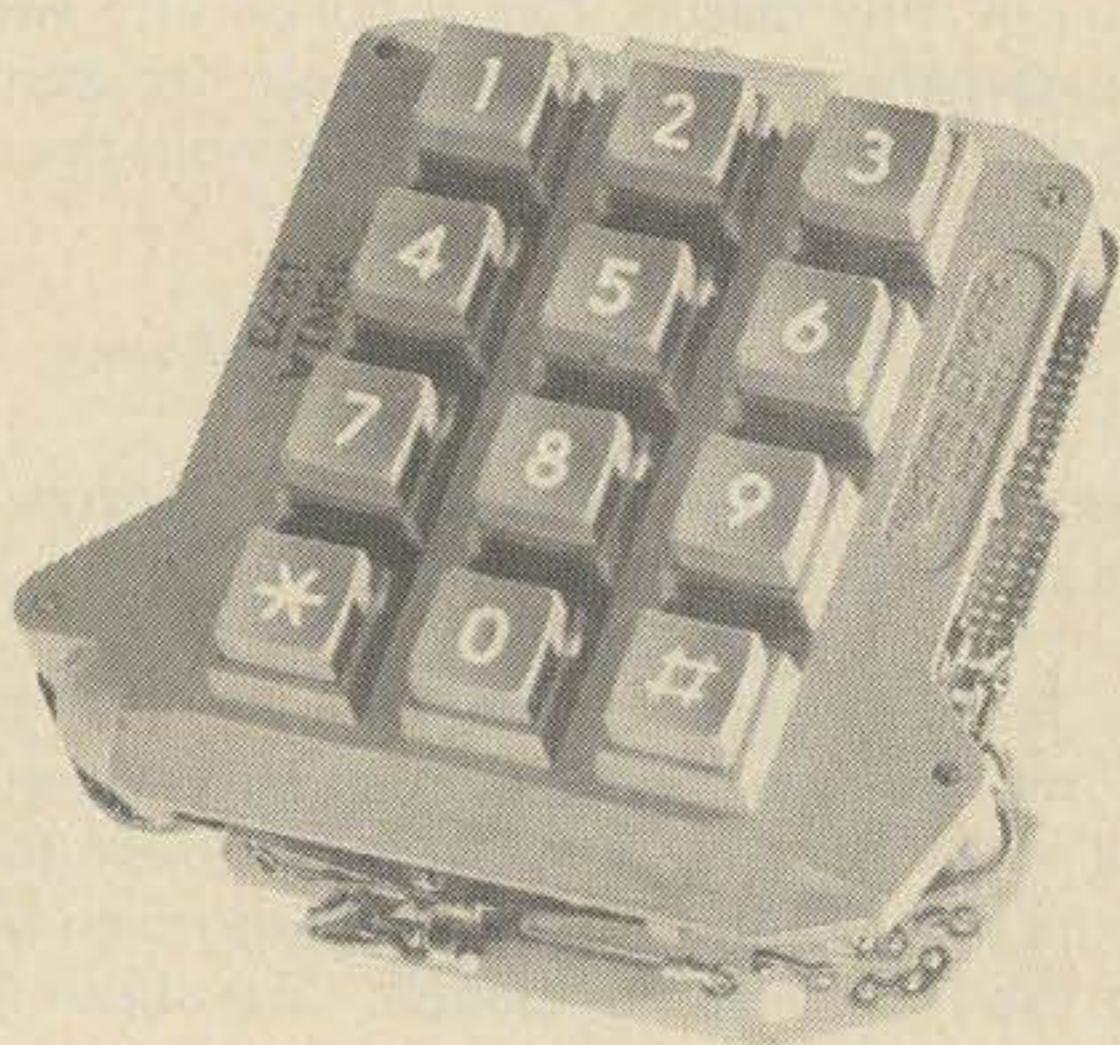

Fig. 22. Mainframe.

# TOUCH TONE PADS



**NEW \$19.50** Postpaid

COMPLETE WITH DIAGRAM

WESTERN ELECTRIC  
MODEL NO. 35N1A  
HIGH STABILITY L.C. TYPE

- REPEATER
- COMPUTER
- PHONE
- SECURITY, etc.
- SECURITY, ETC.

## Dollar Value Electronic Supply

20748 Plummer Street  
Chatsworth, Calif. 91311  
Calif. residents add 6% tax.

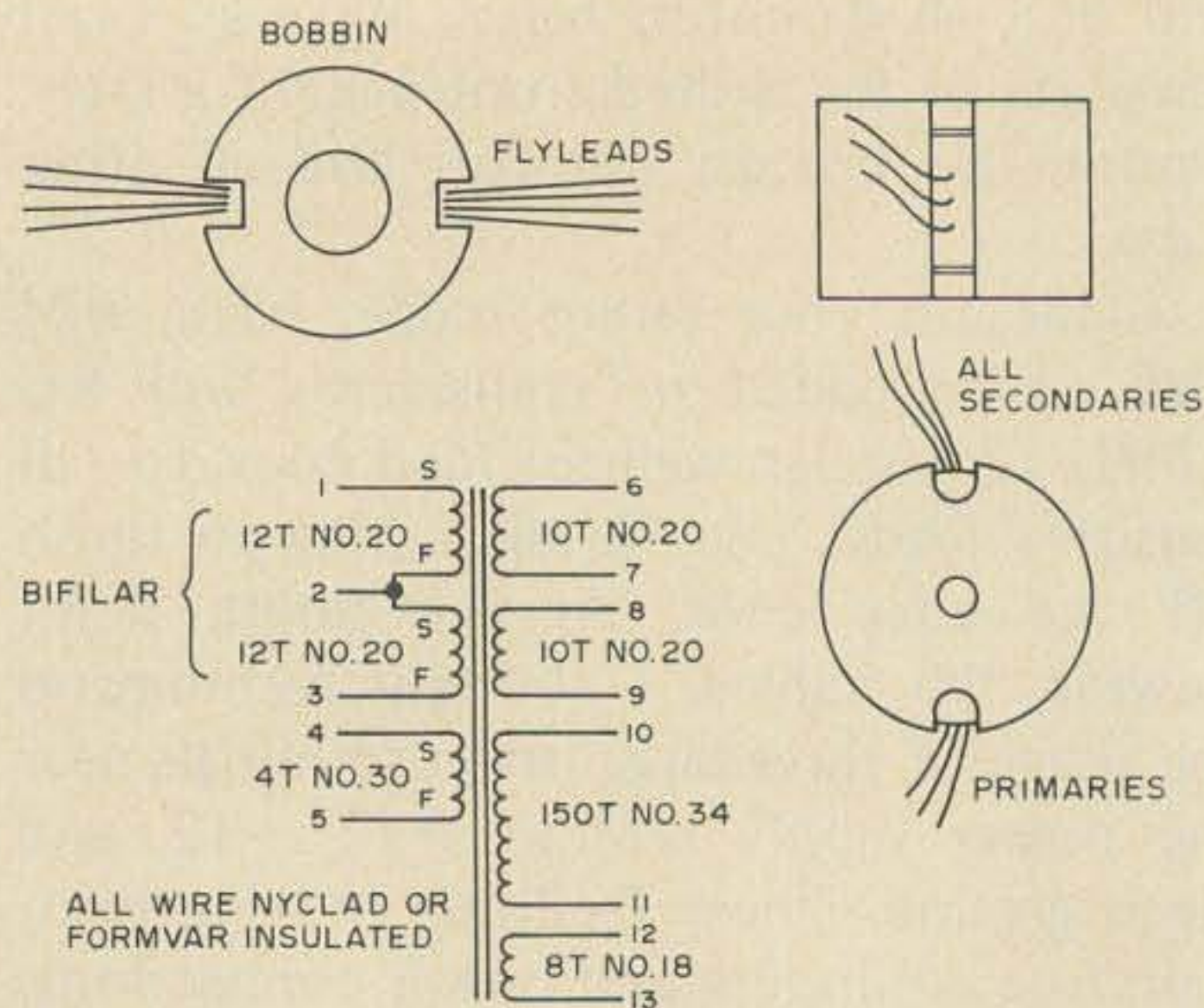

Fig. 23. LVPS transformer schematic.

ON positions. You can use a 1 pole, 3 position miniature rotary, or similar.

**HV Transformer** — Often marked "Lionel," it's 1x1x2 inches, with 22k, 5.2k, and 600 Ohm windings, all centertapped. Surplus goodies at a dollar.

**Precision Resistors** — Total of 14. Using 1% resistors will cost you about \$10. However you can test the R-Ohm resistors, which will run you about 30¢, and a little time. Most of them check out well within 1½%, so you might get away without even testing them; they are essentially as stable as 1% types. Values for the alternate 1-3-10 timebase sequence are: 10k, 30k, 100k, and 300k; normal 1-2-5 values are shown in Figs. 10 and 16.

**Timing Capacitors** — You need six: 100 pF and .001 uF may be mica or zero-TC ceramic; .01 uF through 10 uF should be miniature tantalums (TAG or similar) for best stability. Tolerances seem high for this usage, but the tantalums usually end up quite close to marked value.

**Active Components** — Part numbers given have all been used in the scope, and work well. Except for rare instances (\*), the circuits seem content with nearly any reasonable sub.

Q303, 305, 307, 309, 405, 408, 503: RCA 40594, or 2N5320 ( $V_{ce0}$  95 V min,  $f_T$  50 MHz min);

Q304, 308, 406, 409, 504: RCA 40595, or 2N5322 ( $V_{ce0}$  95 V min,  $f_T$  50 MHz min);

Q302\*, 306\*: 2N918, 2N5179 ( $f_T$  must be greater than 500 MHz);

Q301: 2N3954 through 2N3958 (must be monolithic dual FET);

Q101, 102: GE type D40C6, or RCA 2N5294 ( $V_{ce0}$  40 V,  $I_c$  4 A);

Q103: 2N3440 ( $V_{ce0}$  200 V min, 1 Watt NPN);

Q203\*, 402\*: 2N4302 or 2N5457 (IDSS 2 to 3 mA);

Q201, 202, 204: 2N697, 2N2219 (40 V, 5 Watts NPN);

All remaining NPN: 2N697, 2N2222, 2N2219, 2N718, 2N6002 (any HF silicon NPN);

All remaining PNP: 2N1132, 2N6003, 2N2905 (any HF silicon PNP);

A301:  $\mu$ A733;

A401: CA3046/3086 or LM3046/3086;

A402: NE555 (Signetics);

REG 101, 102: 7805 (Fairchild or Motorola);

BR 101: MDA-920-4 (Motorola), or fittable equal;

BR 102, 103: MDA-920-3 (Motorola), or fittable equal;

D205 through D210: Preferably 1N5060 series, as they are avalanche protected; 1N4005 and HEP 170 are OK, but will not take a Murphy screwdriver treatment;

Zeners: 1N47XX series is recommended; however, any good 1 Watt type is fine. Voltage ratings are on the schematics.

**Capacitors** — Below 1  $\mu$ F use ceramic or mica; above 1  $\mu$ F use "TAG" type tantalums. Values are non-critical. Multiplier capacitors in the HVPS are 0.1  $\mu$ F, 500 V Sprague or CRL ceramics.

**Trimmers** — All are 3.5-13 pF,  $\frac{1}{4}$ " dia. ceramic, with 3 pins (two are common), and no name. Most end up adjusted to midrange, so you can juggle the end values a bit. Surplus is a must on these, as new price is out of sight.

**Resistors** — Highly recommended are "R-Ohm"  $\frac{1}{4}$  Watt film resistors. You have to buy 50 at a whack, but 2¢ each makes them mighty attractive!

**Pots** — Surplus, military type is your best bet here. For the most compact construction, use the  $\frac{1}{2}$ " dia. kind.

**Calibration Pots** — Beckman 62 and 82 series were used; however, any correct resistance  $\frac{1}{4}$ " dia. pot is fine. CTS and Weston also make them. Also consider Beckman series 91, a 39¢ cermet; it's a little bigger, but will fit.

# FREE!

## The All-New 1976 Lafayette Radio Electronics Catalog



### The most comprehensive consumer electronics catalog available!

Hams, see the exciting new 1976 line of exclusive Lafayette Parts, tools and test equipment for do-it-yourself projects at Lafayette's traditionally value-packed prices. Stay tuned to the top amateur gear, name brand equipment and our huge selection of the latest in electronics. Send for your copy today!

- Stores Coast-to-Coast
- BankAmericard and Master Charge

- Transceivers • Antennas • Meters
- Transmitters • Rotators • Test Equipment
- Receivers • Masts • Parts, Cable

## Lafayette

The Electronics Shopping Center  
111 Jericho Turnpike Syosset, L.I., N.Y. 11791

**Lafayette Radio Electronics**

Dept. 38095

111 Jericho Tpke., Syosset, L.I. N.Y. 11791

Send me your FREE 1976 Catalog

Name \_\_\_\_\_ Apt. \_\_\_\_\_

Street \_\_\_\_\_

City \_\_\_\_\_ State \_\_\_\_\_

Zip

Particular?  
try this high-performance  
**circuit-builder's  
Super-strip™**

840  
solderless  
plug-in  
tie-points

holds  
up to 9  
14-pin  
DIP's

Size  
2.25"  
x 6.5"



fastest, most reliable  
method known...to build, test  
and modify experimental circuits

8-bus distribution system  
plus universal .1" by .1" matrix  
of solderless, plug-in tie points  
all in one integral device.

Accepts all DIP's and discretes  
with leads up to .032" dia.

Interconnect with any solid wire  
up to No. 20 A.W.G.

**ORDER BY PART NUMBER**

923252 (nickel-silver terminals) ..... \$17.00

923748 (gold-plated terminals) ..... \$18.90

We honor M.C. and B.A.C. charges.  
Add sales tax on OH and CA orders.  
(F.O.B. Painesville on company P.O.'s.)  
Dealer inquiries invited

High-performance A P Super-Strip component matrices consist of 128 terminals of 5 tie points each. The 8 buses of 5 connected 5-tie-point terminals are for voltage, ground, reset and clock lines, shift command, etc. New, non-shorting, instant-mount backing and quick-removal screws are supplied... use several Super-Strips to create large-scale breadboards on panels up to 1/8" thick.

SHIPPING/HANDLING	C.O.D.
Up to \$10.00	\$1.00
\$10.01 to \$25.00	1.50
25.01 to 50.00	2.00



All products guaranteed to meet or exceed published specifications

**AP PRODUCTS INCORPORATED**

Box 110-Z • Painesville, OH 44077 • 216/354-2101

**Mechanical Items** — Following is a potpourri of hardware found to be useful in construction. Look for similar items that will fit your scope's needs.

Turret Terminals: Cambion 3563-02 (for PC boards);

Spacers: 1/4" dia., 1/4" long, tapped 4-40 (PC board mounts);

Rod: .125 dia., about two feet (shaft extensions for focus and intensity); steel or brass is fine;

Couplings (2): Insulating type, .125 shaft (for intensity and focus controls);

Magnetic Shield: To fit your CRT; try to get surplus, or get a little of the bendable foil and form-fit it;

Knobs: Bet you forgot 'em! Get dressy ones;

Heatsinks: Thermalloy 6107B-14 (4 needed), and one Wakefield NF-204; all are in the LVPS; painted aluminum scraps are OK.

*Next month: Testing and calibration.*

... WØACR

# 2 Rigs in one!

## Comcraft's NEW VHF Two-Band Transceiver for 2 and 1 1/4 meters with Digital Frequency Synthesis



Model CST-50

The new CST-50 Two-Band Transceiver provides coverage of two complete amateur bands with all the features needed by most operators. Imagine! The two most popular VHF bands in one rig with Phase Locked Loop frequency synthesis. In the CST-50 all frequencies are generated digitally by reference to one highly accurate and easily adjustable crystal. As soon as a new repeater is on you can use it, no waiting for crystals. Write for further information.

- Covers entire 2 meter and 1 1/4 meter bands
- Covers MARS, CAP and CD frequencies from 142 to 149.995 MHz
- Full digital frequency synthesis with 5 kHz steps
- Lighted thumbwheels for night mobile operation
- No crystals to buy — ever
- Built-in repeater offsets of 600 kHz, 1 MHz and 1.6 MHz
- 25 watts output on each band
- No transmitter retuning across either band
- FM-AM receiver
- 8 pole crystal filter
- Front mounted speaker

- PTT microphone and mobile mount included
- Operates on 12 volts DC
- AC supply available
- Accessory connector for tone burst and tone coded squelch

CST-50 two-band transceiver ..... \$869.95  
CPS-6 AC power supply ..... \$139.95



MADE IN USA by

**COMCRAFT**

P.O. BOX 266, GOLETA, CA 93017



# Predicting Third Order Intermod

Since the beginning of channelized FM, the problems of 3rd order intermodulation distortion have become of major importance to the VHF operator in the heavily populated metropolitan areas. The problem of intermodulation distortion is not a new problem. It has always been with us but has not been dealt with sufficiently since analysis has been complicated and ineffective. The procedure which follows deals with the understanding and analysis of 3rd order intermodulation distortion using a method called the intercept point.

Simply stated, intermodulation distortion is caused by signals from other transmitters in band which mix somewhere in the receiver and produce interfering signals. These mixing products in the case of third order intermodulation are related to the interfering signals by the relationship  $2f_1 - f_2$  and  $2f_2 - f_1$ , where  $f_1$  and  $f_2$  are the two unwanted in-band signals. These new frequencies are properly referred to as third order intermodulation distortion products (IM). The two input signals will mix and produce two additional unwanted frequencies within the receiver. Once generated they remain in the system. The problem must be solved at the point of mixing. There are other products present but only the 3rd order products will be analyzed here since they are the most troublesome.

Fortunately, the problem is not as com-

plicated as it appears. Most of the intermod is generated because the designer uses a marginal device, or chooses a good device and biases it improperly. For example, he may choose a transistor and bias it for the lowest possible noise figure and accept the resulting gain compression, or non-linearity of gain. This non-linearity of gain is responsible for the generation of spurious responses which we shall see later. The gain compression describes the useful dynamic range of a device at the high end, just as the noise figure describes the useful range at the low end.

## Third Order IM

The photo shows what happens when two signals of equal amplitude are fed into our test amplifier. Each signal has a power level of  $-60$  dBm. The two larger signals,  $f_1$  and  $f_2$ , are at  $145.5$  MHz and  $146$  MHz, respectively. When fed into our amplifier, two new signals are generated. Both signals are  $50$  dB below the two main signals for a given input power of  $-60$  dBm.

The first signal on the left is at  $145$  MHz and is generated by  $2f_1 - f_2 = (2)(145.5) - 146$ . The last signal on the right is at  $146.5$  MHz and was generated by mixing  $2f_2 - f_1 = (2)(146) - 145.5$ .

Remember that these two new signals are not present in the air. They were generated by the mixing action of the amplifier when

the two signals of 145.5 MHz and 146 MHz were injected into the amplifier simultaneously. Considering all the transmitters on the air in a given area, it is not a wonder that your receiver sometimes acts strange. Rather than try to calculate all the possible combinations of signals that may be bothering you, it may be wise to consult one of the many computer readouts available. One of the best appeared in 73 in April, 1971, by W6YAN.<sup>1</sup>

### Understanding Gain Compression

The more linear a device, the less is the chance of generating IM. The graph of Fig. 1 is a log-log plot of input versus output power for an rf amplifier stage with 20 dB of gain. The graph shows that for an increase in input power the output should increase accordingly. Let us assume that we increase the input power by 3 dB; then the output should also increase by 3 dB. As long as this relationship is maintained, the amplifier is said to be linear. The point of non-linearity is referred to as the 1 dB compression point. This point can be found on the graph as that point where increasing our input signal by 3 dB only causes a 2 dB increase in power output.

So far, we have determined the mathematical relationship of the IM and have observed the IM products. We have defined gain compression and briefly singled it out as a major cause of IM. In the next few minutes we shall see how to accurately predict IM.

### The Intercept Point

Electronic engineers in the communications field have for years used a method to accurately classify and predict the IM in amplifiers and mixers. This method is called the intercept point. The first mention of the intercept point is in an article from *Electronic Design* in 1967 upon which I have drawn heavily.<sup>2</sup> The original work on this concept as far as I can determine seems to have been developed at Avantek. The intercept point is a fictitious point. In actual measurement concept, the intercept point is that point at which the extrapolated linear portion of our gain plot intercepts with a plot of our IM. The gain plot is extrapolated because at high levels it deviates from a straight line because of gain compression.

The plot of Fig. 2 shows a pair of straight lines plotted on a log-log scale. It is an expansion of Fig. 1, which showed the gain plot and its compression. The third order line has been added. This line indicates the relative strength of the internally generated responses or IM for any given power input.

In actual laboratory practice, the third order IM is measured at some convenient power level using a spectrum analyzer, Fig. 4.

Referring to the photograph, we observe that the IM products are 50 dB below the fundamental signals for two signals of  $-60$  dBm input. In Fig. 2 the distance from the fundamental line down 50 dB for a  $-60$  dBm input signal has been plotted and this distance labeled "X".

The intercept line can be drawn horizontally across the graph at a point one-half times from the  $-60$  dBm input signal. The point at which the intercept line crosses the fundamental gain line is the intercept point.

The third order IM line can now be drawn so that the measured point and the intercept point form a straight line. When talking about the intercept point it is common usage to refer to the output intercept point. It is possible, and sometimes convenient, to specify the amplifier performance in terms of its input intercept point.

For all practical purposes, our plot is complete. We can now predict what the IM will be for any given input signal. (Example: For two input signals of  $-80$  dBm, third order IM is 90 dB below the carrier.)

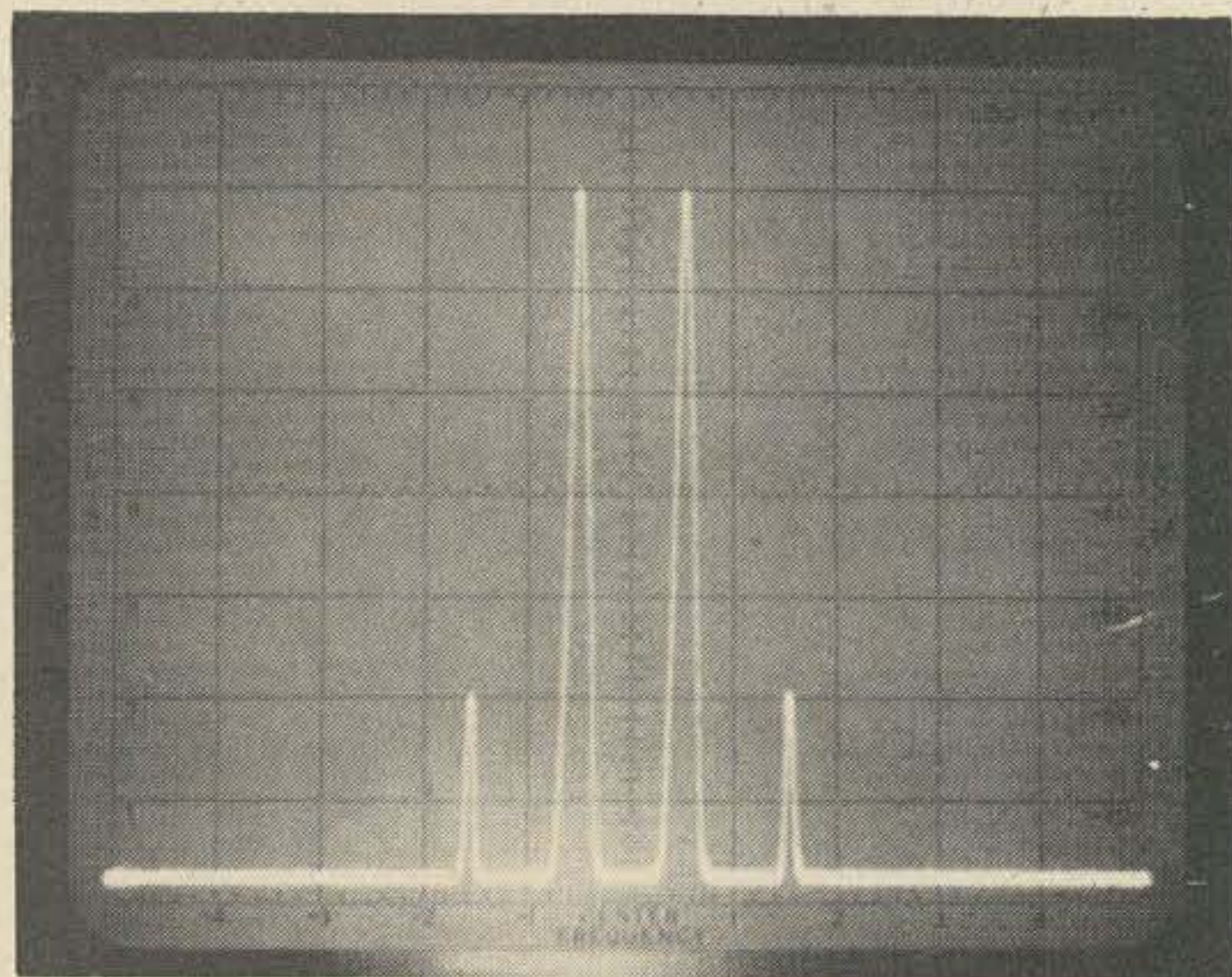

Third order IM 50 dB down.  $F1=145.5$ ;  $F2=146$ ;  $F1$  and  $F2$  at  $-60$  dBm input.

# Merry Christmas

from the Telecommunication People



*Watch for surprise announcement*

**Telecommunication Control SYSTEMS**

*Div. of Communications, Inc.  
Haverhill and York Sts.  
Andover, Mass. 01810*

If you stare at Fig. 2 long enough, you will realize that by changing the input level by 1 dB the IM will change by 2 dB. Our original measurement produced an IM of 50 dB down for 2 signals of  $-60$  dBm input. Therefore, by decreasing our input signals 20 dB to a new level of  $-80$  dBm, we have improved our IM products by 40 dB and our new level is 90 dB down for 2 signals of  $-80$  dBm input.

### Rule Of Thumb

In the absence of a spectrum analyzer, a reasonable and accurate plot of the third order IM products can be obtained by assuming that the intercept line is approximately 8 dB to 15 dB above the 1 dB compression point with 10 dB being a good guess. This assumption will produce an error of 2 dB for each 1 dB we are off in our assessment. Care must also be used in making the 1 dB gain compression measurement for the same reason.

After carefully measuring the 1 dB compression point of the amplifier, plot the gain line on your graph and note the 1 dB point. Approximately 10 dB above the 1 dB point, draw a horizontal line across the graph. We are now reconstructing Fig. 2 backwards. From the horizontal intercept line note the number of dB to the gain line at any input signal level you choose. For this same input

level plot a point twice that number of dB down from the gain line. This is the amount of 3rd order intermodulation distortion in your amplifier at the input level you have chosen. You now have one IM point on your chart and the intercept point and can now draw a straight line between these two points and complete your graph.

### Unequal Signal Levels

Almost all manufacturers of rf amplifiers now include the intercept point as part of the data on the spec sheet. As we have just seen, the intercept point is measured using two signals of equal power. Unfortunately, this is usually not the case in an actual system. One signal is likely to be from a strong nearby transmitter and the other from a source quite a distance away. When the amplitudes of the two signals are known and they are not the same power level, they can be converted to two signals of equal amplitude quite simply. In this case, take the stronger of the two signals and subtract from it one-third of the difference between the two signals. This calculation equalizes the two signals and generates the same worst case IM as the two unequal signals.<sup>3</sup> (Example: One signal is at  $-40$  dBm and another at  $-70$  dBm. The difference between the two signals is 30 dB. One-third of 30 dB is 10 dB, which when subtracted

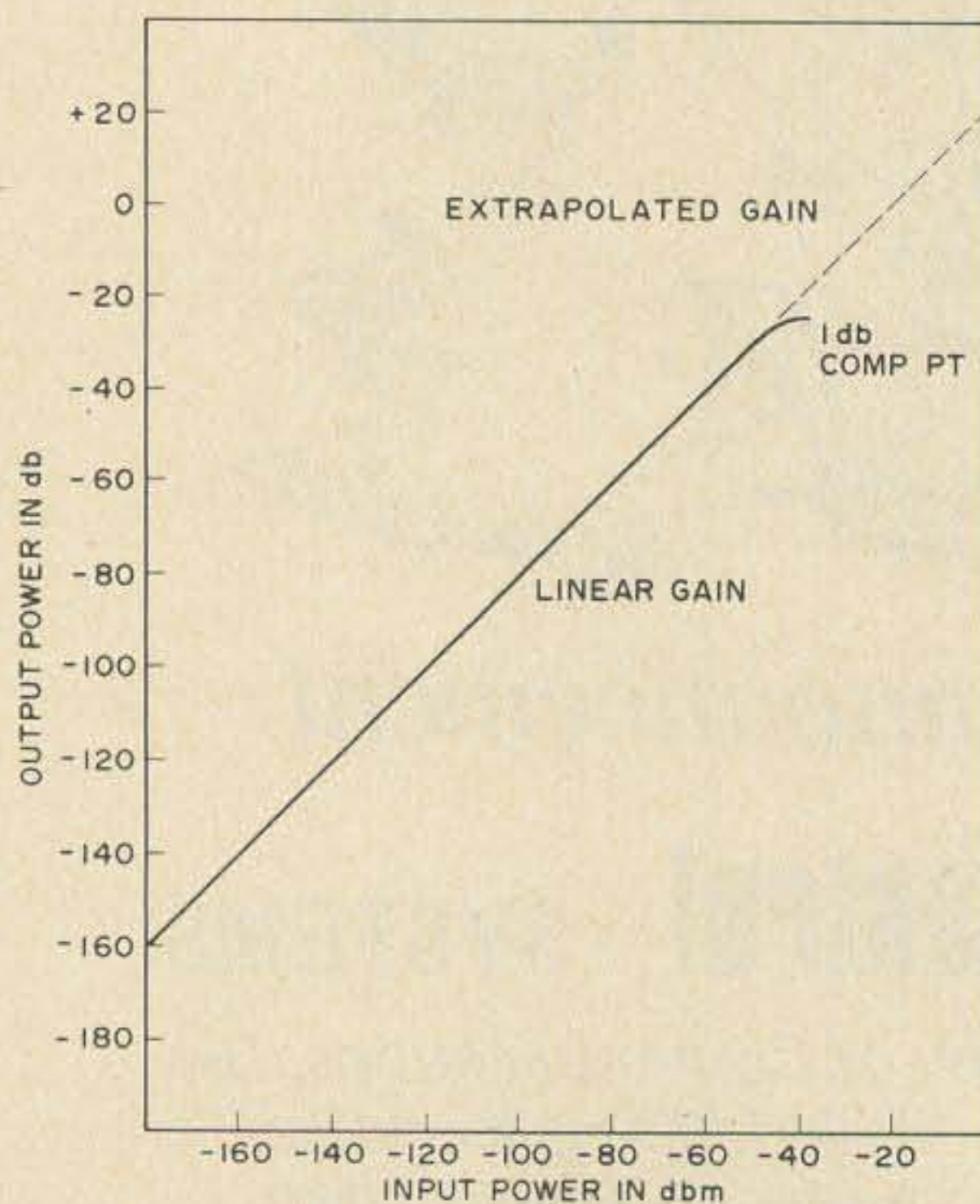

Fig. 1. Linear gain and the 1 dB compression point.

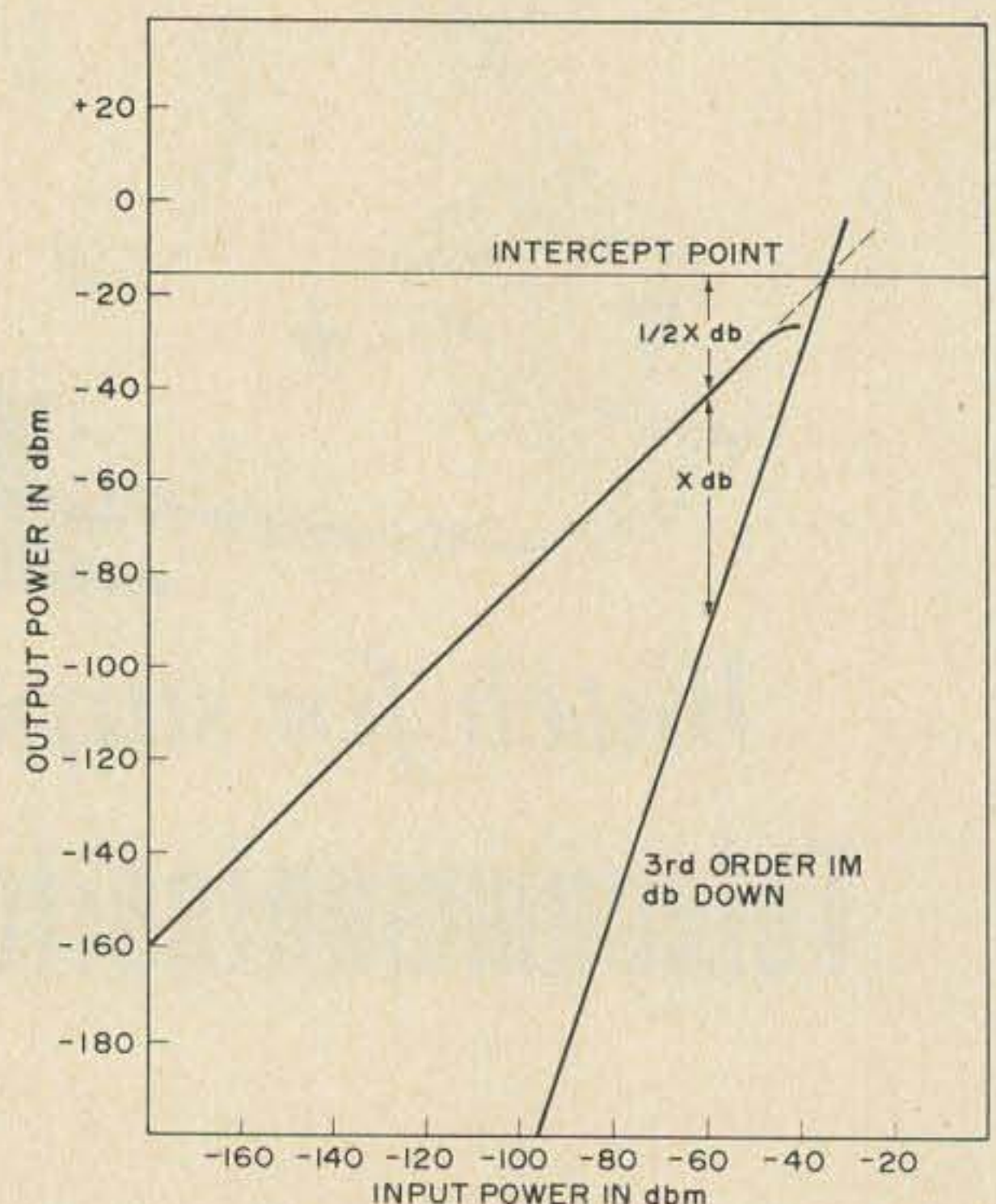

Fig. 2. 3rd order IM vs input power using the intercept point.

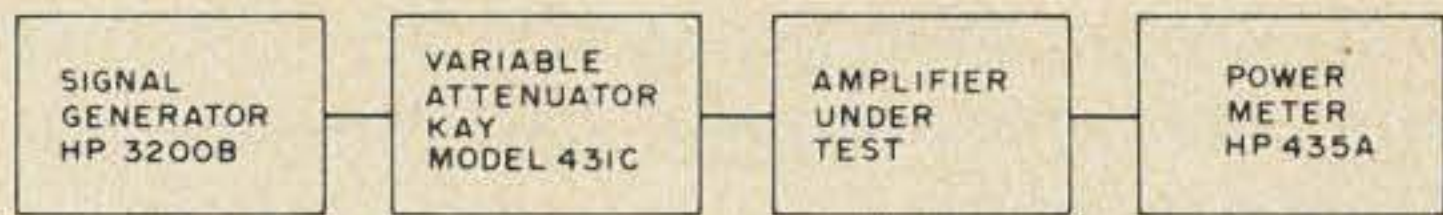

Fig. 3. Test set-up to determine amplifier 1 dB compression point.

from  $-40$  dB yields an equivalent of two equal signals of  $-50$  dB.)

### Additional Calculations

There are still many amplifier manufacturers who do not use the intercept point and simply specify the 3rd order IM as being so many dB down for a given two signal input level. When using this type of data, it is convenient to be able to convert to the intercept point quickly without resorting to the graphical analysis. Presented here are some formulas which have been derived from the graphical analysis. They may be used by themselves or as an aid in preparing a graphic presentation. The pertinent terms are the input intercept point or IIP, the output intercept point or OIP, the amplifier gain, and the third order IM for a given two signal input.

$$\text{IIP} = \frac{1}{2} \text{IM} + \text{Signal in}$$

$$\text{OIP} = \text{IIP} + \text{Amplifier Gain}$$

Combining these two equations

$$\text{OIP} = \text{Amplifier Gain} + \frac{1}{2} \text{IM} + \text{Signal in}$$

By rearranging these terms the IM can be calculated directly.

$$\text{IM} = [\text{OIP} - (\text{Amplifier Gain} + \text{Signal in})] (2)$$

Remember that the OIP is approximately 10 dB above the 1 dB compression point. Therefore if only the 1 dB compression point is given, the problem may still be solved by substituting the 1 dB compression point +10 dB for the OIP.

### Analyzing Your IM Problem

From all our observations, we can see that if IM is a problem, one or more of the transistor stages is probably operating with a low 1 dB compression point. The obvious solution is to try to make the transistors run as linearly as possible and raise the com-

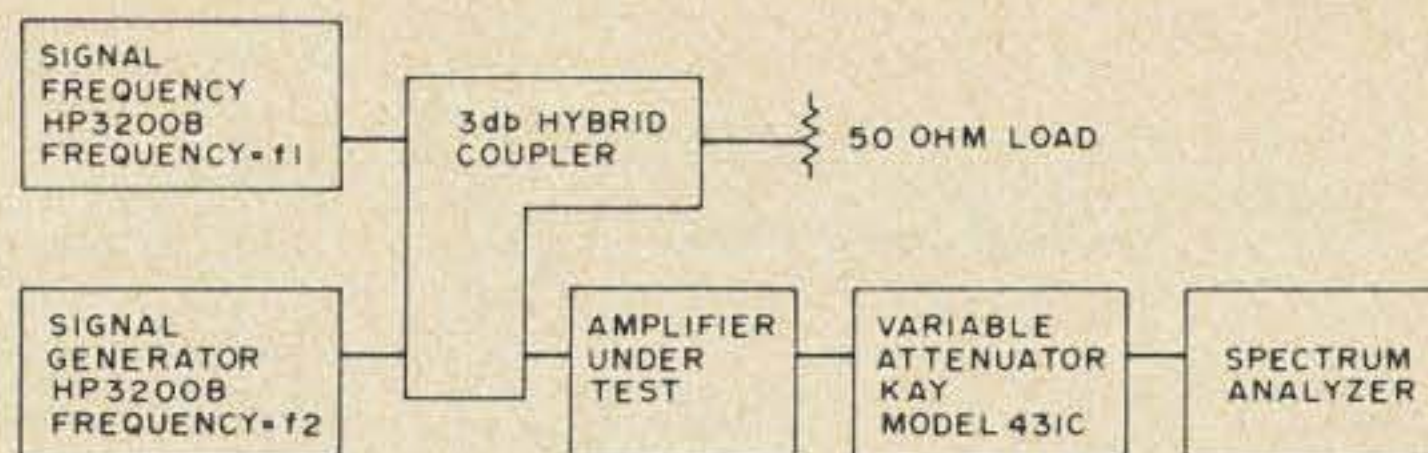

Fig. 4. Test set-up for 3rd order intermodulation distortion measurements. Note: It is very possible to overload the spectrum analyzer and generate intermodulation distortion in the analyzer itself. It is therefore a good idea to include an attenuator between the amplifier and the analyzer. Always use the lowest possible signal level to the amplifier to generate IM when making this measurement.

pression point. As I stated earlier, many transistors are biased for lowest noise figure and the resultant gain compression is accepted. If the transistor is not being operated near its maximum power dissipation, a little more collector current might do the job. Be careful not to over dissipate the transistor. A better choice would be to choose a new transistor, one which is capable of higher linear output power. Some of the new CATV devices work great, because they were designed for low IM and good noise figure.

A good project would be to collect as many data sheets as possible on devices which might be useful at your frequency of interest and compare the optimum NF and required current. Some types such as the 2N5109 are specified as 3 dB max. noise figure at 200 MHz with 10 mA.

Somewhat higher priced types (MS-175, K6001) will give 1.5 dB NF at 15 mA at 150 MHz. In a feedback amplifier, gain is 15 dB and the output compression point is over 20 milliwatts. At 2 mW out, that is, two two-milliwatt signals the in-band intermodulation product (third order product) is more than 40 dB down. Such an amplifier is still operating with good linearity when succeeding stages are overloading, and therefore, there is little point in worrying about how to further improve the first stage.<sup>4</sup>

I have quoted the above paragraph because it sums up nicely everything that I wanted to say and includes a fine problem. All the information needed to complete a graph of the IM plot is present. The gain at 15 dB for our gain line and the 1 dB compression at 20 mW or +13 dB out. If we again assume the intercept point line to be approximately 10 dB above our 1 dB com-

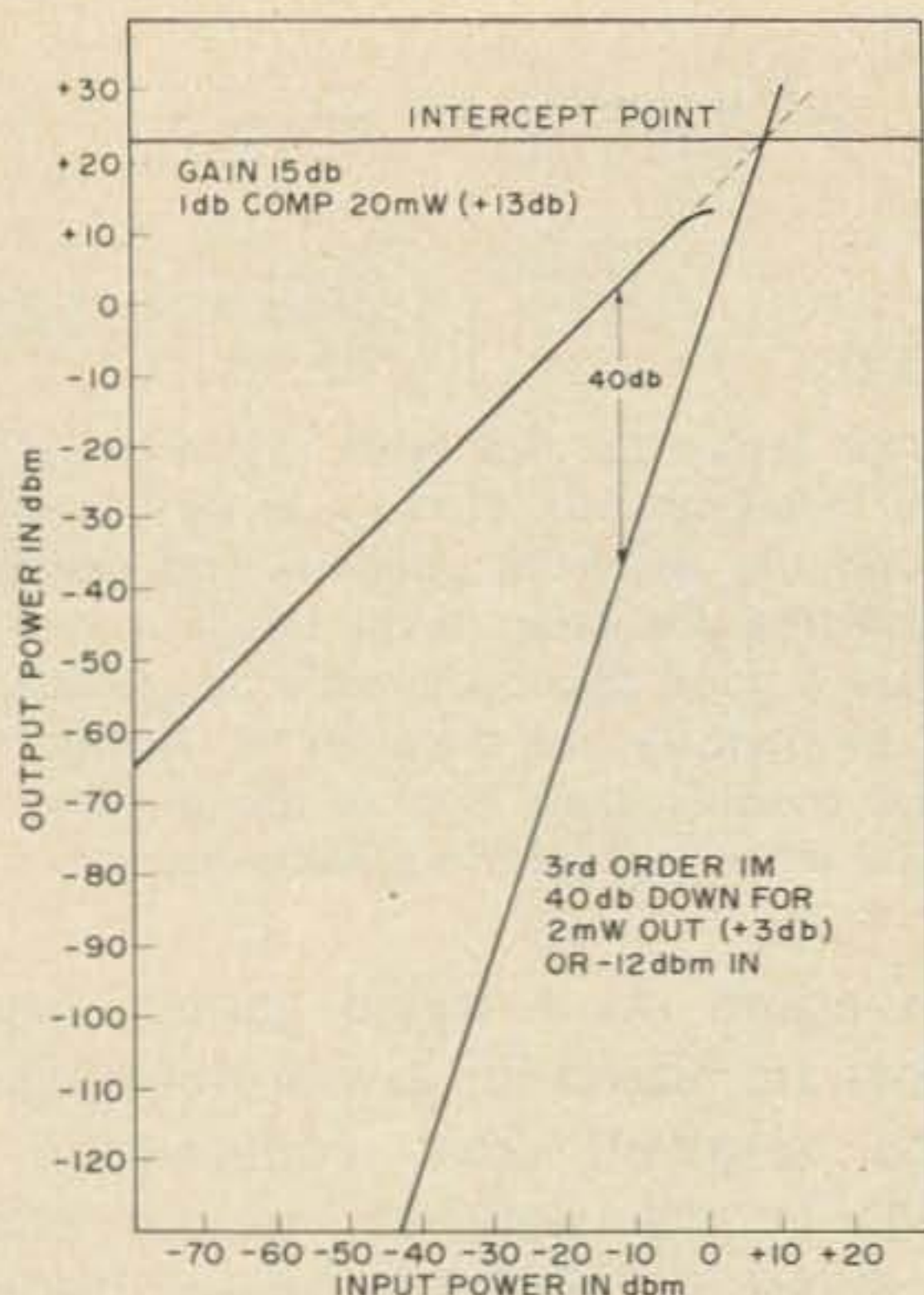

Fig. 5. Solution to IM problem given in text. Note: This graph has been plotted using the information quoted in the text. The only assumption made was that the intercept point was 10 dB above the 1 dB compression point. The graph shows that the amplifier has an output intercept point of +23 dBm or an input intercept point of +8 dBm.

pression point, we can plot a graph of third order IM products and see that the results agree favorably with the IM statement given at an output level of 2 mW or +3 dB. When analyzing this problem remember that the IM statement given was for an output level of 2 mW or +3 dB. So as not to confuse things, it might be easier to work with an input level of -12 dBm, which is the input level required to give an output of +3 dB in an amplifier with 15 dB of gain.

### Comparing Two Amplifiers

With the formulas derived from the graphical analysis we can now compare amplifier performance. The amplifiers of Figs. 2 and 5 can now be compared quickly since both have been characterized by the intercept point. The input level I have chosen is for a signal level of -73 dBm or 50 microvolts. In the old day of AM this represented an S9 signal and I suppose it is as good a place as any to establish a reference input. The data we need to work with is only the amplifier gain and the intercept point. Since we have graphed both amplifiers, we can look up the IM on the graph at the -73 dBm input point or we can

solve the problem mathematically, assuming that the manufacturer has provided the intercept point.

Fig. 2.  
AMPLIFIER SPECIFICATIONS  
Gain = 20 dB  
OIP = -15 dBm

Fig. 5.  
AMPLIFIER SPECIFICATIONS  
Gain = 15 dB  
OIP = +23 dBm

*Problem:* Calculate 3rd order IM at input level of -73 dBm.

*Solution:*

Fig. 2.  

$$IM = [OIP - (Gain + Signal\ in)] (2)$$

$$= [(-15) - (20) + (-73)] (2)$$

$$IM = 76\text{ dB down}$$

Fig. 5.  

$$IM = [OIP - (Gain + Signal\ in)] (2)$$

$$= [(+23) - (15) + (-73)] (2)$$

$$IM = 162\text{ dB down}$$

(Note: Fig. 5 must be expanded to read this IM value.)

There is no contest in this case and the amplifier of Fig. 5 wins easily.

Assuming that your receiver is ideal and generates no IM, let's see what happens when the preamplifier of Fig. 2 is placed ahead of the receiver. First, the two input signals of -73 dBm are amplified by 20 dB, which is the gain of the amplifier. The signals at the output of the amplifier are now -53 dBm, which is applied to the receiver input. In addition, the IM generated in the amplifier is 76 dB below our -53 dBm output signals or at a signal level of -129 dBm. This would be a very marginal amplifier since most good receivers can begin to hear at -129 dBm or .08 uV. Remember, we are analyzing this system at a 50 uV input level so signals of 20 dB over S9 could easily cause problems. The fact that we have added 20 dB of gain to our system will probably cause IM to be generated further on down the receiver. These solutions can therefore be carried through a receiver right through the i-f stages. If you do decide to improve the intermod don't get carried

away. It usually takes two people to solve these problems — one to do the actual work and another to tell him when to stop.

### Conclusion

The same procedures can be used to accurately predict other orders of IM and are dealt with in the references.

Even if you decide not to dig into your receiver (a very wise move) and try to lower its IM, I hope that this article will help you next time you compare amplifier specifications.

When writing to amplifier manufacturers for data, ask them to specify the intercept point. You can then graphically analyze the amplifier and pick the one which suits you best. Remember, an amplifier with a lower noise figure will not make operating any easier if it adds IM to your system.

### References

1. Milbury, Donald L., W6YAN, "Technological Locusts that Plague the Age of Repeaters", *73 Magazine*, April 1971, page 20.
- 2,3. McVay, Franz C., "Don't Guess the Spurious Lever", *Electronic Design* 3, February 1967, page 70.
4. Cross, Hank, W1OOP, "Solving Overload Problems with VHF Converters", *Ham Radio*, January 1973, page 53.

### Bibliography

Gadwa, T. A., W2JO, "Computerized Search for Receiver Birdies", *QST*, February 1974, page 28.

Gonsior, Marv, W6VFR, "Intermodulation-Distortion Measurements on SSB Transmitters", *Ham Radio*, September 1974, page 34.

Karpen, E. W., and Mohr, R. J., "Graphing Spurious Responses in Microwave Receivers", *Microwaves*, November 1966, page 42.

Meade, Edward, Jr., K1AGB, "Using the Double Balanced Mixer in VHF Converters", *QST*, March 1975, page 12.

Moore, Ray, "Some Design Ideas for Specialized Communications Receivers", *Ham Radio*, June 1974, page 12.

Reid, J. R., "Spurious Free Dynamic Range in Wide Band, High-Sensitivity Amplifiers", *Microwave Journal*, September 1965, pages 26-32.

Steiner, J. W., "An Analysis of Radio Frequency Interference Due to Mixer Intermodulation Products", *IEEE Transactions on Electromagnetic Compatibility*, January 1964, pages 62-68.

Sutherland, Robert, W6UOV, and Orr, William, W6SAI, "Rating Tubes for Linear Amplifier Service", *Ham Radio*, March 1971, page 50.

... WA2OKZ

## THE BEST WAY TO MONITOR RADIO CHANNELS WITHOUT LISTENING

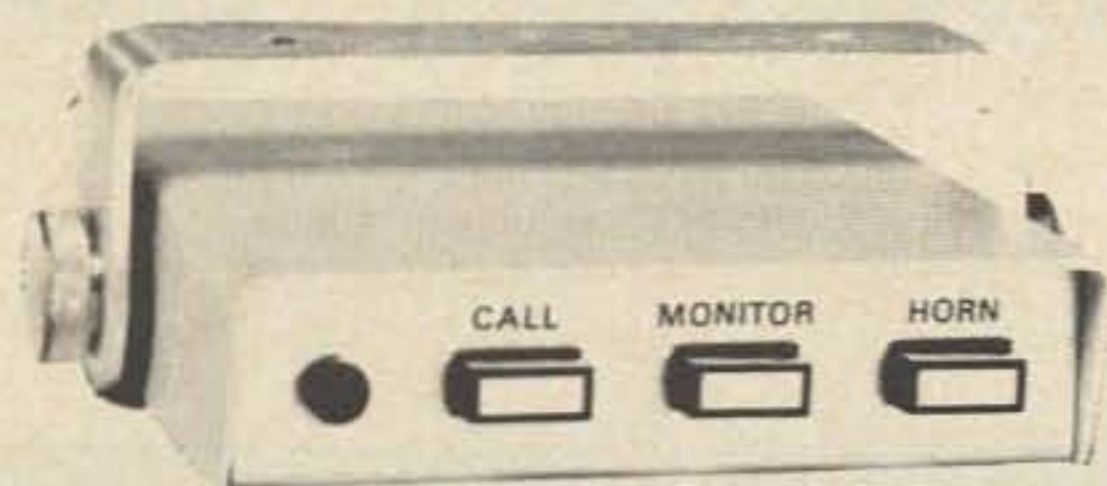

TOUCH-TONE® DECODER  
\$75.00

### LOWEST PRICE EVER OFFERED FOR A QUALITY TOUCH-TONE DECODER

MAYNARD ELECTRONICS recently purchased the entire stock of discontinued models of PLL TOUCH-TONE DECODERS from a major commercial manufacturer. Our agreement stipulates that the sale of these units will be limited to the amateur radio market. Because the sale price is below the manufacturers cost, it is necessary to limit sales to five units per ham to prevent commercial speculation.

### FEATURES:

- \* Virtually immune to falsing by voice, CTCSS tones, music and noise
- \* Includes a CALL LIGHT and BUZZER
- \* Output for vehicle HORN connection
- \* Relay UNMUTES SPEAKER when call is received
- \* Field programmable for UP TO EIGHT DIGIT code sequence
- \* May be used for MOBILE or FIXED
- \* Designed for 12 VOLT DC Pos. or Neg. operation
- \* DIMENSIONS: 1 1/4 X 4 3/4 X 5 15/16 inches

Units are brand new. Complete satisfaction is guaranteed. If for any reason you are not completely satisfied, just return the undamaged unit within ten days for refund.

Model 2000B Touch-Tone Decoder and Manual \$75.00

Mating Cable. Multi-Conductor Cable with Molex Connector \$10.00

Please enclose check or money order for the total amount plus \$5.00 for shipping and handling. A \$10.00 deposit is required on C.O.D. shipments. F.O.B. Belmont.

Include your name, shipping address, zip code and ham callsign. CA residents add 6% sales tax

**MAYNARD electronics co.**

P.O. BOX 363, DEPT B

PHONE

BELMONT, CALIF. 94002

(415) 592-1553

# IF YOU HAVE ALREADY GONE 450 ♦ ♦ ♦ ♦

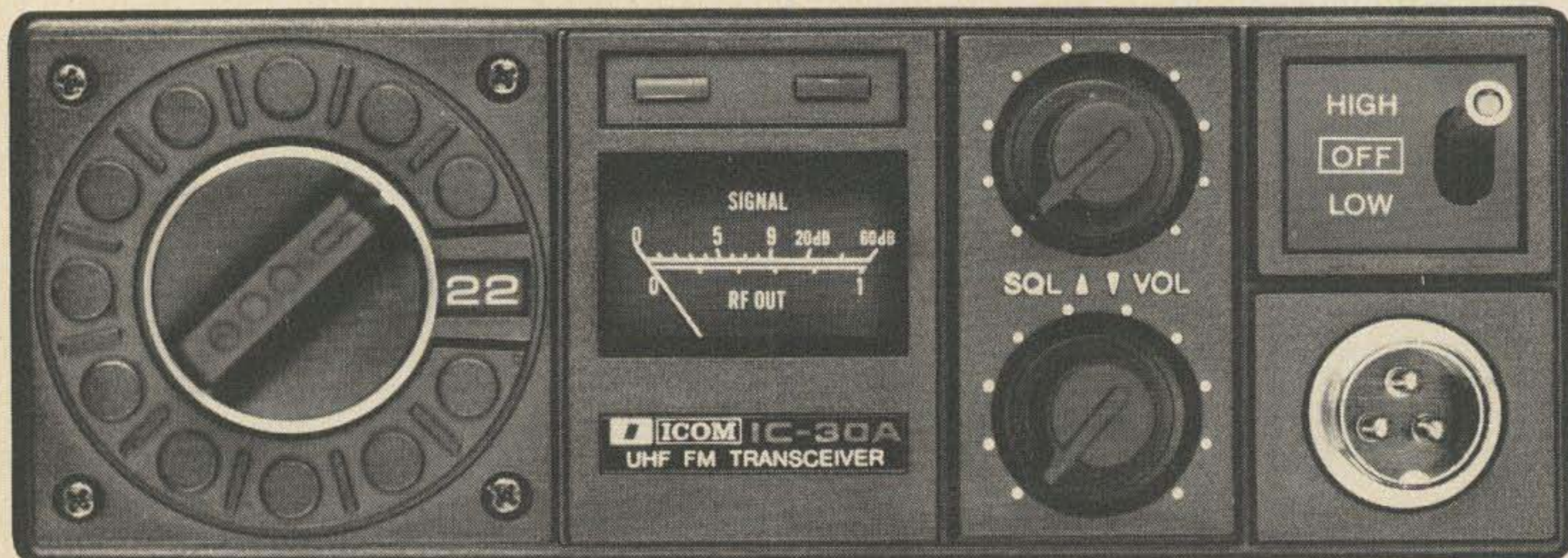

## GO ICOM 30A ♦ ♦ ♦ ♦ before you go bananas!

If you have been trying to resurrect something from the pre-transistor past that more closely resembles the mechanism used to keep large ships in place, or if the sound of bumble bees is keeping you awake at night--REJOICE!!! The ICOM 30A is here and working!

Consider these reasons for owning an IC-30A:

- (1) Despite the fact that the radio is completely solid state, it has output of ten watts.
- (2) Receiver sensitivity is better than 0.6UV for 20 db of quieting and that means easy on the ears listening.
- (3) The IC-30A comes with five channels of the 22 channel capacity installed.
- (4) Shielding is excellent because the unit is modularly constructed.
- (5) Your car tires will last long because the IC-30A weighs less than ten pounds.
- (6) Like its predecessors, the unit is equipped with a 9 pin plug in the side of the radio to provide you easy access to the discriminator and room for adding the necessary wiring for external accessories — with all this and more, for only \$399.00.

SEE ONE !! BUY ONE !! AT YOUR ICOM DEALER TODAY

Distributed by:



# ICOM

ICOM WEST, INC.  
Suite 3  
13256 Northrup Way  
Bellevue WA 98005

ICOM EAST, INC.  
Suite 307  
3331 Towerwood Drive  
Dallas TX 75234



# Feedline Primer

**N**o matter how carefully we try to arrange our station, it's next to impossible to put the antenna and the transmitter in the same place. As luck would have it, antennas must be high off the ground, and clear of surrounding objects that might dampen their power, while the transmitter is usually put indoors where it's convenient to use. The solution to this problem is to use a "transmission line" which is designed to carry the radio-frequency power from one particular place to another.

Ideally, a transmission line should be able to transport power over any distance without letting any escape, but at radio frequencies a wire acts quite differently than it does at the 60 Hz power-line frequency, and it's this difference that makes transmission line more lossy and complex than ordinary wire.

The difference is related to the fact that at 60 Hz a wavelength of wire is on the order of 3100 miles, so that a 100 mile length of line is only an insignificant 1/31st of a wavelength, but at 30 MHz (10 meters) a 100 foot feedline is nearly 3 wavelengths long. Consequently, as discussed later, very different things can be happening at various points along the line. Because of this, the line can begin to lose power, which means that less power will reach the antenna than should.

Before we start, though, it might be a good idea to describe what the ideal line would be like. The ideal "infinite line," as it's called, consists of two perfect conductors placed side-by-side and extending on into infinity. At any one time, the polarity of the current in the first conductor is exactly opposite that in the second conductor. In other words, the two currents are 180 degrees out of phase. As a result, if any radio-frequency energy is lost by one of the conductors, it will be opposite to that lost by the other conductor, and the two fields will cancel each other out. To cancel completely, both losses must be equal in amplitude (the same strength) which would only happen if the two wires occupied *exactly* the same spot in space. Since this cannot take place, there will always be some loss from any line. However, these losses will be negligible so long as the two conductors are spaced at less than 1/100th wavelength.

## Characteristic Impedance

In our infinite line, the characteristic impedance, sometimes called "surge impedance," is roughly equal to the square root of the ratio between line inductance and capacitance:

$$Z = \sqrt{L/C}$$

The inductance, while small, is due to the fact that the wire sets up a magnetic field

around itself, which in turn induces a current back on the wire that is opposite in direction to the existing current flow. This results in cancellation, the total effect being that of inductance. The capacitance is due to the separation of the two conductors (which act like the two plates of a capacitor), by some type of dielectric such as air, or plastic insulation.

The capacitance, inductance and impedance of a particular line will depend upon the distance between conductors, and their size. The larger the conductors and the closer their spacing, the lower the inductance and the greater the capacitance, and vice versa. A high impedance line will have small conductors widely spaced, while a low impedance line will have large conductors closely spaced. In the infinite line, this impedance is purely resistive, but in a real line there will be some reactive component due to inductive and capacitive effects. It might be noted that characteristic impedance determines the amount of rf current

that can flow for any given voltage. Consequently, as the impedance decreases, a higher current will flow for any given power level.

### The Practical "Matched" Line

The practical line (one that can really be built) will only try to act like an infinite line if it is terminated by a pure resistance equal to the line's characteristic impedance. If this condition is satisfied, then the line is said to be "matched." In other words, the line acts just like an infinite line delivering all its power to a load (the resistance). In practice, the load would be the antenna, which would radiate all the power presented to it. Consequently, to the radio wave the load only looks like a continuation of the line because it has the same resistance as the line does. In addition, under matched conditions the line's actual impedance (that which can be measured, and is really there) will be equal to its characteristic impedance (that which should be there). As we will soon see, this is

**Table A**

Attenuation in dB/100 Feet

Type	3.5 MHz	7 MHz	14 MHz	21 MHz	28 MHz	50 MHz	144 MHz
RG-58/U	.78	1.1	1.7	2.2	2.5	3.5	6.3
RG-8/U	.30	.45	.66	.83	.98	1.35	2.5
RG-59/U	.60	.90	1.3	1.6	1.9	2.7	4.8
RG-11/U	.35	.55	.80	.98	1.15	1.5	2.3
Twin-Lead	.19	.28	.41	.52	.60	.85	1.5
Open-Wire	.03	.05	.07	.08	.1	.13	.25

**Table B**

Type	Impedance	Velocity Factor	30 MHz Power Rating
RG-8/U	52	.66	1700 Watts
RG-58/U	53.5	.66	430 Watts
RG-11/U	75	.66	1400 Watts
RG-59/U	73	.66	680 Watts
RG-17/U	52	.66	5600 Watts
Twin-Lead	300	.82	-----
Open-Wire	-----	.95	-----

*Fig. 1. In Table A, attenuation figures may vary from manufacturer to manufacturer. In Table B, the open-wire line impedance will vary depending upon conductor spacing. Wattage capacities of parallel conductor line will depend upon wire size and conductor spacing, there being no "standard" size open-wire line, but many differently built types.*

**Additional Loss Due To swr  
(In dB)**

	swr								
	1.5	2.0	3.0	4.0	5.0	7.0	10	15	20
.2	*	*	.13	.22	.30	.48	.7	1.2	1.5
.3	*	*	.18	.3	.42	.63	1.0	1.6	2.0
.4	*	.1	.23	.38	.54	.85	1.25	1.9	2.5
.5	*	.13	.27	.47	.65	1.0	1.5	2.3	3.0
.6	*	.14	.32	.54	.75	1.2	1.75	2.6	3.3
.7	*	.15	.36	.6	.85	1.3	2.0	2.8	3.6
.8	*	.18	.4	.69	.95	1.5	2.2	3.0	3.9
.9	*	.19	.45	.75	1.1	1.6	2.3	3.3	4.0
1.0	*	.2	.5	.82	1.2	1.7	2.5	3.5	4.3
1.5	*	.26	.67	1.2	1.5	2.2	3.0	4.3	5.1
2.0	.1	.3	.8	1.3	1.8	2.5	3.5	4.8	5.8
2.5	.13	.35	.9	1.5	1.9	2.8	3.8	5.1	6.0
3.0	.14	.39	1.0	1.55	2.0	3.0	4.0	5.3	6.5
4.0	.15	.41	1.05	1.7	2.3	3.3	4.3	5.8	6.8
5.0	.16	.45	1.1	1.75	2.4	3.4	4.5	6.0	7.0
6.0	.17	.48	1.15	1.8	2.5	3.5	4.6	6.2	7.2
7.0	.18	.49	1.2	1.8	2.5	3.5	4.8	6.4	7.4
8.0	.18	.5	1.2	1.8	2.5	3.6	4.9	6.5	7.4
9.0	.19	.5	1.25	1.9	2.5	3.7	4.9	6.5	7.5
10.0	.19	.5	1.25	1.9	2.5	3.7	4.9	6.5	7.5

\*Additional loss is less than .1 dB.

Fig. 2. Find the loss for your cable from Fig. 1, and then locate the nearest dB figure in the left column of this table. Follow that line to the right until you reach the proper vertical column for the swr you have. At this point is the additional loss figure.

not always the case, especially when the line is mismatched.

### Standing Waves On A Mismatched Line

As pointed out above, if the line is terminated in a load having the same resistance as the line's characteristic impedance, just about all power is delivered to the termination. But suppose that the load is a different value? In this case, some of the power is reflected backward down the line. This may be visualized by picturing water flowing through a six inch pipe which represents the line. If the pipe is coupled through a reducer to a three inch pipe (representing the load), pressure would be higher in the three inch pipe than in the six. As a result, water would flow backwards at the junction as the pressure tries to equalize. Because of this, both *forward* going and *reflected* power will be present along the line. In some places this power will cancel, while in others it will reinforce, thus causing peaks and valleys (referred to as antinodes and nodes) in the voltage and current distribution. The actual voltage or current at any

one point will be equal to the sum of the forward and reflected voltages, or currents, found at that point. Consequently, as you move along the line, if the voltage could be measured, you would find that readings would vary up and down at equal distances coinciding with the maximums and minimums resulting from the sum of the two opposite currents. In a perfectly matched line, the voltage and current will be constant along the line's length because there is only one current traveling through the transmission line, so there is nothing for it to reinforce with.

Since the peak voltage found on a line is related to the severity of the mismatch, the ratio of maximum to minimum voltage is used as an indication of how well the transmission line is matched to the load. Current may also be used in this manner. This is called the "standing wave ratio" and it may be expressed either as  $swr = V_{max}/V_{min}$  or  $swr = I_{max}/I_{min}$ . In a perfectly matched condition, the maximum voltage or current will be equal to the minimum, so the ratio is equal to 1. This is

the "ideal" condition that most hams shoot for, but an swr of anywhere from 1.05 to 1.5 is often considered to be hard enough to obtain, and certainly good enough for most people.

Swr may also be expressed as a quotient between the impedance of the load, and the impedance of the line with the numerator of the fraction being the larger of the two numbers ( $swr = Z_O/Z_R$ , or  $swr = Z_R/Z_O$ .  $Z_O$  = characteristic impedance,  $Z_R$  = load impedance). Because the largest number is customarily put on top, the swr can never be less than one.

Since it is easier to measure than either impedance, capacitance or inductance, swr is used more commonly in determining just how well lines are matched. In the average shack, a reflectometer is used to measure the forward and reverse voltages on the line. From these voltages the swr is then calculated by using the equation  $swr = (V_O + V_R)/(V_O - V_R)$ , in which  $V_O$  = forward voltage, and  $V_R$  = reverse voltage. Notice that the sum of  $V_O$  and  $V_R$  will be the maximum voltage that can appear anywhere on the line, and  $V_O - V_R$  will be the minimum voltage, so we are back to our original equation,  $swr = V_{max}/V_{min}$ . Lest this look like an awful mess to tackle each time you want to find out what your swr is, most reflectometers (swr bridges) have a calibrated swr scale to eliminate the nuisance of repeated calculations.

### Input Impedance of Mismatched Lines

As mentioned earlier, the impedance of a line that is perfectly matched to the load is equal to the characteristic impedance of the line. Consequently, a transmitter operating into the line's "input" side would see an input impedance equal to the characteristic impedance. On the other hand, if standing waves are present, the input impedance may vary considerably from the expected characteristic impedance value.

The reason for this variance is the fact that the voltage and current phase relationship found at the input side of the line can change when an swr is present. This will create an impedance that is very different from the characteristic impedance of the line. Remember that impedance is equal to

the ratio of voltage to current ( $Z=E/I$ ) so the input impedance will change in step with whatever voltage and current there is at the input point. Since voltage is not in phase with the current, the voltage to current ratio at different points along a wavelength of line will vary. Correspondingly, since the voltage and current waveform repeats itself at intervals of one-half wavelength, the values of impedance will do the same. It may now be seen that the input impedance of a mismatched line will be very different depending upon how far the input is from the load. If the swr and line length are such that a low voltage and a high current appear at the input, then the input impedance will be lower than the characteristic impedance. High voltage and low current will result in an input impedance higher than the characteristic impedance.

In addition to causing a variation in input impedance, swr also causes it to contain reactance. This effect is present regardless of whether the load is purely resistive or reactive. The presence of a reactive component is due to the out-of-phase relationship between voltage and current caused by swr. If voltage lags current, then the reactance is capacitive; if current lags voltage, it is inductive, just as if a capacitor or inductor were connected across the line. The only exceptions to this effect are at the nodes, where the voltage and current are in phase. At these points, which appear at one-quarter wavelength intervals, the impedance is purely resistive.

### Resonant Lines

Many transmitters are capable of operating into a variety of resistive impedances,

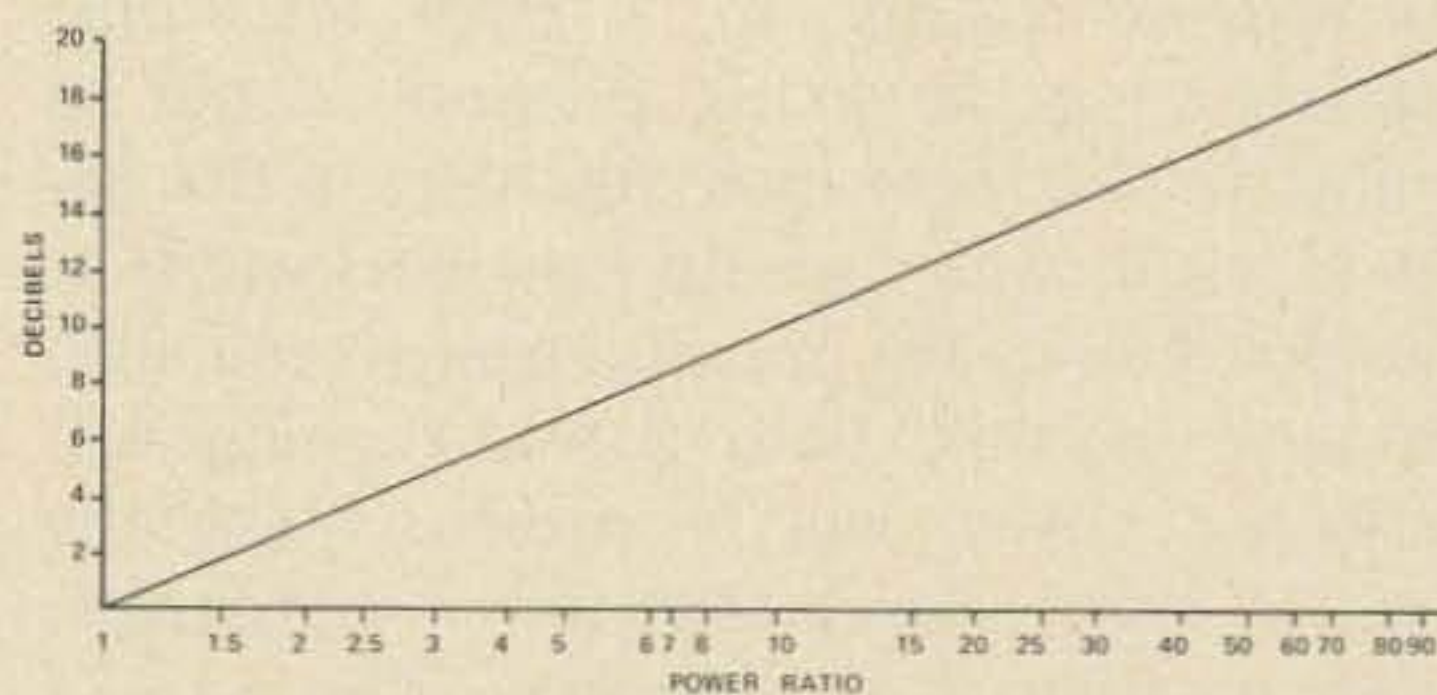

Fig. 3. Chart used to convert decibels to a power ratio. For instance, 7 dB represents a ratio of 5 to 1.

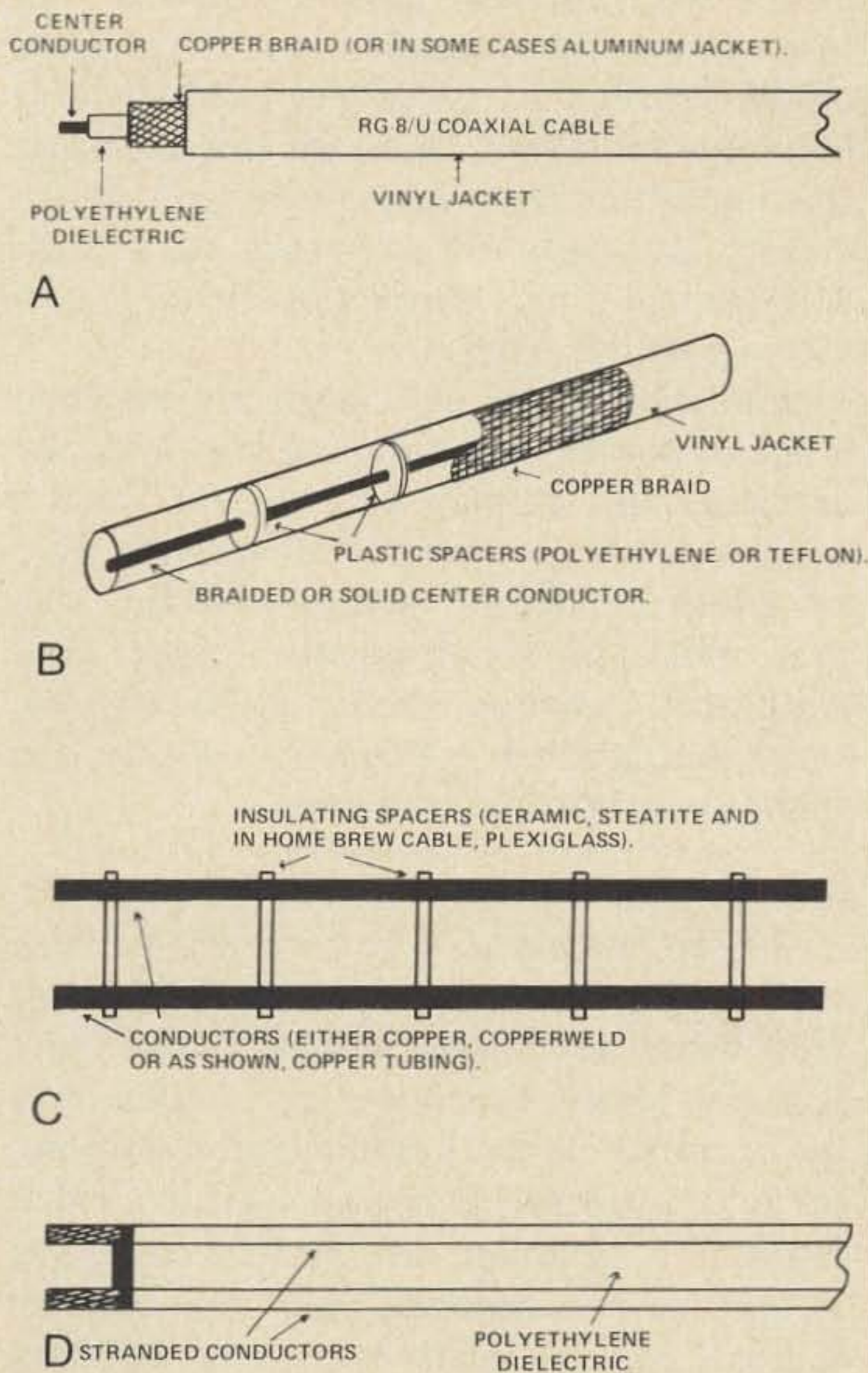

Fig. 4. Four examples of transmission line often used by amateurs.

but they cannot tolerate reactance. Consequently, it is possible to load up into a mismatched line only so long as the input is at one of the nodes. When a feedline is cut to benefit from this situation the line is said to be "resonant" or "tuned." A line with a low swr, and a fairly uniform impedance that falls close to the characteristic impedance regardless of line length, is called "nonresonant" or "flat."

A flat line is usually considered to be one having an swr of 2:1 (i.e., 2.0 or 2 to 1) or less, and can be as long as necessary. When the swr rises above 3 to 1, the line falls into the "resonant" category, because it can only be used efficiently if its length is adjusted so that the input is at a node.

As a rule, the lower the swr the better, so a "flat" line is generally the objective. In most cases, a resonant line is resorted to only if there is a bad mismatch between the

## FM YOUR GONSET

(or your Clegg 22'er, Poly Comm 2, PC 62, Johnson 6N2, Aerotron 500, Ameco TX 62 or VHF 1)

- New! Plug-in modulator puts the Communicator transmitter on FM.
- No modification or rewiring on your Communicator. Just plug into mike jack and crystal socket.
- Compact self-contained modulator measures 4" x 3" x 1½".



- Works with Communicator I, II, III, IV and GC-105, and other rigs listed.
- FM at a tenth the cost of a new rig.
- Frequency adjust for netting built in.
- \$37.50 postpaid USA & Canada. Specify transmitter model. Calif. residents add sales tax. (HC-6/U crystal and 9 volt transistor battery not supplied.)
- Send for free descriptive brochure.

## PALOMAR ENGINEERS

BOX 455, ESCONDIDO, CA 92025

## 18" FACSIMILE RECORDERS FOR SALE

The leading manufacturer of 18" FACSIMILE WEATHER CHART RECORDERS is now updating an existing network to solid state equipment. This updating is making available a number of 18" weather map recorders ideally suited for anyone interested in experimenting with facsimile.

These recorders, with suitable receiver and FSK converter, can be used to monitor radio weather chart broadcasts as well as press wire photo transmissions. With some modifications data from weather satellites can also be received.

These recorders are priced from \$50 to \$200 and are available on a first come first served basis.

Call or write Mr. Armand D. Bouchard

**Alden Electronics & Impulse  
Recording Equipment Co. Inc.**

Washington Street, Westboro MA 01581  
617-366-8851

line and the load, and neither can be adjusted to straighten everything out.

### Velocity Factor

In the common types of available transmission line, polyethylene insulation is used between the two parallel conductors. The plastic is used both to separate the conductors, and to keep them at a fixed distance from each other. However, the use of this insulation has two drawbacks: It causes power loss, and it reduces the speed at which power may pass through the line because electromagnetic fields travel more slowly through solid materials than through free space. This means that for the same frequency, the wavelength in a transmission line is shorter than it would be in air. In other words, the wave doesn't travel quite as far during one cycle because it has been slowed down.

Throughout this article, when reference has been made to a "wavelength" of line, it is the so-called "electrical" wavelength that has been meant. To convert from physical to electrical length, the "velocity factor" must be used. The velocity factor is the ratio of wave velocity within the line to wave velocity in free space. The equivalent physical length of a wavelength of line may be calculated by using the equation: length in feet =  $(984V)/F$ ,  $F$  = frequency in megahertz, and  $V$  = velocity factor.

The velocity factors for several popular types of cable are given in Fig. 1, Table B.

### Transmission Line Losses

Coming back to the perfectly matched transmission line, there are three major ways in which power may be lost: by  $I^2R$  losses in the wire (heating of conductors), by heating of the insulation (dielectric heating), and by radiation.

To a small extent, heating of the conductors is due to the inherent resistance of the wire. These are usually referred to as  $I^2R$  losses because they follow the power formula  $P = I^2R$ . Major heating is caused by the conductors' inductive reactance. Unlike resistance, the reactance increases with frequency, so that losses become quite considerable at high frequencies. Conductor

losses also increase as the characteristic impedance decreases, because higher currents may flow for a given voltage in a low impedance line. Dielectric losses are just the opposite: They increase as voltage increases, so greater loss occurs on a high impedance line. Dielectric losses also increase with frequency.

Radiation losses, in a perfectly matched line, are due to stray coupling of rf from the antenna. This rf may be phased in such a manner as to cancel part of the existing wave on either conductor, and it is in this way that much of the loss takes place. Any additional radiation loss is caused by the small uncancelled leakage caused by the slight separation of conductors.

### Swr And Line Losses

As swr increases, it is normally assumed that line losses become severe, and efficiency falls below acceptable values. As we have seen previously, tuned or resonant lines may be operated under mismatched conditions. In fact, a low swr is not necessarily all that important. Whether swr related losses are serious or not depends upon the inherent line loss under perfectly matched conditions. If the original line is air-insulated, for instance, the inherent loss is low because of the absence of a lossy dielectric, so the swr related loss is also small. However, if the line has polyethylene insulation, there is a much greater dielectric loss, hence a high swr related loss. Since dielectric and conductor losses increase with frequency, so will the losses due to swr. Consequently, an acceptable swr at 14 MHz may well be unacceptable at 28 MHz, because of increased inherent loss. For this reason, low loss air-insulated transmission line is often used to feed a multiband antenna, which has a wide variety of swr values across different bands, so that swr related losses will be nearly as insignificant on 10 meters as on 80, no matter what happens to the swr.

When computing total line losses, take the inherent loss for the cable you are using from Fig. 1, Table B, and *add* it to the swr caused loss from Fig. 2. Accuracies in Fig. 2 are  $\pm .05$  dB for losses less than 1 dB and  $\pm .5$  dB for loss values greater than 1 dB. Remember that the inherent loss is shown in

dB per 100 feet, so the dB figure must be corrected for the length of cable you are using. For example, if you were using 50 feet of line, you would multiply the appropriate dB value by 1/2, for a 75 foot piece you would multiply by 3/4, and so on. Fig. 3 may be used to convert the dB figure into an actual power ratio.

In addition to increasing line losses, swr also affects the power handling capabilities of a transmission line. All lines will have a voltage limitation imposed by the voltage breakdown, or arc voltage for air-dielectric lines, between the two parallel conductors. The current limitation is dependent upon conductor diameter and metallic composition, and the melting or ignition point of any insulation that is used. The amount of power that can be safely handled when an swr is present is inversely proportional to the standing wave ratio (reduced power handling capacity = original capacity/swr). In other words, if the line was originally able to handle 1000 Watts, an swr of 5 to 1 will reduce this capability to 200 Watts.

### Coaxial Cable

Several types of transmission lines fall into the coaxial cable group, but by far the most common is the solid dielectric type. In this form, as seen in Fig. 4, at A, a solid or stranded center conductor is surrounded by polyethylene insulation. A shield of braided copper follows, forming the second conductor, and a waterproof vinyl protective cover encircles the braid. For low power handling capabilities, the center conductor is usually #18 copper, single conductor.

Copperweld, comprising of a steel inner wire bonded to an outer coating of copper, is used to increase strength in the center conductor. However, both hard and soft-drawn copper (though more easily broken), are 7 times more conductive than steel. The only reason that copperweld can be used effectively is that at radio frequencies inductance in the wire's center will tend to force the rf into the outer copper layer, where resistance is lower. It is for this reason that cable used at high frequencies, where efficiency must be at a maximum, often has silver plated conductors. Silver is about 6%

## POWER SUPPLY KITS

**\$ 18.95 POSTPAID**

IC Regulated Short Proof Supplies

- I.  $\pm 15$  V at 50ma and +5 or +12 at 100ma
- II. +5V at 1amp Heavy Duty Heat Sink
- III. +12V at  $\frac{3}{4}$ amp Included

All parts including Printed Circuit and Transformer. You supply line cord, switch & case.

**SEND TODAY**

Designed by  SPACE TIME PRODUCTIONS

Box 2527

Carbondale, Ill. 62901

Mfg. by

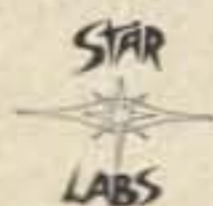

## CASHARROONIE

Money! You can get top dollars now for U.S. surplus electronics, particularly Collins. Write or call now for your bigger than ever quote. Space Electronics Co., div. of Military Electronics Corp., 35 Ruta Court, S. Hackensack, N.J. 07606 (201) 440-8787.



200 MHz freq. counter kit

Range 60 cycles to 200 MHz. Sensitivity less than 100 MV. 50 ohm 8 digit LED readout boards, all parts and case. Complete kit - Bezel sockets etc. \$140.00 All TTL logic.

Send for 24 page catalog. Encl. 25¢ for postage & handling.

*Open Wednesday Nights 'til 11 PM*

**ELECTRONIC SUPERMART, INC.**

219 West Sunrise Highway,

Freeport, LI, NY 11520,

516-623-3346-9



more conductive than copper, which may not seem very impressive, but every little bit counts when dielectric and reactive losses approach 2 dB/100 feet, such as one might find at 432 MHz.

In cables intended for use at high powers (1000 Watts and above), a stranded center conductor is used instead of a solid copper, or copperweld conductor. Unfortunately, the spiraling of the stranding creates a spiraling of the rf, resulting in a longer rf path. Also, there is a higher center conductor resistance because of the contact resistance between each strand and its neighbor. This resistance contributes to a higher total attenuation in this type of cable.

As mentioned before, solid polyethylene, with a dielectric constant of 2.3, is the insulation used in most coaxial cable. The ideal cable would be an inner conductor suspended exactly in the middle of the outside conductor, with air as the only dielectric. In this case, the dielectric constant would be that of air (1.0) which is the "ultimate" (except for a vacuum) and provides the lowest attenuation. This is impossible in practice, because supporting material must be used to maintain proper spacing between conductors. Therefore, a compromise can be made between the high constant of polyethylene and the low constant of air. In some cables a foamed polyethylene dielectric having countless encapsulated air bubbles is used, resulting in a dielectric constant of 1.5 or thereabouts. With such cables, attenuation figures at 100 MHz are at least 1.5 dB better than regular cable, and even greater at higher frequencies.

Another method of lowering the dielectric constant is shown in Fig. 4, at B. During production, the areas between each spacer are filled with air so that a high percentage of the dielectric is of a low loss nature. Since this type of cable must be pressurized as it is extruded, it is more costly to manufacture and not frequently used in amateur applications. Another disadvantage is the fact that cables of this nature are not very flexible. Also, in the areas between spacers, the distances between conductors can vary, causing different impedances to be present. All of these small mismatches can

Table of Coax Data

RG #	Imp.	Cap.	Max. Volts
5B/U	50	29.5	3000
8/U	50	29.5	5000
8A/U	52	29.5	5000
9/U	50	30.0	5000
9B/U	50	30.0	5000
11/U	75	20.5	5000
11A/U	75	20.5	5000
14A/U	52	29.5	7000
17A	52	29.5	11000
22/U	95	-----	-----
54A/U	58	-----	-----
55B/U	53.5	28.5	1900
58/U	53.5	28.5	1900
58A/U	50	29.5	1900
58C/U	50	29.5	1900
59/U	73	21.0	2300
59A/U	75	20.5	2300
59B/U	75	20.5	2300
62/U	93	13.5	750
62A/U	93	13.5	750
63B/U	125	10.0	1000
71/U	95	13.5	750
71A/U	95	13.5	750
71B/U	125	13.5	-----
79B/U	125	10.0	1000
108A	78	20.0	1000
141/U	50	29.0	1900
174/U	50	30.0	1500
178/U	50	29.0	1000
179B/U	75	19.9	1200
187/U	75	19.3	1200
187A/U	75	19.5	1200
188/U	50	29.0	1200
188A/U	50	29.0	1200
195/U	95	15.2	1500
196A/U	50	29.0	1000
212/U	50	29.5	3000
213/U	50	30.5	3000
214/U	50	30.5	3000
215/U	50	30.5	3000
217/U	50	29.5	7000
223/U	50	30.0	1900

Fig. 5. These figures may vary slightly from manufacturer to manufacturer.

add an swr of as much as 4 to 1 at some frequencies.

In most cable the shield is made up of many fine wires braided into a tube that surrounds the insulation. Since there are a large number of individual wires, there is a considerable total contact resistance. Also, the shield is not 100% efficient, because rf can leak out through small chinks between each wire. Cable is available that replaces the braid with a seamless aluminum shield having much better shielding characteristics.



With this type of transmission line, radiation is eliminated and isolation figures approaching 100 dB may be achieved. The shield also serves as a protective jacket, and as such, weight is reduced 1/2 pound per 100 feet over conventional cable.

Most flexible coaxial cables use vinyl as the jacket material. As polyvinylchloride is brittle, plasticizers are added to make a more flexible material. Under exposure to heat and sunlight, these plasticizers tend to leach out, or migrate through the braid and into the polyethylene dielectric. This migration results in an increase in dielectric constant with an abrupt increase in attenuation, and with the leaving of the plasticizers, the vinyl becomes brittle and cracked. This allows moisture to enter the cable and causes the dielectric constant to deteriorate even more. At this point, which may take anywhere from five to ten years, the cable must be replaced. Much of the cable now available uses resinous plasticizers that will not migrate, resulting in a cable having a lifetime well in excess of 10 years.

Another type of jacket material called Xelon does not contain plasticizers at all, so life expectancies of over 25 years may be realized. Xelon jackets also allow direct burial and submersion in water for those really exotic antenna systems.

Solid dielectric coax is available in impedances ranging from 50 to 75 Ohms. Other impedances are available, but they do not match the feedpoint resistance of the antenna systems that are in common use by hams, so they are to be avoided in most cases. Unfortunately, it is this "mongrel" cable that's often sold "cheap" by surplus houses.

#### Parallel Conductor Lines

There are two major types of parallel conductor lines: Open-wire line shown in Fig. 4, at C, and twin-lead shown at D. Open-wire line is constructed of either #12 or #14 copper (or copperweld), separated at intervals by spacers. In commercially made lines, these spacers range from 1 to 6 inches long and are made of ceramic, porcelain, or steatite. The shorter spacers are used at high frequencies to prevent incomplete cancellation. The characteristic impedance of most

#### BUILD YOUR OWN TV CAMERA!

*Ideal for home & business*



THE ECONOMICAL APPROACH TO AMATEUR TELECASTING, BUSINESS & INDUSTRIAL SURVEILLANCE, ITV, GENERAL HOME MONITORING OF NURSERIES, ETC. MODEL XT-1A, SERIES D - KIT FORM \$185; FACTORY ASSEMBLED \$275. SOLID-STATE. CONNECTS TO ANY TV SET WITHOUT MODIFICATION. OPTIONAL SOUND KIT \$28.95. PHONE OR WRITE FOR ILLUSTRATED CATALOG...DIAL 402-987-3771 TODAY.

1301 N. BROADWAY **ATV Research** DAKOTA CITY, NEBR. 68731

#### SST T-1 RANDOM WIRE ANTENNA TUNER



All band operation (80-10 meters) with most any random length wire. 200 watt power capability. Ideal for portable or home operation. A must for Field Day. Size: 2 x 4 1/4 x 2-3/8. Built-in neon tune-up indicator. Guaranteed for 90 days.

COMPACT - EASY TO USE.

... only **\$24.95**

POSTPAID. (ADD SALES TAX IN CALIF.)

SST Electronics, P.O. Box 1, Lawndale CA 90260

#### PRINTED CIRCUIT

MATTE FILM; ARTWORK TAPE;  
1X DIP AND DOUGHNUT RUB-OFF  
TRANSFERS; CARBIDE BITS

**TRUMBULL**

833 BALRA DR., EL CERRITO, CA. 94530

#### WORLD QSL BUREAU

5200 Panama Ave., Richmond CA USA 94804

THE ONLY QSL BUREAU to handle all of your QSLs to anywhere; next door, the next state, the next county, the whole world. Just bundle them up (please arrange alphabetically) and send them to us with payment of 6¢ each.

## CATALOG

GOVERNMENT SURPLUS  
ELECTRONIC EQUIPMENT

# For 1975

**FREE** UPON REQUEST! Write for  
Copy of Catalog WS-75 Now!

Address: Attention Dept. 73

**FAIR RADIO SALES**

1016 E. EUREKA • Box 1105 • LIMA, OHIO • 45802

## Keyer Module



**\$40**

This new, low-cost, two-ounce keyer module has full squeeze or normal operation, yet draws less than one ma., key down! Attach a 9v transistor battery and forget it! Has dot, dash and space memories. Use with any key lever and 4 to 15 vdc source. Write or call for brochure. (303)794-7234. Dealer inquiries invited.

**CONTROL SIGNAL CO** 5964 W. COLUMBIA PLACE  
DENVER, COLORADO 80227

open-wire line is on the order of 400-600 Ohms, depending upon wire size and spacing.

Although the absence of a lossy dielectric, except at the insulators, allows this line to have lower attenuation than coax, there is a fly in the ointment. The problem stems from the fact that open-wire line must be balanced. In other words, the current in one conductor must be exactly out of phase with, but the same amplitude as, its neighbor in the other conductor, if full cancellation is to take place. These conditions are not as important in the "unbalanced" coaxial cable where one conductor is completely surrounded by the other. Because of this, open-wire line must be kept away from metal objects that might couple to one conductor more than the other, causing imbalance. For this reason, open-wire line should run for a quarter wavelength at right angles to the antenna it is feeding. Don't let this influence your choice of a type of feeder. Open-wire line can be operated at much higher standing wave ratios than coax, an advantage that may prove to out-weigh quite a number of disadvantages.

Several types of television type lines are made that can be used in ham applications. The first is called "ladder line," and is a close-spaced (1/2 to 1 inch) version of open-wire line. The second type is twin-lead. Twin-lead is more lossy than ladder line, but it still has a considerable edge over coax. It is also very flexible, being only a thin, small ribbon, and is inexpensive due to its simplicity.

### Characteristic Impedance

At this point, on the chance you may have occasion to use it, a quick mention should be made of how to calculate the characteristic impedance of various types of transmission line.

The impedance of air dielectric coax is given by the equation  $Z_0 = 138 \log_{10} (D/d)$ ,  $D$ = inner diameter of shield, and  $d$ = wire diameter. The impedance of solid dielectric coax is given by the equation:

$$Z_0 = (138/\sqrt{K}) \log_{10} (D/d),$$

where both  $D$  and  $d$  are the same as above, and  $K$  = the dielectric constant of the

material between conductors. Finally, the characteristic impedance of air-insulated parallel conductor line is given by the formula  $Z_0 = 276 \log_{10} (b/a)$ , where  $b$  = the center-to-center distance between conductors, and  $a$  = the conductor radius. In all of the above, the measurements may be in any convenient unit, so long as all measurements are in the same unit, with the exception of  $K$ , of course.

### Choosing A Transmission Line

Important factors involved in choosing a transmission line include antenna impedance, operating frequency, feedline length and where the cable will be used.

Fig. 5 gives the pertinent characteristics of about 40 types of cable found on the new and surplus market. Although this table doesn't cover the entire RG series, it should prove helpful in finding out the impedance of military and other surplus cables. If low cost is important, surplus should be strongly considered, though it would be good to keep in mind that military surplus may have been stored for a long time. In this respect, surplus cable might be a bit less flexible than new cable, but all-in-all surplus is in good shape.

When choosing your transmission line, the first consideration is the feedpoint impedance of your antenna. Today, commercial antennas have been standardized to either 50 or 75 Ohms. For 50 Ohms RG-8/U (or RG-8A/U) is used for high power (over 400 Watts) purposes. For low power applications, particularly below 30 MHz, either RG-58/U or RG-58A/U are used. The 75 Ohm counterpart of RG-8/U is RG-11/U and the counterpart of RG-58U is RG-59/U.

As a point of reference as to what transmission line to use, dipoles have impedances ranging from 60 to 70 Ohms, so either of the above mentioned cables may be used. Verticals have impedance values of 30 Ohms, making 50 Ohm cable suitable. Folded dipoles are 300 Ohm, making TV ladder line and twin-lead a good choice. For the most part, all antennas will have some type of corresponding cable that will serve your purposes.

Above 100 MHz, either low-loss coax or

open-wire line should be used, especially if you're operating low power. Both RG-8/U and RG-11/U are acceptable, but when even lower losses are desired, coax with foamed polyethylene and seamless aluminum jacket should be put into service. Below 30 MHz, unless the feedline will be hundreds of feet long, any type of cable is adequate, including open-wire line. Long runs of coax, covering more than 200 feet, can be detrimental even at 3.5 MHz, meaning that more efficient types of coax will be necessary. Other than that, the five coaxial cables and two parallel conductor feedlines shown in Fig. 1 should hold you in good stead.

The final consideration in your choice of transmission line, and one that is not worried about very much, is jacket material. As we mentioned back under "Coaxial Cable," the average coax is good for around 10 years, at best, when used under bright sunlight or warm temperatures. If 10 years sounds long enough, then regular coax is for you, but for lifetimes approaching 15 years, coax intended for outside *rigorous* conditions should be purchased. This coax has resinous plasticizers mixed with the vinyl and is often called semi-contaminating, which may help you to identify this cable from the short descriptions given in most catalogs. If you really want to get your money's worth, coax with a Xelon jacket will provide over 25 years of service, even under conditions that would hasten the deterioration of ordinary cable. Xelon is also your best bet for long-term burial or submersion in water.

### Conclusion

Now that you probably know more than you ever wanted to about transmission lines, believe it or not, there's plenty more. But even though many facets have not been covered in this article, it is hoped that enough has been presented to allow you to choose the proper line for your installation. In any case, a knowledge of transmission lines is valuable for the FCC exams and will put you in a position where you can understand and use them whenever necessary.

... WA1SNG

## NEW! THE FINEST COMMUNICATIONS FILTER AVAILABLE

- WIDELY VARIABLE FREQUENCY AND SELECTIVITY!
- PEAK, NOTCH AND LOWPASS POSITIONS FOR SSB, CW, AM, FM & DIGITAL MODES!
- EXTREMELY STEEP SKIRTS (NOT A SIMPLE ONE-STAGE DESIGN).



AT LAST! An "infinitely-variable" filter to combat any interference in any mode — our QF-1. • One knob adjusts its frequency from 250 to 2500 Hz, in all 3 positions. Zero-in on any signal without touching your rcvr. Optimize response instantly! • Peak CW, RTTY, etc. with selectivity variable from 50 Hz to flat! • Eliminate whistles, jammers, CW, etc. with a wide, deep (to 70 dB) notch. With variable width & frequency, it really works! • Reject SSB, AM, FM, etc. hiss & splatter in the sharp-cutoff lowpass position! • 8 IC op amps plus pwr. amp. 1 Watt peak to spkr or phones. Improves even the best \$2000+ rcvrs in all modes! Vastly superior to a 400 Hz IF CW filter, or any "fixed-frequency" filter. Use with any rcvr or xcvr made. Just plug into the phone jack!

Model QF-1, "The Finest" 115 VAC, 5x4x3½", \$52.95 Model QF-2, Basic circuit-board (2¼x3¾") version for custom installation. 5 minute hookup to receiver volume control. Requires 6 to 30 VDC. Less pwr amp, etc. 10" leads to 3 controls. Instructions, \$32.95. Add \$1.50 postage/handling in U.S. Add 6% tax in CAL. Add 10% outside N. America (airmailed). 1 yr warranty.

ISN'T IT TIME YOU INVESTIGATED WHAT AN ACTIVE FILTER CAN DO FOR YOU? SEND FOR FREE "TIPS FOR SELECTING AN ACTIVE AUDIO FILTER."

**AUTEK RESEARCH**  
BOX 5390F, SANTA MONICA CA 90405

## R-X NOISE BRIDGE

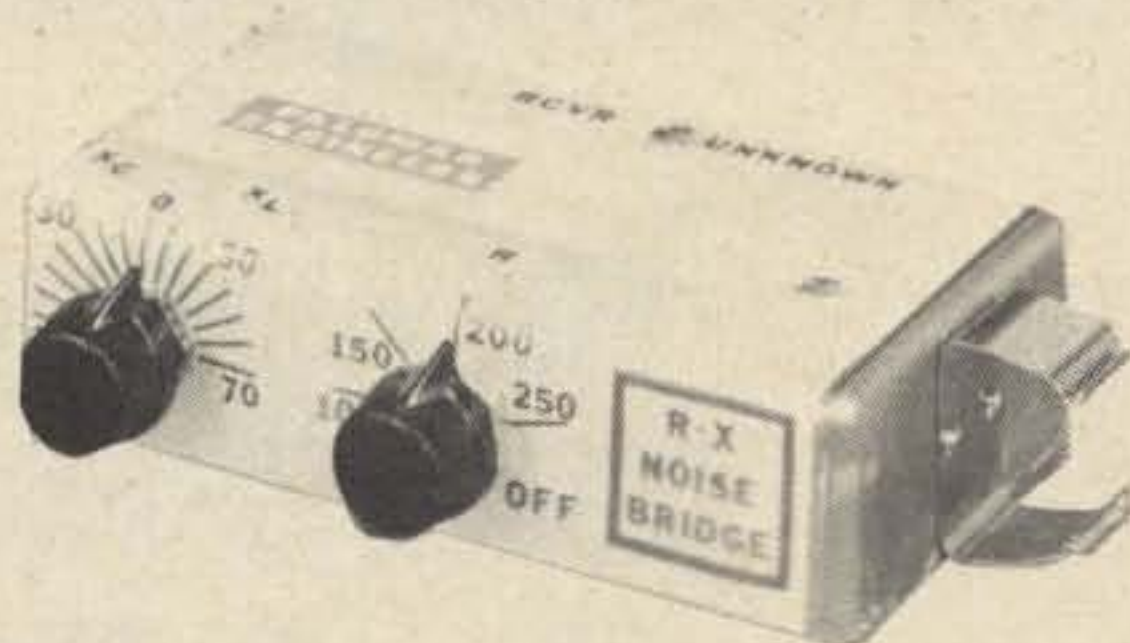

- Learn the truth about your antenna.
- Find its resonant frequency.
- Find R and X off-resonance.
- Independent R & X dials greatly simplify tuning beams, arrays.
- Compact, lightweight, battery operated.
- Simple to use. Self contained.
- Broadband 1-100 MHz.
- Free brochure on request.
- Order direct. \$39.95 PPD U.S. & Canada (add sales tax in Calif.)

**PALOMAR ENGINEERS**  
BOX 455, ESCONDIDO, CA 92025

# **Three new reasons why Heath is the leader in amateur radio.**



**New 5-Band SSB/CW  
New 2-Meter Synthesized  
New 2-Meter Hand-Held**

## NEW HW-104 5-Band SSB/CW Transceiver — the latest in broadband technology at lower cost... only 539.95

In keeping with the tradition of the famous Heathkit HW-series, the new HW-104 is the inheritor of the advanced technology of the SB-104 and the high value concept of the HW-101.

**Completely solid-state.** Frp, receiver front end to transmitter output. Cool and quiet.

**Totally broadbanded.** Instant QSY. Just choose the band, frequency and mode. Move anywhere in any band without preselector, load, or tune controls.

**Clean transmissions.** 100 watts out or 1 watt. Low harmonic and spurious radiation. At 100 watts, third order distortion is down 30 dB and carrier and unwanted sideband suppression are down 55 dB. Broadband design keeps it that way.

**Clear reception.** Broadband design minimizes cross-modulation and intermodulation so signals stand-out from a quiet background. Active devices are minimized ahead of the 4-pole crystal filter. Adjacent signal overload is minimized yet sensitivity is less than 1  $\mu$ V. Convenient 15 MHz WWV receive position on the band switch with a "pull-to-calibrate" position on the RF gain control.

**Easy-to-read circular dial.** Covers from 3.5 MHz to 29.0 MHz. The dial spinner covers about 15 MHz per turn. Built-in 100 kHz and 25 kHz calibrator insures accuracy with 2 kHz (dial markings are 5 kHz). Backlash less than 50 kHz. The VFO is the same basic circuitry as in the SB-104 with less than 100 Hz/hour drift after warmup. To cover the top end of the 10-meter band, order the HWA-104-1 accessory.

**Easy to build and align.** Phenolic plug-in circuit boards and 2 wiring harnesses. Aligns with just a dummy load, mic. and VTVM.

**Super operating, super value.** You get both in the HW-104.

Kit HW-104, 31 lbs., mailable ..... 539.95

Kit HP-1144 AC power supply, 28 lbs. ... 89.95

Kit HS-1661 Matching speaker, 5 lbs. ... 19.95

Kit HWA-104-1, Ten-meter accessory, 1 lb. .... 16.95

SBA-104-1, Noise blanker, 1 lb. .... 26.95

SBA-104-2, Mobile mount, 6 lbs. .... 36.95

SBA-104-3, 400 Hz CW crystal filter, 1 lb. 39.95

## NEW HW-2026 gets you on 2 with synthesis for 50% less... only 289.95

**True digital frequency synthesizer.** No crystals to buy, no channel limitations. Digital technology with a voltage controlled oscillator and crystal time base whose outputs are divided down and phase-detector compared. You control the divisor and therefore the frequency from the front panel lever switches.

**Lever-switched channel selection with digital readout.** Just flip the levers to any frequency in any 2 MHz segment of 144 to 147.995 MHz. 5 MHz steps open all channels to you.

**Automatic repeater offset plus built-in tone encoder.** Burst and continuous. Simplex or offset.

**10 watts minimum output;** infinite VSWR without failure. True FM for great audio, too.

**Hot receiver;** 0.5  $\mu$ V sensitivity; dual conversion; 8-pole crystal filter; linear audio; built-in speaker. Best value going in synthesized 2-M.

Kit HW-2026, 12 lbs., mailable ..... 289.95

Kit HWA-202-1, AC supply, 7 lbs. .... 32.95

## NEW HW-2021 2-M 1-watt Hand-Held with 5 receive & 10 transmit channel capability, batteries & charger for only 169.95

**One crystal does the work of two** — gives both receive and transmit frequencies. Works offset, too, so each crystal gets you one receive and two transmit channels. Buy just four crystals (not pairs); we include 146.94 MHz and — 600 kHz to get you started.

**One watt minimum output** — 0.005% stability. And frequency modulation plus built-in separate mic. for better audio.

**Optional "Auto-Patch" Encoder** accesses land-lines through repeaters with touch-tone input. 12 digit keyboard & circuit board fits HW-2021.

**Built-in Battery Saver, rechargeable Battery Pack & Battery Charger** — all included.

**Compact, rugged.** High-impact, black plastic case; glass epoxy circuit board; wt. 2 lbs. w. batteries. Not recommended for beginner kit builders due to compactness.

**It's the best value in go-anywhere 2-M rigs.**

Kit HW-2021, 5 lbs. mailable ..... 169.95

Kit HWA-2021-2, carrying case, 1 lb. .... 12.95

Kit HWA-2021-3, Auto-patch, 2 lbs. .... 39.95



## See them in the FREE Heathkit Catalog

HEATHKIT ELECTRONIC CENTERS —  
Units of Schlumberger Products Corporation  
Retail prices slightly higher.

ARIZ.: Phoenix; CALIF.: Anaheim, El Cerrito, Los Angeles, Pomona, Redwood City, San Diego (La Mesa), Woodland Hills; COLO.: Denver; CONN.: Hartford (Avon); FLA.: Miami (Hialeah), Tampa; GA.: Atlanta; ILL.: Chicago, Downers Grove; IND.: Indianapolis; KANSAS: Kansas City (Mission); KY.: Louisville; LA.: New Orleans (Kenner); MD.: Baltimore, Rockville; MASS.: Boston (Wellesley), Boston (Peabody); MICH.: Detroit; MINN.: Minneapolis (Hopkins); MO.: St. Louis (Bridgeton); NEB.: Omaha; N.J.: Fair Lawn; N.Y.: Buffalo (Amherst), New York City, Jericho (L.I.), Rochester, White Plains; OHIO: Cincinnati (Woodlawn), Cleveland, Columbus, Toledo; PA.: Philadelphia, Pittsburgh; R.I.: Providence (Warwick); TEXAS: Dallas, Houston; VA.: Norfolk (Va. Beach); WASH.: Seattle; WIS.: Milwaukee.

HEATH		
Schlumberger		
<input type="checkbox"/> Enclosed is \$_____. Please send models_____.		Heath Company Dept. 11-11 Benton Harbor, MI 49022
<input type="checkbox"/> Please send my free Heathkit Catalog.		
Name _____		
Address _____		
City _____	State _____	
Prices & specs. subject to change without notice. Mail order prices, FOB factory. AM-318		

# Horizon "2"<sub>mtr.</sub>

12 channels/25 watts for

a Merry Christmas from  
the Gang at  
**Standard**



## ASTROPOINTS

- ✓ 144-148 Mhz for Ham, CAP, & MARS
- ✓ 12 channels, 3 included
- ✓ Glass Epoxy Circuit Board
- ✓ TX and RX Trimmers
- ✓ PL option
- ✓ Tone burst option
- ✓ FCC Type accepted family for Business/Industrial & Marine
- ✓ 25 watts output (nom.)
- ✓ .4  $\mu$ V sensitivity
- ✓ 70 db selectivity
- ✓ 3 watts Audio
- ✓ Built in speaker
- ✓ Small size, 6" x 2" x 9"

**All this Horizon "2"<sub>mtr.</sub> under "3"**

Get all the specs and complete Amateur Brochure,  
write today:

 **Standard  
Communications**

P.O. Box 92151 Los Angeles, California 90009 Telephone 213/532-5300

# Caught "Spying" by the Gestapo

**A** rising banshee wail of air raid sirens suddenly drowned out the drone of voices and music in one of Munich's most famous sidewalk cafés. From around the corner came a series of Nazi squad cars filled with brown-shirted troops, led by a big, open-topped Mercedes, all screaming their tires as they headed for the Ludwigstrasse. Almost immediately the roar of low-flying aircraft descended upon us. Looking up in startled amazement, one could see bombs in great clusters coming down from the misty, overcast sky.

In a matter of seconds, the peaceful normalcy of the place was turned into chaos. Waiters dropped their trays. Amidst crashing glasses and crockery, tables and chairs were upset as people scampered for safety.

My friend Hans von Liliencron D4VAG smiled and lifted his beer glass. "Take it easy. This is a fake." As he spoke, a number of bombs came plummeting into the Maximiliansplatz, bouncing as they hit. "That Hitler fellow is a tough customer," he said. "I learned only yesterday that on his orders Goebels and Der Dicke cooked up this deal to frighten the German people into accepting his plans for rearmament. The planes are anything they could scrounge up from local airports — and this same stunt, or air raid, is being staged simultaneously in a good many of our cities."

"Who is Der Dicke?" I asked.

"Hermann Goering, of course, the fat one, who is in charge of building up the German air force again. Go out and grab one of those bombs. It'll make a good souvenir to take back to the States. They are harmless — papier-mâché, with a slight weight in the nose, so they'll come down realistically. They'd hardly knock your hat off if one happened to hit you. But hurry. We must be off."

He didn't need to tell me twice. I managed to retrieve the last fake bomb available. Other people with the same idea had rushed out and scooped up the rest of them. The bombs were remarkably real, light as a feather — but slightly weighted in the nose end and deadly looking, painted a glistening grey-black. Mine had France's tricolor stenciled with significant phony letters and numerals on its side, obviously to scare the German population into fits as to what could happen.

It seemed to me that after the first shock, people were more amused than scared. Nevertheless, it was a psychological triumph for the Nazis — because the dread of what could happen remained after the laughs.

My friend Hans von Liliencron's ham station D4VAG in Sölln, a suburb of Munich, was a renowned DX signal on 20 meters back in the early thirties. Frequent QSOs with him on CW and voice from my

old W2AMD at Catskill, New York, had now led to my meeting him personally, shortly after enrolling at the University of Munich in 1933. His family's manufacturing firm was one of the great machine tool outfits in Germany, of which he was president.

On this late November afternoon he'd told me to meet him at the Café Luitpold for a beer. We'd then head out to his villa in Sölln for cocktails, dinner and some DX contacts back to the USA. I hoped to get through to my brother, Dick, who was operating my station at Catskill, to tell him I'd be sailing for home from Cherbourg on the Cunarder Mauritania at the end of the week.

"I'll take the bomb," Hans said. "You'd have trouble handling that thing on the motorbike. We're going to be much interested this evening in hearing about your meeting with Der Fuehrer today. I've asked a few friends in."

His red and black LaSalle convertible pulled out from the curb, as I kicked the motorcycle into action and fell in behind him. A few moments later, though, I lost out as a traffic cop raised his white-gloved hand. By the time I could get going again, Hans was out of sight.

With fall mists from the Isar River rising up at about dusk, it is easy to get lost in Munich. I sure did. Besides, thoughts of the morning meeting with Adolf Hitler tended to jumble my attention. Once more the white-gloved hand of the law brought me to a halt. This time I'd gone merrily the wrong way through a one way street, with no attention to traffic signs or speed limit. It's doubtful that my two glasses of beer were not in some way involved. Fortunately, the law failed to consider this possibility.

He just ticked me off in no uncertain terms. When he'd finished getting all the data his arresting formula demanded, including the names of my parents and grandparents with their nationality, dates of birth, education and professions, plus my own, and, most particularly, the name of someone who could vouch for me — he let me proceed, after handing me my ticket. The Germans are very thorough. Of course, I named Hans as my local sponsor, it being his motorcycle.

Shortly later, I managed to find the house on the Albrecht Dürerstrasse in Sölln and chugged in to park amidst a dozen or so fancy cars. Obviously, a party was in progress, the white stucco villa gay with lights, voices and music.

The Johnson Q 20 meter antenna looked just great, hung between a chimney pot and a 70-foot pole on the back lawn. Recently, conditions had been excellent by mid-evening for QSOs with the States.

They must have been watching for me. Hans appeared immediately behind the old family butler, coming to the door with Frau von Liliencron, a famous Bavarian beauty. Except for my skiing friend, young Baron Ubi von Talphal, most of the faces were new to me. Hans raised his hand and shook a finger in the direction of the small Bavarian band that was playing on the glassed-in terrace. Their music faded to silence, as he introduced me to his friends. The hush was a bit disconcerting. We walked toward the dining room punch bowl. "I've told our guests you'd give us some details about your meeting this morning. OK?" He handed me a silver cup of the punch, which was a powerful mixture of cognac and cherry brandy, somewhat diluted with soda and fruit juices. Strawberries floating around in it gave the stuff an innocent appearance. It was strong enough to loosen the tongue on a plastic ski boot.

"Sure," I replied, "but there's not much to tell."

He put his hand on my shoulder. "Please, let's have it in English. Your German is pretty OK — but so is our English."

The punch was warming. All eyes were on me and the hush was vibrant. There was something odd about their eyes, though, particularly the women's. One of them, in a sort of reflex action accompanied by an embarrassed grin, had even reached out with a hesitant hand and touched my arm. It was as if I were the little man from outer space. Then it dawned on me — I had met their God. I'd better be careful what I said.

"It all happened rather fast," I began, "so there's not much to describe. A committee at the University selected three of us from the hundred or so foreign students to meet





"Looked like a party'd been going on! Der Fuehrer was Heil Hitlering himself in front of the big new mirror. I got the door closed without his noticing me. He'd have had me shot before breakfast." From the memoirs of Heinz Spitzlein, Hitler's personal servant during early days of The Third Reich.

the Chancellor. With me was a Norwegian girl and a South African language student.

"At 10:00 am we met at the partially completed Bavarian headquarters of the Nazi Party. At least we were told that's what the building would be. When I got there the other two students were already talking to a Reichswehr Colonel, the Fuehrer's Aide, who had interviewed us at the University. The place was practically buzzing with activity, storm troopers hurrying this way and that. Immediately inside was a large entrance hall, with a high ceiling and many supporting columns running its length. Some construction platforms and other gear indicated the building was either being repaired or was incomplete. But you must know these details."

"Not at all," said Hans. "None of us has ever been in the place. Do go on."

"Well, we were ushered by the Colonel through an extremely narrow corridor in single file, and out into a rather huge room, which was the Chancellor's office, or reception room.

"Almost a silhouette because of the big windows behind him, Mr. Hitler was studying some papers and did not look up at first. Several troopers were standing at ease along the walls, each of them watching us carefully.

"Then Mr. Hitler, I mean Der Fuehrer, got up and came around the edge of his desk. Our escort, the Colonel, then introduced us one by one, my turn being the last, as we shook his rather limp, dry hand. It was an exciting moment for us, so it's hard to remember the details."

Ubi von Talphal cut in, "What did he say to you? We'd certainly like to know that."

"Sorry. Of course. The only word I understood was 'Gruesse'. The rest of it was so fast and in his Austrian dialect that it didn't register. However, the Aide translated for us: 'The Fuehrer greets you with warm welcome and suggests that when you go home you tell your countrymen of the wonderful progress we are making — in contrast to what your rotten newspapers say about us.'"

About then the guests all started talking at once. Hans raised his hand again to quiet things. "There must be something further

you can recall? Herr Hitler's remark about the newspapers, even our own, has much truth to it, as we all know. Perhaps there was something else of significance?"

I thought for a moment. "Yes, indeed there was. His eyes. Although looking at us — his focus seemed to be way beyond, perhaps on the people who would hear of this meeting."

That seemed to please them. Hans gave the signal for the orchestra to start again, and we headed for the punch bowl. What I hadn't said, out of courtesy to my host — and it certainly would have gone over like a fox in the chicken house — was that their beloved Fuehrer smelled, smelled to high heaven. The musty, sour smell of dried perspiration surrounded him like a cloud. Reflecting his peasant background where bathrooms were few and far between, if available at all, he probably was unaware that he smelled like a pigsty and assumed that everyone else did, too. At the time, a good many of us didn't realize that his politics had a similar aroma.

One other thing I noted but did not mention: The long, narrow passageway we passed through on the way to Der Fuehrer's reception room undoubtedly was an electronic screener, an x-ray deal to detect any dangerous looking objects on visitors. These gadgets were quite new, but I'd already seen one in the Deutsches Museum in Munich.

Like everything in Hans's establishment, the buffet dinner was delightful. Shortly thereafter the rest of the guests departed and we repaired to the radio room. Twenty meters was really hot, with stations from all over Europe and Scandinavia booming in. Hans allowed that we were in luck. "Within half an hour or so the USA will be coming through. You'll find out what your own station sounds like 3,900 miles away. How about that?"

The crystal controlled phone/CW transmitter had a pair of 852s in the final, with about 400 Watts input, most of the parts imported from the States. He had several receivers: a National HRO, a British Edisto and several German jobs. The place was a ham's paradise.

In short order, we'd worked a dozen or more countries, including Morocco and the

**\* a CHRISTMAS  
PRESENT for you  
from  
VENUS**

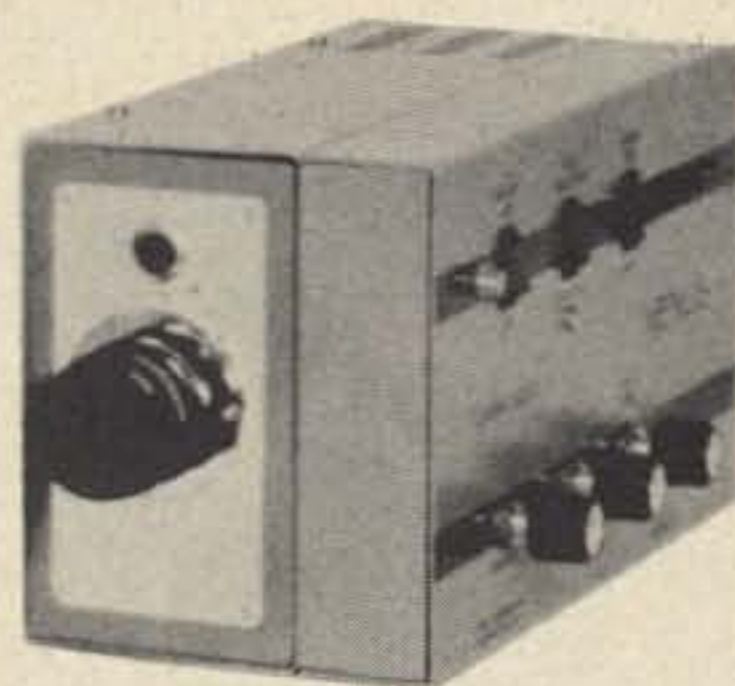
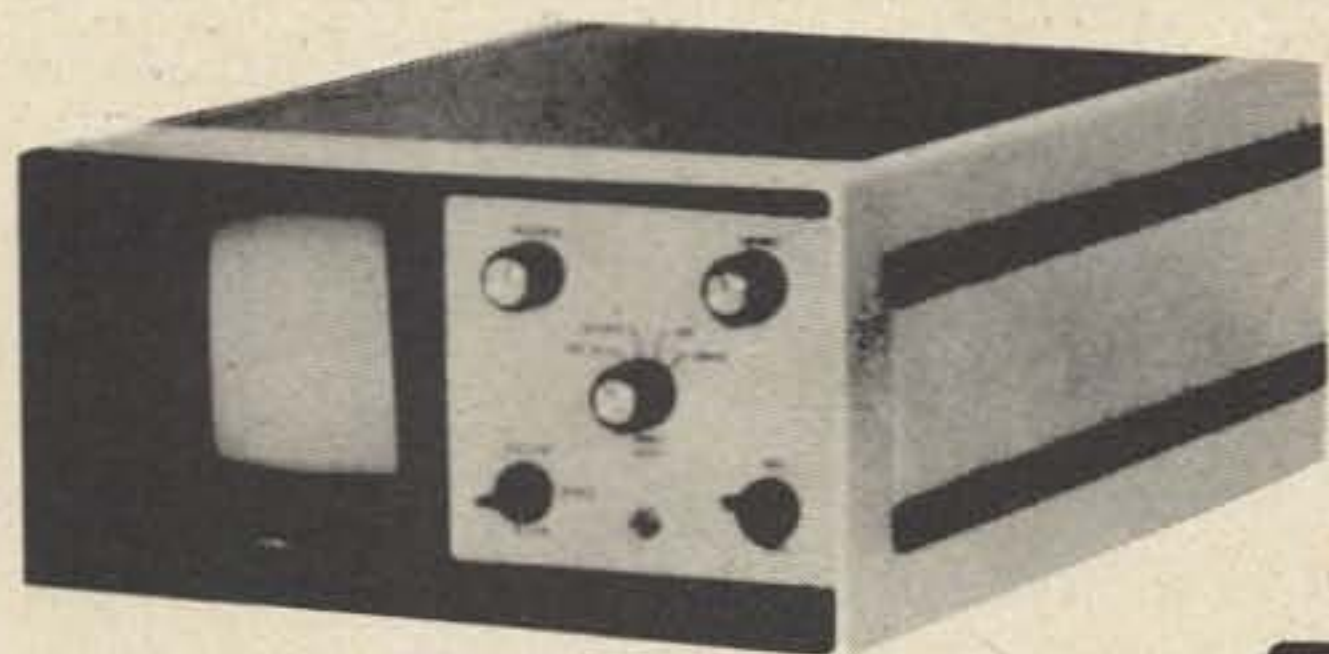

**SAVE**

WITH



**\* PRICE:**

**\* KIT:**



SS2 MONITOR STILL ONLY ~~\$349~~

XMAS SPECIAL — \$279

THE VENUS SS2 IN KIT FORM FOR ONLY ~~\$269~~ \$229

— 25 PAGE MANUAL

— TEST AND ALIGNMENT TAPE

**\* PERFORMANCE:**

ACCUSYNC<sup>TM</sup> OSCILLOSCOPE DISPLAY OF SSTV SIGNAL  
FAST SCAN/SLO SCAN CAMERA

— USE CAMERA WITH YOUR HOME TV SET

— FOCUS ON POSTAGE STAMP

**\* COMPLETE LINE:**

● SS2 MONITOR ~~\$349~~ \$279

● SS2K MONITOR KIT ~~\$269~~ \$229

● C1 FAST/SLO SCAN CAMERA ~~\$469~~ \$369

● P1 POLAROID<sup>TM</sup> CAMERA ADAPTER \$34.50

● V1 VIEWING HOOD \$14.50

● T1 TRIPOD \$24.95

**\* LOCAL DISTRIBUTORS:**

VENUS SSTV AVAILABLE FACTORY DIRECT OR FROM  
ONE OF THE FOLLOWING AUTHORIZED DISTRIBUTORS:

Aerocom LTD  
Rua Henrique Martins 204  
Manaus, Brazil

Argon Electronics  
Miami Springs, Fla.

CFP Enterprises  
Lansing, N.Y.

Harrison Electronics  
Farmingdale, N.Y.

A-G Co., Inc.  
Imperial, Pa.

A and W Electronics  
Medford, Mass.

Electronic Distributors  
Muskegon, Michigan

Henry Radio  
Los Angeles, Calif.

Amateur Electronics Supply  
Milwaukee, Wisc.  
Cleveland, Ohio  
Orlando, Fla.

Barry Electronics  
New York, N.Y.

Goldstein's  
Pensacola, Fla.

Hobby Industry  
Council Bluffs, Iowa

**Venus Scientific Inc.**

*The company that put high voltage on the moon, now brings you expanding amateur radio technology*

399 Smith Street  
Farmingdale, N.Y. 11735  
Phone 516-293-4100  
TWX 510-224-6492

**\* THIS OFFER GOOD FROM NOV. 1 THRU DEC. 31 '75.**

Azores. At the scheduled time, sure enough, there was W2AMD calling us with a good strong CW signal. I passed the word along to brother Dick about my reservation on the Mauritania, which would be sailing for New York two days later.

We were in the midst of the QSO when the butler came in with word of an urgent telephone call for Hans. There'd been an automobile smash-up involving a close friend down near Starnberg, some 20 miles to the southwest. "Not too bad," Hans said a few minutes later, "but I probably won't be back until the wee small hours. Carry on and have fun with the rig. I'm sure you can find your way back to Munich under the full moon."

He should have shooed me out of the place at that point. Definitely.

A series of swell QSOs followed, several out to the West Coast of the USA, some South Americans — and then the band closed off in that direction. Suddenly I heard some Russian stations, either just tuning up or calling CQ. Oh boy, I'd never worked a Russian up to that point.

RA-2ZL, giving his location as Moscow, exchanged reports with a guy in Stockholm. Then he called CQ and came right back to my answer. We not only exchanged reports and locations but I gave him my name, local and home address. I wanted to get at least one Russian QSL card. I did the same thing with several other Russians before closing down about midnight and heading back to town.

Early the next morning my landlady banged on my bedroom door. Her face was white as a sheet. "There are two men here from the Secret Police to see you — the Gestapo," she managed to say, a trembling hand over her mouth. I was dressed and ready to head for the University. Must be something to do with my motorcycle arrest, I thought.

My callers were in the new black uniform of the Schutzstaffel, or personal bodyguard of the Fuehrer, which had been adopted by Himmler's goons. They were solemn, tough looking troopers. Raising the Hitler flapping-arm salute, the senior of the two requested my identification card, which I gave him. "Please, you will come with us,"

he said. His German was a lot more understandable than the noises his big boss had made the day before.

There was no question about compliance. I would obey — or else they'd take me with them anyhow. Machine pistols in dull black holsters were very much in evidence on their belts. The car was a trim looking black BMW, ornamented with the Nazi swastika and a black and white Maltese cross. A sinister chariot.

As we got in, I asked, "What's this all about? Would you gentlemen please tell me why going through a one way street incorrectly warrants all this attention?"

A faint smile from the hulking older Nazi, our driver, indicated that my reference to "gentlemen" had touched him. He'd probably never been referred to that way before. But he remained silent as we roared down the Ludwigstrasse.

At Gestapo Headquarters in a ratty looking building near the Rathaus (town hall), my escorts hustled me into the presence of their officer-in-charge, a sleazy looking, black-uniformed character with very bright eyes and dirty fingernails. After a few moments of hushed conversation with them, he turned his attention to me. "You don't think much of our laws here in Germany, do you?" Before I could come up with an answer to that one, he lifted some papers from his desk and continued, "What's this about your ignoring a one way street? Perhaps we should change all the rules to suit your fancy?"

My big mouth. "Well," I offered, "I just wasn't paying attention, didn't notice the sign. I apologized for the error to your police officer who told me there'd be a small fine."

"That is correct," he snapped. "But that is not why you are here. Do you realize there are serious penalties for spying?" He raised his eyebrows and stared at me coldly.

"Spying?" I could hardly believe my ears. A thin, icy chill raced up and down my spine. This guy was not fooling. Thoughts of dungeons and firing squads flashed to mind. I was alone, a foreigner.

"Yes, spying," he said. "The Third Reich is going to deal harshly with anyone who gets in our way. Now tell me, just what

transpired last night in your talks over the wireless with those Russian communists?"

So that was it! I suddenly remembered I'd heard something about Nazi decrees as to what countries were taboo, but it hadn't made much impression. Hans had not mentioned it, probably assuming I knew the regulations. In any event, I must make sure he didn't get in trouble.

The Nazi seemed to read my mind. "Your friend Herr von Liliencron is an important Bavarian, but we take no chances. He was in Starnberg last night checking on an automobile accident while you were operating his wireless. He is not involved in this in any way, except allowing you to use his equipment unsupervised. Please answer my question. What did you tell those miserable communists?"

"Nothing," I said. "We merely exchanged reports as to how loud our respective signals were, and I gave my name and home address to several Russian stations."

"We know all that. You also sent a lot of signals that began with the letter 'Q'. In these we are interested. Do you deny this is a code, an international code?"

"Of course it's a code, a means of exchanging information from one language to another in short order."

"Precisely what we wanted to know!" His eyes narrowed and he pointed an accusing finger at me. "So you were giving the communists quick information in a code?"

"That is true — but not in the way you infer. Perfectly innocent stuff. I don't speak any Russian and those guys didn't speak any English."

"That remains to be seen. We are going to put you under house arrest until this entire matter is investigated. It's almost certain you amateur radio nuts are going to be closed down before long. You mess up our programs on the Deutscherundfunk and we've decided to really fix you."

Apparently the monitoring outfit hadn't tuned in on us when I was talking to W2AMD. Otherwise these birds would know I was about to beat it out of their Third Reich. The guy was a fanatic, a BCL, who was out to get my scalp. And at the moment there was nothing to be said in their book in my defense. Just then, with no warning, the

door onto the Marianplatz burst open and in strode the Reichswehr Colonel, Aide to Der Fuehrer, followed by Der Fuehrer himself. They whirled by our little group, our BCL Gestapo official and his pals at stiff attention with their right arms up in rigid obeisance to the Chief. "Heil Hitler!" they shouted.

Fortunately, the Fuehrer's Aide, before disappearing with his boss down the corridor, did a double take when he saw me. More loud "Heil Hitler's" in the background indicated that some kind of big time conference of the brass was about to commence.

My inquisitor was squaring away for more nasty questions as he shuffled papers that obviously were the monitoring notes on my radio transmissions.

Suddenly the Colonel came pounding back down the corridor. He greeted me with a curt nod and touched the visor of his cap. "What the devil is going on here?" he demanded of the Gestapo officer.

Hurriedly the latter explained deferentially, almost humbly, the nature of my evil activities. It seemed that he had no desire to tangle with a high official on Hitler's staff. The Colonel listened carefully but impatiently and thumbed over the monitoring notes. "Does Herr von Liliencron know about this?" he rasped.

"Oh no, Sir, we had the telephone to this man's pension (boardinghouse) blocked so that no one could communicate with him before we got out there for the arrest."

The Colonel looked as though he were about to explode. Even then there was no love lost between the Reichswehr, the Brownshirts and the Gestapo. "This is the most colossal piece of damn nonsense I've ever heard! This young man has been thoroughly investigated and only yesterday had the extreme honor of being presented to the Fuehrer at the Brauneshaus. I sponsored him."

The Gestapo boys were beginning to look sick, their eyes unblinking, their mouths open. "And further," the Colonel continued, "I shall personally apologize to Herr von Liliencron for your intrusion into his private affairs. You will of course release this young man at once and not annoy him any more. Do you understand?"

## The 6 Meter Radio With Power To Spare



*American Made  
Quality at Import Price*

## MODEL HR-6 25 Watt, 12 Channel Transceiver With Solid State Performance

Here's the power to get you out on the 6 meter band without use of black box power hogs in your car trunk. Work repeaters or work skip on your choice of 12 channels, with independent switching for transmit and receive. That gives you 144 frequency combinations across the entire band . . . 52-54 MHz. This compact package delivers 0.35  $\mu$ v sensitivity and 3 watts audio output for great listening. And the price is as compact as the radio . . .

only \$ **239<sup>00</sup>**

Amateur Net

 **Regency ELECTRONICS, INC.**

7707 RECORDS STREET  
INDIANAPOLIS, INDIANA 46226

**An FM Model For Every Purpose . . .  
Every Purse**



<b>HR-2MS</b> 8 Channel Transcan 2 Meter FM Transceiver	<b>HR-212</b> 12 Channel-20 Watts 2 Meter FM Transceiver	<b>AR-2</b> 2 Meter FM Power Amplifier
---	--	--

"But yes, Herr Colonel." The Gestapo officer looked ashen.

The Colonel turned to rejoin his meeting. "One other thing. My son is studying to be an amateur radio operator himself. He says there are altogether too many artificial regulations already. The ban regarding communication with the Soviets is ridiculous, so far as radio amateurs are concerned. Action is being taken to have it rescinded. There may come a time when we need these young men in the armed services. The more training and experience they get now, the better." He looked at me. "Please accept our apologies. I shall have a staff car return you to your pension. Heil Hitler!"

"Thank you, Sir," I stammered.

For an instant he glared at the Gestapo threesome, and then made off down the hall to his meeting.

Later, over another beer at the Luitpold, I gave Hans the gory details, offering profound regrets for my bad judgment in talking to the Russians.

"Forget it," he said. "It was a natural error, partly my fault for not telling you of the ban. The Colonel handled those black-shirted roughnecks very well. However, we have to be careful these days. I think it is most fortunate you are leaving the country tomorrow, while those fellows are still shaking from the dressing down they took in front of you. You can be sure they won't forget this — and probably would make you some serious trouble if you stayed on."

He wouldn't take the 20 Reichsmarks I'd found out would be the fine for my motorcycle caper. I never saw him again, although we had a few QSOs on my return to the States before all German hams were closed down prior to World War II.

On leaving Munich the next day, I didn't draw an easy breath until my train had rumbled across the Rhine and entered France from Kehl to Strasbourg.

Long years later, I learned that the Reichswehr Colonel, by that time a General, was part of the conspiracy and one of those who lost his life as a result of the attempted assassination of the Fuehrer on July 20, 1944.

. . . W1BNN

J. R. Johnson WA5RON  
4558 Avenue A #205  
Austin TX 78751

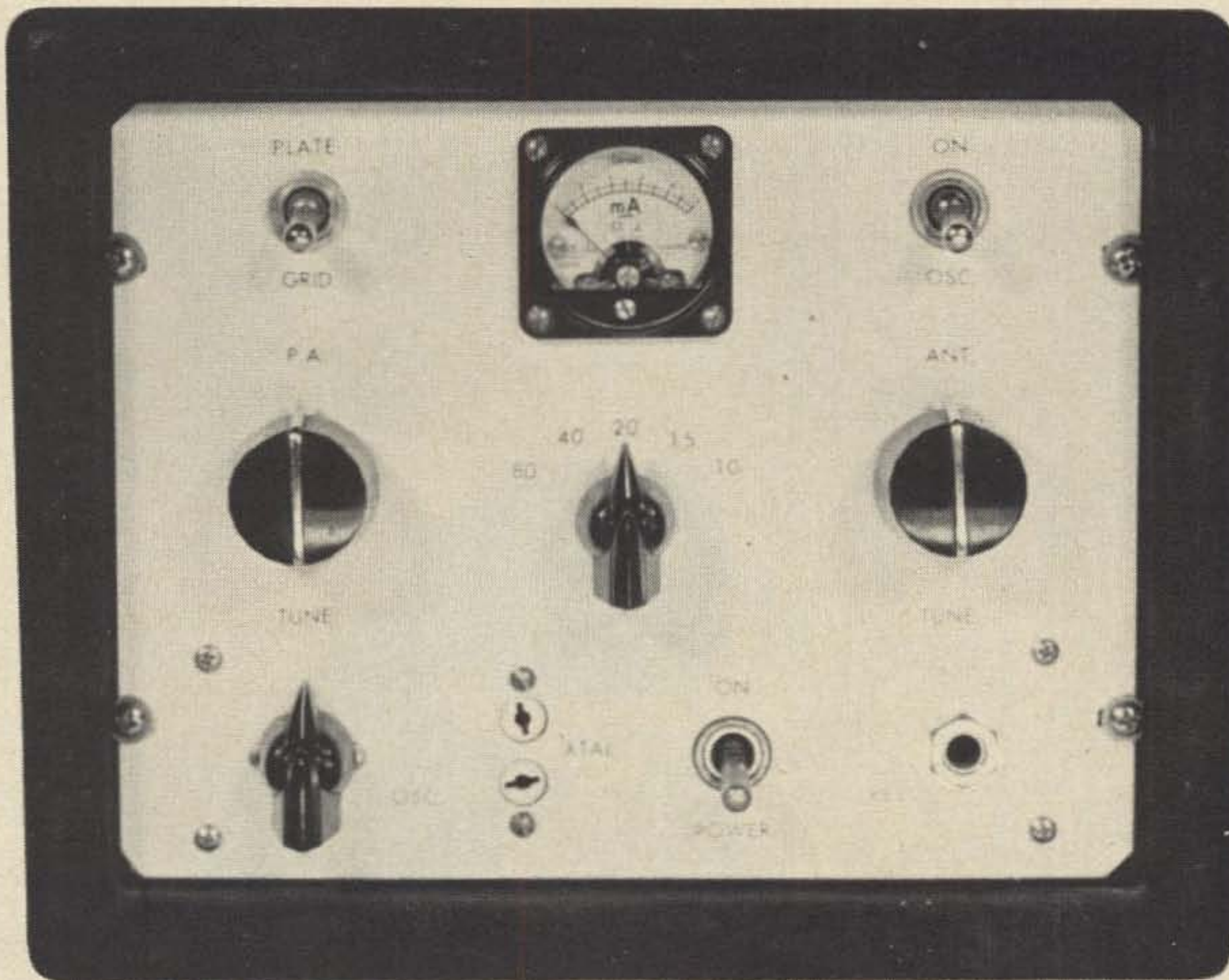

## Why Tubes Haven't Died

I am told that some veteran hams are not building anymore, and that some newcomers to the radio hobby haven't yet tried to build a piece of equipment for their shack. I am told that this is happening because of a preponderance of transistor and IC projects appearing in the magazines, while the average ham's junk box remains best suited for constructing vacuum tube projects.

How often have you become frustrated trying to find some prototype IC that a parts list requires, or a 2N --- transistor for which there is no SK, GE, ECG or HEP equivalent, or just discouraged by the number of special devices you would have to buy? Well, here is an excellent opportunity to use some of those toggle switches, tube sockets, transformers and variable capacitors you have stored away in that junk box. Your reward

will be a nice little 5 band CW transmitter: QRP, but not too QRP. It will run off that old H.V. supply you probably have around the shack, or a dynamotor and 12 V source for field day or mobile CW work (have you tried mobile CW?). The project uses only two tubes, no semiconductors (unless you count resistors), and all standard junk box type parts. There is simply no excuse for not building this portable CW transmitter.

The unit is small, compact but not crowded. It was designed to fit into a surplus cabinet that I had on hand, with compartments on each side for storing the power cable and CW key. The front panel is 19.3 cm wide, 15.1 cm tall, and the chassis extends to a depth of 14 cm. The actual layout you use will depend upon the box you intend to put it in.

*Continued on page 128*

# The Incomparable SPEC COMM 512/560

## 5 Watt 2M FM Portables With "Snap Pack" Modules

From K8OVJ, Detroit, whose repeater group retrofitted a SCR100 Receiver board in a repeater which previously used a well known amateur repeater receiver board: "The wait was well worth it! I am more than impressed with the receiver and I gave it a quick test in intermod alley and, mounted in a small enclosure with no precautions of any kind, intermod was a thing of the past as far as we are concerned." (2 wks. later)

"I've been running a lot of tests with the receiver and the more I use it the better I like it. I've tried, at one time or another, most of the current crop of 2M gear including the highly touted synthesized one using helical resonators and still find that they are subject to intermod despite their reports to the contrary. We have 11 repeaters in the Detroit area as well as Ma Bell and other commercial repeaters and believe me the intermod is terrific! I'm still unable to desense the SCR100 even using my base station transmitter on one antenna and the receiver on another with 20 ft. vertical separation. I've parked alongside the antenna of one of our best repeaters and still am unable to intermod the unit!! It works like a charm in downtown Detroit which has been the downfall of many, many, high priced rigs." (2 wks. later) — "Still no intermod of any kind from commercial or amateur repeaters in our immediate vicinity which is not true of any receiver I've ever built or any commercial one I've ever used including Motorola or G.E."

Note: The SCR100 is the same receiver in the SC512/560 transceiver.

How's the Warranty Service?? A K2 in Oaklyn, NJ writes: "... Let me thank you for the nice letter I received with my Spec Comm 560 which I had returned for repair. It was a personal letter giving me full details of the repairs made, improvements added and a full checkout and at no cost. This is a far cry from the experiences I've had with other items I have purchased from well advertised companies. I think it is only fair to give your outfit a pat on the back for a fine product, excellent service, and most of all a personal touch that is so lacking in this day and age."

BESIDES ORDERS, WE GET LETTERS — DON'T TAKE OUR WORD  
ABOUT PERFORMANCE & QUALITY, SEE WHAT OUR CUSTOMERS SAY!

### SC512 WITH "SNAP PACK" MODULE ATTACHED and MB-1



"O.K.!! Nice little package! The 560 works F.B. You did a good job setting it up. No problems." WA1, Boston, MA

"... I am very well pleased with the little radio! It works!" W5, Berwick, LA

"Very pleased with performance ... & have had flattering reports." W8, Parma, OH

"It really is a nice little radio. So light." WB6, Woodland Hills, CA

"I see many metal can types (semiconductors) — GOOD, (plastic types die around here from humidity) ... Think I'll modify my Swan to use that Squelch Circuit." W1/KP4, Arecibo, PR

"I am thoroughly enjoying portable/mobile operation with my Spec Comm 560. It made a recent hurried trip to Canada (in fact 2 trips) go much faster." W3, West Chester, PA

"Southern Calif. is a hotbed of RF signals. So far no desense or intermod even next to a 70 watt mobile on 76. A great design for a very happy price." W6NYF, L.A., CA

And from KL7IFX, who took a trip to the "lower 48" with his SC560: "My trip covered more than 17,000mi. in 58 days and about 250 contacts. The Kansas City group was noticeably impressed when I had no cross talk or intermod in areas where everyone else's rigs dropped dead! Had a buddy figure that if he could get into the next room and talk on 97 direct while I was on 94 receive the cross talk would dishearten me. You know what — he had to be on high power (10W) and 5 ft. from my antenna! His rig dropped dead each time I went to 34 xmit and he 97 receive, even at 100 ft. away!! ... There were many repeaters I copied at 140 mi. out and had many reliable 2 way contacts at 65-80 mi. on 5 watts into a 5/8 wave vertical. No joke, you have a Fantastic Transceiver."



# It's Three No-Compromise Transceivers in One!

- **5 TIMES THE POWER** of the usual 1 Wt portables! But draws *only 2x* the current! While BP-1 Battery Module provides *3x the capacity* of the usual portable or HT batteries for many hours of operation.
- **EXCLUSIVE HOT CARRIER DIODE MIXER** virtually eliminates intermods & receiver overload in strong signal areas. Now you can copy those weak signals that were "buried" before!
- **LARGE SCALE USE OF ICs IN RCVR and XMTR** for superior, more reliable performance at lower cost!
- **ENGINEERED AND BUILT IN U.S.** — Top Quality throughout.

### FEATURES

- BP-1 Btry. provides apx. 8 hrs. norm. operation/chg.
- LED Btry. voltage indicator
- Super eff. xmtr — draws *only* 900 mA @ 5W. out
- High quality Ceramic mic
- Fantastic Squelch — fast & Sensitive
- Extremely sens. MOSFET front end, 0.3uV/20dB Qt.
- Incredibly sharp IF, at least -80dB @ ±30 kHz
- Single Conv. Rcvr. — superior to dual conv. designs for spurious resp. rejection!
- Uses inexpensive TR22 xtals
- 146.52 xtals supplied
- Trimmers on all xtals
- Reverse polarity protection
- Final transistor fully protected
- Large 3" spkr. for *unusually good sound*
- Ext. spkr. jack
- Front and rear antenna jacks
- Rugged but light — 2 lbs.
- Size 2 1/4 X 6 X 8"
- Very easy to service.

See Review Article in April 73 Mag.  
Send Card for Data Sheet.



SC512 W/BA-1 "Snap Pack"

- **USE IT PORTABLE — OVER THE SHOULDER** — with the Heavy-Duty BP-1 Nicad Battery "SNAP PACK"
  - **USE IT MOBILE** with the BA-1 25 Wt. Amp "SNAP PACK"
  - **USE IT FIXED** with the AC-1 AC Supply "SNAP PACK"
- 
- **UNIQUE "SNAP PACK" MODULES** merely Snap-On and automatically interconnect — No messy wires or cables to hook-up. It only takes a few seconds!

**SPEC COMM 512** \$249<sup>95</sup>  
5W 12 channels

**SPEC COMM 560** \$224<sup>95</sup>  
5W 6 channels



### DEALER INQUIRIES INVITED

**AVAILABLE FROM DEALERS SOON — or Factory Direct**  
A limited number of units are in Stock for Immediate Shipment. (Allow two weeks for personal checks to clear.)

**SCR & SCT100 REPEATER RCVR. & XMTR. BOARDS** - Join the many rptr. groups now retrofitting SPEC COMM boards in their rptrs. — either old tube gear, or solid state equip. w/IM or desense problems, etc. (See K8OVJ's comments, above)



SC512 W/BP-1 "Snap Pack"

  <p><b>100% Moneyback Guarantee</b> <b>100 Day Warranty</b></p>	<p><b>Please ship the following:</b></p> <p><input type="checkbox"/> SC512 @ \$249.95</p> <p><input type="checkbox"/> SC560 @ \$224.95</p> <p><input type="checkbox"/> MB-1 Mobile Mount @ \$8.50</p> <p><input type="checkbox"/> BP-1 Pkg. (Btry pack, chgr., ant., carrying stp) @ \$89.95</p> <p><input type="checkbox"/> BA-1 Amp @ \$84.95</p> <p><input type="checkbox"/> AC-1 Sply. @ \$49.95</p>	<p><input type="checkbox"/> SCR100 @ \$95.00</p> <p><input type="checkbox"/> SCT 100 @ \$115.00.</p> <p><input type="checkbox"/> Precision Xtals ±0.001% @ \$4.95 (List on separate sheet)</p>	<p>Amt. Encl. \$ _____</p> <p><input type="checkbox"/> M.O. <input type="checkbox"/> CK.</p> <p><input type="checkbox"/> M/C <input type="checkbox"/> BAC Exp. Date _____</p> <p>Card No. _____</p> <p>M/C Interbank No. _____</p> <p>Add \$3.50 Shipping/Handling PA residents add 6% tax.</p>
	<p>Name _____</p> <p>Address _____</p> <p>City _____ State _____ Zip _____</p>		

# SPECTRUM COMMUNICATIONS

BOX 140, WORCESTER PA 19490 (215) 584-6469

The tube complement is a pair that should be familiar to most readers: a 5763 operating as straight-through or multiplying oscillator, and a 2E26 power amplifier running about 20 Watts input. The filaments are tied in series with an equalizing resistor across the 5763 for 12 volt use. You can wire them in parallel and omit the resistor if you intend only to run off a 6.3 V ac supply. The "OSC" switch opens the B+ line to the 5763 to silence the oscillator while receiving; it otherwise runs continuously to provide a chirp-free signal.

A meter (0-1 mA) on the front panel provides the necessary indication for tuning up and input power monitoring. "GRID" position on the meter switch allows you to peak the grid drive to the final, and "PLATE" lets you dip the plate current. An antenna loading control is also provided to the right of the band switch. The key jack is a closed circuit type.

Since there are no multiplier stages, it would appear that crystals cut for the particular band of intended operation would be required. It was found; however, that the

harmonics of 80 meter crystals were usable on 40 and 20, and 40 meter rocks provided usable output on 20, 15 and 10 meters. Select crystal frequencies that will allow you to work in several bands.

The band switch is a 2 section rotary with special shielding to separate the output of the P.A. from its input. You will notice that most oscillator components are on the underside of the chassis, while the output circuit is all above the chassis. This, and the bypass capacitors (.001) used on all dc lines, prevents self-oscillation of the final tube. The shield around the rear section of the band switch was folded up from a 6.4 cm wide strip of aluminum and drilled to pass the switch shaft and standoffs. The shield itself is bolted to the chassis over a slot, through which connection is made to the oscillator coil (L1) taps. Connections to the amplifier tank coil (L2) taps come over the top of the shield from the forward switch section.

The coil L1 is 46 turns of B&W no. 3016 or Airdux 832: 26 mm diameter, 36 mm long. It is tapped at 3-1/4, 6-1/4, 8-1/4 and

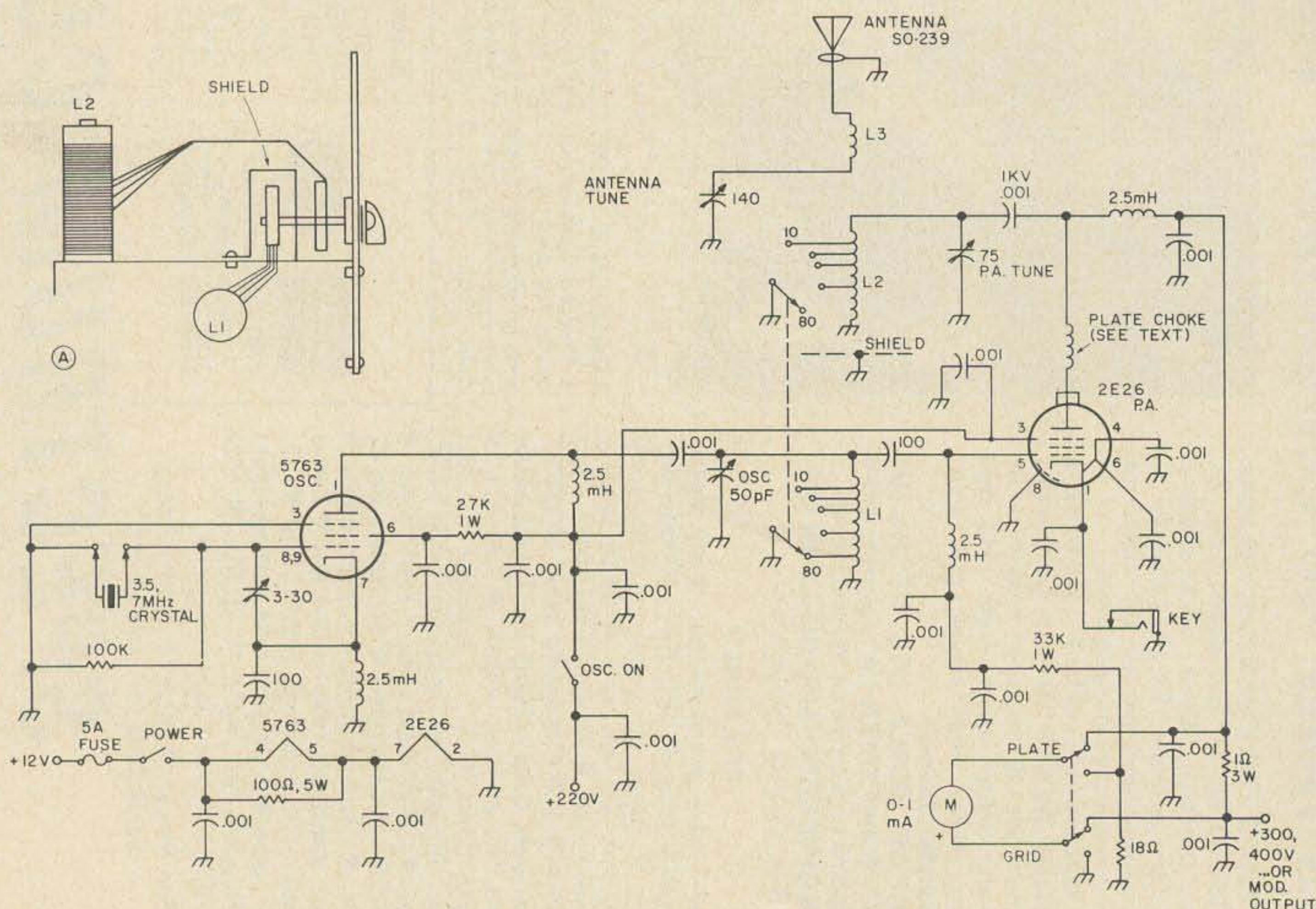
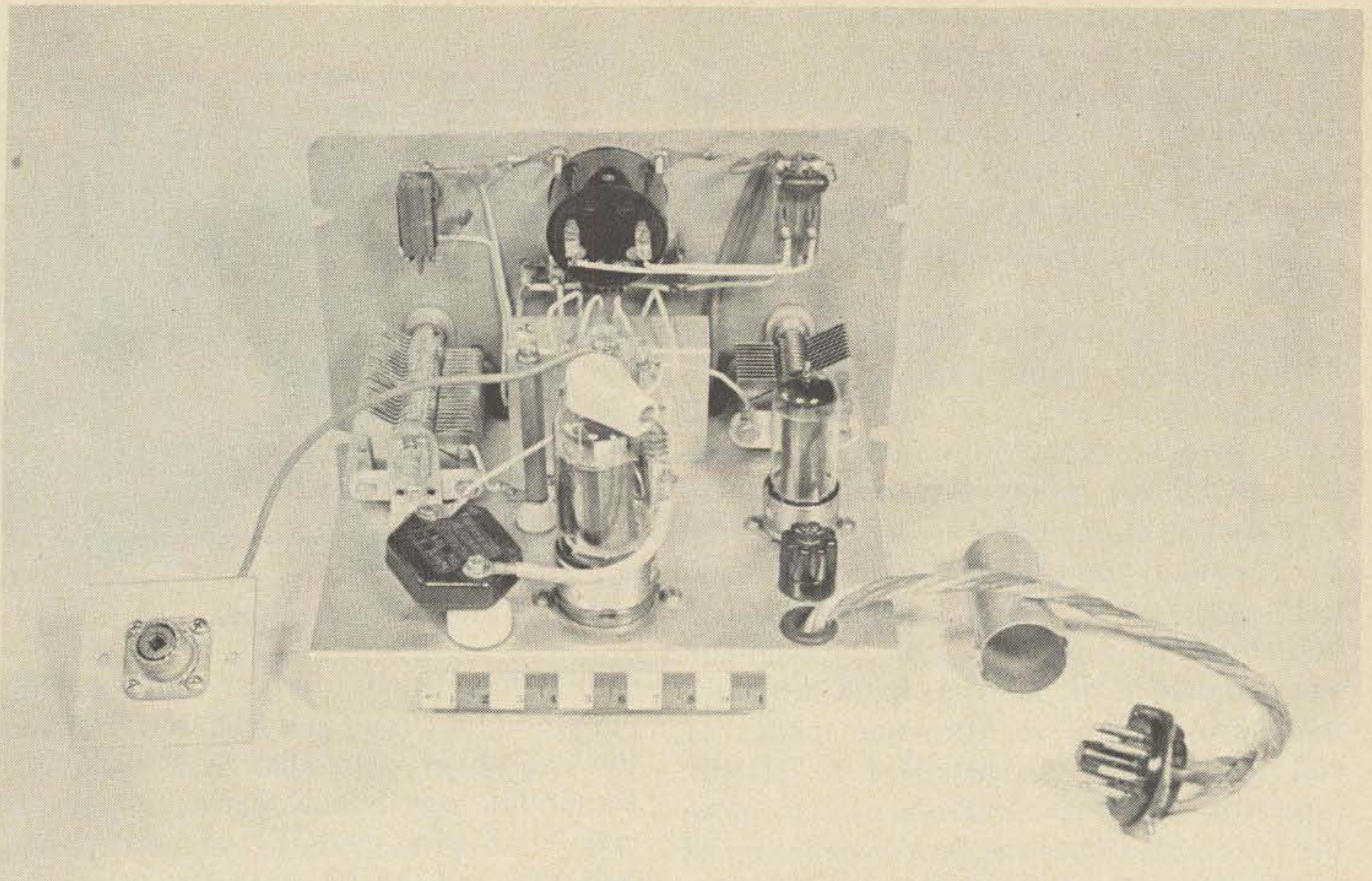

Fig. 1. Schematic. (A) Side view showing position of coils, band switch, and shield.



*Rear view.*

21-1/4 turns from the high end, for 10, 15, 20 and 40 meters. It is easier to solder taps to this type of coil stock if you push in the wire on either side of the turn to be tapped with a pointed tool first. The wires from these taps to the band switch are about 5 cm long.

Coil L2 is the output tank, wound on a piece of wood dowel, 19 mm diameter, with no. 24 tinned wire. 52 turns are wound, evenly spaced, to make a 55 mm long coil on the wood form, which is about 65 mm long. I wound this coil by taking 4 meters of no.

24 wire, tying both ends to a doorknob, and looping the middle of this wire once around a small tack near one end of the dowel. You then wind this double wire tightly up the coil form, in the same direction as the store-bought coils. Wind your 52 turns, keeping the wire tight, while walking toward the doorknob. Secure one of the wires around a tack and unwind the other wire completely. This should leave a single winding on the form evenly spaced. Check that no turns are shorted, and slap on a heavy coat of shellac to finish your coil. Winding

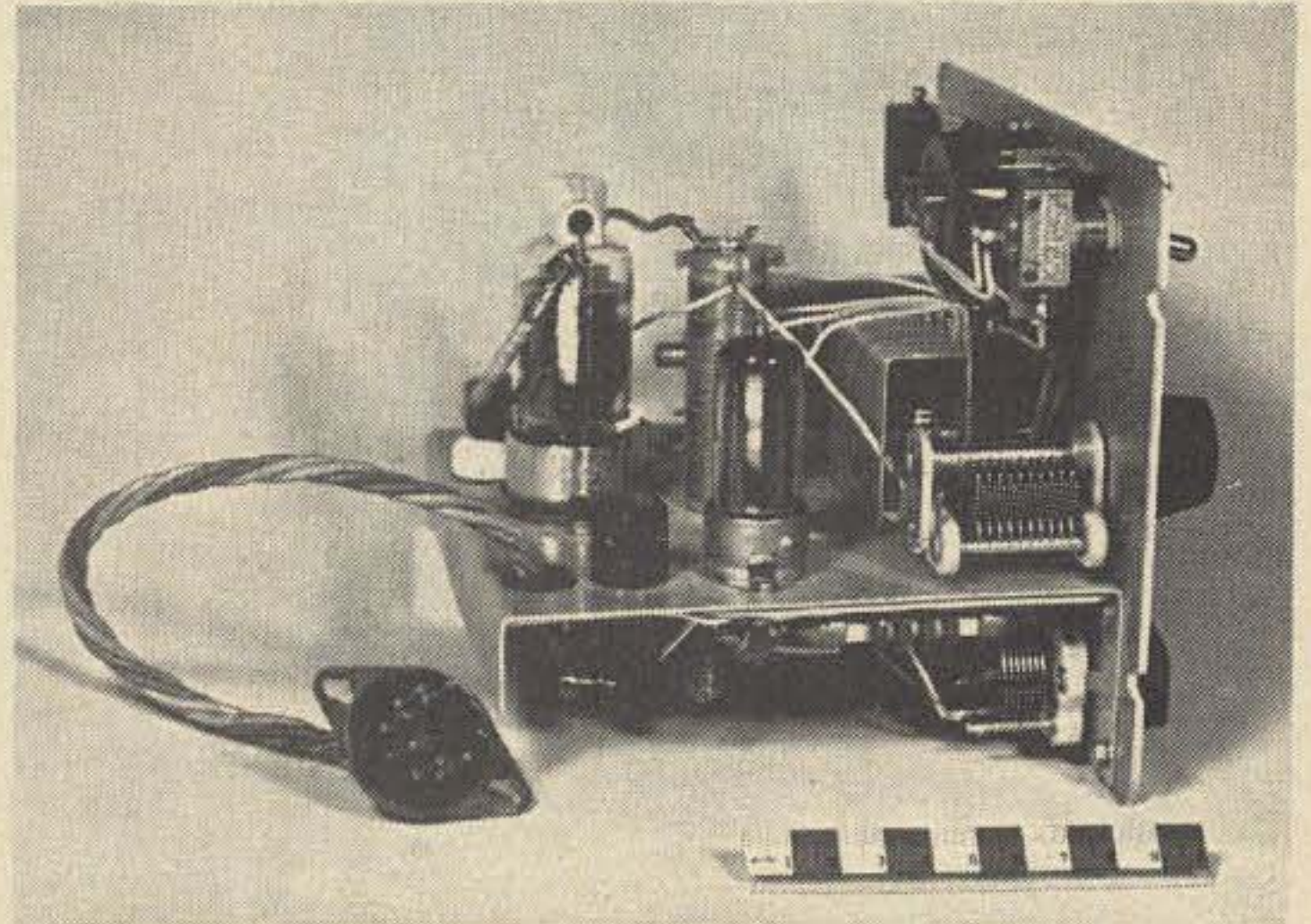
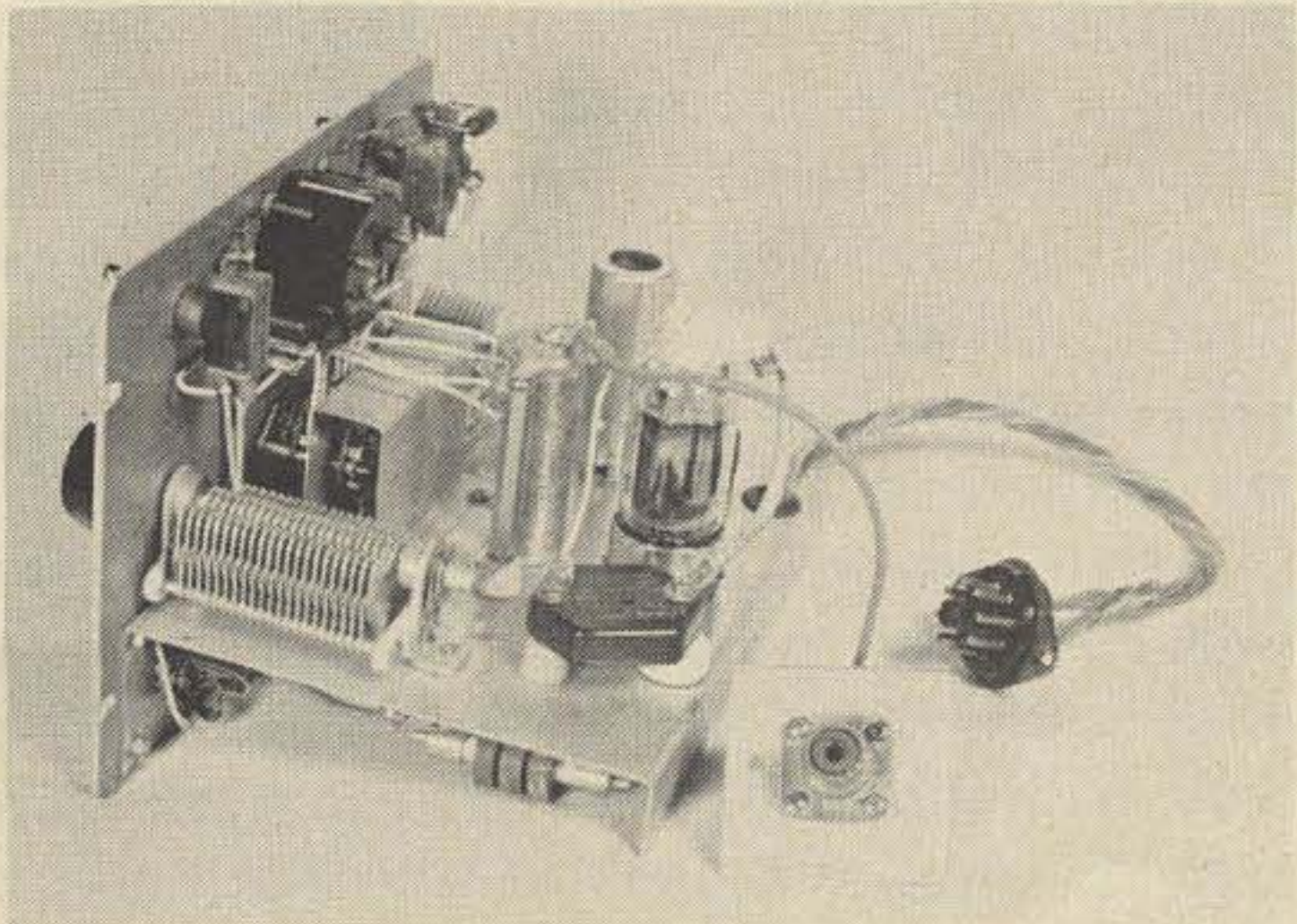

*Two side views.*

your own coil makes you feel that you've really home brewed the project, like they did in the good (?) old days. You can wind the output link (L3) too, but I had some of the stock coil left over from L1 and used that. L3 is 3 turns no. 24, 26 mm diameter, 2 mm long, mounted just above the high end of L2.

Taps on L2 occur at 4-1/2, 8-1/2, 13 and 24 turns down from the high end. Wires to the band switch average about 7 cm. If you have a grid-dip meter you should check both L1 and L2 for proper placement of these taps after all components are wired together. By coupling your G.D.O. to coil L1 and rotating the 50 pF "OSC TUNE" capacitor, you should find a dip at both the high end and low end of the amateur band for which the band switch is set. The same applies for coil L2 and the associated "P.A. TUNE" capacitor. You may find you have to move the taps a bit to get the best coverage on all bands. If you don't have access to a G.D.O., then just follow my guidelines about taps and wire length as closely as possible.

One additional "coil" you have to wind is the choke at the plate cap of the 2E26. This is just 4 turns, 5 mm diameter, 7 mm long. It can be air-wound with stiff (no. 16) wire or wrapped around any high-value 1/2 Watt resistor. This plate choke is included to suppress any spurious VHF oscillation in the final. The 2E26 is a VHF power amplifier and is somewhat prone to this type of problem. If you ever detect rf output with the "OSC" switch off and the key down, this is spurious oscillation in the final indi-

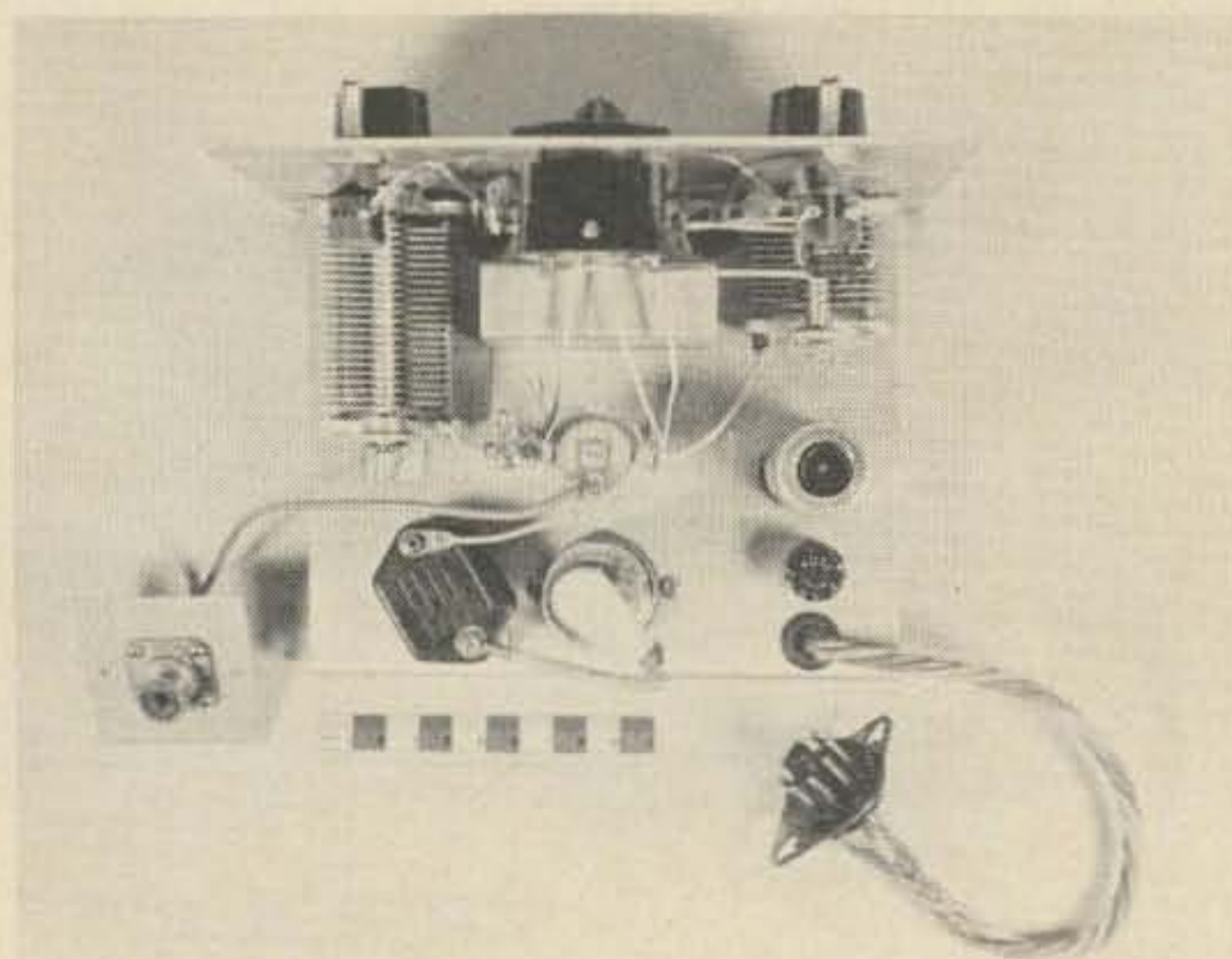

Top view.

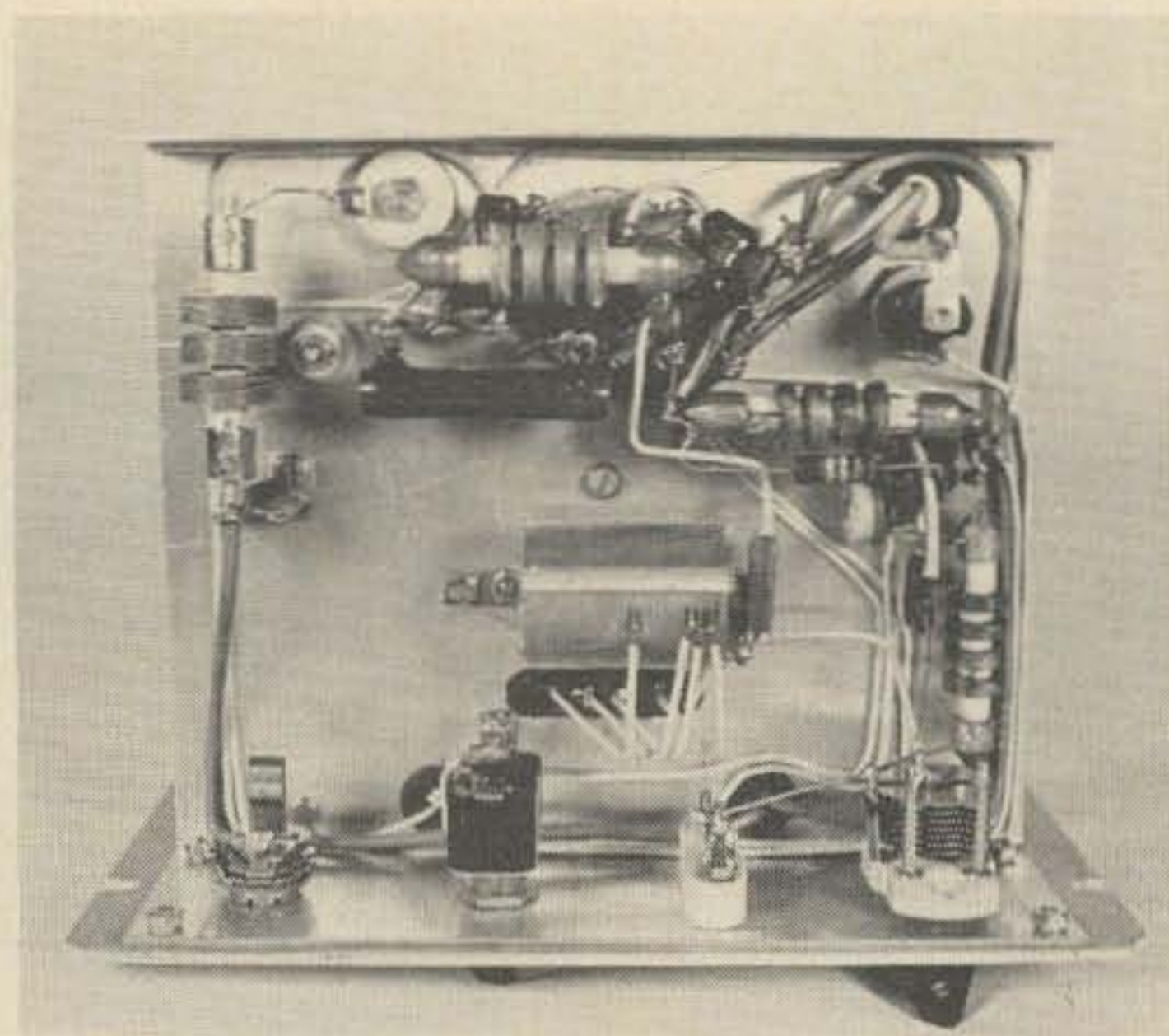

Bottom view.

cating insufficient bypass and shielding between grid circuit and output. If you keep the two always separated by a thickness of aluminum, use bypass capacitors at both ends of all wires going to the meter or panel switches, and use those .001 caps as shown around the base of the 2E26, you should have no problems.

After you finish the construction and wiring, connect filament power and oscillator B+ but not P.A. plate power. Plug in a crystal, set the band switch to the band of the crystal's fundamental frequency and adjust the "OSC" capacitor for maximum grid indication. Adjust the 3-30 pF cap in the oscillator grid circuit for maximum and you are all ready to go. Put the transmitter into its cabinet, connect the final B+, and attach your antenna or matching unit. Touch up the "OSC" setting once again and then switch the meter to "PLATE." With key down, you should get some plate current. Tune the "P.A. TUNE" for a definite dip in the plate indication. Adjust the "ANT. TUNE" for best output as indicated by a field-strength meter, swr bridge, or whatever you use. Now go back and dip the plate again, since the two large capacitors interact quite a bit.

If all goes well and no smoke arises, you will be proud to own and operate this nice little transmitter you built yourself. Once you have finished, you can get started on that IC keyer project (Man does Not Live by Tubes Alone). Enjoy your CW operation.

... WA5RON



# SUPER-STRIPS

## UNIVERSAL BREADBOARDING ELEMENTS WITH SOLDERLESS PLUG-IN TIE POINTS

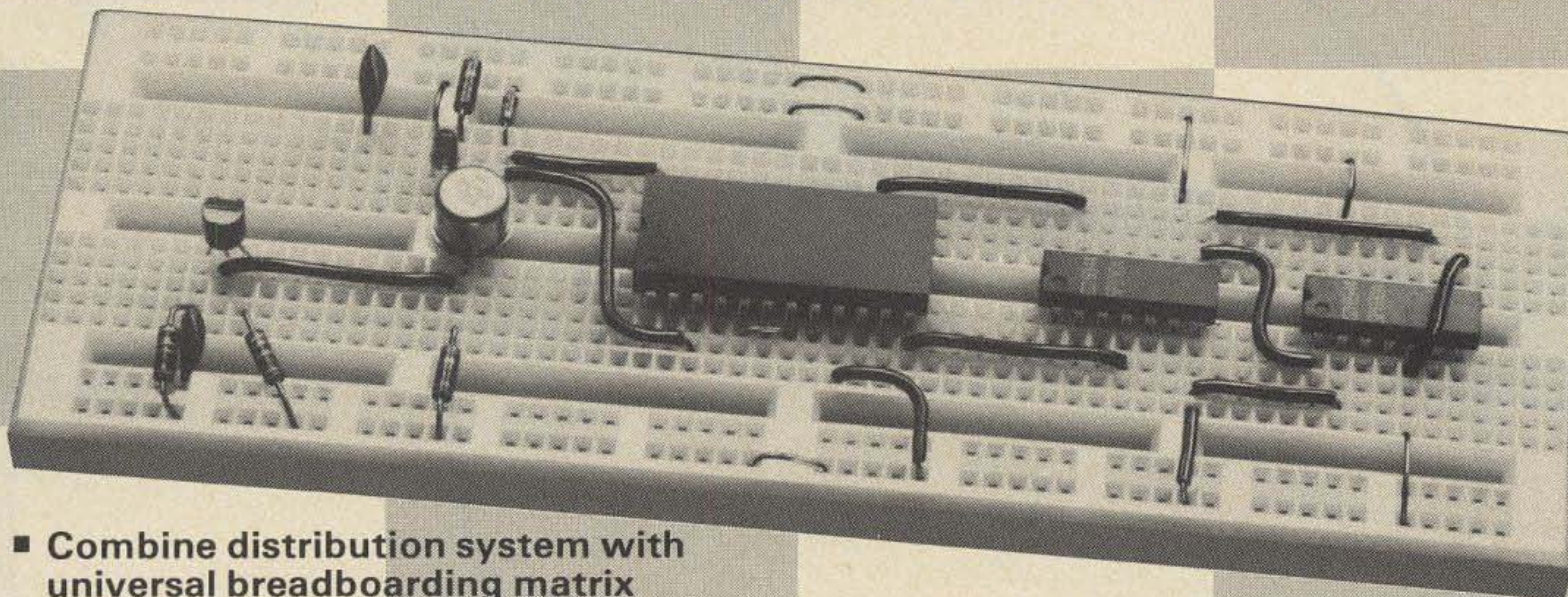

- Combine distribution system with universal breadboarding matrix
- 840 solderless, plug-in tie-points
- Accommodate all DIP's and discretes with lead diameters to .032"
- Require no special patch cords

The A P Super-Strips combine a power/signal distribution system with a matrix of 128 terminals, each with 5 tie points. The distribution system consists of eight buses, each individual bus consisting of a line of 25 tie points. All tie points are the solderless, plug-in type, used on A P Terminal and Distribution Strips.

The Super Strip will accept all DIP's, TO-5's and discrete components with leads up to .032" dia. As many as eight 14-pin DIP's can be accommodated. Use any solid wire up to No. 20 AWG for interconnections. Super-Strip can be panel-mounted with the No. 4 screws provided. A vinyl-insulated backing prevents short circuiting. Included are four self-adhesive polyurethane feet for protection during bench work. Body is acetal copolymer.

**Super-Strip 1: 923748** (Gold-plated terminals) \$18.90 ea.  
**Super-Strip 2: 923252** (Nickel/silver terminals) \$17.00 ea.

## IC TEST CLIPS FOR DUAL-IN-LINE PACKAGES

- Provide full access to integrated circuit DIP leads
- Solve probe attachment problems
- Simplify prototype and production testing, field service work, and quality control
- Remove DIP's damage free
- Available in sizes to accommodate all DIP's;

The unique design of the A P Test Clip assures positive, non-shorting electrical connection and positive mechanical clamping to dual-in-line packages.

Gold-plated phosphor bronze spring contacts are designed for wiping action. The "contact comb" separating the spring contacts provides positive positioning to prevent accidental shorting of adjacent leads.

Oscilloscope probes can hang free on the longer terminal wires in the top row of the Test Clip and not interfere with the terminals in the bottom row.

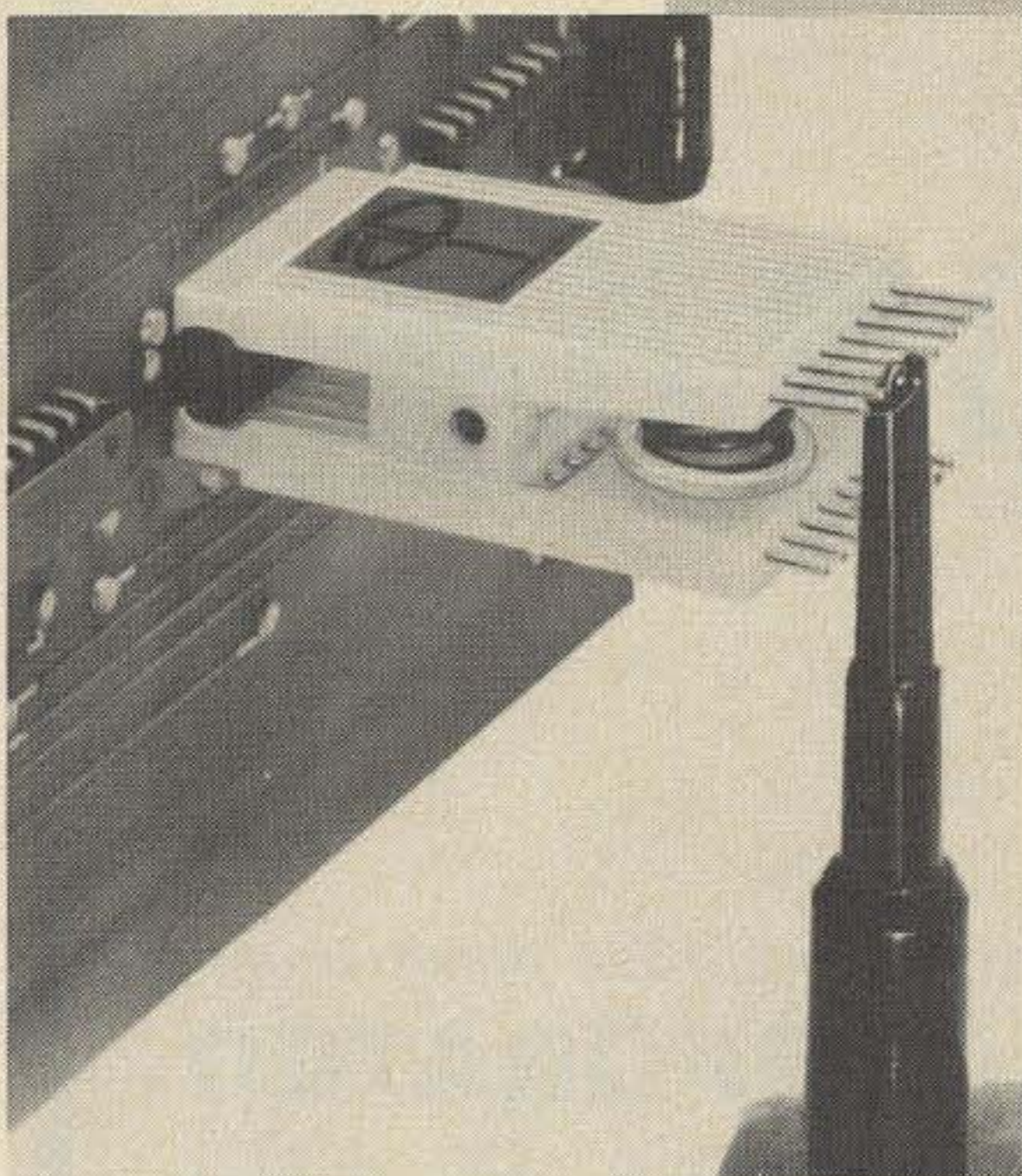

All products are guaranteed to meet or exceed published specifications

**A P PRODUCTS INCORPORATED**  
 Box 110-Z • Painesville, OH 44077

TC-14	TC-16	TC-24
923689.....\$ 5.25 ea.	923700.....\$ 5.75 ea.	923714.....\$13.85 ea.

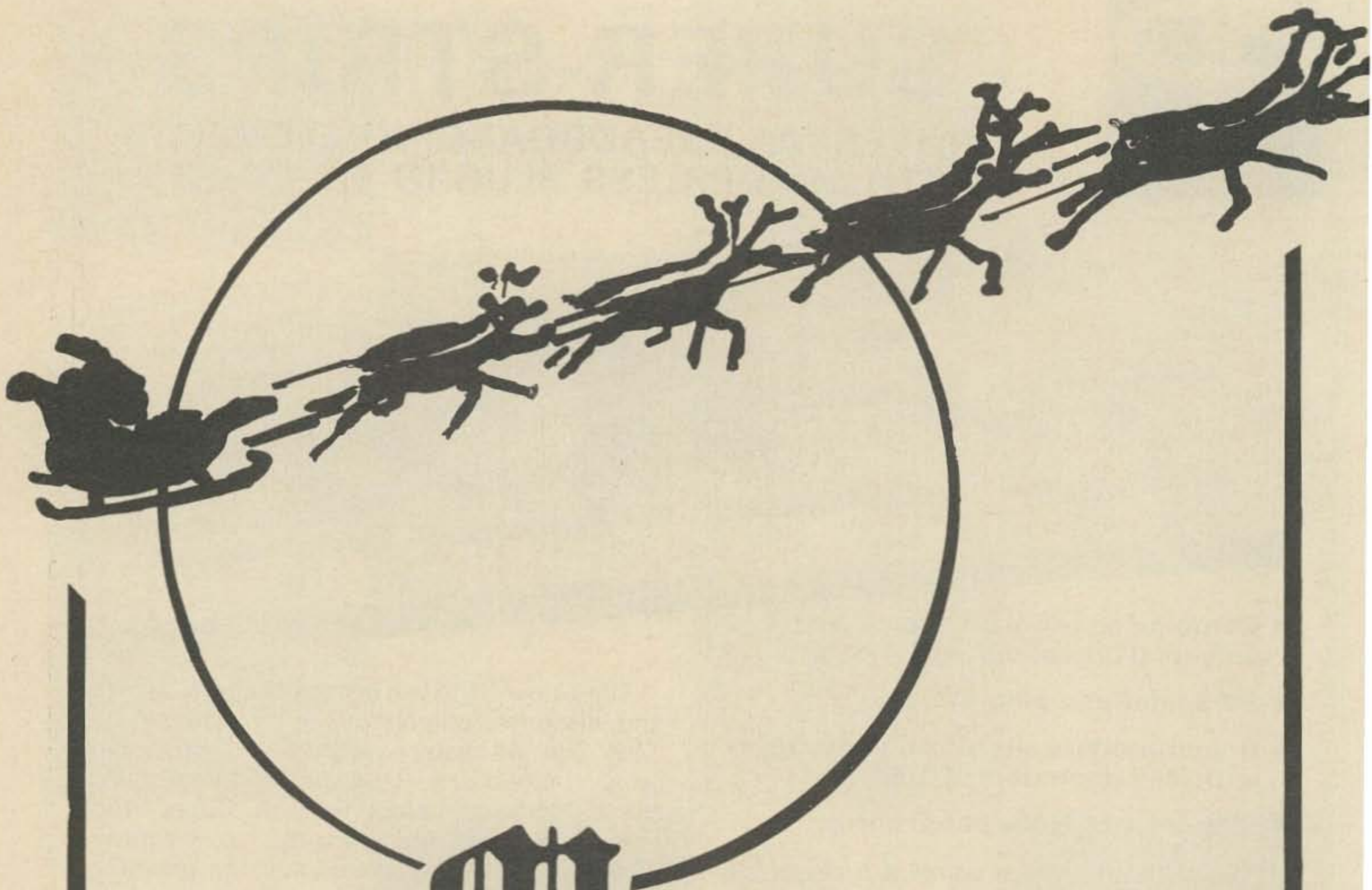

# Merry Christmas



*All products guaranteed to meet or exceed published specifications*

**AP PRODUCTS INCORPORATED**

Box 110-G • 72 Corwin Drive • Painesville, OH 44077  
or phone 216/354-2101 • or Twx 810-425-2250

# Instant Circuits

**E**very once in a while, something small happens that changes the course of events in our lives. For example, the simple "happening" of an apple falling on Sir Isaac Newton's head several centuries ago triggered the discovery of gravitational fields.

Although not quite in the same class, but equally important to anyone working with electronics, a product has been recently developed that is destined to play an important role in future developments. I'm referring to the various solderless, matrix terminal sockets now available for breadboarding electronic projects.

Depending on which manufacturer you talk to, the sockets may be referred to as "Super-Strips," "EI Sockets," "QT Sockets," or "Klip-bloks." But regardless of what they are called, they all have one thing in common — convenience. In fact, after being introduced to their simplicity, you tend to ask yourself, "Now why didn't I think of that?"

With these sockets, a new circuit can be thrown together in a matter of minutes, making electronic projects that much more fun. Also, last minute changes may be incorporated into a new circuit merely by rearranging connections. This feature alone

will save you much anguish in working with stubborn circuits.

Most of the discussion here will center around AP's "Super-Strip," although each manufacturer has a complete line and assortment of terminal strips for you to choose from. A listing of some of the major manufacturers is contained in Table 1, and I suggest you send for a copy of their brochure before you decide to purchase one.

## Background

I was first introduced to breadboarding techniques through an article in *73* several years ago.<sup>1</sup> The solid state breadboard described was constructed and it has been a great aid to me in building electronic projects on short order.

The bus bars were installed in a manner similar to the original design, but I also incorporated additional features such as transistor and IC sockets, internally connected to individual bus circuits. This feature facilitated changing transistors and ICs, and also helped to avoid damaging the semiconductors while soldering other components to the bus.

---

<sup>1</sup> Goodwin, G. W., "A Solid Solid State Breadboard," *73*, November, 1972, p. 178.

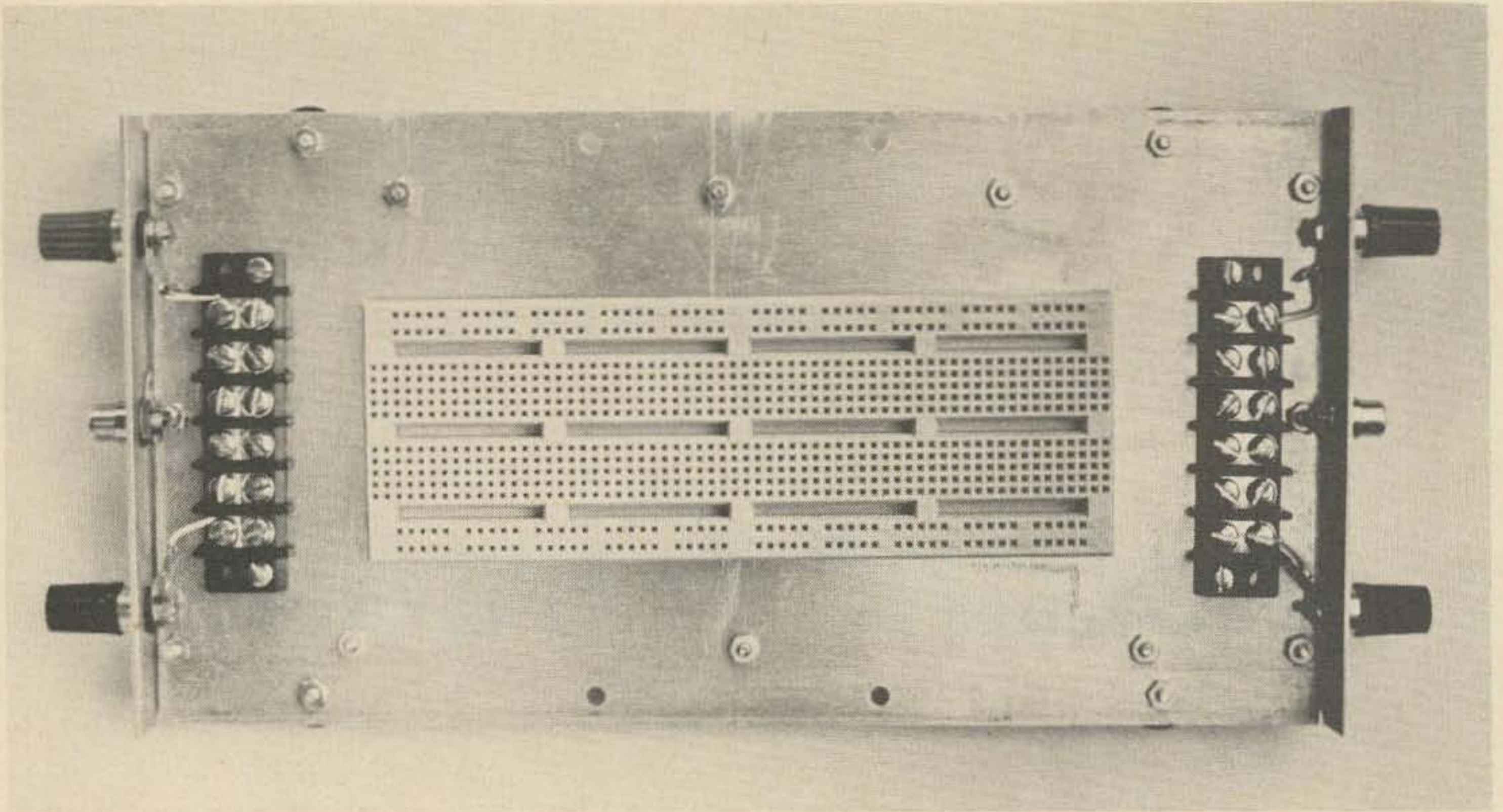

*This particular distribution strip consists of 840 plug-in, solderless tie-points, which can accommodate a variety of circuit configurations.*

For the past few years, this arrangement has been adequate for my purposes and has been of great assistance. However, there is always room for improvement in everything, and breadboarding techniques are not excluded.

With the advent of new techniques, we now have available universal, solderless terminal blocks for quick circuit building and testing.

These terminal and distribution strips provide you with unlimited freedom in connecting components together to form a circuit. No special tools are required and any solid wire up to #20 AWG may be used for connections.

Terminal strips are also available in many different sizes and configurations to accommodate any circuit layout desired. The terminals accept all component leads between 0.015" and 0.032" in diameter.

As an example, 1/8 Watt resistors have lead diameters of 0.015", 1/4 Watt resistors have lead diameters of 0.025", and 1/2 Watt resistors, 0.032".

### "Super-Strip"

My own experience with these products has been with the AP Products' "Super Strip." This particular socket is a combination distribution system with a universal

breadboarding matrix consisting of 840 solderless, plug-in tie-points which can accommodate a variety of components and circuit configurations.

The socket measures 2.25" by 6.50" and is currently selling for about \$18.00. While this price may seem high at first for an item so small, it is really a super bargain. Once you begin using one and realizing the advantages it has over all other breadboarding systems, I think you will agree that the sockets are worth their weight in gold.

My "Super-Strip" actually paid for itself in one month, considering the time it saved me and the cost savings of reusable components.

### Applications

With regard to component locations on the terminal strip, all ICs are mounted in the center as shown in the photographs. In this manner, each IC lead is connected to one terminal of a 5-terminal strip, leaving 4 terminals for other components. The terminals along the edge are connected to form a bus for power supply connections.

I mounted my "Super-Strip" on a 5½" x 10½" aluminum plate with end panels for external connections. Each panel has two 5-way terminal posts along with a phono jack for input and output connections. As an



TRADE NAME	MANUFACTURER	ADDRESS
Super-Strip	AP Products, Inc.	Box 110 Q, Painesville OH 44077
EL Socket	E & L Instruments, Inc.	61 First St., Derby CT 06418
QT Socket	Continental Specialties Corp.	44 Kendall St., New Haven CT 06512
KLIP-BLOK KLIP-STRIP	Vector Electronics Co., Inc.	12460 Gladstone Ave., Sylmar CA 91342

*Table 1. Major manufacturers of solderless terminal strips.*

interface between these jacks and the "Super-Strip," I use a terminal block to allow changes without soldering.

There is usually enough room on the sides of the aluminum plate to mount large components such as coils, variable capacitors, pots and similar components. I sometimes add a strip of masking tape along each edge of the "Super-Strip" and label component leads to help keep track of connections.

Other arrangements are also possible. For example, the "Super-Strip" can be mounted to a plug-in type printed circuit board. It is then possible to plug this assembly into a master plug board for sophisticated circuits.

Another application is to mount the "Super-Strip" on a mini-box or chassis, and then put a power supply inside with power

brought out through terminals. This provides a completely self-contained unit.

If you really want to get fancy, add a function generator or pulse generator for signal sources — all in one, neat package.

### Conclusion

Whether you are a serious experimenter or construct projects on rare occasions, one of the solderless terminal blocks described here can make your project more fun to build. Also, if you are not sure a new circuit will work or needs de-bugging, build it first on a "Super-Strip." Once the circuit is functioning properly, you can build it in more permanent form. This approach can save you both time and money and make life a lot easier.

... WB5DEP

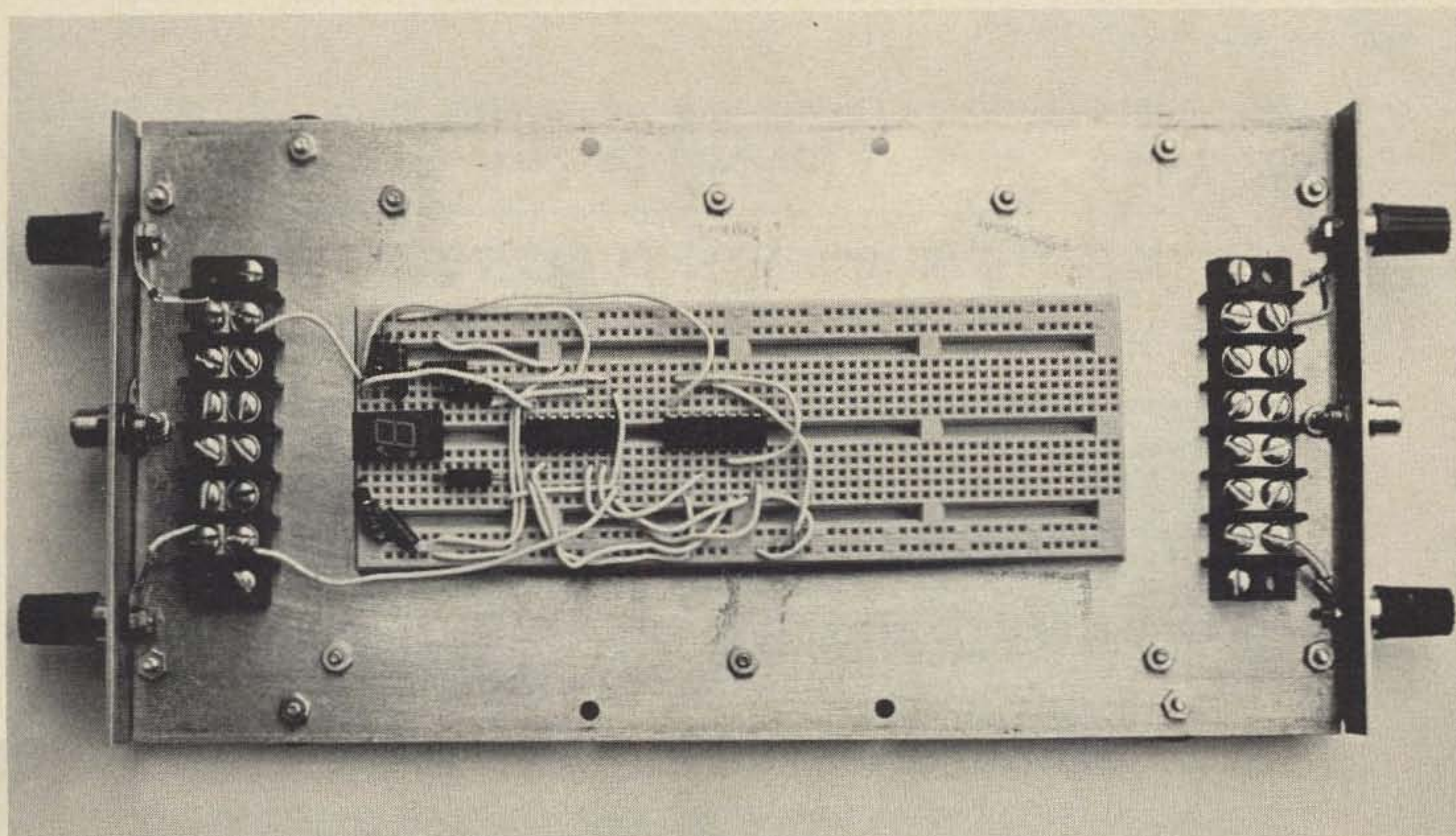

*Components are generally mounted in the center, leaving at least four tie-points per device lead for interconnection to other components. Input and output terminals are shown on each end of the breadboard.*

# It's nice to know you're The Best...

*That's why we at ITC are proud to introduce the latest and most complete two meter transceiver, the ITC MULTI 5000.*

We surveyed our happy Multi 2000 owners to find out what additional features they wanted. Then we took their advice and designed the MULTI 5000. Some of their complaints were low sensitivity, low power output, no LSB, poor AGC, too big and some didn't like the colors. Well we didn't change the colors but we did greatly improve the sensitivity ( $.25\mu\text{V}$  for 10dB S/N and  $.33\mu\text{V}$  for 20dB quieting), we increased the power output to 80 watts, a new AGC was developed to give almost a constant AF output from  $.5\mu\text{V}$ , and we added LSB (and AM). We made a lot of other changes too. Like the built-in VOX and Clipper (both fully adjustable), the adjustable sidetone level and mic gain/dev. controls, and the adjustable-threshold noise-blanker. We made it smaller too (about 95 cubic inches smaller). A glance at the specifications for the MULTI 5000 will give you an idea of what we, and our customers really want in a two meter transceiver. Best of all, we did not change the price, it is still \$695 (Plus \$55 for the 13.6V, 15A regulated power supply). Of course you can use your old amplifier power supply (you won't need the amplifier anymore) or you can build your own (we even supply the schematic).

*See the new ITC MULTI 5000 at your favorite dealer, it just might change your mode of living... for the better.*

---

## THE ITC MULTI 5000 TRANSCEIVER...

*PERFORMANCE THAT CHALLENGES YOUR IMAGINATION*



**INTERNATIONAL TELECOMMUNICATIONS CORP.**

P.O. Box 69623, West Hollywood, California 90069 (213) 652-3616

# MULTI 5000 SPECIFICATIONS

## RECEIVER SECTION: \_\_\_\_\_

- Sensitivity:  
FM:  $0.33\mu\text{V}$  for 20dB Quieting  
SSB:  $0.25\mu\text{V}$  for 10dB S+N/N
- Intermodulation:  
Third-order intermodulation products reduced more than 70dB
- Crossmodulation:  
Better than 90dB
- Selectivity:  
FM: 15 kHz at -6 dB, 6/60dB Shape factor 2.25:1. Ultimate rejection greater than 90dB  
SSB: 2.2 kHz at -6dB, 6/60dB Shape factor 2:1. Ultimate Rejection greater than 95dB
- Spurious signals:  
Reduced more than 75dB

## TRANSMITTER SECTION: \_\_\_\_\_

- Power Output (All Modes):  
Continuously adjustable 1W — more than 80W
- Unwanted Sideband and Carrier Suppression:  
Greater than 50dB
- Spurious Output  
All spurious signals reduced more than 70dB

## GENERAL: \_\_\_\_\_

- Frequency Coverage:  
143 MHz — 148.99MHz in 10 kHz (PLL Synthesized) steps with continuous between channel tuning (RIT and VXO). Digital Readout.
- Repeater Offset:  
Standard Simplex plus/minus 600kHz with three optional offsets for MARS, CAP and other nonstandard repeaters.

## CONTROLS: \_\_\_\_\_

Power/AF Gain, RF Gain, Clipper/IDC, Noise-Blanker Threshold, VOX, Sidetone Level, MIC/Dev., RIT VXO, Power Output (1W-80W), MOde (NBFM, WBFM, LSB, USB, AM . . . CW and MCW on USB, LSB and AM), Offset, Frequency (MHz, 100kHz, 10kHz), Squelch.

## Size/Weight: \_\_\_\_\_

12"W x 3.1"H x 11"D. Approximately 8 lbs.

## Warranty: \_\_\_\_\_

Full one year parts and labor.

# K2OAW Synthesizer

## PROM-oted

*A BCD effort.*

This article is the end result of finally building a synthesizer for two meters. A few people in town have built the K2OAW synthesizer and a printed circuit board for one was available. I had strong reservations about the switch coding scheme used in the original article since it used several large multi-deck rotary switches and I wanted to use miniature BCD coded thumbwheel

switches. The divider coding required on this synthesizer does not lend itself to either BCD coded inputs or direct digital frequency readout. A local ham had a circuit available to do the required code changing, but it required a second circuit board as big as the synthesizer and about fourteen more ICs.

I have some programmable read-only-memories (PROM) on hand and these

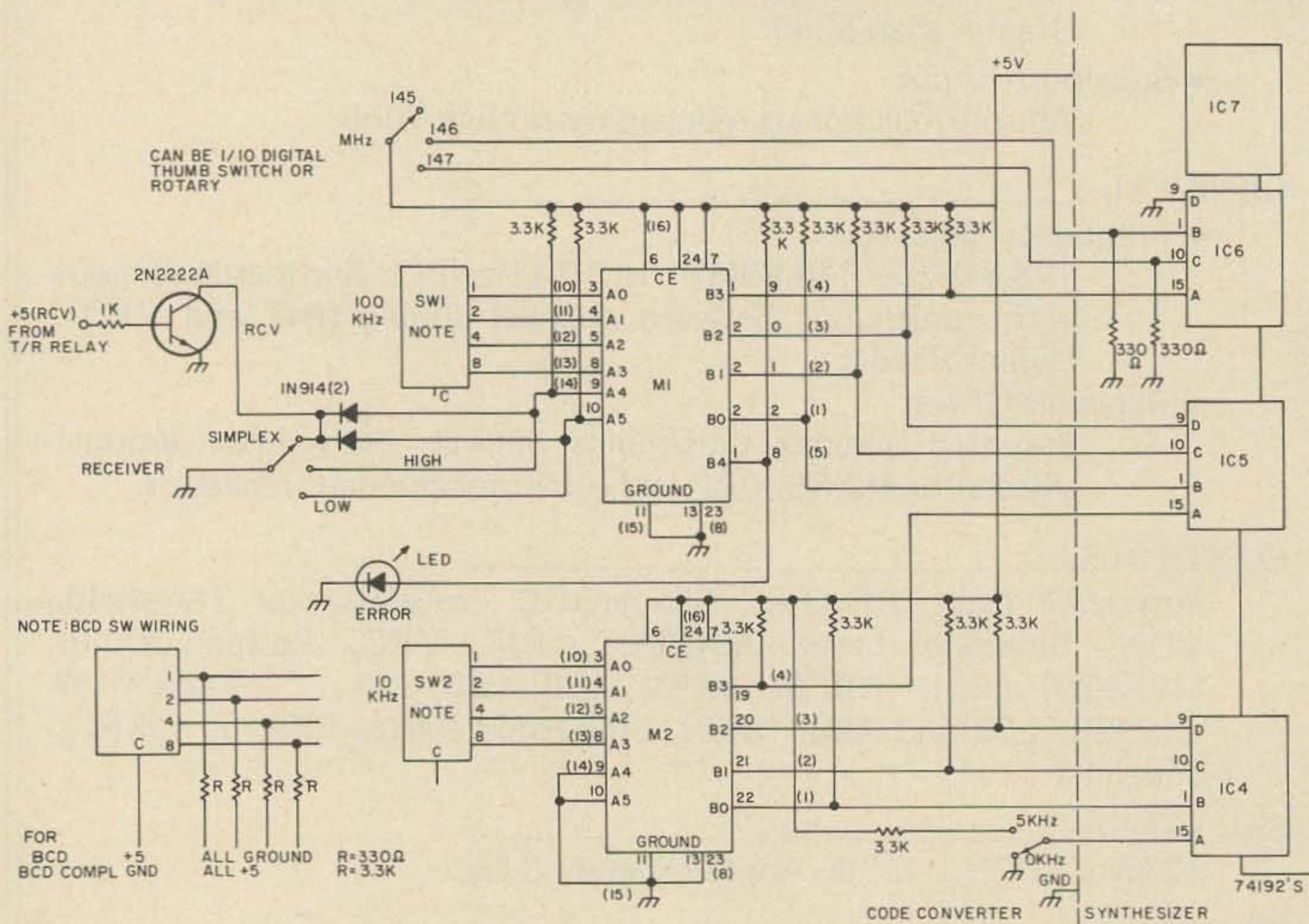

Fig. 1. Schematic diagram for the code converter using a 74186 or Motorola MCM5003. Numbers in parentheses refer to 8223 equivalent pins. The right hand side of the diagram is the interface with K2OAW's synthesizer. M1, M2 - pins for MCM5003 or 74186. All resistors 1/4 W 10%.

WORD ADDRESS		DATA OUTPUTS								WORD ADDRESS		DATA OUTPUTS								
DEC	OCTAL	B7	B6	B5	B4	B3	B2	B1	B0	DEC	OCTAL	B7	B6	B5	B4	B3	B2	B1	B0	
0	0	0	0							3	2	4	0					X	(3)	
0	1	0	1						X	3	3	4	1					X	(3)	
0	2	0	2					X	(1)	3	4	4	2					X	(3)	
0	3	0	3					X	X	3	5	4	3					X	(3)	
0	4	0	4				X		(1)	3	6	4	4					X	(3)	
0	5	0	5			X			(1)	3	7	4	5					X	(3)	
0	6	0	6			X			(1)	3	8	4	6						(3)	
0	7	0	7		X	X		X	(1)	3	9	4	7						X	(3)
0	8	1	0		X	X		X	X	4	0	5	0					X	(3)	
0	9	1	1		X	X	X	X	(1)	4	1	5	1					X	X	(3)
1	0	1	2							4	2	5	2							
1	1	1	3							4	3	5	3							
1	2	1	4							4	4	5	4							
1	3	1	5							4	5	5	5							
1	4	1	6							4	6	5	6							
1	5	1	7							4	7	5	7							
1	6	2	0			X		X	(2)	4	8	6	0							
1	7	2	1			X		X	(2)	4	9	6	1							
1	8	2	2			X		X	X	5	0	6	2							
1	9	2	3			X			(2)	5	1	6	3							
2	0	2	4		X				(2)	5	2	6	4							
2	1	2	5		X				(2)	5	3	6	5							
2	2	2	6		X				(2)	5	4	6	6							
2	3	2	7		X				(2)	5	5	6	7							
2	4	3	0		X				(2)	5	6	7	0							
2	5	3	1		X				(2)	5	7	7	1							
2	6	3	2							5	8	7	2							
2	7	3	3							5	9	7	3							
2	8	3	4							6	0	7	4							
2	9	3	5							6	1	7	5							
3	0	3	6							6	2	7	6							
3	1	3	7							6	3	7	7							

NOTE 3  
(8223 ONLY)

Fig. 2. Programming chart for either 8x32 or 8x64 PROMs. (1) programming same for both M1 and M2. (2) Plus 600 kHz pgm for M2. (3) (74186/5003 only) Minus 600 kHz pgm in address 32 through 41 in 74186 or in address 00 through 09, bits 4 - 7 in an 8223.

devices are ideally suited for code changing applications. The 32 word devices such as the 8223 are becoming readily available at a reasonable price. While I was at the code changing business I discovered I had lots of memory left over, so I decided to do away with the second bank of switches in the K2OAW version and just change receive coding to obtain standard repeater offsets.

My synthesizer now has three thumb-wheel switches: One each for MHz, 100 kHz and 10 kHz, followed by a toggle switch for 0/5 kHz. I then have a rotary switch which selects "SIMPLEX," "RCV HIGH" and "RCV LOW." The switch offsets the receive frequency either 600 kHz high or low from the frequency (transmit) set on the switches. Any desired offset can be programmed into

the PROMs but 600 kHz is pretty well standardized.

Circuit

The basic circuit and interface with the synthesizer are shown in Fig. 1. The pins are shown for an 8 x 64 word memory such as a 5003 and also shown, in parentheses, are the pins for an 8223.

To change repeater offsets I simply use the dc receive switching signal (+5 for RCV, GND for XMIT) routed through a switch to select which portion of memory is used in the receive mode. If a 32 word memory is used, one of the memory location shifts could be done by externally selecting either the B0 to B3 or B4 to B7 output bit locations with a data selector chip. With my

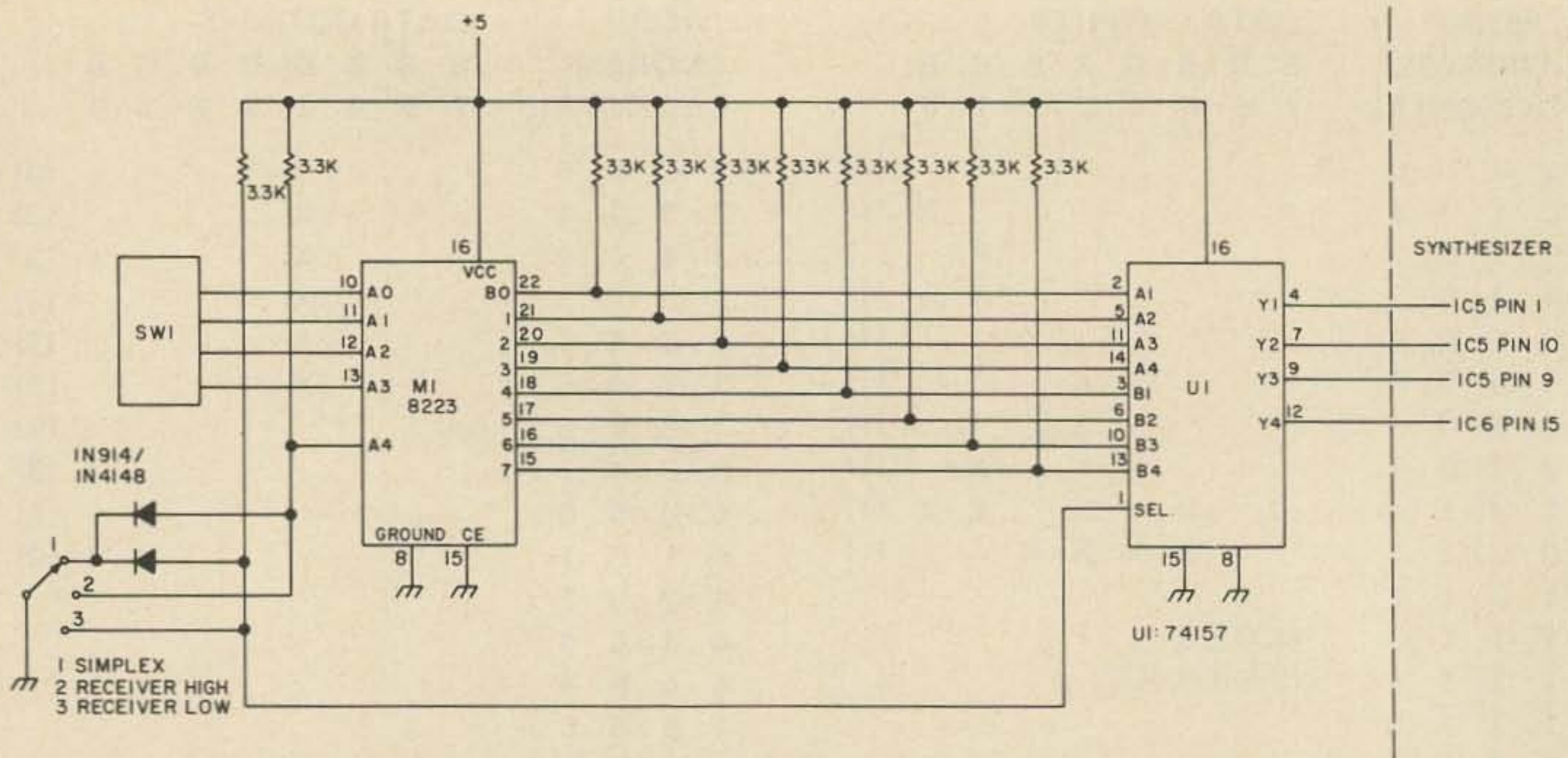

Fig. 3. This circuit will provide similar capacity to Fig. 1 using 8 x 32 word PROMs. All resistors are 4.7k ¼ Watt. M2 wiring is the same as shown in Fig. 1.

64 word memories, the receive code addressing starts at 00, 16 or 32 depending upon switch setting.

One problem could arise with my scheme. If the offset selected ( $\pm 600$  kHz) combined with the dialed frequency falls outside the one MHz band selected, then the receive frequency will be in error, the error depending upon the memory coding (e.g., if 146.40 or above and "RCV HIGH" were selected the frequency would be in the next band segment). I developed a circuit to change the MHz switching automatically,

but it added three more ICs to the circuit, which turned out to be more complex than I wanted. Instead I used the B4 output bit in the 100 kHz memory to indicate an error by use of a LED. This output can be used to light a light, ring a bell or whatever turns you on. A note to those of you who already have the K20AW synthesizer built or planned: The 3.3k resistors on the memory outputs take the place of the 330 Ohm resistors and diodes on the synthesizer board for those lines.

### Using PROMs

Contrary to some popular belief, PROMs are NOT particularly difficult to program. Although I have now built myself a fixture

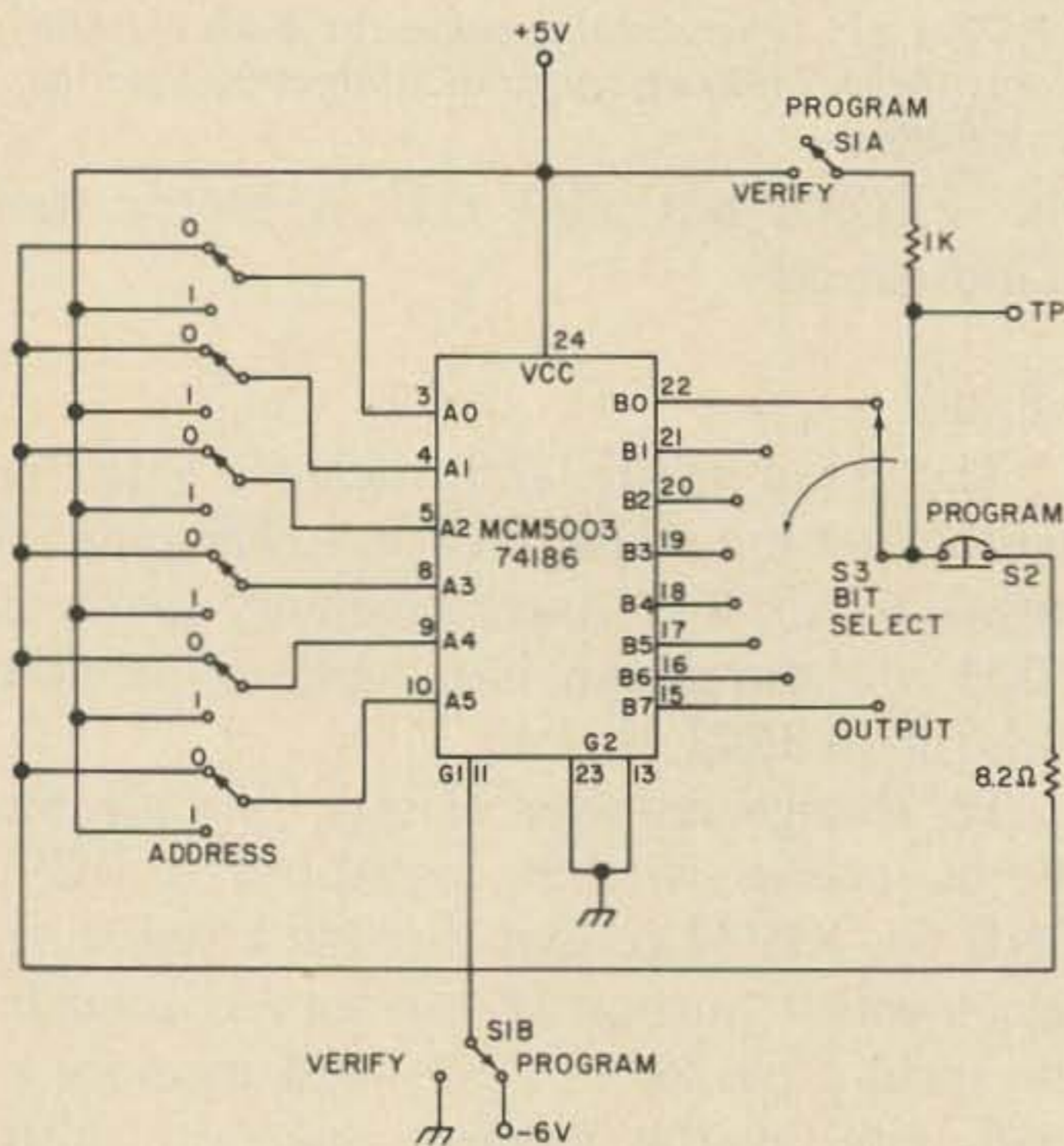

Fig. 4. Simple method of programming the 74186/MCM5003 type device. Operation is explained in the text.

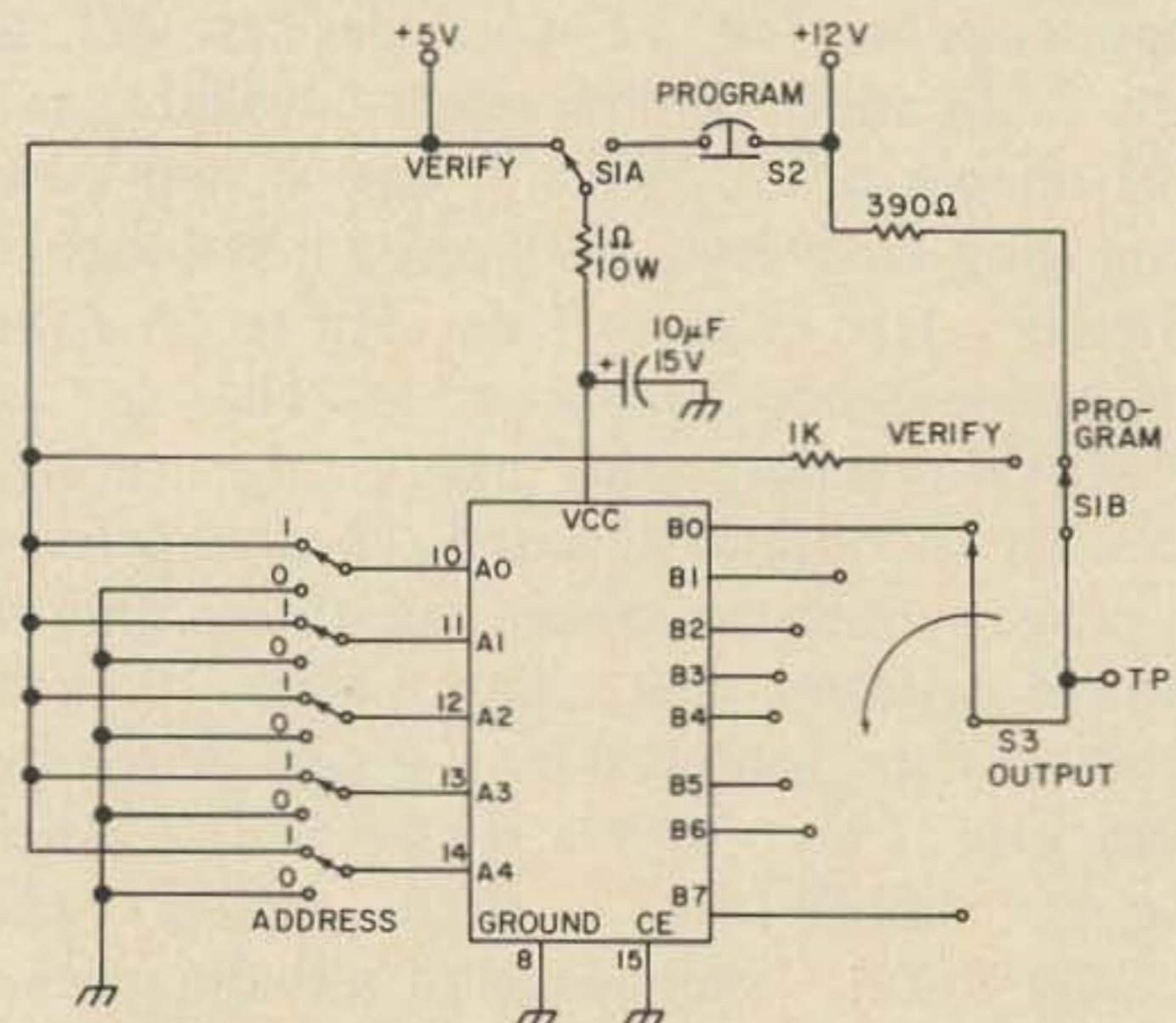

Fig. 5. Simple circuit for programming the 8223 type devices.

for programming the 74186/MCM5003 type device, I originally did it with a breadboard IC socket, 2 power supplies, and a few clip leads — it's slow but it works. The basic circuits are shown in Figs. 4 and 5.

Programming procedure is the same for both types of device. The steps are (with power applied):

1. Select word address with binary switches.

2. For that word select output bits from the program chart which are ones with select switch S3.

3. As each desired output bit is selected, momentarily depress S2. This sets a logic one in that location.

4. Select the next word address and repeat the operation. After programming, the bit can be checked by switching S1 to "VERIFY" and looking for a logic high or low on that bit.

If you decide to build yourself a programming fixture you might note the octal addressing on my programming chart (Fig. 2). It is somewhat easier to set up thumb-wheel switch addressing in octal than to make the required BCD to Binary conversion necessary to address in decimal. One word of warning when programming the devices: Don't attempt to program more than one bit at a time, as you will exceed the device dissipation.

### Conclusion

The memory coding for use with manual MHz switching is shown in Fig. 2 on one of my coding sheets. An SASE will get you either memory device info or the circuit for the automatic MHz switching (whichever you need). In my synthesizer the two PROMs and associated parts are mounted on a small piece of perforated board. The board is then mounted on spacers on the synthesizer board over the place where the diodes/resistors go. The code switching works perfectly. I am working on a small circuit board for this but haven't gotten it done as yet.

... W7JSW

### Reference

Peter A. Stark, "Frequency Synthesizer For 2 Meter FM," Parts I, II and III, 73, September, October, November, 1972.

# K-ENTERPRISES

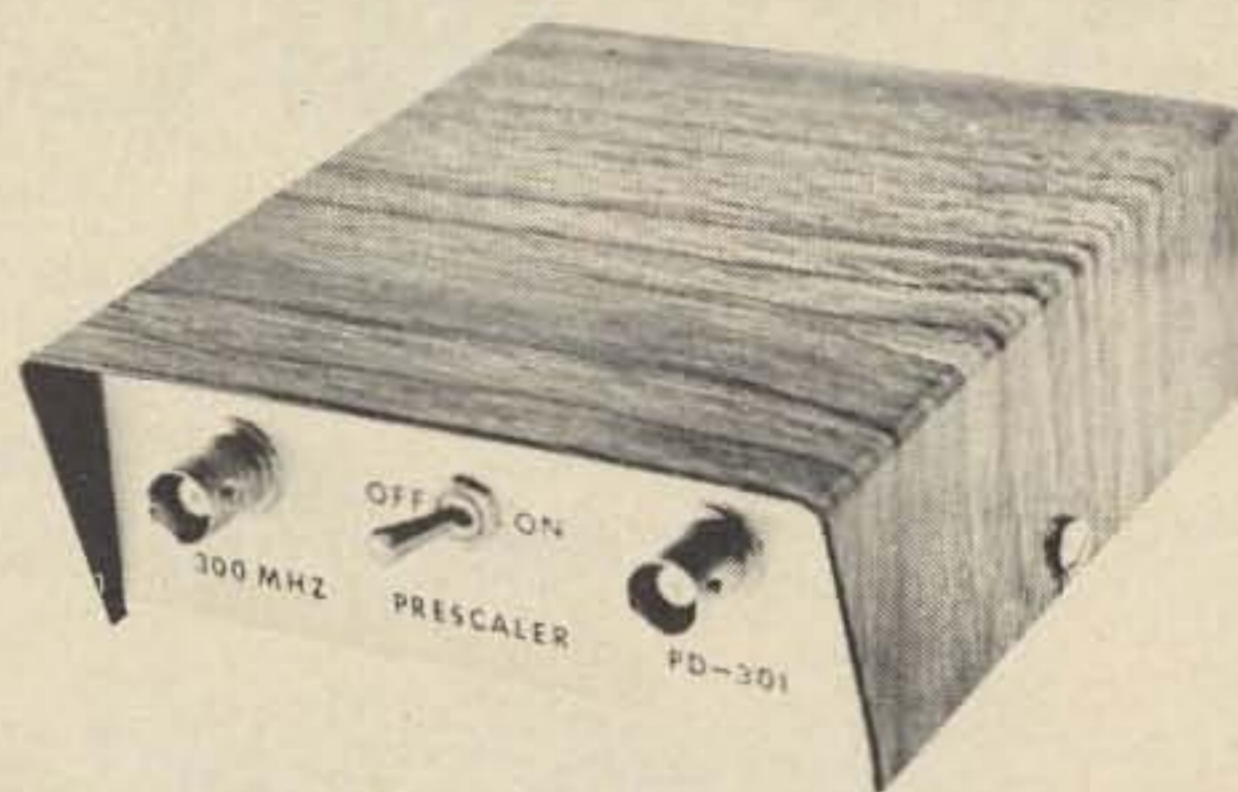

## PRESCALER MODEL PD-301

**\$55.50 plus \$1.50 postage**

Model PD 301 is a 300 MHz prescaler designed to extend the range of your counter ten times. This prescaler has a built-in preamp with a sensitivity of 50 mV at 150 MHz, 100 mV at 260 MHz, 175 mV at 300 MHz. The 95H90 scaler is rated at 320 MHz. To insure enough drive for all counters, a post amp. was built-in. The preamp has a self contained power supply regulated at 5.2V +.08%. (Input 50 Ohms, Output Hi Z)

All prescalers are shipped in a 4" by 4" by 1 1/2" cabinet. All are wired and calibrated.

## K-ENTERPRISES

1401 NORTH TUCKER  
SHAWNEE, OK 74801  
405-273-1598

# 500 MHZ PRESCALER

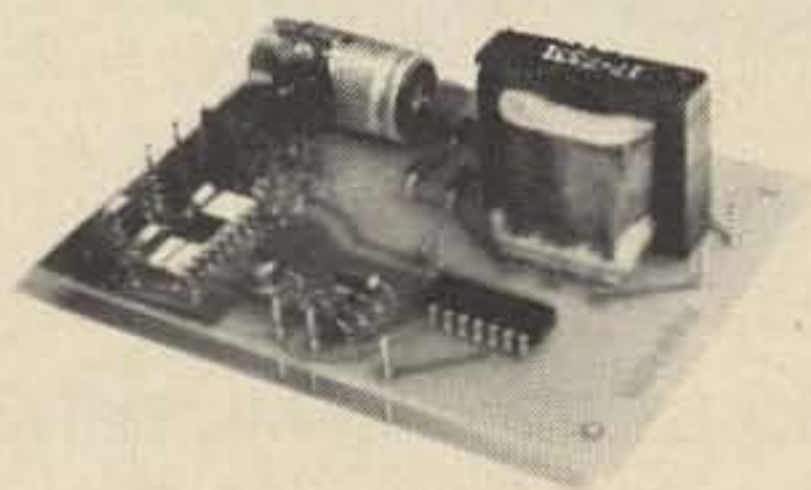

3" x 4" x 1 1/2"

**EXTEND YOUR COUNTER to 500 MHz!!!**  
Can be used with Any counter capable of 5 MHz.

- FMAX greater than 500 MHz.
- HIGH INPUT SENSITIVITY: less than 150 mV needed at 500 MHz — overload protected
- HIGH INPUT IMPEDANCE: 500 Ohms
- OUTPUTS: ÷10 and ÷100 TTL compatible
- INCLUDES POWER SUPPLY

PS-K kit ..... \$ 89.00  
PS-A wired and tested ..... \$109.00

BRAND NEW!  
500 MHz COUNTER  
WRITE FOR DETAILS

plus \$.85 postage  
Calif. residents add 6% sales tax

## LEVY ASSOCIATES

P.O. Box 961 S  
Temple City, Calif. 91780

# Special Crystal Deals

CALL OR WRITE FOR OUR LOW PRICES

*Now in stock*

*The latest in Synthesized and crystal rigs available*



ICOM 230 146-148  
FM

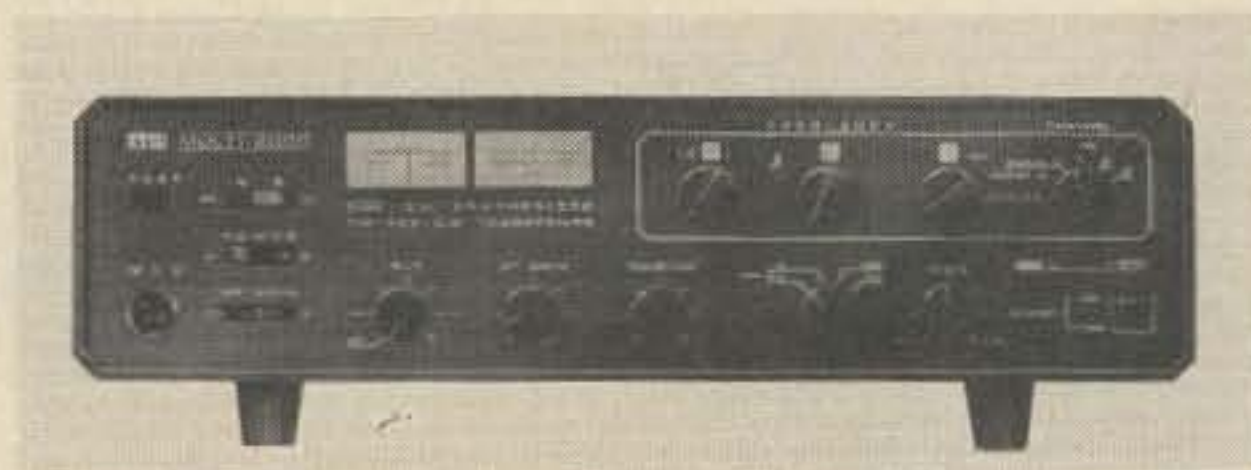

ITC Multi-2000 144-148  
FM-CW-SSB



Brimstone 144 142-149  
FM



ICOM 22A 146 - 148



ICOM 21-A 146-148  
ICOM DV-21

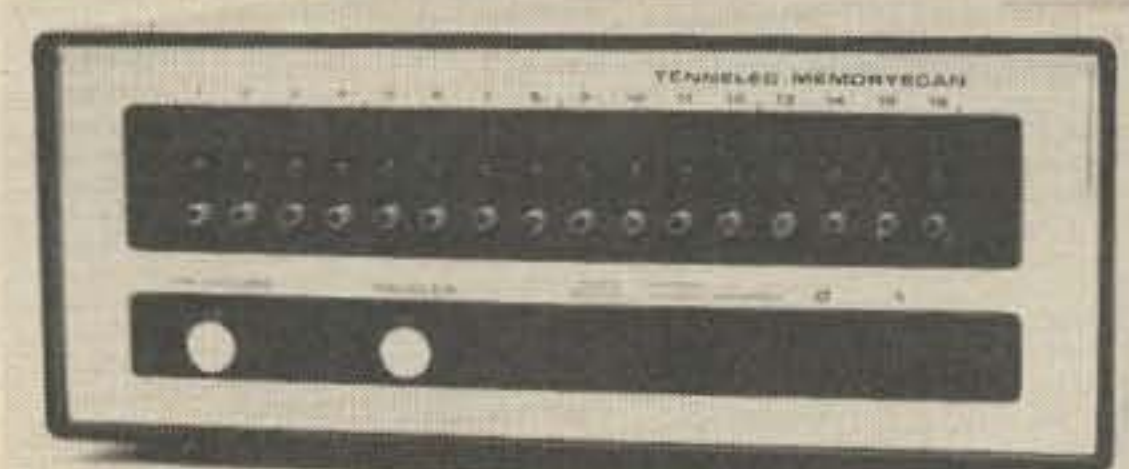

Tennelec Memory Scanner 30-50 146-170  
450-510 MHz

AUDIO LAND is now offering high trade-in prices for your used equipment. Write for trade-in prices and price quotes. Now in stock - CUSHCRAFT - REGENCY - SBE - HAL COMMUNICATIONS - NEWTRONICS - HY GAIN - AMPHENOL - TURNER - E.V. - SHURE - STANDARD - TEMPO. 3000 xtals for most rigs. Rotors and cables. Stereo and Quad equipment - and much more. N.P.C. regulated power supplies. All major charge cards accepted. Several finance plans available. Write for our latest trade-in listing.

*OUR HAMS SERVE YOU!*

Sales: Earl K8BHP - Chris WB8OHK - Dave WB8TOB

Service: Jerry WB8OHJ - Jerry K8IDE

## Audioland

36633 S. Gratiot  
Mt. Clemens, Michigan 48043  
(313) 791-1400





# Christmas Special

TENNELEC  
MEMORY SCANNER

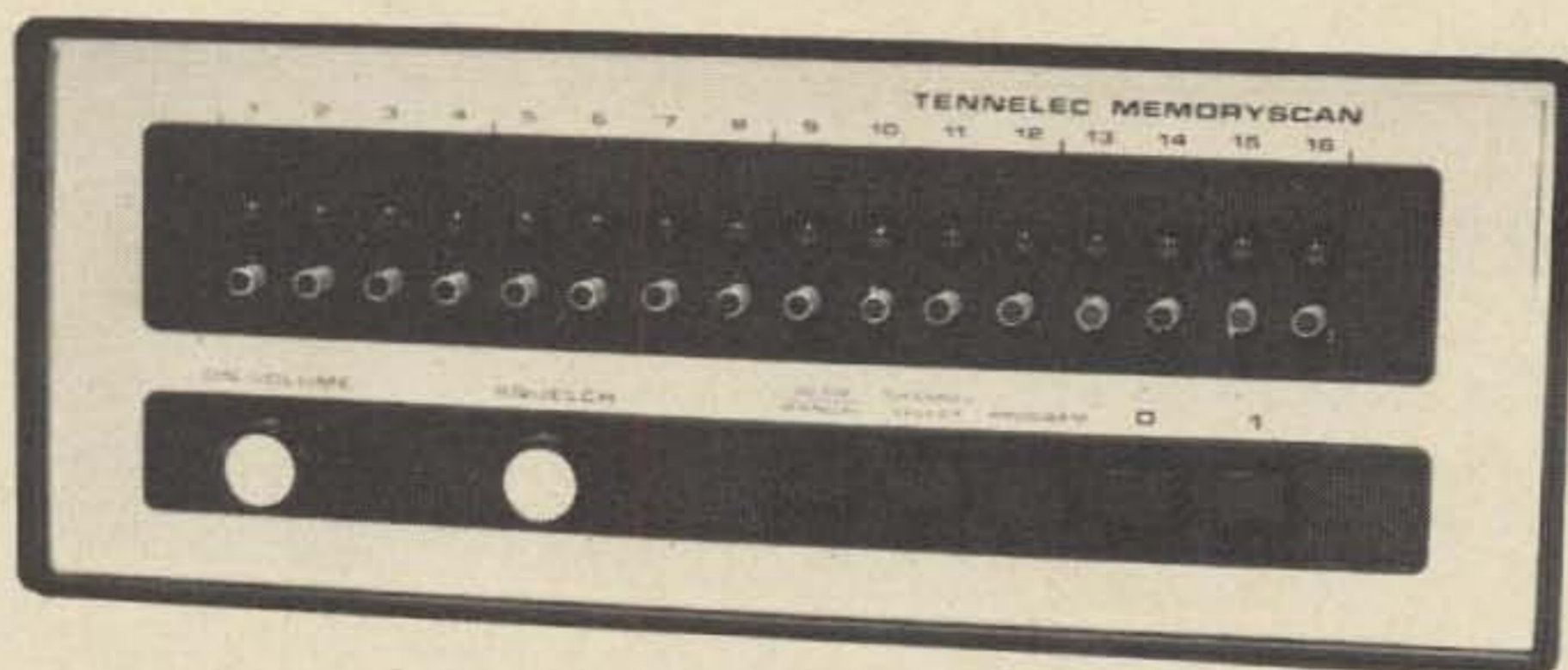

- PROGRAMMABLE UP TO 16,000 DIFFERENT FREQUENCIES.
- 30 - 50, 146 - 170, 450 - 510 MHz.

## *We Carry the Following*

Amphenol Connectors  
Antenna Specialists Antennas – Ham and CB  
Belden Cable  
Beltek Equipment  
Bomar Crystals  
Communication Specialties Equipment  
Cush Craft Antennas  
Electrovoice Microphones  
Fanan Equipment  
Hal RTTY Equipment  
Hy Gain Antennas  
Icom Equipment  
KLM Amplifiers and Equipment

L-S Digital Electronic Equipment  
Multi 2000 Equipment  
NPC Power Supplies  
Newtronic Antennas  
Regency Ham Equipment and Scanners  
Satan Electronics Brimstone 144  
SBE Equipment  
Standard Equipment  
Shure Microphones  
Swivetek Duplexers  
Tennelec Equipment and Scanners  
TPL Amplifiers  
Turner Microphones

*We Need Good Clean Lowband Equipment  
Will Buy or Trade*

---

# **Audioland**

36633 S. Gratiot, Mt. Clemens, Michigan 48043

Phone: (313) 791-1400

---

# WHAT IN TARNATION IS A BYTE?

It's the amount of memory it takes to keep a character (number, letter, etc.) in a computer memory . . . usually 8-bits in small systems. Actually BYTE is 12 bits if you go the singles routine, which we try to discourage by making an attractive subscription deal.

But what about BYTE? Is it any good? WAØIOT writes in,"

Whoops! The phantom mouth strikes again. I wrote, before publication, that I was hopeful but not optimistic about BYTE. Your first issue was terrific - fantastic - superb!

Of course, I've been there before, so I know that crow isn't too bad if I use enough salt. I'll even get off the "lousy sawbuck" I talked about before, as that first issue alone is worth that. Naturally, I'll mention BYTE when writing for data, etc., and may even try to write an article sometime. Meanwhile, it's to bed with a severe case of hoof-in-the-mouth disease I have to cure.

C. Southard WAØIOT

That's about typical of the comments on BYTE.

Computers (and BYTE) are not for the lazy. The fact is that there is a whole technology developing which requires an understanding of both electronics and programming . . . and neither is for the faint of heart. BYTE will help you get into this fantastic new field . . . it really didn't seriously exist until 1975. BYTE has articles to get you in on the ground floor technically, covering hardware, software and applications. BYTE will be covering various user groups such as game players, computer music, computer art, small business uses, etc.

The first issue was September 1975 and subscriptions are \$12 per year . . . cash, check, BankAmericard, Mastercharge, or IOU. Makes a great Christmas gift for yourself . . . and a few friends.

**YES! Enter my subscription to BYTE . . . start with the \_\_\_\_\_ issue.**

Name \_\_\_\_\_ \$12 enclosed

Address \_\_\_\_\_ Bill me the \$12

City \_\_\_\_\_ State \_\_\_\_\_ Zip \_\_\_\_\_ (\$12 worldwide . . . for now)

(Please allow a lot more time than you might think for our computer to handle this difficult problem of entering a subscription. . . computers, phooey.)

**BYTE** MAGAZINE, Peterborough NH 03458

# Computers are for Hams!

**D**uring the last few years, there has been a dramatic growth in the availability of digital computers to the average person — or ham. Almost any college or university now provides computer access to its students, and many high schools now have some computer facilities. This is due, in part, to the equally dramatic drop in prices for small computers, also known as minicomputers, which range in cost from about \$1500 to as much as several hundred thousand dollars. Another factor is the increase in large time-sharing systems, which make computer time available to anyone with a telephone and a paid-up account. If you can't see spending even a few thousand dollars for a mini, you can always buy a microcomputer. MITS sells its Altair model for \$439, and complete kits using the 8008 chip have been advertised for under \$400. If you have some of the makings, and like to experiment, you

can pick up so-called microprocessor chips for under \$30.

But computers are useless unless they are programmed. A computer program is like an instruction manual that the computer can use to solve the problem which you want it to solve. Computers are dumb; they can't do anything without explicit instructions. If programming scares you, there are many programs that have already been written; all that you have to do is to feed them in and start them up. But it is cheaper, and much more fun, if you write your own programs. Besides, not every problem which you may want to solve has already been written as a program.

Writing programs requires two things of the programmer. The first is an algorithm — which is simply a method of solving the problem. But as was mentioned before,

computers need very explicit instructions to do anything. Each computer understands one, and usually only one, language. This language is nothing like a human language. In fact, to a computer, a typical statement in computer language might look like this: 111000000100000110. That particular statement would tell a PDP-9 computer to print one letter on the teletype connected to it. If one had to write all programs like that, we would still be using slide rules to send men to the moon — if we ever wanted to try. But fortunately, someone decided to take it upon himself to write, just once, a program in this kind of form which would translate a more usable language into 1s and 0s. Once this was done, you never had to write a program in 1s and 0s; instead, you could use little combinations of three or four letters called mnemonic op-codes, usually called simply op-codes. (Try to

pronounce mnemonic!) For example, the sequence of 18 1s and 0s above could be written like this: TLS. The program which does all of this is called an assembler, and you usually can get one from the manufacturer of the computer. Unfortunately, you must get a different one for every computer, and usually you must learn a new set of op-codes for every computer.

Anyway, now that we have a language that both we and the computer understand, we can take our algorithm and put it into our computer's language, feed it in, and the computer should solve the problem. Much of the commercial and scientific programming is done this way. But to write a program in op-codes is very tedious, because most op-codes express very simple ideas. Therefore, some geniuses wrote programs which would translate a high level language into op-codes. A high level language is one which even a

---

## A SHORT GLOSSARY OF COMPUTER TERMINOLOGY

*ASCII.* American Standard Code for Interchange of Information. An 8 bit code used for teletypes and other I/O devices.

*Assembler.* A program which translates op-codes into 1s and 0s.

*Bit.* The smallest unit of information — either a 1 or a 0.

*Byte.* A unit of information which commonly consists of 8 bits, or one ASCII character.

*Compiler.* A program which translates a high level language into either op-codes or 1s and 0s.

*Core.* A kind of memory which the computer uses to store the program it is using and the data it needs.

*CPU.* Central Processor Unit — the heart of the computer, which executes the program and does calculations.

*Disk.* One of the most common forms of mass storage; like a magnetic tape except it looks something like a phonograph record.

*Flow chart.* A diagram of a computer program in symbolic terms; somewhat like a schematic diagram of an electronic circuit.

*Interpreter.* A program which causes a computer to simulate an understanding of a high level language; not really a translator.

*I/O device.* I/O stands for Input/Output; an I/O device is what the computer uses to communicate with the outside world.

*Mag-tape (Magnetic tape).* Used to store data or programs; looks like wide recording tape.

*Memory.* Anything which is used for storage of data or programs; usually refers to core or short term storage.

*Paper tape.* Inch-wide strips of punched paper which are used to store programs for small computers or cheap ones.

*Time-sharing.* When several users share the computer's time. Contrasts with Batch-processing, when each user has the computer to himself until his problem is completed.

*Word.* The basic unit of information for a particular computer; usually one op-code. Word lengths range from 1 bit to over 60 bits.

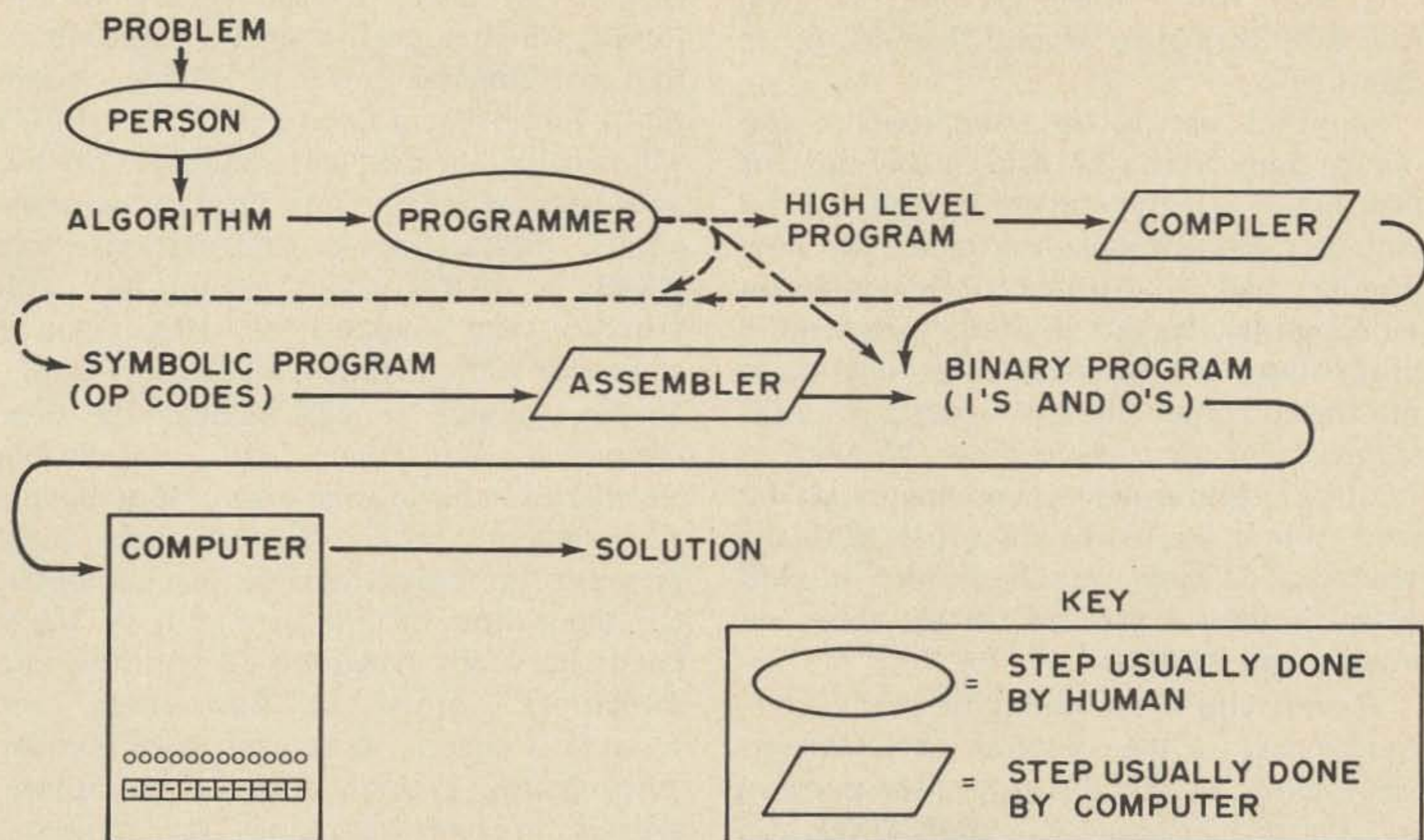

Fig. 1. Procedure for solving a problem by computer.

junior high school student can use, because it is very simple to understand. Some of the widely used high level languages are FORTRAN, BASIC, ALGOL, COBOL, APL, FOCAL, and PL/1, to name a few. In BASIC, the statement: PRINT "HAM RADIO IS FUN" would cause the teletype to print out HAM RADIO IS FUN. The same procedure would require 42 op-code instructions, or 756 1s and 0s if done on a PDP-9 computer. The program which translates high level language to op-code language is usually called a compiler.

One of the most common ways of using a computer is to use a time-sharing system. This is when anywhere from 2 to 2,000 (or even more) people are connected simultaneously to the same computer. Each person uses the computer as though he were the only one using it, and the computer is fast enough to give each user a little time every few milliseconds, so that it seems as though it is devoting itself completely to each user. This is like a movie; the pictures aren't really moving, just presented fast enough so that we think they are. If you use a time-sharing system, you will probably use a high level language, since most time-sharing systems do not allow use of op-code

languages. The two simplest languages to use, and therefore most common on large time-sharing systems, are BASIC and FORTRAN. FORTRAN, which stands for FORMula TRANslation, is not as well suited to time-sharing as is BASIC, and is somewhat confusing to the neophyte programmer.

BASIC stands for Beginner's All-purpose Symbolic Instruction Code, and was the first time-sharing language. It was developed at Dartmouth College, and the primary goal of the developers was to give the programmer as easy a time as possible. Many other, more advanced, versions of BASIC have since been written, but they share the feature that a program can be written in the simplest version and be usable with any of the advanced ones. As one learns more about programming, more and more features can be added to one's computer "vocabulary." BASIC compilers are available from almost any minicomputer manufacturer, ranging from the Digital Equipment Corporation (DEC) PDP-8, at about \$2000, to the Wang Laboratories \$7,400 System 2200, which has the language wired into the computer itself, to the \$80,000+ RSTS/E system used with DEC's PDP-11 series. (DEC, incidentally, is the biggest computer success

story since IBM — there are more of their little PDP-8s floating around than any other computer.)

So what use is the computer to the average ham, you ask? Almost any area of ham radio activity can be helped by the computer. For example, my radio club now produces mailing labels for our newsletter on the computer. We put all of our membership information onto punched cards, feed them into the computer, and out comes a gummed address label for each member. We used to sit up for several nights, copying names by hand from a list to the envelopes. With the same stack of cards, we can produce the club roster in several minutes, all set to go on mimeograph masters.

Even if you don't belong to a radio club, you can still use the computer. OSCAR users can get lists of OSCAR orbits for any area and for several years at a shot. DXers can make personalized tables of beam headings for their most important targets. Computers can print QSL cards, keep and check contest logs, predict spurious outputs for FM-27s, predict receiver birdies<sup>1</sup>, coordinate DX hunting<sup>2</sup>, design and test new circuits, graph antenna patterns and produce the Callbook. I have heard about repeaters that are completely controlled by a microprocessor. The computer can solve virtually any problem which requires the manipulation of numbers or data. I doubt if anybody has tried, but it should be possible to have computer chess tournaments over RTTY or slow scan TV. Some chess-playing computers, like Chess 4.0 of Northwestern University, have achieved high intermediate ratings.

It makes little sense for every ham to write his own programs for every problem he wants to solve ... in fact, there are many organizations which already exist for the sole purpose of exchanging programs between programmers. For example, Digital Equipment Computer Users Society (DECUS), sponsored by DEC, provides such a service. Catalogs of programs are sent free to members, and paper tapes of programs are available for little cost. Members contribute programs and articles to the society magazine, DECUSCOPE. DECUS holds conventions several times each year. Within

DECUS are many Special Interest Groups (SIGs), which appeal to smaller segments of the programming fraternity. There is room for a Radio Users Group (RUG?). DECUS will provide, for free, certain services for any SIG, such as mailing and printing of newsletters. Perhaps some organizations, like ARRL or IARU, could get together with DECUS and support a RUG. Other computer manufacturers, MITS for example, already provide similar services for their customers, but there are considerable advantages in having one organization handle all amateur programs. Although most programs are only usable on one computer, the algorithms behind them can be translated into any language. Algorithms are sometimes expressed in "flow charts," and these flow charts can be exchanged as easily as programs. I think that, in the future, articles in ham magazines on computer programs will be as common as construction articles, and programs will be distributed in the same way that printed circuit templates are.

I hope that this article has given you some idea of what the computer's place in ham radio is, and perhaps removed some of the mystery which shrouds the computer and its uses. The computer has been described as the most important technological innovation of the twentieth century, and although we all know that radio is more important, we can certainly give the computer a good shot at second place. We have nothing to lose but our slide rules!

... WA1PAZ

#### References

1. Gadwa, "Computerized Search For Receiver Birdies," *QST*, February, 1974.
2. Cone, "Computerized DX Chasing Made Easy," *73*, December, 1974.
3. "Introduction to Programming," Digital Equipment Corporation, 1970.
4. John G. Kemeny, "Man and the Computer," New York, Scribners, 1972.
5. Norbert Wiener, "Cybernetics," The MIT Press, Cambridge, Mass., 1961.
6. "Digital Computer Basics," Dover Publications, New York, 1968.
7. "BASIC-PLUS Language Manual," Digital Equipment Corporation.

# GET TO THE FAST!

NOW YOU CAN CHANGE, ADJUST OR JUST PLAIN WORK  
ON YOUR ANTENNA AND NEVER LEAVE THE GROUND!

ROHN manufactures towers that are designed and engineered to do specific jobs and that is why we have the FOLD-OVER TOWER . . . designed for the amateur. When you need to "get at" your antenna just turn the handle and there it is. Like other ROHN big communication towers, they're hot dip galvanized **after** fabrication to provide a maintenance free, long lived and attractive installation. ROHN towers are known and used throughout the world . . . for almost a quarter century . . . in most every type of operation. You'll be in good company. Why not check with your distributor today?



**ROHN** MANUFACTURING

®

DIVISION OF



P.O. Box 2000 / Peoria, Ill. 61601

# SEVEN UP

## ON THE COMPETITION

The Clegg FM-DX has many advantages over competitive 2-meter transceivers. Here's seven reasons why you should look to Clegg's FM-DX before you invest in any FM rig.

1. **FULL** 2-meter coverage from 143.5 to 148.5 . . . includes most MARS frequencies.
2. **CLEAN**, beautiful 35-watts transmitter output . . . enough for good simplex range when you want to escape the repeater crowd.
3. **SIMPLICITY** of operation . . . stability and accuracy of the Clegg synthesizer.
4. **RUGGED** modular construction . . . will outlast most of the lesser quality radios in today's marketplace.
5. **UNPRECEDENTED IMMUNITY** from intermod . . . thanks to a super single-conversion receiver. Forget about those police, taxi cab, and other spurious response problems you may have encountered in the past.
6. **PRECISE** large LED frequency read-out . . . just like having a frequency counter.
7. **ACCEPTANCE** . . . tells the gang that you own the very best in a dependable American-made transceiver.

For complete info, Call Clegg TOLL FREE now... (800) 233-0250.

In Pennsylvania, Call COLLECT (717) 299-7221.



Amateur Net \$645.00  
Factory Direct Only



*Clegg* DIVISION

208 CENTERVILLE ROAD LANCASTER, PA. 17603



# The Unzapper

*A keep-alive circuit for yourself.*

**W**henever you use an electric power tool or any electrical device for that matter, you expose yourself to the possibility of a fatal electric shock by coming in contact with faulty wiring and providing a path through your body to any surrounding grounded surface. Most wiring in homes now makes use of grounded three wire outlets to insure the extra conductor to protect against a drill or other electrical equipment from becoming shorted by tripping the circuit breaker. However, this is no 100% guarantee of safety since the return ground conductor could become faulty without your knowledge (bad connections, etc.). For this reason, the new National Electric Code is

requiring Ground Fault Interrupter circuits to be installed on all outdoor circuits and bathroom circuits in new homes. This new requirement is doubly important for outlets near swimming pools or outlets used for lawn tools and power tools.

A Ground Fault Interrupter (GFI) is a device which continuously monitors the current balance in an ungrounded conductor with the current in a neutral conductor in order to protect the user from ground faults. If the current in the neutral conductor is equal to that of the hot conductor, a ground fault condition does not exist since this is the normal operation of a load connected to the circuit.

However, if the current in the neutral wire becomes less than the current in the hot wire, then a ground fault exists, because a portion of the current is finding a return by an unintended path such as a leaky electrical appliance or tragically, through an

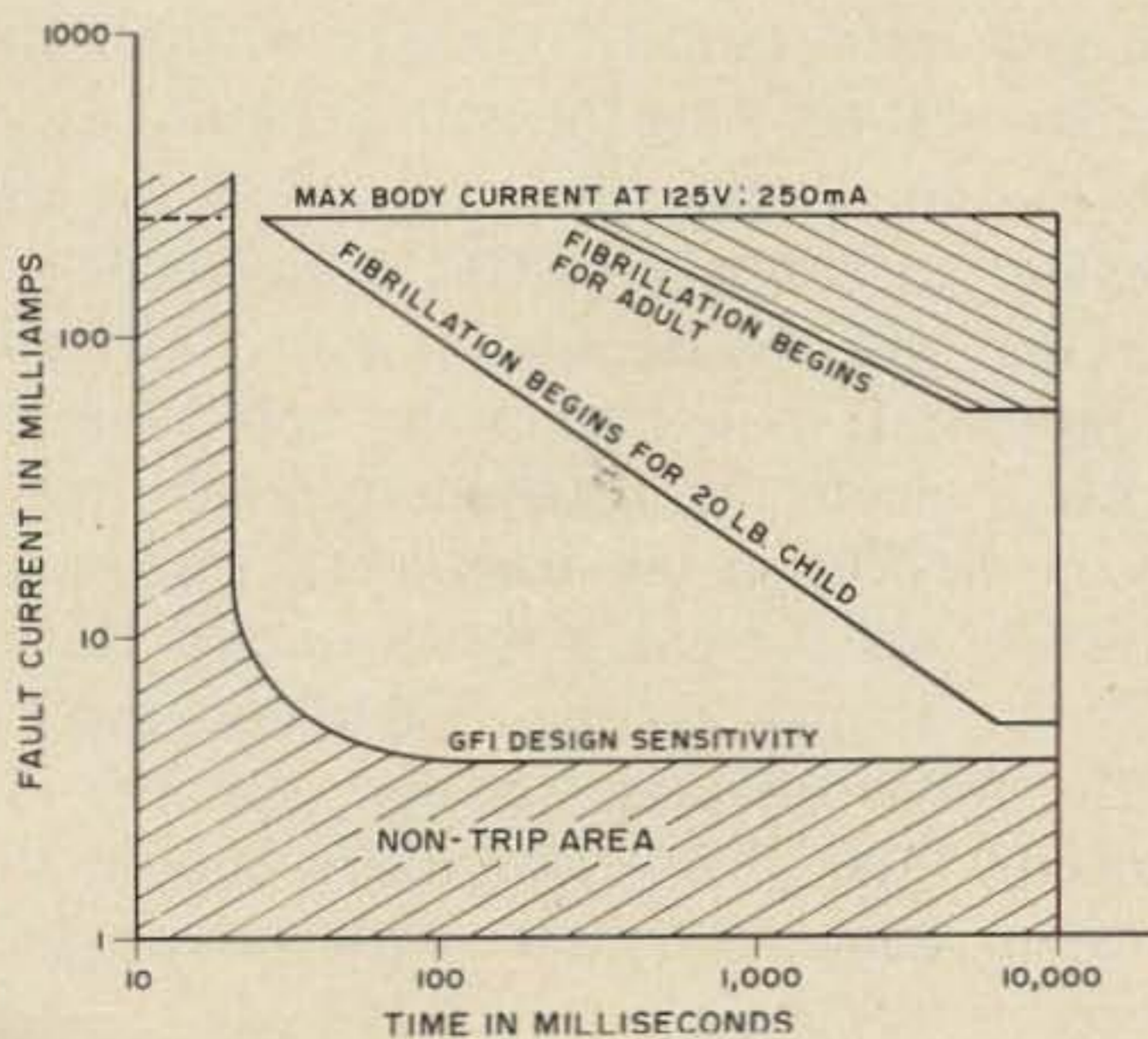

Fig. 1. For an adult, as little as 60 mA of current can cause fatal fibrillation of the heart. The GFI described in this article has a sensitivity of 4 mA. (Graph courtesy Pass & Seymour, Inc.)

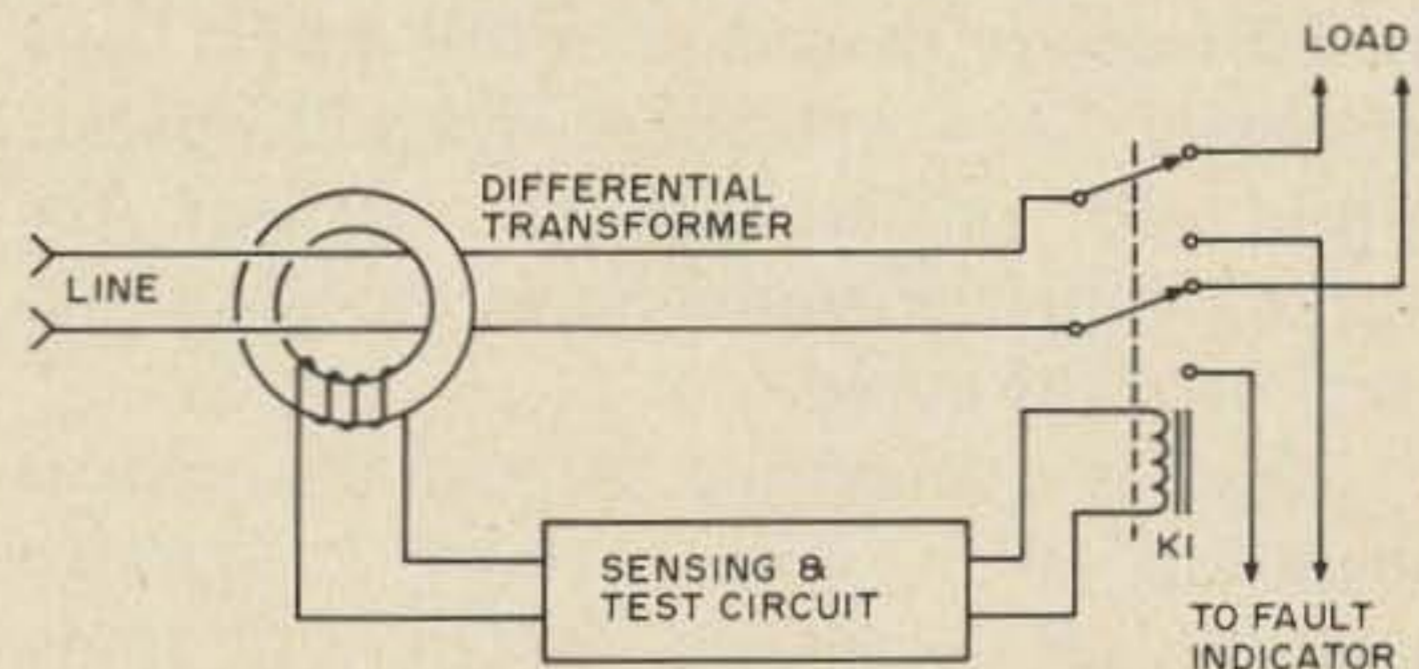
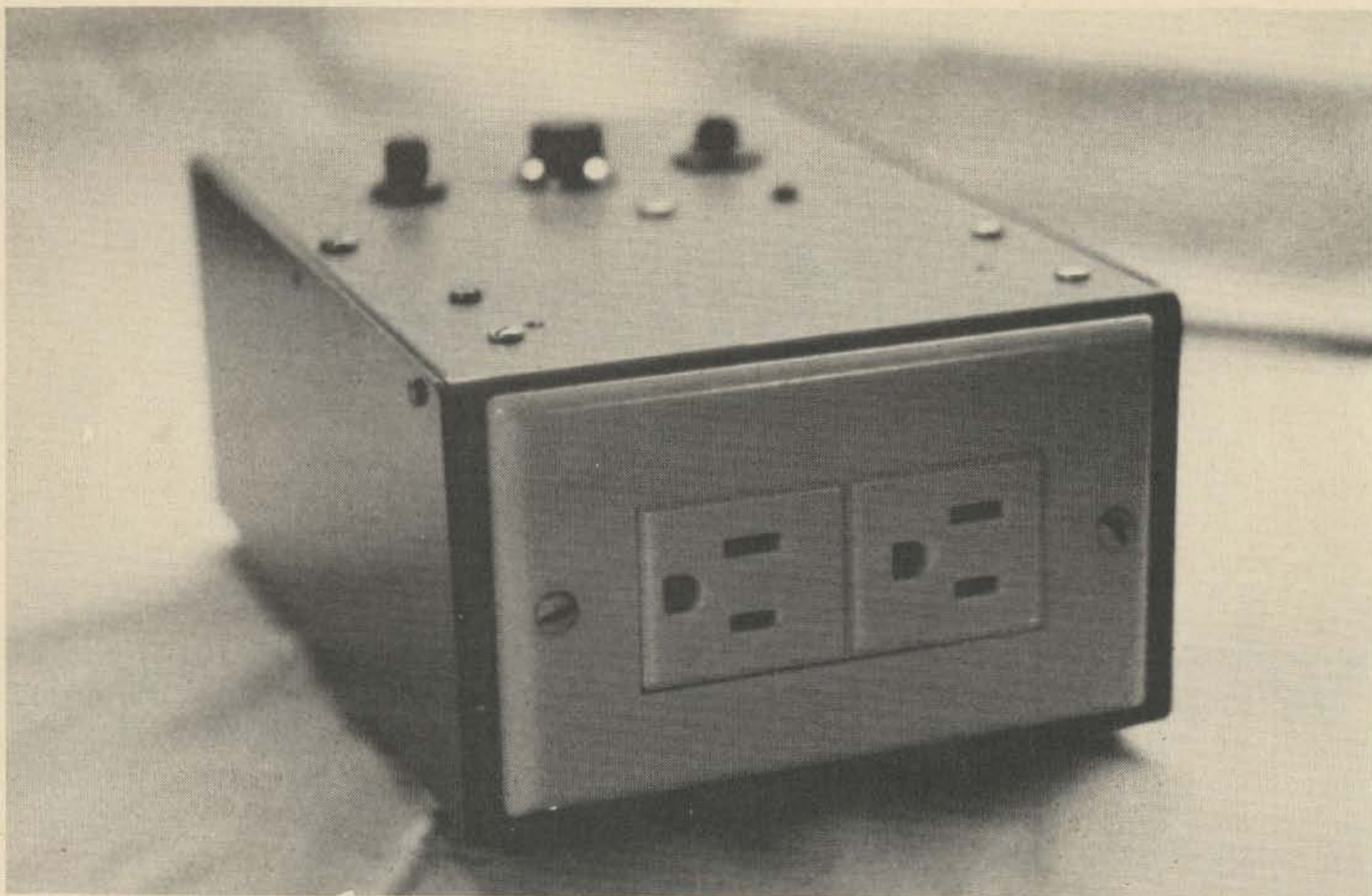

Fig. 2. Current leakage to ground on the load side causes an imbalance in the circuit. The resultant induced voltage in the toroid is amplified and used to actuate relay K1. The GFI does not depend on a third wire ground and incorporates a built-in test circuit for periodic checking.



*Front view of the GFI.*

individual. The GFI device will detect this situation and operate a relay which disconnects the power going to that particular load fast enough to protect the individual.

To understand the nature of a fatal electric shock, we refer to the graph shown in Fig. 1. This graph indicates that the maximum body current that an individual can withstand at 125 volts is 250 milliamps. It also indicates that muscle control leading to a fatal condition occurs at approximately 8 milliamps for a small child and up to approximately 60 milliamps for an adult. From the graph, it's also possible to see that the GFI device described in this article has a sensitivity of 4 milliamps and will operate within 30 milliseconds to prevent the current from ever appearing in the hazardous portion of the curve.

Fig. 2 is a simplified diagram of the basic operation of a GFI system. It consists basically of a sensing differential transformer, the sensing and test circuit, and a relay to de-energize the main circuit. Current leakage to ground on the load side causes an imbalance in the transformer circuit. The resultant induced voltage in the toroid is amplified and used to actuate an SCR which

controls relay K1. From the basic diagram, it is possible to see that the GFI device does not depend on a third wire ground system. It also incorporates a built-in test circuit for periodic checking. There are two basic commercially available models of GFI devices, one that installs directly into an outdoor outlet. There are also commercial models available as portable units that may be plugged into standard circuits without the necessity of rewiring the house circuit.

This article describes a method for the amateur to construct a GFI device which is portable and can be used in many different situations. It is exceptionally applicable to amateur electronic installations where many of the devices in use have metal enclosures which could present a shock hazard to the amateur. It may also be used in conjunction with transformerless power supplies to prevent fatal shock conditions should the amateur come in contact with various portions of the circuit.

#### **Circuit Description**

Referring to Fig. 3, one of the main elements of the circuit is a toroid transformer, T1, which consists of a two-wire

primary circuit and a secondary circuit used to sense the unbalanced condition. The actual details of the winding of this transformer are contained in a later section of this article. Resistor R1 is connected in such a way as to provide a 4 milliamp imbalance in the primary circuit used to simulate actual ground fault conditions for testing the circuit.

Resistor R2 and C1 form a filter circuit to help suppress spikes which may appear on the secondary side of the transformer from turning load equipment on and off. This eliminates tripping of the relay under these conditions, while having a negligible effect on normal operation of the circuit.

The integrated circuit, IC1, is an operational amplifier type 741 which is used to amplify the small voltage generated in the secondary winding of transformer T1. The gain of this operational amplifier is determined by the ratio of R5 and R6 expressed as follows:

$$\text{GAIN} = \frac{R5}{R6}$$

In this particular circuit, with R5 set at one megohm and R6 @ 2.7k, the gain is well over 300. However, the actual gain is limited by the input gain control, R3. A gain of 300 should be sufficient to fire the SCR, since it requires approximately 0.8 volts to trigger its control gate. With an imbalance of 4

milliamps on the primary of T1, approximately 3 millivolts appear across the secondary winding connected to the input of IC1. Since the gain of the op amp is set at 300, about 0.9 volts appear on the gate of the SCR which is sufficient to trigger it and cause relay K1 to operate. Once the SCR triggers, the circuit must be broken manually for it to reset. The reason for this is that we are supplying power through the relay coil to the SCR from a dc source and due to the nature of the SCR, this dc path must be broken before the SCR will turn off and restore the circuit to normal operation. Since the 120 V ac output is supplied through double-pole double-throw relay contacts, when the relay operates, the 120 volts ac is transferred from the output of the unit to a neon indicator light making it possible to see that the unit has operated and the power has been turned off.

Diodes D1 and D2 also work in conjunction with the RC filter circuit to reduce transients that would cause false triggering of the unit. These diodes should be fast acting switching diodes such as the 1N914 type.

A parts list and PC circuit board details are contained in Figs. 4 and 5 respectively.

The basic components such as the integrated circuit, SCR, and other small components are located on a circuit board as shown in Fig. 6. The toroid transformer,

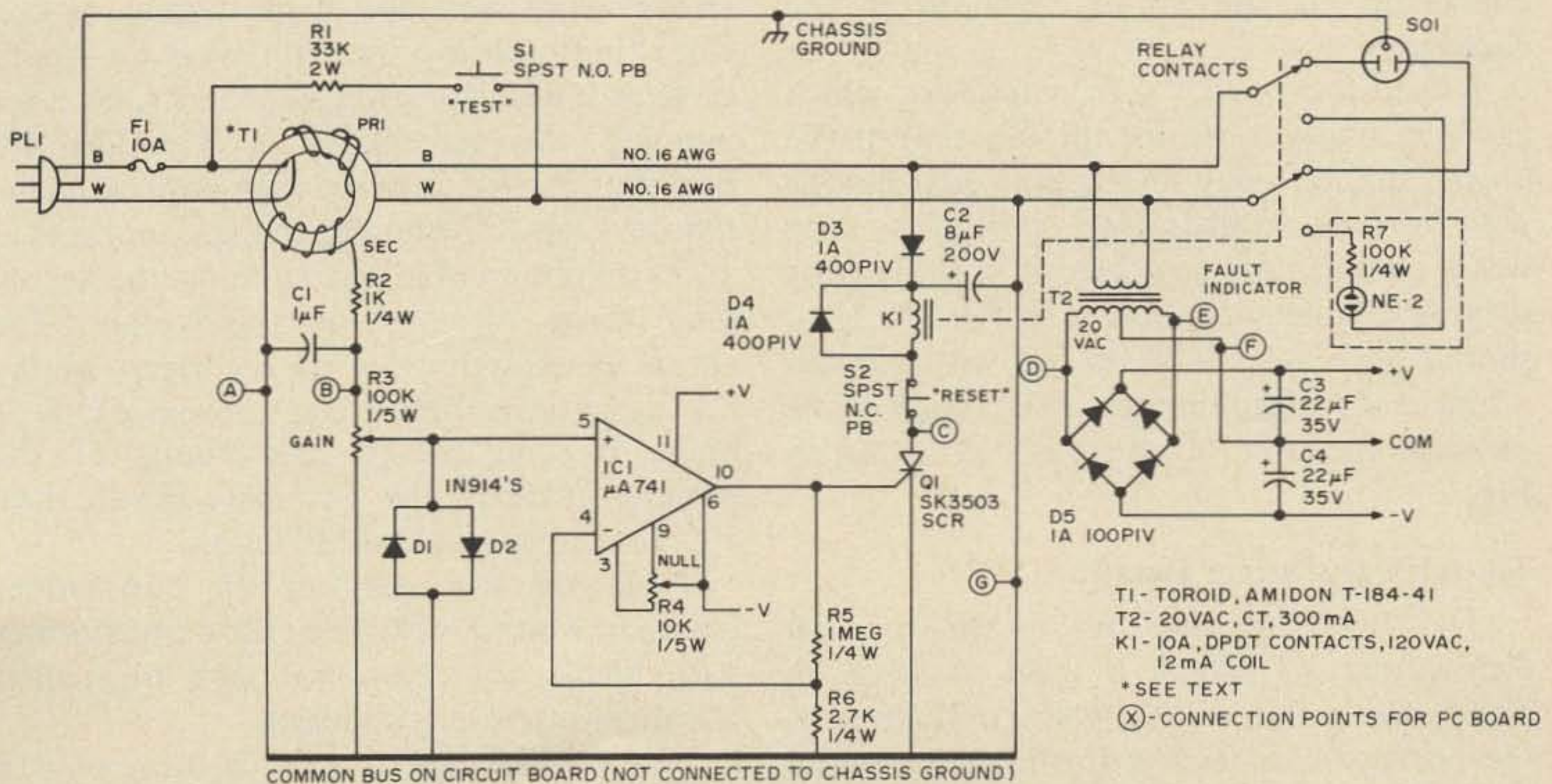
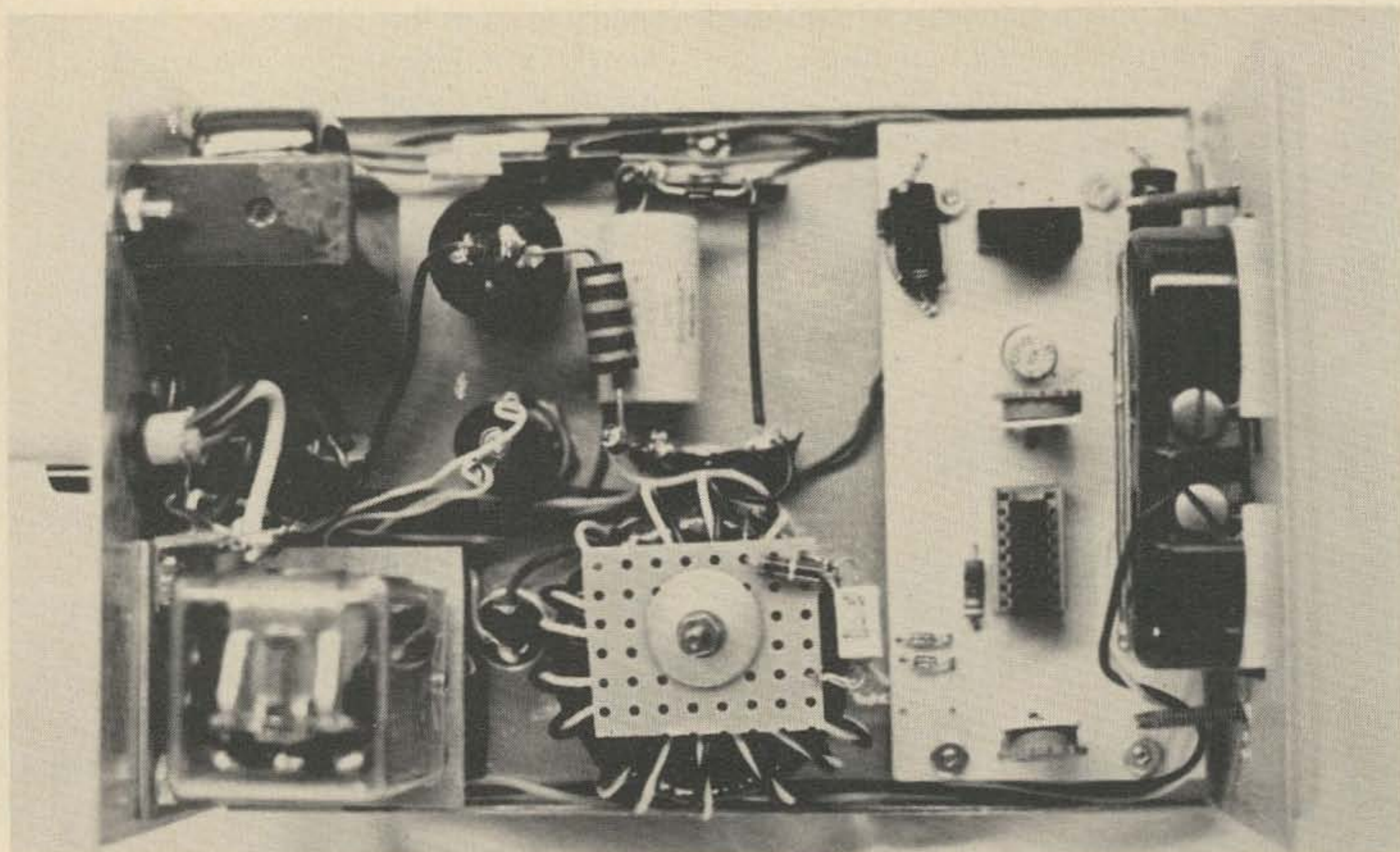

Fig. 3. Schematic diagram.



*Top view.*

relay and power supplies are located externally to the circuit board and connected by suitable wiring as shown in the diagram. It is important to note that the ground conductor from the ac supply should be connected directly to the metal chassis of the enclosure. However, since we are using a transformerless power supply to operate relay K1, it should also be noted that the common bus on the electronic circuit is not connected to the chassis ground of the enclosure.

I used a 3" x 7" x 5" enclosure which allowed ample room for the location of the power supply, relay and circuit board along with toroidal transformer. The relay used was a plug-in type, available at several of the surplus suppliers advertising in 73. The relay should have a 120 volt ac coil with contact ratings of approximately 10 Amps. The physical location of the parts is shown in Fig. 7.

#### **Toroid Transformer Details**

The heart of the unit is the toroidal transformer T1 which is used to sense an imbalance in one of the main conductors of the primary circuit. The toroid which I used is an Amidon Associates type T-184-41 iron toroid core. This toroid core has an inside

diameter of 1.84 inches and is light green in color.

The secondary winding of the transformer consists of approximately 600 turns of #30 enamel wire covering the entire circuit of the transformer. While this appears at first to be a very tedious operation to wind this many turns on the toroid, there is a method of winding it in a very short period of time. In my particular case, I used the enamel wire obtained from a peaking coil from the television set. This wire appears to be approximately #30 gauge and is ideal for winding the secondary of T1. The TV peaking coil has a certain amount of adhesive to keep its windings in place and acts as an excellent bobbin for running the secondary turns through the transformer. The actual winding time for the secondary on my particular transformer was approximately 1/2 hour. If you should lose count of the number of turns, the secondary should have a dc resistance of about 30 Ohms.

After the secondary of the transformer has been wound, wrap the entire transformer with black vinyl electrical tape to protect the small diameter conductor.

The primary consists of 12 turns of #16 solid conductor twisted pair wire. I used one black and one white wire conductor to

### Parts List

- C1 – 1  $\mu$ F, non-polarized
- C2 – 8  $\mu$ F, 200 V
- C3, C4 – 22  $\mu$ F, 35 V
- D1, D2 – 1N914 or equiv.
- D3, D4 – 1 Amp, 400 piv rectifiers
- D5 – 1 Amp, 100 piv bridge
- IC1 –  $\mu$ A741 operational Amp
- K1 – 10 Amp, DPDT contacts, 120 V ac, 12 mA coil
- Q1 – SK3503 SCR or equiv.
- R1 – 33k, 2 W
- R2 – 1k,  $\frac{1}{4}$  W
- R3 – 100k,  $\frac{1}{5}$  W trim pot
- R4 – 10k,  $\frac{1}{5}$  W trim pot
- R5 – 1 meg,  $\frac{1}{4}$  W
- R6 – 2.7k,  $\frac{1}{4}$  W
- R7 – 100k,  $\frac{1}{4}$  W
- S1 – SPST, N.O. push-button switch
- S2 – SPST, N.C. push-button switch
- T1 – Toroid, Amidon T-184-41 (see text)
- T2 – 20 V ac, CT, 300 mA
- Miscellaneous – three prong ac plug and line-cord, socket, enclosure, fuse and fuse holder

Fig. 4.

conform to the color coding of the National Electric Code and to help to keep the polarity of the entire system in accordance with the wiring throughout the house. The 12 turn twisted pair primary winding is spread out over the entire transformer to get maximum flux linkage to the secondary. By winding the transformer in this manner, it is possible to see that the current in both conductors of the primary winding should be equal under normal circumstances and since they are twisted together, should

cancel out completely within the toroidal transformer. Also, if an imbalance exists between the conductors, this imbalance will be sensed by the secondary winding and produce an ac signal which can be amplified to trigger the SCR. The secondary winding produces an output of approximately 3 to 4 millivolts when there is a 4 milliamp imbalance on the primary. This voltage output is sufficient to operate the SCR when amplified by the integrated circuit amplifier.

To mount the transformer, use 2 small squares of perf board with a hole drilled in the center for mounting onto the enclosure. Once the toroid is sandwiched between the 2 pieces of perf board, it is possible to install the mounting bolt and tighten the boards down for permanent installation. Then the small secondary wire can be fed through a couple of the holes on the top portion of the insulator, and soldered to terminals installed at this point. The RC filter consisting of R2 and C1 can also be mounted on the perf board and the output from this filter brought down to the input of the amplifier with regular hook-up wire.

By using a circuit board mounted to the transformer as a connection point for the secondary, it is possible to avoid any problems with breaking the very small enamel wire which has been used for the secondary to transformer.

### Conclusion And Results

Once the GFI has been constructed and

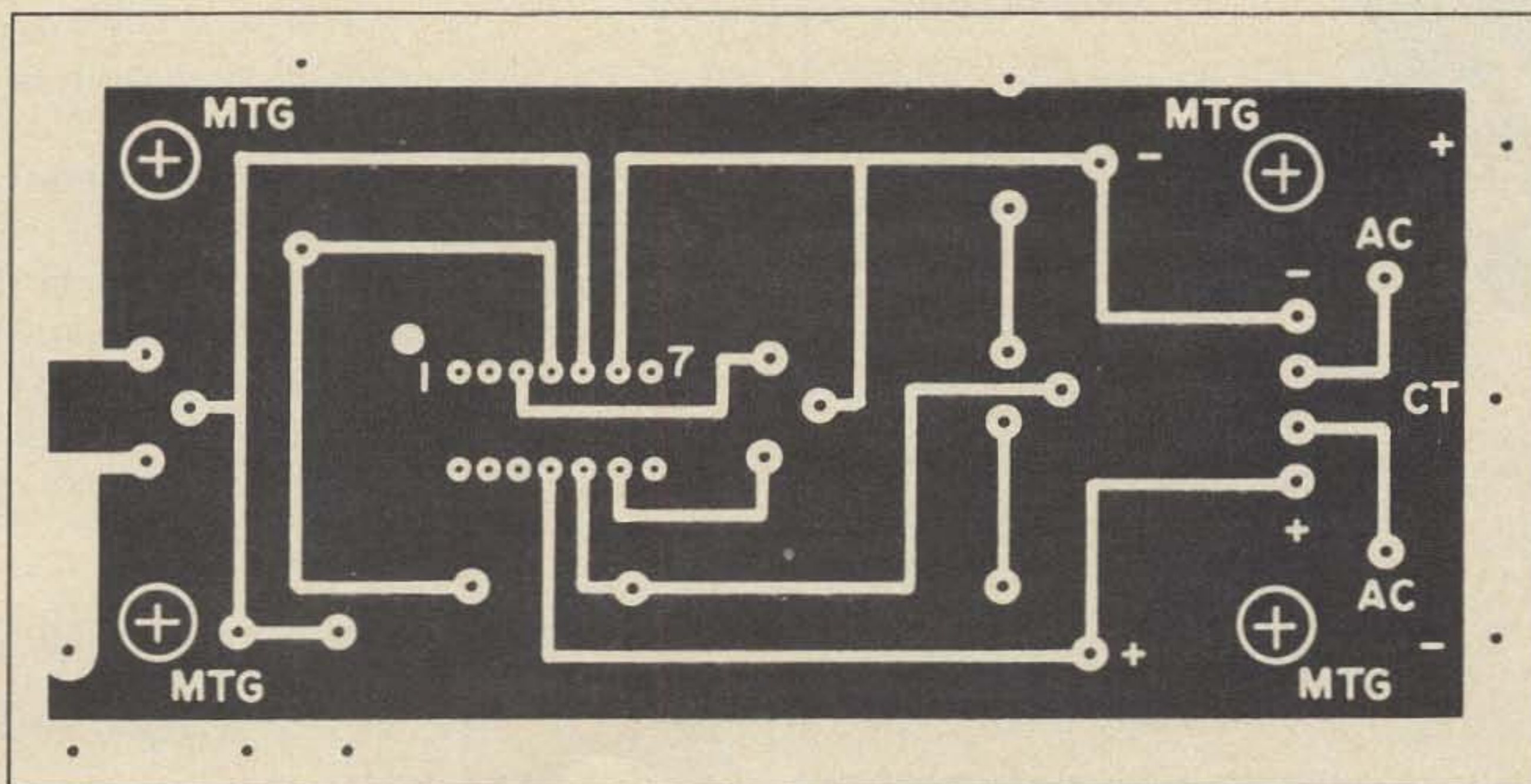

Fig. 5. Printed Circuit Board Layout (full size).

operating, there are only two minor adjustments which have to be made. First of all, the null adjustment, R4, should be adjusted so that there is zero voltage between the output terminal and the common bus during idle conditions. This is necessary to prevent false triggering of the SCR.

The next step is to adjust the input gain of the unit for proper operation. By depressing the test button, it is possible to introduce simulated fault condition. While holding the test button down, advance the gain control R3 until the relay operates. You may want to advance the gain somewhat further to provide even more sensitivity on the unit. Since most commercial units operate with a 5 milliamp sensitivity, any sensitivity greater than this provides that much more protection for the user. However, if the gain is set too high, it may result in nuisance tripping by spikes, and transients that are not controlled by the filter circuits.

In actual operation, it is best to test the circuit before each use to make sure that the circuitry is operating and will protect the user from ground fault conditions. This is done by depressing the test button and

seeing if the unit operates to remove the ac from the outlet. Then by pressing the reset button, the circuit to the SCR is broken and the relay returns to its normal position.

It should be obvious from the circuit and discussion that this unit protects the user only from "ground fault" conditions. It will not protect an individual if he gets directly across the power line.

The circuit is also designed for a 3 wire system, but will operate satisfactorily on 2 wire systems since it detects any type ground leakage whether it be through the ground conductor operating the unit, a ground path through a water pipe, or any other metal conductor that travels back to the grounded conductor of the power system.

I am sure that there may be some improvements to the circuit that I have not incorporated at this time. Perhaps, it may be possible to tune the toroid to 60 Hertz and thereby greatly increase the sensitivity of the T1 transformer. However, I have not investigated this possibility at this time, and would be interested to hear from anyone who has

## IC troubles? try these high-performance Super-Grip™ IC Test Clips

for fast,  
non-shorting access  
to all leads on dual-in-line  
IC packages



11  
models  
to fit all  
DIP's

TC-16 fits  
16 pin DIP's, etc.

Model	Row-To-Row Dim.	Part Number	Price
TC-8	.3 IN.	923695	\$7.35
TC-14	.3 IN.	923698	4.50
TC-16	.3 IN.	923700	4.75
TC-16 LSI	.5/.6 IN.	923702	8.95
TC-18	.3 IN.	923703	10.00
TC-20	.3 IN.	923704	11.55
TC-22	.4 IN.	923705	11.55
TC-24	.5/.6 IN.	923714	13.85
TC-28	.5/.6 IN.	923718	15.25
TC-36	.5/.6 IN.	923720	19.95
TC-40	.5/.6 IN.	923722	21.00

We honor M.C. and B.A.C. charges.  
Add sales tax on OH and CA orders.  
(F.O.B. Painesville on company P.O.'s.)  
Dealer inquiries invited

Add →  
fees from  
this chart.

SHIPPING/HANDLING	C.O.D.
Up to \$10.00	\$1.00
\$10.01 to \$25.00	1.50
25.01 to 50.00	2.00



All products guaranteed to meet or exceed published specifications

**AP PRODUCTS INCORPORATED**

Box 110-Z • Painesville, OH 44077 • 216/354-2101

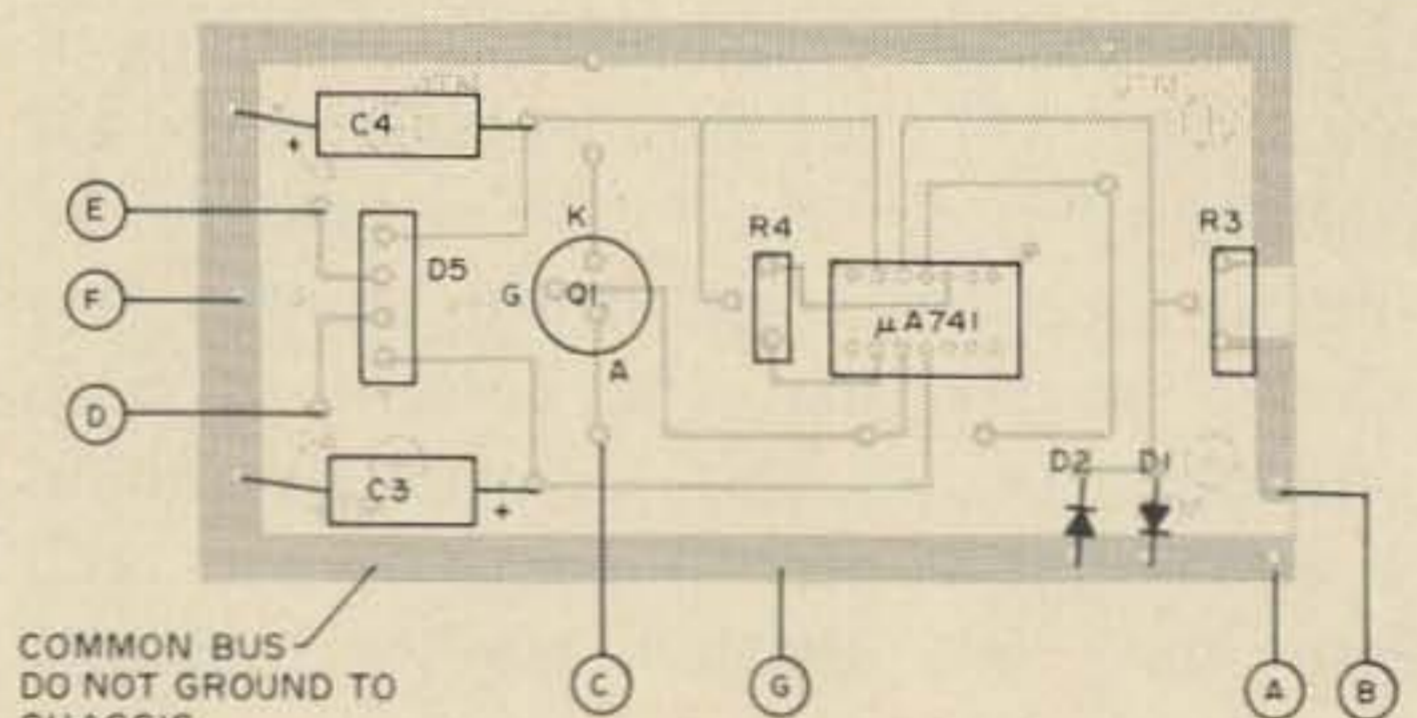

SEE FIG 3 FOR CIRCUIT CONNECTION POINTS

Fig. 6. Connection of Components External To PC Board.

had experience with toroidal transformers concerning this type of circuit. Perhaps if the transformer was resonant at 60 Hertz, fewer turns on the secondary winding would result in satisfactory operation of the circuit. At any rate, the unit as described could save your life, and that's its most important feature.

### References

National Electrical Code — 1975 Edition, pg. 31, paragraph 210-8.

Pass & Seymour, Inc. — Syracuse, New York 13209, brochure #3375.

... WB5DEP

# A \$1.00 Strip Chart Recorder !

**I**n many instances a recording of a change against time can be of value in examining cause and effect. With recorders costing more than a hundred dollars, this advantage is not available to most amateurs.

The strip chart recorder described, while of less than commercial stature, cost the writer about a dollar, has served its purpose very well, and can be an interesting exercise in utilizing commonly possessed or available

parts. The variations possible are myriad: direct clock motor drum drive, or through pulleys for mechanical reasons or to obtain the desired paper speed from an available motor. Similarly, the chart can be tensioned and paid off from its drum by simply attaching the loose end of the chart to a weight, or a more elaborate take-up may be devised by using another drum with an overriding rubber band slipclutch drive.

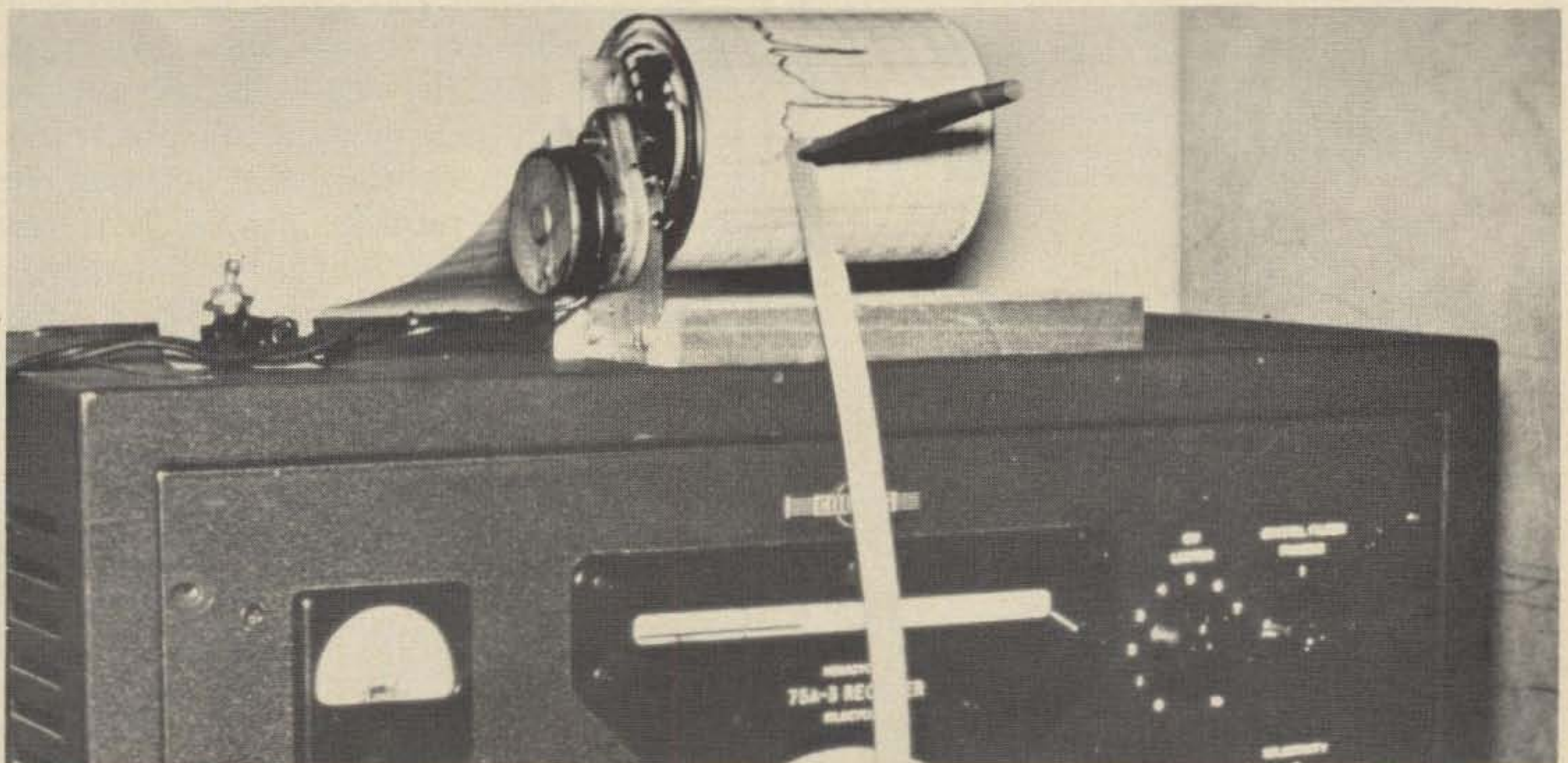

## Hale Electronics Brings You . . .

### REPEATER ID'er MODEL IDC-100

- All solid state fully automatic repeater identifier and ID control mtd on 3" x 6" PC board
- Includes CW ID memory, interval timer, hvy duty xmitter-hold switch, tone generator, CW speed and audio level controls.
- Requires 5vdc @ 200 mA, regulated. Wired, tested and programmed with your call

**\$46.50**

Call/write for details on HP-2A Preamp for 2 mtrs (\$9.95 kit, \$13.95 wired & tested). (Mo. res. add 4% sales tax) Prices ppd US & Canada

### Hale Electronics

P. O. Box 682 — Cape Girardeau, Mo. 63701  
Tel. 314-334-0420

## NOVICES!

### Now • A QSL Bureau FOR YOU!

For only \$2 per year the Novice QSL Bureau will handle all your QSL cards to other Novices. Save \$4 on 100, \$10 on 200 cards a year sent through us. Saves time, money and ends trying to exchange addresses through the QRM. Just put your cards in an envelope and mail to us — we do the rest. All Novices should keep a SASE on file with us.

NOVICE QSL BUREAU BOX 1111,  
BENTON HARBOR MI 49022

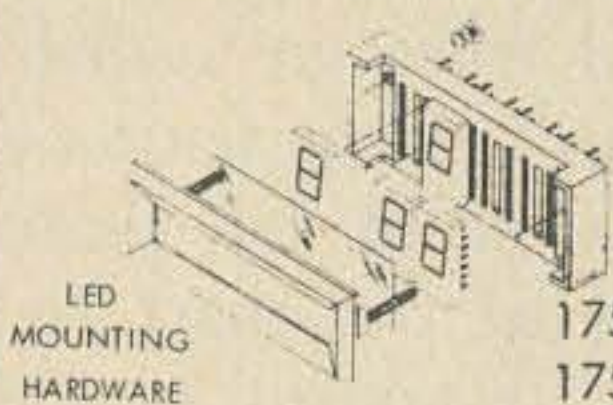

*new*

#### LED Mounting Hardware (Specify screen color)

1750-04 (4 readout) . . . . .	\$7.00
1750-06 (6 readout) . . . . .	\$9.00
1750-08 (8 readout) . . . . .	\$11.00

screen available in red, amber or neutral color

AY5-1013A UART . . . . .	\$10.90, 2/\$19.95
8038 VCO . . . . .	\$4.95
MK5002 4 Decade counter . . . . .	\$13.95
MM5318, MM5841 TV Time/channel display. W/specs and apps. set . . . . .	\$21.50
MM5320N. T.V. Sync Gen . . . . .	\$18.80
MM5322N. Color Bar Gen . . . . .	\$20.00
MM5740AAEN ASCII Keyboard Encoder . . . . .	\$17.99
XR205 Function Generator . . . . .	\$8.40
XR210 FSK Demod . . . . .	\$5.25
XR320 Precision Timer . . . . .	\$1.55
XR2206CP Monolithic Function Gen	\$5.50
XR2207CP VCO . . . . .	\$3.85
XR2240CP Prog. counter timer . . . . .	\$4.85
100V/3A Epoxy Diodes SPECIAL10	\$1.00
500µf/50V Electrolytics SPECIAL10	\$2.50

All orders postpaid — please add insurance  
minimum order — \$5 U.S./\$15 foreign  
latest lists — 10¢ stamp



**TRI-TEK, INC.**

P.O. BOX 14206, DEPT 7  
PHOENIX, ARIZONA 85063

The choice in construction is facilitated by the wide range of drums available in practically every household — empty tin cans.

As an application example, the photo shows such a recorder mounted above the main tuning dial of a receiver to record frequency deviations. The drum is an empty tomato can, 3¼" diameter, overhung from a 1 rph clock motor shaft, giving a chart speed of 10"/hr. The tuning dial motion is carried to the recorder pen by a hacksaw blade, which is ideally springy in the line of the pen, while being quite rigid laterally. The recording is made by constantly adjusting the receiver for zero beat, if the strength varies. If the signal strength is constant, a preferred method is to tune for a constant "S" meter reading on the side of the band pass skirt. The chart is attached to the drum with tape and prewrapped about a half dozen times. The loose end of the chart hangs over the back of the receiver and table, and is weighted to take up the slack as the chart is paid off the recorder drum.

It is obvious that the receiver dial in the photo could be replaced by a variable resistor (pot) in a simple bridge circuit to record voltage or current, the XYL observing the bridge balance meter, preferably with a fixed magnifying glass, and adjusting the dial on the resistor to hold the balance meter constant. (She might go on from this to learn the code and theory and get a ham or driver's license??)

For convenience and a further exercise in applying junk box components, the bridge unbalance may be electrically sensed and used through an amplifier and small gear-motor to keep the bridge pot balanced and thus drive the recorder pen, as it is well known that many of the commercial recorders do. The January, 1975 issue of *Scientific American* shows such an arrangement of the do it yourself variety.

The paper for the recorder may be cut from rolls of regular recording chart paper. If lines are not deemed necessary, plain paper or adding machine tape can be used. Pens can range from commercial recorder pens to fountain, ball or felt tip.

... W6NLB/7



# ME-3 microminiature tone encoder

Compatible with all sub-audible tone systems such as: Private Line, Channel Guard, Quiet Channel, etc.

- Powered by 6-16vdc, unregulated
- Microminiature in size to fit inside all mobile units and most portable units
- Field replaceable, plug-in, frequency determining elements
- Excellent frequency accuracy and temperature stability
- Output level adjustment potentiometer
- Low distortion sinewave output
- Available in all EIA tone frequencies, 67.0 Hz-203.5 Hz
- Complete immunity to RF
- Reverse polarity protection built-in

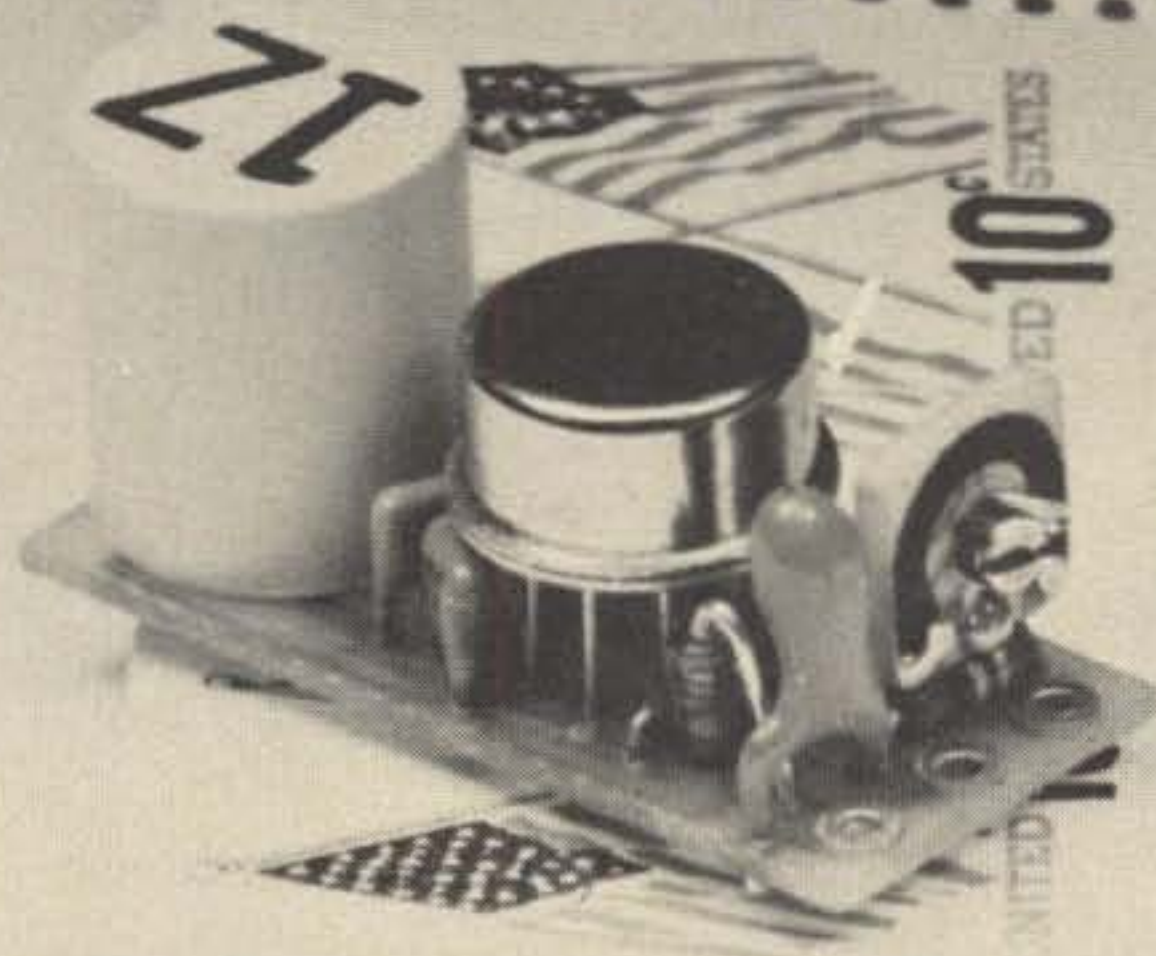

**\$29.95 each**

Wired and tested, complete with K-1 element

**communications specialists**

P. O. BOX 153  
BREA, CALIFORNIA 92621  
(714) 998-3021

K-1 FIELD REPLACEABLE,  
PLUG-IN, FREQUENCY  
DETERMINING ELEMENTS

**\$3.00 each**

---

# NOT JUST ANOTHER "PRETTY FACE"



TWS-3 \$59.95 kit pdd — WIRED/TESTED \$79.95 ppd

SURE IT'LL LOOK GREAT IN YOUR SHACK — but  
that's not all it'll do!

THIS 3 digit "JUST FOR HAMS" frequency counter is the state of the art answer to the crystal calibrator . . . if you worry when you are close to the band or subband edges — just take a look . . . you get crystal accurate readings to 100 Hz . . . at a glance! 160 thru 10 meters!

IF your rig has 5-5.5 MHz VFO you can have FULL TIME DIGITAL TUNING!

---

TWS LABS  
**HUFECO**

P.O. BOX 357 — PROVO UT 84601  
(801) 224-3355

# UNBEATABLE!



TWS-6 \$69.95 ppd  
INTRODUCTORY  
OFFER KIT

WIRED/TESTED

\$89.95 ppd

THE LOWEST COST GENERAL PURPOSE 6 DIGIT COUNTER  
KIT - EVER!

## FOR YOUR WORKBENCH

- Align 2M FM Rigs (Oscillator Stage) • Service Ham & CB Gear •
- 100 Hz Readout • 30 Plus MHz • Lowest Price! • For
- Experimenters - Reads out to 1 Hz with Xtend \$9.95!

## NUMBER TWO OF OUR GREAT 1-2 COUNTER PUNCH!

SEND ME:

- A TWS-3       Kit       Assembled price
- A TWS-6       Kit       Assembled price
- One of each       Kit       Assembled price

Xtend kit for my TWS-6

Here's \_\_\_\_\_ cash

Charge it: \_\_\_\_\_

Master Charge

BankAmericard

Expiration date \_\_\_\_\_

Name \_\_\_\_\_ Call \_\_\_\_\_

Street \_\_\_\_\_ City \_\_\_\_\_ State \_\_\_\_\_

Zip \_\_\_\_\_

TWS LABS

# HUFECO

P.O. BOX 357 - PROVO UT 84601

(801) 224-3355

# NEW PRODUCTS

## VHF Eng. CW ID Kit

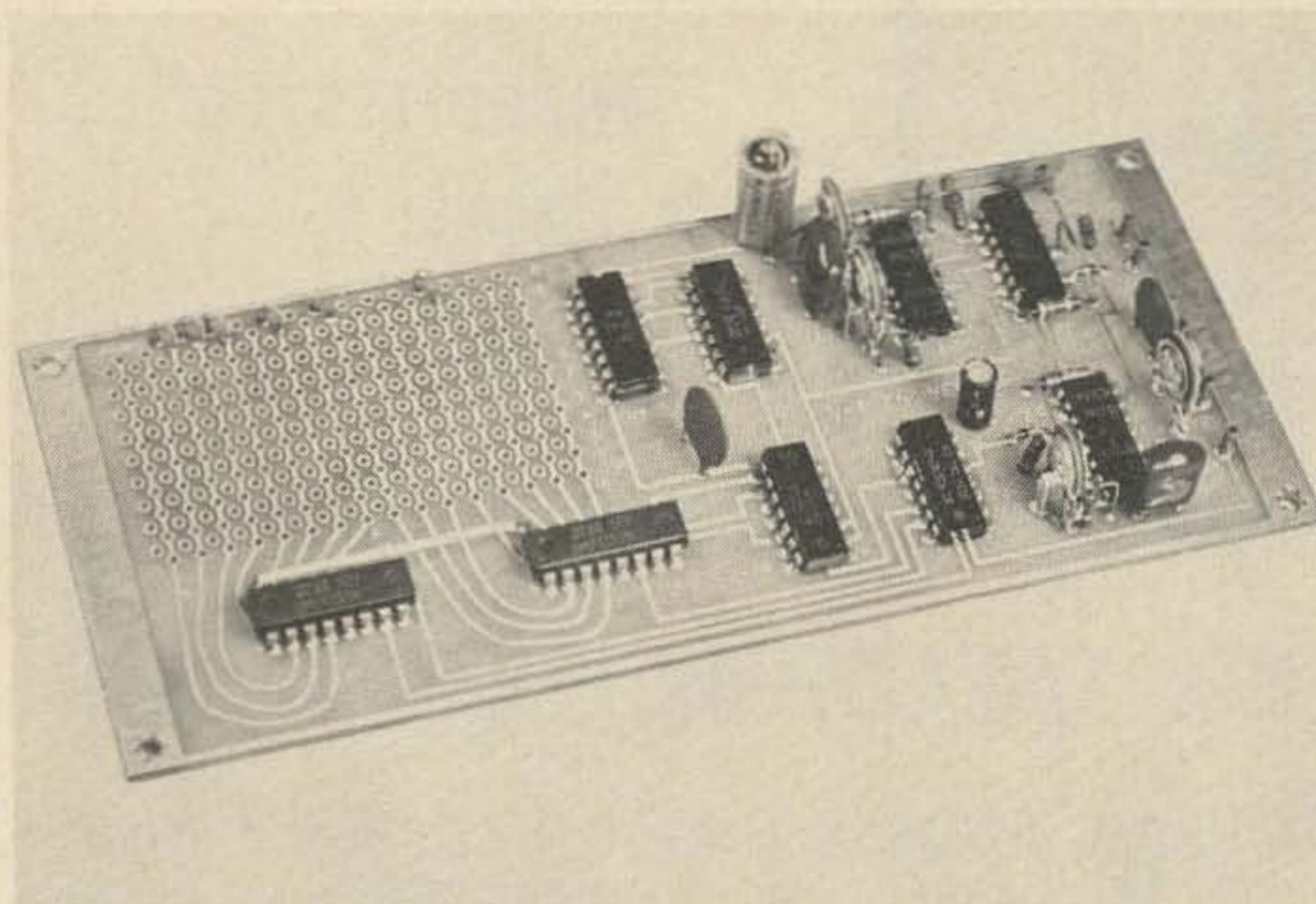
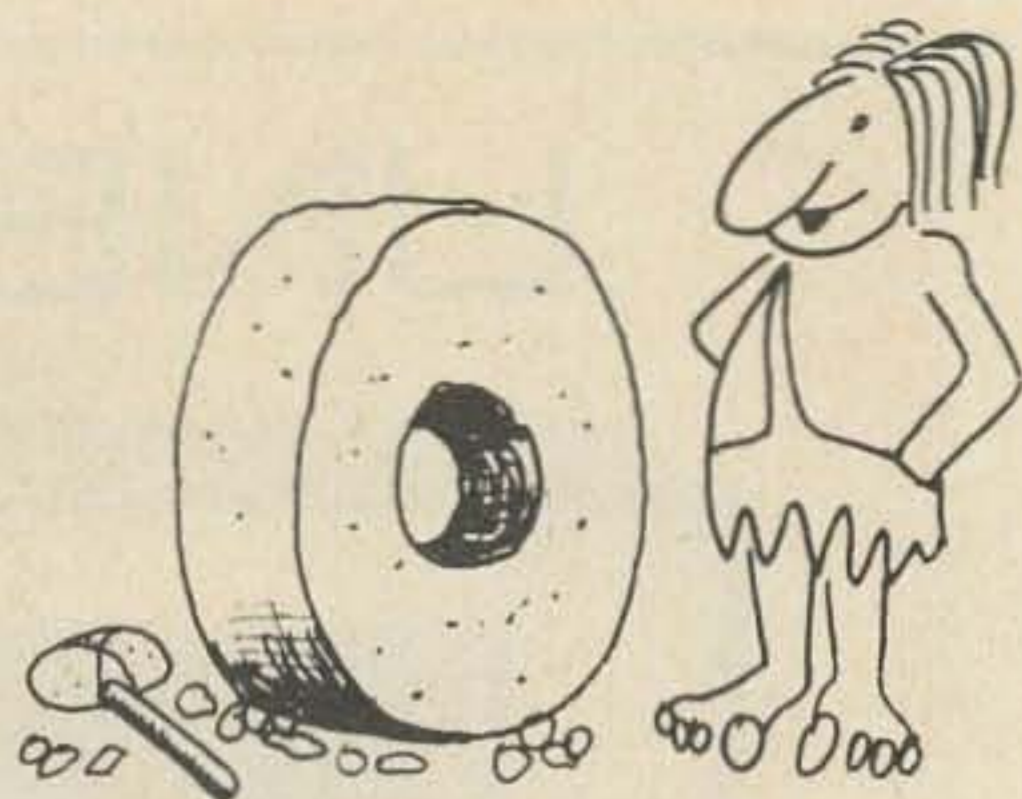

A CW ID kit for commercial or amateur repeaters has just been announced by VHF Engineering of Binghamton, New York. The CW ID kit consists of high grade components, drilled epoxy glass circuit board, programming diodes, and can be built in approximately one evening by amateurs with nominal building experience.

This new CW ID from VHF Engineering presents a price breakthrough for the amateur. The kit price is \$39.95, plus postage. Sufficient diodes are included to permit programming of virtually all repeater calls. Programming is accomplished in an easy manner by soldering diodes directly to the matrix board. Diodes are placed on the board

### HAM DIES OF BURST BLADDER!

Word has just reached the 73 offices of the recent departure for that great DXpedition in the sky of a very avid 73 reader. Upon investigation it was ascertained that said ex-ham had, shortly before his demise, received delivery of a bundle of back issues of 73. Apparently these so captured his attention that other functions were totally forgotten.

BE WARNED. Back issues of 73 should be taken in moderation. Even though they arrive in bundles of twenty, no more than two should be read at any one sitting (of course that depends to some extent upon where exactly you are sitting).

Back issues are available in three different assortments — vintage, mid-years and recent. These are packed by the mentally handicapped (73 is an equal opportunity employer), so no specific issues can be requested . . . you take what you get . . . the only guarantee is that all will be different and some will be musty, particularly the VINTAGE BEAUTIES.

It is advised that you warn your mailman (or UPS man) that these are coming . . . 73 refuses to be held responsible for any more mailman hernia complaints.

The supply of these FANTASTIC GEMS is very limited so run do not walk to your checkbook and flip the \$6.50 per bundle to us right now. You'll have more sleepless nights reading these than you've had since your honeymoon.

### 73 BACK ISSUES

\*\*\*\*\*

Name \_\_\_\_\_

Address \_\_\_\_\_

City \_\_\_\_\_ State \_\_\_\_\_ Zip \_\_\_\_\_

Vintage Years \$5.00 (shpg. \$1.50)

Mid-years    MasterCharge # \_\_\_\_\_ BankAmericard # \_\_\_\_\_

Recent years    Cash \_\_\_\_\_ Check \_\_\_\_\_ Money Order \_\_\_\_\_ Expiration Date \_\_\_\_\_

Total Enclosed \$ \_\_\_\_\_ Signature \_\_\_\_\_

Send to: 73 Magazine Peterborough NH 03458

in a straight line fashion using three diodes for a dash, one diode for a dot, and no diodes for a space. Programmed calls may be changed at will merely by rearranging diodes on the board. Additional flexibility is provided since the unit may be programmed in either CW or RTTY code — thus this IDer may be used for automatic identification of any RTTY station.

The CW ID is also available wired and tested for \$49.95, plus postage. VHF Engineering, 320 Water Street, PO Box 1921, Binghamton NY 13902.

... W1HCI

**CTS KNIGHTS PUBLISHES  
NEW 72-PAGE GUIDE FOR  
CRYSTAL SELECTION**

CTS Knights, Inc., has announced a new 72 page Crystal Guide which lists all standard CB, synthesized CB, monitor and 2 meter amateur crystals that are available from CTS distributors and dealers. All CTS crystals are gold calibrated to assure ultrastable frequency ... for clean, crisp reception all the time.

Included in this complete guide to

crystal selection are CB cross reference charts ... monitor and 2 meter equipment vs. CTS part number listings ... frequency charts for standard and synthesized CB crystals, as well as general information about each crystal type.

CTS crystals are available in color-coded packages to make it easier to find low band, VHF or UHF monitor

crystals. Most all are in distributor stock or can be ordered directly from CTS Knights by sending a convenient certificate to the Company.

A free copy of "CTS Knights Crystal Guide" is available from Bill Doede, Distributor Sales Manager, CTS Knights, Inc., 400 Reimann Avenue, Sandwich IL 60548. Phone (815) 786-8411.

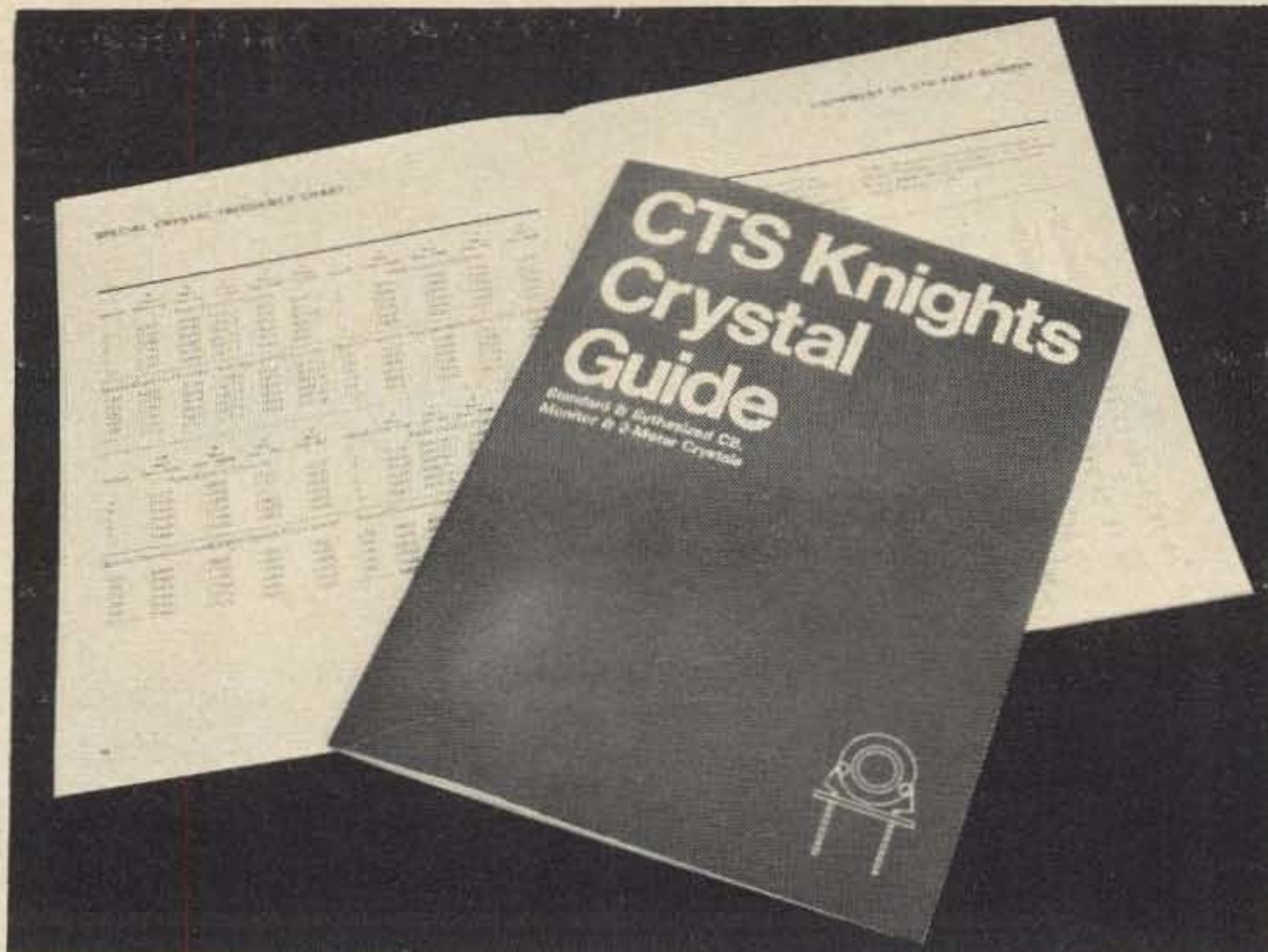

**JUST RELEASED!**



**VHF  
Antenna  
Handbook**

**ALL  
NEW**

Hot off the press, the NEW VHF Antenna Handbook details the theory, design and construction of hundreds of different VHF and UHF antennas ... antennas for FM, for DXing, for repeaters, for mobiles, for emergencies, for contests, quickies, mammoth arrays ... EVERYTHING IS RIGHT HERE!

A practical book written for the average amateur who takes joy in building, not full of complex formulas for the design engineer. Packed with fabulous antenna projects you can build.

This quality reference book would normally sell for as much as \$5 or \$6, but the publishers have agreed to keep the price at an inflation fighting price of \$2.95. Send cash, check or money order ... or give your Master Charge or BankAmericard number . . . ORDER TODAY!

Dealer Inquiries Invited

**GREEN PUBLISHING, INC.**

Peterborough NH 03458

Name \_\_\_\_\_

Address \_\_\_\_\_

City \_\_\_\_\_ State \_\_\_\_\_ Zip \_\_\_\_\_

BankAmericard or Master Charge No. \_\_\_\_\_

Signature \_\_\_\_\_ Exp. date \_\_\_\_\_

## An Even Simpler Clock Osc.

Many articles have appeared in 73 and other magazines in which crystal oscillators used either two sections of a TTL hex inverter or two sections of a TTL quad NAND gate such as the SN-7400. Since a TTL quad AND gate (SN-7408) is also available, and the output of a section would be in phase with its input (with the other input held on), I wondered if a crystal oscillator could be designed using only one section of a SN-7408. This could result in circuit simplifications — especially if the remaining sections are used elsewhere. Or you could use all four sections for four crystal oscillators.

Fig. 1 shows the experimental circuit that I came up with, and it seems to work fine. The crystal must be specified for series

resonance and 30 pF series capacitance with the values shown. A parallel resonant crystal will not operate on frequency. The 1k pot is a little screwdriver adjust type, and it's adjusted for reliable oscillator starting or, if (and only if) you have a good *wideband* scope, it's adjusted for symmetrical square wave output. The diodes may be either 1N34As or 1N914s. I used 1N34As. They seem to improve oscillator stability.

The "gimmick" is a very small capacitance formed by wrapping an *insulated* wire around the output lead a time or two. This capacitance makes the square wave "squarer." If you should experience weird oscillations, reduce this capacitance a bit.

... WADE

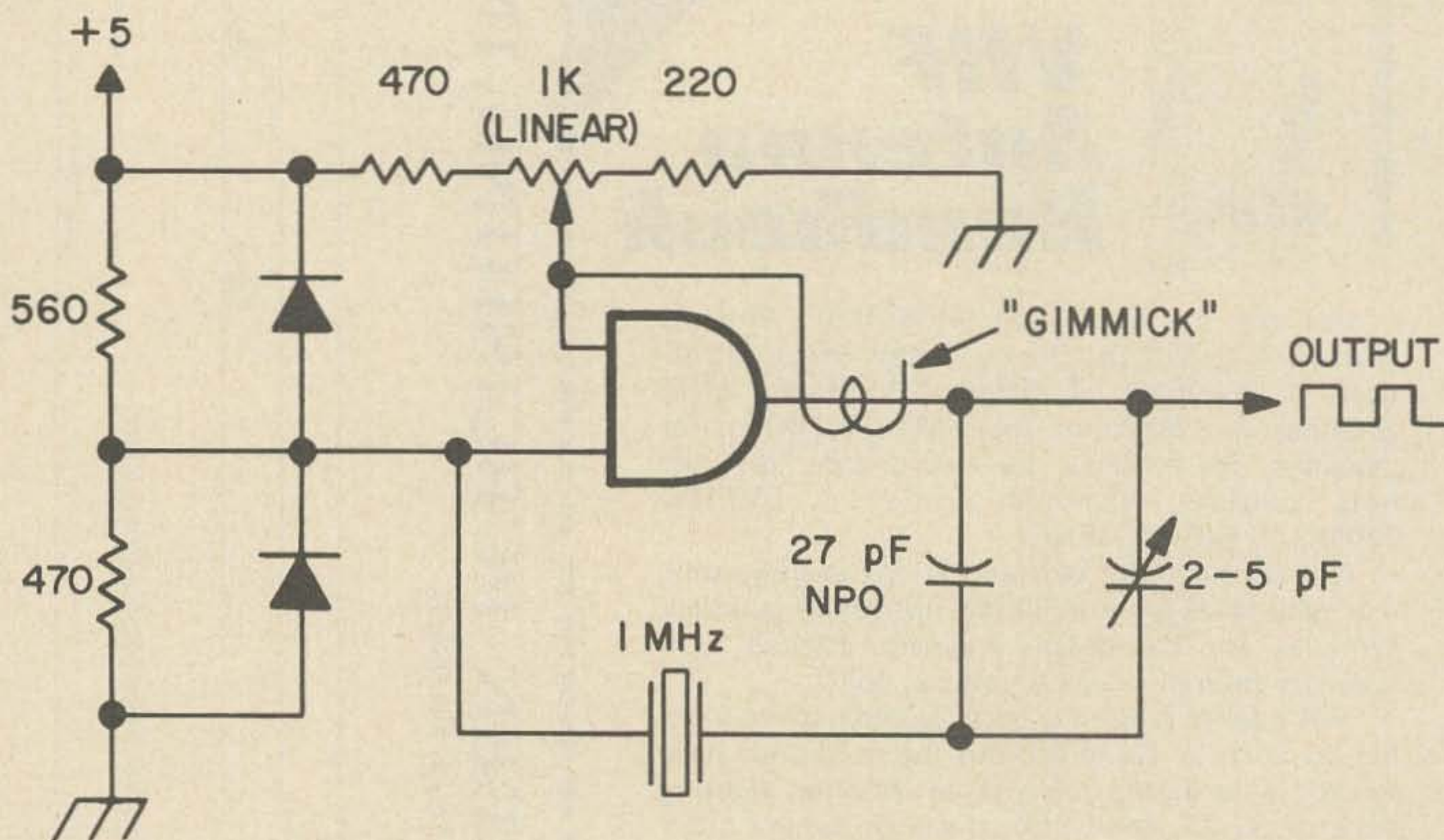

Fig. 1.

# COUNT ON **TECO**

WHEN PRICE AND QUALITY ARE IMPORTANT

## 5 Good Reasons Why YOU Should Buy Your Ham Equipment From TECO

- 1.** **Wats Communication:** You can shop by either mail or by telephone, toll free. You merely dial 800-527-4642 and ask for Teco. Your questions will be promptly answered.
- 2.** **Trade-ins:** We will allow top dollar for your excess test equipment in trade for new ham equipment. Typical trade-in allowances: HP 200 CD (\$100.00), HP 608D (\$600.00), HP 410B (\$90.00), Bird 611 (\$100.00). We will also take Ham and CB equipment and calculator trade-ins.
- 3.** **Financing:** You can finance your purchase through BankAmericard, Master Charge or American Express, with up to 24 months to pay.
- 4.** **Shipping Facilities:** Complete facilities for both domestic and export shipments.
- 5.** **Service:** Teco is service oriented. Complete service facilities in-house. A complete comprehensive technical manual library is available to assist you with equipment problems.

**USED HAM EQUIPMENT FOR SALE  
GOOD SELECTION AVAILABLE  
REASONABLE PRICES**

**Walt Van Arsdale, K5SXO**



**TECO**  
ELECTRONICS

P. O. Box 1050 • Garland, Texas 75040

TOLL-FREE CALL  
**800-527-4642**

(In Texas call collect 214-348-8800)

1933

Collins started in business to build a better transmitter  
—became the leader in amateur radio.



**1975**  
Still the  
performance  
leader.

**NOW AVAILABLE FROM TECO!**



**TECO**  
ELECTRONICS

P. O. Box 1050 • Garland, Texas 75040

TOLL-FREE CALL  
**800-527-4642**

(In Texas call collect 214-348-8800)



# How to make a good transceiver better...



## Increase the frequency coverage



*Introducing the new*

# ATLAS 210X (and Atlas 215X)

Even though the Atlas 210 and 215 have been the hottest selling solid state SSB transceivers on the market, we never stop looking for ways to improve our products.

The new Atlas 210X/215X have the same compact size (9½" x 3½" x 9½") and light weight (7 lbs.), with the same 200 watt power rating, and same super selectivity. But several improved features have been engineered into the new 210X/215X.

- Full band coverage of 160 through 15 meters
- 1000 kHz coverage on 10 meters.
- Extended coverage for MARS operation when used with the Model 10X crystal oscillator. Special MARS model no longer required.
- Improved Automatic Gain Control (AGC).
- Improved S-meter calibration.
- Improved image suppression.
- Plus all the performance, reliability and

versatility that have made Atlas transceivers the talk of the ham bands.



\$649



**TECO**  
ELECTRONICS •

P. O. Box 1050 • Garland, Texas 75040



YAESU FT-101E TRANSCEIVER

# Now, more radio from the radio company.

Are Yaesu's FT-101's the finest all-around transceivers in the world? Yes — and now the best is even better. The new FT-101E includes a potent R. F. speech processor. Plus improved, easy-to-use lever switches. A more refined clarifier control for push-button, independent clarifier operation. There's also a 160 meter crystal included without extra charge.

And all the other features that have made the FT-101 series of transceivers among the world's most popular are still here: 260 watts SSB

PEP. Globe-circling power on CW and AM. 160 to 10 meters range. 0.3uV receiving sensitivity. And one very important feature you never want to forget is the famous Yaesu warranty, strong dealer network and convenient serviceability.

If you're a serious amateur, you're always looking for more radio. And the FT-101E is just that. \$749\* buys you a million bucks worth of enjoyment.

\*FT-101EE (less processor): \$659.

**YAESU**

 **TECO**  
ELECTRONICS

P. O. Box 1050 • Garland, Texas 75040

TOLL-FREE CALL  
**800-527-4642**

(In Texas call collect 214-348-8800)

# The radio station

...from  
the radio  
company.



YAESU

For the discriminating amateur who wants it all, Yaesu offers the radio station. With an advanced 160-10 meter transmitter, the FL-101. With a sensitive receiver—the FR-101S, with flexible options that allow 160 through 2-meter coverage. And for continuous signal monitoring, the famous Yaesu YO-100 monitor scope.

Put this three-unit combination in your shack and you'll have it all. No more stacks of home-brew or contrasting boxes. No more tangle of cables. Just an elegant grouping of some of the best amateur radio gear you can buy. And when you buy it—you'll have the radio station. From the world's leading manufacturer of amateur radio gear. Backed up by a solid warranty, a nation-wide dealer network, convenient serviceability and technology second to none. What's more the radio station is available at a surprising value.



**TECO**  
ELECTRONICS

P. O. Box 1050 • Garland, Texas 75040

TOLL-FREE CALL  
**800-527-4642**

(In Texas call collect 214-348-8800)



# ICOM

## At ICOM the benchmark is quality.

ALL ICOM RADIOS HAVE . . .

- 5 Helical Resonators
- 0.4UV Sensitivity
- High and Low I.F. Filters
- Extremely Low Spurious TX
- Transmit and Receive Trimmers
- ESP
- 5KHz Freq. Deviation
- "S" Meter

### INOUE'S NEW PLL SYNTHESIZED IC-230



- 67 + Channels (Direct or  $\pm 600$  KHz)
- 30 KHz Steps (Optional 15 KHz)
- 146-148 MHz PLL Synthesized
- Modular Construction
- Socket For Tones or Dial
- Digital Readout (No Tuning)
- P.L.L. Lock Indicator
- \$489.00

- 5 Channels Included
- 22 Channels Total
- No Relays
- Large Speaker
- Carrier Operated Light



\$249.00

IC-22A



IC-21A

- 24 Channels
- Discriminator Meter
- Wide Range - 144 - 148 MHz + MARS
- SWR Bridge
- AC Supply Built In
- DC Supply
- Modular Construction
- \$449.00



## TECO ELECTRONICS

P. O. Box 1050 • Garland, Texas 75040

TOLL-FREE CALL  
**800-527-4642**

(In Texas call collect 214-348-8800)

# IF YOU HAVE ALREADY GONE 450 . . . .



## GO ICOM NOW . . . . Before you go bananas!

If you have been trying to resurrect something from the pre-transistor past that more closely resembles the mechanism used to keep large ships in place, or if the sound of bumble bees is keeping you awake at night--REJOICE!!! The ICOM 30A is here and working!

Consider these reasons for owning an IC-30A:

- (1) Despite the fact that the radio is completely solid state, it has output of ten watts.
- (2) Receiver sensitivity is better than 0.6UV for 20 db of quieting and that means easy on the ears listening.
- (3) The IC-30A comes with five channels of the 22 channel capacity installed.
- (4) Shielding is excellent because the unit is modularly constructed.
- (5) Your car tires will last long because the IC-30A weighs less than ten pounds.
- (6) Like its predecessors, the unit is equipped with a 9 pin plug in the side of the radio to provide you easy access to the discriminator and room for adding the necessary wiring for external accessories -- with all this and more, for only \$399.00.



**TECO**  
ELECTRONICS

P. O. Box 1050 • Garland, Texas 75040

TOLL-FREE CALL  
**800-527-4642**

(In Texas call collect 214-348-8800)



## DV-21

The perfect companion for your IC-21A, the DV-21 is an all new unique digital VFO to complete your ICOM 2 meter station. The DV-21 will operate in 5 or 10 KHz steps over the entire 2 meter band. It can also scan either empty frequencies, or the frequencies being used, whichever you select. Complete, separate selection of the transmit and receive frequencies, is as simple as touching the keys. When you transmit, bright easy to read LEDs display your frequency. Release the mic switch, and the receive frequency is displayed. There are also two programmable memories for your favorite frequencies. You won't believe the features and versatility of the DV-21 until you've tried it. It's new, and it's from ICOM.



**NOW AVAILABLE FROM TECO!**  
**CALL OR WRITE FOR COMPLETE SPECIFICATIONS**

 **TECO**  
 ELECTRONICS

P. O. Box 1050 • Garland, Texas 75040

TOLL-FREE CALL  
**800-527-4642**

(In Texas call collect 214-348-8800)

# MEET THE STATE OF THE ART ON 2 METERS... KLM MULTI-2000 CW/SSB/FM TRANSCEIVER



Whether your interest is simplex, repeater, DX or OSCAR the new KLM MULTI-2000 lets you get into all the action on all of the

band. Fully solid-state and employing modular construction, the MULTI-2000 enjoys features found in no other 2m transceiver.

## FEATURES

- PLL synthesizer covers 144-148 MHz in 10 kHz steps
- Separate Vxo and RIT for full between-channel tuning
- Simplex or  $\pm 600$  kHz offset for repeater operation
- Three selectable priority channels
- Multi-mode operation (CW/SSB/NBFM/WBFM)
- Built-in AC and DC power supplies, noise-blanker, squelch and rf gain control
- Selectable 1W or 10W output
- Separate S-/power and frequency deviation meters
- Built-in test (call) tone and touch-tone provision
- Excellent sensitivity ( $.3 \mu\text{V}$  for 12 dB SINAD)
- Superior immunity to crossmodulation and intermodulation

\$ 795



**TECO**  
ELECTRONICS

P. O. Box 1050 • Garland, Texas 75040

TOLL-FREE CALL  
**800-527-4642**

(In Texas call collect 214-348-8800)

**TEN-TEC**

TEN-TEC, INC. FROM

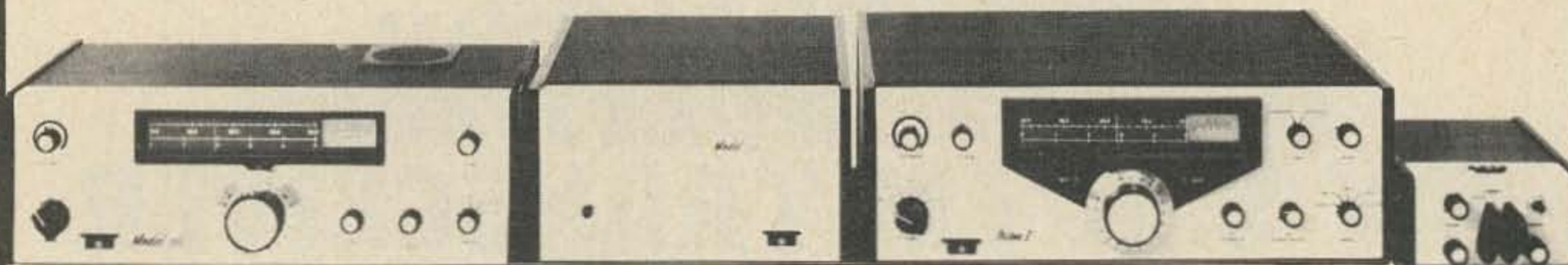
**TECO**

The **TRITON** is a One-of-a-Kind HF transceiver, totally solid state including the final amplifier. The new generation that does more things better than ever before.

**One**, you can change bands instantly. Just turn the bank switch — and go!

**Two**, there is less internal heat to prematurely age components and no high voltage to break down insulation or cause accidental shock.

**Three**, it has ample reserve power to run at full rating even for RTTY or SSTV without limit. Great for contests or emergency service.

**Four**, it is light and compact with a detachable AC power supply to work directly from 12 VDC — For mobile operation without tedious installation.

**Five**, the TRITON is a delight to operate. SSB is clean, crisp and articulate. Amplified ALC puts all available speech power into the antenna without splatter. CW is wave-shaped to cut through QRM and pile ups. Instant break-in (not "semi" which really isn't break-in) lets you monitor the frequency while transmitting.

**And six**, a lot more goodies such as excellent dial illumination, plug-in circuit boards, offset tuning, built-in SWR bridge, speaker, crystal calibrator, boards, offset tuning, built-in SWR bridge, speaker, crystal calibrator, snap-up anti-parallelax front feet, light indicators for offset and ALC, direct frequency readout, WWV, entire 10 meter band coverage — and a lot more.

The **TRITON** brings together all that is new and exciting in Solid State for your greater enjoyment of Amateur Radio.

TRITON I — 100 Watt Input \$579<sup>00</sup>  
MODEL 251 — Power Supply \$79<sup>00</sup>

TRITON II — 200 Watt Input \$669<sup>00</sup>  
MODEL 252 — Power Supply \$ 99<sup>00</sup>

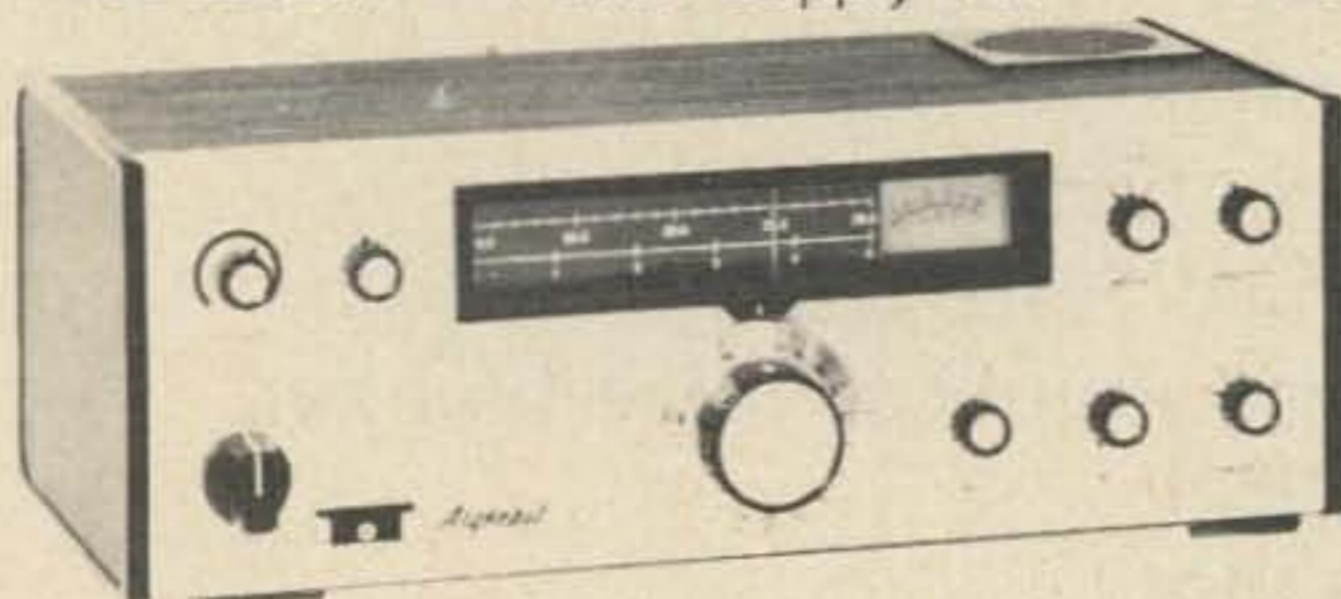
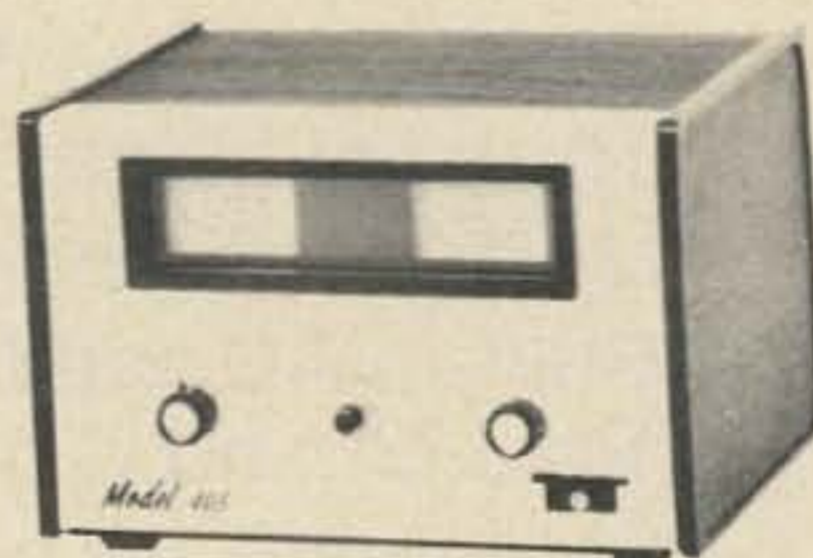
**Argonaut****Model 405 Linear**

The sustained demand and the enthusiastic comments from happy Argonaut owners are music to our ears. We designed this portable pair to be fun, and your response tells us that it's just what you've been looking for. The Argonaut and it's companion, the 405 Linear, are here to stay — thanks to you.

Argonaut, Model 505 .....\$329<sup>00</sup>  
Linear, 100 Watt, Model 405 .....\$159<sup>00</sup>

Power Supply for 505 only, Model 210 .....\$24<sup>95</sup>  
Power Supply for 505 and 405, Model 251 .....\$79<sup>00</sup>

**TECO**  
ELECTRONICS

P. O. Box 1050 • Garland, Texas 75040

TOLL-FREE CALL  
**800-527-4642**

(In Texas call collect 214-348-8800)



Give Your Signal A  
**DOUBLE BOOST**  
 And Spend More Time Communicating

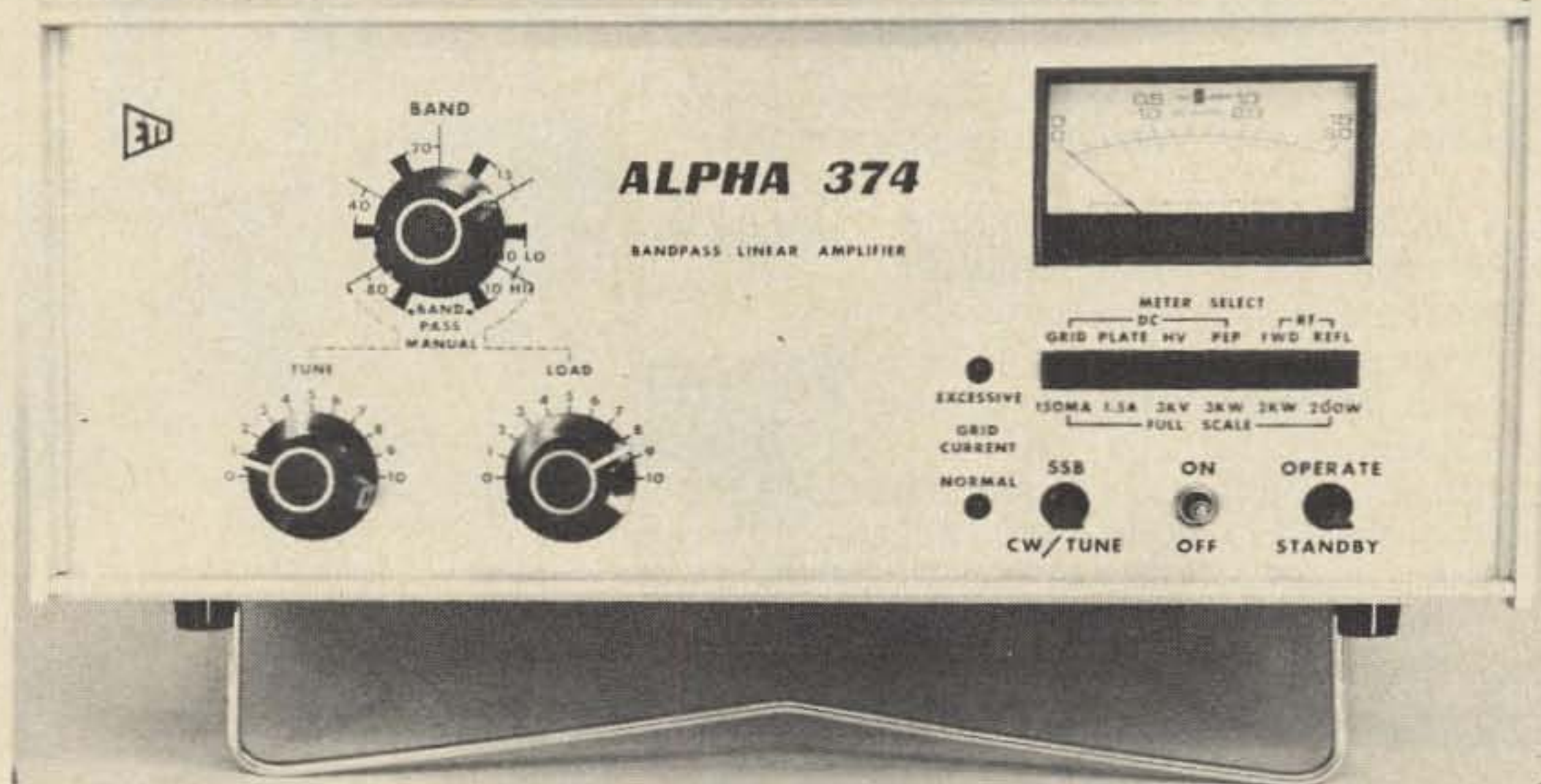

\$ 1295

**1** Let an ALPHA 374 Bandpass Linear deliver all the power you can legally use (in any mode, continuously!) *and* eliminate the chore of amplifier tune-up, too. Using a '374, maximum legal power with true 'instant band change' is a reality.

**2** Add even more punch and crispness to that big signal with a Magnum Six rf speech processor (or a DX Engineering model, if you prefer). The rugged *continuous duty* ALPHA 374 easily handles the extra *average power* demanded by an effective rf speech processor.

With *any* ALPHA maximum-legal-power linear you'll enjoy a new level of convenience and operating pleasure.

**NOW AVAILABLE FROM TECO!**  
 CALL OR WRITE FOR COMPLETE SPECIFICATIONS



**TECO**  
 ELECTRONICS

P. O. Box 1050 • Garland, Texas 75040

TOLL-FREE CALL  
**800-527-4642**

(In Texas call collect 214-348-8800)

**LEADER**  
"Put Us To The Test"

## Get the most out of your rig with LEADER test equipment

Get stronger, cleaner output . . . Enjoy more air time . . . obtain long-lasting contacts — all with Leader test gear. Monitor output, deviation & audio levels. Match your antenna for maximum radiation. Obtain the right impedance match. Leader instruments are easy-to-use, moderately priced and designed to help you get more power and more mileage out of your rig. Leader . . . your "performance test center".

**(A) LBO-310Ham Oscilloscope with LA-31 RF Monitor Adapter.**

Observe IF circuit waveforms and monitor SSB and AM transmitter signals. With use of LA-31 Adapter, this quality scope provides continuous monitor of RF output (to 500W). The LBO-310Ham will also indicate tuned condition for RRTY operation. Internal 2 tone generator checks SSB. Vert. sensitivity - 20mVp-p/div. DC-4MHz b'width. It's a sensitive, general purpose scope, too!

**LBO-310Ham Scope \$269.95      LA-31 Adapter \$22.95**

**(B) LDM-815 Transistorized Dip Meter**

Checks receiver, x'mitter and antenna in 1.5 to 250MHz range. Determines LC network resonance freq'y. Helps align receivers and find parasitic oscill'tns. Instrument combines with the LIM-870A for proper antenna impedance matching. **\$99.95**

**(C) LIM-870A Antenna Impedance Meter**

Take your time. Adjust your antenna slowly for perfect matching. This self-contained, battery operated Impedance Meter lets you make adjustments on your roof or at the antenna by combining with the LDM-815 Dip Meter. The combination also measures linear amplifier and receiver input impedance. Compact, lightweight with 1.8 to 150MHz freq. range; 0-1K $\Omega$  direct-reading impedance range. **\$99.95**

**(D) LPM-880 RF Watt Meter**

Measure RF x'mitter power output in the 0.5 to 120W range from 1.8 to 500MHz. Features pushbutton range selection with 50 $\Omega$  load impedance. Also measures power losses in low pass filters and coaxial cables. - Complete with sturdy tilt stand. **\$149.95**



**NOW AVAILABLE FROM TECO!**

**CALL OR WRITE FOR COMPLETE SPECIFICATIONS**



P. O. Box 1050 • Garland, Texas 75040

TOLL-FREE CALL  
**800-527-4642**

(In Texas call collect 214-348-8800)

# RCA Electronic Instruments



WV-517A VOM



WV-518A VOM



WV-519A VOM

YOUR CHOICE OF ONE OF THESE RCA VOM'S FOR ONLY 1c WITH PURCHASE OF ANY ITEM BELOW.

# 1¢ each

That's right. Just purchase any of the eight super RCA Test Instruments illustrated below from TUCKER ELECTRONICS and for only 1c more we'll send you your choice of one of the three RCA VOMs shown above. Act promptly.



WO-535A — \$349.00\*  
5" Oscilloscope  
Triggered Sweep  
DC to 10 MHz

WO-505A — \$329.00\*  
5" Oscilloscope  
DC to 10 MHz



WO-33B — \$229.00\*  
3" Oscilloscope System

WR-515A — \$195.00\*  
Master Chro-Bar  
Signalist



WA504B/44D  
\$114.95  
Audio Generator

WT-524A — \$159.00\*  
FET/Transistor Tester



WT-333A — \$199.00\*  
3-Meter Picture Tube  
Tester/Rejuvenator



WV-510A — \$139.00\*  
Solid State AC/Portable  
VoltOhmyst

ASK YOUR TUCKER SALESMAN FOR THE FULL LINE RCA CATALOG

**TUCKER**  
ELECTRONICS • COMPANY  
P. O. Box 1050 • Garland, Texas 75040

TOLL-FREE CALL  
**800-527-4642**  
(In Texas call collect 214-348-8800)

You know you can count on

**hy-gain**

for the finest in Ham  
Radio Antennas!

The voice of



is heard around the world

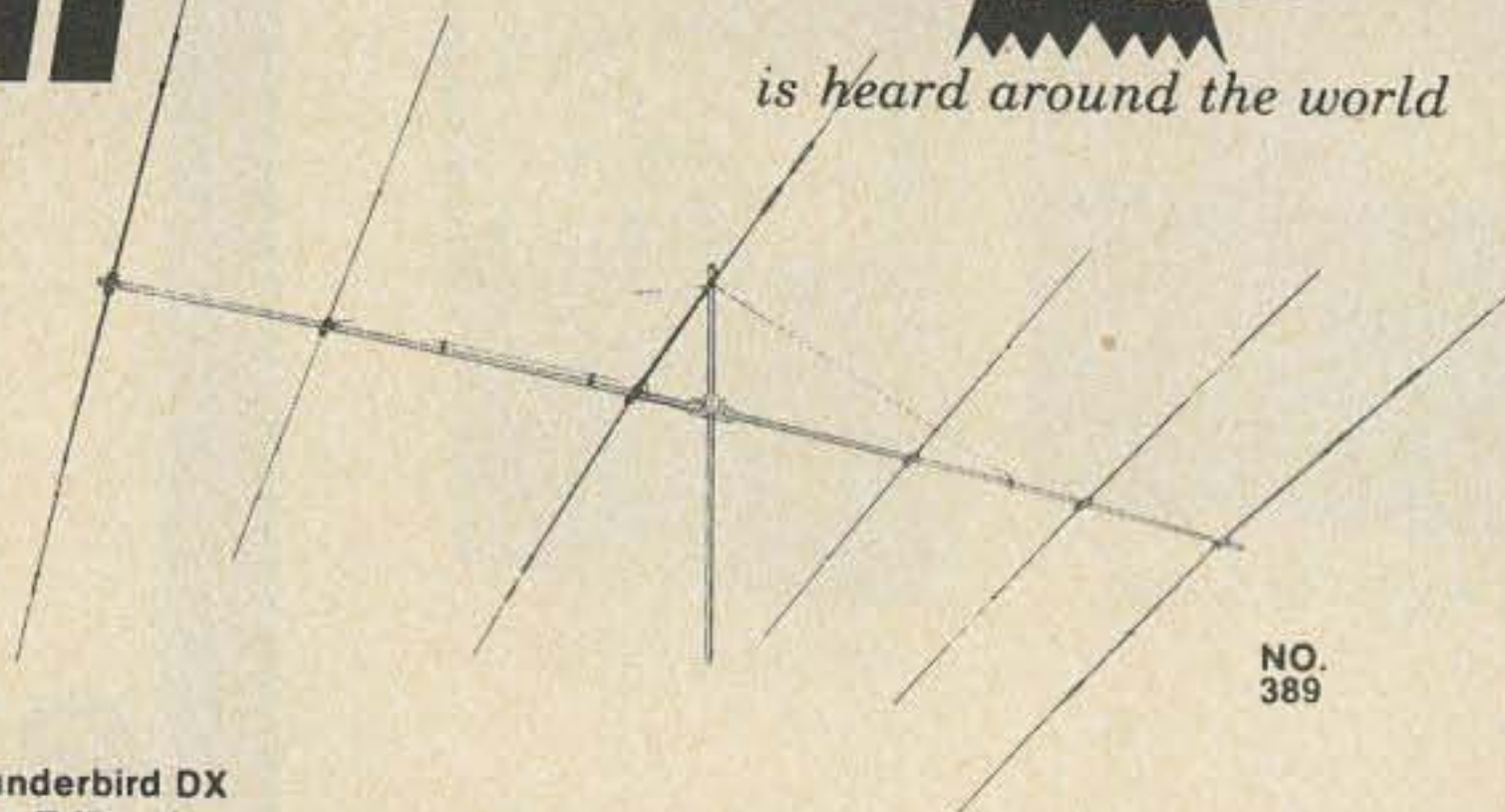

NO.  
389

**TH6DXX**  
6-Element Super Thunderbird DX  
Superior Performance TriBander.

Impressive coverage 10-15-20 meters. Separate, improved Hy-Q traps for each band... SWR less than 1.5:1 on all bands. Takes maximum legal power, up to 1 kw AM, 2 kw PEP. Exclusive Beta Match. Factory pre-tuned. Feeds with 52 ohm coax.

ORDER NO. 389 **\$ 239.95**

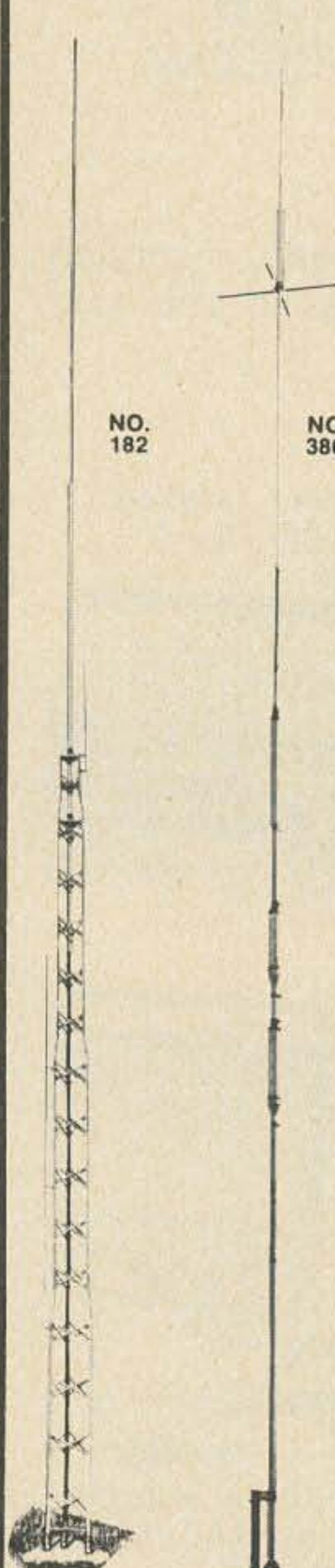

NO.  
182

NO.  
386

**TH3Mk3** 3-Element Super Thunderbird  
Popular TriBand Beam Improved!

Outstanding performance 10-15-20 meters at reasonable cost. Separate, matched Hy-Q traps for each band. Exclusive Beta Match for tapered impedance, DC ground. SWR less than 2:1 at resonance. Accepts maximum legal power and feeds with 52 ohm coax.

ORDER NO. 388 **\$ 199.95**

**18V**  
Low cost, high efficiency vertical. Can be easily tuned to any band 80 thru 10 meters. Highly portable.

ORDER NO. 193 **\$ 33.00**

**TH2Mk3**  
2-Element Super Thunderbird. Compact TriBander delivers excellent performance. Beta Match. Hy-Q traps.

ORDER NO. 390 **\$ 139.95**

**18 HT** Incomparable Hy-Tower  
Finest Multiband on the Market!

Automatic band selection 80 thru 10 meters. Unique stub decoupling system isolates electrical 1/4 wavelengths for each band. Takes maximum legal power. Feeds with 52 ohm coax. 24' tower is entirely self-supporting, virtually indestructible. Requires only 4 sq. ft. for installation.

ORDER NO. 182 **\$ 259.95**



NO.  
388

**TH3JR**  
3-Element Thunderbird TriBand Junior. Ideal for top performance in limited space. Beta Match. SWR 2:1 or less.

ORDER NO. 221 **\$ 144.95**

**18AVT/WB** The Great Wide Band Vertical  
Super Performer 80 thru 10 Meters!

Superb omnidirectional capabilities. Automatic band switching. Beefed-up Hy-Q traps. Top loading coil. True 1/4 wave resonance on all bands. SWR 2:1 or less at band edges. Outstanding low radiation pattern. Entirely self-supporting.

ORDER NO. 386 **\$ 97.00**

**14AVQ/WB**  
Wide band performance 40 thru 10 meters with one setting. Hy-Q traps. True 1/4 wave resonance on all bands.

ORDER NO. 385 **\$ 67.00**

**12AVQ**  
For 10-15-20 meters. Hy-Q traps. Low angle of radiation. Self-supporting.

ORDER NO. 384 **\$ 47.00**



**TECO**  
ELECTRONICS

P. O. Box 1050 • Garland, Texas 75040

TOLL-FREE CALL  
**800-527-4642**

(In Texas call collect 214-348-8800)

NEW  
(A)

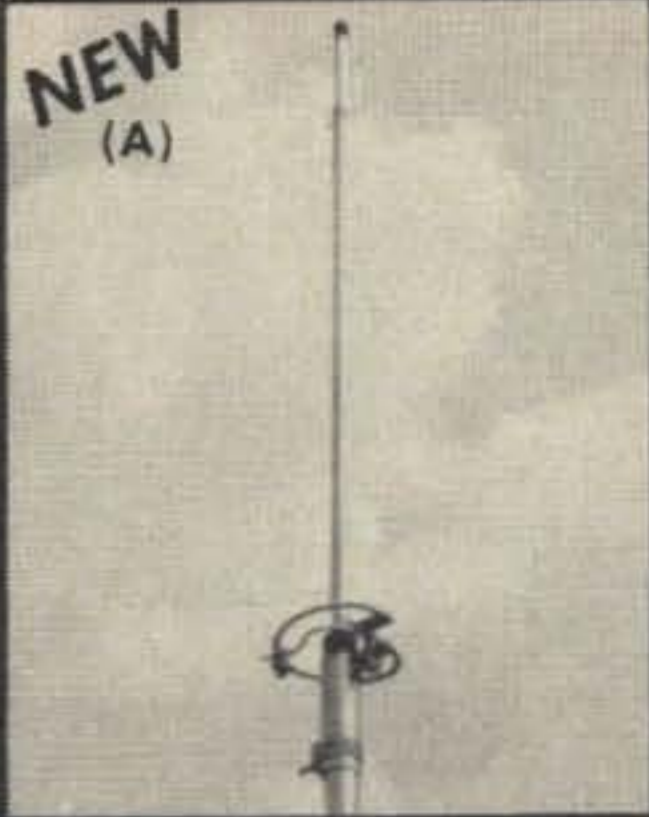

NEW  
(B)



NEW  
(C)

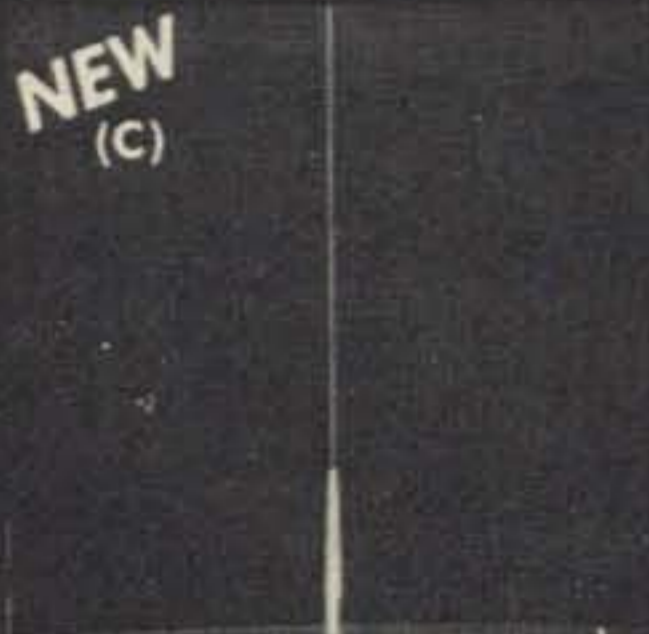

NEW  
(D)

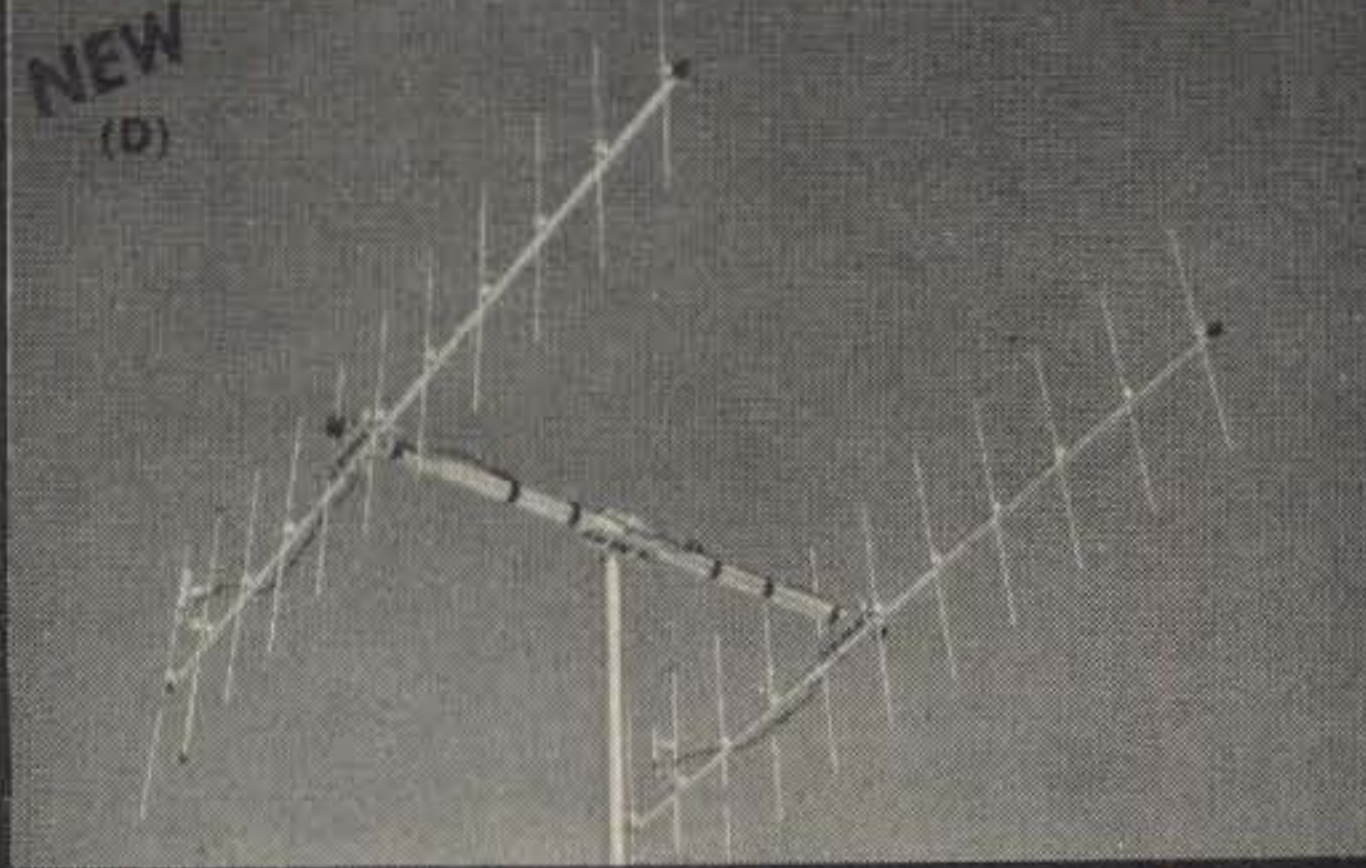

NEW  
(E)

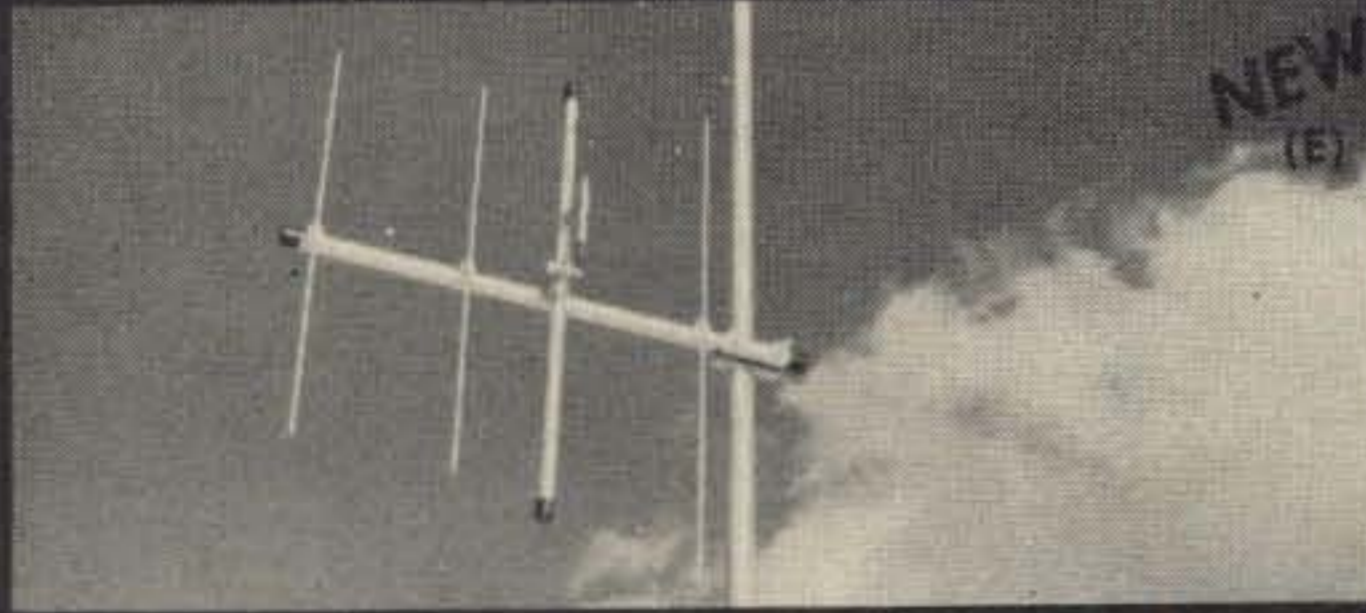

NEW  
(F)

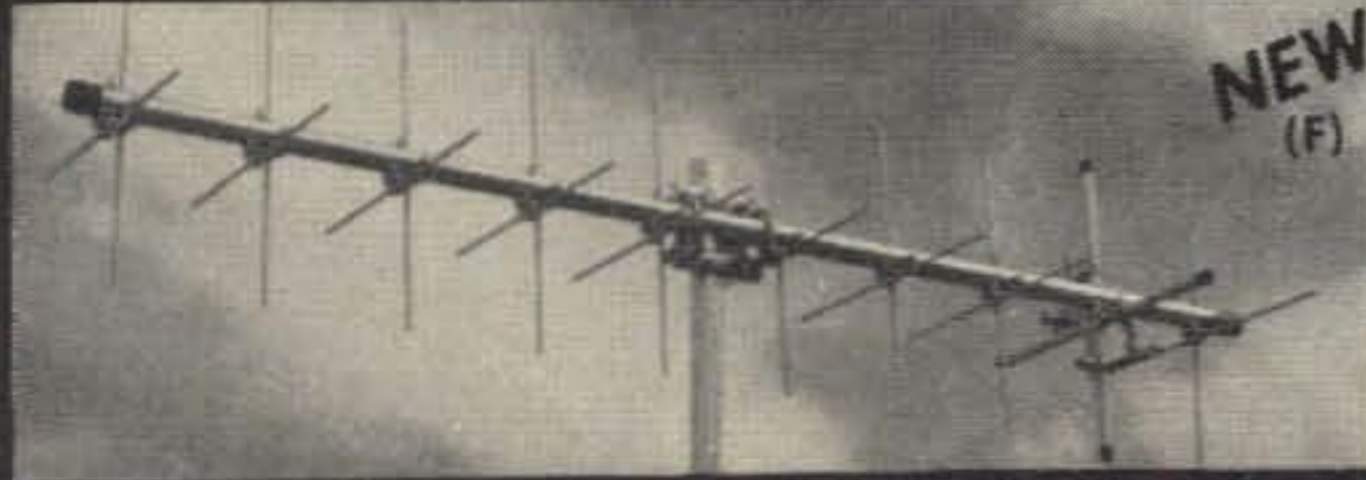

# Cush Craft

## 2 METER FM ANTENNAS

**NEW** FROM THE WORLD'S LEADING MANUFACTURER OF VHF/UHF COMMUNICATION ANTENNAS

(A) **FM GAIN RINGO:** The most popular — high performance, half-wave FM antennas. Give peak gain, and efficiency, instant assembly and installation.

AR-2	100 watts	135-175 MHz	\$16.50
AR-25	500 watts	135-175 MHz	\$19.50
AR-220	100 watts	220-225 MHz	\$16.50
AR-450	100 watts	420-470 MHz	\$16.50
AR-6	100 watts	50-54 MHz	\$23.50

(B) **4 POLE:** A four dipole gain array with mounting booms and coax harness 52 ohm feed, 360° or 180° pattern.

AFM-4D	1000 watts	146-148 MHz	\$52.50
AFM-24D	1000 watts	220-225 MHz	\$48.50
AFM-44D	1000 watts	435-450 MHz	\$46.50

(C) **FM MOBILE: IMPROVED** Fiberglass 5/8 wave mobile antenna with new molded base and quick grip trunk mount. Superior strength, power handling and performance.

AM-147T	146-175 MHz mobile	\$29.50
---------	--------------------	---------

(D) **POWER PACK:** A 22 element, high performance, vertically polarized FM array, complete with all hardware, mounting boom, harness and 2 antennas.

A147-22	1000 watts	146-148 MHz	\$68.50
---------	------------	-------------	---------

(E) **4-6-11 ELEMENT YAGIS:** The standard of comparison in VHF/UHF communications, now cut for 2 meter FM and vertical polarization. 4 & 6 Element models can be tower side mounted.

A147-4	1000 watts	146-148 MHz	\$14.50
A147-11	1000 watts	146-148 MHz	\$23.95
A220-11	1000 watts	220-225 MHz	\$21.95
A449-6	1000 watts	440-450 MHz	\$14.95
A449-11	1000 watts	440-450 MHz	\$19.95

(F) **FM TWIST:** A Cush Craft exclusive — it's two antennas in one. Horizontal elements cut at 144.5 MHz, vertical elements cut at 147 MHz, two feed lines.

A147-20T	1000 watts	145 & 147 MHz	\$46.50
----------	------------	---------------	---------



# TECO

ELECTRONICS

P. O. Box 1050 • Garland, Texas 75040

TOLL-FREE CALL

## 800-527-4642

(In Texas call collect 214-348-8800)

# TECO has the newest from *Dentron*

## The Brand New 160-V Vertical Antenna

Another eye opener from Dentron, this new vertical antenna will solve your 160, 80 and 40 meter problems. 

- Efficient Vertical Design
- Self Supporting
- Weatherproof
- Quick & easy one man installation
- Covers 160, 80 or 40 meter band with only one adjustment.

160-40V Antenna ..... \$79.50 ppd. USA



 Here is another Dentron first, a six band antenna tuner designed to solve virtually any matching problem you may have.

- Covers all bands 160 through 10 meters
- Handles maximum legal power
- Matches coax feed, random wire and balanced line
- Includes heavy duty balun for balanced line
- Black wrinkle finish cabinet

160-10 Super Tuner \$119.50 ppd. USA

Be ready for restructuring —  
Special Supertuner handles 3  
KW PEP amplifiers —

\$229.50 ppd. USA

This is the low cost way to match almost any random length wire on the five most used HF bands.

- Covers 80 through 10 meters
- Handles maximum legal power
- Matches random length long wire antennas
- Features Dentron quality and value

Model 80-10 Antenna Tuner \$59.50 ppd. USA

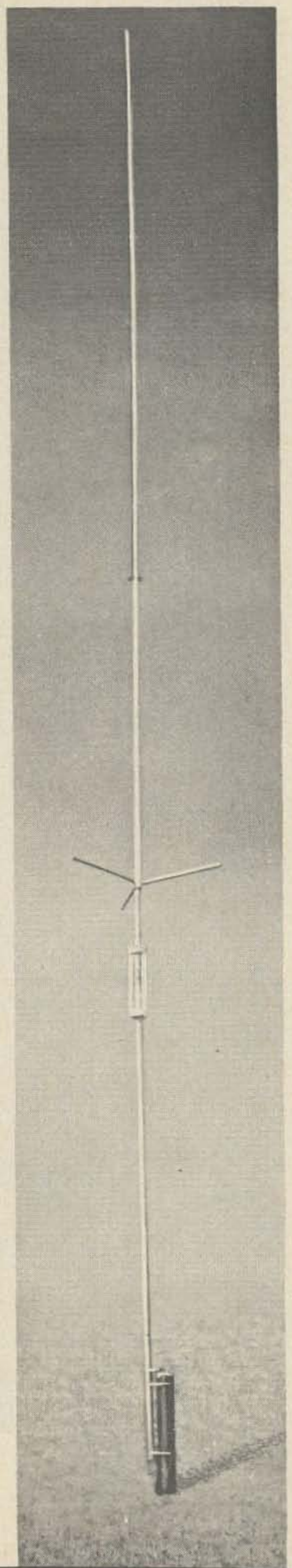

# TECO

ELECTRONICS

P. O. Box 1050 • Garland, Texas 75040

800-527-4642 toll free

In Texas Call 214-348-8800

# ROHN Towers

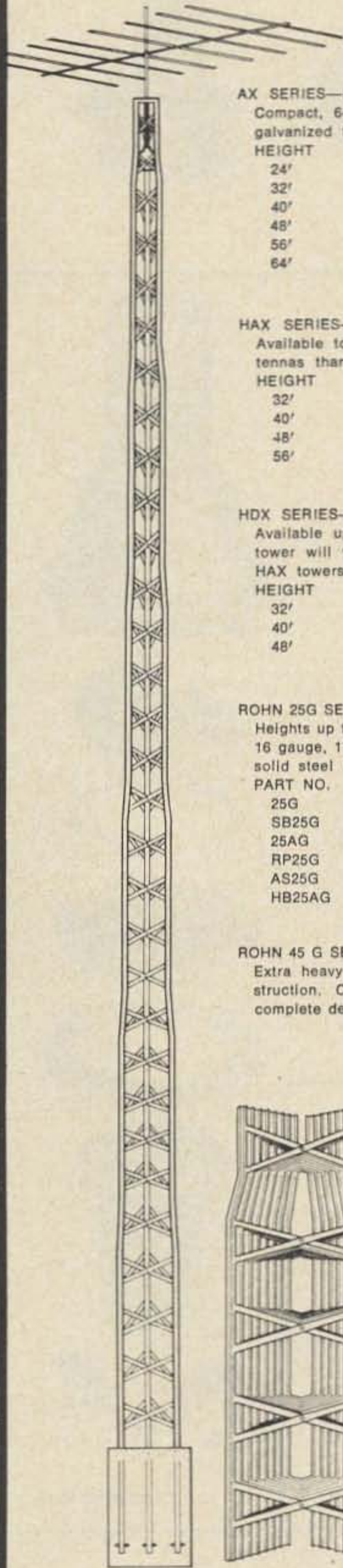

### AX SERIES—LIGHTWEIGHT TOWER

Compact, 64' maximum height. All steel, heavily galvanized for long life. All riveted.

HEIGHT	TECO PRICE
24'	\$ 77.00
32'	\$ 97.00
40'	\$125.00
48'	\$154.00
56'	\$208.00
64'	\$263.00

### HAX SERIES—FOR STANDARD INSTALLATIONS

Available to 56'. This tower will hold larger antennas than AX series.

HEIGHT	TECO PRICE
32'	\$110.00
40'	\$140.00
48'	\$192.00
56'	\$249.00

### HDX SERIES—HEAVY DUTY TOWER

Available up to 48'. Due to heavier design this tower will withstand greater loading than AX or HAX towers.

HEIGHT	TECO PRICE
32'	\$127.00
40'	\$179.00
48'	\$237.00

### ROHN 25G SERIES TOWERS

Heights up to 80' self supporting, up to 200' guyed. 16 gauge, 1 1/4" steel tubing, triangular design with solid steel "zig-zag" cross bracing every 15".

PART NO.		TECO PRICE
25G	10' tower section	\$ 38.50
SB25G	3/4" short base	\$ 12.60
25AG	9' top section	\$ 40.00
RP25G	rotor post	\$ 2.70
AS25G	accessory shelf	\$ 13.00
HB25AG	adj house bracket	\$ 7.30

### ROHN 45 G SERIES TOWERS

Extra heavy, 14 gauge, special quality steel construction. Call your TECO tower specialist for complete details.

ROHN Engineering Data and Specifications Handbook  
TECO PRICE \$ 2.00

**NOTE:** Local building and/or zoning laws frequently require a building permit. Engineering data required, in some instances, for building permit. Available Data should be submitted for approval prior to purchasing a tower.



# ROHN Telescoping MASTS

### ROHN TELESCOPING MASTS

First in design, first in performance, yet low in cost. Equipped with special clamp and ring arrangement. All tubing hot dipped galvanized steel of highest quality.

MODEL	HEIGHT	TECO PRICE
E20	20'	\$ 11.00
E30	30'	\$ 17.50
E40	40'	\$ 24.50
E50	50'	\$ 33.50
Mast Section	5'	\$ 1.69
Mast Section	10'	\$ 2.89

### ROHN RIDGE MOUNTS—UNIVERSAL

For all types of roof installations:

MODEL	FITS MASTS	TECO PRICE
UM20	1 1/2" diameter	\$ 2.75
UM30	1 3/4" diameter	\$ 2.85
UM40	2" diameter	\$ 3.05
UM50	2 1/4" diameter	\$ 3.25

### ROHN VENT MOUNTS

An easy to use vent mount.

MODEL	VENT DIAMETER	TECO PRICE
VP40	2" to 4"	\$ 4.35
VP60	4" to 6"	\$ 4.35

### ROHN MAST BRACKET

Firmly clamps mast along side of building 3" away from mounting surface. Fits masts 1 1/4" to 2 1/2" OD.

MODEL TMC	TECO PRICE
	\$ 3.60

### GC WALL MOUNT

Economical way to mount antennas to wall where overhang is less than 2 1/2".

MODEL U2-002	TECO PRICE
	\$ 1.25

### GC CHIMNEY Z TYPE "QUIK" MOUNT

Low cost, good quality mount for small to medium size antennas.

MODEL U2-010	TECO PRICE
	\$ 2.75

### GC "SNAP-IN" CHIMNEY MOUNT—Y TYPE

Extra heavy gauge steel construction.

MODEL U2-000	TECO PRICE
	\$ 4.75

### GC UNIVERSAL "SWING-UP" ROOF MOUNT

Adjusts to any angle for roof or wall mounting. Fits masts up to 1 3/4" diameter.

MODEL U2-008	TECO PRICE
	\$ 5.00

### GC VENT MOUNT

Made of heavy steel, zinc plated to prevent rust. Fits plumbing vents up to 2 1/4" diameter, antenna masts up to 1 1/4" diameter.

MODEL U2-018	TECO PRICE
	\$ 1.55

### ROHN GROUND ROD

Heavy gauge steel 6' rod, 3/8" dia. Heavy copper plating. Sharp point for easy installation.

MODEL GR-386	TECO PRICE
	\$ 4.95

### ROHN CABLE CLAMP

Heavy gauge steel, zinc plated.

MODEL	CABLE	TECO PRICE
3/16-CCM	3/16"	\$ .45
1/8-CCM	1/8"	\$ .45

### GROUND WIRE—50' coil AGW-8 (Aluminum)

GROUND WIRE—50' coil AGW-8 (Copper)  
TECO PRICE \$ 1.90

### GUY WIRE—50' coil, 6 strand, 20 gauge.

TECO PRICE \$ 1.49

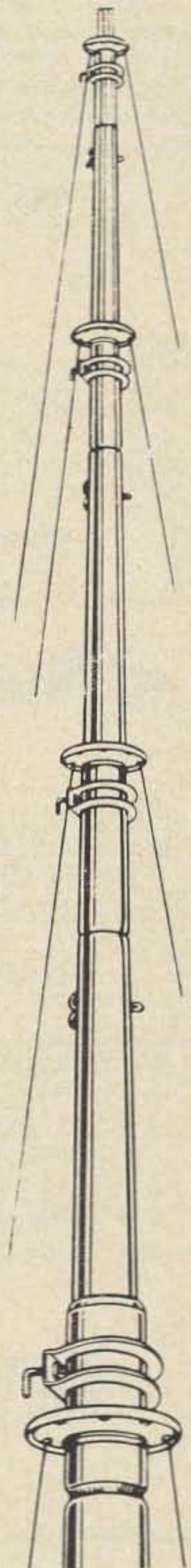

CALL FOR SPECIAL TECO PACKAGE PRICE

**800-527-4642**

(In Texas call collect 214-348-8800)



# TECO

P.O. Box No. 1050 • Garland, Tx. 75040



**NORMAL DUTY**

**AR-20L Automatic Rotor**

With Electro-mechanical control  
Direction Accuracy within ±2%.

This system provides years of trouble-free service for normal amateur antenna applications. The superior strength rotor housing is die-cast into groove-fitted halves which, with protected neoprene shaft seal, shields the mechanism against inclement weather. High torque motor, through reduction gearing, turns the upper half of the rotor 360°. Positive worm gear brake system prevents over-travel and locks the shaft firmly in place.

Electro-mechanical control box provides fully automatic selection of antenna position within ±2%. Just dial the desired direction and the rotor turns your antenna to that direction. **TECO PRICE \$ 39.95**

Control box size: 5 3/8" x 8 1/4" Cable: 4 wire 100 ft. **\$ 6.95**

Accepts mast size: 7/8" to 1 1/2" O.D.

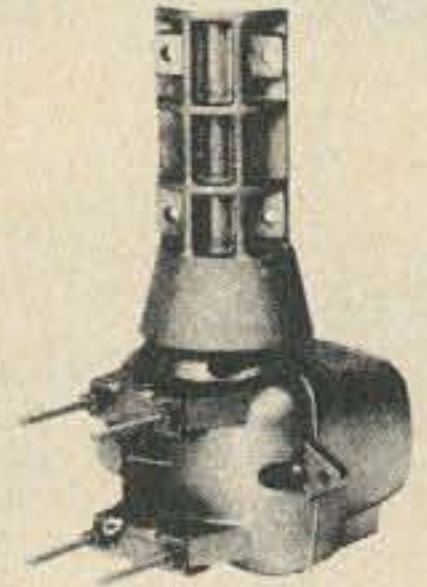

**HEAVY DUTY**

**AR-22L Automatic Rotor**

With Electro-mechanical control  
Direction Accuracy within ±2%

**TECO PRICE \$ 49.95**

100 ft. cable **\$ 6.95**

This system has an extra heavy duty rotor to handle the largest TV/FM antennas or stacked arrays. Die-cast aluminum "Bell-shaped" housing provides weathertight construction with unexcelled strength. Powerful motor drives a unique planetary gear system, providing more torque than most other TV rotors. Built-in 6" diameter, ball-bearing thrust assembly coupled with magnetic friction brake turns and holds the mast under icing conditions and high-winds.

**SPECIFICATIONS**

Control box size: 5 3/8" x 8 1/4"

Warranty: One year

Accepts mast size: 7/8" to 2 1/8" O.D.

Cable: 4 wire

Shipping weight: 14.3 lbs.

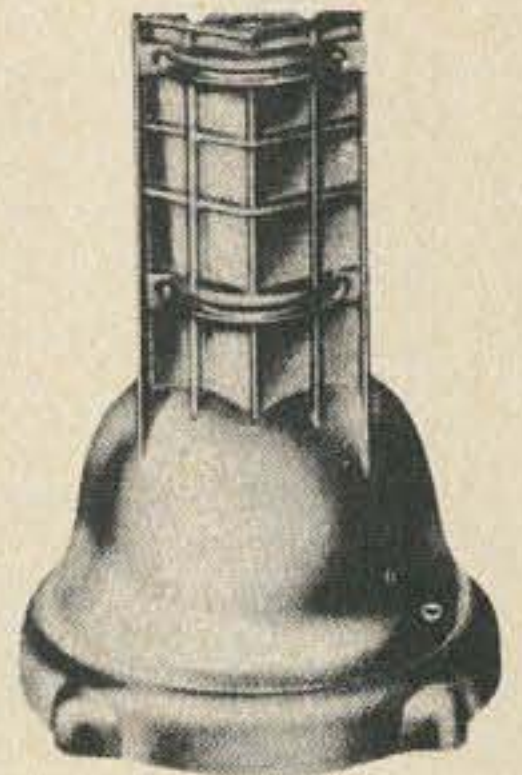
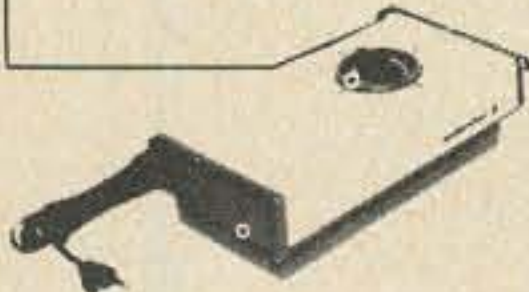

**HEAVY DUTY**

**AR-40 Solid-State Controlled Automatic Rotor**

Direction Accuracy within ±1%

**TECO PRICE \$ 59.95**

100 ft. cable **\$ 7.95**

Like the AR-22L this system has an extra-heavy duty "Bell-shaped" rotor for the largest Amateur antennas or stacked arrays. The AR-40 system, however, has a more precise and quieter control. The solid-state control box provides silent and fully automatic positioning of the antenna to within ±1%. Just dial the direction desired and momentarily press the dial knob.

**SPECIFICATIONS**

Control box size: 4 3/4" x 8 5/8"

Warranty: One year

Accepts mast size: 7/8" to 2 1/8" O.D.

Cable: 5 wire

Shipping weight: 14 lbs.

■ **Two rugged systems.**

For antennas with wind area:

up to 2.5 sq. ft. — type CD-44

**TECO PRICE \$ 99.95**

up to 7.5 sq. ft. — type HAM-II

**TECO PRICE \$ 129.95**

100 ft. cable **\$ 13.95**

- **Electrically operated wedge brake on HAM-II** — slowly stops mast rotation; greatly decreases stress on rotator, antenna, and supporting mechanism.

- **Front panel calibration.**

- **Clockwise and counter-clockwise directional snap-action switches.**

- **Lighted direction meter accurately indicates antenna position.**

- **Time-tested CDE Bell rotor construction.**

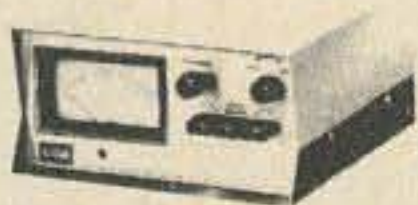

Control Box



HAM-II Rotor

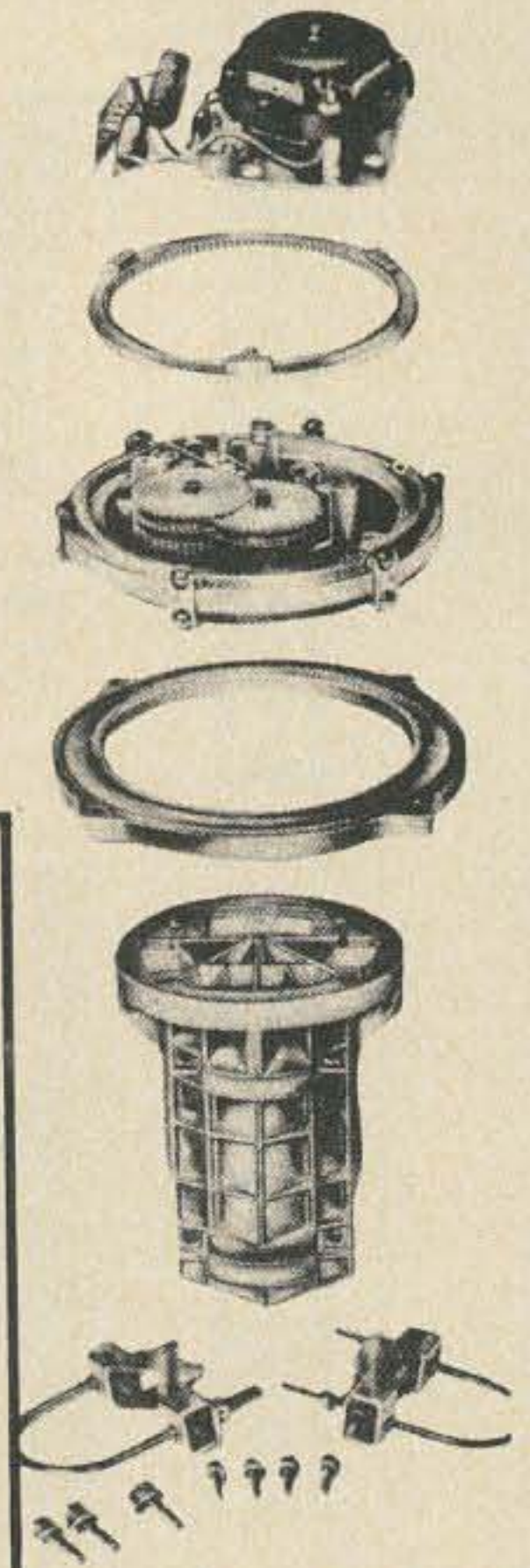

Exploded view



**TECO**

P.O. Box No. 1050 • Garland, Tx. 75040

**800-527-4642**

(In Texas call collect 214-348-8800)



# ACCESSORIES



**ALTERNATOR FILTER**  
GLC 1044  
TECO PRICE  
\$ 4.59



**GENERATOR FILTER**  
GLC 1045  
TECO PRICE  
\$ 5.25



**VOLTAGE REGULATOR FILTER**  
GLC 1058  
TECO PRICE  
\$ 3.95



**FEED-THRU NOISE SUPPRESSOR FILTERS**  
Prevents noise in your radio caused by electrical systems such as air conditioning, voltage regulators and power accessories.  
Electrical system noise appears as a whining or rushing sound

Model	Rated at	Capacitance	Working Voltage	TECO PRICE
GLC 1059	40 amps	.5 MFD	50 working volts	\$ 3.49
GLC 1060	60 amps	.5 MFD	50 working volts	\$ 3.99
GLC 1082	20 amps	.1 MFD	600 working volts	\$ 2.99



GLC 1090  
100 amps - 35 volts  
TECO PRICE \$ 4.99

**NYE VIKING LOW PASS FILTER**



Model 250-20  
TECO PRICE \$ 19.95

**ROYCE MODEL 2-100 COMBINATION FIELD STRENGTH AND SWR METER**  
Two units in one. Field strength meter shows relative RF field strength. Also check SWR of your coax. Indicates up to 3:1 with 99.5% accuracy. Check antenna radiation. Uses telescopic antenna.



TECO PRICE  
\$ 18.95

**ALTERNATOR & GENERATOR FILTER**



TECO PRICE  
GLC 1076 60 Amp \$ 8.25  
GLC 1080 100 Amp \$ 12.95

**SPARK PLUG NOISE SUPPRESSOR**

Carbon type push-on suppressors. Eliminates noise created by spark plugs. Installs in minutes—requires no tools. 18-290  
2 per pkg. TECO PRICE \$ 1.00

**ALTERNATOR NOISE SUPPRESSOR**

Reduces or eliminates whining noises caused by automobile alternators. Easily installed.  
18-284 TECO PRICE \$ 2.95

**DISTRIBUTOR SUPPRESSOR**

Carbon Type  
Reduces or eliminates noise from distributor coil wire. Simple, snap-in connection—requires no tools.  
18-274 TECO PRICE \$ .39

**SPARK PLUG NOISE SUPPRESSOR**

Wire Wound Super Suppressors  
RF choke design for low resistance—heavy suppression of spark plug noise. Requires no tools to install, simply push on spark plug!  
18-292 TECO PRICE \$ 1.19

**GENERATOR NOISE SUPPRESSOR**

Heavy duty 0.5 mfd condenser for all auto generators. Reduces or eliminates generator noise.  
18-271 TECO PRICE \$ 1.00

**DISTRIBUTOR SUPPRESSOR**

Wire Wound Super Suppressors  
R.F. choke design for low resistance—heavy suppression of spark plug noises. Installation requires no tools. Snaps onto distributor center wire, then plugs into distributor.  
18-280 TECO PRICE \$ 1.19

**NOISE SUPPRESSION KIT (GENERATOR TYPE)**

Reduces or eliminates the most common causes of engine noise in cars equipped with generators. Includes 8 spark plug suppressors, a distributor suppressor and a generator noise suppressor. Easy installation—takes only minutes! Includes complete instructions.  
18-262 TECO PRICE \$ 3.95

**MOBILE RADIO HOT LINE FILTER**

For Transistorized Units Only  
Special RF choke allows necessary positive voltage to radio while blocking ignition noise. Ignition noise often enters radio (or tape player) through the "hot" wire or positive lead to the battery. Also includes ac electrolytic capacitor that reduces or eliminates noise created by ignition coil. Easy to install—includes complete instructions.  
18-252 TECO PRICE \$ 2.50

**NOISE SUPPRESSION KIT (ALTERNATOR TYPE)**

Reduces or eliminates the most common causes of engine noise in cars with alternators. Includes 8 spark plug suppressors, a distributor suppressor and an alternator suppressor. Easily installs in minutes.  
18-260 TECO PRICE \$ 5.95



**TECO**  
ELECTRONICS

P.O. Box No. 1050 • Garland, Tx. 75040

800-527-4642  
(In Texas call collect 214-348-8800)



**TECO**  
ELECTRONICS

P. O. BOX 1050  
GARLAND, TEXAS 75040

in a hurry — place your order by using our toll -  
free telephone number 800 -527 -4642. Ask for **TECO**  
(In Texas call 214-348-1560 or 348-8800)

please fill in below

NAME: \_\_\_\_\_

ADDRESS: \_\_\_\_\_

CITY \_\_\_\_\_ STATE \_\_\_\_\_ ZIP \_\_\_\_\_

Telephone No. (\_\_\_\_\_) \_\_\_\_\_

I've enclosed my check or Money Order for \$ \_\_\_\_\_

Please Charge My:

Please ship C.O.D.

Bank Americard  American Express  Master Charge

Acct. Number 

--	--	--	--	--	--	--	--	--	--	--	--	--	--	--	--	--	--	--	--

Interbank No. (Master Charge Only) 

--	--	--	--

Expiration Date \_\_\_\_\_

Signature (if charge) \_\_\_\_\_

MFR/MODEL/DESCRIPTION	QTY	UNIT PRICE	TOTAL CHARGE

SALES TAX: Residents of Texas and New Jersey add 5%. Residents of California add 6%.



**TECO**

P. O. BOX 1050  
GARLAND, TEXAS 75040

Shipping & Handling

2.50

TOTAL CHARGE

# BICENTENNIAL

1976 and your BICENTENNIAL Callsigns are almost here!

ORDER your QSL cards immediately to be sure you have them in time. Try to be the first (this time) in your area with a special BICENTENNIAL QSL card.

These cards are gorgeous — red, white and blue (you were expecting fuchsia and mauve?). And they are 100% custom made ... with the exception of the bicentennial design and contact report form on the back ... you can have your own call letters (unless you'd rather be AC2NSD/1 for a year (which is no bargain, believe it).

You also get your own name and address on the card (unless you happen to be another Wayne Green, which happens).

These cards are ganged up into large batches and run off the 73 presses in between other work, so you don't get real fast delivery, but you do end up with a fantastic QSL at a ridiculously low price (and there are a lot of fans for that sort of service these days). Somewhere in between producing 73 and BYTE, the staff manages to get QSLs set up and printed. It's a living.

Suggestion: order today, right now, not later, not next week. Send cash, check, money order, stamps, IRCs, Master Charge or BankAmericard numbers ... send something negotiable.

## QSL CARDS

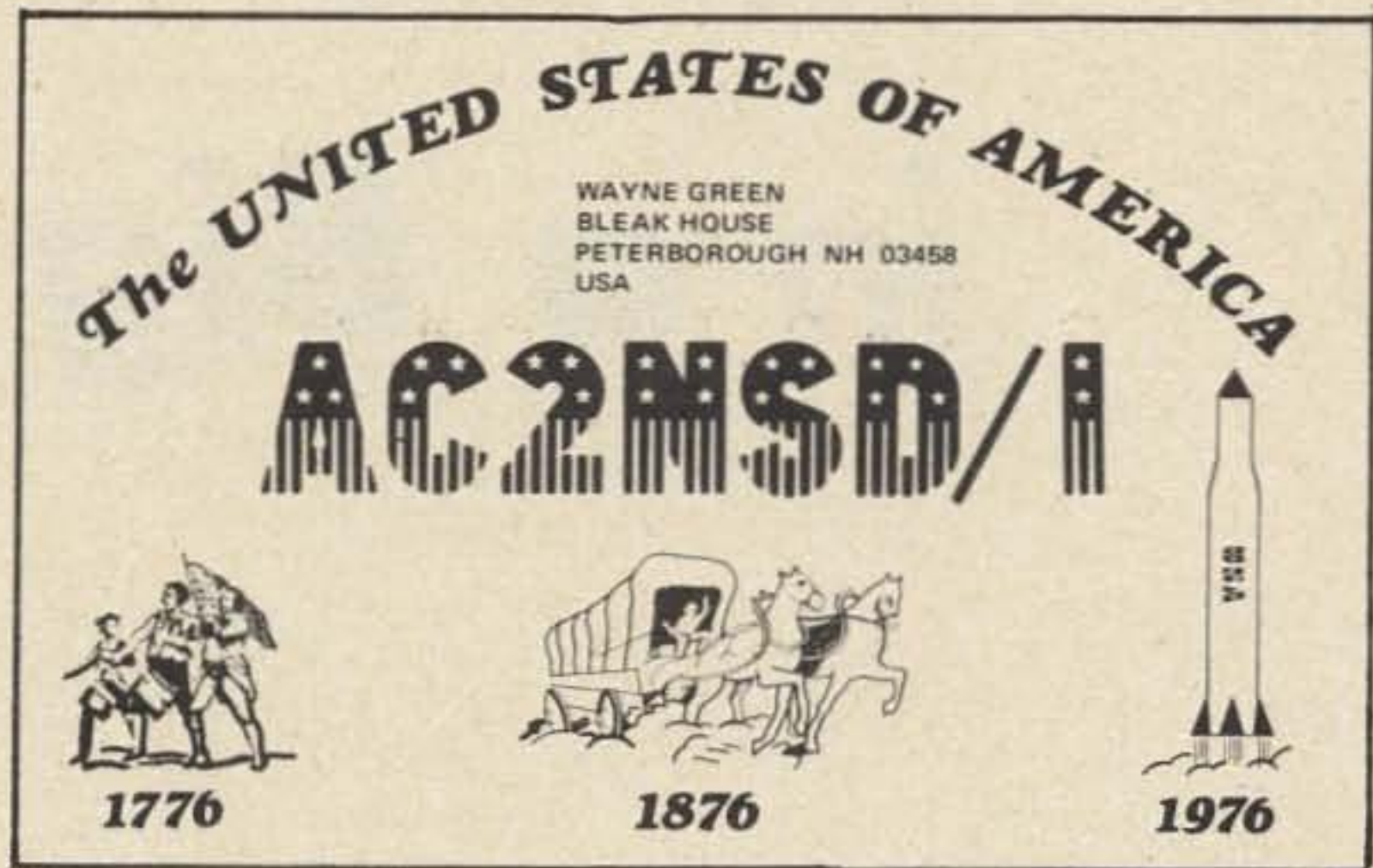

### ORDER — AND PAY

AMOUNT ENCLOSED \$ \_\_\_\_\_

<input type="checkbox"/>	250 cards .....	\$ 7.50
<input type="checkbox"/>	500 cards .....	\$12.50
<input type="checkbox"/>	1000 cards .....	\$20.00

official order blank (any other will do as well)

Name (as it should appear on the card ... use first and last name for informal approach ... use initials if your importance must be communicated)

Name \_\_\_\_\_ Call \_\_\_\_\_

Address (keep it as short as you can) \_\_\_\_\_

City \_\_\_\_\_ State \_\_\_\_\_ Zip \_\_\_\_\_

QSL CARDS 73 MAGAZINE

PETERBOROUGH NH 03458 USA

Domestic orders only.

Jack Grimes W4LLR  
Box 16004  
Memphis TN 38116

# Display Yourself in a Big Way

**H**ave you ever had a yen for one of those fancy, high priced ON THE AIR signs that give forth a bright glow when you hit the big switch? Or maybe have you wished for a super-attractive call letter display?

How often have you searched for a house number on a dark night, and, even with the

aid of a flashlight, made your way to half a dozen doors before locating the right address?

Wouldn't it be nice to surprise the XYL and dress up the doorway of your place with nice, bright, two and one half inch numerals? Or if you would like to add a different touch, how about spelling out the

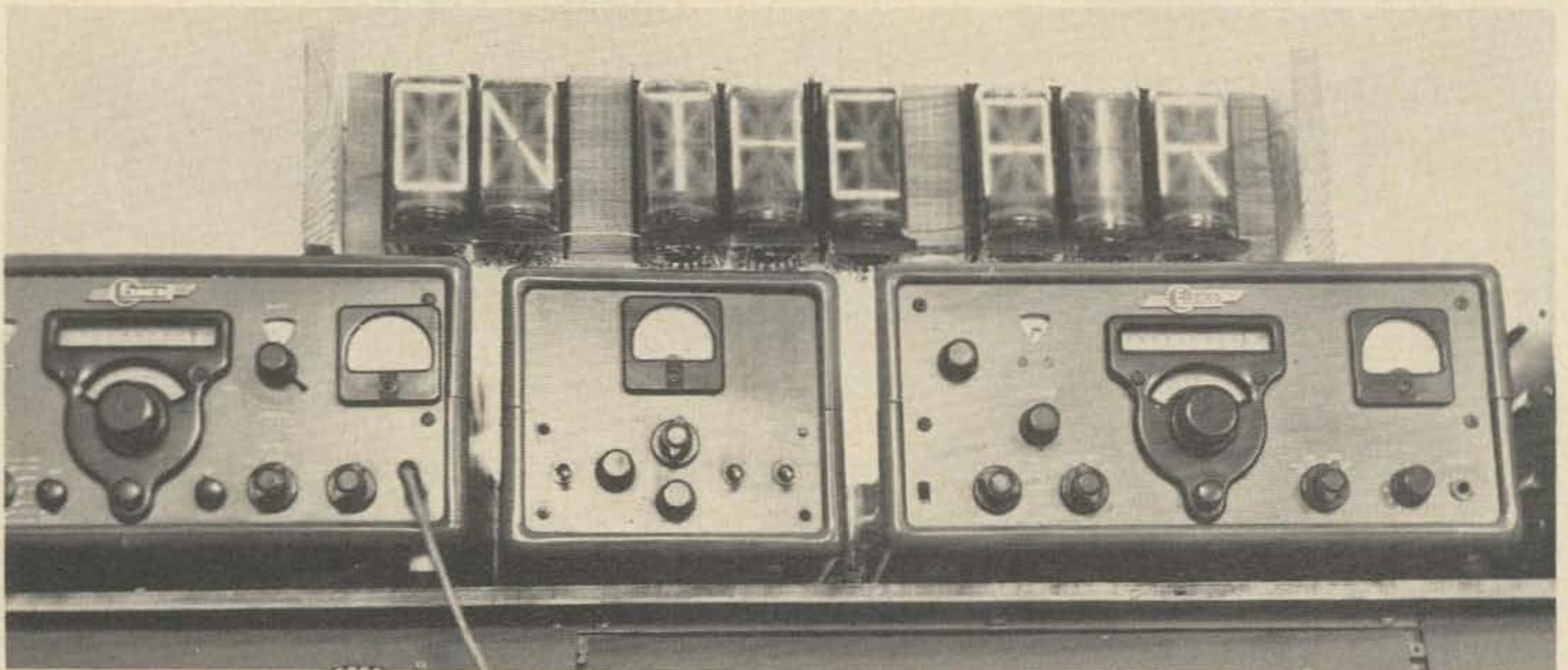

number in block letters that shine with a golden glow?

Perhaps you own a business or moonlight with a repair service and could use an eye-catching sequence of letters and numbers to inform the waiting public of your availability.

Or, for you tipplers, how about a friendly bit of neon advising: "Bar is Open"?

If you are interested read on and learn how simple and economical it can be to create your own displays. Chances are if you complete one project, soon you'll have the whole place all lit up!

There is nothing in ham radio more pleasurable to me than finding a worthwhile use for a genuine surplus bargain. One item presently readily available at a low price is the giant alpha-numeric tube, B-7971. Not only are the tubes available from \$1.00 up, but also offered, in pairs, are sockets plus tubes on a board with resistors, transistors and diodes, for as low as three pairs for \$5.00.

Use the tubes and sockets for a six letter display and you will still have a solid \$5.00 worth of parts for the junk box, saved from the boards.

The actual construction of a display is so simple that Figs. 1 and 2 are almost self-explanatory.

The power supply is a simple half wave, line voltage rectifier with a minimum amount of filtering. Values are not critical, except that the diode must handle the ac line voltage and the filter capacitor be of high enough voltage rating for the 150 volts dc output. No bleeder is necessary, but the 1 M resistor was included to slowly discharge the filter when power is removed.

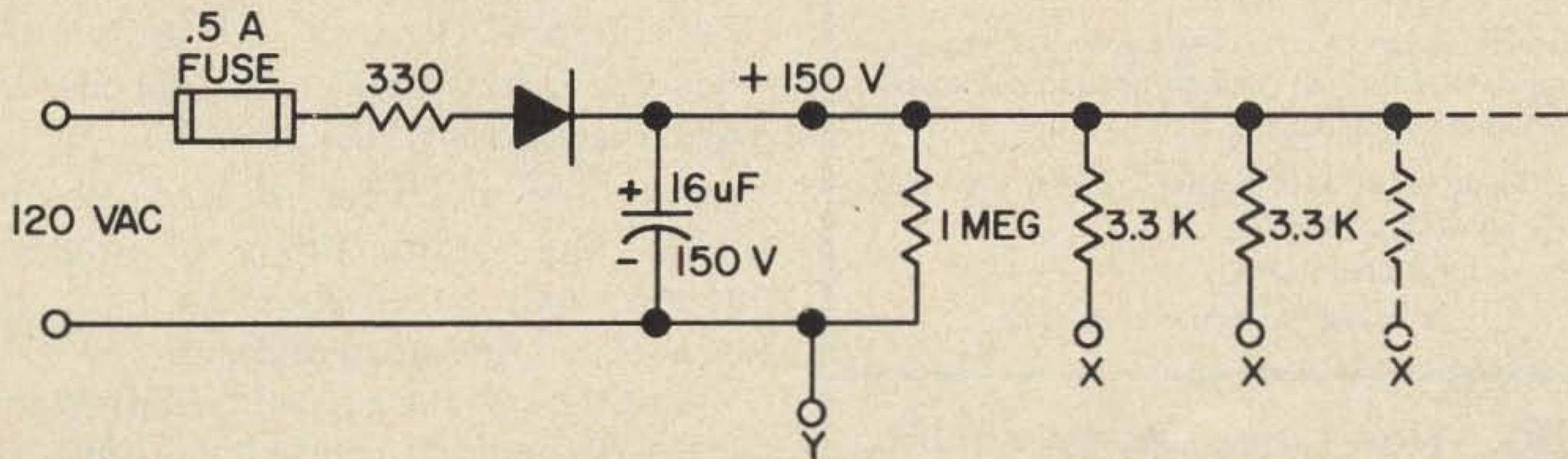

Fig. 2. Simple power supply for the giant nixies. Connect a 3,300 Ohm resistor from +150 V to pin 13 of each nixie. Connect each segment to be lighted to point "Y" (-150 V).

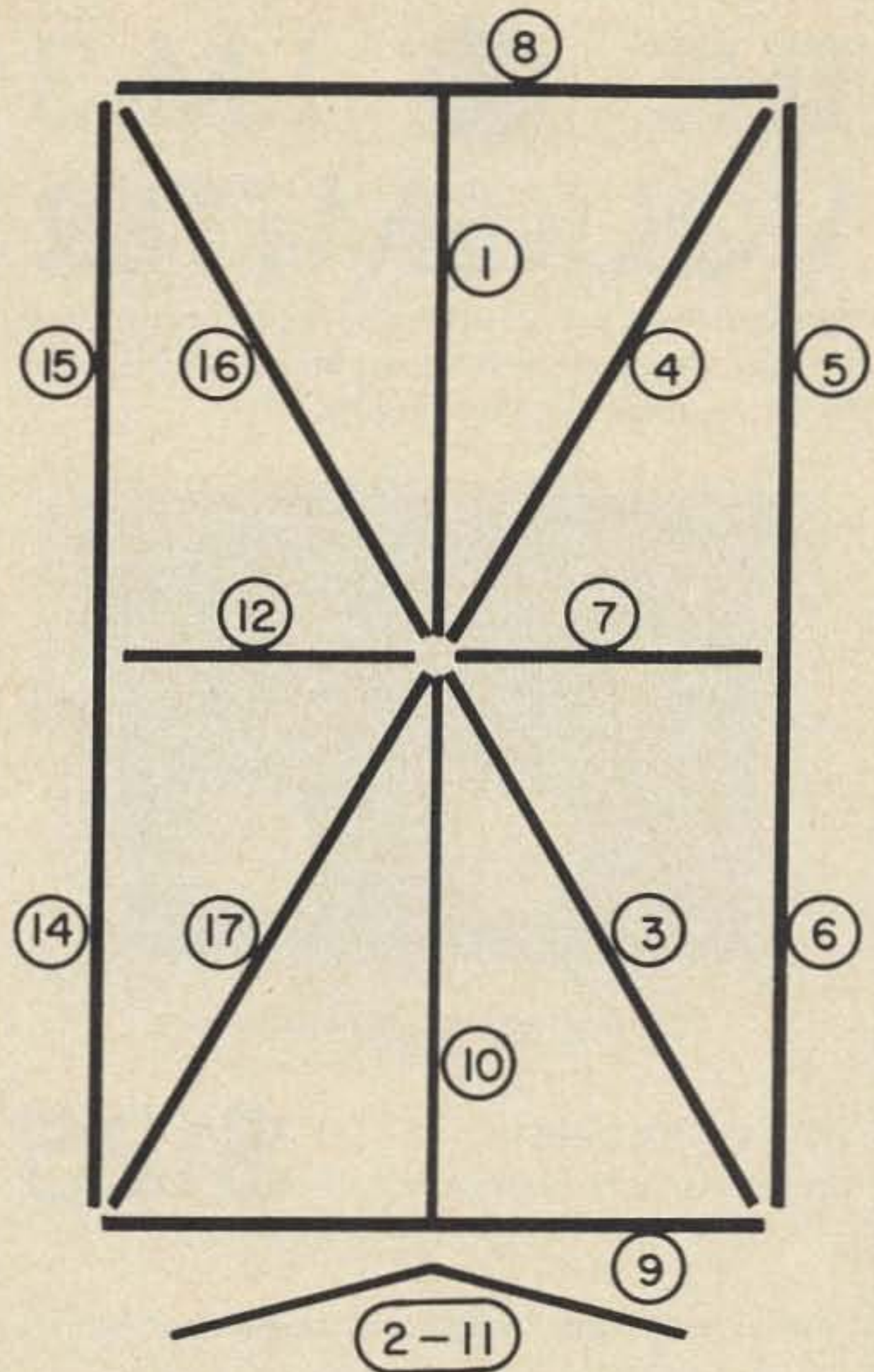

Fig. 1. Pin connections for B-7971 nixie readout. Pins 2 and 11 internally connected (used only for decorative purposes if desired). Pin 13 is anode (+voltage). The actual size of each alpha-numeric nixie character is 2½" high by 1½" wide.

The anode (pin 13) of each nixie is fed through a 3,300 Ohm resistor. If a higher voltage supply is tapped, a higher value resistor must be substituted. With 300 volts the resistor should be 68,000 Ohms.

Refer to Fig. 1 to program each nixie. Simply pick out the segments you need to light, to form the desired letter or number. Connect those pins together and wire to the negative terminal of the power supply. It is

# THE LM-3 VOLKSMETER

World's lowest priced precision digital multimeter  
-- more accurate and rugged than the old pointer  
meter -- ideal for field service.

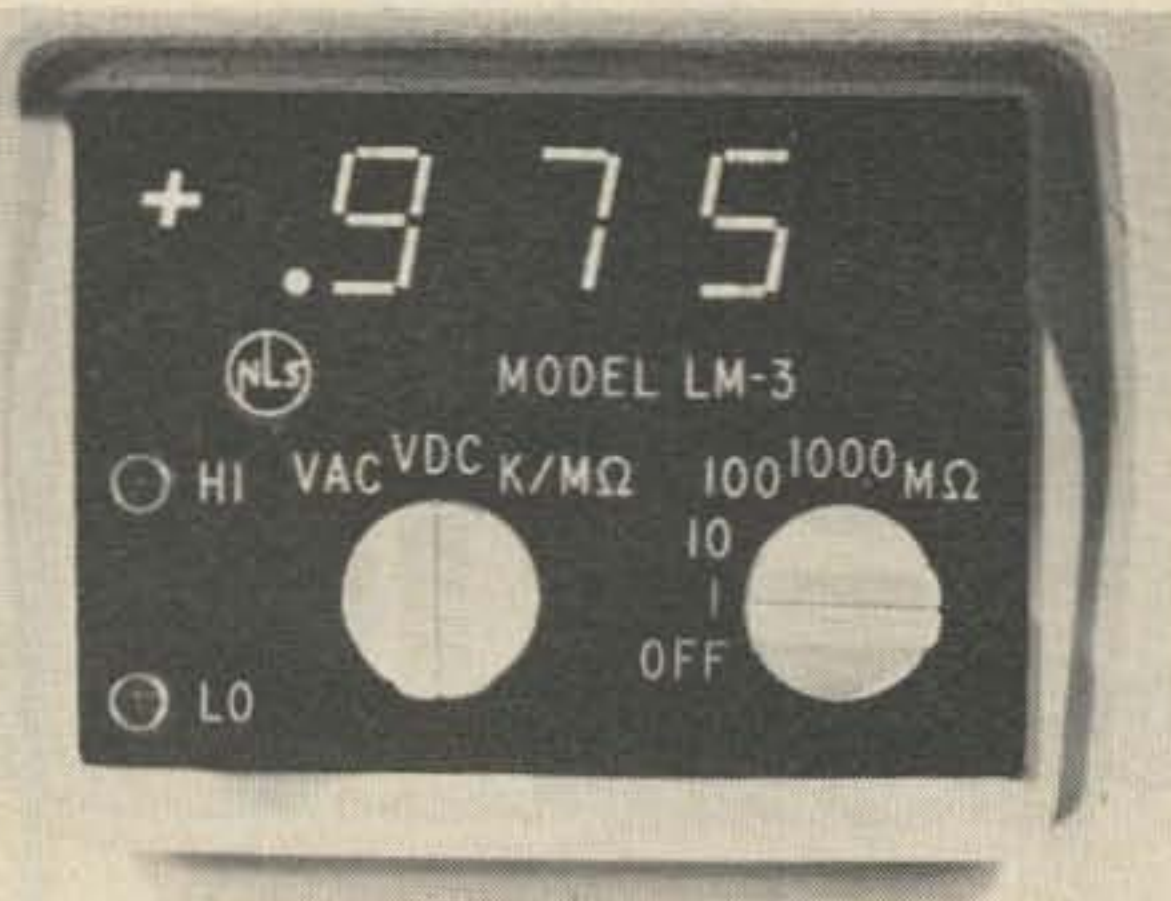

With rechargeable  
batteries and charger unit **\$125**

Now a multimeter with truly outstanding features.

- Super Rugged: Ideal for field service use - you don't have to recalibrate or replace if dropped.
- High Input Impedance: 10 megohms on all ranges; no more circuit loading.
- Automatic Polarity: No more test lead reversing or switching.
- Automatic Zero: No more adjustment of the zero when you change range, function or position; no more full scale ohms adjust.
- Full three digits without parallax or required interpolation; a 0.33" high LED display. A true one percent meter.
- 13 ranges: 4 vdc, 4 vac and 5 ohms.
- Measurements: Up to 700 vdc or 500 vac and up to 10 megohms.
- Small Size: 1.9" H x 2.7" W x 3.9" D.
- Versatile: Operates from standard 115V outlets or on self-contained rechargeable batteries.
- Fully Protected: No damage from overload on volts and ohms measurements.

#### Optional Features:

- Leather Case.
- High Voltage Probe: For measuring up to 30KV.
- Current Shunts: One percent accuracy from 1 $\mu$ A to 1A.

LM-3 basic meter also available in four digits with 0.02% accuracy. Ask for LM-4.

See your local distributor!

Distributor inquiries invited.



**Non-Linear Systems, Inc.**

Originator of the digital voltmeter.

Box N, Del Mar, California 92014

Telephone (714) 755-1134 TWX 910-322-1132

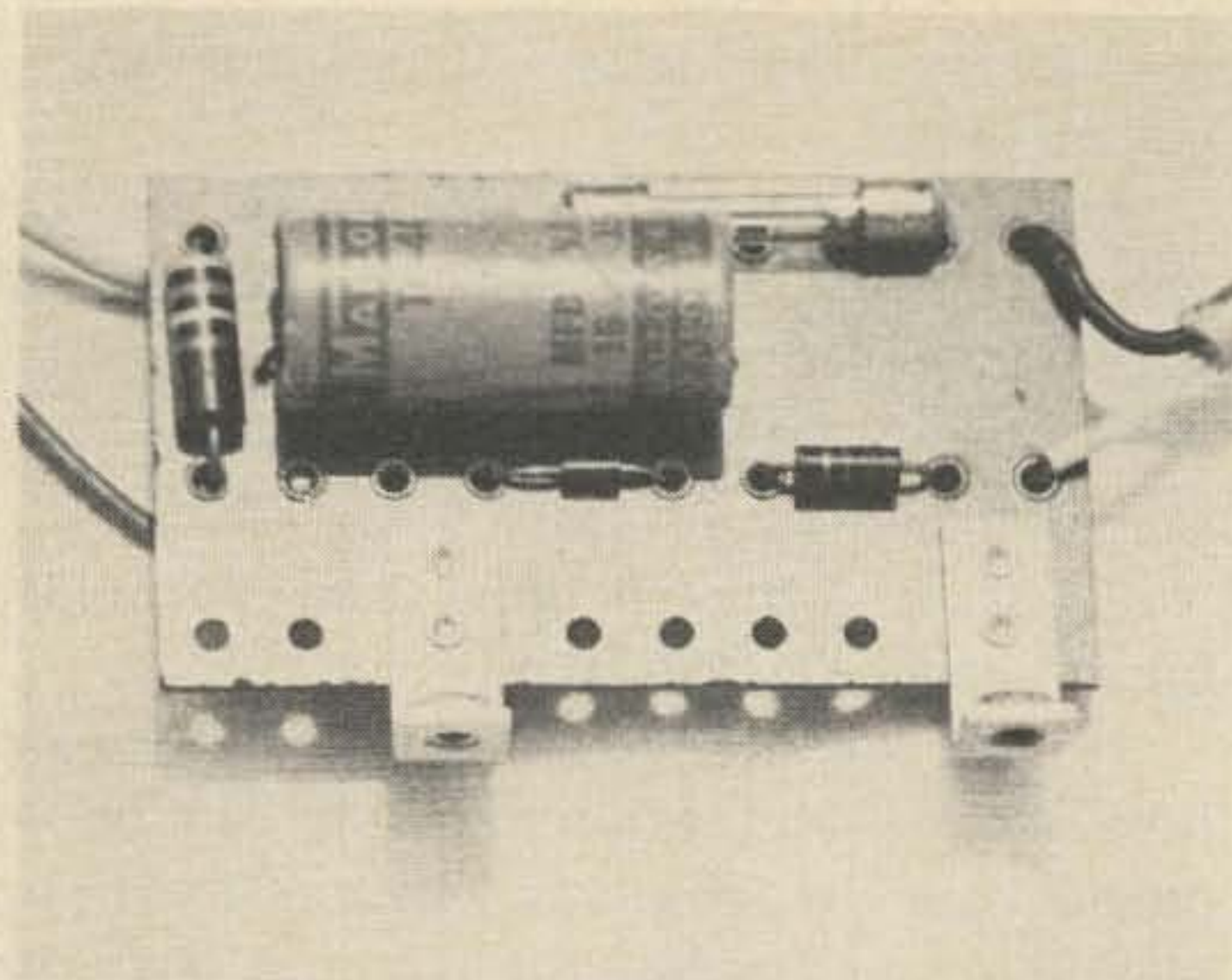

*Simple power supply.*

not recommended that the negative line be grounded to the brackets or chassis or cabinet, as this point is directly connected to the ac source.

If you purchase your nixies in pairs with the sockets and boards you will find the tubes mounted end to end on an aluminum bracket. It is quite simple to mark and hacksaw the brackets in half at the center. They may then be mounted on a wooden strip or metal angles and spaced as desired.

Your final housing may be as elaborate or simple as desired, from a highly polished wood cabinet hung with brass chain for your bar, to a panel mount for the shack.

The giant nixies will draw only about 2 mA per tube at this low voltage. The current drain is so minute that leaving house numbers lighted 24 hours will put no strain on the pocketbook, even if the XYL decides to be fancy and spell out the numbers rather than use simple numerals.

The giant nixie is a tremendous bargain. Its suggested use as a fixed display is in no way meant to downgrade its performance in various multiplexed arrays such as clocks and counters. However, for these projects, adequate interfacing with expensive and hard-to-get parts is required.

By using the tubes as set forth in this article any combinations of words and numbers may be produced at a fraction of the cost of other neon displays.

And the same setup can be reprogrammed when desired, in minimum time at no additional cost.

... W4LLR

# SPREAD JOY!

We'll help you in the Sandy Claws act with a Christmas special subscription bargain.

## YOU BUY THREE SUBSCRIPTIONS AND GET A FOURTH FREE!

You'll be remembered every month by your friends when that great big fat issue of 73 arrives in the mail. Biggest of the ham magazines. . . the most articles. . . the most thought provoking.

With the cover price at \$1.50 starting with the mammoth January issue, the \$10 subscription price is pretty reasonable. . . you're ahead of the game in seven months!

Don't forget yourself when you're being generous — extend your subscription another year! With the coming Communicator ticket and other remarkable developments, 1976 will be a year to remember in amateur radio. . . and you will be able to keep up with it best via 73 Magazine.

## THE DEAL. . . four subs for \$30. . . special.

Single subs are \$10 each apiece. . . three for \$30. Four are \$30, Merry Christmas!

**73** MAGAZINE  
Peterborough NH 03458

Name \_\_\_\_\_  
 Call \_\_\_\_\_  
 Address \_\_\_\_\_  
 City \_\_\_\_\_  
 State \_\_\_\_\_ Zip \_\_\_\_\_  
 \_\_\_ New \_\_\_ Extend \_\_\_ Don't know  
 \_\_\_ Send gift card please

Name \_\_\_\_\_  
 Call \_\_\_\_\_  
 Address \_\_\_\_\_  
 City \_\_\_\_\_  
 State \_\_\_\_\_ Zip \_\_\_\_\_  
 \_\_\_ New \_\_\_ Extend \_\_\_ Don't know  
 \_\_\_ Send gift card please

Name \_\_\_\_\_  
 Call \_\_\_\_\_  
 Address \_\_\_\_\_  
 City \_\_\_\_\_  
 State \_\_\_\_\_ Zip \_\_\_\_\_  
 \_\_\_ New \_\_\_ Extend \_\_\_ Don't know  
 \_\_\_ Send gift card please

Name \_\_\_\_\_  
 Call \_\_\_\_\_  
 Address \_\_\_\_\_  
 City \_\_\_\_\_  
 State \_\_\_\_\_ Zip \_\_\_\_\_  
 \_\_\_ New \_\_\_ Extend \_\_\_ Don't know  
 \_\_\_ Send gift card please

Sign Gift Card

**MERRY CHRISTMAS**

From: \_\_\_\_\_

Call \_\_\_\_\_

Check enclosed     Cash  
 BankAmericard     Master Charge

# \_\_\_\_\_

Expiration date \_\_\_\_\_

Signature \_\_\_\_\_



# AMATEUR RADIO BOOKS FROM HOWARD W. SAMS

**RADIO HANDBOOK (19th Edition)**  
by William I. Orr, W6SAI. The standard work on practical and theoretical aspects of radiocommunication and electronics. Provides detailed construction information and a complete understanding of theory on modern circuitry of transmitters, receivers, transceivers, power supplies, and test equipment. Broad coverage of fm, rtty, ssb, and a-m, plus full data on workshop practices, radio math, and other fields of special interest to the engineer and advanced amateur. 978 pages; 6¼ x 9¼; hardbound.  
**No. 24030 \$16.95**

**ELECTRONICS FOR THE AMATEUR**  
by Louis M. Dezettel, W5REZ. Discusses radio-wave propagation as it applies to amateur band frequencies, reception and transmission as they pertain to the equipment "hams" use, and the special field of antennas and how to feed them. 272 pages; 5½ x 8½; hardbound.  
**No. 24022 \$7.95**

**HAM AND CB ANTENNA DIMENSION CHARTS**  
by Edward M. Noll, W3FQJ. Tabulates dimension information in feet and inches for all the popular antenna configurations. Gives data for dipole antennas, quarter-wave verticals, two-element beams, quads, triangles, inverted dipoles, and inverted vees. 64 pages; 6 x 9; softbound.  
**No. 24023 \$2.25**

**AMATEUR TESTS AND MEASUREMENTS**  
by Louis M. Dezettel, W5REZ. Contains the know-how the average amateur needs to perform almost all necessary performance tests and make adjustments to transmitters, receivers, and antennas. 208 pages; 5½ x 8½; softbound. **No. 24007 \$5.50**

**SO YOU WANT TO BE A HAM (6th Edition)**  
by Robert Hertzberg, W2DJJ. Learn what types of licenses are available and the requirements and procedures for obtaining them. Technical aspects of radio equipment are also discussed. 192 pages; 5½ x 8½; softbound.  
**No. 20977 \$5.50**

**SEMICONDUCTOR AMATEUR PROJECTS**  
by Louis M. Dezettel, W5REZ. Contains instructions for making 16 useful ham-radio accessories—all designed to make a ham station more efficient and more enjoyable to operate. 160 pages; 5½ x 8½; softbound.  
**No. 24025 \$4.95**

**SINGLE SIDEBAND: THEORY AND PRACTICE**  
by Harry D. Hooton, W6TYH. A one-source guide emphasizing basic principles and circuitry, rather than mathematics. Includes information about the origin of ssb, the derivation of ssb signals, carrier-suppression techniques, sideband selection, carrier generators, and more. 388 pages 5½ x 8½; hardbound.  
**No. 24014 \$6.95**

## ABC'S OF HAM RADIO (3rd Edition)

by Howard S. Pyle, W7OE. Includes all the study material necessary to obtain the novice-class amateur radio license. Covers FCC regulations. Gives helpful hints on how to learn the code and how to set up your first station. 144 pages; 5½ x 8½; softbound.  
**No. 20638 \$3.50**

## 101 QUESTIONS AND ANSWERS ABOUT AMATEUR RADIO

by Kenneth M. Bourne, Robert M. Brown, and Leo G. Sands. Serves not only as an introduction for the beginner to the many facets of amateur radio but also as a valuable reference source for the old-timer. 112 pages; 5½ x 8½; softbound.  
**No. 20731 \$2.95**

## 73 DIPOLE AND LONG-WIRE ANTENNAS

by Edward M. Noll, W3FQJ. Covers practically every type of wire antenna used by amateurs. Gives dimensions, configurations of noise bridges, line tuners, and more. 160 pages; 5½ x 8½; softbound.  
**No. 24006 \$4.95**

## 73 VERTICAL, BEAM, AND TRIANGLE ANTENNAS

by Edward M. Noll, W3FQJ. Contains data on practically all types used by amateurs. The 73 different antennas have all been built and air-tested by the author. 160 pages; 5½ x 8½; softbound.  
**No. 24021 \$4.95**

## IC OP-AMP COOKBOOK

by Walter G. Jung. Covers not only the basic theory of the IC op amp in great detail, but also includes over 250 practical circuit applications, liberally illustrated. Organized into three basic parts: introduction to the IC op amp and general considerations, practical circuit applications, and appendixes of manufacturers' reference material. 592 pages; 5½ x 8½; softbound.  
**No. 20969 \$12.95**

## TTL COOKBOOK

by Donald Lancaster. Explains what TTL is, how it works, and how to use it. Discusses practical applications, such as a digital counter and display system, events counter, electronic stopwatch, digital voltmeter, and a digital tachometer. 336 pages; 5½ x 8½; softbound.  
**No. 21035 \$8.95**

## RTL COOKBOOK

by Don Lancaster. Explains the how and why of RTL (Resistor-Transistor Logic) and gives design information that can be put to practical use. Gives a multitude of digital applications ranging from the basic switch to the sophisticated counter. 240 pages; 5½ x 8½; softbound.  
**No. 20715 \$5.50**

## ABC'S OF SHORT-WAVE LISTENING (3rd Edition)

by Len Buckwalter. An easy-to-understand introduction to the exciting world of short-wave radio. Tells what programs are available and how to get the most out of short-wave listening. 96 pages; 5½ x 8½; softbound.  
**No. 20797 \$2.95**

## SAMS BOOK ORDER FORM

Please fill in your order below:

- |                                    |                                    |                                    |
|------------------------------------|------------------------------------|------------------------------------|
| <input type="checkbox"/> No. 24030 | <input type="checkbox"/> No. 24025 | <input type="checkbox"/> No. 24021 |
| <input type="checkbox"/> No. 24022 | <input type="checkbox"/> No. 24014 | <input type="checkbox"/> No. 20969 |
| <input type="checkbox"/> No. 24023 | <input type="checkbox"/> No. 20638 | <input type="checkbox"/> No. 21035 |
| <input type="checkbox"/> No. 24007 | <input type="checkbox"/> No. 20731 | <input type="checkbox"/> No. 20715 |
| <input type="checkbox"/> No. 20977 | <input type="checkbox"/> No. 24006 | <input type="checkbox"/> No. 20797 |



CARD NO.



EXPIRATION DATE

NAME

ADDRESS

CITY

STATE

ZIP

SIGNATURE

CHECK OR MONEY ORDER  
TOTAL AMOUNT ENCLOSED

MAIL ORDERS TO: RADIO BOOKSHOP/PETERBOROUGH, NEW HAMPSHIRE 03458



## Fun City's Surplus Scene

**T**here is a shortage of surplus. This is not meant to be funny. Nowadays a surplus ad often means they want to *buy your* surplus, not sell theirs. The exception is the venerable Command Set, available since WW II. The government must have ordered one for every man, woman and child in the country.

We surplus hounds have never been understood. Our severest critics themselves

buy antiques and nostalgia items, some pretty gamey. Their more extravagant purchases are justified on the basis of historical significance — Paul Revere's megaphone, Death Valley Scotty's skis, or whatever.

Amateur interest is now mostly in integrated circuits and readouts, so industrial surplus has replaced military almost entirely. And these needs are best taken care of by mail-order specialists. Mostly they are slow,



but all are reliable.

There are many surplus emporia scattered around the country — probably one for each large city. Kingston, New York has P & D Surplus. Philly has Herback & Rademan. But the mecca is New York City.

Those of you who live within range, or visit the city for other reasons, may plan to drop by Radio Row and actually handle and examine the stuff before buying. This is a good plan since you will see many *one-of* items, and many others new to you, about which the proprietor will be glad to furnish specs and answer any answerable questions.

Back in 1969 I wrote a thing on the surplus scene. Radio Row had just been relocated to make room for the World Trade Center, a complex of skyscrapers then building. (In mid-May of this year, some patriot set three fires in one of the buildings, doing extensive damage, for obscure reasons.) Before the WTC, Radio Row was mostly Cortlandt Street, with spill-overs from Liberty to Dey. It has now moved to Warren Street as an axis, with a scattered few elsewhere. Canal Street is growing and may outshine Warren in a few years.

Before making any plans, if you are unfamiliar with New York, it might be well to know something about the magnificent distances in that city. Manhattan is all one borough, but the Cloisters, the museum/Planetarium complex in the 80s, Central Park, Wall Street, Chinatown — in your community, they would probably be in separate towns, that's how far they are apart. NYC is *big*. It is unrealistic to plan seeing more than one or two of them in a day. I can spend a week in the museum alone, if my legs would stand up. Their arms and armor section is fabulous! The knights of old were shrimps, most of them, judging by the armor they could get into. And tough shrimps, too, since the armor was heavy.

Taxis? Catch them at their roosts, like sitting ducks. Flagging one is like flagging a pigeon.

Subways? The whole population rides them. Rush hours resemble the march of soldier ants. By the time this sees print, the fare may be raised again, but it is 50¢ at the moment.

The city administration loses money on

the subways. No one else could, but New York is headed for bankruptcy.

Your first glimpse of a subway car will startle you. The cars are covered, inside and out, by Psycho-Delicatessen Graffiti, like dazzle-painting, or camouflage, so that you can't even find the train designations. The cars used to have "A" or "D" on front and sides, but the trainmen don't bother anymore. You have to ask a native rider, who recognizes his train by smell or ESP or something. In the rush hours, which start as early as 4 pm, you could get your pocket picked, but there is little or no danger of violence.

New Yorkers have their own code of conduct. Perhaps every city has. Anyway, they will never allow a door to slam in your face. Step on it, yes, but never let a door slam in it. In other cities your fellows will punt you into the lobby with one. Another thing: New Yorkers are very patient about giving directions. In broken Croat, maybe, with a lot of arm waving, but their concern in getting you headed right is heartwarming.

Subway trains take different routes on regular as opposed to rush hours, so you may wind up far from your expected destination. There are maps inside the cars, but don't expect them to help you. They require study.

If you get carried past your stop, don't panic. All you have lost is time. Wait until you get to a *big* station, cross over to the other side via platform or stairway, and head back the other way. A small station will exit on the street; you must cross and pay another fare. Don't cross the tracks! It has a third rail. People get killed. This rail is outside the main ones, not in the center like Lionel.

Passengers have been Pavlov'ed to enter and exit cars briskly. All you have to do is stand in the crowd and be swept aboard without effort on your part. When you ride, avoid the doors, or you may be left outside on some platform without ever knowing how you got there.

There are many more subway cops than there used to be, and subways are presumably safer. They should be avoided late at night, however.



Warren at Broadway, facing east.

Incredible as it seems, Manhattan was once a place of white wooden houses and shady lanes and cornfields. Oh, it was a city all right, but on the 1900 model. The story goes that in the early years, a promoter proposed that some rather drastic changes in the physical makeup of the island be implemented. He announced that he was going to hire a thousand men to dig pits, another thousand to handle cross-cut saws (the big, double-ended jobs), and more thousands to man push-poles on the riverbanks.

He planned nothing less than to station sawyers in the pits, which were to be dug along Fourteenth Street (then a dirt lane), who were to saw that end of the island free from the rest. The pole men would push it out in the bay and anchor it there. Besides high wages, he offered free food, including steamed clams and barbecued oxen and a small ocean of beer. Fantastic as it sounds, the idea has merit.

On the appointed day, an army of indigents showed up, together with the

various contractors including butchers, fishmongers and brewers, reporters, spectators and police. Only the promoter was missing. When the unpaid suppliers began to reload their wagons, the picnic turned into a riot. The lower end of Manhattan is still firmly attached.

Hoaxes are no longer perpetrated by private citizens. Pity. Those we get nowadays lack *espièglerie*; they're no fun, nobody laughs. They're not even *supposed* to be funny.

Everyone drives a car in this day and age, so why not just drive to New York City? Well, there are precautions to take here, also. For one thing, as you will discover for yourself, there are too many cars in Manhattan. The city administration mounted policies which actively discourage people from driving into the city. It is not legal to keep you out, but they can make you sorry you came.

The first thing they did was to make the tolls on bridges and tunnels one-way. For example the Holland Tunnel, Lincoln

Tunnel, George Washington Bridge and Tappan Zee Bridge — all cost a dollar eastbound, and are free westbound. This is to encourage emigration. Some inequities exist in any plan, of course: A Jerseyite drives to work in Manhattan and dies there, he's out fifty cents.

Parking in the city is not merely tricky, it's a near impossibility. If you do see a parking space, stay out of it. It's a trap. If it weren't, some native would be already in it. "NO PARKING" signs are usually on poles, but sometimes you park in a cleared space and come back to find that *portable* no parking signs have been set up by your car, and you are in retroactive violation.

My wife drove down to the city to see a specialist near 75th Street. We parked at what looked like a reasonable place. The signs seemed to say that we could park for two hours. There was a Tow-Away Zone sign well down the block, but so placed that it didn't seem to apply where we were. We fed the parking meter a good breakfast of dimes and left. We came back a few minutes late. No car. I found out where the car pound was (on a dock; they tow away motorboats, too). It cost us \$50 to get our car, and this is the going rate. I asked three times if \$50 covered all charges and was thrice assured that it did. Months later I got a bill from the City for \$30, of which \$25 was for the violation, and \$5 for a scofflaw charge. Included was a threat to take it out of my hide. Granted, we were over-parked, but \$80? Probably, a summons had been placed on my car, stolen and hawked by the junior citizenry. The man I called about it told me this often happened. He thought it was funny.

If you park in a lot, they will demand your key "so we can move it if we need to." If and when they need to, they move it out in the street. It won't get tagged, but it may suffer a scraped fender. "Must 'a happened before you come in, Mack."

Parking garages are fine, but they close at 5:30 pm or some such, and your car is locked up for the night. They will admit this if you ask, but would never volunteer the information — you are supposed to know.

When I go, I take the bus all the way — and this is harassing, too — or I drive and

park in the municipal lot at Fort Lee, New Jersey. Then cross the river on a bus, subway downtown. Saves \$80 parking fees.

This last trip, my first stop was Canal Street. I talked to L. Cates, who started in the middle 40s. He has one of the best stocks in the city, including solid state. He told me that Leopold was no longer at Leeds, and that Mike Kranz had retired. Many of the old stores are gone. Leotone on Dey Street. For that matter, so is Dey Street. Cates' place is the first I'd visit on a subsequent trip. It is on Canal between Sixth Avenue (Avenue of the Americas in the modern mode) and West Broadway, north side of the street, number 383. Across the street on the corner at 380 is his old place, now called Richmond.

The store is a little different, the stock is different, but with many good items. The walls are lined with test equipment — few oscilloscopes, and these mostly early Tektronics, the small ones. The bulk is special stuff of all kinds. I noticed a bolometer, whether with bridge element or not I don't know. But this is an indication of what you can find.

In the next block, three plastics houses, one metals house (rod tube, sheet, aluminum, stainless, grill) and three or four radio houses. One good.

Then on to Chinatown for lunch. At the corner of Mulberry and Canal, something new: A small movie house for Chinese, showing Japanese X-rated films. It had to be small, being in an office/apartment building. Chinese, because the show-cards were titled in ideographs, without any Roman letters at all. Why Japanese? Good question. The Japanese consider luxuriant eyebrows to be a beauty mark, and the pictured characters had them. Shaggy ones. This ends the question period.

Up to Mott Street and following it nearly to its far end, to a Chinese restaurant, downstairs. I remembered it from 20 years ago. Egg Foo Yong. Yat Gar Mein ("Yah-ka-minn") kumquats. The tea is genuine Chinese tea now, from Tai Wan, far more tasty than the dark stuff of only a year ago.

Now downtown to Warren Street. Leeds (at 57 Warren) under new ownership, looks

much the same, except for a less lavish window display. Metro, on the other corner is supposed to be all hi-fi now. Isn't. A studio has been added, but the place is the same as it always has been, even to the Grebe receiver in the window. He has a different kind of customer, less sophisticated than Cates', but still inclined to do his own electronics. They want information, and more than that, reassurance, and they get it. I can remember when I thought speakers and transformers had to be matched *to thee Ohm*, and sympathized. I had to talk to Denby, the proprietor, between customers, of course, and these came in a steady stream.

It came to me, then: Surplus merchants and customers understand each other. Denby didn't waste any time, but he gave each customer his full attention. The traffic flow was steady, and fairly rapid. With Cates on Canal Street, a customer would duck in, ask for something, get and pay for it, and then duck out. The rate seemed to be about four in ten minutes — I should have timed it. They knew exactly what they wanted, and he knew what he had. It takes that kind of merchandising with small-profit items and New York rents. Lots of other merchants could learn from men like these.

Blan, next door at 52 Warren, has a lot of special industrial stuff, *not* surplus. Lafayette at 45 Warren, is blister-packed. G & G has moved upstairs over Lafayette, no longer at Leonard Street. The proprietor is a very old gentleman who could have retired many years ago but chose to continue merchandizing. His sign at the door is a sign of the times: "Door locked. Call 267-4605 for entry. Retail sales Saturday only, 9:30 am to 4:30 pm." He always had a good catalog, and specialized in military/radio surplus and aircraft instruments.

Cortlandt Radio also has a good catalog, and was also locked up, though it was only about 4:45 pm. This parts house is at 1144 West Broadway, near Chambers. Arrow, at Chambers and Church, a couple of blocks east, is an old parts house with a ham department. They had crystals for any frequency in the old days. You can still get miniboxes there. I even saw the long ones, that you put the strip-lines in for UHF

converters and such. But all of these merchants like the large unit sales and this means TV and hi-fi. That's where the money is.

Back on Warren Street — Radio Row, Inc. holds no interest for hams, because it is a TV outlet. Pity, with a name like that. On Church Street (number 178) between Reade and Duane Streets dwells Adson. They too have miniboxes, and a lot of books and parts.

Harrison has moved out of town, so there is no big ham-only store.

Uptown: Another Lafayette at 55 45th Street. It was closed, but all I saw was TV and hi-fi. But a few doors to the east, at 35 West 45th, is Heathkit. It was closed when I got there, but appears to be agency/advisory/test center, with an extensive window display. Leonard Radio is now uptown at 1165 Broadway, north of 45th. Radio Shack is on West 45th, next to the Hotel Normandie, opposite the Topless Go Go Bar, west of 6th Avenue.

Oh yes, Barry is still at 512 Broadway, just north of Canal, between Broome and Spring. You can spot his yellow sign, with just the name in vertical letters.

Last, but not least, the FCC office where ham exams are given has moved from the old brick Post Office building on Christopher Street, about ten blocks south to 201 Varick Street. Varick is the continuation of 7th Avenue, starting at Houston, which is a divided parkway as of recent years. Take the West Side IRT subway to Houston and you will be very close.

It is a pity that so many street signs are missing, and so many house numbers over doors, but that's New York. Got to keep the cars out some way. Oh, I forgot: The ham exams are Wednesdays only and require a Post Office money order for \$4 made out to the FCC, or you don't get to take it.

Now that you know where some of these places are, and you don't have to hunt for them, you can at least manage a Chinese lunch in addition to shopping. (In Chinatown everyone drinks coffee, the place is full of coffee shops.)

If you can, get the Exxon map of New York City and Long Island. It is excellent. And if you watch, you will see some odd

**Creative ?  
try these high-performance  
circuit-builder's  
Terminal and  
Distribution  
Strips**

All solderless plug-in tie-points

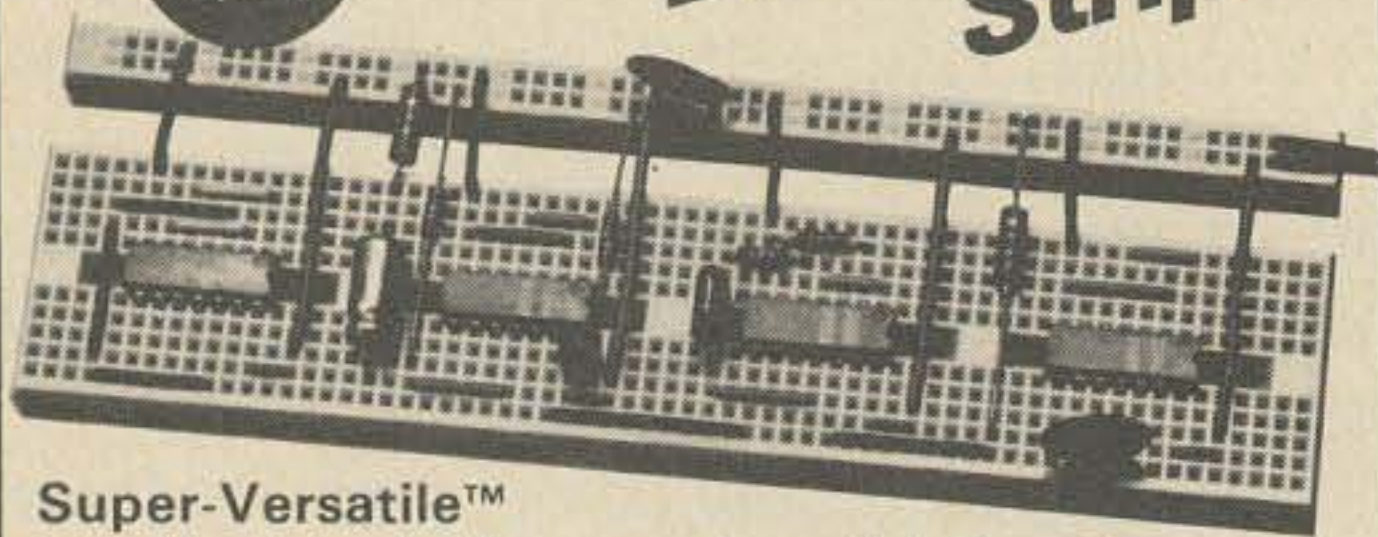

**Super-Versatile™  
building blocks for experimental circuits**

Universal .10" matrices of solderless, plug-in tie points

For all DIP's and discretes with leads to .032" dia.

Interconnect with any solid wire up to No. 20 A.W.G.

Nickel-silver terminals

**ORDER BY PART NUMBER**  
923277 distribution strip . . . \$2.50  
923261 terminal strip . . . \$12.50

Create custom breadboards in minutes with these new instant-mount strips. DISTRIBUTION STRIP (top) contains 2 continuous buses of 12 connected 4-tie-point terminals. Size: 6.5" by .35". TERMINAL STRIP contains 128 5-tie-point terminals, holds up to nine 14-pin DIP's. Size: 6.5" by 1.36". Integral, non-shorting, instant-mounting backing permits quick build-up of special breadboards using any mix of strips.

Other models available.

We honor M.C. and B.A.C. charges. Add sales tax on OH and CA orders. (F.O.B. Painesville on company P.O.'s.) Dealer inquiries invited

Shipping/Handling Fees	C.O.D.
Up to \$10.00	\$1.00
\$10.01 to \$25.00	1.50
25.01 to 50.00	2.00



All products guaranteed to meet or exceed published specifications

**AP PRODUCTS INCORPORATED**

Box 110-Z • Painesville, OH 44077 • 216/354-2101

sights in the city. I saw a Rolls Royce turning into Reade Street and did a double take. A Rolls is not a large car, about Buick-sized, but Reade is a small street. Then I saw that the classic Rolls front end had been mated to a VW, or the bug behinder grafted on to a Rolls front end — anyway, the mutant made the turn as if hinged in the middle. Beautiful workmanship, no seams, a body-shop job, likely, but there was no advertising sign on it. Possibly somebody's comment on body styling or prestige cars.

On Canal I saw a Pontiac sedan double-parked, way out in the street, in *that* traffic! A police officer was writing out a \$25 ticket, and a woman was leaning out the right front window and milking the horn, the cop threatening her the while. It looked as if Pop told her "I'll only be a minute" and went into a store, taking the keys with him. He was probably hiding there. First time in years I saw a big car get a ticket. Maybe they should leave the island where it is.

... BACH

# Soon to be extinct . . .

Destined to follow the path of the dinosaur and low taxes . . . GONE FOREVER! Since 73 is going to the new 8½ x 11 format in January, no additional binders for the current 9 x 6 size are being ordered. That means, when the few we have on hand are gone, there will be no more available . . . EVER! They will probably become collector's items.

Keep your pre-1976 issues of 73 safe from being lost or damaged . . . in these handsomely appointed binders with rich red covers and gold lettering. Each binder holds 12 issues . . . making an excellent reference handbook . . . several binders form a quality library you can be proud of.

Order yours today . . . before they are gone . . . only \$4.95 each or 10 for \$45. SEND IN YOUR ORDER RIGHT NOW . . . DON'T MISS OUT ON THIS LAST CHANCE! Order right from this ad . . . by check, BankAmericard or Master Charge (include card number and expiration date).



Get 'em while they last!

name \_\_\_\_\_

address \_\_\_\_\_

city \_\_\_\_\_

state \_\_\_\_\_

zip \_\_\_\_\_

Check/Cash

BankAmericard # \_\_\_\_\_

MasterCharge # \_\_\_\_\_

Expiration date \_\_\_\_\_

Signature \_\_\_\_\_

Send to: 73 MAGAZINE, Peterborough NH 03458

Note: Offer valid only until current supply is depleted.

**LIMITED SUPPLY**

**ORDER TODAY!**

\$4.95 ea. or \$45 for 10

# NEW CODE SYSTEM

*Now you can learn the code in a fraction of the time it used to take!*

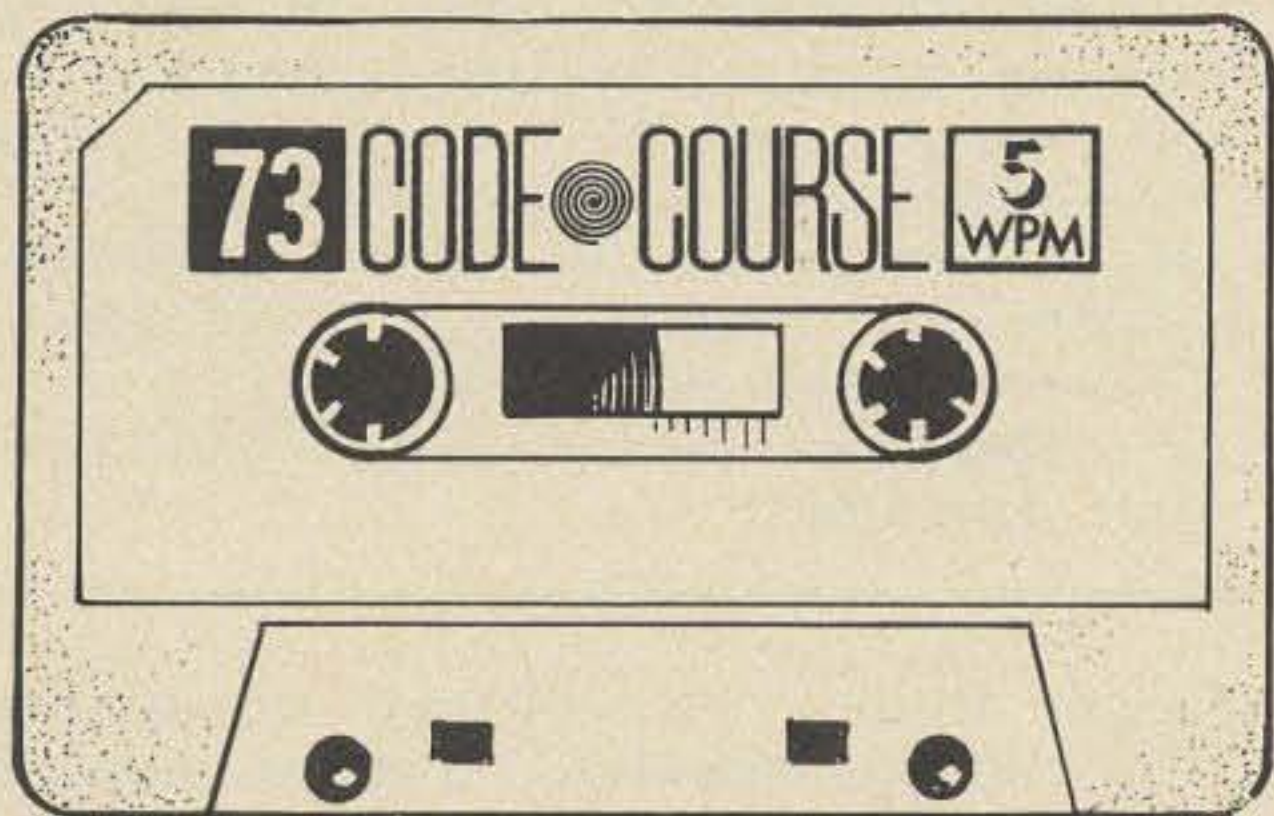

## four speeds available

**Plays on any cassette player so you can practice anywhere anytime!**

**5 WPM** This is the beginning tape for people who do not know the code at all. It takes them through the 26 letters, 10 numbers and necessary punctuation, complete with practice every step of the way using the newest blitz teaching techniques. It is almost miraculous! In one hour many people — including kids of ten — are able to master the code. The ease of learning gives confidence to beginners who might otherwise drop out.

**14 WPM** Code groups again, at a brisk 14 per so you will be at ease when you sit down in front of the steely eyed government inspector and he starts sending you plain language at only 13 per. You need this extra margin to overcome the panic which is universal in the test situations. When you've spent your money and time to take the test you'll thank heavens you had this back breaking tape.

**6 WPM** This is the practice tape for the Novice and Technician licenses. It is made up of one solid hour of code, sent at the official FCC standard (no other tape we've heard uses these standards, so many people flunk the code when they are suddenly — under pressure — faced with characters sent at 13 wpm and spaced for 5 wpm). This tape is not memorizable, unlike the zany 5 wpm tape, since the code groups are entirely random characters sent in groups of five. Practice this one during lunch, while in the car, anywhere and you'll be more than prepared for the easy FCC exam.

**21 WPM** Code is what gets you when you go for the Extra Class license. It is so embarrassing to panic out just because you didn't prepare yourself with this tape. Though this is only one word faster, the code groups are so difficult that you'll almost fall asleep copying the FCC stuff by comparison. Users report that they can't believe how easy 20 per really is with this fantastic one hour tape. No one who can copy these tapes can possibly fail the FCC test. Remove all fear of the code forever with these tapes.

**ONLY \$3.95!** 73 is in the publishing business, not tapes, so these are priced much lower than anyone else could sell them. Have you ever seen one hour cassettes for under \$6?

### ORDER NOW!

Name \_\_\_\_\_ Call \_\_\_\_\_

Address \_\_\_\_\_

City \_\_\_\_\_ State \_\_\_\_\_ Zip \_\_\_\_\_

- 5 WPM 1 hr cassette \$3.95       14 WPM 1 hr cassette \$3.95  
 6 WPM 1 hr cassette \$3.95       21 WPM 1 hr cassette \$3.95  
 all four cassettes \$13.95

**73 Magazine — Peterborough NH — 03458**

GIANT NIXIE CLOCK — 4 digits — 2.5" displays. Complete kit — circuit board, instructions and all parts except case and line cord. Only \$29.95 ppd.

Big Display VAN CLOCK — designed to mount into the wall of a van or motorhome. This clock features six .6" readouts and a flat case, 4" x 7" x 1.5" for easy reading and easy mounting. All the features of our smaller car clock are also built into this clock.

Parts kit without case . . . . . \$39.95 ppd.  
Parts kit with case incl. . . . . \$45.95 ppd.

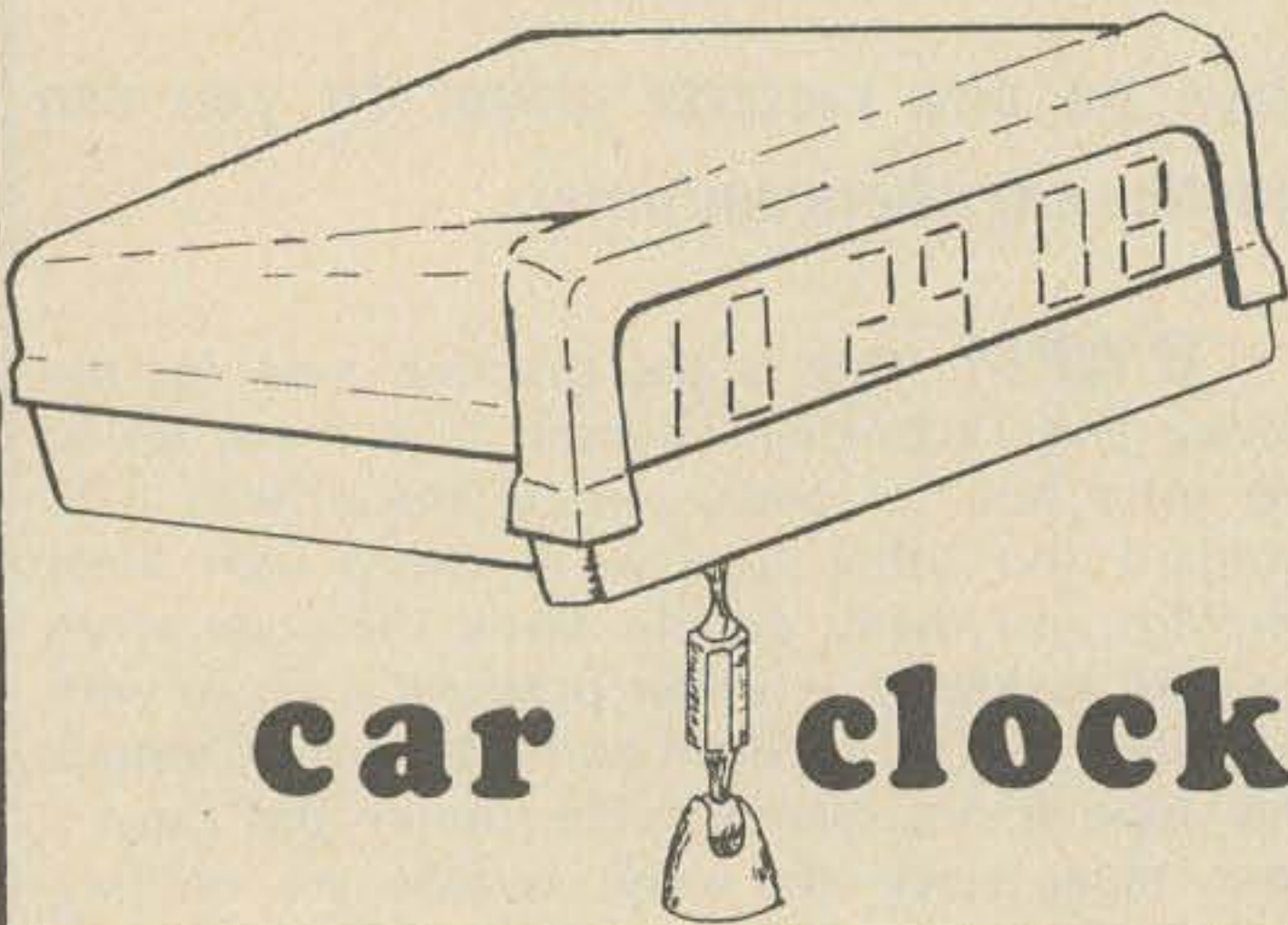

**car clock**

6 digit AUTOMOTIVE CLOCK KIT complete with a crystal timebase accurate to .01 percent. 12 volts dc operation — built-in noise suppression and voltage spike protection. Readouts blank when ignition is off — draws 25 mA in standby mode. Has .3 in. readouts. Use it in your car or for all applications where a battery-operated clock is needed. Approximate size — 3" x 3.25" x 1.75".  
Parts kit without case . . . . . \$29.95 ppd.  
Parts kit with case incl . . . . . \$34.95 ppd.

60 Hz. CRYSTAL TIMEBASE KIT with .01 percent crystal. 5-15 V dc operation. Draws only 3 mA at 12 V dc. Single IC — very small size — the PC board is 1½" x 2". 9 other output frequencies are available on the board. Ideal for use with the MM 5309 clock chip as a clock, timer or stopwatch.  
Complete parts kit . . . . . \$10.95 ppd.  
Wired . . . . . \$15.95 ppd.

*Except for the assembled memory board, all items are shipped within 24 hours.*

# NEXUS

## TRADING CO.

Solid State Music's 4K x 8 MEMORY BOARD KIT. Directly Mark 8 compatible — Altair interface data provided. Complete kit comes with dual-sided, plated-through board, sockets, all necessary capacitors and resistors, and 32 prime 2102 memory chips, tested to either 1 msec or 500 nsec.

Parts kit — 1 msec chips . . . . . \$100 ppd.  
Assembled board — 1 msec . . . . . \$130 ppd.  
(1 week delivery time)  
Parts kit — 500 nsec chips . . . . . \$132 ppd.  
(kit form only)

Solid State Music's UNIVERSAL I/O BOARD KIT. Altair 8800 compatible — 1 8-bit input port, 1 8-bit output port — both TTL compatible. Breadboarding space for 2 regulators, 34-16 pin dips, 6-14 pin dips and 2-28 pin dips. Kit includes parts for both I/O ports, 1 +5V regulator, dual-sided plated-through board and instructions. Only \$49.95

MM 5320 TV CAMERA SYNC GENERATOR — this LSI chip supplies the basic sync functions for either color or monochrome 525 line/60 Hz camera and video applications. The price is \$4.95 ppd and includes the data sheet.

MM 5309 CLOCK CHIP — features reset, 4 or 6 digit operation, MULTIPLEXED seven segment and BCD output, leading zero blanking, 12 or 24 hour, operates over 11-19V range. Only \$5.95 ppd., includes data sheet.

**PARTS:**

1 msec 2102s . . . . .	8/\$21.95
500 nsec 2102s . . . . .	8/\$29.95
1702A $\mu$ V erasable PROM (data) . . . . .	\$24.95
5314 6 digit clock . . . . .	\$ 3.95
MC 4024 Dual 25 MHz voltage controlled multivibrator . . . . .	\$ 4.95
MC 4044 Phase/Freq. Detector . . . . .	\$ 4.95

*All are ppd.*

Kits include all electronic parts, instruction sheet and etched and drilled PC board. Calif. residents add 6% sales tax.

**FLYER AVAILABLE —  
WRITE FOR IT**

TO ORDER OR REQUEST INFO WRITE:

# NEXUS

• Box 3357 San Leandro, Ca 94578



# Looking Back - Looking Ahead

**I**n October of 1960, a man's dream became a reality. The man was Wayne Green W2NSD and his dream was to publish an amateur radio magazine that would truly serve the needs and interests of all amateurs. Wayne must have done something right, because today, some fifteen years later, 73 is still around and still growing. There have been many changes since Volume 1 — Issue 1 and what you are reading today is the culmination of many years of hard work, yet ever changing to keep up with your needs.

I was 18 years old and living back in Brooklyn where it all started at the time. 1379 East 15 Street, Brooklyn, New York, was the original "office" for 73, if it could be called an office. Actually, it was a rented apartment on the second story of a two story house in what is known as the Flatbush area of Brooklyn and served the multiple purpose of editorial office, drafting room, and layout area as well as a home for the editor himself. The staff: basically 99% Wayne and Virginia.

I learned about 73 just before Issue 1 went on the newsstands through two friends

that would both figure in the early success of the magazine. One afternoon in mid-September of '60 I was "bumming" around with Larry Levy WA2INM and we happened to run into John Peterson WA2FMF. At that time John lived on East 8 Street and after a couple Cokes at John's house it was suggested that we walk over to pay Wayne a visit and see how his project of a new amateur radio magazine was getting on. It was on that day that I too became hooked on writing about our wonderful hobby due to the mystique of that man himself, Wayne Green. Looking back over the years, I can see that I was not the only member of our "trio" that got hooked into the amateur publication field. Within months of the first issue, Larry had become a regular contributor to 73 and most of his articles were far ahead of their time. In fact, Larry discovered the transistor and the many uses it could be put to about 10 years ahead of the ARRL, and whenever something new came out of the INM basement workshop on East 18 Street, it was shared with the world in short order through 73. John became a

staff assistant in '61 and remained with 73 till he entered the Air Force. Of our trio, Larry is the only one left back in New York. A few years ago, John and I became native Californians. Actually, it was talking with Larry this morning via Ma Bell that brought on this article.

On page 25 of Issue 1 is where the guidelines for the future of 73 were set. In looking back over the past 15 years, I think the magazine has tried to live up to what was said there.

*Policy #1: We are not mad at anybody.* We weren't, but unfortunately others were mad, or perhaps jealous of 73. Till that time there had been little competition within the field of amateur radio magazine publishing. In fact it had been for many a year a two magazine market with one echoing the ideas of the other. All of a sudden new competition with new forward looking ideas. Not only was 73 breaking down all the old "dogma" that had been fed to hams for many a year, but giving the others a run for the money in doing it. Of course the competition would get mad and try to retaliate; in business you are a fool if you don't. But the fact that 73 is still here today must say something. That fact that 73 continues to grow must even say more.

*Policy #2: Amateur Radio, in its dual role as a means of arousing the interest of youngsters and providing the basic training for entry into the field of electronics, one of the largest and most promising fields we can see ahead, and as one of the most important means of communications between the peoples of the world on a people to people basis instead of through the press or government channels, is probably the most important hobby in the world today. We can keep it important by being aware of what is going on in our hobby and being technically up to date. 73 Magazine is dedicated to focus the frontiers of amateur radio. I will strive to broaden the technical interest of the amateurs and encourage them to higher technical attainments and abilities by means of technical and construction articles written by the best talent available. Through the years and down to the present the foregoing has held true. No one can deny that 73 has*

always been a bit ahead of the others in bringing to amateurs the most innovative technological advances, and doing so on a level that the average ham could comprehend. You don't have to be an engineer or physicist to read and understand what comes in 73. It's written for the average amateur, not the intellectual minority.

Broaden interest and encourage higher levels of technical interest? That began with Issue 1. A glance at the table of contents revealed everything from a tubeless electronic key to a tech article on how to FM your transmitter with a newly discovered device known as a Varicap Diode. This was well before the days of packaged import radios and mountaintop repeaters! Today's biggest trend being written about way back then, wow! Down through the years 73 has tried to keep a little ahead of the rest and has made a couple of boo-boos. But, 73's staff has never been too big or complacent to admit they made a mistake and publish corrected information. Maybe that's part of the reason 73 is still around; it grew but never forgot what it set out to do. The staff may make mistakes in the future; no one is





73

amateur radio



Ham PR  
IC Guide  
Op Amps  
Computers  
Synthesizer  
FAX System  
TTY Keyboard  
Regulated Supplies

perfect but at least 73 is willing to face the challenge of the future with a keen eye and open mind. The precept as set down in policy #2 holds as true today as it did in 1960 and perhaps even more so. To that ideal this magazine is and always has been dedicated.

*Policy #3: Few talented writers have continued to buck the present system whereby they receive either nothing for their efforts or else have to wait from one to three years for minimal pay. 73 has established the policy of paying for all accepted articles with immediate cash. This seems to be bringing new life to the field for we are receiving top notch articles from some of the best authors in the hobby. In the years that I have been associated with 73 the above has held true without exception. It's simply the principle of getting what you pay for. If you are going to stimulate an author to write, then pay on the line if you want it. But it was more than that. Out of the ranks of contributors came some of today's best known and respected writers because 73 was not scared to print the work of a then unknown. It was equal treatment to all*

regardless of writing background that was paramount. Articles were judged on their technological merit and the kind of interest they would provide the reader. Some authors have gone on to careers in the field while to others it was a one-shot deal and they were never heard from again. In all cases it has been up to the author to decide if he wanted to continue on his writing, but the pages of 73 have always been open to all. It has been you, "Joe Amateur," that has guided the destiny of 73 all these years; the staff has only given what you asked of it. I personally have never had to request payment for an article published in 73; the check has always arrived well before the publication date. To 73, a promise made in print is a promise.

*Policy #4: It is our intention, the SEC permitting, to open the ownership of Amateur Radio Publishing Inc., to interested amateurs so that the ownership of the magazine can be widespread and the magazine will be truly owned and run by licensed hams. This is one part of the dream that has yet to come to fruition, but who are we to know what the future might hold? Someday, this part of the dream that is 73 might well come to pass. Who are we to say?*

*Policy #5: We intend to encourage and promote the publication of bulletins to bring specialized operating news of the many facets of amateur radio: VHF, RTTY, DX, Traffic Handling, TV, etc. No one can deny that over the years we have lived up to this one. There have been countless specialized publications as an outgrowth of 73 over the years: books on ATV, VHF, repeaters, coax cable; the list is almost endless and continues to grow. Well before repeaters were the big "in thing," 73 was publishing its Repeater Bulletin as an aid to the owners and users in the Northeast. Believe me, as one of the contributors to Repeater Bulletin, it was strictly a labor of love that served the purpose of its time and finally outlived its utility. But it was there when the need was there and because the need was there. Financially it was an economic disaster. There were but two organizations that could have handled such a project, the League or*

# THE CURVE TRACER THAT WON'T COLLECT DUST.



The Hickok Model 440 semiconductor curve tracer is all purpose and convenient to use. It's the ideal instrument for testing, evaluating, classifying and matching all types of transistors, FET's and diodes. You'll get stable, full range dynamic displays that you can accurately scale right from the screen.

- Pull-out card for easy, fast set-up and operation.
- Set-up marks for rapid set-up of 80% of tests.
- Unique INSTA-BETA display takes the guesswork out of transistor and FET parameter measurement.
- In-or-out of circuit testing.
- A full range professional tracer at a price you can afford.

The Model 440 is the most modern, versatile tracer available. See it at your Hickok distributor or send for our technical bulletin.

**\$165<sup>00</sup>**

## HICKOK

**the value innovator**

INSTRUMENTATION & CONTROLS DIVISION  
THE HICKOK ELECTRICAL INSTRUMENT CO.  
10514 Dupont Avenue • Cleveland, Ohio 44108  
(216) 541-8060 • TWX: 810-421-8286

73. Since the League showed no interest in that direction, 73 took on the task since someone had to do it. When its job was done it went away, but the job had been done and that's what really counts.

Well, there you have it. A brief synopsis of the past 15 years and a review of the accomplishments that have gone before us. If I seem a bit proud to be associated with this magazine, you are absolutely right. We have proven the self-professed experts wrong, survived and prospered, thanks to you. We never forget that a magazine is only as good as its readership and being associated with amateur radio operators like you is one of the most stimulating experiences one can imagine. The new ideas, new concepts and new frontiers are but limited by your own imagination, and when that imagination takes root, blossoms into a reality, the first notice of it usually is to be found in the pages of 73. Maybe we have not been able to keep each and every promise verbatim, but we are still trying. We are not afraid to try!

... WA6ITF

## NEW! GLOW•IN•THE DARK "TT" PADS

GUARANTEED RF PROOF  
WILL MODULATE ANY TRANSMITTER

LED TONE & BATTERY INDICATOR...

ADJ. LEVEL CONTROL 6-16VDC @ 15 mA max.  
XTAL CONTROLLED DIGITAL CMOS

TEK SERIES  
(All .40" THICK)

TEK-125  
1.58" x 2.08"  
**\$57.50**

TEK-165  
2.08" x 2.08"  
**\$65.00**

CLUB DISCOUNT  
ON 10 OR MORE

SHIPPED  
FROM STOCK

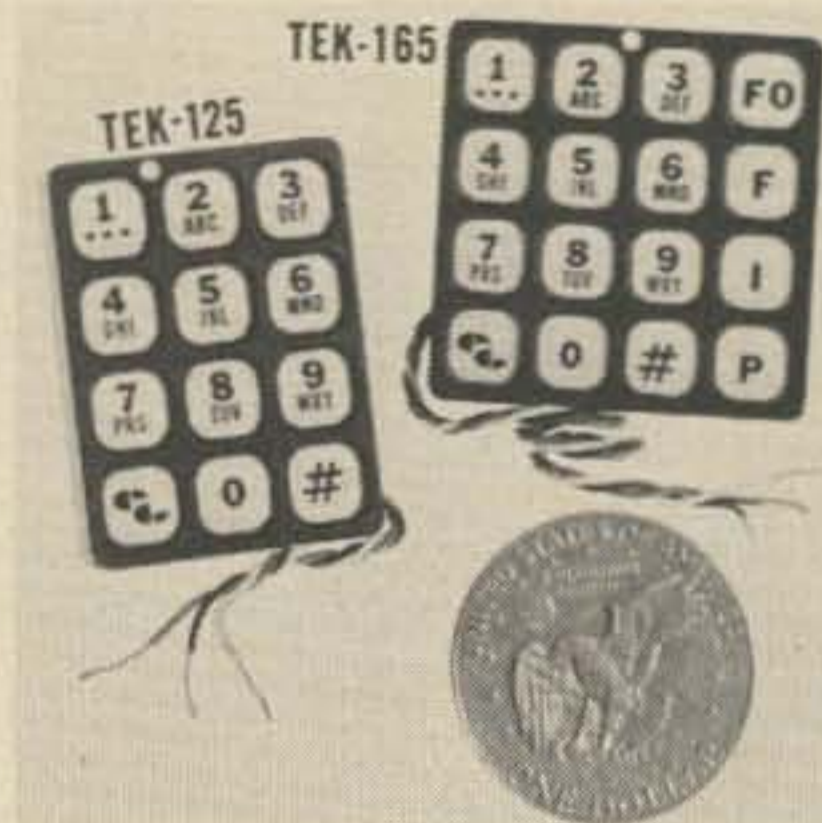

SINGLE UNIT ABS CASE — FALSE TONE PROOF  
SCHEMATICS FOR 3 WIRE HOOKUP ON REQUEST  
SPECIFY POS OR NEG GROUND

(Quantity & OEM prices on application)

(714) 627-4287 - (714) 627-1753

MONEY BACK GUARANTEE

SEND CHECK or M.O. (CA RESIDENTS ADD 6% TAX)  
WITH MAKE & MODEL OF TRANSMITTER TO:

**ELECTROGRAFIX** P.O. BOX 869  
CHINO, CA 91710

## Startling Learning Breakthrough



NOVICE THEORY TAPES  
Set of 4 Tapes only \$13.95

You'll be astounded at how really simple the theory is when you hear it explained on these tapes. Three tapes of theory and one of questions and answers from the latest Novice exams give you the edge you need to breeze through your exam.

73 is interested in helping get more amateurs, so we're giving you the complete set of four tapes for the incredibly low price of ONLY \$13.95.

Scientists have proven that you learn faster by listening then by reading because you can play a cassette tape over and over in your spare time — even while you're driving! You get more and more info each time you hear it.

You can't progress without solid fundamentals. These four hour-long tapes give you all the basics you'll need to pass the Novice exam easily. You'll have an understanding of the basics which will be invaluable to you for the rest of your life! Can you afford to take your Novice exam without first listening to your tapes?

SPREAD  
the  
WORD!

RADIO AMATEUR'S  
TALK TO THE WORLD!!  
...ask me about it!

ONLY .50¢

Ham radio is too great a hobby for us to keep it to ourselves. Let's tell the whole world about it! And what better way than by sporting this attractive lime-green bumper sticker on your car! It's only 50¢ — and it's phosphorescent so you can see it even at night. Go ahead... SPREAD THE WORD! Order yours TODAY!

### SOLID STATE PROJECTS

\$4

More than 60 projects of interest to anyone in electronics. The devices range from a simple transistor tester to a ham TV receiver. This collection will help you become more intimately acquainted with zeners, ICs and varactors, etc.

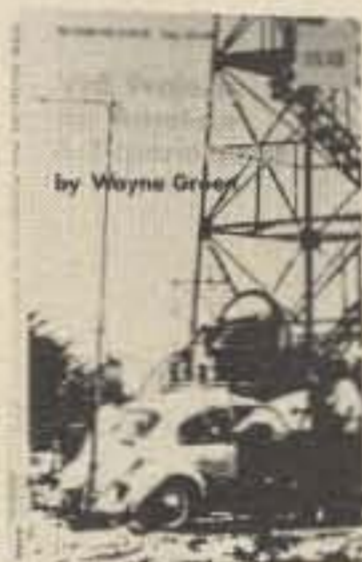

### VHF PROJECTS FOR AMATEUR AND EXPERIMENTER

\$4

A must for the VHF op. Opening chapters on operating practices and getting started in VHF, both AM and FM, followed by 58 chapters on building useful test equipment, modifying existing and surplus gear.

### 2M FM HANDBOOK

hardbound \$7  
softbound \$5

Contains almost every conceivable circuit that might be needed for use with a repeater. All circuits explained in detail. All aspects covered, from the operator to the antenna.



4 STUDY GUIDES  
NOVICE — \$4    GENERAL — \$6  
ADVANCED — \$4    EXTRA — \$5

FCC exams got you scared? Frustrated by theory fundamentals? There's no need to worry. 73's four License Study Guides will help you breeze through any of the four tough exams! They are the ONLY guides which cover ALL the material you will have to know. Many amateurs find that one quick reading through our guides is enough to get them through with no sweat.

## LATEST RELEASES from 73 publications

### RF and DIGITAL TEST EQUIPMENT YOU CAN BUILD

RF burst, function, square wave generators, variable length pulse generators — 100 kHz marker, i-f and rf sweep generators, audio osc, af/rf signal injector, 146 MHz synthesizer, digital readouts for counters, several counters, prescaler, micro-wavemeter, etc. 252 pages. \$5.95



### PRACTICAL TEST INSTRUMENTS YOU CAN BUILD

37 simple test instruments you can make — covers VOMs, VTVMs, semiconductor testing units, dip meters, watt meters, and just about anything else you might need around the test lab and ham shack. \$4.95



### DIGITAL CONTROL OF REPEATERS

softbound \$5 hardbound \$7  
Here's a book for the FMer who wants to design and build a digital repeater control system. Contains sections on repeaters, basic logic functions, logic circuit design, control systems, support circuits, mobile installations, touch-tone, plus a special section on a "mini" repeater control system.

- Novice Theory Tapes \$13.95
- Bumper Stickers .50 ea.
- Solid State Projects \$4.00
- VHF Projects \$4.00
- 2M FM Handbook
  - Hardbound \$7.00
  - Softbound \$5.00
- Rf and Digital Test Equip. \$5.95
- Practical Test Instruments \$4.95
- Novice Class Study \$4.00
- General Class Study \$6.00
- Advanced Class \$4.00
- Extra Class Study \$5.00
- Digital Control of Repeaters
  - Hardbound \$7.00
  - Softbound \$5.00

Name \_\_\_\_\_

Address \_\_\_\_\_

City \_\_\_\_\_ State \_\_\_\_\_ Zip \_\_\_\_\_

Cash  Check  BankAmericard  Master Charge

Card No. \_\_\_\_\_ Expiration date \_\_\_\_\_

Signature \_\_\_\_\_

Total enclosed \$ \_\_\_\_\_

Order from: 73 MAGAZINE, Peterborough NH 03458

# BAD NEWS

## for the Hamburglar!

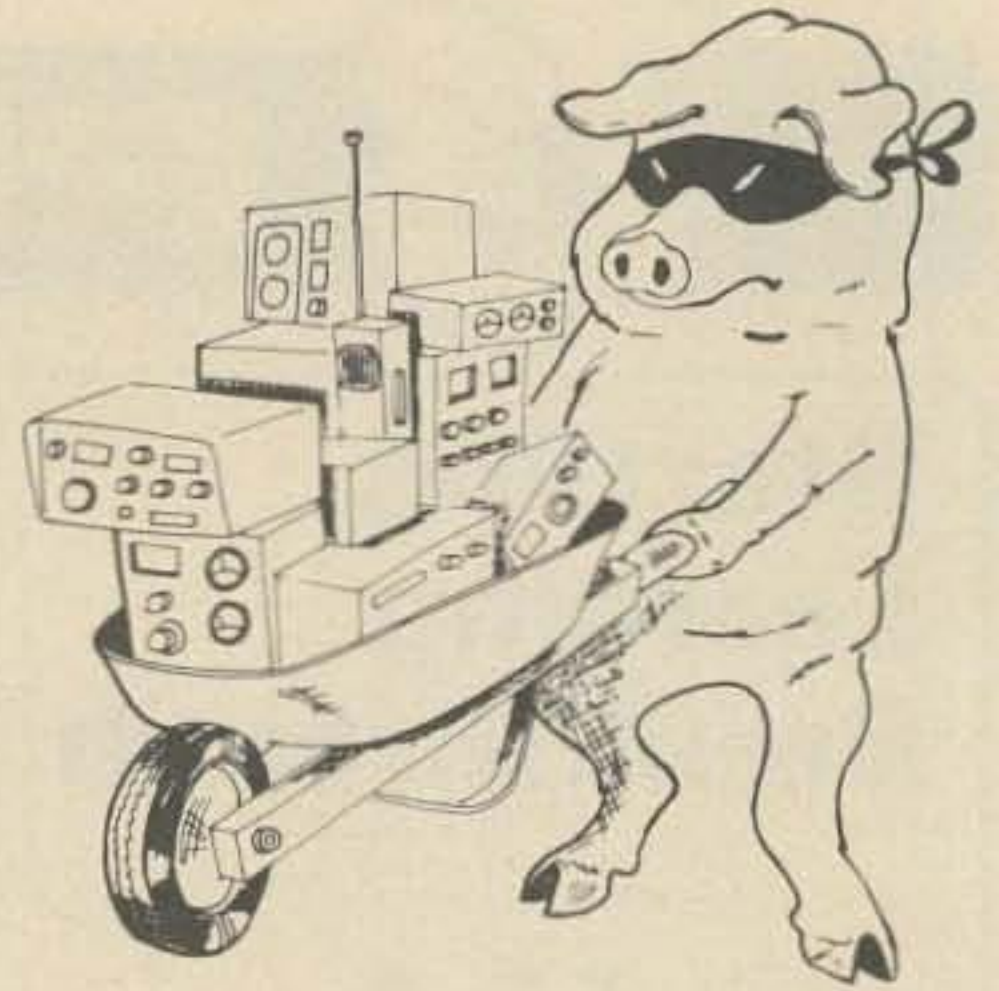

Keep your eyes peeled for these hot ones — and thank W7UD for compiling the list!

RIPPED OFF: HR-2 s/n 04-02655 on August 28 in E-Systems parking lot in Huntington, Indiana. Contact: Joe Shaw WB9GEO, Lot 90 Wall's Trailer Court, Huntington IN 46750.

MAKE	MODEL	SER. NO.	CONTACT:	MAKE	MODEL	SER. NO.	CONTACT:
Black Cat Amp.		5301	KEQ 4502	Collins	312B 5	59502	MARS
Browning	SST mobile	T 50162	Danny Dehart 638 1/2 Nold Ave. Wooster, OH 44691	Collins	516F2	18607	MARS
Clegg	FM 27B	72013-1068	W3BXL	Collins	KWM 2	10095	MARS
Clegg	22er	1900-578	W1DHP	Collins	KWM-2	10731	MARS
Clegg	FM 27B	27013-1141	W2LNI	Collins	KWM-2	11218	MARS
Clegg	FM 27B	27043-1541	K3HPI	Collins	KWM-2	16066	MARS
Clegg	FM 27B	27103-2891	WA1ECF	Collins	KWM-2 A	13551	W9JS
Clegg	FM 27B	27104-3498	W9VHD	Collins	75S3C	11359	MARS
Cobra	29	40708011	Don Mittela 317 Mullica Glassboro NJ 08028	Collins	75S3C	30268	W7UD
Collins	75S3C	10434 & W5QQQ	W5QQQ	Collins	75S3C	13187	W7UD
Collins	312 B4 control	54870	W5QQQ	Collins	32S3	102096	W7UD
Collins	3253	10840	W5QQQ	Collins	30L1	29625	W9VHD
Collins	KWM 2	10185	WA5DGR	Drake	L 4B	2342	W7UD
Collins	MM 2	4812	WA5DGR	Drake	L 4PS	3353	W7UD
Collins	KWM 2	13636	W6JZ (ex W3JW)	Drake	ML 2	10582	W3MSN
Collins	MP 1	10902	W6JZ	Drake	ML 2	20212	K6YUV
Collins	30L1	10620	MARS	Drake	SW-4A	1786	W7UD
Collins	30L1	11012	MARS	Drake	T4XB	17801 G	WA8GVK
Collins	312B-5	10016	MARS	Drake	T4XB	18504 B	WA8FJK
Collins	312B 5	10394	MARS	Drake	TR-3	12746-A	W9VHD
				Drake	TR-4	31764	WB6RDW
				Drake	TR-22	620272	K3NCL
				Drake	W-4	8390	WA8GVK
				Drake	TR-22	340137	WB8DLP

NEW! Fall Edition

## brand new edition of the **REPEATER ATLAS**

- More than twice the listings of any other repeater list.
- New Double Listing — by location and also by frequency.
- New Handier Grouping — by call areas — makes repeaters easier to find.
- New Simplified Listings for fast reading — easier to read in the car.
- New listing of all Pirate Repeaters.
- Know what repeater you can use and where.
- Almost 3,000 repeaters listed — for the entire world — not just ARRL affiliated repeaters.

Name \_\_\_\_\_

Address \_\_\_\_\_

City \_\_\_\_\_ State \_\_\_\_\_ Zip \_\_\_\_\_

Cash  Check  BankAmericard



Master Charge



Card Number \_\_\_\_\_ Expiration Date \_\_\_\_\_

Signature \_\_\_\_\_

Order now from:

**RADIO BOOKSHOP, Peterborough NH 03458**

**ONLY \$1.95**

MAKE	MODEL	SER. NO.	CONTACT:	MAKE	MODEL	SER. NO.	CONTACT
Drake	TR-22	720583	WA2BRF	SBE	SB-34	720087	WA3IID
Dynascan Cobra	DTK-123	255-789	KBY-2810 4519 So. Fawcett St. Tacoma WA 98408	SBE	SB-144	46316	K4KVF-5
Dynascan Cobra	DTK-123	720-323	KFX-3140 4902 Harbor View Dr. N.E. Tacoma WA 98408	SBE	SB-144	460118	K3MPZ
Electra Bear Cat Scanner 6x		16526	KEQ-4502	SBE	SB-144	720242	K3MPZ
GE	Master Pro	3040380	Cuyahoga Falls OH Police Dept.	SBE	SB-144	460118	(CB) D0 3807
Genave	GTX-2	2958	K9HCK	SBE	21CB CORTZZ	44617220	K3MPZ
Genave	GTX-200	1713	QST 10/74	SBE	8CB	212020	KEQ 4502
Gladding	25	96960159	WB4HKP	SBE	6CB	051011	David W. Luby 227 Ridge Ave. Hilltop Blackwood NJ 08012
Gonset	G66B	1170	WB4QEB	Sonar			K1UXD
Heath	IB-1100	04404	Dan Smith SK2-6468 Tacoma WA	Standard	826	011268	WA2FSD
Heath	SB-610	R-67061	W7UD	Standard	826M	110082	K2LSX
Heath	HW-202	2342	K7BUT	Standard	146 A	208070	W7DKB
Heath	HW-100	R24-3166	Theodor Stathis 491 Fulton Ave. Hempstead NY 11990	Standard	146 A	310377	WB2HYW
Heath	HP-23	R24-3166	Same as above	Standard	826M	11200	WA8PCG
HyGain	482	3119	KEQ 4502	Standard	826M	203085	WA9VNW
Icom	IC230	2401724	K8TIA	Standard	826M	205182	WA3IFX
Icom	IC230	2401853	WABPGD	Standard	826MA	208078	WB2DEW
Icom	IC230	2402350	WBOYL	Swan	350	C136803	Anton C. Theodos PO Box 610 Williston ND 58801
Icom	IC22	1312385	K8SOM	Swan	350	C-596050	W7UU
INOUE	IC-20	1161	W1PVF	Swan	500C	1-422033	W6QKX
J.C. Penney's	Pinto	54200088	KBY-2810	Swan	250	289219	Archie Ashcraft DeMossville KY 41033
J.C. Penney's	Pinto 6211	981-6211	Mr. Dewey Leap 604 Church St. Cheraw SC	Swan	ACP/S	0653556	WABGVK
J.C. Penney's	6211 Mobile	40507878	Gilbert White 8913 So. 26th Ave. Tacoma WA 98409	Swan	250	F-154806	WABGVK
Johnson Messenger	123A	023F103-5164	KHZ-2915 R. L. Parker PO Box 2522 St. Leo College St. Leo FL 33574	Swan	270	M-252616	W4NTB
Johnson Messenger	123A	123A045-33881	Marshall Norman 923 E. Hayward Independence MO 64050	Swan	500	1-469237	W8ARW
Johnson Messenger	323	50688	KFX-3140	Swan	700CX	1630855	K8ONV
Kenwood	TS-520	840092	W7JFR	Swan	1011	H-437934	D. Smith SK2 6468 Tacoma WA
Kris	300M	131959	Danny Dehart 638 1/2 Nold Ave. Wooster OH 44691	Swan	1200W	Z-143105	Same as above
Lafayette	PB/AM	99-3522L	Same as above	Swan	FM-2X	11087	WA1CRY
Lafayette	VHF Rec.	99-3533L	Same as above	Tempo	FMH	0163	WB4RTP
Lafayette	HB 600	15518	KRM-2906	TRIO	TR2200	241969	WA2ZBV
Marker	Luxury	2296	W7BVP/6	TRIO	TR-7100	461177	WA4JSE
Midland	13-505	030303	WA4BRO	Ultracom	25	090561	VE7AZG
Motorola	HT 220	GJ713Y	Kent Police, Kent OH	Varitronics	HT-2	640256	K3ZPH
Motorola	MH 70	L70J5J	Kent Police, Kent OH	Yaesu	FT101	82G-12279CW	W4GF
Motorola	HT 220	GJ-7327	State Univ. of New York Albany NY	Yaesu	FT101B	316247	Dan Smith SK2 6468 Tacoma WA
Motorola	D33APA-1800 AK	NPZ 11B	K4LXF	Zenith	R7000y	3730765	WB7AEK
Pace	2300	56473	Don Mittela 317 Mullica Glassboro NJ 08028				
Pace	223	36733	S. Volturmo KGW-0547 Bldg 3F Unit 85 5215 Sepulveda Blvd Culver City CA 90230				
Pace	123A	2213531	KHQ-4658 5007 W. Fondulac Ave. Milwaukee WI 53223				
Pace	208	771324	Danny Dehart 638 1/2 Nold Ave. Wooster OH 44691				
Pearce Simpson	Tomcat 23	309299	KHV-1636 K. Kendall 2713 Chestnut St. Hannibal MO 63401				
Ray Jefferson	CB 705	D03807	K3MPZ				
Realistic	TRC5	101236- 292073579	F. Sheehan Box 8352 Savannah GA 31402				
Realistic	CB 9er	E170345	D. Dehart 638 1/2 Nold Ave. Wooster OH 44691				
Regency	HR-2B	4900191	K8DQH				
Regency	HR-2B	49/02780	W9VWX				
Regency	HR-2B	4900633	K8MAE				
Regency	HR-2B	49/01389	WA8FJK				
Regency	AR-2 amp.	1150469	K8MAE				
Regency	HR-212	2400829	K8COT				
Regency	HR-2A	0407273	K8ORL				
Regency	HR-2B	4900493	W8KDW				
Regency	HR-2	03-1752 & W4CAH	W4VMQ				
Regency	HR-2	0302030	W4GF				
Regency	HR-2	04-C2879	W6GSR				
Regency	HR-2-A	04-0787	WA3TV1				
Regency	HR-2-A	04-05632	WB8NSU				
Royce	1-605-A	29528	D. J. Townsend 2328 Betsy Dr. Jacksonville FL 32210				
SBE	SB-34	21-1828	W6GSR				

### PRINTED CIRCUIT

EPOXY GLASS CIRCUIT BOARD STOCK;  
CARBIDE DRILL BITS; TAPE RESIST;  
ARTWORK; BUBBLE ETCHERS  
SEND S.A.S.E. FOR FLYER

**TRUMBULL**

833 BALRA DR., EL CERRITO, CA. 94530

Isolated - Pad - Drill - Mill

Duplicate any etched board without  
etching. Professional - compact -  
useable breadboards. Sizes: .20, .15,  
.10 in dia - \$7.95 ea. See: 73, Nov  
73, p-19. QST, May 73, p-44, Dec 73,  
p-14. Hints & Kinks, p-82.



**A F STAHLER Co**

PO BOX 354 CUPERTINO, CALIF 95014 408-252-4219

WE GOT 'EM

KENWOOD, COLLINS, DRAKE,  
SWAN, YAESU, TEMPO and many  
more in stock. Good selection of  
used equipment, antennas and  
accessories. Quick courteous ser-  
vice.

Serving amateurs since 1928

Come visit with us in "The Land in the Sky"

MASTER CHARGE - BANKAMERICARD - IMMEDIATE DELIVERY FROM STOCK

**FRECK** radio & supply  
co., inc.

38-40 Biltmore Avenue, P.O. Box 7287, Asheville NC 28807

Phone: (704) 254-9551

# Mobile Amplifiers With Versatility

- 2M10-70L \$139.95  
10 W in – 70 W out 144-148 MHz amp
- 2M30-140L \$179.95  
30 W in – 140 W out 144-148 MHz amp
- 2M10-140L \$199.95  
10 W in – 140 W out 144-148 MHz amp
- 1.3M10-60L \$159.95  
10 W in – 60 W out 220-225 MHz amp
- 1.3M30-120L \$199.95  
30 W in – 120 W out 220-225 MHz amp
- 1.3M10-120L \$219.95  
10 W in – 120 W out 220-225 MHz amp

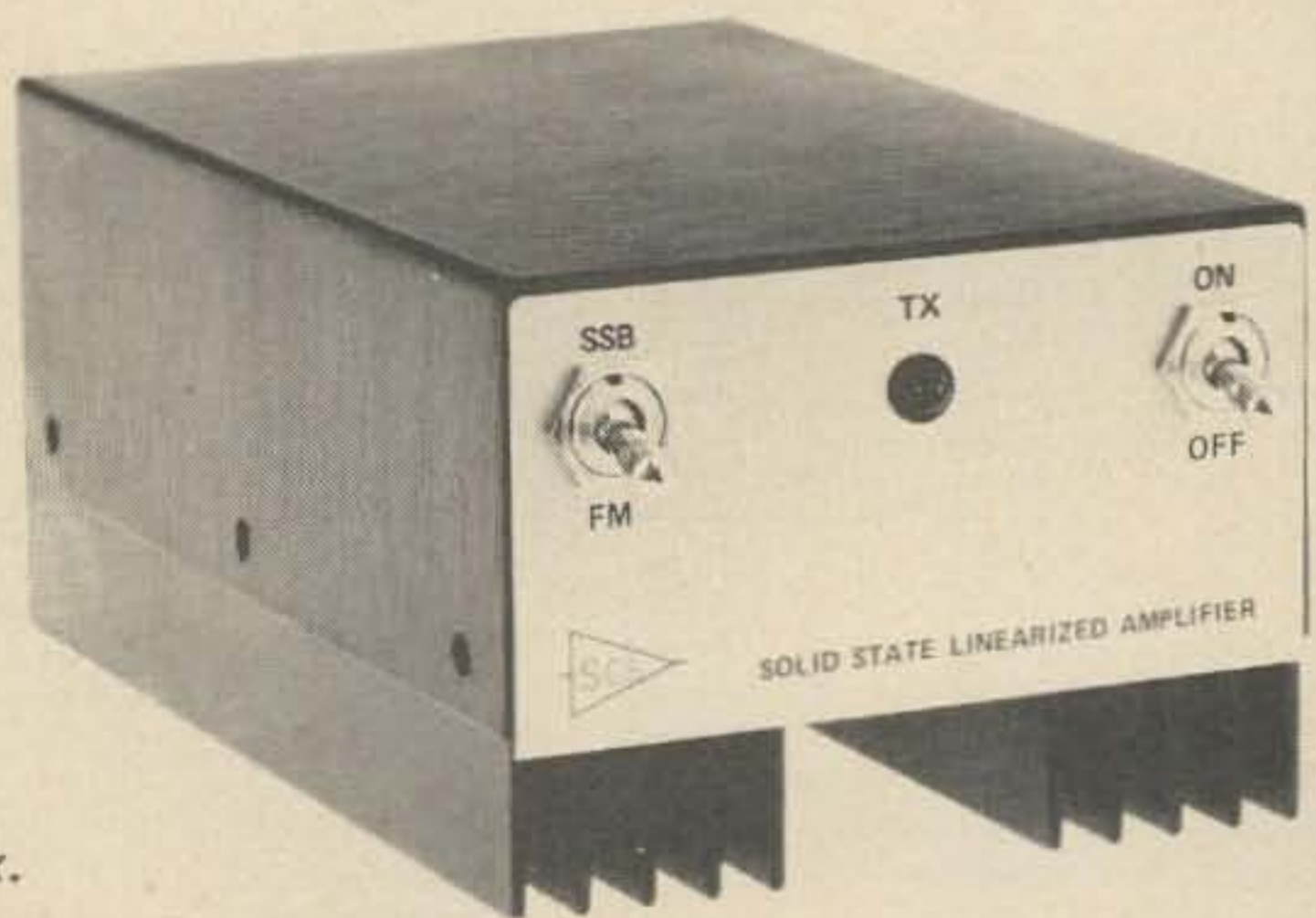

\$2.50 shipping USA, CA residents add 6% tax.

- All Amps:
- NEW – Variable T–R delay for SSB and CW
  - Fully VSWR & reverse voltage protected
  - No tuning required across band
  - Switchable Class C or AB operation
  - Built-in TR switching, w/increased delay for SSB
  - Fully compatible with all 1-15W FM/SSB/AM/CW rigs
  - All solid-state and microstrip construction

Also available: 1–10W, 10–40W and 420–450 MHz linearized amps

*See your local dealer or write for further information*

*Dealer inquiries desired*

## SPECIALTY COMMUNICATIONS SYSTEMS

4519 Narragansett Ave., San Diego CA 92107

Louis N. Anciaux WB6NMT,

Phone: 714-222-8381

## TUFTs

*"New England's Friendliest Ham Store"*

INVITES YOU TO SEE THE ABOVE LINE

**TUFTS** Radio Electronics

386 Main St., Medford MA 02155  
Phone: 617-395-8280

*Open Monday through Saturday until 9 pm*





**DRAKE**®

**DRAKE'S**  
newest  
**Dealer!**

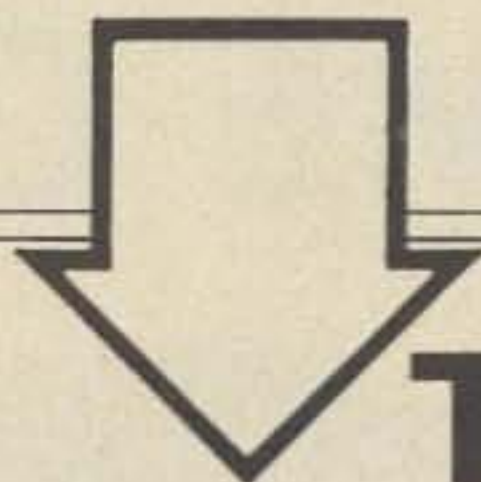

---

---

**TUFTS**

*"New England's Friendliest Ham Store"*  
INVITES YOU TO SEE THE ABOVE LINE

**TUFTS**

Radio Electronics

386 Main St., Medford MA 02155  
Phone: 617-395-8280

*Open Monday through Saturday until 9 pm*

# Caveat Emptor?

*PRICE — \$2 per 25 words for non-commercial ads; \$10 per 25 words for business ventures. No display ads or agency discount. Include your check with order. Deadline for ads is the 1st of the month two months prior to publication. For example: January 1st is the deadline for the March issue which will be mailed on the 10th of February.*

*We will be the judge of suitability of ads. Our responsibility for errors extends only to printing a correct ad in a later issue.*

*For \$1 extra we can maintain a reply box for you.*

HW-7 KIT. Overpurchase. Absolutely new in original box. Sent postpaid for first \$60. Schultz, Box L, FPO New York 09544.

FOR SALE: Icom 230 complete with all splinter crystals, with gorgeous red touch-tone phone. Manual. 73 staffer's pride and joy. \$355. UPS — prepaid — cashier's check only. Bill Edwards WB6BED/1, c/o 73 Magazine.

PC BOARD negatives made photographically from your artwork. Now obtain professional results quickly, simply. 4x5 \$3.00 or SASE for information. Hatfield WA4FRV, 10139 Apache Road, Richmond VA 23235. 804-272-8403.

LOOKING FOR JAN 1961 issue 73 Magazine. Please write, stating price, only mint condition. All letters answered. R. H. Wilson, 4011 Clearview Drive, Cedar Falls IA 50613.

FREE: 8 Extra Crystals of your choice with the purchase of a new ICOM IC-22A at \$249. With the 10 crystals that come factory-installed in the IC-22A, this gives you a total of 18 crystals! For equally good deals on Drake, Collins, Kenwood, Ten-Tec, Regency, Swan, Atlas, Midland, Alpha, CDE, Standard, Tempo, Genave, Hy-Gain, Antenna Specialists, CushCraft, Mosley, Hustler, and others, write or call Hoosier Electronics, your ham headquarters in the heart of the Midwest and become one of our many happy and satisfied customers. HOOSIER ELECTRONICS, P.O. Box 2001, Terre Haute IN 47802. NOTE OUR NEW PHONE NUMBER: (812) 238-1456.

QSL CARDS — Something completely different. Nothing even close to it on the market! Samples: 25¢ stamps or coin. W5UTT, Box 1171F, Garland TX 75040.

CALL LETTER LICENSE PLATES — still being collected by 73 Magazine for possible cover use. Please send in an old call letter plate — most treasured are out-of-district plates such as W2NSD/NH, etc. Got any real oldies? 73 Magazine, Peterborough NH 03458.

## NO MORE TIME OUTS!

The RT-1 R.F. actuated timer puts an end to timed out repeaters forever.

NO— Connections to your rig. (CARRIER TRIGGERED)

NO— Clocks to watch.

NO— Switches to throw.

The RT-1 leaves you free to concentrate on your driving and your QSO. Just preset the timer to any time from 0-3 minutes and forget it. Every time you transmit, your carrier triggers the unit which times until the preset value is reached then gives an audible tone. If your carrier is dropped before the end of the timing interval, the timer resets instantly and is ready for the next transmission.

Range: 0-3 Minutes in 5 sec. steps.

Voltage: 12-16 Volts DC.

Accuracy:  $\pm 3\%$  from +10 to +120 Degrees F.

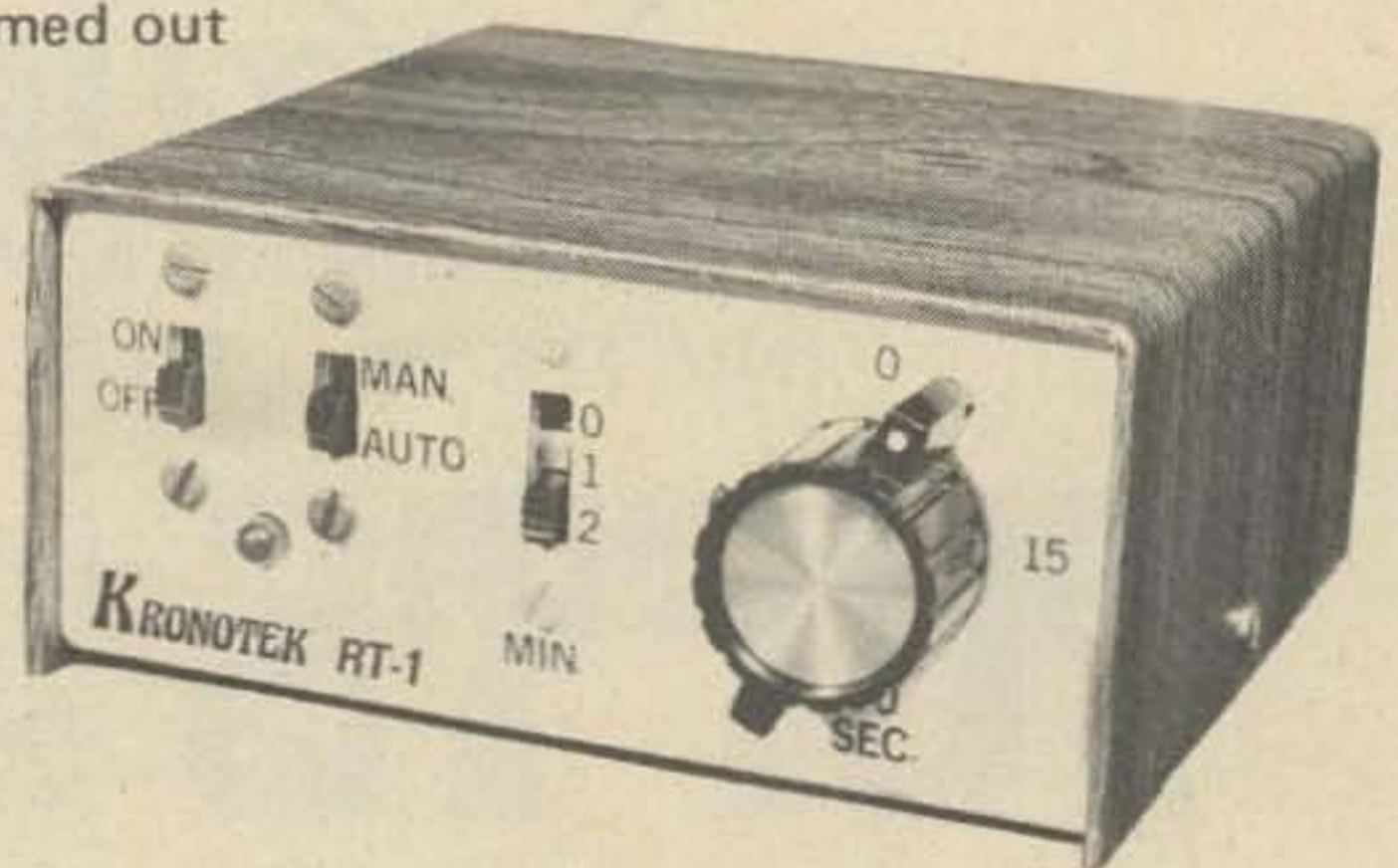

WRITE FOR LITERATURE

**\$39.95** Plus \$1.50 postage and handling (NJ residents add sales tax).

# KRONOTEK

DIV. FRANKLIN UNIVERSAL CORP.

925 CLIFTON AVE., CLIFTON, NEW JERSEY 07013 (201) 778-0003

FOR SALE: Drake TR22C 2 meter FM transceiver with mike crystals, 10 new Nicad batteries, Drake ac 10 power supply, AA10 amplifier vinyl carrying case, manuals. Above purchased new in 1975. \$224. Postpaid or acceptable offer. George Konnick, Apt P2, 1750 West Main Street, Riverhead, N.Y. 11901.

HP-65 USERS exchange ideas, programs, methods. Monthly newsletter. Request information and sample newsletter. Richard Nelson, 2541 W. Camden Pl, Santa Ana CA 92704.

SURPLUS RECEIVERS, components, test equipment. Catalog free. Ed French, P.O. Box 249, Aurora IL 60507.

HT220's, 2 meters and 450 and PT300 on 6 for sale. Like new and guaranteed so not inexpensive. (804-272-8403) Want late aircraft radio equipment.

WESTERN Electric 3A Speakerphone complete \$125.00. TT Card Dialer with cards \$100.00. Bob Crotinger, 687 French Road, Rochester NY 14618. (716) 244-6296 after 7 pm.

WANTED - DRAKE TC 2 transmitting converter, any condition. Will pay shipping. Also need INTEL 8080 IC, non working Argonaut. WB0GAZ, 457 Farrand CU, Boulder CO 80302.

MICRO-TO MK II deluxe epoxy-glass drilled circuit boards. \$4.00 postpaid; with semicons \$11.80. K3CUW, 1304C Mass. Ave. S.E., Washington DC 20003.

WANTED: Mobile telephone equipment such as Delco, GE, etc. Also heads, decoders, duplexers. Greg Hyman, WA2OTG, 19 Sicard Ave., New Rochelle, New York 10804, (914) 636-2494.

BLIND HAM, just passed General exam, would really appreciate used 160m to 10m transceivers donated. Please send to: WA0YQO, 137 N. Lawn-Apt. 10, Kansas City MO 64123.

FREE BARGAIN CATALOG. LEDs, ICs, microphones, headsets, resistors, relays, ultrasonic devices, precision trimmer capacitors, unique components. Low, low prices! Chaney's, Box 15431, Lakewood CO 80215.

PHOTO-STAMPS. Great for QSL cards. Sheet of 100 stamps. Gummed and perforated. Send any photo and \$3.95 to: Unique Photo, Box 496, Hudson MA 01749.

KWM-1 KWM-2/2A S/Line Booklet on Problems and Solutions is completed. Price \$2.50 to cover printing, material and postage. Frank Andrei W3OEL, MR 1, Saltsburg PA 15681.

VERY INTERESTING! Next 4 issues \$1. "The Ham Trader," Sycamore IL 60178. (Ask about our "HAM EQUIPMENT BUYERS GUIDE" covering receivers, transmitters, transceivers, amplifiers 1945-75. Indispensable!)

RADIO ARCHIVES, amateur ANECDOTES (then & now) solicited for proposed (SASE subscription) monthly PR newsletter. Electronic Avocations, 3207 fourth St. N., Mpls., Mn. 55412.

FM RECEIVER, preamp, scanner, UHF converter kits. Hamtronics, Inc., 182 Belmont, Rochester NY 14612.

POLICE AND FIRE Scanner Special - Regency ACT - R - 10 H/L/U 10 channel 3 bands, combined ac/dc 10 free crystals included \$169.00 pre-paid, dealer inquiries invited, Four Wheeler Communications 10-F New Scotland Avenue, Albany NY 12208.

TECH MANUALS - \$6.50 each: R-220/URR, SG-3/U, URM-25D, USM-159, TT-63A/FGC. Thousands more available. Send 50¢ (coin) for large list. W3IHD, 7218 Roanne Drive, Washington DC 20021.

COLLINS: 30S-1 2kW amplifier, excellent operating and physical condition, trade for Bendix R-1051B/E receiver same condition. Sid Sidman, Star Rt #1, Box 88, Oakhurst CA 93644.

FOREIGN LANGUAGE cassettes. 2 - 60 minute quality tapes per set. French, German, Italian, Spanish. \$6 a set, 4 sets \$20. Royal, Box 2174, Sandusky, Ohio 44870.

WANTED: Tower, heavy duty, motorized crank-up, 80 foot or more. Also want 30-S1 or Alpha Linear. W0PDI, Route 2 Box 218, Buffalo MO 65622.

### ELDOR ELECTRONIC SALES

Attention Canadians, large selection of ICs and transistors available. Guaranteed quality components, no seconds. SASE for free price list. "If we don't list it, request it, we'll get it."



*Eldor Electronic Sales, Chase,  
British Columbia, Canada*

*In time for Christmas Compcode offers  
W2EMs Beginner Radio Telegraph Course  
on six cassette tapes complete with written  
material structured to accelerate learning.*

Six hours of lessons are self-sufficient and have been enthusiastically used by amateurs, clubs and groups for over fifteen years. Operator jargon, procedure signs, etc., are fully explained. Learn code from an expert! Perfect for novices and retreads! The course to beat all others!

#601 Complete Course \$24.95 (plus \$1 handling)

### TRY SURE MASTER CODE CASSETTES!!

TAPE #	SPEEDS WPM
401	5, 10, 15, 20
201	5, 10 WPM
202	10, 15 WPM
203	15, 20 WPM
101	25 WPM
102	30 WPM

COMPUTER GENERATED  
RANDOM CODE PRACTICE MATERIAL  
EACH ONLY \$3.95 plus .25 handling  
Ohio residents add 4% sales tax.  
Each tape one hour in length  
**COMPCODE** P.O. Box 13087  
Columbus OH 43213

### HANDS OFF!

The best policy when working with printed circuit boards. This little gem

**\$7.50** POSTPAID

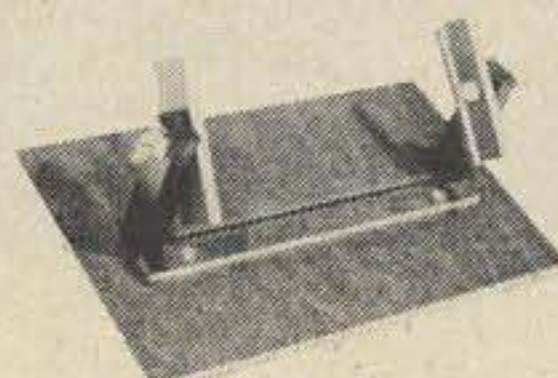

will let you solder all those connections on both sides of the board in jig time. Full 180° rotation - grips firmly, yet will not mar.

**W.N. Wellman Co.**  
Box 722 fenton mo 63026

# Which would you rather be, jack-of-all-bands or master of one?

We make our SkyClaw™ vertical antennas for the ham who doesn't want to be a jack-of-all-bands. Because no antenna can be all things to all people. You tune our SkyClaw™ to your choice of 160 (50kHz bandwidth), 80 (200kHz bandwidth), or 40 (the whole band). We don't fudge the tuning for multi-band performance. We put the materials into it that let you pump the legal limit through it. We build it to withstand more wind than you'll find in a QSO on 75.

And we deliver the whole thing for \$79.50, postpaid in the USA. Radial and phasing harness kits are available, too.

It's self-supporting. Weatherproof. You put it up yourself with just 4 tools. It stands

24'7". And you connect to an SO-239 in its base.

Now, then. Have you decided which kind of operator you want to be?

Yes, Master.



**It's faster than a speeding bullet!  
More powerful than the legal limit!  
And able to match long wires with a single bound!**

## SuperTuner



Did we mention smaller than a breadbox?

This amazing visitor from far-off Ohio has powers and abilities far beyond ordinary mortal antenna tuners. Single-handedly, it matches coax feed, random wire, balanced or unbalanced line on any band, 160 through 10, up to the full legal limit. And Dentron's new Super SuperTuner handles a full 3 KW PEP—in case you-know-who passes you-know-what. SuperTuner and Super SuperTuner. Who, in black wrinkled finish, fight a never-ending battle for truth, justice, and juicier signals. Up, up and away. Just \$119.50 ppd. in the USA.

# KLAUS RADIO Inc.

8400 N. Pioneer Parkway, Peoria IL 61614, Phone 309-691-4840  
Cliff Morris W9GAO — Jim Plack WB9BGS

# MEET THE STATE OF THE ART ON 2 METERS... THE ITC MULTI-2000 CW/SSB/FM TRANSCEIVER



Whether your interest is simplex, repeater, DX or OSCAR the new ITC MULTI-2000 lets you get into all the action on all of the

band. Fully solid-state and employing modular construction, the MULTI-2000 enjoys features found in no other 2m transceiver.

## FEATURES

- PLL synthesizer covers 144-148 MHz in 10 kHz steps
- Separate VXO and RIT for full between-channel tuning
- Simplex or  $\pm 600$  kHz offset for repeater operation
- Three selectable priority channels
- Multi-mode operation (CW/SSB/NBFM/WBFM)
- Built-in AC and DC power supplies, noise-blanker squelch and rf gain control
- Selectable 1W or 10W output
- Separate S-/power and frequency deviation meters
- Built-in test (call) tone and touch-tone provision
- Excellent sensitivity ( $.3 \mu\text{V}$  for 12 dB SINAD)
- Superior immunity to crossmodulation and intermodulation
- Introductory price: \$695.

# KLAUS RADIO Inc.

8400 N. Pioneer Parkway, Peoria IL 61614, Phone 309-691-4840  
Cliff Morris W9GAO — Jim Plack WB9BGS

# 73 GOOFEED

**EVERYONE IS ENTITLED TO ONE – RIGHT?**

**The S.D. SALES Contest is still going on.**

**We left the ad out in OCTOBER 73.**

**OUR face is RED.**

**Win An Atlas Radio Transceiver. See the**

## **S. D. SALES**

**Ad on page 229 of this issue.**

**SUPER PACKAGE DEAL  
80 WATTS AND AN ICOM IC-230 TOO!**



**Buy an IC-230 at the  
Regular Price \$489.00 and get  
this PRA 80W Amplifier for  
just \$9.95**

**IC-230** 67 channels with 30KHz separation for simplex operation from 146.01 to 147.99MHz, synthesized with INOUE'S unique Phase Locked Loop (PLL) system. One switch puts you up or down 600KHz for use with repeaters. Modular construction makes service a snap if its ever needed. Helical filters, MOSFET front end, and an Automatic Protection Circuit, for the final transistors, are only some of the outstanding features of the IC-230. It's the great synthesized two meter radio **today**—and will still be tomorrow!

The PRA 10/80 RF Amplifier is the newest addition to the PRA line. At 13.5 VDC and 10 Watts input it delivers a Big 80 WATTS OUT. REGULAR PRICE IS \$93.00



SIMILAR DEALS ON OTHER ICOM EQUIPMENT.

— IN STOCK BUT QUANTITY IS LIMITED —

**UTAH RESIDENTS ADD 5% SALES TAX**

TOLL FREE (800) 453-5718



UTAH FM SALES  
1365 East 5360 South  
Salt Lake City, Utah 84117

Name \_\_\_\_\_  
Address \_\_\_\_\_  
Zip \_\_\_\_\_  
Bank Card # \_\_\_\_\_  
Expiration Date \_\_\_\_\_

# Updating the Heathkit IB-1101

For people like myself, who want a frequency counter for a tool instead of a construction project, a good way to go is to buy a kit. In particular, I have found the Heathkit IB-1101 to be a very good counter for the price. The time base is quite stable (mine drifts from 1.2 Hz high to 0.6 Hz high during warm-up) and it will count to somewhat in excess of 100 MHz.

However, it has a problem. The only counting periods available are 1 millisecond and 1 second. This makes the use of the counter annoying in the "kHz" position because it only updates its display with a new count every 2 seconds. Also there is no way to make an accurate count on frequencies below 100 Hz. A 10 second count is needed for this.

With these facts in mind, I added circuitry and switching to make each decade from 10 seconds to 1 millisecond available from the time base. I also provided for external gating and reset. This freed the counter for a wide variety of counting and timing uses.

At this point, I might mention that I have never used the external inputs. If you are not interested in the external gating and reset functions, and you do not need accuracy at the low audio frequencies, you

can get away with no added integrated circuits, only switching.

## Circuit Description

To accomplish the desired functions, switching must be provided for the decimal point, the range indicator, the gate, and the reset. As in the original circuit, no switching is required for the input to the memory latch. Of these functions, the generation of

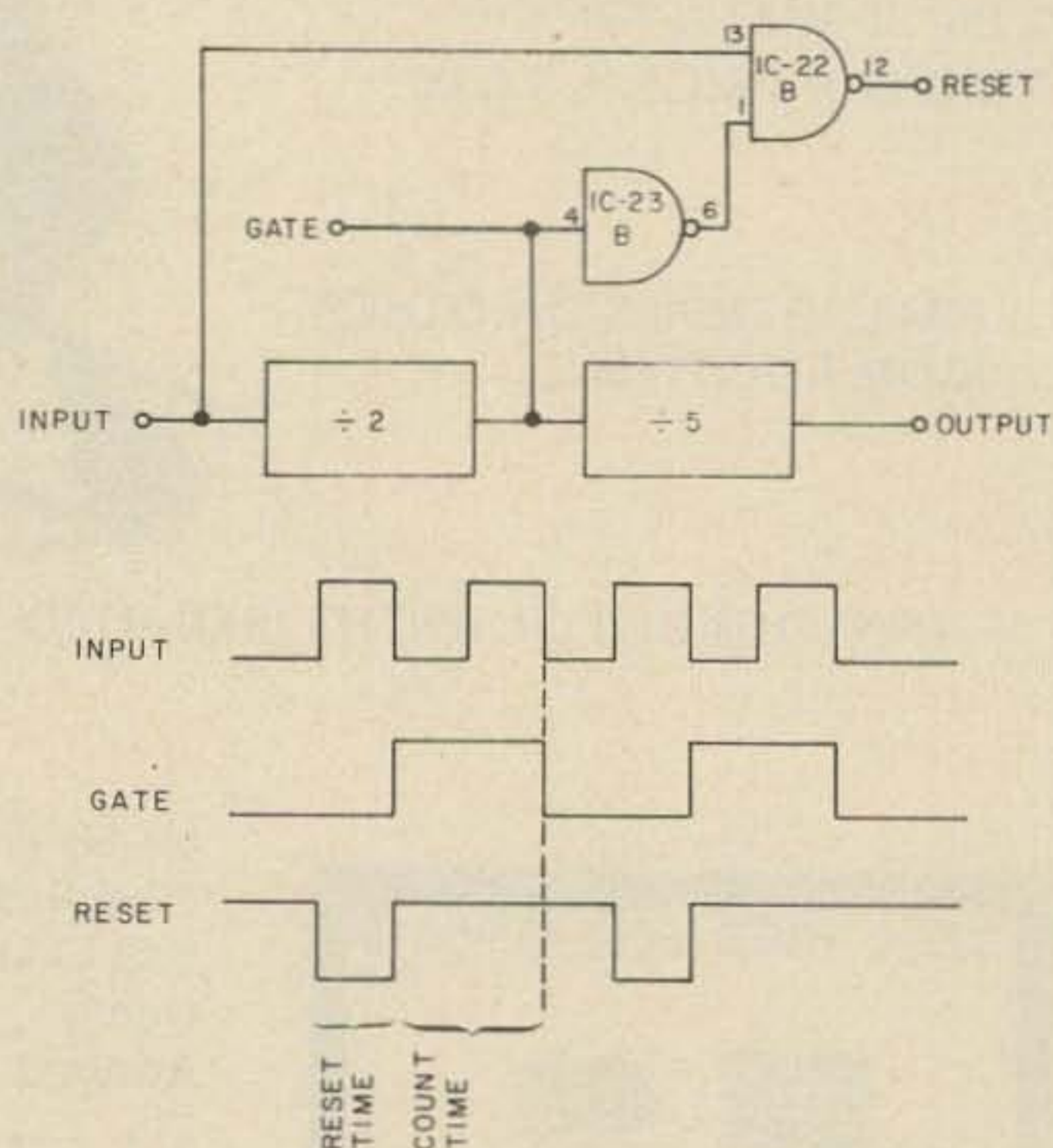

Fig. 1. Gate and reset generator, before modification.



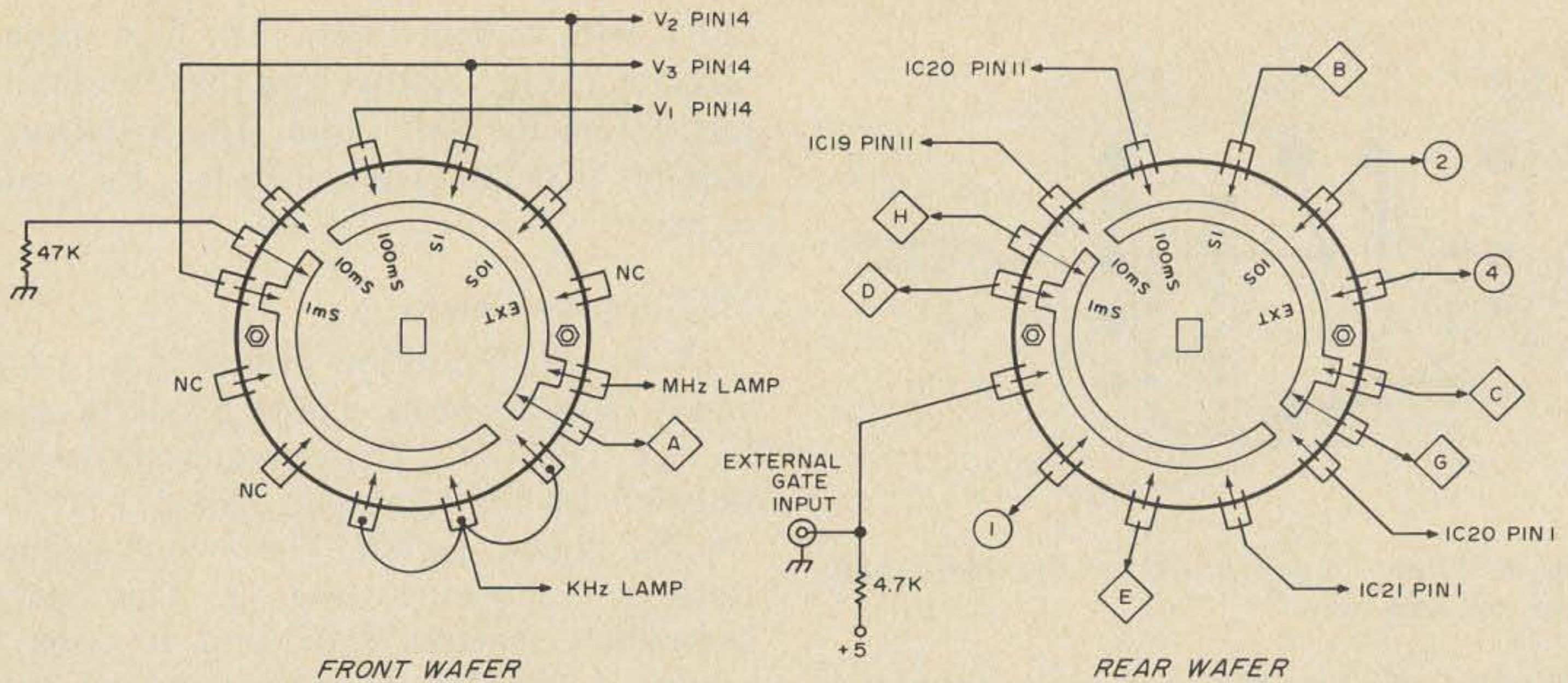
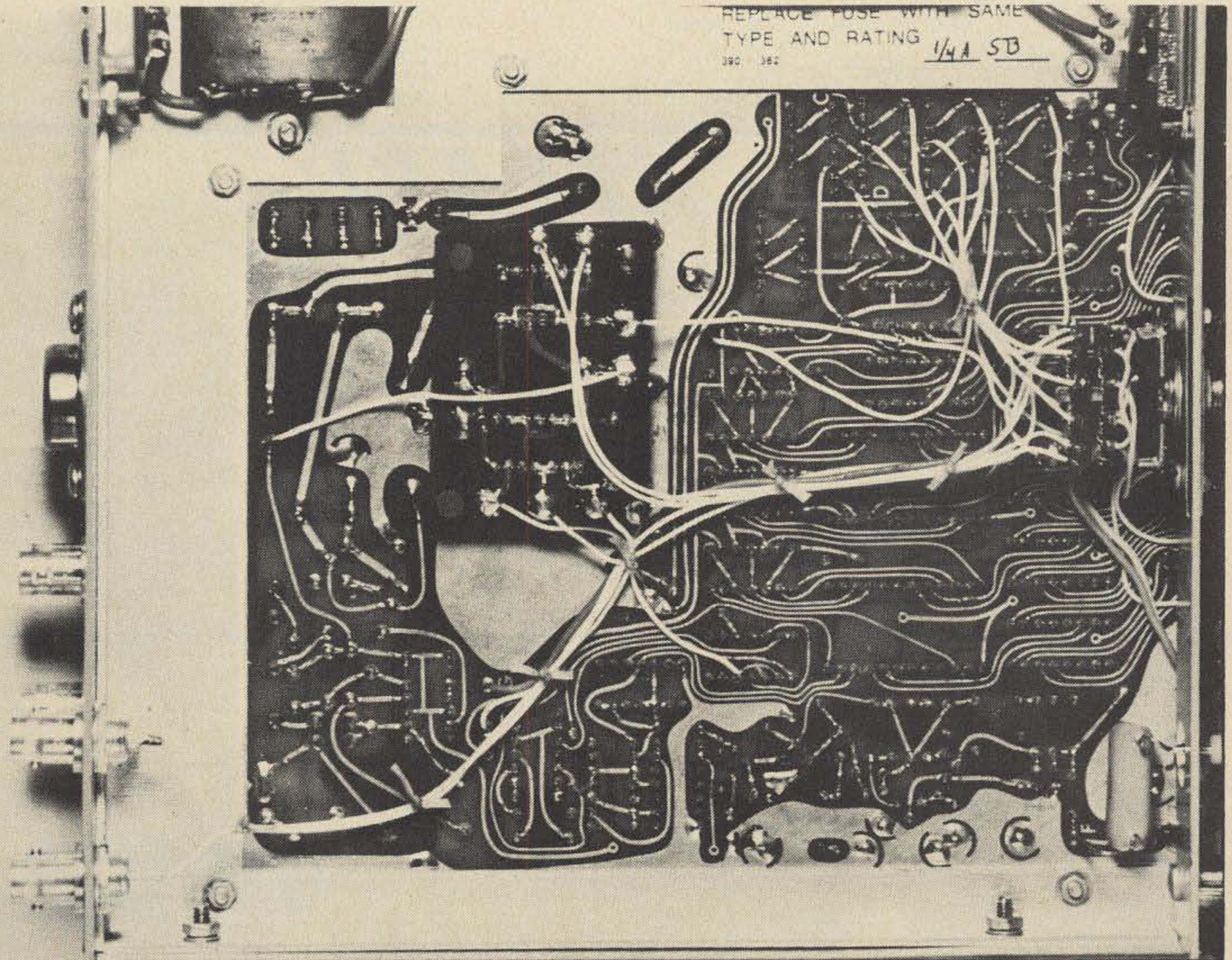

Fig. 2. 4-pole, 6-position rotary switch connections. Numbers in circles refer to Fig. 3. Letters in diamonds are Heathkit designations printed on PC board. Switch wafers are shown from the rear in the MHz (1 ms) position.

the gate and reset signals might be of interest to home brewers who do not own an IB-1101, so I will explain it here.

Following the time base oscillator is a string of 7490 decade counters. Each 7490

consists of a divide by 2 and a divide by 5 circuit. For this application, the binary stage is used as the input. As shown in Fig. 1, the gate signal is simply the output of the binary stage. This line connects to the J and K



Underside view of the counter, showing the added printed circuit board and rotary switch.

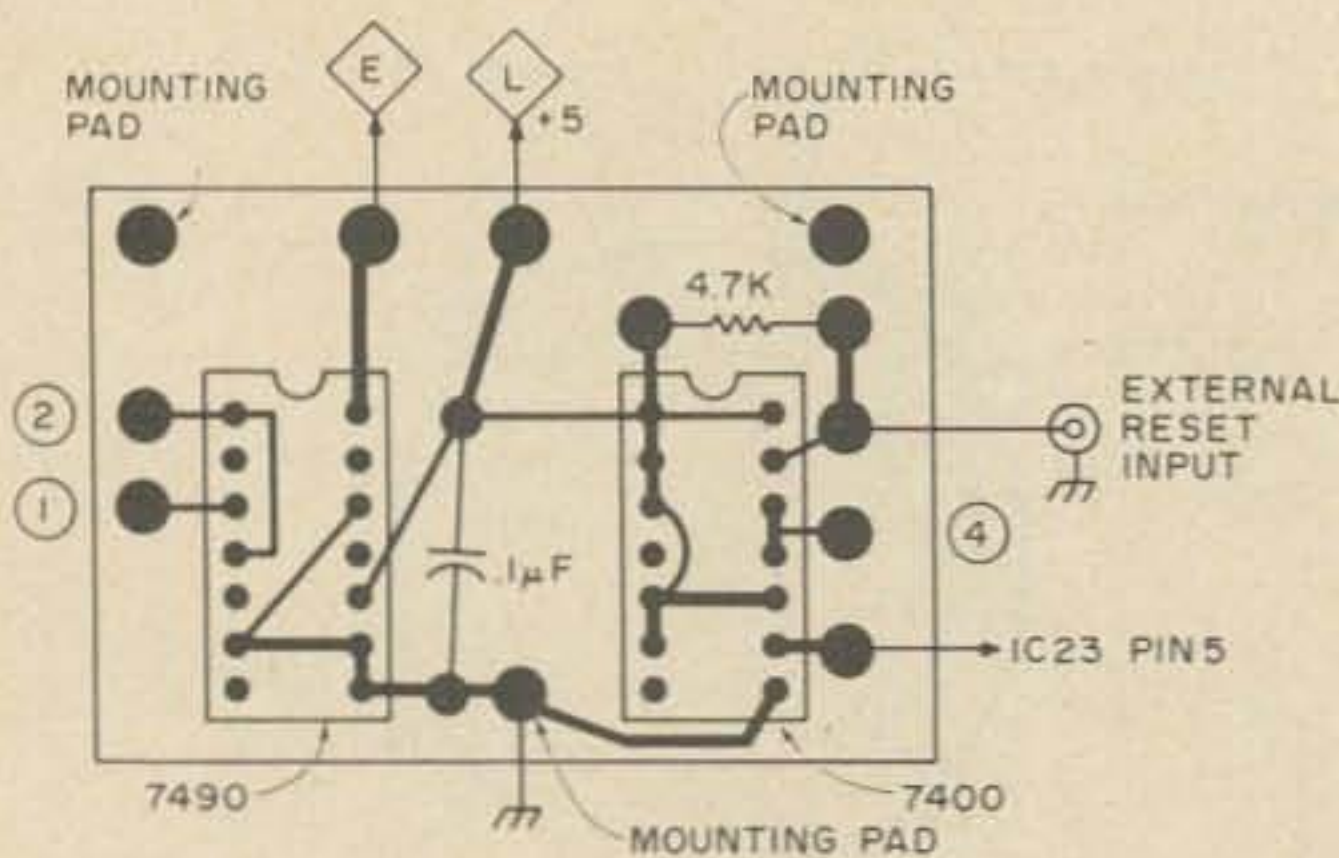

Fig. 3. Printed circuit board for the added functions, foil side view.

inputs of the first flip flop in the counter (a JK flip flop, of course); thus, the gate is open when the gate signal is high. Using this scheme,  $T=1/F$ , where T is the time that the gate is open, and F is the frequency of the square wave input to the binary stage. To get a 1 millisecond count, therefore, apply a 1 kHz wave to the input.

Reset is in effect when the reset line is low. The integrated circuits used in the counter will not count when the reset is activated. By the way, to reset a 7490, this reset signal must be inverted because a 7490

resets with a high input. The logic timing diagram in Fig. 1 shows how the reset occurs just before the gate pulse. The NAND gate requires that the gate line be low for a reset to occur.

#### Modification Details

A 4-pole, 6-position switch is necessary and it must be small, due to a lack of space in the IB-1101. These requirements are satisfied by the Centralab PSA-211. It is a 2-wafer rotary switch. The switch connections are shown in Fig. 2. This switch completely replaces S102, and, in order to mount it, you must make a pair of small plates to cover the square hole for S102. The plates are drilled for the PSA-211 and bolted to the chassis using the mounting holes for S102.

Two changes must be made in the printed circuit board. R21 must be removed. Also, the printed circuit bridge between pins 2 and 5 of IC-23 must be broken so connection can be made from the external reset circuitry to pin 5. Do not break this bridge if the external functions are not desired.

Due to the small size of the pads on the

## You need an ATLAS!

Lucky for you we still have atlases. These are not cheap junky discount-house type trash atlases, these are the finest ever made, profusely illustrated, exquisite in appointment, a joy to behold, a pride to own, a king couldn't do better. Hammond spares no expense to turn out the very finest atlases in the entire world. The only expense that is spared is the one we spare you by making these extraordinary books available. Where else can you buy a \$20 atlas for only \$7. Order now, we have a limited supply, and can't get more before Christmas.



Send to: **WORLD ATLAS**

73 Magazine, Peterborough NH 03458

Name \_\_\_\_\_ Call \_\_\_\_\_

Address \_\_\_\_\_

City \_\_\_\_\_ State \_\_\_\_\_ Zip \_\_\_\_\_

Cash  Check  Money Order

Master Charge# \_\_\_\_\_ BankAmericard# \_\_\_\_\_

Expiration date \_\_\_\_\_ Signature \_\_\_\_\_



Heathkit board, small wire and care in soldering should be used. I used #24 stranded wire with teflon insulation (Alpha Wire #2844/19). The teflon is very convenient because it will not scorch or shrink from the heat.

Fig. 3 shows the printed circuit board for the added decade and external inputs. It is installed by perching it on 3 pieces of stiff (#18) bare wire which are soldered to the mounting pads on the added board, and to the ground plane on the Heathkit board, as shown in the photo. One of these provides the ground connection for the extra board.

Take a look at Fig. 4. I did not notice this when I originally performed the modification, but if you connect pin 5 of IC-23 directly to the external reset input, one of the added gates (inverters) can be eliminated. The advantage of doing this is that IC-23 has an unused gate. So, by making the proper changes to the Heathkit circuit board, the extra 7400 can be eliminated. I leave this as a suggestion to you.

The only thing left is the functioning of the external inputs. When the external gate input is low, the gate is closed. When the external reset input is low, the counter resets, independently of the gate. With the connections as in Fig. 4, the count cannot be transferred to the memory and display until the gate is low. This means that you cannot see the tally until you close the gate. The addition of a switch, as shown in Fig. 5, will allow the count to update 5 times per second independently of the gate and reset conditions.

To do this, remove IC-23 and break the printed circuit bridge between pins 3 and 9. After reinserting IC-23, solder the 4.7 k 1/4

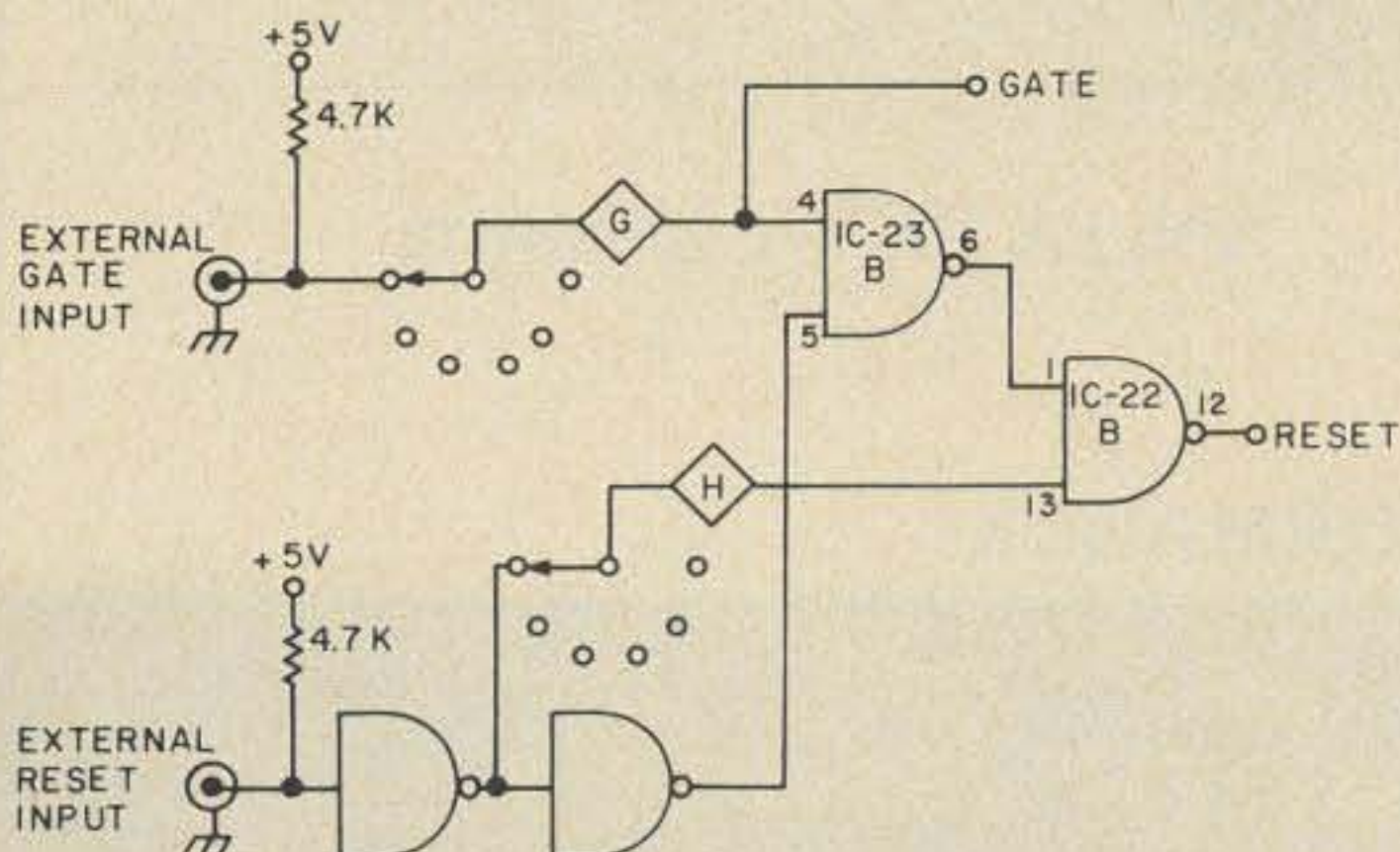

Fig. 4. Modified gate and reset generator with the function switch in the external position.

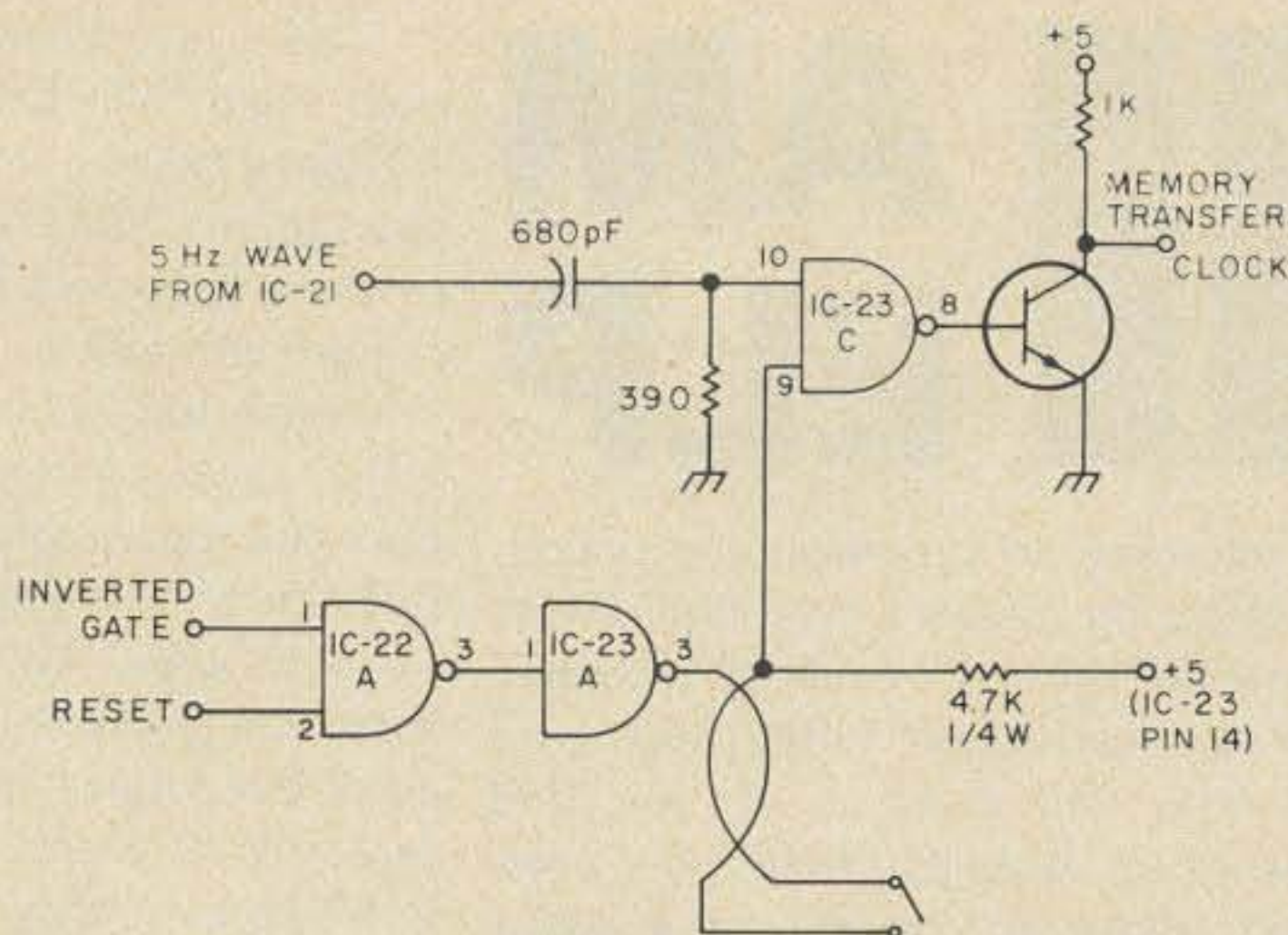

Fig. 5. Circuit to allow continuous transfer of the count to memory, independent of the gate or reset state.

W resistor between pins 9 and 14. The switch is then mounted on the back panel and connected between pins 3 and 9 with a twisted pair. When you close this switch, the counter will function normally. This modification is not in the photograph, but it is in my counter and it is quite satisfactory.

These modifications should add greatly to the use and enjoyment of your IB-1101 counter.

...WA5OKA

## 500 MHZ SCALER MODULE



Only 1.55 x 1.65 x .4 inches

Fits right into existing equipment

High sensitivity: 35 mv, at 500 MHz

15 mv, at 150 MHz

Input impedance: 50 Ohms

Requires 12 to 15 V dc at 100 mA max.

TTL compatible output  $F_{IN}/10$

Overload protected

PS-M prescaler module wired & tested

**\$ 99.00** plus \$.85 shipping

WRITE FOR DATA ON ENTIRE LINE OF PRESCALERS

All orders please add \$.85 for shipping Calif. residents add 6% sales tax

**LEVY ASSOCIATES**

P.O. Box 961, Temple City, CA 91780

# I AM HELP

According to long-standing policy, 73 Magazine makes a continual effort to match those in need of technical help or instruction with those who feel they can offer it. If you find yourself in one of these two categories, please do yourself and amateur radio a favor by contacting Ham Help, 73, Peterborough NH 03458.

I would like to get on the air, but need a little help in code practice and general laws, plus a brush up on transistors. Have most of my technical background in tubes. Would sure appreciate someone's help, around the Santa Monica, Ca. area. You sure are a Godsend to people like us.

Louis W. Schwamberger  
3139 Sawtelle Blvd.  
W. Los Angeles CA 90066  
Phone 398-3046

I have just finished reading one of your Ham Help columns. I have been trying to get in contact with someone, anyone, in San Antonio, Texas, to help me become a ham radio operator — the right way.

I have looked in the phone book, called several radio repair shops (and even the local radio and TV stations), but the only things they could come up with were "CB" clubs. I am sure there are hams and ham clubs in the area, but I have been unable to contact any of them — and even then I don't know if they would help me.

I know quite a lot about "CB" but almost nothing about ham operation. "CB" has turned into such a nightmare that it is no longer serving a useful function in this area. I would desperately like to become a "good" ham but I do need HELP.

Dale C. Babb  
5763 Broken Lance  
San Antonio TX 78242  
(512) 623-3942

*For the names of this month's Ham Helpers, please refer to our LETTERS section, beginning on page 6. — Ed.*

STATEMENT OF OWNERSHIP, MANAGEMENT and CIRCULATION (Act of August 12, 1970: Section 3685, Title 39, United States Code) 1. Title of publication 73 Magazine. 2. Date of filing 30 September, 1975. 3. Frequency of issue, Monthly. 4. Location of known office of publication (Street, city, county, state and ZIP code) (Not printers) Pine, Peterborough, Hillsboro, NH 03458. 5. Location of the headquarters or general business offices of the publishers (Not printers) Pine, Peterborough, Hillsboro, NH 03458. 6. Names and addresses of publisher, editor, and managing editor. Publisher (Name and address) Wayne Green, Peterborough NH 03458. Editor (Name and address) Wayne Green, Peterborough NH 03458. Managing Editor (Name and address) Jack Burnett, Peterborough NH 03458. 7. Owner (If owned by a corporation, its name and address must be stated and also immediately thereunder the names and addresses of stockholders owning or holding 1 percent or more of total amount of stock. If not owned by a corporation, the names and addresses of the individual owners must be given. If owned by a partnership or other unincorporated firm, its name and address, as well as that of each individual must be given.) Name 73 Inc, Peterborough NH 03458. Wayne Green, Peterborough NH 03458. Virginia Green, Peterborough NH 03458. 8. Known bondholders, mortgagees, and other security holders owning or holding 1 percent or more of total amount of bonds, mortgages or other securities (If there are none, so state) Name none. 9. For optional completion by publishers mailing at the regular rates (Section 132.121, Postal Service Manual) 39 U.S.C. 3626 provides in pertinent part: "No person who would have been entitled to mail matter under former section 4359 of this title shall mail such matter at the rates provided under this subsection unless he files annually with the Postal Service a written request for permission to mail matter at such rates." In accordance with the provisions of this statute, I hereby request permission to mail the publication named in Item 1 at the reduced postage rates presently authorized by 39 U.S.C. 3626. (Signature and title of editor, publisher, business manager, or owner) Wayne Green, Publisher. 11. Extent and nature of circulation. (X) Average No. copies each issue during preceding 12 months. (Y) Actual number of copies of single issue published nearest to filing date. A. Total No. copies printed (Net Press Run) (X) 91,846 (Y) 93,201. B. Paid circulation 1. Sales through dealers and carriers, street vendors and counter sales. 2. Mail subscriptions. (X) 88,621, (Y) 90,002. C. Total paid circulation (X) 88,621 (Y) 90,002. D. Free distribution by mail, carrier or other means samples, complimentary, and other free copies (X) 303, (Y) 312 E. Total distribution (Sum of C and D) (X) 88,924, (Y) 90,314. F. Copies not distributed 1. Office use, left-over, unaccounted, spoiled after printing (X) 2,922, (Y) 2,887. G. Total (Sum of E & F — should equal net press run shown in A) (X) 91,846, (Y) 93,201. I certify that the statements made by me above are correct and complete. Signature of editor, publisher, business manager, or owner. Wayne Green.

## FAST SCAN AMATEUR TELEVISION EQUIPMENT

- SOLID STATE
- BROADCAST QUALITY PERFORMANCE

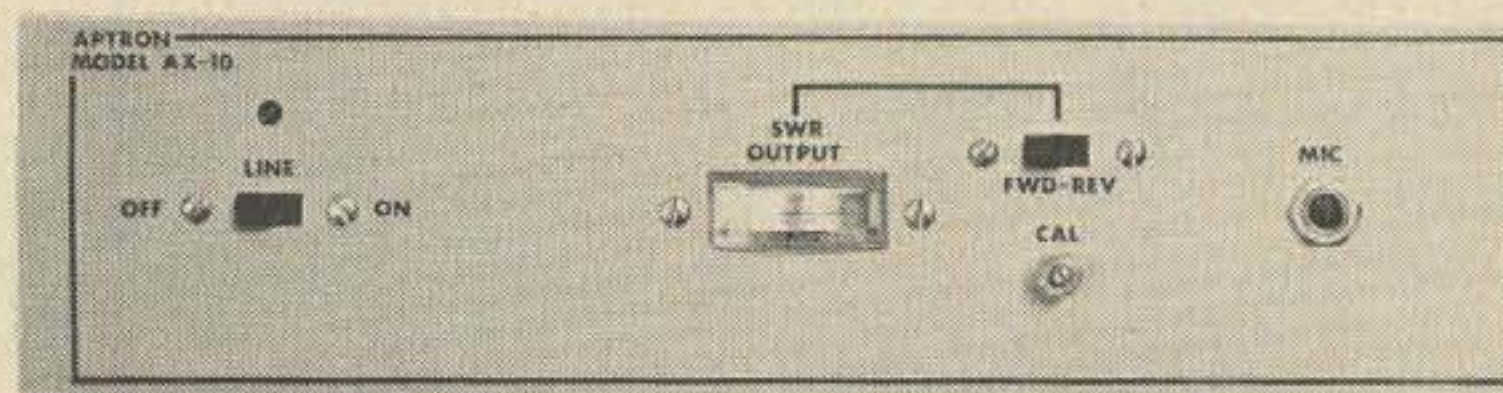

AX-10 TRANSMITTER

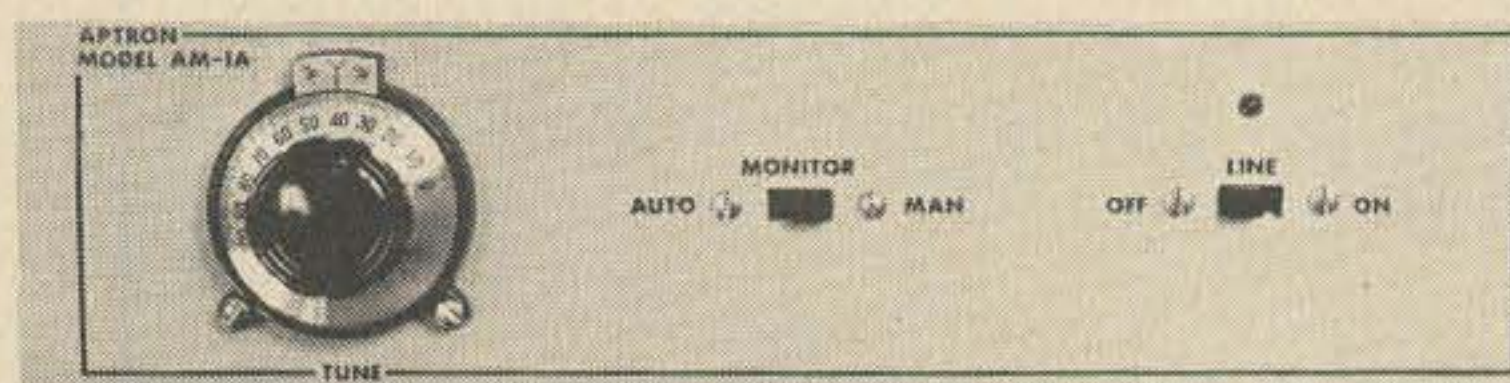

AM-1A RCVR MODEM



**Aptron Laboratories**

Box 323 Bloomington IN 47401

# NEW... HIGH POWER RF AMPLIFIERS

2 meters

- All solid state
- strip line design
- Broad band
- High efficiency

PA140/10 5-15 watts in for 100-150 watts out @ 13.6 volts  
Typically 140 watts for 10 watts in

PA140/30 15-40 watts in for 100-150 watts out @ 13.6 volts  
Typically 140 watts for 30 watts in

Power boosters for 2 meters, Class C using balanced emitter transistors for long life and high SWR protection. For FM mobile or fixed operation.

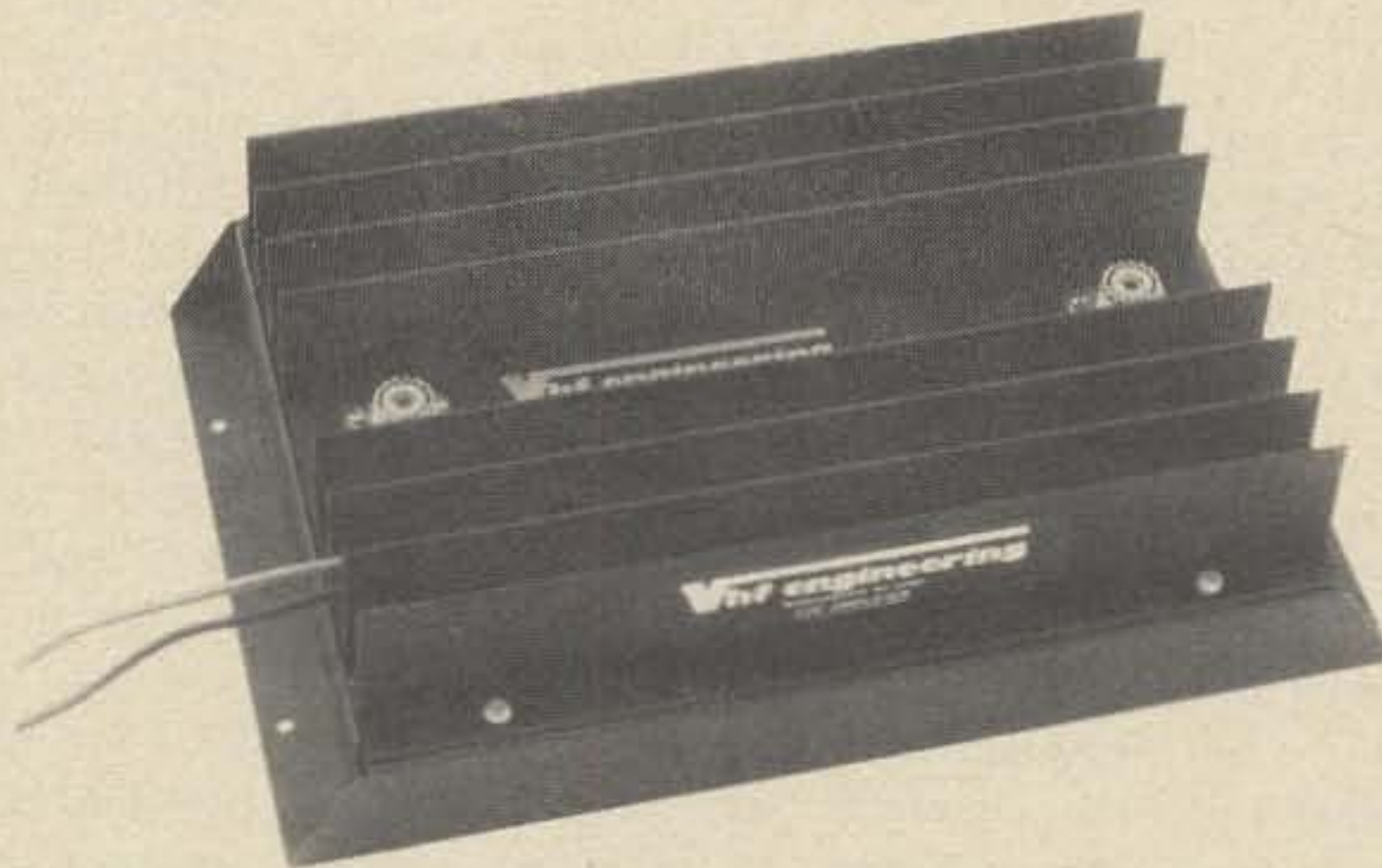

## UP TO 150 WATTS OUTPUT

POWER GAIN: PA 140/10 . . . 12DB

PA 140/30 . . . 7DB

INPUT POWER: PA 140/10 . . . .5 to 15 watts PA 140/30 . . . .15 to 40 watts

INPUT VOLTAGE: 12 to 14 volts DC negative ground

NOMINAL INPUT CURRENT: PA 140/10 . . . .22 Amps PA 140/30 . . . .18 Amps

STANDBY CURRENT: Virtually insignificant

INSERTION LOSS: Less than 1 DB on receive

DUTY CYCLE: 50% or less

RF sensing relay switched

DIMENSIONS: 7" x 10-1/2" x 2-7/8"

WEIGHT: 4 lbs.

PRICE: PA 140/10 . . . . . \$179.95 wired and tested

PA 140/30 . . . . . \$159.95 wired and tested

**vhf engineering**

PO Box 1921-7 Binghamton, N.Y. 13902 • 607-723-9574  
DIVISION OF BROWNIAN ELECTRONICS CORP.





...de W2NSD/I

from page 19

typewriter and the rapid pace of new IC designs for this application means the umbilical cord has been cut to our dependence upon antique Teletype equipment. This means that in short order we could experience a growth in RTTY such as we haven't seen before. We do need a lot of good design work now and articles to provide communications between designers ... we need some more modern rules and regulations from the FCC to unfetter our growth in this area.

Right now, where would you go in the ham bands if you wanted to run RTTY and SSTV on one frequency? You'd have to head for the VHF's and you'd lose the basic benefits of the whole deal. The fact is that RTTY and SSTV are growing together ... the television typewriter did it. If you've ever watched one of these tediously unfolding on SSTV you already know why we need to be able to shift to RTTY for typing.

Both RTTY and SSTV are ideal for storage on audio cassettes ... both are frequency shift systems. We will shortly have dynamic storage devices which will permit us to use the same television screen to display both RTTY and SSTV, so we will be needing common frequencies on the ham bands for this. How about some petitions to the FCC? And don't forget to stress ASCII for the RTTY, okay?

In the meanwhile, I'll bet that some of the more adventurous will be able to get STAs (special temporary authority) from the FCC for development work. And don't forget 73 when you write the articles.

#### PREVENTATIVE LICENSING

Since the expected new rules do not bode well for the Tech license, most Techs have been giving serious thought to getting a General before the fan gets hit. In view of what has been threatened in the rule proposals, this is the only prudent response.

Since most Techs have, in essence, already passed their technical exam, the main problem is that old Morse code ogre. The fact is that this is highly overrated as an obstacle — not because it hasn't been difficult to master, but because most operators have been using just about the worst possible way of learning the code,

making it ten times as difficult and tedious as it needs to be. Unfortunately, virtually every code course available today perpetuates this ridiculous remnant of the 1930s.

If you stop and think for a moment (and who has time to do this, right?), ask yourself whether you might have a better chance of learning the code if you learned it once and for all at the speed you need rather than having to learn it over and over at different speeds. And that is what it comes down to ... the usual method is to learn the code at maybe one word per minute with very long characters ... then step that up to 3 wpm ... then 5 wpm ... then 7, 8, 9, 10 ... etc. In essence, the brain is being asked to set up recognition patterns for each of the 40 characters we are supposed to know at many different speeds. We could avoid all that total waste of time and effort by learning the patterns of code sound once and once only ... at 13 wpm.

This is the secret of the 73 cassette code course ... even the 6 wpm cassette has each character sent at 13 wpm speed, so you learn the sound of each character just once instead of over and over at different speeds. These cassettes are available directly from 73 or from many of the better ham dealers. The series consists of four cassettes, including one for rank beginners, which teaches the 40 characters, and one for 6 wpm (very handy for passing the FCC given 5 wpm tests when you are called up for a recheck, and you sure don't want to goof it). The 13+ cassette will overprepare you for the FCC's 13 per test. The 20+ cassette is a terror and it will make sure you breeze through the Extra test. We also have a 10 wpm for Canadians and a 25 wpm cassette for fanatics.

#### TELETYPE PARTS

A note from W8KAJ enclosed an announcement from Teletype Corporation to the effect that they are discontinuing the stocking of parts for the models 14, 15, 19 and 20 machines as of December first this year. Pity.

While the more modern machines do have considerable prestige, the old models have much to recommend them. The models 15 and 19 were designed to run 24 hours a day in newsrooms and they go for years with few repairs being needed. Machines such as the Model 33, so popular today, are designed for intermittent

use, such as on TWX circuits, and they don't do well with constant use.

Amateurs interested in RTTY and computer folk needing an inexpensive I/O typewriter can do a lot worse than get an old model 15. They run between \$35 and \$100 these days most places. They are 60 wpm geared, so they are slower than newer machines — but then most applications don't call for speed anyway.

#### POSTAL MODERNIZATION

For years the post office has been using a simple 6" envelope (business reply size) to let us know that a subscriber had moved without notifying us. They would tear the label off the magazine wrapper, indicate the new address, send it to us and throw out the magazine and the rest of the wrapper.

Now some of the post offices are automated and a new form has replaced the rubber stamp on the wrapper address. This is a 10" wide, 22" long computer printout sheet mailed in a 10½" x 11½" brown envelope! The computer printout may be a lot more efficient, but they sure use a whole lot more paper ... new envelope is ten times as large. Not only is it immense, it is also completely unstandard in size — so it has to be handled by hand.

#### JORDAN IN THERE HELPING

Amateur radio does have friends in high places. A resolution proposed by New Zealand and seconded by Jordan was unanimously accepted by the recent World Scout Organization in Copenhagen to the effect that radio amateurs would be supported in their effort to retain the present frequency allocations. There were delegates from 86 countries, representing 14 million scouts.

#### SAROC HAWAII

A letter in the PHD News of Northwest Missouri brought a report on SAROC Hawaii. KH6BW wrote ... "I finally found out what SAROC means. It is Sahara Amateur Radio Operators Convention, originated at the Sahara Hotel in Las Vegas, and is a sort of professional convention, money making affair. The attendance was not what was expected — not many exhibitors were on hand and a lot of the technical talks were trite. According to the gal at the table, only about 250 persons were at the convention."

... W2NSD/I

you goons don't  
 busy  
 bunch of  
 you ignored  
 I insist that you print ev

# LETTERS

from page 29

However, since most hams are expected to be honest, perhaps you could see that Mr. Biddle gets this info.

Basically, the device is nothing more than a balanced modulator with an audio frequency local oscillator. The oscillator was lifted from an article in 73 on a sine wave oscillator. Other oscillators will work, but from my experience, it must be a sine wave. Frequency should cover from about 2200 Hertz to 3500 Hertz. The transformers were junk box and no effort was made to optimize their inductance. The balanced modulator should see about 500 to 600 Ohms, so line to voice coil transformers should work. There is some loss (15 to 20 dB through the bal mod), so it would be useful to have a small audio amp on the output of the demod. The transformer on the output of the audio osc. can be chosen to match the output of the osc. and the input to the bal mod. The purpose here is to maintain a balance on the rig modulator (demod). Juggle levels into the device, audio levels, etc. I tape the ENcoded audio and play it back

through my DEcoder. This permits adjustment of audio frequency and audio levels. The 20k and 400 Ohm trimmer resistors, once set, do not require frequent adjustment. Again, if you really want a decoder, and you are adept at figuring out small problems, then this should be enough to get one going. Mine works better than the PD unit. They have trouble with frequency drift and low audio, both of which can be corrected in my unit.

Charles R. Helmick W8JZN  
 Parkersburg WV

page after page of contest results, outdated projects, and ultra-complex articles aimed at the privileged few who are lucky enough to belong to the ARRL clique. Wouldn't you think that such an intelligent bunch of super engineers could design their own "Modular Counter" without stealing Mr. Stark's? Keep up your good work and well written articles for those of us who are not fortunate enough to have engineering degrees. Keep up the weather satellite articles by WB8DQT.

Paul J. Dujmich WR3TLD  
 McKeesport PA

### GREAT GLADE

I attended the Glade Valley Amateur Radio Session this year — and it is really super. I think that, after 16 years, Carl Peters K4DNJ should be commended for his outstanding job. I intend to go back next summer and work on Extra class.

Rev. G. Wayne Heck WB9HJM  
 Fort Wayne IN

### SOCK IT TO HER

Your September 1975 cover made me think of a swell XYL-pleasing idea, which I would like to share with anybody who has a problem with a drawer full of stray, single, one of a kind socks.

Use one of these forgotten socks for a microphone cover. It works very well and keeps dust off a non-used microphone.

I said XYL-pleasing and so it is; just think how pleased she will be to see how clever and thrifty you are.

If you really want to please her, change socks every day!

Ray Sanders WA8VZO  
 Follansbee WV

### ANOTHER YEAR

Enclosed please find a check for \$8.00 for another great year of 73. I have stopped my subscription to QST because I am tired of running through

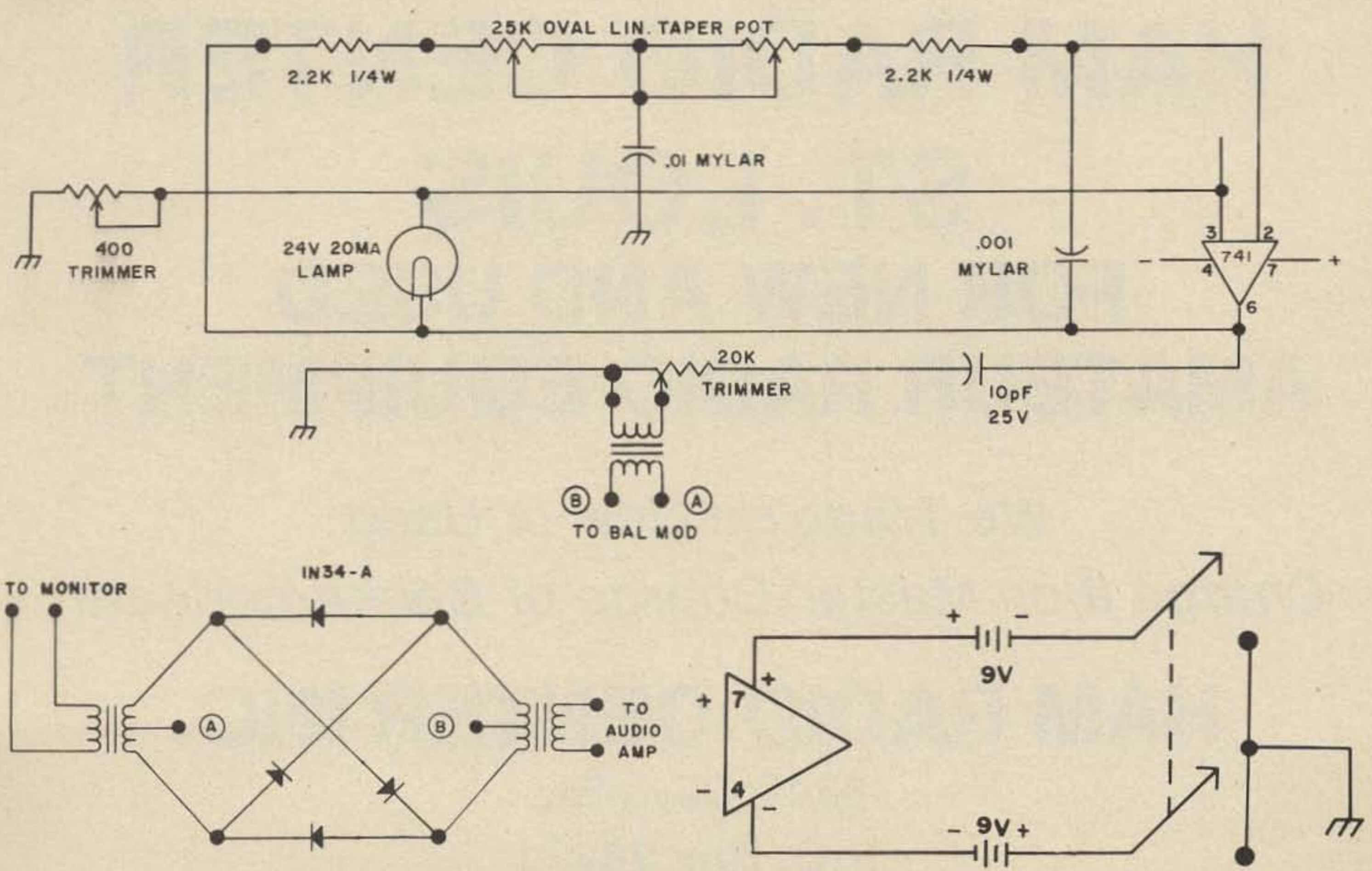

The 10-0 Decoder.

**WE DON'T HAVE  
YOUR NUMBER  
BUT YOU HAVE OURS**

**Toll Free**  
(Cont. 48 States)

**800-325-3636**

(MO. cust call 314-993-6060 coll.)

**CALL  
HAM RADIO CENTER  
ST. LOUIS  
FOR NEW AND USED  
AMATEUR RADIO EQUIPMENT**

*We Trade on New or Used  
Charge it on Master-Charge or BankAmericard*

**HAM RADIO CENTER INC.**

8342 Olive BL.  
P.O. Box 28271  
St. Louis, MO 63132



---

# THE HAM KEY

FOR THE FINEST IN C. W. SENDING

---

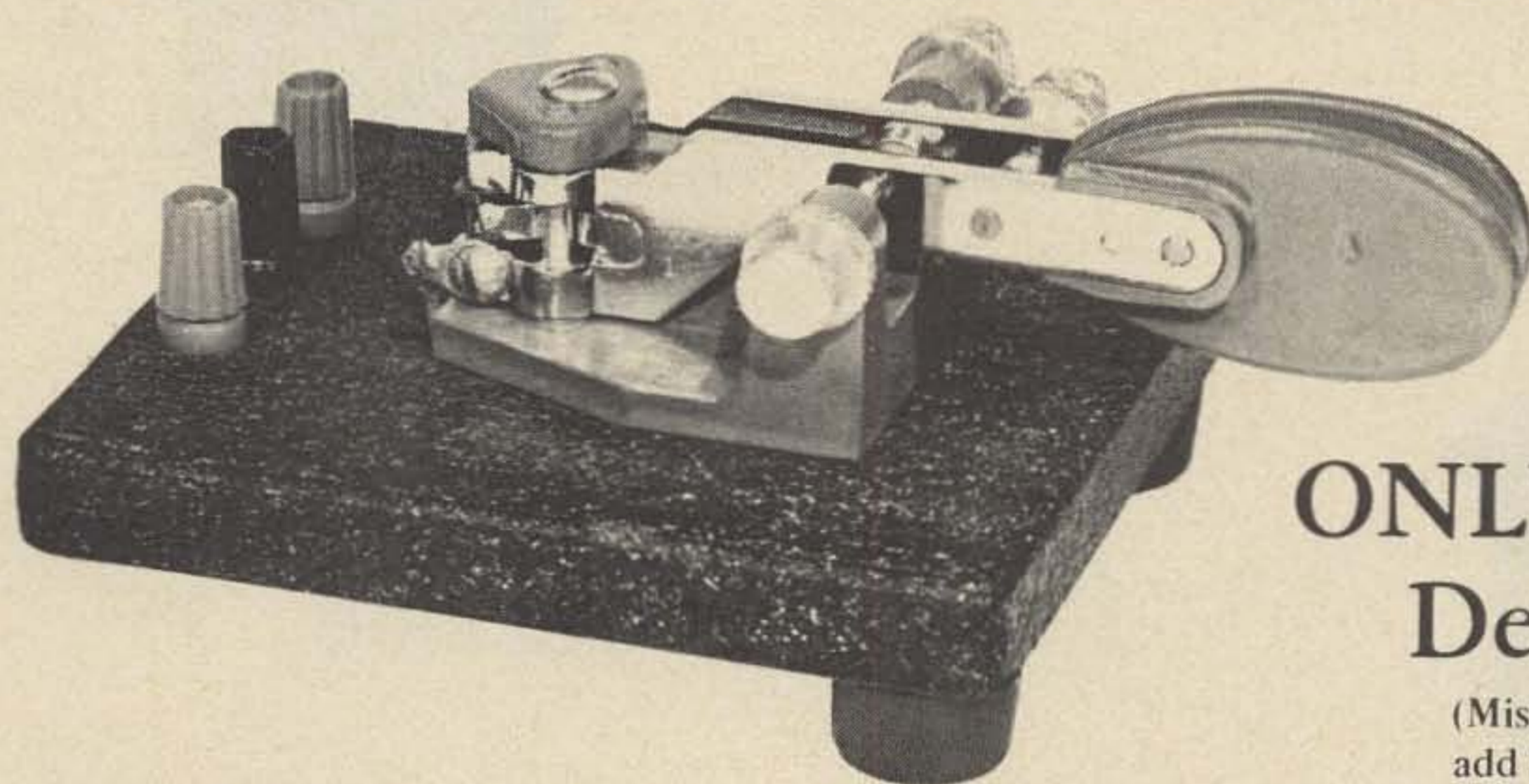

**Model HK-1**

**ONLY \$29.95  
Delivered**

(Missouri Residents  
add \$1.35 Sales Tax)

- \* FOR USE WITH ALL ELECTRONIC KEYERS
- \* HEAVY DUTY CONTACTS
- \* COMPLETELY ADJUSTABLE
- \* NON-SLIP RUBBER FEET
- \* DUAL LEVER PADDLES
- \* ALL PLASTIC PARTS HI-IMPACT STYRENE
- \* HEAVY BASE
- \* COLOR CODED BINDING POSTS
- \* PADDLES REVERSIBLE FOR WIDE OR CLOSE FINGER SPACING

**ORDER DIRECT OR FROM YOUR DEALER**

**call TOLL FREE 800-325-3636**

**CHARGE IT ON .....**



---

## **HAM RADIO CENTER INC.**

**8342 Olive BL.**

**P.O. Box 28271**

**St. Louis, MO 63132**

---

# **GIVE Your Repeater A Duplexer For Christmas**

Completely Pre-Tuned

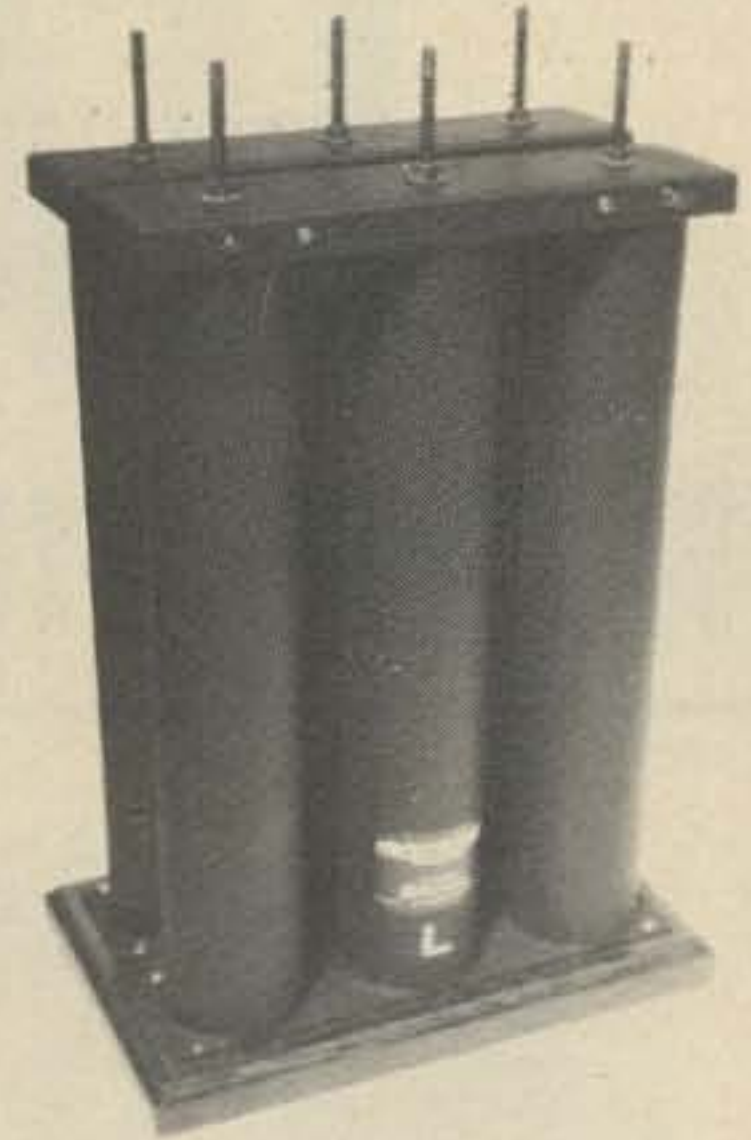

2 Meter \$350.00



220 MHz \$250.00

Ready for Service



450 MHz \$350.00

Guaranteed

Order your SWIVETEK MICROPLEXER now for Christmas delivery.  
Shipping time - 3 weeks.

\$100.00 deposit required. Balance shipped COD, FOB. San Mateo, CA  
We pay shipping on all pre-paid orders.

# MICROPLEXER<sup>®</sup>

The Microstrip Duplexer

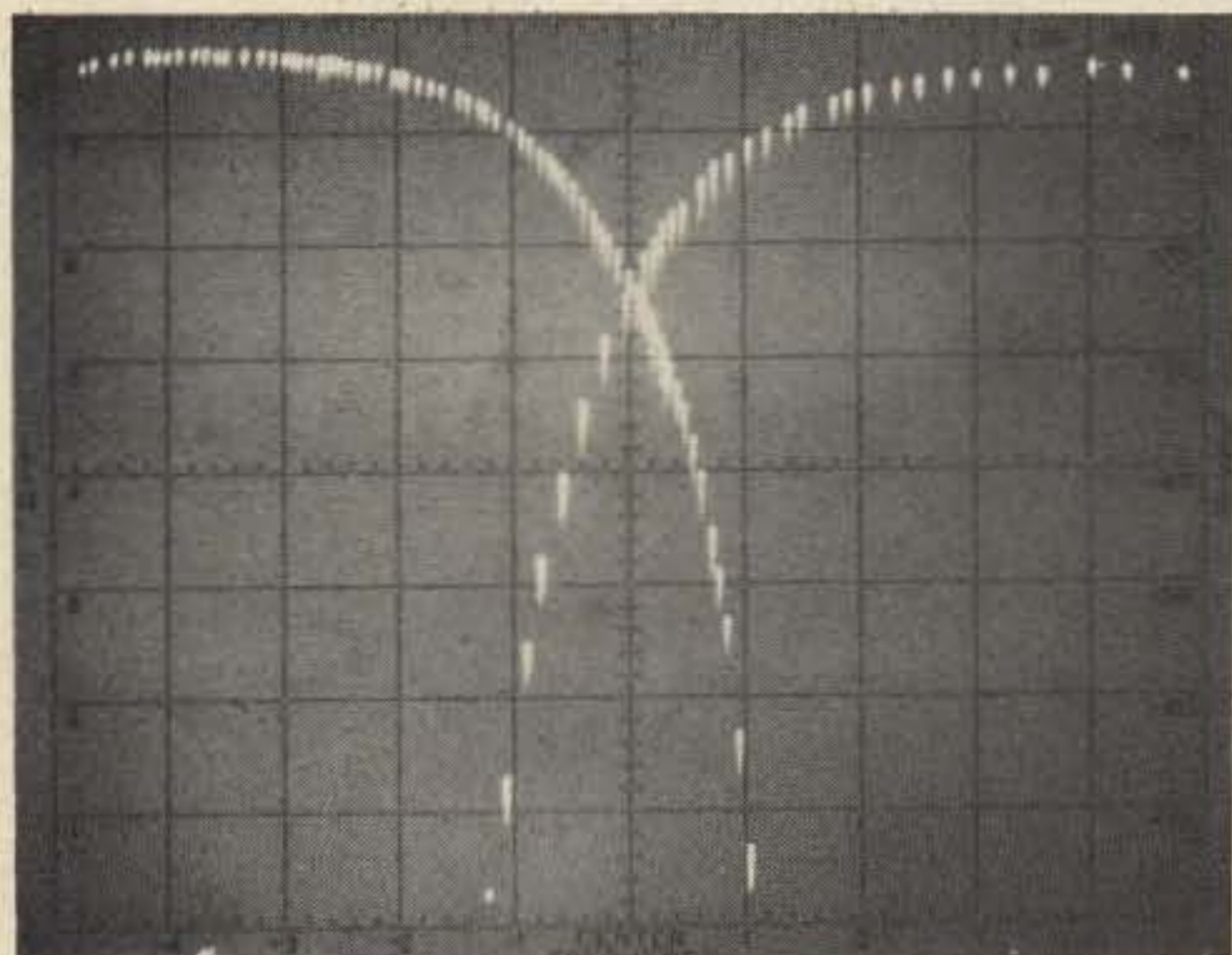

Insertion Loss

1.5 DB

100 KHZ / DIVISION

High Pass  
105 DB Isolation

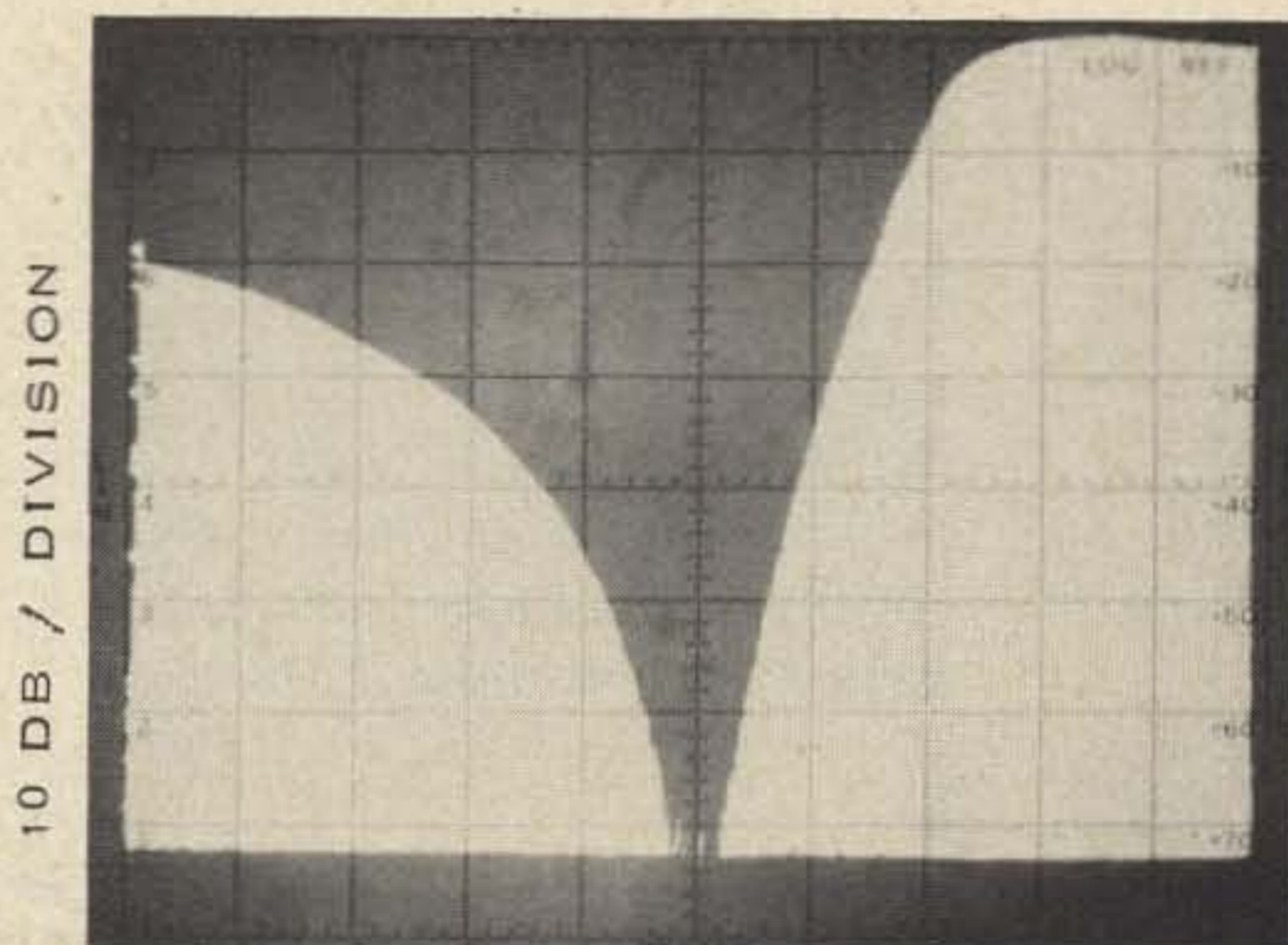

200 KHZ / DIVISION

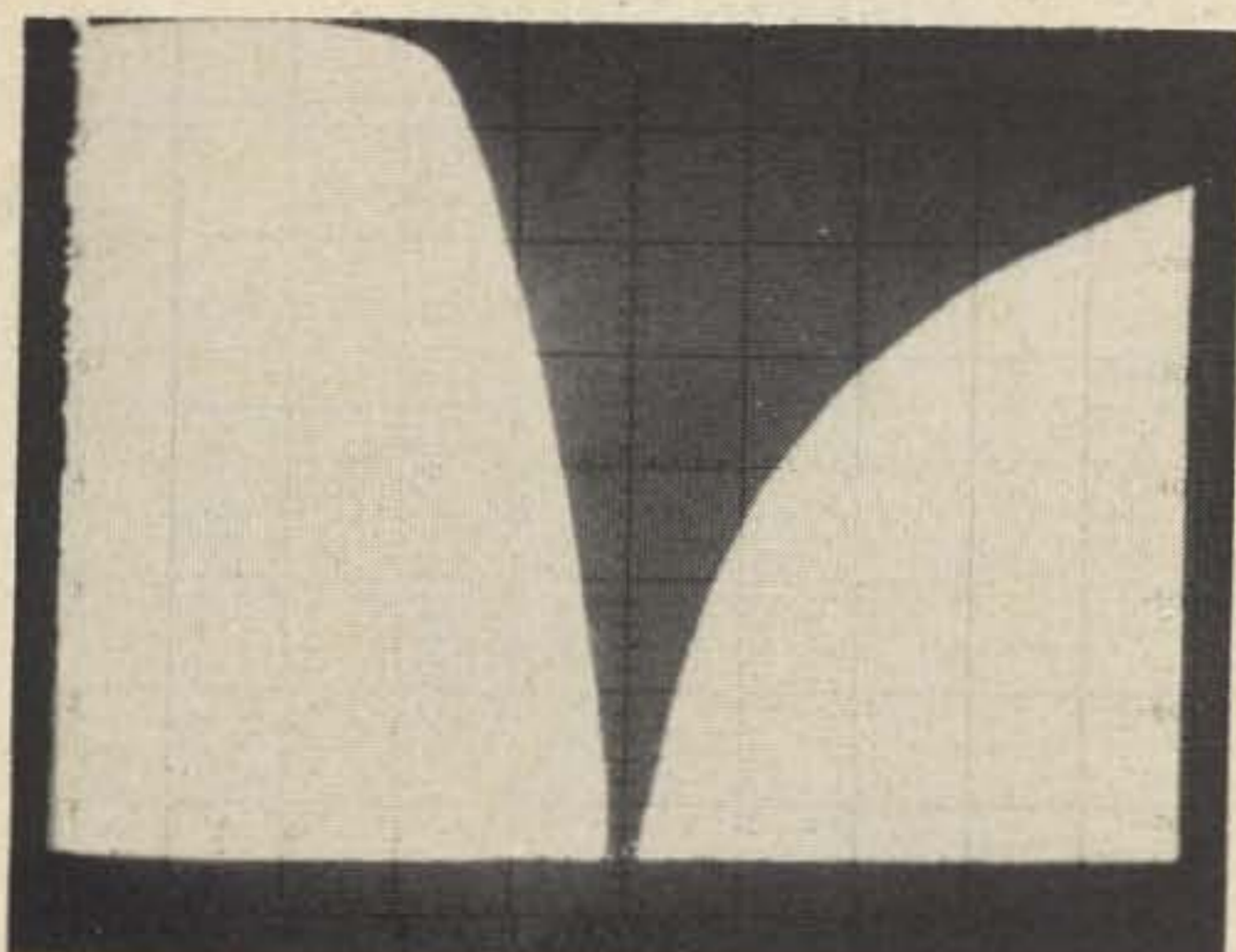

200 KHZ / DIVISION

Low Pass  
105 DB Isolation

Photos from a typical  
2M6A duplexer.



Duplexers and Cavity Filters

105 No. Amphlett Blvd.

San Mateo, CA 94401

(415) 348-3858

# S. D. SALES CO.

P.O. BOX 28810 DALLAS, TEXAS 75228

## 6 Digit Digital Clock Kit

We wanted **our word** to mean something to **you**. When we first introduced our clock we used such words as "impossible", "unbelievable bargain", "prime quality", and "unconditional money back guarantee". We anticipated selling several hundred kits. Your response to our clock has been fantastic. Now several thousand kits later, we hear such comments as "outstanding value", "exceptional service", "I can't believe it", etc. One enthusiastic customer even wrote saying it was "the best thing since bottled beer."

### Here's What The Kit Includes:

- 1 — MM5314 National Clock Chip with socket
- 6 — Common Cathode Led Readouts (.25 in. char.)
- 13 — NPN and PNP Driver Transistors
- 2 — Push Button Switches for time set
- 1 — Filter Cap
- 4 — IN4001 Rectifiers
- 1 — IN914 Diode
- 2 — .01 Disc. Caps
- 9 — Carbon Resistors

Transformer — \$1.50.

**\$9<sup>95</sup>**  
(KIT)  
**WITH SPECS.**  
**POSTPAID**

P.C. BOARD FOR ABOVE — \$3.00 each

In keeping with our philosophy of **service, quality, bargains** and **no back orders**, we want to offer you another S.D. first. We're betting a silver dollar\* that if you order 2 complete kits for \$28.90 (with PCB and XFMR) you will be completely satisfied or return the two kits for a complete refund. You keep the dollar, regardless! Bet you didn't know that S.D. meant silver dollar.\* (It doesn't, but it serves our purpose this month.)

Offer good until Nov. 30.  
(\*New Style Clad Dollars)

2N2222 BY ITT Silicon NPN. TO-92 Plastic Case. 8 for \$1	936 DTL BY ITT Prime, house numbered. Hex Inverter 10 For \$1
NATIONAL 2K ERASEABLE PROM 2048 Bit, static units. U.V. light eraseable. MM5203. Factory prime new units. Special — \$12.50	SUBMINIATURE TRIMMER CAPS Ultra stable. Range: 3.5 to 18 PF. 2 for \$1
DIGITAL CLOCK CHIPS BY NATIONAL FACTORY NEW UNITS! MM5314 — 4 or 6 digits. 24 pin DIP. Use with LED Readouts. With Specs. — \$3.95 MM5316 — Alarm chip. 40 pin DIP. \$4.44	FILTER CAPS Dual section, 2000 MFD and 1500 MFD at 30 WVDC. Twist Lock. 79c ea. 3 For \$2
TEXAS INSTRUMENTS 8 DIGIT CALCULATOR CHIP TMS0 103NC. Four function. Same style as used in TI pocket calculators. Factory new units, with specs. 99c each.	NATIONAL VOLTAGE REGULATOR Like 7805. 5VDC — 1 AMP output. Has TO-220 plastic power tab — 99c
1AMP 1000 PIV SILICON RECTIFIERS IN4007. Factory prime devices. 10 for \$1.00.	IN4148 COMPUTER DIODES Same as IN914. Factory prime. 20 for \$1
741C OP AMPS Prime, factory tested and marked. Full spec on all parameters. Not re-tested, functional only, units as sold by others. 741CH — TO-5 8 Lead Metal Can . . . . . 3/\$1 741CV — 8 Lead Mini Dip . . . . . 4/\$1	FULL WAVE BRIDGE By G.I. 1.5 AMP 800PIV — 75c
DISC CAPACITORS .1 MFD 50V-12/\$1 .01 MFD 50V-20/\$1	2N706A 400MHZ. TRANSISTORS Silicon NPN. 1 WATT. TO-18 Case. 5 For \$1
	723CH PRECISION VOLTAGE REGULATOR Build a circuit regulating the voltage from 2 to 37 volts. Complete specs included. One of the easiest to use regulators now on the market. 39c

# S. D. SALES CO.

P.O. BOX 28810 DALLAS, TEXAS 75228

**FAST SERVICE — QUALITY MERCHANDISE  
BARGAINS GALORE — NO BACK ORDERS**

**We are SMALL enough to give personalized service, but  
LARGE enough to handle every order swiftly and efficiently!**

<p><b>INTEL 1K 2102 RAM</b> Factory prime, tested units. Factory selected for much faster speed than units sold by others. 650 NS. These are static memories that are TTL compatible and operate off + 5 VDC. The real workhorse of solid state memories because they are so easy to use. Perfect for TV typewriters, mini-computers, etc. With specs. \$3.95 ea. or 8 for \$30</p>	<p><b>FAIRCHILD LED READOUTS — 69c</b> FND-70. Common cathode. Right hand decimal point. .25 inch character. Prime new units. Perfect for clocks, frequency counters, etc. 69c 10 For \$6 Best Readout Buy In USA!</p>																																																																								
<p><b>SIGNETICS 1K P-ROM</b> 82S129. 256 x 4. Bipolar, much faster than MOS devices. 50NS. Tri-state outputs. TTL compatible. Field programmable, and features on chip address decoding. Perfect for microprogramming applications. 16 pin DIP. With specs. \$2.95 ea.</p>	<p>74164 — TTL SPECIAL — 69c 4 for \$2.00</p>																																																																								
<p>LM324 — QUAD 741 OP AMP — 99c</p>	<p><b>DO YOU NEED A LARGE, COMMON ANODE READOUT AT A FANTASTIC PRICE?</b> S.D. presents the MAN-64 by Monsanto - .40 inch character. All LED construction - not reflective bar type, fits 14 pin DIP. Brand new and factory prime. Left D.P. \$1.59 ea. 6 For \$7.50</p>																																																																								
<p>NE555 — Timers — 49c</p>	<p><b>DL747 JUMBO LED READOUTS</b> By Litronix. .65 inch character. Common anode. Outperforms SLA-3. Perfect for giant digital clocks. Only 20 MA. per segment. Special — \$2.50 ea.</p>																																																																								
<p><b>GE SCR C106B1</b> 4 AMP 200PIV. Sensitive Gate. 59c</p>	<p><b>LARGE SIZE LED LAMPS</b> Similar to MV5024. Prime factory tested units. We include plastic mounting clips which are very hard to come by. Special 5 for \$1</p>																																																																								
<p><b>MOTOROLA POWER DARLINGTON — \$1.99</b> MJ3001 - .NPN - 80 Volts - 10 Amps - HFE 6000 typ. To-3 Case. Ideal for power supplies, etc. We include a free 723 regulator w/schematic for power supply with purchase of the MJ3001. You get the two key parts for a DC supply for only \$1.99. Regular catalog price for the MJ3001 is \$3.82</p>	<p><b>PC BOARD MATERIAL</b> FR-4 blank epoxy boards. 2 oz. copper, 5 x 10 in. Single Sided. Limited Qty. — 99c</p>																																																																								
<p><b>TRANSISTORS</b></p> <table border="1"> <thead> <tr> <th>Type</th> <th>Mat.</th> <th>Pol.</th> <th>Vceo</th> <th>Ic</th> <th>Hfe</th> <th>Case</th> <th>Price</th> </tr> </thead> <tbody> <tr> <td>2N3904</td> <td>S</td> <td>N</td> <td>40</td> <td>100MA</td> <td>200</td> <td>TO-92</td> <td>8/1.00</td> </tr> <tr> <td>2N3906</td> <td>S</td> <td>P</td> <td>40</td> <td>100MA</td> <td>200</td> <td>TO-92</td> <td>8/1.00</td> </tr> <tr> <td>2N4401</td> <td>S</td> <td>N</td> <td>40</td> <td>250MA</td> <td>200</td> <td>TO-92</td> <td>10/1.00</td> </tr> <tr> <td>2N4403</td> <td>S</td> <td>P</td> <td>40</td> <td>250MA</td> <td>200</td> <td>TO-92</td> <td>10/1.00</td> </tr> <tr> <td>2N3638</td> <td>S</td> <td>P</td> <td>25</td> <td>150MA</td> <td>60</td> <td>TO-105</td> <td>8/1.00</td> </tr> <tr> <td>EN930</td> <td>S</td> <td>N</td> <td>45</td> <td>50MA</td> <td>300</td> <td>TO-106</td> <td>10/1.00</td> </tr> <tr> <td>2N2905</td> <td>S</td> <td>P</td> <td>40</td> <td>350MA</td> <td>200</td> <td>TO-5</td> <td>4/1.00</td> </tr> <tr> <td>2N4249</td> <td>S</td> <td>P</td> <td>60</td> <td></td> <td></td> <td></td> <td>10/1.00</td> </tr> </tbody> </table>	Type	Mat.	Pol.	Vceo	Ic	Hfe	Case	Price	2N3904	S	N	40	100MA	200	TO-92	8/1.00	2N3906	S	P	40	100MA	200	TO-92	8/1.00	2N4401	S	N	40	250MA	200	TO-92	10/1.00	2N4403	S	P	40	250MA	200	TO-92	10/1.00	2N3638	S	P	25	150MA	60	TO-105	8/1.00	EN930	S	N	45	50MA	300	TO-106	10/1.00	2N2905	S	P	40	350MA	200	TO-5	4/1.00	2N4249	S	P	60				10/1.00	<p><b>MOTOROLA NEGATIVE VOLTAGE REG</b> MC1469R. TO-66 9 Lead package. For 3 TO 30V Outputs. Provides 600 MA direct output or more by using an external power transistor. Reg. catalog \$4 ea. With specs. \$1.95 ea.</p>
Type	Mat.	Pol.	Vceo	Ic	Hfe	Case	Price																																																																		
2N3904	S	N	40	100MA	200	TO-92	8/1.00																																																																		
2N3906	S	P	40	100MA	200	TO-92	8/1.00																																																																		
2N4401	S	N	40	250MA	200	TO-92	10/1.00																																																																		
2N4403	S	P	40	250MA	200	TO-92	10/1.00																																																																		
2N3638	S	P	25	150MA	60	TO-105	8/1.00																																																																		
EN930	S	N	45	50MA	300	TO-106	10/1.00																																																																		
2N2905	S	P	40	350MA	200	TO-5	4/1.00																																																																		
2N4249	S	P	60				10/1.00																																																																		
<p><b>RCA HIGH VOLTAGE POWER TRANSISTOR</b> 100 Watts. 5 Amps. 300 VCEO. TO-3 case. Silicon NPN. Mfg. house numbered 2N5240. Regular catalog is \$6. Perfect for H.V. supplies or vertical and horizontal circuits. SPECIAL — 99c</p>	<p><b>MOTOROLA NEGATIVE VOLTAGE REG</b> MC1463R — Like our 1469R above, except for negative voltage. Reg. catalog \$5. Our price \$1.95.</p>																																																																								
<p><b>HEAVY DUTY TRANSFORMER</b> 36 VAC, 3.5 AMPS. 115VAC 60HZ. PRI. For power supplies or audio power amps. Best quality, fully enclosed. \$4.95</p>	<p><b>POWER TRANSISTOR PC BOARD</b> Mfg. by Memorex Computer Corp. Board has 20 Power Transistors. 10-RCA 2N3585 TO-66 SILICON NPN. VCEO-300 IC-2AMPS. 10-MOTOROLA MJE-340. NPN Silicon. VCEO-300. Plastic power tab case. Also has 10-2N2222A TO-18 NPN transistors and 10-1N5059 1 AMP 200 PIV rectifiers, plus 32 resistors. LIMITED QTY. Board #103. \$3.99 ea.</p>																																																																								
<p><b>8T97B</b> Signetics, TRI-State Hex Buffer. MOS and TTL interface to TRI-State Logic. Special: \$1.49.</p>	<p><b>48 HOUR SERVICE</b> You deserve, and will get prompt shipment. On orders not shipped in 48 HRS., a 20% cash refund will be sent. We do not sell junk. Money back guarantee on every item. WE PAY POSTAGE. Orders under \$10 add 75c handling. No C.O.D. Texas Res. add 5% tax.</p>																																																																								
<p>ORDERS OVER \$15 CHOOSE \$1 FREE MERCH.</p>	<p><b>FREE BONUS</b> All clock or calculator chips are shipped with free socket.</p>																																																																								
<p><b>S. D. SALES CO.</b> P.O. BOX 28810 DALLAS, TEXAS 75228</p>																																																																									

**MONSANTO MAN-64  
LARGE COMMON ANODE LED READOUTS**

The response to this readout has been fantastic. Our customers have used the MAN-64 in large clocks, frequency counters, etc., with beautiful results. We wanted to make a good deal an even better deal, so we have cut the price on the MAN-64, but for **this month only.**  
**SPECIAL 6 for \$6**

**S. D. SLASHES LINEAR PRICES**

Tired of getting ripped off? Tired of paying high prices for linear IC's of questionable quality? Then you should be buying your linears from S. D. Below devices are all factory prime, full spec of all parameters. Compare these prices!

741C	MINI DIP OP AMP	4/\$1
741CH	TO-5 CAN OP AMP	3/\$1
555 V	TIMER IC	2/\$1
565 A	PHASE LOCKED LOOP	2/\$1
LM 380-8	MINI DIP AUDIO AMP	2/\$1
703 CH	TO-5 CAN FM IF AMP	3/\$1

**INTEL 1702A 2K ERASEABLE PROM'S \$6.95**

We tell it like it is. We could have said these were factory new, but here is the straight scoop. We bought a load of new computer gear that contained a quantity of 1702A's in sockets. We carefully removed the parts, verified their quality, and are offering them on one heck of a deal. First come, first served. Satisfaction guaranteed.

**PROFESSIONAL QUALITY STEREO HEADPHONES**

Here is the kind of super deal that S. D. is famous for. Treat your ears to a super sound at a super price. Soft padded ear cushions, lightweight, fully adjustable headband, long coiled cord, wide response. **\$6 Post Paid — NEW IN ORIGINAL FACTORY BOXES**

**SALE ON CUT LEAD SEMICONDUCTORS**

Leads were cut for PCB insertion. Still very useable. IN4148 Diode - 40/\$1      2N3904 (House #Transistor) - 25/\$1

**INSTRUMENT KNOBS**

Black with brushed aluminum insert. Medium size. Very attractive style.  
**SPECIAL 5 FOR \$1**

**VERNIER DIAL**

From a close out of a metal detector manufacturer. 1/2 Turn, 8 to 1 ratio. Internal stops easily removed to make unit multi-turn.  
**LIMITED QUANTITY - \$ .99 EACH**

**S. D. SALES CO.**  
**P. O. BOX 28810 DALLAS, TEXAS 75228**

*Win! Win! Win!*



## an Atlas Transceiver

*ONE EACH MONTH UNTIL FURTHER NOTICE*

---

You made S.D. SALES successful with your patronage and we want to say

*Thank You*

In cooperation with 73 Magazine, we will give an Atlas Transceiver complete with deluxe mobile mount, each month until further notice.

*No Purchase Required*

Send your name and address in a letter — tell us in 25 words or less — why you like S. D. SALES. The winner will be notified by Air Mail.

---

**S. D. SALES CO.**

P.O. Box 28810, Dallas TX 75228

# Thank you!

**SUNTRONIX** COMPANY would like to take this opportunity to say "THANKS" to all our many customers and friends for a very gratifying (and profitable) year. We've offered some outstanding bargains — you've gained the benefit of our hi-volume purchasing power. We couldn't offer these state-of-the-art products at such low prices if you did not recognize them for the truly outstanding opportunities they are. We'll continue to bring newer and better items to the hobbyist and experimenter market just as long as you continue to respond as you have in the past. We have big plans for our future product line. Included in our planning are kits for all of the interface modules used in CPU to outside world applications (UARTS, USRTS, Code Converters, Keyboard ROMs, PROMs, RAMs, Printer Drivers, CRT Modems, Baudot Rate Generators, Counters, Timers and on and on). Watch for our announcements of new products in 73 in the coming months.

Now, since this is the holiday season, with gift lists to fill and projects to plan — get started! Here is our gift to you.

- ITEM 101 — 709 OpAmp in T0-5 pkg. BRAND NEW AND UNCONDITIONALLY GUARANTEED ..... \$ .19 ea
  
- ITEM 201 — SMC KR2376 KEYBOARD ROM — BRAND NEW (Not a factory reject or floor sweeping). Will generate standard ASCII code (up to nine bits) with SPST switch closure for each alphanumeric. Completely self-contained. Data sheets with each unit ..... \$4.95 ea
  
- ITEM 301 — 1N4448 Silicon Diode (or equiv) BRAND NEW 100PIV — 10mA like a 1N914 only better ..... \$ .05 ea
  
- ITEM 401 — UART COM2502/2017 in 40 pin dip pkg. Advertised elsewhere for \$14.95. This is an untested HOBBY grade chip for experimentation and use ..... \$4.95
  
- ITEM 501 — 2N3859 equiv. SILICON NPN general purpose transistor. Used for switching, LED driver, oscillators, amplifiers, etc. Small plastic ..... \$ .10 ea

All items ppd. PLEASE add \$1.00 per order to cover handling costs. Orders shipped same day in most cases. Minimum order — \$5.00



## SUNTRONIX COMPANY

6 KING RICHARD DRIVE, LONDONDERRY, N. H. 03053

603-434-4644



THE SUNTRONIX MODEL KBD IV Keyboard is ideally suited as a general purpose ASCII Keyboard for data terminal applications. This keyboard more than meets the needs of the data entry market for long life and reliability.

The KBD IV utilizes the 2 key rollover solid state read-only MOS memory allowing encoded outputs to be strobed out as each key is depressed. A second key may be depressed concurrent with the first, but the second key encoded output will not be strobed out until the first key is released. This feature prevents ambiguity of character codes as a result of two keys being depressed in rapid succession.

#### ELECTRICAL SPECIFICATIONS:

- \* Voltage requirements — +5.0 V and —12.0 V
- \* Power consumption — less than 200 mw
- \* Outputs — standard ASCII; 8-bits + strobe
- \* Negative or positive logic output, jumper selectable
- \* Output connector — standard 14 pin DIP IC socket

#### MECHANICAL FEATURES:

- \* Size — 12¼" x 6¾" x 2½"
- \* High grade glass epoxy PC board
- \* Keyboard ROM SMC KR2376 40 pin MOS
- \* Electronic shift lock, not mechanical
- \* Keyswitches one integral assembly, not individual keys
- \* Switches have four-finger phosphor bronze contacts with gold inlay
- \* Keycaps are 2-shot high strength ABS plastic

These keyboards are available off the shelf in two forms — fully assembled and unconditionally warranted against defects in manufacture or materials for a full ninety days, or in the more economical kit version. Kit parts are fully warranted against defects in manufacture or materials for a full ninety days. In either version, full instructions are supplied for operation, including specifications and data sheets. In the kit version, complete instructions are supplied for the assembly process. A reasonably competent technician can completely assemble and test this keyboard in one evening. All parts needed are included.

#### INTRODUCTORY PRICES

- Factory assembled — \$59.95 ppd.
- Complete kit, w/instructions — \$54.95 ppd.
- Please add \$1.00 handling per order.
- Minimum order — \$5.00



# SUNTRONIX COMPANY

6 KING RICHARD DRIVE, LONDONDERRY, N. H. 03053

603-434-4644

# Season's Greetings





General Aviation Electronics, Inc.  
4141 Kingman Drive, Indianapolis, IN 46226  
317-546-1111

# Wilson Electronics Corp.

FACTORY DIRECT

## CHRISTMAS SUPER SPECIAL

### FEATURES

#### 1405 SM

- 6 Channel Operation
- Individual Trimmers on all TX/RX Crystals
- All Crystals Plug In
- 12 KHz Ceramic Filter
- 10.7 and 455 KC IF
- .3 Microvolt Sensitivity for 20 dB Quieting
- Weight: 1 lb. 14 oz. less Battery
- Battery Indicator
- Size: 8 7/8 x 1 3/4 x 2 7/8
- Switchable 1 & 5 Watts Minimum Output @ 12 VDC
- Current Drain: RX 14 MA TX 400 MA (1w) 900 MA (5W)
- Microswitch Mike Button
- Unbreakable Lexan® Case

#### 1402 SM

- 6 Channel Operation
- Individual Trimmers on all TX/RX Crystals
- All Crystals Plug In.
- 12 KHz Ceramic Filter
- 10.7 IF and 455 KC IF
- .3 Microvolt Sensitivity for 20 dB Quieting
- Weight: 1 lb. 14 oz. less Battery
- S-Meter/Battery Indicator
- Size: 8 7/8 x 1 7/8 x 2 7/8
- 2.5 Watts Minimum Output @ 12 VDC
- Current Drain RX 14 MA TX 500 MA
- Microswitch Mike Button

### ACCESSORY SPECIALS

(valid only with radio purchase)

DESCRIPTION	REGULAR SPECIAL PRICE	CHRISTMAS SUPER SPECIAL
BC1 - BATTERY CHARGER FOR 1402 SM AND 1405 SM .....	\$36.95	\$29.95
BP - NI-CAD BATTERY PACK.....	15.00	10.95
LC1 - 1402 LEATHER CASE.....	14.00	8.50
LC2 - 1405 LEATHER CASE.....	14.00	8.50
SM2 - SPEAKER MIKE FOR 1402 SM and 1405 SM .....	29.95	24.95
TE1 - SUB-AUDIBLE TONE ENCODER INSTALLED ....	39.95	34.95
TTP - TOUCH TONE PAD .. INSTALLED .....	\$59.95	44.95
XF1 - 10.7 MONOLITHIC IF XTAL FILTER .....	\$10.00	8.95
CRYSTALS: TX OR RX (Common Freq. Only) .....	4.50	3.00

Add \$7.50 per Transceiver for Factory Crystal Installation

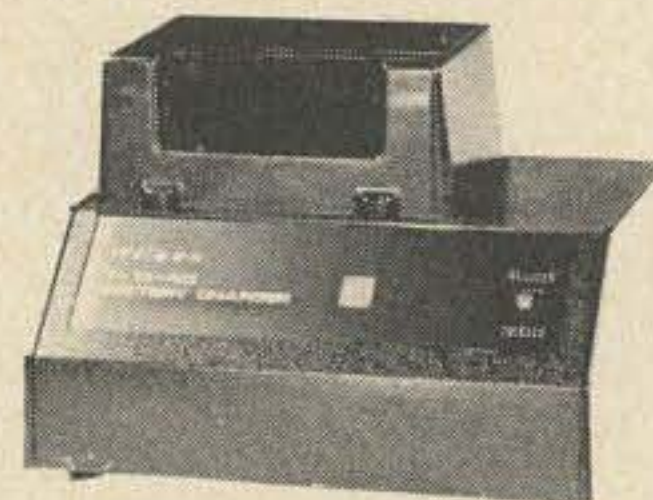

BC-1 NI-CAD BATTERY CHARGER

OVER 1,000 UNITS IN STOCK FOR CHRISTMAS SPECIAL

ORDER EARLY TO INSURE DELIVERY BY CHRISTMAS

TO: WILSON ELECTRONICS CORP., 4288 S. POLARIS AVE., LAS VEGAS, NEVADA 89103  
(702) 739-1931

### CHRISTMAS SUPER SALE ORDER BLANK

\_\_\_\_\_ 1402 SM @ \$164.95. \_\_\_\_\_ 1405 SM @ \$239.95. \_\_\_\_\_ FACTORY XTALS INSTALLED @ \$7.50.  
 \_\_\_\_\_ BC1 @ \$29.95. \_\_\_\_\_ BP @ \$10.95. \_\_\_\_\_ LC1 @ \$8.50. \_\_\_\_\_ LC2 @ \$8.50.  
 \_\_\_\_\_ SM2 @ \$24.95. ( \_\_\_\_\_ TE1 @ \$34.95 SPECIFY FREQUENCY \_\_\_\_\_ )  
 \_\_\_\_\_ TTP @ \$44.95. \_\_\_\_\_ XF1 @ \$8.95. \_\_\_\_\_ TX XTALS @ \$3.00 ea. \_\_\_\_\_ RX XTALS @ \$3.00 ea.

EQUIP TRANSCEIVER AS FOLLOWS: XTALS A. \_\_\_\_\_ 52/52 \_\_\_\_\_ B. \_\_\_\_\_  
 C. \_\_\_\_\_ D. \_\_\_\_\_ E. \_\_\_\_\_ F. \_\_\_\_\_

ENCLOSED IS \_\_\_\_\_  CHECK  MONEY ORDER  MC  BAC

CARD # \_\_\_\_\_ EXPIRATION DATE \_\_\_\_\_

XTALS \_\_\_\_\_

NAME \_\_\_\_\_ ADDRESS \_\_\_\_\_

CITY \_\_\_\_\_ STATE \_\_\_\_\_ ZIP \_\_\_\_\_

SIGNATURE \_\_\_\_\_

SHIPPING AND HANDLING PREPAID FOR CHRISTMAS SPECIAL  
 SALE ENDS DECEMBER 31, 1975 NEVADA RESIDENTS ADD SALES TAX

*Wilson Electronics Corp.*  
**CHRISTMAS SUPER SPECIAL**

1405SM HAND HELD  
5 WATT  
TRANSCEIVER

SPECIAL INCLUDES:  
RUBBER FLEX ANTENNA  
52-52 CRYSTAL

**\$239<sup>95</sup>**



1402SM HAND HELD  
2.5 WATT  
TRANSCEIVER

SPECIAL INCLUDES:  
RUBBER FLEX ANTENNA  
52-52 CRYSTAL

**\$164<sup>95</sup>**

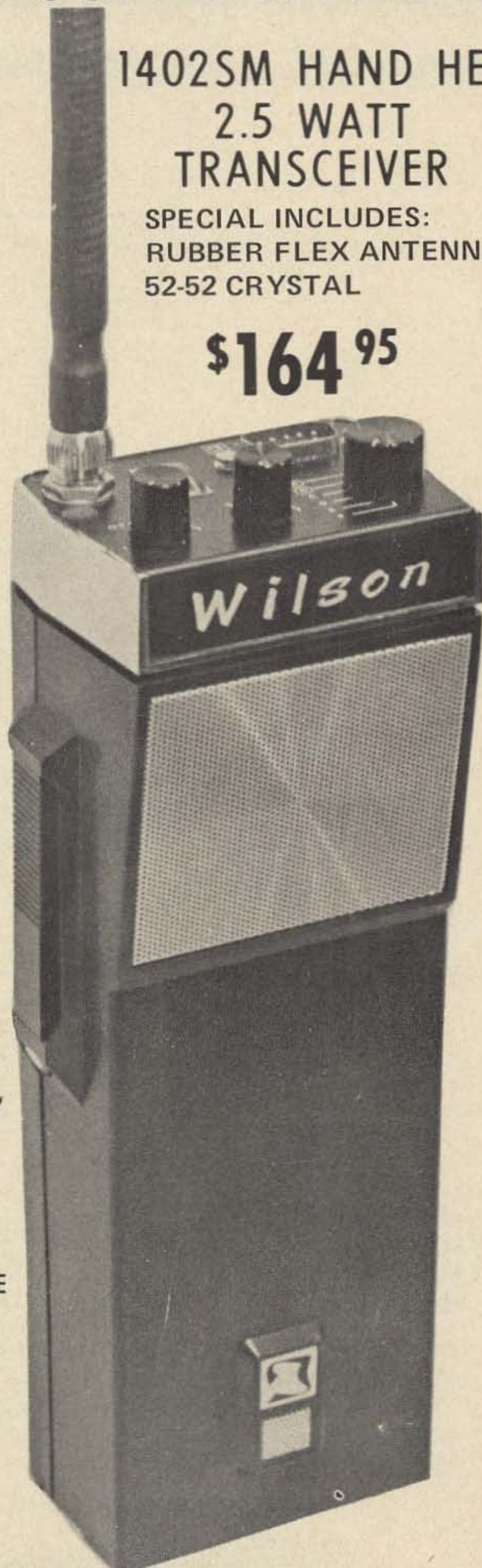

90 DAY  
WARRANTY

10 DAY  
MONEY  
BACK  
GUARANTEE

CAN BE  
MODIFIED  
FOR  
MARS  
OR  
CAP

**ORDER EARLY FOR CHRISTMAS DELIVERY**

# Wilson Electronics Corp.



## WILSON 204 MONOBANDER PLUS DB33

REAL  
MONO  
PERFORMANCE  
ON  
10-15-20

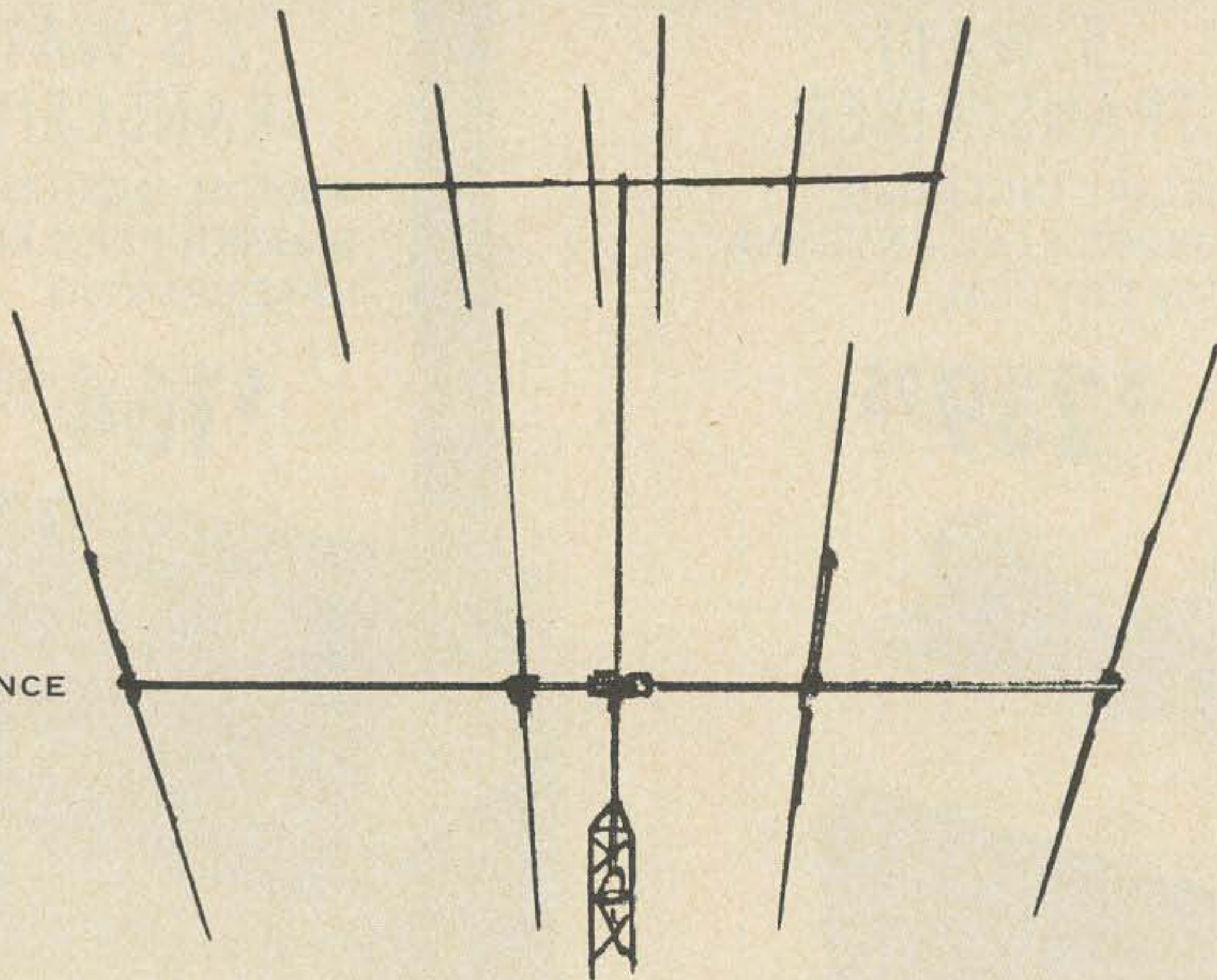

The Wilson 204 is the best and most economical antenna of its type on the market. Four elements on a 26' boom with Gamma Match (No balun required) make for high performance on CW & phone across the entire 20 meter band.

The 204 Monobander is built rugged at the high stress points yet using taper swaged slotted tubing permits larger diameter tubing where it counts, for maximum strength with minimum wind loading. Wind load 99.8 lbs. at 80 MPH. Surface area 3.9 sq. ft., Weight 50 lbs., Boom 2" OD.

All Wilson Monoband and Duoband beams have the following common features:

- Taper Swaged Tubing
  - Full Compression Clamps
  - No Holes Drilled in Elements
  - 2" or 3" Aluminum Booms
  - Adjustable Gamma Match  $52 \Omega$
  - Quality Aluminum
  - Handle 4kw
  - Heavy Extruded Element to Boom Mounts
- |                                       |  |
|---------------------------------------|--|
| • M204 4 ele. 20, 26' 2" OD \$139.00  | • M240 2 ele. 40, 16', 3" OD \$299.00            |
| • M155 5 ele. 15, 26' 2" OD \$139.00  | • M520 5 ele. 20, 40', 3" OD \$269.00            |
| • M154 4 ele. 15, 20', 2" OD \$ 89.00 | • DB54 5 ele. 20, 4 ele. 15, 40', 3" OD \$299.00 |
| • M106 6 ele. 10, 26', 2" OD \$ 99.00 | • DB43 4 ele. 15, 3 ele. 10, 20', 2" OD \$119.00 |
| • M104 4 ele. 10, 17', 2" OD \$ 64.95 | • DB33 3 ele. 15, 3 ele. 10, 16', 2" OD \$ 89.00 |

All Wilson Antennas are FACTORY DIRECT ONLY! The new low prices are possible by eliminating the dealer's discount. All antennas in stock. If you order any antenna you may purchase a CDR Ham II for \$124.95 or a CDR CD44 for \$85.95. Send check or money order, or phone in BankAmericard or Master Charge. All 2" Boom antennas shipped UPS or PP. 3" by truck.

Call for special Tower, Antenna & Rotor package.

## Wilson Electronics Corporation

4288 S. Polaris Avenue, Las Vegas, Nevada 89103

702-739-1931

**If you are on 2-meters now**

**... but you're tired of being stuck  
with too few channels**

**... and you'd like more versatility**

**... and you really do need tunable  
VFO**

**... and SSB-CW (don't forget  
OSCAR!)**

**... you need Kenwood's  
NEW**



## TS-700A

It solves all of these problems and lots more. And best of all... the TS-700A reflects the type of quality that has placed the Kenwood name out front.

- Operates all modes: SSB (upper & lower), FM, AM, and CW
- Completely solid state circuitry provides stable, long lasting, trouble-free operation
- AC and DC capability. Can operate from your car, boat, or as a base station through its built-in power supply
- 4 MHz band coverage (144 to 148 MHz) instead of the usual 2
- Automatically switches transmit frequency

600 KHz for repeater operation... reverses, too

- Outstanding frequency stability provided through the use of FET-VFO
- Zero center discriminator meter
- Transmit/Receive capability on 44 channels with 11 crystals
- Complete with microphone and built-in speaker
- The TS-700A has been thoroughly field-tested. Thousands of units are in operation throughout Japan and Europe

The TS-700A is available at select Kenwood dealers throughout the U.S. For the name of your nearest dealer, please write.

*Kenwood... pacesetter in amateur radio*

Distributed by



**TRIO-KENWOOD  
COMMUNICATIONS INC.**

116 East Alondra / Gardena, California 90248



# KLM MULTI-2000



*Get in on all the action of Simplex, Repeater, DX, OSCAR or local SSB with the new KLM MULTI-2000.*

## FEATURES

- PLL synthesizer covers 144-148 MHz in 10 kHz steps
- Separate VXO and RIT for full between-channel tuning
- Simplex or  $\pm 600$  kHz offset for repeater operation
- Multi-mode operation capability SSB/CW/NBFM/WBFM
- Built-in ac and dc supplies, noise blanker, squelch and rf gain control
- Selectable low power 1-10 watts and 10 watt output
- Separate "S"/rf power and frequency deviation meter
- Built-in test tone and provision for touch tone
- Excellent sensitivity

*Something this good DESERVES the best in sales, service and support. KLM now stands behind the performance and quality of the MULTI-2000 as we do with all our fine products.*

# KLM

*See your nearest dealer or call on us*

## ELECTRONICS

17025 Laurel Rd., Morgan Hill, CA 95037 (408) 779-7363





# RADIOS UNLIMITED

## *Featuring the Multi 2000*



- PLL synthesizer covers 144-148 MHz in 10 kHz steps
- Separate VXO and RIT for full between-channel tuning
- Simplex or  $\pm 600$  kHz offset for repeater operation
- Three selectable priority channels
- Multi-mode operation (CW/SSB/NBFM/WBFM)
- Built-in AC and DC power supplies, noise-blanker squelch and rf gain control
- Selectable 1W or 10W output
- Separate S-/power and frequency deviation meters
- Built-in test (call) tone and touch-tone provision
- Excellent sensitivity (.3  $\mu$ V for 12 dB SINAD)
- Superior immunity to crossmodulation and intermodulation
- Introductory price: \$795.

*Covers 144-148 MHz in 10 kHz. Separate VXO and RIT for full tuning. Simplex or Gooke offset, etc.*

### *Also:*

Bearcat scanners — Turner microplexers, CDR Rotators, Rohn towers, Mosley antennas, Brimstone 2 Meter XCVR, KLM complete line of amplifiers — Echo 2, beams, etc.

# RADIOS UNLIMITED

86 Balch Ave., Piscataway, N.J. 08854

Phone: 201-752-4307

# DUPAGE FIN

EVEN I CAN'T  
BEAT DUPAGE'S  
LOW PRICES!



# DUPAGE FM

**WILL NOT BE UNDERSOLD!**



## **Santa Claus Specials**

RE72JB3 — 42 to 50 MHz. 100 Watts output, with noise blanker to eliminate ignition and other noises. Two frequency transmitter, single frequency receiver. These should be great for six meter use, with accessories.  
Regularly \$335, Santa Claus Special .....\$275

FE/RE72 JA3 — 42 to 50 MHz, 100 Watts output. Single frequency transmitter and receiver with accessories.  
Regularly \$250, Santa Claus Special .....\$225

FE/RE73 JA6 — 152 to 162 MHz, 80 Watts output. Single frequency transmitter and receiver with accessories.  
Regularly \$225, Santa Claus Special .....\$195

RE/FE 53 JA6 — 152 to 162 MHz, 35 Watts output. Single frequency transmitter and receiver, with accessories.  
Regularly \$175, Santa Claus Special .....\$155

RE/FE53 JC6 — 152 to 162 MHz, 35 Watts output. Two frequency transmitter and receiver, with accessories.  
Regularly \$200, Santa Claus Special .....\$180

**DU PAGE FM Inc.**

*P.O. Box 1, Lombard IL 60148*

*(312) 627-3540*

TERMS: All items sold as is. If not as represented return for exchange or refund (our option). Shipping charges prepaid within 5 days of receipt. Illinois residents must add 5% sales tax. Personal checks must clear before shipment. All items sent shipping charges collect unless otherwise agreed. Accessories do not include crystals, reeds, relay or antennas.

# Shipmates wanted.

to join 'barefoot' expedition to West Indies Islands.



And, we'll promise you only one thing. The most adventurous vacation you have ever experienced. Hop aboard our schooner for 10 sunfilled days and moonlit nights. A congenial group of shipmates now forming and setting their heading for Saba, Grenada, St. Lucia, Guadeloupe. And, Dutch St. Maarten. And, French Martinique. Explore pink, white and black sand beaches. Scale the cliffs, climb a volcano, prowl old forts and quaint towns. Hoist the sails, take a turn at the wheel or feet on the rail and let us do the work. Then limbo to a steel band and fall asleep under a star spangled Caribbean sky. Share from \$250. If you have the spirit...come Windjammin'... a true life adventure. This coupon will bring you a full color adventure brochure.

#### *SPECIAL HAM DISCOUNT*

Send me your color brochure on 10 day 'barefoot' vacations from \$250.

Name \_\_\_\_\_

Address \_\_\_\_\_

City \_\_\_\_\_ State \_\_\_\_\_ Zip \_\_\_\_\_

 **Windjammer Cruises.**

Post Office Box 120, Dept. 00, Miami Beach, Florida 33139.

# 'Round the world cruise'

## Meet adventure head on!

Rapa, Tahiti, Moorea, Galapagos,  
Zanzibar, Devil's Island, Madagascar,  
Martinique, Samoa, Tutuila, Danger Island  
aboard the world famous motor sailer Yankee Trader.

On December 10, 1975 you can share one of the most exciting experiences in the world. 6 adventurous months prowling the world's most unusual ports. First come . . . first served. Write now for information on adventure that won't stop.

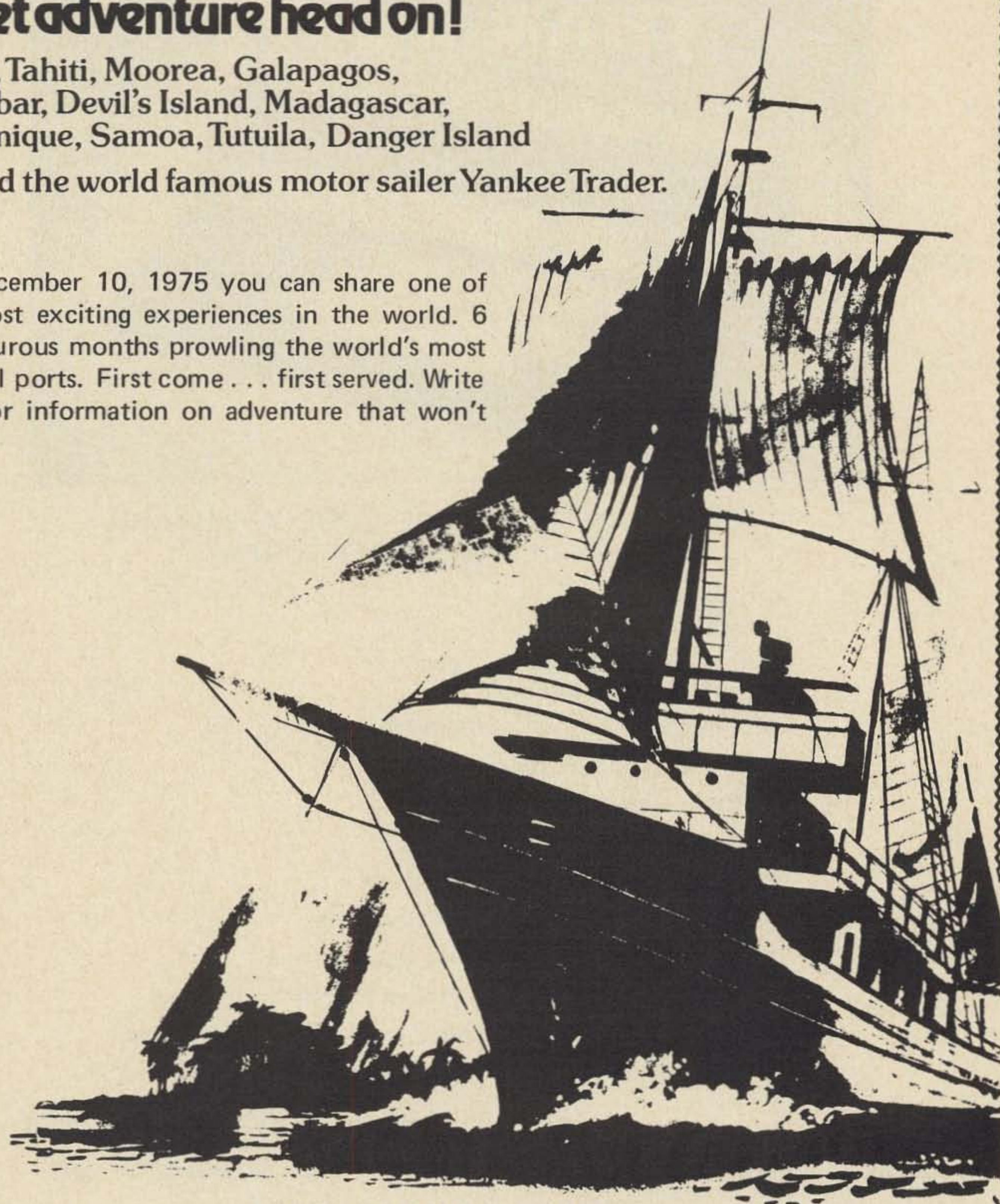

*SPECIAL HAM DISCOUNT*

Name \_\_\_\_\_

Address \_\_\_\_\_

City \_\_\_\_\_ State \_\_\_\_\_ Zip \_\_\_\_\_

 **Windjammer Cruises.**

Post Office Box 120, Dept. 00, Miami Beach, Florida 33139.

# MORE MEMORIES THAN AN



## DOES ANY OTHER MORSE CODE KEYBOARD HAVE ALL THESE FEATURES?

- Programmable memory right on the keyboard
- Running memory lets you type up to 72 characters ahead
- Variable speed from 4 to 100 WPM
- Memory overload indicator (LED)
- 48-hour burn-in prior to shipment
- Space bar is used for word spacing
- Computer grade switches and keytops
- Cooling fan to assure long component life
- 110 V/ac operated with built-in audio monitor
- Double sided-plated thru-G10 Glass Printed Circuit Board
- Black naugahyde finish on metal case with walnut end plates
- 90-day parts/labor warranty, plus 2 years on all parts

ORDERING INFORMATION		
MODEL	PROGRAMMABLE MEMORY INCLUDED	PRICE
TS-172	One	\$369.95
TS-272	Two	\$389.95
TS-372	Three	\$409.95
TS-472	Four	\$429.95
TS-572	Five	\$449.95
TS-672	Six	\$469.95



TELSTAR ENTERPRISES  
P. O. Box 235  
Spokane, Washington 99215

- Enclosed is \$ \_\_\_\_\_
- Charge Master Charge # \_\_\_\_\_
- Charge BankAmericard # \_\_\_\_\_
- Send Free Brochure

Call Letters \_\_\_\_\_

Name \_\_\_\_\_

Address \_\_\_\_\_

\_\_\_\_\_  
City/State/Zip

# Merry Christmas



TELSTAR ENTERPRISES

P.O. Box 235

Spokane, Washington 99215

# Get Your MITTS on a GODBOUT RAM KIT 4Kx8

Tri-state buffered out drives 20 TTL loads; good buss drive, low noise susceptibility. Extend feature, memory protect. On board voltage regulation. PRESENTS 1 LPTTL LOAD TO ALTAIR & OTHER BUSSES.

**\$109.22 \* 1/3c per bit**

## LOW POWER EROM BOARD KIT(S)

**4k x 8 \$200**

ADD \$25 & WE'LL PROGRAM

**2k x 8 \$125**

ADD \$15 & WE'LL PROGRAM

Put your editor/assembler or whatever in these low power EROM board kits. Fast-- 1 usec, 1 wait. Full 4K needs only 5V @ 1/2 A and -12V @ 100 ma; board runs cool, power supply doesn't grunt.

ALTAIR 8800 OWNERS, PLEASE TAKE NOTE: THE ABOVE MEMORY BOARDS ARE DIRECTLY PLUG-IN COMPATIBLE! NO JUMPERS, NO RASSLE, NO HASSLE. (ALSO ELECTRICALLY COMPATIBLE WITH OTHER 8 BIT MACHINES---RGS 008A, MARK VIII, ETC.)

## INTEGRATED CIRCUITS



DM8097	\$1.20	TRI-STATE HEX BUFFER
DM8131	\$2.50	6 BIT UNIFIED BUS COMPARATOR WITH HI Z INPUTS AND HYSTERESIS
DM8544	\$0.90	QUAD TRI-STATE SWITCH DEBOUNCER
DM8833	\$1.90	QUAD TRI-STATE TRANSCEIVER WITH HYSTERESIS
DM8837	\$1.85	HEX UNIFIED BUS RECEIVER WITH HYSTERESIS
DS0026	\$3.00	DUAL CLOCK DRIVER
DS3608	\$3.00	HEX TRI-STATE MOS TO TTL CONVERTER WITH PROGRAMMABLE INPUT CURRENT
8008	\$17.95	POPULAR 8 BIT MICROPROCESSOR---IDEAL FOR PERIPHERAL CONTROL AT A BELIEVEABLE PRICE
5204	\$24.50	SIMILAR TO 5203 (SEE BELOW), BUT 4K BITS WORTH OF EROM



**SPECIAL!** ORDERS POSTMARKED BEFORE NOVEMBER 30: 5203 2K EROM: ORGANIZE AS A 4X512 OR 8X256 BIT MEMORY. FULLY PROGRAMMABLE AND ERASEABLE, COMPLETELY STATIC AND NON-VOLATILE. **\$9.95!**

**ANOTHER SPECIAL!** 8 BIT MICROCOMPUTER CHIP SET: 1-8008, 8-2102s (1K STATIC RAMS) FOR **\$32.50**

## 16 BIT KIT COMPUTER NEWS REPORT

THIS AD IS BEING PREPARED IN MID-AUGUST, SO WE DON'T HAVE ALL THE DETAILS NAILED DOWN YET. HOWEVER, WE'VE HAD THE SYSTEM UP AND RUNNING FOR A COUPLE OF MONTHS NOW; IT'S SITTING IN BERKELEY, EXECUTING INSTRUCTIONS AND WAITING FOR ITS CASING AND FRONT PANEL. OUR TARGET PRICE FOR THE KIT? UNDER \$600---AND THIS INCLUDES AUDIO CASSETTE I/O, BIT-SERIAL INTERFACE FOR TELETYPE, EDITOR AND ASSEMBLER, 1K x 16 INTEGRAL RAM, AS WELL AS THE KEYBOARD, READOUTS, PANEL, POWER SUPPLY, AND MORE. FINAL BIDS ON SHEET METAL WORK AND THE LIKE ARE DUE IN ANY DAY NOW; AND WE'VE JUST ABOUT DECIDED ON A NAME---SO DON'T SEND IN ANY MORE SUGGESTIONS! THANKS TO ALL OF YOU WHO TOOK THE TIME TO ENTER OUR CONTEST. BY THE TIME THIS AD HITS THE NEWSSTAND, WE'LL HAVE A SYSTEM DATA PACKAGE AVAILABLE AT SOME NOMINAL COST. WE'LL KEEP YOU POSTED; THANK YOU FOR YOUR INTEREST AND SUGGESTIONS.

WE'RE CONTINUING OUR  
2<sup>nd</sup> ANNIVERSARY  
**SPECIAL!**  
2102 1K STATIC RAM  
**\$1.95**

DISCOUNTS: BUY 100, TAKE 20% - BUY 1000, TAKE 30%

**GUARANTEED LESS THAN 750 NS.**

THANK YOU VERY MUCH FOR YOUR OVERWHELMING RESPONSE TO OUR SPECIAL!

## CLOCK kit 6 DIGITS

INCLUDES ALL  
PARTS; EASY  
ASSEMBLY  
TOO!

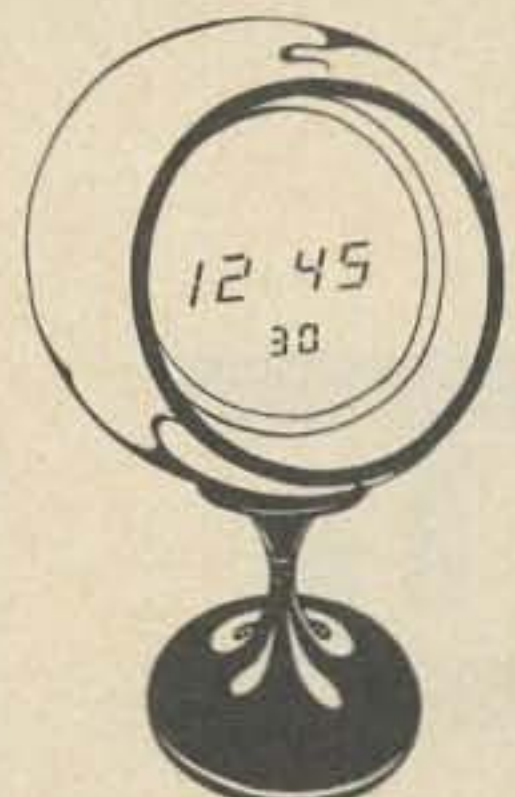

**\$19.95 + 2 LBS**



TERMS: ADD 50¢ TO ORDERS UNDER \$10.  
CAL RES ADD TAX. ADD SHIPPING WHERE  
SHOWN. SORRY, NO COD.

HOT LINE: CALL (415) 357-7007 FOR  
MASTERCARD® OR BANKAMERICARD® OR-  
DERS, 24 HOURS A DAY.

# GODBOUT

BILL GODBOUT ELECTRONICS  
BOX 2355, OAKLAND AIRPORT, CA 94614

## ★ ↻ PACE 16 BIT ↻ ★ MICROPROCESSOR \$125

Real 16 bit parallel microprocessor. 40 pin DIP, 45 classes of instructions, and up to 337 instructions. A powerful processor! Supplied with interface chips for TTL compatibility, and our **PACE** data packet.

THE PACE DATA PACKET IS AVAILABLE SEPARATELY FOR \$2.50 (TO COVER POSTAGE AND PRINTING--REFUNDABLE WITH PACE PURCHASE). YOU GET MANY PAGES OF DETAILED AND SPECIFIC INFORMATION ON THE CHIP ITSELF, SYSTEM ORGANIZATION, SOFTWARE, AND MORE. NOT JUST A DATA SHEET---A COMPLETE PACE REFERENCE PACKAGE. AN EXPERIENCED COMPUTER BUILDER COULD BUILD A COMPLETE SYSTEM FROM INFORMATION IN THIS PACE PACKET ALONE.

Note to OEMS: National Semiconductor is cooperating with us so that schools, hobbyists, and experimenters can have easy access to this powerful new microprocessor for immediate evaluation and prototyping. However, we are not set up to handle OEM orders: OEMS should contact their National distributor or sales office.

RIBBON  
CABLE

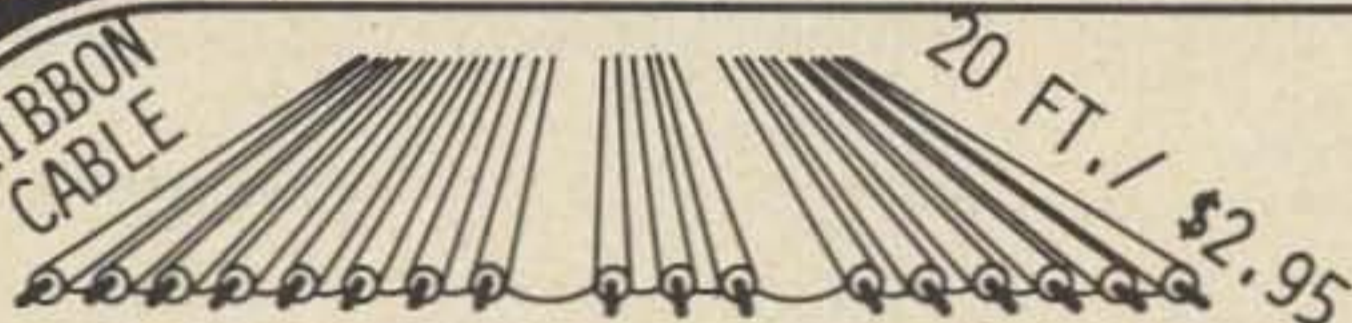

17 Conductor, color-coded; wire width spaced  
for low interlead capacitance.

TWISTED PAIR  
20 FT./ \$4.95

15 twisted pairs, yellow and black

**HAM SPECIALS:**

### COLOR-CODED SPECTRA-STRIP

This is a flat, multiconductor wire, available in multiples of 10 conductors up to 100 conductors. Comes in 20 ft. lengths only. Cost is 1¢ per conductor foot; for example, a 20 conductor cable 20 ft. long = \$4.00

### 2" DYNAMIC SPEAKER:

FOR ACOUSTIC  
COUPLERS, TOYS,  
RADIO'S,  
ETC.  
3/\$2.50

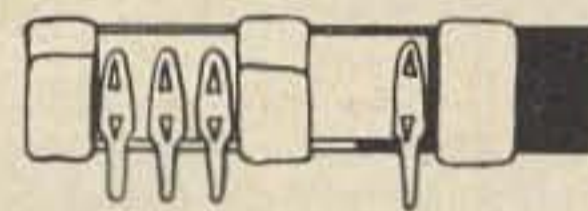

### FERRITE LOOPSTICKS

FOR TRANSISTOR TYPE  
RADIO'S AND OTHER AP-  
PLICATIONS.

THREE FOR \$2.00

## BOOK \$6.95 ! PLUS POSTAGE

"ELECTRONIC PROJECTS FOR MUSICIANS is a new book, written by my friend Craig Anderton, which I heartily endorse for all electronic and musical types. The first 4 chapters tell how to obtain and identify parts, select and care for tools, and apply basic construction techniques; in short, an introduction to basic electronics a la Radio Amateur's Handbook. Chapter 5 contains 19 projects for musical/audio applications, and the book concludes with sections on troubleshooting and where to find more information.

"I believe the book to be of equal interest to the neophyte and to more experienced electronic types. For the neophyte with musical know how the book provides a very understandable, practical, and readable insight into the world of electronics---which can do so much to extend his or her capability. For those already versed in electronics this book opens the door to the world of musical and electronic effects. I'm very enthused about the book and have enjoyed reading portions of it during its creation; I believe it's an ideal primer for anyone interested in music/electronics regardless of their age or experience."

----Bill Godbout

From Guitar Player Productions. With recording of project sounds; forward by Joe Walsh.

## JAMES CHRISTMAS SPECIALS

DIODES		TTL/LINEAR		CLOCK & CALC. CHIPS	
IN4001	50V @ 1 Amp	15/\$1.00	7400	Gate	7/\$1.00
IN4002	100V @ 1 Amp	15/\$1.00	7447	Decoder	.79
IN4003	200V @ 1 Amp	15/\$1.00	7490	Counter	.49
IN4004	400V @ 1 Amp	15/\$1.00	74100	8 Bit Latch	.99
IN4148	Switching	20/\$1.00	74154	Decoder	.99
			74197	Counter	.75
<b>TRANSISTORS</b>			LM301H-LM741H		4/\$1.00
2N2907A	PNP Switching	6/\$1.00	LM324N-Quad 741		1.19
2N2222A	NPN Switching	6/\$1.00	LM309H 5V Reg TO-5		.79
2N3904	NPN Amp	6/\$1.00	LM309K 5V Reg TO-3		.99
2N3906	PNP Amp	6/\$1.00			
2N918	NPN RF	6/\$1.00			
2N5951	NJ Fet	6/\$1.00			
C106B1	3.6 Amp SCR	2/\$1.00			
			<b>DYNAMIC SHIFT REGISTERS</b>		
			MM500H MM504H MM510H	2 FOR	
			MM503H MM506H-MM5016H	\$1.00	
			<b>26 Awg RIBBON CABLE</b>		
			1 Ft. Minimum	1-9 ft. 10 ft.	
			4 Cond.	.49 ft. .39 ft.	
			8 Cond.	.89 ft. .69 ft.	
			16 Cond.	1.49 ft. 1.19 ft.	
			32 Cond.	2.49 ft. 1.99 ft.	

### DISPLAY LEDS

FND70	Com. Cath.	.250	.69
MAN 1	Com. Ano.	.270	\$1.95
MAN 2	5x7 Matrix	.300	3.95
MAN 3	Com. Cath.	.125	.39
MAN 4	Com. Cath.	.187	1.95
MAN 7	Com. Ano.	.30	1.50
DL33	Com. Cath.	.125	1.95
DL747	Com. Ano.	.625	2.50

### DISCRETE LEDS

MV 10	Red	5/\$1.00
MV 50	Red	6/\$1.00
MV 5024	Red	5/\$1.00
MV 5024	Green	4/\$1.00
MV 5024	Yellow	4/\$1.00
MV 5024	Orange	4/\$1.00
MV 50*	Red 1 1/2" Leads	5/\$1.00



### 4' POWER SUPPLY CORDS . . . .

Black **SPECIAL**  
3/\$1.00

### THUMBWHEEL SWITCHES

THUMBWHEEL SWITCH ONLY		
Part No.	Description	Price
SF 12	Single Pole 10 Position	\$2.50
SF 12	Decadal	3.00
SF 21	10 Position BCD only	2.50
SF 21		3.00

Snap together - No Hardware

SERIES SF Front Mount Assembly (811.70)



Note: Picture to the left has the following  
4 ea. SF 12, 1 ea. SF 12, 1 ea. SF 21,  
1 ea. SF 21 and 1 ea. SF 21

ACCESSORIES		
Part No.	Description	Price
SF EP	End Plates (pair)	.50
SF DP	Divider Plate (each)	.40
SF BB	Blank Body (each)	.40
SF HB	Half Body (each)	.40

SERIES SR Rear Mount Assembly (813.70)



Note: Picture to the left has the following  
4 ea. SR 12, 1 ea. SR 12, 1 ea. SR 21,  
1 ea. SR 21 and 1 ea. SR 21

ACCESSORIES		
Part No.	Description	Price
SR EP	End Plates (pair)	.50
SR DP	Divider Plate (each)	.40
SR BB	Blank Body (each)	.40
SR HB	Half Body (each)	.40

Ordering: Order desired switch or switches and add necessary accessories for your particular application.

## NEW PROTO BOARD-100

Here's a low cost, big 10 IC capacity breadboard kit with all the quality of QT Sockets and the best of the Proto-Board series... complete down to the last nut, bolt and screw. Includes 2 QT-35S Sockets; 1 QT-35B Bus Strip; 2 5-way binding posts; 4 rubber feet; screws, nuts, bolts; and easy assembly instructions.



COMPLETE KIT...  
**\*Special \$17.95**

### POCKET CALCULATOR KIT

5 function plus constant - addressable memory with individual recall - 8 digit display plus overflow - battery saver - uses standard or rechargeable batteries - all necessary parts in ready to assemble form - instructions included. 3" x 5 1/4" **SPECIAL \$12.95 each**

OPTIONS -  
115VAC Transformer . . . . . 4.95 each  
6 each "N" Alkaline Batteries . . . . . 1.95 lot



### .394" DIAM. TRIMMER

STANDARD RESISTANCE VALUES

MODEL 100Ω 500Ω 1K  
2K 5K 10K 20K  
100K 200K 1Meg



**SPECIAL Model TR II**

RESISTANCES (OHMS)	1-8	10-34
STD100Ω		
1 MEGΩ	4/\$1.00	

### 1/16 VECTOR BOARD

P Pattern  
0.1" Hole Spacing

MATERIAL	STOCK NO.	LONG	WIDE	PRICES	30
PHENOLIC	64P4 062XXP	4.50	8.50	1.72	1.54
	18P4 025XXP	4.50	17.00	3.88	3.22
EPOXY GLASS	64P4 062	4.50	8.50	2.05	1.86
	18P4 062	4.50	17.00	5.04	4.53
EPOXY GLASS COPPER CLAD	18P4 062	4.50	17.00	6.22	5.25
	18P4 062CT	4.50	17.00	8.80	6.12

### WALL or T.V. DIGITAL CLOCK

12 or 24 Hour 115 Vac  
25" VIEWING DISTANCE  
Walnut Case 6" x 3" x 1"  
Hr. & Min. 6" High  
Seconds 3" High  
KIT - All Comp. & Case . . . . . \$34.95  
Wired & Assembled . . . . . \$39.95



## IC'S EXAR KITS FUNCTION GENERATOR KIT

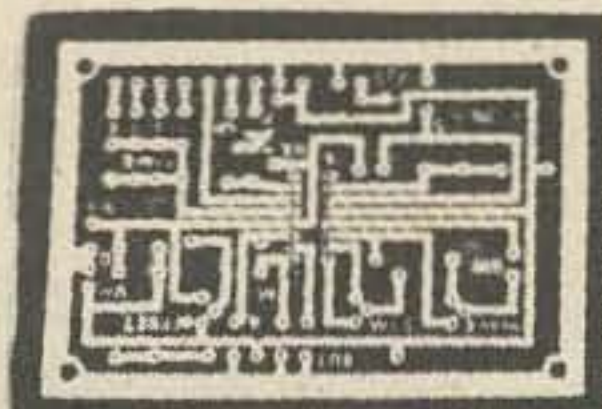

features sine, triangle and square wave, THD 0.5% typ., AM/FM capability

XR-2206KA **SPECIAL \$17.95**  
Includes monolithic function generator IC, PC board, and assembly instruction manual.

XR-2206KB **SPECIAL \$27.95**  
Same as XR-2206KA above and includes external components for PC board.

**TIMERS**  
XR-555CP Monolithic Timer **SPECIAL \$ .69**  
XR-320P Precision Timer 1.55  
XR-556CP Dual 555 Timer 1.85  
XR-2556CP Dual Timing Circuit 3.20  
XR-2240CP Programmable Counter/Timer **SPECIAL 3.25**

**PHASE LOCKED LOOPS**  
XR-210 FSK Demodulator 5.20  
XR-215 High Frequency PLL 6.60  
XR-567CP Tone Decoder (mini DIP) 1.95  
XR-567CT Tone Decoder (TO-5) **SPECIAL .99**

**STEREO DECODERS**  
XR-1310P PLL Stereo Decoder 3.20  
XR-1310EP PLL Stereo Decoder 3.20  
XR-1800P PLL Stereo Decoder 3.20

**WAVEFORM GENERATORS**  
XR-205 Waveform Generator 8.40  
XR-2206CP Monolithic Function Generator **SPECIAL 4.49**  
XR-2207CP Voltage-Controlled Oscillator 3.85

**OTHER EXAR IC'S**  
XR-1468CN Dual +15V Tracking Regulator **SPECIAL 2.95**  
XR-1488N Quad Line Driver 5.80  
XR-1489AN Quad Line Receiver 4.80  
XR-2208CP Operational Multiplier 5.20  
XR-2211 CP FSK Demodulator/Tone Decoder 6.70  
XR-2261 Monolithic Proportional Servo IC System w/4 ea. Driver Transistor 3.79

### \*Special Requested Items\*

RC4194	Dual Track V Reg	\$5.95	N8T97	\$3.00	2533	\$7.95
RC4195	±15V Track Reg	3.25	4024P	2.25	8263	5.95
F9368	Decoder	3.95	2513	11.00	8267	2.75
LD110/111	DVM Chip Set	28.00	2518	7.00	8288	1.15
CA3130	Super CMOS Op Amp	1.49	2524	3.50	8826	3.00
MC1408L7	A/D	9.95	2525	6.00	8880	1.35
F3341	FIFO	8.95	2527	5.00	7497	5.00

### ZENERS-DIODES-RECTIFIERS

TYPE	VOLTS	W	PRICE	TYPE	VOLTS	W	PRICE
IN746	3.3	400m	4/1.00	IN4003	200 PIV	1 AMP	.10
IN751A	5.1	400m	4/1.00	IN4004	400 PIV	1 AMP	.10
IN752	5.6	400m	4/1.00	IN3600	50	200m	6/1.00
IN753	6.2	400m	4/1.00	IN4148	75	10m	15/1.00
IN754	6.8	400m	4/1.00	IN4154	35	10m	12/1.00
IN965B	15	400m	4/1.00	IN4734	5.6	1w	.28
IN5232	5.6	500m	.28	IN4735	6.2	1w	.28
IN5234	6.2	500m	.28	IN4736	6.8	1w	.28
IN5235	6.8	500m	.28	IN4738	8.2	1w	.28
IN5236	7.5	500m	.28	IN4742	12	1w	.28
IN456	25	40m	6/1.00	IN4744	15	1w	.28
IN458	150	7m	6/1.00	IN1183	50 PIV	35 AMP	1.60
IN485A	180	10m	5/1.00	IN1184	100 PIV	35 AMP	1.70
IN4001	50 PIV	1 AMP	.09	IN1186	200 PIV	35 AMP	1.80
IN4002	100 PIV	1 AMP	.10	IN1188	400 PIV	35 AMP	3.00

MPS-A05	5/1.00	TRANSISTORS	PN4249	4/\$1.00	
MPS-A06	5/\$1.00	PN3567	3/\$1.00	PN4250	4/\$1.00
2N2219A	3/\$1.00	PN3568	4/\$1.00	2N4400	4/\$1.00
2N2221	4/\$1.00	PN3569	4/\$1.00	2N4401	4/\$1.00
2N2222A	5/\$1.00	2N3704	5/\$1.00	2N4402	4/\$1.00
2N2369	5/\$1.00	2N3705	5/\$1.00	2N4403	4/\$1.00
2N2369A	4/\$1.00	2N3706	5/\$1.00	2N4409	5/\$1.00
FN2415	5/\$1.00	2N3707	5/\$1.00	2N5086	4/\$1.00
2N2484	4/\$1.00	2N3711	5/\$1.00	2N5087	4/\$1.00
2N2906A	4/\$1.00	2N3724	\$1.00	2N5088	4/\$1.00
2N2907A	5/\$1.00	2N3725	\$1.00	2N5089	4/\$1.00
2N2925	5/\$1.00	2N3903	5/\$1.00	2N5129	5/\$1.00
2N3053	2/\$1.00	2N3904	4/\$1.00	2N5138	5/\$1.00
2N3055	\$1.89	2N3905	4/\$1.00	2N5139	5/\$1.00
MJE3055	\$1.89	2N3906	4/\$1.00	2N5209	5/\$1.00
2N3392	5/\$1.00	2N4013	3/\$1.00	2N5951	5/\$1.00
2N3398	5/\$1.00	2N4014	3/\$1.00	C106B1 SCR	2/\$1.00

# JAMES Electronics

P. O. Box 822 - Belmont, Ca. 94002

PHONE ORDERS WELCOME

(415) 592-8097

Satisfaction Guaranteed. \$5.00 Min. Order. U.S. Funds.  
California Residents - Add 6% Sales Tax  
Write for FREE 1975 Catalog - Data Sheets .25¢ each

# JAMES ELECTRONICS

P. O. BOX 822

BELMONT, CALIFORNIA 94002

(415) 592-8097

## JE801 DIGITAL VOLTMETER

NEW



**\$39.99 Per Kit**  
SINGLE UNIT

### GENERAL DESCRIPTION

The JE801 is a three and one half digit, auto polarity digital voltmeter, in a kit form. It features several options not available in any commercial digital voltmeter. Its low cost is perhaps the most important feature, which is achieved by offering it in a kit form. A kit allows the unit to be used by small OEM's where cost effectiveness is an important factor,

and by the hobbyist who has to be concerned with cost. The unit also features on card regulators, allowing it to be operated off a single plus and minus fifteen volt, unregulated power supply. The unit has a small size of three inches width, three and three quarters of an inch length, and one and a quarter inch height.

# See the Bargains at our Year End Sale! Money Back Guarantee on all Goods--

## Memories



82S129 - 1024 bit ROM (256x4 PROM)

- Access time 50 ns
- Power dissipation .5 MW/BIT
- Tri-state output
- Field Programmable
- 16 pin DIP with data

Each \$5.00 8 for \$34.95

1702 - 2048 bit PROM

- 2K static units
- Ultra-violet light erasable
- New units

Each \$9.95

3107 - 256/1 TTL

- 45 ns
- Random access
- Output is complement

Each \$3.95 8 for \$25.60

74S206 - 256/1 TTL

- 60 ns
- Random access
- Output is complement

Each \$3.95 8 for \$25.60

## CT $\mu$ L SPECIAL

Complementary Transistor Logic. This logic family is unique in that both NPN and PNP transistors are combined in the same package. Unlike TTL & DTL, the outputs are current sources (in the high state) as well as sinking current in the low state. These are brand new units, some of which are mismarked with DTL numbers.

CTL 9956 dual 2-input AND buffer

CTL 9953 2-2-3-input AND/OR gate

CTL 9952 dual 2-input NOR gate

Data supplied; all parts are dual-in-line. MIX OR MATCH. 5 FOR \$1.00

## Transistors

TYPE	DESCRIPTION	PD	VCE	HFF	Ft	1-9	10 for	CASE
2N3440	S NPN GPA	5W	250V	1A		.60	\$5.00	TO-5
2N3904	S NPN	625W	40V	200	300	.15	1.35	TO-92
2N4248	S PNP	.5W	40V	50	-	.15	1.35	TO-92
2N5910	S PNP	625W	20V	100	700	.20	1.75	TO-92
2N5964	S NPN	625W	150V	120	100	.15	1.35	TO-92
GED40D4	S NPN PWR	6.25W	60V	100	200	.40	3.50	TAB
D16P1	S NPN darl.	4W	12V	4K+	20	.60	5.00	TO-98

## LEDs

1.	2.	3.	4.	5.	6.	7.	8.
Fig. 1 ME3	Fig. 2 ME4	Fig. 3 ME5	Fig. 4 MV5040	Fig. 5 ME60	Fig. 6 MV1	Fig. 7 MV2	Fig. 8 MV4
Infra-Red.....	Infra-Red TO-46 Dome.....	Infra-Red.....	5 Lead Epoxy 4 LED Red Array..	Infra-Red Micromini Dome.....	Amber TO-18 Dome 70 MA 2V.....	Green TO-18 Dome.....	High Power Red Wide Dispersal.
.40	.30	2.95	1.25	.25	1.00	1.00	2.95

All merchandise is new unused surplus and is sold on a money back guarantee. Five dollar minimum order. Free first class postage on all orders. California residents please add sales tax.

**SEND FOR FREE FLYER**

Phone (916) 334-2161  
Mail orders to:  
P.O. Box 41778  
Sacramento, CA  
95841

TWX # 910-367-3521

# BABYLON ELECTRONICS

## CMOS

CD4000	dual 3 in NOR plus inverter	\$.29
CD4001	quad 2 in NOR	.29
CD4002	dual 4 in NOR	.29
CD4007	dual comp. pair plus inv.	.29
CD4008	four bit full adder	1.98
CD4009	hex buffer inverter	.59
CD4010	hex buffer non inverting	.59
CD4011	quad 2 in NAND	.29
CD4012	dual 4 input NAND	.29
CD4013	dual D flip flop	.69
CD4015	dual 4 stage SR with SI/PO	1.98
CD4016	quad bilateral switch	.69
CD4019	quad AND-OR select.	.69
CD4023	triple 3 in NAND	.29
CD4024	7 stage ripple counter	1.50
CD4025	triple 3 in NOR	.34
CD4030	quad exclusive OR	.65
74C20	dual 4 in NAND gate	.65
74C42	one of ten decoder	2.00
74C157	quad 2 in data selector	2.50
74C161	syn. 4 bit binary counter	3.00
74C195	4 bit parallel access SR	2.00

## KEYBOARD ASSEMBLY

TRW Data Systems unit; 10 keys 0-9; 3 (or 4) 24V lamps; printed circuit board w/14 1N4001 diodes, capacitors, transistor, and resistors. All mounted in an attractive case approx. 4 1/2 x 4 1/2 x 2 1/2". These are used; no schematic is available. EACH \$6.95

## Utilogic-Signetic

LU300	dual 3 input expander	\$.75
LU301	quad 2 input doide expander	.75
LU305	6 input NAND gate	.75
LU306	dual 3 input NAND gate	.75
LU321	dual JK flip flop	.35
LU333	dual 3 input expandable OR	.35
LU334	dual 4 input expandable NAND	.75

## NPN TO-3 POWER TRANSISTORS

410 (RCA)	200V - 10A	\$1.75
2N3772	70V - 30A(max.)	1.75

## Numeric Display 1/4" Single Digit GaAsP LED

COMMON CATHODE WITH RH DECIMAL

**SUPER SPECIAL \$ .59**

**TEN for \$4.95**

Compact - 10 digits in 3" panel width  
Highly legible - bright red 1/4" character easily read within 10 feet over a wide viewing angle (140°)  
Low power - 125 mW per digit at typical brightness



ACTUAL SIZE

## 812; Monostable Multivibrator

Equal to Signetic 8126 DIP Monostable Multivibrator; features an internal timing resistor and capacitor. External timing components may be added to provide delay from 80 ns to 2s. With internal timing resistor, pulse width is approximately 1 MS per microfarad. Parts are brand new and are branded Signetics and are marked '812'. Data supplied.

Each \$ .40  
10 for 3.50

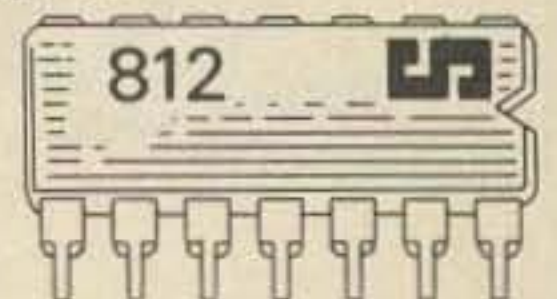

## 949; Special

Triple 3-input NAND gate - pin interchangeable with SN7410 DIP. Branded Signetics and marked '949'. Data supplied.

Each \$ .16  
10 for 1.50

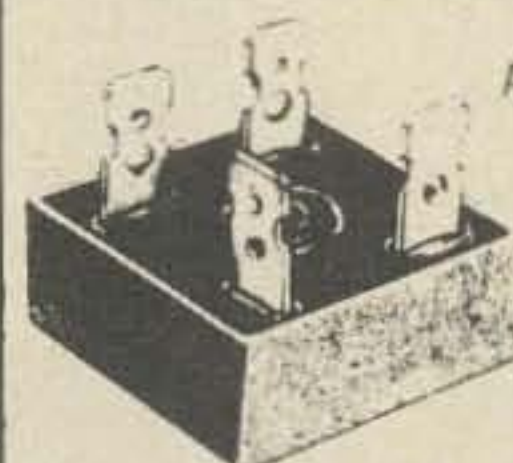
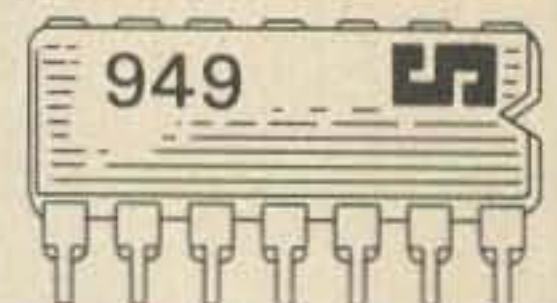

Actual Size

Full Wave Bridge Rectifiers  
25 Amp 500 PIV

Each \$2.00 10 for \$16.50

## Rectifiers

ACTUAL SIZE

1 Amp - Random testing indicates 1200 volts or better. Satisfaction guaranteed.

15 for \$1.00 100 for \$5.00

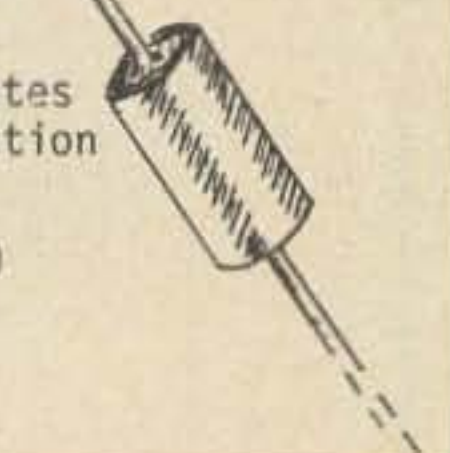

## 0-9 plus MAN 3 Letters.

Right-hand decimal point. Flat-pack type case. Long operating life. IC voltage requirements. Ideal for pocket calculators!

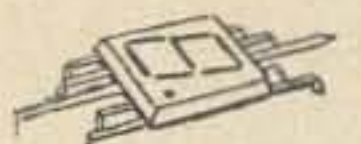

EACH \$.50;  
10 FOR \$3.95

## CD-3 Counter Kit

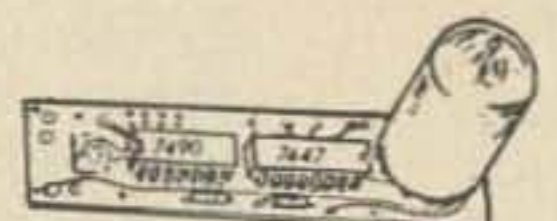

Can be programmed to count to any modulus; 2-9 for one kit, 2-99 for two kits, etc. Includes everything as in CD-2--two resistors, three diodes, but is without the 7475 quad latch. Full instructions included - perfect for displaying seconds, minutes, hours, etc. NOTE: Boards can be supplied in a single panel of up to 10 digits (with all interconnects); hence, when ordering, please specify whether you want them in single panels or in one multiple digit board. COMPLETE KIT ONLY \$9.95



### 7-Segment Readout 12-PIN DIP

Three digits with right-hand decimal  
Plugs into DIP sockets  
Similar to (LITRONIX) DL337  
Magnified digit approximately .1"  
Cathode for each digit  
Segments are parallel for multiple  
operation  
5-10 MA per segment  
EACH \$1.75      4 (12 DIGITS) \$6.00



### Dale Trimmer

-12 turn trimpots which plug  
into a DIP socket  
-5K and 200K  
-1/2" x 1/2" x 1/4"  
-4 leads spaced .3" x .2"  
Each \$.65 10 for \$4.95

### 25K Trimmer

PRINTED CIRCUIT BOARD TYPE  
EACH \$.20      10 FOR \$1.50

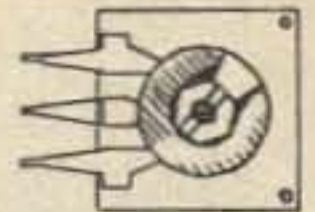

### Rectifiers

VARO FULL-WAVE BRIDGE



VS647    2A    600V    \$1.10  
MR810 Rectifier    50V    1A    \$.10

### RCA Numitron

EACH.....\$ 5.00

SPECIAL: 5 FOR \$20.00

### DR2010



### 1000 MHz Counter

11C05 Fairchild 1GHz Divide By Four

-DC to 1000 MHz operation  
-AC or DC coupled  
-Voltage compensated  
-TTL or ECL power supply  
-50 ohm drive output  
-Lead compatible with Plessey SP613  
-True and complement ECL outputs  
-14 pin DIP  
-Data and application notes  
Each \$49.95

### Special 811: Hex Inverter

TTL DIP Hex Inverter; pin interchangeable with SN  
7404. Parts are brand new and branded Signetics  
and marked "811."

EACH \$ .16  
DATA 10 FOR 1.50  
SHEET 100 FOR 14.00  
SUPPLIED 1000 FOR 110.00



### MOS MEMORY 2102-2

1024 Bit Fully Decoded Static MOS  
Random Access Memory

-fast access 650ns  
-fully TTL compatible  
-n channel silicon gate  
-single 5 volt supply  
-tri-state output  
-1024 by 1 bit  
-chip enable input  
-no clocks or refreshing  
required

Brand New Factory Parts  
16 PIN DIP Each \$4.00  
8 for \$27.95

### LED's

MV50 Red Emitting    \$.20  
10-4 MA @ 2V    10 FOR \$1.25

MV5024 Red TO-18    \$.35  
High Dome    10 FOR \$2.95

MV10B Visible Red    \$.30  
5-7 MA @ 2V    10 FOR \$2.50

### CMOS

CD4001	\$.45	CD4023	\$.45
CD4002	.45	74C20	.65
CD4011	.45	74C160	3.25
CD4012	.45		

### 3-Amp Power Silicon Rectifiers

MARKED EPOXY AXIAL PACKAGE

PRV	PRICE	PRV	PRICE
100.....	\$.10	800.....	\$.30
200.....	.15	1000.....	.40
400.....	.18	1200.....	.50
600.....	.23	1500.....	.65

**DIODE ARRAY** 10-IN914 silicon  
signal diodes in one package. 20  
leads spaced .1"; no common connec-  
tions.  
EACH... \$.25  
10 FOR \$2.25



7400	.20	74H51	.25
74H00	.30	7453	.20
7401	.20	7454	.20
74H01	.25	74L54	.25
7402	.25	74L55	.25
7403	.25	7460	.16
7404	.25	74L71	.25
74H04	.30	7472	.40
7405	.30	74L72	.60
7406	.40	7473	.35
7408	.30	74L73	.75
74H08	.30	7474	.45
7410	.20	74H74	.75
7413	.75	7475	.80
7417	.40	7476	.55
7420	.20	74L78	.70
74L20	.30	7480	.50
74H20	.30	7483	.70
74H22	.30	7489	3.00
7430	.20	7490	1.00
74H30	.30	7492	.65
74L30	.30	7493	1.00
7440	.20	7495	.65
74H40	.30	74L95	1.00
7442	1.00	74107	.35
7447	1.50	74145	1.25
7450	.20	74180	1.00
74H50	.30	74193	1.50
7451	.20	74195	.65

### 7400 Series      DIP

### 1 AMP RECTIFIER

EACH \$ .15

1N4007 1KV PRV

SALE 10 for \$1.00

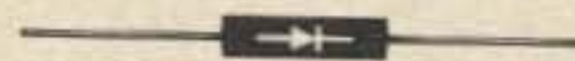

**MAN 4** 7-Segment, 0-9 plus letters.  
Right-hand decimal point. Snaps in 14-  
pin DIP socket or Molex. IC voltage re-  
quirements. Ideal for desk or pocket  
calculators!

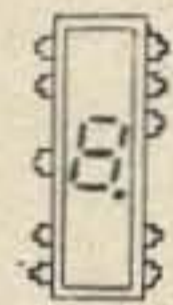

EACH \$1.20      10 OR MORE \$1.00 EACH

### CD-2 Counter Kit

This kit provides a highly sophisticated display  
section module for clocks, counters, or other nu-  
merical display needs. The unit is .8" wide and  
4 3/8" long. A single 5-volt power source powers  
both the ICs and the display tube. It can attain  
typical count rates of up to 30 MHz and also has  
a lamp test, causing all 7 segments to light. Kit  
includes a 2-sided (with plated thru holes) fiber-  
glass printed circuit board, a 7490, a 7475, a  
7447, a DR2010 RCA Numitron display tube, complete  
instructions, and enough MOLEX pins for the ICs...  
NOTE: boards can be supplied in a single panel of  
up to 10 digits (with all interconnects); there-  
fore, when ordering, please specify whether you  
want them in single panels or in one multiple  
digit board. Not specifying will result in ship-  
ping delay.

COMPLETE KIT ONLY \$10.95  
FULLY-ASSEMBLED  
UNIT \$15.00

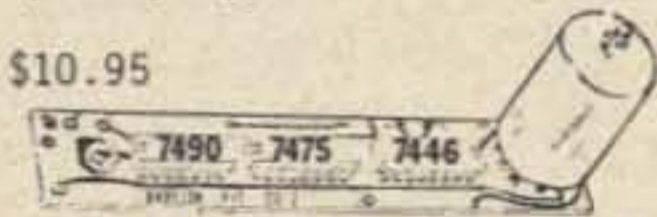

Boards supplied separately @ \$2.50 per digit.

### LINEARS

NE555	Precision timer.....	.90
NE560	Phase lock loop DIP.....	2.95
NE561	Phase lock loop DIP.....	3.00
NE565	Phase lock loop.....	2.95
NE566	Function generator TO-5.....	3.50
NE567	Tone decoder TO-5.....	3.50
709	Popular Op Amp DIP.....	.40
710	Voltage comparator DIP.....	.60
711	Dual comparator DIP.....	.45
723	Precision voltage regulator DIP.....	1.00
741	Op amp TO-5/MINI DIP.....	.45
748	Op Amp TO-5.....	.80
CA3018	2 Isolated transistors and a Darling- ton-connected transistor pair.....	1.00
CA3045	5 NPN transistor array.....	1.00
LM100	Positive DC regulator TO-5.....	1.00
LM105	Voltage regulator.....	1.25
LM302	Op Amp voltage follower TO-5.....	1.25
LM308	Op Amp TO-5.....	2.00
LM309H	5V 200 MA power supply TO-5.....	1.00
LM309K	5V 1A power supply module TO-3.....	1.00
LM311	Comparator Mini.....	1.75
LM370	AGC amplifier.....	1.75
LM380	2-Watt Audio Amp.....	1.75
LM1595	4-Quadrant multiplier.....	1.70
MC1536T	Op Amp.....	1.35

### Power Supply SPECIAL!

723 DIP variable regulator chip 1-40V,  
+ or - output @ 150 MA 10A with exter-  
nal pass transistor--with diagrams for  
many applications.  
EACH \$1.00      10 FOR \$8.95

### 5001 Calculator

40-Pin calculator chip will add, sub-  
tract, multiply, and divide. 12-digit  
display and calculate. Chain calcula-  
tions. True credit balance sign out-  
put. Automatic over-flow indication.  
Fixed decimal point at 1, 2, 3, or 4.  
Leading zero suppression. Complete  
data supplied with chip.

CHIP AND DATA.....ONLY \$2.49  
DATA ONLY (Refundable)... \$1.00  
5002 LOW POWER CHIP AND DATA \$12.95

### High Quality PCB Mounting IC Sockets

8-PIN, 14-Pin, 16-Pin and 24-Pin PCB  
mounting ONLY--no wire wrap sockets.

8-Pin.....\$ .22  
14-Pin.....\$ .26  
16-Pin.....\$ .30  
24-Pin.....\$ .75  
40-Pin.....\$1.25



All IC's are new and fully tested. Leads  
are plated with gold or solder. Orders  
for \$5.00 or more will be shipped prepaid  
Add \$ .55 for handling and postage for  
smaller orders; residents of California  
add sales tax. IC orders are shipped  
within 2 workdays--kits are shipped with-  
in 10 days of receipt of order. \$10.00  
minimum on C.O.D.'s.

### BABYLON ELECTRONICS

Mail orders to: TWX # 910-367-3521  
P.O. Box 41778  
Sacramento, CA Phone (916) 334-2161  
95841

Money back guarantee on all  
goods. Send for free flyer.

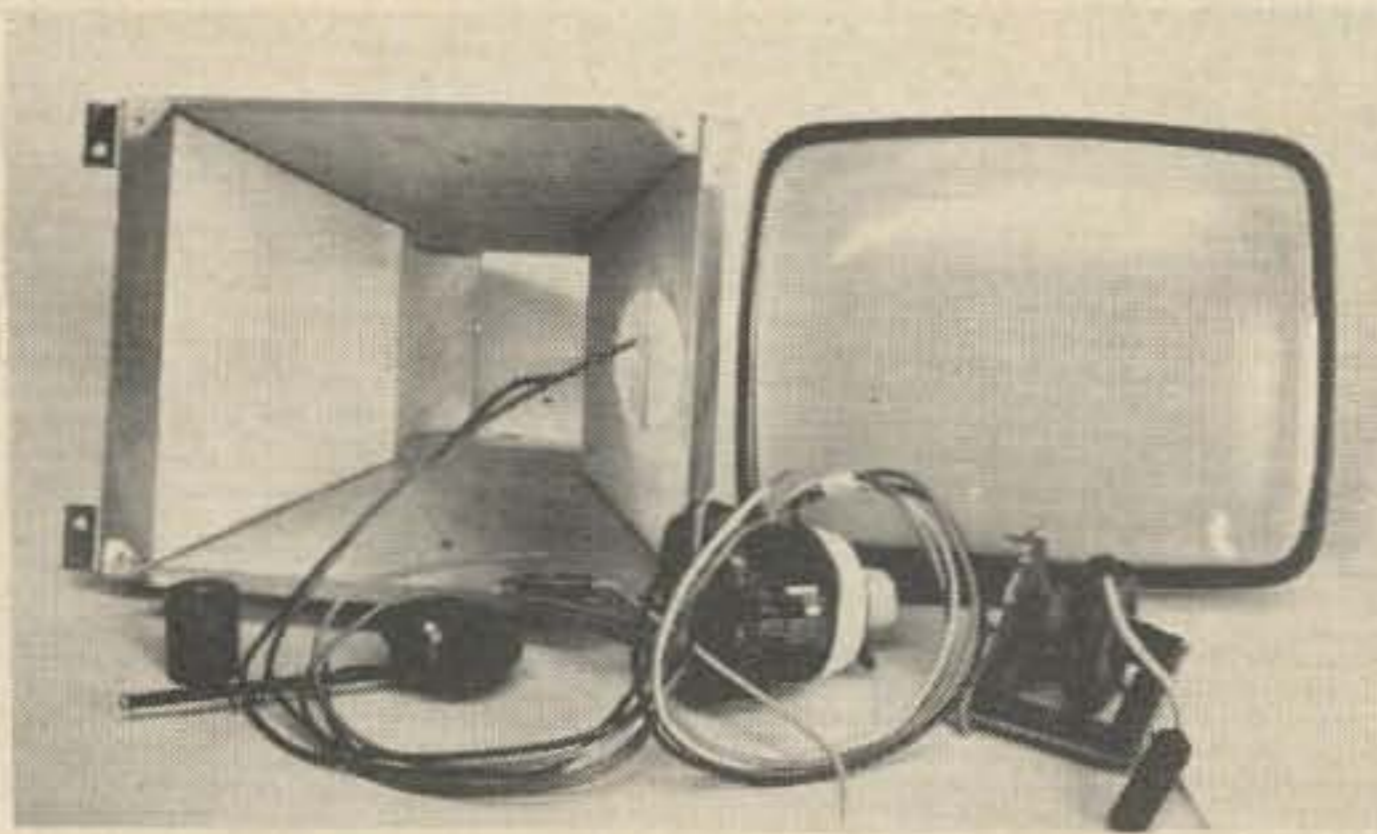

### VIDEO CRT KIT

Kit of parts to build CRT display all brand new parts. Contains 9 inch CRT Sylvania 9ST4716AP39 tube shield, yoke, flyback transformer, socket, grid cap, 20KV door knob capacitor.

Complete kit, all brand new . \$20.00

### NIXIE COUNTER

Preset your count and it counts 0-99 on 2 nixie tubes. Large boards contains the drivers and transistors for decoding. Two switches shown for setting the preset count. 2 nixies shown just above switches. #SP-138A . . . . . \$6.95

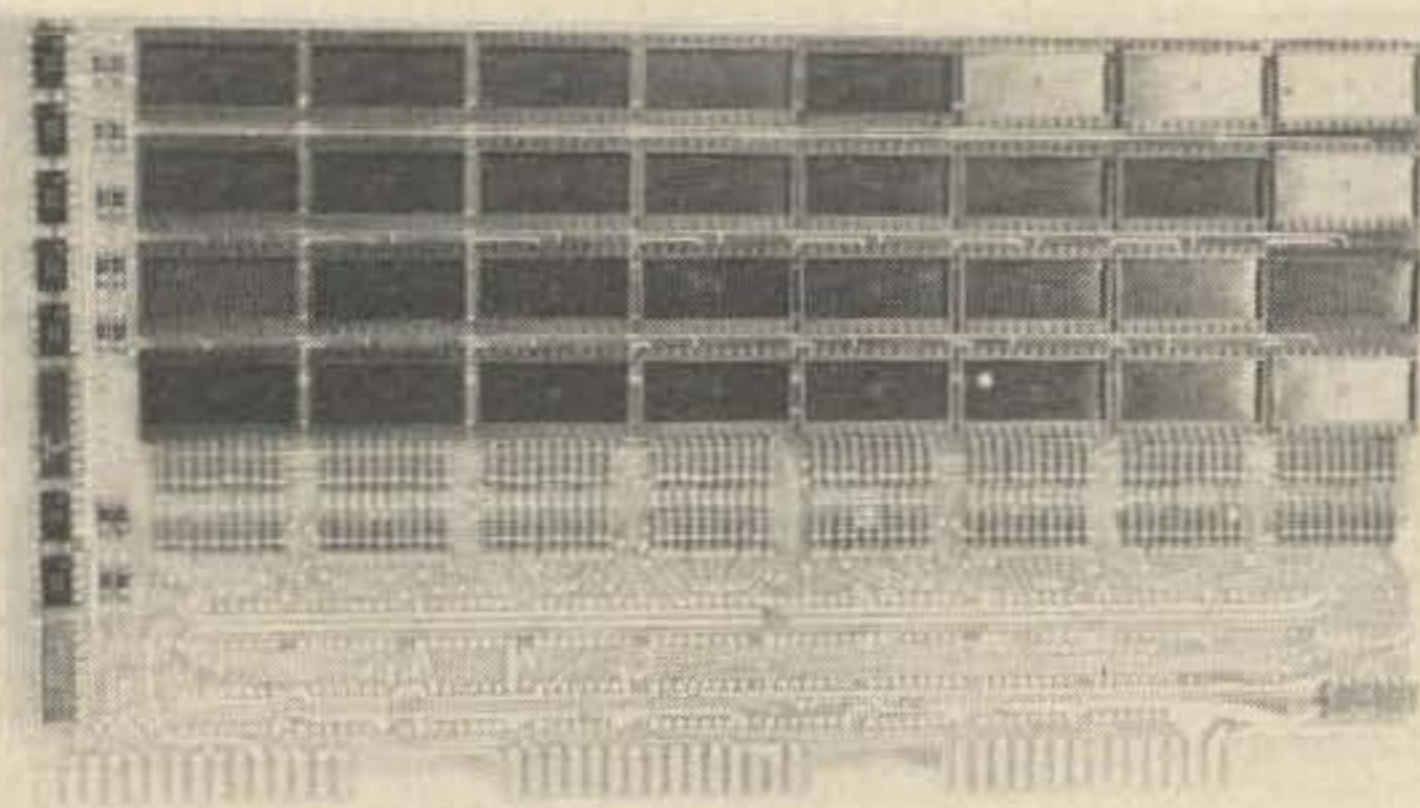
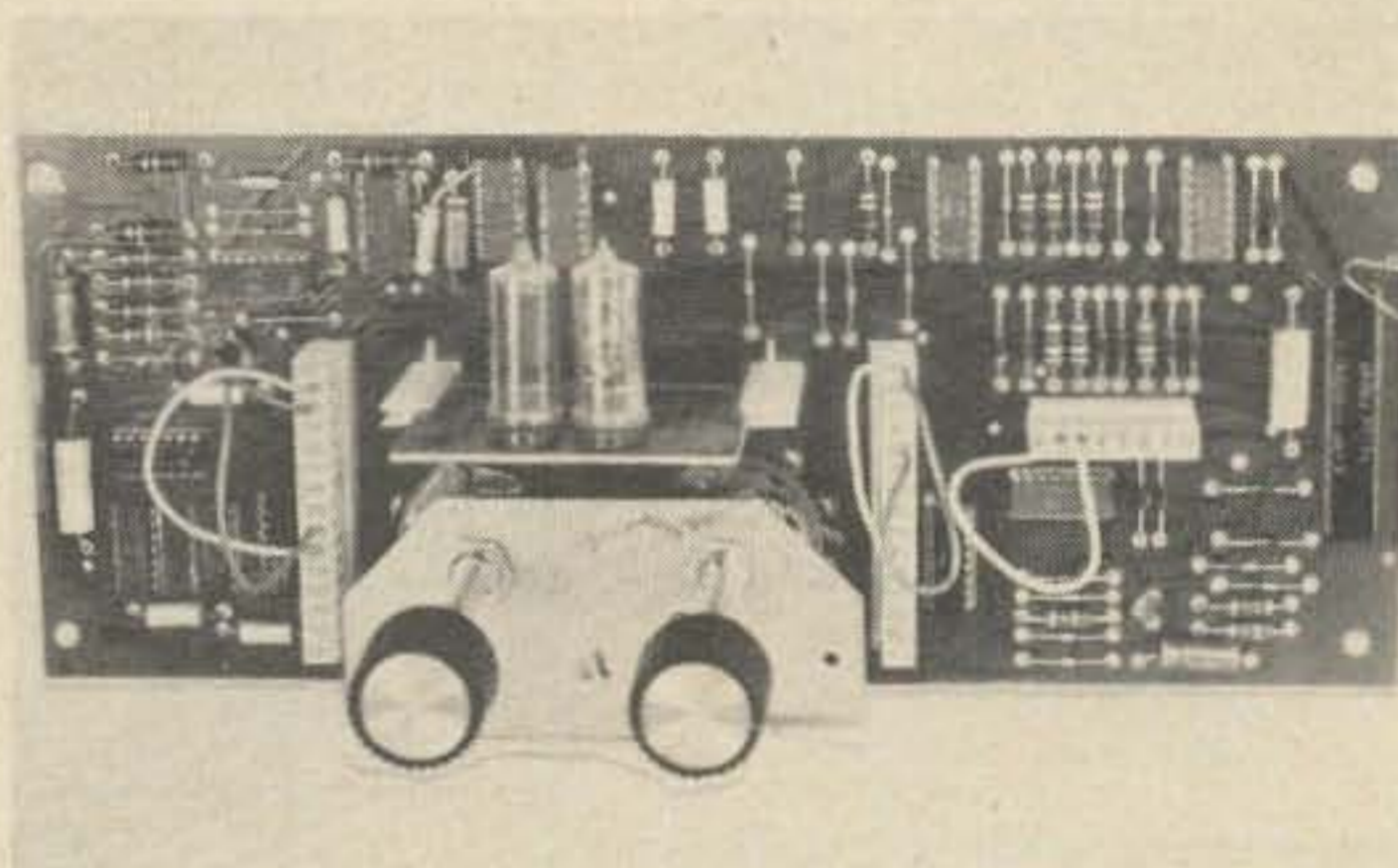

### SALVAGE BOARD

Contains 32 calculator IC sockets, 24 pin giant DIP. 174 resistors, 7 minidip ICs #7530P, one SN 74195N.

#CP-1 . . . . . \$4.95

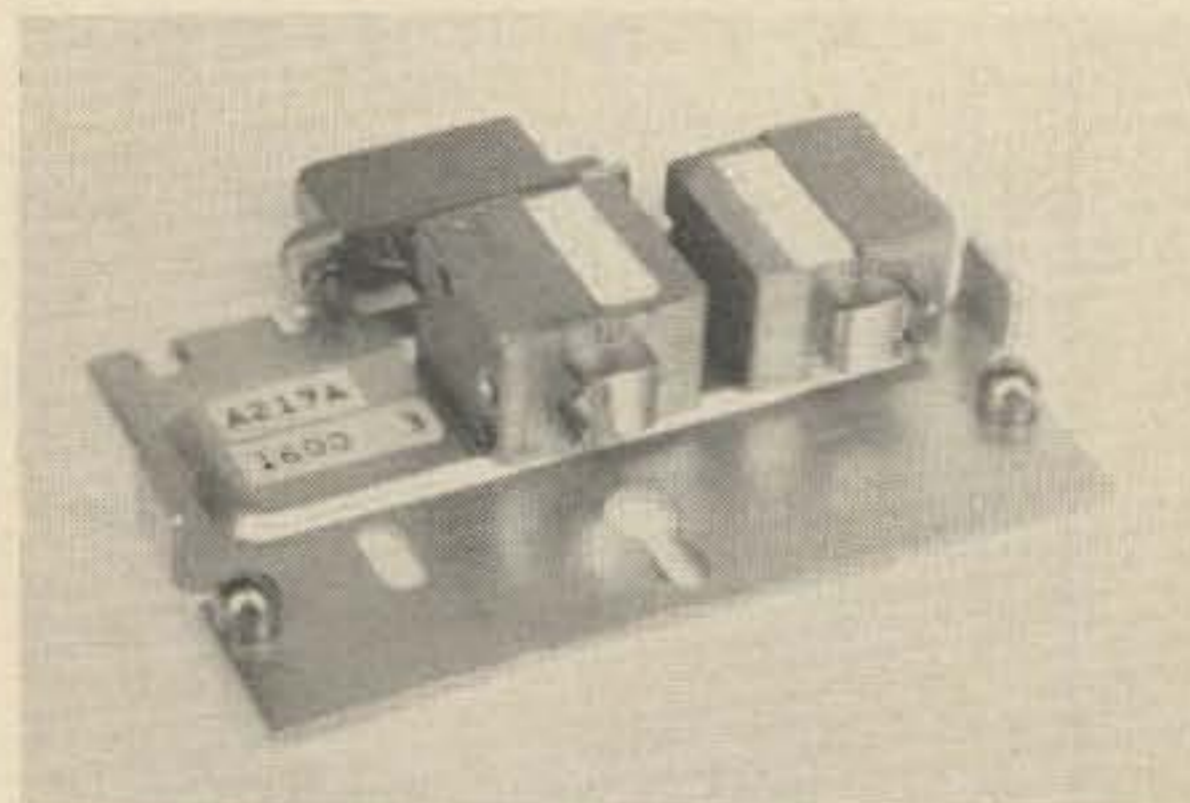

### COMPUTER TAPE HEADS

Brand new by ARVIN Industries made for use on cassette cartridges. Incorporates "Read after write" for verification. Should work out for conversion of cheap cassette machine into quality computer device. Original cost \$16.

#SP-152A . . . . . Now \$5 ea., 6/\$25

*Postage extra on above.*

*Meshna*

P.O. Box 62  
E. Lynn MA 01904

**SN7400 SERIES**

7404	.....	\$ .19
7430	.....	.16
7442	.....	.70
7446	.....	1.00
7473	.....	.36
7474	.....	.36
7476	.....	.39
7492	.....	.59
7493	.....	.59
74124	.....	1.00
74194	.....	1.00

MM 500 dual 25 bit shift register	.....	\$1.50
MM 502 dual 50 bit shift register	.....	1.00

**24-12-6 VOLT 2 AMP KIT**

Power supply kit puts out 24-12-6 volts DC 2 amps. Includes transformer, AC cord, full wave bridge, filter, instructions ..... \$9.00

**B & L NEON HELIUM GAS LASER** .... \$15.00  
 Factory assembled by B & L, 115 volt AC operated. No laser tube

CLOCK 5314	.....	3.00
CLOCK 5316	.....	3.00
CALC. C-550	.....	1.50
CALC. 4204	.....	3.00

MC 790 dual JK flip flop	.....	1.50
MC 792 triple 3 input gate	.....	1.00
ul 900 buffer	.....	3/1.00
ul 914 dual 2 input gate	.....	3/1.00
ul 923 JK flip flop	.....	3/1.00
8H90 Hex inverter	.....	3/1.00
PLR 532 16 bit memory	.....	\$1.00 ea., 6/\$5.00
MC 1440G sense amp	.....	2/1.00
1103 1024 RAM	.....	2.50 .5/10.00
1N1131 Sil. Sig diode 1500 PIV	.....	.50
2N2222 transistor	.....	8/1.00
OPTICAL COUPLER Motorola	...	1.00 .6/5.00

**480 AMP THYRISTOR (SCR) 200 PIV**  
 Perfect for motor control of electric cars, hi current battery chargers, plating, etc. Press-Pac style GE \$20.00 ea., 6/\$100.00

**TOUCH-TONE PHONE \$24.95**

Like new, a value for the touch tone pad alone. Desktop model with cradle phone. Made by Automatic Electric.

#SP-205 \$24.95

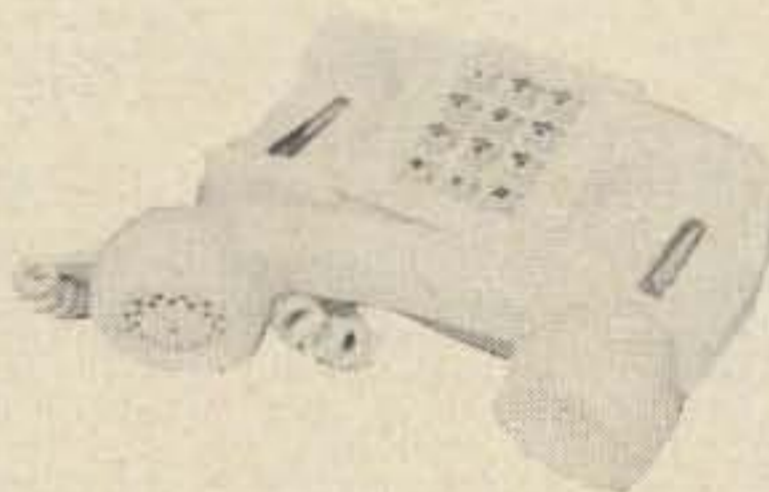

**ANTIQUE SOUNDER**

Takes you back to the Pony Express days. A genuine antique relic dating back to the old days. A real beauty, polished brass, wood base, bright and shiny new despite its age. In original packing as issued to the US Navy Dept. Already worth more than our asking price. Makes an unusual gift or desk top conversation piece for the man who has almost everything.

#SP-115 \$15.00 2/\$25.00



**NIXIE BOARD \$2.50**

Unused PC board with 2 nixies B-5750S mounted and pins terminating on PC board edge. Useful for counters, clocks, etc. Numerals 1/2 inch high. 180 volt neon.

#SP-206 \$2.50



*Please add shipping cost on above.*

*Meshna*

P.O. Box 62  
 E. Lynn, Massachusetts 01904

**FREE CATALOG**

## 4-DIGIT AM-PM FLUORESCENT CLOCK PANEL

YOU ASKED FOR IT! Found only at Poly Paks at this l-o-w price! It's ONLY 1 3/4 x 1 3/16 x 3/8" deep panel. Designed specifically for our MM-5316 fluorescent driving clock chip. Indicates 4-digits, AM-PM, pulsating second indicator, requires minimum of parts to build. Color: BLUE-GREEN; you can use RED or GREEN filters. Character height: 0.5". Filament voltage is 1.75 VAC or DC @ 160 mills. Anode voltage 25V @ 250 microamps per segment. With spec sheets, clock construction diagrams, P.C. board layouts, specs. A DIGITAL CLOCK BUILDER'S SPECIAL.

Made By **TUNG-SOL** D2004 "PANEL OPTICS"

**\$9.99**

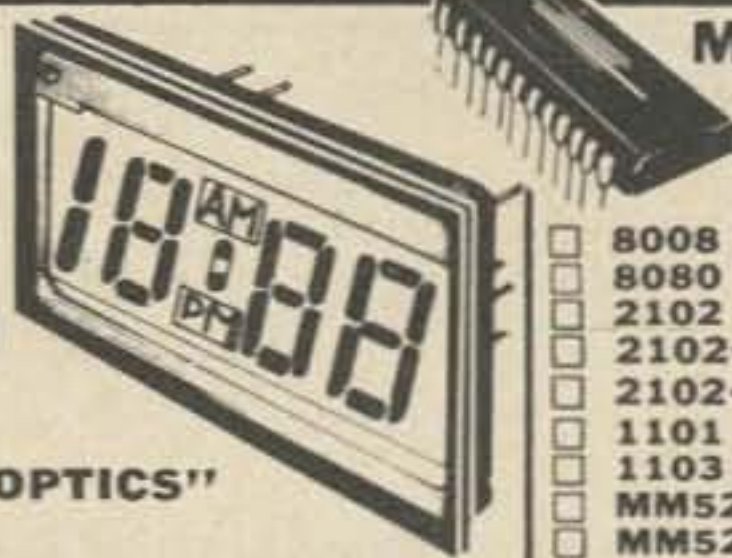

## MICROPROCESSORS! ROMS! RAMS! MEMORIES!

<input type="checkbox"/>	8008 Microprocessor	\$29.95
<input type="checkbox"/>	8080 Super 8008	150.00
<input type="checkbox"/>	2102 1024 Static RAM	3.95
<input type="checkbox"/>	2102-1 1024 Static RAM	4.95
<input type="checkbox"/>	2102-2 1024 Static RAM	4.95
<input type="checkbox"/>	1101 256 bit RAM	1.50
<input type="checkbox"/>	1103 1024 bit RAM	2.95
<input type="checkbox"/>	MM5260 1024 RAM	2.95
<input type="checkbox"/>	MM5262 2048 bit RAM	6.50
<input type="checkbox"/>	2513 Character generator	12.50
<input type="checkbox"/>	MM5203Q Eraceable PROM	14.95
<input type="checkbox"/>	MM5202Q Eraceable PROM	14.95
<input type="checkbox"/>	1702A Eraceable PROM	19.95
<input type="checkbox"/>	8223 Programmable ROM	2.95

## LOWEST PRICES IN POLY PAKS SMASHES U.S.A! 'CALCULATOR' PRICES



9-FUNCTION, 8-DIGIT MEMORY CALCULATOR KIT **\$16.95**  
It's the easiest multi-function kit today!

4-Function Arithmetic 22 KEYS!

KIT INCLUDES: case, 22-key keyboard kit, ON-OFF switch (part of keyboard) PC board, driver and memory calculator chips, 9-digit "bubble" magnifier LED array, array cable, AC adapter jack & wires, battery case, 6 battery card display, instruction and pictorial step-by-step construction booklet. AC/DC too!

DOUBLE MEMORY Percent, Constant, Display Restore

## 'BLASTAWAY' ON 1N4000 RECTIFIER PRICES

Type	PIV	Sale
<input type="checkbox"/>	1N4001	50 10 for 45c
<input type="checkbox"/>	1N4002	100 10 for 55c
<input type="checkbox"/>	1N4003	200 10 for 65c
<input type="checkbox"/>	1N4004	400 10 for 75c
<input type="checkbox"/>	1N4005	600 10 for 85c
<input type="checkbox"/>	1N4006	800 10 for 99c
<input type="checkbox"/>	1N4007	1000 10 for 1.29

## LED Revolution!

### MONSANTO! XCITON! LITRONIX! OPCOA!

#### 5 for \$1

.340x.260 Jumbo		.240x.200 Medium	
<input type="checkbox"/>	Red	<input type="checkbox"/>	Red
<input type="checkbox"/>	Green	<input type="checkbox"/>	Yellow
<input type="checkbox"/>	Yellow	<input type="checkbox"/>	Green
<input type="checkbox"/>	Amber	<input type="checkbox"/>	Amber
<input type="checkbox"/>	Clear	<input type="checkbox"/>	Clear

Micro (Axial) MV-50 style  
 MV-50 Clear . . . . 10 for \$1.  
 MV-55 Red . . . . 6 for \$1.

## 7-SEGMENT READOUT SALE!

\* Up to 20 mills per seg. at 5V. MAN-1  
\* All fit into 14-pin IC socket.

Type	Size	Color	Sale	3 for
<input type="checkbox"/>	MAN-1	.27 Red	\$2.50	\$6.00
<input type="checkbox"/>	MAN-3MA	.12 Red	.69	2.00
<input type="checkbox"/>	MAN-4AB	.27 Red	1.95	5.00
<input type="checkbox"/>	MAN-5	.27 Green	1.50	4.00
<input type="checkbox"/>	MAN-7	.27 Red	1.00	2.50
<input type="checkbox"/>	MAN-8	.27 Yellow	1.50	4.00

ALL ABOVE BY MONSANTO

Type	Size	Color	Sale	3 for
<input type="checkbox"/>	SLA-1	.33 Red	\$1.95	\$5.00
<input type="checkbox"/>	SLA-1	.33 Green	1.95	5.00
<input type="checkbox"/>	SLA-1	.33 Yellow	1.95	5.00
<input type="checkbox"/>	SLA-3	.7 Yellow	4.95	12.00
<input type="checkbox"/>	707	.33 Red	1.95	5.00
<input type="checkbox"/>	704A	.33 Red	1.95	5.00
<input type="checkbox"/>	701C	.33 Red	1.50	3.00
<input type="checkbox"/>	FND-70	.25 Red	1.50	3.00
<input type="checkbox"/>	FND-500	.5 Red	3.95	11.00
<input type="checkbox"/>	FND-507.A	.5 Red	3.95	11.00

A—Common Cathode; others Common Anode  
B—With bubble magnifier  
C—Plus or Minus 1

## LITRONIX "JUMBO'S"

\* Singles size: 1 x 3/4 x 5/16  
\* Duals size: .8 x .9 x .29  
\* 7-Segment, 25-mills per segment

Type	Size	Color	Sale	3 for
<input type="checkbox"/>	721D	.5 Red	\$5.95	\$15.00
<input type="checkbox"/>	727E	.5 Red	5.95	15.00
<input type="checkbox"/>	746F	.6 Red	3.95	11.00
<input type="checkbox"/>	747	.6 Red	3.95	11.00

D—Plus or Minus 1 plus a digit (1 1/2 digits)  
E—Dual digits  
F—Plus or Minus 1

Terms: add postage Rated: net 30  
Phone Orders: Wakefield, Mass. (617) 245-3829  
Retail: 16-18 Del Carmine St., Wakefield, Mass. (off Water Street) C.O.D.'S MAY BE PHONED

20c CATALOG Fiber Optics, 'IC's, Semi's, Parts  
MINIMUM ORDER — \$4.00

## POLY PAKS

P.O. BOX 942A, LYNNFIELD, MASS. 01940

## 4 1/2 DIGIT DIGITAL VOLTMETER DVM CHIP

**\$14.95**

Type MM5330 by National utilizes P channel low-threshold enhancement mode devices and ion implanted depletion mode devices. Provides logic circuit for 4 1/2 digit DVM. TTL compatible. With instruction sheets and diagram on "how-to-build a 4 1/2 digit DVM". Ideal with our Litronix 1/2" single, 1 1/2" and dual digits. 16-pin DIP.

## Touch Tone KEYBOARD KIT **\$4.95**

Kit includes 4 x 2 1/2" G-10 glass etched pc board, with 10 OAK "smooth touch" white keys with black numerals, plus diagram on "touch tone encoder". Makes many "keyboard systems" readily available. 0-to-9



This unit is not advertised anywhere! Made for Motorola Communications at the original cost of \$4.50 each (for insertion in their Walkie Talkie Program). It's a 60-ohm imp MIKE. It's an excellent speaker

## POSTAGE STAMP MOBILE SPKR MIKE **\$1.98**

too, covering broad range in sound. Extremely well-made.

## INDUSTRIAL SPEED CONTROL **\$4.95**



A \$30 item from G.E. Model 533A (made for Xerox) that controls home, shop and industrial lighting tool! A very elaborate circuit for controlling many electrical and electronic devices. Easily controls speeds of electric drills, brush type motors, etc. 115vac, rated at 1100 watts. With variable speed or dimming control in heavy-duty aluminum case. 3 x 2 3/4 x 2. With diagram and hookups.

## **555**

Timer 2 for \$1

OR

## **558**

Dual 741 3 for \$1

## NATIONAL LM-340T VR's

\* TO-220 Case \* 1 Amp \* POSITIVE VOLTAGE

## **\$1.75 Each**

Type	Volts
<input type="checkbox"/>	LM-340-05T 5v
<input type="checkbox"/>	LM-340-06T 6v
<input type="checkbox"/>	LM-340-08T 8v
<input type="checkbox"/>	LM-340-12T 12v
<input type="checkbox"/>	LM-340-15T 15v
<input type="checkbox"/>	LM-340-18T 18v
<input type="checkbox"/>	LM-340-24T 24v

Wow!  
INCREDIBLE  
PRICES

## TUN'S BUY ANY 10 TAKE 15%

## BUY 100 TAKE 25%

<input type="checkbox"/>	SN7400	\$ .16	<input type="checkbox"/>	SN7489	2.45	<input type="checkbox"/>	SN74155	.95
<input type="checkbox"/>	SN7401	.16	<input type="checkbox"/>	SN7490	.59	<input type="checkbox"/>	SN74156	.95
<input type="checkbox"/>	SN7402	.16	<input type="checkbox"/>	SN7491	1.10	<input type="checkbox"/>	SN74157	.95
<input type="checkbox"/>	SN7403	.16	<input type="checkbox"/>	SN7492	.59	<input type="checkbox"/>	SN74158	.95
<input type="checkbox"/>	SN7404	.19	<input type="checkbox"/>	SN7493	.59	<input type="checkbox"/>	SN74160	1.35
<input type="checkbox"/>	SN7405	.19	<input type="checkbox"/>	SN7494	.95	<input type="checkbox"/>	SN74161	1.25
<input type="checkbox"/>	SN7406	.35	<input type="checkbox"/>	SN7495	.79	<input type="checkbox"/>	SN74163	1.35
<input type="checkbox"/>	SN7407	.35	<input type="checkbox"/>	SN7496	.79	<input type="checkbox"/>	SN74164	1.50
<input type="checkbox"/>	SN7408	.19	<input type="checkbox"/>	SN74100	1.40	<input type="checkbox"/>	SN74165	1.50
<input type="checkbox"/>	SN7409	.19	<input type="checkbox"/>	SN74104	.44	<input type="checkbox"/>	SN74166	1.50
<input type="checkbox"/>	SN7410	.16	<input type="checkbox"/>	SN74105	.44	<input type="checkbox"/>	SN74173	1.45
<input type="checkbox"/>	SN7411	.25	<input type="checkbox"/>	SN74106	.52	<input type="checkbox"/>	SN74174	1.39
<input type="checkbox"/>	SN7413	.59	<input type="checkbox"/>	SN74107	.44	<input type="checkbox"/>	SN74175	1.30
<input type="checkbox"/>	SN7414	1.65	<input type="checkbox"/>	SN74108	.89	<input type="checkbox"/>	SN74176	1.20
<input type="checkbox"/>	SN7416	.34	<input type="checkbox"/>	SN74112	.89	<input type="checkbox"/>	SN74177	1.20
<input type="checkbox"/>	SN7417	.34	<input type="checkbox"/>	SN74113	.89	<input type="checkbox"/>	SN74180	.95
<input type="checkbox"/>	SN7420	.16	<input type="checkbox"/>	SN74114	.89	<input type="checkbox"/>	SN74181	2.98
<input type="checkbox"/>	SN7412	.45	<input type="checkbox"/>	SN74121	.49	<input type="checkbox"/>	SN74182	.74
<input type="checkbox"/>	SN7423	.29	<input type="checkbox"/>	SN74122	.48	<input type="checkbox"/>	SN74184	1.98
<input type="checkbox"/>	SN7425	.29	<input type="checkbox"/>	SN74123	.85	<input type="checkbox"/>	SN74185	1.98
<input type="checkbox"/>	SN7426	.25	<input type="checkbox"/>	SN74125	.59	<input type="checkbox"/>	SN74190	1.40
<input type="checkbox"/>	SN7427	.29	<input type="checkbox"/>	SN74126	.59	<input type="checkbox"/>	SN74191	1.40
<input type="checkbox"/>	SN7430	.16	<input type="checkbox"/>	SN74132	1.75	<input type="checkbox"/>	SN74192	1.25
<input type="checkbox"/>	SN7432	.25	<input type="checkbox"/>	SN74140	2.10	<input type="checkbox"/>	SN74193	1.25
<input type="checkbox"/>	SN7433	.49	<input type="checkbox"/>	SN74145	1.05	<input type="checkbox"/>	SN74194	1.20
<input type="checkbox"/>	SN7437	.34	<input type="checkbox"/>	SN74148	2.25	<input type="checkbox"/>	SN74195	.85
<input type="checkbox"/>	SN7438	.34	<input type="checkbox"/>	SN74150	.98	<input type="checkbox"/>	SN74196	1.80
<input type="checkbox"/>	SN7440	.16	<input type="checkbox"/>	SN74151	.75	<input type="checkbox"/>	SN74197	.90
<input type="checkbox"/>	SN7441	1.00	<input type="checkbox"/>	SN74153	.90	<input type="checkbox"/>	SN74199	1.75
			<input type="checkbox"/>	SN74154	1.35	<input type="checkbox"/>	SN74200	4.95



## GIANT DIGIT CLOCK KIT

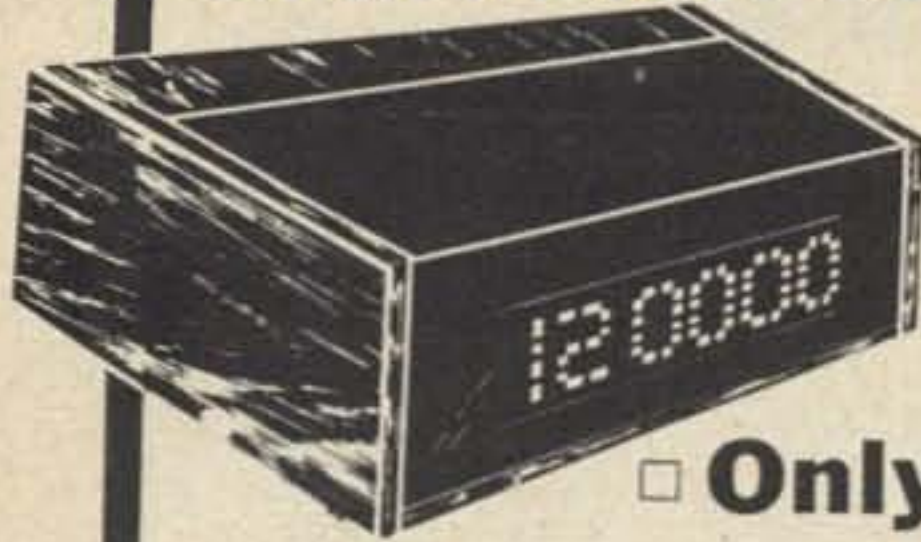

"2001"  
BEEPIN'  
ALARM

Only \$39.95

"Alarmin" low price. Uses famous "MK" Beepin' clock chip. That's right, can you imagine a clock chip that's within itself — B-E-E-P-S! It's the "tomorrow" chip today. Uses the famous all LED MAN-6 or equal readouts from the big "M" people. Minimum parts, in attractive walnut cabinet with black crackle tone. Giant "NO GLARE" red filtered panel. 10 minute SNOOZE ALARM. 3 push buttons and toggle control hours, minutes, alarms and AM-PM indications. EASY TO BUILD! FUN! Instruction booklet. With rubber mounting on cabinet. Power 115VAC. Size 7 3/4 x 7 x 2 1/2". Wt. 2 lbs.

### "C" MOS IC'S

Type	Sale	Type	Sale
<input type="checkbox"/> CD4000AE	\$ .53	<input type="checkbox"/> CD4022AE	2.10
<input type="checkbox"/> CD4001AE	.53	<input type="checkbox"/> CD4023AE	.53
<input type="checkbox"/> CD4002AE	.53	<input type="checkbox"/> CD4024AE	2.15
<input type="checkbox"/> CD4006AE	3.75	<input type="checkbox"/> CD4025AE	.53
<input type="checkbox"/> CD4007AE	.61	<input type="checkbox"/> CD4026AE	8.50
<input type="checkbox"/> CD4008AE	3.50	<input type="checkbox"/> CD4028AE	2.75
<input type="checkbox"/> CD4009AE	.75	<input type="checkbox"/> CD4030AE	.53
<input type="checkbox"/> CD4010AE	.55	<input type="checkbox"/> CD4033AE	3.50
<input type="checkbox"/> CD4011AE	.51	<input type="checkbox"/> CD4040AE	4.50
<input type="checkbox"/> CD4012AE	.53	<input type="checkbox"/> CD4042AE	2.75
<input type="checkbox"/> CD4013AE	1.05	<input type="checkbox"/> CD4043AE	1.10
<input type="checkbox"/> CD4014AE	3.50	<input type="checkbox"/> CD4044AE	1.10
<input type="checkbox"/> CD4019AE	1.10	<input type="checkbox"/> CD4047AE	.80
<input type="checkbox"/> CD4020AE	3.25	<input type="checkbox"/> CD4066AE	3.75

### FULL EPOXY SILICON BRIDGE RECTIFIERS

WAVE	PIV	2 Amp	6 Amp	10 AMP
<input type="checkbox"/>	50	\$ .69	\$ .88	\$1.49
<input type="checkbox"/>	100	.79	.99	1.69
<input type="checkbox"/>	200	.95	1.25	1.89
<input type="checkbox"/>	400	1.19	1.50	2.09
<input type="checkbox"/>	600	1.35	1.75	
<input type="checkbox"/>	800	1.59	1.95	
<input type="checkbox"/>	1000	1.79	2.25	

Code: 2 amp TO-5 case  
6 Amp 1/2 x 1/2 x 3/16 sq.

### GIANT VENTILATING FAN

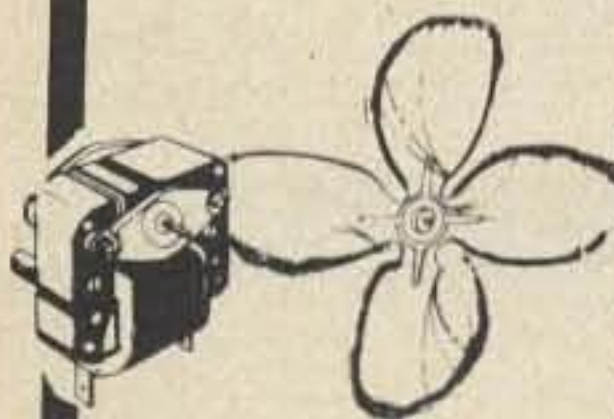

Heavy-duty powerful hitorque motor, ruggedly constructed. Permanently lubricated type bearings. Thermalloy protected. Motor size: 3 x 3 x 2 1/2". By Molon ZM04047. 115 vac 60 hz. 0.77 amps. With 6 1/2 TORIN fan blade. 1500 rpm. For all types of ham & industrial equipment.

Only \$4.98

### XENON FLASH STROBE TUBE



\$1.95

### 6-VOLT NICAD POWER PAK



\$4.95

Includes 4 "A" cell nicad batteries hooked up to give you 6-volts for all types of energy uses. The best batteries made. Rechargeable.



TO-61

### HIGH POWER — NPN POWER TRANSISTORS

• Solitron, TRW, Fairchild! Cat. No. 92CU2796

• Some units worth \$118 each!

• HI AMPS  
• HI VOLTS  
• HI VALUE

Type	Case	W.	IcA	Bvceo	Hfe	Mhz	Value	Sale
2N5154	TO-5	10	10	80	70-200	70	\$18.	\$3.95
2N5152	TO-5	10	10	80	30-90	60	15.	3.50
2N2891	TO-5	6	5	80	50-150	50	19.	3.50
2N3506	TO-5	6	5	40	40-200	60	11.	2.95
2N4896	TO-5	6	5	60	100-300	80	11.	3.50
2N3675	TO-5	6	5	55	12-60	60	11.	2.95
2N5327*	TO-5	5	10	80	100-300	100	25.	4.95
2N5326*	TO-59	50	5	80	50-150	80	16.	3.95
2N5328*	TO-59	50	5	80	100-300	100	26.	4.95
2N5004*	TO-59	50	5	80	30-90	60	45.	5.95
2N3749**	TO-111	30	5	80	40-120	40	31.	4.50
2N3752**	TO-111	30	5	80	100-300	50	59.	5.95
2N3997**	TO-111	30	5	80	80-240	40	54.	6.95
2N3621*	TO-61	50	10	40	40min	200	15.	5.95
2N3629*	TO-61	50	10	50	40min	200	49.	8.88
2N5329*	TO-61	100	20	90	40-120	30	70.	11.50
SVT-350-3B*	TO-61	116	3	350	15	30	19.	6.50
SVT-2505B*	TO-61	116	5	250	15	30	29.	8.50
SVT-20010B*	TO-61	140	10	200	15	30	25.	8.50
2N6046	TO-63	114	20	60	20-100	30	24.	8.50
2N6215	TO-63	125	50	80	25-150	20	118.	14.95
2N5733	TO-63	100	30	80	30-300	30	70.	11.50
2N4211	TO-63	100	20	80	20 100	10	66.	9.95



TO-59



TO-63

### SANKEN HYBRID AUDIO POWER AMPS

Mfgr's Type	Watts	Sale
<input type="checkbox"/> SI-1010Y	10	\$ 8.88
<input type="checkbox"/> SI-1025E	25	18.88
<input type="checkbox"/> SI-1050E	50	29.95

Used extensively in hi-fi systems, tape decks, FM tuners, record players, stereo components, musical instruments, P.A., etc. All amplifiers, flat within 1/2 db from hz to 100,000. Each unit properly heat-sinked, with heavy-duty connecting tie lug connections. Single-ended pushpull output. Power supply required 24VDC. Output to 8 ohms. Order by Stock No.



## THE SIMPLEST! FINEST! SMALLEST! 6-FUNCTION AC-DC CALCULATOR KIT!

\$13.95

- Simplified indexing
- Mark up and Mark down
- Constant multiplication and division
- AC adaptor jack
- Lightweight, pocket size
- Extra large display
- 6 functions plus, minus, times, percentage, constant
- Floating decimal
- Chain and Mix calculations

8  
BRITE  
DIGITS

Designed specifically for Poly Paks under the Daltone 80 brand. IMAGINE! only 2 1/2 x 1 x 4 1/2". Slides easily into your vest pocket, brief case, or handbag. We hunted everywhere to find a calculator kit that can be small, do the many functions, with fine engineering design and SIMPLE TO BUILD! WHY? Because it has the fewest parts in a kit. Imagine the pc board only has the chip, 4 resistors, two transistors, two driver ic's with the 9 digit readout. SIMPLE! You bet it is. The entire kit is even packed in a multicolor attractor story. Kit includes: attractive black case with red filter; Flex Key (type 20SK-66) 18 key keyboard that measures only 2 1/2 x 2" with 2 switches, one for ON-OFF, one for K constant; MAIN pc board; readout board; famous Cal Tech 5030 26-pin calculator chip; two 75491 ic drivers; 9 digit array; ac jack; 9 Volt battery connector resistors; two transistors; back protective plate; necessary wire plugs; easy instructions. (Less 9 volt standard battery and AC adapter)



EASIEST KIT TO BUILD

### "BEEPER" AND "DATER" CLOCK ON THE CHIPS

8.50

Imagine a chip (MK50250) "Beepin" and audible alarm! All others are external. It also features internal brightness control. The CT7001 requires external triggering of alarm, date of the month and direct drive to LED readouts. Both require minimum current drain and voltages, for either 4 to 6 LED readouts, 12 or 24 hours. AM and PM.

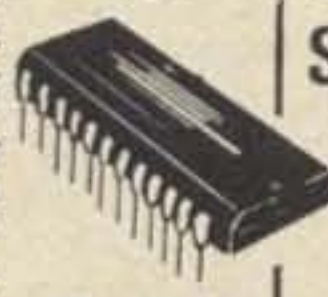

MK50250  
BEEPER

CT7001 Alarm and Date

\$6.95

SEE-THRU  
MINI.....  
S-METER  
Only  
\$1



Mini sized meter. 1/2 x 1/4" indication with RED and BLACK face. Red indicating needle.

### LED MITY DIGIT "DCM'S"

"Digital Counting Modules" outperform any other DCM on the market today. More features than ever before! Not gaseous, not incandescents, not nixie but the modern LED. Choose from such famous manufacturers as Monsanto's MAN-1, MAN-4, Litronics 707 and 704, Opcoa's SLA-1 (the last 4 having character heights of 0.33 at no extra charge). Each kit includes 3x2" pc board with fingers for a FREE edge connector, side-mounting dip socket, LED readout of your choice, resistors, 3 IC's, and Molex connectors (this ELIMINATES SOLDERING YOUR IC'S) and booklet. INCLUDES P.C. EDGE CONNECTOR — FREE!

\* Pin-for-pin MAN-1, \*\* Pin-for-pin MAN-4, elec. char.

Buy 3 —  
Take 10%

Only  
\$8.88

READOUT	Char.	Maker
<input type="checkbox"/>	MAN-1	.27 h. Monsanto
<input type="checkbox"/>	MAN-4	.19 h. Monsanto
<input type="checkbox"/>	707*	.33 h. Litronics
<input type="checkbox"/>	704**	.33 h. Litronics
<input type="checkbox"/>	SLA-1*	.33 h. Opcoa
<input type="checkbox"/>	MAN-4	.4 h. Monsanto

\* Pin-for-pin MAN-1, \*\* Pin-for-pin MAN-4, elec. char.

# 73 reader service

Check appropriate boxes for desired company brochures, data sheets or catalogs and mail in to 73. Include your zip code, please. Send money directly to advertisers. **LIMIT: 25 requests.**

## ADVERTISER INDEX

- |  |   |
|--|---|
| <input type="checkbox"/> Active Elec. 61                           | <input type="checkbox"/> Kronotek 208               |
| <input type="checkbox"/> Aldelco 71                                | <input type="checkbox"/> Lafayette 93               |
| <input type="checkbox"/> Alden 107                                 | <input type="checkbox"/> Levy 141, 217              |
| <input type="checkbox"/> A. P. Products 54, 94, 131, 132, 156, 196 | <input type="checkbox"/> Maynard 101                |
| <input type="checkbox"/> Apron 218                                 | <input type="checkbox"/> Meshna 252, 253            |
| <input type="checkbox"/> Atlas 20, 48                              | <input type="checkbox"/> Newtronics CII             |
| <input type="checkbox"/> *ATV 111                                  | <input type="checkbox"/> Nexus 198                  |
| <input type="checkbox"/> Audioland 142, 143                        | <input type="checkbox"/> Non-Linear Systems 85, 188 |
| <input type="checkbox"/> Autek 113                                 | <input type="checkbox"/> Novice QSL 158             |
| <input type="checkbox"/> Babylon 250, 251                          | <input type="checkbox"/> Palomar 107, 113           |
| <input type="checkbox"/> BYTE 144                                  | <input type="checkbox"/> Poly Paks 254, 255         |
| <input type="checkbox"/> Clegg 150                                 | <input type="checkbox"/> Radio Am. Callbook 86      |
| <input type="checkbox"/> Comcraft 94                               | <input type="checkbox"/> Radios Unltd. 239          |
| <input type="checkbox"/> Comm. Specialists 77, 159                 | <input type="checkbox"/> Regency 124                |
| <input type="checkbox"/> Compcode 209                              | <input type="checkbox"/> Rohn 149                   |
| <input type="checkbox"/> Control Signal 111                        | <input type="checkbox"/> S. D. Sales 212, 226-229   |
| <input type="checkbox"/> D-D Enterprises 60                        | <input type="checkbox"/> Sentry 67                  |
| <input type="checkbox"/> Dollar Value 92                           | <input type="checkbox"/> Space Elec. 109            |
| <input type="checkbox"/> DuPage 240, 241                           | <input type="checkbox"/> Space Time 109             |
| <input type="checkbox"/> Eldor 209                                 | <input type="checkbox"/> Spectrum Comm. 126, 127    |
| <input type="checkbox"/> Electrografix 202                         | <input type="checkbox"/> SST 111                    |
| <input type="checkbox"/> Electronic Supermart 109                  | <input type="checkbox"/> Stahler 205                |
| <input type="checkbox"/> Fair 111                                  | <input type="checkbox"/> Standard Comm. 116         |
| <input type="checkbox"/> Freck 205                                 | <input type="checkbox"/> Suntronix 230, 231         |
| <input type="checkbox"/> GENAVE 24, 25, 232, 233                   | <input type="checkbox"/> Swivetek 224, 225          |
| <input type="checkbox"/> Godbout 246, 247                          | <input type="checkbox"/> Telecomm. Control 36, 97   |
| <input type="checkbox"/> Green Publishing 163                      | <input type="checkbox"/> Telstar 244, 245           |
| <input type="checkbox"/> Hale 158                                  | <input type="checkbox"/> Tri-Tek 158                |
| <input type="checkbox"/> Ham Radio Center 222, 223                 | <input type="checkbox"/> Trumbull 111, 205          |
| <input type="checkbox"/> Heath 114, 115                            | <input type="checkbox"/> Tucker 165-184             |
| <input type="checkbox"/> Henry 9, 51                               | <input type="checkbox"/> Tufts 16, 17, 206, 207     |
| <input type="checkbox"/> Hickok 202                                | <input type="checkbox"/> TWS Labs 160, 161          |
| <input type="checkbox"/> Hy-Gain 55                                | <input type="checkbox"/> Utah FM 213                |
| <input type="checkbox"/> ICOM 62, 89, 102                          | <input type="checkbox"/> Venus Scientific 121       |
| <input type="checkbox"/> Int. Telecomm. 136, 137                   | <input type="checkbox"/> VHF Eng. CIV, 219          |
| <input type="checkbox"/> James 248, 249                            | <input type="checkbox"/> WEIRNU 71                  |
| <input type="checkbox"/> K-Enterprises 141                         | <input type="checkbox"/> Wellman 209                |
| <input type="checkbox"/> Kenwood 47, 237                           | <input type="checkbox"/> Westcom 72, 73             |
| <input type="checkbox"/> Klaus 210, 211                            | <input type="checkbox"/> Wilson 234, 236            |
| <input type="checkbox"/> KLM 238                                   | <input type="checkbox"/> Windjammer 242, 243        |
|  | <input type="checkbox"/> World QSL 111              |
|  | <input type="checkbox"/> Yaesu CIII, 35             |
- 
- |                       |                    |
|-----------------------|--------------------|
| 73 Stuff              | Binders 196        |
| QSLs 56               | Code Tapes 197     |
| Back Issues 162       | 73 Products 203    |
| Bicentennial QSLs 185 | Repeater Atlas 204 |
| Subs 189              | World Atlas 216    |
| Radio Bookshop 190    |                    |

This 73 was acquired through:

- NEWSSTAND  SUBSCRIPTION

\*Reader service inquiries not solicited. Correspond directly to company.

Reader's Service NOV/DEC 1975  
 73 Inc., Peterborough NH 03458  
 Please print or type.

Name \_\_\_\_\_ Call \_\_\_\_\_

Address \_\_\_\_\_

City \_\_\_\_\_

State \_\_\_\_\_ Zip \_\_\_\_\_

Coupon expires in 60 days . . .

## PROPAGATION CHART

J.H. Nelson

Good (open) Poor (0)

Fair (□)

November - 1975

Sun	Mon	Tue	Wed	Thu	Fri	Sat
						I
2	3	4	5	6	7	8
9	10	11	12	13	14	15
16	17	18	19	20	21	22
23 30	24	25	26	27	28	29

### EASTERN UNITED STATES TO:

GMT: 00 02 04 06 08 10 12 14 16 18 20 22

	7A	7	7	3	3	3	3	3A	7	14	14	14
ALASKA	7A	7	7	3	3	3	3	3A	7	14	14	14
ARGENTINA	7	7	7	7	7	7	14	14A	21	21	21	14A
AUSTRALIA	14	7B	7B	7B	7B	7B	7	14	14	14	14	14A
CANAL ZONE	7A	7	7	7	7	7	14	14A	21	21	14A	14
ENGLAND	7	7	7	3	3A	7	14	14A	14A	14	7B	7
HAWAII	14	7B	7	7	7	7	7	3A	7B	14A	14A	14
INDIA	7	7	7B	7B	7B	7B	14	7B	7B	7	7	7
JAPAN	7A	7B	7B	3B	3	3	3	3	7	7B	7B	14
MEXICO	14	7	7	7	7	7	7	14	14A	14A	14	14
PHILIPPINES	7A	7B	7B	7B	7B	7	7	7	7	7B	7B	7A
PUERTO RICO	7	7	7	7	7	3	14	14	14A	14	14	14
SOUTH AFRICA	7	7	7	7	7B	7A	14	21	21	14A	14	14
U. S. S. R.	7	7	3	3	7	7B	14	14	14	7B	7	7
WEST COAST	14	7A	7	7	7	7	7	14	14A	14A	14A	14

### CENTRAL UNITED STATES TO:

	14	7	7	3	3	3	3	3	7	14	14	14
ALASKA	14	7	7	3	3	3	3	3	7	14	14	14
ARGENTINA	14	7	7	7	7	7	7	14	21	21	21	14A
AUSTRALIA	14A	14	7B	7B	7B	7B	7	7	14	14	14	14A
CANAL ZONE	14	7	7	7	7	7	7	14	21	21	21	14A
ENGLAND	7	7	7	3	3A	7	7B	14	14	14	7B	7
HAWAII	14	14	7	7	7	7	7	3A	7A	14A	14A	14A
INDIA	7	7	7B	3B	7B	7B	3B	7A	7A	7B	7B	7B
JAPAN	14	7B	7B	3B	3	3	3	7	7	7	7B	14
MEXICO	14	7	7	7	7	3	3	7A	14	14	14	14
PHILIPPINES	14	7A	7B	3B	3B	7	3	7	7	7	7B	14
PUERTO RICO	14	7	7	7	7	7	7A	14	14A	14A	14	14
SOUTH AFRICA	7A	7	7	7	7B	7B	7A	21	21	14A	14	14
U. S. S. R.	7	7	3	3	7	7	7B	14	14	7B	7B	7

### WESTERN UNITED STATES TO:

	14	7A	7	3	3	3	3	3	7	14	14	14
ALASKA	14	7A	7	3	3	3	3	3	7	14	14	14
ARGENTINA	14	14	7	7	7	7	7	14	21	21	21	14A
AUSTRALIA	14A	14A	14	7B	7B	7	7	7	14	14	14	14A
CANAL ZONE	14	7	7	7	7	7	7	14	21	21	21	14A
ENGLAND	7	7	7	3	3A	3A	3B	7B	14	14	7B	7B
HAWAII	21	14	7A	7	7	7	7	7	7A	14A	21	21
INDIA	7	14	7B	3B	3B	7B	3B	3	7	7	7	7B
JAPAN	14A	14	7B	7	3	3	3A	3	7	7	7B	14
MEXICO	14	7A	7	7	7	7	7	7A	14A	14A	14	14
PHILIPPINES	14A	14	7B	7B	3B	7	7	3	7	7	7B	14
PUERTO RICO	14	7	7	7	7	7	7	14	14	14A	14A	14
SOUTH AFRICA	14	7	7	7	7B	7B	7B	7A	14A	14A	14	14
U. S. S. R.	7	7	3	3	3	3A	3	7A	7A	7B	7B	7B
EAST COAST	14	7A	7	7	7	7	7	14	14A	14A	14A	14

A = Next higher frequency may be useful also.  
 B = Difficult circuit this period.

# Get away to it all... with two new VHF rigs from the radio company.

Get away from the crowd and get to real VHF performance with two potent new transceivers from Yaesu — the radio company.

There's the FT-221 two-meter rig that that operates in SSB, FM, CW, and AM modes. With features like phase-lock loop circuitry for stable, clean signals. Plus modular plug-in boards for easy maintenance. Complete VFO coverage of 144–148 MHz and 88 crystal-controlled channels. AC/DC operation for base or mobile work. 12 watts SSB PEP. 14 watts FM or CW. 2.5 watts AM. Built-in speaker. And a whole catalog of features for easier and better operation. Whether you're into FM, DX-ing or OSCAR work, the FT-221 promises to outperform anything else you might buy.

Companion to the FT-221 is the Yaesu FT-620B 6-meter transceiver. The FT-620B has all the features going for you for exciting QSO's. Work in

SSB, CW and AM modes with plenty of power. And check out all the features you get in this compact unit: complete 6-meter band coverage in eight, 500 KHz segments with 1 KHz VFO readouts across the entire band. You can have up to four crystal-controlled channels in each of the eight band segments. You have an offset clarifier, noise blanker, AGC, ANL. Plus 24 watts PEP on SSB, 20 watts CW (50% duty cycle), and 8 watts AM. And it's AC/DC powered for mobile or base use.

See these two new state-of-the-art transceivers at your dealer now or send for our catalog. And get with a couple of VHF rigs that have it all!

Yaesu Musen USA, Incorporated,  
7625 E. Rosecrans, No. 29, Paramount,  
California 90723.

**YAESU**  
*The radio.*



# hf engineering

DIVISION OF BROWNIAN ELECTRONICS CORP.

P.O. Box 1921-7 • BINGHAMTON, NY 13902 • 607-723-9574

## 50-144-220-432 MHz RECEIVERS

### INEXPENSIVE AND UNIQUE MODULAR CONCEPT

- Performance equal to commercial equipment
- Monitor receivers
- Repeaters: using our transmitter, 15 or 25 watt amplifier and COR modules
- 10 channel auto-scan receivers: using our SC-3 scanner kit and CD-1 crystal deck
- Transceivers using our transmitter module
- Size: 4" x 6" — \*RX-432C is 4" x 6-1/2"

All Receiver kits are dual conversion with squelch and COR output.

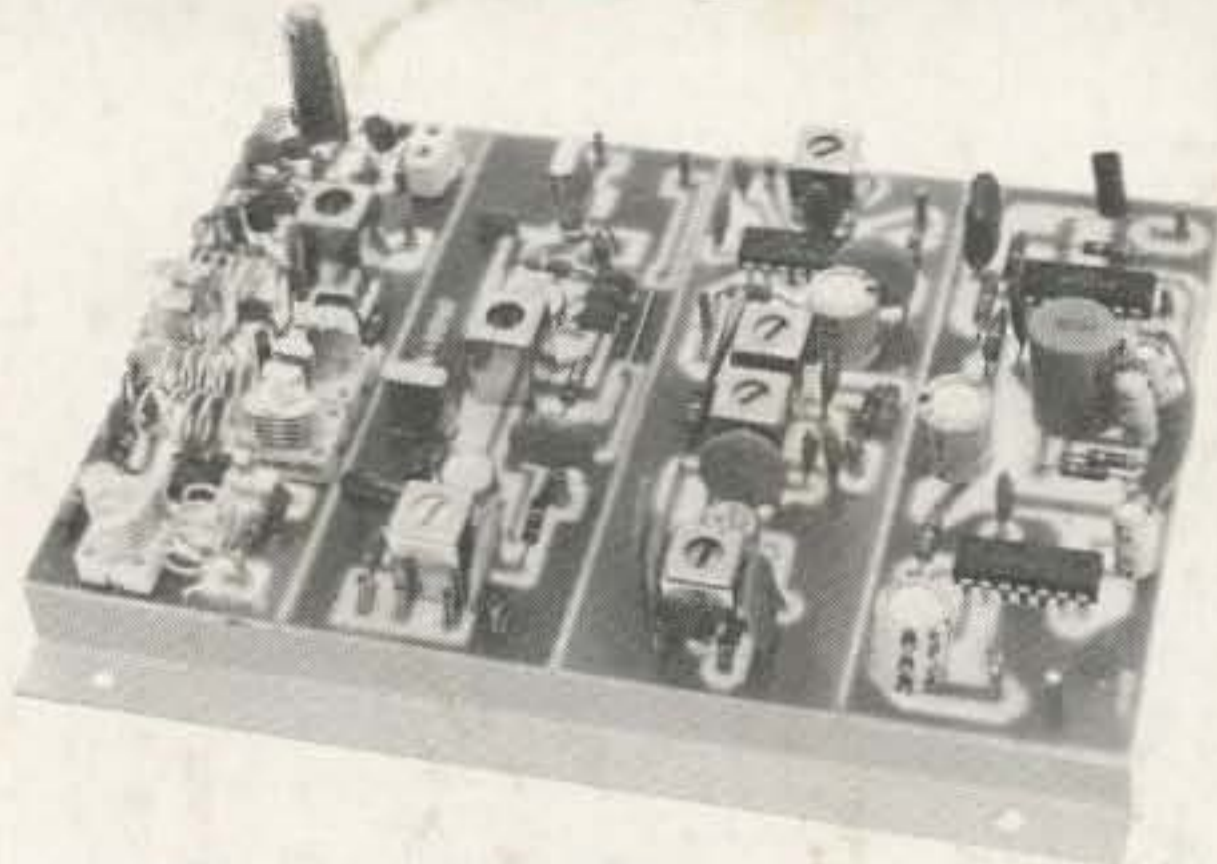

RX-50C	30-55 MHz	.....	\$59.95
RX-144C	140-170 MHz	.....	\$69.95
RX-220C	210-240 MHz	.....	\$69.95
RX-432C	420-470 MHz	.....	\$79.95

\*RXCF — 70bb filter add \$8.50 to above.

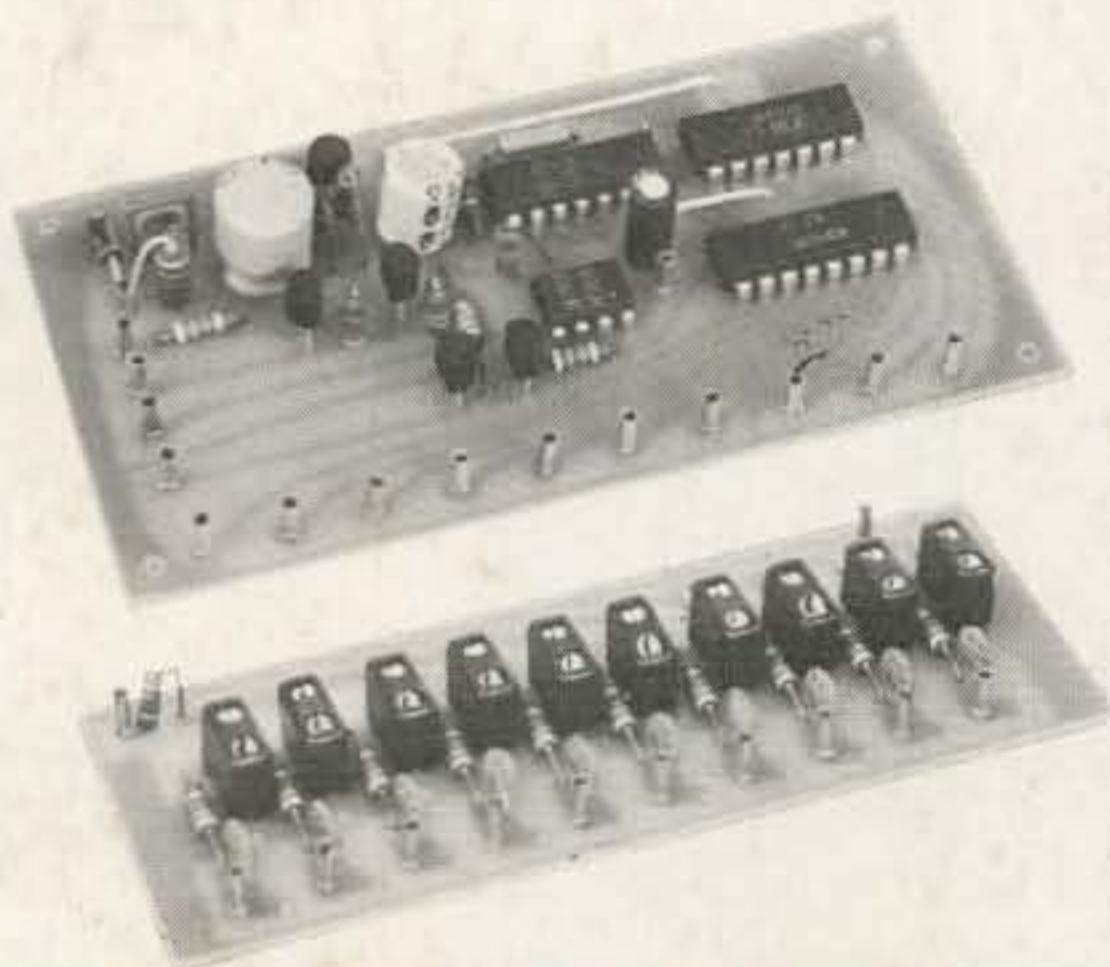

### 10 CHANNEL SCANNING

SC3 — Capable of scanning up to 10 channels. Scan delay allows both sides of a conversation to be monitored without the scan starting each time the carrier drops. The priority feature allows the user to program the scanner to return to his favorite channel whenever it is active. Price **\$19.95** kit

CD-1 — A ten channel receive crystal deck which utilizes diode switching to select the crystal position required. This module can be used to expand your present single channel receiver to multichannel capability. Price **\$6.95** kit

### ORDER FORM

Item	Part No.	Description	Price	Extension

Name \_\_\_\_\_ Total \_\_\_\_\_

Address \_\_\_\_\_ Shipping \_\_\_\_\_

City \_\_\_\_\_ NYS Resident Sales Tax \_\_\_\_\_

State \_\_\_\_\_ Zip \_\_\_\_\_ Total Enclosed \_\_\_\_\_

Master Charge No. \_\_\_\_\_ BankAmericard No. \_\_\_\_\_

TERMS: C.O.D., cash or check with order. We also accept BankAmericard and Master Charge.

CLAIMS: Notify VHF and the carrier of damage within seven (7) days of receipt of shipment.

RETURNS: Obtain authorization from VHF before returning any merchandise.

PRICES AND SPECIFICATIONS: Subject to change without notice.

SHIPPING INFORMATION: All shipments are F.O.B. Binghamton, N.Y. 13902. Shipments will be made by the most convenient method. Please include sufficient funds to cover shipping and handling. Allow \$1.00 for each item.

