

73 AMATEUR RADIO

JUNE 1975

ONE DOLLAR

SSTV Monitor

Cheapo Super
Beam

Burglar Alarm

432 MHz Power

Ma Bell's Circuits

Minirepeater



new



the real performer! specifically for repeater

...or any TWO-METER FIXED STATION OPERATION

With **6** db—
db—

- Gain compared to 1/2 wave dipole
- FCC accepted for repeater application

mechanical

- Vertical element—117" long, 1-1/8" telescopic to 3/8" OD high strength aluminum
- Radials—four, 21" x 3/16" OD aluminum rod
- Connector—SO-239
- Wind load—26 pounds at 100 mph.
- Wind survival—100 mph.
- Completely self-supporting
- Mounting—fits vertical pipe up to 1-3/4" OD

electrical

- 6 db. gain over 1/2 wave dipole
- Omnidirectional radiation pattern
- Maximum radiation—at horizon
- 50 ohm feed impedance
- Field adjustable—140-150 MHz
- SWR at resonance—1.2:1 measured at antenna
- Bandwidth—6 MHz for 2:1 or better SWR
- Power—one kilowatt FM
- Feed—Shunt with D.C. grounding
- Radiator—5/8 wave lower section, 1/4 wave phasing, 5/8 wave upper section

The gain you gain—you gain transmitting and receiving—get both with Hustler!

Available from all distributors who recognize the best!

THE HUSTLER MASTER GAINER
MODEL G6-144-A

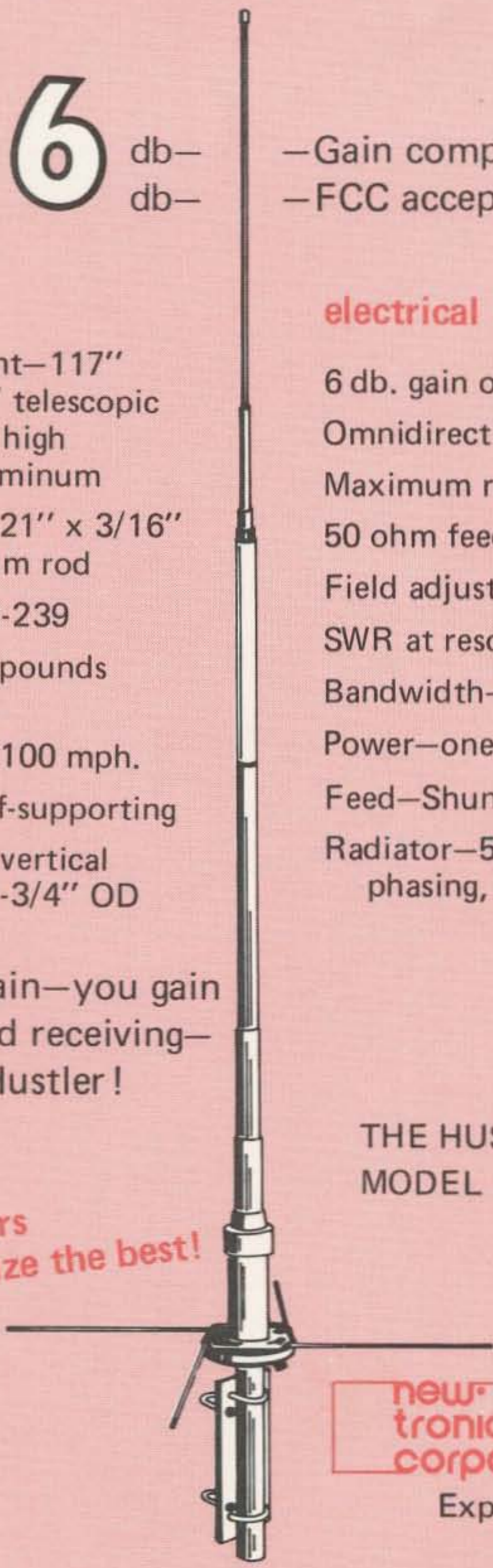

**new
tronics
corporation**

15800 commerce park drive,
brook park, ohio 44142

Exporter: Roburn Agencies, Inc.,
New York, N.Y.

W7IDF	17	Me Friend
WA9MFF	22	Homebrew this SSTV Monitor
WA6NLQ	31	El Cheapo Superbeam
WA6KBL	37	The Smart Alarm
W2NYU	43	An Intimate Look at 160 Meters
K1CLL	48	RF Power at 432
WB4DBB	55	The Minirepeater
WHIPPLE	67	Inside Ma Bell
KØVQY	81	Dirt Cheap Tunable I-F for Converters
K1CLL	85	6m IC Rx
W1KNI	88	All Band Frequency Marker
IVES	93	Protect Your Gear with a Latching Relay
WØFEV	97	A Case for CW
WB4MYL	108	ID Timer
WBØHKB, WBØDQC	111	Build an 11 dB Coatrack
WB4DBB	115	Front Burner for Six
W2AOO	119	A Digital Dial for Your Receiver
WA5CNG	123	Three on Fifteen
WB8DQT	128	More Weather Satellite Pictures
K4SHE	135	Solid Gold PR: Washington!
W4ATE	139	Tit for Tat and Others
W8WLM	144	Presto! Transistor checker from VOM
WB4KTY	148	Easy BFO Project for All Wave Receivers
WA3AJR	155	How to Put on a Professional Slide Show

73 amateur radio

#177 June 1975

2	Never Say Die	16	Caveat Emptor
3	Hotline Headlines	161	Circuits
4	Be My Guest	164	New Products
6	Ancient Aviator	167	Grrreen
7	AMSAT	168	Voxpoop
7	Ham Help	172	New Products
8	Letters	175	Circuits
10	Social Events	176	Upcoming
11	Corrections	192	Advertiser Index
12	New Products	192	Propagation

COVER: When you're in the repeater. This pioneer repeater, the most active 220 MHz re- and is the envy of many other facilities. Photo credit goes to goes to Arnold Chase WA1RYZ.

Hartford area, listen for lovely Cindy Tucker over the WR1AEC with one of the finest locations in the Hartford area, is one of peaters in the country. It has been on the air for about a year local repeater groups due to its clean operation and autopatch Bruce WA1GDX and credit for organization and production

73 Magazine is published monthly by 73, Inc., Peterborough, New Hampshire 03458. Subscription rates are \$8 for one year in North American and U.S. Zip Code areas overseas, \$9 per year elsewhere. Three years, \$16 and \$17 overseas. Second class postage paid at Peterborough, New Hampshire 03458 and at additional mailing offices. Phone: 603-924-3873. Microfilm edition of 73 available from University Microfilms, Ann Arbor MI 48106. Magnetic tapes available from Science for the Blind, 332 Rock Hill Rd., Bala Cynwyd PA 19004. Entire contents copyright 1975 by 73 Inc. Peterborough, NH 03458.





73 staff

EDITOR/PUBLISHER
Wayne Green W2NSD/1

BUSINESS MANAGER
Virginia Londner Green

EDITORS
Alex Barvicks WB4RVH
John Burnett

EDITORIAL ASSISTANTS
Susan G. Philbrick
Ernestine Blodgett

PRODUCTION MANAGER
Lynn Panciera-Fraser

ART DEPARTMENT
Bob Drew
Nancy Estle
Neal Kandel
Bob Sawyer

PRINTER
Biff Mahoney

PHOTOGRAPHY
Bill Heydolph

TYPESETTING
Barbara Latti

ADVERTISING
Bill Edwards WB6BED/1
Cathy Greenwood

COMPTROLLER
Knud E.M. Keller KV4GG/1

CIRCULATION
Barbara Block
Dorothy Gibson
Judy Havey
Cheryl Hurd

INVENTORY CONTROL
Marshall Raymond

PLANT MAINTENANCE
Bill Barry

ASSOCIATES
Schley Cox WB9LHO
Tom DiBiase WB8KZD
Terry Fox WB4JFI
W. Sanger Green
Dave Ingram K4TWJ
Joe Kasser G3ZCZ
Bill Pasternak WA6ITF
John Schultz W2EY
Waller Scott K8DIZ
Peter A. Stark K2OAW
Bill Turner WA0ABI

DRAFTING
Bill Morello
Lynn Malo
T.M. Graham Jr.



NEVER SAY DIE

...de W2NSD/1

EDITORIAL BY WAYNE GREEN

JUNE 16TH DEADLINE

Comments on docket 20282 — “restructuring” — are due the 16th, complete with 14 copies. Before I get into a discussion of why, day by day, I am more and more opposed to virtually every aspect of this proposal, there are a couple of other bases to cover.

The fact is that one single copy of your comments will do a lot of good if you are hung up on getting free photocopier time and supplies. This comment will get into the main file and be used by whoever loses the coin flip and has to put things together at the FCC. Extra copies go to individual Commissioners, and other sections of the Commission — many of whom could care less about our problems or future. Moral: Don’t let that 14 copy nightmare stop you from getting in your two cents...er, ten cents, today.

You, like the rest of us, may be a little hazy about the exact wording of the docket. Read it over again — February issue of 73 — complete.

NOW! There are two aspects to this docket that you should consider... first make a note of every way that this docket will effect you personally — what privileges it will take away from you — what it will gain for you (if anything) — what it will cost you in license fees — in study time — in lost time going for exams under the beady eyes of FCC examiners. Secondly, take a good look at the docket from the viewpoint of amateur radio as a hobby in the long run.

Will a Communicator license bring in millions of CBers or will it result in as little increase in ham tickets as the Novice and Tech licenses did — despite the high hopes of the FCC and dire warnings of curmudgeons? The fact is that we *don't* know and can only make a wild guess.

Few amateurs have any enthusiasm for thousands of handle-wielding CBers coming on the repeaters. Club newsletters are generally in agreement that this will bring about a large scale closing of repeaters to these Commun-

icators. Can the Communicator ticket work if amateurs refuse to talk with them? The general opinion is no.

My own opinion is that this whole matter has been brought up with too little consideration for the impact on amateur radio. There is an air of hysteria over the stagnation in amateur growth — more hysteria over the unbelievable CB growth which shows serious signs of spilling over via 220 MHz into amateur bands — and frustration on the part of Walker over the failure of “incentive licensing” to force amateurs into the Extra Class. Is docket 20282 really an answer to any of these “problems?” I think not.

We’ve lived with five classes of ham ticket (eleven, counting sub-classes) and I have no doubt we can live with seven (seventeen, counting sub-classes) — but I don’t think it will be healthy. To me this is against the very precepts of America. In amateur radio, in particular, we are all supposed to be equal — a big group of people all in communications with each other where you can one minute talk with a garbage man and the next with a senator. It is utterly alien to the whole system of license classes where Techs talk only to Techs, Generals talk to Generals, etc.

Look at it another way. When you work someone and he announces that he has an Extra Class ticket — why has he mentioned this? Obviously it is bragging and intended to put you down. An Extra Class licensee has to either keep quiet about it or else put himself down if he is going to maintain much communications with lower classes. It is an unhealthy situation.

The same problem exists with Techs. Most Techs are very defensive about their license class — and many spend a lot of time explaining to higher classes that they could get their General if they wanted to — that they got their Tech ticket honestly — etc. Terrible situation.

So now we are well on our way toward making it even worse with two more classes. Good grief! You want to bet that many Experimenters will manage to feel inferior to Generals

and Advanced? And with the new system of call letters the operator won't even have to say anything for his call will give him away. How long will Generals put up with Extras coming down to slum in a crowded General band?

Well, enough of that.

Sure, we need growth — but we can get it anytime we really want to just by setting up ham classes in our clubs and getting high school kids into them — we'll have all the hams we can manage without giving away ham tickets for free. This is what the Japanese have done and they've proven the idea works. Oh, we can set up a superannuated CB license and fill in one or two VHF bands with Communicators — it's always possible. But I think we'll lose a lot of our self respect.

I have to admit that at first I liked the idea — but despite the opinion of my detractors that I won't change my mind about things, I have changed a lot on this one.

FILE YOUR COMMENTS

Drop your comments on 20282 to the FCC, Amateur Division, FCC, Washington DC 20554 and get 'em in the mail by the 15th of June.

If you think I'm wrong about clubs being able to generate ham growth then you'll probably favor the docket. If you think I'm wrong about thousands of CB/Communicators forcing most repeaters to go closed then you'll favor the docket. If you like the idea of snobbery between classes... etc.

As far as the first aspect of the docket is concerned... the way the restructuring would effect you personally... which is about all I've heard discussed over the air, at club meetings, or seen in comments filed so far... what possible difference should that make in rules that we all are going to have to live with for quite a few years?

It probably won't help my popularity when I let you know that I now, after a lot of thinking about this, favor our going back to a two ticket system — beginner and advanced. This may destroy any rapport that I've built up with liberals, since it essentially takes us back about 30 years — but having been both there and here, there was better, at least as far as amateur licenses were concerned.

To me amateur radio is amateur radio and this splitting of it into HF and VHF licenses is bad news. I enjoy every band I can operate — 160m is

enormous fun — I love 75m DXing and rag chewing — 40m is certainly a challenge and some top RTTY boys are there — 20m is the backbone of amateur radio... I don't count a country as really worked unless I get it on 20m — 15m is a little weak these days — 10m... sigh — 6m would be okay if we could interface our two meter repeaters again — two meters is two bands... FM on the high end and DXing and SSB on the low — 220 is coming along nicely — 450 is three bands... ATV... FM... and Oscar! Better make that four — add in a touch of DX and moonbouncing.

The Experimenter who has to get another ticket to go on 160m is probably going to stay off 160m. You can vote that enormously complicated system in if you want, but I'll say right now that it isn't going to work. Bitch all you want about me being reactionary, the fact is that my predictions have been disturbingly accurate.

Amateur radio will be better able to meet its responsibilities if it is left with a minimum of classes and a minimum of restrictions. We need to be free to experiment, not be hemmed in at every turn by rules. Repeater and VHF systems development were held back disgracefully by the ill thought out and overly complicated repeater rules. Experimenters are presently being hamstrung by restrictions on telemetry transmission. More and more amateurs are into developing computer systems and these could be tied together by radio much better than telephone — if our rules permitted. Some of the RTTY chaps are

Continued on page 11

DOCKET 20111

Report and order regarding special events station licenses... effective May 27th applications for special events stations should be sent by letter to the FCC Amateur Division, Washington DC 20554... stating the name, mail address, and including a photocopy of the Advanced or Extra Class license of the applicant, plus a signature... then give the name and a description of the celebration for which the special events station license is justified and the significance of the event to the public or to amateur radio... the location of the station (may not be mobile or portable) and any special call sign requested. The station license is \$4 and a special call request calls for \$25 extra.

HOTLINE HEADLINES

Bicentennial call signs released by FCC — W/AC, K/AD, WA/AA, WB/AB, WR/AF, WN/AK — starting Jan 1.

WA6LBP Wins Tower Battle — another nasty tower case won by amateur radio — this time in Ventura CA.

CBer with stolen 2m rig lured into coffee break and bust by cops over WR1ABQ in Derry NH.

Oscar 7 being zapped by Gulf non-ham signals — may be Hiran or TI's ERENS systems — whatever it is, it has been hurting Oscar 7 at times... seriously.

Ham PR going strong — Newsday article — VFW magazine article — Englewood NJ mayor declares ham week — AMC news piece on ham help during Alabama tornado.

SSTV Contest winner works 44 countries and 101 contacts, six continents! Paul Furman WB4ECE of Dunwoody GA was this year's winner.

Phonetele \$30 million suit against Bell may help amateurs — involves phony couplers which run up charges, but add nothing to the circuit.

NC/TN repeater war solution proposed by Carolina-Virginia Repeater Association. WR4ADO requested to change frequency after careful study of facts.

Job Op: 73 Magazine is looking for experienced hams/writers to work on Hotline, books, etc.

QST Cops Out: reveals K2OAW as previous author to recent QST counter article, but gives no reference to publication in 73 of updates and improvements in the circuit.

Amsat meeting — Oscar 8 set for 1978 — DL/VE/VK groups will cooperate to design and produce the flying repeater. It'll probably be an advanced 435/145 MHz system.

MARS theft hoax story being investigated by AF. Was there a theft of \$3.5 million? Who sent out the story dated Air Force Information Service?

Ham biz up — manufacturers falling further and further behind as economy picks up and rush is on for HF and VHF gear, ICs, everything!

CQ makes papers — even an Action Line can't get CQ to pay author, it appears. This will help offset some of the good ham PR in other papers.



BE MY GUEST

Visiting views from around the globe.

What is ATIS ?

The Federal Communications Commission has recently released a proposal for changing certain parts of the Rules and Regulations to require installation of an Automatic Transmitter Identification System on all radios manufactured for the Safety and Special Services beginning one year after adoption of final rules (FCC Docket 20351). This will apply to Citizens Band, Aircraft, Commercial, and other VHF services, but not directly to amateurs. The Commission specifically cited its difficulties with enforcing radio regulations in an environment where a large number of operators fail to properly identify themselves or their station. The new rules would end this problem by requiring that an automatic identifier be placed into each transmitter by the manufacturer. The ATIS identifier would send an audible tone code sequence containing the station's call-sign at the beginning, end and every 30 seconds during a transmission using the ASCII code ("8-level" Teletype code). This burst of data, lasting about 1 second, would start with the special character "SYN," followed by the station call (or the transmitter

serial number for equipment not yet assigned to a station), followed by "i" (little i), transmitted as a two tone frequency shift between 1285 and 1115 Hz at 50% modulation. This identifying signal could be displayed real-time on any standard computer terminal, or tape recorded and slowed down for decoding by ear.

The Commission proposes that these devices be "an integral part of the transmitter," and in the case of Class D Citizens Band, it "... shall be designed in such a manner that the transmitter will not function unless an encoded ATIS device is installed and operating." The FCC wants the device to be made tamperproof, yet the ATIS must be reprogrammable since a licensed technician will encode the purchaser's call after the transmitter is sold.

The manufacturers have apparently assured the FCC that this is practical to accomplish without adding much to the cost of the equipment. The ATIS would probably be a single, many legged IC, possibly incorporating portions of the transmitter's frequency synthesis circuitry to discourage removal or tampering. It

should not be any more complicated or costly than a pocket calculator chip when produced in large quantity.

The ATIS plan, as proposed, has several drawbacks. One might be the possible interference with voice intelligibility, especially on short transmissions. A second would be the psychological effect of the incessant identification codes following each mike-squeeze, and the added tail at the end of each transmission.

Only new equipment would contain the ATIS devices, thus leaving millions of radios in operation without the automatic identification feature. The problem of seeing that the ATIS is immediately coded after equipment sale or trade by an *honest* technician is not dealt with; the licensee, rather than the radio store, would be responsible for getting this done, with no assurance that it would be (tracking down a bootlegger through an equipment serial number seems unlikely). The rules changes in their present form do not offer much toward the solving of enforcement problems on 27 MHz.

For the ATIS plan to be useful at all it would have to be evenhandedly

MOBILE CALLING FREQUENCIES

For many years now, certain frequencies have become recognized internationally for RTTY and latterly for SSTV. We felt it high time that radio amateurs knew where to listen for mobiles and hence, where to call if operating from the car.

Accordingly, the Amateur Radio Mobile Society, having members in all continents, has adopted the following frequencies for Mobile Calling Purposes:

10m band — 28550 & 29550 kHz

15m band — 21210 & 21370 kHz

20m band — 14110 & 21370 kHz

In addition, as far as amateurs in IARU Region 1 are concerned, we will

use 3755 & 7050 kHz for calling purposes.

Now we realize it is too much to expect universal acceptance of our proposals and any attempt to get together any kind of international conference would be doomed to failure from the start, inevitably becoming bogged down by paperwork and waffle.

We are contacting the editors of the journals of all major, national amateur radio societies asking them to publicize our proposals, as well as contacting the independent amateur radio press.

In view of the prevailing poor propagation conditions in the 15m band, we have shifted our members' weekly net to the 20m band. Consequently, the new schedule is:

Saturdays 1330 GMT on;
14320 kHz; G4AMS.

We particularly listen for members but all mobiles are most welcome to call in. The station is operated by our Chairman, Jim Farlow G3BXI, the station being a KWM-2 + 30L-1 to the TH6DXX at 70 feet.

Norman Fitch G3FPK
Purley, Surrey
England

applied to all users of the radio equipment. This would require that the seller of the equipment take the responsibility of getting the buyer's callsign encoded into the ATIS device, at the point of sale, with strict sanctions against dealers found not in compliance. Since we could assume that "(SYN)EIGHTEENWHEELER-DADDYi" would not be an acceptable station identification, it would then be necessary for the purchaser of a radio transmitter to produce a license and callsign at the point of sale, something that has not been required up to now. The ATIS requirement must also be made retroactive to include at least the new SSB rigs sold for Citizens Band and the VHF-FM rigs on the marine frequencies. Since the AM equipment in both cases is scheduled to be phased out, installation of ATIS in the recently sold equipment would mean total coverage within a reasonable and definite time frame.

As was mentioned, amateurs are not included in this plan for automatic transmitter identification. We may, however, find applications for these miniature identifiers on the VHF bands. One suggestion might be for the members of a private repeater group to install the identifiers in their transmitters. Since the code used is standard ASCII, it is machine readable and a small processor could be incorporated to compare the station's call to a list of valid member stations in memory. A member of the group could be given full privileges on the repeater, while a non-member station, or a station with no identification signal, would have only limited privileges.

The FCC might be willing to settle on some compromise for the automatic control of repeater access based on this ATIS system, relieving the control operators from the tiresome task of monitoring. If stations without ATIS identifiers were excluded from using the repeater altogether, then the stations that do get through would certainly be licensed operators, known to and authorized by the repeater trustee. If that doesn't satisfy the FCC, then perhaps a digital record of "who used the repeater when" might be accepted. Once again the ATIS code makes it possible to record the station ID and a binary coded date/time reference in a very small space on a tape cassette (compare this with the miles-long tapes required for a complete audio recording of repeater use). A real time repeater log could even be

Opening Pandora's Box

The following is a text of a talk given by Byron H. Kretzman W2JTP before the Larkfield Radio Club at a regular meeting April 11, 1975, in Huntington, Long Island.

I have asked for "Equal Time" to present to you my opposition to the views Harry Dannals gave to you March 14th, the same views expressed by Stan Zak, the Hudson Division Director. (I see I haven't that much time, but it won't take me that long to counter his "hard sell.") There are two main areas of my disagreement with the "party line" these fellows have been spouting in reference to Docket 20282:

1 - The recent ARRL poll was limited to members only.

2 - The desirability of the "no-code" Communicator Class.

First, limiting an ARRL poll to members has not been general practice in the history of the ARRL. (When they first did that in 1938 the results were disastrous to occupancy of the 5 meter band.) Now, there exists a standing resolution adopted years ago by the Board of Directors. It says:

"On any matter, the Board may order the taking of an advisory, informative poll, through the columns of *QST*, as to the wishes of the amateurs or the members, as the case may require; and thereafter the Board, in acting upon the question presented, shall take into consideration the result of such a poll, the number of expressions received, and the percentage of votes by which such poll was determined. Whenever an advisory poll is taken through the columns of *QST* . . . , then there shall be provided a detachable postcard in the pages of *QST* to be used for balloting purposes;

and the call for such poll and information published concerning it shall be printed in reasonably prominent form, using type and headings no smaller than those used for articles in the same issue."

This was done, for example, in February 1948 on the question of asking the FCC to allow 'phone on 40 meters. Why wasn't this done this time on Docket 20282? Let me read you Stan Zak's reply (letter of February 22, 1975):

"A survey of all 225,000 amateurs would be rather expensive. I believe League members are very well informed through *QST*, club bulletins, etc., on various happenings so that I would value an opinion from a League member (as) opposed to one who just sits in front of his rig and doesn't care about anyone else. This is one of the benefits of League membership.

"I myself cannot get too enthused about a non-League member or his opinions. They expect the League to do everything for them, to reap the rewards without benefit of supporting the League . . ."

What kind of an answer is that? Harry Dannals gave me a similar reply on March 14th. He said, in essence, "Since there are about 200,000 non-member hams, we can't afford to consider their opinions."

Let me ask you, "Why are there so many non-members?" (The ARRL is "the only game in town.") Sure, some are discontents. Well, I travel quite a bit, and I think the major reason is economics - many of these fellows can't afford the \$9 dues. You may laugh, but let me tell you that we live

Continued on page 176

printed out on a Teletype machine, if every user had the ATIS on his transmitter.

An even more elaborate system might allow a station to record a message in the repeater, using touch-tone codes to control the recorder and inform the repeater as to which club member the message is directed. When the "addressee" next uses the repeater, it will recognize him by his ATIS code, and play out the pre-recorded message. For these uses, the

identification signal need only occur once at the beginning of each transmission. Sub-audible frequencies may be employed instead of 1200 Hz \pm 85, if that proves to be an annoyance.

Other applications will no doubt suggest themselves as the ATIS identifiers become available at low cost, a beneficial spinoff to amateurs from the problem of illegal operating practices now running rampant in the other radio services.

. . . J. R. Johnson WA5RON

Autobiography of an Ancient Aviator

W. Sanger Green
1379 E. 15 Street
Brooklyn NY 11230

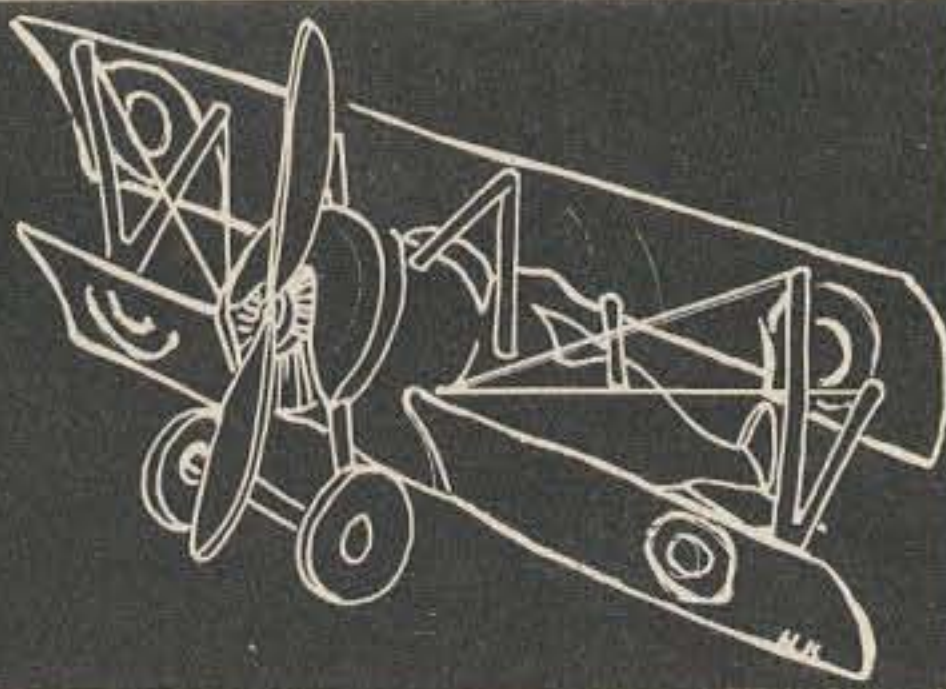

VACATION AT POST AND KELLY FIELDS

We arrived at Lawton, Oklahoma on the afternoon of May 19, 1922, made our way out to Post Field, and reported in. The matter of married quarters on the field was solved the next day by assigning us to a low ranking officer's house. (Who ever heard of a married Flying Cadet?) The place hadn't been lived in for a while, judging by the quantity of mice, ants, roaches and scorpions we had to clean out. We never did quite get rid of the scorpions. They kept popping up in unexpected places such as on the wall in back of pictures, etc.

Several members of our class had preceded us to Post Field. They greeted us with the news that their only duty so far had been "bunk fatigue" and that there seemed to be some doubt as to whether our advanced training was to be at Post Field. It seems that a class of officers, among them Gene Vidal, had not yet finished their training, so no instructors were available for us cadets. Gene was famous as a West Point football star. He was to be Gore Vidal's father. I was associated with Gene several years later in the Ludington Line.

There was a flying game that I was able to participate in a few times. Ten to fifteen cadets and student officers would be assigned to DHs (DeHavillands) on the line, then go to the operations office and each put \$2 into a pool. Then we would put our names on slips into a bag and have the operations officer draw one out. The one whose name was drawn would take off and have a ten minute start. He carried some identifying article and had to land somewhere on the reservation. (The Fort Sill reservation was something like ten by twenty five miles in area.) Then the others would all take off at once and try to find him. The first one to find him, land near him and bring the identifying

article back to the operations office would split the pot with the pilot who took off first. There were usually a number of near collisions in the mad take off scramble. I won once. It was fun.

On June 20th I received orders to proceed to Kelly Field, arriving there not later than 1 July. By that time Cleo was quite pregnant and was expecting in early September. We wanted the baby to be born in Littleton, New Hampshire so we

Some farmers used to maintain mud holes . . .

decided that it would be better for her to join her parents there for the last two months of her pregnancy than to go to Kelly Field for a few weeks. So on June 25th I put her on the train for New Hampshire.

Cadet John Paul Riddle had a 1920 Dodge touring car, so he invited myself and three other cadets to ride to Kelly Field with him (and share the expense). We got away from Post Field on June 28th and arrived at Kelly on June 30th. We made pretty good time on the 500 mile trip, considering the road conditions in those days. There were practically no paved roads except in cities and towns. We only had three flat tires on the trip. In those days you changed the tire and inner tube — not the wheel. Also you carried chains to get you out of mud holes in case no farmer was near to pull you out with a team of horses (\$2). Some farmers used to maintain mud holes in the road near their farm.

There were two Kelly Fields at that time. Kelly #1 was a flying instruction field during WW1, but now housed an air depot with storage hangars and aircraft and engine maintenance and repair shops. Kelly #2 was adjacent. All the routine and instruction flying

was done there. When we arrived we found that the Flying Cadets were quartered at Kelly #1. The Carlstrom Field class following ours arrived a day or so after we did, and was combined with us to become the class of 1922.

There followed three weeks of no classes and no flying. We made good use of the officer's club swimming pool which was turned over to us four afternoons a week. Ed Conerton and I bought a 1913 Cadillac touring car for \$20. It was something of a maintenance problem but it lasted while I was at Kelly Field. Gasoline at the Post Exchange service station was only 10¢ a gallon so we visited most of the points of interest in and around San Antonio. We also made a little extra cash once in a while by hauling other cadets to and from San Antonio.

During this waiting time I visited the Kelly #1 hangar where Jimmy Doolittle was modifying a DH for his projected transcontinental one stop flight from Daytona Beach, Florida to San Diego, California via Kelly Field. He did everything he could to streamline the ship, and also installed auxiliary gas and oil tanks and some navigating instruments that were an improvement over the regular equipment. Our Advanced school started before he finished the job, so I wasn't around to see it completed. I know that he tested it several times before he was satisfied with it. I got to be pretty well acquainted with Jimmy during the short time I was able to call on him. He made the flight successfully after I had left Kelly.

Along toward pay day each month I was a trifle short of cash. I solved this problem by hocking the gold watch my grandfather Sanger had willed me (now valued at \$250) for \$20 and redeeming it right after payday for \$21.50. Two or three Saturday evenings a month Ed Conerton or Art Caperton and I would step out to the extent of having dinner at the St. Anthony Hotel roof. Dinner and music at \$2 each with a 25¢ tip. Caperton and I couldn't go the same evening because I had the only presentable civilian suit that fitted Caperton.

The Advanced Flying School got under way full throttle the last week in July — ground school in the morning and flying in the P.M.

Next month I'll tell you about the ups and downs of the ground and flying schools, including an account of my furlough and the happening of September 3, 1922.

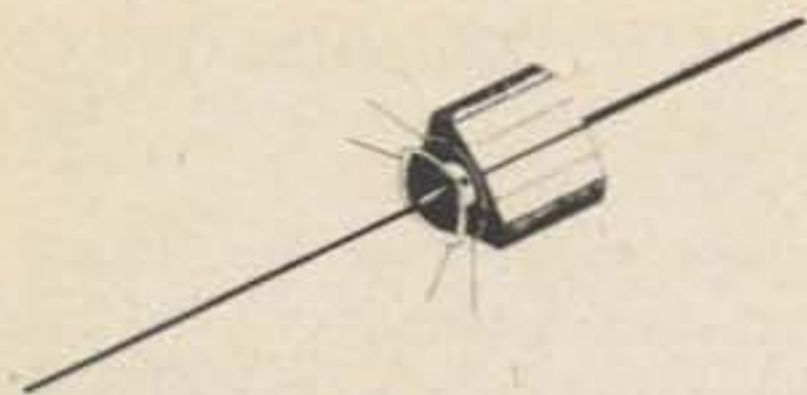

Satellite Orbiting Data

AMSAT

FIRST DAY COVERS

Official first-day cover envelopes commemorating the launch of AMSAT-OSCAR 7 are now available in two styles from AMSAT for \$1.00 each (or 5 IRCs). Be sure to enclose a business size (#10) self-addressed, stamped envelope (or an additional IRC in lieu of stamps). The first day cover envelopes were postmarked at the launch site, Lompoc, California, on the day of the launch, and make an excellent collector's item for any ham shack or philatelist.

OSCAR NEWS

Oscar News is a regular U.K. publication designed to inform and assist all users of OSCAR satellites. The publication contains operating tips, orbital data and info on OSCAR DX activity. Contact Tony Bailey G3WPO, 5 Erwin Way, Burgess Hill, RH15 9PN, England for sub info.

Oscar 6					Oscar 7				
Orbit	Date (June)	Time (GMT)	Longitude of Eq. Crossing °W	Mode	Orbit	Date (June)	Time (GMT)	Longitude of Eq. Crossing °W	
12001	1	0119.3	70.3	B	2472	1	0004.7	51.0	
12013	2	0019.2	55.2	A	2485	2	0059.0	64.6	
12026	3	0114.1	69.0	B	2498	3	0153.3	78.2	
12038	4	0014.1	54.0	AX	2510	4	0052.6	63.0	
12051	5	0109.0	67.7	B	2523	5	0146.9	76.6	
12063	6	0008.9	52.7	A	2535	6	0046.2	61.4	
12076	7	0103.9	66.4	B	2548	7	0140.5	75.0	
12088	8	0003.8	51.4	A	2560	8	0039.9	59.8	
12101	9	0058.7	65.2	B	2573	9	0134.1	73.4	
12114	10	0153.7	78.9	A	2585	10	0033.5	58.2	
12126	11	0053.6	63.9	BX	2598	11	0127.8	71.8	
12139	12	0148.5	77.6	A	2610	12	0027.1	56.6	
12151	13	0048.5	62.6	B	2623	13	0121.4	70.2	
12164	14	0143.4	76.3	A	2635	14	0020.7	55.0	
12176	15	0043.3	61.3	B	2648	15	0115.0	68.6	
12189	16	0138.3	75.1	A	2660	16	0014.3	53.4	
12201	17	0038.2	60.1	B	2673	17	0108.6	67.0	
12214	18	0133.1	73.8	AX	2685	18	0008.0	51.8	
12226	19	0033.1	58.8	B	2698	19	0102.2	65.4	
12239	20	0128.0	72.5	A	2710	20	0001.6	50.2	
12251	21	0027.9	57.5	B	2723	21	0055.9	63.8	
12264	22	0122.9	71.2	A	2736	22	0150.1	77.4	
12276	23	0022.8	56.2	B	2748	23	0049.5	62.2	
12289	24	0117.7	70.0	A	2761	24	0143.8	75.8	
12301	25	0017.6	55.0	BX	2773	25	0043.1	60.6	
12314	26	0113.3	68.7	A	2786	26	0137.4	74.3	
12326	27	0012.5	53.6	B	2798	27	0037.0	59.1	
12339	28	0107.5	67.4	A	2811	28	0131.2	72.7	
12351	29	0007.5	52.4	B	2823	29	0030.4	57.5	
12364	30	0102.4	66.1	A	2836	30	0125.0	71.1	

HAM HELP

I'm enrolled in the National Radio Institute's Advanced Course in Communication (rbl57-c438) and I would be glad to help any one in any way possible.

Jonathan F. George WN1UST
25 Dwight Street
Dalton MA 01226

Helpers: Times are tough all over, but remember when you were just starting out? Brighten one of the following's ham day by getting in touch and lending a hand. Preserve the race!

SFC. James F. Widener
229-44-3461
S&M Co USASAFS Box 2034
APO New York 09458
(Augsburg, Germany)

Peter Osroff
2442 East 26 Street
Brooklyn NY 11235
(212) 646-7757

Robert C. Boucher
90 Shawsheen Road
Billerica MA 01866

Robert A. Sorento
503 E. Darby Road
Havertown PA 19083

William Prago
2240 Center Avenue
Fort Lee NJ 07024
(201) 944-2860

Clarence Lowe
2330 Lucas Street
Cayce SC 29033
(803) 796-1177

Helpees: Don't be bashful. Drop a postcard to 73, Ham Help, Peterborough, NH 03458.

INITIAL MADNESS

Blame the Mt. Tom Repeater Association for this — much of it came from their newsletter, "Intermod."

Non-ham readers of 73 (and other ham magazines) struggle through the abbreviations which are so standard to amateurs that few are given a second thought. Try these on and see how you do — most are amateur oriented. 95% or better, take a bow. 90% = well versed. 80% = average. 70% = Novice. 60% = CB.

- | | | | |
|---------|---------|---------|----------|
| 1. GDO | 26. SCR | 51. OOT | 76. OBS |
| 2. FSK | 27. EMF | 52. MOS | 77. AST |
| 3. RFI | 28. PTO | 53. AFC | 78. CCS |
| 4. TTL | 29. SCM | 54. RST | 79. VAC |
| 5. BPL | 30. VOM | 55. TVI | 80. HFO |
| 6. PEP | 31. UHF | 56. ITU | 81. ROM |
| 7. USB | 32. LDE | 57. SEC | 82. AWA |
| 8. ANL | 33. UJT | 58. LSD | 83. WAC |
| 9. SWL | 34. FMT | 59. NCS | 84. VCO |
| 10. WPM | 35. CUL | 60. PTT | 85. ILS |
| 11. VFO | 36. GMT | 61. SNR | 86. VLF |
| 12. SWR | 37. MAH | 62. RCC | 87. DOT |
| 13. WAS | 38. COR | 63. MUF | 88. RMS |
| 14. ERP | 39. BFO | 64. VTR | 89. EME |
| 15. SET | 40. RIT | 65. CPS | 90. VDC |
| 16. MCW | 41. FET | 66. ATV | 91. UFO |
| 17. RFC | 42. LMO | 67. VOA | 92. CTS |
| 18. CRT | 43. STA | 68. OEM | 93. PRV |
| 19. PIV | 44. EEG | 69. MMF | 94. NBS |
| 20. VOX | 45. ALC | 70. CGS | 95. DSB |
| 21. CAP | 46. BCI | 71. FCC | 96. VXO |
| 22. PLL | 47. FAA | 72. ORS | 97. RTL |
| 23. OTP | 48. LSI | 73. AGC | 98. SAE |
| 24. LED | 49. CDI | 74. ECO | 99. DIP |
| 25. NTS | 50. BST | 75. TRF | 100. CCW |

ou goons don't ever proofr
lasy manuscripts from bab
bunch of rocks preening on
you ignored my comments in
I insist that you print ev

HELP!

I need some assistance. I am an unemployed Disabled Veteran and I am trying to obtain a SSB transceiver capable of working on the Illinois MARS frequencies (7632 MHz, 3311 MHz, and 3309 MHz). As I am unemployed and disabled, I don't have any (or very little) funds to purchase a unit. I do, however, have many VHF units that I can swap. This unit does not have to be totally operational as I can (needless to say) repair it. *Anything* your staff can do to aid me in this search would be greatly appreciated, even if someone sells me a set on faith that I will pay upon gainful employment, or loan me a set until I am able to purchase one. I do request, however, that if you print this appeal, that you don't print my name or call letters. I would attempt to purchase a unit from a commercial house if I were employed and if my credit rating wasn't so horrible from being out of work so long.

(Name and address withheld)
Contact Box 4
73 Magazine

FRENCH LICENSING

Here is some information as requested in your March issue, concerning class privileges and exam requirements in other countries.

Voila for France:

First of all the cost of the examination: It comes altogether to about \$26 at today's exchange rates of 4.5 francs for \$1. Of this total, 30 Fr. (\$6.6) are due for the Post Office's fee for opening a file. The rest is for the exam fee (\$20).

There are at present two different classes of licenses in France: One permits the holding of a CW operator ticket (CW exam) which gives full privileges and the use of all radio amateur bands. (French amateurs' bands!)

The second does not require the

CW test and is only valid for the VHF bands on phone or any other mode.

Wide band TV requires a special extension of any license.

The technical test is extremely simple and there is not a written exam.

The official does give the exam at the candidate's home in most cases, and if you don't try to kill him, everybody gets "okay" with the "technical examination."

The CW exam is also quite simple. The official sends a written text for about 5 minutes at a speed slower than 10 wpm! The regulation requires 10 wpm copying speed. When I passed the exam 2 years ago, the text (CW) was sent to us 3 times before the final one. The official takes with him the written text as a proof of the exam.

At present, power is limited to 100 W dc, but anything is tolerated.

The annual fees at present are 70 Fr. or about \$16 a year.

Although I am a foreigner in this country, I have full privileges and a real French call, F6CVU. This is due to the fact that I have a resident's status here.

Foreigners getting a license under any agreement for a provisional time do have F0 prefixes. And as a general rule all F1 prefixes are only VHF stations.

Here are the French amateurs' band complements. HF: 3.5 to 3.8 MHz (shared with other services, such as Army, Police, etc.); 7 to 7.1 MHz; 14 to 14.35 MHz; 21 to 21.45 MHz; 28 to 29.7 MHz; 50 to 54 MHz (not in region one, but OK for French Guiana, Martinique, etc.). VHF and UHF: 144 to 146 MHz (shared with other services); 430 to 433 MHz (shared with other services); 4345 to 440 MHz (last year this portion was lost by the inaptitude of the French Amateur Radio Club and the weight of the Army here); 1220 to 1260 MHz (shared); 2300 to 2450 MHz (shared and requires a special permit from the Post Office!); 5650 to 5050 (shared); 10000 to 10500 (shared); 24000 to 24500 (shared).

Special attention is given to the following sub bands: 433 to 434.5

MHz; 1215 to 1220 MHz; 1260 to 1300 MHz; 2300 to 2450 MHz (special permit required).

All these frequencies are strictly forbidden and apparently their use endangers one's life (some special aviation services are working these frequencies).

Any official information can be requested from: Direction Des Telecommunications du Reseau International, Immeuble P.T.T., Bercy, 75584 Paris Cedex-12 or from the French Radio Club: R.E.F., 21 Square Trudaine, 75009 Paris, Phone 878 14 49.

And by the way, VHF repeaters are not legal in France!

Jacinto Lirola
21 Rue Lavoisier
67200 Strasbourg
France

WESTERN SAMOA

I have had a license from Western Samoa for many years. Callsign: 5W1AT. Western Samoa will issue licenses to licensed amateurs from foreign countries for a period of one year at the cost of three tala, W.S. A U.S. dollar is worth sixty W.S. cents. The privileges granted are equivalent to the U.S. Extra. Licenses from General (U.S.) on up are accepted as evidence. I don't know what would happen in the case of a Novice, since none has applied as yet. There is no reciprocity between Western Samoa and the U.S. The licenses are granted as a courtesy, and there has been no problem to date. For a W.S. license, send the equivalent of three tala to Mr. E. D. Williams, Director of Post Office and Radio, General Post Office Building, APIA, Western Samoa. Make money orders payable to the Government of Western Samoa.

I hope this information may help you in your compilation.

Jim Jaeger KS6EX and 5W1AT
Pago Pago, Samoa

GREASY KID STUFF

I was just loafing around the house yesterday, and decided I had to get something off my chest. It has been building up for two weeks, since I tuned up on 15m and got hold of a guy out west. From his call I assumed he had been around for some time and he confirmed this by saying he had his

ticket back in '53. After giving him the usual signal report, rig and wx bit, I thought I would give him a little background on myself. So I told him I was 25 years old and operated 80-10m on CW and SSB. Also I told him I had a 2m FM rig and operated simplex and the local repeaters. When I turned it back to him I was promptly informed that 2m FM was greasy kids' stuff and that he had to go QRT for now. He promptly signed off. About four minutes later I heard him calling CQ down frequency.

I don't know if that person reads this magazine but I want to tell him — and the many other people that remind me of him — what I think.

I remember when the big tornado hit Zenia, Ohio. I live about 25 miles north. While a few people were on their lowband rigs trying to fight through the QRM, QRN, QSB and generally some of the worse conditions in years, the real work was going on with the two meter crowd. Ask the people in Zenia what they think of "greasy kids' stuff." Ask the police, the National Guard, the Red Cross and all the other relief workers.

And while you're running your high powered rig to talk to a guy 20 miles away I think I'll use my battery operated 1 Watt rig to do it.

To conclude this I would like to say that I derive most of the pleasure I get from amateur radio from operating on 15m SSB and CW. However, I work every frequency I can to some extent or the other. I find it absurd and detestable to see blind prejudice against any frequency or mode, when they all have their practical and pleasurable aspects.

Gary L. Robinson WB8ROL
Troy OH

GRIBE

Was quite interested in W4AEO's Log Periodic antennas in the March 73. Had occasion to want to squeeze a few more decibels out of a low frequency end of a Log Periodic so I hung a couple of parasitic reflectors at 33% of the free-space-distance behind the last element. It helps.

Also have a gripe to pick with those chaps who think a receiver works better grounded to a water line than independent grounds. In these days of transite water mains, insulated pipe couplings between copper and galvanized pipe and water-pipe grounded electrical equipment, a lot of house-

hold and powerline racket can be inductively coupled into the set via the ground linkage. It's much better to use a couple of good grounds in parallel located well away from any buried water lines. Also add a couple of .05 uF 600 volt condensers to shunt exterior power line racket to the ground out at your breaker box following the meter. It keeps the house wiring from feeding it into the antenna, etc.

L. S. Hannibal
Fair Oaks CA

ECUADOR

I am enclosing a picture which I thought might be of interest to you. It was taken with my new 5BWAS, No. 182 issued in August. The picture was taken in our shack and also in the picture is my OM, Joe HC2OM, and our little 19 month old daughter, Diane Renee.

Have been participating in various contests including the annual YL-OM Contest and got about 72,000 points in the phone portion but had bad luck in the CW portion with only 12,900 points. My rotor was stuck toward Europe due to a damaged ring gear (there are no spares in Guayaquil), I had a power outage, and then came a heavy rain with rain static — severe for about 4 hours.

Darleen Magen HC2YL
Guayaquil, Ecuador

SPLIT-SPLITS

Bill Pasternak's article on 15 kHz split repeater channels in the April issue of 73 was of some interest to me

since we have been considering for some time the problems of having a repeater 15 kHz above or below our repeater. Clearly, Bill has had more than enough practical experience operating repeaters to understand the problems with split-split channels, but I find a serious error in his explanation of the channel placement. His discussion is based on the misconception that 5 kHz deviation produces a 10 kHz channel. Now it seems simple enough to space 10 kHz channels every 15 kHz leaving a 5 kHz guard channel between each repeater to allow for frequency drift and over-modulation. The whole idea fails because the actual bandwidth of an FM signal is equal to twice the deviation plus twice the highest modulating tone. In commercial service this works out to be the familiar 16 kHz for narrowband FM. Rather than leaving a guard channel between repeaters, there is in fact an overlap of 2 kHz on each side of each channel when the channels are spaced at 15 kHz intervals.

Bill was close to the problem when he said that the WA2ZWP was operated at 4 kHz deviation, which reduced the interference to the other repeaters. What he actually did was reduce his bandwidth to 14 kHz, which removed most of his sideband energy from his adjacent channels. The important point to remember is that there is no guard channel between repeaters as is suggested in the figures in the article. Instead, there is an overlap of 2 kHz on each channel which puts a considerable amount of energy in each adjacent channel.

Split-split repeaters of either the

Continued on page 12





**OLD WESTBURY NY
JUNE 1**

The Long Island Mobile Amateur Radio Club (LIMARC) will hold an all-electronic flea market and auction on Sunday, June 1 (rain date June 22) from 10 am to 6 pm at the New York Institute of Technology at Route 25A and Whitney Lane, Old Westbury, New York. Auction will begin at 4 pm. Items to be sold include communications equipment, hi-fi, TV, components, test equipment, etc. Admission is \$1 for buyers and \$2 for sellers. Call-in on 25/85. Refreshments will be available.

**WINFIELD PA
JUNE 1**

The Twelfth Annual Penn-Central Hamfest will be held by the Williamsport and Milton clubs on Sunday, June 1, at the Union Township Volunteer Fire Co. grounds on Route 15 in Winfield PA. This informal hamfest with indoor and outdoor facilities for contests, auction and flea market, will start at 12 noon. Gate registration \$3, XYL and children free, free parking. Talk-in on 3940, 146.13/.73, .37/.97, or .94 MHz.

**BURLINGTON KY
JUNE 1**

Sunday, June 1 at the Boone County Fairgrounds, Burlington, Kentucky. Located 10 miles south of Cincinnati, Ohio near I-75. Features prizes, indoor exhibits, flea market, refreshments. Tickets: \$1.50 advance, \$2 at door. Contact: WA8OGS, 6381 Mullen Road, Cincinnati, Ohio 45239.

**BROOKLYN NY
JUNE 6**

An auction sponsored by Brooklyn College Amateur Radio Society and Radio Society of Greater Brooklyn will be held Friday evening, June 6 at Brooklyn College, Bedford Avenue between Campus Road and Avenue "I", Room 148, Ingersol Extension. Doors open 7:30 for sellers auction starts 8 pm sharp. Admission \$1 for non-sellers, \$1.50 for sellers. No commission charge.

**FLUSHING NY
JUNE 7**

The Hall of Science Radio Club will hold its Second Annual Flea Market on Saturday, June 7. The flea market will begin at 10 am. Tickets will be \$12 for everyone and we will have several door prizes. Rain date June 8.

**GRANITE CITY IL
JUNE 8**

The Egyptian Radio Club Inc. Hamfest will be held on Sunday, June 8, 1975 located at the Clubhouse ¼ mile south of Old Chain of Rocks Canal Bridge. Prizes, swappers row, games for kiddies, ladies' white elephant sale and Bingo. Admission free. Talk-in on 146.16/146.76.

**MANASSAS VA
JUNE 8**

Ole Virginia Hams ARC, Inc. will sponsor a Hamfest Sunday, June 8, 1975 in Manassas, Virginia at the Prince William County Fairground, 1/2 mile south of Manassas on Route 234. Indoor and outdoor exhibit bldgs, FM clinic, 2 YL programs, ECARS, door prizes and refreshments. Advance reg. \$1.50, at gate \$2.50, children under 12 — free. Tailgating \$2 per space. For Advance reg write to Ole Virginia Hams ARC, Inc., c/o Tim Wayne WA4GVX, 1708 Sharp Drive, Woodbridge VA 22191. Talk-in on 146.37-146.97, 146.94 Simplex, 3.955 MHz.

**ANDERSON IN
JUNE 8**

The Madison County Amateur Radio Club in Anderson, Ind., will hold a Hamfest on June 8, 1975. A free fleamarket, auction, displays and prizes will be offered. The Hamfest will be at the Old Linwood School, north of Anderson on S. Road 9 and 600 N. Time: 9 am to 4 pm. Call-in on 22-82 WR9ACI.

**WILLOW SPRINGS IL
JUNE 8**

Six Meter Club of Chicago, Inc., 18th Annual Hamfest, Sunday, June 8, 1975. Southwest of Chicago at Sante Fe Park 91st and Wolf Road, Willow Springs IL. Advance reg. \$1.50, at the gate \$2.00. Large swap row, color TV, and many other goodies, picnic grounds, plenty of parking space, refreshments. Advance tickets from Val Hellwig K9ZWV, 3420 South 60th Court, Cicero IL 60650 or any club member. Talk-in on 146.94 FM or WR9ABC 37-97(PL2A).

**DES MOINES IA
JUNE 8**

The Des Moines Radio Amateur Association invites you to participate in the Des Moines Hawkeye Hamfest, the largest hamfest in Iowa. Located at Iowa State Fairgrounds in Des Moines. It will be held on Sunday, June 8, 1975 at 8:00 am to 6:00 pm CDST. For more information contact Des Moines Radio Amateur Association, Box 88, Des Moines IA 50301.

**JEFFERSON CITY MO
JUNE 8**

The Missouri Single Sideband Net Annual Picnic will be held at the shelter house of Memorial Park in Jefferson City, Missouri, June 8, 1975. Activities begin 8 am — swap tables — door prizes — carry-in dinner — refreshments provided — all hams welcome. Direct inquiries to any MOSSB net control 3.963 MHz, WBQFND net manager. Talk-in on 146.94 and 3.963.

**TRAPPE MD
JUNE 8**

Eastern Shore of Maryland Hamfest — sponsored by The Easton Amateur Radio Club on June 8, 1975 from 10 am - 4 pm, rain or shine. Only 35 minutes south of the Bay Bridge, one block off Rt. 50, in Frappe MD, between Easton and Cambridge at the old Trappe Elementary School on Main St. Talk-in on 146.52, 94, and 146.445/147.045 rept. in Cambridge. Tables, food, drinks, ladies program, prizes and plenty of room for tailgaters. Admission \$2 or \$4 for tailgaters. Contact K3RUQ.

**ORLANDO FL
JUN 14-15**

Orlando Hamfest at Exposition Park.

**AKRON OH
JUNE 15**

The Goodyear Amateur Radio Club WA8UXP (Akron) will hold its 8th Annual Fathers Day (Hamfest) Picnic on June 15, 1975 at Wingfoot Lake Park located east of Akron, Ohio, one mile west of Suffield, Ohio, on County Road #87 and near County Road #43. Join us for an enjoyable day of entertainment, swap and shop, prizes every hour, refreshments, displays, huge flea market, picnic tables and children's games available. \$2.00 family admission prepaid or \$2.50 at the gate. For details, map, tickets and program write Floyd T. Gilbert WB8ALK, 1976 Newdale Avenue, Akron OH 44320.

**BALTIMORE MD
JUNE 15**

The Maryland Mobileers Amateur Radio Club, Inc. will hold its 5th Annual Hamfest, RAIN or SHINE, June 15, 1975 at the Anne Arundel Community College. The college is approximately 12 miles south of Baltimore just off Route 2. Registration \$2, tailgating \$2. Talk-in 10/70, 16/76, 94, 52 and others.

**ROME NY
JUNE 22**

The Rome Radio Club sponsors its 23rd consecutive "Ham Family Day" on Sunday June 22, 1975 at Beck's Grove, 10 miles west of Rome, New York. This is a true ham-family event with a complete program for all ages — technical talks, meetings, flea market, contests, equipment displays, ladies' and children's fun programs. Advance reservations: Adults \$7.25, children under 12 \$4.00, under 6 free. Tickets at the gate without dinner: adults \$2.50, children free. Send your reservation to the Rome Radio Club, Box 721, Rome, New York 13440.

**JACKSONVILLE IL
JUNE 29**

The Jacksonville Area Amateur Radio Club will hold their 11th Annual Hamfest, Sunday June 29, 1975 at the Morgan County Fairgrounds as in previous years. A large trading area available for rain or shine. Talk-in via WR9ACS or .16/.76 and .94 direct.

**HEAR PROSE SPEAK
(or)**

"HERE, PROSE . . . SPEAK!"

Spend the Fabulous Fourth of July weekend at the 47th annual Atlanta Ham Radio Festival and ARRL Georgia State Convention. Center of

Never Say Die from page 3

paving the way, but the rules make their work slow and painful. There are stations you can work and even get a printed out QSL — and no one is there! The "operator" is off at work, but his station still is available to communicate.

If we can put a halt to this escalation of the rules, we will all benefit in the long run. It's up to you. Are you going to write the FCC this week?

**AUTOMATIC
IDENTIFICATION**

The recent FCC docket ushering in

activity will be the Royal Coach Motor Inn, I-75 North, July 5th and 6th.

Highlight of the Festival will be the Saturday night banquet with Keynote Speaker, FCC's A. Prose Walker whose topic will be, "Docket 20282 — Restructuring."

Activities cover all phases of amateur radio including ARRL Forum, FCC examinations, biggest flea market and manufacturer's display in the south, special events for XYLs and Junior OPs, Sunday afternoon grand prize drawing, MARS meetings, technical programs, something of interest to every ham and his family.

Pre-registration — \$2 per person or \$4 per family (\$3 or \$5 at hamfest). Special hamfest motel rates \$16 single and \$21 double (children under 13 free).

For more info write: Atlanta Ham Radio Festival, P.O. Box 76553, Atlanta, Georgia 30328.

**MAPLE RIDGE BC
JULY 11-13**

Maple Ridge Hamfest is being held on July 11, 12 and 13 at the Maple Ridge Fairgrounds approximately 30 miles east of the city of Vancouver on the north side of the Fraser River. The hamfest includes: Technical seminars and displays; contests for the women and children, as well as the OMs; a hidden transmitter hunt; mobile judging; technical IQ quiz; home brew equipment contest; commercial displays; two meter home brew antenna contest; Saturday evening meal. Registration: At the door, \$3.00 no meal, \$7.00 with Saturday meal. Pre-registration available for \$6.00, cutoff date June 30. Overnight parking for trailers and campers plus spaces for tents available for \$2.00, but no hook-ups. VE7MRC will be monitoring 146.94, 146.76, 146.79,

automatic identification of just about all transmitters except amateur may have some valuable fallout for us.

Once inexpensive ICs are available for encoding identification, it should be possible to have your call precede each transmission, sent in a brief burp. By using a sharp audio filter on the receiver to feed this burp into a decoder, but not into the speaker output, you wouldn't hear the identification at all. A decoder could then translate the burp into the callsign of the transmitting station and present it on a set of LEDs so you would have the call of any station talking to you right on the front of your rig. Hell,

John Gearhart WA0AQO
1408 Dawn Drive
Columbia MO 65201

**REVISIONS FOR "SCANNING
WITH A SYNTHESIZER"
(April, 1975, pages 23-36)**

Page 25 — Fig. 2. Ground pin 6 of IC10.

Page 26 — Fig. 3. Connect pin 5 of IC31 to Vcc; connect pin 12 of IC31 to ground.

Page 32 — Fig. 6. See revised version.

Page 33 — Interface. The sentence, "Hex buffers are used as shown in Fig. 6," should read, "Fig. 6 shows how AND gates are used as buffers."

Page 36 — Parts List. Interface: IC40, IC41, IC42 — 7408.

Fig. 6 (revised).

147.33 and 3970, 3755 for talk-in purposes from 1600 July 11 on.

**CHARLESTON SC
JULY 12-13**

The Charles Town Hamfest will be held on July 12-13, 1975 in Charleston, South Carolina. For more information write: P.O. Box 12502, Charleston SC 29412.

why not add the name, too? It would require perhaps seven readouts for the call and another seven for a handle.

Let's see what we can do to get some experimentation going on this and some articles on hardware into 73 Magazine . . . and please, don't anyone dare to petition the FCC to make this a rule.

One serious drawback: I can see bitter opposition from the substantial group dedicated to self-righteous and indignant demands that the breaker identify himself immediately — this

Continued on page 16

ARRL plan or the California plan will require that we narrow band our equipment in a way similar to the narrowbanding of commercial equipment a decade ago. It will not be necessary for everyone to buy expensive filters for their receivers unless they want to work a distant repeater on a channel adjacent to a strong local repeater. It will be very important that everyone adjust their equipment to 4 kHz or less, which will keep them from keying up the adjacent repeaters unintentionally, and it would be nice if everyone could stay within 500 Hz

of the channel center. All of this leads to the second misunderstanding, that the repeater is the cause of the problems. It is of little importance how the repeater is adjusted, since it is supposed to provide local coverage only. The burden falls instead on the users, who must maintain their equipment to some rather high standards to keep from interfering with adjacent repeaters — and these standards cannot be met by adjusting by ear.

I see two alternatives to this problem. I expect that there will be much more tone access in the future because repeaters are hard to monitor

when they are frequently keyed up by nuisance signals. Even with all the split-split channels allocated, the populated areas of the country will have fully used up the spectrum on 2 meters within the next three years. I agree with Bill that the long term solution is to develop 6, 220, 450 and eventually 1215 MHz. To that end, we will shortly operate repeaters on 6 and 450. See you there.

Robert W. Condon K1WUK
Shrewsbury MA

Continued on page 14

NEW PRODUCTS

INEXPENSIVE FM FREQ STANDARD

Magtech Engineering has come up with a nifty answer to the need for a frequency generator to standardize repeaters and FM transceivers. The FM-146 is a little blue box (don't get nervous Ma Bell) which needs +12 V and a couple of short antennas... everything else is done by ICs.

Anyone who needs to have a digital wristwatch which is accurate to the second will want to have his rig or repeater accurate to at least 10 Hz, right? The FM-146 has a crystal oscillator at 3 MHz which is then divided down to 1 MHz and harmonicked out to enable you to zero it in with WWV on any frequency out to 15 MHz.

There is a small trimmer capacitor for this function. Another chain divides the 3 MHz down to 30 kHz (by 100) and this too is made rich in harmonics... then it is put through a high pass filter. The result is a lot of 30 kHz signals in the 146 MHz band, radiated by the small antenna on the FM-146, allowing FM rigs to be tuned up right on channel for every 30 kHz frequency — and that does it for both transmit and receive.

Simplest thing in the world to use... put in the power and start tweaking your capacitors. At \$60 this has to be one of the better bargains in amateur radio... imagine, accuracy as great as 10 Hz at 146,000,000 Hz... which is ten to the minus what? Drop 'em a note for further details, which you really don't need, but which you may want if you prefer buying things in two steps instead of one... Magtech Engineering, Box 21979, San José CA 95151.



THE HEATH SCOPE

The 4530 Heath single-trace oscilloscope features TV coupling, DC-10 MHz bandwidth and wide-band calibrated X-channel input, making it a versatile, easy-to-use scope for the service technician and a good general purpose scope for the ham.

The 4530 is one of the few single-trace scopes with two input channels. The Y-input has a maximum sensitivity of 10 mV with an 11-position attenuator. For true X-Y operation, a calibrated X-input is provided with maximum sensitivity of 20 mV. Its calibrated 3-position attenuator can be switched through three ac or dc ranges from 20 mV/cm to 2 V/cm.

High or low frequency waveforms are no problem since the 4530's wide range of time bases can be switched from 200 ms/cm to 200 ns/cm. Any sweep speed can be magnified five times.

Trigger circuits are digitally controlled, requiring only a level control and a slope switch. Signals can be dc coupled, ac coupled or TV coupled to the trigger circuits. In the TV trigger coupling mode, the 4530 can easily be triggered on the vertical or horizontal component in a complex TV signal.

The 4530 is available in kit or assembled versions. The Heathkit 10-4530 is priced at \$299.95. The factory assembled and calibrated S0-4530 is \$420.00. For more information, contact the Heath Company, Benton Harbor MI 49022.

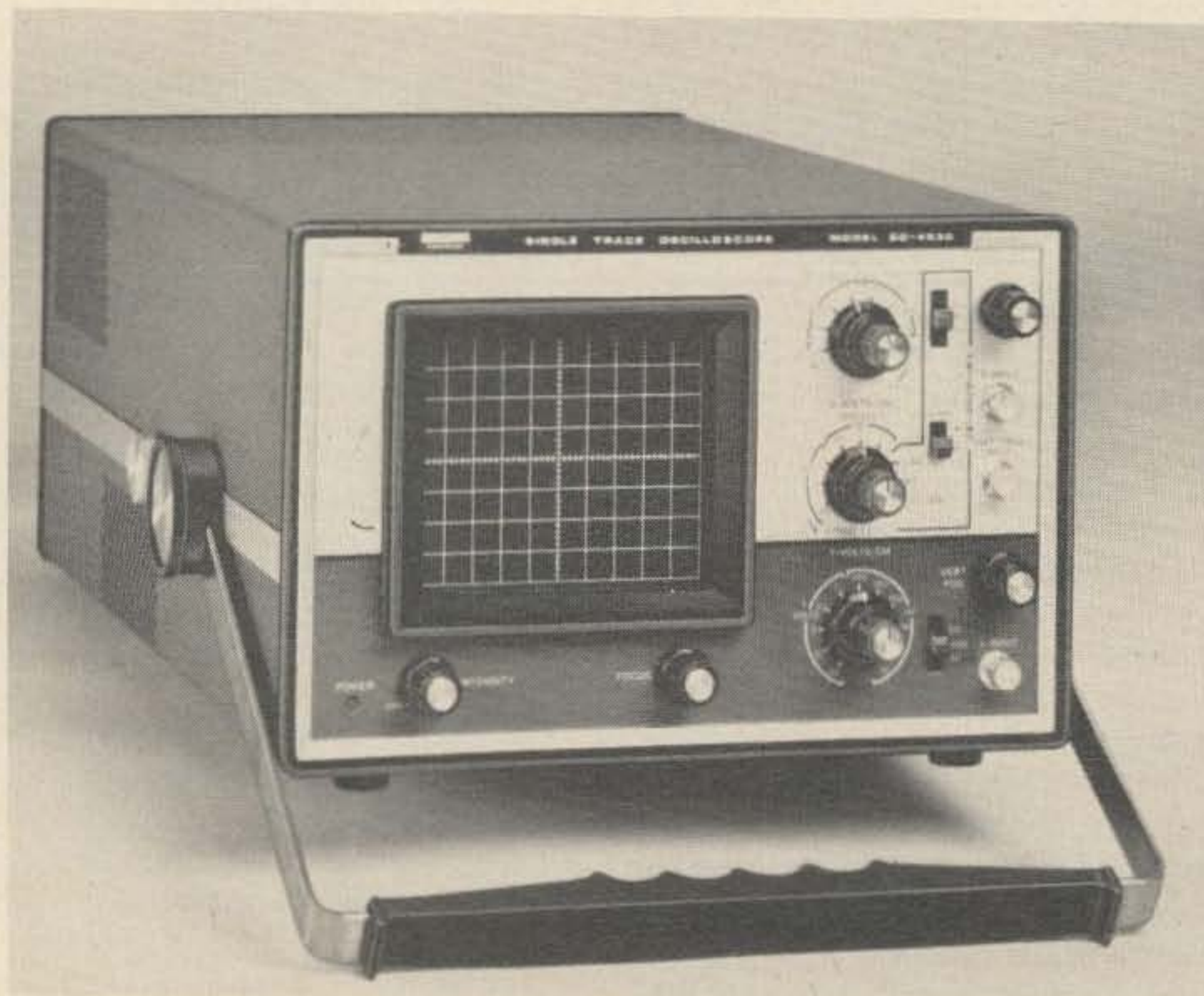

Horizon "2"_{mtr.}

12 channels/25 watts from

Standard

NEW



ASTROPOINTS

- ✓ 144-148 Mhz for Ham, CAP, & MARS
- ✓ 12 channels, 3 included
- ✓ Glass Epoxy Circuit Board
- ✓ TX and RX Trimmers
- ✓ PL option
- ✓ Tone burst option
- ✓ FCC Type accepted family for Business/Industrial & Marine
- ✓ 25 watts output (nom.)
- ✓ .4 μ V sensitivity
- ✓ 70 db selectivity
- ✓ 3 watts Audio
- ✓ Built in speaker
- ✓ Small size, 6" x 2" x 9"

All this Horizon "2"_{mtr.} under "3"

Get all the specs and complete Amateur Brochure,
write today:

 **Standard
Communications**

P.O. Box 92151 Los Angeles, California 90009 Telephone 213/532-5300

RUDE AND FOOLISH

I read with great interest the article by WN7KUD, 73 Magazine February 1975. A biographical piece about certain radio amateurs and their boorish behavior.

Regrettably, I, too, have had personal experiences of rude and foolish behavior on 20m SSB (it's DX time and get off my frequency) and 2m VHF (this is our repeater and who the hell do you think you are?), usually blurted over the ether by the "older" and "Big John" radio amateurs.

Further, such activities as "closed" repeaters, regrettably frequent use of words such as "jerk" and "wap," constant criticism of CB operators, and a boorish high mindedness is, to me, far too prevalent within the American Amateur Radio fraternity.

It would seem that the recently published docket from the FCC is one final attempt to responsibly organize the U.S. Amateur Radio fraternity without kow-towing to the ARRL nor to the whims of amateur radio's "Big Guns."

**John Anthony G3NDY/W2
Croton-on-Hudson NY**

THINKING METRIC

Will you please (for sake) stop the idiot practice of printing article dimensions in both the U.S. and metric systems? What kind of imbeciles do you think your readers are that they must be given the same conversion information many times per page, page after page, month after month? Shucks (), I'm 58+ years (704.194 months) old and learned the metric/English conversions when in the sixth grade, which makes it about 46 years (16,802.25 days) ago, probably some years before you were born. Only supercilious egotists would take it upon themselves to teach a technical audience an utterly simple set of conversions that they already know, then do so in a spoon feeding manner suited only to Sesame Street TV for pre-school children. Every time I read one of those "about a foot and a half (45.72cm) long" asinities my teeth ache as if a large rasp had been dragged across them.

Besides, if there is anything I can't stand it's sloppy workmanship. The December issue gave a score of linear dimensions without their metric

equivalents (pp 42, 44, 45, 84 & 108), gave temperatures in Fahrenheit on page 28 without telling us what they were in centigrade, and told us on page 45 how to calibrate an anemometer in miles per hour (horrors, how many kilometers are those old things?). This last shapes up as a nice coming battle for you "let's convert" nuts, by the way. I'm a private pilot as well as a ham, and while you metric buffs are shouting "kilometers" in one ear and the air controllers, AOPA and FAA are yelling "knots and nautical miles" in the other I am gazing down at a beautiful land nearly criss-crossed and checkered from coast to coast with varied patterns of roads, fences and fields of grain all laid out in statute miles (5,280 ft. each). Ah, me.

One more dig and a suggestion. I'm sorry to tell you the bad news, but mindless repetition of precise English/metric conversions is exactly the wrong approach to the real problem, which is to get people to "think in metric". You're trying to teach code by "dash-dash-dot-dash" instead of by "dah-dah-di-dah". If you must continue the metric crusade and role of educator, I suggest that if you will print only the metric figures, and carry them out only to the last important significant digit, we readers will be "thinking in metric" in no time. Let's try an example.

On page 89, December issue, we find "... a lot of us are putting up with a 40m inverted vee 7.62m (25'0) high in the middle and 3.05 (10') off the ground at the ends." Utterly absurd, teeth-grinding reading, authored (or edited) carefully to be false. The vees are 40 meter (band) antennas, not 40m antennas, and it is unlikely that even one of them will measure 7.62m, which implies a tolerance of $\pm 0.005m$, high at the middle and 3.05m to the same tolerance at both ends.

Since we all know that a meter is a little over three feet, let's try instead "... a lot of us are putting up with a 40 meter inverted vee less than 10m high in the middle and only 3m or so off the ground at the ends". Voila, we can Think Metric already!!

**Jim Bowles
Ukiah, California**

WE BUY IT OR WE DON'T

May I say a word of warning regarding the proposed changes?

Current regulation can't be all that

bad or we wouldn't still be enjoying the pleasures of amateur radio. If we start nitpicking the rules just to get our petty desires incorporated, then sure as heck we will get burned by some changes we don't like (some we haven't even heard of yet).

Either we buy Docket 20282 in its entirety or we don't buy it.

I for one don't buy it.

**John M. Marshall WA7YCY
Gresham, Oregon**

DON'T CHANGE

73 is the only ham magazine I read now, outside of an occasional copy of QST. Don't change a thing. I especially enjoy the editorials, solid state news, and Looking West. (I do believe many of the problems and solutions in the West column will one day be occurring here in the midwest, also.)

**... P. Scott Smith WB9JSE
7723 W. Bender Avenue
Milwaukee WI 53218**

CW ALIVE AND WELL

I was reading your "GRRReen" column from the December '74 issue and was intrigued by your comment that "(the military) seems to have little interest in code any longer." As a military radio operator, I can assure you that CW is far from "dead" in the military. In the 10th Special Forces Group, we use CW almost exclusively for our long-haul communications. We have found that at long distances, using low power, CW is the fastest, most accurate, most jam resistant means of communicating.

**Sgt. Hartley J. Gardner WA1KNG
Fort Devens MA 01433**

FANTASTIC

I think your magazine is fantastic. Although I am not a ham (yet) I am trying to keep up with the technical advances of radio.

From just the amateur's view, over a year's time (according to the annual index) you have had an article on every phase of amateur radio. 73 is the best ham magazine I have come across including QST, CQ and Ham Radio.

**Johnnie David Twine
APO New York**

Continued on page 170.

Stability.



That's what you get from Sentry crystals. The best frequency stability you'll find anywhere. Because Sentry crystals are made of the finest quartz to the latest state-of-the-art specifications.

And since Sentry has the largest semi-processed crystal bank in the world, we can custom-make crystals for any rig. And frequency. Faster than anyone else in the business.

Sentry gold-plated crystals are for long term reliability. Our order processing is quick and efficient. And we stand behind our work. With solid guarantees.

So send for our free catalog. And place your next order with Sentry. You can depend on us.

Sentry Manufacturing Company.
Crystal Park, Chickasha, Oklahoma 73018.
Phone: (405) 224-6780,
TWX-910-830-6425.

Sentry
Manufacturing Company
Tuned-In to Quality.

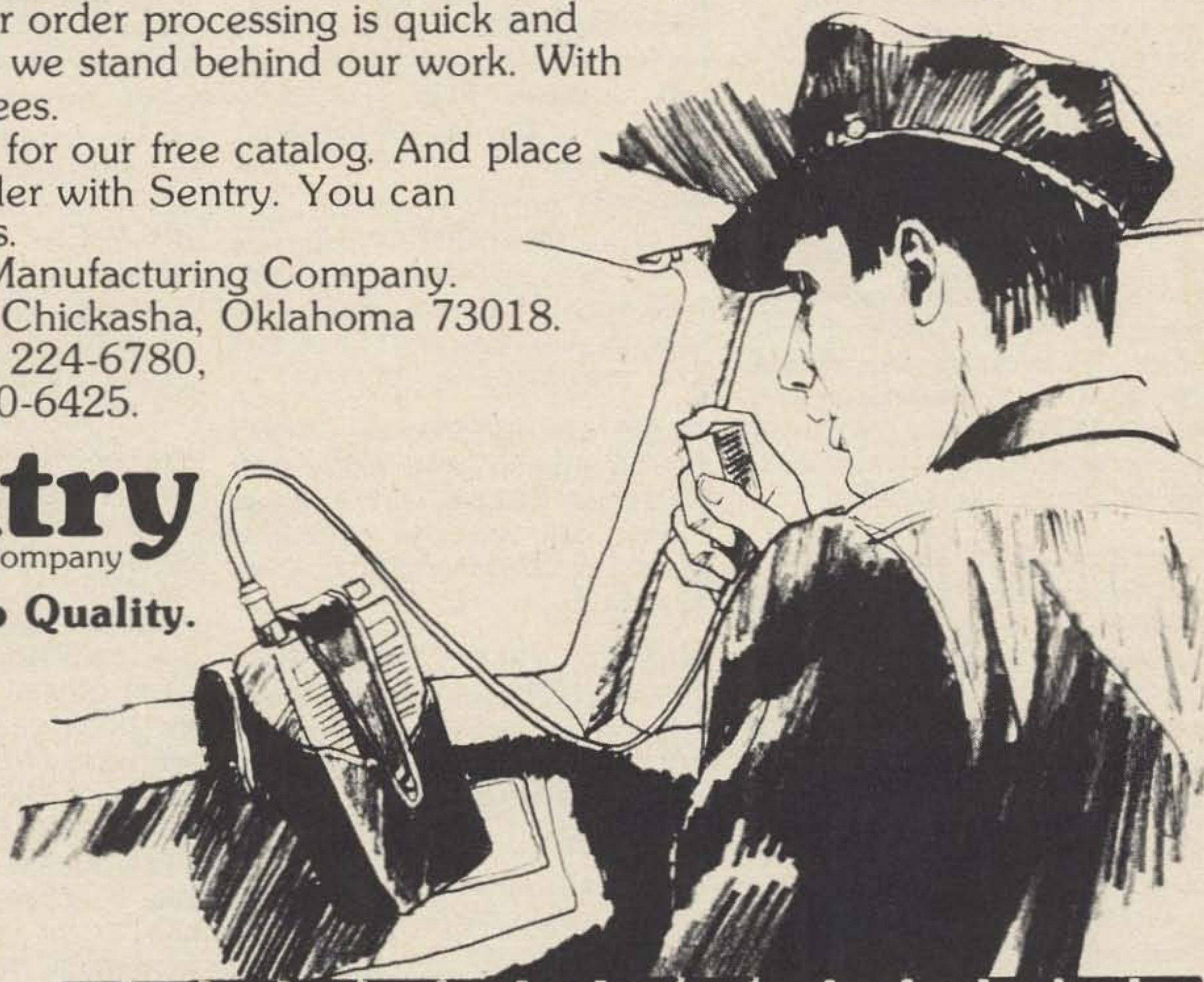

73:2



Sentry Manufacturing Co.
Crystal Park
Chickasha, Okla. 73018

**Please send me your Free 1975 Sentry Catalog.
RIGHT AWAY!**

Name _____

Street _____

City _____ State _____ Zip _____

**Send for
Sentry's
FREE 1975
Catalog!**

Caveat Emptor?

PRICE — \$2 per 25 words for non-commercial ads; \$10 per 25 words for business ventures. No display ads or agency discount. Include your check with order. Deadline for ads is the 1st of the month two months prior to publication. For example: January 1st is the deadline for the March issue which will be mailed on the 10th of February.

We will be the judge of suitability of ads. Our responsibility for errors extends only to printing a correct ad in a later issue. For \$1 extra we can maintain a reply box for you.

THE 3RD ANNUAL Des Moines Hawkeye Hamfest will be held on Sunday, June 8, 1975 at the Iowa State Fairgrounds. Plenty of free parking. Flea market, covered display booths available, small charge; open arena, no charge. Dealer displays, prizes, XYL activities. Camping available, small charge. Registration \$1.50 advance/\$2.00 at gate. Write Des Moines Radio Amateur Association, Box 88, Des Moines IA 50301.

MONTREAL HAMFEST 75, Aug 3, MacDonald College Farm, Ste. Anne de Bellevue, prizes, giant fleamarket, technical sessions, family fun \$2.50/adult. Info contact VE2RM, Box 201, PointeClaire-Dorval, Quebec H9R 4N9.

COMPLETE QSL Catalog! Hundreds of cuts, stock and ink samples. Ten sample QSLs 25¢. Corneilson's Quality QSLs, 321 Warren Street, N. Babylon NY 11704.

ANTIQUA RADIO BUFFS. Do you need a schematic for your radio? For information send SASE showing make and model number. Joseph C. Crockett K3KUL, 762 S. Gulph Road, King of Prussia PA 19406.

WANTED — Make, Model and Serial number of stolen ham gear for big list. W7UD, 3637 West Grandview, Tacoma WA 98466.

RTTY . . . Model MRB-TU Terminal Unit. Features: automatic shift selection — delayed autostart — all solid state — no toroids — operates on 12 V dc — compact size — guaranteed. Assembled board with motor relay, less loop supply . . . \$60.00 PPD. Less relay . . . \$57.00 PPD. G&M Electronics, P.O. Box 22, West Carrollton, Ohio 45449.

ELECTRONIC PRINTING Calculator — Unicom Model 1011P — Brand new — still in box. Original cost \$195. Received as gift. Want to trade for any kind of Ham Gear. PAT, P.O. Box 314, Shiremanstown, PA 17011.

RADIO ARCHIVES, amateur ANECDOTES (then & now) solicited for proposed (SASE subscription) monthly PR newsletter. Electronic Avocations, 3207 fourth St. N., Mpls., Mn. 55412.

WANTED: TRI-EX TOWER Model HZR471N (71' rotating tower) galvanized and complete with rotating rings. W1 WL — Arthur C. Egan, 56 Stilson Avenue, Northampton MA 01060, 413-586-4244.

SELL: Kenwood T-599 & R-599 w/converters. \$275 ea. or \$500 both. Jesse Newton, c/o Ben Byron MHP, Box 10, McDonald, TN 37353.

SWAN, CushCraft at prices I dare not publish. Call or write WØNGS, Bob Smith Electronics, 1226 9th Avenue North, Fort Dodge IA 50501. (515) 576-3886.

RTTY FOR SALE: Model 15-19 friction-feed conversion kit, \$13.00, Model 28 style table-stand, \$25.00, Model 15-19 printer bases, \$7.00, Model 28ASR motors, \$25.00. Model 28 printers, gearshifts, cabinets, parts, accessories. SASE for complete list. Motorola T53GKT, Mint, \$225.00. Antique tubes. Lawrence R. Pflieger, P.O. Box 21956, Milwaukee WI 53221.

FREQUENCY COUNTERS. 5 digit readout expands to 8. Range 10 kHz to 250 MHz \$159.95. Free flyer. LAD Systems 5178 Bellaire, Oak Forest IL 60452.

HEATHKIT HD-15 phone patch, mint, \$30; Westinghouse 3" reel tape recorder and 4 tapes, needs some work, \$20. Dick Morofsky, Box 11, Nemaquin PA 15351.

VERY INTERESTING! Next 5 issues \$1. "The Ham Trader," Sycamore IL 60178. (Ask about our "HAM EQUIPMENT BUYERS GUIDE" covering receivers, transmitters, transceivers, amplifiers 1945-75. Indispensable!)

FM RECEIVER, preamp, scanner, UHF converter kits. Hamtronics, Inc., 182 Belmont, Rochester NY 14612.

WANTED: Navy surplus AS-390/SRC or AT-150/SRC 200-400 MHz antenna. Ed Alves WN6BJD, 305 E. Acorn Cir., Monrovia CA 91016.

ANELEX HIGH speed printer, model 4.5-80-DD 80 column, complete with P.S. and driver cards SASE for details. Best offer. Mike Vande Voort, Route 1, Leighton IA 50143. 515 626-3195.

PHOTOSTAMPS make QSLs distinctive. 100 unique stamp-size photos \$3.00 QUICK! Gummed. Perforated. Made from your photo, returned unharmed. KENDALL BAKER, 5342 LaLuna, LaPalma CA 90620.

COLLINS R-390 Receiver. Completely realigned and in mint condition. First \$500 plus shipping will take. D. M. Haworth, 1407 W. B, North Platte, NB 69101.

INSTRUMENTATION Recording Tape, precision, one inch, 10/14 inch reels, Scotch, Memorex, bottom prices. SASE details, WA6ZTN Radio Club, 34022 Blue Lantern, Dana Point CA 92629.

Never Say Die from page 11

would spoil their fun. Nuts to them, let's get them back on CB where they belong and get some ID gear into article form — and have some fun.

BUMPER STICKERS

As you all know, the readers of 73

are a particularly creative lot since the entire magazine, except for the editorials, is written by them. But their fertile minds do not stop there. They continuously suggest other interesting projects to us. Most of these we do not have the time and manpower to carry out, tempting as they be, but

Gordon Bello WA1JWQ came up with one that was both simple to produce and something really helpful for ham PR: a bright bumper sticker with a good slogan. They are 50¢ apiece from 73. You'll find an ad elsewhere in this issue.

. . . W2NSD/1

Me Friend

In round figures there are 150,000 hams whose licenses are not printed in English, and when we hear their calls most of us automatically lean forward and pay closer attention. Nothing much else happens. If a contact is made it is usually brief, stereotyped and unproductive in terms of minds meeting. Very likely data on a QSL card will be the consequential evidence of communication. Lack of a common language is effective insulation.

Some DX stations will exchange reports with you so smoothly you may never guess you've heard all the English they know. A routine encounter and then they vanish like the Cheshire cat. Now and then a few will venture farther into our idiomatic jungle and with informative diffidence inquire about the weather, our equipment, and perhaps family status — nervously hoping for a reply they can translate. Failure to compliment and encourage these adventurers is, sad to say, rather common. English is a tricky language to learn from the outside, more difficult than those of us who were born to it generally believe. A foreigner struggling with English needs all the help he can get.

A minuscule number of foreign operators will manage our language as well as you or I do, but for these gentlemen (and ladies) simple attention to the courtesies of conversation is sufficient acknowledgement. They know their proficiency, and *noblesse oblige* — it is for them to encourage us.

It is a fact that we need encouragement

for we are notoriously reluctant to learn foreign languages. Perhaps we lived too much of our national history under the cozy illusion that our own resources and opportunities were inexhaustible. Today insularity makes less sense and attitudes are changing. Radio amateurs are a special group, being routinely in one-to-one contact with our foreign colleagues, so I think we have a particular responsibility to improve communications, and I don't mean improving signal-to-noise ratios.

QSO's where language is more barrier than conduit are about as meaningful as hat-tipping by Edwardian types who meet and pass on a busy street. Common interests go undiscovered and potential friendships are just missed opportunities. Cooperative endeavors and productive problem-solving are blocked, and man's segregation by national boundaries is mutely emphasized. Despite the marvelous electronic overriding of oceans, politics and prejudice, it's just hello and goodbye. A sad and curious folly when, after all, communication's the name of our game.

Foreign language study has had a poor press in this country. I remember that in high school the consensus among my peers put down languages as even more pointless and difficult than algebra — a harsh verdict. We noticed that the girls customarily out-classed us in both subjects and saw this as confirmation of our judgment. Soon the course of history made clear how foolish

"pointless" was, but I think "difficult" is alive and well and doing harm.

True, a language is an evolved tool for the exchange of ideas and must be complex. To qualify it needs a vast dynamic range to sing for the poet, bark for the drill sergeant, serve science with accuracy and resonate for trial lawyers awash in eloquence. It must provide a lexicon of rhetoric for politicians and a thesaurus of ambiguities for diplomats.

"Even if you do learn correct English, who are you going to talk it to?"

Clearly no language can be easy to master, but mastery is beyond our needs.

Addressing a pride of professors of English, Clarence Darrow remarked, "Even if you do learn to speak correct English, who are you going to talk it to?" The humor is apposite, and it applies to any language. Simple speech suffices. "Me friend" is the big message.

The vocabulary of any ten year old schoolboy in Wolfsburg would put to shame my modest inventory of German, and yet I wouldn't take a new VW for the fun I've had laying on busted Deutsch. The warm response was really no surprise, but as more "D" calls were logged, and new friends discovered among erstwhile enemies, a splinter of Rhineland steel in the left knee seemed to lose its edge. I would like to think that new generations, less burdened by historical tragedy, will waste less time. International discourse is the key, and we have the means.

The first attempt in a foreign tongue is like standing with one foot on the warm sand and testing the ocean temperature with the other, except for one thing — that initial chill is missing. Warm encouragement is the rule, and it doesn't matter in which language you are experimenting. Russians are especially swift to respond — behind that funny looking thirty-three letter Cyrillian alphabet you will find smiles and hospitality.

Some years ago, when the Kremlin and the White House were not on the friendliest of terms, a trip across Siberia was planned for our daughter, en route to school in England. Prior to her departure I made an all-out effort with a phrase book and a

dictionary to contact Russian hams for any useful information. UAØGF, John Glushin, coped patiently with my sweating and stammering and promptly sent us a welcoming letter, helpful and reassuring — carefully typed in English. Similar ventures in Japanese and Spanish were comparably rewarding: cordiality and encouragement invariably, and often more than that. As if by remote control doors open from the ham shack to the home, to the people and their country. Given the state of our world, could a modest effort be better repaid?

Getting started in a foreign tongue is probably easier than you think. From my own experience as a high school dropout past middle age I can assure you that mental sparkle is not a prerequisite. Fortunately we have useful aids available cheaply, and let's start with Dover Publications. Please write to them at 180 Varick Street, New York, 10014, for their "Catalogue of Books and Records in All Fields." It's a treasury of well-bound paperbacks at prices old men remember, and fascinating just to read. The language section we are concerned with is a small part of the catalogue, which includes everything from Walter's "Traveling Wave Antennas" and Lebedev's "Special Functions" to an exciting treatise on "Mad Inventions" — which describes such patented triumphs as an edible tie pin, a balloon propelled by indentured vultures and a locket for the safe-keeping of used chewing gum. In between, Architecture, Folklore, Cookbooks and almost everything else. I

"The Helpful Interpreter: Ideal for Collectors, Hobbyists, Lonelies, Pen-Friends, Salesmen."

first wrote to them for this catalogue some years ago, and it befell that I've been hooked on their books ever since. That's what befell.

Presently Dover has in print six classifications of foreign language aids, and the "Say it In" and "Essential Grammar" series probably are the most useful to hams in a band-scanning mood. From ninety five cents to a buck and a half. Buy some just to keep these people in business and I will be your friend.

Carl Sletten W1YLU is even more deserving of our support. Since 1970 Carl

has been offering us help over the language barrier with reel-to-reel, cassettes and texts in a series he calls "Foreign Language QSO's." His faithfulness in supplying a tiny market with high quality products qualifies him for some kind of award, but I hope instead that he gets what he would prefer — expressions of interest, and orders, from the amateur fraternity. In a recent letter he remarked, "This is a good cause in terms of preparation for the big cultural collisions in the future as well as for the satisfaction it brings." We're lucky he feels that way about doing a job that requires a special talent, determination and forward-biased optimism.

languages. In addition, comments and questions we use most often and technical terms are listed first in English and then French, Spanish, German, Swedish, Finnish, Serbo-Croat (Yugoslavian) and Russian. In contrast to Carl Sletten's approach, DL1CU's is an end-run around the language barrier for a quick score. But I think he would prefer a different metaphor: a push to get your motor started. By the way, YU1AO made an impressive contribution to the Yugoslavian and Russian sections by ingeniously replacing the Cyrillian alphabet with Latin characters. I don't know enough to say whether this was a good or bad thing to do,

Friendly peoples rarely wage war. Isolation blocks friendship. Communication ends isolation.

Years of creative labor turning out specialized tapes and texts with minimal financial return suggests a kind of free-wheeling idealism, but Carl's products are truly practical and efficient tools. They work. But not unless we buy them and get busy.

The following is excerpted from one of his booklets: "There is no doubt international goodwill is won by our efforts to work at the languages of other countries . . . anyone who has been able to switch languages with a struggling English speaker knows the immediate friendliness and confidence that results . . . conversational ability lifts a curtain on a whole new world . . ."

At present texts and tapes are available for German, Spanish and Japanese. An Italian text has just been finished and Carl is working now on Portuguese. French will be offered if enough of us write and ask for it. A postcard to: Foreign Language QSO's, Post Office Box 53, Acton, Massachusetts 01720, will bring you a price list and greetings from a ham who is doing something for amateur radio.

Carl's goal is, I think, to lead us gently into learning another language as we ride our hobby. However, two other hams, DL1CU and OH2SQ, heard a different drum and brought out an instant-communication booklet in which typical QSO's in English are repeated in seven other European lan-

but it must have required kilos of smarts and pounds of patience.

At this point I must confess I can't tell you where to get KL1CU's booklet or how much it costs. I ordered my copy from Germany three or four years ago, and I don't remember how much I paid for it but I do recall thinking it was a bargain. Printed in the front is "4th Edition, DL1CU, Box 585, Stuttgart, Germany". Two months ago I wrote to that address but there was no reply, and I wrote again with the same result. A letter to the D.A.R.C. may bring results as I think I first came across the booklet in an advertisement in the German ham magazine "DL-QTC." I really doubt it's out of print and when I find out more I'll pass the word on to Wayne for printing in 73.

Comes now from Austria Christian Zangerl ex-OE9CZI, mit freundlichsten Grüßen and a number of publications. Christian lives in Dornbirn, a charming town in the western part of the country, where he turns the Alpine air into energy and spends thirty hours daily running a printing press, writing letters and thinking up things to publish. This really doesn't keep him busy so he is also turning out tapes. No way has been found to calm Christian, and if you correspond with him I think you will recognize in his uniquely antic communications (I don't really know how to put this) something of the inner fireworks and post-liftoff accelera-

tion characteristic of the publisher of this magazine.

A couple of years ago I fell into the Zangerl net when I sent for his "Radio-amateur's Vocabulary," a 4,000 word German-English dictionary which I found very useful. By January of this year Christian had located 3,500 more words and a new edition is now ready. It's still right-hand drive, with the German words first, but I found that having to dig around for the English before I could find the German equivalent usually adds a few new German words to the brain bank. Christian doesn't readily come to a stop, so a coda of miscellaneous tables is appended like the tail of a comet. Buck and a half for the 4,000 word dictionary and three dollars for the expanded version.

For those of you already into European languages the Dornbirn "Funk Wörterbuch" (from the French side, "Vocabulaire TSF") could be a kind of self-propelling prime mover, being a double-barreled dictionary of radio and television terms in German-French and then French-German. Tacked to the back is a list of handy phrases for technicians (preferez-vous le vin rouge ou blanc?),

also a couple of crossword puzzles and a photo of OM Christian. The same format is available in German-Italian and includes a "Tourist Guide."

Next is "The Helpful Interpreter," described as "Ideal for Collectors, Hobbyists, Lonelies, Pen-friends, Salesmen." The first half is a collection of comments and questions in English, then French, then German. "It is very costly today to stay in a new house after being married, yes, I know." "I am a lonely heart." "No, I don't cook. That's for women." "Would it be possible to stay in the household of your parents later on?" (Why didn't I think of that?) "I have been punished only once by police." When the moon was full my wife and I used to watch Johnny Carson — if Dick Cavett wasn't on — then we fell into the enjoyment of taking turns reading aloud from "The Helpful Interpreter." Yes, and that is not a quote from Christian's book. Which is two bucks or nine IRC's.

Write to ex-OE9CZI at: Nachbauerstr. 28, A-6850, Dornbirn 1, Austria. Write in any language; Christian is the municipal interpreter. Incidentally, for you W6 swingers he also offers "Pleasure With Pussycats" for the same price as the one above. Christian loves cats. Specify German or English.

It's true that for hams the airwaves provide a language lab and make it easy to get a foot up, but for some of us learning another language is far easier in a classroom. Professional guidance, a syllabus and the company of other aspirants combine in such a way that the total advantage seems greater than the sum of the parts. If you agree and you're not working a swing shift then check with your local school board, and probably you will find that adult-education evening classes are available in several languages. Fees are nominal. And if Carl Sletten and Dover are helping you at home, so much the better. Whatever the means, it's really only a matter of getting started. As an ancient Chinese aphorism puts it: "Journey of a thousand miles begins with release of handbrake."

Finally, let me restate the message in three sentences. Friendly peoples rarely wage war. Isolation blocks friendship. Communication ends isolation.

... W7IDF

R-X NOISE BRIDGE

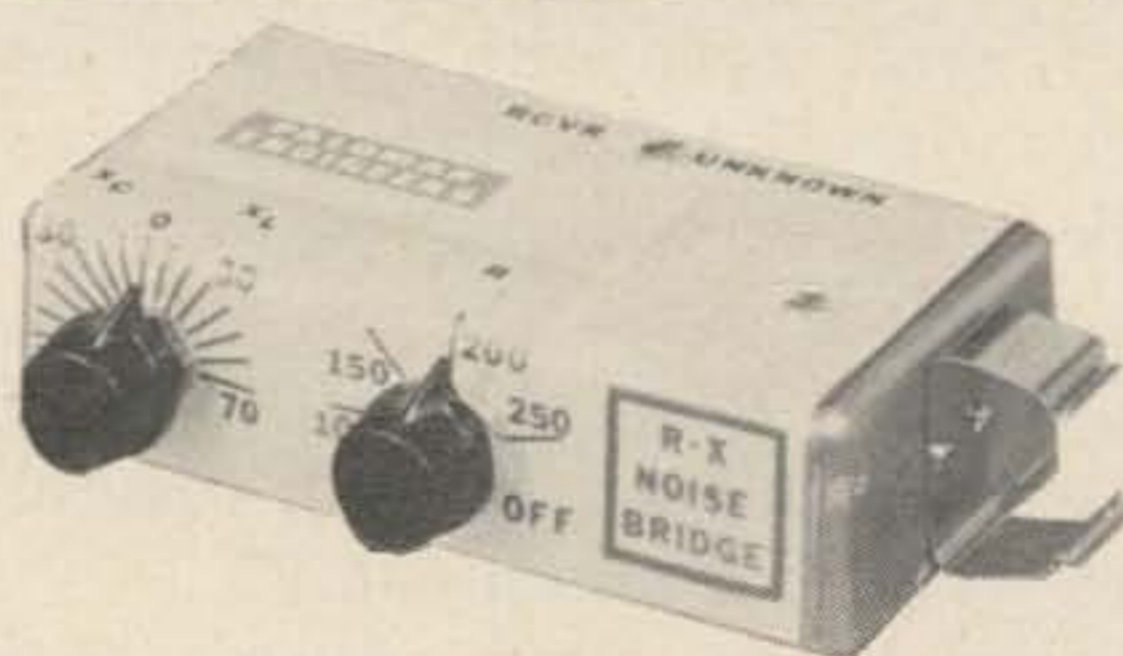

- Learn the truth about your antenna.
- Find its resonant frequency.
- Find R and X off-resonance.
- Independent R & X dials greatly simplify tuning beams, arrays.
- Compact, lightweight, battery operated.
- Simple to use. Self contained.
- Broadband 1-100 MHz.
- Free brochure on request.
- Order direct. \$39.95 PPD U.S. & Canada (add sales tax in Calif.)

**PALOMAR
ENGINEERS**
BOX 455, ESCONDIDO, CA 92025

What's All the Shouting About ?



It's the All New *Clegg* FM-DX

Amateur Net \$589.95 — Factory Direct Only

**Owners are shouting their praise
for all sorts of reasons**

The ones we hear most often are ,

- The operating simplicity, accuracy and stability of the Synthesizer and LED Frequency Readout.
- The unmatched receiver performance with super sensitivity and freedom from spurious responses.
- Those beautiful, clean 35 Watts of Transmitter Output.
- The rugged Modular construction.
- The 143.5 — 148.5 MHz coverage — opens a whole new world of SIMPLEX operation.

**UNTIL YOU TRY ONE YOU WON'T KNOW WHICH
FEATURE YOU WILL SHOUT ABOUT - PROBABLY
ALL THE ABOVE - AND MORE! CALL CLEGG'S TOLL
FREE NUMBER TODAY FOR DETAILS ON THE FM-DX.**

Clegg

208 Centerville Rd. Lancaster, Pa.

Toll free sales & services phone (800) 233-0250

In Pa. call (717) 299-7221 (collect)

Larry Pryor WA9MFF
5940 Carrollton Avenue
Indianapolis IN 46220



HOMEBREW THIS SSTV MONITOR

This article contains some information that may be useful to someone building an SSTV monitor. It is not a new design, but rather several monitors rolled into one.

I had a lot of fun building the monitor. It took about nine months from start to finish. That means I pretested each circuit, and modified it as I went along so that I knew just what parts it really took to get it to

work. When I thought I had a rock solid circuit, I began laying out my PC boards.

Choosing The Tube and Chassis

I had a 5FP7 CRT so I knew I was going to use that tube. At that time a 5FP7 or any other P7 tube was hard for me to locate. I had seen many SSTV monitors at hamfests. While they were original in circuit design and worked very well, they did not appeal to me as a decorative piece of gear. So, if nothing else, I was going to make my monitor look good. Or try to. See Figures 1 and 2, for the monitor and power supply schematics.

I have the Drake T4X, R4A and MS speaker, so I looked into the possibility of using a Drake cabinet. The only factor I had to consider was the size of the CRT. So I got my rule out and did some measuring. I was in luck. The Drake TR4 cabinet was just the right size. If I had chosen a 17.78cm (7") tube, I would not have chosen the Drake cabinet. A cabinet for this tube is a SB-202 Heath Kit cabinet. Anyone who has seen Don Miller's W9NTP monitor at a hamfest

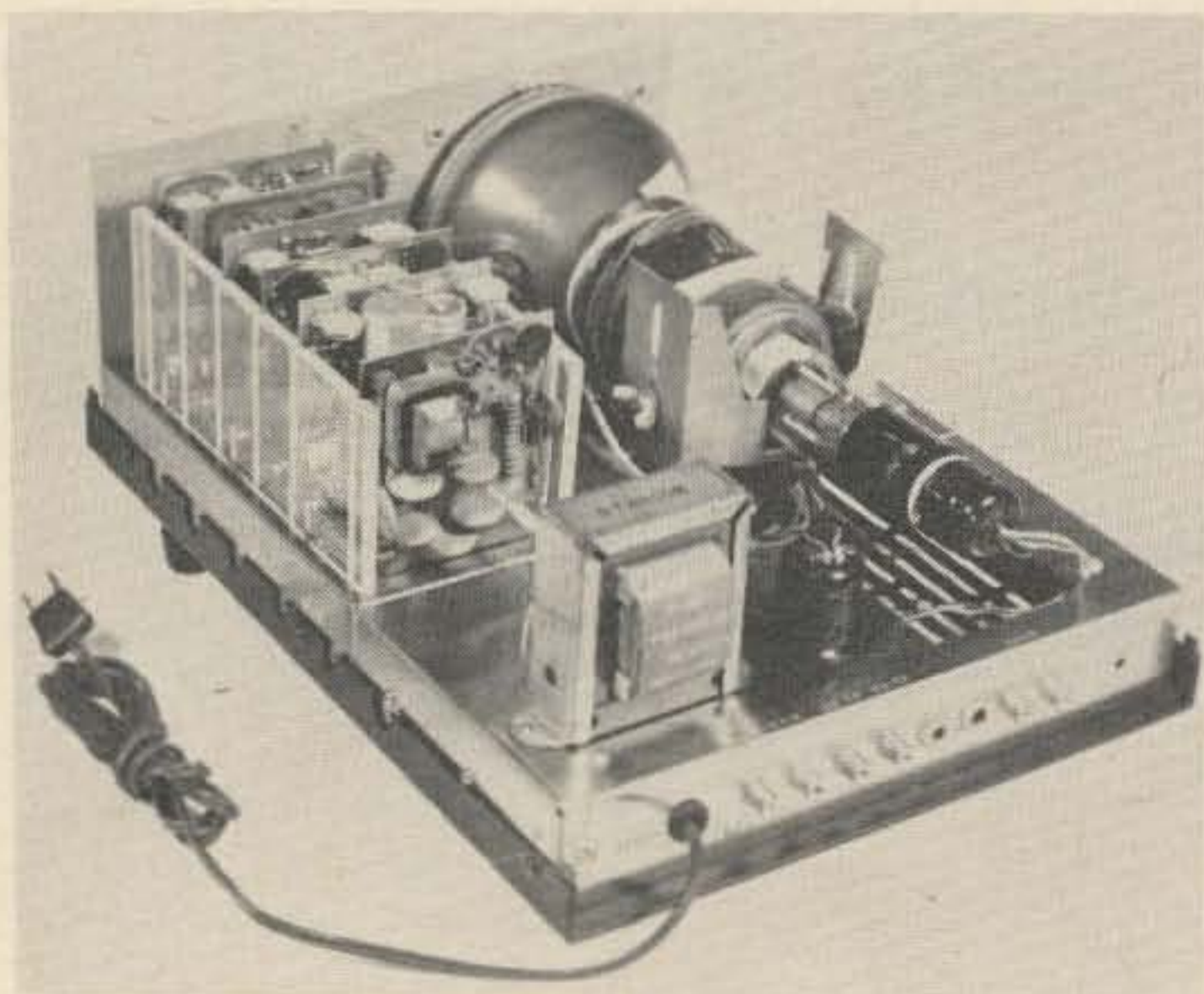

Rear view.

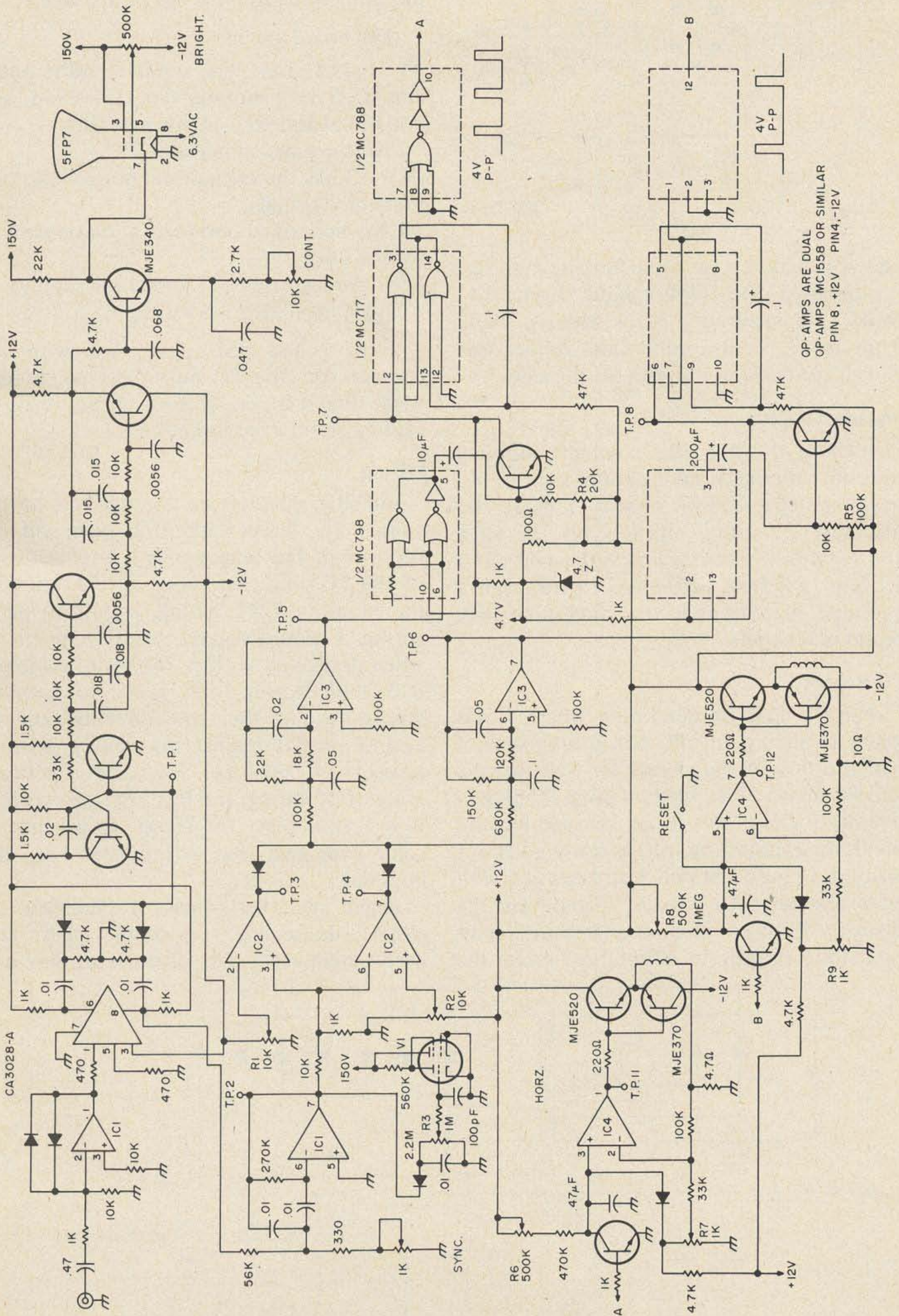

Fig. 1.

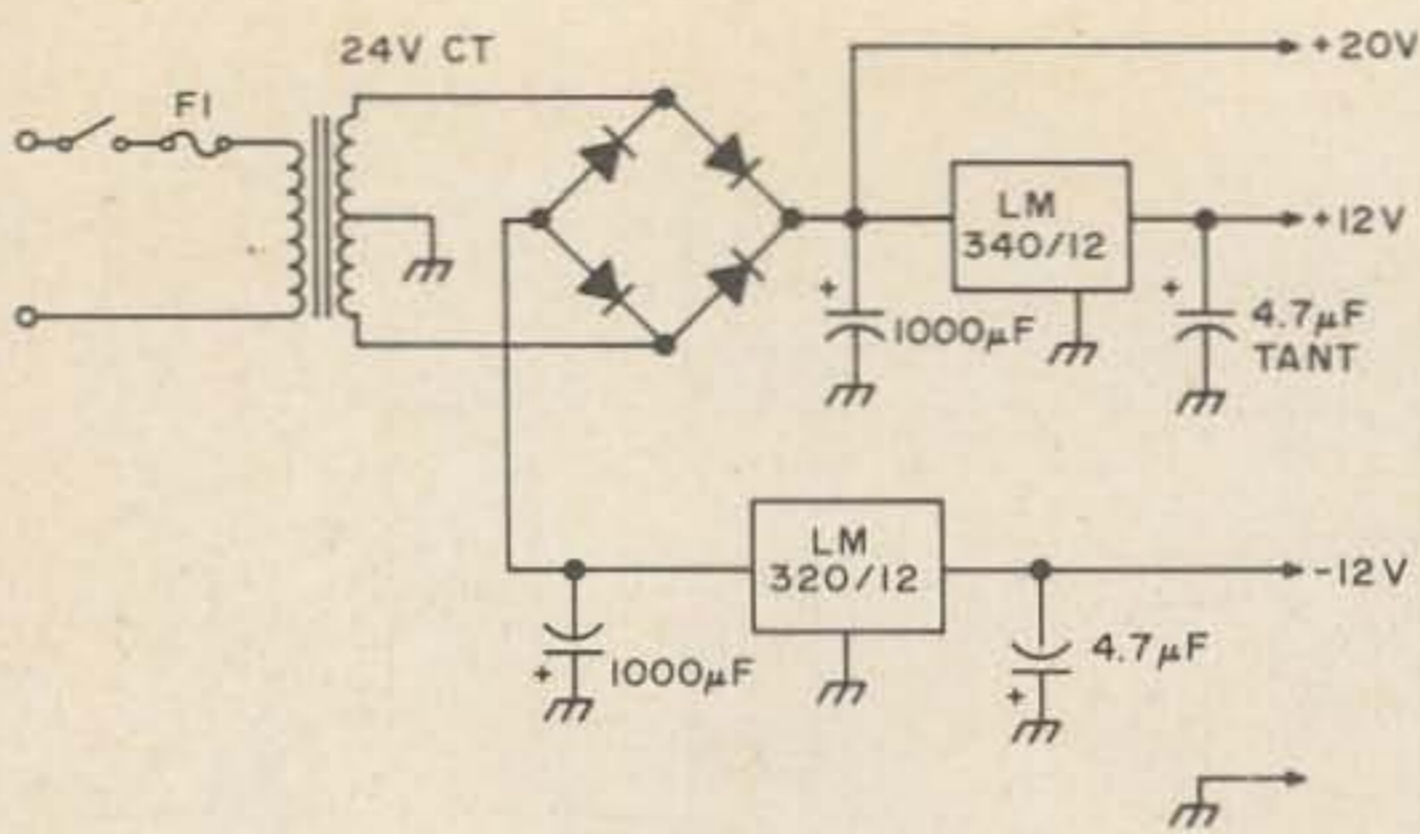

Fig. 2.

knows it makes a very fine looking monitor. I purchased the TR4 cabinet from R.L. Drake and received a blank chassis, blank front panel, wrap around case, rubber feet and all the necessary screws for the case.

Placing To CRT

I chose the left side. I got my nibbling tool out and began taking chunks out of my newly purchased TR4 chassis. I made the necessary mounting brackets for the CRT and located my center line so I could cut a 12.7cm (5") hole in the front panel. Don't you just hate to drill that first hole in a brand new panel?

PC Boards

Next I had to determine where I was going to mount my PC board or boards. I had the rest of the chassis for transformers and PC boards. I decided on using PC plug-in boards. I chose this route because I could break the monitor up into as many parts as I wanted. I could just pull a card out and with an extension cord I made, I could lay the board in front of me on the table and repair or modify it with no difficulty. I broke the

monitor into six different parts, so I have six different PC plug-in boards all in a row.

The board lineup:

- #1 board has the limiter, differential amplifier, sync tuning, sync threshold, and horizontal and vertical low pass filter;
- #2 has the video amplifier;
- #3 card has the vertical and horizontal noise immunity circuits;
- #4 has horizontal and vertical sweep circuits for the yoke;
- #5 is the regulated +12 and -12 V supply;
- #6 is the regulated 7.5 kV supply.

I have had no trouble yet with the contacts on the PC plugs and no trouble with the copper getting dirty, thereby causing an intermittent circuit.

Wiring

All the circuits are on the top of the chassis. This leaves the bottom open and free for wiring. The only wiring is between each of the PC plugs, and from all the inputs to the monitor, CRT wiring, and front panel wiring. I would suggest using a color code when doing any wiring. The use of cable ties makes all wiring look good, so keep all wiring running the same direction and up against or flat against the chassis. When a project of any size has any significant amount of wiring, and it is just "hay-wired," it is a good place for "bugs" to get into. A color code and neat wiring helps keep the bugs out.

There are two pieces of Plexiglass on either side of the row of PC cards. This keeps them vertical at all times so they will

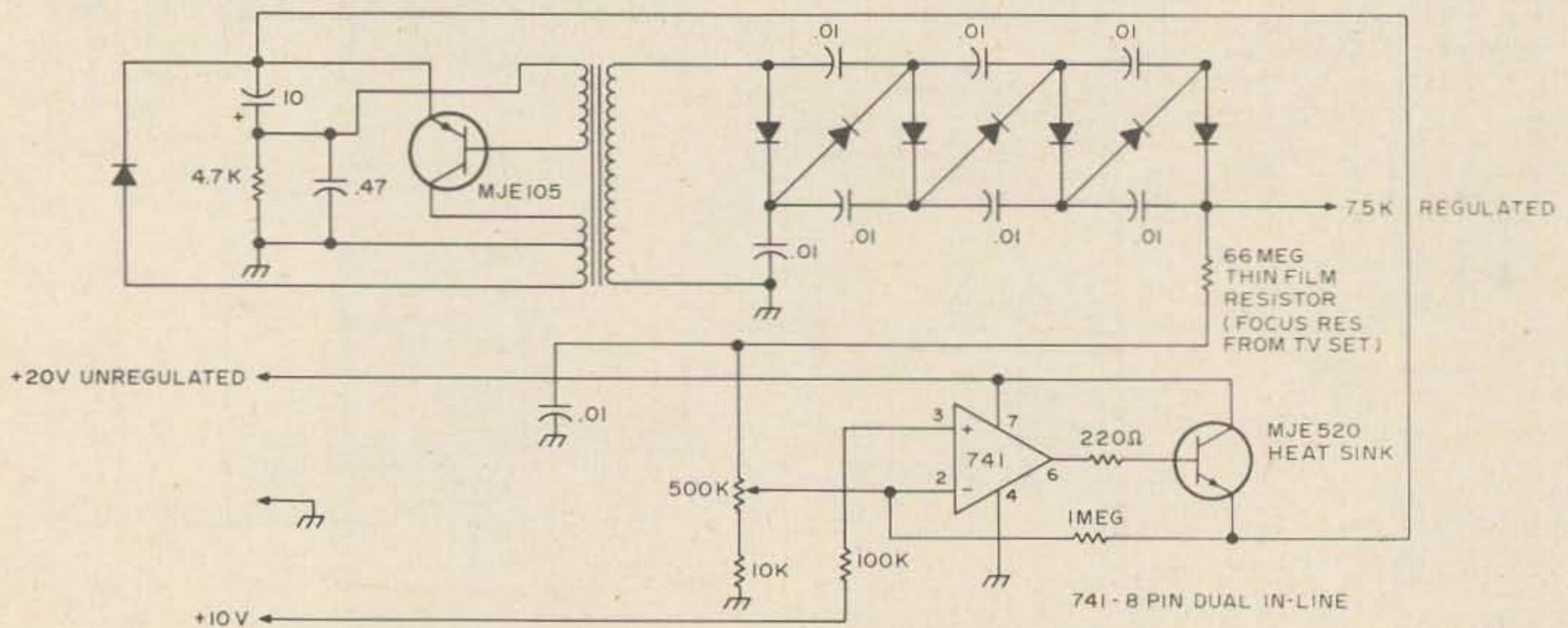

Fig. 3.

the new look of a proven performer



the tempo 'ONE' SSB TRANSCEIVER

... a proven name, a proven value. Look at the specifications, look at the price tag, ask any of the thousands of Tempo ONE owners about its reliability... and the reason for its unparalleled popularity will be obvious.

SPECIFICATIONS

FREQUENCY RANGE: All amateur bands 80 through 10 meters, in five 500 khz. ranges: 3.5-4 mhz., 7-7.5 mhz., 14-14.5 mhz., 21-21.5 mhz., 28.5-29 mhz. (Crystals optionally available for ranges 28-28.5, 29-29.5, 29.5-30 mhz.)

SOLID STATE VFO: Very stable Colpitts circuit with transistor buffer provides linear tuning over the range 5-5.5 mhz. A passband filter at output is tuned to pass the 5-5.5 mhz. range.

RECEIVER OFFSET TUNING (CLARIFIER): Provides ± 5 khz. variation of receiver tuning when switched ON.

DIAL CALIBRATION: Vernier scale marked with one kilohertz divisions. Main tuning dial calibrated 0-500 with 50 khz. points.

FREQUENCY STABILITY: Less than 100 cycles after warm-up, and less than 100 cycles for plus or minus 10% line voltage change.

MODES OF OPERATION: SSB upper and lower sideband, CW and AM.

INPUT POWER: 300 watts PEP, 240 watts CW

ANTENNA IMPEDANCE: 50-75 ohms

CARRIER SUPPRESSION: -40 dB or better

SIDEBAND SUPPRESSION: -50 dB at 1000 CPS

THIRD ORDER INTERMODULATION PRODUCTS: -30 dB (PEP)

AF BANDWIDTH: 300-2700 cps

RECEIVER SENSITIVITY: $1/2 \mu\text{v}$ input S/N 10 dB

AGC: Fast attack slow decay for SSB and CW.

SELECTIVITY: 2.3 khz. (-6 dB), 4 khz. (-60 dB)

IMAGE REJECTION: More than 50 dB.

AUDIO OUTPUT: 1 watt at 10% distortion.

AUDIO OUTPUT IMPEDANCE: 8 ohms and 600 ohms

POWER SUPPLY: Separate AC or DC required. See AC "ONE" and DC "ONE" below.

TUBES AND SEMICONDUCTORS: 16 tubes, 15 diodes, 7 transistors

TEMPO "ONE" TRANSCEIVER \$399.00

AC/ONE POWER SUPPLY

117/230 volt 50/60 cycle... \$99.00

DC/1-A POWER SUPPLY 12 volts DC \$120.00

Prices subject to change without notice.

11240 W. Olympic Blvd., Los Angeles, Calif. 90064 213/477-6701
931 N. Euclid, Anaheim, Calif. 92801 714/772-9200
Butler, Missouri 64730 816/679-3127

Henry Radio

1/2 KW WIND ELECTRIC GENERATOR



NEW KIT INCLUDES:
BLADES
SPECIAL ALTERNATOR
CONTROL UNIT
FABRICATION INSTRUCTIONS

BASIC KIT AS LOW AS:
\$ 147⁰⁰

STANDARD RESEARCH INCORPORATED
P. O. BOX 1291
EAST LANSING, MICH. 48823

**some people
talk power -
we
deliver it.**



VHF Class C
Power Amplifiers

- Superb Craftsmanship
- State of the Art Performance
- Full One Year Warranty

MODEL P15A1 — 1-3 W input 12-25 W output.
13.6 V at 2 Amps \$55 ppd.

MODEL P50A10 — 1.5-15 W input 12-65 W
output. 13.6 V at 6 Amps \$98 ppd.

MODEL P100A5 — 2-5 W input 60-100+ W
output. 13.6 V at 14 Amps \$198 ppd.

MODEL P100A10 — 3-10 W input 60-100+ W
output. 13.6 V at 14 Amps \$198 ppd.

MODEL P100A20 — 15-30 W input 75-100+ W
output. 13.6 V at 14 Amps \$155 ppd.

M-Tech Engineering, Inc.

Box C, Springfield VA 22151 (703) 354-0573

M-TECH . . . The Quality Company

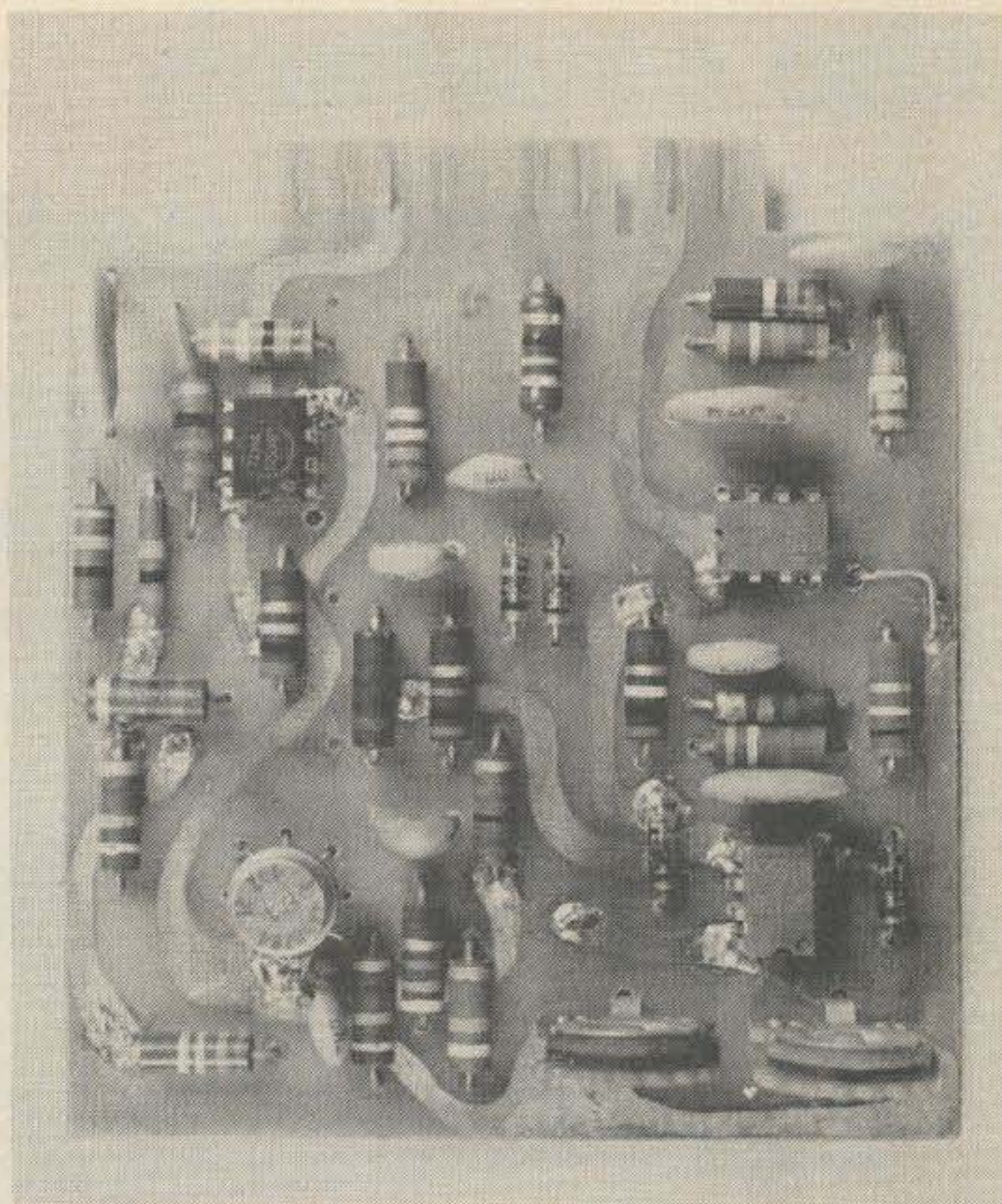

Board #1.

not wobble back and forth, causing damage to both PC boards and plugs. The Plexiglass was cut on a table saw and grooves were also cut so the boards could slip in and out. Then I drilled and tapped the bottom of the holders so I could screw it down onto the chassis.

Well, at this point we have the CRT mounted, all the plugs for the PC boards on the chassis, and the front panel is drilled. Next comes the fabrication of the PC boards.

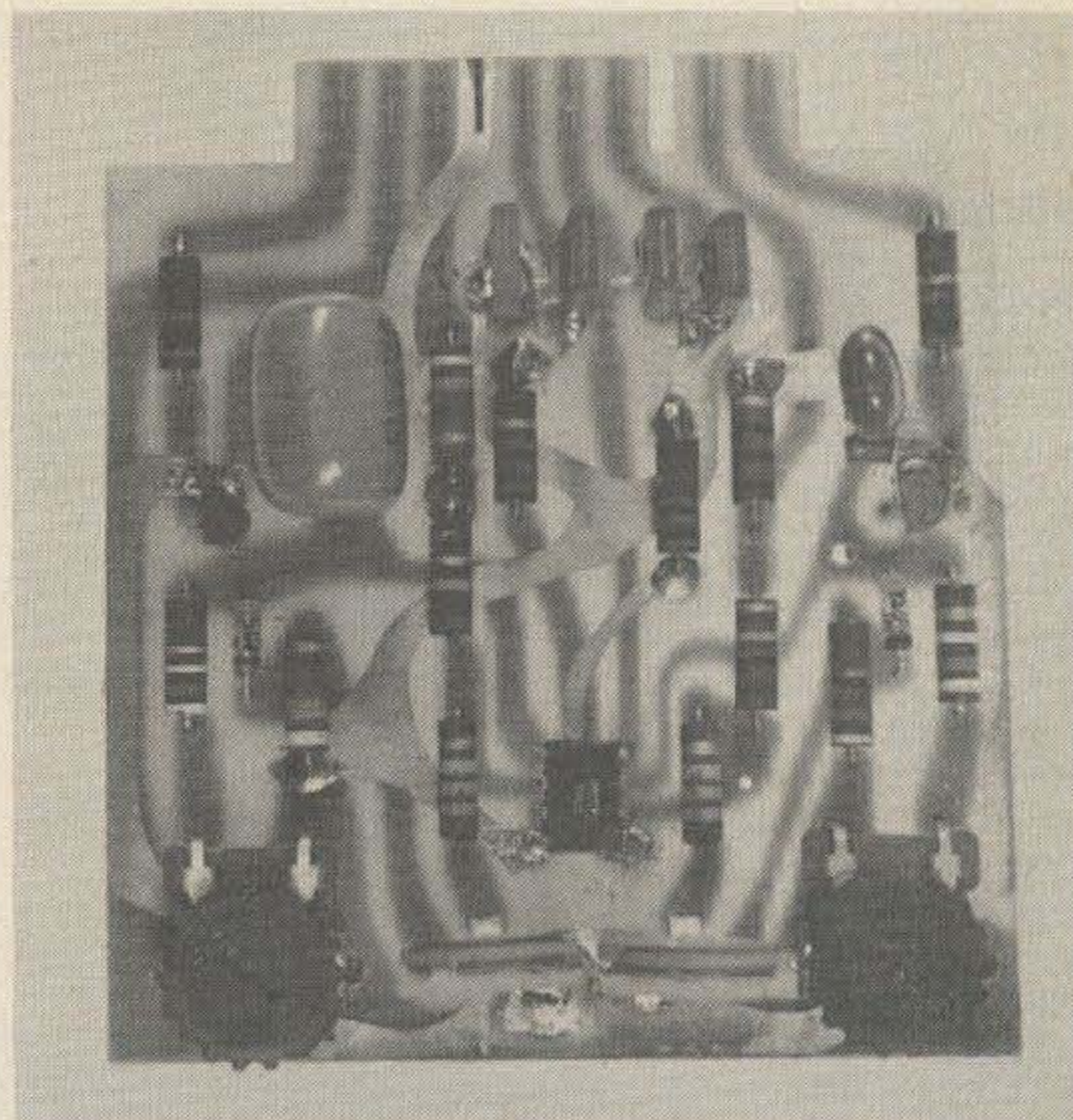

Board #4.

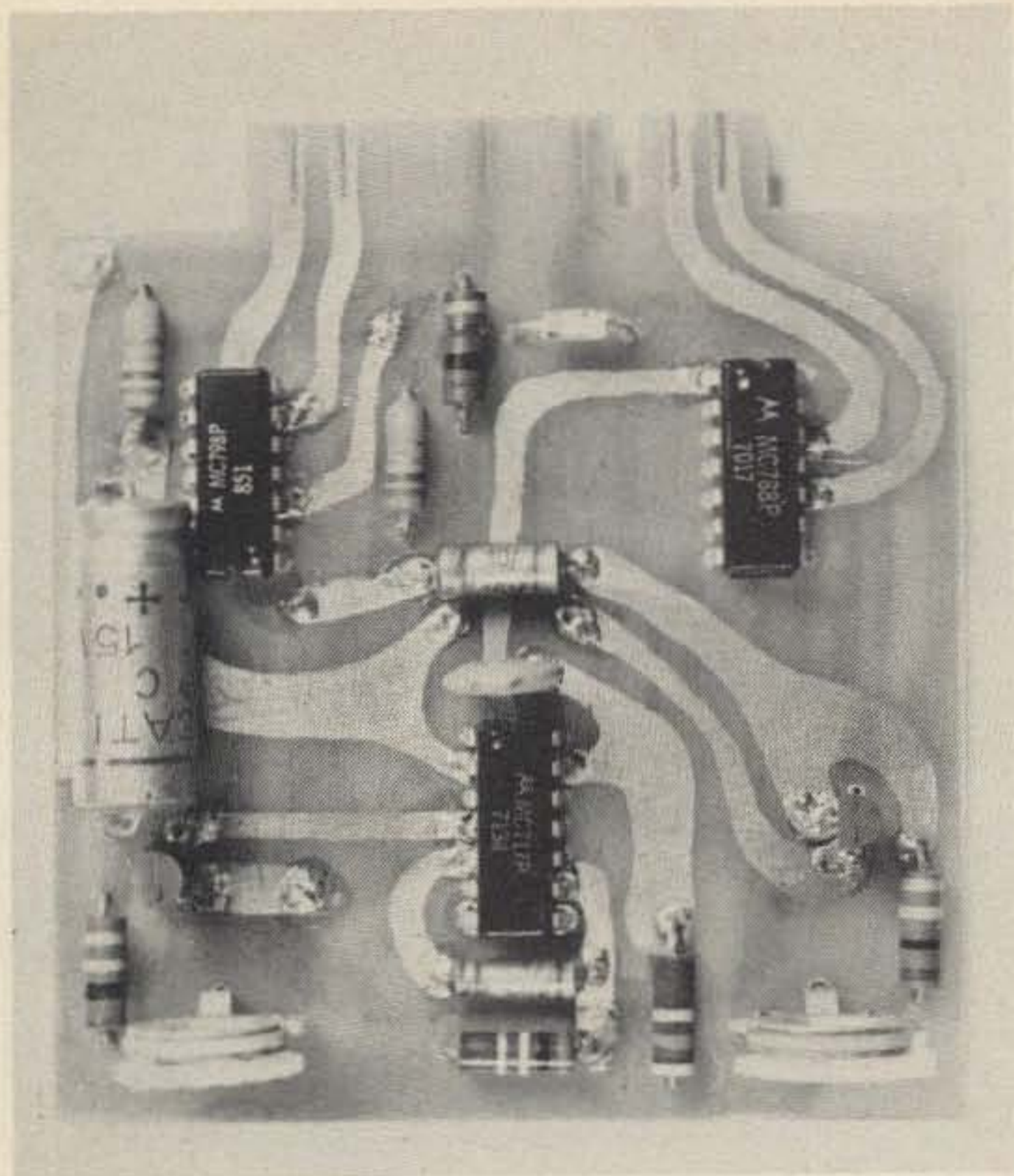

Board #3.

Laying Out The Boards

I'll briefly describe the way I do my boards, since everyone has his own way of doing them. I do my layout four times actual size and use a grid paper that represents 2.54mm (.1") for every square. This lets me see all that room I really have. After the circuit is drawn on the paper I must transfer the drawing to the PC board. I use a pinigraph for this, set for a 4:1 reduction. With a nail or scribe at the end of it I can trace the drawing and at the same

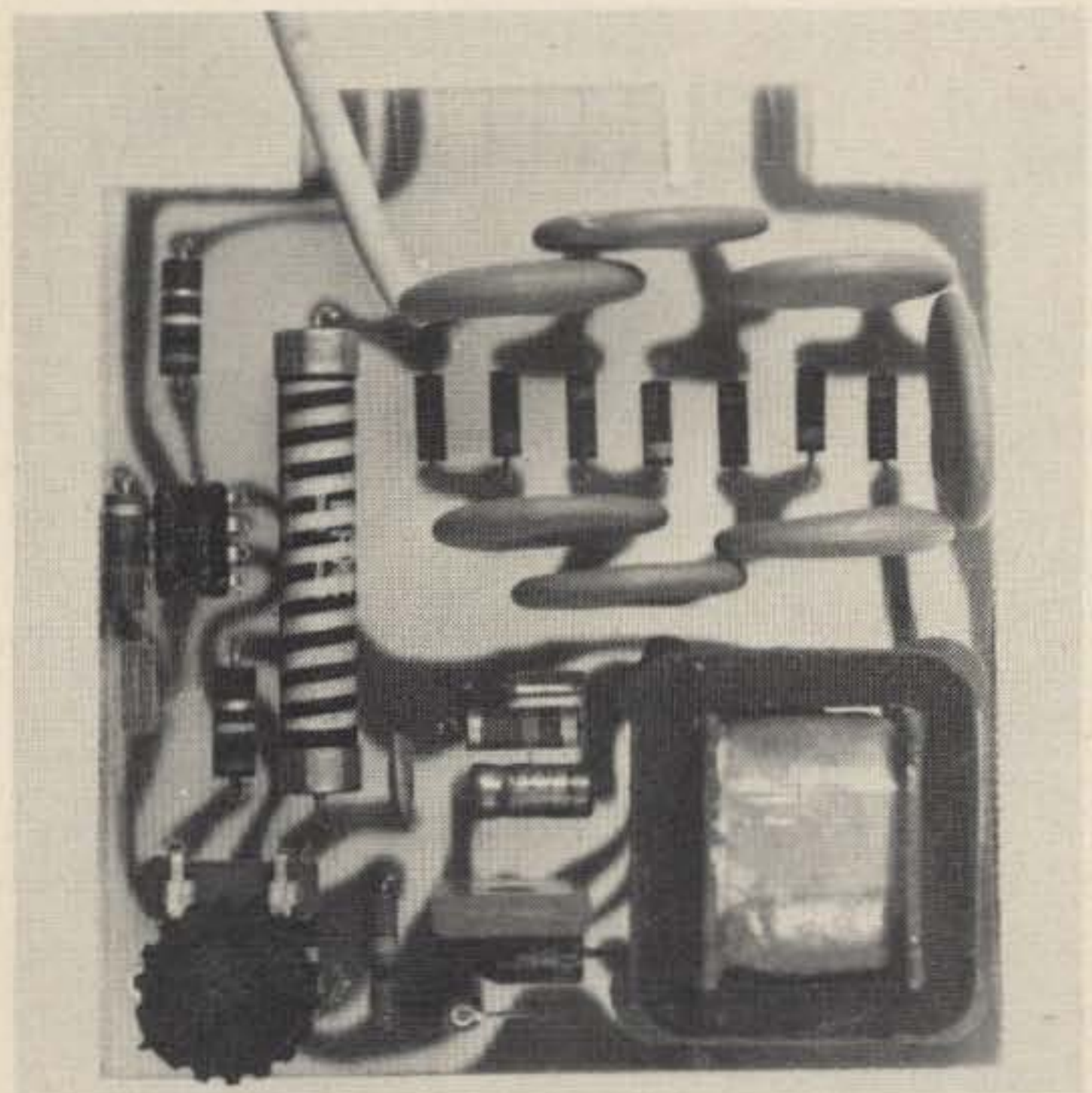

Board #6.

DELUXE RECEIVER PREAMPS

Specially made for both OLD and NEW receivers. The smallest and most powerful single and dual stage preamps available. Bring in the weakest signals with a Data Preamp.

FREQ. (MHz)	USE	STAGES	DELUXE PREAMPLIFIER			
			GAIN dB	NF dB	KIT	WIRED
14, 21 or 28	HIGH FREQ.	SINGLE	25	2	\$10.50	\$13.50
		DOUBLE	48	2	\$20.50	\$26.50
28 to 30	OSCAR SPECIAL	SINGLE	25	2	\$12.50	\$15.50
		DOUBLE	48	2	\$24.50	\$30.50
50 to 54	6 METER	SINGLE	25	2	\$10.50	\$13.50
		DOUBLE	48	2	\$20.50	\$26.50
108 to 144	VHF AIRCRAFT	SINGLE	20	2.5	\$ 9.50	\$12.50
		DOUBLE	40	2.5	\$18.50	\$24.50
135 to 139	SATELLITE	SINGLE	20	2.5	\$ 9.50	\$12.50
		DOUBLE	40	2.5	\$18.50	\$24.50
144 to 148	2 METER	SINGLE	20	2.5	\$ 9.50	\$12.50
		DOUBLE	40	2.5	\$18.50	\$24.50
146 to 174	HIGH BAND	SINGLE	20	2.5	\$ 9.50	\$12.50
		DOUBLE	40	2.5	\$18.50	\$24.50
220 to 225	1 1/4 METER	SINGLE	18	2.5	\$ 9.50	\$12.50
		DOUBLE	35	2.5	\$18.50	\$24.50
225 to 300	UHF AIRCRAFT	SINGLE	15	2.5	\$ 9.50	\$12.50
		DOUBLE	30	2.5	\$18.50	\$24.50
1 thru 30	HF BROADBAND		19-36	3	—	\$17.95

Write today for complete details

Data Signal, Inc.

Successor to Data Engineering, Inc.

2212 PALMYRA ROAD

ALBANY, GA. 31701

912-435-1764

NEW! NEW! NEW! DELUXE P.C. KEYS



*The complete P. C. keyer
you can't afford not to buy!*

In either a 5 volt TTL or a 9 volt C-MOS version this new module type IC keyer can be easily adapted to your own custom package or equipment.

Versatile controls allow wide character weight variation, speeds from 5 to 50 w.p.m. plus volume and tone control.

Solid-state output switching saves power, eliminates all those annoying relay problems and is compatible with both grid block and solid-state circuitry.

With its side-tone monitor and 90 day warranty the Data Signal PC Keyer is the one for you.

TTL Keyer Wired \$19.95 Kit \$14.95
C-MOS Keyer Wired \$24.95 Kit \$19.95

Write today for complete details

Data Signal, Inc.

Successor to Data Engineering, Inc.

2212 PALMYRA ROAD, ALBANY, GA. 31701

912-435-1764

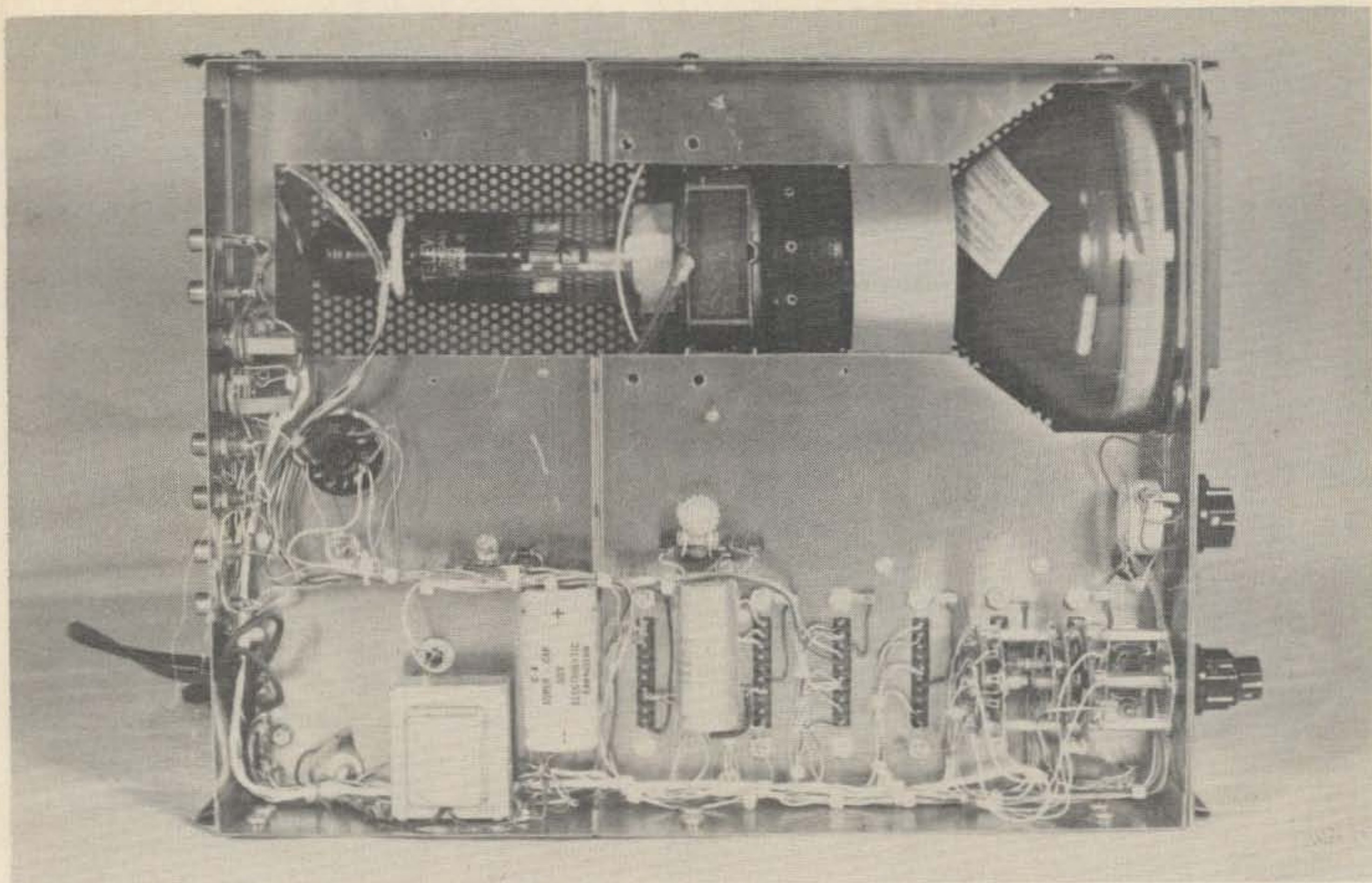

Bottom view.

time scratch in the circuit on the board. (The copper should be clean at this point.) Next I drill all holes to their proper size. I then take a K and E writing pen filled with lacquer paint that has been thinned down, and begin coloring inside the lines. The board is then etched and cleaned. In this monitor it was necessary for me to use 4 double-sided boards and 2 single-sided boards.

The bezel for the CRT front panel is made from Plexiglass. I give most of the credit for that piece to my grandfather. It was cut on a table saw. I first cut the size square I wanted. Next, I lowered the saw blade below the table, then centered the Plexiglass over the blade at the correct distance from the center and edge. With the Plexiglass secure I raised the saw blade up and through the Plexiglass. I did this to all 4 sides, then with a jig saw finished cutting the inside corners out. Using the table saw I was able to get very straight inside and outside edges. The outside corners were cut with a jig saw and rounded smooth with a file. The inside lip of the bezel is just 4 straight pieces cut to fit, then glued in with some liquid glue. The entire bezel was painted flat black.

Touch Ups

The only thing left to do is put on the knobs, lettering, rubber feet, etc., and this I leave to the builder.

As you can see from Fig. 1, it is not an original. It started out as a MXV monitor, but now has MXV, WØLMD, and my own design in it. But like many other serious SSTV builders, when I start on an original circuit, I am bound to deviate from it. Maybe I went too far, but it works very well for me.

Monitor Set Up

- (1) Monitor should be set up with a good slow scan signal.
- (2) With a VTVM check T.P. 9 for -12V, and T.P. 10 for +12V.
- (3) Refer to Fig. 4 for all waveforms.
- (4) With scope probe on T.P. 1, waveform A should be present.
- (5) The 1K sync control adjusts for the 1200 Hz sync freq. T.P. 2 shows the sync signal B.
- (6) Adjust R1 (10K pot) for waveform C.
- (7) Adjust R2 (10K pot) for waveform D.

" THE ULTIMATE IN SSTV EQUIPMENT "

ALL AMERICAN MADE — HAND CRAFTED CHASSIS & PC BOARDS



THE SEEC HCV-3KB SLOW SCAN TV KEYBOARD

Announcing another first from the company and the designer of the world famous HCV-1B SSTV Camera and the HCV-2A SSTV Monitor, now the HCV-3KB Slow Scan TV Keyboard. This is the first commercially made SSTV Keyboard and it is built with the same quality as all SEEC/THOMAS equipment. We will not attempt to list all the features of the HCV-3KB here and we suggest that you write for full specifications. For those that are not familiar with SSTV Keyboards, the HCV-3KB eliminates the need for a menu board or other number/letter set-up arrangements which is very time consuming to set-up a meaningful text by arranging letters one at a time, by hand on a board or other surface. It also "frees up" the SSTV camera for other uses, such as live shots of the operator or other subject matter. Simply type out the message you wish to send. #DD-033469 on file in U.S. Patent Office.

BASIC SPECIFICATIONS

- *30 characters per SSTV frame. Six characters horizontally and 5 characters vertically. Special 35 characters per frame available.
- *Meets all standard accepted SSTV specifications.
- *Positive-Negative color (video) reversal.
- * $\frac{1}{4}$ and $\frac{1}{2}$ frame rates.
- *4 shade gray scale generator.
- *Dual Fast and Slow Scan rf and video outputs (special-optional).
- *Plug-in printed circuit board-gold flashed edge connector.
- *ICs, op amps, transistors in plug-in sockets.
- *Built-in 115 V 50/60 Hz power supply.
- *Special 16 $\frac{1}{2}$ " x 8 $\frac{1}{2}$ " x 3 $\frac{1}{4}$ " aluminum cabinet — black and white or optional 2 tone gray — specify. B&W Standard.
- *Special introductory cash with order price: \$455.00. Regular price \$495.00. Five ways to purchase: Cash, C.O.D. (20% deposit), Mastercharge, BankAmericard, SEEC Financing plan (up to 36 months). Note: All credit cards pay regular price of \$495.00. All prices F.O.B. Hendersonville TN. Standard 1 year warranty.

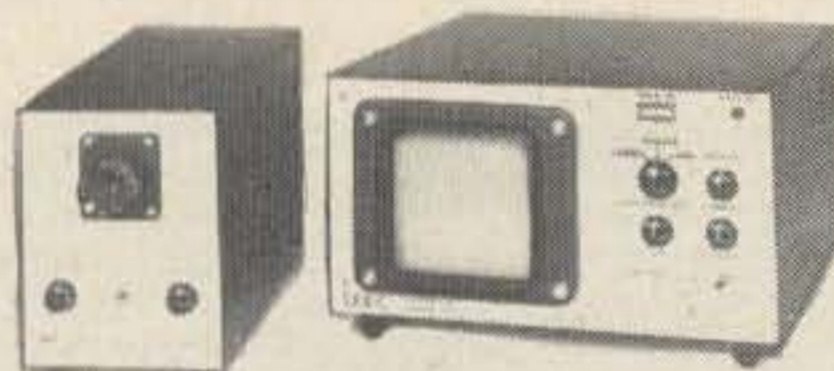

- HCV-1B SSTV Camera \$452.00. (Reg. \$475.00) with lens & power supply.
- HCV-1B SSTV Camera with ALC \$492.00 (Reg. \$515.00) with lens & power supply.
- HCV-2A SSTV Monitor with 2 CRT filters \$398.00 (reg \$425.00).
- HCV-2B SSTV Monitor with built-in Fast Scan viewfinder \$493.00 (reg. \$520.00).
- HCV-70FSVFK Fast Scan viewfinder modification kit for 70 and 70A. Monitors \$69.95. Factory installation \$37.50 additional.
- Sony TC110A Cassette Recorder \$134.95.
- Heavy Duty Camera tripod \$34.95.

A complete line of camera and monitor accessories are available — please write for current prices and delivery. Five ways to purchase: Cash With Order, C.O.D. (20% deposit), Mastercharge, BankAmericard, SEEC Financing Plan (up to 36 months). Note: All credit cards pay regular price shown. All prices are F.O.B. Hendersonville TN. Call or write us for complete specifications on any of our equipment or to be put on our mailing list. We have a 24 hour telephone answering service to better serve you, plus on the air technical assistance from the designer, WB4HCV (Jim). Two locations to better serve you. Our main plant at 138-B Nauta-Line Drive, and our lab at 218 Tyne Bay Drive, Hendersonville. Complete 80-2 meter operation from either location. Drop in to see us if you are ever near Nashville, Tennessee.

ALL EXPORT INQUIRIES AND ORDERS SHOULD BE SENT TO: SINGER PRODUCTS, CO. INC., ATTN: JOHN HAYES, ONE WORLD TRADE CENTER, SUITE 2365, NEW YORK NY 10045.

Summer Electronics & Eng. Co. inc.

P.O. BOX 572
HENDERSONVILLE, TENNESSEE 37075
TELEPHONE: 615-824-3235

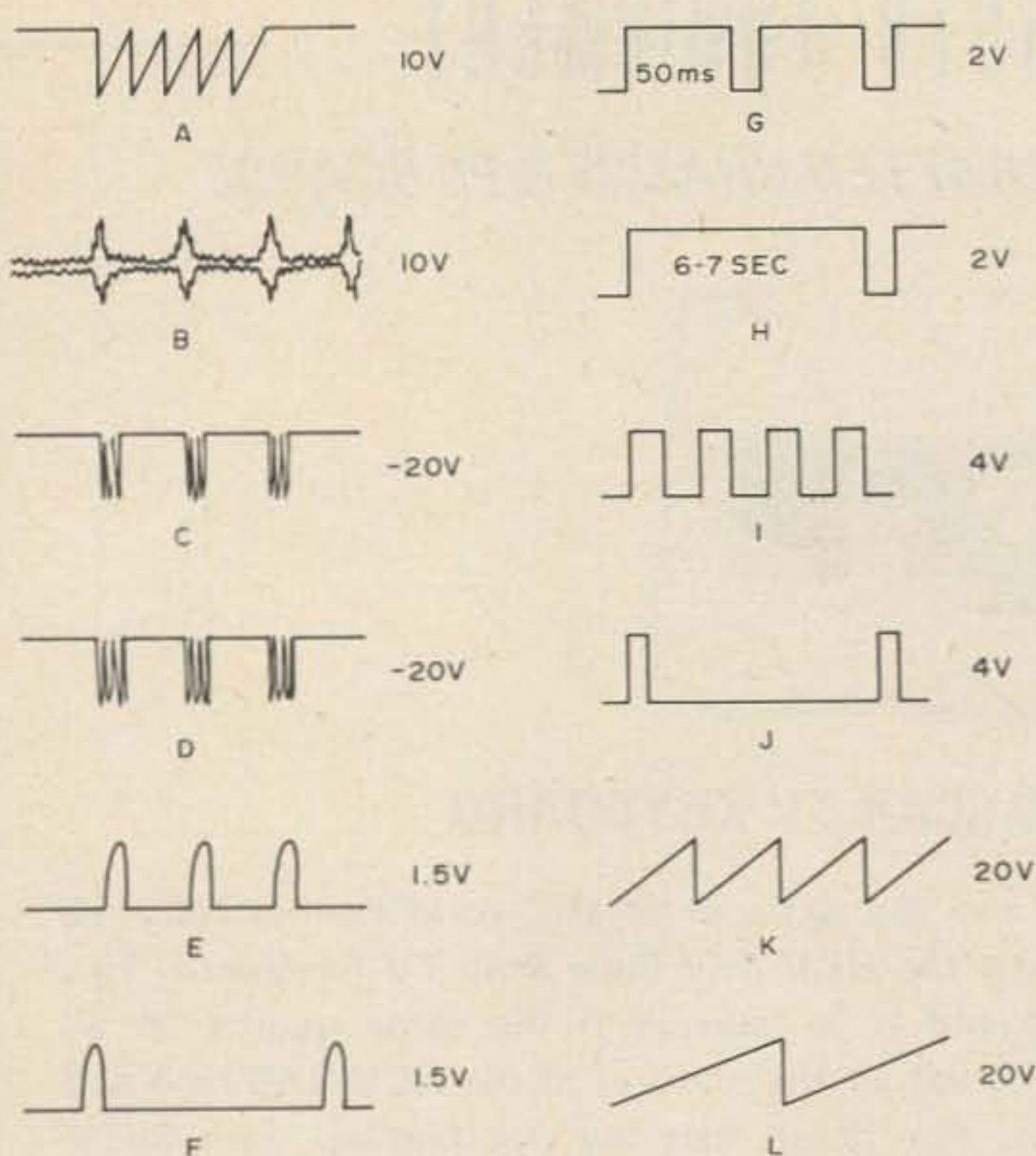

Fig. 4.

(8) T.P. 5 is a low pass filter, and the 15 Hz sync pulse should be present, about 1.5 volts (E).

(9) T.P. 6 is a low pass filter and the 8

second vert pulse should be present about 1.5 volts (F).

(10) Adjust R4 (20K pot) for a +2 volts pulse on T.P. 7, (G), 50 ms.

(11) Adjust R5 (100K pot) for a +2 volt pulse on T.P. 8, (H), 6.5 sec.

(12) Pin 10 on the MC 788 should be the 15 Hz sync pulse about \$4 volts, (I).

(13) Pin 12 on the MC 788 should be the 8 sec. vert pulse about +4 volts. (J).

(14) On T.P. 11 there should be a 15 Hz horz ramp, (K).

(15) On T.P. 12 there should be the 8 sec. vert ramp, (L).

(16) R6 in the horz ramp generator-adjust horz size.

(17) R7 — adjust for horz center.

(18) R8 in the vert ramp generator-adjust for vert size.

(19) R9 — adjust for vert center.

(20) With an accurate 1200 Hz study tone on the audio input to the monitor, adjust R3 for maximum deflection on the 6FG6 indicator tube.

... WA9MFF



WA9MFF and his shack. The camera is homebrew, as well as the "EFG" sampler and WØLMD audio analyser.

El Cheapo Superbeam

This article describes a rotary beam antenna for 10, 15 and 20 meters, with two elements on each band. It works well and is very inexpensive to build.

Design

The antenna uses the idea of multiple dipoles connected to one feedline to achieve triband operation. The driven element consists of separate 10, 15 and 20 meter dipoles joined at their centers and fed with one RG-8/U line. Three separate parasitic reflectors are each spaced approximately .22 wavelength behind the driven element. The reflectors are tuned lower in frequency than the driven elements and are about 5% longer physically.

A spacing of .22 wavelength is somewhat greater than the .15 spacing which, according to the charts, yields maximum forward gain. The sacrifice in gain is only on the order of .75 dB, hardly detectable, and is justified by a higher front-to-back ratio and an increase in radiation resistance. The choice of using a reflector as opposed to a director was made to obtain yet another increase in radiation resistance, and for greater bandwidth. To keep cost to a minimum the antenna uses wire elements instead of the more common aluminum tubing found in similar antenna designs, and so it was deemed desirable to keep the radiation resistance high in order to reduce loss due to the ohmic resistance of the thin elements.

Construction

Constructing antennas out of wire elements always poses the problem of how to support them. Ropes and trees and chimneys would severely limit the usefulness of a unidirectional beam such as this tribander. In order to make the antenna rotatable, a framework was built on which the wires could be "hung." The frame is made of bamboo poles and standard hardware — very inexpensive items. If bamboo is not available, plastic water pipe might be tried as a substitute. The photographs and diagrams show how the frame is constructed.

The exact position of the pipe flange under the mounting plate is best determined by holding the water pipe and flange vertical

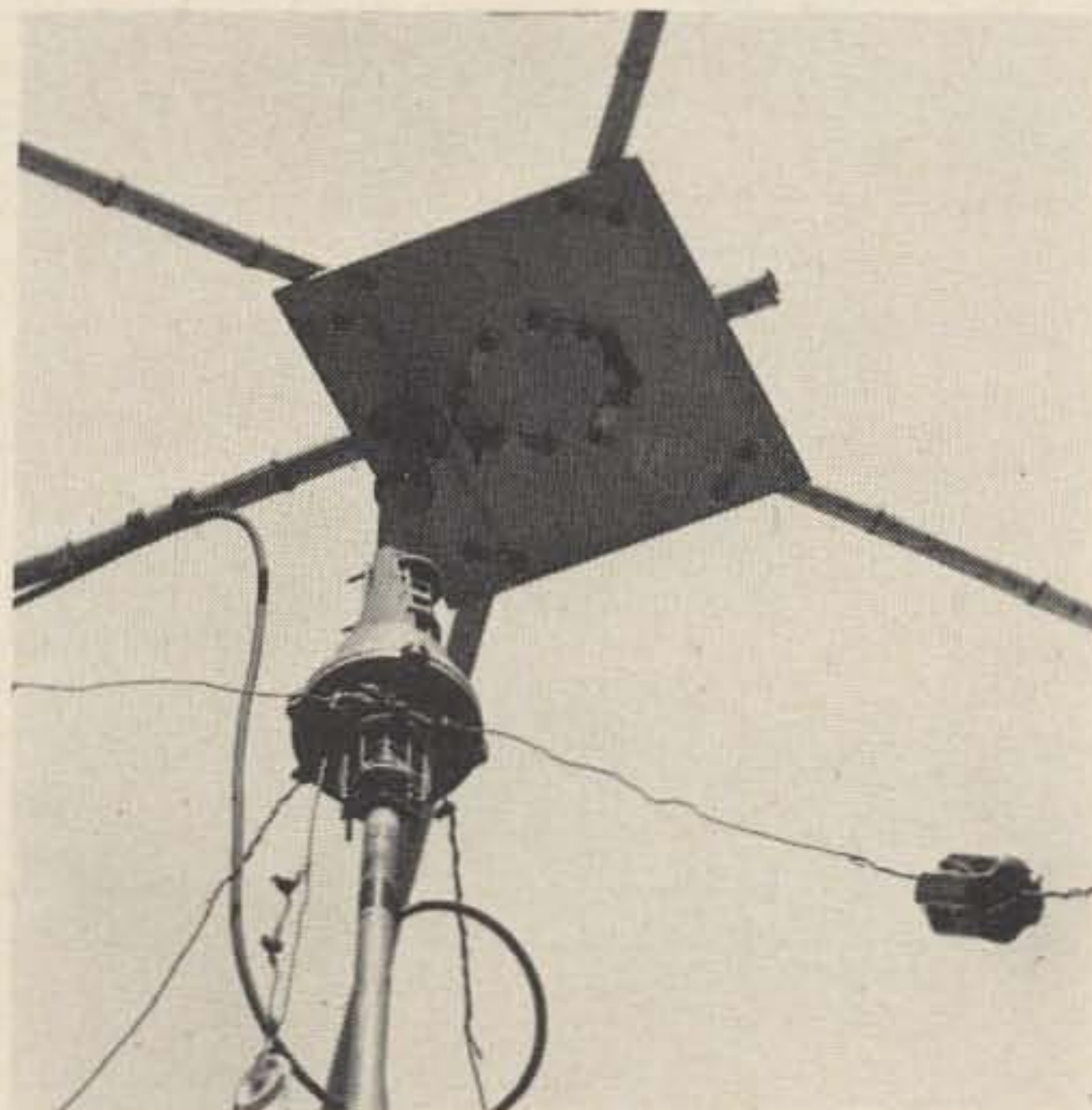

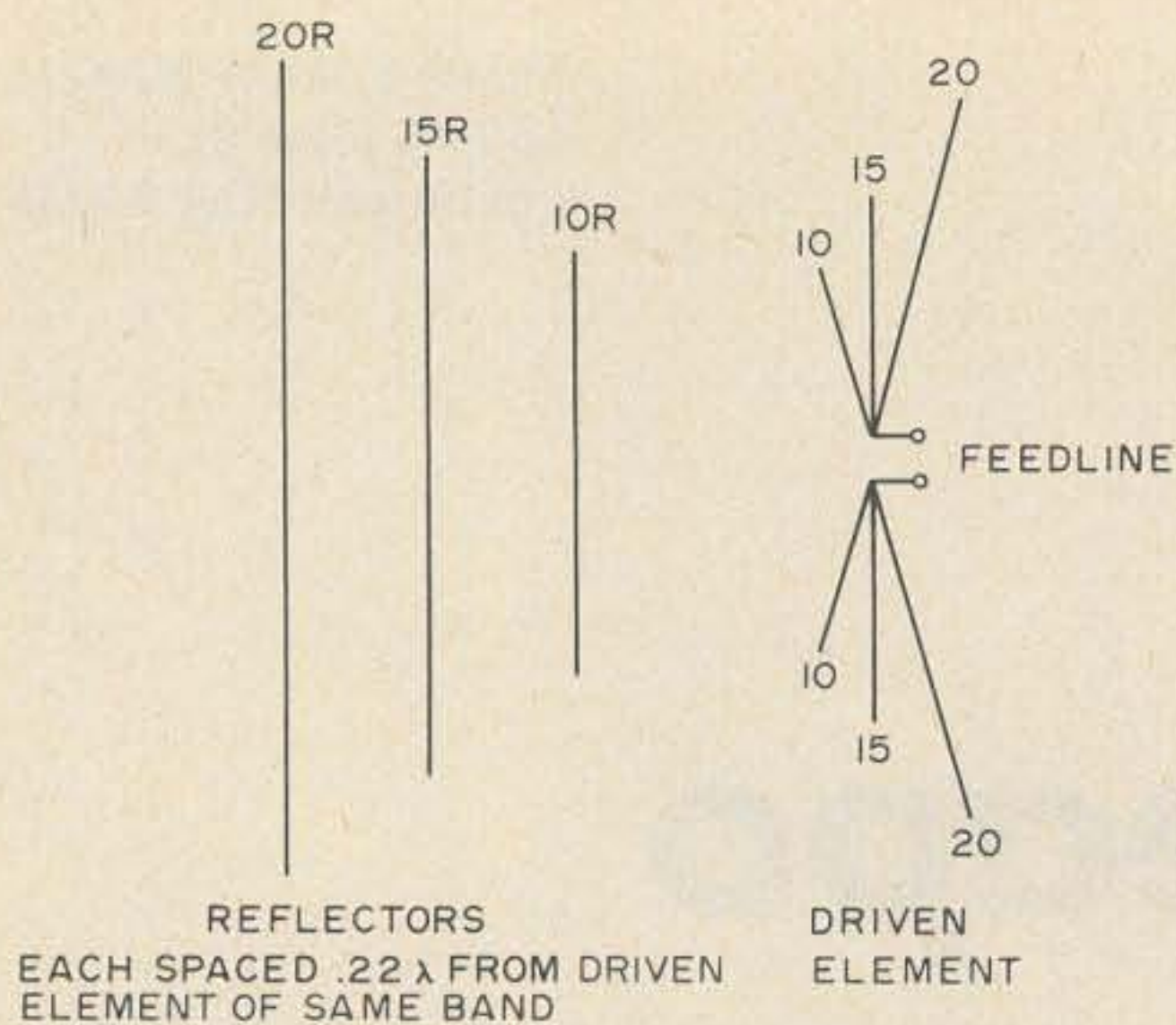

Fig. 1. Antenna theory.

while balancing the assembled frame on top of them, and marking the location. This will not be in the center of the plate since the fifth support arm unbalances the weight distribution. Mounting the flange at the point of balance will reduce the strain on the rotator bearings.

The wire elements can be fastened to the support arms by means of tape or fish line or whatever you have handy. The excess length of the wire is allowed to hang down from the supports. Allowing the ends of the elements to droop does not seem to hamper operation of the antenna. After all, this beam is really just the top half of a quad.

Although no tests were run to compare performance with and without the 1:1 balun in the feedline, there is no reason why the antenna should not work without it. The beam shown in the photographs uses a

Hy-Gain BN-86. Less expensive baluns such as the kit from Amidon Associates or the Greene Insulator might be tried. Even if the balun is eliminated, it is wise to include the fifth support arm to carry the weight of the coax feedline and prevent sagging of the driven element supports. The feedline is taped to this arm, and the center insulator in the driven element is also supported from this pole by a short piece of wire or fish line.

Installation and Tuning

The performance of this antenna will be determined by the height at which it is mounted. Towers are expensive; however, telescoping type TV masts are reasonably priced, with 50 footers going for around \$35. If you must ground mount the mast, a 50 footer should allow you to get the antenna up to around 37 feet. This allows for some overlap of sections and assumes you will not extend the thin top section more than a couple of inches. Mounting the rotator between the mast and beam will give you another foot or so, and if you can set the whole thing up on a rooftop, so much the better. A very successful – slow but safe – method of raising the antenna is to temporarily fasten the guy wires, leaving some slack, and then extend the mast until the wires are taut. Loosen the guys, again let out a little slack, refasten them, and raise the mast a couple more feet. Repeating this operation several times takes longer, but is much safer, than getting three or four men

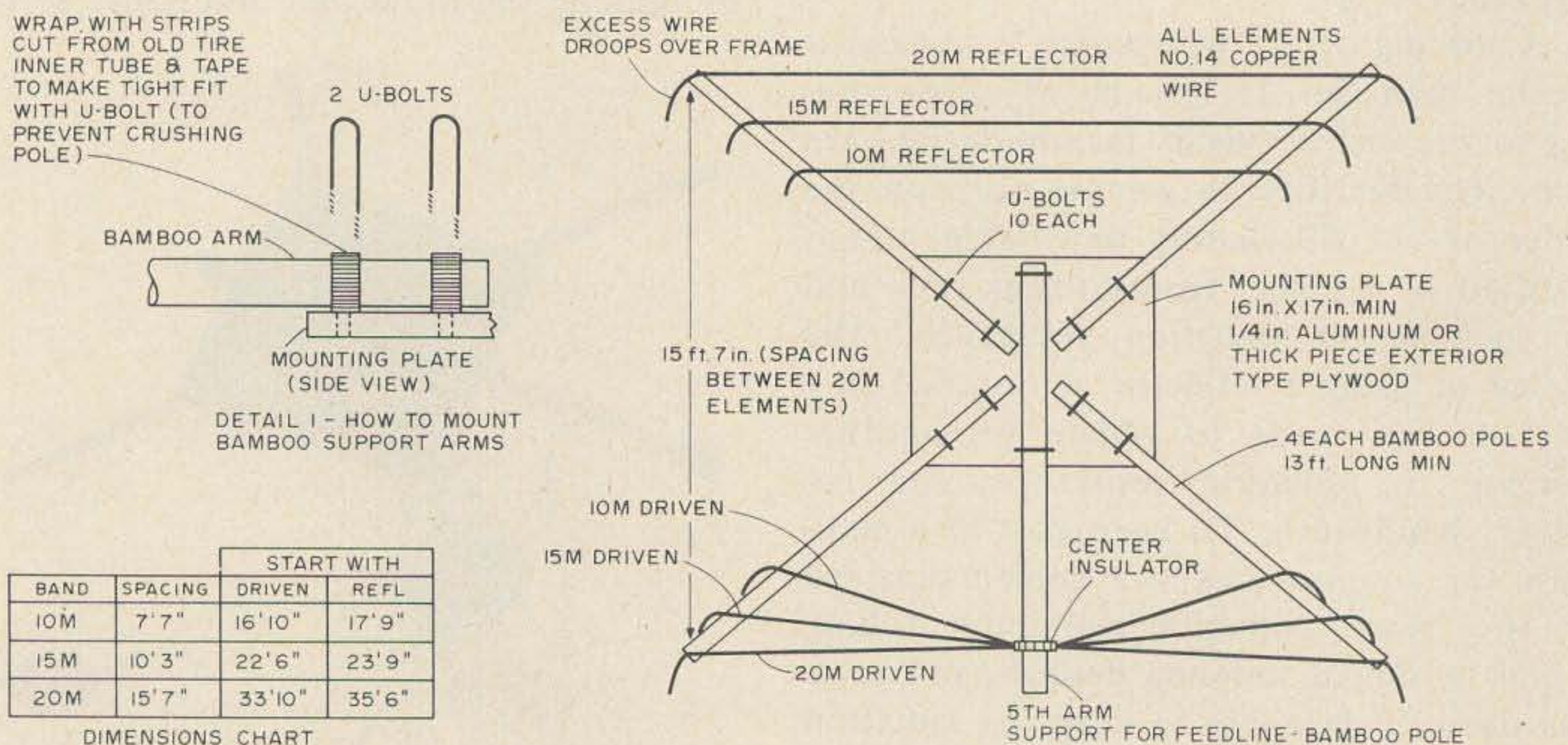
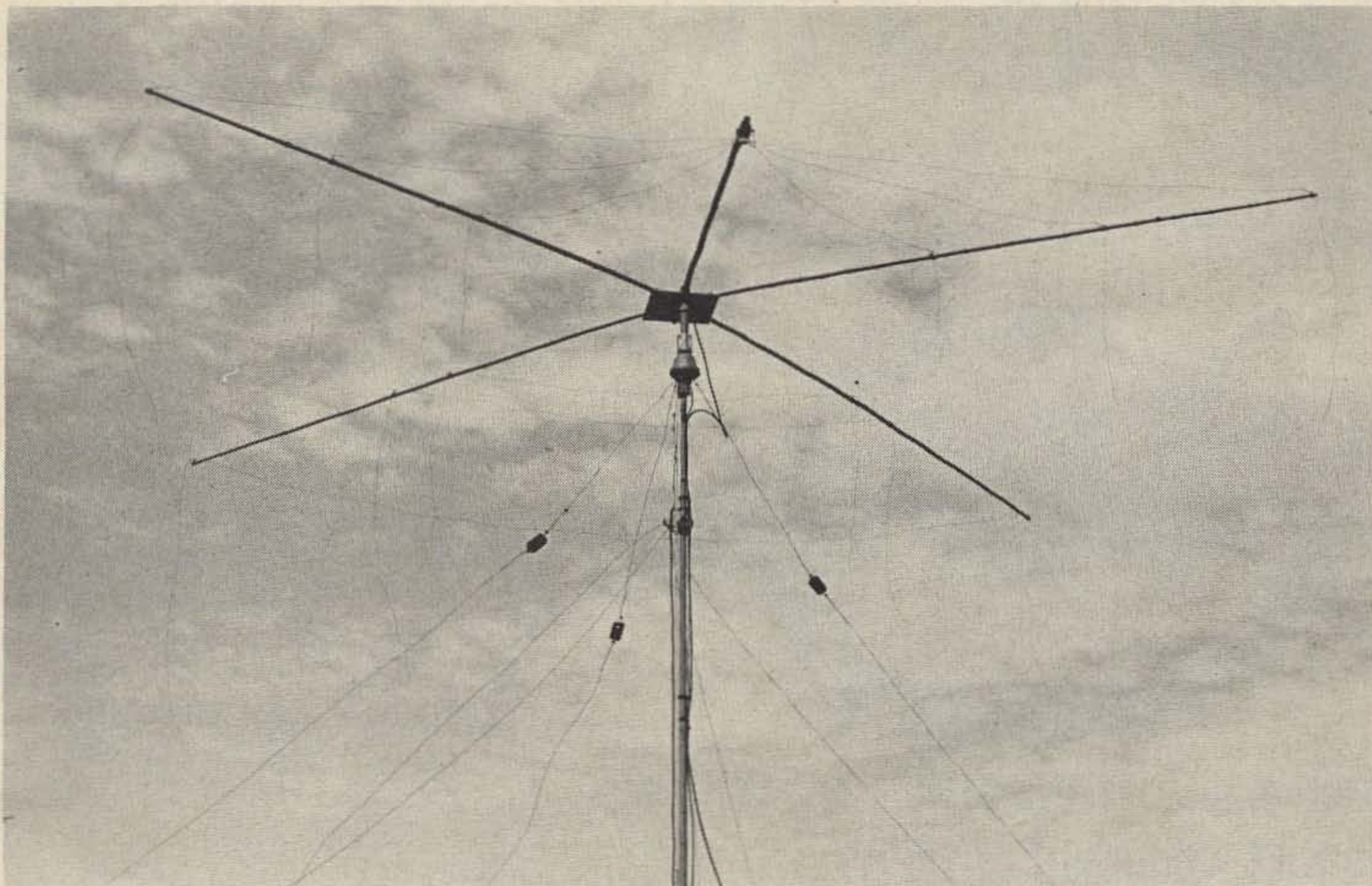

Fig. 2. Frame – top view – this frame mounts parallel with the ground.



to hold the ends of the guys and juggle their tensions and positions, trying to keep the antenna, rotator, and mast from all crashing to the earth. The heartbeat increases rapidly as a slight bow in the mast becomes a full-fledged bend just as the crunching of bamboo fills the air. Ask one who has been there!

Before you raise the antenna out of reach, it should be tuned. (It might also be wise to attach a rope and pulley somewhere near the top of the mast for use as the apex of a 40/80 meter inverted V, thus completing a 5 band antenna system.) Tuning this antenna is rather easy, as there is nothing to tighten or loosen, or slide in or out. Merely snip at the drooping ends of the elements with wire cutters. Trim as you watch your grid dip meter, or swr bridge, or noise bridge. Adjust the reflector and driven elements together, one band at a time, remembering that the reflector should be maintained about 5% longer than the driven element. The dimensions given are starting points only and are purposely long to allow for tuning. It would be best to start with 20 meters and work your way up in case there is any interaction between bands. Keep in mind that the resonant frequency of the

antenna will go up when it is at its full height, and also that a 2 element beam with a reflector will drop off in performance faster as you move down in frequency than as you swing upward. So tune for a lower

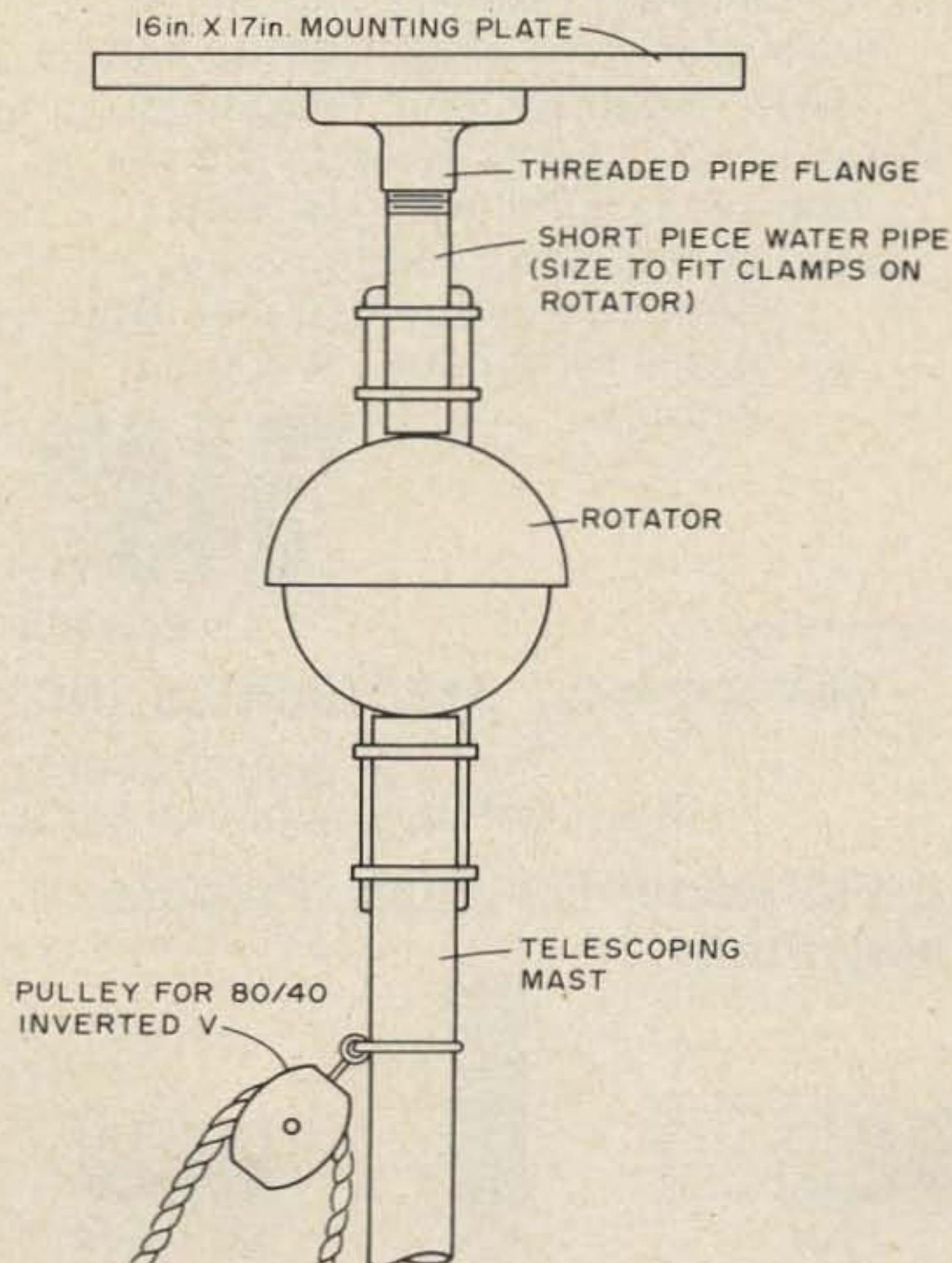

Fig. 3. Antenna-to-mast mounting.

NEW! HR-440

12 Channel 440 MHz FM Transceiver



American Made
Quality at Import Price

Delivers 10 Watts of Power and 12 Channel Capability

You'll like the crystal clear transmit and receive performance of this compact 440 MHz unit . . . and so will those listening. Solid state design brings you the best in American Made circuitry. Features include Automatic Frequency Control and UHF power module. Frequency range is 420-450 MHz, with 0.5 μ v tune-up sensitivity and 3 watts audio output. No need to worry about current drain, either. And all of this for the low, low price of only

\$349⁰⁰

Amateur Net
Regency ELECTRONICS, INC.

7707 RECORDS STREET
INDIANAPOLIS, INDIANA 46226

An FM Model For Every Purpose . . .
Every Purse

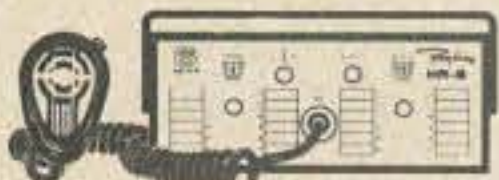

HR-6

12 Channel-25 Watts
6 Meter FM Transceiver



HRT-2

5 Channel Hand-Held
2 Meter FM Transceiver

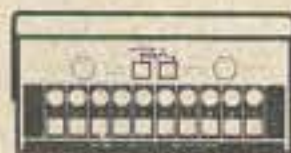

ACT 10H/L/U

3 Band-10 Channel
FM Scanner Receiver

frequency in the band, and if you err on the length of the reflectors, it is better to be on the long side. At 35 feet this antenna has given a good match to RG-8 coax with no extra matching devices. This is due, at least in part, to its higher than usual radiation resistance as compared with the close spacing of some commercial 2 element tri-banders.

Performance

If you have tuned the elements correctly, the antenna will exhibit a definite front-to-back ratio. You can check this by listening to a signal on the station receiver while rotating the beam. On some signals the effect will be more dramatic than on others, due to the angle at which the signal is arriving and the fact that some DX signals may be coming through over both long and short paths simultaneously. In general, though, there should be a difference of two or three S units when making this test. The front-to-side discrimination will be even greater.

With this antenna at a height of only 35 feet it has been possible to hear and work plenty of DX, although no one should expect to be able to crunch the Big Guns using large arrays up at 80 feet. Running 100 W input I worked about 80 countries in 9 months time. Adding a pair of 813s and 5 months brought the total up to over 130 worked. This was during 1970 and early '71. I am a college student, so my operating hours are somewhat limited, and I did not spend all day every day tuning for DX. I do feel this project can provide the ham operating on a limited budget (pun) with an effective rotary beam antenna and a chance to work some new ones.

In closing I wish to thank my non-ham dad, Mr. Abraham Smolar, for his helpful suggestions and great patience.

... WA6NLQ

References

Antennas and Radio Propagation, TM 11-666, Department of the Army, February 1953.

The Radio Amateur's Handbook, 44th Edition, ARRL, 1967.

Radio Handbook, 16th Edition, Editors and Engineers, Ltd., 1962

73 Magazine, July 1963, p. 62.

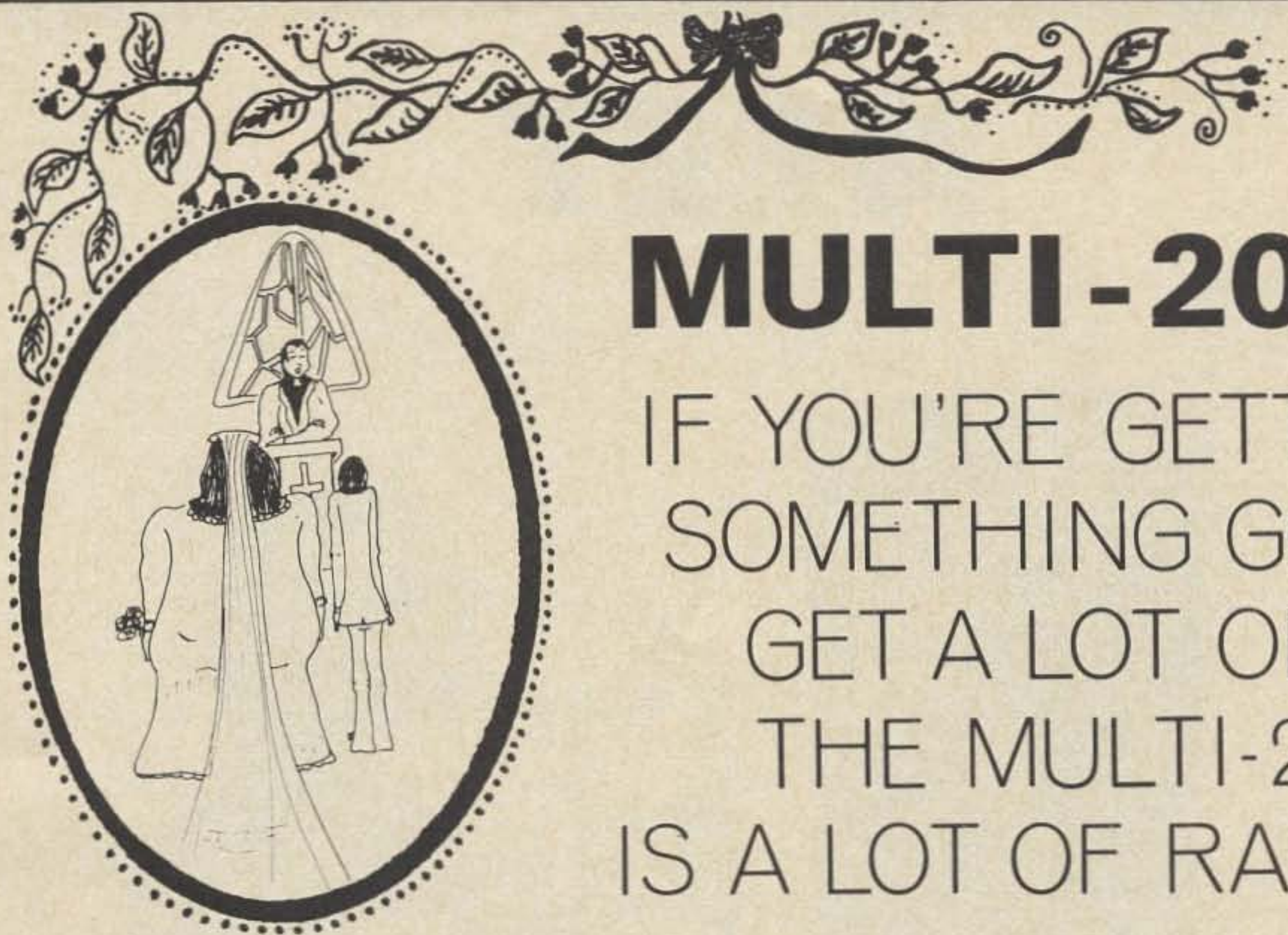

MULTI-2000

IF YOU'RE GETTING
SOMETHING GOOD
GET A LOT OF IT!
THE MULTI-2000
IS A LOT OF RADIO!



FEATURES

- PLL synthesizer covers 144-148 MHz in 10 kHz steps
- Separate VXO and RIT for full between-channel tuning
- Simplex or ± 600 kHz offset for repeater operation
- Three selectable priority channels
- Multi-mode operation (CW/SSB/NBFM/WBFM)
- Built-in AC and DC power supplies, noise-blanker squelch and rf gain control
- Selectable 1W or 10W output
- Separate S-/power and frequency deviation meters
- Built-in test (call) tone and touch-tone provision
- Excellent sensitivity (.3 μ V for 12 dB SINAD)
- Superior immunity to crossmodulation and intermodulation
- Introductory price: \$695.

TUFTS Radio Electronics

386 Main St., Medford, Mass. 02155

MEET



THE DUPLEXER

INTRODUCING MODEL 2M6A

- Frequency Range 146–148 MHz
- Rejection >105 db
- Completely Preassembled
- Insertion Loss <1.5 db
- VSWR 1.2:1
- Price \$350.00

For more information on this or any of our duplexers and tuned cavities for 70 cm.; 1.5 M and 2 M, call or write:



544 Lassen St.
Los Altos, Ca. 94022
(415) 941-2118

DEALER INQUIRIES INVITED

The Smart Alarm

One evening I returned to where I had parked my car, only to find it gone. Since then I have installed a burglar alarm in the two cars that I have subsequently owned.

This article reviews the basics of installing an alarm system in a car and describes a new, all solid-state circuit that replaces the key operated switch in an ordinary alarm system.

Basics

All alarm systems are basically made of three sections — the sensors, the control circuit and the alarm. The control circuit must be able to take the signal from the sensors and turn on the alarm. The alarm must remain on in spite of the fact that the signal from the sensor is only momentary. In Fig. 1, the simplest alarm circuit is shown. The relay is wired so that it is self latching, thus a momentary closure of the sensor

circuit will cause the bell to ring continuously until the keyswitch is turned off.

I had installed this type of alarm system in a previous car, and after more than a year of use I was keenly aware of its drawbacks. On several occasions I returned to my car and opened the door without first turning off the alarm. This was very embarrassing, especially late at night after returning from a movie. Also, it was difficult to first go to the driver's side to turn off the keyswitch and

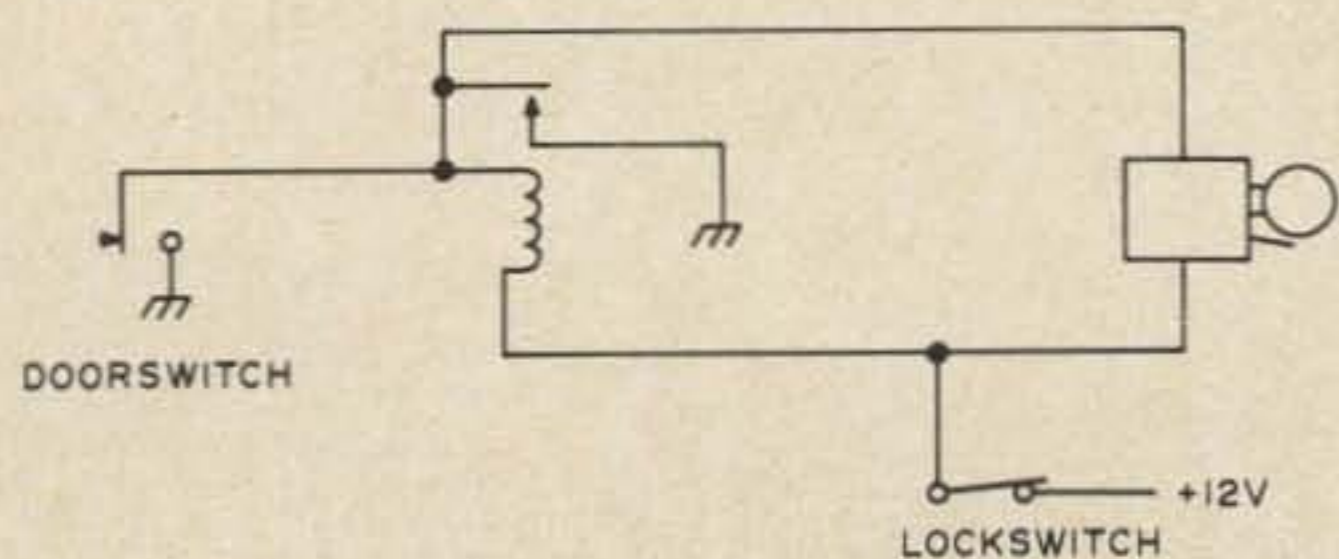

Fig. 1. Typical alarm circuit.

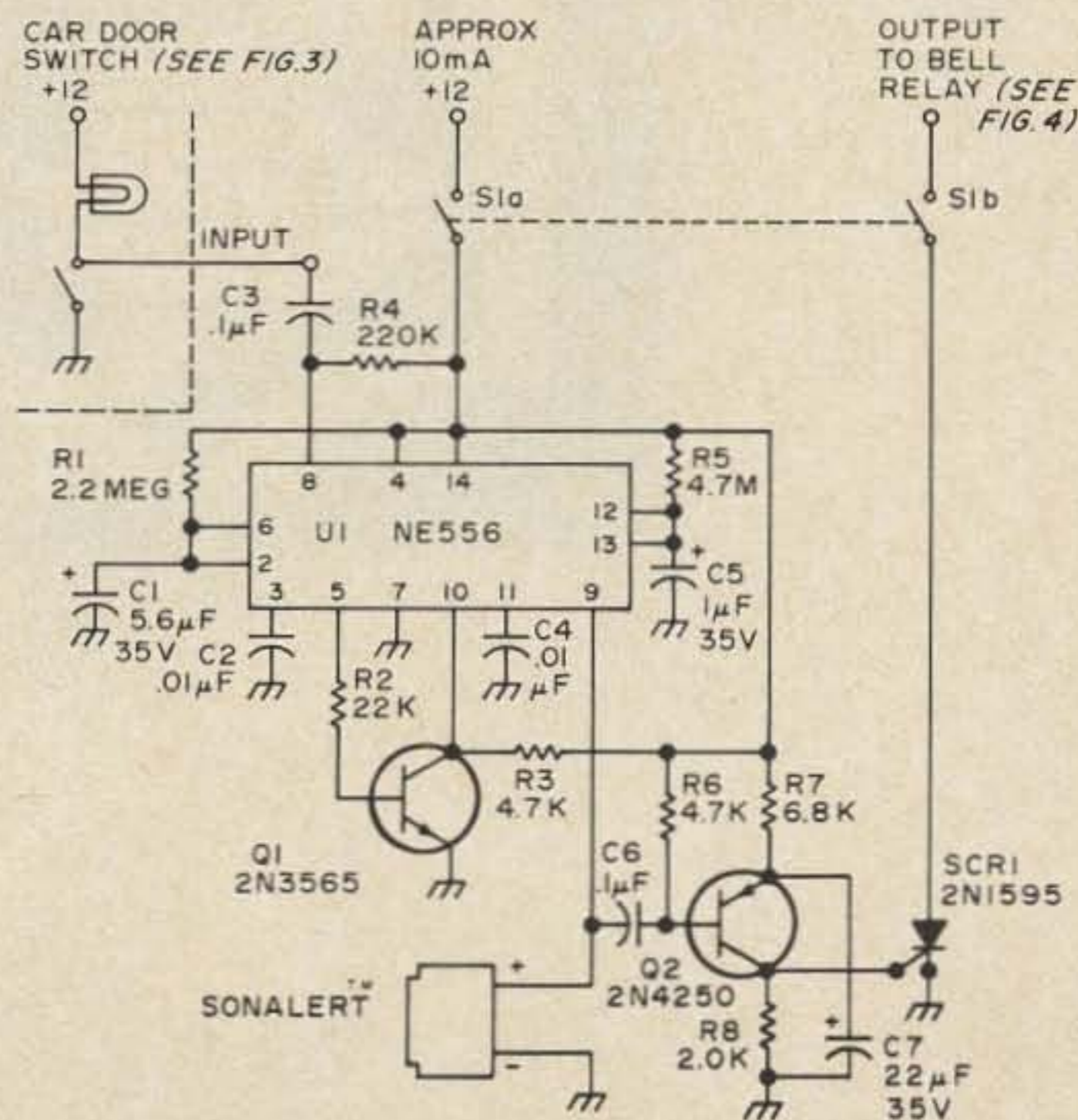

Fig. 2. Solid state burglar alarm.

TOP FOIL SIDE VIEW

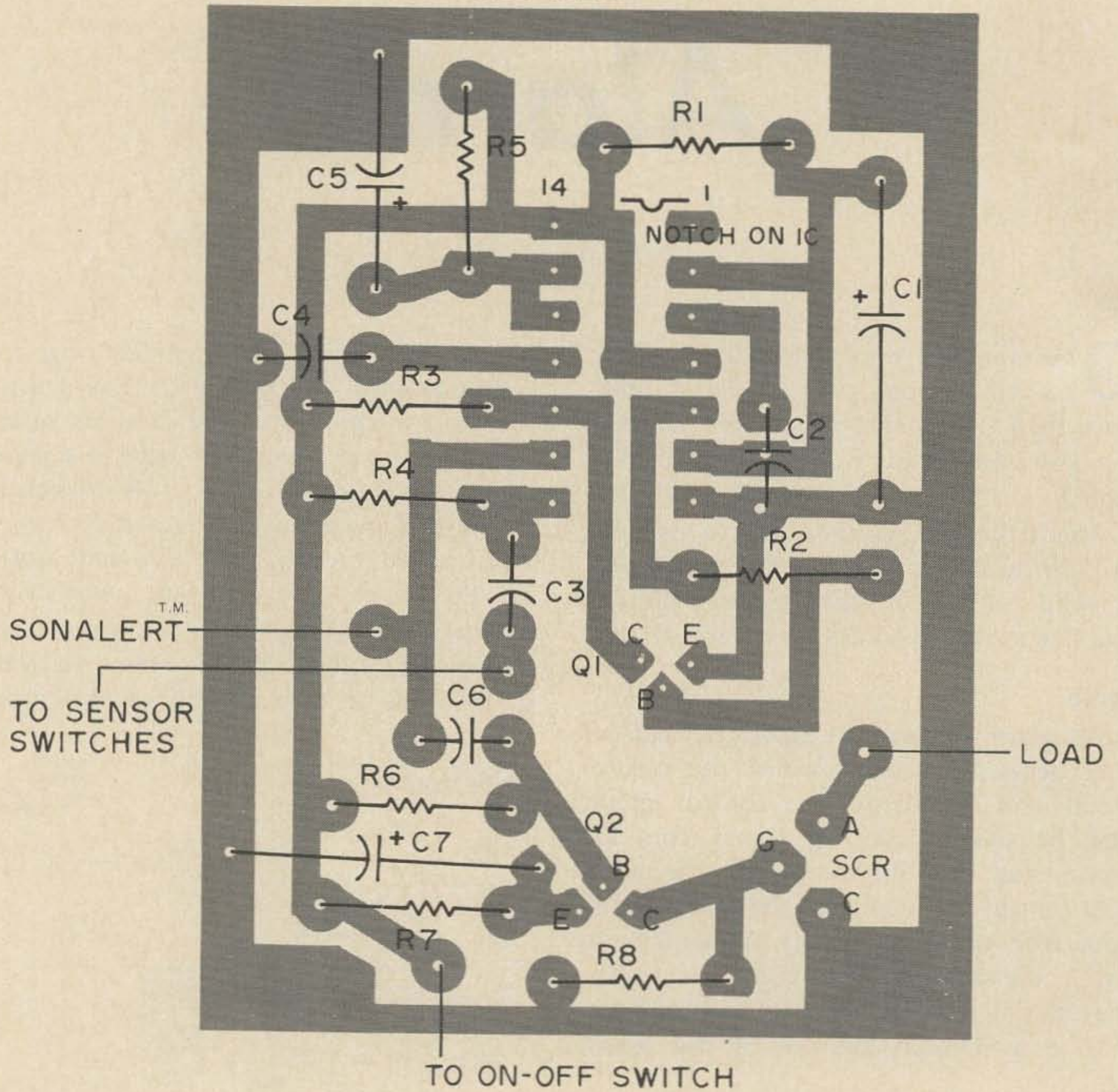

Fig. 3. PC layout (200%).

then go back to the passenger's side to let someone in the car. In addition, the lock-switch is difficult to hide. At least one ham in the Los Angeles area found that a burglar outsmarted the alarm system in his car by breaking the window and removing the mobile rig without opening the car door.

Another suggestion that is not obvious is that the alarm system is worthless if the battery and battery cables are accessible. This means that you are protected if you have a Volkswagen because the battery is inside the car, but if the battery in your car is under the hood you are vulnerable. It is advisable to invest in a set of hood locks for your car. In addition, burglars have been known to crawl under a car with an alarm system and reach up next to the engine block and cut the battery ground wire. This means that your alarm cannot be secure unless you run an extra - and + wire in such a way that it is inaccessible from the bottom of the car. Ordinary small gauge wire (preferably with teflon or high temperature insulation) can be used as the maximum current it will need to carry is about 4A. Unless the main battery leads are cut, they will not be carrying any current.

a certain timed interval the alarm would be armed. When the owner returns and opens his car, he has a few seconds delay to be able to shut off the alarm system before it can ring. However, there is no reason why the control system cannot be built with solid-state circuitry rather than using thermal time delay relays.

Circuit Description

This circuit is inexpensive, easy to build and reliable. It uses a dual timer integrated circuit that is available from Signetics, National and Raytheon. If you use good electrolytics, the circuit will be very stable over a wide temperature range.

The first half of the IC is designed to begin a timed interval beginning with the first application of the 12V supply. R1, C1 provide the time constant and with the values given in the schematic the timed interval is about 14 seconds. The output of timer 1 is HIGH during the timed interval and LOW after timeout. This is inverted by Q1. Pin 10 is the reset input of timer 2. When timer 1 is timing, the output of Q2 is forcing pin 10 LOW thus timer 2 is ignoring any trigger inputs. After timer 1 has completed its period, timer 2 is able to function the first time that its trigger input drops from HIGH to LOW. The trigger input, pin 8, is biased high by R4 and when the door switch or sensor makes contact, C3 makes the necessary falling edge to trigger timer 2. Note that in Fig. 3 the courtesy light provides the +12V to discharge C3. Some cars, such as Volkswagens and Ford Pintos, do not use a grounding type switch, but instead use a complicated switch that is completely above ground potential. So in this case it is necessary to install independent grounding type switches for the alarm sensors. It is necessary in this case to put a resistor, R9, from this trigger line to the +12V supply in order to keep C3 discharged.

Timer 2 has a time constant of about 6.1 seconds when using the values specified for R5, C5. This is about the minimum time that one can comfortably enter the car and shut off the enable switch, even when carrying a bag of groceries.

The output of timer 2 is high during its timing period but we are only interested in

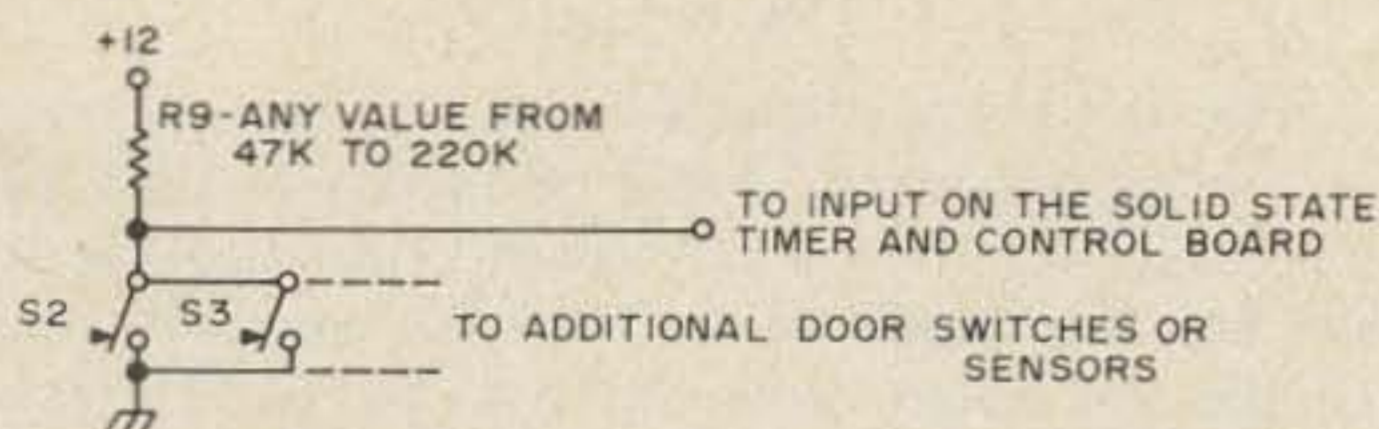
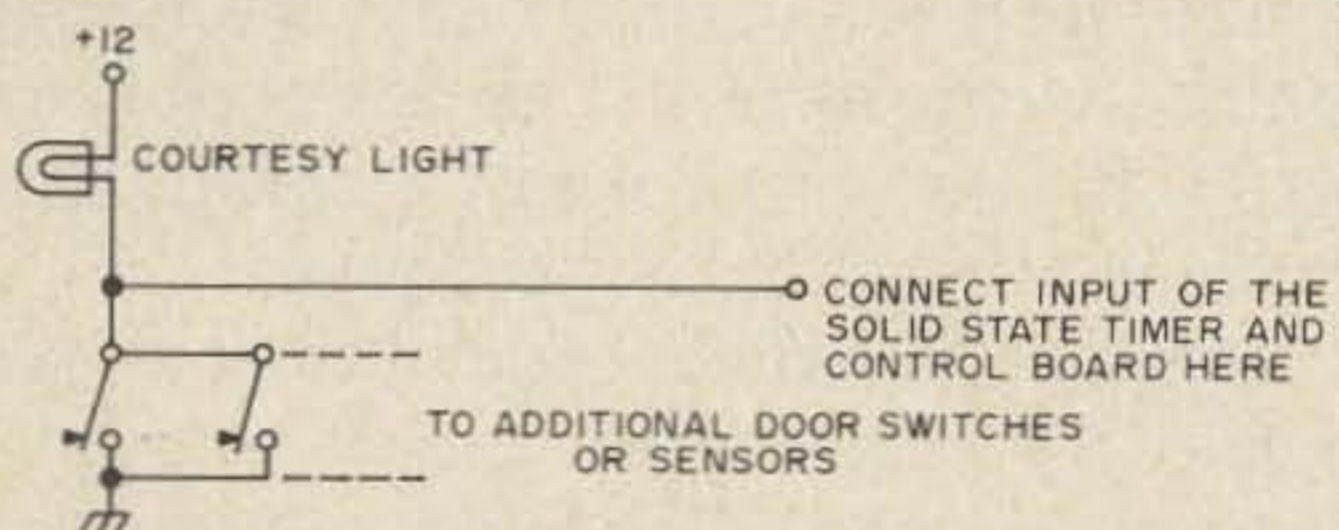

Fig. 4. (a) Alarm system using the existing switches in a car with grounding type courtesy light door switches. (b) If you install separate switches or sensors, use this circuit (see text).

A previous article in 73 Magazine (Mobile Burglar Alarm, May, 1973, 73 Magazine) gave me the idea of using timers to allow a person to turn on the alarm system by throwing a switch inside of the car, and after

the falling edge, indicating the end of the timed interval. Transistor Q2 translates this falling edge to a positive going pulse. This turns on the gate of SCR1 which is self-latching. The SCR grounds one end of the relay coil, Fig. 4, and the relay pulls in causing the bell to ring. The SCR cannot turn off until the enable/disable switch is turned off, removing current flow through the SCRA. R7 and C7 are necessary to keep transients from turning on the SCR when the enable switch is first turned on.

In addition, I am absent minded and forget that I have the alarm system on so a Mallory Sonalert makes a loud tone during the 6 second period beginning when the car door is opened.

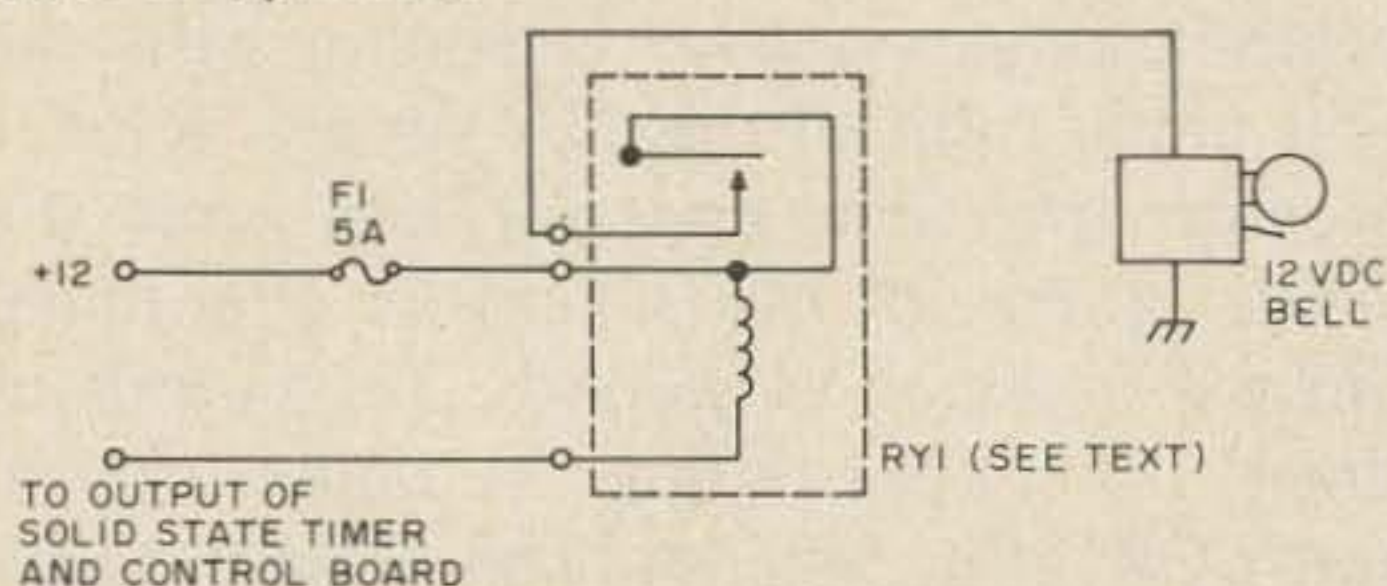

Fig. 5. This circuit is not latching because the SCR on the solid state timer and control board does the latching.

If a burglar enters the car, he will hear this tone and perhaps be wise enough to leave quickly. If he does not, at the end of 6 seconds this tone will stop and simultaneously the bell will begin to ring — hopefully scaring him away. This added feature of having a reminder tone that the alarm is still activated is very convenient.

Construction and Operation

A layout is provided for a printed circuit board. The parts that I used may not be available in your junkbox. If not, this is simple enough to breadboard on perf board. The transistors are very inexpensive plastic types. Note that Q2 is a PNP and is wired as a grounded collector configuration. The switch S1 is a DPDT subminiature toggle switch that is carefully hidden in my car, but you can use anything that has at least DPST contacts. It is, of course, necessary to hide this switch in a place that is well hidden but accessible. Avoid obvious places.

The relay and bell that I am using are one unit but if you get a bell without a relay inside of it, any 12V relay with SPST

contacts rated at 5A will do. A horn relay is wired internally with one contact connected to one end of the coil as shown in Fig. 4. The relay is necessary because the SCR must see a constant load to remain in the ON state.

This circuit is not meant to be used while the engine is running. Most ignition systems have huge voltage spikes when the engine is running. These could damage the IC so it is better to not turn on the enable switch while the engine is running. As a burglar alarm is not usually used when the engine is running, it would be unnecessary to add the filter and zener to protect the circuit.

This circuit may also be used in a home alarm system. It may be operated from a simple filtered 12V supply. It is not necessary that the supply be regulated. It would be even better if the alarm system were powered with batteries with an ac supply in parallel. Then the system would not be off in the event the ac were shut off, and the batteries would not discharge as long as the ac is on. The output relay may drive anything — a transmitter, lights, horns, bells or an automatic telephone dialer. The sensors may be anything that provides a contact closure, such as a normally open momentary contact. Don't forget to use R9 as shown in Fig. 3. If your sensor is not normally open, simply use a small relay to convert it.

This circuit cannot guarantee that your mobile rig is safe, but it will help. It is inexpensive and easy to build, and its advantages over the ordinary alarm system make it well worth the effort.

Parts List

The following suggested parts are the ones used for the layout shown. Other parts may be used, but they may not fit the PC layout. Tantalum capacitors are recommended as they are generally more reliable and stable, especially over the wide temperature range to which a car is often subjected.

- C1 — 5.6 μ F 35V (Sprague 150D565X9035B2)
- C2 — .01 μ F ceramic (CK06BX103K)
- C3 — .1 μ F ceramic (CK06BX104K)
- C4 — .01 μ F ceramic
- C5 — 1.0 μ F 35V (Sprague 150D105x9035A2)
- C6 — .1 μ F ceramic
- C7 — 22 μ F 15V (Sprague 150D226X0015B2)
- F1 — 5A fuse in an in-line fuseholder
- Q1 — 2N3565
- Q2 — 2N4250
- U1 — 556 Dual timer

R1 - 2.2M 1/4W (RC07 style carbon resistor)
 R2 - 22K 1/4W (RC07 style carbon resistor)
 R3 - 4.7K 1/4W (RC07 style carbon resistor)
 R4 - 220K 1/4W (RC07 style carbon resistor)
 R5 - 4.7M 1/4W (RC07 style carbon resistor)
 R6 - 4.7K 1/4W (RC07 style carbon resistor)
 R7 - 6.8K 1/4W (RC07 style carbon resistor)
 R8 - 2.0K 1/4W (RC07 style carbon resistor)
 R9 - any value between 47K and 220K (not located on the circuit board)
 RY - 12 volt SPST relay, see text
 S1 - DPST or DPDT subminiature switch (Alco MST 205N)
 S2 S3 - grounding type car door switches, see text
 SCR1 - 2N1595
 Sonalert or equiv. (SC628)
 Bell - a LOUD 12 V bell or you can use your horn or a transmitter.

(Author's Note: I have noticed that there is a substantial variation from device to device in gate sensitivity of the 2N1595 SCR. If you happen to get an SCR with a low gate sensitivity, it may be necessary to lower the value of R7. In that case, it will be advisable to change C7 to 100 uF 15 V, to remove transients that can trigger the SCR and bell when the car door is closed.)

... WA6KBL

Legal touch pads	
Automatic electric version	
Touch-calling unit	\$27.75
Enclosure with bracket	\$ 7.00
wiring diagram furnished completely compatible	
<i>Allow three weeks for delivery. Add \$1.75 for shipping and handling. Rhode Island residents add 5% sales tax.</i>	
Communications Specialties	
97 Amsterdam Avenue Warwick, Rhode Island 02889 401-738-3287	

All three Digits $\frac{1}{3}$ " tall!!	
3 DIGIT Decimal Counting Unit	DCU COMPLETE (free catalog)
BUILD CLOCKS, COUNTERS, DVMS, ETC., USING THESE "three digit for the price of two" units. \$17.99 ppd	
TWS LABS • PO BOX 357 • PROVO UT • 84601 •	

WANNA WORK MORE DX ?
 Subscribe to THE WORLDS ONLY weekly DX Magazine. Strictly DX news in depth. I give you upcoming events, dates, times, freqs, DX QSL info, contest info, DX articles, etc. **SUBSCRIBE NOW and WORK EM ALL ! DX NEWS GALORE !** \$ 6.00 for 6 mo. or \$ 12. per yr to W/K, VE, XE, First Class mail. **THE DXERS MAGAZINE, (W4BPD), Drawer "DX", CORDOVA, S.C. 29039. DXING IS GREAT USING OUR INFO !**

complete stock of the following lines:

- * ITC MULTI-2000
- * ATLAS
- * VHF ENG.
- * STANDARD
- * REGENCY
- * BOMAR CRYSTALS FOR 2 MTR FM
- * 73 MAGAZINE PUBLICATIONS
- * QST PUBLICATIONS
- * EMERGENCY BEACON
- * NEWTRONICS
- * TEN-TEC

* * * * *

Largest inventory of used equipment in the Boston area.

TUFTS

Radio Electronics

386 Main St., Medford, Mass. 02155

MEET THE STATE OF THE ART ON 2 METERS... THE ITC MULTI-2000 CW/SSB/FM TRANSCEIVER

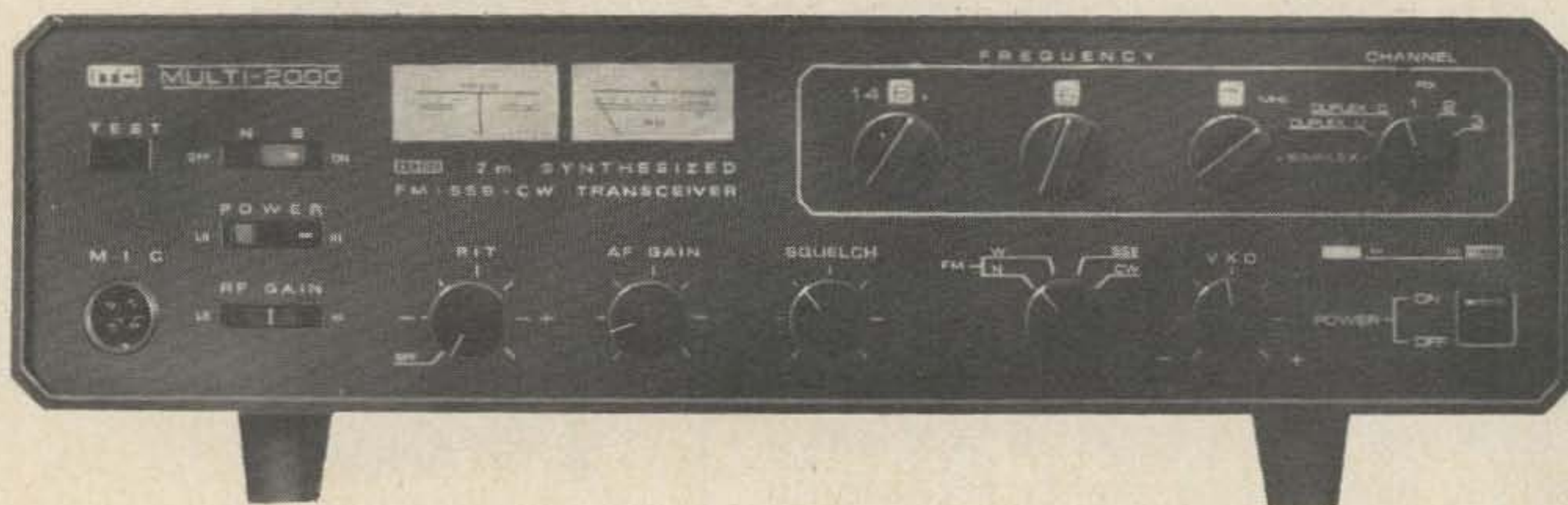

Whether your interest is simplex, repeater, DX or OSCAR the new ITC MULTI-2000 lets you get into all the action on all of the

band. Fully solid-state and employing modular construction, the MULTI-2000 enjoys features found in no other 2m transceiver.

FEATURES

- PLL synthesizer covers 144-148 MHz in 10 kHz steps
- Separate VXO and RIT for full between-channel tuning
- Simplex or ± 600 kHz offset for repeater operation
- Three selectable priority channels
- Multi-mode operation (CW/SSB/NBFM/WBFM)
- Built-in AC and DC power supplies, noise-blanker squelch and rf gain control
- Selectable 1W or 10W output
- Separate S-/power and frequency deviation meters
- Built-in test (call) tone and touch-tone provision
- Excellent sensitivity (.3 μ V for 12 dB SINAD)
- Superior immunity to crossmodulation and intermodulation
- Introductory price: \$695.

Ham Import Sales

P.O. Box 1009 • Blaine, Washington • 98230

Arnold H. Rand W2NYU/WA1JJV
124 Woodcliff Avenue
Woodcliff Lake NJ 07675

An Intimate Look at 160 Meters

Since its return after WWII, the 160 meter band has been largely ignored by the majority of amateurs, many having never operated there at all during their entire amateur experience. With the decline in usability of the "big three," 20, 15 and 10 meters, due to the decline in sunspots, and the consequent pressure on the remaining hf bands to absorb this influx of "displaced persons," the interest in our 6th hf band is growing at a great rate, as the numbers of new or recently reactivated stations testify. Since the band is unique in its characteristics, the purpose of this article is to try to explain what to expect from 160, and offer some suggestions which may help the newcomer get started on this interesting and challenging band.

Recent changes in the FCC regulations have increased the available frequencies and raised the maximum power limits in most areas of the U.S., although still requiring substantial decrease in power at sundown to prevent the possible interference with the Loran "A" service which shares the 1.8- 2 MHz band and has priority. The 160 meter band was taken over at the start of WWII and the Loran service established there. Like many things, once established, it became difficult to dislodge, and only now with the increased use of the Loran "C" service at

100 kHz and the reduction in the use of Loran in general as a prime navigation system, have the restrictions been eased for the ham operators.

For purposes of frequency assignment, the band has been divided into eight sub-bands, designated "a" thru "h", "a" being 1.800-1.825, "b" 1.825-1.850, etc. Unlike other bands, there is no exclusive CW segment in each sub-band and everyone has the right to operate anywhere within the band. A gentleman's agreement has grown up, with phone above the first 10 kHz of each sub-band and CW below. There is *no* authorized operation of RTTY, FM or Slow Scan; only A1 and A3 operation is permitted.

Probably the first problem that you will face in getting active on this band is finding equipment that will cover 160. Many so-called all band rigs are 80 thru 10, leaving out 1.8 - 2 MHz. There are still many of the older AM era rigs around such as the Elmac AF 67, the Ranger series, the perennial Arc 5 equipment and others, often reasonable in price. They will do an excellent job on CW and of course can be used on AM as well. The Central Electronics 20-A has 160 side-band and CW provisions. Newer equipment with 160 capabilities include the Yaesu FT-101, the Drake Twins, the KW line and

others. Heathkit had a 2 channel crystal-controlled rig on the market, but recently dropped it from their line. There are many home-brew rigs in use, and, as another approach to the problem, there are a number of HW-12 rigs that have been modified to cover 160 and sound great. (*73 Magazine*, January 1969, p. 12, "HW 12 on 160.") The transverter in the 1969 ARRL handbook (*Radio Amateur's Handbook*, 1969 edition, p. 285, "Transverter for 160") is a unique and very satisfactory method of getting on the band by making use of a SSB rig that does not cover the band. The frequencies involved are low enough to make inexpensive solid state equipment with fairly high power a possibility, as many of the low-priced, high-power transistors will perform well at 2 MHz.

After one has bought, built or modified a rig that will be suitable, the next hurdle is the antenna. Those of us who need a tractor and gang mowers to do the lawn don't really have a problem, but the apartment dweller and the suburbanite are almost certain to have problems trying to fit a full sized 260 foot dipole in the back yard or on the roof. However, many potent signals come from less than full sized antennas and for casual work, tying the feeders of the 75 meter dipole together and feeding the whole thing through a tuner is a popular approach. If serious DX work is attempted, some form of loaded vertical is usually used, and with the best possible ground system, even if it is only a connection to a cold water pipe. The better the ground, the better the results. On this band the "underground antenna" is almost a reality. More effort can be profitably spent in planting radial wire, as much as possible, in the ground, rather than hanging it in the air, and the results will be almost a reflection of the effort expended along these lines. (*QST*, July 1971, p. 16, "Recommended Reading for Ground Plane Antenna Installation.")

After considerable experimenting with various antennas, including a full sized inverted vee, loaded verticals, etc., the antenna diagrammed in the accompanying sketch has worked well both locally and for DX. It consists of a total of 180 feet of wire and therefore it occupies no more space than a

conventional 80 meter dipole. As an added bonus, it may be used as a 3/4 wave antenna on the 80-75 meter band with excellent swr characteristics across the whole band, simply by shorting out the series tuning capacitor. The vertical and horizontal components seem to give both high and low angle radiation, and it seems to be completely omni-directional, with no noticeable lobes appearing. (*Radio Handbook*, Orr, 18th edition, p. 485.) (*Wire Antenna Handbook*, Orr, p. 103.)

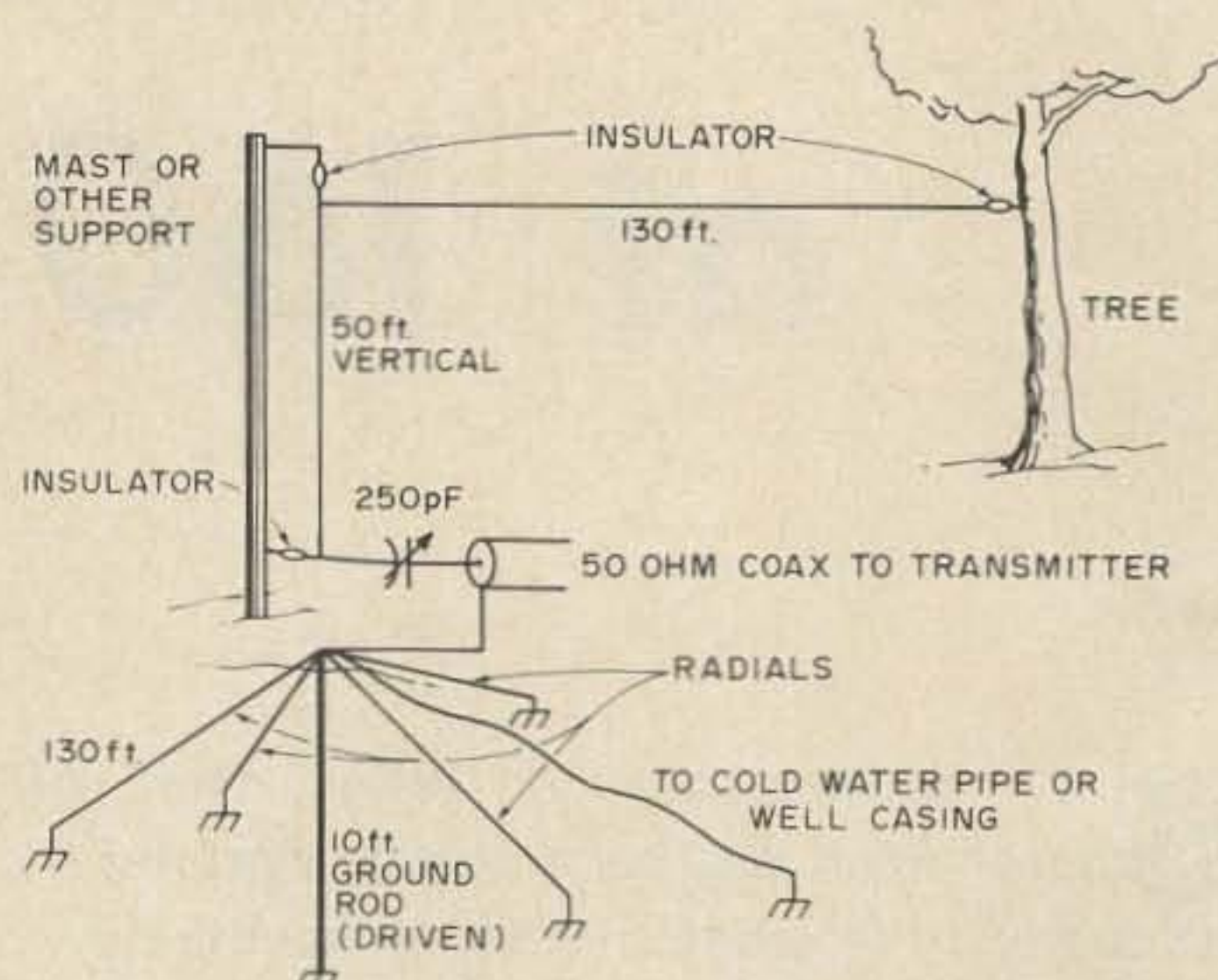

3/8 Wave 160 meter antenna. 3/4 Wave 75-80 meter antenna. Ground should be at base of antenna. Drive a 10-foot ground with at least 2 130-ft radials and 2 60-ft radials. Also run a wire from this point to the nearest coldwater pipe or well casing. Run radials in a straight line if possible, but DO NOT SHORTEN. If space considerations do not allow full length, zig-zag or spiral to fit. Bury a scant inch in ground to protect wire.

75-80 meter adjustments: Short circuit tuning condenser and trim antenna for lowest swr at desired portion of band, or at midband if both CW and Phone operation is desired. Short should remain in place for 75-80 operation.

160: Remove short and adjust capacitor for lowest swr.

The techniques for working DX on 160 are a bit different, and a brief explanation may help you to understand what to look for and what to expect on this band. Many times, DX openings, or the possibilities for openings, may be anticipated by making use of various commercial and other stations in

different parts of the world and of the USA. These signals, when heard with good strength, are a good indication that a DX opening may exist. For example, DHJ, a commercial station in Europe, operates on 1830 kHz. If you hear it peaking S-9 you can be almost certain that an opening to Europe is probable. Other stations may help pinpoint openings to areas of the U.S. These include:

WWV	Denver, Colo	2.5 MHz
WWVH	Hawaii	2.5 MHz
KPH	San Francisco, Calif	2054 kHz
WNU	Gulf Coast	2048 kHz
WCC	East Coast	2036 kHz

There is also a low-power ship-to-shore AM station in Ireland, EJK, Valencia Radio, on 1827 kHz. If you hear him, the band is really open. In addition there are a number of commercial AM stations operating in the 1.6 MHz area that might be used as beacons to a desired area within the USA, and W1AW, with its scheduled code practice and bulletin transmission on 1805 kHz nightly is also a good band condition indicator.

The "DX Window" is a 5 kHz wide segment, 1825 - 1830, and is the agreed-on international calling frequency. The whole thing is a gentleman's agreement, DX calls CQ in the window and listens 1800 to 1808 for replies. We do the reverse. If we all cooperate and keep the window open for weak DX stations to use, we all benefit. If a strong U.S. or other station exercises his *right* to use the frequency, the system fails, and the weak DX signals go unheard and unworked. Even in the northeast, with the least assigned bandwidth, the small portion set aside voluntarily for this purpose seems like an excellent investment with a high potential return for all of us.

The summer months can produce long periods where the S-9 plus static level makes the band useless for all but strong local contacts. However, a cool front may move in and bring with it good to excellent conditions, equal perhaps to an average winter evening with low noise levels. Remember, when our conditions are at their worst due to thundershower activity, the southern hemisphere is experiencing their best. DX signals are almost always between areas of

darkness, with peak periods at dawn and, to some lesser extent, dusk. A calculation of local sunrise or sunset and the DX areas suntime should indicate optimum listening times to a given area of the world.

Although working DX on this band is not easy, that seems to make the band more interesting and challenging. An afternoon of casual operating can result in a WAC on the higher frequency bands, but on this band the certificate represents far more effort, skill and, let's face it, luck. At present there are over 50 holders of WAC on 160, according to Stew Perry's latest 160 DX Bulletin. Incidentally, Stew Perry W1BB, "Mr. 160", has WAC #1 and over 120 countries confirmed at last count.

Both ARRL and CQ sponsor special contests for 160, and the turnout is excellent, the competition is fierce, and everyone has a ball. CQ has a world wide DX contest in January and ARRL has a Sweepstakes-like affair in December. Both are CW only contests, but possibly one or both may be expanded to include phone. With increased use of SSB, and higher power authorized, it might be quite a bash. Of course, the regular DX contests, field day, and the sweepstakes all include top band activity, and some DX expeditions in fact are primarily for operation on this band.

There are a number of nets that use 160, among them the "Greyhaired Net" which is an AM only group, and the "Top Band SSB Net" which meets at 2100 EDST on Wednesdays at 1812 kHz, and which has over 225 members at last count, which for a net that is about 2 years old is quite remarkable.

Daytime activity is practically nil, although 50 to 100 mile contacts seem routine with average installations. Consider for a moment the possibility of using NBFM, or mobile operation as an adjunct to the service nets such as ECABS and MIDCARS. Who knows, possibly a whole new use for the band might be developed, as with the repeater service on 2 meters. As I said at the beginning, the band is lightly occupied, and has more frequencies available than in the past, and room still exists for experiments and new ideas.

See you on the low end of "Top Band!"
 ... W2NYU/WA1JJV

IT'S A
NEW
BALLGAME



DATA SIGNAL SCORES AGAIN

NOW WELL ESTABLISHED IN THEIR NEW FACILITIES THE SUCCESSORS TO DATA ENGINEERING ARE LEADING OFF WITH BOTH EXCITING NEW PRODUCTS AND TIME PROVEN FAVORITES. YOU CAN DEPEND ON DATA SIGNAL FOR THE FINEST IN AMATEUR RADIO ACCESSORIES.

AUTOMATIC TOUCH TONE DIALER

Now, by the push of a single button you can automatically dial up to six separate 7-digit telephone numbers. All solid state with automatic PTT operation. Can send telephone number only, or repeater access code plus telephone number automatically.

AD6 Sh. Wt. 2 lbs. without keyboard	99.50
AMD-6 Sh. Wt. 2 lbs. with keyboard	119.50
Factory programming of #s	7.50

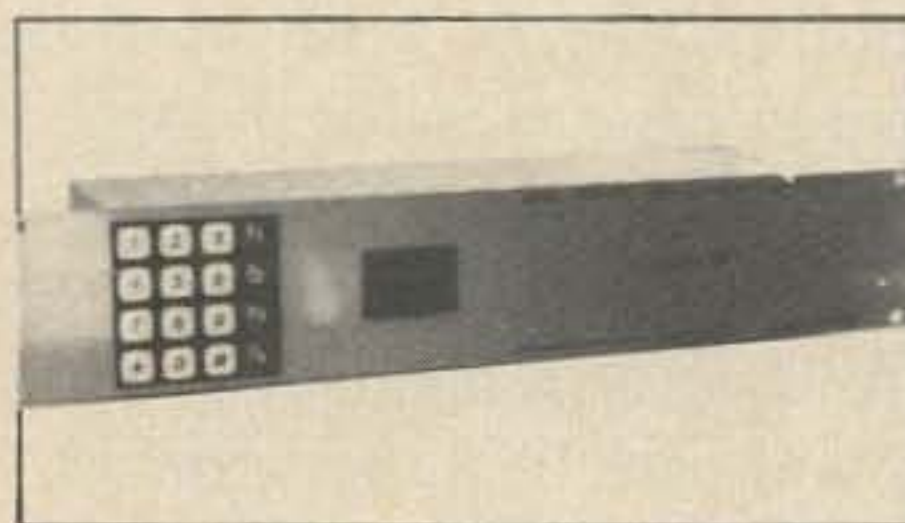

DELUXE REPEATER AUTO PATCH

The auto-patch your club will be proud to own. It's complete in every aspect. Two 1-4 digit access codes, one 1-4 digit disconnect, rotary dial or regenerated Touch Tone output, dial-in capability, "1", "0" and numerical disconnects, ID by-pass, audio monitor, keyboard, digital readout, plus many more features. Send for brochure. Rack mount only.

RAP-101 Sh. Wt. 15 lbs.	549.00
-------------------------	---------------

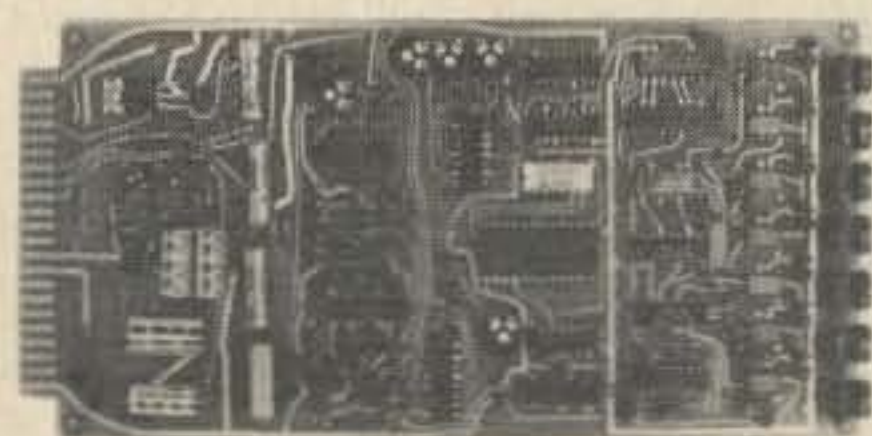

TOUCH TONE REGENERATOR

Give your Auto Patch users and the telephone exchange a break. Now all touch tone digits received by the telephone exchange is from ONE touch tone standard and not from a multitude of individual pads. Regeneration eliminates miss-dials caused by pads with off-frequency tones, incorrect amplitude adjustments, improper tone length, split tone bursts, etc. Includes complete 16-digit decoder plus rotary dial capability. PC board and rack mounting available.

DCR-71	PC 249.00	Rack 325.00
	Sh. Wt. 2 lbs.	Sh. Wt. 8 lbs.

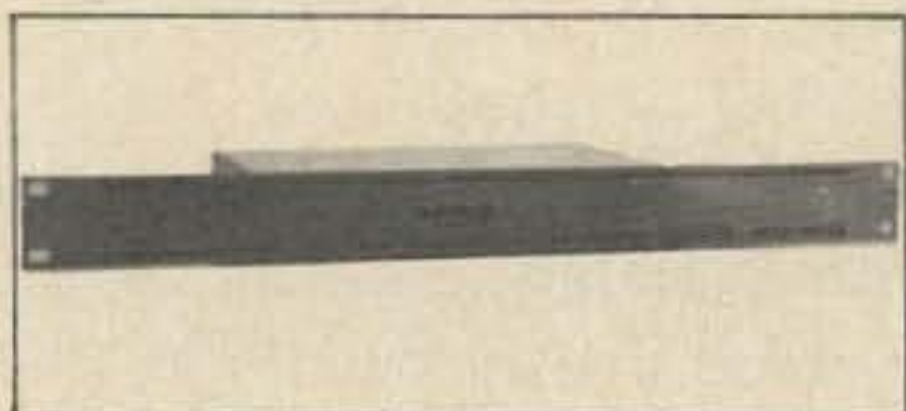

REPEATER AUTO PATCH

It's complete — a single digit access/disconnect Auto Patch facility. All you need is a repeater and the phone line. Complete with automatic disconnect, dial-in capability, two way audio monitor plus remote control. When used with a rotary dial exchange, Data Signal's DPC-121 dial converter is also required. P.C. board or Rack Mount available.

RAP-2	PC 99.50	Rack 149.50
	Sh. Wt. 2 lbs.	Sh. Wt. 8 lbs.

TOUCH TONE TO DIAL PULSE CONVERTER

Don't let the lack of a Touch Tone telephone exchange prevent your repeater club from going auto-patch. Convert 0-9 TT digits to Bell System compatible dial pulse code. Uses anti-falsing TT decoder, 64-digit memory and solid state pulsing. Starts dialing on first incoming digit. Memory will not overload. Cancel function. * and # output provided for control purposes. PC Board and rack mount available.

DPC-121 PC **195.00** Rack **285.00**
Sh. Wt. 2 lbs. Sh. Wt. 10 lbs.



TOUCH TONE KEYBOARD/ENCODER

The smallest, thinnest keyboard with built-in touch tone encoder. Only 1/4" thick. Completely self-contained, designed for mounting directly to hand-held portables. Operating temperature -20°F to +150°F. R. F. proof.

DT-4M Miniature Encoder 2 1/4" x 3" x 1/4" **89.95**
Sh. Wt. 1 lb.

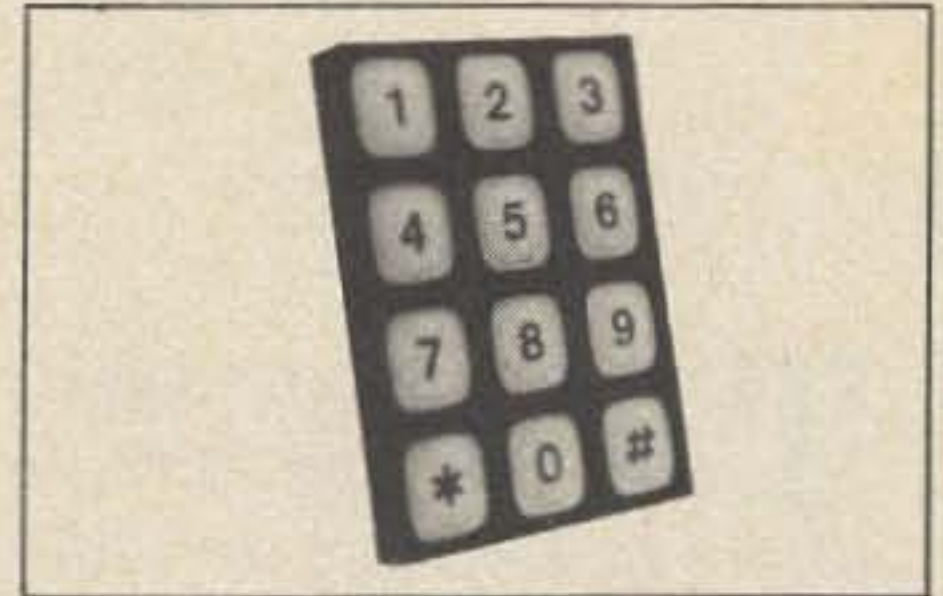

TOUCH TONE PADS

Standard size 12 and 16 digit Touch Tone Pads. Automatic PTT operation with 1 1/2 second transmitter hold. Self powered via internal 9V battery. Audio and PTT outputs, TTP-1 and TTP-2 also has low volume audio monitor for acoustically coupling of tones to microphone. Zero quiescent current. Operating temperature -20°F to +150°F. R. F. proof.

TTP-1 16 digit 3" x 5 1/2" x 1 1/2". Sh. Wt. 2 lbs. **79.50**
TTP-2 12 digit 3" x 5 1/2" x 1 1/2". Sh. Wt. 2 lbs. **59.50**
TTP-3 12 digit 2 1/4" x 4 1/4" x 1 1/2" Sh. Wt. 2 lbs. **59.50**

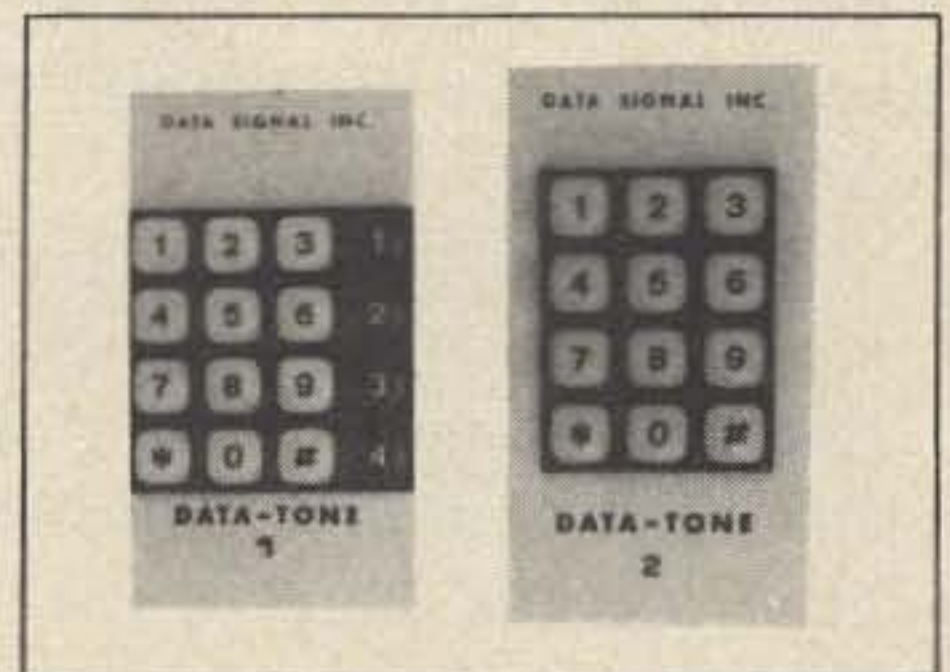

ANTI-FALSING TOUCH TONE DECODER

Now, a true anti-falsing decoder, immune to high noise and voice falsing. 12 to 16 digit capability. Single 5-volt power supply. Heavy duty transistor output. Complete p. c. board or standard 19" rack available.

TTD-126-12 12 digit PC **149.95** Rack **219.95**
TTD-126-16 16 digit PC **169.95** Rack **239.95**
Sh. Wt. 2 lbs. Sh. Wt. 10 lbs.

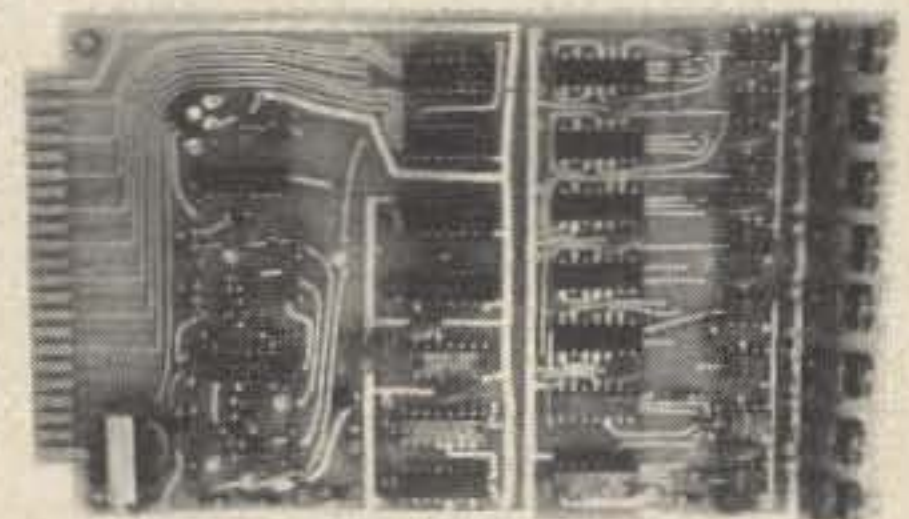

ORDER TODAY OR WRITE FOR COMPLETE DETAILS

DATA SIGNAL, INC.

Successor to Data Engineering, Inc.

2212 PALMYRA ROAD, ALBANY, GA. 31701

912-435-1764

RF POWER AT 432

This is a down-to-earth description of the kind of nitty-gritty details involved in getting a portable solid state UHF amateur station on the air. The overall design is flexible, leaving room for improvement, modification, or adaptation to specific needs.

It may not be the best station of its kind in the world – which would cost you N times as much – but it does work, is low cost, is lots of fun, and you can't buy one like it off the shelf!

RF Power

Don't go getting ideas now. When I say power with low-cost solid state UHF I mean lots of milliwatts. Right now the rf output is lighting a No. 48 bulb to more than 2V brilliancy, and that has to be at least 120 mW because the 48 is a 60 mil 2V job. On the amateur's milliwattmeter it measures a good 150 mW.

And don't think that's so easy, either. When you hook up the exciter, the first rf amplifier with its dc bias – and the second one which may or may not have dc bias because it is supposed to be driven by the first – don't be disappointed if the bulb doesn't light up right away. Mine didn't. All sorts of things can happen. Remember, you're back in the old triode days once again now, with plenty of unwanted feedback available through those pesky little scraps of silicon. The inputs and outputs of each one of them (and note that we're up

to a total of six already) beginning with the 54 MHz rock stage, must be reasonably matched and reasonably loaded to avoid the necessity of neutralization. And they must be reasonably in tune also. When you do arrive at this happy condition, the rf bulb – or other good UHF indicator-load if you're lucky enough to have one – will show milliwatts to the tune of over a hundred.

The first stage takes the 1–3 mW out of the exciter and brings it up to 15 or 20, and the second stage brings that up to about 150 mW. At least there's an approximately consistent gain of at least 10 dB per stage showing. Anyone for a solid-state 1½W at 432? Maybe so, but start with a stuffed pocketbook.

With the 20 dB beam the 150 mW will sound like 15W from a dipole in the direction you point it.

Now the details of getting that 150 mW. Fig. 1 shows one way to do it. I chickened out on the two connectors and a cable between the first and second rf stages, but don't let that bother you. Those phono plugs are only 4¢ each, so who cares. I had the power up to about 150 mW with them in, and probably would get the 150 now anyway, with the additional peaking since then. It's the same old story, you fight and fight and gradually, after hours and maybe days, things begin to match up . . . your output climbs, and finally you throw the switch and that old

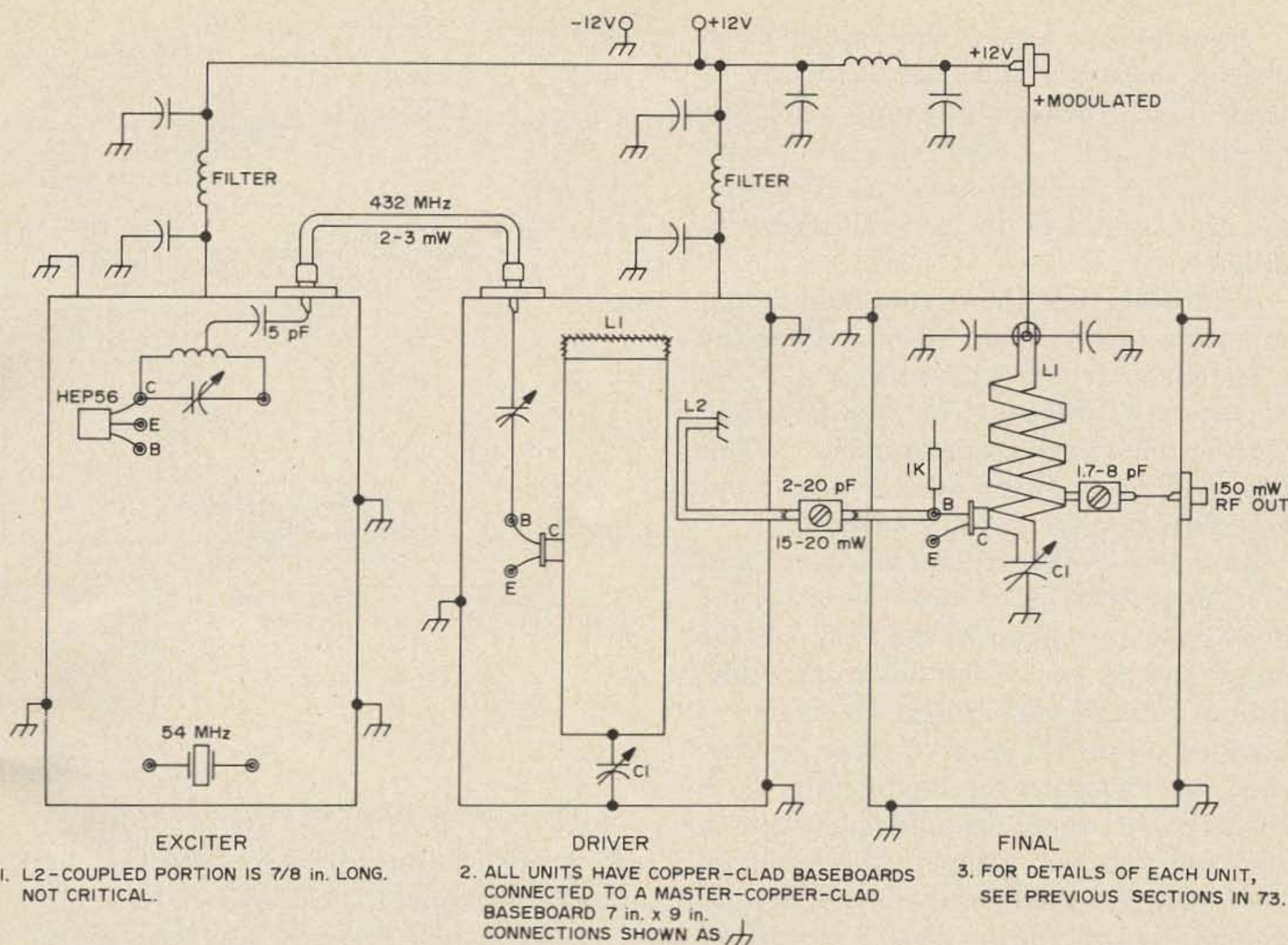

Fig. 1. Schematic of rf section, driver and final. Note that the coupled portion of L2 is about 7/8" long, but is not critical. The three units are all made on copper clad board and connected to a master copper clad board 7" x 9".

bulb really shines in the output jack every time.

The main adjustment points are as follows: The output coupling capacitor, the tap on L1, and the tuning capacitor of the 432 doubler stage in the exciter. The same points on the driver and final stages. Also the emitter resistors of those two stages. So that's about 11 places for adjustments. Actually you don't have to use all of them all the time. Just some of them some of the time.

A few other items you can fix and leave alone: The dc bias was left in the final

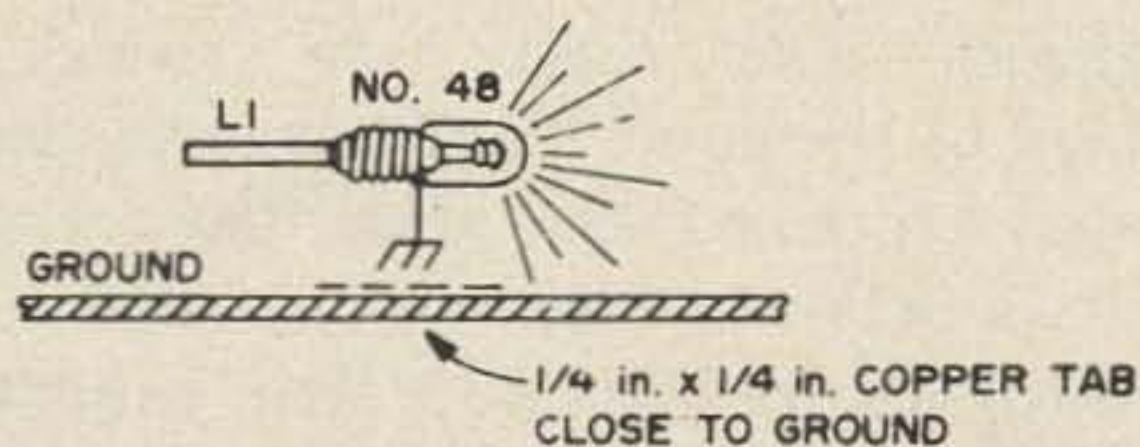

Fig. 2. A No. 48 pilot bulb will indicate the best match at 432 MHz. Solder the bulb to L1 near the center, between the cold and hot end.

because with certain amounts of power from the driver the modulation was a little cleaner, and the final tuned smoother. Not too much different with or without.

The use of a choke between the final base and ground was checked instead of the 1K resistor and no difference could be noted, so the 1K was left in as being less troublesome.

Generally the rf input from the crystal exciter to the driver can be tuned up and left alone. The output from the driver seems to be quite important for power, and also for clean modulation and smooth tuning, as you will see in the modulation section.

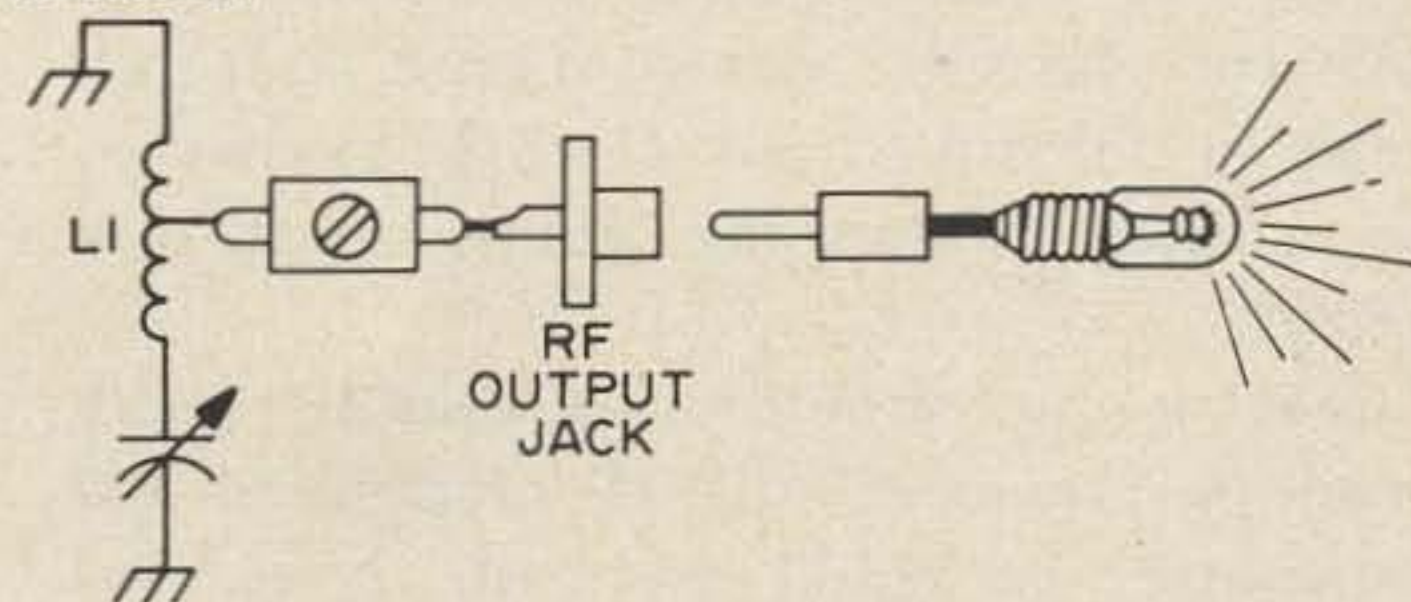

Fig. 3. Plug-in No. 48 pilot bulb load.

I wound up with a series-tuned loop between the driver and final. It seemed to handle best. You can still use connectors and cables and a closed minibox if you want to. I'm just the tinkering type who likes to have knobs to turn and screws to adjust.

About this time the output bulb should be getting pretty bright. You can use the maximum matching method of Fig. 2 and get 150 mW brilliancy, or plug one right into the final output jack as in Fig. 3. This latter will not show up quite as bright, but should be good for 120 mW at least.

As a final word, try for the smoothest adjustments; that is, as you tune either the driver collector circuit or the final one, the output should go up and down smoothly, without jumps and clicks. Or maybe I should say with the least of these, because when you listen to the modulation, there will be places where the modulation is very good and clear and places in the tuning of those collector circuits where the modulation muffles up a little. This is normal for unneutralized stages.

If at any time you don't seem to have any drive, unplug an rf stage and plug in the tuned diode and meter and check for drive out of the preceding stage. The exciter gives about 2½V, the driver 5V, and the final about 6V. This latter jams the diode in its detection curve, so don't worry about only seeing 6V.

So now we have a transmitter rf section.

Modulation

First, unload the final and tune it to resonance. A spark now should show with the old reliable pencil tip test on the hot end of the collector inductance. It is possible to work two states from a New England hill-top with this kind of action. The modulation on the rf should be audible in your receiver. The class B modulator collector current meter should kick up nicely to 50 mils or so. It's always nice to see a little something going on in the meters.

AM people should note that the peak envelope power of a 100% modulated AM transmitter is equal to 2.66 times the average power. I extracted that from the

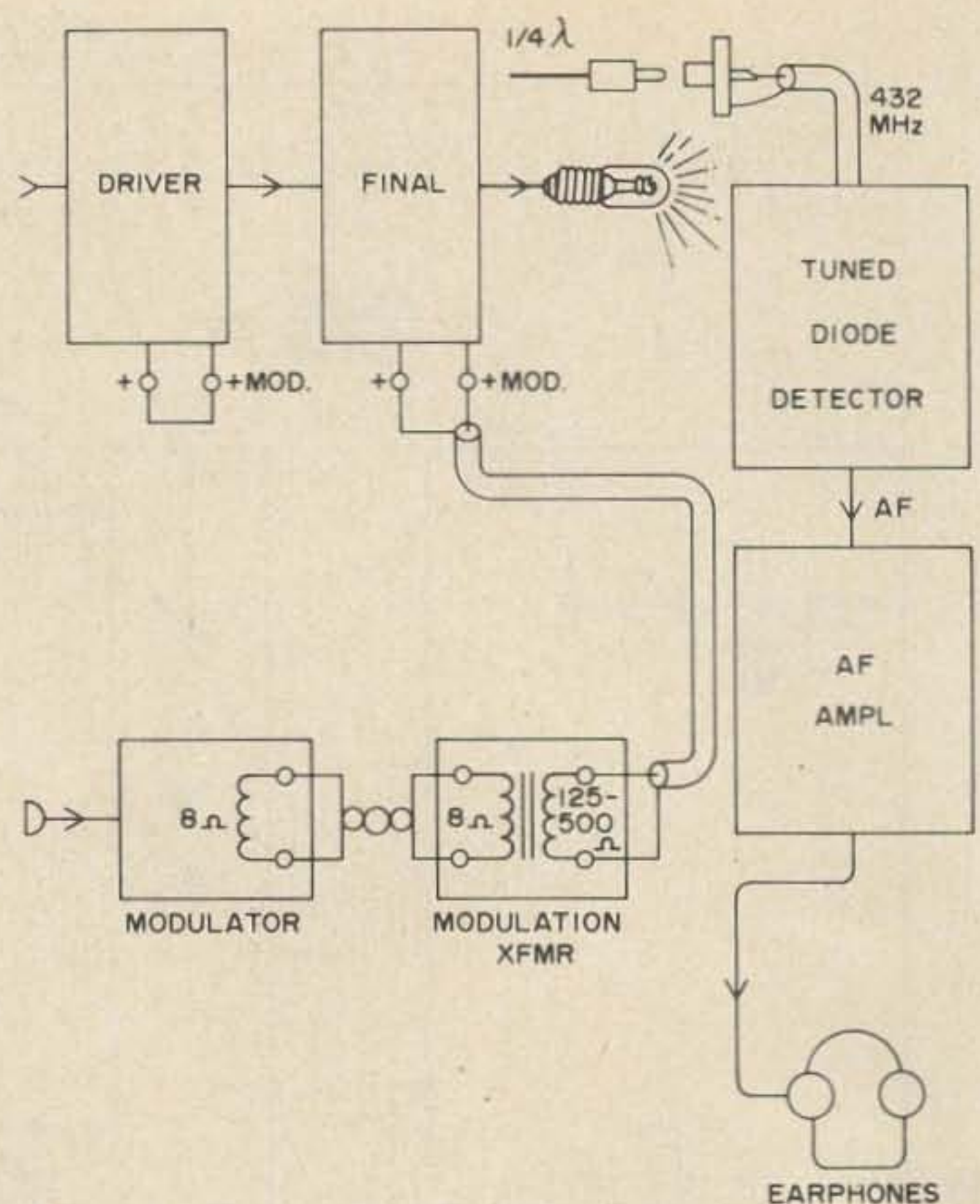

Fig. 4. Modulation test setup for the 432'er.

RCA application note AN-3749, Commercial Engineering, RCA, Harrison, NJ.

As you will know if you have looked into the matter, SSB gets rapidly more costly, complex, and touchy as you go up in frequency from the hf bands of 2 to 30 MHz. Some of the reasons follow: More converters with more crystal oscillators are required. Sideband requirements on UHF call for the usual stability, but multiplied by the frequency increase, such as 432 MHz being over 100 times the frequency of the 75 meter phone band. Only one cycle in a crystal LO can throw your audio out by 100 cycles on 432 MHz. If you try for high-level solid state converters you should not inquire as to the cost. If you do you're in the wrong store. Think it over a little.

Fig. 4 shows the test setup for checking modulation components and circuit. It is best to do this because — as mentioned — with solid state devices you're back in the good old triode days again, and what happens in one stage may reflect back into a previous stage. Of course if you want to try neutralizing 432 MHz amplifiers, go

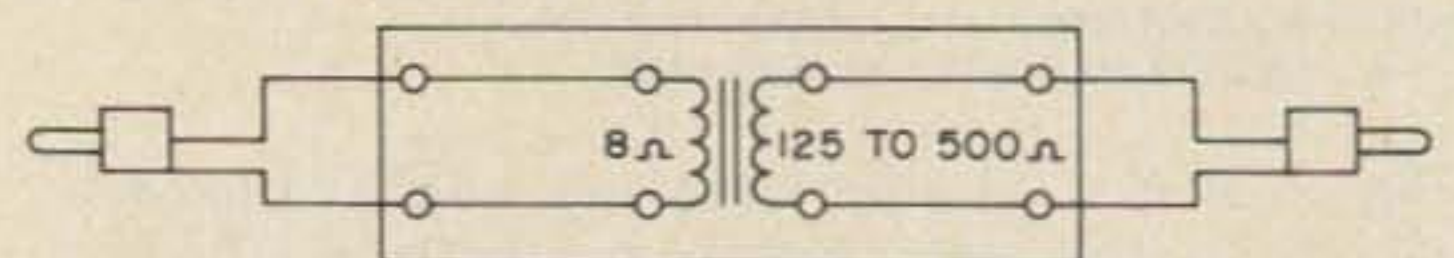

Fig. 5. Plug-in modulation transformer.

ATLAS 210

for 10, 15, 20, 40 and 80 METERS AND THE COMPANION MODEL 215 FOR 15 through 160 METERS.



ATLAS
RADIO INC.



Measuring only 0.18 cu. ft. and weighing less than 7 pounds, the Atlas 210/215 Solid State Single Sideband Transceiver is a real GIANT KILLER. It packs a hefty 200 watts P.E.P., offers 5 band coverage, and unprecedented selectivity (only 9200 cycles at 120 db down).

Priced at just \$599, it's the best transceiver value on the market today.



PERFECT CHOICE FOR
THE ATLAS WHEN
MOBILE

STANDARD HUSTLER RESONATORS—

Model RM-10	10 meter resonator
Model RM-15	15 meter resonator
Model RM-20	20 meter resonator
Model RM-40	40 meter resonator
Model RM-75	75 meter resonator
Model RM-80	80 meter resonator

SUPER HUSTLER RESONATORS— Legal Power Limit —Normal SSB Duty Cycle

Model RM-10S	10 meter resonator
Model RM-15S	15 meter resonator
Model RM-20S	20 meter resonator
Model RM-40S	40 meter resonator
Model RM-75S	75 meter resonator
Model RM-80S	80 meter resonator

TUFTS Radio Electronics

386 Main St., Medford, Mass. 02155

ahead. I'm going to try again myself someday "when I have nothing else to do."

It is handy to have the modulation transformers on small planks with plugs ready as in Fig. 5, because they don't work the same, and some of them may drop your dc volts to the final a little. The dc resistance of one of my 500Ω windings was 6Ω.

Stancor has about the best selection of transistor-to-transistor modulation transformers, but remember we're going up to somewhere between ½ and 1W in rf power out pretty soon, with luck, and even then you'll probably want to use a ready-made 3W amplifier like the \$7.95 Lafayette which has 8 and 16Ω on the output. If we do get up to 1W that will mean about 2W dc, which means some 165 mls at 12V. This in turn means approximately 75Ω ac modulating impedance for the rf final, following the old and still good formula $Z_m = E/I \times 1000$.

There is a Stancor with 8 and 16Ω on one side and 100Ω centertapped on the other, and it's only \$3, so that problem isn't hard to solve.

One nice thing about transistors modulating transistors — you don't have to buy much copper!

The Modulator Itself

This time we used a 1W Lafayette job priced at \$6.95 because the rf power of our 432'er may increase soon. I just might put in a push-pull stage for fun. The wiring diagram of the modulator is shown in Fig. 6, and a small control panel in Fig. 7, with input jack, gain control, "on" switch, and 8Ω output jack. Note that this little gem is useful as a receiver for listening to your modulation, etc. Fig. 8 shows the top view, with lip below the amplifier level for fastening to a shelf.

Inasmuch as most of these little af jobs use PNP transistors, there is a positive ground side to them. So the front panel is insulated, and the 8Ω output winding connection with the black wire attached is tied to the positive battery side.

This should be cut loose by carving out the piece of printed board plated copper, as in Fig. 9. This allows the use of the

single 12V battery or your car battery for the modulator supply as well as for the exciter and rf stages of the transmitter.

You could use one of those little 9V batteries if you're in a hurry, but when you whistle in the mike the amplifier draws 50 mls or more and the poor little battery drops to only 6 or 7V. The two rf stages and the exciter are beginning to draw current also — a total of 80 mls now — with close to 150 mW rf output. And then

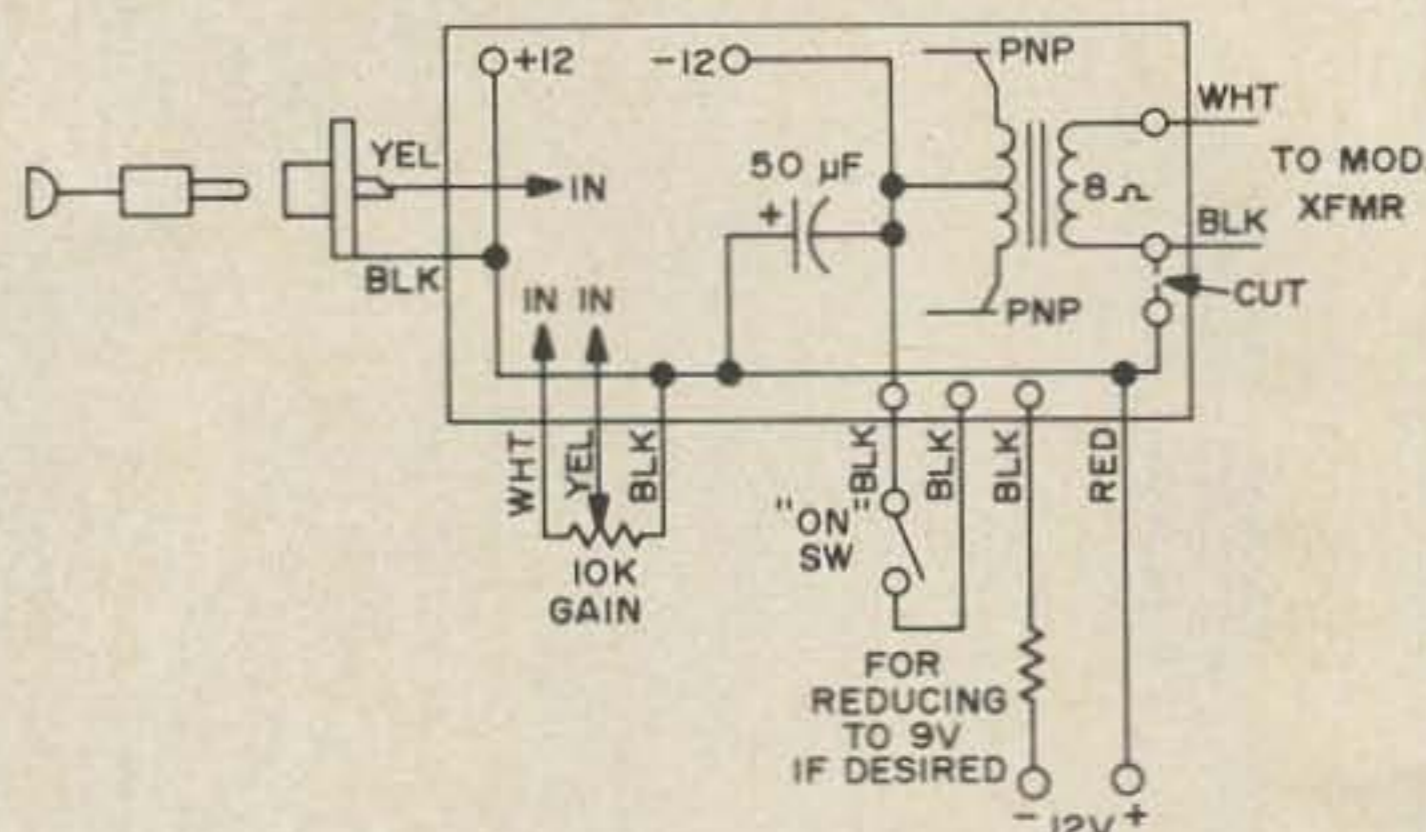

Fig. 6. 1W modulator wiring connections.

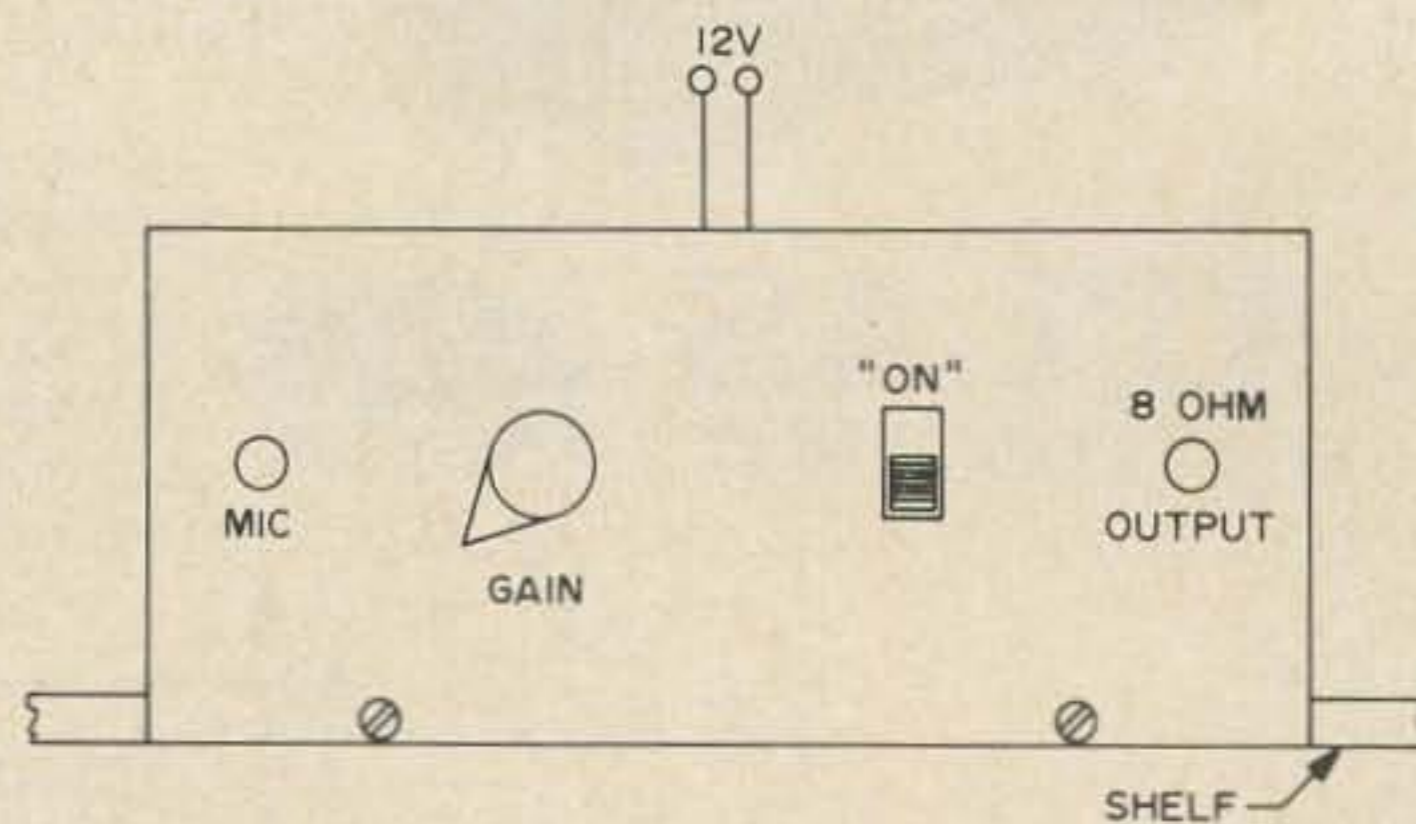

Fig. 7. Modulator control panel.

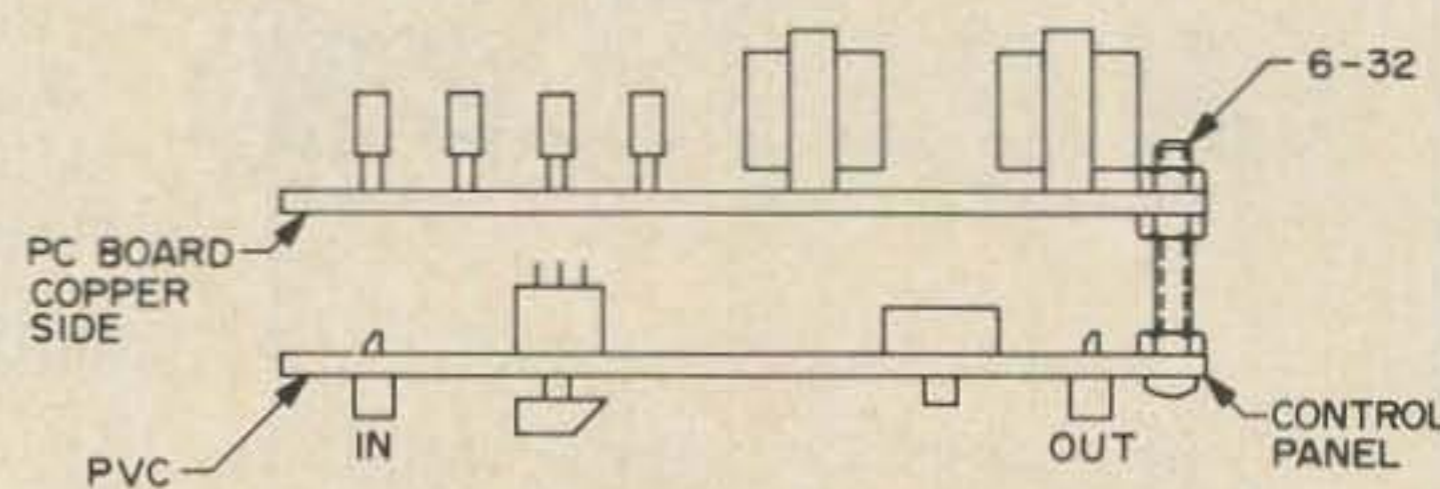

Fig. 8. Modulator top view.

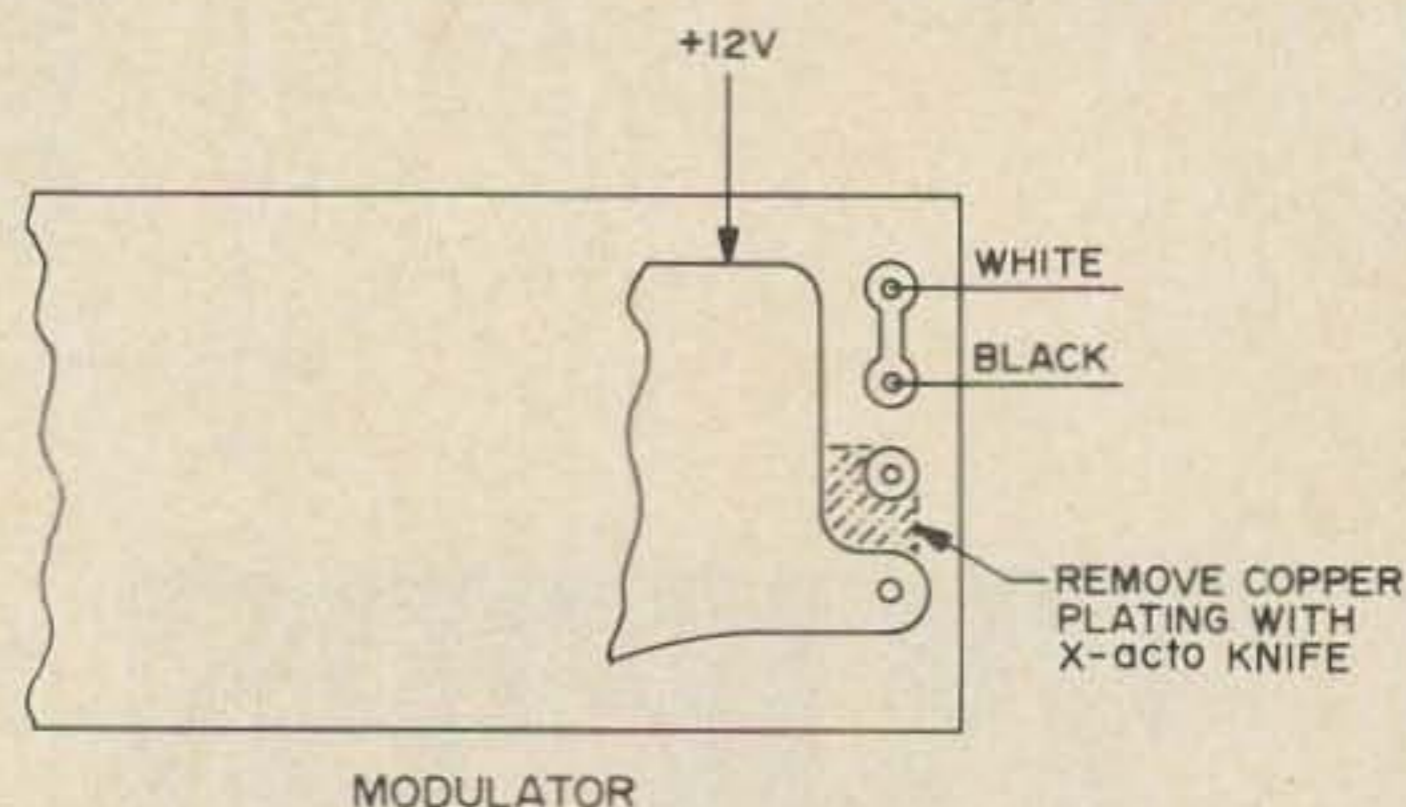

Fig. 9. Details of modulator output connections showing 8Ω output disconnection.

when your class B modulator kicks up to 50 or 75 mils, there is a total of over 200 mils, so forget about those little 9V jobs. You can also forget about the D cells while you're at it! Over 100 mils is *not* good for an ordinary "D" flashlight cell. If you build any kind of portable rig and it runs over 100 mils, don't count on "running all day on ordinary flashlight cells" as some of the Madison Avenue boys so quaintly put it. It'll drop in ten minutes or sooner. The lantern type 6 or 12V Eveready jobs are rated by Union Carbide at 500 mils (maximum).

Checking various items using the setup of Fig. 4, one of the first things I noticed was upward modulation when modulating the driver along with the final. Just for the moment, however, I'm going to leave the modulation off the driver. It seems a little clearer and easier to adjust at first, and also the big deal with more power is coming soon, at which time I will try it again. Some circuits use modulation on the final, the driver, and on a stage called the "pre-driver" as well. You might as well expect to see and use *lots* of amplifier stages on almost any transmitter you make up with solid state devices on UHF. None of that 30,000 Gm transconductance shown by the miracle tube, the World War II number 2C39.

A 10 mF capacitor between the final emitter and ground, which is also the minus battery, seems to give a little more modulation and a slightly better quality to the audible speech.

A little asymmetry can be noticed when checking the full tone quality of the voice under modulation, on the high frequency side of the driver tuning, and on the low frequency side of the final tuning. You can always try neutralization on 432 MHz, if you're the chancy kind.

Adjustments for "BC" type modulation seem a little easier without the driver being modulated. This can be the subject of an interesting series of tests with a DX station later.

That's about it for modulation. All we need now is a beam with some sock to it, and a drive-up mountain.

... K1CLL

ATLANTA HAM FESTIVAL
 P. O. Box 76553
 Atlanta, Georgia 30328
WRITE:
 For Information & Registration Forms
 ARRL Forum .. Mars Meetings Technical Programs
 Subject: DOCKET 20282
 SPEAKER FCC'S A. Prose Walker
 SATURDAY NIGHT BANQUET-KEYNOTE
 Junior OPs.
 Activities and Prizes for XYLs and
 Many Atlanta Attractions. Special
 Special Low rates for Motels and
GIGANTIC SHELTERED SWAP AREA
LATEST HAM EQUIPMENT
 1-75 North at Howell Mill Road
Royal Coach Motor Inn
TWO GREAT DAYS . . . JULY 5th. & 6th.
ARRL STATE CONVENTION
 &
ATLANTA HAM RADIO FESTIVAL
47th. ANNUAL
 Than Ever!
This Year BIGGER & BETTER
in PRIZES Given Away!
Last Year Over \$10,000

CASHARONIE

Money! You can get top dollars now for U.S. surplus electronics, particularly Collins. Write or call now for your bigger than ever quote. Space Electronics Corp., 76 Brookside Ave., Upper Saddle River, N.J. 07458 (201) 327-7640.







STAMP-IT ETCH-IT



Reduces Printed Circuit Board Art Work From 2 Hours to 10 Min. . . .

Simple as A.B.C.

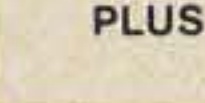
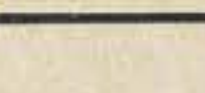
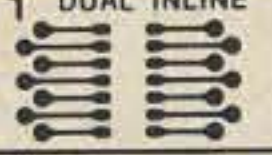
A. Stamp Components on P.C. Board. B. Use Pen to Interconnect Lines. C. Etch Board.

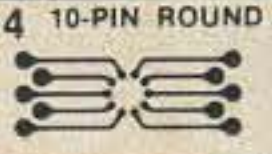
SE-2 KIT CONTAINS:	ADDITIONAL STAMPS:
 CONNECTOR FINGERS  16 PIN DUAL IN LINE IC SOCKET  10 PIN ROUND IC SOCKET  8 PIN ROUND IC SOCKET  TO-5 TRANSISTOR SOCKET  TO-18 TRANSISTOR SOCKET  LARGE & SMALL DONUT PAD PLUS RESIST INK INK PAD RESIST PEN	Bread board stamps for all integrated circuits "Great" for experimenters. Only \$2 ⁹⁵ each four \$9 ⁹⁵ # 1 DUAL INLINE # 2 FLAT PACK   # 3 8-PIN ROUND # 4 10-PIN ROUND  

ONLY \$9⁹⁵
M-TECH
 ENGINEERING, INC.
 BOX C
 SPRINGFIELD, VA. 22151

500 MHZ PRESCALER

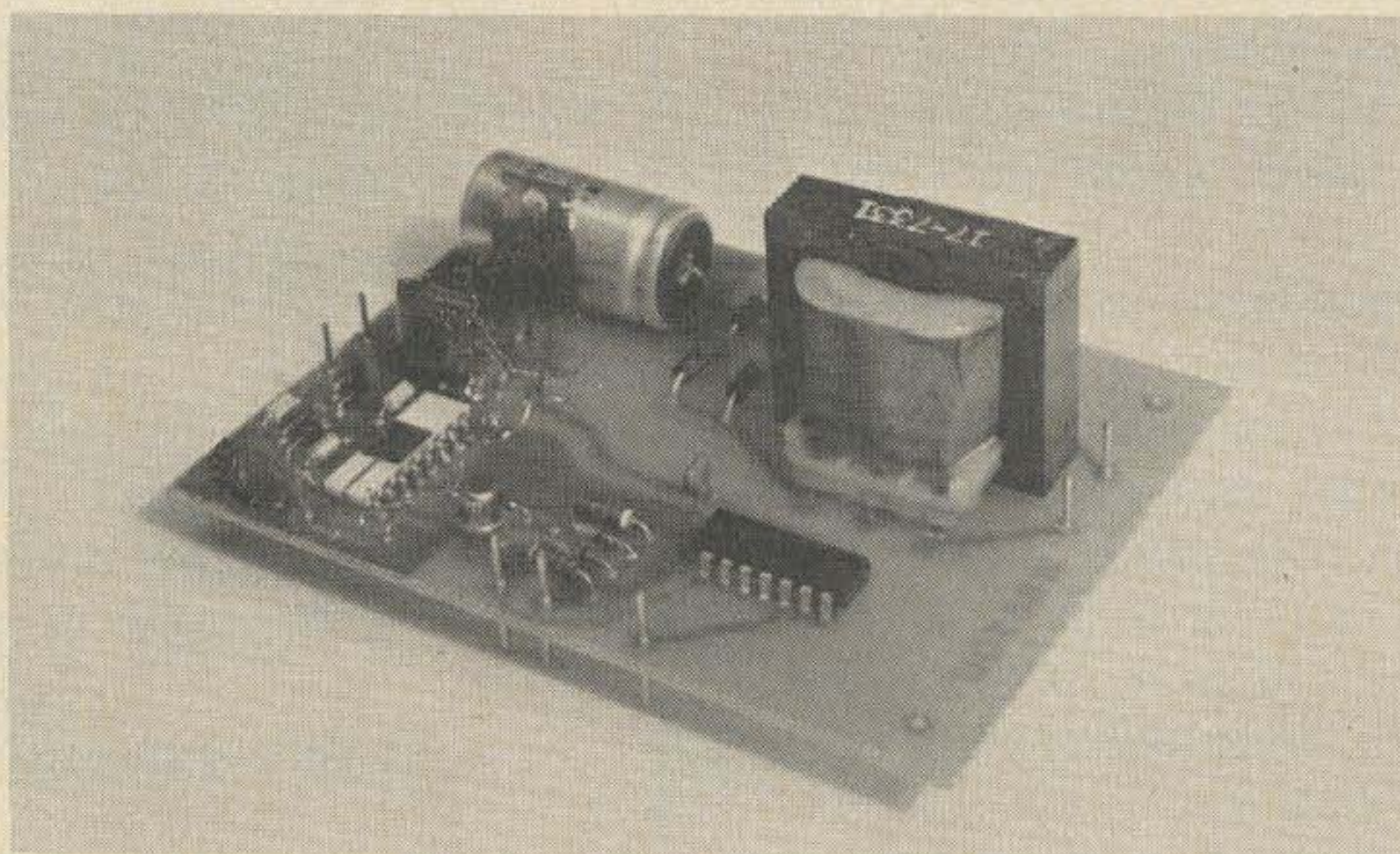

3" x 4" x 1½"

EXTEND YOUR COUNTER to 500 MHz!!!
Can be used with Any counter capable of 5 MHz.

- FMAX greater than 500 MHz.
- HIGH INPUT SENSITIVITY: less than 150 mV needed at 500 MHz — overload protected
- HIGH INPUT IMPEDANCE: 500 Ohms
- OUTPUTS: ÷10 and ÷100 TTL compatible
- INCLUDES POWER SUPPLY

PS-K kit \$ 89.00

PS-A wired and tested \$109.00

BRAND NEW!
500 MHz COUNTER
WRITE FOR DETAILS

plus \$.85 postage
Calif. residents add 6% sales tax

LEVY ASSOCIATES

P.O. Box 961 S
Temple City, Calif. 91780

The Minirepeater

During the past year or so, I have been doing a lot of work on the G.E. Pocket Mate. I have put quite a few of them on the air, and after a few 2m FM QSOs went by, someone told me it was about time I made a repeater out of one — so I did.

This may seem a little odd to some people, but there are many assets to a repeater using a pocket mate receiver and transmitter. The transmitter, although it puts out only 1W, is reliable, stable, draws very little current and puts out a clean signal with very little white noise over the spectrum. This last feature is very important in any repeater, since white noise is a source of desensitization.

The receiver is sensitive, selective, has good squelch and draws only 5mA of current on standby. It is easy to wire a carrier operated switch to it and it too is reliable.

The entire repeater as described here draws only 40-50mA on receive and 200-250mA on transmit, which makes an emergency battery operated repeater practical. All that need be added are two antennas and the necessary control circuitry, which can either be custom designed or built from earlier articles in 73. Many articles have been written on this subject in the past few years, so I will describe only the basic repeater, which consists of the receiver, transmitter, carrier operated switch (cos), audio circuits, and power supply.

Although I built mine in a 30.48cm x 17.78cm x 7.62cm (12" x 7" x 3") box, the basic repeater could be "shoehorned" into a box of less than a third of this volume. Mine has room for all of the control circuitry (including automatic ID) that is needed before the repeater can be legally turned loose on the air.

Here is how to build the "minirepeater." Although all color codes of wires given here should be standard with all pocket mates, there may be some variances due to repairs made in the field on some units.

Taking the Pocket Mate Apart

The article in the October, 1973 issue of 73 should be read first, as it has some information that is useful here.

First, remove the case and speaker. Next, remove the two small wires that connect the antenna block to the on-off switch located on the receiver audio squelch board. (The audio squelch board is held in place by four tiny screws on the top of the board.) Find the two orange wires that went to the speaker. One goes to the receiver audio squelch board, and it should be left intact. Remove the other one, which goes to the antenna block. Remove the red wire that is connected to the positive battery spring (on the antenna block). Remove the three shielded wires coming from the antenna block. One went to the receiver front end board, to a choke and a capacitor. One went

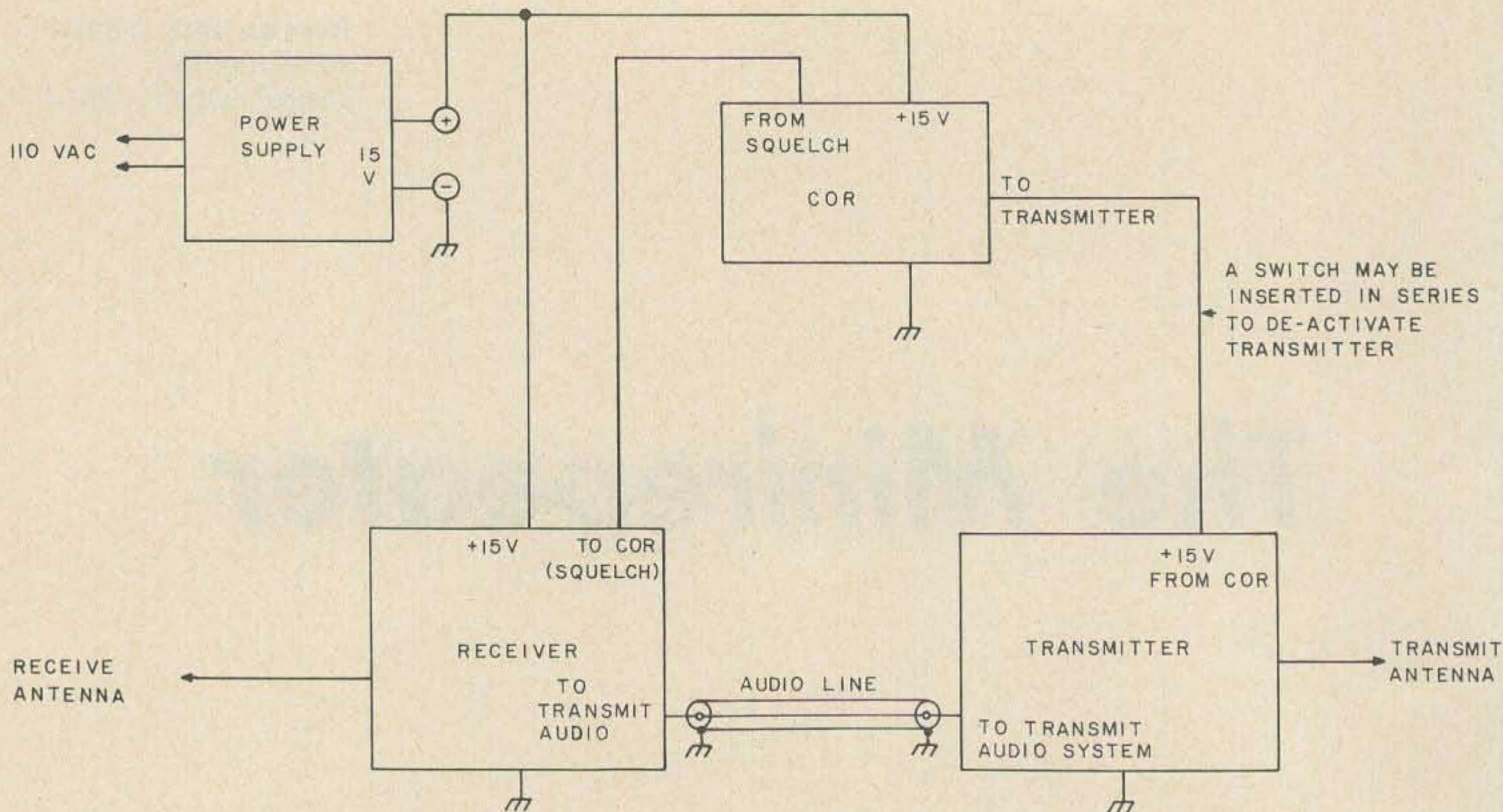

Fig. 1. Block diagram.

to the transmitter audio board. The third went to the transmitter PA module. Find the oscillator switching leads if you have a two channel on it. Two go to the receiver's oscillators and two go to the transmitter's oscillators. *Cut these near the antenna block.* They will be either green and yellow or white and yellow. Yellow represents channel 1 and the other color (white or green) represents channel 2. Grounding the appropriate lead will key its oscillator (single channel units have jumpers on the circuit boards instead of these wires). If you desire, you can have a 2 channel repeater if you have a 2 channel pocket mate to begin with.

The antenna block should easily come off the chassis now and be discarded or salvaged for the few parts (including reed relay) inside. Using some metal shears, separate the receiver and transmitter by cutting the metal strip that holds them together. You have finished the tearing apart. Now, here are the modifications. Be careful and use a tiny soldering iron.

Receiver Modifications

Front End Board

Find the 3.3pF capacitor and the 1.2μH rf choke, both located on the foil side of the board (the coax lead removed earlier went to the junction of these two components).

Carefully remove both, noting where the two pads on the board came from. Connect a short length of hook up wire to where the choke lead went. This is the receiver B+ lead. Label it. Connect the inner conductor of a short length of RG-174 (or some other small 52Ω coax) to the pad where the capacitor went and solder the shield to a nearby common ground point. Be careful not to melt through the inner insulation. This will be the lead that goes to the receiver's antenna. Solder two small UHF signal diodes such as the 1N914 or 1N4148 back to back from the antenna input pad to ground. The cathode of one and the anode of the other go to ground. These diodes tend to reduce strong signal overloads as well as protect the front end of the receiver. Be sure that you have the oscillator(s) wired so that the receiver will work.

The crystal filter and i-f boards require no modifications.

Audio-Squelch Board

Before attempting these modifications, get a manual to find these points on the circuit board. If you can't locate one send me an SASE and I will send a diagram.

Remove the plastic top cover by unscrewing the earphone jack nut and the two small screws. Remove the four tiny screws that fasten the audio squelch board to the chassis

and *carefully* tilt the board over to gain access to the foil side. The wires soldered to it are easy to break so don't put any stress on them. Solder one small wire to the junction of R-60, R-61 and the collector of Q21. Label this lead "cor," as it goes to the carrier operated relay (or switch). Solder another small wire to the junction of the collector of Q16 and the base leads of Q17 and Q18. This wire will carry audio from the receiver to the audio section in the transmitter. Label it.

Carefully replace the board on the chassis, using the four tiny screws. It is not necessary to replace the plastic cover.

Miscellaneous Receiver Changes

Locate the orange wire that comes from the audio squelch board (the wire that used to go to the speaker) and solder it to one end of a 56-68Ω resistor. Solder the other end of this resistor to ground.

Install the new receive crystal in the same way that the old crystal was soldered. If you have a dual channel receiver you can install two 2m crystals. Make sure that the appropriate oscillator key line is grounded. On single channel receivers a short bare jumper wire is soldered so that the oscillator is keyed all of the time. There are no leads coming from the oscillator to the antenna block on single channel units.

Carefully install the receiver in an rf tight box, connect the cor line, audio and +15V line to .001μF ceramic feedthrough capacitors leading to the outside of the box. The RG-174 coaxial line goes to the pins of either a BNC or VHF type coaxial receptacle. It is important that the box is as rf tight as possible, so that rf can get in *only* through the antenna jack.

Transmitter Modifications and Wiring

The transmitter does not require any modifications other than some work in the audio system. This is described elsewhere in this article and the diagrams give the necessary details.

One thing to make sure of — if you have a 2 channel transmitter, be certain that the key line of the desired channel oscillator is grounded.

The rf output and the B+ input to the

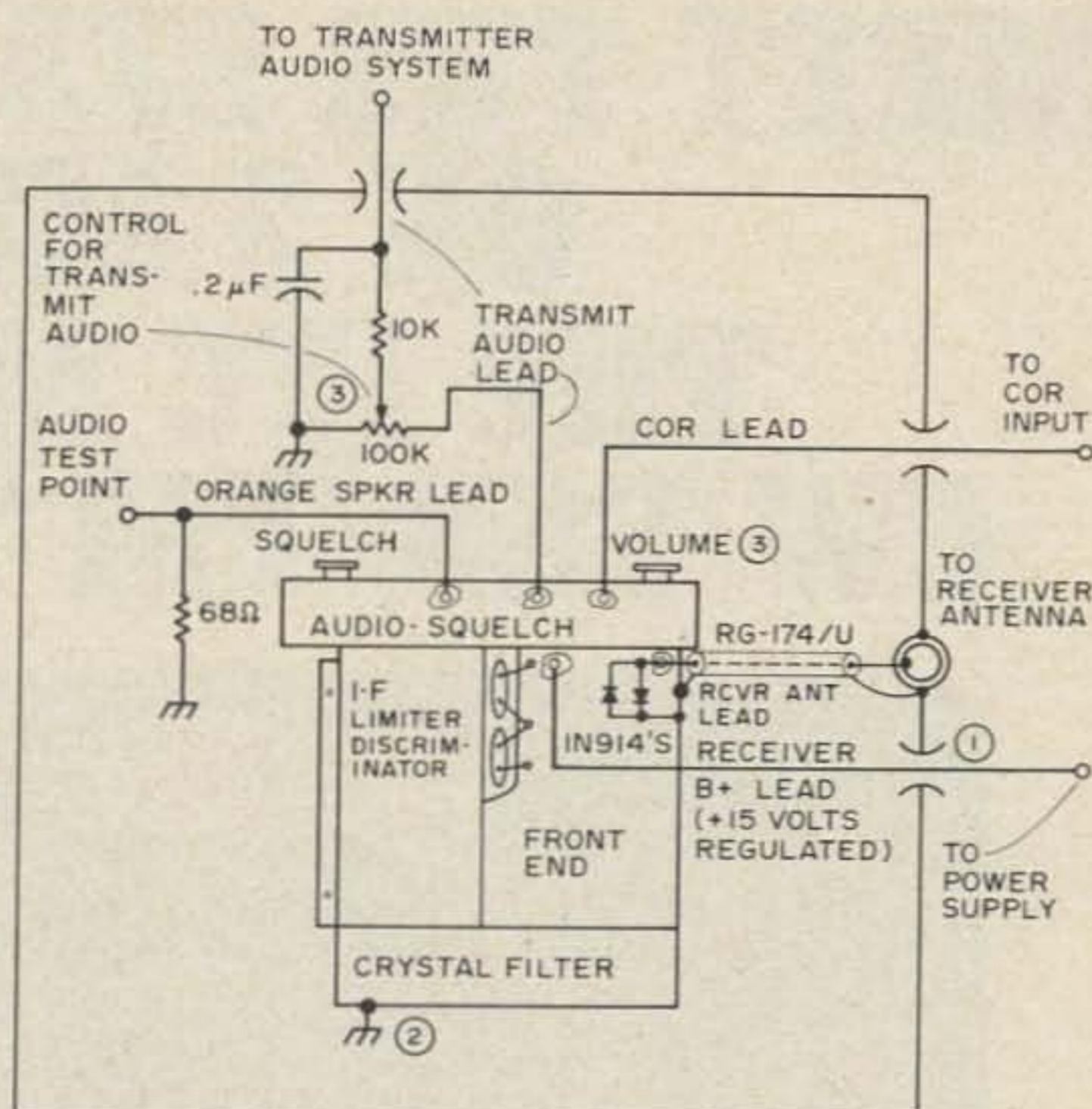

Fig. 2. Receiver.

Notes: (1) All feedthrough capacitors .001 μF. (2) Solder receiver to bottom of box. (3) Volume and compression controls both affect audio going to transmitter audio. (4) Audio enough to drive a 50-100 Ω spea.

transmitter both are tied to the same point on the final power amplifier module. This is where the coax to the relay in the antenna block is tied. Remove this coax and connect the two leads and the indicated rf and dc bypassing components. This permits you to feed 15V dc to the transmitter and get a watt of rf back, both through the same solder joint. It is possible to go into the transmitter's PA stage and separate the two paths, but it is a lot of trouble and nothing is really gained by doing it that way. Simply wire in the rf choke (which can be salvaged from either the reed relay or the input on the receiver front end board), the two capacitors and a couple of ferrite beads, if you have them. These components will do a good job of separating the rf and dc from each other.

The transmitter should also be put in an rf tight enclosure, with .001μF feedthrough capacitors at all external connection points, except at the antenna receptacle, which can be of the same type as used in the receiver. Solder the bottom of the transmitter's PA module to the bottom of the box to give the transmitter a better heat sink.

Receiver Testing and Alignment

Connect a 50-100Ω speaker to the receiver's audio output (across or in place of

MEET THE STATE OF THE ART ON 2 METERS... THE ITC MULTI-2000 CW/SSB/FM TRANSCEIVER

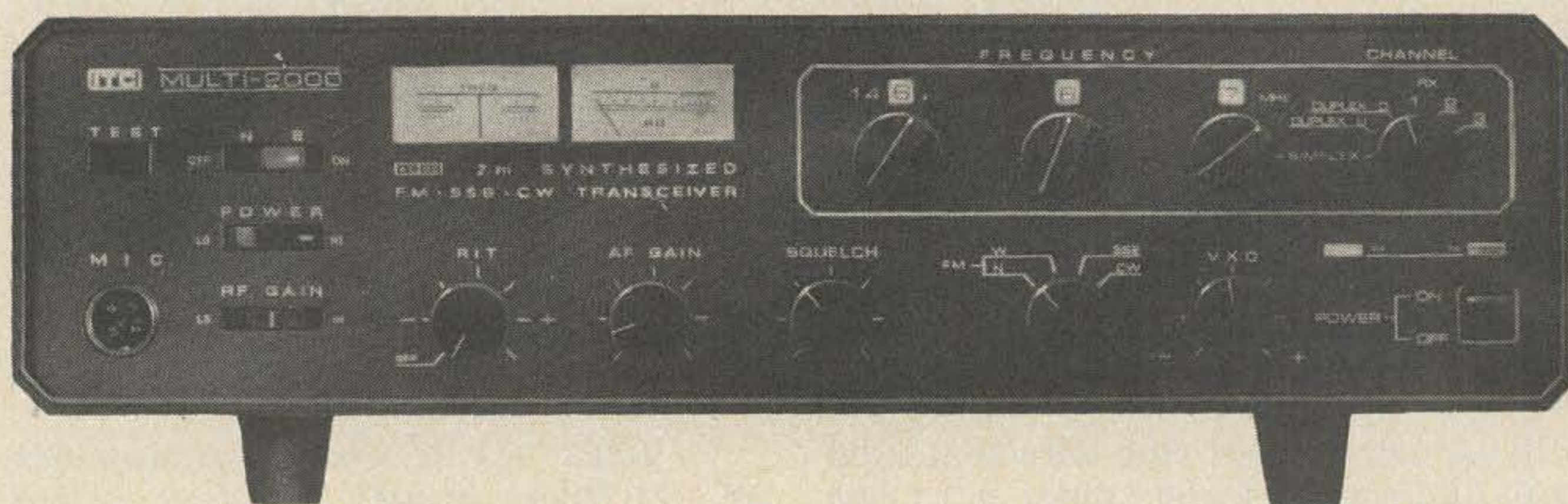

Whether your interest is simplex, repeater, DX or OSCAR the new ITC MULTI-2000 lets you get into all the action on all of the

band. Fully solid-state and employing modular construction, the MULTI-2000 enjoys features found in no other 2m transceiver.

FEATURES

- PLL synthesizer covers 144-148 MHz in 10 kHz steps
- Separate VXO and RIT for full between-channel tuning
- Simplex or ± 600 kHz offset for repeater operation
- Three selectable priority channels
- Multi-mode operation (CW/SSB/NBFM/WBFM)
- Built-in AC and DC power supplies, noise-blanker squelch and rf gain control
- Selectable 1W or 10W output
- Separate S-/power and frequency deviation meters
- Built-in test (call) tone and touch-tone provision
- Excellent sensitivity ($.3 \mu\text{V}$ for 12 dB SINAD)
- Superior immunity to crossmodulation and intermodulation
- Introductory price: \$695.

THE ITC MULTI-2000 TRANSCEIVER...
PERFORMANCE THAT CHALLENGES YOUR IMAGINATION
INTERNATIONAL TELECOMMUNICATIONS CORP.
P.O. BOX 4235, TORRANCE, CALIF. 90510 • (213) 375-9879

MULTI-2000

SPECIFICATIONS

RECEIVER SECTION:

- Sensitivity:

- FM: 0.3uV for 12 dB SINAD
1.0uV for 20 dB Quieting
- SSB: 0.25uV for 10 dB SN + N
Noise Figure less than 3 dB

- Intermodulation:

- Third-order intermodulation products reduced more than 70 dB below one of two RF test signals within the RF passband.

- Crossmodulation:

- Better than 80 dB

- Selectivity:

- FM: 15 kHz at -6 dB, Shape Factor 2.5:1 (6/60 dB)
Ultimate rejection greater than 90 dB
- SSB: 2.4 kHz at -6 dB, Shape Factor 2:1 (6/60 dB)
Ultimate rejection greater than 95 dB

- Spurious Signals:

- Reduced more than 70 dB.

- IF Rejection:

- Greater than 60 dB.

TRANSMITTER SECTION:

- Power Output:

- FM: Low power 1.5 Watts (Adjustable 0W — 10 W)
High power 10 Watts (Typically 15 W)
- SSB: 15 Watts PEP Output

- Carrier Suppression:

- Greater than 50 dB

- Unwanted Sideband Suppression:

- Greater than 50 dB at 1 kHz.

GENERAL:

Continuous tuning in 10 kHz bands... Stability better than 50 Hz after 5 minute warmup... Separate VXO and RIT for independent transmitter and receiver tuning... Built-in AC/DC Power Supply, Noise Blanker, IDC... Built-in Test Tone, provision for PL or Touch-Tone.

INTERNATIONAL TELECOMMUNICATIONS CORP.

P.O. BOX 4235, TORRANCE, CALIF. 90510 • (213) 375-9879

the 56-68Ω resistor added earlier) and connect the receiver's B+ line to +15V. Turn the squelch control to "0" and the volume control to "5" or a comfortable listening level. White noise should be heard from the speaker if everything has been done correctly. Tune the receiver up according to the instructions in the October, 1973 issue of 73, or use the following alternate procedure.

Put an ac voltmeter across the speaker terminals and tune *all* of the receiver front end slugs for maximum noise and maximum meter deflection. Do this *after* L10 has been properly set, so that the crystal oscillator will be going. There should be no signal source connected to the antenna jack while tuning for maximum white noise. When you tune the receiver using this method you are tuning all of the stages for maximum gain, which results in more white noise and therefore more ac voltage at the speaker terminals. Final "tweaking" should be done using a weak *on frequency* signal, either from a signal generator or from a distant transmitter. The coils should then be tuned for maximum quieting, or *minimum* reading on the meter.

When properly aligned, the threshold of the squelch control (in the absence of a signal) should be around 3 or 4. If it is significantly higher (over 4½), you have less than normal gain and probably need re-alignment. This is because the squelch threshold is dependent directly on white noise level.

Connect a signal tracer amplifier (or any general purpose medium gain audio amplifier) and a speaker to the audio line that goes to the transmitter audio circuitry. Audio should be present here.

Connect the positive lead of a high impedance dc voltmeter to the cor line, and the negative lead to ground. The meter should indicate 6-8V when the receiver is unsquelched (when audio can be heard in the speaker or when a carrier opens the squelch) and less than a volt when it is squelched. This voltage swing can be obtained by either turning the squelch control back and forth (in the absence of a signal at the antenna input) or by squelching the receiver and then feeding in a weak and on frequency signal.

Transmitter Testing and Tuning

Once the transmitter is mounted, connect a wattmeter and a 50Ω non-inductive load to the rf output jack. A pair of 100Ω, 1W carbon resistors in parallel (with short leads) will serve nicely as a dummy load. Ground the appropriate oscillator keying wire (if you have a 2 channel transmitter board). Hook the transmitter's +15V B+ lead through a push-button on-off switch to a +15V power source, so that B3 (regulated) can be applied to the transmitter by pushing the button. It is also a good idea to have a dc ammeter in this line, so that you can monitor the current drawn. Do not allow the current to exceed 250 mA at any time.

Going by the tune up procedure described in the earlier article, tune the transmitter for 1W output. The drive control pot(s) may have to be adjusted several times — you want each coil set at its peak when the transmitter is delivering 1W. Many pocket mate transmitters are capable of 1.5-1.9W out (or more), but it is not advisable to run this kind of power for any length of time. You may also notice some slight interaction between tuning and drive pot settings, so it is important to tune the rf coils last, after leaving the drive pot in its final position.

If your transmitter will not quite make it to a watt, and the driver coil has just one peak (with the slug all the way in), then you need to add 6-10pF across this coil. See the material concerning this in the "Updating the Pocket Mate" article in the May, 1975 issue of 73.

If your unit has a deviation control, the audio board is wired this way:

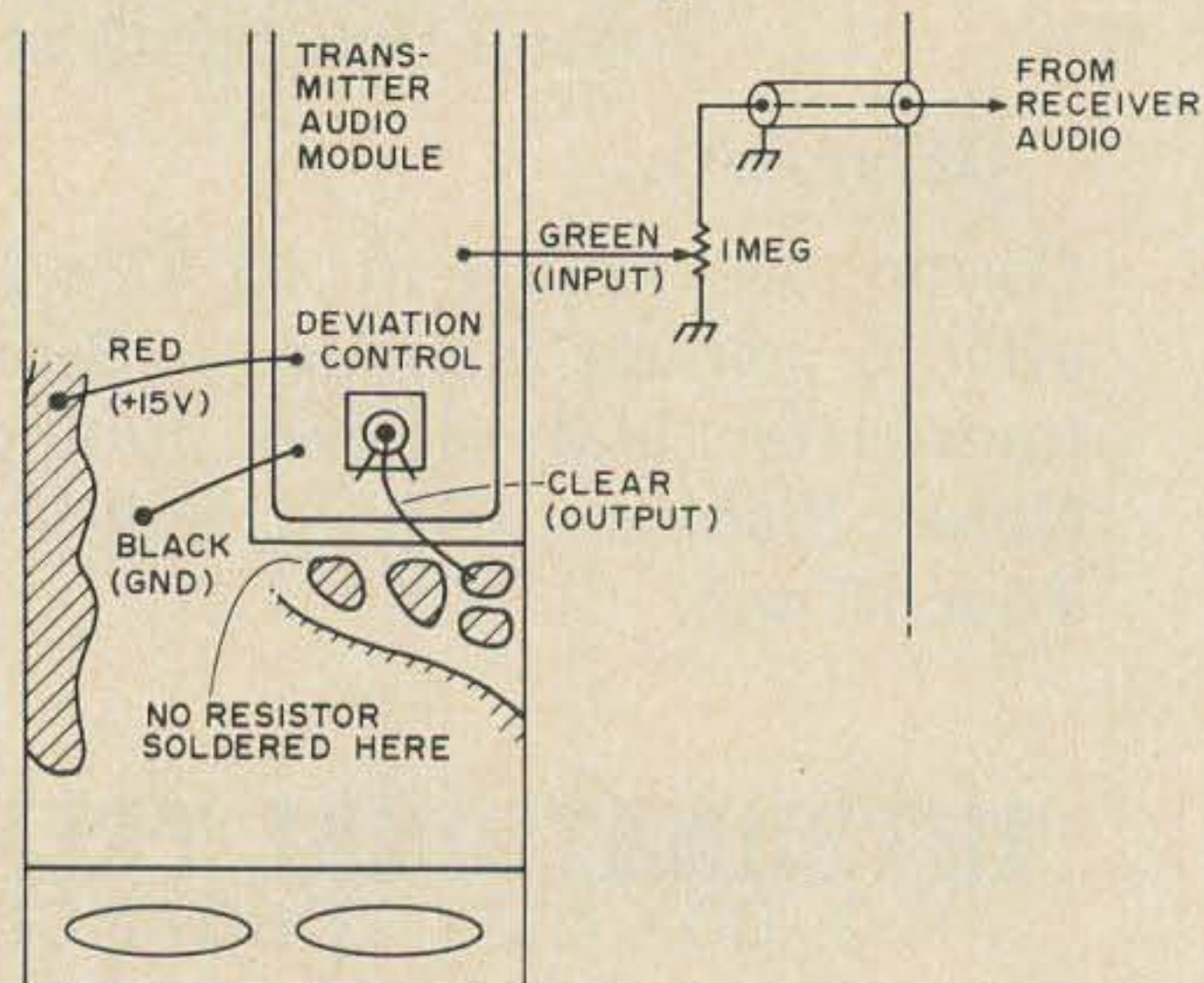

Fig. 3. Transmitter.

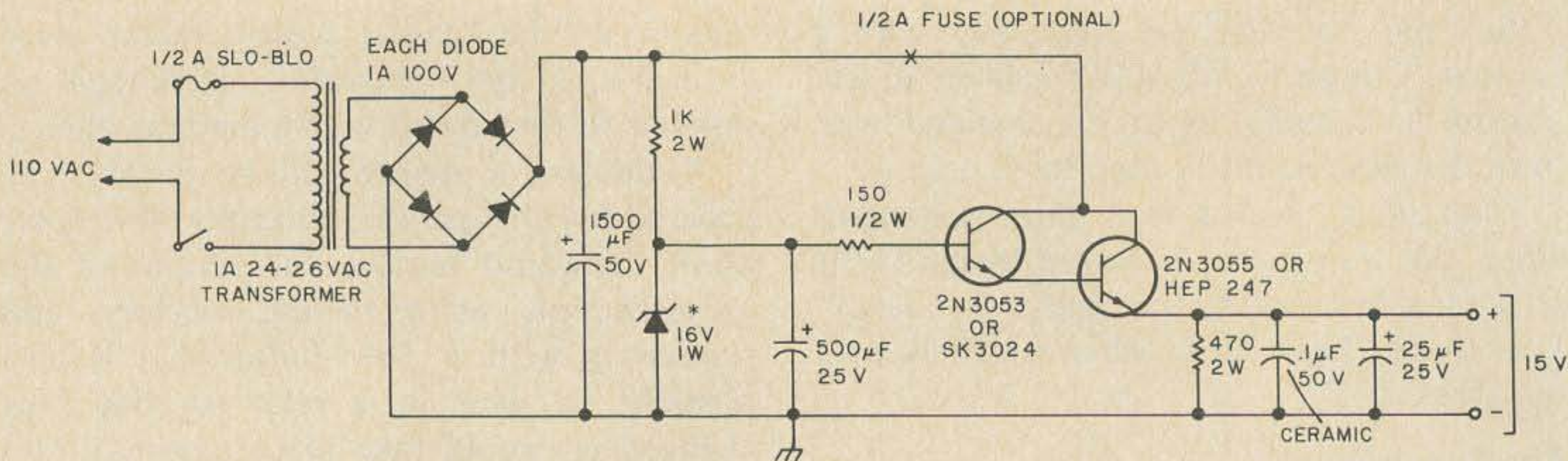

Fig. 5. Regulated power supply.

*Choose this Zener diode for an output (at the terminals) of 14.5 to 15.5 volts.

end goes to the emitter of Q5. The relay can be used to switch 15V to the transmitter as well as to switch other circuits you may wish to add.

The input to the cor board comes from the audio squelch board. This lead does not have to be shielded.

Once the cor board is built, it should be tested by itself. Connect it to a 15V power supply and ground its input lead. Close to zero voltage should be present at the output. Remove the ground lead on the input and connect the input lead to a variable 0 to 15V power source. Turn the input pot on the cor board to maximum sensitivity (so that the wiper arm is nearest the input connection). Turn the pot on the variable power supply back and forth *slowly*. The output of the cor should indicate 14-14.5V when a small voltage is present at the cor input.

Turn the power source to zero. The cor output should be near zero within a second or so. Quickly turn the power source to 10-15V. The cor output should jump to 14.5-15V. Quickly turn the power source back to zero. The cor output should remain at 14.5-15V for approximately a second, and then fall to near zero. If you wish for this time to be longer, increase the size of the electrolytic capacitor.

Later, after you have the receiver working properly, connect the cor line from its audio squelch board to the cor input. Apply 15V to the power leads of both, and put a dc voltmeter on the output of the cor. Almost no voltage should be present when the receiver is squelched. Turn the squelch control into the "white noise" range. The output of the cor should jump to 14.5-15V, and should remain there. Turn the squelch

control back again. After a second or so, the cor output should drop to near zero again.

Audio Circuits

The components that are wired between the receiver's audio squelch board and the transmitter's audio module provide a proper audio match from the repeater's receiver to its transmitter. Two different circuits are shown and the one to be used in each individual case is determined by which type of transmitter audio module is used in your transmitter. The diagrams are self-explanatory, so no details will be given here. Just be sure to use shielded wire in the places indicated.

The orange wire coming from the area near the earphone jack on the audio squelch board (one of the two orange wires that used to go to the speaker) and that now goes to ground through a 56-68 Ω speaker will have receive audio across it. If desired, a 50-100 Ω speaker can be used in place of it and it will serve as a monitor so that you can hear the received signals directly. One thing to remember — the volume control on the audio squelch board affects the audio being fed into the transmitter as well as the audio heard in the speaker.

The pot added to the transmitter, the pot already on the transmitter audio board (deviation control — if yours has one), the pot added to the receiver, and the volume control *all* interact and affect the audio that the repeater transmits. The 0.2 μ F capacitor in the circuit limits some of the high frequency components in the audio going from the receiver to the transmitter. Experimenting with the size of this capacitor as well as the settings of the pots will produce

2 METER CRYSTALS IN STOCK

We can ship C.O.D. either by parcel post or U.P.S. Orders can be paid by: check, money order, Master Charge, or BankAmericard. Orders prepaid are shipped postage paid. Phone orders accepted. Crystals are guaranteed for life. Crystals are all \$5.00 each (Mass. residents add 15¢ tax per crystal).

We are authorized distributors for: Icom and Standard Communications Equipment. (2 meter)

We stock A/S and Mosley two-meter antennas

We have thousands of crystals for monitor radios (Bearcat, Regency, etc.) along with many C.B. crystals

Note: If you do not know type of radio, or if your radio is not listed, give either fundamental frequency or formula and loading capacitance.

LIST OF TWO METER CRYSTALS CURRENTLY STOCKED FOR RADIOS LISTED BELOW:

- | | |
|----------------|--|
| 1. Drake TR-22 | 5. Ken/Wilson |
| 2. Drake TR-72 | 6. Regency HR-2A/HR212/Heathkit HW-202 |
| 3. Genave | 7. Regency HR-2B |
| 4. Icom | 8. S.B.E. |
| | 9. Standard |

The first two numbers of the frequency are deleted for the sake of being non-repetative. Example: 146.67 receive would be listed as - 6.67R

- | | | | | | | | |
|----------|------------|------------|-----------|-----------|-----------|-----------|-----------|
| 1. 6.01T | 8. 6.70R | 15. 6.175T | 22. 6.85R | 29. 6.37T | 36. 7.60T | 44. 7.72T | 52. 7.84T |
| 2. 6.61R | 9. 6.13T | 16. 6.775R | 23. 6.28T | 30. 6.97R | 37. 7.00R | 45. 7.12R | 53. 7.24R |
| 3. 6.04T | 10. 6.73R | 17. 6.19T | 24. 6.88R | 31. 6.39T | 38. 7.63T | 46. 7.75T | 54. 7.90T |
| 4. 6.64R | 11. 6.145T | 18. 6.79R | 25. 6.31T | 32. 6.99R | 39. 7.03R | 47. 7.15R | 55. 7.30R |
| 5. 6.07T | 12. 6.745R | 19. 6.22T | 26. 6.91R | 33. 6.52T | 40. 7.66T | 48. 7.78T | 56. 7.93T |
| 6. 6.67R | 13. 6.16T | 20. 6.82R | 27. 6.34T | 34. 6.52R | 41. 7.06R | 49. 7.18R | 57. 7.33R |
| 7. 6.10T | 14. 6.76R | 21. 6.25T | 28. 6.94R | 35. 6.94T | 42. 7.69T | 50. 7.81T | 58. 7.96T |
| | | | | | 43. 7.09R | 51. 7.21R | 59. 7.36T |

* * * * *

SPECIAL • BUY THE STANDARD 146A W/T AND RECEIVE A \$60.00 MERCHANDISE CREDIT GOOD FOR THE FOLLOWING ACCESSORIES:

SR-CSA DESK TOP CHARGER \$43.00

SR-C-AT19 RUBBER DUCKY ANTENNA \$6.00

NI-CAD BATTERIES (10 REQUIRED) \$2.00 ea.

CRYSTALS (UNIT COMES WITH 34/94 AND 94 DIRECT) \$5.00 ea.

SR-C-PT3644 LEATHER CASE \$8.50

SPECIFICATIONS

Microphone:	Internal dynamic type	Frequency range:	143 to 149 MHz
Dimensions:	9" h x 3" w x 1-5/8" d	Number of channels:	5
Weight:	32 oz. max. (including batteries)	Channel spread:	2 MHz max.
Supplied with 2 channels:	146.94Tx/Rx (national calling channel)	Input voltage (negative ground):	12.5V dc ±20%
	146.34Tx/146.94 Rx (repeater channel)	Circuitry:	All solid state
	Internal 2" dynamic	Current drain:	15ma squelched max., 100ma receive max., 0.62A transmit max.

CASH, CHECK OR M.O. ONLY TO QUALIFY FOR W/T SPECIAL

STORE HOURS: MON-FRI: NOON-9 P.M. SAT: 10 A.M.-6 P.M.



Kensco 46 PEARL STREET PHONE (617) 471-6427
QUINCY MA. 02169
Communications INC.

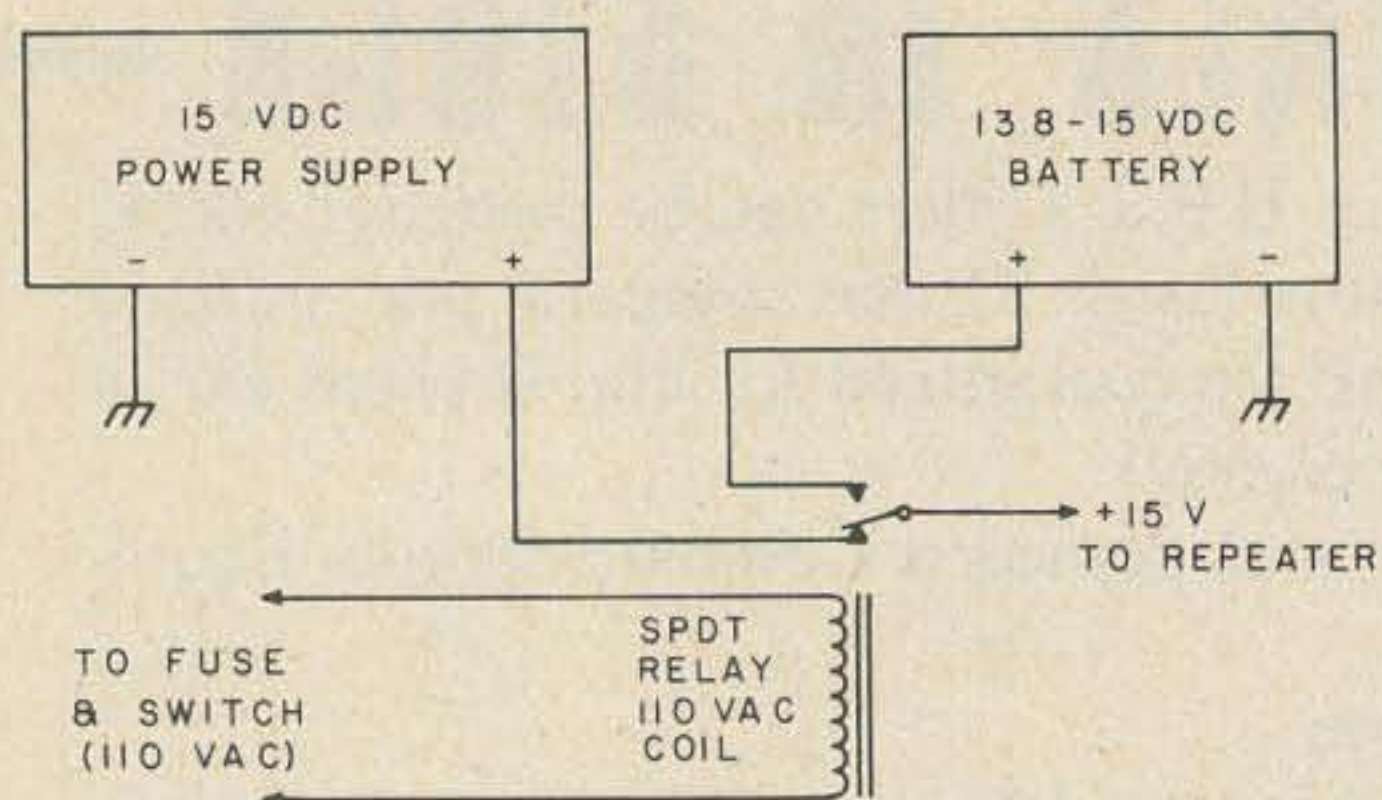

Fig. 6. Emergency power option. The battery can be most any type, and its amp-hour rating will determine how long it will run the repeater before it is discharged. If a rechargeable battery is used, a trickle charger can be left on it at all times so that it will always be at or near full charge, and ready to go when needed.

different characteristics of audio in the system. The pots in the receiver section can be set to give some clipping action, while those in the transmitter will tend to set maximum deviation limits. It is possible to get an almost exact reproduction of audio so that little difference is noted between audio heard direct and audio heard through the repeater. A little time spent making these adjustments will pay off in very good audio quality.

Once you have the receiver and transmitter working properly, wire up the audio circuitry and turn the receiver and transmitter on at the same time. If you have the cor and all the rest of the associated circuits wired and working properly, the transmitter should key up when the squelch control is turned towards zero (you may want to back the drive pot back some during the following tests so that you will be putting out just a few milliwatts). Listen to the transmitter's output signal on another receiver. As you turn the various controls in the audio circuitry, you should hear different levels of white noise coming through. Try talking through the repeater with another transmitter. You should hear yourself in the monitor receiver. Turn the squelch control back to mute the repeater's receiver. You should be able to key up the repeater, hear your audio through it and have a carrier tail for about a second after you stop transmitting through it. The transmitter should drop *completely* off the air after this carrier tail. It should also key up *promptly* after the receiver's squelch is broken.

Putting it Together

Once you are sure that everything is working properly, assemble the complete system in its cabinet. I used a bud chassis box with a piece of sheet aluminum for a cover. Use coaxial cable where indicated, and be sure that the receiver and transmitter compartments are as rf tight as possible. The main cabinet need not be rf tight. In fact, you don't have to have the cover on while it is operating.

You may wish to add the necessary control and automatic identification circuitry that is required to put it on the air as a licensed repeater. Several excellent articles on these circuits have been written up in 73 in the past.

Final Adjustments

The cor circuitry should be adjusted carefully. Setting it too close to the threshold will be unsatisfactory because very weak (and unreadable) signals will be able to key up the repeater. If you have any desensitization, this problem will be accentuated, as a weak signal will sound worse as soon as the transmitter comes on in the repeater. Setting it too far the other way is also undesirable because it would take a very strong signal to be usable. "Desense" also makes this problem even worse. When the cor is properly adjusted, a signal of around .3 to .4 μ V should easily bring up and hold the repeater. If you have desense, the repeater will "motorboat" on and off in the presence of a weak signal. You will get *substantial* desense unless you use two antennas a *great* distance apart, or use some correctly tuned cavities to eliminate it.

One way to get a feel of how much desense you have is to set the repeater up with the desired antennas and cavities, if you have any. Have a rf signal generator with a variable attenuator and a small whip antenna a short distance away from the repeater's receiver antenna. Tune the generator to the repeater's receive frequency. Listen to the audio in the repeater's receiver speaker. De-activate the repeater's transmitter and adjust the attenuator's output to get a reasonable amount of quieting. Actuate the transmitter and see how far *up* you have to

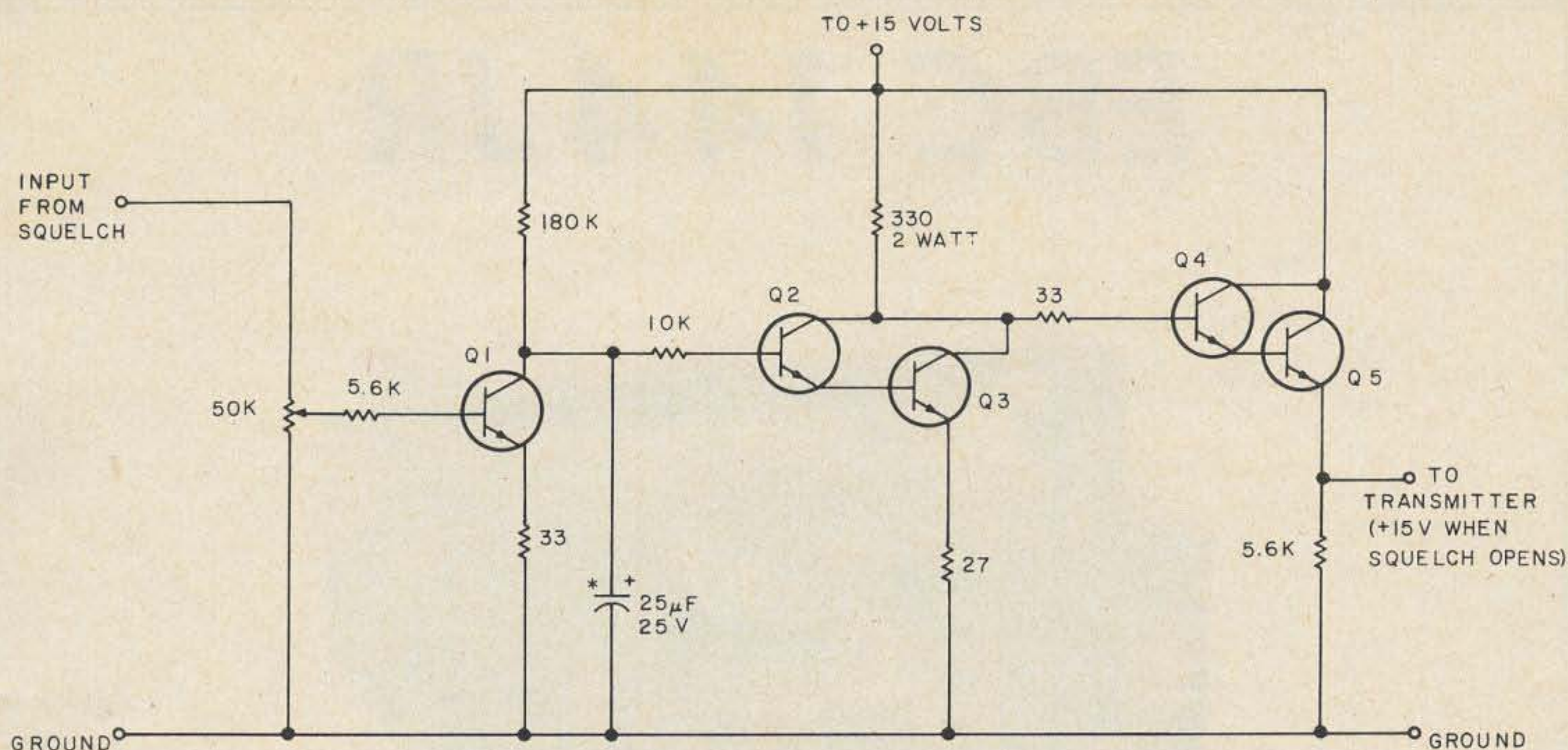

Fig. 7. Carrier operated relay.

Q1 - Q4 Any NPN switching transistor similar to 2N2222, 2N3904, etc. Q5 2N3054 or equivalent. Make this larger for longer delay and smaller for shorter delay. 25 μ F here will hold transmitter keyed for approximately one second after the signal keying it disappears. (Repeater will have a one second "carrier tail.")

turn the generator's output until you have the same amount of quieting (an ac voltmeter across the speaker is useful here). The less desense you have, the less you will have to turn the attenuator. If you have no desense, turning the repeater's transmitter off and on will make *no* re-adjustment of the attenuator necessary. If you do have appreciable desense, you will notice that the repeater's transmitter will "motorboat" on and off over a range of settings on the generator. At the low end, the repeater will drop off and stay off. At the other end it will stay on and the transmitted white noise will lessen as the attenuator is turned up.

Normally, the pot on the cor board is left at or near maximum sensitivity and the actual cor sensitivity is set by the squelch control. The cor is actually squelch operated. That is, the transmitter is activated when the audio gate is opened by the squelch in thy receiver.

The audio circuits can be adjusted best by having someone transmit to you through the repeater while you listen to him on another receiver. Try comparing his audio as you hear him through the repeater to the way he sounds direct without it.

Finally, using a wattmeter, frequency counter and signal generator, retune the

transmitter for 0.9-1.0W into the antenna system, and make certain that both the receiver and transmitter are on frequency.

Operation

I have had surprisingly good results using a couple of "Ringo" antennas spaced apart both horizontally and vertically. There will be some desense unless they are spaced a considerable distance apart (or unless you use some cavities). But you can live with some desense if you want this repeater to be compatible with stations running 10W or more. It is possible to use a duplexer and one antenna, but you will be lucky to get a $\frac{1}{2}$ W output. Many interesting articles can be found on the topic of antennas and cavities for repeaters, and they should be read for optimizing the operation of this repeater.

Another attractive feature is that the repeater can be made very compact and portable - and it can run for hours on a battery. Higher power could be added with another power transistor or two, but this would detract from some of the novelties of the system.

I plan to get a license for mine, so look for WR4??/4 from the top of Mount Mitchell at 6600 feet some weekend.

... WB4DBB

EBC 144JR



HEY! This is like two transceivers in one! Fully synthesized covering 143.5 to 148.5 MHz in 5 kHz increments. Operate Simplex or Repeat on either Channel A or B at the flip of a switch! Split mode allows total independent receive and transmit frequencies. PLUS, standard or reverse 600 kHz offsets up or down automatically and a priority channel that switches you over as soon as a signal is detected.

\$599.00

- Sensitivity — .35uV for 12 dB sinad, .30uV for 20 dB quieting
- 20 Watts output
- Intermodulation, spurious and image 60 dB minimum
- 10 pole xtal filter
- Frequency stability .001%
- Built in S-meter and speaker
- 12 volt operation

**write for your closest
stocking dealer**

**emergency
beacon corp.**

15-B9 River Street
New Rochelle NY 10801



Basic Telephone Systems Conclusion

Spenser Whipple, Jr.
c/o 73 Magazine
Peterborough NH 03458

Inside Ma Bell

The automatic couplers we have described so far would be ideal for a repeater autopatch or possibly an answering machine or automatic dialer (although we'll mention others specifically designed for answering machines and dialers later), but to connect just a few extension phones we need a bit more. We need a battery to provide power for the carbon mike, a series relay to detect when the extension goes off hook and when it dials, and also a 20 Hz ringing generator to ring bells.

While it is no great problem to build just this, if all you want is a telephone-company-approved way to connect 10 extensions in your 25-room mansion, you can order the STC Voice Connecting Arrangement for \$5.80 a month plus \$25 installation.

As shown in Fig. 12, the STC has only one varistor but two transformers. As usual, the main PC board (KS-20721) is used in almost a dozen different couplers and has a number of jumpers which can be hooked up

in many combinations.

On the right-hand side we see that a +21 volt supply is connected to the CT output through one transformer winding, while ground is connected to the CR lead through a resistor and another transformer winding. This provides the talking power to the extension phone, and the voltage drop produced across the resistor when the extension is off hook is sensed by the control circuits and used to operate the line relay. When you pick up the extension phone, the line relay closes and puts the coupler on the line. As you dial, pulses are repeated by the line relay.

The ringing circuit is also interesting. As usual, a ring detector across the line detects the 20 Hz ringing and pulses a relay. But usually the relay pulses at 40 Hz, once on each half cycle of the 20 Hz. In this case the circuit is set up so the ring relay pulses at only 20 Hz. The ringing generator is simply a dc-to-dc inverter which changes 21 volts dc into about 120 volts dc. The ring relay contacts then change this into 20 Hz ac by

reversing the polarity at a 20 Hz rate (remember, an x means a normally open contact, while the short line means a normally closed contact). The resulting ringing signal is then applied to the CT and RV1 leads.

As mentioned in the figure caption, any number of extensions can be hooked up, but the ringing generator can only feed a maximum of three bells. This means that all the non-ringing extensions need only two-wire connections via the CT and CR leads; unfortunately the three ringing phones require a three-wire connection. This is done in order to keep the coupler simple, as it is a bit messy to test for dc continuity (off hook) on the tip and ring leads at the same time (there is 100V ac there) as it is normally done at the CO.

For some reason this coupler has the ring (CR) and tip (CT) leads mixed up. In Fig. 12, we see that the ringing generator applies its voltage between the CT (tip) lead and RV1. Since the ringer goes between the red and yellow wires in the extension (see Fig. 2), that means that the red wire has to go to the tip and the green to the ring side of the line. A rotary dial phone won't mind this, but a Touchtone phone won't work like this. You have to move the black ringer wire from the L2 terminal to the L1, and then connect red to ring (R to R) and green to tip, as normal.

Let's just quickly cover some other couplers you might be interested in:

The GC2 is just a plain ring detector, similar to the one in Fig. 7, which closes a relay contact when there is ringing voltage on your line.

The CTD is a toll-denial relay which senses long distance calls.

The C1V and HZM couplers monitor a line and provide a signal when the line is busy. Intended to allow customers to run timers or pen recorders to measure line usage.

The CEZ and CEZAW couplers allow you to make conference calls if you have two or more lines. Actually, just shorting the two lines together (tip-to-tip, ring-to-ring) would work just as well.

The CEK coupler, along with an extra line and some changes in the CO, allows you

to have a message unit counter on your premises to keep track of your own message units. Probably intended for hotels and motels, which charge guests by the call.

The RDL, RDM, RDMZR, RDMZY and RDY couplers are various versions designed for telephone answering machines or for automatic recording (dictating) machines. Depending on the model, you get one-way or two-way transmission, volume limiting, or automatic cutoff when the message stops.

The RCT and RCW are couplers for recording a two-way conversation. The RCT automatically generates a beep every 15 seconds, and the RCW doesn't. I think only law enforcement agencies can get the RCW. The RCT runs \$2.46 a month and \$12.30 installation, while the RCW is only \$1.23 a month and \$12.30 installation. The RCZ is similar.

The RTT and RC1 are similar, but only beep. Used with a customer owned call duration timer, they beep to tell you you've been talking too long. The RTT sends the beep to both parties, while the RC1 only beeps the local party.

The SU7 and SU7QW (at \$3.85 a month and \$25 installation) allow outward dialing only for automatic dialers.

Finally, there is a group of couplers designed for burglar and fire alarm systems. Real fancy alarm systems may have a private line running straight to a police station or private detective agency; a somewhat cheaper alternative is to get an automatic dialer which dials a number and then feeds in a tape-recorded message. That's where these couplers come in (although burglar alarm installers often connect a dialer directly without a coupler.)

The CAU coupler (\$4.36 a month and \$14.47 installation) allows an alarm dialer to seize the line (and at the same time disconnects any other telephones on the line to prevent a burglar from interfering with the call), dial a call, and then play a pre-recorded message. It provides only one way outgoing audio transmission. An SU6AQ coupler (at \$4.25 a month and \$25 installation) is also for alarm systems but allows two-way voice and tone transmission; it has a ring detector and is actually built just like the STC coupler (Fig. 12) but without a ringing

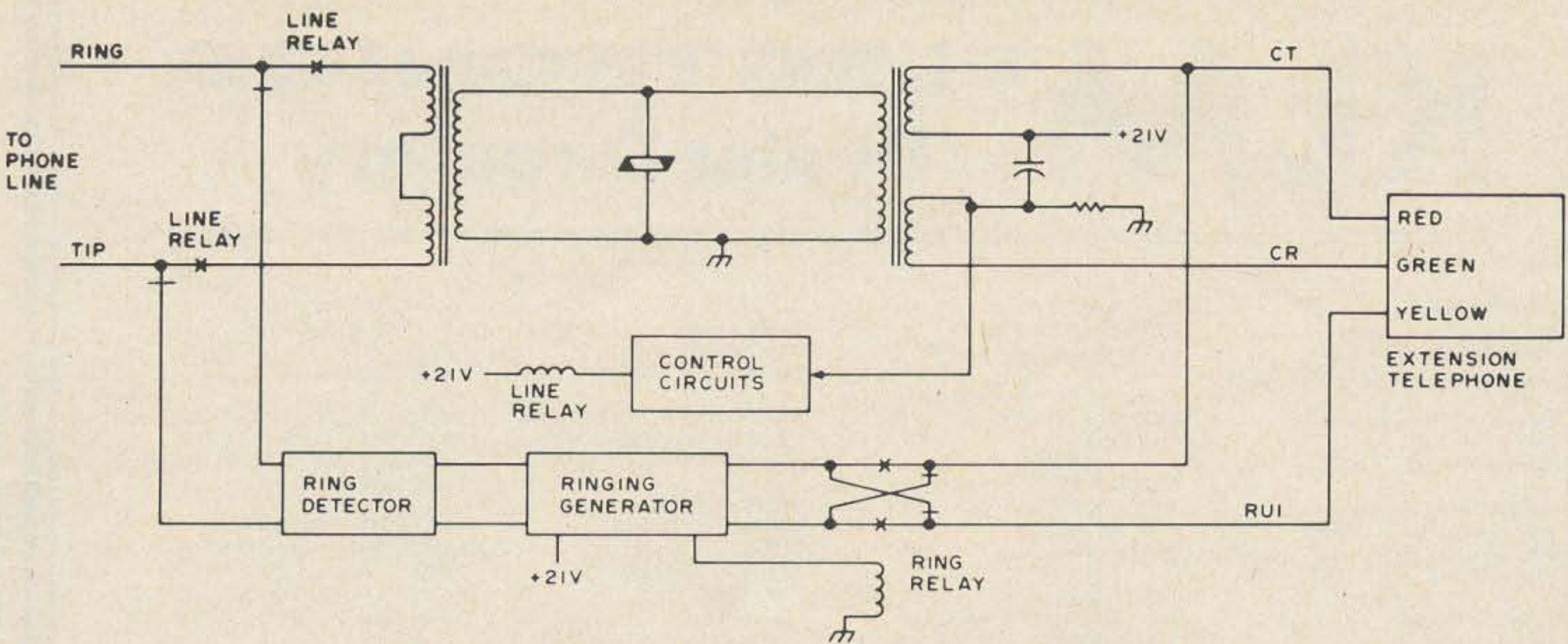

Fig. 12. Simplified diagram of STC Coupler, when equipped with options W, Z, S, P and X. Any number of extension telephones can be connected, but the ringing generator can only drive three bells.

generator so it could be used for extensions but not to ring them. The STS (\$5.65 and \$25 installation) is the same as the SU6AQ but with an added volume limiter for received audio.

Of greater interest, especially for simple (though expensive compared to a homebrew version) control of things like repeaters, is the SU4 or SU6 coupler. Both are similar to the CAU with the SU4 being one way and the SU6 being two way. In normal alarm service, both of these allow an alarm to dial out and send a voice or tone message. But, in addition, they allow remote testing of the alarm.

They work like this: To test the alarm, you need either a 1475 Hz tone generator or a Touchtone phone (which can generate a high-group tone of 1477 Hz if you simultaneously push two buttons in the right-hand column (3-6-9). You call the SU4 or SU6 coupler from the outside. The coupler detects the 20 Hz ringing, answers the call, and automatically sends a pulsed 2125 Hz tone back to you. Now it waits for your 1475 Hz tone; if no such tone comes, it simply waits 20 seconds and hangs up. If it gets 1475 Hz, it gives the alarm (or what-have-you) a relay contact closure, and changes the pulsed 2125 Hz to a continuous tone to confirm receipt. By appropriate relay closures the alarm can now silence the 2125 Hz, send out audio (and in the SU6, receive audio), or wait for further 1475 Hz signals. Altogether a very interesting gadget.

It is fairly hard to get information on

these and other couplers from your local telephone company. For each coupler there is a Technical Reference supposedly available from "the local Telephone Company Business Office or the Marketing Representative." Unfortunately, the gals in the Business Office don't know what you're talking about, and the marketing reps have unlisted numbers. If you don't ask for too many at a time, I've found that the best way to get Technical References is with a neat letter (preferably on letterhead) to the Engineering Director, Transmission Services, American Telephone and Telegraph Co., 195 Broadway, New York, New York 10007. Publication Pub-40000 is an index of the Technical References available and is a good starting point. These publications are intended for customers and so they will tell you what the coupler will do and how to use it the way they want it used, but not what's in it. The latter information (on couplers and most other telephone company equipment and procedures) is contained in BSPs (Bell System Practices). These are "cookbooks" for installers and repairmen which tell them anything they need to know; I wouldn't be surprised if there is a BSP somewhere telling them how to climb a ladder or drive a truck.

If you've been reading carefully so far, you've probably been wondering who these phone phreaks are whom I mentioned a few thousand words ago. We've actually alluded to two other related items, the magic signalling frequency of 2600 Hz, and billing for very short calls. Maybe now is a good time

KLM ELECTRONICS

Dealer Directory

ALABAMA

Rickles Electronics
2800 W. Meighan Blvd.
Gadson AL 35904 547-2534

Rogers C. McCauley
2417 Penn St.
Huntsville AL 35801

ARIZONA

Apache Auto Machine & Parts
8825 N. Central
Phoenix AZ 602-992-8506

Eugene Kuklin
431 Lazy Horse Pl
Tucson AZ 602-297-2111

CALIFORNIA

Communication Devices
1211 Topper Ln.
El Cajon CA 92020

Gary Radio
8199 Clairmont Mesa Blvd.
San Diego CA 714-292-1440

Global America Corp.
P.O. Box 246
El Toro CA 714-533-4400

Ham Radio Outlet
999 Howard Ave.
Burlingame CA 415-342-5737

Henry Radio
931 N. Euclid Ave.
Anaheim CA 213-477-6701

L A Electronics
23044 S. Crenshaw Blvd.
Torrance CA 213-534-4456

M'Tron
2811 Telegraph Ave.
Oakland CA 415-763-6262

Quements
1000 Bascom Ave.
San Jose CA 408-998-5900

Sequoia Stereo
773 8th St.
Arcata CA 707-822-0328

Teletronics
4175 San Felipe Rd.
San Jose CA 408-274-3100

Webster Radio
2602 E Ashlan
Fresno CA 209-224-5111

Westcom Engineering
Bcx 1020
Escondido CA 714-744-1395

Halted Specialties Co.
915 Kifer
Sunnyvale CA 415-969-1448

WMS Service Co.
14639 Maryton St.
Norwalk CA 213-921-1575

Chuck Oleson
Unit 54 12521 Centralia
Lakewood CA

Microcomm
14908 Sandy Lane
San Jose CA

Channel Island Communications
P.O. Box 99
Goleta CA

C.B. Radio
2515 So. H Street
Bakersfield CA

C and A Electronics Enterprises
P.O. Box 5232
Carson CA

COLORADO

Loc Electronics
P.O. Box 7515
Pueblo West CO

CONNECTICUT

Marcus Communications
134 E Center St
Manchester CT 203-646-1839

FLORIDA

Amateur Wholesale Electronics
8817 SW 129 Terrace
Miami FL 305-233-3631

Holmes Radio & TV
5057 North Dixie Highway
Pompano Beach FL
421-1880

Lasater Electronics
4617 Paxton Ave.
Tampa FL 813-839-5907

Help Radio
1055 Liberty St.
Jacksonville FL 32206
904-356-8545

GEORGIA

Stereo City, Inc.
481 Highland Ave.
Augusta GA 404-738-1058

Arthur P. Laws
2040 River North Pkwy.
Atlanta GA

HAWAII

Honolulu Electronics
819 Keeaumoku St.
Honolulu HI

ILLINOIS

Erickson Electronics
4135 W. Main St.
Skokie IL 312-677-2161

Hill Radio
212 Hammitt
Normal IL 309-452-6104

Global Research and Supplies
1020 S. Cornell
Villa Park IL 312-279-4658

IDAHO

United Electronics Wholesale
217 Second Ave. N
Twin Falls ID
208-733-7324

IOWA

Antenna Mart
P.O. Box 2
Rippey IA 515-436-7718

Huntor Sales
3621 Beaver Ave.
Des Moines IA
515-255-2186

KENTUCKY

Ramsey Mobile Home Sales, Inc.
P.O. Box 2747
Pikeville KY

LOUISIANA

Preston Electronics
611 Highland Dr.
Houma LA 504-868-2213

Electronics Parts & Supply
7214 Washington Ave.
New Orleans LA

MARYLAND

CQM Electronics
900 Crain Hwy. SW
Glen Burnie MD
301-768-2728

Tycol Communications
Rt. 3, Langdon Dr.
Mt. Airy MD 301-253-4376

MICHIGAN

Ray Liby
2112 South Burdick
Kalamazoo MI

MINNESOTA

Sub-Tronics Inc.
10129 Edon Prairie Road
Eden Prairie MN
612-941-3652

Robert D. Bliss
1440 Lakeview Ave.
Minneapolis MN

MISSISSIPPI

Morreville CB Radio Center
P.O. Box RR1
Morreville MS

MONTANA

Conley Radio Supply
101 S 31 St
Billings MT 59101
406-259-9554

NORTH CAROLINA

Speed Supply Company
P.O. Box 194
Stanfield NC

NEW YORK

J H Electronics
254 Captain's Dr.
West Babylon NY

South Fork Electronics
36 Hampton Rd.
So. Hampton NY
516-283-8686

Bratty Communications
1854 Colvin Rd.
Tonawanda NY

VHF Communications
915 N. Main St.
Jamestown NY

Westchester Comm. Spec. Div.
53 Hayward St.
Yonkers NY

NEW JERSEY

E. J. Narwid Electronics
61 Bellot Rd.
Ringwood NJ 201-962-4695

Radios Unlimited
86 Balch Ave
Piscataway NJ
201-752-4307

Hi-Fi & Photo Supply
P.O. Box 290
Toms River NJ

Curts BP Service
Rt 130 & Broad St.
Penns Grove NJ
609-299-9881

Spaford Communications, Inc.
883 Jaques Ave.
Rahway NJ 07065
201-382-7979

NORTH DAKOTA

CDS Electronics & Hobbies Unltd.
3611 13th Ave. N.
Grand Forks ND
701-772-5480

OHIO

Challenger Electronics
1700 Central Ave.
Middletown OH
513-424-2475

Communications World
4788 State Rd.
Cleveland OH 216-398-6363

Queen City Electronics
1583 McMakin Ave.
Cincinnati OH

Kelly Schelmsberg
7379 Calmcrest Ct.
Dayton OH

Talley Electronics
8520 Winton Rd.
Cincinnati OH 513-931-1577

Advance Communications
1778 Adams Rd.
Loveland OH

OKLAHOMA

Larry Dillard
2624 S.W. 69th St.
Oklahoma City OK

Cal's Radio
3rd and Davis
Tipton OK

OREGON

Juniper Electronics
2648 S.W. 25th St.
Redmond OR

LJ Electronics
2075 S. Marylwood Ct.
West Linn OR

Silke Communications
680 Tyler
Eugene OR 97402
687-1611

PENNSYLVANIA

Hamtronics
4033 Brownville Rd.
Trevose PA 215-357-1400

SOUTH DAKOTA

J L Shaffer
Rt. 1, Box 13
Rapid City SD 605-343-8061

SOUTH CAROLINA

Greene's Electronics
Hwy. 15, So.—P.O. Box 626
St. George SC

TEXAS

Bolen Control Systems
5424 Ammons St.
Ft. Worth TX 817-485-1325

Madison Electronics
1508 McKinney Ave.
Houston TX

Texas Technical Products
Route 2, Box 325-D
San Antonio TX 695-8430

Kennedy Associates
2618 Rigsby Ave.
San Antonio TX

J. P. Ashcraft
5641 Dyer St.
Dallas TX

Trimble Electronics
1918 Mary Ellen
Pampa TX

Maverick Electronics
1905 N. Waterview
Richardson TX

Dependable TV & Electrical Supply
3812 Link Valley
Houston TX

Tucker Electronics
1717 S. Jupiter Road
Garland TX

TENNESSEE

Sere-Rose Electronics
1465 Wells Station Road
Memphis TN

UTAH

John H. Lloyd Jr.
5081 Woodmont St.
Salt Lake City UT

WASHINGTON

Jerry Ford
18604 Bonney Lk Blvd.
Bonney Lake, Sumner WA
206-863-7557

Dave Robinson
1716 So. 8th
Tacoma WA

Carl Automotive & Electronics
7611 MacArthur Blvd.
Vancouver WA

WEST VIRGINIA

Communications Incorporated
Longwood Road
Huntington WV

FOREIGN

Dollard Electronics
3863 Oak St.
Vancouver BC Canada

Electronica Fernandez
P.O. Box 415
Mato Rey Puerto Rico
767-3500

West Indies Sales Co.
606 Calle Aboy
San Juan, Puerto Rico

Piza Radio
P.O. Box 2001
Ponco, Puerto Rico

EUROPEAN STOCKING DISTRIBUTOR

Sideband Communications
64020 Bjorkbik
Sweden 0155-712-54

Gemini Electronics Lt.
P.O. Box 5889
Auckland, New Zealand

Ing. Hans Scrmulze Ltda.
P.O. Box 4155
San Jose, Costa Rica

Pt. Radio P.O. Box 70
Bandung, Indonesia

Omnicom
Minterrothweg 15
CH-3414 Obergurg, Switzerland

Walt Wiechem DJ2OU
2139 Lauenbrueck
West Germany

Racal Electronics, South Africa. Ltd.
P.O. Box 1463, Pretoria
Republic of South Africa



MIKE STAAL K6MYC

MEL FARRER K6KBE

NEW ECHO II
2 meter SSB/CW xcvr and

NEW 432 16 element
Long Boom Yagi

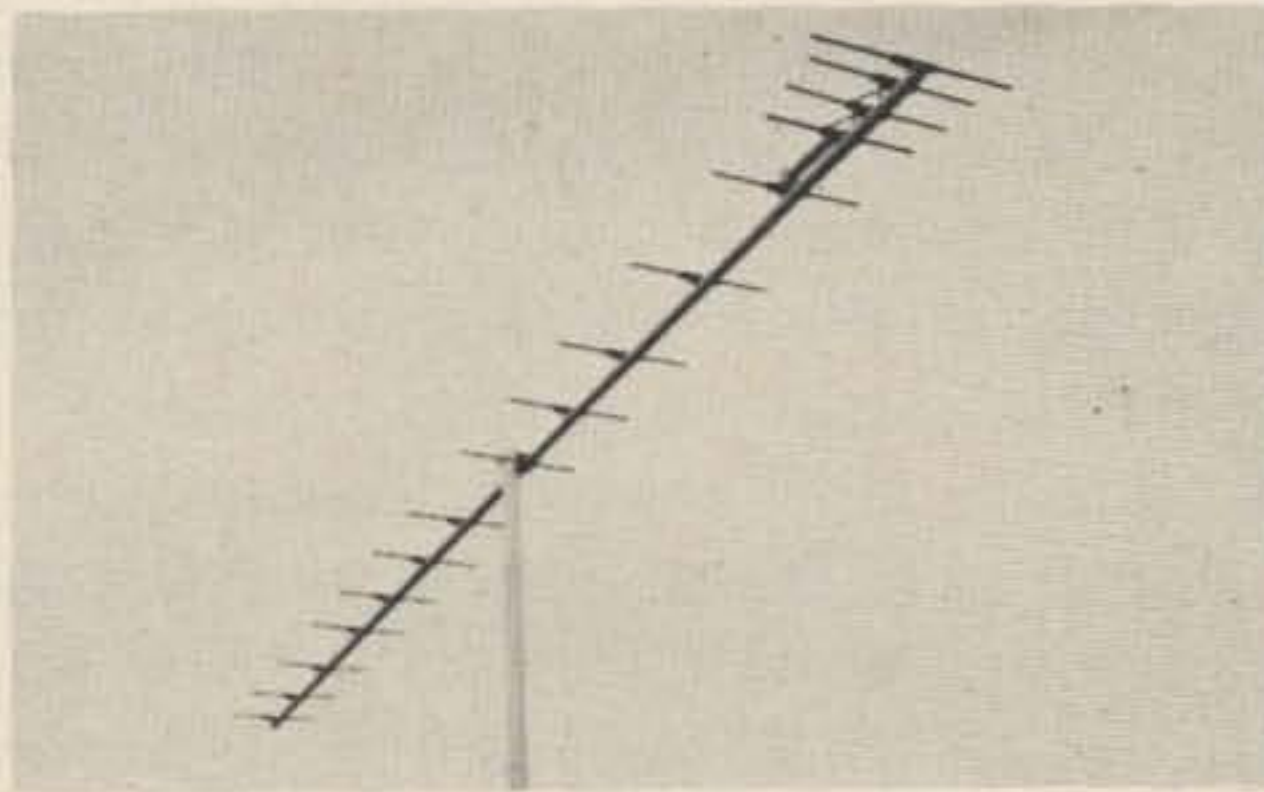

KLM ELECTRONICS

1600 Decker Avenue, San Martin CA 95046 408-683-4240

to explain. But first a word of caution: The following technical information is a matter of public knowledge and has been previously published in many places (see, for example, *Esquire* for October 1971 and *Ramparts* for June 1972 and October 1972.) Although you are free to read it and marvel at the perseverance of a group of blind kids *don't try to use it yourself*. The phone companies are very uptight about the following subjects and don't hesitate to prosecute anyone they catch using the techniques we're about to describe.

Sometime in the late sixties, a few blind kids interested in the phone company happened to meet at a camp for the blind. By pooling their knowledge and talents (excellent hearing and musical pitch, as well as lots of free time to experiment) they were able to develop a number of techniques for placing and receiving free long distance calls. Elated with their knowledge, they got great kicks out of routing their calls through foreign countries and even all around the world. Some of them even got to be quite famous — ever hear of Captain Crunch and his magic whistle, which just happened to whistle at 2600 Hz?

The simplest of their techniques involves the so-called black box, which allows you to receive free long-distance calls (calls for which the other party is not charged). It works like this:

When someone calls your number, the dial system connects his phone to your phone and then starts ringing your bell. If you had a way of coupling to your line *between the rings* in such a way that you didn't complete the dc circuit, you could actually talk to him without his being charged for the call, because as far as the CO is concerned, there is no dc connection and therefore there is no answer at your end.

Of course, the 90 volt ringing signal makes it tricky, because it can blow your eardrum out. Wouldn't it be nice if you could stop it? Then you could talk continuously. But we mentioned earlier that the call doesn't register unless it lasts a second or so. By picking up and then slamming down the regular telephone set as fast as possible (or having a ring-detector relay as in Fig. 7 with its n.o. contacts right across the line,

which puts a very fast short circuit across the line), you get the bell to stop! That's all there is to the Black Box.

Somewhere along the line, somebody came up with an even neater version: if a 10k resistor is placed in series with the phone, enough dc current passes through to provide talk current for the carbon mike, but not enough to trip the CO relays. A 1 μ F capacitor or so across the resistor is needed to let audio through, as well as an SPST switch to remove the resistor when not needed. On a 500 style telephone the extra capacitor is not even needed if the 10k resistor is placed between the F and RR terminal on the network (see Fig. 3) and the switch is placed in series with the pulsing contacts of the dial.

Before continuing, let us again stress the admonition that you not use any of these ideas — they are presented here only for your own information. As mentioned earlier, widespread usage of any of these techniques could cause havoc and the telephone companies are determined to catch any users as fast as possible. They are hard at work to develop equipment which would identify and trace such calls, and a number of people have already been prosecuted. For example, rumor has it that black boxes can be detected on calls longer than a minute or two in duration.

Another device is popularly called the Red Box. If you remember the old-style coin phones with three coin slots on top (nickel, dime, and quarter), you may remember the sounds they made when you dropped a coin in — two bells inside made a ding on a nickel, a ding-ding on a dime, and a bong on a quarter. Unfortunately, some unscrupulous individuals either looted a pay-phone and stole the bells, or tape-recorded the sound, and then used this to fool operators into thinking that calls were being paid for. To counter this, a new coin phone was designed which used an electronic oscillator, rather than a bell, to signal the type of coin inserted. When the oscillator is on, the earphone is muted so you can't hear it, and an electronic gizmo indicates to the operator how much money was inserted.

The Red Box is simply a 2.2 kHz oscillator, switched on and off electronically just

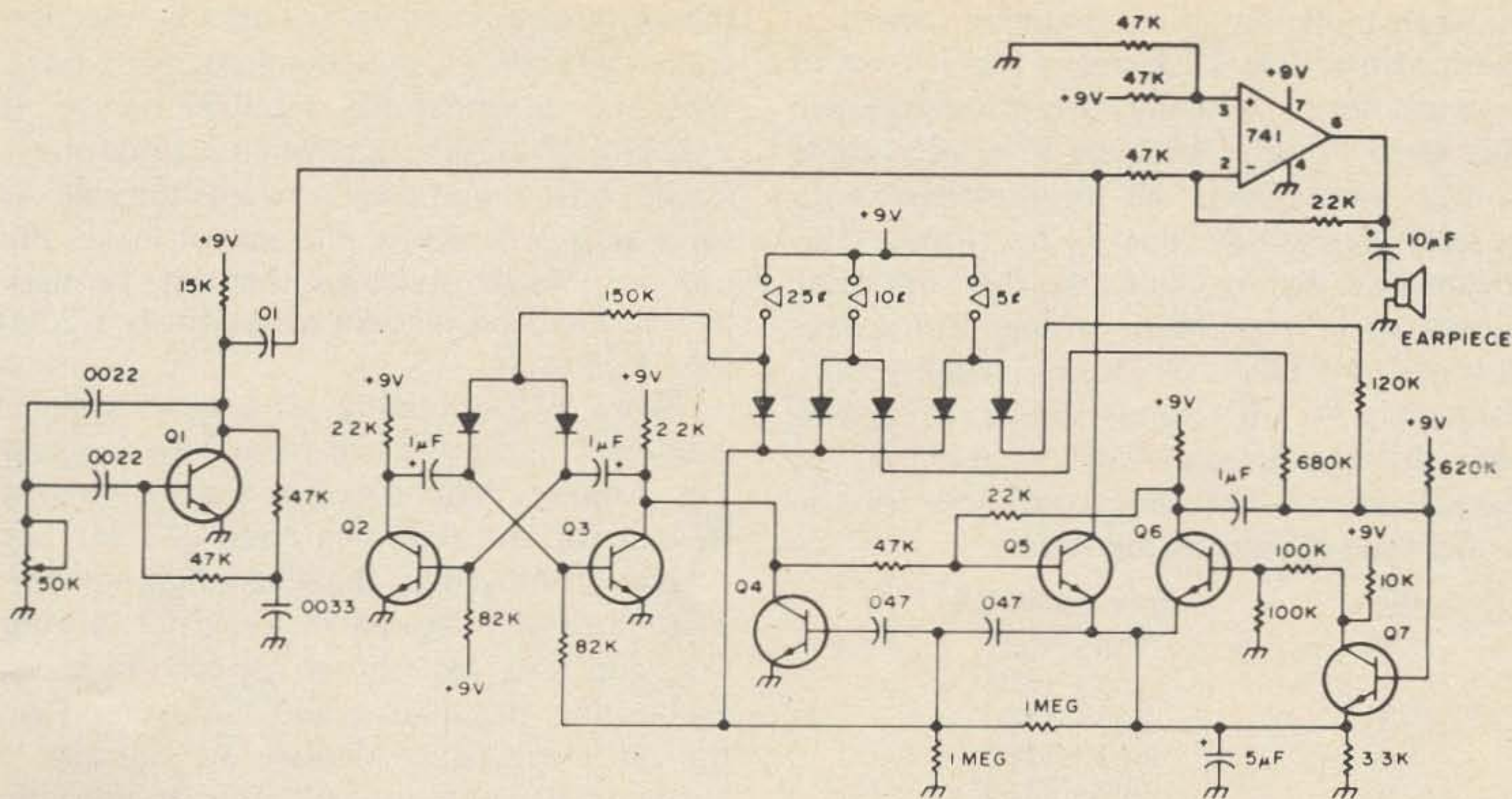

Fig. 13. Early version of the Red Box, circa 1972. Transistors are NPN silicon (2N2222 or HEP55), diodes 1N914 or similar, resistors $\frac{1}{4}$ Watt, 5%. Small capacitors are high quality mylar, epoxy, or polystyrene.

like the one in the payphone, with a small speaker to couple it to the mike. The pulses are coded as follows:

- Nickel — One 60 millisecond pulse;
- Dime — Two 60 ms pulses separated by 60 ms;
- Quarter — Five 35 ms pulses separated by 35 ms.

Some of the phone phreaks must be fairly knowledgeable about electronics as the Red Box circuits are reasonably modern — even using ICs.

Fig. 13 shows an early version of the Red Box. To see how it works, suppose the 10¢ button is pushed. This starts an astable multivibrator (Q2 and Q3), which feeds Q5, turning it on 60 ms, and off 60 ms. Q5 shorts the output of Q1, the 2.2 kHz oscillator, generating pulses of tone. Q6 and Q7 are a timer that lets exactly two of these pulses reach the IC, which feeds a speaker. True to form, the phone phreaks prefer to use a 600 Ohm earpiece (borrowed from a phone handset) rather than buying a speaker.

A later version, in Fig. 14, is quite a bit more sophisticated. IC1 is the timer, while IC2 is the astable.

The most famous (and most powerful as well as most dangerous) is the Blue Box. Because it goes to the heart of long distance

switching systems, let's talk about long distance calls for a while.

All the way at the beginning of this article, in Fig. 1, we showed your local CO as being connected to other local subscribers, other COs, and also to long distance switching centers; the latter are called "tandems."

There are many COs in any city, just as there are many tandems throughout the country. It would clearly be impractical for every CO to be connected directly to every other CO, and likewise it's not practical for every tandem to be connected directly to every other tandem. This means that in a few instances (such as over common routes — say, New York to Chicago) a long distance call may be routed directly from a tandem near New York to another tandem near Chicago. But many times a call may have to be routed through several tandems — Chicago to San Diego, for instance, might go through Los Angeles. Because of this, the tandems are so arranged that if they cannot route a call directly (either because all direct lines are busy, or else there are no direct lines) they simply route a call some more indirect way. Also, if a tandem office receives a call not intended for it, it just relays it on in the right direction.

Whenever there is a direct connection

between tandem offices, that may consist of many lines, carrying many simultaneous conversations. Actually, we shouldn't use the word "lines," because in reality these conversations may be multiplexed onto coaxial cables or microwave links. This means that dialing can't take the form of dc pulses, as in your home phone, but always consists of pairs of tones called multi-frequency or MF tones, similar to Touch-tone dialing. The only difference is that the frequencies are different from those used in Touchtone dialing, as follows:

Digit	Frequencies (Hz)
1	700 + 900
2	700 + 1100
3	900 + 1100
4	700 + 1300
5	900 + 1300
6	1100 + 1300
7	700 + 1500
8	900 + 1500
9	1100 + 1500
0	1300 + 1500

In addition, 3 additional signals are:

KP (Key Pulses)	1100 + 1700
ST (start)	1500 + 1700
Disconnect	2600

Another aspect to keep in mind is that it takes quite a bit of equipment to establish a connection, but little equipment is needed to maintain it. To avoid useless duplication,

the equipment used to set up a connection (called a sender) is shared among many lines. Whenever a sender has a call to handle, it searches for an idle line; when it finds one it latches onto it and then forwards the call. As soon as it is finished, the sender leaves the call and goes to service another call. To mark an idle line, the tandem office feeds a 2600 Hz tone into it.

Now let's examine a typical call — suppose you place a call from New York to Los Angeles. You pick up your phone in New York and dial area code 213 for Los Angeles, followed by the seven-digit number. That number is stored in a register in your CO, and now two things happen. First, an accounting machine called CAMA — Centralized Automatic Message Accounting — keeps track of your call. This is done by punching your number, the time, and the number you dialed into a paper tape (which will later be fed to a computer). Your CO now sets up a connection with the nearest tandem office and sends the area code and number you dialed to the tandem. In the tandem a sender decides on the route, and starts looking for an idle line. Suppose there is an idle direct connection from this tandem to the one in L.A. Since this line can be used for calls in either direction, both tandems are marking it as idle by feeding 2600 Hz

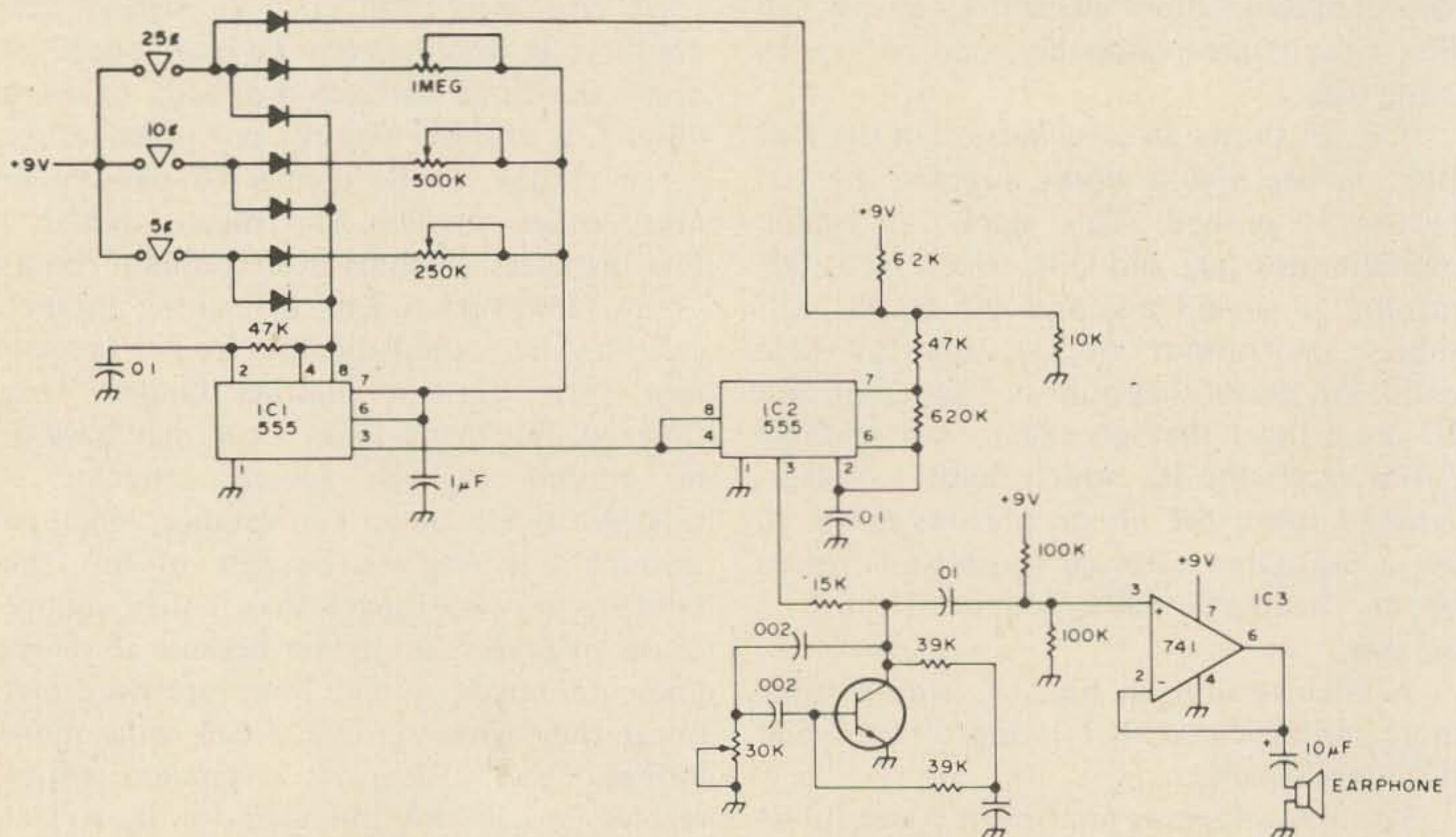

Fig. 14. Later version of the Red Box, circa 1973.



TPL
RF power amplifiers
may cost
a little more
...but
they're worth a
lot more

Even with thousands of amplifiers in use, our one man repair department spends no more than four hours each week doing repairs and modifications. . . the rest of his time is spent making sure the amplifiers that are shipped won't come back for him to repair.

Because of our extra attention to quality control our amplifiers are specified by more government agencies and private organizations than any other product of its type.

Our product line is the only one chosen by many major two-way radio manufacturers for use with their products.

Our Quality Control department rejects almost as many parts as they accept.

Our engineering staff not only designed our products, but also were instrumental in the development of RF Power Transistors.

The TPL package has been imitated by many competitors, BUT NEVER DUPLICATED, because it costs more to make a quality product.

For prices and specifications please write for our Amateur Products Summary.

FCC type accepted power amplifiers also available. Please call or write for a copy of TPL's Commercial Products Summary.

TPL puts more in. . .so you'll get more out!

talk
power
by **TPL**

COMMUNICATIONS INC.

13125 YUKON AVENUE / HAWTHORNE, CALIF. 90250 / (213) 679-0131

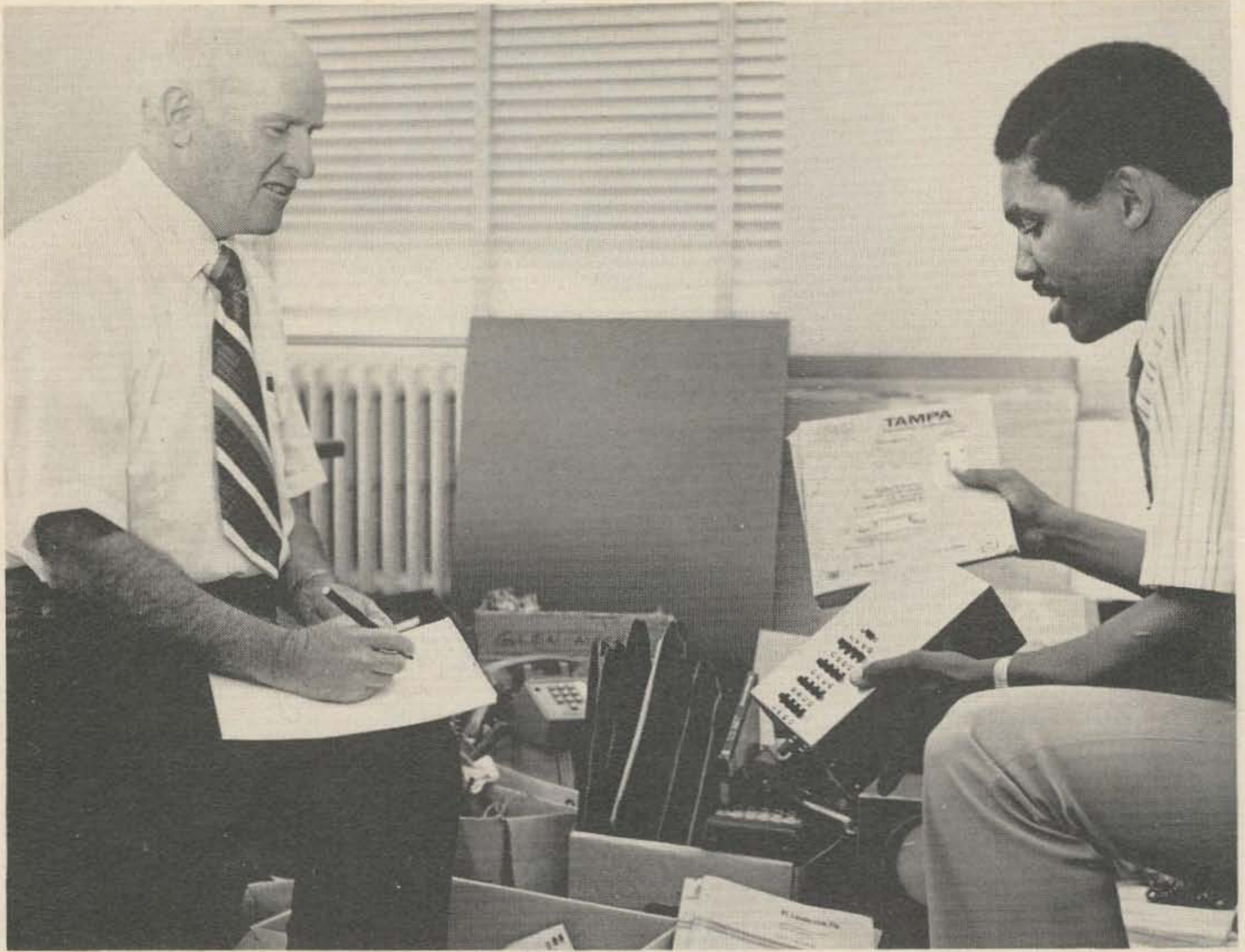

Chester County (Pa.) Detective Ronald Johnson (right) displays an illegal "Blue Box" used to bypass toll charges and seize long distance telephone circuits. Johnson and Chief of County Detectives Eugene Sharpe (left) were part of a law enforcement team which raided several Chester County residences of suspected "phone phreaks." Four persons were arrested in connection with charges ranging from toll fraud to impersonation of telephone company employees and, in one case, wiretapping. Authorities said "several carloads" of illegal equipment were confiscated, some of which is shown here.

into it, one from each end.

Now the sender finds this idle line. First, to prevent L.A. from trying to send a call in the opposite direction at the same time, the New York sender removes its 2600 Hz tone. This tells L.A. that a call is about to come on this line, and so L.A. assigns an incoming sender to it. The New York sender sends the 213 area code and the 7-digit number to L.A., using the MF (multi-frequency) tones described earlier. The code is preceded by the KP tones, and followed by the ST tones. The LA tandem office decodes the tones and, in this case, connects you to the CO serving the party you dialed. The CO now decodes the last four digits of the number, connects you to the proper line, and starts ringing it.

When the other party answers, the ringing stops and a signal is sent all the way back to your CO to indicate that the call has reached its destination. This too is punched into the CAMA paper tape.

If you hang up first, your CO of course knows this immediately. On the other hand, if the party hangs up first, a signal has to be sent back to your CO. The L.A. CO notifies the L.A. tandem, the L.A. tandem puts 2600 Hz back on the line to signify a disconnect, the New York tandem gets the tone and breaks the connection, and notifies your CO. If you listen carefully, you may hear a short burst of 2600 Hz just before the connection is broken at your end.

At this point your CO again punches your number, the time and the number you dialed

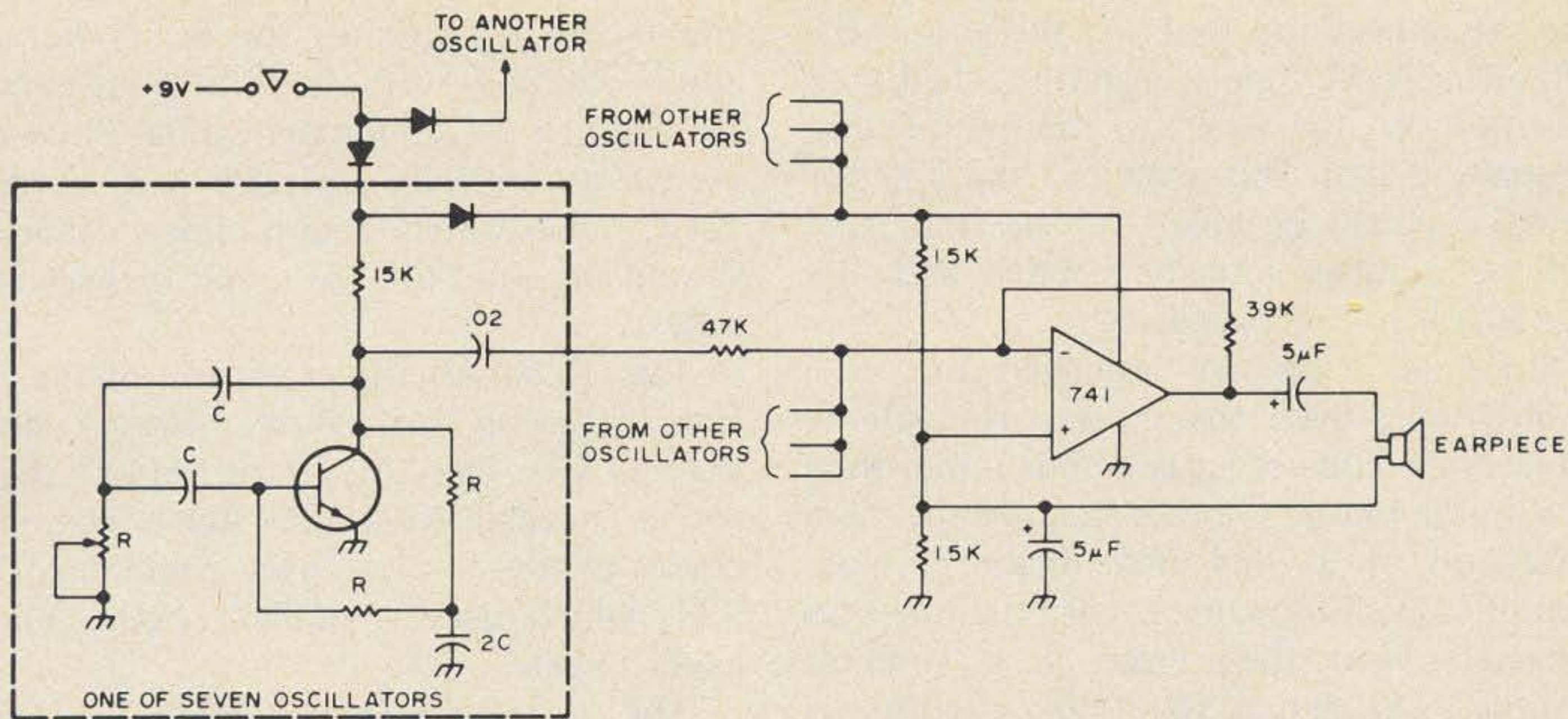

Fig. 15. Early version of the Blue Box, circa 1972. Seven identical oscillators are needed.

into paper tape. Once a day this tape is sent to the computer, which then reads the tape and eventually uses it to prepare the bill.

The CAMA tape runs on every call, even calls on which there is no answer, or which are free (such as information calls or calls to area code 800). It's up to the computer to decide at the end of the month what to bill and how much. This, by the way, is one way to detect black, blue and red boxes since a record is kept of all calls and the computer can be programmed to look for any suspicious calls.

Now, where does the Blue Box fit into the story? The Blue Box is just a box with thirteen buttons and the oscillators to generate the MF tones — 0 through 9, KP, ST and 2600 Hz disconnect. These tones are acoustically coupled from the Blue Box into the mike of the phone. With it the phone phreak can use the toll circuits to place calls anywhere in the world without charge. With enough knowledge of the system he can route himself via a specific path and can even choose whether he will go via cable or satellite. Some phone phreaks delight in sitting in a phone booth and routing a call to the very next booth all the way around the whole globe; then they talk to themselves and enjoy the fact that their voice is delayed by having to travel all the way around the world.

The procedure for using the Blue Box is simple. You start by placing a long distance call in the normal way either to a free number (information or a valid 800 series

number) or else to a close-by destination which is cheap to call. This is the call which will appear on the CAMA tape. Since a long call to information or to a non-existent number is suspicious, dedicated phone phreaks usually make sure to use a valid 800 number or, if not too stingy (or stubborn), even a paid call to a nearby place.

Once dialing is completed, your nearby tandem routes the call to the tandem office at the destination, possibly through intermediate tandems along the way. As soon as you hear ringing from the other end, you feed 2600 Hz into your phone for one second.

Your local CO is unaccustomed to getting 2600 Hz and so simply ignores it, but passes it on to the nearby tandem.

This tandem can recognize 2600 Hz as a disconnect idle from other tandems, but is not built to react to the signal coming from a CO. So it ignores it and passes it on. But the *next* tandem, thinking you hung up, cancels the call. This leaves you hanging, still connected to a toll line between tandems. After one second of 2600 Hz, you remove it. The distant tandem now sees that the line is no longer idle, and so it connects an incoming sender. As soon as you hear the click signifying this, you have ten seconds to dial the desired number, preceded by KP and followed by ST. For example, to call (603) 924-3873 you would press KP6039243873ST.

When the number answers, a signal is sent back and the CAMA tape punched to indi-

cate the connection time. At the end of the call, the CAMA tape is again punched with your number, the time and the number you originally dialed. This is the call and time for which you will be billed (unless it is free) and the number actually reached with the Blue Box is not recorded.

Since all calls are punched into the CAMA tape, even the most daring phone phreakers would use a pay phone rather than their home phone. Moreover, since the mere possession of a Blue Box might be considered suspicious, some record the tones on a cassette and then erase it as soon as possible. The actual Blue Box circuitry is interesting not only for the insight into the technical competence of the phone phreaks, but also because with just a retuning, it can be used for Touchtone generation.

Fig. 15 shows an early version of a Blue Box, where each tone is generated by a separate one-transistor oscillator. There would be a total of 7 oscillators and 13 push-buttons, with each push-button (except the 2600 Hz disconnect/idle button) feeding two oscillators, through a diode.

The Twin-Tee oscillators generate a relatively clean sine wave, but some juggling of values is needed. The oscillation frequency is

$$f = \frac{1}{2\pi RC}$$

where the best values for R are between about 30k and 100k. In all of these circuits, see Fig. 15 for component data. Since disk capacitors are very unstable with temperature, frequency-determining capacitors should be good quality mylar or preferably polystyrene.

Fig. 16 shows a later version of the Blue Box, showing real state-of-the-art design with all ICs. The LM100 (or LM300) regulator is needed to assure stable frequency characteristics — my own preference is a 723, which uses a similar circuit, and is easier to get.

The use of the Intersil 8038CC shows a good knowledge of the field by whoever designed this circuit in late '73 or early '74. The uninitiated wouldn't know about this new ultra-stable IC which, unlike the 566 or other popular oscillator ICs, generates a very low-distortion sine wave. Only two oscillators are needed, as the switches and diodes select different pots for different tones. Although most Blue Boxes seem to use plain push-buttons, Chomerics makes nice switches which are suitable.

Just to give you an idea of the power of the Blue Box, here are some numbers and destinations that have been published in various places:

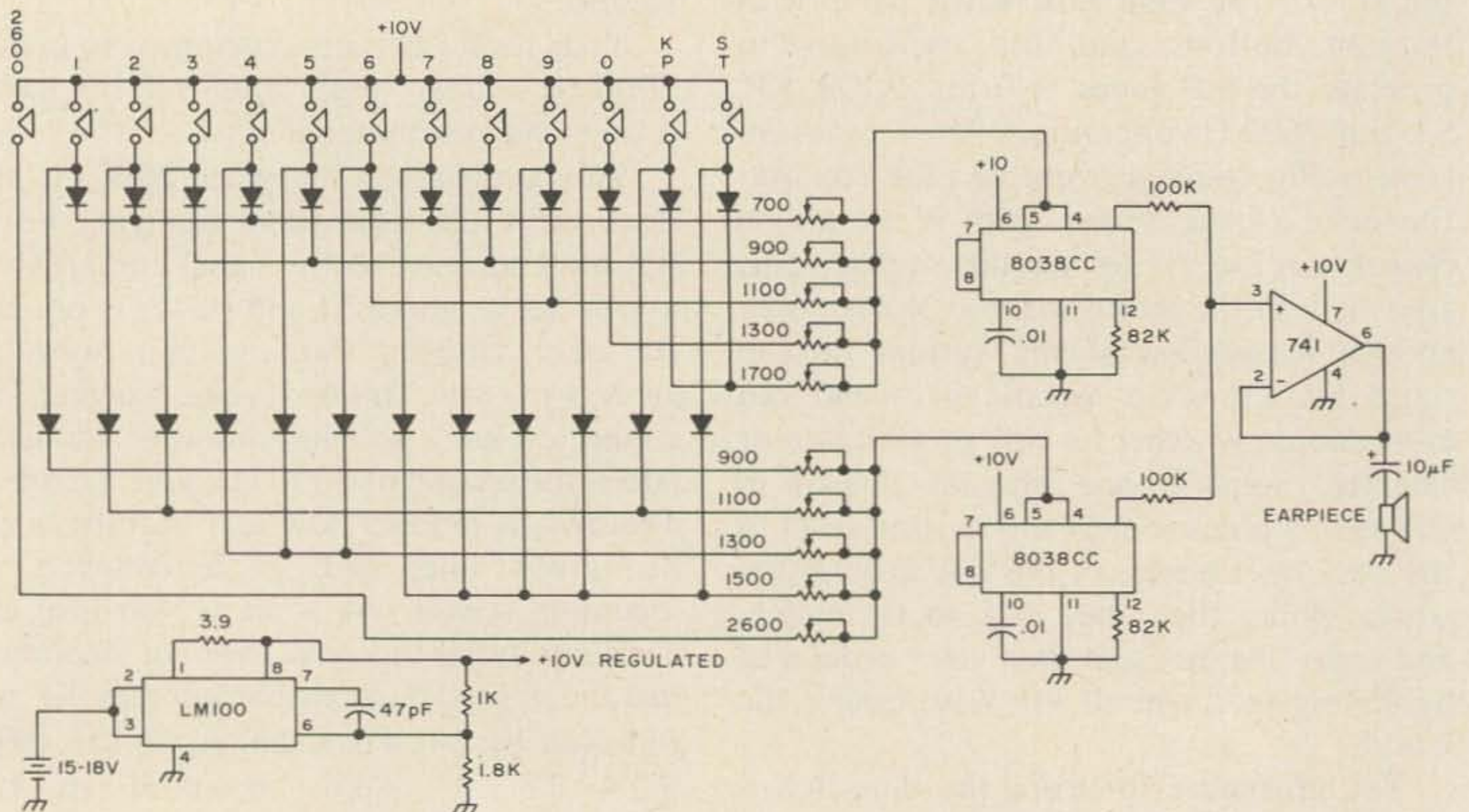

Fig. 16. Later version of the Blue Box, circa 1974. The pots are 25k; .01 uF capacitors are mylar or polystyrene.

Mobile Amplifiers With Versatility

220 MHz

- 10 W in - 60 W out
- 9 dB linear gain
- Under 1 dB Rx (0.7 dB typ.)

Model #113M 10-60L

144 MHz

- 10 W in - 70 W out
- 10 dB linear gain
- Under 1 dB Rx (0.6 dB typ.)

Model #2M 10-70L

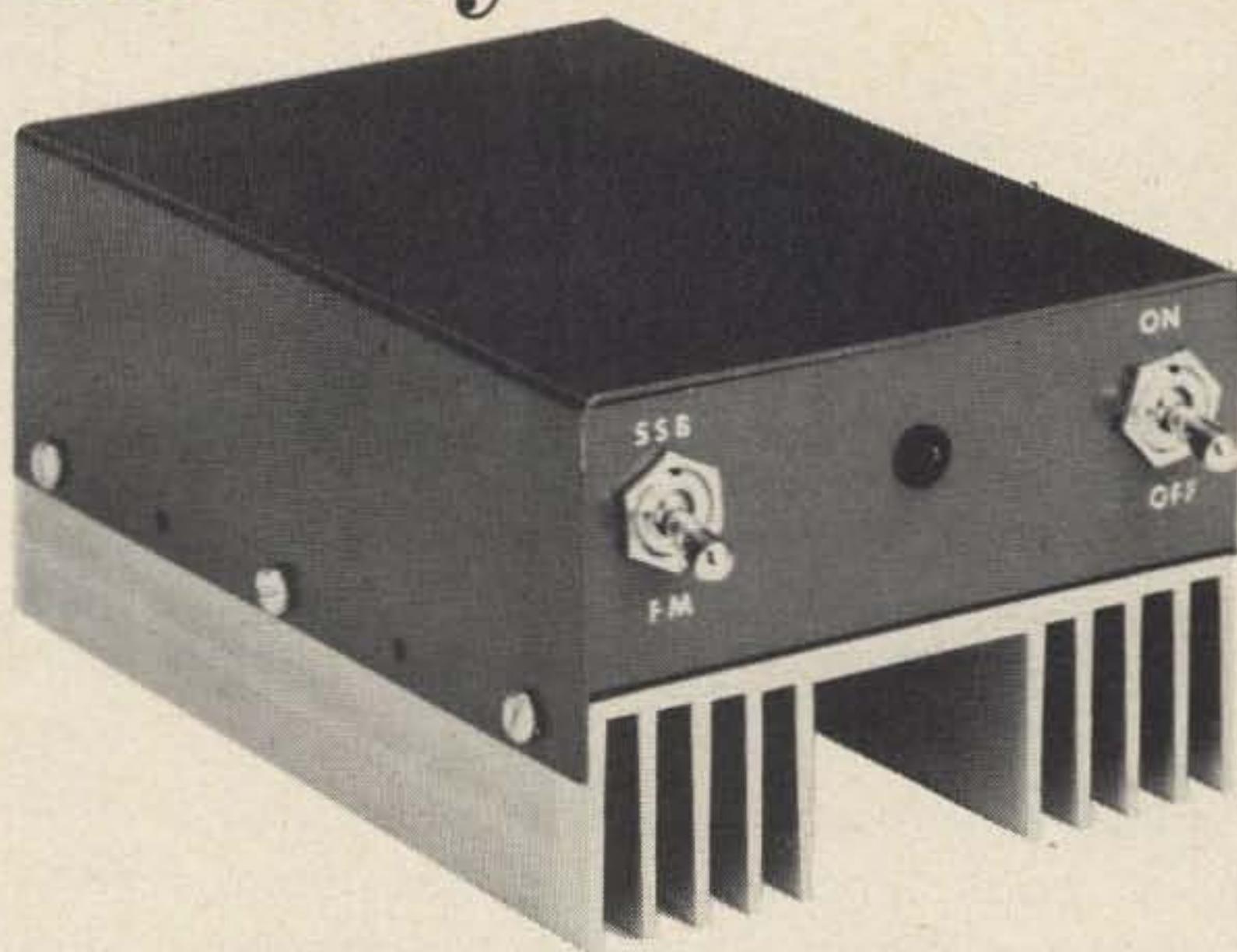

- Both Amps:
- Fully VSWR & reverse voltage protected
 - No tuning required across band
 - Switchable Class C or AB operation
 - Built-in TR switching, w/increased delay for SSB
 - Fully compatible with all 1-10W FM/SSB/AM/CW rigs
 - All solid-state and microstrip construction
 - 432 MHz 1W in - 10W out

*See your local dealer, or write for further information
Dealer inquiries desired*

Dealers

Vegas Radio
1108 S. 3rd
Las Vegas NV 89101

Discount Electronic Supply
Dept M-1, 99 Asylum Ave.
Hartford CT 06105

Gary Radio Inc.
8199 Clairmont Mesa
San Diego CA 92105

SPECIALTY COMMUNICATIONS SYSTEMS

4519 Narragansett Ave., San Diego CA 92107

Louis N. Anciaux WB6NMT, Proprietor

TUFTs

"New England's Friendliest Ham Store"

INVITES YOU TO SEE THE ABOVE LINE

TUFTS Radio Electronics
386 Main St., Medford, Mass. 02155

London weather: KP 044 1 246 8091 ST
Sidney, Australia weather: KP 061 3 6064 ST
Sidney time: KP 061 2 2074 ST

The digits 044 or 061 in the above numbers are the country codes agreed on by the CCITT; further information on country codes, Blue Box tone frequencies, etc., is published in Chapter 2 of *Reference Data for Radio Engineers* (Howard W. Sams) as well as in an underground (and sometimes nasty and violent) newsletter called TAP (\$2 for a one-year subscription from TAP, Room 504, 152 West 42 Street, New York NY 10036).

Further information may be obtained from a book entitled *Basic Telephone Switching Systems* by David Talley (Hayden Book Company), *Communications System Engineering Handbook* edited by D. Hamsher (McGraw-Hill Book Company) and various telephone company periodicals. *The Bell System Technical Journal* should be available in most engineering college libraries, and carries a lot of abstract and mathematical articles as well as some fairly practical descriptions. For example, the November 1960 issue has an article on "Signaling Systems for Control of Telephone Switching." A much more readable publication is the *GTE Lenkurt Demodulator* (GTE Lenkurt, 1105 Country Road, San Carlos CA 94070) which is a monthly magazine available free to people working in the communications field or in schools.

The GTE equivalent of the Bell Systems Practices is called the General System Practices, and may just possibly be available locally or from GTE Automatic Electric Inc., Northlake, Illinois. You may also be able to get your hands on a mail-order course offered some years ago by Don Britton Enterprises in Hawaii. A new book, *How to Cut Costs and Improve Service of Your Telephone, Telex, TWX and Other Telecommunications* by Frank Griesinger (McGraw-Hill) and a monthly magazine called "Communications News" are other possible sources.

In closing, I would again like to caution readers that the telephone companies do their best to "discourage" the use of the

various colored boxes described in this article; the information presented here has been written only for your own information and entertainment, not as a guide for construction or use.

(AUTHOR'S NOTE: Some time after this article was written, AT&T, in response to a complaint lodged with the FCC by Phone-Mate Corp., a large manufacturer of telephone answering machines, made a concession in its insistence on the use of a coupler with an answering machine. It applies *only* to telephone answering machines though. For a fee, the Bell System will license the answering machine manufacturer to build and install a coupler directly into the answering machine, using a design developed by Bell System engineers. The coupler consists of several transistors, resistors and capacitors, limiting diodes, a relay, and a three-winding transformer, and is estimated to cost less than \$20 to build. It is basically a receive-only coupler which prevents the answering machine from dialing outgoing calls. Although further details haven't been released at the time of writing, it doesn't look as though the answering machine manufacturers will be making these couplers separately for updating older machines, and there seem to be quite a few strings attached.)

(SECOND AUTHOR'S NOTE: Gradually, more details are coming out about the strings attached to the coupler offer to answering machine manufacturers. AT&T will consider only inquiries from actual manufacturers, who must submit a \$1000 non-refundable "inspection fee," for which AT&T will send a team to inspect the manufacturer's factory to determine whether he is "qualified" to manufacture the coupler. Only if he passes, will AT&T discuss the price with him, apparently on a take-it-or-leave-it basis. The coupler design appears to be more complicated than was announced originally, and includes an opto-electronic coupler — neon bulb/photocell combination — to detect ringing, similar to the circuit on page 31 of the April 1974 issue of 73 Magazine. Only time will tell how many answering machine manufacturers will decide to gamble the \$1000 on such a basis.)

... WHIPPLE

Dirt Cheap Tunable I-F for Converters

Having a 6 meter Tunaverter and having tried it with various small transistor radios, I thought there had to be something better. I began to look for a used solid state auto radio that was small and cheap! I was lucky — I found two that were made for foreign cars (one was a Motorola and the other was a Peptone, which I understand Volkswagen uses) and they cost \$6 for the two. One had a broken plastic dial shaft (which epoxy cured) and the other was just dirty.

I saw a picture of a set-up where a ham mounted a car radio and converter in a cabinet, making a VHF solid state radio, but he was using it as it was. I chose the Motorola to change. Be sure to check out your radio before any changes and make repairs if needed. As is, they are much too hard on batteries (even small cads, where you have a transistor transmitter and modulator working from the same supply); the power stage alone, according to service records, draws 350 mA. Still want to buy dry batteries?

I took the cheap way out. I had a partly stripped AM/FM radio and I took a hacksaw and cut the push-pull audio section out, repaired the broken (sawed) connections, soldered leads to it and mounted it in the radio where the original output transformer had been located. Mine had a positive ground, so I had to insulate it from the chassis by fiber washers.

The emitter's resistor was originally 2Ω , but the transistors heated up using 12 volts, so I broke the lead and added a $1/2W$ 5Ω resistor and all was well. My heatsinks (until

I can get some to fit TO-1 case) are short lengths of sawed off acid brush, with silicon grease. Plain old iron!

Fig. 1 shows the original circuit of the car radio and Fig. 2 shows what I used. When you remove the input, output transformers, the power transistor and the resistors and bias pot associated with it, make a diagram and put it with the parts, as you may want to make a 12 volt one or two watt amplifier someday and you have already got all the output section.

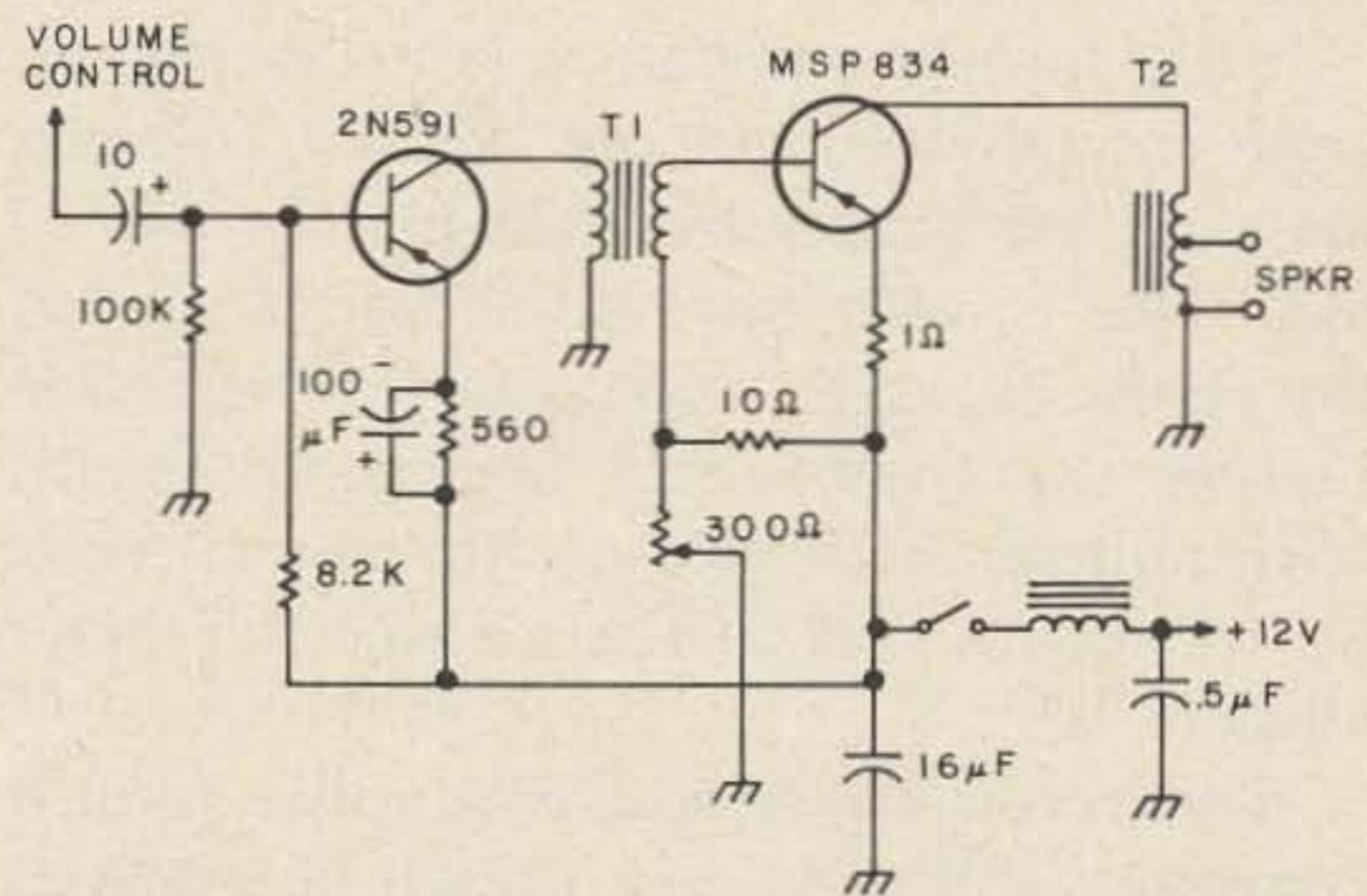

Fig. 1. Basic audio before change.

Fig. 3 shows an output you may use (from GE Transistor Manual). You can use RCA SK3004s or any transistor that they replace (see SK sub-booklet from any RCA dealer), as there are many, many types. Notice that the SK3005 is for 9 volt service while the SK3004 is used up to 15 volts. The booklet should be in every ham shack anyway!

If you use the power stage from a 9 volt radio, be sure to heat sink the transistors

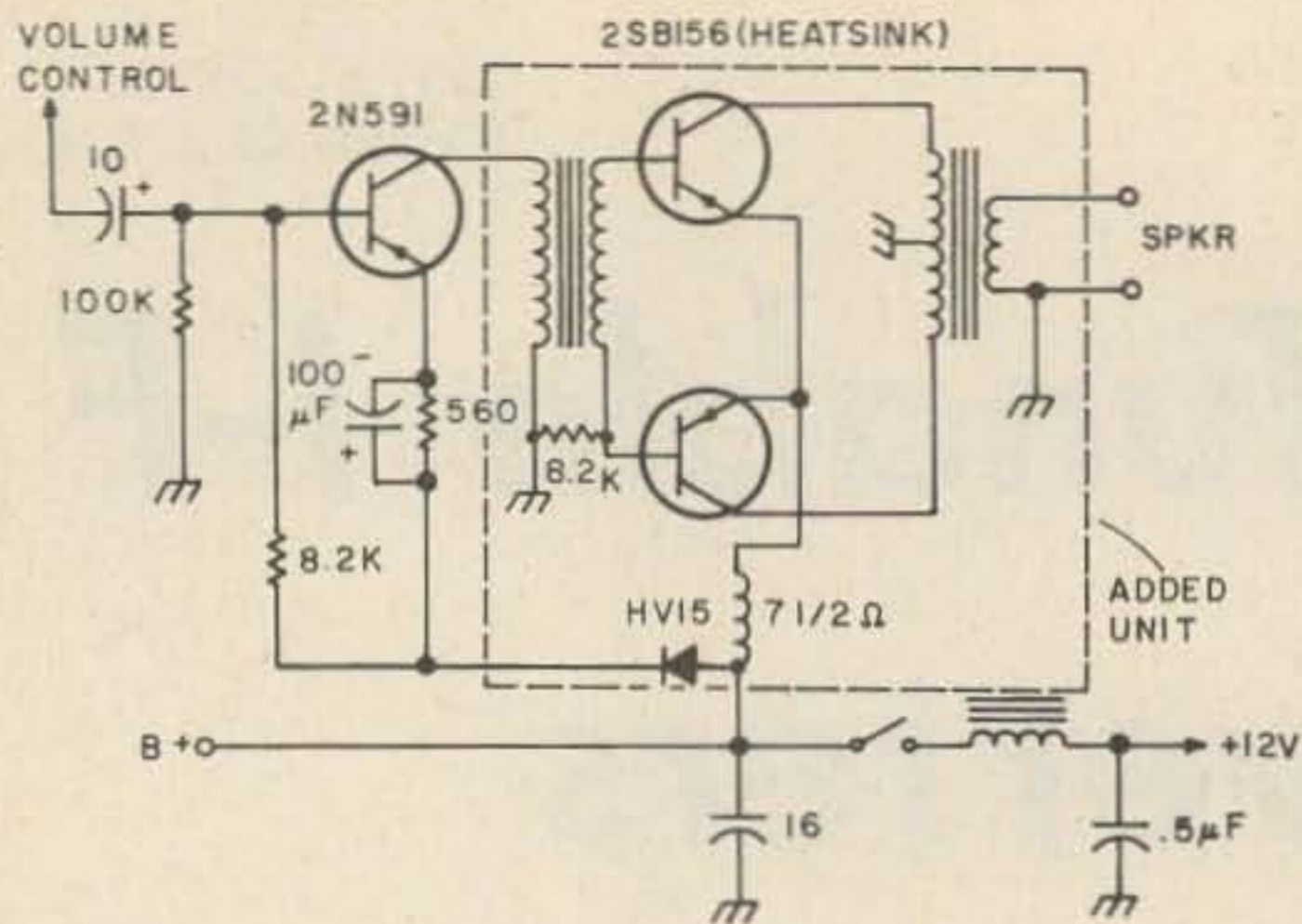

Fig. 2. Audio used in radio after change.

and raise the emitter resistor value at least two times.

Results

The auto radio is well shielded and *does not* have the pickup of BC stations an unshielded loop antenna radio has. That is a big improvement. No. 2 is that the auto radio has a tuned rf stage ahead of the mixer, better agc action and no pulling of the oscillator when a strong signal is received.

Another big improvement is battery saving. Remember that old power stage took 350 mA alone!

With the set on and volume turned up loud enough to hear and with a 100 mA meter in the supply lead, the meter reads 20 mA. This is with the volume control set so the class B stage makes little noticeable flickers (loud enough to hear signals well). With normal room volume the meter swings up to 40 mA and at full volume the meter kicks to 45 mA.

Tunaverters makes 6, 2, SW, police and CB converters (tunable and crystal controlled) which are a natural for this set-up as they use a 1500 kHz i-f. I have this set-up for 6. Now I am 100% solid state.

This is also a natural for those of you who want to home brew a converter from SW ham bands to VHF. You could never build a radio cheaper that equals this.

Remember while using a converter that you have a double conversion receiver. The first i-f is at 1500 kHz (or any frequency you choose in the BC band) and a second i-f of 262 kHz. You may want an S-meter. I have not tried that yet. I may try an expanded milliammeter using a zener diode

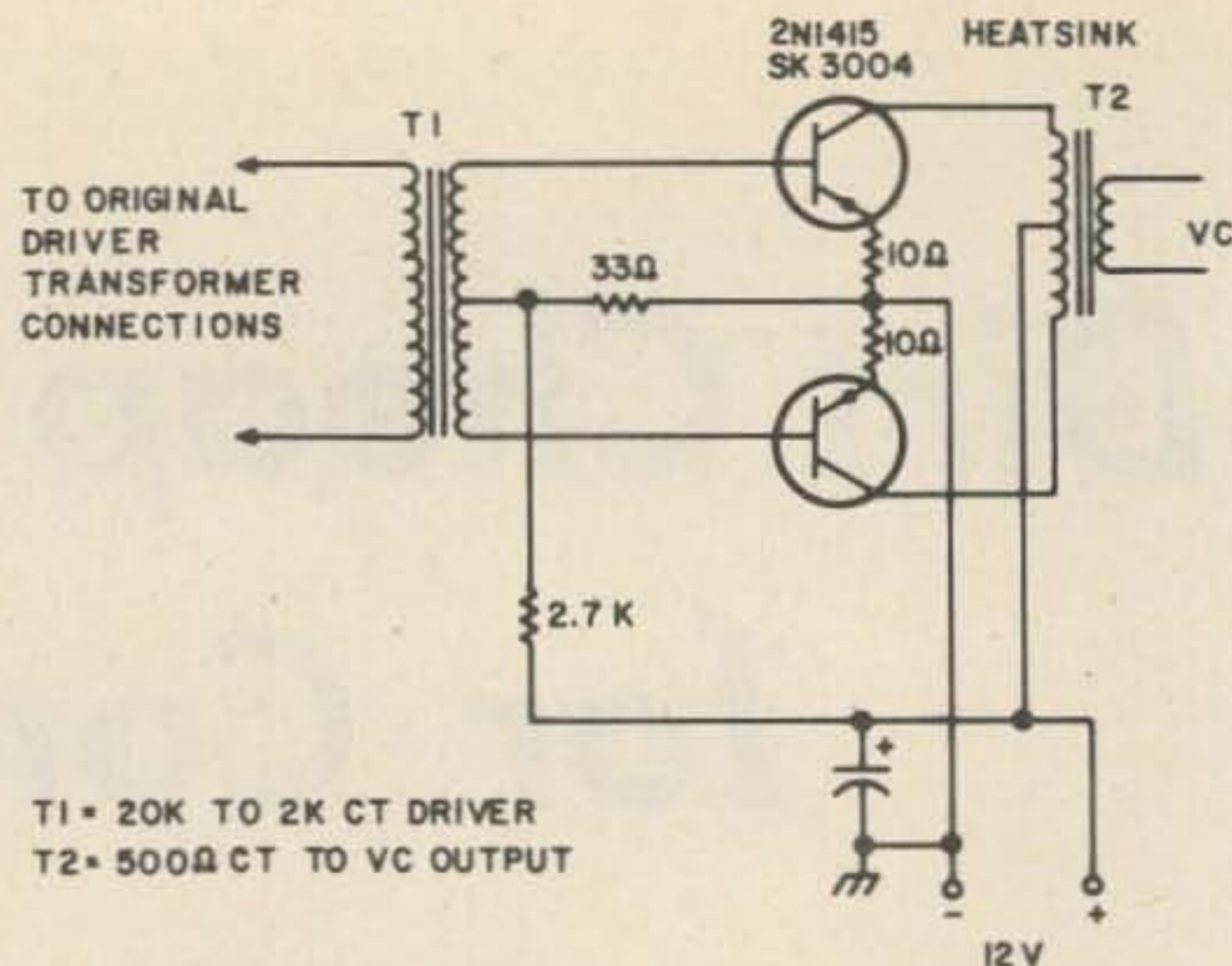

Fig. 3.

so the meter won't read transistor current (rf or i-f or both stages) without a signal, but most likely will build a small transistor version of a VTVM and connect it to the agc or output of the diode detector, whichever works best. Any meter connected to circuits would load too much, although you might try to take a 0-50 μ A meter and with 100,000 Ω resistor (makes a 0-5 volt meter) connect it to the diode detector. This value won't load the 5-25K diode circuit very much.

I disconnected the pilot light to save a few hundred miles of battery power.

If you can, get a diagram of your radio. If you go my route, most transistor radios (older ones anyway) use a positive ground, so the power unit will have to be insulated from the chassis. Check this over and plan before you start cutting. It can save you a lot of grief later.

Some radios may have a feedback loop from one side of voice coil winding back to the emitter of the driver (or somewhere in the first audio section). If you connect this up to the "new" output and get a howl, don't panic, just solder that voice coil lead to ground and lift the other from ground and connect the feedback loop to this (merely reversing voice coil leads and reversing phase 180 degrees). The feedback loop is sort of a bass boost and is desirable if you have it.

Since the Tunaverters' older line is selling cheaply, I plan to have six, two, police and WWV, with a band switch to switch in the converters and power. As portable, I intend to use a nicad battery, and at home base use a well regulated power supply. . . .KØVQY

TEN-TEC

The TEN-TEC Argonaut and LINEAR AMPLIFIER

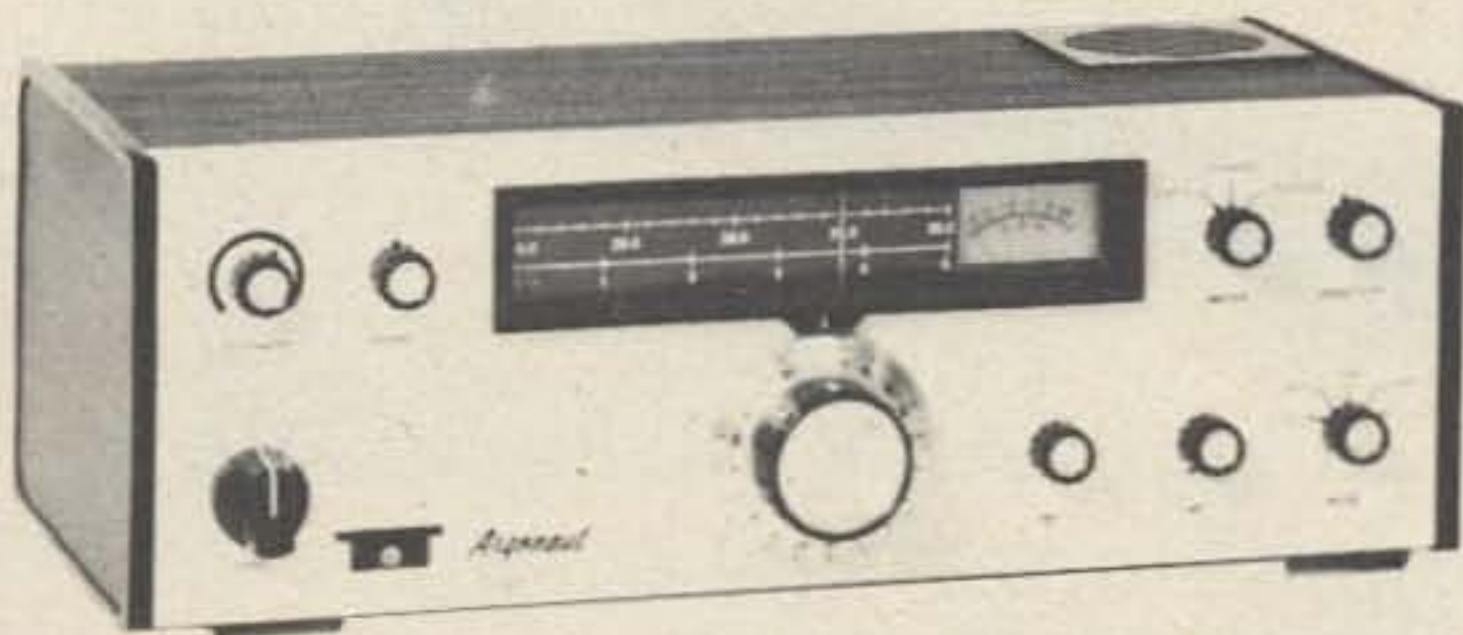

Argonaut

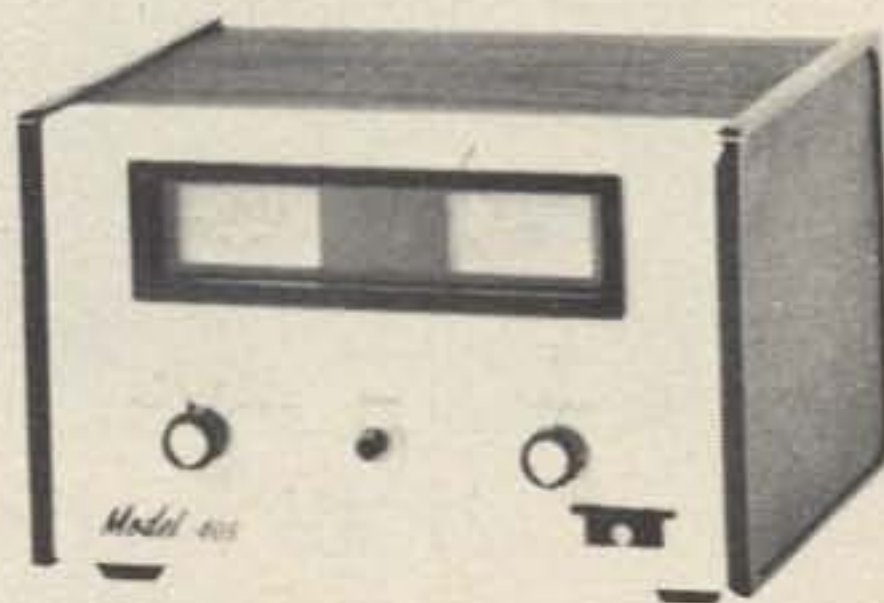

Model 405 Linear

SPECIFICATIONS

ARGONAUT, MODEL 505

GENERAL: Covers all Amateur bands 10-80 meters. 9 MHz crystal filter. 2.5 kHz bandwidth. 1.7 shape factor @ 6/50 dB points. Automatic sideband selection, reversible. Solid state design. Permeability tuned circuits. Seven plug-in circuit boards. Direct frequency readout. Vernier tuning. Dial accuracy ± 5 kHz (slightly more at 10 meters). Drift less than 100 Hz. Power required 12-15 VDC @ 150 mA receive, 800 mA transmit at rated output. Construction: aluminum chassis, top and front panel, molded plastic end panels. Cream front panel, walnut vinyl top and end trim. Size: HWD 4½" x 13" x 7". Weight 6 lbs.

RECEIVER: Sensitivity less than ½ μ V for 10 dB S+N/N. "S" meter. AGC. Offset tuning. Tuned MOSFET RF amplifier and mixer. Audio distortion less than 2%. Internal speaker. Headphone/external speaker jack.

TRANSMITTER: 5 watts input power. Broad band final amplifier eliminates tuning. 50-75 ohms output impedance. Press-to-talk. Instant CW break-in. SWR bridge. Integral TVI filter. CW sidetone. Integrated circuit balanced modulator. Automatic CW offset of approximately 700 Hz. Shaped keying.

LINEAR AMPLIFIER, MODEL 405

Covers all Amateur bands 10-80 meters. 50 watts output power, continuous sine wave. Broad band design eliminates tuning. Less than 2 watts of drive required. RF wattmeter. SWR meter. Exciter actuated antenna changeover. Front panel T/R time delay control. Individual band-switched low pass filters. TVI filter. Two plug-in circuit boards. Computer estimated life of output transistors 25.7 years. Power required 12-15 VDC @ 8 A, max. Construction: aluminum chassis, top and front panel, molded plastic side panels. Cream front panel, walnut vinyl top and end trim. Size: HWD 4½" x 7" x 8". Weight 2½ lbs.

TUFTS

Radio Electronics

386 Main St., Medford, Mass. 02155

617-395-8280

NEW ENGLAND'S EXCLUSIVE DEALER

MORE MEMORIES THAN AN



DOES ANY OTHER MORSE CODE KEYBOARD
HAVE ALL THESE FEATURES?

- ▣ Programmable Memory right on the Keyboard
- ▣ Running Memory lets you Type up to 72 Characters Ahead
- ▣ Variable Speed from 6 to 35 WPM
- ▣ Memory Overload Indicator (LED)
- ▣ 48 Hour Burn-In Prior to Shipment
- ▣ Space Bar is used for Word Spacing
- ▣ Computer Grade Switches and Keytops
- ▣ Cooling Fan to Assure Long Component Life
- ▣ 110 VAC Operated with Built-In Audio Monitor
- ▣ Double Sided-Plated Thru- G10 Glass Printed Circuit Board
- ▣ Black Naugahyde Finish on Metal Case with Walnut End Plates

ORDERING INFORMATION		
MODEL	PROGRAMMABLE MEMORY INCLUDED	PRICE
TS-172	One	\$369.95
TS-272	Two	\$389.95
TS-372	Three	\$409.95
TS-472	Four	\$429.95
TS-572	Five	\$449.95
TS-672	Six	\$469.95



TELSTAR ENTERPRISES
P. O. Box 235
Spokane, Washington 99215

- Enclosed is \$ _____
- Charge Master Charge # _____
- Charge BankAmericard # _____
- Send Free Brochure

Call Letters _____

Name _____

Address _____

City/State/Zip _____

Bill Hoisington K1CLL
 c/o 73 Magazine
 Peterborough NH 03458

6m IC Rx

This article describes design methods and a working breadboard example of a foundation receiver for 6 meters using ICs for the rf, i-f and af, and tuning from 50 to 54 MHz. The rf, i-f and af are in individual sections and many things can be learned about VHF receivers by working with this concept, starting with single conversion.

Front-end sensitivity, noise and stability, suitable ICs, i-f selectivity, gain and avc, are among the parameters that can be adjusted separately in this basic receiver. It is an interesting low cost piece of equipment to have around for monitoring 6 meters in your area, checking crystals, etc.

Fig. 1, the block diagram, shows the concept of separating the three different ICs, which allows testing and comparison of various kinds of ICs. This can be important today, especially in the rf and i-f range where those tiny little integrated circuits become more fussy frequency-wise than when used in computers.

The rf section, shown in Fig. 2, uses the Motorola HEP 590, an IC which has interesting parameters against which other ICs and transistor stages can be compared. The main features of the HEP 590 are some 30dB of gain and no self-oscillation.

Where tunable peaking is used as in this basic circuit, there is one trouble you could encounter. Putting the input and output tuning capacitors C1 and C2 on the same

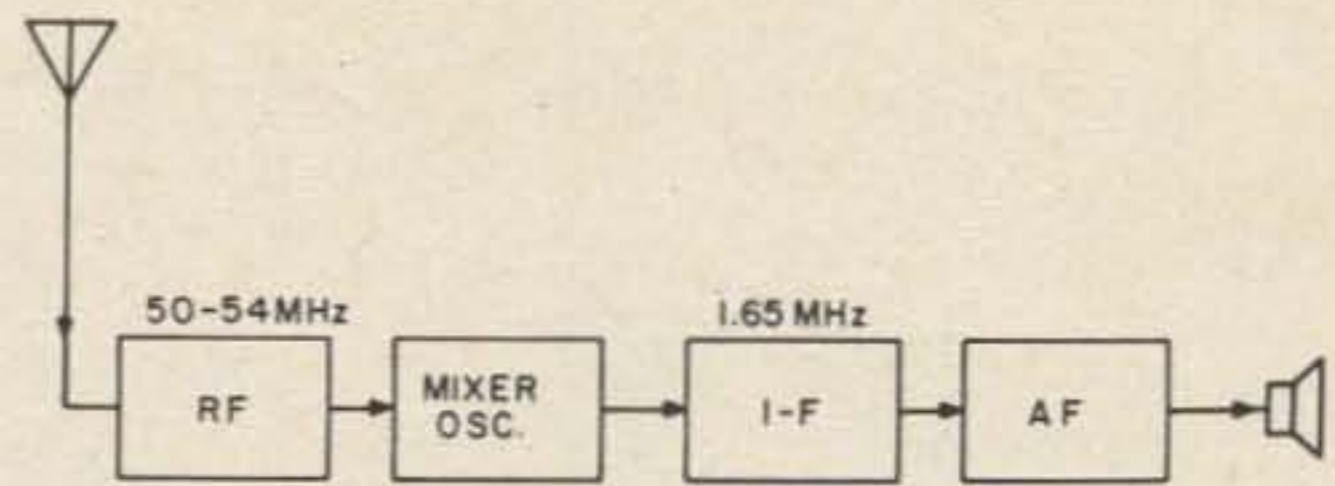

Fig. 1. Block Diagram.

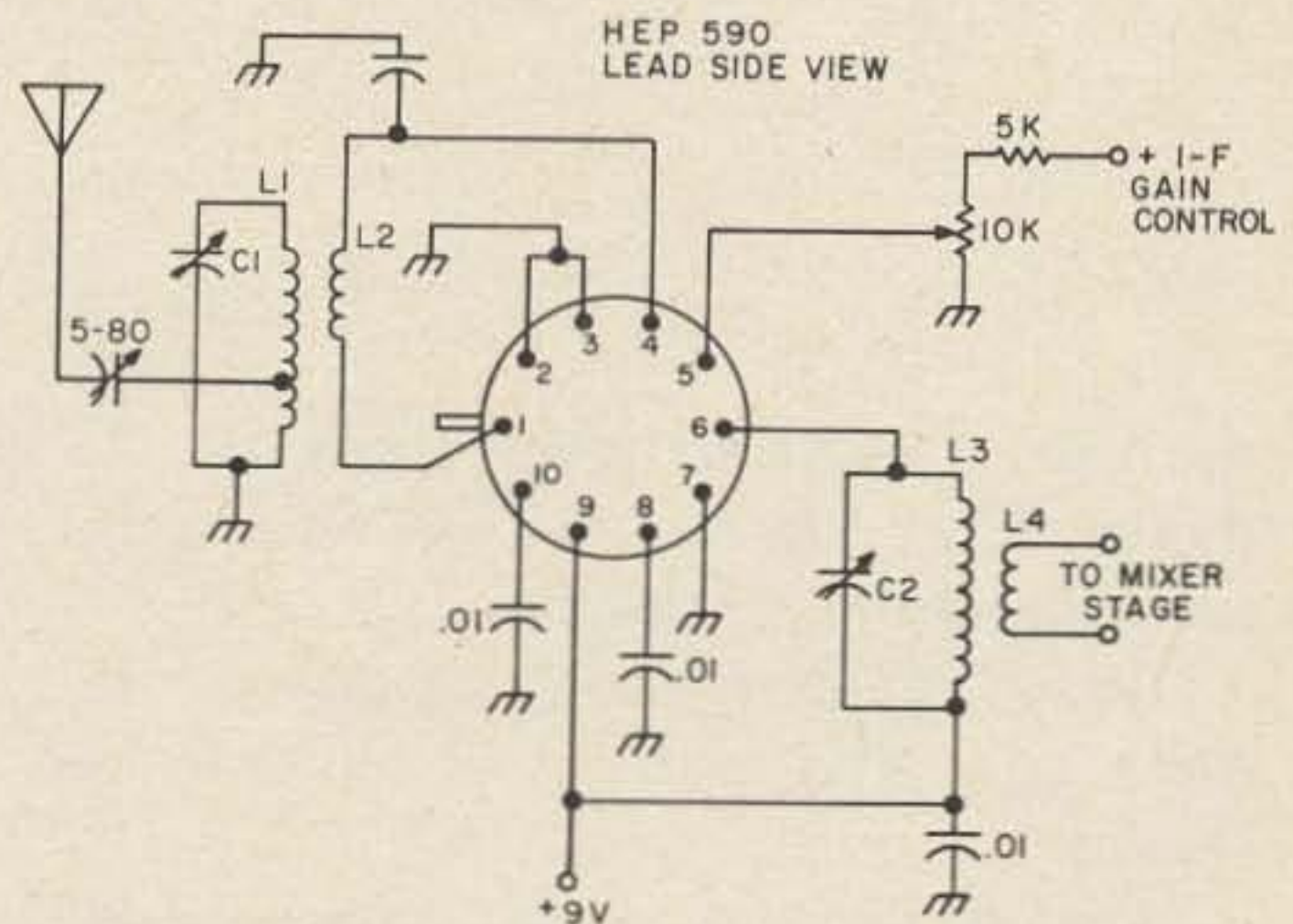

Fig. 2. Rf stage. L1, L3 — 6 turns airwound, 8 turns per inch, 1/2 inch diameter. L2 — 2 turns wound on L1. L4 — 3 turns wound on L3. C1, C2 — see text.

small metal front panel produced a feedback path which caused rf oscillation. Just keep those grounds somewhat apart and you'll be alright.

With 75 pF for C1 and C2 this unit is an excellent preamp for 6 and 10 meters, and (although I don't like to say it) for CB also.

The mixer and oscillator are shown in Fig. 3, are sure fire, and have all the bugs worked out of them. The oscillator is link-coupled to the mixer and is thus very easy to change over to crystal control if you want to make a fixed-tuned front end converter out of it later. The coupling between the rf and mixer stages can be adjusted for bandpass by

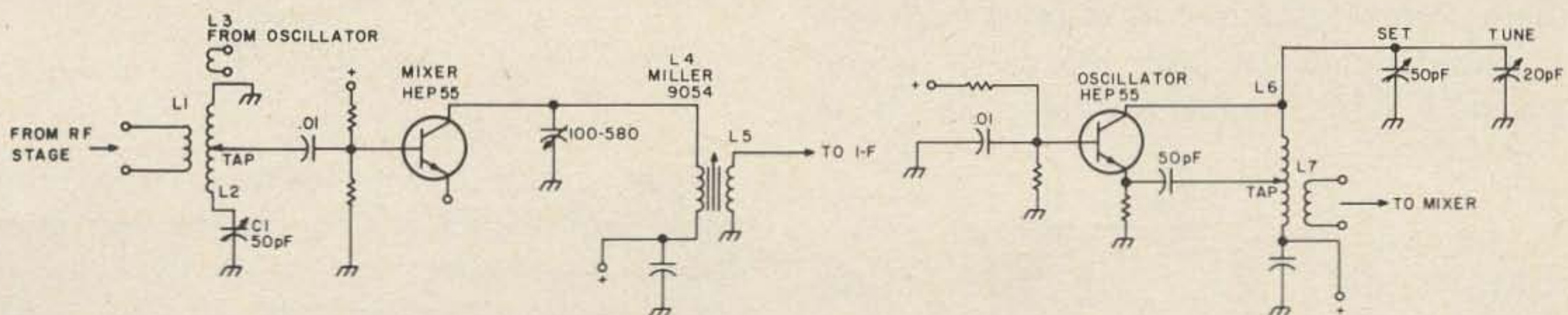

Fig. 3. L1 — 2 turns on L2. L2 — 6 turns airwound, 8 turns per inch, tapped at 2 turns. L3 — 2 turns on L2. L4 — Miller 9054. L5 — 2 turns on L3. L6 — 7 turns 1/4 inch diameter, 1/2 inch long tapped 1 turn from cold end. L7 — 2 turns on cold end of L6.

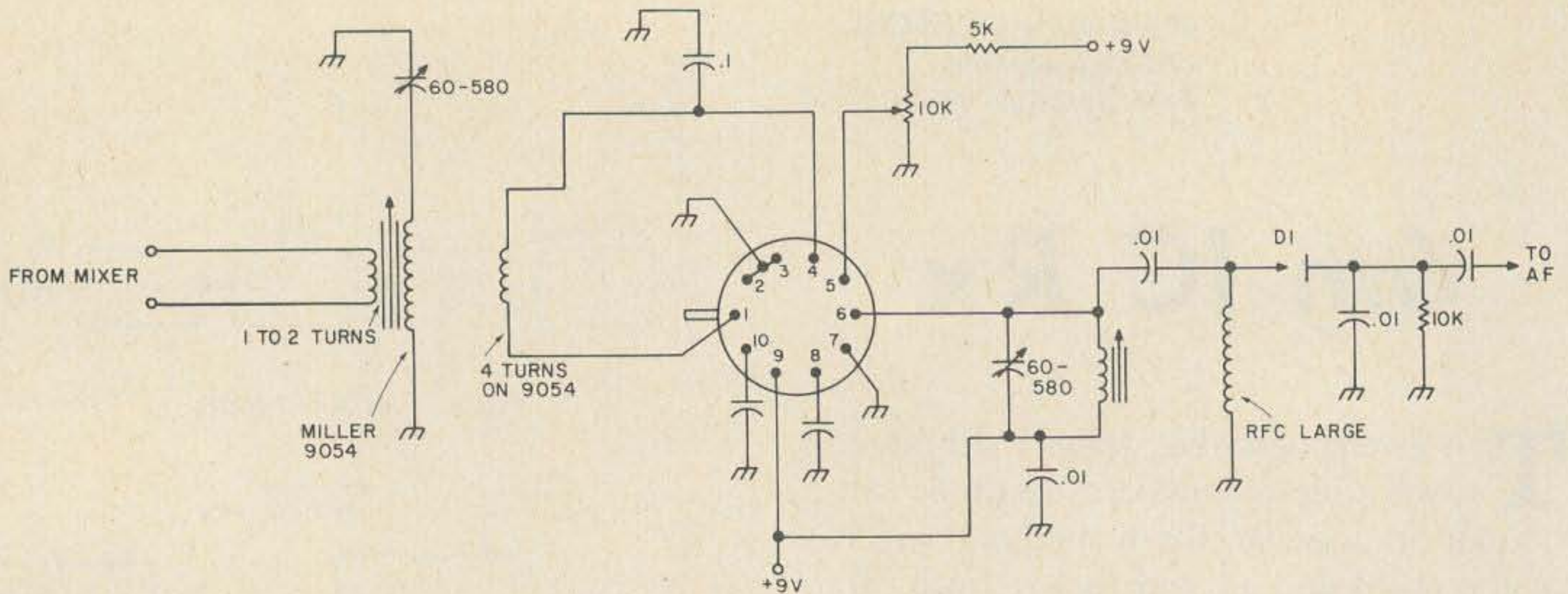

Fig. 4. I-f stage, 1.65 MHz.

the use of more or fewer turns on L1. The mixer base tap on L2 is also useful in controlling the rf selectivity.

L3 is tuned to the i-f frequency of 1.65 MHz and goes out on a cable to the i-f section.

The i-f also uses a Motorola HEP 590 IC and is quite similar to the rf stage but tuned to 1.65 MHz. Fig. 4 shows the details, with Miller 9054 ½ inch slug-tuned, electrostatically and magnetically shielded coils for the i-f transformers. The gain control can be used or not as desired. For more selectivity or a check on filters, use another i-f stage like this one, with a filter in between, as shown in Fig. 5. This filter is very interesting because of its low-cost, ease of construction and adjustment, and what it can do for you. By keeping L1 and L4 small, such as one turn only, peaking up L2 and L3, and reducing C3, a high degree of selectivity can be obtained considering the low cost and simplicity of single conversion. I have used this filter design from 10.7 MHz to 135 kHz and it really works. You can also put more than two sections into it, but do not use too many in series without an amplifier stage, as there is some attenuation through each one.

The demodulator uses the power circuit which I have found excellent at all i-f

frequencies. The diode is connected to the high end of the i-f output transformer. There is a slight loss in selectivity which can be made up anywhere in front, but the af seems to always have more punch with this detector circuit.

The Amperex TAA-300 is *it* for the audio section. A single ten pin transistor can, a few bypass capacitors, a gain control, an 8 Ohm speaker and there you are with up to one watt out and flat response from 25 to 25,000 Hz at 1 dB. Need I say more? Fig. 6 shows the external connections to be used. I checked the details for bypass capacitor values that can be used for voice frequencies and these are the lower values in the schematic. The higher values are the recommended ones for a miniature hi-fi set, which it then really is.

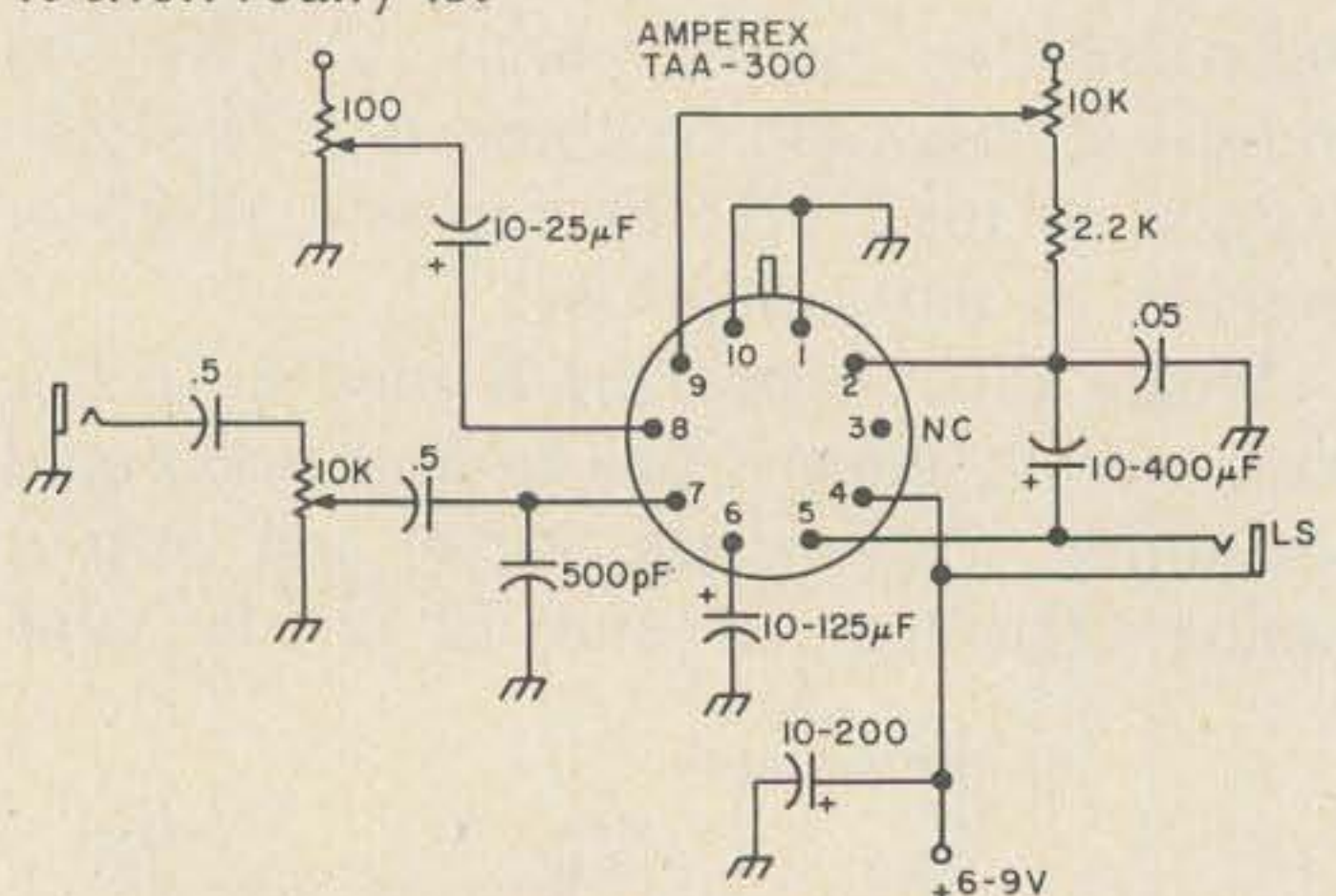

Fig. 6. Af IC.

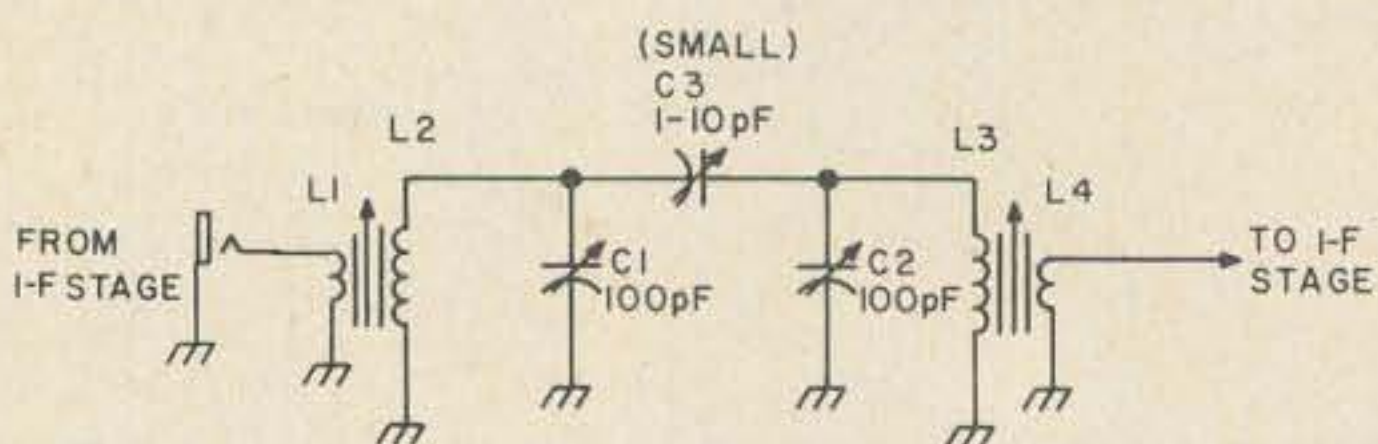
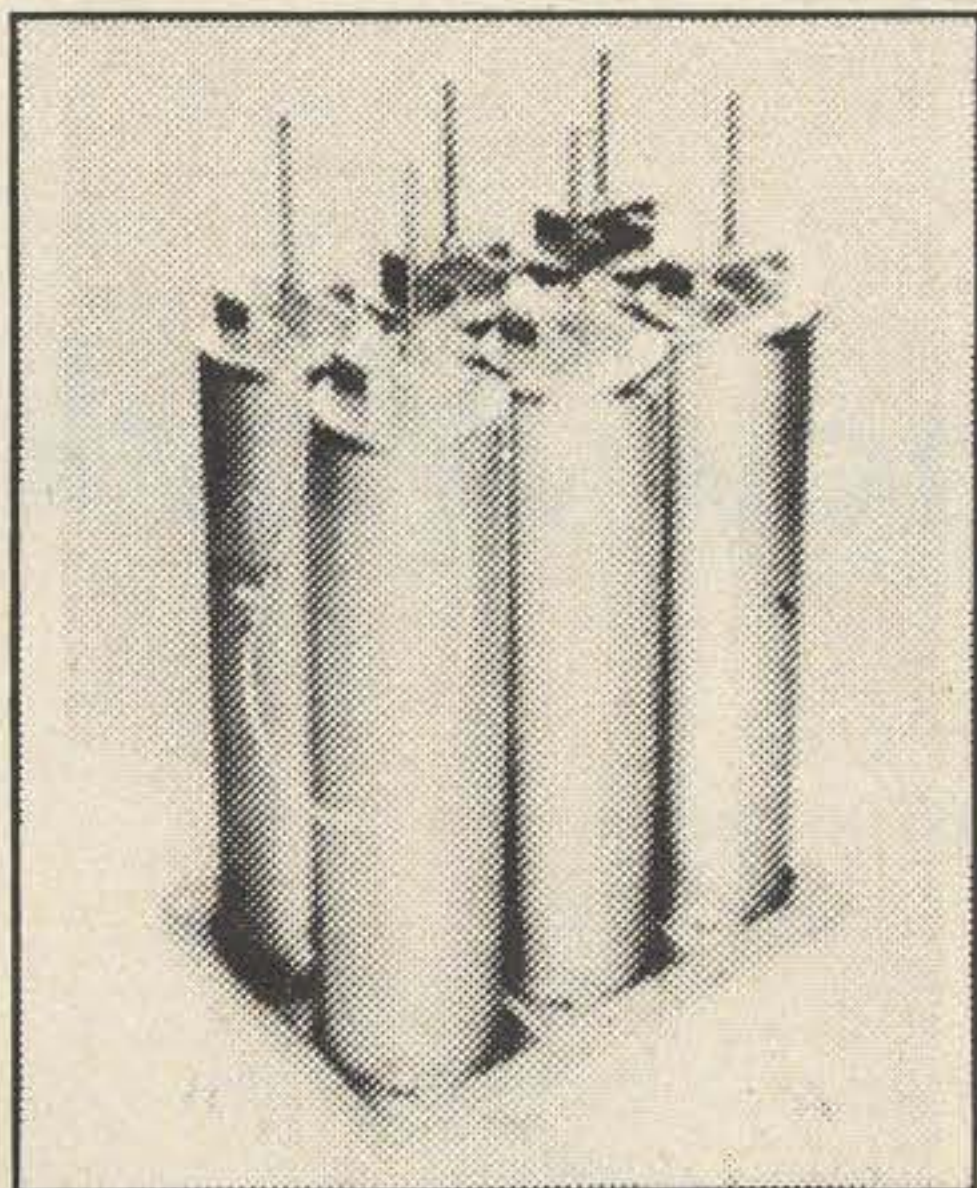

Fig. 5. I-f filter, 1.65 MHz. L1 — 1 or 2 turns. L2 — Miller 9054. L3 — Miller 9054. L4 — 1 or 2 turns.

Once again, this is really a foundation design, for seeing what's on the air on 6 around your area, and with the plug-in cable-connected sections, allows you to test out all kinds of components for rf and i-f, transistors, ICs and all.

... K1CLL

DUPLEXER KITS



PROVEN DESIGN
OVER 150 SOLD IN U.S.,
CANADA AND EUROPE.
CONSTRUCTION —
WELDED ALUMINUM IRIDITE
AND SILVER PLATED.
ALL PARTS PROFESSIONAL QUALITY
EVERYTHING SUPPLIED.

CAN BE ASSEMBLED & TUNED IN ONE EVENING. NO SPECIAL TOOLS. RECEIVER & TRANSMITTER CAN BE USED FOR TUNE UP.

MOD. 62-1 6 CAVITY 135-165 MHz POWER 250W ISOLATION GREATER THAN 100dB 600 kHz. INSERTION LOSS .9 dB MIN. TEMP STABLE OVER WIDE RANGE
PRICE \$349.00

MOD. 42-1 4 CAVITY SAME AS 6 CAVITY EXCEPT ISOLATION GREATER THAN 80 dB 600 kHz INSERTION LOSS .6 dB MAX
PRICE \$249.00

OTHER KITS SOON TO BE AVAILABLE

146 to 148 MHz band pass filter, 1296 & 2304 Interdigital Mixers
144 to 450 MHz 250w tube amp. 130 to 170 MHz notch filter kit

NORTH SHORE RF TECHNOLOGY

TUFTS

Radio Electronics

386 Main St., Medford, Mass. 02155
617-395-8280

NEW ENGLAND'S EXCLUSIVE DEALER

All Band Frequency Marker

A Simple C/MOS Marker Generator

Crystal controlled marker generators are useful adjuncts in any frequency determining situation requiring high accuracy, such as locating band edges, sub-bands and calibrating receivers. If you've been entertaining thoughts about construction of one, a version is described here which uses the new C/MOS integrated circuits powered by a 9 volt transistor radio battery. And instead of the usual rotary harmonic selector switch, a multi-pin IC connector strip and three test

plugs serve as a miniature patch panel to enable various divisions of the reference crystal, with a maximum countdown of 256. "Rocks" from 100 kHz to 4 MHz oscillate readily in this circuit. In this model an FT241 xtal set to 400,000 Hz has been chosen for control and has usable receiver calibration divisions down to 2.5 kHz. The harmonic spectrum extends to at least 160 MHz, the tuning limit of a transistor super-regen used in testing. When used in densely

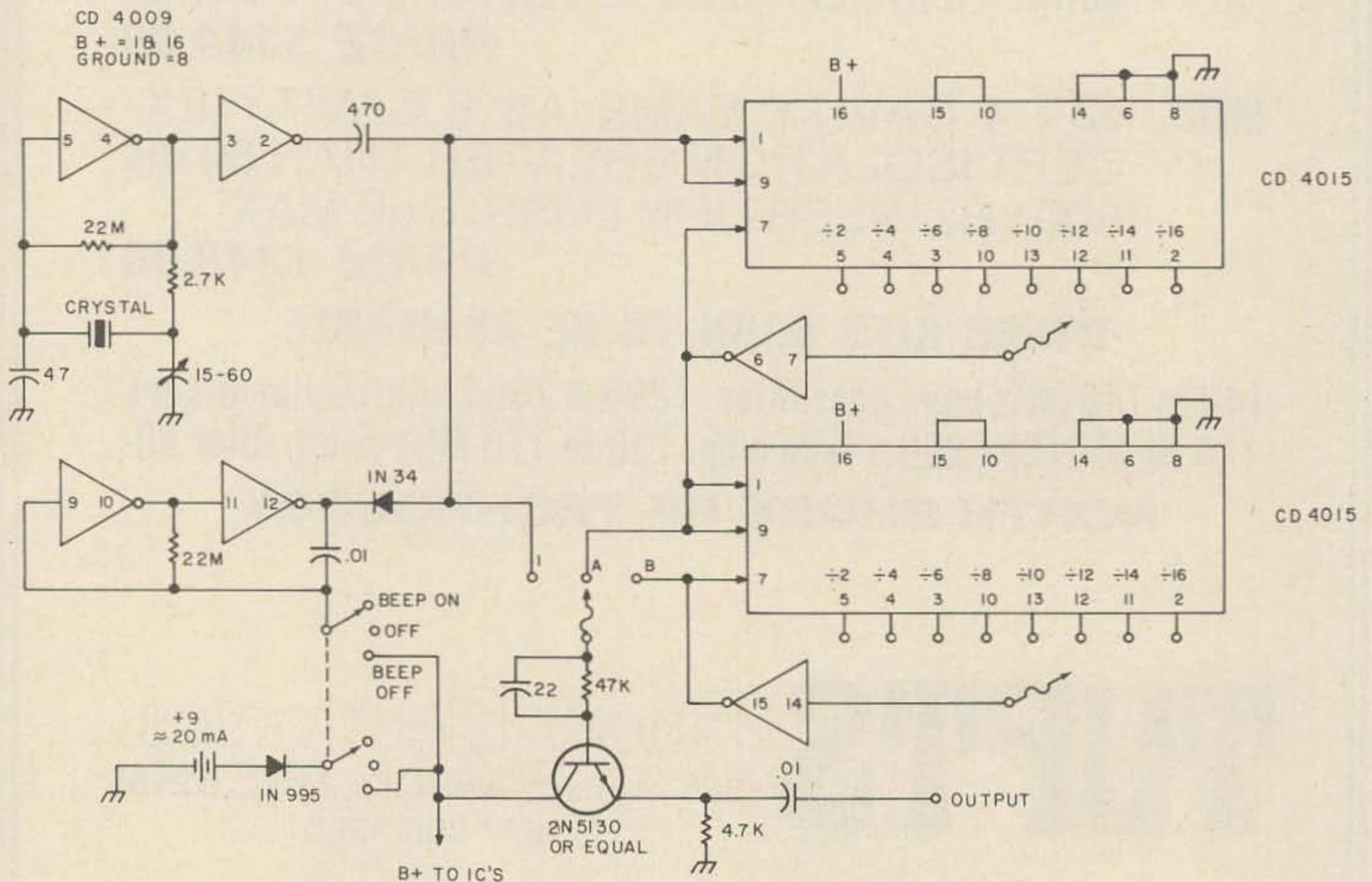

Fig. 1. Schematic.

Divide by	Output, kHz
1	400
2	200
4	100
8	50
10	40
16	25
20	20
40	10
80	5
100	4
160	2.5

Table 1.

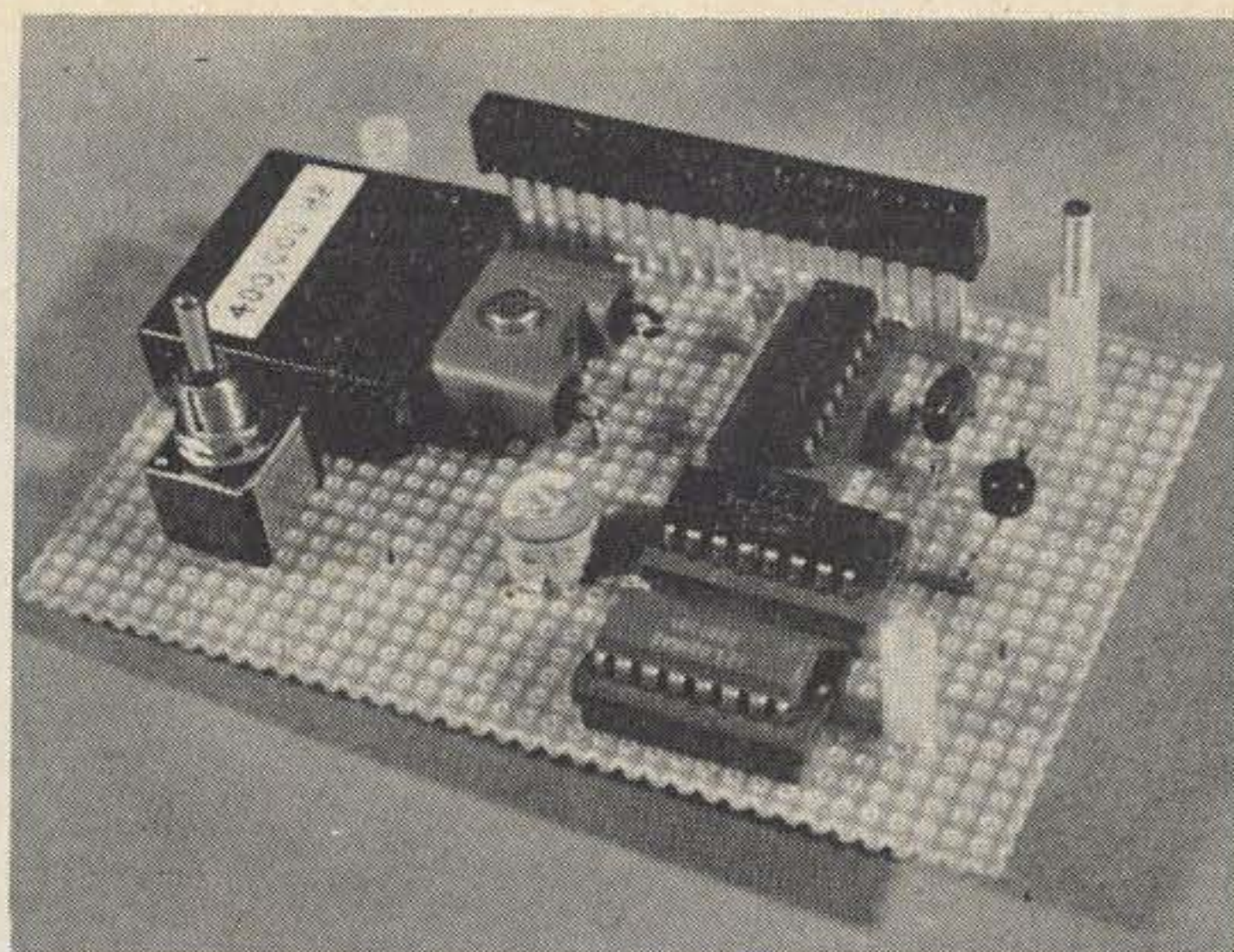

Photo 1.

occupied HF bands, an AM beeper can be switched on as an identification aid.

Referring to Fig. 1, one third of a hex inverter makes up a crystal controlled oscillator and buffer, another third is a slow rate pulser and the two remaining units function in the dividing section. These are all standard circuits described in RCA's COS/MOS Data Book #SSD-203. An emitter follower minimizes loading on the IC outputs, speeds up

through the front panel via a 1/2" (13mm) insulating spacer and plastic shoulder washers. Two regular 4-40 screws and spacers complete the four corner mounting. This spacing allows the contact strip to project partly through a panel cutout so that it is mechanically secure without fastening.

Photo 2 (completed assembly) shows a stick-on label with patching connection call-outs for various division ratios. If only one

1 CD4009	1 15/60pF trimmer
2 CD4015	1 .01 uF
1 1N34	1 xtal; see text
1 1N995	1 xtal socket
1 2N5130 or equiv.	1 Alco #MST205P switch
1 2.7k	1 Bud #CU-2115HG minibox
1 4.7k	1 Vector #44P29-062 perfboard
1 47k	1 #216 battery
2 22M	1 Battery connector
1 22pF	3 16 pin IC sockets
1 47pF	3 Augat patch pins or equiv.
1 100pF	1 20 pin contact strip
1 470pF	SAE #Series 7000

Table 2. Parts List.

rise time to increase harmonic content, and provides a low impedance output. The AM beeper is a simple clamp that gates rf on or off to following stages.

Photo 1 shows all components mounted on Vector P pattern perf-board that fits inside a Bud minibox. Sleeving 3/8" (10mm) long is slipped over the wire trap terminals of the contact strip to space it up from the board. A DPDT center-off miniature toggle switch acts as one board to panel spacer. Diagonally across from it, a 4-40 threaded rod conducts emitter follower output up

crystal is employed, labeling could indicate most used frequencies instead. A typical frequency vs division listing for this model is shown in Table 1. You can easily make up a complete table of all possible ratios, remembering that each CD4015 shift register divides by even numbers ONLY, starting at 2 and ending at 16.

Uses to which a marker generator may be put have been described before: i-f alignment, BFO, scope linearity, etc. A type that divides down to the audio range like this one is especially useful in checking superhets. A

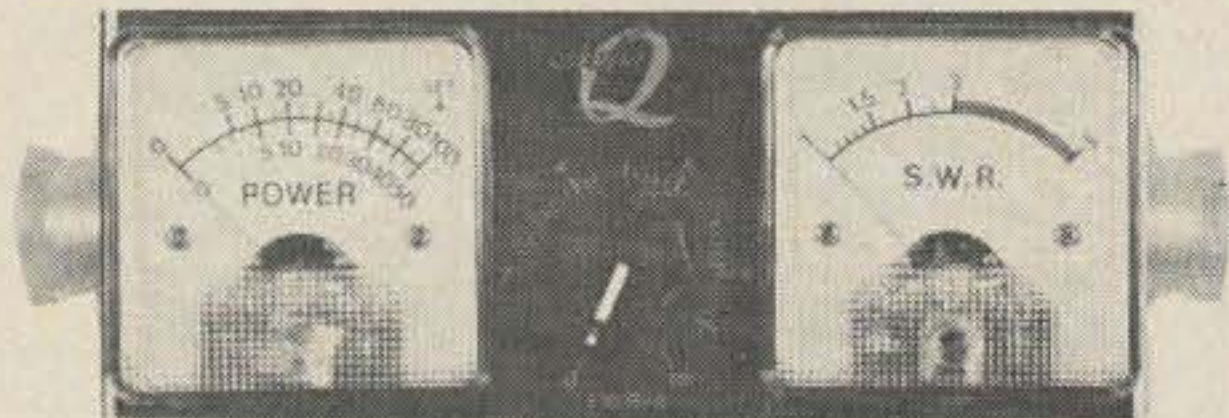

SWB-2 \$21.95 *

SWR BRIDGE READS FORWARD & REFLECTED POWER SIMULTANEOUSLY 'EASY READ' METERS

DUAL 100-MICROAMP METER MOVEMENTS

LOW INSERTION LOSS SIZE 5X2X2

MAY BE LEFT IN LINE UP TO 2,000 WATTS' 3 TO 150 MHZ

ADD \$1.50 FOR POSTAGE

* prices subject to change without notice . . .

OUR BEST "HAM" BUY



QUEMENT ELECTRONICS
1000 SO. BASCOM AVE.
SAN JOSE, CA. 95128

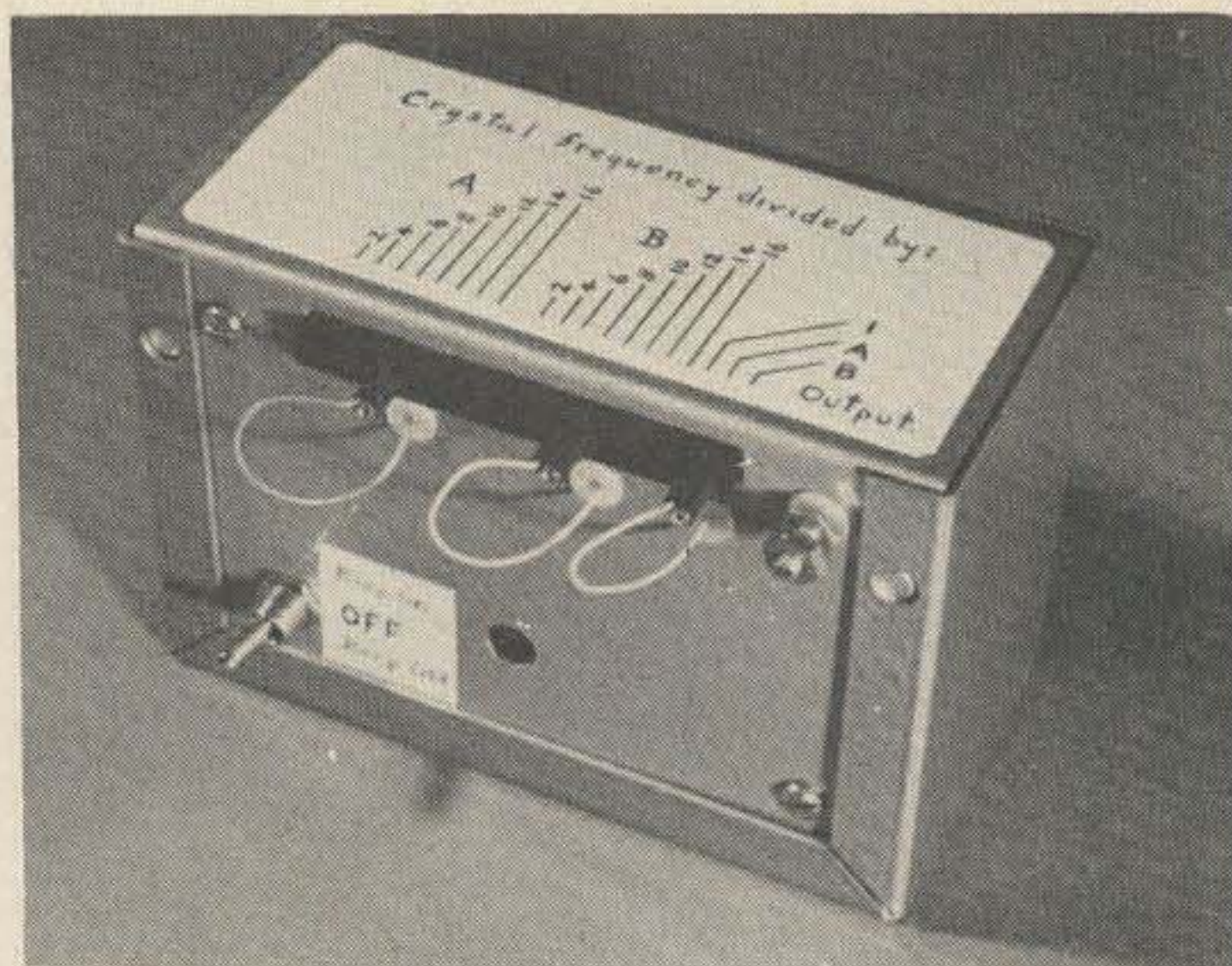

Photo 2.

very broad and flat spectrum of overlapping signals is generated and an audio tone will be heard no matter where the set is tuned. If its tracking and sensitivity are top-notch, the S meter will hold steady over the tuning range. Tracking adjustment amounts to tweaking for maximum meter reading or loudest audio tone. Then patch for 100 KHz markers and check calibration. It's a lot faster and easier than using a conventional signal generator.

... W1KNI



For detailed technical information and pricing—write to:



Dept. AMTV
 P.O. Box 113, R.R. 2
 Bloomington, IN 47401

FAST SCAN Amateur TELEVISION

NOW YOU CAN ENJOY FSTV
 AT REASONABLE COST.

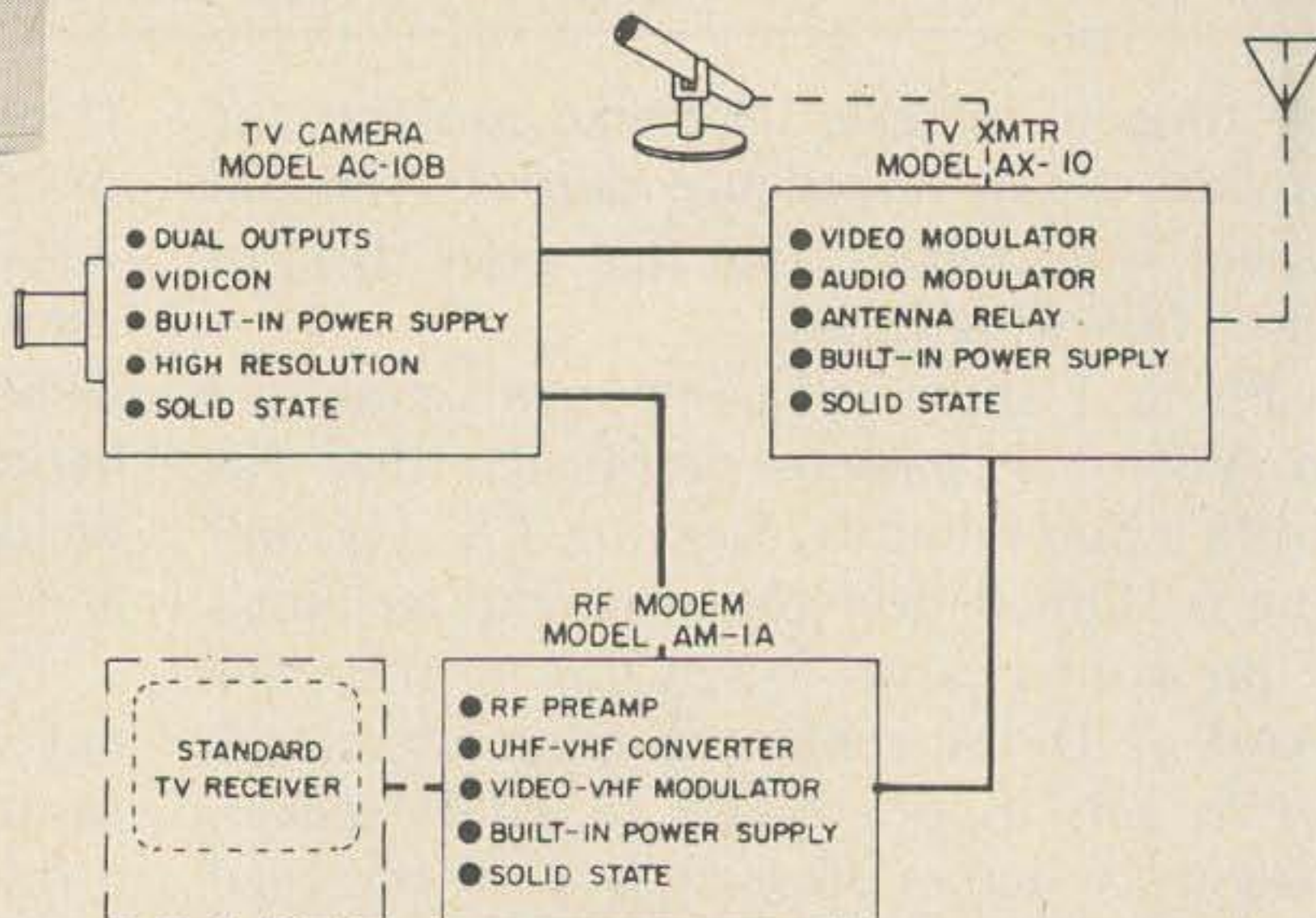

IF YOU HAVE ALREADY GONE 450



GO ICOM NOW Before you go bananas!

If you have been trying to resurrect something from the pre-transistor past that more closely resembles the mechanism used to keep large ships in place, or if the sound of bumble bees is keeping you awake at night--REJOICE!!! The ICOM 30A is here and working!

Consider these reasons for owning an IC-30A:

- (1) Despite the fact that the radio is completely solid state, it has output of ten watts
- (2) Receiver sensitivity is better than 0.6UV for 20 db of quieting and that means easy on the ears listening.
- (3) The IC-30A comes with five channels of the 22 channel capacity installed
- (4) Shielding is excellent because the unit is modularly constructed.
- (5) Your car tires will last long because the IC-30A weighs less than ten pounds.
- (6) Like its predecessors, the unit is equipped with a 9 pin plug in the side of the radio to provide you easy access to the discriminator and room for adding the necessary wiring for external accessories--with all this and more, for only \$399.00.

SEE ONE !! BUY ONE !! AT YOUR ICOM DEALER TODAY

Distributed by:



ICOM

ICOM WEST, INC.
Suite 232-Bldg. 11
300-120th Ave. N.E.
Bellevue, Wash. 98005

ICOM EAST
Suite 307
3331 Towerwood Dr.
Dallas, Tx. 75234

TUFTS Radio Electronics

386 Main St., Medford, Mass. 02155

"FEATURING VHF ENGINEERING"

THE WORLD'S MOST COMPLETE LINE OF VHF—FM KITS AND EQUIPMENT

CD1 Kit	10 channel receive xtal deck w/diode switching	\$ 6.95
CD2 Kit	10 channel xmit xtal deck w/switch and trimmers	\$14.95
COR2 Kit	complete COR with 3 second and 3 minute timers	\$19.95
SC2 Kit	10 channel auto-scan adapter for RX	\$19.95
TX144 Kit	exciter—1 watt—2 meters	\$29.95
TX220 Kit	exciter—1 watt—220 MHz	\$29.95
TX432 Kit	exciter— NEW —432 MHz	coming soon
RX144/220 F Kit	140-170 or 210-240 MHz rcvr w/8 pole cer 455 filter	\$65.95
RX144/220 C Kit	140-170 or 210-240 MHz rcvr w/2 pole 10.7 xtal filter	\$69.95
RX432 C Kit	NEW —432 MHz receiver	coming soon
HT144 B Kit	2 meter—2w—4 channel—hand held xcvr	\$129.95
PA1501H Kit	2 meter pwr amp—15w—compl. kit w/SS switching	\$49.95
PA2501H Kit	similar to above—24w	\$59.95
PA144/15 Kit	similar to PA1501H less case, connectors and switching	\$39.95
PA144/25 Kit	similar to above—25w	\$49.95
PA220/15 Kit	similar to PA144/15 for 220 MHz	\$39.95
PA432/10	NEW —similar to PA144/15 except 10w and 432 MHz	coming soon
PA4010H Kit	10w in—40w out—relay switching	\$59.95
PA110/10	10w in—110w out 2 meter amp	factory wired \$179.95
PA110/30	30w in—110w out 2 meter amp	factory wired \$149.95
PS3 Kit	power supply regulator card	\$ 8.95
PS12C Kit	12 amp—12 volt regulated power supply w/case	\$69.95
PS24C Kit	24 amp—12 volt regulated power supply w/case	\$99.95
RPT144	NEW —15 watt—2 meter repeater	factory wired \$595.95
RPT220	NEW —15 watt—220 MHz repeater	factory wired \$595.95
RPT432	NEW —10 watt—432 MHz repeater	coming soon

Repeaters are available in kit form—write for prices

ITEM	PART #	DESCRIPTION	PRICE	EXTENSION

NAME _____ TOTAL _____
 ADDRESS _____ SHIPPING _____
 CITY _____
 STATE _____ ZIP _____ TOTAL ENCLOSED _____

Protect your Gear with a Latching Relay

In a wide variety of commercial and amateur amplifier and oscillator circuits, failure of the excitation causes failure of the bias, so that plate and screen currents rise to dangerous levels. If either the excitation is not promptly restored, or the power cut off, one or more tubes, and sometimes the power supply, will be damaged or destroyed.

To protect the circuitry from the results of excitation failure, a wide variety of protective circuits, ranging from a fuse to a contacting milliammeter with a back-up relay, have been devised. Most common protective circuits consist of a current-operated relay of some sort, usually in conjunction with a fixed protective bias. Many of the proposed protective circuits work, and some of them work well.

Not commonly used in either amateur or commercial equipment, but most effective for shutting off the power when the current drain soars, are circuits incorporating a latching relay. With these, a sharply rising current shuts the equipment off, and it stays off until power is restored manually, hopefully after the cause of the trouble has been located and removed.

Symmetrical Latching Relays

The symmetrical latching relay normally consists of two relays, mechanically and electrically similar, mounted on the same base, and mechanically interlocked, so that either one can be operated by a short power pulse, and latches in actuated position,

drawing no more power until a change of state is desired.

The appearance of a commercially-made symmetrical latching relay is shown in photo. The specific relay shown is a Potter and Brumfield type KB 17 AY, with 115 volt ac coils. The mechanical latching mechanism is visible in center of this view. Here, the armature of relay A is down and latched, that of coil B is up and unlatched.

Happily for our purposes, change of state of a symmetrical latching relay is not instantaneous. If the armature controlled by coil A is down and latched, it will remain so after energization of coil B until the armature of coil B is firmly seated. In consequence, dependable operation of both relays is

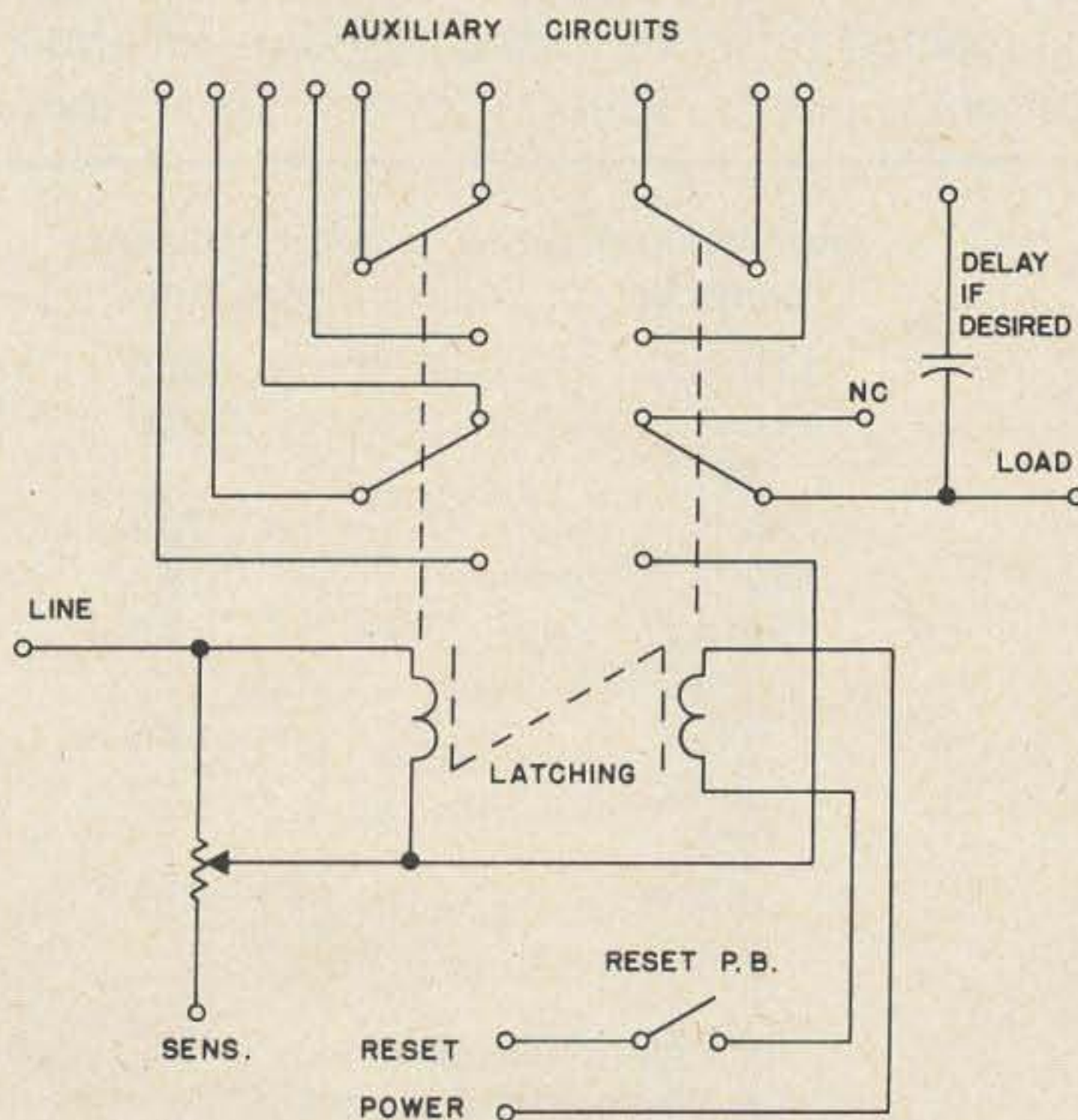
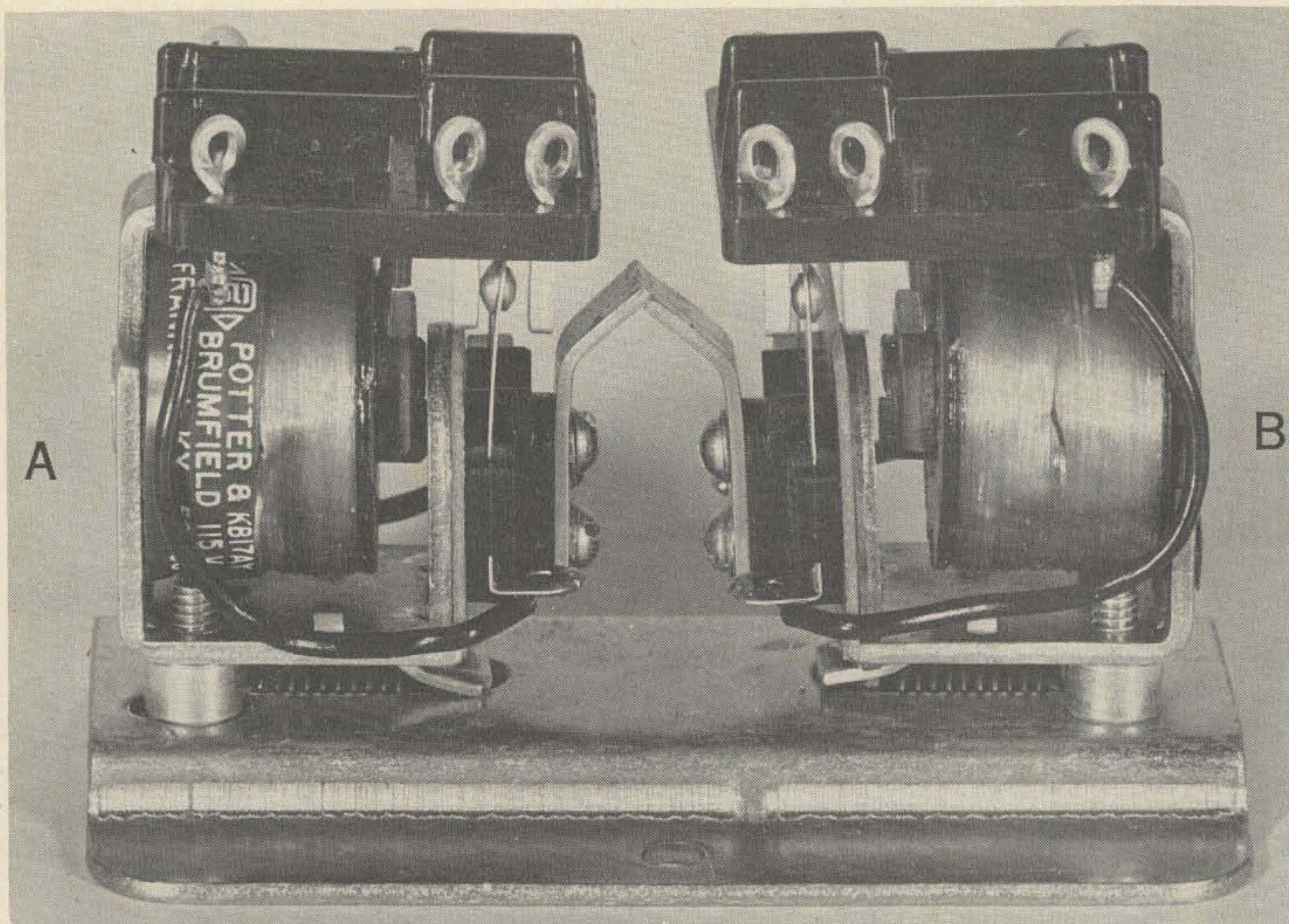

Fig. 1. Typical overcurrent relay circuit.



Typical symmetrical latching relay.

possible with the coil of each in series with the contacts of the opposite relay.

Overcurrent Circuit

For overcurrent protection, one coil of the latching relay is connected in series with the load, as in Fig. 1. The other coil is connected in series with a push-button and a suitable power source to act as a reset.

Contacts of this second coil (B) are in series with the first coil and the load.

When the armature of coil B is down and latched, load current flows through coil A. When current in coil A exceeds the operating current, the armature pulls down, releasing armature B, and opening the load circuit. No further current reaches the load until the system is reset, and it will not stay reset if

Nominal coil volts (a)	Coil resistance in Ohms	Nominal current in mA (b)	Relay type (P and B)
110 D.C.	4560	24	KB-17-D
110 A.C. (72)	1030	70	KB-17-AY
24 D.C.	230	104	KB-17-D
12 D.C.	52	230	KB-17-D
24 A.C. (11)	42	265	KB-17-AY
6 D.C.	13.1	460	KB-17-D
12 A.C. (7.1)	10	710	KB-17-AY
6 A.C. (3.4)	2.3	1500	KB-17-AY

(a) Figure in parentheses is D.C. voltage computed from volt-ampere rating of coil.

(b) When operated on D.C.

TABLE 1.

**digital
electronic
QUARTZ
watches**

Large bright LED display • Adjusts automatically to ambient light • Single button operation • Displays hours, minutes, seconds, month and day • Perpetual calendar changes date automatically for 28, 30 and 31 day months

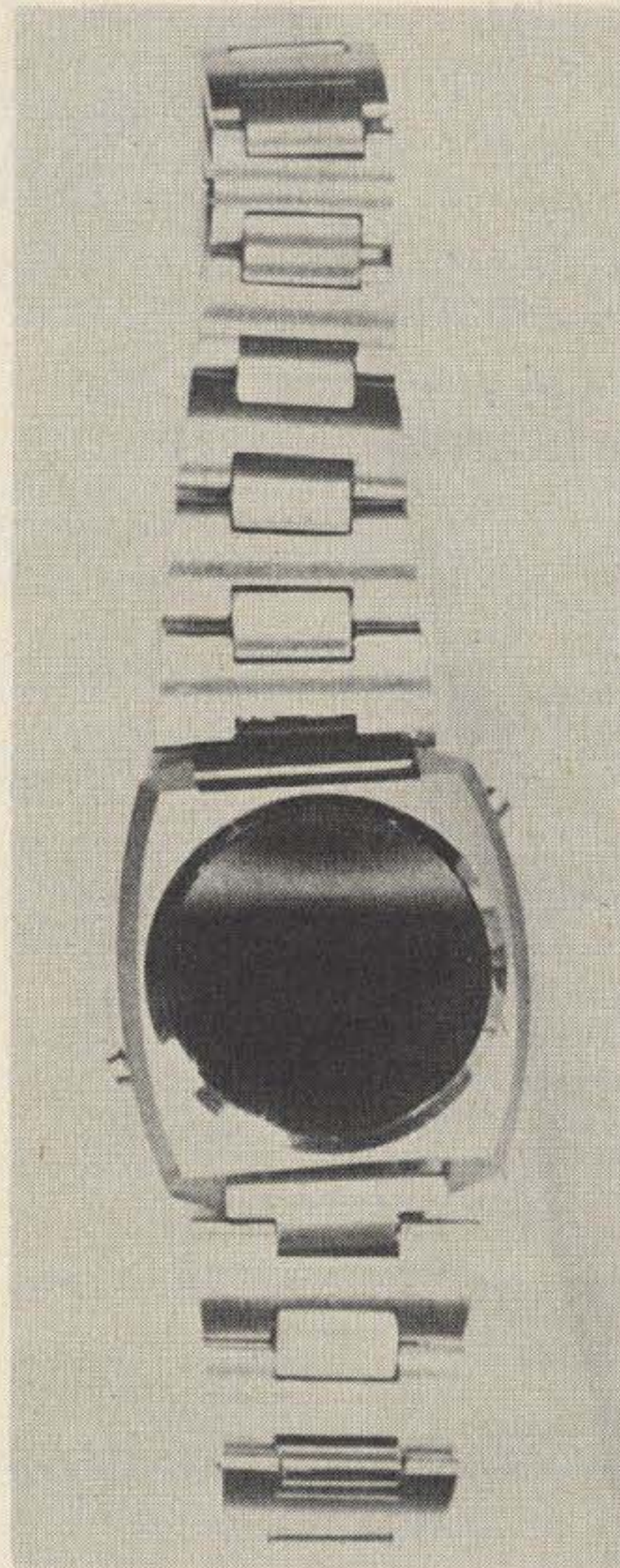

GUARANTEED 3 YEARS

Available in Gold or Rhodium

WATER RESISTANT, SHOCK RESISTANT, ANTI-MAGNETIC

special ham price ~~\$149.95~~

33 1/3% discount price **99.95**

Extra set of batteries with each watch

Attractively boxed

Delivery from stock

NOT A KIT

CHECK, Money Order or Bank Americard acceptable.

Dealer inquiries invited.

CHRONEX watch co.

418 S. Yale

Garland TX 75042

Phone: 214-272-7506

GLADE VALLEY SCHOOL RADIO SESSION — 16th Year

July 26 — August 8, 1975



Courses Taught:

General Theory and Code, Advanced Theory and Code, Amateur Extra Theory and Code

UPGRADE YOUR HAM TICKET BE READY FOR ANY FCC RESTRUCTURING

The Glade Valley Radio School is the only place in the country where you can get two solid weeks of concentrated radio theory and code — all taught by instructors with Extra Class licenses and years of experience in teaching.

You meet fine people of all ages and backgrounds. All with a sincere interest in ham radio. During the 15 years of this school's operation, over 900 have attended, and many long lasting friendships have developed.

Instruction is given at the General, Advanced and Extra Class levels, with small groups for personal attention.

Excellent rooms and meals are provided, and the schedule is planned for a healthy mixture of learning and recreation, all in the beautiful mountains of cool North Carolina. Facilities are available for single people as well as for married couples.

Have a Vacation with a Purpose.

C.L. Peters K4DNJ *DIRECTOR*
Box 458 Glade Valley NC 28627

Please send me the booklet and application blank for the Glade Valley School Radio Session.

Name _____ Call _____

Address _____

City/State/Zip _____

load current exceeds the operating current of coil A.

The rheostat shunted across coil A is a sensitivity adjustment, to set the pull-in point of the relay at the exact current desired. The system can be made insensitive to short-term current surges by shunting a fairly large capacitor (10 μ f or more) across the load. This will also improve system regulation, reduce ripple, and may raise the output voltage a trifle.

Available Equipment

The relay chosen for an overload protection function depends primarily on the current normally drawn by the load. Knowing this requirement, we can pick the most suitable relay from the available equipment, making minor adjustments in sensitivity with the shunt rheostat.

Characteristics of stock latching relays, based on Potter and Brumfield catalog data (mechanically and electrically similar relays, at similar prices, are made by Globe, Magnecraft, Line, Ohmite, Phillips-Advance, and Schrack, among others), have considerable

excess sensitivity, so they operate at lower current than indicated by the table. Most dc relays pull in at from .5 to .65 of computed current: most ac relays pull in at from .3 to .5 of computed current, but operate more slowly than dc relays due to the shading ring.

All of these relays will stand either 110V or twice the rated voltage (whichever is greater) to ground indefinitely (years). Several 110V dc relays in this group, used as plate relays, have withstood 500V to ground for long periods, but this is not a recommended practice. A little added insulation is very much cheaper than a replacement relay.

Dependability And Consistency

The symmetrical latching relay has been with us for quite a few years. Many from the first production runs are still in service. The life of a symmetrical latching relay exceeds one million operations in normal industrial service, with only nominal maintenance, like blowing the dust and dead insects out periodically, and cleaning the contacts (not filing them) every six months or so.

Tests with a number of stock relays indicate that their performance is consistent within better than five percent over a period of months, with a slow drift to sluggishness with time and accumulations of gummy dirt (removable with carbon tetrachloride — ventilate well). In consequence, for overcurrent detection, when the current overage is catastrophic (many times normal), these relays are ideally suited. They should not, however, be used in close differential service in the circuit shown.

Auxiliary Circuits

Symmetrical latching relays are normally supplied in four pole and six pole double throw. Only one pole is needed for overcurrent protection, leaving either three or five poles available for auxiliary functions. One pole double throw is usually adequate for idiot lights; the others can be used for anything desired.

... IVES

John J. Risch WØFEV
3508 Whispering Woods Dr.
Florissant MO 63031

A Case for CW

Ever since I can remember, my impression of an Amateur Radio Station was one where the operator was wearing headphones and sending with a hand key. The idea that he would use, or even own, a microphone never crossed my mind. Radio communication seemed synonymous with CW; there was no other way. It still seems that way to me.

To most hams, CW is looked on as a thing of horror, an annoying source of interference, that hopefully someday will go away. They wonder why anyone in his right mind would ever consider it as a means of communication. They think that if the Good Lord in His infinite wisdom wanted us to communicate that way, He would have provided us with a built-in 400 Hertz filter. To this "unenlightened" group, this article is respectfully dedicated.

I suppose there are as many valid reasons for not using CW as there are for using it, most of them technical (which won't be repeated). Instead, I offer two additional reasons.

CW, like tennis, bowling, chess, "The Game", or whatever, is a skill that must first be learned then developed. The degree of this development is directly related to the effort expended. Likewise, the degree of enjoyment obtained is related to the proficiency attained. To those in our fraternity who pursue a sport or other endeavor simply for the joy of conquering a new "field", or to excel in an existing one, I submit CW as worthy challenge.

There is yet another area of appeal which may not be appreciated by most. CW is an excellent means of "escape". What better way is there to set aside your problems of the day and enter into another world — one that completely absorbs your full consciousness — than to get on CW? All you need to "enter" is a little knowledge, lots of patience and some basic skill; the rewards can be very gratifying. To the old timers who regularly operate in this mode, I can only say "You know what I mean". To the outsiders I say, "Try it, you'll like it."

...WØFEV

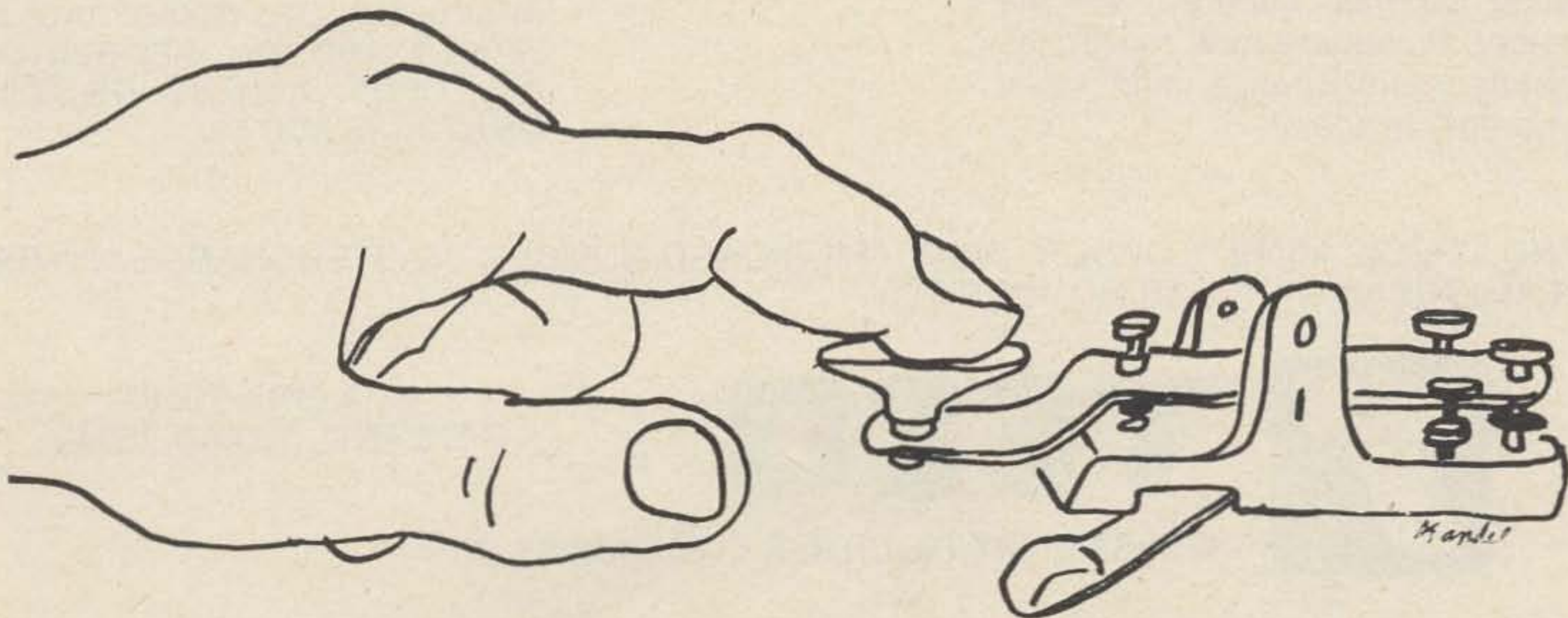

SCIENTIFIC CALCULATORS

FROM

TECO

\$99.95

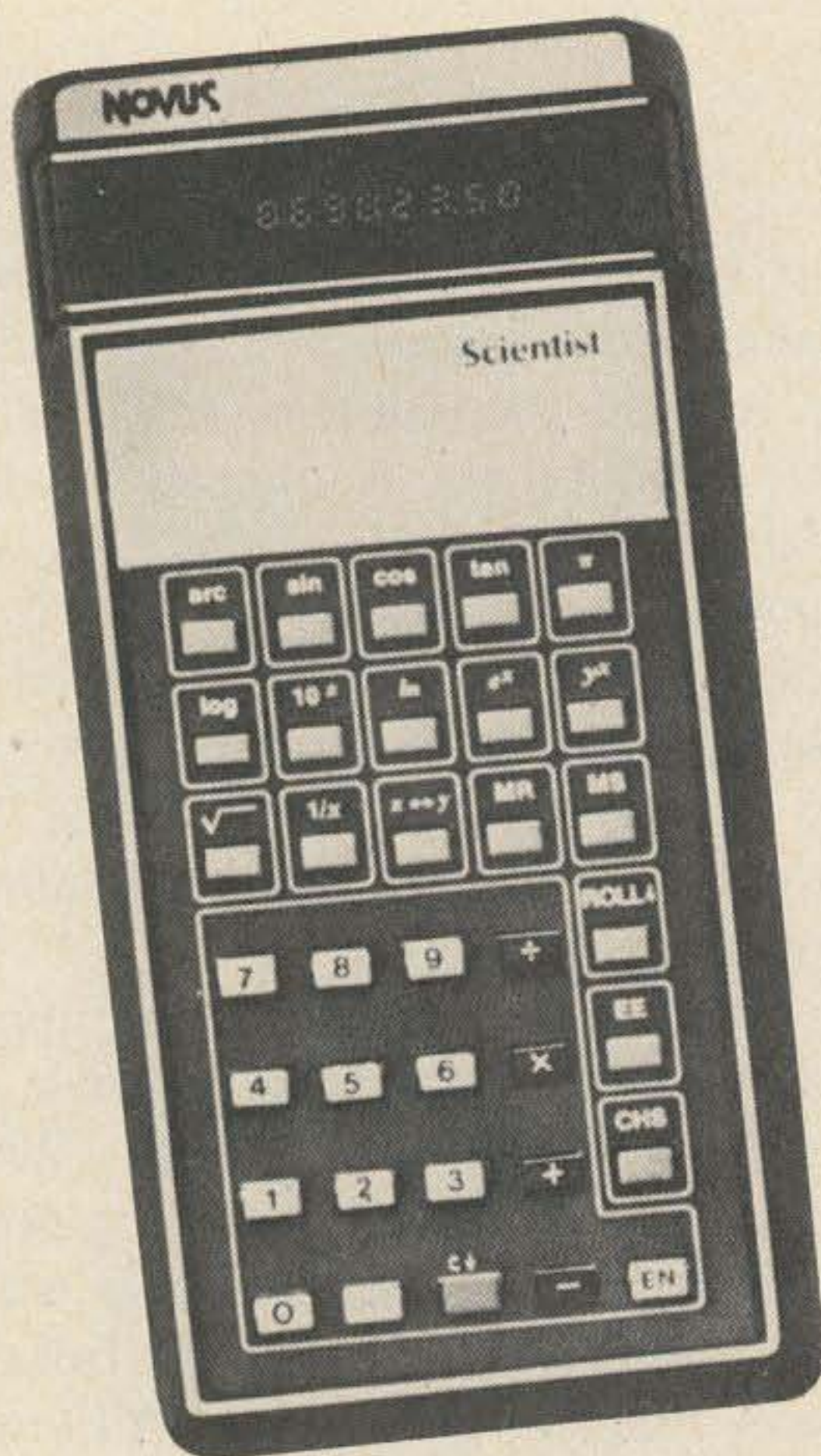

NOVUS 4520 SCIENTIST

8-digit plus 2-digit exponent LED display slide rule with scientific notation. Arithmetic, trigonometric and logarithmic functions. RPN logic with rollable 4-level stack, floating decimal, separate storage memory, Pi, square root, reciprocal, exchange and change sign keys, low battery indicator.

\$79.95



61R ADVANCED SLIDE RULE ELECTRONIC CALCULATOR

The Rockwell 61R Advanced Slide Rule can handle trigonometric, inverse trigonometric, logarithmic and inverse logarithmic functions. But that's not all. This easy-to-operate electronic calculator computes roots, powers, reciprocals, squares, sum of the square and more. All this plus a full accumulating memory.

RESIDENTS OF TEXAS AND NEW JERSEY ADD 5%. RESIDENTS OF CALIFORNIA ADD 6%. RESIDENTS OF ILLINOIS ADD 4%.

SEND CHECK, MONEY ORDER, BANK AMERICARD NUMBER, MASTERCARD NUMBER OR AMERICAN EXPRESS NUMBER TO:



TECO

A SUBSIDIARY OF TUCKER ELECTRONICS CO.

P. O. BOX 1050
GARLAND, TEXAS 75040

FOR RUSH ORDERS CALL TOLL-FREE 800-527-4642 (IN TEXAS CALL 214-348-8800)

TEN-TEC

TEN-TEC, INC. FROM



TECO

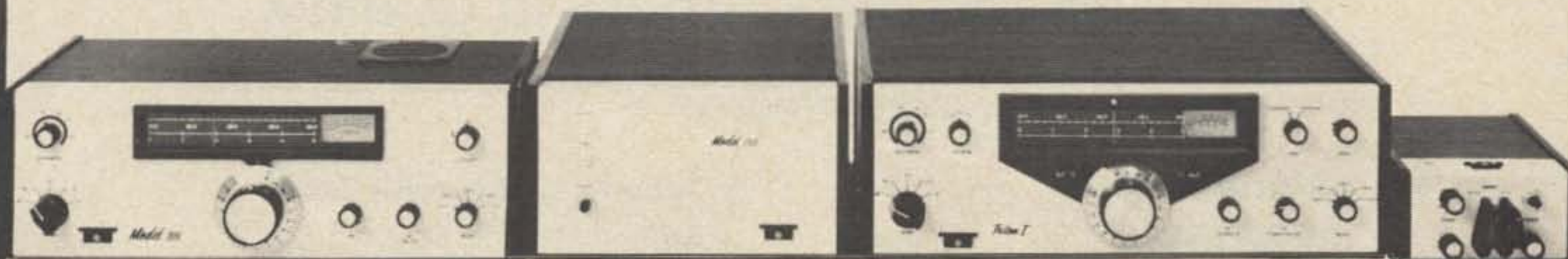

The **TRITON** is a One-of-a-Kind HF transceiver, totally solid state including the final amplifier. The new generation that does more things better than ever before.

One, you can change bands instantly. Just turn the bank switch — and go!

Two, there is less internal heat to prematurely age components and no high voltage to break down insulation or cause accidental shock.

Three, it has ample reserve power to run at full rating even for RTTY or SSTV without limit. Great for contests or emergency service.

Four, it is light and compact with a detachable AC power supply to work directly from 12 VDC — For mobile operation without tedious installation.

Five, the TRITON is a delight to operate. SSB is clean, crisp and articulate. Amplified ALC puts all available speech power into the antenna without splatter. CW is wave-shaped to cut through QRM and pile ups. Instant break-in (not "semi" which really isn't break-in) lets you monitor the frequency while transmitting.

And six, a lot more goodies such as excellent dial illumination, plug-in circuit boards, offset tuning, built-in SWR bridge, speaker, crystal calibrator, boards, offset tuning, built-in SWR bridge, speaker, crystal calibrator, snap-up anti-parallelax front feet, light indicators for offset and ALC, direct frequency readout, WWV, entire 10 meter band coverage — and a lot more.

The **TRITON** brings together all that is new and exciting in Solid State for your greater enjoyment of Amateur Radio.

TRITON I — 100 Watt Input \$579⁰⁰
MODEL 251 — Power Supply \$79⁰⁰

TRITON II — 200 Watt Input \$669⁰⁰
MODEL 252 — Power Supply \$119⁰⁰

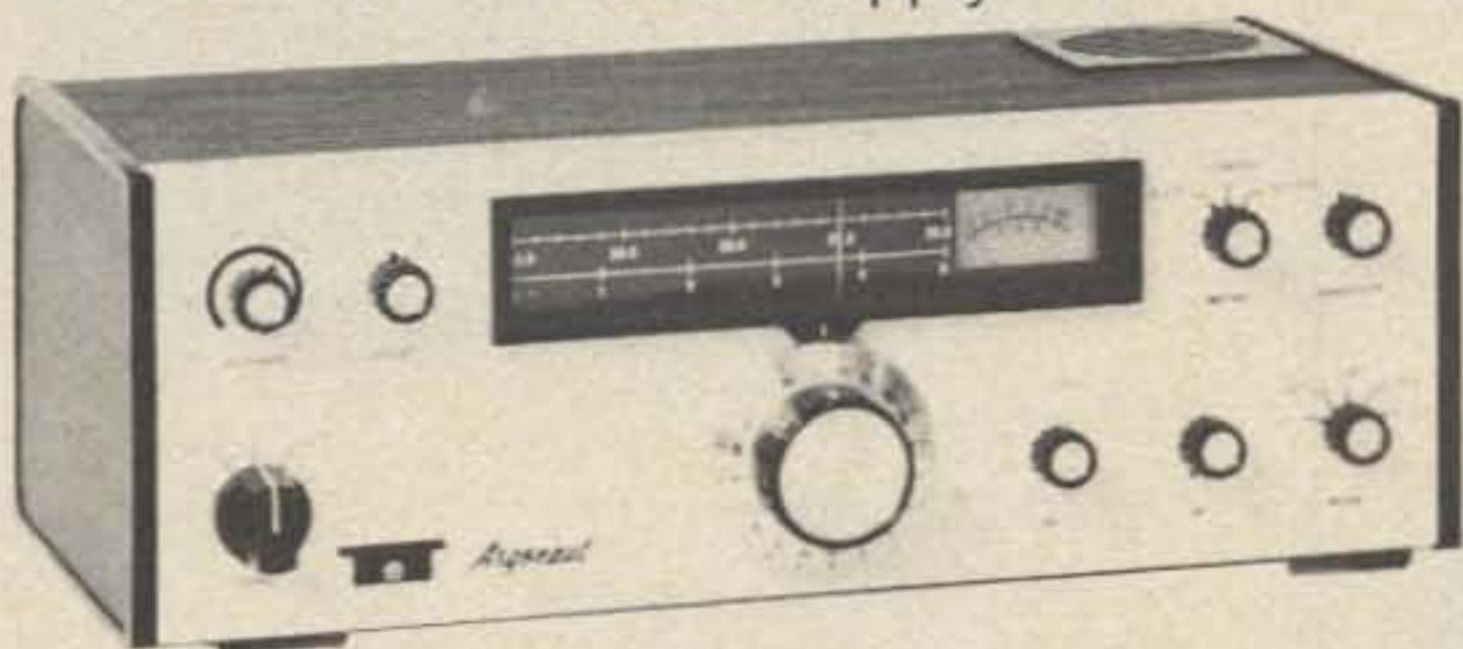

Argonaut

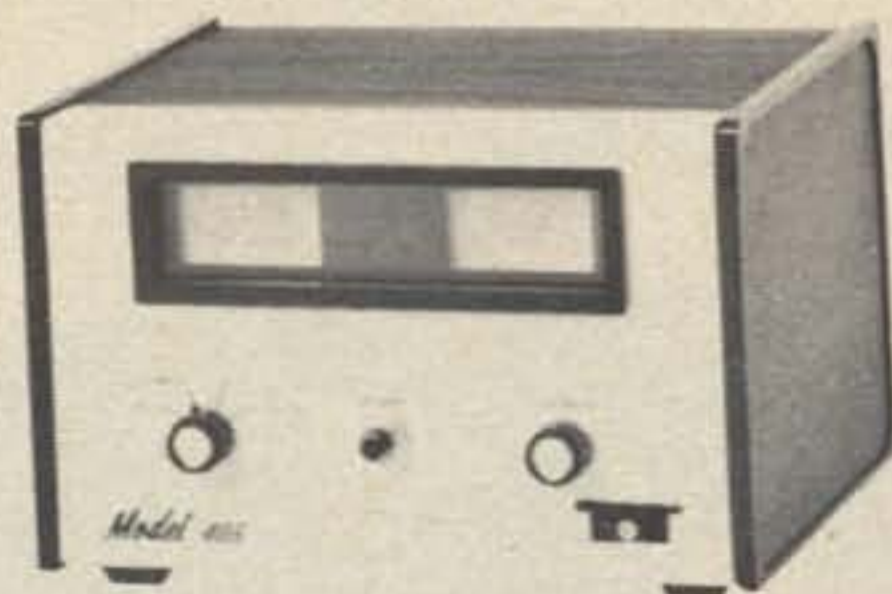

Model 405 Linear

The sustained demand and the enthusiastic comments from happy Argonaut owners are music to our ears. We designed this portable pair to be fun, and your response tells us that it's just what you've been looking for. The Argonaut and it's companion, the 405 Linear, are here to stay — thanks to you.

Argonaut, Model 505\$319⁰⁰
Linear, 100 Watt, Model 405\$149⁰⁰

Power Supply for 505 only, Model 210\$24⁹⁵
Power Supply for 505 and 405, Model 251 ..\$69⁰⁰



TECO

a subsidiary of Tucker Electronics Co.

P.O. BOX 1050 1717 S. Jupiter Rd. GARLAND, TX. 75040

214—348-1560



ICOM

At ICOM the benchmark is quality.

ALL ICOM RADIOS HAVE

- 5 Helical Resonators
- 0.4UV Sensitivity
- High and Low I.F. Filters
- Extremely Low Spurious TX
- Transmit and Receive Trimmers
- ESP
- 5KHz Freq. Deviation
- "S" Meter

INOUE'S NEW PLL SYNTHESIZED IC-230



- 67 + Channels (Direct or ± 600 KHz)
- 30 KHz Steps (Optional 15 KHz)
- 146-148 MHz PLL Synthesized
- Modular Construction
- Socket For Tones or Dial
- Digital Readout (No Tuning)
- P.L.L. Lock Indicator
- \$489.00

- 5 Channels Included
- 22 Channels Total
- No Relays
- Large Speaker
- Carrier Operated Light



\$249.00

IC-22



IC-21A

- 24 Channels
- Discriminator Meter
- Wide Range - 144 - 148 MHz + MARS
- SWR Bridge
- AC Supply Built In
- DC Supply
- Modular Construction
- \$449.00



TECO

a subsidiary of Tucker Electronics Co.

P.O. BOX 1050 1717 S. Jupiter Rd. GARLAND, TX. 75040
214-348-1560

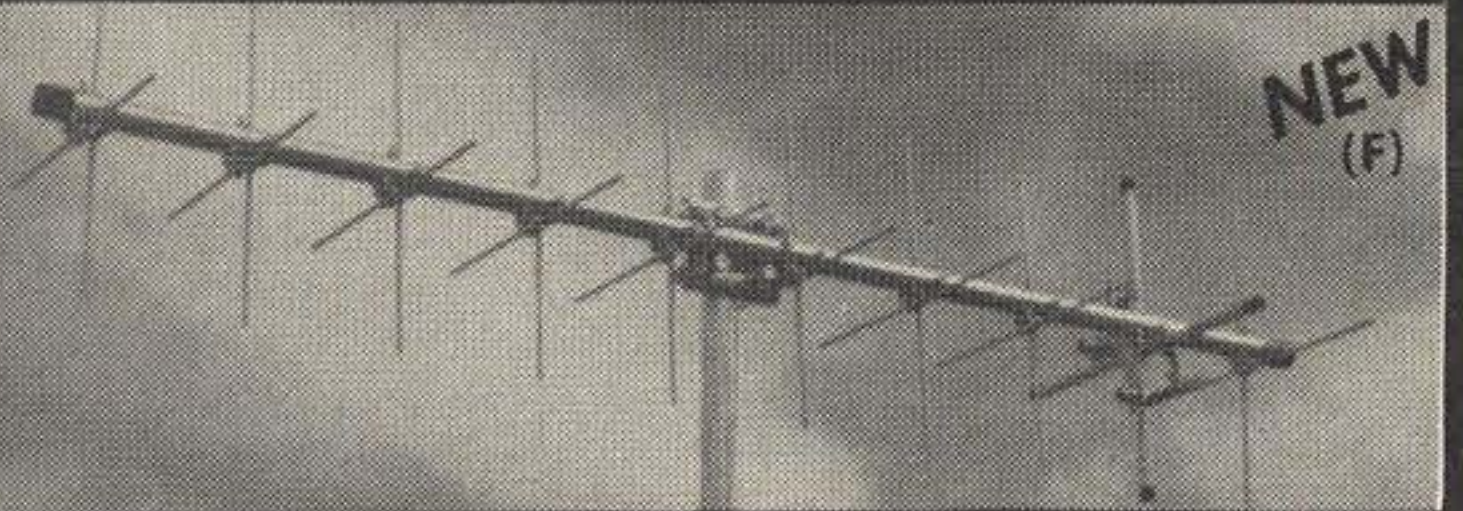
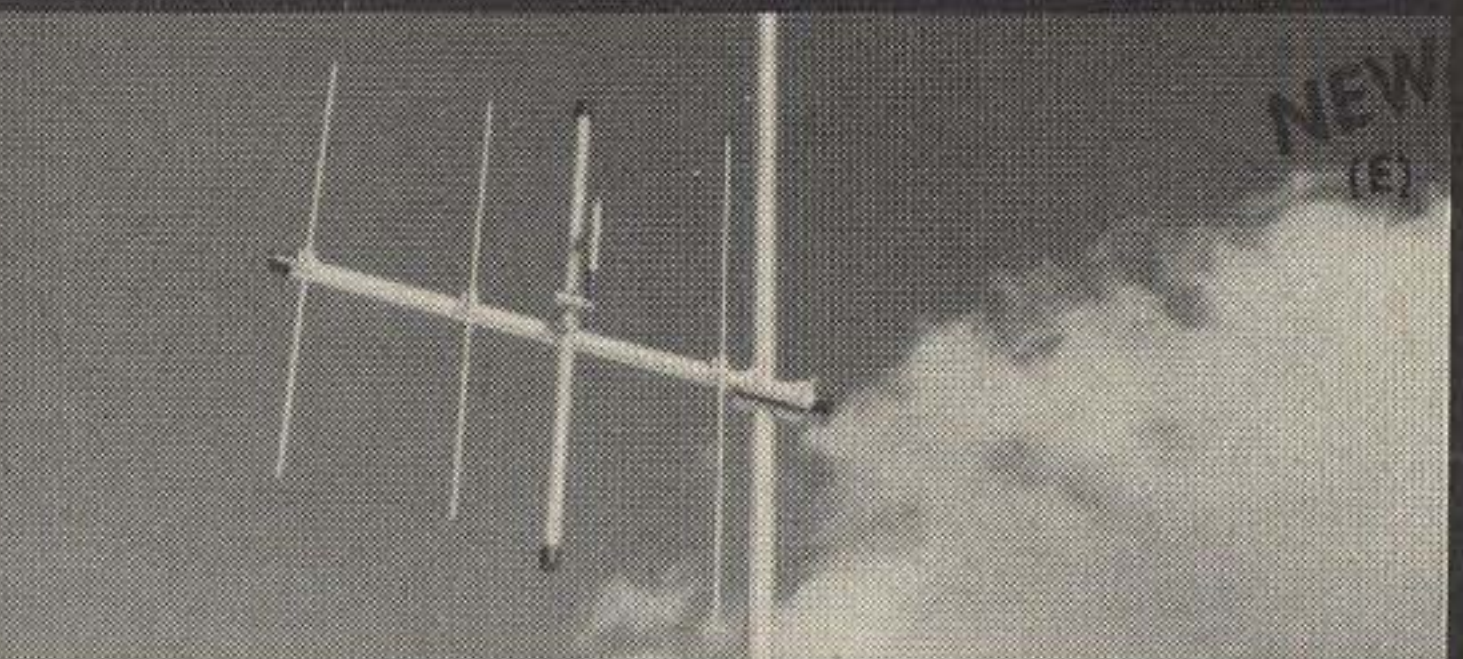
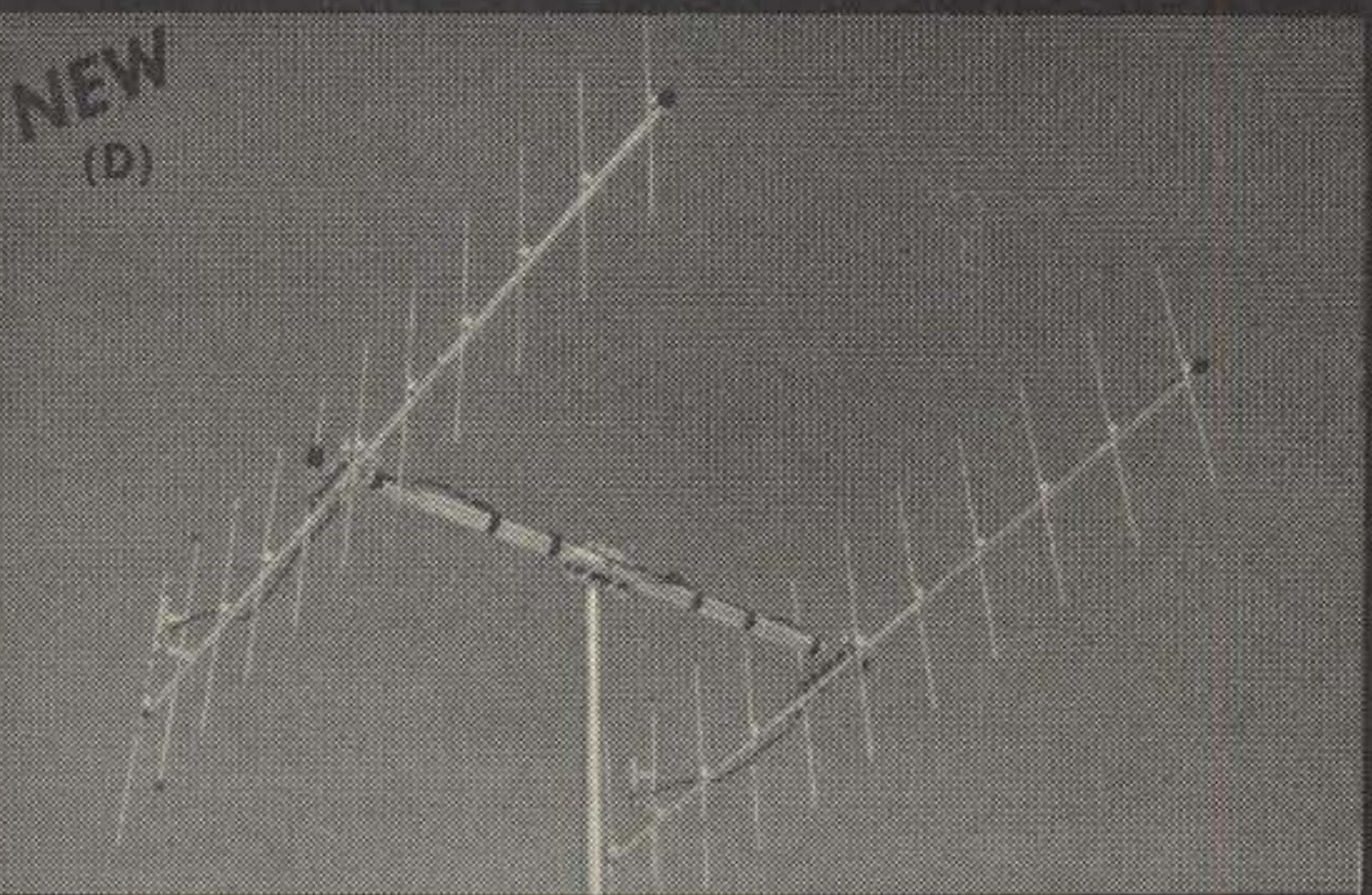
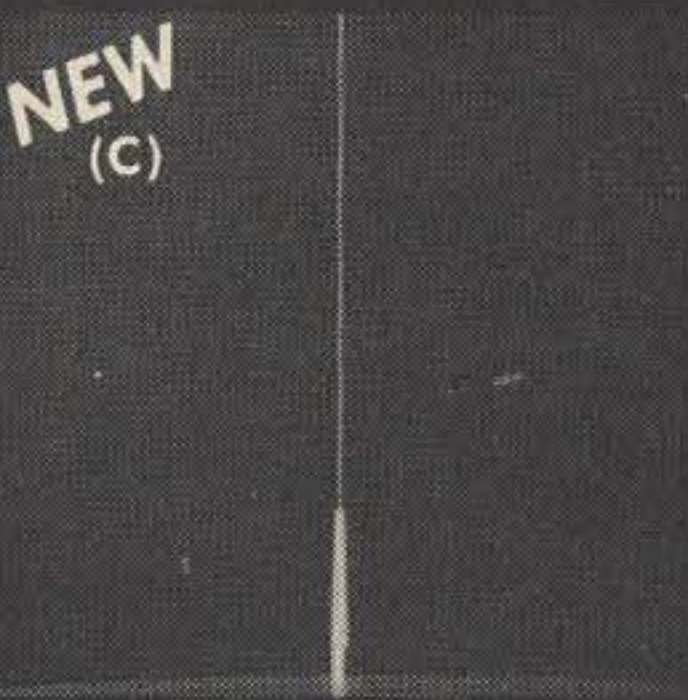
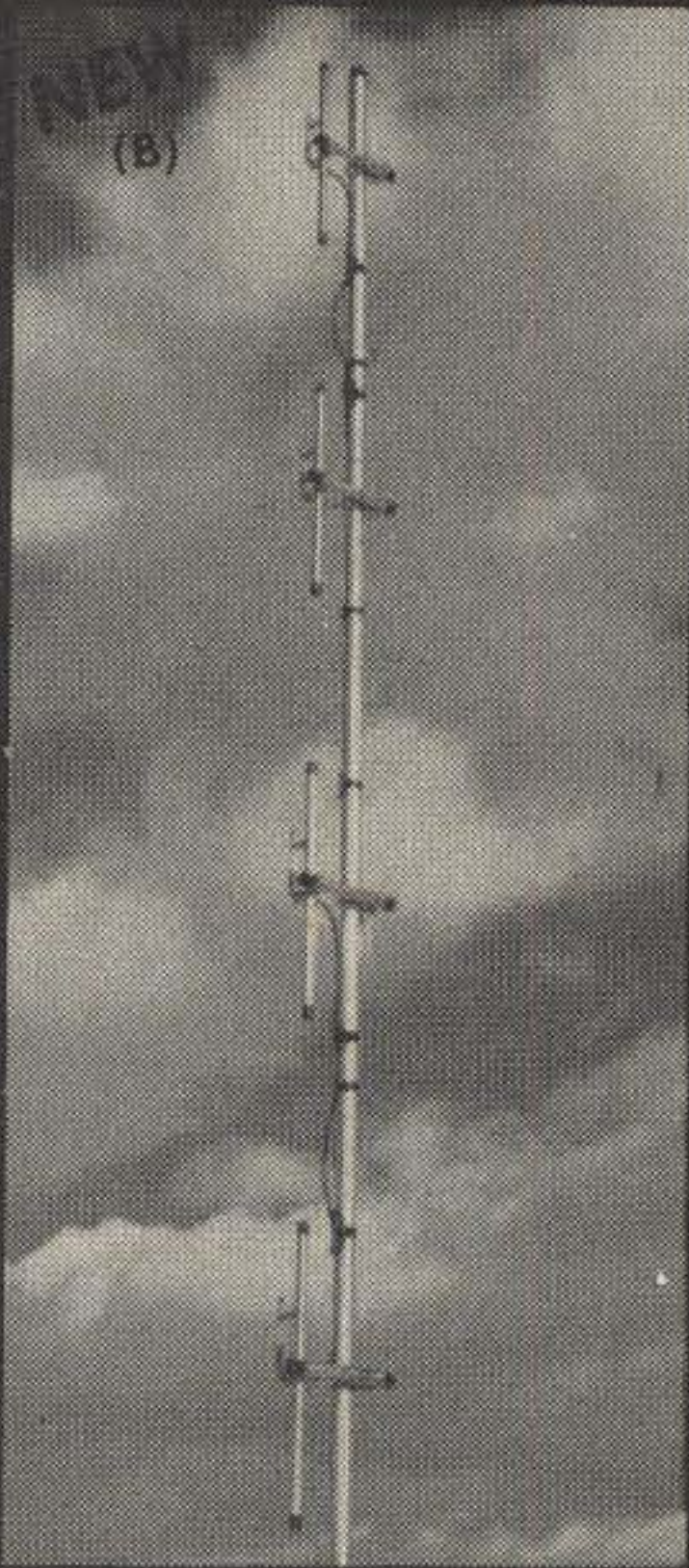
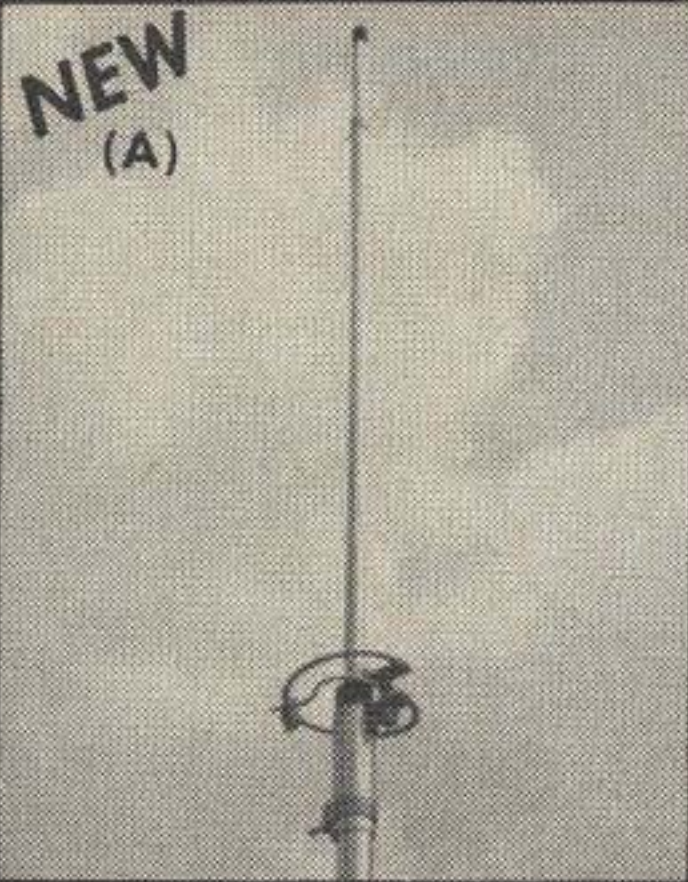

Cush Craft

2 METER FM ANTENNAS

NEW FROM THE WORLD'S LEADING MANUFACTURER OF VHF/UHF COMMUNICATION ANTENNAS

(A) **FM GAIN RINGO:** The most popular—high performance, half-wave FM antennas. Give peak gain, and efficiency, instant assembly and installation.

AR-2	100 watts	135-175 MHz
AR-25	500 watts	135-175 MHz
AR-220	100 watts	220-225 MHz
AR-450	100 watts	420-470 MHz
AR-6	100 watts	50-54 MHz

(B) **4 POLE:** A four dipole gain array with mounting booms and coax harness 52 ohm feed, 360° or 180° pattern.

AFM-4D	1000 watts	146-148 MHz
AFM-24D	1000 watts	220-225 MHz
AFM-44D	1000 watts	435-450 MHz

(C) **FM MOBILE: IMPROVED** Fiberglass $\frac{5}{8}$ wave mobile antenna with new molded base and quick grip trunk mount. Superior strength, power handling and performance.

AM-147T 146-175 MHz mobile

(D) **POWER PACK:** A 22 element, high performance, vertically polarized FM array, complete with all hardware, mounting boom, harness and 2 antennas.

A147-22 1000 watts 146-148 MHz \$68.50

(E) **4-6-11 ELEMENT YAGIS:** The standard of comparison in VHF/UHF communications, now cut for 2 meter FM and vertical polarization. 4 & 6 Element models can be tower side mounted.

A147-4	1000 watts	146-148 MHz
A147-11	1000 watts	146-148 MHz
A220-11	1000 watts	220-225 MHz
A449-6	1000 watts	440-450 MHz
A449-11	1000 watts	440-450 MHz

(F) **FM TWIST:** A Cush Craft exclusive—it's two antennas in one. Horizontal elements cut at 144.5 MHz, vertical elements cut at 147 MHz, two feed lines.

A147-20T 1000 watts 145 & 147 MHz



TECO

a subsidiary of Tucker Electronics Co.

P.O. BOX 1050 1717 S. Jupiter Rd. GARLAND, TX. 75040

214—348-1560

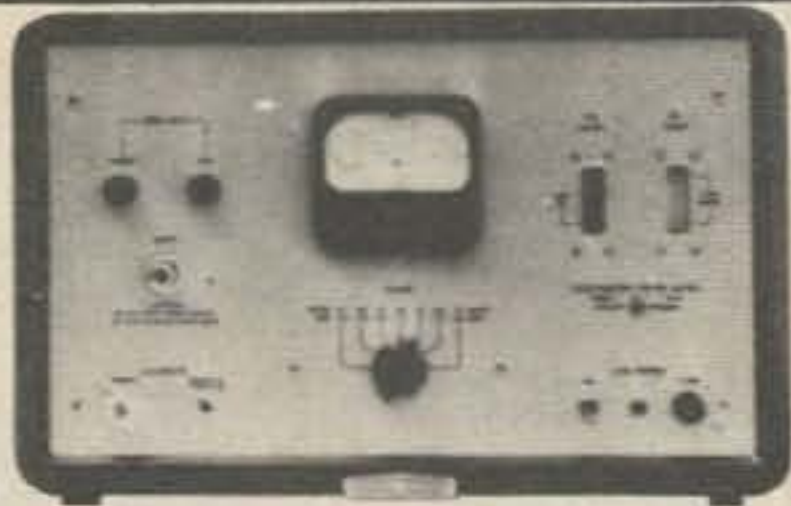

HP 434A CALORIMETRIC POWER METER: Just connect to the Type "N" input and read the power from 10 mW to 10 watts anywhere in the frequency range from DC to 12.4 GHz. No external terminations or detectors - readings directly in watts or dBW. 50 ohms input with internal calibrator circuit and $\pm 5\%$ accuracy. (Accuracy at low end of frequency range is as good as 0.5%). New price exceeds \$2000.00.

TECO PRICE\$695.00



BALLANTINE 300H VTVM: The 300H is a compact, conservatively designed instrument for applications where high accuracy, low maintenance cost, long life, freedom from power line disturbances and simplicity of operation are of prime importance. Its basic accuracy of 2% of reading combined with calibration stability of 5000 hours and high sensitivity of $30\mu\text{V}$ in the null detector mode makes the 300H a versatile laboratory tool. It is also usable as a 40dB gain wide band amplifier. Voltage range is $300\mu\text{V}$ to 300V with frequency range from 10 Hz to 1 MHz, input impedance of $2\text{M}\Omega$ shunted by 15 or 25 pF and -10 to +10 linear dB scale\$130.00



MILITARY TS-537/TSM CRYSTAL IMPEDANCE METER.

With a frequency range from 75 to 1100 KHz in 6 ranges and measurement scales from 0 to 99,000 Ω and 12 to 110 nanofarads this portable, general purpose, test instrument is designed to measure equivalent electrical parameters of quartz crystals of the type used for communications purposes. Provision is made to measure directly the effective series-resonant and anti-resonant resistances of a piezo-electric quartz crystal in its holder. The load capacitance is obtained by applying dial markings to a calibration chart. With the static capacity measured by an external capacity measuring device and with the series-resonant and anti-resonant frequency measured by an external frequency measuring device, the series capacitance and inductance can be calculated. A microammeter indicates the magnitude of oscillation of the oscillator tube by measuring its grid current. Frequency is selected by a switch and a fine tuning control. Equipment can be bench or rack-mounted\$55.00

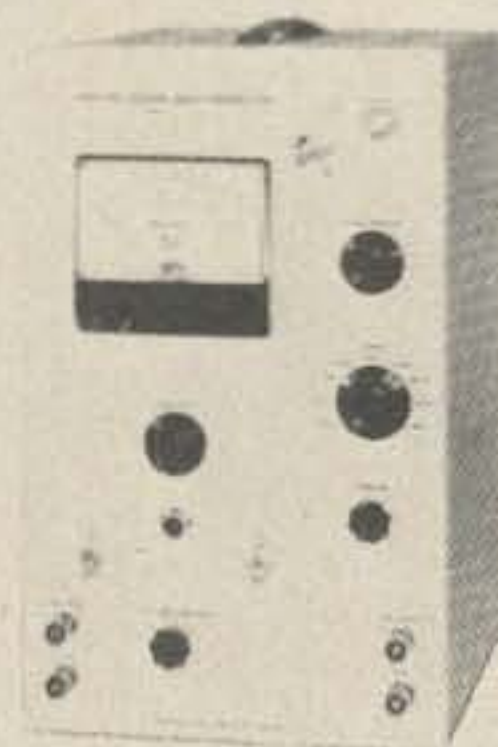

TEXTRONIX 105 SQUARE-WAVE GENERATOR:

From 25 Hz to 1 MHz and with a risetime of less than 20nsec into a terminated 93 ohm cable - the 105 will generate up to 15V and more than 15mA peak-to-peak. Precision square waves over the complete range make the 105 a perfect instrument for testing amplifiers and other test instruments.

The TECO price makes it even better \$75.00

DID YOU EVER need a scope, meter or power supply, but really didn't need it all calibrated and checked out? Well, TECO understands and saves you more money than you could believe at the same time. TECO is just the place to pick up that extra counter or generator . . . or for that matter anything from a vacuum pump to a TV monitor. AND THERE'S ONLY ONE PRICE AT TECO - CHEAP.



TECO

a subsidiary of Tucker Electronics Co.

P.O. BOX 1050 1717 S. Jupiter Rd. GARLAND, TX. 75040

214-348-1560

OSCILLOSCOPES AND RELATED INSTRUMENTS

HP 185 SAMPLING OSCILLOSCOPE: DC to 1 GHz \$195.00
HP 1100A DELAY LINE: 120nsec \$75.00

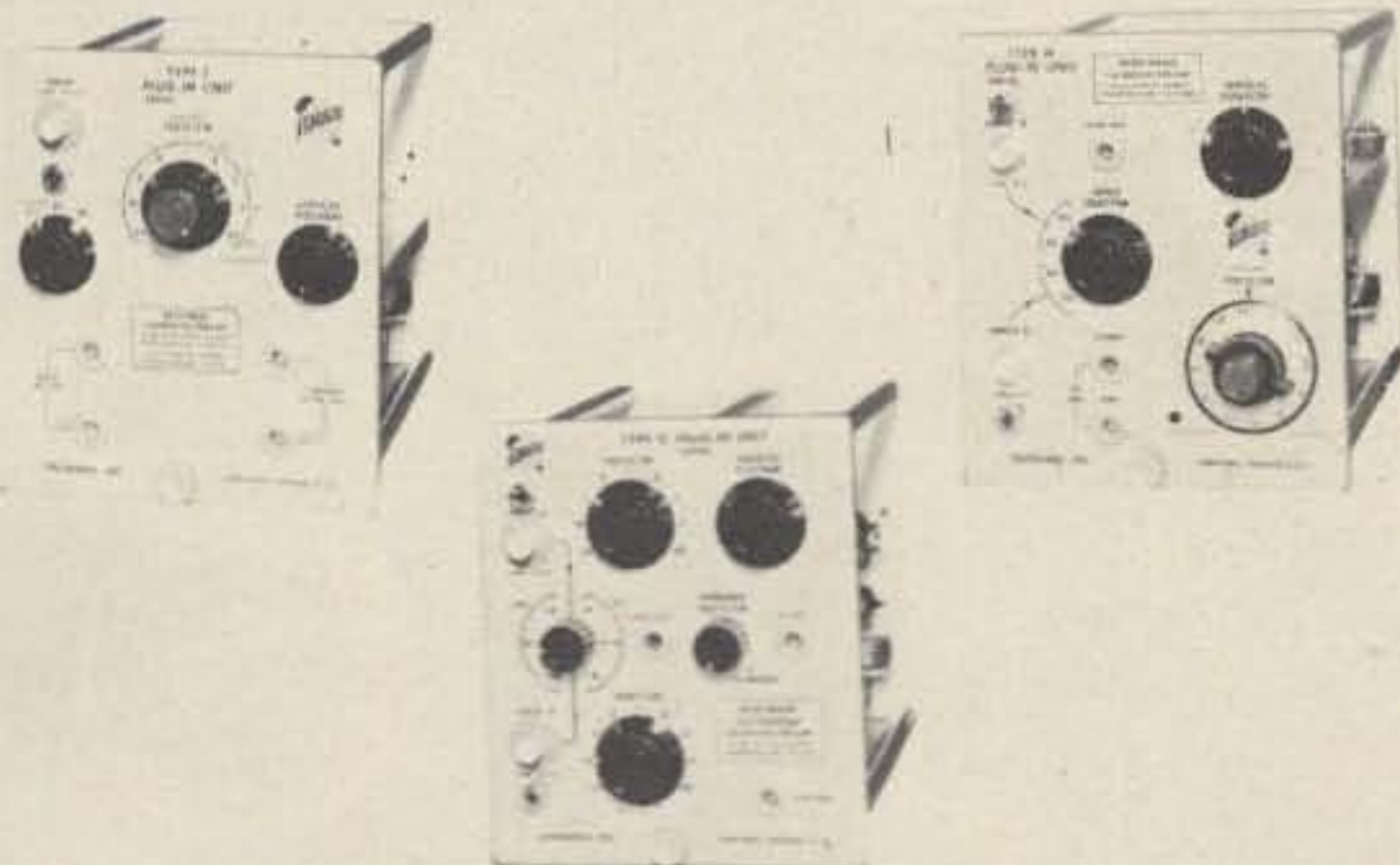

TEKTRONIX OSCILLOSCOPE PLUG-INS: Can be used with the 530, 540 or 550 series oscilloscopes with equal performance.

Model 53/54C dual trace 20 MHz unit \$95.00
TEKTRONIX A PLUG-IN: DC - 20 MHz wideband DC. \$40.00
TEKTRONIX B PLUG-IN: DC 20 MHz High gain wide band \$50.00
TEKTRONIX C PLUG-IN: DC - 24 MHz Dual trace. Same as Model CA except no algebraic add. \$125.00
TEKTRONIX CA PLUG-IN: DC - 24 MHz dual trace \$150.00
TEKTRONIX E PLUG-IN: DC - 60 KHz differential. \$75.00
TEKTRONIX G DIFFERENTIAL PLUG-IN: 50mV to 20V/cm sensitivity, DC to 20 MHz bw, 18ns risetime. \$65.00
TEKTRONIX H SINGLE TRACE PLUG-IN: 50mV to 20V/cm sensitivity, DC to 15 MHz bw, 23ns risetime. \$75.00
TEKTRONIX K SINGLE TRACE PLUG-IN: 50mV to 20V/cm sensitivity, DC to 30 MHz bw, 12ns risetime \$50.00
TEKTRONIX R PLUG-IN: Transistor risetime .. \$65.00
TEKTRONIX 82 DUAL TRACE PLUG-IN: For use with 585 scope, 10 mV to 5V/cm sensitivity, DC to 80 MHz bw, 4ns risetime \$395.00
TEKTRONIX 262 PROGRAMMER: Remotely program the 6R1A digital unit \$250.00
TEKTRONIX 517 OSCILLOSCOPE: DC to 1 GHz with power supply \$295.00
TEKTRONIX 535 OSCILLOSCOPE: DC to 11 MHz less plug-in \$425.00
TEKTRONIX 536 OSCILLOSCOPE: DC to 15 MHz less plug-in \$350.00

RECORDERS AND PRINTERS

BRUSH RE3610-60 100 CHANNEL EVENT RECORDER: "as-is" \$150.00

EAI BAR CHART RECORDER: 40 channels recording time 9, 18, 27 hours \$150.00
ESTERLINE ANGUS RECORDER: Different models available \$75.00
FAIRCHILD 321-A OSCILLOSCOPE RECORD CAMERA: Continuous motion 35mm camera with magazine and variable speeds \$75.00
HP 560A DIGITAL PRINTER: Up to 11 columns capacity with plug-in boards, 5 line/second print speed \$250.00
HP 561B DIGITAL PRINTER: Up to 8 columns, 5 line/second speed \$225.00
L&N W RECORDER: 24 point portable recorder \$525.00
RUSTRAK 120B DUAL CHANNEL RECORDER: 100 to 140 VAC, 0 to 5 amps \$60.00
RUSTRAK 133 TEMPERATURE RECORDER: 15C to 55°C. \$65.00
SANBORN 150 SERIES: All types amplifiers, recorders, plug-ins. Write for details. P.U.R.
TI RECTIWRITER: Dual channel, 1mA movement, multispeed \$75.00

SEND FOR YOUR NEW LEADER CATALOG.



CALL OR WRITE FOR CATALOG



NEW RCA METERS AT SPECIAL TECO SAVINGS



TECO

a subsidiary of Tucker Electronics Co.

P.O. BOX 1050 1717 S. Jupiter Rd. GARLAND, TX. 75040
214-348-1560

IF YOU HAVE ALREADY GONE 450



GO ICOM NOW Before you go bananas!

If you have been trying to resurrect something from the pre-transistor past that more closely resembles the mechanism used to keep large ships in place, or if the sound of bumble bees is keeping you awake at night--REJOICE!!! The ICOM 30A is here and working!

Consider these reasons for owning an IC-30A:

- (1) Despite the fact that the radio is completely solid state, it has output of ten watts
- (2) Receiver sensitivity is better than 0.6UV for 20 db of quieting and that means easy on the ears listening.
- (3) The IC-30A comes with five channels of the 22 channel capacity installed
- (4) Shielding is excellent because the unit is modularly constructed.
- (5) Your car tires will last long because the IC-30A weighs less than ten pounds.
- (6) Like its predecessors, the unit is equipped with a 9 pin plug in the side of the radio to provide you easy access to the discriminator and room for adding the necessary wiring for external accessories--with all this and more, for only \$399.00.



TECO

a subsidiary of Tucker Electronics Co

P.O. BOX 1050 1717 S. Jupiter Rd. GARLAND, TX. 75040

214-348-1560

You know you can count on

hy-gain

for the finest in Ham
Radio Antennas!

The voice of



is heard around the world

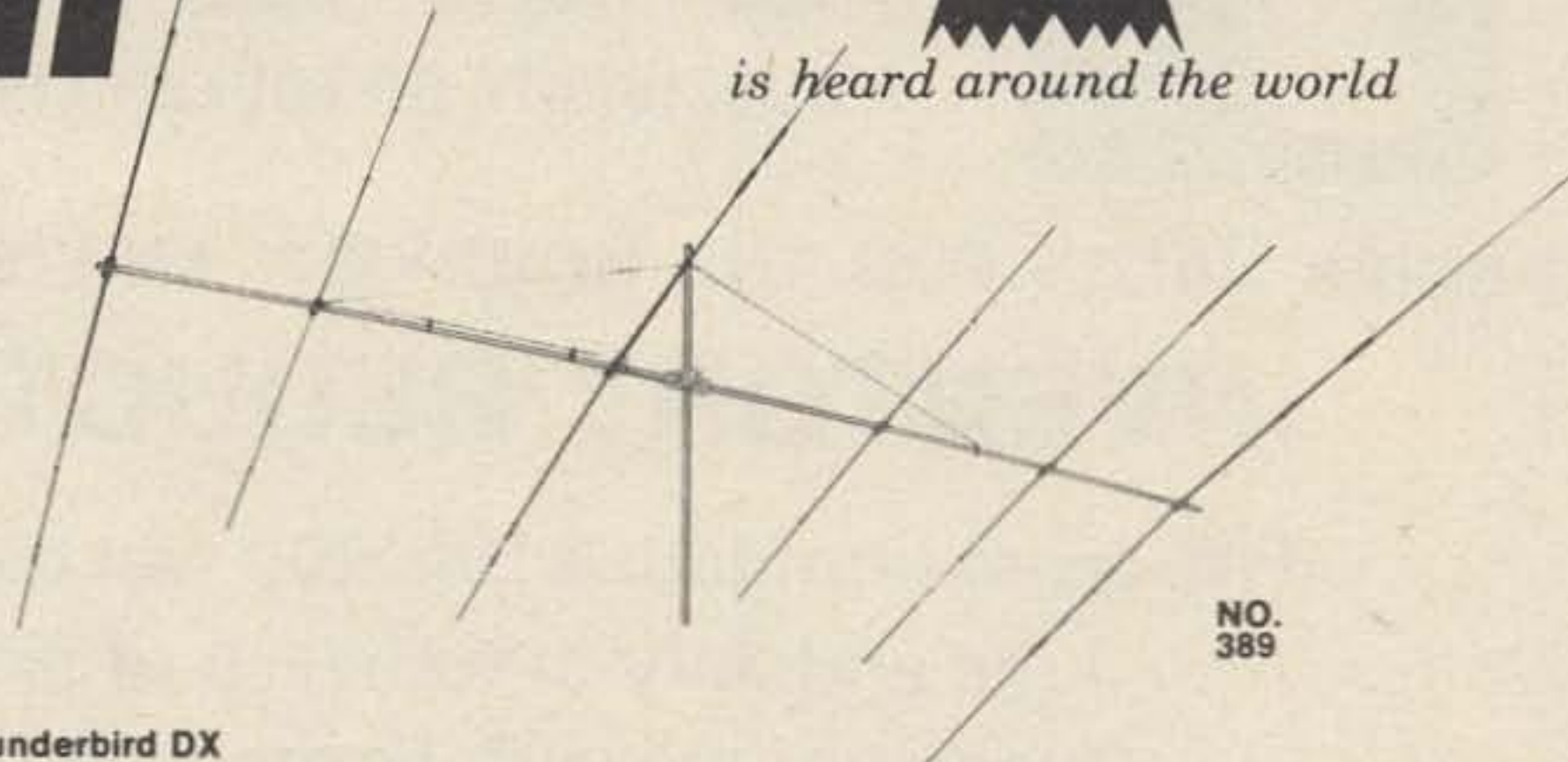

NO.
389

TH6DXX
6-Element Super Thunderbird DX
Superior Performance TriBander.

Impressive coverage 10-15-20 meters. Separate, improved Hy-Q traps for each band... SWR less than 1.5:1 on all bands. Takes maximum legal power, up to 1 kw AM, 2 kw PEP. Exclusive Beta Match. Factory pre-tuned. Feeds with 52 ohm coax.

ORDER NO. 389

NO.
182

NO.
386



NO.
388

TH3Mk3 3-Element Super Thunderbird
Popular TriBand Beam Improved!

Outstanding performance 10-15-20 meters at reasonable cost. Separate, matched Hy-Q traps for each band. Exclusive Beta Match for tapered impedance, DC ground. SWR less than 2:1 at resonance. Accepts maximum legal power and feeds with 52 ohm coax.

ORDER NO. 388

TH3JR

3-Element Thunderbird TriBand Junior. Ideal for top performance in limited space. Beta Match. SWR 2:1 or less.

ORDER NO. 221

18V

Low cost, high efficiency vertical. Can be easily tuned to any band 80 thru 10 meters. Highly portable.

ORDER NO. 193

18AVT/WB

The Great Wide Band Vertical
Super Performer 80 thru 10 Meters!

Superb omnidirectional capabilities. Automatic band switching. Beefed-up Hy-Q traps. Top loading coil. True 1/4 wave resonance on all bands. SWR 2:1 or less at band edges. Outstanding low radiation pattern. Entirely self-supporting.

ORDER NO. 386

TH2Mk3

2-Element Super Thunderbird. Compact TriBander delivers excellent performance. Beta Match. Hy-Q traps.

ORDER NO. 390

14AVQ/WB

Wide band performance 40 thru 10 meters with one setting. Hy-Q traps. True 1/4 wave resonance on all bands.

ORDER NO. 385

18 HT

Incomparable Hy-Tower
Finest Multiband on the Market!

Automatic band selection 80 thru 10 meters. Unique stub decoupling system isolates electrical 1/4 wavelengths for each band. Takes maximum legal power. Feeds with 52 ohm coax. 24' tower is entirely self-supporting, virtually indestructible. Requires only 4 sq. ft. for installation.

ORDER NO. 182

12AVQ

For 10-15-20 meters. Hy-Q traps. Low angle of radiation. Self-supporting.

ORDER NO. 384



TECO

a subsidiary of Tucker Electronics Co

P.O. BOX 1050 1717 S. Jupiter Rd. GARLAND, TX. 75040

214-348-1560



TECO

A SUBSIDIARY OF TUCKER ELECTRONICS CO.

SPECIAL SALES FOR THE HOBBYIST, AMATEUR AND BARGAIN HUNTER.

INVENTORY REDUCTION SALE!!

(We must liquidate \$100,000 worth of inventory during June and July at unheard of prices.)

Quantities are very limited on many items and will not likely be available again at the low prices.

The instruments listed are surplus unless otherwise stated. Each unit is sold as-is and every attempt is made to assure completeness. While most instruments are operational, no warrantee is implied or stated. There is a 10 day trial period for each instrument which allows you to inspect and assure yourself that you are satisfied. You may return the instrument for full credit during this 10 day period-paying only freight charges. Since it is impossible to list the individual condition of each instrument-call and discuss your choice. Should you desire the same instrument completely reconditioned and guaranteed, we can put you in touch with our parent company for price and availability information.

CREDIT - TECO'S terms are cash or COD with the following exceptions. TECO accepts BankAmericard, MasterCharge and American Express. TECO will sell on net 10 days to D&B or credit established customers. Our aim is to keep our overheads as low as possible so we can continue to offer instruments at the very lowest prices. Please help us to meet our goals and send your check with your order.

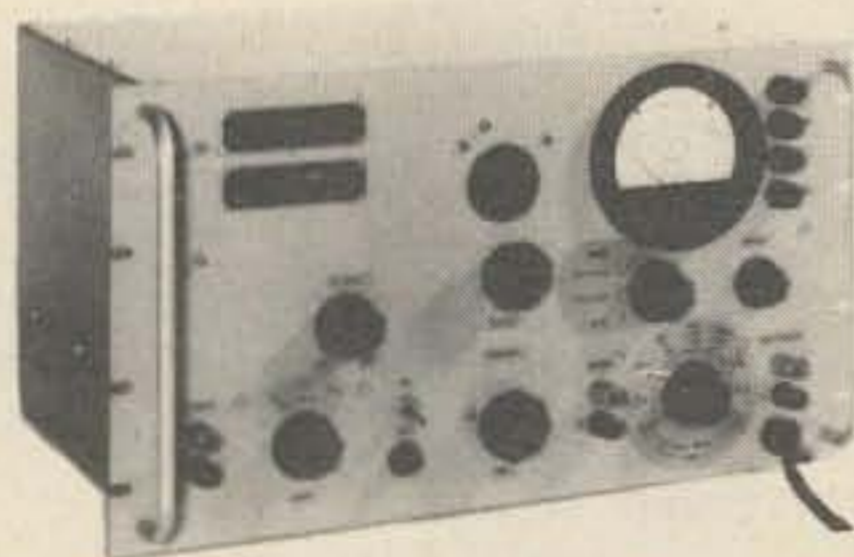

MILITARY TS-723B/U (HP 330B) DISTORTION ANALYZER

This marvelous noise and distortion analyzer gives accurate direct readings from 20 Hz to 20 KHz. Perfect for measuring audio distortion, voltage level, power output, gain, distortion of AM RF carrier, measuring hum and noise level and audio signal frequency. Blanking the audio spectrum the TS-723 measures noise levels as small as 100 μ V and distortion as low as 0.1%. A wide-band 20dB gain amplifier is built in as well as a VTVM with nine full scale ranges from 0.03 to 300 volts and nine dB ranges spaced exactly 10dB per range from -12dB to +2dB. Residual frequencies are measured to within $\pm 3\%$ of full scale value. TECO'S special sale price is only\$125.00



LEEDS & NORTHRUP 5430 A (MILITARY ZM-4B/U) RESISTANCE BRIDGE.

This advertised special is a portable, general purpose wheatstone bridge designed primarily to measure resistances when locating faults which occur in conductors used for communications systems and those used for power transmission. It can also measure the value of any fixed resistor. In addition to the self-contained galvanometer it has provision for external null indicator and batteries. Measures resistance values from 0.001 to 1,011,000 ohms, internal battery power supply. Ratio dial multiplying values for resistance measurements and Varley loop tests are 1/1000, 1/100, 1/10, 1/9, 1/4, 1, 10 and 100. Ratio for Murray loop tests are M1000, M100 and M10. Accuracy is $\pm 0.1\%$ of indicated resistance\$75.00



TECO

a subsidiary of Tucker Electronics Co

P.O. BOX 1050 1717 S. Jupiter Rd. GARLAND, TX. 75040

214-348-1560

MEET THE STATE OF THE ART ON 2 METERS... THE ITC MULTI-2000 CW/SSB/FM TRANSCEIVER



Whether your interest is simplex, repeater, DX or OSCAR the new ITC MULTI-2000 lets you get into all the action on all of the

band. Fully solid-state and employing modular construction, the MULTI-2000 enjoys features found in no other 2m transceiver.

FEATURES

- PLL synthesizer covers 144-148 MHz in 10 kHz steps
- Separate VXO and RIT for full between-channel tuning
- Simplex or ± 600 kHz offset for repeater operation
- Three selectable priority channels
- Multi-mode operation (CW/SSB/NBFM/WBFM)
- Built-in AC and DC power supplies, noise-blanker squelch and rf gain control
- Selectable 1W or 10W output
- Separate S-/power and frequency deviation meters
- Built-in test (call) tone and touch-tone provision
- Excellent sensitivity ($.3 \mu\text{V}$ for 12 dB SINAD)
- Superior immunity to crossmodulation and intermodulation
- Introductory price: \$695.



TECO

a subsidiary of Tucker Electronics Co.

P.O. BOX 1050 1717 S. Jupiter Rd. GARLAND, TX. 75040

214—348-1560

ID Timer

For about \$6.00¹ this project can be many things to many people. This ten minute station timer utilizes a digital readout display indicating elapsed time in minutes. When nine minutes has passed, the 9 numeral blinks for 60 seconds, which is a real eye catcher, before resetting to zero, starting another count cycle. A manual zero reset is provided to start the timer at the beginning of your QSO.

If you have not, as yet, "gotten your feet wet" with relaxation oscillators, ICs, or numeric display tubes, this is a simple starter project.

Circuit

The timer is line operated, and all circuitry should be isolated from the exterior cabinet. Line voltage is divided to supply 10 volts to the bridge rectifier. This voltage is dropped and regulated to 5 volts for the unijunction pulse generator and ICs. Adjustment of the 1 meg pulse generator pot determines the time necessary to charge the 100 μ F timing capacitor, which should be of good quality. When this capacitor charges sufficiently to turn on the unijunction, the transistor fires, discharging the capacitor and generating a voltage pulse across its 47 Ω resistor. These pulses are counted by the 7490 decade IC. The output of the counter is fed to the 7441 decoder driver which turns on the proper numeral in the readout tube.

The 9 numeral is connected as a relaxation oscillator and flashes. The flash rate may be varied by changing the value of the 100k resistor. The 3 μ F capacitor must be paper, not electrolytic. Approximately 140 V dc for the readout is obtained from the line via a single diode and filter.

Reset

Depressing the manual reset button lifts the 7490 terminals 2 and 3 off ground, resetting the count to "0." At the same time, the 100 μ F capacitor is shunted to ground through four diodes, which discharges it to approximately the same level as does the transistor. This eliminates an extra long first count after a manual reset.

If you have not done so before, the action of all functions of this circuit may be observed with a scope or VTVM.

This circuit, of course, may be used for other timing functions by changing the value of the unijunction timing components.

Accuracy on several units built was within 15 seconds over any ten minute period.

...WB4MYL

¹Poly Paks. Some surplus 7441 ICs were found to generate wide band noise on some or all digits (455 kHz - 180 MHz). This, of course, is not tolerable and will not be observed on a 100% good 7441. Radio Shack's pre-etched board, "One Digit Counter," may also be used for this project.

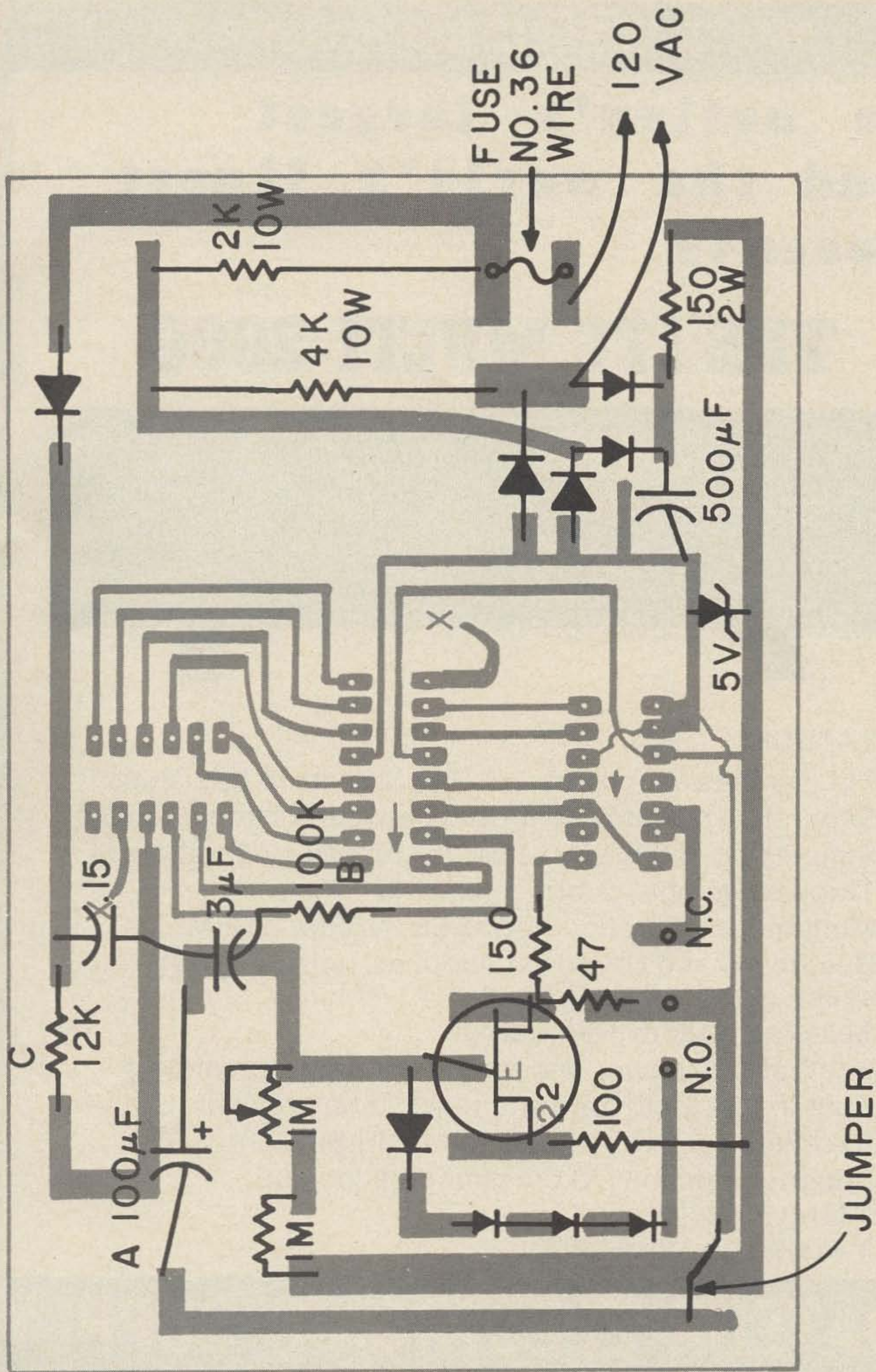

Fig. 1. All parts are mounted on foil side. A—If 100 μ F cap has leakage greater than 10 μ A, reduce the value of 1 meg resistor at timing pot as needed. B—"9" flash rate: adjustment of the 3 μ F paper cap and 100k resistor may be necessary on some NIXIE tubes for desired flash rate. C—This value may be reduced for brighter display; check NIXIE data for maximum allowable current. X—Jumper.

AMATEUR ELECTRONIC SUPPLY

**the nation's largest
and the world's finest
presents**

THE ITC MULTI-2000



FEATURES

- PLL synthesizer covers 144-148 MHz in 10 kHz steps
- Separate VXO and RIT for full between-channel tuning
- Simplex or \pm 600 kHz offset for repeater operation
- Three selectable priority channels
- Multi-mode operation (CW/SSB/NBFM/WBFM)
- Built-in AC and DC power supplies, noise-blanker squelch and rf gain control
- Selectable 1W or 10W output
- Separate S-/power and frequency deviation meters
- Built-in test (call) tone and touch-tone provision
- Excellent sensitivity (.3 μ V for 12 dB SINAD)
- Superior immunity to crossmodulation and intermodulation
- Introductory price: \$695.

AMATEUR ELECTRONIC SUPPLY

4828 West Fond du Lac Ave. Milwaukee, Wis. 53216

Phone (414) 442-4200

STORE HOURS: Mon & Fri 9-9, Tues, Wed & Thurs 9-5:30, Sat 9-3

Kelly D. Anderson WBØDQC ex-WB4ODG
37 N. Ely
Colorado Springs CO 80911

and

Walter J. Atkins, Jr. WBØHKB/K4AJQ
3907 Alameda Circle
Colorado Springs CO 80918

Build An 11 dB Coatrack

We have designed and built parasitic beams for 2 meters at practically no cost that provide gains and front to back ratios comparable to commercial models. Our six element model gives about 11 dB gain and 14 dB front to back ratio, while our eight element model gives about 12 dB gain and 14 dB front to back ratio. Either model can be built for about two dollars.

Everything in electronics is a compromise. We sacrifice perfection for expedience, trade optimum performance for ease of operation, simplicity and reduced cost. But then, we need not compromise away excellence. One of the fundamental principles of engineering is to selectively compromise in order to obtain the best possible results under the circumstances; the creative use of the circumstances separate the men from the boys. Common examples of selective compromise are the tri-band beam and the familiar transceiver.

For those of you shaking your heads and mumbling "no compromise," let us put the advantages of ignoring results slightly less than perfect in a more concrete way. If you were to stand an engineer and a mathematician at one end of a room, and a voluptuous brunette at the other, then instruct them to take one step halfway across the room, the second step half the length of the first, the third half the second, and so on, the mathematician would never start, because he knows he will never reach his goal. The engineer will walk right over, knowing that whatever distance remaining

after "X" number of steps will be negligible. Thus, the extra effort and expense to obtain the best possible is not always justified.

When operating VHF with low power, however, it is highly desirable to utilize an antenna which compromises as little as possible in efficiency and directivity. A no-compromise, high gain, efficient array can be constructed for a very small capital investment. The key to low cost in such an antenna is in the selection of materials of which it is to be comprised. We have constructed and tested two such arrays, a six-element and an eight-element Yagi for two meters.

The performance of these antennas has been exceptional. Yet quality must be designed into an antenna. High quality components will not make up for inferior design. Thus, we will first turn to the developmental stage of this experiment.

Design Parameters

Since we are frequent operators on the two meter band using low power, and our QTH is fortunate to have several repeaters within range, we required a directive array which afforded us a good front-to-back ratio, high efficiency, and rugged construction capable of withstanding high winds and severe ice loading. Our antenna must also be vertically polarized because all the local repeaters are vertically polarized. Cross-polarization means little after a few skips off the ionosphere, but when operating line of sight, it can mean as much as 14 dB or more

loss in signal strength. Finally, broadbandedness was desirable, since the operating frequencies of the local repeaters cover most of the 146 MHz spectrum.

Optimum spacing of elements was selected over less than optimum spacing and a greater number of elements, since this design affords an advantage in forward gain. A tapered director approach was also taken because of the increased bandwidth, with only slight reduction in forward gain. In this way we made our compromise to our advantage.

The first experimental antenna was a six-element array assembled on a boom slightly over six feet in length. The performance of this antenna was so impressive that a second array, built on a ten foot boom, and consisting of eight elements, was constructed.

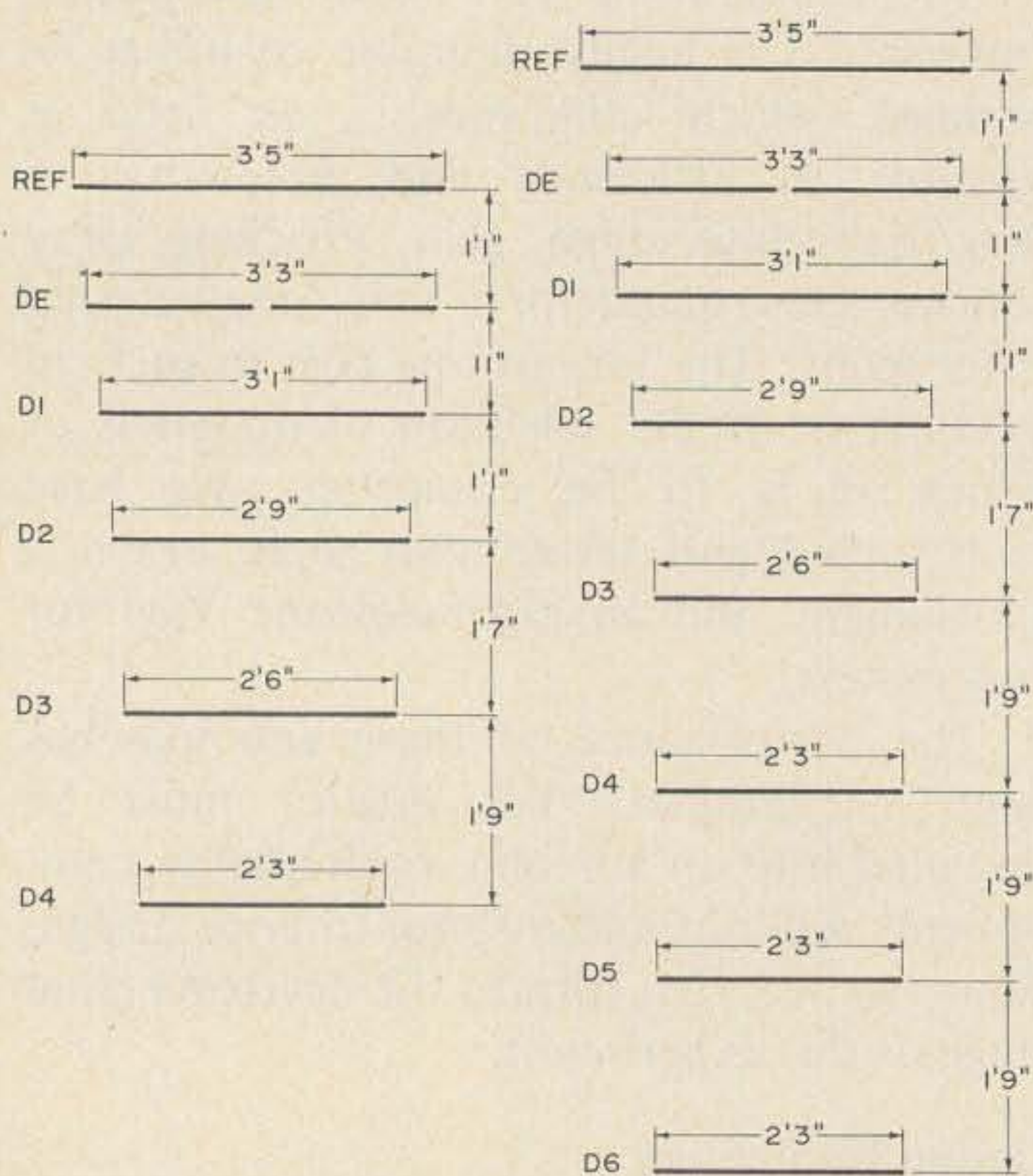

Fig. 1.

Fig. 1 depicts the dimensions used for both arrays, designed for 146.2 MHz. Fig. 2 shows these dimensions as a function of wavelength for the amateur who wishes to construct an array for a different resonant frequency.

Construction

As previously mentioned, the cost of these two antennas was next to nothing. The secret is in using 2½ inch diameter PVC for

DIMENSIONS AS A FUNCTION OF WAVELENGTH (λ)

$$\lambda = \frac{1005}{f_0 \text{ (MHz)}}$$

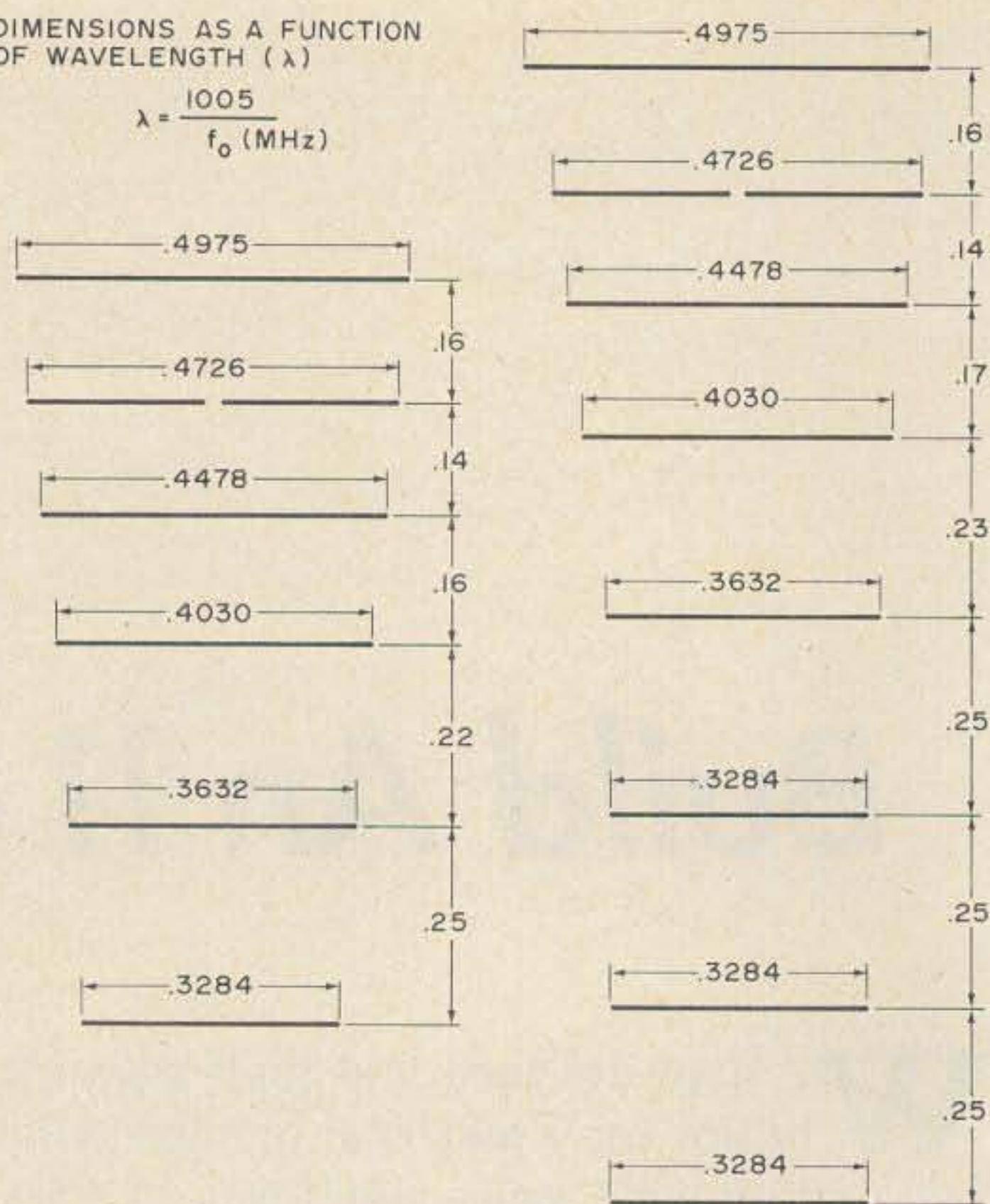

Fig. 2.

the boom, and coat hangers for elements. The PVC is fairly rigid, weather proof, non-conductive, light, comes in ten-foot lengths, and is inexpensive. Coat hangers are rigid enough to be self supporting at VHF, they are easily soldered, and are free. (If your closets are like ours, a semi-infinite supply of element material is readily available.)

The first step is to gather up enough hangers, cut off the hooks, and straighten them. We found the average length of the straightened hangers to be about 34 inches, so you can see that the longer elements must be made of two hangers spliced together. This is easily done by cleaning about an inch of the ends of the two elements with sand paper, overlapping them in a vise, and soldering them together. You will then have more than enough length. The driven element is a simple half-wave dipole, so remember to cut two pieces half the total length given in the formula. The half-wave dipole allows for simplicity in construction and tuning, and is also a more efficient radiator than a gamma or "T" matched driven element.

Once the elements have been cut to length, measure out the spacing on the PVC boom. Drill holes just big enough to allow the wire to pass through. Center the ele-

MEET THE STATE OF THE ART ON 2 METERS... THE ITC MULTI-2000 CW/SSB/FM TRANSCEIVER

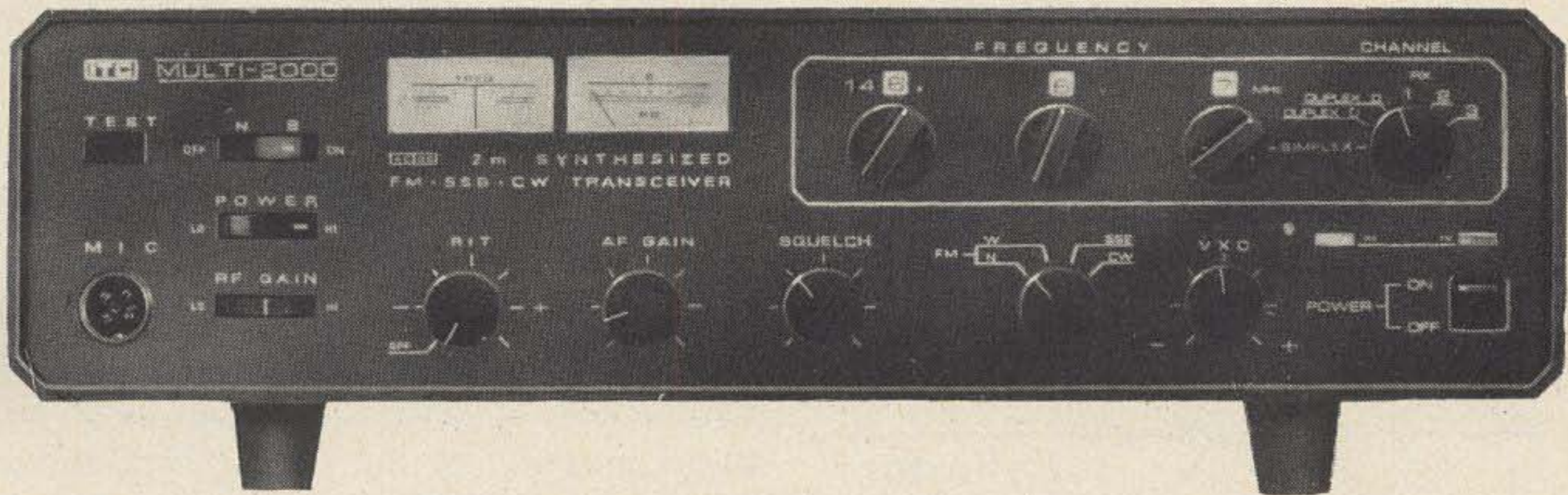

Whether your interest is simplex, repeater, DX or OSCAR the new ITC MULTI-2000 lets you get into all the action on all of the

band. Fully solid-state and employing modular construction, the MULTI-2000 enjoys features found in no other 2m transceiver.

FEATURES

- PLL synthesizer covers 144-148 MHz in 10 kHz steps
- Separate VXO and RIT for full between-channel tuning
- Simplex or ± 600 kHz offset for repeater operation
- Three selectable priority channels
- Multi-mode operation (CW/SSB/NBFM/WBFM)
- Built-in AC and DC power supplies, noise-blanker squelch and rf gain control
- Selectable 1W or 10W output
- Separate S-/power and frequency deviation meters
- Built-in test (call) tone and touch-tone provision
- Excellent sensitivity (.3 μ V for 12 dB SINAD)
- Superior immunity to crossmodulation and intermodulation
- Introductory price: \$695.

KLAUS RADIO Inc.

8400 N. Pioneer Parkway, Peoria IL 61614, Phone 309-691-4840
Cliff Morris W9GAO — Jim Plack WB9BGS

ments on the boom, and hold them in position with tape. Then apply epoxy glue to permanently bond the elements to the boom. Fig. 3 illustrates the finished assembly for the driven element and the reflector.

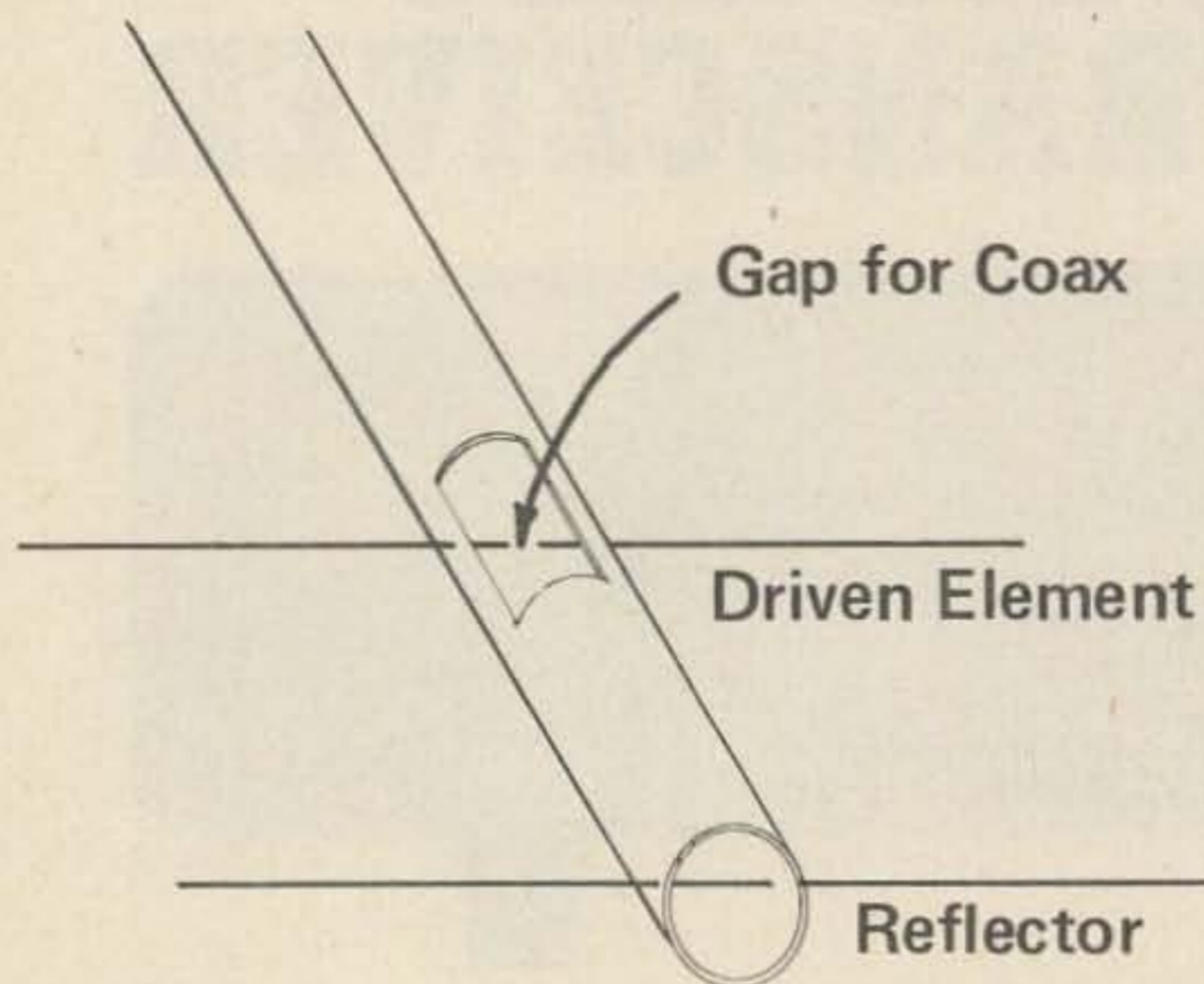

Fig. 3.

When the glue has hardened, the antenna is ready for tuning and pruning. Solder the coax to the driven element, and tune for minimum swr at your selected resonant frequency. We were able to obtain an swr of 1.05:1 at 146.16 MHz, climbing to 1.5:1 at 146.94 MHz. If we can extrapolate from this, and assume an swr of 2:1 as acceptable, then the bandwidth of this array would be in the neighborhood of 2 MHz.

Performance

Once the six element array was tuned, field strength measurements were made. The results showed about 11 dB forward gain and a front to back ratio of about 14 dB. We were able to work the WRØADF repeater located near Denver from our QTH in Colorado Springs with 30W. This is about 60 miles with high ground between us. Using 1W of power, we were full quieting through the WRØADR repeater located in Pueblo about forty miles away with no intervening terrain.

We then ran some field tests using a TR-22. Operating simplex from an automobile, we were able to maintain good communications with only 1W out to about twenty miles. Operating with the same equipment, except switching to a ground plane antenna at the fixed QTH, the maximum range of reliable communications was less than five miles. The eight element array was tested in a similar manner. It showed slightly better gain, about 12 dB, and about the same front to back ratio.

Of course, these figures depend upon how you tune your array. If you tune for maximum gain, there is some sacrifice in front to back ratio, and vice versa. You will have to determine if you want maximum gain, maximum front to back, or a compromise between the two.

...WBØDQC and WBØHKB

IT PAYS TO ADVERTISE IN 73

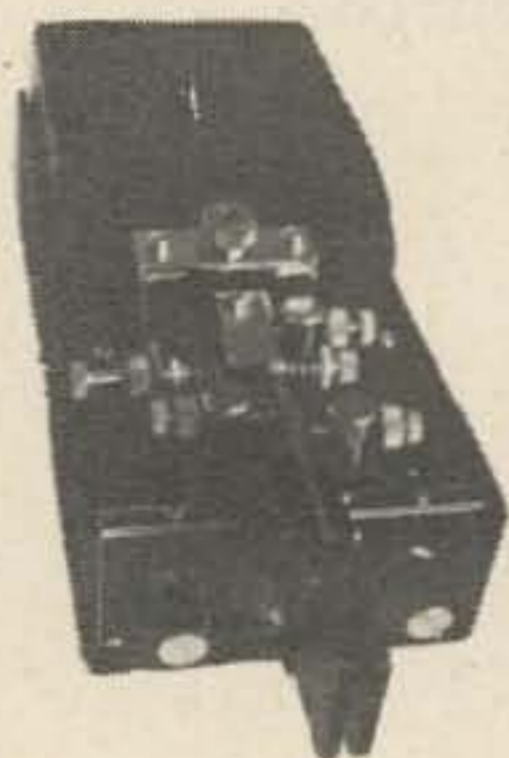

GLOBALMANtm ELECTRONIC KEYSER

EK-108D
with built in monitor
\$74.95 ppd.

Jam-Proof IC Circuitry • 5-50 wpm self completing • Output heavy-duty TR switch 250v. 2 amps • Power: 2 flashlight batteries or external 6VDC
We have speech processors, code monitors, electric alarms, Also!

1 year unconditional guarantee — 10 day return privilege
Write for specs & photos. Dealers Wanted

W6PHA — GLOBAL IMPORT CO.

714-533-4400 Telex 678496 Box 388P El Toro, Calif. 92630

8080, 8 BIT CPU: \$175.00;
8038, VCO: \$4.95
MM5203Q-1, 2048 BIT RE-PROM: \$16.50
8T11, 1K RAM: \$12.25;
8T97, HEX INV: \$3.50
AY5-1008, TTY RX: \$6.00;
AY5-1010, TTY TX: \$6.00
AY5-1013A, UART: \$14.50;
XR205, FUNCT. GEN: \$12.00
XR210, FSK: \$6.00;
VA210C 10GHZ KLYSTRON: \$35.00

100% Satisfaction Guaranteed, Catalog 10¢

ELECTRONIC DISCOUNT SALES
138 N. 81st ST., MESA, ARIZONA 85207

Front Burner For Six

Solid State Two Stage Preamp

Although 6m FM is not enjoying the popularity that 2m FM is, there is still some activity between 52 and 53 MHz. Simplex coverage is somewhat better here than on 2m, and many people leave their rigs squelched on 52.525. When the band opens, one can have a great time.

Many surplus portables, usually the tube only or hybrid types, have appeared on the market at fairly low prices. I have a G.E. H-11 prog line portable that puts out about 1W, which is inadequate power a lot of the time. Using the amplifier to be described with it, I can get about 35W out, which represents some 15dB. I am in the process of building an all transistor, 1W exciter to replace the tube type that the G.E. uses, so I will end up with a completely solid state 35W transceiver.

This amplifier is easy to build, easy to tune, stable, lightweight and efficient. At 14V with 1W drive, the amplifier delivers 38W output and draws 4.7A. This works out to an efficiency of 58% overall. Like all class C amplifiers, it draws no current unless rf is put into it. No provisions for switching will be given here — see the article on 2m amplifiers in the April, 1973 issue of 73 Magazine for more information.

Circuit Description

The circuit, Fig. 1, actually consists of two separate amplifiers, each one being able to work into and accept a 50Ω impedance. If the amplifier is divided at the short piece of coax, you will have two separate ampli-

fiers, either of which can be used alone.

The first stage uses an inexpensive device that was designed to run up to 100 MHz with 28V on the collector. It will give about 7-8 dB of gain on 6m running at 13-14V. I used the 2N3818 because of its price — they can be found surplus for one to three dollars.

The second stage uses a device that is designed to run on 12.5V up to 50MHz. If you have 4 to 6W of power available, this stage will give you about 40-45W out. If you do use it alone, add a variable capacitor of 25 to 280pF, such as an Arco #464, in series with the input to the junction of L3 and C7.

When I built these amplifiers, I did them separately. Later, when I decided to use them together, I combined them into one assembly. There is no reason why they cannot both be built on the same board and heat sink.

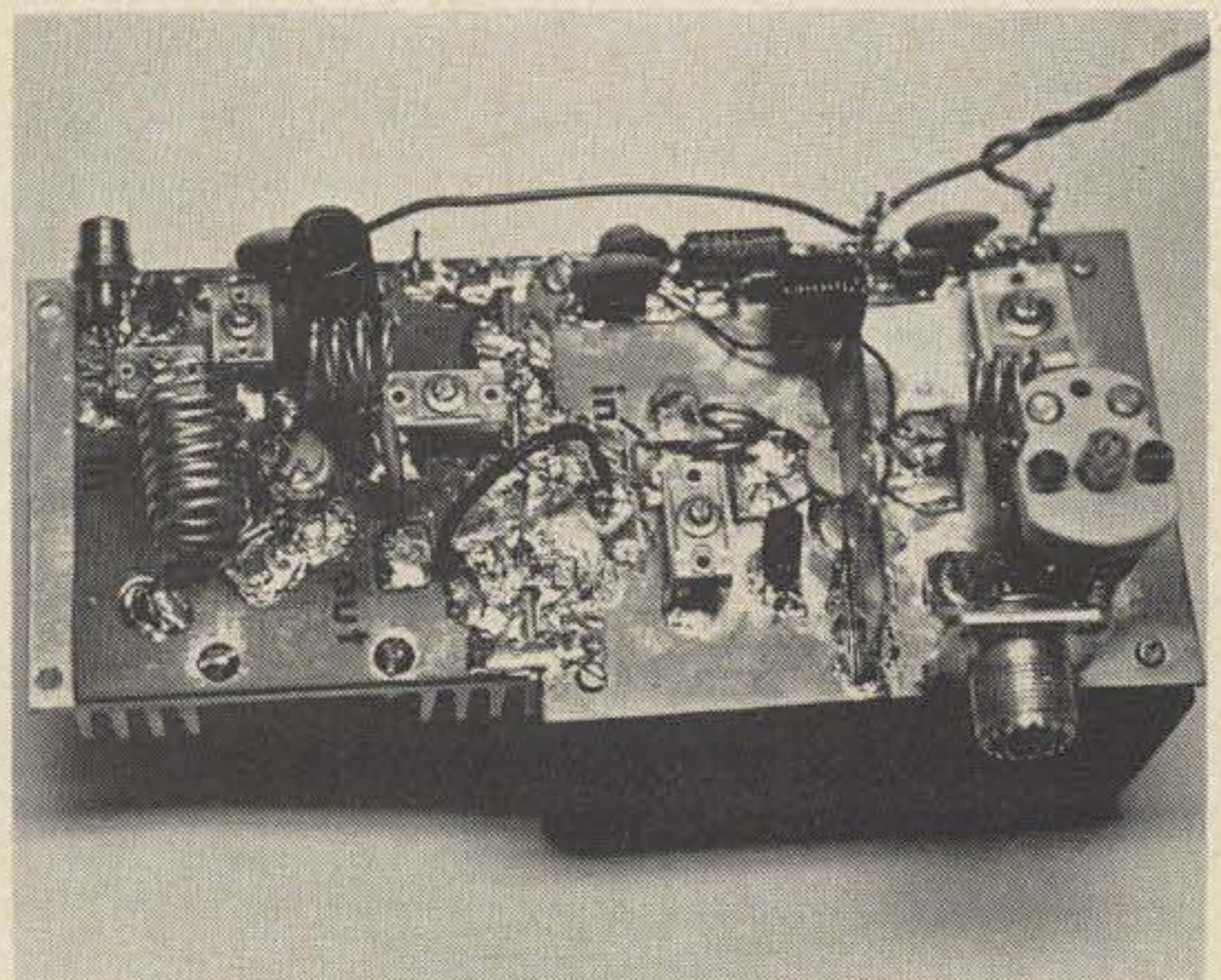

Construction

Construction of the amplifiers is simple and straight forward. A minimum of metal-work is required, and the pads on the circuit board (which must be glass-epoxy but need not be double-sided) can either be etched or cut out with a hand grinder. Be sure to use heat sink compound when mounting Q1 and Q2 — see Fig. 2. Q1 is a stud package with three pins on top. Connections to them should be made carefully so that they won't be broken. I used some scrap brass flashing to ground the emitter and to form a tie point at the collector, although heavy tinned wire could be used instead. The studs on both Q1 and Q2 are isolated, so they need not be insulated from ground.

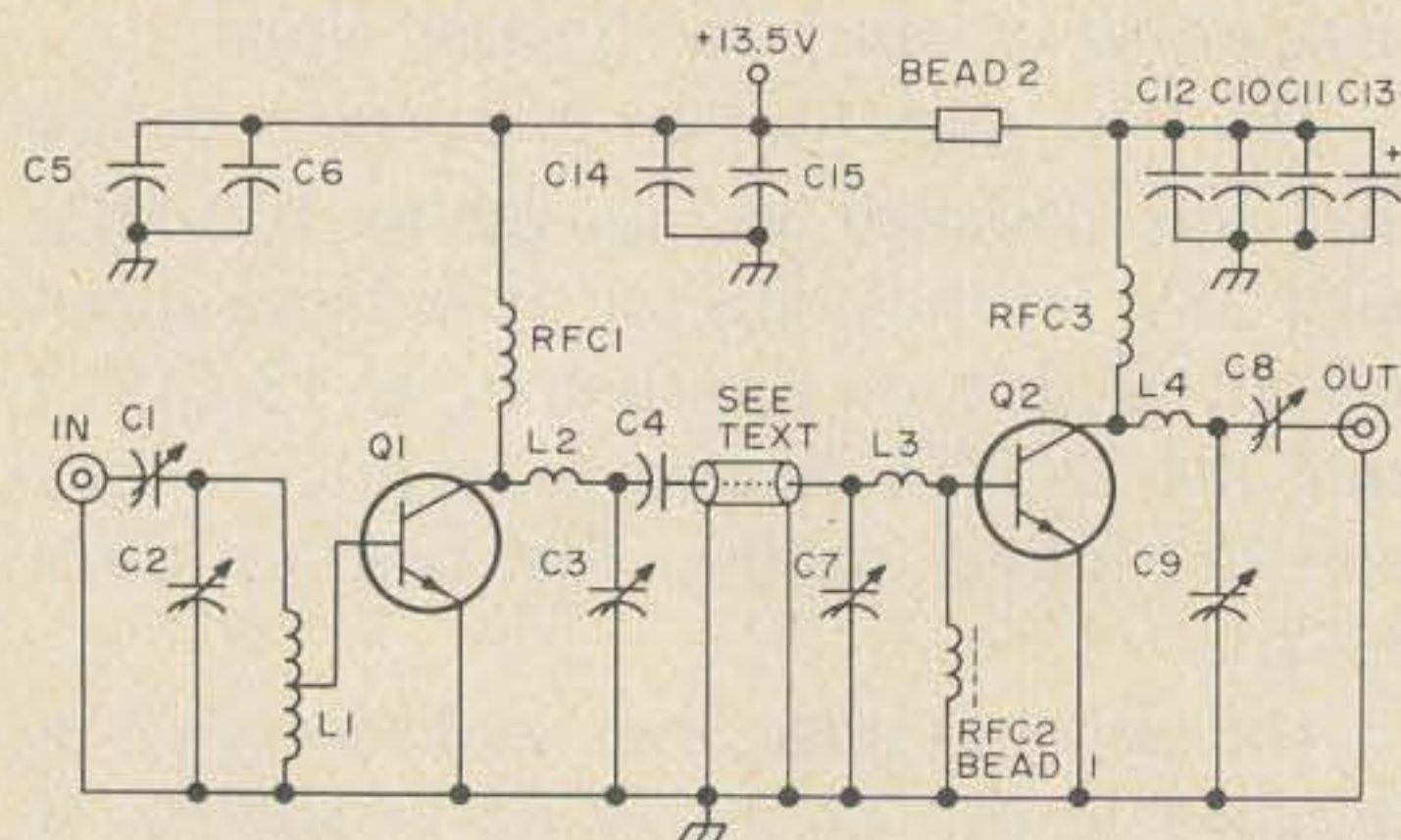

Fig. 1. Schematic of the 6 meter amplifier.

Q2 should be mounted according to the diagram in Fig. 3. Spacers should be used between the board and the heat sink so that the flat leads on the transistor are just above the pads on the board when the nut on the stud is tightened. It is important that the nut is not over tightened, and that you *do not solder the leads until the device is secure*. Once the transistor is mounted and soldered, put a metal shield over it as in the picture. A short length of coaxial cable, such as RG-174, is used to connect the output of the first stage to the input of the second one. (If desired, it can be eliminated and replaced with a short jumper wire if the two pads are situated close together, or the board can be made so that one common pad is used.)

Once construction is complete, apply +12-14V to the appropriate pad. Connect the output of your 1W exciter to the input of the amplifier, and connect a wattmeter and a 50W (at least) non-inductive 50Ω dummy

load to the output. Tuning is straightforward — adjust all capacitors for maximum output. Stretching and compressing the coils may improve output somewhat. Moving the tap on L1 also may increase the overall gain.

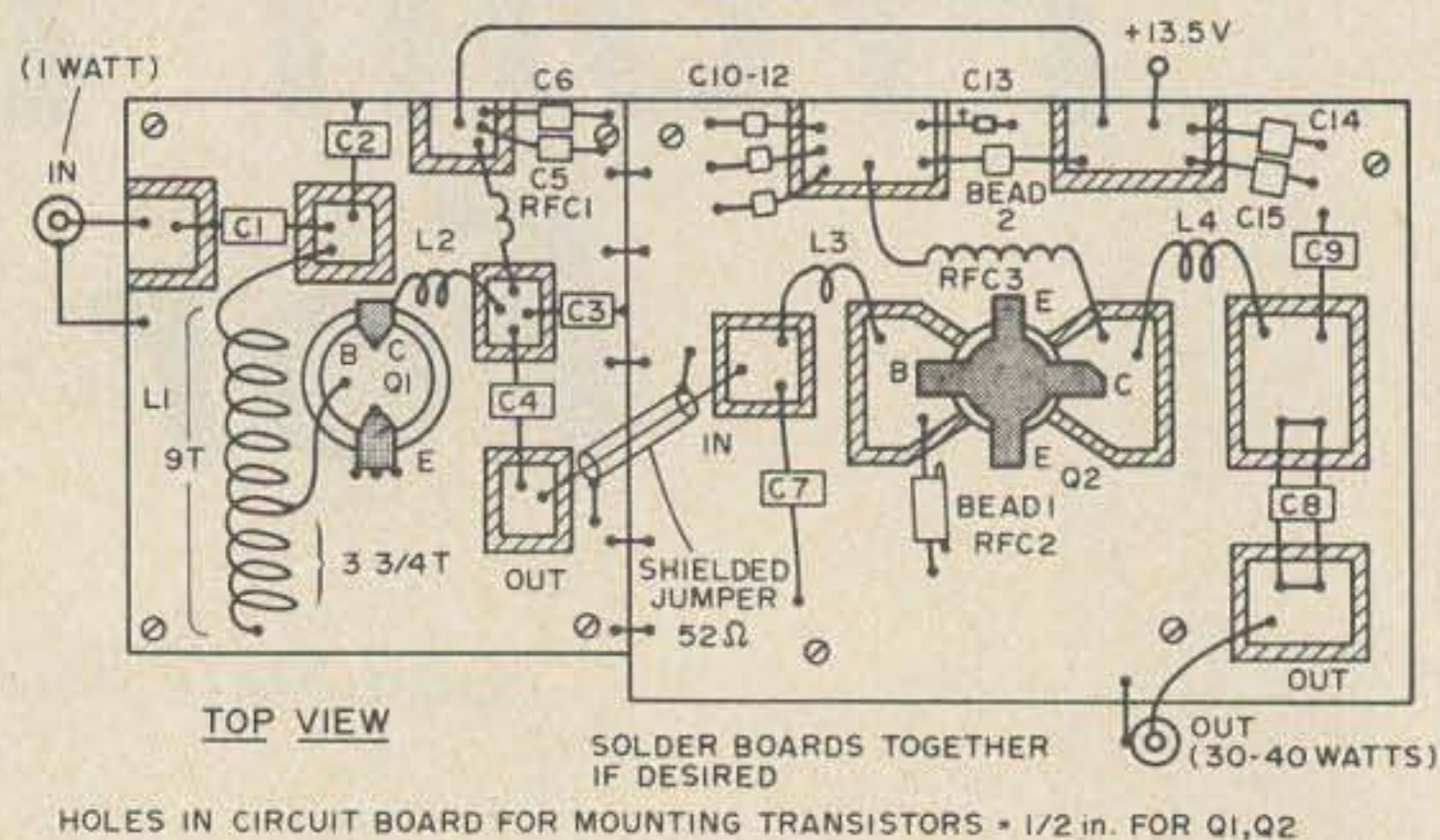

Fig. 2. Diagram of the amplifier.

A better way to tune the two stages is to do them one at a time. Tune the first one by removing the output going to the second stage and replacing the second stage with the dummy load and wattmeter. Tweak it for maximum, re-connect the second stage, and tune the second stage for maximum output. Go back and set *all* adjustments for maximum indication on the meter.

When adjustments are completed, you should get approximately the following performance with one watt of drive:

12V	—	30W out
13V	—	33W out
14V	—	38W out
15V	—	43W out

The amplifier should draw approximately 4-5A, depending on the voltage. The heat sinks on mine get just warm to the touch after several minutes of operation.

ONE WORD OF CAUTION: This is a class C amplifier which is fine for CW and FM. **DO NOT TRY TO RUN AM OR SSB** through it: It is not linear and so doing so will cause distortion.

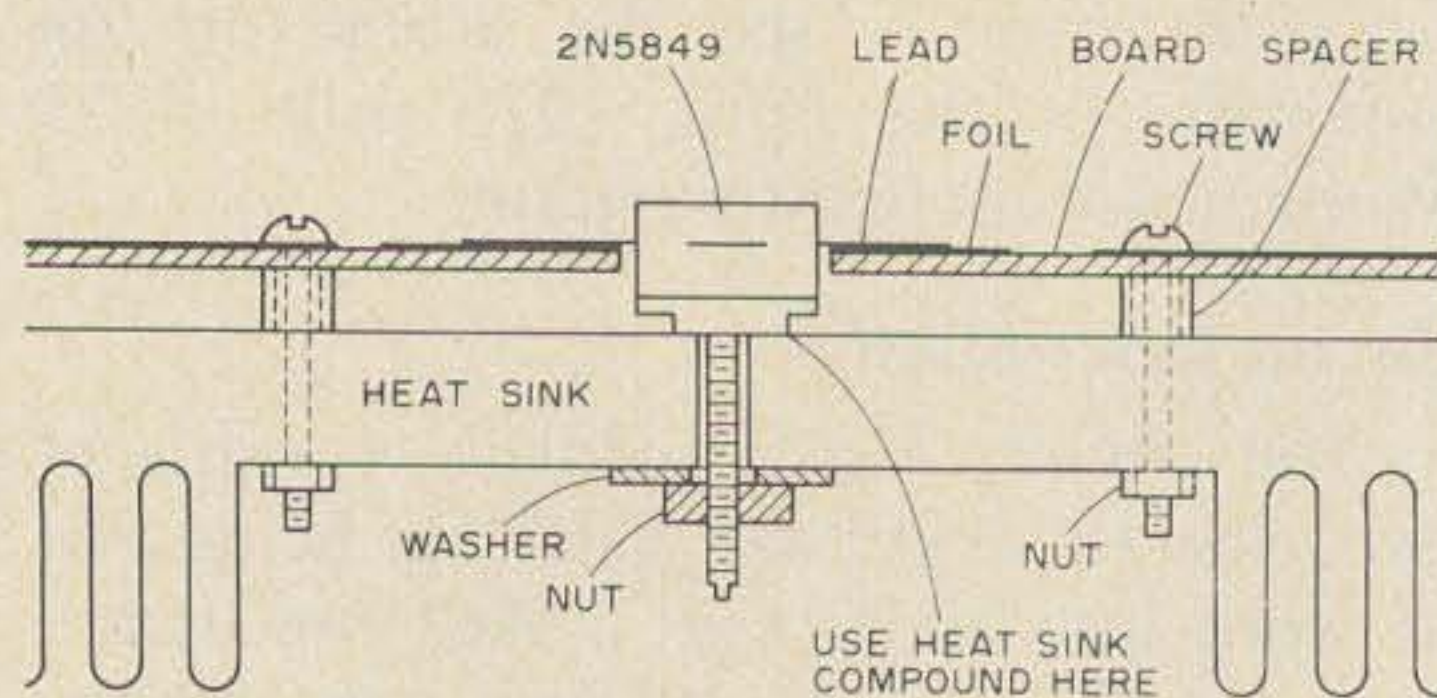

Fig. 3. Details for mounting Q2.

Specializing in VHF-UHF FM & SSB Equipment

The ITC MULTI-2000 CW/SSB/FM transceiver



Whether your interest is simplex, repeater, DX or OSCAR the new ITC MULTI-2000 lets you get into all the action on all of the band. Fully solid-state and employing modular construction, the MULTI-2000 enjoys features found in no other 2m transceiver.

Full one year written warranty — Introductory price \$695

KLM Accessories in stock (partial list)

KLM 144-150-12C Circularly polarized (for OSCAR)	\$54.95
KLM 144-148-12 12 element DX antenna	43.95
KLM 144-148-16 16 element DX antenna	54.95
KLM Balun (recommended, optional)	13.95
KLM Two Antenna Coupler	19.95
KLM PA-10-140BL 2m 140 W linear (FM-CW-SSB)	199.95
(add \$3.00 shipping per antenna or amplifier.)	

We Ship!

Our large inventory of VHF equipment assures shipment within 24 hours ARO. WESTCOM prepays delivery and insurance on transceivers when full payment accompanies order (M.O. or cashiers check). COD available with \$25 deposit. California residents add 6% sales tax.

Westcom

BOX 1020 • ESCONDIDO • CAL • 92025

GATEWAY ELECTRONICS

8123 Page Blvd.
St. Louis MO 63130
(314)427-6116

2839 W. 44th Ave.
Denver CO 80211
(303)458-5444

THUMBWHEEL SWITCHES

STANDARD SIZE - 0.5 x 2.125 x 1.78
10 position decimal **\$3.00**
10 position BCD & compl. **\$4.00**
End Plates (per pair) **\$1.45**

MINIATURE SIZE - 0.312 x 1.3 x 1.3
10 position decimal **\$3.00**
10 pos. BCD & comp. **\$4.00**
10 pos. BCD only **\$2.75**
End Plates (per pair) **\$1.00**
Divider Plates **\$1.25**
Blank Body **\$.30**

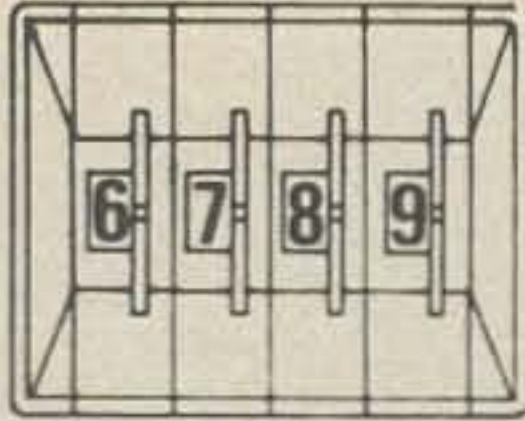

All switches are black with white figures and snap-in front mounting.

Radio-Control Joy Stick – Both X & Y axis with two 5K pots which may be changed to provide other values. Ship wt. ½ lb. **\$3.95**

48 Volt C.T. Transformer – 1 amp, 2½ x 2½ x 3. Ship wt. 2 lbs. **\$2.75**

18 Volt Transformer – 2 amp., 2½ x 2 x 2¼. Ship wt. 1 lb. **\$2.50**

20 Amp Transformer – secondary tapped @ 6, 7 and 8 volts. Use two in series for heavy duty DC power supply. 4½ x 6 x 4. Ship wt. 10 lbs. **\$10.00**

Wire-Wrap – 300 foot spool, 30 gauge solid wire. Ship wt. ½ lb. **\$2.50**

12 Volt Miniature Reed Relay – 10 ma to pull in, DPST 1200 ohm coil. 1 1/16 x ½ x 5/16. Ship wt. ¼ lb. **\$1.50**

JUNE SPECIALS

PL-259 Connector – **\$.50**

SO-239 Connector – **\$.40**

UG-176 Reducer – **\$.20**

*\$5.00 minimum order —
Please include sufficient postage.*

VISIT US WHEN IN ST. LOUIS OR DENVER

Parts List

Capacitors

- C1 8-60 pF mica (or Arco 462 or equiv.)
- C2 8-60 pF mica (or Arco 462 or equiv.)
- C3 14-150 pF mica (Arco 424 or equiv.)
- C4 .1 MFD ceramic disc (at least 50V.)
- C5 .1 MFD ceramic disc (at least 50V.)
- C6 .01 MFD ceramic disc (at least 50V.)
- C7 90-400 pF mica (Arco 429 or equiv.)
- C8 10-50 pF air variable or mica (Arco 462 or equiv.)
- C9 5-80 pF mica (Arco 462 or equiv.)
- C10 .1 MFD ceramic disc (at least 50V.)
- C11 .02 MFD ceramic disc (at least 50V.)
- C12 .001 MFD ceramic disc (at least 50V.)
- C13 1 MFD 25V electrolytic
- C14 .1 MFD ceramic disc (at least 50V.)
- C15 .001 MFD ceramic disc (at least 50V.)

Other Components

- Q1 2N3818 transistor
- Q2 2N5849 transistor
- L1 9 turns #16 tinned wire, 1" long, ½" I.D., tapped 3¼ turns from ground
- L2 4 turns #16 tinned wire, ½" long, 7/16" I.D.
- L3 1 turn #16 tinned wire, 5/16" I.D.
- L4 4 turns #14 tinned wire, 3/8" long, 15/32" I.D.
- RFC1 22 turns #18 enameled wire, tightwound, 13/32" I.D.
- RFC2 2½ turns through a 6 hole ferrite bead, or 2½ turns through a 3/8" one hole bead
- RFC3 18 turns (9 over 9) #16 enameled wire, tightwound, 3/8" I.D.
- Bead (in B+ line) 1 hole ferrite bead

... WB4DBB

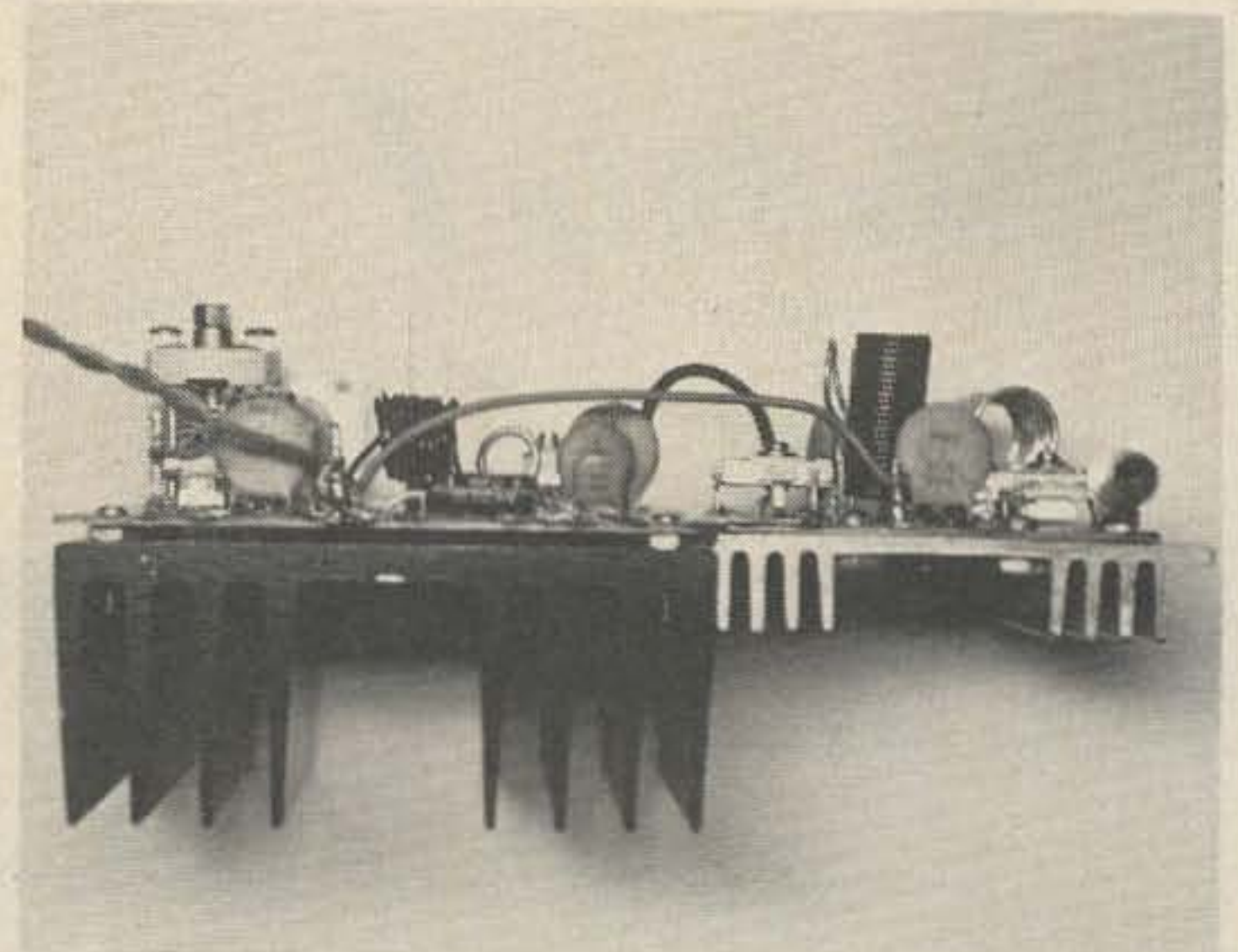

A Digital Dial for Your Receiver

The great majority of amateur radio stations in this day and age of digital techniques have some sort of frequency counter — or at least have construction plans in mind. Over the last few years 73 and other amateur magazines have published counter construction articles that can be built for \$50 or less.

In writing this article, we are directing information to those who are the proud owners of both an AX-190 receiver and a digital frequency counter.

The AX-190 is a completely solid state receiver that is both sensitive and selective. Radio Shack stores sold these receivers a year or so ago and apparently have discontinued this particular model. It seems strange that a good receiver such as this was discontinued. However, it should indicate also that one can be obtained at a moderate price.

The digital dial converter certainly enhances the operating ease and accuracy of the AX-190. The converter will work with receivers other than the AX-190 with slight modifications. We will delve into this data later in the article.

The AX-190 is a dual conversion receiver with a first i-f of 2920-2940MHz. The second i-f is 455kHz. Main tuning is accomplished with a vfo that tunes from 3.375MHz to 2.875MHz. Following the vfo is a "built-in" buffer stage that feeds a jack on the receiver rear panel. Therefore, you have a vfo sample that is ideal to feed a frequency counter.

In operation, the vfo actually tunes

"backward" from 3.375MHz to 2.875MHz to cover each amateur band. As an example, 21.000MHz = 3.375MHz and 21.500MHz = 2.875MHz. Therefore, feeding this vfo sample signal directly into a counter would not mean much as far as actual received frequency. You would have to make up a chart so as to interpolate vfo frequency and true received frequency. The fact that the vfo tunes backward would just add to the confusion.

There is also a jack on this receiver to sample the hfo frequency which means that a multi-stage mixer system could be created so as to add the hfo, 1st i-f, vfo and 2nd i-f. Adding the extra rf "take off" jacks and building a mixer such as this seemed like an expensive and complicated route.

When considering the backward vfo scheme, a simpler mixer system evolved. We cooked up a mixer so as to use only the vfo output sample and convert this directly to the received frequency. When describing the following frequencies, "x" will represent any of the megacycle (least significant) digits of amateur bands such as 21., 14., 3. etc... The tuning of the AX-190 is such that a vfo sample of 3.375MHz equals the band edge or "x" .000MHz. The lower limit of the vfo is 2.875MHz which represents "x" .500MHz or the upper band limits.

Considering that $3.375 \text{ vfo} = \text{"x"} .000$, a mixer crystal of "x" .375MHz above 3.375MHz would be needed, so as to, through subtractive mixing, indicate "x" .000MHz on your counter.

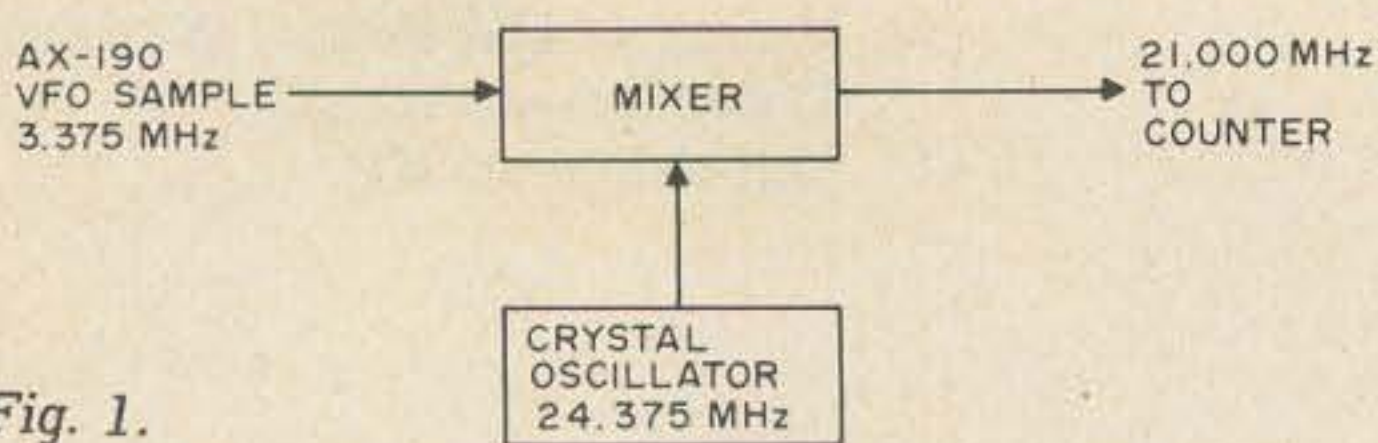

Fig. 1.

To provide a counter readout that would be "x" accurate on all bands or accurate to the last two insignificant digits, a series of mixer crystals would have to be switched along with the receiver band switch. Appropriate coils also would have to be switched in the mixer for various bands. This, of course, would be both complex and expensive.

The last four most significant digits are the ones to be most concerned with. The "x" or megacycle readout on the counter can usually be ignored provided your counter is working properly. Bearing this in mind, any crystal above 3.375MHz (high limit of receiver vfo) with the last three digits "x" .375MHz can be used as a mixer crystal.

Of course, the counter "megacycle" readout will be incorrect. However, the most significant digits will be accurate. Of course the mixer crystal will have to be accurate or the resultant counter accuracy will suffer.

Possible crystals that can be pressed into mixer service (with appropriate coils) are:

Mixer Crystal	Counter Readout	
	High End	Low End
4.375	1.000	1.500
5.375	2.000	2.500
6.375	3.000	3.500
7.375	4.000	4.500
8.375	5.000	5.500
9.375	6.000	6.500
10.375	7.000	7.500
11.375 (we used)	8.000	8.500
12.375	9.000	9.500
13.375	10.000	10.500
14.375	11.000	11.500
15.375	12.000	12.500
16.375	13.000	13.500
17.375 (correct for 20 meters)	14.000	14.500
etc.	etc.	etc.

In the case of 80 meters which begins at 3.500MHz and one 10 meter segment which begins at 28.500MHz, a separate mixer crystal of "x" .875MHz above 3.375 will give a proper mixer output for your counter.

Let's take an example using a mixer crystal of 4.875MHz: 4.875MHz (mixer) — 3.375 (vfo) = 1.500, 4.875MHz (mixer) — 2.875 (vfo) = 2.000MHz. Therefore on your counter, 1.500MHz would be 3.500MHz and 2.000MHz would represent 4.000MHz.

We might add at this point that your basic counter unit does not have to be modified when using this mixer scheme. It can be switched at any time so as to measure your transmitter or vfo frequency directly.

The mixer crystal that we happened to have in the junk box was 11.375MHz. Therefore, the coils in the mixer were designed about this frequency. Of course, crystals at 1/2 or 1/3 the desired mixer frequency can be used. When doubling or tripling the crystal frequency, it may not exactly come out "x" .375MHz.

In Fig. 1, Q1 is a RCA 40673 dual gate protected mosfet. Q1 is the mixer stage and is used with an "untuned" input stage. The receiver vfo buffer provides sufficient mixer excitation for this purpose so a resonant circuit was not placed in the mixer input. Excessive input voltage would not damage the 40673 as it is internally protected by built-in zener diodes.

Q2 is a 2N4416 mosfet employed as a crystal oscillator. D1 protects the gate of the 2N4416 from excessive voltages. Crystal oscillator injection for the mixer is coupled from Q2 to Q1 via a 22pF capacitor into Gate 2 of the 40673.

The resultant difference frequencies appear at the resonant drain circuit of Q1.

If the input circuit of your frequency counter is reasonably sensitive, you may be able to eliminate U1 (HEP-590) and couple directly to the drain circuit of Q1 through a small (15pF) capacitor. U1 was included as an rf amplifier so as to provide adequate gain for driving just about any frequency counter input stage.

Coil L1 resonates at 11.375MHz which is the crystal fundamental frequency. Coil L2 and L4 resonate at 8.0MHz which is the subtractive difference frequency of the mixer stage. Coil and capacitor arrangements will have to be altered depending on the "x" .375 crystal you use in the mixer/oscillator stage. A grid dipper is very valuable in adjusting the various coil frequencies.

**THE ATLAS 210 AND 215
SOLID STATE SSB TRANSCEIVERS**



Plug-In-and-Go-Power!

This may sound like just another catchy headline, but this is the best, and quickest way we can think of to describe the Atlas transceiver.

Plug-In

For mobile operation all you have to do is make a one time installation of the Plug-in Mobile Mount, and thereafter, when you want to operate mobile, just slide your Atlas transceiver into the mount. All connections are made automatically, as shown below. It takes only seconds, and you are ready to operate. Fixed station operation is achieved in the same easy manner, since the Atlas AC Console has the same plug-in system as the mobile mount.

soever. This permits instant QSY or band-switching. Simply tune in to your frequency and GO!

No other rig on the market will provide you with so much operating pleasure.

When you combine the simplicity of operation with unparalleled selectivity, immunity to cross modulation or overload, solid state reliability, 200 watts P.E.P. input power and 5 band coverage...the Atlas 210/215 has everything you could want in a transceiver.

Model 210 covers 80 through 10 meters.
Model 215 covers 160 through 15 meters.

Go-Power!

No Transmitter Tuning!

This is another outstanding feature of the Atlas transceiver. There is no transmitter tuning what-

Plug-in and GO!

\$599

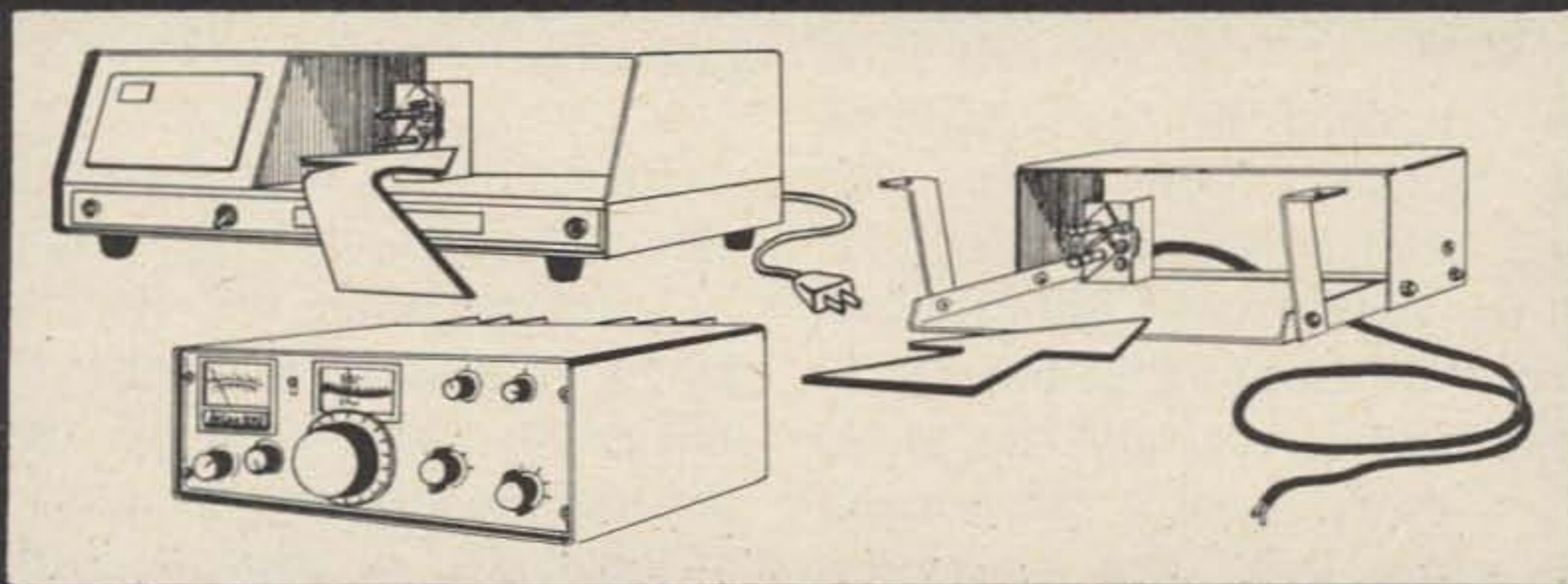

AMERICAN MADE AND GUARANTEED BY:



**ATLAS
RADIO INC.**

417 Via Del Monte Oceanside, CA 92054
Phone (714) 433-1983

Available NOW at your Atlas dealers. See him for complete details, or drop us a card and we'll mail you a brochure and dealer list.

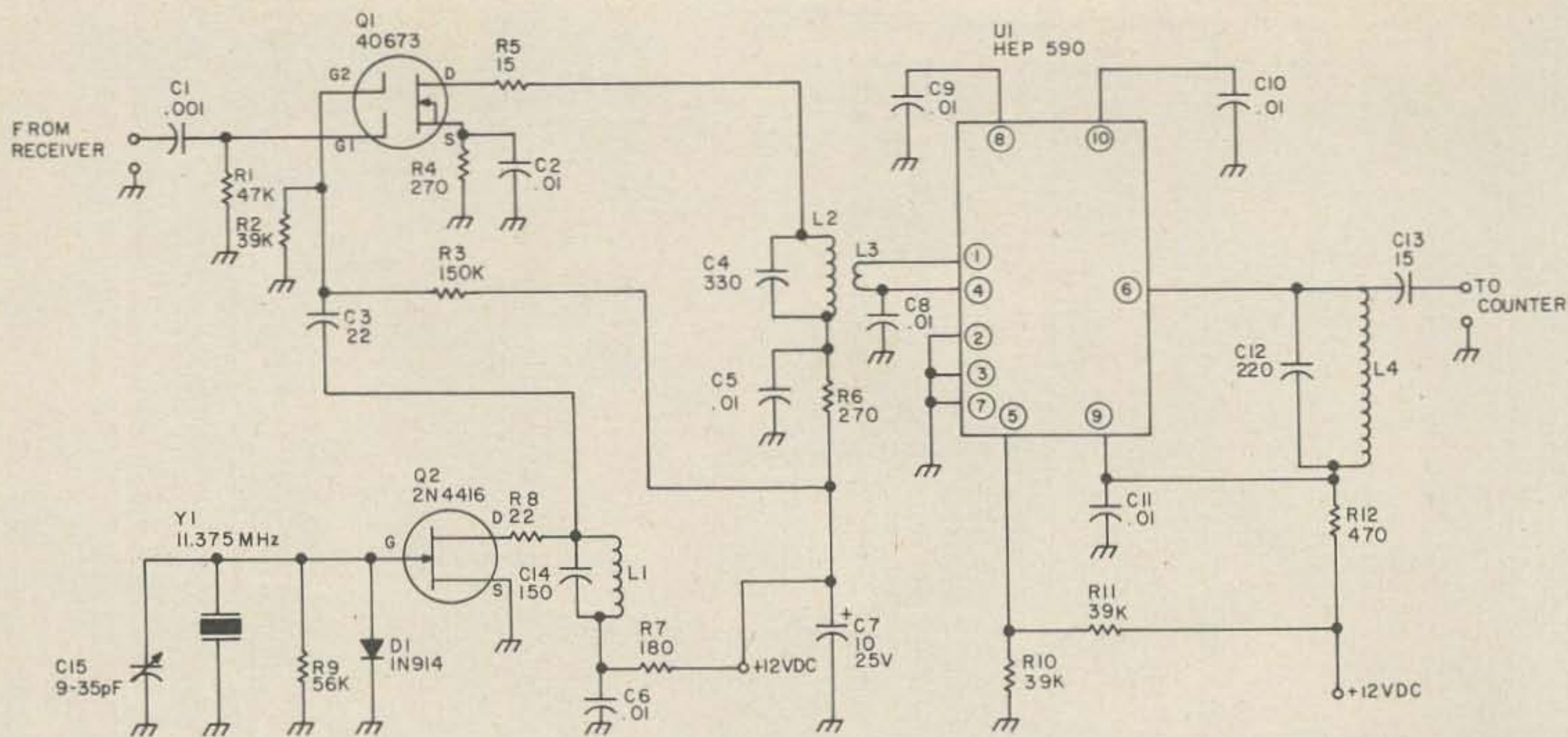

Fig. 3. Digital Dial Converter.

**Parts List
(for Fig. 2.)**

Capacitors

- C1 = .001 disc, 100V
- C2, C5, C6, C8 - 11 = .01 disc, 100V
- C3 = 22pF disc, 100V
- C4 = 330pF disc, 100V
- C7 = 10mF, 25V elec
- C12 = 220pF disc, 100V
- C13 = 15pF disc, 100V
- C14 = 150pF disc, 100V
- C15 = 9-35pF trimmer

Diode

- D1 = 1N914 silicon diode

Coils

- L1 = 11T. #26, ¼" form
- L2 = 11T, #26, ¼" form
- L3 = 2T. hookup wire over L2
- L4 = 11T #26, ¼" form

IC

- U1 = HEP 590

Crystal

- Y₁ = 11.375MHz xtal

Transistors

- Q1 = RCA 40673 Mosfet
- Q2 = 2N4416 Mosfet

Initial adjustment of the mixer crystal oscillator can be accomplished with the aid of your frequency counter. Apply power to the mixer and attach your counter to Gate 2 on Q1. Adjust the crystal trimmer so that your counter reads "x" .375MHz. The other method of frequency adjustment is to tune in WWV at 15MHz on the AX-190. The counter, when attached to the converter output should read "x" .000. Should this not be the case, adjust the mixer oscillator crystal so that the counter does indicate "x" .000MHz. There is no doubt that this mixer system with appropriate crystals/coils could be applied to other double conversion receivers with vfo's that tune backward. Determining the mixer crystal is the only major problem. Of course, a vfo sample would have to be extracted ideally through a small transistor buffer stage for vfo isolation.

Power supply requirements are minimal and any small 12 Vdc supply will work well. If you are really under pressure to test your unit, a 12V lantern battery will work well and last a long time.

... W2A00

It's a fact

You think old Sam Morse invented electric telegraphy? Don't make any bets on it! Sam invented the electromagnetic telegraph, but several forms of electrostatic telegraphs had been in use many years before Sam got into the act.

When and in what country was the first television receiver made that employed a cathode ray tube to display the image? In 1906, in Munich, Germany.

... W5JJ

Three on Fifteen

The purpose of this article is not to say "Presto, here is the absolute final word in the way of building a 3-element beam for 15 meters," but to bridge the gap (if there is one) between the antenna theory manuals and the actual construction of the antenna. In doing so, we will look at some of the problems I ran into in building one for myself in the hope that prospective antenna builders may benefit from my problems and their solutions. The ideas advanced here can also be applied to a 10 meter beam construction and to some extent on 6 meters. The use of my cheapie construction methods would have to be altered considerably to apply to antennas for the lower frequencies (20, 40 meters, etc.).

In the actual construction, as well as for preliminary study before beginning construction, I used *Beam Antenna Handbook* by William I. Orr W6SAI (3rd Edition). It is a very well constructed book and I couldn't have done as well without it. I reference p. 102 for the basic design curves and p. 113+ for the information on the gamma match construction details.

I did not — from here on — stick to the strictest of W6SAI's specifications. As I mentioned before, I went "cheapie." This article, therefore, may appeal to the novice or any other with a limited budget. My first deviation from the Handbook was to use small size tubing for the elements. This narrowed my frequency coverage over the whole band but as I operate near the top end of the band most of the time, this did not present a problem.

The tips of the elements are of TV antenna 3/8 in. O.D. aluminum tubing that I salvaged from the reflector section of an old

Davis fringe area antenna. These were in 8 ft lengths and I used 6 of them. These telescope beautifully into the 1/2 in. O.D. tubing that was used for the center sections (Fig. 1).

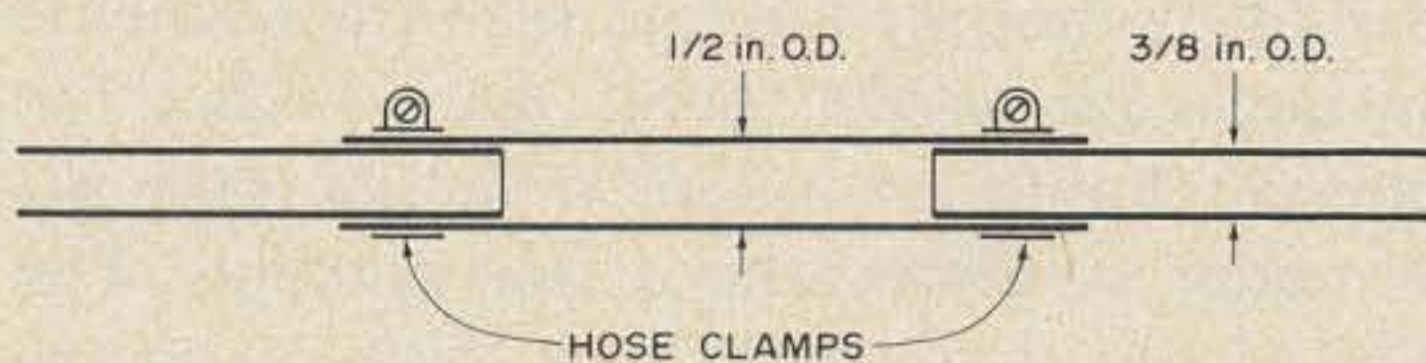

Fig. 1.

This 1/2 in. O.D. tubing is the kind that can be obtained at almost any scrap metal yard or through government surplus. The person who wants to buy it outright can get it at almost any electrical supplier of conduit. The tubing I used was one of the softer varieties and this seemed to be a boon, as I will explain later.

As far as the actual mounting of the elements to the boom, I used regular TV type U-bolts and clamps with a short section of square conduit notched with a long vee under the elements for added strength at the mounting point (Fig. 2). This length of

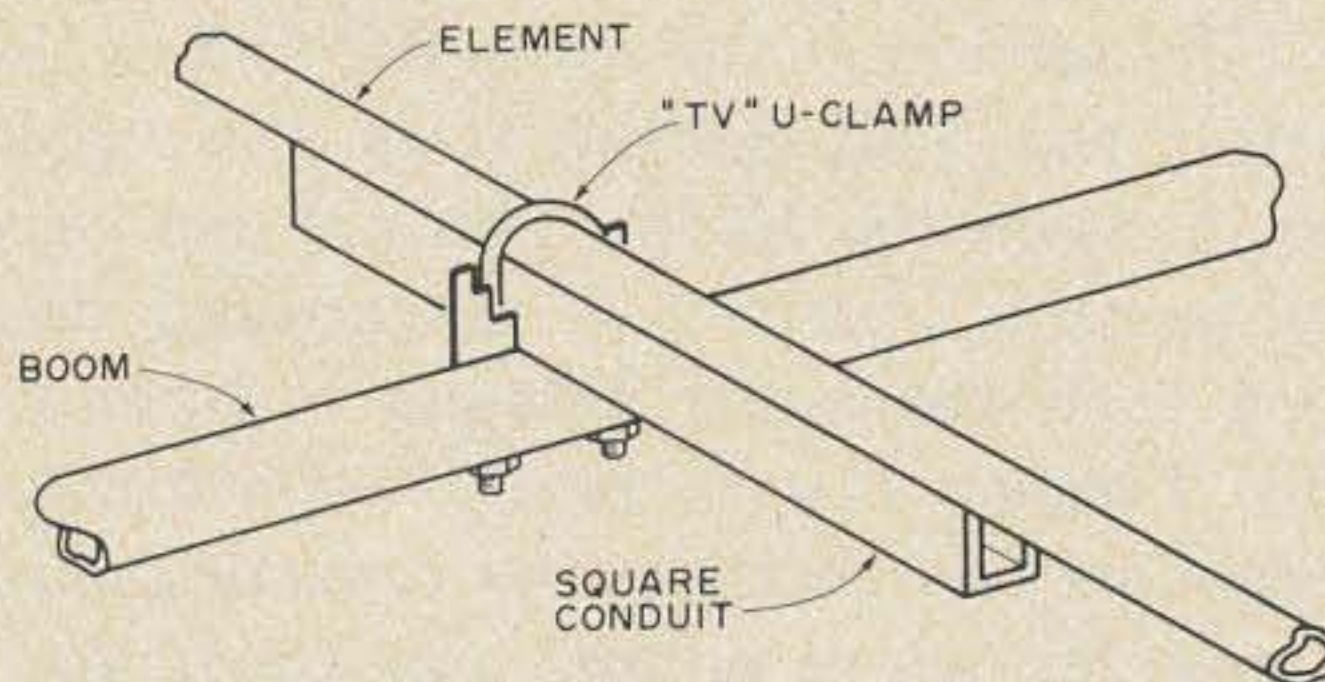

Fig. 2.

square conduit can be from 36 to 48 in. long, at the discretion of the builder. There is quite enough leeway in the mounting so as to leave the rest to the imagination and resources of the builder.

The boom is of three 5 ft lengths of TV antenna mast of the sort that will fit end into end for extension use. This gave me a boom of a little less than 15 ft in length. I used the galvanized type, although I'm sure the aluminum could be used equally well if a little more care is taken not to tighten the nuts on the U-clamps too much and cause the boom to collapse.

Attachment of the boom to the mast was done with a homemade mounting bracket consisting of an 8 x 8 in. piece of 3/8 in. plywood sandwiched in between two 8 x 8 in. pieces of galvanized sheet metal (I found mine in a scrap pile) and four of the same kind of TV U-clamps.

None of the articles I have read ever said whether or not the gamma match unit should be mounted in line with the elements or under or above them, nor whether the gamma should go in-line with the elements or under or above the driven element. The W6SAI handbook is the best I've seen on the gamma match. It gave me at least a direction to start with, and I ended up mounting the gamma "box" on the boom behind the driven element with the gamma rod extending to the right, in line with the elements and about 5 in. behind the driven element. The rod was a 48 in. length of TV antenna tubing I salvaged from the reflector of an old conical TV antenna. My shorting strap was made of this same type of tubing about 7 in. long with the ends bent at right angles about 1 in. from the ends to maintain the 5 in. spacing of the gamma rod. This shorting rod was clamped onto the driven element and gamma rod by use of hose clamps over the respective connection and the 1 in. section at the respective end of the shorting rod. This shorting strap was placed 30½ in. from the boom. This distance may vary in each situation as the ground over which each individual antenna is mounted varies. I used a 120 pF variable capacitor for the gamma capacitor. As this capacitor must be mounted above ground and all standard units are rotor-ground units (and new floating variables cost good money) I cemented some insulating material in the bottom of an aluminum minibox on which to mount the capacitor. I drilled a hole in the box for the capacitor shaft to extend through and fitted

the hole with a rubber grommet which fit around the shaft snugly. I then tied the capacitor to the box with nylon cord. The back of the box was fitted with a coaxial jack to facilitate removal of the coax transmission line, which was, by the way, 52Ω polyfoam RG-8/U.

Here again is where things started to depart from the Handbook specifications. When I completed it and began to try to tune it, it didn't want to cooperate. I then borrowed an antennascope-wattmeter and grid dip meter from John K5HIH, and found the resonant frequency to be about 21.55 MHz — too high. This is where the telescoping elements came into play. My final lengthening of the elements came out somewhat off as far as theory goes, but all I can say is that it works (Fig. 3). The spacing

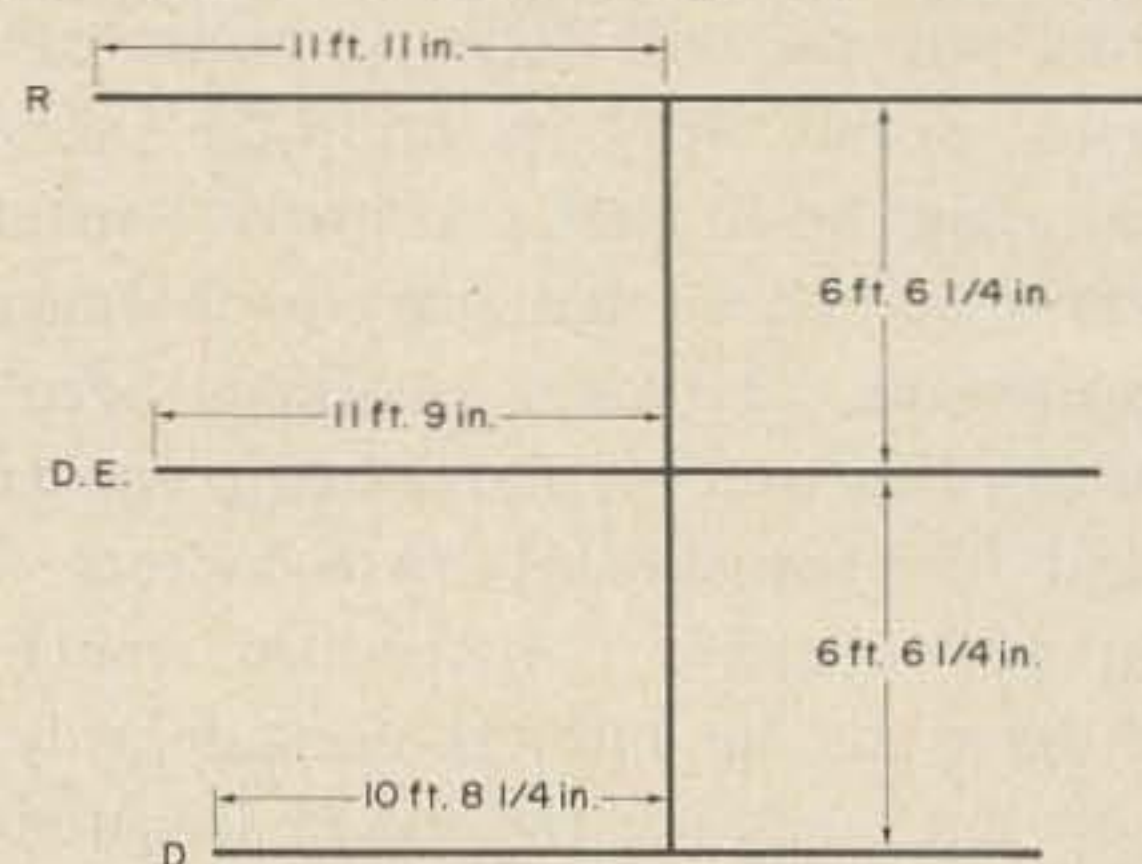

Fig. 3.

between elements remained the same as I calculated from the formula but the element length didn't remain true to the formula. The moral is, don't pull your hair out if the meters and signal reports say it is right but it doesn't measure out right. Accept it!

How does it stand up in the wind? Well, I constructed it in March 1970 just in time for the March winds and it withstood those upwards of 60 mph just fine. Three elements on the right side were bent slightly in November 1971 when we had a blast of tornadic winds upwards of 100 mph. Straightening them was no problem as I was taking it down anyway to move from the front to the back of the shack. It is mounted on a telescoping TV mast and slides up and down beautifully because of the antenna's light weight. A light-weight TV rotator can be used if a thrust bearing is employed. The softer tubing, as I said previously, was a boon. It allowed me to bend the elements

back into place by hand and with no apparent weakening of the element as happens quite often when straightening the harder elements of a TV antenna.

Performance? Beautiful. One of my first QSO's using the antenna was with OA4AEN/4, Clif. A minister friend of mine was in the shack and I was demonstrating the equipment when we heard Clif. My friend said, "I want to talk to him." Clif, by the way, is a missionary pilot. I fired at him and he returned the first thing. He asked how many kilowatts I was running, to which I replied only 400 watts from a Galaxy V Mk2. His reply to this was, "Well, they must be 400 Texas size watts."

From here, it's up to you. Try it, use your own imagination, draw your own conclusions, and the best of DX to you. The swr on mine was about 1.2:1 at 21.45 MHz and a little less than 2:1 at 21.35 MHz. I haven't noted any appreciable difference in performance over this range of frequencies. I'll be looking for you some afternoon on a weekend when the skip comes rolling in.

...WA5CNG

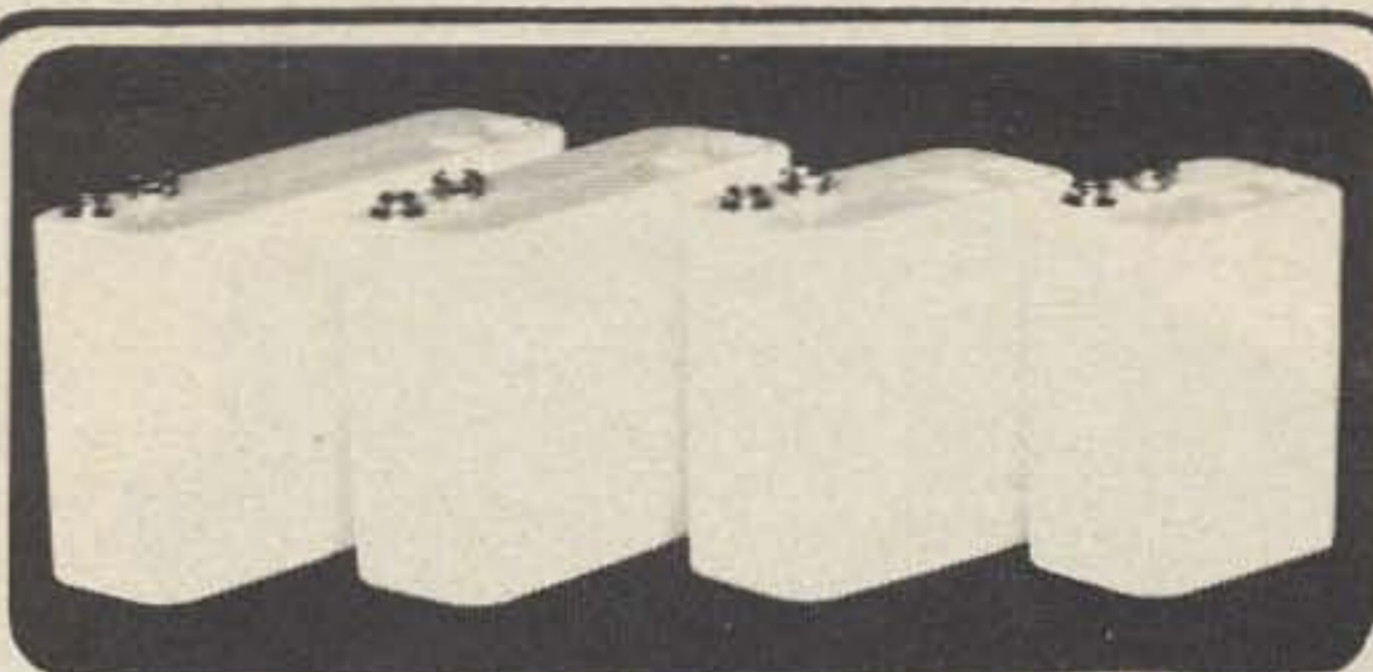

New BATTERIES for Hams

Fits all popular Hand Held units

**NO LOOSE
CONNECTIONS**

**COMPACT
RELIABILITY**

ALL BATTERIES ARE
RESISTANT WELDED

AVAILABLE IN
NICKEL CADMIUM, MERCURY OR ALKALINE

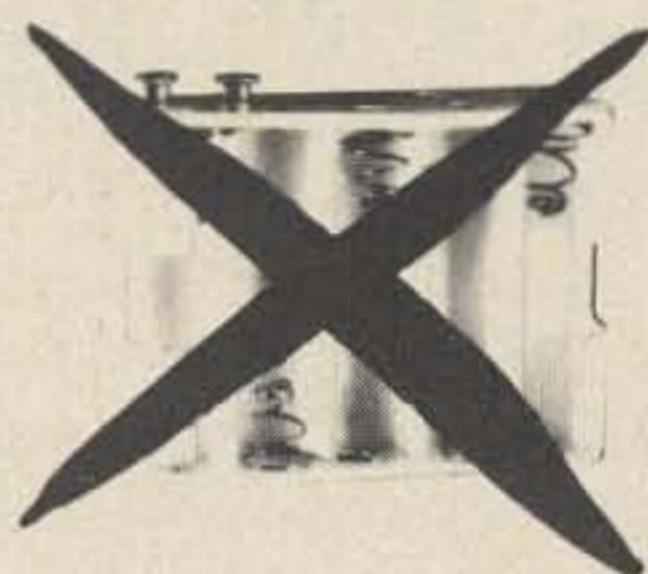

Write—Wire—or Phone

ALEXANDER manufacturing co.

BOX 1645 Mason City, Iowa 50401

Phone (515) 423-8963



introducing

MODEL 4 X 6

250 MHZ FREQUENCY COUNTER

250 MHz for \$1.00 per MHz

\$250

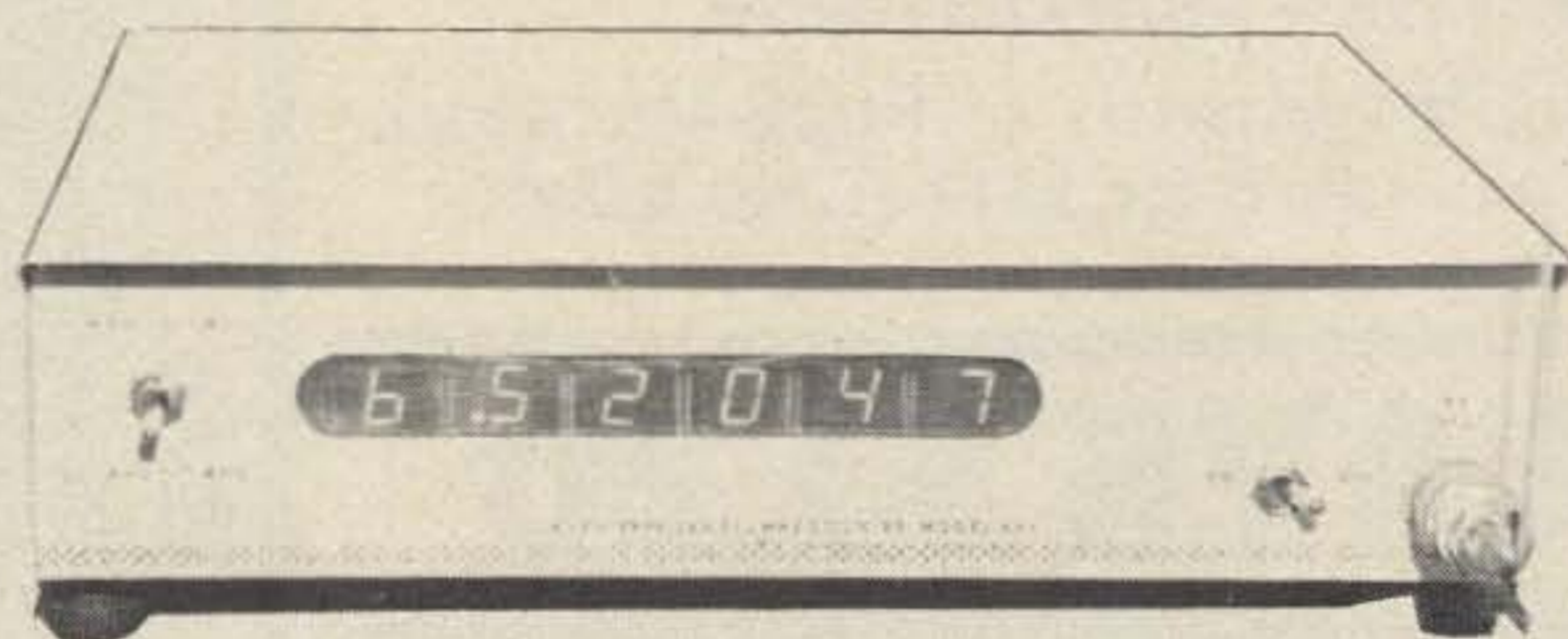

MODEL 4 x 6 WIRED
and TESTED

Include \$2.50 to cover
Postage and Insurance



Price FOB Shawnee, Oklahoma

SPECIFICATIONS

Frequency Range	500 kHz — 250 MHz
Sensitivity	Less than 80 mV at 150 MHz
Input Z	50 ohms
Max. Input Voltage	15 V rms, 50 V dc
Time Base	Crystal Clock plus-minus 10 ppm 0°C to 40°C ambient
Readout	6 Digit 7 Segment LED
Power	120 V ac
Dimensions	2 1/4" H, 10" L, 7" D
Cabinet	Light blue

K-ENTERPRISES

1401 NORTH TUCKER • SHAWNEE, OKLAHOMA 74801

SAVE \$50



SWAN FM2XA

Reg. \$299—Now only \$249

SWAN FM2XA 2m FM transceiver, 10 watt, 12 channels w/crystals for 146.34T/.94, .34/.76R and .94 simplex. 12vdc WITH detachable 110vac supply. Extra crystals \$5 each (special order). Add \$5 for shipping in the "48 states".

Use Your SWAN CREDIT CARD!

YAESU

Special Offer!

**SAVE \$40 on YAESU's FRdx-400SD Receiver (with 2 & 6 meters).
Reg. \$399 — Now Only \$359.**

A limited quantity of FLdx-400 Xmtrs. are available for \$319 (Reg. \$339).

SAVE \$120



SBE SB-450, UHF FM Xcvr, 5 watt, 12vdc, 12 channels w/xtals for 449.5T/444.5R & 446 MHz simplex. Reg. \$399 — Now \$279

SAVE \$130



Clegg LATEST MODEL!
FM-27B
reg. \$479 — Now \$349

SAVE \$50

Purchase a Regency HR-2B for the reg. price of \$229 (Without Trade) and we'll give you 10 Free Crystals (reg. \$5 ea.).

Standard
SAVE \$60



Purchase a Standard CI46A Hand-Held for the regular price with No-Trade, and you may take a \$60.00 Credit toward the purchase of any other new merchandise.

SR-CI46A 2w hand-held, 5 ch. w/xtals for 146.34T/.94R & 146.94. . . . \$298.00

- ACCESSORIES FOR SR-CI46A**
- SR-CMP08 Miniature microphone \$ 22.00
 - SR-CSA Desk-top charger 43.00
 - HM-4 6" Flexible antenna. 6.59
 - SR-CPT-3644 Leather case. 8.50
 - SR-CLCC-1 Deluxe case. 19.50
 - Crystals for Certificates 6.50
 - SR-CMA Mobile Charger. 13.00
 - SR-C12/120-6 AC Charger. 16.00
 - SR-CAD Antenna adaptor. 8.00
 - #2GCI Pair of Ni-Cad batteries. 3.10
(5 pair required for C-146A)

- E-Z Ways to Purchase**
- 1- CASH
 - 2- C.O.D. (20% deposit)
 - 3- Master Charge
 - 4- BankAmericard
 - 5- American Express



AMATEUR ELECTRONIC SUPPLY

4828 West Fond du Lac Ave. Milwaukee, Wis. 53216

Phone (414) 442-4200

STORE HOURS: Mon & Fri 9-9, Tues, Wed & Thurs 9-5:30, Sat 9-3

AMATEUR ELECTRONIC SUPPLY USED GEAR

★ 10 Day Free Trial (Lose only Shipping Charges) ★ 30 Day Guarantee ★ Full Credit Within 6 Months on Higher Priced New Equipment ★ We Welcome your Master Charge or BankAmericard ★ Order Direct from this Ad!

ALLIED AX-190 Receiver \$159 SP-190 Speaker 9	DYCOM 10-0 2m Amplifier \$129	HEATHKIT GR-78 Receiver \$ 99 SB-300 Receiver 209 SB-301 Receiver 229 HS-24 speaker 9 XC-2 2m converter 25 XC-6 6m converter 25 SBA-300-4 2m conv. 19 DX-60 Transmitter 59 DX-60B Transmitter 69 DX-100B Xmtr 99 TX-1 Transmitter 99 HX-10 Transmitter 189 HX-20 Transmitter 125 VHF-1 6-2m Xmtr 79 SB-400 Transmitter 225 SB-401 Transmitter 249 HW-7 QRP Xcvr 59 HWA-7-1 AC supply 9 HW-12 75m Xcvr 75 HW-12A 75m Xcvr 85 HW-22A 40m Xcvr 85 HW-100 Xcvr 249 SB-100 Xcvr 325 SB-101 Xcvr 349 SB-102 Xcvr 369 SB-630 stn. console 69 SB-650 Digital frequency display 169 HW-18 Xcvr 99 HW-30 (Two'er) 29 HW-17 2m Xcvr 75 HP-13 DC supply 49 HP-13A DC supply 54 HP-23 AC supply 45 HP-23A AC supply 49 HO-10 monitor 69	AC-500 AC supply 75 NCL-2000 Linear 349 P & H AFC-2 compressor \$ 39 LA-400C Linear 69 PEARCE-SIMPSON Gladding 25 w/AC \$169 POLYTRONICS PC-2 2m Xcvr \$ 99 PC-62B 6-2m Xcvr 149 REGENCY HR-25 2m FM Xcvr \$239 HR-212 2m FM 189 AR-2 2m Amplifier 89 HR-6 6m FM Xcvr 169 HR-220 220mHz FM 189 HR-2B 2m FM 169 SBE SB-34 Transceiver \$249 SB2-LA Linear 175 SB2-VOX 15 SB2-CW codaptor 25	SB2-MIC mike 9 SB-450 UHF FM 229 SB-144 2m FM Xcvr 179 SWAN SW-240 Xcvr \$169 400 Xcvr/420 VFO 299 406B VFO 49 410 VFO 69 22B VFO adaptor 19 117B AC supply 59 160 external VFO 75 260 Cygnet Xcvr 289 14A DC converter 29 350 Xcvr (late) 259 350C Xcvr 299 500 Xcvr 309 500CX w/SS-16B 449 700CX w/SS-16B 499 117C AC supply 65 117XC AC supply 85 14C DC module 49 512 DC supply 69 14-117 DC supply 99 600T Transmitter 399	FM-2XA 2m FM 199 FM-1210A w/AC 249 TEMPO Tempo One Xcvr \$289 AC/One AC supply 75 2000 Linear 295 TEN TEC RX-10 Receiver \$ 49 200 VFO 49 315 Receiver 169 TX-100 Transmitter 59 AC-5 antenna tuner 6 210 AC supply 19 PM-3 Transceiver 49 YAESU FL-200B Xmtr \$169 FT-101 Xcvr 499 FT-101B Xcvr 549 FTDX-401 Xcvr 449 FV-401 rem. VFO 75 FL-2100B Linear 249
AMECO R-5 Receiver \$ 39 CB-6 (7-11) 29 CB-6 (14-18) 29 CN-50 (14-18) 29 CN-144 (30-34) 29 CN-144 (14-18) 29 PS-1 AC supply 9 TX-62 VHF Xmtr 75 621 VFO 39	ELMAC AF-67 Transmitter \$ 49 PS-2V AC supply 29 M-1070 AC/DC sup. 39 GENAVE PSI/10 AC supply \$ 49 GTX-200 2m FM 159 Ham-Pak 25 GLOBE/GALAXY/WRL Galaxy III Xcvr \$169 Galaxy V Xcvr 199 Galaxy V Mk II 239 Galaxy V Mk III 269 GT-550 Xcvr 279 GT-550A Xcvr 329 AC-35 AC supply 69 AC-400 AC supply 79 DC-35 DC supply 65 G-300 DC supply 39 G-500 DC supply 75 CAL-35 calibrator 9 SC-35 speaker 9 DAC-35 dlx. console 69 2000 Linear/supply 275 Economy AC supply 39 FM-210 2m FM 99 R-530 Receiver 599	ICOM IC-21 2m FM Xcvr \$299 JOHNSON Challenger \$ 49 Viking I 49 Ranger I 89 Ranger II 139 Valiant I 139 Invader 200 199 Invader 2000 449 275w M'box/SWR 129 6N2 VHF xmtr 89 6N2 conv. (250-43) 39 K-W KW-204 Xcvr \$329 KENWOOD PS-511S AC supply \$ 79 VFO-5SS rem. VFO 79 KNIGHT R-100A Receiver \$ 69 TR-108 2m Xcvr 89 LAFAYETTE HA-250 Linear \$ 59 HA-260 2m Amp. 59 HA-800 Receiver 89 LETTINE 242 6m Xmtr \$ 39 MASTER MOBILE MPS-800 DC sup. \$ 39 MOTOROLA Metrum II (25w) w/9 xtals & offset \$339 NATIONAL NC-155 Receiver \$ 99 NC-190 Receiver 139 NC-270 Receiver 119 NC-300 Receiver 129 NCX-3 Transceiver 169 NCX-5 Transceiver 279 NCX-5 Mk II 299 NCXA AC supply 69 NCXD DC supply 75 500 Transceiver 199 200 Transceiver 199	B & W/WATERS 3001 Hybrid coupler \$34 CENTRAL ELECT. 20A Exciter (table) \$ 89 CLEGG/ SQUIRES-SANDERS 66'er 6m Xcvr \$109 Thor 6 (RF only) 75 417 AC sup./mod. 65 418 DC sup./mod. 25 Zeus VHF Xmtr 249 Interceptor Receiver 219 Interceptor B 289 Venus 6m SSB Xmtr 175 Apollo Linear 175 FM-27A 2m FM 269 FM-27B 2m FM 299 011 AC supply 49 22'er FM (ser. 25) 199 22'er Mk II (AM) 199 COLLINS 75A-1 Receiver \$139 75A-2 Receiver 199 75A-3 Receiver 269 75A-4 (ser. #1452) 349 75A-4 (ser. #1669) 349 75A-4 (ser. #5113) 449 75S-1 Receiver 325 75S-3 Receiver 495 75S-3B Receiver 695 32S-1 Transmitter 349 312B-3 Speaker 19 312B-4 stn. control 169 KWM-1 Xcvr 225 351D-1 mount 35 KWM-2A Xcvr 695 351D-2 mount 75 316F-2 AC supply 125 316E-1 DC supply 75 PM-2 AC supply 95 IC-2 carrying case 49 L. L. DRAKE A Receiver \$119 A Receiver 149 B Receiver 189 C Receiver 189 AC calibrator 9 4-4 Receiver 269 4-4A Receiver 289 4-4B Receiver 339 4-4C Receiver 399 NB noise blanker 49 L-500 filter 39 L-6000 filter 39 PS-1 conv. supply 12 C-1 conv. console 39 R-3 Xcvr 299 R-4 Xcvr 389 R-4/NB Xcvr 459 V-4 remote VFO 69 R-4C Xcvr 449 V-6 remote VFO 89 NT Transmitter 99 C-4 AC supply 85 C-3 DC supply 75 C-4 DC supply 95 N-4 matcher 69 L-2 2m FM Xcvr 199 R-22 2m FM Xcvr 149 R-22C FM Xcvr 179		

12/31/74

All items subject to prior sale. Amateur Electronic Supply reserves the right to sell such items as power supplies with their matching equipment only, and not separately - depending upon our stock situation. To insure quality, our used gear is sent through our repair shops after we receive your order - so please allow for a possible slight delay (approximately 5 to 10 working days).

Model	Reg.	Factory	NOW
GTX-10	\$209	\$169	\$159
GTX-2	259	189	179
GTX-200	269	199	189
PS-1	79	49	48

★ New ★
Clegg FM-27B
Reg. \$479.
NOW \$349.

SAVE on Genave *While our supply lasts! Factory Warranty

Factory Authorized Sale!

SAVE Up to \$240



MOTOROLA

If you purchase a Metrum II on Sale as shown below - We will also sell you a PK-736 Tone Encoder kit for just \$1 (reg. \$45) and, or a T-1670A AC Power Supply for just \$99

	reg.	Now
10 watt Metrum II	\$399	\$279
25 watt Metrum II	499	349

Crystals (one per channel)	9.00	PK-735 Multiple Repeater
Repeater Offset Crystal	13.50	Offset Modification Kit
T-1670A AC Power Supply	150.00	PK-736 Tone Encoder Kit
		45.00

SAVE \$50 ICOM



Purchase a ICOM IC-230 for \$489, with No-Trade, and you may take a \$50 Credit towards the purchase of other merchandise.

AMATEUR ELECTRONIC SUPPLY
828 West Fond du Lac Ave. Milwaukee, Wis. 53216
Phone (414) 442-4200
OURS: Mon & Fri 9-9; Tues, Wed & Thurs 9-5:30; Sat 9-3

IMPORTANT! - Please Be Sure to send all Mail Orders and Inquiries to our Milwaukee store, whose address is shown above. The following Branch stores are set up to handle Walk-in business only.

17929 Euclid Avenue; Cleveland Ohio Phone (216) 486-7330
621 Commonwealth Ave.; Orlando, Florida Phone (305) 894-3238

More Weather Satellite Pictures

In a series of two articles in 73 (September, 1974 and December, 1974) I described a simple video adapter that allows weather satellite pictures in the APT and DRIR modes to be displayed on a conventional SSTV monitor. The response to these articles has been rather startling and indicates a high level of interest in this type of activity. Sorting through the multitude of reader questions in regard to the articles, I find they fall into three general categories. Are there any new circuit ideas that can be incorporated into the system? How can I utilize the circuit if I have a Robot or Brand X monitor? If I don't have an SSTV monitor is there any way I can use the circuit for picture display? This article was prepared to answer these and other questions. It will describe a 2400 Hz crystal controlled sync reference system, a 2400 Hz video bandpass

filter to improve video display in the presence of noise, and an external deflection system that permits the adapter to be used with any electromagnetic SSTV monitor or even an old TV set!

The 2400 Hz Sync Reference Source

In the original series of articles the PLL of the sync system was locked to the satellite signal as the timing reference for the sync system. This approach was chosen because it permitted the use of a monaural tape recorder and therefore simplified the equipment requirements for picture reception. There are two limitations to the direct lock approach for the PLL that may on occasion cause some difficulty. A prolonged interruption of the satellite signal due to aircraft QRM (on the ATS frequency) or prolonged fades in the case of ESSA or

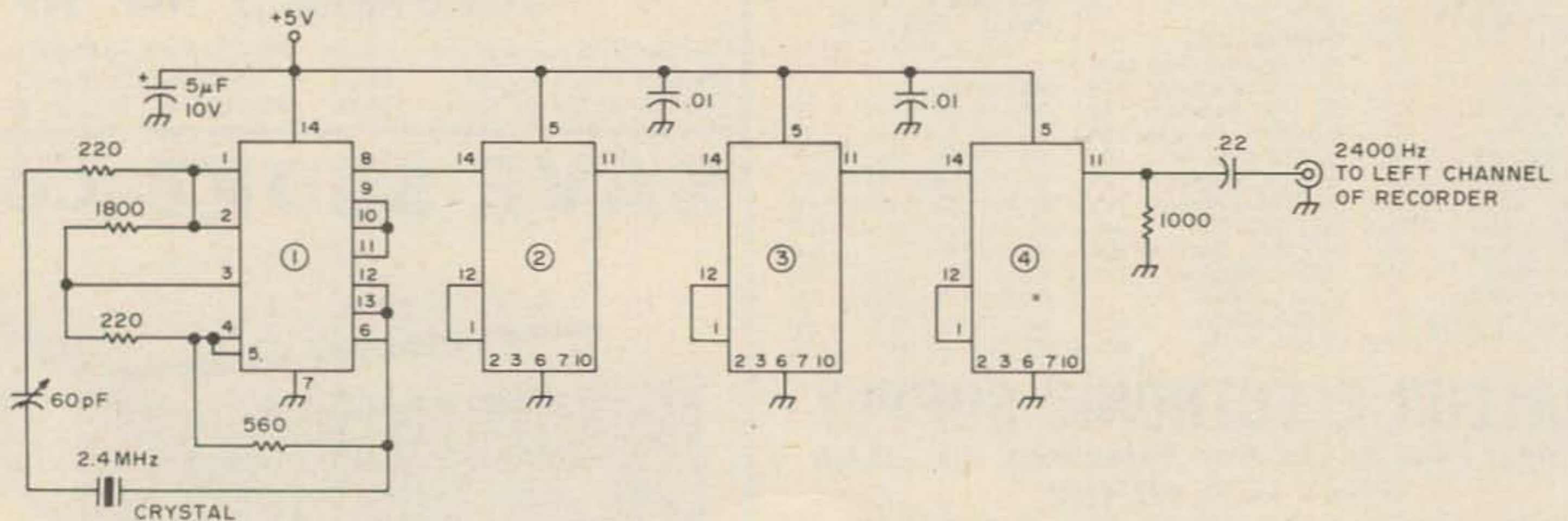

Fig. 1. Schematic of a suitable reference unit. IC1 - 7400, IC2,3,4 - 7490, xtal - commercial standard (AT cut), enclose osc. schematic when ordering from International or other mfg. co.

MEET THE STATE OF THE ART ON 2 METERS.. THE ITC MULTI-2000 CW/SSB/FM TRANSCEIVER

FEATURES

- PLL synthesizer covers 144-148 MHz in 10 kHz steps
- Separate VXO and RIT for full between-channel tuning
- Simplex or ± 600 kHz offset for repeater operation
- Three selectable priority channels
- Multi-mode operation (CW/SSB/NBFM/WBFM)
- Built-in AC and DC power supplies, noise-blanker squelch and rf gain control
- OTHER FEATURES TOO NUMEROUS TO MENTION.

■ Introductory price:

\$695.



WE SHIP ANYWHERE IN USA FREE!



HAMTRONICS

A DIVISION OF TREVISE ELECTRONICS

4033 BROWNSVILLE ROAD, TREVISE, PA. 19047

NOAA signals can cause the PLL to unlock, resulting in a picture phasing error. Additionally, the subcarrier duty cycle of the NOAA satellites can be quite low during night passes when the visible channel is black causing some difficulty in maintaining a locked condition. If a stereo recorder is available for satellite use it is possible to get around these problems by recording a 2400 Hz signal of high stability on one channel of the recorder while the satellite signal is recorded on the alternate channel. During playback it is possible to lock the PLL to the 2400 Hz reference signal and maintain proper phasing even if the satellite signal is obliterated for extended periods of time. Fig. 1 shows the schematic of a suitable reference unit. A 2.4 MHz commercial standard crystal controls the operation of a square wave oscillator (IC1). This signal is divided by three decade counters (IC2, 3 and 4) to provide an ultra-stable 2400 Hz reference signal. This signal can be recorded on the left channel while the satellite signal is recorded on the right channel. During playback the output of the right channel (satellite video) drives the adapter video

circuits and the left channel output is routed through the phasing switch to the input of the PLL. Fig. 2 shows the adapter modifications. A number of articles on facsimile type displays suggest using the 60 Hz line frequency as a reference source but this is rarely satisfactory. Although the long term accuracy of the line frequency may approach that of the satellite subcarrier (2400 ± 0.014 Hz) the *short term* accuracy comes nowhere close! Any attempt to use the 60 Hz line source as a reference during recording will almost certainly result in wandering line rates. Given normal room temperature variations, the reference system described here is always right on frequency. If set up as shown in Fig. 2, you can still use the satellite signal for reference should the left channel recording fail for some reason or if the stereo recorder is temporarily out of service and a monaural machine must be used.

Video Bandpass Filter

The quality of the video display can be improved in the presence of noise if a

YOUR HAM TUBE HEADQUARTERS!

TUBES BOUGHT, SOLD AND TRADED
SAVE \$\$\$ - HIGH \$\$\$ FOR YOUR TUBES

MONTHLY SPECIALS

2K25	\$ 28.00	6146B	\$ 4.25
3-500Z	42.00	6360	3.75
3-1000Z	120.00	6883B	4.50
4-125A	42.00	6939	9.00
4-400A	45.00	811A	5.00
4CX250B	24.00	813	18.00
4X150A	19.00	7735A	38.00
572B	18.00	8236	22.00

BRAND NEW****FACTORY GUARANTEED

TOP BRAND Popular Receiving Tube Types.
BRAND NEW 75%+ Off List*Factory Boxed.
FREE LIST Available - Minimum Order \$25.



COMMUNICATIONS, Inc.

2115 Avenue X
Brooklyn, NY 11235
Phone (212) 646-6300

SERVING THE INDUSTRY SINCE 1922

Clegg

Bargains

New FM27B-HT146 & Extras

At a low low price tag.

WRITE

AL'S 2-WAY RADIO

J. AL DEWALD RT. 3

DANVILLE, PA. 17821

CALL 717-437-2622.

CFP Enterprises

the home of

THIRD GENERATION FM

Trade-ins accepted. Write for quote. For the economy-minded, we have some of the best in second generation, too — new and used. Send SASE for our monthly used equipment list.

CFP Enterprises

866 RIDGE ROAD

LANSING, N. Y. 14882

Hours: Mon, Tues & Thurs 8:30-8:30

24-hour telephone 607-533-4297

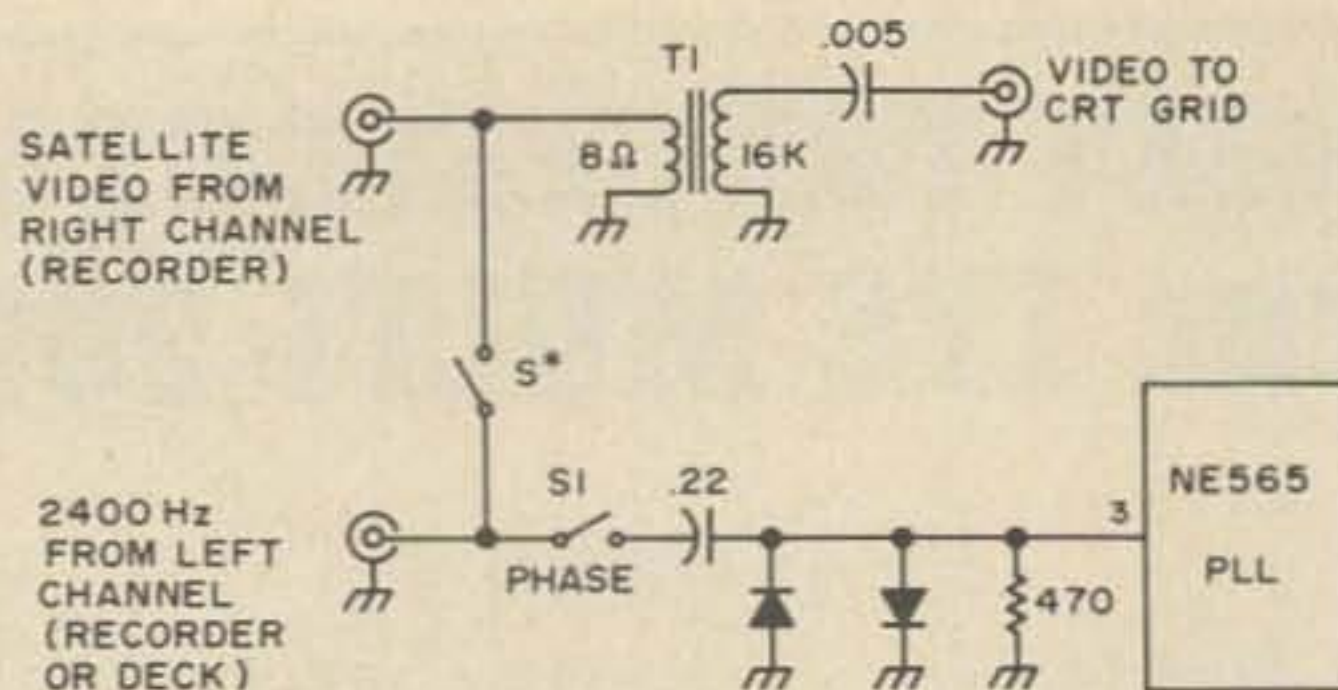
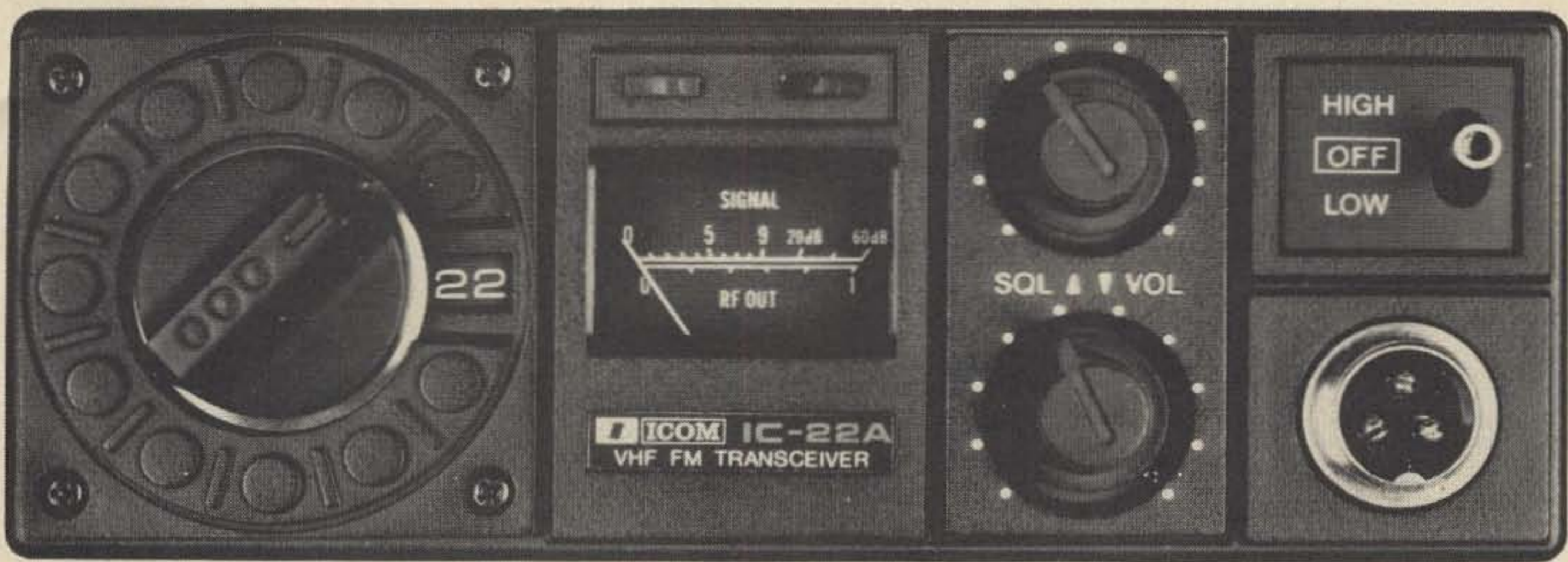

Fig. 2. Changes in the satellite converter if the 2400 Hz reference is used to lock the PLL.

Adding an additional SPST switch here permits the PLL to be locked to the satellite signal if the reference recording failed or a stereo recorder is not available. Normal operation with the reference signal involves keeping S open; close it for locking on satellite video.

bandpass filter, centered on 2400 Hz, is inserted in the video line at some point in the system. Fig. 3 shows an active filter using a single 741 op amp. The filter is set up for approximately unity gain, a center frequency of 2400 Hz, and a bandwidth of 1000 Hz. Ideally such a filter would be 1600 Hz wide for APT use but narrowing it to 1000 Hz has no noticeable effect on APT reception and is a good match for the 900 Hz video bandwidth of the NOAA visible channel. There are two ways in which the filter can be used, depending upon whether a tape recorder or tape deck is used. In the case of a recorder the simplest scheme is to insert the filter in the record line as indicated in Fig. 4a. In this way the signal is cleaned up prior to recording and the output of the recorder can drive T1 with the previously filtered signal. Some operators would like to be able to use a tape deck with the satellite signal. Fig. 4b shows how this can be accomplished. The filter is inserted between the deck output and a small 1 Watt audio amp which then drives T1 in the video circuit. Any one of the many discrete component boards of IC chips may be used as long as the amplifier will supply approximately 1 Watt into the 8 Ohm winding of T1. I use a small amplifier board available from Radio Shack. The gain control of the small amplifier is thus used as the system contrast control. The extreme sensitivity of the NE565 PLL permits the left channel of a tape deck to drive the PLL with the sync reference signal without additional amplification.

WE'VE GIVEN IT A NEW LOOK!



IC-22A

The front panel and control locations have been changed to make the IC-22A even better looking and easier to operate. The new design allows the use of larger channel numbers which may be

viewed from the left side or right side by reversing the window position and installing a new dial. (optional at nominal cost)

Inside is the same high quality radio construction and engineering that has made the IC-22 the most reliable, most popular two meter crystal controlled set on the market.

When you join 22 channels of capacity (five supplied) with the unexcelled performance of helical RF filtering in the receiver front end then add solid state T-R switching you get one great radio for your money. All the great features that made the IC-22 so desired are still there. Including, 1 watt/10 watt switch option, trimmer capacitors on both receiver and transmitter crystals plus a 9 pin accessory jack with the discriminator already wired for frequency calibration.

SEE ONE !! BUY ONE !! AT YOUR ICOM DEALER TODAY.

Distributed by:



ICOM

ICOM WEST, INC.
Suite 232--Bldg. 11
300-120th Ave. N.E.
Bellevue, Wash. 98005

ICOM EAST
Suite 307
3331 Towerwood Dr.
Dallas, Tx. 75234

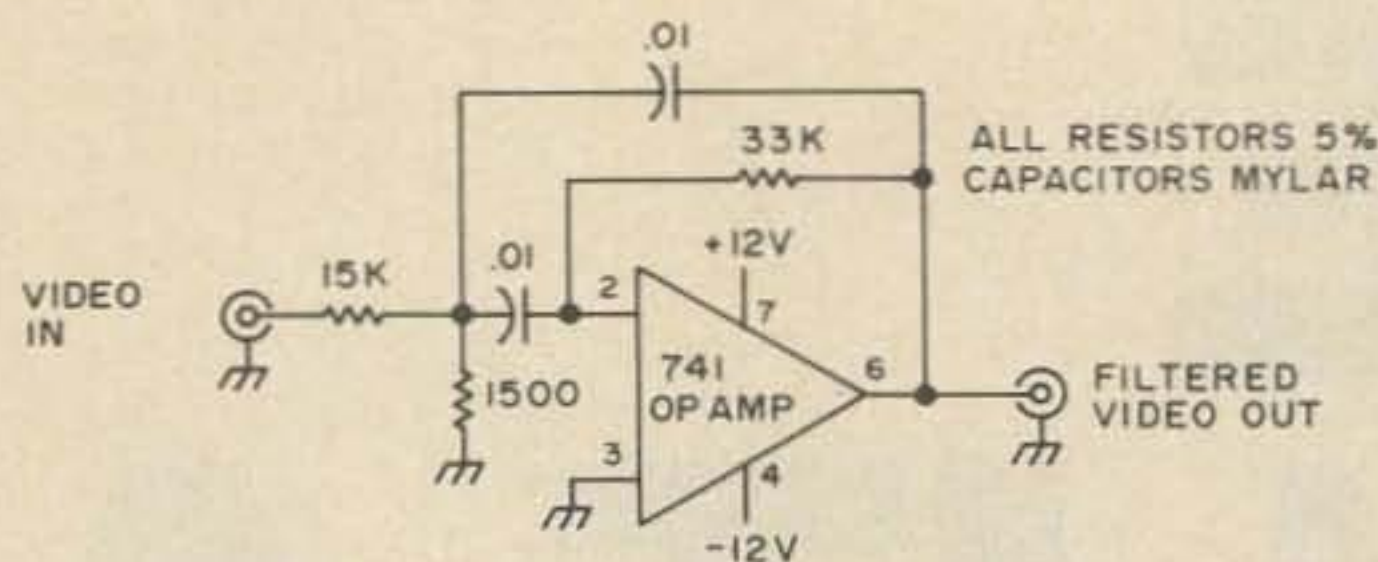

Fig. 3. Basic 2400 Hz bandpass filter.

External Deflection System

Proper video modulation of the monitor CRT can be achieved by running a shielded lead to the grid as described in the original article, but monitors such as the Robot which use continuous running sweep circuits instead of the driven sweeps of the WB8DQT circuit present a problem in terms of getting proper triggering and deflection for weather satellite display. The deflection system diagramed in Fig. 5 can solve this problem. The circuit is essentially a modification of the standard SSTV deflection circuit used in the W6MXV monitor and W9NTP flying spot scanner (both described in the 73 SSTV handbook) and in my own monitor circuit. A single pole single throw switch changes discharge capacitors for the APT and DRIR modes and the two size pots can be calibrated for the two modes. S1 resets the vertical sweep when closed and initiates it when opened. With the mode switch (S2) in the APT position close S1 and adjust the vertical centering so the trace is at the top of the CRT. Open S1 and adjust the vertical size pot for a 200 second sweep time from top to bottom. Use a pointer type knob on the vertical size pot and mark the proper position for the APT 200 second sweep. Use a similar knob for the horizontal size pot and adjust horizontal size and centering so the raster just sweeps across the bezel when driven by the APT trigger pulses from the adapter. Mark the position of the size pot for future reference. Place S2 in the DRIR position and adjust the vertical size pot for a six minute vertical sweep when S1 is opened. Mark the position of the pot for DRIR display. Adjust the horizontal size pot for a raster that sweeps slightly beyond the right margin of the CRT bezel when the mode switch of the adapter is in the DRIR position. Mark the appropriate DRIR position on the horizontal size control.

Fig. 6 shows one way of interfacing the external deflection system with the Robot monitor. An eight pin Cinch Jones plug (P-308AB) is mounted on the rear of the monitor. A dummy socket (S-308CCT) wired with jumpers permits normal SSTV display while another socket (S-308CCT) on a cable will interconnect the Robot deflection coils with the external deflection unit. A similar plan can be used to permit satellite picture display on a small TV set. Remove the TV yoke from the CRT but do not disconnect it. This will permit the set's HV circuits to function and lets you restore normal TV operation with a minimum of trouble. Obtain a replacement yoke to fit your set and connect this yoke to the external deflection system. A shielded lead from the set CRT grid to the video output of the satellite adapter completes the job. When interfacing the deflection board with either an SSTV monitor or a TV set, proper yoke polarity can be checked by closing S1 on the deflection system. The vertical trace should reset to the top. If it goes to the bottom reverse the vertical yoke connection, preferably on the plug at the end of the cable from the deflection unit. Shorting out the horizontal discharge capacitors should cause the trace to displace off the left hand side of the screen — if it moves to the right, reverse your horizontal yoke connections at the cable plug. In the case of the Robot conversion, should the SSTV picture be upside down or backwards in terms of the horizontal scan, make the appropriate changes in the jumper wiring on the dummy plug.

As in the case of the original conversion

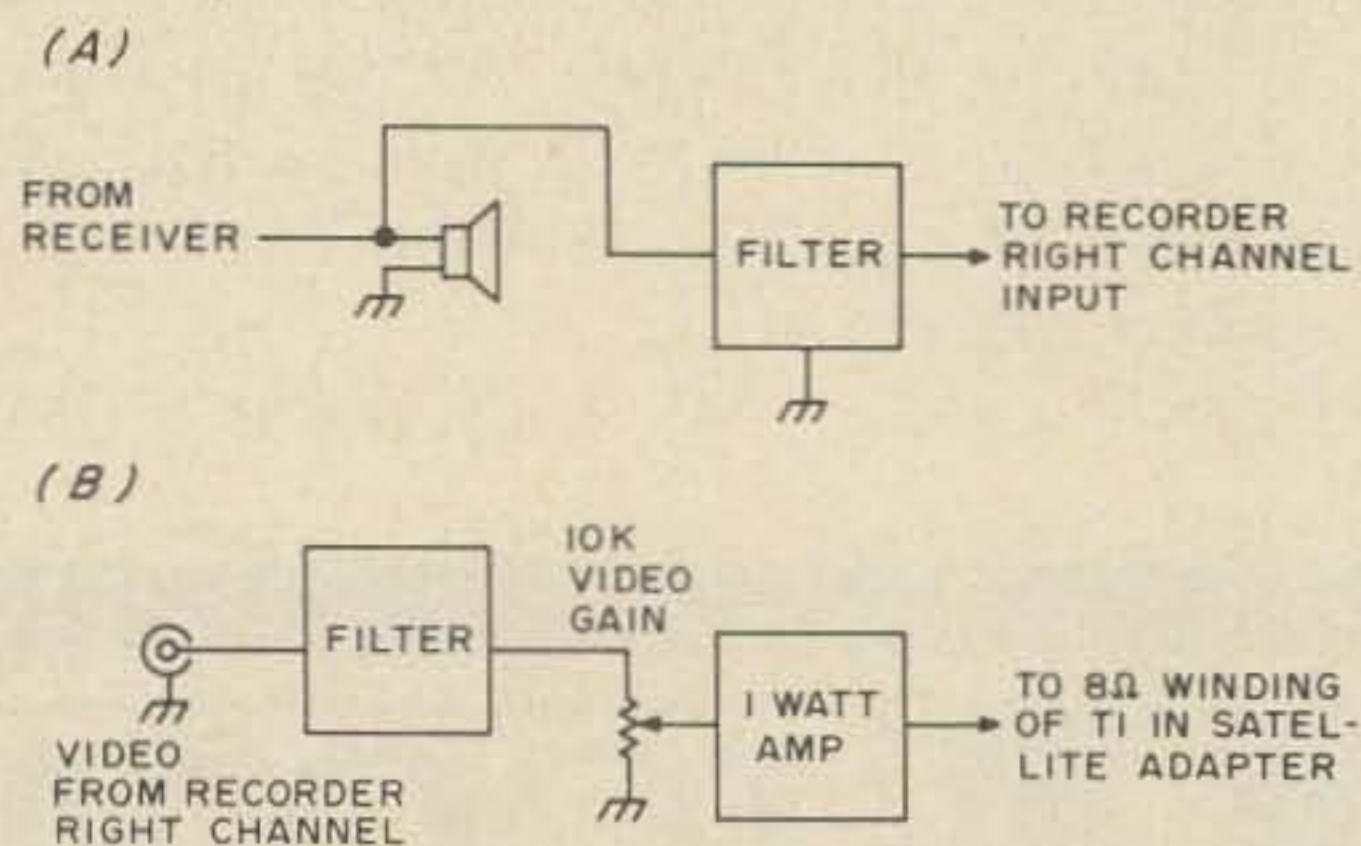

Fig. 4. Use of the video filter if a tape recorder (A) or a tape deck (B) is used. In the case of a deck, the left channel reference output is sufficient to drive the PLL (see Fig. 1).

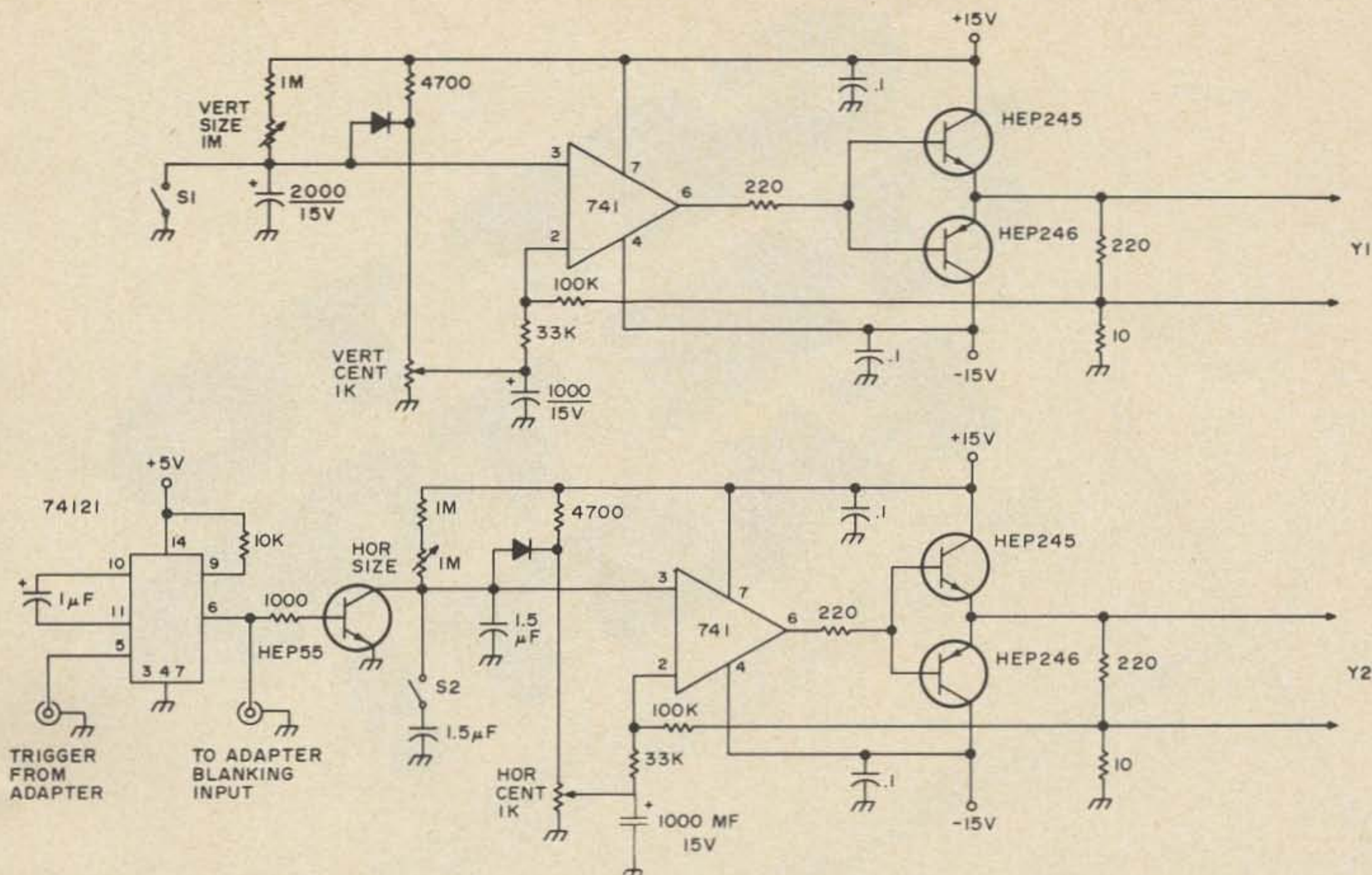

Fig. 5. Vertical and horizontal deflection system for utilizing the adapter with Robot monitors or TV sets. S1 functions as the vertical reset when closed, initiating vertical sweep when open. The 74121 IC is a 5 ms single shot that produces a trigger pulse when driven by the countdown chain in the adapter. This pulse drives the horizontal ramp generator (HEP55) and also provides a pulse to operate the retrace blanking circuit (Q1) of the adapter. S2 is the mode switch (open = APT, closed = DRIR). Use knobs on the size pots so that the proper APT and DRIR positions can be marked. Y1 is the vertical winding and Y2 the horizontal winding of the Robot or TV deflection coil assembly. If the deflection system is used with the Robot monitor the + and - 15 volts can be obtained from the camera power socket on the rear apron.

with the WB8DQT SSTV monitor, proper size and phasing adjustments are easy to make with an SSTV monitor because of the persistence of the P7 phosphor. In the case of display with a TV set, a square area should be masked out on the face of the CRT and size adjustments, as described, should be made in a darkened room to compensate for the short trace persistence. With a little practice, phasing adjustments are quite easy despite the short persistence of the P4 phosphor. However, you will have

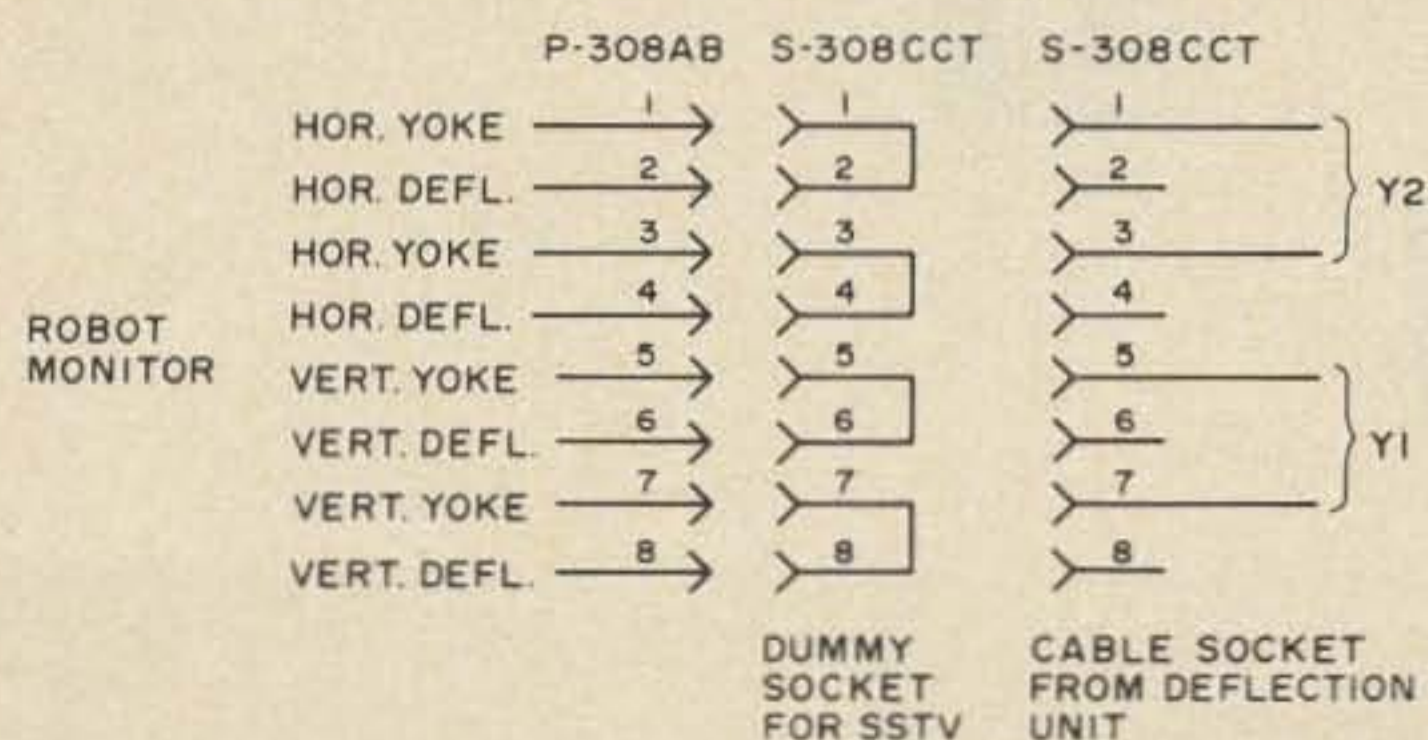

Fig. 6. One possible scheme for interfacing the deflection unit with the Robot monitor. Inserting the dummy socket on the new plug at the rear of the SSTV monitor restores SSTV deflection.

to depend entirely on photographs for picture interpretation; unlike the P7 phosphor, the P4 will not hold enough of the picture to be useful for visual evaluation. With both the TV or SSTV monitor approach the brightness control should be adjusted for a barely visible trace with no video from the adapter. Signal level from the adapter is then adjusted for a reasonable white level without blooming.

The addition of the crystal controlled sync source and video filter to the basic satellite adapter will result in a unit that is fully comparable to commercial units costing many thousands of dollars. The addition of the external deflection board will permit interfacing the satellite system with any SSTV monitor or monochrome TV set. The latter approach is particularly desirable for those without access to an SSTV monitor and should find particular application for low budget educational institutions that desire high quality satellite display.

...WB8DQT

GET TO THE FAST TOP!

NOW YOU CAN CHANGE, ADJUST OR JUST PLAIN WORK ON YOUR ANTENNA AND NEVER LEAVE THE GROUND!

ROHN manufactures towers that are designed and engineered to do specific jobs and that is why we have the FOLD-OVER TOWER . . . designed for the amateur. When you need to "get at" your antenna just turn the handle and there it is. Like other ROHN big communication towers, they're hot dip galvanized **after** fabrication to provide a maintenance free, long lived and attractive installation. ROHN towers are known and used throughout the world . . . for almost a quarter century . . . in most every type of operation. You'll be in good company. Why not check with your distributor today?



ROHN **MANUFACTURING**

®
DIVISION OF 

P.O. Box 2000 / Peoria, Ill. 61601

Solid Gold PR: Washington!

The interview has ended. We walked away, looking back at the long, yellow and white striped tent. The luring di-dahs of a CW contact met our ears. Even the unfortunate souls who have not been initiated into hamdom are fascinated by the code. Its mysterious, elusive, almost hypnotizing quality demands your attention.

And just as the code is so enticing, so is the whole hobby. Just as I captured your attention with my first paragraph, we must capture the attention of the public with good publicity. Too many dedicated hams work thousands of hours unbeknownst to their neighbors and friends. How often the ham remains unnoticed, until he has a TVI problem, when amateur radio is then shown in a less than favorable light. This kind of scrutiny is not desirable, because long after the TVI has been rectified, the ham is remembered only for his interference, and not for his good deeds.

One of the numerous ways to invite interest is to perform services that are beneficial. Other ways to draw the public eye, subtly, are through the arts and crafts that make up the history of our country. These vehicles of advertising ham radio take the public down memory lane, which is usually a pleasant experience for all. Reminiscing is an enjoyable pastime. It's harmless, fun, and best of all...cheap! Like free! I present for your criticism the following example of ham radio at work in the community. We all love our hobby, but it must be presented to the public before they will have the desire to take part.

Stretching from the Lincoln Memorial to the Washington Memorial was a swarming mass of humanity. The cool, refreshing water of the reflecting pool, usually peaceful, was dotted with people wading. A large raft slowly made its way back and forth, transporting people from one side to the other. There were huge tents, striped with many colors, pavillions, long, brown mobile homes (for staff use), golf-type vehicles to convey people, and small carts pulled by ponies. People were walking, people were jogging, and people were! Lots of people! Park Police on beautiful horses plied their way through the throng. Vendors peddled their wares, while the more easily exhausted folks sprawled on the grass in a variety of positions. Some slept, with the noonday sun hot on their backs.

Music came from all directions, trying to attract the passers-by. Songs of many countries filled the air. Dancers vied for attention, as they performed the dances of their native countries in brightly colored costumes. Palate-tempting aromas and the fragrance of spices promised a real culinary treat to the hungry.

All this activity was centered in our nation's capital, July 3-11, 1974 — the annual celebration of the Festival of American Folklore, sponsored by the Smithsonian Institution.

There were representatives of six labor unions, Native Americans from twenty two tribes, and dancers from Scandinavian, African, and European countries. This year's featured state was Mississippi.

Amateurs (too many to list here) were prominent in the group called Working Americans. Many clubs from the Washington area, including Virginia and Maryland, had tables with displays to illustrate the purpose of ham radio, hoping to enlist a few of the spectators. ARRL had a well manned (for you Women's Libbers, well personned) table set up to collar prospective hams. Several rigs operated to demonstrate what a QSO is. The special call WW3FAF (Festival of American Folklore) was used. Hams from many states signed the guest directory. There was an almost "Hamfest" atmosphere, as old friends renewed acquaintances and caught up on the latest news. It was reminiscent of Field Day, except for the absence of the familiar generator hum.

Forest, my OM (W4QVL), is with the Voice of America in Washington. He had the brilliant idea that the women listeners in other parts of the world, might be interested in the part YLs have in the festival each year and in amateur radio. Augusto Meyer, of the Brazilian service of the VOA, agreed with my OM. American women are envied world-

wide and have infinitely more privileges. This fragment of an idea emerged as an on the spot interview with this befuddled lady type ham.

Proving that I am not an imbecile twenty four hours a day, I hastily sought the help of Dexter Anderson W3WKJ, of the State Department and the State Department Radio Club. He was an unending source of information, well informed on the elementary, as well as the more exotic, phases of amateur radio.

We were lucky to get Ethel Smith De Bardeleben K4LMB, who had some wise words about her part in the organization of the WAYLARCs (Washington Area Young Ladies Radio Club), the role of YLs in the ARRL and YLRL, and their varied interests and activities in the many facets of ham radio.

Besides taking numerous notes, Augusto, aided by his lovely and talented wife, Lina, recorded with a small cassette recorder, as we led him through the various displays in the big tent. Amateur TV, a solar power



source, and films featuring Arthur Godfrey and Barry Goldwater were all on hand. A phone and CW contact were recorded.

Augusto, speaking in Portuguese, described the setting and then introduced each speaker. The ham spoke in English, which was faded down later in the broadcast while the Portuguese was dubbed over. This kind of recording, called "actuality", carries more realism and credence than a purely Portuguese one. What was to be one broadcast expanded into two broadcasts of fifteen minutes each. The first one was on September 28 at 2300 GMT, on sixteen, nineteen, twenty five and thirty meters. The second was on October 4. There is a possibility that this kind of broadcast may extend into the other 35 language services.

The interview had ended. Another blow was struck for amateur radio, which needs every bit of good publicity it can get. Everyone of us can do our part, large or small, to spread good will in the name of ham radio. Every now and then, a good article gets published, pushing the cause of Ham. With the CBers, and the general public as well, bad mouthing us, it behooves us — each of us — to say a good word or do a good deed, that can be a credit to hams, every chance we get. Such things make better people out of us, too.

There was a great deal of confusion, to say the least, as we walked among the displays. QSOs on four different bands for a starter, but unlike many people, the hams did not mind having a mike thrust in their faces. They kept their QSO going as though they had expected the whole thing. They maintained their cool. We do like to think of ourselves as level headed and able to function in many situations.

The old ham urge to help prevails in every possible circumstance. As we walked through the exhibits with Augusto, speaking in Portuguese, a ham came up to volunteer a friend who spoke Spanish and "would help to translate for us". The language was not Spanish, and the purpose of the interview was to provide on the spot realism, but the guy was ready to help. Which goes to prove that a ham will be there to help, even if he doesn't know what is going on.

...K4SHE

WE'RE FIGHTING INFLATION NO PRICE RISE IN '75

FOR FREQUENCY STABILITY



Depend on JAN Crystals. Our large stock of quartz crystal materials and components assures Fast Delivery from us!

CRYSTAL SPECIALS

Frequency Standards	
100 KHz (HC 13/U).....	\$4.50
1000 KHz (HC 6/U).....	4.50
Almost all CB sets, TR or Rec.....	\$2.50
(CB Synthesizer Crystal on request)	
Amateur Band in FT-243.....	ea. \$1.50
	4/\$5.00

80-Meter..... \$3.00 (160-meter not avail.)
Crystals for 2-Meter, Marine, Scanners, etc. Send for Catalog.

For 1st class mail, add 20¢ per crystal. For Airmail, add 25¢. Send check or money order. No dealers, please.



Div. of Bob Whan & Son Electronics, Inc.
 2400 Crystal Dr., Ft. Myers, Fla. 33901
 All Phones: (813) 936-2397

Send 10¢ for new catalog with 12 oscillator circuits and lists of frequencies in stock.

NEW HIGH PERFORMANCE LIGHTWEIGHT ANTENNAS for 80 through 10 meters designed for maximum efficiency without using inductors, capacitors or traps. Each antenna is complete ready to install. 15 day return privilege.

The NEW DE-8010 covers 80 through 10 meters plus adjacent MARS frequencies. Included is 100' of low loss foam filled twin lead, a balun and a coaxial cable with connector. 130' long for only \$89.50 plus \$2 ship.

The new DE-4015 covers 40, 20 and 15 meters. An excellent tri-band antenna for fixed or portable use.

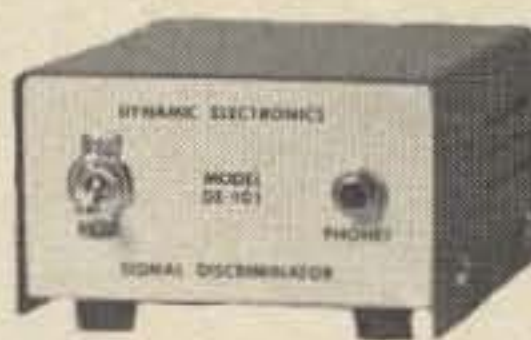

Active filters for superior CW reception through QRM & QRN. Simply plug filter into receiver's phone jack and plug ear-phones or speaker into filter. One year warranty and 15 day return privilege.

DE-101 for phones only	115 VAC \$36.95
DE-101A for SPKR & phones	115 VAC \$49.95
DE-101B for SPKR & phones	12-18 VDC \$37.95
DE-101C for phones only	12-18 VDC \$24.95

Dynamic Electronics, Inc. P.O. Box 1131, Decatur AL 35601

YOU ASKED FOR IT! ECM-5B FM Modulation Meter

ONLY \$132 less batteries and crystals

- 0-7.5 kHz deviation peak reading Meets commercial requirements
- Operates 30-500 MHz
- Crystal Controlled for easy operation
- Telescopic antenna

NEW OPTIONS

- NICAD power pak \$20.46
- Charger \$29.95
- Audio/scope output with earphone \$12.95

Write or call for complete info.

Send check or money order

plus \$1.50 for shipping. Indiana residents add 4% sales tax. Crystals for 146.94 MHz \$3.95. All other freq. \$7



ECM

ECM Corporation
 412 North Weinbach Ave.
 Evansville, Indiana 47711
 812-476-2121

Put together the top-value Heathkit 2-meter package!

Start with the Heathkit HW-202 2-Meter FM Transceiver.

It's an all solid-state design that you can build and completely align without special instruments. And this compact little beauty gives you independent pushbutton selection of 6 transmit and 6 receive crystals. 10 watts minimum output. Will operate into an infinite VSWR without failure. And for the ultimate in convenience there's the optional tone burst encoder for front panel selection of four presettable tones. The HW-202 kit includes two crystals for set-up and alignment and simplex operation on 146.94; push-to-talk mike; 12-volt hook-up cable; heavy duty clips for use with temporary battery; antenna coax jack; gimbal bracket, and mobile mounting plate. See specifications below. Crystal certificates available at 5.95 each.



Kit HW-202, 11 lbs., mailable . . . 179.95*

Kit HWA-202-2, Tone Burst Encoder, 1 lb. . . 26.95*

Kit HWA-202-3, Mobile 2-Meter Antenna, 2 lbs. 19.95*

Kit HWA-202-1, AC Power Supply, 7 lbs. . . 32.95*

Kit HWA-202-4, Fixed Station 2-Meter Antenna, 4 lbs. . 17.95*

Add 40 watts of output

with the Heathkit HA-202 2-Meter Amplifier. It's designed for the HW-202, 4 lbs. 59.95*



Tune-up your 2-meter rig

with maximum precision. The Heathkit HM-2102 VHF/SWR Bridge makes it happen, 4 lbs., 34.95*



New Heathkit 10-Watt Amplifier,

HA-201, is perfect for hand helds or any 1 to 1½ watt 2-meter rig, 3 lbs. 27.95*



HW-202 SPECIFICATIONS — RECEIVER — Sensitivity: 12 dB SINAD* (or 15 dB of quieting) at .5 μ V or less. Squelch threshold: 3 μ V or less. Audio output: 2 W at less than 10% total harmonic distortion (THD). Operating frequency stability: Better than \pm .0015%. Image rejection: Greater than 55 dB. Spurious rejection: Greater than 60 dB. IF rejection: Greater than 75 dB. First IF frequency: 10.7 MHz \pm 2 kHz. Second IF frequency: 455 kHz (adjustable). Receiver bandwidth: 22 kHz nominal. De-emphasis: -6 dB per octave from 300 to 3000 Hz nominal. Modulation acceptance: 7.5 kHz minimum. **TRANSMITTER** — Power output: 10 watts minimum. Spurious output: Below -45 dB from carrier. Stability: Better than \pm .0015%. Oscillator frequency: 6 MHz, approximately. Multiplier factor: X 24. Modulation: Phase, adjustable 0-7.5 kHz, with instantaneous limiting. Duty cycle: 100% with ∞ VSWR. High VSWR shutdown: None. **GENERAL** — Speaker impedance: 4 ohms. Operating frequency range: 143.9 to 148.3 MHz. Current consumption: Receiver (squelched): Less than 200 mA. Transmitter: Less than 2.2 amperes. Operating temperature range: -10° to 122° F (-30° to +50° C). Operating voltage range: 12.6 to 16.0 VDC (13.8 VDC nominal). Dimensions: 2¾" H x 8¼" W x 9⅞" D.

*SINAD = $\frac{\text{Signal} + \text{noise} + \text{distortion}}{\text{Noise} + \text{distortion}}$

HEATHKIT ELECTRONIC CENTERS — Units of Schlumberger Products Corporation
Retail prices slightly higher.

ARIZ.: Phoenix; CALIF.: Anaheim, El Cerrito, Los Angeles, Pomona, Redwood City, San Diego (La Mesa), Woodland Hills; COLO.: Denver; CONN.: Hartford (Avon); FLA.: Miami (Hialeah), Tampa; GA.: Atlanta; ILL.: Chicago, Downers Grove; IND.: Indianapolis; KANSAS: Kansas City (Mission); KY.: Louisville; LA.: New Orleans (Kenner); MD.: Baltimore, Rockville; MASS.: Boston (Wellesley); MICH.: Detroit; MINN.: Minneapolis (Hopkins); MO.: St. Louis (Bridgeton); NEB.: Omaha; N.J.: Fair Lawn; N.Y.: Buffalo (Amherst), New York City, Jericho (L.I.), Rochester, White Plains; OHIO: Cincinnati (Woodlawn), Cleveland, Columbus, Toledo; PA.: Philadelphia, Pittsburgh; R.I.: Providence (Warwick); TEXAS: Dallas, Houston; VA.: Norfolk (Va. Beach); WASH.: Seattle; WIS.: Milwaukee.

Heath Company
Dept. 11-06

Benton Harbor, Michigan 49022

Please send my free 1975 Heathkit Catalog.
 Enclosed is \$ _____, plus shipping.

Please send model(s) _____

Name _____

Address _____

City _____ State _____ Zip _____

Prices & specifications subject to change without notice.

*Mail order prices; F.O.B. factory AM-307A

HEATH
Schlumberger

Tit for Tat and others

Once upon a daylight losing time, there lived a spouse/ham/kid combo named Tit, Tat and offspring Jean or Gene (a gray area). They were all MORE than normal - - - let us say their combined I.Q. was underwhelming. He operated an ice cream parlor in Brainsprain that was so small it had one different flavor.

The tall storm fence around his spread had been erected in a crash program by the neighbors. It was designed to keep things in, not out. As a whole, Tat's shack certainly was - - - it was about as neat as a seal harem in a snow storm. Some glory for this went to little one's cute habit of warming his/her weenies in the linear. He had spoken at great length about this. The swr meter was calibrated Forward, Reverse and Carry-Out. After long-accumulation of oozings, flames licked from the lo-pass filter during hot DX joustings, making the premises smell like a Ubangi bake-out.

The five-yearly maintenance caper always started with pulling the wall breaker and making cautious passes with a miné detector and roto rooter. Tat was outstanding in miner's hat and lantern in the blackout.

Just no end to his ingenuity. One day his Honda came uncranked and he jumper-started his roto tiller from the trolling motor, so he could jump-start his Honda from his roto tiller.

"Where'd he get such talent?", asked Bassmouth, a fat priceless neighbor.

"It came with his genes!" blurted Tit.

"But he's not wearing jeans," echoed BM.

"Jean's not wearing his either," said Tit, logically.

"Who, me?" said little bit, playing with its natterjack.

"Pity!" said someone.

"What'll it cost to spring me from here?" groaned Tat.

On another memorable day Tat thought most of his rf was avoiding the antenna somehow. Tit was programmed to push the key on command, while he was thrusting the box at the bottom of the crank-up.

At a crucial moment, Bad Humor Girl tripped over her low-hung accouterments and lost an ear screw, which welded across the Navy key points. Promptly, Tat became the hottest item in a sleet-melting network and the air departed his framis with vast gusto. The automatic tower crankdown detector felt this as a high wind and lowered his boom. But Alas! The smarts box seeing its error suddenly erected his boom to a devilish angle and the RG-17 Slash U lifted him by the vital apex.

Thus inspired, he seemed to breast-stroke thru the air - - - he wasn't even near the wench! At half-mast, he trapezed merrily thru the Gamma match, which proved quite fitting at the vernal equinox.

He was no match for the Gamma match, and lady misfortune aimed him towards ground zero. He made two big points into a basketball goal he had cleverly welded onto the tower - - - he contacted nothing but the iron rim. A great shudder ran along the coax into the shack, so mighty that it uncoupled his antenna coil.

CATALOG

GOVERNMENT SURPLUS ELECTRONIC EQUIPMENT

For 1975

FREE UPON REQUEST! Write for
Copy of Catalog WS-75 Now!
Address: Attention Dept. 73

FAIR RADIO SALES
1016 E. EUREKA • Box 1105 • LIMA, OHIO • 45802

PL-259

SO-239

Either Plugs OR Sockets

5 for **\$3.50**

POST-PAID

N.J. residents add 18c Sales Tax

Send SASE for other Connectors.

COAKIT P.O. Box 101-A, Dumont, N. J. 07628

PRINTED CIRCUIT

EPOXY GLASS CIRCUIT BOARD STOCK;
CARBIDE DRILL BITS; TAPE RESIST;
ARTWORK; BUBBLE ETCHERS
SEND S.A.S.E. FOR FLYER

TRUMBULL

833 BALRA DR., EL CERRITO, CA. 94530

Dangling sunny-side-up from the net (he'd been in some before), he saw things differently. Man, he needed a break! and it was coming to him — the winch crank, placed there for those delightful powerless moments, turned on him and clobbered him roundly in the guess where.

“What was that all about?” yelled Tit, her face screwed into a granny knot, and even more unbalanced without one ear screw.

“Oh, I just felt unnecessary, lying there doing nothing,” he garbled, grabbing for his dentures in the Zoysia.

“That was simply beautiful,” signed his neighbor Bedlam to the east, as he hit a hot lick on his gusle. “But I missed the intermezzo - - - would you do it again?”

“Double pity!” said Bassmouth, the philharmonic neighbor, wearing his hard hat for the luau.

Conclusion: Some neighbors just don't know what they're missing.

... W4ATE

Battery Operated Cassette Tape Recorder

only \$19.95



We have just bought out a manufacturer's supply of quality cassette tape recorders. This means that we can sell them to you at WHOLESALE PRICE. Formerly we sold these recorders for \$24.95. Now they're yours for ONLY \$19.95! You'll never find a better deal...anywhere, anytime. But hurry — supply is limited!

- Self-contained unit
- Remote stop-start
- Remote control dynamic microphone
- Complete with batteries and earphone
- Rotary knob for easy operation
- Uses any standard cassette tape
- Fine for voice or Morse Code Study
- Good for lo-fi music listening

Order Yours Today!

PM 760 RECORDER

Name _____

Call _____

City _____

State _____

Zip _____



Signature _____

Card No. _____

Expiration Date _____

\$19.95 plus \$1.00 shipping and handling. Total encl. _____

73 MAGAZINE, PETERBOROUGH NH 03458

Wilson Electronics

FACTORY DIRECT

SPECIAL JUNE SALE !!!

WILSON 1402SM HAND HELD 2.5 WATT FM TRANSCEIVER

- * Rubber Flex Antenna
- * Complete Set NiCad Batteries
- * Leather Case
- * Three Sets of Crystals, 52-52,

Plus Your Choice Of 2 Pair of Common Frequencies
Extra Crystals, \$4.50 ea., Common Frequencies Only

\$ 320 VALUE ALL FOR JUST **\$ 199⁹⁵**

- 6 Channel Operation, Individual Trimmers On All TX and RX Xtals. All Xtals Plug In.
- S Meter Battery Indicator.
- 10.7 IF and 455 KC IF. 12 KHz Ceramic Filter.
- .3 Microvolt Sensitivity For 20dB QT.
- 2.5 Watts. Nominal Output 12 VDC.
- Microswitch Mike Button.
- Size 8-7/8 x 1-7/8 x 2-7/8 Inches.
- Weight 1 lb. 4 ounces. Less Battery.
- Current Drain RX 14MA TX 380 MA.

ACCESSORIES:

- SMI Speaker Mike \$24.00
- BCI Battery Charger \$29.95
- 1410A Amplifier Mobile Mount \$99.00

To: Wilson Electronics
P.O. Box 794
Henderson, Nevada 89015
(702) 451-5791

Ship me 1402 SM Special
Plus SM1 1410A BC1

Enclosed is \$ _____ Check Money Order

Master Charge Bank Americard

Expiration Date _____ M/C Interbank # _____

Card # _____

Xtals _____

Name _____

Address _____

City and State _____ Zip _____

Signature _____

All orders will be shipped Parcel Post within 48 hours after receipt of order (excluding weekends). Enclose additional \$4.00 for prepaid shipping & handling. Nevada residents add sales tax.

Sale ends June 30th.

90 DAY WARRANTY

10 DAY MONEY BACK GUARANTEE

CAN BE MODIFIED FOR ARMY MARS

NEW!



Operate Auto-Patch

use antenna and power . . . The GTX-200-T does all the rest!

The 12-digit tone encoder is an integral part of the 2-meter VHF-FM transceiver (WOW!) Separate controls allow independent transmit and receiver frequency selection.

The GTX-200-T is all solid state, transmits at 30 watts (nom.), also features super-sensitive dual-gate MOS FET preamp receiver. Same old GTX-200—but what an addition!

Your Low Price

\$249⁹⁵

Use coupon to order direct from factory

**IMMEDIATE DELIVERY
FROM STOCK**

TE-II Tel Encoder . . .

so small and compact it can be mounted on the faceplate of most any transceiver, including smaller-sized walkie-talkies. Completely self-contained: connect to B+ ground and signal output, and it's ready to operate.

The TE-II produces all standard double frequency tones used in telephone signalling circuits. It is completely shielded.

Your Low Price

\$44⁵⁰

Use coupon to order direct from factory

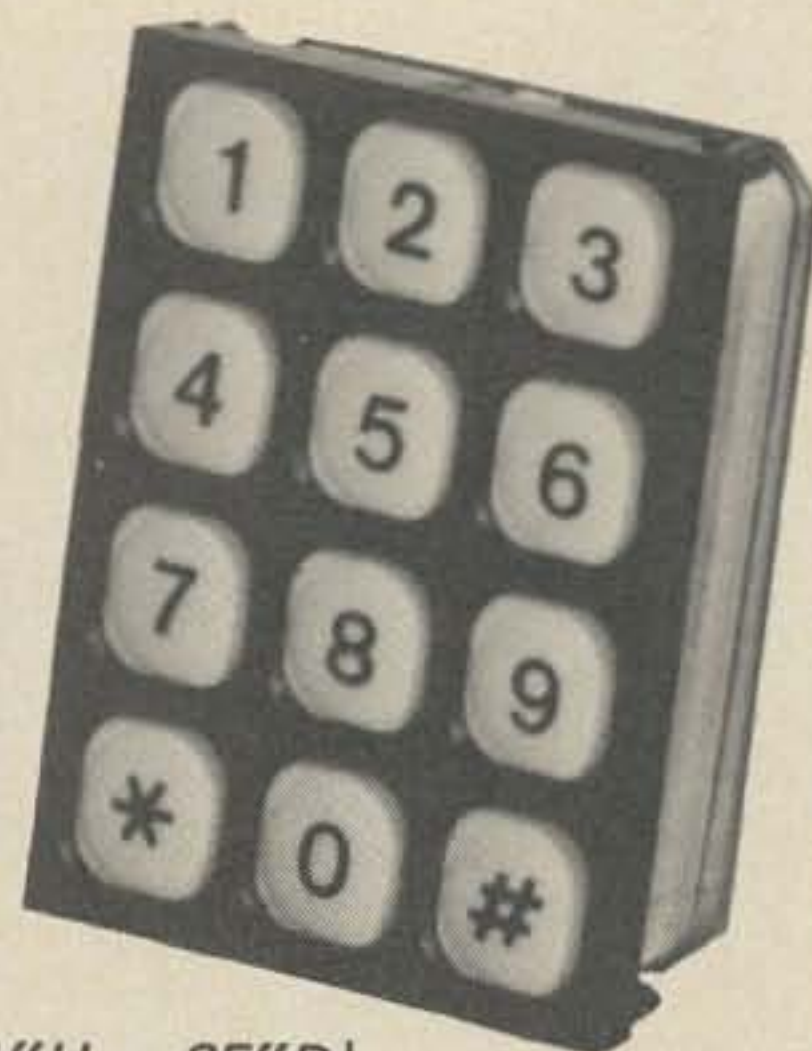

(Size — 1.6"W x 2.1"H x .65"D)

**Use This
Handy Order Form**

CLIP OUT AND ORDER NOW

THIS PAGE IS YOUR ORDER BLANK!

ORDER NOW AND SAVE!

Specials at Unbeatable Prices



GENAVE, 4141 Kingman Dr., Indianapolis, IN 46226

HEY, GENAVE! Thanks for the nice prices! Please send me:

- | | | | | |
|--------------------------|--|--|----------------------------------|---------------------------|
| <input type="checkbox"/> | | GTX-200-T
2-meter FM, 100 channels. 30 watts
(incl. 146.94 MHz) | Special
Introductory
Price | \$249⁹⁵ |
| <input type="checkbox"/> | | GTX-200
2-meter FM, 100 channels. 30 watts
was \$299.95 (Incl. 146.94 MHz) | NOW | \$199⁹⁵ |
| <input type="checkbox"/> | | GTX-100
1 1/4-meter FM, 100 channels, 12 watts
was \$309.95 (Incl. 223.5 MHz) | NOW | \$219⁹⁵ |
| <input type="checkbox"/> | | GTX-10
2-meter FM, 10 channels, 10 watts
was \$239.95 (Incl. 146.94 MHz) | NOW | \$169⁹⁵ |
| <input type="checkbox"/> | | GTX-2
2-meter FM, 10 channels, 30 watts
was \$299.95 (Incl. 146.94 MHz) | NOW | \$189⁹⁵ |
| <input type="checkbox"/> | | GTX-600
6-meter FM, 100 channels, 35 watts
was \$309.95 (Incl. 52.525 MHz) | NOW | \$219⁹⁵ |

- | | | | |
|--------------------------|---|-----------|----------|
| <input type="checkbox"/> | ARX-2 2-M Base Antenna | @ | \$ _____ |
| <input type="checkbox"/> | Lambda/30 2-M Base Antenna | @ \$29.95 | \$ _____ |
| <input type="checkbox"/> | Lambda/4 2-M Trunk Antenna | @ \$39.95 | \$ _____ |
| <input type="checkbox"/> | TE-I Tone Encoder Pad | @ \$29.95 | \$ _____ |
| <input type="checkbox"/> | TE-II Tone Encoder Pad | @ \$59.95 | \$ _____ |
| <input type="checkbox"/> | PSI-9 Port. Power Package (less batteries) | @ \$44.50 | \$ _____ |
| <input type="checkbox"/> | PS-1 AC Power Supply | @ \$29.95 | \$ _____ |
| | | @ \$59.95 | \$ _____ |

and the following **standard** crystals @ \$4.25 each: _____ \$

Non-standard crystals @ \$5.75 each: _____ \$

(allow 8 weeks delivery.)

For factory crystal installation add \$8.50 per transceiver.

IN residents add 4% sales tax:

CA residents add 6% sales tax:

All orders shipped post-paid within continental U.S.

Sub-Total: \$ _____

TOTAL: \$ _____

(minimum order \$12.00)

NAME _____ AMATEUR CALL _____

ADDRESS _____ CITY _____ STATE & ZIP _____

Payment by: Certified Check/Money Order Personal Check C.O.D. Include

Note: Orders accompanied by personal checks will require about two weeks to process.

20% Down.

20% Down Payment Enclosed. Charge Balance To:

BankAmericard # _____ Expires _____

Master Charge # _____ Expires _____ Interbank # _____

Prices and specifications subject to change without notice.

Anthony J. Kalilich W8WLM
 4419 Muriel Avenue
 Cleveland OH 44109

PRESTO!

Transistor Checker from VOM.

Vacuum tubes and transistors have to be tested in special testers usually in the shop or lab, to determine their condition or defect. This still holds true for vacuum tubes but, because the transistor has advanced so rapidly and become so popular in the electronic field, it has been difficult to test.

Many good transistor testers have been designed. But, they still require that they be used in the shop or lab. They may even be tested on an oscilloscope for performance to determine their operative ability or leakage condition.

The Multimeter Test Meter, Simpson or Triplet type, has become the technician's and serviceman's most handy and important tool for servicing on the spot today. This Simpson test meter made possible the fast checking of tube circuits and other electronic parts on the spot on complex systems and important electrical and electronic devices. Today this same meter is being used on the new state-of-the-art printed circuit cards, solid state circuitry, transistors, diodes, etc.

This "adapter/conversion board" makes possible the simple change over of a common test instrument (Simpson or Triplet), into a transistor tester for on the spot testing of normal defects of transistors, diodes, or other solid state devices.

Using the standard Simpson 260 meter, a printed circuit card adapter, with a circuit

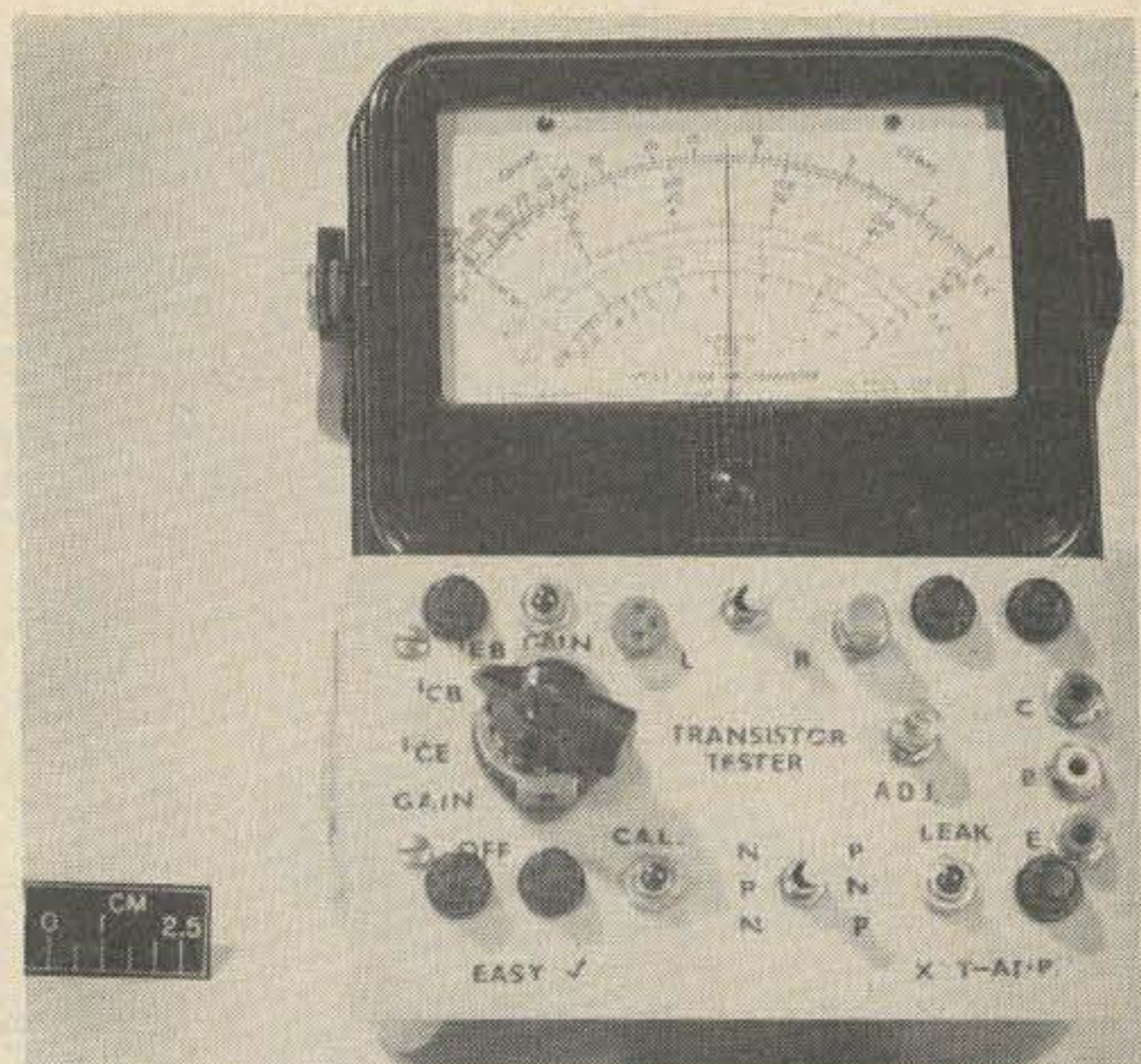

Transistor tester (mounted).

for testing general type NPN and PNP transistors and solid state components for defects, is "piggy-back — plugged-in" over the existing controls on the meter. The settings are then set to 50μA and dc on the meter controls. This results in now having a full transistor tester with new controls on the printed circuit adapter.

Connect the PC board to the meter by way of the mounting banana male studs. This makes the necessary connection to the Simpson 50 microammeter direct. Add the

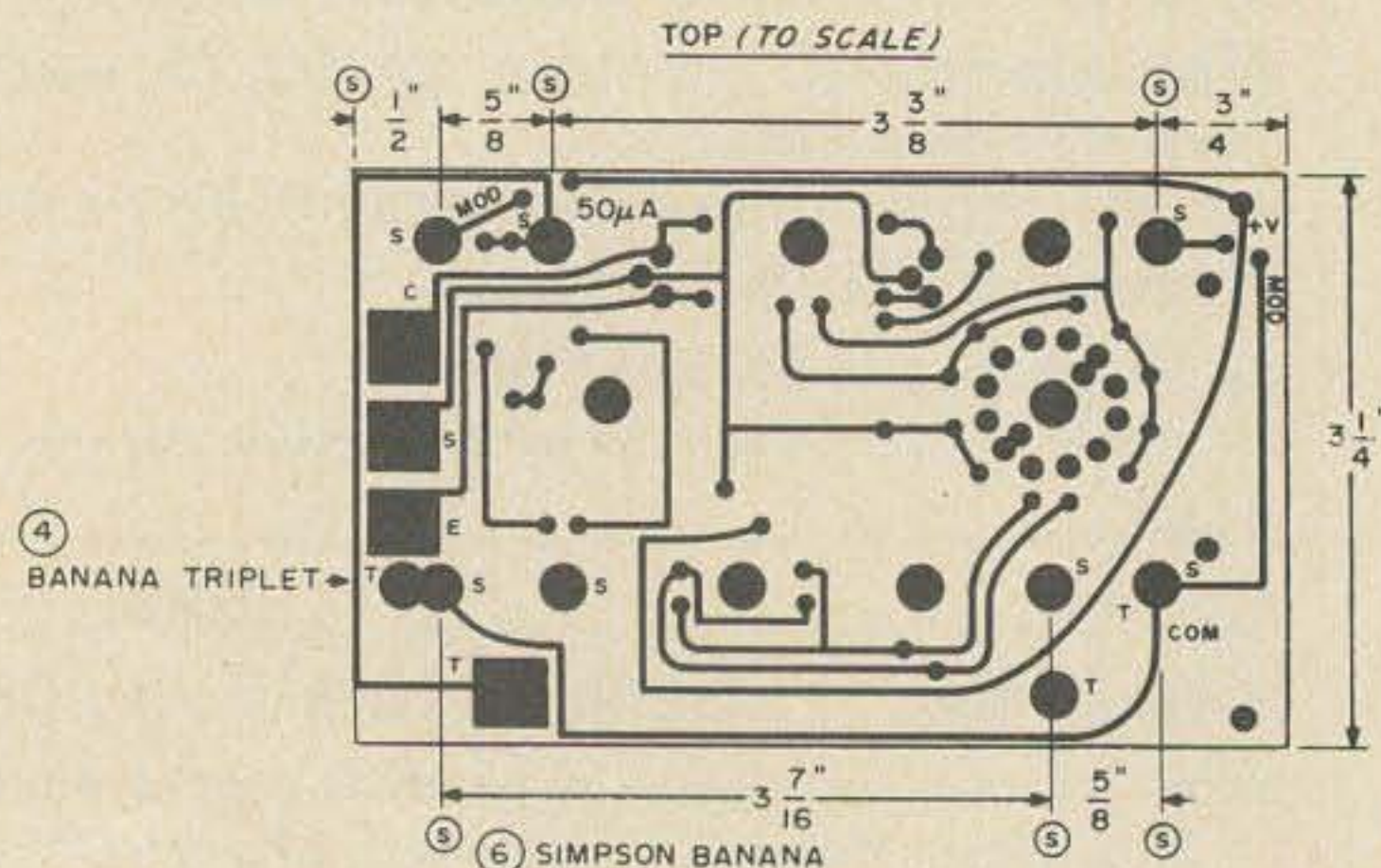
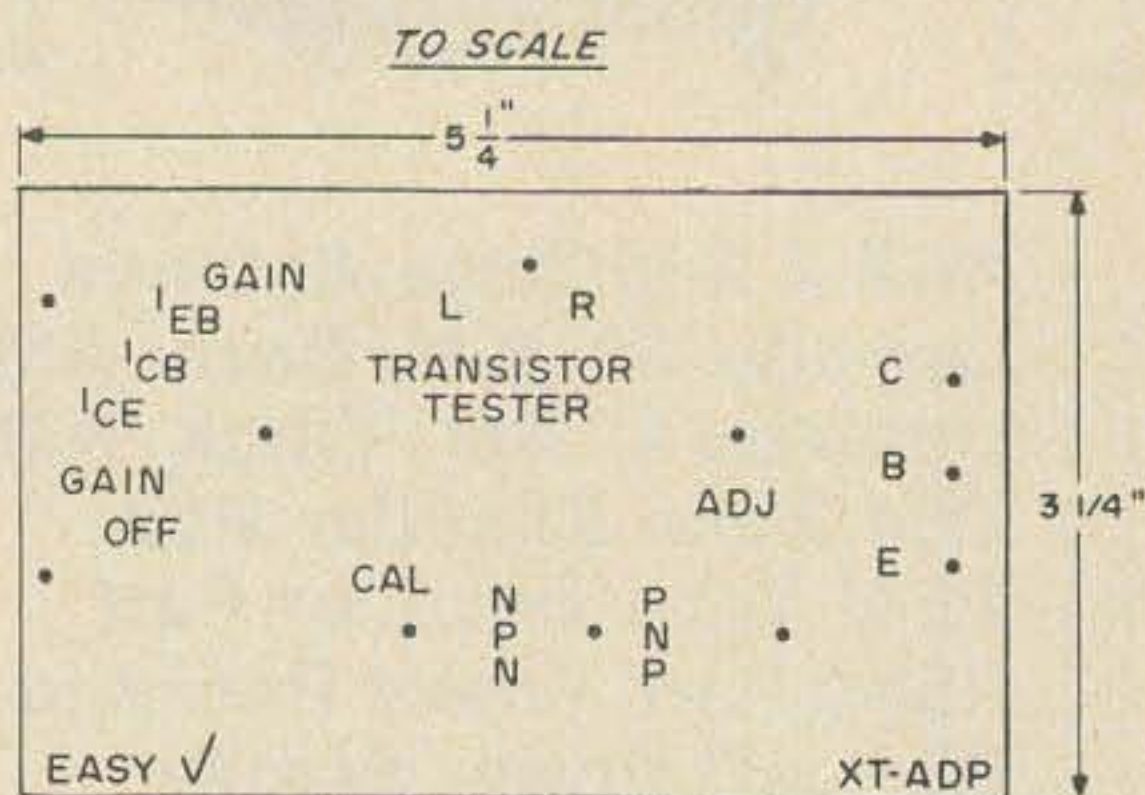
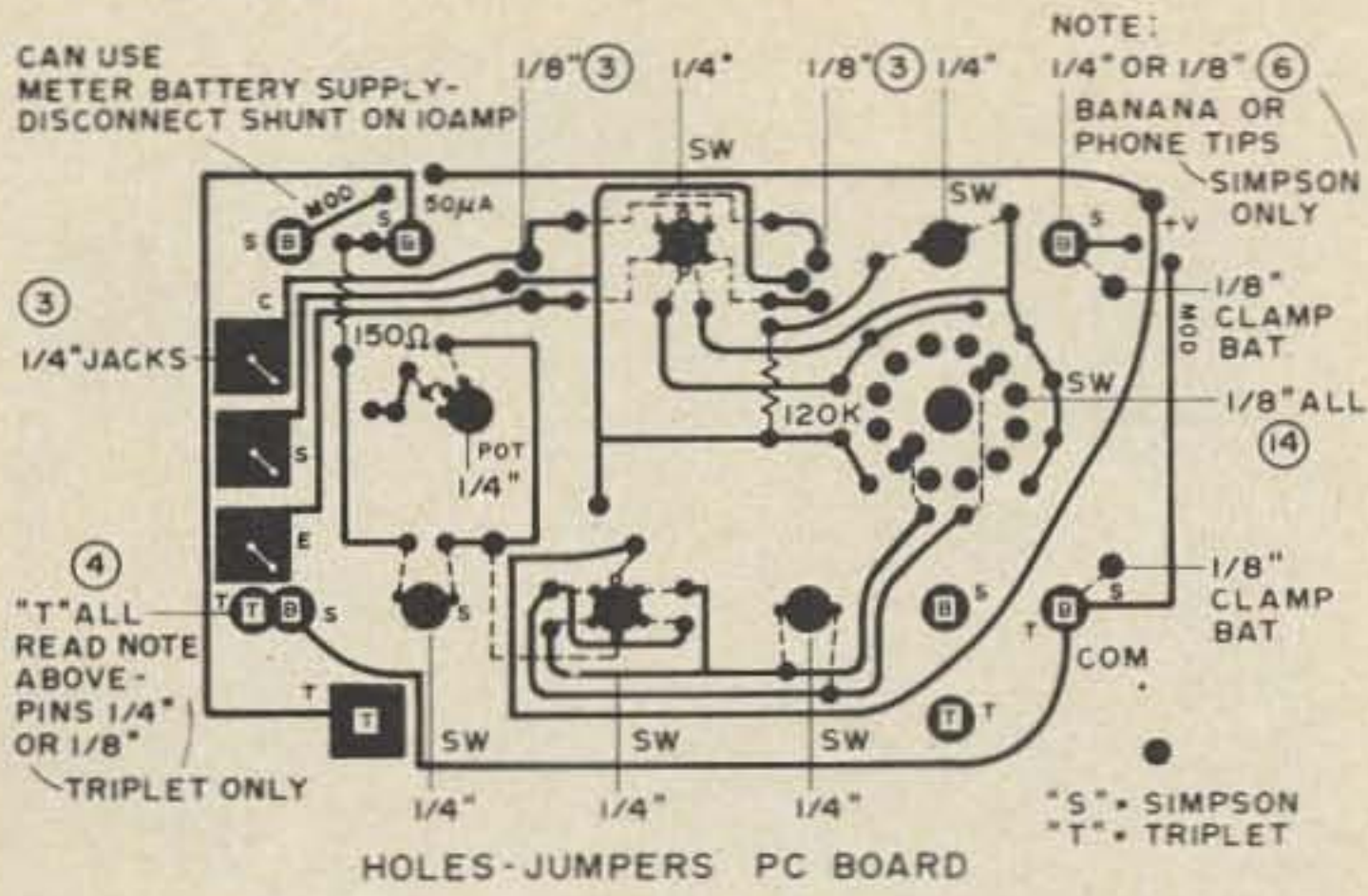

Fig. 1.

NOT TO SCALE



-PARTS-

- ① 2 POLE 5 POS SW NON-SHORT ROTARY (CALECTRO E2-163)
- ① MINI-POT 50K
- ③ PHONE TIPS
- ③ P.B. SW N.O. MINI
- ② DPDT SW MINI
- ② TRANSISTOR SOCKET
- ⑥ BANANA JACK OR PHONE TIPS-LONG
- ① RESISTOR 120K
- ① RESISTOR 150Ω
- ⑥ KNOBS-POINTER

*MOD. -BAT. INTERNAL OR EXTERNAL (2 JUMPERS) OPTIONAL - DROP OUT 10 AMP SHUNTS INSIDE SIMPSON AND CONNECT BAT. VOLTAGE

NOT TO SCALE

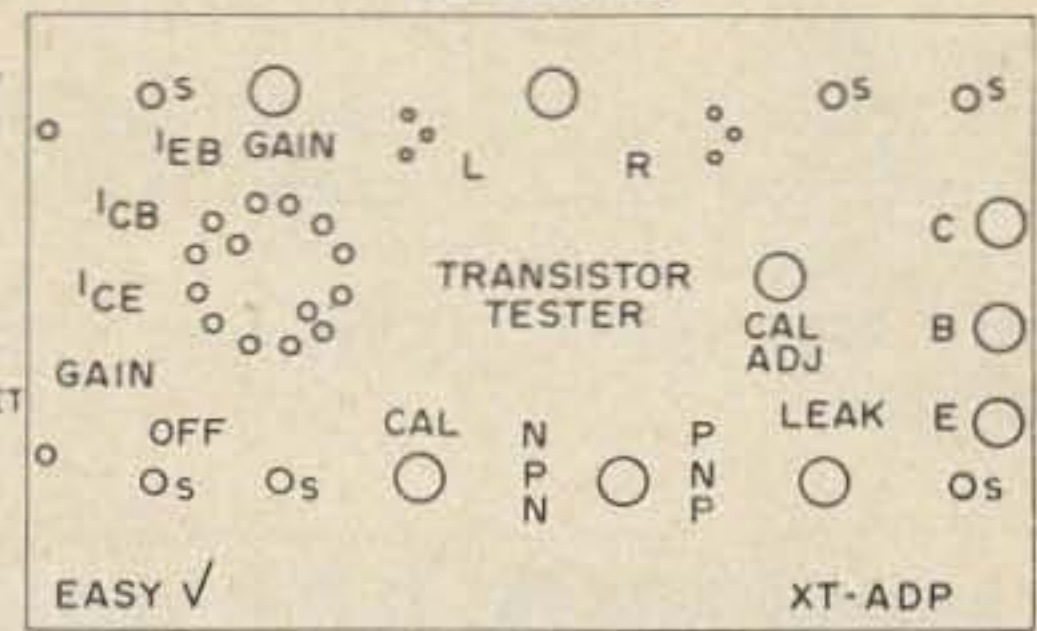

HOLES & DECALS
PC BOARD - FRONT

TRANSISTOR SOCKET

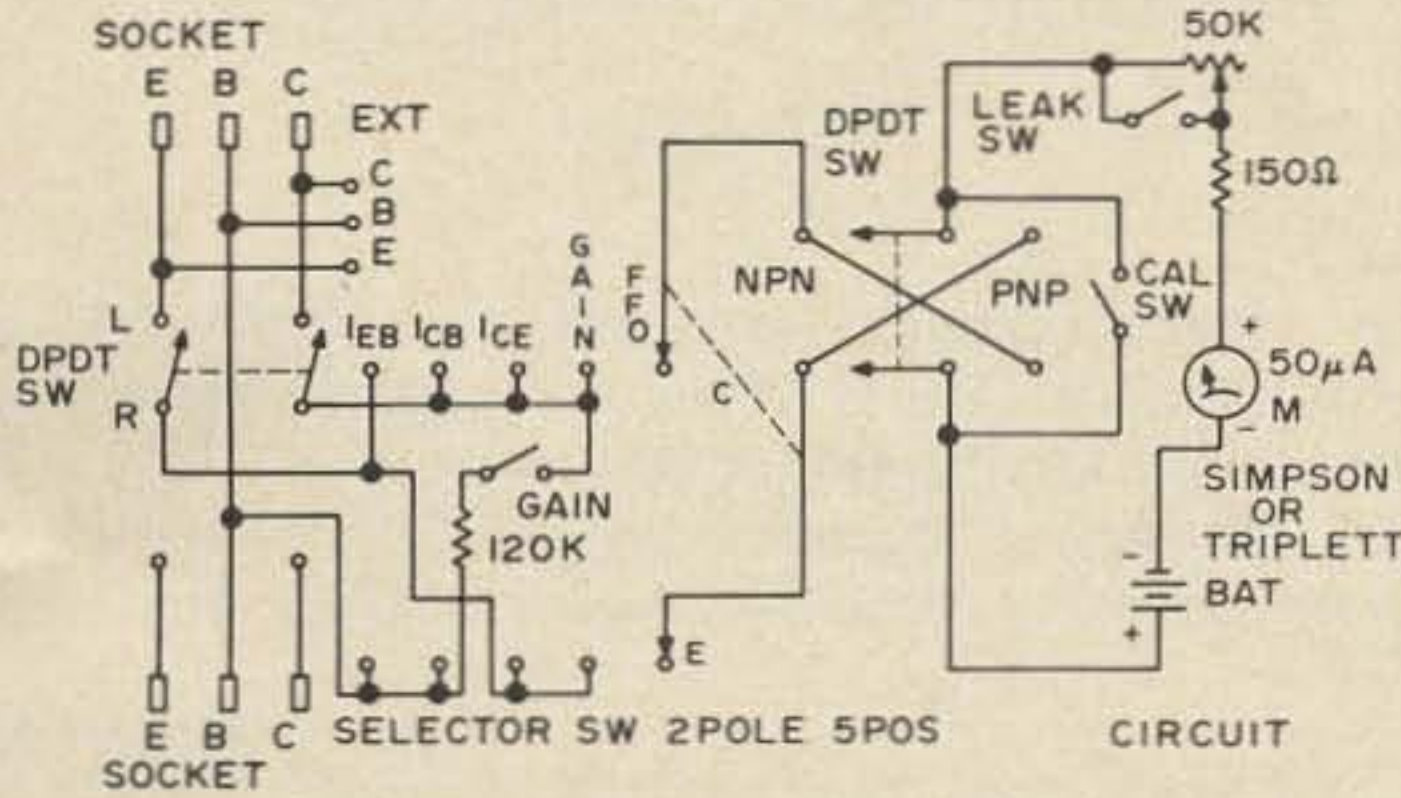
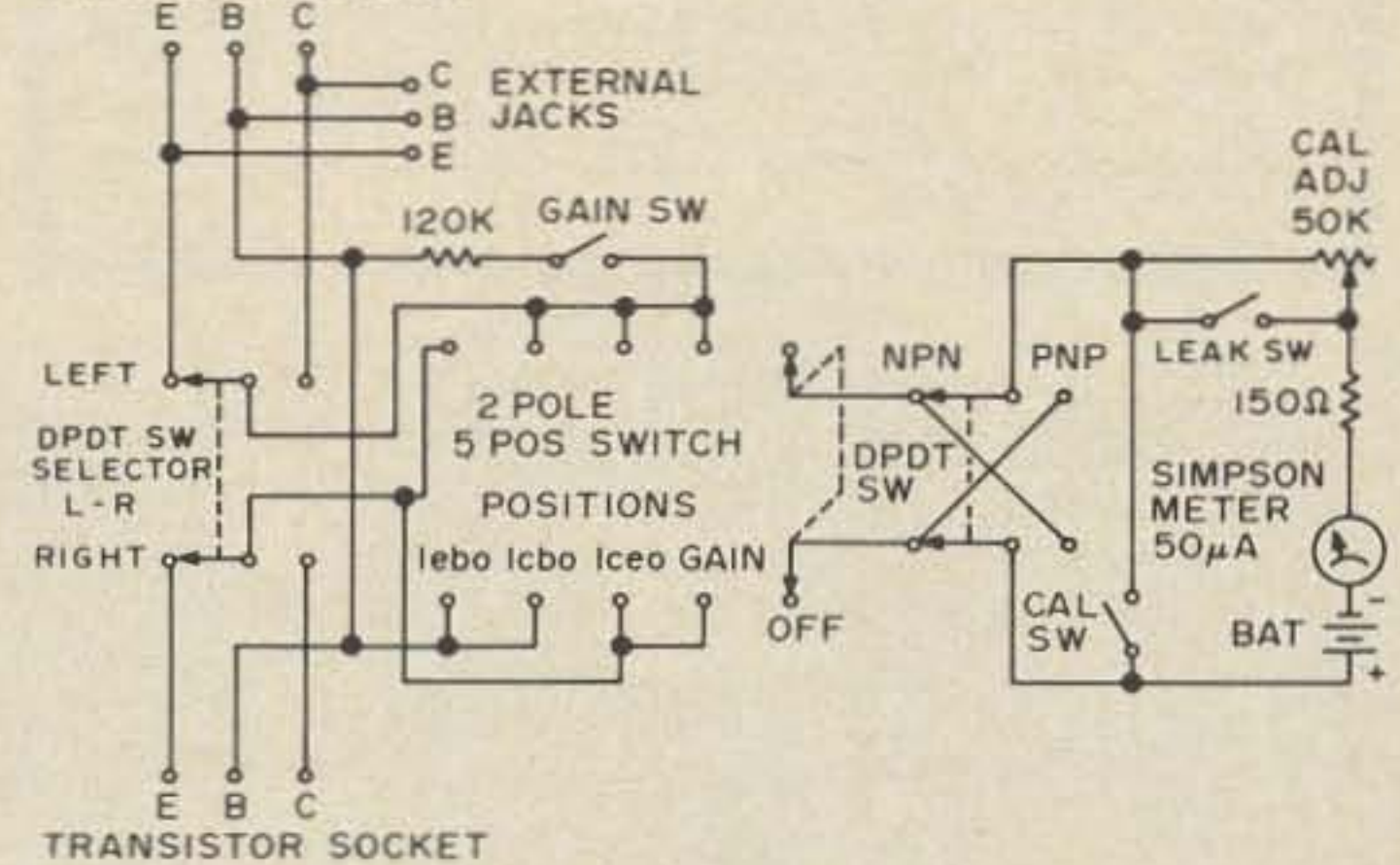

Fig. 2. Transistor adapter circuit for Simpson 260.

clip-on battery, to complete the conversion of the multi-meter to a transistor tester. The controls on the adapter enable the operator to adjust the 50 microammeter for full scale. Or, scale 1.

This full scale of 1 can be used for the gain measurement of dc or alpha, which is less than unity. By using the selector switch on the adapter board, you can check the dc gain — I_{ce0} , $-I_{cb0}$, l_{e0} , — the last three being diode action, reverse current and action test for front-back leakage. This takes care of the leakage currents in the base, emitter and collector, and makes a quick gain check on the tested transistor.

For diodes, external pin connections "C and E" and left position on the selector, make this check possible. Transistor comparison testing is made possible with the "L and R" selector switch. Leakage switch is used to make the 50 microammeter more sensitive for lower leakage readings.

This tester adapter can be hand wired on a small board and adapted to other meters. This PC board has been designed for either the Simpson 260 or 270 and the Triplet 630 series. Mounting and drilling holes for the

two types are marked as "S" and "T" on the PC etching. The board is called "EASY XT-ADP."

PARTS LIST

No.	Name	Description
1	Switch	— 2 pole-5 pos. wafer type 3/4" diameter non-shorting (calectro EE-163) or equal.
1	Adj. pot	— 1/4" mount — 1/2" diameter case 50k (IRC).
3	P.B.SW.	— Mini-type, N.O. contacts -1/4" mount (ALCO).
2	DPDT SW.	— 1/4" mount (ALCO -MST 215) or equal.

More



Unmounted view.

- 2 Sockets — transistor chassis mount type — any type.
- 2 Resistor — 150 Ohm & 120k 1/4 Watt.
- 3 Phono jacks — chassis mount — 1/4" type (external).
- 1 Bat. clip — (Keystone Enterprises) single #139.

WORLD QSL BUREAU

5200 Panama Ave., Richmond CA USA 94804

THE ONLY QSL BUREAU to handle all of your QSLs to anywhere; next door, the next state, the next county, the whole world. Just bundle them up (please arrange alphabetically) and send them to us with payment of 6¢ each.

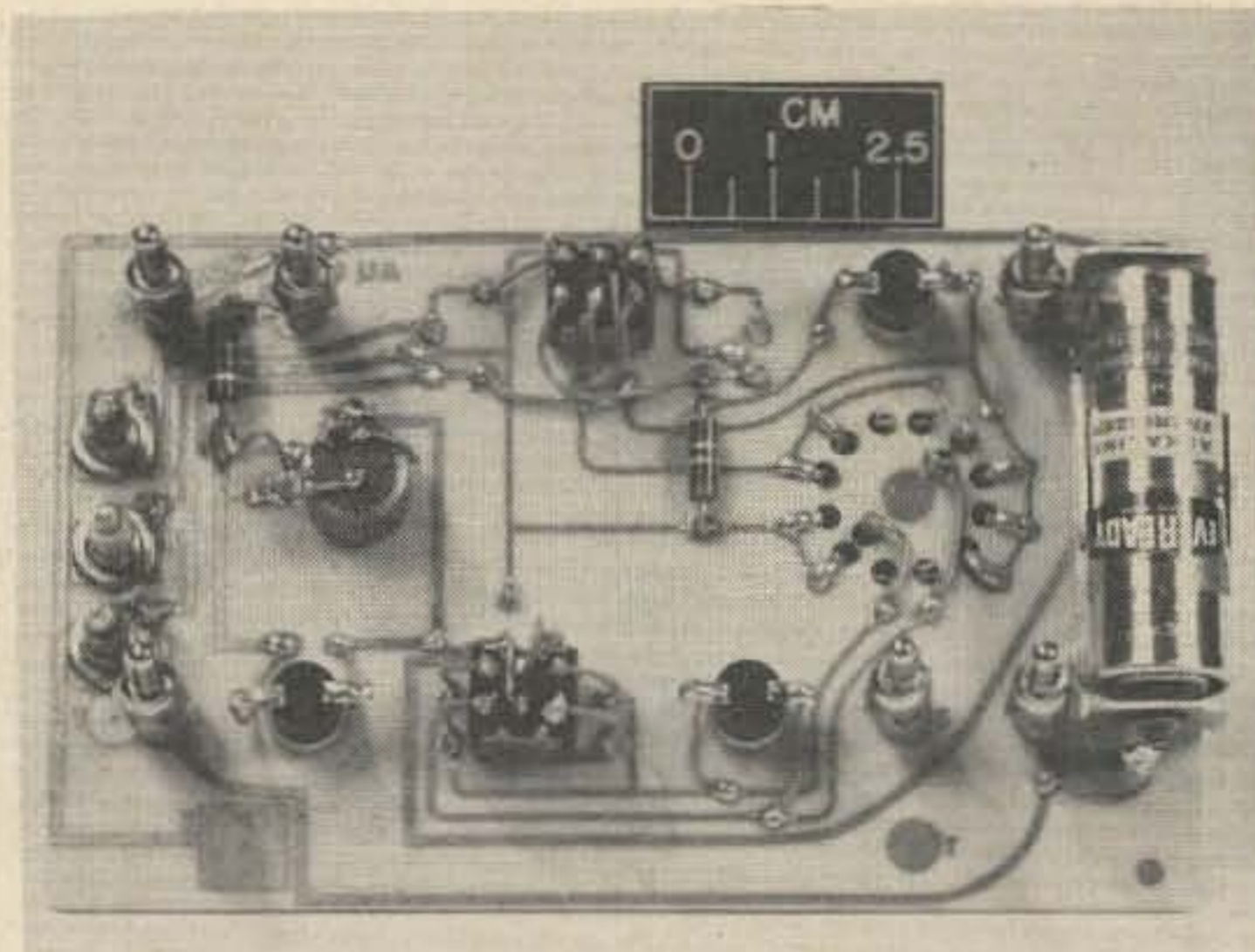

PC board.

PARTS! CORNELL TUBES!

FREE Send For FREE

CORNELL'S
New Color
Catalog

48 Pgs. New Items IN LOTS OF 100

4215 S University Ave. San Diego, Calif. 92105

33¢
per tube

36¢
per tube

ORDER FREE
IF NOT SHIPPED
IN 24 HOURS!

- 6 Banana plugs — male test type plug — 1/8" or 1/4" mount. (Note: May take apart a test lead-male plug and use tip, or banana.)

- 1 Battery — (Eveready type #523) or equal.
- Misc. decals, 4-40 & 6-32 nuts and bolts, etc.

...W8WLM

IC
checker
champ



the
A P
test clip

new
lower pricing

TC-14 \$ 5.25 ea.
TC-16 5.75 ea.
TC-24 13.85 ea.

All products are guaranteed
to meet or exceed
published specifications

A P TEST CLIPS
provide full access
to DIP leads

11 models
available to fit
all DIP sizes



A P PRODUCTS INCORPORATED
Box 110-Z, Painesville, Ohio 44077
(216) 354-2101 • Twx 810-425-2250

CRYSTALS are OLD FASHIONED

*Now in stock
The latest synthesized rigs available.*



ICOM 230 146-148
FM

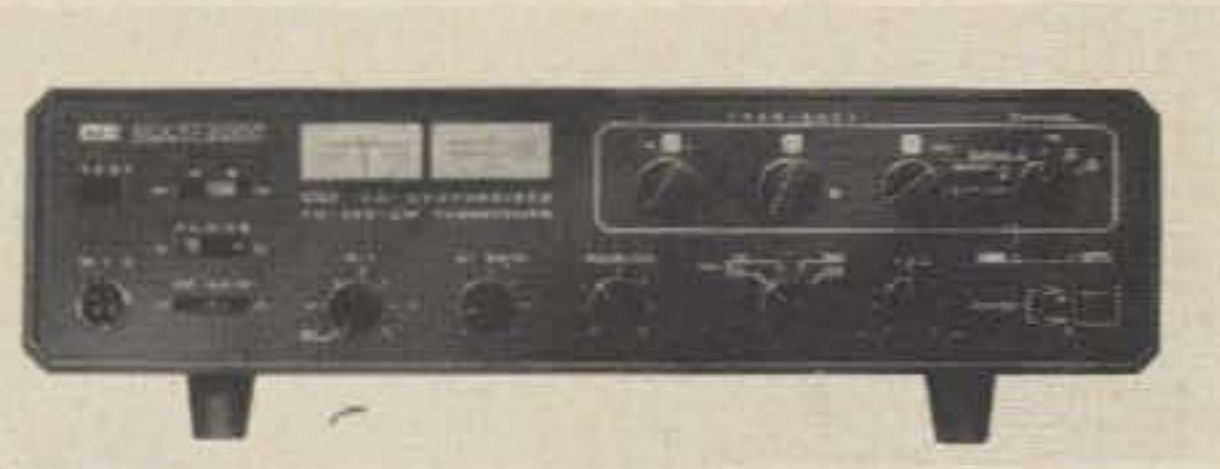

ITC Multi-2000 144-148
FM-CW-SSB

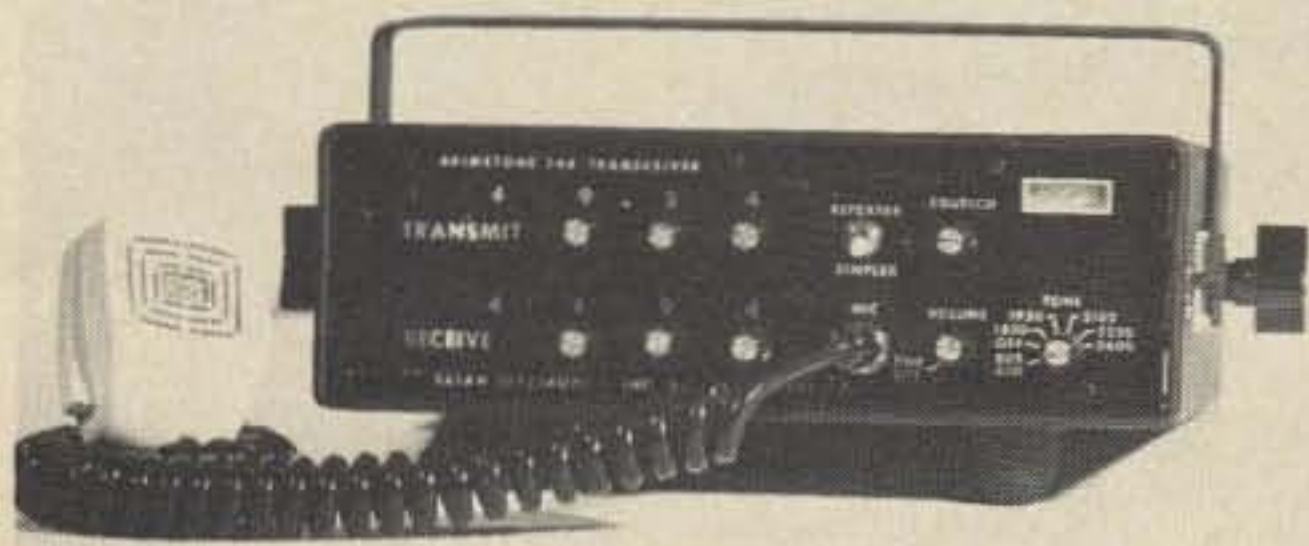

Brimstone 144 142-149
FM



EBC 144 Jr. 143.5-148.5
FM



ICOM 21-A 146-148
ICOM DV-21

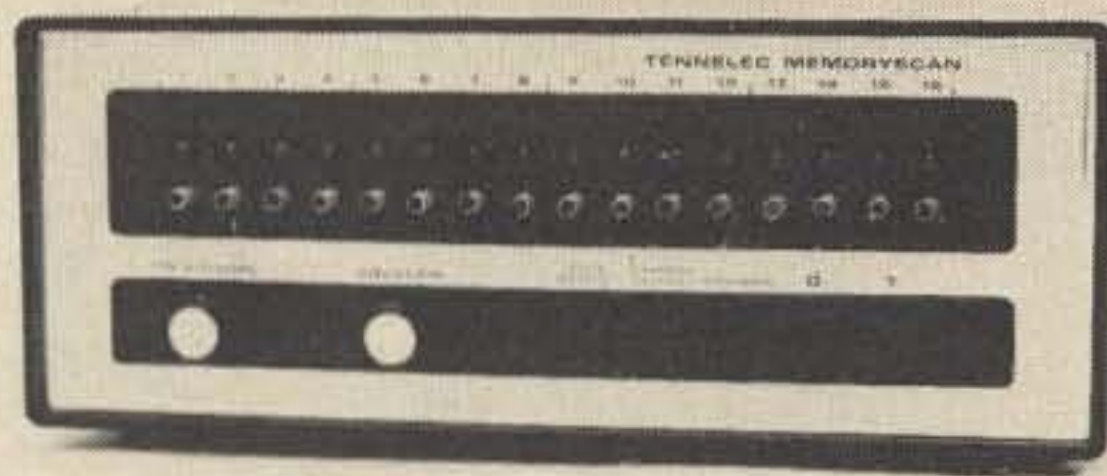

Tennelec Memory Scanner 30-50 146-170
450-510 MHz

AUDIO LAND is now offering high trade-in prices for your used equipment. Write for trade-in prices and price quotes. Now in stock — CUSHCRAFT — REGENCY — SBE — HAL COMMUNICATIONS — NEWTRONICS — HY GAIN — AMPHENOL — TURNER — E.V. — SURE — STANDARD — TEMPO. 3000 xtals for most rigs. Rotors and cables. Stereo and quad equipment — and much more. Specials on N.P.C. regulated power supplies. All major charge cards accepted. Several finance plans available.

Audioland

36633 S. Gratiot
Mt. Clemens Michigan 48043
313-791-1400

Ralph B. Mott WB4KTY
1816 Marion Avenue
North Augusta SC 29841



Easy BFO Project for All Wave Receivers

There are many good quality solid state general coverage receivers available to the new amateur. One of the best and most economical is the Radio Shack DX 150B. However, at \$136.95 it is expensive enough to strain the budget of the beginning ham. This article describes a project for adding a bfo and crystal filter to an inexpensive Knight Kit four tube superhet receiver which could be easily adapted to any receiver.

My receiver has a system for introducing feedback in the last i-f stage. The suppressor

grid is grounded through a switch and variable resistor; the amount of feedback is variable and causes the stage to squeal when a signal is being received. Mine never worked very well because when enough feedback was introduced to make the stage oscillate it would take off and begin to motorboat all the time — and was thus useless for copying CW. I used the receiver for a while as best I could, but as soon as the budget would stand it I bought a Heathkit HR 10 B receiver. No one seemed interested in buying my Knight

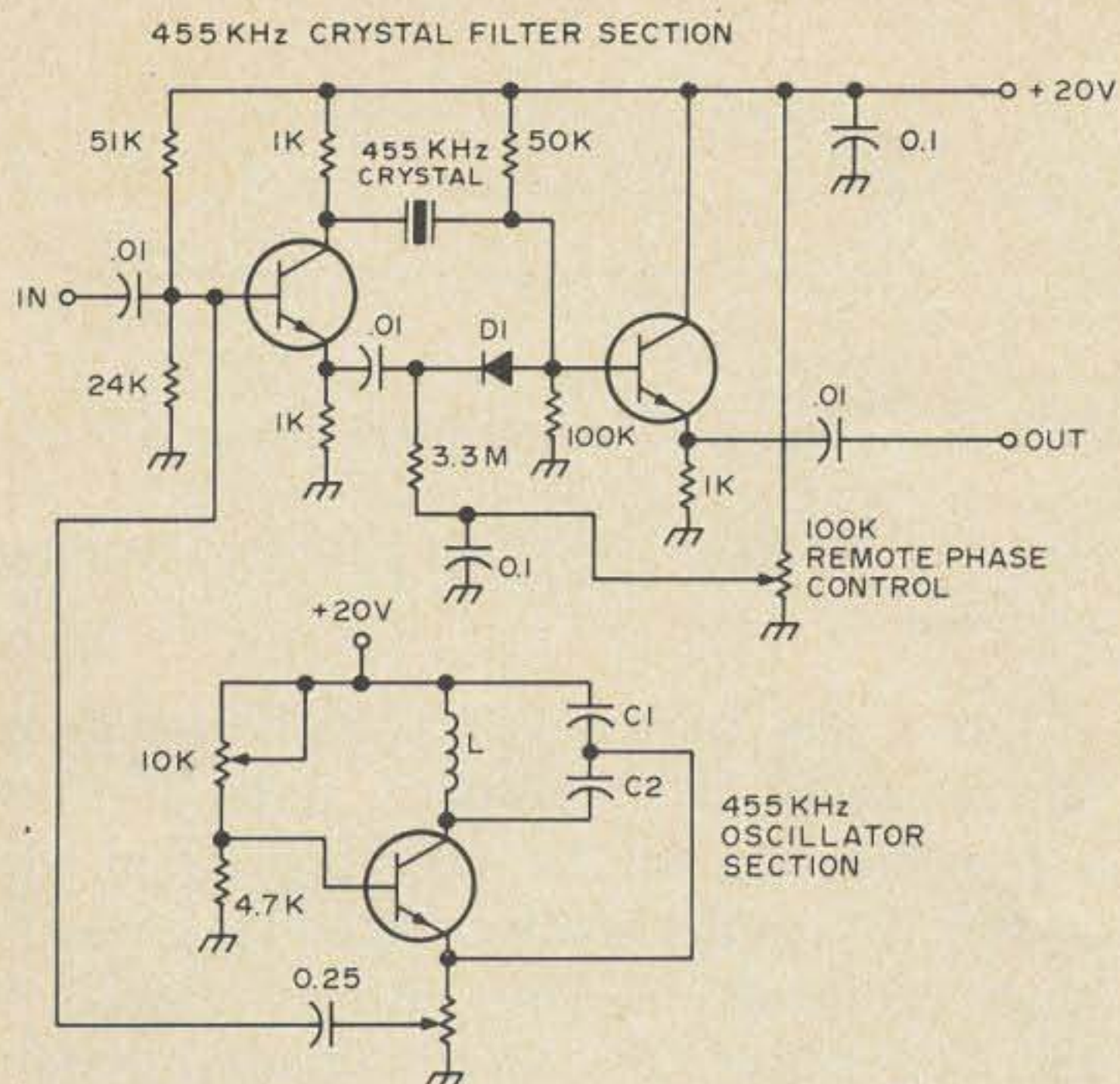

Fig. 1. (From pages 13A and 16A, 73, March, 1967) Values shown are for 455 kHz i-f section. To utilize this circuit for other i-f frequencies, refer to above pages and obtain crystal for your i-f frequency.

Kit Star Roamer so I let it knock around the shack for 7 or 8 years, leaving it tuned to the standard broadcast band or occasionally tuning in Radio Moscow or BBC.

Some time ago I read an article about copying commercial telegraph stations for code practice. As my rig is now a Heathkit SB 102, it has little overlap at the band edges (and this is not where the commercial telegraph stations are). As I aspire to replace the Bendix MRT 6 on two meters with one of those new solid state jobs, there is not enough money in the old sock to cover the expense of a new general coverage receiver. As the Knight Kit has been knocking around gathering dust, I decided to see if it would be possible to upgrade it to an acceptable level for CW copy.

After casting about for circuits to use for the bfo, I came across the book bonus section in the March 1967 issue of 73 Magazine, *73 Useful Transistor Circuits* by W1DTY. The circuit board consists of two sections: the bfo section on the right and a single crystal 455 kHz filter on the left. Both circuits are from the same article and the book is still available from 73 Magazine for a mere dollar.

The bfo is simple in theory and is no problem to get working. Solder the parts in and tune bias control until oscillation is heard in the speaker of your receiver. Turn

volume up and if the signal is not heard in the receiver run a short lead to the i-f strip and tune for maximum. However, I was able to hear the signal loud and strong without much fuss and bother.

I intended from the start to use the voltage tripler shown in the accompanying photographs for my power source; however, for experimenting and just getting the bfo working I snap two #1602 Eveready 9V transistor batteries together as shown to get the voltage necessary. This works fine and can be used for a quick and simple 18V source for all sorts of breadboarding.

The 0.5 coupling capacitor proved to be too large for my unit so I went to the 0.25 μ F shown. The transistor used in my original version of the bfo was an RCA SK 3011. A variety of transistors were tried in the circuit including SC 3011, SK 3019 and Motorola HEP 50. All worked well. The SK 3011, being a germanium where the others are silicon, made the use of 12 and 20V sources necessary. No problem though, I mentioned

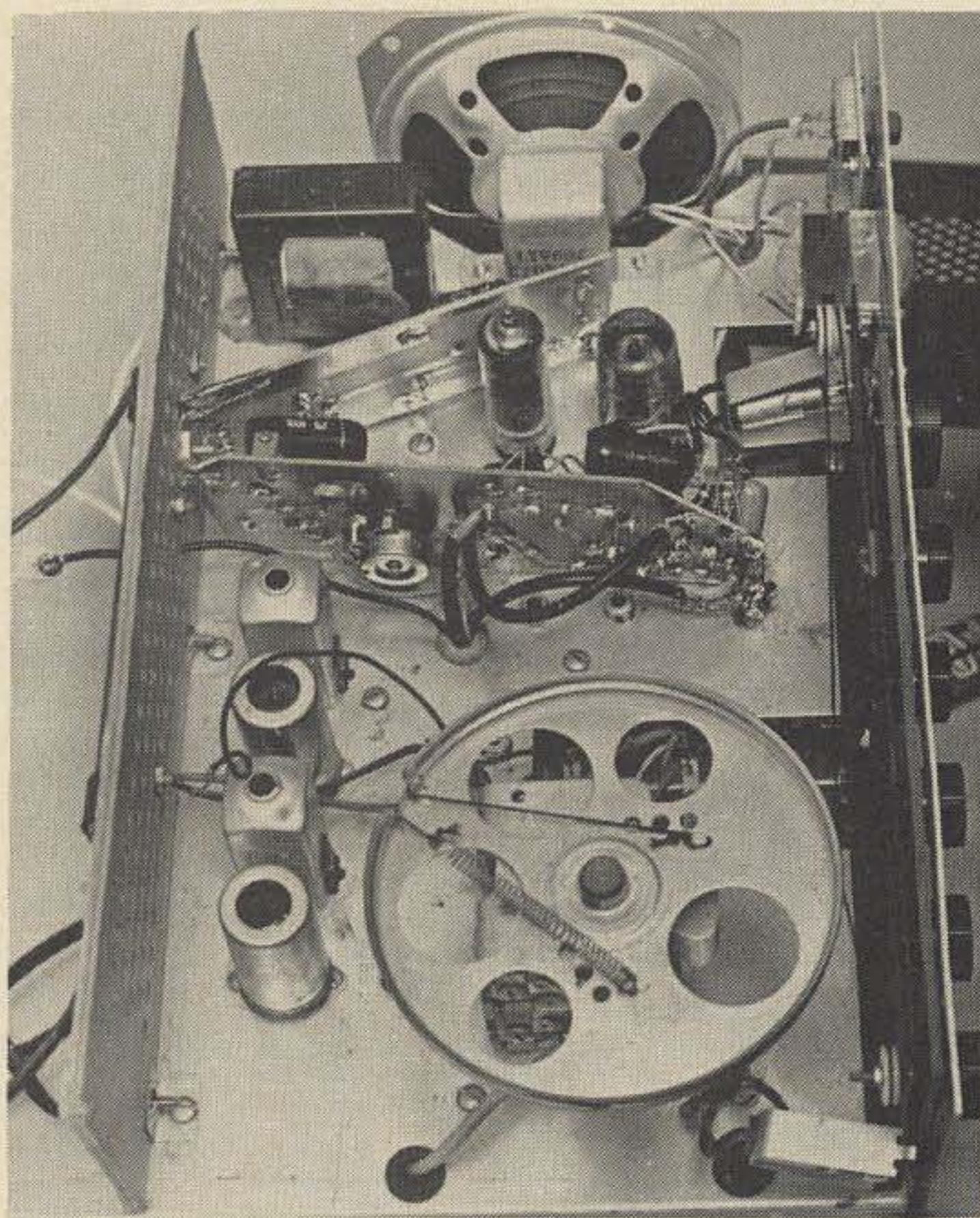

Top view of chassis. Lower circuit board is oscillator and crystal filter. Upper board (next to speaker) is voltage tripler. Shown from foil side of the board. Large circular disc at left on bottom board is base bias control pot for the 455 kHz oscillator. Photos courtesy of W4PED.

it just in case different transistors are selected. Be sure the voltage is correct: you can blow a transistor with improper voltages and polarity. I decided on the use of all Motorola HEP 50's because they are inexpensive (79¢ each). Shopping around would probably cut the price somewhat but they are readily available at any parts house handling Motorola equipment.

The output level is critical on the bfo so base bias and output level must be adjusted to give proper peak to peak voltage. This circuit put out 10V peak to peak with the SK 3011 installed. This will overdrive the stage and cause loss of signal, pulling and distortion. For this application we found the voltage to be around 4.5V peak to peak.

In feeding the bfo signal into the receiver I tried several different places and all seemed to be acceptable with proper adjustment; however, I went to the circuit board shown because it was much easier to feed the signal into the circuit board, making it unnecessary to run another wire to the i-f section.

The Filter

In deciding on a suitable filter system, several circuits were tried. Most involved tuned circuits, which tend to get rather complicated. At about this time I received a flier in the mail from Jan Crystals, Fort Myers, Florida. They had 455 kHz crystals for \$1.75. I had already noted the single crystal circuit in the 73 transistor circuits manual using a varicap diode for the crystal phasing control which gives remote tuning. The control can be put on the front panel and the varactor diode mounted on the

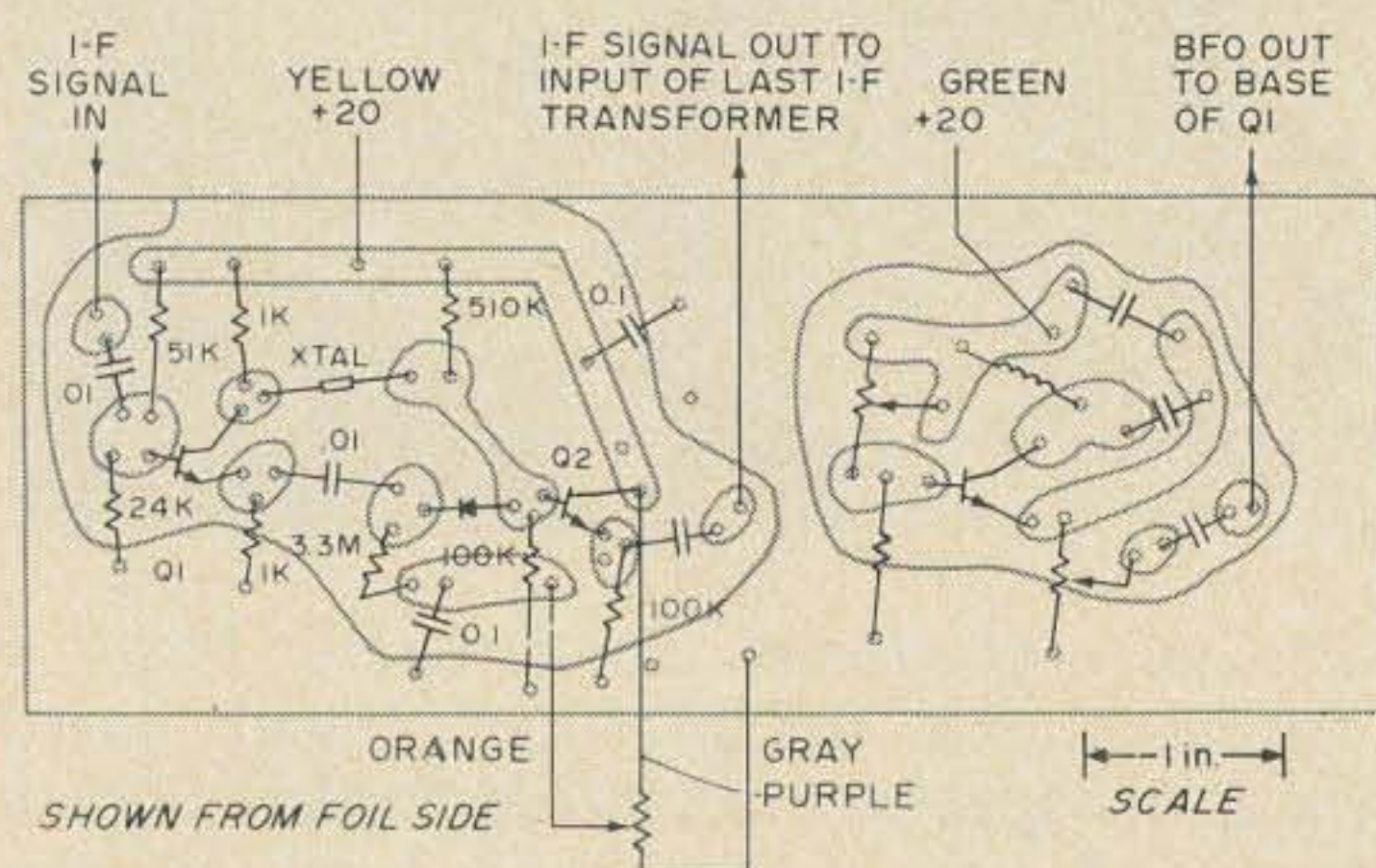

Fig. 2. Oscillator-filter circuit. Q1 - 2N2925 or 2N3392; Q2 - 2N3478, 2N3564, 2N3707, 40236, or HEP 50; D1 (20 pF) - 1N954 or TRW V20.

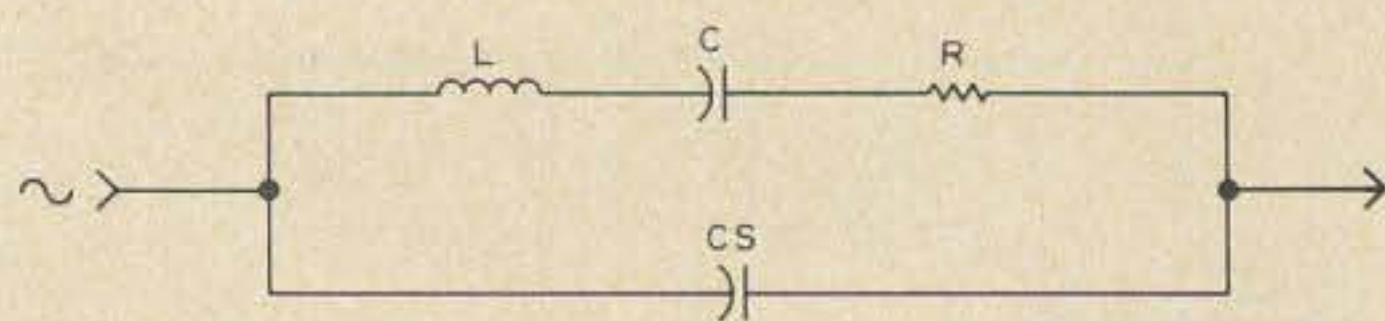

Fig. 3. Equivalent circuit of single crystal filter.

circuit board, making remote tuning possible.

The single crystal filter can be made as narrow as 50 Hz if properly isolated. This is possible due to the very high Q of the crystal. This very narrow bandwidth presents some problems. As this project utilizes a \$39.95 receiver, the local oscillator is not the most stable and the receiver will drift a bit. Even with a voltage regulator the problem is not entirely eliminated as temperature sensitive components throughout, together with the mechanical instability due to the length of the frequency sensitive wiring of the bandswitch, make it difficult to correct entirely.

How It Works

To understand the operation of the single crystal filter, it is assumed that a parallel resonant circuit exists, formed by the crystal LCR on the one leg, and the shunt capacitance, represented by the holder and associated wiring, on the other. Though small by comparison, this shunt capacitance CS is many times the capacitance of the crystal and must be balanced out to prevent unwanted signals from being bypassed around the crystal. This is done by taking a signal which is of the proper phase and passing it around to the output side of the crystal, thus effectively cancelling the signal which was passed by the holder CS.

Various circuits have evolved which change the selectivity of the circuits chosen; however, as I wanted to avoid complicated tuned circuits necessary to make the selectivity variable, I stuck with the basic circuit.

As varicap diodes are really simple to work with but difficult to explain without getting into depletion regions and the like, any explanation short of major theory will have to be an oversimplification. In any

event, minimum capacitance occurs with maximum reverse bias roughly equivalent to plates open or unmeshed, and maximum capacitance, plates meshed, at some value approaching zero. The exact voltage varies from type to type and from manufacturer to manufacturer. Some value of capacitance is taken at a given amount of reverse bias, usually around 4 to 4.5 V, and used as a reference point. The capacitance value is not linear, i.e. a given uniformly changing reverse bias voltage does not cause a corresponding change of capacitance at a uniform rate. Due to this non-linearity of the tuning rate of varicap diodes and the wide variation of capacitance which will have to be neutralized, maximum selectivity will be difficult to predict. It will not necessarily fall at the point where the phasing control shows maximum. It is not like a volume control but rather is a neutralizing capacitor and thus maximum selectivity will occur at that point where the capacity of the holder and associated wiring is exactly neutralized, allowing no signal to pass except that which goes through the crystal.

The filter is removed by finding the point at which maximum by-passing occurs. This is the point of broadest bandpass. The band-pass can be made quite narrow and this filter has a tendency to ring at maximum selectivity on the strong signals, a really weird signal sound and very difficult to copy. When ringing occurs, back off on the control until it stops. The stronger the signal the more ringing.

This may not be the ideal solution, but for \$7.00 worth of parts and a little help from the junkbox we have a general coverage receiver which does the job and gives adequate performance on the Maritime Service bands.

The filter will effectively cut down on the gain of the receiver. This is the reason transistor amplifier stages are added. The circuit loss of the filter must be overcome.

Some Notes on Construction

Use miniature coaxial cable for all rf connections, remembering to ground the coax at one end only to avoid ground loops. The bfo was fed to the circuit board filter

section as it was necessary to minimize the number of connections to the i-f section (because any point where the signal is intercepted could introduce enough voltage to bypass the crystal). These points are kept at a minimum by injecting the bfo as shown. Use only as much bfo signal as is needed to give comfortable copy, as too much bfo will distort the signal.

I tried three different power sources. The first consists of two 9 V batteries. While this is the simplest, it is also the most expensive. To get some idea of battery life in this application, I monitored the battery current drain for some 4 hours and found it to be just under 20mA at 18 V. This gives adequate volume for comfortable CW copy. As I usually copy CW with headphones this gives less battery drain. I paid \$1.07 for two Eveready 9 V batteries at a local discount drug store and with an anticipated battery life of about 30 hours this definitely is not the best way to go. Besides, it is necessary to disconnect the batteries each time the receiver is turned off. One night I turned the power off and left the batteries connected

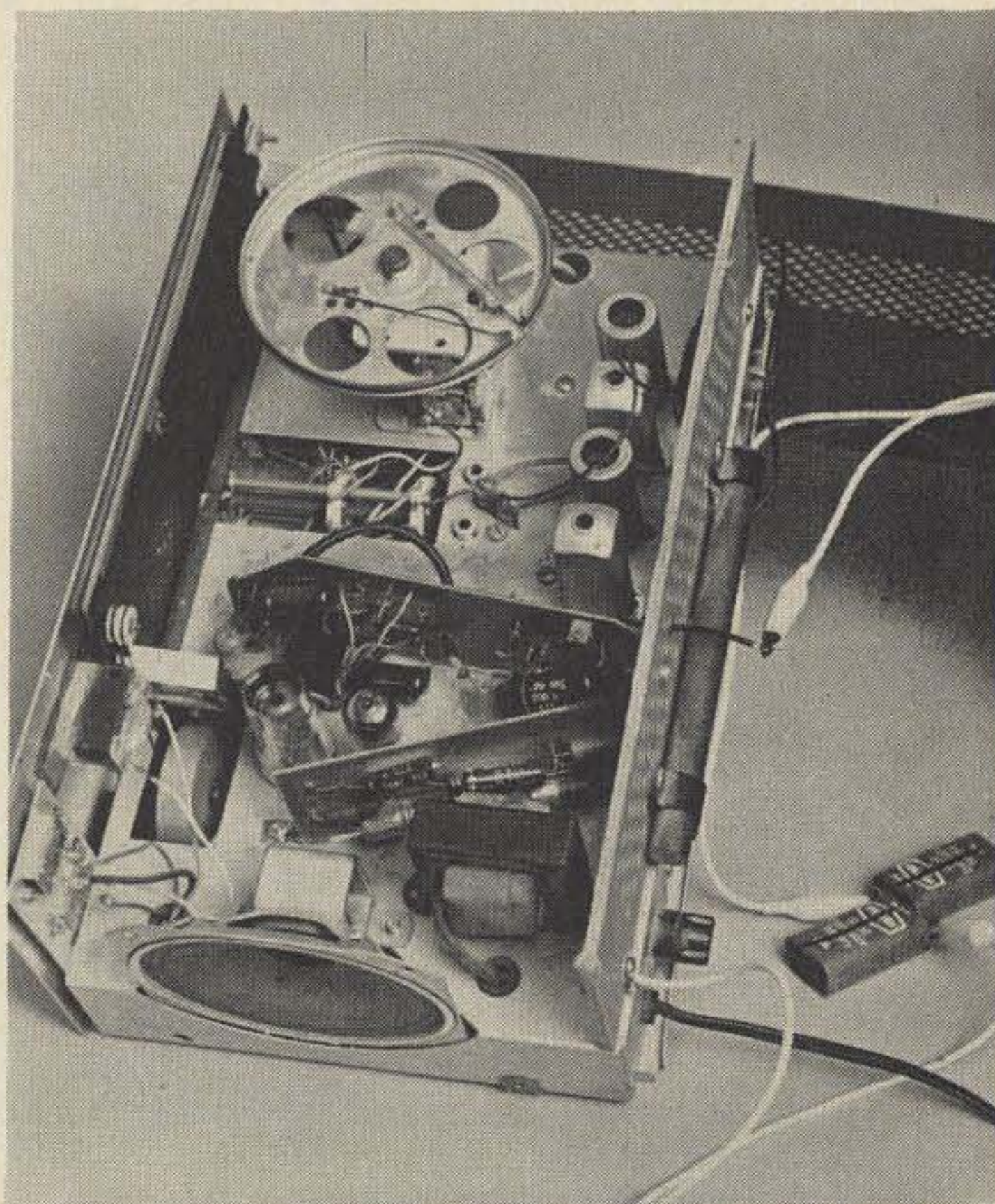

Chassis top from component side of circuit boards. Voltage tripler power supply is at the bottom. 455 kHz oscillator and crystal filter are at center. Note 9 volt batteries. When used as an alternate power source, snap together as shown for 18 volts.

YOU WOULDN'T
START A LOG
IN JUNE



RIGHT NOW

is the time to order your

75 callbook

Don't wait until 1975 is half over. Get your new Callbooks now and have a full year of the most up-to-date QSL information available anywhere.

The new 1975 U. S. Callbook will have over 300,000 W & K listings. It will have calls, license classes, names and addresses plus the many valuable back-up charts and references you have come to expect from the Callbook.

Specialize in DX? Then you're looking for the new, larger than ever 1975 Foreign Callbook with over 225,000 calls, names and addresses of amateurs outside of the USA.



Foreign Radio
Amateur Callbook
DX Listings
\$11.95

United States
Callbook
All W & K Listings
\$12.95

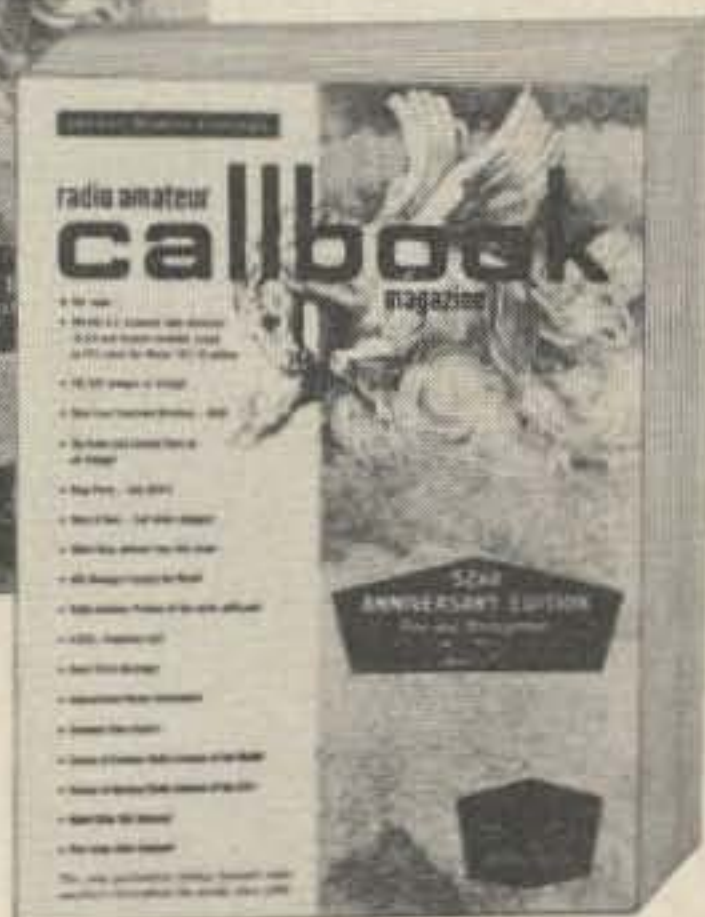

Order from your favorite electronics dealer or direct from the publisher. All direct orders add 75¢ shipping and handling per Callbook.

WRITE FOR RADIO AMATEUR
FREE BROCHURE **callbook** INC.
Dept. B 925 Sherwood Drive
Lake Bluff, Ill. 60044

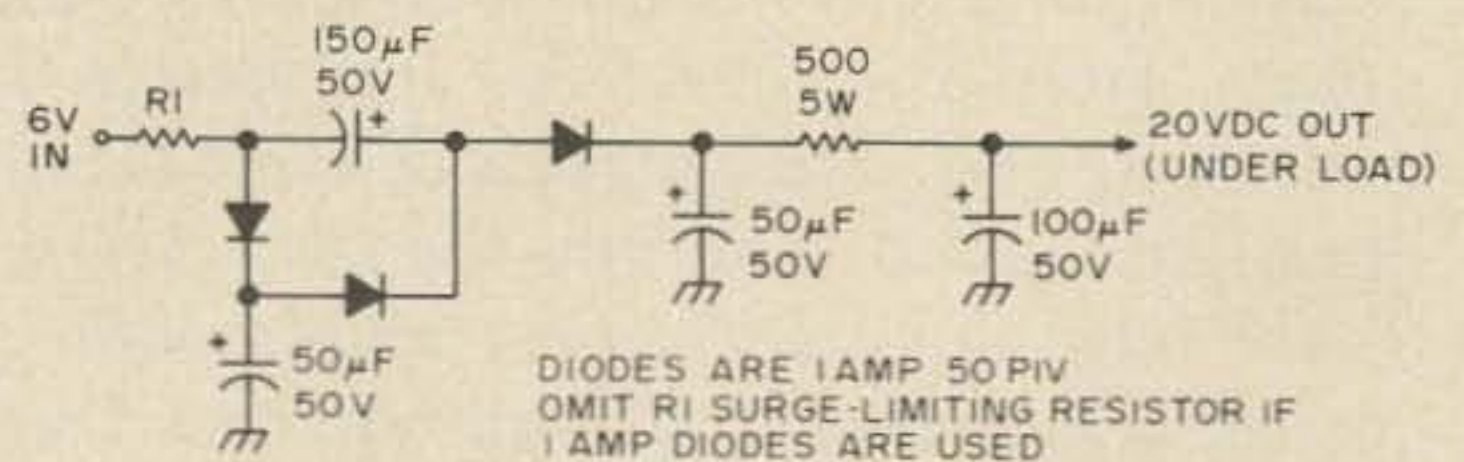
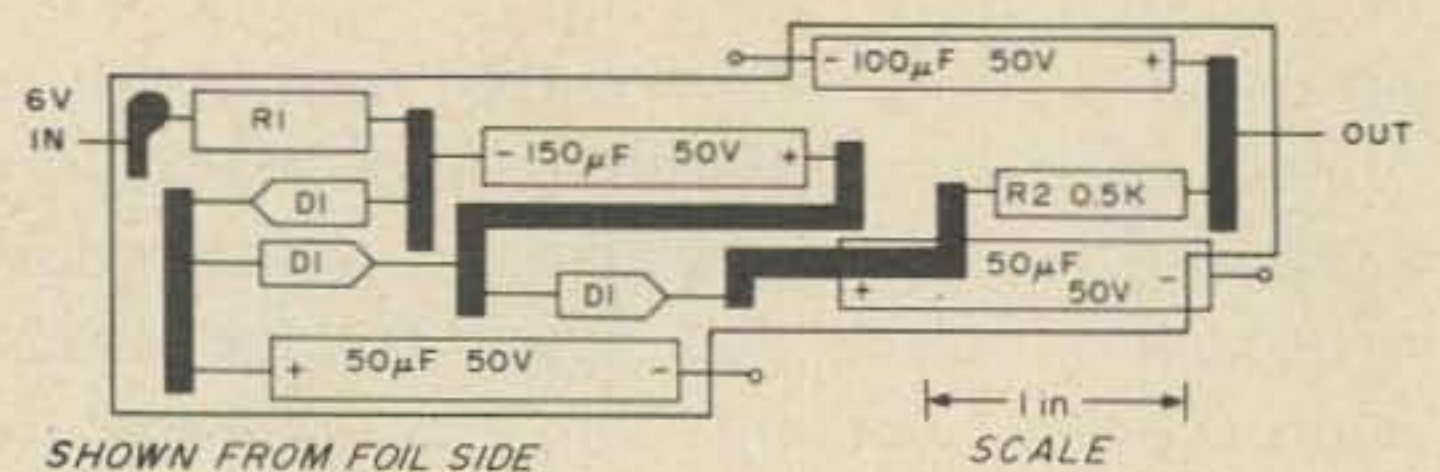

Fig. 4. Voltage tripler.

overnight — and allowed a set of batteries to drain.

The diodes are Radio Shack, two for 29¢, part number 276-1135 one Amp at 50 piv. The voltage tripler is straight out of the handbook and is taken from the 6 V filament winding. Capacitors are 150 µF at 50 volts, 100 µF at 50 volts, and two 50 µF at 50 volts. The 150 and 100 µF came from the junkbox. The 50 µF capacitors came from a local wholesale house at 77¢ each. The total cost of the project was less than ten dollars, including the crystal. My decision to use the voltage tripler was based on the need for as much stability as possible. The most obvious source of B plus for the circuit boards was the use of a dropping resistor with a zener diode. This tended to fluctuate with the line voltage and had a weird effect on the signal. Obviously, this is the most inexpensive way to go, but in my circuit, it tends to contribute to the instability of the set.

This circuit will work in any of the older tube type receivers which do not have a bfo. If you want to increase the selectivity of your receiver for more comfortable CW copy, while at the same time retaining the standard broadcast capability, I recommend it highly. Further, if an i-f frequency of other than 455 kHz is desired it may increase the price slightly due to the necessity of using a special rather than a surplus crystal. I also soldered the crystal directly to the foil side of the board to avoid the use of a crystal holder, which increases the capacitance and must also be neutralized.

...WB4KTY

Now get commercial TV picture quality

on Amateur SSTV operation



Introducing the **ROBOT MODEL 300** **SSTV SCAN Converter.**

Offers both fast-to-slow and slow-to-fast scan conversion capabilities.

Accepts standard closed circuit TV video signals from a TV camera or other video source and converts to amateur standard SSTV audio tones in the accepted range of 1200 to 2300 Hertz.

Also accepts amateur-standard SSTV audio tones in the same range and converts to TV standard

video signals capable of being reproduced on any CCTV monitor or home set.

\$1295

For complete information, write today for our special 6 page Robot Newsletter on the Model 300.

ROBOT

ROBOT RESEARCH, INC.
7591 Convoy Court
San Diego, California 92111

A head start on the future

Midland's 220 MHz mobile transceiver puts you into this fast developing band for less than you might think. 10-watt output power, 12-channel capability with crystals for 223.5 simplex, plus these professional performance features...

A dual conversion receiver with complete multiple FET front end coupled with high-Q helicalized cavity resonators • Zener regulated, crystal controlled first and second oscillators • 10-watt output power transmitter (switchable to 1 watt) with zener regulated crystal oscillator • High-Q and shielded stages for minimal interstage reaction • Encased low-pass filter • VSWR bridge and four DC amplifiers to monitor output and give instant automatic protection • Accessory jack for tone burst and discriminator filter • Swing-up circuit board for easy access to all sections... all modules easily removable • Operation on 13.8 volts DC, negative ground • Compact steel case 2¼" h. x 6¾" wide x 8⅞" d. Complete with mike, mounting bracket and hardware.

Midland's exclusive
added ingredient

R.S.V.P.

Positive, practical support
for your repeater service
when you buy any Midland
amateur mobile transceiver.

Write for free Midland Amateur
Radio Catalog... see why
"COMMUNICATIONS IS OUR
MIDDLE NAME"

MIDLAND
INTERNATIONAL®
Communications Division

P.O. Box 19032
Kansas City, Missouri 64141

MODEL 13-509



How to put on a Professional Slide Show

With A Slide Synchronizer

And this is a shot of me by the White House, (click) and here's the wife in front of the White House, (click) this is the White House without any of us in the picture. . ." Is this how your slide shows go? Dull, monotonous, with a tendency to put people to sleep? Just the thing to perk up your presentations, our S&TS Slide and Tape Synchronizer is a snap to build and will let you breathe some life into your slides.

The S&TS allows you to record a sound-track on any stereo recorder, using one track for audio and the other tracks for tones that are demodulated and converted to a signal which activates the change mechanism of your slide projector, using the existing remote control. It can be built in an evening, uses readily available parts, and costs far less than commercial units.

The first step in building the S&TS is to determine the switching arrangement of your remote control. Measure the resistance

from pin to pin on the remote control while operating the forward, backward, and focus, if any, button. Of course, do this with the control disconnected from the projector. A circuit diagram of the Honeywell 630 control is shown on the right of Fig. 1. As can be seen, the basic switch is a normally open SPST, with a DPDT switch for forward-reverse slide direction. If this projector were equipped with remote focus, additional switching would be included.

Armed with the specifications of the control, the circuit shown on the left of Fig. 1 was constructed. A relay acts as the slide change switch, with the regular remote push button for manual override. Connection is made to the projector through the remote control connector. The 5-pin connector used in the Honeywell is a standard configuration which is available widely. Similar connectors are used on other equipment.

The audio signal for the unit may be generated in many ways. The most elegant

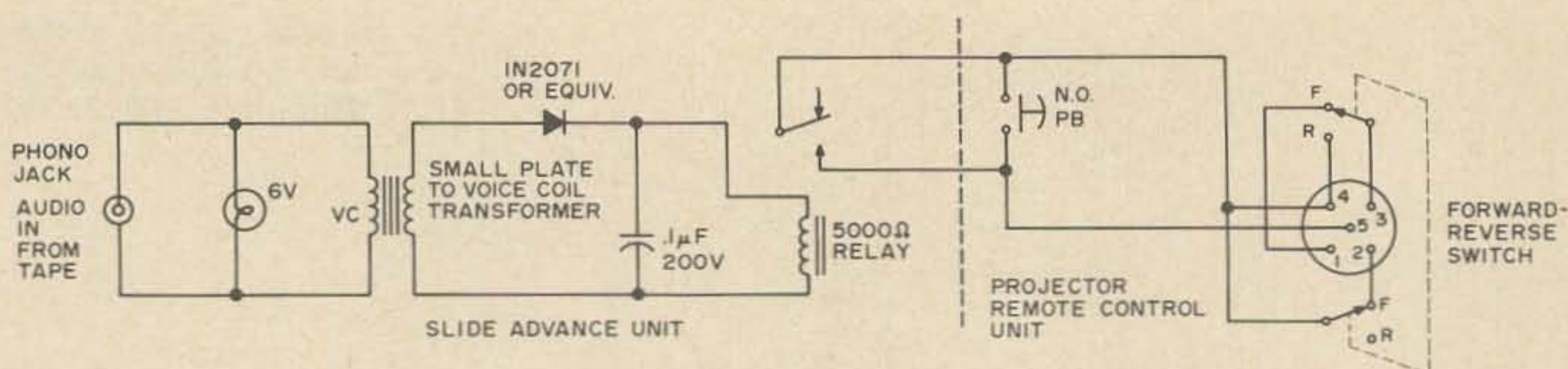

Fig. 1. Schematic.

would be an audio oscillator, of the type often used for ham code practice, included in the unit. But this would increase the size, cost, and complexity needlessly. A much easier solution is to use any audio generator around the shop, with the cheapest, easiest and most available being a whistle or vocal "beep" into a mike. An exact frequency is not critical, so long as it is above 1 kHz or so to permit adequate smoothing by the filter capacitor. If lower tones are desired, a larger capacitor should be used.

Construction technique is up to you. The method I used was point to point wiring in a small plastic box. Parts may be scrounged from the junk box, but if bought all new they should run under \$10. Frequency

selective R/C circuits with hi-lo tones may be used to feed two relays for full forward-backward control, if you want to get really fancy.

The pilot light across the audio input is included so that tapes may be reviewed and slide changes noted without having to listen to the tones or run the projector. It may be omitted if it is not desired.

Now a word on program production. The thing you want least to do is record a monologue and play it straight. Arrange your slides in a logical sequence, which may or may not be the order in which they were taken. Get rid of slides that show nothing, or are duplicates of others. Comment *about* the slide, don't *describe* it. Give interesting background material. Lead into a slide by talking about it before and while the slides are changing. Use nondescript but otherwise attractive slides as spacers between slides in your story line, to be shown without comment. And finally, appropriate background music may be used with voice-over to complete the continuity of the show. If your collection does not include such music, suitable selections may often be found in the public library or in friends' collections.

To use the S&TS, first assemble your slides in a logical sequence, and write either notes or a full script. Select the music to be used for background. Record the script and music onto one track. Then go back and, while listening to the script, record the slide change tones on the other track. Connect the speaker output of the tape track with the tones to the sync unit and the S&TS output to your slide projector, making sure the direction is on forward. Turn out the lights, turn on the projector and tape recorder, and enjoy a truly professional quality tape-slide show.

...WA3AJR

— WE GOT 'EM —

CLEGG, COLLINS, DRAKE, SWAN, YAESU, TEN-TEC, and many more in stock. Large selection of used equipment. See us for quick courteous service. Established 1928.

FRECK RADIO & SUPPLY CO. Inc.

P.O. Box 7287 W4WL

Asheville NC 28802

704-154-9551



DIPOLE ANTENNA CONNECTOR

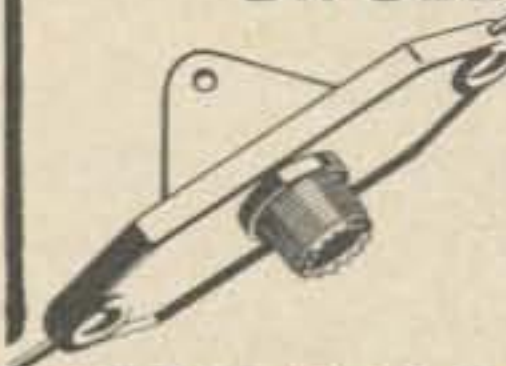

HYE-QUE (HQ-1) dipole connector has coax SO-239 socket molded into glass filled plastic body to accept coax PL-259 plug on feedline. Drip-cap keeps coax fittings dry. Instructions included. Guaranteed. At your dealers or \$3.95 postpaid. Companion insulators 2/\$.99.

BUDWIG MFG. Co. PO Box 97B, Ramona CA 92065

Temtron Electronics

"We carry the largest stock of all types of ELECTRON TUBES, SEMICONDUCTORS, ICs. Special prices on 4CX1000As, 3-400Zs, 829Bs, 811As — and many other industrial and receiving types. Prices and catalog on request.

138-69 FRANCIS LEWIS BLVD. ROSEDALE NY 11422 (212)978-5896

NEW!

Integrated Circuitry + Plug-In Modules = Versatile, *state of the art* 2m FM Performance!



*The hot carrier diode mixer
virtually eliminates inter-
mod problems!*

Speech processing for clean
sharp audio with plenty of
punch!

Buy factory direct and SAVE!

100% Moneyback Guarantee - (10 days -
you can't lose)
100 days full Warranty

SPEC COMM 560
5W 6 channels **\$179⁹⁵**

SPEC COMM 512
5W 12 channels **\$199⁹⁵**

Accessories:

Clip-on battery pack — Nicad — complete with charger, whip antenna and carrying strap — heavy duty Nicads (not those penlight size cells). Clip-on and automatically connects. \$79.95 (BP-1)

Clip-on ac supply — automatically interconnects when you clip on — uses newest type high efficiency transformer and IC regulator. \$44.95 (AC-1)

Clip-on 25 Watt amplifier — automatically connects to power and rf. Fully protected from shorted or open antenna. \$84.95 (BA-1)

Synthesizer in the works! Xtals ±0.001% (any frequency) \$4.95.

Features

- Uses inexpensive TR-22 xtals
- Reverse polarity protection
- Final transistor fully protected
- Large 3" speaker for good sound
- Front *and* rear antenna jacks
- 146.52 crystals supplied
- Clip-on accessory modules
- Lightweight — 2 lbs
- Size 2¼x6x8"
- Electronic T/R — no clicking relay
- Battery voltage indicator
- Ceramic mic — non stealable
- Fantastic squelch circuit — fast
- Extremely sensitive MOSFET front end
- Trimmers on *all* crystals
- Modular construction
- Very easy to service
- Versatile — over-shoulder — mobile — fixed
- Incredibly sharp i-f.



*Pennsylvania residents
add 6% sales tax.
Include \$3.50 shipping.*

*SCR-100 Repeater Receiver Board — Greatly reduce or eliminate
"desense" or intermod problems! \$89.95*

SPECTRUM COMMUNICATIONS

"advanced communications electronics"

BOX 140, WORCESTER PA 19490 (215) 584-6469

BRAND NEW QSL'S



X Style X — Black type, blue satellite



W Style W — Black type, blue world
"back by popular demand!"

- three styles
- QSO info back
- two colors
- LOW PRICES



Y Style Y — Black type, red lightning bolt

These QSLs are printed on Fine Quality Coated Card Stock and are as good or better than cards sold elsewhere for several times the price. We can offer this fantastic low price, because we "gang print" orders between other jobs in our own print shop which keeps the costs way down and we pass the savings on to you. If you haven't been QSLing as much as you'd like to because of the cost of cards, do you really have an excuse anymore? Get some cards and help improve the image of U.S. Amateurs. Please allow 6-8 weeks for delivery.

SPREAD
the
WORD!

RADIO AMATEURS!
TALK TO THE WORLD!!
...ask me about it!

ONLY .50¢

Ham radio is too great a hobby for us to keep it to ourselves. Let's tell the whole world about it! And what better way than by sporting this attractive lime-green bumper sticker on your car! It's only 50¢ — and it's phosphorescent so you can see it even at night. Go ahead... SPREAD THE WORD! Order yours TODAY!



4 STUDY GUIDES
NOVICE — \$4 GENERAL — \$6
ADVANCED — \$4 EXTRA — \$5

FCC exams got you scared? Frustrated by theory fundamentals? There's no need to worry. 73's four License Study Guides will help you breeze through any of the four tough exams! They are the ONLY guides which cover ALL the material you will have to know. Many amateurs find that one quick reading through our guides is enough to get them through with no sweat.

SOLID STATE PROJECTS

\$4
More than 60 projects of interest to anyone in electronics. The devices range from a simple transistor tester to a ham TV receiver. This collection will help you become more intimately acquainted with zeners, ICs and varactors, etc.



VHF PROJECTS FOR AMATEUR AND EXPERIMENTER

\$4
A must for the VHF op. Opening chapters on operating practices and getting started in VHF, both AM and FM, followed by 58 chapters on building useful test equipment, modifying existing and surplus gear.

2M FM HANDBOOK

hardbound \$7
softbound \$5

Contains almost every conceivable circuit that might be needed for use with a repeater. All circuits explained in detail. All aspects covered, from the operator to the antenna.



DIGITAL CONTROL OF REPEATERS

softbound \$5 hardbound \$7

Here's a book for the FMer who wants to design and build a digital repeater control system. Contains sections on repeaters, basic logic functions, logic circuit design, control systems, support circuits, mobile installations, touch-tone, plus a special section on a "mini" repeater control system.

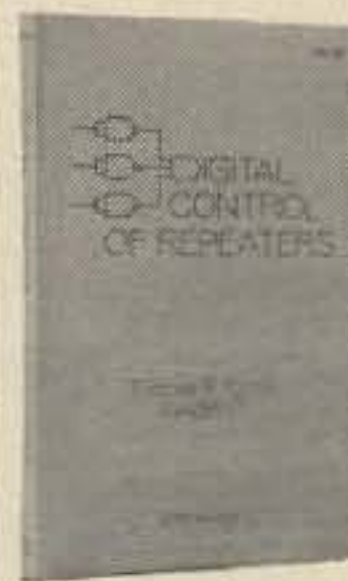

LATEST RELEASES from 73 publications

RF and DIGITAL TEST EQUIPMENT YOU CAN BUILD

RF burst, function, square wave generators, variable length pulse generators — 100 kHz marker, i-f and rf sweep generators, audio osc, af/rf signal injector, 146 MHz synthesizer, digital readouts for counters, several counters, prescaler, micro-wavemeter, etc. 252 pages. \$5.95



PRACTICAL TEST INSTRUMENTS YOU CAN BUILD

37 simple test instruments you can make — covers VOMs, VTVMs, semiconductor testing units, dip meters, watt meters, and just about anything else you might need around the test lab and ham shack. \$4.95



COAX HANDBOOK

\$3

All about coaxial cables, connectors and applications. It's all here — pictures, part numbers and specifications for all types. Includes lengths for different types for quarter, half and full wave feedlines.



73 BINDERS

\$5

These binders are a gorgeous red and come with the nicest set of year stickers you've ever seen. The perfect thing for storing your issues of 73 so that they won't get lost or spilt on, or into the hands of the Jr. Op. Dress up your shack with these binders.

Startling Learning Breakthrough



NOVICE THEORY TAPES
Set of 4 Tapes only \$13.95

You'll be astounded at how really simple the theory is when you hear it explained on these tapes. Three tapes of theory and one of questions and answers from the latest Novice exams give you the edge you need to breeze through your exam.

73 is interested in helping get more amateurs, so we're giving you the complete set of four tapes for the incredibly low price of ONLY \$13.95.

Scientists have proven that you learn faster by listening than by reading because you can play a cassette tape over and over in your spare time — even while you're driving! You get more and more info each time you hear it.

You can't progress without solid fundamentals. These four hour-long tapes give you all the basics you'll need to pass the Novice exam easily. You'll have an understanding of the basics which will be invaluable to you for the rest of your life! Can you afford to take your Novice exam without first listening to your tapes?

1975 fm repeater atlas



LISTINGS BY STATE ORDER TODAY!

STILL ONLY \$1.50

73's all new REPEATER ATLAS is a must for every ham on 2 meters. There are 2,500 repeaters around the world (2,000 of them in the U.S.), and this atlas lists them all! Just off the presses, the 1975 edition is the most up-to-date listing you can buy. And monthly repeater updates in the 73 newspapers makes sure that it stays that way! You can still purchase this invaluable tool for JUST \$1.50. Isn't it nice to know that there are a few places left where your dollar is still worth something?

GET IT while it's HOT!



Latest FCC News
(from inside the FCC)
Latest Docket Releases
usually in entirety
Late DXpedition News
Hot Propagation Report
Job Openings
Contest News
Conventions — Hamfests
Brand New Products
Inside Industry News

The fact is, if you are an astute shopper, you can pay 50% more for Brand X than the subscription price of Hotline (a mere \$8 per year by First Class Mail) and end up with a newsletter which is about half as big (half as much news).

Hotline overcomes the two month news delay of 73 Magazine (and all other ham magazines) by bringing you the latest hot news while it is still news. This puts you in the know on the air — over the repeater — and at your ham club.

Now you can learn the code in a fraction of the time it used to take!

four speeds available

\$4.95 for one hour.
All four \$14.95.

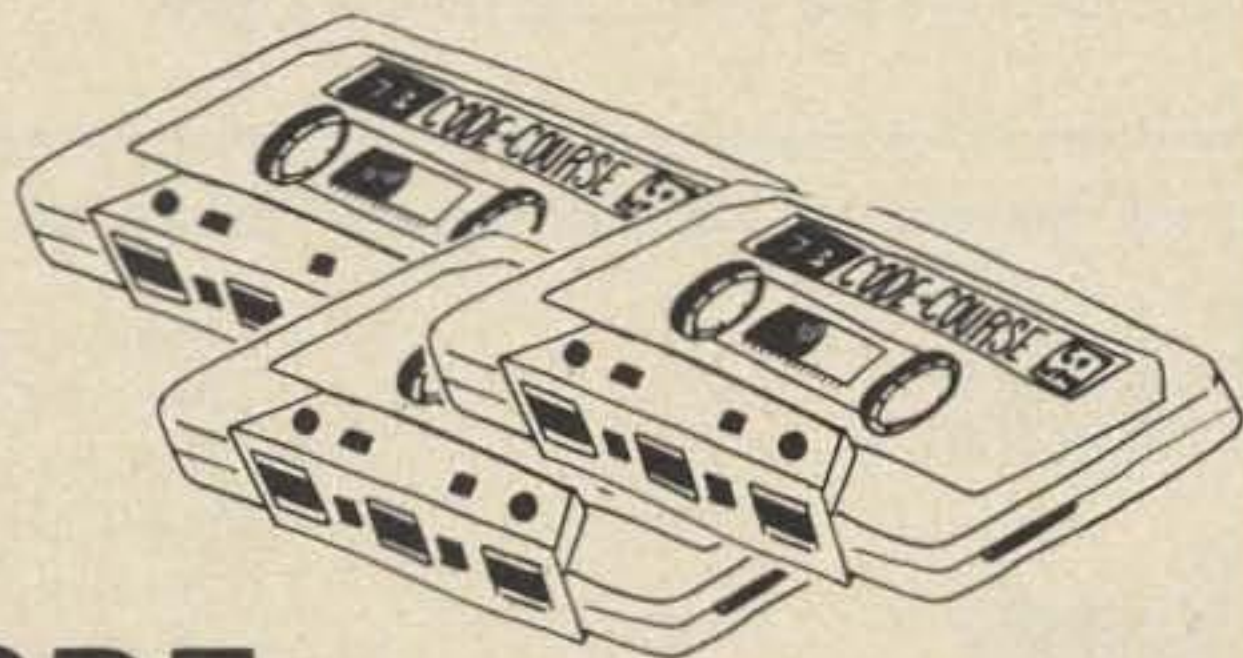

NEW CODE SYSTEM

Plays on any cassette player so you can practice anywhere anytime!

□ **5 WPM** This is the beginning tape for people who do not know the code at all. It takes them through the 26 letters, 10 numbers and necessary punctuation, complete with practice every step of the way using the newest blitz teaching techniques. It is almost miraculous! In one hour many people — including kids of ten — are able to master the code. The ease of learning gives confidence to beginners who might otherwise drop out.

□ **14 WPM** Code groups again, at a brisk 14 per so you will be at ease when you sit down in front of the steely eyed government inspector and he starts sending you plain language at only 13 per. You need this extra margin to overcome the panic which is universal in the test situations. When you've spent your money and time to take the test you'll thank heavens you had this back breaking tape.

□ **6 WPM** This is the practice tape for the Novice and Technician licenses. It is made up of one solid hour of code, sent at the official FCC standard (no other tape we've heard uses these standards, so many people flunk the code when they are suddenly — under pressure — faced with characters sent at 13 wpm and spaced for 5 wpm). This tape is not memorizable, unlike the zany 5 wpm tape, since the code groups are entirely random characters sent in groups of five. Practice this one during lunch, while in the car, anywhere and you'll be more than prepared for the easy FCC exam.

□ **21 WPM** Code is what gets you when you go for the Extra Class license. It is so embarrassing to panic out just because you didn't prepare yourself with this tape. Though this is only one word faster, the code groups are so difficult that you'll almost fall asleep copying the FCC stuff by comparison. Users report that they can't believe how easy 20 per really is with this fantastic one hour tape. No one who can copy these tapes can possibly fail the FCC test. Remove all fear of the code forever with these tapes.

SPECIAL BACK ISSUE OFFERING



NOW YOU CAN BUILD UP YOUR HAM LIBRARY FOR NEXT TO NOTHING!

25 different issues (of our choice) for ONLY \$5.00. That's just 20¢ an issue — it costs us more than that to print them! Choose from three different categories:
Vintage: 1962-1965
Recent: 1966-1969
Very Recent: 1970-1973

FREE?

ONE YEAR SUBSCRIPTION

Well-Ahem-almost- look at it this way-

1 YEAR = \$8.00
3 YEARS = \$16.00

So how much does the second year cost? - Nothing, really!

12 REASONS FOR SUBSCRIBING TO 73 MAGAZINE. . . RIGHT NOW.

- You get every issue — makes a first rate electronics reference library
- No more missing issues sold out at the newsstand
- Many more articles every month than other ham magazines
- The most and the best of the ham advertising — see new products first in 73
- The editorials — like 'em or hate 'em — they do make you think
- Complete FCC releases in detail so you won't miss anything important
- The newest state of the art construction projects by top authors
- Plus five other reasons which are too obvious to mention here

mail TODAY to:



73 magazine

Peterborough, New Hampshire 03458

Name _____ Call _____

Address _____

City _____ State _____ Zip _____

Check

Signature _____

Card No. _____

Expiration Date _____ Total enclosed _____

- Novice Theory Tapes \$13.95
- 5 WPM Beginners Cassette 4.95
- 6 WPM Back Breaker Cassette 4.95
- 10 WPM Canadian Code Tape 4.95
- 13 WPM General Practice Tape 4.95
- 20 WPM Extra-Back Breaker Tape 4.95
- 5-6-13-20 Tape Package 14.95
- Vintage Back Issues 5.00
- Recent Back Issues 5.00
- Very Recent Back Issues 5.00
- Hotline — 1 year 8.00
- 1975 Repeater Atlas 1.50
- 250 QSL — Style W X Y 6.00
- 500 QSL — Style W X Y 10.00
- 1000 QSL — Style W X Y 15.00
- 2000 QSL — Style W X Y 20.00
- Bumper Stickers @ 50c each
- Novice Study Guide 4.00
- General/Tech Guide 6.00
- Advanced Guide 4.00
- Extra Guide 5.00
- Solid State Proj 4.00
- VHF Projects 5.00
- 2m FM Handbook Hard \$7 Soft 5.00
- SSTV Handbook Hard \$7 Soft 5.00
- Digital Control Hard \$7 Soft 5.00

CIRCUITS, CIRCUITS, CIRCUITS...

The following circuits have appeared in reference books, magazines, application notes, etc. While we try to reproduce all of the information that should be needed by an experienced constructor, readers may want to avail themselves of the original sources for peace of mind.

Readers are requested to pass along any interesting circuits that they discover in sources other than U.S. ham magazines. Circuits should be oriented toward amateur radio and experimentation rather than industrial or computer technology. Submit circuit with all parts values on it, a very brief explanation of the circuit and any additional parts information required, give the source and a note of permission to reprint from the copyright holder, if any, and the reward for a published circuit will be a choice of a 73 book. Send your circuits to 73 Circuits Page, 73 Magazine, Peterborough NH 03458.

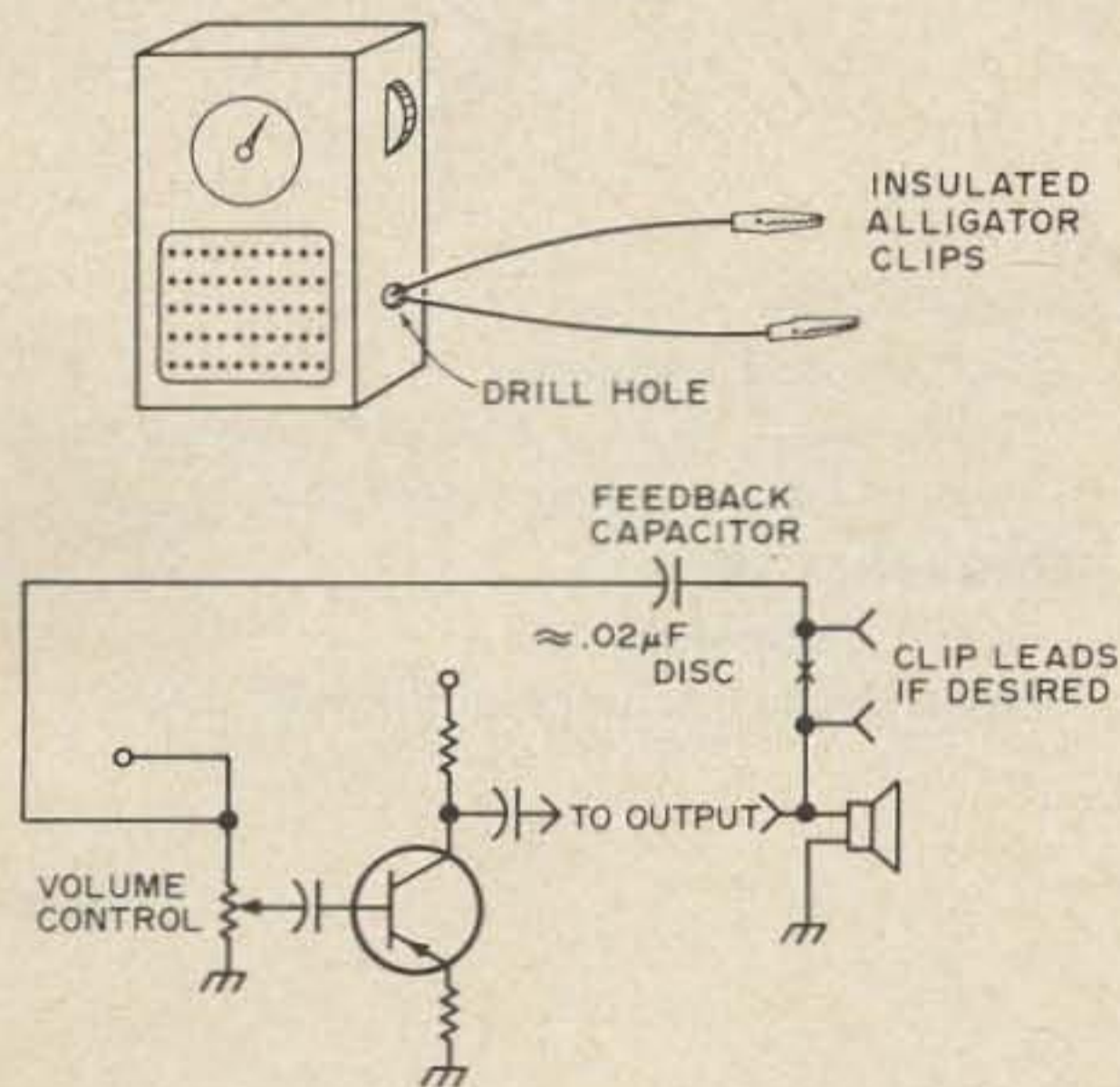

Code osc or continuity tester from a transistor radio. Add a .02 μF from the high side of the vol control to the speaker. If this fails, pick a spot in the output section that gives feedback. Thanks WB2IGR.

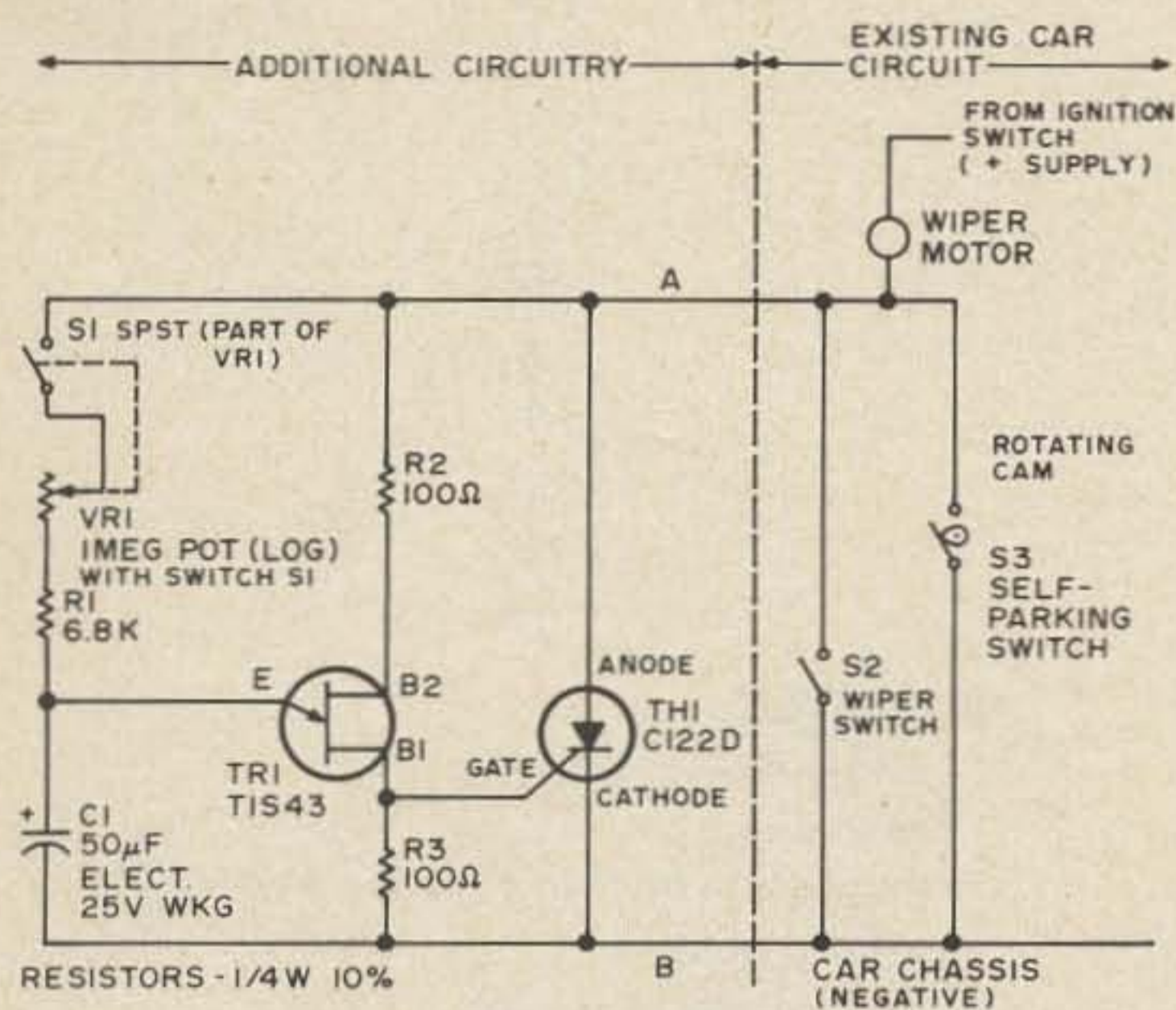

Windshield wiper delay circuit for negative ground cars. For positive ground systems merely put the wiper motor in the positive lead of the circuit. Complete project is in Radio & Electronics Constructor for July 1974, 57 Maiden Vale, London W91SN, England. Subs are \$7/year. Circuit will allow double wiper sweeps at intervals of from a half second to a minute and a half — great for fog, mist, stuff like that.

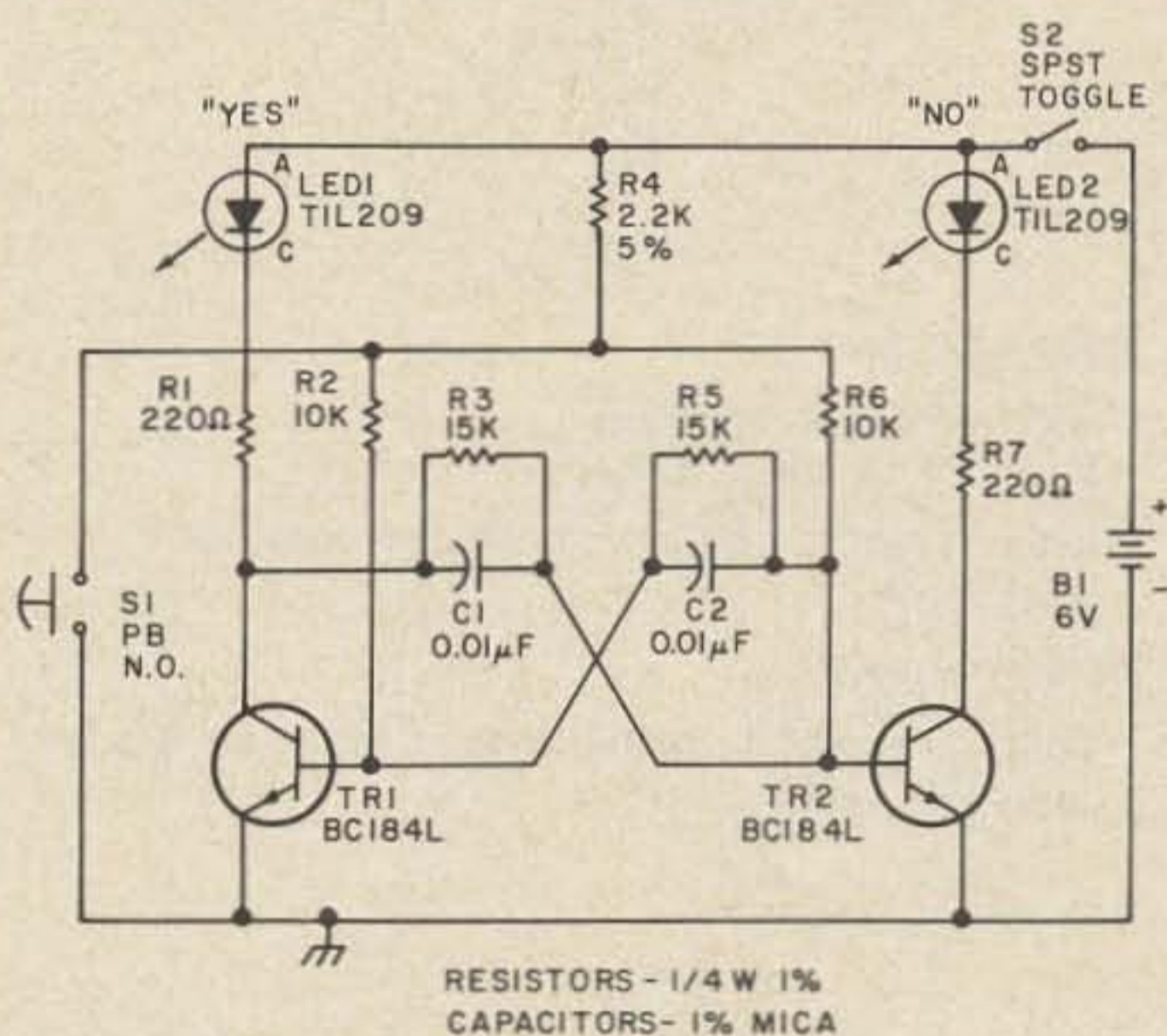

Electronic coin tosser. Complete project is in June 74 issue of Radio & Electronics Constructor. Circuit will give random result if zero volts on test between lower end of R1 and R7.

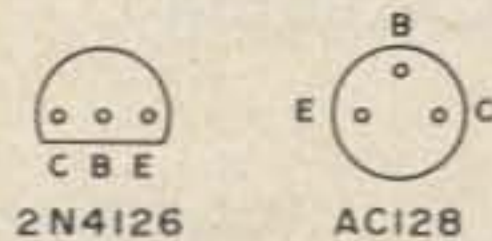
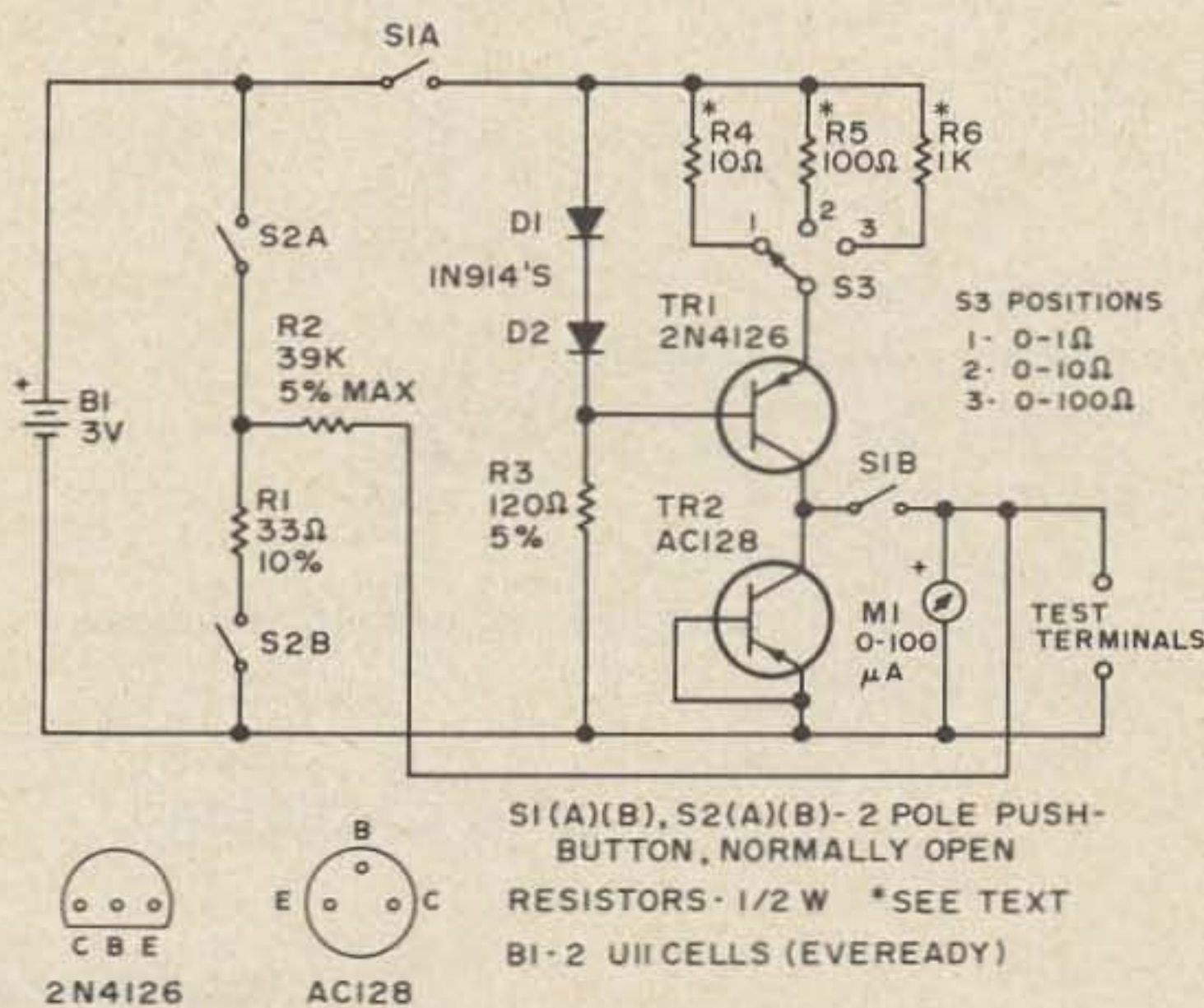

Low value linear ohm meter (down to .05 ohms). Project is from July 1974 Radio & Electronics Constructor.

TTL OUTPUT CONFIGURATIONS

a. DARLINGTON

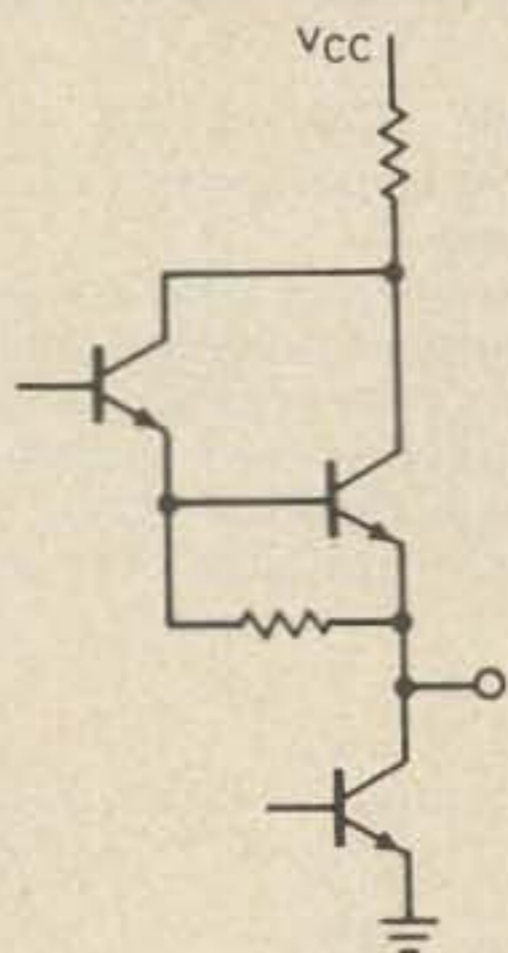

ADVANTAGE:

High ac drive capability
 $V_{OH} = V_{CC} - V_{BE}$ at $I_O = 0$
 Small size (transistors share one common isolation)

DISADVANTAGE:

Output cannot be pulled higher than one diode drop above V_{CC}

b. 2-STAGE EMITTER FOLLOWER ("DARLINGTON SPLIT")

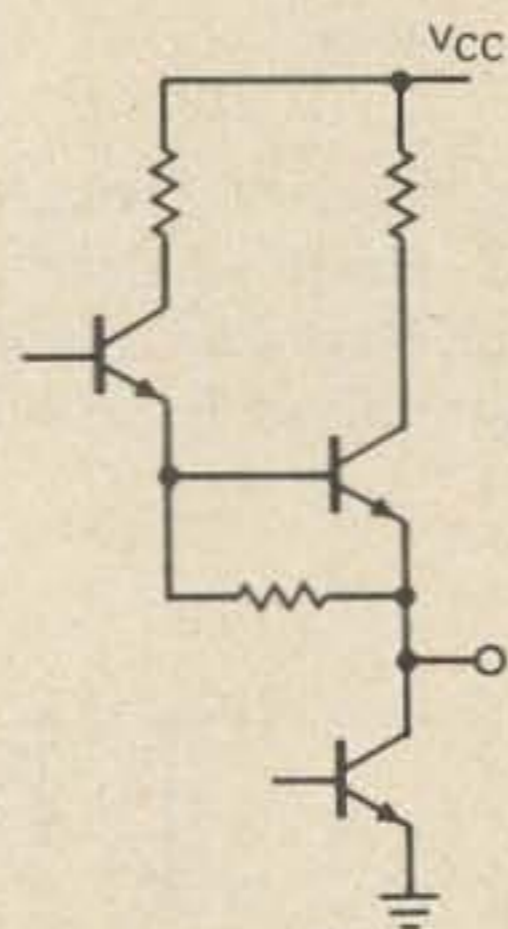

ADVANTAGE:

High ac drive capability
 $V_{OH} = V_{CC} - V_{BE}$ at $I_O = 0$

DISADVANTAGE:

Larger than circuit A
 Output cannot be pulled higher than one diode drop above V_{CC}

e. OPEN COLLECTOR

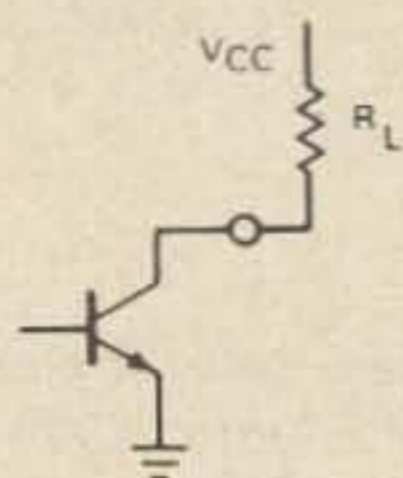

ADVANTAGE:

Bussable, allows collector ANDing (Wired-OR)

DISADVANTAGE:

High output impedance in the High state
 Slow, especially with capacitive loading
 Requires additional resistor

c. DARLINGTON WITH RESISTOR TO GROUND

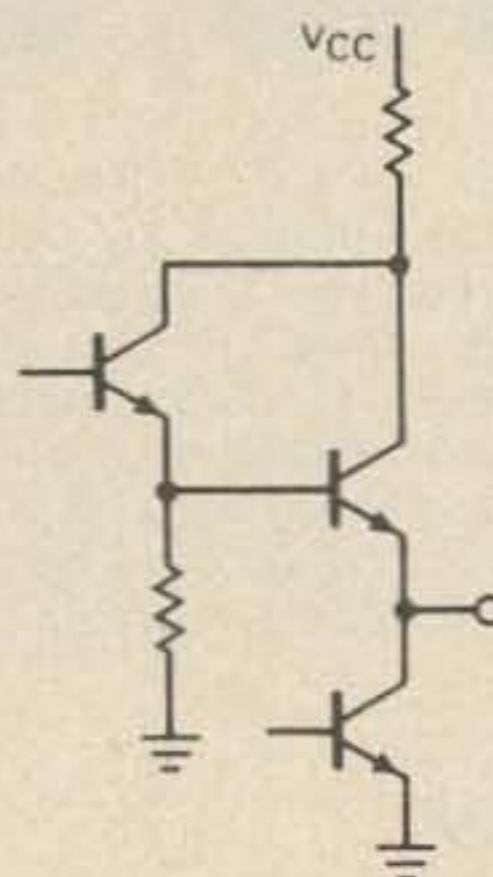

ADVANTAGE:

High ac drive capability
 Lower $V_{OH} = (V_{CC} - 2 V_{BE})$ increases speed
 Outputs can be pulled higher than V_{CC}

DISADVANTAGE:

Higher dissipation
 Lower noise immunity in the High state

d. TRANSISTOR - DIODE

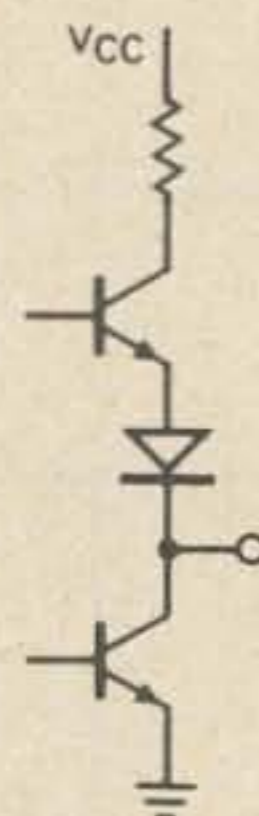

ADVANTAGE:

Lowest power consumption
 Small size
 Outputs can be pulled higher than V_{CC}

DISADVANTAGE:

Less ac drive capability

BASIC TV SYNC GENERATORS

MODULO 525

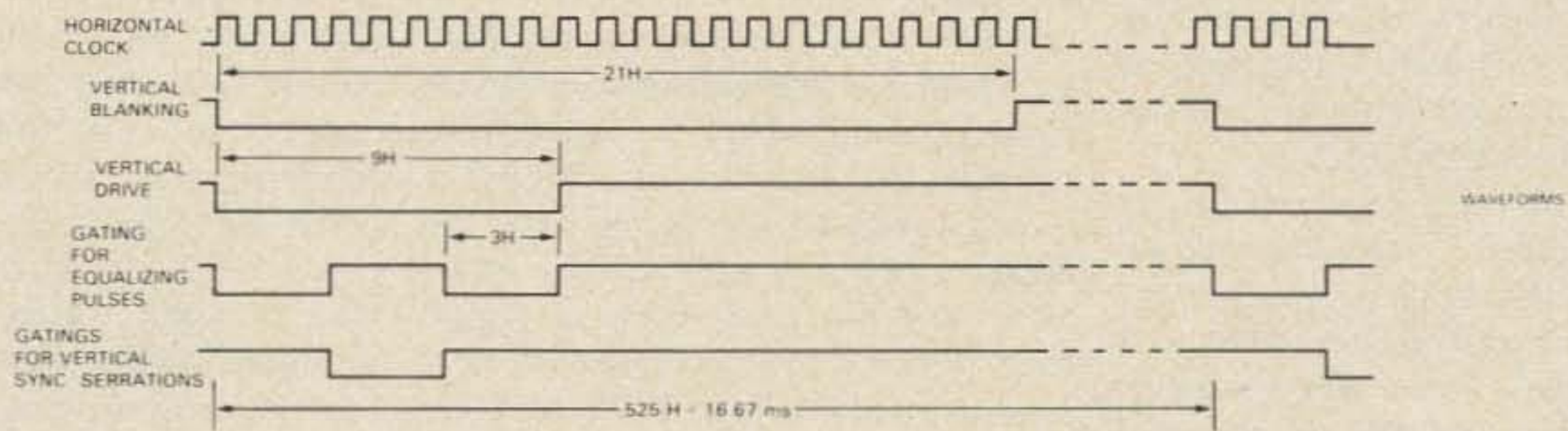
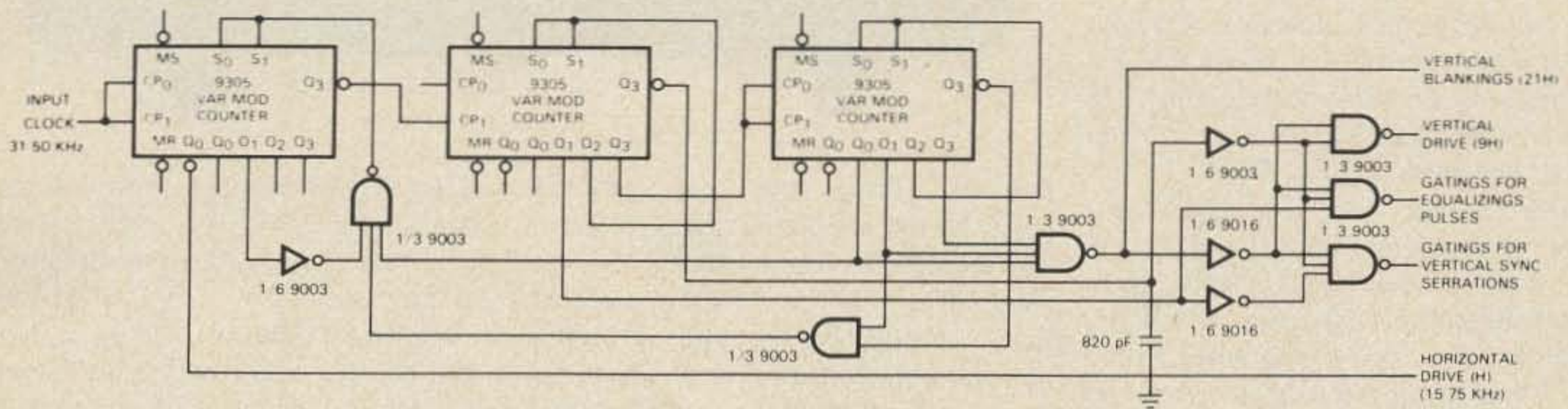

MODULO 625

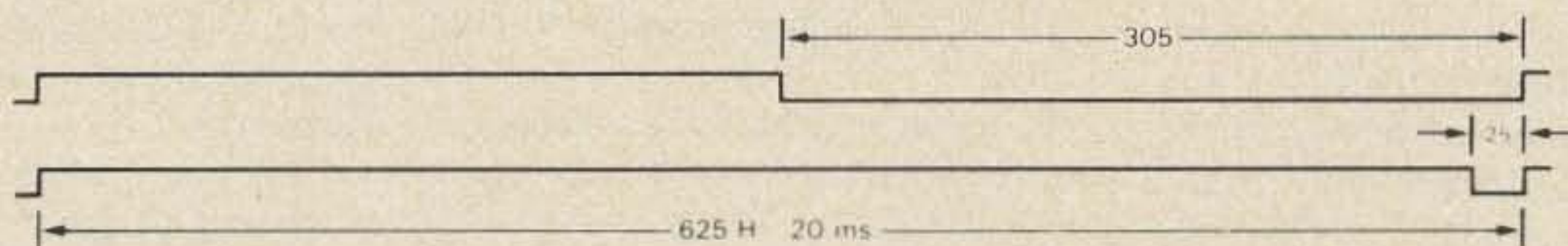
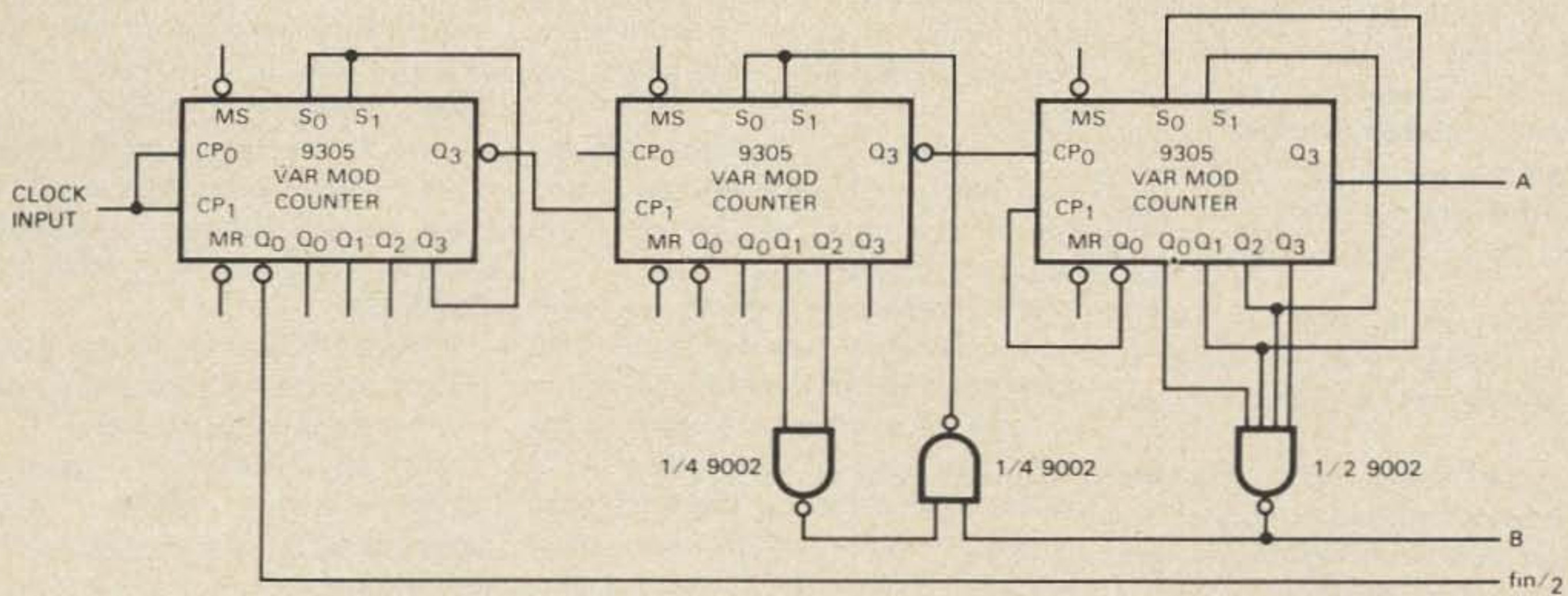

Two basic TV sync generators are illustrated above. The 525 divider produces waveforms basic to the American EIA standard and the waveforms of the modulo 625 divider are the primary timing waveforms. By gating the waveforms shown with appropriate equalizing, vertical serration and blanking signals, standard sync waveforms can be generated.

NEW PRODUCTS



ITC MULTI-2000

Synthesized FM, sideband and CW, all in one little rig! The Multi-2000 is an amazing package, and sells for not much more than an ordinary synthesized two meter FM rig: \$695.

The FM part first. The 2000 has a fully synthesized circuit and covers the entire two meter band, from 144-148 MHz. It switches in 1 MHz, 100 kHz and 10 kHz segments, with a +/- 7 kHz offset pot so you can get on any frequency you want. This means you can work any 30 kHz channel repeater or even the 15 kHz splinter channels. It will even permit you to zero in on oddball repeaters such as the Boston 146.39-99 machine.

The channel switch permits you to operate simplex — sending and receiving on the same channel — or duplex, transmitting either 600 kHz up or down from the received channel. There are also four crystal controlled channels available, if you want to use them. If you want to work with a repeater with other than 600 kHz split there is simple mod for the 2000 to meet this emergency, too.

There are two meters on the unit — an S-meter and a discriminator meter which indicates frequency deviation. Using the RIT control you can zero an off channel repeater without having your own transmitter off frequency. Most synthesized rigs send and receive 600 kHz apart and are locked into this.

The 2000 puts out about 12 Watts in the high power position (rated at 10 W) and about one Watt in low power.

Touchtone? Plugs right into the handy accessory socket in the back.

Quality reports on the speech have been universally excellent — it is clean, crisp, sounds great — and has good punch due to speech processing.

Sideband

In addition to all that FM up there between 146-148 MHz, there is a lot of sideband excitement going on in the lower reaches of the band. If you have any interest whatever in DX you need sideband. All aurora work is by sideband or CW — and most real long distance work is by sideband and CW.

All this brings us to Oscar — if you haven't listened in to Oscar yet you are hiding your head in the sand. Oscar is fantastic — both Oscars are

fantastic. More and more of the Multi-2000s are being used to work through Oscar from 145.95 MHz to 29.5 MHz. You can do it barefoot! Some fellows are up over 20 states and several countries with these rigs barefoot through the Oscars. The rig is well worth the price for that application alone.

When Oscar 7 goes by you can tune it in with the 2000 and hear all those fellows having a ball. You tune from 145.925 to 145.975 — the 50 kHz is spread out in 10 kHz segments on the 2000 so there is no problem separating everyone. The Oscar 7 signals come in on lower sideband, so you need a mod on the 2000 to copy them, the rig being set for upper sideband work. This calls for a change of the sideband selecting crystal inside (takes a moment). If you want to have switchable sidebands you add a toggle switch, the crystal and a couple of switching diodes. Oscar 6 and 7 require upper sideband input to work through to 29.5 MHz, so that is all set to go as is.

On sideband and CW operation the noise blanker circuit is available — and that is a state of the art invention which works like magic.

The 2000 is exceptionally well built — as a matter of fact the insides were used as the background for the picture of Judy Repeater on the cover of the April FM issue of 73. It is built in Japan, where the rig has been very popular. Since there are more Japanese two meter amateurs than there are in the U.S., the large volume of units being made has kept the price down substantially — so we are benefiting directly from the fantastic expansion of amateur radio in that country.

The importer sent along some specifications which seem reasonable. Sensitivity 0.2 uV for 12 dB Sinad — 1.0 uV for 20 dB quieting. Desense at 100 kHz greater than 135 dB. SSB sensitivity 0.12 uV for 10 dB S/N. Intermods more than 72 dB down for 3rd order Intermod products. Stability better than 10 Hz drift after 2 minute warmup. I-f of 16.9 MHz.

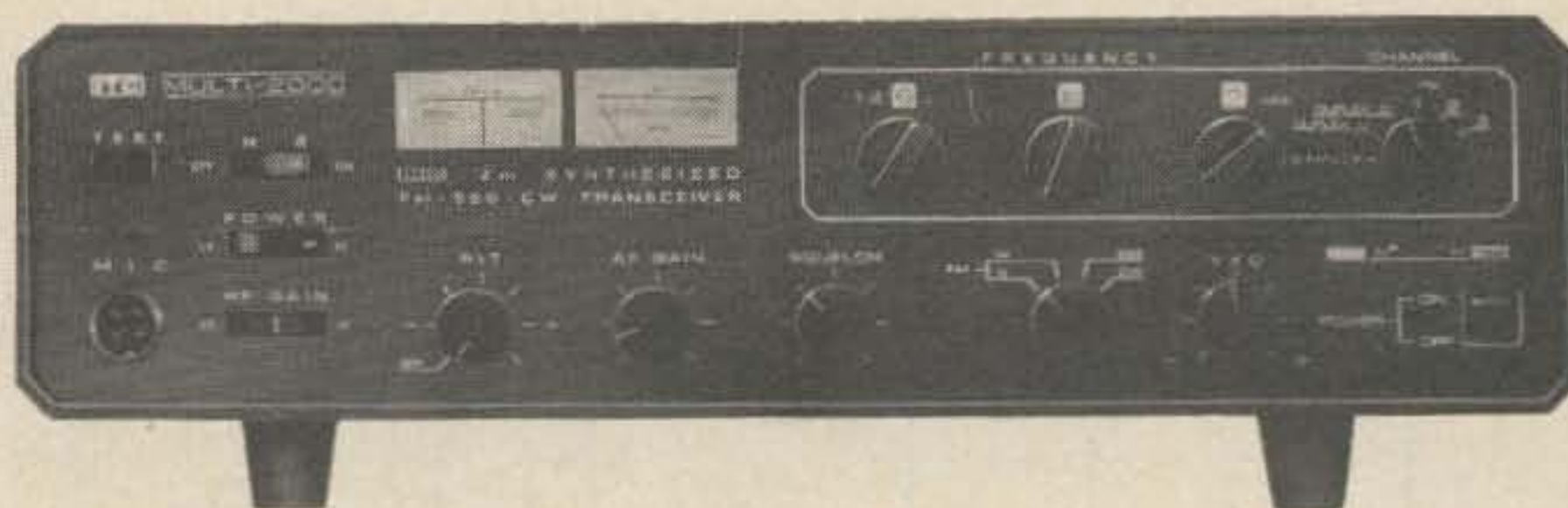

The 73 Mountain was snowed in, so tests of the 2000 in a high rf atmosphere had to be made in the Boston rf pollution by Tufts Radio entrepreneur Chuck Martin in Medford. Chuck, who runs a split channel repeater, is all too familiar with the deficiencies of virtually all FM rigs as far as adjacent channel signals are concerned. He claims that in the month he's used the Multi-2000 he hasn't heard one spillover from the other repeaters! And he says the 2000 is the best he's every used for sharpness of the i-f. After a couple days with the 2000, he got so many local amateurs interested that he opened an account with International Telecommunications and ordered several 2000s for his customers.

In addition to the outstanding performance on FM, Chuck has been doing a lot of mobile sideband work, getting remarkable ground wave ranges with it. There apparently is a re-awakening interest in two meter sideband and in two meter DXing. Chuck claims that more and more fellows are coming on sideband every week in the greater Boston area and many are able to easily make contacts out over 100 miles, with some out to 200 miles.

73 and Hotline will be interested in reports of sideband occupation of 2m in other parts of the country.

The Multi-2000 is a good step ahead — a fine FM rig — a good sideband rig — and a needed link for satellite work.

CHRONEX WATCHES

A couple of years ago I sent my Rolex watch in to the company office in New York for cleaning. It disappeared.

That was a blow. I'd become used to having a watch which would go anywhere with me and provide accurate time. Jean Sheppard K2ORS had gotten the watch for me in Ireland back around 1956.

Once the insurance money was in hand I decided to get a digital electronic watch... the question was,

which one? After looking over the field carefully, it came down to one watch which seemed to be really state of the art — the Chronex. Not only did this one tell time, it also read out the seconds and gave the day of the month and month. Better than that, it even had compensation built in to handle the varying length months — even February (except leap year... you have to correct for that one once every four years).

The fact is that you get used to a LED readout watch very quickly. The numbers are bright enough to read easily even while skiing on a dazzling sunny day — the watch is a snap to set... a little recessed switch which can be activated with a ball point pen allows you to set the functions. One push of either of the two switches on the side of the watch causes it to flash the time for about two seconds. If you hold in the switch, the hours and minutes will disappear and you will see the seconds reading off. Two

pushes of either switch will flash on the month and day.

I understand that the chap who designed the Chronex is the same one who came up with the older Pulsar watch — Pulsar had better watch out. Heh.

In addition to a certain smugness at always knowing the time right down to the second (which has little value other than getting me to the few TV programs I watch on the split second), the watch is a great talking point in explaining the changes that have taken place in electronics in the last few years. I point out that such a device would have taken a six foot rack of equipment just a few years ago... now there are about 1500 transistors in the one little chip in the watch... the whole circuit being about 1/8-inch square!

Alert readers may have noticed that Chronex is advertising their watches in 73 — with a special price for 73

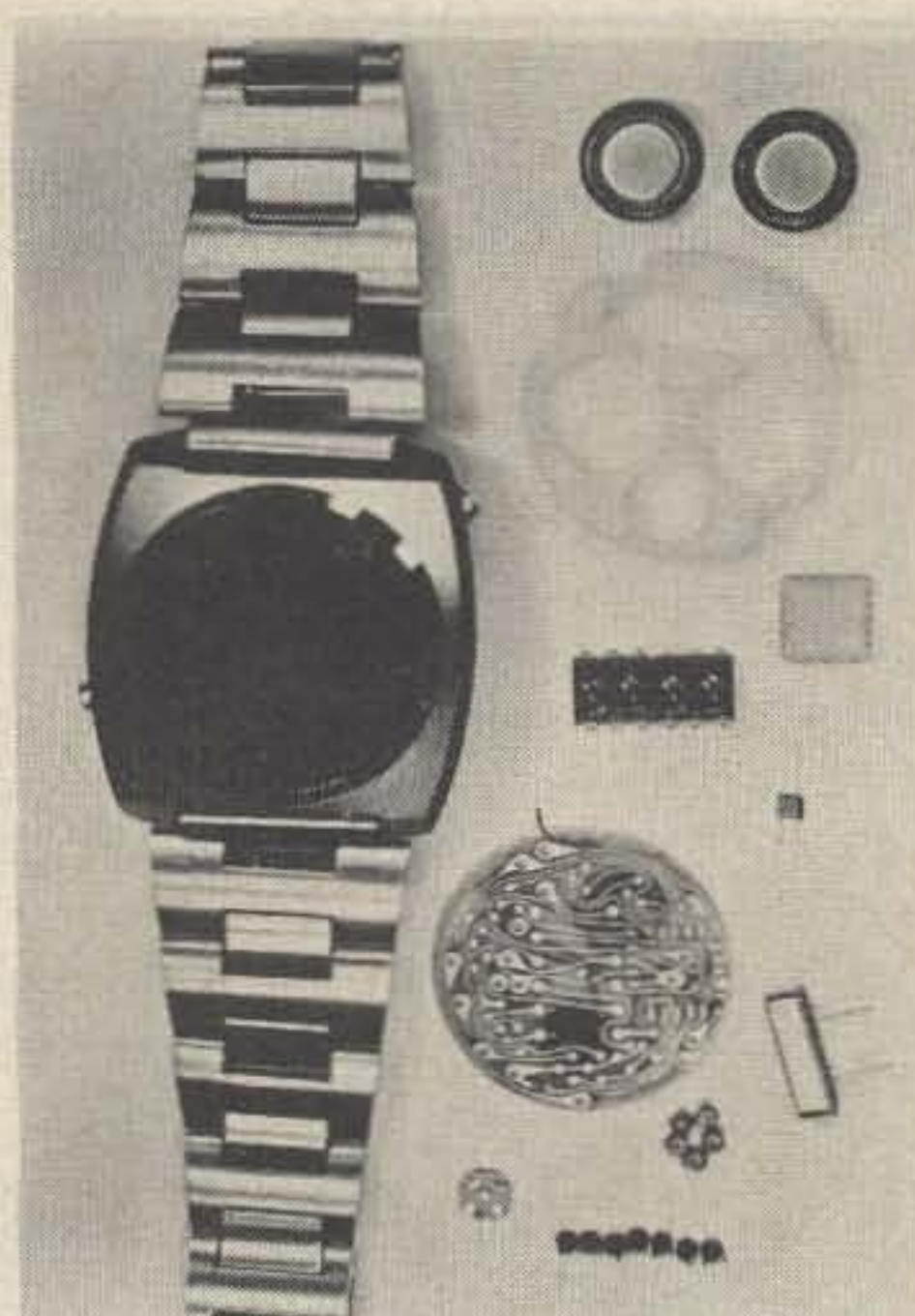

readers — the jeweler wholesale price — about 50% of the regular retail price! Chronex, 418 S. Yale, Garland TX 75042.

... W2NSD/1

GOING FIRST CLASS: THE CURTIS IK-440

Here is a combination first class keyer and code practice unit which should be of particular interest to any amateur who is enough into helping others get their tickets to provide code practice.

The keyer unit, which sells for \$125 alone, has self-completing dots, dashes and spaces, sidetone, perfect dot memory and variable element weighting.

The code generator provides random code from four to fifty words per minute, with a selector for either just letters or letters/numbers/punctuation — fantastic for code practice. Amateurs or clubs providing code practice classes or on the air code practice will find this gadget most helpful. The price is only \$225!

Write Curtis Electro Devices, Box 4090, Mountain View CA 94040 for more data. See it at your local distributor.



NEW HEATHKIT PORTABLE DIGITAL MULTIMETER

The new IM-2202 Portable Digital Multimeter is the lowest-priced professional-grade digital multimeter Heath has ever offered. It's truly portable — included in the unit are four rechargeable nickel-cadmium batteries and a built-in charging circuit. Up to eight hours of continuous operation can be obtained from each charge.

Its 26 ranges include full scale ranges of 100 mV to 1000 volts dc,

100 mV to 750 volts ac, 100 uA to 1000 mA and 100 Ohms to 1000 kilohms. The 100% overrange capability allows measurements up to 1.999 on all ranges except 1000 V dc and 750 V ac, giving full 2 Amp or 2 megohm capability. Overrange condition is automatically indicated by a flashing "1" display.

If a lab standard is used for calibration, dc accuracy is $\pm 0.2\%$. For ac, accuracy with a lab standard is $\pm 0.5\%$ to 10 kHz. Internal standards supplied with the kit allow easy field calibration to $\pm 0.5\%$ for dc and $\pm 1\%$ for ac.

The large 3½-digit display features automatic polarity indication and decimal point placement. A continuous-rotation range switch and four push-button function switches select any of the measurement ranges.

Assembly of the IM-2202 is aided by circuit board construction and "plug-in" components. Mail order price is \$179.95, F.O.B. factory. For more information, contact Heath Company, Benton Harbor MI 49022.



NEW**PRODUCTS**

HEATH MULTIMETER

The new Heath SM-1212 Digital Multimeter includes ac measurements up to 700 volts. Four overlapping ac and dc ranges make operation fast and simple. And it's hard to find better accuracy for less money: 1% on dc volts, 1½% on ac volts and ac/dc current, and 2% on resistance.

It's simple to operate, and the large 2½-digit display with automatic

decimal positioning ends "reading the wrong scale" errors. Lighted front panel indicators show overrange, + and - dc voltages and current at a glance. The built-in calibration standards are all that is needed for

periodic adjustments.

Mail order price of the factory assembled and calibrated SM-1212 is \$120.00, F.O.B. factory. For additional information, contact the Heath Company, Benton Harbor MI 49022.



THE GENAVE GTX-100 TRANSCEIVER

Genave has announced their 220 MHz transceiver — ten channels — ten Watts — with some interesting features such as a high-low power switch, a little gadget that makes it possible to rig the unit up as a walkie-talkie with a small portable power pack. They also have a switch which disconnects the receive crystal switch from the transmit crystal switch, allowing you to leave the transmitter on any of the ten channels while you put the receiver on any other of the ten channels. Under normal usage the two switches are connected together so they switch simultaneously.

The rig is designed to fit easily into your car — the front panel is only 6-1/2" x 2-1/2" and it is 9" deep. The mounting bracket has a provision for a padlock to make theft of the unit difficult. This is a very good feature these days when the 73 Hamburglar column is getting almost daily inputs on stolen ham equipment.

The GTX-100 is built on a single

circuit board — a feature which greatly simplifies any servicing that you may want to do — and makes the addition of accessories quite simple. Genave had left plenty of room in the cabinet for such things as tone burst or continuous tone circuits if you like to modify your equipment. What a pleasure it is to work on a set like this after trying to follow wires around one of the rigs which has a bunch of circuit boards jammed together with cabling. Many amateurs like to do their own servicing, but if they can't even get at the circuits without major surgery they have to send it back to the factory.

The Genave instruction book is quite thorough. It not only gives you a complete schematic, but also shows the circuit board layout with schematics superimposed on it so you can see what parts are mounted where and what interconnections go where.

Hopefully the GTX-100 will help entice more amateurs to use the repeaters which are being set up all around the country on 220 MHz. Use it or lose it.

HIGHLY RECOMMENDED

A very interesting and readable catalog is available free from MFJ Enterprises. Listed are CW and SSB filters, electronic keyers, frequency standards, audio amps, active filters, PC boards, electronic components and many other items. The specs on the

items are followed by suggestions of possible applications which read more like articles than ads. Available for the asking from MFJ Enterprises, P O Box 494, Mississippi State, MS 39762. Mention 73 when writing.

SNAP-IN TIP FOR CORDLESS SOLDERING IRONS

A new snap-in tip design is featured in all models of the new Iso-Tip Cordless Soldering Irons by Wahl Clipper Corporation. Previously, mounting screws had to be loosened and retightened to replace a tip. With the new design, the user simply inserts the tip and snaps it into place. No further locking is required, although the user still has the option of screw-tightening the tip if desired. Tips can also be easily snapped out for safer carrying in tool box, tube caddy, etc.

More information may be obtained from Wahl Clipper Corporation, Sterling, Illinois 61081.

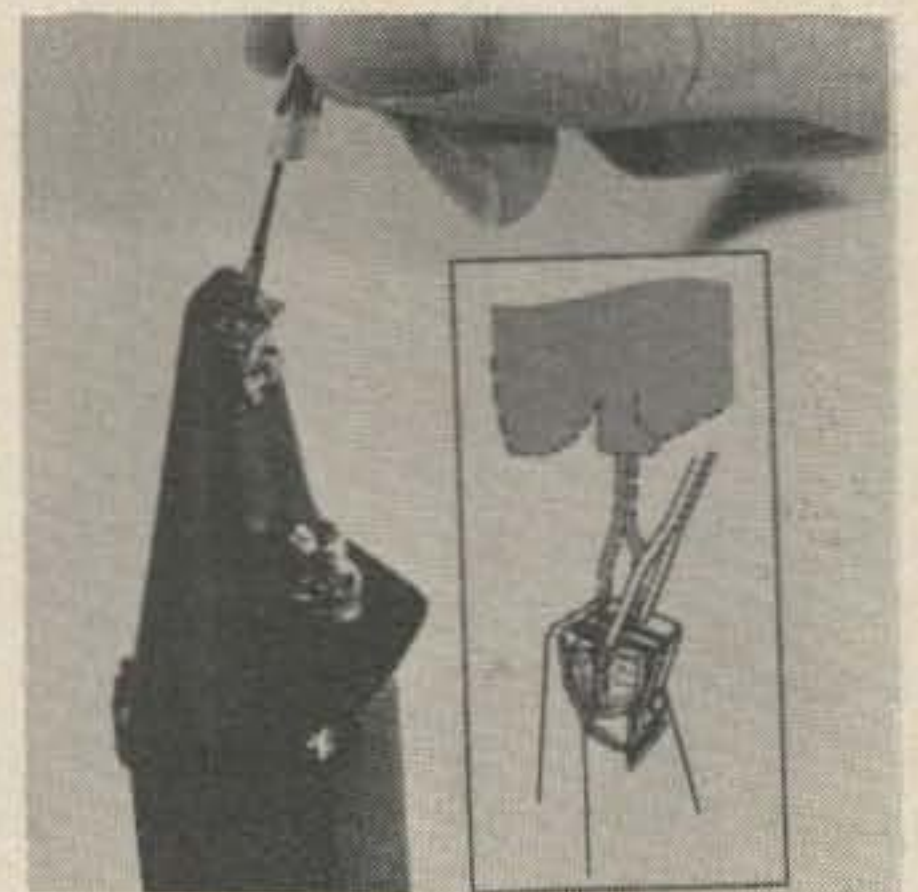

TWO METER AMPLIFIER

Specialty Communications of San Diego has announced a 2m amplifier which is designed to work both class C for FM and CW, and AB linear for SSB or AM (AM?). Model SCS-2M10-70L puts out 70W with 10 in, 50W with 5 in, and about 15W with 1.5 in (like from HTs). The price is \$120. For data write SCS, 4519 Narragansett Ave., San Diego CA 92107. In the works are a 25W amplifier, complete with battery, for HTs — a pair of 432 amplifiers which run 1W-10W and 10W-40W — 220 MHz amplifiers — and a 28/432 MHz transverter system! Watch out Oscar fans.

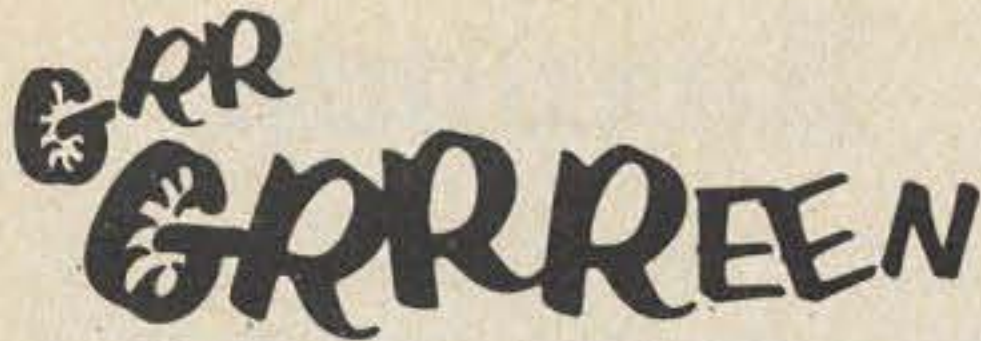

73 VS ARRL?

When 73 first started, one of the basics stated was that "we aren't mad at anyone." This is a fact today, just as it was fifteen years ago. Not being mad has not kept us from either complimenting or criticizing the League. The fact that we don't hate the ARRL does not mean that we are in love with it either . . . hopefully we have it in reasonable perspective.

The League, being made up of people, cannot be perfect — since people are never perfect. The League, in reality, is the people at HQ in Newington, for the 16 directors, who meet for a few hours once or twice a year, are effectively isolated from the running of the organization and have historically exerted little control over HQ. Their main influence could have been in the hiring and firing of people, but when there has been a change of management at HQ they have in every case promoted the next in line, regardless of his qualifications.

Since little ever appears in QST about HQ, and certainly nothing in any way critical, few members are able to have much perspective on the League. Most of the ham magazines have, through fear of the League, ignored it. The whole situation has encouraged many amateurs to build up a fantasy image of the ARRL as promoted in QST.

It is unfortunate that the League has decided to build their reputation on a mystique rather than on their accomplishments, for they have plenty to point to with pride. W1AW has helped tens of thousands of amateurs get their licenses. The ARRL traffic system is an important part of amateur radio. League contests and awards are world leaders. League comments filed with the FCC are usually very well done. ARRL publications have been a backbone of the hobby for over half a century. There are too many plus items to list . . . yet we find, despite all of this, an exceedingly thin-skinned HQ which seems to lose perspective of any criticism.

Many amateurs are upset over the lack of elections for officers of the League, feeling that the automatic

appointment system does not make for the best talent in these key jobs — which have such a profound effect on our hobby. To these complainers I would suggest that they look around and try to find a system that works better. We have had U.S. presidents elected by the people, yet see what we've had! Nixon . . . Johnson . . . ! Do we have any evidence that general elections bring us better qualified people?

I suspect, if the 16 directors were to take their job seriously and go through a talent hunt for the best man they could find as manager of the ARRL, that amateur radio might become a hobby to be reckoned with. I think we would not only grow, but would do it without having to prostitute our entry requirements with a no-code ticket. I think we would be growing, filling up our many unused bands, and even getting more bands to work with.

A really good business manager running the League would modernize the publications, set up a national PR program, have a strong lobby in Washington, revamp the ARRL investments so they would stop losing money (they have over \$1 million salted away in savings accounts and securities) and galvanize the thousands of ham clubs into programs for growth of the hobby.

Think about it for a moment — please — do you really think that it is the amateur rules that have failed us and resulted in the lack of growth of the hobby? Do you really believe that changing the rules to make it easier to get a ham ticket is the answer? Or do you suspect, as I do, that we would have plenty of growth if we had an organization enthusiastically encouraging clubs to get out there and get more hams?

One aspect of ARRL that has not worked out too well is the system of carrying news from the members to HQ via the directors. The more usual

BIG REWARD

The big companies in amateur radio today were, for the most part, started by one or two amateurs . . . and many grew very rapidly as a result of the low ad rates in 73 and the wide circulation among active (buying) hams. We'll give you 10% of the first ad run by a new company if you let us know about them and they advertise first in 73. Do yourself and the new firm a big favor — drop a note to 73 Advertising, Peterborough NH 03458.

arrangement has been the reverse, which has been the result of the lack of communications between HQ and the directors. The few hours a year they have at directors meetings just aren't enough for meaningful contact with HQ . . . so directors find that they get form letters from HQ and pass along the material to their clubs, rather than getting input from members and passing it along to HQ.

Let me state once more — 73 is not anti-ARRL — I do not hate the ARRL (nor do I love it). I've been a member for 37 years, with a possible interruption of a few months during WWII when I was beyond the post office while on war patrol in a submarine. Having been an editor and publisher in the ham field for about 25 years, and having been pretty much on the inside during most of those years where I knew what was really going on, not just the scenario (to use Nixon's terms), I probably have fewer illusions than most amateurs about the League, the FCC and amateur radio in general.

Though I've tried to keep from venting my ingrained sarcasm at some of the things HQ has done, I haven't always succeeded. This has angered many ARRL lovers, which is too bad. Communications break down under these circumstances and nothing is gained.

I do believe that the hobby of amateur radio will be healthiest if all of us keep after the League to be positive — to do the best it can — and let HQ people know that we all do care what they do in Newington. I think that national politics has made it clear that if we don't exercise our right to have our say that we will lose it. If we don't all keep pressure on the fellows at HQ to do our bidding, they will be all too human and bow to the pressures they do feel . . . which may not be just what we want. It takes a lot of voices to outshout a manufacturer who is donating \$25,000 to the League in return for something he wants . . . and this does happen.

When you hear people putting the League down, pin them down and try to find out exactly why . . . if they can explain it. When you hear people praising the League to the sky, find out about that, too. Let's aim toward being realistic about the ARRL . . . about the FCC . . . and even about 73. You need not be realistic about our very good friends down at CQ magazine, if you don't want to. Hi.

. . . Wayne

Noxpoop

Here are some comments received recently in the mail... Would like to see a Novice column, you would sell a few more magazines — K7GHZ. (*Let's see a lot of smaller articles for Novices — talk with them, find out what they need to know, then write it and make your hobby pay for itself... wayne.*) Loved your article on VOM design — would like more circuits³ — more Novice antennas — keep after the IRS — WN9MXO. More on FM, mods for 2m FM gear — WB2IUD. How about more articles on RTTY? — WB6VFC. (*Yes! By all means let's have more RTTY articles.*) Wayne, for some reason, news and discussion of surplus gear fascinates many people, including myself. I'm sure someone could do a much better column than Gordon Elliot White. QST fails because it is an antique rag devoted entirely to the CW spark operator, which is the only mode they acknowledge. CQ is variable and the only time we hear from puppet Ross is when Cowan uses him to blast Wayne again — K6BB. (*Come on you surplus fiends, modify and write... publish or perish from the evil 73-Whammy which is aimed at all surplusers who are too lazy to write and become rich and famous. CQ? So who reads Congressional Quarterly?... wayne.*) Best ham magazine in the world — WA5TDF. (*Perceptive chap.*) More devices for around the shack, humor, 2m articles, antennas, operating practices — McMichael. How about a 5 kW linear for CB that can be pulsed to 50 kW so

Noxpoop

those XXX's can wipe each other out? And try to find part time jobs for FCCers who are thinking up new ways to put hams out of business — KL7HKQ. More SSTV and RTTY — WB9FLM. How about a technical staff to check accuracy of construction articles, schematics, etc.? You have the best ham publication on the market — W9BLR. (*You looking for work?*) Keep up the flow of construction projects and your circulation will soon surpass QST — W4GBG. (*That's a deal!*) Very, very good... but more, MORE, M-O-R-E! Down with the other ham magazines — WB5FWE. (*Here, here!*) Generally great mag! — WB9ICR. (*Whaddya mean generally?*) Keep magazine as it is, leave the operating news to others, let them waste space — W0DL. (*Okay, you're probably right, Harry.*) Let's push 220 MHz, and give us some far out articles such as on gravity... look forward to the magazine every month — WB2IUT. (*Gravity? What's that?*) More technical articles on VHF and UHF — WB2YLI. More ads from dealers in used gear. With few in Texas and none in San Antonio, I depend on you for used gear info — Jarvis. (*How about it, dealers?*) More articles on log periodics for 2m, FM and the TV bands — LA1FP. (*Your March issue should have gotten to Norway by now — and we still have a lot more antenna articles up our sleeve!*) Liked everything in March, especially Ancient Aviator. Real good idea to have a good hard shot at antennas. How

Noxpoop

about power supplies next? — WN7AVK. (*We're working on it, Tom.*) Would like to see the following articles: 1) Simple self-calibrating deviation monitor for 2m FM; 2) How to make antenna field strength pattern measurements at 2m; 3) More electronics crossword puzzles, quizzes, and cartoons; 4) Tuning up, padding and improving various rigs like Motorola 41V, 43, GE TPL, etc.; 5) Mobile aids for keeping the old car running a little longer — troubleshooting — tune-ups — using the average ham's test equipment for special purposes; 6) A cross reference between magazines, such as for articles appearing in Electronics, Popular Electronics, etc.; 7) Touch-tone usage relative to sequential logic circuits to provide various control outputs as long as proper sequence is fed in; 8) How to build a capacitive and/or inductive broadband rf sniffer with preamp; 9) A good battery powered VHF grid dip meter with a remote small sensing head able to get into small places, possibly using a varicap in the sensing head and a remote meter, battery and pot for adjusting frequency; 10) An assist to get ideas flowing, in the form of an outline showing antennas, xmtrs, rcvrs, SSTV, etc., as major topics, along with a list of minor sub-topics, to see where you can make a contribution of an article to an area perhaps you hadn't thought of. Great magazine — keep up the good work — W4UXJ.

NEW PRODUCTS



New "Thermal Spot" Locates Circuit Faults, Serves As Heat Gun

Wahl is introducing its Thermal Spot Tester as a new type of electronic circuit fault detection method. The Thermal Spot is a small blower heater with an extension tube. Providing 260° F directed at a single spot, it heats up individual capacitors and transistors to find malfunctions that only appear when circuits are warmed. Wahl claims the Thermal Spot is faster, safer, more convenient and more economical than the opposite method of warming up the entire set and chilling individual components.

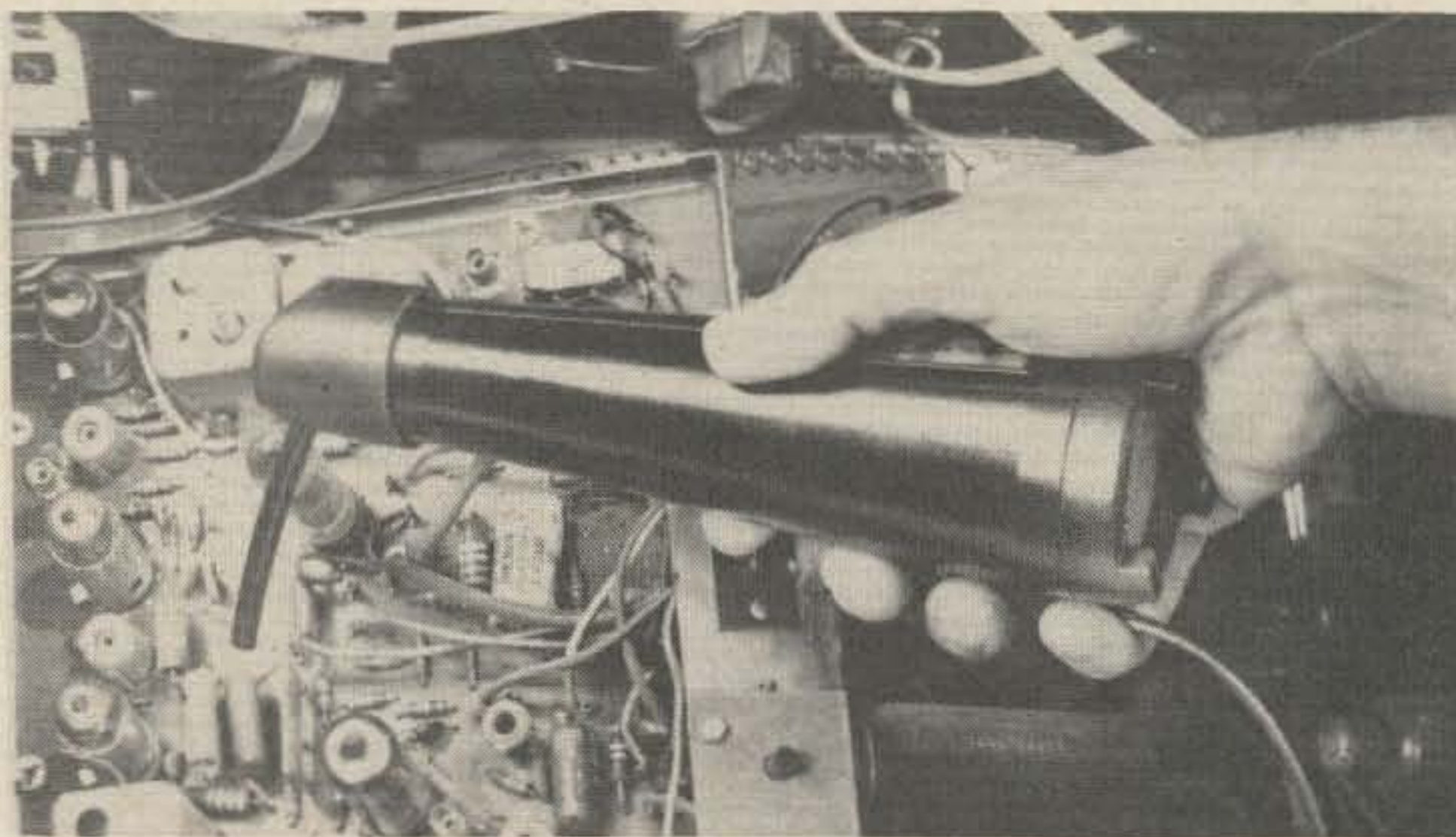

The Thermal Spot has other uses, too, says Wahl. With or without the concentrator nozzle tube, it can dry epoxies or tuners and other components after cleaning. It can be

generally useful anywhere a heated air stream is needed.

For more information, write Wahl Clipper Corporation, Sterling IL 61081.

32 GOOD REASONS FOR ADVERTISING IN 73

1. The readers of 73 are a livewire bunch — they love to build (you've no doubt noticed that 73 carries more parts advertising than any other electronics magazine — more than all other ham magazines combined — and that's for just one reason: 73 readers buy), so your ad here will bring results if you make or sell parts . . . any parts.
2. Surplus? Wow! Do 73 readers grab that up — John Meshna will deny it because he doesn't want anyone else to know what a good thing ads in 73 are, but the fact is that 80% of the 73 readers claim they bought some surplus last year — and no other magazine can come close to that.
3. 73, the FM magazine, right? Baloney! Oh, FM ads in 73 sell better than they do any place else, but the fact is that we run a lot fewer FM articles than we should when you consider that one half of the active amateurs are presently active on two meter FM. In March we ran a total of zero pages of FM or 2m articles — that was the big antenna issue. In the April FM Annual we cheated and ran 31 pages on non-VHF articles (to 39 pages of VHF articles). In May there were only 22 pages of VHF articles — that's 5 FM articles to 18 non-FM. Maybe we'd better get cracking on more FM stuff if we're going to continue to be the biggest mover of FM gear in our ads.
4. Slow scan — RTTY — ATV — you name it and 73 has run more articles and more state of the art stuff than the other ham magazines — so where do you go fishing, in a bucket or a fish pond? We honestly shake our heads in despair when we see manufacturers throwing money away like drunken sailors with ads in magazines that just can't do them any good. SSTVers read the magazine that runs the most stuff for them . . . 73. Ditto TTers, and the rest. The fact is that 73 covers every phase of amateur radio — low bands — 160 meters — DXing and DXpeditions — and on down the line. We admit there isn't much on certificates and contests — you have to turn to CQ for those. The construction projects for the engineers, they're in HR, and operating news you can get in QST.
5. Such a big magazine every month and so many readers — it must cost fantastically to advertise! Well, it isn't cheap, but you can spend a whole lot more elsewhere and not get as good response. Remember that the bottom line is sales, not controversy or lack of controversy — not supporting a club — or helping the downtrodden — charity begins at home and you want to make your business grow. 73 has a long history of going out of the way to help new firms — consulting on products, prices, marketing and advertising — 73 does ad agency work to help small companies get started — give us a call.
6. Do you do better to spread your money around among the ham magazines, making sure you reach as many amateurs as possible, or do you do better to run your ads in one magazine and run bigger ads? The fact is that by the time you've advertised in 73 you have reached over half of the active hams — and if you add QST to that you've covered about 80% of the active hams. This means that you pay through the nose for those last few — about 10% don't read any magazine at all! What a waste of money trying to reach the handful that don't read either 73 or QST!
7. If 73 does so well for advertisers, how come some of the big companies are not advertising in 73? Only big companies can afford the loss of hundreds of thousands of dollars of sales that they lose by not advertising in 73. The fact seems to be that Wayne Green has made them mad — said something about their products — written something controversial — run a disgusting naked man streaker on the cover — etc. Even Wayne doesn't claim to be right every time — but he does make people think, and who else in the ham field can boast that? Wayne is ever the devil's advocate — and he is worse on his friends than his enemies, for he fires them with enthusiasm for things and changes their lives — a talk with Wayne can be an experience. Wayne, by the way, is very proud of the enemies of which he is aware and wouldn't have them otherwise. There are good guys in this world and there are bad guys — the good ones are enthusiastic and trying to move things ahead a bit — the bad ones are trying to get everything they can for themselves and doing everything in their power to stop anyone else from gaining.
8. 73 Magazine must be making an incredible profit, right? Yes, it is incredible. We haven't the figures for 1974 yet, but for the four preceding years, 73 managed to come out in the red from a little to a whole lot. Actually, 73 does not have this down to the perfection of QST, which has managed to be in the red for years and still put away over a million dollars in stock and bank accounts. Amateurs who believe that it is rotten to make a profit from ham radio should be justifiably proud of both 73 and QST.
9. We're out of room, but not out of reasons.

*Send for advertising rates and be **ASTOUNDED!***

73 Magazine, Peterborough NH 03458. Phone: (603) 924-3873.

LET'S GET GOING

In many of the ham publications, including 73 and QST, we're seeing advertisements on minicomputers and associated hardware but I have not seen any articles, except for a recent one in Popular Electronics, on the subject.

Imagine, if you will, the applications that amateurs can put these units to. How about a system that will monitor all aspects of a repeater station and, if something goes haywire, transmit a recorded message on a discrete frequency regarding the particular problem? Similarly, what about data link-ups with the Oscar satellite? The possibilities are endless!

I understand that the state of the art is such that alphanumeric readout (common letters and numbers) is possible. If we can be inventive with SSTV and transmit data signals around the world, this should be within the realm of reason. Here's an area when the "home brewers" can really shine! The industry is young and the talent within ham circles (remember we already have one who just won a Nobel Prize!) can put Bell Laboratories to shame!

I would sure like to hear from any hams working on this already (now why the devil haven't you spoken up before?) and ones who'd like to. Wayne, we can probably get a column going on the activities across the country (and world) and the new field means more advertisers for hamdom (and, therefore, more popularity, bigger issues, etc.). Come on, fellows, let me hear from you and let's get something going on this.

Richard M. Bash WB9EUV
Fairbanks AK

GOODER GOODIES

First — my Voxpop vote goes to the Ancrona Corporation ad on page 141 of the December issue. I've been scouring the ads for 2N3053, 2N5323 and other transistors — now only to figure out how to divide it up for \$10 worth.

Next — I have no problems with a code free license class despite the fact that 90% of my operating is currently on CW. I think that code free licenses in certain VHF bands would be great with reduced requirement for HF. Even though I've had my Extra for

awhile before "incentive" licensing, I would vote to give back the bottom 25 kHz frequencies and extend extra phone privileges a bit. The reason I operate CW is that I like QRM free QSOs, don't like roundtables and enjoy the "skill" factor. From experience it *is cheaper* to build CW gear from scratch than SSB gear, so I would like to see it maintained as a way of promoting technical competence — but see no reason why it is needed as an *entry* to amateur radio.

Last — how do you find advertisers with more and different goodies than QST or HR? I find that designing and building gear provides a similar function to CW — people should do it because they want to, because they enjoy it, because they get a kick out of it — not because they have to. Also, like CW, I would think it a great loss if we did not have the option to do it so keep finding advertisers that sell parts and I'll keep buying.

Bill Farone
Teaneck NJ

BRILLIANT IDEA

This is just a quick note of appreciation. Being a new XYL had its more difficult moments especially when it came to Christmas presents for my OM. However, I must give you and your magazine credit for a brilliant idea. I got him one of the package deals on back issues. What a hit! (Of course, I can't remember what his face looks like, but I sure am glad you have interesting covers as I am always staring at the back of one.)

Thanks again for a great gift idea.

Evelyn Cronyn
XYL of WA1UIG

PUTTING UP WITH GREEN

I can continue to put up with Wayne Green for the rest of my life and his, if you will continue to publish articles of the quality of "The Mystery of Antenna Radiation" in the March 1975 issue.

Dr. Young VE3DDS is in the class of Dr. Peter Paul Kellogg who taught this dumb Ham about Radar at Bell labs in the beginning of WW2. Kellogg taught me to use Time Constant, and Young, with his most clear instructive style of writing, has me seeking after light again in the right way.

My radios and cameras keep me young. I have all the law allows in power on most all bands, thus my

interest has been antennas for a long period of time. My antenna farm will soon have some new ideas for radiators installed.

My thanks to Dr. Young for the time he spent writing the article and to you for publishing it.

Phil A. McMasters W4BCZ
QCWA, OOTC

SM#EEE, Past Chairman IRE, S.C. Section
Senior Engineer, Western Electric (RET)
Consultant, Fred A. Smith, P.E. Charleston, S.C.

HELP!

I am writing on behalf of a cerebral palsy victim, a 17 year old boy, who is interested in amateur radio. The boy is totally incapacitated as regards use of his limbs, but he has some movement of head, neck and facial muscles.

I appeal to any and all hams who have worked with similarly handicapped persons to advise us of problems they have encountered and solved.

I understand that various special controls and harnesses have been built for other victims so that the small muscular movements possible can be applied to perform various ON/OFF and adjustment functions. The Morse code has been sent by either muscular movements or by breath sounds.

May we see someone's designs (or be told) of how best to accomplish these things? We will be very grateful. Please send information to:

Mr. Al Ross, Media Department,
Child Development and Mental
Retardation Center, University of
Washington, Seattle, Washington
98105, Phone: (206) 543-4011, ext.
77.

Al Ross
Seattle WA

THEY'RE GREAT

Just wanted to let you know how much I think of your CW tapes. I got my Novice and Tech license at the same time in 1966. The Novice ran out in a year and I was still stuck at the 10 word plateau. I've been a Tech ever since.

Last spring I ordered your 14 wpm tape and after copying it for a month, ½ to 1 hour almost every day, I took my general and passed. Three months later, I passed my Advanced. Just can't recommend your tapes too highly. They're great!

Bob Hileman WA8SSM
Weirton WV

Continued on page 173



DEAR GABBY

Dear Gabby:

From reading your column for years I know how often you have found answers for people who didn't know which way to turn, and I hope you can help me with a terrible personal problem. I don't mean give me one, either. Sometimes you like to smart off I've noticed. Anyway, I was ashamed to ask about this before but now it's the style to let it all hang out. We all have troubles. Besides, it's this dummy I'm married to that needs the help.

My husband, so-called, is a ham radio operator. At least that's what he says he is, and how would I know? I don't suppose you ever heard of them but I'll give you an idea of what it's like living with one.

It's only exaggerating a little bit to say our marriage has consisted of a series of brief encounters at the dinner table. Since we were married twelve years ago John has spent eleven plus talking to little boxes in the basement. Sometimes this goes on all night and then he says it was a contest. What kind of contest do you have alone in a basement? He gets his own breakfast before I get up, and after he comes back from work he doesn't come upstairs until dinnertime. His end of the conversation at the table is a thrilling hello like you give someone you aren't sure you know. In minutes he's off again, carrying his dessert and coffee. I remember trying candles and a centerpiece of roses — the response was a fit of sneezing and a prompt check of the lighting fuses. When I invited my brother and his wife to dinner John's routine didn't change except he left a fifty cent tip on the table. I guess he did notice we weren't alone and thought he must be in a restaurant.

For some reason the roof of our house is

tied with wires to a lot of trees. When I asked about this John said it was some kind of earthquake protection, but he told the neighbors it was to keep lightning from striking anywhere on the block. On a pole in the backyard he put up a TV antenna so big you wouldn't believe it, saying it would give us a better picture, and now Lawrence Welk comes in on the bias and all wiggly.

Have you heard of lightning rods on cars? Ours has two of them — a little one on the roof and a big one on the rear bumper. More of those little boxes under the dash and cables everywhere. I've snagged my hose and caught my heels so many times I sit in back now. While he's driving John constantly punches buttons and talks into a funny telephone. He never uses the telephone at home and I've never heard of a car being hit by lightning. What's going on?

I asked my mother for advice and that was a mistake. I remember just what she said: "Oh, sure. We had some weirdo neighbors like that. They're called Citizen Band operators. Forget it, honey. It's kid stuff they grow out of." That night I asked John if he was one and just never wanted to tell me. He only gritted his teeth and went downstairs to his wires and boxes. He even forgot to take his coffee. In a few minutes he was back gritting his teeth at me again. This time they were in his hand. Then he flounced out, slamming the door, and spent the night down there. Having another contest, I suppose. Thanks a lot, MAMA.

A week ago a friend asked if I would have her doctor talk to John and I agreed. When he arrived last night we could hear the usual racket from the basement and the doctor hurried down there before I could explain all this funny business to him. In minutes he popped back up, shouted "Ten is wide open!" and laid a nice patch of rubber getting out of our driveway. Dear Gabby, can you help me?

Exasperated.

Dear Exasperated:

What you told me indicates that your husband does indeed have a problem. Ten hasn't been wide open for a long, long time and I think you'd be smart to try a different doctor.

73, Gabby

ONE LICENSE?

Just a short note to congratulate you on your editorial in the April, 1975, 73 Magazine, on Docket 20282. I agree with you on almost every point. I hope the staff of the ARRL and FCC read this excellent editorial. I received my first license in 1924 and it seems to me that one ordinary license (possibly except for Novices and Conditionals) should take care of all amateur needs.

Lewis S. Lamar
Weston MO 64098

MA BELL

I'm remaining anonymous to avoid a possible confrontation with the Bell System.

Hooking up stuff to Bell's lines is like fighting a war — you often can make only one mistake. I am among the few in this affluent (or effluent) land with a two-party line. I am also the "second party" thereon. Which

SWIVETEK DUPLEXERS

The Swivetek duplexer has been designed to be a low cost, rugged, highly reliable device for use in communications services. The construction of each individual cavity has been designed for accurate and repeatable performance. Cavity sections are made from seamless aluminum alloy tube that is TIG welded to base and top plates. All internal conductor pieces have been highly cleaned and silver-plated for low loss. These in turn are mounted in the cavity with adjustable silver-plated brass bullets, allowing variable position for the control of insertion loss.

Anti-resonant elements are made using strip-line techniques for low insertion loss. High Q air dielectric capacitors are also used. Individual cavities for the 2 meter band have a typical range of 135-175 MHz and by the appropriate anti-resonant element, can be made into high pass or low pass cavities. Inter-connecting cables supplied with all Swivetek duplexers are made of RG-223 cable.

The 6 cavity 2 meter duplexer has been tested and evaluated at 250 Watts rf power. Typical stop-band rejection for high pass and low pass sections is greater than 105 dB, with

means that the ringer is connected:

Wire on Ringer	Terminal on Network
	W.E. 500 Set
Red	B
Red-Slate	G
Slate	K
Black	B

Now, it has been a well-observed practice simply to get rid of the ringer to avoid detection when you "boot-leg" in an extension. However, in this case, removing the ringer also removes a path to ground which signals the exchange that the "second party" is offhook and that calls should be billed to the second party. Remove the ringer, and the "first party" gets billed for all your direct-dialed calls made from that phone!

So, leave the ringer in but move the Slate wire from network terminal K to G, and be sure that the yellow ground wire is carried to the extension. Now the ringer is "gone" when you're on hook, and its high-resistance winding provides the "leak" to ground to trip the billing circuit properly. Needless to say, if you don't take this precaution, a very mad "first party" will

start complaining, a truck with a bell on the side will pull up at your house, and you may get stuck with a toll fraud suit.

If you're "brewing" a patch or other device, do it this way:

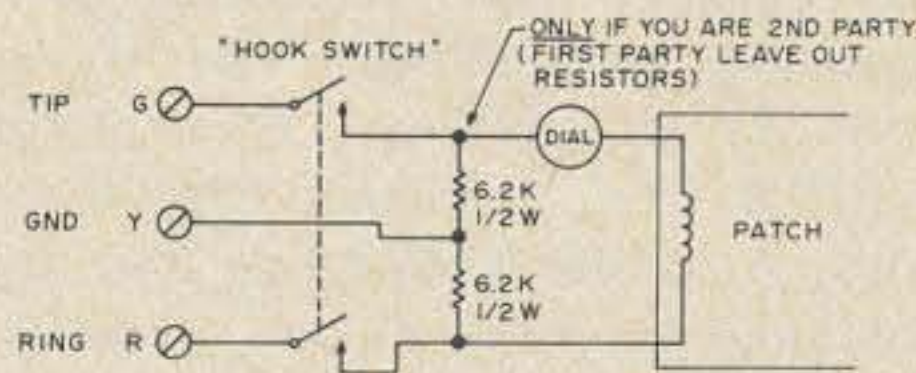

(Name and address withheld)

REDHEADS

In response to writer Jules W3YZE's observation, "... the best one I ever heard was Keeper To Her Majesty's Jewels":

My phonetics may not be better, but, for the rest of my life, I will be Kissing Two Heavenly, Cute Red-heads.

Andy Zum K2HCR

Continued on page 174

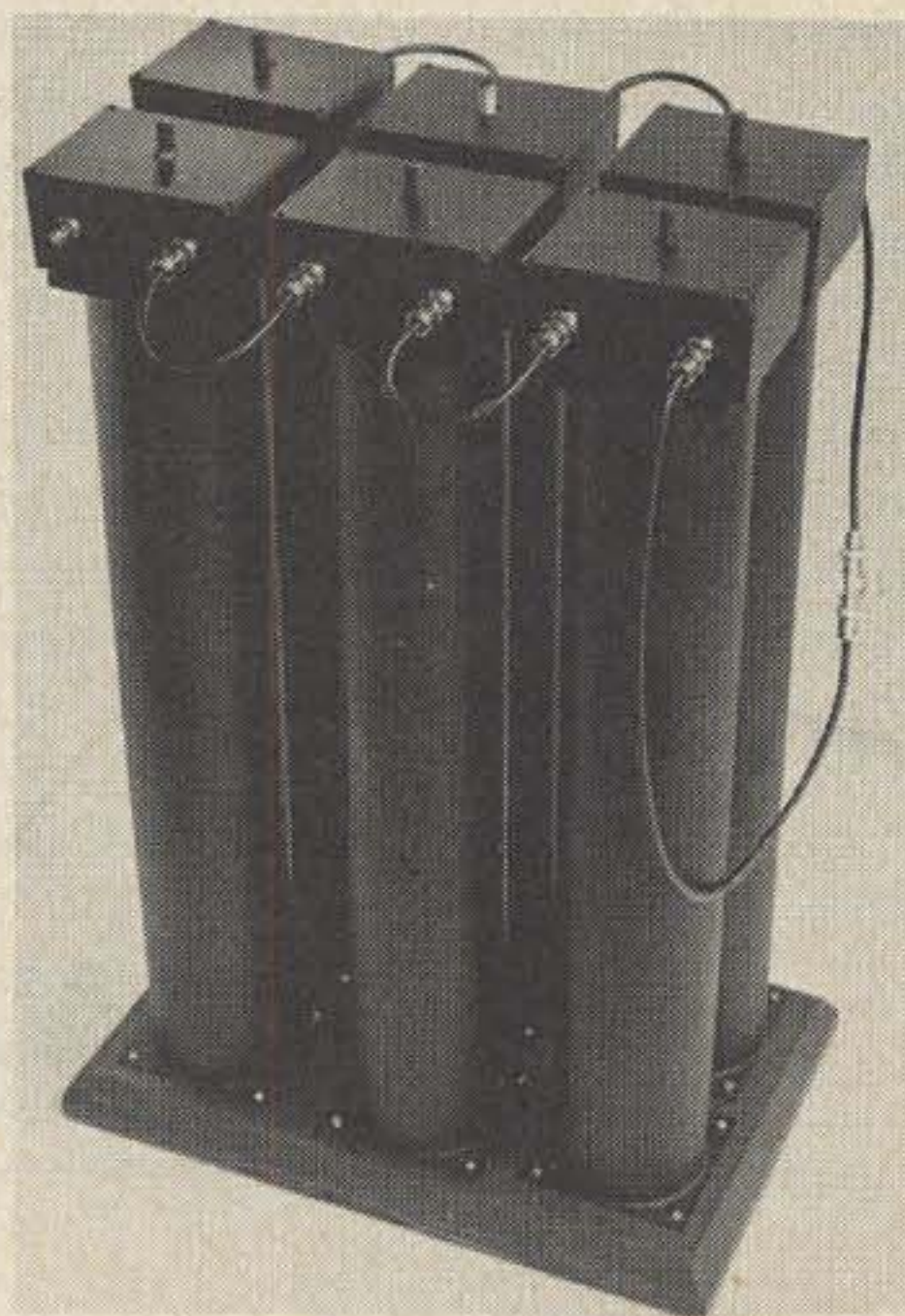

overall insertion loss less than 1.5 dB typical. These cavities are mounted on a wooden base to provide ground isolation. The split is pre-tuned at the factory for 600 kHz, unless otherwise ordered. Precision tuning service is available for \$35.00. Complete instructions are included with every Swivetek duplexer. Swivetek single element and dual element suck-out cavities also are available from Swivetek, 544 Lassen St., Los Altos CA 94022.

ASCOM VHF TEST METER

A new multi-tester designed for use in testing and monitoring VHF communications systems has been announced by Ascom Electronic Products, a division of The Antenna Specialists Company. The unit, Model ASMR100, checks both transmitter and antenna operation over a frequency range of 144 to 174 MHz. This range includes the entire 2 meter amateur band.

Featured on the new ASMR100 tester is a dual range wattmeter function, 0-25 and 0-50 Watts. Transmitter output is indicated directly in Watts on either scale with ±8% accuracy.

The price of the Ascom ASMR100 multi-tester is \$69.95. Details are available from Ascom dealers or by writing directly to Ascom Electronic Products, 12435 Euclid Avenue, Cleveland OH 44106.



FAX PAPER

I was able to obtain some Western Union telefax equipment at last year's Dayton Hamvention. However I have been unable to get any information on this equipment (no schematics or even operating instructions). The equipment is as follows: Preamplifier #6575-B, Mfd. by Marcon Electronics Corp; Amplifier #5621.1-A, Mfd. by Columbus Electronics Corp., Yonkers, New York; Telefax Recorder #5616-7-A, Mfd. by The Seeburg Corp; Regulator Inverter #6574-C, Mfd. by Marcon Electronics Corp; and Telefax Transmitter #5617.2-A, Mfd. by J. P. Seeburg Corp.

I also have the desk fax unit and plan to build K7QXL's converter in the January issue of 73. Does anyone know where I can get the fax paper for the desk fax? I have the fax paper for the units listed above, and I'm sure that if I could get the main station above operating, I would have a terrific fax station. Any help that readers can give will be appreciated. I am also going to write to Western Union to see if they have anything on the units.

Jeffrey White
Albany Road Box 142
Athens OH 45701

CLASSES GROWING

Thanks to your recent comments, I have been sparked into starting up the school radio club which until now was made up of only two amateurs.

At present, two persons have taken the Novice test and the code and theory classes are growing larger. (75% are CBers!)

Thanks to you, and my advisor, Ted Johnson WA1KJI, I sincerely doubt if this would have even made it off the ground.

Keep up the good work and maybe soon I'll even get on 2 meters and have a rag chew with you!

Mike Taylor WN1TBV, WA1CCH
Mount Anthony Radio Club
Bennington VT

ULTIMATE PORTABLE

How often have you missed an important sked, failed to check into your favorite SSB net, or, for any number of other reasons, been unable to get on the air because you had to

leave the shack to go into town or to do something else?

My ultimate portable lets me have the facilities of a 1 kW transceiver almost anytime or any place without hauling a truckload of antennas and equipment around. Even while at work I can contact others during my coffee break.

Actually all I do is pick up any telephone and call the private line in my shack at home. When the phone rings, a relay connects the phone line to my phone patch and the rig is left on VOX.

When I hang up the phone, the relay disconnects the phone patch and everything is restored to normal.

I'm sure you can see the possibilities of this system. It turns any telephone booth into an instant ham shack. A small battery operated tone encoder (Egbert Electronics' "Select Call") satisfies the requirement of maintaining control over my transmitter.

Try it, you'll like it.

RJ Bareham VE1AFM
Hubbards NS

MISSILE TUBES?

I just received your February issue and read the comment on page 160 on transistors in nuclear blasts. Being a physics major, I've inquired about this and it seems tubes would be great in a situation like this when used in defensive or offensive missiles.

How do they cut down the power requirements? From what I could gather a radioactive filament is used needing no current. I was wondering if any readers know more about this. I can't seem to get any information on it. Seems this could be a tube come back.

T. Mohr
1513 Tracy
Green Bay WI 54304

ENJOYABLE

I would like to thank you and your staff for a very fine and informative magazine. I particularly enjoyed in the past two issues the articles about the proposed rule changes in the entrance into Amateur Radio for those who at this time do not particularly relish the prospect of going through the hassle of learning code and also going through the General Class Theory just to be able to work on 2 meter FM. This is especially enjoyable to me

because I am a member of the American Red Cross Disaster Services in Huntsville, Alabama, and the local radio club — Huntsville Amateur Radio Club — has a base station here at the Red Cross Chapter House. This would allow me to assist more with the exchange of information from the National Weather Service and the Civil Defense stations that are operated during severe weather and tornado watches.

Ralph A. Brigham
Huntsville AL

POWER DENSITY

I read the article on antenna gain by Pete Stark in your March issue with great interest. Even though we are going metric, the formula for power density can be worked out in miles very simply. As a matter of fact, the power density will immediately be expressed in microwatts per square meter.

The "new" formula is:

$$P = \frac{.3861 Pt}{4 \pi r^2}$$

where "P" is in microwatts per square meter and "r" is in miles.

Using the example in the text, a 1000 meter radius sphere is approximately .62 miles. Plugging into the above formula we get:

$$P = \frac{.3861 Pt}{4 \pi r^2} =$$

$$\frac{38.61}{4.8305} = 7.99 \text{ microwatts per square meter.}$$

For myself this means my QRP rig with a Watt and a half input is pumping all of about 3 picowatts per square meter into Milwaukee, Wisconsin from my QTH.

Thanks for such an interesting article and keep up the good work.

John A. Czupowski WN9OTE
Cicero IL

HOTLINE NETS

Your suggestions in 73 Magazine and in the Hotline newsletter for the organization of more technical and theory nets is excellent.

Would it be possible for 73 Magazine to gather together and publish occasionally a listing of the technical and theory nets with day, time and frequency of operation? This could be very useful information.

Robert E. Becker
Kent, Washington

Splendid idea — all scheds will be listed in Hotline — please send a card giving days, time and frequency of all theory and code practice scheds... Wayne.

CIRCUITS, CIRCUITS, CIRCUITS.

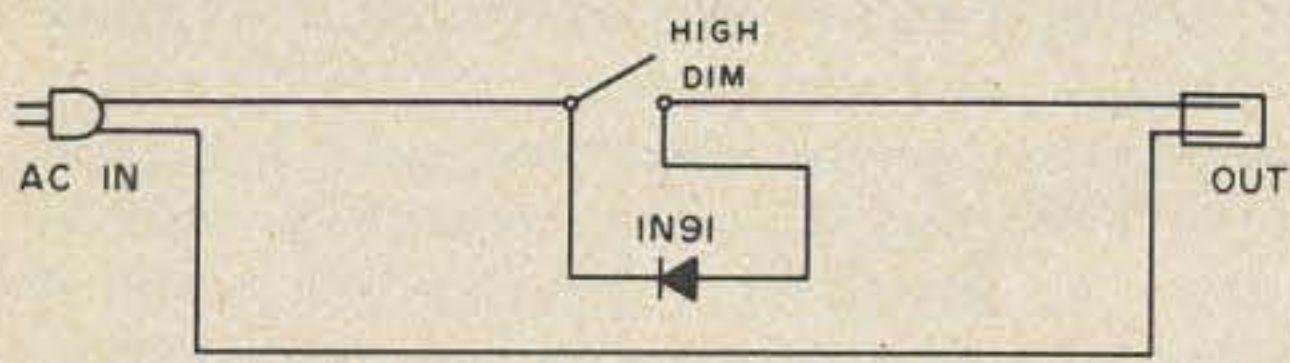

Cheap light dimmer. The diode is a 200PIV 1A. In series it changes the line voltage from

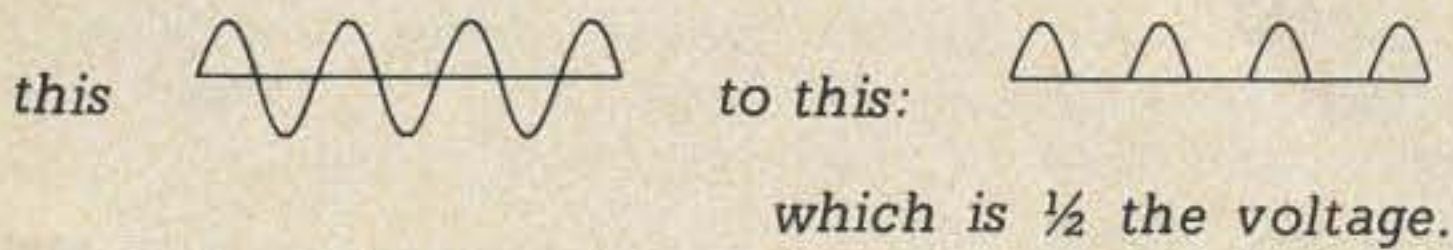

Use this circuit on lights, motors, etc. Using it with a 3-way lamp will give you a 6-way lamp. — WA3SWS

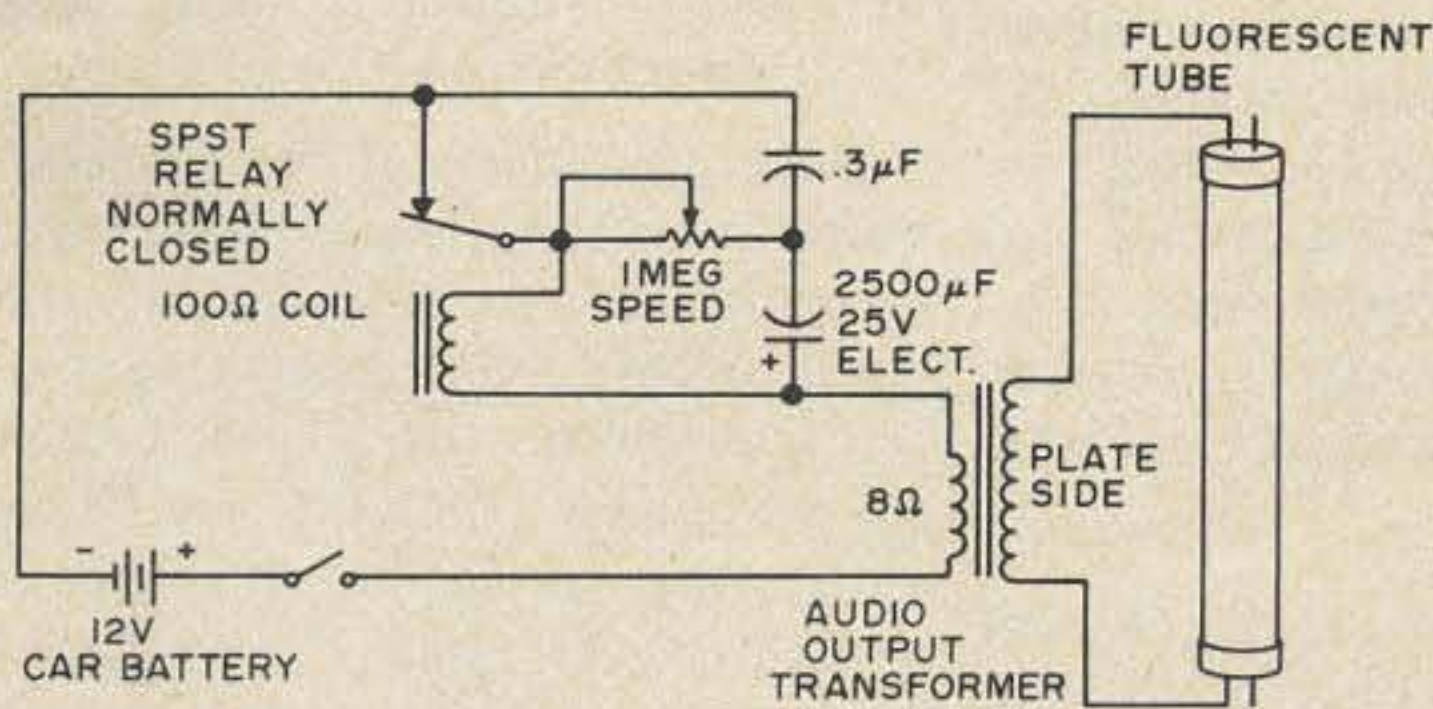

Really great car emergency flasher. This is really bright! Relay is mechanical dc to ac converter. Each time it opens up the inductive kick is stepped up in the output transformer and ionizes the tube. — WA3SWS

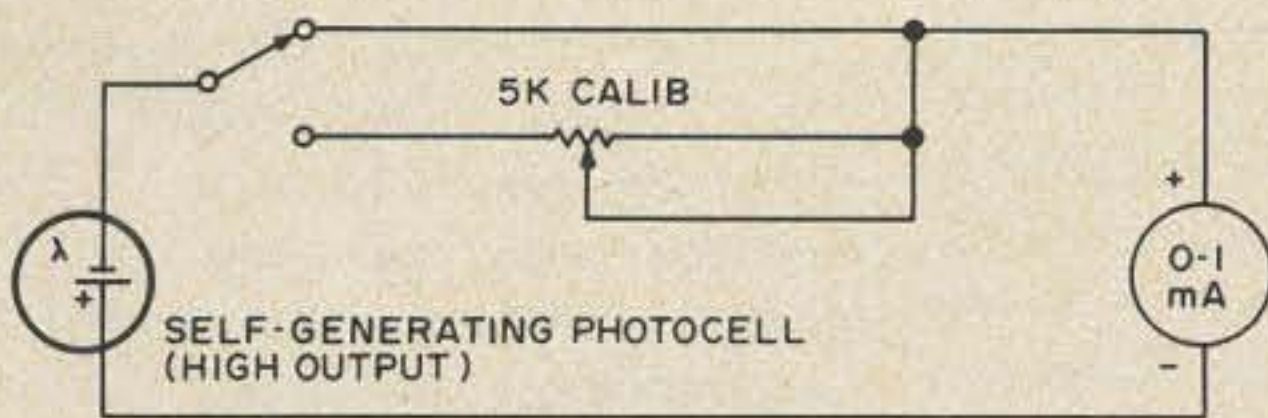

Light meter for ATV fans — WA3SWS

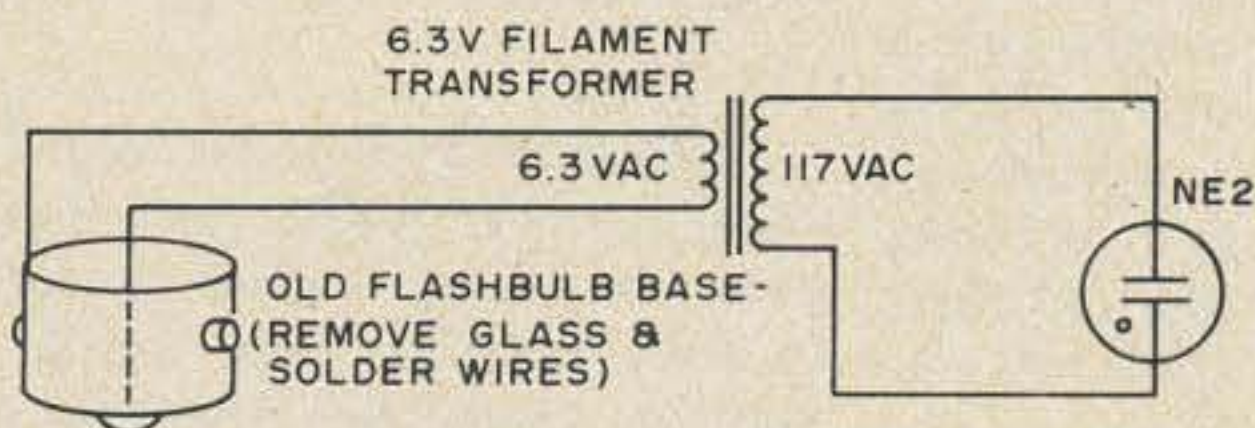

Flashgun tester. Plug base of old bulb into flashgun. If neon light flashes, flashbulb will too. — WA3SWS

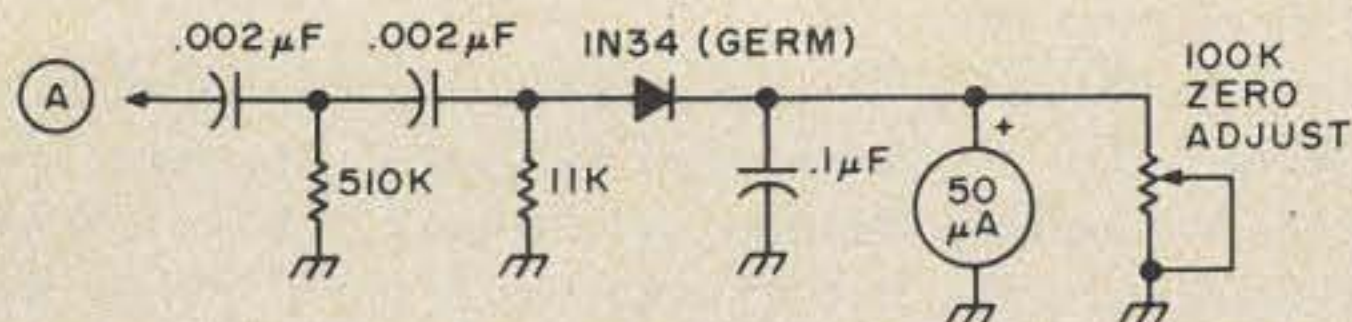

S-Meter for Regency HR-2 series. "A" goes to emitter load resistor of detector. — WA3SWS

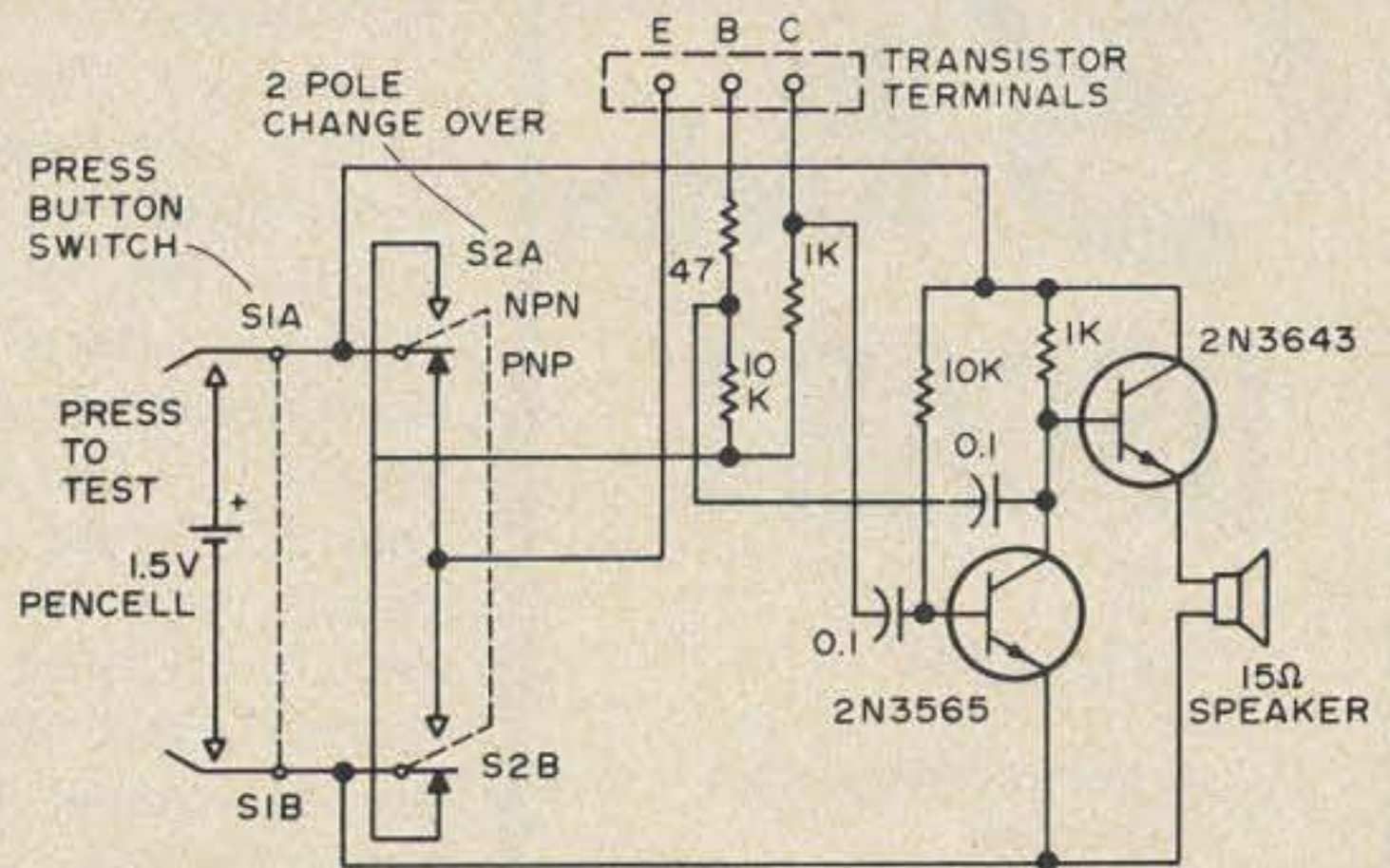

Transistor tester for all types of bipolar transistors, both small signal and power, silicon or germanium. Tone of about 1 kHz when transistor is good. AA battery will last about two years. Thanks VK5GV — and a SSTV book for your effort is on its way.

want some? quality - value integrity - variety fast ppd delivery

try **TRI-TEK, inc.** 10¢ Stamp for Latest Flyers Full of New and Surplus Electronics Bargains

P. O. Box 14206 • PHOENIX, ARIZONA 85063

MINIATURE SUB-AUDIBLE TONE ENCODER



- Compatible with all sub-audible tone systems such as Private Line, Channel Guard, Quiet Channel, etc.
- Glass Epoxy PCB, silicon transistors, and tantalum electrolytics used throughout
- Any miniature dual coil contactless reed may be used (Motorola TLN6824A, TLN6709B — Bramco RF-20)
- Powered by 12vdc @3ma
- Use on any tone frequency 67Hz to 250Hz
- Miniature in size 2.5x.75x1.5" high
- Wired and tested \$14.95
- Complete less reed (Available in 33 freqs. for \$17.50 ea)
- Output 3v RMS sinewave, low distortion
- Postpaid — Calif. residents add 5% sales tax

COMMUNICATIONS SPECIALISTS

P.O. Box 153, Brea CA 92621

18" FACSIMILE RECORDERS FOR SALE

The leading manufacturer of 18" facsimile weather chart recorders is now updating an existing network to solid state equipment. This updating is making available a number of 18" weather map recorders ideally suited for anyone interested in experimenting with facsimile.

These recorders, with suitable receiver and FSK converter, can be used to monitor radio weather chart broadcasts as well as press wire photo transmissions. With some modifications, data from weather satellites can also be received.

These recorders are reasonably priced and available on a first come, first served basis.

Call or write Mr. Armand D. Bouchard:

ALDEN ELECTRONICS & IMPULSE RECORDING EQUIPMENT CO., INC.
Washington Street, Westboro MA 01581
617/366-8851

73 in the works

OSCAR!

The Satellabe

Automatic Reception Control

Oscar RTTY Terminal

Preamp for 29.5 MHz

Check Up For Oscar 7

Simplified Satellite Tracking

DXing Oscar Style

Oscar Antennas

PLUS MUCH MORE!

UP COMING



APRIL FOOLED?

Us. Through no fault of Bob Harding's, the mH's for his Torrid Toroid (page 37) turned up as MHz's. You knew what we meant.

You? Many readers (not to mention us) feel that WA0ABI may have picked up his Voltmeter Switch Quiz (page 38) from the Extraterrestrial Repeater (page 21).

Be My Guest from page 5

in the very affluent Hudson Division. Go upstate or to Appalachia and see for yourself. I've lived for several years in both Vermont and Minnesota. I know a game warden ham who earns about \$600 a month, runs a trap line on the side, and comes down to Highway Patrol Headquarters to occasionally scrounge an 807 or a resistor. Do you think he can afford that \$9? Those of you who are old enough to remember the Depression days in the "thirties" know what I am talking about. Both Harry and Stan are too young to remember those days, bad days even in the Hudson Division.

These fellows are insensitive to the economic crunch on the ham in other Divisions. And those fellows in Newington are running the ARRL like the hard-heeled businessmen they are. Stan's Fall 1974 Newsletter says, "Today it is the numbers game that counts, and brings in the dollars." (To whom?)

These fellows have lost touch with the fundamental traditions of ham radio.

Second, the desirability of the "no-code" license has been brought up before. Let me read, in part, a letter published in *QST* some years ago:

"For years there have appeared in our Correspondence columns criticisms of the trend towards manufactured apparatus, not components but read-made units for the 'amateur amateur' whose only contribution to the design of his station is the placement of it in the living room. Let us by all means take advantage fully of the splendid array of new tubes and components made available by commercial research. It is not this that spoils the amateur game; it is the availability of 'amateur' transmitters and receivers, now sold not only by the old firms from whom we have been buying parts for so long, but by others who suddenly realize the existence of a new lucrative field. Some of these jobs (not all) are well engineered units. But if the ARRL is still an amateur organization it should do something to discourage this particular type of commercial expansion. Already it is leading to agitation for the removal of code requirements for five meters; this can only be to enlarge the market for manufactured transceivers. None of us wants to kill legitimate business when

it is legitimate, but if the manufacture and sale of complete units continues at the present rate, these 'amateur amateurs' will grow in number until they can outvote the rest of us in our own organization, the ARRL. Then good-bye code test, good-bye operating efficiency, good-bye emergency organization, good-bye our spirit of research, progress and brotherhood. Ten million bored stiffes will sit in front of ten million identical rigs; 'Amateur Radio' will be a bigger business than ever before, but its soul will be dead." (G. S. Light, ex-VE3ABW, *QST*, Feb., 1939.)

These words, written way back in 1939, are still applicable today, aren't they? I asked the editor of *QST* to reprint it, back in January, and got the usual brush-off post card, "... held for possible use ..."

Those proponents of the "no-code" license, especially Harry, expect that it would open the doors for new hams, getting them started, so they can advance up the ranks to real amateur radio. Bunk, I say. They point with pride to the Novice program as the great "open door." But, don't you remember? Novices were originally permitted to use 'phone on 2 meters. They changed that when they found that those Novices seldom advanced up the ladder. Now, Novices are not permitted to use 'phone.

If this "no-code" Communicator Class comes to pass, I would like to predict the results to be as VE3ABW predicted years ago. Only now, Pandora's Box will have been opened, and these operators will largely consist of a stagnant, CB-type group with no intention of upgrading to become real radio amateurs.

What am I asking you to do? First of all join the ARRL. (It is the only game in town.) Vote carefully in Director elections; put up a more sensitive candidate. File directly to the FCC.

... Byron W2JTP

PS: I've been an ARRL member for more than 30 years; I'm now a life member. I hold an Extra Class license but operate much more 'phone than CW. I am not a candidate for Hudson Division Director; I will not run for that office.

CHARGE IT
ON



CHARGE IT
ON



**CALL
FREE**

**TOLL
FREE
NUMBER**

(Continental 48 States)

800

325-3636

**MO CUSTOMERS CALL
314-993-6060
COLLECT**

**CALL
FREE**

**TRADE
ON
NEW**

CALL

**TRADE
ON
USED**

HAM RADIO CENTER

(9 A.M.—5 P.M. Central, Closed Sun. & Mon.)

**FOR
A SQUARE DEAL
ON**

- **DRAKE**
- **TEMPO/ONE**
- **TEN-TEC**
- **ATLAS**
- **STANDARD**

- **YAESU**
- **SWAN**
- **COLLINS**
- **KENWOOD**
- **REGENCY**

We carry all major brands and a large stock of used reconditioned equipment

HAM RADIO CENTER INC.

8342 OLIVE BL. PO Box 28271 ST. LOUIS, MO 63132

**SPECIAL PURCHASE
LED DISPLAY MAN 3M**
\$.25 ea. 5/\$1.00 8/\$1.50

**NINE DIGIT LED ARRAY
FAIRCHILD 37 .17" DIGITS**
with clear magnifying lens
\$5.95 ea.

**NINE DIGIT SPERRY
GAS DISCHARGE DISPLAY**
SP-425-09 1.25" x 3" overall — .25"
digits — connects to 18 lead edge
connector — hi voltage — prime
quality **\$1.99 ea.**

4 DIGIT DISPLAY
HP 50827414 Comm. Cathode
\$2.75 ea.

5 DIGIT DISPLAY
HP 50827405 **\$2.95 ea.**

JUNE SPECIALS

**16 BIT
MICROPROCESSOR CHIPS**
MM5750
Arithmetic and logic unit **\$30.00 ea.**

MM5751
Control and read only memory **\$40.00 ea.**
(Imp-16 standard set or extended set)
Set of 4 MM5750 and 1 MM5751 **\$129.00**

CT5002 CALCULATOR CHIP
12 digit — 4 function — chain operation
— battery operation — 28 pin
\$2.95 ea.

567 TONE DECODER
8 pin DIP **\$2.75 ea.**

POCKET CALCULATOR KIT
5 function plus constant —
addressable memory with
individual recall — 8 digit
display plus overflow —
battery saver — uses standard
or rechargeable batteries — all
necessary parts in ready to
assemble form — instructions
included. 3" x 5 1/4" **\$24.95**
ASSEMBLED **\$29.95**



2102 MEMORY
1024 bit N-chan. Static Ram **\$5.95**
5262 MEMORY
2048 bit RAM **\$5.95**
**8038 FUNCTION
GENERATOR**
Voltage Controlled Oscillator Sine,
Square, Triangular Output 16 Pin
Dip **\$4.95**

CT7001 CLOCK CHIP
4 or 6 digit — 12, 24 hr — alarm —
timer & date circuits. **\$6.95 ea.**

TTL

7400	\$.19	7485	\$1.39
7401	.19	7486	.44
7402	.19	7489	2.75
7403	.19	7490	.76
7404	.22	7491	1.29
7405	.22	7492	.79
7406	.39	7493	.79
7407	.39	7494	.89
7408	.25	7495	.89
7409	.25	7496	.89
7410	.19	74105	.49
7411	.29	74107	.49
7413	.79	74121	.57
7415	.39	74122	.53
7416	.39	74123	.99
7417	.39	74125	.69
7420	.19	74126	.79
7422	.29	74141	1.23
7423	.35	74145	1.15
7425	.39	74150	1.09
7426	.29	74151	.89
7427	.35	74153	1.29
7430	.22	74154	1.59
7432	.29	74155	1.19
7437	.45	74156	1.29
7438	.39	74157	1.29
7440	.19	74161	1.39
7441	1.09	74163	1.59
7442	.99	74164	1.89
7443	.99	74165	1.89
7444	1.10	74166	1.65
7445	1.10	74173	1.65
7446	1.15	74175	1.89
7447	1.15	74176	1.65
7448	1.15	74177	.99
7450	.24	74180	1.09
7453	.27	74181	3.65
7454	.39	74182	.89
7460	.19	74190	1.59
7464	.39	74192	1.49
7465	.39	74193	1.39
7472	.36	74194	1.39
7473	.43	74195	.99
7474	.43	74196	1.85
7475	.75	74197	1.15
7476	.47	74198	2.19
7483	1.11	74199	2.19

Data sheets supplied on request
Add \$.50 for items less than \$1.00

10% Off on orders over \$25.00
15% Off on orders over \$100.00
20% Off on orders over \$250.00

LINEAR CIRCUITS

301	Hi perf. op amp	mDIP	\$.32
307	Op amp	mDIP	.29
308	Micro-pwr op amp	mDIP	.99
309K	5V reg 1A	TO-3	1.50
310	V follr. Op Amp	mDIP	1.19
311	Hi perf. V comp	mDIP	1.05
319	Hi-speed dual comp	DIP	1.29
320	Neg. regulator (5V, 5.2V, 12V, 15V)	TO3	1.25
324	Quad op amp	DIP	1.89
339	Quad comp	DIP	1.69
340T	Pos V reg (5V, 6V, 8V, 12V, 15V, 18V, 24V)	TO-220	1.75
372	AG-IF strip det	DIP	.79
376	Pos V reg	mDIP	.59
377	2 w stereo amp	DIP	2.69
380	2w audio amp	DIP	1.29
380-8	.6w audio amp	mDIP	.89
381	Lo noise dual preamp	DIP	1.69
550	Prec. V reg	DIP	.79
555	Timer	mDIP	.99
560	Phase locked loop	DIP	2.75
562	Phase locked loop	DIP	2.65
565	Phase locked loop	DIP	2.65
566	Function gen	mDIP	2.50
567	Tone Decoder	mDIP	2.95
709	Op amp	DIP	.29
710	Hi speed V comp	DIP	.39
723	Volt reg.	DIP	.69
739	Dual hi perf amp	DIP	1.19
741	Comp. op amp	mDIP	.35
747	Dual 741	DIP	.79
748	Freq adj 741	mDIP	.39
1304	FM mux st demod	DIP	1.19
1307	FM mux st demod	DIP	.82
1458	Dual Comp op amp	mDIP	.69
1800	Stereo Multiplexer	DIP	2.75
3900	Quad amp	DIP	.39
7524	Core mem sense amp	DIP	.79
7525	Core mem sense amp	DIP	.95
75451	Dual prl. driver	mDIP	.39
75452	Dual prl. driver	mDIP	.39
75453	Dual prl. driver	mDIP	.39
75491	Quad seq driver	DIP	.79
75492	Hex dig. driver	DIP	.89

Data sheets supplied on request
Add \$.50 for items less than \$1.00

MEMORIES

1101	256 bit RAM MOS	\$1.75
1103	1024 bit RAM MOS	3.95
2101	1024 bit static RAM	6.95
5203	2048 bit UV eras PROM	19.95
5260	1024 bit RAM	2.95
5261	1024 bit RAM	2.95
5262	2048 bit RAM	7.95
7489	64 bit ROM TTL	2.75
8223	Programmable ROM	3.95
74200	256 bit RAM tri-state	7.95

CALCULATOR & CLOCK CHIPS

5001	12 DIG 4 funct fix dec	3.95
5002	Same as 5001 exc btry pwr	4.95
5005	12 DIG 4 funct w/mem	5.95
MM5725	8 DIG 4 funct chain & dec	2.25
MM5736	18 pin 6 DIG 4 funct	4.95
MM5738	8 DIG 5 funct K & Mem	5.95
MM5739	9 DIG 4 funct (btry sur)	5.95
MM5311	28 pin BCD 6 dig mux	4.95
MM5312	24 pin 1 pps BCD 4 dig mux	4.45
MM5313	28 pin 1 pps BCD 6 dig mux	4.95
MM5314	24 pin 6 dig mux	4.95
MM5316	40 pin alarm 4 dig	5.95

LED'S AND OPTO ISOLATORS

MV10B	Red TO 18	\$.25 ea.
MV50	Axial leads	.20
MV5020	Jumbo visible red	.25
ME4	Infra red diff. dome	.60
MAN1	Red 7 seg. .270"	2.50
MAN2	Red alpha num .32"	4.95
MAN4	Red 7 seg. .190"	2.15
MAN5	Green 7 seg. .270"	2.95
MAN7	Red 7 seg. .270"	1.35
MAN8	Yellow 7 seg. .270"	3.95
MAN66	60" high dir. view	4.65
DL707	Red 7 seg. .3"	2.15
MCT2	Opto-iso transistor	.69

CMOS

4000 AE	\$.40	4019 AE	\$2.10	4066 AE	\$1.05
4001 AE	.40	4020 AE	2.20	4068 AE	.40
4002 AE	.40	4021 AE	2.05	4069 AE	.40
4006 AE	1.75	4023 AE	.40	4071 AE	.40
4007 AE	.40	4024 AE	1.45	4072 AE	.40
4008 AE	2.45	4025 AE	.40	4073 AE	.40
4009 AE	.80	4027 AE	1.20	4075 AE	.40
4010 AE	.80	4028 AE	1.75	4078 AE	.40
4011 AE	.40	4030 AE	.85	4081 AE	.40
4013 AE	.80	4042 AE	1.90	4082 AE	.40



Satisfaction is guaranteed. Shipment will be made via first class
mail — postage paid — in U.S., Canada and Mexico within three
days from receipt of order. Minimum order — \$5.00. California
residents add sales tax.

INTERNATIONAL ELECTRONICS UNLIMITED

(408) 659-3171

P.O. BOX 1708

MONTEREY, CALIF. 93940 USA



7-Segment Readout 12-PIN DIP

Three digits with right-hand decimal
Plugs into DIP sockets
Similar to (LITRONIX) DL337
Magnified digit approximately .1"
Cathode for each digit
Segments are parallel for multiple
operation
5-10 MA per segment
EACH \$3.00 4 (12 Digits) \$11.00

RCA Numitron

EACH.....\$ 5.00

SPECIAL: 5 FOR \$20.00

DR2010



MOS MEMORY INTEL #2102-2

1024 BIT FULLY DECODED STATIC
MOS RANDOM ACCESS MEMORY, . . .
* fast access 650ns.....
* full TTL compatible
* N channel silicon gate
* single 5 volt supply...
* tri-state output.....
* 1024 by 1 bit
* chip enable input.....
* no clocks or refreshing
required.....

BRAND NEW FACTORY PARTS

16 PIN DIP - - - - - EACH \$6.95
EIGHT FOR \$49.95

Power Supply SPECIAL!

723 DIP variable regulator chip 1-40V,
+ or - output @ 150 MA 10A with external
pass transistor--with diagrams for
many applications.
EACH \$1.00 10 FOR \$8.95

5001 Calculator

40-Pin calculator chip will add, sub-
tract, multiply, and divide. 12-digit
display and calculate. Chain calcula-
tions. True credit balance sign out-
put. Automatic over-flow indication.
Fixed decimal point at 1, 2, 3, or 4.
Leading zero suppression. Complete
data supplied with chip.

CHIP AND DATA.....ONLY \$6.95

DATA ONLY (Refundable)... \$1.00

5002 LOW POWER CHIP AND DATA \$12.95

High Quality PCB Mounting IC Sockets

8-PIN, 14-Pin, 16-Pin and 24-Pin PCB
mounting ONLY--no wire wrap sockets.

8-Pin.....\$.22

14-Pin.....\$.26

16-Pin.....\$.30

24-Pin.....\$.75

40-Pin.....\$1.25

All IC's are new and fully-tested.
Leads are plated with gold or solder.
Orders for \$5 or more will be shipped
prepaid. Add 55¢ for handling and
postage for smaller orders; residents
of California add sales tax. IC orders
are shipped within 2 workdays--kits
are shipped within 10 days of receipt
of order. \$10 minimum on C.O.D.'s
(phone in). (916) 334-2161

MAIL ORDERS:

P. O. Box 41727 4811 Myrtle Ave.
Sacramento, CA Sacramento, CA
95841 95841

MONEY BACK GUARANTEE ON ALL GOODS!
SEND FOR FREE FLYER LISTING 100's OF
MONEY-SAVING BARGAINS!

CTUL SPECIAL

Complementary Transistor Logic.
This logic family is unique in that
both NPN and PNP transistors are
combined in the same package. Un-
like TTL & DTL, the outputs are
current sources (in the high state)
as well as sinking current in the
low state. These are brand new
units, some of which are mismarked
with DTL numbers.



CTL 9956 dual 2-input

AND buffer

CTL 9953 2-2-3-input

AND/OR gate

CTL 9952 dual 2-input

NOR gate

Data supplied; all parts are dual-
in-line. MIX OR MATCH. 5 FOR \$1.00

LED's

MV50 Red Emitting \$.20
10-4 MA @ 2V 10 FOR \$1.25

MV5024 Red TO-18 \$.35
High Dome 10 FOR \$2.95

MV10B Visible Red \$.30
5-7 MA @ 2V 10 FOR \$2.50

CMOS

CD4001 \$.75	CD4023 \$.75
CD4002 .75	74C20 .75
CD4011 .75	74C160 3.25
CD4012 .75	

3-Amp Power Silicon Rectifiers

MARKED EPOXY AXIAL PACKAGE

PRV.	PRICE	PRV.	PRICE
100.....	\$.10	800.....	\$.30
200.....	.15	1000.....	.40
400.....	.18	1200.....	.50
600.....	.23	1500.....	.65

DIODE ARRAY 10-IN914 silicon
signal diodes in one package. 20
leads spaced .1"; no common connec-
tions.

EACH.....\$.29
10 FOR \$2.50

BABYLON ELECTRONICS

7400 .20	74H51 .25
74H00 .25	7453 .20
7401 .20	7454 .20
74H01 .25	74L54 .25
7402 .25	74L55 .25
7403 .25	7460 .16
7404 .25	74L71 .25
74H04 .30	7472 .40
7405 .30	74L72 .60
7406 .40	7473 .35
7408 .30	74L73 .75
74H08 .30	7474 .45
7410 .20	74H74 .75
7413 .75	7475 .80
7417 .40	7476 .55
7420 .20	74L78 .70
74L20 .30	7480 .50
74H20 .30	7483 .70
74H22 .30	7489 3.00
7430 .20	7490 1.00
74H30 .30	7492 .65
74L30 .30	7493 1.00
7440 .20	7495 .65
74H40 .30	74L95 1.00
7442 1.00	74107 .50
7447 1.50	74145 1.25
7450 .20	74180 1.00
74H50 .30	74193 1.50
7451 .20	74195 .80

7400 Series DIP

25K Trimmer

PRINTED CIRCUIT BOARD TYPE
EACH \$.20 10 FOR \$1.50

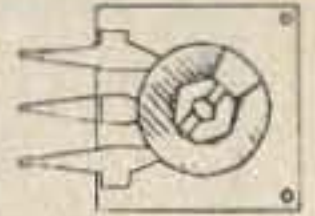

Rectifiers



VARO FULL-WAVE BRIDGES
V5447 2A 400V \$.90
V5647 2A 600V \$1.10
MR810 Rectifier 50V 1A \$.10

Special 811: Hex Inverter

TTL DIP Hex Inverter; pin interchangeable with SN
7404. Parts are brand new and branded Signetics
and marked "811."

EACH.....\$.30
DATA 10 FOR..... 2.50
SHEET 100 FOR.... 23.00
SUPPLIED 1000 FOR...\$220.00



0-9 plus Letters. MAN 3

Right-hand decimal point.
Flat-pack type case. Long
operating life. IC vol-
tage requirements. Ideal
for pocket calculators!



EACH \$1.25
10 OR MORE \$1.00 EA

MAN 4 7-Segment, 0-9 plus letters.

Right-hand decimal point. Snaps in 14-
pin DIP socket or Molex. IC voltage re-
quirements. Ideal for desk or pocket
calculators!

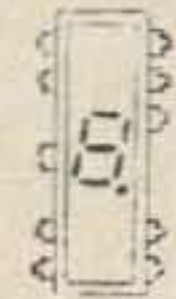

EACH \$2.75 10 OR MORE \$2.50 EACH

CD-2 Counter Kit

This kit provides a highly sophisticated display
section module for clocks, counters, or other nu-
merical display needs. The unit is .8" wide and
4 3/8" long. A single 5-volt power source powers
both the ICs and the display tube. It can attain
typical count rates of up to 30 MHz and also has
a lamp test, causing all 7 segments to light. Kit
includes a 2-sided (with plated thru holes) fiber-
glass printed circuit board, a 7490, a 7475, a
7447, a DR2010 RCA Numitron display tube, complete
instructions, and enough MOLEX pins for the ICs...
NOTE: boards can be supplied in a single panel of
up to 10 digits (with all interconnects); there-
fore, when ordering, please specify whether you
want them in single panels or in one multiple
digit board. Not specifying will result in ship-
ping delay.

COMPLETE KIT ONLY \$11.95

FULLY-ASSEMBLED

UNIT \$15.00



Boards supplied separately @ \$2.50 per digit.

LINEARS

NE555	Precision timer.....	1.50
NE560	Phase lock loop DIP.....	3.25
NE561	Phase lock loop DIP.....	3.25
NE565	Phase lock loop	3.25
NE566	Function generator TO-5.....	4.00
NE567	Tone decoder TO-5.....	3.00
709	Popular Op Amp DIP.....	.45
710	Voltage comparator DIP.....	.75
711	Dual comparator DIP.....	.40
723	Precision voltage regulator DIP.....	1.00
741	Op amp TO-5/MINI DIP.....	.55
748	Op Amp TO-5.....	1.00
CA3018	2 Isolated transistors and a Darling- ton-connected transistor pair.....	1.00
CA3045	5 NPN transistor array.....	1.00
LM100	Positive DC regulator TO-5.....	1.00
LM105	Voltage regulator.....	1.25
LM302	Op Amp voltage follower TO-5.....	1.25
LM308	Op Amp TO-5.....	2.00
LM309H	5V 200 MA power supply TO-5.....	1.00
LM309K	5V 1A power supply module TO-3.....	2.00
LM311	Comparator TO-5.....	1.75
LM370	AGC amplifier.....	2.00
LM380	2-Watt Audio Amp.....	1.75
LM1595	4-Quadrant multiplier.....	2.00
MC1536T	Op Amp.....	2.00

MEET THE STATE OF THE ART ON 2 METERS...

THE ITC MULTI-2000 CW/SSB/FM TRANSCEIVER

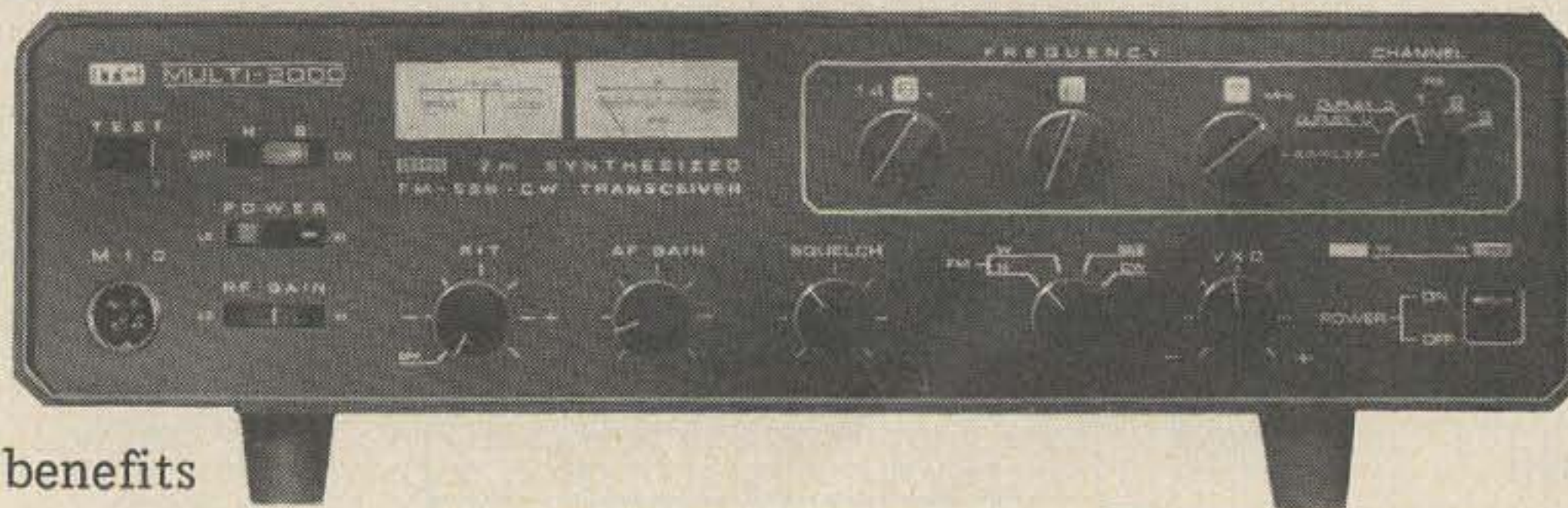

Multi-2000 benefits

Fully synthesized two meter FM rig

Covers all repeaters, including 15 kHz splinters

Automatic 600 kHz up or down split for standard repeaters

Three crystal channels available for priority repeaters

Vernier on frequency to zero in off frequency repeaters

Discriminator meter indicates kHz high or low

Wide band – narrow band switch to match repeaters

High-low power switch

Ac power supply built in

12 V dc operated for mobile use

Provides one of the most flexible FM rigs on the market today – gives you first class FM operation anywhere in the country you may drive or visit.

Join some of the FMers operating in the 145 MHz part of the band

Single Sideband transceiver for two meters

Most of the serious DXers are using SSB on 2m

Operate over any of the 144 – 148 MHz with SSB

Synthesized SSB

Listen to Oscar 7 output on either SSB or CW

Work via Oscar 6 or 7 with SSB or CW

More and more SSB being used mobile – you get extra mileage

You meet the more interesting amateurs on SSB

Look at it this way – for \$500 you get a completely flexible synthesized

FM transceiver, complete with ac power supply – and for \$200 extra you get another complete SSB transceiver – and this has to be one of the best bargains in the history of ham radio. Perhaps this is why the Multi-2000 is now the best selling 2m rig on the market.

*SEND YOUR ORDER TODAY, SATISFACTION GUARANTEED OR MONEY BACK.
IMMEDIATE SHIPMENT FOB OTTO NC. WRITE OR PHONE BILL SLEP
704-524-7519*

**Slep
Electronics
Co.**

P.O. Box 100

Highway 441 – Dept. 73

Otto, North Carolina 28763



"DECO-TEL" complete, ready to plug in.

CRADLEPHONES Red Brocade • Green & Gold Brocade • White & Gold Brocade • Blue & White Cameo • Any one of the above for only \$49.95 each.

CANDLESTICK PHONES HOT LINE RED \$34.95 each.

ERICOS WITH CHIRPER RINGER Swedish designed, all-in-one-unit, has rotary dial at bottom. Complete with standard 4 prong plug. Available in beige, aqua mist, red, mint and pink. New \$35.00 each.

CINDERELLA Rotary dial available in pink, blue, beige and green. Less ringer, new \$19.95 each.

STANDARD DESK PHONE type 2500 with touch pad available in red, green, pink, black and yellow, less ringer, new \$26.95 each.

DESK PHONE type 500 or 80 rotary dial available in yellow, green, grey. Less ringer, new \$14.95. Less ringer, used, \$8.95 each. Extension w/o dial, used \$4.50 each.

WALL PHONES type 554 or 90 rotary dial available in beige, yellow, red, blue, black, less ringer, new \$14.95.

SPACE MAKER, WALL PHONE rotary dial. Available in turquoise, black, beige, white. Less ringer, new \$17.50 each. Less ringer, used \$12.50 each.

"MINI WALL" PHONES (ITT) WITH TOUCH PAD available in pink, beige, green, black, blue, ivory and yellow. New \$27.50 each.

KEY PHONES-CALL COMMANDER TYPE rotary dial Stromberg Carlson 1700 series, all factory rebuilt 3 lines - 3 hold buttons - \$22.50 each. 6 button - 5 line 1 hold - \$27.50 each. 12 button - 11 lines 1 hold - \$35.00 each. Available in beige, green and black. (List 1st, 2nd and 3rd choices in colors for all above phones).

TOUCH PADS similar to Touch Tone pad - 12 button, but manufactured by Automatic Electric, checked out \$12.50 each.

2 VOLT STORAGE BATTERY Polystyrene encased 2 volt rechargeable battery rated at 20 amp hours. Each \$2.50.

FACSIMILE UNIT Transmitter and receiver. 12" x 12" x 6". Used in many offices, sends 2-way message complete with 60 cy power supply, with conversion sheets. All for \$14.95 each.

5 LEVEL TELEPRINTER TAPE READER Western Union Model 8C, 5 level tape reader. Magnet tape advance good for high speeds. Excellent for use with Electronics. Parallel-to-serial converter (transmitting dist.) Each \$7.95.

PRC 9 BACK PACK WALKIE TALKIE FM 27 to 39 MC with antenna and battery case. Good for camping, hunting, etc. Each \$27.50.

PRC 6 WALKIE TALKIE Range 47 to 56 MHz FM. Lightweight still being used, with antenna only \$19.95 each.

16 MM MOVIE CAMERA complete with F3.5 lens. Magazine load type motor driven only, each \$6.95.

OUTDOOR SPEAKER HORN (Executive Mod.-MRP (02) 20" diameter, -22" long, used, 160 Ohm Imp., used good \$35.00 each.

LINEMAN BELTS complete with safety strap \$9.95. Pole climbers, complete with pad and straps \$9.95.

ALL RINGERS ARE \$3.00.

TEST EQUIPMENT

FLUKE DIFFERENTIAL VM MODEL 803B, \$149.95.

HP 624B X BAND TEST SET \$250.00.

TECHTRONIX SCOPES 511AD, 5 to 10 MHz, \$135.00.

541 MAIN FRAME only DC to 30 MHz, \$295.00.

541-A MAIN FRAME only DC - 33 MHz, \$325.00.

661 - with two plug-ins, 5T 1 A and 451 sampling scope DC to 3900 MHz, \$595.00.

661 as above with fittings and probes, \$675.00.

536 MAIN FRAME only DC to 11 MHz, \$245.00.

RECEIVER 390A 5-32 MHz \$495.00

CLEAN URR 35 excellent, 225-400 MHz, \$69.50.

551 DUAL BEAM DUAL TRACE SCOPE with plug-ins, DC to 37 MHz w/power supply, 53-54 C&D, \$450.00.

SPECIAL PURCHASE RTTY'S MODEL KSR 28, \$250.00 Console or desk.

J. J. GLASS ELECTRONICS CO.

1624 South Main Street
Los Angeles, CA 90015

213-749-1179 213-749-1170

DU PAGE FM

WILL NOT BE UNDERSOLD!

TPL Specials for June

TPL Stands for Transistorized Progress Line made by General Electric.

TPL features all transistorized receiver, exciter and power supply, with three or four tubes in the transmitter depending upon the model . . .

SIX METER TPLS

RE72JB3— 42 to 50 MHz. 100 Watts output. With noise blanker to eliminate ignition and other noises. Two frequency transmitter, single frequency receiver. These should be great for six meter use, with accessories. Regularly \$335.00, for June only — \$275.00.

FE/RE72 JA3— 42 to 50 MHz, 100 Watts output. Single frequency transmitter and receiver with accessories. Regularly \$250.00, for June only — \$225.00.

TWO METER TPLS

FE/RE 73JA6— 152 to 162 MHz. 80 Watts output, single frequency transmitter and receiver with accessories. Regularly \$225.00, for June only — \$195.00

RE/FE 53 JA6— 152 to 162 MHz. 35 Watts output, single frequency transmitter and receiver, with accessories. Regularly \$175.00, for June only — \$155.00

RE/FE 53 JC6— 152 to 162 MHz. 35 Watts output, two frequency transmitter and receiver, with accessories. Regularly \$200.00, for June only — \$180.00.

Quantities are limited . . . please specify second choice.

DON'T DELAY, SEND A CHECK TODAY TO!

**DU PAGE FM INC. P.O. Box 1 Lombard, Ill. 60148
(312) 627-3540**

TERMS: All items sold as is. If not as represented return for exchange or refund (our option) shipping charged prepaid within 5 days of receipt. Illinois residents must add 5% sales tax. Personal checks must clear before shipment. All items sent shipping charges collect unless otherwise agreed. Accessories do not include crystals, reeds, relay or antennas.

RGS ELECTRONICS

008A MICROCOMPUTER KIT

8008 CPU, 1024 x 8 memory; memory is expandable. Kit includes manual with schematic, programming instructions and suggestions; all ICs and parts supplied except cabinet, fuses & hardware. Includes p.c. boards. \$375.00

MANUAL ONLY, \$25.00
(no discount on manual)

008A-K ASCII keyboard input kit. \$135.00

008A-C Audio cassette adapter kit. \$100.00

Details on computer, peripheral kits in our flyer.

TTL

7400	\$.20	7485	\$1.40
7401	.20	7486	.50
7402	.20	7489	2.90
7403	.20	7490	.80
7404	.25	7492	.80
7405	.25	7493	.80
7406	.45	7495	.90
7407	.45	7496	.85
7408	.25	74107	.50
7409	.25	74121	.60
7410	.20	74122	.60
7411	.30	74123	1.10
7413	.85	74125	.65
7416	.45	74126	.65
7417	.45	74141	1.25
7420	.20	74150	1.70
7430	.20	74151	1.00
7432	.30	74153	1.40
7437	.50	74154	1.70
7438	.50	74157	1.40
7440	.20	74161	1.50
7442	1.10	74163	1.70
7446	1.45	74164	2.00
7447	1.45	74165	2.00
7448	1.45	74166	1.75
7450	.20	74174	2.20
7451	.20	74175	2.20
7453	.20	74176	1.60
7454	.20	74177	1.35
7473	.45	74181	3.90
7474	.45	74192	1.50
7475	.80	74193	1.45
7476	.50	74195	1.00
7483	1.10		

"THE CUBE" Fully assembled subaudible tone generator for small handheld or portable FM radios. 9-16 volts; no moving parts, set anywhere between 98 & 240 Hz with a trim resistor.

.5" x .6" x .8" \$19.95

Set on frequency by the factory, \$5.00 extra

POWER SUPPLIES

PS 5-1 5v 1a regulated power supply kit with p.c. board & instructions. Board measures 2" x 5", completed kit is 2" high. Transformer has internal r.f. shield. \$8.00

PS 25-1 0 to 25v 1a lab type power supply with adjustable current limiting; remote sensing & remote programming for voltage & current. Instructions included. All parts except chassis, meter(s), p.c. board. Kit of parts with schematics \$14.95
P.C. boards available, No. 007 \$3.00 ea.

SOME NEW TRANSISTORS . . .

	1-99	100+
N1 T0-92 NPN Darlington	\$.35	.30
N2 T0-92 NPN lo-noise, lo-level	.15	.10
N3 T0-92 NPN medium purpose	.20	.15
N4 T0-92 NPN 2N3904 type	.15	.10
N5 T0-92 NPN UHF	.20	.15
N6 T0-92 NPN RF-IF	.15	.10
P2 T0-92 PNP lo-level	.15	.10
P3 T0-92 PNP medium power	.20	.15
P4 T0-92 PNP 2N3906 type	.15	.10
P7 T0-92 PNP high-voltage	.25	.20
P8 T0-92 PNP higher-voltage	.30	.25

AND SOME OLD TRANSISTORS . . .

	1-99	100+
2N2222 T0-18 NPN	\$.25	.20
2N2907 T0-18 PNP	.25	.20
NPN T0-92 general purpose	.08	.0595
PNP T0-92 general purpose	.08	.0595

Data on all transistors and JFETS is now in our flyer.

BRAND NEW ALUM. ELECTROLYTIC CAPS, RADIAL LEAD

	10wv	35wv	50wv
1mfd	\$.10	\$.12	\$.15
2mfd	.10	.12	
5mfd	.10	.12	
10mfd	.11	.13	.16
30mfd	.12	.20	.28
50mfd	.13		
100mfd	.15	.30	.45
200mfd	.20		.70
500mfd	.28	.75	
1000mfd	.50		

RGS ELECTRONICS

3650 Charles St., Suite K ■ Santa Clara, CA 95050 ■ (408) 247-0158

We sell many ICs and components not listed in this ad. Send a stamp for our free flyer. **TERMS OF SALE:** All orders prepaid; we pay postage. \$1.00 handling charge on orders under \$10.00. California residents please include sales tax. Please include name, address and zip code on all orders and flyer requests. Prices subject to change without notice.

DISCOUNTS: 10% OFF ORDERS OVER \$25.00; 20% OFF ORDERS OVER \$250.00

EXAR

IC'S AND KITS NOW AVAILABLE FROM: JAMES ELECTRONICS

FUNCTION GENERATOR KIT

Introductory Offer

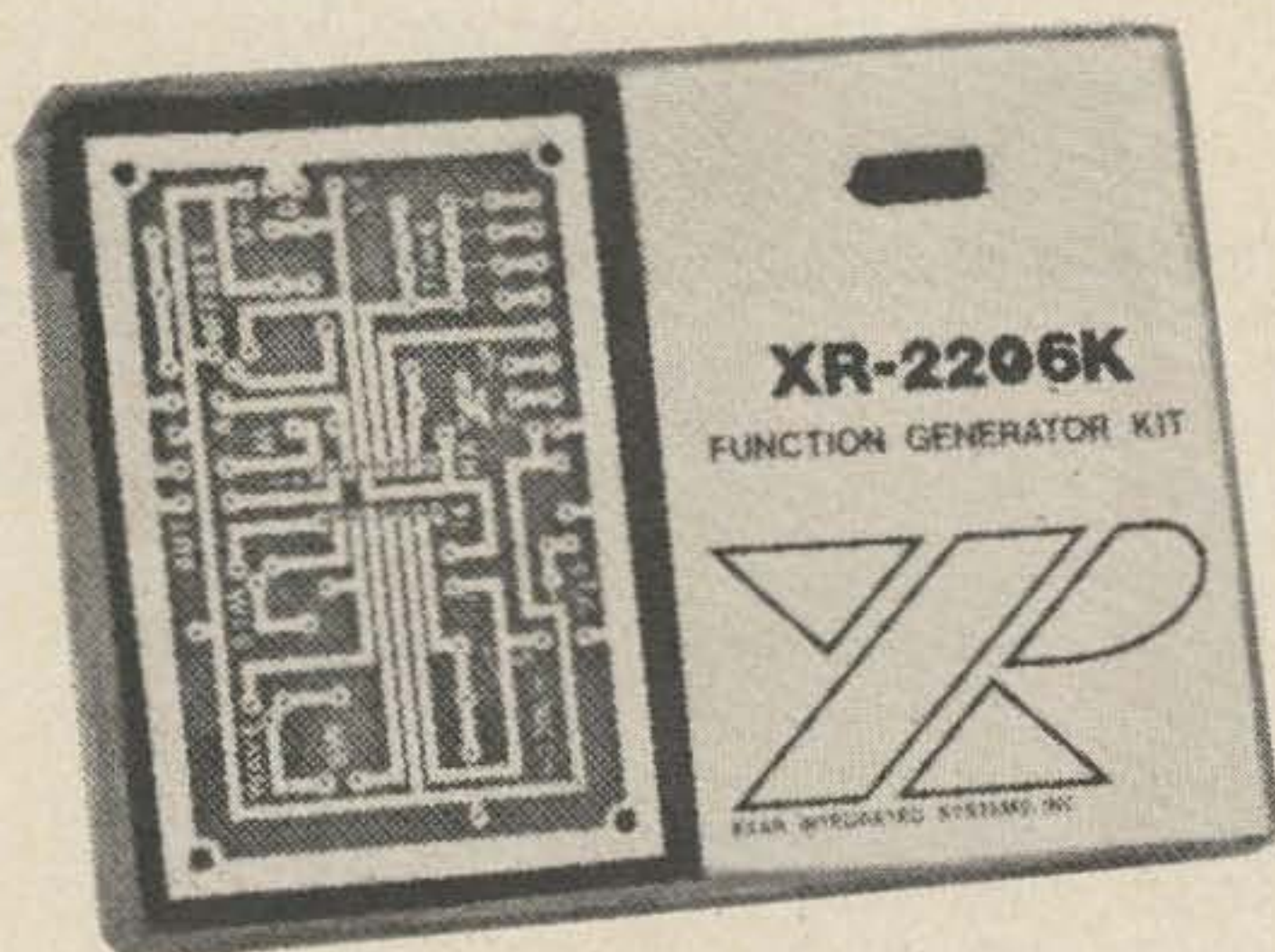

The Function Generator Kit features sine, triangle and square wave; THD 0.5% typ.; AM/FM capability.

XR-2206KA

Includes monolithic function generator IC, PC board, and assembly instruction manual.

\$19.95

XR-2206KB

Same as XR-2206KA above and includes external components for PC board.

\$29.95

MONOLITHIC IC'S

TIMERS

XR-555CP	Monolithic Timer	\$1.10
XR-320P	Precision Timer	1.55
XR-556CP	Dual-555 Timer	1.85
XR-2556CP	Dual Timing Circuit	3.20
XR-2240CP	Programmable Counter/ Timer	4.80

PHASE LOCKED LOOPS

XR-210	FSK Demodulator	5.20
XR-215	High Frequency PLL	6.60
XR-567CP	Tone Decoder (mini DIP)	1.95
XR-567CT	Tone Decoder (TO-5)	1.70

STEREO DECODERS

XR-1310P	PLL Stereo Decoder	3.20
XR-1310EP	PLL Stereo Decoder	3.20
XR-1800P	PLL Stereo Decoder	3.20

WAVEFORM GENERATORS

XR-205	Waveform Generator	8.40
XR-2206CP	Monolithic Function Generator	5.50
XR-2207CP	Voltage-Controlled Oscillator	3.85

OTHER EXAR IC'S

XR-1468CN	Dual $\pm 15V$ Tracking Regulator	3.85
XR-1488N	Quad Line Driver	5.80
XR-1489AN	Quad Line Receiver	4.80
XR-2208CP	Operational Multiplier	5.20

Satisfaction Guaranteed. \$5.00 Minimum Order —

1st Class Mail No Charge

California Residents Add 6% Sales Tax.

JAMES

P.O. BOX 822, BELMONT, CA. 94002
PHONE ORDERS — (415) 592-8097

TTL

7400*	.17	7491*	1.00
7401	.23	7492	.95
7402	.23	7493	.95
7403	.17	7494	.97
7404	.25	7495	.89
7405	.24	7496	.95
7406	.50	74100	1.50
7407	.50	74107	.47
7408	.25	74121	.55
7409	.25	74122	.47
7410	.17	74123	1.05
7411	.30	74125	.80
7412	.40	74126	.60
7413	.75	74141	1.15
7416	.45	74145	1.15
7417	.45	74147	1.75
7418	.25	74148	2.95
7420	.23	74150	1.10
7421	.27	74151	1.20
7423	.32	74153	1.50
7425	.27	74154	1.25
7426	.31	74155	1.30
7427	.32	74156	1.30
7429	.40	74157	1.55
7430	.33	74160	1.65
7432	.26	74161	1.65
7437	.45	74163	2.50
7438	.50	74164	1.65
7439	.50	74165	1.65
7440	.23	74166	1.75
7441	1.10	74170	3.00
7442	1.05	74173	1.75
7443	1.10	74174	1.85
7444	1.15	74175	.85
7445	1.10	74176	.85
7446	1.25	74177	.85
7447*	.89	74180*	1.00
7448	1.25	74181	3.75
7450	.25	74182	1.00
7451	.27	74184	2.30
7453	.27	74185	2.30
7454	.40	74187	7.00
7455	.25	74190	1.50
7460	.25	74191	1.50
7470	.45	74192*	1.25
7472	.41	74193*	1.25
7473*	.39	74194	1.50
7474	.47	74195	1.05
7475*	.75	74196	1.25
7476*	.40	74197	1.05
7480	.50	74198	2.25
7482	1.75	74199	2.75
7483	1.15	74200	7.00
7485*	1.10	74250	5.00
7486	.47	74251	2.50
7488	4.00	74284	5.00
7489*	2.25	74285	5.00
7490*	.69		

20% Discount for 100 pcs. Combined
7400's

8000 Series	2.59
8091	.59
8092	.59
8095	1.39
8121	.89
8123	1.59
8130	2.19
8200	2.59
8210	3.49
8214	1.69
8220	1.69
8223*	3.00

CMOS

CD4000	.48
CD4001	.48
CD4002	.48
CD4006	3.75
CD4007	.55
CD4009	.89
CD4010	.69
CD4011	.48
CD4012	.48
CD4013	1.00
CD4016	1.00
CD4017	2.65
CD4019	1.15
CD4020	1.50
CD4022	1.50
CD4023	.48
CD4024	1.95
CD4025	.48
CD4027	1.15
CD4028	2.65
CD4029	3.95
CD4030	1.00
CD4035	2.65
CD4040	3.95
CD4042	2.75
CD4044	2.75
CD4046	2.75
CD4047	2.75
CD4049	1.00
CD4050	1.00
CD4051	3.95
74C00	.39
74C02	.55
74C04	.75
74C10	.65
74C20	.65
74C42	2.15
74C74	1.15
74C90	3.00
74C107	1.50
74C151	2.90
74C160	3.25
74C161	3.25
74C163	3.25
74C164	3.50
74C173	2.90
74C195	3.00
80C97	1.50
1702A EROM	29.95/8B

LOW POWER

74L00	.33
74L02	.33
74L03	.33
74L04	.33
74L10	.33
74L20	.33
74L30	.33
74L42	1.69
74L72	.49
74L73	.69
74L74	.69
74L78	.79
74L85	1.25
74L86	.69
74L90	1.69
74L91	1.45
74L93	1.69
74L95	1.69
74L164	2.79
74L165	2.79
74L192	2.25
74L193	2.25

LINEAR

LM739N	\$1.29
LM741H/N	.31*
LM747N	.69
LM748N	.35
LM1303N	.79
LM1304N	1.00
LM1307N	.79
LM1310P	3.25*
LM1458N	.69
LM1496N	.99
LM1556V	1.85
CA3013	1.70
CA3023	2.15
CA3035	5.00
CA3039	1.35
CA3046	1.15
CA3059	2.46
CA3060	2.60
CA3065N	.75
CA3080	.85
CA3083	1.60
CA3086	.70
CA3089	3.25
CA3091	8.25
CA3123	1.85
CA3600	1.75
LM3900	.55
LM3905	.55
LM7805	1.75
80388	3.95*
LM9601	.55
LM9602	.75
75450	.49
75451	.39
75452	.39
75453	.39
75491	.79
75492	.89
75494	.89
75324N	1.75*

1/4 W 5% CARBON RESISTORS

5-25	30-95	100-495	500-995	1000 UP
.05	.04	.03	.0275	.025

All Std. Values - 5 Ea. Min.
Add 5¢ per value if sorting is required

50 PCS. RESISTOR ASSORTMENTS \$1.75 per ASST.

Asst. 1	5 ea. 10 OHM - 12 OHM - 15 OHM - 18 OHM - 22 OHM
Asst. 2	5 ea. 27 OHM - 33 OHM - 39 OHM - 47 OHM - 56 OHM
Asst. 3	5 ea. 68 OHM - 82 OHM - 100 OHM - 120 OHM - 150 OHM
Asst. 4	5 ea. 180 OHM - 220 OHM - 270 OHM - 330 OHM - 390 OHM
Asst. 5	5 ea. 470 OHM - 560 OHM - 680 OHM - 820 OHM - 1K
Asst. 6	5 ea. 1.2K - 1.5K - 1.8K - 2.2K - 2.7K
Asst. 7	5 ea. 3.3K - 3.9K - 4.7K - 5.6K - 6.8K
Asst. 8	5 ea. 8.2K - 10K - 12K - 15K - 18K
Asst. 9	5 ea. 22K - 27K - 33K - 39K - 47K
Asst. 10	5 ea. 56K - 68K - 82K - 100K - 120K
Asst. 11	5 ea. 150K - 180K - 220K - 270K - 330K
Asst. 12	5 ea. 390K - 470K - 560K - 680K - 820K
Asst. 13	5 ea. 1.2M - 1.5M - 1.8M - 2.2M
Asst. 14	5 ea. 2.7M - 3.3M - 3.9M - 4.7M - 5.6M

Calculator Chips

MM5311	\$4.95
MM5312	4.95
MM5313	4.95
MM5314	4.95
MM5316	6.95

Clock Chips

5001	\$3.95
5005	5.95
5007	6.95
5030	7.95
7001	9.95

WALL or T.V. DIGITAL CLOCK

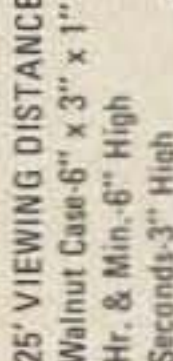

25' VIEWING DISTANCE
Walnut Case-6" x 3" x 1"
Hr. & Min.-6" High
Seconds-3" High
KIT - All Comp. & Case
Wired & Assembled 115 Vac

\$39.95
\$44.95

SWITCHES



SLIDE SWITCHES
DP-DT Locking 0.5A-DC
PART NO. 1-9 10-29 30 up
223-462061 B .39 .30 .27

PB PUSH-BUTTON SERIES - (SPDT)

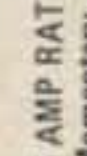

5 AMP RATINGS
Momentary Action Switch
Normally Open or Normally
Closed. (For N.C. circuit use
terminals 2 & 1; for N.O. 2
& 3; for N.C. and N.O. 1,2&3 PB-126 \$2.35 \$1.95

SUB-MINATURE TOGGLE



Part No. 1 2-9
SPDT ON NONE ON JMT-2.05 1.65
DPDT ON NONE ON JMT-2.95 2.15

Special Requested Items

8008 Processor	\$49.95	8263	\$ 7.00	2524*	\$ 3.50
1101 256 x 1 RAM	2.25	8267	4.00	2525	7.00
2102 1024 RAM	6.95	2513*	11.00	2529*	4.00
AY5-1013 UART	9.95	2518	7.00	4024P*	2.25
RC4194 TK	5.95	2519	4.00	N8197	3.00

(Zener)		(Rectifier)	
TYPE	VOLTS W	TYPE	VOLTS W
IN746	3.3 400m	IN4003	200 PIV 1 AMP
IN752	5.6 400m	IN4004	400 PIV 1 AMP
IN753	6.2 400m	IN3600	50 200m
IN754	6.8 400m	IN4148	75 10m
IN5232	5.6 500m	IN4154	35 10m
IN5234	6.2 500m	IN4734	5.6 1w .28
IN5235	6.8 500m	IN4735	6.2 1w .28
IN5236	7.5 500m	IN4736	6.8 1w .28
IN456	25 40m	IN4738	8.2 1w .28
IN458	150 7m	IN1183	50 PIV 35 AMP
IN485A	180 10m	IN1184	100 PIV 35 AMP
IN4001	50 PIV 1 AMP	IN1186	200 PIV 35 AMP
IN4002	100 PIV 1 AMP	IN1188	400 PIV 35 AMP

TRANSISTORS

MPS-A05	5/S1	2N3905	4/S1
2N918	25	2N3906	4/S1
2N2219A	3/S1	PN4249	4/S1
2N2221	4/S1	PN4250	4/S1
2N2222A	5/S1	2N4409	5/S1
2N2369	5/S1	2N3725A	.19
2N2369A	4/S1	2N5129	.19
2N2484	4/S1	2N3904	2/S1

CAPACITOR CORNER

50 VOLT CERAMIC DISC CAPACITORS	
10-49	50-100
10pf	.04
22 pf	.03
47 pf	.03
100 pf	.03
220 pf	.03
470 pf	.03

100 VOLT MYLAR FILM CAPACITORS

.001	.09	.05	.022	.10	.08
.0022	.09	.07	.05	.047	.12
.0047	.09	.07	.05	.1	.12
.01	.10	.08	.06	.22	.18

± 20% DIPPED TANTALUMS (SOLID) CAPACITORS

.1	35V .28	.23	.17	1.5 35V .30	.26
.15	35V .28	.23	.17	2.2 25V .31	.27
.22	35V .28	.23	.17	3.3 25V .31	.27
.33	35V .28	.23	.17	4.7 25V .32	.28
.47	35V .28	.23	.17	6.8 25V .36	.31
.68	35V .28	.23	.17	10 25V .40	.35
1.0	35V .28	.23	.17	15 25V .63	.50

MINIATURE ALUMINUM ELECTROLYTIC CAPACITORS

Axial Lead		Radial Lead	
Value	Price	Value	Price
.47	.50	.47	.25
1	.50	.47	.25
3.3	.50	1	.15
10	.25	1	.15
10	.25	1	.15
10	.25	1	.15
22	.25	4.7	.25
22	.25	4.7	.25
47	.25	10	.25
100	.25	10	.25
100	.25	10	.25
220	.25	10	.25
220	.25	10	.25
1000	.16	100	.25
2200	.16	220	.25

Satisfaction Guaranteed. \$5.00 Min. Order. U.S. Funds.
California Residents - Add 6% Sales Tax
Write for FREE 1975 Catalog - Data Sheets - 25¢ each

JAMES

P.O. BOX 822, BELMONT, CA. 94002
PHONE ORDERS - (415) 592-8097

INTEL 1K 2102 RAM
 Factory prime, tested units. Factory selected for much faster speed than units sold by others. 650 NS. These are *static* memories that are TTL compatible and operate off +5 VDC. The real workhouse of solid state memories because they are so easy to use. Perfect for TV typewriters, mini-computers, etc. With specs. \$6.99 ea. or 8 for \$40

SIGNETICS 1K P-ROM
 82S129. 256 x 4. Bipolar, much faster than MOS devices. 50NS. Tri-state outputs. TTL compatible. Field programmable, and features on chip address decoding. Perfect for microprogramming applications. 16 pin DIP. With specs. \$5.99 ea. 8 For \$40

LM324 — QUAD 741 OP AMP — \$1.50

NE555 — Timers — 69c or 10 For \$6

709C — OP AMPS — 4 For \$1

GE SCR C106B1
 4 AMP 200PIV. Sensitive Gate. 59c

2N706A 400MHZ. TRANSISTORS
 Silicon NPN. 1 WATT. TO-18 Case. 5 For \$1

10 PIN SOCKETS FOR FND-70
 An S.D. exclusive. For use with our Fairchild LED readouts. 29c ea. 10 For \$2.50

FAIRCHILD LED READOUTS — 69c
 FND-70. Common cathode. Right hand decimal point. .25 inch character. Prime new units. Perfect for clocks, frequency counters, etc. 69c 10 For \$6
 Best Readout Buy in USA!

PLASTIC CASE DRIVER TRANSISTORS
 For clocks or calculators. The two most popular numbers. TO-92 case. 2N3904 NPN. 2N3906 PNP. 6 For \$1

FULL WAVE BRIDGE
 By G.I. 1.5 AMP 800PIV — 75c

PC BOARD MATERIAL
 FR-4 blank epoxy boards. 2 oz. copper, 5 x 10 in. Single Sided. Limited Qty. — \$1.49

MOTOROLA VOLTAGE REGULATOR
 MC1469R. TO-66 9 Lead package. For 3 TO 30V Outputs. Provides 600 MA direct output or more by using an external power transistor. Reg. catalog \$4 ea. With specs. \$1.95 ea.

MOTOROLA NEGATIVE VOLTAGE REG
 MC1463R — Like our 1469R above, except for negative voltage. Reg. catalog \$5. Our price \$1.95.

POWER TRANSISTOR PC BOARD
 Mfg. by Memorex Computer Corp. Board has 20 Power Transistors. 10-RCA 2N3585 TO-66 SILICON NPN. VCEO-300 IC-2AMPS. 10-MOTOROLA MJE-340. NPN Silicon. VCEO-300. Plastic power tab case. Also has 10-2N2222A TO-18 NPN transistors and 10-1N5059 1AMP 200 PIV rectifiers, plus 32 resistors. LIMITED QTY. Board #103. \$3.99 ea.

IC SOCKETS
 14 PIN-5 For \$1 16 PIN-4 For \$1

ORDERS OVER \$15
 CHOOSE \$1
 FREE MERCH.

FREE BONUS
 All clock or calculator chips are shipped with *free socket*.

ELECTRONIC PARTS BARGAINS

DIGITAL CLOCK CHIPS BY NATIONAL FACTORY NEW UNITS!
 MM5314 — 4 or 6 digits. 24 pin DIP. Use with LED Readouts. With Specs. — \$3.95
 MM5316 — Alarm chip. 40 pin DIP. \$4.95

TEXAS INSTRUMENTS 8 DIGIT CALCULATOR CHIP
 TMS0103NC. Four function. Same style as used in TI pocket calculators. Factory new units, with specs. \$2.95 each

LARGE SIZE LED LAMPS
 Similar to MV5024. Prime factory tested units. We include plastic mounting clips which are very hard to come by. Special 4 For \$1

DL747 JUMBO LED READOUTS
 By Litronix. .65 inch character. Common anode. Outperforms SLA-3. Perfect for giant digital clocks. Only 20 MA. per segment. Special — \$2.50 each.

HEWLETT-PACKARD LED READOUT
 .30 inch character. Common cathode. One of the brightest readouts around. Factory prime units, not retested seconds as sold by others. #5082-7740 99¢ ea.

1AMP 1000 PIV Silicon Rectifiers
 IN4007. Factory prime devices. 10 for \$1.00.

RCA HIGH VOLTAGE POWER TRANSISTOR
 100 Watts. 5 Amps. 300 VCEO. TO-3 case. Silicon NPN. Mfg. house numbered 2N5240. Regular catalog is \$6. Perfect for H.V. supplies or vertical and horizontal circuits. SPECIAL — 99¢

741C OP AMPS
 Prime, factory tested and marked. Full spec on all parameters. Not re-tested, functional only, units as sold by others.
 741CH — TO-5 8 Lead Metal Can 3/\$1
 741 CV — 8 Lead Mini Dip. 4/\$1

12VDC RELAY
 DPDT. Heavy gold plated 5 amp contacts. 300 OHM coil. Limited Qty. 99¢

SWITCHES FOR DIGITAL CLOCKS, ETC.
 Rocker style. SPDT. miniature size. 4 for \$1.
 Push Button. SPST N.O. Enclosed, mini. 4 for \$1.

HEAVY DUTY TRANSFORMER
 36 VAC, 3.5 AMPS. 115VAC 60HZ. PRI. For power supplies or audio power amps. Best quality, fully enclosed. \$4.95.

SUBMINIATURE TRIMMER CAPS
 Ultra stable. Range: 3.5 to 18 PF. 2 for \$1

FILTER CAPS
 Dual section, 2000 MFD and 1500 MFD at 30 WVDC. Twist Lock. 79c ea. 3 For \$2

NATIONAL VOLTAGE REGULATOR
 Like 7805. 5VDC — 1AMP output. Has TO-220 plastic power tab — 99¢

IN4148 COMPUTER DIODES
 Same as IN914. Factory prime. 20 for \$1.

48 HOUR SERVICE
 You deserve, and will get prompt shipment. On orders not shipped in 48 HRS., a 20% cash refund will be sent. We do not sell junk. Money back guarantee on every item. WE PAY POSTAGE. Orders under \$10 add 75¢ Handling. No C.O.D. Texas Res. add 5% tax.

S. D. SALES CO.
 P.O. BOX 28810
 DALLAS, TEXAS 75228

S. D. SALES CO.

P. O. BOX 28810 DALLAS, TEXAS 75228

6 Digit Digital Clock Kit

Our Engineer said it would be "impossible" to sell a **Six Digit** kit for this price. But because of several special super buys we made on chips and displays we can offer this unbelievable bargain on our Clock Kit. Sure, this price is too good to be true, but rest assured, all parts in this kit are prime, first run units. Also, all kits are sold with an unconditional money back guarantee.

Here's What The Kit Includes:

- 1 — MM5314 National Clock Chip with socket
- 6 — Common Cathode Led Readouts (.25 in. char.)
- 13 — NPN and PNP Driver Transistors
- 2 — Push Button Switches for time set
- 1 — Rocker Switch for time hold
- 1 — 1000 MFD 25V Filter Cap
- 4 — IN4001 Rectifiers
- 1 — IN914 Diode
- 2 — .01 Disc. Caps
- 9 — Carbon Resistors

\$9⁹⁵
(KIT)
WITH SPECS.
POSTPAID

P.C. BOARD FOR ABOVE — \$3.00 each

All you need to add is a 12VAC Transformer, perfboard, and your choice of case. The above parts, if ordered separately from our competitors, could cost you as much as \$20. Buy from S.D. and you'll be happy with our quality parts and ultra fast shipment.

ARNOLD TORROID CORES

#A-759135-2. Perfect for chokes, transformers, etc. OD-1.875 IN. ID-.918 IN. H-.745 IN. Permeability — 60. L-135 MH/1000 turns. Cross Sectional Area — 1.95 CM². Regular Factory Cost \$5.00
Our Price — 99¢

GODBOUNT

BOX 2355
OAKLAND
AIRPORT,
CA 94614

CIRCLE THE
BINGO CARD NUMBER

BELOW AND WE'LL SEND
YOU THE STORY ON OUR
CMOS, TTL, LINEARS,
LEDS, KITS, COMPON-
ENTS, MINICOMPUTER
STUFF, POWER SUPPLY
KITS, AND MORE. OUR
FLYER TELLS ALL.....
SEND FOR IT! BE SUR-
PRISED.

**HOBBYWRAP
TOOL \$41.95**



WHY SOLDER? NOW
YOU CAN AFFORD TO
WIRE WRAP. CORDLESS
FOR EASY HANDLING.
COMES W/ CHARGER,
NICADS, BIT, INSTRU.

**FLASH!
95h90
\$13.50**

brand new!
**250 MHZ
PRESCALER**

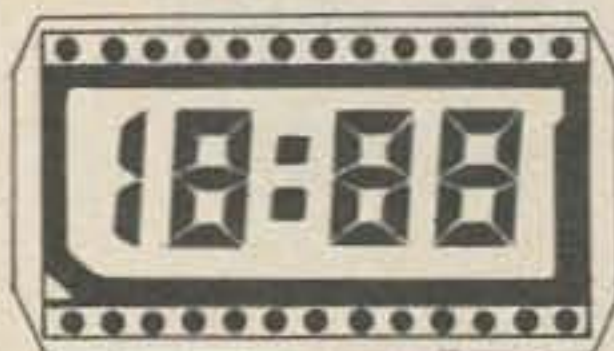

**\$4.95
LIQ. XTAL
DISPLAY**

BIG .2" HI CONTRAST BLACK
DIGITS ON SILVERY BACK-
GROUND. 3 1/2 DIGITS PLUS
COLON. NOT TO BE CONFUSED
WITH RUN OF THE MILL TINY
READOUT STUFF; IDEAL FOR
CLOCKS, TIMERS, COUNTERS,
OTHER MICROPOWER APPLICA-
TIONS. QUANTITY LIMITED.

TERMS: ITEMS IN THIS AD, EXCEPT POWER SUPPLY, SHIPPED
POSTPAID U.S. CAL RES ADD TAX. CALL (415) 357-7007
FOR MASTERCARD OR BANKAMERICARD. SORRY, NO COD.

\$17.95
postpaid!

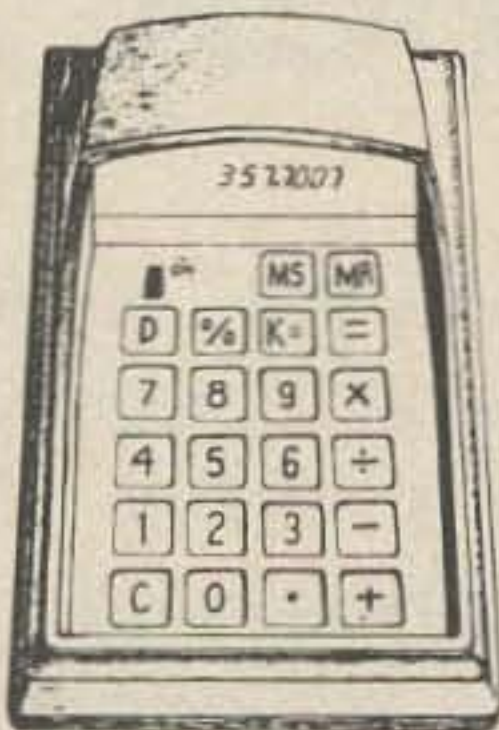

CALCULATOR
8 DIGIT-FIVE
FUNCTION (+
-X÷%) PLUS
MEMORY,
CONSTANT,
FLOATING PT,
LOW BATTERY
INDICATOR,
TIMED DIS-
PLAY TURNOFF
(PRESS "D" TO
RECALL). KIT
IN-
CLUDES PARTS,
INSTRUCTIONS,
AND CASE. ALKA-
LINE BATTERIES
FOR CALCULATOR
AVAILABLE AT 6/
\$2.75 POSTPAID.

**CHEAP
CLOCK**
\$12.95
6 DIGIT BASIC --
COMPLETE, LESS
CASE & TRNSFRMER

break-through!

YOU'VE
READ
ABOUT
IT -
NOW YOU
CAN AF-
FORD TO EX-
PERIMENT
WITH IT!

**8 BIT
CPU 8008**
\$27.95

**STATIC
RAM**
2102 \$5.50
8 FOR \$39.50

1024 X 1 BIT NMOS STATIC MEMORY-
THIS POPULAR CHIP REQUIRES A +5
VOLT SUPPLY ONLY AND IS FAST...

**5203 REPROGRAM-
MABLE ROM**
\$14.50

SAVE MORE! \$65
**COMPUTER
BASIC CHIP KIT PPD**
8-2102 PLUS AN 8008

**12VOLT 8 AMP
POWERSUPPLY**
FEATURED IN THE MAY 75 ISSUE OF 73. WE
HAVE SOLD HUNDREDS AT \$18.95, BUT MUST
INCREASE PRICE EFFECTIVE JULY 1 TO:
\$20.95+SHPG CASE+HARDWARE NOT INCL

WE COULD GIVE YOU A LOT
OF BULL ~ but,

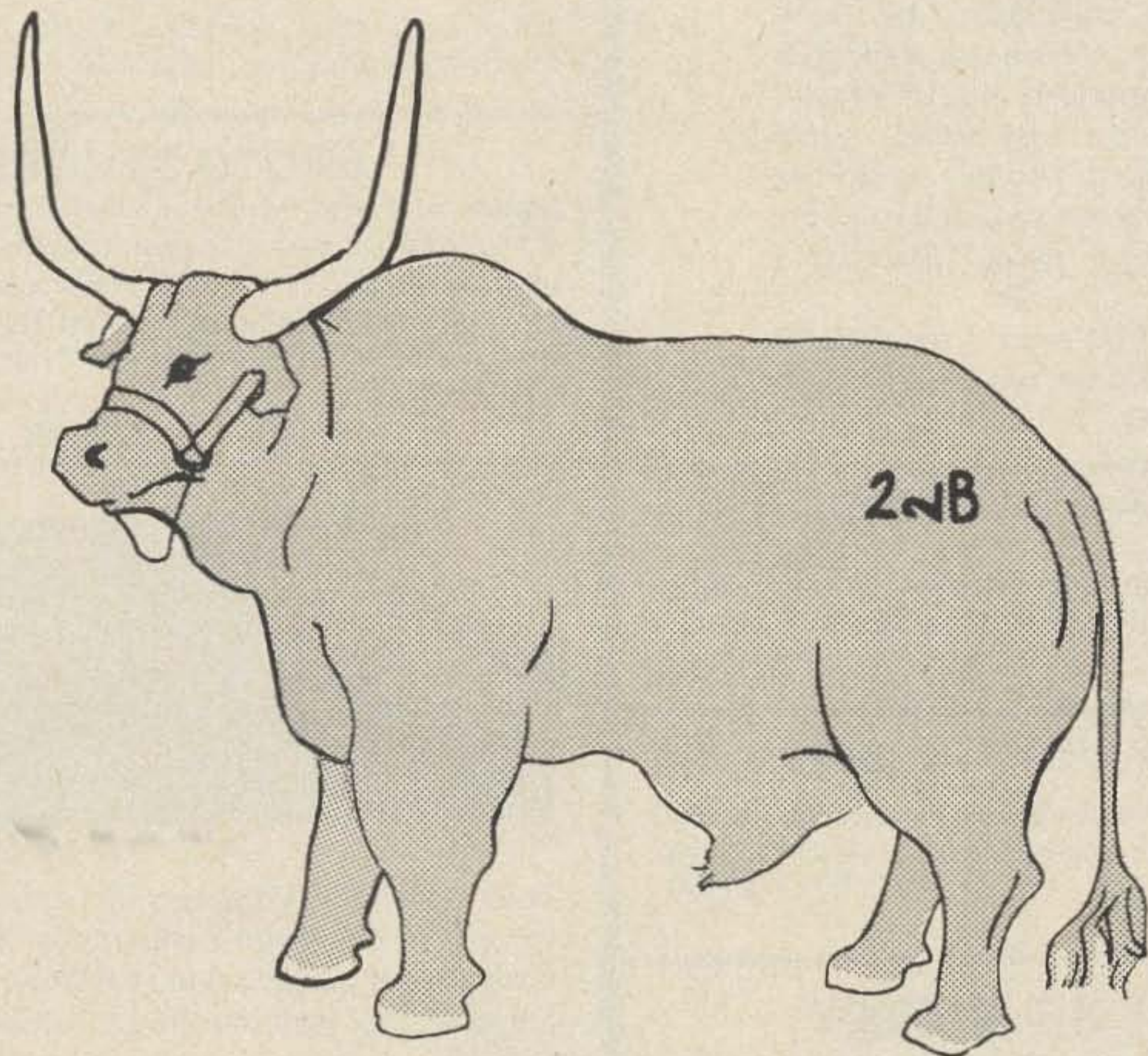

READ THE COMPETITIONS' ADS FIRST, THEN CHECK OUR
AD ON OPPOSITE PAGE, FOR EXAMPLE 8008 @ \$27.95,
CALCULATOR @ \$17.95.

GODBOUT

Box 2355, Oakland Airport, California 94614



Desk top calculator by well known mfr. These are rejects, 8 digit, 4 function, liquid crystal display. Fully assembled, some factory reject, some customer returns. Most are repaired in a few minutes. Sold "as is." Ship wt 3 lbs.

AC model \$10 each 3 for \$26.50
 Battery portable model \$11 each 3 for \$30.00

SINGLE CHIP ASCII ENCODER

A hot item today. We furnish full data booklet with each order. \$10 each 3 for \$25.00

8 CHAN MULTIPLEX SWITCH

Solid state 16 pin IC MOS. 8 channel w/output enable control & one-of-eight decoder in chip. With data. Fairchild 3705. . \$5.00

RC OSCILLATORS

16 pin IC chip contains 4 RC osc. Ideal for touch tone encoder. TCA 430. . \$5.00

PHOTO-STROBE

Made for Instamatic but useful on any camera with instructions provided. Info also on trick uses, automotive strobe, slave strobe, automotive strobe, Psychedelic repetitive strobe, etc. Complete with charger & Nickel Cadmium batteries.

\$9.00, 3 for \$25.00

COLUMBIA 4 CHANNEL SQ

Solid state SQ 4 channel adapter, 2 amps built in. Decodes 4 channel or synthesizes 4 channel.

\$20.00

LED READOUTS 5/\$1.00!

The price is not a mistake. We have some hobby variety with some segments out. Ukinbuyem for as low as 5 for \$1.00

DUAL 16 BIT MEMORY

Dual 16 bit memory, serial MOS by Philco TO-5 case, brand new with 2 page specs.
 #PLR 532 \$1.00 each \$10/12

AM-FM RADIO

For console installation, w/face plate, no knobs. Stereo amplifiers for tape or turnable playback. \$15.00

Pair of matching speakers w/xfmrs for above \$5.00

CALCULATOR CHASSIS

Fully assembled pocket calculator chassis with calculator chip. Uses LED readouts not included. \$5.00

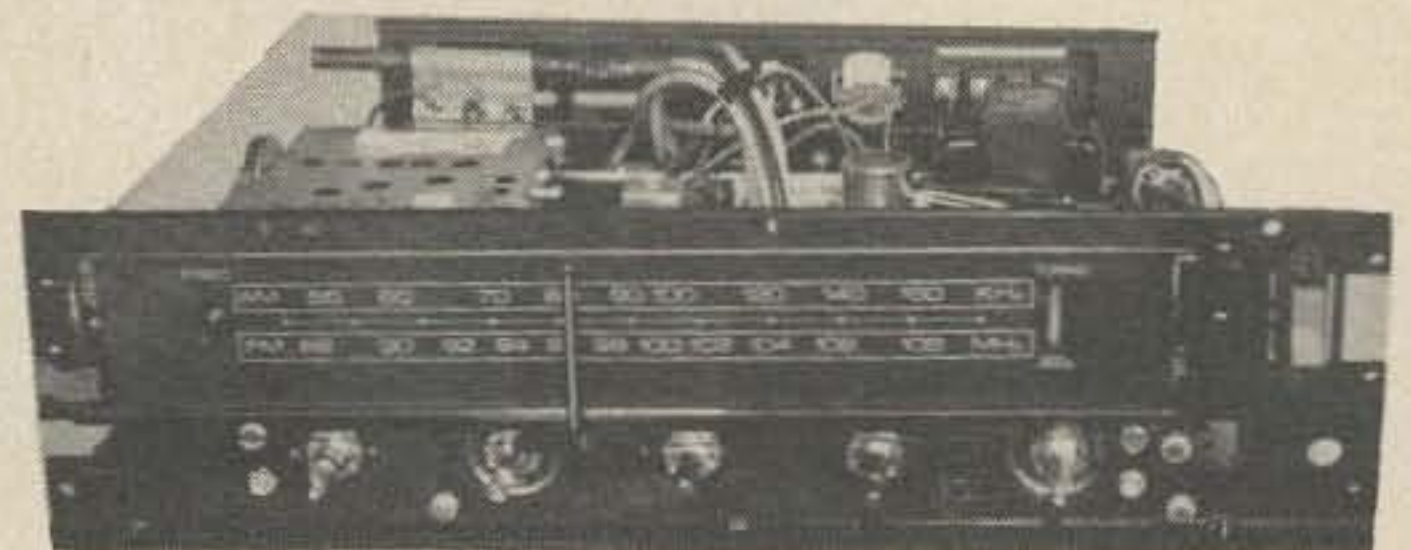

Beautiful AM-FM Stereo Multiplex radios made to sell in the over \$100 range. Picture shows typical unit. Solid state. AC powered, made for famous US manufacturer. Ship wt 10 lbs. \$35.00

BELLTONE PAGER

Genuine "Ma Bell" belt clip radio receiver beeper. Picks up specific radio signals in 35 MHz area, encoded by internal reed encoder. Seems to be a "natural" for construction jobs, in-plant calling. An interesting experimental gadget. Self contained antenna, adjustable coding by shifting wires on coding module.

#SP-125 \$5.00 each, 6/\$25.00

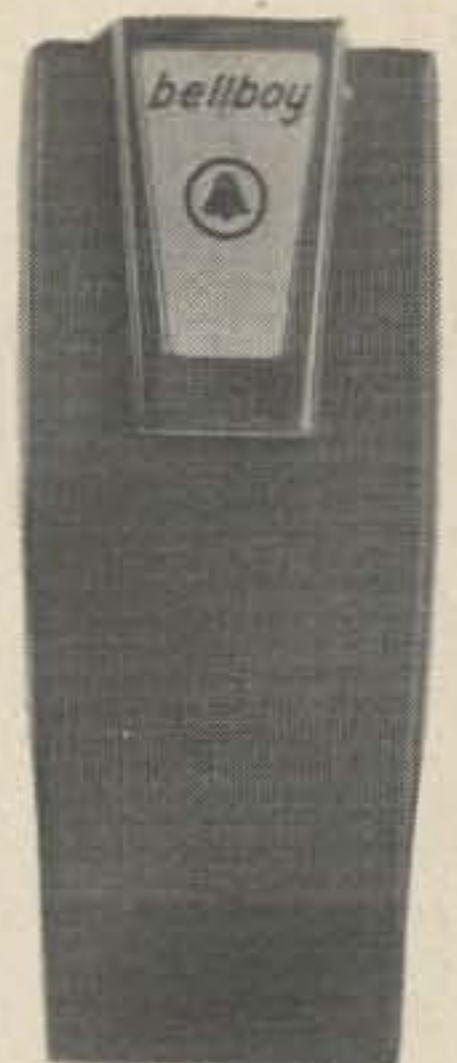

Please add shipping cost on above.

Meshna

P.O. Box 62
 E. Lynn MA 01904

FREE CATALOG



**SEE-THRU
MINI.....
S-METER**
Only **\$1.49**
3 for \$3

Mini sized meter. 1/2 x 1/4" indication with RED and BLACK face. Red indicating needle.

**WRISTWATCH
LIQUID
CRYSTAL
DISPLAY** **\$9.95**



3 1/2 digit, 7-segment only 1 1/16 x 1 1/16 x 1/4". Includes readout, socket, "slide-in-place" chrome slide face plate. Same display as found in \$200. units.

**"BLASTAWAY"
ON 1N4000
RECTIFIER PRICES**

Type	PIV	Sale
1N4001	50	10 for 45c
1N4002	100	10 for 55c
1N4003	200	10 for 65c
1N4004	400	10 for 75c
1N4005	600	10 for 85c
1N4006	800	10 for 99c
1N4007	1000	10 for 1.29



Sanken Watts	Sale
SI-1010G 10	\$ 8.88
SI-1020G 20	14.95
SI-1030G 30	18.88
SI-1050G 50	29.95

**SANKEN HYBRID
AUDIO POWER AMPS**

All amplifiers, flat within 1/2 db from 100 Hz to 100,000. Each unit properly heat-sinked, with heavy-duty connecting tie lug connections. Single-ended pushpull output. Power supply required 24VDC. Output to 8 ohms. Order by Stock No.

555 Timer
OR
558 Dual 741
2 for \$1
Sale good till
July 15, 1975



**NATIONAL
LM-340T VR's**
Buy 3 - Take 10%
Type Volts
LM-340-05T 5v
LM-340-06T 6v
LM-340-08T 8v
LM-340-12T 12v
LM-340-15T 15v
LM-340-18T 18v
LM-340-24T 24v
1.75 Each

Type	Volts
LM-340-05T	5v
LM-340-06T	6v
LM-340-08T	8v
LM-340-12T	12v
LM-340-15T	15v
LM-340-18T	18v
LM-340-24T	24v

'ALL LED' MONSANTO READOUTS
*35 LED matrix

MONSANTO CHAR. TYPE	HT.	SALE EACH	Quantity Discounts
MAN-1	.27	\$2.95	3 for \$ 7.
MAN-2	.32*	4.95	3 for \$14.
MAN-3	.12	1.00	3 for \$2.50



OPCOA SLA-1 REFLECTIVE LED READOUT 3 for \$ 6.
7-segment Litronix 704
Red \$2.50
Yellow Litronix 707
Green Red \$2.50

**Inflation-Fighting
IC PRICES**
Buy 100 - Take 25%
Buy 10 or more 15% discount

Type	Sale	Type	Sale	Type	Sale
SN7400	.22	SN7443	1.00	SN74163	1.75
SN7401	.22	SN7444	1.00	SN74164	2.85
SN7402	.22	SN7445	1.00	SN74165	2.85
SN7403	.22	SN7446	1.10	SN74166	1.85
SN7404	.27	SN7447	1.10	SN74173	1.85
SN7405	.24	SN7448	1.45	SN74174	2.25
SN7406	.79	SN7450	.27	SN74175	1.99
SN7408	.27	SN7451	.28	SN74176	1.25
SN7409	.27	SN7452	.28	SN74177	1.25
SN7410	.19	SN7453	.28	SN74180	1.10
SN7411	.31	SN7455	.28	SN74181	3.95
SN7413	.89	SN7462	.39	SN74182	1.05
SN7414	2.25	SN7464	.39	SN74190	1.49
SN7415	.45	SN7465	.39	SN74191	1.49
SN7416	.45	SN7471	.55	SN74192	1.59
SN7417	.50	SN7472	.42	SN74193	1.59
SN7420	.22	SN7473	.52	SN74195	1.10
SN7422	.29	SN7474	.39	SN74197	1.10
SN7423	.32	SN7475	.91	SN74198	2.45
SN7425	.35	SN7476	.52	SN74199	2.45
SN7426	.31	SN7477	.79	SN74200	7.50
SN7427	.35	SN7478	.59		
SN7430	.24	SN7480	1.25		
SN7432	.28	SN7481	.99		
SN7437	.45	SN7482	.99		
SN7438	.49	SN7483	1.19		
SN7440	.19	SN7484	.49		
SN7441	1.00	SN7486	.49		
SN7442	1.00	SN7488	2.95		
		SN7489	1.81		
		SN7490	1.35		
		SN7491	.99		
		SN7493	.99		
		SN7495	.99		
		SN7496	.99		
		SN74100	1.55		
		SN74104	1.25		
		SN74105	.95		
		SN74106	.95		
		SN74107	.49		
		SN74108	.95		
		SN74112	.95		
		SN74113	.95		
		SN74114	.95		
		SN74121	.49		
		SN74122	.55		
		SN74123	1.09		
		SN74125	.65		
		SN74126	.89		
		SN74140	2.50		
		SN74141	1.19		
		SN74145	1.19		
		SN74148	2.95		
		SN74150	1.19		
		SN74151	.99		
		SN74153	1.39		
		SN74154	1.69		
		SN74155	1.29		
		SN74156	1.45		
		SN74157	1.45		
		SN74158	1.45		
		SN74161	1.59		

12 or 24-hr clock **6-digits** **DIGITAL CLOCK**
Now two clocks in one!
For 12VDC* 110VAC!
Scientific Devices introduces the new any LED Kronos digital clock. That's right, you can choose the "ALL-LED" Man-1, Man-3, and the new reflective bar types with the larger digits, at only one price. Scientific Device first! It's easy to construct, easy to slip into the Kronos of your choice and connect with easy instructions. Its overall design is simple and easy to construct. The kit is complete with famous black-and-white TEN-TEC cabinet, plus all accessories with booklets. Features include 3 setting controls, 1-hour per second, 1-minute per second, and hold button.

CHOOSE YOUR READOUT
Type LED Charac. Buy Any
KR-101 MAN-3 .12
KR-102 MAN-1 .27
KR-105 707† .33
KR-106 704† .33
KR-107 SLA-1† Red .33
KR-108 SLA-1† Green .33

Cabinet is 6" x 5 1/2" x 6".
29.95

GIANT VENTILATING FAN
Only **\$4.98**
Heavy-duty powerful high-torque motor, ruggedly constructed. Permanently lubricated type bearings. Thermalloy protected. Motor size: 3 x 3 x 2 1/2". By Molon ZM04047. 115 vac 60 Hz. 0.77 amps. With 6 1/2 TORIN fan blade, 1500 rpm. For all types of ham & industrial equipment.

"THE PRO" — HI-Q DYNAMIC PENCIL MIKE Only **\$6.95**
General Electric. NO IMPORT! Highly polished with chrome trim. Omni-directional, 20,000 ohm imp., 60 to 100KHz freq resp. Crisp, ultra-sensitive, high quality, hi-fidelity. Ideal for PA, CB, and all HAM equipment. May be hand-held too! Mike 5" long 1" dia., with taper. Heavy-duty grey metal stand, 2 1/2 x 2 1/4 x 1/2". Ideal for our 60w stereo Amp. wt. 1-lb. 6-ft. cord.

LED MITY DIGIT "DCM'S"
"Digital Counting Modules" outperform any other DCM on the market today. More features than ever before! Not gaseous, not incandescent, not nixie but the modern LED. Choose from such famous manufacturers as Monsanto's MAN-1, MAN-4, Litronix 707 and 704, Opcoa's SLA-1 (the last 4 having character heights of 0.33 at no extra charge). Each kit includes 3x2" p.c board with fingers for a FREE edge connector, side-mounting dip socket, LED readout of your choice, resistors, 3 IC's, and Molex connectors (this ELIMINATES SOLDERING YOUR IC'S) and booklet. INCLUDES P.C. EDGE CONNECTOR — FREE!
* Pin-for-pin MAN-1. ** Pin-for-pin MAN-4, elec. char.

Buy 3 — Take 10%
Only **\$8.88**

READOUT Char. Maker
MAN-1 .27 h. Monsanto
MAN-4 .19 h. Monsanto
707* .33 h. Litronix
704** .33 h. Litronix
SLA-1* .33 h. Opcoa
MAN64 .4 h. Monsanto

Same as above except uses MAN-6....\$9.95 Character Size: 0.6

Touch Tone KEYBOARD KIT **\$4.95**
Kit includes 4 x 2 1/2" G-10 glass etched pc board, with 10 OAK "smooth touch" white keys with black numerals, plus diagram on "touch tone encoder". Makes many "keyboard systems" readily available. 0-to-9

Imagine a chip (MK50250) "Beepin" and audible alarm! All others are external. It also features internal brightness control. The CT7001 requires external triggering of alarm, date of the month and direct drive to LED readouts. Both require minimum current drain and voltages, for either 4 to 6 LED readouts, 12 or 24 hours, AM and PM.

'BEEPER' AND 'DATER' CLOCK ON THE CHIPS
MK50250 BEEPER ONLY \$ 8.50
CT7001 Alarm and Date...\$ 6.95

CLOCK CHIPS ON A "DIP" as Low as **3.95**
WITH DATA SHEETS
MM5311 6-digit 28-Pin \$5.50
MM5312 4-digit 24-Pin 5.50
MM5313 6-digit 28-Pin 5.50
MM5314 6-digit 24-Pin 5.50
MM5316 4-digit 40-Pin, alarm 5.50
MM5316-A no alarm 3.95

SCRS! TRIACS! QUADRACS! SAME PRICE SALE!
10-Amp Power Tab Plastic Units
PRV Sale
50 \$.75
100 .95
200 1.25
300 1.50
400 1.98
500 2.25
600 2.50

FULL EPOXY SILICON BRIDGE RECTIFIERS
WAVE PIV 2 Amp 6 Amp 10 AMP
50 \$.69 \$.88 \$ 1.49
100 .79 .99 1.69
200 .95 1.25 1.89
400 1.19 1.50 2.09
600 1.35 1.75
800 1.59 1.95
1000 1.79 2.25
Code: 2 amp TO-5 case
6 Amp 1/2 x 1/2 x 3/16 sq.

BIGGEST MAN-7 SALE
7-segment "reflective bar" version of the famous MAN-1. The optimum in light efficiency and construction. Looks like, acts like, the MAN-1. Pin connections same. Wide angle viewing. 0.27" character height, color red.
MAN-5 as MAN-7 except green **1.49**
MAN-8 as MAN-7 except yellow **1.49**

Terms: add postage Rated: net 30
Phone Orders: Wakefield, Mass. (617) 245-3829
Retail: 16-18 Del Carmine St., Wakefield, Mass. (off Water Street) C.O.D.'S MAY BE PHONED

20c CATALOG Fiber Optics, IC's, Semi's, Parts
MINIMUM ORDER — \$4.00

POLY PAKS
P.O. BOX 942A LYNNFIELD, MASS. 01940

Money-Back GUARANTEE on all items

73 reader service

Check appropriate boxes for desired company brochures, data sheets or catalogs and mail in to 73. Include your zip code, please. Send money directly to advertisers. **LIMIT: 25 requests.**

ADVERTISER INDEX

- | | |
|---|---|
| <input type="checkbox"/> Alden Elec. 175 | <input type="checkbox"/> James 184, 185 |
| <input type="checkbox"/> Alexander 125 | <input type="checkbox"/> Jan 137 |
| <input type="checkbox"/> Al's 2-Way 130 | <input type="checkbox"/> KLM 70, 71 |
| <input type="checkbox"/> Amateur Elec. 110, 126, | <input type="checkbox"/> Kensco 63 |
| <input type="checkbox"/> A. P. Products 146 127 | <input type="checkbox"/> K-Enterprises 125 |
| <input type="checkbox"/> Aprtron 90 | <input type="checkbox"/> Klaus 113 |
| <input type="checkbox"/> Atlanta Hamfest 53 | <input type="checkbox"/> Levy 54 |
| <input type="checkbox"/> Atlas 51, 121 | <input type="checkbox"/> Meshna 190 |
| <input type="checkbox"/> Audioland 147 | <input type="checkbox"/> Midland 154 |
| <input type="checkbox"/> Babylon 179 | <input type="checkbox"/> M-Tech 26 53 |
| <input type="checkbox"/> Budwig 156 | <input type="checkbox"/> Newtronics CII, 51 |
| <input type="checkbox"/> CeCo 130 | <input type="checkbox"/> North Shore 87 |
| <input type="checkbox"/> CFP 130 | <input type="checkbox"/> Palomar 20 |
| <input type="checkbox"/> Chronex 95 | <input type="checkbox"/> Poly Paks 191 |
| <input type="checkbox"/> Clegg 21 | <input type="checkbox"/> Quement 90 |
| <input type="checkbox"/> Coakit 140 | <input type="checkbox"/> Radio Amat. Callbook 152 |
| <input type="checkbox"/> Comm. Specialists 175 | <input type="checkbox"/> RGS 183 |
| <input type="checkbox"/> Comm. Specialties 41 | <input type="checkbox"/> Regency 34 |
| <input type="checkbox"/> Cornell 146 | <input type="checkbox"/> Robot 153 |
| <input type="checkbox"/> Data Signal 27, 46, 47 | <input type="checkbox"/> Rohn 134 |
| <input type="checkbox"/> DuPage 182 | <input type="checkbox"/> S.D. Sales 186,187 |
| <input type="checkbox"/> DX-ers Mag. 41 | <input type="checkbox"/> Sentry 15 |
| <input type="checkbox"/> Dynamic Elec. 137 | <input type="checkbox"/> Slep 180 |
| <input type="checkbox"/> ECM 137 | <input type="checkbox"/> Space 53 |
| <input type="checkbox"/> Ehrhorn 171 | <input type="checkbox"/> Specialty Comm. 79 |
| <input type="checkbox"/> Elec. Discount 114 | <input type="checkbox"/> Spectrum Comm. 157 |
| <input type="checkbox"/> Emergency Beacon 66 | <input type="checkbox"/> Standard Research 26 |
| <input type="checkbox"/> Fair 140 | <input type="checkbox"/> Standard 13 |
| <input type="checkbox"/> Freck 156 | <input type="checkbox"/> Sumner 29 |
| <input type="checkbox"/> Gateway 118 | <input type="checkbox"/> Swivitech 36 |
| <input type="checkbox"/> GENAVE 142, 143 | <input type="checkbox"/> Telstar 84 |
| <input type="checkbox"/> Glade Valley 96 | <input type="checkbox"/> Temtron 156 |
| <input type="checkbox"/> Glass, J. J. 181 | <input type="checkbox"/> Ten-Tec 83 |
| <input type="checkbox"/> Global Import 114 | <input type="checkbox"/> TPL 75 |
| <input type="checkbox"/> Godbout 188, 189 | <input type="checkbox"/> TriTek 175 |
| <input type="checkbox"/> Ham Import 42 | <input type="checkbox"/> Trumbull 140 |
| <input type="checkbox"/> Ham Radio Center 177 | <input type="checkbox"/> Tucker 98-107 |
| <input type="checkbox"/> Hamtronics 129 | <input type="checkbox"/> Tufts 35, 41, 51, 79, |
| <input type="checkbox"/> Heath 138 | <input type="checkbox"/> 83, 92 |
| <input type="checkbox"/> Henry 25 | <input type="checkbox"/> TWS Labs 41 |
| <input type="checkbox"/> ICOM 91, 131 | <input type="checkbox"/> VHF Eng. CIV, 92 |
| <input type="checkbox"/> Int. Elec. Unltd. 178 | <input type="checkbox"/> Westcom 117 |
| <input type="checkbox"/> Int. Telecomm. 35, 42, 58, | <input type="checkbox"/> Wilson 141 |
| <input type="checkbox"/> 59 110, 113, 117, 129 | <input type="checkbox"/> World QSL 146 |
| | <input type="checkbox"/> Yaesu CIII |

73 Stuff
140, 158-160

NEWSSTAND SUBSCRIPTION

*Reader service inquiries not solicited. Correspond directly to company.

Reader's Service JUNE 1975
73 Inc., Peterborough NH 03458
Please print or type.

Name Call

Address

City

State Zip

Coupon expires in 60 days . . .

PROPAGATION CHART

J.H. Nelson

Good (open) Fair (□) Poor (O)

June - 1975

Sun	Mon	Tue	Wed	Thu	Fri	Sat
1	2	3	4	5	6	7
8	9	10	11	12	13	14
15	16	17	18	19	20	21
22	23	24	25	26	27	28
29	30					

EASTERN UNITED STATES TO:

GMT: 00 02 04 06 08 10 12 14 16 18 20 22

	00	02	04	06	08	10	12	14	16	18	20	22
ALASKA	14	14	7	7	7	7	7	7	7	7	7	7A
ARGENTINA	14	14	14	7	7	7	14	14	14	14A	14A	14
AUSTRALIA	14	14	7A	7B	7	7	7	7	7	7	14	14
CANAL ZONE	14	14	7A	7	7	7	7	14	14	14	14	14
ENGLAND	7A	7	7	7	7	7	14	14	14	14	14	14
HAWAII	14	14	7A	7	7	7	7	7	7A	14	14	14
INDIA	7	7B	7B	7B	7B	7B	14	14	14	14	7A	7
JAPAN	14	14	7	7	7	7	7	7	7	7	7	14
MEXICO	14	14	7	7	7	7	7	14	14	14	14	14
PHILIPPINES	14	7	7B	7B	7B	7B	7B	7	7	7	7	14
PUERTO RICO	14	7	7	7	7	7	7	7	7A	14	14	14
SOUTH AFRICA	7	7	3A	7	7	14	14	14	14	14	7	7
U. S. S. R.	7	7	7	7	7	7	7	7A	14	14	14	7A
WEST COAST	14	14	7	7	7	7	7	7	7A	14	14	14

CENTRAL UNITED STATES TO:

	00	02	04	06	08	10	12	14	16	18	20	22
ALASKA	7A	14	14	7	7	7	7	7	7	7	7	7A
ARGENTINA	14	14	14	7A	7	7	7	14	14	14	14	14
AUSTRALIA	14	14	14	7	7	7	7	7	7	7	14	14
CANAL ZONE	14	14	7A	7	7	7	7	14	14	14	14	14
ENGLAND	7A	7	7	7	7	7	7	7	7A	7A	14	14
HAWAII	14	14	14	7A	7	7	7	7	7A	14	14	14
INDIA	7	7	7	7	7B	7B	7B	7	14	14	14	7
JAPAN	14	14	14	7	7	7	7	7	7	7	7	14
MEXICO	14	14	7	7	7	7	7	7	7	7	14	14
PHILIPPINES	14	14	14	7B	7B	7B	7	7	7	7	7	14
PUERTO RICO	14	14	14	7	7	7	7	14	14	14	14	14
SOUTH AFRICA	7	7	3A	7	7	7B	7B	7A	14	14	7	7
U. S. S. R.	7	7	7	7	7	7	7	7	7A	7A	7	7

WESTERN UNITED STATES TO:

	00	02	04	06	08	10	12	14	16	18	20	22
ALASKA	7A	14	14	7	7	7	7	7	7	7	7	7
ARGENTINA	14	14	14	7A	7	7	7	7A	14	14	14	14
AUSTRALIA	14A	14A	14A	14	7A	7	7	7	7	7	14	14
CANAL ZONE	14	14	7A	7	7	7	7	14	14	14	14	14
ENGLAND	7A	7	7	7	7	7	7	7	7	7	7A	14
HAWAII	14	14A	14	14	14	7	7	7	7A	14	14	14
INDIA	14	14	14	7B	7B	7B	7B	7	7	7	7	14
JAPAN	14	14	14	14	14	7	7	7	7	14	14	14
MEXICO	14	14	7	7	7	7	7	7	7	14	14	14
PHILIPPINES	14	14	14	14	14	7B	7	7	7	14	14	14
PUERTO RICO	14	14	14	7	7	7	7	14	14	14	14	14
SOUTH AFRICA	7	7	3A	7	7	7B	7B	7B	7A	14	7A	7
U. S. S. R.	7	7	7	7	7	7	7	7	7A	7	7	7
EAST COAST	14	14	7	7	7	7	7	7	7A	14	14	14

A = Next higher frequency may be useful also.
B = Difficult circuit this period.

The radio station

...from
the radio
company.



For the discriminating amateur who wants it all, Yaesu offers the radio station. With an advanced 160-10 meter transmitter, the FL-101. With a sensitive receiver the FR-101S, with flexible options that allow 160 through 2-meter coverage. And for continuous signal monitoring, the famous Yaesu YO-100 monitor scope.

Put this three-unit combination in your shack and you'll have it all. No more stacks of home-brew or contrasting boxes. No more tangle of cables. Just an elegant grouping of some of the best amateur radio gear you can buy. And when you buy it—you'll have the radio station. From the world's leading manufacturer of amateur radio gear. Backed up by a solid warranty, a nation-wide dealer network, convenient serviceability and technology second to none. What's more the radio station is available at a surprising value. So visit your Yaesu dealer today. Or write for complete information on this, the amateur's complete rig.

Yaesu Musen USA, Inc., 7625 E. Rosecrans, No. 29, Paramount, Ca. 90723.

YAESU
The radio.

NEW!

2 MTR
RF Power Amplifiers

UP TO 150 WATTS OUTPUT

- All solid state
- Strip line design
- Broad band
- High efficiency

PA140/30 15-40 watts in for 100-150 watts out @ 13.6 volts
Typically 140 watts for 30 watts in
\$159.95 wired & tested

PA140/10 5-15 watts in for 100-150 watts out @ 13.6 volts
Typically 140 watts for 10 watts in
\$179.95 wired and tested



25 OR 40 WATTS OUTPUT

PA2501 1-4 watts in for 20-30 watts out @ 13.6 volts
Typically 25 watts for 2 watts in
\$59.95 kit **\$74.95** wired & tested

PA4010 2-12 watts in for 25-45 watts out @ 13.6 volts
Typically 40 watts for 10 watts in
\$59.95 kit **\$74.95** wired & tested

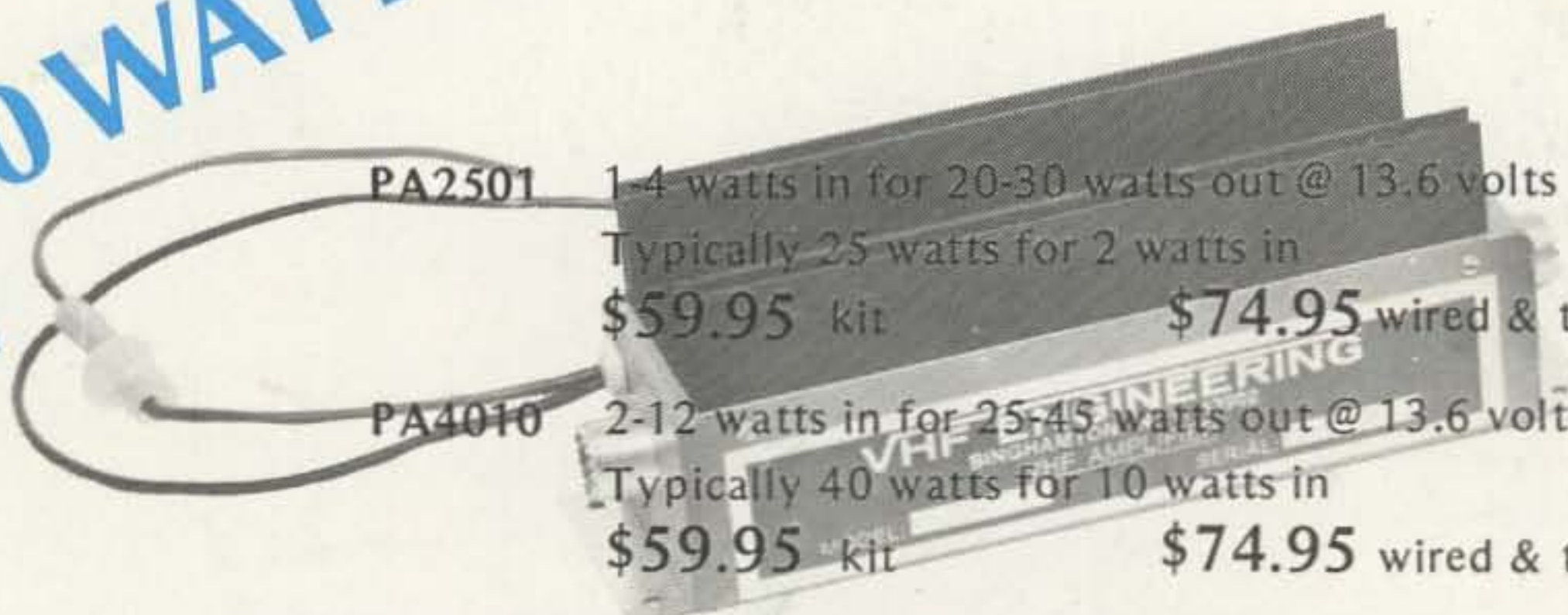

WANT TO USE YOUR AMPLIFIER IN-DOORS?

PS24 Power Supply \$99.95 kit \$114.95 wired & tested
PS12 Power Supply \$69.95 kit \$85.95 wired & tested



PO Box 1921 Binghamton, N.Y. 13902 • 607-723-9574
DIVISION OF BROWNIAN ELECTRONICS CORP.



ORDER FORM

Item	Part No.	Description	Price	Extension

Name _____ Total _____
 Address _____ Shipping _____
 City _____ NYS Resident Sales Tax _____
 State _____ Zip _____ Total Enclosed _____
 Master Charge No. _____ PA140/30 & PA140/10 ship wgt. 4 lbs.
 BankAmericard No. _____ PA2501 & PA4010 ship wgt. 2 lbs.