

# 73

**magazine**  
for radio amateurs

\$1.50  
November 1972  
26009

**A**  
CE



ou goons don't ever proofr  
leasy men...  
bunch of trocks...  
you ignored my comments in  
I insist that you print ev

Thanks for the Advanced Class Study Guide with my new subscription to 73 magazine. I passed my Advanced Class License Exam in Houston, Texas, August 21, 1972 (just two days ago) by using this book and by using Advanced Handbook by Howard Pyle W70E (Howard W. Sams book). Both books are excellent study guides.

Ben W. Thomas

Six meter activity is rare around here, especially 6 CW. I decided to brave the TVI with a good LP filter, and try to build up 6 CW activity.

I'll only run 60w with a 6 element beam, until I see how the TVI is, with channel 2 only 25 miles away. Then, maybe more power if things work out.

I will welcome any skeds with anyone looking for Iowa on 6, CW preferred, but will also work AM.

Robert Lucas WA0DXZ  
Iowa City IA

Recently I ordered parts for your current frequency counter project from your advertiser, Circuit Specialists. They do not carry some of the items, but because of my remote location, they shopped for me outside

of their own store in order to send me the whole kit.

Any magazine with that kind of advertising just has to be something special!

Same goes for the advertiser... give them a discount rate!

Leonard C. Nelson KW6EG  
Wake Island

First of all I would like to tell you how much I enjoy 73, and look forward to every issue. Please find enclosed payment for the next 2 years. The purpose of this letter is to point out something I read in your August 1972 issue covering the recent expedition to Navassa Island. The comment was made that KC4DX did not leave any signatures or such painted on rocks and buildings, which I'm sure they didn't. However, it was also stated that in 1958, KC4AF did not leave any signatures. Upon looking through some old CQ magazines trying to find another article, I ran across the June 1958 issue of CQ, and there on the front cover, as big as life, painted on the wall of Navassa Island, were the call letters W2NSD, which I have to assume were painted there

during the KC4AF expedition. I did notice that on a similar picture of KC4DX that this wall had been painted black, or the picture painted over. Like I said in the beginning, I enjoy your magazine very much and this is not in the form of a complaint, only I do think an explanation is in order.

Keep up the good work, especially in WA0ABI articles on the 50 MHz band.

Ted Hogan K4VAA  
Cheraw SC

*I was afraid that no one would ask. The fact is that rather than paint up the island, I chose the easy way out and painted up the photograph just for that cover picture on CQ. If you'll look closely at the picture, you'll see that I put in a shark swimming around the boat too. That was back when I was devious.*

Wayne

I'm finally back in the land of infinite variety after a busy year at Harvard. Didn't get a chance to stop up and visit with you folks again so see you at the next Dayton convention if I get there.

About a year ago *The Milliwatt* announced two awards for the low power operator - DXCC QRPP and DXCC MILLIWATT for working 100 countries at the five and one watt power levels. Well, first QRPP DXCC goes to K4OCE for submitting proper QSL proof. I'm enclosing a photo of the award aptly displayed by my editorial assistant, Karen Thomas. We



still have announcement sheets for the awards upon request. I'm sure that the boys would appreciate getting an eyeball look at this DX award. If you can't use the photo, I'd appreciate getting it back. Keep plugging away up there old man. I envy you guys for your idyllic surroundings. These flats depress me something awful. But that's life, I guess.

Ade Weiss K8EEG/Ø  
Vermillion SD

*What? FLATLANDS? Maybe you should reevaluate your surroundings.*

continued on page 246

#### SSTV continued

niche on the neck... if it shows where it was filed, it is soft. And I understand also, this varies in individual tubes - like some 5FP7's might be "soft" and some "hard." VK3LM has all the info if you're anxious to have a tube reworked.

Does a Slow Scan station equipped with a camera have a justifiable need for a flying spot scanner? This is one question Clarence K6IV and I discussed recently during a brief meeting. The advantages of a camera are obvious, but what are the advantages of a flying spot scanner? Possibly heat dissipation and pre-focusing. Although modern cameras perform quite well with a mediocre amount of light, this still adds to the heat produced in the shack. (How often do you duck out for some cool air, eh?) And, if you show a group of different pictures, a portion of time is required for re-focusing, so photos and a FSS under certain conditions could prove worthwhile. One method of obtaining these results (for those of you with Slow Scan cameras) is by the use of a snap-on adapter. A minibox (or other suitable enclosure) can be fabricated

so pictures will slide in one end. The other end is cut to fit over the camera lens, and securely fasten to the camera in a light, tight manner. Then a couple of small pilot lamps are added in the box, pointing toward the picture area. (The physical layout of a "photo end of an FSS" is covered fully in the SSTV Handbook if you don't understand my brief description.) Since this home-brewed adapter uses all your existing Slow Scan transmitting circuitry, nothing else need be taken off or added onto the camera, as desired. It is quite possible Robot may come out with an accessory like this in the future, if sufficient interest is generated.

I'm sure most of you recognize the chap in the photo as K6IV. Clarence transmitted this picture of himself to JA3JEW, and this is a photo of the received picture. Not bad for a California/Japan QSO, eh?

Color Slow Scan is on the upswing. If you are operating color, drop me a line on your progress, ideas, etc. I will add it in the column and possibly we can expand the color SSTV horizons in the near future.

Dave K4TJW

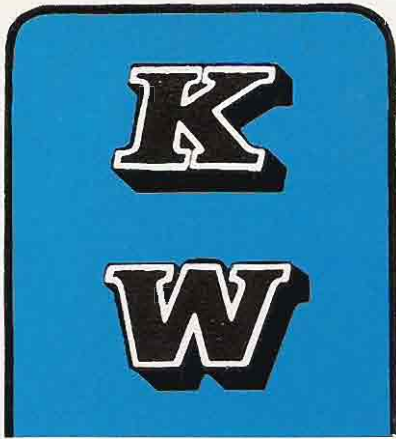

INDUSTRIES  
INC.



INDUSTRIES  
INC.

Dealers! Write for our special  
Distribution Price Program.

Post Office Box 508  
919 Eighth Street  
Prague, Oklahoma 74864

AT LAST  
A PRICE  
BREAKTHROUGH!  
2-METER crystals \$3.75\*  
ea.

±.0025% guaranteed tolerance

\*For most standard FM sets —  
Regency — Clegg — Drake —  
Swan — Sonar — Telecomm —  
Tempo — Varitronics — IC-21 —  
Johnson — Ross & White. Standard  
& Gladding add \$1.00 ea.

72 HOUR SERVICE ON  
10 CRYSTALS OR LESS

PHONE - (405) 567-2286

Please rush the following crystals to:  
M.O. or check enclosed for full amount.  
For postage and handling add 1-5 crystals  
25¢; 6-10 45¢.

NAME .....  
ADDRESS .....  
CITY ..... STATE ..... ZIP .....

Quantity	Channel MHz	Crystal Freq.	Equip. Make and Model

USE YOUR CREDIT CARD!



\$10.00 Minimum billing on credit cards  
BankAmericard or Master Charge only.



M.C. Account Number \_\_\_\_\_ B.A. Account Number \_\_\_\_\_

I hereby authorize this purchase to  
be charged to my account as indicated.

Signature \_\_\_\_\_ Date \_\_\_\_\_

My card expires on: \_\_\_\_\_

## THE COVER:

Henry Radio strikes back at last month's lovely cover girl with this picture of curvacious Myra Kotlar using the Tempo FNP transceiver — and loving it!

- |     |                                  |          |     |                                   |        |
|-----|----------------------------------|----------|-----|-----------------------------------|--------|
| 2   | Never Say Die                    | W2NSD/1  | 127 | Extra Class Q&A Part IV           | Staff  |
| 3   | SSTV Scene                       | K4TJW    | 134 | Indestructable Voltmeter          | W9DTW  |
| 4   | AMSAT News                       | WB8LBP   | 141 | Who Was Tesla?                    | Quinby |
| 4   | 50 MHz Band                      | WA0ABI   | 154 | A Simple VHF SWR Meter            | W2EEY  |
| 5   | The Travelling Ham               | G3ZCZ/W3 | 157 | Transistor Regenerative Receivers | VK3IQ  |
| 5   | MARS                             | A4SCF    | 159 | Antenna Measuring Contest         | WB2HJD |
| 6   | Hot Gear                         | Bandit   | 163 | SSB on 432 MHz                    | WA8VHG |
| 6   | Microwaves                       | WB6BHI   | 170 | A 185 Amp Arc Welder              | W9IMS  |
| 6   | Repeater Update                  |          | 174 | Rig of the Month                  |        |
| 7   | New Products                     |          | 178 | Solid Solid State Breadboard      | VE2DQ  |
| 8   | New Products Special             |          | 183 | Want Your Own Computer?           | WA7SCB |
| 14  | Letters                          |          | 202 | The Minimod                       | G3ZCZ  |
| 15  | Solid State Power                | W6EI     | 205 | Update Your Heath HR-10           | VE4RE  |
| 20  | TTL SELCAL for RTTY              | W9ZTK    | 207 | 10 Meters Solid State             | W6OSA  |
| 29  | An IC TRF Receiver               | W6DNS    | 212 | A Husky 40m Ground Plane          | VE1TG  |
| 33  | The Mark II Electronic Keyer     | W6JJI    | 216 | One Converter into Two Receivers  | W1OOP  |
| 37  | Emergency Power for Home OTH     | WA8OIK   | 217 | ICC Logic                         | W3KBM  |
| 42  | High Power Mobile                | W9NTP    | 222 | Protect Those Diodes              | WA4CMQ |
| 45  | 220 MHz Front End Using FETS     | K1CLL    | 223 | Solid State Overload Protection   | WA0ABI |
| 52  | Double Delta Antenna             | W2EEY    | 226 | IF/RF Sweep Generator             | K4DHC  |
| 57  | FMP Review                       | Staff    | 228 | Crossword Puzzle Answer           |        |
| 59  | A Simple Converter for Beginners | WA8OIK   | 245 | Crossword Puzzle                  |        |
| 65  | The Third Hand... Tester         | WB4MYL   | 249 | Amateur Radio in Yugoslavia       | YU3BH  |
| 69  | "Lumped Line" Oscillator VFO     | W6HDM    | 251 | Radio Amateurs in Poland          | SP5HS  |
| 75  | A Mobile Base Station            | VE3ADI   | 253 | Amateur Radio in the G.D.R.       | DM2HGO |
| 78  | Ten-Roger                        | K4YKB    | 257 | "APC"                             | WA0ABI |
| 81  | Synthesizer for 2m FM Part III   | K2OAW    | 259 | A Professional Digital Counter    | WA5LFN |
| 92  | Counter Corrections              | K2OAW    | 261 | Propagation                       | Nelson |
| 93  | Gravity Abecedarium              | W0HLZ    | 271 | Repeat It — The Long Way          | W9CGI  |
| 98  | FCC Order                        | FCC      | 275 | Interested in Antennas?           | K1CLL  |
| 112 | New Low Band FCC Regulations     | FCC      | 283 | All About Lasers                  | W2FEZ  |
| 113 | Petitions to the FCC             | W2NSD    | 285 | Put 'Em All in One Box            | G3KPO  |
| 120 | Low Noise Economy Preamp for 2m  | K6MVH    | 296 | Circuit, Circuits, Circuits       | Staff  |
| 126 | 2m Crystal Correlation Chart     | W2NSD    | 305 | An Aural Transmitter Tuning Aid   | W1KPN  |
|     |                                  |          | 318 | Caveat Emptor                     |        |
|     |                                  |          | 319 | Advertiser Index                  |        |

73 Magazine is published monthly by 73, Inc., Peterborough, New Hampshire 03458. Subscription rates are \$6 for one year in North America and U.S. Zip Code areas overseas. \$7 per year elsewhere. Two years \$11 in U.S. and \$12 overseas. Three years \$15, and \$16 overseas. Second class postage paid at Peterborough NH and at additional mailing offices. Printed at Menasha, Wisconsin 54952 U.S.A. Entire contents copyright 1972 by 73 Inc., Peterborough NH 03458. Phone: 603-924-3873. This issue of 73 started out like all the others — and then got away from us (obviously), turning out to be the biggest ham magazine ever produced in the western hemisphere. Readers have an obligation to sit down and write checks to as many advertisers as possible so they'll be back next month and we can bring you another whopper issue like this. The radio gear and parts will be a bonus to remind you of your support of a good cause. Reading time: 31 days.



EDITORIAL BY WAYNE GREEN

## THE NEW REGULATIONS WAYNE'S VIEW

The heavy hand of an insensitive government has just dealt a cruel blow to the most exciting and fun aspect of amateur radio in many, many years. FM will never be the same.

It is sad to listen to the voices on the bands agreeing that, yes, the new rules do seem rather restrictive, but we can live with them. Sure, we can live with them. Man has shown himself to be eminently adaptable — able to live under almost any conditions, from Russian prison camps to the Inquisition.

But now, just as amateur radio has at last been staggering back from the blow of "incentive licensing," one of the last things we really need is to have a hysterectomy in the FM department.

### THE GOOD PART

Many years late, the Commission has finally opened the 147 MHz segment of the two meter band to Techs. This move appears to have been purposely held up to try and sweeten the bitter pill of repeater restriction. It is the *only* major benefit from this otherwise negative and crushing report and order.

The other dim ray of light in the order was the relaxing of logging rules for repeaters. Much of the charm of this change was taken out by a reaffirmation of the need for detailed logging by everyone but repeaters. The Commission cannot, I believe, produce any substantial arguments to support the continuing of such logging. It is a hold over from the earliest days of radio and serves little purpose today.

### THE BAD PART

The licensing of repeaters is now set up so that it is a great big deal just to apply for the license — and expensive. You have to have topographical maps to work out the average terrain — antenna radiation pattern charts, vertical and horizontal — diagrams of the entire repeater and control system (which has to be approved before each and every change) — provision for monitoring input and outputs of the repeater — a license for each and every control point — a license for the link — and a license for the repeater.

At \$9 per license, this can mount up rapidly.

Another disaster is the matter of monitoring. The new regulations are quite explicit in demanding continuous monitoring of the repeater input and output frequencies. This means that all but a few repeaters will have to be shut down when the control operators are asleep — when they are at work — on vacation — at the movies — playing cards — at a party — or (hopefully) with the wife. There doesn't seem to be any logical reason for this rule other than harassment and hamstringing of amateur repeater service since it is not difficult to provide safeguards which will shut down a repeater in the event of malfunction or funny business.

Let's take that to an extreme. Let's suppose that a berserk amateur has taken over the input of the repeater and is yelling porno and mayhem through the air — and he carries on for 24 hours straight before collapsing. A few of us with the patience to stick it out will have had something to talk about for years to come — the rest of us will have to use another repeater for a day. One or two sensitive souls may suffer a mental hernia from hearing such terrible things — providing they haven't ever been in a locker room or in the armed forces — or in college or high school during their lives. The rest of us will come out of it unscathed.

Direction finding gear being as it is, I doubt it will take very long to find the idiot. A recent case in New York hardly took any time at all before the repeater group was able to pinpoint the dingo who broke in on a repeater with hair-curling filth. Getting the FCC to do something about it was something else again, they seemed more entertained than alarmed.

The removal of the 220–222 MHz segment from repeater use blows the national agreed-upon plan for that band to bits. Pity, for the amateurs have displayed admirable cooperation in working out their own rules and allocations, complete with unofficial governing committees to keep everything in order. The FCC obviously was not impressed. The only logical reason

that comes to mind for the shoving of repeaters out of the lower two MHz of the 220 band is to make room for the new citizens band which the Electronics Industry Association is buying for the Japanese.

The removal of repeaters from the 440–442 MHz segment of that band is another kick in the head. In view of the degree of organization that amateur groups have shown in the development of this band, it is difficult to understand this move. It serves little purpose and will be tremendously expensive to us.

Section 97.111c prohibits the crossbanding of repeaters. How come? There has been so little of this done that there is no way for it to have yet caused any problems. The two repeaters that I have used that had crossband facility (W1ALE in Concord NH and WA1KGO in Peterborough NH) never had any problems worthy of mention. Indeed, both provided a good deal of fun for those involved and made it possible for the six meter FMers to have a little window to talk with the two meter boys — and vice versa.

It is not practical to set up mobile FM gear for 52 MHz, 146 MHz, 220 MHz and 440 MHz all in one car. It is just too much. Too much investment — too much space — too much antennas — and too much to operate while driving. So what are we to do, have four different groups of amateurs using repeaters, with few ever able to talk with any of the other groups? Crossband repeaters with suitable controls are important, not only for fun, but particularly in times of emergency when it can be critical to be able to reach everyone.

Since repeaters are, under these new regulations, only permitted to operate in bands where all licenses above Novice are legal, there is no question of any operator being repeated out of his class of license.

I believe most amateurs will join me in thanking the Commission for finally opening up 147 MHz for Techs — for relaxing logging for repeaters — for permitting mobile control points for repeaters and remote base stations.

As for the rest of the regulations, they appear to be gratuitous harassment of the amateur service. They do not seem necessary. They are in some cases extremely harmful to the spirit of amateur radio. Little good can come from them.

### ARTICLES NEEDED

While we do try and cover all bases in 73, the readership seems to prefer construction projects — particularly those using the newer ICs and transistors, so if you are building gear along

this line please keep in mind that many, many other amateurs would like to benefit by your experience.

By the way, when you send in diagrams using solid state devices, please be sure to include base diagrams to help those who will follow in your footsteps.

If your unit is of enough interest for a printed circuit board to be made available to the readers — or perhaps even a parts kit — we can arrange this with one of our advertisers unless you have sources of your own. Sometimes it is difficult to find all of the parts needed for a project, so we often try and work with an advertiser to make kits available.

If you are not sure about writing for 73, please send a stamped self-addressed envelope for *How to Write for 73*.

### SAROC FM PROGRAM

As chairman of the FM program at Saroc, I am going to do my best to put on one whale of a show. It will be worth while coming to see, I guarantee.

The FM programs will start early on Friday morning and run all day Friday and all day Saturday until the big prize drawing Saturday afternoon. In addition to manufacturers on the spot to answer technical questions, there will be reports on FM activities around the country, an FM Symposium on changes we need in the FCC regulations — a report on the status of 220 MHz, and other topical subjects.

Representatives of repeater councils who will be at Saroc are hereby requested to drop a line to me so I can schedule you on the program. All of us want to know what has been happening in your area, so please bring a report. Repeater groups with slide shows or interesting FM oriented movies are also requested so let me know what you have available so I can schedule your part of the program and make arrangements for whatever equipment is needed.

FM will be the BIG deal at Saroc again this time, as it has for the last three years. Standard Communications is planning a lavish hospitality suite this time, complete with a built in Standard Repeater, of course. This custom has turned out to be a fabulous place for FMers to get together almost any time of the day or night to swap exaggerations about their repeater problems.

Several interesting technical papers will be read at the Symposium — and, if you have a paper that you would like to put on the docket, please let me know so I can get your talk scheduled.

The FM editors of all of the ham magazines will be present and will have their chance to say what they

# SST V SCENE

Dave Ingram K4TWJ  
Rte. 11 Box 499, Eastwood VII. 50N  
Birmingham AL 35210

First off, Ralph WB8DQT, has some suggestions to supplement the photographic techniques I mentioned in the August column. If your camera is one that utilizes an electric eye for controlling the shutter speed, a piece of black electrical tape over the eye will automatically give you time exposures. Then all you need do is hold the shutter down 8 seconds. Also, you don't necessarily need to remove the yellow filter on the cathode ray tube. If your pictures are too dark, use the camera's color film settings of approximately ASA 75. Be sure to mark your settings after getting them right, so you will save time (and film) in the future.



Taggart also suggests using the popular SCR motor speed control units that are now available from most large department stores, to control light intensities on those camera flood lights. Usually these plug right in, so it should be super-quick, and sure beats fumbling with the camera's settings.

I understand that Mike W6MXV is developing a programmable MOS Memory unit. Slow Scan transmission capabilities without the aid of a camera or tape recorder. Probably he

*continued next page*

think of FM — and of Wayne Green, bless them.

It is likely that I will have a few words to say and that any lagging doubts as to why I am considered controversial will be settled once and for all. The fact is that I believe that a straight line is the shortest distance between two points, even if it bisects an advertiser or an ARRL official.

Saroc will run January 4th through 7th this time, with most of Thursday

*continued next page*

# 73

magazine  
for radio amateurs

NOVEMBER 1972

### EDITORIAL STAFF

Wayne Green W2NSD  
Keith Lamonica W7DXX  
Ron Subka WA9FPP  
Yvette Grimes WA8ULU

### ASSOCIATES

Jim Kyle K5JKX  
Mike Frye WB8LBP  
Bill Turner WA0ABI  
Jim Weir WB6BHI  
Harry Simpson A4SCF  
Dave Ingram K4TWJ  
Bill Hoisington K1CLL

### PRODUCTION AND ADVERTISING STAFF

Janet Subka  
Lynn Panciera-Fraser  
Philip Price  
Mark Poole  
Janet Oxley  
Jacqueline Lamonica  
Bill Suderman  
Ruthmary Davis  
Cynthia Schlosser  
Biff Mahoney

### BUSINESS STAFF

Georgiana Sage  
Douglas Oxley

### CIRCULATION

Dorothy Gibson  
Barbara Block

### PROPAGATION

John Nelson

### DRAFTING

R. K. Wildman W6MOG  
Bill Morello  
Wayne Peeler K4MVW  
T. M. Graham W8FKW

### ARRL & FM

The League is showing an increased (if belated) interest in FM and was represented at the recent FM Symposium (hosted by 73) by W1ICP, who was most helpful with suggestions and ideas.

More on the symposium on page 281...

# AMSAT NEWS



Mike Frye WB8LBP  
640 Dauville Dr.  
Dayton OH 45429



OSCAR 6 launch date October 11.

From all the reports I have been receiving, A-O-C is progressing at a good rate. Launch preparations are progressing smoothly and to my knowledge the launch is on for late October.

## W2NSD/1 continued

talk from one end of Circus-Circus to the other — get rides from one casino to another via cruising FM mobiles — the 4th spent meeting and setting up the exhibits. On Friday everything gets going bright and early as the last arrivals drive in from California — the exhibits are going all day — the FM Symposium will be going strong — and that evening a couple of thousand amateurs spread out all over Las Vegas, handy-talkies in hand, to see what mischief they can manage. They make a few rolls at the tables — hit the slots — and end up in the Standard FM Hospitality room to lie a lot.

Things are in high gear on Saturday too until the big prizes are given away in the late afternoon. After a short rest everyone is ready to get out to see the extravaganzas up and down the strip. If you monitor 94 you will hear something akin to CB channel 10. You may hear one chap asking another to pass the salt to the other end of his table — or, after a few drinks, you may hear almost anything. And what about the chap, who had better remain nameless, who put his hand unit down so it stuck on and broadcast every intimate detail of a most interesting contact? I understand tapes are available.

Work Saroc into your schedule this time — it'll be fun.

My plans are to stop up at Aspen on the way back for a few days on the skis. Anyone else interested?

... Wayne

I have been getting a good response from amateurs all over the country. Although many still seem unclear as to the exact uses of the satellite. The ten to two meter repeater will accept any form of transmission — this of course includes FM. However, the repeater operates most efficiently on CW, SSB, and AM respectively.

The estimated area that can be utilized through the satellite is easy to determine. Simply draw a circle from your location with a radius of 5000 miles. This should give you an idea of the countries you should be able to work.

A-O-C provides for DX every day. Information I have received from John Gregory W3ATE indicates that the satellite should be in the local area at 7, 9 and 11 a.m. and p.m. for about 25 minutes each duration. Length of the duration depends on your latitude. Twenty-five minutes is a good estimate for the latitude through Pennsylvania, Ohio, etc. The greater your latitude the longer the duration of the signal. If you were to live on the upper edges of Canada you would receive almost three hours of continuous use twice a day! **WB8LBP**

## SSTV continued

will make this available on P.C. boards, like the W6MXV monitor. Incidentally if you have a chance to see this monitor or the J & R Electronics MXV 100 (similar circuitry with some additional goodies), don't pass it up. This one really comes on strong and the pictures are great. Watch for my upcoming reports on these units in 73 for full technical details.

Asia is again being represented on Slow Scan by a few 4X4's. I really can't describe the thrill of seeing those boys identifying with Israeli writing on the screen, but it surpasses even the best DX audio QSO's. Watch for them on 14.230 kHz around 0000 GMT. Also, you might watch for ON4CZ, VP2ME or 8R1W, some of the newer hams to join the SSTV ranks. I understand also that the U.S.S. Hope is on SSTV, but I don't know their call. And watch those VK3's on SSTV. They recently formed the Eastern Mountain Radio Club (for SSTV) and are really coming on strong. You will probably be hearing quite a bit about the special P26 Phosphor they have come up with especially for SSTV use. This is a real beauty and can be viewed in any light; even daylight. I understand they can re-gun and re-phosphor (no splitting — they do both or no deal) any cathode ray tube with a "soft envelope." They determine if a crt is "soft" envelope by filling (carefully) a *continued on page 14*

# 50 MHz BAND

Bill Turner WA0ABI  
Five Chestnut Court  
St. Peters MO 63376

The band continued opening through early September, while not as frequently as earlier, it provided many excellent contacts. Conditions and activity during the ARRL contest were good-to-excellent for this time of year. Groundwave during the first two weeks of September was exceptionally good with contacts to 500 miles commonplace. TV signals were noted on all (VHF) channels on a number of occasions. During the early morning hours of September 2, WTWO Indianapolis, was received for several hours with signals as strong as the local channel 2. Numerous calls on 6 brought no reply.

Six meters is in the midst of a period of rapid growth in the St. Louis area. In the past six weeks WA0ROH, K0YYV, K0RWV, K0WYN, WB9JGR and K9YNN have become active for the first time on SSB; in addition W0WEO, K0RMF and W0AJQ have returned after periods of inactivity.

Terry WA4WDU, and John WB2VNI/5, are increasingly active from Memphis. WB4HEL/4, also from Tennessee, was heard almost constantly during the contest. WA5SJM, Marked Tree, Arkansas, is active on a daily basis on CW and SSB.

The annual conference of the Central States VHF Society was an interesting 3 days for the serious VHF crowd. Items of special interest to the 6 meter group were tape recordings of the first (CW) moonbounce contact between K5WVX and WA5HNC, tapes and slides from the VP5RS DXpedition presented by WW4GDS and WB4BND, and Dr. D. E. Olson of the University of Minnesota Physics Department presented a most interesting talk on the subject of magnetic storms. On the lighter side, W1HDO, "Mr. VHF," recounted the virtues of 2 meter FM to what is without a doubt the largest gathering of knowledgeable VHF/UHF people anywhere. Among the 6 meter group in attendance were K8LEE, WA8PEB, WA0VJF, WB0BBC, W0GNS, K0LCB, K0TLM, WA0TXV, WA7FPO, W7EN, VE4MA, W5WAX and W0PEP.

WB4WNV asks some questions on behalf of four hams in his area, the answers to which might be helpful to others. It is easy to get in the habit of assuming all readers have 6 meter experience. Lowell's letter reminds me

## THE TRAVELLING HAM

Joe Kasser G3ZCZ/W3  
1110 Fidler Lane, Apt. 1610  
Silver Spring MD 20910

Connecting a rig up to the ac line overseas can pose problems. In fact, connecting anything American causes a potential problem, be it a rig, an electronic flash gun, or anything requiring a recharge of internal batteries.

Just because you have a plug that fits the wall socket does not mean that you can connect the plug to the line cord and plug it in. It is first necessary to determine the value of the local line voltage, as described last time. Then knowing the requirements of the rig, something can be arranged. If the rig does not have multi-voltage line input facilities (like an FT 101) then a transformer will be needed.

If you wish to buy one, ac transformers for dropping 220 volts down to 110 volts can be obtained at Lafayette and other places, suitable for use at powers of up to one and a half kilowatts, more than enough to run any rig barefoot. These transformers can be home-brewed by connecting plate transformers up in reverse, that is, by plugging the secondary into the ac line and the primary into the rig. Turns can be added or removed from the secondary to make almost any hefty ex-TV transformer suitable. The only thing to watch is that overseas, power line frequencies are usually 50 Hz, which means that the transformers used over there require more core area than if used stateside. If the transformer is not used under full load conditions that requirement should not bother the travelling ham.

When winding or unwinding turns, the transformer can be tested by running it in reverse. That is, by plugging the primary into the ac line and measuring the voltage at the secondary. When fiddling with the turns, aim at a value around 230 volts.

When you are satisfied with the voltage ratio, tidy up the loose windings. Use lots of masking tape or similar stuff. Next connect a female ac line connector to the 110 volt side. A heavy duty drugstore ac adaptor is just the thing. Leave as much cord in the line as possible. Then connect some cord to the 230 volt side and leave the ends bare. When overseas, obtain a local line connector. A connector can usually be borrowed from a nearby appliance — the trusty screw-driver strikes again!

If you are not taking an antenna with you, or are unable to get one up, a unit such as a Johnson Matchbox and an swr bridge is a must. With those devices you can load up bed-springs, window frames or long thin wires. You may not work any exotic DX, but you will put out a signal and work something on the HF bands. Being an avid VHF'er I recommend VHF for working the locals, but the HF bands have their place in enabling contact to be kept with home while in far-off lands.

G3ZCZ

### INTERESTING FREQUENCIES

SSTV	QRPP
3845	3540
7220	7040
14230	14040
21340	21040
28680	28040

that this is not the case. Q. "Is the TVI problem as bad with SSB as it is with AM? It would seem not, due to the absence of a carrier." A. The lack of carrier does little to reduce interference. SSB produces RF as you talk, giving the TV viewer the opportunity to watch between words and sentences. I have found they will seldom settle for a shared time status. Probably the greatest reason for TVI reduction is heterodyning rather than multiplying to the output frequency. This minimizes the change of oscillator harmonics falling in a TV channel. The average AM transmitter uses 8 MHz crystals multiplied by 6; if you were operating on 50.400, an 8.4 MHz crystal would be used. The seventh harmonic would fall in channel 2, the eighth in channel 4, etc. In a well-designed SSB rig the only harmonic you need normally worry about is the

fourth of your output frequency which falls in one of the high VHF channels. This is not difficult to trap out if the need arises. The major TVI problem with SSB is fundamental overload. This may be cured in most cases by the installation of a GOOD high pass filter on the TUNER of the affected TV. Most manufacturers supply these free on request. By the way, don't believe the old wives' tale to the effect that you can't understand an SSB transmitter on a TV or Hi-Fi, nothing could be further from the truth! Q. "What frequencies are commonly used in this part of the country?" A. 50.110 MHz has become the calling frequency for most of the world, only in areas where this frequency is not assigned to the amateur service is activity greatly removed from 50.150 ± 50 kHz.

WAØAB/

# MARS

Harry Simpson A4SCF  
P.O. Box 27015  
Memphis TN 38127

Several months ago when this column was visualized, it was intended to be a sort of clearinghouse for MARS information — a column designed primarily to inform MARS members in one area of happenings elsewhere. Many telephone calls were made, many letters written and scores of personal friends were contacted, requesting information that would be of general interest to the entire MARS membership.

After the first effort appeared in the May, 1972 issue of 73 Magazine, it became apparent that most MARS members are already well informed, and that the column was of more interest and benefit to non-MARS members. That change in direction was all right with the author — since his feelings for the MARS program border on the apostolic! After more than twenty years as an active member of Third US Army MARS it could hardly be otherwise.

You see, in spite of propaganda from other sources, MARS is unique in that it exists solely as a result of the efforts of thousands of dedicated individuals. Reactionary and bureaucratic conditions are not allowed to exist — on the contrary, MARS is progressive and innovative! Whatever the field or interest MARS members are numbered among the leaders. Suggestions for the betterment of the program are welcomed, quickly evaluated and just as quickly placed into effect if worthwhile. No Board of Directors, No General Manager — just pleasant, efficient communications at its most enjoyable best!

Your response during the past six months has been, to say the least, terrific! Last month alone, over two hundred letters were answered. The writer has an aversion to form letters, feeling that those who took their time to write deserve nothing less than a personal answer; however, due to the massive influx of correspondence, the only solution was to mail a MARS brochure and trust that all questions were answered thusly.

A suggestion — if you would like to become involved in MARS and do not know any MARS members — attend your local ham club meeting and let it be known that you would like to become a member of MARS. It probably won't take more than a couple of minutes to make your first contact.



# HOT GEAR

This gear was stolen on August 23, 1972: Swan 270B, Ser. No. M-395430, hand-held microphone for above, model No. 404, with groove filed in P.T.T. switch to lock in talk position. Contact Jeff Lackey W8HST, 7760 Willis Road, Ypsilanti, Mich. 48197.

Roger WA1NVC has had his HR-2A lifted from his car in Somerville MA. If you know anything about the whereabouts of Roger's rig (Ser. No. 04-07152) please let him know. Most ham gear looks like CB equipment to thieves; and there is a big market for CB gear. Please take the proper precautions with your rig.

List from Past Issues:		
Mfr., Model, Ser. No.	Owner	Issue
Yaesu FT-101 No. 107036	WA2YSW	4/72
Standard 2m FM No. 102703	W6NPV	4/72
Drake ML2 No. 20189	WB2LLR	4/72
Standard SRC-806M No. 009210	K1TLP	5/72
Aerotone 6M 355LT, No. 685064	RR Police Grd.Ctrl.Trm. NYC	5/72
Standard SRC-806M, No. 102703	C. Mathias 3234 Coronado Ave Imperial Beach CA	5/72
Lafayette HA-410 No. 009210	WA2KDG	5/72
Coll., 6251 No. 10728	MSU ARC E.Lansing MI	6/72
WRL Duo-Bndr 6010AT302	WA6FCY	6/72
HR-2A, 11 chan., 04-07152	WA1NVC	9/72
Swan Cynget 270, No. 313022	K4ACJ	9/72
Collins Mic, Mod. MMs, No. 4294	K4ACJ	9/72
Heath HW-100 & AC PS	WA2JGP	10/72

On the other hand, if you reside in an isolated area with no ham club, you are just as important and welcome. In such a case, if you live in the East write MARS Director First Army, Ft. George Meade, MD; in the Southeast write MARS Director Third Army, Ft. McPherson, GA; in the Mid- and Southwest write MARS Director Fifth Army, Ft. Sam Houston TX; in the West and Northwest write MARS Director Sixth Army, Presidio, San Francisco, CA. They will gladly furnish information concerning your entry into the MARS program.

Sincere thanks to all who have helped this effort with information and/or moral support—to Wayne Green for the soapbox, to Col. Woodside in Washington, Jim Cooper in New Jersey, Hal Mulkey in Atlanta, "Andy" Anderson in Rome, "Doc" Klotz in Memphis, Bill and Margaret Pearre in Houston, Russ and Lucille Peck in Oregon and Maurie Schmitz in Hollywood—to name a few.

If even one amateur has found his niche—a new and exciting way of life in the MARS program, then these hours shall not have been spent in vain!

A4SCF

# Microwaves

Jim Weir WB6BHI  
Box 23233  
San Diego CA 92123

Nice letter and enclosure from Bill Turner (WA0ABI). It seems Bill works in the Gallium Arsenide facility (that's the Gunn and Impatt diode material—GaAs) of Monsanto Chemical in St. Louis, and found a few hundred surplus GaAs diodes in the microwave package. Unfortunately the diodes had been used in a destructive life test, and were 75% shorted and 25% open. Oh, well, Bill had good intentions of supplying all you microwave cats out there with free diodes. Sorry it didn't work out. How about some inputs from you other people in the industry.

An item in one of the trade magazines notes that the FCC has purchased a mobile van to study "crowding conditions" in the bands 25–512 MHz. A computer controlled spectrum analyzer will sample specific signals and note the time usage of each frequency in this band. Why no study of the microwave bands? Simply because there is no crowding in the bands above 1 GHz. For instance, above amateur "1" band (1215 MHz) there is more spectrum space in this band than in *all of the lower bands* combined. The same statement holds true for all higher bands. Each higher band contains more space (spectrum width) than all the bands below it combined.

An interesting sidelight of the above discussion for those of you interested in the "ultimate" antenna location for the dc bands; put your 20-acre rhombic for 160 meters, your 500 foot mast and 15 element beam for 80/10 meters, and all the other antennas you need for all bands through 2 meters up on the 5000 foot hill, and beam all signals on *all* bands (not just the amateur bands) through 150 MHz down to your house on amateur "s" band. Yes, you will have a full 150 MHz bandwidth from 2300–2450 MHz.

Or, for those of you interested in ATV, you could put 20 fast-scan TV signals with 4 MHz (broadcast quality) bandwidth in amateur "1" band with enough space left over to put all the amateur signals from 160 through 6 meters in simultaneously.

Let's hear from those of you who are using the amateur microwave bands—your fellow amateurs will benefit from your experience.

WB6BHI

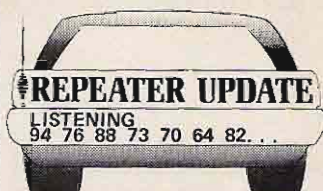

NC WB4QGE	Winston-Salem	25-85
OH K8ALB	Toledo	10-70 01-61
OH WB8CQO	Toledo	34-94 20-80
TX WA5GRE	Amarillo	34-94 444.5-449.5
TX W5CBT	Amarillo (Delete)	
TX WB5EMR	Lvelland	28-88
TX (no call)	Perryton	34-94
CANADA		
Manitoba		
VE4BDN	Brandon	46-94

## CALIFORNIA ACTS!

The repeater groups of Southern California gathered on September 9th for an FM symposium. Approximately one hundred attended the conference, representing over 40 repeaters. The result was an agreement (with but one nay) to adopt the 600 kHz plan.

The meeting was moderated by Skip Clark WB6TXX. It was co-hosted by the Edgewood ARS and the Paliades ARC and the chairman was John Griggs W6KW.

The result of the scramble for standard channels at the end of the meeting was this:

01-61	WB6ZDI (PARC)
04-64	WB6WLV
07-67	WA6FLH
10-70	WA6TIC (RTTY)
13-73	W6IN, WB6RSK
16-76	WA6ZZR, WB6SLC, W6ZGC
19-79	K6SYU
22-82	W6FNO, WB6TSO, K6ZXZ
25-85	WA6ALV, WB6IWF
28-88	WA6SIN, K6QE, WA6ZYN
31-91	WB6VQD
34-94	WB6GUA + simplex
37-97	WA6ZZE, WB6SZO
147.42-146.40	WA6TDD
147.60-00	WA6IRY
147.63-03	W6GY
147.66-06	W6IYW
147.69-09	WA6TWF
147.72-12	W6QFK, WB6VMV
147.75-15	W6AOE
147.78-18	WA6VFO
147.81-21	WB6GGL
147.84-24	K6MYK
147.87-27	K6SIR, K6CPT
147.90-30	WA6PPS
147.93-33	WA6SKB
147.96-36	K6YDQ/K6VGP
147.99-39	WA6FLL (FAX)

## FIRST BERMUDA REPEATER

The first two meter repeater on Bermuda is going on 34-94. This will be VP9BDA and, after getting checked out, will be set up on the lighthouse. It will cover the entire island. Remember to bring your handy-talkies when you go to Bermuda. Getting a license is simplicity — you get in touch with VP9EP, the Wireless Inspector (in the phone book) and he will get you set up. You'll get your own call/portable VP9. A visit to Bermuda is about 800% more fun when you get to meet and talk with the local amateurs — they are really great guys. 94-simplex fanatics may not be welcome.

## NEW ENGLAND COORDINATOR 220 MHz BAND PLAN

The frequency coordinating team of K1KEC, K4GGI/1 and F2BO/W1 got together on the air the other evening to work out a new scheme for repeater occupation of the 220 MHz band in case the FCC is resistant to all requests to change their minds about cutting out the lower two MHz of the band.

The previously agreed upon 3 MHz split between repeater inputs and outputs will be changed to 1.6 MHz and the simplex channel will be 223.5 MHz.

Inputs	Outputs	Inputs	Outputs
224.98	223.38	224.42	222.82
224.94	223.34	224.38	222.78
224.90	223.30	224.34	222.74
224.86	223.26	224.30	222.70
224.82	223.22	224.26	222.66
224.78	223.18	224.22	222.62
224.74	223.14	224.18	222.58
224.70	223.10	224.14	222.54
224.66	223.06	224.10	222.50
224.62	223.02	224.06	222.46
224.58	222.98	224.02	222.42
224.54	222.94	223.98	222.38
224.50	222.90	223.94	222.34

The frequencies 222.3 and below are reserved for the time being for present occupants of the band such as AM, sideband, CW, etc.



Look who was smiled upon by the Fates at the Six Meter Club of Chicago Picnic and Hamfest last August. Winning a year's subscription to 73 is Don K9TZZ on the left. Jack K9ZTU looks like he is a bit reluctant to let go of the prize... he must recognize the true value.



Some pictures taken at the Dayton Hamvention flea market. You missed it? Too bad!

## INDIA ACTIVE ON SSTV

The first U.S. contact for VU25KV on slow scan was W6KZL. Glen is right in there pitching — and was the only six to make it to Navassa. He also makes a speciality of working as many countries from his car as possible and is now up to 251 — probably the mobile record.

KH6HJF has been putting his slow scan camera to a telescope. This is not only remarkable for views of the moon and the sun spots, but he has been able to transmit 1/2 in. letters clearly 83 ft from the camera!

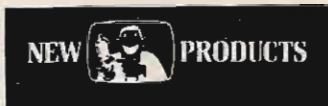

## NEW TEMPO 220



While several of the manufacturers have been firming up their 220 MHz transceiver designs, Henry Radio has been spurring their Japanese supplier to provide a unit. It looks as if Henry will be the first one to be able to supply the 220 rigs in quantity.

Two samples of the New Tempo 220 were checked out at 73 and run through their paces. We must say congratulations to Ted Henry for getting these designed, manufactured and imported.

The rig is similar to the two meter FM rigs, but is deluxe all the way. It has all sorts of nice features. The twelve position channel switch is back lighted so you can easily see the numbers in the car at night — and the numbers are big enough for middle-aged hams to read without getting out their glasses. The power on-off switch is separate so you don't louse up either your volume or squelch settings every time you turn the rig off. The hi-lo power switch will no doubt stay in the 10 watt high power position when the rig is used in the car or at home, but the 3 watt position may be just what you want if you add a little nicad battery pack to this for shoulder use. The low battery drain makes it a natural for this — only 150 mA on standby and 250 mA on receive. It draws 2.8 amps on high power transmit.

The receiver has plenty of poop (2 watts) to drive your car speaker — and there is a jack on the back of the rig to plug in the external speaker (this mutes the built in speaker).

This may be the first FM rig to have an S-meter which also doubles as a deviation meter! There is a switch to provide this function. On transmit the meter shows power output. The final is protected in case you forget to put on the antenna — or it happens to short out.

Both the transmit crystals and the receive crystals have warping capacitors. Less deluxe rigs save the cost of those receive capacitors. The warping

*continued on page 12*



AKIRA KOBAYASHI JAZAMD in his shack.



## NEW PRODUCTS

### 100 WATTS SOLID STATE LINEAR!

It looks like solid state has finally hurdled the last barrier toward its conquest of the vacuum tube. TRW has announced that it is manufacturing a new line of RF power transistors designed for HF linear applications. Designated PT5740, PT5741 and PT5742, they will deliver 15, 30 and 60 watts output respectively when powered by a 12 volt source. They are brutes! In typical linear installations they will withstand a wide range of bias and temperature conditions. They are impervious to load variations as extreme as an open line or a complete short. Compromising protection and compensating circuitry is not required in most cases because of the unique TRW design. Intermodulation distortion products are claimed to be better than -30 dB and collector efficiency averages about 45% in SSB service.

True portability is here. No more big tubes, transformers or separate HV supplies for fixed and mobile operation. From now on the output stage

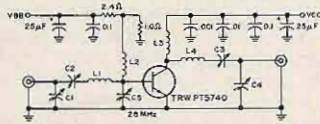
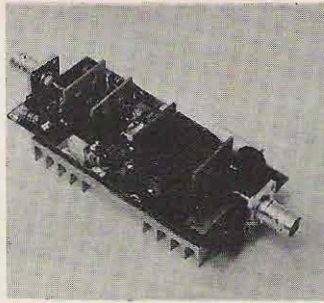

Fig. 1. 10 meter 15 watt amplifier.

- C1, ARCO No.467, 110-580 pF
- C2,3,4, ARCO No.466, 80-480 pF
- C5, ARCO No.469, 170-780 pF
- L2,3 10 TURNS No.18 AWG, 0.5" MEAN DIAMETER
- L1,4 5 TURNS No.14 T.C., 0.5" MEAN DIAMETER, L1 EQUALS 1.0"
- V<sub>CC</sub> 12.5 VOLTS
- B<sub>bb</sub> 1.6 VOLTS (IC [QUIES] = 25mA)



25 Watt solid state linear amplifier

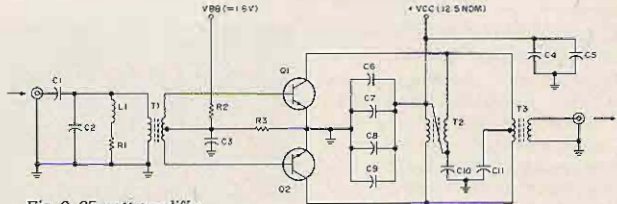

Fig. 2. 25 watt amplifier

- C1,C6,C7 .01  $\mu$ f disc
- C2 56 pf dipped mica
- C3,C10 Unelco 1000 pf
- C4,C11 .1  $\mu$ f disc
- C5 25  $\mu$ f 35V
- C8,C9 .001  $\mu$ f disc
- L1 1.5  $\mu$ h molded
- R1 56 $\Omega$  1/2 W carbon
- R2,R3 1 $\Omega$  1/2 W carbon
- T1,T2,T3 See Text
- Q1,Q2 TRW PT5740

switching gets pretty complicated when matching low impedances and a broadband arrangement simplifies things considerably. It will amplify anything fed into it, so a clean driving signal is a must. Harmonic suppression also suffers because of the non-resonant output. This is not too much of a bother because the even order harmonics are cancelled fairly well by the push-pull configuration. The odd order harmonics need not be troublesome if care is taken to make sure that the antenna system is Hi-Q and resonant. Or use a filter.

The transformers are interesting and they deserve a bit of discussion. The center tapped winding on T1 and

T3 consist of two pieces of .190" brass tubing mounted between two PC board end plates. On one end plate the tubing is soldered together for the center tap. The other winding consists of a single wire wound through both tubes. The tube length for T1 is .80"

can be as compact as the rest of an SSB rig. Take a look at Fig. 1 and see how simple it is to get 15 watts SSB out of a transistor. With careful placement everything would probably take up less space than an average filament transformer.

### 25 Watt Amplifier

Figure 2 is a 25 watt amplifier using two PT5740's push-pull class AB. It will operate anywhere in the HF spectrum from 1.5 to 30 MHz without the need for bandswitching. Band-

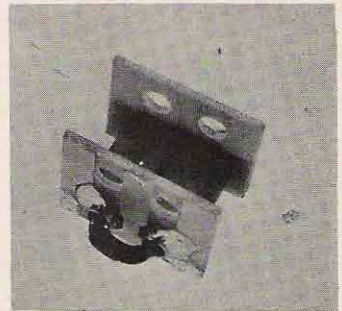

Details of transformer T1.

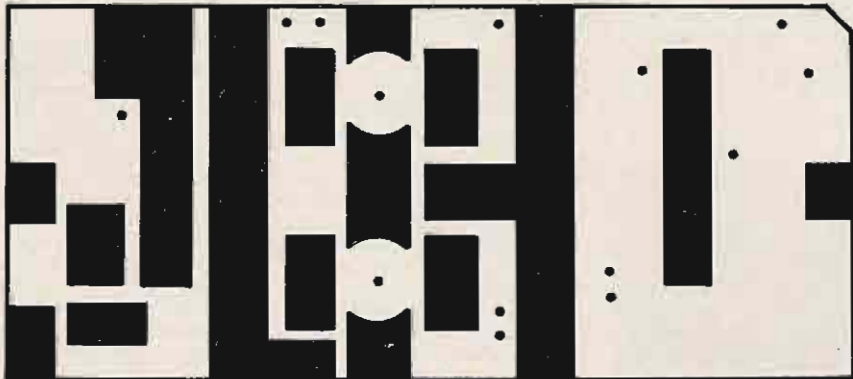
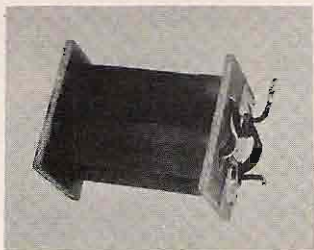

Fig. 3. Full size P.C. board for 25 watt amplifier.



T2 and T3, T2 is at the top.

and the wire winding is 4 turns No. 20 enameled. The tubes for T3 are 1.375" long and the wire winding is 3 turns No. 20 enameled. Large ferrite beads are slipped over the length of each brass tube before final assembly. T2 is mounted between the same end plates as T3 but consists of a twisted pair of No. 18 enameled wire run through both stacks of ferrite beads once (no tubing used). The photographs give details on the transformer construction.

This amplifier is perfect for an ultra-compact low power portable transceiver. With intelligent use of IC's and miniature components, it should be possible to build an all-band SSB rig about the size of the FM rigs currently on the market. A high-low

power switch could be easily incorporated to make battery operation possible when no sizable amount of power is near.

### 100 Watt Amplifier

While a 100 watt amplifier could be constructed using only two of the higher power PT5742's, difficulty arises in trying to achieve the ex-

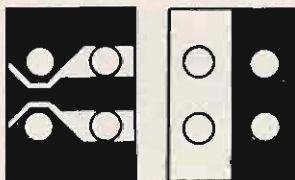

Fig. 4. Full size transformer end plates.

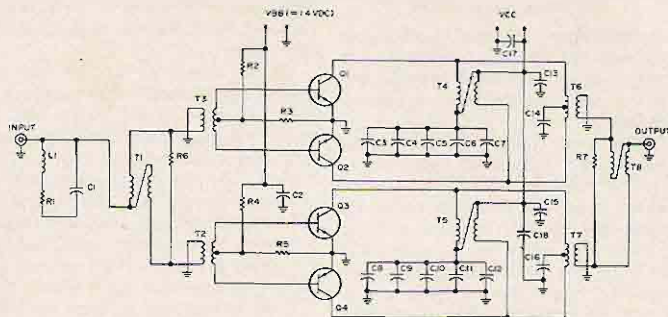

Fig. 5. 100 watt amplifier.

- C1 62 pf dipped mica
  - C2 13,15 Unelco 1000 mmf
  - C3,8,14,16 1  $\mu$ f 50 v disc
  - C4,5,9,10 .01  $\mu$ f 50v disc
  - C6,7,11,12 .001  $\mu$ f 50v disc
  - C17,18 25  $\mu$ f 35v electrolytic
  - L1 2.2  $\mu$ h molded inductor
  - R1,6 100 $\Omega$  1/2w carbon
  - R2,3,4,5 1.0 $\Omega$  1/2 w carbon
  - R7 100 $\Omega$  2w carbon
  - Q1-Q4 TRW PT5741
  - T1,8,4,5 Identical to 25 w T2. T1,8 are not mounted on P.C. end plates.
  - T2,3 Identical to 25 w T1 except wire winding is 5T No. 18.
  - T6,7 Identical to 25 w T3 except wire winding is 4T No. 18
- NOTE: Tr--T6 and T5-T7 are mounted on the same P.C. end plates like the 25 w T2-T3 pair.

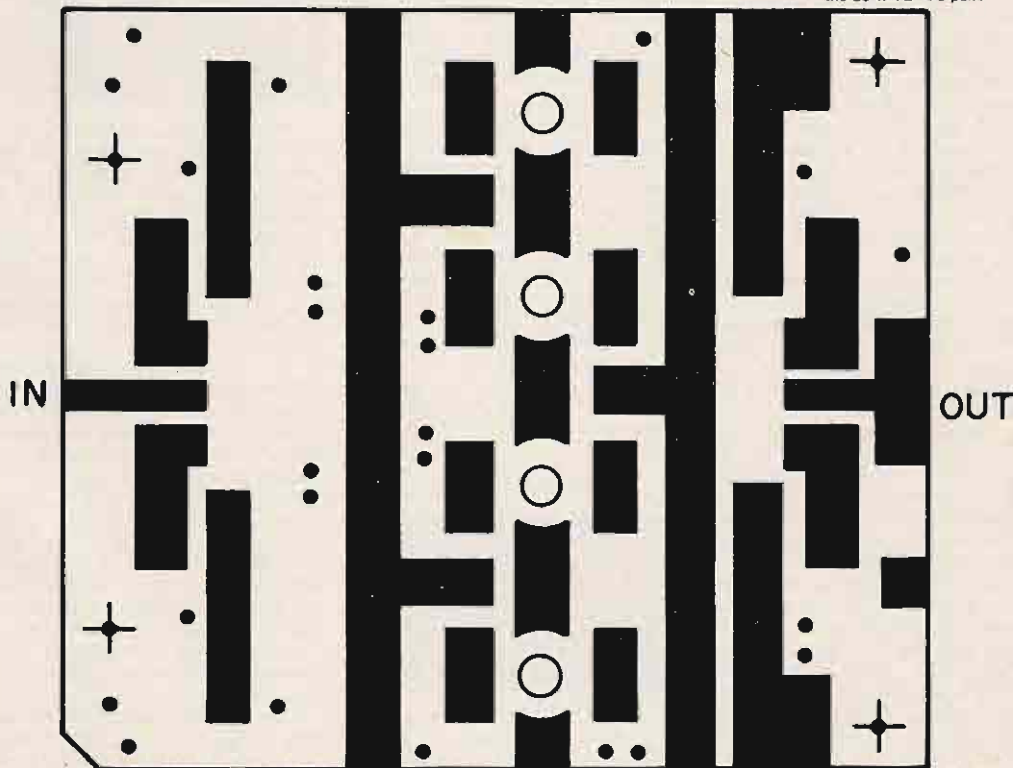
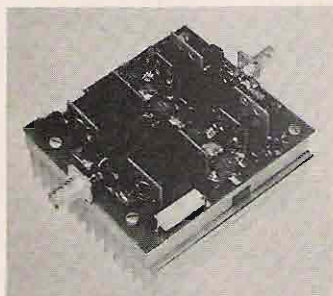

Fig. 6. Full size P.C. board for 100 watt amplifier.

### New Products continued

capacitors are very easy to get to, by the way. We say that in memory of an earlier rig or two where you had one hell of a time getting your crystals on channel.

The front panel is right up to date — black with green back lighting on the channel switch and meter. There is a little light that comes on when the squelch operates and we suspect that not a few amateurs will be using this for an emergency carrier operated relay. This rig looks as if it could be converted into a repeater



100 Watt solid state linear amplifier

remely low load impedance they require over the full range of 1.5 to 30 MHz. Thus they are more suited to limited bandwidth applications. The four PT5741's used here require a slightly higher load impedance than the PT5742's which makes broad-banding the circuit a bit easier. The 100 watt amplifier in Fig. 5 is essentially two 50 watt push-pull amplifiers that are fed in phase with each other through T1. Each output is combined in T8 and 100 watts overall is fed into the antenna. Any amplitude or phase unbalance is absorbed by R6 and R7.

This amplifier is designed to be driven by the 25 watt amplifier running class A. A slight bias adjustment will do this and the power falls to 5 clean watts which is the proper amount to drive the 100 watt amplifier to full output.

These two amplifiers are perfect for an all-band all solid state rig. They could both be incorporated into a small transceiver, or the higher power amplifier could be left forever in the trunk of your car to be powered by the miniature 25 watt rig that you store away in the glove compartment.

The two PT5740's and 30 ferrite beads needed to construct the 25 watt amplifier are available for \$36.00 as Kit #PKT 3104 and the four PT5741's and 84 ferrite beads for the 100 watt amplifier are available for \$112.00 as Kit #PKT 3103, from Ham Radio Center, 8342 Olive Blvd., St. Louis MO 63132.

very easily. The modules are all separate and relatively well shielded from each other.

We set one unit up on top of nearby 73 mountain and drove around with the other in the Rover, with a trunk mount Hustler 220 antenna (5/8 wave, of course). Frankly we couldn't see much difference in the coverage between the 220 rig and a ten watt 146 MHz rig. They both held up about the same and started falling off about the same. There seemed to be a few more hot spots where the 220 rig would peak up than on 146 once we were in a shadow area, but the difference wasn't remarkable.

The price is not firm on this new rig yet, but it is expected to run under \$350. It would make a fantastic package at that price.

### MARK XII REGULATED SUPPLY



It probably has not totally escaped you that most of the equipment today is designed to run with a twelve volt supply. If you live in a car this is probably fine. If you want to use the gear at home then you have to come up with twelve volts.

The Mark XII people are not insensitive to your problems and desires. Their new 3A power supply has a voltage regulator built in which puts a lid on the voltage, holding it down to about 14 volts with no load. This is low enough so it should not cause any problems on low-current applications. An unregulated supply could pop your receiver or converter by swinging up to about 16 volts with a light load.

At \$24.95 this is not a bad bargain to have around for running those gadgets which don't need much more than 3A maximum.

### NEW HF BALUN



Palomar Engineers announces a new 1:1 Balun. It matches 50 or 75Ω coaxial cable to center-fed dipole or inverted Vee antennas. By preventing

radiation from the coax it improves antenna radiation pattern, reduces noise on receive, and helps prevent TVI, BCI, and rf feedback within the station.

The Balun transformer is wound on a large ferrite toroid core and handles a full kilowatt power from 1.7 to 30 MHz. The transformer is enclosed in a white plastic housing and is completely encapsulated to prevent moisture from entering. All hardware is stainless steel.

Eye bolts on the sides allow the Balun to replace the center insulator of the antenna and an eye bolt on top can be used to support the antenna. The Balun is a compact 2 1/4 in. diameter and 2 in. high. It is priced at \$12.95 postpaid in U.S. and Canada (plus 5% tax in California). Write to Palomar Engineers, Box 455, Escondido CA 92025 for a descriptive brochure.

### FM ANTENNA MOUNT



A new mobile antenna mount that features fewer parts, simplified and quicker installation, lower silhouette and positive weather protection has just been introduced by Larsen Electronics. Designed to go into the usual 3/8 in. hole, the mount is adaptable to any location on roof, fender, trunk, etc. Only three parts are involved and no special tools are required for installation.

The mount will accommodate either soldered or solderless fastening of coax according to the desires of the installer. A case hardened steel flange assures positive grip and ground connection to the vehicle. It will fit any antenna that requires a 5/16 by 24 thread and when used with the Larsen LM Antenna provides a low, low silhouette and thread to thread connection for greatest electrical efficiency. It also provides an installation that permits quick and easy removal of the antenna when the car goes through mechanical car washing facilities.

To install the Larsen mount one has only to attach the coax (step-by-step full scale illustrated instructions are included) and feed it to the equip-

ment. The under part of the mount goes easily through the  $\frac{3}{8}$  in. hole and a tough plastic fitting and weather-proofing "O" ring spins into place. With those three steps the mount is ready to receive the antenna. For more details, write to *Larsen Electronics, Inc., P.O. Box 1686, Vancouver WA 98663.*

#### PORTABLE FM ANTENNA



A new industrial type, continuously loaded VHF portable antenna, Model HM-5, has been added to Antenna Specialists high performance amateur line. Designed to withstand the rough handling that makes telescopes impractical, the new spring antenna is completely insulated and cannot accidentally be shorted out. It features a connector fitting that attaches directly to portable equipment with SO-239 connectors. Power rating is 25W with nominal input impedance of 50Ω. A companion model, HM-4, is identical except for a standard 5/16" - 32 threaded male mounting base. Both antennas are available from amateur distributors at a suggested ham net price of \$5.95. For additional specifications, write to *Antenna Department, The Antenna Specialists Company, 12435 Euclid Avenue, Cleveland OH 44106.*

#### DIGITAL TIME

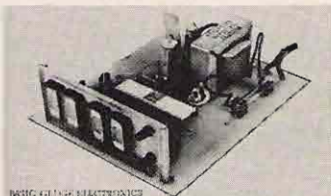

Ever since the first digital clocks came on the market, probably 30 years or so ago, we've been fascinated by them. And when the nixie readout clock became practical as a result of large scale ICs, we had to go that route, at any cost.

We started out with the Logicconcepts clock—a beauty. We use them in every part of the 73

offices. Those numbers lighting up are fun to watch, better than a navel. The only drawback was that the Logiclocks are over \$100 and that limits their appeal a bit.

So along comes K-A Sales with a clock kit for \$52.50! Grass did not grow under our feet—we sent for one. Beauty. With one enormous IC the clock converts the 60 hertz line into whatever it is the display numbers need to read out the hours and minutes—and, with a switch, the seconds. If that isn't enough it also has an alarm circuit built in, complete with a five minute snooze delay.

This clock is terrific for every ham shack. You can build it right into your control console and the alarm will help you remember those skeds—unless you are a lot better at remembering them than we are. We miss as many as we remember—or at least we did until K-A came along with this device.

If you get every accessory (most of them are just switches you probably already have) the whole bill only comes to about \$75. Take a closer look at the K-A ad and see this gadget.

#### HIGH-RESOLUTION DIGITAL AUDIO SYNTHESIZER

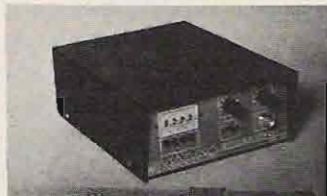

A new, precision frequency synthesizer with an output range of .1000 Hz to 9.999 MHz, and a single-unit price of \$495, has been introduced by Syntronics Inc.

The unique solid-state instrument puts out a TTL-compatible square-wave signal having a frequency accuracy and stability of  $\pm$  ppm from 0 to 50° C (With 1 ppm from 0–50° C available as an option). Frequency, to four significant figures, is selected manually by means of front panel thumb wheels and a rotary switch which selects one of 8 available ranges. Decimal point position is automatically indicated by LED's on the front panel.

The Model SI-70 is believed to be the first high-accuracy instrument of its kind to offer a price comparable to that of many inherently less accurate audio oscillators and signal generators.

The new unit is extremely compact, measuring 8 $\frac{1}{4}$ " x 3 1/8" x 6 $\frac{3}{4}$ " and weighs approximately 5 $\frac{1}{2}$  lbs. Power requirements are 115V, 50–60 Hz @ 17 watts. Other options include: An output range extended down to .001 Hz; external BDC programming; ex-

ternal dc power unit; and an external 1 MHz-standard input. Write to *Syntronics, Inc., 169 Millham St., Marlboro MA 01752* for additional information.

#### NEW LEADER DIGITAL MULTIPLIER



The LDM-850, a digital readout ac/dc multimeter that measures voltage, current and resistance in 25 ranges, is now being offered by *Leader Instruments Corp., Long Island City NY 11101*. It offers a dual slope operating mode and has a maximum input voltage of 1,000V dc and 350V ac with 10MΩ input impedance. Sensitivity ranges from 100 μV to 1V with current from 0.2 mA to 1,000 mA, ac or dc.

The Model LDM-850 measures 10" x 7 $\frac{1}{4}$ " x 3 $\frac{1}{4}$ " and weighs 10 lbs; priced at \$299.50.

#### CAPACITIVE DISCHARGE IGNITION SYSTEM



C-D SYSTEMS has announced a totally new CD ignition system, the MACH II COMPU-SPARK. The unit is designed to permit the length of the spark to be regulated with engine rpm. A very long spark at low rpm aids starting and idle smoothness. A built-in three-position switch permits C-D operation, standard ignition usage or "off" as an anti-theft feature.

The ignition system utilizes only silicon semi-conductor components for reliable operation under extreme temperature conditions. The unit will operate with any 12-volt negative ground system. It carries a no time limit free repair or replacement guarantee and costs \$49.95. A free brochure is available from *C-D SYSTEMS, P.O. Box 484, Berkeley CA 94701.*

**THE TEMPO "VALUE LINE" ... THERE'S NO BETTER BUY!**



### TEMPO/fmp

Truly mobile, the Tempo/fmp 3 watt portable gives amateurs 3 watts, or a battery saving 1/2 watt, FM talk power anyplace at anytime. With a leather carrying case included, this little transceiver will operate in the field, in a car, or at home with an accessory AC power supply. The battery pack is included. The price: \$225.00

(Accessory rechargeable battery available: \$22.00)



### TEMPO/220 TR

A brand new 220 MHz solid state AM/FM transceiver. The 220 TR's power output is 4 Watts on FM, 1.5 Watts on AM. The receiver is double conversion with a tunable receiver. FM is detected by a limiter discriminator featuring full noise saturation for weak signal reception. AM signals are detected by a bridge diode detector and full AGC is employed to make the most high powered signals distortion free. Sensitivity is typically .3 microvolts for 20 db quieting. Tuning is accomplished in two bands, 220-222.5 MHz and 222.5-225 MHz. Its size.. only 7" W x 2 3/4" H x 10 1/2" D. Its price.. only \$220.00



### TEMPO/fmv 2

So much for so little! This little 10 Watt VHF FM transceiver offers high quality performance and features usually found only on more expensive units. Features such as AFC on receive and separate switchable Transmit/Receive sections. Includes mounting bracket, heavy duty power cord and provisions for accessory AC power supply. Frequency: 146-148 MHz, 11 channels, 25 KHz channel spacing, 13.8 VDC ±10% operation (standby -100 ma, receive -150 ma, transmit -3.0 amp.)

The price: \$199.00



### TEMPO/TPL high power fm amplifiers

Miniature power houses! Operates directly from a 12 VDC power source, automatic antenna switching, incorporates Balanced Emitter transistors and state of the art design practices, making it virtually immune to damage due to high VSWR or misloading conditions.

MODEL NUMBER	POWER INPUT	POWER OUTPUT (min)	BAND	PRICE
TPL1002-3	5 to 25W	100-135W	2M	\$220.00
TPL1002-3B	1-3W	80W	2M	\$235.00
TPL802	5W	80W	2M	\$180.00
TPL802B	1 to 3W	80W	2M	\$195.00
TPL502	5 to 15W	35-55W	2M	\$105.00
TPL502B	1 to 3W	45W	2M	\$130.00
TPL252-A2	1W	25W	2M	\$ 85.00
TPL445-10	1 to 2.5W	12W	440MHz	\$125.00
TPL445-30	4W	30W	440MHz	\$215.00
TPL445-30B	1W	30W	440MHz	\$235.00
TCP 12A Control Head . . .				\$32.00

# Henry Radio

11240 W. Olympic Blvd., Los Angeles, Calif. 90064 213/477-6701  
 931 N. Euclid, Anaheim, Calif. 92801 714/772-9200  
 Butler, Missouri 64730 816/679-3127

"World's Largest Distributor of Amateur Radio Equipment"

# Amateur FM Comes of Age

Henry Radio proudly announces the new Tempo line of amateur FM transceivers for the 146 and 220 MHz bands. The Commercial Line transceivers are so fine they can meet the tough FCC requirements for Type Acceptance in commercial two-way service. A broad line of transceivers so modestly priced that any amateur can own one. Transceivers that defy comparison for both performance and value. Transceivers that are not a dream for tomorrow but are available right now . . . today.

## TEMPO'S "COMMERCIAL LINE" TRANSCEIVERS... THE BEST!

### TEMPO/CL 220



As new as tomorrow! The Tempo Commercial Line VHF transceivers offer commercial performance at amateur prices. Both units include an audio limiter to assure constant deviation at all times and an instantaneous impulse squelch. Microphone, power cord, mounting bracket and one pair of crystals is included.

#### GENERAL SPECIFICATIONS:

- Frequency Range: 220-225 MHz (2 MHz operating range)
- Number of Channels: 12 channel capability for transmit and receive
- Microphone: Dynamic with coil cord
- Dimension: 2.36" H x 5.90" W x 7.66" D
- Weight: 4.5 pounds
- Frequency Stability:  $\pm 0.001\%$  ( $-20^\circ$  to  $+60^\circ$ )

- RF Power Output: 10 Watts or 3 Watts.
- Output Impedance: 50 ohms unbalanced.
- Sensitivity: 0.5 microvolts nominal for 20 db quieting.
- Spurious & Image Attenuation: 70 db below desired signal threshold sensitivity.
- Adjacent Channel Selectivity (15 KHz channels): 70 db attenuation of adjacent channels.
- Type of Receiver: Dual conversion superheterodyne.
- Audio Output: 2 Watts minimum w/internal speaker (at less than 10% distortion)
- The price: \$329.00

### TEMPO/CL 146

- Frequency Range: 146-148 MHz
- Same general specifications as CL 220
- The price: \$279.00



destroyed the micas in the higher power version. Figure 5 is the photo of the model being described. As usual, the largest single component is the heatsink. The one shown is minimum in size for the rating. Since the heatsink could be secured to the case of the equipment, additional cooling would be available. Figure 6 is the four-in-series string which delivers 200W CW output. Figure 7 is the photo and, of course, is the experimental

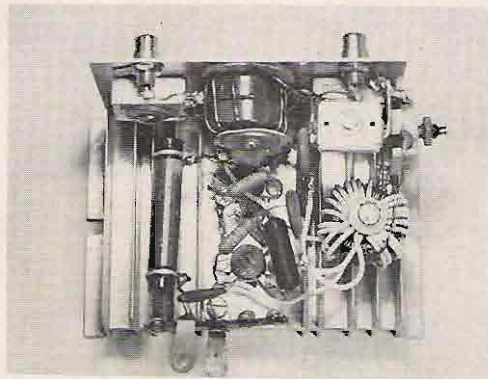

Fig. 5. 75W amplifier. Note heatsink size.

version. In both models the input circuits use a toroid made of ferrite cores by Amidon. For best efficiency, the driver stage would have the link secondaries wound over the primary; eliminating capacitor and toroid. A  $50\Omega$  output from the driver made development much simpler. Power measurements were made using a Bird wattmeter and dummy load. The driver was adjusted to deliver a maximum of 5W at 7.1 MHz. Driver turns ratio to primary was 5:1, but was not critical. Multicolored solid conductors proved to save time when wiring to the bases. All windings were the same in number of turns and polarities of phasing.

When the first model was made, all driving circuits to the base were series fed. About the only thing good about that connection was the self-oscillation. Simply by making the base shunt fed, the oscillation was stopped.

Here are some suggestions that may be of help in designing an amplifier that will operate as it should. I have seen as much as a 50% loss in power when the contacts were not as they should be.

1. All connections should be made with a mechanical contact, if possible with a copper strap. Then the joint should be soldered to prevent later corrosion.

2. Low resistance is a must in all circuits carrying rf, dc, or both. Don't take any chances with components when connecting to the heatsink or some other contact.

3. The conductor size should be large for best results. If a solenoid coil is used for the final, the wire size should be No. 9 or 10. If the toroid type is used, 3 sizes smaller will have the same rating when both windings are connected in multiple.

4. The number of turns is important in the tank coil if maximum output is desired. There is also the need of matching the load with the output. If a pair of ferrite toroids are used and wound as one core, the output will be reduced slightly but there will be space savings which may be important.

5. Each transistor should be balanced with the adjustment of the forward biasing resistor. When all are balanced for the same static current, the correct voltage division takes place and the dissipation should be reasonably uniform, as well as providing better linearity.

6. Do not be stingy with heatsinks! Operate the transistors cool if you want long transistor life. Blowers or fans can reduce the need for large heatsinks but there is the noise and other problems from the vibration and size of the cooler.

7. The use of silicon thermal lubricant is recommended, plus the secure mounting of the heatsink of the transistor to the heatsink.

8. The tuneup should be done with a variable rf source. Do not tune up at first with more than a few watts. The dc supply

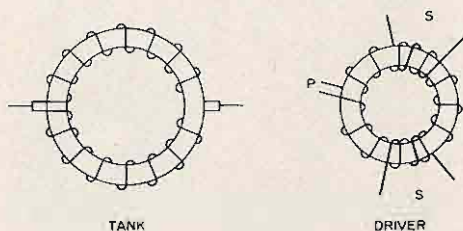

Fig. 5A. Toroid winding details for tank and driver coils.

# SOLID STATE STATE POWER

**F**or many years there has been a need for increased rf power from transistor amplifiers to replace the output tubes in excitors. Cost, efficiency, distortion, power output, reliability, and stability from temperature changes have prevented the use of transistors in hybrid equipment.

The obvious advantages of this design will not be discussed in this article, as the purpose is to disclose a method of generating higher rf power from small transistors. Although the cost of transistors is greater than tubes, it is now possible to eliminate tubes and still be compatible with present costs. Two experimental designs are presented here. The first has two transistors in series and delivers 75W CW on 7.1 MHz. The second version is made with four in series and has a maximum output of 200W with approximately 5W drive. Using series strings of transistors has the advantages both in load impedance current ratings, and only a slight increase in collector voltage. TRW manufactures an HF isolated heatsink Model PT4526

which was used for all tests. A few other types were tried and operated as calculated. The other types did not have the isolated heatsink which presented a problem in thermal dissipation and mica isolation.

## General Background

Three basic circuits will be discussed briefly. Figure 1 is the well-known grounded emitter. Since transistors operate efficiently in this mode, there is a tendency under certain conditions to go into self-oscillation. A second and more serious problem is in regard to the loading. Should excitation be

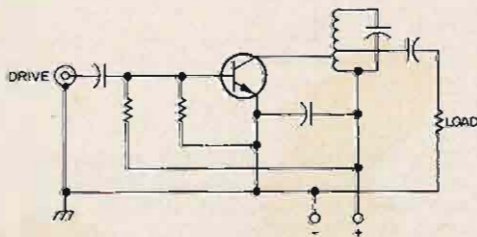

Fig. 1. Grounded emitter xstr amplifier.

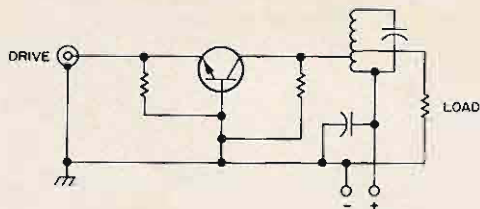

Fig. 2. Grounded base xstr amplifier.

applied without a load, the transistor in most cases will be destroyed due to the voltages developed in the high "Q" circuit.

Figure 2 can be compared to the grounded grid tube operation. This circuit is quite stable but requires more drive than the first circuit. For this reason, it was not used in the new design. Figure 3 is the grounded collector and has the following advantages: First, in the use of non-isolated heatsinks from the case, the collector is in good thermal conduction with the heatsink. Second, when the load is removed, the circuit is out of resonance and there is little danger of damage to the device with excitation applied. Third, much less driving power is required than the grounded base. Fourth, the circuit is quite stable in operation.

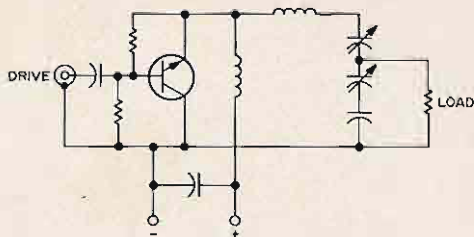

Fig. 3. Grounded collector. Notice detuning effect of the removal of the load.

### Description

The schematic diagram shown in Fig. 4 uses two TRW transistors in series. Toroids have been employed to save space. A smaller heatsink was also used, as there was less dissipation due to the reduced output. Small mica adjustable mica capacitors were used to contain the complete stage within the small heatsink. More output would have been obtained with larger components. The "L" net as shown has a different method of coupling than for the four transistor version. A link also could have been used, but this gave good flexibility in a small space. I might add that this is about the limit for compression micas. Increasing the power successfully

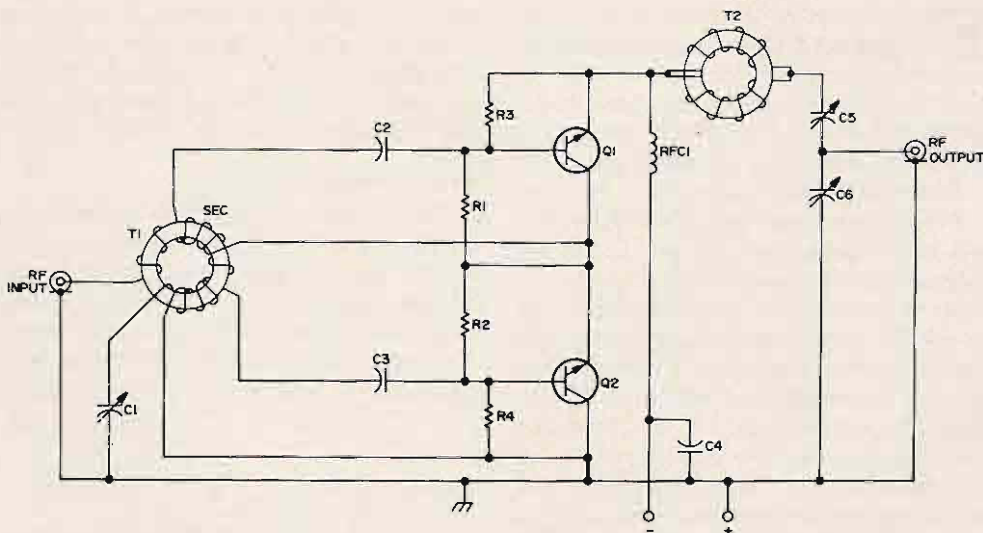

Fig. 4. 40m, 75W amplifier. T1: Amidon 15/16 in. toroid. Primary; 50T, No. 24. 2 secondaries; 10T, No. 24, solid insulated wire each. T2: Same type core except 2 used: 2 windings No. 16 Formvar 5T each connected in parallel. RFC-3/8 in. dia. ferrite rod, 60T No. 22 Formvar. C1, C5 - mica adjustable 200-800 pF. C2, C3 - 1  $\mu$ F, 100V discap. C4 - .1 mF discap, 100V max., 25V min. C6 - mica adjustable 400-1200 pF. R2, R3 - 10 $\Omega$ , 2-5W. R1, R4 - 450 $\Omega$ . Q1, Q2 - TRW PT4526 or similar.

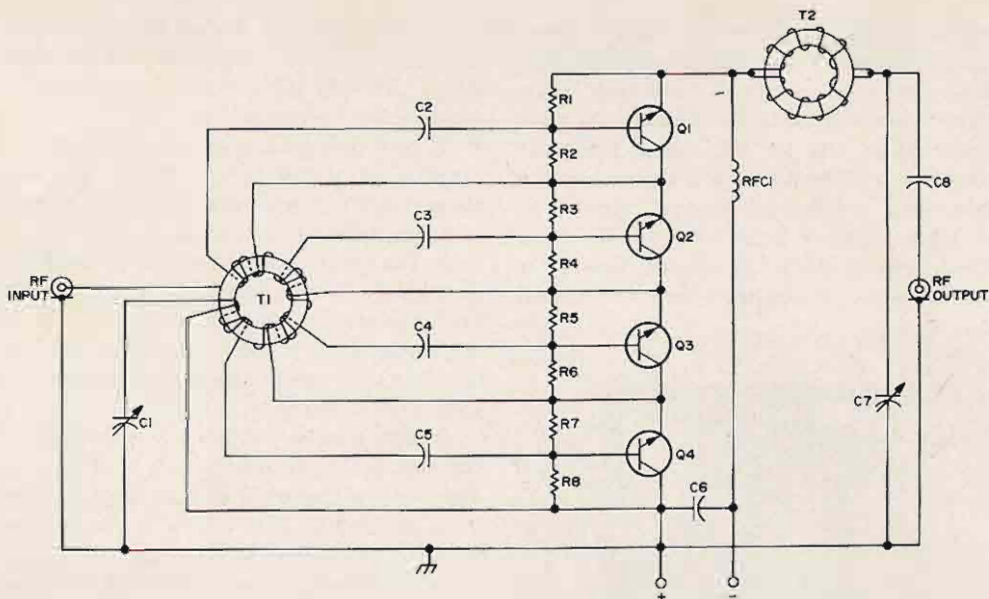

Fig. 6. 40m, 200W amplifier. T1: 2 Amidon 15/16 in. diam. toroids. Primary; 25T No. 22 Formvar. Four secondaries; 5T No. 22 Formvar each. T2: 2 airwound windings, 18T each, No. 14 Formvar, 1 3/16 in. diam. These windings are paralleled and shaped into a doughnut 3 1/2 in. diam. C1 - 450 pF broadcast variable. C2 through 6 - .1  $\mu$ F, 100V. C7 - 450 pF wide spaced variable. C8 - .01  $\mu$ F, 500V (vary for best coupling). Q1, Q2, Q3, Q4 - TRW PT4526 or similar. R1, R3, R5 - 7 to 10 $\Omega$ , 2 to 5W wirewound. R2, R4, R6, R8 - 450 $\Omega$ , 1W. RFC - 3/8" diam. ferrite rod 50T No. 22 Formvar.

should be started at a few volts and raised to the maximum operating value only after the output is linear with the collector voltage. When an increase in dc voltage does not show much increase in output, reduce the collector voltage at once to a place where the linearity is restored. Operating above the linear point will only destroy the transistors. Increased loading usually permits the increase in collector voltage with a corresponding increase in power output. Always use a load to make the tests. After the amplifier is

adjusted, both with the tank resonance and the drive resonance, then increase the drive. It should not be necessary to use above 5W of drive for high Beta transistors. Less efficient models will, of course, require more. Do not try to overdrive.

### Conclusion

The disclosure of this circuitry is done to aid those who wish to pursue the possibility of increasing the usefulness of solid-state amplifiers. No attempt was made to make a finished version, only to show one way to accomplish the production of higher rf output than has been previously possible. Although only tested briefly, the same excitation circuits worked on 75, as well as 14 MHz. The output was reduced in the final because of the improper LC ratios.

Wide ranges of operating frequencies should be possible when more time and energy can be expended in this direction. I have also considered the use of a push-pull "L" net for doubling the output. So far, not enough time has been available to pursue phase of development.

...W6EI/KH6HLN

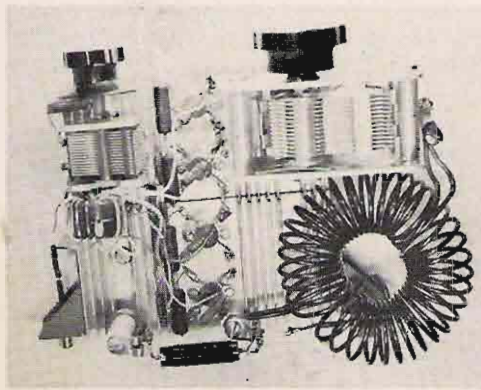
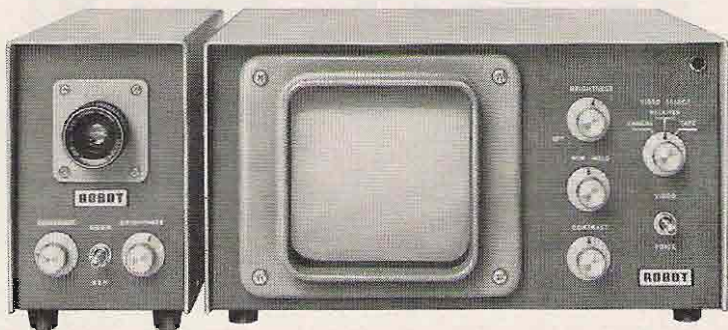

Fig. 7. Breadboard 200W amplifier.

# The most important development since the beginning of SSTV



ROBOT MODEL 70 MONITOR AND MODEL 80 CAMERA

# \$295 EACH

## Robot Goes Factory Direct

These are the identical camera and monitor that have been selling through dealers for \$495 and \$465. But with our new factory direct marketing program and our substantial growth in sales volume we can now offer our complete line of SSTV equipment at new, low prices.

You can now order your equipment direct from our factory and we will ship freight collect. All prices are F.O.B. San Diego, Ca., and **APPLY IN U.S. & CANADA ONLY!**

DIRECT EXPORT INQUIRIES TO: MAGNUS OVERSEAS CORP.  
5715 North Lincoln Avenue, Chicago, Ill. 60645. Cable ULLMAG



ROBOT RESEARCH INC.

7591 Convoy Court  
San Diego, California 92111

- Please send your new factory direct price list.
- Enclosed \$ \_\_\_\_\_ Please send the following equipment via AIR  or SURFACE
- Model 70 Monitor \$295
- Model 80 Camera \$295
- 25 mm f1.9 lens \$25

Name \_\_\_\_\_ Call \_\_\_\_\_

Address \_\_\_\_\_

City \_\_\_\_\_ State \_\_\_\_\_ Zip \_\_\_\_\_

California residents add 5% sales tax.

# AN RTTY SELCAL WITH TTL LOGIC

The Selcal or automatic character recognizer has become a fairly popular accessory in stations equipped for RTTY operation. Particularly so in the case of people interested in automatic use of their printer while they are not actually in the station. With this equipment installed, a receiver may be left on continuously monitoring a frequency for RTTY signals, and the printer will start up and print a message only after the call letters of the station (or other start-up coded sequence) are received through the station terminal unit. A suitable turn off sequence to stop the printer is included.

The original description of a circuit of this type appeared in 1968.<sup>1</sup> It made use of the TRL logic available at that time. Since then, the entire line of TTL logic has become readily available to amateurs, and in fact is now so low in price as to be more than competitive with the RTL used in the original Selcal design. The merits of TTL have been discussed at length; and the great number of special and medium scale integration circuits available makes it very attractive for projects such as the Selcal.

With the thought of updating the circuit somewhat, yet retaining the original logic idea, the circuit to be described was devised and tested. This article describes the logic diagram, timing chart and functioning of the circuit; and presents a basic TTL design for the character recognizer which can be expanded for other features as desired.<sup>2,3</sup>

The overall circuit diagram is shown in Fig. 1. A preliminary glance at this shows it to be somewhat less formidable than the diagram of the original unit. This is mainly due to the use of two SN 7496 5-bit shift register medium scale integrated circuits. These replace the shift register which had to be hand wired in the case of the RTL design, and take care too of the turn off sequence circuit. The decoding is identical to the original using JK flip-flops.

## Input

The input circuit shown in Fig. 1 (Q1 and Q2) can accept information from a number of sources. Probably the best input is a regenerated RTTY signal from the terminal unit which switches from a positive voltage on space to a negative voltage on mark. This sort of signal is available with the floating loop type terminal units like the TTL/2 and ST-6 that are favored by serious enthusiasts. A system making use of the keyer transistor with an emitter resistor as used in the ST-3 and ST-4 demodulators followed by suitable transistor circuitry has been described.<sup>4</sup>

For use with older type terminal units, it is possible to connect the input of Fig. 1 to the audio voltage developed on the space filter coil of the demodulator. This connection is often brought out as one lead to be used on an oscilloscope display of the received signal. If this connection is used, it is important to make sure that there is sufficient isolation between the T U filter

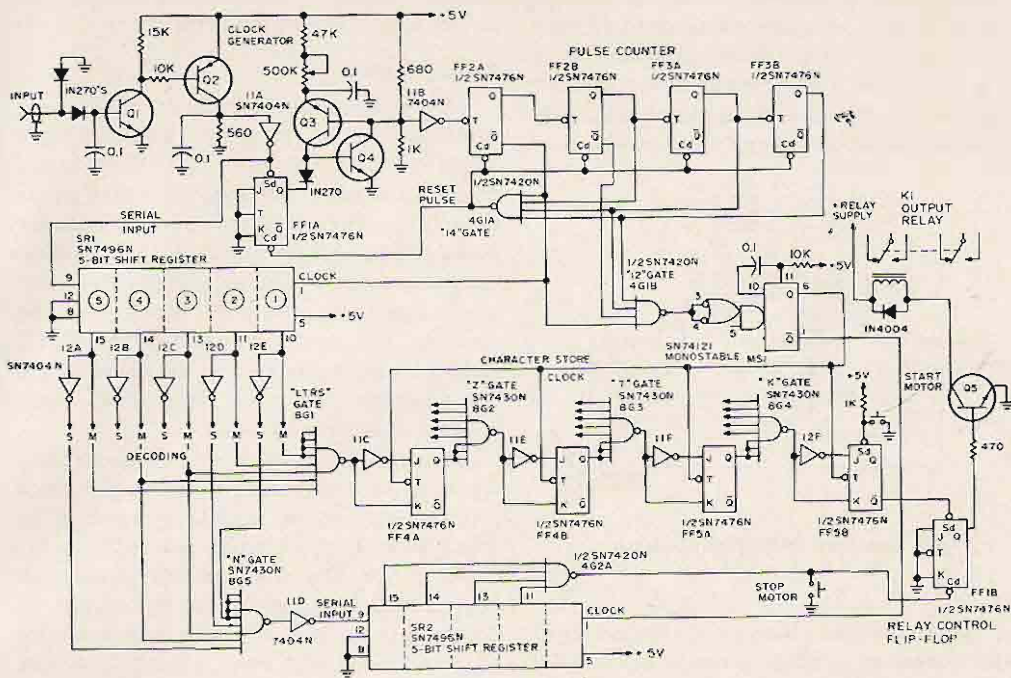

Fig. 1. TTL Selcal — logic diagram.

circuit and the Selcal input to prevent undue loading effects. Not much audio voltage is required to "trigger" the circuit. The diodes in the input circuit take care of rectifying the audio if used, or make correct usage of a digital type plus/minus signal if this is supplied.

For the condition of a continuous mark input, Q1 and Q2 are both off, and there is no voltage developed across the 560Ω resistor in the collector of Q2. This resistor acts to pull down the input of the SN7404 inverter, I1A, which is connected to the collector of Q2. Since its input is low, the output of this inverter is high for a mark condition. If the input to the Selcal goes positive (for a space signal) or audio voltage from the space filter appears at the input, Q1 and Q2 both get turned on; and the current through the Q2 collector resistor brings the inverter input up high, and so its output is then low for a space condition.

The base of Q1 and collector of Q2 are shown bypassed with 0.1 μF capacitors, and it is important that these values do not become too large so that the input switching

circuit can accurately follow the reversals from mark to space of the RTTY signal and provides a good solid TTL level logic signal to the rest of the circuits.

#### Clock Generator Circuit

The clock circuit is familiar and has seen much use in electronic keyers and the like. It makes use of two transistors (Q3 and Q4)

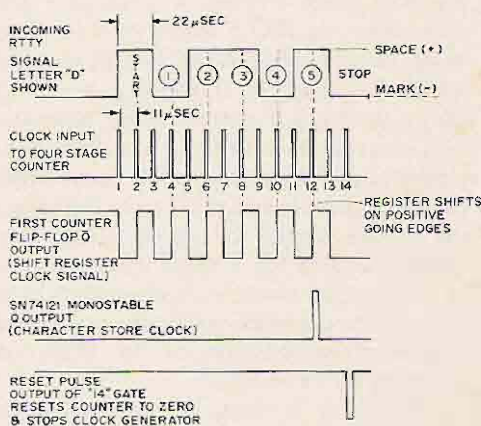

Fig. 2. TTL Selcal — waveform/timing diagram.

and one half of an XN7476 dual JK flip-flop which is used as a control element to start and stop the clock. When connected as in Fig. 1, Q3 and Q4 act much like a unijunction transistor, but with increased reliability in operation at lower supply voltages.

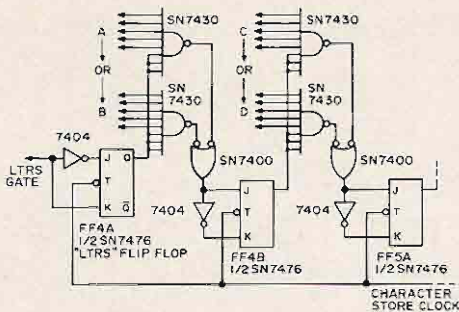

Fig. 3. Expanded decoding TTL Selcal.

As the 0.1 mfd capacitor at the emitter of Q3 charges up, a point is reached where Q3 starts to conduct and as this happens, Q4 also starts to turn on. Conduction in Q4 makes Q3 conduct even harder, so the result is a collapse of the capacitor charge in short order after which it starts to recharge, and the process repeats. The clock rate may be adjusted by varying the resistance in the charging circuit. A 500 K potentiometer is shown in Fig. 1.

The JK flip-flop during the mark condition is reset, and the Q output is then low. This clamps down the base of Q4 and stops the clock from running. As soon as a start pulse from an RTTY signal (space) comes along, this flip-flop gets set through its direct set input making the Q output go high. This allows the clock to start running. Note that as soon as the base of Q4 is not clamped to ground any longer, the clock immediately begins by generating a pulse since the capacitor at the emitter of Q3 is sitting there charged waiting for a space signal to come in. It is not necessary to go through a charge cycle on the capacitor which makes for more reliable synchronization of the clock and incoming RTTY signals.

The clock is stopped again when the control flip-flop receives a clear pulse. The operation of this portion of the circuit is

covered during a discussion of the counter circuit and its associated decoding.

### Pulse Counter

The pulse counter consists of four JK flip-flops which are series connected as a ripple counter. If not reset, they could provide a count of sixteen. The clock pulses from the collector of Q4 are thin negative going spikes, and are inverted to clean them up and provide a suitable thin positive pulse clock signal for the first flip-flop in the counter. The clock runs at twice the RTTY rate; 11 milliseconds for a 60 speed signal. By adjusting the clock frequency, other speeds can be accommodated.

So upon receiving a start pulse (space) from an incoming RTTY signal, the clock immediately begins running generating an input pulse to the counter forcing it to the count of one. The clock remains running and toggles the counter until the count of fourteen is reached, at which time it is reset to zero by the four input nand gate labeled "14" gate. This gate also feeds its output back to the clock control flip-flop and resets it stopping the clock after the count of 14.

There is another decoding gate connected to the counter circuit which detects the count of twelve on the counter. At this time, the output of the "12" gate goes low which triggers the SN74121 monostable I.C. This monostable is used to generate a one short pulse which is applied to the character recognition flip-flops to store a valid character if it is present in the register on the count of twelve.

The SN74121 is a versatile circuit. It can be triggered to generate a one shot output with either a positive going input on pin 5, or a negative going input on either pin 3 or 4. The negative going input is used here with pins 3 and 4 tied together. When the negative going input is used, the voltage on pin 5 must be at a high level (1 state) or else simply left unconnected as shown, which automatically places it at logic 1. The monostable also has suitable connections brought out for connection of external timing components to set the length of the pulse generated. The 10K resistor and 0.1  $\mu$ F capacitor shown generate a pulse of suitable width for this application; slightly



### MEMORY-MATIC 8000 DELUXE

Capacity for 8000 bits in 8 Read/Write Pluggable Memories. Each memory can store either a single message or a number of sequential messages. Near-full and Overload alarms. "Message Stop" for char. insertion. "Full Control" weight ratio, message interrupt switch, var. trans. delay, 115/220V ac, 50/60 Hz, incl. SM-21B and MST-60 features. Sh. wt. 8 lbs. (Incl. 3-500 and 1-1000 bit memories.) . . . . . \$698.50

Additional Memories  
500 bit \$21.50  
1000 bit \$37.50



### MEMORY-MATIC 500-B

500 or 800 bit R/W memory. Stores either a single message or a number of sequential messages. "Message Stop" for char. insertion. Near-full and Overload alarms, remote control for Stop/Start of message. Incl. SM-21B features. Sh. wt. 4 lbs. (500-bit memory) \$198.50 (800-bit memory) \$219.50



### HF FREQUENCY STANDARD - FMS-3

Markers at 5, 10, 25, 50, 100, 200 and 400 kHz. 400 kHz crystal. No unwanted markers. Latest low-power ICs. Osc. and output buffered. Sh. wt. 2 lbs. (Less Batteries) . . . . . \$32.95



### CRICKET 1

The "feature-packed" moderately-priced keyer! Keyed time base, jam-proof spacing, sidetone/speaker. Rear controls for weight, speed, volume, tone, auto-semi-auto., tune. 115V ac or 12V dc. Sh. wt. 3 lbs. \$49.95



### VHF FREQUENCY STANDARD - FMS-5

Cal. receive and transmit crystals in 10, 6, 2 and 1/4 meter FM bands. Markers for all FM channels. Check deviation. Precision 12 MHz crystal. No unwanted markers. Osc. and output buffered. Sh. wt. 2 lbs. (Less Batteries) . . . . . \$44.50



### METEORIC SCATTER TIMER - MST-60

Precision timer for meteoric scatter communications. 60 Hz time base provides 15, 20, 30 and 60 second output. Synchronized to WWV. Automatic and manual outputs. Sh. wt. 2 lbs. . \$49.50



### BROADBAND PREAMP

1-30 MHz, 36 dB gain dropping to 19 dB at 30 MHz. 3 dB Max. N.F., 12V dc, metal case with mounting lugs. 2 x 1 1/2 x 3/4. 90-day guarantee. Sh. wt. 6 oz. . . . . \$17.95



### SPACE-MATIC 21-B

This SWITCHABLE keyer gives you "eight-keyers-in-one." Rear switches can delete dot or dash memories or char./word spacing. Instant start, self-completing dots, dashes and char./word spacing. Adj. weighting, sidetone/speaker, dot-dash memories, Iambic, 115V ac or 12V dc (SM-21B only.) Sh. wt. 4 lbs. . . . . \$89.50

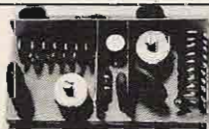

### 2-METER PREAMP

. . . . . \$9.50 Kit  
. . . . . \$12.50 Wired  
Option for 150-250V dc  
Operation . . . . . \$2.95  
20 dB Gain, 2.5 N.F., 12V dc, Size 1" x 1 1/4" x 1/2".  
Diode protected MOSFET.  
90-day guarantee. Sh. wt. 4 oz  
Major Components Separately Shielded.



### ELECTRONIC FEATHER TOUCH KEY

A completely solid-state key. Detects mere touch of finger. Use as single or twin lever key. Operates with all positive or negative ground digital keyers.  
Sh. wt. 2 lbs. \$22.95  
(Remote S/S Swts. for MM-500B and MM 8000) \$27.95



Send for Catalog

5-year guarantees

DATA ENGINEERING, INC. 5554 Port Royal Road,  
Ravenworth Industrial Park, Springfield VA 22151

less than a millisecond. Thinner pulses could be used to clock the character store flip-flops. With no external timing components, the monostable generates an extremely thin output pulse; something in the nanosecond area.

### Shift Register and Character Recognition

The incoming RTTY signal reversals are fed into the character recognition shift register, SR1, and this register is clocked once every 22 milliseconds (for 60 speed) by the "not-Q" output of the first flip-flop in the pulse counter. The register shifts on a positive going edge as it has internal buffering on its flip-flops in order to present a single normalized load to the driving circuitry.

The SN7496 shift register has a serial input, and also inputs so that the individual flip-flops can be present to any desired state. The enable input for this preset function is pin 8 on the I.C. and is grounded in this application as the preset inputs (parallel load) are not used.

So, as an RTTY character start pulse comes in, the counter starts and clocks SR1 entering the various bits of the RTTY character in serial fashion. Inspection of the timing diagram, Fig. 2, shows that when the counter reaches the count of twelve, the start pulse has been shifted out the end of the register, and its five flip-flops contain the states corresponding to the RTTY character input. These states are a logic 1 for a mark bit, and a logic 0 for a space bit. At this point in the counting period, the character is in the register and ready to be inspected to see if it is one of the desired characters in the turn-on sequence.

### Decoding

The Selcal as originally devised was used to look for and detect four consecutive RTTY characters, the first of which was the LTRS character sent after the area numeral in a typical amateur call sign. The logic diagram in Fig. 1 shows circuitry for a similar decoding sequence. However, if one's call letter suffix is not likely to occur in normal English text, the LTRS character may be omitted, using just the three letters of the station call. For two letter calls, the

LTRS character probably should be included depending upon the make-up of the two letter suffix.

Omission of one or more letters for turn-on can eliminate a flip-flop in the character storage section if desired. Addition of the necessary circuits is worthwhile if maximum prevention of unwanted starts is desired, and the required circuits do not cost much.

Since only the true (Q-output) outputs are available on the I.C. shift register, a bank of inverters is used to provide a signal which will be at logic 1 level for a space entered in that flip-flop. The outputs before inversion are at logic 1 for a mark entry. This arrangement then provides a set of five lines, all of which will be at a high level if and only if the proper character is entered in the shift register.

The coincidental logic 1 on all five lines is detected using a series of 8-input nand gates (SN7430). The unused inputs on the gates are tied to one of the used inputs. When a desired character comes in, the output of the 8-input gate goes low since all its inputs are high for this character. Any other character input will provide at least one logic 0 input, making the output of the decoding gate high.

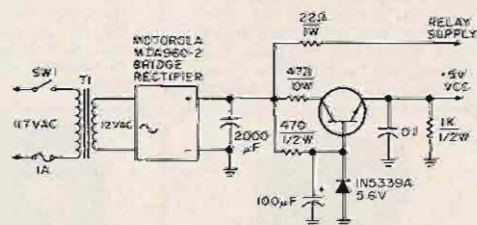

Fig. 4. TTL Selcal typical power supply.

### Character Storage

The outputs of the 8-input character detection gates are applied to the inputs of four JK flip-flops, and these flip-flops are all clocked simultaneously by the pulse generated by the monostable, MS1, on count twelve in the counter. These flip-flops can only change to the true state (Q output at logic 1) if the J input is high. This state of affairs on the J and K inputs of the flip-flops

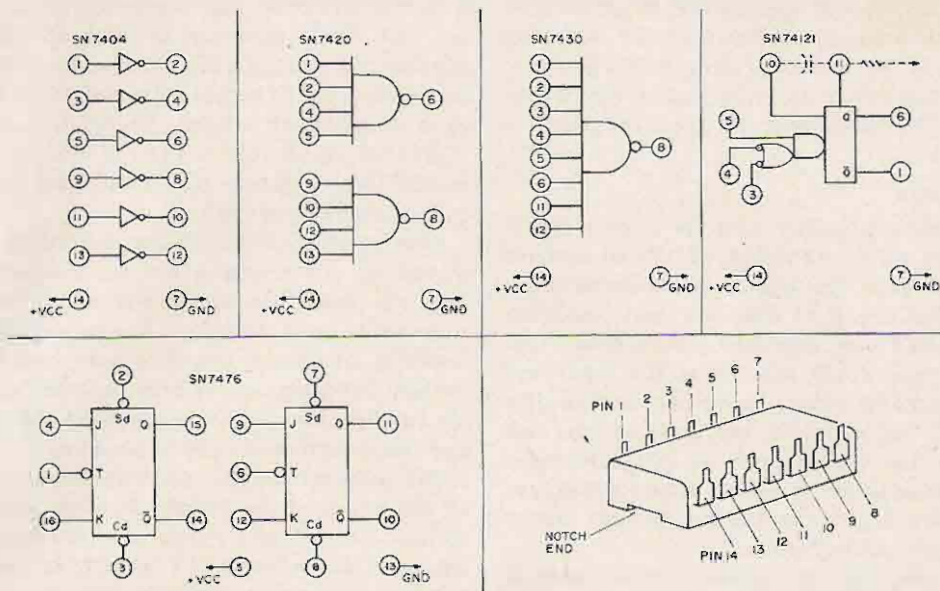

Fig. 5. TTL Selcal integrated circuit pin connections.

is present only when the desired character has been entered in SR1. In addition, the second, third and fourth flip-flops in the chain are fed with information containing the state of the previous flip-flop. If it is not at true level, the following flip-flop cannot change state. What this means is that for normal RTTY inputs containing text, the four flip-flops are continuously being reset by the clocks from MS1. However, for example, any time a LTRS character is received, the first flip-flop FF4A, will be set; and if the next letter is the appropriate one in the call letter sequence, the FF4A will be reset on the next character store clock, while the second flip-flop, FF4B, will then be set because the LTRS character has been received and FF4A was in the high state when the clock was applied. In this manner, only reception of the four desired letters consecutively can make the flip-flops FF4A, FF4B, FF5A and FF5B go set in "domino" fashion. Any false letter in the series stops this "cabin reaction."

When the last letter in the sequence has been properly recognized, the FF5B is set, its not-Q output applies a logic zero to the direct set input of FF1B and sets it which in turn drives on the relay through Q5. FF1B remains set even though other RTTY charac-

ters now come through the system, until it receives a turn-off pulse.

#### Four "N" Turn-off

Amateur users of the Selcal and other stunt box devices have adopted the standard commercial turn-off sequence of four "N" characters sent consecutively. In the TTL design for this Selcal, a different method of detecting four consecutive "Ns" is used, and makes use of another of the SN7496 5-bit shift registers. This further simplifies the circuit.

An 8-input nand gate, 8G5, is permanently wired up to detect the presence of an "N" character in the shift register, SR1. The "N" detection shift register, SR2, is clocked once each character by the inverse character store clock generated on count twelve. The not-Q output of the monostable provides this inverted clock signal.

If an "N" is present in the first shift register, the output of 8G5 will be low, and a logic 1 applied to the serial input of SR2 through the inverter ahead of it. When the clock comes along, the logic 1 is shifted into the register; and if a second "N" comes along, it too shifts a logic 1 into the register shifting the first 1 further along into the register. If four "N" characters come along,

the register will contain four logic 1 levels, and this situation activates the "N" decoding gate, 4G2A. Its output immediately goes low and this resets the relay control flip-flop at the direct reset input and opens the relay.

### Hit Gate

Readers familiar with the original Selcal design will note that the TTL Selcal contains no hit gate. This feature was included in the original circuit to sense if a mark condition occurred part way into a start pulse. This situation would arise when the input was triggered by receiver noise and the like. If a "hit" was indicated, the pulse counter was reset and started over, so that continuous monitoring of receiver noise would not eventually provide the proper data inputs and give a false turn-on.

Since most of the more recent terminal units like the ST-3, ST-4 and ST-6 contain an autoprnt section which requires a valid RTTY signal to be present for a short period of time before any loop output signals can be generated, the hit gate did not seem to be necessary, assuming that inputs for the Selcal were derived from the loop circuit in some fashion.

However, if input information were to be taken from the space filter audio voltage as mentioned earlier, some unwanted turn-ons from receiver noise might be expected.

### Power Supply

The power supply must handle a 5V dc for the logic circuits at a couple hundred milliamperes, plus a suitable dc voltage to operate the control relay. A typical supply for use with the 12V dc relay listed is shown in Fig. 4. The relay is a DPDT type and requires a coil current of about 80 mA for operation. Its contacts are rated at 10 amps ac and will handle the typical motor on a teleprinter. The unused set of contacts can be used for other control functions as desired. For example, they might light a light or activate a chime in a living area of the home to indicate that the printer was on.

### Other Turn-on Sequences

Some Selcals were originally set up so that they would also turn on the printer upon receiving the combination

LTRS\*N\*LTRS\*N. This signal was used as an "All Call" sequence so that all the machines monitoring a given frequency using the Selcal could be turned on simultaneously by a transmitting station. Recognition of "QST" as an all call or the call letters of another active station on an autostart frequency are also popular.

One possible solution to the addition of a second set of turn-on letters is to decode only the mark and space bits which are common to each character. For some combinations of letters, this does not produce enough ambiguity among other possible letter combinations to give many false starts, and this system can be implemented without additional logic. In the simplest case, tying all the inputs of the 8-input decoding gates to logic one will give a turn-on after receiving any four valid RTTY characters and provides some protection from CW and continuous carriers over that normally provided by the autoprnt and motor control circuits in the demodulator.

In most cases, it will be more suitable to slightly expand the decoding logic as shown in Fig. 3. This allows for two different turn-on combinations to be decoded if desired. However, it should be recognized that not only does this allow for these two sequences, but others as well as each stage of decoding is an "or" arrangement introducing a number of other possible combina-

tions which will turn on the printer. The use of the LTRS character in the first place is of great benefit when this expanded code is used, but the combinations in each instance should be examined to see how many ordinary three letter words might be possible as valid turn-on codes. In most cases the first LTRS character pretty well eliminates false starts.

The addition of this logic requires an SN7400 quad two input nand gate as well as three more SN7430 eight input nand gates for decoding the three additional characters. Of course even further expansion would be possible using gates with more inputs.

### Parts List

A list of parts for the major components is given. Also shown is a chart of I.C. pin connections for all but the SN7496 shift

ORDER

RUSH  
*(check one)*

RUSH

RUSH

Name \_\_\_\_\_

Call \_\_\_\_\_

Address \_\_\_\_\_

City \_\_\_\_\_

State \_\_\_\_\_ Zip \_\_\_\_\_

TRANSMIT RECEIVE

- |                             |                             |
|-----------------------------|-----------------------------|
| <input type="checkbox"/> 01 | <input type="checkbox"/> 61 |
| <input type="checkbox"/> 04 | <input type="checkbox"/> 64 |
| <input type="checkbox"/> 07 | <input type="checkbox"/> 67 |
| <input type="checkbox"/> 10 | <input type="checkbox"/> 70 |
| <input type="checkbox"/> 13 | <input type="checkbox"/> 73 |
| <input type="checkbox"/> 16 | <input type="checkbox"/> 76 |
| <input type="checkbox"/> 19 | <input type="checkbox"/> 79 |
| <input type="checkbox"/> 22 | <input type="checkbox"/> 82 |
| <input type="checkbox"/> 25 | <input type="checkbox"/> 85 |
| <input type="checkbox"/> 28 | <input type="checkbox"/> 88 |
| <input type="checkbox"/> 31 | <input type="checkbox"/> 91 |
| <input type="checkbox"/> 34 | <input type="checkbox"/> 94 |
| <input type="checkbox"/> 37 | <input type="checkbox"/> 97 |
| <input type="checkbox"/> 52 | <input type="checkbox"/> 52 |

TOTAL

Make & Model Transceiver \_\_\_\_\_

\$ \_\_\_\_\_ enclosed

VALPEY FISHER CORP. 1015 FIRST, HOLLISTON, MASS 01746

# IMMEDIATE DELIVERY

*Why wait until next week?*

**ALL STANDARD REPEATER CHANNELS IN STOCK AT ALL TIMES — NO BACK ORDERS. SHIPPED FROM MASSACHUSETTS. YOU GET FAST MAIL\* DELIVERY.**

Crystals are available for the following two meter FM transceivers at this special price offer: Drake, Regency, Simpson, SBE, Sonar, Standard, and Tempo. Please specify the make and model transceiver when you place your order so we can be sure to send you the correct compensated Crystals. Crystals are available for other FM transceivers and other channels... please write for prices... very reasonable prices.

*\*We realize that this is a contradiction of terms.*  
Crystals in HC-25/U holders for the 146 MHz channels listed in the order blank are available for

**just \$3.<sup>75</sup> each**

...plus 50¢ per complete order for postage and handling.

**This low price for Drake — Regency — Simpson — SBE — Sonar — Standard — and Tempo. ONLY**

Eastern customers may appreciate our fast mail service... it can save you days to weeks on your order. Western customers may appreciate getting crystals that work on channel the very first time and don't have to be returned for further compensation to match your set.

**Valpey Fisher — 40 long hard years of experience.**

**VALPEY FISHER** CORP. *Dealers — Have we got a deal for you!!!*  
A VALTEC CORPORATION  
1015 FIRST, HOLLISTON MASS 01746

register, whose pin connections are indicated on the main logic diagram, Fig. 1.

The integrated circuits can all be obtained from a number of sources that advertise in the amateur magazines. They should cost somewhat under \$20 when obtained on the surplus market.

Substitution for the transistors shown is easily possible as any switching types will do in these circuits. 0.1  $\mu$ F Sprague Orange Drop type capacitors are specified throughout to be consistent, but the only requirement for a stable capacitor of this type is in the clock circuit. Others can be disc ceramic or other bypass types if they are available.

If another dc supply voltage is available, it might be used to operate the relay for motor control. The newer solid state de-

modulators mentioned already contain a motor control relay, and it might well be put to use in some way or other to be used in conjunction with the Selcal output signal. The method of control seems to be an individual thing which is best suited to the station at hand. Each one seems to be slightly different as are most RTTY installations overall.

### Conclusion

In building this sort of circuit, be sure to include adequate bypassing on the 5 volt Vcc line around the circuit board. In addition a shielded enclosure for the circuits is a must to eliminate stray rf from getting in and upsetting circuit operation. Adequate filtering and bypassing of the signal lines going in and out helps here too. However, in most cases, a nearby transmitter will not be operating when the Selcal is required to do its job, unless of course, the station is transmitting on one band while monitoring another band at the same time. In such a case, rf elimination can best be achieved on a cut and add basis for the individual station layout.

A couple of Selcals using this circuit have been built by other amateurs using hand wiring techniques. These operated without difficulty. The author will be glad to try to answer individual queries regarding the circuit, construction techniques, etc. The considerable simplicity of this design makes for much easier wiring, even on a point to point basis, eliminating much of the chance for error in the final product.

...W9ZTK

### TTL SELCAL PARTS LIST

#### Integrated Circuits

I1, I2 - SN7404 hex inverter

4G1, 4G2 - SN7420 dual four input nand gate

8G1, 8G2, 8G3, 8G4, 8G5 - eight input nand gate, SN7430

SR1, SR2 - five bit shift register, SN7496

FF1, FF2, FF3, FF4, FF5 - SN7476 dual JK flip-flop

MS1, SN74121 monostable multivibrator

#### Transistors

Q1, Q4 - 2N4124, NPN silicon

Q2, Q3 - 2N4126, PNP silicon

Q5 - relay driver transistor, 2N697 or equivalent

#### Capacitors

0.1  $\mu$ F Sprague type 225P Orange Drop, 100V dc (4)

#### Resistors, $\frac{1}{4}$ W composition

560 $\Omega$  (1)

680 $\Omega$  (1)

10 K $\Omega$  (2)

1 K $\Omega$  (2)

15 K $\Omega$  (1)

470  $\Omega$  (1)

#### Diodes

1N270 germanium (3)

1N4004 silicon (1)

#### Relay

Allied Radio Type KN105-2C-12D, DPDT, 12V dc coil, 80 mA

### SOURCE FOOTNOTES

1. Malloch and Lamb, The Selcal - An RTTY Character Recognizer, 73 Magazine, May 1968, Page 58.
2. Wenskus, The Selcal As A Signal Analyzer, RTTY Journal, July - August 1971.
3. Chan, An Auto-Responder for the Selcal, RTTY Journal June 1971.
4. Haynes, A Standard System for Simple Station Control, RTTY Journal, January 1971.

# AN

## INTEGRATED CIRCUIT TRF RECEIVER

An inexpensive Integrated Circuit has been available for some time which contains the complete gain, detection and agc functions required in 455 kHz AM i-f strips. Intended for use with ceramic filters and an outboard front-end converter, the LM372 is presently designed into the AM section of several commercial AM/FM high fidelity receivers, where it replaces the hand-assembled "i-f can" type strip formerly used.

The LM372 is, in reality, a much broader-band device than its 455 kHz applications would suggest. It has useful sensitivity throughout the AM broadcast band, the 160 and 80 meters bands, and even into the 40 meter band, when used to amplify pretuned AM signals directly from an antenna. Sensitivity, of course, is not as great as when used with the additional gain of a superheterodyne conversion stage, but is adequate for urban area broadcast reception, or local 160 and 80 meter net reception.

As may be seen in Fig. 1, there is considerable difference between the LM372 and a conventional i-f strip. The IC is basically a very high gain dc amplifier, with all its gain in one "lump," as opposed to the transformer coupled individual gain stages usually used. To keep the dc biasing constant, a negative feedback loop is used, with capacitor C3 making the loop effective for dc only; thus, ac (rf) gain is not reduced by the feedback system.

In conventional strips, agc is performed by shifting the dc biasing of the individual gain stages, effectively reducing their gain for strong input signals. Unfortunately, such bias shifting detunes the conventional inter-stage transformers. In the IC, however, the gain stages operate at maximum efficiency at all times; they are preceded by a separate agc attenuator stage, which can cut incoming signals by as much as 80 dB (10,000 to one).

Conventional diode-type AM detectors require dc biasing through the last i-f "can" in the strip, and are inherently nonlinear, causing distortion. The LM372 uses a more sophisticated detector, adapted from the op-amp type peak-following circuits used in analog computers. In this "active detector," the diode is inside an amplifier's feedback loop, which automatically biases the diode for linearity with small signals, actually gives voltage gain, rather than the loss of conventional detectors, and is directly, rather than transformer coupled, to the output of the gain stages. In Fig. 1, C5 is the detector smoothing capacitor, with the R4, C4 combination forming the agc loop.

The schematic of Fig. 2 illustrates in detail how the blocks of Fig. 1 operate. With no agc, Q2 is simply an emitter follower, with unity gain. Its output is coupled to the three gain stages, Q6, Q7 and Q8, whose output is directly coupled to the active detector, formed by Q11, Q12 and Q14. Dc feedback for the gain stages is performed through R8, C3, Q5, R6 and R7.

As input signals become stronger, the dc output level of the detector, at pin 6, rises

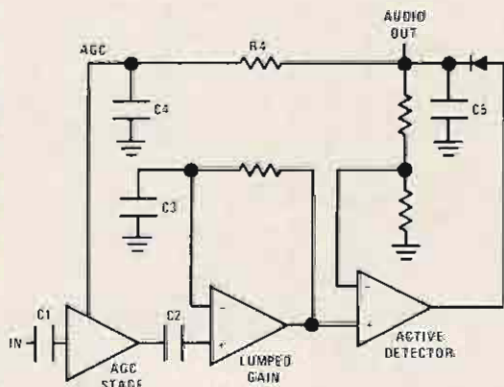

Fig. 1. LM372 block diagram.

R4 and C4 couple this voltage, with the audio component filtered out, to Q4 and Q3. Stronger signals begin to turn on Q3; since Q3 and Q2 form a differential pair, this tends to turn off Q2, giving an agc action that is both series (turning off Q2) and shunt (turning on the low-impedance emitter of Q3).

The string of diodes, D1–D7, and the various emitter followers attached to the string, act as separate power supply regulators for each stage of the LM372, which also eliminates the need for separate rf decoupling of each stage's supply line.

### Broadcast AM TRF Receiver

As can be seen, there is no internal tuning in the LM372; it will amplify, detect, and agc all signals applied to its input. While in a superheterodyne receiver, it would be fed by an already bandpassed 455 kHz signal, the circuit of Fig. 3 allows it to roughly select any signal in the 550–1650 kHz band. The Tune Radio Frequency circuit has of course, poor selectivity, since it uses only a single tuned circuit which also acts as an

antenna. Its selectivity is sufficient, however, to peak the desired station, which will then operate the agc so that overall gain is minimum required for that station. Thus, other stations will be far down on the single LC circuit's selectivity curve. More sophisticated designs might use multisection tuning ahead of the strip.

The prototype was constructed using very inexpensive imported "transistor radio" components. In fact, virtually any junked transistor radio will supply nearly all of the required external components for broadcast band use. A ferrite "loopstick" antenna, L1, resonates with a small, polyethylene dielectric tuning capacitor. If operation is desired above the broadcast band, a smaller capacitor may be used, or the broadcast type may be connected in series with another capacitor, and then shunted across the coil, to lower the net capacitance.

The LM372 performs its gain function just as it would in an i-f application, but in this case directly drives a class A power amplifier. Since the dc voltage at pin 6 is relatively constant (varying from 2.1 to 2.4V

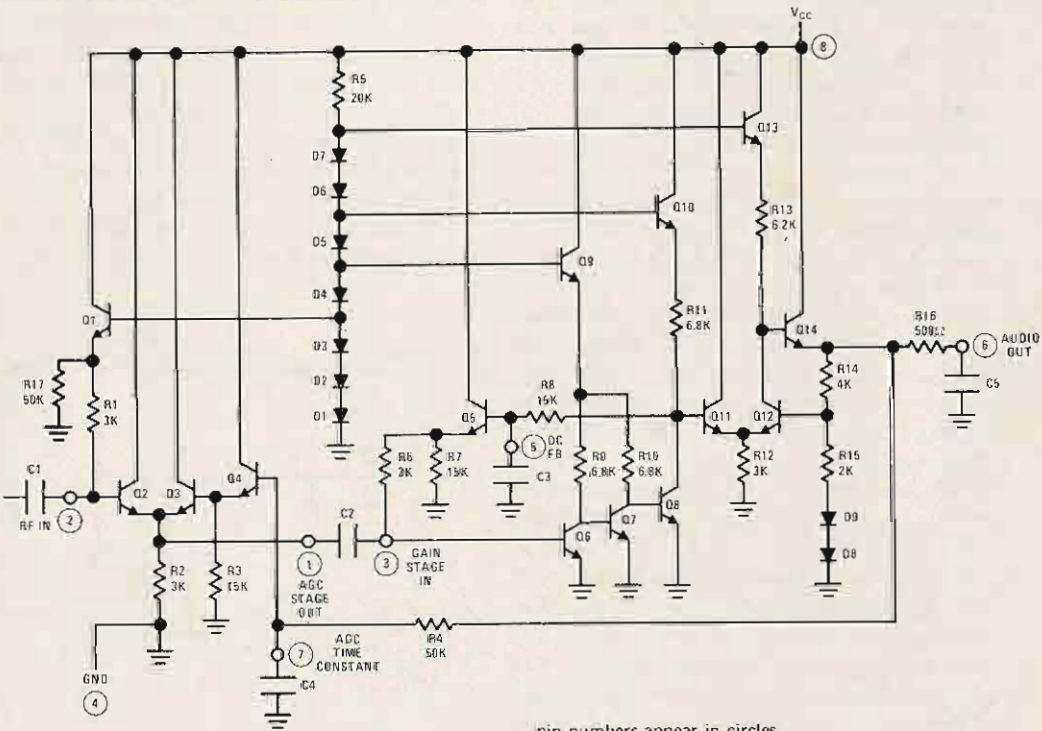

Fig. 2. LM372 schematic.



# BE SNEAKY!!!

*(Tell the XYL they will do the dishes)*

Maybe they won't, but that is one of the few things we didn't build in, so take her along, let her see all those features, these transceivers sell themselves —

**IC-20, 12 channels,  
3 built-in xtals,  
APC built-in, &  
modular constructed**



**IC-21, 24 channels,  
4 built-in xtals,  
RIT, Microphone gain,  
S & Discriminator meters,  
AC/DC power supply,  
modular constructed**

Of course, if you are single, and eat off paper plates anyway, all those goodies are still there.....

## **AUTHORIZED DEALERS**

**Dealer Inquiries  
Invited**

Adirondack Radio Supply, Inc. 188 W. Main St., Amsterdam, N.Y. 12010  
NHE Communications 15112 AW 44th, Bellevue, Wash. 98006  
Aquarius Comm. Systems PO Box 20898, Dallas, Texas. 75220  
Technical Systems Engineering PO Box 175, Overbrook, Kans. 66524  
RC Engineering 18051 SE 128 St., Renton, Wash. 98055

**Where quality counts**



**INOUE COMMUNICATION EQUIPMENT CORPORATION**  
3-8 Kamikuratsukuri cho, Higashisumiyoshi ku, Osaka 546 Japan

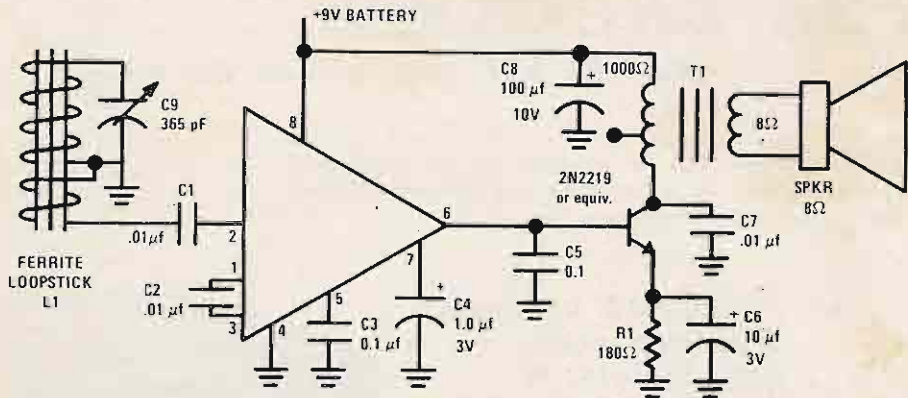

- L1 - Ferrite Loopstick - Philmore FF15 (packaged as set of 3 sizes)  
 C9 - Sub-miniature variable capacitor - Philmore 1949G - 365 pF max.  
 T1 - Midget Audio Transformer, 1000Ω:8Ω - Archer 273-1380 (Radio Shack, Inc.)  
 SPKR - 2" PM Speaker, 8Ω, 0.1 watt - Philmore TS20

Fig. 3. TRF receiver using LM372.

as a function of agc), it is used to bias the class A stage directly, eliminating a number of extra components. C7 and C8 are needed to prevent regenerative audio oscillations with weak batteries. Care must be exercised in building the breadboarded circuit, as excessive lead length anywhere is likely to permit the very high gain strip to oscillate. A good technique is to use pin 4 on the TO5 can as a tie point for ground, and to connect all capacitors and other grounded leads to that pin with absolutely minimum lead lengths. Disc ceramics seem to have less stray inductance at these frequencies than the larger tubular types.

A volume control was not provided in the prototype, as volume was excellent with the small (2 in. diameter) speaker used, and agc was so effective that no perceptible difference in stations was heard in the broadcast band. A volume control which also reduces the class A stage's power drain at low levels can be achieved by inserting a pot between the emitter of the audio output transistor and R1. With the circuit shown, total drain from a 9V transistor type battery is 10 mA, of which only 1.9 mA is used in the LM372; the rest is needed for the audio amplifier.

#### Other Uses

Variations on the circuit of Fig. 3 might include padding of the C9 tuning capacitor,

so that the loopstick could be used at 455 or 262.5 kHz as an i-f "signal sniffer" in receiver troubleshooting. If T1, C7, C6, R1, the speaker and audio output transistor are eliminated, the TRF receiver can be used, capacitively coupled, to drive high impedance headphones, or as a complete AM tuner in high fidelity applications. While selectivity is very broad, the high fidelity application will reveal that commercial AM stations really transmit more "tweeter material" than the average selective AM tuner will pass.

Another application would be to replace the loopstick with an equivalent shielded inductor, and to capacitively couple a broadcast-output VHF converter to the parallel tuned combination. Such a combination might be a simple answer to the monitoring of local VHF repeaters, where selectivity is unimportant.

#### Conclusion

The LM372 is a handy building block, in fixed i-f and TRF or variable i-f applications. A number of similar i-f "strips" are known to be under development; these will make the experimentally-inclined ham's life a lot more pleasant, and, along with other forthcoming communication-type IC's, should renew interest in the vanishing art of homebrewing.

...W6DNS

# THE MARK III ELECTRONIC KEYS

The Mark III electronic keyer (Fig. 1) is the end result of a joint cooperative effort by its designer Wes Hayward W7ZOI, and myself. Design improvements were worked out by W7ZOI in response to my requests for improvements in the original keyer circuit<sup>1</sup>, for fixed station operation.

The Mark III keyer uses two additional transistors (Q4 and Q5), which replace one set of DPST relay contacts formerly required in the original circuit. The addition of three Fairchild 2N3564 NPN-type transistors used as zener diodes (in the base circuits of Q1, Q2, and Q5) replace two penlite batteries formerly required for reference voltage in the emitter circuitry. The addition of Q4 and Q5 permits the use of an economically-priced SPST relay, in place of the more expensive DPDT relay. The addition of the "space" and "mark" controls was my idea, since the manual adjustment of the off (space) and on (mark) duration times is a very desirable feature to have on any electronic keyer.

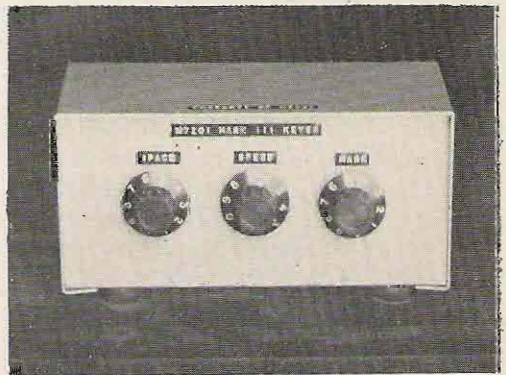

The keyer power supply was previously covered in the original article, "A Simple Electronic Key," which suggested voltage doubling a 6.3V filament winding to obtain 18V dc. I added an 18V zener (International Rectifier Z1116) connected across the output of the power supply as shown in Fig. 2. The 18V zener stabilizes the output voltage at a constant 18V dc. Voltage stabilization is most desirable, since it helps stabilize the keyer timing circuits.

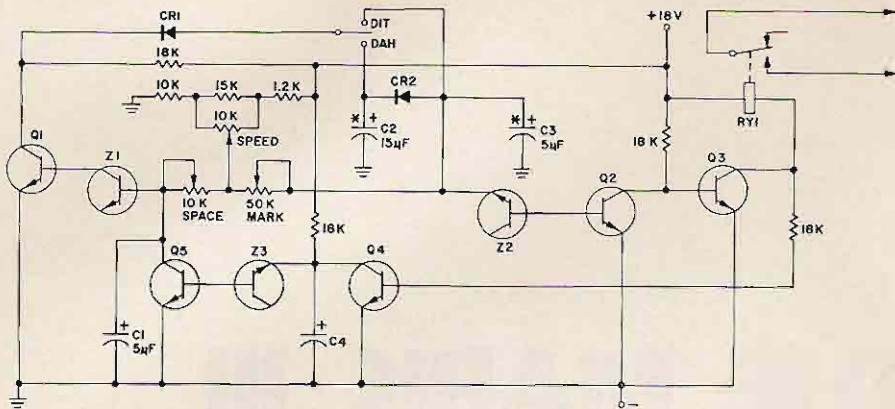

Fig. 1. Keyer circuit diagram.

- NOTES:
1. Q1, Q2, Q3, Q4, Q5 = 2N697 (NPN)
  2. Z1, Z2, Z3 = 2N3564 (NPN) CAN ALSO USE 2N697, 2N388 OR GE-8
  3. \* = SEE TEXT

### Mark III Theory of Operation

For the benefit of those readers who do not possess the December 1965 issue of *QST*, the following explanation of Q1 through Q3 is briefly repeated. The theory of operation of Q4 and Q5 is added to cover the Mark III improvement.

During the "at rest" (paddle contacts open) condition, Q1 and Q2 are in saturation, Q3 is off, Q4 is saturated, and Q5 is off. See Fig. 1. Q1 is saturated because capacitor C1 in its base circuit is positively charged. Q1's collector current is maximum, and Q1 is said to be "saturated." Q2 is also saturated in a similar manner during this "at rest" condition. Q3 is off, because its base voltage is nearly zero volts (the same as the collector of Q2.) Q4 is saturated, because its base voltage is highly positive (the same as Q3's collector) and Q5 is off at this time, because its base voltage is nearly zero volts (the same as Q4's collector).

When the paddle "dit" contacts are closed, a negative pulse from Q1's collector is "steered" through diode CR1, and through the paddle "dit" contacts into the 5 µF "dit" storage capacitor C3. This negative pulse swings the base of Q2 negative, which turns Q2 off, and causes its collector voltage to rise to the supply voltage of 18V dc. The highly positive Q2 collector swings the base of Q3 highly positive, turning on Q3 (saturation). As Q3 goes into saturation, its collector current energizes the relay coil, which

closes the relay contacts. Simultaneously, the base of Q4 drops to nearly zero volts (the same as Q3's collector), and Q4 is cut off. As Q4 turns off, its collector voltage rises to the highly positive supply value of +18V dc. Q4's high collector voltage swings the base of Q5 highly positive and Q5 goes into saturation. The emitter-collector current flow of Q5 causes a low resistance (short circuit) across the C1 "space" storage capacitor. This short circuit grounds the base of Q1, turning Q1 off. The collector voltage of Q1 rises immediately to the high positive value of the power supply voltage, but it does not upset the keyer sequence (even though the "dit" paddle contacts may still be closed at this time), because diode CR1 prevents passage of this positive high voltage.

The keyer circuitry continues in this "dit-mode" of operation, until the negative pulse (charge) on the "dit" storage capacitor (C3) has discharged through the "mark" and "speed" potentiometers to chassis ground. This, in effect, is the self-completion feature of the keyer. When C3 is discharged, the base of Q2 starts to rise toward a positive value. When Q2's base rises to approximately 0.7V, Q2 goes into saturation. This turns Q3 off, which opens the relay contacts and simultaneously swings Q4 into saturation. With Q4 saturated, Q5 turns off and removes the "short circuit" from the "space" capacitor C1. The *time* required for the voltage on C1 capacitor to rise to approximately 0.7V

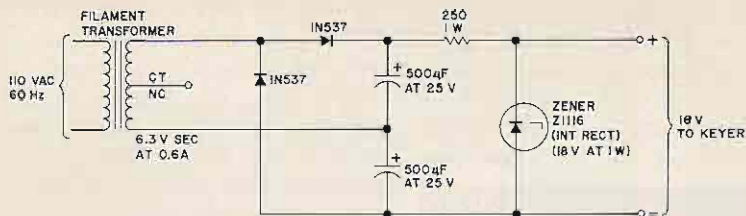

Fig. 2. 18V power supply circuit.

creates the automatic space interval between dits. When this voltage reaches 0.7V dc, it swings Q1 into saturation. If the paddle is still being held in the "dit" position at this time, the entire dit sequence will be repeated. If the paddle had been returned to the neutral (at-rest) position prior to the saturation of Q4 and the turn-off of Q5, the keyer would only make one "dit".

When the paddle contacts are actuated to the "dah" position, the keyer operates in a similar manner as described for the dit sequence, except that the "dah" storage capacitor (C2) Diode CR2 (between C2 and C3 capacitors) steers the negative "dah" pulse into the "dit" capacitor C3, whenever a "dah" selection is made. The time required to discharge both storage capacitors should equal the normal "dah" duration time. For proper "dah" length, the combined capacity values of C2 and C3 should create a "dah" duration time which is 3 times longer than the "dit" time. However, because capacity values (as marked on capacitors) do not necessarily represent the actual capacity value, I recommend that these capacitors be selected by the "cut-and-try" method, until

a satisfactory "dit" and "dah" length is obtained. (As a ball park figure, a continuous string of dits should cause the transmitter final plate current to hover at approximately 50% of the key-closed value. A continuous string of "dahs" should cause the plate current to hover at approximately 75% of the key-closed value.)

I added the 15K fixed resistor across the "speed" control to make the speed change more linear. The 1.2K fixed resistor at the top end of the "speed" control was added to limit the keyer top speed to approximately 45 wpm.

The "space" and "mark" potentiometer resistance values may require some juggling to cause the normal keying response to occur at the mid-range position of these controls. This juggling is necessary to compensate for the combined effects of relay return spring tension, relay contact spacing, relay armature mass, etc., which differs from relay to relay.

### Construction Hints

The following construction hints are offered if the reader cares to duplicate my

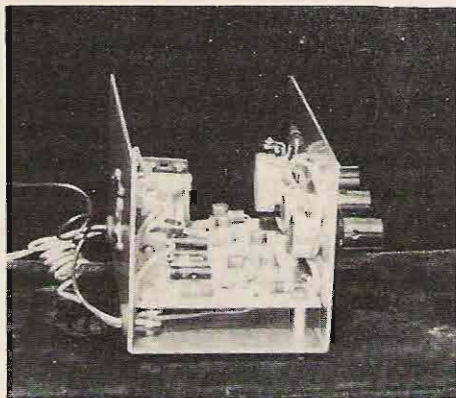

Fig. 3. Top view of keyer showing parts placement.

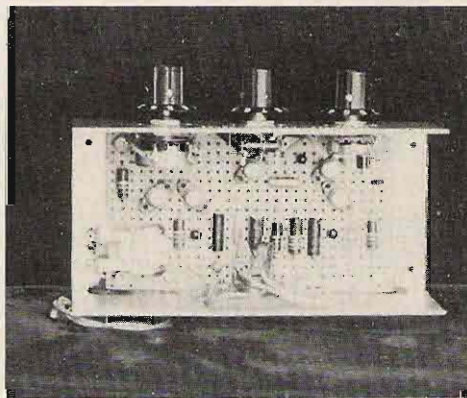

Fig. 4. Side view showing mounting spacers.

layout: Use a rectangular-shaped piece of phenolic pegboard as the base upon which to mount the circuit components (See Fig. 3). Use transistor sockets, so that transistors can be removed when troubleshooting or making continuity checks on the keyer circuitry.

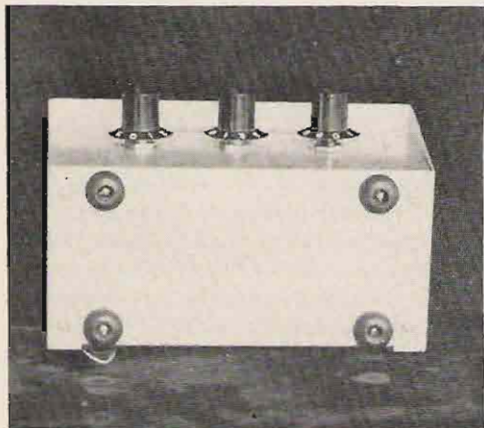

Fig. 5. Bottom details.

Support the phenolic pegboard at the corners with metal sleeve spacers (or equivalent) so that the pegboard is raised above the bottom surface of the metal cabinet. (See

Fig. 4.) Use long machine screws to secure the phenolic pegboard to the metal cabinet. Pass these long screws upward through the rubber feet, the bottom of the cabinet, through the metal sleeve spacers, and through the corner holes in the phenolic pegboard. (See photos.) Secure long screws with lockwashers and nuts on top side of pegboard. Use a 1/8 in. thick, 2 in. square piece of plexiglas to insulate the 3-conductor jack sleeve connection from the hole in the backside of the keyer metal cabinet. Insert rubber grommets in the holes on the backside lower skirt of the metal cabinet to provide protection for transmitter key leads and power supply lead connections to keyer. When locating 3-conductor jack and "speed," "space," and "mark" potentiometers be sure to temporarily install the phenolic pegboard, so that the locations for the jack and potentiometers can be chosen in a manner which will not interfere with the components on the pegboard.

...W6JJI

<sup>1</sup>"A Simple Electronic Key," Wes Hayward WA6UVR, *QST* Dec. 1965.

## For Antenna/R.F. Type Coax Switches insist on **Barker & Williamson** quality switches.



### B. & W. PROTAX Model 375 (Switch up to 6 antennas)

Single Pole—5 position switch with automatic grounding to give you that added protection from lightning damage. Rear mounted connectors.

PRICE

\$17.95



### B. & W. PROTAX Model 376 (Switch up to 5 antennas)

Single Pole—5 position switch with the same protection features as above but with side mounted connectors.

\$17.95



### B. & W. 595G (Switch up to 6 antennas)

Single Pole—6 position switch with the same protection features as above. Designed for *DESK* top operation or *WALL* mounting facilities. Attractive gray finish which will enhance the appearance of any C. B. or Ham Shack.

\$14.95



## **BARKER & WILLIAMSON INC.**

CANAL STREET, BRISTOL, PENNSYLVANIA 19007 • (215) 788-5581

# EMERGENCY POWER FOR THE HOME QTH

When the power goes off, do you reach for a candle or a power transfer switch? A small gasoline-powered alternator wired into the home electrical system can provide a lot of peace of mind by just being there. I live in a relatively remote area in the upper peninsula of Michigan. Power failures are not uncommon, and they can be a real inconvenience.

I installed an alternator large enough to operate the furnace, a few lights and the lower powered ham gear in the shack. The alternator was installed to be easily removable for field day or emergency service.

## Installation

Nearly every installation will have at least slight variations. Also, wiring code requirements are not uniform nation wide. Some areas permit solderless connectors in service boxes, as would be used for connecting the alternator input line to the wiring harness. Other areas require all connections in service boxes to be made at rigidly mounted terminal blocks. Some may require the large commercial power transfer box regardless of the size of the alternator. If in doubt, contact the power company or public utility commission. It is beyond the

scope of this article to go into the details of all types of installations or the automatic and semi-automatic power transfers.

There are two basic precautions to observe when installing an alternator. First, most power companies require a reasonably fail-safe switching system for power transfer so power from the alternator cannot be fed to the power lines. The interconnect also prevents the power from being accidentally fed to the alternator with disastrous results. The ideal switch is the commercial power transfer switch. These switches are required for the larger 220 volt alternators. An acceptable, and considerably more

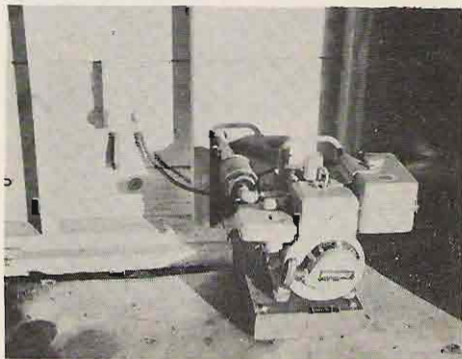

*Alternator mounted in garage.*

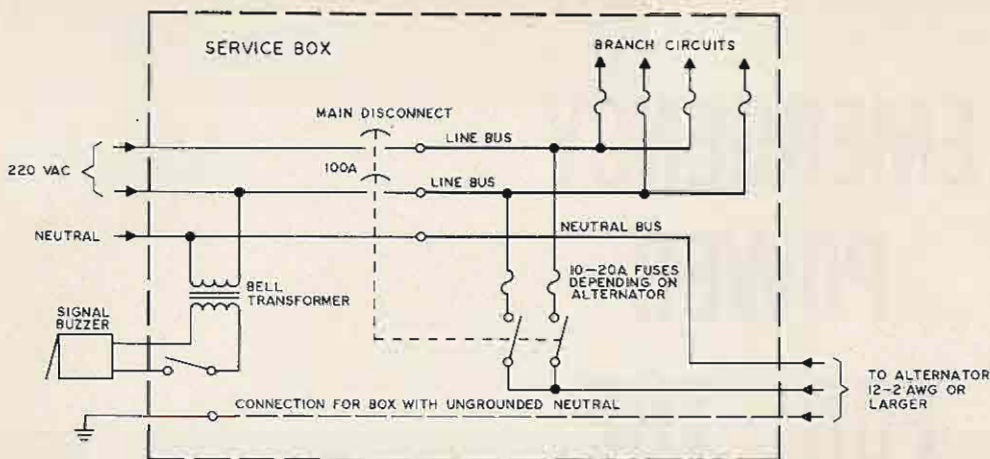
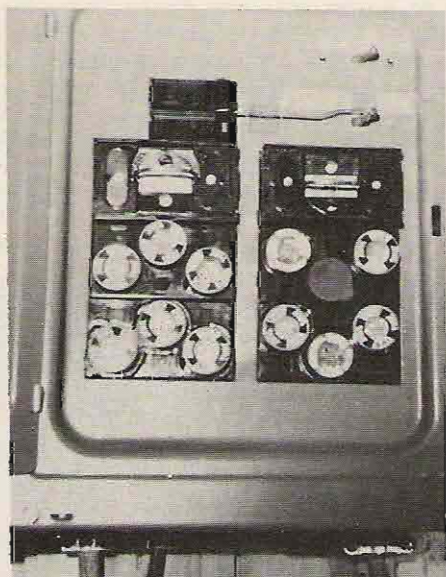

Fig. 1. Residence service box modified for power transfer switching.

economical, switch can be made for the small 115 volt alternators.

I have a hybrid service box with a circuit breaker for main disconnect and fused circuits. An all-breaker box would be wired essentially the same. The fused main disconnect will be described later.

The service box cover was removed and a 30 amp double pole single throw toggle switch was mounted to line up with the circuit breakers. The switch was a surplus



Service box modified for power transfer. Note interconnect between main breaker and transfer switch. Signal switch is above transfer switch.

unit with holes in the handle. A 1/16" steel rod was formed to make an interconnect between the switch and circuit breakers. The rod must be formed so it won't interfere with the circuit breaker action. With the rod in place, the alternator is automatically disconnected when the main disconnect is on and connected when the disconnect is off. To wire the transfer switch a wiring harness can be made from a piece of No. 12-3 or 14-3 stranded flexible cable. Length will depend on box. An additional two-circuit fuse block was plugged into the service box. If you use this system, be sure the fuses connect to each side of the line. If there are no extra fuse circuits, the alternator can be connected directly to the main bus lines, as it is fused at the control panel. Starting at the fuses, strip and connect the white and black wires. Cut off the green wire. Dress the cable to the alternator input and slit the cable to expose the green wire. Cut the green wire and connect it to the hot alternator input. Make the remaining cable long enough so the service box cover can be removed for service. Strip the white and black wires and connect to the outside terminals of the transfer switch. Strip the green wire and connect to both center terminals of the transfer switch.

I have not made an installation for a fused main disconnect. Based on my wiring experience (licensed journeyman) the following notes will aid in making an acceptable installation. Bring the alternator input into the service box as with the circuit breaker box. The wiring harness can be a two conductor stranded flexible cable of No.



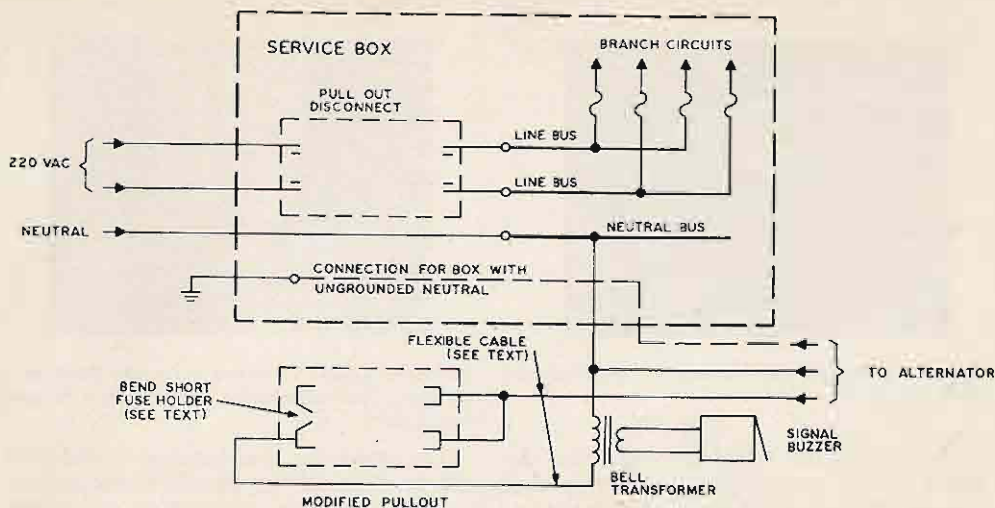

Fig. 2. Alternator connections for pull-out disconnect box.

12 or 14 wire for this box. Strip the white and black wires. Connect the black to the alternator input. Bring the cable out of the box and make it long enough to easily reach the main disconnect pullout. Get a replacement pullout and drill it so the black wire can be connected to both fuse terminals on the branch circuit end. Drill the pullout so the white wire can be connected to one fuse holder on the line side. The white wire will be used for the signal system described later. Bend the short fuse holder clip so a fuse cannot be inserted in this modified pullout. Make an insulated (wood is okay) holder for this pullout. The insulated holder will permit test running the alternator with no danger of short or shock to anyone around the service box while the alternator is running.

To transfer the power, the main disconnect is pulled out as usual. Plug in the modified disconnect for alternator power.

There are many other types of residence service boxes. The two described are the most popular in this area. If you have a pull lever for a disconnect, a small two-circuit lever box can be mounted above or below the service box and interconnected with a steel rod.

It is convenient to have a signal system to indicate when main line power has been restored. A bell transformer can be mounted inside the service box and connected to the main line input terminals.

The transformer is on, even with the main disconnect off, so it must be mounted inside the service box. A switch was wired in the

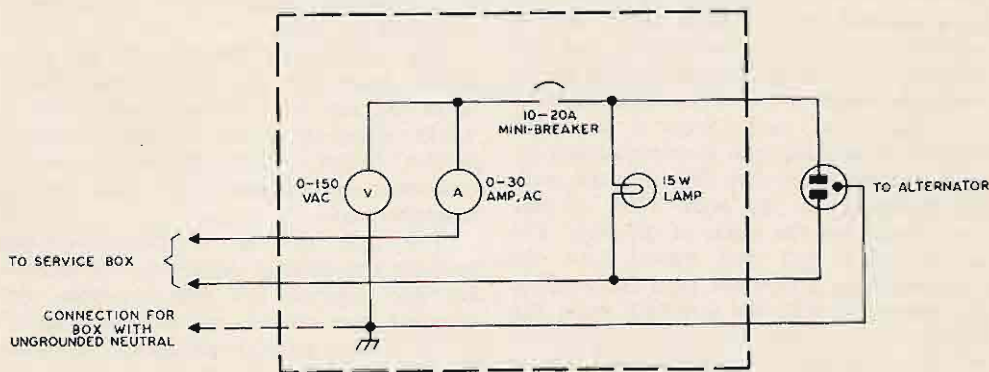
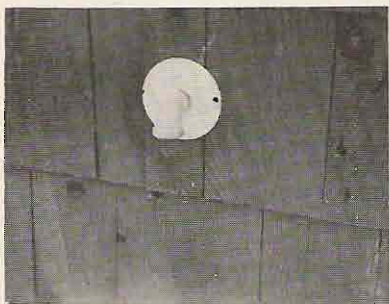
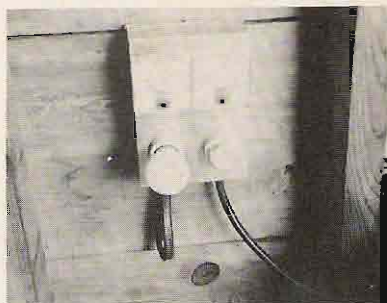

Fig. 3. Alternator panel (optional).



*Exhaust wall plate made from 4" junction box cover. See text.*



*Alternator panel. Voltmeter is on left. Ammeter is on right. The minibreaker screws into a standard fuse holder.*

secondary of the transformer to turn the signal off for normal use. A buzzer or bell may be used for a signal. It is not necessary that the transformer be mounted in the box with a fused main as the transformer is plugged in only when the alternator is in use.

The hookups described connect all circuits in the residence to the alternator. A small alternator will not carry all appliances, so a list of appliances to be turned off when using the alternator should be attached to the service box cover.

The second basic precaution is the engine exhaust. Locate the alternator as close to an outside wall as possible, and preferably in the garage of an outbuilding. A small exhaust leak can accumulate lethal quantities of carbon monoxide in a closed area. It is also important to have a free air flow for proper cooling of the engine and alternator. My unit was mounted three inches off the floor to aid in oil changing. A low tone muffler is a good investment. They are considerably quieter than the standard mufflers. A flexible muffler extension for small engines can be made from flexible conduit. Use muffler cement to seal the conduit to the threaded ends. Drill at least a two-inch hole in the wall for the exhaust. A wall plate was made from a four-inch junction box cover with a center knockout.

Two more holes were drilled in the cover for fastening to the wall. Place a pipe coupling against the inside of the plate. The flexible pipe end will thread into the coupling. Turn a pipe nut on a short nipple and thread it into the coupling from the outside and through the knockout hole in the plate. This will hold the exhaust pipe in place. Turn an elbow on the nipple to keep the rain out.

The alternator was fastened to the base with two lag screws. Rubber shock mounts for the lags were made from small sink stoppers.

A control panel was made from a 5 x 7 x 2 inch aluminum box. If meters larger than 2½-inch face are used, a larger box will be required. The panel has an ammeter and voltmeter. The voltmeter is optional. The ammeter is very convenient for checking the load. A minibreaker and fifteen-watt lamp were put in the panel. A flexible lead was made from heavy (14-3 or larger) extension cord to plug the panel into the alternator.

To use the alternator for portable use, remove the lag screws, unplug the cord, remove the elbow, close nipple and flexible exhaust from the engine. This takes about two minutes.

You will find that wiring for the alternator is much more convenient than laying a wire from the alternator to the service box and then connecting it up with alligator clips. Also the family will be able to use it when you are away.

The installation described is for alternators from 1250 to 2500 watts. Smaller units do not have enough output to be worth wiring them into the home electrical system. Larger units are not easily portable (unless trailer mounted) for field day or emergency use.

The new catalog of alternators and supplies arrived after this article was written. Flexible exhausts are now available with standard pipe thread ends in sizes from ½" to 1¼". These exhausts will fit the wall plate described without change.

... WA8OIK

## WALLER ELECTRONICS TEST EQUIPMENT SALES

P.O. Box 9913, Chevy Chase, Md. 20015  
Telephone 302-652-0996

The "TESCO-PAD" has no tuned coils to go off frequency, no tuning necessary or even there! It's all in one "Black Box I.C." ready to go. The "TESCO-PAD" has a 1 second hold-up for your transmitter, complete P.T.T. operation, available with dual audio output levels, 12 or 16 tone combinations.

**KIT \$29.95      \$34.95 Wired**  
(Add \$1.00 for 16 tone version)  
(\$2.00 for dual output version)

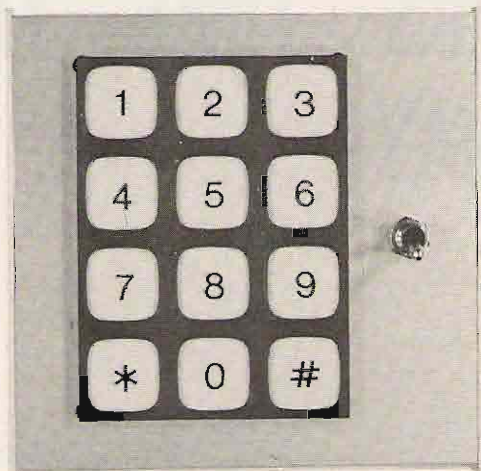

---

**NOW** run your entire mobile rig, tube type or solid state, including amplifier at home with the new **WALLER 60 and 12V** supply.

---

### TUNE-UP METER MODEL UT-1

Portable Tune-up Meter with cables to plug into MOTOROLA, LINK, GE, STANDARD, Etc., This unit gives you the meter functions of the radio being tested in a 1-2-3-4-5 etc step to simplify tune-up. The unit has a built in Field Strength Meter. Get your order in now ..... \$49.95

The UT-1 comes with one cable, your choice at no charge; Extra cables (specify rig) ..... \$4.00 each

---

## CALL OR WRITE WALLER NOW

# HIGH POWER MOBILE... THIS TIME THE EASY WAY

**M**obiling has always been one of my favorite modes of ham radio. I can remember back in the late forties when I used a low power homemade AM transmitter. My mobile contacts were few and the cost per contact averaged about ten dollars.

Eventually I learned about loading coils, antennas, and mobile power supplies. I began to get good results with my 807, which was later replaced with a 6146. It was about this time that I became employed (previously in school) and I built my first high power transmitter for the 1949 Chevrolet. This final amplifier had four 812s in push pull, was modulated with four 811s and the dc plate supply was an ac 60 cycle power supply using 866 mercury vapor rectifiers. The power source was an old Bendix aircraft 800 cycle alternator that I modified to work from a belt connected to the engine. The centrifugal clutch and carbon pile filed regulator kept the voltage to about 110 volts ac. This alternator also had 24 volts dc available which I used to remotely turn my tuning

capacitors with dc motors from the front seat of the car. There were two sets of meters on the transmitter and it was possible to tune the trunk mounted final amplifier from the trunk or the operating position in the front seat. Some wonderful DX was worked from this 1949 Chevrolet but after 130,000 miles and 11 years, I reluctantly removed the rig and bought a new 1960 Chevrolet.

Next I built a small 100 watt 6146 SSB monoband transmitter for this car and I began to see the advantages of SSB mobilizing. The results with the 100 watts of SSB was equivalent to the ease of making contacts on the 1000 watt AM rig. Not being satisfied with a single band transmitter I eventually succumbed to a salesman at the used ham equipment counter and brought home a used KWM-1. I could now work three bands and I found my cost per contact had dropped to about one cent. This was quite a change from the beginning.

During the next six years I worked hundreds of stations on the KWM-1 and

hauled it all over the United States. Like all good mobilers, I put off the purchase of a new car as long as possible but in 1966 a new Chevrolet was purchased and the KWM-1 was transferred over.

With a new car and all the experience of high powered mobiling of the past, I began to dream of a KW linear for the car. Eventually Heathkit brought out the HA-14 and I was an early purchaser of the gear with its dc to dc transistor converter. A whole new layer of contacts was possible because of the extra "S unit" which set my signal slightly above the other mobile stations. The Heath linear performed very well as long as the power supply held out. Without going into a long story, it can be said that the power transistors in the power supply could not be made to last. Heath was very generous about supplying free replacements of these transistors, but neither Heath nor I ever really succeeded in solving the problem. I eventually decided to tackle the problem another way. I used the 60 cycle ac supply on the HA-14 and installed an ac inverter in the car. This inverter worked well but eventually the transistors gave me trouble and I was forced to turn to other sources for mobile power.

The old Bendix alternator kept coming back to my mind. I really didn't want to put that monstrosity in the new 1970 (yes another Chevrolet) car so I looked around for another rotating power source.

At the Cincinnati hamfest several years ago I saw a remarkable demonstration of a mobile power source (Don Smith, Fairfield OH). A small ac alternator was belted to an automobile and was electrically loaded with twenty 100 watt incandescent light bulbs. This demonstration ran all day continuously without over heating. The alternator was made by Porta-Power of Sarasota, Florida and was made in several power levels from 3 to 4 KW. The alternator had a transistor field regulator to keep the voltage constant at 120 volts. With the variable RPM of the car, the frequency varies over wide limits but since the alternator frequency is always above 60 Hz there should be no problem with 60 Hz ac power transformers. Contact

was made with Porta-Power and eventually I was the proud possessor of one of these rotating beauties. This particular alternator was rated at 3 KW. It was mounted as

It seemed that as I grew more interested in high power mobile transmitters that cars grew smaller. I used to be able to sit straight up in a standard Bel-Air, but in the new 1970 my head hit the roof, my knees had to be in a non-vertical position to avoid the steering wheel, and my knuckles disappeared into the dashboard when I shifted gears. I hate to think how a compact car would fit me. The old KWM-1 still performed perfectly after 300,000 miles and I managed to get it mounted on the transmission hump of the car.

Heathkit was now in production with their new 2 KW SB-220 linear and I knew that this piece of equipment had to be my next high power mobile amplifier. When it came to mounting the SB-220 under the dash it was a different story. I did want to be able to see the meters from the driver operating position so I built a small removable table which mounted on the floor under the dashboard on the XYL's side of the car. I might add that the reader might not find their XYL as agreeable, but my wife, W9CNW, was so brow beaten after passing the Extra Class exam that she agreed to let me do this before she had regained her sanity. Photo 2 shows the story. When we are on the air my occasion-

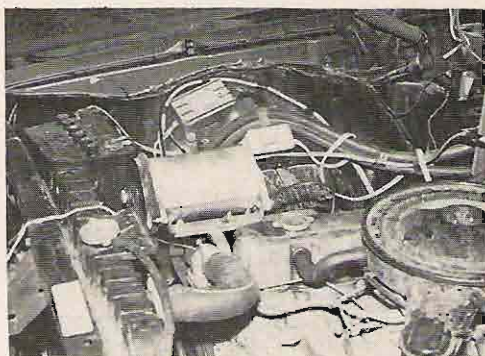
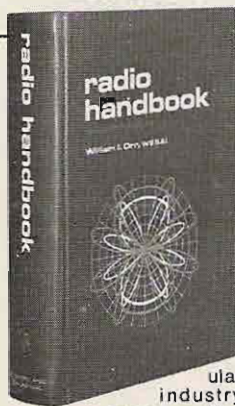

Photo 1. The Porta-Power alternator can be seen behind the radiator and battery. The transistor field regulator is just behind the alternator. The SB-220 is plugged into the 110 volt outlet near the regulator.

# Special Prepublication Price on the completely updated 19th Edition of the E&E RADIO HANDBOOK



Pre-  
publication  
price  
only  
**\$13<sup>95</sup>**

By far the most popular manual in the radio industry for amateurs, electronics engineers, and technicians, this comprehensive book has been completely revised and updated by its author, William L. Orr, W6SAI.

### LATEST HOW-TO-BUILD DATA

The new 19th Edition of Radio Handbook contains authoritative, detailed instructions for designing, building, and operating all types of radiocommunications equipment. It provides a complete understanding of the theory and construction of all modern circuitry, semiconductors, antennas, power supplies, full data on workshop practice, test equipment, radio math, and calculations.

### AN INVALUABLE REFERENCE

Gives the broadest coverage in the field, including the latest information on new high-frequency linear amplifiers of 1 and 2kw PEP output featuring the new 8874 and 8877 tubes, a new solid-state LED-readout receiver, new high-performance 2-meter "moonbounce" converter, and solid-state f-m amplifiers for vhf. All equipment described is of modern design, free of TVI problems. 6½" x 9¼"; hardbound.

### PREPUBLICATION OFFER!

No. 24030, New 19th Ed. Radio Handbook  
Special price until Nov. 30, 1972 \$13.95  
(After Dec. 1, 1972, regular price will be \$14.95)

Order from your electronic parts distributor or bookstore, or send coupon below:

**HOWARD W. SAMS & CO., INC. 73112**  
4300 W. 62nd St., Indianapolis, Indiana 46268  
 Send me the new 19th Edition of Radio Handbook at the special prepublication price of \$13.95.  
\$ \_\_\_\_\_ enclosed.  Check  Money Order

Name \_\_\_\_\_

Address \_\_\_\_\_

City \_\_\_\_\_

State \_\_\_\_\_

Zip \_\_\_\_\_



Photo. 2. The KWM-1 and SB-220 are mounted under the dash. The second mike is for the Motorola 2 meter FM fixed frequency two way radio. A common speaker is used for the KWM-1 and FM radio.

al passenger feels somewhat apprehensive when the plate meter reads 3000 volts.

The only modification on the SB-220 was changing the split phase fan motor that refused to turn on the varying frequency of the car alternator. This fan motor was replaced with a 12 volt dc motor which uses rectified ac from a 24 volt filament transformer. The 12 volt fan could have been run on the car's 12 volt system, but I wanted to preserve the ability to run the mobile system on a 60 cycle extension cord when parked at motels.

The results have been all that was expected. DX is very easy to work. I can switch off the linear by a toggle switch on the control box of the alternator. All stations contacted report a change of two S units when the linear is switched off and on. The center loaded antenna is a Master Mobile open coil type. Poor results have always been obtained with other types of loading coils that have solid dielectric. This type heats with rf. No antenna corona discharge problems have been observed.

Mobiling has been particularly good in recent years on Interstate highways. It appears that the metal in the concrete acts as a very good ground plane which gives efficient low angle radiation. Mobilers, let's give those fixed stations some competition. This morning two fixed stations asked two of us mobilers to change frequency. They just couldn't break through our signals.

...W9NTP

# 220 MHz: FRONT END USING FET'S

This article describes the design, circuit, and practical working model for the home brewer. One rf, mixer, and channel-crystal L.O. are used. A second similar rf stage may be used as desired.

## Today's FET

The protected and insulated dual gate metallic oxide semiconductor field effect transistor, to spell out just what is inside one of those little tin cans, is shown in symbol form in Fig. 1. This device is good for rf amplification up to 500 MHz, which makes it fine for 146, 220 and 432 MHz.

The main features are high gain, high

input impedance, large reduction of inter-modulation (which is important today with ever-growing band occupancy and climbing transmitter output powers), no neutralization is required, separate inputs for signal and L.O. when used as a mixer, large dynamic range which also helps on nearby signals, protection from transient HV inputs, and last — but not least — easily applied low drive power agc to keep down distortion on stations a few blocks away.

## Design

A good practical, stable rf stage for 220, single wire-coupled to another FET as a



Fig. 1. The 3N200 and its connections when mounted upside down on baseboard.

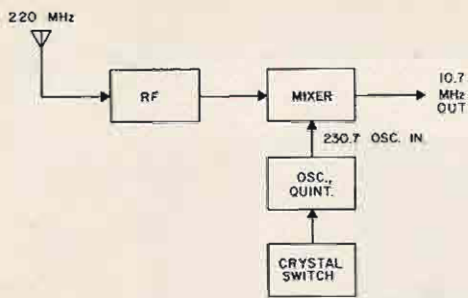

Fig. 2. Block diagram of 220 MHz converter.

dual-input mixer, and a channel type crystal controlled L.O. are shown. Low cost methods of testing are described, assuming that most do-it-yourselfers, like me, cannot afford signal generators and other test equipment costing hundreds and/or thousands of dollars. This tuner was built and tested with a \$30 rf generator and a \$14 voltmeter. Because the three are described as separate units and are connected by single wires, no overall schematic is needed (see Fig. 2).

The rf source connection (Figs. 1, 4 and 5) calls for special attention. Use two of the smallest ceramic 1000 (or 10,000) pF capacitors available, about 1/8 in. square, and solder them carefully to the source lead, pin No. 4, as closely as possible to the case. I used Lafayette stock No. 33R69022, to be exact. Then solder one of the capacitor leads to the copper clad baseboard and one to the shield. These leads should tie down the source lead for rf feedback and no oscillation should now occur, even when the input and output are tuned to exactly 220 MHz.

The pictorial layouts shown provide working units and also make good test

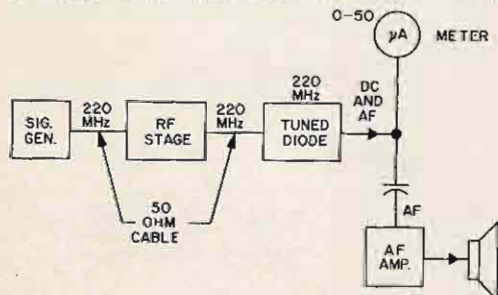
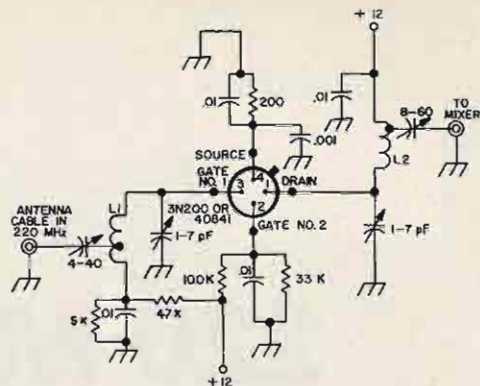

Fig. 3. Test setup for tuning rf stage.



L1 - 3 TURNS NO. 12 WIRE  
TAP AT 1/4 TO 1/2 TURN  
FROM COLD END. OD -  
7/16", 3/8" LONG

L2 - 3 TURNS NO. 12 WIRE  
TAP AT 1 TURN FROM  
COLD END. OD - 7/16"  
3/4" LONG

Fig. 4. Circuit of rf stage.

boards to get together sets of tested and working parts for a final layout. For example, if you wish to make a PC board, or incorporate this circuit into a very small box, the test boards shown allow you to check several sets of components and then, knowing that the coils, capacitors, etc., are correct, install them in the final form chosen. For very small units or PC boards, using pre-tested components also makes for a much neater final job. Every try to modify a PC board?

#### Signal Generator and Test Circuit

The low cost signal generator used here has such a low output on the harmonic used for 220 MHz that it is almost inaudible on a 10.7 diode tuned circuit (see Fig. 3) - without the rf stage, that is. But the amplitude level remains steady, allowing you to build up the stage gains in a relative fashion in good style. Exactly as shown in this article, as in Fig. 3, there is about 4,000 microvolts into the diode which moves the meter in great shape, and the audio signal will drive you out of the shack if you don't turn down the gain. The whole idea of this setup is that you can see everything that contributes to rf gain, conversion to 10.7 MHz in the mixer, matching, and stabilization, which is what you're after here. Also, when everything is tuned and matched correctly, the noise figure will be mainly what the manufacturer says it is. For the 3N200



CW or RTTY, whichever way you go,  
**HAL HAS TOP QUALITY  
 YOU CAN AFFORD!**

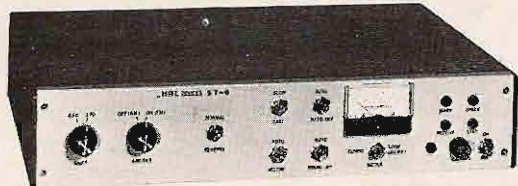

**TOP QUALITY RTTY... WITH THE HAL MAINLINE ST-6 TU.** Only 7 HAL circuit boards (drilled G10 glass) for all features, plug-in IC sockets, and custom Thordarson transformer for both supplies, 115/230 V, 50-60 Hz. Kit without cabinet, only \$135.00; screened, punched cabinet with pre-drilled connector rails, \$35.00; boards and complete manual, \$19.50; wired and tested units, only \$280.00 (with AK-1, \$320.00).\*



**TOP QUALITY... WITH THE HAL 1550 ELECTRONIC KEYSER.** Designed for easy operation; perfectly timed CW with optional automatic ID for sending call letters, great for DX and RTTY; TTL circuitry, transistor switching for grid block, cathode keying. Handsome rugged crackle cabinet with brushed aluminum panel. With ID, only \$90.00; without ID, \$65.00.\*

**OTHER HAL PRODUCTS INCLUDE:**

ID-1 Repeater Identifier (wired circuit board) . . .	\$ 75.00*
ID-1 (completely assembled in 1 1/2" rack cabinet) . . . . .	\$115.00*
HAL ARRL FM Transmitter Kit . . . . .	\$ 50.00*
W3FFG SSTV Converter Kit . . . . .	\$ 55.00*
Mainline ST-5 TU Kit . . . . .	\$ 50.00*
Mainline AK-1 AFSK Kit . . . . .	\$ 27.50*
HAL RT-1 TU/AFSK Kit . . . . .	\$ 51.50*



**TOP QUALITY... WITH THE HAL MKB-1 MORSE KEYBOARD.**

As easy as typing a letter—you get automatic CW with variable speed and weight, internal audio oscillator with volume and tone controls, internal speaker, and audio output jack. Smooth operation; completely solid-state, TTL circuitry using G10 glass boards, regulated power supplies, and high voltage transistor switch. Optional automatic ID available. Assembled MKB-1, \$275.00; in kit form, \$175.00.\*



**NEW FROM HAL—TOP QUALITY RVD-1002 RTTY VIDEO DISPLAY UNIT.** Revolutionary approach to amateur RTTY . . . provides visual display of received RTTY signal from any TU, at four speeds (60, 66, 75, and 100 WPM), using a TV receiver modified for video monitoring. Panasonic solid-state TV receiver/monitor, or monitor only, available. Complete, \$525.00; Panasonic TV receiver/monitor, \$160.00; monitor only, \$140.00.\*

**TOP QUALITY... WITH THE HAL RKB-1 TTY KEYBOARD.** Gives you typewriter-easy operation with automatic letter/number shift at four speeds (60, 66, 75, and 100 WPM). Use with RVD-1002 video display system, or insert in loop of any teleprinter, for fast and easy RTTY. Completely solid state, TTL circuitry using G10 glass boards, regulated power supplies, and transistor loop switch. Optional automatic ID available. RKB-1 assembled, only \$275.00; in kit form, only \$175.00.\*



HAL provides a complete line of components, semi-conductors, and IC's to fill practically any construction need. Send 24c to cover postage for catalog with info and photos on all HAL products available.

\*Above prices do not include shipping costs. Please add 75c on parts orders, \$2.00 on larger kits. Shipping via UPS whenever possible; therefore, street address required.

**HAL COMMUNICATIONS CORP.,** Box 365 L, Urbana, Illinois 61801

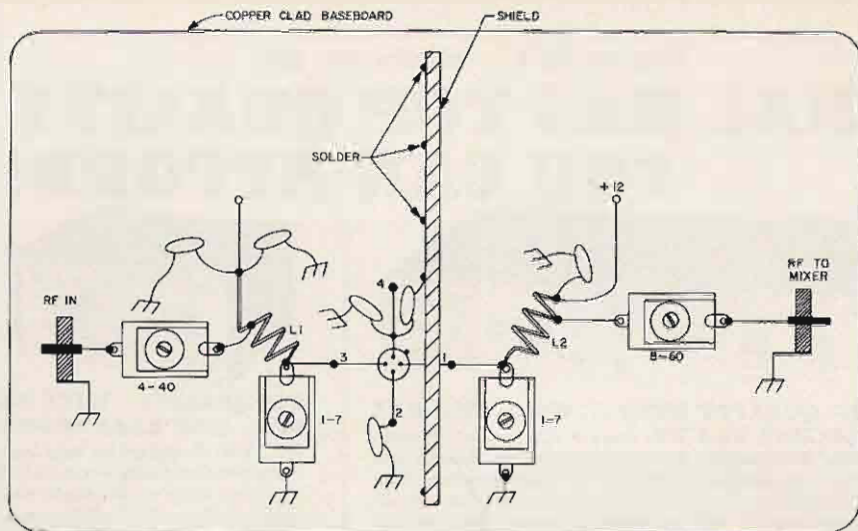

Fig. 5a. Pictorial view of rf stage. Not all parts shown for clarity.

this is somewhere around "typical" 3.9 dB at 400 MHz. For 220 it will be lower and very good. Believe it or not, I can hear radar signals using just one diode for the i-f in the test circuit shown in Fig. 3.

### The rf Stage

The schematic is in Fig. 4 and the pictorial layout in Figs. 5a and 5b. This shows the pin view with the signal flowing from left to right. Attention should be paid to the three bias voltages, self bias on the source (similar to a cathode or an emitter) and separate fixed bias voltages on each of the two gates. Bypassing the source is the only real critical point, and if you do it correctly at first you can forget about it from then on. Use several of the smallest available capacitors such as the Lafayette 1,000 pF jobs, which are only 1/8 in. square,

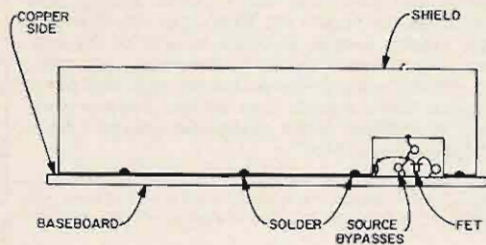

Fig. 5b. Side view of rf stage.

and make the connections no longer than 1/8 in.

Two methods for the input from the antenna are shown because for certain types of antennas one may offer higher gain than the other. Figures 3 and 4 are sufficiently detailed for the rest of the circuit.

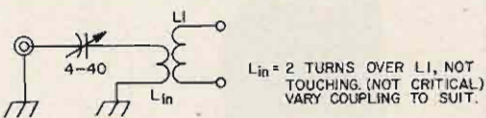
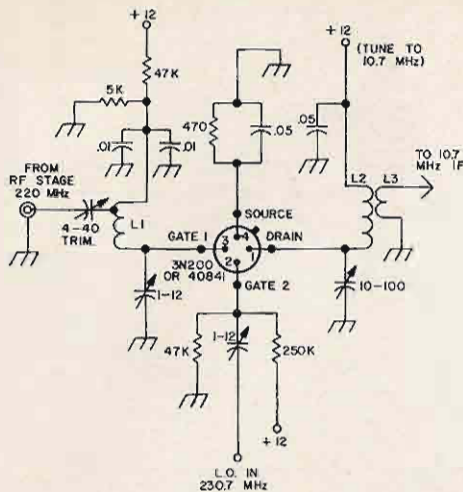

Fig. 6. Alternate rf stage input circuit.

### Mixer

There is nothing too critical about this unit, whose schematic is shown in Fig. 7 and the pictorial layout in Fig. 8. Getting the L.O. energy into gate No. 2 must be done with care, however, but once done you can leave it alone. It is important to get enough L.O. into the mixer so that you can reduce the amount and still maintain full sensitivity. This means you have some L.O. power to spare, which is good. When you do get sufficient L.O. into the mixer, gate No. 2 dc bias voltage becomes a lot less critical. The dual gate mixer has shown no tendency to self-oscillate, sometimes a nasty feature with bipolar transistors. Remember, the circuit as shown works well!



L1 = 3 TURNS NO. 12 BARE WIRE  
7/16 O.D., 3/4" LONG, TAP AT  
1/2 TURN FROM COLD END

L2 = 50 TURNS NO. 34 WIRE  
ON 3/16 PHENOLIC FORM  
(OR SIMILAR, FOR 10.7  
MHz)

L3 = 2 TURNS ON L2

Fig. 7. Schematic of 220 MHz mixer.

### The Local Oscillator Unit

The schematic is in Fig. 9 and the layout in Fig. 10. This unit, once set up, needs no further attention. After checking the oscillator in the 46 MHz range with a tuned diode, tune the multiplier to 230.7, or a little higher as required by other 220 channels, and that's it. You should get a volt or so rectified dc out of the diode L.O. test circuit shown in Fig. 11. I put in a 2N3866 which is an excellent multiplier in order to get plenty of punch on 232 MHz because the

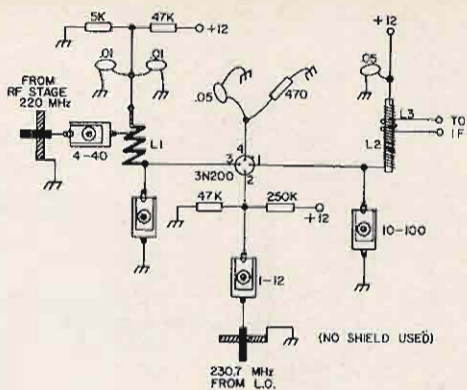
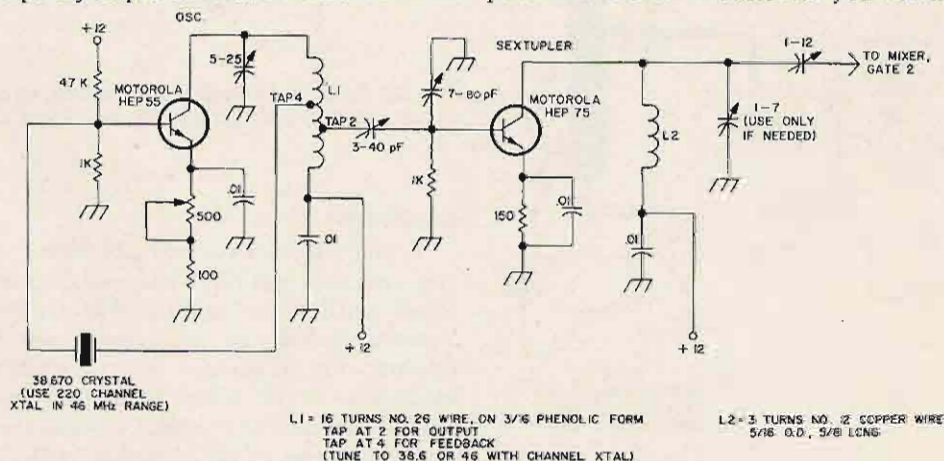

Fig. 8. Pictorial view of 220 MHz mixer.

only crystal I had on hand for the 220 band was a 38.667 job, which means multiplying by six. You should order your 220 channel crystals first and use the higher mode (220 plus 10.7). You can get this by quintupling from around 46 MHz, etc. Standard frequency crystals for the 220 FM band channels are shown in the Repeater Bulletin.

You can transfer energy from the quintupler coil to gate No. 2 of the mixer in several ways, but the method shown in Fig. 10 produced the greatest sensitivity. The series coupling capacitor can be used to tune L2. In case it does not, add the optional capacitor shown in Fig. 9. When checking the quintupler for output you should of course use the shunt capacitor to tune L2. Note again that you should have some L.O. power "left over" — otherwise you will not



L1 = 16 TURNS NO. 26 WIRE, ON 3/16 PHENOLIC FORM  
TAP AT 2 FOR OUTPUT  
TAP AT 4 FOR FEEDBACK  
(TUNE TO 38.6 OR 46 WITH CHANNEL XTAL)

L2 = 3 TURNS NO. 12 COPPER WIRE  
5/16 O.D., 5/8" LONG

Fig. 9. Circuit of local oscillator chain.

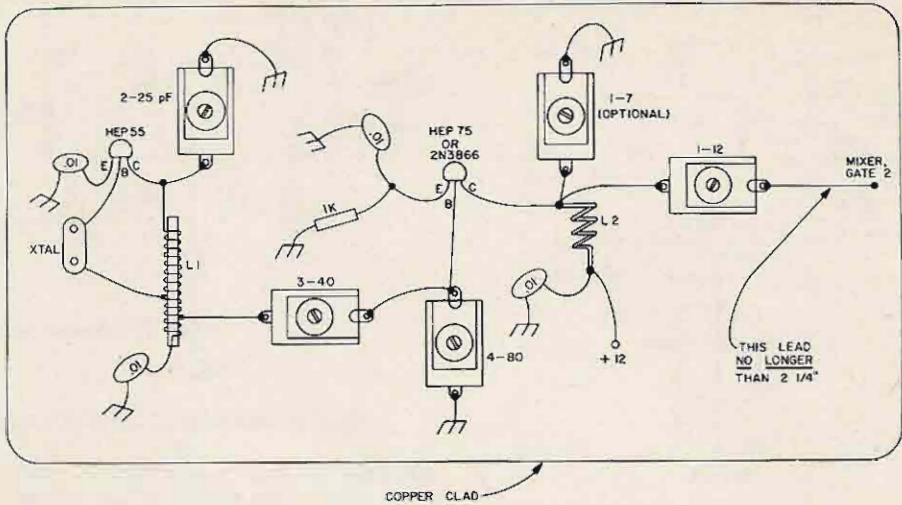

Fig. 10. Pictorial view of oscillator chain. Not all parts shown for clarity.

know if you have enough. You can check this by reducing the quintupler output with a series 1K pot in the emitter of Q2.

The mixer, oscillator and quintupler took about 16 mA at 12V in this unit. The rf stage takes around 6 mA, depending on bias adjustments and the individual FET used.

Figure 12 shows the optional crystal switching and tweaking capacitors that can be incorporated to the circuit of Fig. 9 when you get to where you want to use several channels.

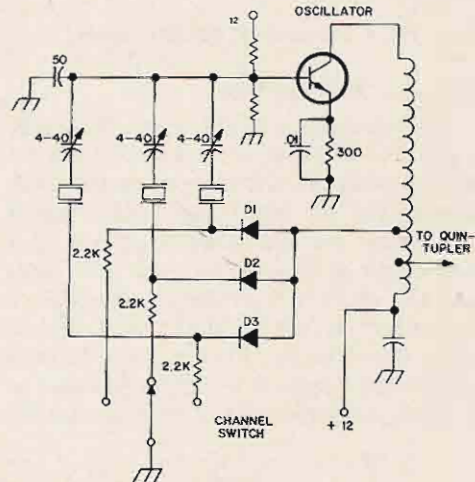

Fig. 12. Optional oscillator circuit incorporating crystal switching and frequency pulling trimmers.

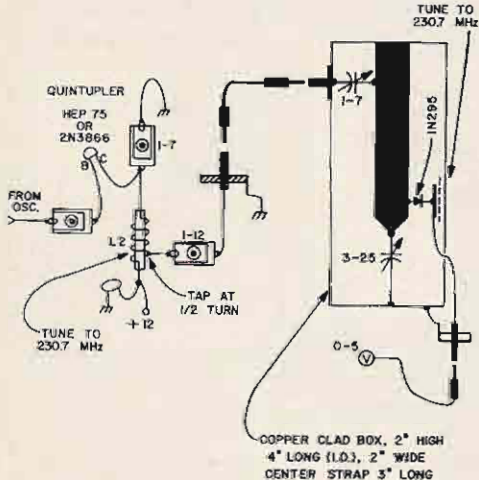

Fig. 11. Diode test circuit for tuning the oscillator circuit.

### Conclusion

A practical do-it-yourself 220 MHz front end using dual gate FET's has been designed, tested, and described in detail. Built on three separate boards, all components can be checked out in advance for reduction to small size, or PC board work. It is very sensitive, and with just a small vertical dipole you will be able to get acquainted with 220 in your area.

...K1CLL

# STEP UP TO TELREX

## Professionally Engineered Antenna Systems

### Single transmission line "TRI-BAND" ARRAY

By the only test that means anything... on the air comparison... this array continues to outperform all competition... and has for two decades. Here's why... Telrex uses a unique trap design employing 20 HiQ 7500V ceramic condensers per antenna. Telrex uses 3 optimum-spaced, optimum-tuned reflectors to provide maximum gain and true F/B Tri-band performance.

#### ONLY TELREX GIVES YOU ALL THESE FEATURES...

- Power rating 4 KW PEP... rain or shine
- Wind rating survival 110 MPH
- Patented broad-band coaxial Balun
- Heavy-duty steel gusset mounting plate
- Aluminum boom 2 in., 2½ in. O.D. x 18 ft.
- Large diameter, .058 wall taper-swaged dural elements for minimum

weight and exceptional strength to weight ratio

- Stainless steel electrical hardware

With a Telrex Tri-band Array you get 49 lbs. of educated aluminum engineered and built to provide many, many years of performance unmatched around the world by any other make. Longest element 36 ft. Turning radius 20 ft. Shipping weight 65 lbs. Shipping container 13 in. x 5 in. x 13 ft.

Note: If not available from your dealer, order direct. You'll get fast, personal service.

Telrex Labs are design engineers, innovators and manufacturers of the world's finest ¾ to 160 meter communication systems and accessories priced from \$25 to \$25,000.

For technical data and price on complete Telrex line, write for Catalog PL 71.

TB5EM **\$395**

Other Multi-Band Arrays Available

Elements shortened to show details.

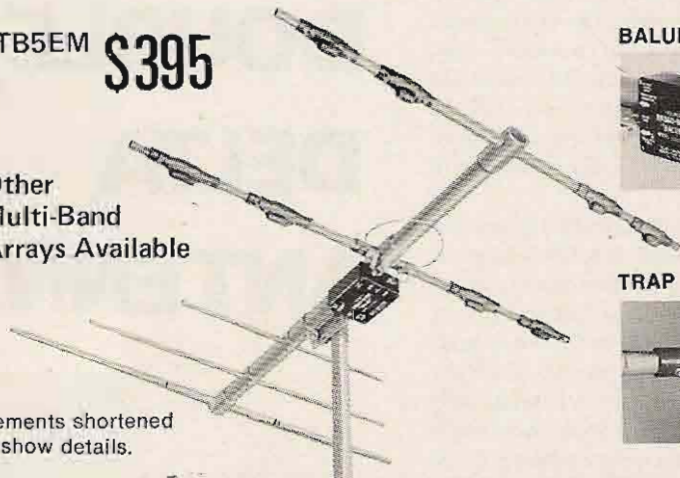

BALUN



TRAP

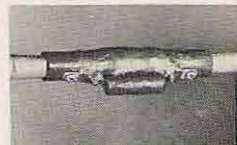

#### TYPICAL TELREX "MONO-BAND" ANTENNAS

15M317	- "Monarch", 10 DBD, 3 EI., 4 KWP, 2-1/2" O.D., 17' boom	\$175.00
20M326	- "Monarch", 10 DBD, 3 EI., 8 KWP, 3-1/2" O.D., 26' boom	\$355.00
2M609	- "Monarch", 14 DBD, 6 EI., 6 KWP, 1" O.D., 9' boom	\$ 39.95
2M814	- "Monarch", 16 DBD, 8 EI., .8 KWP, 1.375" O.D., 14' boom	\$ 59.00
6M516	- "Monarch", 13 DBD, 5 EI., .8 KWP, 1.5" O.D., 16' boom	\$ 63.95

and ----- many, many more! send for PL-71 Dept. C

**telrex** LABORATORIES

TV And Communications Antennas Since 1921  
Asbury Park, New Jersey 07712 201-775-7252

*The Double Delta is a new and unique design which provides both broad-band and efficient performance on the low-frequency bands for a compact, vertically polarized antenna. The ease of tuning and the simple construction are special features.*

**D**uring recent years many forms have been developed for reasonably compact low-frequency antennas that would exhibit better efficiency than base-loaded verticals, be reasonably broad-band, and have a more predictable and controlled radiation pattern than random long-wire antennas. Various antenna forms have achieved some combination of these electrical qualities, but usually their forms were such as to pose many constructional problems. One example would be low-frequency cage-type vertical antennas. The cone shaped cage requires at least 8 to 16 radial wires, and the open end of the cone must be at the apex of the antenna structure and not at the ground end. Also, a good ground radial system is required for efficient operation of such an antenna.

This article, however, describes a new and unique type of compact low-frequency antenna design which combines many of the features of previous designs but yet is very simple to construct and can have a wide range of physical dimensions. No inductive loading is used in the design, it is reasonably broad-band (over two low-frequency bands with reasonable antenna dimensions), it can be fed with any common transmission line, it has an omnidirectional radiation pattern and the efficiency is good (again with reasonable antenna dimensions) without the use of a ground radial system. Although the design can certainly be used for any fixed station operation, its ease of construction and erection makes it particularly applicable to portable operations.

#### Basic Design

The design of the antenna, nicknamed the

# THE DOUBLE DELTA ANTENNA

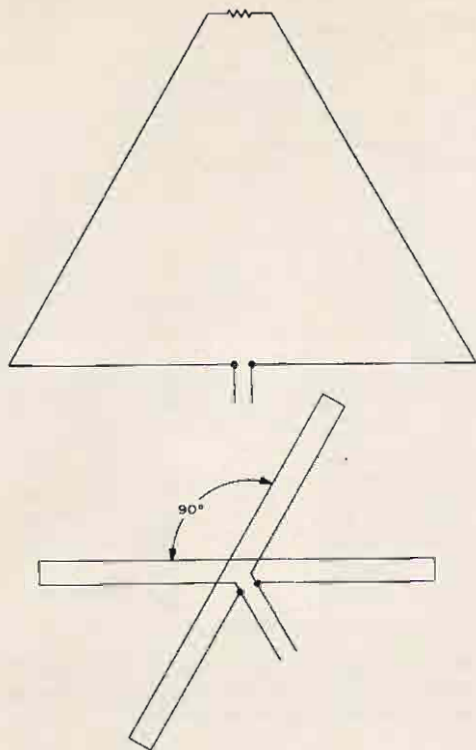

Fig. 1. The Double Delta antenna is basically a combination of a vertical half rhombic design (A), frequently called a delta antenna, and a turnstile antenna (B) made from folded dipole antennas.

Double Delta, was not simply "pulled out of the hat" but is based upon two well established and proven antenna forms. Figure 1 shows these forms. The antenna forms of Fig. 1 (A) may not appear immediately familiar, but it is really just half a terminated rhombic antenna which is vertically oriented, and is frequently referred to as a Delta antenna. It radiates mainly at high radiation angles, and is particularly useful for short-skip work on the lower-frequency bands. In its proper rhombic form and to provide some directivity and gain, the dimensions of the antenna have to be fairly large - at least a 60 ft center height on 40 meters, for instance. However, because the terminating resistor makes the antenna non-resonant, it will accept power over a broad range of frequencies even when its physical dimensions are contracted. The terminating resistor value must only be chosen for given physical dimensions of the antenna. The

radiation pattern of the antenna will change as its dimensions are reduced to the point where a small loop configuration is reached. Generally, the vertical plane radiation pattern becomes much broader, and for a given loop or delta size on a given frequency, the horizontal plane radiation may be mainly broadside or in line with the physical plane of the antenna. Such an antenna could be used alone with reduced dimensions, but one real disadvantage would be the radiation pattern change with frequency.

The antenna form of Fig. 1 (B) is that of a conventional turnstile antenna which consists of two half-wave folded dipoles phased so that an omnidirectional horizontal radiation pattern is produced. The necessary phasing is often done with a separate phasing line, but it can also be done by proper interconnection of the dipole feed terminals as shown. When done in this manner, the phasing will remain correct over whatever range the basic dipole antennas can be operated.

Figure 2 shows how the basic two foregoing antenna ideas are combined to form the Double Delta antenna. As can be seen, it

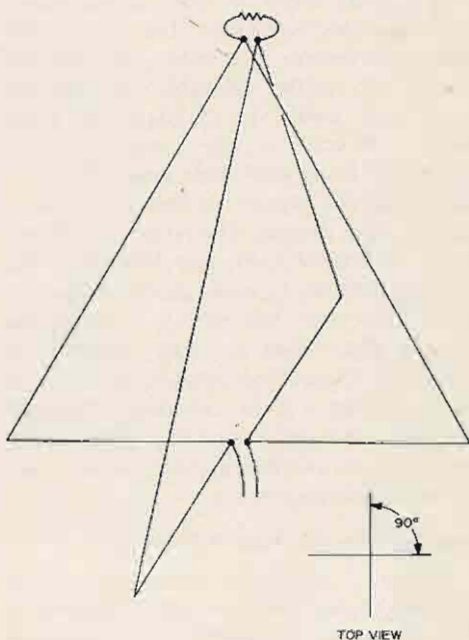

Fig. 2. The Double Delta consists of two Delta antennas placed at right angles to each other and phased in a manner similar to a turnstile antenna.

consists of two single Delta antennas oriented and phased like the dipole antennas in a turnstile configuration. Although the radiation pattern of the single Delta antenna will change with frequency (depending upon dimensions), the turnstile type phasing makes the Double Delta retain an essentially omnidirectional radiation pattern. The use of two Delta antennas further broadens the frequency bandwidth of the overall antenna system. Although a separate terminating resistor could be used in each Delta, the use of a single resistor was found to be sufficient.

No specific dimensions, even in terms of wavelength, was mentioned in the foregoing discussion because, in fact, no hard and fast dimensions can be given. The following section of this article describes a Double Delta antenna which I constructed for use on 80 and 40 meters, but the dimensions shown are by no means the only possible ones. Although studies could not be made of a large variety of antenna dimensions, it would appear that good efficiency will be achieved as long as the total lineal length of each Delta element (sides plus bottom section) is made about  $\frac{1}{4}$  wave on the lowest frequency band to be used. The antenna will work with shorter dimensions, but the efficiency will suffer. Probably an absolute lower limit would be to make the lineal length  $\frac{1}{8}$  wave at the lowest operating frequency. Even with these restrictions, the antenna height required is only a fraction of that of other designs. The ratio of total base length to height (not side length) at the center should not be made greater than a 1:1 ratio. This great latitude in choosing the antenna dimensions is partly possible because the terminating resistor can be "tailored" to suit a given impedance transmission line, and one is not dependent solely upon the antenna configuration to establish the feed point impedance.

#### Practical "Double Delta" Example

Figure 3 shows the dimensions of one "Double Delta" design which I tried for 80 and 40 meter operation. The total lineal length of each Delta was made about  $\frac{1}{4}$  wave on 80 meters. The base length to height ratio was chosen such that the height was about

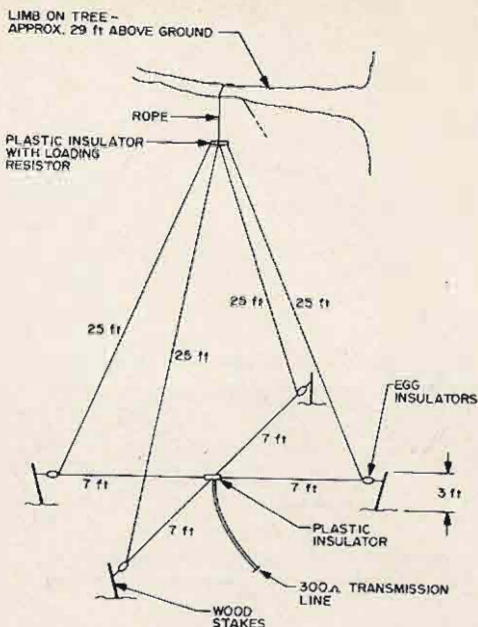

Fig. 3. Dimensions of a Double Delta antenna which was tested. Coaxial transmission line can also be used as explained in the text.

27 ft in order to allow simple erection of the antenna via a rope support around a high tree trunk.

The antenna was constructed of ordinary stranded antenna wire with egg insulators attached to wooden stakes, driven in the ground, used to place the two Delta triangles at right angles to each other. Special plexiglass insulators were fabricated to join the wires at the apex of the antenna and at the base where the transmission line is joined to the antenna. Probably many other schemes can be used for these insulators, but the plexiglass types are simple and inexpensive to fabricate. Details of the construction of these insulators is shown in Fig. 4. The upper insulator joins the individual Delta elements in a criss-cross fashion with the non-inductive type terminating resistor mounted on one side of the plexiglass insulator and connected by jumper wires to the Delta elements. A hole was drilled in the center of the insulator and  $\frac{1}{4}$  in. nylon rope knotted underneath the insulator for use as a support line. The bottom insulator is basically the same as the upper insulator, except that the jumper wires for the Delta elements





**Clegg** DIVISION

3050 Hempland Road  
Lancaster, Pennsylvania 17601

Tel: (717)299-3671 • Telex 84-8438

**IF YOU HAVE ALWAYS WANTED TO  
CHANGE OVER YOUR REPEATER,  
REMOTE BASE, OR TRANSCEIVER  
TO SOLID STATE – WHY WAIT?  
THIS IS THE ONLY WAY TO FLY:**



#### TYPICAL PERFORMANCE SPECIFICATIONS

Transmitter output into 50 ohms	100 MW @ 8.1 v
Frequency Stability	$\pm 0.0025\%$ ( $-35^{\circ}\text{C}$ to $+55^{\circ}\text{C}$ ), nom. freq. ref.
Current Drain	70 ma. @ 8.1 v
FM Noise	45 dB below 3.3 KHz. deviation @ 1000 Hz.
Modulation	Phase Modulation
Audio Response	$\pm 3\text{dB}$ of 6dB/octave pre-emphasis over 300–3000 Hz.
Deviation	$\pm 5\text{KHz}$ . (adjustable)
Crystal Multiplication	18X-trimmer for fine freq. adj. included.

**Complete transmitter \$35.00**

Complete receivers for  
10, 6, or 2 meters  
Fantastic performers



**WRITE NOW FOR DETAILS**

**DO AWAY WITH ALL THOSE TUBE PROBLEMS  
DO AWAY WITH ALL THOSE HEAT PROBLEMS**

**SIMPLICITY PLUS**

**WITH A BONUS OF MINIATURIZATION**

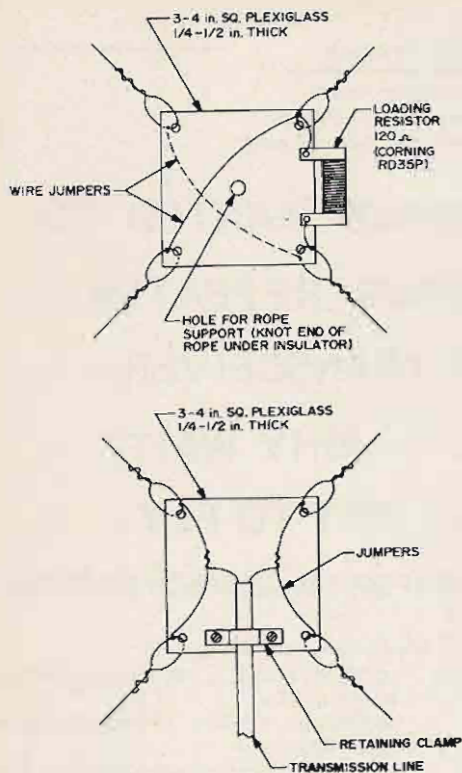

Fig. 4. Details of the upper (A) and lower (B) plastic insulators for the antenna of Fig. 3.

are wired directly from edge to edge. The transmission line used is soldered to the jumper wires and the cable held in place on the insulator by means of a metal or plastic clamp.

Although a 300Ω transmission line was used, any common impedance transmission line, including coaxial types, can be used by properly choosing the value of the terminating resistor. Using 1 or 2 watt carbon composition resistors as test resistors, the value of the terminating resistor can be found which produces the lowest transmission line swr over the desired operating range. Only a few watts of transmitter power output should be used for these tests (enough power to properly set the swr meter) and then a 25-75 watt resistor substituted for operation at full transmitter power. The wattage rating of the terminating resistor depends upon the dimensions of the antenna, but a safe approach would be to choose a resistor with a wattage rating equal

to at least ¼ of the power input of the transmitter used. The 25 watt resistor used with the antenna shown showed no signs of overload when used with a 150 watt transmitter on SSB.

### Performance Results

Swr measurements made on the antenna of Fig. 3 showed an swr of less than 2:1 across both the 80 and 40 meter bands. It probably would be possible to further reduce the swr on any one band by more careful selection of the terminating resistor. The total bandwidth of the antenna was not determined, since only 80 and 40 meter operation was of interest. However, there is a good possibility that when properly configured the antenna can be used as a tri-band affair. The only possible disadvantage to such operation is that as the Delta elements become larger in terms of wavelength, one may approach the original vertical half rhombic design with its very high radiation angle.

Comparison tests of the Double Delta design against a base loaded 23 ft vertical made of tubing consistently showed the Double Delta to produce stronger signals on the order of ½ to 2 "S" units.

### Summary

The Double Delta shows good promise of being a very useful and simple antenna for use on the low-frequency bands. No claim is made that the optimum dimensions for the antenna have been determined, but the results achieved certainly indicate the validity of the basic design.

Many variations on the basic design suggest themselves, especially if one were interested only in single-band operation. For instance, going back to Fig. 1 (A), one could use a variable capacitor to resonate the antenna "loop style" on a particular frequency. The Double Delta of Fig. 2 could then be constructed with a resonating capacitor in each Delta. This would increase the antenna efficiency by eliminating the dissipation loss in the terminating resistor. However, one would have to accept the feed point impedance thus produced and use a matching network, if necessary, at the feed terminals to couple to a transmission line.

...W2EY/1

# TEMPO FMP

**H**ave you ever had the desire to carry your FM rig at your side to keep in touch with the gang on the local repeater? The Tempo FMP is a convenient way to do it. You can use it over your shoulder or in your car or in your home. Dollar for dollar, it contains many features not found in other rigs.

This little jewel has two power levels. There is the battery saving half-watt out and the fringe fighting three watts out. The half watt is perfect for local direct work or if you are high up in your hotel while traveling. The high power position is great for making the repeaters that seem to be installed on the outskirts of all cities. The high power position is more than adequate for driving amplifiers that require one to two watts of drive. The self contained batteries are C cells that can stand high drain for periods of time. There is even a little switch on the front panel that allows you to change the meter from a S-RF meter to a battery monitor. When you put it in the monitor position, a little pilot lamp is turned on and the meter is illuminated. Besides keeping meters off the batteries and producing a slight drain, you check the battery condition only when needed. The little pilot light is also perfect for lighting up a small area so that you can read your logbook.

There are more channels in this portable rig than there are in some of the available base station rigs. The crystals for the channels are very easily reached. Jumping is simple because there is a lot of room for even the stubbiest of fingers to get in with a soldering iron. All crystals can be trimmed right on frequency. With eight possible channels, you have convenience and versatility. Leave channels one through five for your local work and six, seven, and eight for

the channels in the areas that you visit most frequently. Or if you live in the crowded Boston and New York and Los Angeles areas, all eight channels will be filled up for local work.

It may be hard to conceive getting your whole hand into a tiny rig that you can carry around with you, but it is true. The rig comes in two sections that are snapped together. Shades of the low bands, the power and rf units are separate! The batteries and speaker are mounted in the lower box and there is a cable interconnecting the two units. Audio and other leads can be tapped here. There is room for an ac power supply, battery charger, tone burst assemblies, and more in this section. And it is still tiny. The rf unit has the printed circuit boards for the transmitter and receiver and all switches and controls: power, volume, squelch, power level, meter switch, and channel selector. This unit is a little less than half the total size of the whole FMP. You can carry the FMP over your shoulder in its leather case or you can lay it flat on your desk or mount under the dashboard. The antenna connects with a twist on the front panel BNC antenna connector. The FMP is supplied with a quarter wave whip from which kinks may be quickly removed even if you fall on top of it. The shape of the rig is rectangular but with a slightly sloping front panel that leans the antenna away from your body and it also lets the rig look up at you if it is under the dash or on your desk. It looks sharp wherever you leave the radio.

The portable FM transceiver, watertight leather carrying case, and excellently written instruction book costs only \$225 from Henry Radio and their distributors. Isn't that a low price for such fun?

...Staff



# NEW ALL SOLID STATE 2 METER FM TRANSCEIVER FULL 30 WATTS 10 CHANNELS (144 to 148 MHz) NOW ONLY \$249.95

Meet Genave's GTX-2. It gives you pushbutton frequency selection . . . backlighting . . . multi-position switch allows setting for longtime low power drain operation . . . netting trimmer for each transmit crystal . . . easily wired for duplex crystal operation.

Made in USA, by one of America's leading aircraft electronics manufacturers, in facilities registered with and inspected by a branch of the Federal government.

Now read the specifications! You'll be amazed at what you get for the low, low price: The GTX-2, only \$249.95

**GTX-2**  
2 METER FM  
**\$249.95**  
(Includes 146.94 MHz)

**HamPak-2** portable  
power case **\$189.95**

## Specifications

### GENERAL:

- Front Panel Size: 6½" x 2½"
- Over-all Dimensions: 9" deep x 6½" wide x 2½" high
- Number of Transistors: 11 all silicon transistors, 4 diodes, 5 FETs, 3 integrated circuits
- Power Supply: 12 VDC System, negative ground
- Current Drain: Receive .09 amps  
Transmit: High 5.0 amps, Low 1.7 amps
- Frequency Range: 144 to 148 MHz
- Number of Channels: 10  
(includes 146.940 MHz. Remaining 9 frequencies, at nominal charge each for installation at factory or by owner.)
- Weight: 5-lbs. (approx.)

### RECEIVE:

- Sensitivity: less than 0.5 microvolts for 12 db SINAD
- Image: More than 45 db
- Spurious: More than 50 db
- Selectivity: ±8 KHz
- Receiver Circuit: Double conversion, superheterodyne, crystal controlled
- Audio Output: 1.5 watts at less than 15% distortion
- Modulation Acceptance: More than 7.5 KHz.
- Squelch Threshold: 0.5 microvolt max.

### TRANSMIT:

- Frequency Range: 144 to 148 MHz
- Power Output: 30 watts, Nom
- Output Impedance: Matches standard 50 ohm amateur antennas
- Deviation: Adjustable to 10 kHz max.

**General  
Aviation  
Electronics, Inc.**  
4141 Kingman Dr.  
Indpls., Ind. 46226



# A Simple Converter for Beginners

## USING EXPERIMENTER'S MODULES

**W**ant to build a converter for any frequency from 3 MHz to 170 MHz? The International Crystal Company experimenter kits can be selected and assembled to make any input and output combination in this range.

A brief explanation of how a converter works will help you understand the functions of the stages. Assume we want to listen to the 20 meter (14.00–14.35 MHz) band and we have an 80 meter (3.5–4.0 MHz) receiver. Our problem is to convert the 20 meter band to the 80 meter band. Subtracting  $14.0 - 3.5$  we get 10.5 MHz. Note that the 20 meter band is .35 MHz wide. Adding this to 3.5 we get 3.85 MHz. Logically, if we subtract  $14.35 - 3.85$  we again get 10.5 MHz. We have this constant 10.5 MHz difference at any corresponding points on the bands. If we make an oscillator with 10.5 MHz output and mix it with 14.0 MHz we can produce a beat frequency or difference of 3.5 MHz. Again, any corresponding points on the two bands will have a difference of 10.5 MHz. From this we find that by using a converter we can tune our receiver 3.5 to 3.85 MHz and listen to 14.0 to 14.35 MHz.

We could make a converter with only a mixer and oscillator, but it would have some faults that would limit its usefulness. The first and most obvious is that the 10.5 mixer, or injection, frequency plus the output frequency 3.5 MHz gives us 14.0 MHz which is the desired frequency — but at the

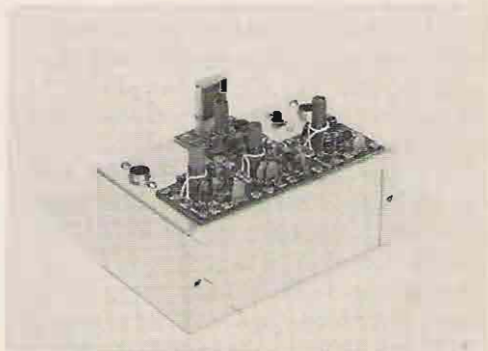

same time we have 10.5 MHz minus the 3.5 MHz output frequency which is 7.0 MHz — so we would also be receiving the 40 meter ham band at the same time. This undesired frequency is called the image frequency.

To receive only the 20 meter ham band we need a tuned circuit that will amplify the 20 meter band and attenuate the 40 meter band. To do this we add a tuned rf amplifier stage between the antenna and mixer.

We produce the injection frequency with an rf oscillator. This can be a typical Hartley or Colpitts LC (tuned coil-capacitor) controlled oscillator or a crystal controlled oscillator. The advantage of an LC oscillator is that the injection frequency is easily changed. An adjustable coil or variable capacitor will permit changing the frequency at will. The disadvantage is that it is not as frequency stable as the crystal controlled oscillator. Frequency stability is the advan-

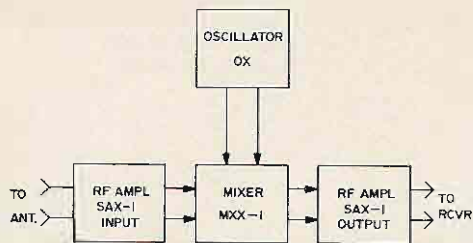

Fig. 1. Block diagram of converter.

tage of the crystal controlled oscillator. The disadvantage is that a new crystal must be purchased to change frequency. This injection or local oscillator frequency is coupled to the mixer where it mixes, or beats, with the signal frequency and produces the output frequency (and image). As the signal input to the mixer is quite small, only a weak injection frequency is required — usually not more than a few mW. You cannot increase the gain of a converter by increasing the injection frequency strength.

We can further improve the gain and signal-to-noise ratio by adding a tuned stage after the mixer. This is an rf amplifier tuned to the output frequency or 3.5 to 3.85 MHz in our example.

We are now ready to begin construction. Refer to the block diagram of the converter (Fig. 1) and Table I to determine the kits to use for the band you want to listen to.

Prepare a 5 1/4 x 3 x 2 1/8 in. aluminum minibox as shown in Fig. 2. There is room to use any type antenna and output connectors you want. I used Motorola jacks. The switch

Table I: Converter Components

<b>INPUT RF AMPLIFIER</b>
To receive signals 3 to 20 MHz use SAX-1 LO
To receive signals 20 to 175 MHz use SAX-1 HI
<b>MIXER</b>
Converter input 3 to 20 MHz use MXX-1 LO
Converter input 20 to 175 MHz use MXX-1 HI
<b>OUTPUT RF AMPLIFIER</b>
Output to receiver 3 to 20 MHz use SAX-1 LO
Output to receiver 20 to 60 MHz use SAX-1 HI
<b>OSCILLATOR</b>
Subtract output frequency from input frequency
If difference is 3 to 20 MHz use OX LO
If difference is 20 to 60 MHz use OX HI
If difference is over 60 MHz divide by 3 and mixer will work on third harmonic of oscillator OX HI
<b>CRYSTAL</b>
Same frequency as difference in input-output above. If difference is over 60 MHz order crystal for 1/3 of frequency difference.

can be slide or toggle. The miniature imported switches work very well.

Assemble the printed circuit kits with the following changes: The connector pins are inserted in the printed circuit boards when you get them. Carefully push these pins out and reinsert them on the foil side. This will put all wiring inside the minibox and make a neater job. Refer to the charts supplied with the kits for coil and capacitor combinations for the frequency you want. There are several coils and capacitors with each kit. When you insert and solder the coil and capacitor do not bend the coil tabs or capacitor wires. This will permit easy removal if you want to change either for a different frequency.

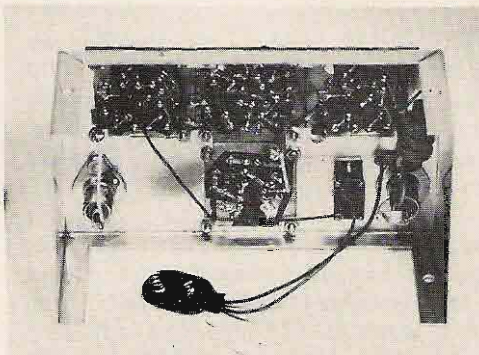

Keeping the above notes in mind, assemble the kits following the directions. The same interconnections and power connections are used with all kits regardless of frequency. The converter I assembled was for 2 meters with a 28 to 32 MHz output. I used two SAX-1 HI rf amplifier kits. One MXX-1 HI mixer kit. One OX HI oscillator kit with a 38.6667 crystal (the crystal is not supplied and must be ordered separately. For the input rf amplifier I used the green dot coil and 6.8 pF capacitor. All the coil designations and capacitors referred to will be from the charts supplied with the kits. The mixer also used a green dot coil and 6.8 pF capacitor. The output is a red dot coil and 47 pF capacitor. The oscillator has a red dot coil and 28 pF capacitor. Slugs were used in all coils except the oscillator coil (there is a further note in the summary about this coil). Make the links from instructions in the charts. The schematic of my converter is shown in Fig. 3.

# BUY HER CHRISTMAS PRESENT NOW!

TRANSMITTER  
FITS INTO  
YOUR POCKET

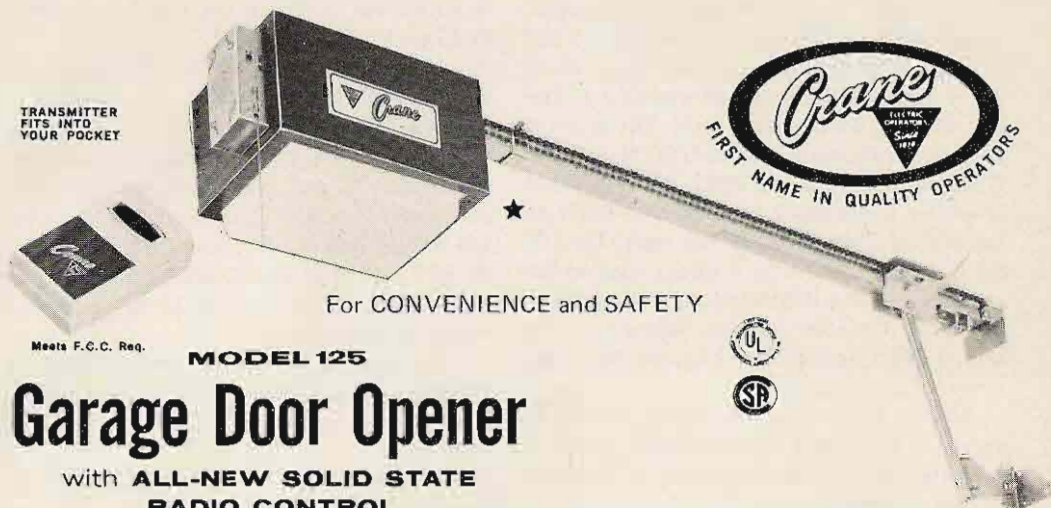

For CONVENIENCE and SAFETY

Meets F.C.C. Req.

MODEL 125

## Garage Door Opener

with ALL-NEW SOLID STATE  
RADIO CONTROL

WHOLESALE

EDI price **\$99.95**  
Reg. price ~~\$129~~  
Add \$5.00 shipping

Just the touch  
of a button—will open,  
close or reverse  
your garage door.

- Opens, closes and locks your garage door from inside your car.
- Light turns on as door opens or closes
- Stops on contact with any object when closing
- Can be operated electrically without radio control.
- Thermal overload device protects against burnout.
- Reverses door whenever required by push of a button.

Individually packed in carton 36 $\frac{3}{4}$ " x 10" x 10". Shipping weight 47 lbs.

Radio control operates on high frequency over 200 megacycles. Combination of RF and modulation frequencies make available many hundreds of individually coded controls to assure best security.

MODEL CTL. 4 \$19.95

Transmitter only (with mounting clip) available when additional transmitters are required.

Operator is driven by a powerful motor, 115 volt, capacitor start instantly reversible motor to handle any residential door up to 18' x 7' (Adaptor kit available for 8' high doors).

Overall depth required 9' 7"

Headroom requirement—1 $\frac{3}{4}$ " over highest turning point of door.

- ★ Model 310 with cover (pictured above) — add \$20.00.

**One Year Unconditional Guarantee**

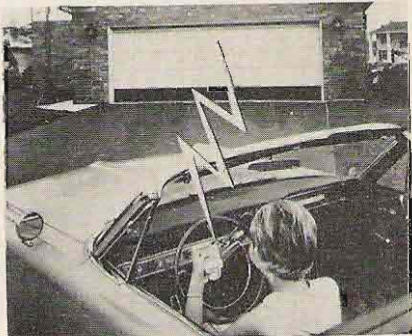

From the MIDWEST'S LARGEST HAM GEAR SUPPLIER—our 34th year

## ELECTRONIC DISTRIBUTORS, INC.

1960 Peck St.

Tel. (616) 726-3196

Muskegon, Mich. 49441

Mount the kits on the minibox. The mounting screws supplied with the kits are quite long. 4-40 x 1/4 in. screws will be neater. Mount the kits so the inputs and outputs line up for minimum connector length. With the three cutouts in front and the oscillator cutout behind, the signal input kit is mounted with the In and Out to the left, rf OUT LINK to the right. The mixer is mounted with the rf IN and GND to the left, GND and OUT to the right. The rf output amplifier is mounted with IN and GND to the left, rf OUT LINK to the right. The OX kit is mounted with the crystal socket to the rear and parallel with the long dimension of the box. Use the press-on connectors for interconnections so the kits can be easily removed if desired.

Step-by-step interconnections follow. If there is a number by the word solder it indicates the number of wires to be soldered at that terminal.

A wire from the antenna jack (solder) to IN connector on input SAX-1 (solder)

A wire from the HI rf OUT link on SAX-1 (solder) to rf IN on MXX-1 (solder)

A wire from LO rf link on SAX-1 to rf GND on MXX-1 (solder)

A wire from rf on OX (solder) to OSC IN on MXX-1 (solder)

A wire from GND on OX (solder) to OSC GND on MXX-1 (solder)

A wire from OUT on MIXX-1 (solder) to IN on output SAX-1 (solder)

A wire from GND on MXX-1 (solder) to GND on output SAX-1 (solder) (note these wires cross, be sure they don't touch)

A 2.5 mH rf choke from HI rf OUT link to LO rf OUT link (solder) on output SAX-1

A .001 mF capacitor from HI rf OUT link on output SAX-1 (solder 2) to converter output jack (solder)

This completes the rf wiring. The remaining wiring is for power to the units.

A wire from one terminal of switch (solder) to 6V on OX

A wire from 6V on OX (solder 2) to + dc on input SAX-1

A wire from + dc on input SAX-1 (solder 2) to + dc on MXX-1

A wire from + dc on MXX-1 (solder 2) to + dc on output SAX-1 (solder)

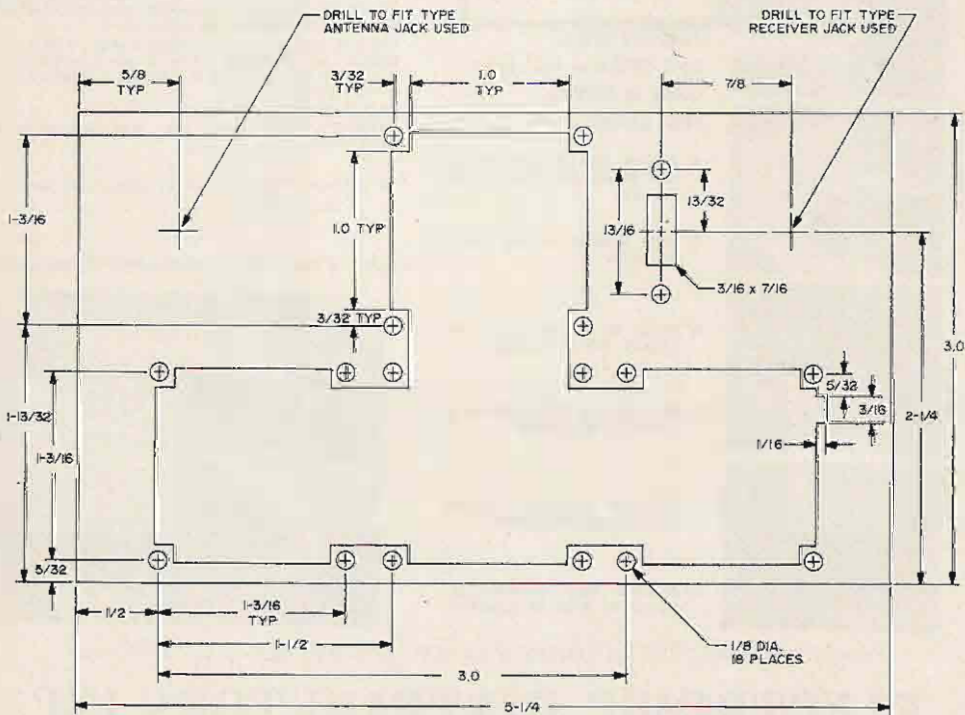

Fig. 2. Template of converter chassis.



Come on. If your feet itch for a bit of adventure, take off your shoes and hop aboard. We're doing our thing loafing through the little West Indie isles. Fun your way through tropic islands with those funny little names... Saba, Nevis, St. Marteen, Antigua, Mustique, Montserrat, Guadalupe, Great grub and a daily ration o' grog for all shipmates. Your share from \$245. No stuffed shirts... just a great bunch of adventuresome guys and gals. Groove aboard for 10 days of white sail, sunshine and Caribbean moon. Come on!

Name \_\_\_\_\_

Address \_\_\_\_\_

City \_\_\_\_\_

State - Zip \_\_\_\_\_

Phone \_\_\_\_\_

Windjammer  
Cruises. 

# Take off your shoes.

Write Cap'n Mike for adventure brochure, P.O. Box 120, Dept. 934E, Miami Beach, Florida 33139

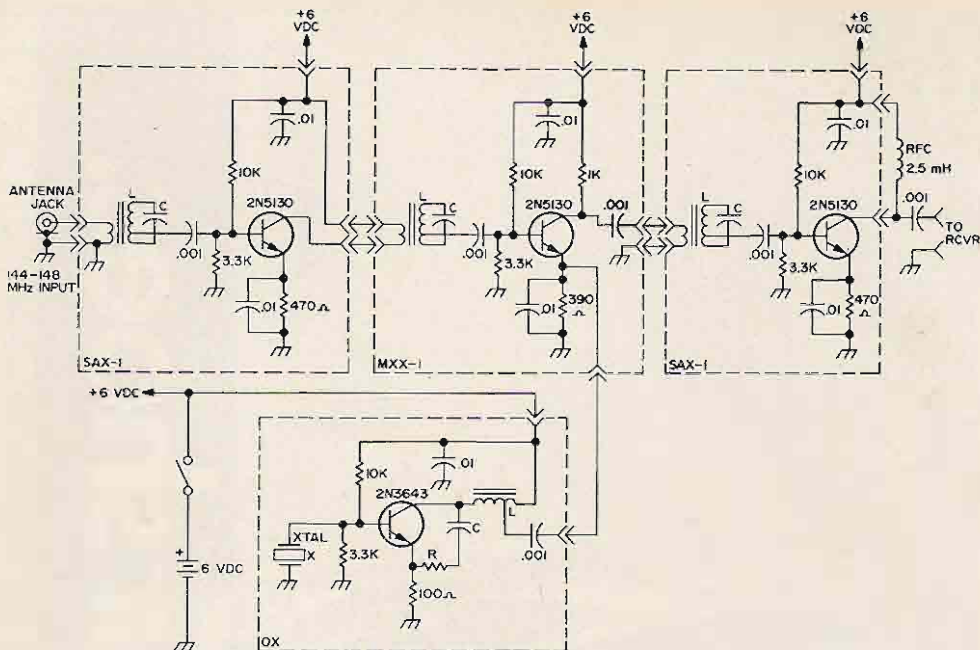

Fig. 3. Block diagram of converter overall circuit.

Battery connector leads Black to GND on OX (solder) red to switch (solder)

This completes the wiring. Check all connections to be sure they are correct.

Turn switch off and connect battery. Insert crystal. Center all coil slugs (use a plastic alignment wrench, a metal wrench will affect the tuning). Connect converter to receiver with short piece of coax. Connect converter to signal generator or antenna. Be sure receiver is on correct band. Turn converter on and tune receiver for signal or tune signal generator to correct frequency. When a signal is heard, tune each slug, starting with the signal input coil, for maximum signal. Your converter is now completed.

Some of the frequencies that can be tuned with this converter are close to the edge of a frequency range for a particular coil and capacitor. If it is and you find that when tuning the coil slugs the signal is still increasing when you reach the bottom of the coil form with the slug, replace the capacitor with the next larger capacity supplied with the kit. If the signal is increasing as the slug is turned all the way out, use the next smaller capacity. Conversely, you could use the higher and lower frequency coils. You should be able to tune through maximum

signal strength with the correct coil-capacitor combination. A slug can be used in the OX kit when not specified, if you have the equipment to check maximum oscillation, by using smaller capacitors than specified.

The rf choke in the converter output circuit can be replaced with a coil-capacitor that will tune the output frequency. However, the rf choke and capacitor are satisfactory as is, and no tuning or changes are required for any output frequency.

The converter is simple and you can try some of the suggestions in the notes to learn more about converters. The tuning is so simple that if you get "lost" and cannot receive a signal, just go back to the original coil, capacitor and slug tuning and you will be back in business.

There are fine articles in 73 on the construction of converters that will give outstanding performance. After you get familiar with a simple converter — like the one described — you should have less apprehension about building one of the state-of-the-art converters. The only basic difference will be higher 'Q' coils and more tuned circuits with the necessary shielding and bypassing.

...WA80IK

# THE THIRD HAND..... TESTER

*A portable impedance bridge, crystal calibrator, field strength meter, etc.*

When was the last time you hung on the tower or in a tree trying to couple your dip-meter with one hand to the bridge which was in the other hand while hanging on with the third hand - not to mention the problem of how to turn the

dials while untangling the extension cords (if you had enough to reach) and other associated problems.

The following are construction details for a 3" x 5" battery operated, self-excited built in rf source impedance bridge. With just a little extra effort you can also have a field strength meter with tuned input or use as a band spotter when using crystals at other than their fundamental frequency. You can also check crystals in the 1 to 30 MHz range for activity. In addition, with a 1 MHz crystal you have a handy dial calibrator or rf signal source for general alignment and peaking of receiver circuits.

The circuit is a common impedance bridge coupled to, and driven by a built-in

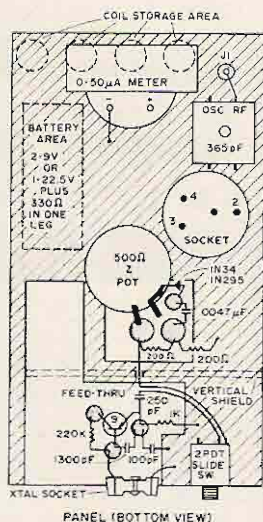

Fig. 1a Circuit board layout. Meter - 0-50µA from mail order listed as light meter movement; 365 pF variable - from old transistor radio socket & coil form allied radio D1899 45¢ transistor GE9; J1 - pin jack for field strength meter whip antenna.

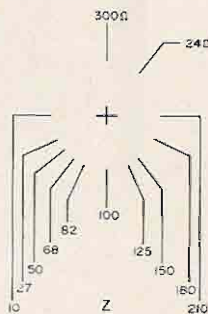

Fig. 1b Impedance dial scale.

# From the World's Number One Manufacturer of Amplifiers

The biggest, broadest, finest line of amateur and



The 2K-ULTRA

The 2K-4

TEMPO TPL Amplifiers

The TEMPO 2001

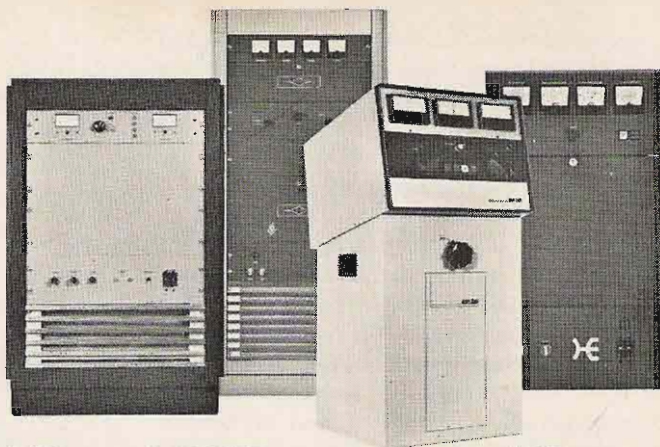

## commercial HF, VHF and UHF power amplifiers

### 2K-4... THE "WORKHORSE"

The 2K-4 linear amplifier offers engineering, construction and features second to none, and at a price that makes it the best amplifier value ever offered to the amateur. Constructed with a ruggedness guaranteed to provide a long life of reliable service, its heavy duty components allow it to loaf along even at full legal power. If you want to put that strong clear signal on the air that you've probably heard from other 2K users, now is the time. Move up to the 2K-4. Floor console or desk model... \$795.00

### 2K-ULTRA... THE "ULTIMATE"

There has never been an amateur linear amplifier like the new 2K-ULTRA. Small and lightweight, yet rugged and reliable... all that the name implies. The ULTRA loafs along at full legal power without even the sound of a blower. Its anode heat is silently and efficiently conducted to a heat sink through the use of a pair of Eimac 8873 tubes. In fact, all of its components are the very best obtainable. The price... \$845.00

### TEMPO/2001

Small but powerful, reliable but inexpensive, this amplifier is another top value from Henry Radio. Using two 8874 grounded grid triodes from Eimac, the Tempo 2001 offers a full kilowatt of power for SSB operation in an unbelievably compact package (total volume is .8 cu. ft.). The 2001 has a built-in solid state power supply, a built-in antenna relay, and built-in quality to match much more expensive amplifiers. This equipment is totally compatible with the Tempo One as well as most other amateur transceivers. Completely wired and ready for operation, the 2001 includes an internal blower, a relative RF power indicator, and full amateur band coverage from 80-10 meters. PRICE: TBA

### TEMPO/6N2

The Tempo 6N2 combines most of the fine features of the 2001 for 6 and 2 meter amateur operation. The amplifier uses the same small cabinet, the same modern tubes, the same inherent quality for 2000 watts PEP input on SSB or 1000 watts input on FM or CW. The rig is completely wired in one small package with an internal solid-state power supply, built-in blower, and RF relative power indicator. PRICE: TBA

### TEMPO TPL POWER AMPLIFIERS

Tempo is exclusive distributor for a full line of solid state 2 meter, amateur VHF and UHF FM amplifiers designed for mobile or base station operation. Output ranges from 25 to 130 watts for drive power of 1 to 25 watts. Commercial, type-accepted amplifiers are available also. Please write for prices and specifications.

### 3K-A

A high quality linear amplifier designed for commercial and military uses. The 3K-A employs two rugged Eimac 3-500Z grounded grid triodes for superior linearity and provides a conservative three kilowatts PEP input on SSB with efficiencies in the range of 60%. This results in PEP output in excess of 2000 watts. In addition, the 3K-A provides a heavy duty power supply capable of furnishing 2000 watts of continuous duty input for either RTTY or CW with 1200 watts output. Price... \$995.00

### 4K-ULTRA

The 4K ULTRA is specifically designed for the most demanding commercial and military operation for SSB, CW, FSK or AM. The amplifier features general coverage operation from 3.0 to 30 MHz. Using the magnificent new Eimac 8877 grounded grid triodes, vacuum tune and load condensers, and a vacuum antenna relay, the 4K ULTRA represents the last word in rugged, reliable, linear high power RF amplification. 100 watts drive delivers 4000 watts PEP output. This amplifier can be supplied modified for operation on frequencies up to about 100 MHz. Please write for full information. Price: \$2400.00

### 8K

The 8K is an 8000 watt PEP input (5000 watt nominal output) linear amplifier, covering the 3.5 to 25 MHz frequency range. It is designed for the most demanding military and commercial applications. Please write for price and specifications.

### 1-K4

A four channel automatic tune linear amplifier designed to exceed the most demanding commercial requirements. Operates on SSB, AM, CW, RTTY and FM. 1 kw output for only 100 watts drive. Please write for price and full specifications.

### 2-KVH

A high power linear amplifier capable of covering any specified 20 MHz segment in the 130 to 170 MHz range. Delivers 2000 watts continuous duty... trouble free performance. Please write for price and full specifications.

### HENRY ELECTRONICS' PGB INDUSTRIAL POWER GENERATORS FOR PLASMA GENERATION

RF power generators, with built-in exciters, used to supply high power radio frequency for commercial, industrial and scientific uses. Frequency: 13.56 MHz  Frequency stability:  $\pm 2$ KHz  Continuous Duty  Power output continuously adjustable from 0 to full output  Simplified controls for operation by unskilled personnel  Self-contained Bird power output and reflected power sensor  Conservative heavy duty components for long life and reliability

- 500 PGB/0 to 500 watts output
- 1000 PGB/0 to 1000 watts output
- 2000 PGB/0 to 2000 watts output
- 3000 PGB/0 to 3000 watts output
- 5000 PGB/0 to 5000 watts output
- 10,000 PGB/0 to 10,000 watts output

# Henry Radio

11240 W. Olympic Blvd., Los Angeles, Calif. 90064

931 N. Euclid, Anaheim, Calif. 92801  
Butler, Missouri 64730

213/477-6701  
714/772-9200  
816/679-3127

un-tuned crystal oscillator. Any fundamental crystal between 1 and 30 MHz will drive the 50  $\mu$ A meter to full scale. Inserting an unknown impedance in pins 1 & 3 of the test socket will allow you to read the impedance on the calibrated dial. Should it be convenient to drive the bridge with an alternate rf source such as the transmitter or an rf generator, merely leave the power switch off and inject the rf into pins 2 & 1 of the test socket (pin 1 is ground). Connect the unknown impedance to pins 3 & 1.

To check crystal activity, install the crystal, turn the power on and the relative crystal activity will be indicated on the meter.

To use the tester as a frequency spotter or rf source for alignment plug in the crystal, turn on the power and put a whip antenna in pin 3 of the test socket. For maximum rf output set the impedance dial to  $\infty$ .

To operate the tester as a field strength meter leave the power off and install a whip antenna in pin 2 of the test socket. For greater sensitivity or band spotting leave the power off, install the whip antenna in the pin jack, and insert the coil for the frequency to be checked in the test socket. Adjust the 365 pF tuning capacitor for a maximum meter indication.

### Construction

The complete unit is housed in a 3" x 5½" mini-box. A circuit board may be etched to provide the six islands needed or phenolic vector board may be utilized and solder pins installed in the six locations indicated. The mini-box top is cut away to accommodate the circuit board.

The crystal socket and power switch are mounted on the box end to minimize lead length. The 500 $\Omega$  potentiometer has one outside terminal cut off to eliminate interference with the diode and .0047 capacitor. If the component placement and lead length and values are as shown, the impedance dial calibration scale provided should be reasonably accurate. A final calibration may be made by inserting precision resistors in pin 1 & 3 of the test socket and comparing the null obtained to the dial readings.

The whip antenna is a replacement type available for transistor radios. Obtain a

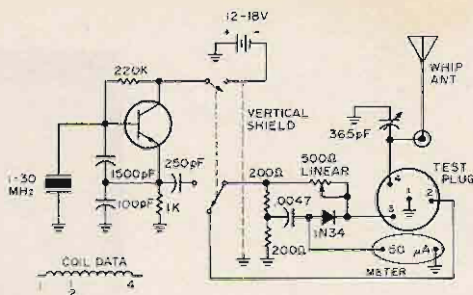

Fig. 2 Schematic 3 - 7.5 MHz 35 turns No. 24 tap 12 T from ground end. 6 - 14 MHz 20 turns No. 24 tap 7 T. 13 - 22 MHz 11 turns No. 24 tap 4 T. 21 - 30 MHz 6 turns No. 24 tap 2 T. All coils on Calectro G-C No. DI899. Available from Allied Radio Corp. Meter 0-50  $\mu$ A. Available through mail order houses as light meter movements. CHEAP! 365 pF tuning capacitor is from an old transistor radio. Don't use the oscillator section or frequency coverage will be higher than indicated. Transistor - GE9 or similar. The power/function switch is a slide type 2P2T miniature. Whip antenna: rabbit ear or similar device (see text).

broken TV rabbit ear from the local repair shop (lots of 'em) and solder a pin jack to the broken end. Hint - file away the chrome finish before attempting to solder.

As indicated on the schematic, two 9V batteries may be used for power or one 22½V battery with a 330 $\Omega$  series resistor in one lead. Current drain is approximately 8 mA.

Four plug-in coils are needed to cover the range of 3 to 30 MHz. Using the coils specified you will find ample room inside the mini-box to store the coils vertically when they are not needed. To secure the coils I merely cemented a piece of foam rubber to the cover and standing the coils up allows the pins to rest in the foam when the cover is installed.

A standard fuse holder (open type) was mounted on the outside of the box and makes a convenient holder into which the whip antenna may be snapped. Should you desire real accuracy from the 1 MHz crystal for dial calibration purposes, the 100 pF capacitor off the transistor base may be made variable and the crystal can be beat with WWV. Considerable adjustment may be made without effecting rf output or frequency range of oscillation.

...WB4MYL

# HIGH STABILITY "LUMPED LINE" OSCILLATOR

Many self-excited oscillator circuits have stimulated the interest of the designer and constructor. Each of these can be readily optimized for a particular performance feature, or exploited for some practical advantage. When frequency stability commands high priority, the Clapp oscillator is likely to be the chosen circuit. Although it has been shown that the attributes of the Clapp circuit can be attained by directing special design approaches to other configurations, the fact remains that frequency stability is a readily forthcoming operating feature of the practical Clapp oscillator. It is for this reason that this circuit is so frequently used as vfo in both amateur transmitters and commercial equipment. When one considers the extent and tenure of the popularity enjoyed by the Clapp oscillator circuit, the question naturally arises, "Does the possibility exist for further upgrading of self-excited oscillator performance?" In the exploration of such a possibility, we would not be concerned with such techniques as temperature compensating components, regulated power supplies, feedback limitation, etc. These performance-enhancements can be applied to any oscillator circuit. Rather, we would like to see a new or modified approach which would possess inherent virtues prior to ap-

plication of such compensation and optimization methods.

In seeking to displace or improve the basic Clapp circuit, it is only apropos that we first cite some of its real or alleged shortcomings. The most obvious one is likely to receive the least attention because of general acceptance as the "nature of the beast." In the Clapp, as well as in all other self-excited oscillators employing L-C frequency determining "tank" circuits, oscillation frequency is profoundly susceptible to conditions associated with the inductor. This sensitivity includes turn-spacing, dielectric between turns, moisture, dust, temperature,

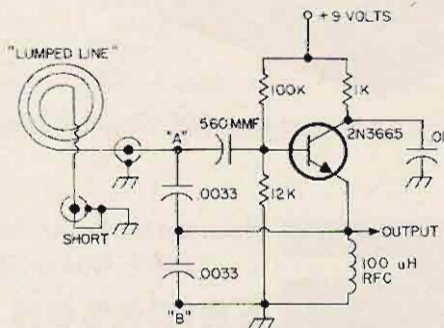

Fig. 1. Basic "lumped-line" oscillator. Tank circuit has appearance of conventional coil but functions as full-wave transmission line with no exposed high-impedance or "hot" points.

# 2 METER FM HEADQUARTERS

Rigs for every use . . .  
for every pocketbook!



## HANDY-TALKY STANDARD SRC-146

5 Channels — .94/.94 and .34/.94 supplied  
.3 uV receiver — 1.5 W transmitter  
Compact — 8" h x 3" w x 1 1/2" d  
Full line of optional accessories includes external  
speaker-mike — desktop charger — "stubby" an-  
tenna — and more!

Available NOW! — ~~Only \$279.00~~ —

**SPECIAL!**  
**CLOSE OUT**  
... only \$229.95

## ALL PURPOSE STANDARD 826M

12 channels (4 with crystals)  
10 Watt output  
All solid state  
Hot MOSFET receiver

~~Only \$339.95~~



**CLOSE OUT!**  
... only \$279.00

## TEMPO SOLID-STATE POWER AMPS



U.S. Made

MODEL	DRIVE POWER	OUTPUT POWER	PRICE
1002-3	5-25 watts	100-135 watts	\$220
1002-3B	1-2.5 watts	120-130 watts	\$235
802	5-12 watts	70-90 watts	\$180
802B	1-2.5 watts	80-90 watts	\$195
502	5-15 watts	35-55 watts	\$105
502B	1-2.5 watts	45-50 watts	\$130
242-A2	1-2.5 watts	25-30 watts	\$ 85

And many more from SBE/Clegg/Gladding/Kenwood/Tempo/Antenna Specialists/Larsen

Make ERICKSON your headquarters for all your FM needs . . .

**SEND QSL FOR COMPLETE SPECIFICATIONS**

## ERICKSON COMMUNICATIONS

4653 N. Ravenswood Ave., Chicago, Ill. 60640 (312) 334-3200





## TEMPO/CL 220



As new as tomorrow! The Tempo Commercial Line VHF transceivers offer commercial performance at amateur prices. Both units include an audio limiter to assure constant deviation at all times and an instantaneous impulse squelch. Microphone, power cord, mounting bracket and one pair of crystals is included.

#### GENERAL SPECIFICATIONS:

- Frequency Range: 220-225 MHz (2 MHz operating range)
- Number of Channels: 12 channel capability for transmit and receive
- Microphone: Dynamic with coil cord
- Dimension: 2.36" H x 5.90" W x 7.66" D
- Weight: 4.5 pounds
- Frequency Stability:  $\pm 0.001\%$  ( $-20^\circ$  to  $+60^\circ$ )

- RF Power Output: 10 Watts or 3 Watts.
- Output Impedance: 50 ohms unbalanced.
- Sensitivity: 0.5 microvolts nominal for 20 db quieting.
- Spurious & Image Attenuation: 70 db below desired signal threshold sensitivity.
- Adjacent Channel Selectivity (15 KHz channels): 70 db attenuation of adjacent channels.
- Type of Receiver: Dual conversion superheterodyne.
- Audio Output: 2 Watts minimum w/internal speaker (at less than 10% distortion)
- The price: \$329.00

## TEMPO/CL 146

- Frequency Range: 146-148 MHz
- Same general specifications as CL 220
- The price: \$279.00

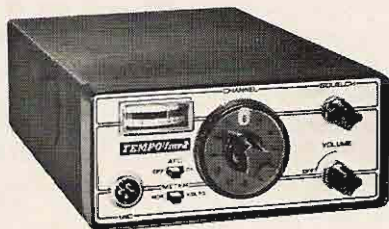

**TEMPO/fmv 2**



**TEMPO/fmp**

Make ERICKSON your headquarters for all your FM needs .

SEND QSL FOR COMPLETE SPECIFICATIONS

**ERICKSON COMMUNICATIONS**

4653 N. Ravenswood Ave., Chicago, Ill. 60640 (312) 334-3200

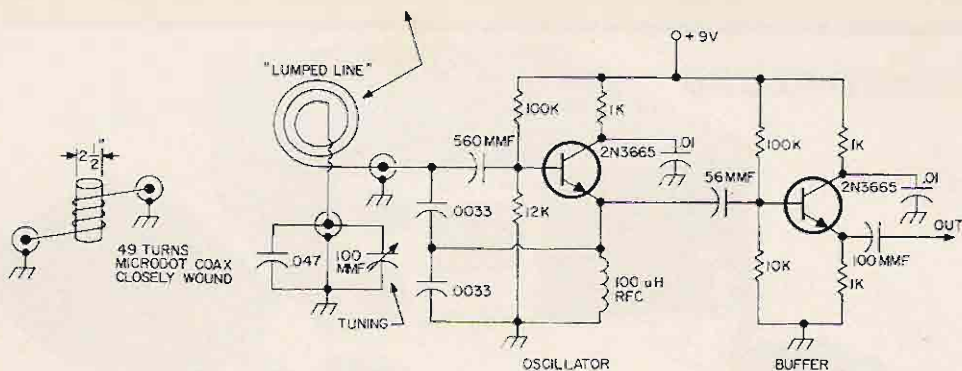

Fig. 2. Lumped-line oscillator with tuning provisions and buffer amplifier. Circuit values shown for 21 MHz oscillator.

proximity of conducting surfaces, and mechanical vibration. In the Clapp circuit in particular, the juncture of the inductor and the resonating capacitor is at a very high impedance level and displays very high sensitivity to stray capacitance. Awareness of these matters leads to defensive measures such as rugged construction, shielding, short leads, etc. But would we not have a more desirable situation if "built-in" immunity against frequency change could be achieved? This seems to suggest a different type of resonant circuit. In what follows, the revival of an "old-hat" approach may suggest itself. However, if attention is focused on the *mode of operation* involved, it will be seen that the described oscillator embodies a combination of theoretical and practical approaches which makes it unique and, to the best of my knowledge, is not to be found in the technical literature.

Oscillators employing *transmission lines* are well known. Chief claim to fame here

stems from the high Q attainable from lines, especially at the higher frequencies. The quarter-wavelength resonance generally utilized has precluded the construction of such oscillators for use below the vhf region, too, the general design approach of such oscillators has endowed them with familiar shortcomings. The obsession with push-pull configurations results in "hot" lines wherein the detuning effect of the immediate environment is much in evidence. The high impedance end of the quarter-wave lines is associated with the active device and thereby becomes very susceptible to frequency pulling. Moreover, such an association with a transistor would be even more detrimental than with a vacuum tube. On the basis of such facts, the usual substitution of a resonant line for an L-C tank circuit constitutes neither improvement nor innovation. But the transmission line has not been brought up for the sake of rejecting it! When one considers certain properties of such lines, it becomes apparent that conventional line-type oscillators *do not advantageously use these properties*.

The reader should by now be prepared for some kind of marriage between the Clapp circuit and a transmission line. This, indeed, is the destination of our discussion, but we shall direct our attention not to the conventional quarter-wave line, but to the full-wave line. Whereas odd quarter-wavelengths simulate the parallel resonant condition of an L-C tank, even quarter-wave lines simulate the condition of L-C series resonance. Let us further stipulate that our full-wave line be coaxial cable. For the

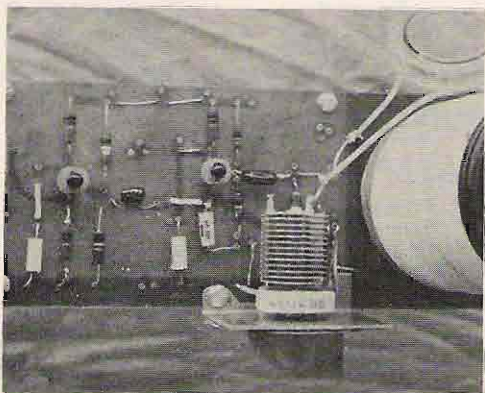

moment, we will deal with the simple full-wave coaxial line shorted at the far end. Inasmuch as we will be interested in establishing full-wave resonance at least as low as the amateur forty-meter band, we can make use of one of the Microdot miniature coaxial cables, and wind it solenoid-fashion around a cylindrical form. Now the cat is out of the bag: We have a "coil" which behaves as a series-tuned tank circuit and is therefore suitable for use in the basic Clapp circuit. *Yes, but what a coil this is!* It possesses the following features:

It can be wound on either a metallic or insulating form.

Its resonance frequency is not influenced by turn spacing, turn diameter, or winding length.

Its resonance frequency is not influenced by surface dust or moisture.

It will not participate in undesired inductive or capacitive coupling to other parts of the circuit.

The entire length of the outer sheath is a rf ground potential and there are no frequency disturbances from proximity effects.

It displays virtually no microphonic effects and is very nearly immune to mechanical vibration.

Its temperature coefficient is relatively low, being a calculable function of its change in end-to-end length.

There is no "nerve ending" in the form of a high impedance junction.

Such a line is "happy" to work into the low impedance input of a transistor.

Reasonable compactness is readily attained. Layer winding may be employed for lower frequencies.

Nearly complete shielding with no reduction of "Q."

The circuit of the basic "limped line" oscillator appears in Fig. 1. From the viewpoint of the active device, i.e., the transistor, a series resonant "tank" circuit is seen from points A-B. This being the case, oscillation occurs in the same manner as in a Clapp oscillator. Although the circuit has the same configuration as a conventional Colpitts with a resonant line operating in the quarter-wave mode (simulating a parallel-tuned L-C tank) such operation is here ruled out by the *very*

## "HOW TO MAKE MONEY IN MOBILE RADIO MAINTENANCE?"



107-C

1st — GET OUR FREE BOOK  
"HOW TO MAKE MONEY IN MOBILE  
RADIO MAINTENANCE"

2nd — ORDER THE LAMPKIN  
COMMUNICATION SERVICE  
MONITOR

MODEL 107C — GREATEST IN  
VERSATILITY & RELIABILITY —  
LOWEST IN COST, WEIGHT  
AND PROBLEMS

WRITE OR CALL  
LAMPKIN LABORATORIES INC.  
P.O. Box 2048 • Dept. L • Phone 813-746-4175  
Bradenton, Florida 33506

large capacitors across the open end of the line. These capacitors tune quarter-wave resonance to such a low frequency that the circuit Q is too low to allow oscillation to occur. Indeed, the purpose of these inordinately large capacitors is to all but short out the transistor end of the line! This of course is perfectly agreeable to a line which operates in a mode simulating a series-tuned L-C tank. And why not use the line in the half-wave rather than the full wavelength mode? Although transmission line operation is similar in all multiples of one half-wavelength, it so happens that the phase-relationship between voltage and current is suitable for oscillation in this circuit only for even multiples of one-half wavelength. So a full-wavelength line is the shortest one which will function in the simulated series-resonant mode in this circuit.

Digressing back to LC tank circuits, the usually cited formula for parallel resonance is:  $f_0 = 1/2\pi\sqrt{LC}$  but the true formula is actually:  $f_0 = \frac{1}{2\pi}\sqrt{LC(\sqrt{L-RL^2C/L-RC^2C})}$  where  $R_L$  and  $R_C$  are respectively the equivalent series resistance of the inductor and the capacitor. Although  $R_L$  and  $R_C$  can often be considered negligible in order to enable the use of the simpler formula, the true formula clearly shows that the frequency of parallel resonance is affected by tank circuit losses. Conversely, the frequency of a series resonant tank circuit losses. Conversely, the frequency of a series resonant tank is not per se directly detuned by resistance associated with the tank. Although the Q is adversely affected in both types of resonances, the series-tuned type is more likely to be superior in providing an oscillator with immunity against frequency

instability. I have found this to be the case too when one compares the resonant line in terms of simulated parallel and series resonances! Thus, in Fig. 1 a resistance low enough to almost stop oscillation can be placed across the transistor end of the line with very little effect upon the frequency oscillation.

In order to make the basic "lumped-line" oscillator of Fig. 1 more adaptable to practical applications, an emitter-follower buffer stage is added. This stage is operated as a class A amplifier in order to provide good isolation from subsequent circuitry. Power output is purposely kept relatively low - several tens to several hundreds of milliwatts. This enables us to greatly minimize certain thermal problems which tend to adversely affect any oscillator. It is simple and inexpensive to boost power level via tuned class C amplifiers and generally proves more satisfactory than trying to squeeze the requisite watts from an oscillator, whose chief mission in life is frequency stability. Also, a tuning adjustment can be added. This control should not be expected to provide a wide tuning range, but rather a change in frequency comparable to that needed to tune across the amateur bands. Here again we find a very advantageous situation. By replacing the shorted end of the line with a large capacitor in parallel with a small variable capacitor, both the rotor and stator of the variable capacitor will be at low impedance relative to ground. Here again we avoid sensitivity to proximity effects. Figure 2 shows both the emitter-follower and the tuning provision.

The circuit is sure-fire and shows no indication of being critical. It should yield readily to various modifications to comply with the constructor's specific needs. One thing is mandatory, however: *Be sure to ground the coaxial line at the near end*, i.e., the transistor end. The far end can then be grounded also. If the far end *only* is grounded, the circuit may oscillate at a relatively low frequency determined by the inductance of the "coil" of coax and the associated capacitors. When the near end is grounded, the coil configuration of the coaxial cable has no effect upon oscillation frequency.

...W6HDM

#### Calculation of Frequency of Oscillation

1. Wavelength = physical length/velocity of propagation where velocity of propagation is approx. 0.66 times the free-space velocity.
2.  $\lambda = \text{wavelength in meters} = \pi \times N \times D / 39.4 \times 1/0.66$   
For our experimental oscillator:  
N = 49 turns of Microdot coaxial-cable  
D = 2 1/2" diameter  
39.4 factor converts inches to meters  
then  $\lambda = \pi \times 49 \times 2.5 / 39.4 \times 1/0.66$   
 $\lambda = 3.14 \times 49 \times 2.5 / 39.4 \times 0.66 = 14.75\text{m}$
3. f = frequency in MHz =  $300/\lambda = 300/14.75 = 20.3\text{ MHz}$

# A MOBILE BASE STATION

**M**any was the time when you wanted to be mobile with the comfort of a base station. Since I spend a lot of time in my car I decided that I would do something about it. Using a piece of coat hanger I made a shape of the seat of the car and cut two side panels, a bottom and ends. I had an arm rest with a padded top cover and an auxiliary glove compartment underneath.

Since the push-to-talk mike is very bad in traffic, I got a small flexible boom (from a

small lamp) and mounted it at the same spot as the left hand sun visor. No holes had to be drilled in the car for this. A bracket was made to mount under the sun visor bracket. When not in use the mike clips out of the way onto the sun visor. The mike used cost \$5.00 and is tapped to hold the flexible coupling. The mike is a high impedance magnetic (Japanese DM-175 made by Primco Co. Ltd.). The mike switch and a touch tone pad are right at the finger tips when my arm is at rest. An indicator light shows that the mike is in use. This set up is so convenient that while operating you can concentrate on driving with both hands when necessary and it's very safe. Even in a quick stop the mike just goes out of the way when it gets hit because it is so flexible.

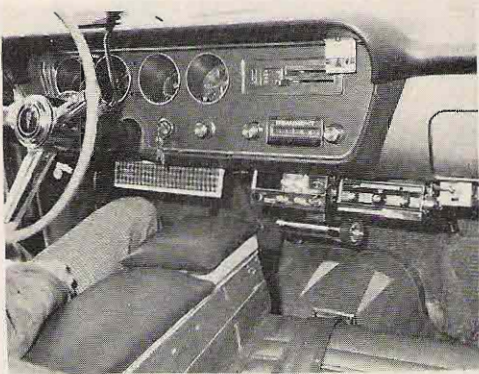
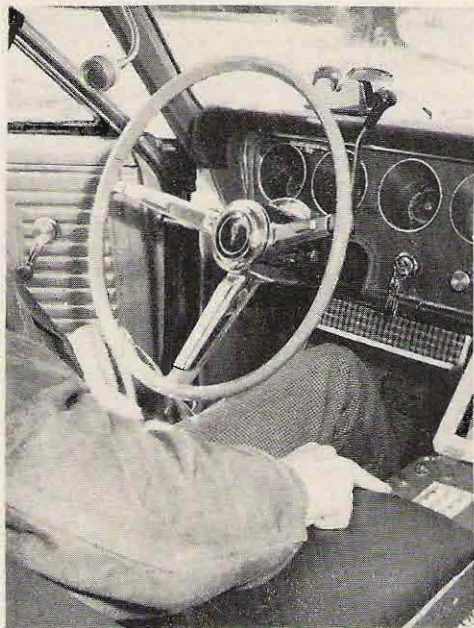

...VE3ADI

# Heathkit Ham Gear

Choose a Heathkit Transceiver with —

- Single or multi-band coverage
- SSB, CW, or both
- Fixed or mobile operation — interchangeable
- Prices to fit your budget



## NEW HW-7 CW QRP Transceiver...69.95\*

Work the globe on "flea-power" with this 3-band QRP CW transceiver featuring VFO and provision for xtal transmission operation. Covers CW portion of 40, 20 and 15 meters. Solid-state circuit. Sensitive Synchrondyne detector. Built-in sidetone and relative power meter. Operates on optional AC power supply (14.95\*) or 12V batteries. 6 lbs.



## 80, 40, and 20-Meter Single-Banders...112.50\*

The transceivers designed to get you on the air on a budget. Choice of HW-12A (18-meter), HW-22A (40-meter), or HW-32A (20-meter) models. Full 200 W PEP input SSB. Choice of fixed or mobile operation with optional Heathkit power supplies. Other features are 2 kHz dial calibration, ALC input, S-Meter, VOX and PTT. 15 lbs.

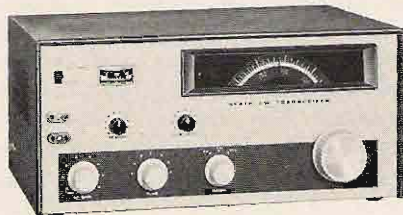

## HW-16 Novice CW Transceiver...99.95\*

A high-performance 3-band CW transceiver covering the lower 250 kHz of 80, 40, and 15 meters. 75 watts input for novice class, 90 watts for general class. Provisions for VFO transmitter control with Heathkit HG-10B 80-2 Meter VFO. 25 lbs.

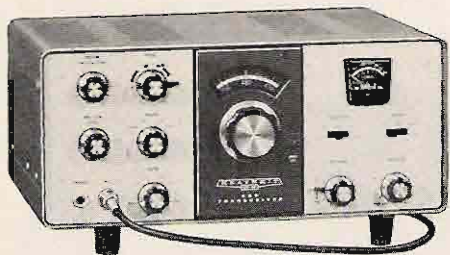

## HW-101, 80-10 Meter SSB/CW Transceiver...259.95\*

Improved version of the famous HW-100 with new receiver circuitry for 0.35  $\mu$ V sensitivity. New dial drive mechanism for smoother, more positive tuning. New selectable CW filter option. World's best buy in an SSB rig. 21 lbs.



## SB-102, 80-10 Meter SSB Transceiver...385.00\*

World's most wanted rig. 180 watts PEP SSB, 170 watts CW. Front panel selection of built-in 2.1 kHz or optional CW crystal filters. Solid-state LMO. 0.35  $\mu$ V receiver sensitivity. Fixed or mobile operation with optional Heathkit power supplies. 24 lbs.

# Gives You a Choice

Choose from a new lineup of Heathkit accessories

- New Electronic Digital Clock
- New VHF Band-Scanning Monitor Receiver
- New 2½-Digit Multimeter
- New economy 30 MHz Frequency Counter

## NEW GC-1005, 6-Digit Electronic Clock...54.95\*

New solid-state timepiece with computer logic accuracy and high-visibility cold-cathode readouts tells time to the second. Reads 12 or 24-hour time on 120 or 240 volts, 50 or 60 cycles. "Beeper" alarm automatically sounds every 24 hours; repeating "snooze" switch gives extra 7 minutes sleep. A timely addition to any ham shack...and nothing like it at this low kit price. 4 lbs.

## NEW GR-110 VHF Band-Scanning Monitor Receiver...119.95\*

Crystal-controlled. Tunes any selected 9 MHz segment of 146 - 174 MHz band - police, fire, marine, ham 2-meter, etc. Manual or automatic scanning with numerical readout. Channel lockout buttons. Priority channel "0" takes precedence in "automatic." Built-in speaker; rear-panel remote speaker jack. 120/240 VAC or 12 VDC fixed or mobile use. Crystal OSC/Mixer signal source for easy adjustment. Order up to 8 Crystal Certificates with kit (\$4.95\* ea.). 9 lbs.

## NEW IM-1202, 2½-Digit Multimeter...79.95\*

A compact, solid-state multimeter with digital readout - and priced for the average ham. Has four overlapping ranges to measure voltages from 10 mV to 1000 V on DC (either polarity), 10 mV to 700 V rms on AC, 10 uA to 2.5 A on AC or DC current. Five resistance ranges measure from 1 ohm to 2 megohms. Front panel polarity switch reverses inputs without changing lead. 6 lbs.

## NEW IB-1100, economy 30 MHz Frequency Counter...169.95\*

Gives you 1 Hz to over 30 MHz counting on a full 5-digit readout with 8-digit capability. The lighted overrange indicator makes misreading virtually impossible. Stable time-base circuitry assures accuracy better than  $\pm 3$  ppm from 22° to 37°C. Diode protected J-FET gives improved triggering over 100 mV to 150 V input range. Solid-state circuitry mounts on one large board. Another accessory you can count on - from the hams at Heath. 6 lbs.

Send for your FREE '73 Catalog

HEATHKIT ELECTRONIC CENTERS - ARIZ.: Phoenix, 2727 W. Indian School Rd.; CALIF.: Anaheim, 330 E. Ball Rd.; El Cerrito, 6000 Potrero Ave.; Los Angeles, 2309 S. Flower St.; Pomona, 1555 Orange Grove Ave. N.; Redwood City, 2001 Middlefield Rd.; San Diego (La Mesa), 8363 Center Dr.; Woodland Hills, 22504 Ventura Blvd.; COLO.: Denver, 5940 W. 38th Ave.; CONN.: Hartford (Avon), 395 W. Main St. (Rte. 44); FLA.: Miami (Hialeah), 4705 W. 16th Ave.; GA.: Atlanta, 5285 Roswell Rd.; ILL.: Chicago, 3452-66 W. Devon Ave.; Downers Grove, 224 Ogden Ave.; IND.: Indianapolis, 2112 E. 62nd Ave.; KANSAS: Kansas City (Mission), 5960 Lamar Ave.; MD.: Baltimore, 1713 E. Joppa Rd.; ROCKVILLE, 5542 Nicholson Lane; MASS.: Boston (Wellesley), 185 Worcester St.; MICH.: Detroit, 18645 W. Eight Mile Rd. & 18149 E. Eight Mile Rd.; MINN.: Minneapolis (Hopkins), 101 Shady Oak Rd.; MO.: St. Louis, 9296 Gravois Ave.; N.J.: Fair Lawn, 35-07 Broadway (Rte. 4); N.Y.: Buffalo (Amherst), 3476 Sheridan Dr.; New York City, 35 W. 45th St.; Jericho, L.I., 15 Jericho Turnpike; Rochester, Long Ridge Plaza; OHIO: Cincinnati (Woodlawn), 10133 Springfield Pike; Cleveland, 5424 Pearl Rd.; PA.: Philadelphia, 6318 Roosevelt Blvd.; Pittsburgh, 3482 Wm. Penn Ave.; TEXAS: Dallas, 2715 Ross Ave.; Houston, 3705 Westheimer; WASH.: Seattle, 221 Third Ave.; WIS.: Milwaukee, 5215 Fond du Lac.



HEATHKIT

Schlumberger

HEATH COMPANY, Dept. 11-11  
Benton Harbor, Michigan 49022

Please send FREE Heathkit Catalog.

Enclosed is \$\_\_\_\_\_ plus shipping.

Please send model(s): \_\_\_\_\_

Name \_\_\_\_\_

Address \_\_\_\_\_

City \_\_\_\_\_

State \_\_\_\_\_

Zip \_\_\_\_\_

Prices & specifications subject to change without notice.  
\*Mail order prices; F.O.B. factory.

CL-447

**E**very now and then, amateur radio magazines print articles about other radio services of interest to amateurs. This article is intended to brief you on the state of the Citizens Band. Why? You may wish, as I have done, to tune around the 11 meter band in the United States or Canada and see for yourself what is going on. You may wish to join them. On the other hand, you may wish to prepare yourself for the day when they might join us on 220 MHz.

The title of this article is taken from the current form of receipt on the Citizens Band . . . sort of a cross between Ten-Four and Roger.

#### Skip vs Local

The FCC Rules and Regulations permit only local communication within a 50 mile radius. While only a three day sample was taken, about 98% of the stations heard were working skip. At one point, a station was heard telling someone about another station working local on a "skip" channel.

#### Channels

Class D Citizens Radio channels are assigned as follows:

1 26965 kHz	13 27115
2 26975	14 27125
3 26985	15 27135
4 27005	16 27155
5 27015	17 27165
6 27025	18 27175
7 27035	19 27185
8 27055	20 27205
9 27065	21 27215
10 27075	22 27225
11 27085	23 27255
12 27105	

When skip is in, all 23 channels are solid heterodynes. To avoid congestion, some stations operate halfway between the channels.

# TEN - ROGER

Others operate out of band from 16915 to 26995 and 27235 to 27275 kHz. There is also some voice operation in the five Class C channels (26995, 27045, 27095, 27155 and 27195 kHz) reserved for model airplane and other control purposes.

#### Power

FCC Rules and Regulations limit the transmitter power to 5 watts input to the final amplifier. Serious CBers regard this restriction suitable only for excitors. Some talk cryptically about "having a little help on the side" or make passing remarks about having an afterburner. Others may be heard carrying on a discussion of the merits of a pair of 813's vs a 4-400.



## Profanity

From some remarks made by other amateurs, I was prepared to hear a considerable amount of profane or indecent language. In three days of monitoring, only one such outburst was heard. Instead, it appears that the CBers have built up a preferred list of euphemisms for use on the air. These include: Cotton Picking; By Golly; Doggone and Mercy (sometimes repeated or followed by the words Sakes or Me).

## Tones

A number of different types of tone signaling may be heard. No doubt most of these are for selective calling. Two stations were heard making long transmissions of swept tone electronic sirens similar to the type used in pilots' survival radios. The purpose of these transmissions could not be determined. However, one might speculate that a siren could be used to "clear" a channel, to override interference, or simply to "do one's thing."

## Operation

Undoubtedly there is some sense of accomplishment after one has assembled a 23 plus channel transceiver, a kilowatt afterburner, a 3 element cubical quad and mounted it on a new 90 foot tower. However, the enjoyment in CB comes mainly from operating.

Efficient operation on the Citizens Band depends on short, push-to-talk transmissions. This technique is necessary to cope with the severe co-channel interference and reduces the likelihood of being DFed.

It is also necessary to cultivate a "country" accent and develop a repertoire of folksy sayings, like: "If the good Lord's a willin' an' the crick don't rise." It is customary to refer to another CBER as "good buddy," "ole buddy" or "you cotton picker." "You loudmouth" is equally endearing but carries the added meaning of good signal strength.

## Operating Procedures

The following is a primer on current CB operating procedures:

*Calls:* A general call may be initiated by transmission of BREAK BREAK BREAK. For variation, the words BREAKER or BREAKETY may be substituted. This is followed by the identification of the calling station as well as the general location and an invitation to transmit.

*Station Identification:* The word HANDLE is used to refer to the tactical call sign selected to identify the station. Care is taken to avoid duplication. Typical call signs are: GRANDDADDY LONGLEGS, SNAKE EYES, DOG CATCHER, OKLAHOMA OUTLAW, BROOMSTICK, JITTERBUG GIRL, ARKANSAS SAILOR, DIRTY BIRD, CHICKEN HAWK and MUD TURTLE.

*Location:* Station locations are given only in general terms. Normally it is localized only to the part or quadrant of the state or province. The name of the state may be given, but giving its nickname (e.g., the Buckeye State) is considered to be more innovative. In large metropolitan areas, the name of the city may be given. References to the CBER's house may be made by the term HOME TWENTY or BASE TWENTY, which doubtless are mutations of the amateur radio expression "HOME QTH." For the purpose of exchanging WALLPAPER (QSL cards), it is customary to use a post office box, preferably at a post office some distance away.

*Invitation to Transmit:* The equivalent of the amateur K or OVER is COME ON, COME BACK, or COME ON BACK. HOW 'BOUT IT may also be used.

*Typical Call:* BREAK BREAK BREAK THIS IS THE OLD RIVER SNAKE IN NORTHEAST FLORIDA COME ON.

*Replies:* Replies consist of the words HOW 'BOUT IT (or THAT), the identification and/or location of the called station, similar information on the calling station followed by an invitation to transmit.

*Typical Relay:* HOW 'BOUT IT RIVER SNAKE DOWN THERE IN NORTHEAST FLORIDA THIS HERE'S THE OLD BROKEN WHEEL UP HERE IN SOUTHEAST NEW JERSEY COME ON BACK.

*Signal Strength and Readability:* Signal reports are not as formalized as on the

# the EL SOCKET

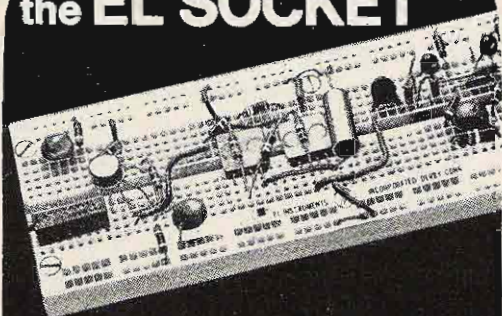

**Test new circuit ideas...  
I.C. circuits...  
discreet components...  
at no risk!  
Money back guarantee!**

**\$17<sup>25</sup>**

All you need are #4 mounting screws . . . just plug-in components . . . like ¼ watt resistors, ceramic capacitors, diodes, I.C.s, transistors and more . . . and your circuit's built! No special patch cords needed! Components interconnected with any solid No. 22-26 gauge wire.

And you can try it with absolutely no risk for 5 days. If not satisfied, just return your EL Socket and receive a full refund. Trying is believing. How can you go wrong? Order your EL Socket now!

- Nickel/silver plated terminals — very low contact resistance
- Low insertion force
- Mounts with #4 screws
- Initial contact characteristics beyond 10,000 insertions
- Vertical, horizontal interconnecting matrices
- Accommodates wide range of wire and component leads from .015"-.032"

**Send check or M.O. today!**

Add 50¢ for postage and handling  
25% deposit on C.O.D.s



Dept.  
**EL INSTRUMENTS, INC 73**  
61 First St., Derby, Conn. 06418  
Telephone: 203/735-8774

amateur bands. Reports such as YOUR SURE HAVE A BODACIOUS SIGNAL UP HERE or YOU'RE WALKING ALL OVER THEM are used. Others are: GOT A GOOD COPY ON YOU, YOU SOUND LIKE A LOCAL, and YOU WIPE THE CHANNEL CLEAN. The "S" meter system of reporting signal strength is used to some extent. This is normally restricted to the upper part of the scale in dB's over S9.

*Messages:* Messages consist of informal conversation between the two stations in communication. These transmissions are called MODULATING. Much of the exchanges center around discussions of the amount of interference on the channel. Another general topic is the weather in the vicinity of the HOME TWENTY.

*Reports:* Procedures for requesting repeats are informal. A request for the other station's location may consist of WHERE YOU AT? A general request for a repeat may be made by transmitting ONE MORE TIME.

*Receipts:* Receipts are normally given for each transmission. TEN-ROGER is normally used for this purpose. The words ROGER and TEN-FOUR, though deprecated, are still in use.

*End of Transmission:* At the end of the contact, it is customary to thank the other station and wish him well. The other station may be told GLAD YOU COULD MAKE THE TRIP. A station may also say that we would welcome seeing the other station sometime later ON THE CO-AX. The expressions SEVENTY-THREE and EIGHTY-EIGHTS are sometimes heard, but oblique references to them are gaining favor. Some variations are: THREES AT YOU, THREES AND EIGHTS, or simply THREES. NUMBERS TO YOU or ALL THEM GOOD NUMBERS are used for variety.

*Sign-Off:* The sign-off procedure is left to the ingenuity of each station. While conventional sign-offs such as CLEAR may be heard, more innovative sign-offs are the rule. Examples: WE'LL BE STANDIN' or WE'RE OUT OF IT. More often than not, the COTTON PICKER is simply GONE.

...K4YKB

# FREQUENCY SYNTHESIZER FOR 2M FM

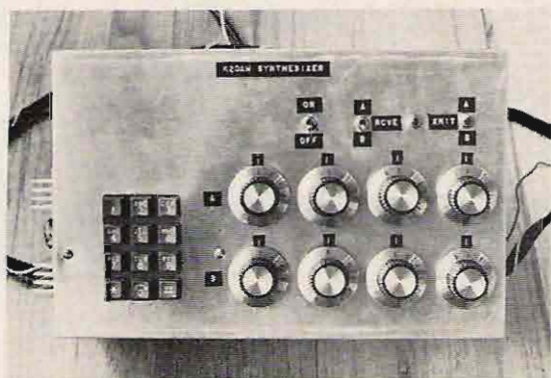

## PART III

As the last part of our FM synthesizer series, this month we cover the actual construction of the unit. Most of the details are pretty well covered by the layout drawings, and so the text itself will cover only some items. When looking at the drawings, make sure to read the fine print in the notes which may explain some questions.

The main body of the synthesizer fits on the p.c. board, which is shown in Fig. 13. It is a little smaller than 7" x 9", and is etched on only one side to make it easier to duplicate. This means there are a lot of jumpers, so watch out and don't miss any. You can use bare wire for the jumpers, since none of them cross any other jumpers or

components. Be careful, though, since some of the jumpers run under IC sockets.

In order to explain where all the p.c. board mounted parts go, we have broken up the main board into smaller sections, shown in Figs. 14 through 19. Each of these takes one or two of the main circuits shown in the diagrams last month, and shows the actual layout of the parts. In each drawing, a small sketch in the corner shows where to find that circuit on the overall board. In all of these pictures we are looking at the copper side of the board — the components themselves actually mount on the other side of the board.

Orientation of the FETs is shown on the layout drawings. The letters B, C, and E indicate the way regular transistors plug into the board. The LM309H on the VCO section of the board plugs in (from the non-copper side of the board, naturally) so

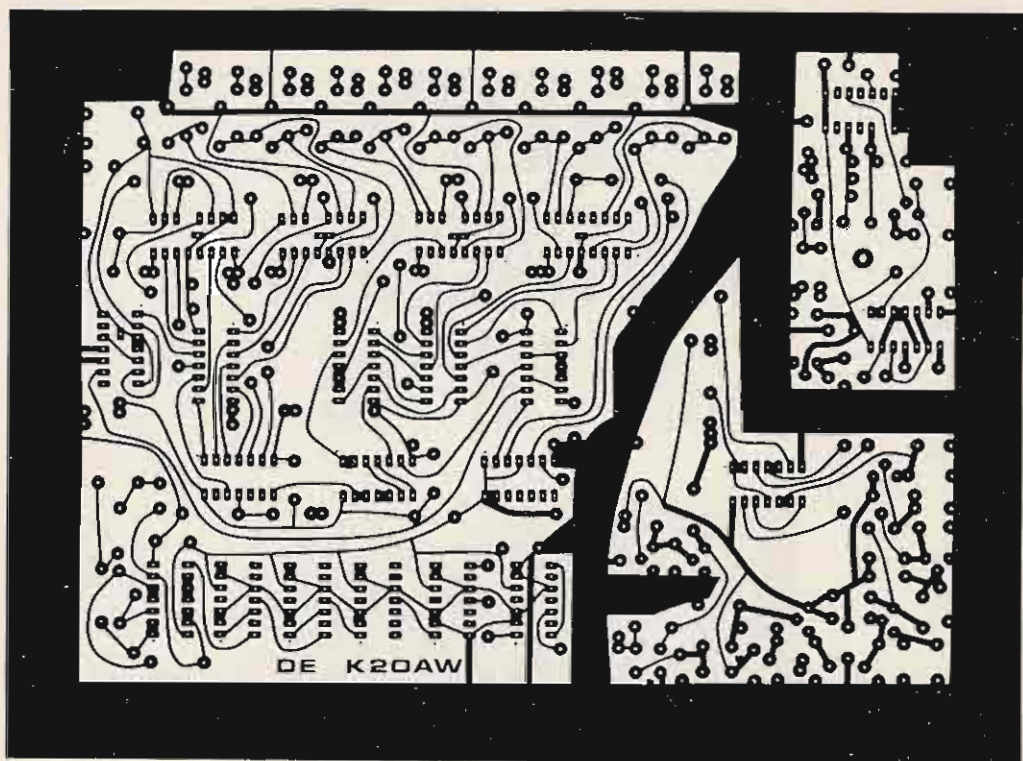

Fig. 13. Copper side of printed circuit board (60% reduction).

that the three leads line up with the three holes. Note also that the other IC's have to be inserted in a certain way. There is usually a small notch or depression at one end of the IC body, on the end near pin 1. We have marked pin 1 of each IC on the board and board layout with a small dot.

For a number of reasons, IC sockets are a must for a project this size. Since IC sockets of the molded type are quite expensive (even more expensive than most of the IC's them-

selves) we suggest something called Molex Soldercon IC terminals, or just Molex pins. These are individual little clips, one for each IC pin, which come in long strips. You break off as many as you need (such as 7 for one side of a 14-pin IC), insert the whole strip into the board and solder, and then snap off the connecting strip. This leaves seven independent little clips standing up from the board. Put another seven on the other side of the lineup, and you have fourteen clips, ready for the IC itself. It's essentially the same as a regular socket, but without the plastic to hold it all together. They are available for about a penny each in lots of 500 or 1000 - thus you get a 14-pin socket for 14¢, instead of shelling out 50¢ or more for a regular socket.

While wiring the board, you will have several choices to make, depending on whether you want 6, 8, or 12 MHz output. In the reference frequency divider, see Fig. 3 for the type of IC to use for IC18, and for the proper output pin to use; then put the

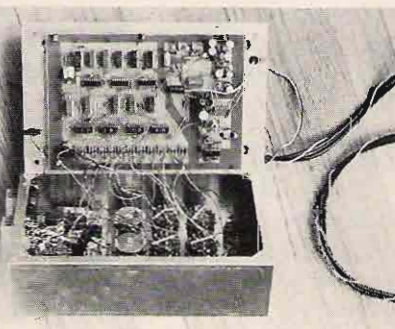

jumper in the right place between IC18 and IC17 (see Fig. 15). In the phase comparator, you must choose the correct value for the integrator capacitor (see Fig. 4). In the VCO, you must choose the correct values for C1, C2, and L1, as shown in Fig. 5 and described in last month's issue.

If you intend to use the synthesizer with an 11.7 MHz i-f in the receiver, make the change in the programmable divider as described in last month's article.

Special precautions are needed in installing the two FET transistors. The RCA 40673 is gate-protected so it is relatively free from burnout due to careless handling, but we did manage to ruin one anyway, so it pays to be careful with both. The problem is that the gate resistance on MOSFETs is so high that static electricity can induce very high voltages between the gate and the rest of the FET. As a result, it is very easy to exceed the breakdown voltage between the gate and the channel, and literally puncture a hole in the insulation layer between them.

The FETs should be the last components mounted on the board. When removing the MFE3002 from its package, you will note that a metal ring is slipped over all the leads, shorting all the leads together. Do not remove this ring at first. Instead, take some very fine bare wire (one strand from a length of zip cord is fine) and carefully wrap it around all the wires, up near the body of the transistor. Go around and in and out between the leads, to make sure that you have all the transistor leads securely connected together. Do the same with the 40673. Don't solder this wire to the leads, since it will be removed later. Now that the four leads from the FET are shorted together, you can remove the small ring supplied by the manufacturer, slip the leads into the p.c. board and solder them. In soldering, use a small pencil iron (not a solder gun). Let the iron heat up, and then just before using it to solder the FET, unplug the iron and connect a clip lead from the iron to the ground strip on the board. In this way you will prevent stray voltages from sneaking up on the FET and zapping it. Only after it is soldered do you remove the bare wire from between the leads. Once the FET is on the board it is relatively safe, but try not to touch the FET

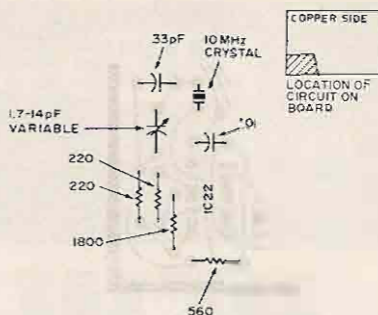

Fig. 14. 10 MHz crystal oscillator. Notes: 1. See Fig. 2 for diagram. 2. Capacitor marked \* is a bypass capacitor not shown on diagram. 3. Adjust variable capacitor to zero-beat crystal with WWV on 10 MHz.

case and circuitry anyway. These precautions are a little conservative, but we believe in playing it safe with these little critters.

Once the board is finished, it's time to decide how to mount it and the switches and other components in one assembly. The photos in this part of the article show our prototype, but there are other (and probably better) ways of packaging the synthesizer. The important thing to keep in mind is that the overall assembly should be such that you can get to the board for testing or repairs, if needed. Wire the power supply regulator next, since it is a good idea to test the board before continuing further.

For testing purposes, connect the power supply regulator to the board. +5V and ground connect to the corner of the board,

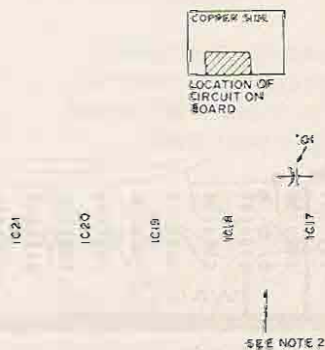
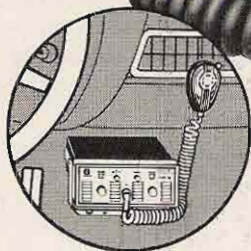

Fig. 15. Reference frequency divider. Notes: 1. See Fig. 3 for diagram. 2. Jumper between IC18 output (pin 8 or pin 11) and IC17 input (pin 1) as shown in Fig. 3. 3. Capacitor marked \* is a bypass capacitor not shown on diagram.

ED

**JUGE ELECTRONICS, INC.**PHONE:  
(817) 926-52213850 SOUTH FREEWAY  
FORT WORTH, TEXAS 76110

# NEW HR-6

12 Channel  
Solid State  
6 Meter FM  
TransceiverModel HR 6  
\$239.00  
Amateur Net

Complete dash mount  
operation . . . does not  
require black box power  
hog in your trunk

25 Watts Out  
Long Range Signal Capability  
12 T and R Channels  
Independently Switched  
144 Frequency Combinations  
5 Watts Audio output  
Compact for Dash Mount.

Designed and use tested to perform against TVI. Designed to utilize the most modern components of the solid state art—integrated circuits, dual gate MOSFET transistor, silicon BET power transistor, etc. Designed with the power in the frequency range to work FM Skip. And, designed and built in America in a compact package that will appeal to your taste and pride of ownership.

## SPECIFICATIONS

Power Output:	25 watts Min. @ 13V DC
Frequency Range:	52-54 MHz
Channels:	12 with independent switching
Sensitivity:	.35 $\mu$ V (nom) 20db quieting
Selectivity:	6db $\pm$ 16KHz
Audio Output:	5 watts max.
Size:	2 5/8" x 6 1/2" x 9 1/2"

State of the art receiver utilizes MOSFET mixer for superior front end overload and intermodulation performance.

Hours: 9:00 - 5:30 Tues. thru Sat.

# JUGE



## 2 METER "BLOCKBUSTER"

180W P.E.P. SSB • 150W DC input AM-FM uses a 5894B twin tetrode • Built-in AC supply — operate DC with Swan's Model 14C DC converter. Identical size and styling to Swan's SSB transceivers. Built-in antenna relay.  
 Swan VHF-150 \$299.95  
 14C DC Converter ..... \$65.00

## new Swan FM 1210-A

### INDEPENDENT SELECTION

of 12 transmit and 12 receive channels  
 Comes with transmit — .22, .34, .76 and .94  
 receive — .28, .88, .76 and .94  
 Includes microphone, DC cord, AC supply.

AVAILABLE NOW ..... **\$359.95**

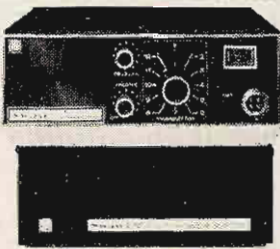

## SWAN FM-2X

10 watts output • 12 channels  
 Snap-on-the-back AC supply  
 "Broadcast Quality" audio  
 A truly outstanding value

Extra xtals \$3.95 ea  
 installed free

**\$299.95**

**"FACTORY-DIRECT" CASH PRICES**  
**24 HOUR SHIPMENT**  
**WE HONOR SWAN CREDIT PLAN**  
**ENTIRE SWAN LINE IN STOCK**

Send your check or money order or call in your order. Our phone is answered after hours automatically for your convenience. Call at night — cheaper rates.

**ED JUGE ELECTRONICS, INC.**

3850 SOUTH FREEWAY  
 FORT WORTH, TEXAS 76110



Phone (817) 926-5221

Telex 75-8329

Hours: 9-5:30 Tues. thru Sat.

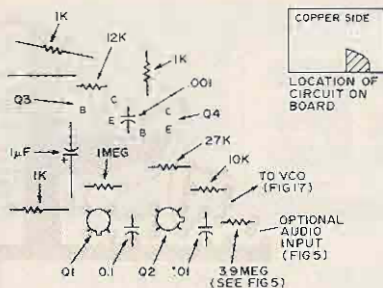

Fig. 16. Phase comparator. Notes: 1. See Fig. 4 for diagram. 2. Capacitor marked \* is a bypass capacitor not shown on diagram.

as shown in Fig. 19. +12V connects near IC13, as shown in Fig. 18, and goes to the VCO through the 68Ω resistor (Figs. 17 and 18). A good source of power for the regulator is a 12V car or motorcycle battery.

Before applying power, check the resistance between the +5V and +12V lines to ground. If there is a short circuit, look for a wrong connection or tiny sliver of solder on the board. Don't forget to remove the Molex connecting strip before applying power, since it shorts adjacent terminals.

From now on, a frequency counter is probably the best test instrument you can have. We used the one described in 73 Magazine in the May-Sept. 1972 issues. If you can at all borrow one, it is well worth the effort since, even if you don't need it in troubleshooting and everything works well, at least you will be able to check the accuracy of the synthesizer's output at different switch settings.

Connect the counter to the collector of Q6 in the VCO. Disconnect the VCO control line from the phase comparator, and connect it to a source of variable dc voltage, adjustable over the range of about 1.5 to about 5.0V. Check that the output frequency of the VCO at the various input voltages shown in the VCO description last month is in the right range.

If necessary, adjust L1 so that the VCO gives the right output. The important thing is to check that the VCO frequency swings over the whole range needed with an input voltage change from about +2.2 to about +4.1V, both on receive and transmit. If you don't get enough swing with this amount of

voltage input, try another pair of 1N4001 diodes in the control line. It is possible to get a diode which does not have a large enough capacitance range, although only one diode out of all the ones we tried gave us trouble in that respect. If this does not help, then you will have to experiment with the values of C1, C2, and L1 until you get the right VCO frequency swing. This part of the synthesizer must be aligned first, or you may never get the rest of it to work. Only if the VCO tracks right can the rest of it lock onto frequency.

Now disconnect the variable voltage source from the VCO control line, and measure the output frequency. It should be somewhere near the lower edge of the required frequency swing. Check that the same frequency is also on pin 4 of IC4 (though there may be a slight difference because of loading changes as you move the counter). Then check IC5 pin 4, IC6 pin 4, IC7 pin 4, and finally IC12 pin 1. Each of these should have a frequency one-tenth of the frequency on the preceding test point. If you get the wrong reading, try interchanging IC's with another of the same number.

Since at this point you don't have the frequency selection switches connected yet, the programmable divider is dividing by exactly 29,000. Connect your counter to IC14 pin 6 to check the output frequency from the divider - it should be the VCO frequency, divided by 29,000, which makes it probably fairly close to the reference frequency.

Next, check the output of the 10 MHz crystal oscillator and the reference frequency divider - Fig. 3 (last month) tells the frequencies to be expected at various places in the reference divider.

Still without the VCO control line connected, use a scope to look at the inputs to the phase comparator (see Fig. 4). The square wave reference frequency is easily observed, but you will need a very good scope (with triggered sweep and good high frequency response) to see the output from the programmable divider (that's why a frequency counter is so useful - you can tell the signal is there and measure its frequency even though it is too narrow to see). Then



check the phase detector output. Since the loop is not closed the phase detector output should be varying all over the place. Seen on the scope, it should look like a staircase which continuously shifts directions and slopes.

Now comes the big step. If everything is working so far, connect the phase detector output to the VCO control input with a wire jumper on the underside of the board. Make it as short as possible, and keep it tight against the board. The synthesizer should now lock on to frequency. Since the frequency selection switches are still missing, you are set to 145 MHz transmit. The frequency counter should now measure the correct frequency (145 MHz divided by 24, 18, or 12, depending on whether your output is at 6, 8, or 12 MHz, respectively). The counter reading should be constant, with possibly a flicker in the right-most digit. Listen to the output of the synthesizer on a general coverage receiver to make sure it is reasonably clean.

If the synthesizer locks on to the correct frequency but has a lot of hum or buzzing on the signal, chances are that something is wrong with the phase detector. Put a scope on the output—it should be a pure dc level—a straight line right across the scope screen. If it has a slight sawtooth to it, it's possible that one of the two FETs is shot.

Once you have gotten this far, wire up the frequency switches and package the

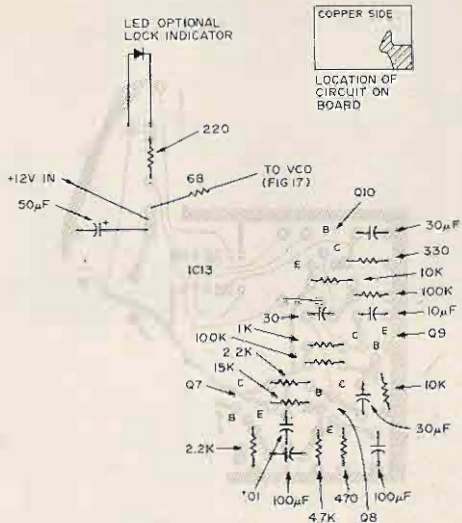

Fig. 18. Unlock detector. Notes: 1. See Fig. 6 for diagram. 2. Capacitor marked \* is a bypass capacitor not shown on diagram.

whole system in a cabinet or box. The outside edge of the printed circuit board is ground. Mount the board on standoffs on a chassis or grounded metal plate so that the ground area of the board is grounded through the screws. (You may have to readjust L1 in the VCO once this is done.) Keep all the leads short, and keep all leads as far away from L1 and Q5 in the VCO as possible.

Now comes the tricky part. The VCO is very sensitive to ground loops and hum pickup. As you remember, a voltage change of about 2.2 to 4.1V (a total swing of slightly under 2V) causes the VCO to cover the range from 145 to 147 MHz. This is a swing of about 1.5 MHz per volt of control voltage, which corresponds to about 1.5 KHz per mV. All this means that if you have a mV of ripple or noise anywhere around the VCO, that will show up as 1.5 kHz of deviation in your signal. To keep your output clean and pure, you have to avoid all pickup—that includes ground loops, inductive and capacitive coupling, and such. This is an experimental process at best. Adjust the synthesizer for an output on some frequency for which you have receive crystals in your transceiver.

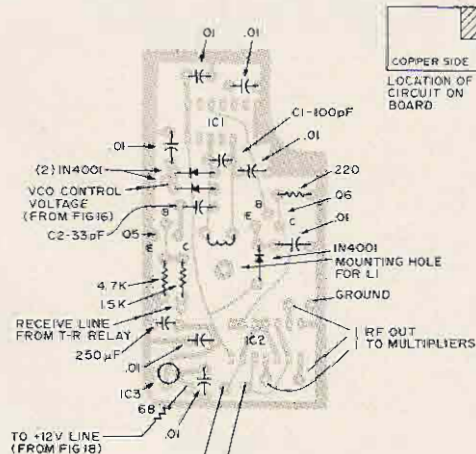
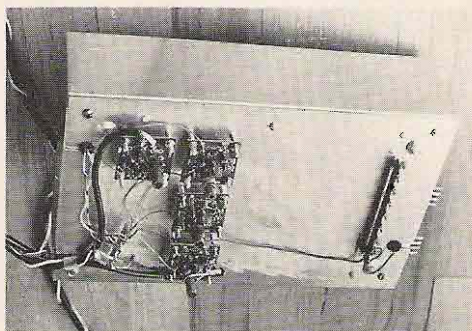

Fig. 17. VCO and switched buffer amplifier. Notes: 1. See Fig. 6 and 7 for diagram.



Place the transceiver close by, and you will be able to hear the synthesizer output on your rig. If you hear a buzz or hum, you will have to try every trick you can think of to get rid of it. This involves removing mounting screws holding the board to the chassis (in our unit we found that we had to keep all mounting screws located within two inches of the VCO insulated from ground), moving wires around, and checking ground connections between the power supply, switches, and relay.

This should be done with the synthesizer in the transmit mode, either by putting +12V on the T-R relay, or by bypassing the

contacts. In our unit, placing our transceiver close by permits us to hear the 24th harmonic of the 6 MHz signal on the rig. Once you have checked the signal in the transmit mode, repeat the check in the receive mode. It is possible to hear the 26th harmonic of the 6 MHz signal, for instance, on your rig by setting the frequency switches in the right position. If you set the switches to receive on 146.335 MHz, the 6 MHz synthesizer outputs a signal at 5.6514583 MHz (146.335, minus 10.7, all divided by 24). The 26th harmonic of this falls near 146.94 and can be heard.

Once the unit is putting out a fairly clean signal on 6 MHz, you must interface it with your transceiver. This is done by using International Crystal PAX-1 rf power amplifier modules for doubling and tripling. If your synthesizer outputs on the frequency you need for your rig, then you should still use a PAX-1 module as a straight-through amplifier for buffering the output signal. This also puts a tuned circuit in the line, and changes the square wave output of the switched buffer amplifier into a reasonably good sine wave. This points up the fact that it doesn't pay to build a 12-MHz synthesizer to provide a 12 MHz output, since either

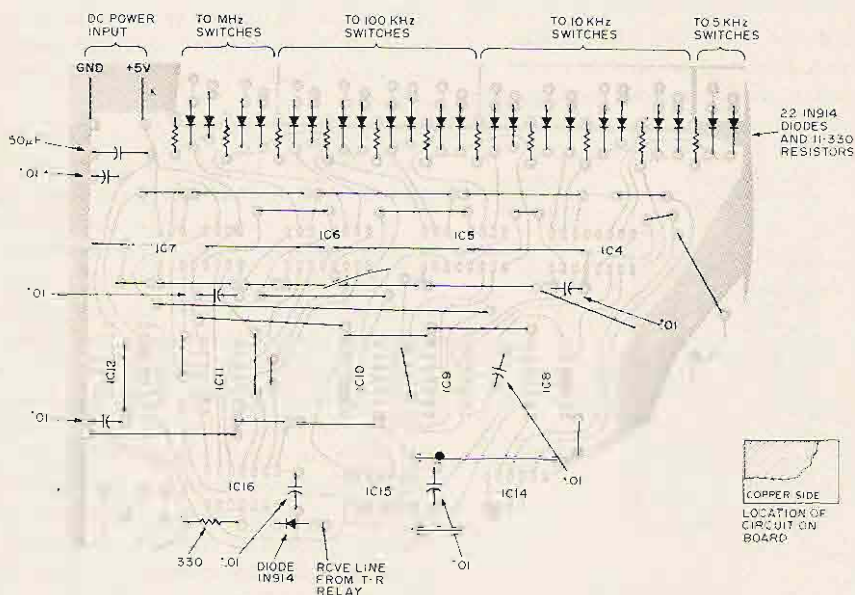

Fig. 19. Programmable divider. **Notes:** 1. See Fig. 8 for diagram. 2. Capacitors marked \* are bypass capacitors not shown on diagrams. 3. Note the jumpers running under IC4, 5, 6, 7, and 12.

## UPDATED PARTS LIST

The parts list in PART I has been closed to those  
who do not know the correct decoding sequence

4	SN7400N	TTL Quad two-input <i>nand</i> gates	1		1.7-14.1 pF air variable capacitor
3	SN7490N	TTL decade counters	2	33 pF	(Johnson 189-505-5)
1	SN7492N	TTL Divide by 12 counter	1	.001	NPO disk capacitors
1	SN7492N	TTL Divide by 12 (8 MHz output only)	1	0.1	disk capacitor
			18	0.01	disk capacitor
1	SN7493N	TTL Binary counter (6 and 12 MHz outputs only)	2	100 pF	disk capacitor
			1	2000 $\mu$ F	disk capacitor
4	SN74192N	TTL programmable up-down decade counters	1	1 $\mu$ F	15Vdc electrolytic
			3	250 $\mu$ F	15 Vdc electrolytic
1	SN7473N	TTL dual J-K flip-flop	2	100 $\mu$ F	15 Vdc electrolytic
1	SN7474N	TTL Type D flip-flop	3	30 $\mu$ F	15 Vdc electrolytic
2	SN7404N	TTL hex inverters	1	10 $\mu$ F	15 Vdc electrolytic
1	SN7430N	TTL eight-input <i>nand</i> gate	1	47 $\Omega$	15 Vdc electrolytic
2	SN7410N	TTL triple 3-input <i>nand</i> gate	1	68 $\Omega$	1W resistor 10%
1	LM309	5V regulator, 250 mA. (may be replaced by an LM309K if you mount it off the board)	4	220 $\Omega$	1/2W resistor 10%
			1	1800	1/4W resistor
			1	560	"
1	LM309K	5V regular, 1 amp., plus finned heatsink.	4	1K	"
			1	1 meg	"
1	MC1648P	MECL oscillator	1	12K	"
1	40673	RCA dual-gate-protected FET transistor	1	27K	"
			3	10K	"
1	MFE3002	Motorola enhancemnt N-channel FET transistor (caution - don't remove clip on wires.)	1	1.5K	"
			2	4.7K	"
			2	2.2K	"
6	2N706	NPN fast switching transistors, or equiv. (sil.)	1	15K	"
			1	470	"
1	2N5771	PNP fast switching transistor, or equiv. (sil.)	2	100K	"
			14	330	"
1	HEP52	PNP transistor or equiv. (sil.)			
1	2N3055	(or TIP3055) NPN silicon power transistor (or equiv.)	1	7"x9"	p.c. board
			300		MOLEX Soldercon pins, used for IC sockets
1		12-volt 10-watt zener diode			
7	1N4001	silicon diodes (1 amp, 50 PIV) (Do not substitute for the two paralleled ones in the VCO unless you know what you are doing.)	1-4	PAX-1	International Crystal power amplifiers, one for each doubler or tripler
			1-4	33K	1/2 resistors, one for each PAX-1 used
23	1N914	silicon switching diodes (or equiv.)			
1		LED indicator diode - red (LOCK light) (optional)			Miscellaneous
1		12VDC 10 mA SPDT relay (Sigma 65F1A-12dc or Calectro D1-967)			Chassis, case, power switch, connectors, coax, #32 enamel wire for coil, knobs, power supply providing 12V at 750 mA (or auto or motorcycle battery) - must be well filtered.
2		SPDT toggle switches (CHANNEL SELECT)			
2		SP3T rotary switches (MHz SELECT)			
4		3P10T rotary switches (100 kHz and 10 kHz)			
2		SPDT rotary switches (0.5 kHz)			
1		AT-cut 10 MHz series-resonant HC-18/U crystal			
1		Coil form, 7/32" dia., 15/32" long, ferrite slug (Calectro or equiv) (Coil is 3-6 $\mu$ Hy, adj.)			

### Notes

Printed circuit board layouts are available from the author (send SASE); etched boards and parts kits are available from Circuit Specialists, Box 3047, Scottsdale, Arizona, 85257. Contact them directly for information.

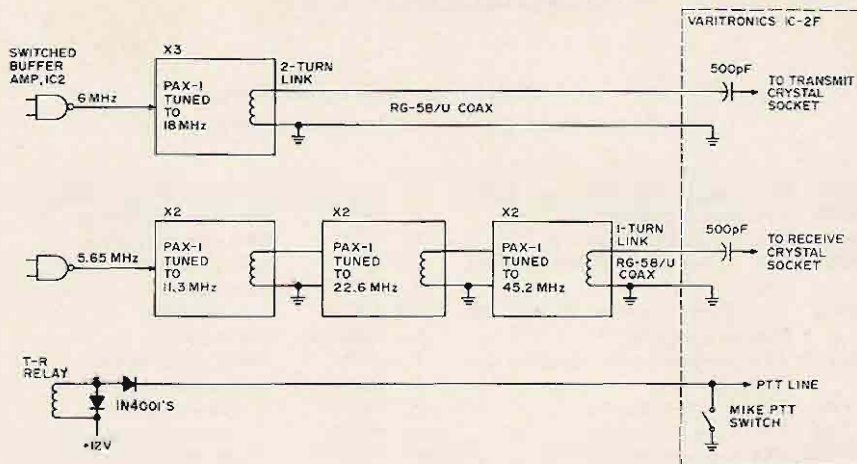

Fig. 20. Interfacing between the synthesizer and our Varitronics IC-2F.

way you will need a PAX-1 module tuned to 12 MHz; you might as well follow our 6 MHz design as is, and use the PAX-1 as a doubler.

Since the PAX-1 tuned circuit is fairly sharp, you will need separate multipliers for transmit and receive, since the output frequencies in the two modes differ by about 10%. Figure 20 shows the interfacing between our transceiver, the Varitronics IC-2F, and the synthesizer. The output links were the same as those recommended by International Crystal for the coil/capacitor combination used in the final tuned circuit. We measured the amount of drive required by the transceiver at about 1 to 1.5V peak-to-peak, which was easily provided by the small links. RF connections between the synthesizer and the transceiver were made by 52Ω coax.

There are probably dozens of other hints we could give if only we could think of them at the moment. We have found the synthesizer an exciting project since there is so little factual information in other magazines and books on the subject — and a lot of manufacturers' application notes have turned out to be misleading and wrong. We have spent literally hundreds of hours tracking down leads, doing calculations, and trying first one circuit and then another. We'll be happy to answer any questions or solve any problems you may have if you specify the question or problem exactly, and

enclose a SASE. But we think you will enjoy building your synthesizer — at the time of writing, at least, this is something you can't go out and buy — and that's the best kind of project to build.

...K2OAW

*Author's note: When building the synthesizer, remember that the VCO has all the problems of a two-meter VFO. It is just as prone to drift off frequency under shock or mechanical stress. While the phase-locked loop will bring it back on frequency, that takes about ¼ second. In our prototype we found that, under mobile operation on bumpy roads in a small, bouncy foreign car, the VCO would wander back and forth. For this reason it is important to build the VCO stage as rigidly as possible, using all the techniques you would use for a mobile VFO. For mobile use, probably the best trick is to carefully cut off the VCO section from the main board with a coping saw or nibbling tool, and carefully mount it in a small minibox reinforced with extra washers or a small metal plate under the mounting screws, trying to keep the printed circuit board from bending under shock. This type of mounting should greatly improve the situation, since keeping the VCO on the main board lets any vibration from the large board, flexing under the weight of quite a few parts, to be transmitted over to the VCO.*



## HENRY 3K-A



exclusive  
export  
agent  
for  
*signal/one*

Cool and Easy Max. Legal Power ★ SSB, CW, RTTY or SSTV through commercial ratings ★ 3.5 to 30 MHz ★ Continuous duty ★ Silver plated Pi-L plate tank ★ DC relays ★ ALC ★ Built in SWR bridge ★ Output power 2 KW min. in commercial service ★ THE linear for THE CX-7A ★ \$995

## *signal/one* CX-7A

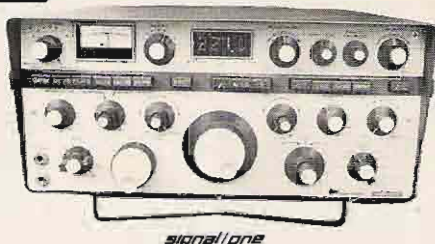

- ★ 160-10 Meters ★ 300 Watts ★
- ★ Transceive or split frequency with two built in VFOs ★ CW keyer built in ★
- ★ IF shift - new patented QRM remover ★
- ★ IF noise blanker ★ Digital nixie frequency readout ★ superb computer grade construction by CMI
- ★ AFSK keyer ★ adjustable output power ★ broadband tuning ★ output wattmeter and reflected power meter ★ \$2395

AMATEUR-WHOLESALE ELECTRONICS  
8817 S.W. 129 Terrace-Miami, FL 33156

YOU will never know how little it costs to own THE incomparable CX-7A or Alpha 77A until YOU write or phone us and let us know the trade in deal YOU WANT. ★ We usually say yes! NO ONE ANYWHERE BEATS OUR DEAL ★



Telephone-days (305) 233-3631 - nights and weekends call (305) 666-1347 Use your Master Charge card

	REG.	OUR PRICE			
AMECO					
TX-62 w/VFO - 621, Dow Relay, like new	175.00	115.00			
BIRD					
43 Wattmeters (new) limited quantity		90.00			
CLEGG					
Interceptor rcvr w/All Bander Hf-tuner (80-2 meters) like new	304.00	189.00			
COLLINS					
KWM-2, NB, 516F-2 AC	895.00	795.00			
75S3-B, late, new cond. in carton	549.00	489.00			
F455 FA 1.5 Kc filter for 75S3-B	61.00	30.00			
F455 FA 3.1 Kc filter for 75S3-B	50.00	25.00			
30L-1 linear	369.00	325.00			
MP-1 DC ps	119.00	89.00			
351-D2 mount	125.00	49.00			
KWS-1	595.00	450.00			
DRAKE					
SPR-4, amateur xtal pack, 1 mo. new, in carton	399.00	329.00			
T4XB, w/AC-4, like new	449.00	389.00			
R4B, new cond.	345.00	319.00			
GALAXY					
FM-210/wPA-210 35-60 watt amplifier (new) and 34, 64, 94T & 76, 64, 94, R xtals, Like new cond.	169.00	129.00			
GONSET					
6m Comm IV	149.00	89.00			
HALLICRAFTERS					
HA-5 VFO	49.00	39.00			
HAMMARLUND					
HQ-110C (working as is)	129.00	79.00			
HEATH					
IO-18 5 mc Lab scope, new cond.	119.00	79.00			
HW-10 Shawnee 6 m Am, CW, VFO, xceiver	119.00	79.00			
QF-1 "Q" mult.		10.00			
Warrior Linear	149.00	89.00			
SB-200 Linear	219.00	189.00			
SB-630 console (new)	89.95	69.00			
HW-18-3 160 meter xceiver w/HP-23A ps and HA-5 VFO	189.00	139.00			
SB-220 linear, like new, professionally wired		339.00			
HW-100 xceiver/wHP-23 AC ps, like new	299.00	269.00			
SB-303 rcvr. w/AM & CW acc. filters, new cond. professionally wired	349.00	299.00			
IOW-102 5mc, solid state scope, factory wired, like new	189.95	129.00			
NATIONAL					
NCX-5 MK-2 w/NCX-A AC ps	455.00	395.00			
ROBOT					
Model 70 monitor, 2 mos new in carton		279.00			
Model 80 camera w/F1.4 lens, never used, 2 mos new, in carton		289.00			
SWAN					
VX-2 (new) VOX	35.00	25.00			
SIGNAL ONE					
CX7-A, 2 mos. new		1,395.00			
WILSON					
M-510 5 el. 10 meter beam (new)	89.95	65.00			

Special prices all new and used equipment. Please see our other ads in this issue. Write for quote. IN STOCK! SWAN (not Swan Electronics) MULTI-DRIVE BAND PASS YAGI ANTENNAS for 2 meters, 6, 3/4, etc. These are the antennas that win every West coast antenna gain contest going away. Write for literature.

# ERRATUS MAXIMUS

# K20AW Counter

The Parts Placement Diagrams were not quite complete for *A Modern Frequency Counter* in the September issue. Here are the corrections. Also, the fifth line from the bottom on page 95 should read "... 220Ω resistors."

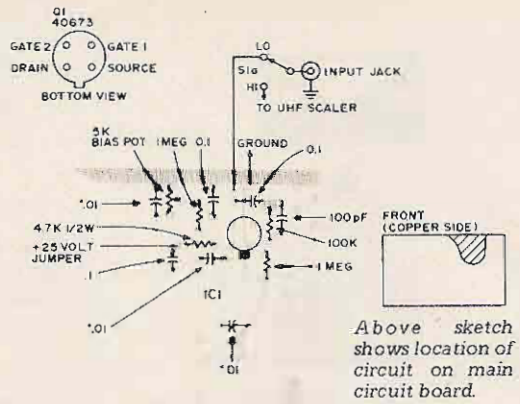

Fig. 20, page 91.



Fig. 25, page 95. Qu = Q4.

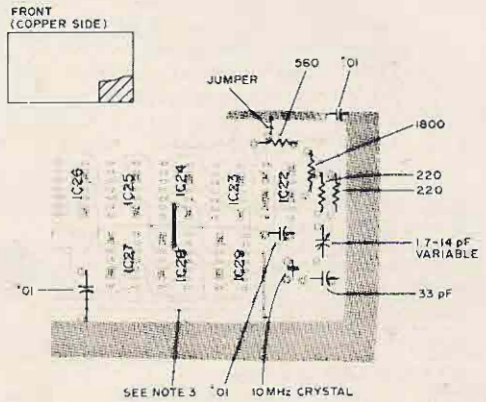

Fig. 24, page 94.

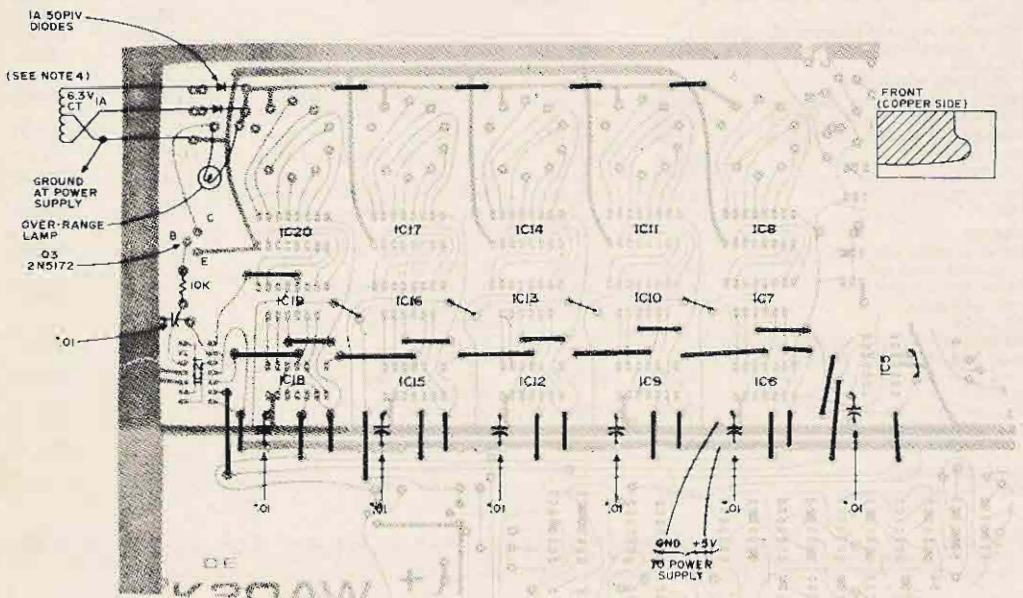

Fig. 23, page 93.

# GRAVITY ABECEDARIUM

**M**an's concern with the concept of gravity dates back to the early Greek astronomers and philosophers, particularly Ptolemy and Aristotle. The generally accepted view was that "The natural motion of all material objects was toward the center of the earth, and only Fire, which had something divine in it, defied the rule."<sup>1</sup> More recently the idea of using gravity as a possible basis for communication, especially for outer space operations, has been mentioned by Wayne Green and others. The purpose here is to provide some background material on gravity with the belief that radio amateurs, being of a special breed, may generate some fresh ideas on the subject which after more than 2000 years of speculation is still wide open for experimentation and exploration.

For many hundreds of years the propositions of Aristotle (384–322 B.C.) held a close grip on the minds of men. Thus it was with his concept of gravity: "A thing, then, which has the one kind of matter is light and always moves upward, while a thing which has the opposite matter is heavy and always moves downward."<sup>2</sup> Various things could contain different mixtures of the heavy stuff and the light stuff and so possess varying degrees of motion.

The Aristotelian view was rudely shaken by Galileo Galilei (1564–1642) who discovered the fundamental laws of falling bodies during his tenure at the University of Pisa, 1589–1592, although his work was not published for about 200 years later. Galileo demonstrated experimentally that all bodies fall with precisely the same acceleration and was able to show the mathematical relationship between the time of fall and the distance traversed.

Next on the scene came Isaac Newton (1642–1727) who was born in December of the same year Galileo died. One cannot know whether to credit the traditional fall-

ing apple or the great plague of London during 1665–66 for Newton's grappling with the problem of gravity; but the plague *did* force Newton to retire from London to his home in Lincolnshire and it was while puttering around the manor that he developed his now historic laws of motion and the principle of universal gravity.

Newton's principle of universal gravity became a cornerstone in physical theory: Every particle of matter in the universe attracts every other particle with a gravitational force; the magnitude of the gravitational force between two particles is proportional to the square of the distance between them; the gravitational force of attraction between two particles acts along the line joining the two particles. Expressed mathematically,

$$f = G \frac{m_1 m_2}{d^2}$$

where  $m_1$  and  $m_2$  are the respective masses of the particles,  $d$  the distance between them, and  $G$  is a fixed constant of proportionality called the gravitation constant.

$$G = \frac{6.673 \times 10^{-8} \text{ dyne cm}^2}{\text{g}^2}$$

and is indicative of the basically weak nature of gravitational forces.<sup>3</sup> Using the mass of the earth as  $5.975 \times 10^{27}$  grams and  $d$  equal to the radius of the earth at the equator, the force on a mass of one gram is found to be 978.049 dynes (1 dyne =  $1.02 \times 10^{-3}$  gram force).

When the masses of the particles or bodies are great, the resultant gravitational forces are large, but for small masses the gravitational forces are exceedingly weak. Thus two masses each of one pound, separated by a distance of one foot would show a gravitational force of attraction on only  $3.3 \times 10^{-11}$  pounds force, a very minute force indeed.

# PERFORMANCE PLUS!

## MOBILE 5/8 VERTICAL

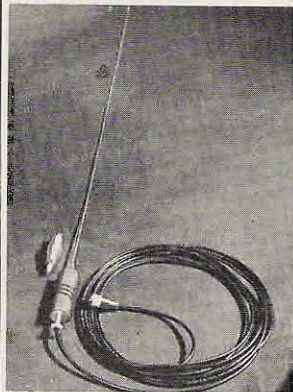

Model M

### FEATURES

- 3.0 DB Gain Over 1/4 Wave G.P.
- 1/8" Tempered Stainless Whip
- Rugged Fiberglass Coil
- Whip Unscrews to Accept Spring (\$3.25 Extra)
- Includes Exclusive "Adjustable Head-space" Mount With 20 Ft. Coax.
- Antenna at D.C. Grd.

## UHF-VHF COMMUNICATIONS ANTENNAS

### BASE & REPEATER

#### FULL 7 ELEMENT COLINEAR

### FEATURES

- 6.5 DB Gain Over 1/4 Wave Ground Plane
- Aluminum & Stainless Construction
- Mounting & Radials Included
- Antenna at D.C. Ground

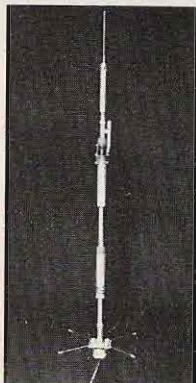

Model B

**Antenna Engineering Company, Inc.**

P. O. Box 19449  
Indianapolis, Ind. 46219

FREQ.	MODEL #	PRICE EA.
140-160 MHZ	M150	\$16.95
220-250 MHZ	M220	\$16.45
430-470 MHZ	M450	\$15.95
(Add \$2.00 for Comm'l. Freq.)		
140-160 MHZ	B150	\$39.95
220-250 MHZ	B220	\$35.95
430-470 MHZ	B450	\$29.95
(All Prices FOB Indianapolis)		

### NOTE —

Built for Amateur & Commercial Use.

- See Your Local Dealer or Order Direct.
- DEALERS WRITE — We Need You.

As revolutionary as Newton's concepts were, even more amazing was his ability to generalize on his gravity theory and to apply these same earth-derived principles to the astronomical system extending for vast millions of miles. Using the excellent observational data gathered by the Danish astronomer Tycho Brahe and the German Johannes Kepler, Newton was able to show that his principle of universal gravity did in fact explain beautifully the complex motions of the planets that had baffled men for centuries. It is also interesting to note that modern experiments have verified Newton's principles to an experimental accuracy of one part in 100 billion. But as to the nature of cause of the gravitational force, Newton was unwilling to make any conjecture: "But hitherto I have not been able to discover the cause of those properties of gravity from phenomena, and I frame no hypothesis . . . And to us it is enough that gravity does really exist, and acts according to the laws which we have explained . . ."4

One of the first to speculate on the nature of gravity was Michael Faraday

(1791-1867) better known to us for his work in the fields with which we are familiar. He wrote in 1849, "Gravity — surely this force must be capable of an experimental relation to electricity and magnetism, so as to build it up with them in reciprocal action and equivalent effect."<sup>5</sup> Faraday conducted numerous ingenious experiments attempting to establish a relationship between gravity and electromagnetic forces, but with negative results. Time may well justify his conviction that despite the failure of his experiments, such a relationship does exist.

In any event, Faraday's work on the transmission of electric and magnetic forces provided the basis for James C. Maxwell's mathematical theory of the electromagnetic field in 1865 and elaborated in 1873 with his great work, *Treatise on Electricity and Magnetism*. And in turn, Maxwell's theory of the electromagnetic field eventually provided the take-off point for the next major joust with gravity when the genius of Einstein became manifest.

Einstein's concept of gravity developed



first from his special theory of relativity and subsequently from his general theory of relativity. In 1918 Einstein obtained solutions of his basic equation of general relativity which predicted the existence of gravitational waves propagating through space with the velocity of light. The strength of these predicted waves is exceedingly weak. Calculations showed that the earth in its motion around the sun would radiate an equivalent power of only 0.001 watt. The task of devising methods for the detection of gravitational waves of this magnitude is obviously formidable.

It will be recalled that although the gravitational force is quite small for everyday, garden-variety masses, the force becomes very substantial when earth-size masses and larger are considered. In like manner, although the gravitational radiation from the earth is indeed minute, when masses such as those of the white dwarf stars are considered, intense gravitational radiation would result. It can be shown that for a double star system where each star has a mass equal to that of the sun and are separated by one astronomical unit (earth-sun distance) the gravitation radiation is negligible. If, however, the mass of the sun is squeezed down to about the size of the earth and if two such compacted white dwarf stars are only 10,000 kilometers apart, the resultant period of revolution would be reduced to less than a minute and intense gravitational radiation of energy would occur. Such a binary star system would have a gravitational radiation some 10,000 times greater than the electromagnetic radiation of the sun!

It would seem probable, therefore, that the detection of gravity waves would be most likely from the radiation of multiple star systems involving very dense bodies such as the white dwarf stars. Such systems may have radiation frequencies from 1/10 to 1/100 Hz although the astronomically observed systems have periods ranging from a few hours to years. It is also possible that gravitational radiation could occur from the gravitational collapse of star systems, from plasma, quasars, pulsars, and other sources yet unknown. Such radiation must be labeled as possible, but highly conjectural.

So it would appear that the most probable gravitational radiation of adequate intensity to permit detection would fall in the 1/10 to 1/100 Hz range and originate in the multiple star systems. Although Professor Weber of the University of Maryland has reported the detection of gravity waves<sup>6</sup> there remains considerable doubt as to the existence of such waves.

Gravity waves, from the work of Einstein, have the same velocity of propagation as light waves. Yet gravitation appears to act instantaneously — with infinite velocity. If the velocity was finite, the gravitational forces on moving bodies would depend not only on their physical relationship to each other, but also on their relative velocities and the time required for the gravitational force to operate. Thus a finite velocity of propagation of gravitational force would require corrections in the calculation of planetary position based upon Newton's laws and instantaneous action.

But no such corrections are required! Could it be that the corrections are so small as to be undetectable within the limits of our observational error? Laplace calculated the minimum velocity of propagation that would allow such a correction to pass undetected within the experimental error of astronomical observation and concluded that the velocity of propagation of gravity would have to be greater than the velocity of light by at least a million times.<sup>7</sup>

And so there appears to be a conflict between the concept of gravitational waves propagating with the velocity of light, and the Newtonian instant-action theory verified experimentally by observational astronomy.

Now the prediction of the existence of gravitational waves with a velocity equal to that of light is fathered by Einstein's theory of relativity. Because of this intimate relationship, experimental verifications of relativity build confidence in and acceptance of the finite-velocity gravitational-wave concept.

One well-known instance where the application of Newton's universal gravity provided predictions on planetary positions that were not precisely verified by observation pertained to the orbit of the planet Mercury. There was always a slight but nagging varia-

tion between the predicted and observed position... over and above the observational errors. Using the relativity theory, however, predictions were made of the value of the "abnormal" variations of Mercury's position and these predictions proved to be almost precisely equal to the observed values.

Relativity theory also predicted that atomic oscillators would "slow down" and hence oscillate at a lower frequency when under intense gravitational forces; the light emitted from an oscillator under these conditions would be shifted toward the red end of the spectrum. The very dense companion star of Sirius provided the intense gravitational forces and measurements made showed that a "red shift" did occur and that the amount of the red shift observed was in good agreement with the predicted value. On the other hand, for certain other white dwarf stars which should show large values of red shift, the measurements indicated either no shift or only slight amounts of shift.<sup>8</sup> Thus experimental verification of Einstein's predicted red shift is not conclusive as of this time. The relativity theory also predicted that a beam of light would be deflected in passage through an intense gravitational field. The existence of such bending and a fair agreement with the predicted amount has been verified by observation of the change in apparent position of a star when its beam passes close to the sun during an eclipse.

It is important to emphasize that in these experimentally verified predictions, gravitational forces were assigned a velocity equal to the velocity of light. Thus it would appear that gravity operates instantaneously when applied to slow-moving objects and moderate gravitational fields, and where rapidly moving bodies or intense gravitational fields are involved, it operates with the velocity of light.

Like Faraday, Einstein was convinced that there was a close relationship between gravity and electromagnetic phenomena. His general theory of relativity ascribed gravity to the geometric properties of space-time and his unified field theory attempted to give the electromagnetic field similar space-time derivations. To date, the unified field

theory has not met with the success of the special and general theories of relativity.

In about 1959, Dirac was able to quantize the gravitational field equations and showed that the equation of energy of gravity quanta (gravitrons) was of the same form as the equation for light quanta (photons) and equal to Planck's constant times the frequency. In the case of gravitrons, however, we may have quite some wait before being able to detect one. An atomic nucleus requires about  $10^{-12}$  second to emit a photon; the beta decay of a neutron takes about 12 minutes; the calculated time for the emission of a gravitron by a nucleus is  $10^{53}$  years!<sup>1</sup> Since the age of the universe is thought to be approximately  $10^{10}$  years, the probability of emission of a gravitron by a nucleus is negligible. Which may mean simply that the general dimensions of the atomic nucleus is not suitable for gravitron emission and that systems of more substantial size comparable to the wavelength of the gravitational radiation would be required.

And so we appear to be left with no clear-cut decision with experimental evidence on the one hand pointing to an infinite velocity of gravity propagation, and on the other hand indicating a wave system of gravitational effects propagating with the velocity of light. No doubt all of the votes are not yet counted, and continued thought and research will resolve the apparent conflict or at least provide understanding of this seeming duality of gravitational properties.

WØHLZ

#### References:

1. "Gravity" by George Gamow - Doubleday.
2. "On the Heavens" by Aristotle; Book IV, ch. 4.
3. "Handbook of Geophysics & Space Environments" - McGraw-Hill.
4. "Principia" by Newton; Book III, General Scholium.
5. Gravity" by George Gamow.
6. 73 Magazine, Oct. 1969.
7. "An Elementary Survey of Celestial Mechanics" by Y. Ryabov - Dover.
8. "Handbook of Physics" by Condon & Odishaw - McGraw-Hill; Part 6, ch. 8-14.

#### See also:

- "The Meaning of Relativity" by A. Einstein - Princeton University Press.  
"General Relativity & Gravitational Waves" by J. Weber - Interscience Publishers.  
"Relativity & Space" by Steinmetz - McGraw-Hill

the Incomparable

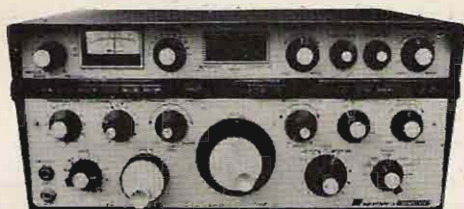

by **CX7A**  
**signal/one**

**Specifications:**

- **SENSITIVITY:** Better than 10db signal-plus-noise-to-ratio for .25 microvolts at 28 MHZ.
- **SELECTIVITY:** 2.4 KHZ @-6db, 1.8:1 (6:60db) shape factor. (16 pole crystal lattice Filters) optional: CW-300 and 400 HZ. FSK-1200 HZ.
- **CARRIER** and unwanted sideband suppression. Minimum 60db.
- **IMAGE** and **IF REJECTION:** more than 60db.
- **POWER LEVEL:** 300 to 500 watts p.e.p. continuous duty cycle.
- **POWER AMPLIFIER:** 8072 final completely broad-banded driver and final. 150 watts continuous dissipation rating.

**Features:**

- **RELIABILITY IS NOW** standard equipment. Every CX7A "burnt-in" and cycled more than 96 hours.
- **QUALITY-PLUS.** Every component is instrument grade, American-made, and individually tested.
- **ALL MODES** 10 thru 160 meters in full 1 MHZ bands with overlaps.
- **BROAD-BAND TUNING.** Instant band changes without tuning.
- **TRUE BREAK-IN** CW with T/R switching.
- **IF SHIFT** - deluxe QRM slicer.
- **PRE-IF NOISE-BLANKER** that really works.
- **RF ENVELOPE CLIPPING** - sounds like a Kw.
- **TWO VFO'S** Transceiver Plus receiver.
- **BUILT-IN:** Spotter, FSK shift, transmit offset, watt-meter, SWR meter, electronic CW Keyer.

**SIGNAL ONE** now presents the most complete line of State-of-the-Art equipment ever offered the Amateur. Available very soon from Payne Radio.

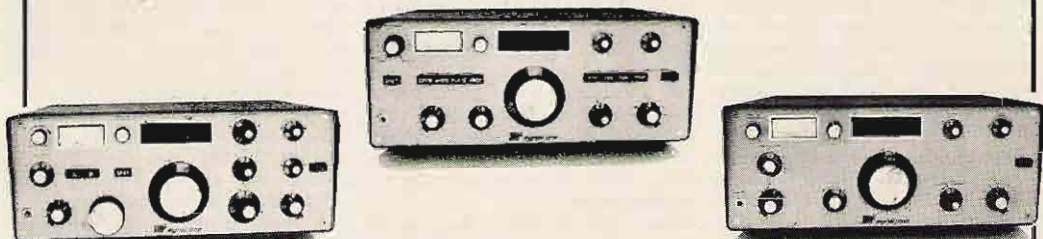

<b>CX7A - Deluxe integrated station</b> Still top of the Line - even greater quality and reliability than ever before	<b>\$2395</b>
<b>CX-10 - Integrated station</b> Single VFO, P/S-10 required, optional built-in Keyer	<b>\$1795</b>
<b>CR-1200 State-of-the-Art Receiver</b> Single VFO, I.F. Shift, blanker, high sensitivity-selectivity	<b>\$1095</b>
<b>CT-1500 State-of-the-Art transmitter</b> Single VFO, 300 watts, P/S-10 required	<b>\$1450</b>
<b>CR-1500 - Special Application Receiver</b> dual VFO's	<b>\$1650</b>
<b>PS-10 A/C</b>	<b>\$210</b>
<b>PS-10 D/C</b>	<b>\$210</b>
<b>EV-10 - External VFO for CX-10</b>	<b>\$225</b>
<b>SC-10 - Station Console</b>	<b>\$350</b>
<b>CX-2X - Two meter Transverter</b>	<b>\$460</b>

Phone/write **DON PAYNE, K4ID**, for a brochure, personalized service, and a **KING-SIZE** trade-in on any gear you have - one piece - or the whole Station. A small deposit will reserve any piece of signal/one equipment as it becomes available.

**PAYNE RADIO**

Box 525

Springfield, Tenn. 37172

Phone  
six days  
(615) 384-5573

Phone  
Nites - Sundays  
(615) 384-5643

# NEW FCC REPEATER REGS

Adopted:

By the Commission: 8/29/72

1. The Commission adopted a Notice of Proposed Rule Making in the matter of Amendment of Part 97 of the Commission's Rules concerning the licensing and operation of Repeater stations in the Amateur Radio Service on February 26, 1970, which was published in the Federal Register on March 5, 1970, (35 FR 4138). Interested parties were invited to file comments on or before May 15, 1970, and reply comments on or before June 1, 1970. The time for filing comments and reply comments was subsequently extended to June 15, 1970 and July 7, 1970, respectively.

2. The Notice proposed to specifically provide rules for the operation of amateur stations which receive and automatically repeat the radio signals of other amateur stations. Although the rules have not specifically referred to amateur repeater stations, per se, the Commission has licensed hundreds of repeater stations to operate under the rules applicable to amateur radio stations in general. We are of the opinion that this activity is in keeping with the fundamental purpose of the Amateur Radio Service expressed in the principles set forth in Section 97.1 of the Rules, particularly with respect to paragraphs 97.1(b) and (c):

“(b) Continuation and extension of the amateur's proven ability to contribute to the advancement of the radio art.

(c) Encouragement and improvement of the amateur radio service through rules which provide for advancing skills in both the communication and technical phases of the art.”

The high quality of the technical content of the comments received is evidence that the basis and purpose of this Service are being served by this amateur repeater activity.

3. Both formal and informal comments were received from numerous individuals and amateur radio organizations. Since the comments received were so numerous, it is not practicable to discuss each herein. However, every comment has been given careful consideration by the Commission. Many include statements describing the value of repeater stations to the Service and predict further technological developments and increasing benefits

if their usage is permitted to continue unhampered by the imposition of unnecessary restrictions. Generally, they heavily favor the adoption of specific rules governing the licensing and operation of repeater stations, but not necessarily in the manner proposed in the Notice.

4. The Commission finds that amateur terrestrial repeater stations are useful for increasing the reliable range of VHF and UHF (Article 2, Section III of the I.T.U. Radio Regulations defines VHF as Band 8, 30-300 MHz [Metric waves] and UHF as Band 9, 300-3000 MHz [Decimetric waves].) vehicular and hand-held mobile stations in conducting intra-community amateur radiocommunication, and for effecting emergency radiocommunication which possibly could not otherwise be conducted on the amateur bands. Again, this is in keeping with Section 97.1 of the rules:

“(a) Recognition and enhancement of the value of amateur service to the public as a voluntary non-commercial communication service, particularly with respect to providing emergency communications.”

Accordingly, we believe that rules to provide for the operation of repeater stations are desirable. It is apparent that repeater stations have become a significant part of the Service. There is no reason to expect their growing popularity to quickly diminish, nor is there reason to anticipate the innovative skills that amateur operators have demonstrated in designing and planning repeater systems to suddenly dissipate. We would prefer to have this activity continue in an orderly fashion, in a spirit of cooperation among amateur operators. Just as it was not possible to foresee the interest in repeater stations, it is similarly impossible to fully predict the eventual products of the amateurs' imaginative application of the electronic and radio arts. For this reason, the rules adopted herein are intended to introduce provisions into the rules which permit the flexibility needed in the Service, and to provide the licensing framework for accommodating future technical and operational advancements in amateur radiocommunication. Despite our efforts to

forecast future needs and provide appropriate rules, we recognize that in all probability further advancements in remote control and automatic control technology will necessitate additional amendments. We urge interested parties having information and suggestions in these areas to submit them to the Commission for consideration.

5. Beginning July 1, 1973, a separate station license will be required for every amateur repeater station regardless of when it was first licensed. Applications for new, modified or renewed repeater station licenses must meet the new requirements upon the effective date of the new rules. These stations will be identified by a call sign having the distinctive prefix WR. In order to qualify for a repeater station license, the applicant must be at least a Technician Class licensee and must submit certain data regarding the technical and operational provisions included in his proposed station. The requirements for this showing are intended to verify that the applicant has given careful consideration to the planning and design of his repeater station, addressing particular attention to the geographical area to be covered. We desire that the applicant for a repeater station license predict by analysis the approximate coverage area needed for intra-community amateur radiocommunication, using the desired mode of emission. After the repeater is licensed and in operation, the licensee should verify his assumptions of community radiocommunication requirements and his prediction of the station coverage through testing and operating experience, and make appropriate adjustments based thereon. The foregoing approach should be accomplished giving due consideration to minimizing harmful interference to other amateur radio operators in the same or nearby communities desiring to use the same frequency, or frequency bands.

6. Upon reviewing the comments, and in consideration of the increasing complexity of systems described in applications received by the Commission for remotely controlled repeater stations, we recognize the need emerging in the Service for a licensing

Don't be misled by:  
**"WHAT YOU SEE IS WHAT YOU GET,"**

when buying 2 meter FM equipment (or any other Ham gear, for that matter).

**SWAN ELECTRONICS**  
gives you much more  
—a lot of which you can't see!

INVESTIGATE BEFORE YOU BUY! Compare Swan's FM-1210A for, example, to other 2 meter FM transceivers with a rated RF output of 10 watts. The FM-1210A gives you:

- 144 channel combinations through independent switching of 12 transmit and 12 receive frequencies from 144 to 148 MHz.
- Eight crystals (not just 3) . . . TRANSMIT: 146.22, 146.34, 146.76 & 146.94 MHz; RECEIVE: 146.28, 146.76, 146.88 & 146.94 MHz.
- A 16.9 MHz crystal lattice filter for adjacent channel rejection of -55 db providing greatly improved selectivity.
- A fully solid state transmitter with automatic protection of the output transistor from improper-load damage.



- A crystal oven for superior stability of  $\pm .001\%$  from  $-30^{\circ}$  to  $+50^{\circ}\text{C}$ . (Who else gives you this for 2 meters?)
- A squelch threshold of less than 0.3 mv with 2 watts of clear reception at less than 10% distortion.

**PLUS:** A heavy-duty pedestal type AC power supply, dynamic microphone, antenna connector plug, spare fuses and lamps, DC power cord, and mobile mounting bracket.

FM-1210A Transceiver . . . \$359.95



2 Meter FM Economy is available with the SWAN FM-2X . . . everything you need for AC or DC operation is included at one low price, just hook up your antenna and you're on the air. Frequency coverage extends from 144 to 148 MHz over 12 channels. Crystals are installed for Channel 1 to transmit and receive on 146.94 MHz; Channel 2 to transmit on 146.34 and receive on 146.94 MHz; Channel 3 to transmit on 146.34 and receive on 146.76 MHz. 10 watt RF output. Microphone, AC power supply, DC power cord and mobile mounting bracket furnished.

FM-2X Transceiver . . . \$299.95



When reaching out for long range contacts, Swan's VHF-150 Linear Amplifier is a perfect companion to the FM-1210A or the FM-2X. Operates class "C" at 150 watts DC input on CW or FM with a frequency range of 143 to 149 MHz. A flip of a switch gives you 180 watts of P.E.P. when working SSB class "B". Its self-contained AC power supply is designed for continuous operation, and a DC converter is available for mobile installations.

VHF-150 Linear Amplifier . . . \$299.95

14C DC Converter . . . \$ 69.95

USE YOUR SWAN REVOLVING CREDIT SERVICE ACCOUNT AT 10% DOWN

 **SWAN**  
ELECTRONICS  
*A subsidiary of Cubic Corporation*

305 Airport Road • Oceanside, CA 92054 • Phone (714) 757-7525

structure that facilitates combining several amateur radio stations into a radiocommunication system. It has not been uncommon to receive an application for a proposed "station" having fifty or more remote control points and a half-dozen remote receiving sites which involve a multiplicity of transmitters and frequencies. This is clearly a complex system comprised of special purpose stations, each performing one or more functions in a network. A thorough review of this matter has been undertaken, and the resulting Commission determination is reflected in the amended rules. The review indicated the difficulty in providing operating and licensing rules for the Service without taking into account the functions performed by various types of specialized amateur radio stations. Accordingly, we are adopting a structure of definitions and station privileges related to the major functions performed by such specialized stations. Under this concept, and with the one exception of repeater stations, a single station may be licensed for one or more special purpose privileges according to the functions to be performed by that station. This permits a licensee to combine several stations into a system. We feel this "building block" approach is consistent with the increasing complexity of amateur system networks, will provide the necessary flexibility, and at the same time, retain the means for the Commission to exercise its requisite obligations.

7. Every amateur radio operator is affected by the adoption of this licensing structure to some degree. For example, an amateur's license which now specifies the location of his station and indicates his operator privileges, i.e., Technician, General, etc., will also include the privileges authorized for his station. As a minimum, the station privilege would be "primary station." Every operator must have a primary station. This is necessary so that every amateur will have a call sign with which he may identify his radiocommunication, if required. Normally, the primary station license will be issued for the amateur's home address. However, those amateurs not having a permanent address within the United States, its territories and possessions should furnish the address of a relative or friend who will receive and forward mail to the licensee. Every licensee will be accountable for mail sent to the address of record given for a station license. Therefore, every amateur must have a license for a primary station, and this license will also authorize his operating privileges. The license may also contain additional station privileges for the same station. Licensees other than those

desiring remote control or repeater station privileges will have their licenses updated upon renewal.

8. The various kinds of additional station privileges, some of which may be combined with a primary station license, are: repeater station, control station, auxiliary link station and secondary station. Repeater station privileges may not be combined with another station license because of their distinctive call sign assignment. A control station privilege authorizes the station to exercise control over a remotely controlled station. An auxiliary link station authorizes a station to relay a radio signal point-to-point within the same system network. Either or both may be combined with a primary station for the same location. A secondary station license is for a station at a different location, such as a vacation home, and is obviously a license issued in addition to the primary license. These various privileges may be added to an existing license by modification, or at renewal, upon submittal of the appropriate information.

9. The rules for remote control proposed in the Notice have been relaxed in three major areas. First, the control operator may be any qualified amateur designated by the licensee. Secondly, provisions are adopted for any repeater station authorized to be operated by radio remote control to also be so operated from a portable or mobile station, provided all of the required monitoring and control functions can be satisfactorily performed, from either the authorized control point or from the mobile or portable control station. This will enable a licensee to make use of his own repeater station while he is operating mobile or portable. Thirdly, since the comments frequently and persuasively mention terrain and other considerations which make necessary "multiple-hop" control links, we are deleting the proposed limit to a direct (single-hop) control link and providing for auxiliary link stations, which may be authorized for this and also for other point-to-point intermediate relay applications, such as a relay between a remote receiving site and a repeater station.

10. We have considered the advisability of adopting rules for control links based upon current amateur control providing for auxiliary link stations, would allow greater latitude. We find the latter approach to be more flexible and appropriate to the amateur service, but it requires a showing of the design and operational features of an applicant's proposed control system network. The applicant must submit a diagram showing the interrelationship of all of the stations and

control points in the system network configuration. The station license will list the control points and the control stations authorized to operate the remotely controlled station.

11. In the past, we have permitted a very broad interpretation of the term "wire" remote control as applied to Part 97 of the rules, including the use of commercial telephone lines and command signal techniques. This has exempted stations employing relatively sophisticated and sometimes questionable approaches in the design and operation of wire remote control links, from submitting information on their proposed station with their applications. Upon the release of this Report and Order, only stations having the most elementary form of interconnection comprised of electrical conductors directly between the transmitter and the control devices, and having all of the elements of the station located on the same premises, will be considered as not constituting remote control. Applicants proposing to use any other form of remote control must submit the information required by Section 97.41. Stations other than repeater stations now authorized to be operated by wire remote control and not in compliance with the licensing requirements of the amended rules may continue to operate under their present authorization until the expiration date of their current station license.

12. Restriction of repeater operation to specific portions of the amateur bands above 50 MHz has not been adopted as proposed in the Notice. Approximately one-half of the Amateur VHF bands and 8 MHz of the 420 MHz band is being authorized for repeater usage. The Commission is persuaded by the comments and by observation that regional and national frequency planning and coordination by amateur radio operators themselves can result in the best spectrum utilization appropriate to the service. However, we are prepared to reverse this decision should plans and their implementation not occur within a reasonable period. To solve the problem presented by Technician Class privileges in only one-half of the 146-148 MHz sub-band authorized for repeater operation, the Rules are amended to permit Technician Class licensees to also operate in the entire 145 to 148 MHz segment.

13. We are of the opinion that terrestrial repeater stations should be utilized only for intra-community radiocommunication and should not be used, directly or indirectly, as a means to circumvent the rules regarding authorized amateur operator privileges for the different classes. Repeating a lower class operator's radio signal from one frequency band into

# CONSIDERABLY SPECIAL CONSIDERING THE SPECS

## 2 METER FM TRANSCEIVER

Model SRC-146A



Frequency . . . . . 143-149 MHz  
(2MHz spread)  
Number of channels . . . . . 5  
Supplied with 146.94 simplex,  
146.34 / .94 (same plug in  
crystals as SR-C826M)  
R.F. output . . . . . 2 watt minimum  
Sensitivity . . . . . better than 0.4  
uv / 20 DB Q.S.  
Audio output . . . . . 500 mw  
Meter . . . . . monitors battery voltage on  
Tx, S Meter on Rx  
Current drain . . . . . 620 ma Tx,  
15 ma Rx standby  
Size . . . . . 8 $\frac{3}{8}$ " high x 3" wide x 1 $\frac{1}{8}$ " deep  
Weight . . . . . 24 oz., less batteries

Options: *Private channel (CTCSS), external mic, or mic-speaker,  
stubby flexible antenna, desk top charger, leather case.*

**\$289<sup>00</sup>**  
Suggested  
Amateur  
Net Price

## NEW 2 METER REPEATER

SCA-RPT-1

All solid state, 2M, 10W, FM  
REPEATER. Built-in C.O.R., adjustable  
carrier delay and time out timer.



*Write for complete specifications and cost.*



**Standard**  
COMMUNICATIONS CORP.

213/775-6284 · 639 North Marine Avenue, Wilmington, California 90744

another band having higher operator privilege requirements is unfair to those operators who have properly qualified for the higher requirements. For these reasons, we are persuaded to adopt the provisions of the Notice prohibiting multiband, crossband and linked repeater operation even where operator privileges would permit it. Similarly it is not in the interest of spectrum conservation to utilize crossband and multiband operation. Many comments argued against the proposed rule to prohibit linking repeaters. In weighing these arguments against the desire to conserve spectrum and to encourage the use of amateur terrestrial repeaters for intra-community coverage, we find that a majority of situations can be accommodated with a maximum of two linked repeaters. Therefore, two repeaters may be linked together, and under certain circumstances as provided for in Section 97.89(c), more than two.

14. As pointed out by a large number of respondents, the changes proposed by the Notice for defining the maximum authorized transmitter power for an amateur station would affect a much broader segment of the Service than those pursuing an interest in repeaters. For that reason, action on this topic is postponed with the intention of making it the subject of a future rule-making proceeding as recommended in the comments submitted by the American Radio Relay League and others.

15. The proposed 600 watt input power limit on repeater transmitters is not being adopted herein as a means of regulating a reasonably balanced receive-to-transmit repeater coverage. A decision is made to incorporate into Section 97.67 the provisions of Section 324 of the Communications Act of 1934, as amended, to emphasize its particular applicability to amateur terrestrial repeater stations. We conclude that a repeater station which transmits a signal at many times the range over which it is capable of receiving would be in violation of the Act. In reviewing several frequency plans proposed for the VHF bands, we observe that a typical plan would allocate about one to two dozen frequency channel pairs per megahertz. With limited channels available, the possibility of interference between repeater stations in adjacent communities desired to use the same frequencies must be considered. For this reason, limits are established for effective radiated power from a repeater station antenna, based upon the power normally required for reception by a typical vehicular mobile station over a nominal community coverage area. A major consideration in establishing these limits is the en-

couragement of the practice of achieving the desired coverage through the use of a low power transmitter in conjunction with an antenna located at an optimum height above average terrain. The operation of a control station or an auxiliary link station which does not use directional antennas in conjunction with low transmitter power to minimize the possibility of harmful interference is not considered good amateur practice, and will be carefully evaluated by the Commission if proposed.

16. As stated in the Notice, Section 210(b) of the Communications Act requires, in effect, that the licensee of a repeater station maintain supervision and control of both the technical and operational performance of his station. Although several of the comments addressed this topic, as do RM-1542 and RM-1725 filed by Mr. Ken W. Sessions, the Commission is not ready to make a determination of rules for automatically controlled stations in the Service. We do not consider access to a repeater station controlled by the users via coded signals alone on the receiving frequency to be active supervisory control by the control operator. Such coded signals are permissible for secondary control but are not required.

17. Comments were received in response to the additions to Section 97.87 proposed in the Notice, correctly noting that the implications extend beyond that of properly identifying a repeater station. All stations would be affected. However, the proposal reflected the policy position then held by the Commission, and the comments prompt a review of the matter. The amended section is a means to accomplish two partially conflicting purposes: rapid identification of a station causing interference to another service, and identification of the operator in order to determine his class of license for verification of his privilege to operate within a restricted sub-band. Under the amended rules, a visiting operator must use the call sign of the station he is operating. Should his class of operator privilege exceed that of the station license, and should he desire to operate the section within the sub-bands available to him but not to the station license, he must identify with both the station call sign and his own. Provision for automatic identification of a repeater station by telephony as well as telegraphy is adopted. The requirement for repeater identification is designed to provide assurance that a short single transmission or a short exchange of transmissions will include at least one repeater station call sign transmission.

18. Received comments highly favor simplified logging. The section

has been restructured and requires only a minimum of information to be recorded in written form. The proposed requirement for recording all installation, service or maintenance work in the station log is deleted. Although the use of such a routine is encouraged, we find that since the station licensee is responsible for the technical performance of the station, the procedure to be employed to meet this obligation is a matter of personal choice.

19. A new requirement is added for the identification of the antenna and/or transmission line associated with a remotely controlled transmitter in order to facilitate contacting the station licensee should the need arise — a process which has been time consuming in some instances where the radiating antenna of a station in violation has been identified by radio location techniques. To minimize the prospect of interference to radiocommunication already in progress on a given frequency, the rules to require continuous monitoring of a remotely controlled transmitter are expanded to require continuous monitoring of the frequencies while in operation, which is good operating practice. Frequencies above 225 MHz used for remotely controlling a transmitter are exempted from the continuous monitoring requirement since the interference potential with UHF is much less than with VHF.

20. Section 97.89 has been reorganized editorially and the invitation to incorporate into the text a reference to Appendix 2 is taken. Numerous comments were concerned with the omission in the Notice of provisions for various test, control and experimental transmissions. The amended rule includes these provisions.

21. The Section containing definitions, §97.3 has been expanded to include those terms frequently used in the amendments. They are defined in order to minimize possible ambiguities in the statement of the rules.

22. The rules adopted herein do not proscribe amateur radio station, including repeaters, from being automatically interconnected to a telephone exchange system. Amateur licensees should be aware that rules governing that type of facility will be considered for other of the Commission's radio services in a separate proceeding. It has been brought to the Commission's attention that numerous violations of Sub Part E of Part 97 of the Rules have taken place through the use of such interconnection, which facilitates communication from moving vehicles. Therefore, it may be necessary at some future date to examine in detail the current usage of "autopatch" facilities; and possibly



# IF YOU'VE EVER USED A REPEATER,

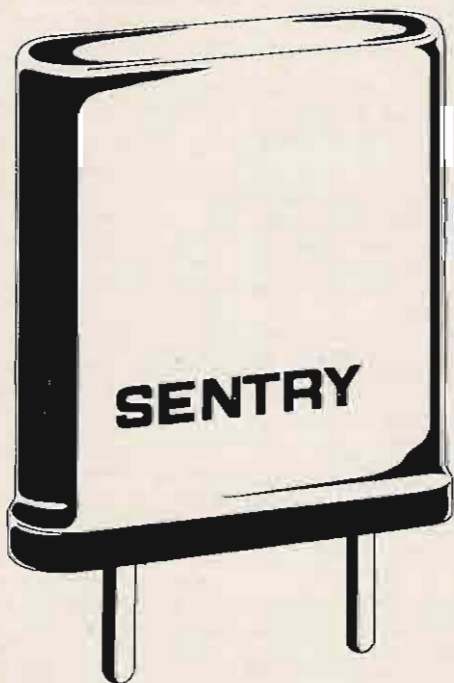

## YOU'VE USED A SENTRY CRYSTAL

If you haven't  
already received  
a copy of our **NEW**  
1972 Catalog of Precision  
Quartz Crystals & Electronics  
for the Communications Industry,  
**SEND FOR YOUR COPY TODAY!**

Somewhere along the line, in virtually every ham repeater in the world, you'll find a couple of Sentry crystals.

Repeater owners and FM "old-timers" don't take chances with frequency—they can't afford to. A lot of repeater users depend on a receiver to be on frequency, rock stable...in the dead of winter or the middle of July. The repeater crowd took a tip from the commercial "pros" a long time ago—and went the Sentry Route.

That's one of the reasons you can depend on your local repeater to be there (precisely there) when you're ready to use it. FM'ers use the repeater output as a frequency standard. And for accuracy, crystals by Sentry are THE standard.

**IF YOU WANT THE BEST,  
SPECIFY SENTRY CRYSTALS.**



**SENTRY MANUFACTURING COMPANY**  
Crystal Park, Chickasha, Oklahoma 73018

PHONE: (405) 224-6780

TWX-910-830-6425

restrict the use of such devices in the Amateur Radio Service. Pending the adoption of any such regulations, amateurs are warned that usage of such interconnecting devices must be limited to amateur radiocommunication and may not be used for any type of business communication.

23. These amendments shall become effective upon the date stated in paragraph 25. Existing remotely controlled stations may continue to operate under their current authorizations until midnight local time June 30, 1973, or until the expiration date of their license, whichever occurs first. All new and renewed stations must comply with the rules as amended. Applications for all stations will continue to be filed on Forms 610 or 610-B, as appropriate. Parties desiring instructions for completing applications requiring additional showing may obtain same upon written request addressed to the Chief, Amateur and Citizens Division, Federal Communications Commission, Washington, D.C. 20554.

24. We find the attached amendments to the rules are necessary and desirable for the execution of the Commission's duties. Authority for adoption of these amendments is contained in Sections 4(i) and 303 of the Communications Act of 1934 as amended.

25. Accordingly, IT IS ORDERED, that effective October 17, 1972, Part 97 of the Commission's Rules IS AMENDED as set forth in the attached Appendix. IT IS FURTHER ORDERED, that in addition to RM-388, RM-1087 and RM-1209, the pending petitions of Mr. Ken W. Sessions, Jr., RM-1542, filed December 8, 1969, and RM-1725 filed December 7, 1970, have been fully considered and, to the extent that they are at variance with the rule changes adopted herein, they are DENIED.

26. IT IS FURTHER ORDERED, that this proceeding IS TERMINATED.

FEDERAL COMMUNICATIONS  
COMMISSION

Ben F. Waple  
Secretary

#### APPENDIX

Part 97 of the Commission's Rules is amended as follows:

1. Section 97.3 is revised to read as follows:

#### §97.3 Definitions

The following definitions are used in this part:

(a) *Amateur Radio Service.* A radiocommunication service of self-training, intercommunication and technical investigation carried on by amateur radio operators.

(b) *Amateur radiocommunication.* Non-commercial radiocommunication by or among amateur radio stations solely with a personal aim and without pecuniary or business interest.

(c) *Amateur radio operator.* A person interested in radio technique solely with a personal aim and without pecuniary interest, holding a valid Federal Communications Commission license to operate amateur radio stations.

(d) *Amateur radio license.* The instrument of authorization issued by the Federal Communications Commission comprised of a station license, and in the case of the primary station, also incorporating an operator license.

*Operator license.* The instrument of operator authorization including the class of operator privileges.

*Station license.* The instrument of authorization for a radio station in the Amateur Radio Service.

(e) *Amateur radio station.* A station licensed in the Amateur Radio Service embracing necessary apparatus at a particular location used for amateur radiocommunication.

(f) *Primary station.* The principal amateur radio station at a specific land location shown on the station license.

(g) *Military recreation station.* An amateur radio station licensed to the person in charge of a station at a land location provided for the recreational use of amateur radio operators, under military auspices of the Armed Forces of the United States.

(h) *Club station.* A separate amateur radio station for use by the members of a bona fide amateur radio society and licensed to an amateur radio operator acting as the station trustee for the society.

(j) *Additional station.* Any amateur radio station licensed to an amateur radio operator normally for a specific land location other than the primary station, may be one or more of the following:

*Secondary station.* Station licensed for a land location other than the primary station location, i.e., for use at a subordinate location such as an office, vacation home, etc.

*Control station.* Station licensed to conduct remote control of another amateur radio station.

*Auxiliary link station.* Station, other than a repeater station, at a specific land location licensed only for the purpose of automatically relaying radio signals from that location to another specific land location.

*Repeater station.* Station licensed to automatically retransmit the radio signals of other amateur radio stations for the purpose of extending their intra-community radiocommunication range.

(j) *Space radio station.* An amateur radio station located on an object which is beyond, is intended to go beyond, or has been beyond the major portion of the Earth's atmosphere. (Regulations governing this type of station have not yet been adopted and all applications will be considered on an individual basis.)

(k) *Terrestrial location.* Any point within the major portion of the Earth's atmosphere, including aeronautical, land and maritime locations.

(l) *Space location.* (reserved)

(m) *Amateur radio operation.* Amateur radiocommunication conducted by an amateur radio operator from an amateur radio station. May include one or more of the following:

*Fixed operation.* Radiocommunication conducted from the specific geographical land location shown on the station license.

*Portable operation.* Radiocommunication conducted from a specific geographical location other than that shown on the station license.

*Mobile operation.* Radiocommunication conducted while in motion or during halts at unspecified locations.

(n) *Remote control.* Control of transmitting apparatus of an amateur radio station from a position other than one at which the transmitter is located and immediately accessible, except that direct mechanical control, or direct electrical control by wired connections, of an amateur radio transmitter from a point located on board any aircraft, vessel, vehicle, or on the same premises on which the transmitter is located, shall not be considered remote control within the meaning of this definition.

(o) *Control link.* Apparatus for effecting remote control between a control point and a remotely controlled station.

(p) *Control operator.* An amateur radio operator designated by the licensee of an amateur radio station to also be responsible for the emissions from that station.

(q) *Control point.* The operating position of an amateur radio station where the control operator function is performed.

(r) *Antenna structures.* Antenna structures include the radiating system, its supporting structures and any appurtenances mounted thereon.

(s) *Antenna height, above average terrain.* The height of the center of radiation of an antenna above an averaged value of the elevation above sea level for the surrounding terrain.

(t) *Transmitter.* Apparatus for converting electrical energy received from a source into radio-frequency electromagnetic energy capable of being radiated.

*Drake has made The Best better!*



**The New  
DRAKE  
TR-4C  
Transceiver**

*A step better  
than the TR-4  
at no increase  
in price! . . .*

**\$599<sup>95</sup>** Amateur  
Net

**NEW FEATURES**

- 1 kHz dual concentric dial
- Higher audio output
- Plastic-encased relay

**TR-4C FEATURES**

- 80 thru 10 Meters Frequency Coverage
- 300 Watts PEP input on SSB
- Shifted-Carrier CW 260 watts input
- Upper and Lower Sideband all bands
- Controlled-Carrier Screen Modulator for AM
- VOX or PTT
- Output Impedance Adjustable with pi-net
- Two Special 9 MHz Crystal Filters for sideband selection
- 100 kHz Crystal Calibrator

**ACCESSORIES**

MC-4 Mobile Console . . . . .	\$ 69.00
MMK-3 Mobile Mounting Kit . .	\$ 6.95
AC-4 115/230 VAC 50/60 Hz Power Supply . . . . .	\$ 99.95
DC-4 12 VDC Solid State Power Supply . . . . .	\$125.00
34PNB Noise Blanker . . . . .	\$100.00

**TR-4C SPECIFICATIONS:** • **Frequency Coverage:** Full Coverage on all amateur bands 80 thru 15 meters and one 10 meter segment, in five 600 kHz ranges: 3.5 to 4.1 MHz, 7.0 to 7.6 MHz, 13.9 to 14.5 MHz, 21 to 21.6 MHz, 28.5 to 29.1 MHz. Accessory crystals needed for 28 to 28.6 MHz and 29.1 to 29.7 MHz ranges. • **Solid State VFO:** Has linear permeability tuning. Tunes 4.9 to 5.5 MHz for all ranges. • **Dial Calibration:** Two concentric dials. 100 kHz Markings on one dial and 1 kHz divisions on second dial. • **Frequency Stability:** High stability solid state VFO tunes same range on all bands. Drift is less than 100 cycles after warm-up, and less than 100 cycles for plus or minus 10% line voltage change. • **Modes of Operation:** SSB Upper and Lower Sideband, CW and AM. • **Misc:** 20 tubes including voltage regulator; two transistors; 8 diodes; 100 kHz crystal calibrator built in; Dimensions: 5 1/2" high, 10 1/2" wide, 14 3/8" deep. Weight: 16 lbs . . .

**TRANSMITTER:** • **Single Sideband:** 300 watts P.E.P. input power, VOX or PTT. Two special 9 MHz crystal filters provide upper or lower sideband selection on any band, without the necessity of shifting oscillators. • **CW:** Power input 260 watts. Carrier is shifted approximately 1000 cycles into one sideband, and mixer and driver are keyed. Grid block keying is free from chirps and clicks. Automatic transmit/receive switching when key is operated. CW sidetone oscillator for monitoring. • **AM:** Controlled carrier AM screen modulator is built-in. 260 watts P.E.P. input. Low carrier power increases 6 times to 50 watts output at maximum modulation. This system is compatible with SSB linears. VOX or PTT. Diode detector used for receiving on this mode. Product Detector can be used by switching manually . . .

**RECEIVER:** • **Sensitivity:** Less than 1/2 microvolt for 10 dB S/N • **I.F. Selectivity:** 2.1 kHz at 6 dB, 3.6 kHz at 60 dB. • **Antenna Input:** Nominal 50 ohms. • **Audio Response:** 400 to 2500 cycles at 6 dB. • **Audio Output Power:** 3 watts. • **Impedance:** 4 ohms.

**R. L. DRAKE COMPANY**



**DRAKE**

540 Richard St., Miamisburg, Ohio 45342  
Phone: (513) 866-2421 • Telex: 288-017

(u) *Effective radiated power.* The product of the radio frequency power, expressed in watts, delivered to an antenna, and the relative gain of the antenna over that of a half-wave dipole antenna.

(v) *System Network diagram.* A diagram showing each station and its relationship to the other stations in a network of stations, and to the control point(s).

2. In Section 97.7, paragraph (c) is amended to read as set forth below and the note at the end of the Section is deleted.

§97.7 Privileges of operator licenses.

(c) *Technician Class.* All authorized amateur privileges on the frequencies 50.1–54.0 MHz and 145–148 MHz and in the amateur frequency bands above 220 MHz.

\* \* \*

3. Section 97.37 is revised to read as follows:

§97.37 *General eligibility for station license.*

An amateur radio station license will be issued only to a licensed amateur radio operator, except that a military recreation station license may also be issued to an individual not licensed as an amateur radio operator (other than an alien or a representative of an alien or of a foreign government), who is in charge of a proposed military recreation station not operated by the United States Government but which is to be located in approved public quarters.

4. Section 97.40 is added to read as follows:

§97.40 *Station license required.*

(a) No transmitting station shall be operated in the Amateur Radio Service without being licensed by the Federal Communications Commission.

(b) Every amateur radio operator must have a primary amateur radio station license.

(c) An amateur radio operator may be issued one or more additional station licenses, each for a different land location, except that repeater station control station, and auxiliary link station licenses may also be issued to an amateur radio operator for land locations where another station license has been issued to the applicant.

(d) Any transmitter to be operated as part of a control link shall be licensed as a control station or as an auxiliary link station and may be combined with a primary, secondary, or club station license at the same location.

(e) A transmitter may only be operated as a repeater station under the authority of a repeater station license.

5. Section 97.41 is amended by modifying paragraph (a), adding new paragraphs (b), (c), (d), (e) and (f), then

re-designating former paragraphs (b) and (c) as (g) and (h).

§97.41 *Application for station license.*

(a) Each application for a club or military recreation station license in the amateur radio service shall be made on the FCC Form 610-B. Each application for any other amateur radio station license shall be made on the FCC Form 610.

(b) Each application shall state whether the proposed station is a primary or additional station. If the latter, the application shall also state whether the proposed station is a secondary, control, auxiliary link or repeater station.

(c) When an application(s) is made for a station having one or more associated stations, i.e., control station and/or auxiliary link station, a system network diagram shall also be submitted.

(d) Each application to license a remotely controlled amateur radio station, whether by wire or by radio control, shall be accompanied by a statement giving the address for each control point. The application shall include a functional block diagram and a technical explanation sufficient to describe the operation of the control link. Additionally, the following shall be provided:

(1) Description of the measures proposed for protection against access to the remote station by unauthorized persons.

(2) Description of the measures proposed for protection against unauthorized station operation, either through activation of the control link or otherwise.

(3) Description of the provisions for shutting down the station in case of control link malfunction.

(4) Description of the means to be provided for monitoring the transmitting frequencies.

(5) Photocopies of control station license(s) and auxiliary link station license(s), or the application(s) for same if such stations are proposed for the system network.

(e) Each application to license a control station or an auxiliary link station in the amateur radio service must be accompanied by the following information:

(1) The station transmitting band(s).

(2) Description of the means to be provided for monitoring the transmitting frequencies.

(3) The transmitter power input and justification that such power is in compliance with §97.67(b).

(4) If remote control of an auxiliary link station is proposed, all of the information required by paragraph (d) of this section shall also be provided.

(f) Each application to license a repeater station in the amateur radio service must include the following information for each frequency band proposed for operation.

(1) Location of the station transmitting antenna, drawn upon a topographic map having the scale of 1:250,000 and a contour interval of 50 feet. (Indexes and ordering information are available from U.S. Geological Survey, Washington, D.C. 20242, or Federal Center, Denver, Colorado 80225.)

(2) The transmitting antenna height above average terrain. (See appendix 5.)

(3) The effective radiated power in the horizontal plane for the main lobe of the antenna pattern, calculated for maximum transmitter output power.

(4) The transmitter power output with an explanation of the basis for the measurement or computation.

(5) The loss in the transmission line between the transmitter and the antenna expressed in decibels, and method of determination of the loss.

(6) The horizontal and vertical radiation patterns of the transmitting antenna as installed, with reference to True North (for horizontal pattern only), expressed as relative field strength (voltage) or in decibels, drawn upon polar coordinate graph paper, and method of determination of the patterns.

(7) The relative gain of the transmitting antenna in the horizontal plane and method of determination of the gain.

(8) If remote control of the repeater station is proposed, all of the information required by paragraph (d) of this section shall also be provided.

(9) If auxiliary link station(s) are also proposed, include photocopies of the auxiliary link station license(s), or the application(s) for such licenses.

\* \* \*

6. Section 97.43 is revised to read as follows:

§97.43 *Location of Station.*

Every amateur station must have one land location, the address of which is designated on the station license. Every amateur radio station must have at least one control point. If the control point location is not the same as the station location, authority to operate the station by remote control is required.

7. In Section 97.47, the note following paragraph (c) is deleted and paragraphs (d) and (e) are added to read as follows:

§97.47 *Renewal and/or modification of amateur station license.*

\* \* \*

(d) When an addition to the control point(s) authorized for a remotely controlled station is desired, an appli-

# The 2-Meter FM Rig The Experts Praise

## GLADDING 25™



## 6 CHANNELS/2 METER/TRANSCEIVER/25 WATTS

Power is the keyword when discussing Gladding 25™, the two-meter transceiver the experts recommend.

Gladding 25 is so similar to our marine gear (we're the leader in AM and FM marine communications) we are able to take advantage of the tremendous buying power and production efficiencies our huge volume gives us. The result is remarkably low priced. A Gladding 25™ has the power, price and the features amateurs want most, with unmatched quality.

- 25 Watts output • 0.3 micro volt uv sensitivity for 12 db SINAD • Dynamic microphone for unmatched audio • Six separately switchable transmit and receive channels • Crystal supplied for 149.94 simplex and repeater capability on 146.34/146.76 and 147.34/146.94 mHz • 12 volt mobile unit has matching accessory AC power supply • Vacuum tube driver and final for reliability and economy • 8 pole crystal lattice filter • Solid state receiver • Transistor sockets • Glass epoxy printed circuit boards • Quick disconnect power plugs • Mobile mounting brackets • One watt output capability for short range communications.

### \$249<sup>95</sup>

for mobile unit

### \$299<sup>95</sup>

with accessory AC power supply

Write for complete information.

**PEARCE-SIMPSON**  
DIVISION OF **GLADDING** CORPORATION  
P.O. Box 800, Biscayne Annex, Miami, Florida 33152



cation for modification of the remotely controlled station license shall be submitted. Authorized control points may be deleted by letter notification to the Commission.

(e) Should the licensee desire to effect changes to his station which would significantly change the system network diagram or other technical and operational information on file with the Commission, revised showings for the proposed alterations shall be submitted for approval. An application for modification of the station license is not required.

8. In Section 97.61, the introductory text of paragraph (a) is amended, and new paragraph (c) is added to read as follows:

§97.61 *Authorized frequencies and emissions.*

(a) Following are the frequency bands and associated emissions available to amateur radio stations, other than repeater stations, subject to the limitations stated in paragraph (b) of this section, §97.65, §97.109 and §97.110.

\*\*\*

(c) The following transmitting frequency bands and the associated emission authorized in paragraph (a) of this section are available for repeater stations, including both input (receiving) and output (transmitting):

FREQUENCY BAND (MHz)

- 52.0 - 54.0
- 146.0 - 148.0
- 222.0 - 225.0
- 442.0 - 450.0

any amateur frequency above 1215 MHz. Frequency band 29.5-29.7 may be authorized upon a special showing of need for repeater station operation in this band for intra-community amateur radio communications.

9. Section 97.67 is revised to read as follows:

§97.67 *Maximum authorized power.*

The existing paragraph is revised by designating existing text as paragraph (a) and by adding new paragraphs (b) and (c) to read as follows:

\*\*\*

(b) Notwithstanding the provisions of paragraph (a) of this section, amateur stations shall use the minimum amount of transmitter power necessary to carry out the desired communications.

(c) Within the limitations of paragraphs (a) and (b) of this section, the effective radiated power of a repeater station shall not exceed that specified for the antenna height above average terrain in the following table:

10. In §97.79, the headnote and text are revised to read as follows:

§97.79 *Control operator requirements.*

(a) The licensee of an amateur station shall be responsible for its proper operation.

Antenna height above average terrain	Maximum effective radiated power for frequency bands above:			
	52 MHz	146 MHz	442 MHz	1,215 MHz
below 50 feet	100 watts	800 watts	800 watts	Paragraphs (a) and (b)
50 to 99 feet	100 watts	400 watts	800 watts	Paragraphs (a) and (b)
100 to 499 feet	50 watts	400 watts	800 watts	Paragraphs (a) and (b)
500 to 999 feet	25 watts	200 watts	800 watts	Paragraphs (a) and (b)
above 1,000 feet	25 watts	100 watts	400 watts	Paragraphs (a) and (b)

(b) Every station when in operation shall have a control operator at an authorized control point. The control operator may be the station licensee or another amateur radio operator designated by the licensee. Each control operator shall also be responsible for the proper operation of the station.

(c) An amateur station may only be operated in the manner and to the extent permitted by the operator privileges authorized for the class of license held by the control operator, but may exceed those of the station licensee provided proper station identification procedures are performed.

(d) The licensee of an amateur station may permit any person to participate in amateur radiocommunication from his station, provided that a control operator is present and continuously monitors the radiocommunication to ensure compliance with the rules.

11. In Section 97.87, paragraph (d) is amended and redesignated as (h) and new paragraphs (d), (e), (f), and (g) are added as follows:

§97.87 *Station Identification.*

\*\*\*

(d) Under conditions when the control operator is other than the station licensee, the station identification shall be the assigned call sign for that station. However, when a station is operated within the privileges of the operator's class of license but which exceeds those of the station licensee, station identification shall be made by following the station call sign with the operator's primary station call sign (i.e. WN4XYZ/W4XX).

(e) A repeater station shall be identified by radiotelephony or by radiotelegraphy when in service at intervals not to exceed five minutes at a level of modulation sufficient to be intelligible through the repeated transmission.

(f) A control station must be identified by its assigned station call sign unless its omissions contain the call sign of its associated station.

(h) The identification required by paragraph (a), (b), (c), (d), (e), (f) and (g) of this section shall be given on each frequency being utilized for transmission and shall be transmitted

either by telegraphy using the International Morse Code, or by telephony, using the English language. If by an automatic device only used for identification by telegraphy, the code speed shall not exceed 20 words per minute. The use of a national or internationally recognized standard phonetic alphabet as an aid for correct telephone identification is encouraged.

12. Section 97.89 is amended to read as follows:

§97.89 *Points of Communications.*

(a) Amateur stations may communicate with:

(1) other amateur stations, except those prohibited by Appendix 2.

(2) stations in other services licensed by the Commission and with United States Government stations for civil defense purposes in accordance with Subpart F of this Part, in emergencies and, on a temporary basis, for test purposes.

(3) any station which is authorized by the Commission to communicate with amateur stations.

(b) Amateur stations may be used for transmitting signals, or communications, or energy, to receiving apparatus for the measurement of emissions, temporary observation of transmission phenomena, radio control of remote objects, and similar experimental purposes and for the purposes set forth in §97.91.

(c) Notwithstanding the provisions of paragraph (a), no more than two repeater stations may operate in tandem, i.e., one repeating the transmissions of the other, excepting emergency operations provided for in §97.107 or brief periods to conduct emergency preparedness tests.

(d) Control stations and auxiliary link stations may not be used to communicate with any other station than those shown in the system network diagram.

13. Section 97.95 paragraph (a) (1) is amended as follows:

§97.95 *Operation away from the authorized permanent station location.*

(a)

(1) When there is no change in the authorized land station location, the amateur radio station other than a military recreation or an auxiliary link

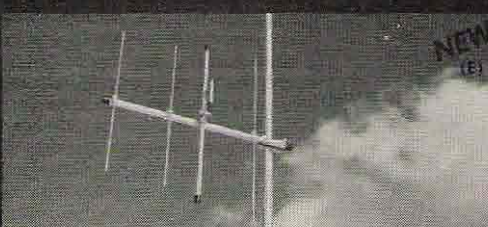
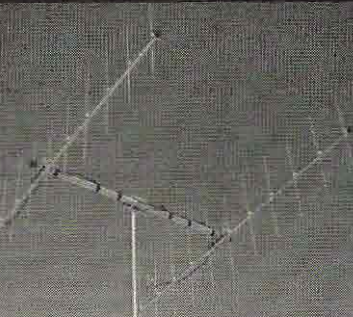
**NEW**  
(A)**NEW**  
(B)**NEW**  
(C)**NEW**  
(D)**NEW**  
(E)**NEW**  
(F)

# Cush Craft

## 2 METER FM ANTENNAS

**NEW**

FROM THE WORLD'S LEADING  
MANUFACTURER OF VHF/UHF  
COMMUNICATION ANTENNAS

(A) **FM RINGO 3.75 db GAIN:** The most popular — high performance, half-wave FM antenna. Gives peak gain, and efficiency, instant assembly and installation.

AR-2	100 watts	135-175 MHz	\$12.50
AR-25	500 watts	135-175 MHz	17.50
AR-6	100 watts	50-54 MHz	18.50

(B) **4 POLE:** A four dipoles array with mounting booms and coax harness 52 ohm feed up to 9 db gain.

AFM-4D	1000 watts	146-148 MHz	\$42.50
AFM-24D	1000 watts	220-225 MHz	40.50
AFM-44D	1000 watts	435-450 MHz	38.50

(C) **FM MOBILE 3 db GAIN:** Fiberglass  $\frac{1}{2}$  wave professional mobile antenna for roof or trunk mount. Superior strength, power handling and performance.

AM-147	146-175 MHz mobile	\$26.95
--------	--------------------	---------

(D) **11 ELEMENT YAGIS 13.2 db GAIN:** The standard of comparison in VHF communications, now cut for 2 meter FM and vertical polarization.

A147-11	1000 watts	146-148 MHz	\$17.95
A449-11	1000 watts	440-450 MHz	13.95

(D) **POWER PACK 16 db GAIN:** A 22 element, high performance, vertically polarized FM array, complete with all hardware, mounting boom, harness and 2 antennas.

A147-22	1000 watts	146-148 MHz	\$49.50
---------	------------	-------------	---------

(E) **4 ELEMENT YAGI 9 db GAIN:** A special side mount 4 element FM yagi can be fixed or rotated—good gain and directivity.

A144-4	1000 watts	146-148 MHz	\$ 9.95
--------	------------	-------------	---------

(F) **FM TWIST 12.4 db GAIN:** A Cush Craft exclusive — it's two antennas in one. Horizontal elements cut at 144.5 MHz, vertical elements cut at 147 MHz, two feed lines.

A147-20T	1000 watts	145 & 147 MHz	\$39.50
----------	------------	---------------	---------

IN STOCK WITH YOUR LOCAL DISTRIBUTOR

Cush Craft  
CORPORATION

621 HAYWARD STREET  
MANCHESTER, N. H. 03103

station may be operated under its station license anywhere in the United States, its territories or possessions as a portable or mobile operation, subject to §97.61.

\* \* \*

14. Section 97.97 is revised to read as follows:

**§97.97 Notice of operation away from authorized location.**

Whenever an amateur station is, or is likely to be, in portable operation at a single location for a period exceeding 15 days, the licensee shall give advance written notice of such operation to the Commission's office specified in §97.95. A new notice is required whenever there is any change in the particulars of a previous notice or whenever operation away from an authorized station continues for a period in excess of one year. The notice required by this section shall contain the following information:

- (a) Name of licensee
- (b) Station call sign
- (c) Authorized station location shown on station license
- (d) Specific geographical location of station when in portable operation
- (e) Dates of the beginning and end of the portable operation
- (f) Address at which, or through which, the licensee can be readily reached.

15. Section 97.103 is revised to read as follows:

**§97.103 Station log requirements.**

An accurate legible account of station operation shall be entered in a log for each amateur radio station. The log shall bear the call sign of the station and the signature of the licensee. The following information shall be recorded as a minimum:

(a) Written entries for all stations which are required only once, or when there is a change thereto.

(1) The signature of the control operator on duty and the call sign of his primary station, if he is other than the station licensee.

(2) The location of the station. Stations in mobile operation may enter the word "local" for amateur radiocommunication conducted within 100 statute miles of the address shown on the station license, otherwise the location of the first and last radiocommunication of each day. Stations in mobile or portable operation shall make an entry showing compliance with §97.97, if required.

(3) The input power to the transmitter final amplifying stage.

(4) The type of emission used.

(5) The frequency or frequency sub-band used for transmitting.

(b) Other entries for all stations which may be recorded in a form other than written but which can readily be transcribed by the licensee into written form:

(1) The dates of operation.

(2) Except for repeater stations, names of persons other than the control operator using the station, either directly or indirectly, for amateur radiocommunication.

(3) A notation of third party messages sent or received, including names of all participants and a brief description of the message content.

(4) The call sign of each station actually contacted, or other purpose of the transmission, i.e., those set forth in §97.89. Stations in mobile operation and repeater stations may omit this entry. Control stations shall enter the call sign(s) of each station in the control link. An auxiliary link station shall enter the call sign of its associated station(s).

(5) All stations shall enter the times when the station is put into, or taken out of, service. Stations other than those in mobile operation, control stations, auxiliary link stations, and repeater stations shall enter the times of commencing and terminating each exchange of radiocommunication.

16. Section 97.105 is revised as follows:

**§97.105 Retention of logs.**

The station log shall be preserved for a period of at least 1 year following the last date of entry and retained in the possession of the licensee. Copies of the log, including the sections required to be transcribed by §97.103, shall be available to the Commission for inspection.

17. Section 97.111 is redesignated as 97.112 and a new undesignated center heading and Sections 97.108 through 97.111 are added to read as follows:

**Operation of additional stations.**

**§97.108 Operation of a remotely controlled station.**

(a) An amateur radio station may be operated by remote control only from an authorized control point, and only where there is compliance with the following:

(1) The license for the remotely controlled station must list the authorized remote control point(s). A photocopy of the remotely controlled station license must be posted in a conspicuous place at the authorized control point(s), and at the remotely controlled transmitter location. A copy of the system network diagram on file with the Commission must be retained at each control point. The transmitting antenna, transmission line, or mast, as appropriate, associated with the remotely controlled transmitter must bear a durable tag marked with the station call sign, the name of the station licensee and other information so that the control operator can readily be contacted by Commission personnel.

(2) The control link equipment and

the remotely controlled station must be accessible only to persons authorized by the licensee. Protection against both inadvertent and unauthorized deliberate emissions must be provided. In the event unauthorized emissions occur, the station operation must be suspended until such time as adequate protection is incorporated, or there is reasonable assurance that unauthorized emissions will not recur.

(3) A control operator designated by the licensee must be on duty at an authorized control point while the station is being remotely controlled. Immediately prior to, and during the periods the remotely controlled station is in operation, the frequencies used for emission by the remotely controlled transmitter must be continuously monitored by the control operator. The control operator must terminate transmission upon any deviation from the rules.

(4) Provisions must be incorporated to automatically limit transmission to a period of no more than three minutes in the event of malfunction in the control link.

(5) A remotely controlled station may not be operated at any location other than that specified on the license without prior approval of the Commission except in emergencies involving the immediate safety of life or protection of property.

(6) A repeater station may be operated by radio remote control only where the control link utilizes frequencies other than the repeater station receiving frequencies.

**§97.109 Operation of a control station.**

(a) Amateur frequency bands above 220 MHz, excepting 435 to 438 MHz, may be used for emissions by a control station. Frequencies below 225 MHz used for control links must be monitored by the control operator immediately prior to, and during, periods of operation.

(b) Where a remotely controlled station has been authorized to be operated from one or more remote control stations, those remote control stations may be operated either mobile or portable.

**§97.110 Operation of an auxiliary link station.**

(a) An auxiliary link station may use amateur frequency bands above 220 MHz excepting 435 to 438 MHz for emissions. Frequencies below 225 MHz used by an auxiliary link station shall be monitored by the control operator immediately prior to, and during, periods of operation.

(b) An auxiliary link station may only be used for fixed operation from the location specified on the station license, and only when its associated station(s) is operated from its authorized land location.





# RIGHT NOW!

Delivery from stock . . .  
no waiting —  
**FACTORY TO YOU**

Prepaid delivery by UPS  
... no waiting . . . no expense  
**ORDER DIRECT: ONLY \$239.95**

●**12 Channels**

You don't need 12 channels yet? You will! You will!

●**Tweak BOTH xmtr & rcvr**

Big deal? You'll know it is if you get a set where you can't zero the receiver.

●**Front speaker**

Most sets have the speaker aimed up under the dash or at your feet with the result that you can't hear diddely beans. The front speaker can be heard, even when you are driving.

●**10 watts.** Also 0.1 and 1 watts, switchable.

Big deal? Have you thought how easy it is to make this little set into a shoulder unit with a small battery pack? The low power position is excellent for this.

●**Very, very small.** Tiny, in fact. Mounts anywhere.

●**Minimum adjacent channel interference.**

The ceramic filter eliminates most adjacent channel spillover. You may not appreciate this unless you've tried a couple of other sets and found them unusable anywhere near a strong signal.

●**S-meter.**

Big deal? How many sets in this price bracket have an 'S-meter and power output indicator meter? The S-meter is very handy.

●**Includes matching mike, mounting bracket, etc.**

●**Available with tone burst encoder built in and tested.**

Ross & White also makes these tone burst units and sells them. Send for prices and info.

●**Can you do without this terrific FM unit one more week? Don't miss any more of the fun on 2m. Instant delivery, prepaid!**



**ROSS and white**  
SINCE 1932  
**electronics**  
company

50 W. DUNDEE RD., WHEELING, ILL. 60090  
312/537-0060



**ORDER RIGHT NOW!**  
Available with built in tone burst encoder:  
**\$279.95.**

§97.111 Operation of a repeater station.

(a) Emissions from a repeater station shall be discontinued within five seconds after cessation of radio-communication by the user station. Provisions to automatically limit the access to a repeater station may be incorporated, but are not mandatory.

(b) The transmitting and receiving frequencies utilized by the repeater station shall be continuously monitored by the control operator immediately prior to, and during, periods of operation.

(c) A repeater station may be concurrently operated on more than one frequency band, provided the necessary showings have been approved by the Commission for each frequency band of operation. Crossband operation of repeater stations is prohibited, i.e. both input (receiving) and output (transmitting) frequencies for a particular repeated transmission must be within the same frequency band. Operation on more than one output frequency on a single frequency band is prohibited except when specifically approved by the Commission. Repeater stations authorized to operate in conjunction with one or more auxiliary link stations may utilize an input frequency in a different frequency band provided the input frequency of the auxiliary link station(s) is in the same frequency band as the output frequency of the repeater station.

(d) A repeater station shall be operated in a manner so as to assure that the station is not used for one-way radiocommunication other than provided for in §97.91.

(e) A station licensed as a repeater station may only be operated as a repeater station, excepting for short periods for testing or for emergencies.

18. In Section 97.193, the introductory text of paragraph (a) is amended, and a new paragraph (e) is added to read as follows:

§97.193 Frequencies available.

(a) Except as provided in paragraph (e) of this section, the following frequency and frequency bands and associated emissions are available on a non-exclusive basis to the individual class of stations or units of such stations in the Radio Amateur Civil Emergency Service.

(e) A repeater station in the Radio Amateur Civil Emergency Service may operate on any frequency, and with any associated emission, above 50 MHz listed in paragraph (a) of this section, except for 220 MHz to 333 MHz.

19. Appendix 2 is amended by adding a footnote to Section 1:

Sec. 1. Radio communications between amateur stations of different countries<sup>1</sup> shall be forbidden if the administration of one of the countries concerned has notified that it objects to such radiocommunications.

20. Appendix 5 is added, reading as follows:

APPENDIX 5  
DETERMINATION OF  
ANTENNA HEIGHT  
ABOVE AVERAGE TERRAIN

The effective height of the transmitting antenna shall be the height of the antenna's center of radiation above "average terrain." For this purpose "effective height" shall be established as follows:

(a) On a United States Geological Survey Map having a scale of

<sup>1</sup> as may appear in public notices issued by the Commission.

1:250,000, lay out eight evenly spaced radials, extending from the transmitter site to a distance of ten miles and beginning at 0°, T (0°, 45°, 90°, 135°, 180°, 225°, 270°, 315° T). If preferred, maps of greater scale may be used.

(b) By reference to the map contour lines, establish the ground elevation above mean sea level (AMSL) at 2, 4, 6, 8, and 10 miles from the antenna structure along each radial. If no elevation figure or contour line exists for any particular point, the nearest contour line elevation shall be employed.

(c) Calculate the arithmetic average of these 40 points of elevation (5 points of each of 8 radials).

(d) The height above average terrain of the antenna is thus the height AMSL of the antenna's center of radiation, minus the height of average terrain as calculated above.

Note 1: Where the transmitter is located near a large body of water, certain points of established elevation may fall over water. Where it is expected that service would be provided to land areas beyond the body of water, the points at water level in that direction should be included in the calculation of average elevation. Where it is expected that service would not be provided to land areas beyond the body of water, the points at water level should not be included in the average.

Note 2: In instances in which this procedure might provide unreasonable figures due to the unusual nature of the local terrain, applicant may provide additional data at his own discretion, and such data may be considered if deemed significant.

## NEW FCC REGULATIONS

Effective November 22nd there will be some changes in the 10, 15, 40 and 80m bands. These changes are the result of the efforts to set up more voice bands in recognition of the high percentage of amateurs using voice instead of CW.

On the 80m band the Extra Class phone segment was extended 25 kHz down to 3775 kHz. On 40m the phone band was extended down to

7150, thus moving the Novice band down to 7100-7150 kHz. American stations outside of Region 2 may also use phone in the 7075-7100 kHz band. The 15m Novice band was cut back, with 21.2-21.25 being deleted from Novice use. A new Novice band was opened on 10m, running from 28.1 to 28.2 MHz. Because of the extensive changes in the Novice bands the requirement for crystal control was removed. How about that!

# NEW FCC REPEATER PETITIONS

**PETITION:** To extend amateur repeater operation to the 440-442 MHz band.

The recent Commission report and order (8-29-72) restricts repeater operation in the amateur 420 MHz band to the frequencies 442-450 MHz.

Since this is completely contrary to the self regulating frequency allocations set up by the amateurs, a system which has been working quite satisfactorily, and which has been responsible for the orderly growth of the 420 MHz band in all parts of the country, implementation of the new Commission regulation would disrupt the work of the last decade - it would cause considerable hardship and expense - it would be a slap in the face of those serious amateurs who have labored so hard over the years to keep the growth and development of this band orderly.

## THE 420 MHz PLAN

Amateurs have been working together with remarkably good results to bring about an orderly use of the 420 MHz band. When you consider the variety of groups and individuals involved, the self restraint has been admirable.

Repeaters and repeater control links have been self-allocated to the 440-450 MHz segment of the band, with the exception of southern California where this segment has been filled and some allocations have been made in the 420-430 MHz segment. The allocation by the Commission of repeaters to the 442-450 MHz segment of the band could have the impact of forcing repeater link stations to move out of this segment and into the 420-430 MHz part of the band - a part which has presently been allocated by amateurs to fast scan television experimentation.

There has been no demonstrated need for a change in the amateur self allocation scheme. It has been working well and with effectiveness. The heavy hand of the Commission was not needed in any way and is quite undesirable.

If the Commission would limit itself to regulations for which there is some demonstrated need, the amateur service would be able to progress and grow with the times.

Amateur radio is important to the United States and to the world. The future of business and government is largely electronic and any moves made by the Commission which tend to

limit the number of youngsters who take up this hobby which is the entryway to a professional career cannot be considered as other than detrimental to the good of the country.

The Commission is all too familiar with the future of electronics and communications as a major part of the activities of the Commission are involved with trying to cope with the changes that these developments bring about. There is going to be a need - a great need - for more and more engineers and technicians to design, build, install, operate and service the electronic future that all of us see ahead. What a disaster if the Commission should make moves today which would make amateur radio less attractive as a hobby and thus precipitate a shortage of trained professionals a few years hence.

The results of the Commissions' adventure with "incentive licensing" should serve as a warning. To some degree that change in the amateur regulations - and the threat of it - turned away tens of thousands of youngsters who might otherwise have become radio amateurs. How much of the sudden drop in growth of amateur radio was attributable to incentive licensing and how much to the FCC license fees is debatable, but the effect is not.

During the ten year period from 1951 to 1961 the number of operators grew from 88,729 to 216,720 (FCC figures), a growth of about 9% per year average. During the period 1961 to 1971 the growth was only about 68,000, an average of about 2½% per year. During the years of Commission indecision on incentive licensing the growth was miniscule, going from 256,237 in 1964 when the Commission put the matter on the docket to 260,294 in 1968 when it was finally concluded. During four years the amateur service grew by only 4,000 operators.

Had it not been for the interference by the Commission it seems likely that the growth pattern of the service would have continued as it had for many previous years and we would today have about 600,000 operators. When one considers what that would mean in terms of service in times of emergency - in manpower lost to industry and the military - it is a terrible loss.

The Commission is begged to stop this trend toward unnecessary restric-

tion of the amateur service. When there is no clearly demonstrated need for regulation of amateurs we beseech the Commission to leave us alone - and there is no clear or even indistinct call for regulations prohibiting the use of amateur repeaters in the 440-442 MHz segment of the band.

## PETITION:

It is hereby petitioned that the FCC permit repeater operation in the 440-442 MHz amateur band. It is requested that section 97.111(c) be changed to indicate that repeaters may use the 440-450 MHz segment of the band; and that in section 97.67 the table of authorized power be changed to read 440 MHz instead of 442 MHz.

Wayne Green  
Peterborough NH 03458

18 September 1972

**PETITION:** To permit crossband linking of repeaters.

The recent Commission report and order (80334) prohibits crossband operation of repeaters (97.111(c)).

This ruling would seem to be in basic opposition to the very fundamental spirit and purposes of the amateur service. It is unnecessarily restrictive in that it prevents the application of amateur ingenuity which would otherwise be devoted to the development of multiband communications systems - systems which could hardly fail to be of extreme value in times of emergency - systems which would tax amateur ingenuity and further demonstrate his ability to design and build equipment to meet demands far beyond those of commercial applications.

## CLASSES OF LICENSE

With the restriction of repeaters in all of the amateur bands to frequencies allocated to all classes of license, from Technician through Extra Class, there cannot be any question of the repeater of a Technician operating on his own authorized frequencies into a band for which he is not licensed. Thus there can be no such excuse given for limiting or prohibiting cross band operation of repeaters.

## FREQUENCY CONSERVATION

The availability of several different 220 MHz transceivers would seem to put any questions of overoccupancy of repeaters in any one area far enough in the future so there could be little reason for ruling against current

uses of repeaters on the grounds of possible distant future crowding.

The fact is that even in the most congested areas we have adequate spectrum space for double or triple the number of repeaters that are presently active in the amateur service. Further, few of the repeaters are kept active for more than a few hours a day.

It is interesting to note that such time consuming services as autopatch tend to be used less and less as other uses develop for a repeater. The busiest repeater in the country, WA2SUR, has autopatch facility, but the over 400 active users of the repeater keep it so busy that operators wanting to use the autopatch switch channels to less active repeaters.

The same tendency would tend to limit the use of any repeater for cross band operation, in all probability. Cross band operation would generally tend to be used during times when regular repeater activity is at a minimum.

This has certainly proven to be the case with the WA1KGO repeater. This repeater is active on 146.19-146.79 MHz and can be interconnected with 52.525 MHz by use of tone access. In practice the 146 MHz activity takes precedence and cross band operation is only attempted when the repeater is not otherwise in use.

It would seem unreasonable to prohibit cross band connection of repeaters on the basis of frequency conservation.

#### CROSSBANDING BASE STATIONS

Since there is no prohibition of interconnecting a 146 MHz signal on any other band when an intermediary operator is present, it does not seem reasonable or logical to differentiate against repeaters. If there are adequate safeguards built into the system, an automatic cross connection between two bands should be the same as if it were being done by a third operator.

There is nothing illegal if I am in contact with an amateur station on 146 MHz and one on 52.525 MHz simultaneously in a three-way contact with me rebroadcasting each of the other two operators so they can hear the entire contact. For that matter there is nothing illegal in my transmitting any class of license on any band permitted me by my license as long as I am in control.

The new regulations spell out in detail that someone must be in control of a repeater station at all times - so where is the difference between the repeater and a base station? In each case there is an operator in constant control, yet with the base station cross banding is permitted and with the repeater it is not. This does not seem logical, reasonable or fair.

#### INCENTIVE LICENSING?

The concept that amateurs might use repeaters to circumvent the band allocations set up in recent years for different classes of license has no basis in fact. It is technically possible, of course, for an amateur with a Technician license, to operate through a repeater and work 20 meters, complete with a kilowatt, rotary beam, and first class location and receiver. But since this has never happened, to my knowledge, and seems unlikely to happen, the need for regulations prohibiting it seem uncalled for - and the side effects of the regulations so damaging and prohibitive to amateur ingenuity and progress as to be worthy of immediate reconsideration.

The amount of ingenuity required for automatic remote operation of a low band station seems sufficient to be self regulating.

There is something to be said about the possibility of the limited use of cross band to a lower band as an incentive toward getting a higher class of license. The Technician who has never made an international contact might be impressed enough if he were able to occasionally do this via a repeater to get a higher grade of license so he could set up his own low band station. In my experience, many Technicians have no idea what they are missing.

But, since the repeater regulations restrict all repeater operation to bands usable to all classes of license above Novice, the matter of repetition outside of the license restrictions is not pertinent.

#### INTERCONNECTING SYSTEMS

Amateurs have repeater systems operating in all of the VHF bands, 52 - 146 - 220 - 450 MHz. Each band is relatively isolated at present, with one group on 52 MHz, another on 146 MHz, etc. Indeed, unless one is to jam a car full of expensive equipment, there is no practical way of operating all of these bands with a mobile station. Four transceivers and the array of antennas on the car would provide a very tempting target for thieves.

A four band mobile installation could easily cost more than the car. Even using the latest solid state equipment, it would take a large car to leave room for the driver once the four stations were installed.

If a few repeaters were permitted to interconnect the different systems, it would be possible for a mobile operator to talk with any of the four groups in his vicinity. Hopefully it is not necessary to point out the tremendous value of this flexibility in time of emergency. Without such an interconnection the four systems would be

individual and in many instances three of them would be wasted.

With suitable safeguards it should be possible to permit repeaters to be interconnected. Since all repeaters are under constant supervision and control, they can be shut down at any time that trouble develops, though amateur ingenuity should not be seriously taxed in providing automatic disconnection of such functions when problems arise.

#### PETITION:

The Commission is requested to permit crossbanding of repeaters, provided adequate safeguards are built into the system to disable it in case of difficulty.

A deletion of the second sentence of section 97.111(c) is requested.

Wayne Green W2NSD/1  
Peterborough NH 0345818  
September 1972

PETITION: Expansion of repeater frequencies in the 220-225 MHz amateur band.

#### REPEATER MAIN USERS

Though amateurs have had the 220-225 MHz band for many years, the activity in that band has been slight. This has been the result of many circumstances such as the lack of suitable military surplus equipment which could be modified for operation on this band, the lack of commercial surplus equipment for the band, the lack of commercial amateur equipment for the band, the power limitations which prevailed for that band for many of the earlier years thus discouraging moonbounce and weak signal work, the narrowness of the band which precluded television experimentation, the availability of commercial and military surplus equipment for the adjacent amateur bands (thus encouraging their use over the 220 MHz band), the pre-emption of the band for military use on a priority basis, and other considerations.

The rapid growth of repeater FM operations in the 146 MHz band indicate that, even with the expansion of that band to the 147 MHz segment, an end is in sight in many areas of the country for repeater channels. The obvious band for further repeater development is the 220 MHz band. Indeed, amateurs and repeater groups have recognized this and a series of FM symposiums have been held to coordinate the development of repeaters in this band. Over two hundred repeater groups have agreed to set up repeaters on the 220 MHz band as soon as practical. Many have already fulfilled this agreement and there are an estimated 70 repeaters actually in operation around the country at this date.

Since the users, other than FM repeaters, have not successfully developed the 220 band in the years that it has been available, it does not seem likely that any great influx of them can be expected in the future. The fact is that 220 MHz offers little for the AM or CW operator over operation on 144 MHz. There is no shortage of open channels on the 144 MHz band for these operators, and there are far more stations to contact. The few stations active on the 220 band (other than repeaters) are not likely to attract much more company.

There is no amateur radio development in sight on any horizon which would provide activity in any substantial numbers in the two MHz left open by the new regulations.

In the foreseeable future it would appear that the bulk of the activity that can be expected to develop on the 220 MHz band would be repeaters. The need is there — the equipment is being manufactured — the interest of the amateurs is there. Everything would appear to be favorable for extensive repeater use of this band.

In the face of this need and prospective growth, the deletion of 40% of the band from repeater use would seem to the detriment of the amateur service.

#### NEW EQUIPMENT

Several manufacturers have taken note of the growth possibilities of the amateur 220 MHz band and have been working diligently to provide good FM transceivers for this band. TPL has a 220 transceiver in production which will sell for around \$250. Henry Radio has a fine 220 FM transceiver which should sell at around \$300. The Clegg 21 is in production. And several other companies are rushing transceivers into production for this band.

Both TPL and Clegg are also working on repeaters for the band and they should be available before the end of the year.

The lack of equipment which has previously limited the use of this band by amateurs would seem to be ending shortly.

#### SELF REGULATION

Amateurs have clearly shown the Commission that they have little need for restrictive rules and regulations and are quite capable of keeping their own house in order. This has been particularly true as far as the 220 MHz band is concerned.

The FM symposiums held earlier this year in the east, midwest and west developed national agreements on 220 MHz repeater input and output channels, repeater channel allocations, frequency coordination to keep interference to a minimum, deviation stan-

dards, simplex channels, control frequencies, etc. Repeater councils have been established in most parts of the country to deal with any problems that do come up.

#### WHY NOT OPEN 220—222 MHz?

Since the use of this band by other than FM repeaters is negligible and would seem to be negligible for the foreseeable future, there would seem to be no adequate reason for the Commission to prohibit the use of the entire band by repeaters.

Perhaps it should be pointed out that the amateurs have agreed to leave the 222—223 MHz segment of the band open for non-repeater use, and have also agreed to leave the lower part of the 220 MHz segment open for continued use by the few present AM and CW users.

What purpose can there be for the Commission to make a rule which will essentially leave two MHz of this band open and almost totally unused? The only possibility that suggests itself is one which is certainly unbecoming of the Commission, though it seems almost inescapable: this regulation would seem to pave the way for a deletion of all or part of this two MHz from the amateur service and thus make it available for citizens band service as is being fervently urged by the Electronics Industries Association.

In the absence of any Washington lobby on the part of the amateurs, there would seem little that amateurs can do to preserve their bands against the pressures of money and influence of big business. The amateurs have depended entirely upon the Commission to be honest and protect their future, having no organization of their own to lobby for them and thus provide this protection.

The net gain to amateurs using the 220 MHz band, should the Commission return the lower two MHz for repeater use, would be one MHz, since the middle MHz has been allocated to non-repeater uses. This segment, from 222—223 MHz is in active use by non-repeater groups right now and has several advantages which make it desirable for this use: the freedom from radar interference which is more serious in the lower parts of the band — and the freedom from adjacent channel interference from television transmitters (and interference to television sets) which results from operation on the lower part of the band. The upper part of the band suffers seriously from spurious emissions of television sets and is less desirable as a result. The result of these and other factors is that the most valuable part of the band for weak signal operations is in the middle part of the band in most areas of the country.

Repeater use of the high end of the band for inputs would seem to be ideal since most repeater receivers are normally situated far enough away from television sets so they would tend to receive little interference from spurious emissions.

The low end of the band would seem better for repeater outputs since their remoteness from television sets would cause much less adjacent channel interference or front end overload to television sets.

The plan that emerged from the FM symposiums would seem to best consider all of the presently known factors as far as amateur utilization of the band is concerned — with the exception of leaving two MHz open and unused for allocation to a new citizens band.

The difference in the number of repeater channels which will be available to amateurs is important. If repeaters are kept to but 3 MHz of the band this would permit perhaps 34 repeater channels using 40 kHz splits instead of the 50 that would result from using 4 MHz.

There are an estimated 30,000 radio amateurs presently active using FM repeaters on 146 MHz. The total population of licensed amateurs is presently about 285,000, according to the latest FCC and Callbook figures. If we make allowances for second stations, licensed wives and children, this still gives us about 210,000 amateurs who might be users of repeaters.

At present amateurs are using approximately fifty 146 MHz repeaters in the New England area. If we project this forward we find that we could need as many as 350 repeaters in the area to handle the activity. The two meter band will probably be able to hold one hundred of these. Obviously the 220 MHz band will be strained to provide the repeater channels that could be needed.

#### PETITION:

The FCC is hereby petitioned to reopen the entire 220—225 MHz amateur band for repeater use.

It is hereby requested that section 97.61(c) be amended to read 220—225 MHz instead of the present 222.0—225.0 allocation.

Wayne Green W2NSD/1  
Peterborough NH 0345818  
September 1972

PETITION: To drop the requirement that a repeater be constantly monitored by a control station during operation.

Amateur automatic relaying stations — repeaters — serve several uses. It is important to consider these uses when devising restrictions and setting them up to limit possible misuses, while not interfering with the uses.

Repeater stations extend the range of communications of amateur base, mobile and hand transceivers, making it possible for amateurs in a fairly wide area to establish contact. As an example, the repeater station atop Mt. Mansfield in Vermont makes it possible for amateurs in northern New Hampshire, northern Vermont, north-eastern New York and adjacent sections of Quebec and Ontario to maintain contact with ten watt mobile units. For instance, I have no trouble using this repeater from New Hampshire, fifty miles away, with a one watt handy-talky to talk with mobile amateurs in Ontario over 200 miles away.

The amateur service provides a supply of trained operators and equipment for use in times of emergency, as well as technical developments which benefit industry and the country. But amateur radio is able to provide the service that it does because of the hobby it provides. The equipment amateurs buy or build or convert is bought with personal funds — funds on which the government has already extracted an income tax. Amateurs will continue to invest this time and money as long as the Commission does not prevent the enjoyment of the hobby which spurs this investment.

The latest report and order by the Commission is not calculated to increase the enjoyment of the hobby — and to that extent will be detrimental to the service that amateurs provide.

The Commission must be aware that in every serious emergency communications falls upon local amateurs. The recent devastation in Pennsylvania was typical of the emergency situations which amateurs encounter and can serve as an example and model.

After trying for several days to handle emergency communications via the lower amateur bands, the importance of a repeater was so apparent that one was flown from a factory over a thousand miles away and set up in the disaster area. The Civil Defense communications, largely set up in basements, were flooded out. Police were too busy with their own problems to provide health and welfare message service or to help the stricken Civil Defense groups. Citizens band operators tried to help, but interference on their channels from skip stations running high power, their lack of range due to low power, and their lack of training in handling messages rendered them only of limited use. Only amateur radio was able to step in and provide the short, medium and long range communications needed.

Once the repeater had been set up, the emergency coordinators in the

area had to put out a call for portable and mobile FM stations and operators to come from outside to help since the local amateurs were not set up for FM and repeaters. A helicopter was sent to the Clegg factory to pick up a dozen of the newest FM transceivers and these were put to immediate good use by local amateurs. FM amateurs from hundreds of miles around responded.

If FM and repeaters had already been established in the flood area it would have been possible for amateurs to provide much better service early in the emergency. It would seem important for the Commission to keep in mind the end effect of each new regulation and weigh it in terms of how it might affect the communications capability that amateurs can provide. The requirement that a control operator continuously monitor a repeater while it is in service is so extremely restrictive as to be severely damaging to the amateur service.

The Commission requirement that a repeater station be controlled via a control and link station on a band above 225 MHz sets definite limitations as to the practical number of control points that can be used, both from a license fee and cost of equipment standpoint. The addition of 450 MHz control equipment to the 146 MHz transceiver in a car would more than double the investment necessary for the mobile installation — and would require a second communications type antenna on the car, thus making it stand out substantially from others and be an inviting target for thieves.

The practical result of the Commission requirement for monitoring at a control point during repeater service is that few repeaters would be in service through the night or during regular working hours of the day. There would be exceptions, of course, where a control operator happened to be an engineer at an all night radio or television station, or the like. These would more likely be the exception rather than the rule.

Repeaters which are turned off a good deal of the time are not very valuable in times of emergency. In some areas it is possible to have a choice of repeaters and it might be feasible to try one channel after another to find a repeater in service. In most areas a mobile operator has little choice and if the repeater within his range is off he is helpless.

It is much more likely that someone somewhere might be listening to the repeater, even though all of the four or five control operators might be asleep, and provide help. And, in the case of the repeater with autopatch, no operator at all is needed to

provide help since police or others can be notified directly through the repeater and the telephone line. The proliferation of scanning receivers makes it even more likely that someone who is awake would be on hand to render service in time of emergency.

Emergencies come in all sizes, from earthquakes and wars to a warning to the wife that you are going to be late. The Commissioner who does not consider notification of late arrival to a wife an emergency must be a bachelor.

There are lesser emergencies where repeaters are helpful. Many amateurs use repeaters when they are driving late at night and through the early morning hours to help keep them awake. Two drivers a hundred miles apart can keep each other awake and alive. To be personal about it, I now undertake long drives at night that I would never undertake without the safety of open repeaters along the way. I know that I will not fall asleep and that should anything happen to my car that I will be able to reach help immediately. If all these repeaters were to be turned off, as the Commission regulations will almost certainly force, many amateurs would suffer along with me.

In this day of integrated circuits there is little problem for amateurs to build and maintain the sophisticated circuits which will enable a repeater station to operate without immediate direct control. With timers set to disable the repeater when trouble develops anywhere in the system, little can go wrong. The fact is that there are about one thousand amateur repeater stations in operation in the U.S. today and the number of problems they cause are very few. The Commission requirement to continuously monitor the input and output of the repeater does not seem to serve the purpose of correcting any existing problem.

As the editor and publisher of the one amateur magazine which has specialized in FM and repeaters and the publisher of a monthly bulletin providing communications to all of the repeater users and operators in the northeastern U.S., and as the publisher of virtually all of the many books on the subject of FM and repeaters, I am perhaps in better communications with the repeater situation as it is in 1972 than most other people.

I would ask that the Commission keep in mind that the comments received on Docket 18803 were sent in over two years ago and reflect, if anything, the state of the art at that time and the thinking of those with experience in the field at that time.

Since then FM and repeaters have grown enormously and the state of the art has changed markedly. There are about 400% more amateurs using FM and repeaters today — there are perhaps 300% more active repeaters, minimum.

In my experience the problems that amateurs are having with repeaters are few and, in virtually every case, are easily solved by the amateurs themselves. There has been no demonstrated need for extensive and extremely restrictive regulations. Repeaters are quite capable of being set up by amateurs to run automatically without perpetual monitoring and it is in the interest of the hobby and the service it provides that repeaters be so set up in most cases.

Amateur repeater technicians and groups will provide any sort of reasonable safeguard that the Commission requires to assure that an automatic unmonitored repeater station is not operated in a way that will cause

problems for other services or for other amateurs. The repeater councils have clearly demonstrated that amateurs are quite capable of self government and handling all but the most serious problems that arise. Amateurs have been able to arbitrate and agree on repeater channels, on interference between repeaters on the same channels, and all other problems attendant to the growth of this valuable service. The fact that problems have arisen is of much less importance than the demonstrated ability of the amateurs to surmount them unaided by the Commission. About the only serious difficulties where amateurs have need of help from the Commission has been in cases of illegal jamming of a few repeaters and the occasional use of abusive language. These cases have been so few and far between that they are not and have never been a substantial problem. And this is a problem that amateurs face on all bands, not just via repeaters.

The Commission gives no reason for the ruling on continuous monitoring, so it is difficult to provide arguments. Indeed, it is difficult to even imagine why such a ruling could ever have been made. It seems to serve no useful purpose and seems so unnecessarily prohibitive and restrictive to the whole fabric of amateur radio as to be worthy of immediate change.

#### PETITION:

To delete the ruling which requires a repeater control operator to monitor the input and output of the repeater continuously. It is requested that the words "and during," in section 97.111b be struck from the regulations, and that 97.109a and 97.110a be changed to eliminate "and during" in the cases of remote control or link operation of a repeater.

Wayne Green  
Peterborough NH 03458

18 September 1972

### CRYPTOGRAM

IGC GCOWS GOLB RY ULVCLVUIUWC JRWCDLKCLI GOV EFVI BCOAI O  
TDFCA ZARX IR IGC KRVI CQTUIULJ OLB YFL OVHCTI RY OKOICFD  
DOBUR UL KOLS, KOLS SCODV.

XOSLC JDCCL

*Drop her a hint that this is the Christmas Present you really want this year . . .*

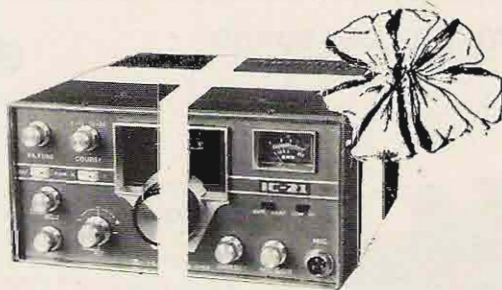

The INOUE IC-21 at \$399.95 is the premium 2 meter transceiver on the market today. Surely you deserve only the best as your very own Christmas present. I know she will approve, as nothing makes the Christmas Day more enjoyable than having a happy 2 meter ham.

JUST TELL HER TO SEND A CHECK TODAY TO:

**ADIRONDACK RADIO SUPPLY, INC.**  
INOUE DEPT.  
185 West Main St. Box 88  
Amsterdam, New York 12010

We'll do our part to make a Merry Christmas for you by immediately shipping out your rig. Also, we're going to enclose a little Christmas present for her for being so nice to both of us.

# FM TRANSCEIVER under \$100.00

YOU SUPPLY CASE – MIKE – SPEAKER – CONTROLS.

## 144–220 TRANSMITTER KIT

**ANNOUNCING! A Breakthrough for the Homebrewer**

COMPLETE WITH DRILLED BOARD

**\$39.95**

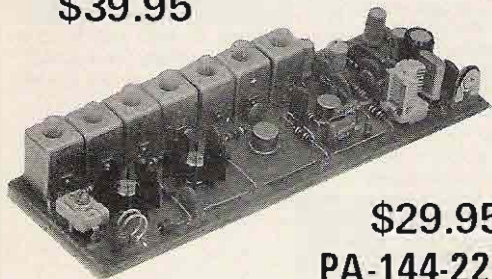

**\$29.95**  
**PA-144-220**

- TYPICALLY 1 1/2 WATTS OUTPUT AT 12.6 VOLTS (1 WATT ON 220)
- ADJUSTABLE DEVIATIONS TO 10 kHz
- AUDIO CLIPPING AND ACTIVE FILTER
- CRYSTAL NETTING TRIMMER
- DOUBLE TUNED RF STAGES FOR A CLEAN SIGNAL
- STANDARD 12 MHz CRYSTALS (14 MHz FOR 220)
- ZENER REGULATED OSCILLATOR
- PROVISIONS FOR METERING EACH RF STAGE
- PREDRILLED AND TINNED GLASS CIRCUIT BOARDS
- MEASURES ONLY 2" x 6"

A one watt exciter using four RF transistors, two diodes, and one integrated circuit. The RF transistors are operating well below their ratings allowing long keying periods without damage. The exciter may be used alone as a transmitter or with our PA-144 or 220 amplifier for a ten watt station.

## 144–220 MODULAR RECEIVER KIT

COMPLETE WITH DRILLED BOARD

**\$59.95**

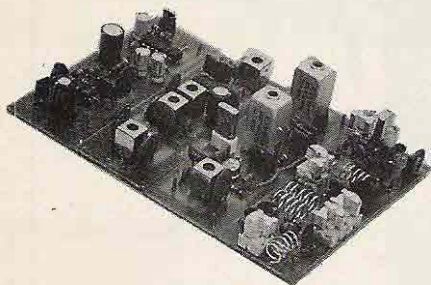

- BETTER THAN .3  $\mu$ V SENSITIVITY
- 15 KHz BAND WIDTH
- ONE WATT AUDIO OUTPUT
- DUAL CONVERSION 10.7 Mhz AND 455 KHz IFs
- ALL IC EXCEPT FOR FRONT END
- STANDARD 45 Mhz CRYSTALS
- OPTIONAL CERAMIC FILTER
- OPERATES FROM 12 VOLTS NEGATIVE GROUND

**Measures only 4" x 6"**

Order TX-144 or 220—\$39.95; PA-144 or 220—\$29.95; RX-144 or 220—\$59.95.

Receiver with 7 KHz ceramic filter — \$65.95. Include \$1.00 postage and handling for each kit ordered. New York state residents add 6% sales tax.

# VHF ENGINEERING W2EDN

1017 CHENANGO ST. BINGHAMTON NY 13901



# VHF HEADQUARTERS

FOR SOUTHERN FLORIDA

WE FEATURE THE COMPLETE LINE  
OF  
STANDARD AMATEUR FM EQUIPMENT

**2M FM TRANSCEIVER SRC-146A**  
Solid state, 2 watt, 5 channel,  
hand held transceiver.



**\$289.00**



**DIGIPET 160** Frequency Counter  
1000 Hz - 160 MHz  
.05 microvolt sensitivity  
**\$349.95 ppd USA**

**NEW! SOLID STATE 2M REPEATER SC-ARPT-1**

Complete packaged repeater designed for today's popular 2M FM  
band. 12 vdc. Ideal for new system or emergency portable operation.

## *Clegg* FM 27 A \$ 479.<sup>95</sup>



ALSO IN STOCK  
REGENCY, CUSHCRAFT, HY-GAIN

*Modify your Gladding 25  
with our  
Coincidence Detector*

- True FM Detector
- Improved Sensitivity
- Improved IF Gain
- Superior Squelch Action
- Install in just a few minutes

Complete G-10 epoxy board wired and  
aligned ready to install.

1 year warranty

**\$19.95 ppd USA**

EMPORIUM SOUNDS OF POMPANO  
51 NORTH FEDERAL HIGHWAY  
POMPANO BEACH, FLORIDA 33060

# LOW NOISE ECONOMY PREAMP FOR 2M

**L**ow gain is almost a meaningless parameter in an rf preamplifier specification unless some notation is made about the noise characteristics of the circuit. A gain of 20–30 dB is not uncommon in a VHF preamplifier with a single semiconductor of modern vintage. But if the active device tends to generate and amplify noise, that healthy signal could be reduced to such an extent that copy is actually better with the preamp completely out of the receiver circuit. A signal-to-noise-ratio measurement made before installing the preamp should, under ideal conditions, read the same with the preamp *in* the circuit provided the *specified* gain is actually the effective gain — which, unfortunately, is rarely the case. In practice, the effective gain of a typical two meter preamp is considerably less than half the rated gain!

Bandwidth is another parameter worthy of a builder's consideration. A broad amplification curve might be a real blessing for the frequency-hopper who operates at the low end of the band one night and at the other end the next, providing he's not trying to operate from an area noted for spectrum congestion. The fact is, the broader the bandwidth of the preamp, the more likely

the receiver will be to be "swamped out" by strong signals on adjacent frequencies. Obviously, then, for such applications as FM repeaters, and for metropolitan operation in general (where plenty of strong signals abound), selectivity would take precedence over broadband capability.

The two meter preamp described here represents what I feel to be a sound compromise with respect to bandwidth and gain. It is relatively broadbanded, but not so much as to allow tuning of the entire two meter band without some retuning. It is capable of resisting strong signals (above a millivolt) at adjacent 30 kHz points without desensitizing the receiver — a feature that qualifies it well for use with repeaters. The effective gain of this preamplifier is 14 dB; and the noise contribution is as low as the state of the art will allow.

The preamp owes its extremely low noise figure to the single HEP 802, a low-cost VHF junction-type field-effect transistor produced by Motorola for the hobbyist and experimenter market.<sup>1</sup> FETs in general have lower noise figures than ordinary bipolar transistors, and the junction FET has a significantly lower noise figure than the metal-oxide (MOSFET) type.

The circuit presented here – designed, by the way, by Motorola engineers – uses the FET in a common-gate configuration. While common-gate amplifiers don't exhibit the sometimes astronomical gain that can be achieved with common-source or common-drain circuits, other factors make it an ideal choice for VHF applications. Chief among those "other factors" is the devilish *Miller effect*, the FET's traditional "most serious threat" to VHF applications. The Miller effect is the name applied to a FET's characteristic high-frequency feedback capacitance problem; as the frequency goes up, the gate-to-drain capacitance increases and actually appears *across* the amplifier, making the input impedance in effect a capacitive reactance.

Fortunately, while the Miller effect is horrendous with common-source amplifiers, and just plain terrible for common-drain configurations, it is a negligible consideration with the common-gate amplifier hook-up. Clever engineers have developed methods for skirting the Miller effect, such as cascading (with an "o" not an "a") the common-gate FET with a common-source type<sup>2</sup>, but these add complexity – and complexity means expense. Considering the various tradeoffs, the most practical approach appears to be to settle for a little less overall gain than what is technologically possible in return for improved selectivity and a noise figure that is virtually incomparable.

### Construction

The schematic diagram is shown in Fig. 1. As shown, the circuit represents a conservative use of components – a feature that is attractive from both the standpoint of economy and miniaturization. If you've worked with FETs at VHF before, you'll have no trouble with this excellent-performing circuit.

Just remember to keep the leads short; make good solder connections; don't overheat the FET leads (use sockets); and use effective shielding.

It's always a good idea to use printed circuit boards for projects like this, of course, but I didn't. The very good per-

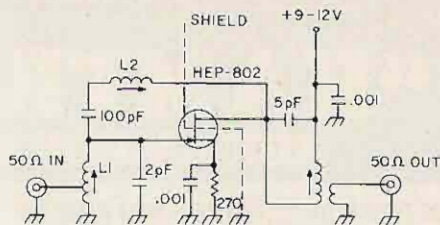

Fig. 1. This single-FET preamp offers an ideal compromise between selectivity and gain; not easily swamped by adjacent frequency signals, it will provide better than 14 decibels of signal improvement for fixed-frequency two-meter operation. Coil values are given in the text.

formance of my own unit serves as proof that a small piece of Vector board and point-to-point wiring with solid conductors can be as effective (and as small) as a printed circuit – and it is a darn sight less trouble.

The preamp contains three coils wound on forms, plus one loop overwind. I used ceramic coil forms with 1/4" brass slugs. Inductor L1 consists of 5-1/2 turns of 26 gauge solid wire (tinned copper) wrapped on the slug-tuned form. This coil should be tapped 1-1/4 turns in from the ground end. Coil L2, also on a slug-tuned form, is 9-1/2 turns of 34-gauge wire. L3 is 5 turns of 26 gauge wire, and L4 is 1-1/4 turns of the same type of wire wrapped around the lower end of L3.

To avoid power-supply problems, I used a simple 9V transistor radio battery to operate my preamp. But for some applications, such as those involving use with a repeater, a battery would be impractical in spite of the preamp's low power consumption. The preamplifier's input voltage range, however, is broad enough to allow connection to a 12V source (rectified and filtered repeater filament supply, for example, or auto battery for mobile installations) with no circuit modifications.

### Performance Checkout

If you plan to use the preamp with an AM receiver, you can adjust it for optimum performance in this fashion: first connect the antenna directly to the receiver and tune to a spot where there are no signals (but close to the frequency of maximum interest for you). If your S-meter has an adjustment

# "HAMTRONICS" IS

A DIVISION OF TREVOSE ELECTRONICS

## GET THE BIRD FROM HAMTRONICS

We have a complete stock of all Bird wattmeters and slugs on hand . . . immediate delivery. Order a new BIRD Ham-mate wattmeter for only \$79, but please specify if you want the 200/1000 watt model or the 200/2000 watt model.

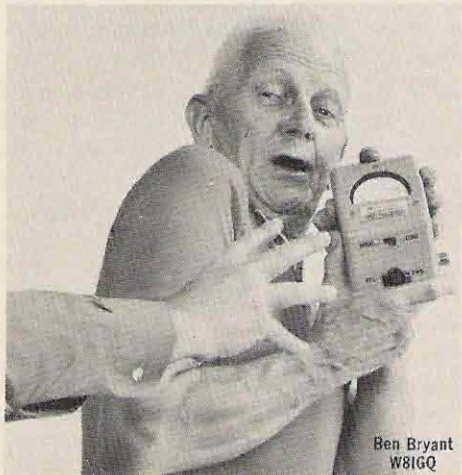

## THE HAMTRONICS EXCHANGE PROGRAM

We will exchange Bird wattmeter slugs (in good shape) bought from Hamtronics for any other slug that you may need in the future — no charge! Your wattmeter can never be outdated.

**Oh no you don't!  
Get your own BIRD!**

Come to HAMTRONICS  
and see the largest  
stock of new and  
used ham gear on  
the East Coast.

P.S. — We  
will trade any  
kind of electronic gear

Credit cards honored —  
Mastercharge, Bank Americard,  
PNB, GEC, etc.  
We ship anywhere in USA  
via UPS — NO CHARGE  
TO YOU

## FM 2 METER ANTENNAS

- Complete stock of FM Antennas for base or mobile
- Large drive-in on the premises for immediate installation or service
- Complete line of Motorola H.E.P. transistors at all times

by

**Cush**  
  
**Craft**  
CORPORATION

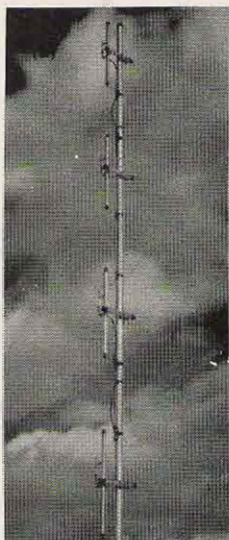

4033 BROWNSVILLE RD., TREVOSE, PA. 19047

# FM HEADQUARTERS!

- Over \$5,000 crystal inventory, all standard frequencies in stock.
- Complete lab set-up, Cushman E-3 counter and deviation scope.
- Every set sold checked out by our FM experts.
- Put precisely on your frequency before shipping to you at no charge.

**DRAKE  
MODEL  
TR-22**

**2 meter  
FM  
Transceiver**

**\$199.95**



RECEIVE ANY FREQUENCY IN THE 2M BAND  
(146-147 MHz) WITH 2 SIMPLE SETTINGS  
ON THE NEW CLEGG  
FM-27A MOBILE

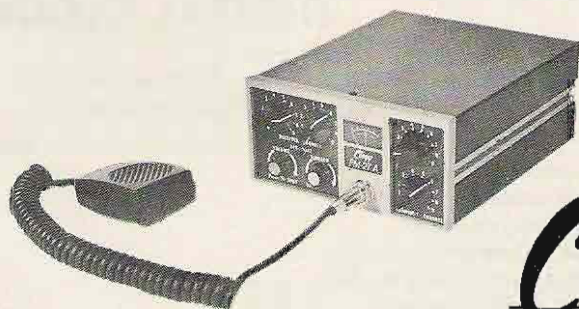

**Clegg** DIVISION

Stop in and browse at FM HEADQUARTERS. Free coffee and donuts. FREE — for your use — Frequency Counter in our showroom window runs 24 hours a day. Pull up in front and check your own frequency.

(215) 357-1400

PHONES

(215) 757-5300

pot, set it to zero; if not, simply note the average no-signal reading. Then set the preamp's slug-tuned coils (L2 and L3) to about mid-position and apply power to the preamp. Disconnect the antenna from the receiver, place the preamp in line, and connect the preamp's output to the receiver antenna terminal. Slowly adjust the L2 slug for a maximum S-meter indication, then adjust L3. L2 is slightly more critical than L3, and it should be readjusted after each L3 adjustment. The S-meter reading should increase by at least two units. If broadband operation is desired, adjust L2 at the lower end of the frequency range you want and adjust L3 at the upper end. Then trim L2 for identical S-meter indication at both ends of the range.

If the preamp is to be used with a repeater, you'll probably have some test equipment on hand. If you have access to a signal generator and an ac voltmeter, you're in luck. Set the ac voltmeter to the decibel range (0-10V ac) and connect the leads to the speaker terminals. Turn on the receiver and open the squelch. Then adjust the receiver volume control for a reading of plus 20 dB on the meter. (If your ac voltmeter

has no dB scale as such, adjust the receiver volume control for a reading of 7.8V on the 10V ac scale of a 20,000 $\Omega$  per volt instrument.)

Connect a signal generator (properly warmed up for stability, of course) to the receiver without the preamp in the circuit, and increase the generator output until the meter reading drops to plus 14 decibels (6 dB quieting). This reading will be just under 4 volts on the 10-volt ac range. Recheck the generator for frequency stability, then insert the preamp, with power applied, between the receiver and the generator. Adjust L2 and L3 for minimum indication on the voltmeter - without readjusting the signal generator. If you've done a good job on the preamp, the adjustment operation should bring the meter reading down to well below zero decibels (less than 0.6 volt on the ac scale).

..K6MVH

1. "Tips on Using Fets," Motorola Semiconductor Products, Box 20924, Phoenix AZ 85034.
2. "An Introduction to FETs," Siliconix, Inc., 2201 Laurelwood Rd., Santa Clara CA 95054.

## SOLID STATE



## DIGITAL CLOCK

This product of space age technology computes and displays time of day to the exact second. High visibility Nixie tube readout. Encased in handsome oiled solid walnut case with matching base for desk or shelf mounting in any decor.

- Silent solid state operation.
- Fractional second accuracy.
- Polaroid displays/red filter.
- Three special time settings
- Full year guarantee (made in USA).
- 12 or 24 hour time display.
- TTL integrated circuits.

Please specify 12 or 24 hour model. Send check or M.O. for \$159, postpaid. COD's accepted with \$30 deposit. Calif. residents, add 5% sales tax.

● MELREX PRODUCTS ●

8142 Ridgefield Dr. Box 5  
Huntington Beach, CA 92646

# HAMTRONICS

A DIVISION OF TREVISE ELECTRONICS

1033 BROWNSVILLE ROAD, TREVISE, PA. 19047 PHONES: (215) 357-1400/(215) 757-5300

## NEW HR-6 12 Channel Solid State 6 Meter FM Transceiver

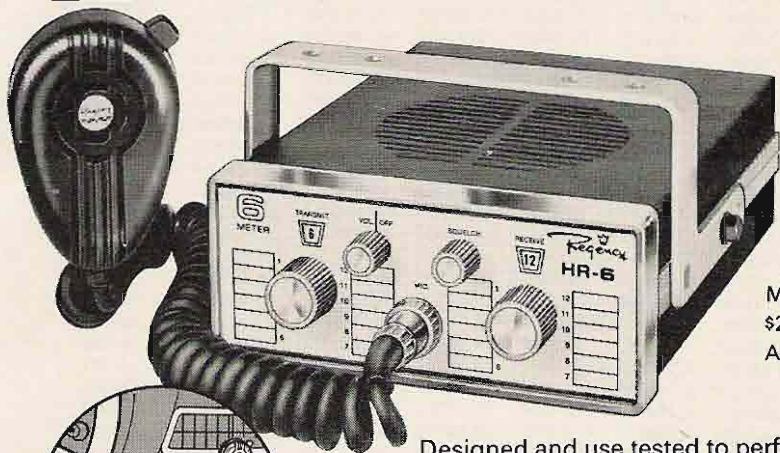

Model HR 6  
\$239.00  
Amateur Net

Designed and use tested to perform against TVI. Designed to utilize the most modern components of the solid state art—integrated circuits, dual gate MOSFET transistor, silicon BET power transistor, etc. Designed with the power in the frequency range to work FM Skip. And, designed and built in America in a compact package that will appeal to your taste and pride of ownership.

**Complete dash mount operation . . . does not require black box power hog in your trunk**

**25 Watts Out  
Long Range Signal Capability  
12 T and R Channels  
Independently Switched  
144 Frequency Combinations  
5 Watts Audio output  
Compact for Dash Mount.**

### SPECIFICATIONS

Power Output:	25 watts Min. @ 13V DC
Frequency Range:	52-54 MHz
Channels:	12 with independent switching
Sensitivity:	.35 $\mu$ V (nom) 20db quieting
Selectivity:	6db $\pm$ 16KHz
Audio Output:	5 watts max.
Size:	2 7/8" x 6 1/2" x 9 1/2"

State of the art receiver utilizes MOSFET mixer for superior front end overload and intermodulation performance.

# TWO METER FM CRYSTAL CHART

CHANNEL	6 MHz Tx	8 MHz Tx	12 MHz Tx	18 MHz Tx	45 MHz Rx	STANDARD Rx	INOUE Rx
146.01	6.08375	8.111666	12.1675	18.25125	45.103333	14.923333	15.034444
146.04	6.08500	8.113333	12.1700	18.25500	45.113333	14.926666	15.037777
146.07	6.08625	8.115000	12.1725	18.25875	45.123333	14.930000	15.041111
146.10	6.08750	8.116666	12.1750	18.26250	45.133333	14.933333	15.044444
146.13	6.08875	8.118333	12.1775	18.26625	45.143333	14.936666	15.047777
146.16	6.09000	8.120000	12.1800	18.27000	45.153333	14.940000	15.051111
146.19	6.09125	8.121666	12.1825	18.27375	45.163333	14.943333	15.054444
146.22	6.09250	8.123333	12.1850	18.27750	45.173333	14.946666	15.057777
146.25	6.09375	8.125000	12.1875	18.28125	45.183333	14.950000	15.061111
146.28	6.09500	8.126666	12.1900	18.28500	45.193333	14.953333	15.064444
146.31	6.09625	8.128333	12.1925	18.28875	45.203333	14.956666	15.067777
146.34	6.09750	8.130000	12.1950	18.29250	45.213333	14.960000	15.071111
146.37	6.09875	8.131666	12.1975	18.29625	45.223333	14.963333	15.074444
146.40	6.10000	8.133333	12.2000	18.30000	45.233333	14.966666	15.077777
146.43	6.10125	8.135000	12.2025	18.30375	45.243333	14.970000	15.081111
146.46	6.10250	8.136666	12.2050	18.30750	45.253333	14.973333	15.084444
146.49	6.10375	8.138333	12.2075	18.31125	45.263333	14.976666	15.087777
146.52	6.10500	8.140000	12.2100	18.31500	45.273333	14.980000	15.091111
146.55	6.10625	8.141666	12.2125	18.31875	45.283333	14.983333	15.094444
146.58	6.10750	8.143333	12.2150	18.32250	45.293333	14.986666	15.097777
146.61	6.10875	8.145000	12.2175	18.32625	45.303333	14.990000	15.101111
146.64	6.11000	8.146666	12.2200	18.33000	45.313333	14.993333	15.104444
146.67	6.11125	8.148333	12.2225	18.33375	45.323333	14.996666	15.107777
146.70	6.11250	8.150000	12.2250	18.33750	45.333333	15.000000	15.111111
146.73	6.11375	8.151666	12.2275	18.34125	45.343333	15.003333	15.114444
146.76	6.11500	8.153333	12.2300	18.34500	45.353333	15.006666	15.117777
146.79	6.11625	8.155000	12.2325	18.34875	45.363333	15.010000	15.121111
146.82	6.11750	8.156666	12.2350	18.35250	45.373333	15.013333	15.124444
146.85	6.11875	8.158333	12.2375	18.35625	45.383333	15.016666	15.127777
146.88	6.12000	8.160000	12.2400	18.36000	45.393333	15.020000	15.131111
146.91	6.12125	8.161666	12.2425	18.36375	45.403333	15.023333	15.134444
146.94	6.12250	8.163333	12.2450	18.36750	45.413333	15.026666	15.137777
146.97	6.12375	8.165000	12.2475	18.37125	45.423333	15.030000	15.141111
147.00	6.12500	8.166666	12.2500	18.37500	45.433333	15.033333	15.144444
147.03	6.12625	8.168333	12.2525	18.37875	45.443333	15.036666	15.147777
147.06	6.12750	8.170000	12.2550	18.38250	45.453333	15.040000	15.151111
147.09	6.12875	8.171666	12.2575	18.38625	45.463333	15.043333	15.154444
147.12	6.13000	8.173333	12.2600	18.39000	45.473333	15.046666	15.157777
147.15	6.13125	8.175000	12.2625	18.39375	45.483333	15.050000	15.161111
147.18	6.13250	8.176666	12.2650	18.39750	45.493333	15.053333	15.164444
147.21	6.13375	8.178333	12.2675	18.40125	45.503333	15.056666	15.167777
147.24	6.13500	8.180000	12.2700	18.40500	45.513333	15.060000	15.171111
147.27	6.13625	8.181666	12.2725	18.40875	45.523333	15.063333	15.174444
147.30	6.13750	8.183333	12.2750	18.41250	45.533333	15.066666	15.177777
147.33	6.13875	8.185000	12.2775	18.41625	45.543333	15.070000	15.181111
147.36	6.14000	8.186666	12.2800	18.42000	45.553333	15.073333	15.184444
147.39	6.14125	8.188333	12.2825	18.42375	45.563333	15.076666	15.187777
147.42	6.14250	8.190000	12.2850	18.42750	45.573333	15.080000	15.191111
147.45	6.14375	8.191666	12.2875	18.43125	45.583333	15.083333	15.194444
147.48	6.14500	8.193333	12.2900	18.43500	45.593333	15.086666	15.197777
147.51	6.14625	8.195000	12.2925	18.43875	45.603333	15.090000	15.201111
147.54	6.14750	8.196666	12.2950	18.44250	45.613333	15.093333	15.204444
147.57	6.14875	8.198333	12.2975	18.44625	45.623333	15.096666	15.207777
147.60	6.15000	8.200000	12.3000	18.45000	45.633333	15.100000	15.211111
147.63	6.15125	8.201666	12.3025	18.45375	45.643333	15.103333	15.214444
147.66	6.15250	8.203333	12.3050	18.45750	45.653333	15.106666	15.217777
147.69	6.15375	8.205000	12.3075	18.46125	45.663333	15.110000	15.221111
147.72	6.15500	8.206666	12.3100	18.46500	45.673333	15.113333	15.224444
147.75	6.15625	8.208333	12.3125	18.46875	45.683333	15.116666	15.227777
147.78	6.15750	8.210000	12.3150	18.47250	45.693333	15.120000	15.231111
147.81	6.15875	8.211666	12.3175	18.47625	45.703333	15.123333	15.234444
147.84	6.16000	8.213333	12.3200	18.48000	45.713333	15.126666	15.237777
147.87	6.16125	8.215000	12.3225	18.48375	45.723333	15.130000	15.241111
147.90	6.16250	8.216666	12.3250	18.48750	45.733333	15.133333	15.244444
147.93	6.16375	8.218333	12.3275	18.49125	45.743333	15.136666	15.247777
147.96	6.16500	8.220000	12.3300	18.49500	45.753333	15.140000	15.251111
147.99	6.16625	8.221666	12.3325	18.49875	45.763333	15.143333	15.254444



# EXTRA CLASS LICENSE STUDY GUIDE

## Questions & Answers Part IV

66. *How are grounded-grid amplifiers used in electronic circuits? List some advantages and disadvantages of their use. Describe the input impedance characteristics of a grounded-grid amplifier.*

A. Grounded-grid amplifiers are used in rf stages of both transmitters and receivers, but for different reasons. In receivers, the grounded-grid circuit eliminates the need for neutralization of triodes, and permits simple low-noise stages to be designed. The grounded-grid configuration also provides better voltage gain at higher frequencies than can be achieved in other configurations.

In transmitters, the grounded-grid circuit has become popular because of its low input impedance and ability to "feed through" excess power, making it ideal for bringing the output of a medium-power SSB transmitter up to the legal limit.

Advantages of the grounded-grid circuit include freedom from the neutralization requirement, relatively constant load upon the driving source, voltage gain comparable to that of a grounded-cathode circuit, and feed-through of excess driving power.

Disadvantages include the requirement for more driving power than required by more conventional circuits, the low input

impedance (which at times is an advantage), and the requirement that the preceding stage be modulated if the g-g stage is to be modulated.

Input impedance, as mentioned, is low; 50 ohms is an approximate typical value. Output impedance is high. The circuit has no current gain, and does not reverse signal phase.

67. *What constitutes a parasitic antenna element?*

A. A parasitic antenna element is any antenna element which is not electrically connected to a driving feedline, but operates by means of re-radiation of received energy.

68. *What is the image-response of a receiver? How can it be reduced?*

A. Every superhet receiver has the capability of responding to signals at two distinct input frequencies, for a single setting of the local oscillator. One input frequency is that which, when mixed with the local-oscillator signal, produces the i-f as the difference between input and local-oscillator frequencies, and the other is that which, when so mixed, produces the i-f as the difference between local-oscillator and input frequencies. That is, one is below the local-oscillator signal, and the other is above, by

the amount of the i-f. Only one of these two possible responses is the desired signal; the other is called the "image." The choice as to which is desired and which is image is made at the time the receiver is designed. The ratio between desired-signal strength, and image-signal strength (assuming equal-level input signals) is the image response criterion, and is usually expressed in dB of rejection of image. Image rejection can be improved by increasing selectivity of the circuits preceding the mixer, or by using a higher i-f, which separates the desired and image signals by a larger degree. Both remedies can be used.

69. *What is a third party agreement? What countries have agreements with the United States?*

A. A third party agreement is a special agreement between two nations, in which each agrees to permit its radio amateurs to handle messages for third parties in international communications between the two. In the absence of such special agreements, third party messages are prohibited.

At the time of writing, the United States had such agreements with at least 22 countries, all in the Western Hemisphere except Israel and Liberia. The list is subject to relatively rapid change, however, and current information should be checked for the exact list of countries at any specific time.

70. *What effect will extending the low-frequency audio response of a signal have on the design of an SSB transmitter?*

A. In a filter-type SSB exciter, extension of the low-frequency audio response requires redesign of the filter to have a wider passband, and may make carrier rejection more difficult. In a phasing exciter, achieving extended low-frequency response requires redesign of the audio phase shift networks, which are already a compromise. In either case, communications effectiveness is reduced, because the highest-power parts of the voice spectrum are in the frequencies below 300 Hz, while the parts producing intelligibility are above 300 Hz. Extending low-frequency response below 300 Hz thus limits the amount of power which can be devoted to the significant parts of the signal, while simultaneously making design and operation more difficult. For this reason

most SSB rigs are restricted to 300-3000 Hz response.

71. *List some different types of beam antennas.*

A. Parasitic arrays, including the Yagi, the log-periodic, and as special cases the parabolic reflector and the corner reflector; Driven arrays, including the endfire, the Franklin collinear, the ZL Special, and the 8JK; and long-wire beams, including the rhombic, the vee-beam, and the simple long-wire. The term "beam antenna" includes all antennas having marked directional beam. Driven arrays can be composed of a number of parasitic arrays, and the elements of any driven array may themselves be complete driven arrays. Such complex beam systems are often used at VHF to achieve high power gain and extreme directionality.

72. *What radioteletype transmitter operating deficiencies may be indicated by a decreasing antenna rf current during modulation of the final rf amplifier?*

A. Decreasing antenna current during modulation, often called "downward modulation," may be due to several causes, depending upon the manner in which the modulation is applied. With conventional high-level plate modulation, downward modulation may be due to inadequate rf drive to the modulated stage, faulty tubes in the modulated stage, poor voltage regulation in the power supply (causing the modulator's power to be robbed from the modulated stage and thus causing a net loss in output), incorrect operating conditions in the modulated stage (particularly grid bias), or impedance mismatching between modulator and modulated stage.

With grid modulation the condition can arise as a result of attempting to get too much signal out at the carrier level, thus leaving room for upward modulation on peaks. This is improper adjustment of the loading. Lack of drive can also cause it, as can improper grid bias.

With screen modulation, downward modulation can result from improper loading, wrong grid bias, wrong screen voltage, inadequate drive, or insufficient modulator power. In all cases, the drive and loading conditions must permit the modulated stage to produce 4 times as much power at the

positive peaks of the modulating cycle as is produced at the carrier level, in order to achieve 100 percent modulation. If the stage is not capable of producing full output on positive peaks, downward modulation results because the indicated antenna current is the average over the modulating cycles, and with the peaks being clipped on the positive side, the negative peaks will reduce the average below the carrier level.

73. *What improper operating conditions are indicated by the upward or downward fluctuation of a Class A amplifier's plate current when a signal voltage is applied to the grid? How can this be corrected?*

A. Fluctuation of plate current when signal is applied to a supposedly Class A amplifier indicates only one thing: the amplifier is not actually operating Class A. This may be due to either of two possible causes: the input signal may be too large, driving the amplifier outside its intended operating range, or the grid bias is incorrect.

The remedy for overdrive is obvious — reduce the level of the input signal to that for which the stage is designed. Correcting improper bias is a bit more subtle.

If the plate current increases with signal, the stage has too great grid bias and it should be reduced. If the plate current decreases with signal, the bias is insufficient and should be increased. The correct bias is achieved when the plate current remains constant with application and removal of input signal.

At maximum drive and output, Class A power amplifiers show a slight increase in plate current as compared to the no-signal case, because of DC rectification in the output circuit. This should not be confused with the fluctuations referred to in this question.

74. *What improper operating conditions are indicated by grid current flow in a Class A amplifier?*

A. None, necessarily, because Class A amplifiers which depend upon grid current flow have been designed and operated. The conventional Class A amplifier, however, is designed to operate without grid current, and any grid current flow in such a circuit indicates overdrive. The chances are great

that any such amplifier in which grid current is observed is not actually operating Class A because of the overdrive. See also question 73.

75. *What may be the cause of a decrease in antenna current during modulation of a Class B rf amplifier?*

A. The Class B rf amplifier should not be modulated directly; it operates properly only as a linear. If used as a linear, amplifying a signal to which modulation has been applied earlier, downward modulation indicates improper loading (too light) or an attempt to get excessive efficiency from the circuit. Downward modulation cannot occur with SSB.

76. *What determines the skip distance of radio waves?*

A. Skip distance depends upon two factors: the effective height of the reflecting layer, and the angle of reflection. These establish the altitude and one angle of a triangle, thus fixing the opposite leg's length (which is the skip distance). Both effective height and reflection angle in turn depend upon the frequency of the signal, and the condition of the ionosphere at the time.

77. *How can parasitic oscillation be prevented?*

A. By preventing the conditions (appreciable impedances at frequencies where the phase shift occurs) which permit them. This can be done by appropriate physical layout, choice of the proper types of bypass capacitors and rf inductors, and by application of parasitic suppressors to reduce gain at parasitic frequencies.

78. *Give some proven methods of harmonic reduction in transmitters.*

A. See question 61, Part III.

79. *Describe briefly some well known types of antennas and antenna systems used by amateurs which do, and do not, reduce harmonic radiation.*

A. Any non-resonant antenna will radiate energy at any frequency within the normal rf range equally well (or equally poorly). Thus it cannot reduce harmonics. Antennas which are themselves resonant, or which use resonant matching systems are selective and reduce at least some of the possible harmonics. Both types of antennas are widely used by amateurs.

One of the most well-known non-resonant antennas is the ordinary "long-wire" system. In its most common form, this consists of a length of wire of random length, insulated at one end and driven at the other. It is a common antenna for beginners' use because it is so simple to install. With luck, it can even be made to operate after a fashion. If the length is not some multiple of  $1/4$  wavelength at any specific operating frequency, the antenna is not resonant and so can radiate at any frequency. It therefore has virtually no reduction of harmonics.

The most common resonant antenna is the half-wave dipole. This consists of an electrical half-wavelength of wire, insulated at each end, split in the middle by an insulator, and driven in a balanced configuration at the center insulator ends of the two halves. It is resonant at every frequency for which the element halves are an odd multiple of  $1/4$  wavelength, and readily accepts power. Thus it will radiate at the 3rd, 5th, 7th, and other odd harmonics of the design frequency. It is also resonant at the frequencies for which the element halves are even multiples of  $1/4$  wavelength, but impedance at the feedpoint is inverted and it will not readily accept power from a low-impedance line. Thus it tends to reject energy at the 2nd, 4th, and all even harmonics of the design frequency.

Beam antennas achieve their directive qualities through careful phasing of the radiated energy, and this phasing is a function of frequency. Thus, most beam antennas reject all harmonics of their design frequency.

A popular class of ham antennas is the "all-wave" group which is designed to accept and radiate power at all ham frequencies using only one antenna system. Since the HF ham bands are all harmonically related, these antennas have had their harmonic-reduction properties carefully engineered OUT of them and consequently cannot adequately reject harmonics. Use of additional tuned circuits between transmitter and antenna system will restore selectivity and permit harmonic reduction.

80. What must the value of an inductor be to cancel a capacitive reactance of 12.6

kilohms at an operating frequency of 2 Mc/s?

A. The inductor must have inductive reactance of 12,600 ohms at the same 2 MHz frequency, so its value must be 0.001 H (henry), or 1 mH (millihenry).

81. What is meant by "end effects" in an antenna? How can they be compensated for in half-wave antennas?

A. The end effect in an antenna is an apparent lengthening of the antenna element. That is, its electrical length is slightly greater than would be expected from its physical length, because of capacitance at the end of the conductor.

In half-wave antennas, end effects are compensated by making the physical length of the wire approximately 5% less than the desired electrical length would indicate.

82. What are the bandwidths normally used for A1, A3 (single and double sideband), and F3 (narrowband) type emissions?

A. Bandwidth of A1 signals depends upon keying speed. Most A1 signals occupy less than 50 Hz bandwidth. A3 with both sidebands, whether or not carrier is suppressed, requires at least 6 kHz and often occupies as much as 30 kHz. A3 with single sideband takes 3 kHz with carrier, and 2.7 kHz without. F3 in HF ham usage cannot exceed 6 kHz; at VHF it is not limited.

83. Describe briefly how an ac power supply produces a dc output voltage. Discuss the merits of using choke-input versus capacitor-input filters in power supplies. How does the leakage resistance of the capacitors affect the output voltage? Also, what is voltage regulation as related to power supplies?

A. The power supply uses a suitable transformer to convert the input ac to the appropriate voltage level, followed by a rectifier circuit which converts the ac to pulsating dc. Finally, a filter circuit smooths out the pulsations, yielding an approximation to "pure dc" as output. The quality of the approximation depends upon the quality of the filter.

A choke-input filter provides better voltage regulation than does the capacitor-input filter, but produces lower output voltage under light load conditions. The

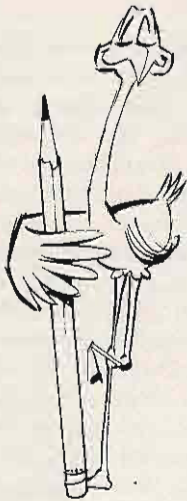

**SAROC** room rate \$15.00 per night plus room tax single or double occupancy send directly to Flamingo Hotel, Las Vegas NV 89109.

**SAROC** Advance Registration \$10.00 per person, includes admission to Swan and Hy-Gain Cocktail parties, Exhibit area, Technical sessions and seminars, Sunday Hunt Breakfast with Champagne.

**SAROC** Advance Registration with Flamingo Hotel Dinner show (brisket of beef) \$21.00 per person, includes tax and gratuity, no drinks.

**SAROC** Advance Registration with Flamingo Hotel Mid-night show and two drinks, \$17.00 per person, includes tax and gratuity.

Mail Advance Registrations to **SAROC**, P.O. Box 73, Boulder City, Nevada 89005 before January 1, 1973, requests for refunds must be in writing and received before January 6, 1973.

**MAKE A DATE**

**8th Annual JANUARY**  
**SAROC 4-7**  
**fun convention 1973**

# PRINTED CIRCUITS

**FAST — EASY**  
 with **DATAK's**

# DIRECT ETCH SET

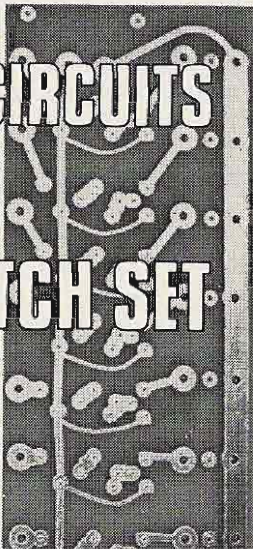

Circuit Made With ER-1

**EASY**—patterns rub down directly on the copper board and connect with rub-down lines or tapes supplied.

**FAST**—safe new etchants will etch a 2 oz. copper board in 30 minutes.

**ACCURATE**— $\pm .002$ " print tolerance so parts and connectors mate with no errors.

**COMPLETE ER-1 SET** contains hundreds of dry transfer DIP, flatpack, TO-5, IC, and transistor patterns;  $\frac{1}{16}$ " and  $\frac{1}{32}$ " etch resist tapes; 4 copper clad boards;  $\frac{1}{4}$  lb. dry etch; tray and instructions. \$4.95 ppd.

**IN STOCK AT ALLIED AND OTHER DISTRIBUTORS**  
 WRITE FOR FREE CATALOG listing this and many other dry transfer marking sets.

**The DATAK Corporation**

85 Highland Avenue • Passaic, New Jersey 07055

capacitor-input filter produces higher output voltage, but puts more strain upon the preceding components in the power supply. In consequence choke-input filters are normally used where high power is required, and capacitor-input filters are restricted to applications requiring comparatively low power (receivers and test equipment).

If a filter capacitor develops excessive leakage, (abnormally low leakage resistance), it will act as an additional load on the power supply thus reducing output voltage. It will also degrade filter performance. In most cases, such a situation is self-destructive; the abnormal current through the capacitor results in overheating, further weakening the capacitor, and the capacitor fails shortly.

Voltage regulation is a measure of the change in power supply output voltage between the no-load and fully loaded conditions, usually expressed as a percentage. The precise definition of voltage regulation varies, depending upon the reference book consulted. Thus a power supply which produces 105V dc at no load and drops to 95V dc at full load may have a voltage regulation of 95/105 (99.5%), 10/105 (9.5%), or 10/95 (10.5%), depending upon the definition used.

84. Compare silicon and vacuum tube diodes. What is meant by the "forward voltage drop" of a conducting silicon diode?

A. The silicon diode is a semiconductor device which operates upon the junction principle, while the vacuum tube diode operates upon the principle of thermionic emission. Thus most vacuum tube diodes require that the cathode be heated, while silicon diodes do not. Silicon diodes can conduct much greater current per cubic inch, but are far more subject to damage by improper operating conditions such as excessive reverse voltage or overheating.

Any diode is characterized by a "forward voltage drop." In a tube, this is the operating voltage required to move electrons across the cathode-to-plate distance, and ranges from 5 to 15 volts in most cases. In a silicon diode, it is the energy-level barrier between operating energy levels at the atomic level, and is approximately 0.65 volts (germanium diodes have a barrier of approximately 0.25 volts). The voltage drop is subtracted from the

applied voltage; if 5V dc are applied to a silicon diode, 4.35V dc will appear at the output.

85. *What is push-pull amplifier operation?*

A. Push-pull amplifier operation is a circuit arrangement in which a single stage contains two identical amplifiers, which are driven by input signals which are 180 degrees out of phase with each other. Outputs are similarly 180 degrees out of phase. If balanced input and output are available, no phase-inverting components are necessary. If input and/or output is to be unbalanced (single-headed), phase inversion is required. One of the simplest phase-inverting components is a transformer with a center-tapped winding. The center tap is the common return, and out-of-phase signals are either taken from or applied to the opposite ends of that winding. The other winding will combine the energy of both halves of the first, producing an unbalanced signal as required.

The push-pull or balanced circuit cancels out most even-order harmonics. It is widely used in industrial electronics under the name "differential amplifier" because any signal which is in the same phase at the inputs of both sides is cancelled out of the output.

86. *For what purpose is a Q-multiplier used in amateur equipment? What major factors affect the Q of a coil? Of a circuit?*

A. The Q-multiplier is usually used to increase the selectivity of a tuned circuit in a receiver; it may also be used to reject a specific signal frequency.

The Q of a coil is determined by the ratio of energy stored in the coil's magnetic field to energy dissipated in the coil's conductor, or the ratio of reactance to resistance. Thus size, material, and proximity to other components affect it.

The Q of a circuit is determined by the individual Q's of the circuit components, and again is defined as the ratio of energy stored to energy lost. Anything which causes loss of energy reduces the circuit Q; anything which increases its energy-storage capacity without increasing the energy loss will increase the Q.

87. *How can the final amplifier of a transmitter be tested for self-oscillation?*

A. See question 53, Part III.

88. *How does a frequency converter operate?*

A. Whenever two ac signals are simultaneously applied to a non-linear circuit, four ac signals are produced: the two original signals, a third signal having the frequency equal to the sum of the frequencies of the two original signals and the amplitude characteristics equal to the sum of the amplitudes of the two originals at each instant, and a fourth signal whose frequency is the difference of the original frequencies, also having amplitude determined by the instantaneous sum of the amplitudes of the originals. This action is known as mixing, modulation, demodulation, detection, or frequency conversion, depending upon what part of the communication chain contains it.

A frequency converter accepts an input signal at one frequency and converts it to an output signal at some different frequency by mixing it in a non-linear circuit with a local signal of constant amplitude. Since the local signal's amplitude is constant, the output signal's amplitude characteristics follow those of the input signal exactly. Output signal frequency is determined by the local signal frequency. Either the sum or the difference signal may be used for output. Tuned circuits eliminate the three unwanted signals from the output.

89. *What visual observation within an operating vacuum tube's envelope would indicate that the tube is gaseous?*

A. An intense blue glow in the space between plate and cathode of the tube, during operation, would indicate that the tube is gassy. A "gaseous" tube would be somewhat difficult to identify, being neither solid nor liquid (those being the three states in which matter can exist at normal temperatures); the ability to pass one's hand through it might be a valid indication of its being gaseous!

*Questions based on Part 97 of the Commission's rules.*

A. Obtain a copy of Part 97 and study it well, taking care to be familiar with those provisions which specify frequency bands and sub-bands, types of modulation, technical requirements, power limits, and administrative details such as license term, display of license, etc.

... Staff

**Now! Get all the advantages of Regency  
2 Meter FM...on the 6 Meter FM Band, too.**

# NEW HR-6

12 Channel  
Solid State  
6 Meter FM  
Transceiver

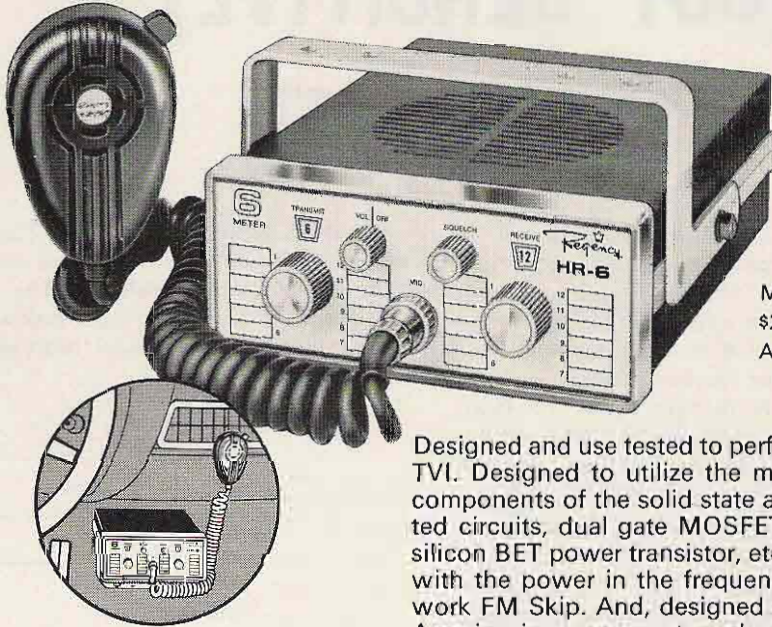

Model HR 6  
\$239.00  
Amateur Net

Designed and use tested to perform against TVI. Designed to utilize the most modern components of the solid state art—integrated circuits, dual gate MOSFET transistor, silicon BET power transistor, etc. Designed with the power in the frequency range to work FM Skip. And, designed and built in America in a compact package that will appeal to your taste and pride of ownership.

**Complete dash mount  
operation . . . does not  
require black box power  
hog in your trunk**

**25 Watts Out  
Long Range Signal Capability  
12 T and R Channels  
Independently Switched  
144 Frequency Combinations  
5 Watts Audio output  
Compact for Dash Mount.**

## SPECIFICATIONS

Power Output:	25 watts Min. @ 13V DC
Frequency Range:	52-54 MHz
Channels:	12 with independent switching
Sensitivity:	.35 $\mu$ V (nom) 20db quieting
Selectivity:	6db $\pm$ 16KHz
Audio Output:	5 watts max.
Size:	2 5/8" x 6 1/2" x 9 1/2"

State of the art receiver utilizes MOSFET mixer for superior front end overload and intermodulation performance.

 **Regency**

**ELECTRONICS, INC.**  
7707 Records Street • Indianapolis, Indiana 46226

American Made

# THE INDESTRUCTIBLE (BUT SENSITIVE) VOLTMETER

One piece of test equipment found in many hamshacks is the voltmeter. There are many voltmeter variations and each variation has advantages and disadvantages. Many of us have an idea of what we would like for the "perfect" voltmeter. Over the years, I have thought about my ideal voltmeter but never applied the elbow grease. Recently, the urge became strong and I actually built it. I can best describe my ideal voltmeter by describing the result of this urge. The voltmeter features a zero-center meter with a sensitivity of  $1.33 \text{ M}\Omega/\text{V}$  for the 0.25–25V full-scale ranges. The input resistance is a constant  $33.3 \text{ M}\Omega$  for the 25–750V ranges. Two current ranges of 0.75 and  $7.5 \mu\text{A}$  were also included. The voltmeter can withstand most conceivable overloads without the slightest damage.

## Theory

High input resistance is one very desirable characteristic of a voltmeter. Most panel meters are much too insensitive to provide the high input resistance; therefore, some kind of amplifier must be used. The common vacuum-tube voltmeter or transistor voltmeter, with which many of you are familiar, generally use the input-output or transfer characteristic of a tube or transistor to provide the amplification. The accuracy is affected by the inherent instability and nonlinearity of the tube or transistor as well

as by power supply fluctuations. There is another way to obtain the required amplification without these problems. The technique (negative feedback) is not new and is used extensively in industrial instrumentation and analog computers.

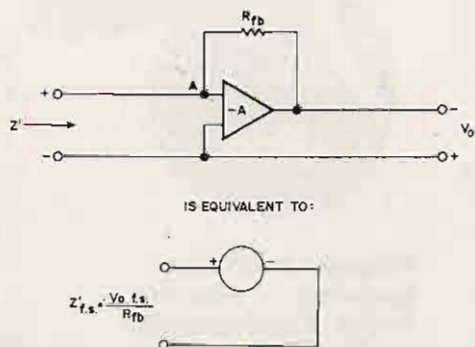

Fig. 1. Feedback amplifier equivalent circuit.

Negative feedback is used in many applications to reduce distortion and, in general, provide stable amplification. If sufficient feedback is used, such factors as transistor (or tube) variations and power supply instabilities have negligible effect on the overall gain of the amplifier. This type of circuitry is more complicated and, therefore, more expensive. In the past, the additional expense has eliminated this technique from the lower priced instruments and ham designs. Now, with the availability of good quality



economical transistors, all of us can afford this "sophisticated" technique.

One way to explain this technique is to think of the amplifier in Fig. 1 as a balancing device. If the amplifier has very high gain, a small voltage at the summing point (A) will appear at the amplifier output as a large voltage. Since the amplifier gain is negative (that is, a positive input produces a negative output and vice versa) the current through  $R_{fb}$  will oppose the input current. The opposing current will tend to drive the summing point back to zero voltage. In other words, the amplifier output opposes the input current until a balance or zero voltage is approached at point A. This balancing action will produce a current through  $R_{fb}$  which is very nearly equal to the input current. Even though summing point A is not directly connected to ground, the action of the feedback will maintain the voltage near zero. A more technical term for this point is a "virtual ground;" it appears like a ground point but actually isn't.

If the input voltage is always near zero voltage and the current through  $R_{fb}$  is equal to the input current, the output voltage (with reference to actual ground) is proportional to the input current. Applying Ohm's law, input current will be equal to the output voltage divided by the feedback resistance.

The advantages may not be apparent yet, but if we consider that the amplifier input can be a very, very small current, then the current through  $R_{fb}$  can also be very small. While the amplifier is balancing out this small current through  $R_{fb}$ , it can also supply a much larger current for the output voltmeter. The amplifier, feedback resistance, and output voltmeter can now be thought of as a sensitive current meter.

Without going into detail, a simplified example will demonstrate how feedback can reduce the effect of amplifier gain change on the overall circuit performance. If we assume an amplifier gain of 100 and output voltage of 1V, the amplifier input voltage will be  $-0.01V$  (remember the amplifier gain is negative). The actual voltage across  $R_{fb}$  will be 1.01V. Now, let the amplifier reduce gain by 50% or to a gain of 50. With this condition, the input voltage will be  $-0.02V$

when the output is 1.0V. Now the actual voltage across  $R_{fb}$  will be 1.02V. The voltage change across  $R_{fb}$  between the two conditions will be 0.01V or slightly less than 1% (0.01/1.01) change. Thus, a 50% change in amplifier gain produced only about 1% change in feedback current. Since all such things as instabilities, nonlinearities, and power supply variations are reflected in amplifier gain, the effect of these factors on the overall performance is reduced.

To sum up, the amplifier, feedback resis-

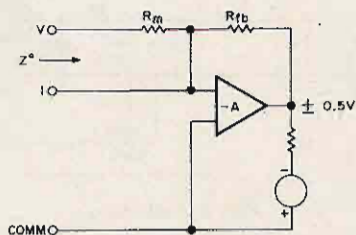

RANGE (VOLTS)	Z ( $\mu A$ )	Rm (ohms)	Rf (ohms)
$\pm 0.25$	$\pm 0.75$	333K	667K
0.75	"	1.00M	"
2.50	"	3.33M	"
7.50	"	10.0M	"
25.0	"	33.3M	"
75.0	2.25	"	222K
250	7.50	"	66.7K
750	22.5	"	22.2K

RANGE RESISTOR CALCULATION

Fig. 2. Range resistor calculation.

tance, and output voltmeter can be thought of as a sensitive current meter. The sensitivity, accuracy, and linearity is a function of the output voltmeter and feedback resistance and is relatively independent of amplifier variations. For the remainder of the voltmeter design, this combination can be replaced with an equivalent current meter. The input current sensitivity will be equal to the full scale output voltage divided by the feedback resistance.

Two methods are used to provide voltmeter ranges from 0.25 to 750V. As you will see, other ranges are easily calculated. For purpose of calculation of feedback resistors ( $R_{fb}$ ), the voltmeter circuitry can be simplified as illustrated in Fig. 2. On the lower ranges, the current sensitivity is constant and the multiplier resistor ( $R_m$ ) is changed with the range switch. The output voltage is the

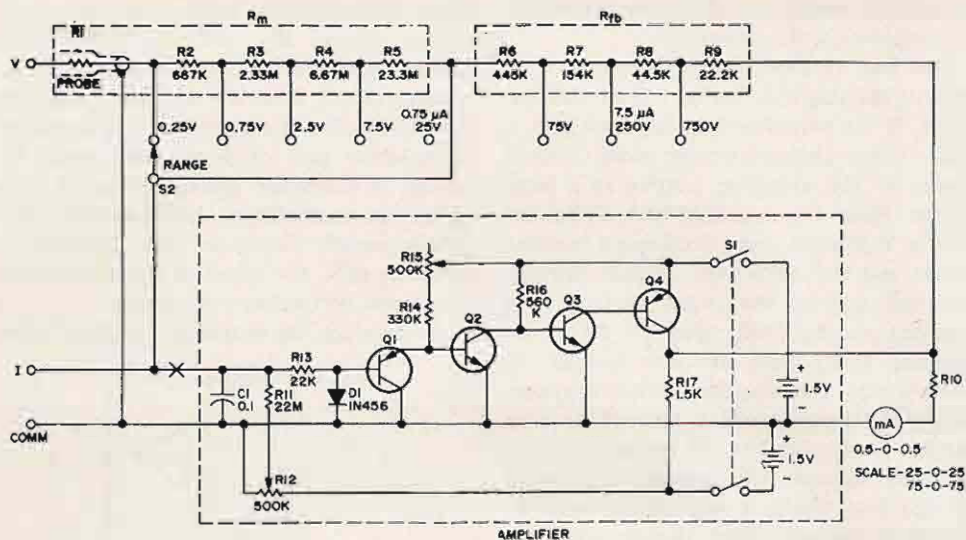

Fig. 3. Schematic.

same for all ranges. The output voltage swing determines the series resistance for the milli-ammeter. Full scale current for the lower ranges was selected at  $0.75 \mu\text{A}$ . The feedback resistance, which also will be constant for the lower ranges, is equal to the full scale output voltage divided by the full scale current, or  $0.5\text{V}$  divided by  $0.75 \mu\text{A}$ . With this resistance ( $667 \text{K}\Omega$ ), we now have an input current sensitivity of  $0.75 \mu\text{A}$  full scale. The multiplier resistances are calculated as if we had an  $0.75$  microammeter. For the  $0.25\text{V}$  range, the resistance will be equal to  $0.25$  divided by  $.00000075$  or  $333,000\Omega$ . The ranges up to and including the  $25\text{V}$  range are calculated the same way.

For the higher ranges, the multiplier resistance is held constant and the current sensitivity is changed by selecting the feedback resistance. The multiplier resistance ( $33.3 \text{M}\Omega$ ) for the  $25\text{V}$  range becomes the constant multiplier resistance for the higher ranges. As an example, on the  $750\text{V}$  range the input current will be  $22.5 \mu\text{A}$  ( $750/33,300,000$ ). A new value feedback resistance must be calculated to provide this current sensitivity. With the same  $0.5\text{V}$  output voltage, the feedback resistance will be  $22.2 \text{K}\Omega$ . All resistances values and the equivalent circuit are shown in Fig. 2.

Either method could be used for all ranges, but this combination was chosen as a

PARTS LIST		
Component	Description	Suggestions
B1, B2	1.5V battery	Any size
C1	$0.1 \mu\text{F}$	Mylar or paper - any voltage rating
CR1	1N456, 1N4148	Low leakage silicon diode
M1	500-0-500	Simpson Model 129 29 43G resistance
	Microammeter	Newark 55F2518
Q1, Q4	2N3906, 2N3702	Low leakage, low current silicon PNP transistor
Q2, Q3	2N3904, 2N2925	Low leakage, low current silicon NPN transistor
R1	$333\text{K } 1\%$	$332\text{K}$ R1 thru R10
R2	$667\text{K } 1\%$	$665\text{K}$ Texas Inst. Type CD 1/2 MR
R3	$2.33\text{M } 1\%$	$2.32\text{M}$ Newark 12F080 (spec. value)
R4	$6.67\text{M } 1\%$	$6.65\text{M}$
R5	$23.3\text{M } 1\%$	$7.87\text{M} + 7.87\text{M} + 7.50\text{M}$
R6	$445\text{K } 1\%$	$442\text{K}$
R7	$154\text{K } 1\%$	$154\text{K}$
R8	$44.5\text{K } 1\%$	$44.2\text{K}$
R9	$22.2\text{K } 1\%$	$22.1\text{K}$
R10	$957 \Omega$	953 See text
R11	$22\text{M } 10\% \frac{1}{2}\text{W}$	
R12, R15	$500\text{K}$ trimpot	Mallory 55L1 Newark 60F2210
R13	$22\text{K } 10\% \frac{1}{2}\text{W}$	
R14	$330\text{K } 10\% \frac{1}{2}\text{W}$	
R16	$560\text{K } 10\% \frac{1}{2}\text{W}$	
R17	$1.5\text{K } 10\% \frac{1}{2}\text{W}$	
S1	D.P.S.T.	Optional
S2	Single pole $8 \text{ ps. rotary.}$	Centralab type PA2001 Newark 22F601

compromise to maintain low input current on the lower ranges without requiring extremely large - and expensive - resistance values on the high ranges. Either procedure can be used to calculate feedback and multiplier resistances for other ranges. The feedback current should be selected within the amplifier design range of  $0.75$  to  $50 \mu\text{A}$ .

A current function is also available as an added feature. For the particular ranges selected, only two ranges agree with the meter scales. The other ranges would be  $2.25$  and  $22.5 \mu\text{A}$ , which can also be used, with a few mental gymnastics, to convert from one of the scales.

The voltage drop across the input used as

# Clegg

## FM 27 A

### \$ 479.<sup>95</sup>



Complete with Noise Cancelling  
Microphone and Antitheft Mobile Mount

Accessories available include:

AC Power Supply ..... \$59.95  
Sub-audible Tone on TX ..... \$24.95

Only the FM-27A offers the 2 Meter FM'er the complete freedom of frequency – receive and transmit – with accuracy and stability comparable with conventional crystal control. Only the Clegg transceiver uses Teflon wire throughout.

In addition – the FM-27A provides the hottest performing receiver and most conservatively rated 25 watt transmitter on the market.

See your Clegg Dealer today or write or phone our factory for detailed data sheet on the fabulous FM-27A.

WATCH FOR THE ANNOUNCEMENT OF OUR FM-21 (220 MHz)  
TRANSCEIVER NEXT MONTH.



## Clegg DIVISION

3050 Hempland Road  
Lancaster, Pennsylvania 17601

Tel: (717)299-3671 • Telex 84-8438

a current meter is very low. Since the amplifier gain determines how near zero the summing point is maintained, it also determines the voltage drop when the circuitry is used as a current meter. The amplifier voltage gain is about 100; therefore, when the meter indicates full scale (0.5V), the input voltage will be about 0.005V. Most milliammeters or microammeters will have 0.05–0.20V drop at full scale.

#### Circuit Description

Four direct-coupled silicon transistors form the amplifier portion of the voltmeter. The first two stages are operated at low collector voltage and current. In both cases, the base-to-emitter voltage (about 0.6V) of the following stage is also the collector-to-emitter voltage of the driving stage. This type of connection may appear strange, but it is a very legitimate application of silicon transistors. The last two stages are connected in a more conventional manner. This amplifier layout provides high current gain with a minimum of components.

The first two stages are operated at nearly equal collector currents and connected so that the base-to-emitter drops will cancel. The NPN (Q2) base voltage will be about +0.6V. When we connect a PNP (Q1) to this base, the PNP (negative) base-to-emitter voltage will tend to cancel the positive voltage of the NPN transistor. Actually, by adjusting the collector current ratio of the two transistors, the two base-to-emitter voltages can be made to cancel exactly. Similar reasoning will show that the temperature coefficient of the base-to-emitter voltages will also tend to cancel. The temperature coefficient defines the change in base-to-emitter voltage with temperature. This coefficient is the prime cause of instability in transistor dc amplifiers and is a source of operating-point change in ac amplifiers.

The interconnection between the first two stages is also a current summing point or virtual signal ground. The current through R14 must divide and flow through either Q1 emitter or Q2 base. Therefore, any Q1 emitter current change will become a base-current change for Q2. The voltage at this point will *not* change. A similar situation occurs between the Q2 collector and Q3 base. Since Q3 collector is connected to Q4

base, it is obvious that the Q3 collector current changes are passed on to Q4. The result is an overall current gain of the amplifier which is the product of the current gains of the transistors. Even with the first two transistors operating at a low current gain (result of low collector current and voltage), the overall amplifier current gain is greater than 100,000.

The input offset current (current required for zero output voltage) is supplied by R11. The offset current adjustment is similar to biasing a single transistor, except in this case we are "biasing" a complete amplifier. An adjustment is shown in the schematic but the adjustment is not critical and fixed resistances could be used. When the amplifier is operating in closed loop (with the feedback connected) some offset current can be supplied through the feedback resistance without noticeable effect on the voltmeter performance.

Overload protection is supplied by R13, CR1, and the base-to-collector junction of Q1. As explained, the amplifier input is at zero potential during normal operation. If overloads are applied, the amplifier may saturate and not supply sufficient feedback current. Since the feedback current normally maintains the zero input voltage, loss of the feedback current will allow the summing point to stray from zero. If allowed to increase without limit, the input transistor could be damaged. The solution is to provide some current limiting (R13) and clamp the amplifier input with diodes. The positive excursions are clamped with CR1 and the negative excursions by the base-to-collector junction of Q1.

Meter current is also limited to a safe value by resistors R10 and R17. The output transistor (Q4) will either be cut off (positive input) or saturated (negative input) during overload situations. Maximum meter current is therefore limited to about 1.5 mA on negative inputs and 0.6 mA on positive inputs. Neither value will damage the meter movement.

The circuit is most susceptible to overloads when used in the current function. A couple of quick calculations will demonstrate the protection provided. Both the clamping diode (CR1) and the base-to-collec-

tor junction of Q1 will pass 100 mA for short periods without damage. As long as the diodes function, the amplifier and meter will be protected. Since the input current is limited by R13, the input voltage would be 2.2 kV with a diode current of 100 mA. The R13 wattage rating limits continuous overloads to about 100V.

When the voltmeter function is used, higher overload voltages are easily accommodated. On the 0.25V range, the total series resistance is 355 K $\Omega$ . Now the half-watt resistor rating limits the continuous overload to about 350V and the diode current will protect up to "3.5 kilovolts" — hardly conceivable!

Higher-wattage resistances could be used but most of us would not subject the voltmeter to continuous overloads. The worst that could happen from a continuous overload would be to burn up either R1 or R13. I don't think it is possible to damage a transistor or the meter with conceivable overloads. By the way, one point to think about — how many 0.75  $\mu$ A meters are protected from continuous overloads up to 5 mA and terminal voltages of 100V? How many 0.25V meters are protected against 350V continuous or momentary kilovolts?

The feedback network completes the voltmeter circuitry. For any one range only two resistance values are required. The capacitor (C1) provides high-frequency attenuation to prevent amplifier oscillation. The range switching is not quite conventional. A single-pole switch is used to select the proper multiplier and feedback resistance. The switch actually shorts out the unused portion of the resistance string.

### Construction

The layout is not critical and is left up to the builder. Standard solid-state construction methods must be used — watch the heat when soldering! The ranges selected may seem strange but fit very nicely with a standard 50-division meter scale. The meter I used was a 1.0 mA unit I readjusted to a 500-0-500  $\mu$ A span. I removed the numbers on the original face with an eraser, leaving the scale markings. The new numbers were hand-lettered on the face. On the 50-division scale, the selected ranges require one unit

per minor division on the 25-0-25 scale, with 5, 10, 15, 20 and 25 at major division. The second scale requires 3 units per minor division with 15, 30, 45, 60 and 75 at the major divisions.

Feedback and multiplier resistances (R1–R9) must be accurate if the precision of the voltmeter is to be maintained. I selected resistances from carbon resistor stock using a Heathkit impedance bridge. The builder who does not have access to measuring equipment can buy 1% precision resistors from a parts house. I believe it is possible to buy 1% resistors, a 2% panel meter, and assemble this voltmeter with 3% or better error without further calibration. This demonstrates the beauty of the feedback amplifier — final accuracy is only dependent on the resistors and meter used.

The voltage probe is constructed of shielded cable with one multiplier resistor (R1) mounted in the tip. The shielding reduces ac pickup which might cause non-linear operation of the amplifier, and the tip-mounted resistor reduces capacity loading of the circuit under test.

All components are described in the parts list. Most of the components are not critical as long as the noted characteristics are met. The transistors are not critical with regard to voltage rating or frequency response but must have low leakage and some current gain at low current (around 3  $\mu$ A collector current). The transistors specified have been used successfully, although many other types are available which should be satisfactory. The suggested precision resistor series is the most economical that could be found which is readily available.

The final performance of the voltmeter can be no better than the quality of the meter. A quality movement can be used to advantage if the wallet can afford it. Some of the new taut-band meters which are very rugged would be a good choice. Other movement sensitivities can be used with some circuit modification. First, the scale divisions must be considered. The ranges in this voltmeter are based on a 50-division scale. Other scales will require some rearrangement of the ranges. One rule to follow when selecting ranges and scales is: Minor divisions should always represent

whole numbers (a minor division should represent either 1, 2, 3, etc., but not 1.5, 1.33, or other noninteger values). One exception to this can be 2.5, which sometimes works out reasonably well. As a last resort, you can always draw a second scale along the original scale.

A different meter sensitivity also requires different meter resistors (R10) and load resistor (R17). The amplifier output is  $\pm 0.5V$  full scale, so R10 must be chosen to make the selected meter read (with the resistor in series) 0.5V full scale. This calibration can be either calculated (if the meter resistance and sensitivity is known) or a portion of the series resistance can be replaced with a Trimpot. After the meter is completed, the voltmeter can be calibrated to a known voltage with the Trimpot adjustment. Following this procedure for the described voltmeter, R10 should be replaced with an  $887\Omega$  1% resistor and a  $100\Omega$  Trimpot (assuming the meter resistance is less than  $100\Omega$ ). This procedure is also better for the perfectionist who would like to get the most accuracy from his voltmeter.

The load resistor (R17) which also determines battery current should be changed to agree with the meter sensitivity. It should be 1.5 times the total resistance of the meter and the series resistor (R10). With a little investigation, you will find that the battery current, with no input to the voltmeter, will be twice the full-scale meter sensitivity. With the described voltmeter, the battery current will be about 1.0 mA. If a more sensitive meter is used, the battery can be reduced proportionately. As an example, if a 50-0-50  $\mu A$  meter is used, the battery current would be 100  $\mu A$  and two RM1 mercury cells (1000 mA-hr) would last for about 10,000 hours, or one year of continuous operation. With this meter sensitivity, R17 would be  $15 K\Omega$  and R10 plus the meter resistance would be  $10 K\Omega$ .

The described voltmeter should operate continuously for about 6 months with two size D flashlight batteries. Therefore, the off-on switch is optional, depending on how often you would like to change batteries. Even with small batteries, the voltmeter can be left on occasionally without running the batteries down.

## Checkout

Do not connect the range switch to the amplifier as indicated by the X on the schematic. Now, with the power applied and R12 adjusted for zero voltage on the arm, the meter should be pegged. Slowly adjust R12 and the meter should swing down-scale. Try to adjust for an on-scale meter reading. It isn't necessary to be very accurate since the amplifier feedback will take care of considerable misadjustment. If the meter doesn't swing down-scale, R11 can be decreased to about  $5 M\Omega$  or a different transistor tried for Q1.

To adjust the voltage offset, short the amplifier side of X to ground. Adjust R15 for a midscale meter reading (within 5 divisions of zero). Again, it isn't necessary to be very accurate. This completes the initial adjustment of the voltmeter. The wiring can be completed by connecting the range switch. The voltmeter is now operational. If a Trimpot was added to the meter resistance (R10), now is the time to apply a known voltage to the input and adjust the pot for the correct meter reading. These adjustments should not change in the future. I actually selected fixed resistances for my voltmeter and no change has been apparent in over a year of operation. *Do not* attempt to re-adjust R12 and R15 with the switch connected. The effect of these adjustments is not very noticeable except under detailed examination.

## Conclusion

Several voltmeters have been built with good results. One model was subjected to temperature stability tests from  $-20$  to  $+140^{\circ}F$  with less than 2% of full-scale drift in calibration and zero reading. The basic circuit has also been used for a dc oscilloscope amplifier.

The feedback and instrumentation techniques that have been presented are also useful in other ham applications. This circuit can be used for other sensitive current measurements in conjunction with field strength meters and swr bridges. Other applications will become more apparent as the circuit capabilities are better understood.

...W9DTW

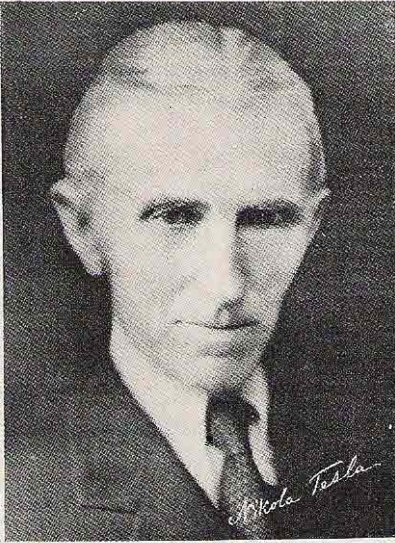

# WHO WAS TESLA?

**A**sk any electrical engineering student today to tell you something about Tesla, and you are likely to get a blank stare. Or the counter-question: "Who *was* Tesla?" It seems preposterous that our educators should have ignored entirely the founder of our ac age, but such is the fact. Something should be done about our technical education system.

Born July 9, 1856 in the village of Smiljan in what is now Yugoslavia, Tesla rose from relative obscurity to a top position in the scientific world. He became a millionaire at 32 through his important inventions, only to fade later into obscurity, and died penniless.

His father was a clergyman. His mother, though she never learned to read and write, was known in the community as an inventor of domestic labor-saving devices, and it is to her that Tesla attributed much of his inventive genius. The young Tesla, opposing his father's urging to study for the ministry, insisted on a career in engineering. His mother encouraged him. He attended the polytechnic school at Graz, specializing in

physics and mathematics, and continued his education at the University of Prague. There he took a course in foreign languages, so that he could read the foreign technical literature. He became proficient in English, French and Italian, in addition to the German with which he was already familiar, and of course, his native Serbian.

Finishing at Prague in 1880, he took a post-graduate course in Budapest, where he debated the merits of alternating current with his professors. He then went to work for a Paris telephone company, where he acquired considerable experience with dc dynamos and motors. While there he invented regulating and control devices to protect the rotating machines he served.

## Electrical Industry Was Limited

In those early days, direct current was universally acknowledged to be the only practical medium for generating, transmitting and applying electricity for heat, light or power. But dc resistance losses were so great that a power plant was needed for every square mile served. Early incandescent

lamps, glowing none too bright on 110 volts even close to the power plant, became pitifully dim on the power that dribbled from the lines less than a mile away. And everyone believed that motors could run only on dc. An alternating current motor was considered an impossibility.

This was the picture when, in 1884, young Tesla stepped off a ship in New York, his head full of ideas, and four cents in his pocket. His experience had convinced him that the commutator in direct current motors and dynamos was an unnecessary complication, causing endless troubles. He realized that the "dc generator" actually produced ac, which was rectified by the commutator into a series of waves, all flowing in the same direction through the external circuit.

Then, to get this dc to produce rotary motion in a motor, the process had to be reversed. The armature of each electric motor was equipped with a rotating switch (commutator) that changed the polarity of its magnetic poles just at the right instant as it revolved, to supply ac to the motor.

### The Inspiration

To Tesla, this was sheer nonsense. It seemed logical to eliminate the commutator at both generator and motor, and use ac through the whole system. But no one had ever built a motor that could operate on alternating current, and Tesla struggled mentally with the problem. And one day in February, 1882, while strolling with a classmate named Szigetti in a Budapest park, he suddenly blurted out: "I've got it! Now watch me reverse it!" At that moment he had visualized the rotating magnetic field, which would revolutionize the whole electrical industry. He saw the magnetic pull racing around the stationary field (stator) of his motor while the armature (rotor), attracted by the moving field, chased around after it faster and faster until it was revolving at the same rate. He would need no switching to the rotating element — no commutator!

Subsequently he worked the whole alternating current electrical system out in his mind — including alternators, step-up and step-down transformers for economical transmission and delivery of electric power,

and ac motors to supply mechanical power. Impressed by the wealth of available water power going to waste around the world, he visualized the harnessing of this great supply with hydro-electric plants capable of distributing the power to where it was needed. He startled fellow-students in Budapest by announcing: "Some day I will harness Niagara Falls."

### Discouraged by Edison

The opportunity and fortune Tesla sought in the promised land did not come easy. When he met Edison, then actively engaged in developing a market for his incandescent lamp through his pioneer Pearl Street plant in New York, Tesla launched with youthful enthusiasm into a description of his alternating current system. "You are wasting your time on that theory," the great man told him, dismissing the idea promptly and finally.

For a year, the tall, gaunt Yugoslav struggled to keep from starving in this strange land. At one point he dug ditches to make a living. But the foreman of the Western Union ditch-digging project on which he was working listened to the visionary descriptions of new electrical systems that Tesla related during lunch hours, and introduced him to a company executive named A. K. Brown. Fascinated by Tesla's vivid plans, Brown and an associate decided to take a flyer. They put up a limited amount of money, with which Tesla set up an experimental laboratory at 33-35 South Fifth Avenue (now West Broadway). There Tesla set up a complete demonstration of his system, including generator, transformers, transmission line, motors and lights. He worked tirelessly, and without drawings; the plans for every detail were indelibly etched in his mind. He even included two-phase and three-phase systems.

Professor W. A. Anthony of Cornell University examined the new ac system, and promptly announced that Tesla's synchronous motor was equal in efficiency to the best dc motors.

### Alternating Current Arrives

Tesla then attempted to patent his system under a single comprehensive patent cover-



ing all its components. The Patent Office would not approve the all-in-one application, insisting on separate applications for each important idea. Tesla's applications, filed in November and December of 1887, resulted in the granting of seven U.S. patents in the next six months. In April, 1888, he filed for four more patents, covering his polyphase system. These too were promptly granted, as were 18 more U.S. patents later in the year. These were followed by numerous European patents. Such an avalanche of patents, so promptly issued, was without precedent, but so completely novel were the ideas — so completely absent was any element of interference or "anticipation" — that the patents were issued without a single challenge.

Meanwhile Tesla staged a spectacular lecture and demonstration of his ac system — single phase and polyphase — at a meeting of the AIEE (now the IEEE) in New York. The engineers of the world were made aware that the limitations on electric power transmission by wire had been removed, opening the door to tremendous expansion.

But who would adopt this obviously better system? Certainly not the established Edison-General Electric organization — it would have made their whole investment obsolete. Apparently Tesla was stuck — with no market, no customer for what he had to offer.

It was at this moment that George Westinghouse walked into Tesla's laboratory and introduced himself. Tesla was then 32 years old, Westinghouse 42. Both were capable inventors, accomplished engineers and electrical enthusiasts. Westinghouse listened to Tesla's explanations, watched his demonstration, and quickly made up his mind.

"I will give you one million dollars cash for your alternating current patents, plus royalties," offered Westinghouse.

"Make that royalty one dollar per horsepower, and it's a deal," replied Tesla, without apparent excitement.

As simply as that, the two men arranged the historic deal and shook hands on it.

Tesla had arrived! But he was not a man to forget those who had placed their faith in

his ideas, and promptly signed over his million-dollar fee to Brown and his associate, who had financed his laboratory. Although the backers of Westinghouse later forced him to get a release from Tesla on the dollar-per-horsepower part of the agreement, such was the friendship that had developed between the two men that an amicable settlement was quickly reached. Tesla relinquished the royalties that would have supported him and his research efforts for the rest of his life.

The phenomenal success of the Westinghouse ac systems across the nation made it clear to General Electric engineers that they would have to get a license from Westinghouse if they were to keep up in the rapidly expanding electrical industry. The license negotiated at a handsome fee — was a feather in Tesla's cap; he distinctly recalled Edison's statement that there was no future in alternating current and that experimenting with it would be a waste of time.

#### A Dream Realized

In 1890, the International Niagara Commission began trying to determine the best way of using the power of Niagara Falls to generate electricity. The scientist Lord Kelvin was appointed chairman of the Commission — and he immediately announced that a dc system would obviously be best! It was not easy to challenge this world-famous authority, but he eventually came to realize that if power were to be transmitted even the 26 miles to Buffalo, ac would be necessary. So it was finally decided to use Tesla's system and generate ac with massive water turbines. Bids were invited by the newly formed Cataract Construction Co. in 1892. Westinghouse won the contract for the ten 5,000-HP hydro-electric generators, and General Electric the contract for the transmission system. The whole system — the line, step-up and step-down transformers all followed Tesla's two-phase design. He designed the big alternators with external revolving fields and internal stationary armatures, to minimize the weight of the moving members.

This historic project created a sensation, for nothing of this magnitude had been

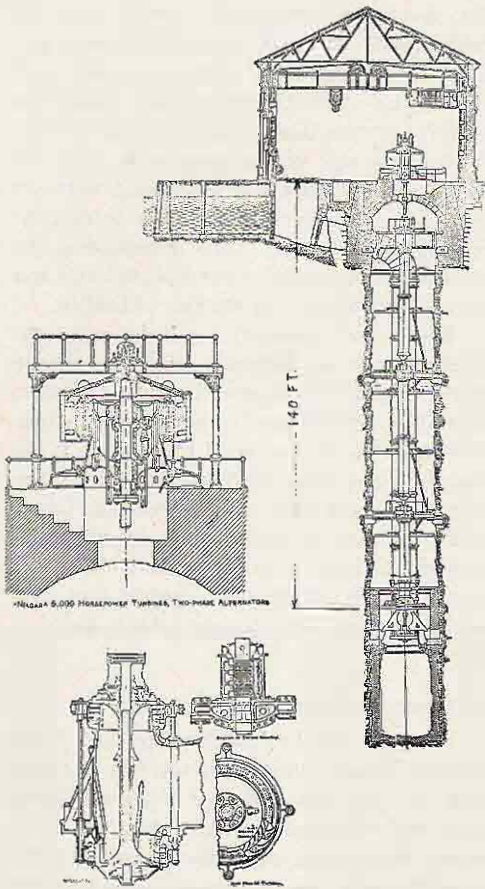

One of the 5,000 h.p. Niagara Falls units, with detail at left. Upper drawing shows the hollow drive shaft that goes through the stationary armature to rotate the field, which hangs outside and around the armature.

attempted at the time. The ten big 2,250-volt alternators, revolving at 250 rpm and delivering 1,775 amperes each, produced an output of 50,000 HP or 37,000 kW, 25 Hz, two-phase. The rotors were 10 feet in diameter and 14 feet long (14 feet high in these vertical generators) and weighed 34 tons each. The stationary members weighed 50 tons each. The voltage was stepped up to 22,000 for transmission.

### Remote Radio Control

Tesla's pioneering in the realm of radio ("wireless" as it was then called) went further than Morse code communication. In 1898 he staged a spectacular demonstration of remote control without wires at the

original Madison Square Garden, New York City. The first annual Electrical Exhibition was then in progress, and in the center of the vast area where Barnum & Bailey's circus usually performed, he had a large tank constructed and filled with water. Afloat on this small lake he had a 3-foot-long iron-hulled boat, with its mast supporting an antenna. Inside the hull was a radio receiver and an assortment of electric motors, driven by storage battery, to perform various "ship" functions.

From the opposite end of the auditorium, Tesla put the vessel through a variety of maneuvers, including sailing forward, steering left and right, stopping, reversing, and lighting the lights in its rigging in response to audience requests. The impressive demonstration of course "stole the show" and made the front page of the daily newspapers. But how many dreamed that one day, using these radio-remote-servo-control principles, we would land some of our citizens on the moon?

### Mathematical Wizardry

Tesla's mathematical genius stood him in good stead in the design of the items of ac equipment that Westinghouse and GE undertook to manufacture. (In his early student days, he solved complex problems in his head, without pencil and paper). His teachers suspected him of cheating, and put him to conclusive tests. Young Tesla, it developed, had memorized whole logarithmic tables!) The now established frequency of 60 cycles per second (Hz) stems from Tesla's mental calculations, which convinced him that it was the most practical frequency for commercial use. At higher frequencies, ac motors would become inefficient; at lower frequencies they would require too much iron. Lights would also flicker at low frequencies.

Though the original Niagara Falls plant was designed for 25 Hz to accommodate the limitations of the early Westinghouse turbine generators, subsequent expansion included conversion to 60 Hz. Today this Niagara power is transmitted all the way to New York City, 360 miles away, and at times is fed over the Northeast power grid for much greater distances. (When Tesla arrived in

# GO FIRST CLASS WITH WILSON ELECTRONICS

WILSON ELECTRONICS  
*present*

## *The Famous DX Contest* WINNING COMBINATION

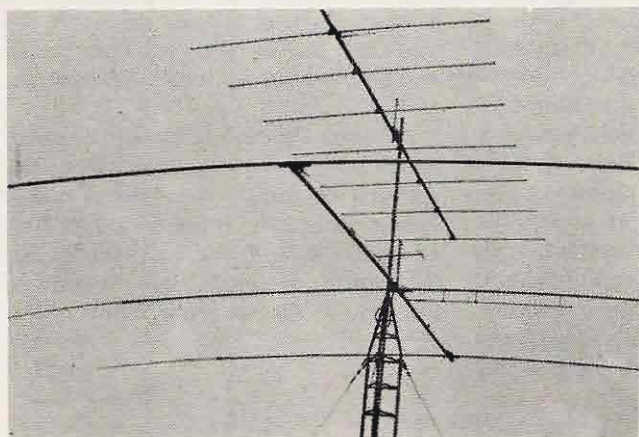

WA8ZDF  
WILSON M340 & M810 plus SIGNAL ONE'S CX7A

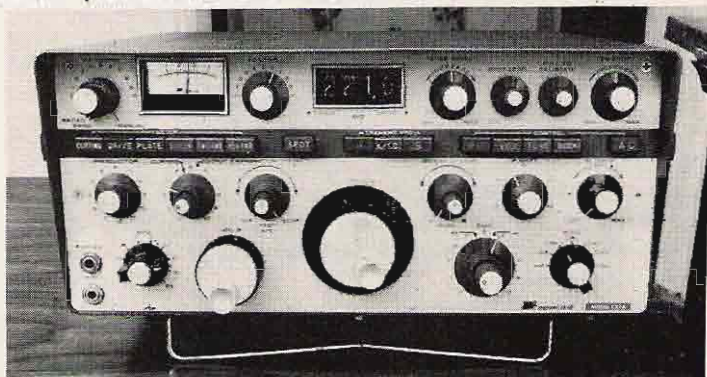

Wilson Electronics has gotten together with Signal One to make it easy to own the best DX combination available. If you purchase a Signal One CX7A from Wilson Electronics for \$2395.00 we will give you a 6-element 20 meter beam for \$1.00. Now the 6-element 20 sells for \$300. If you don't want a 6-element 20 meter beam, we will apply the same value to any other combination of antennas you want. Trade-ins also accepted. For a winning deal call Jim Wilson at the number below.

# WILSON ELECTRONICS

PO Box 116 Pittman Nev. 89044 (702) 457-3596

New York, the limit for efficient power transmission was less than a mile!)

### High Frequency Pioneering

During his investigations into the unknown realms of high voltage and high frequency, Tesla adopted a most sensible practice. When handling high-voltage apparatus, he always kept one hand in his pocket. He insisted that all his laboratory assistants take this precaution, and to this day it is always employed by sensible experimenters around potentially dangerous equipment.

Tesla's explorations in higher frequencies and in the field of incredibly high voltages paved the way for modern electronics, although the word had not yet even been coined. With his unique high-frequency transformers (Tesla coils) he showed that he could actually pass millions of volts harmlessly through his body to glow-tube lamps held in his bare hands. They would light up to full brilliancy from the high-frequency, high-voltage currents. In those early days he was actually demonstrating neon-tube and fluorescent tube lighting!

Tesla's experiments up and down the frequency scale sometimes led him into unexplored regions. Studying slow mechanical or physical vibrations, he caused a virtual earthquake in the vicinity of his new laboratory on Houston St. His mechanical oscillator, approaching the natural period of the building itself, threatened to tumble the old structure. Furnishings in the police station over a block away began to dance around mysteriously as Tesla confirmed his mathematical theories of resonance, vibration and "natural periods."

### World's Most Powerful Transmitter

Investigations of high-voltage and high-frequency electrical transmission led Tesla to construct and operate the world's most powerful radio transmitter, on a mountain near Colorado Springs. Around the base of a 200-foot mast, he built a 75-foot diameter air-core transformer. The primary was only a few turns of wire. The secondary within it was 100 turns, 10 feet in diameter. Using power from a generating station several miles away, Tesla created the first man-made lightning. Deafening bolts 100 feet long

leapt from the 3-foot copper ball at the top of this mast. The thunder was heard as far away as the horizon. He was using voltages of the order of 100 million — a feat not to be equalled for half-a-century.

Tesla burned out the power plant generator with his first experiment but repairing it, continued his experiments until he was able to transmit power without wires for a distance of 26 miles. At that distance he was able to light a bank of 200 incandescent lamps — a total of 10 kilowatts. Fritz Lowenstein, later to become famous for his own radio patents, witnessed this spectacular accomplishment, as Tesla's assistant on the project.

In 1899, Tesla had somehow spent the last of the money he got from Westinghouse for his ac patents. Colonel John Jacob Astor came to his financial rescue, and put up the necessary \$30,000 for the Colorado Springs experiments. Now this money was also gone, and Tesla returned to New York.

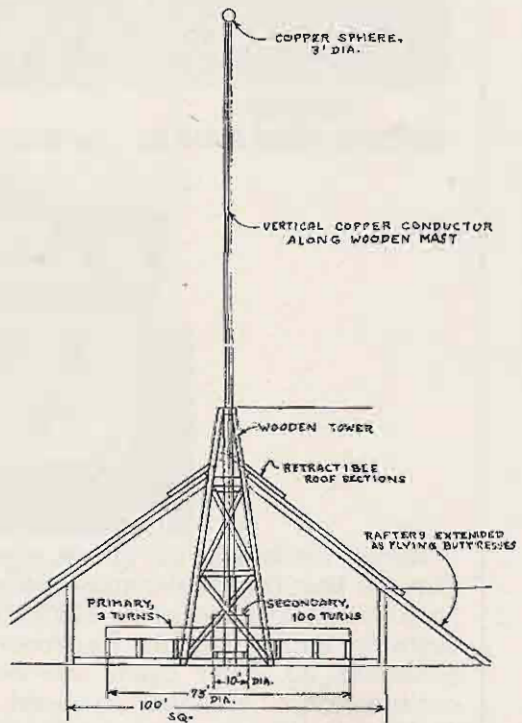

The 100-million-volt transmitter, power from which lighted 200 50-watt lamps at a distance of 26 miles.

## Enter J.P. Morgan

In New York, Tesla was prevailed upon by his friend Robert Underwood Johnson, editor of *Century* magazine, to write a feature story describing his accomplishments at Colorado Springs. But the story Tesla turned out proved to be an involved discourse on the subject of philosophy and "the mechanical process of humanity." Although of the highest literary quality, the treatise said little about the powerful transmitter at Colorado Springs. Johnson had to return the manuscript three times before getting some coverage of the subject he had requested.

In the end, the article was published under the title, "The Problem of Increasing Human Energy." It created a sensation when it appeared in print. One of the readers who was deeply impressed was John Pierpont Morgan, who had financed the General Electric Co. in its pioneer dc days, and more recently its part of the Niagara Falls project. Morgan was fascinated by the genius of Nikola Tesla, by his spectacular accomplishments and his winning personality. Tesla soon became a regular guest at the Morgan home. Impeccably dressed, always the polished gentleman with European manners and cultured speech in several languages, Tesla became a favorite of New York and Newport society. Many prominent matrons regarded him as a "good catch" for their daughters, but Tesla insisted that there was no room in his life for women and romance - that they would interfere with his research efforts.

Historians differ on what motivated Morgan to finance Tesla's next big project. Some believe that he was genuinely interested in the wireless transmission of power. Others argue that - in the light of subsequent developments - it seems obvious that Morgan's interest was in getting control of Tesla and his achievements to protect the Morgan investments in the electrical industry.

Finding that Tesla was broke again, Morgan agreed to underwrite Tesla's project of transmitting electric power without wires. In 1904, Tesla acknowledged in *Electrical World and Engineer*: "For a large part of the

work I have done so far I am indebted to the noble generosity of Mr. J. Pierpont Morgan."

From this alliance sprouted the fantastic "world-wide-wireless" tower on Long Island.

## World Wide Wireless

The strange structure that slowly rose near Wardencllyffe, in the hilly portion of Long Island, mystified all observers. Resembling nothing so much as a huge mushroom, except that it was not solid, it had a lattice-work skeleton, broad at the base and tapering toward its 200-foot top. There it was capped by a 100-foot diameter hemisphere. The structure was made of stout wooden members joined by copper gussets bolted to the wood with sturdy bronze bolts. The hemispherical top was draped over its upper surface with copper mesh. There was no ferrous metal in the entire structure.

The famous architect Stanford White became so interested in the project that he did the design work without charge, assigning one of his best designers, W.D. Crow, to the task.

Tesla commuted daily to the construction from his quarters in the old Waldorf-Astoria Hotel on 34th St., riding the streetcars to the East 34th St. ferry, then the paddle-wheel steam ferry to Long Island City and the Long Island Railroad to Shoreham. The railroad's dining service prepared special meals for him so that his supervision of the project would not be interrupted.

When the 100-foot square brick power plant was completed near the base of the big tower, Tesla began moving his Houston St. laboratory into the structure. Meanwhile, annoying delays were encountered in the manufacture of the radio-frequency generators and their driving motors. Several glass-blowers were busy fashioning special tubes, the design of which still remains a mystery.

## The Prophet Tells of The Future

Meanwhile, Tesla issued a descriptive brochure that revealed his far-reaching insight into the future of the great industry that at that time (1904) was limited to dot-and-dash telegraphy. That document has persuaded many that the man was actually clairvoyant. He announced that the World

# Chew the rag all day or win the contests...

## the CX7A makes them both easier

There are a couple of different ways to look at signal/one's CX7A. You might compare it to a car.

For the rag-chewer's convenience and ease of operation, it's strictly in the Rolls-Royce category.

For the competitive-minded amateur, it's like driving a Ferrari.

That's because the CX7A was designed with uncompromising quality. With more features than you can imagine. The rig equals a room full of gear, all neatly enclosed in a compact, desk-top unit.

It lets you do things no other rig lets you do. And do all of them better. Sitting at the console of the CX7A you're in command of the amateur radio universe.

Whether you're a Rolls-Royce type or a Ferrari-minded guy.

See the remarkable CX7A at your signal/one dealer's. Or write for a detailed brochure. For \$2,395, you'll be the coolest rag-chewer in town.

Or the hottest competitor.

 **signal/one**

13130 Yukon  
Hawthorne, California 90250  
Phone (213) 679-9022



**With Signal/One's CX7-A  
you settled for the best.**

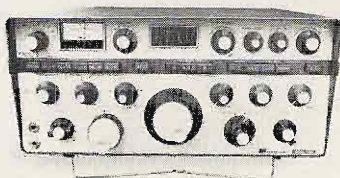

**Now meet the rest of the best.**

A few short years ago, Signal/One introduced the solid-state CX7-A. It was quickly recognized as the world's most advanced radio transceiver. It still is. Now, Signal/One is more than just the CX7-A. A lot more.

**For openers, we've added two new receivers.** One, the CR-1500, a dual-channel system is so advanced — in selectivity, sensitivity and versatility — you won't find anything like it this side of a research laboratory. The CR-1200 receiver, our other new one, features a single VFO. If it weren't for its bigger brother, it would be the finest receiver you could buy.

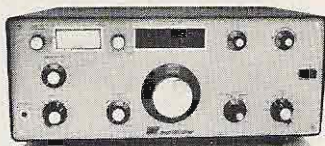
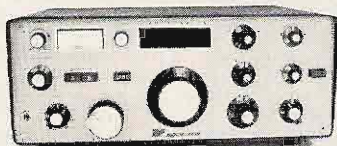

**There's a new CT-1500 transmitter,** the matching transmitter for use with the CR-1200 and CR-1500 receivers. It incorporates all modes of operation and includes the famous Signal/One RF envelope clipping, broadband tuning, full-automatic CW keying, and many other features.

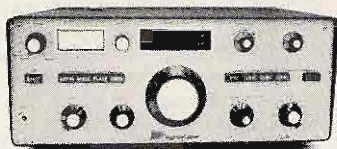

**We're also introducing a new transceiver,** the CX-10, which contains several CX7-A features. In addition, it can be used with either our new AC or DC power supplies, an external VFO, and other accessories.

**Our new accessories** include a deluxe station console, speakers, 2-meter and 6-meter transverters with direct digital readout and FM capability, and custom microphones.

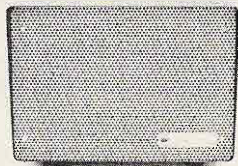

In the past years, there were one or two names in amateur radio gear that meant the finest. In their time they were.

Times have changed. Now, if you want the finest, choosing is easy. It's all at Signal/One.

13130 Yukon, Hawthorne, Ca. 90250 (213) 679-9022

 **signal/one**

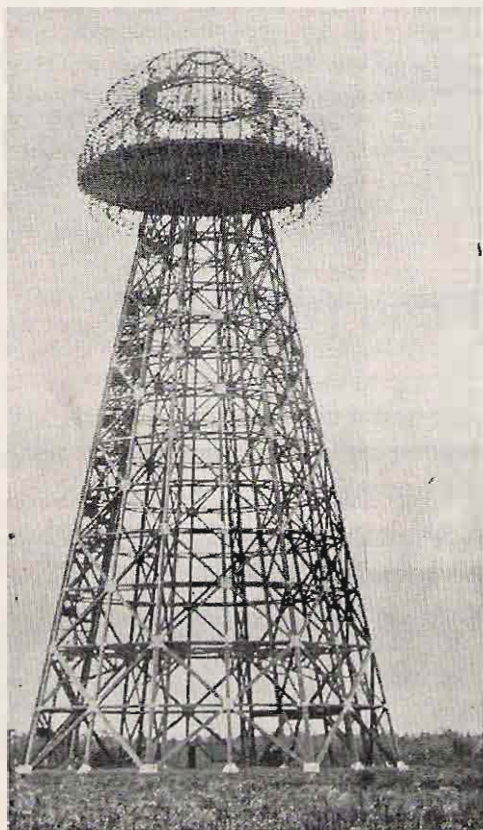

Not all the facts on the mysterious Long Island tower were ever known. Some believe that it was intended to transmit at low frequencies, "shaking the earth" to send signals to distances then believed impossible. Tesla foresaw a complete modern type of service, but never stated how large an area he intended to cover. But, he called it the *World Wide Wireless System!*

Wide Wireless system was being prepared to provide a variety of facilities, including:

Telegraph Communication, Telephone Communication, News Broadcasting, Stock Market Quotations, Aids to Navigation, Entertainment and Music Broadcasting, Accurate Time Service, Facsimile, Telephoto and Teleprinter services.

Tesla was describing the Radio City of the future, which he actually lived to see come into existence!

#### **Morgan's Support Ends**

In *Electrical World and Engineer* of March, 1904, Tesla revealed that the Canadian Niagara Power Co. had offered him

inducements to locate his wireless power transmission project at their plant, and that he proposed to employ those facilities to distribute 10,000 horsepower at a potential of 10 million volts.

The Niagara project never materialized, but may have had some influence on the fate of the spectacular Long Island project. For reasons that have never come to light, J.P. Morgan had a change of heart, and Tesla's financial fountain suddenly went dry. At first Tesla refused to believe that Morgan would not arrange for the nearly finished job's completion, but Morgan's withdrawal was abrupt and final. Historians of the industry wonder why. Did Morgan lose patience? Did engineers of high repute convince him that Tesla's visions, so openly revealed in the brochure, were nonsense, and that he was wasting his money on a hopeless dream? Did he suspect that Tesla was diverting time and money to the Niagara project? The facts will probably never be known.

#### **Brainless Desecration**

During World War I much senseless desecration was perpetuated in the name of national defense. For some strange reason (or lack of reason) it was decided that Tesla's spectacular tower at Wardenclyffe, Long Island jeopardized the safety of the United States, and must be destroyed. After vain attempts to topple the lofty structure by attaching cable to it and trying to drag it off balance, it was finally capsized by dynamiting its foundations. Even then, the tower did not collapse nor disintegrate. It simply lay intact on its side, and was finally dismantled piece by piece.

But why did this structure have to be dispensed with? Many taller objects closer to New York City — including the Ramapo Mountains — were allowed to remain intact!

#### **The Radio-Frequency Alternator**

As early as 1890 Tesla built high-frequency ac generators. One, which had 184 poles, produced a 10 kHz output. He later produced frequencies as high as 20 kHz. More than a decade was to pass before Reginald Fessenden developed his rf alternator, which had an output of 50 kW. This machine was scaled up to 200 kW by



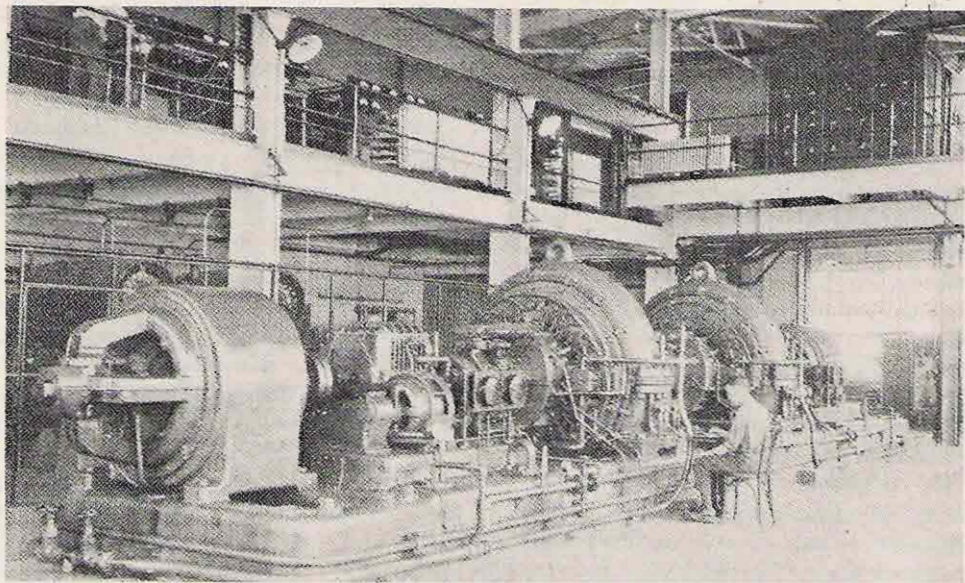

*"The Author as a Young Man," E. J. Quinby  
New Brunswick, N.J.*

*watches over the great 200 KW alternators at WII,*

General Electric, and put on the market as the Alexanderson alternator, named after the man who had supervised the job, and who had constructed some of Fessenden's earlier alternators.

When it appeared that British interests (already in control of most of the world's cables) were about to acquire the patents for this machine, the Radio Corporation of America was organized, at the urgent suggestion of the United States Navy. The new company was formed in 1919, around the Marconi Wireless Telegraph Co. of America, and the powerful but inefficient Marconi spark transmitters were replaced by the highly successful rf alternators. The first one was installed in New Brunswick, N.J. at station WII. It produced a 21.8 kHz signal at 200 kW, and handled commercial business previously the exclusive domain of the cables. This was the first continuously reliable trans-Atlantic radio service.\*

\*Dr. E. Stuart Davis, of the National Telegraph Office (Museum) in Union, N.J., happily reports that one of these giant alternators has been preserved in the Smithsonian Institute, where it stands as a monument to Tesla's pioneering, Fessenden's perserverance, Alexanderson's development and Sarnoff's leadership. This one originally served at Trans-Atlantic Transmitter Station WSO at Marion, Mass.

The writer, as the most junior of the junior engineers on the project, struggled like the rest to keep the first machine running until the next was ready to provide relief. So well did these alternators perform that a whole battery of them was ordered, to be installed at Radio Central, Rocky Point, L.I., almost within the former shadow of Tesla's tower.

Thus Nikola Tesla's World Wide Wireless dream was fulfilled some three decades after he initiated the project and right where he started it, using the type of transmitter he devised.

#### **Radar and Turbines**

Tesla continued active research in many fields. In 1917 he suggested that distant objects could be detected by sending short-wave impulses to them and picking up the reflected impulses on a fluorescent screen. (If that doesn't describe radar, what does?) He described cosmic rays 20 years before other scientists discovered their existence.

At various times up to 1929, he devoted his attention to a "bucketless" high-speed turbine for steam or gas. Friction between the increasingly irascible Tesla and some of the engineers and assistants cooperating with him on tests at the Edison Waterside power

plant and in the Allis-Chalmers factory did not help his cause, but many respected engineers today agree that we have not heard the last of the Tesla turbines with the smooth rotor discs.

As the years passed, less and less was heard from him. Occasionally, some reporter or feature writer would look him up and manage to get an interview. His prophecies became increasingly strange and involved, inclined toward the abstract and delving into the occult. He never acquired the habit of writing notes, always claiming (and proving) that he was able to retain complete detailed data on his researches and experiments in his mind. He said that he intended to live to 150, and upon reaching age 100, would write his memoirs, which would include a detailed record of all the data he had compiled during his researches and experiments. At his death — during World War II — the contents of his safe were impounded by military authorities, and nothing has been heard as to the contents of the records — if any — it might have contained.

One of the peculiar inconsistencies of Tesla's character was revealed when two high honors were offered him, and he rejected the one but accepted the other. In 1912 it was announced that Nikola Tesla and Thomas A. Edison had been chosen to share the Nobel Prize, including the \$40,000 honorarium. Tesla could well have used the \$20,000 at the time. Nevertheless, he flatly refused to share an honor with Edison. However, when in 1917 the AIEE's Edison Medal — founded by anonymous friends of Edison — was awarded to Tesla, he was persuaded to accept it, after first refusing.

### The Esteemed Eccentric

Tesla's natural demeanor was that of the aristocrat. With the passage of time and the depletion of his resources, he sank into a condition of genteel poverty. Continuing to live in the best hotels, his credit would become exhausted and he would be forced to seek other quarters. Finally, moving into the newly opened New Yorker, he found his problems solved. Some of the organizations for which he had made millions arranged with the hotel management to take care of the aging genius.

Having once met Tesla through the mutual friendship of the intrepid Hugo Gernsback (possibly Tesla's last friend) this writer later recognized the distinguished pioneer strolling in the grand concourse of the Pennsylvania Terminal. Impeccably dressed, his head bowed low over his pristine collar and red-and-black silk necktie, his whole bearing was that of a high-born nobleman from the past.

"Good evening, Dr. Tesla," I ventured, disturbing his solitude in the midst of the turmoil. "Are you catching a train for somewhere?" His soft-spoken reply was memorable. "No," he explained, "I often come here to think."

Tesla insisted on carefully wiping each item of silverware, china and glass before starting a meal, using a fresh napkin for each. In view of this effort to achieve perfect sanitation, it seems inconsistent that the maids reported Tesla's room to be an "unholy mess." It wasn't Tesla's untidiness they complained about — it was the pigeons! When he was not feeding them out in the park, he fed them in his room, where he left the window open so they could come and go.

The gold-plated telephone beside his bed, over which he enjoyed a universal frank to talk to anyone anywhere in the world without charge, was the roost of his favorite pigeon, a white one with grey-tipped wings. "When she dies, I will die," predicted Tesla.

And so it was that one day in January 1943, his favorite dove paid him her last visit. "She was dying," lamented the lonely, unhappy Tesla. "I got her message, through the brilliant beam of light from her eyes."

One of the maids, observing that the "Don't Disturb" sign had been hanging on Tesla's doorknob for an unusually long time, used her pass key to investigate. Tesla had passed to his reward, leaving his gaunt 87-year-old frame peacefully in bed. She fed the mourning pigeons, gently ushered them out, and closed the window.

... Quinby

**Author's Note:** I am indebted to the late Hugo Gernsback, friend and confidant of Nikola Tesla; to *Prodigal Genius*, the biography of Tesla by John J. O'Neill; to the *Proceedings of the AIEE*, and various publications for help and information.

# Drake AA-10 Power Amplifier

Greatly  
increases the  
transmitting  
distance  
covered by  
your 2-meter  
transceiver

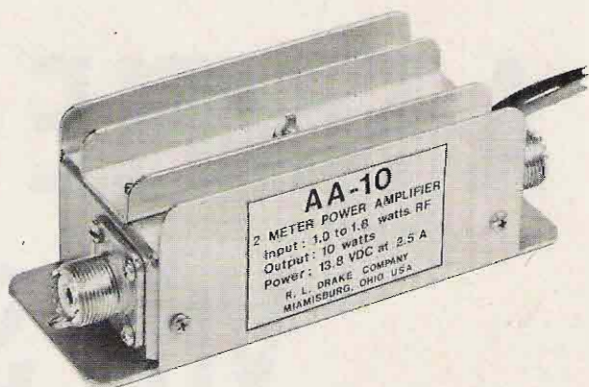

## FEATURES

Single stage solid-state power amplifier using balanced emitter VHF power transistor with VSWR protection.

- Designed to be used with the TR-22 or any transceiver with up to 1.8 watts output power.
- Gives 10 dB power increase
- At least 10 watts output @ 13.8 VDC.
- Has no relays — automatic transmit/receive switching
- Small size 5½" x 2" x 2¼"
- \$49.95 amateur net

## SPECIFICATIONS

**Frequency Coverage:** 144-148 Mhz.

**RF Output Power:** 10 Watts minimum at 13.8 Volts DC and rated input power.

**RF Input Power:** 1 Watt nominal, 1.8 Watt maximum

**Receive Loss:**  
Fraction of 1 dB — unnoticeable.

**Connectors:**  
Type SO-239 Antenna Connector,  
Type SO-239 Transceiver Connector.

**8 Semi-conductors.**

**Power Requirements:**  
13.8 Volts DC at 1.5 Amperes.

**Dimensions:** 2"H x 2¼"W x 5½"D.  
(51 x 52 x 140 mm)

**AC-10 Power Supply** Designed to provide a base for the TR-22. Powers the AA-10 and TR-22. Simultaneously can charge the TR-22 nicads. Supplies 13.8 volts up to 3 amps from 120 VAC 60 Hz input. **\$39.95** amateur net

At your distributors, or write:

**R. L. DRAKE COMPANY**



540 Richard St., Miamisburg, Ohio 45342  
Phone: (513) 866-2421 • Telex: 288-017

# A SIMPLE VHF SWR METER

I recently wanted to do some work on a 2 meter antenna and since no other instrument was handy, started to use an SWR meter manufactured for use on the high frequency bands. After some erratic results, it was decided to check the SWR meter accuracy on 2 meters with some carbon resistors to simulate different SWR's. The results readily confirmed that the SWR meter was useless at VHF unless one didn't care whether a SWR was really 1:2 or 1:5. Rather than purchase another SWR meter, it was decided to construct one that would render reasonable results, within 10% accuracy or so, on the VHF bands, particularly 144 and 220 MHz.

There is nothing basically new in the circuitry of the SWR meter to be described. What is different about it is that it utilizes a particularly simple and inexpensive method of construction that yields reasonable results. It can be constructed as a completely self-contained SWR meter or only the pickup element can be constructed and used

with an external meter. The circuitry as shown here for the meter utilizes two meter

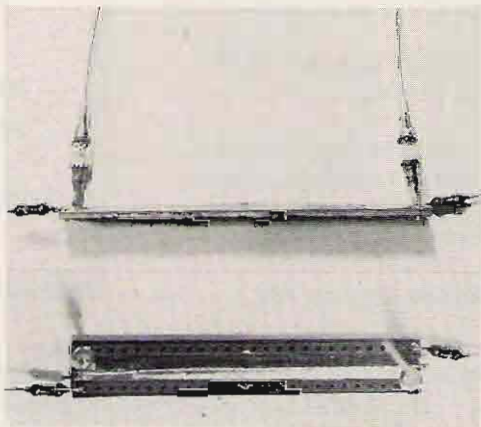

*The heart of the SWR meter is a carefully constructed pickup element. Details of construction are discussed in the text but the photo shows how closely the diodes and terminating resistors must be soldered to the pickup element.*

movements so one can read forward and reflected power simultaneously and avoid the annoyance of having a forward-reflected switch arrangement for a single meter.

### Pickup Element

The "heart" of any SWR meter of the reflectometer type is the pickup element. Many elaborate forms for such elements have been devised which involve complicated mechanical construction. Such complicated construction does become necessary if very accurate results are desired and if the meter is to maintain linearity over a very wide frequency range. However, over a smaller frequency range and with some minor sacrifice in accuracy, the construction of a pickup element can be greatly simplified. Basically, the pickup element should not cause any discontinuity in the transmission line section in which it is inserted but yet be long enough so enough voltage can be picked up in both the forward and reflected directions to make the meter usable with even low power transmitters.

The pickup element I devised is shown in the photo. It is a 2-7/8" long piece of alternate grid pre-punched perf-board stock. The board is about 7/16" wide and within this width contained 4 separate copper strips spaced about 1/16" or less apart. The center two strips are soldered together to act as the inner conductor continuation of a coaxial line section. To solder the two inner strips together tack solder a bare piece of hookup wire between the two strips and then cover the entire two strips with solder.

Without the use of pickup wire, it will be nearly impossible to develop a smooth solder

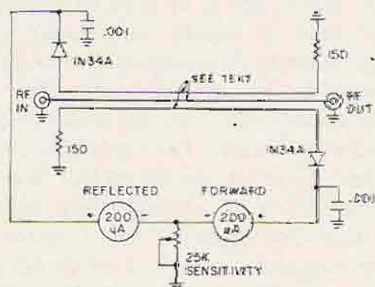

Fig. 1. SWR meter circuit. Two identical meters should be used (current range and internal resistance).

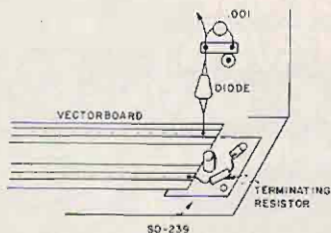

Fig. 2. Center strip of vector board is soldered to center post of SO-239. Other components are mounted at each end of board as shown (only one end shown here).

flow between the strip. Each outer strip acts as a pickup element for the SWR meter circuit shown in Fig. 1. The terminating resistor and diode are soldered to each end of the outer strip as shown in the photo and with minimum excess lead length to the strip. The use of a heat sink on the diode is necessary to prevent damage during soldering.

### Mounting The Pickup Element

The pickup element made from the board stock is mounted between two approximately spaced SO-239 chassis connectors. The center strip of the board is soldered at each end to the center post of the SO-239 connector. The terminating resistor at each end is grounded as directly as possible to a ground lug held in place by one screw of the SO-239 mounting hardware. These details are shown in Fig. 2. It is important that the terminating resistor be grounded in this manner with minimum lead length. The enclosure in which the pickup element is contained should just be wide enough to accommodate the SO 239 connectors so that when the enclosure is secured together, the pickup element is boxed in by a metal surface on each side except directly above it. Many chassis or enclosure types are suitable for this purpose and the overall size of the enclosure will depend, of course, on the meter used and sensitivity control placement. These details are not covered here because they can be made as desired. They will not affect the basic accuracy of the meter as long as the pickup element is properly mounted and enclosed. The bypassing of the pickup rectifier diodes must also be done with as short leads as possible on

# HAPPINESS IS HAVING YOUR OWN HAM-MATE™

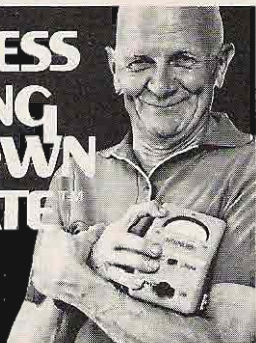

The New HAM-MATE™ Directional RF Wattmeter is a direct descendant of the famous model 43 THRULINE® — the professional standard of the industry. Designed specifically for the serious radio amateur, three models currently available measure forward and reflected power in the following ranges:

4350: 2000/200W, 1.8-30MHz (160 meters to 10 meters)

4351: 1000/200W, 1.8-30MHz (160 meters to 10 meters)

4352: 400/40W, 50-150MHz (6 meters, 2 meters)

All have an Insertion VSWR below 1.1 in 50-52 ohm lines, a minimum of 20dB Directivity, 8% Accuracy, \$0-239 female UHF connectors and carry the 12 months guarantee of all Bird instruments.

ONLY \$79 (plus \$1 shipping)

Also available at Henry Radio, Hamtronics, etc.



## BIRD ELECTRONIC CORPORATION

30303 AURORA RD. • CLEVELAND (SOLOM) OHIO 44139  
Phone 216-248-1200 • Cable BIRDELEC

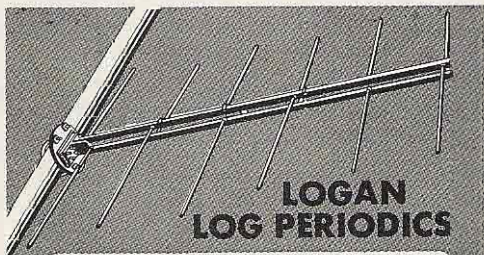

### LOGAN LOG PERIODICS

#### NULL OUT REPEATER INTERFERENCE ONLY \$39.95

- Wide angle frontal lobe
- Deep back null for co-channel rejection
- Broadband, low vswr 144 to 148 MHz
- Quality materials, construction

Logan LOG PERIODIC beams and arrays can be used vertically or horizontally and mounted on top or side of tower of mast with negligible tower effect. Stacking kits available.

Ideal for rejecting that high-power repeater you've been hearing.

Only \$39.95 F.O.B. Farmingdale, N.Y.

Write for technical literature



INSTRUMENTS FOR INDUSTRY  
Logan Antenna Division  
151 Toledo Street  
Farmingdale, N.Y. 11735 • 516-694-1414

the bypass capacitor. As shown in Fig. 2, a two lug terminal strip (one lug grounded), mounted on the side wall of the enclosure immediately at the cathode end of the diode will perform this task very well. The length of the IN34A diodes is such that the bypass capacitor cannot be connected to the same ground lug used for the terminating resistor. The leads on the capacitor would be too long and it will be ineffective.

### Operation and Results

The dual meter circuit of Fig. 1 reads forward and reflected power simultaneously. The sensitivity potentiometer is set to read full scale on the forward meter and the SWR read directly from the reflected meter. The latter meter can be calibrated for various SWR's by the use of small carbon resistors (100Ω to simulate a 1:2 SWR in a 50Ω line, etc.). Usually, it is only necessary to calibrate the reflected meter for SWR's of 1.5, 2 and 3 at the frequency of interest. Calibrated in this manner, the accuracy of measurement will be roughly 10% and is certainly good enough for most general antenna work. A particularly nice meter display can be made if one can find a two meter movement in one enclosure. I purchased a surplus stereo VU meter which had dual 200 μA movements and used it in the SWR meter.

The sensitivity of the SWR meter is such that transceivers of the 1-2 watt output class can easily be used with it on the VHF bands. The basic meter, of course, can also be used on the lower frequency bands as well and it will retain good accuracy. The only problem on the lower frequency bands is that the pickup strips are so short that more transmitter power has to be used to activate the meter than is usually convenient to use during antenna experiments. No exact tests were made but probably 70-100 watts would be needed to use the meter on as low a band as 80 meters. The meter was used and checked, however, on 40 meters. The accuracy of the meter remained very good and full scale deflection of the forward level meter required a power level of 60 watts. Being an in-line type meter, it can be left permanently in line when used on any band with a minimum of loss.

...W2EEY

# BETTER CONTROL FOR TRANSISTOR REGENERATIVE RECEIVERS

From time to time, various amateur magazines have had notes on using transistors in regenerative detector circuits. Some time ago, I made a two-transistor receiver, and immediately ran into trouble with the regeneration. The problem was that as the regeneration control was advanced to the point of oscillation, the received frequency was "pulled," and stations disappeared as I tried to tune them in. Also, the start of oscillation was very violent, and when the control was backed off, the dropout was equally sudden and uncontrollable. Some couple of years ago, in 73\*, there were a few brief notes on using transistors in regenerative circuits. It was suggested that large values of tuning capacitance and small coils would tame the regeneration, and when this was tried, a big improvement was noticed. The result was that a quite usable unit was made for 3.5

MHz, to operate as a companion to a 1W portable transmitter.

Recently, it was decided that the portable rig would be more useful on 7 MHz. The transmitter, (dreadfully old fashioned as it uses a 1T4 and a 3A4) was easily modified, but all attempts to make the two-transistor receiver operate effectively on 7 MHz proved futile. The regeneration just wasn't controllable. The regeneration control was a variable resistor, which not only controlled feedback, but varied the collector voltage. It was reasoned that the frequency shift was due to junction capacitance changes with varying voltage, and this effect would naturally be worse at the higher frequencies.

I then remembered that when I made my first one-tube receiver, in 1946, the regeneration control was not a potentiometer, but a variable capacitor, and the tube's plate voltage was fixed. Maybe the old ways are best; maybe not — but I thought it was worth a try. A simple change in the circuit to that shown in Fig. 1 brought instant improvement. The transistor can now be slid gently in and out of regeneration, and there is only a few hertz shift in the received frequency when this occurs. The receiver is now quite usable on 7 MHz, and I am looking forward to regular QRP contacts during afternoon outings. I throw my antenna wire into a tree, ground the rig to a 40 ft wire, and let it go — all 1.3W of it. The two-transistor regenerative receiver is giving a good account of itself on CW and would make an ideal "last resort" receiver, or as in my case, a real QRP portable unit.

...VK3IQ■

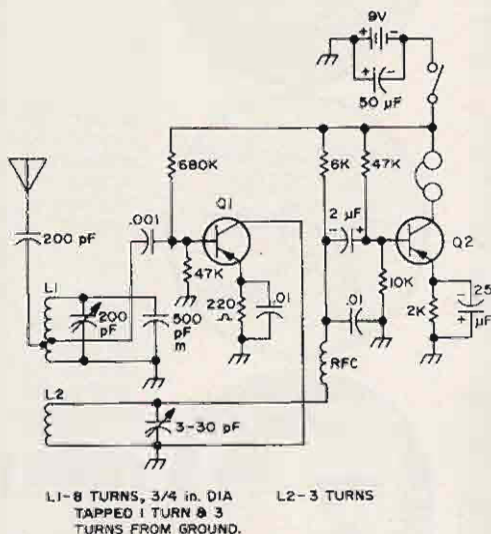

Fig. 1. Revised circuit. Q1 = 2N370, 2N371, 2N572 or 3N2083. Q2 = OC70 or OC71.

\*Reference: "Superhet or Regen," K6BIJ, March 1964 "73" Page 58.

# SBE

# SCANVISION SLOW-SCAN TV

## SCAN- VISION

Now—unexcelled picture performance with exclusive-feature equipment of highest quality in which the most advanced SSTV techniques are expertly applied—**SBE Scanvision**. Here, carefully considered design has simplified operation to the point where the non-engineer radio amateur can have his **SBE Scanvision** monitor connected and start enjoying slow scan in just a matter of minutes.

Most of the many hundreds of SS TV'ers now active on the air agree that the full excitement and enjoyment of SSTV can best be realized only when a tape recorder is part of the system. Incoming pics are taped for future viewing on SS monitor—pre-taped pictures, scenes, I-D—can be transmitted. So—exclusive!—every **SBE Scanvision** monitor has a **cassette-type tape recorder built-in**—wired—ready to go and selectable with panel switch. Here is the ultimate in convenience.

**SBE Scanvision** is conservative—reliable, with picture-proved circuitry and is all solid-state except for the scope tube in the monitor and the videocon picture pickup tube, heart of the SB-1CTV camera. Both tubes are standard types with predictable characteristics—not surplus.

High quality is everywhere evident—throughout, the to-be-expected **SBE approach**—fastidious—professional. The **SBE Scanvision**, SB-1MTV Monitor, complete with cassette recorder and SB-1CTV Camera with f/1.9, 25mm lens, connect with patch cable to comprise a **system**. Units are also separately available.

**SEE SCANVISION AT YOUR SBE DEALER**

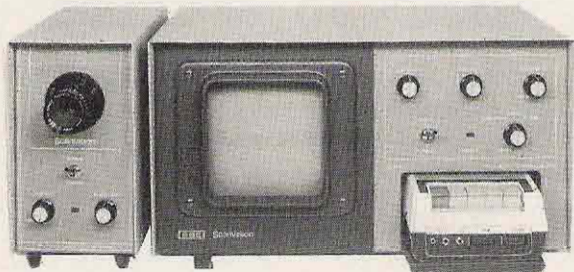

Fully meets all accepted SSTV standards. Compatible.

**Exclusive!**  
Built-in, cassette-type recorder. Ready Instantly

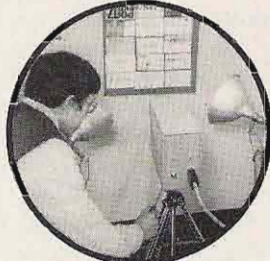

Available—camera with high quality videocon for "live" or "still" pics.



Camera is supplied with quality f/1.9, 25 mm lens. No extra charge.



Monitor connects to spkr or phones for receive—to mic input for transmit.



"Live" SSTV pic photographed from monitor. Un-retouched.

# SBE

**LINEAR  
SYSTEMS, INC.**  
220 Airport Blvd.  
Watsonville,  
CA 95076.



# "WHAT'S AN ANTENNA MEASURING CONTEST?"

**Y**ou'll see," my husband of one year directed. His answers to my further inquiries had me envisioning a large crowd similar to that at a Fourth-of-July fireworks display, with picnickers gathered around plentiful tables and short-order food easily available. On some sprawling platform would be an impressive array of electronic hardware, with a master of ceremonies comparing antennas and from behind a microphone announcing auctioneer style the relative merits of each.

Disillusionment was inevitable when the apparently deserted park finally revealed a small group of people huddled around a few wires. One portable shanty sold candy bars and potato chips. Club funds had been used to supply a tub of ice filled with cans of soda. No other food was available. Gradually some thirty people filtered in, about half of whom brought strange-looking contraptions made of wire, screen, wood and sheet metal, almost none of which I had been used to seeing as antennas.

We walked around looking in on people here and there, and having brief conversations with passing strangers wearing call-letter badges. Everybody seemed to be busy doing nothing, but for some reason my husband radiated excitement and anticipation. I decided there must be something more to come. "They're starting!" Dick said, and abandoned me to rush, camera in hand, to the original group with the wires. I hurried to the spot, fearful of losing a good position for observation. But no one gath-

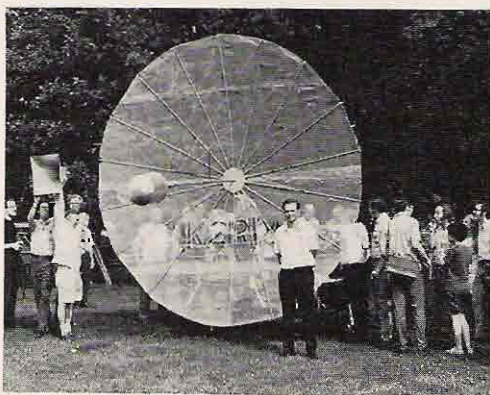

*Dick K2RIW stands in front of his 12-ft. dish which won in both categories, as Dick W2IMU makes a reference measurement with a standard gain horn.*

ered around. There were no official announcements. I asked Dick if anything had gone wrong. Someone was holding up a square megaphone with a wire attached to it, but saying nothing. "No," Dick answered, "It's okay." I stepped in closer to get a better look. "You're in the way," Dick said. I stepped back and almost slammed into a mass of uniformly-spaced spikes being held waist-high.

"When will they start?" I asked ingenuously.

"They already have. That's the third antenna."

When it dawned on me that what I was seeing was all there was, I resolved to discover the point of interest by attempting to understand what was happening. I in-

quired about the measuring process, reprocessing the answers to conform to my limited understanding.

Several years and a legitimately-earned license later, I have come to better understand the enjoyment of an antenna measuring contest. But the East Coast VHF Society has grown in those years, too, and the August 1971 annual ECVHFS Antenna Measuring Contest was vastly different from that first one I attended. Picnickers were already hovering comfortably around tables when we arrived at Saddle Brook Park, New Jersey, and quite a crowd was wandering in the pavilion, where a noise-figure measuring contest, a tube guessing contest, and a QSL card competition would soon be getting underway. A tightly-massed gathering identified the registration table where tickets could be obtained for the drawing to be held later. A picnic table with a receiver and calibration equipment had already been set in the field, and 125 ft further out the signal generator waited.

Friendly waves greeted us as we pulled into the main area, and almost before the car came to a stop we were surrounded by inquisitive amateurs eager to watch us assemble Dick's portable 12 ft-parabolic dish and to examine the "goodies" Dick habitually brings along. I set up the baby's playpen and turned away from him and the friendly XYLs to lend my husband the usually much-needed hand, but discovered he already had all the help he needed. I got out



*QMs with quads collinears, dishes and yagis wait patiently as calibrations are made before their antennas are measured.*

the camera and began snapping familiar faces, interesting-looking antennas, and contest activities. When the dish was fully assembled and the competition was about to begin, I interrupted Dick in his technical discussion with several other amateurs to force him to eat a sandwich. A respected amateur requested a picture. Then came the rain, a circumstance luckily avoided at all earlier ECVHFS contests in my experience. Everyone gathered in cars and in the pavilion. Our baby napped in his car bed. As the skies gradually cleared, a young couple accidentally wandering into our area approached the amateurs in the truck near our car, and pointing to a large parabola asked what it was. The straightforward answers were so badly misconstrued and the simple functions of the antennas held in such naively exaggerated awe that I, overhearing, couldn't help but chuckle, remembering my first exposure.

The measuring resumed and the crowd, fortified by amateurs returning from the nearby ECVHFS ham radio auction and flea market, filtered back into the field, some 130 strong. Somebody tapped me on the shoulder. "Do you believe in God?" It was a two-man team taking a religious "survey." I gave them answers to their brief oral questionnaire, dismissing them courteously. Somebody was cooking hamburgers on an hibachi. Two amateurs worked together to repair an antenna with a Bernz-O-Matic torch. Amateurs inquired about the gains of each other's antennas and generally gos-



*Paul, president of the ECVHFS, holds up the 1296 MHz standard gain horn, as a former president, Al K2UYH, looks on benignly.*

sipped. DB's written on contest forms were compared for the 26 antennas entered in two categories. A ham received congratulations for having won the noise figure measuring contest. A child played with a stuffed animal won by a parent in the drawing. Someone handed out cucumbers from his Pennsylvania garden. Certificates were issued and plaques given to the 432 and 1296 MHz antenna measurement winners. An ARRL official capitalized on the occasion to present an award of achievement to an amateur. Just as the crescendo of activity began the descent, it began to rain again. Amateurs, YL's, XYL's, supplies, antennas and children were packed into cars and the homeward trek was begun.



*These technical diehards won't let a little rain ruin their chance for an eyeball QSO. Left to right are Bill W2DWJ, Dick K2RIW, Reed W2CQH and Al K2UYH.*

We began dismantling the dish in the downpour. "What about lightning?" I insisted.

"Don't worry about it."

What's an antenna measuring contest? It's a serious electronic effort: a place to announce an antenna of your own design or to measure the gain of a favorite commercial one. It's a chance to exchange ideas or equipment; it's a family picnic, a brag-and-gossip session, a place to display your specialized electronic acumen, an opportunity to meet friends as well as the serious VHF amateurs; it's an experience. But you've got to see one for yourself.

...WB2HJD

# SUPER CRYSTAL THE NEW DELUXE DIGITAL SYNTHESIZER!!

FROM **R  
P**

TRANSMIT AND RECEIVE  
WORK REPEATERS  
SUPER ACCURATE---.0005%  
FULL 2M COVERAGE--10 KHZ

SEND FOR FREE DETAILS

ALSO: PARTS, ETC.,

COMPLETE STATIONS--  
ALL CHANNELS SYNTH.

**R  
P** ELECTRONICS  
BOX 1201B  
CHAMPAIGN  
ILL 61820



### Be The First!

Are you going to let the EIA steal one of our most promising ham bands without a fight? Are you going to sit still while this piracy takes place? Or are you going to fight back? Are you going to get on 220? Are you going to help get a repeater on 220? Are you going to let the manufacturers know that they can't buy our ham band by lavishing dollars in Washington?

To help you get the spirit started with your club 73 is offering these shirts - 220 - USE IT OR LOSE IT - you may be the first in your club and make everyone eat their heart out. Wear these to hamfests and conventions - let's get the word out.

These 220 shirts are \$2.50 each postpaid - state size desired - small, medium or large - state color desired as long as it is blue. USA only.

73 Magazine, Peterborough NH 03458

# BARRY

HAS IN STOCK  
AND READY FOR SHIPMENT

SIGNAL ONE CX7A

*PLUS THE NEW SIGNAL ONE LINE*

The *ENTIRE* DRAKE LINE

PEARCE-SIMPSON—2METER FM GEAR & MARINE GEAR  
HALLICRAFTERS

COLLINS

DX ENGINEERING SPEECH COMPRESSORS

FOR COLLINS 32S SERIES \_\_\_\_\_ \$79.50

FOR COLLINS KWM-2 \_\_\_\_\_ 79.50

FOR DRAKE TR3 or TR4 \_\_\_\_\_ 98.50

*PLUS ANYTHING YOU COULD POSSIBLY NEED IN THE  
WAY OF EQUIPMENT AND ACCESSORIES*

*YOUR ONE STOP HEADQUARTERS FOR  
ALL YOUR HAM NEEDS*

# BARRY

## ELECTRONICS CORP.

CALL BARRY, W2LNI 212-925-7000  
DEPT 7 512 BROADWAY, NEW YORK N.Y. 10012

# SSB ON 432 MHZ

**R**ecently, after a fruitless evening of calling CQ on 432, I decided it was time more hams were encouraged to use this interesting band. Most people think that 50 miles on 432 is real DX. That's just not true. Although my best DX this past year was only 415 miles, many hams cover distances as great as 700 miles; some claim more. SSB is now starting to come into greater use, and does show its worth on 432, so I decided to put together a complete working unit. This unit is a modified version of a design by K7RKH that originally appeared, in part, in the old VHF'er magazine.

When building this mixer I decided that, while the General Class operators would probably be more inclined toward construction, there are also many Technicians with 50 MHz SSB who would like to get on 432. With this idea in the back of my head, I chose 50 MHz as the mixer input frequency.

While some 432 MHz mixer designs have appeared in print, it appears that few hams

have completed rigs that work with much success. One reason for this may be they have not been able to obtain the degree of oscillator stability required. Some have gone to the extreme of building a transistorized oscillator inside a thermos bottle, burying it in the ground and letting it run 24 hours per day. This of course results in excellent stability. With a little care my oscillator chain will equal or surpass the current 432 rigs. Keep in mind that only one hertz change in the oscillator will give you a change of 54 hertz in the output.

At VHF/UHF the use of choice selected hardware such as ceramic tube sockets, good quality resistors and capacitors and constant-impedance connectors is a must. Those inexperienced in working with 432 circuits should use a copper chassis, but advanced experimenters can construct this oscillator/mixer on other materials such as aluminum, using the necessary precautions such as short leads, direct ground paths, and



The 382 Mc oscillator chain is on the left, the 432 Mc mixer with an added buffer amplifier in the center, and a 500 watt cavity on the right.

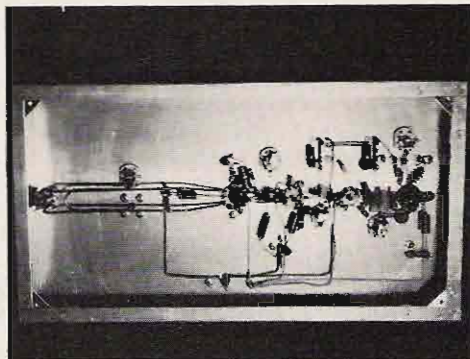

Bottom view of the oscillator chain, with C6 at the lower left and L6-L7-C5 at the right.

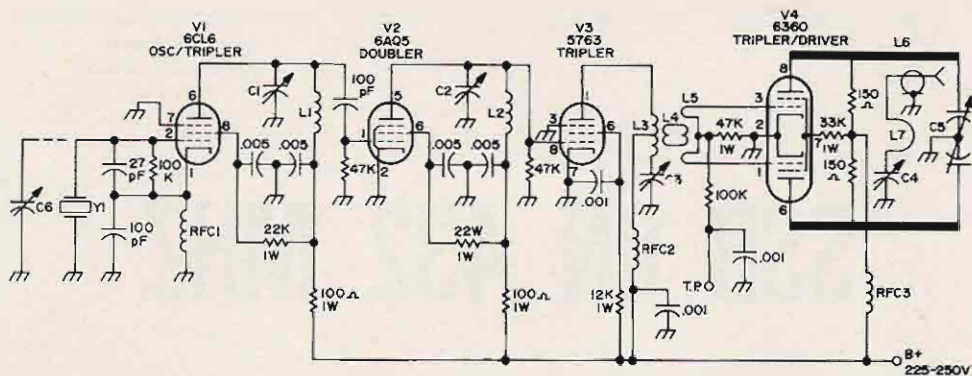

Y1-7074 FUNDAMENTAL CRYSTAL.  
 C1, C2-25 pF (E.F. JOHNSON 160-130).  
 C3-10 pF (E.F. JOHNSON 160-107).  
 C4-5 pF (E.F. JOHNSON 160-102).  
 C5-10 pF (E.F. JOHNSON 160-108).  
 C6-8 pF (E.F. JOHNSON 160-104). See Text.  
 RFC1-.750 uH RF CHOKE.  
 RFC2-J.W. MILLER RFC 144.  
 RFC3-J.W. MILLER RFC 420.

L1-9#1 NO. 20 AWG, 3/4 in. DIA., SPACED 5/8 in. (8 @ W 3011).  
 L2-6#1 NO. 20 AWG, 5/8 in. DIA., SPACED 3/8 in. (8 @ W 3007).  
 L3-4#1 NO. 20 AWG, 3/4 in. DIA., SPACED 5/16 in., CENTER TAP (8 @ W 3011).  
 L4-2#1 EACH END, NO. AWG HOOKUP WIRE, ON PLATE END OF L3 @ CENTER OF L5.  
 L5-8#1 NO. 18 AWG, 5/16 in. DIA., CENTER TAP, SEPARATE INTO 4 TURNS EACH, 1/8 in. APART.  
 L6-5-1/2#1 NO. 12 AWG SOLID, SEPARATE 3/4 in.  
 L7-4-1/2#1 NO. 12 AWG SOLID, BEND INTO U SHAPE, 3/4 in. WIDE, PLACE 1/8 in. ABOVE L6 (PICTORIAL)

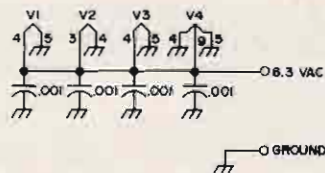

Fig. 1. Circuit diagram of the 382 MHz oscillator chain.

proper bypassing/decoupling. Shielding per se is not a critical factor here as power generation itself was not the desired end product.

### Construction

The oscillator chain is constructed on an aluminum chassis 2x7x13 in. Be sure to make preliminary parts layout, as the full length of the chassis will be used. If you are not experienced at building VHF circuits it is recommended that you build only one stage at a time and get it working before proceeding to the next. The mixer was built on a separate 2x5x7 in. chassis for experimental purposes, but you may want to build both on a larger common chassis.

You need not include frequency adjust/variable capacitor C6, but if you do it will give you about 100 kHz change at the output frequency, more than enough to correct for crystal error, or to enable you to move to a predetermined frequency. With proper adjustment of C6, you could actually go to full transceiver, but in actual practice a fixed crystal frequency would be better in case you are running skeds.

### Tuneup

A grid tip meter is an absolute must. Without one you will not have much success in tuning up because the tuned circuits will actually pick either the second or third harmonic of the previous stage. Dip each stage as follows: C1/L1 dip to 21.222 MHz, C2/L2 dip to 42.444 MHz, C3/L3 dip to 127.333 MHz. There is only one dip in C5/L6, so it is a simple matter to peak for maximum rf output. To assist in tuneup, construct an rf indicator from a GE49 pilot bulb and a 1 in. loop of hookup wire. After each L/C circuit is dipped, apply filament and B+ voltage. Starting with the oscillator, hold the indicator near the plate end of each coil and peak for maximum output. Now go

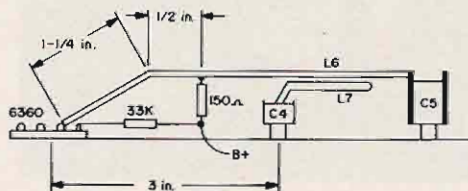

Fig. 2. Side view of 6360 tank circuit showing parts placement.

# SBE

feature  
after  
feature  
after  
feature

In addition to those pictured---there's 500 watts P.E.P. power input---digital readout to 100 Hertz---husky matching 115VAC power supply/speaker unit and external VFO as an available accessory.

Add all of these and you have the brilliant SB-36---a beautiful experience in operating convenience and enjoyment.

See it at your dealer---write for data sheet.

## SB-36

SSB/CW TRANSCEIVER

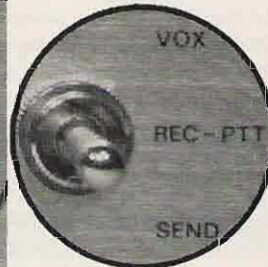
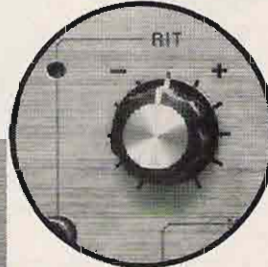
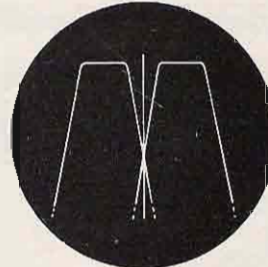

Separate bandpass filters for USB and LSB. Absolutely no carrier shift when changing sidebands!

**SBE**

LINEAR SYSTEMS, INC.

220  
Airport Blvd.  
Watsonville, CA  
95076

**FREE  
HAM  
CATALOG**

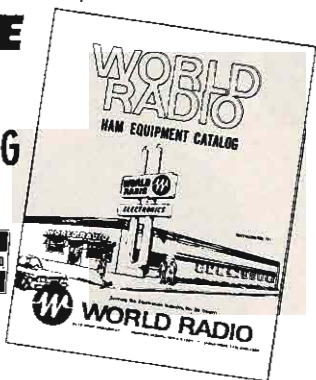

**H.F.—S.S.B.—F.M.—ACCESSORIES**



**WORLD RADIO**  
3415 WEST BROADWAY  
COUNCIL BLUFFS, IOWA 51501

Name \_\_\_\_\_ Call \_\_\_\_\_

Address \_\_\_\_\_

City \_\_\_\_\_

State \_\_\_\_\_ Zip \_\_\_\_\_

## New! BALUN

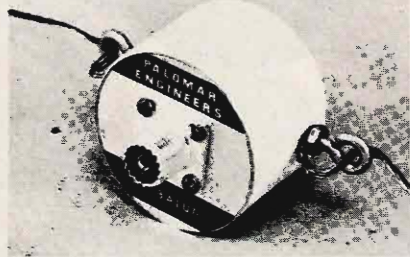

- 1 : 1 ratio for dipole or inverted Vee.
- Replaces center insulator.
- Cuts noise in receive. Cuts TVI in transmit.
- Wideband 1.7 to 30 MHz. Full Kw power.
- Stainless hardware. Sealed. Weatherproof.
- \$12.95 PPD USA. 5% tax in Calif.
- Order direct. Free brochure. Send to:

**PALOMAR  
ENGINEERS**

BOX 455, ESCONDIDO, CA 92025

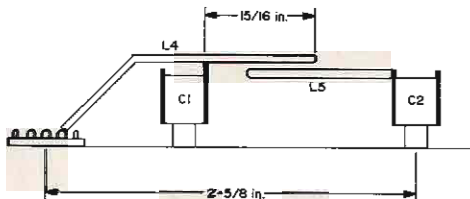
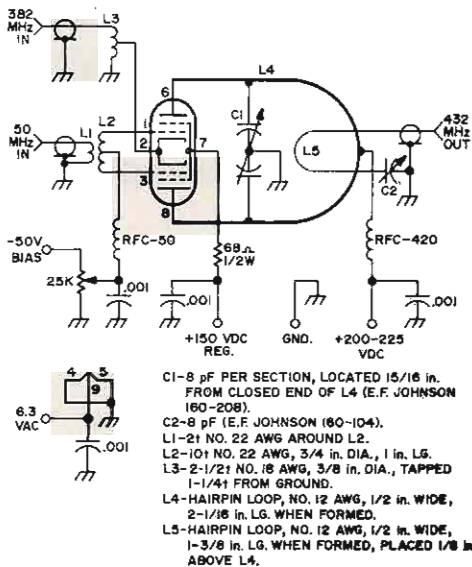

Fig. 3. Circuit diagram of the 432 MHz mixer, and the pictorial of the tank circuit.

back and redip each coil to make sure you are still on the proper frequency. When each stage is in tune there will be enough output to brightly light your indicator. While tuning C3/L3 for maximum output, couple your indicator to coil L5 and peak C3. Now connect a vom or vtvm to point "TP" and set your meter to read 100V dc. Again apply power and tune each capacitor for a peak reading on your meter. The final reading should be 50–85V dc. When tuneup is completed you should have 3–4W of 382 MHz rf, much more than will be needed, but the excess will help to overcome circuit losses.

### Mixer

A 6360 works as a mixer with suitable modifications, but it requires more drive and injection. A 6939 costs more, but has more output with less drive and injection, less than half that of the 6360. The 382 MHz



injection is fed into the cathode through a tapped rf choke resonant between 382 and 432 MHz. Care must be exercised not to resonate this coil at 432 MHz, for if you do, output instability will result. The tap, placement of which is critical, provides an impedance match and expends the rf driving power efficiently for proper loading of the cathode. The vr tube for the 6939 screens is an OA2. The bias is set for 35 mA standing plate current with no drive.

The simplest method of obtaining the 1W of 50 MHz SSB, without making modifications to the rig, is to feed the full output of the driver into a dummy load with a tee connector and pull off only the amount of rf needed (Fig. 4).

### Final Tuneup

Connect the 382 MHz oscillator chain to the mixer with a piece of RG-58/U coax about 14 in. long. This length can be critical, so if any problems are found, vary this length a bit. Connect the output of the mixer to a proper dummy load or wattmeter. Apply the appropriate voltages to the oscillator/mixer and adjust the 6939 static plate current to 35 mA. Now repeak the oscillator stages for the maximum voltage at "TP." Apply a small amount of 50 MHz drive and dip the mixer capacitors C1 and C2 for maximum output. Again repeak all capacitors and adjust the 50 MHz drive to the 6939 for about 50 mA plate current. With 225V on the oscillator plates, total current should be about 165 mA. Do not try to run the oscillator chain at its maximum input as the increased output if not needed and a lower input level will give you a much more stable unit. Allow at least 15 minutes warm-up before making the final frequency adjustments.

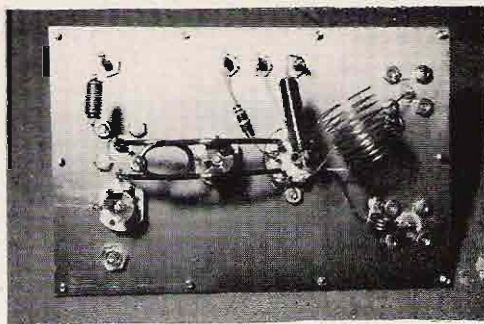

Bottom view of the 6939 mixer, with L5-C2 at the left and L3 at the lower right.

### Summation

If problems such as FM'ing should be encountered, decrease the 50 MHz drive, since we're more interested in quality than in power. You should now have enough output to drive such tubes as the 6939, 5894, 2C39, and, amazingly enough, should be able to drive a 4X250 to as much as 135W input, class AB1.

It is always recommended that a filter be used on the output of any mixer worked directly on the air. When driving low Q buffer or amplifier stages, some of the spurious energy such as 382 MHz will get through to the output. Some odd loading effects will occur in broad frequency amplifier stages because the 382 and 432 MHz energies are relatively close together for a UHF circuit. A strip line filter between the mixer and the final amplifier stage is highly recommended. Refer to the ARRL VHF Handbook. Even an output filter is desirable. Although I have only used CW and SSB the 50 MHz drive may be almost any mode — CW, A3, SSB, FM, FSK, PM, or what have you — but the modulation/purity index must be clean or it will show up in the output.

If this mixer is used as a source signal directly for tuning up 432 antennas, the swr bridge will go crazy and will not give readings truly indicative of tuning or antenna performance.

I am using a Heath SB-110 as the 50 MHz driver, using the auxiliary transmit with a 5.031 crystal (about 432.030) in the auxiliary oscillator and have had good on-the-air comments. See you soon on 432 SSB.

...WA8VHG

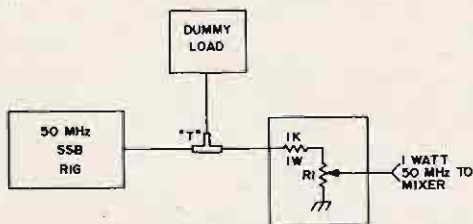

Fig. 4. Method of obtaining low level drive to the mixer. R1 is a 1K A.B. composition pot. This may be built in a small minibox using rf connectors.

# TECO ELECTRONICS

P.O. BOX 1050, 322 KIRBY ST.  
GARLAND TX 75040 214-276-4931

## COUNTERS

TUCKER 60: 1 KHz to 60 MHz TRANSISTOR 5 NIXIE . . . NEW . . . . .	\$299.00
HP 521A: DC to 120 KHz, 4 DIGIT NEON . . . . .	\$ 40.00
HP 521C: DC to 120 KHz, 5 DIGIT NEON . . . . .	\$ 50.00
HP 521G: DC to 1 MHz, 5 DIGIT NEON . . . . .	\$ 65.00
HP 522B: 10 Hz to 120 KHz, 5 DIGIT NEON . . . . .	\$ 35.00
HP 523B: 10 Hz to 1.2 MHz, 6 DIGIT NEON . . . . .	\$ 75.00
HP 524B: DC to 10 MHz, 8 DIGIT NEON . . . . .	\$ 495.00
HP 524C: DC to 10 MHz, 8 DIGIT NIXIE . . . . .	\$ 295.00
HP 524D: DC to 10 MHz, 8 DIGIT NEON . . . . .	\$ 75.00
HP 525A: 10 MHz to 110 MHz CONVERTER UNIT . . . . .	\$ 75.00
HP 525B: 110 MHz to 220 MHz CONVERTER UNIT . . . . .	\$ 75.00
HP 525C: 100 MHz to 510 MHz CONVERTER UNIT . . . . .	\$195.00
HP 540A: 10 MHz to 5 GHz TRANSFER OSCILLATOR . . . . .	\$ 95.00
BECKMAN 7359R: EPUT, DC to 100 KHz, 5 DIGIT NEON . . . . .	\$ 35.00
BECKMAN 7360R: EPUT, DC to 1 MHz, 6 DIGIT NEON . . . . .	\$ 50.00
BECKMAN 7370R: EPUT, DC to 11.5 MHz, 7 DIGIT NEON . . . . .	\$125.00
BECKMAN 7170R: DC to 11.5 MHz, 7 DIGIT NEON . . . . .	\$ 95.00
BECKMAN 7175R: 10 Hz to 110 MHz, 7 DIGIT NEON . . . . .	\$195.00
BECKMAN 8175R: 10 Hz to 110 MHz, 8 DIGIT LUMINESCENT READOUT . . . . .	\$295.00
BECKMAN 7870: BASIC HETERODYNE UNIT FOR 7571-7573 CONVERTERS . . . . .	\$ 25.00
BECKMAN 7571: 10 MHz to 110 MHz CONVERTER . . . . .	\$ 25.00
BECKMAN 7572: 110 MHz to 220 MHz CONVERTER . . . . .	\$ 35.00
BECKMAN 7573: 220 MHz to 1 GHz CONVERTER . . . . .	\$ 50.00
BECKMAN 5571: EPUT, DC to 42 MHz, 6 DIGIT NEON . . . . .	\$ 50.00
BECKMAN 554: EPUT, 20 Hz to 100 KHz, 5 DIGIT NEON . . . . .	\$ 25.00
BECKMAN 5510: DC to 1 MHz, 6 DIGIT NEON . . . . .	\$ 35.00
MLT FR-38: SAME AS HP 524B: . . . . .	\$ 75.00
CMC 707D: DC to 50 MHz TRANSISTOR 7 DIGIT NIXIE . . . . .	\$95.00

## SCOPES

DUMONT 304: DC to 300 KHz . . . . .	\$ 50.00
DUMONT 401: DC to 500 KHz . . . . .	\$ 75.00
FAIRCHILD 701: DC to 500 KHz . . . . .	\$195.00
FAIRCHILD 760H/76-08/74-13A: DC to 50 MHz DUAL TRACE TRANSISTOR . . . . .	\$785.00
HP 150/152B: DC to 10 MHz DUAL TRACE . . . . .	\$195.00
HP 160/USM105: DC to 15 MHz DUAL TRACE . . . . .	\$385.00
HP 175A: DC to 50 MHz DUAL TRACE . . . . .	\$695.00
HP 185B/BR: DC to 1 GHz SAMPLING SCOPE . . . . .	\$295.00
TEK 512: DC to 2 MHz SINGLE TRACE . . . . .	\$ 95.00
TEK 514A: DC to 10 MHz SINGLE TRACE . . . . .	\$125.00
TEK 531: DC to 1 MHz LESS PLUG-IN . . . . .	\$195.00
TEK 532: DC to 5 MHz LESS PLUG-IN . . . . .	\$225.00
TEK 533: DC to 15 MHz LESS PLUG-IN . . . . .	\$250.00
TEK 535: DC to 11 MHz LESS PLUG-IN . . . . .	\$350.00
TEK 541: DC to 30 MHz LESS PLUG-IN . . . . .	\$250.00
TEK 543: DC to 30 MHz LESS PLUG-IN . . . . .	\$395.00
TEK RM15: RACKMOUNT 515 DC to 15 MHz . . . . .	\$295.00
TEK RM 16: RACKMOUNT 316 DC to 10 MHz . . . . .	\$195.00
TEK RM17: RACKMOUNT 317 DC to 10 MHz . . . . .	\$225.00
TEK RM31: RACKMOUNT 531 LESS PLUG-IN . . . . .	\$175.00
TEK RM31A: RACKMOUNT 53A LESS PLUG-IN . . . . .	\$225.00
TEK RM32: RACKMOUNT 532 LESS PLUG-IN . . . . .	\$195.00
TEK A: PLUG-IN DC-20 MHz WIDE BAND DC . . . . .	\$ 40.00
TEK C: PLUG-IN DC-24 MHz DUAL TRACE . . . . .	\$125.00
TEK E: PLUG-IN DC-60 KHz DIFFERENTIAL . . . . .	\$ 75.00
TEK K: PLUG-IN DC-30 MHz FAST RISE TIME . . . . .	\$50.00
MANY OTHERS - WRITE FOR DETAILS	

## MISCELLANEOUS

NEMS-CLARKE 1400: 215-260 MHz RECEIVER . . . . .	\$ 50.00
NEMS-CLARKE 1412: 215-260 MHz RECEIVER . . . . .	\$ 75.00
NEMS-CLARKE 1465: 215-260 MHz RECEIVER . . . . .	\$125.00
MLT TV-2C LATE MODEL TUBE TESTER . . . . .	\$ 50.00
LAMPKIN 205A FM MODULATION METER . . . . .	\$165.00
HAMMARLUND HO110 RECEIVER . . . . .	\$ 75.00
MLT M582 WATTMETER: 50 to 600 MHz 0-120 WATT . . . . .	\$ 50.00
HICKOK MODEL 534 TUBE TESTER . . . . .	\$ 50.00
HICKOK MODEL 605 TUBE TESTER . . . . .	\$ 50.00

*CONDITIONS: All equipment supplied working "AS IS" FOB Garland, Texas. Order of less than \$50.00 subject to \$5.00 packing and handling charge. Satisfaction guaranteed, item may be returned within 10 days if shipped prepaid. Many other items in stock which changes day to day.*

METERS	
HP 400 CR VTVM: 10 Hz to 4 MHz 1 MV to 300 V	\$ 15.00
HP 400C VTVM: 10 Hz to 4 MHz 1 MV to 300V	\$ 25.00
HP 400D VTVM: 10 Hz to 4 MHz 1 MV to 300V	\$ 35.00
HP 400H VTVM: 10 Hz to 4 MHz 1 MV to 300V	\$125.00
HP 405AR AUTOMATIC DC DVM: 3 DIGIT 1 MV to 1 KV	\$125.00
HP 410B OLD STYLE VTVM: AC-DC AND OHMS	\$ 75.00
HP 411A RF MILLIVOLTMETER: 10 MV-10V RMS	\$295.00
HP 412A DC VTVM: 1 MV to 1 KV, 1 MICROAMP to 1A	\$195.00
HP 415A VSWR INDICATOR	\$ 20.00
HP 415B VSWR INDICATOR	\$ 35.00
HP 428A CLIP-ON DC MILLIAMMETER 3 MA to 1A	\$250.00
HP 430C MICROWAVE POWER METER	\$ 35.00
HP 430C WITH 477B MOUNT	\$ 85.00
HP 500A FREQUENCY METER: 50 Hz to 50 KHz	\$ 35.00
HP 500B FREQUENCY METER: 3 Hz to 100 KHz	\$ 40.00
HP 500C TACHOMETRY: 180 RPM to 5 MEG RPM	\$ 35.00
GR 1800 VTVM	\$ 50.00
FAIRCHILD 7080 DVM TRANSISTOR UNIT	\$125.00
FLUKE 801 DVM: 0 to 500V DC 0.05%	\$ 95.00
FLUKE 801R DVM 0 to 500V DC 0.05%	\$75.00
FLUKE 803 DVM: 0 to 500V DC OR AC	\$150.00
FLUKE 803R DVM: 0 to 500V DC OR AC	\$125.00
FLUKE 821AR DC DVM: 0 to 500V 0.01%	\$250.00
FLUKE 910A TRUE RMS VOLTMETER: 10 Hz to 7 MHz	\$175.00
MILLIVAC MV27 VTVM: 1 MV to 1 KV DC	\$ 25.00
BALLANTINE 300 VTVM: 1 MV to 100V 10 Hz to 150 KHz	\$ 20.00
BALLANTINE 314 VTVM: 1 MV to 1 KV 15 Hz to 5 MHz	\$ 75.00
ORION V-100M VTVM: SIMILAR TO HP 400H	\$ 50.00
MLT TS-375 VTVM: SIMILAR TO HP 410B	\$ 35.00
KINTEL 202BR DC MICROVOLT METER	\$ 95.00
BORG WARNER-SINGER M401 SWR INDICATOR	\$ 65.00

POWER SUPPLIES	
DRESSER BARNES: 20-10 MODULE P.S. 10 VDC @ 550 MA	\$ 10.00
DRESSER BARNES: D3 500B DUAL 0-300V @ 500 MA + BIAS & FIL	\$ 65.00
ELECTRONIC MEASUREMENTS 212A: 0-100 VDC @ 100 MA	\$ 25.00
ELECTRONIC MEASUREMENTS 218AM: 0-100 VDC @ 3 AMPS	\$ 50.00
ELECTRONIC MEASUREMENTS REGULATION CALIBRATOR: 0-300V @ 300 MA IN 1 VOLT STEPS	\$ 50.00
LAMBDA 64M: 100-200 VDC @ 500 MA	\$ 25.00
LAMBDA 65M: 0-100 VDC @ 600 MA	\$ 25.00
LAMBDA 25: 200-325 VDC @ 100 MA	\$ 15.00
LAMBDA 50: 0-500 VDC @ 500 MA	\$ 50.00
LAMBDA C-1581-M: 125-325 VDC @ 1.5A	\$ 75.00
LAMBDA C-1581: 125-325 VDC @ 1.5A	\$ 65.00
LAMBDA LMD10: NEW, 8-13V @ 10A 0.02% REG	\$ 75.00
LAMBDA LMD48: NEW, 48V @ 4A 0.02% REG	\$ 50.00
LAMBDA LM204: NEW, 0-10 VOLTS @ 900 MA 0.05% REG	\$ 30.00
LAMBDA LM207: NEW, 0-50 VOLTS @ 130 MA 0.02% REG	\$ 20.00
KEPCO 2400B: DUAL 0-600 VDC @ 300 MA	\$ 45.00
KEPCO 150: 0-150 VDC @ 50 MA	\$ 15.00
KEPCO KR/M: 0-500 VDC @ 600 MA	\$ 35.00
SORENSEN E28-10: 28 VOLTS @ 10A	\$ 25.00
SORENSEN E6-15: 6 VOLTS @ 15A	\$ 25.00
SORENSEN 500 98: 0-500 VDC @ 500 MA	\$ 50.00
SORENSEN 500B: 0-500 VDC @ 150 MA	\$ 35.00
SORENSEN 1000: AC LINE REGULATOR 1 KVA	\$ 65.00
CEA: MODULE P.S. 15 VOLTS @ 2.5A 0.25% REG	\$ 25.00
CEA: MODULE P.S. 28 VOLTS @ 2.5A 0.25% REG	\$ 30.00
CON: MODULE P.S. 12 VOLTS @ 1.5A	\$ 20.00
RADIATION TDMS P.S.	\$ 15.00
HP 715A KLYSTRON P.S.	\$ 45.00
FLUKE 301E: 1.02-512V @ 300 MA	\$125.00
FLUKE 301C: 1.02-1012V @ 400 MA	\$195.00
COLLINS MP-1: P.S. FOR KWM-2	\$ 70.00
COLLINS 516E-2: 28V P.S. FOR KWM-2	\$150.00

GENERATORS	
HP 2008R AUDIO OSCILLATOR: 20 Hz to 20 KHz	\$ 35.00
HP 200 JR INTERPOLATION OSCILLATOR: 6 Hz to 6 KHz	\$ 95.00
HP 200TR TELEMETRY OSCILLATOR: 250 Hz to 100 KHz	\$ 40.00
HP 202CR AUDIO OSCILLATOR: 1 Hz to 100 KHz	\$ 75.00
HP 205AG AUDIO OSCILLATOR: 20 Hz to 20 KHz	\$150.00
HP 206 AR AUDIO OSCILLATOR: 20 Hz to 20 KHz	\$250.00
HP 211A SQUARE WAVE GENERATOR: 1 Hz to 1 MHz	\$ 60.00
HP 212AR PULSE GENERATOR: 60 Hz to 5 KHz	\$ 25.00
HP 233A CARRIER TEST OSCILLATOR: 50 Hz to 500 KHz	\$ 75.00
HP 608D SIGNAL GENERATOR: 10 MHz to 420 MHz	\$750.00
HP 614A SIGNAL GENERATOR: 900 MHz to 2100 MHz	\$850.00
HP 616A SIGNAL GENERATOR: 1.8 GHz to 4.2 GHz	\$395.00
HP 650A TEST OSCILLATOR: 10 Hz to 10 MHz	\$125.00
HP 670 SWEEP GENERATOR: 2 GHz to 4 GHz	\$ 65.00
TEK 105 SQUARE WAVE GENERATOR: 25 Hz to 1 MHz	\$ 50.00
TEK 180A TIME MARK GENERATOR	\$195.00
DUMONT 404: SINGLE PULSE TO 100 KHz	\$ 25.00
MLT TS-382 AUDIO GENERATOR: 20 Hz to 200 KHz	\$ 50.00
MLT PRM-10 GSD: SIMILAR TO MEASUREMENT	\$ 65.00
MLT URM-12 AUDIO GENERATOR TRANSISTOR TS-382 NEW	\$125.00
RUTHERFORD B-24 PULSE GENERATOR: 10 Hz to 100 KHz	\$ 45.00
RUTHERFORD B-7 PULSE GENERATOR: 20 Hz to 2 MHz	\$ 50.00
RUTHERFORD B-7B PULSE GENERATOR: 20 Hz to 2 MHz	\$ 95.00
RUTHERFORD B-14 PULSE GENERATOR: 20 Hz to 2 MHz	\$ 50.00
MEASUREMENTS 2100 FM SIGNAL GENERATOR: 148-174 MHz	\$195.00
MEASUREMENTS 90 FM SIGNAL GENERATOR: 2 MHz to 420 MHz	\$225.00
MEASUREMENTS 80R FM SIGNAL GENERATOR: 5 MHz-470 MHz	\$250.00
BOYDEN 190 PULSE GENERATOR: 2 Hz to 125 MHz TRANSISTOR	\$295.00
FERRIS 16C SIGNAL GENERATOR: 50 KHz to 28 MHz	\$ 60.00
FERRIS 18-FS SIGNAL GENERATOR: 14 MHz to 235 MHz	\$ 25.00

TECO DIV OF



**TUCKER**  
ELECTRONICS COMPANY

# A 185 AMPERE AC ARC WELDER

**T**he welder, although not an essential item in the hamshack, is a welcome addition to the experimenter's supply of tools. It serves such areas as tower construction and general repair. The high cost of an adequate commercial welder and my native curiosity started me on this project which has seen a year and several different transformer designs pass. The present unit is the culmination of my experimentation. It is a continuously variable unit that will weld to 185 ac amperes maximum. The duty cycle for this unit at maximum current is about 15%, which would not satisfy the industrial user, but for the average shop is quite adequate. A simple duct and fan cooling arrangement could raise this value.

The type of transformer I have designed allows one to control the leakage of the unit, which in turn controls the maximum amount of current that can be drawn. By varying the amount of leakage, one can control the current available at the welding electrodes. Most transformers are designed to minimize leakage. This application is an exception. The formula used to calculate the number of turns for the primary and secondary windings is:

$$V/N = 4.44 B F S A \times 10^{-8}$$

B = flux density in gauss (flux is the number of lines of magnetic force and is dictated to a certain degree by the metal used in the core).

F = frequency of operation of the transformer (in this case 60 cycles).

S = stacking factor (this allows for varnish between the laminations of the iron core).

A = cross-sectional area of a core leg in square centimeters.

V = volts applied or desired.

N = number of turns required.

After choosing the flux density at which to operate the transformer, considering the iron used (I chose 15,000 gauss), the other terms are fixed by external conditions, except for the number of turns and the cross-sectional area. I picked a cross-sectional area that would be large enough to

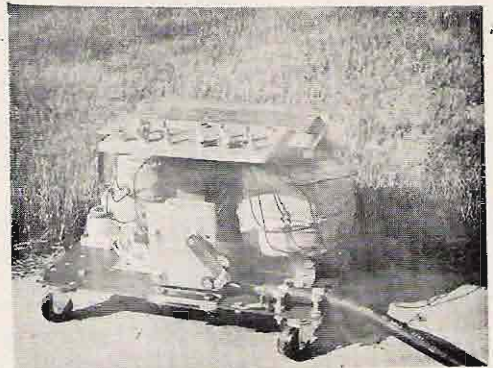

*The completed welder. Note the on-off switch, fuses and shunt mechanism in place.*

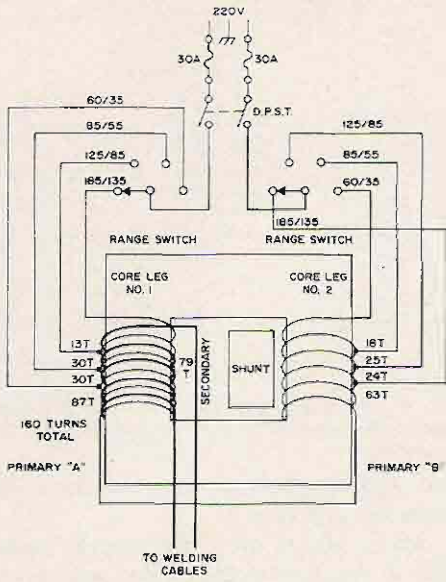
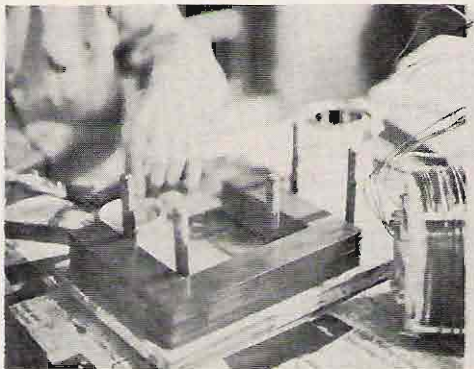

Fig. 1. Welder schematic.

give a reasonable value for the number of turns required. The cross-sectional area that was chosen required approximately 235 turns on the primary (the winding connected to the 220V main line) and 79 turns on the secondary (the winding the welding cables are connected to).

To vary the leakage of welding current, there are two controls. The range switch, which is the coarse current control, actually varies the proximity of the primary winding to the secondary winding by a series of taps which puts a greater or lesser part of the primary directly over the secondary and the rest around the other leg of the core. The



Here, the U-shaped part of the core is being assembled. The large bolts and plywood base are part of the temporary clamping device for the core.

farther apart the primary and secondary, the greater the leakage and the lower the welding current. Vernier current control is accomplished by sliding a laminated iron bar between the two coils and thus shunting flux away from the coil on the other leg of the transformer (leg 2), see Fig. 1. Flux is the term used to describe the magnetic field which couples the primary to the secondary and thus allows the transformer to function. The less flux, the less coupling and the lower the welding current.

### Construction

The core itself is a laminated structure made of .025 in. thick .25% silicon steel sheet. Plain cold rolled steel will serve if the silicon steel cannot be located. The steel is cut into strips as per Fig. 2. The laminations are then assembled with varnish in alternating layers 1 and 2 (Fig. 2). A metal shear is necessary to cut the laminations. Make sure that the shear is in good condition or you may have to file burrs off each and every lamination since it is necessary to avoid metal-to-metal contact between the laminations. If liberal amounts of varnish are used and the laminations are reasonably free of the

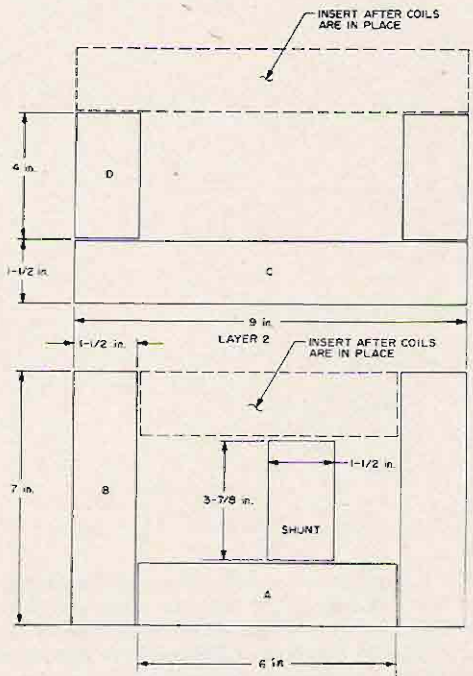

Fig. 2.

burrs, no problems should be encountered.

After the U-shaped part of the core is completed, it should be placed between two  $\frac{3}{4}$  in. plywood boards and clamped tight to remove excess varnish. After clamping, the core should be approximately  $2\frac{1}{4}$  in. high. This will require approximately 109 layers of iron. The core laminations may need to be aligned after clamping the first time. Although the varnish will not completely dry for over 9 months, it is very difficult to realign the core after only a few hours, so make sure that it is square. The shunt can also be assembled at this time. The partially finished core and remaining lamination can now be put aside to cure and the coils can be wound. After a week, the clamps can be removed if the core is handled with a little care.

The first job is to build the bobbins that the coils will be wound on. They are constructed out of  $\frac{3}{32}$  in. plywood, which can be purchased at any hobby shop dealing in radio controlled airplanes. I have left out the exact dimensions for the bobbins because they should be custom fitted to your

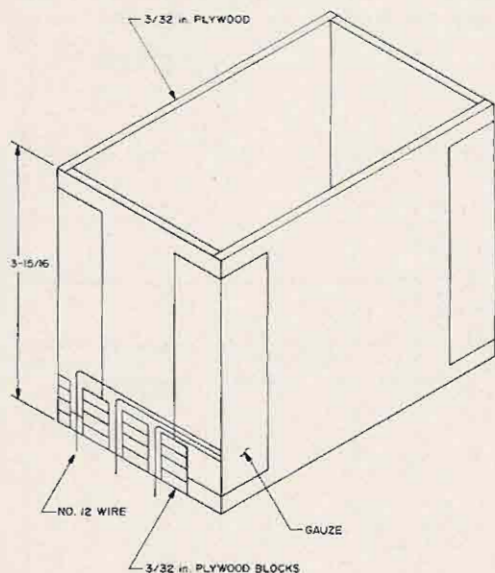

Fig. 3. Bobbin. Note: Adjust the inside dimensions of the bobbins to fit the core that you have constructed. The bobbin shown is the one for the secondary in which three 12-gage wires are wound together. For the primary, only one wire slot is required.

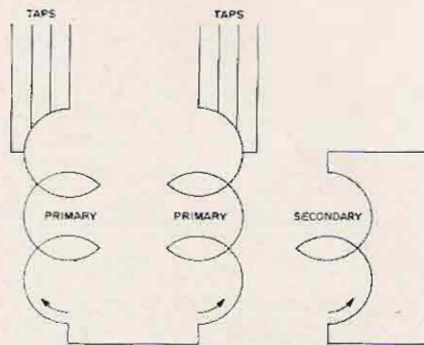
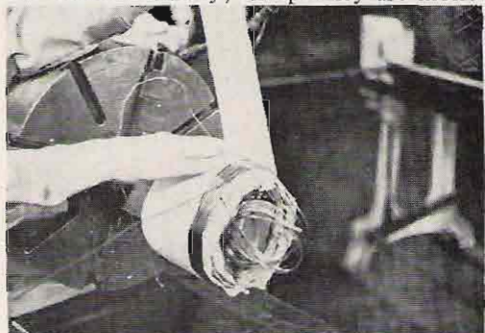

Fig. 4. Coil orientation pictorial. Note the direction of the windings of the various coils and follow it exactly!

core legs. The bobbins were assembled with gauze and glue (Fig. 3).

About 700 ft of 12-gage copper magnet wire is required to make the coils. It was obtained through a local wire distributor. The secondary was wound first. It is a trifilar winding consisting of three strands of 12-gage wire side by side and wound together.

Cut a piece of wood that will just fit inside the bobbin and clamp it in a vise; then get a friend to help and start winding. Seventy-nine turns are required on the secondary (Fig. 4). This will be approximately 6 layers of wire. Between each layer place a couple of layers of paper insulation (wrapping paper is fine) and four  $\frac{1}{4} \times 4 \times \frac{3}{32}$  in. plywood spacers on each of the four sides. Varnish the paper after it is wrapped around the coil. The air spaces provided by the plywood spacers allow for air cooling of the coils during operation. The primary coils are wound similarly, except they are mono-



The winding is most easily done on a lathe although it can be done by hand. Note the tap wire protruding from the coil. Here, paper insulation is being placed between two layers of wire.

filament windings consisting of one strand of wire. One hundred and sixty turns are wound directly over the secondary. One hundred and thirty turns of primary are wound on the second bobbin. A layer of gauze is placed over the last layer on each bobbin and varnished.

In wiring the two primaries together, the relationship of the two coils in respect to the direction they are wound and the way they are connected together is critical, so follow the diagram to the letter. If by chance a mistake is made, the welder will hum loudly and heat up excessively when turned on. When winding the primaries, observe the positions of the taps and place them as you wind, using a 100W soldering iron and rosin-core solder. The ends of the coils, both primary and secondary, can be held securely by fastening the ends of the wire with string. Tie the string onto the end of the wire, then wrap the string around the coil several times and tie it.

Remove the U-shaped part of the core from its clamps and clamp the bottom of the core with two  $1\frac{1}{2} \times 1\frac{1}{2} \times \frac{1}{8} \times 10$  in. angle-iron pieces with holes drilled at the ends to accept 3 in. machine bolts. Insert the bolts and tighten. Place the coils on the legs of the U-shaped piece and complete assembly of the core. Clamp the new assembled portion of the core with plywood and C-clamps. After several days, angle-iron clamps can be placed on the top of the core as on the bottom in place of the C-clamps. The phenolic board for the range switch can be mounted directly on one of these angle-iron pieces.

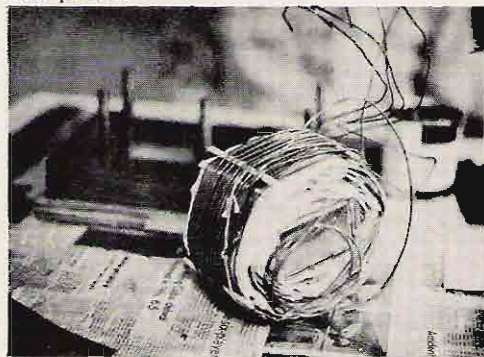

A complete bobbin ready to be placed on one of the core legs. Note the string used to tie down the end of the primary winding.

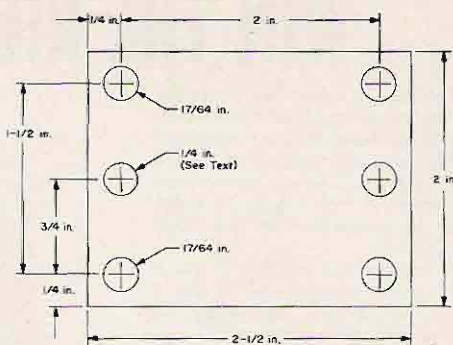

Fig. 5. Shunt clamp plate. Note; (1) Two plates are required; (2) One of the holes marked for  $\frac{1}{4}$  in. hole in one of the plates is drilled with a #6 drill and tapped with a  $\frac{1}{4} \times 20$  tap. This will ride on the threaded rod which, when turned, moves the shunt in and out of the core.

If the shunt has not as yet been made, it can be done at this time. It is made just like the core. It is a stack of  $3\frac{7}{8} \times 1\frac{1}{2}$  in. iron plates varnished together; however, it is only made 2 in. high instead of  $2\frac{3}{4}$  in. as the core proper. Two  $\frac{3}{8}$  in. plates, one aluminum and one phenolic, are drilled appropriately to clamp the shunt (Fig. 5). One of the guide holes in the aluminum plate is threaded ( $\frac{1}{4}$ -20). A threaded rod along with a support rod on the opposite side of the shunt both support and move the shunt in and out of the core as the threaded rod is turned. Minimum current for a particular range is when the shunt is all the way inside the core and maximum is when the shunt is all the way out.

For the main switching deck, a piece of  $\frac{3}{8}$  in. phenolic board is used. Brass bolts are mounted in the board and serve as binding posts. When shorting wires are connected across the appropriate posts, a particular current range is selected.

Observe the wiring diagram. The arrangement of parts is not critical but try to keep the secondary leads as short as possible. The electrode and ground clamps as well as a face shield can be purchased from Sears, Roebuck. The welding cables, two 12 ft lengths of 4-gage stranded wire, can be purchased from any welding supply house.

At this time there are three of these welders in operation and functioning quite satisfactorily.

...W9IMS

# WIN THE RIG OF THE MONTH!

The Ross & White two meter FM transceiver seems to have been overlooked by many amateurs because of its low price. Just take a look at some of the features of this rig and see what you think of it on a dollar for dollar basis as compared with the other available rigs.

If you are not yet on FM this is your golden opportunity to win a great FM rig free. Just follow the instructions below and enter the contest — there is nothing to buy — no obligation — it's absolutely free. If you are already on FM, then you can surely use this rig as a second (or a first, since the chances are that it will perform better than the one you are presently using) rig for the car — office — ham shack — trips — etc. You might even want to use it as a shoulder portable — it is ideal for this.

## 12 CHANNELS

While you may not need this many channels right now in your area (if you live outside of the larger cities, the east coast and midwest), the chances are that you will be needing them very soon, for FM is growing incredibly fast and the number of repeaters has doubled in just the last year.

## WARPING CAPACITORS

Many of the lower priced transceivers economize by leaving out the warping capacitors on the receiver oscillator. The result is that you may well have a tough time hearing a repeater — or you will have to pay a premium for extremely accurate crystals to make up for the lack of capacitors. It costs extra to put these capacitors in the Ross & White — but they are there.

## FRONT SPEAKER

Have you ever tried to hear a voice coming out of a two inch speaker which was aimed at your feet in the car? By the time you turn up the volume to where you can hear the speaker over the car noise the distortion is so bad that you can't understand what is being said. The speaker on the front panel of the Ross & White overcomes this problem — it is aimed right at your ears and you can hear everything clearly.

## TEN WATTS

Most repeaters are designed to work with mobile rigs running ten watts output. This is exactly what you get with the Ross & White and it is certainly adequate. If you hunger for more, the most economical amplifiers are those designed for ten watts drive. The power switch on the front panel



# ROSS & WHITE

of the rig permits you to cut down to one watt or even 1/10th watt. This don't make much difference in the car — after all, what is ten watts to your car's power system? But this rig can be used with a small nicad pack as a shoulder portable and in this case the 1/10th watt position will be fine for most use — with the one watt available if the tenth watt doesn't cut the mustard — and the ten watts can be used for short periods when you are desperate. What other rig can do this?

## VERY SMALL

Mounts anywhere — or goes under the arm for walkie-talkie use. One of the smallest 10 watt rigs available.

## LOW INTERMOD

One of the big miseries in FM is interference from nearby or overly strong adjacent channel repeaters. The ceramic i-f filter in the Ross & White virtually overcomes this problem. This rig will perk perfectly in areas where other rigs are completely bombed out. If you are a newcomer to FM you may not appreciate the importance of this feature — if you are an old timer you wish you'd bought one of these rigs earlier.

## S-METER

So who needs an S-meter? Once you try to get along without one on FM you know quickly who needs one. One way to know when you can or can't get into a repeater is to see how strong you are receiving it and you can only do this with an S-meter. When you hear more than one repeater on a channel you can only tell one from the other by signal strength. And without the meter how can you check various antennas of your own and others? The S-meter is very important.

## STONE BURST

The prize Ross & White transceiver will include one of the excellent Ross & White tone burst units. This set normally sells for \$280 with this tone burst unit built in and \$240 without. The tone burst permits you to turn on repeaters which are matched to this type of entry — lets you operate tone burst functions on repeaters — etc.

## MIKE-ETC

A matching mike and mounting bracket are included with the rig.

## HOW TO WIN!

Take the entry blank from page 175 (or even a copy of it) to your local distributor and get him to initial it. If you spend anything during the visit have him mark that in — and should you be the winner that will be refunded in its entirety. Then send the entry blank to 73 so it can be in the hat for the next drawing. Extra entry blanks are available at the distributors listed on pages 176-177. No purchase is necessary, of course.

## FULL REFUND

When you get your local dealer to initial your entry blank you should have him mark down at the same time the amount that you have spent with him during your visit. If your entry wins you will get a check from 73 Magazine for the amount of your purchases.

## WHEN IS THE DRAWING

A drawing for the Rig Of The Month will be held on the 15th of each month. All entry blanks received before that date will be eligible for the prize rig.

The Ross & White transceiver drawing will be held for the following month's drawing. The drawing for the Ross & White will be December 15th — Merry Christmas!



# RIG OF THE MONTH

## HAM RADIO CENTER Announces!

STOP IN  
AND  
GET YOUR  
RIG OF THE  
MONTH  
BLANK



**NOW:** Call your order in, and we'll pick up the tab for the phone call. (Minimum order \$25.00)  
**HOW:** Place station to station call. When phone bill is received, forward copy along with our invoice covering order phoned in, we'll send refund check. DO NOT CALL COLLECT.

COMPLETE STOCKS ALL NATIONAL BRANDS  
WE BUY-SELL-TRADE USED EQUIPMENT

Write for List  
**HAM RADIO CENTER, INC.**  
8342 Olive Bl., St. Louis, Mo. 63132  
Phone (314) 993-6060

### DEALERS:

You should be participating in the Rig of the Month Contest. Call Keith, W7DXX/1 person to person collect at 603-924-3873



### READERS:

If you want to win the Rig of the Month plus get all your money back for your monthly purchases, you need a nearby participating dealer in the 73 Rig of the Month Contest. If your local dealer is not participating, write him, threaten him, boycott him, but talk him into participating.

## RIG OF THE MONTH ENTRY BLANK

Drawing - 15th of Each Month

Send the rig to (if I win):

Name \_\_\_\_\_ Call \_\_\_\_\_

Address \_\_\_\_\_

City \_\_\_\_\_ State \_\_\_\_\_ Zip \_\_\_\_\_

Participating Dealer \_\_\_\_\_

Amt of Purchase \$ \_\_\_\_\_ Salesman \_\_\_\_\_ Date \_\_\_\_\_

(to be refunded)

I am a 73 Subscriber       I'd like to subscribe       Nuts!

73 Magazine is giving away, absolutely free, no strings attached, a rig each and every month - drawing on the 15th - so send in this entry blank. Blanks like this should be available from your local participating dealer or from 73. In addition to the rig of the month, the amount of your purchase at your dealer (marked on the entry blank) will be refunded in full, up to a limit for any one month of \$10,000.

Enclose self-addressed stamped envelope with request for additional entry blanks from 73.

# 73 RIG OF THE

BE GOOD TO YOURSELF! . . .

Before you buy or trade anywhere get our deal! All the hams at THE HAM SHACK pledge prompt, personal service. We'll plan a package deal on a whole station from Mike or Key to Antenna. Our trading shoes are always on - try us. You'll be glad you did.

Bill - WB4JFK

hi-gain Power-Full GALAXY transceiver



Galaxy GT-550A transceiver. Full 550 watts, SSB, 360 watts, CW. Compact, beautiful! Really hot receiver; on-frequency selectable sideband, superb AGC. 17 pounds weight! **\$595.00**

RF-550A WATTMETER  
AND ANTENNA SWITCH  
**\$75.00**

SC 550A/AC400 SPEAK-  
ER/SOLID STATE AC  
SUPPLY **\$129.90**

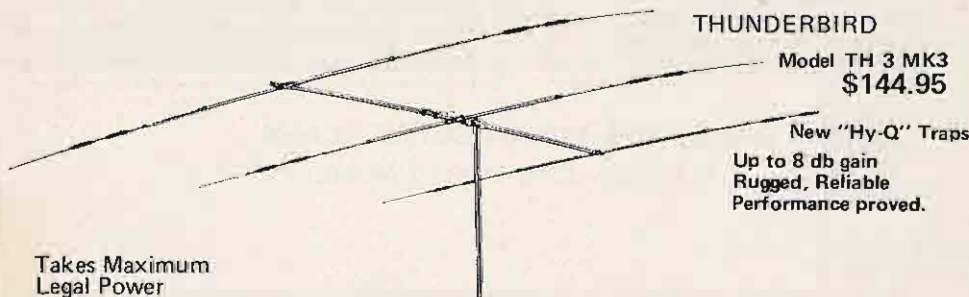

STOP IN FOR YOUR RIG OF THE MONTH ENTRY BLANK - FREE

STOCKING ALL MAJOR  
HAM LINES'

MASTER CHARGE CREDIT



## THE HAM SHACK

AMATEUR RADIO SALES AND SERVICE

2116 BEE RIDGE RD. SARASOTA, FLA. 33579  
TEL. (813) 921-4602

# MONTH SPONSORS

# FM HEADQUARTERS!

YOU MAY WIN THIS



(THE RIG, NOT THE GAL, SORRY FELLOWS)

STOP IN TODAY AND PICK UP YOUR RIG OF THE MONTH  
ENTRY BLANK AT HAMTRONICS — ASK PRESS TO SHOW  
YOU THE GREAT BARGAINS YOU WILL FIND AT —

**FM HEADQUARTERS**

# HAMTRONICS

A DIVISION OF TREVOSE ELECTRONICS

4033 BROWNSVILLE ROAD, TREVOSE, PA. 19047 PHONES: (215) 357-1400/(215) 757-5300

# A SOLID SOLID STATE BREADBOARD

If transistorized projects are your "thing" then this article is for you.

Many times an interesting article appears in your favorite radio magazine or other publication, but some particular transistor or specific component is not readily available.

The junk box, however, yields something similar; or perhaps your friendly supplier can sell you something "just as good," not having exactly what you want in stock.

All too frequently this is the situation where we get into trouble if we make up a printed circuit board and carry on with our substituted components. Upon completion, we invariably find that our pet project leaves something to be desired, if it wasn't a complete waste of time.

Endeavoring to improve matters, we then continue merrily on our way unsoldering and substituting other condensers, resistors and what have you, until our project looks in sad shape indeed. So sad in fact, that we could cheerfully throw the whole thing out into the garbage can before the XYL gets her soft little pinkies on it first and does it for us.

P.C. boards are just not intended for this sort of treatment.

Yours truly has tried for many years to circumvent Murphy's Law which, in general, states that if anything can go wrong, it will. Personally I have found this law to be as inviolable to the constructor as George Simon Ohm's.

After some few failures of this sort — and being of a somewhat stubborn disposition by refusing to give up ham radio — I decided something better had to be done to improve the situation.

What is required primarily is something other than P.C. boards until satisfied that the circuit, with the substituted components, is working as intended.

All components should be easily accessible to facilitate any changes we deem necessary.

Once one is satisfied with the circuits operation and no further substitutions or alterations need to be made, then a P.C. board can be made up and all the bits and pieces transferred and transformed into the thing of beauty it was intended to be. The answer to this, of course, is the so-called "breadboard."

The vision of a breadboard brought to mind the nostalgic days of World War II when we were privileged to see a well-known commercial receiver in the process of development. Each resistor, bypass condenser and all the sundry bits and pieces that go to make up a receiver were individually mounted on a piece of Bakelite (remember that "low loss" stuff?) with a pair of plugs and a pair of jacks for easy changeability.

The whole receiver was spread out, with little room left over, on a bench measuring about 8 x 10 ft in the center of a room for easy access to any component which the design engineers wished to change.

Well, that is a solution, but hardly a practical one for the average ham. So what else is new?

An examination of the problem shows that our circuits require 7 or more basic connections, namely — emitter, base, collector, input, output, a common or ground and a "hot" line from the voltage source. A couple of neutral tie points should be added for convenience. These basic connections are always required so they should be made permanent fixtures.

Copper nails, screws, or what have you hammered into a piece of wood have some use, but again remembering Murphy's Law it will be apparent that the component to be changed is the one soldered under all the others. Not too convenient to say the least. What is required is a larger soldering area.

Also required is a means of holding variable condensers, potentiometers, phone jacks, etc., which is taken care of by the usual panel. The panel, however, should be kept as shallow as possible to facilitate wiring and any changing of components from the front rather than keep juggling the board around every time a change is necessary.

There should also be room on the board for easy mounting of such things as coils, crystals, or transformers as required for any individual project.

With the foregoing points in mind, the following simple but highly effective breadboard was constructed and has proved to

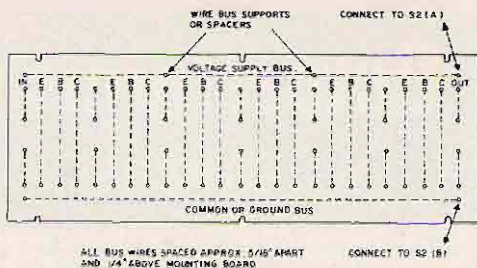

Fig. 1.

be well worth the time and effort spent in construction.

Representative dimensions are shown in the accompanying sketches but this, of course, is left to the discretion of the individual and his personal requirements (see Fig. 3).

The board shown has a capacity of six transistors but obviously only one or more need be used at any one time.

A suitable computer board, approximately 8½ x 3 in. stripped of any copper which will interfere with the operation of the assembled board is ideal.

It is not a requirement, however, and any piece of insulating material will do, even wood or masonite.

A series of holes are then drilled according to Fig. 1 to accommodate No. 14, or larger, solid tinned wire bus leads which are bent and fed into the appropriate holes, leaving each wire spaced about ¼ in. from the top of the board and approximately 5/16 in. apart. This spacing keeps the board clear of all resin residue which would build up in subsequent use if the wires were

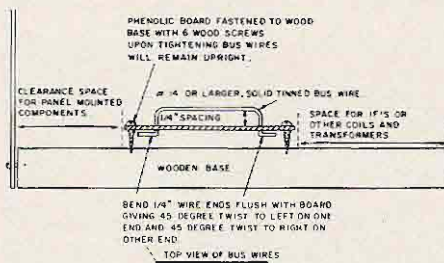

Fig. 2.

# Outperforms ALL OTHERS!

The finest crystals you can put to work for you come from Bomar! Precision ground, highly active quartz... each crystal exceeds FCC regulations for frequency tolerance by 40%. With a Bomar crystal you're right in the middle of the channel with clearer signals and no drift! Long life is assured by hermetic sealing with ingredient Double-N.

**AVAILABLE FOR ALL POPULAR  
2-METER TRANSCEIVERS**

WRITE FOR NAME OF NEAREST DEALER



## BOMAR CRYSTALS

*the "long playing" crystals*

**BOMAR CRYSTAL COMPANY**

201 Blackford Ave., Middlesex, N. J. 08846

Phone (201) 356-7787

## THE NEW VXO'S FROM MicroComm



### THE NOVICE NVX-1

- 80 & 40 Meter Novice Bands
- PERFECT with HW-16 or DX-60
- FCC APPROVED

\$42.75 plus postage



### THE GENERAL NVX-2

- ANY Two 50 KHz Segments from 5.0 MHz to 9.0 MHz
- USE Your Own FT-243 XTALS

\$39.75 plus postage

Shipping wt 2 lbs. - Calif. res. + 5% sales tax.

*MicroComm*

BOX 373, CUPERTINO, CALIF. 95014

PHONE (408) 257-0802

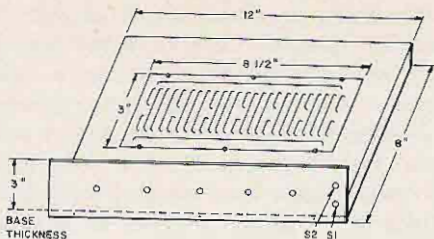

Fig. 3.

placed directly on top of the board. It also facilitates cleaning the bus wires of excess solder buildup when it is only necessary to tilt the board up, resting on its panel and run a hot iron along each wire when it will run off, leaving everything nice and clear again, ready for the next project.

If you use a computer board and have any usable copper underneath each hole where the ends of the bus wires project, you can anchor each wire by soldering and snipping off any excess wire.

If not, an alternate means, and just as satisfactory, is to have about 1/4 in. of bus wire project through each hole and then bend it toward the outside edge of the board and flush with the bottom. Each end is then given a slight twist of about 45 degrees to the left for all those wires terminating at one edge of the board and to the right, or opposite direction, for those terminating at the opposite edge. See Fig. 2.

This opposite twisting is necessary to prevent the bus wires from falling against each other when fastened to the base, holding them rigidly in place. Don't worry about it at this point if all the wires are flopping around in the breeze; just make sure they won't touch each other when mounted and fastened down on the base.

Our breadboard is now required for the base and as the name implies, one can actually be used just as baking tins can be used for chassis. However, any suitable piece of lumber on hand can be used either finished or unfinished, painted or unpainted, depending on your aesthetic taste. If you are a stubborn type and insist on using one of the XYL's baking tins, don't forget to insulate the bus bar board from it first before fastening the two together.

The actual size of the base is not important, but it is recommended that it be 2 or 3 in. larger around each edge of the bus board and something about 12 x 8 in. would do fine.

The bus board is then centered onto the base with all the bus wires in place and fastened down with six wood screws (Fig. 3.)

A shallow panel is now required which can be aluminum, thin plywood or what have you, drilled with a series of 3/8 in. mounting holes for variable condensers, pots, etc., which may be required to be used later when trying out some circuit. A small speaker or meter should also be considered at this point. This is left to the discretion of one's individual requirements. The panel runs the length of the base and is fastened to the edge of the base with a couple of wood screws.

Two toggle switches are an integral part of the board. They are mounted permanently on the right hand side of the panel and wired as shown in Fig. 4. S1, a DPST, controls the on-off function, and S2, a DPDT, switches or reverses the power supply, be it battery or variable voltage power supply, depending upon whether a PNP or NPN transistor is being used.

A battery snap connects to the on-off switch, S1, for convenience in switching to different battery holders and voltages as required, for those not in possession of variable voltage power supplies and who must use batteries. If batteries are used, a suitable clamp should be incorporated to hold the battery down. This is easily fashioned from a piece of scrap aluminum,

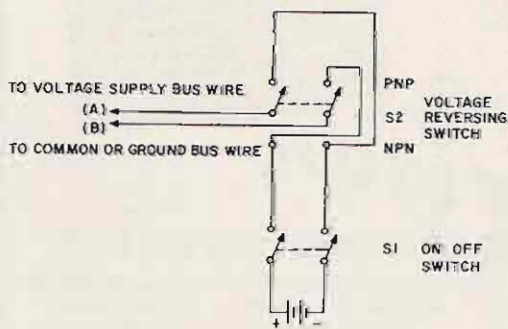

Fig. 4.

wire, or even an elastic band and should be mounted on the wood base or panel, adjacent to the on-off switch, S1.

For those with variable voltage power supplies S1 is probably not required and can be connected to the voltage reversing switch, S2, directly through a plug and jack arrangement. It could even be made an integral part of the board if desired.

In using the board any components such as coils, transformers, etc., not provided for on the panel are conveniently placed on the base adjacent to the bus wires to which they connect. In most cases it will not be necessary to fasten them down, but this can be done with wood screws if required.

As for the transistors, they can either be placed in sockets and wired to the appropriate bus wires or soldered directly onto each bus wire if the leads are long enough, whichever one prefers.

Fixed resistors and condensers are simply soldered onto each bus wire as required without fitting or cutting off excess lead lengths, and no attempt is made to have the circuit look pretty at this point. If we wanted it to look pretty, we could tie a pink ribbon in it or something - whatever your favorite color.

If a number of connections terminate at any one bus wire, spread them out rather than have them sit one on top of the other under one blob of solder. If it is then necessary to unsolder a component or lead, the other half dozen or so won't come off too.

By now some purists are screaming like mad about efficiency and losses and making rude remarks. Don't you believe it, or if you do, forget it temporarily, as we are only interested in getting a circuit to percolate properly at this point in the overall scheme of things. The efficiency can be found with this circuit board first and then built into our finished project - or can it?

Upon reflection, Murphy's Law also states that while the breadboard model functions perfectly, the finished product won't. Oh well, at least you will have tried before getting out of the game altogether.

...VE2DQ

73 RIG OF THE MONTH SPONSOR

# Harrison IS\*

STOP IN AND GET YOUR  
RIG OF THE MONTH BLANK

"HAM HEADQUARTERS U.S.A."

And Harrison is HQ for everything else you need to complete the FB station of your dreams!

**FOR ALL THE BEST!**

## COLLINS

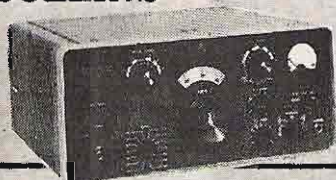

32S3	TRANSMITTER	\$938.00
75S3B	RECEIVER	\$862.00
KWM2	TRANSCEIVER	\$1248.00

## KENWOOD



R-599	SOLID STATE RECEIVER	\$349.00
T-599	HYBRID TRANSMITTER	\$395.00
T-511S	SSB TRANSCEIVER	\$415.00

## TEMPO



"ONE"	SSB TRANSCEIVER	\$319.00
AC/ONE	POWER SUPPLY	\$99.00
FMP	2 METER FM TRANSCEIVER	\$225.00

## DRAKE



R4B	RECEIVER	\$475.00
T4XB	TRANSMITTER	\$495.00
TR22	2-METER FM TRANSCEIVER	\$199.95
ML2	VHF - FM TRANSCEIVER	\$299.95

### \* HERE'S WHY:

- BIG, BIG SELECTION • COMPETENT ASSISTANCE
- INSTANT AVAILABILITY • SERVICE • And at HARRISON RADIO - CUSTOMER SATISFACTION IS OUR HIGHEST RECOMMENDATION

**CHARGE IT!** On your Master Charge, or Bank Americard  
Spread payments up to two years.

### PROMPT ORDER

We carefully pack and ship ham gear, accessories and parts to most any part of the world.

Address your orders to:

18 SMITH STREET

FARMINGDALE, NY 11735

Or - Phone your orders to

(516) 293-7990

**TRADE-INS WELCOMED!**  
The Harrison Trade-In Center needs your old gear, so we can give you top allowances. (Also, will buy for on-the-spot cash.)

# Harrison "HAM HEADQUARTERS U.S.A."®

FARMINGDALE, L.I. • NEW YORK CITY • VALLEY STREAM  
2265 ROUTE 110      8 BARCLAY STREET      10 SUNRISE HWY.  
2 miles South of LIE exit 495      Near City Hall      (At Rockaway Ave.)  
(516) 293-7990      BArlcay 7-7922      (516) 872-9565

OPEN NITES TILL 9 P.M.

OPEN NITES TILL 10 P.M.

ORDER NOW!  
Or, ask for literature.



# DID YOU EVER WANT YOUR OWN COMPUTER ?

The objective of this article is to provide a ham with enough information to allow him to build a pretty nice minicomputer. An alternative to building your own is at least understanding what makes the brain machine tick. This means if you don't meet the qualifications of a computer builder, you can buy yourself a good used computer and understand enough of its operation to put it to work for you. (Hint, do not trade the XYL in on a used computer - the computer would undoubtedly make a more intelligent companion, but it would have a heck of a time washing your socks.)

The basic requirements for being a computer-builder are; of course, patience, clean living, a large state-of-the-art goodie box, and/or lots of money. You must also have an understanding wife and kids because this project will take you about as long as building a good receiver. Seriously, the amazing supply of cheap integrated circuits available will keep the overall cost low, and will save you considerable time in constructing and designing your computer. Anyway, if you want to build, or have the interest to find out the "why" of the computer... here we go!

## The Basic Machine

The major circuits making up any computer are shown in Fig. 1. The five basic circuits are the input, output, arithmetic, storage and control circuits. Each one of these circuits is actually made up of many smaller sub-circuits which you will be concerned with building. The five major circuits work together to form a machine capable of accomplishing tasks that are described for it

by human operators. The input and output circuits (I/O), provide the means for data signals to enter and leave the computer. The arithmetic circuit performs arithmetic operations on the data signals within the computer. The storage circuits act as the computer memory to store selected data. The control circuits control all the operations within the computer; they control when data is input and output, what and where data is stored, what arithmetic operations are performed, and in general, they keep command of the whole machine. The five basic circuits of the computer are made up of actual electronic components and as such are called the hardware of the computer. Ultimately, all the operations in the computer's hardware are controlled by a bunch of data signals called "words" that make up the computer software.

The software shown in Fig. 1 actually is a group of logic 1 and logic 0's (ground levels and voltage levels) that control the computer through the control circuits in the hardware.

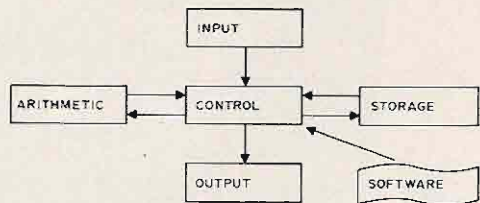

Fig. 1. Typical computer. This is the classical configuration common to all computers. The "software" is actually data (words) that control the operations in the computer via the control circuits. Actual circuits in the computer are the "hardware."

The software allows you to program the computer to carry out desired tasks such as calculating antenna length, etc. We must merely know how to arrange the logic 1 and logic 0 bits into groups so we can talk the machine language. Of course, if the computer is big enough, we can build in an interpreter to allow us to talk to the machine in English. (One such interpreter is the famous FORTRAN COMPILER that I'm sure you've heard of before. FORTRAN stands for FORMula TRANslation; this means formulas are translated to the machine language.) You will have to go to the trouble of learning to use our machine's language unless you want to write a compiler for it after you've built it. Actually, you will merely write down the words that perform a task in your machine and use this as a reference for programming. (Even the pros use a "program reference manual" to translate, since languages get more than just a little complex!) Well, now that we have some background, let's consider building.

### Major Construction Considerations

Armed with the basics of computer operation let's consider some of the factors that will war against our construction. Probably the major factor to consider is packag-

ing. You may not want your little jewel to take up half your hamshack or most of your bedroom! Consider some of the little monsters shown in the photos. These computers range from everything from a job that is contained on four circuit cards to a magnificent machine that would consume my house or yours! Consider the approximate size of your proposed machine. Don't limit yourself to a 3x5x7 minibox, but don't envision a monster consuming four or five 7-foot racks either. You'll want the machine large enough to be easy to service, but small enough to move across the room without calling in Allied Van Lines. Don't buy a box and then try to fit in the components. First get a feel for how large and how many circuit cards there will be, then buy a pretty box.

Speed and size of memory will become primary considerations in planning your machine. Read this whole article first, then figure out how much memory you want, what kind of speed to shoot for, etc. Speed and size of storage will both tend to be factors in the size of your machine. Higher speed generally means smaller circuits, shorter interconnecting wiring, etc. and a general overall reduction in size. Larger memory generally means more circuits and a bigger machine.

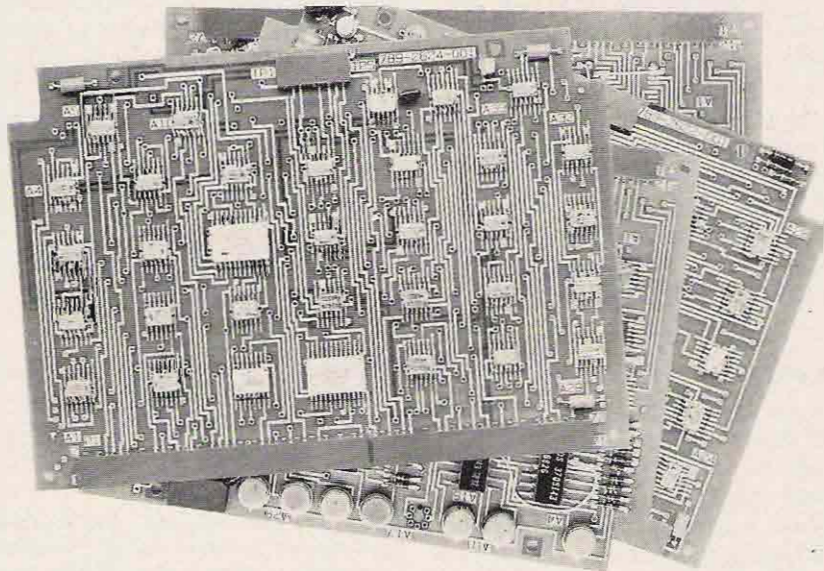

*Collin's Radio company's Micro-Minicomputer. The mini is used throughout this article as a reference to describe computer circuits. This mini has a 16 bit word and a 4096 word instruction read only memory.*



The Wang 700A -- a powerful desk top calculator with 8,192 bits of memory organized as 120 storage registers. Programs for the calculator are stored on magnetic tape cassettes.

Price would undoubtedly be a consideration. For many of us, price may be the first consideration! This could possibly be the main reason you would like to build your computer instead of buying. Anyway, here's the scoop; a fairly decent used computer will generally cost you about \$10,000. One can buy a little minicomputer from one of the electronics companies for about \$3,000. My estimate for the cost of a simple unit that every ham should have in his shack places the price under \$200! If you have a full junkbox or you work for a company that offers employee discounts and surplus component sales, you can cut this price considerably. It's obvious, however, that you will have to spend some money on this project to obtain some specialized parts.

Parts for the project are readily available on the discount semi-conductor market or as aforementioned discounts or company stock surpluses. You will definitely have to buy some of the parts at regular prices unless you want to make the major circuits from small-scale integrated circuits rather than from large and medium-scale integrated circuits. You can fabricate any of the circuits

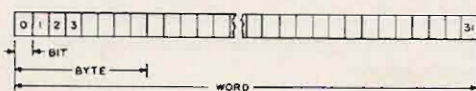
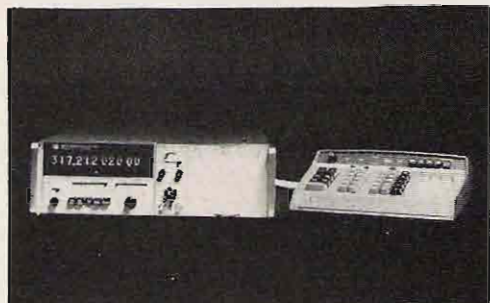

Fig. 2. Large computer, typical word. The computer word is broken down into data "bytes" as explained in the text. The bytes are further broken into their respective data "bits." The "home brew" computer is "byte oriented" to the extent that registers are 8-bits (one byte, or character, long).



The Hewlett Packard Computing counter performs sophisticated analysis and doubles as a desk top calculator with the counter input serving as one of the variables.

from discrete components. Keep in mind that, unless you have the parts on hand, building each flip-flop, etc. will increase the cost of the project, and using discrete components will definitely increase package size.

### Circuit Details

Now let's look at the individual circuits of the computer and see if we can point out any other construction problems. When you begin to understand how the circuits within the computer function, you can more fully understand the overall operation of the machine. First, we will give a basic description of the circuits, then go into the details.

### Input/Output

The input/output circuits (I/O) carry the data signals to and from the computer and the peripheral device. In most ham shacks, the peripheral will be the shack's teletype machine. The input/output circuits must provide buffering for the data signals to and from the computer. To buffer data, you must simply store enough of the data to allow the computer to take data when it is ready. If the data signals entered the computer before the computer needed the data, the result would be a very confused computer and an even more confused operator.

In order to buffer, the input/output circuits will have to store at least one complete teletype character. In fact just one TTY character would be called a "byte" (pronounced bit) in computer language, because the byte is the lowest number of data bits capable of storing a complete character. A data word would be a group of bytes just



# NEW REPEATER

## 2 Meter Fixed Station

Designed for the man who demands professional standards in 2 meter equipment. *REPEATER LINE* fixed station antennas are the 2 meter HAM's dream come true. With everything you need for top fixed station performance...toughness, efficiency and the gain to gain access to distant repeaters with ease. Work many stations, fixed or mobile, without access to a repeater.

The right antennas for the new FM transceivers...or any 2 meter fixed station.

### *REPEATER LINE* Fixed Station Antennas

Tough, high efficiency antennas with a long, low radiation. For the top signal and reception you want...and the top performance your transceiver's ready to deliver.

- 267 Standard 1/4 wave ground plane. May be precision tuned to any discrete frequency between 108 and 450 MHz. Takes maximum legal power. Accepts PL-259. Constructed of heavy gauge seamless aluminum tubing.
- 268 For repeater use. Special stacked 4 dipole configuration. 9.5 db offset gain. 6.1 db omnidirectional gain. Heavy wall commercial type construction. 144 thru 174 MHz. 1.5:1 VSWR over 15 MHz bandwidth eliminates field tuning. Extreme bandwidth great for repeater use. Center fed for best low angle radiation. DC ground. Complete with plated steel mounting clamps.
- 338 Colinear ground plane. 3.4 db gain omnidirectionally. Vertically polarized. 52 ohm match. Radiator of seamless aluminum tubing; radials of solid aluminum rod. VSWR less than 1.5:1. All steel parts iridite treated. Accepts PL-259.
- 362 SJ2S4 high performance all-driven stacked array. 4 vertically polarized dipoles. 6.2 omnidirectional gain. 52 ohm. May be mounted on mast or roof saddle. Unique phasing and matching harness for perfect parallel phase relationship. Center fed. Broad band response. DC ground.
- 340 3 element high performance beam. 9 db gain. Coaxial balun. Special VHF Beta Match configuration. Unidirectional pattern. VSWR 1.5:1. 52 ohm impedance. Heavy gauge aluminum tubing and tough aluminum rod construction.
- 341 8 element high performance beam. 14.5 db gain. Coaxial balun. VHF Beta Match. Unidirectional. Boom length 14'. VSWR 1.5:1. 52 ohm feedpoint. Heavy gauge commercial type aluminum construction.
- 231 15 element high performance beam. 17.8 db gain. Coaxial balun. Beta Match. Unidirectional. Boom length 28'. VSWR 1.5:1. 52 ohm feedpoint. Extra-strength heavy wall commercial aluminum tubing.

# LINE from **Hy-gain** Antennas with real PUNCH!

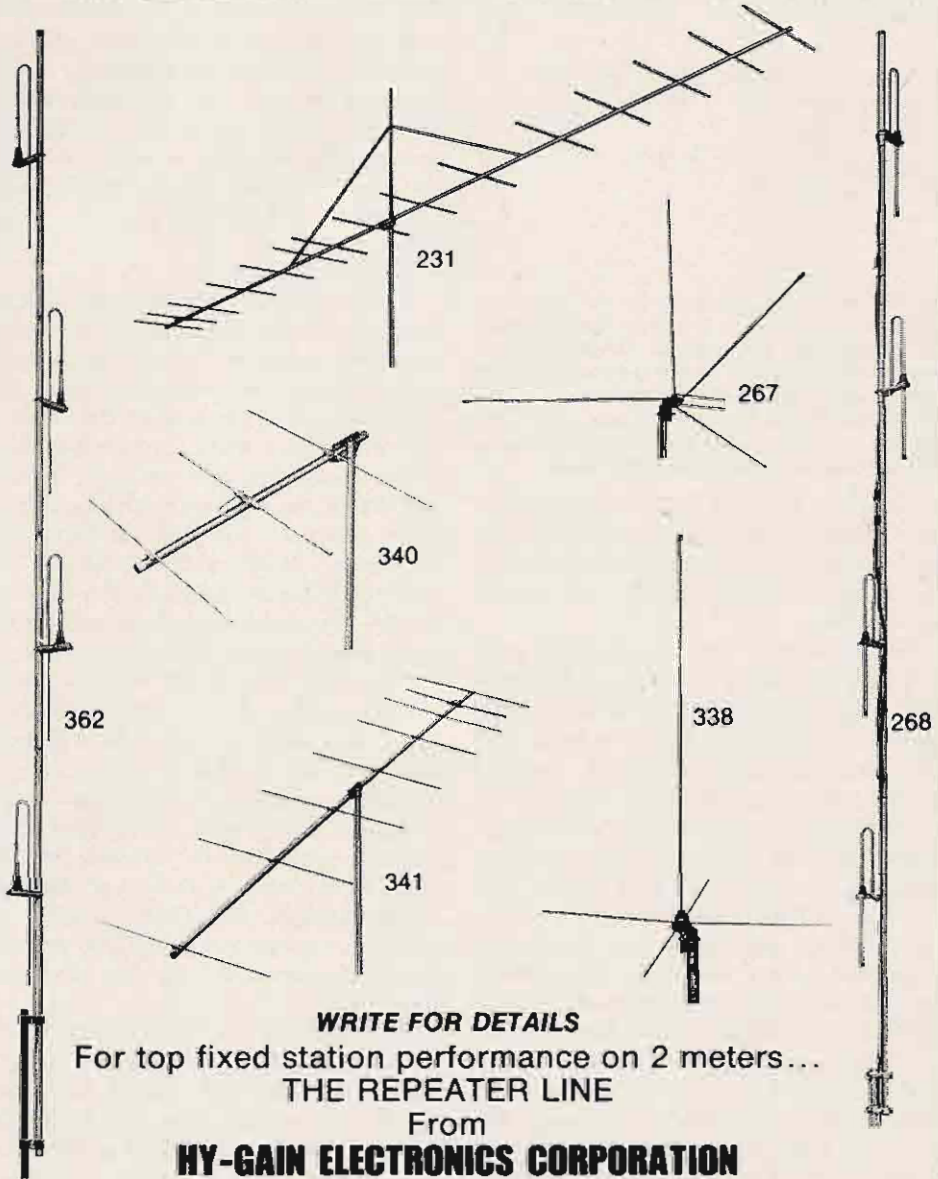

**WRITE FOR DETAILS**

For top fixed station performance on 2 meters...  
**THE REPEATER LINE**

From

**HY-GAIN ELECTRONICS CORPORATION**

BOX 5407-WH LINCOLN, NEBRASKA 68505

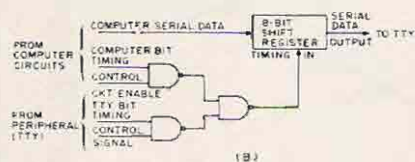
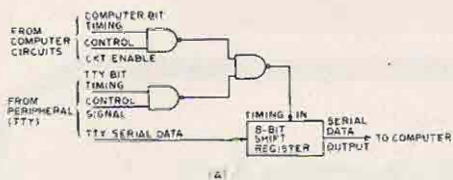

Fig. 3(A & B). I/O Circuits. Fig. 3A shows the computer input circuits. Data from the TTY enters the register under TTY control. This data is stored until "computer timing" drives it from the register under program control (control CKT enable). Fig. 3B shows the computer output signal. This time the computer enters and stores data and the TTY removes the data at TTY timing rates.

as a byte is a group of bits. The word can be any number of bytes; in most computers a word contains at least four bytes as shown in Fig. 2. In our "mini" a word will contain only one byte.

You must make the I/O circuits in your computer capable of storing a data word. Since a word and a byte are the same in this machine, the word will be 8 bits long. Thus your computer can affectionately be called an "8-bit machine." Now it is obvious that we must devise a circuit that is capable of storing 8-bits of data. The data must load into the input circuit at a timing rate determined by the peripheral (TTY), and the data must be taken out at a timing rate determined by the computer. The opposite must happen in the output circuits, that is, the data must load in at a computer rate and read out to the peripheral at a peripheral rate. Take a look at the circuit shown in Fig. 3. This is the input circuit to a commercially produced minicomputer altered somewhat to make it compatible to our requirements.

Notice how the TTY CONTROL signal controls the entry of the TTY timing signal

into the gate which clocks the register. The TTY CONTROL signal could be generated by a circuit which detects the depression of a key on the TTY. The TTY TIMING signal is one that occurs at TTY bit times and each bit of the TTY signal is clocked into the machine. When the STRF (store) signal goes high, the computer's internal timing reads out the signal stored in the byte register. This signal is routed to the control circuits (Fig. 1) and the control circuit will decide what to do with it, i.e.; whether to store the signal, process it in the arithmetic circuits, or to ship it on out to the output circuits. The selection of what's done with the signal depends on the program of the "software" shown in Fig. 1.

### Arithmetic Circuits

The arithmetic circuit provides arithmetic and logical operations on the data signals within the computer. Upon command of the control circuits, the arithmetic section of the computer can ADD Logical OR, Exclusive OR, or Logican AND any two data signals. Some computers can multiply or divide directly in the arithmetic circuits, our computer will not offer this "hardware multiply/divide." If you want to multiply, you'll have to add again and again. If you want to divide, you are going to have to learn two's complementing and take it from there.

The arithmetic circuit mostly consists of simple steering of data signals through the gates that will perform the appropriate operation on the data. Figure 4 shows the arithmetic circuit recommended for our computer. It is simple, straightforward, and easy to troubleshoot. Probably the main thing in its favor is that it is cheap! The inputs marked CONTROL INPUT come from the control circuits. These inputs are ultimately controlled by the program (or software).

If you use this circuit, you should be able to contain the entire arithmetic circuit on one card. This will greatly aid you in troubleshooting and construction. The adder can be most any full adder which is compatible with the logic you use. If you are using RTL or compatible TTL you might try the MC796P for only a shade over \$5.00.

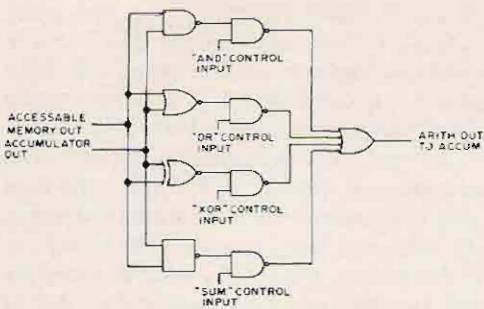

Fig. 4. Arithmetic circuits. The output of the workable storage memory (accessible memory), and the accumulator are combined in AND, OR, EXCLUSIVE OR, or ADDER. The gated data outputs are chosen by the various control inputs from the control circuits. These control signals are generated in the computer program.

This is much cheaper than you can build one yourself. Since this particular unit is a Dual-full adder, you will have a spare: this is a good policy because it's just like buying an extra fuse. By the way, if you want to hardware subtract, you can add the MC796P; two full subtracters (same price as the 796). Of course, there are many adders and subtracters on the market. Be sure to select one that is compatible with the type of logic you are using, i.e.; TTL, RTL, ECL, etc.).

### Storage Circuits

There actually are many storage circuits within the computer. These circuits store instructions or data in the computer and allow the computer to use the data or instructions at some later time. Your log is a "storage area" and stores information regarding your past QSO's. One example of a storage circuit is the input/output circuits already mentioned. The data input (or output) is stored until the computer (or peripheral) is ready to use it.

Storage circuits within the computer are usually classified to their degree of importance. In reality, one is just as important as the other in overall operation, but we order their importance in the same way that we consider the fuse less important than the overall transmitter. Yet we know that the fuse can mean the difference between the transmitter operating or not.

In our small machine, we have three levels of storage or memory: main memory which stores the software and the programs that make the computer carry out a desired function; workable memory which allows for semi-permanent storage of data while an operation is performed; and temporary memory which includes all temporary storage such as the registers in the input/output circuits. First, look at some main memory systems and decide on some version to use in our computer.

### Main Memory

The main memory must store the computer program along with the software (called the operating system) that tells the computer when to do what thing. The simplest main memory would be a shift register that is fed from the peripheral with the program, and then stores the instructions until the computer has need to read out an instruction. Assuming your computer was to have a limited number of instruction words, this shift register memory would probably work rather well. However, keep in mind that the computer does things in very minute steps and you will see that you must be able to insert many instructions into the machine to

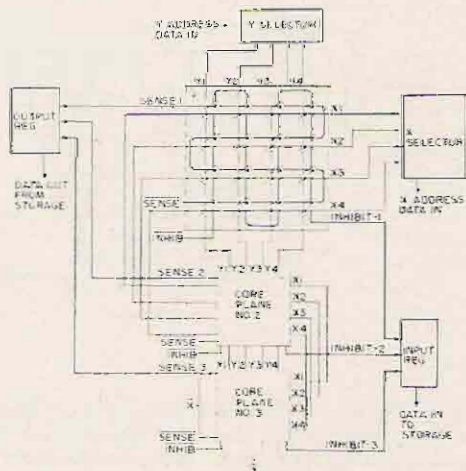

Fig. 5. Core-Main memory. This core memory will store 3-bit instruction words or data words. Instruction words are stored in "protected" areas of core. Workable areas of core will be used as temporary storage for program-selected data. These areas of core work as "accessible memory."

perform a relatively simple task. This would mean many shift registers and lots of money. Enter, the magnetic core memory. The magnetic core memory saves the day for us. Cores are cheap, reliable, and easily obtained. They have their problems though, the cores are extremely small and are very sensitive to temperature changes and not normally as small or as fast as shift register memories. Core memories basically consist of a matrix of magnetic cores. The cores are addressed by selecting X and Y coordinates. The X and Y lines are pulsed and the cores selected and magnetized. Cores magnetized in one direction equal a logic 1 and cores magnetized in the opposite direction equal logic 0.

Figure 5 shows a section of a simple core memory. The currents in the X and Y lines are called the half-select currents. Two times the current flowing in either the X or Y lines is required to saturate a core. With half the select current in each of the X and Y lines, only the cores that appear at the intersection of the X and Y lines will be saturated. All the X and Y lines feed all core planes as shown in Fig. 6. A specified X and Y address will find the intersection of the same core position in each plane. The two half currents

(X and Y) will switch the core in each plane to logic 1. Note that for any one X and Y drive line, the same position in all three core planes will store logic 1. The inhibit signal causes the selected core to store logic 0.

To read from the cores, the X and Y read addresses are chosen, and a half current in each (opposite of the write current) switches the addressed cores in each plane to logic 0. If the core is presently a logic 1, the sense line for that core plane will feel an output pulse. If the core is at logic 0, there will be no output.

The read action causes the core to switch and the stored data changes. This is called a "destructive read" because the stored data is lost. To compensate, the computer rewrites the data back into the core, while the X and Y addresses remain the same. Thus, core memories have a "write after" cycle to keep data from being completely lost.

Your problem as the builder, is to incorporate the write after read cycle and the bi-directional drive currents to the core. The write after read cycle can be hardwired into the machines timing circuits. Integrated circuits can be had that will supply the bi-directional drive currents for the cores.

Finding the cores is actually easy. One can obtain 14x16 bit core planes in a 5-plane stack from Herbach and Rademan Inc., 401 East Erie Avenue, Philadelphia, Pa. 19134. The price for an IBM surplus stack is only \$24.95. One of these little jewels would provide a dandy start for your computer, and you could add a stack as you could afford it.

There is one more type of main memory you might consider; the read-only memory. The read only memory can be a simple, diode matrix arranged to form instruction and data words when pulsed. It would take a lot of diodes to work (maximum of eight per instruction). For 8-bit instructions and about 144 instructions in all, it could take a maximum of 1152 diodes! Sounds bad, but you can buy 1000, 1N34's (which should be OK at our slow speeds) for only \$19.00 from B-A. If you decide to go the read-only memory (rom) route, you will have to wait till you decide on some control circuits before you build the rom. This is because you program the thing when you build it

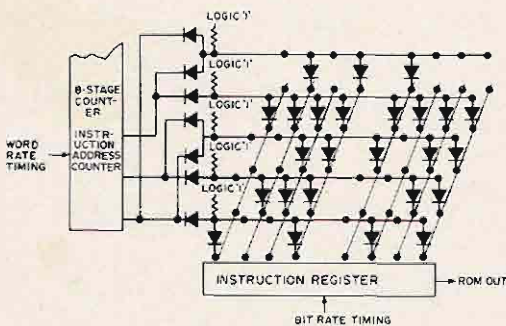

Fig. 6. 256 Bit rom (partial drawing). Contrasting the core memory, the read only memory (rom) provides instruction outputs. The instruction word is formed by the diodes. Where a diode is present a logic 1 will be stored in the instruction register. Note that if you are using an instruction register which is clamped by its SET input you will have to add a pulse-forming network on the SET input of each stage. Also if your register needs logic "0" to set, reverse your logic. The diodes on the 8-stage counter insure a "word 1,2,3,4,5. . ." count.



and you'll have to know the capabilities of the machine.

The disadvantage to the rom is that it reads only. In order to change the program, you'll have to rewire, or make another rom. The average ham might go with the rom, because it will be cheaper in the long run since there are no special circuits or two-directional currents to switch. By building several rom's on separate cards, you could change programs merely by swapping rom's. Later, you could add a core memory, or even a solid-state job if you wanted. Figure 6 shows a portion of a typical rom. This will give you an idea of what you'll need and the control circuits will tell you exactly how to organize the memory.

### Workable Memory

My only recommendation for a workable memory would be a shift register. Of course, if you use a core memory, you can merely use portions of the core memory for workable memory. Several shift registers would be arranged to be accessed as data registers. These registers would be designated "data register 1, 2, . . . etc." Figure 7 shows the workable or "accessible" memory that is used in the example computer. Access to the registers in the accessible memory is provided by the control circuits and thus, the computer program.

The accessible memory will be used to store data from the main memory input signals, data to be output, or the combination of signals from the arithmetic circuits. The registers can feed data from their output back to the input to allow us to rotate, or move the data within the register by any number of bits as selected by the program or to save data signals.

### Temporary Memory

The temporary memory will provide temporary storage of data until the data can be transferred to other registers or circuits within the computer. An example of a temporary memory is the register in the I/O circuits. Another is the Accumulator Register in the example computer. This register merely accumulates data from other sources for one operation of the machine. The accumulator is merely a byte-long register

and is only shown in the block diagram, Fig. 14, because of its simplicity.

That is about all that can be said about memory for your machine. It is your decision as to whether to use a core memory or rom for main storage. Keep in mind that in the example computer herein, a rom is used. Lets go now to where the circuit hardware first meets the software — the control circuits.

### Control Circuits

The control circuits actually make the rest of the computer operate. This is where the commands that you insert in the program are decoded and changed to enable signals that control other parts of the computer. Figure 8 is a block diagram depicting the control circuits and their function. Note that circuits within the computer are input and output selectors that route data signals to and from various registers within the machine.

The hub of the control circuits is the instruction decoder. Instruction inputs from the main memory enter the instruction decoder and become commands to the computer's gating circuits. The gating circuits are: the accumulator input selector; accessible memory input selector; accessible memory/accumulator output selector; arithmetic circuit input selector; input and output circuits; and the timing circuits. All the gating circuits are similar to the gating

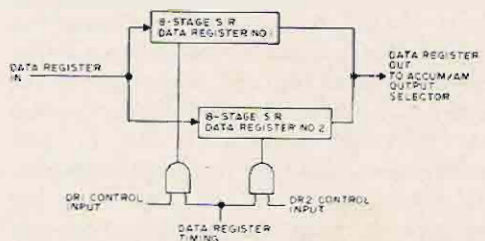

Fig. 7. Accessible memory. The accessible memory provides workable storage when rom is used. It also provides workable storage if you use main core memory. The accessible memory is made up of two 8-stage shift registers (DR1 & DR2). Inputs and outputs to these "data registers" are parallel. The data registers are selected by the program via the control inputs. The control inputs route timing to the selected register.

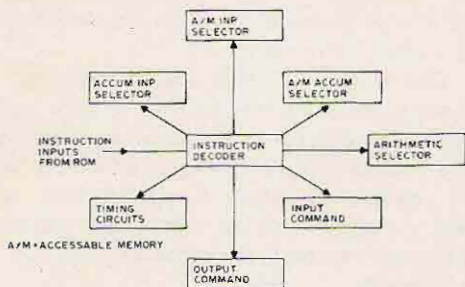

Fig. 8. Control circuits. The control circuits interface the human programmer and the machine. The instruction words from the rom are programmed by the programmer. These words are decoded by the instruction decoder. The many outputs from the instruction decoder go out to control data to/from registers, operations in the arithmetic circuits, data to/from peripherals, etc.

circuits in the arithmetic section of the computer. That is, the instruction decoder supplies the enables and the gating circuits do the routing of the data (see Fig. 10).

The instruction decoder is made up of two major portions, the instruction storage register, and the decoding circuits. For clarity, Fig. 9 shows only a portion of the instruction decoder (the other part is in Fig. 10). The instruction reads in from the main memory and is stored in the instruction storage register. The parallel output of the instruction storage register is decoded in the instruction decoder. The outputs from the instruction decoder are the logic 1 or logic 0 levels that control the computer circuits.

It is the input from the Main Memory (rom in the figure) that determines the actions that take place in the computer. The arrangement of the logic 1's and 0's in the instruction word, control all circuits within the computer. Remember, core or shift register memories have the program inserted by the operator at the same time the machine is programmed. With read-only memory, the program is inserted when the rom is wired.

The instruction decoder is made up of two "one of four" and one "one of 16" decoders and their associated gates. The gates shown in the diagram are not hardware gates. The gates are the logic symbols and you will have to use combinations of AND

and OR gates in order to achieve these logic functions. Let's look over the various circuits in the decoder and find their functions within the machine. At this point, we will look at the hardware and the software in such a way that you may have trouble telling which is which. Just remember that the hardware pertains to the circuits doing the decoding and the software is the word being decoded.

The first two bits from the storage register are decoded by a one-of-four decoder. This means that the four combinations of the two input bits are decoded to achieve one of four possible outputs at any one time. Thus a 0,0 on the input will drive the ACCUM output to a logic 1 (note: you will need to invert to get this from an IC). This selects to send the output of the accumulator to some selected circuit in the computer. A 0,1 input (decimal 1) enables the output called DR1, this is Data Register #1 in the two-register accessible memory. Likewise, a 1,0 (decimal 2) enables the output which controls Data Register #2. The 1,1 output (decimal 3) is not used.

The next two bits of the instruction word control three things: rotation of data, rom output to accumulator, or data register end

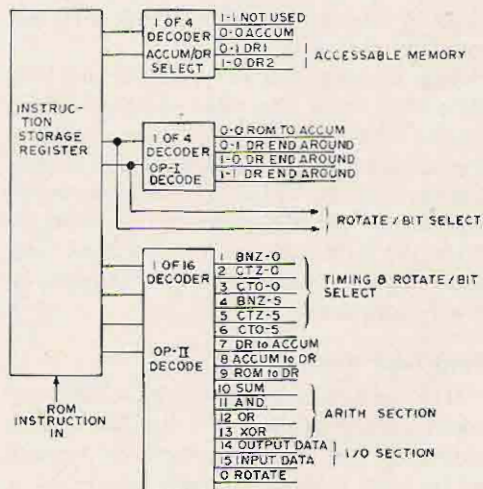

Fig. 9. Instruction decoder (simplified). The instruction decoder provides outputs which control the computer functions. The one of four and one of 16 decoders may be fabricated or may be purchased as MSI circuits from Fairchild.

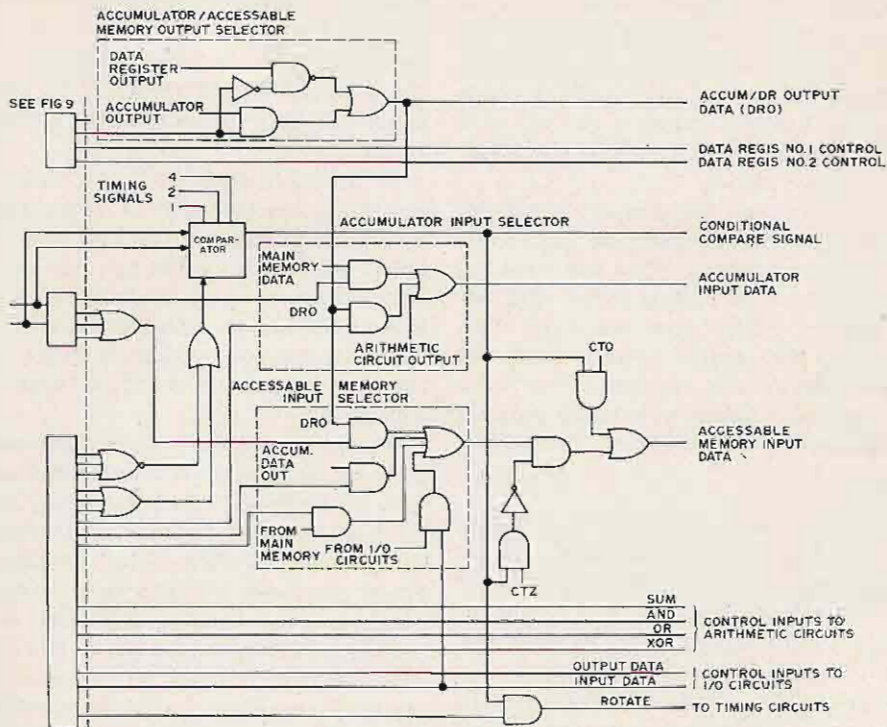

Fig. 10. Instruction decoder. The instructions (Fig. 9) cause outputs from the circuits pictured here. These outputs are switched data signals or control signals as shown.

around. The next four bits of the instruction word actually control operations within the computer. From the block diagram, Fig. 8, these outputs feed the arithmetic operations circuits, accumulator register inputs, data register inputs, and input/output control circuits.

Figure 10 shows the remainder of the control circuits. Primarily the rest of the circuits merely gate the various outputs from the instruction decoder. These circuits should easily fit on their own, separate printed circuit card. Since there will be many actual data signals routed through this card, take care to isolate each data signal with a power or ground lead on the card if possible. This should eliminate many problems caused by feed through of data.

Actually, the operation of these circuits is obvious by taking a close look at the logic. For instance, the ACCUM/AM OUTPUT SELECTOR (accumulator or accessible memory output selector) uses the first output from a one-of-four decoder to control

the data output called DRO (data register out). When the control signal from the decoder is a logical, the AND gate is enabled and ACCUM (accumulator) output data is routed out to become DRO. Under the opposite condition, the AND gate is disabled and the inverter allows the DRO signal to be formed by the data register output.

A little explanation is necessary to understand the purpose of the comparator. The comparator works on inputs from the instruction decoder and the timing circuits to provide an output that is a function of time. When the instruction decoder decodes a binary number, this number (between 0 and 7) is applied to the comparator. The first two bits of the three come from the 3rd and 4th output of the instruction storage register. The third bit comes from the one of 16 decoder and indicates whether a branch or clear instruction is greater or less than 4. Note: since there is no third bit in a rotate condition, you can rotate data only a maximum of three bits per computer operation.

When the timing signals enter the comparator match the binary number on the other three inputs, the comparator will have an output. This output will be used to check a data bit (branch), change a bit to 1 or 0 (clear), or move the data within the accessible memory (rotate).

Be sure to study this part of the computer carefully. These circuits are your interface with the machine. When you want the computer to do something (other than just sit there, of course) you must tell it to happen in the control circuits. Thus the control circuits will determine the word structures that you use in writing a program (and wiring the rom, if you go that route).

### Timing

Timing for the computer is very important. Timing allows the computer to operate properly by controlling the sequence of events that take place in the computer. Various timing signals must be provided, some of which are; word and bit times, and cycle times. Word and bit times are self explanatory; bit times are the fastest, and word times are made up of a number of bit times (8, in this machine). Cycle times are a little weirder, and may require some further explanation.

Your computer will operate in up to three cycle times: two, normally, with a third added if certain conditions are met. The two main times are the instruction read and the instruction execute cycles. During the instruction read cycle, the instruction word reads from the rom and is decoded. During the instruction execute cycle, the

decoded instruction is executed, or performed. For instance, the instruction read cycle may bring in an instruction that tells the computer to ADD two signals. The two signals will then be added in the instruction execute cycle.

If an instruction is a "branch" you generate a new timing cycle. If the decision to branch is positive, the rom puts out a literal word which loads into the accumulator. Then the word is dropped into the instruction address counter. Thus the next computer instruction comes from the rom at the place specified in the literal "branch to" address.

In case you haven't already guessed, the three cycles must be at least a word long. In fact, for insurance, and because this computer isn't going to be the fastest thing on earth, the cycles will be two words long. The actual operations will take place on the first word and the circuits can more or less "settle in" during the last word. This feature will also allow you to increase your machine's capacity to a 16-bit word sometime with little modification to the timing circuits.

You'll have to be fairly careful in laying out the timing circuits. You should come out all right if you remember to follow the rules on IC spec sheets, such as tying all unused J and K's to logic 1. Board layout won't really be critical unless you decide to make your machine run at high frequencies. Try 100 kHz basic oscillator frequency. Do decouple the power leads into the card and tie them to the front of your power bus. These measures will help keep the timing on

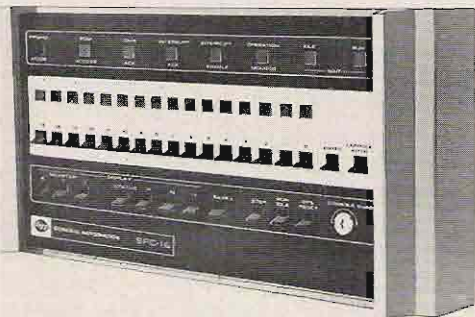

General Automation's minicomputer with a 16 bit word and a 4K expandable memory, does operations less than 1 ms.



The IBM 360/195 - the largest computer in IBM's line. This machine can process an instruction in only 54 nonoseconds.

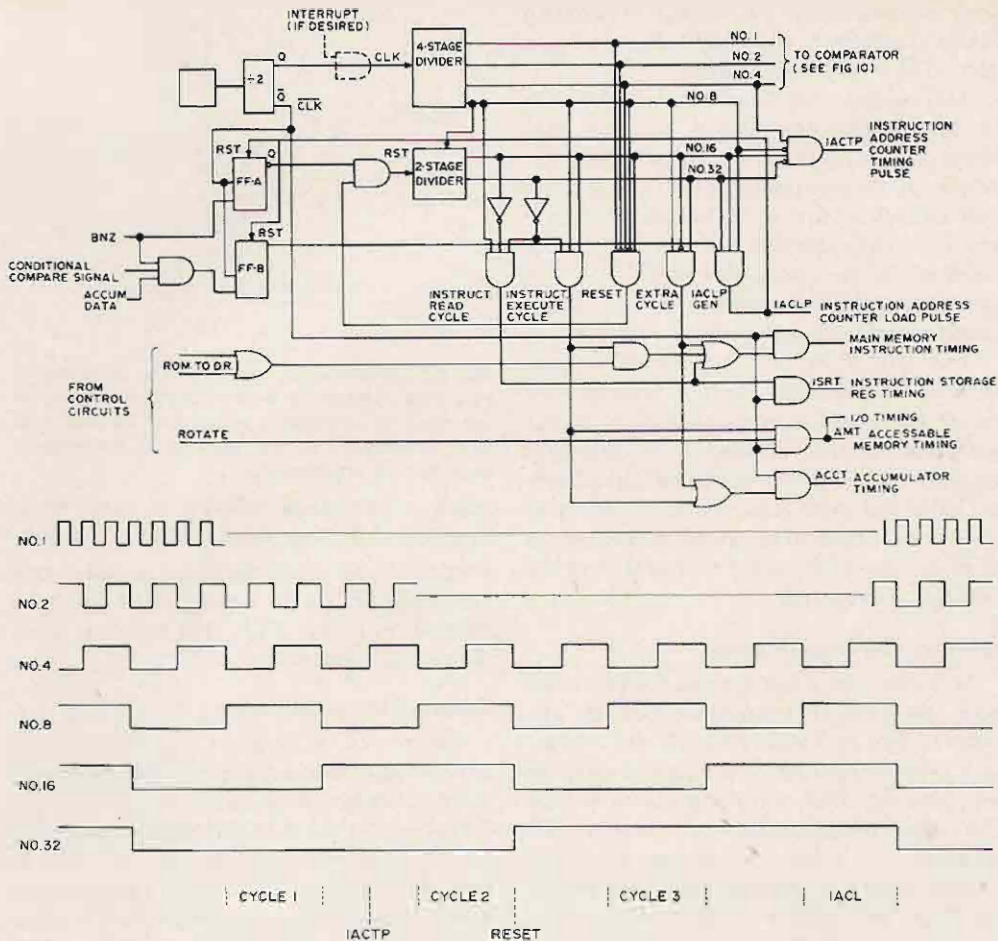

Fig. 11. Timing circuits. These circuits provide timing to the various computer circuits at the proper sequence. When the command is a con-

ditioned branch, and the condition is positive FF-A forms a new timing cycle (see text).

the timing card only, except where you run a wire out.

The circuits shown in Fig. 11 are based on operational circuits. Stick closely to the recommended logic and you should have your timing circuits working a lot faster. If you have good working timing circuits, you will have your computer up and running in a lot shorter time.

Roughly what's going on in Fig. 11 is that timing is generated by the 100 kHz oscillator and divided by the frequency dividers, down

to word length. The word length outputs are gates to form the cycle signals. The timing diagram in Fig. 11 explains the operation of the circuits overall.

The 4-stage divider output signals are applied to the comparator in the control circuits to provide a time variable signal. These signals are also used in combination with the 2-stage counter outputs to provide the cycle timing intervals. Notice that if the reset output is not inhibited at the input, it resets the 2-stage counter after the instruc-

tion execute cycle. A branch command causes flip-flop A to inhibit the reset and thus a 3rd timing cycle begins.

Also during the branch command, the IACLP (instruction address counter load pulse) is generated. This signal loads the output of the accumulator into the instruction address counter if the branch decision is positive. Thus because of the action of flip-flop B, the computer will "skip" as many steps in the program as was determined necessary by the programmer.

The IACTP is the instruction address counter timing pulse and it occurs just before the instruction execute cycle so the next instruction will read from the next memory position. The pulse was placed here so that if the instruction word said the next word was a literal to be placed somewhere in memory, the word could read in during the instruction execution.

### Software and Programming

Software and programming for this computer go hand in hand since you are the builder. The software controls the computer's overall operation. The program controls the computer in a specific problem solving task. The differences between software and program are a little confusing, since the "whole works" of instruction words and all are called the computer's software.

By now you should have a pretty good idea of how to program your computer. If you haven't, refer to the section on the control circuits again and you will. To program the computer, you must know the task you need to perform, then you must generate the instructions that will accomplish this task.

Symbols have been designed to aid you in programming. These symbols are arranged to form a flow chart, or step-by-step picture of the computer's operation. Different flow chart symbols represent different functions just as different schematic symbols represent different components. Some basic flow chart symbols are shown in Fig. 12.

Figure 13 shows the flow chart symbols arranged to form a program. The chart shown is only part of a program, or routine that is used to control equipment from a TTY. This portion of the complete routine is

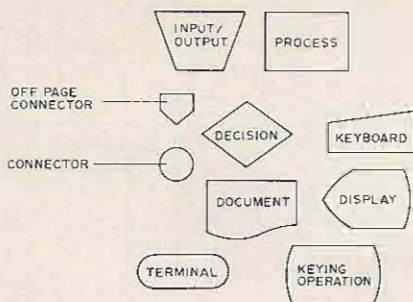

Fig. 12. Flowcharting symbols. The programmer uses these symbols to draw a schematic diagram of the tasks to be done to accomplish an end task. This "schematic" is then used as his reference to complete the programming.

called a subroutine because it performs a complete function within itself. The subroutine shown scans the input circuits again and again to see if a data word has been entered from the TTY. The figure is completely self-explanatory.

### Software Meets Hardware

Figure 14 is a block diagram of the completed computer. You will use this block diagram when you program the computer to keep track of the data floating around in the machine. The machine in Fig. 14 uses an rom, but keep in mind that you may use core. If you use core, it will connect in place of the rom.

Notice how the accumulator register is shown. The accumulator has 8-outputs that parallel feed the instruction address counter. This is to enable the "branch to" address to load from the accumulator during the third operation cycle. Also note the inputs that feed the accumulator and accessible memory input selectors. Don't forget to send commands from the control circuits to the appropriate selectors.

To find out how the machine works as a complete unit, just refer to Fig. 13 and follow along in Fig. 14. The explanation in Fig. 13 should suffice as an explanation of the computer's operation.

### Construction Problems

Wish there would be no construction problems. But for any project of this size, you will have some developmental problems.

IAC  
COUNT

FLOW  
CHART

0  
1  
2  
3  
4  
5  
6  
7  
8  
9  
10  
12

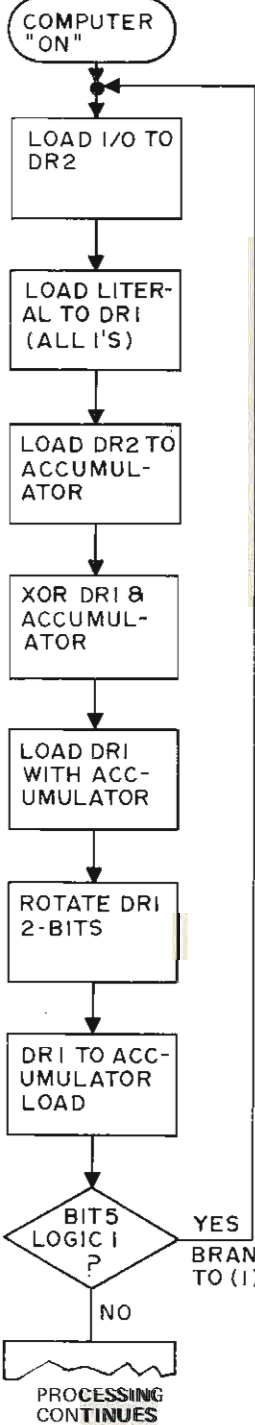

10101110

This command causes data to read in from the I/O circuits. Note that there may be no data if none was entered.

01101001

This command will put the next instruction (a literal) in DR 1.

11111111

The literal.

10010111

We are moving data in to the accum and sending it right back into DR 2 to have it in both places.

01101101

This command will Exclusive Or the DR 1 and Accumulator signals, thus providing an inverted data output.

01101000

The inverted data from the arith section is in accumulator and we want to move it to DR 1.

Now the data in DR 1 is moved ahead two bits.  
Was:



Is:



01010000

Inverted, rotated data is loaded into the accum in preparation for next step in program.

01100111

Data is checked for a "T" at bit 5. This means that there was no stop baud.

11000100

00000001

If no stop baud, the literal loads into the IAC and the program jumps to the beginning and the process starts again.

YOUR PROGRAM  
CONTINUES

If there was a stop baud your program will determine what it is.

Fig. 13. Detailed program. This is the first part of a routine designed to control some equipment on

command of the TTY. This particular "sub-routine" merely looks for the presence of any data input.



## Go all the way into the **REPEATER**

There's nothing half-way about the new Hy-Gain *REPEATER LINE*. Designed for the man who demands professional standards in 2 meter mobile equipment, the *REPEATER LINE* is the 2 meter HAM's dream come true. It's got everything you need for top performance... toughness, efficiency and the muscle to gain access to distant repeaters with ease. Reaches more stations, fixed or mobile, direct, without a repeater.

The right antennas for the new FM transceivers...or any 2 meter mobile rig.

Rugged, high riding mobiles. Ready to go where you go, take what you dish out...and deliver every bit of performance your rig is capable of.

- 261 Commercial duty 1/4 wave, claw mounted roof top whip. Precision tunable to any discrete frequency 108 thru 470 MHz. Complete with 18' of coax and connector. 17-7 ph stainless steel whip.
- 260 Same as above. Furnished without coax.
- 262 Rugged, magnetic mount whip. 108 thru 470 MHz. Great for temporary or semi-permanent no-hole installation. Holds secure to 100 mph. Complete with coax and connector. Base matching coil for 52 ohm match. 17-7 ph stainless steel whip.
- 263 Special no-hole trunk lip mount. 3 db gain. 130 thru 174 MHz. 5/8 wave. Complete with 16' coax. Operates at DC ground. Base matching coil for 52 ohm match. 17-7 ph stainless steel whip.
- 264 High efficiency, vertically polarized omnidirectional roof top whip. 3 db gain. Perfect 52 ohm match provided by base matching coil with DC ground. Coax and connector furnished.
- 265 Special magnetic mount. 3 db gain. Performance equal to permanent mounts. Holds at 90 mph plus. 12' of coax and connector. Base matching coil for 52 ohm match. 17-7 ph stainless steel whip. DC ground.
- 269 Rugged, durable, continuously loaded flexible VHF antenna for portables and walkie talkies. Completely insulated with special vinyl coating. Bends at all angles without breaking or cracking finish. Cannot be accidentally shorted out. Furnished with 5/16-32 base. Fits Motorola HT; Johnson; RCA Personalphone; Federal Sign & Signal; and certain KAAR, Aerotron, Comco and Repco units.



2 meter mobile! with

**LINE** from **HY-GAIN**

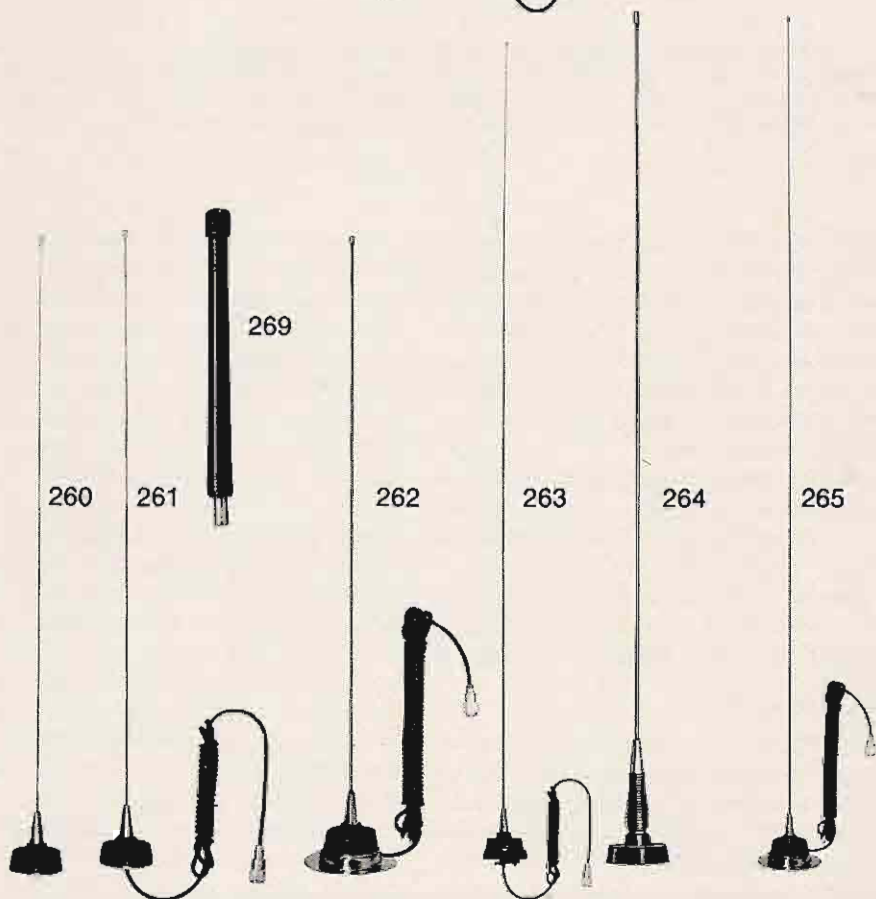

Top performance for 2 meter mobiles

**THE REPEATER LINE**

from

**HY-GAIN ELECTRONICS CORPORATION**

BOX 5407-WH LINCOLN, NEBRASKA 68505

**WRITE FOR DETAILS**

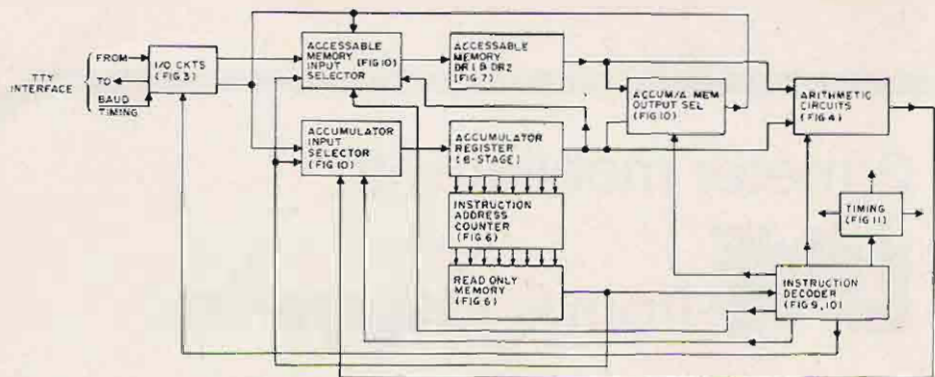

Fig. 14. Minicomputer block diagram. Mix up all ingredients in the manner shown and you have a complete minicomputer! All the action begins when the timing circuits start the count in the

instruction address counter. Instruction number 1 tells the computer what to do next via the control circuits. The instruction will be whatever you program into the computer.

Even if you follow a tried and tested design verbatim. Power supply may end up being the most serious problem for you. Use a rule of thumb - overrate. Use a supply twice as large as necessary. And be sure to use power buses. Don't forget to use a common power ground also. This will eliminate many tears and much swearing!

You may wish to breadboard each of the circuits before you print a circuit. It has been my experience that the breadboard and the final version never work the same. I recommend that you design carefully, re-check, check again after a couple of days, then print the circuit. Build the final version first!

#### Interface Problems

Certainly, you won't be able to interface any or all peripherals with ease. Just choose one type of peripheral and then design for it. You will have to bring in peripheral bit timing to the computer (band rate timing in a TTY). You will have to figure out how to interface the peripheral you choose. A description of peripherals and how to interface them would be enough for a complete article by itself.

#### Now What?

You've got the computer, or you've got the knowledge that you wanted about how computers function. Now what can you do with this knowledge, or the machine?

First of all, with the knowledge, you can read a few good books and articles and understand enough of what they are saying to learn more. Since you know what basic machine language programming is like, you may want to go on and learn a higher level language or compiler. Finally, you can keep your eyes open for a good used computer and this article will provide excellent reference to aid you in programming and troubleshooting. (Incidentally, a friend of mine picked up a fine used computer for \$3000! Don't scoff; he used it in his own little bookkeeping service business and has paid for it, and bought another.) There is a used computer dealer called "The Computer Exchange" which could supply you with price data on a used machine. The Computer Exchange Inc., 30 East 42nd Street, New York, NY 10017, phone 212-661-5870.

If you build your own machine, you can do anything your imagination will allow (the control circuits will have something to say about this too.) There is, of course, a point to what a computer can do. It can't replace your wife, because it couldn't change a baby's diaper. (Never overlook the possibility that you might fabricate a computerized robot that could darn socks or something.) The computer is not an "all solver" for the world's and your problems, but it might make a good sized dent if you're willing to try!

Payne Radio Presents the Incomparable

# ALPHA 77 by ETO

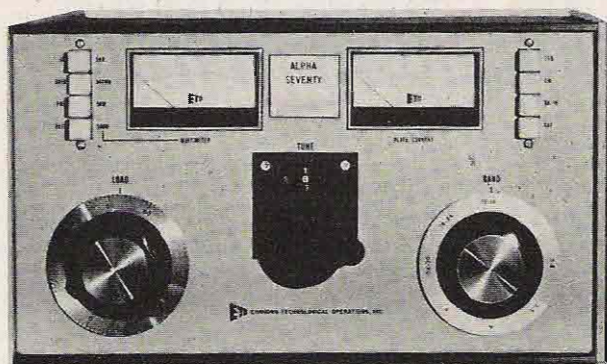

The "77" is the finest Amplifier of its type ever offered for Amateur, Commercial, and Military Service. It is rated at 3000 watts PEP continuous duty for Commercial and Military Service. It's a cool, quiet loafer at 2000 watts PEP.

New Eimac 8877/3CX1500A7 air-cooled grounded-grid triode  4000 volts on plate  1500 watts plate dissipation  1500 watts continuous-duty transformer — tape-wound core of grain-oriented steel — cuts size and weight by 40%  Vacuum-variable tuning capacitor  25 mfd oil-filled filter capacitor  Vacuum relays that don't "clank" — for ultra-quiet, instant T/R switching  6000 volt-20 Amp bandswitch  Battleship construction — ½" Aluminum sides  Electrical and mechanical safety interlocks  Complete metering by two 3½" taut-band quality meters — including 0-5000 RF wattmeter — forward and reverse  ALC-adjustable threshold  120/140 volts 50/60 Hz. 3 wire, single-phase  MIL-SPEC BLOWER — centrifugal, ball-bearing, low-speed, ultra-quiet — thermostatically controlled  Grid over-current relay "kicks-out" when underloaded or overdriven. Protects tube and input circuit. A warning before "flat-topping" occurs.  Desk-Top Cabinet — completely self-contained  9½ x 17 x 18 inches — 70 lbs. net — 90 lbs. shipping  It's perfection for \$1795 — Available for immediate delivery.

## SPECIAL INTRODUCTORY OFFER

The "77" shipped prepaid via Air Freight to nearest air terminal — anywhere in the world.

If you want to move up to the finest, the "77", phone/write Don Payne, K4ID, for a brochure, Alpha 77 operating experience, and a top trade-in on any gear you have — one piece — or the whole station. Exports are our specialty.

Manufactured by Ehrhorn Technological Operations Inc., Brooksville, Fla. 33512

# PAYNE RADIO

Box 525

Springfield, Tenn. 37172

Phone  
Nights-Sundays  
(615) 384-5643

Phone  
six days  
(615) 384-5573

# THE MINIMOD

**T**he Minimod is a hybrid modulator for a low-power VHF transmitter of the type using a 3630 in the final. Since there is a B+ line present in the transmitter, the back end of the modulator has tubes, while the front end is transistorized to save on power consumption and cut down on heat dissipation.

The 2m rig used consists of a two-tube exciter and a 6360 running 12W input, modulated by the minimod. The whole rig is built into a box 8 $\frac{3}{4}$ x5x5 in.

## Circuit Description

The mike is coupled to the first transistor through a blocking circuit. The capacitor across the input socket shorts out any rf that tries to get into the modulator through the input socket. The coupling capacitor blocks the dc, and the series resistor acts as a choke to any rf that may get past the decoupling capacitor and as an impedance in series with the transistor.

The first two transistors form a dc

feedback pair. These have very high gains, so that the first one (an emitter follower) presents a high input impedance. The high impedances in the input match the crystal mike used to generate the audio. The second transistor is a common-emitter amplifier directly coupled to the first transistor. Bias for the first transistor is obtained from its collector through a high value resistor.

The audio is capacitively coupled to the gain control and on to the second dc feedback pair. This second dc feedback pair consists of a common-emitter amplifier with negative feedback followed by a phase splitter. From the phase splitter the audio is passed to the grids of a conventional push-pull tube output stage.

Supply voltages are obtained from the main B+ line, with resistors used to drop the B+ to a suitable value for the transistors.

The second dc feedback pair has a supply voltage of about 50V so these

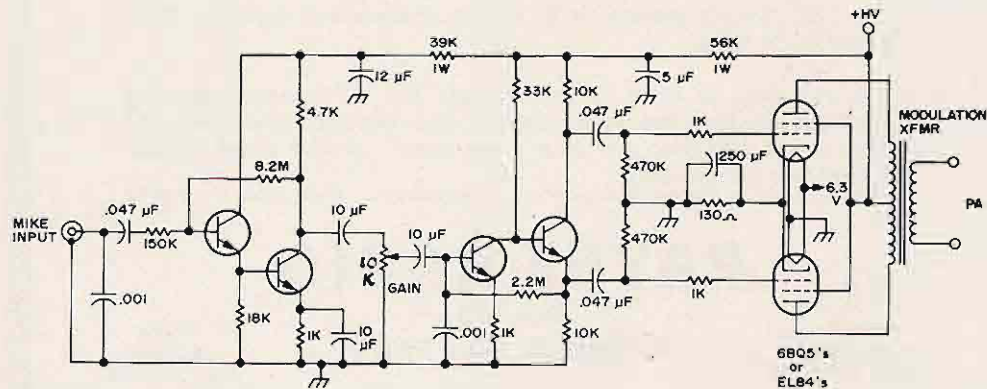

Fig. 1. Minimod schematic.

transistors must have a high collector breakdown voltage.

#### Construction

The main chassis has to be drilled to mount the tube bases and modulation transformer or a subchassis can be mounted in a suitable place. The transistor circuitry is built on a piece of laminate board. Its construction is not critical as long as care is taken to avoid picking up rf. The leads to the input socket and gain control are made up of shielded cable grounded at one end.

The capacitor at the input to the second dc feedback pair is to decouple any rf picked up on the leads to the gain control.

In the prototypes, the B+ was 280V, the phase splitter had a supply of 50V, and the front end 10V. Although the dc feedback pair is very tolerant with respect to supply voltage variations, should the B+ be much higher than 300V, the value of the first dropping resistor will have to be changed. The new value can be calculated using Ohm's Law.

The transistors used in the first dc feedback pair are a pair of 2N2926Gs. The second dc feedback pair uses transistors designed as Nixie drivers. Any type will do provided that their collector breakdown voltage is of the order of at least 80V.

By using dc feedback pairs, the circuit compensates itself for any change of transistor parameters, allowing type substitutions to be made.

The modulation transformer has to match into the final. The match is fairly critical; therefore, for best results choose a transformer that matches the final, although any old transformer will give some results.

#### Results

I have had constant reports of good modulation depth, and good sound, while using the minimod in my subminiature 2m rig. No particular shielding has been built around it and it does not seem to suffer from rf breakthrough.

I would like to thank G8BEH for his help in developing the minimod, and for his patience in the testing.

...G3ZCZ/W8

# IN MEMORIAM

## WIKXM

Licensed 1938

Edward "Corky" Gedney

December, 1903

July, 1972

**HATRY ELECTRONICS**  
Hartford, Connecticut

### CRYSTAL BARGAINS

Depend on . . .

We supply crystals from  
16 KHz to 100 MHz.  
Over 6 million crystals  
in stock.



**SPECIAL!**  
Crystals for most  
amateur 2-Meter F.M.  
Transceivers:  
\$3.75 ea.

DIVISION OF BOB  
WHAN & SON  
ELECTRONICS, INC.

2400 Crystal Dr.  
Fort Myers  
Florida 33901  
(813) 936-2397

Inquire about quantity  
prices. Order direct.  
Send check or money  
order.

Send 10¢ for new  
catalog with  
oscillator circuits  
and lists of  
thousands of  
frequencies in  
stock.

For first class mail add 15¢ per  
crystal. for airmail add 20¢ ea.

#### SPECIALS! CRYSTALS FOR:

Frequency Standards	
100 KH- (HC13/U)	\$4.50
1000 KH- (HC6/U)	4.50
Almost All CB Sets, Trans. or Rec. (CB Synthesizer Crystal on request)	2.50
Any Amateur Band in FT-243 (Except 80 meters)	1.50
80 Meter Range in FT-243	4 for 5.00
Color TV 3579.545 KH- (wire leads)	2.50
	1.60
	4 for 5.00

# WESTERN UNION DESK FAX

PUT ON THE AIR — OR — BACK TO BACK

## PRICED TO SELL

**FAX PAPER**  
1000 sheets \$12.95

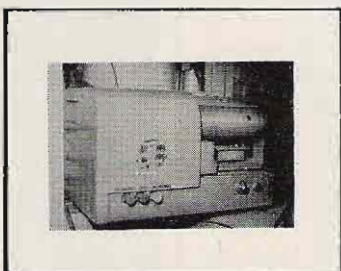

**\$7.95 ea. 2/\$12.95**

COOLING FAN, 4 pole 110V. 60 cyc., Motor, 4 bladed nylon fan. 50 CFM 2¼"W. x 3"H. x 2¼"D. .... \$2.25 each

### ELECTROLYTIC CAPACITORS

4000 MFD at 15V .....75¢ 10/\$6.00  
1000 MFD at 15V .....25¢ 10/\$2.00  
50 MFD at 15V .....20¢ 10/\$1.50

Miniature reed switch, glass enclosure 3/4" long ..... 25¢ ea. 10/\$2.00

88 MH Toroids, potted ..... 10/\$3.00

IRC Trimpots #RT22C2 1K-5K-10K-20K

3/\$1.00

Pots, miniature 1/8" shaft 5K ..... 3/\$1.00

Knobs for 1/8" shaft, brass inserts . 5/\$1.00

1000 PIV 1 amp Diodes ..... 10/\$2.95

Molex I.C. Terminals, 120 per Ft.

\$1.00 per foot

Nixie Tube type Burroughs NL940

\$2.95 ea. 10/\$27.50



**R & R ELECTRONICS**  
311 EAST SOUTH ST.  
INDIANAPOLIS, IND.  
46225

\$5.00 minimum order  
Please add sufficient postage.

## RADIO RECEIVERS R-257/U

### BACK WITH AN EVEN BETTER SUPPLY

R & R has the Motorola Plug In's we sold out of last year and more.

We now have the popular LOW BAND 25-50 MC equipment. Unit comes with these plug-ins:

- 1st IF & 2nd Mixer
- RF & 1st Mixer
- Oscillator-Doubler unit-Amplifier
- 2nd IF & Discriminator
- Audio Squelch
- Filter Unit

SCHEMATIC Diagrams for all units supplied

COMPLETE SET .....\$9.95

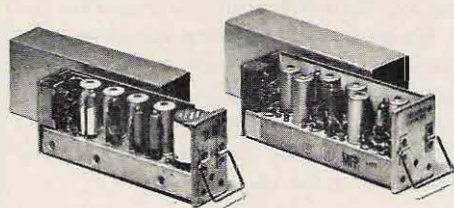

# UPDATE YOUR HEATH HR-10

**A**mong new amateurs the Heathkit HR-10 receiver is a very popular receiver. However although it does a good job on AM signals, its performance on CW and SSB leaves some margin for improvement. One of the problems is the lack of avc action when copying CW or SSB signals. Also the lack of regulated voltage on the local oscillator-mixer and bfo tubes results in some instability on the high bands. The modifications which follow correct these problems to such a degree that it will not seem like the same receiver. The addition of the audio-derived avc brings about the most startling improvement. With the rf gain fully on, copy is excellent on CW and very good on SSB except on very strong signals — all this with the existing detection system, too!

The modifications are not difficult or costly to make. With a little diligence the parts can be purchased for \$10 or less. The changes can be easily incorporated when the kit is assembled. In fact, a new kit with these modifications represents real performance for your money.

## Power Supply Modifications

Modifications to the power supply consist of installing silicon diodes in place of the 6X4 rectifier and adding an OA2 regulator tube. Removal of the 6X4 leaves a tube socket for the OA2 and allows addition of the 12AT7 avc amplifier without undue load on the filament transformer. A few directions follow:

1. Remove V7 and unsolder the red transformer leads from pins 1 and 6. The connections to pins 3 and 4 are left in place. Remove the lead to pin 7.

2. Install a terminal strip for the diodes

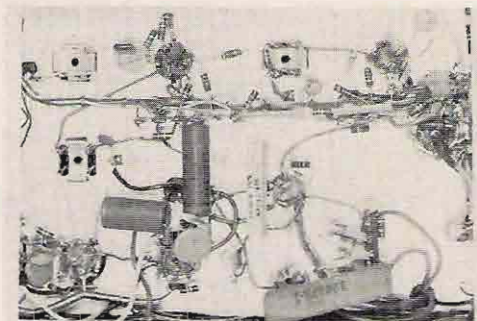

- and  $82\Omega$  surge resistors. Complete the OA2 wiring.

3. Clip the two red leads carrying B+ to the junction of R13 and R41 at the single-lug terminal strip near V2. Solder the two red wires together and tape. Route a lead for the regulated voltage along the rear of the chassis and solder to the vacated lug on the terminal strip referred to above.

4. Run regulated voltage to the bfo switch to supply V4B. All other stages remain unregulated.

**Checks:** B+ voltages will read 15 to 20V higher than before modification. A VOM inserted in series with the  $3300\Omega$  dropping resistor should read approximately 20 mA for proper regulation.

## Audio avc Installation

The existing avc system is discarded except for the avc bus wiring and the avc on-off switch. Notice that the 6BA6 i-f amplifier is modified so that avc can be applied to a third stage. Almost any small-signal diode can be substituted for the 1N34A and either a 12AT7 or 12AU7 will work as an amplifier. Follow the hints below.

1. Remove the fuse block T and install

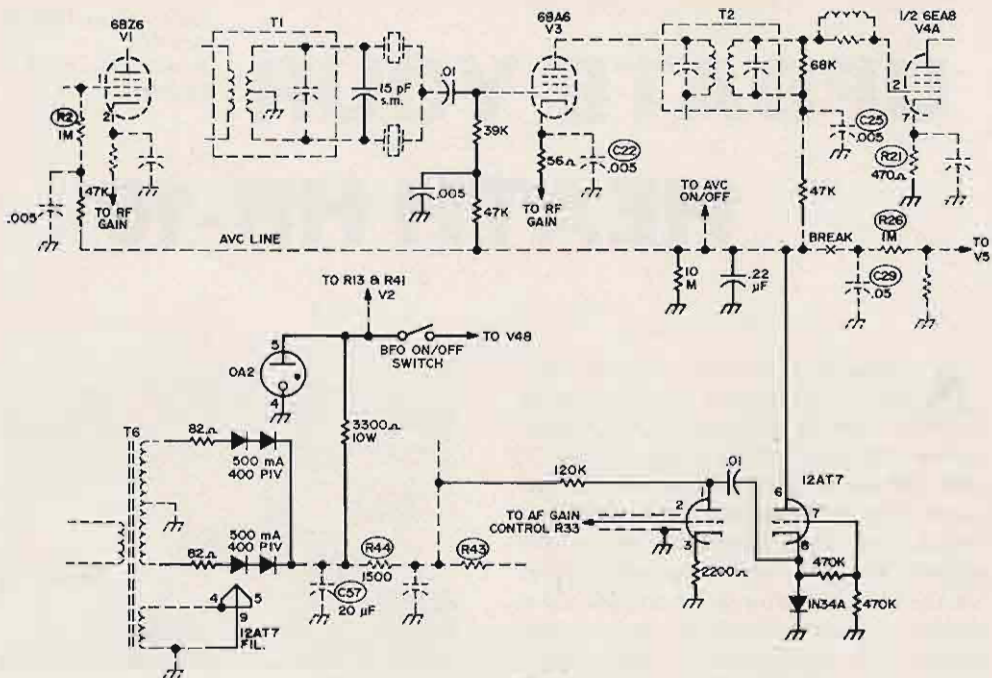

Schematic showing all wiring changes.

it vertically on the rear chassis apron between the speaker jack and line cord.

2. Install a 9-pin socket between the power transformer and V3. Refer to accompanying photo.

3. Run a shielded lead from the 12AT7 grid to the af gain control. The shield connects to lug 1, the center conductor to lug 3.

4. Ground R21 at V4A. This prevents pinning of the S meter when the rf gain is turned down. Modify the 6BA6 i-f stage. Install 47K resistors in place of R3 and R19.

Checks: With the rf gain fully on, the negative avc voltage should read approxi-

mately 1V with no signal and 6-7V on very strong signals. Voltage measurements on the avc line must be made with a VTVM.

### I-f Bandpass Changes

Changes to the secondaries of T1 and T2 will alter the i-f bandpass to give a sharper response. T1 and T2 should be retuned slightly after making these modifications. With antenna disconnected and the gains turned up, adjust the slugs for maximum noise while keeping the "hiss" at its lowest pitch. Alternatively, peak T2 as above and then adjust T1 while listening to a weaker SSB signal. Tune for maximum strength and best sounding signal.

I have made these modifications to several HR-10 receivers, and in all cases the owners were well satisfied with the results. Readers might refer to some earlier articles for background information.<sup>1 2</sup>

...VE4RE

### References

- <sup>1</sup>M. B. Crowley, EI4R, "Controlled Audio AVC System," 73 Magazine, April 1966, p. 84.
- <sup>2</sup>W. Montague, VE3FYL, "Heath HR-10 Modifications," 73 Magazine, July 1967, p. 86.

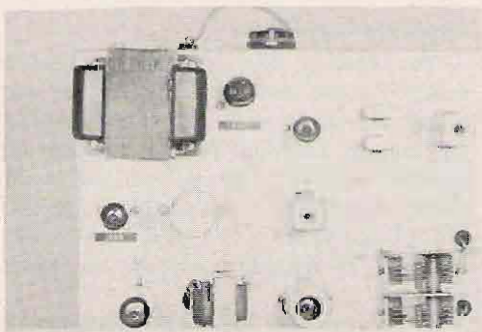



# 10M SOLID STATE

**T**he basic design for this 28 MHz, one watt, solid state transmitter, was developed on 50 MHz. By the time I had it working, the band had gone dead. So I shifted it to 28 MHz. With a few minor changes, it will work on either band, using the same transistors and suitable inductances.

There are three unconventional features about the design, one being the neutralized buffer stage, because on 50 MHz I found it necessary to neutralize *both* buffer and final. The neutralization is not to prevent self-oscillation as one might think. What it does do is to greatly improve the modulation characteristics. On 50 MHz it also cleaned up some TVI that appeared during modulation peaks.

Another unusual feature is the final tank circuit. It is really a pair of tank circuits in parallel. The exact configuration was arrived at by trial and error. However, since any change that I make in it seems to cause the output to drop, the logical thing is to leave it the way it is.

I normally run the transmitter from the cigar lighter in my Volvo. The car battery voltage is 12.4V with a negative ground. At this voltage the final draws .060A for a dc input of 750 mW. The input can be raised to 1W by inserting an extra 1.5V dry cell in series with the 12.4V to the modulation transformer secondary. There is so little difference at the receiving end that I seldom bother to do it.

The audio section is a 12V, 1W commer-

cial amplifier obtained from Radio Shack for \$5.95. At that price, it's hardly worth while to build your own. The only trouble with this one — and most low-priced audio amplifiers — is that it has a positive ground. Be careful what you do with the microphone shield ground and the volume control ground. Naturally you will insulate the amplifier printed circuit board from the metal box in which it resides. Don't do what I did, and hard wire the volume control to both the amplifier ground and the aluminum box at the same time. All it did was to wipe out a half-inch section of printed circuit trace leading to the power switch. Fortunately this was easily replaced.

There is always a problem in locating a suitable modulation transformer for the higher powered solid state transmitters. That is the reason for the 1W output transformer wired back to back with the output transformer of the regular amplifier. This system is not 100% efficient, but it does get around the problem. Since we have more audio than we really need, the loss of efficiency is not serious.

The most unique feature is the combination of the diode and audio bypass condenser in series with the buffer collector. This arrangement was evolved in the process of obtaining upward modulation of the output. The result was semi-spectacular. Since there is no splatter and no appreciable distortion at the receiving end, it appears to be a practical approach. The 1K resistor (in the dc path) was chosen in order to provide the

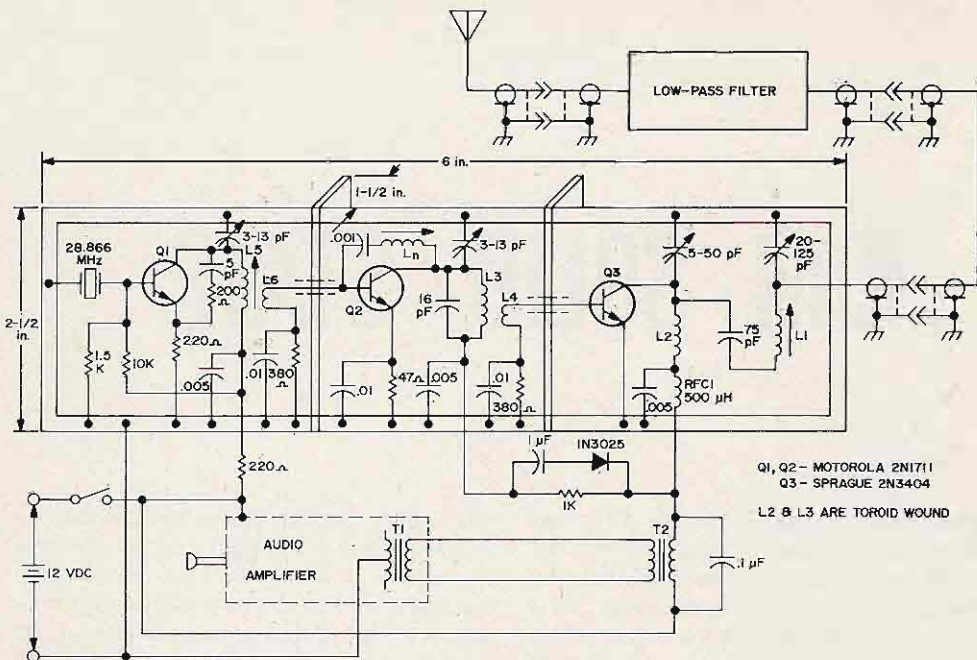

Fig. 1. Schematic of the 28 to 50 MHz rig. Coil data: L1, 3/8 in. dia. 6T #18 1/2 in. length; L2, "Red" core toroid, 7T; L3, "Red" core toroid, 8T; L4, 2T wound over L3; (Note: Buy one Amtron package - use the "Red" core for L2 and the "Yellow" core for L3. Use 10T for L3 and 3T for L4. 28 to 30 MHz happens to be the area in the spectrum where the "red" and "yellow" cores overlap.) L5, 1/4 in. dia. 10T, #22, 1/2 in. length; L6, 2T over cold end of L5; L7, 1/2 in. dia. 24T #24, close spaced (or J. W. Miller #4204 5-12 μH choke); T2, 1W transistor output transformer 150Ω : 8Ω, dc resistance 8Ω pri. : 1Ω sec.

proper amount of drive for the final.

The 2N1711 is a surprise, especially up on 50 MHz. It turns out that only certain brands of 1711's work at the higher frequencies. The Fairchild 2N1711 does not work. Apparently it is manufactured by a different process than the Motorola 2N1711's which I am using. A friend who works at Fairchild refused to believe this. He took my MOT 2N1711's into the Fairchild lab and verified there was indeed a difference.

If you cannot find MOT 2N1711's, then I recommend the little brother of Sprague 2N3404, which is the 2N3414. It can be used as oscillator and buffer. The RCA 2N3118 will work in the final, but it costs four times as much as the Sprague, and does not work any better.

The low-pass filter is pretty much a requirement. My 5W CB transceiver has one built in. Solid state finals are always rich in harmonic output. Be certain to measure the output power on the downstream side of the

filter. Otherwise you won't know whether any improvements you make are increasing the output at the fundamental or merely increasing the harmonic output.

The neutralizing coil for the buffer is rather large at 29 MHz. What is needed is a combination of "C" in picofarads and "L" in microhenries that will equal 30 (for 29 MHz) when multiplied together. My approach is to take a 2 pF fixed capacitor and solder it across the coil. Then adjust the turns on the coil to get a dip at 29 MHz with the slug all the way inserted. That indicates a 15 μH coil (ignoring the distributed capacity of the winding). Of course if you prefer the chicken method, just take a National XR coil form and wind on 24 turns of #24 wire close spaced.

Some type of rf power and VSWR indicator is highly desirable for checking the output and also the modulation. There are two types of these gadgets sold for use in CB rigs for under \$10. Either one works fine on

28 or 50 MHz. My rig with 12.4V input will provide 2.2V deflection on the 3V scale. If I wanted full scale deflection for VSWR measuring purposes I would simply add a 6V battery in series with the 12.4V car battery (but don't modulate it under these conditions).

It turns out that an NE-49 pilot light soldered across the end of a piece of RG-58 coax makes a fine dummy load and modulation indicator. The VSWR checks out about 1.1 to 1.0. I can light the bulb to full brilliance by blowing in the microphone with only 12.4V dc input.

I am using the Hustler mobile loaded whip antenna mounted on the rear bumper of the Volvo. The VSWR checks 1.3 to 1, which is satisfactory. Solid state final amplifiers do not tolerate high VSWRs. Anything worse than 1.5 to 1 may cause trouble.

Just as I was about to mail this article to 73 I made an important discovery. It came about when I moved the modulation transformer T2 from its original position on top of the chassis to a neater looking spot near the crystal oscillator. Everything fell apart. The output fell way off and the modulator ceased to modulate.

Because I am a ham first and an engineer only from necessity, I stumbled over the answer. The bypass condenser across the secondary of the modulation transformer cured the problem. I first tried a .002 mF bypass which did not seem to help at all. Next I tried the .1 mF capacitor that appears in the schematic and everything worked again. You may not need it. It apparently depends on the placement of parts. On the other hand, it doesn't seem to hurt. In fact, it seemed to help a little over the original configuration.

On the air the expanded positive peak modulation can be mistaken for double sideband with slightly more carrier than normal. The only disadvantage is that some distortion products are perhaps generated which appear on Channel 5 if in close proximity to the TV receiver. The Drake 100W lo-pass filter will take care of this problem if it is bothersome. Naturally, we don't really need a 100W filter, but Drake doesn't build a smaller one.

...W6OSA

## NEW from **RP** TONE BURST ENCODERS

- UP to 5 fixed tones (factory set)
- ADJUSTABLE:
  - Duration
  - Output
- NO BATTERIES needed.
- FULLY ADAPTABLE
- EASY INSTALLATION
- CONTINUOUS TONE POSSIBLE
- FULL 1 YEAR RP Warranty

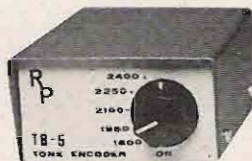

### PRICES:

- TB-5 5 tone std. encoder** ..... \$37.50  
(1800, 1950, 2100, 2250, 2400 Hz.)
- ST-2 Single tone decoder** ..... \$37.50  
(Specify 1800, 1950, 2100, 2250, or 2400 Hz.)

Special tones — Inquire

Ad: \$1.80/unit for shipping (Ill. residents add 5% tax)

FREE SPEC SHEETS  
NOW AVAILABLE

**RP Electronics**

ORDER DIRECT OR FROM  
AUTHORIZED DEALERS

BOX 1201B  
CHAMPAIGN, ILL.  
61820

## FACSIMILE & TELETYPE

- MACHINES
- PARTS
- SUPPLIES

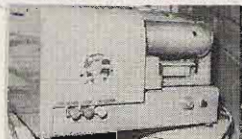

**DESKFAX 6500 TRANSCIVER**  
Conversion in May '72 QST  
Complete Unit: \$15.00. 2/\$25.00



**TOROIDS—88 or 44 mhy**  
Never potted—center-tapped  
Ppd in USA only. 5 for \$2.50  
30 for \$10.00

- Ribbons for all teletype (nylon) 12 for \$3.50 ppd
- 11/16" paper tape: 40 rolls—FRESH. \$8.00
- Single sheet roll paper (8 1/2")—FRESH. case of 12 for \$12.50
- SPECIAL: 60 speed mod 15—19 gears (74912—74913). \$3.50 set ppd
- Manual (TM 11—2258) for TXC-1, A, B, C, D Facsimile Transceivers. \$7.50 ppd
- Fax paper. 12" x 19" for TXC-1, Cut up for Deskfax, 250 sheets. \$3.00/pkg

### VAN W2DLT ELECTRONICS

302X Passaic Ave.  
Stirling, N.J. 07980  
Phone: 201-647-3639

SEND STAMP FOR  
NEW PICTURE CATALOG



# IS BRIBERY LEGAL?

## IMPOSSIBLE OFFER?

The bigger 73 Magazine is the better reading it will be, we hope you'll agree. And the more circulation 73 has the bigger the magazine can be — that makes sense doesn't it? Obviously you have a lot to gain by helping 73 to get more subscribers... including yourself, if you are a newsstand buyer.

In the hopes of making subscribing so attractive that it just cannot be passed up — whether it be for yourself or a friend, we are offering the below selection of books as premiums — one book per subscription — any book. Does that look like a good deal?

## FREE BOOKS

Any one of the following books is available (postpaid) as a premium if you buy a subscription to 73 for yourself or a friend (or an enemy — or even an ARRL official since few of them get it). One book per subscription.



**A** The Novice Class License Study Guide has not yet been published in 73 or in any other magazine. This book contains all the basic technical information needed to pass the Novice License with flying colors — and is invaluable as a basic text for understanding the General Class Study Guide. Profusely illustrated and so clearly written that just reading it is enough to permit most applicants to pass their exam. \$3.95 value.



**B** The 73 General Class Study Guide has helped thousands to easily pass their General License the first time through. At \$9 a whack, isn't it foolish not to hedge your bet with this comprehensive and simple book? No other study guide is as complete or as easy to read. None. A \$4.95 value.



**C** The Advanced Class Study Guide has proven to be the only complete text for preparing to pass the Advanced Class license exam. Never before has radio theory been made so simple. After just reading this book it is almost impossible to fail that exam. And remember that in addition to the trouble of going to the FCC to take that exam, there is a little matter of \$9 you have to ante up. Why take a chance on failing? \$5.95 value.



**D** The Extra Class License Study Guide makes all that complicated electronic theory seem simple. A little study with this book and you will be ready to face the FCC examiner with confidence. A \$4.95 value.

**E** The 73 DX handbook has every DX aid you could hope for... QSL Bureaus, postage rates worldwide, DXCC, and WTV country lists and record pages maps of many areas of the world with prefixes plus a complete wall-sized world map with each book! It is profusely illustrated with pictures of many of the top DXers, plus articles on working DX on the different bands. There are great circle bearing maps and charts, and more... more... more.

## MORE & MORE BOOKS



**F** The FM Anthology has reprints of all the articles and technical data from the early issues of the FM Journal. No FM library is complete without this data, much of it just not available elsewhere. \$5.95 value.



**G** The BEST of FM is a compilation of the best articles that appeared in the FM Journal from March 1968 through June 1969, the last of the magazine. Read the extremely controversial Chronicles of 76. Plus dozens of technical and circuit articles available nowhere else. \$4.95 value.

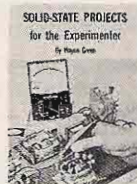

**J** Solid-State Projects for the Experimenter contains over 60 projects taken from the pages of 73 Magazine. Build a Six-Meter Fet Converter. Or, maybe a ham TV receiver. It's all here. \$3.95 value.

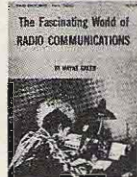

**K** The Fascinating World of Radio Communications is an introduction to radio communication. This book gives you some of the history of radio communication and an idea of what you can expect from your new hobby. \$3.95 value.



**L** IC Projects for Amateur & Experimenter is an anthology of IC construction projects taken from 73 Magazine. Edited by Wayne Green, it's a must for any ham library. \$3.95 value.

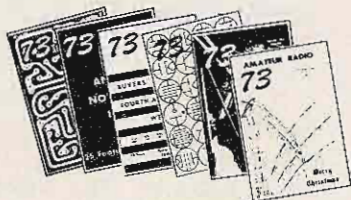

## BACK ISSUES TOO?

Where can you buy a one year subscription to a magazine and get a set of twelve back issues as a bonus? That sounds like a pretty good deal doesn't it? Well, unless you have a complete set of back issues of 73 that is a fabulous deal. It is such a good deal that it has a string attached — the twelve back issues are a free bonus for a subscription, but there is one more problem that has to be faced. This is the postage involved. Twelve back issues are darned heavy and the postage cannot be dismissed lightly. If you want one of the three different back issue packages you will have to send along an extra \$2 to cover the cost of postage and handling. It's still a great deal. The problem is that books can be mailed at the library book rate, while magazines have to go parcel post, which costs an arm and a leg.

Over 3000 great articles have appeared in our back issues and most of them are just as good today as the day they were printed. You will have the time of your life reading all those wonderful issues you missed. We have separated the back issues into three packages, issues from 1960 — 1964 (I), 1965 — 1967 (II), and 1968 — 1970 (III). These back issue bundles are put together by illiterate apple pickers borrowed from other ham magazine staffs and thus there is no possibility of our guaranteeing any particular issue in your bundles... you take pot luck.

## A DX FRIEND?

Foreign subscriptions to 73 are a bit more expensive than local ones, naturally — however we will be happy to enter a gift subscription for a DX op at the same low U.S. rate as part of this book offer. Here is your chance to spread a lot of happiness around the world. One of the most appreciated gifts any DX ham can get is a subscription to 73. Indeed, we suspect that 73 is read in more countries around the world than any other ham magazine — in well over 200 countries at last count!

If you work DX you must have a couple good friends who will practically fall out of their tree over a subscription to 73. Try them.

Have you ever been shown a kindness by a DX op? Maybe you visited him? Remember his kindness with a 73 subscription.

## WHY THIS OFFER?

The whole purpose of this offer is to bring 73 to the attention of more active amateurs — to get more subscriptions. Obviously we are paying dearly for the initial subscription — but we frankly intend to make it up next year when the renewal comes due. In the long run all of us will benefit from this.

It is obvious that it is not possible to send two books with a two year subscription. This offer is valid for one year subscriptions only.

## MONTHLY GIFT

A wonderful answer to Christmas gifts.

If you have a friend who might enjoy getting 73, how about sending him a gift subscription? This will bring him twelve monthly reminders of your thoughtfulness — twelve monthly sessions enjoying the magazine.

Your gift will start with the January issue, if you like, which will be delivered a couple days before Christmas (in time for him to get you a present?), plus a gift card telling him who was so thoughtful.

You get the book — if you like. If you insist, we will send along the bonus book to the giftee instead, again with your compliments. Whatever turns you on. But if you give the gift subscription you certainly rate the book yourself.



# FREE HANDBOOK

1200 PAGES!

Where else can you get an amateur radio handbook for free? That's right, you get about 1200 pages of articles in 73 every year and the magazine is designed so that each and every article is on separate pages — and 73 is the only magazine that does this — with no flipping to the back of the magazine for a parts list or anything. Every page of the magazine is numbered with the regular numbers plus special yearly handbook page numbers — all so you can, if you like, take apart your issues of 73 and put them together by subject into a giant handbook at the end of the year. No other magazine has anything like this available.

## ACTIVE EDITORS

Only one ham magazine of the four has editors that are active and on the air — and have been for years. 73 has its own repeater going — the only ham magazine staff that has done this. 73 has its own mountain top laboratory for VHF — the only ham magazine with one. 73 is active on slow scan television — the only magazine to do this. 73 goes on DXpeditions — the only ham magazine to do this. 73 runs DX tours — the only ham mag to do this. And so it goes.

And what difference does all this make? Perhaps you've noticed that 73 is more involved with the hobby — 73 not only reports the most interesting news, sometimes it helps to make the news. It helps 73 to be more fun to read, to attract better authors for articles, to bring you more valuable information on the newest of ham products.

Which ham magazine was the first to report on the first commercially made two meter synthesizer? 73 of course. And which got the first new units made by Genave? And which got the first Clegg units? The first International Signal units? The first Drake FM units? The first Tempo units? And so on — being active and on the air helps make 73 more interesting and valuable, doesn't it?

## 73 NEWS PAGES

You'll enjoy the monthly news reports on what is going on in the hobby — new products — political happenings — news of DX — RTTY news — Slow Scan news — VHF news — FCC news, etc. 73 is the ONLY ham magazine to cover the news of amateur radio in this easy to read manner. Keep really up to date with the 73 newspapers.

## SUBSCRIPTION ORDER BLANK

Name \_\_\_\_\_ Call \_\_\_\_\_

Address \_\_\_\_\_

City \_\_\_\_\_ State \_\_\_\_\_ Zip \_\_\_\_\_

Book wanted (give letter) \_\_\_\_\_

New subscription  Renewal or extension

Gift — please send Christmas card from \_\_\_\_\_  
and send free book to: \_\_\_\_\_

\$6 Enclosed  \$2 extra if back issues ordered.

73 MAGAZINE PETERBOROUGH NH 03458

## SUBSCRIPTION ORDER BLANK

Name \_\_\_\_\_ Call \_\_\_\_\_

Address \_\_\_\_\_

City \_\_\_\_\_ State \_\_\_\_\_ Zip \_\_\_\_\_

Book wanted (give letter) \_\_\_\_\_

New subscription  Renewal or extension

Gift — please send Christmas card from \_\_\_\_\_  
and send free book to: \_\_\_\_\_

\$6 Enclosed  \$2 extra if back issues ordered.

73 MAGAZINE PETERBOROUGH NH 03458

## SUBSCRIPTION ORDER BLANK

Name \_\_\_\_\_ Call \_\_\_\_\_

Address \_\_\_\_\_

City \_\_\_\_\_ State \_\_\_\_\_ Zip \_\_\_\_\_

Book wanted (give letter) \_\_\_\_\_

New subscription  Renewal or extension

Gift — please send Christmas card from \_\_\_\_\_  
and send free book to: \_\_\_\_\_

\$6 Enclosed  \$2 extra if back issues ordered.

73 MAGAZINE PETERBOROUGH NH 03458

If you prefer not to shred your copy of 73 there is no real reason why you should not put the subscription information on a separate piece of paper, on the margin of a hundred dollar bill, or whatever turns you on. Regular subscriptions ordinarily start with the next published issue of 73 — the November issue, in this case. Gift subscriptions marked for Christmas will start with the Giant January issue since that is the one that should arrive right around Christmastime. If you want otherwise just indicate same on the order.

The regular subscription rate for 73 is \$6 for one year \$11 for two years, \$15 for three years in North America and \$1 extra per year for foreign subscriptions. This special book premium offer is valid world wide at \$6 for one year until December 31, 1972.

The recent serious rise in postal rates will be forcing 73 to increase the subscription rate soon — don't say you weren't warned.

Did you enjoy the article in August on the DXpedition to Navassa? This is one of the reasons that 73 is different — it is involved. The editors get out there and operate, go on DXpeditions, organize them even — organize ham tours — set up repeaters — work in the contests — work lots of DX — are actually on slow scan — on RTTY — it makes the magazine come alive. When the editors write about something you know that they have the background to bring you the inside scoop. If you are the type of person who fights progress — opposes change, you are going to find 73 getting your back up, for 73 is in there first with the new things.

Amateur Radio  
is more fun  
When you read 73

# A HUSKY 40 M GROUND PLANE

**I**t seems that the middle of the winter is the time I end up building antennas, which may be because of the coincidence of the contest season. However, this was quite a mild winter in these parts, so come February the need for a 40m antenna found another project being conducted between the sporadic snowflakes.

Since I had experience with 40m groundplanes in high-wind areas, it was obvious that such an antenna must be built with an eye to strength as well as performance. It seems most groundplanes are thrown together out of TV tubing or similar material, and the end product seldom lasts long. On 40m the 33 ft of vertical radiator must be well supported.

A little study of Fig. 1 and the photographs will reveal most of the construction features of this antenna. The main support framework is made of well-seasoned 2x4s, with four sections being used to form the legs and a number of short pieces used for spacer blocks. Carriage bolts and lag screws are used in place of nails to prevent premature parting due to wind flexing.

Two short pieces of angle aluminum are also bolted across the frame legs; these are used as the main supports for the radiator. The radiator itself is very sturdy, being made of three sections of aluminum tub-

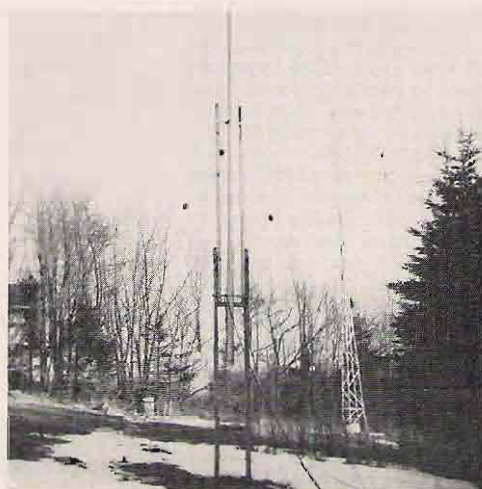

ing. The bottom section is a 20 ft length of 3 in. irrigation tubing, an item respected for use in yagi beam construction. Besides being very lightweight, this material is able to withstand years of wind and weather stresses.

Telescoped inside the bottom section is a length of 2 in. irrigation tubing. In my case this was a scrap piece from a quad project, but if you have a full 20 ft length available, this would be ideal to complete the overall length of the antenna. In my situation I was forced to go to a third section which is a 10 ft length of thick-wall aluminum conduit such as the type used for house wiring. The three pieces are telescoped inside each other to make up the required 33 ft of overall length, with sufficient overlap to insure strength at the two junction points.

Probably the hardest part of the whole project is to accurately position the pipes inside each other so that the three pieces are concentric, while allowing proper electrical connection between each other. The best way, if a machine shop is available, would be to machine aluminum spacers or collars that would fit inside the larger diameter tubing and have a hole in the center to accommodate the smaller size. However, some study of Fig. 2 will show a

suitable method which will serve the purpose.

Four small blocks of hardwood are used, cut from a single piece of square hardwood molding. The four blocks are wrapped in thick aluminum foil (the kind used to wrap electronic equipment for shipment). The foil usually has a backing of a canvas-like material, and the idea is to wrap the wood so that the foil will make contact with both the outer and inner pipe.

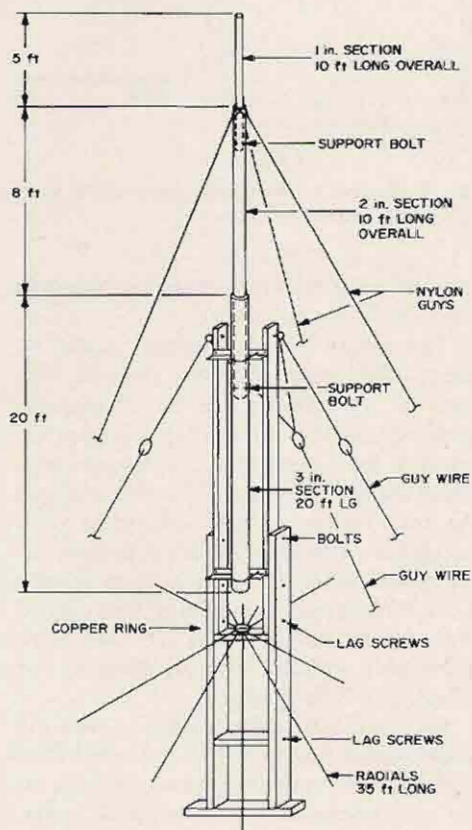

Fig. 1. Details of overall construction.

I held the foil on the wood with a generous dose of glue. Position the four blocks around the inner tubing and use dabs of epoxy to fasten them to the pipe. This is only really necessary on the lower blocks because they will be too far down inside the outer pipe to be reached. The blocks at the upper end of the pipe can be tapped into place at the top of the pipe.

As a means of supporting the pipe at the correct length, two small aluminum bolts

are used to hold the inner pipe in position. These are deliberately placed at the lower end of the inner pipe to avoid any mechanical weakness at the junction.

We cannot really depend upon this for good electrical connection, although it will likely be quite sufficient. However, Fig. 3 shows the bridging connection at the junction of the pipes. This is made quite simply by using strips of grounding braid and stainless steel hose clamps.

Fastening the completed radiator in position is the next step. The simplest way is by using two large muffler clamps, well primed with several coats of rust inhibitor. These are ideal for gripping the large tubing firmly and yet not denting it. The clamps are placed around the tubing and mounted onto the two angle aluminum cross pieces on the frame.

At this point, decide upon the distance you want from the ground level to the bottom of the radiator, and then slide the radiator through the clamps until it is in the required position. The distance will depend somewhat on personal preference or availability of space for radials. If you intend to bury the radials, the base can be very close to the ground, but in my case I have the radials above ground and sloping downward at a 10-degree angle. This gives a little better match for RG-8/U cable, and also allows the radials to be rolled up easily when summer lawn mowing becomes necessary.

Before attaching radials, the antenna can be raised into position and guyed. By pegging the base to a short pipe or stake driven into the ground, the antenna can be raised by one man. However, have a helper on hand to tie down the guy wires or disaster may overtake you! Two sets of guys are used. The lower guys are attached to the main frame, and can be your choice of materials. I used heavy aluminum clothesline wire covered with heavy plastic — it's easy to work with and not prone to kinking. A strain insulator in each guy breaks up any possible resonance in the wire.

Mark the positions for the three lower guys, in an equal triangle and about 10 ft out from the base. The stakes should be at

least 4 ft long and driven into the earth to almost their full length. As a suggestion, drill the ends of the stakes and insert a steel U-bolt, which will offer much easier attaching of the guy wires. A steel turnbuckle between this U-bolt and the guy wire will offer precise adjustment of tension on each guy and save a lot of bothersome hit-and-miss tightening later. I have also extended the guy wires from the turnbuckle back to the base of the frame. This prevents any tendency of the base to move sideways under high winds.

The upper set of guys are made from an insulating line (nylon, polypropylene, etc.), but try to use a line with minimum stretch and also one which is impervious to rapid changes in temperature or wetness. Be especially certain it will not rot. If available in your area, it's hard to beat the woven line used for deep-sea fishing nets. This is virtually indestructible and good for years of use.

Fasten the upper set of guys directly to the radiator at the top of the 3 in. pipe. These guys may be fastened to the same stakes as the lower set, but a much stronger arrangement can be had by using another set of stakes some 5-10 ft farther out from the base.

When the antenna is raised and guyed, the radial system can be installed. How many? Simple. The most you can get. More radials mean more efficiency and lower angle of radiation. Of course it's very hard to measure the slight improvement that one more radial makes, but 10 more radials

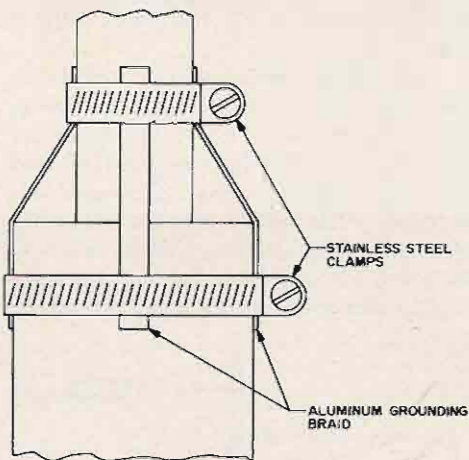

Fig. 3. Method of electrically bridging the junction of the radiator sections.

may get your attention. They can be made from any wire you can get.

The length of the radials should be about 10% longer than the radiator. The ends of the antenna can be all cleaned, soldered together, and then clamped or soldered to a short piece of copper braid which in turn is soldered to the shield of the coax feedline, either directly or via a connector. Although the ideal pattern for the radials would be to space them equally in a circle around the radiator, they can be bent or crammed into whatever odd space is available without seriously lowering the efficiency of the antenna.

Standard 50Ω cable is used to feed the radiator, and direct feed to the base of the element will result in a reasonable swr in the neighborhood of 1:1.5 or a little lower. However, a closer match (and an swr nearer unity) can be achieved by use of a coaxial matching section.

The antenna will perform very well. I believe my best DX (in rarity, not miles) is FB8XX, but the log contains many QSOs with VK, ZL, 9J2, 5H3, 5Z4 and most European countries. The wind loading is slight, and with reasonable attention to painting the frame occasionally and checking the guys, the antenna should give excellent satisfaction for many years.

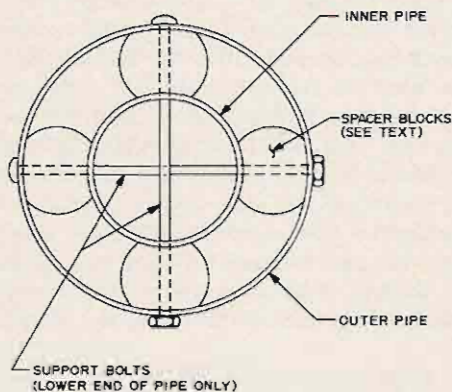

Fig. 2. Details of pipe junctions for tight fit.

...VE1TG



# WHICH ANTENNA WINS THE CONTEST ?

In open competition against thousands of commercial and home-brew antennas, WA1JFG won the New England championship with a Gotham beam, by a margin of 5,982 points! WB2JAM won the sectional award for the Sweepstake contest in 1969 and 1970 with a Gotham 4-element 15-meter beam! Hundreds of unsolicited testimonials from grateful hams are our proof that Gotham antennas give you the best design, and the best materials. Forget our low prices — rely on the results of open, competitive contests. Ask yourself: Why do Gotham antennas win?

**QUADS** Totally satisfied with quad. Worked DK4VJP, SM7DLH, XE1AB, DM4SEE, FL8SR, F6AUM, HK7YB in few hours. Instructions a breeze...WB8DOI

## CUBICAL QUAD ANTENNAS

— these two element beams have a full wavelength driven element and a reflector (the gain is equal to that of a three element beam and the directivity appears to us to be exceptional! ALL METAL (except the insulators) — absolutely no bamboo. Complete with boom, aluminum alloy spreaders; sturdy, universal-type beam mount; uses single 52 ohm coaxial feed; no stubs or matching devices needed; full instruction for the simple one-man assembly and installation are included; this is a fool-proof beam that always works with exceptional results. The cubical quad is the antenna used by the DX champs, and it will do a wonderful job for you!

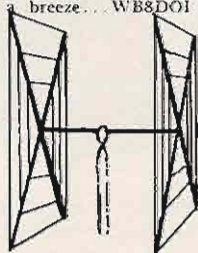

### 10/15/20 CUBICAL QUAD SPECIFICATIONS

Elements: A full wavelength driven element and reflector for each band.

Frequencies: 14-14.4 Mc.; 21-21.45 Mc., 28-29.7 Mc.

Dimensions: About 16' square

Power Rating: 5 KW.

Operation Mode: All.

SWR: 1.05:1 at resonance.

Boom: 10' x 1 1/4" OD, 18 gauge steel, double plated, gold color.

Beam Mount: Square aluminum alloy plate, with four steel U-bolt assemblies. Will support 100 lbs.; universal polarization.

Radiating elements: Aluminum wire, tempered and plated, .064" diameter.

X Frameworks: Two 12' x 1" OD aluminum 'hi-strength' alloy tubing, with telescoping 7/8" OD tubing and dowel insulator. Plated hose clamps on telescoping sections.

Radiator Terminals: Cinch-Jones two-terminal fittings.

Feedline: (not furnished) Single 52 ohm coaxial cable.

Now check these startling prices — note that they are much lower than even the bamboo-type:

10-15-20 CUBICAL QUAD. . . . . \$37.00  
 10-15 CUBICAL QUAD. . . . . 32.00  
 15-20 CUBICAL QUAD. . . . . 34.00  
 TWENTY METER CUBICAL QUAD 27.00  
 FIFTEEN METER CUBICAL QUAD 26.00  
 TEN METER CUBICAL QUAD. . . . 25.00  
 (all use single coax feedline)

How to order: Send money order only (bank, store, or United States) in full. We ship immediately by REA Express, charges collect. **DEALERS WRITE!**

**GOTHAM, 1805 Purdy Ave, Miami Beach, Fla. 33139**

DEPT. 73

NOVEMBER 1972

**BEAMS** "Just a note to let you know that as a Novice, your 3-EI. 15 Beam got me RI Section Winner and New England Division Leader in Novice Round-up. See June QST, p. 57 for picture of ant. (below). Tnx for a fine working piece of gear. 73s, Jay, WA1JFG"

Compare the performance, value, and price of the following beams and you will see that this offer is unprecedented in radio history! Each beam is brand new! full size (36' of tubing for each 20 meter element for instance); absolutely complete including a boom and all hardware; uses a single 52 or 72 ohm coaxial feedline; the SWR is 1:1; easily handles 5 KW; 7/8" and 1" aluminum alloy tubing is employed for maximum strength and low wind loading; all beams are adjustable to any frequency in the band.

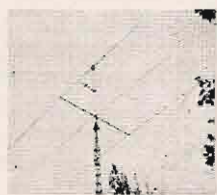

2 EI 20. . . . .	\$21	4 EI 10. . . . .	\$20
3 EI 20. . . . .	27*	7 EI 10. . . . .	34*
4 EI 20. . . . .	34*	4 EI 6. . . . .	20
2 EI 15. . . . .	17	8 EI 6. . . . .	30*
3 EI 15. . . . .	21	12 EI 2. . . . .	27*
4 EI 15. . . . .	27*		*20-ft. boom
5 EI 15. . . . .	30*		

## ALL-BAND VERTICALS

"All band vertical!" asked one skeptic. "Twenty meters is murder these days. Let's see you make a contact on twenty meter phone with low power!" So K4KXR switched to twenty, using a V80 antenna and 35 watts AM. Here is a small portion of the stations he worked: VE3FAZ, TI2FGS, W5KYJ, W1WOZ, W2ODH, WA3DJT, WB2FCB, W2YHH, VE3FOB, WA8CZE, K1SYB, K2RDJ, K1MVB, K8HGY, K3UTL, W8QJC, WA2LVE, YS1MAM, WA8ATS, K2PGS, W2QJP, W4JWJ, K2PSK, WA8CGA, WB2KWY, W2IWJ, VE3KT. Moral: It's the antenna that counts!

**FLASH!** Switched to 15 c.w. and worked KZ5IKN, KZ5OWN, HC1LC, PY5ASN, FG7XT, XE2I, KP4-AQL, SM5BGK, G2AOB, YV5CLK, OZ4H, and over a thousand other stations!

V40 vertical for 40, 20, 15, 10, 6 meters. . . . . \$14.95  
 V80 vertical for 80, 75, 40, 20, 15, 10, 6 meters. . . . \$16.95  
 V160 vertical for 160, 80, 75, 40, 20, 15, 10, 6 meters. . . \$18.95

# NEW Instant access to 144 frequency pairings with 20 watts out on the new HR-212 twelve channel 2 Meter FM Transceiver by Regency

## Specifications

Power Output: 20 watts (nom.) at 13.8 V DC

Frequency Range: 144-148 MHz

Channels: 12; crystal controlled

Sensitivity: 0.4  $\mu$ v, 20 DB quieting

Spurious Rejection: 60 DB

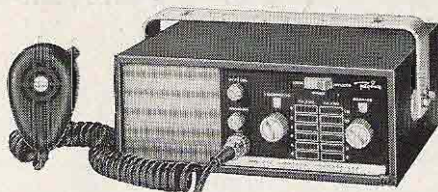

**Model HR-212** \$259 Amateur Net  
Includes microphone, mounting bracket and factory installed transmit and receive crystals for 146.94 MHz.

## for all your 2 Meter FM needs



**Model HR-2MS** 8 channel Transcan™ with signal search reception and 15 watts minimum output. \$319.00 Amateur Net



**Model HR-2A** 6 channel transmit, 12 receive 2 Meter FM Transceiver with 15 watts minimum output. \$229.00 Amateur Net



**Model AR-2** Amplifier boosts 2 Meter FM output power 300%. \$119.00 Amateur Net



Electronics, Inc.

7900 Pendleton Pike • Indianapolis, Indiana 46226

Regency 2 Meter FM—American made at import prices

Henry H. Cross W1OOP  
111 Birds Hill Ave.  
Needham MA 02192

pair of #30 Formvar wires together and wound five bifilar turns through a ferrite bead of the kind we used to use for heater decoupling — 3/16 in. diameter by 3/16 in.

## ONE CONVERTER INTO TWO RECEIVERS (such as for VHF contests)

If we assume that your converter output is 50 $\Omega$  and that the average ten- or twenty-meter receiver you use for a tunable i-f is something like 100 $\Omega$  input impedance, it would seem that you could parallel two receivers with no trouble. However, you will find trouble with (1) leakage and (2) "sucking out" of the signals by the antenna-tuned circuit of the other receiver.

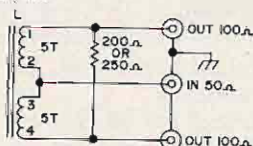

Padding with resistor networks helps, but the right way is with a "power divider." L is a centertapped coil. I twisted a

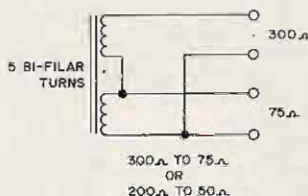

long x 1/16 in. hole. Pick the proper ends to hook together, and we have 10 turn, centertapped coil. The two outputs are 100 $\Omega$  each. Ten turns tapped at seven on

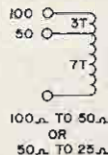

one of the same beads will make you a 100:50 $\Omega$  auto transformer, if you think it will help.

...W1OOP

# IC LOGIC DOESN'T HAVE TO BE OBSCURE

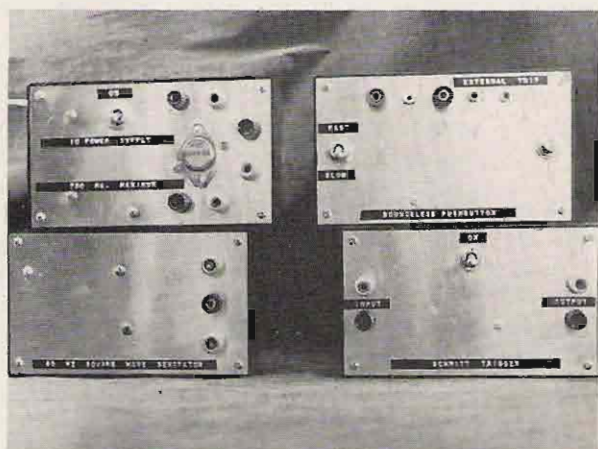

With 40 meters a mass of heterodynes and 15 meters sporadic my two Novices had some time on their hands. Putting aside a study of the latest schematic diagram in the Playboy centerfold, I unveiled my latest bargain buy, a gaggle of J-K flip-flops and dual two-input gates. With an introduction to the world of IC's via the verbal route, it soon became apparent that some sort of dynamic demonstrator was needed. Several days of drawing schematics, hacking up perf board and constant construction produced a number of units which brought reality to the fundamentals of "counting with educated stones."

The first unit was a power supply. Since all the IC's were RTL, the supply voltage ballpark figure was 4V no-load running down to 3.6V when loaded to about 700 mils. Just a word about the power transistor

in the regulated supply — while I used an available unit on hand, there is nothing magic about the number. Almost any decent

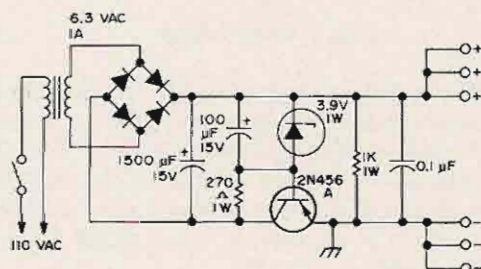

Fig. 1. Power supply for IC demonstration projects.

power transistor will work. By changing the base resistor a bit, up or down, depending on the zener you have on hand, the power supply should present no problem. I used

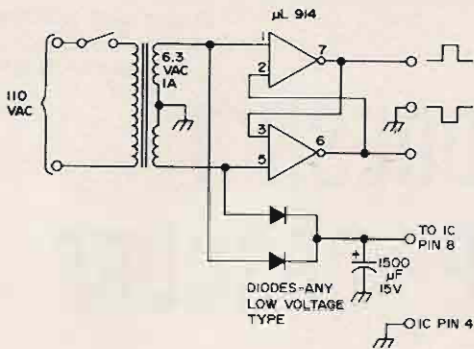

Fig. 2. 60 Hz square waver.

standard 5-way binding posts on all units.

The second unit constructed was the 60 Hz square waver. This essentially is an R-S flip-flop using a dual two-input gate, which is triggered by the 60 Hz from the filament transformer.

This unit was handy as its known frequency square wave was used in demonstrations of methods of frequency counting via oscilloscope patterns when the logic counting board was to be used.

The third unit was a Schmitt trigger

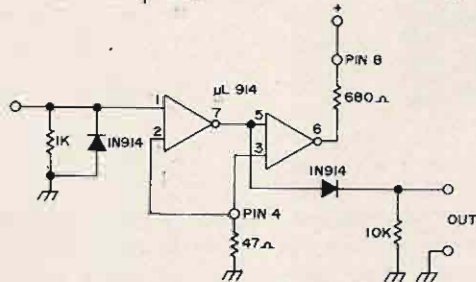

Fig. 3. Schmitt trigger.

which will produce relatively decent square waves from any audio source of 3V or more. It uses another dual two-input gate. Two C cells power this unit. As the current drain is well in excess of what would allow normal shelf-life of the cells, an on-off switch is part of this unit.

The fourth unit was a bounceless pushbutton. This is a device using another dual two-input gate which gives you one – and only one – output pulse when a pushbutton is pushed. I have incorporated two different pulse lengths selected by a toggle switch. The long duration pulse (about one second)

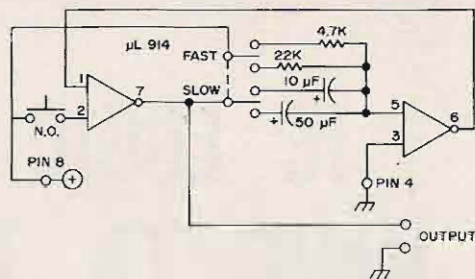

Fig. 4. Bounceless pushbutton.

is very useful as it allows you to put a meter from the output terminal to ground and see very graphically how when the button is pushed, the output voltage drops to ground, stays there for the designated interval and then snaps back to its initial value. The current drain of this unit is very low so no battery switch was incorporated and the two C cells will give long service. All four units described so far were built into small plastic boxes with metal panels, readily available from such outlets as Lafayette or Radio Shack.

The final unit, the logic board, was built on a 10 by 10 in. piece of Masonite. The perf board carrying the semiconductors is mounted underneath this panel. Essentially the logic board consists of four RTL J-K flip-flops. Each output of each flip-flop has a lamp driving transistor to show the state of each output. The NPN lamp drivers can be any small transistor with a gain of fifty or more. The base resistor serves to limit the loading on the flip-flop and also control the current through the lamps so they are not overvolted. The No. 49 pilot lamps were friction-fitted into 3/8 in. holes in the Masonite panel and connection to them made by soldering directly to the base. Note

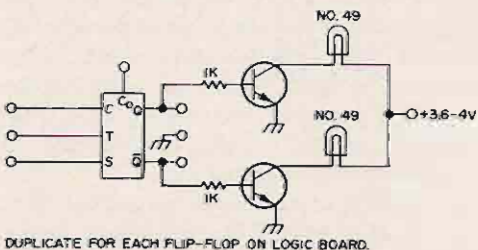
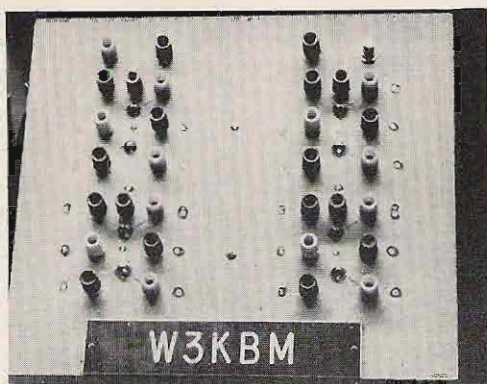

Fig. 5. Sample logic board flip-flop with pilot light display. Author's model included four of these.



Top view of logic board. Reset button at top right.

that each IC has a panel binding post for each input and output for a total of six per IC. In addition a ground binding post is included in each IC binding post cluster.

The only other item on the logic board is a "reset" button. This normally gives a ground when connected to the Preclear inputs. When pushed, however, it gives a momentary connection to Plus which serves to restore the flip-flop to its normal state.

A patch cord system like this is very flexible but demands many connecting cords. I made up multiple connecting cords for the ground system of each IC using spade lugs — three wires in multiple to one spade lug and the other end of each wire having its own spade lug. A similar harness was made up for the "reset" button but this included four wires so all flip-flops could be reset at once if the occasion demanded.

With the simple units described here you can demonstrate binary counting up to number 16 or by alternate connection of the flip-flops, divide by any other number. The bounceless pushbutton is particularly valuable in this use because as you step the counter pulse by pulse, you can make up truth tables based on what the lights show. Naturally if the input is derived from the 60 Hz square waver or the Schmitt trigger, the



Fig. 6. Reset button detail.

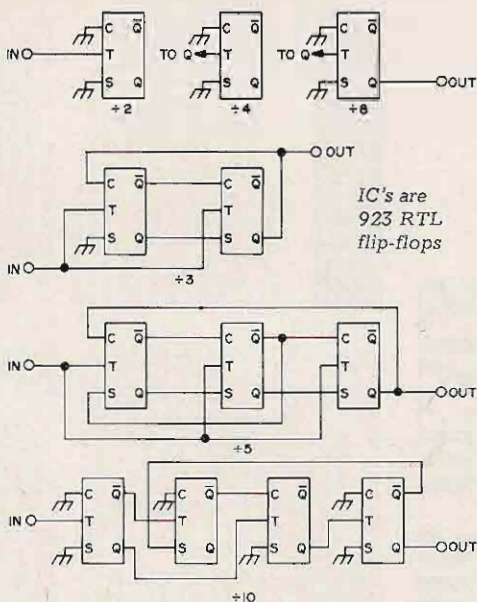
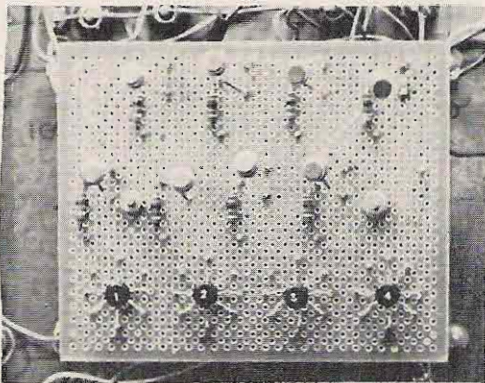

Fig. 7. Logic board sub-assembly

lights in each counting stage will flash at varying rates dependent on the division ratio involved. If the count is much above 140 Hz the bulbs will not blink but will give a steady light due to the persistence of vision and thermal capacity effects of the lamp filaments.



Underside of logic sub-assembly. Black TO-5 cases are RTL flip-flops. Others are lamp drivers.

This little logic demonstrator has really brought the world of IC's alive for my crew. The only tough part is getting the "toy" away from the younger harmonics so it can be used for "serious" teaching.

...W3KBM

# RADIO BOOKSHOP BIG DEALS

## BOOKS!

### ATV EXPERIMENTER \$2.95

Invaluable book if you are interested in amateur television. This book contains reprints of the most important material from the now defunct ATV Bulletin.

### COAX HANDBOOK \$3.00

Invaluable book for the ham or the lab and for everyone else who doesn't want to have to keep a whole library on hand for reference—or even worse have to write to the manufacturer for coax spec.

### Diode Circuits Hdbk \$ .95

There are 115 diode circuits in the handbook, including power supply applications, regulators, ac meter applications, all sorts of receiver detectors (AM-FM-SSB), noise limiters, squelch, AGC, varicap tuning, audio clippers, compressors, FM modulators, RTTY keying, varactor multipliers, field strength meters, wavemeters, noise generators, and many etc. Very enjoyable book. Cheap too.

### VHF ANTENNA HDBK \$2.95

If you are now or ever intend to be active on any of the VHF bands can you really afford not to spend a lousy \$2.95 for a complete and detailed book on VHF antennas? You will find descriptions, dimensions, tuning data, and diagrams of all types of antennas in this book. From an instant coathanger antenna to a giant collinear beam, it is all here. Your antenna is the cheapest amplifier you can build. Get this book.

### 73 Transistor Circuits \$ .95

Audio amplifiers, preamplifiers, clippers, filters, modulators, receiver bfo, AGC, squelch, tuned audio amplifier, crystal filters, super-regen, 2m preamp, 220 MHz preamp, oscillators, variable crystal oscillator, UHF oscillator, 10m transmitter, 6m transmitter, 2m transmitter, signal tracer, 1 kHz and 100 kHz calibrators, sweep frequency generator, sawtooth generator, test equipment of all kinds, stuff. Fun, inexpensive.

### 108 Q's and A's \$1.95

Discussions of transmitting, receiving, antennas, power and audio measurement devices etc. Circuits, gadgets, small construction projects, profusely illustrated. A wealth of interesting information and reading. Cheap, too, considering.

### RADIO HANDBOOK \$7.95

The book has been nationally advertised at \$12.95; however we have a few copies available at this special price as a close-out on the 17th edition. 850 pages of handbook data and construction projects. This is one of the best book bargains you'll find—while it lasts!

### SIMPLIFIED MATH \$ .50

Does math scare you? It shouldn't. This easy-to-understand book explains the simplified exponential system of arithmetic, simple formulas, logarithms, and their application to the ham shack.

### TV INTERFERENCE \$1.50

Why suffer with TVI? It is curable and this newest and most complete book will help you get rid of that pesky misery.

### Transistor Projects \$2.95

Crammed with home construction projects such as a complete communications receiver, a converter converter, CW filter and monitor, 10-15-20m FET converter, 40 & 160m converter, 2-6-10m converter, 30 MHz i-f strip, audio bandpass filter, 6m FETS, audio derived AGC, 432 MHz converter, 2m converter, megaphone, 1296 MHz converter, simple 10m receiver, FET preamps for 144 & 432 MHz, noise clipper, SSB transmitter, 6m station, 6m ultra-midget, 160m transmitter, 432 MHz exciter, varactor tripler for 1296 MHz, FET VFO for 80m, VFO for HF and VHF, VHF parametric amplifiers, diode controlled break-in, slide bias modulator, modulating transistor transmitter, FET audio compressor—plus technical and theory material on designing rf power amplifiers, zenor diodes, integrated circuits, simplified transistor design for the amateur, CW monitor, RTTY indicator, crystal oscillators and more.

## DX STUFF

### WORLD DX MAP \$1.00

This is the same wall-sized DX map that is included with the DX Handbook except it comes to you rolled up instead of folded. This is so you can put it on the wall or have it framed. The map is designed with all country prefixes indicated and space for you to color in the countries as you work them. Visitors can see immediately how much of the world you have contacted! The zones are on the map as well as prefixes. Maybe you need several maps.

### CUSTOMIZED DX BEARING CHART \$4.00

This is not available on the subscription bonus because it is provided purely as a service of 73. An amateur who works for a big computer company has a program which permits him to plug in your location and have it print out the bearings of all of the countries of the world from your shack. Once you have this list you will use it for every DX contact. The chart gives the bearing and distance to all major cities and countries. Be patient when you order for these have to be run through in groups at this low cost to you.

### DX HANDBOOK \$2.95

How to work DX, how to get QSLs country lists, award lists, postage lists, QSL bureaus, maps of the World, North America, Caribbean, South America, Africa, etc. Great circle maps centered on major U.S. cities, bearing charts for beam headings for major cities, how to go on your own DXpedition, and much, much more. This is the biggest selling DX Handbook ever published, written by 73's editor-publisher who has DXed from nearly 100 countries. This book includes a wall sized DX map of the world, itself worth the price of the book.

### U.S. MAPS Four for \$1.00

These wall sized maps show the states and call areas. They are specially designed for coloring to show the progress toward the Worked All States award of ARRL or the Worked Almost All States award put out by 73 (for proof of contact with 49 states). Since you will probably be wanting to work for the award on several bands you will want several maps. They come in groups of four.

## 73 BINDERS

### 73 BINDERS \$4.95

These are not available as a subscription bonus. But you still need them to make your issues of 73 stand up on the shelf. It also helps keep back issues from getting lost or spilt on. Or into the hands of the Jr Op. The binders are a gorgeous red and come with the nicest set of year stickers you've ever seen. Dress up your shack with these binders.

### LAPEL BADGES \$1.00

Name and call identifies you at club meetings, hamfests, busted pot parties. Hand engraved by skilled New Hampshire craftsman with loving care. Only one lousy dollar. Send first name and call.

### Call Letter Desk Plate \$1.95

How about dressing up your operating table with a desk plate showing your first name and call? These embossed desk plates are nice—and inexpensive. No zero available, sorry. There is room for twenty letters and spaces total.

### Sideband Log Book \$2.00

Are you tired of using a log book designed back in the 1920's? Try one of these 1972-type logs designed by W2NSD/1. A pad of 125 log sheets, 8½ x 11, with 20 contacts per page will last you for 2500 contacts. Try this first really modern log sheet.

## FM BOOKS

### Atlas of FM Repeaters \$1.50

Listing, by state and city, of all repeaters, both open and closed, in the world, complete with coverage maps of many of the major repeaters. Maps are included showing the states and counties, with the areas of repeaters indicated.

### FM Repeater Handbook \$6.95

This hardbound book from Howard Sams is not available on the subscription bonus deal. Sorry, because it is one you will want if you intend to set up a repeater.



### Maxi Tool Kit . . . \$14.89 ppd

One of the handiest things a ham can get for a gift is tools—and here is a tool kit that every amateur needs and hardly any has—miniature tools for working on modern solid state equipment. The day of using gas pliers and a wrench to work on radio equipment is over, now you need jeweler's screw drivers and other tiny tools.

The Moody Maxi Tool Kit has everything you need—six screw drivers, going from .025" to .10", in width, two Phillips head drivers (size 0 & 1), and awl, three Allen wrenches (4-6-8), five end wrenches (5/64 to 5/32) and five socket wrenches (5/64 to 5/32), plus the handle for the whole set. The kit comes in a clear plastic case with an individual marked hole for every tool. Once you have this set you will find it in use almost every day—it will be invaluable.

And what a gift the kit makes—a remembrance of you every time it is used.

### FM Rptr. Circ. Manual \$4.95 Hardbound Edition \$6.95

This 300-plus page book has material on basic FM repeaters, national standards for FM repeaters, carrier operated repeaters, tone decoders for repeaters, controlling repeaters with tones, improving repeater intelligibility, minimizing densitization, solving intermodulation problems, digital identification, the WB6BFM identifier, a computer-optimized digital identifier, WAQZHT design data, the Curtis identifier, the K6MVH autopatch, the Zero DKU autopatch, the touchtone autopatch, setting up a mobile station encoders for sub-audible tone burst and whistle-on use, multichannel scanning, RF preamplifiers for repeaters, antennas for 2m FM, collinear gain antenna for repeaters, welding rod ground-plane, high gain mobile antenna, poor man's frequency meter, signal generator circuits.

### Repeater Bulletin \$2.00 yr

Monthly bulletin of news and activities of the New England Repeater Groups. Lots of opinions, controversies, reports, even technical articles and think pieces. This bulletin is available free to all amateurs living in the New England states who are active on 2m FM. Outside of this area the subscription price is \$2 per year. Issue number one was January 1972.

The Bulletin is the place where the mass of FM information is published that doesn't make it into 73 because there just isn't enough room. It runs about 24 pages per month (8½ x 11).

If you are interested in a subscription, send your name, call, address, including zip, a list of the FM equipment you are using, the repeaters you use, and any repeater clubs or other amateur radio clubs that you are a member of.



### Master Tool Kit . . . \$35.00 ppd

Do you like to go first class? Then feast your eyes on the Moody Precision Tool Kit—six sets of miniature tools in a foam plastic travel case. Each set comes in a separate clear plastic case with its handle.

The Phillips driver and Allen wrench set contains Phillips drivers #0 and #1, and Allen type wrenches #4, #6 and #8, with chuck type handle.

The offset open end wrench set contains five wrenches in sizes 5/64", 3/32", 7/64", 1/8", 5/32", with chuck type handle.

The socket wrench set (magnetized) contains hex socket wrench sizes 5/64", 3/32", 7/64", 1/8", and 5/32", with chuck type handle.

The tiny tap set contains tap sizes 0-80, 1-72, 2-56, 3-48, and 4-40, with chuck type handle.

The tap drill set comes with a swivel handle chuck and five drills in sizes 3/64", #53, 50, 47 and 43.

The six tool kits will handle just about anything that you will come up against in working with modern miniature equipment. The drills are terrific for making holes in PC boards—the taps ditto. This tool kit will be within reach wherever you go. On trips it fits into your suitcase. These are not cheap imported tools which break the first time you use them, they are made of the toughest steel and should last a lifetime. Own this beautiful set of precision miniature tools.

### 73 Back Issues Vol. 1 \$3.95

This is an assortment of twelve different back issues of 73 from the years 1960 through 1964. Normally these back issues would cost you \$1.00 or more each, but since this assortment is our choice instead of yours, thus the bargain. Here is a good way to build up your technical library with hundreds of interesting and valuable technical articles and construction projects. You may have missed these great issues when they originally came out, but don't miss the fun of reading them now! The emphasis on articles with no operating news or monthly columns means that little of the material is dated.

### 73 Back Issues Vol. 2 \$3.95

Twelve different back issues of 73 from the years 1965 through 1967. These are the real vintage years of 73 for home builders of transistorized gear. Lots of VHF projects and gadgets galore. See for yourself what 73 was doing back when QST was still bringing you only tubes. At this price you get our choice of back issues. This is an excellent way to fill in missing back issues, if you like to gamble.

### 73 Back Issues Vol. 3 \$3.95

Twelve different back issues of 73 from the years 1968 to 1970. These bundles are already made up so you have to accept our choice at this price. Individual issues for most months are still available for \$1.00 each for these years.

### BUMPER STICKERS 4/\$1.00

Stick these bright stickers on your car bumper or window to let passing FMers know what channel you are monitoring. Available in any combination of the following channels: 70, 73, 76, 82, 85, 88, 91 and 94.

## CLOSE OUT

We have only a limited number of the following items. Hurry and order yours before they're all gone.

### CLOSE OUT

3 Pair: Walkie-Talkie TR 3 Elco — per pair: \$10.00  
8 Travel Clock Radio Model 8NC-115 \$10.00  
30 13" Globes \$10.00  
8 18" Globes \$17.50  
14 Classics Ed. Atlases \$10.00  
3 Imperial Edition \$5.00  
18, 10 Transistor AM-FM-AFC -AC Model 10FD-212 Digital Timer: Clock Radio \$19.00  
4 North American Solid State AM Clock Radio/Lamp Model No. LC9898 \$15.00  
13 K-12 Prep Slide Rules \$3.00  
2 Pololoroid Swingers \$17.50

### IC PROJECTS \$3.95

IC Projects for Amateur & Experimenter is an anthology of IC construction projects taken from 73 Magazine. Edited by Wayne Green, it's a must for any ham library.

### SOLID STATE PROJECTS

\$3.95

Solid State Projects for the Experimenter contains over 60 projects taken from the pages of 73 Magazine. Build a Six-Meter FET Converter, Or, maybe a ham TV receiver. It's all here.

### FASCINATING WORLD OF RADIO COMMUNICATIONS

\$3.95

The Fascinating World of Radio Communications is an introduction to radio communication. This book gives you some of the history of radio communication and an idea of what you can expect from your new hobby.

# PROTECT THOSE DIODES

In designing the high voltage supply for high power equipment, many amateurs are turning to silicon diodes, and rightly so, because of their low internal voltage drop, filamentless operation, and reliability. Reliability, that is, if their maximum ratings are not exceeded. In order to rectify a high ac voltage, it is often necessary to use several diodes in series. However, a problem rears its three ugly heads in the form of Peak Inverse Voltage, creating headaches both in the cranium and billfold departments.



Fig. 1. Standard bridge rectifier using series silicon diodes.

Take Fig. 1, a typical bridge rectified unit. As the primary of the transformer is opened and closed, a high voltage transient appears across the secondary due to a change in core flux. The transient may exceed the PIV rating of the diodes, causing one or more to 'Go West,' and taking the rest of the string along because of a high distributed inverse voltage across them.

The second ugly head is the different characteristics of diodes of the same style. Their maximum PIV may be close, but not the same. These differences may cause the designed PIV to exceed the actual diode PIV rating. The result — abject failure.

The third ugly head arises in the multiple series diode rectifier legs. As the state of the diodes changes from non-conducting to conducting, an indefinite period of time (charge recovery time) occurs. If one diode

in the string has a longer recovery time than the rest, it forces the other diodes to carry the extra PIV load until the diode recovers. This additional distributed voltage may be enough to cause one or more diodes to fail, again taking the entire string with it.

As in Fig. 2, the problems can be solved. The transient across the secondary can be eliminated by placing C1, a .005 mF disc, across the entire winding. The capacitor presents a low impedance to the transient, shunting it around the rectifier stack. The voltage rating of C1 should be greater than the peak secondary voltage. (A 5 kV unit will do for a 2000V secondary.) The extra distributed PIV is also easily eliminated. All that is necessary is to distribute the inverse voltage drop across *each* diode by shunting each diode with a .002 mF disc (1200V rating in this case). During the recovery time, capacitors C2—C13 present a low impedance shunt for the inverse voltage around the rectifiers. They also compensate for the different characteristics of the diodes.

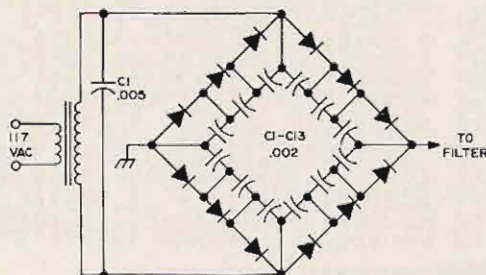

Fig. 2. Capacitor protection from transients across series diodes.

Try these hints and see if they relieve the headaches (especially those in the wallet) and improve the reliability of your operation.

...WA4CMQ



# SOLID-STATE OVERLOAD PROTECTION

**T**here are two basic reasons for overload protection in your transmitter or linear. The first is a desire to protect the final tubes from the ravages of excess current. The second and equally important reason is to protect the power supply. While the transformer is often overlooked, it too requires care if it is to survive. In commercial and homebrew equipment careful calculations have been made to extract the last possible watt from a given transformer, the duty cycle has been figured to a fraction of a percent, and if ratings are exceeded there may well be dire consequences in the form of overheating and eventual failure.

Overload protection may be gained in any of several ways. The most common and least expensive over the short haul is a common fuse in the primary and/or secondary of the high voltage transformer. If a high current fuse is used, protection is sacrificed while a fuse near the normal current consumption of the equipment will give rise to frequent fuse changes due to the peaks found in all sideband equipment. Another common form of overload protection is a relay in series with the plate circuit. Excess current will pull the relay in, after which time a holding contact on the same relay will keep the contacts open until reset. The major drawbacks of this system are the lack of precise and lasting adjustment and the usual buzzing of the relay as pull-in current is approached. Presented here is another method which is silent, fully adjustable, reliable, and best of all, inexpensive.

A low value resistor (R1) has been inserted in the negative lead of the power supply. All current flowing from the supply must flow through this resistor and as it does it creates a voltage which is a reflection of the current flow. In parallel with this resistor is a potentiometer (R2) which allows the selection of any desired percentage of the voltage so developed. The slider of the pot is connected to a zener diode (D1) which blocks the flow of current until the applied voltage exceeds the zener point of the diode. The instant the zener voltage is exceeded, current flows through limiting resistor (R3) and the gate circuit of the SCR. The current flow locks the SCR into conduction, a condition which will remain until the anode/cathode circuit is broken or the supply voltage is removed. The overload relay coil is wired in parallel with the SCR. When the SCR conducts, the coil is effectively shorted and its contacts open. This in turn opens the coil circuit of the high voltage control relay and turns off the high voltage.

The high voltage on/off switch wiring is reduced to a single low voltage wire running from the power supply to a convenient location on the main chassis. The same line is also used for reset purposes, thus eliminating complicated switching and cabling. The reset function consists of turning off the high voltage switch momentarily. This removes the voltage from the SCR and allows the overload relay to operate when voltage is again applied. Both pull-in and reset are accomplished in a matter of microseconds. If the condition

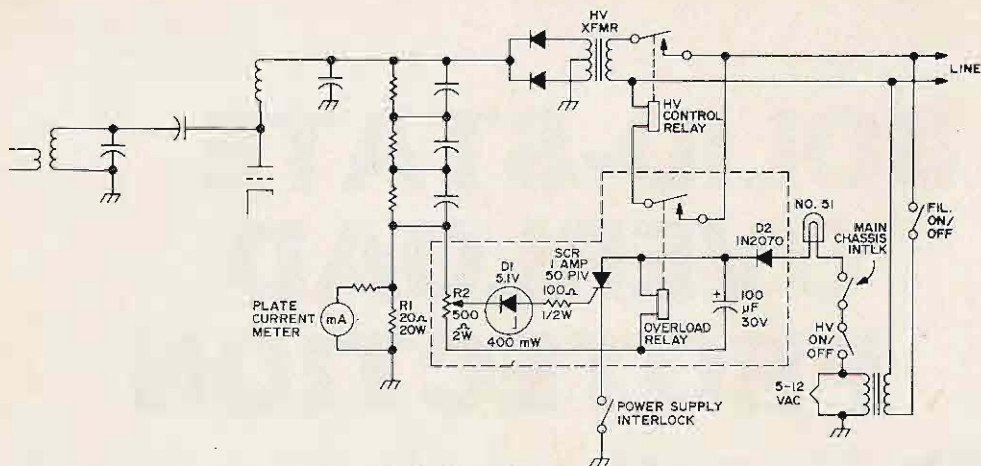

Fig. 1. Typical installation.

originally causing the high current remains, it will be impossible to reset the overload, or rather it will reset only long enough for the SCR to conduct again. The circuitry is also such that it is impossible to apply high voltage without the filaments/heaters having been turned on first. Interlock switches are provided for both the power supply and main chassis. It will be noted that these are required to carry only low dc voltage.

As yet nothing has been said about the pilot lamp in series with the control voltage. This bulb serves several purposes — the first is to limit the current drawn from the control voltage source. The source is effectively shorted in the “tripped” condition without it. The second function is to indicate the presence of power to the high voltage control circuit by a dim glow and of a “tripped” condition by lighting to full brilliance.

The relay used here was intended for 12V dc service. It will, however, actuate at around 5V allowing completely normal operation with heater supplies of 5 to 12 ac volts. This relay is similar to those found in Radiosondes and several types of surplus. The original was purchased for \$1.50 from a local surplus house. The exact nature of the relay is not critical.

In equipment having one side of the filament of heating winding grounded, that source may be used for the control voltage. When the winding is above ground a small filament transformer must be added for this purpose.

The circuit as described is capable of adjustment from 150 mA to well over one ampere. Increased sensitivity may be accomplished by installing a lower voltage zener diode or the current sensing resistor may be increased in value.

The parts are inexpensive, readily available, and not at all critical. The original cost \$3.18. It was mounted on a PC board measuring 2 x 2½ in. This is definitely not a requirement, and in fact is not even desirable in view of the extreme simplicity of the circuit and the “one of a kind” nature of the project.

Calibration is very straightforward. First disconnect the high voltage transformer primary from the power line as a safety measure. A source of low voltage dc (battery charger or bench supply) is connected in series with the current sensing resistor and an ammeter. Adjust the current to the desired trip point by adjusting the applied voltage or the resistance in series with the circuit. Advance the sensitivity control slowly until the overload relay drops out. Decrease the current to slightly below the trip point and reset the overload. Again increase the current to verify the setting and make any necessary final adjustment. Remove the test setup and reconnect the power transformer.

If a low voltage relay with larger contacts were available it would be possible to use the overload relay to directly control the transformer primary... for financial reasons this was not done. . . .WAØABI

You may need the new T-UG8 desk stand or one of these STAND ADAPTOR KITS to convert to the new transistorized CB and ham outfits...but

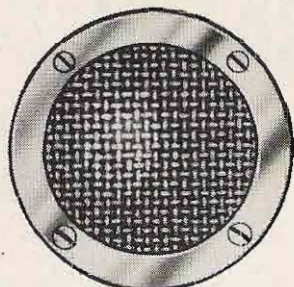
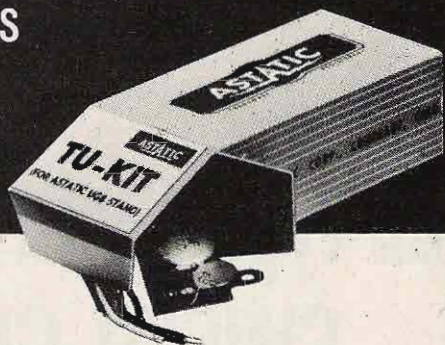

## THE D-104 MIKE STILL REIGNS SUPREME

When you convert your Astatic G Grip-to-talk Stand with a TG Adaptor Kit, or UG8 Stand with TU Kit, you obtain impedance match and gain control. A complete, new T-UG8 Stand does the same thing for you. Without buying a new mike, you still have the finest that money can buy.

- Kits and T-UG8 Stand provide sufficient level to fully modulate transmitters with any Astatic "Plug-in" Mike.
- Volume control under base adjusts with screw driver to prevent over-modulation from absent-minded fiddling or tampering, after you find the sweet spot.
- Rugged Silicon type transistors in a printed circuit.
- Noise-free, click-free switching with silver contacts which do not need cleaning.
- Internal slide switch for choice of relay or electronic type control (Available in T-UG8 Stand only).
- Powered by internal, 9-volt, readily available battery.

NOW AVAILABLE  
AT YOUR DISTRIBUTOR  
OR WRITE FOR FULL DETAILS.



**THE ASTATIC CORPORATION**

Conneaut, Ohio 44030 U. S. A.

In Canada: Canadian Astatic Ltd.,  
Scarborough, Metro Toronto, Ontario



# Lab type IF/RF SWEEP GENERATOR using IC'S

**J**ust about every kit-type sweep generator on the market starts life out at around 3 or 4 MHz and ends up at 200 MHz or so. This always made analysis or display of 456 kHz i-f amplifier response characteristics a tedious step-by-step plotting procedure or required time out to rig up a temporary gimmick to do the job. No more. The sweep generator to be described here will do the job with ease and precision. Even if you do not intend to duplicate the instrument, you may find parts of it useful for other applications.

The generator covers a frequency range of from 400 kHz to 30 MHz in five bands. It can be operated in the CW mode as well as swept, thus allowing it to be used as an ordinary signal generator. Maximum output is 350 mV p-p across 50Ω. When sweeping, the return trace may be blanked or not, as desired. Two calibrated dials are provided for setting the start and stop frequencies and the maximum sweep width would be the entire band in use. The frequencies covered by the five bands are: 400 to 900 kHz, 850 kHz to 2.3 MHz, 2 to 6 MHz, 5 to 15 MHz, and 10 to 30 MHz. Sweep time is variable between 20 ms and 6 seconds per sweep. A step attenuator in conjunction with a vernier

control provide a maximum attenuation of the output of 120 dB. An input is provided for a post-injection marker system built into the unit. A synchronous ramp with gain control is provided for driving the oscilloscope horizontal sweep. Blanking pulses are also brought out to a connector in case they are needed for synchronizing external equipment.

## A New IC

The heart of the generator is a new Motorola IC, the MC1648 emitter-coupled oscillator. It was intended for use in phase-locked loop systems operating in excess of 150 MHz, but may be used in many other applications such as this one. The device provides output of high spectral purity and incorporates an internal age system which simplifies design of the sweep generator by eliminating the need for external leveling. A buffer amplifier and emitter-follower output are also incorporated on the chip, eliminating the need for external amplifiers. Figure 1 is a schematic of the MC1648 IC. Figure 2 illustrates two methods for tuning the oscillator. The device is packaged in a 14-pin DIP and requires a 5V dc supply. Since it was

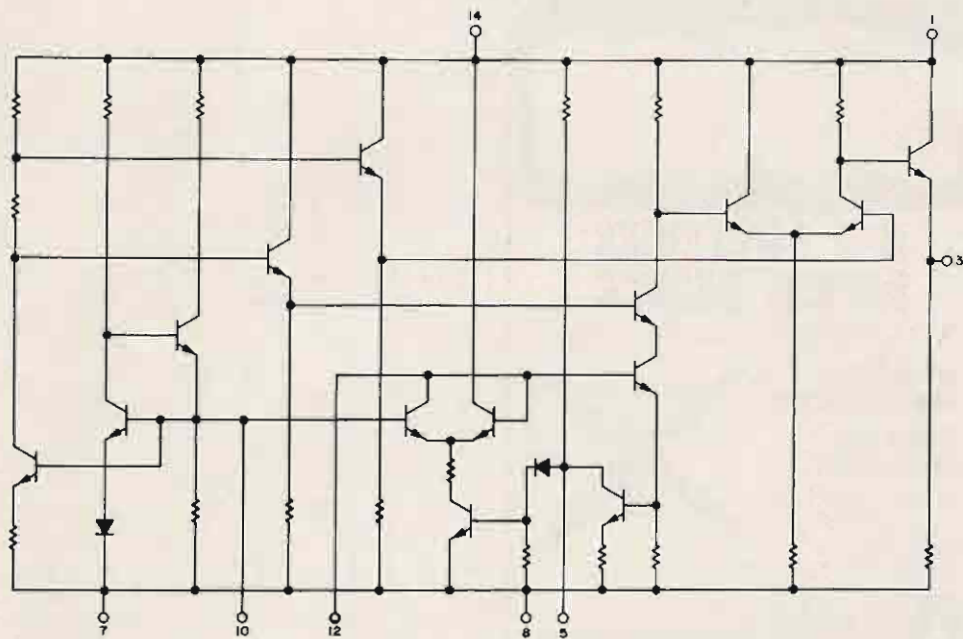

Fig. 1. Schematic of the MC1648 IC.

intended to be used with Motorola MECL III logic, either polarity is permissible. A positive supply is used here, connected to pins 1 and 14 with 7 and 8 grounded.

All the information covered by the data sheet for the MC1648 dealt with operation from 10 MHz up to about 180 MHz. Since I was interested in going as low as 400 kHz, I had to do some experimenting with tank circuits. My best results were obtained with the use of cup cores for the two lowest bands. I also found that ordinary molded iron core rf chokes of the miniature variety did an excellent job the rest of the way. Use of these tiny components made possible a very compact 5-band assembly.

### The VCO

In order to facilitate shielding and simplify construction, electronic band switching is employed. Figure 3 is the schematic for the rf portion of the generator. The 2N4391 J-FET has a low 'on' resistance and works very well as a switch. One of these transistors is placed in series with each tank circuit

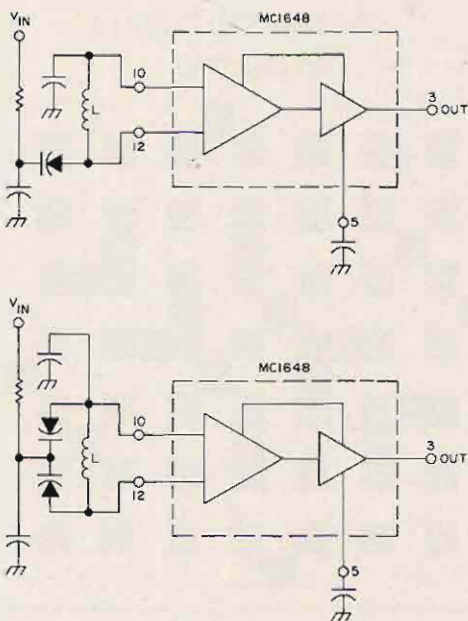

Fig. 2. Tuning the MC1648 with a single diode (A) and using back-to-back diodes (B).

# New BATTERIES for C.B. PEOPLE

FITS MIDLAND, STANDARD, etc., etc.

**NO LOOSE  
CONNECTIONS**

**COMPACT  
RELIABILITY**

ALL BATTERIES ARE  
RESISTANT WELDED

AVAILABLE IN  
NI-CAD, MERCURY OR ALKALINE



Write—Wire—or Phone

**ALEXANDER manufacturing co.**

BOX 1645 Mason City, Iowa 50401

Phone (515) 423-8963

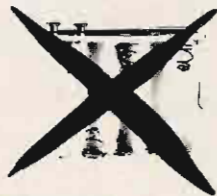

Answer to  
CROSSWORD PUZZLE  
on page 245

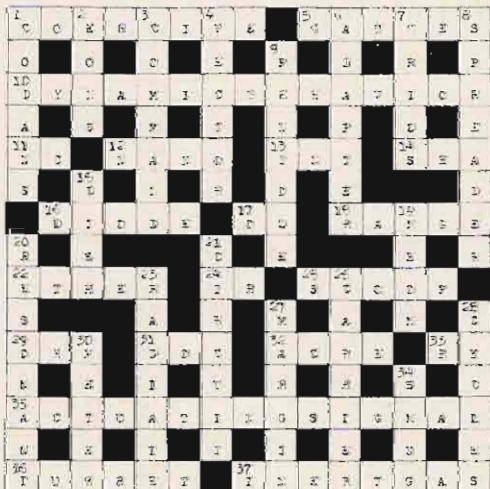

**PLEASE INCLUDE YOUR ZIP CODE  
WHEN YOU WRITE 73.**

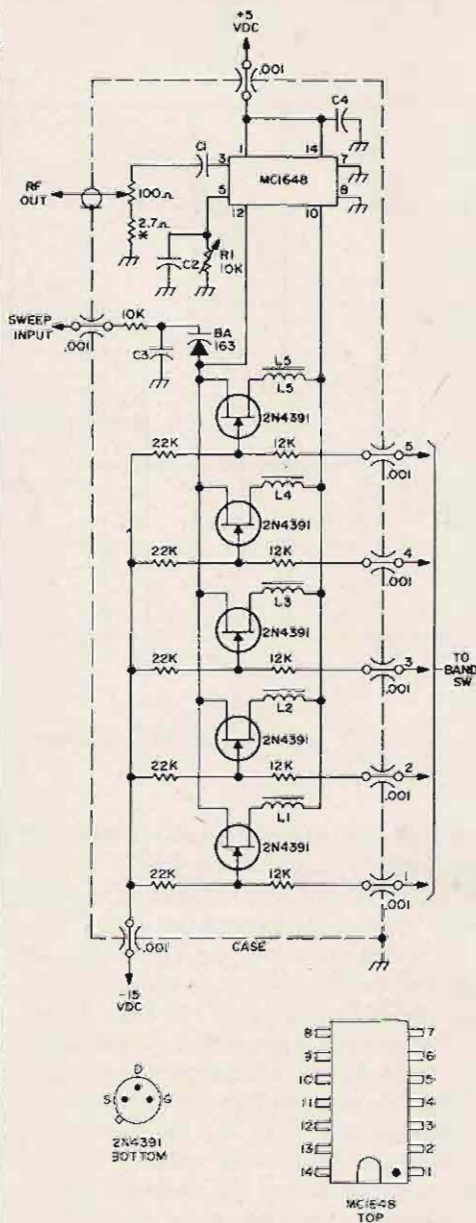

- ALL RESISTORS—1/4W, 5%
- L1—28 TURNS NO. 30 AWG ENAMEL
- L2—12 TURNS NO. 28 AWG ENAMEL
- (L1 & L2 MOUNTED IN CUP CORE—See Text)
- L3—16 μH MINIATURE MOLDED RFC.
- L4—4.7 μH MINIATURE MOLDED RFC.
- L5—1.1 μH MINIATURE MOLDED RFC.
- C1, C2—TYPE 150D TANTALUM—2.2 μF/20V.
- R1—BECKMAN B9PR10K 15-T TRIMMER.

\*—SELECTED PART—See Text.

Fig. 3. Schematic of the rf assembly using dc band switching.

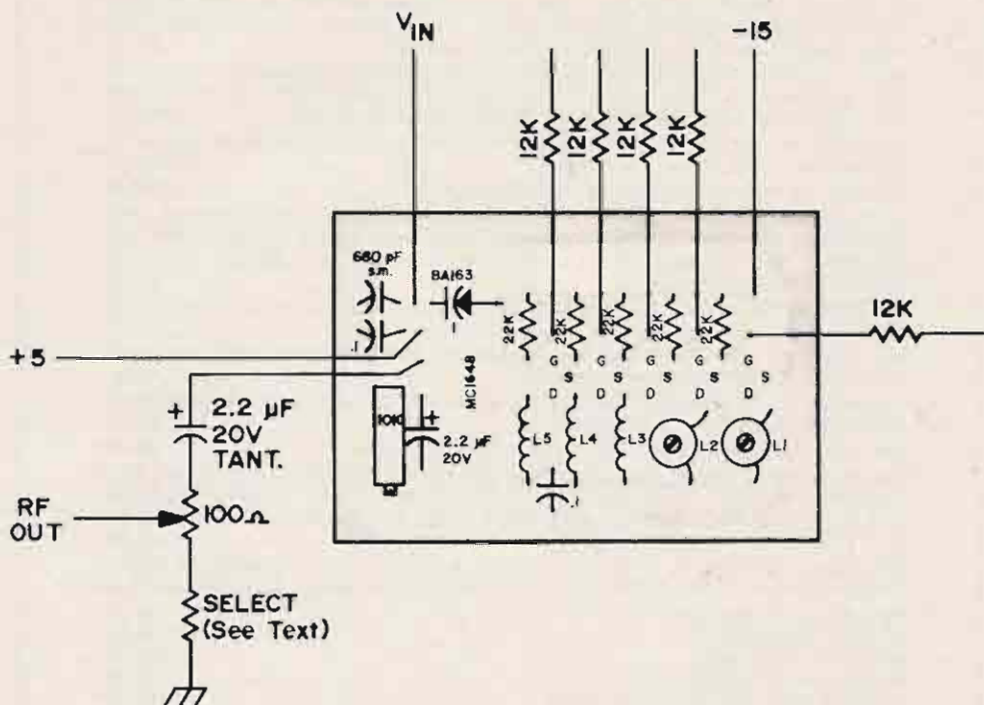
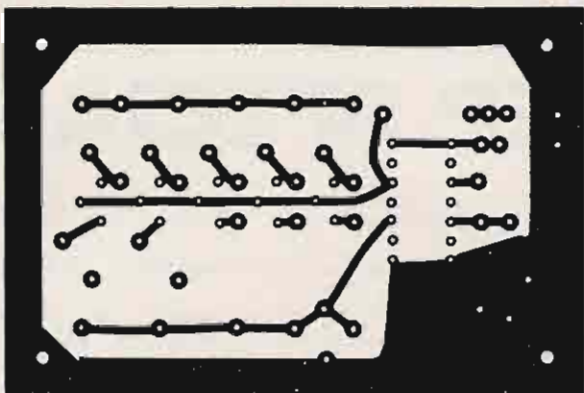
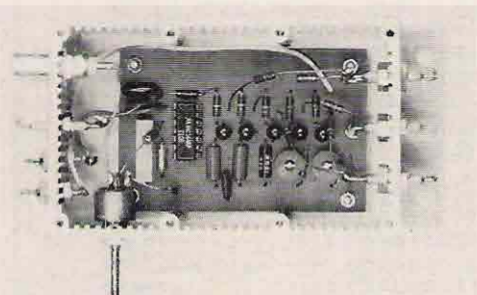

Fig. 4. (A) Foil side of rf pc board. (B) Location of parts on component side.



Completed rf assembly ready for mounting in the cabinet. A plastic version of the 2N4391 was used with a considerable savings in parts cost.

and can be turned on by application of a positive voltage at the gate. This allows the use of a strictly dc-operated remote switching arrangement. The entire assembly is built on a 2 x 3 in. pc board and mounted in a Pomona Model 3306 enclosure with a Model 3328 bottom mounting plate.

A BA163 tuning diode by ITT is used to sweep the oscillator. Although it is intended for bc band use, it performs admirably at these higher frequencies and its high capacitance ratio allows wide sweep excursions. If

# SLEP SPECIALS

R-390A/URR, THE CADILLAC OF ALL RECEIVERS TUNES 500KHZ THRU 30.5 DIGITAL TUNING AM/CW/FSK/SSB. 115V/60HZ 19" RACK MOUNT. TRADES TAKEN .....	\$750.00
HAMMARLUND SP-600JX, TUNES 540KHZ THRU 54MHZ IN 6 BANDS 19" RACK MOUNT .....	265.00
AN/URR-13 RECEIVERS, TUNEABLE UHF 225-400MHZ, USED TO MONITOR MILITARY AND ASTRONAUT FREQUENCIES, AM/CW,115V/60HZ .....	85.00
BENDIX RA-10 RADIO COMPASS RECEIVER, RECEPTION AM,CW, MCW, AND VOICE, FREQ RANGE 100 TO 1750KHZ IN 4 BANDS .....	9.95
BC-348, A GREAT RECEIVER FOR AM/CW AND MARINE VLF/HF WORK, UNMODIFIED ORIGINAL 28VP/S, EASY TO CONVERT FOR 12VDC OR 115V/60HZ, TUNES 200-500KHZ and 1.5 TO 18MHZ .....	65.00
COLLINS KW-1 TRANSMITTER. THIS IS THE ONE YOU DREAMED ABOUT IN THE AM DAYS. A FULL 1000 WATTS AM/CW/FSK. NOW POPULAR WITH THE CW, RTTY AND 10 METER AM AMATEURS. TRADES TAKEN .....	850.00
COLLINS 51J-4 RECEIVER, 550KHZ THRU 30MHZ, SUPPLIED WITH 3 and 6KC MECHANICAL FILTERS, 115V/60HZ .....	550.00
HP-430C RF POWER METER, 19" RACK MOUNT .....	39.00
COLLINS CU-351 ANTENNA COUPLER, SAME AS 180L-3, TUNE 2-30MHZ, HAS VACUUM VARIABLE RATED 5000VDC, METERED, USED BY MILITARY AS ANTENNA MATCH-BOX. SMALL IN SIZE, WEIGHT 28 LBS. IN COLLINS CATALOG FOR \$1800.00 .....	29.50
RT-67/GRC FM ARMY JEEP TRANSCEIVER TUNEABLE 27.0 TO 38.9MHZ 16 WATTS .....	32.50
R-278/GRC-27 RECEIVER 225 TO 400MHZ 10 PRE-SET CHANNELS AM, 1750 SELECTED CHANNELS, 115V/220VAC .....	49.50
T-217/GRC-27 TRANSMITTER 225 TO 400MHZ 100 WATTS, 1750 SELECTED CHANNELS AM/MCW 115/220VAC .....	49.50
MD-129/GRC-27 MODULATOR, GOES WITH T-217/GRC-27 .....	39.50
TV-2/U TUBE TESTER, MUTUAL CONDUCTANCE CHECKS OLD AND LATE TYPE RECEIVERS, TRANSMITTER AND SUB-MIN TYPE. COMPLETE WITH ROLL CHART AND BOOK. LATE VIET NAM VINTAGE, THE BEST, COST GOVT. \$960.00 .....	65.00
HP-524C FREQUENCY COUNTER, BASE FREQ 10HZ TO 10MHZ, 8 DIGIT NIXIE READ-OUT, 525 SERIES PLUG-INS EXTENDS RANGE TO 510MHZ 375.00	
HP-525A 10-100MHZ .....	69.50
HP-525B 100-200MHZ .....	85.00
HP-525C 100-510MHZ .....	195.00
HP-526A VIDEO AMPLIFIER .....	85.00
HP-526B TIME INTERVAL PLUG-IN .....	85.00
TS-413/U SIGNAL GENERATOR 75KHZ TO 40MHZ IN 6 BANDS, PRECISE CALIBRATION FROM LMHZ CRYSTAL OSCILLATOR, HAS % MODULATION METER CW, OR AM 400/1000CPS VARIABLE 0-50% AND RF LEVEL METER 0-1.0V. IDEAL FOR AMATEUR, MARINE, AIRCRAFT and HOBBYIST FOR IF AND RECEIVER-TRANSMITTER ALIGNMENT OR DEVELOPMENT WORK 89.50	
SG-66A/ARM-5 OMNI SIGNAL GENERATOR, MILITARY VERSION OF ARC H-14. FAA APPROVED FOR AIRCRAFT RADIO SHOPS .....	550.00
TS-382/U AUDIO OSCILLATOR, 0-200KHZ WITH 60 AND 400 CYCLE REED FREQUENCY METER CHECKPOINT. A FINE LAB INSTRUMENT .....	79.50
SG-299D/U SQUARE WAVE GENERATOR, A WIDE RANGE 1HZ TO 1MHZ CONTINUOUS COVERAGE, USE WITH ANY OSCILLOSCOPE TO DETERMINE FREQUENCY RESPONSE AND PHASE SHIFT CHARACTERISTICS OF VIDEO AND AUDIO AMPLIFIERS, MILITARY VERSION OF HP-211A .....	39.50
BALLANTINE 300AC VTVM, 10HZ TO 15KHZ RANGE, 1MV TO 100VOLTS IN 5 RANGES, LOGARITHMIC SCALE 1-10DB ACCURACY 2% .....	29.50
TS-505D/U VTVM 0-250VAC, 0-1000VDC, 0-1000M OHM RESISTANCE MEASUREMENTS, AC FREQUENCY RESPONSE 30HZ-500MHZ, HIGH INPUT IMPEDANCE, PORTABLE RUGGEDIZED CONSTRUCTION COMPLETE WITH PROBE .....	\$45.00



# SLEP SPECIALS

SG-55/URM-34 SIGNAL GENERATOR 1.8 THRU 4.6 KMHZ CW/PM USED TO CHECK BAND RADAR RECEIVERS, ANTENNA TRANSMISSION LINES AND INDICATORS .....	37.50
CV-89/URA-8 AUDIO TYPE RTTY CONVERTER. A POPULAR UNIT WITH BUILT-IN SCOPE, WORKS WITH ANY TELETYPE MACHINE .....	125.00
COLLINS R-540/ARN-14C OMNI RECEIVER 108.1 TO 135.9MHZ. MILITARY VERSION OF THE COLLINS 51R-3 .....	32.50
COLLINS RT-178/ARC-27 UHF TRANSCEIVER 225 THRU 400MHZ .....	65.00
R-109/GRC FM RECEIVER, 27 TO 38.9MHZ .....	21.50
BIRD 82A RF DUMMY LOAD, 500 WATTS, 50 OHMS .....	85.00
GR 1605A IMPEDANCE COMPARATOR. A FINE INSTRUMENT FOR ANY LABORATORY OR SHOP .....	45.00
WATTMETER MILITARY DA-72, METER READS 0-400 WATTS 52 OHM, 2 TO 500MHZ. OUR 200 SETS WILL GO FAST AT THIS LOW PRICE .....	19.50
WESTERN ELECTRIC A2A VIDEO TRANSMISSION SYSTEM. PERMITS THE TRANSMISSION OF VIDEO OR DATA SIGNALS IN THE RANGE OF 30CPS TO 4.5MHZ OVER A BALANCED WIDEBAND CABLE. MAXIMUM LINE LENGTH 4.5 MILES (84DB) WITHOUT REPEATERS .....	175.00
CV-431A/AR TRANSVERTER, CONVERTS ARC R-19, R-15 VHF RECEIVERS TO 220MHZ. SEE JUNE '64 ISSUE 73 MAGAZINE .....	18.50
URC-11 HANDIE TALKIE TRANSCEIVER, NOW CRYSTAL CONTROLLED ON 243MHZ. IDEAL FOR AIRCRAFT, MARINE OR 220MHZ CONVERSION. SEE MAY '69 CQ .....	14.50
ARN-30: 108-135MHZ TUNEABLE RECEIVER. LATE VHF VERSION OF THE FAMOUS COMMAND RECEIVER, IDEAL FOR AIRPORT/AIRCRAFT LISTENING OR CONVERT TO 2 METERS .....	16.50
PRC-6 WALKIE-TALKIE, 47 TO 56MHZ FM COMPLETE WITH ANTENNA, LESS BATTERY .....	32.50
OSCILLOSCOPE OS-8/U, PORTABLE 20"l x 14 3/4"H x 11"W, 3" CRT PLUS 10 OTHER TUBES, VERTICAL FREQUENCY RANGE 0 TO 2MHZ, ACCURACY 3% 115V/60HZ .....	49.50
AN/URM-25 RF SIGNAL GENERATOR 10KHZ THRU 50MHZ IN 9 BANDS, INTERNAL MODULATION 0-50%, 100-15,000CY OUTPUT VOLTAGE 0.1MV - 0.1 VOLT 50 OHM LOAD, AM/CW ACCURACY .5%, 12 POSITION ATTENUATION SELECTOR. IN GREY CABINET LESS FRONT CASE COVER ....	185.00

## TECHNICAL MANUALS AND SCHEMATICS:

WE HAVE A LARGE STOCK OF MILITARY, ELECTRONIC AND TEST EQUIPMENT MANUALS, AND SCHEMATICS ON EQUIPMENT THAT MANUALS ARE NO LONGER AVAILABLE. NO LISTS, SO PLEASE SEND US YOUR NEEDS FOR QUOTATION.

NEW BOXED FACTORY FRESH CETRON 572B TUBES. ORDER NOW FOR THAT LINEAR \$16.50. ALSO IN STOCK EIMAC TUBES AND SOCKETS FOR FAST OFF THE AIR DELIVERY.

ALL EQUIPMENT EXCELLENT CONDITION, F.O.B. ELLENTON, FLORIDA, SATISFACTION GUARANTEED OR MONEY REFUNDED. IMMEDIATE SHIPMENT.

WRITE - PHONE (813) 722-1843

SLEP ELECTRONICS COMPANY  
2412 HIGHWAY 301 NORTH  
ELLENTON, FLORIDA 33532

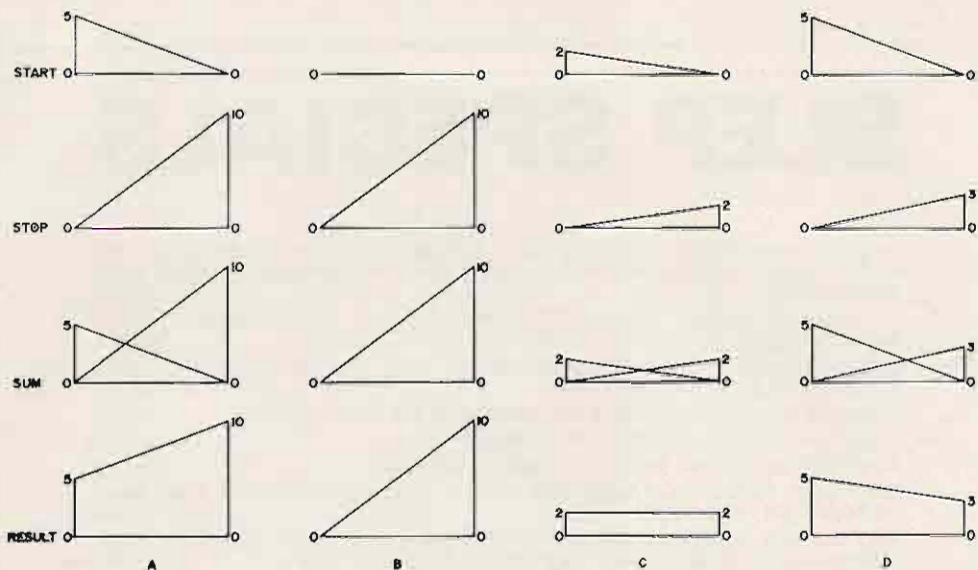

Fig. 5. Pictorial demonstration of ramp generation.

you are planning to use this oscillator for VHF applications, a more suitable diode would be in order. According to the data sheet on the MC1648, typical maximum output frequency is 225 MHz.

The vernier attenuator is a 100 $\Omega$  RV6 style potentiometer mounted inside the enclosure. A coupling and extension shaft are used to bring the control out to the front panel. The value of the resistor at the bottom end of the pot will have to be selected so that a range of 20 dB is provided with full swing of the control. Since end resistance varies from one control to another, an exact value will have to be arrived at experimentally.

The output from the VCO is a square wave. If sine wave output is desired, the agc characteristic may be modified by introducing resistance between pin 5 and ground. The small trimmer incorporated on the board is used for this purpose. It was my experience, however, that this may introduce instability with some MC1648s. Although the trimmer was left in, the one in my unit is turned to maximum resistance where it has no effect and left there. It would do no harm to leave it out altogether since no other changes would be needed.

If any readers are contemplating exact duplication of this generator, you will find the cup cores I used are no longer available. These were Ferroxcube part number 332P133B4-3C and are obsolete. I had a large number of these on hand left over from another project and saw no sense in buying more. I am sure some of the presently available cup cores will make excellent substitutes. Those used here are about 3/8 in. in diameter and are ungapped. You may have to experiment with the number of turns in the coil to obtain the coverage you require. One handy trick you can pull with a cup core is to rotate the slots in each half so that fractional turns are produced when the coil wires are brought out separately through the two spaced holes. Exerting pressure on the core by means of the mounting screw will also shift the frequency and is almost like having a slug to tune. Increasing pressure seems to raise the frequency. The rf chokes used for the higher bands may also vary slightly from piece to piece and several may have to be tried to get the desired coverage. There isn't much we can do to alter the frequency where the chokes are used. Of course, slug-tuned coils may be used if the pc layout is modified. I do not recommend

their use on the two lowest bands, however, since my results were rather unsatisfactory with this sort of tank circuit.

One final point would be in order before leaving the VCO. Note that the 10 K $\Omega$  resistor going to the tuning diode, the 2.2  $\mu$ F rf output capacitor and each of the 12 K $\Omega$  resistors going to the transistor gates are not mounted on the board. One end of each has a hole provided on the board and then the component itself is used to make the connection to its final destination. This saves board space and eliminates separate wires. The small resistor at the bottom of the vernier attenuator is similarly mounted between the board and the bottom lug on the control. These points are more clearly seen in the photo. Also note that the cup cores are fastened directly to the board by means of 1-72 screws into threaded holes.

### The Ramp Generator

In contrast with kit-type sweep generators that use the 60 Hz line for sweeping the oscillator, laboratory instruments have in-

ternal circuitry designed for this purpose. In our case, as with most sweep generators, a voltage ramp is used to control the oscillator during the sweep period. The circuitry has been arranged so that we can adjust the starting point (dc level) of the ramp independently of the stopping point. This simply means that we can set the frequency at which the sweep starts as well as the frequency at which it stops. We can also control, over a fairly wide range, the time it takes for a complete sweep. In this case, the sweep time is continuously adjustable between 20 ms and 6 seconds per sweep.

To get a better idea of how the ramp generator produces the results we've described above, let's look at Fig. 4. Note that a negative-going linear ramp (start) is combined with a positive-going linear ramp (stop) to produce the resultant ramp being applied to the varactor diode. If either input ramp is zero, the resultant will be the same as the single ramp since adding zero to anything will not change its value. Naturally, if both are zero, the output will be zero and

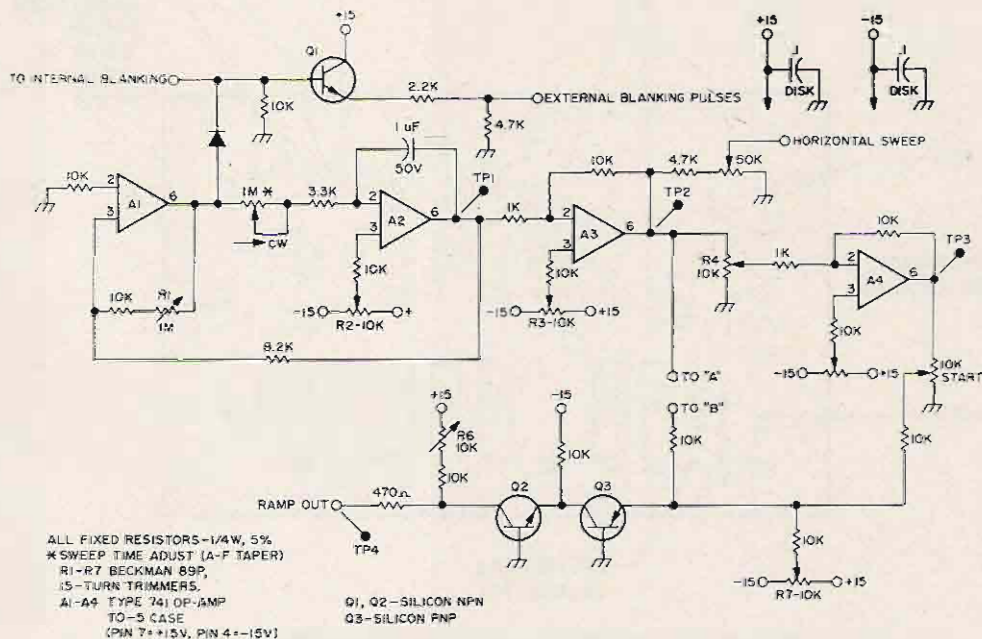

741 BOTTOM

NOTE: CUT OFF PINS 1, 5 & 8.

Fig. 6. Schematic of the ramp generator circuit.

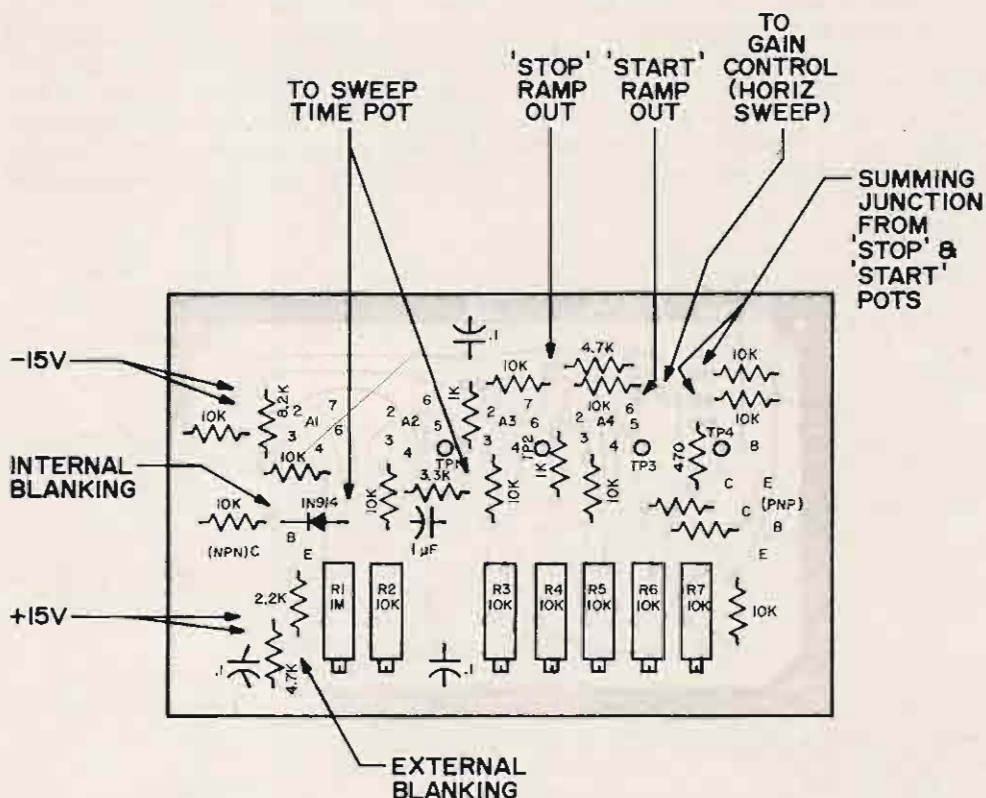
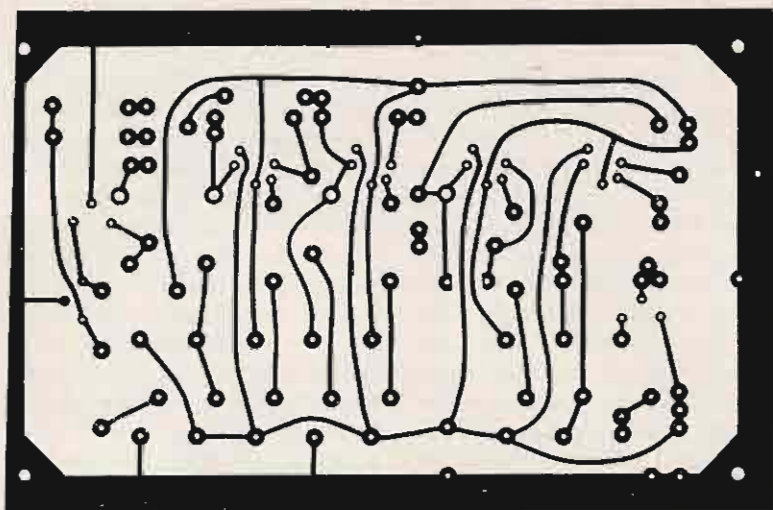
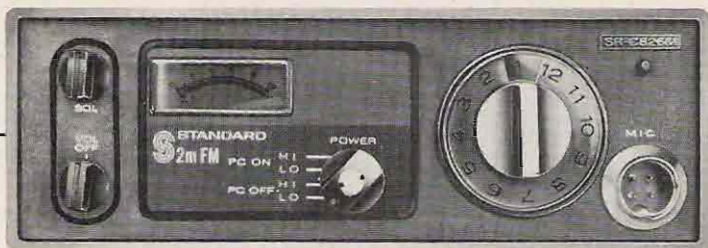

Fig. 7 (A) Foil side of ramp generator board. (B) location of parts on component side.

the oscillator output frequency will be constant during the sweep period. The same is true whenever both ramps are of equal amplitude, except that the output will be a

steady voltage other than zero. Also note that the resultant ramp could have a negative slope if the 'stop' input is lower than the 'start' input, and the oscillator would ob-



## MAXIMIZE YOUR AMATEUR RADIO

What new 2M FM gives me most for my money, performance vs. price? The answer's as clear as the superb reception you'll get on the new Standard 826MA, 10 watt, 2 meter FM transceiver. You'll find such outstanding features as 12 channels — with the four most popular ones included — and a RF output meter with selection of 10 watts or 0.8 watt for battery conservation. And of course, our "Astropoint" system

**MONEY.**

that assures: top selectivity, great sensitivity, and rejection of unwanted signals on today's active 2M band. **Helical Resonators** & FET front end provide the performance needed for tomorrows crowded channels. Provision for **tone coded squelch** to activate modern repeaters. A radio that won't become obsolete. Occupies less than 200 cu. in. Weighs less than 5 lbs. It has all the same "Astropoints" as entire Amateur line.

### NEW 22 CHANNEL BASE STATION SRC-14U

Ultimate in a 2M FM Transceiver features:

- 22 channels
- AC & DC supplies Built In
- 10W (1, 3 & 10 selectable)
- Receiver offset tuning
- VOX
- Three Front Panel Meters
- Plus many more exciting features.



*For detailed information on these; the complete Standard line and the name of your nearest dealer write:*



**Standard**  
Communications Corp.

213 / 775-6284 • 639 North Marine Avenue, Wilmington, California 90744

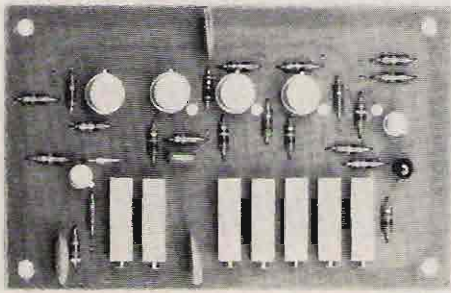

The ramp and blanking generator pc assembly. The leads going to external points will go in the holes visible on the board.

viously sweep down in frequency rather than up.

The schematic for the ramp generator is shown in Fig. 5. Operational amplifiers A1 and A2 form a triangle wave generator with A1 acting as a threshold detector and A2 as an integrator. One half of the triangle (negative-going) represents the sweep period while the other half represents the retrace time. Since a square wave is generated at the

output of A1, we have a convenient source of blanking voltage built right in. This signal is positive during the sweep period and is connected to the band switch when Swept 1 (blanked retrace) operation is selected. During retrace the square wave drops to zero and actually disconnects the tank circuit until the next sweep starts. An emitter-follower, Q3, buffers the square wave output for external use.

The output of inverting amplifier A3 is a positive-going ramp during the sweep period and is used for both the 'stop' signal and horizontal sweep for the oscilloscope. Since an additional inversion takes place in the output of A4, the negative-going ramp at this point is used as the 'start' signal. These two ramps are applied across front panel controls which have 6:1 reduction drives and are fitted with dials calibrated in frequency for the five operating bands. The outputs from these two pots are fed to summing amplifier Q1, where the output will be the resultant ramp we discussed above. Because the output Q1 is in the negative region (PNP

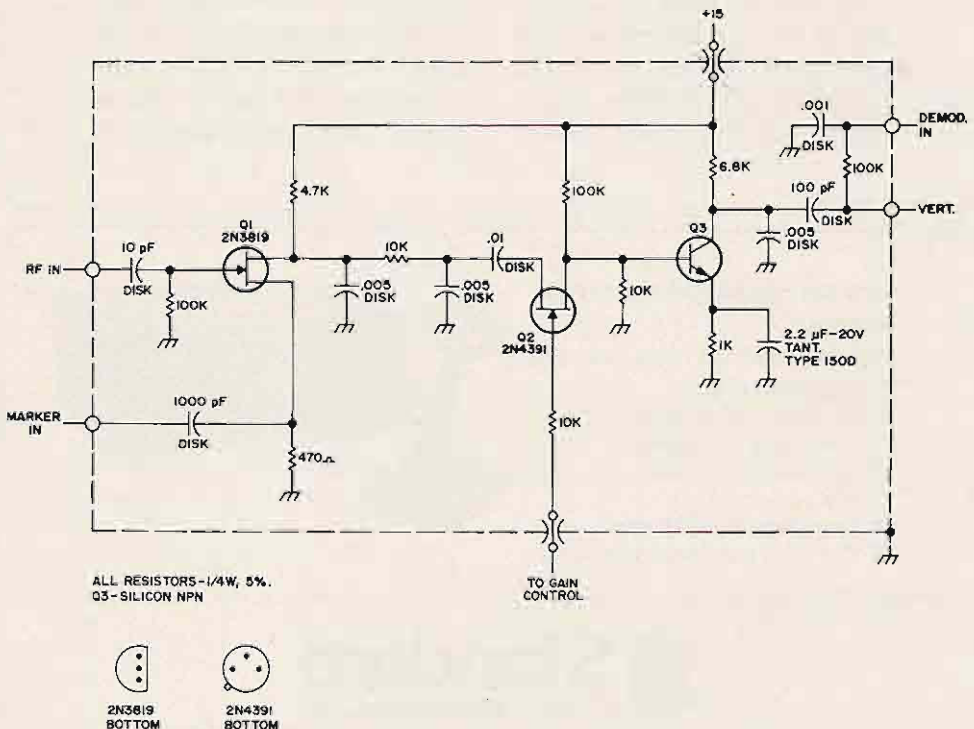

Fig. 8. Post-injection marker circuit with dc gain control of marker size.

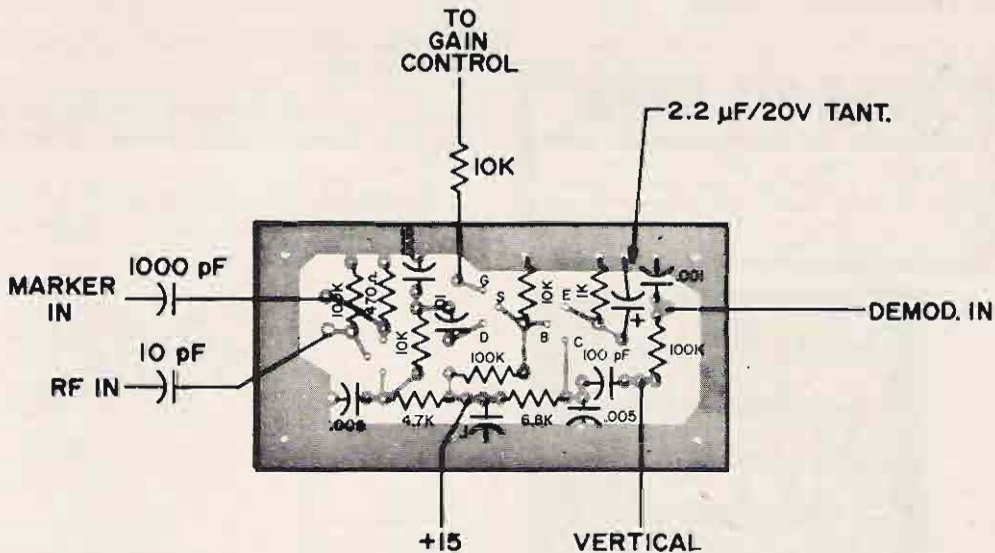
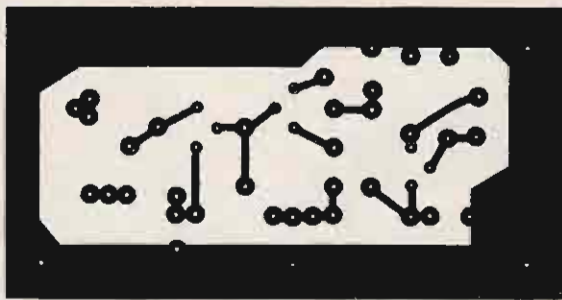

Fig. 9. (A) Foil side of mixer/amplifier pc board. (B) Location of parts on component side.

transistor), a second common-base (NPN) amplifier is used to shift the output back to where it will always be positive.

The ramp and blanking generator is constructed on a pc board 2.6 x 4.1 in. in size. For convenience, all the trimmer resistors were mounted along one edge. As seen in the photo, this board was mounted by means of two small brackets in a vertical position with the trimmers facing up. To simplify pattern layout, unused pins 1, 5 and 8 on each of the four 741 opamps were clipped off right at the case. Color-coded wires were connected to all necessary points on the board before it was mounted, with the leads made long enough to reach their destinations. For those interested in building this unit, a detailed procedure for setting up the ramp generator will be given later.

### The Mixer/Amplifier

In order to provide a means for displaying frequency markers, a mixer and amplifier circuit was built into the sweep generator. The schematic for this circuit is shown in Fig. 6. A marker generator was not included inside the sweeper because other rf generators were available for use as markers and the added expense seemed unnecessary. Because the mixer board was to be installed inside a shielded box, dc gain control was resorted to as with the band switching discussed earlier. A 2N4391 is used as a variable resistor to control the signal input to the amplifier stage. This in turn controls the size of the marker being displayed on the curve. A 2N3819 FET is used in a simple mixer circuit which worked the best of several tried. Incidentally, the PNP and NPN

## ACTIVE AUDIO FILTERS

IC'S FOR SUPER HIGH PERFORMANCE

### CW FILTER:

Get razor sharp selectivity. No impedance matching! BW (selectable) 180 Hz, 110 Hz and 80 Hz; Center frequency  $\pm$  F = 750 Hz. Skirts 60 db down at  $\frac{1}{2}$  F and 2F. 4 op amps. 2" X 3" PC board. \$12.95 wired, tested, guaranteed.

### LOW PASS FILTER:

Resistors set cutoff 500 Hz to 20. kHz. Factory set to 2.5 KHz. Roll-off max 48 db/oct. min 40. Input Imp. 1M; Load  $>$  2K. Gain = 1.9 op amps. 2" X 3" PC board \$15.95 wired, tested, guaranteed.

\*\* Write for free spec sheets\*\*  
\* Dealer inquiries invited\*

**MFJ  
ENTERPRISES**

**CW  
FILTER**

**LOW  
PASS  
FILTER**

13<sup>PS</sup> KIT

P.O. Box 494, State College MS 39762

## WORLD QSL BUREAU

5200 Panama Ave., Richmond CA USA 94804

THE ONLY QSL BUREAU to handle all of your QSLs to anywhere; next door, the next state, the next county, the whole world. Just bundle them up (please arrange alphabetically) and send them to us with payment of 5¢ each.

Next time  
you light up  
a cigarette,  
get a look  
at your kid's  
face

AMERICAN CANCER  
SOCIETY

THIS SPACE CONTRIBUTED BY THE PUBLISHER

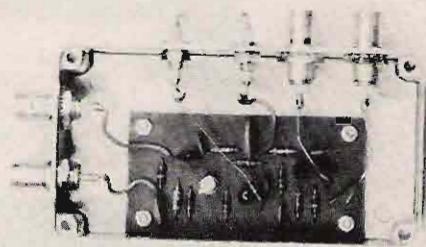

Completed mixer/amplifier board mounted in the die-cast housing.

transistors used here and on the ramp generator board are unknown surplus silicon units.

The pc board for the mixer is 1.5 x 2.9 in. and is mounted in a Bud CU-124 die-cast

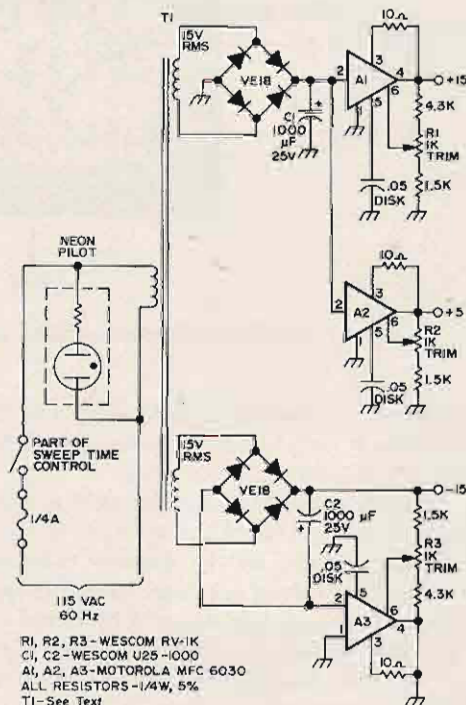
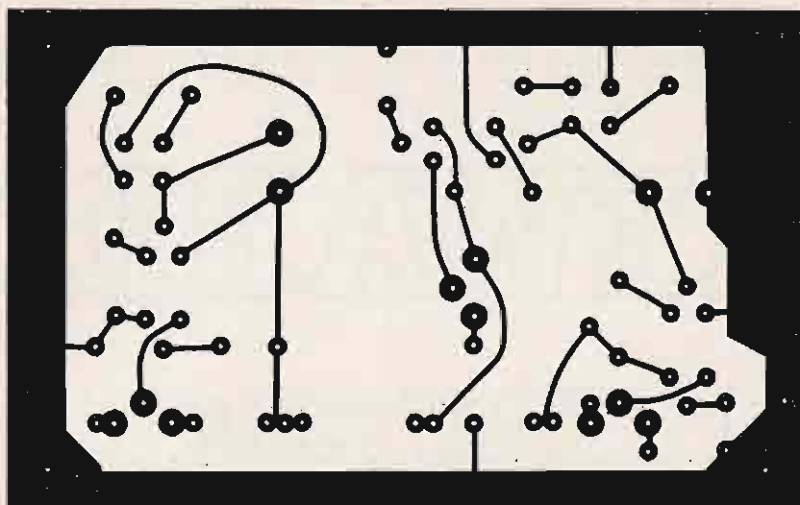
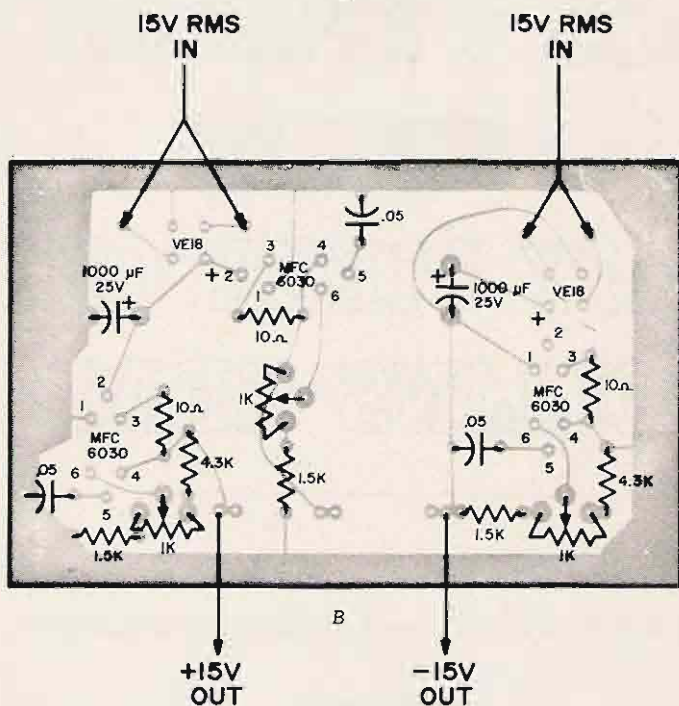

Fig. 10. (A) Foil side of power supply pc board. (B) location of parts on component side.





A



B

Fig. 11. (A) Foil side of power supply PC board. (B) Location of parts on component side.

aluminum box. Note that here again some of the components are mounted between the board and their external connectors. These include both the 10 pF and 100 pF input capacitors to the 2N3819 and the 10 K $\Omega$  resistor going to the gate of the 2N4391.

### The Power Supply

Figure 7 is a schematic for the power supply. Voltage requirements for the sweep generator are +15V, -15V and +5V dc. The current drawn by any of the above circuits runs no more than 30 or 40 mA maximum,

# REWARD!

## WANTED:

ALL TYPES OF  
TUBES  
ANY PIECE OF  
COLLINS GEAR

---

We buy for cash any tube, transceiver, receiver,  
or test gear at 5% over prevailing market price.

**THE  
TED DAMES COMPANY**

308 Hickory Street, Arlington, N.J. 07032  
(201) 998-4246 DAYS - (201) 998-6475 NIGHTS

making the use of small IC voltage regulators ideal. Motorola MFC6030 (plastic) regulators are used in each supply and are overload protected against accidental short circuit. Varo type VE18 molded bridge rectifiers, together with 1000  $\mu$ F filter capacitors, supply the dc input to the regulators. The +15V and +5V regulators are both fed from the same source. The power transformer was a surplus unit with a 30V CT secondary. The center tap was uncovered and the two leads separated so as to provide two independent 15V windings. A small trimmer is provided in each supply for voltage adjustment.

The pc board for the power supply is 2.6 x 4.1 in. All components but the transformer are mounted on the board. The transformer is mounted directly on the chassis. Relative placement of the various components making up the complete generator can be seen quite clearly in the photo.

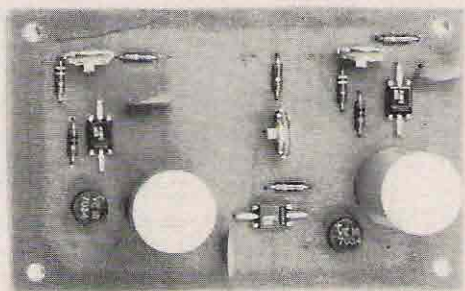

The power supply pc assembly.

### Control Circuits

Figure 8 is the wiring diagram for the control circuitry. Note that for CW operation of the generator, a dc voltage is applied to the varactor by way of the Start pot. In order for the dial calibration to be valid in either mode, the dc level applied to the control must be exactly the same as the peak amplitude of the ramp during swept operation. As will be explained in the set-up procedure, the ramp will vary from a starting point of approximately +1.4V and peak at +12V. Resistor R1 in series with the +15V line is selected for a +12V level at the high end of the pot. R2 is selected for a level of +1.4V at the low end. The reason for the offset of 1.4V at the low end is because the

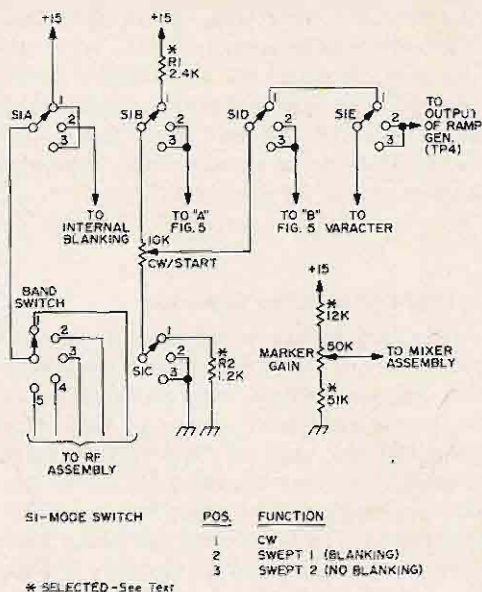

Fig. 12 Control circuit wiring schematic.

pin to which the tuning diode is connected at the MC1648, sits at this level. The source of this bias is the drop developed across two forward-biased junctions within the IC and not from any external source. Once these dc levels have been set for CW with the fixed resistors, the ramp can be made to match by means of the trimmers in the ramp generator circuit.

The rest of the control circuitry is quite straightforward. In position 2 (Swept 1) of the mode switch, positive pulses from the ramp generator are fed to the band switch during the sweep period. When retrace occurs, the pulse drops to zero and the oscillator shuts off until the next sweep starts. In the CW and Swept 2 positions of the mode switch, a steady +15V is applied to the band switch and the oscillator runs continuously.

The final function performed by the mode switch is to route the dc for CW or the ramp for swept operation to the tuning diode. The two fixed resistors are mounted point-to-point behind the panel since all points are readily accessible within every short distances. The fixed resistors associated with the marker gain control are also

mounted the same way behind the panel. The switches are ordinary rotary types and the potentiometers are all ordinary carbon controls. The Start and Stop controls as well as all gain controls have linear tapers. The Sweep Time pot is an audio taper type with built-in switch for ac power.

### Setting Up the Ramp Generator

For best results, a calibrated dc scope is required to properly adjust the ramp generator. Test points have been provided on the pc board and short pieces of bare wire connected to each of these points make excellent tie points for the scope probe. The circuit may be aligned either before or after installation. The Start, Stop and Sweep Time pots can be connected at the ends of their respective leads if the unit is checked outside the cabinet.

Set all seven trimmers to mid-range. Connect the scope to TP1 and adjust the horizontal for a full sweep of 20 ms. Set the Sweep Time control to minimum resistance and apply power. Some sort of triangular wave should be displayed. Adjust R1 for a 3V p-p amplitude of the waveform. Turn R2 cw until the negative-going portion of the triangle is 20 ms long. Since R1 and R2 interact, you will have to stop occasionally and reset R1 for proper amplitude. Once the ramp is set at 20 ms with the Sweep Time pot at minimum, the slow speed end will automatically be about 5 or 6 seconds with a 1 M $\Omega$  pot.

Transfer the scope probe to TP2 where a positive-going ramp should be seen. Set the starting point of the ramp to zero volts by means of R3. Amplitude of this ramp must be 10V. If it is not, go back and adjust R1 slightly until it is. If necessary, reset R2 for 20 ms trace length. As soon as a 10V, 20 ms, zero-based, positive-going ramp has been achieved at TP2, go on to TP3.

At TP3 there should be a negative-going ramp. Once again we require a zero base line or starting point. Adjust R5 to accomplish this. Amplitude should once again be 10V and is controlled by R4. Once you have a 10V, zero-based, negative-going ramp, move on to TP4.

Connect the probe to TP4 and set the Stop control to full cw. The Start pot should be at minimum setting. A positive-going ramp should be present at TP4. By means of trimmer R7, move the ramp up or down until the starting point is approximately +1.4V. Ordinarily the ramp will not go below zero but will flatten out as the positioning control is adjusted. This is due to clipping in the output amplifier. If the ramp generator is going to be used with another type of VCO, the ramp can be set to exactly zero if desired. In our case we can't as explained previously.

Because a substantial amount of capacitance change occurs in the tuning diode up to 12V, the final ramp amplitude is set to 12V by means of R6. Because R6 stretches the signal in a negative direction, R7 will have to be used to reset the base line at 1.4V. Other than for checking tracking between the CW and swept modes, this completes the alignment procedure for the ramp generator.

When the generator is finished, you can check the tracking by observing actual signals at the input to the VCO. Connect the scope probe to the feedthrough capacitor on the VCO assembly that goes to the tuning diode and set the Start control to maximum. Switch rapidly between the CW and Swept 1 positions of the mode switch. The CW input will be a straight line sitting at +12V while the swept input will be a ramp peaking at +12V. Next, turn the Start control to minimum and again compare levels. If the Stop control is also at minimum, both signals will be straight lines at +1.4V. If there is any substantial difference between the two modes, use R6 and R7 on the generator board to make the ramp agree with the dc levels. That completes all phases of the ramp set-up procedure.

### Construction

The cabinet used here is one manufactured by Sorensen Electronics in their Mod-U-Line series. These are the most reasonably priced instrument enclosures I've come across so far and I've used them for several projects. This one is a Model MCH-5129 with a CP-129 chassis plate.

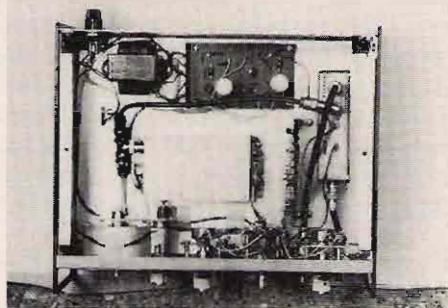

This bird's eye view of the interior shows the location of all major assemblies.

Total cost of the enclosure is around \$22. Dimensions are: 5 1/4 in. high by 12 in. wide by 9 in. deep.

The 5-step attenuator was picked up surplus from Fertik's Electronics for about \$10. It is well made and designed for 50Ω systems operating up to 1 GHz. It has an integral female BNC output connector on the front face along with four threaded mounting holes for ease of installation. The input connector is a BNC male at the end of a short piece of coax.

All rf assemblies are interconnected inside the cabinet by means of coax cables. This is clearly evident in the photo.

The Start and Stop pots were mounted on brackets behind the front panel so that Jackson Brothers type 4511/DAF reduction drives could be installed for easier tuning. The two circular dials are slightly under 2 in. in diameter and were cut from sheet plastic. While operating in the CW mode, one of these was calibrated in pencil to provide a pattern for the finished product. A master

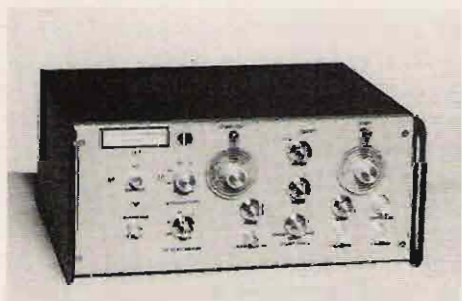

The finished sweep generator makes a professional appearance.

**MORE RANGE . . .  
with NO NOISE**

**FOR ALL  
MOBILE UNITS**



CUSTOM SYSTEMS  
KITS • ACCESSORIES

ELIMINATE IGNITION NOISE  
**ELECTRO-SHIELD®**  
YOUR ENGINE

FROM \$44.95

**ESTES ENGINEERING CO.**

543 W. 184th St., Gardena, Calif. 90247



**IF YOU WANT  
PROMPT SERVICE  
ON AMATEUR PARTS & EQUIPMENT**

— WRITE US —

*We stock many major lines, including:*

SWAN | EXPERIMENTERS SUPPLIES | DRAKE | TEMPO  
CORNELL DUBILIER | G. E. TUBES | MOTOROLA (HEP)  
HY-GAIN | CALIFORNIA CHASSIS | MINI PRODUCTS  
TEN-TEC | CALECTRO | B & W | ANTENNA SPEC.  
CUSH CRAFT | BOOKS & MAGAZINES | NEWTRONICS  
ROHN-SPALDING | TRI-EX | ALL SAMS PHOTOFACTS  
REGENCY | OMEGA-T | KENWOOD | COLUMBIA PROD'S

**PROMPT SERVICE TO ALASKA, TOO!**

Please include postage with remittance.

**AMATEUR RADIO SUPPLY CO.**

6213 Thirteenth Avenue South  
Seattle, Washington 98108

**MINIATURE  
SUB-AUDIBLE  
TONE  
ENCODER**



- Compatible with all sub-audible tone systems such as Private Line, Channel Guard, Quiet Channel, etc.
- Glass Epoxy PCB, silicon transistors, and tantalum electrolytics used throughout
- Any miniature dual coil contactless read may be used (Motorola TLN6824A, TLN6709B - Bramco RF-20)
- Powered by 12vdc @3ma
- Use on any tone frequency 67Hz to 250Hz
- Miniature in size 2.5x.75x1.5" high
- Wired and tested . . . . \$14.95
- Complete less read (Available in 33 freqs. for \$17.50 ea)
- Output 3v RMS sinewave, low distortion
- Postpaid - Calif. residents add 5% sales tax

**COMMUNICATIONS  
SPECIALISTS**

P.O. Box 153, Brea CA 92621

**PARTS! CORNELL TUBES!**

FREE Send For FREE  
**CORNELL'S**  
 New Color  
 Catalog  
 48 Pgs. New Items\* IN LOTS OF 100

**33¢** per tube  
**36¢** per tube

ORDER FREE IF NOT SHIPPED IN 24 HOURS!

**4215 S University Ave. San Diego, Calif. 92105**

**GENAVE GTX-2**

FM Transceiver - 30 WATTS POWER ALL SOLID STATE (no tubes) - 100 Ohm Imp. and mobile mounting bracket - Professional level case distinguished by 421250 Avionics Mfg. - (Amplifier) - 220.054 coil

AMATEUR-WHOLESALE  
 1887 S.W. 129 TERRACE • MIAMI • FL 33156  
 Phone: (305) 239-3631 • Nights-Weekends (305) 666-1347

**CLEARANCE SALE**

30% Off All Used Equipment in Stock

LARGE SELECTION -  
 SEND FOR FREE LIST

**FRECK RADIO**

38 Biltmore Ave  
 Asheville NC 28801  
 704-254-9551

**VHF  
UHF**

Crystal Controlled CONVERTERS for DX, FM ATV, Space and other uses. Extremely sensitive and free from spurious responses. With A.C. power supply. Choice of I-F many in stock. Upgrade your station to JANEL.

50 MHz	2.0 dB NF	\$74.95
144 MHz	2.5 dB NF	\$74.95
220 MHz	3.0 dB NF	\$79.95
432 MHz	5.5 dB NF	\$74.95

All postpaid. Write for full details. Also preamps. Ask about our OSCAR special 435 MHz converters.

**JANEL LABORATORIES**  
 P.O. Box 112  
 Succasunna NJ 07876  
 201-584-6521

was laid out using Rubylith® film and rub-on numbers. A negative of this was then made using 3M reversing film. From the negative a finished set of dials was printed on aluminum material of the presensitized variety. These were cut out and stuck to the plastic by means of their own pressure-sensitive adhesive backing. The nameplate was made from the same material. The two index pointers are clear plastic with hairlines scored on the inside surface. They are mounted on spacers directly over each dial. All remaining labeling was done with tub-on lettering.

**Summary**

It is assumed that anyone contemplating construction of an instrument like this is thoroughly familiar with the use of sweep generators so no instructions will be given here. You should find the generator quite useful for making narrow sweep displays such as those for filter response. The ability to control sweep speed is an asset where slow speeds are required. Although only one marker input is provided for, a comb is sometimes useful and can be generated by your crystal calibrator or other square wave source and fed into the marker input. Input level to the mixer should be kept below 100 mV in general since no input gain control is provided.

Purchasing parts is often one of the greatest problems encountered with a project of this nature. In some cases, as with Wescom, minimum billing is a way of life and makes small purchases nigh impossible even though the eventual per piece price is very low. Since I generally buy in larger quantities than needed, I may be able to help out with some of the parts if any of you are really desperate. At any rate, I hope you have found this worthwhile, and to those of you who plan to build the sweep generator - best of luck.

**Vendor Addresses:**

- Fertik's Electronics, 9th & Tioga Sts., Philadelphia PA 19140.
- Sorensen Electronics Co., Inc., 418 Queens Lane, San Jose CA 95112.
- Wescom, P.O. Box 2436, El Cajon CA 92021.

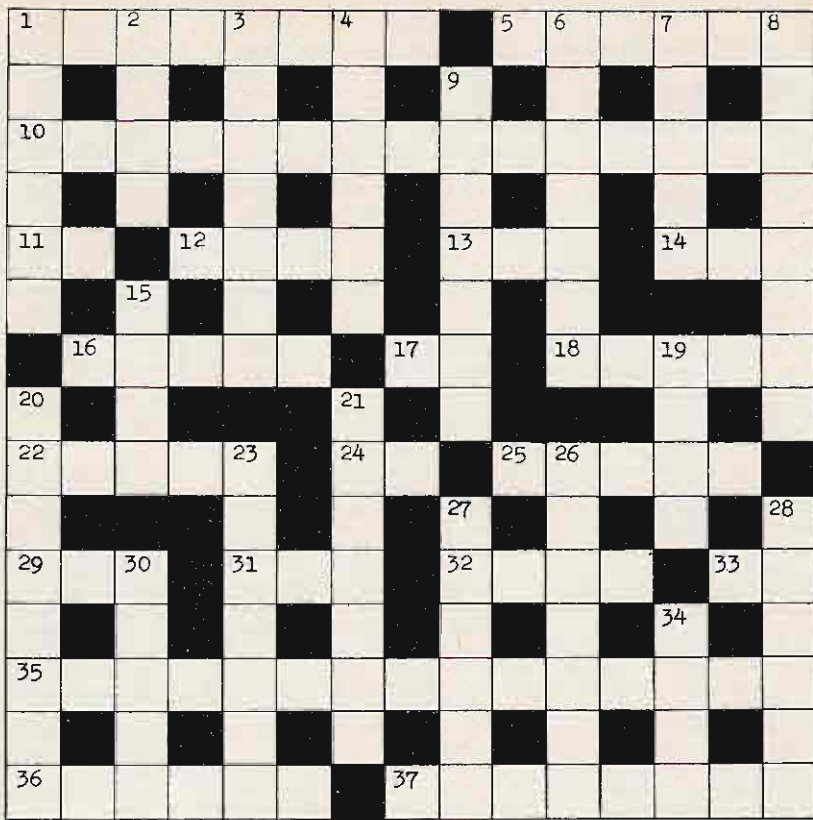

1. The amount of opposite magnetomotive force necessary to eliminate residual magnetism.
5. Devices used for determining whether a specified dimension is within specified limits.
10. Describes how a control system or an individual unit carries on with respect to time. (2 wds).
11. No Connection. Abbr.
12. Prefix meaning one-billionth.
13. Explosive.
14. Body of water.
16. A device having two electrodes, the cathode and the plate.
17. Outside dimension. Abbr.
18. The maximum useful distance of a radar or radio transmitter.
22. The medium that was once supposed to fill all space and through which radio, heat, and light waves were supposed to travel.
24. A type of loss.
25. A ladle.
29. Unit of electrical resistance.
31. Document. Abbr.
32. Measure of land.
33. Near.
35. In control systems, the reference input minus the primary feedback.
36. A revolving plate mounted at the front of some television cameras carrying two or more lenses, for rapid interchange.
37. One of a group of gases that will not combine with another element (2 wds).

**ACROSS**

**DOWN**

1. A squelch circuit. (P1)
2. Indefinite periods of time.
3. A signal which initiates or triggers an action in the device that receives the signal.
4. A quantity having magnitude and direction.
6. A fitting designed to change the terminal arrangement of a jack, plug or socket.
8. The crossarm separating the parallel wire elements of an antenna.
9. A five-electrode electron tube.
15. A microwave antenna, usually shaped like a parabola.
19. Inert gas used in some electron tubes.
20. Increasing the intensity of sounds.
21. An electronic path between two or more points capable of providing a number of channels.
23. To emit rays from a center source.
26. A wave of constant amplitude, frequency, and phase which can be modulated by changing amplitude, frequency, or phase.
27. The difference between an actual operating point and the point or condition where a failure to operate properly will occur.
28. An off-on application of power.
30. Instrument used for making electrical measurements.
34. Tight fit.

Michael Kresila  
Box 57  
Marion OH 43302

## LETTERS CONT.

Some time ago, when I wrote you in the context of "Caveat Emptor," I agreed with myself that it was my last excursion into the controversial world of amateur radio. Tiling with windmills can be pretty exhausting, as Don Quixote discovered, and the quasi-independence of various amateur groups makes conciliatory efforts equally debilitating; if not more so.

However, as I see another divisive tempest brewing among amateurs, this time in the FM repeater ranks, I cannot in good conscience ignore it. At least without pointing out that the present conflicts are symptomatic of the very actions that lost much of the available space, in other bands, for us. And with more emphasis, has helped to persuade the FCC that we can't get together, don't know what we really want, don't use what we have — all to the end of more regulation and fewer privileges.

Now we see the familiar dog-eat-dog pattern developing in the relatively sophisticated (technically) world of the FM repeater. Courtesy and conciliation seem again to be unknown quantities in the ham world, insofar as promotion and operation of repeaters in general is concerned. I'm sure that most users, like myself, try to remember that there may be others "waiting on the line," and so keep an ear out for breakers. But I've already heard the type of stuff that pretty much ruined phone for most of us on 20 and 75. And now it seems that the brute force output philosophy is being applied to repeaters.

So I suppose this is a plea for maturity in judgment and for common sense in approach. Surely we all understand that there are no private frequencies or coverage areas. Surely we are sufficiently advanced in techniques — either with respect to antenna patterns or with respect to triggering — to find ways and means to reduce QRM between repeaters to a minimum.

Let's not drop the ball *this* time! Hell's bells, if the associations and individuals concerned will only get together on a non-power-politics basis, we can stop the fragmentation and begin to achieve cohesion. And realize the real potential of FM repeaters.

Al Smith W1GAA/K3ZMS

*Well, Al, I have a feeling that your erudite and polite request which is aimed at a select few will not get their attention. They are much too involved with the alligators snapping at their ass, which is an apropos expression for repeater squabbles.*

*One of the functions of the Repeater Bulletin — actually one of the major functions in my view (and the Bulletin is obviously an expression of my view, though more by default than*

*intention — if others would learn to express themselves in writing as well as they do with amplifiers and insulting remarks on repeaters I think that more progress could be made) — oh, yes, the Bulletin function is to throw light on bad situations as they develop with the hope that the scurvy characters who are working so diligently to make things miserable for others would scurry away from the light.*

*If you get on the air and use the repeaters quite a lot, Al, you'll find that the battles in our ranks are, in perspective, quite minor. Perhaps the reporting of them in detail in the Bulletin has made them seem more important than they are. Listening to one or two repeaters can give you a biased perspective — like the Marcus-ARRL machine KGO could give someone a very bad idea of how things are — ditto the KHB machine in Weston. I doubt if you'll hear much negative on many of the other repeaters.*

*You should keep in mind that, all in all, repeaters in New England are so far ahead of the rest of the country that our situation is a model for the whole world. This does not mean that we can't improve or that we should stop trying to clean up the little pockets of childishness that are bothering us.*

*May I take issue with you regarding the "ruined" 20 and 75 meter bands? The only big problems that I see with these bands are the General Class segments which are generally horrible. Even with a BIG signal I find these parts of the band depressing and I head back for the QRM-free two meter repeaters.*

*There are times when the Advanced portion of these bands gets filled up, but for the most part I find little difficulty in making contacts with about the same level of QRM as I have been used to for all of the sideband years. When I remember back to the old AM days I am ever thankful — for there is no comparison.*

*I do not think that the FCC did the amateurs any favors at all when they established the split phone bands. It obviously has had little effect in getting amateurs to change their grade of license. I suspect that this has helped FM to grow — perhaps a lot more than suspected. The intensive QRM of the General part of 20m is enough to get anyone to think in terms of looking for something better. The almost total lack of QRM on 2m FM stands out as a shining beacon to the beleaguered low banders.*

*The arrogant and the childish will always have their problems — with their own repeaters — with the press, and I don't know of any way for these difficulties to be resolved since psychotherapy seems the only out and it isn't going to be used. No, I think that there will always be some areas of controversy. It is up to the readers to decide which sides of the controversy are most in need of electric shock*

*treatment. On this point, the switch to solid state leaves some doubts since twelve volts will never impress anyone like 2000 volts will. Looking on the bright side — all those old Gil cartoons on Switch To Safety can at last be put in the ARRL museum.*

*In the long run we are all headed for a listing in QST under Silent Keys. In my mind, the measure of an amateur is how much fun he was able to bring to others. 1200 watts output on 79 brings fun only to the chap with the fiendish gleam in his eye as he watches his output meter. The alligator he creates brings un-fun to everyone else. Badmouthing over the air may gratify the chap who is doing it, but it is unpleasant for most listeners.*

*I'm the proud possessor of a used (new to me) Hallicrafters SR-42A. I'd love to FM the thing, and I'm really curious about any other things I could do to it to make it even better.*

*I'd appreciate any help you could give me on this. Might be a problem getting enough deviation, since the vfo is in the 20 MHz area, as are the crystals for the thing.*

*Many thanks for any help you can give me. And keep up the fine work in 73 — it's the one ham magazine that makes the hobby fun, as opposed to an oldtimer's "remember when...." journal.*

George Lesch WB2ENP  
Staten Island NY

*Can anyone bail old George out?*

*I am curious to know what the message from Wayne (BIMEK FUSAJ CAQOF) on the "contents" page of the September '72 issue. Would appreciate any light you might shed on this matter.*

Reggie W5SSB

*Naval crypto prefix to indicate cypher being used.*

*Please enter my name for a one year subscription to 73. I've been buying it on the newsstand for about a year and it has definitely been the best magazine I never subscribed to.*

*I hope you don't mind my not sending the coupon which forms such an integral part of your last issue. I detest cutting up magazines for the purpose of removing coupons almost as much as I detest others cutting up my magazines for the purpose of removing coupons. There almost always is a good article worthy of saving on the reverse. And when there is not, there is an advertisement which I want to keep for reference. Is there a publishers' conspiracy against those who want to keep their magazine collection intact?*

*Bill Garfield's "Poor Man's Transcanner" in the August issue brought to mind a letter from Regency which I got from a friend about two years ago. It provides some conversion infor-*

CONTINUED



# WORLD'S LARGEST SELECTION OF NEW & USED TV CAMERAS & ASSOC. EQUIPMENT

## SONY

Versatile TV Camera with Viewfinder,

### \$399<sup>95</sup>



#6740 - Sony Viewfinder camera with plug-on matching viewfinder (4" diagonal screen). Both video and RF output, accessory socket, H resolution 450 lines. Completely solid-state. Complete with standard 25mm C mount lens and tripod. Checked out for proper operation. Used, only \$399.95 - Complete package.

Plus transportation charges.

## GENERAL ELECTRIC

TE-23-A CAMERA

### \$199<sup>95</sup>

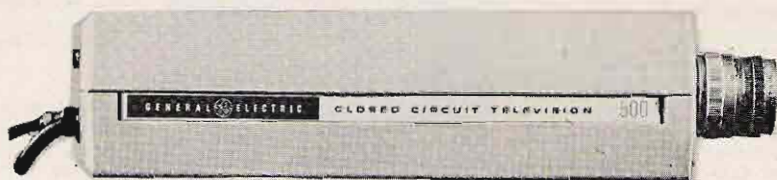

#6741 - GE 1" Vidicon TV camera. 500 line center resolution, 4000:1 ALC, both video 1.4V (p-p) composite and RF output, tuneable channels 2 through 6. Solid state input power 117V 60 cps 12W. Dimensions 5.25"W 3.54"H 11.75"L, wt. 8 lbs. Used, reconditioned, complete with standard 1" lens. Only \$199.95

Plus transportation charges.

*Free Flyers: 972#3M - Special flyer containing bargain prices on both new & used television cameras, VTR's & associated equipment such as lenses, video tape, etc.*

*972#6 - Loads of bargains in CCTV Cameras, Lenses, etc.*

*972#7 - Special sale of Ampex Printed Circuit Boards.*

*972#8 - Last minute items covering the entire broadcast & CCTV field.*

*Be sure your name is on our mailing list for free flyers and a copy of our giant 1973 catalog out early next year.*

*See you at SAROC in Las Vegas, Nevada, January 4 - 7 at our booth. Al Denson, WIBYX and crew.*

THE DENSON ELECTRONICS CORP.

PO Box 85, Longview Street

Rockville, Conn. 06066

203/875-5198

mation not provided by Bill. Whether or not the changes will improve the sensitivity I cannot say. The earlier units may have had trouble tuning down to the 2m band and the current ones may do so with no difficulty at all. No matter what the case, your readers may appreciate having the supplemental details. I doubt if Regency would have any objections to your quoting the letter, especially since it can do nothing but help their sales.

**Robert E. Tashjian**  
Canoga Park CA

*Here are the details from the Regency letter:*

Subject: TMR-H Series  
in Two Meter Band

1. Modifications that are necessary to move this unit into 146-148 MHz portion of the 2 meter amateur band.  
A. Replace three capacitors and retune the RF section.

C201 replaced with a 12 pf.

C203 & C206 replaced with 6.8 pf.

Retune L201, L202 & L203

Note: The ceramic filter presently being used is only proper for NBFM (5 KC deviation). If wide band FM is employed, the filter would have to be replaced (CF455-AP should be adequate). The quadrature coil may have to be swamped more than it is now.

B. You can expect 0.7 or better, microvolt sensitivity for 20 DB of quieting.

C. By adding one wire, terminals 3 and 4 can be utilized for muting purposes, connect terminal 3 to the junction of the blue wire and R310 (33k) on the scanner board. If terminal 3 is then externally switched to terminal 4 during transmission, the receiver is effectively muted or disabled.

D. Two germanium diodes, back-to-back, soldered across the receiver's input, will provide sufficient RF transistor protection.

Each time details of an airline hijacking appear in a newspaper, probably three more are committed. And, at least two guys have been killed in an Italian restaurant since "The Godfather" came out. But never before have I seen published step-by-step instructions for killing hams.

The "Cigar Tube" article on page 28 in the September 1972 issue, suggests forming a ground connection through your body by holding the chassis with one hand and the damn tube with the other hand.

Well, even if the .1 Cap isn't shorted and the thing isn't built wrong, at any frequency over a few cycles, that .1 Mfd impedance starts looking mighty small in comparison with your body resistance. Just try accidentally probing an RF output or the output of your hi-fi set, using your arms as a ground return. Pffff!

Please edit these articles more care-

fully and print some sort of retraction to the paragraph in question in the next possible issue. How about a signal injector that will only work with one arm behind your back?

**Gary Budiansky WA1MCR**  
Acton MA

*Sorry, but something strange comes over us every time we publish a "tube" article.*

I noted with interest the picture and article on page 50 of July 73. I had the same problem with a 1969 Fiat 124 coupe. I use a Motorola D-43 trunk-mount and had the control head between the driver's seat and the console. When I bought a new Fiat 124 Spyder, I decided to do it right.

As you can see from the enclosed photo, the control head is built into the rear ashtray of the console. The purpose was twofold: to make the existence of the rig a secret (I park in downtown Boston daily) and to preserve the interior "esthetic beauty" of the 124 Spyder.

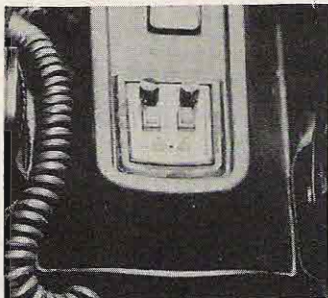

The cable seen at the bottom of the enlargement runs to the D-43 in the trunk. The microphone cable can also be seen going under the console into the control head. By running all cables under and inside the console, I have been able to avoid drilling holes in it. A twisted pair runs from the control head to the BC receiver's speaker. Another pair run forward to the engine compartment to activate the 12VDC 80Amp relay which turns everything on and off. The controls are pretty straightforward: volume, squelch, green light power on, red light for transmit, on-off switch and frequency select switch. The antenna incidentally is a Larsen 5/8 wave mounted on the trunk.

**Barry W. Fox K3IWW/1**  
Ayer MA

On a rainy afternoon last June, I had the pleasure to visit you and the staff of 73. I wish to extend my sincere appreciation for your time and personal interest extended to a fellow amateur by yourself and staff.

Although the state of Mississippi may be remote on your itinerary, I

would like to extend to you the warm hospitality I received in New England, should you chance this way.

As I mentioned to you, Wayne, I have followed your articles over the years through thick and thin with avid interest.

**Laurence P. Williams W5IIQ**  
Ocean Springs MS

*Our pleasure!*

From time to time you mention foreign hams having trouble getting electronic equipment because of lack of funds or import problems.

I have a General Electronics, Inc., multiphase Exciter MOD 20A with a BC 458 modified for use as a VFO including instruction manual for the 20A. I would be pleased to donate this equipment and pay postage if you can suggest anyone needing it.

**David D. Blackmer WA6UNK**  
Rt. 1, Willow Road  
Nipomo CA 93444

*Suggest you write to B.A.N. Raju, Radio Constr. & Development Unit, Civil Aviation Department, Safdarjung, New Delhi, India for name and data on getting rig to them through customs. If anyone knows amateurs in any countries who would appreciate and use some older gear please let 73 know - and if you have gear, why let it sit in the closet - why not get it into needy hands?*

73 is by far the best. I let my QST subscription run out so I could subscribe to 73 for two years instead of just one.

**J. E. Babeckis WB9GXH**  
Chicago ILL

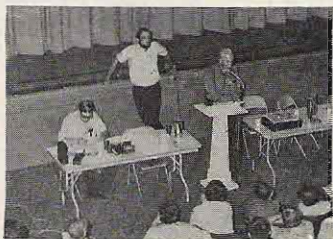

Here is a photo of the Baldwin Park frequency coordination meeting held on 9 September '72. I hope it can be of some use to you. John Griggs W6KW is at the mike and Skip Clark WB6TXX is leaning against the stage.

Thank you for your motivation of the people here on the west coast. I feel that it was you who got us moving, and temporarily out of the grips of the FCC.

**Dan Halpert WA6JQR**  
Malibu CA

**Dan Halpert WA6JQR**  
Malibu CA

*continued on page 318*

# AMATEUR RADIO AND EDUCATION IN YUGOSLAVIA

A. Stipanic YU3BH  
Secretary SRJ

The Union of Radio-Amateurs of Yugoslavia (Savez radioamatera Jugoslavije - SRJ) is one of the youngest national organizations of radio amateurs in Europe. In 1971 it will celebrate the twenty-fifth anniversary of its foundation. Today, SRJ has in its ranks about 42,000 members, and among these are some 10,000 licensed radio operators. It is evident that the technical education of such a large number of members and radio operators in a relatively short period of time has required considerable efforts on the part of that organization, and special working methods, which may be summarized as follows:

The basic organizational unit of the SRJ is the radio club. At present there are 415 radio clubs and 348 branch clubs in Yugoslavia. These are organized within the radio amateur unions of 6 Federal Republics and 2 provinces. These various unions are then grouped together into one national organization - the SRJ.

Following this organizational scheme, the SRJ represents radio amateurs of Yugoslavia at a federal level, uniting them and establishing a policy of developing amateur radio throughout the country as a whole.

All the radio clubs, the unions of radio amateurs of the federal republics and provinces and the SRJ itself, are headed by committees which are elected every two or three years by the members of the organization they represent, or by assemblies in which every member can participate. There are no representatives of local, republic or federal state authorities in these committees.

Every licensed radio amateur in Yugoslavia must be a member of a Yugoslav radio club. This is provided for by law, and hence the SRJ is in a position to unify the educational policy of radio amateurs throughout the country.

The basic methods of education are evening courses in electronics, radio techniques, Morse code, etc., which are usually

organized by the radio clubs or their branches, and sometimes also by public schools, universities, factories, or other appropriate institutions in which sufficient candidates can be found to justify the preparation of such a course.

The SRJ has established a special plan for these courses, laying down a certain minimum knowledge required to become a radio operator within a club or private amateur radio station.

Under Yugoslav law, the SRJ has the right and duty to form examination boards, the members of which are experienced Class I or II operators. No representatives of the state authorities sit on these boards, and the operators one can hear every day, under YU or YT call-signs, are the exclusive products of the education acquired in radio clubs by the members of the SRJ.

In addition to this, we also have special seminars and courses for so-called constructors, to qualify them as lecturers at evening courses in radio clubs. These seminars, lasting from 10 to 20 days, and courses for lecturers, are usually organized in summer camps by the unions of radio amateurs of the federal republics and provinces, during the vacation period. In addition to theoretical lectures, participants quite often build a practical instrument, such as a converter, antenna, etc., which they use in their own radio clubs to improve the equipment they already possess. Sometimes seminars are also held for the special branches of amateur radio. To cite a few examples only: fox hunting, VHF and UHF work by meteor scatter, moonbounce, and so on.

I must stress that all the work of lecturers at evening courses, seminars or other forms of education of radio amateurs in Yugoslavia, is on a strictly voluntary basis.

All the foregoing is merely what may be termed the *technical* aspect of the work. To teach radio amateurs to know their equip-

**WB4NAK**

**ATTENTION MOBILE OPS!  
HAM-CALL MAGNETIC SIGNS**

For your auto or shack! Absolutely will not mar surfaces. Withstands 120 mph winds yet may be easily removed (for the XYL). Large size: 4" x 10" av. White plastic with your choice of colored letters (red, black, green or blue). Your name may be included for 50¢ per sign. Satisfaction guaranteed. Shipped postpaid. 2/7.00 2/10.00 Only \$3.95 ea.

Dealer Inquiries Welcomed - Club Fund Raising Plans!

**HE HOWARD ENTERPRISES P.O. Box 1035 - Dept 73  
Longwood FL 32750**

**F.C.C. EXAM MANUAL**

The Original Test Answers exam manual that prepares you at home for FCC First and Second Class licenses. Includes updated multiple choice tests and key schematic diagrams PLUS "Self-Study Ability Test" - ONLY \$9.95 Postpaid.



COMMAND PRODUCTIONS P.O. BOX 26348 - S  
RADIO ENGINEERING DIVISION SAN FRANCISCO, CALIF. 94126

**READ THIS BY "GUS" W4BPD**

(Actually an advertisement in "disguise"). YOU spend hundreds of \$ on gear, antennas, mikes, etc. then YOU spend countless hours of listening & HOPING for some DX. WHY NOT do it the easy way? Subscribe to the WORLDS ONLY weekly DX Magazine and do it THE EASY WAY. DX news in depth, upcoming events, dates, freqs, times, DX QSL info, stories & articles by DXers, pictures, ALL you want to know ABOUT DX; NOTHING ELSE! OH YES - I also print FB QSL's, priced right. Send 25¢ for 25 samples and price list. How about it? **SUBSCRIPTION RATES:** First Class Mail to USA, Canada & Mexico 6 mo. \$6.00 or 1 yr. \$12.00. THE DXERS MAGAZINE, DRAWER "DX" CORDOVA, S.C. 29039 - U.S.A. (THANKS)

**VIBROPLEX**

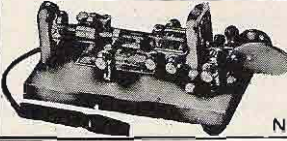

**ENJOY EASY, RESTFUL KEYING**  
\$22.95 to \$47.95  
THE VIBROPLEX CO., INC.  
833 Broadway, New York, NY 10003

**MDR 6 AIN**

EXCLUSIVE 66 FOOT 75 THRU 10 METER DIPOLE

**NO TRAPS - NO COILS - NO STUBS - NO CAPACITORS**

Fully Air Tested - Thousands Already in Use



#16 40% Copper Weld wire annealed so it handles like soft Copper wire—Rated for better than full legal power AM/CW or SSB Coaxial or Balanced 50 to 75 ohm feed line—VSWR under 1.5 to 1 at most heights—Stainless Steel hardware—Drop Proof Insulators—Terrific Performance—No coils or traps to break down or change under weather conditions—Completely Assembled ready to put up—Guaranteed 1 year—ONE DESIGN DOES IT ALL: 75-10HD—ONLY \$12.00 A PAND!

Model 75-10HD	\$60.00	66 Ft	75 Thru 10 Meters	Model 75-40HD	\$40.00	66 Ft	75 Thru 40 Meters
Model 75-20HD	\$50.00	66 Ft	75 Thru 20 Meters	Model 40-20HD	\$33.00	35 Ft	40 Thru 20 Meters
		Model 80-40HD	\$42.00	69 Ft	80-40-15 Meter (CW)		

ORDER DIRECT OR WRITE FOR FULL INFORMATION

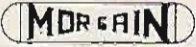

300 S. Shawnee Leavenworth, Kansas 66048

OR THRU YOUR FAVORITE DISTRIBUTOR

**NOW**

**IS BACK**

ment thoroughly and to learn how to work efficiently in the field of amateur radio, special care is dedicated to educating future radio amateurs in "ham spirit," to ensure that they will ultimately become true ambassadors for peace amongst all the nations of the world.

That is one of the reasons that we have on our programme of examinations several questions concerning the international amateur radio movement, its organization, etc.

That is, briefly, what I wished to say about the education of radio amateurs in Yugoslavia. It is understandable that all this work also represents a noteworthy contribution by radio amateurs in aiding the education of youth. This is, in fact, one way - and a fine way - of raising the general technical and humanitarian level of young people.

I must here also underline that many elementary schools, as well as some high schools, have assimilated certain parts of the educational programme of the SRJ into their own technical education programmes. The practical consequence of this procedure is

that the SRJ has its radio clubs in all universities in Yugoslavia and in many high schools. Several hundred teachers and professors are radio amateurs, and it is obvious that they seize every opportunity to influence their students to enter amateur radio.

SRJ has organized a special activity, called "Spring on the Radio Waves," when groups of radio amateurs with their stations visit public schools to transmit their prepared programmes to other schools in the country. There is no doubt that this also offers another real opportunity to inspire young people to join amateur radio.

Furthermore, television, radio, newspapers and various magazines often broadcast or publish articles on amateur radio. This is especially the case when radio amateurs have shown their ability to help at times of national disaster. You will all remember the earthquakes in Skopje, and Banja Luka and the floods in Zagreb, where radio amateurs were the only ones able to link up the stricken areas with the rest of the world. . . .YU3BH

# THE EDUCATION OF RADIO AMATEURS IN POLAND

The Polish Amateur Radio Society (Pol-ski Związek Krótkofalowcow – PZK) is continuing its training programme in close cooperation with the Polish PTT Administration. This cooperation is based on the well-known fact that the field of amateur radio is one of the best training schools for highly qualified radio and telecommunication specialists. And what is also important – this specialized training is provided by the amateurs themselves, without any expensive buildings, equipment or teachers.

The PZK also carries out its amateur educational programme in cooperation and alliance with two other youth organizations in Poland: the Polish Boy-Scouts (ZHP) and the League of Home Defence (LOK). The first of these unites hundreds of thousands of schoolboys and girls; the second has multiple activities, such as motoring, competition shooting, the building of ship or aircraft models, telephone and radio training, etc. Each has its own radio clubs, operating amateur radio stations.

The educational programme of the PZK is orientated in the following three directions:

1. The propagation of the basic principles of amateur radio among a wide public, especially among boy scouts, and schoolchildren.
2. The technical and general education of newcomers, both short-wave listeners and novices;
3. The specialized training of experienced amateurs, helping them to be "au courant" with the latest state of the art in telecommunications.

The first line of action is administered by the Public Relations Commission of the PZK

HQ Council, directed by Vice-President SP5JE who is Director of the Technical Department in the Polish PTT Ministry. The commonly used methods are: amateur programmes in broadcasting and television, articles concerning amateur radio in newspapers and popular magazines, and PZK's own publications and leaflets, such as: "How to become a Radio Amateur," "Amateur Radio" (intended for boy scouts), etc.

At the end of 1970 the second TV programme came into operation in Poland and the PZK has commenced weekly amateur lectures at a popular level. In addition, the weekly bulletins, dedicated not only to amateurs, are transmitted on 80 and 40 meters by our HQ station, SP5PZK.

The most important activity in the second direction is aimed at converting the young newcomer, who is just starting to listen in on the amateur bands, into an experienced amateur operator ready to construct a complete do-it-yourself station and to operate it under various conditions. This part of our programme is supervised by the HQ Commission for Amateur Education, and managed by PZK Vice-President SP5JH (who is also Chief of Communications in the Boy-Scouts' Headquarters).

The newcomer's training programme is based on the fact that our Society is responsible not only for strictly technical education, but also helps schools and parents in the general education of young people.

The training programmes of the PZK are officially accepted by the PTT Ministry and are coordinated with the official requirements for amateur examinations.

... SP5HS

# FOR SALE NEW

## MOTOROLA OA 442/GR 2m AMPLIFIER

A pair of 4X150's delivering 250 watts output with 5 watts drive. Simple modification will enable amplifier to deliver 1000 watts . . \$365.

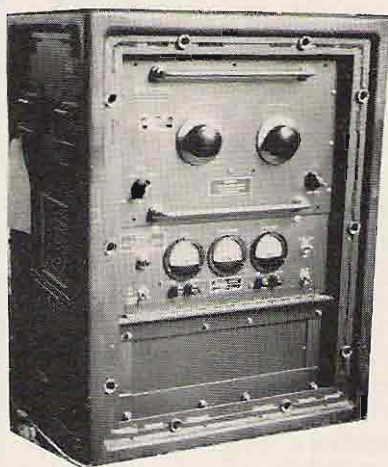

# FOR SALE USED

TS403/U Signal Generator	225.00
TS147/UP Signal Generator	150.00
TS155/UP Signal Generator	125.00
URM-25D Signal Generator	200.00
UPM-33 Spectrum Analyzer	175.00

FRR-33 Receiver control units including dial pulse decoding unit for frequency and transmitter selection. These units are ideal for any application where remote function selection over any audio signal path is desired. Units are capable with slight modification to control up to 99 separate functions.

*We are looking for aircraft electronic equipment and test equipment and will consider a trade for the above equipment.*

**TETERBORO AVIONICS, Inc.**  
481 Industrial Ave. Teterboro, N.J. 07608  
Phone: 201-288-1619

# AMATEUR RADIO TRAINING IN THE GERMAN DEMOCRATIC REPUBLIC

**T**he training activities of the German Democratic Republic Radio Club are based on the amateur radio regulations first issued by our national telecommunication authority, the "Ministry for Post and Telecommunications." The present version came into force in 1965. We consider that these regulations, which were worked out in cooperation with experienced radio amateurs, are very liberal and progressive. Our view has been confirmed by many OM's from other countries.

As from the age of 14, every citizen may become a radio amateur - i.e., may be granted a radio amateur license. In some cases, this is even possible at an earlier age.

Finally, the fourth permit is assigned to radio amateurs who only wish to use radio-teleprinting (RTTY). No telegraphy ability is required here either, merely the proof of competence in the operation of a teleprinter.

I have begun this explanation about our amateur radio regulations because from these arise the demands for the training of radio amateurs. In conformity with the subject of the examinations comprised within these Regulations, the Radio Club of the G.D.R. has worked out a comprehensive and unitary programme of training, which reflects every aspect of radio amateur activity, both theoretical and practical. Training schedules are developed in the clubs, based on this programme, which include a thematic and time arrangement.

When selecting the literature, we restricted ourselves to a few publications available everywhere in the Republic, so as to maintain unity with the standard of training. Moreover, extensive documentation exists concerning amateur radio in the G.D.R., Foreigners who have been resident in the Republic for a long period, such as students at our universities or high schools, or mechanics and businessmen in foreign firms, can also get an amateur radio license, free of charge and without membership of our Club being obligatory. To complete the picture, I would just mention that foreigners who are the guests of our Republic and who already hold an amateur radio license in their home country, are also granted a guest's license.

Our amateur-radio Regulations provide for four classes of permit: Class "2" is provided for newcomers and requires an ability of only 40 letters per minute CW and a relatively simple knowledge of radio technology. This license therefore only entitles the holder to work on 80 and 20 meters, with a maximum antenna input of 20 Watts.

The holder who has worked under such conditions for one year may apply for another class of permit, namely, the main class "1." This entitles the holder to work on all bands, in any mode and with a maximum input of 300 Watts.

Another type of permit, considered as a technical license, is for VHF amateurs. CW ability is not required for this class.

some of which is also internationally known, such as "*The Antenna Book*" by Rothammel (DM2ABK) and "*Amateur Radio Practice*," by the same author, to cite only two examples.

In the booklet series "*The Practical Radio-Amateur*," of which more than 90 numbers have been issued until now, nearly all the desires and interests of radio amateurs are taken into consideration.

For three years a new book series, "*The Amateur Library*" has been published. In this series, five special works for radio amateurs and amateur electronics have so far been published. Besides this, the Radio Club of the G.D.R. issues special instructions for amateur construction activities, in which especially approved standard equipment is described in detail. The training programme and the relevant literature for teaching and private study both provide a good basis for an effective amateur radio training.

Training is carried out in our club stations, of which more than 600 exist at present in the Republic. They are to be found within youth-clubs, clubs of various industries and business firms and within the precincts of our own club.

In principle, the future radio amateur, in his training, passes the qualification stage as a receiving amateur. Prior to this, he has already had the opportunity of acquiring a diploma of the Radio Club of the G.D.R., the so-called HADM-Diploma (Heard All DM), by fulfilling simple tasks as a broadcast listener.

Within the qualification stage, as a listening amateur, he may at first be active as a receiving amateur candidate. He is given a listener's number and may benefit from all the facilities offered by the Radio Club to amateurs. The examination, which does not require any knowledge of telegraphy, is passed in a club station before an examining committee, consisting of licensed radio amateurs.

Thereafter, he receives from the radio club a listener's diploma, which entitles him to work as a receiving candidate for two years. Within this period, he may further qualify as a receiving amateur; depending on his inclination, he may qualify for listening

activity in all radio amateur bands, including the 2m and 70 cm bands, whether he has knowledge of telegraphy or not.

The club stations are equipped with the financial aid of our union and by that of industries and other institutions.

The sound policy of school education in our state, which, among others, is also reflected by polytechnical training, is a good basis for our young citizens to understand the phenomena of natural science and consequently the secrets of electrotechnics and radio engineering.

A great number of our listeners are young people, which does not mean that there is any limitation to age, for we had the case in Berlin where a 65-year-old engineer qualified as a radio amateur!

In the field of the listener's movement, we have created a possibility for receiving amateurs, having reached corresponding results, to acquire a permanent "master" title or, by means of a competition of limited duration, the title of a so-called "master of the year."

The activities of our radio amateurs are guided, on the part of the radio club, by a special section devoted to youth work and listener's affairs, which is directed by prominent pedagogues, themselves radio amateurs. Needless to say, this technical training goes hand-in-hand with general education and training in citizenship.

In his further advanced training, the receiving amateur qualifies, in the club station or in central courses of the radio club, as a transmitting amateur. Our regulations lay down that, at first, he should cooperate for some time as a radio amateur in one of our club stations, in order to extend his experience and knowledge under the direction of experienced amateurs.

In accordance with these regulations, he can work either as a short-wave or as a VHF amateur. The latter is a type of authorization which, at international level, is known as a Technician's License, for which no telegraph knowledge is required and which is acquired by a great number of experts from the electronic and radio-engineering world, particularly as, in the examination, chief stress is laid on technical matters, in addition



to comprehensive knowledge of the relevant regulations.

Radio amateurs who are knowledgeable and who assist our union in the fulfillment of its duties, have the opportunity of receiving the authorization to operate a private station. This is considered a distinction for good work.

Great value is set on the continuous advanced training of our radio amateurs and neither effort nor money is stunted to this end. By means of our radio amateur technical journal "Funkamateur" and other special series, some of which are licensed editions which are also known in other countries, the amateur has the opportunity of qualifying by private study. These series are also available to beginners and are widely read and studied by others interested in technical matters. In addition, meetings of radio amateurs which are organized in club stations, or at district or republic level, offer excellent chances of advanced training in all fields.

We plan to increase the stimulus for continuous perfecting, by creating an amateur radio master title or qualification degree that can be acquired by the radio-transmitting amateur.

It is taken for granted that participation of our amateurs in competitions organized by our own and foreign unions is also considered an excellent opportunity for advanced training, and both radio receiving and transmitting amateurs make wide use of this means.

Cooperation in the field of national and international amateur radio observation, for which our union issues relevant instructions jointly with competent scientific institutions, is also included in training and advanced training.

We maintain a constant exchange of experience with the unions of socialist countries and would be very glad to enter into an exchange of ideas with other unions too. Unfortunately, it would appear at present that close contacts rarely exist at an official union level, and it is our hope to be able to change this situation by future membership of the I.A.R.U.

...DM2HGO

## LEARN RADIO CODE

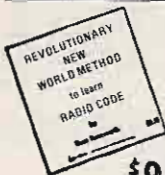

**\$9.95**

Album contains three 12" LP's 2½ hr. Instruction

## THE EASY WAY!

- No Books To Read
- No Visual Gimmicks To Distract You
- Just Listen And Learn

Based on modern psychological techniques—This course will take you beyond 13 w.p.m. in **LESS THAN HALF THE TIME!** Available on magnetic tape \$9.95 — Cassette, \$10.95

## EPSILON [S] RECORDS

508 East Washington St., Arcola, Illinois 61910

### GOV'T. SURPLUS ELECTRONICS

#### NEW ITEM

RT-176/PRC-10

TRANS. & RECEIVER

FM 38.0 to 54.9 MHz. Approx. 1 Watt Portable Pack Set, 16 tubes, continuous tuning, 1 MC calibration check points, Battery power required: 67.5/7.5, 6 and 1.5 VDC. Size: 9.5 x 3 x 10.5; Actual Wt.: 9 lbs. less Batt. Price — Used: \$19.95

AM-598/U POWER SUPPLY & AMPLIFIER  
Operates from 24 VDC and PRC-10 plugs into top of unit. Size: 11 x 11 x 10; Wt 34 lbs. Price — Used: \$18.95  
H-33/ET Handset and Plug for PRC Sets — Used: \$5.95  
MANUAL for PRC-10 Radio Set . . . . . 7.50  
AN-130 Goose-neck Whip Antenna 30' . . . . . 1.00

TV-7/U TUBE TESTER . . . . . Used — \$19.95; Checked — \$25.00  
TV-2/U TUBE TESTER . . . . . Used — \$55.00; Checked — \$65.00

SEND NOW FOR NEW CATALOG  
All Prices F.O.B., Lima, O. Dept. 73

### FAIR RADIO SALES

1016 E. EUREKA • Box 1105 • LIMA, OHIO • 45802

## FM Schematic Digest

A COLLECTION OF  
MOTOROLA SCHEMATICS  
Alignment, Crystal, and Technical Notes  
covering 1947-1960  
136 pages 11½" x 17" ppd \$6.50

S. Wolf  
Box 535  
Lexington, MA 02173

### Ready To GO!



THE VHF 1 PRESALER with a useful sensitivity above 240 MHz.

DIVIDE BY 10 AND 100

AC POWER SUPPLY

\$89.95 postpaid in U.S.A.

Indiana Residents add 2% sales tax.

Write now for further details

## AN-TEK INDUSTRIES

Box 357 R. R. 5

Elkhart, Indiana 46514

# COUNT ON TUCKER

WHEN PRICE AND QUALITY ARE IMPORTANT



The Model 60 Frequency Counter (shown with 160 Hetrodyne unit) measures frequency from 1 KHz to 60 MHz with a full 5 digit readout (overranging feature provides an equivalent 8 digit display). With the optional 160 Converter, this tiny (less than 4 pounds) counter will also read 130 to 160 MHz with a sensitivity of 50 MV. With inputs of up to 100 MV, the unit will cover the full range of 110 MHz to 170 MHz. Only three switch controls provide complete operation—just plug in your signal and read the answer. Not a kit and no adjustments to be made!

- 10 MHz Crystal Time Base 1 PPM/Wk
- 1 KHz or 1 Hz resolution
- 115 VAC or 12 VDC operation
- Automatically positioned decimal

Model 60 with Manual and Accessories ..... \$299.00  
Model 160 Converter ..... \$ 50.00



The Tucker Model 5509 Frequency Counter has a full 9 digit readout from 10 Hz to 550 MHz. The Tucker Model 5509 provides the finest resolution, highest accuracy, and highest sensitivity of any counter in this price range. Many features found on the Model 5509 can only be found on a counter costing much more. Like the Model 60, the Model 5509 is simple to operate—just apply the signal (10 MV or less) and select the frequency resolution required (from 1 KHz to 1 Hz) and you have the answer. No where else can you obtain a counter with the sensitivity, readout, and accuracy of the Model 5509.

- 10 MHz Crystal Time Base 1 part in 10<sup>6</sup>/per day
- Sensitivity of 10 MV to 550 MHz
- Full 9 digit In-Line Display
- 115 VAC or 12/24 VDC with Option Power Converter available.

Model 5509 with Manual and Accessories ..... \$950.00

 **TUCKER**  
ELECTRONICS • COMPANY  
P.O. Box 1050 • Garland, Tx. 75040

WRITE FOR SPECIAL  
BARGAIN BROCHURE

FOR INSTANT INFORMATION OR SERVICE, CALL:

- GARLAND, TX (214) 348-8800
- EDISON, NJ (201) 225-2900
- ELK GROVE VILL. (312) 437-8190
- ORLANDO, FL (305) 894-4261
- CHATSWORTH, CA (213) 882-4560

IN TIME FOR CHRISTMAS!  
LAMPKIN'S NEW FM AND AM MODULATION MONITORS

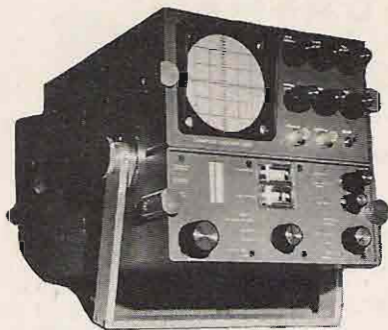

210S — \$790.00



210M — \$485.00

FORTY YEARS OF LAMPKIN KNOW HOW ARE DESIGNED INTO THESE NEW PRECISE WIDE RANGE, VERSATILE FM AND AM MODULATION MONITORS.

WRITE OR CALL  
LAMPKIN LABORATORIES INC.  
P.O. Box 2048 — Phone 813-746-4175  
Bradenton, Florida 33506

NOTE: A FEW OF THE FAMOUS LAMPKIN 205B DEVIATION METERS ARE AVAILABLE AT \$348.00.

# Increase the Usefulness of an "APC"

*William P. Turner WA0ABI  
5 Chestnut Court  
Saint Peters MO 63376*

One of the most common, least expensive, and useful variable capacitors around is the "APC" type. They are available new and used in military surplus as well as in the form of replacement parts. These capacitors are well made and have practically endless uses in any builder's shack.

The major disadvantage of this capacitor is the single bearing design, but this is a problem only in frequency determining circuits such as a vfo. A second and relatively minor disadvantage is the almost universal practice of soldering the rotor tensioning spider to the end of one of the mounting posts. This type construction dictates the grounding of one side of the

capacitor. When using an APC in above-ground circuitry it is necessary to insulate the post from metallic portions of the chassis through the use of standoffs, a non-metallic subchassis, or shoulder washers. Very often these alternatives are not in keeping with the desires of the constructor.

Another less cumbersome route is to carefully unsolder the spider and slip a scrap of fishpaper or similar insulation into the void. The same must be done to other legs of the spider even if they are not soldered. Both the rotor and stator are now above ground and may be connected as desired.

...WA0ABI

# PRICES SLASHED!

- 7-SEGMENT READOUT** Plug-in. 5V-60 ma. per segment. \$3.85, 10/2.85, 100/2.49. Mating socket, .40.
- REED KEYBOARD SWITCHES** 2-Gang, \$1.95, 10/1.35, 3-Gang, \$2.85, 10/1.95.
- REV. DC MOTOR** 1½-3V. Reversible. .49, 10/.29, 100/.24.
- T-1LAMPS** Choice, 5V-60 ma. or 30 ma. .45, 10/.39, 100/.35.
- DYNAMIC MICROPHONE** with stand. \$3.95.
- MALE CABLE PLUGS** with covers. Fit miniature 7 or 9 pin tube sockets. Choice. .29, 10/.19, 100/.12.
- T. I. LED TIL 209.** .95, 10/.70, 100/.60.
- RCA 7-SEGMENT DECODER-DRIVERS**  
 CD2500E or CD2501E \$4.95, 10/3.95.  
 CD2502E or CD2503E \$6.85, 10/4.95.
- POWER SWITCH** 6A-250V. DPST. Fits 1" hole. Momentary or ON-OFF-ON. \$1.49, 10/.99, 100/.85.
- 49 DIODE BCD TO 7 SEGMENT MATRIX** \$3.95, 10/3.29.
- 7 or 9 PIN TEFLON TUBE SOCKETS** .19, 10/.14, 100/.09.
- 200 AMP SCR G.E. & WEST.** 250 PIV \$8.95, 50 PIV \$3.95.
- NEON READOUT** 9 Segment. \$3.49, 10/2.89, 100/1.99.
- LEAD BENDER** for ¼ & ½ watt resistors. \$2.95, 10/2.49.
- PRIME 35 AMP SCR's G.E. or WESTINGHOUSE**  
 250 PIV \$2.95, 10/1.99, 100 PIV \$1.89, 10/1.29.
- DPDT REVERSIBLE SWITCH** Choice of momentary or ON-ON. .39, 10/.29, 100/.19.
- 1" DC MILLIAMMETER** Choice of 1 ma., 5 ma., 20 ma., or S-Meter. \$2.95, 10/1.95 (mix).
- 1" DC VOLTMETERS** 0-20 or 0-300 \$2.95, 10/1.89.
- 1" DC MICROAMMETER** Choice of 0-100, 0-200 or 100-0-100 µa. \$3.95, 10/2.29 (mix).
- NEON PILOT w/series res.** For 115V. .39, 10/.29, 100/.26.
- SS SHAFT COLLARS** for ¼" shaft. .29, 10/.19, 100/.12.
- REED SWITCH** Choice of ¾" or 1" long. .59, 10/.39, 100/.29.
- GENUINE DYMO TAPE** All 12' long.  
 ¼" Reg. \$1.00, 10/.55, 100/.45.  
 3/8" Reg. \$1.25, 10/.65, 100/.55.  
 ½" Reg. \$1.65, 10/.85, 100/.70.
- MAGNET SWITCH** For doors & alarm circuits. SPST-N.O. (apart) \$2.85 pr. 10/2.45, 25/1.90.
- TOP HAT SILICON RECTIFIER** 400 PIV .29, 10/.19, 100/.12.
- SYMBOL READOUT** Choice of 6, 14 or 24 volts. Shows +, -, Ω, V, %. \$2.95, 10/1.95.
- SUB-MINI TOGGLE SWITCH** Highest quality SPDT 6 Amp rating. \$1.89, 10/1.49, 100/1.19.
- LONG TOGGLE SUB-MINI SWITCH, BLACK**  
 SPDT. ON-ON or Center-OFF. \$1.39, 10/.99, 100/.79.
- MINI-ROTARY SWITCH** ½" Dia. 10-positions. 1/8" shaft. \$1.89, 10/1.69, 100/1.29.



# **ELECTRONICS**

**BOX 1348-73, LAWRENCE, MASS. 01842**

# A PROFESSIONAL DIGITAL COUNTER

Quite a few articles have appeared in the literature of the past months, describing digital counters as a brilliant addition to the experimenter's arsenal. Some of these almost stimulated me to action, but there always seemed to be a vital objection to each of them somewhere along the line. A number of these designs required neon bulbs or nixie tubes with the necessary 200V power supply and high-voltage transistors. Some of the logic circuits seemed cumbersome, some of the articles seemed simple enough but were so sketchy that the builder was almost left to start from scratch when confronted with the actual layout and circuit design.

A recent development made it possible to eliminate all these objections and started a labor of love which will be described here. Tung-Sol recently announced a new readout device which is actually a tiny cathode-ray tube. Two tiny filament wires (requiring only 1.6V at 45 mA) supply electrons to bombard a seven-segment digital-8 (See Fig. 1), each of these seven segments being a separate phosphor anode which requires from 12 to 25V at only a few mA. This miniscule power requirement and compact readout tube makes a really small and inexpensive counter possible. It is called the Digivac S/G, and is relatively cheap in small quantities, at \$5.30 each. Texas Instruments makes an integrated circuit which takes BCD information from a set of flip-flops, resolves

it into seven-segment logic, and drives the Digivac tubes directly with the proper voltages. Another company, General Instrument Corp., even includes the decade counter and driver circuitry in a single IC package. This makes a really tiny counter possible, but at a pretty stiff price for the average ham. This article describes a compromise approach which utilizes the advantages of the Digivac tube to build a compact counter with simple power-supply requirements, but at a rock-bottom cost.

I believe that this layout is the ultimate in tiny counters, when cost is considered. The low voltage requirements of the Digivac tube make it possible to use any old transistors that will block 22V (I took mine off old surplus computer boards) and the least expensive of RTL IC's easily furnish enough drive for our purposes, and will count at better than 10 MHz. The complete 6-digit counter was built on a 4½ x 5½ in. etched board. The board is etched both sides

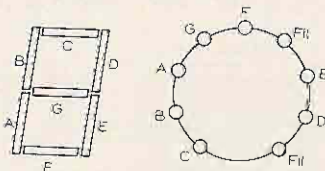

Fig. 1. Anode layout and base diagram of the Digivac S/G readout tube.

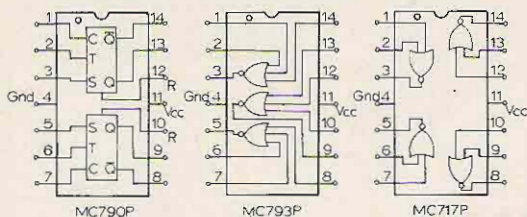

Fig. 2. Basing diagrams of the integrated circuits, as seen from the top of the package.

because of the complexity of the circuit, the clearances for the components are pretty close, and the soldering must be precise to avoid solder bridges to other conductors, but this should not be a real problem with proper equipment. I used a Princess soldering pencil with a 10W element and the finest pointed tip I could find. With this, I soldered all the transistors, diodes, and IC's, both above and below the board, without a heat sink, and didn't ruin a single one.

The logic could be made slightly more simple using *nand* gates or various combinations of *nand* and *nor* gates, but at considerable greater expense. Not counting the transistors and diodes, which I took off old computer boards, the counter cost about \$13.00 per digit to build. As each consecutive pair of digits shares one of the IC's, the counter can be built in multiples of two digits — if you only require four digits for the readout on your vfo, you can just lop the board off at that point.

### The Digital Logic

The devices used for the actual counting are Motorola MC790P's which contain two J-K flip-flops in one package (Fig. 2). Rather than simply dividing by two, J-K flip-flops make other options possible. Each of these flip-flops has two output pins, each of which can have two states — "high," which is a little over +1V, and "low," which is just a

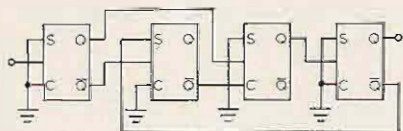

Fig. 3. Connection scheme for the Modulo-ten minimum-hardware circuit.

**Table 1**  
Truth tables for the *nor* gates and J-K flip-flops.

Nor Gate			J-K Flip-Flop		
Input A	Input B	Output	S	C	Q
Lo	Lo	Hi	Hi	Lo	Hi
Hi	Lo	Lo	Lo	Hi	Lo
Lo	Hi	Lo	Lo	Lo	Reverse
Hi	Hi	Lo	Hi	Hi	No Change

tenth of a volt or so above ground. These two output pins are called "Q" and "Q̄," and they are always complementary to each other — when "Q" is high, "Q̄" is always low and vice versa. There are four inputs: a reset pin, which brings "Q" to the low state, "Set," "Clear," and "Toggle." The flip-flop changes state only following a *fast* negative-going pulse on the "Toggle" pin. Which state is entered after a "toggle" pulse depends on the voltages on Set and Clear. (See Table 1.) If more information on this subject is required, see References.

Four flip-flops can most easily be made to count to 16, but for our purposes, we want these to count to only 10. The arrangement used here is called the Modulo-ten minimum-hardware circuit, and is commonly used to divide by ten (Fig. 3), but more complex arrangements are usually used in counters for decimal readouts such as nixie tubes. The states of the outputs through a count of ten are found in Table 2.

In this case, the Modulo-ten was the simplest arrangement I could find from a logic standpoint, because I wanted to energize a 7-segment readout. It was also noted that a matrix which switches off the segments, is a lot simpler than one which switches them on. So that is what this circuit does. All of the segments of the tube are "turned on" except when +0.7V or so is

Table 2  
"Q" output states in a Modulo-ten circuit, through a count of ten.

	Q1	Q2	Q3	Q4
0	0	0	0	0
1	1	1	0	0
2	0	1	1	0
3	1	1	1	0
4	0	1	0	1
5	1	0	0	1
6	0	0	0	1
7	1	1	0	1
8	0	1	1	1
9	1	0	1	1

present at the base of the shunt resistor for that particular segment, which then effectively grounds that segment. The complete logic diagram for each digit is found in Fig. 4.

The gates used are *nor* gates; the output of these gates will always be *low* except when *all* inputs are low; then it will be *high* (Table 1). There are also three diode gates used, which simplifies the circuit (this translates "cheaper") considerably. The 2700Ω resistor at the output of one of the gates, slightly increases the voltage output, which otherwise did not reliably energize the "B" and "G" transistors, because of the additional voltage drop through the series diodes. These are used on the underside of the board, 1/10th watt resistors are a convenient size here. (For placement, see photograph.) You may know that the MC792P has a higher output, voltage-wise, but do not use it! The MC792P would also load the flip-flops much too heavily for this application.

### Construction

The circuit board is etched on both sides, and care is indicated to assure that the two

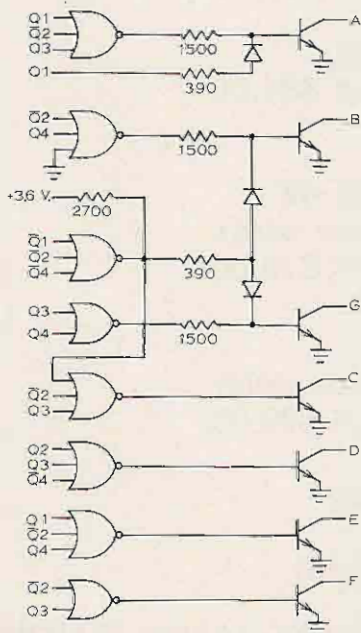

Fig. 4. Logic diagram for each digit. Each of the transistors will ground one anode segment when turned on.

## PROPAGATION CHART

J.H. Nelson  
Good (Open), Fair (□), Poor (O)

NOVEMBER • 1972

S	M	T	W	T	F	S
			1	2	3	4
5	6	7	8	9	10	11
12	13	14	15	16	17	18
19	20	21	22	23	24	25
26	27	28	29	30		

### EASTERN UNITED STATES TO:

GMT: 00 02 04 06 08 10 12 14 16 18 20 22

ALASKA	14	7	7	3A	3A	7	3A	7	7A	14	21	14
ARGENTINA	14	7	7	7	7	7	14A	21	21	21	21	21
AUSTRALIA	14	7A	7B	7B	7B	7B	7B	14	14	14	14A	21
CANAL ZONE	14	7	7	7	7	7	14	21A	21A	21	21	21
ENGLAND	7	7	7	3A	7	7B	14	21	21	14	7B	7
HAWAII	14	7A	7	7	7	7	7	7B	14	21	21	21
INDIA	7	7	7B	7B	7B	7B	14	14	7A	7B	7B	7
JAPAN	14	7B	7B	7B	7	7	7	7	7B	7B	7B	14
MEXICO	14	7	7	7	7	7	14A	21	21	21	21	21
PHILIPPINES	14	7B	7B	7B	7B	7	7	7	7B	7B	7A	
PUERTO RICO	7	7	7	7	7	7	14	21	21	21	14A	14
SOUTH AFRICA	7B	7	7	7	7B	14	21	21A	21A	21A	21	14
U. S. S. R.	7	7	3A	3A	7	7B	14	14A	14	7B	7	7
WEST COAST	14	7A	7	7	7	7	7	14	21	21	21	21

### CENTRAL UNITED STATES TO:

ALASKA	14	14	7	3A	3A	7	3A	7	7A	14	21	21
ARGENTINA	14	14	7	7	7	7	14	21	21	21	21	21
AUSTRALIA	21	14	7B	7B	7B	7B	7	7	14	14	14A	21
CANAL ZONE	14	7A	7	7	7	7	7A	21	21A	21A	21A	21
ENGLAND	7	7	7	3A	7	7	7B	14	21	14	7B	7
HAWAII	21	14	7	7	7	7	7	7	14	21	21	21A
INDIA	7	7	7B	7B	7B	7B	3B	7A	7A	7B	7B	7
JAPAN	14A	14	7B	7B	7	7	3A	7	7	7B	7B	14A
MEXICO	14	7	7	7	7	3A	3A	14	21	14A	14A	14
PHILIPPINES	14	14	7B	3B	7B	7	3A	7	7	7B	7B	14
PUERTO RICO	14	7	7	7	7	7	14	21	21	21	21	21
SOUTH AFRICA	14B	7	7	7	7B	7B	14	21	21A	21	21	14
U. S. S. R.	7	7	3A	3A	7	7B	7B	14	14	7B	7B	7

### WESTERN UNITED STATES TO:

ALASKA	14A	14	7	3A	3A	7	3A	3A	7	14	21	21
ARGENTINA	21	14	7	7	7	7	7	14	21	21	21	21
AUSTRALIA	21	21	14	7B	7	7	7	7	14	14	14A	21
CANAL ZONE	14A	14	7	7	7	7	7	14	21A	21A	21A	21
ENGLAND	7	7	7	3A	7	7	3B	7B	14	14	7B	7B
HAWAII	21A	21	14	7	7	7	7	7	14	21	21	21A
INDIA	7B	14	7B	3B	3B	7B	3B	3A	7	7	7B	7B
JAPAN	21	14	7B	7B	7	7	7	3A	7	7	7A	21
MEXICO	14A	14	7	7	7	7	7	14	21	21	21	21
PHILIPPINES	21	14	7A	7B	7B	7	7	3A	7	7	7B	14
PUERTO RICO	14	7	7	7	7	7	7	14	21	21A	21	21
SOUTH AFRICA	14B	7	7	7	7B	7B	7B	14	21	21	21	14A
U. S. S. R.	7	7	7	3A	3A	7	3A	7A	7A	7B	7B	7B
WEST COAST	14	7A	7	7	7	7	7	14	21	21	21	21

MANN IS MOVING MANN IS MOVING MANN IS MOVING

*Write for a complete catalog*  
**Mann**

**MANN IS ON THE MOVE** — Please note our new address  
and phone number

# **SPECIALS !!!!!**

## **TWO METERS:**

### **GENERAL ELECTRIC ME-33**

30 watts with vibrator supply  
includes accessories **ONLY \$89.00**

### **MOTOROLA T43GGV**

30 watts with vibrator supply  
includes accessories **ONLY \$84.00**

## **450 MHZ:**

### **GENERAL ELECTRIC MT-42**

18 watts with transistor power supply  
without accessories **ONLY \$79.00**

### **MOTOROLA U44BBT**

18 watts with transistor power supply  
includes accessories **ONLY \$79.00**

28710 Canwood Road  
Drawer M 73  
Agoura, California, 91301

MANN IS MOVING MANN IS MOVING MANN IS MOVING M



MANN IS MOVING MANN IS MOVING MANN IS MOVING

# COMMUNICATIONS

**MANN C&E. INC**

**NOW HAS AVAILABLE**

**NEW NICADS (3.75v / 170 MAH)**

**ONLY \$6.00 ea**

**FOB AGOURA, CALIFORNIA**

**THESE NICADS ARE AMERICAN MADE  
AND NEW WITH A FULL YEAR WARRANTY.**

**NICADS ARE AVAILABLE FOR THE FOLLOWING:**

Motorola Page Boy (tone only)  
Motorola Page Boy (tone & voice)  
Cook Pager (tone & voice)  
Please specify model

*In the near future MANN will have a complete line of NICAD batteries for most portables - write us with your needs.*

**Terms: Cash or C.O.D. - No C.O.D. under \$25.00**

**CALL JIM OR BOB AT OUR NEW NUMBER**

**213-889-6666**

MANN IS MOVING MANN IS MOVING MANN IS MOVING

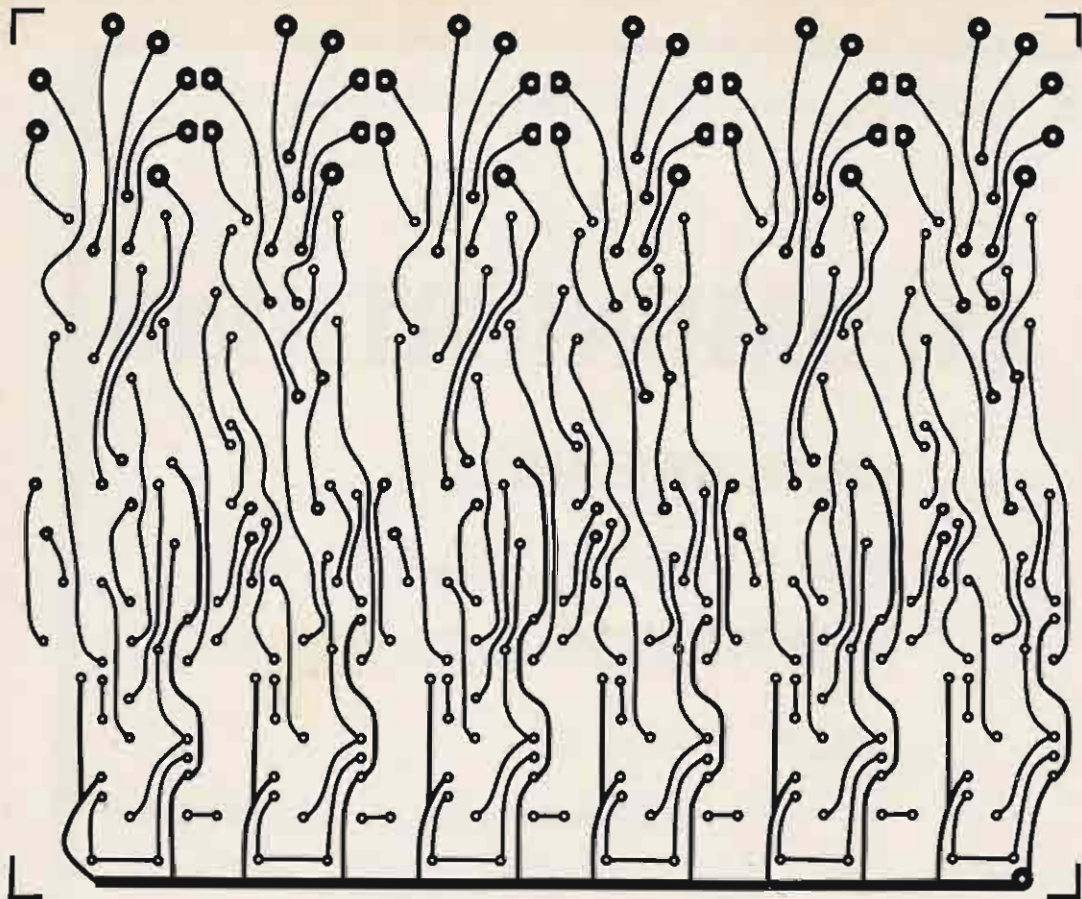

Fig. 5. Component side of the circuit board, full-size.

sides are properly matched. I built a jig for this purpose out of 2 7 x 7 in. pieces of 1/8 in. Lucite. All four corners of the Lucite are drilled with the two sheets clamped together. Tape the two negatives to the adjacent sides of the Lucite so that the negatives match properly with the two sheets of Lucite bolted together. Then the sensitized board can be clamped between the two negatives and exposed with assurance that the holes will match up once the board is etched.

It is also possible to etch the board one side at a time. For this method, only one side is etched at first with the other side protected from the etching solution. Then several pilot holes are drilled in the edges of the board. The second negative is then placed on the other side of the board and made to line up with the pilot holes for the second exposure. This method would prob-

ably be satisfactory only when you are equipped to use spray photo-resist. However, a pre-sensitized board, coated on both sides, would be very hard to expose, etch, and drill without damaging the sensitive emulsion on the second side of the board. It can be done very easily if you are properly equipped, but be sure to cut the burrs from drilling off the second side of the board before coating and etching, as the burrs pick up an extra collar of resist which gets in the way, and they also tend to scratch up the negative.

Once the board is etched, the holes are drilled. It is probably possible to this with with a 1/4 in. electric drill, with extreme care, but a drill press is strongly recommended if you can possibly get access to one. I used a No. 72 drill for the integrated circuits, transistors, and diodes, a No. 60 drill for the resistors, and a 1/16 in. drill for the tube sockets. If you are using fiber glass board, be

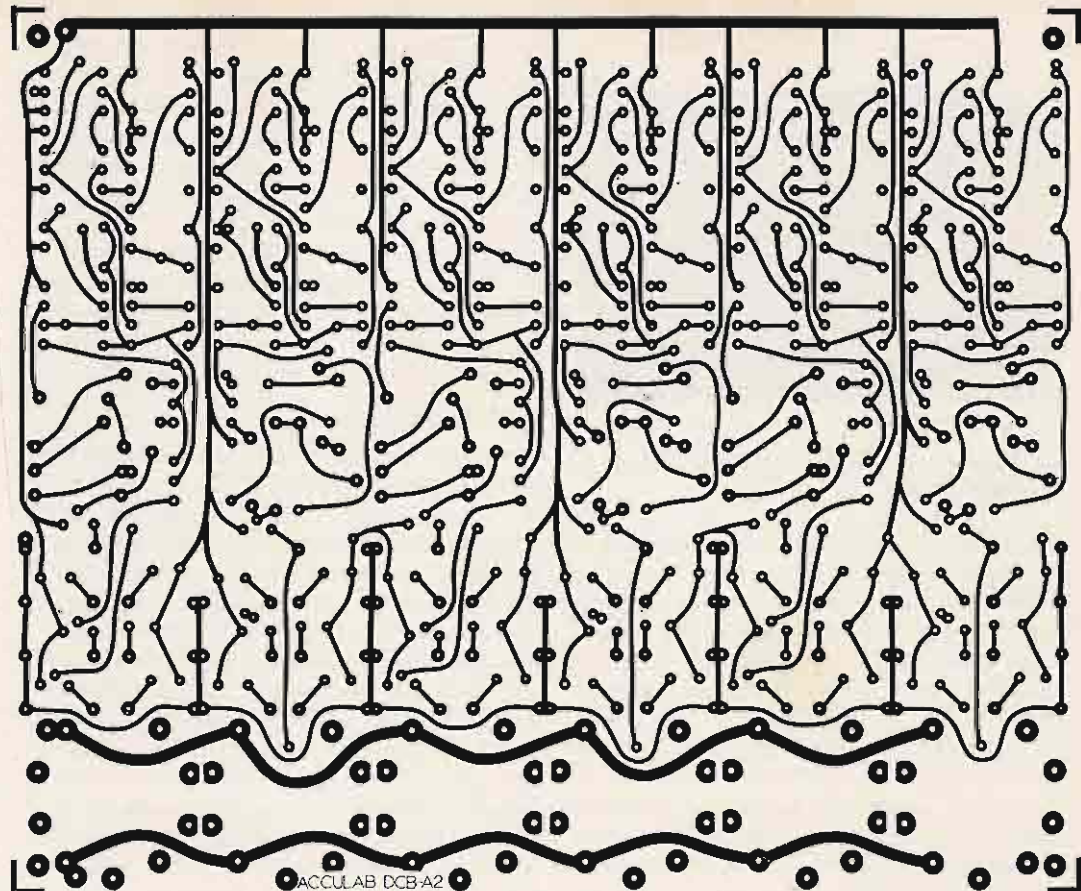

Fig. 6. Second side of circuit board, full-size.

sure the drills are sharp, because I found that a drill which is dull creates much heat which swells the fiber glass, and this can pop the foil terminals right off the board. Fiber glass also dulls the drill bits much more quickly, too, and there are something over 840 holes to be drilled in this board! The drill sizes specified are not sacred, but anything much bigger may just drill the terminals right out of existence, as they are necessarily small.

Once the board is etched and drilled, the next step is to install the jumper wires. Most of these are for power supply or ground connections, or for reset lines to the flip-flops. There are also a number of through-wires to bring current through the board from one side to the other. I used 22-gage wire for this.

Now you can begin installing the actual components. Note that the component side of the board contains the conductors to

most of the tube pins. The other side carries the label. It is wise to install one tube socket, then a pair of load resistors (10K) next to the socket, then the first pair of transistors. Note that some of the connections must be soldered on *both* sides of the board.

Once the first two transistors are installed, it is wise to put +18V between the B+ terminal and ground, to be sure that these transistors will hold this voltage satisfactorily without breaking down. Then put the same voltage, through a 22K resistor, or so, between the bases of the transistors and ground, while measuring the collector voltage, to be sure that it will ground the anode of the tube properly. It is best to test these in pairs as you install them, as it is a lot more trouble to get to them once some of the others are in place. Once you are sure that a pair of transistors works, then go on



Arrangement of 1/10th watt, 2700 $\Omega$  resistors under the board

to the next pair of load resistors and then the next pair of transistors. Then be sure to check all of the solder joints and be sure you haven't missed one or more on the component side, and be sure there are no solder bridges, which will be harder to eliminate later on.

After the transistors, the next step must be installation of the first IC, the MC717P. It is very wise to first tin the foil terminals for the IC's, at least on the component side of the board, as there is no way to heat-sink these soldering operations, and this greatly reduces the amount of heat exposure to the IC. It will be almost impossible to get to some of these joints above the board, once the resistors and diodes are in place. Note that the MC717P's are the only IC's which have the notch and dimple on the package, positioned *away* from the tube sockets — all the others have the notch and dimple on the end *toward* the tube sockets.

Next the diodes can be installed. The cathode ends of the diodes, usually marked with colored bands, are always on the side toward the conductor leading to the bases of the transistors. On the digits where the diodes are horizontally arranged, this is the end *toward* the tube sockets. On the digits where the diodes are vertically arranged, this is the end *toward* the MC717P, except the center diode is reversed.

Now the other resistors can be installed. Note that two of these are 390 $\Omega$  resistors, these lead from outputs Q1 and Gate 7. The rest are 1500 $\Omega$ .

Following this, install the two MC793P's and two MC790P's. Be sure the notch and dimple on the cases are on the end *toward* the tube sockets. Be sure to tin the foil terminals on the component side, for these IC's, also, to minimize the heat loads they have to take in soldering.

Next, solder the 1/10W, 2700 $\Omega$  resistor, on the underside of the board, between the output of Gate 7 and the adjacent pin 11 of IC4. This increases the voltage output of this one gate, as described above.

### Testing the Counter

I found it convenient to test each digit as wiring was completed on it. The filaments of the tube require 1.6V. One side of the filament must be connected to the common ground. Connect +18V to B+. Without the +3.6V supply being connected, all the segments of the tube should light up. When the +3.6V supply is connected, the pattern may not represent any number, but should become '0' when +3.6V is connected to the reset line. Any of the segments which do not light up at this point, probably represent a missed solder joint or jumper wire, or a shorted transistor. A segment lighting up when it shouldn't might mean a missed solder joint somewhere between one of the gates and the base of a transistor, an open diode, or a faulty transistor. Since these are all dc circuits, these should be easy to trouble-shoot with a voltmeter.

To test the counting operation, it is very convenient to have a source of negative-going pulses. I used the clock which I had built for this counter, which will be described in another article. It furnishes pulses from 100 kHz to one per second. One pulse per second makes the operation of all the circuits very easy to follow, and you can stop the input pulses whenever you note a problem, and then check the states of all the outputs with a voltmeter, referring to Table 2.

Lacking a convenient source of pulses, you can check the operation of the flip-flops by feeding a sine-wave signal of a volt or so peak-to-peak, and above 100 kHz, into the input of FF1, and checking the Q output of FF4 with an oscilloscope to be sure the circuit is dividing by ten. If it is, very few

# Save over \$9,000.00 on this AN/WRR-2 SSB Receiver!

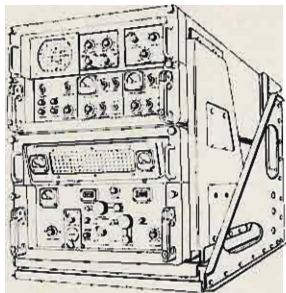

Original government cost: over \$10,000.00! One of Navy's most modern radio receiving sets. Built by National Radio Co. in last decade. A triple conversion super-heterodyne. Frequency range: 2 to 32 MC. in 1 kc increments. 4 bands. Featuring full carrier suppression, unit receives AM, CW, MCW, voice, facsimile, teletype and ISB. **REQUIRES NO**

**MODIFICATION!** Greatly superior to earlier R390A/URR model. Good cond. Complete, operational. Spec sheet available. Spare parts as needed.

## \$495.

Overhauled and certified . . . \$595.00

### NAVY TCS TRANSMITTER

Just arrived! This collector's item is now available in new condition! 1.5 to 12 Mc. CW and AM. 50 watt CW. Ideal for a raft of multi-purpose uses. Designed by Collins Radio. Brand new! A Columbia special . . . . . \$75.00

### IP-69/ALA-2 PANADAPTER

This compact unit can be used with most Ham Receivers after conversion. Complete with conversion info and schematic. Good condition . . . . . \$19.95

### 2 METER AIRCRAFT MONITOR RECEIVER 130-150MC

R-748/TRC-47 single channel AM crystal controlled 110V 60CPS, pwr supply & speaker built in, squelch, r-f gain, dual conversion modern design. Size 19"W x 5"H x 14"D for rack mtg. Supplied with schematic & hookup info. No conversion required. Exl condition . . . . \$29.95

### XMTRS - TRANSCEIVERS - REC'rs

- T-47/ART-13 2-18MC transmitter Less tubes - Good condition . . . . . \$14.95
- T-47/ART-13 with tubes Exl. Condition . . . 49.95
- RT-18/ARC-1 transceiver 100-156Mc Exl. Condition . . . . . 39.95
- ARC-3 transmitter 24 channel 100-156Mc Exl. Condition . . . . . 14.95
- BC-348 200 500KC & 1.5 18MC Reconditioned 24V DC . . . . . 75.00

- R-444/APR-4Y AM & FM Excellent Condition . . . . . 49.95
- R-105/ARR-15 1.5-18MC Collins Receiver, Good . . . . . \$49.95
- RBB 600-4000KC Recond. 115/1/60 . . . . 100.00
- RBC 4-27MC Reconditioned 115/1/60 . . . 100.00
- ARC-3 Receiver 100-156MC 24 Channel Exl. Condition . . . . . 14.95

### COLUMBIA SLASHES TEST TEST EQUIPMENT PRICES!

• TEK., H.P., G.R. ETC.

World's largest storehouse of meters, signal generators, scopes, etc. All popular models. Immediate delivery!

Write for lowest prices in country!

### URGENTLY NEEDED!

We will pay top dollar for your late model military communication equipment, and military/commercial lab grade test equipment. Write or call today:

(213) 875-2970

(213) 764-9030

### FM TRANSMITTERS & RECEIVERS

- 70-100 Mc. Single channel. 50 W. output. 110 V, 60 cycle. New and like new.
- R-19/TRC-1 Receiver . . . . . \$75.00
- T-14/TRC-1 Transmitter . . . . . 75.00
- FREE schematics. Convertable to 6 or 2 meters.

### TELETYPE EQUIPMENT

Tested OK

- M-15KSR Page Printer w/Keyboard & Table . . . . . \$ 199.50
- M-28KSR Page Printer . . . . . 795.00
- M-28ASR Teletypewriter . . . . . 1750.00
- CV-89A/URA-8A RTTY Audio Type Terminal Unit, Good condition, less cabinet . . . . . 75.00

### COMMAND Receivers Transmitters

- RECEIVERS
- 190-550KC Q-5er Good Condition . . . . \$14.95
- Or Like New . . . . . 19.95
- 6-9MC 40 Meters Good Condition . . . . 12.95
- XMTRS
- 2.1 3MC T 18/ARC-5 New . . . . . 4.95
- 4-5.3MC T-20/ARC-5 Exl. Condition . . . . 3.95
- 4-5.3MC BC-475 New . . . . . 5.95
- MD-7/ARC-5 Plate Modulator For Above Xmtrs Exl. Condition . . . . . 4.95

## Columbia Electronic Sales, Inc.

P.O. Box 9266, 7360 Atoll Ave., North Hollywood CA 91609 Tel (213) 875-2970 & 764-9030

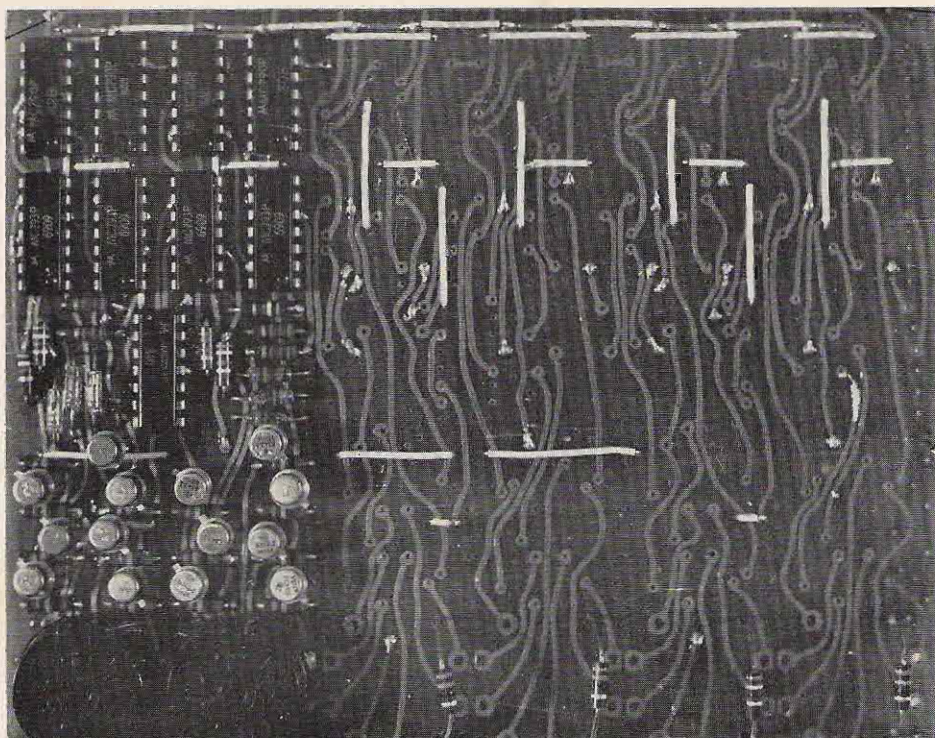

The counter with the first two digits completed. Jumper wires are in place. Note a 10K load resistor next to each driver transistor. These are merely to

limit the current through the transistor when turned on. The resistors with the light stripes are the 390Ω

things could be wrong with IC1 and IC2. The output of each of the gates should be near +1V, when all of its inputs are grounded, and it will not harm the outputs of the flip-flops if they are grounded.

If the +3.6V power supply is not well filtered, pulses from the power supply could possibly leak through into the counting circuitry and foul up the counting process, or make the flip-flops count without any input signal. Three nickel-cadmium "D" cells in series, make an excellent power supply for 30 minutes or so, if you suspect this possibility. In fact, the counter could easily be powered entirely by batteries.

With all six digits counting, the board requires 3.6V at about 500 mA, 1.6V at about 270 mA, and 18V with a current demand which fluctuates widely but peaks at about 60 mA with a readout of "111111," and reaches a minimum of about 8 mA, with a readout of "888888."

If you have had a little experience in building solid-state devices and are willing to

use care in soldering, this counter should go together with no trouble. The counting logic is extremely simple and the digital readout logic is easy to understand. If you will make sure that you understand the operation of these basic digital circuits before beginning construction it should be a pleasure for you, as it was for me.

...WASLFN

#### Bibliography

1. Olson, H., "Micro-logic for Non-logical Users," 73, June 1967, p. 58.
2. Jorgensen, E., "Integrated Circuit Crystal Calibrator," 73, Jan., 1967, p. 6.
3. Jones, G., "An Integrated Circuit Electronic Counter," 73, Feb., 1968, p. 6.
4. Eppley, D., "Build an IC Decade Divider," *Radio-Electronics*, July, 1968, p. 55.
5. Genter, R., "Built a \$10 Experimenter's IC Decimal Readout Module," *Radio-Electronics*, Nov., 1968, p. 60.
6. Genter, R., "9 Digital Readout IC Instruments," *Radio-Electronics*, Dec., 1968, p. 57.
7. Edwards, A., "Frequency Measurements with the Electronic Counter," *Electronics World*, Jan., 1967, p. 84.

# GATEWAY ELECTRONICS

8123 PAGE AVENUE  
ST. LOUIS, MISSOURI 63130  
314-427-6116

---

MEMORY PLANE — 4096 CORES 10" x 16" x  
1/2". Ship. wt. 2 lb. \$6.00

HIGH VOLTAGE TRANSFORMER — new —  
115/220 V input — 5000 V and — 3500 VDC  
output @ .35 ma 4" x 3" x 6" Ship. wt 8 lb.  
\$10.00

5763 TUBES — new Ship. wt. 1/4 lb. \$1.50

MINIATURE LAMPS — #327, #328, #330 —  
new 100/\$25.00; .35 ea.

40-0-40 MICRO-AMP METER — 3" Round Ship.  
wt. 1/2 lb. \$1.50

## DATAK DIRECT ETCH RESIST

ER-1 KIT — Resist Patterns, Etch, Tray &  
Boards Ship. wt. 1 lb. \$4.95

ER-2 REFILL KIT, Etch Patterns, and Tape  
Ship. wt. 1/2 lb. \$2.75

ER-3 ETCH — Makes enough for 200 Sq.  
Inches Ship. wt. 1/2 lb. .89

---

**\$5.00 Minimum Order**  
**Visit us when in St. Louis**

## SUPER COUNTER . . .



\$349

Miida  
DIGIPET 60/160

*Here's the affordable professional grade counter you've been waiting for, to 160 mhz for just \$349.00 complete with scaler!*

- And look at these features . . . . .
- Equiv. 8 digit display with 5 digit readout and display storage
  - Overflow indicator
  - Extremely compact (6.7" X3.6" X7.0") as shown above, with scaler, 4.5 lbs
  - Both AC and DC operation (8 watts)
  - Xtal stability: 1 pt. in 106/ week
  - Resolution: 1 Hz, Sens. 50 mV
  - full 1 year U.S. warranty
  - engineered & constructed for the professional.

*Order this State OF THE ART counter NOW, and we will air ship it to you immediately (at our expense), in plenty of time for Xmas. It's yours for just \$349.00.*

**6.5 DB GAIN FOR \$39.95! THE BEST DB GAIN FOR THE DOLLAR YOU'LL FIND .**

**7 ELEMENT VERTICAL COLLINEAR, COMPLETE WITH RADIALS & COAX**

- REPEATER OR BASE USE
- LIGHT WEIGHT, YET RUGGED
- HERE'S THE GAIN YOU NEED WITHOUT HAVING TO SWING THE BEAM EVERY 5 SECONDS.
- LOW SWR WITH GAMMA MATCH
- FOR ONLY \$39.95, THIS JUST CAN'T BE BEAT!

**SUPER GAIN Antenna \$39.50**  
by  
**Antenna Engineering**

*For mobile use, order the stainless steel mobile whip, with coax, for 3 DB gain . . . . . underpriced at \$16.95 (All of the above available for 140-160, 220, 450 MHZ)*

**ORDER ONE EACH OF THESE BEST BUY ANTENNAS FOR XMAS . TODAY!**

*Phone in or send in your order today, and you'll have yourself a Xmas present.*

## SUPER RIGS . . . .



\$259.50  
INOUE  
IC-20



*State OF THE ART 2 METER FM . . . INOUE . . . . .  
When you go INOUE,  
. . . you are going First Cabin  
with the trend setter for 2 meter FM*

*A look at the IC-20 for just \$269.50  
Try to match these features with any other rig . . . . .*

- 12 channels, .6 supplied. individual tweaking on all 12 T & R channels.
- battery saving high or low power. 1 or 10+ watts . . . . .
- plug-in, shielded, modular construction.
- hot rcvr . . . less than .4 uV/20 db
- built in final protection circuit
- built in alternator whine filter
- helicalized cavity resonators
- noise canceling mike, & mbl. mike inc.
- each rig thoroughly checked prior to shipment
- sharp appearance (your wife will love it)



\$349.50  
Inoue  
IC-21

- Or the . . . IC-21 . . . Base or Mobile . . . . .  
Similar to the IC-20 but with many additional features, including . . . . .
- 24 channels . . . . .T&R for just \$349.50
  - built in AC & DC supply
  - SWR-"S" & Discriminator meters
  - calibrator & RIT included
  - mic. gain and xmit peaking controls

*90 day warranty inc. (replacement parts in stock, inc. many Xtal freq. @ \$4.00)*

*Inoue, the unbeatable rig for performance, appearance, construction, engineering and reliability. . . ask the guy who owns one.*

**NHE COMMUNICATIONS**  
CALL 206-747-8421, OR WRITE TO BOB BRUNKOW  
15112 S.E. 44TH BELLEVUE, WA. 98006



# REPEAT IT - - THE LONG WAY

**L**et me be quick to say that this is not just another of the many fine articles on FM or repeaters, as the title may suggest. The availability and low cost of used commercial FM equipment in recent years has brought many hams into the use of channel-type and repeater communications. I would like to introduce you to what I feel might produce results far beyond the present dream of linking the four corners of the U.S. via FM repeaters. Moonbounce is the name of our game, via a system of repeaters!

Two years ago, when our project started, a group of five local hams were already operational on the VHF bands. Many hams had preceded us there, and many were already quite active on moonbounce projects. Many of these efforts made fine reading, but how many of us have an Areceibo size hole in our back yards, or finances for a large dish antenna on our own?

Since the group is all involved in the electronics field, the idea of researching past articles and ideas came quite naturally. In our jobs, this is done to get a starting

point as well as to avoid future patent difficulties. That's when our first problems began. Articles were found, to be sure, but none contained current EME activity, amateur calls, or frequencies in use. What was worse, no column seemed to exist dealing specifically with this area. Since 73 Magazine, with Wayne Green, W2NDS/1 at the helm, seemed to contain more VHF construction articles per column inch than the others we checked, a quick letter to Wayne seemed in order. True to form, he has even offered space for such a column pending enough interest (write Wayne, c/o 73 Magazine) and, of course, finding someone in the know willing to write it. Good magazines are always looking for good articles and good column writers, so try to help if you can. Please contribute where and when you can.

Since this is an "idea" article, I want to present it in a block diagram, no math, no construction format. I will present future articles dealing with specifics. Our idea is a system of many sub-systems which I will divide and discuss independently.

## The Links

Most of us don't have the back yard room for a large antenna for moonbounce. Because I do, we had the biggest problem licked. Look around your area, city, club or group. Surely one member has the room, or like FM repeaters, it is for rent inexpensively just outside of town. Remember, no mountaintops are required. 5000 isn't much over a moonbounce path! So look for a low noise area if you can find one. Organize, but don't overdo it, as you will scare off the guy that doesn't feel he has anything to contribute. A club, or even just a group of amateurs meeting together with a common purpose is fine. Communicate! This is where the first building block takes shape. Everyone is busy and can't always make meetings, but we all get on the air. At least this way the XYL knows you are home. Choose a locally *unused* FM spot on 144-220-420 MHz, and get equipment on. I caution you now, please, don't use existing FM channels except to initially keep in touch no matter how tempting. I chose the 420 MHz band, since local activity there is almost non-existent, but this is a good chance to get active on the 220 MHz band as there have been some recent conversion articles for 2m FM gear. Due to the very inexpensive equipment and antenna size, the 420 MHz band may still be your best choice. This usually means building your own 110 VAX power supply for existing mobile type equipment. By all means coordinate, and try to buy the same type of gear so the power supplies, crystals, and other accessories will or can be alike and thus save many headaches. This also can lower the price by group purchasing. Once the equipment is on, you have a "meeting place," any day or hour, and someone else to help you iron out problems. This equipment is not at all lost when moonbounce time comes along. Quite the contrary. It will form the only equipment needed by anyone, except the site chosen for the moonbounce equipment. Plan on adding tone encoding equipment to the control head as you build it in order to be able to control the site from each amateur's home. If the site chosen is in one of the amateur's homes and he is to be

present during moonbounce attempts, you don't even need a repeater license.

## The Site

The equipment here can be completely a group effort. However, if it is, get the agreement in writing that it is donated to the group effort to avoid future problems and hurt feelings. Most of our site equipment will be my own. Parts and much building help overcome the problem this way. The overall equipment should be "racked," and cabled, and a full set of diagrams drawn. Believe me, this has already saved us much grief. Unless you can work with the equipment daily, and you aren't far enough along to have much gear yet, you would be surprised how much you can forget even if you wired it!

The transmitter should be crystal controlled, preferably using an oven, and CW makes a good inexpensive mode choice. For the purpose of our own experimenting, we will also have NBFM from the beginning, adding SSB as time and finances permit. Build your rack by building blocks, and if you home brew from scratch, add many, many test points brought out to the panel. The blocks will give you a sense of accomplishment as each is added and checked, and the test points allow for fast checks, periodic maintenance, and rapid trouble shooting. By all means build. Why waste a \$700 transceiver on a spot frequency job. Get the low level exciter running, and test it unmercifully for local contacts. You may wish to add AM modulation capabilities at this level to increase your number of local contacts. Let it run 24 hours a day, and build it so it will. Use caution concerning fire if the equipment is unattended for long periods. This is why we rack mounted everything (confine it) and temperature monitor all of it (shuts it down). As you add control, identification, and taping functions, allow the exciter to "talk back" on a local 2m link anything sent in on the link. This is exactly what it must do later.

The power amplifier cannot be slighted. Mount it at the EME antenna if at all possible, and go as close to the legal 1 KW as you can muster. One man may have a meter, another a transformer, etc. Anything

less and you may be very marginal. This is one time when you are using the "minimum power to maintain the circuit," per FCC regulations. If you find you need less later, dropping down only buys you nice long tube life and like benefits.

The receiver can be a well overhauled, and in top-notch working order, surplus gear item. This saves money and saves tears if you decide later to modify it extensively. Automatic scanning can be added later for complete remote use. Remember, Uncle Sam pays thousands for these items, so you're not getting junk and you can get a real bargain if you try. The converter/pre-amp must be top-notch. Here you may have to pool talent or resources or both. You may have to buy one to get on, and later try building from one of the newer MOSFET type articles. This area is totally up to the time, talent, and the funds available within your own group.

I left the best for last, since another article will cover this one in detail. The EME antenna can be as varied as the number of hams actively working moonbounce. If you start with 144-148 MHz, and I suggest you do because of the equipment, stability, and activity, you unfortunately end up with the largest physical size of antenna. However, if you chose carefully as we did, you can later use it for higher frequency work. This is what we did and why.

Our dish will initially be a quasi-parabola, looking at the side like a parabola, and from the front, a rectangle. From the description you can see this is not a readily steerable antenna for a polar mount. It is not. It is driven el-az, or independent elevation and azimuth. If your only interest is moonbounce, by all means stay with polar mount as steering becomes difficult otherwise. We intend satellite work and space shot tracking as well, and thus our decision to suffer the consequences of a complex steering arrangement. Our dish is entirely wood-of-sorts, covered with hardware cloth, and built in 4 ft. by 8 ft. panels for ease of construction and placement. Wood can be very strong and warp resistant if the right types are chosen and it is finished with the proper materials.

Multi-element yagis and co-linears are being used, but bear in mind the aluminum cost, single-bandedness, and sheer size of these arrays. The collinears for example are of the 150-plus element type. The size and cost of our dish, the means of mounting and steering it using inexpensive (modified) TV rotators, brings it down to the level of many more amateurs' funds and capabilities.

### The Assault

I will present you with the ideas and means we are really using to accomplish our goal - 2m moonbounce. To prove to you that no design work is necessary on your part, many hours of research on the part of the initial members of our groups has been spent compiling the following list of articles that can be directly applied to your efforts. Full credit for these fine articles appears with them, and they are lettered to tie them in with the block diagram. Just to give you an idea of what we did, some are singled out as being our choices.

- A. Link Antenna (corner or yagi home stations - gain at site).
  1. 432 MHz Corner Reflector Antenna, WA2FSQ, *Ham Radio* November 1971, p. 24.
  2. Gain Antenna for VHF/UHF Repeaters, K6MVH, *73 Magazine*, July 1971, p. 42.
  3. VHF Antennas, ARRL, *Radio Amateur's Handbook* 1964, p. 456.
- B. Link Receiver (Motorola T44AAV-Rcvr. TA 141A).
  1. Converting 420-450 MHz Equipment *FM Schematic Digest* pp. 61-71, Two-Way Radio Engineers, Inc. Boston, Massachusetts.
  2. Converting WBFM Equipment for 420-450, W8FWF, *QST* August 1968, p. 31.
- C. Link to EME Interface (COR, Audio transfer, tape amp, etc.).
  1. COR Hold-on, WA2KEC, *FM Magazine* date unknown-early issue, p. 35.
  2. Understanding the COR K6MVH, *73 Magazine* April 1970, p. 41.
  3. Amateur VHF Repeaters, VE7BBM, *CQ* June 1968, p. 37.

4. VHF Operation by Remote Control, K6MVH, *73 Magazine*, April 1968, p. 37.
  5. Mod-2 Digital Identification Unit, WB6BFM, *73 Magazine*, April 1971, p. 49.
  6. Programmable Repeater Identifier, W6AYZ, *Ham Radio* April 1969, p. 18.
  7. IC Repeater Identifier, T. Woore, *FM Magazine* January 1969, p. 15.
  - D. EME Exciter (we use #1 with modifications).
    1. An AM/CW Exciter for 144 Megacycles, W1CER, *QST* September 1965, p. 39.
    2. An FM technique for VHF/UHF SSB, DJ4ZC, *QST* October 1970, p. 32.
  - E. See Item B-1 for oven type crystal oscillators used.
  - F. Amplifier (we use #3 with modifications).
    1. KW Amplifiers for 50-144 Megacycles, W1HDQ, *QST* February 1964, p. 11.
    2. Top Efficiency at 144 Megacycles using 4 CX250B's, W0MOX, *QST* December 1961, p. 11.
    3. New Ideas for the 2m KW, W1QVF & W1HDQ, *QST* February 1971, p. 24.
  - G. Antenna System EME (ours is home brew with ideas from all).
    1. Simple Antenna Mount for Satellite, Work, W4HJZ, *CQ* October 1966, p. 42.
    2. Antenna Tracking Systems for Satellites, GM3BST *CQ* June 1968 p. 55.
  - H. Converter/Preamp (#1 is our choice).
    1. Hi-Performance MOSFET Converter, WB2EGZ, *Ham Radio* August 1968, p. 22.
    2. Transistor Preamp for 50 thru 432 Megacycles, W1HDQ, *QST* February 1966, p. 36.
  - I. Receiver (a much modified BC-348 can be used as tunable i-f).
    1. Converting A Vacuum Tube Receiver to Solid State, W1OOP, *Ham Radio* February 1969, p. 26.
    2. Converting the BC348Q, W0WIT, *QST* January 1947, p. 19.
    3. Converting the BC348O, W3IWX, *QST* November 1947, p. 66.
    4. Double Conversion for BC348M, VU2TV, *73 Magazine*, November 1968, p. 54.
    5. RF Discriminator, K7DEP, *73 Magazine*, October 1966, p. 78.
  6. Surplus, W2HDM, *CQ* March 1959, p. 47.
  - J. Below Noise Systems
    1. I.F. Tracking Filter for Weak Signal Reception, W8FKC, *QST* September 1964, p. 11.
    2. Under The Noise, W2NSD/1, *73 Magazine*, April 1964, p. 20.
  - K. EME to LINK Interface (same as Section C).
  - L. Link Transmitter (Motorola T44AAV - Transmitter TU204).
    1. Same as B-1.
    2. 50W on 420 Megacycles (More power for link if needed), W0WGWZ, *CQ* April 1952, p. 13.
  - M This section covers the entire station as a whole.
    1. Tracking The Moon-In Simple English, W3SDZ, *QST* January 1965, p. 37.
    2. Moonbounce Problem, 28 Mc. and Up, W6VGL, *QST* September 1963, p. 20.
    3. Lunar Nomograph, WA6NCT, *Ham Radio* October 1970, p. 28.
    4. Appearance of the Moon at Radio Frequencies, W2TTV, *QST* May 1961, p. 21.
    5. Mechanisms of Space Communications, K2QBW, *QST* December 1961, p. 22.
    6. How High The Moon, WA0IQN, *QST* July 1965, p. 55.
- Put this kind of line up together, using the articles for a guide, and a respectable moonbounce station will result. For the obvious cost reason, many amateurs have never tried. I hope it will now be possible for you to share costs and rewards by using a shared system. It should be monitored more, and used more, and this yields more activity.
- I would like to acknowledge the assistance (both physical and research) of the following members of our group: K9LNX, K9MKU, K9RYK, WA9BHF, and WA9DTM. Further thanks to all the active moonbounce stations that have helpfully replied to my mailed inquiries. More information can be obtained by stating your question as clearly as possible and sending a SASE to Echo Amateur Radio Group, c/o R.R. 5, Box 39, Noblesville IN 46060.
- ...W9CGI

# INTERESTED IN ANTENNAS?

## *Table-top the Main Features . . . Indoors*

Try reflector and director lengths, spacings, numbers, combining yagis, extended-expanded collinears,  $\frac{1}{4}$  wave,  $\frac{1}{2}$  wave, and two-half waves in phase for 160 and 80 meters right inside your shack!

Complete construction details for an antenna test set of 432 MHz. Easy-to-build units; a 432 MHz oscillator and a tuned detector are detailed for you. These *rf* units may be used later to build a complete hand-carried solid state portable station on 432, with superhet receiver. This station is described in *73 Magazine* in the article "The 432'er Solid State."

With care and using a small iron you can also test spare or surplus VHF or UHF diodes and transistors lying around the shack, by substituting them in these *rf* sets.

### **Oscillator Construction.**

Figure 1 is the oscillator schematic. A UHF transistor, like a 918 or RCA 2N3600, is used in a grounded-base circuit, which makes it a good oscillator right away. The copper strap over copper-clad baseboard results in quite a high-Q circuit, is easy to couple out of, and tunes over a lot more than just the 420 to 450 MHz amateur band, unless you wish to pad it down and/or remove plates from the Johnson type M capacitor. An output coupling capacitor is provided for better adjustment to the 50 ohm output cable.

Figure 2 is a top view, and Fig. 3 is the side view. This unit is similar to the one in the

"432'er, Solid State" article in *73 Magazine*, making it easy to transfer it into the complete rig described there later on, if you wish to do so. There is a slight difference in the dc bias network because in antenna test work a lot (like 100 milliwatts!) of power is desirable, while for local oscillator service in the superhet receiver, lower harmonic content and less power are wanted.

### **Tuned Detector Unit.**

The schematic is in Fig. 4, the top view is Fig. 5, and Fig. 6 shows the side view. The detector diode unit is also similar to the "432'er" mixer unit, except that the *if* coil is not installed and the dc output is brought out of the *if* jack. Be sure to leave space for the *if* coil if you want to use this detector later on as a mixer.

### **Operating the Antenna Test Sets.**

After building the *rf* units, set up two card tables, one for the oscillator and transmitting antenna test units, the other for the receiver antenna and tuned detector, as in block diagram.

*Next step.* Go over to the other card table and set up the tuned detector. This is very convenient for indoor work, as you will see. For checking directivity, good gain measurements. Getting away from the "near field" are some of the reasons for the two tables.

The diode detector needs no battery but you will need a good meter, which should be a 50 mA unit for best sensitivity. You can use a heavier meter, but it will just not be as

# FM 2 Meter UHF 6 Meter USED

GENERAL ELECTRIC ... RCA ... MOTOROLA

## VOICE COMMANDER III

GENERAL ELECTRIC  
FULLY SOLID STATE FM  
Transmitter - Receiver

132 to 174 MHz  
1 WATT OUTPUT  
1/2 MICRO-VOLT SENSITIVITY  
Size: 9.5" x 5.3" x 1.7"

High Performance, completely self-contained two-way FM radio. Compact, lightweight, easily operated and hand-carried. Housed in high-impact 2-section case. All external hardware polished stainless steel.

Proper charger available separately. \$15. each.

### \$148.00

Lots of 5 ea. \$133.20  
Lots of 10 ea. \$125.80

Includes rechargeable nickel cadmium battery pack and charger. . . . .

(Crystals & tuning, add \$50)

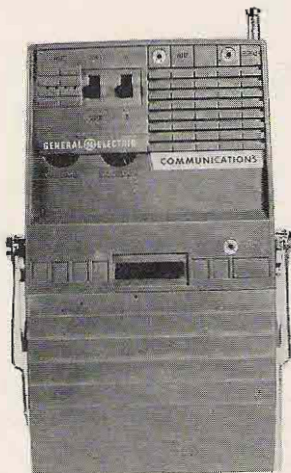

### PROGRESS LINE STRIPS

These strips are physically complete, but are sold on an as-is basis only.

	MA/E13	MA/E16	MA/E33	MA/E36	MA/E42
Power supply, 30W, less vibrator	\$20	—	\$20	—	\$20
Power supply, 60W, less vibrator	—	\$25	—	\$25	—
TX narrow band, less final tubes Note: MA/E42 wide band	\$18	\$25	\$25	\$30	\$12
RX wide band, less ovens	\$18	\$18	\$18	\$18	\$12

14" Progress Line Case, consisting of front basket and front plate with lock . . . . . \$10.

Low band dual front end, 2 freq. RX strip . . . . . \$20.

Hi-Band TPL RX with TX exciter strips less speaker, as is, missing parts . . . . . \$25.

15,000 2-way FM mobile units in stock! Send for new 1973 catalog.



## GREGORY ELECTRONICS CORP.

The FM Used Equipment People

243 Route 46, Saddle Brook, N. J. 07662

Phone (201) 489-9000

Dept. 73

sensitive, and will require the two tables to be closer together.

Plug the antenna cable into the detector jack No. 1, and the other end into the dipole jack. Tune the detector to 432, and you should then have current showing, if the antennas are only a few feet apart to start.

#### Important Notice!

As soon as possible after positioning and tuning up a dipole, reflector, and director, set up at least a three-element beam to use as the receiving antenna for the test meter, and point it at the transmitter antenna under design and test.

A simple three-element unit for 432 is shown in Fig. 7, as a sample of what can be done for the purpose of getting started. You may well tune up a *better* one which you can then scale up to six meters, ten, or whatever band you wish. Nothing prevents you from using as many elements as you want to tune up! Three elements are handy for indoor work.

The use of a three-element (at least) beam eliminates a great deal of nuisance reflection, including *yourself* as you move about. The stability of the detector meter when two beams are pointed at each other is remarkable. Such an antenna, for test purposes, can be used for reception of energy from any other type of antenna you may wish to try.

#### Cable Matching

You will notice a trimmer capacity on the radiator. This is an important little item, as you will see when you adjust it. It is part of the gamma match, and quite necessary (as you can find out by shorting it out). In general, use more capacity for lower impedance, with closer spacing. Use quite a bit less for the dipole alone.

I use a long-handled fiberglass screwdriver and adjust the capacitor from *in back* of the reflector, readjusting the spacing and oscillator tuning each time. This can be important. You also can vary the *length* of the gamma match and its *spacing* from the radiator.

When you get that antenna "matched to space," which is exactly what you're after, you'll see the difference.

Of course you can try other types of feed too. An intriguing type which can give you a

perfect match to a 50 ohm cable is shown in Fig. 8. I "invented" this style while with a large antenna project on Commonwealth Avenue in Boston about 1957, and it won out over a "conventional" dipole with stubs and all.

#### Cable Length

This is also important to check. The only time cable length is *not* important is when you have a perfect match, and usually that is never! Just try it. If you can add an eighth wave or a quarter wave and not change results on the antenna, that is an absolute check on vswr.

#### Radiators, Reflectors, and Directors

The results should open your eyes. For example, let's see you try to tune up a three-element job with close spacing, like a tenth-wave!

Get yourself an extra roll of aluminum clothesline and some more dowel wood at the hardware store and have *more* fun. Cut reflectors, 5, 6, 8, 10, and 15% *longer* than a half-wave in free space, and see what happens. Let yourself go!

Get still more aluminum and try 5, 6, 8, 10, and 15% *less* length for the directors. You may have *more* surprises. I have only described material for two three-element beams, to illustrate the basic principles and tuneup of reflectors and directors, but don't let that stop you from adding as many more elements as you wish to try.

My biggest so far was the 36-foot-long job, with 16 wide-spaced elements on two meters that I used on mountain tops. Incidentally, each director you add to the beam should have a length of a little less than the previous one, till you get about half a dozen tuned up and placed.

Just a word about many-section yagis. After the "launching section" is tuned up, comprising those first half-dozen or so, the rest of the directors *can* be the same length. I have never found it possible so far, however, to sue the same *spacing* for numbers six to sixteen. You *can* do this, like some of the commercial lads, but I have not found this to give maximum gain which is what I've always been looking for, personally. You will be able to check this yourself with this antenna setup. You will

# USED FM EQUIPMENT

NOVEMBER SPECIAL SALE FOR  
73 READERS ONLY

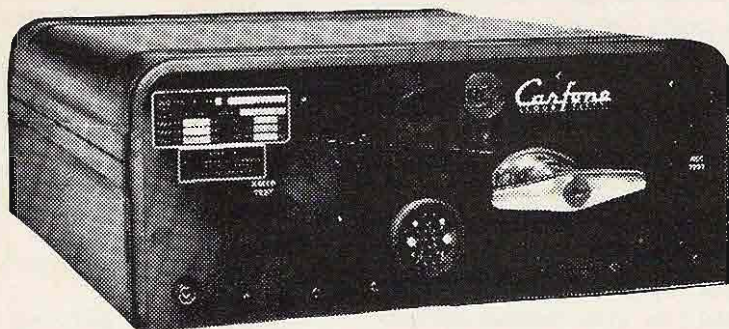

RCA CMU-15  
450-470 MC. Mobile Units  
6/12 Volt Vibrator Power Supply

IDEAL FOR REPEATER LINKS

EASILY CONVERTED    REGULARLY    \$35.00

*SPECIAL PRICE FOR NOVEMBER ONLY*

*\$25.00 each less accessories*

Send check or money order to:

**DuPAGE FM**  
**P.O. Box 1**  
**Lombard, ILL. 60148**

**Terms:**

All items sold as is. Accessories not included  
unless indicated. Illinois residents add  
5% for sales tax.



# USED FM GEAR

1. Multi Conductor Control Cables  
25 – Conductor . . . 20 feet long . . . . \$5.00
2. Battery Cables – 3 Conductor  
20 feet long . . . . . \$4.00
3. RCA Power speakers – Have built-in  
Transistor Amp. . . . . \$7.50
4. RCA "E" Line Mobile  
450 mc, with accessories, (one left) . . . \$45.00
5. RCA Receiver Strips  
Low Band . . . . . \$35.00  
High Band . . . . . \$35.00  
450 mc . . . . . \$30.00
6. RCA Transmitter Strips  
Low Band . . . . . \$20.00  
High Band . . . . . \$20.00  
450 mc . . . . . \$15.00
7. ASP Gain Antennas for Two  
Meters – used . . . . . \$10.00
8. Pre-Progress Line 60 Watt Mobile  
30–50 mc, with accessories 4ES16 A2 . . \$25.00
9. CSF 6 60 Watt  
Table Top Base Station . . . . . \$125.00

**TERMS:**

All equipment sold as is. Accessories not included unless listed. Allow three weeks for delivery. Illinois residents add 5% sales tax. Send check or money order to:

**DuPage FM Inc.**  
Post Office Box 1  
Lombard, Illinois 60148

also see that every director you add will *increase* your gain, even the *last* one you add.

### Sheet Reflectors

If you want to pursue this matter further, get some aluminum sheet at the hardware store. Better yet, for the dollars involved, get some aluminum flashing and try various sizes and spacings for sheet reflectors. Take a large piece of sheet, such as 18 x 18 inches (not critical) and mount it on a movable dowel like the other reflectors, and watch that meter. I have always found that the tuned reflector (some 10% greater length than the radiator) has better gain than the sheet reflector. Also check the front-to-back ratio with the sheet reflector; it could be better.

### Two Yagis Together

As you see, this can go on and on. Don't say I didn't warn you. Just try for fun adding two yagis together. Or better, try adding two dipoles first. You will soon see that even two dipoles have to be spaced greater than a half wave for best performance. This is because the capture area of even a dipole extends out beyond the half wavelength.

It wasn't so long ago that I used to manufacture and sell collinear arrays, as owner of the UHF Resonator Co., Rye, N. Y. These were spaced only a half wave and did not have the gain they should have had. This was because a "time-honored" method of feeding a collinear beam in all the books shows the half wave line as a matching section, which precludes anything *greater* than half-wave spacing.

The day came, however, after reading about capture area for the umpteenth time, that I felt I should check this item out for the two-element yagis that compose most collinear arrays. This is a large part of the deal. The collinear, as usually made up, has *reflectors* as well as dipoles so that you are really combining two yagis together with every two sections of the collinear. And, two yagis *must* be spaced much wider than the half wave if you do not want the capture areas to interfere. When they do, you are just putting up more aluminum than you are using. Check it out for yourself.

Match up a good radiator and reflector, then make a second identical one and check it out for similar gain and directivity. Then connect both together as a four-element array composed of two yagis, using equal length cables for phase maintenance. See Fig. 9. You should join the cables close to the oscillator, or use a quarter-wave matching section of 35 ohm cable. This is because joining two 50 ohm cables makes a 25 ohm impedance at the joint.

Start with the reflectors almost touching and the yagis side by side, which is the way they are in a collinear array. Fig. 9 shows them already "expanded." When you get them set up, watch the meter as you pull them apart — what a revelation that was when I first did it.

### 80 and 160m Beams

Figure 10 shows a setup on 432 MHz for checking end-feeding of a half-wave antenna for 80 and 160 meters. If you have the territory, two of these, known as two half waves in phase, makes a very powerful antenna for 80 or 160 meters. This is shown in Fig. 11. Note the low capacity of the end fed coupling units. This is important, because you should *not* load a half-wave antenna directly onto a tuned circuit, and expect much tuning.

### Marconi Types and Angle of Radiation

Put a piece of that aluminum flashing on the table, add a little wet earth (maybe not in the living room) and add a little salt if your shack is near the ocean. Now you can check verticals against ground, and ground effect of high gain beams, which shouldn't be noticeable if your beam is putting 90% of its energy out in front, which it must do to have some 10 dB gain.

With a little ingenuity, wooden dowels, and still more aluminum (or maybe you can use smaller copper wire for these tests), you can check scale model quads, halos, stacked halos, hula hoops, big wheels and almost anything you can dream up. Of course you're now getting near the professional style of antenna scaling. But maybe that isn't too bad.

### Gain and Front-to-Back Measurements

There is a positive way of checking the

## FM SYMPOSIUM SEPTEMBER 24TH

The release of the repeater regulations by the FCC with an October 9th deadline for comments demanded some fast footwork by repeater groups if they were going to be able to intelligently respond to the situation.

After waiting for several days for the Northeast Repeater Association to get into gear and come up with a meeting, and after it became obvious that this group would not get together before their annual meeting on October 7th, far too late for repeater groups to return home and organize a response to the FCC order, 73 Magazine hurriedly set up a meeting place in Waltham (Mass.) and announced it in the Repeater Bulletin.

The Bulletin, by the way, was in the mail to its subscribers on Monday September 11th with the full text of the new regulations which were released on Friday the 8th! The order had been tentatively released about ten days earlier, but it took some time to actually get printed and mailed from the FCC.

The Waltham symposium drew representatives from nearly 30 repeater groups, not counting multiple representation by individuals, some of

which claimed to represent up to eight repeaters. Despite repeated attempts of NRA representatives to interfere, the meeting went very well and its objectives were met.

### 220 MHZ BAND PLAN

The frequency coordinating committee of K1KEC, K4GGI/1 and F2BO/W1 were all present and had come to the meeting prepared to explain their plan for the modified 220 MHz band. This committee has been working together for several months organizing the New England repeater frequencies — with spectacular success and cooperation. It perhaps should be explained that this committee pre-dated the NRA and agreed to work with NRA when that group was formed since it seemed beneficial to get together with them.

The committee did not expect to find NRA officers demanding that they keep their work a secret from New England repeater groups in order to give more prestige and power to NRA, but this is just what happened. NRA said no, you cannot be part of NRA if you do not do what we say — and we say you cannot present your 220 MHz plan at Waltham, but must hold it until October 7th for the NRA meeting.

When this fact became known to the Waltham symposium repeater rep-

resentatives, their anger and irritation with the high-handed actions of NRA grew noticeably.

The plan was presented anyway — and adopted by the representatives. It consisted of using a 1600 kHz split with repeater input on the low end and output high, starting at 224.98 and working down every 40 kHz. This leaves a few channels in the middle to avert repeater outputs getting into other repeater inputs. Simplex 223.50. Agreed also to leave 222.0 to 222.3 open for weak signal work for the time being. Late word has it that the California Amateur Relay Council has approved the same plan — and NRA is expected to put its stamp of approval on it.

### VETO REGULATIONS

The group discussed the new regulations in depth. The pros and cons of the entire order were considered and the vote was taken on whether the group preferred to go with the new regulations, hoping to change them later, or to stop everything and continue with the regulations (or lack of them) the way they were. The vote was, with one exception, opposed to adopting the new regulations.

The complete report on the Waltham symposium is in the Repeater Bulletin (\$2 per year as yet).

. . . Wayne

actual gain and front-to-back ratio of beams which will not cost you a cent. This method is simply the distance method. Twice the distance (with equal power showing on the meter of the detector) is a power gain of four times. How could it be simpler than that? A gain of 3.33 in distance equals 10 dB in power. This of course is in free space. If you really match up your *dipole* radiator for maximum output and find it registers 50 on the meter at ten feet, then substitute your new tuned-up beam and find you can go out to one hundred feet with the receiver array and still have it register 50, you've got a 20 dB beam! I should warn you though that *that* amount of gain takes a beam of about six wavelengths square, which, even on two meters, is some 36 feet *on a side*.

There can also be some ground effect, so you should average it out by raising and lowering one or both of the beams up and down to check.

The front-to-back-ratio check is equally easy. With the main signal on, go around to the back of the beam with the detector, meter, and receiving beam in your hand.

Adjust your distance in back of the transmitting beam for a low reading on the detector. This is probably what you'll get anyway. Then go around in front. The difference in distance is the front-to-back ratio, naturally. Don't forget, for the power ratio you have to square the *distance*. Good luck on that one.

Remember the law on antennas, "Gain is equal to directivity." Under certain conditions, not generally encountered nor desirable, you can get directivity without a corresponding gain, but never gain without directivity.

It is generally considered that a beam tuned for maximum forward gain does not at the same time have a maximum front-to-back ratio. This is more evident with three-element beams than with high-gain jobs. You can check yourself with these test sets, plus a little more aluminum, wood, and time.

That's about it, so hope you have as much fun as I do with these kind of tests. It seems that every time I work with antennas, even after some 44 years of it, there are still new things to be learned.

. . . K1CLL

Counter FRR 38 same as HP 524B 8 places frequency measurements 10 Hz to 10 mH also can be used to 100 MHz and 500 MHz with proper plug-ins, counter with MX 1636 plug in (for greater sensitivity) for 10 mc use \$75.00 100 mc plug in \$24.50 additional.

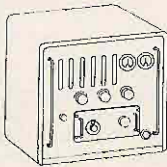

LM Frequency Meter 125 kHz to 20 MHz  $\pm 0.01\%$  heterodyne unit for measuring and setting rec. & trans. Signal gen. etc. in good cond. with 1000 kHz crystal & tubes and proper book \$35.00



Facsimile unit trans. & receiver with 60 Hz supply 12" x 12" x 6" used in many offices. Send 2 way messages complete with conversion sheets only \$12.50 ea or 2 for \$19.95.

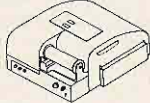

Walkie talkie solid state HT1E manf. by Hallicrafter used in Viet Nam 30 to 50 kHz AM. Can be put on citizen band or converts to 6 meters powered by flashlight batteries. Size 12" x 3" x 3" with schematic. \$35.00 ea.

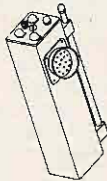

Audio oscillator TS 382 20 to 200,000 cycle. A reed freq. meter permits a check at 2 points. In good condition. \$75.00



Stereo Scope Indicator. Compact 3" scope unit with 110 VAC supply; many used for teletype distortion. Ind. converts to pan-adaptor or stereo output indicator. (Sit back and watch changes in pattern on the scope.) With conversion \$24.50

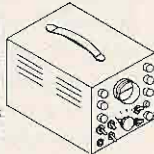

Multimeter TS 352. Portable accurate multirange meter. 0-5000V AC & DC. Current: 0-250 & 0-500 mA. Resistance: 0-30 Meg. Good cond. \$27.50

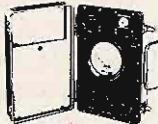

Converter, telegraph & telephone signal conv. Housed in a waterproof, metal case 12" x 7" x 6". Wt: about 10 lbs. Complete with 110V, 60 cy. power supply. (Some hams have converted this unit to a teletype converter.) With schematic \$7.95



PRC-10 back pack transceiver, lightweight, 38-55 MHz FM. Complete with battery pack case. Handset & ant \$59.50

PRC6 WALKIE TALKIE Range 47-56 MHz FM. Lightweight - still being used by military. With antenna only \$39.50.



LIGHT SENSITIVE DIODE Self contained lens. Point contact - talk over light beam - works as electric eye - burglar alarm etc. \$1.00 ea 6 for \$4.95

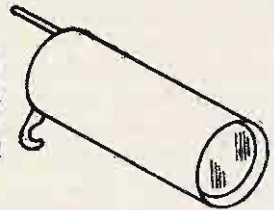

OUTDOOR LOUD-SPEAKER  $8\Omega$  voice coil. Housed in a cast aluminum case. Complete with an  $8\Omega$  to  $600\Omega$  transformer. Cone is treated for weather. Size 5" x 5" x 3" Only \$3.95

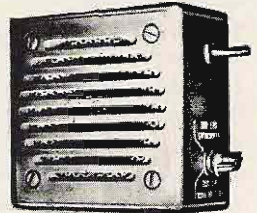

PRECISION VOLT-AMP METER Weston range 0-3-15-150 VDC and 0-3-15-30 ADC. With carrying case \$9.95.

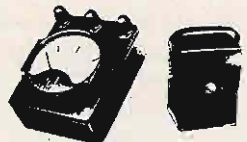

## J. J. GLASS ELECTRONICS CO.

1624 South Main Street, Los Angeles CA 90015

TERMS: Remittance in full or 25% deposit on COD order. Minimum order \$5.00 FOB L.A.

# ALL ABOUT LASERS

The atomic spy stood on the shores of Jupiter's Red Lake and focused his radar binoculars on the enemy ship 1100 miles away. Then with savage sneer he drew his laser pistol. There was a resounding "ZAP" and a blinding flash. The ship was instantly vaporized.

This is the picture most junior operators get when they hear the word laser. Well kids, I hate to spoil your dreams, but it just isn't so. There isn't a laser in the world that could destroy even a toy ship. In fact, the average laser doesn't generate as much power as a 22 calibre bullet. Believe me, I know. I've built 'em. The big thing about a laser isn't how much power it generates, but how it's concentrated.

The word laser comes from the initials of the words, "Light Amplification Stimulated by Electromagnetic Radiation." This means that one kind of energy is pumped into the laser, and another kind comes out. It doesn't "create" energy.

The heart of the most popular kind of a laser is a solid ruby about the size of a cigarette. (I've seen them much larger, but this is average.) Each end is plated so that it will reflect light. The plating of one end is thin enough so that it will let out about one tenth of the light and reflect the rest. The ruby is surrounded by an electronic flash lamp similar to those used by photographers, only much more powerful. The power supply for this flash lamp can weigh several hundred pounds. (That's why they haven't built many laser pistols.)

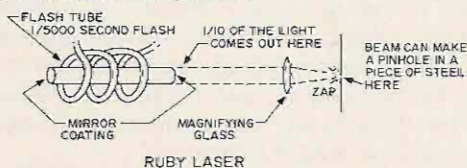

When this flash lamp goes off, nearly all the light is forced into the ruby by a system of mirrors. This starts a chain reaction in the ruby which generates more light. The light generated inside the ruby is very pure — that is, it's only one color, while the flashlamps were, like most lamps, a mixture of many colors. The light within the ruby cannot get out through the sides, so it tries to come out the ends. The reflective coatings on the ends causes it to bounce back and forth through the ruby. Each time it passes through it makes the ruby generate more, until it gets so powerful that it shoots out through the thinner reflector. All this takes place within a few millionths of a second.

When the light comes out of a laser, it doesn't spread out as the light from a flashlight would. If the beam is  $\frac{1}{4}$  in. wide as it leaves the ruby, it will still be  $\frac{1}{4}$  in. wide a mile away. This is what makes a laser beam so valuable. You don't lose any power at all. An ordinary light would spread out and much of the power would be lost, but a laser beam sends all the light where you want it. And, if you could see the light waves, you would see that they were all the same wavelength, and all vibrating in the same direction, or as the scientists say, they are all *polarized* in the same direction. This way, no matter how far you send the beam, you can recover all the energy at the other end.

Anybody knows if you take a magnifying glass and focus the sun's rays into one tiny spot, they will burn a hole through a piece of paper. Now sunlight contains many colors, and each color will focus differently from the rest. When you try to focus sunlight with a magnifying glass, the best you can do is come close for all but one color. Not so with a laser beam. Since it contains only one color to begin with, you

When you want  
an authoritative,  
up to date,  
complete,  
reference  
It's the **QTH**  
and  
**you know it**

The U.S. and DX Editions lists licensed radio amateurs throughout the world plus many other valuable features including maps, charts & tables all designed to make your operating more efficient and more fun.

**PLUS**

New this year!

A special subscription service of one basic CALLBOOK plus three service editions, one issued every three months to keep you completely up-to-date for less than half of the cost of purchasing four complete CALLBOOKS as before. You save money — you stay better informed.

Over 285,000 QTH's  
in the U.S. edition  
Complete for 1972 U.S.  
CALLBOOK subscription  
just **\$14.95**

U.S. CALLBOOK for 1972  
(less service editions)  
**\$8.95**

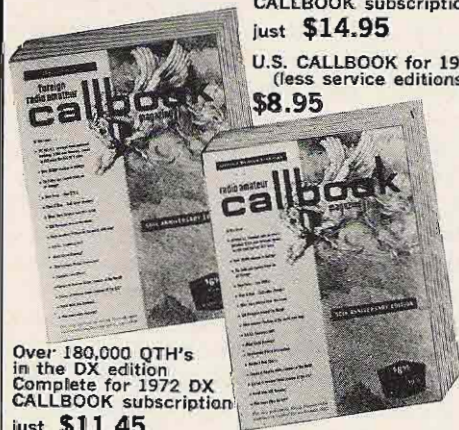

Over 180,000 QTH's  
in the DX edition  
Complete for 1972 DX  
CALLBOOK subscription  
just **\$11.45**

DX CALLBOOK for 1972  
(less service editions)  
**\$6.95**

(Mail orders add 25¢ per CALLBOOK  
for postage and handling)

See your  
favorite dealer  
or Send today to

WRITE FOR  
FREE  
BROCHURE

RADIO AMATEUR  
**callbook** INC.  
Dept. D 925 Sherwood Drive  
Lake Bluff, Ill. 60044

can get all the energy into one tiny point. When you gather it all together, a little bit will go a long way. In fact, a flash that lasts only 1/1000th of a second will, if concentrated by a magnifying glass, burn a hole through a piece of steel such as a razor blade. However it would be very impractical to use a laser beam to make a hole in an enemy warship. You would have to have somebody near the ship to hold the magnifying glass, and the enemy might not like it.

Seriously, though, while you can't sink the Queen Mary, or vaporize Newington CT with a laser, it still can be used to do a lot of good. For instance, hospitals use them to weld the tissue on the inside of an injured eye. Before lasers were discovered, that was an impossible operation.

So far I have only discussed the ruby laser. There are several other kinds. For instance, a gas laser, made of a glass tube something similar to a neon light, is one of the most promising kinds. The glass tube contains a neon-helium mixture and is excited by a radio transmitter. The laser beam is steady rather than a quick flash, and if the beam is modulated messages can be sent with it. A communications laser can be beamed exactly and sent to only the receiver it is meant for. Hams have long ago communicated with laser beams over hundreds of miles. One type generates a microwave signal instead of visible light. This is called a Maser.

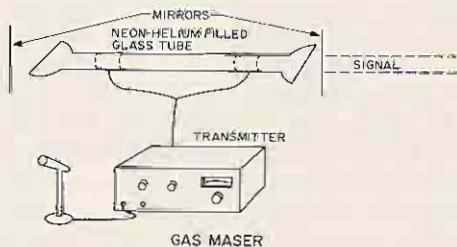

Eventually, I suppose, somebody will figure out a way to make a destructive weapon from a laser. Meanwhile, without getting fantastic, this fascinating beam of light holds a lot of promise, and beckons invitingly from the doorway of an amazing space-age world of incredible technology.

... W2FEZ

Here is a quick-switch antenna patchbox,  
with built-in transmatch and dummy load.



## Put 'Em All In One Box

o you already have half a dozen different transmitters, a like number of antennas, plus a transmatch, dummy-load and rf-ammeter?

OK, OK, but how do you connect up this lot, eh? My bet is with odd lengths of coax, alligator clips, or even, like me, by twisting together odd bits of flex, kept in the sockets with matchsticks . . . right the first time?

Of course this is all in the true amateur spirit, but is really the quickest way to get the wires crossed — literally — and maybe sustain a nasty rf burn (and don't they take a long while to heal up?). And it can be just as painful to the pocket when you inadvertently put things to the "smoke test" . . . such very expensive smoke!

All such dangers can be eliminated by knocking together this nifty little unit which combines a switched antenna patchbox, transmatch, dummy-load, and rf-ammeter.

You'll wonder how you ever did without it when you find you can instantaneously switch *any* of your transmitters to the dummy load or any antenna. And switch so quickly that a *true* comparison can be made between different antennas — both on reception and transmission. Valuable time is also saved in contest working.

It will be noted at once that this unit embodies only the best ergonomic principles! The various inputs from the transmitters are on the left hand side, right next to the switches so as to keep the leads short. The

meter is in the center, the tuning knob is on the right, and output sockets to various antennas are on the right hand side of the cabinet. To keep them cool, the dummy-loads are on top (actually, there's no room inside), while the high-Z output for the

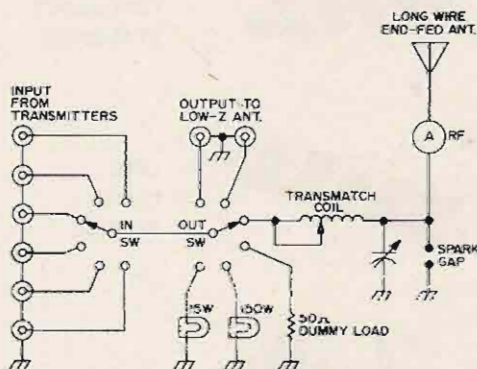
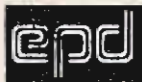

Fig. 1. Inputs from the various station transmitters enter on the left and are switched either straight-through to low-Z antenna, or alternately to the dummy-load, resistance, a load-bulb, or the transmatch "rotary-roller" tuner feeding the long-wire antenna.

end-fed longwire is way behind the capacitor, where it is more or less safe from straying fingers.

The basic requirement of this particular magic box is the Coil Aerial Tuning No. 2A for the Canadian Marconi No. 52 transmitter, currently available on the surplus market. This consists of a massive "rotary



# MOD-KITS



UNIVERSAL  
DCU/DRIVER

These universal counting modules have heavy duty outputs to drive all 7 segment displays requiring up to 15V and 40mA per segment. TTL used throughout. Requires 5 volt @ 120mA per module and any number of modules may be cascaded. Typ. count rate is 20MHz except the NR-3H which is 70 MHz. Will drive any display in this ad (not included).

- NR-3 Modulo 10 Counter 20 MHz .....\$7.95
- NR-3A Modulo 6 Counter 20 MHz ..... 7.95
- NR-3H Modulo 10 Counter 70 MHz ..... 8.95
- NR-3B Modulo 12 Counter clock .....12.95



The most versatile multi-digit counting kit ever offered!! Comes with 5½ digits of counting and 7 segment decoding with the same heavy duty outputs as the NR-3. Typ. maximum count rate is 70 MHz. Each counting stage is completely independent allowing a custom approach to your application. The "+" and "-" sign are great for DVM or over-under circuitry. The overrange stage also has an overflow latch and reset buffer. Displays not included. PC board is 3½" x 6".

- NR-3FM Multi-Stage Counting Unit .....\$33.95



CRYSTAL  
FREQUENCY  
STANDARD

Contains a .002% crystal oscillator with TTL decade dividers to give output frequencies of 10, 1 MHz, 100, 10, 1 kHz, 100, 10, 1, & 0.1 Hz. Kit requires 5 volt supply @ 175mA. Uses low TC components and has zero-beat trimmer. Great for freq. meter, digital clock, etc. W/ complete instructions. ....CRO-1D \$22.95



LINE  
CLOCK  
SOURCE

The DCC-2 derives precision gating and clock signals from the 60 Hz line. The input is a combination schmidt trigger and integrator which eliminates false triggering from line noise. The input is over-voltage protected and requires no adjustment. TTL compatible output frequencies are 10, 1, 0.1, & 0.01667 (1 pulse/min.) Hz. PC board measures 1.2" x 3.5".

- DCC-2B Line Frequency Standard .....\$9.95



ANALOG  
POWER  
SUPPLY

Power your OP-AMPS with this versatile, low cost, dual-polarity regulator. One control varies both outputs simultaneously over the range of 0-15V. Electronic current limiting may be set separately for each output over the range of 25-200mA. Regulation is 0.1% and the ripple is below 3mV RMS. All parts conservatively rated for long life.

- APS-5A Op-amp Power Regulator .....\$13.95
- TR-200 Transformer for APS-5A ..... 3.95



LOGIC  
SUPPLY  
REGULATOR

Both kits have an output range of 3.3V to 5V with current limiting and short circuit shut down. Regulation is 1% and ripple & noise is 10mV RMS. Heavy duty components insure long life and allow rugged use.

- DPS-1A Output current 0.6A .....\$7.95
- DPS-2A Output current 2.2A .....10.95
- TR100 Transformer for DPS-1A ..... 2.29
- TR1500 Transformer for DPS-2A ..... 4.50



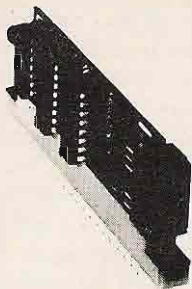

## LED READOUT MODULE · COUNTER · LATCH · DRIVER

This new module has all the most desirable features required in counting and display. Fits 18 pin connector. 5V supply. All TTL logic. 20 MHz count rate.

**\$15.95**



Miniature 7 segment display mounts in 16 pin dual in-line socket. 5V operation at 8 mA. per segment. 100,000 hr. life. W/decimal pt.

3015 Miniature Display .....\$3.45 3/\$10.00

LARGER 7 segment display as pictured with the NR-3 series kits. Bright numerals can be seen even in direct sunlight. Mounts in 9 pin miniature socket supplied with the kits.

2010 7 Segment Display 0-9 DP .....\$4.45

2020 As above except "1" "+" "-" ..... 3.95



## LED

Electrically and physically identical to the popular MAN-1. Has higher light output than MAN-1. Includes LH decimal point. W/spec sheet & app information.

LED700 7 Segment LED Display .....\$6.95  
(QUANTITY DISCOUNTS AVAILABLE)



The 1101 Random Access Memory (RAM) will store and readout 256 bits. The chip is TTL compatible and comes with a complete spec sheet w/applications.

1101 256 Bit RAM .....\$8.95

Build several instruments with this chip and little else. First really useful LSI chip for the experimenter. Contains:

- Four decade counters + overrange
- Four 4 bit latches w/BCD outputs
- Seven segment decoder
- Display multiplexing circuitry
- Two programmable oscillators
- Single 5 volt supply at 5mA!!
- Inputs TTL compatible
- Housed in 28 pin dual in-line pak



## LSI

Comes with 16 p. booklet of specs & app notes. Booklet contains interfacing info on all seven segment displays made.

5002 LSI Chip .....\$19.95



At last! Noncritical memory planes for the experimenter. Made by Ampex for IBM spares. They were removed from NEW core stacks. The large 50 mil cores allow the use of the most inexpensive sense amps. The cores are in an 80x50 array. All the necessary core specs are included with each plane. Available is an 80 page booklet describing an 8 bit x 1000 word memory using the MP-2A. Parts lists, schematics, and app notes are included in the booklet.

MP-1A 4000 Bit Core Plane .....\$12.95

MP-2A 16K Core Stack ..... 47.50

MPB-1 80 Page Core Memory Booklet ..... 5.00

**WE STOCK THESE  
ITEMS & MORE**

**INTEGRATED CIRCUITS  
TRANSISTORS & DIODES  
POWER TRANSFORMERS  
RESISTORS & CAPACITORS  
PC BOARD DRILLS**

## ENVIRONMENTAL PRODUCTS

PO BOX 1014A

Glenwood Springs, CO

81601

48 page catalogue FREE with order  
or send 50¢ for Air Mail copy.

303-945-8527

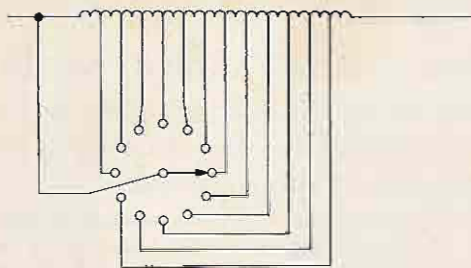

Fig. 2. No roller coasters in the junkbox? Then wind a coil of 30 turns on a 2½ in. former, and short out every few turns by means of a 12-way Yaxley switch.

roller" tuning coil and vernier dial reading up to 1326, which gives it excellent resetability. The coil is mounted on a steel metal panel, which is nicely sprayed grey, but the cabinet is typical "Army finish," and looks much better after a rubdown with sandpaper and a fresh coat of matching paint.

Although there is just room inside to mount the two switches, which were from an old TU5B unit, both the dummy-loads and tuning capacitor have to go up on top.

Now, if this particular item of "desirable surplus" is unobtainable, no need to worry, as practically *any* rotary coil of reasonable size will fill the bill – say, a coil of two to four inches in diameter, and from 30 to 40 turns.

What, no roller coasters in the junkbox? No matter, just wind a tapped coil and short out every few turns by means of a 12-way Yaxley switch, as in Fig. 2.

The tuning capacitor can be of any medium size, somewhere between 100 and 300 pF will be quite OK, but it *must* have wide-spaced vanes – at least as wide as those of the tuning capacitor in the PA tank circuit, otherwise it will spark across on peaks.

The dummy-load is a 50Ω high-current carbon resistor, ten inches long and an inch in diameter, mounted on three-inch standoff insulators. Keep it away from other components, as it dissipates all the rf output of the transmitter when in use, but as this should not be for more than a few minutes at a time under normal conditions, it can be over-run without too much harm. Switch it off when it smokes!

If you do not happen to find a large resistor of suitable value in the junkbox, wire up a string of smaller wattage ones in series-parallel to make the total resistance around 50Ω. Remember that they must all be carbon, not wire-wound, and given plenty of air space to cool them.

The meter shown in the photo is of the hot-wire variety, scaled to 1.5 A, but a thermo-couple type would be as good or even better, as its action would be quicker. The actual current shown varies considerably from band to band. Why not try an 0.5 A meter with a switch to shunt parallel resistances across it as required (see Fig. 3).

Bulb-holders should really be of the pot type, but Bakelite works all right clear up to 30 MHz. The high-impedance output to the long-wire end-fed antenna must exit through a porcelain "feed-through" type of standoff insulator, as there can be considerable rf voltage at this point on some bands.

Internal wiring should be as direct as possible, using short lengths of coax cable; please do *not* forget to ground *both* ends of the outer casing. All metalwork should be bonded with copper strip, not wire, and the unit itself bonded to both transmitters and station ground.

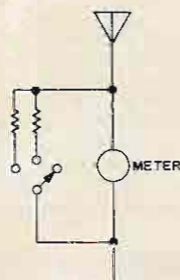

Fig. 3. If your meter knocks against the end-stop on some bands, wire a switch and shunts in parallel. Low-resistance shunts can be made out of old fire-element wire.

It is certainly not advisable to rely on the outer-sheathing of the coax cable for grounding purposes, as this can cause all sorts of problems, including getting a quick kick off the controls.

Your low-pass filter, swr bridge, and T/R relay should be wired together in the order

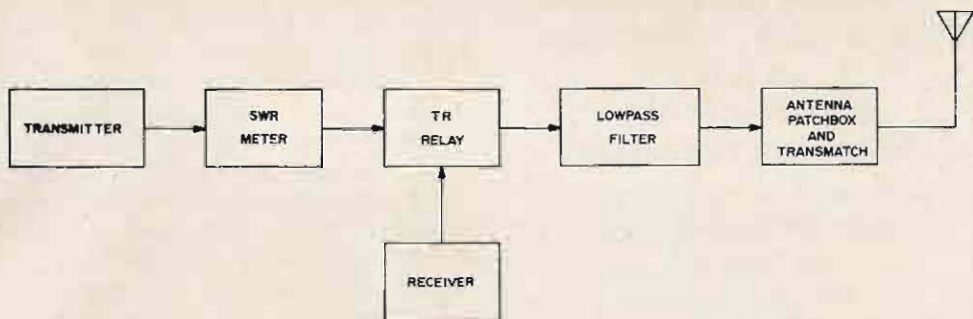

Fig. 4. The swr meter, T/R relay and low-pass filter are placed this way for minimum harmonics.

shown in Fig. 4, in order to keep harmonics down and TVI to a minimum.

### Modus Operandi

First, plug in coax leads from the transmitters, and do the same with the antennas. The output is switched straight through to low-impedance center-fed dipoles, ground-plane, and quarter-wave Marconi, but the end-fed random-length job (the one to the end of the garden!), is hitched to the standoff feed-through insulator, and fed via the transmatch.

Switch to dummy-load and tune the transmitter in the normal way. Flick the output switch to "transmatch," with the vernier dial at zero. Put the capacitor vanes at half-mesh, and wind away on the roller coaster handle until the rf-ammeter reads maximum. At this point, the meters on the transmitter should be back practically where they were when tuned into the dummy-load.

The capacitor can be used for final trimming, but remember that, when correctly loaded, the tuning should be very broad so that considerable movement of the knob will be required to produce any significant change in meter reading. This is the condition of highest efficiency, when the transmatch coil itself consumes a negligible amount of power. All the rf watts are going "right up the spout," where you want them, instead of chasing their own tail round the transmatch tuned circuit!

Although the roller-coaster coil will match any random-length of antenna into the low-impedance pi-output circuit of the transmitter, it should be realized that the actual amount of inductance required in circuit in the transmatch will vary consider-

ably from band to band. For if the antenna happens to be a half-wavelength long (or a multiple of half-wavelengths), then it will present a high-impedance to the transmatch, so that quite a lot of coil will have to be "wound-up" in order to match the widely differing impedances. Whereas, if the antenna is a quarter-wave (or multiple) at the working frequency, then very little lumped inductance will be required in circuit.

The great beauty of the roller coaster is that there are no coils to change, no tappings to adjust, and nothing to do except wind away on that handle and stop when the rf-ammeter reads maximum. Once the correct settings have been noted (there's even a small plate provided on the front panel for this very purpose), it can be reset in a jiffy, without even using the dummy-load.

### The Light Bulbs

While an electric light bulb does not make a precise dummy-load, as its resistance varies widely as it warms up, it is still a very useful guide when making adjustments to the transmitter. One instance is in modulation checks, for it gives a clearly visible sign of upward as well as downward modulation, and also the percentage of modulation as you whistle merrily into the mike. (Cries of Shame!) One bulb can be 10 or 15 watts for low-power jobs, and the other 150 or 250 watts for the QRO rigs.

The second use of these bulbs is in making a fairly accurate estimate of the actual rf output of a transmitter, together with the efficiency of the PA. For this purpose, two identical bulbs are used, one being wired to the 117V mains, and the other to the transmitter output. When they

Central New York Specialty Headquarters

FM by STANDARD COMMUNICATIONS

and CLEGG

ANTENNAS by HY-GAIN

Quality-Selected Used Ham Gear

Write for listing, updated twice monthly

CFP ENTERPRISES

866 Ridge Road  
Ludlowville, N. Y. 14862  
607-533-4297

**2 METER FM  
AMPLIFIER  
WITH BUILT-  
IN AC POWER  
SUPPLY**



- Operate at home — 110 VAC or car-12 VDC.
- Supplies regulated DC for transceiver.
- 1W in/15W out-AC ● 1W in/10W out-DC.
- Auto T/R Send for brochure ONLY \$69.95

QUEZAR COMMUNICATIONS  
PO Box 235  
Titusville, N.J. 08560

**HAL COMMUNICATIONS**

HOT CARRIER DIODES:	HP2800	..S	90.12/S1000	Matched by HAL	4/54.25				
ZENERS:	1N4729(3.6v)	1N4733(5.1v)	1N4736(6.2v)	1N4738(8.2v)					
	1N4739(9.1v)	1N4742(12v)	1N4742(12v)	1 watt.	\$.75				
LINEAR ICs:	705N	..S	75	7001, 7108	..S	25	741N	..S	50
	MC1429C	..S	3.75	MC1495G	..S	2.25	MC1500G	..S	50
DIGITAL ICs:	F-1523	..S	90	MC761P	..S	30	MC723P	..S	95
MRTL:	MC788P	..S	30	MC880P	..S	30	MC890P	..S	20
	MC724P, MC725P, MC789P, MC797P	..S	10		..S	10		..S	10
	MC711P	..S	75	MC970P	..S	30	ME9780P	..S	45

DIP TTL:	7400	7401	7402	7410	7420	7430	7440	..S	48
	7404	7405	..S	50	7461	7465	7496	..S	00
	7472	..S	75	7473	7474	..S	05	7475	..S
	7486	..S	1.15	7490	7492	7493	..S	10	74121
							..S	60	2703019

FETS:	40673-MOSFET	..S	1.60	MPF102	..S	60			
TOROIDs:	Indiana General CF102-05	CF102-01	CF101-02	..S	50				
	CF102-03	..S	1.25	FERROXIDE FERRITE BEADS	10/S125				
CINCHIC SOCKETS:	8-ICS, 16-DIP	..S	60	10 ICS, 16-DIP	..S	70			

MANY OTHER DEVICES AND COMPONENTS IN STOCK. WRITE FOR CATALOG.

**HAL COMMUNICATIONS**

Box 365L, Urbana IL 61801 ● 217-359-7373

**HAL COMMUNICATIONS**

**HAL ID-1 REPEATER IDENTIFIER**

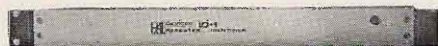

Circuit board wired & tested .... \$75.00

With rack w/cabinet ..... \$115.00

TTL logic. Power line frequency counter for 3 minute or less timing and control. Easily re-programmable diode ROM uses only 27 diodes (depending on call) to send DE "any call". Low impedance audio with volume and tone control. All circuitry including PS on small G10 glass PC board. Write for full details. HAL COMMUNICATIONS, Box 365L, Urbana IL 61801

glow with exactly the same brilliance, obviously the wattage will be identical. A sheet of ground-glass placed in front of the two bulbs will assist in balancing, and of course keep bright lights away from the unit when judging. The efficiency of the PA is easily worked out by reading the final plate voltage and current meters. This experiment shows very clearly how the actual efficiency falls quickly as the operating frequency rises — try it and see the great difference between 80 and 10!

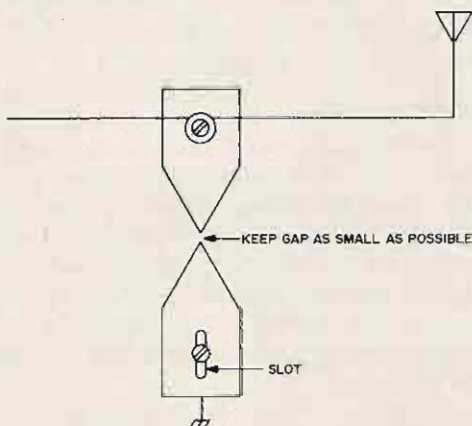

Fig. 5. This lightning-arrestor and static-discharger is easily made from odd scraps of copper strip or tinplate. In order to make adjustment of the gap easy, cut a slot in one plate so that it will slide up and down the fixing-bolt.

Whereas dipole antennas are normally grounded via their coax cable, the sheath going direct to ground in most cases, provision should always be made to ground long-wire antennas. This can easily be arranged inside the box by fabricating a little static discharger out of odd bits of copper or tin, as shown in Fig. 5. Keep the gap as small as possible, but not so that it sparks merrily when you press the key!

The photo was taken outdoors one sunny day with my ancient Leica. Technical details are: hand-held (very shaky) pan-X, 1/20th at f.12.6., developed in . . . but heck, what's all this photographic nonsense to do with 73 Mag?

Absolutely nothing at all, except that a lot of amateurs are also keen cameramen. And, it's one way of ending an article.

. . .G3KPO

# Semiconductor Supermart

• MOTOROLA • RCA • FAIRCHILD • NATIONAL • HEP • PLESSEY



Actual Size

## DIGITAL READOUT

At a price everyone can afford **\$3.20**

- Operates from 5 VDC
- Same as TTL and DTL
- Will last 250,000 hours

## SPECIAL OFFER

- Digital readout
  - BCD to 7 - Segment Decoder/driver
  - 7490 Decade Counter
  - 7475 Latch
- Only **\$8.20**

## PLESSEY SL403D

**3.5 W AUDIO AMP IC  
HI-FI QUALITY  
\$3.95**

with 12 pages of construction data

The MINITRON readout is a miniature direct viewed incandescent filament (7-Segment) display in a 16-pin DIP with a hermetically sealed front lens. Size and appearance are very similar to LED readouts. The big different is in the price. Any color filter can be used.

## NATIONAL DEVICES

LM370	AGC/Squelch amp	\$4.85
LM373	AM/FM/SSB strip	\$4.85
LM309K	5V 1A regulator. If you are using TTL you need this one.	\$3.00

## POPULAR IC's

MC1550	Motorola RF amp	\$1.80
CA3020	RCA 1/2 W audio	\$3.07
CA3020A	RCA 1 audio	\$3.92
CA3028A	RCA RF amp	\$1.77
CA3001	RCA	\$6.66
MC1306P	Motorola 1/2 W audio	\$1.10
MC1350P	High gain RF amp/IF amp	\$1.15
MC1357P	FM IF amp Quadrature det	\$2.25
MC1496	Hard to find Bal. Mod.	\$3.25
MFC9020	Motorola 2-Watt audio	\$2.50
MFC4010	Multi-purpose wide band amp	\$1.25
MFC8040	Low noise preamp	\$1.50
MC1303P	Dual Stereo preamp	\$2.75
MC1304P	FM multiplexer stereo demod	\$4.95

## FETs

MPP102	JFET	\$6.00
MPP105/2N5459	JFET	\$9.96
MPP107/2N5486	JFET VHF/UHF	\$1.26
MPP121	Low-cost dual gate VHF RF	\$3.85
MFE3007	Dual-gate	\$1.98
40673	Dual-gate	\$1.75
3N140	Dual-gate	\$1.95
3N141	Dual-gate	\$1.85

## NEW FAIRCHILD ECL HIGH SPEED DIGITAL IC'S

9258	Dual "D" FF toggles beyond 160 MHz	\$4.65
9582	Multi-function gate & amplifier	\$3.15
95H90	300 MHz decade counter	\$16.00

A 95H90 & 9582 makes an excellent prescaler to extend low frequency counters to VHF - or use two 9528s for a 160 MHz prescaler.

## SIGNETICS PHASE LOCK LOOP

NE561B	Phase Lock Loop	\$4.75
NE562B	Phase Lock Loop	\$4.75
N5111A	FM/IF Demodulator	\$1.50
NE566V	Function Generator	\$4.75
NE567V	Tone Decoder	\$4.75

## CORES AND BEADS

T200-2		\$2.00
KW Balun kit only		\$3.50
T68-2 3 cores		\$1.00
T50-2 3 cores		\$1.00
T50-6 3 cores		\$1.00
T50-10 3 cores		\$1.00
T44-10 3 cores		\$1.00

## BEAD SPECIAL

Ferrite Beads 1 doz. \$1.00

## MOTOROLA TUNING DIODES

Silicon voltage variable capacitance diodes in TO-92 plastic case like plastic transistors. Both standard Motorola and HEP numbers are listed; devices are same. Capacitance value is typical at -4Vdc. Tuning ratio is approx. 3:1.

MV2101/R2500	6.8 pF	\$1.10
MV2103/R2501	10 pF	\$1.10
MV2105/R2502	15 pF	\$1.10
MV2109/R2503	33 pF	\$1.10
MV2112/R2504	56 pF	\$1.10
MV2115/R2505	100 pF	\$1.10

## FAIRCHILD RTL DIGITAL IC's

UL900	Buffer	.80
UL914	Dual 2-input Gate	.80
UL923	JK flip-flop	\$1.50

Please add 35¢ for shipping

## Circuit Specialists

Box 3047, Scottsdale, AZ 85257

**FACTORY AUTHORIZED DISTRIBUTOR FOR**  
Motorola HEP - Circuit-Stick - Plessey  
All devices are first quality and are fully guaranteed.

# FALL 15¢ GATE SALE!

Here's how it works: For every IC you buy from us at our regular low prices, you get to buy one of the following gates for 15¢ each: 7400, 7401, 7403, 7404, 7408, 7409, 7410, 7411, 7418, 7420, 7421, 7430, 7440, 7450, 7451, 7453, 7454, 7460. THIS OFFER GOOD UNTIL DECEMBER 1, 1972.

Catalog Number	Any Quantity Per Item (Mix)			Multiples of 10 Per Item (Mix)			Catalog Number	Any Quantity Per Item (Mix)			Multiples of 10 Per Item (Mix)			Catalog Number	Any Quantity Per Item (Mix)			Multiples of 10 Per Item (Mix)			
	1-99	100-999	1000 up	100-990	1000-9990	10000 up		1-99	100-999	1000-990	1000-9990	10000 up	1-99		100-999	1000-990	1000-9990	10000 up			
7400	.26	.25	.23	.22	.21	.20	7463	1.63	1.55	1.46	1.38	1.29	1.20	SCHOTTKY TTL	74508	1.14	1.08	1.02	.96	.90	.84
7401	.26	.25	.23	.22	.21	.20	7465	1.43	1.35	1.28	1.20	1.13	1.05		74509	1.14	1.08	1.02	.96	.90	.84
7402	.26	.25	.23	.22	.21	.20	7486	.58	.55	.52	.49	.46	.44		74510	1.14	1.08	1.02	.96	.90	.84
7403	.26	.25	.23	.22	.21	.20	7490	.80	.76	.72	.68	.64	.60		74515	1.14	1.08	1.02	.96	.90	.84
7404	.28	.27	.25	.24	.22	.21	7491	1.43	1.35	1.28	1.20	1.13	1.05		74520	1.14	1.08	1.02	.96	.90	.84
7405	.28	.27	.25	.24	.22	.21	7492	.80	.76	.72	.68	.64	.60		74521	1.14	1.08	1.02	.96	.90	.84
7406	.52	.50	.47	.44	.42	.39	7493	.80	.76	.72	.68	.64	.60		74540	1.14	1.08	1.02	.96	.90	.84
7407	.52	.50	.47	.44	.42	.39	7494	1.18	1.12	1.05	.99	.93	.87		74550	1.14	1.08	1.02	.96	.90	.84
7408	.32	.30	.29	.27	.26	.24	7495	1.18	1.12	1.05	.99	.93	.87		74551	1.14	1.08	1.02	.96	.90	.84
7409	.32	.30	.29	.27	.26	.24	7496	1.18	1.12	1.05	.99	.93	.87		74560	1.14	1.08	1.02	.96	.90	.84
7410	.26	.25	.23	.22	.21	.20	74100	1.52	1.44	1.36	1.28	1.20	1.12	74564	1.14	1.08	1.02	.96	.90	.84	
7411	.28	.27	.25	.24	.22	.21	74107	.52	.49	.47	.44	.42	.39	74565	1.14	1.08	1.02	.96	.90	.84	
7413	.58	.55	.52	.49	.46	.44	74121	.56	.53	.50	.48	.45	.42	74573	1.98	1.87	1.76	1.65	1.54	1.43	
7416	.52	.50	.47	.44	.42	.39	74122	.70	.67	.63	.60	.56	.53	74574	1.98	1.87	1.76	1.65	1.54	1.43	
7417	.52	.50	.47	.44	.42	.39	74123	1.21	1.06	1.00	.94	.89	.83	74576	1.98	1.87	1.76	1.65	1.54	1.43	
7420	.26	.25	.23	.22	.21	.20	74141	1.63	1.55	1.46	1.38	1.29	1.20	74578	1.98	1.87	1.76	1.65	1.54	1.43	
7421	.26	.25	.23	.22	.21	.20	74145	1.41	1.33	1.26	1.18	1.11	1.04	745107	1.98	1.87	1.76	1.65	1.54	1.43	
7423	.80	.76	.72	.68	.64	.60	74150	1.63	1.55	1.46	1.38	1.29	1.20	745112	1.98	1.87	1.76	1.65	1.54	1.43	
7425	.50	.48	.45	.43	.40	.38	74151	1.20	1.13	1.07	1.01	.95	.88	745113	1.98	1.87	1.76	1.65	1.54	1.43	
7426	.34	.32	.31	.29	.27	.26	74153	1.63	1.55	1.46	1.38	1.29	1.20	745114	1.98	1.87	1.76	1.65	1.54	1.43	
7430	.26	.25	.23	.22	.21	.20	74154	2.43	2.30	2.16	2.03	1.89	1.76	745140	1.37	1.30	1.22	1.15	1.08	1.01	
7437	.56	.53	.50	.48	.45	.42	74155	1.46	1.39	1.31	1.23	1.16	1.08	LINEAR IC'S							
7438	.56	.53	.50	.48	.45	.42	74156	1.46	1.39	1.31	1.23	1.16	1.08	NE501	2.99	2.82	2.66	2.49	2.32	2.16	
7440	.26	.25	.23	.22	.21	.20	74157	1.56	1.48	1.39	1.31	1.23	1.15	NE526	3.59	3.38	3.17	2.95	2.74	2.53	
7441	1.73	1.64	1.55	1.46	1.37	1.27	74158	1.56	1.48	1.39	1.31	1.23	1.15	NE531	3.81	3.58	3.36	3.14	2.91	2.69	
7442	1.27	1.21	1.14	1.07	1.01	.94	74160	1.89	1.79	1.68	1.58	1.47	1.37	NE533	3.81	3.58	3.36	3.14	2.91	2.69	
7443	1.27	1.21	1.14	1.07	1.01	.94	74164	1.89	1.79	1.68	1.58	1.47	1.37	NE536	7.31	6.88	6.45	6.02	5.59	5.16	
7444	1.27	1.21	1.14	1.07	1.01	.94	74166	1.98	1.87	1.76	1.65	1.54	1.43	NE537	7.53	7.09	6.65	6.20	5.76	5.32	
7445	1.71	1.62	1.53	1.44	1.35	1.26	74176	1.62	1.53	1.45	1.36	1.28	1.19	NE540	2.16	2.04	1.92	1.80	1.68	1.56	
7446	1.24	1.17	1.11	1.04	.98	.91	74177	1.62	1.53	1.45	1.36	1.28	1.19	NE555	.98	.93	.88	.83	.78	.73	
7447	1.16	1.10	1.04	.98	.92	.85	74180	1.20	1.13	1.07	1.01	.95	.88	NE560	3.57	3.36	3.15	2.94	2.73	2.52	
7448	1.44	1.37	1.29	1.22	1.14	1.06	74181	5.20	4.90	4.59	4.28	3.98	3.67	NE561	3.57	3.36	3.15	2.94	2.73	2.52	
7450	.26	.25	.23	.22	.21	.20	74182	1.20	1.13	1.07	1.01	.95	.88	NE562	3.57	3.36	3.15	2.94	2.73	2.52	
7451	.26	.25	.23	.22	.21	.20	74192	1.98	1.87	1.76	1.65	1.54	1.43	NE566	3.57	3.36	3.15	2.94	2.73	2.52	
7453	.26	.25	.23	.22	.21	.20	74193	1.98	1.87	1.76	1.65	1.54	1.43	NE567	3.57	3.36	3.15	2.94	2.73	2.52	
7454	.26	.25	.23	.22	.21	.20	74196	1.98	1.87	1.76	1.65	1.54	1.43	NE5111	.90	.86	.81	.77	.72	.68	
7460	.26	.25	.23	.22	.21	.20	74197	1.98	1.87	1.76	1.65	1.54	1.43	NE556	1.87	1.77	1.66	1.56	1.46	1.35	
7470	.42	.40	.38	.36	.34	.32	74198	2.81	2.65	2.50	2.34	2.18	2.03	NE558	.80	.76	.72	.68	.64	.60	
7472	.38	.36	.34	.32	.30	.29	74199	2.81	2.65	2.50	2.34	2.18	2.03	NE595	3.40	3.20	3.00	2.80	2.60	2.40	
7473	.50	.48	.45	.43	.40	.38	SCHOTTKY TTL						NE596	1.87	1.77	1.66	1.56	1.46	1.35		
7474	.50	.48	.45	.43	.40	.38	74S00	1.14	1.08	1.02	.96	.90	.84	709	.42	.40	.38	.36	.34	.32	
7475	.80	.76	.72	.68	.64	.60	74S01	1.14	1.08	1.02	.96	.90	.84	710	.42	.40	.38	.36	.34	.32	
7476	.56	.53	.50	.48	.45	.42	74S03	1.14	1.08	1.02	.96	.90	.84	711	.44	.42	.40	.37	.35	.33	
7480	.76	.72	.68	.65	.61	.57	74S04	1.37	1.30	1.22	1.15	1.08	1.01	723	1.00	.95	.90	.85	.80	.75	
7482	.99	.94	.88	.83	.78	.73	74S05	1.37	1.30	1.22	1.15	1.08	1.01	733	1.90	1.80	1.70	1.60	1.50	1.40	

All IC's are supplied in 8-, 14-, 16-, or 24-pin DIP (Dual-in-line) plastic or ceramic package except for NE533, NE536, NE537, and NE540 which come in TO-5 package.

We give FREE data sheets upon request, so ask for those data sheets that you NEED, even for those listed IC's that you are not buying. On orders over \$25.00 we'll send you a new 270-page COMPLETE TTL IC data book FREE. Or, you may obtain a new 240-page LINEAR data book instead. Orders over \$50.00 will receive both books. Orders over \$100.00 will receive a complete LIBRARY of DIGITAL & LINEAR data & application books totaling 1,000 pages FREE. PLEASE NOTE: Data books are shipped separate from your order. Please allow two weeks for delivery.

**UNIVERSAL DECADE COUNTING UNITS**

1. Easy to read single plane LED or Filament-type Readout with wide angle viewing.
2. IC'd Outputs, Readout Lamp Test, Ripple Blanking and Counter Reset are available.
3. Plug-in Modules.
4. Molex Sockets for all IC's and Readout.
5. Tin plated G-10, 2-on Coppoh, Glass Epoxy Board.
6. Your choice of 1 to 6 decades on one P. C. Board.
7. Grouping of 2 or more readouts on the same display board.
8. Display board mounts perpendicular to counter/driver board.
9. Up/down counting and counter preset functions available with 74192.
10. 60 MHz typical toggle rate with 74196.
11. Operates from 5 Volt TTL compatible single supply.
12. First in a series of Universal plug-in modules for frequency counting, time measurements, event counting, DVSM, magnitude comparison, etc.
13. P. C. Boards only are available for \$3.00 per decade.

Price (Per Decade):  
 Base Unit consisting of 7490, 7447, Filament-Type 7-Segment Readout ..... \$9.00  
 Options:  
 For LED Readouts instead of Filament-Type, add \$2.00  
 For 7475 Latch, add \$1.25  
 For 74176 instead of 7490, add ..... \$1.00  
 For 74192 instead of 7490, add ..... \$0.50  
 For 74192 instead of 7490, add ..... \$1.00  
 For 74196 instead of 7490, add ..... \$0.75  
 For fully assembled and tested unit, add ..... \$2.50

**VOLTAGE REGULATORS.** Internally-set, overload and short-circuit proof regulators need no external components to set. With data sheet and application notes, TO-3 Package.  
 LM-335, 5V, 600mA ..... \$2.85  
 LM-336, 12V, 500mA ..... \$3.85  
 LM-337, 15V, 450mA ..... \$4.95  
 20 Watt PC-Board Type HEAT SINK ..... \$1.20

**STANCOR PA100, 25.2 VCT, 1-Amp Transformer.**  
 Ideal for use with LM-series. Each ..... \$3.00

DUAL-IN-LINE	Wire-Wrap	Type	IC Sockets	BRAND NEW	with gold plated pins
1-99	100-249	250-999	1000-4999	5K-UP	
14 PINS 0.40	0.35	0.30	0.25	0.20	
16 PINS 0.75	0.70	0.65	0.60	0.55	



**LED  
7-SEGMENT  
DISPLAY**

**\$4.95 Each**

50-99	\$4.75
100-999	\$4.50
1000-	\$4.25

Large 1/4" 7-segment LED readout similar to the popular MAN-1 but with improved brightness. Has left-hand decimal point. Fits in a DIP socket. Expected life: Over 100 Yrs. Regularly \$12.95 in single Lots. These are BRAND NEW with full data sheet and 4-page MULTIPLEXING Application Note. Needs a 7447 for driver and ONE CURRENT-LIMITING RESISTOR PER SEGMENT. We can supply you with one or ten thousand FROM STOCK. Also available, ±1 OVERFLOW digit at the same prices. Mixing of Regular & Overflow digit allowed.

Package of 8, 1/4W Limiting R's ..... 30¢

Incandescent Type of 7-segment display. With right-hand decimal point. Rated 8mA per segment at TTL supply of 5V. Design life of 50,000 hours. Needs a 7447 as a driver. In DIP Package. Each \$3.25

**MOLEX IC SOCKET PINS:** Use these economical pins instead of soldering your IC'S to PC boards. Sold in continuous strips in multiples of 100 pins only.

100 for \$1.00; 200 for \$1.80; 300 for \$2.60; 400 for \$3.40; 500 for \$4.20; 600 for \$5.00; 700 for \$5.80; 800 for \$6.60; 900 for \$7.40; 1000 for \$8.20. Each Additional 1000 \$7.50



**ALLEN-BRADLEY MIL-GRADE (5-band) RESISTORS.** Any of the 84 STANDARD 10% values from 2.7Ω to 22MΩ 1/4 or 1/2 WATT. EACH ..... 5¢

**CERAMIC DISC CAPACITORS, Type 50A-1000VDC.**  
 5, 7.5, 10, 12, 15, 20, 22, 25, 27, 30, 33, 36, 39, 45, 50, 56, 62, 75, 82, 100, 120, 150, 180, 200, 220, 250, 270, 300, 330, 360, 390, 470, 500, 560, 680, 750, 820, 1000, 1200, 1500, 1800, 2000, 2200, 2500, 2700, 3000, 3300, 3600, 3900, 4700, 5000pF.  
 EACH ..... 10¢  
 0.01µF EACH ..... 11¢  
 0.02µF EACH ..... 12¢

**LOW VOLTAGE DISCS, Type UK.**  
 1.0µF, 3V ..... 25¢  
 0.1µF, 10V ..... 12¢  
 0.47µF, 3V ..... 25¢

**ELECTROLYTIC CAPACITORS:**  
 All values are available in both axial or upright (PC Board) mount. PLEASE INDICATE YOUR CHOICE.  
 10µF, 15V ..... 10¢  
 30µF, 15V ..... 10¢  
 60µF, 15V ..... 10¢  
 100µF, 15V ..... 10¢  
 220µF, 15V ..... 15¢  
 100µF, 35V ..... 20¢  
 1000µF, 15V ..... 20¢  
 20µF, 25V ..... 15¢  
 30µF, 35V ..... 20¢  
 50µF, 35V ..... 20¢  
 100µF, 35V ..... 20¢  
 500µF, 35V ..... 40¢  
 1000µF, 35V ..... 50¢  
 2µF, 50V ..... 30¢  
 0.2µF, 10V ..... 30¢  
 0.01µF, 16V ..... 10¢  
 1000µF, 35V ..... 30¢  
 1µF, 50V ..... 10¢  
 2µF, 50V ..... 10¢  
 3µF, 50V ..... 10¢  
 10µF, 50V ..... 10¢  
 10µF, 50V ..... 15¢  
 20µF, 50V ..... 20¢  
 50µF, 50V ..... 20¢  
 100µF, 50V ..... 20¢  
 200µF, 50V ..... 40¢  
 300µF, 50V ..... 55¢



Solid State Systems, Inc.  
 P.O. Box 773  
 Columbia, Mo. 65201

Phone 314-643-3673  
 TWX 910-760-1453

**TERMS: RATED FRAME-NET 30 DAYS.** Others CHECK or MONEY ORDER with order. Add 35¢ to orders under \$5.00 for postage & handling. For UPS or FIRST CLASS add 45¢ and for AIR MAIL, add 65¢ to your order; we pay the balance. If you are served by UPS in your area, we strongly recommend this service with its built-in \$100 insurance; COD orders are FOB Columbia with 65¢ COD for additional. Canadian residents please add \$1.50 for INSURANCE.

**MISSOURI RESIDENTS:** Please add 4% Sales Tax.  
**WRITE OR CIRCLE READER SERVICE CARD FOR OUR CATALOG OF PARTS & SERVICES. IT'S FREE.**

# A NEW STANDARD!... THE 7400 SCIENTIFIC & ENGINEERING CALCULATOR

THE MOST POWERFUL SCIENTIFIC CALCULATOR FOR UNDER \$500.00

The price of the 7400 is low enough to make a desk top computer available to almost anyone.

## SIGNIFICANT FEATURES NOT FOUND IN MOST COMPETITIVE MACHINES

- DYNAMIC RANGE: 10<sup>-99</sup> to 10<sup>99</sup>
- DATA STORAGE: 2 Auxiliary Storage Registers plus up to 7 push-up Stack Registers.
- Roll up and roll down keys for complete control of operational stack
- Interfacing provisions for printer and programmer
- Correct X (Allows the operator to correct one digit, without re-entering the whole problem)
- Polar to Rectangular conversion and Retangular to Polar conversion

DISPLAY: Either full floating or scientific notation, 14 large, easy-to-read digits.

SIZE: 8½" x 12" x 3¼"

WEIGHT: 4 lbs.

7400A 3 Registers

Kit \$299.95

Assembled \$379.95

7400B 5 Registers

Kit \$319.95

Assembled \$399.95

7400C 7 Registers

Kit \$399.95

Assembled \$419.95

### PRICES INCLUDE CARRYING CASE

MITs will repair any 7400 for a fee of \$25.00 for a 5-year period after the normal 1-year warranty has expired.

Use Your Bankamericard or Master Charge

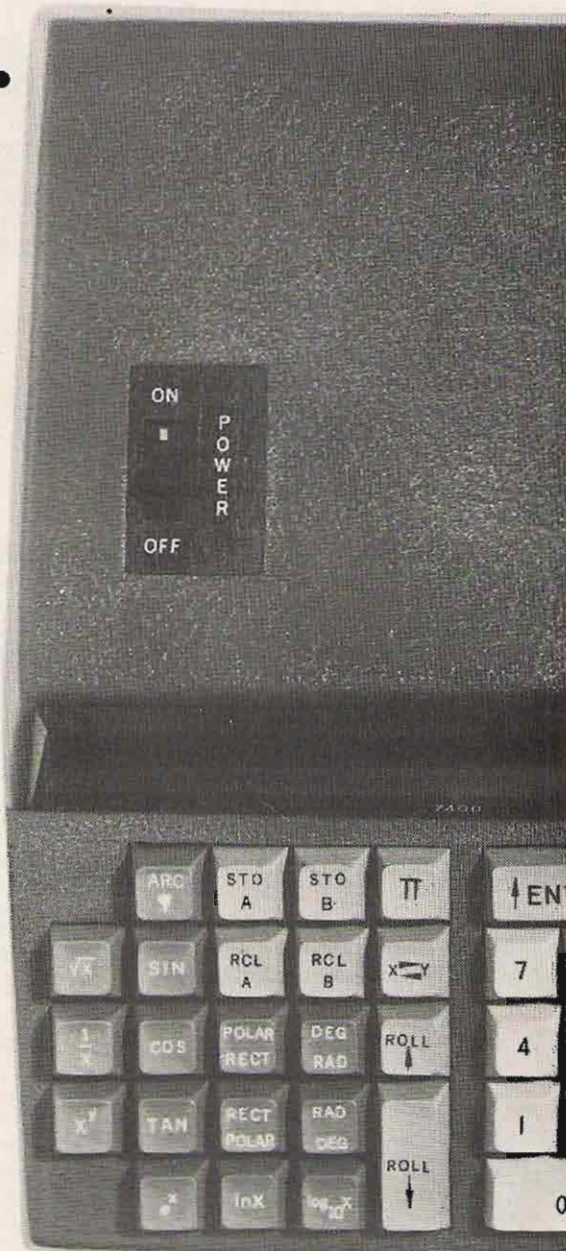

WRITE OR MAIL COUPON FOR  
ADDITIONAL INFORMATION:

**MICRO INSTRUMENTATION  
& TELEMETRY SYSTEMS, Inc**

5404 COAL AVE., S.E., ALBUQUERQUE, NEW MEXICO 87108  
505/266-2330

ENCLOSED IS CHECK FOR MODEL # \_\_\_\_\_  Kit  
 Assembled  
 AMOUNT OF CHECK (Include \$5.00 for Postage & Handling) \$ \_\_\_\_\_  
 I am interested in additional information.  
 NAME \_\_\_\_\_  
 ADDRESS \_\_\_\_\_  
 CITY \_\_\_\_\_  
 STATE \_\_\_\_\_ ZIP \_\_\_\_\_

7-8-112



# our fourth generation family...

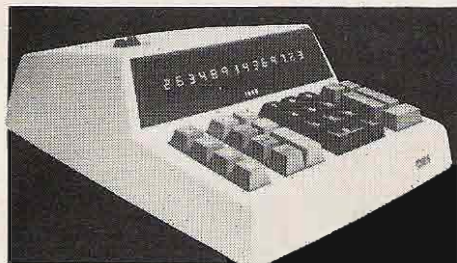

Square root operation and fourteen digit LED display makes this machine the choice of those who want the very best.

Sophisticated functions (made possible by unique MOS-LSI circuitry) include a constant data memory, 14 digit independent data memory, negative number entry, and exchange of operands . . . all are one touch operations!

MITS has provided expanding capability for the 816 and 1440 by providing interfacing for the soon to be released programming module and printer to convert the basic unit into an impressive desk top computer.

1440 Kit . . . . . \$199.95  
1440 Assembled . . . \$249.95

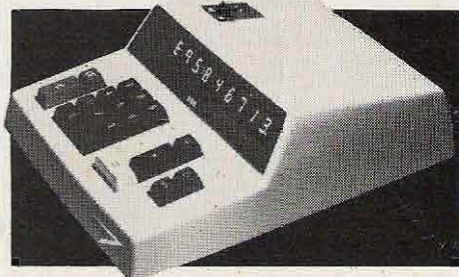

16 digits, the highest output capacity of any MITS calculator, are available on the 816 models only. Constant data memory and computed fixed decimal system makes the 816 a useful tool for business or home use.

Human-engineered color coded keyboard and large electro-flourescent display gives both 816 models a degree of operating ease and flexibility unmatched in machines costing hundreds more.

816A Kit . . . . . \$149.95  
816A Assembled . . \$179.95  
816B Kit . . . . . \$159.95  
816B Assembled . . \$189.95

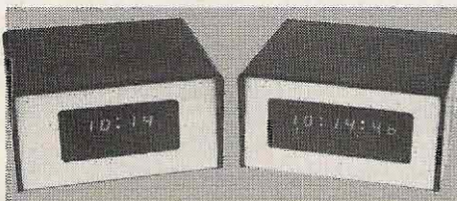

Here are two new members in our fourth generation family of MITS digital products. MITS digital clocks feature large LED displays, 12 or 24 hour operation, highest quality components, A.C. operation, and individual time set buttons.

MITS' DC4 has minute and hour timekeeping and the DC6 model gives seconds as an additional feature.

Available as electronics only, as a kit or assembled.

4 DIGIT [hours, minutes, and 1 sec. pulsed colon]  
DC4-E [electronics only] . . . \$39.50  
DC4-K [complete kit] . . . . \$48.50  
DC4-M [assembled unit] . . . \$89.50

6 DIGIT [hours, minutes, seconds]  
DC6-E [electronics only] . . . \$49.50  
DC6-K [complete kit] . . . . \$58.50  
DC6-M [assembled unit] . . . \$99.50

For information on the complete line of MITS products, write:



**Micro Instrumentation & Telemetry Systems, Inc.**

5404 COAL AVE., S.E., ALBUQUERQUE, NEW MEXICO 87108  
505/266-2330

73-11

I am interested in additional literature.

Enclosed is check for item # \_\_\_\_\_  Kit  
 Assembled

Check amount (include \$5.00 for postage and handling.) \$ \_\_\_\_\_

Name \_\_\_\_\_

Address \_\_\_\_\_

City and Zip \_\_\_\_\_

# CIRCUITS, CIRCUITS, CIRCUITS...

The following circuits have appeared in the referenced books, magazines, application notes, etc. While we try to reproduce all of the information that should be needed by an experienced constructor, readers may want to avail themselves of the original sources for peace of mind.

Readers are requested to pass along any interesting circuits that they discover in sources other than U.S. ham magazines. Circuits should be oriented toward amateur radio and experimentation rather than industrial or computer technology. Submit circuit with all parts values on it, a very brief explanation of the circuit and any additional parts information required, give the source and a note of permission to reprint from the copyright holder, if any, and the reward for a published circuit will be a choice of a 73 book. Send your circuits to 73 Circuits Page, 73 Magazine, Peterborough NH 03458.

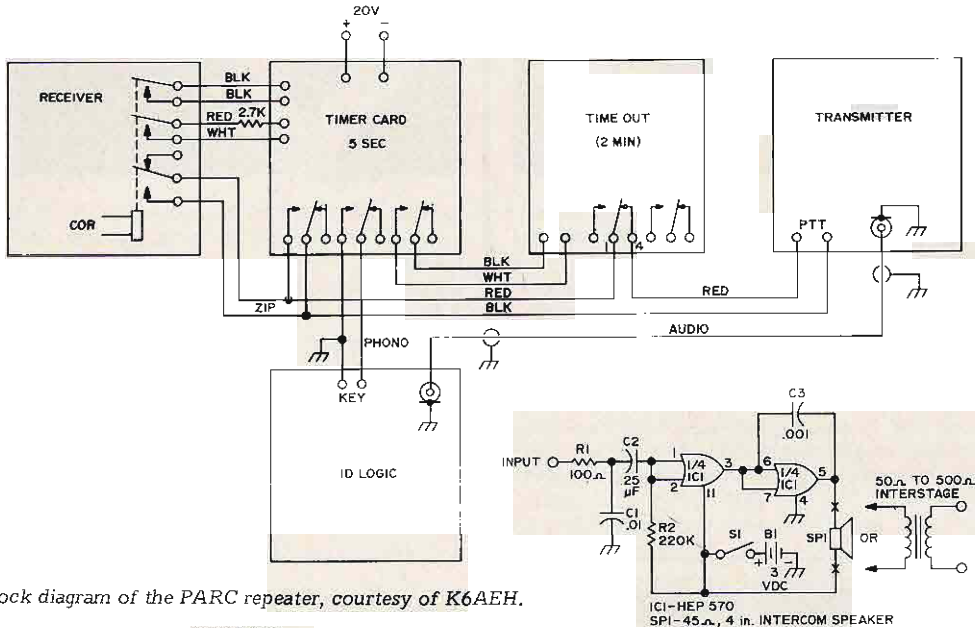

Block diagram of the PARC repeater, courtesy of K6AEH.

Microphone or audio amplifier, Class A, high gain and compact. Circuit courtesy Motorola from their Radio Amateur's IC Projects, HMA-36, available free from Motorola, Dept. 73 Box 20924, Phoenix AZ 85034.

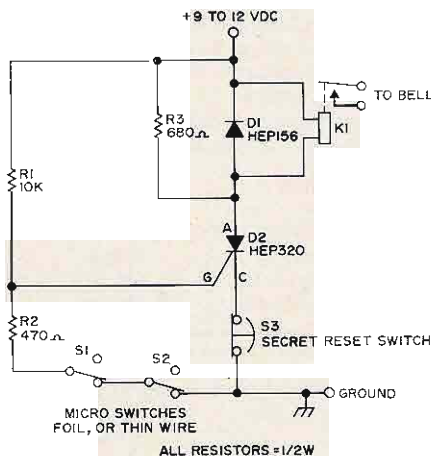

This burglar alarm will turn on a siren, bell or silent warning device. Additional switches may be added in series with SW1 and SW2; foil or thin wire may be used instead of SW1 and/or SW2. Courtesy of Motorola Construction Projects HMA-37.

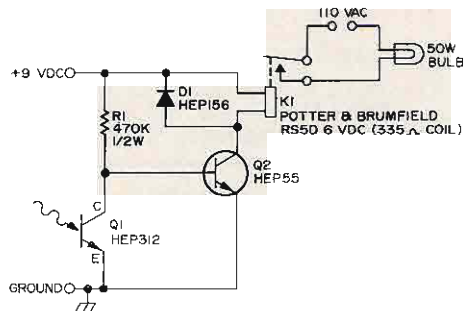

Automatic night light that turns on at dusk and off at sunrise. Courtesy of Motorola Construction Projects HMA-37.

**OPEN FRAMEPLATE TRANSFORMERS**

INPUT: 105, 110, 115, 120, 125 VOLTS - 60 cy.  
 SECONDARY: 3200 VCT @ 1 amp.  
 SIZE: 9 3/4" x 10 1/2" x 10 1/2" NEW  
 SHIP. WT. 100# PRICE: \$39.95

**TOROID TRANSFORMERS**

**MOST VERSATILE WE EVER HAD**  
 3 1/2" RD. 3" H  
 WT. 3#  
 4-14 V INPUT WINDINGS  
 4-5V FEED BACK WINDINGS  
 2-333V - 1/2 amp. WINDINGS  
 2-167V - 1/2 amp. WINDINGS  
 WILL SUPPLY 1000V @ 1/2 amp.  
 CAN USE ANY COMBINATIONS OF ABOVE.  
 SHIP. WT. 5# PRICE: \$5.95 or 2/10.00

**UTC-DOT-7**

200K-PRI. 1K-SEC. PRICE: \$1.50 ea. or 4/\$5.00

**UTC-DOT 9**

10K PRI. 600 OHMS C.T. SECONDARY PRICE: \$1.00 ea. or 3/\$2.50

**TRANSFORMERS**

115V INPUT  
 10 or 20 V.C.T. OUTPUT @ 1/2 amp.  
 SHIP. WT. 1 1/4# PRICE \$1.50 ea. or 3/\$5.00

**SOLA CONSTANT VOLTAGE HARMONIC**

**NEUTRALIZED TRANSFORMERS**  
 INPUT: 110 or 220  
 OUTPUT: 118  
 RATING: 250 VA 2.12 amps  
 ELIMINATE BROWN OUTS  
 PRICE: \$19.95

**TRANSFORMERS STANCOR**

F 610 6.3 VCT @10 amp. 115V INPUT 60 cy.  
 SHIP. WT. 5# PRICE: \$2.95

**DIODES**

1 amp. BULLET TYPE w/ SILVER LEADS 600 P.I.V.  
 PRICE: 10/\$1.00 or 110/\$10.00

**VARIACS**

5 AMP. GENERAL RADIO TYPE V5 NEW  
 PRICE: \$6.95 or 2/\$12.00

**TRANSISTORIZED POWER SUPPLY**

ADJUSTABLE, REGULATED & METERED  
 0-15 V @ 1.5 amp. SHIP. WT. 11# PRICE \$9.95  
 12" CONCRAC MONITOR CKD-14SP HI IMP.  
 INPUT 75 OHMS VIDEO INPUT SHIP WT 60#  
 PRICE ..... \$29.95

**ROTRON FANS  
SAUCER FANS**

280 CFM 7" DIA. x 2 1/2" DEEP 115V-50-60 cy.  
 PRICE: \$4.95 EA.

**FEATHER FANS**

270 CFM 7" DIA. 2-7/16" DEEP  
 PRICE: \$ 4.95

**SPECIAL**

T.S. 323/UR  
 PRICE REDUCED . . . \$49.95 w/ CAL. BOOK  
 Excellent Condition

**MINOR REPAIRS NEEDED**

T.S. 323/UR  
 ALL HAVE CAL. BOOKS BARGAIN NOT JUNK  
 PRICE: \$24.95

**UTC TYPE TGR**

TELEGRAPH TONE FILTERS. WE START AT 765  
 & GO TO 2805. HAVING THEM IN 170 CYCLES  
 STEP.  
 LIMITED QUANTITY PRICE: \$7.95 ea. 2/\$15.00

ALL PRICES ARE F.O.B. OUR WAREHOUSE,  
 PHILADELPHIA, PA. ALL MERCHANDISE DESCRIBED  
 ACCURATELY TO THE BEST OF OUR KNOWLEDGE.  
 YOUR PURCHASE MONEY REFUNDED IF NOT  
 SATISFIED. TERMS ARE CASH. MIN. ORDER \$5.00.  
 ALL MERCHANDISE SUBJECT TO PRIOR SALE.  
 RFE - REMOVED FROM EQUIPMENT.

**WINTRONIX MODEL 850 INDUCED WAVE FORM**

**ANALYZER.** This unit, in conjunction with your  
 present oscilloscope, permits you to view wave forms  
 in the range from audio thru MHz without any direct  
 connection. The probe is simply placed over the tube  
 in question and the wave form is displayed on the  
 oscilloscope. It may also be used as a high gain  
 amplifier to increase scope sensitivity. Excellent for  
 T.V., radio, amplifier, and transmitter repair and  
 maintenance. Brand new, with probe.  
 SHIP. WT. 13# PRICE: \$19.95 ea.

**AMPEX RF-3**

COMPLETE MEMORY - RACK MOUNTED IN CABINET,  
 INCLUDES POWER SUPPLY - SENSE AMPS - READ & WRITE CIRCUITS. ALL I.C. LIKE  
 NEW.  
 SHIP. WT. 200# PRICE ON REQUEST

**MEMORY CORE STACKS**

32K 42K  
 SHIP. WT. 100# PRICE: \$49.50

**IC BOARDS**

962 936  
 946 933  
 948 951  
 EACH BOARD HAS 3 OF ONE TYPE OF ABOVE  
 PRICE: \$2.00 ea. or 3/\$5.00

**IC BOARDS**

15 IC ON BOARD TYPE 900 - 914 & 923  
 PRICE: \$2.00 ea. or 3/\$5.00

**14 PIN DUAL INLINE**

IC SOCKETS GOLD PLATED CONTACTS.  
 PRICE: 50¢ ea. or 5/\$2.00

**METERS**

0-500V DC 3 1/2" NEW PRICE: \$1.95 or 3/\$5.00  
 0-1.5 MA DC 3 1/2" NEW PRICE: \$1.95 or 3/\$5.00  
 0-10V DC 3 1/2" NEW PRICE: \$1.95 or 3/\$5.00  
 0-300 amp. DC 50 MV FSWD/SHUNT PRICE: \$2.50 or 3/\$6.00  
 0-50 UA 2 1/2" RFE PRICE: \$2.50

**METERS PANEL TYPE WESTON MODEL 1238**

0-500 microamps full scale calibrated .005 to 500  
 roentgens/hours. 270 degree scale, approx. 3" dia.  
 excellent for wavemeter etc. New and in original boxes.  
 PRICE: \$1.95 ea. or 3/\$5.00

**#360 TEKTRONIX WAVE FORM INDICATOR**

bandwidth DC to 500 KC. Sensitivity .05/DIV.  
 50V/DIV. waveforms required for hor. deflection.  
 Size: 4" x 12" x 14"  
 #160A regulated power supply for above indicator.  
 Size: 4" x 12" x 14"  
 #162 wave form generator for above indicator.  
 Size: 4" x 12" x 6"

SPECIAL PRICE FOR ALL 3 UNITS  
 SHIP. WT. 35# PRICE: \$99.95

**CAPACITORS**

65,000 MFD 5V  
 25,000 MFD 25V  
 20,000 MFD 30V  
 40,000 MFD 10V PRICE: 3/\$1.00 or 10/\$3.00

**MODIFICATION KIT 110896 TO PROVIDE OPERA-**

**TION OF MODEL 14 TD @ 100 wpm FOR GOVERNMENT MOTORS. NEW. PRICE: \$6.95**

**R 11A LOW FREQ. RECEIVER 190-550 KC**

modern Q 5'er.  
 SHIP. WT. 8# PRICE: \$4.95 or 2/\$8.00  
 #48 REC. freq. 230-250 mc. PRICE: \$24.95  
 SHIP. WT. 45#  
 #T282 D/GR trans. freq. 225-400 mc. PRICE: \$39.90  
 SHIP. WT. 150#

**400-550 MC RECEIVER Xtal controlled, 4 section**

through line - Front and w/crystal mixer. 5 stage I.F.,  
 28V. input, D.C. to D.C. toroid inverter P/S. Sub-  
 miniature tubes - 1-5636, 1-5896, 2-6111, 3-5718,  
 4-6205. 4 miniature Babcock relays, and toroid  
 bandpass filter. Heavy alum. watertight case. 6" x 8" x  
 10"  
 SHIP. WT. 18# PRICE: \$9.95

1206 South Napa Street  
 215-468-7891

**SELECTRONICS**

Philadelphia PA 19146  
 215-468-4645



#### COMPUTER KEYBOARD W/ENCODER \$35

Another shipment just received. Alpha-numeric keyboard excellent condition. Once again we expect an early sellout. Price of \$35 includes prepaid shipment in the US and shipment made within 24 hours of receipt of order.

#### COMPUTER KEYSWITCHES

Another fantastic bargain for the builder. We have brand new bounce-less micro switch keys, spares from the above units, less key-tops. Make up your own keyboards. Made for PC mount. Package of 48 brand new key-switches only \$12.00 postpaid.



#### TS 323 FREQ. METER

Similar to the familiar BC 221 except this one covers range of 20-450 mc. Accuracy .005% Used, guaranteed OK, less batteries, with schematic. TS-323 ship wt. 35 lbs. . . . \$50.00

#### DIGITAL READOUTS



ZM 1000 NEON \$1.75



GE Y 4075 25V Miniature \$1.75

GE Y 1938 24V Standard \$1.75

RAY CK 1905 Standard \$1.75



MAN-3 1.7V Miniature \$3.50 ea. 10/\$30

#### GIANT ALPHA NUMERIC

B7971 \$1.75

#### 1,000µF 450V CAPS

For photo flash or linear power supplies \$1.50 each. 10/\$12

#### LASER DIODE 3 WATT

RCA TA-2628 w/specs. \$5

#### ROPE MEMORY MODULE

From APOLLO project \$10

#### NOISE ACTUATED SWITCH \$1.35

Solid state noise actuated switch fully wired, includes mike pick-up, amplifier, SCR switch. Actuates by noise or whistle. Useful for burglar alarms, lamp lighter, etc. 15 ft range.

#### LIGHT EMITTING DIODES 3/\$1.00

Ruby red, gold plated leads. With mercury cell for instant testing.

#### POWER TUNEABLE VARACTOR \$5.00

Similar to MA-4060, used in doublers, triplers, amplifiers, etc. Fully guaranteed, with specs and some circuits. \$5 each or 6 for \$25 pp.



#### SOLID STATE AUDIO AMP \$1.25

Fully wired, transistorized, uses 6 volts

#### CHARACTER GENERATOR SETS \$50

64 bit ASC II Character Generator IC sets. Vertical scan set includes SK0002 kit, two MM502 and one NH0013C. Horizontal scan sets includes SK0001 kit, two MM502, and one NH0013C. Make your own CRT readout or use it for hard copy. Either set only \$50 and includes 10 pages of info on character generators.



#### ALPHA NUMERIC KEYBOARD

Brand new alpha numeric keyboards with ASC II encoder in base. Made by Synergetics for computer work. Postpaid in US for \$55.00.

All material f.o.b. Lynn, Mass. Send self-addressed envelope for complete list.

JOHN MESHNA JR. ELECTRONICS

P.O. BOX 62

E. LYNN, MASS. 01904

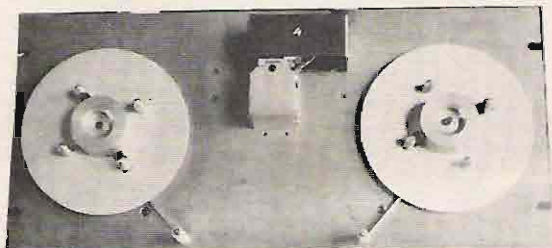

### 8 LEVEL PUNCH TAPE READER \$50.00

8 Level punched tape reader with motor drive. Made by TALLY CORP. 115 volt 60 cycle AC motor. Appearance like new. \$50 postpaid in the U.S.

Alpha-numeric keyboards. Excellent to new in condition. Styles may vary slightly from picture. Two models available, one with ASCII encoder in base \$55.00 postpaid in the U.S. Keyboard with no encoder in base \$35.00 postpaid in U.S.

### KEY BOARDS \$35.00 & \$55.00



### EXOTIC DISCRETE COMPONENTS

- FET N-CHANNEL 2N3819 unused marked, TI ..... 2/1.00
- 709C OP AMP .....75 CA3008 OP AMP ..... 1.50
- TIS-43 UNIUNCTION, TI, branded ..... 2/1.00
- TRIACS 600 PIV 6 AMP. TO-66 case ..... 1.25
- TUNNEL DIODE GE SMTD-760 ..... 1.00
- TUNNEL DIODE GE TD-717 ..... .75
- LED VISIBLE .....75 IR LED ..... 1.25
- LED DETECTOR ..... 1.25 IR LED DETECTOR ..... 1.25
- 2N918 TRANSISTOR NPNS VHF 300MV 15V 200 MC ..... 2/1.00
- 2N2218A TRANSISTOR NPNS 3 watt 40V 250MC ..... 2/1.00
- 2N2907A TRANSISTOR PNPS 1.8 watt 60V 125MC ..... 3/1.00
- 2N706 HI-FREQ TRANSISTORS ..... 3/1.00
- JK FLIP FLOP TEXAS INST'S SN5470F ..... 3/1.00

### SYLVANIA DIP IC

- Brand new dual inline package, factory marked, DTL series. Priced at a new Low, Low
- SPECIAL - ONE FREE** 50¢ ea 1 - 25  
**WITH EACH ONE BOT** 40¢ ea 25 - 100  
 30¢ ea over 100
- 932 - Dual 4 input expandable buffer
  - 930 - Expandable Dual 4 input - NAND/NOR gate
  - 931 - JK/RS Flip-flop
  - 933 - Dual 4 input expander
  - 962 - Triple 3 input NAND/NOR gate
  - 944 - Dual 4 input expandable power gate

### 455 KC IF ASSEMBLY

Complete miniature 455kc IF. amp assembly. 1.5 inches long, little over 1/2 inch square. Ready to use w/schem. Sim to Miller 8902 ..... 2.50

### RF FERRITE CORE CHOKE

Hi-permeability, ultra midget style, coated for moisture resistance, color coded. Used in xmtrs, receivers, converters, TV-peaking. Brand new, worth 40¢ each. Assortment of 1.8, 27.0, 330 µH. Pack of 30, \$12.00 value.  
 #A-71 30/\$1.00 180/\$5.00



### RF VACUUM SWITCH

Made for the ART-13 good for 100 watts RF, no doubt handles much more due to being underrated for the military ... #71-17 3/2.00

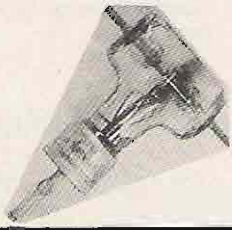

### UHF TRANSMITTER

One of the later designs being released. Superb workmanship by HUGHES. Utilizes 3 pencil triodes worth over \$46.00. Looks like a "natural" for 220 mc transmitter as it's on .264mc now. Simple to lower freq. W/tubes & schematic. Built-in power supply 400 cycle would have to be changed. Measures only 3x4x8 inches. Nice piece of scarce gear, easy to work on & first class condition.  
 4 lbs. .... #TA-40IC 15.00

### 7400 SERIES IC GRAB BAG

Mix of 7400 series DIP, unmarked untested. Some schematics provided ..... 10 for 1.00  
 100 for 8.00  
 1000 for 60.00



### CALCULATOR ON A CHIP

40 pin DIP package —

Add, subtract, multiply, and divide  
12 digit display and calculate  
Chain calculations

True credit balance sign output  
Automatic overflow indication  
Fixed decimal point at 0, 2, 3, or 4  
Leading zero suppression  
Complete data supplied with chip

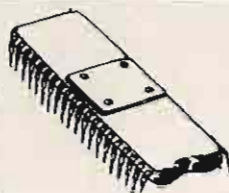

Only \$12.95

### CD-3 Universal Counter Module

Can be programmed to count to any modulus 2-9 for one kit, 2-99 for two kits, etc. Includes board, 7490, 7447, RCA DR2010 Numitron display tube and five programming components. Full instructions included — perfect for displaying second, minutes and hours, etc.

Complete \$9.25

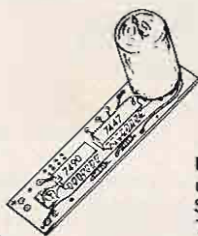

### LINEAR SPECIAL

Ten (10) operational amplifiers with a two-page sheet of application notes covering the basic circuits using op-amps. . . . . \$6.55 each  
Op-amp package 10-741's, data sheet and application notes; 14 DIP, 8 DIP choice. . . . . only \$6.00

### LINEAR IC's (dual-in-line)

LM100 positive voltage reg. . . . . .80  
747 dual 741 op amp DIP . . . . . 1.00  
LM302 voltage follower op-amp . . . . . 1.25  
709 operational amplifier . . . . . .35  
710 voltage comparator . . . . . .50  
LM309K 5V-1A power supply module . . . . . 2.50

### DIGITAL SPECIAL

Ten brand new (on carriers) dual-in-line JK flip-flops—LU321 with data sheet and two pages of application notes describing hookups for—divide by three through ten, and twelve. Also self correcting ring counter hookups, etc.

10 LU321 W/data \$4.00

### TTL dual-in-line

7400, 7401, 7402, 7404, 7405, 7410,  
7420, 7430, 7440,  
7450, 7451, 7453 . . 100 for \$20.00 . . . ea. \$ .22  
7441 BCD decoder driver . . . . . 1.00  
7442 BCD decoder . . . . . .90  
7473 dual JK flip-flop . . . . . .55  
7474 dual type D FF . . . . . .40  
7475 quad latch . . . . . 1.15  
7476 dual JK FF . . . . . .55  
7480 gated full adder . . . . . .50  
7483 4 bit full adder . . . . . 1.15  
7486 quad exclusive or gate . . . . . .65  
7489 64 bit RAM . . . . . 3.00  
7490 decade counter . . . . . .90  
7491 8 bit shift register . . . . . 1.15  
7492 divide by 12 counter . . . . . .90  
7493 4 bit binary counter . . . . . .90  
74154 one of 16 decoder . . . . . 2.50  
74192 up/down decade counter . . . . . 2.25  
74193 up/down binary counter . . . . . 2.00  
74195 unv. 4 bit SR . . . . . .90  
8220 parity gen/checker . . . . . 1.00  
8200 4 bit magnitude comparator . . . . . 1.60  
8280 preset decade counter . . . . . 1.15  
8281 preset binary counter . . . . . 1.15  
8520 25 MC divide by "N"  
2 to 15 . . . . . 2.00  
7495 4 bit SHIFT REGISTER . . . . . 1.15  
8590 8 bit shift register . . . . . 2.00  
8270 4 bit shift register . . . . . 2.00

### DIGITAL COUNTER MODULE 30MC

unit includes board, SN7490, SN7475 quad latch, SN7447 7-segment driver and RCA "numitron" display tube W/decimal. 1" x 4.5" module will mount on 1" centers.

kit \$10.95 — wired and tested \$13

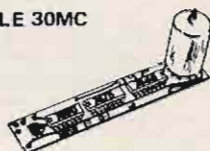

### LAST MINUTE ADDITIONS

NE565 Phase lock loop, TO-5 . . . . . \$3.50 ea.  
NE566 Function Generator, DIP (8 pin) . . . \$3.50 ea.  
NE567 Tone decoder, DIP (8 pin) . . . . . \$3.50 ea.  
7447 7 segment decoder driver . . . . . \$1.30  
74181 Arithmetic Logic Unit, 24 pin, DIP . . . \$4.50  
8261 fast carry for above . . . . . \$2.00  
8223 256 bit bipolar field programmable, read-only memory . . . . . \$10.00  
8570 9 bit S1, PO, shift register . . . . . \$2.50  
LED Red Emitting Lamp . . . . . \$6.00

All IC's are new and fully tested — leads are plated with gold or solder. Orders for \$5 or more will be shipped prepaid. Add 35¢ handling and postage for smaller orders. California residents add sales tax. IC orders are shipped within two workdays of receipt of order — kits are shipped within ten days of receipt of order. Money back guarantee on all goods sold.

# BABYLON ELECTRONICS

SEND FOR FREE FLYER

P.O. Box J  
CARMICHAEL, CA 95608  
(916) 966-2111

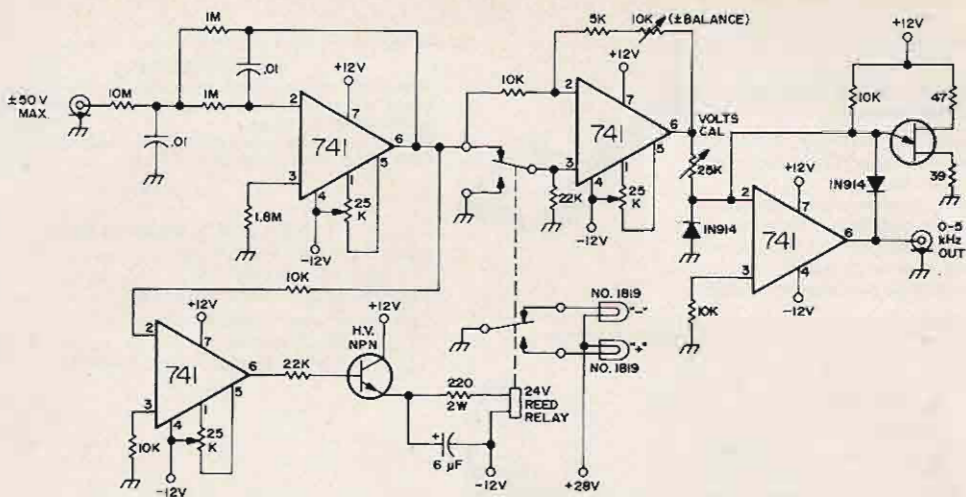

DVM adapter for a frequency counter. This circuit consists of a 200 k-ohm/volt input low pass active filter stage, a polarity detector and automatic switcher/indicator, and a voltage-to-frequency converter. The output frequency is adjusted so that 50 volts input will give a frequency of 5000 out. The three 25K pots are used for offset balancing. Any counter capable of readout to Hz is fine. Circuit by W0MLD.

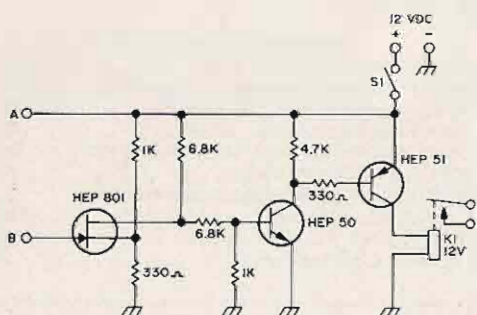

ALL RESISTORS - 1/2W

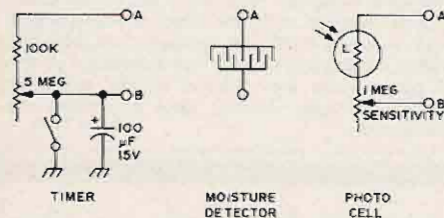

Basic control unit which can be used for almost anything... timer, light activated relay, moisture detector, etc. The timer circuit will range from about 5 seconds to 50 seconds. Change R and C to alter range. The moisture detector normally uses a small printed circuit board with interlaced wire network to allow moisture to bridge the contacts. Light relay operates when light strikes the cell. Circuit courtesy Motorola HMA-33 Tips on using FETs.

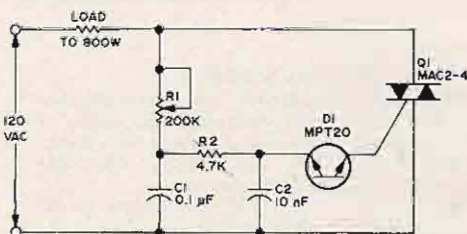

Light dimmer which will handle up to 800 watts of incandescent lamps. 10 nF = .01 μF, by the way. Circuit courtesy of Motorola Semiconductor Power Circuits Handbook.

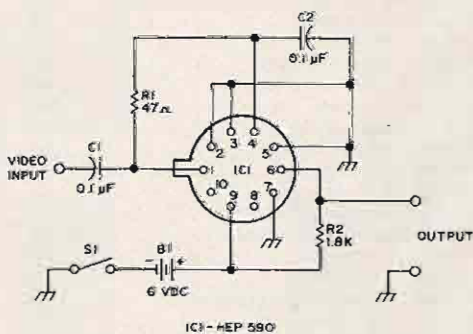

Video amplifier using a HEP 590 IC, courtesy of Motorola.



# MORE CIRCUITS...

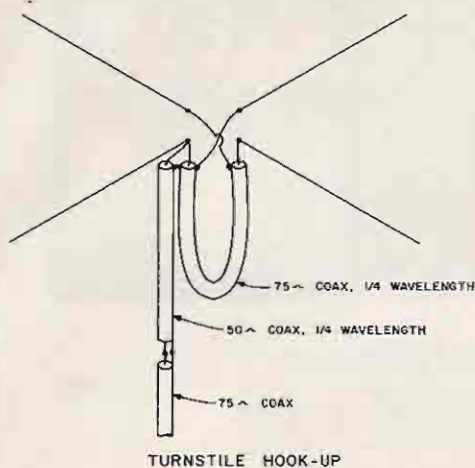

The Turnstile antenna, two dipoles phased 90° apart, is an omnidirectional horizontal antenna developed originally for mobile use. Dimensions for operation at 145 MHz are: elements - 19½" 1/8" brass rod; 50Ω coax Q-section RG59, 13½" long. Support details are shown below. From VHF Antenna Handbook by K5JKX, available from 73 for \$3.00.

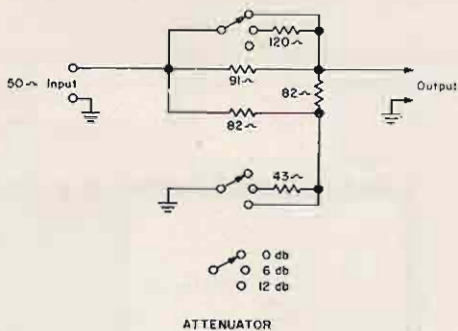
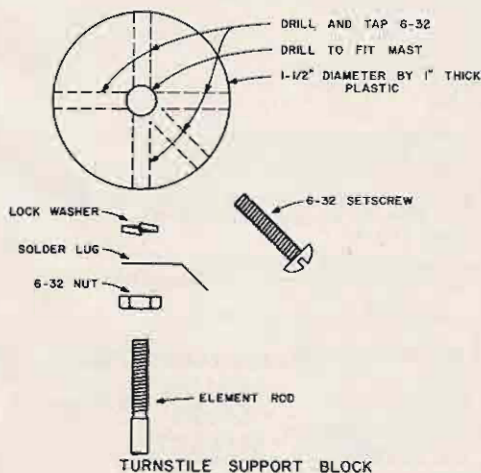

50Ω attenuator circuit for a receiver front end. Use for measuring effectiveness of different antennas by listening to a constant amplitude signal.

W100P

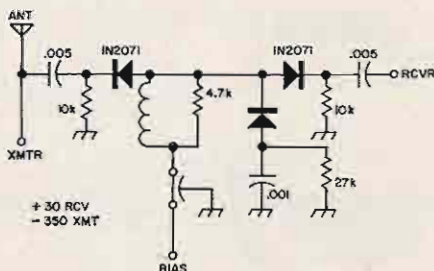

This is a high-frequency antenna switch using diodes. From the Diode Circuits Handbook, edited by WA1CCH, available for \$1.00 from 73.

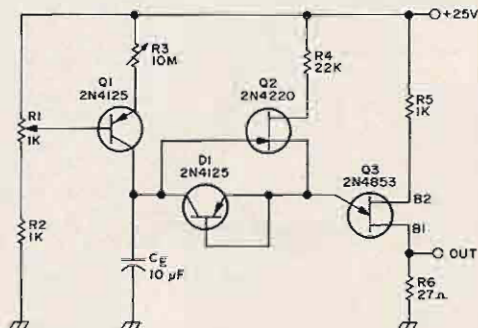

Long duration FET timer which will give a delay up to 10 hours. Circuit courtesy Motorola Semiconductor Power Circuits Handbook.

## ARE YOU CONFUSED

ABOUT THE NEWEST WAYS TO

COUNT

CLOCK

CONTROL

$2_3 + 2_4 = 11,$   
 $2_4 + 2_5 = 100,$   
 $2 + 2 = 4$   
 $2 + 2 = 10,$

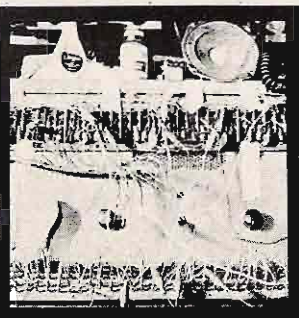
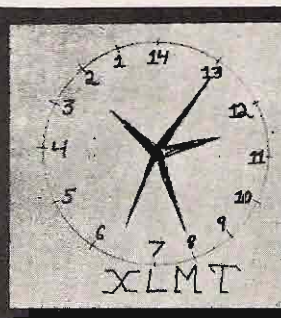

?

$10_2 + 10_3 = 13,$   
 $10_3 + 10_{10} = 15,$   
 $10_1 + 10_2 = 16,$   
 $10_3 + 10_5 = 10,$



### WE CAN HELP

#### WITH THESE NEW PRODUCTS

			PRICES
			KIT    WIRED
	<b>DIC1</b> 50 MHz FREQUENCY COUNTER, 6 DIGIT READOUT 10 MHz Xtal time base, better than .001% stability 6 position time base reference, auto. dec. pt., 100mv sens., full overload protection, other features		\$130    \$170
	<b>DVP1</b> 300 MHz PRESCALER, 50 ohms in & out, better than 100mv sens., fully compatible with all counters	WHEN ORDERED WITH DIC1 COUNTER \$30 WHEN ORDERED SEPARATELY \$40	
	<b>CDC1</b> 12 or 24 HOUR DIGITAL CLOCK, FULL 6 DIGIT READOUT .005% line frequency reference, foolproof setting circuit COMPLETE WITH HANDSOME WOOD-GRAIN CABINET 36 different color filters available		\$60    \$90
	<b>MPM1</b> 2 METER RF PREAMP, 20+db gain, 4 MHz bandwidth, low noise WIRED & TESTED ONLY-specify type of radio used		\$11
	<b>STES</b> SINGLE-TONE ENCODER, 5 ADJ. FREQ., ADJ. DURATION	no kit	\$30
	<b>STE10</b> SINGLE-TONE ENCODER, 10 ADJ. FREQ., ADJ. DURATION	no kit	\$35
	<b>STD1</b> SINGLE-TONE DECODER, WIDE RANGE, NARROW BANDWIDTH, 2/pc card no kit		\$25
	<u>REPEATER CONTROL CIRCUITRY</u>		<u>WIRED &amp; TESTED ONLY</u>
	<b>TDP1</b> TOUCHTONE® DECODER PACKAGE, latest PLL circuits, 16 button cap., COMPLETE WITH 19" RACK MOUNT, POWER SUPPLY, AND YOUR CHOICE OF ANY TWO CARDS BELOW		\$125
	ALL CARDS COME WITH SOCKETS & WIRING INFORMATION		
	<b>TFC1</b> SINGLE BUTTON FUNCTIONS, 4 PER CARD		
	<b>TFC2</b> DOUBLE BUTTON FUNCTIONS, 3 PER CARD		
	<b>TFC3</b> THREE BUTTON FUNCTIONS, 2 PER CARD	ANY CARD, EA.	\$22
	<b>TFC4</b> FOUR BUTTON FUNCTIONS, 2 PER CARD		
	<b>ITC1</b> TIMER CIRCUITS, WIDE RANGE, 2 PER CARD		
	<b>CFE1</b> EMITTER FOLLOWER CIRCUITS, 2 PER CARD		
	<b>TCR1</b> COR CIRCUITS, 2 PER CARD		
	<b>TDP2</b> TOUCHTONE® DECODER AND CONTROL PACKAGE, ALL FEATURES OF TDP1 EXCEPT YOUR CHOICE OF ANY 6 CARDS, AND 2 TOUCHTONE PADS. THIS UNIT WIRED TO YOUR SPECS ADD RADIOS AND YOU HAVE AN INSTANT REPEATER		\$250

ALL OF OUR PRODUCTS UTILIZE THE LATEST STATE-OF-THE-ART DESIGNS, AND AS TECHNOLOGICAL ADVANCES OCCUR THEY WILL BE INCORPORATED IN ALL NEW DESIGNS, INSURING YOU, OUR CUSTOMER, OF AN UP-TO-DATE DEVICE.

NEW ITEMS COMING SOON::::: DIGITAL FREQUENCY SYNTHESIZERS  
 UHF PREAMP:::::2 METER & 220 MHz TRANSCEIVERS::::CRYSTAL ELIMINATORS  
 & MORE:::::

ALL PRICES ARE POSTPAID-----ON COD'S YOU PAY POSTAGE

*All popular ICs available at competitive prices*

SEE OUR COMPLETE LINE

AT  
**SAROC**  
 '73

## Irv Cox Enterprises

P. O. BOX 7003-DEPT. 7  
 LONG BEACH, CA. 90807  
 213 427-3748

**NOVEMBER SPECIAL**

**3015F-BM**  
 7 SEGMENT  
 MINITRON  
**READOUT**  
 5V-8ma req.

**\$3<sup>00</sup>** EACH  
 PPD

# An Aural Transmitter Tuning Aid

*Florian J. Fox W1KPN  
219 Plymouth St.  
Stratford CT 06497*

**A** transmitter can be tuned by adjusting the various circuits for maximum power delivered to the antenna feedline. If the standing wave ratio of the antenna system has been adjusted for a reasonably low value, the antenna feedline voltage will, as in the case of an SWR bridge, serve as an indicator of relative output power. And relative power can be indicated by means other than visual meter deflection.

With my homebrew SSB rig I use either of two methods to obtain rf output for tuning. In the CW mode I reduce the rf drive by adjusting the carrier injection control to such a level that the final amplifier tubes can not possibly be overheated. In the sideband mode I apply about 20 mV of 1 kHz audio to one of the mike input jacks, having previously set the mike amplifier gain so that the final plate current increases to a safe steady state value when the transmitter is tuned and loaded. Since most rigs do not have two mike input circuits, some additional equipment must be provided if this method of obtaining output rf is to be used.

One big advantage of using the "audio tone" method of generating rf output for tuning an SSB rig is that even when the tuned circuits are far off resonance, the final amplifier plate current will be the normal no signal idling current. This current will increase only when the circuits are tuned and loaded, and if the audio level has been properly restricted, the final amplifier tube, or tubes, can never overheat.

If, as is usually the case, the transmitter has only one mike input jack, it would be undesirable to require the handicapped

operator to change the mike amplifier gain setting once it has been adjusted for him. Therefore, the audio oscillator should be provided with an output control so that audio level can be set without disturbing the mike gain control setting. The adjustment of the audio oscillator output is quite simple. Gradually increase its output voltage, when the transmitter has been tuned and the correct mike amplifier gain has been set, until there is a noticeable increase in the final amplifier plate current, a value that will not overheat the tube, or tubes, even if left on for a long time.

The diagram of Fig. 1 shows the tuning concept as a complete system. The circuits needed are the tone oscillator (Fig. 2), a rectifier unit (Fig. 3), and a control box (Fig. 4).

In the case of CW or AM transmitters, since they always produce rf output, the introduction of an audio tone would be useless. Some means should be provided during tuneup for reducing the output rf carrier to a safe level when circuits are off resonance.

Let us now consider the CW method of tuning commercial SSB transmitters. One of the switches will have a position marked TUNE or TUNE-CW and usually a control marked RF GAIN which is used for adjusting the transmitter rf output level. In some cases it is not possible to set the rf gain low enough to prevent the final amplifiers from overheating when the circuits are off resonance. This is why the owner will be cautioned not to tune for longer than about 15 seconds at a time. This could be a real problem for anyone who has to use an

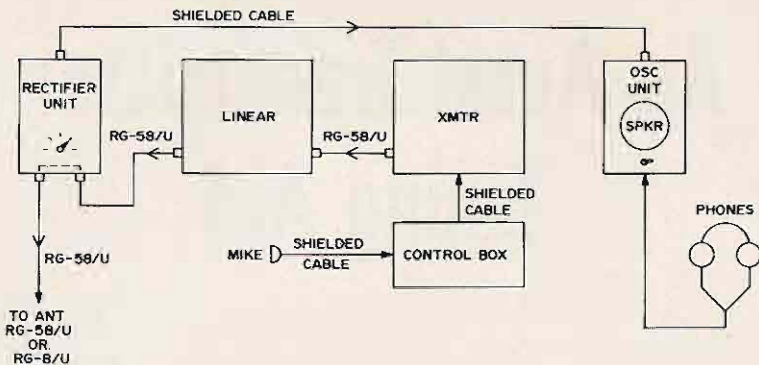

Fig. 1. Block diagram of complete installation.

external tuning aid. It would be well to check this point very carefully before deciding which of the two tuning methods should be used. If there is any chance of damaging the final amplifier tubes, the audio tone method described previously should be used.

This tuning aid has at least two advantages over some of the others that have been published. It is not necessary to make changes or additions to the transmitter, and no external power source is required. Even though it may draw several hundred milliwatts from the coaxial line that feeds the antenna this does not matter because it is disconnected from the feedline when the sensitivity switch is turned off.

Rf voltage in the antenna coaxial feedline is rectified and filtered, producing a dc voltage which is proportional to the rf

voltage. This dc voltage, which attains a maximum value when the transmitter is properly tuned and loaded, is applied to a transistor multivibrator oscillator. The output of the oscillator is fed to a headphone jack or it can be switched to a transistor amplifier driving a small loudspeaker. Any variation of the dc supply voltage will change both the frequency and the intensity of the tone produced by the oscillator. In other words, when the rf voltage in the antenna feedline increases, the frequency and intensity of the audible tone will also increase and vice versa.

Originally the tuning aid was enclosed in a single metal box, but in spite of the filtering, there was so much stray rf that the multivibrator would block at high rf input levels. The layout of the parts made it impractical to add shielding partitions, so

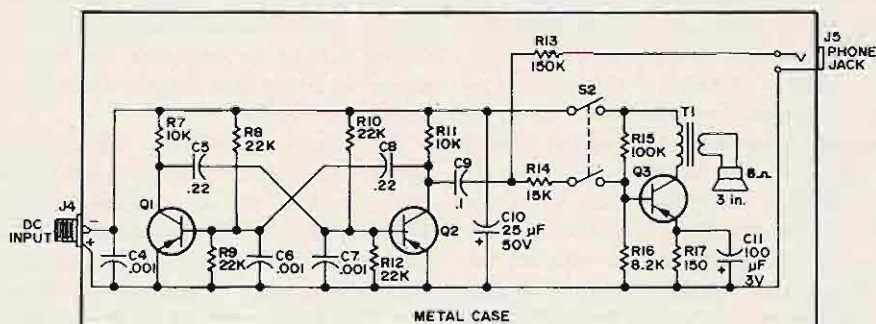
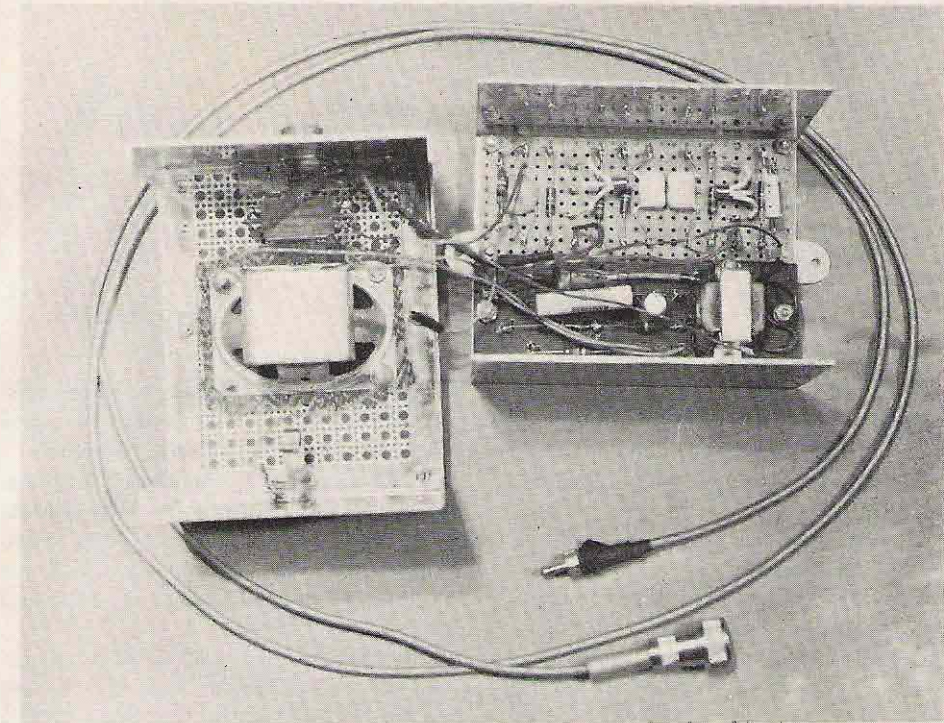

Fig. 2. Oscillator unit. Q<sub>1</sub>, Q<sub>2</sub>: 2N4354; Q<sub>3</sub>: MFD 3V electrolytic (value not critical); T<sub>1</sub>: 2N270; resistors ½W size (or smaller); C<sub>4</sub>, C<sub>6</sub>, C<sub>7</sub>: ceramic; rf bypass (value not critical) .001 MFD used; C<sub>5</sub>, C<sub>8</sub>: .22 MFD paper +/- 20% tol.; C<sub>9</sub>: .1 MFD paper +/- 20% tol.; C<sub>10</sub>: 25 MFD 50V electrolytic (value not critical); C<sub>11</sub>: 100



*The Oscillator*

the problem was solved by the use of two separate metal boxes, one for the rectifier unit and one for the oscillator. A single box probably could be used if the two sections are adequately shielded from each other.

#### **Construction**

The construction is relatively simple, so a detailed discussion is really not required. And since the circuit diagrams and the photos tell most of the story, I shall confine myself to offering a few suggestions. The miniboxes I used measured  $2\frac{1}{4} \times 2\frac{1}{4} \times 5$  in. for the rectifier unit and  $3 \times 4 \times 5$  in. for the oscillator, amplifier, and speaker assembly. Anything smaller will result in crowding. Install the antenna feedline connectors close together. For constructing compact assemblies, Bakelite punch boards with insertable terminals are very convenient. After the boards have been cut to size and mounting details worked out, it is wise to make sketches, preferably to scale, to determine the most logical placement of the components for

easy wiring. If the final sketch, showing all interconnections, is made on tracing paper, the sketch can be turned over so that the back side of the board can be wired with less chance of error.

The interconnecting cable between the two units must be well shielded against stray rf pickup. Coaxial microphone cable or RG-58/U will be satisfactory. The type of connectors is optional.

The frequency variation of the audible tone will decrease when the sensitivity of the tuning aid is reduced. This is due to the increased series resistance in the rectifier circuit. For best results, hold down the transmitter output as much as possible so that a more sensitive setting (less series resistance) can be used. If there is a linear amplifier, tune the exciter first, then reduce the sensitivity and tune the linear.

The headphones should be of the high impedance type — the higher the better. If more volume is required, reduce the value of series resistor R13, but not below  $47 \text{ k}\Omega$ .

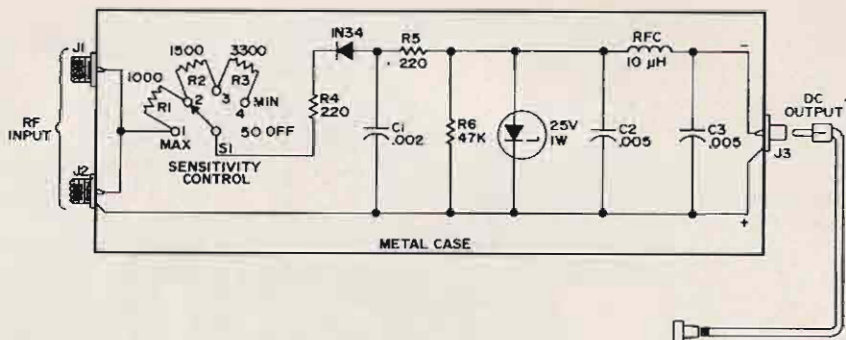

Fig. 3. Rectifier unit

The headphones should be of the high impedance type – the higher the better. If more volume is required, reduce the value of series resistor R13, but not below 47 k $\Omega$ .

If more loudspeaker output is required, the 15 k $\Omega$  transistor base limiting resistor (R14) can be reduced to about 4.7 k $\Omega$  as a limit. If still more output is required, base bias resistor R16 can be increased to around 12 k $\Omega$ . But since this will cause the transistor to draw more current, there will

be some reduction in the range of the tone variation. It might be better to shop around for a more sensitive loudspeaker.

When using the headphones for tuning, switch off the loudspeaker. This reduces the current required by the unit, which increases the dc voltage variation, and this in turn increases the change in pitch and intensity of the tone.

The speaker switch can be eliminated if you can find a phone jack having two separate normally closed switching circuits

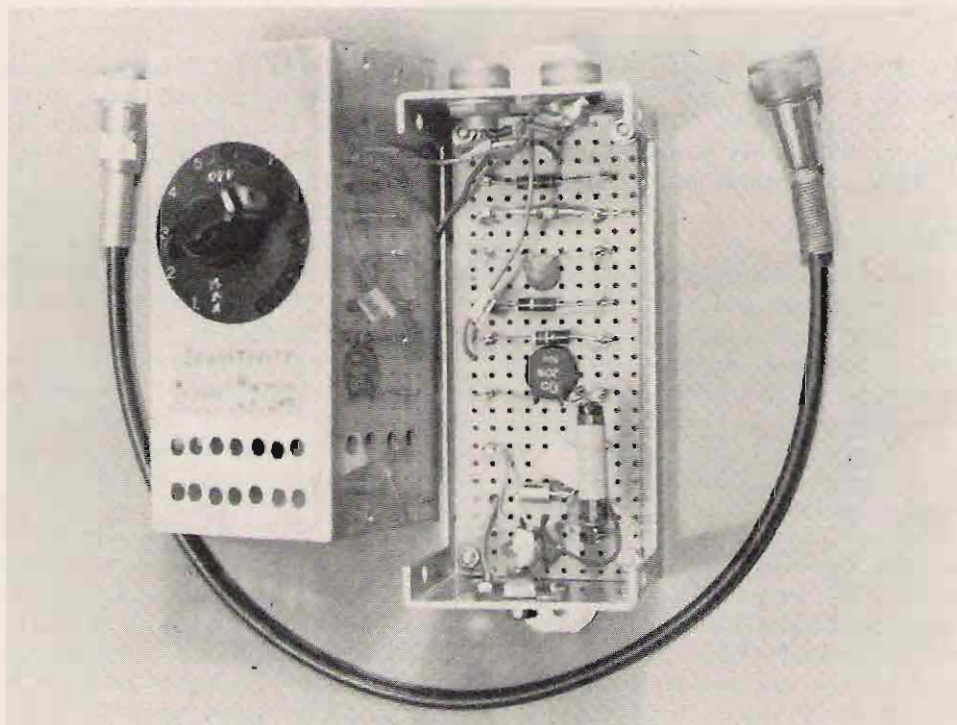

The Rectifier

which will open when the phone plug is inserted.

To install the tuning aid, first select a location for the rectifier unit so that it will be easy for the operator to find the sensitivity control. Remove the antenna feedline from the transmitter output receptacle and connect it to one of the rectifier rf receptacles. (I should have mentioned earlier that these rectifier receptacles should preferably be the same type as used on the transmitter.) Make up a coax jumper cable to go from the transmitter to the other rectifier rf receptacle. Next find a convenient location for the oscillator unit. Make up and install the interconnecting cable between the two units.

If it is desired to tune in the SSB mode by injecting an audio tone into the mike input jack of the transmitter, it will be necessary to make a small audio oscillator having an adjustable output. Its frequency can be between 400 and 1000 Hz and its maximum output need not exceed 50 mV. A compact transistor oscillator, powered by a single penlight battery, can be made up with little effort. The oscillator, a mike jack, a switch, and a shielded output cable should be installed in a small metal box, as shown in Fig. 4, to enable the operator to inject the audio tuning signal by simply throwing a switch. Be sure to procure the same type of jack and plug that is already being used on the microphone and the transmitter.

...W1KPN■

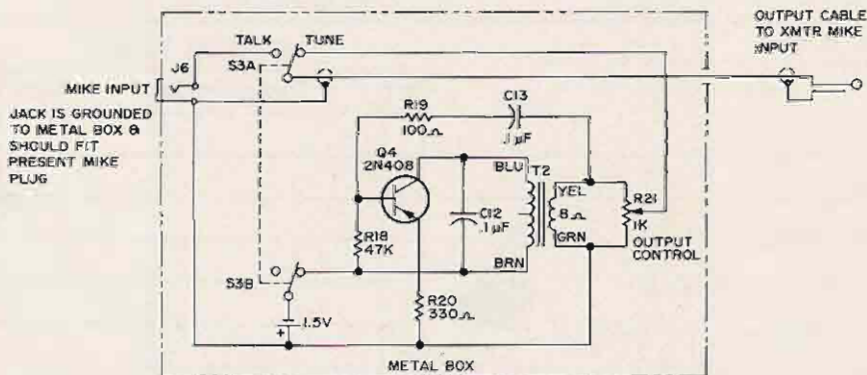

Fig. 4. Mike or audio tone selector box.  
Note: Transistor output type AR 169, 200Ω/8Ω, Argonne, Lafayette Radio, or similar. Other

**SPACE-AGE TV CAMERA KITS & PLANS**

BE A PIONEER IN HOME TELECASTING! Build your own TV CAMERA. Model K10A, Series D, \$118.95 pp. Solid-State. Step-by-step construction manual. High quality. Connects to any TV without modification. Ideal for home, experimenters, education, industry, etc.

PHONE or WRITE for CATALOG.  
DIAL 402-967-3771

Many other kits, parts and plans available including starter kits, focus/det. coils, vidicon tubes, const. plans, etc.

1301 N. BROADWAY **ATV Research** DAKOTA CITY, NEBR. 68731

**ULTRA-BAL 2000**

- Advanced design BALUN
- No radiation from coax, more power to antenna
- Less noise on receive
- Full 2KW - 3 to 30 Mcs., 1:1 or 1:4 ratios.
- Encapsulated, ultra weather-proof.
- Mil type 2KV Teflon insulation over silver plated wire for ultra low loss.

Specify ratio desired \$ 8.95 ppd.

**K.E. Electronics** Box 1279, Tustin Calif. 92680

READ THIS BY "GUS" W4BPD  
(Actually an advertisement in "disguise"). YOU spend hundreds of \$ on gear, antennas, mikes, etc. then YOU spend countless hours of listening & HOPING for some DX. WHY NOT do it the easy way? Subscribe to the WORLDS ONLY weekly DX Magazine and do it THE EASY WAY. DX news in depth, upcoming events, dates, freqs, times, DX QSL info, stories & articles by DXers, pictures. ALL you want to know ABOUT DX! NOTHING ELSE! OH YES - I also print FB QSL's, priced right. Send \$5 for 25 samples and price list. How about IT'S SUBSCRIPTION RATES: First Class Mail to USA, Canada & Mexico 6 mo. \$6.00 or 1 yr. \$12.00. THE DXERS MAGAZINE. DRAWER "DX", CORDOVA, S.C. 29039 - U.S.A. (THANKS)

**FREE CATALOG** **TOOLS**

**HARD-TO-FIND PRECISION TOOLS**

Lists more than 1700 items—pliers, tweezers, wire strippers, vacuum systems, relay tools, optical equipment, tool kits and cases. Also includes four pages of useful "Tool Tips" to aid in tool selection.

**JENSEN TOOLS and ALLOYS**  
4117 N. 44th Street, Phoenix, Arizona 85018

**YOUR CALL**

Please check your address label and make sure that it is correct. In cases where no call letters has been furnished we have had to make one up. If you find that your label has an E3\*8\* on it that means we don't know your call and would appreciate having it.







## NEW and SURPLUS ELECTRONICS FOR THE HAM and EXPERIMENTER

# METERS

■ VOLTMETERS ■ AMPMETERS ■ MILLIVOLTMETERS ■ MILLIAMMETERS  
■ MICROAMMETERS ■ OHM METER ■ WATTMETERS ■ DIGITAL INDICATORS  
■ VOLTAGE TESTERS ■ INDUCTION METERS

### PLASTIC BEZEL METER



2303	0-10 ADC	3.50
2305	0-30 ADC	3.50
2320	0-1 mADC	4.75
2325	0-5 mADC	3.60
2326	0-10 mADC	3.45
2329	0-50 mADC	3.20
2330	0-100 mADC	3.20
2332	0-500 mADC	3.20
2337	0-10 VDC	3.20
2337C	0-50 VDC	3.20
6304	0-10 AAC	4.40
6337	0-15 VAC	4.40
6339	0-150 VAC	5.15

## Eliminate Annoying Channel Chatter

# 37<sup>50</sup>

## SCU-1

### PROBE-MASTER



THE NEW PROBE-MASTER SELECTIVE CALLING UNIT (MODEL SCU-1) ENABLES USERS OF HAM, CB, AND COMMERCIAL RADIOS TO CANCEL OUT ALL UNDESIRABLE SIGNALS AND YET CONTINUE TO HEAR CALLS FROM SIMILARLY EQUIPPED STATIONS.

EACH CALLING UNIT IS A COMPLETE ENCODER/DECODER UNIT WHICH REQUIRES ONLY SIMPLE CONNECTIONS TO AUDIO CIRCUITRY, POWER AND GROUND AND WHICH USES VERY LITTLE OPERATING CURRENT DUE TO ITS ADVANCED SOLID-STATE DESIGN.

WHEN USED FOR SELECTIVE MONITORING, THE UNIT "SWITCHES OFF" THE AUDIO CIRCUIT OF YOUR RECEIVER UNTIL THE SCU IS ACTIVATED BY A SIGNAL FROM A CALLING STATION WHICH IS SCU-EQUIPPED. WHEN THE SCU IS SO ACTIVATED, YOU WILL HEAR AN ALERTING SIGNAL TONE AND THEN THE CALLING STATION. OF COURSE, YOU MAY USE YOUR UNIT TO CALL AND ACTIVATE OTHER STATIONS WHICH ARE USING THE SCU FOR SELECTIVE MONITORING.

## LUMINETICS SEVEN SEGMENT DISPLAY



# 3.25

Recommended operating voltage . . . 4.5 to 6.5V  
Current per segment . . . . . 8mA @ 5VDC  
Life expectancy . . . . . 50,000 hours @ 5VDC  
Viewing angle (included angle) . . . 100°  
Temperature range . . . . . -50°C to +70°C  
Lens . . . . . Borosilicate glass  
Filaments . . . . . Tungsten  
Contacts . . . . . Kovar

### COUNTER-DISPLAY KIT:

Includes Luminetics Display,  
7447 Decoder-Driver, and  
7490 Decade Counter

# 6.00 PER KIT

## New, Exclusive, Low Cost Miniature Solid State Electronic Buzzer



# 5<sup>95</sup>



**Applications** — Portable and battery-operated equipment, alarm clocks, test apparatus, intercom sets, sensors, automotive warning signals, timers, etc.

**High Reliability** — no moving contacts. A semi-conductor drives a vibrating reed coupled to a plastic diaphragm. Cud is enclosed in a magnetic pot core. No arcing, interference or RF noise.

**Low Power Consumption** — Unit consumes less power than a signal lamp. Approximately 15 mA at 1.5 volts, 25 mA at 3 volts, 15 mA at 12 volts. Unit can be activated directly from a transistor gate.

**Rich, Harmonic Sound** — output near 400 Hz gives extra audible penetration. Volume is 80 decibels at 8 1/2 inches at 2.5 volts. Output volume increases and decreases with voltage.

Two Models — GA100: 1.5 to 3 VDC      GA100-12: 12 VDC      Quantity prices and delivery quoted upon request.

## TOUCH CALLING KEYS



A 12-button, alpha-numeric keypad equipped with a tone generator; identical to those used in Touch Calling telephones. The tone generator is mounted on a printed circuit card in back of the keypad. All tone frequencies are produced by a one-transistor oscillator.

# 24<sup>95</sup> NEW

## SPECIAL LED 7 Segment Display

NEW Only \$3.95  
Similar to Monsanto Man-1 or Opcoa SLA-1

### ALL NEW SEMICONDUCTORS

XD-2	Hughes (30V-10914)	10¢
1N4004	400V, 1A	25¢
1N4005	600V, 1A	30¢
1N5392	100V, 1.5A	25¢
1N5400	50V, 3A	25¢
1N5401	100V, 3A	30¢
1N4730	Zener, 2.4V, 400mW	50¢
1N4732	Zener, 4.7V, 1W	50¢
1N4735	Zener, 6.2V, 1W	50¢
1N4746A	Zener, 18V, 1W	50¢
1N5227A	Zener, 3.6V, 3W	50¢
1N5342	Zener, 6.2V, 3W	50¢
1N5245B	Zener, 15V, 3W	50¢
1N5246B	Zener, 27V, 3W	50¢
2N3054	25W, 60V	60¢
2N3711	0.25W, 30V	25¢
2N3957	30W, 30V	60¢
40289	RC4, 3.0W, 40V	50¢
44799C	Op. Amp.	75¢
936	Pril. Box Inventory	25¢
2T12-1	One Watt Audio Amp.	1.00



1312 SLOCUM STREET • DALLAS, TEXAS 75207 • (214) 747-3230

- PLACE ME ON THE PERMANENT MAILING LIST FOR CATALOGS AND FLIERS.
- SEND LATEST PRICE LIST ON 7400 SERIES TTL INTEGRATED CIRCUITS.
- SEND INFORMATION ON A NEW ALL ELECTRONIC CLOCK KIT.
- I'M A COMPANY, SEND LIST SHOWING QUANTITY PRICES ON NEW COMPONENTS.

COMPANY NAME IS: \_\_\_\_\_

NAME \_\_\_\_\_

ADDRESS \_\_\_\_\_

CITY \_\_\_\_\_ STATE \_\_\_\_\_ ZIP \_\_\_\_\_

WHEN IN DALLAS, VISIT OUR STORE AT 1312 SLOCUM ST, OFF STEMMONS FREEWAY, BEHIND LEVITZ. SAT'S 9-5.

**S.P. 600 RECEIVER**

MFD. BY HAMMARLUND. GENERAL COVERAGE RECEIVER, 540KHZ to 54 MHZ. CURRENTLY BEING USED BY THE ARMED FORCES. SELECTIVITY TO 200HZ IN SIX STEPS CRYSTAL CALIBRATOR. NOISE LIMITER. DOUBLE CONVERSION. A BIG FAVORITE WITH S.W.L.'s AROUND THE WORLD. LIMITED QUANTITY AT . \$275.00

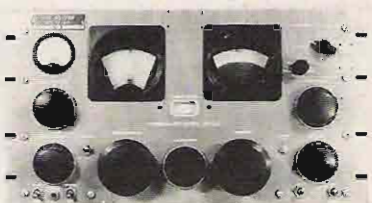

**SRR 13 RECEIVER**

GENERAL COVERAGE 2MHZ. to 32MHZ. MODULAR CONSTRUCTION. STEEP SKIRT SELECTIVITY. DOUBLE CONVERSION. CRYSTAL CALIBRATOR. NOISE LIMITER. VERY POPULAR AS A GENERAL COVERAGE RECEIVER FOR HAM USE. . . \$199.00

**SG 71 AUDIO OSCILLATOR**

VARIOUS MANUFACTURERS, TRANSCOM, MEASUREMENTS, HEWLETT PACKARD. COVERS THE FREQUENCY RANGE OF 50HZ to 500KHZ WITH A METERED OUTPUT THAT'S BALANCED OR UNBALANCED. THIS GENERATOR HAS A HIGH OUTPUT FOR DRIVING FLIP FLOPS ETC. WE HAVE A LIMITED QUANTITY SO HURRY . \$34.95

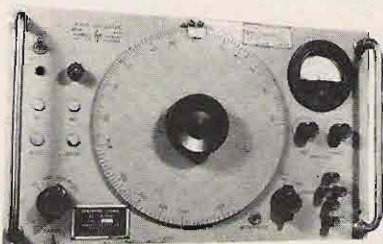

**AM 864/U AUDIO AMPLIFIER**

THIS IS THE CLASSIC PEAK LIMITING AUDIO FREQUENCY AMPLIFIER THAT THE MILITARY RADIO SYSTEM HAS USED FOR YEARS. WITH A FREQUENCY RESPONSE OF PLUS OR MINUS ONE dB FROM 50 Hz to 20 kHz AND ADJUSTABLE LIMITING OF UP TO 18 dB WITH A TYPICAL 2% DISTORTION AT THE UPPER END. 35 dB GAIN ADJUSTABLE BY THE KNOB ON THE FRONT PANEL DEPO REPACK. 35.00

**NEMS CLARKE 1401 TELEMETRY RECEIVER**

FREQUENCY RANGE OF 215MHZ to 260MHZ WITH IFS OF 100KHZ AND 500KHZ. METERS SHOW AUDIO OUTPUT LEVEL, DEVIATION, TUNING, AND APPROXIMATE SIGNAL LEVELS. HAS A BUILT IN SPEAKER AND PROVISIONS FOR PLUGGING A CRYSTAL SOCKET IN THE FRONT OR A VFO ..... \$69.95

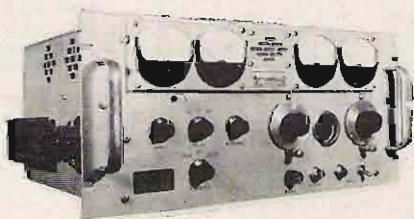

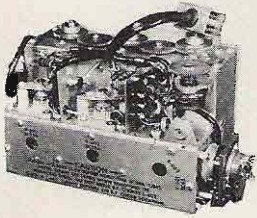

ARC 27 R.F. POWER DECK  
HERE'S A BUY FOR THE BUILDER, THIS DECK HAS THE 2C39 TUBES AND THE 2C43 TUBE STILL IN THEIR SOCKETS, AND THIS DECK WILL COVER THE 220MHZ BAND AND WITH SOME ALTERATIONS CAN BE COAXED TO THE 425MHZ BAND. ALL THIS FOR ..... \$9.95

ARC 27 GUARD RECEIVER  
HERE IS A RECEIVER STRIP COMPLETE WITH SQUELCH, VOLUME CONTROL, IF, AND AUDIO OUTPUT. ALL THAT'S NEEDED TO MAKE THE RECEIVER OPERATIONAL IS A POWER SUPPLY AND A SPEAKER. CURRENTLY THE STRIP IS ABOVE THE 220MHZ HAM BAND WITH A CRYSTAL AND SOME TWEAKING YOU CAN PUT IT WHERE YOU WANT IT ON THE BAND. \$8.95

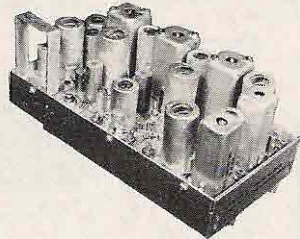

ARC 27 SYNTHESIZER  
OVER 1000 DIFFERENT FREQUENCIES CAME OUT OF THIS MIXER CIRCUIT. GREAT FOR EXPERIMENTS WITH SYNTHESIZER CIRCUITS ON 220MHZ. HAS 10 CRYSTALS FROM 25.7 MHZ TO 34.7 MHZ IN 1 MHZ STEPS. .... \$3.95

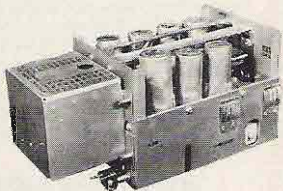

ARC 27 CRYSTAL OSCILLATOR 10 AND 90 MHZ.  
THIS OSCILLATOR HAS A 10MHZ CRYSTAL IN AN OVEN. THE OUTPUTS FOR 10MHZ AND FOR 90MHZ ARE ON THE UNDERSIDE OF THE CHASSIS. JUST APPLY POWER AND GO. .... \$3.95

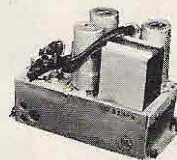

ALL OF THE ARC 27 MODULES HAVE SCHEMATICS WITH THEM AT NO CHARGE.

# AN/COM Electronics

5667 Lankershim Boulevard  
North Hollywood, Ca. 91601  
(213) 769-5518

### 50 MEGAHERTZ LOW COST COUNTER



Here is a new item, featured because of numerous customer suggestions. We have taken the basic power supply, chassis and cover from our clock kit, and by substituting a new front panel and printed circuit board, have made a

lowest cost frequency counter. The unbelievable low cost is due to our use of our large stock of unused surplus pieces, the new 74196 50 MHz decade counter, and the commonality of parts with our other kits. Readout is to six decades, time base is 1 second, 0.1 seconds, or external. Design is modular, for ease of construction, compactness, and expandability.

- 50 MHz six digit counter, using line frequency as time base, complete except for cover . . . \$97.50
- Optional crystal controlled time base plug-in conversion . . . \$23.50
- Cover, blue or black anodized . . . \$4.50

### BUILD YOUR OWN ELECTRONIC CALCULATOR FOR ONLY \$108.00!



A complete calculator kit, complete with self contained power supply and case. Indispensable in the home, office or school. Simple enough for a child to build. Some of the features of the calculator are as follows:

- MOS integrated circuits (extra large scale integration) reduce the number of components to a minimum, for easy assembly.
- Displays eight digits on large size seven segment display.
- Full function complement keyboard features addition, subtraction, multiplication, division, alternate display, multiplication by constant, clear all, clear entry, and decimal point set.
- Sixteen digit entry and sixteen digit results are possible with alternate display key.
- Leading zeroes suppressed.
- Chain operation.
- All integrated circuits and displays are socket mounted and replaceable.

constant, clear all, clear entry, and decimal point set. Sixteen digit entry and sixteen digit results are possible with alternate display key. • Leading zeroes suppressed. • Chain operation. • All integrated circuits and displays are socket mounted and replaceable.

So reliable and simple to build, we can make this guarantee: If for any reason you cannot succeed in getting your calculator to function properly after completing construction for a flat handling fee of \$10.00, B and F will repair and ship back your calculator anywhere in the USA. This applies regardless of the age of the assembler, barring gross negligence or the use of acid core solder in construction.

**\$108.00**

### DIGITAL CLOCK KIT WITH NIXIE DISPLAY



We have well over 20,000 surplus nixies in stock, and because of this bargain purchase we can sell a complete digital clock kit for less than the usual cost of the display tubes only. We provide

a complete etched and thru-plated circuit board, all integrated circuits, complete power supply, display tubes, I.C. sockets and a nice front panel with polaroid visor. We have never seen anyone offer this kit for less than \$100.00. Includes BCD outputs for use as with timer option. May be wired for 12 or 24 hour display. Indicates hours, minutes, seconds.

- Clock Kit, complete less outside cover . . . \$57.50
- Aluminum blue or black anodized cover (specify) . . . \$4.50
- SHRINK TUBING SPECIAL. Assortment of 200 pieces of shrink tubing, diameters 1/8" to 1/2", length 1/2" to 2". \$1.25 Price . . . \$1.25

### KEYBOARDS



Three keyboards are available: 20 key calculator keyboard, 40 key alphanumeric and 12 key touch tone. All have separate contacts carried out to edge connector.

- Touch Tone Keyboard . . . \$9.50
- Calculator Keyboard . . . \$14.50
- Alphanumeric Keyboard . . . \$29.00

### LIGHT EMITTING DIODE NUMERIC DISPLAY



This display is excellent for small portable electronics, such as DVM's, calculators, etc. Equivalent to Montanto MIAN 3A. Operates from 5 volts, 20 milliamperes, with 47 ohm dropping resistor.

\$3.25 Each

- Complete counter kit, 7490, 7475 latch 7447, printed circuit board, led readout . . . \$9.50

### IMPOSSIBLE ? THIS MONTHS FEATURE ITEM

#### POCKET CALCULATOR KIT



This is the kit you have been waiting for. So compact it actually fits in a shirt pocket (3-13/16 x 4-5/8 x 1-1/4). It performs every function you would expect in a desk calculator, including constant and chain operation, and full floating decimal. The unit is powered by self contained batteries, and uses 8 digit LED displays. The calculations are performed by a single 40 pin integrated circuit, which can truly be called large scale integration (LSI).

As a student, engineer, salesman, accountant, or anyone who would like fast accurate answers, this calculator fills the bill, and at a price that unquestionably makes this the lowest price high quality calculator available.

- Pocket Calculator Kit . . . \$75.00

#### RECHARGEABLE BATTERY/CHARGER KIT

This option allows the throw-away alkaline battery to be replaced with a nicad battery, and includes a charger to recharge this battery. The unit may be run during the recharge cycle.

- Battery/Charger Kit . . . \$17.50

#### LOGIC AND OPERATIONAL AMP SUPPLIES



- Figure A, potted logic supply, 5 Volts at 1 Ampere, short circuit proof, ultra high regulation, ultra low ripple . . . \$16.00
- Figure A, potted Op Amp supply, +15 Volts, and -15 Volts at 0.5 Amperes. Mfg. by Analog Devices, similar to their model 902. Short circuit proof, ultra high performance. . . \$29.00
- Figure B, 5 Volt 1Amp supply, regulated by Fairchild 9305, short circuit protected. . . \$9.75
- Same as above, in kit form . . . \$7.75
- Mating connector for above . . . \$1.00
- 5 Volt 5 Amp regulated supply, by Blufyne, (not shown). . . \$29.00

#### LIGHT EMITTING DIODES

- Montanto MV 50 or equivalent LED's. Now less expensive than filamentary bulbs. At this price wire them into logic circuits as status indicators, build low cost counters or use them as panel lights. Rated at 10 - 40 Ma @2V.
- 10 LED's . . . \$3.00
  - 100 LED's . . . \$25.00
  - 1000 LED's . . . \$200.00

#### GIANT ALPHANUMERIC READOUT WITH DRIVER BOARD



This giant size burroughs B7971, 16 segment tube, displays all numbers and letters of the alphabet in giant 2" numerals. Driver board allows operation from standard TTL levels. With instructions and schematics, provided as two tubes with sockets mounted on single board.

- Two Giant Nixies with Drivers \$5.00
- Mating connector for above \$1.00

#### LOUDSPEAKER SYSTEM COMPONENT SPECIAL!!

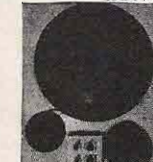

We have made an excellent purchase of an excess inventory of a local manufacturer speaker systems although we aren't allowed to mention the manufacturer's name, the specs should make it self evident. The woofer is a 12" free-edge (acoustic suspension) unit, with 2" voice coil and a 2 lb. magnet.

The mid-range is a 5" unit of the dome type, for best high frequency dispersion. Crossover between woofer and mid-range is by an R-L-C network, while high frequency crossover is by an R-C network. Balance controls are provided for both mid-range and tweeter. Plans for a suitable enclosure are provided.

- Speaker System . . . \$29.00 ea./2 for \$55.00

#### CHARGES WELCOME!

Phone in charges to 617 531-5774 or 617 532-2323. BankAmericard - MasterCard, \$10.00 minimum. No C.O.D.'s please.

### B. & F. ENTERPRISES

Phone (617) 532-2323  
P.O. Box 44, Hathorne, Massachusetts 01937

### AIRCRAFT/AUTO/BOAT QUARTZ CRYSTAL CHRONOMETER



Revolutionary! was the reaction of our customers when they saw our latest kit. Measuring only 2-1/2" x 2-1/2" x 4", and accurate to 10 seconds a month, this chronometer promises to entirely replace mechanical clocks in cars, boats and airplanes.

Fits into a standard 2-1/4" instrument panel cutout. The displays are bright L.E.D. displays that should last a lifetime. Setting controls are recessed and operate from a pointed object such as a pencil point or paper clip, in order to keep non-authorized hands off. The clock should only have to be reset at very great intervals, or in the event of power loss (i.e. replacing battery in car). The clock is wired so that the timing circuits are always running, but the displays are only lit when the ignition is on, resulting in negligible power drain. The low price is only possible because of a new one chip MOS clock circuit, developed for quartz crystal wristwatches.

Operates from 10-14 Volts D.C. An accessory unit which mounts on the back adapts the unit to 20-28 Volts for twin engine aircraft and larger boats using 24 Volt ignition. Know how disgusted you are with the usual car clock? Order this fine unit now for rallying, sports events, navigation, or just to have a fine chronometer that will give you a lifetime of superbly accurate time.

- Quartz Chronometer, Kit Form . . . \$59.50
- Quartz Chronometer, Wired . . . \$99.50
- 24 Volt Adapter . . . \$10.00



### DECADE COUNTING UNITS W/READOUTS

Always one of B & F's most popular items, now revised to include drilled boards, I.C. sockets, and right angle socket for readout. Arranged so that units can be stacked side by side and straight pieces of wire bussed through for power, ground and reset. Several different units are available as follows:

- 7490 Basic 10 MHz souther. Used in frequency counters and events.
- 74196 Same as 7490 except presettable 50 MHz unit. Used where higher speed and/or presetability is required.
- 74192 Bi-Directional counter, 32 MHz operation. Has two input lines, one that makes the unit count up, the other down. Uses include timers, where the counter is preset to a number and counts down to zero, monitoring a sequence of events i.e. keeping track of people in a room by counting up for entries and down for departures.
- 7475 Adds latch capability. Used in counter so display continues displaying frequency while new frequency is being counted for uninterrupted display.
- 7447 Basic decoder module. Drives basic seven segment display which is included for all modules.

- 7490 - 7447 Counter . . . \$8.25 each
- 7490 - 7475 - 7447 Counter . . . \$9.25 each
- 74196 - 7475 - 7447 Counter . . . \$10.25 each
- 74192 - 7447 Counter . . . \$9.25 each

### B. & F. ENTERPRISES

Phone (617) 532-2323  
P.O. Box 44, Hathorne, Massachusetts 01937

# SUMMER SPECTACULAR!! PRICE WAR ON SURPLUS SEMICONDUCTORS

## LINEAR DEVICES, OP AMPS, REGULATORS

- 709 High performance Op-Amp ..... \$5.50
- 711 Dual Comparator ..... \$5.50
- 723 Regulator ..... \$1.25
- 741 Compensated Op-Amp ..... \$5.50
- 558 Dual 741 ..... \$1.00
- LM309 5 Volt 1 amp Regulator, TO-3 ..... \$2.25

## FAIRCHILD VOLTAGE REGULATOR

 Fairchild UGH7805 5 Volt 1 amp voltage regulator. Perfect for logic supplies, very compact ..... \$1.95

## SPECIAL I.C.'S, PHASE LOCKED LOOPS

- NE560 Phase Locked Loop ..... \$4.65
- NE561 Phase Locked Loop ..... \$4.65
- NE562 Phase Locked Loop ..... \$4.65
- NE565 Phase Locked Loop ..... \$4.65
- NE566 Function Generator/Tone Encoder ..... \$4.65
- NE567 PLL/Tone Decoder ..... \$4.65
- NE595 Four Quadrant Multiplier ..... \$3.75
- NE555 Timer, 2u Sec to 1 hour, Special ..... \$1.25
- NE540 Power Driver, for 100w AB amp ..... \$2.25

## MEMORIES, SHIFT REGISTERS, ROM'S

- 1101 256 Bit RAM,MOS ..... \$4.00
- 1103 1024 Bit RAM,MOS ..... \$3.75
- 7489 64 Bit RAM,TTL ..... \$3.75
- 2513 Character Generator ROM ..... \$14.75
- 1402 Shift Register ..... \$4.00
- 1403 Shift Register ..... \$4.00
- 1404 Shift Register ..... \$4.00
- 8224 Programmable ROM ..... \$14.75

## 74L00 SERIES LOW POWER DEVICES

Now available at low prices for the first time. Saves money on total system cost, since power supply requirements and cooling are greatly reduced. Interchangeable with 7400 devices.

74L00	.40	74L72	.50
74L02	.40	74L73	.75
74L03	.40	74L74	.75
74L04	.40	74L78	.75
74L10	.40	74L85	3.00
74L20	.40	74L86	.75
74L30	.40	74L90	2.50
74L51	.40	74L93	2.50
74L54	.40	74L95	2.50
74L55	.40	74L98	3.00
74L71	.50	74L154	3.00

## COMPUTOR GRADE CAPACITORS



Always one of our best sellers these high capacitance units need little introduction. Made for long life over wide ambients, molded terminal block with screw terminals. Perfect for power supplies, audio and energy storage applications.

Wt.(lb.)	Cap(mfd)	WVDC	Order No.	Price
1	1300	50	SP1350	.75
3	3000	250	MA3025	3.50
1	4200	50	G14250	1.50
2	17000	30	GE17030	2.00
2	23900	20	GE23920	2.00
3	60000	20	GE60020	3.50

## HIGH POWER SCR'S



SCR's - invaluable for high power applications, motor speed controls, lighting circuits, welding controls, etc. Never before at this low price. Brand new packaged devices, complete with data sheet and 24 page consumer applications manual.

□ 2N5062	Plastic 100V 1 amp	\$3.35
□ 2N5064	Plastic 200V 1 amp	.40
□ 2N4169	100V/8 amp stud	1.45
□ 2N4170	200V/8 amp stud	1.65
□ 2N4172	400V/8 amp stud	1.95
□ 2N3525	400V/3 amp press fit	.95
□ 2N1772/C15A	100V/8 amp stud	1.75
□ 2N1774/C15B	200V/8 amp stud	1.95
□ 2N1777/C15D	400V/8 amp stud	2.50
□ 2N1844/C20A	100V/12 amp stud	1.75
□ 2N1846/C20B	200V/12 amp stud	1.95
□ 2N5169	200V/20 amp stud	-3.75
□ 2N5170	500V/20 amp stud	4.75
□ 2N5171	700V/20 amp stud	6.75
□ 2N3896/C30A	100V/25 amp stud	2.95
□ 2N3897/C30B	200V/25 amp stud	3.95
□ 2N3899/C30E	500V/25 amp stud	4.95



## CALCULATOR CHIP SPECIAL

B and F has purchased a quantity of MOS large scale integration chips for calculators. We are not allowed to mention the manufacturers name, however, the specs should make them self-evident.

- Set "X" - Four 24 pin I.C.'s, BCD output, 16 digit, fixed automatic decimal point, possible memory expansion, constant ..... \$29.00
- Set "Y" - Single 40 pin, 7 segment output, 12 digit, fixed automatic decimal, no constant ..... \$15.00
- Set "Z" - Single 40 pin I.C., 7 segment output, 8 digit, floating point, constant ..... \$19.50

## 7400 SERIES TTL SUMMER CLEARANCE MOST POPULAR I.C. SERIES MADE!!!!!!



B and F maintains an inventory of over one million brand new, factory packaged integrated circuits, and is continually buying more from sources throughout the country. We intend to offer these at the lowest prices of any supplier, and to prove this point we have just cut our own normally fantastic low prices even lower. We will meet or better any 7400 series price. Data sheets are included with all items. On orders over \$20.00 we will include free, a TTL data book or Linear data book, totaling over 200 pages. Orders over \$100.00 will receive a 1000 page data file. An additional discount of 5% will be allowed for orders over \$250.00 and 10% for orders over \$1000.00.

- 7400 - .22
- 7401 - .22
- 7402 - .22
- 7403 - .22
- 7404 - .27
- 7405 - .27
- 7406 - .50
- 7407 - .50
- 7408 - .30
- 7409 - .30
- 7410 - .22
- 7411 - .27
- 7413 - .55
- 7416 - .50
- 7417 - .50
- 7420 - .22
- 7421 - .22
- 7426 - .32
- 7430 - .22
- 7437 - .53
- 7438 - .53
- 7440 - .22
- 7441 - L64
- 7442 - L21
- 7443 - L21
- 7444 - L21
- 7445 - L62
- 7446 - L17
- 7447 - L10
- 7448 - L37
- 7450 - .22
- 7451 - .22
- 7453 - .22
- 7454 - .22
- 7460 - .22
- 7470 - .40
- 7472 - .36
- 7473 - .48
- 7474 - .48
- 7475 - .76
- 7476 - .53
- 7480 - .72
- 7481 - 2.45
- 7482 - 2.45
- 7483 - 1.55
- 7485 - 2.45
- 7486 - .55
- 7489 - 4.00
- 7490 - .76
- 7491 - 1.35
- 7492 - .76
- 7493 - .76
- 7494 - 1.12
- 7495 - 1.12
- 7496 - 1.12
- 74100 - 1.44
- 74107 - .49
- 74121 - .53
- 74122 - .67
- 74123 - 1.06
- 74141 - 1.55
- 74145 - 1.33
- 74150 - 1.55
- 74151 - 1.13
- 74153 - 1.55
- 74154 - 2.30
- 74155 - 1.39
- 74156 - 1.39
- 74157 - 1.48
- 74158 - 1.48
- 74160 - 1.79
- 74161 - 1.79
- 74162 - 1.79
- 74163 - 1.79
- 74164 - 3.75
- 74165 - 3.75
- 74166 - 3.75
- 74167 - 4.75
- 74170 - 5.75
- 74180 - 1.13
- 74181 - 4.90
- 74182 - 1.13
- 74184 - 2.95
- 74185 - 2.95
- 74190 - 2.95
- 74191 - 2.45
- 74192 - 1.87
- 74193 - 1.87
- 74194 - 2.95
- 74195 - 1.95
- 74198 - 2.65
- 74199 - 2.65

## SANKEN HYBRID AUDIO AMPLIFIER MODULES



We have made a fortunate purchase of Sanken Audio Amplifier Hybrid Modules. With these you can build your own audio amplifiers at less than the price of discrete components. Just add a power supply, and

chassis to act as a heat sink. Brand new units, in original boxes, guaranteed by B and F, Sanken and the Sanken U.S. distributor. Available in three sizes: - 10 watts RMS (20 watts music power), 25 watts RMS (50 watts M.P.) and 50 watts RMS (100 watts M.P.) per channel. 20 page manufacturers instruction book included. Sanken amplifiers have proved so simple and reliable, that they are being used for industrial applications, such as servo amplifiers and wide band laboratory amplifiers.

- SI010Y 10 watt RMS amplifier, industrial grade ..... \$4.75
- SI1025A 25 watt RMS amplifier, industrial grade ..... \$14.75
- SI1050A 50 watt RMS amplifier, industrial grade ..... \$22.50
- SI1025E 25 watt RMS amplifier, entertainment grade ..... \$14.00
- SI1050E 50 watt RMS amplifier, entertainment grade ..... \$21.00
- Transformer for stereo 10 watt amplifiers (2 lbs.) ..... \$3.95
- Transformer for stereo 25 or 50 watt amplifiers (4 lbs.) ..... \$5.95
- Set of (3) 2000 mfd 50V capacitors for 10 watt stereo ..... \$4.00
- Set of (3) 2200 mfd 75V capacitors for 25 or 50 watt amplifiers ..... \$5.00
- 4 Amp Bridge Rectifier, suitable for all amplifiers ..... \$2.00
- Complete kit for 100 watt RMS stereo amplifier (200 watt music) including two 50 watt Sanken hybrids, all parts, instructions, and nice 1/16" thick black anodized and punched chassis ..... \$88.00
- Same for 50 watt RMS stereo amplifier, includes two 25 watt Sanken, etc. .... \$58.00
- Same for 20 watt RMS stereo, includes two 10 watt Sanken, etc. .... \$30.00

## SGS TAA 621 AUDIO AMPLIFIER

□ I.C. audio amplifier in 14 pin DIP package, provides up to 4 watts power with proper heat sink, and 28 Volt supply. Can be used at 12 Volts with reduced output power. \$1.95 ..... \$ for \$10.00

## MOLEX SOLDERCON CONNECTIONS



Molex soldercon connections for I.C.'s. With these you can build low cost I.C. sockets by just cutting off the number of connections required, i.e., two strips of seven for 14 pin socket.

- 500 Molex soldercon ..... \$4.75



## ELECTRONIC PRESET COUNTER

This counter is from a copying machine. It uses two Durant electro-mechanical decade counters, and includes a nice power supply, etc. Two rotary switches allow the unit to be preset with any number from 1 to 50, when the number of pulses in reaches this count, a relay opens, shutting off the controlled unit. Should be useful for coil winders, and other applications requiring shut-off at a predetermined count. The parts alone at our low price represent a "steal", as the unit has high quality switches, silicon rectifiers, transformers, etc.

- Preset electronic counter (6 lbs.) ..... \$6.75

## ALL ITEMS WHERE WEIGHT NOT SPECIFIED

POSTAGE PAID IN THE U. S. A.  
Phone in charges to (617) 531-5774 or (617) 532-2323.  
BankAmericard - Mastercharge. \$10.00 minimum. No C.O.D.'s please.



\$10.00 Minimum Charge



## B. & F. ENTERPRISES

Phone (617) 532-2323  
P.O. Box 44, Hathorne, Massachusetts 01937

# "POLY PAKS INFLATION FIGHTERS"

## PHILCO 11 TRANSISTOR AM RADIO CHASSIS



Use as:

- Mike amplifier
- Phono amplifier
- Tape amplifier
- Covers 555 Kcs to 1500 Kcs Broadcast band
- AC or DC

Only **\$5.95**

Originally design for portable phono systems, and tape cassettes!

One of the most versatile AM Radio and multi-purpose amplifiers we have seen at Poly Paks famous "Economy" price. Measures only 4 1/2" x 3" x 2" high. With tuning capacitor, IF circuitry, loopstick, ant., volume control with switch, AC and phono-mike jacks. Separate switch for changing from AM radio to amplifier. Uses either 110V plug-in adapter (not with unit) and a 9-volt battery power. Exceptional sensitivity and power. Feeds into 16 ohm speaker. Complete with spec sheets, diagrams, and hookup ideas.



## 8 TRANSISTOR AMPLIFIER CHASSIS

Only **\$3.95**

**NEW!** Same as above except minus the radio section of the chassis. 4 1/2" x 4" x 2" high.

## MAGIC "SOUND TRIGGER" **\$1.98**

Unique Scientific Device, "hand claps", sensitizes crystal mike amplifier, triggers SCR. Needs only 3 to 6vdc. Use as burglar alarm, intrusion device. Use with photo cell, triggers SCR's, relays, LED's. Even fiber optic light pipe may be used. With hand booklet.

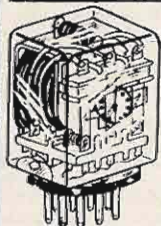

## POTTER BRUMFIELD KAP RELAYS

Your choice **\$2.98**  
 3 for \$7.50

- 115 VAC 3PDT ..... \$2.98
- 12 VDC 3PDT ..... 2.98

Excellent for "HAM" use as antenna switching, latching, transmit, receive, etc., and 100's of commercial or industrial uses. Includes plastic dust-cover with diagram and hookup info. 11-pin plug-in base. Contacts movable gold flashed silver, stationary overlay, with silver cadmium oxide movables. All contacts 10 amp 3PDT. Coil data: 115VAC 2250 ohms, 17.5 ma. 12 VDC 21 ohms 168 ohms. Size: 2 1/4" x 1 5/16". Wt. 4 oss. Center pin missing. Comar Mfg. type equal too.

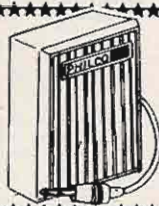

## PHILCO-FORD DYNAMIC MIKE

Replacement for tape recorders, PA systems, audio amps. 200 ohms, 6-ft. cord and mini mike plug. 200-5000 Hz. Wt. 6 oz. Fits in "palm of hand". 2 3/8" x 1 1/8" x 1/8". Impact plastic case. **\$1.98**

## ALLEN BRADLEY'S 'TRANSISTOR' POTS

Type F. Screwdriver adjust. **Any 2 for \$1**

Ohms	75	250	1.0K	7.5K	25K	100K	250K
	100	500	2.5K	10.0K	50.0K	2 Meg	
	200	750	5.0K	20.0K	75.0K	5 Meg	

Terms: add postage, cod's 25%. Rated: net 30  
 Phone Orders: Wakefield, Mass. (617) 245-3829  
 Retail: 211 Albion St., Wakefield, Mass.  
 C.O.D.'S MAY BE PHONED IN

□ 15c CATALOG on Fiber Optics, 'IC's, Semi's, Parts

**POLY PAKS**  
 P.O. BOX 942A, LYNNFIELD, MASS. 01940

BRAND NEW LOWEST PRICES

## GENERAL ELECTRIC **\$2.95** 3 FOR \$6.00

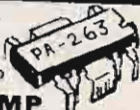

## 3-WATT AUDIO AMP

Delivers 3. watts continuous, 10 watts peak. With heat sinks; micro-mini size: 3/4 x 1/2 x 1/2". 9 to 30V supply. High sensitivity. 8 to 16 ohms. For mono and stereo phonos, tape, FM, AM, TV, servo.

## 12-DIGIT "CALCULATOR ON A CHIP"

Similar to Mostek 5001. Outperforms Texas 8-digit TMS1802. A 40-pin DIP. Adds, multiplies, subtracts, and divides. Use with 7-segment readouts, Nixies, and LED's. We include schematics, instructions from factory to build calculator.



Only **\$12.95**  
 3 for \$35



## NIXIE

## COUNTING SYSTEM

Includes SN7490, decade counter, SN7475 latch, SN7441 BCD decoder driver, 0-to-9 Nixie tube, socket & instructions.

□ 5-Pc. Kit **\$5.95**  
 3 sets for **\$16.00**

## 1 WATT "FLANGELESS" TOP HAT ZENERS

Type TK, Metal Case!

□ 5 for \$1

Volts	4.7	6.3	8.2	9.1	10.	11.	12.	13.	15.	30.	33.
-------	-----	-----	-----	-----	-----	-----	-----	-----	-----	-----	-----

## 12VDC POWER PAC

110 VAC to 12 VDC @ 1.6 Amp  
 Citizen Band mobile ham gear.  
**\$3.33** 5 x 2 1/2 x 3 3/4"

## NATIONAL VOLTAGE REGULATOR

LM-308K5 volts, 1 amp TO-3 case. Internally set. Overload and short circuit proof. No external components. With spec sheets. **2.75**

□ LM-370 AGC SQUELCH AMP **\$1.49** 3 for \$3.75

## LOWEST PRICES ON "TRIACS"

\* Two SCRs in one case! \* Most complete listing!

FRV	3 amp	6 amp	10 amp	15 amp	25 amp
50	□ .22	□ .35	□ \$.45	□ \$.65	□ \$.85
100	□ .35	□ .52	□ .64	□ .85	□ 1.05
200	□ .65	□ .72	□ .88	□ 1.25	□ 1.45
300	□ .79	□ .89	□ 1.10	□ 1.45	□ 1.65
400	□ .92	□ 1.15	□ 1.35	□ 1.85	□ 2.05
500	□ 1.25	□ 1.39	—	□ 2.55	□ 2.85
600	□ 1.50	□ 1.69	—	—	□ 2.65

Code: 3 & 6 amp TO-5, 10 amp TO-66, 15 & 25 amp stud.

## HIGH POWER EPOXY RECTIFIERS

PIV	SALE	□ 5000	2.25
□ 2000*	1.00	□ 6000	2.96
□ 3000	1.35	□ 8000	3.50
□ 4000	1.65	□ 10000	3.95

## EPOXY SILICON RECTIFIERS <sup>1/2</sup>micromini

PIV	2Amp *	2Amp	3Amp
50	□ .05	□ .05	□ .08
100	□ .06	□ .06	□ .12
200	□ .07	□ .07	□ .15
400	□ .09	□ .09	□ .22
600	□ .12	□ .12	□ .28
800	□ .15	□ .15	□ .39
1000	□ .18	□ .18	□ .45

## EPOXY RECTIFIER SPECIAL

**10 for \$1**  
 □ 1 AMP  
 1000 PIV



LINEAR FACTORY GUARANTEED  
FACTORY MARKED

# Op Amps

FACTORY TESTED

100  
or more,  
25%  
discount

Buy Any 3 PAKS  
Take 10% Discount

Type	Description	Price
531	Hi slow rate op-amp	3.58
533	Micro power 709	3.58
536	FET input op amp	4.50
540	70W pwr-driver amp	2.94
550	Fraction 723 voltage reg.	1.17
555	Timer 2Seconds to 1 hour	1.19
558	Dual 741 (mini DIP)	1.00
560	Phase lock loops (A)	3.25
561	Phase lock loops (A)	3.25
562	Phase lock loops (A)	3.25
565	Phase lock loops (A)	3.25
566	Function generator (A)	3.25
567	Tone decoder (A)	3.25
595	Four quadrant multiplier	3.10
702C	Hi-gain, DC amp, TO-5 2 for 1.00	1.00
703C	RF-IF, amp, 14 ckt, TO-5	1.00
709C	Operational amp (A)	.39
710C	Differential amp (A)	.39
711C	Dual diff. comp	.39
723C	Voltage regulator (A)	.95
741C	Frequency compensator 709 (A)	.41
741V	mini DIP 741C	1.00
747C	Dual 741C, TO-5	1.00
748C	Free act. 741C (A)	.79
709-709	Dual 709C (DIP)	1.00
739-739	Dual stereo preamp	1.98
749-749	Dual channel amp	1.98

(A) TO-5 or DIP dual in line pak

Type	Price
SN7400	\$2.21
SN7401	.21
SN7402	.21
SN7403	.21
SN7404	.27
SN7405	.27
SN7406	.45
SN7407	.45
SN7408	.29
SN7409	.29
SN7410	.21
SN7411	.25
SN7413	.50
SN7416	.48
SN7417	.48
SN7420	.21
SN7421	.21
SN7426	.32
SN7430	.32
SN7437	.50
SN7438	.51
SN7440	.21
SN7441	1.00
SN7442	1.12
SN7443	1.21
SN7444	1.21
SN7445	1.50
SN7446	1.40
SN7447	1.10
SN7448	1.25

Factory Marked  
Factory Guaranteed

## LOWEST PRICES ON TTL IC'S

Buy 3 — Take 10% Discount  
No Gimmicks On Pricing, Deliveries, or Quality! We're "The Only IC Advertiser" with MONEY BACK GUARANTEE!

SN7450	.21	SN74121	.49
SN7451	.21	SN74122	.67
SN7452	.21	SN74123	.99
SN7454	.21	SN74141	1.45
SN7460	.21	SN74145	1.25
SN7470	.39	SN74150	1.25
SN7472	.32	SN74151	1.13
SN7473	.44	SN74153	1.25
SN7475	.71	SN74154	1.95
SN7476	.44	SN74155	1.39
SN7480	.65	SN74156	1.39
SN7481	1.10	SN74157	1.25
SN7482	.88	SN74158	1.48
SN7483	1.25	SN74160	1.79
SN7486	.49	SN74161	1.79
SN7489	3.50	SN74162	1.79
SN7490	.69	SN74163	1.79
SN7491	1.10	SN74180	1.10
SN7492	.71	SN74181	4.50
SN7493	.71	SN74182	1.10
SN7494	1.10	SN74192	1.75
SN7495	.95	SN74193	1.75
SN7496	1.10	SN74195	1.19
SN74107	.49		

## NIXIE TUBE SALE

Burroughs B791, 0-to-9, A-to-Z, 2 1/2" high characters, 170V.

## ALLEN BRADLEY'S 'MICRO-POTS'

Type G, 1/2" dia., 1/2" high, mounts 1/4" hole, with shaft, linear, immersion-proof high precision.

2 for \$1

Ohms	2.5K
75	5.0K
100	7.0K
500	10.0K
2.0K	20.0K
	5 Meg

We stock Locknut Bushing & Screwdriver types at same low prices.

## INTEGRATED CIRCUIT SOCKETS

Buy Any 3 - Take 10%

14-Pin, dual in line	\$.45
16-Pin, dual in line	\$.50
TO-5, 8 or 10 pins	\$.29

Poly Paks Will Never Be Undersold!

## 'HAM' UHF 400 MC HIGH POWER TRANSISTORS

Only \$3.95  
3 for \$10.

By RCA or equal 2N3632, NPN, 23 watts, 3 amps, TO-60 case, with stud mtg. VCEV max 65.

## NEW FOR 1973!

Never before offered at this price! You've seen them at \$175, \$149 — but now at a price calculator users can afford. EIGHT-DIGIT fluorescent display has 16-digit capacity! Add, Subtract, Multiply and Divide! In chain or mixed calculations. Includes MINUS sign showing negative credit balance, OVERFLOW INDICATOR 10 to the eight power, CONSTANT (K) MEMORY switch, Floating decimal or 2, 3, 4, 5 decimal points as required. (CE) key clears calculator of last entry error. Automatic loading and trailing zero suppression. LSI (Large Scale Integration) equivalent to more than 8,000 transistors. Calculation speed adds and subtracts 10,000th of a second. Keyboard is REED SWITCH assembly for extensive trouble-free operation. Separate power switch. Removable 115 VAC line cord. Power 110-120 VAC 50-60 cycles. Wt. 3 lbs. Includes black molded cabinet with silver trim, size: 9 1/2" x 5 1/2" x 3 1/4". Complete with easy-to-understand booklet. THE ONLY FACTORY GUARANTEED CALCULATOR BY A MAIL ORDER ADVERTISER. Gift Packed!

### SILICON TUBES

504	\$1.49
585	2.95
866	7.95

Uses single Texas Instrument "Chip"  
Features found in more expensive units  
For Home, Office, Shop, Student, School

The lowest price digital clock kit (with cabinet) as far as we can see in U.S.A. Scientific Devices' engineering dept. took extra patience in designing to give you the finest digital clock kit using the latest techniques in an easy-to-understand booklet. The cabinet-making section gives it the "interior decorating" touch so that it may fit into any room at home, shop or office. Walnut laminated tapered front cabinet, with gold-line front. Tapered legs for easy viewing. Large G.E. 7-segment fluorescent "blue-green" polaroid glow for the latest easy-viewing. FEATURES: 6 display tubes, completely etched and thru plated circuit board, all IC's. Includes BOJ outputs for use with timer options, may be wired for 12 or 24 hour display. Indicates HOURS, MINUTES, SECONDS. 115 VAC 60 cy. Gift packed. Wt. 3 lbs. \* 8" x 5 1/2" x 3" case

## ALPHA-NUMERIC 7-SEG. READOUTS 2.50

Fluorescent Blue-Green	O-9 numerals, decimals and letters.	Price
H. x W. Characters	Filament V.	
MINI-7: 1.75 x 1.75" .360 x .570"	1.5V AC/DC 42 mils	Socket — 50c
SLIM-7: 1.6 x 0.375" .40 x .20"	1.5V AC/DC 42 mils	Socket — 50c

\*Compatible to 7-segment driver IC's.

## Dollar Stretchers

- 3 — "LEDS", visible, micro-miniature, axial leads ..... \$1
- 2 — "LEDS", infrared, Jumbo, TO-18 ..... \$1
- 3 — "LEDS", visible, jumbo, red, TO-18 ..... \$1
- 1 — "LED", invisible, parabolic reflector, RCA ..... \$1
- 1 — PHOTO TRANSISTOR, with darlington amp filter, lens ..... \$1
- 2 — PHOTO TRANSISTORS, with darlington amp, 2N5777, GEC ..... \$1
- 4 — PHOTO CELLS, Clairex, pancake, 30K-70 ohms ..... \$1
- 5 — SOLAR CELLS, round, sq. rect., sun power circuits ..... \$1
- 2 — SILICON SENSORS, TEXAS, H-35, Matchstix, visible ..... \$1

## ELECTRONIC CALCULATOR COMPLETELY WIRED

Only \$99.  
Buy 3 — Take 10% Discount



NOT A KIT

## DIGITAL CLOCK KIT

By Scientific Devices  
Only \$57. WITH CASE  
Buy 3 — Take 10% off  
Smaller & more compact



## 8-DIGIT ELECTRONIC POCKET CALCULATOR

Completely wired, ready to use! Not a kit — hours saved! Most economical and advanced battery operated pocket calculator under \$100. Makes use of the smallest play technology and a unique snap-action keyboard. The 9V battery can be thrown away after use or Recharge with AC power charger (included). Performs Addition, Subtraction, Multiplication, Division functions, including Chain or Mixed Multiplication and Division, as well as true "credit" balance up to decimal point. For added convenience and simplicity the display. Additional display indicators denote overflow sign). Includes simplified instruction booklet. Factory guarantee. Gift packed. Size: 3 1/4" x 5 1/2".

LED Display  
Buy 3 — Take 10%

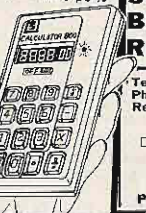

## EPOXY FULL WAVE SILICON BRIDGE RECTIFIERS

PIV	2 Amp	6 Amp
50	\$.69	\$.88
100	.79	.99
200	.95	1.25
400	1.19	1.50
600	1.35	1.75
800	1.59	1.95
1000	1.79	2.25

Code: 2 amp TO-6 case  
6 Amp 1/2 x 1/2 x 3/16 sq

Terms: add postage, cod's 25%. Rated: net 30  
Phone Orders: Wakefield, Mass. (617) 245-3829  
Retail: 211 Albion St., Wakefield, Mass.  
C.O.D.'S MAY BE PHONED IN

15¢ CATALOG on Fiber Optics, 'ICs', Semi's, Parts  
**POLY PAKS**  
P.O. BOX 942A, LYNNFIELD, MASS. 01940

# Caveat Emptor?

Price — \$2 per 25 words for non-commercial ads; \$10 per 25 words for business ventures. No display ads or agency discount. Include your check with order.

Deadline for ads is the 1st of the month two months prior to publication. For example: January 1st is the deadline for the March issue which will be mailed on the 10th of February.

Type copy. Phrase and punctuate exactly as you wish it to appear. No all-capital ads.

We will be the judge of suitability of ads. Our responsibility for errors extends only to printing a correct ad in a later issue.

For \$1 extra we can maintain a reply box for you.

We cannot check into each advertiser, so Caveat Emptor . . .

**SB 303** — Factory aligned/CW and AM filters — SB-600 spkr — SB 300-3 6 mtr conv — excellent cond — 8 months old — \$550.00. Heath Seneca 6 & 2 mtr xmtr — all new tubes and spares — \$200.00. K1NDD M.E. Murray, 171 Elliot St., Brockton, Mass. 617-588-8727. **FIRST \$700 TAKES ALL.**

**FREE INFORMATION** — UHF-VHF Communications Antennas, Mobile/Base, 140-470 mhz. Amateur-Commercial. Antenna Engineering Co. Inc., P.O. Box 19449, Indianapolis, Ind. 46219.

## ...AND MORE!

Enclosed is our 3-year renewal check. Because of our comparatively long term as subscribers (10 years) we feel entitled to a "beef."

Why must your layout-man make the working drawings of schematics and PC board layouts so very tiny as to be impossible to use effectively and yet he wastes much good space (almost half pages) for just the titles of articles. True, the layout is attractive, but the space might better be utilized in making the diagrams and drawings larger and more easily legible — without microscopes.

**Bob Cardinali WA2ZXT  
Fulton NY**

*You said it. . .*

Having subscribed to your publication for a number of years and enjoying every issue, or I wouldn't buy every three years, I'd like to offer a suggestion that in my opinion is VERY important.

If you still delve in tubes you obtain a manual and as a rule find out what you need to know. We're now in the tens of thousands of solid state

**WANTED:** COLLINS 516F-2 ac supply, will pay shipping, ship UPS. Tom Webb WA9AFM/VE8 ITT/ASI (Cambridge Bay) P.O. 6200 Winnipeg, Manitoba R3C 3A4.

**"SUPER COUNTER"** . . . to 160 MHz, five digit, ac/dc, 4.5 lbs., a professional grade counter by MIIDA, "The H.P. of Japan." \$349 with 1 year warrantee. SASE for more info. NHE Communications, Bob Brunkow, (206-747-8421), 15112 S.E. 44th, Bellevue WA 98006.

**SELL:** Touchcoder, typewriter keyboard sends perfect code all speeds, \$125.00 firm, no trades. W8PJH, Stuber, Amherst, Ohio 44001.

**TECH MANUALS** for Govt surplus gear only \$6.50 each: R-388/URR, R-389/URR, R-390/URR, R-220/URR, R-274/FRR, CV-591A/URR, URM-25D, LP-5, TT-63A/FGC. W3IHD, 4905 Roanne Drive, Washington DC 20021.

**HOOSIER ELECTRONICS** — Your ham headquarters in the heart of the Midwest where only the finest amateur equipment is sold. Individual personal service by experienced and active hams. Factory-authorized dealers for Drake, Regency, Standard, Ten-Tec, Hy-Gain, CushCraft, plus many more. Orders for in-stock merchandise shipped the same day. We accept Master-Charge and BankAmericard. Write today for our quote and try our personal, friendly Hoosier service. Hoosier Electronics, R.R. 25, Box 403, Terre Haute, Indiana 47802.

devices and more coming up. You'll never get a manual that will cover the info you want.

It is my suggestion that every schematic printed have the "bottom view" showing E/B/C/ etc. Present prints are good on IC's but they sure could make building a lot easier and the originator has this info.

**Fred Pursell WIDEM  
Mont Vernon NH**

The article (The HW-16 on Phone, by Jim Reichler WN2REW) in the August 1972 issue was of great interest to me. There is only one problem, the HW-16 does not have selectable sideband. Since 40 meter phone is on lower sideband and the rig receives upper sideband, even with the filter modification described, you would still be unable to copy 40 meter phone.

Or did I miss something in the fine print.

**E. I. Fullmer WB6MKA  
Glendora CA**

*What you missed was the schematic showing a switch shorting out the crystal filter. Shame! With the filter gone could you really expect the transceiver to retain selectable sideband?*

**SAROC Eighth National Convention** — the PRESTIGE convention at the Flamingo Hotel Convention Center, Las Vegas, Nevada 89109, January 4 through 7, 1973. SAROC special room rate \$15.00 plus tax, per night, single or double occupancy, only 500 rooms so get your accommodations request in early. Advance Registration \$10.00 per person. Registration and eyeball session on Thursday. Seminars, Meetings, Exhibits, open Friday and Saturday. SAROC-SWAN Electronics Social Hour, Friday. Ladies Program, Saturday. SAROC Sixth National FM Conference, Friday and Saturday. SAROC-HY-GAIN/GALAXY Cocktail Party, with Leo W0GFQ, at the Organ, Saturday. SAROC Buffet Hunt Breakfast, with Champagne, Sunday. Advance Registration with Sergio Franchi Flamingo Midnight Show, two drinks, \$17.00 per person. Advance Registration with Sergio Franchi Flamingo Dinner Show, no drinks, \$21.00 per person. SAROC Jet Roundtrip Vacation Package Plan includes airfare, Deluxe Flamingo Hotel Room for three nights, SAROC Advance Registration with Flamingo Hotel Dinner Show: via United Airlines, departure cities: Baltimore/Washington, \$280.00; Boston, \$312.00; Chicago, \$222.00; Cleveland, \$250.00; Columbus, \$246.00; Detroit, \$244.00; Hartford, \$304.00; Milwaukee, \$233.00; New York/Newark, \$296.00; Philadelphia, \$290.00; Pittsburg, \$262.00; via Frontier Airlines departure cities: St. Louis, \$209.00; Kansas City, \$188.00; Denver, \$135.00; Omaha, \$182.00; Lincoln, \$176.00. The price quoted is per person, double occupancy in hotel room. If single occupancy in hotel room is desired add \$25.00 additional per person to each amount quoted. All fare and schedules are subject to CAB rules and regulations, send for additional details. Remember to send accommodations request to SAROC, P.O. Box 73, Boulder City, Nevada 89005.

**WANTED — OLD RADIO TRANSCRIPTION DISCS.** Any size or speed. Send list and details to Larry Kiner, W7FIZ, 7554 143rd Ave. N.E., Kirkland, Wash. 98033.

**YOUR CALL LETTERS!** Two sets, for windshield and rear glass. Smart white letters with red outline. Easily installed pressure sensitive decals. \$1.00, postage paid, anywhere. Satisfaction guaranteed. Lake Jordan Artists, Slapout AL36092.

**WANTED: QST MAGAZINES** from 1916 to 1922 for private collection. Please write to Paul Kluwe, 610 West Home Street, Edmore MI 48829

**SELL** early years Galaxy science fiction magazine. For details, send 8-cent SASE to KV4FY, Box 1056, Christiansted, St. Croix, USVI 00820.



## READER SERVICE

Please either tear out this list of advertisers and send it in to 73 with as many boxes checked off as you would like to see brochures, data sheets or catalogs... or else make a copy and send that in. Include your zip code, please.

## ADVERTISER INDEX November 1972

- Adirondack 117
- AE Elec 258
- Alexander 228
- Am Radio Supply 243
- Am Wholesale Elec\* 91,244
- Amer. Cancer Society 238
- ANCOM 312,313
- Antek 255
- Antenna Eng 94
- Astatic 225
- ATV\* 309
- Babylon 301
- Barker&Williamson 36
- Barry 162
- B&F 314, 315
- Bird 156
- Bomar 180
- Callbook 284
- CFP 290
- Circuit Spec. 291
- Clegg 137
- Columbia 267
- Comm Prod 250
- Comm Spec 244
- Cornell 244
- Cox 304
- Cush Craft 109
- Dames 240
- Data Eng 23
- Datak 131
- Denson 247
- Drake 105, 153
- DuPage FM 278, 279
- DXers Mag 250, 309
- Elec. Distributors 61
- EL Instruments 80
- Emporium 119
- Environmental Prod. 286, 287
- Epsilon 255
- Erickson 70, 71
- Estes 243
- Fair 255
- Freck 244
- Gateway 269
- Gen. Aviation 58
- Glass 282
- Gotham 215
- Gregory 276
- HAL\* 47, 290
- Hamtronics 122, 125
- Hatry Elec. 203
- Heath 77, 76
- Henry 12, 13 66, 67
- Howard Enter. 250
- Hygain 186, 187 198,199
- INOUE 31
- Inst. for Ind., Logan Antenna Div 156
- Inter. Signal Corp. 55
- Jan Crystal 203
- Janel 244
- Jensen 309
- Juge 84, 85

- Standard 101, 235
- Swan 99
- Telrex 51
- Teterboro 252
- Tucker 168 169 256
- Valpey 27
- Van DLT 209
- VHF Eng 129
- Vibroplex 350
- Waller 41
- Wilson 145
- Windjammer 63
- Wolf, S. 255
- World QSL 238
- World Radio 166
- Rig Of The Month 174, 175
- Ham Radio Center 175
- Ham Shack 176
- Hamtronics 177
- Harrison 182
- KA Sales 310,311
- KE Electronics 309
- KW Industries Cover II
- Lampkin 73, 257
- Linear Systems 158, 165
- Mann 262, 263
- Melrex 124
- Meshna 298, 299
- MFJ 238
- Micro Comm 180
- Morgain 250
- MITS 294, 295
- NHE Comm 270
- Palomar 166
- Payne\* 97
- Pearce Simpson 107
- Poly Paks 316 317
- Quezar 290
- Regency 133, 216
- Robot 19
- Ross & White 111
- RP Electronics 161, 209
- R & R 204
- Sams 44
- SAROC 131
- Savoy Cover III
- Selectronics 297
- Sentry 103
- Signal One 148, 149
- Slep 230, 231
- Solid State 292, 293
- Spectronics Cover IV

### 73 Stuff

Radio Bookshop 220, 221  
Subscriptions 210, 211

*\*Reader service inquiries not solicited. Correspond directly to company.*

Mail to Readers' Service

**73 INC., PETERBOROUGH NH 03458**

**PLEASE PRINT OR TYPE**

Name \_\_\_\_\_ Call \_\_\_\_\_

Address \_\_\_\_\_

\_\_\_\_\_ Zip \_\_\_\_\_

# Savoy

HIGH ACCURACY CRYSTALS  
FOR OVER 30 YEARS



TYPE 900 A

**\$3.75**

Postpaid in U.S.A.

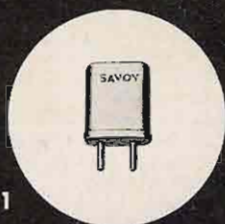

TYPE 901

Either type for amateur VHF in Regency, Swan, Standard, Drake, Varitronics, Tempo, Yaesu, Galaxy, Trio, Sonar, Clegg, SBE, transmitter or receiver. GE, Motorola, RCA or Oven use \$4.95. Quotes on others.

Specify crystal type, frequency, make of equipment and whether transmit or receive when ordering.



## BASSETT VACUUM TRAP ANTENNA SYSTEM

Complete packaged multi-band antenna systems employing the famous Bassett Sealed Resonators and Balun from which air has been removed and replaced with pure helium at one atmosphere. Operating bands are indicated by model designation.

MODEL DGA-4075	...	\$59.50
MODEL DGA-204075	...	\$79.50
MODEL DGA-2040	...	\$59.50
MODEL DGA-152040	...	\$79.50

## BASSETT VACUUM BALUN



The famous sealed helium filled Balun . . . employed with the DGA Series Antenna Systems. Solderless center insulator and easily handles more than full legal power while reducing unwanted coax radiation. Equipped with a special SO-239 type coax connector and available either 1:1 or 4:1.

MODEL DGA-2000-B . . . \$12.95  
Postpaid in U.S.A.

CONTACT YOUR DISTRIBUTOR OR WRITE FOR DATA

# Savoy Electronics, Inc.

P.O. Box 7127 - Fort Lauderdale, Florida - 33304

Tel: 305-566-8416 or 305-947-1191

