

# 73

SEPTEMBER 1967

60¢

## AMATEUR RADIO

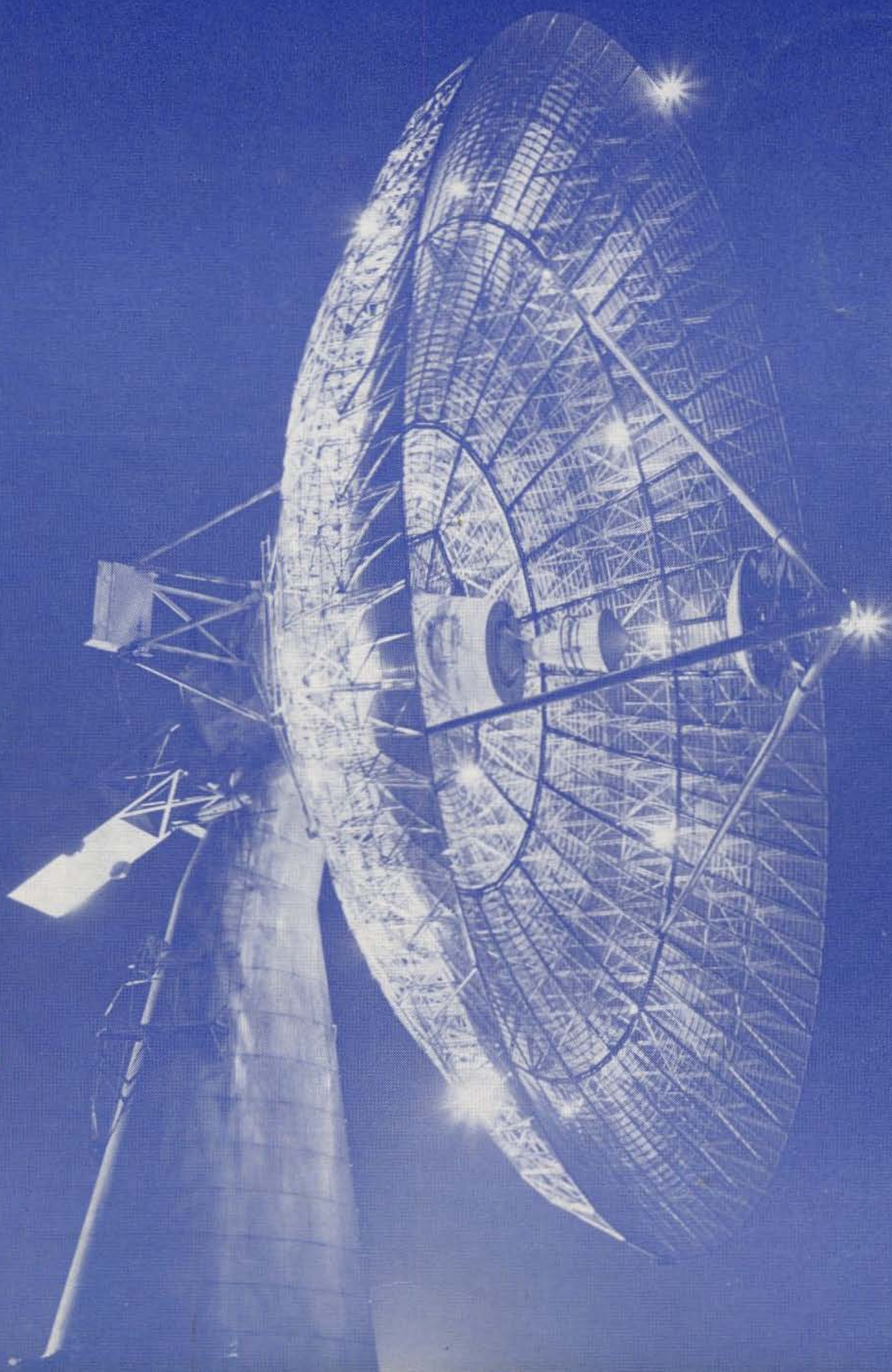





# REPLACEMENT TYPE TRANSFORMERS & REACTORS

Thirty years of pioneering by UTC's research, design, and engineering staffs assures you quality and reliability unexcelled in the industry. UTC's line of stock and special custom built items covers virtually every transformer and filter requirement for both military and commercial use.

UTC replacement type transformers, here described, (Pri. 117 V. 50/60 cycles) provide the highest reliability in this field. All units are low temperature rise, vacuum sealed against humidity with special impregnating materials to prevent corrosion and electrolysis. Shells are finished in attractive high lustre black enamel.

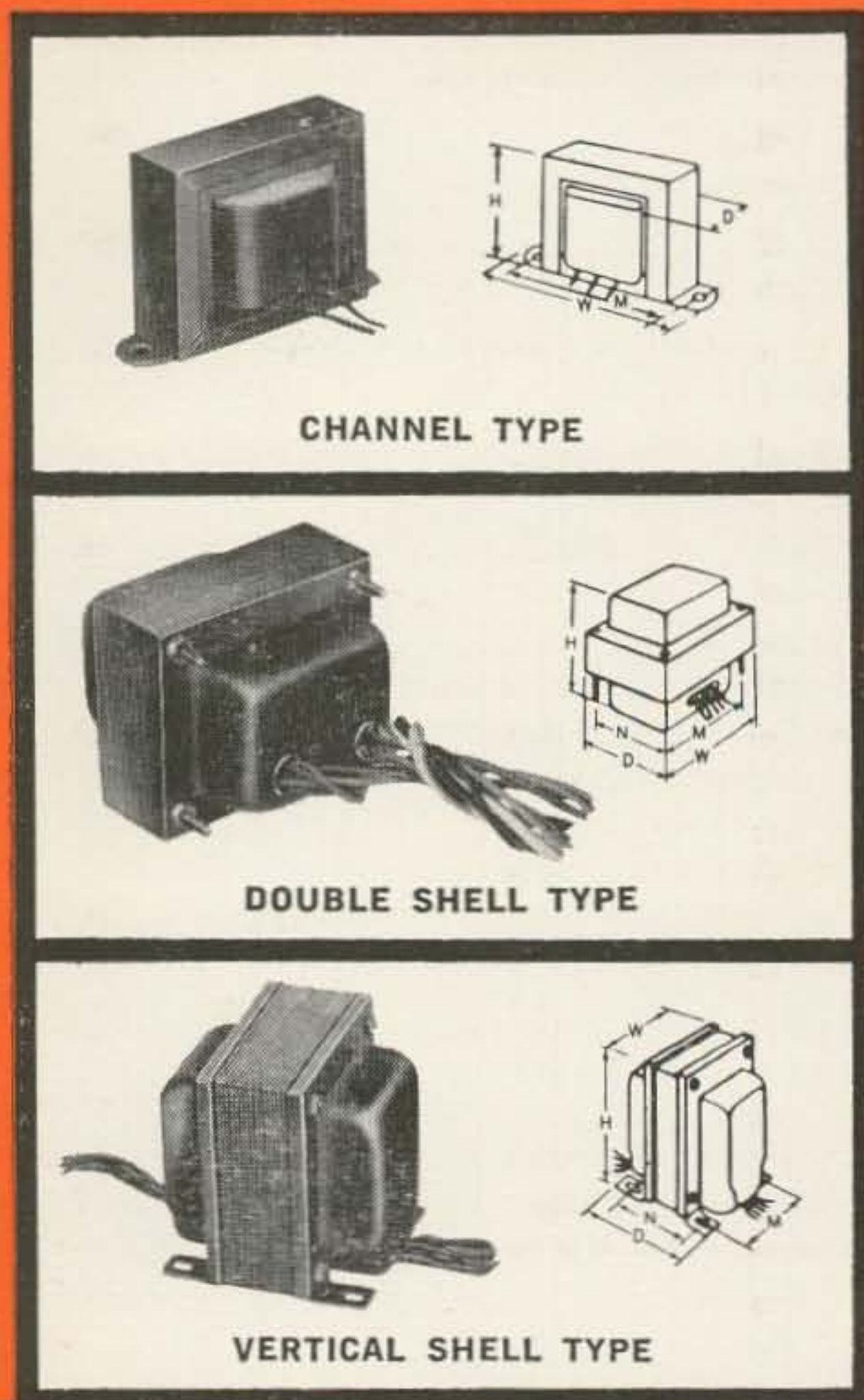

CHANNEL TYPE

DOUBLE SHELL TYPE

VERTICAL SHELL TYPE

## CHANNEL FRAME FILAMENT/TRANSISTOR TRANSFS.

Pri. 115 V 50/60 Cycles—Test Volts RMS: 1500

Type No.	Secondary	W	D	H	M	Lbs.
FT-1	2.5 VCT-3A	2 <sup>7</sup> / <sub>8</sub>	1 <sup>1</sup> / <sub>2</sub>	1 <sup>1</sup> / <sub>8</sub>	2 <sup>3</sup> / <sub>8</sub>	3/4
FT-2	6.3 VCT-1.2A	2 <sup>7</sup> / <sub>8</sub>	1 <sup>1</sup> / <sub>2</sub>	1 <sup>1</sup> / <sub>8</sub>	2 <sup>3</sup> / <sub>8</sub>	3/4
FT-3	2.5 VCT-6A	3 <sup>3</sup> / <sub>8</sub>	1 <sup>7</sup> / <sub>8</sub>	2	2 <sup>1</sup> / <sub>8</sub>	1
FT-4	6.3 VCT-3A	3 <sup>3</sup> / <sub>8</sub>	1 <sup>7</sup> / <sub>8</sub>	2	2 <sup>1</sup> / <sub>8</sub>	1
FT-5	2.5 VCT-10A	3 <sup>3</sup> / <sub>4</sub>	2 <sup>1</sup> / <sub>8</sub>	2 <sup>3</sup> / <sub>8</sub>	3 <sup>3</sup> / <sub>8</sub>	1 <sup>1</sup> / <sub>2</sub>
FT-6	5 VCT-3A	3 <sup>3</sup> / <sub>4</sub>	2 <sup>1</sup> / <sub>8</sub>	2 <sup>3</sup> / <sub>8</sub>	3 <sup>3</sup> / <sub>8</sub>	1 <sup>1</sup> / <sub>2</sub>
FT-7	7.5 VCT-3A	3 <sup>3</sup> / <sub>4</sub>	2 <sup>1</sup> / <sub>8</sub>	2 <sup>3</sup> / <sub>8</sub>	3 <sup>3</sup> / <sub>8</sub>	1 <sup>1</sup> / <sub>2</sub>
FT-8	6.3 VCT-8A	4	2 <sup>1</sup> / <sub>2</sub>	2 <sup>3</sup> / <sub>8</sub>	3 <sup>3</sup> / <sub>8</sub>	2 <sup>1</sup> / <sub>2</sub>
FT-10	24 VCT-2A or 12V-4A	4	2 <sup>5</sup> / <sub>8</sub>	2 <sup>5</sup> / <sub>8</sub>	3 <sup>3</sup> / <sub>8</sub>	2 <sup>1</sup> / <sub>2</sub>
FT-11	24 VCT-1A or 12V-2A	3 <sup>3</sup> / <sub>4</sub>	2 <sup>1</sup> / <sub>8</sub>	2 <sup>3</sup> / <sub>8</sub>	3 <sup>3</sup> / <sub>8</sub>	1 <sup>1</sup> / <sub>2</sub>
FT-12	36 VCT-1.3A or 18V-2.6A	4	2 <sup>5</sup> / <sub>8</sub>	2 <sup>5</sup> / <sub>8</sub>	3 <sup>3</sup> / <sub>8</sub>	2 <sup>1</sup> / <sub>2</sub>

Taps on pri. of FT-13 & FT-14 to modify sec. nominal V, -6% +6%, +12%

FT-13	26 VCT-.04A	2 <sup>7</sup> / <sub>8</sub>	1 <sup>3</sup> / <sub>8</sub>	1 <sup>1</sup> / <sub>4</sub>	1 <sup>3</sup> / <sub>4</sub>	1/4
FT-14	26 VCT-.25A	2 <sup>7</sup> / <sub>8</sub>	1 <sup>3</sup> / <sub>8</sub>	1 <sup>1</sup> / <sub>8</sub>	2 <sup>3</sup> / <sub>8</sub>	3/4

## DOUBLE SHELL POWER TRANSFORMERS

Type No.	High V.	DC ma	5V. Fil.	6.3 VCT Fil.	W	D	H	M	N	Wt. Lbs.
R-101	275-0-275	50	2A	2.7A	3	2 <sup>1</sup> / <sub>2</sub>	3	2 <sup>1</sup> / <sub>2</sub>	2	2 <sup>1</sup> / <sub>2</sub>
R-102	350-0-350	70	3A	3A	3	2 <sup>1</sup> / <sub>2</sub>	3 <sup>3</sup> / <sub>8</sub>	2 <sup>1</sup> / <sub>2</sub>	2	3 <sup>1</sup> / <sub>2</sub>
R-103	350-0-350	90	3A	3.5A	3 <sup>3</sup> / <sub>8</sub>	2 <sup>7</sup> / <sub>8</sub>	3 <sup>1</sup> / <sub>8</sub>	2 <sup>1</sup> / <sub>8</sub>	2 <sup>1</sup> / <sub>4</sub>	4 <sup>1</sup> / <sub>2</sub>
R-104	350-0-350	120	3A	5A	3 <sup>3</sup> / <sub>4</sub>	3 <sup>3</sup> / <sub>8</sub>	3 <sup>3</sup> / <sub>8</sub>	3 <sup>3</sup> / <sub>8</sub>	2 <sup>1</sup> / <sub>2</sub>	5 <sup>1</sup> / <sub>2</sub>
R-105	385-0-385	160	3A	5A	3 <sup>3</sup> / <sub>4</sub>	3 <sup>3</sup> / <sub>8</sub>	4 <sup>3</sup> / <sub>8</sub>	3 <sup>3</sup> / <sub>8</sub>	2 <sup>1</sup> / <sub>2</sub>	7

## VERTICAL SHELL POWER TRANSFORMERS

Type No.	High V.	DC ma	5V. Fil.	6.3 VCT Fil.	W	D	H	M	N	Wt. Lbs.
R-110	300-0-300	50	2A	2.7A	2 <sup>3</sup> / <sub>8</sub>	2 <sup>1</sup> / <sub>8</sub>	3 <sup>1</sup> / <sub>4</sub>	2	1 <sup>3</sup> / <sub>4</sub>	2 <sup>1</sup> / <sub>2</sub>
R-111	350-0-350	70	3A	3A	2 <sup>3</sup> / <sub>8</sub>	3 <sup>3</sup> / <sub>8</sub>	3 <sup>1</sup> / <sub>4</sub>	2	2 <sup>3</sup> / <sub>8</sub>	3 <sup>1</sup> / <sub>2</sub>
R-112	350-0-350	120	3A	5A	3 <sup>3</sup> / <sub>8</sub>	3 <sup>1</sup> / <sub>8</sub>	4	2 <sup>1</sup> / <sub>2</sub>	2 <sup>3</sup> / <sub>8</sub>	5 <sup>1</sup> / <sub>2</sub>
R-113	400-0-400	200	3A	6A	3 <sup>7</sup> / <sub>8</sub>	4 <sup>3</sup> / <sub>8</sub>	4 <sup>3</sup> / <sub>8</sub>	3	3 <sup>3</sup> / <sub>8</sub>	8

## CHANNEL FRAME FILTER REACTORS

Inductance Shown is at Rated DC ma—Test Volts RMS: 1500

Type No.	Induct. Hys.	Current	Resistance Ohms	W	Dimensions, in.			M	Wt. Lbs.
					D	H			
R-55	6	40ma	300	2 <sup>3</sup> / <sub>8</sub>	1 <sup>3</sup> / <sub>8</sub>	1 <sup>3</sup> / <sub>8</sub>	2	1/2	
R-14	8	40ma	250	2 <sup>7</sup> / <sub>8</sub>	1 <sup>1</sup> / <sub>2</sub>	1 <sup>1</sup> / <sub>8</sub>	2 <sup>3</sup> / <sub>8</sub>	3/4	
R-15	12	30ma	450	2 <sup>7</sup> / <sub>8</sub>	1 <sup>1</sup> / <sub>2</sub>	1 <sup>1</sup> / <sub>8</sub>	2 <sup>3</sup> / <sub>8</sub>	3/4	
R-16	15	30ma	630	2 <sup>7</sup> / <sub>8</sub>	1 <sup>1</sup> / <sub>2</sub>	1 <sup>1</sup> / <sub>8</sub>	2 <sup>3</sup> / <sub>8</sub>	3/4	
R-17	20	40ma	850	3 <sup>3</sup> / <sub>8</sub>	1 <sup>5</sup> / <sub>8</sub>	2	2 <sup>1</sup> / <sub>8</sub>	1	
R-18	8	80ma	250	3 <sup>3</sup> / <sub>8</sub>	1 <sup>5</sup> / <sub>8</sub>	2	2 <sup>1</sup> / <sub>8</sub>	1	
R-19	14	100ma	450	3 <sup>3</sup> / <sub>4</sub>	1 <sup>7</sup> / <sub>8</sub>	2 <sup>3</sup> / <sub>8</sub>	3 <sup>3</sup> / <sub>8</sub>	1 <sup>1</sup> / <sub>2</sub>	
R-20	5	200ma	90	4 <sup>1</sup> / <sub>8</sub>	2 <sup>1</sup> / <sub>4</sub>	2 <sup>3</sup> / <sub>8</sub>	3 <sup>3</sup> / <sub>8</sub>	2 <sup>1</sup> / <sub>2</sub>	
R-21	15/3	200ma	90	4 <sup>1</sup> / <sub>8</sub>	2 <sup>1</sup> / <sub>4</sub>	2 <sup>3</sup> / <sub>8</sub>	3 <sup>3</sup> / <sub>8</sub>	2 <sup>1</sup> / <sub>2</sub>	
R-220	100/8 Mhy 25/2 Mhy	2.5A 5A	.6 .16	3 <sup>3</sup> / <sub>4</sub>	2	2 <sup>3</sup> / <sub>8</sub>	3 <sup>3</sup> / <sub>8</sub>	1 <sup>1</sup> / <sub>2</sub>	

Write for latest catalog of over 1,300 STOCK ITEMS with UTC top quality

# UNITED<sup>®</sup> TRANSFORMER CO.

DIVISION OF TRW INC. • 150 VARICK STREET, NEW YORK, N. Y. 10013





# 73 Magazine

September 1967

Vol. XLVI No 9

**Jim Fisk WIDTY**  
Editor

**Kayla Bloom WØHJL**  
Assistant Editor

**Jack Morgan KIRA**  
Advertising Manager

Published by  
**Wayne Green, W2NSD/I**

## ADVERTISING RATES

	1X	6X	12X
1 p	\$298	\$281	\$264
1/2 p	155	147	139
1/4 p	80	76	72
2"	42	40	38
1"	23	22	21

No extra charge for second color (red, usually) or bleed on full page ads. If you're interested in advertising to hams, get our full rate card and other information from Jack Morgan KIRA.

The Synchronous Detection Process .....	W3DUQ	6
If you must use AM, get the most out of it.		
A 160-Meter Sidewinder .....	W6JTT	12
A sideband package for the low band.		
Building Blocks .....	WB2EGZ	17
A 12 to 18 MHz receiver for VHF converters.		
VSWR Supreme .....	W4BRS	20
A compact VSWR unit that can be built into your rig.		
Dual-Band Use of Single-Band Beams .....	W2EEY	26
Get the most use out of those antennas.		
Grounded-Grid Filament Chokes .....	W6RET	30
How to design and wind your own.		
200 Hertz CW Filter .....	K7UDL	34
Maximum selectivity with telephone coils.		
Observations of Note by a VHF Addict .....	WB6JLC	37
Hilltopping in Southern California.		
Getting a Start in Amateur Television .....	WA2EMC	40
Off on the right foot.		
A Compact Linear Amplifier .....	VE2AES	44
500 watts in a small package.		
Cathode Keying Filter .....	W6BLZ	48
Getting rid of key clicks.		
A Simple Resistance Bridge .....	VE3AHU	51
Precision resistance measurement at low cost.		
Compact Heat Sinks .....	Ives	52
Using copper pipe caps for cooling semiconductors.		
Evaluating Antenna Feed Systems .....	W7QAG	56
Using time domain reflectometry.		
Cheapskate's "On the Air" Sign .....	WN3EWV	62
Eliminating in-shack interference.		
Relay Energization in Fixed and Mobile Equipment .....	VE4RE	64
Just what the title says.		
How to be a Ham—By Really Trying .....	VE3GLX	66
It isn't hard if you try.		
Do-It Yourself Mobile Mount .....	W6APE	68
Nice looking but simple floor mount.		
Washing Out Your (Antenna) Shorts .....	W3RZD	70
Keep road salt and water out of your mobile antenna.		
A Polarity Sensitive Meter for the Sightless .....	WA2BCX	72
Used for checking diodes, capacitors and resistors.		
Climbing the Novice Ladder: Part X .....	W7OE	74
FN offers Judy and Joe some sage advice.		
Trindade Island DXpedition .....	PY2BZD	82
The DX-capades of PY2BZD/PYØ.		
Gus: Part 27 .....	W4BPD	84
Gough Island.		
DX'ing .....	W2NSD/I	88
How to get the most out of chasing DX.		
The Knight-Kit KG-663 Low-Voltage Power Supply .....	WIDTY	94
An excellent power supply for the ham shack.		
Heathkit SB630 Control Console .....	W2DJL	96
Handsome mate to the SB301 and SB401.		

73 Magazine is published monthly by 73, Inc., Peterborough, N. H. 03458. The phone number is 603-924-3873. Subscription rate: \$5.00 for one year, \$9.00 for two years and \$12.00 for three years. Second class postage paid at Peterborough, New Hampshire and at additional mailing offices. Printed in Pontiac, Illinois, U.S.A. Entire contents copyright 1967 by 73, Inc. Postmasters, please send form 3579 to 73 Magazine, Peterborough, New Hampshire 03458.

The View from Here .....	2	Antenna Coil Protection .....	71
W2NSD/I .....	4	Sharpening Chassis Punches .....	71
DL4IO-3690 .....	32	WTW News .....	80
Increased Twoer Selectivity .....	49	Propagation .....	92
Simple Test Leads .....	54	New Books .....	106
Mobile Installations .....	63	Letters .....	113
Tuning RTTY with a Piano .....	69	Caveat Emptor .....	123
Ad Index .....	128		



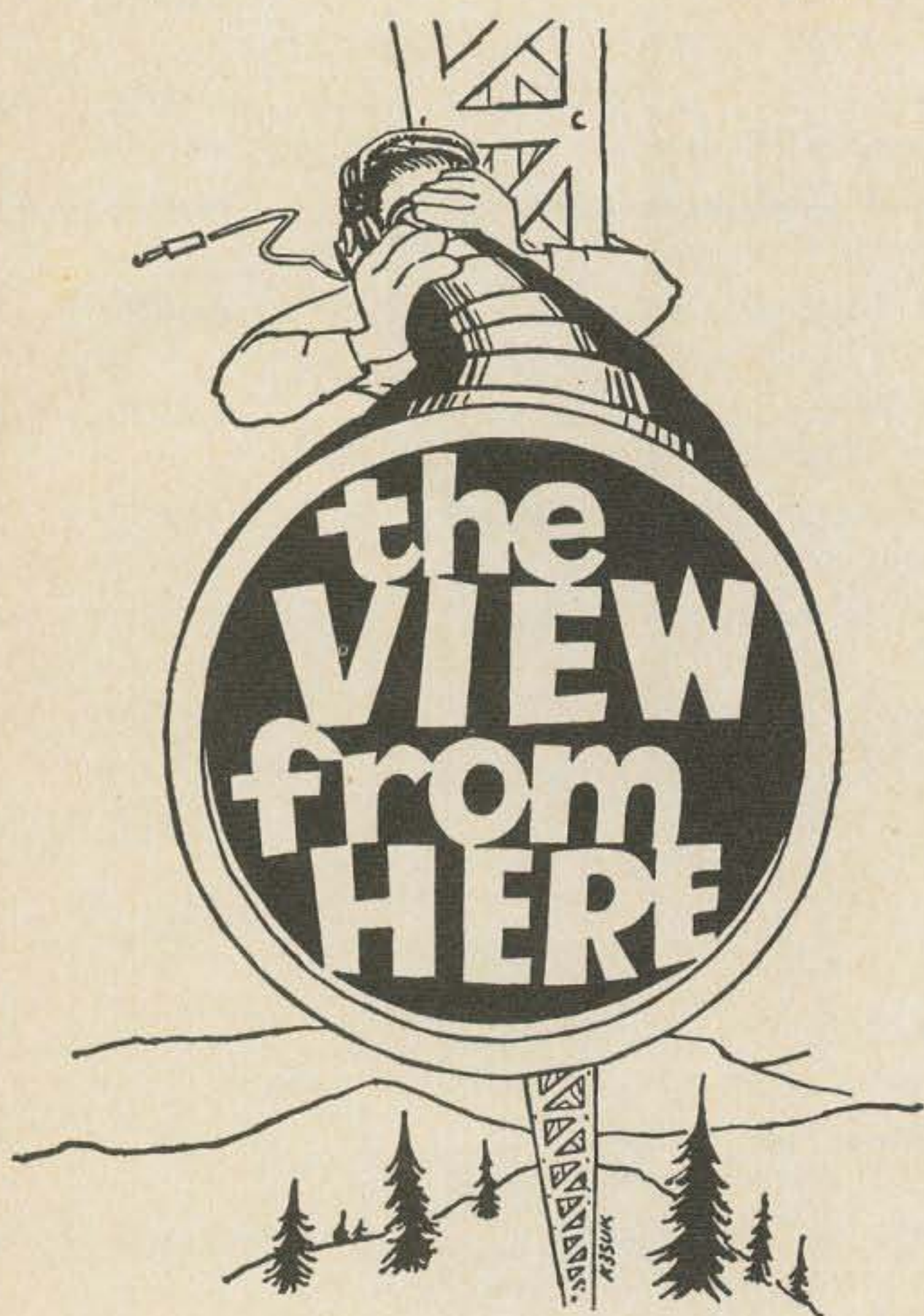

My comments on the use (and elimination) of amplitude modulation on the bands below 30 MHz in the June issue were not taken lightly. The AM operators have denounced me, indicted me, called me narrow minded and expressed desires to have me tarred and feathered. For a review of some of these choice epistles, turn to the letters section in the back of this issue.

None the less, *most* of the arguments in favor of AM are as outmoded as amplitude modulation itself. Granted, good AM sounds better than good sideband. However, we are supposed to be communicators, not broadcasters. If you doubt this, take a close look at the regulations—broadcasting on the amateur bands is specifically forbidden.

The chaps who say that sideband is just a passing fancy echo the cry of the spark operators who held out to the last minute in the 1920's. The fellows who argue that AM is more efficient are badly misinformed. In fact, for the same received signal-to-noise ratio, the AM station must run 2.88 times as much power as the SSB station.

Interestingly enough, for input signal-to-

noise ratios greater than about 7 dB, FM systems (with a deviation ratio of 2) are almost 11 dB better than AM and 8 dB better than sideband. However, below this point the results with FM drop off rapidly and, at low input signal-to-noise ratios, FM is inferior to both AM and sideband. Single sideband maintains a constant 3 dB advantage over AM, regardless of the signal level.

While most AM stations use simple diode detectors in their receivers, a few have gone to coherent detection. This approach *appears* to give AM a 3-dB advantage, but this advantage is lost due to a 3-dB noise increase because the predetection bandwidth is twice as wide.

With strong-signal and low-noise conditions, almost any mode of radio communications will provide the desired results, but you don't evaluate under the best conditions, you use the worst. Under the worst conditions, single sideband will usually provide the only usable telephonic communications, and AM and FM will be completely covered up by static, interference and noise.

Some of the AM operators are under the impression that since I am advocating the complete elimination of AM on our bands below ten meters, I am in favor of appliance operators. Nothing could be further from the truth. There is no reason why most hams should not be able to build a complete single sideband system. I don't know where the mistaken notion came from that you have to be some kind of electronic genius or engineer to build a SSB rig. It's not so. It just reflects the technical competence of today's amateur radio society.

Some AM'ers complain about the high cost of sideband. This is true if you are an appliance operator, but if you build your own SSB exciter, and have a decent junk box, the cost is comparable. The only special components you have to have are a filter or a phase-shift network. Audio phase-shift networks cost less than ten dollars, and high quality crystal and mechanical filters are often available on the surplus market within the same price range. You can't buy much of a modulation transformer for ten bucks!

There have also been a lot of complaints

(Turn to page 111)



# NOW

## International

- LOW COST
- MINIMUM DELIVERY TIME

3,000 KHz to 60,000 KHz

### A low cost Crystal for the Experimenter



type "EX"

# \$3.75

Postage Paid

**SPECIFICATIONS:** International Type "EX" Crystal is available from 3,000 KHz to 60,000 KHz. The "EX" Crystal is supplied only in the HC-6/U holder. Calibration is  $\pm .02\%$  when operated in International OX circuit or equivalent.

**CONDITIONS OF SALE:** All "EX" Crystals are sold on a cash basis, \$3.75 each. Shipping and postage (inside U.S. and Canada only) will be prepaid by International. Crystals are guaranteed to operate only in the OX circuit or its equivalent.

**MINIMUM DELIVERY TIME** We guarantee fast processing of your order. Use special EX order card to speed delivery. You may order direct from ad. We will send you a supply of cards for future orders.

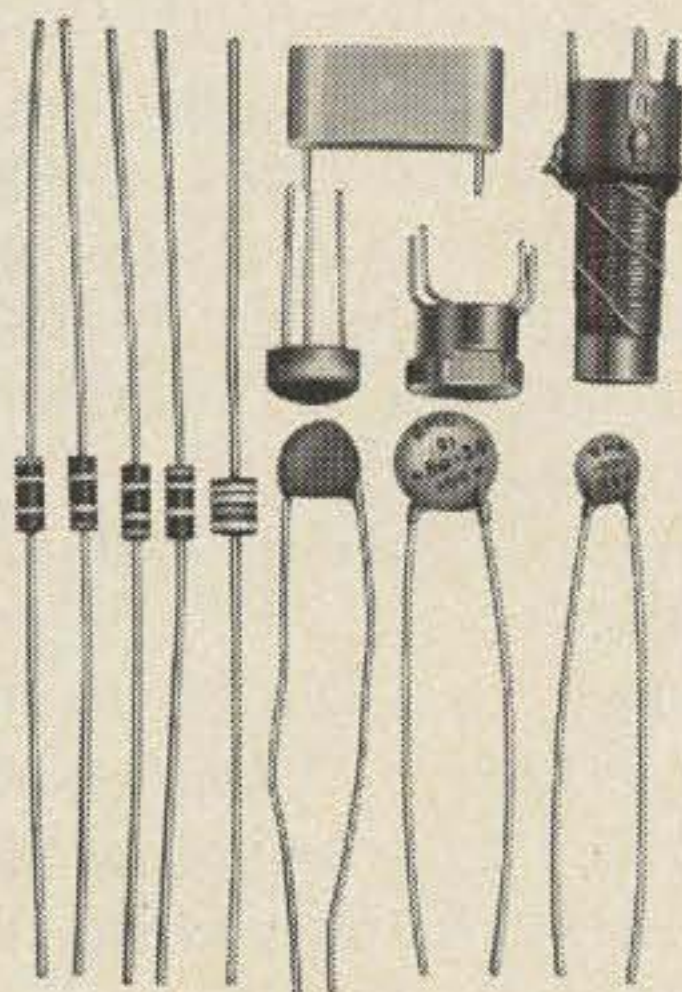
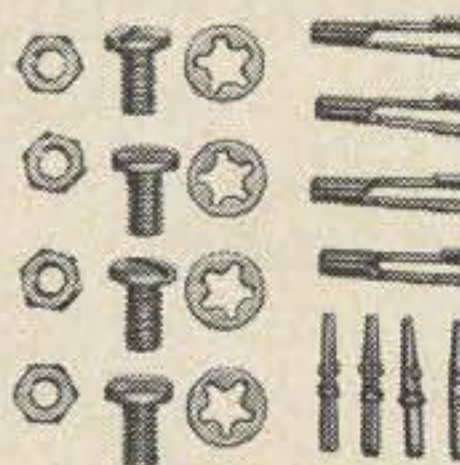
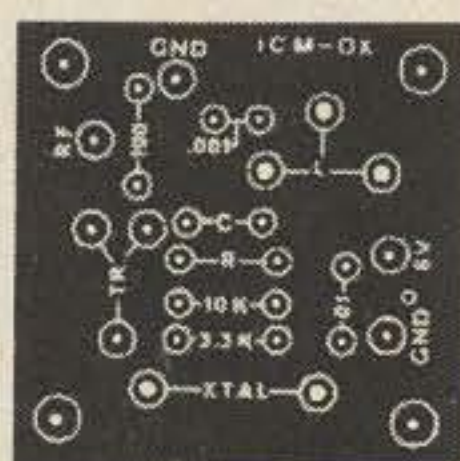
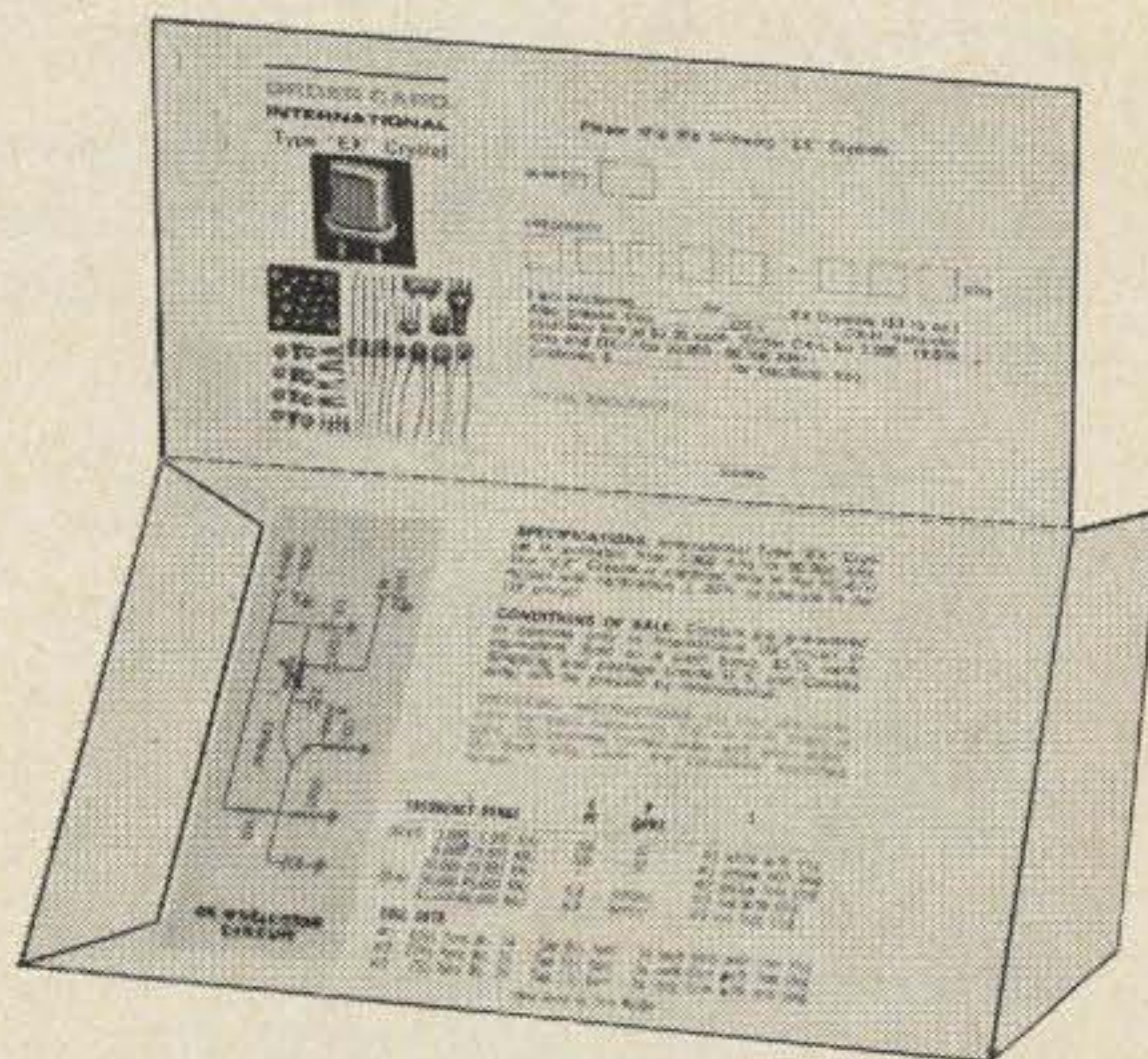

#### COMPLETE OX OSCILLATOR KITS

Everything you need to build your own oscillator. Two kits available. "OX-L" kit 3,000 to 19,999 KHz. "OX-H" kit 20,000 to 60,000 KHz. Specify "OX-L" or "OX-H" when ordering.

# \$2.35

Postage Paid

#### ORDERING INSTRUCTIONS

- (1) Use **one** order card for each frequency. Fill out both sides of card.
- (2) Enclose money order with order.
- (3) Sold only under the conditions specified herein.



**CRYSTAL MFG. CO., INC.**  
10 NO. LEE • OKLA. CITY, OKLA. 73102



# ROHN®

Asks...How do you rate a tower when the stories all sound the same?

There is a one-word answer — PERFORMANCE!

ROHN TOWER performance has made it the top name in the industry. Wherever you go — worldwide — you find ROHN TOWERS — CATV, microwave, communications, broadcast, home TV and amateur — with complete accessories, lighting, microwave reflectors and equipment. ROHN TOWERS — the accepted standard — recognized as the towers that provide strength, durability, ruggedness, appearance, design, adaptability and prestige. ROHN popularity rests on these factors:

- Computer Analysis & Engineering Design
- Manufacturing
- Warehousing
- Turnkey Tower Erection
- Complete Lines of Accessories

Representation and Distribution Worldwide

For further information contact

## ROHN®

Home Office

P.O. Box 2000, Peoria, Illinois 61601

Ph. 309/637-8416 TWX 309/697-1488



## W2NSD/I

*never say die*

### W2NSD in India

My original plan had been to fly from Afghanistan to Pakistan for a couple days and then on to New Delhi in India. Alitalia had confirmed my airline reservations, but when I got to Kabul I found that there aren't any flights from Pakistan to India. The two countries are essentially at war. So I stayed on an extra day in Kabul and then flew directly to New Delhi and spent the extra time there.

Apparently the Chinese have heavily infiltrated Pakistan and have a lot of influence there. If you consult a map of the world for a moment, you will see why Pakistan is so important to China. The western part of China is bottled up by Russia and, if they are going to open up that part of the country at all, it really has to be either through India or Pakistan. They tried the India route and the U.S. started talking about sending in troops to help out. So they have been concentrating on Pakistan and have apparently been winning there without sending troops. Naturally they are anxious to keep Americans out of the country as well as most other tourists. I think this also explains why we haven't heard many AP stations active for so long.

India, from the air, looked green and beautiful. I was surprised. I had sort of expected to see a dry and dusty country where agriculture was a fight against drought. It was in the 90's when I landed at New Delhi and the sun was beating down. The customs officials were cool. I had to do more paperwork here than in any other country I had visited. They wanted a complete list of my cameras, serial numbers, everything. They wanted a list of all money that I was bringing into the country. I filled out forms and more forms. My five cameras caused a great deal of difficulty . . . only two cameras permitted . . . but I finally made it through. I was inexperienced and didn't know that all this bother was just a signal to slip a little money into the palm to smooth my way through. Bribery, I found out later, is a basic way of life here.

*(Turn to page 98)*



*Waters*

\*\*\* **BAND ADDER™**



**Model  
370-3**

Add an easy 10, 15 & 20  
to your mobile antenna\*

Install Band-adder™ on your present 40m or 75m mobile antenna and work 10, 15 and 20 meters without further coil changing or antenna tuning. As simple as that! And get full coverage of the higher frequencies with VSWR at a 2:1 maximum. Band-Adder attaches in a jiffy . . . handles 500 PEP in a walk. Great for marine operation, too! Yep . . . we engineer for convenience, at Waters.

\*Band-Adder installs instantly on Waters Auto-Match or other standard antennas employing 3/8-24 coil threading.

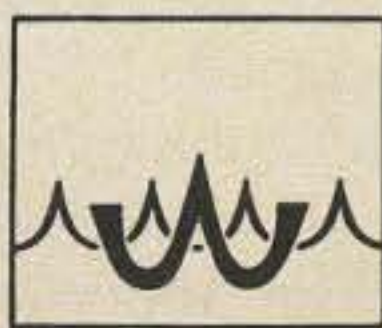

**WATERS**  
MANUFACTURING INC.  
WAYLAND, MASS. 01778



**WATERS  
AUTHORIZED  
DISTRIBUTORS**

These select, full-service outlets are the only authorized distributors of Waters Amateur Radio Products.

AMRAD SUPPLY, Inc.  
San Francisco, Calif. 94121

AMATEUR ELECTRONIC SUPPLY  
Milwaukee, Wisconsin 53216  
Chicago, Illinois 60631

ARROW ELECTRONICS, Inc.  
Farmingdale, L.I., New York 11735  
Mineola, L.I., New York 11501  
Norwalk, Conn. 06850

HARRISON RADIO CORPORATION  
New York, New York 10007

HENRY RADIO, Inc.  
Los Angeles, Calif. 90064  
Anaheim, Calif. 92801  
Butler, Missouri 64730  
Phoenix, Arizona 85017

STERLING ELECTRONIC SUPPLY  
New Orleans, Louisiana 70112

ELECTRONIC DISTRIBUTORS, Inc.  
Wheaton, Maryland 20902

ELECTRONIC CENTER, Inc.  
Dallas, Texas 75204

WORLD RADIO LABS, Inc.  
Council Bluffs, Iowa 51501

**CANADA**

M. J. HOWARD & CO., Ltd.  
Ottawa, Canada

If you live outside of a distributor-area order directly from the factory. Send for our new Amateur Radio Catalog.



William Nagle W3DUQ  
21 Powell Lane  
West Chester, Pennsylvania

## The Synchronous Detection Process

If you want to get the most out of AM or DSB communications, try the synchronous detector. With a synchronous detector at both ends of an AM communications link, the system is as effective as single sideband.

Synchronous detection, when adapted to a communications receiver with an *if* band-pass of six kHz or better, provides an excellent means of single signal reception, along with the capabilities of almost complete rejection of non-synchronous components such as single sideband, RTTY, unmodulated carriers, static, and most spurious sideband splatter emanating from off-frequency signals. It provides a means of phase locking the detector on synchronous type transmissions such as DSB with carrier, DSB without carrier, NBFM, and phase modulation.

A block diagram, shown in Fig. 1, gives the basic elements of the system used at W3DUQ. Blocks marked with an X are the ones necessary for basic synchronous detection if the stereo synthesizer, as will be described later, is not desired. The basic sys-

tem utilizes eleven dual purpose tubes.

Following the block diagram, the signal input is applied to each 7360 demodulator (V1, V2), and the local 455 kHz oscillator voltages are applied to each demodulator in phase quadrature (90° apart). Assume, momentarily, that the "I" channel local oscillator injection voltage is the same phase as the carrier (transmitted or suppressed) component of the AM signal. Then the in-phase or "I" channel will contain the demodulated signal, while the "Q" channel will contain no audio, as its injected local oscillator voltage is shifted 90°. Now, if the local oscillator or signal drifts slightly, the "I" channel will be unaffected, but the "Q" channel will produce some audio. This will have the same polarity as the "I" channel audio for one direction of local oscillator or signal drift, and opposite polarity for the opposite direction of local oscillator or signal drift. The "Q" channel level will be proportional to the oscillator drift, for shifts of 300 Hz or less. By simply combining the "I" and "Q" audio in an audio phase discriminator (V4 and associated circuitry), a dc control signal is obtained. This control voltage tunes the oscillator (V5B) via the reactance tube (V5A), and returns or locks the oscillator to the correct phase where audio is present only in the



The synchronous detector.















DC Voltages—Synchronous Detector Without *if* Signal

Tube No.	Type	1	2	3	4	5	6	7	8	9
V1	7360	5	150		Fil	Fil	80-100	80-100	25	25
V2	7360	5	150		Fil	Fil	80-100	80-100	25	25
V3	12AU7A	75		3.5	Fil	Fil				Fil
V4	12AU7A	240		11	Fil	Fil	240		11	Fil
V5	6AN8	60	-1	4.7	Fil	Fil	200	100		3
V6	12AU7A	247		8	Fil	Fil		0-50	0-12	Fil
V7	12AT7	240	5.5	8	Fil	Fil	212	6.5	10	Fil
V8	12AT7	240	5.5	8	Fil	Fil	212	6.5	10	Fil
V9	12AT7	212	6.5	10	Fil	Fil	120		1.7	Fil
V10	12AT7	212	6.5	10	Fil	Fil	120		1.7	Fil
V11	12AU7A	75		3.5	Fil	Fil	246		2.5	Fil
V12	6AQ5A		15	Fil	Fil	246	250			
V13	OB2	250	150		150	250		150		
V14	OA2	150				150				
V15	6AQ5A		15	Fil	Fil	246	250			
V16	12AX7	240		3.2						

Notes: Oscillator injection at V1, V2 is 6V p-p; maximum signal at V4 grids to be set at 8V p-p with R1; audio at V9b, V10b grids 100 mV p-p; adjust R2 for -1 volt dc on oscillator grid; set AVC depth control for 8-10 volts p-p at V4 grids with external BFO on and detuned 1 kHz.

the oscillator-reactance tube and associated circuitry should be kept away from the rest of the circuit as much as possible, to avoid 455 kHz pick-up by audio circuits.

#### Receiver modification and avc set-up

Take *if* out of the receiver (455 kHz) at the plate of the last *if* amplifier stage, through a 20 pF capacitor to RG62/U coaxial cable, to the grid of V16.

Modify the receiver avc switch to provide an external input position for the detector audio hang AVC voltage. Peak the *if* transformer in the plate of V16 with the rf gain wide open, the AVC switch in *external* receiver AVC, the receiver bfo or crystal calibrator on, and the detector oscillator detuned one kHz from the center of the *if* passband. Note the S-meter reading. Now switch the receiver to *internal* AVC, and note the S-meter reading. If the two meter readings are more than 5 dB apart, adjust the value of R1 (33k) until the meter readings agree.

#### Quadrature set-up

Tune the local oscillator to the center of the receiver *if* passband (you can use the receiver bfo for this), and set-up the oscillator injection quadrature, and alpha-beta networks as follows.

With the receiver tuned 1 kHz from an unmodulated carrier, set switch S1 to the position giving the least audio output, and alternately adjust the 8-50 pF trimmer in the oscillator quadrature circuit, and R8 for minimum audio output at "Q" preamp output. Now adjust R7 for minimum audio output on its rejected sideband at "I" preamp

output.

If the 8-50 pF trimmer adjustment is not the same for the opposite sideband selection on S1 (retune receiver to 1 kHz on the other side of zero beat for this test), the alpha and beta networks are off balance and can be brought in by judiciously trimming the 7k and 2k plate and cathode resistors on V7a and V8a, while adjusting the 8-50 pF trimmer and R8 until a minimum audio output results on either sideband.

#### Audio phase discriminator set-up

1. Short R3 to ground.
2. Tune the receiver 1 kHz from an unmodulated carrier (crystal calibrator works fine here) and adjust the rf gain for four volts rms audio on the plates of V3a and V11a.
3. Connect a dc VTVM or dc oscilloscope to TP1 and adjust R4 for minimum dc.
4. Move the VTVM to TP2 and adjust R5 for minimum dc.
5. Move the VTVM to TP3 and adjust R9 for minimum ac.
6. Remove ground from R3 and adjust R6 for minimum ac at TP3.
7. Repeat steps 3 and 4 until step 6 yields no ac output.

#### Notes

1. The output at the preamp output jacks is approximately 200 millivolts peak to peak.
2. For stereo reception, adjust the two 500k volume controls and the speaker phasing switch (using stereo headphones), until minimum interference on a locked synchronous signal is observed.



3. Adjust the compression depth control (500k) along with R1 for best synchronous locking. Value should come out on the depth control to about 400k.

4. S1 positions, starting at full counter clockwise:

- a. Reject upper sideband.
- b. Reject lower sideband.
- c. Stereo (reject lower "Q", reject upper "I" on earphones).
- d. Receive lower sideband-AFC off.
- e. Receive upper sideband-AFC off.

5. For best synchronous locking on double sideband signals, the receiver should be tuned 100 Hertz or closer to signal zero beat.

6. Set VR current (V13, V14) for 2.2 volts dc across the 100-ohm resistor at V13 pin 1 using the 2.5k, 25-watt adjustable resistor.

7. Set plate voltage for V12, V15 (6AQ5's) for 270 volts, using the 3k, 25-watt adjustable resistor.

8. If the stereo feature is not desired, eliminate V9, V10, V12, V15, and take the audio output from the center tap of R8.

Now sit back and enjoy QRM free reception.

In 1965, a test involving over two hundred students was conducted at Cambridge University, in England. Under controlled conditions, two transmitters were put on the air; one AM, the other SSB. The SSB transmitter was running twice the power output of the AM transmitter. Two identical receivers were set-up, one with a product detector for SSB reception, the other with a synchronous detector for AM reception. Each student was to copy a message, first from one receiver, then the other.

Then white noise was injected into both receivers, 3 dB at a time. In the end, the AM signal, running one-half the power output, was easily copied with over 6 dB more white noise injected into the receiver, while the SSB signal was completely washed out. So you see, it's not the mode of transmission so much as it is the method of detection.

Let's get rid of those outdated, wideband, distorted telephone quality single sideband gizmotchies; and put some good, narrow, maximum intelligibility advanced modulation back on so we may soon rid the bands of 30 kHz wide signals and once again enjoy good, solid communications.

... W3DUQ

## VALUABLE books from E. & E.

### NEW SINGLE SIDEBAND: THEORY AND PRACTICE



by Harry D. Hooton, W6TYH. The

one-source guide to ssb. Covers the origin and principles of ssb, derivation of ssb signals, carrier suppression techniques, sideband selection, carrier generators,

speech amplifiers and filters, ssb generators, balanced mixers and converters, low-power ssb transmitters, linear r-f amplifiers, ssb communications receivers, transceivers, tests and measurements. Includes chapters on how to build air-tested linear amplifiers. 352 pages. Hardbound. Order No. EE-350, only... \$6.95

### NEW 17TH EDITION OF THE FAMOUS RADIO HANDBOOK



Tells how to design, build, and operate the latest types of amateur transmitters, receivers, transceivers, and amplifiers. Provides extensive, simplified theory on practically every phase of radio. Broadest coverage; all original data, up-to-date, complete. 816 pages. Order EE-167, only... \$12.95

### RADIOTELEPHONE LICENSE MANUAL



Helps you prepare for all commercial radio-telephone operator's license exams. Provides complete study-guide questions and answers in a single volume. Helps you understand fully every subject you need to know to obtain an operator's license. 200 pp. Order EE-030, only. \$5.75

### LEADING BOOK ON TRANSISTORIZED COMMUNICATIONS EQUIPMENT

TRANSISTOR RADIO HANDBOOK, by Donald L. Stoner, W6TNS, Lester A. Earnshaw, ZL1AAX. Covers a wide range of communication uses for both amateur and commercial applications. Includes audio and speech amplifiers, VHF transmitting and receiving equipment, SSB exciters, and complete SSB transceivers. 180 pages. Order EE-044, only... \$5.00



Order from your electronic parts distributor or send coupon below.



EDITORS and ENGINEERS, Ltd.

P.O. Box 68003, New Augusta, Ind., Dept. 73E-9

Ship me the following books:

- No. EE-350     No. EE-030  
 No. EE-167     No. EE-044    \$\_\_\_\_\_encl.

Name \_\_\_\_\_

Address \_\_\_\_\_

City \_\_\_\_\_ State \_\_\_\_\_ Zip \_\_\_\_\_



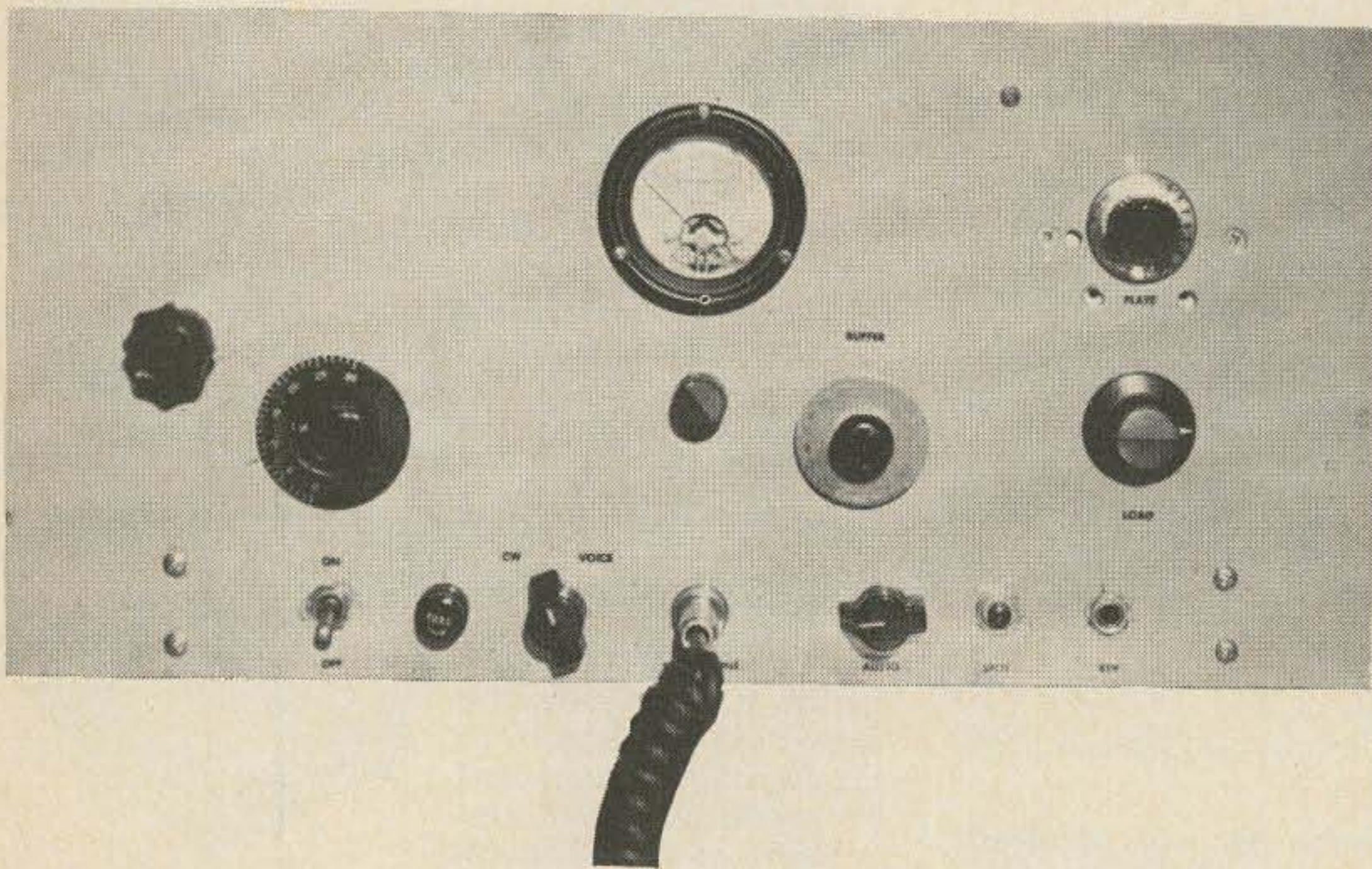

Sam Kelly W6JTT  
12811 Owen Street  
Garden Grove, California

## A 160 Meter Sidewinder

A simple double-sideband and CW transmitter for 160 which uses readily available parts.

160 Meters is a band that is virtually ignored by equipment manufacturers. This makes it even more fun to build your own equipment. After operating CW and plate-modulated AM on the band with a converted TCS, I decided to experiment with double side band suppressed carrier. The DSB has several advantages over AM. The carrier is eliminated giving you more "talk power", inter-channel heterodynes are reduced and the equipment is simple to build.

This low cost DSB/CW transmitter was built entirely from junk box parts. Most of the final tank components were salvaged from TU-5 tuning units which are available surplus for about \$2 each.

The transmitter was built on a 17 x 13 x 2 inch aluminum chassis. A standard 8<sup>3</sup>/<sub>4</sub> inch aluminum EIA panel was used. Parts layout isn't critical, but the rf leads should be kept

as short as possible. The 100 microamp meter was used because it happened to be in the junk box. A 0-1 mA meter would be less likely to be damaged and can be substituted by simply reducing resistors  $R_a$  and  $R_b$  by a factor of 10. Construction was done in stages starting with the power supply. Each stage was checked out before proceeding to the next stage.

### Power supply

The power supply uses separate plate and filament transformers. The filament transformer has a 6.3 V and 12.6 V winding which were placed in series to provide 18.9 Vac for the relay supply. The plate transformer has low voltage taps which were used for the oscillator supply. A dropping resistor can be used to get this voltage if a tapped transformer isn't available.



## Modulator

The modulator is straight forward until you get to the modulation transformer. It is a 400 Hz power transformer rated at 115 V primary and 750-750 on the secondary. I salvaged this one from an airborne jamming transmitter. Any 400 Hz power transformer having at least 5:1 turns ratio will do.

A two-stage 12AX7 speech amplifier was used to provide adequate gain for a crystal microphone. The leads to the gain control and to the grid of the 6V6 must be shielded to prevent the amplifier from oscillating. The 6V6 is run with 350 volts on the plate and screen, providing ample drive for the 5933 screens.

## Oscillator

The VFO is a Hartley oscillator. The tuning capacitor was salvaged from a command transmitter (or they can be bought for \$1.50 each from Fair Radio Sales). Removing one third of the plates spreads the band over most of the dial. A 1-inch piece of  $\frac{1}{4}$  inch diameter brass shafting was drilled out and sweated on the small tuning shaft to accommodate a more convenient size tuning knob. The capacitor was mounted on a  $\frac{1}{4}$  inch thick stiffener plate to reduce the effect of chassis flexure on oscillator frequency. The oscillator coil is wound on a ceramic form mounted in a shielded compartment on the underside of the chassis. Take special care

to insure that the coil and shield are mechanically sturdy.

## Buffer

The 12BY7A buffer-amplifier is straight forward. Be sure that the internal shield and suppressor grid are grounded right at the socket by short leads. Use a good quality ceramic socket. The split stator tuning capacitor was made by sawing the stator section of the 135 pF tank capacitor (from a TU-5 tuning unit) in half. The small trimming capacitor is used to balance the input. Be sure to isolate the buffer tank from the final amplifier tank to prevent the final from taking off and oscillating!

## Final amplifier

The final amplifier consists of a pair of 5933's with their grids in push-pull and their plates in parallel. The 5933 is just a short, ruggedized 807. 807's or 1625's could be used just as well. If you use 1625's you will need a 12V filament supply. A pi section output is used. All final tank components, including the antenna transfer relay, are located in a tightly shielded compartment. Coaxial connectors for the receiver and antenna are located at the back of this compartment.

## CW operation

The final amplifier circuit is just our old friend the push-push multiplier in disguise.

Top view of the transmitter. The homemade split-stator capacitor is in the center.

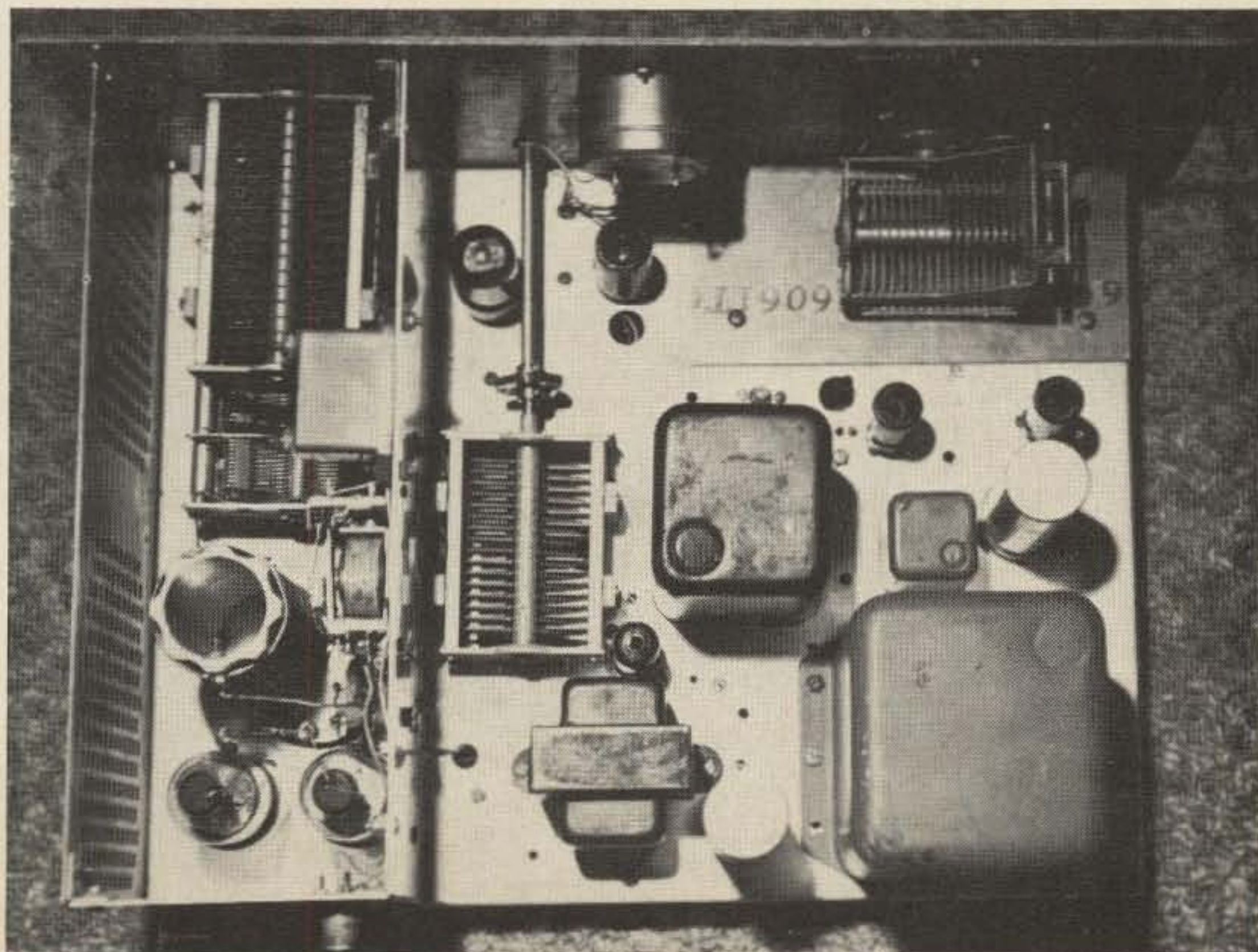



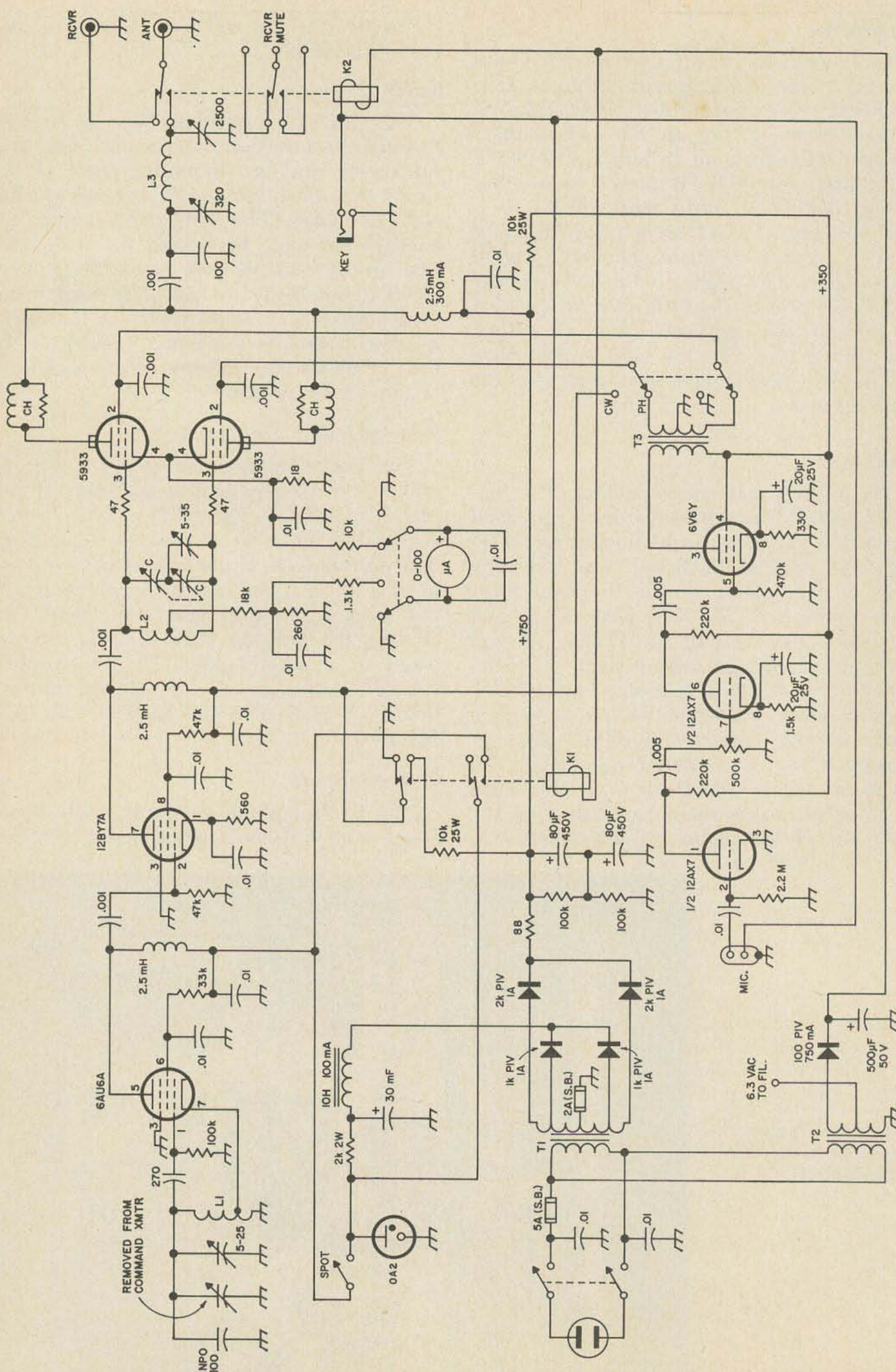

Fig. 1. Schematic diagram of the 160 meter CW/DSB transmitter.



## *budget-priced walnut communications desk groups equipment neatly, right in your living room*



SEND FOR BROCHURE  
OF OTHER MODELS

**DIPLOMAT**  
**\$139.95**

You can operate your amateur radio equipment right in your living room with this inexpensive, "wife-approved" communications desk from Design Industries.

You'll like its custom features . . . functionally tilted top surface holds your equipment at just the right operating angle . . . deep cable trough keeps desk top neat, yet leaves connections accessible . . . three drawers give you plenty of storage room.

She'll like its rich walnut finish and modern furniture styling.

You'll both like its low price.

The DIPLOMAT communications desk accommodates Collins, R. L. Drake, Galaxy, Hallicrafters, and most other modern equipment.

*Sold Only Through Authorized Distributors*



**electronics center, inc.**

2929 N. HASKELL 214-LA6-2023 DALLAS, TEXAS 75204

It doesn't work well with both tubes as a straight-through CW amplifier. For CW one tube is disabled by grounding its screen grid (this could also be done by turning off the filament). The oscillator and screen grid are keyed simultaneously. Be sure to wire K-1 as shown. This grounds the screen grid in the key-up position to prevent the final from oscillating. Power input on CW is 75 watts.

### Check out

After smoke testing, place the CW-phone switch in the CW position. Connect the transmitter to a 50-ohm dummy load, plug in the key and close it. With the meter in position 1, adjust the buffer tuning for maximum grid current (approximately 3-4 mA). Use an rf voltmeter (most VTVM's will work satisfactorily) and adjust the 5-35 pF trimmer until the rf voltage on the grids is equal. Dip the final and tune up normally for a pi section output.

Next switch to phone. There should be approximately 20 mA of idling current. Adjust the buffer tuning for maximum drive. Whistling into the microphone should cause the meter to kick up to approximately 200

mA (depending upon the damping characteristics of the meter).

You are now ready to connect the transmitter to the antenna. I use an antenna tuner that incorporates a TVI filter. For best results look at the rf waveform with an oscilloscope to be sure you aren't overloading on peaks.

. . . W6JTT

### Parts not listed on schematic:

L-1 1½ inch of close wound #28 DDC on ¾-inch ceramic form.

L-2 2 inches of close wound #28 DCC on a 1-inch phenolic form center tapped.

L-3 45 turns of #14 solid copper on a 2-inch diameter ceramic form. Turns spaced the width of #14 wire.

C See text.

K-1 DPDT antenna changeover relay, 24 Vdc coil.

K-2 DPDT crystal can relay, 24 Vdc coil.

CH Parasitic chokes: 6 turns of #20 solid copper wound on a 47-ohm, 1-watt resistor.

T-1 650-0-650 volt, 200 mA, secondary with taps at 200 volts.

T-2 Filament transformer 115 V primary, dual secondary 6.3 V @ 5 amp, 12.6 V @ 2 amp.

T-3 Modulation transformer, 115 V, 400 Hz, primary, 750-0-750 secondary (see text).



# Whats **NEW** from Mosley!

## DIPLOMAT '2'

Meet hams in your area on 2 meters . . . check in on emergency nets! For an inexpensive way to keep in touch, consider the newest addition to the 6 and 10 meter Diplomat family of 5/8 wavelength omni-directional antennas. Only \$8.10. Space saving. Lightweight. Top gain.\* Rated 1 KW AM/CW, 2 KW P.E.P. SSB input. Another Quality Mosley antenna!

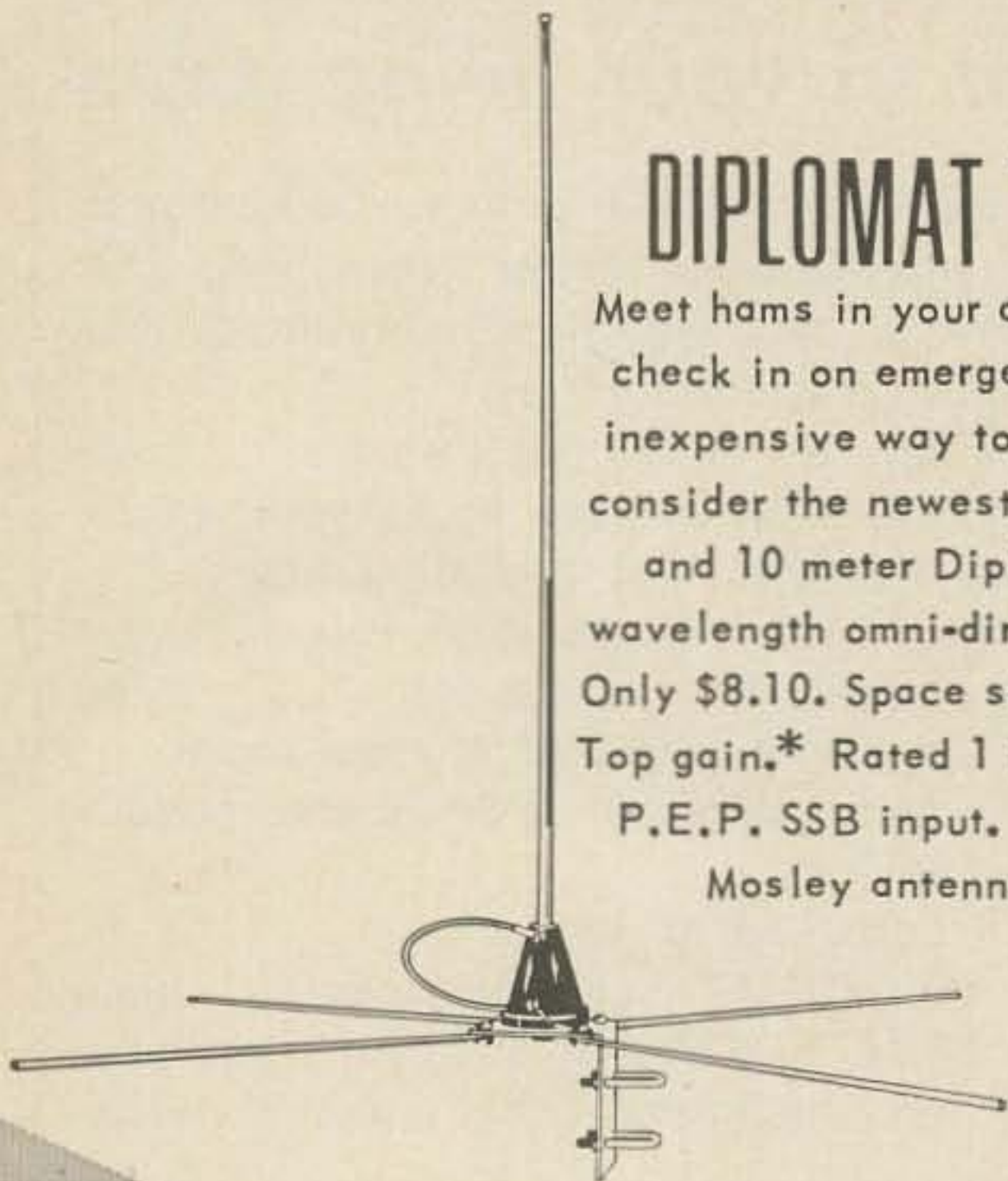

## X-15

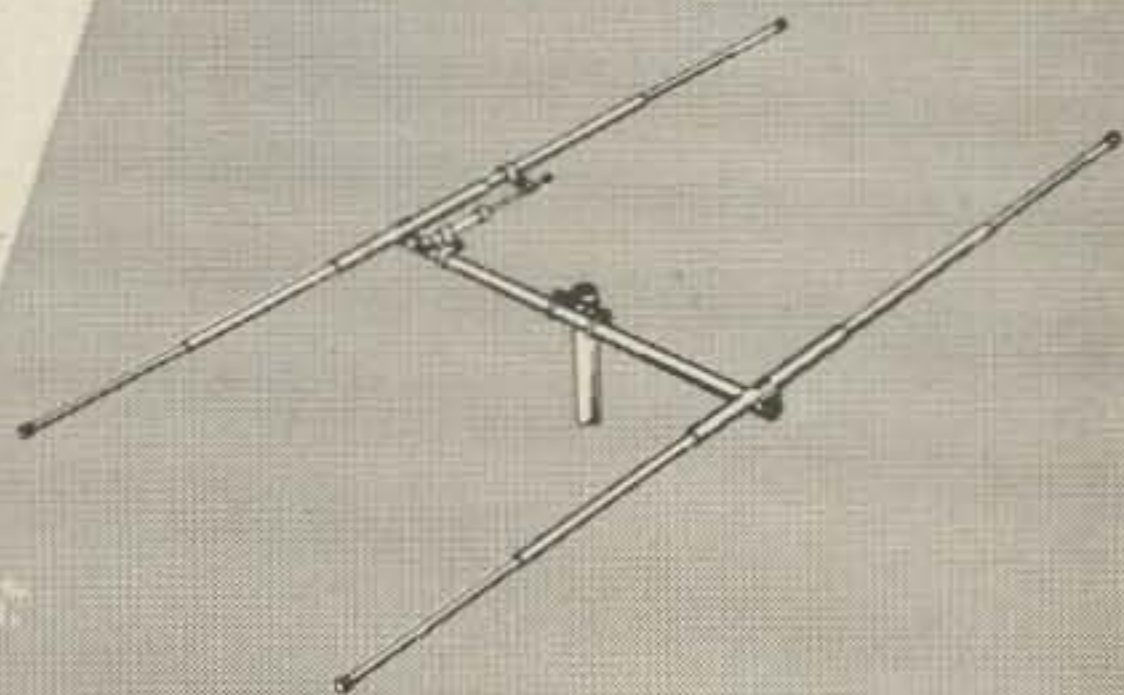

Own a Quality Mosley 15 meter beam, yet build it yourself - - just like in magazine projects. Drill your own holes and assemble according to concise instructions given. All parts included (minus coax). Gamma matched. Outstanding gain.\* Full power rated. By readjusting elements according to instructions supplied, Generals may use this beam on 10 meters.

## LANCER 1000

Hams are working lots of DX with this 5-band mobile antenna! Full power rated. Use on 10 meters without coil. Interchangeable coils for other bands. Adjustable upper whip section for peaking antenna to desired frequency. Coils with whip tip pre-cut and set for each band, available (extra). Hinged break over.

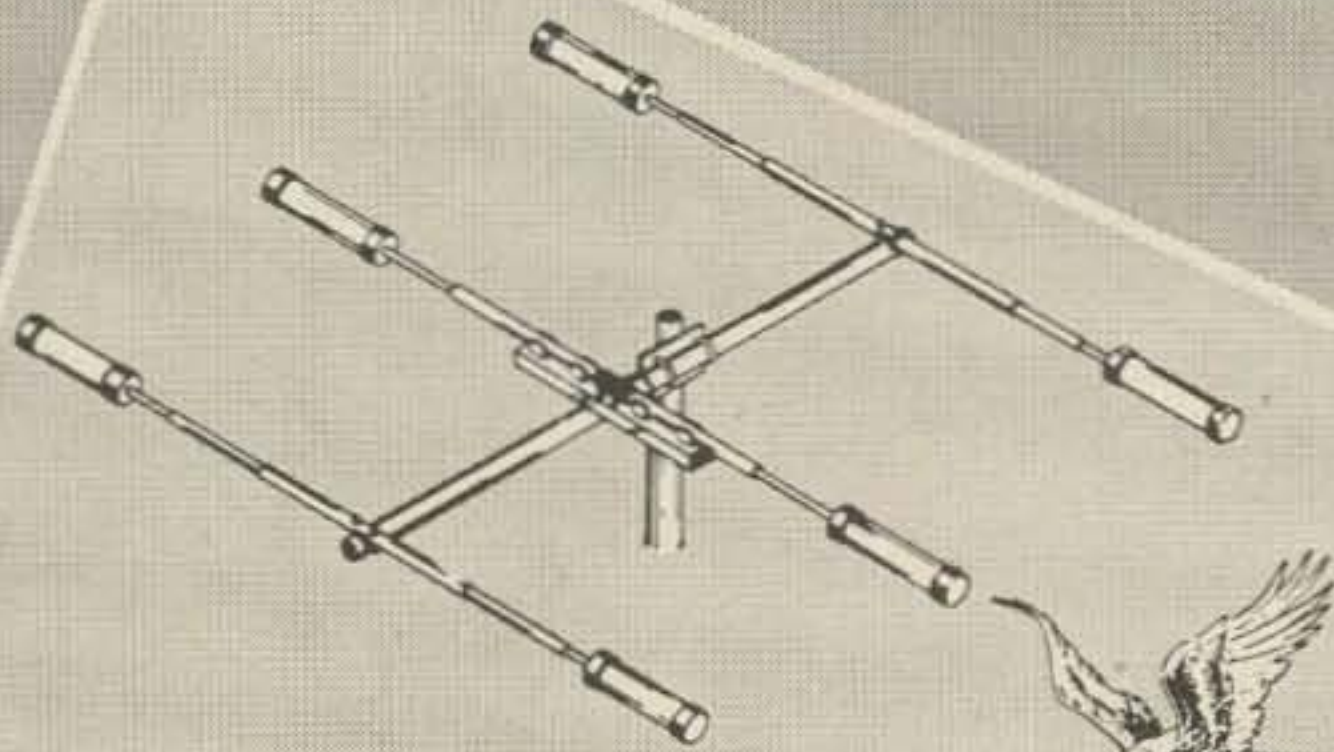

## The Classic 10-15

The 10 and 15 meter bands are hot again! Command your share of DX on these popular bands with this Classic New Trap-Master beam. Full power rated. Broad Band Capacitive Matching. Incorporates performance proven Mosley metal encased traps. Tops in DX punch . . . gain!\*

*\*Gain omitted due to requirements of certain publications. For full details, send for FREE '67 catalog. Dept. 140*

**MOSLEY ELECTRONICS, INC.**

4610 N. LINDBERGH BLVD., BRIDGETON, MO. 63042



Don Nelson WB2EGZ  
9 Green Ridge Road  
Ashland, New Jersey 08034

## Building Blocks

A simple integrated circuit and transistor receiver which tunes from 12 MHz to 18 MHz — it is ideal for many VHF converters.

Here is an idea you might like to try. A small receiver, which is suitable for use with most of the myriad of semiconductor converters, can be built for \$20 and the aid of a good junk box. If a receiver is not what you need, there are still some circuits and ideas to suit your fancy.

The use of discrete electronic components is becoming obsolete in cases where a standard circuit is used. Instead, we use assemblies, or integrated circuits, which are usually superior in design to the original approach. As you will see with this receiver, the use of

building blocks is also a means of economizing.

### Circuit description

By using an RCA CA3020, which costs \$2.80, I was able to build a quality 500 mW audio system at a price competitive with foreign-made audio assemblies. The *if* amplifier and detector is a Miller 8903. This assembly consists of two units, an 8901 and an 8902, which will provide 55 dB gain at 455 kHz. The cost—\$5.75. My only misgiving on this unit is its frequency. That 910 kHz

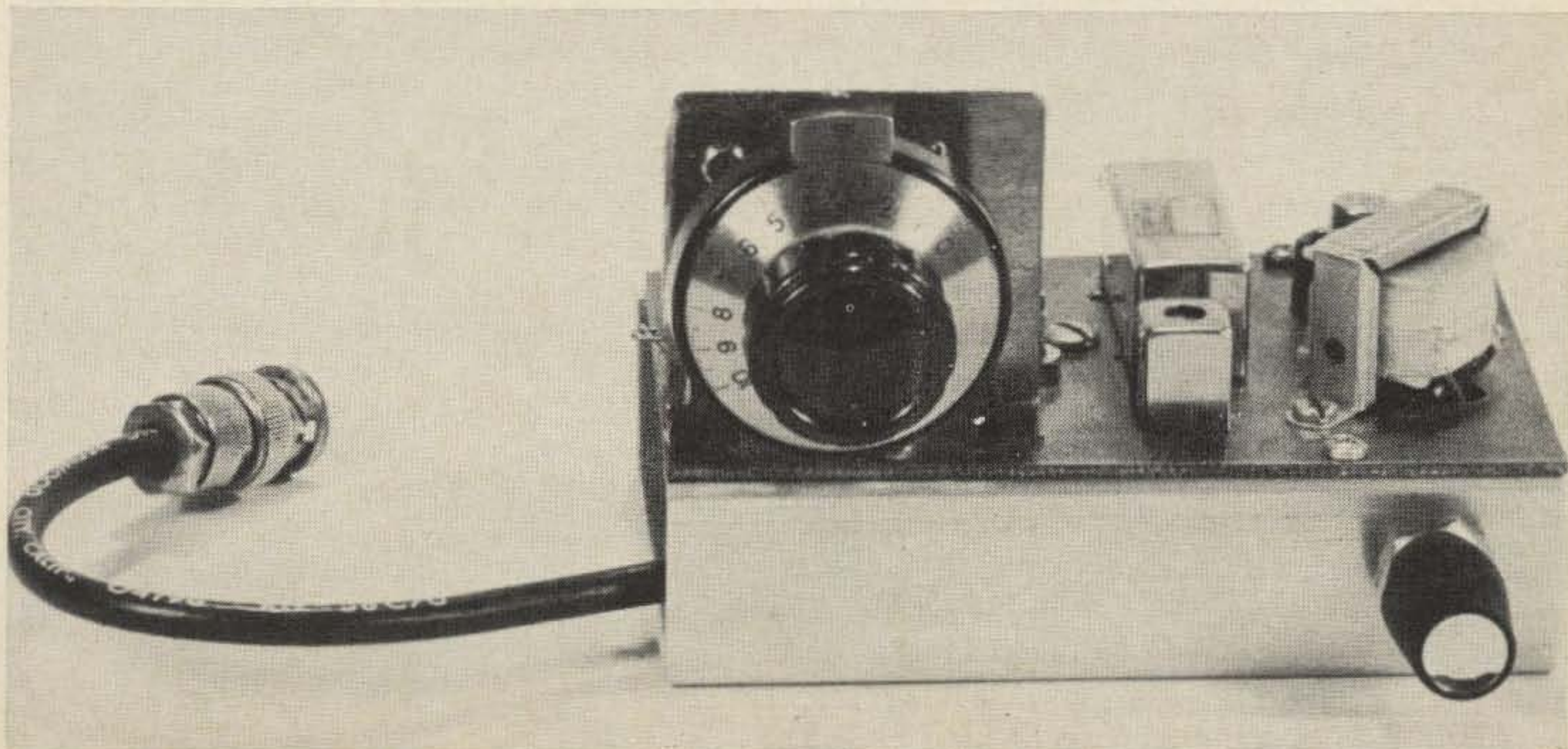



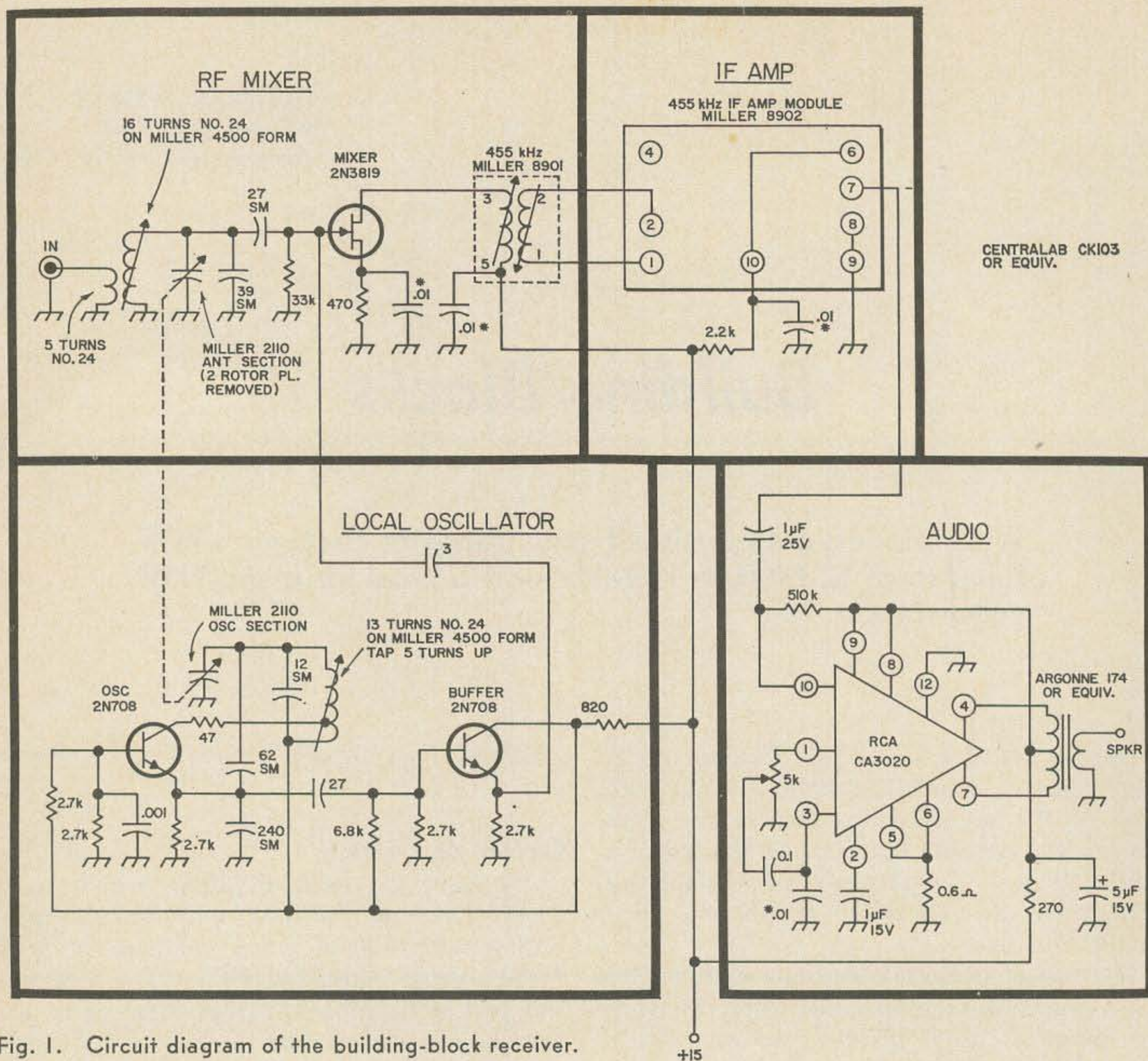

Fig. 1. Circuit diagram of the building-block receiver.

image is a problem when the receiver is used with VHF converters.

After some deliberation, I chose to build the mixer stage with a junction field effect transistor (JFET). The epoxy 2N3819 by Texas Instruments fills the bill for less than \$1.00.

Tuning of this stage, and tracking with the oscillator, provides the only real challenge of the system. The values shown tune from 12 MHz to 18 MHz, but other ranges are easily obtained by changing the tanks. I was able to maintain good tracking with two adjacent rotor plates removed from the antenna section of the tuning capacitor. It was also necessary to bend the outside rotor plates slightly, for good mid-band tracking. Since the transistors are fairly well isolated from the tanks, tracking checks were possible with a grid-dip oscillator with no power applied to the receiver. Slight adjustment of the an-

tenna tank is necessary when power is applied.

If a local oscillator is loaded by the mixer when strong stations are tuned, it will be pulled from its normal frequency. A buffer stage, in the form of an emitter-follower, will overcome that problem. George Daughters, WB6AIG, used a rather elaborate two transistor buffer in his HBR-TR receiver (*QST*, April 1967), but this seemed unnecessary in the unit described here. I did copy George's oscillator with good results, however. Although the 2N708 was used twice in this circuit, there is really no preference for that type. RCA 40237's, or various plastic types, would be less expensive.

The entire unit was mounted on a 2¼ x 4½ inch piece of PC board, which by luck, almost fits a Bud CB1626 chassis. A good PC board designer might lay out the printed wiring and eliminate the 12-pin socket used



Top view of the building-block receiver showing the location of the components.

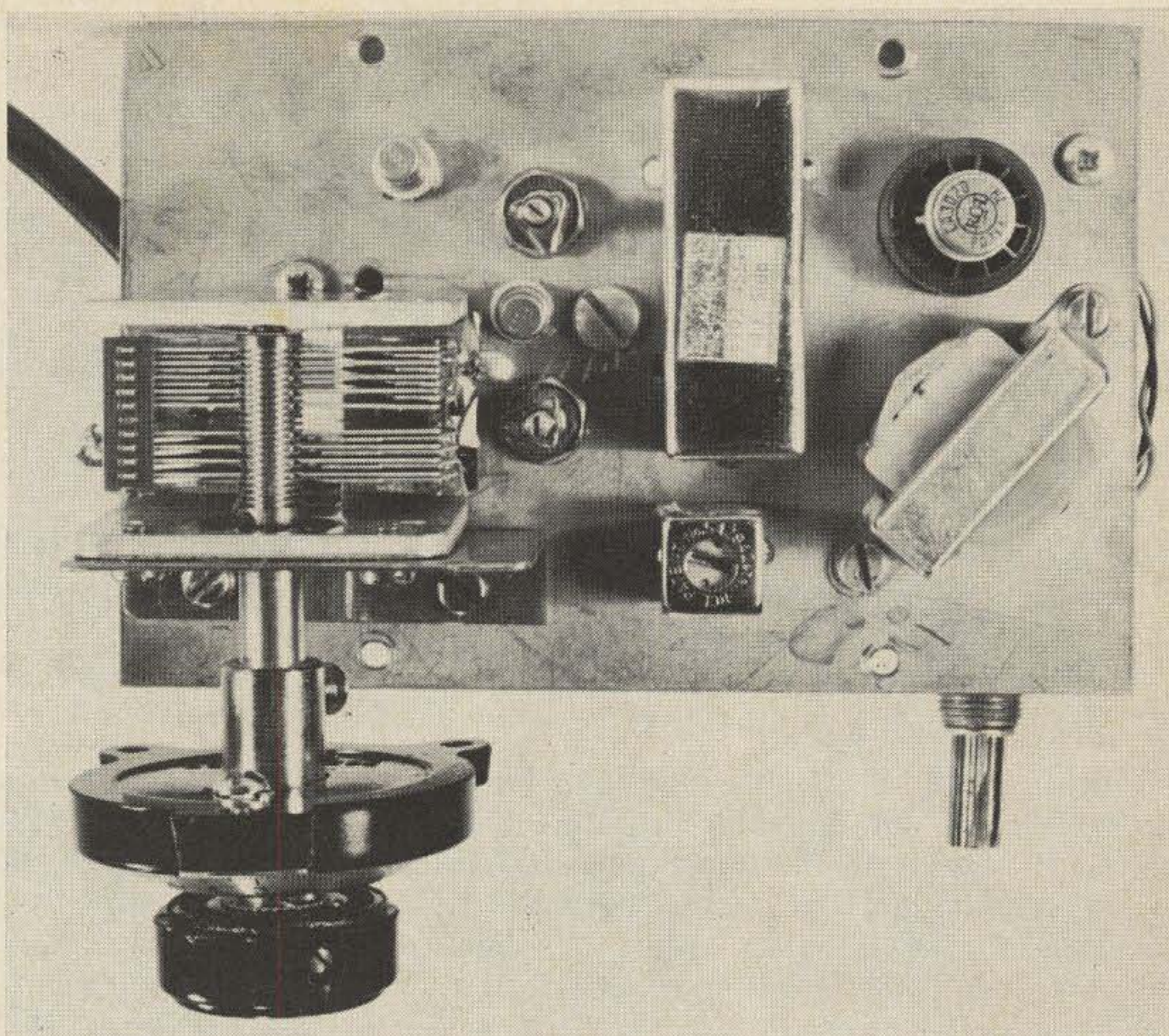

for the integrated circuit. Eventually, the receiver will be part of a more classic enclosure. The Argonne 36 mm vernier dial was photographed to show the intended mounting.

### Performance

While this may not be the ultimate in modern day receivers, its performance is good. I have used it in conjunction with a 2-meter converter similar to that of K6HMO (73, October 1966). Selectivity is excellent, but the sensitivity might be improved. The JFET does not easily overload; however, it appears to have a minimum threshold which acts like a squelch.

An earlier attempt used a bipolar mixer which had better sensitivity, plus more noise and overload problems. Despite the problems, some experimenters may find the bipolar type to be preferable.

In all, this circuit satisfied my immediate need for a small, inexpensive, superheterodyne receiver, and it opens new doors for

experimentation. Some ideas, which seem practicable using these building blocks as stepping stones, are suggested below:

1. A dual conversion system—by adding a 4.5 MHz *if* and crystal oscillator. The RCA CA3022 integrated circuit might be used for the amplifier.
2. An rf stage—because of the noise and selectivity characteristics described, a broadband stage might be suitable.
3. A product detector—several transistorized designs have been described recently in *73 Magazine*.
4. A higher power audio system—by substituting an Argonne AR163 for the present output transformer, the CA3020 will drive a power transistor such as the RCA 40250 or the 2N3054.

It is my intention to work on some of these ideas for a new mobile receiver, but I would not be disappointed if you beat me to completion.

... WB2EGZ



### TELREX (Patd.) "BALUN" FED "INVERTED-V" ANTENNA KITS

EASY-TO-INSTALL, HI-PERFORMANCE LOW-FREQUENCY ANTENNAS

"Mono" Bands from \$23.95—Also "Trapped" 2 and 3 Band Kits.  
3, 4 or 5 Band "Conical-Inverted-V" Antennas from \$52.95  
3, 4 or 5 Band, 5 to 10 DB—"Empirical-I.V.—Logs"—S.A.S.E.

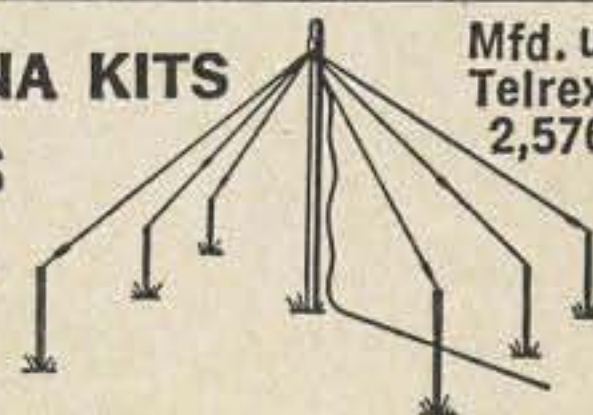

Mfd. under  
Telrex Pat.  
2,576,929

WRITE FOR  
TELREX PL 68

TELREX COMMUNICATION ENGINEERING LABORATORIES—ASBURY PARK, N. J. 07712



# VSWR Supreme

A new construction approach is described here for building a valuable old standby which has found a permanent place in the ham shack of today.

One of the most valuable tools used by the amateur is the Voltage Standing Wave Ratio Meter. It ranks with the grid-dipper and the plate current meter as an indispensable instrument around the ham shack. We know that the VSWR meter is very handy in indicating relative power output when tuning a transmitter, particularly when the plate dip is not too discernable. It is most useful, however, in proving that the last available watt has reached the antenna where it can do some good.

## Why a good match?

Although a good copper connection is made all the way to the antenna, an efficient

transfer of power may not be achieved because of a mismatch between the characteristic impedances of the various portions of the transmission system. The interesting thing is that the "match" is different for each frequency because the antenna is essentially a single frequency device.

We can appreciate the importance of a proper match between the transmitter and the antenna when we are told, for example, that a VSWR of 3 to 1 causes a power loss of nearly 3 dB for 200 feet of RG-8/U coaxial line at 30 MHz. The table below provides the real reason why we should be concerned with the impedance match. Notice how much the transmitter power would have to be increased to make up for a poor match between the transmitter and the antenna. Incidentally, this match involves each and every part of the total transmission system including connectors, antenna relay, low-pass filter, balun, etc., as well as the transmission line itself and that particularly critical point at which it is connected to the antenna.

## A new approach

Most VSWR meters today are an external accessory to the transmitter. But this practice is not good. Coaxial connectors are expensive and cause unwarranted mismatch and power loss. Meter faces usually end up behind the transmitter or in some other inaccessible location. When switching from forward to reverse, the little accessory box scoots across the table leaving scratches and a distraught operator.

The transmitter plate current meter is no longer a plug-in accessory. Why should the

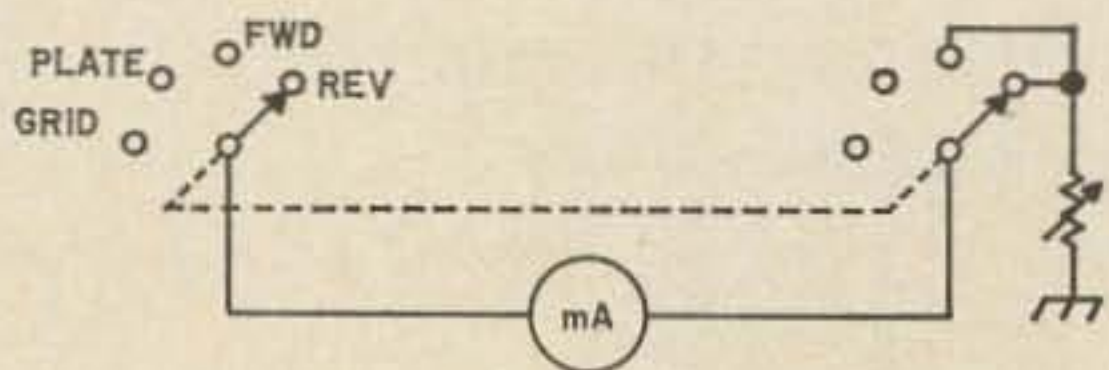
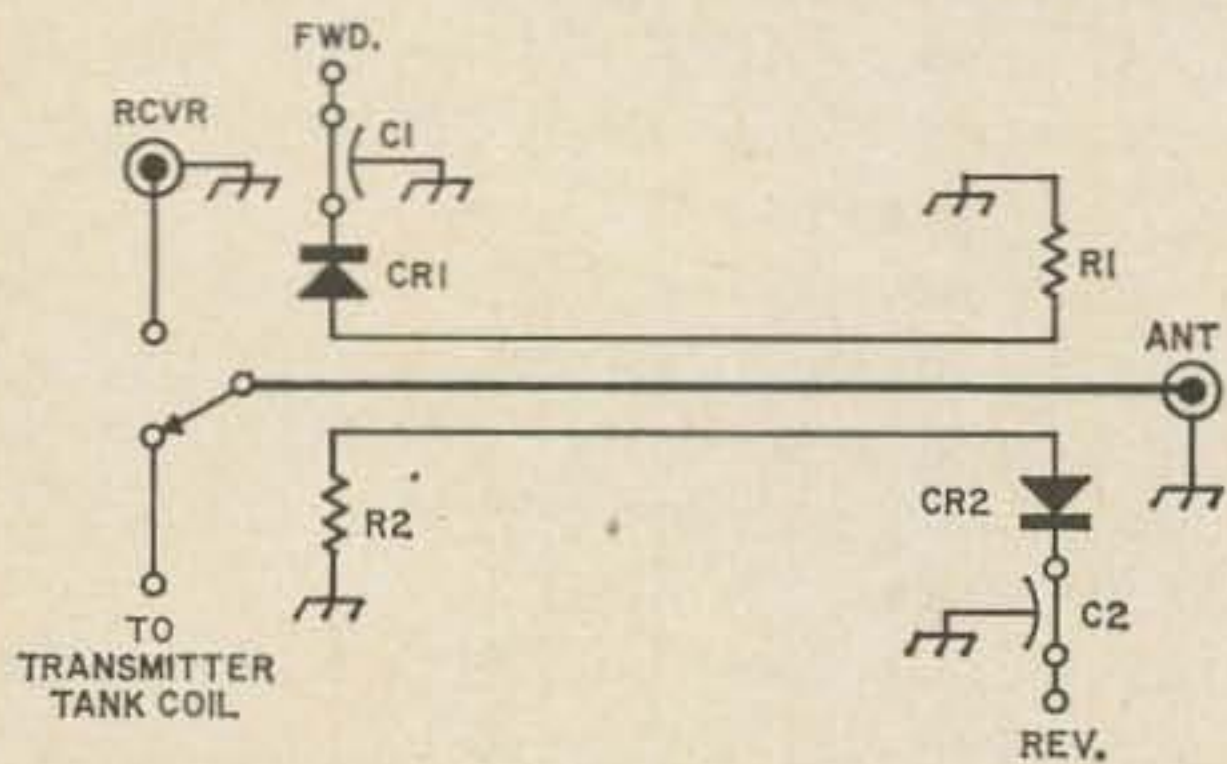

Fig. 1 Schematic of basic VSWR Meter and associated switching circuits.



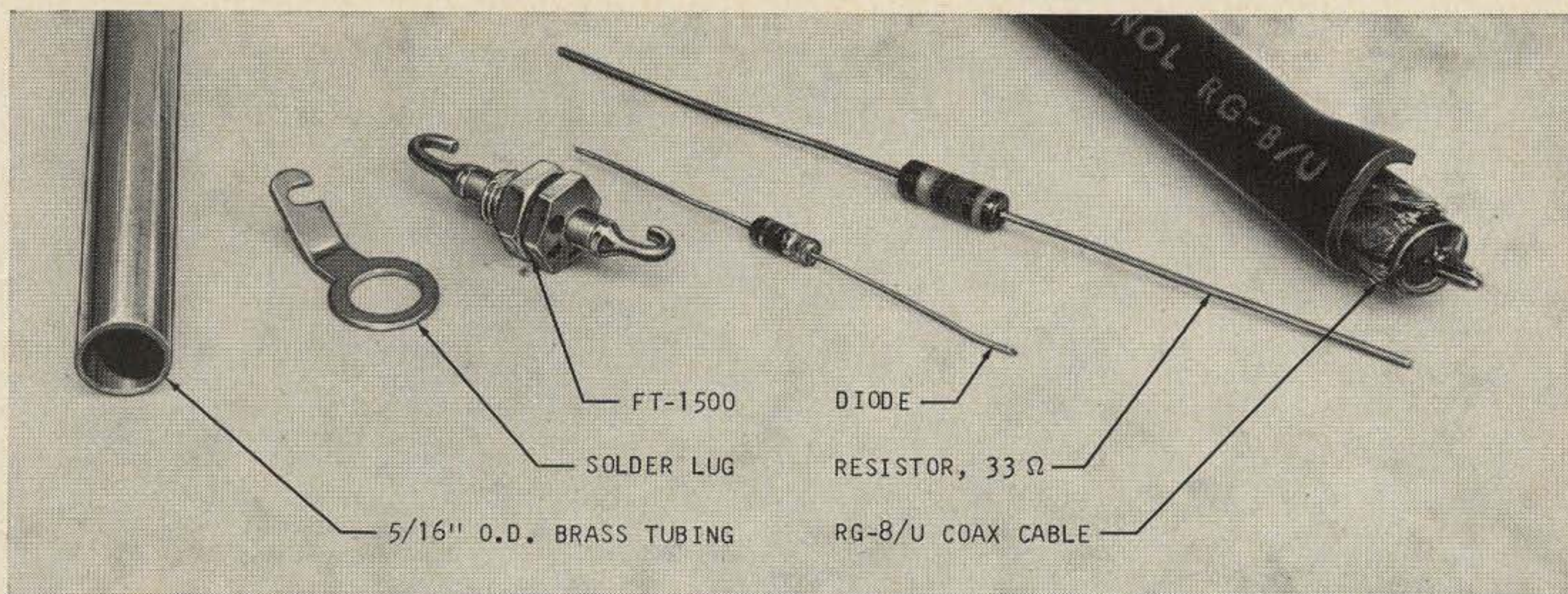

Fig. 2 Component parts used in making the VSWR sensing unit.

VSWR meter be? (Believe it or not, plate meters used to be plugged in with phone jacks.) Using the simple design described here, the home constructor as well as the commercial manufacturer can now build the VSWR meter into the transmitter in the smallest possible space and at only pennies of cost.

### The circuit

Nothing is new about the circuit. It has been adequately described in the past in magazine articles and handbooks. However, for the convenience of the reader, the VSWR meter circuit is reproduced in Fig. 1 for handy reference. Terminating resistors R1 and R2 should be 33 ohms for a 50-ohm transmission line when the physical configuration, as shown here, is used. One-half watt or smaller size resistors may be used. Diodes CR1 and CR2 are any matched pair of silicon diodes or germanium. The types which are enclosed in glass cases are the easiest to use because of their small size. The ohmmeter can be used to select and match the diodes

of the ten-cent surplus variety found in advertisements in the back pages of this issue. Bypass capacitors C1 and C2 are 1500 pF Centralab type FT-1500.

### Physical components

Parts used in this VSWR meter are illustrated in Fig. 2. The brass tubing is about 5 to 7 inches long and of  $\frac{5}{16}$  inch outside diameter. This size tubing fits snugly around the inner polyethylene insulation from RG-8/U coaxial cable. About 10 inches of coax is stripped of its outer jacket and braid. The inner insulation is trimmed to extend  $\frac{1}{8}$  inch past each end of the brass tubing. Two large solder lugs are selected to fit over the  $\frac{1}{4}$  inch threaded shank of the bypass capacitors. These lugs should be of the long variety so they may be shaped and soldered to the brass tubing as shown in Fig. 3. Two 8-inch pieces of #22 enameled copper wire are also required.

### Assembly

After soldering the lugs to the brass tubing about  $\frac{5}{8}$  inch in from each end, the bypass capacitors are assembled to the lugs. Place several fiber washers under the ring nuts prior to tightening them down on the threaded shank of the capacitors. This per-

Table 1

VSWR	Power Loss (dB)	Transmitter Power Needed to Provide 1 kW at the Antenna
1.5:1	2.1	1600 watts
2:1	2.3	1700
3:1	2.8	1900
4:1	3.3	2000
5:1	3.7	2300
7:1	4.5	2800
10:1	5.3	3400

Additional power needed to compensate for a poor impedance match between transmitter and antenna. Figures are based upon 200 feet of RG-8/U cable at 30 MHz.

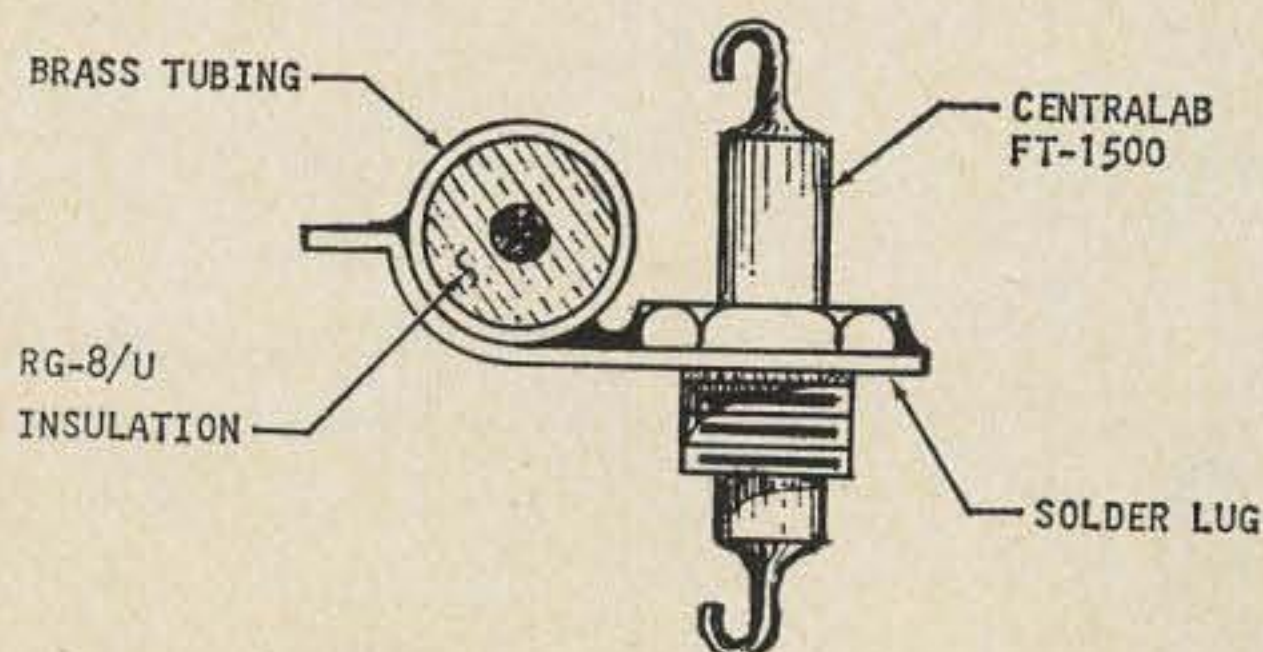

Fig. 3 Solder lug is shaped to fit one-quarter way around the brass tubing.



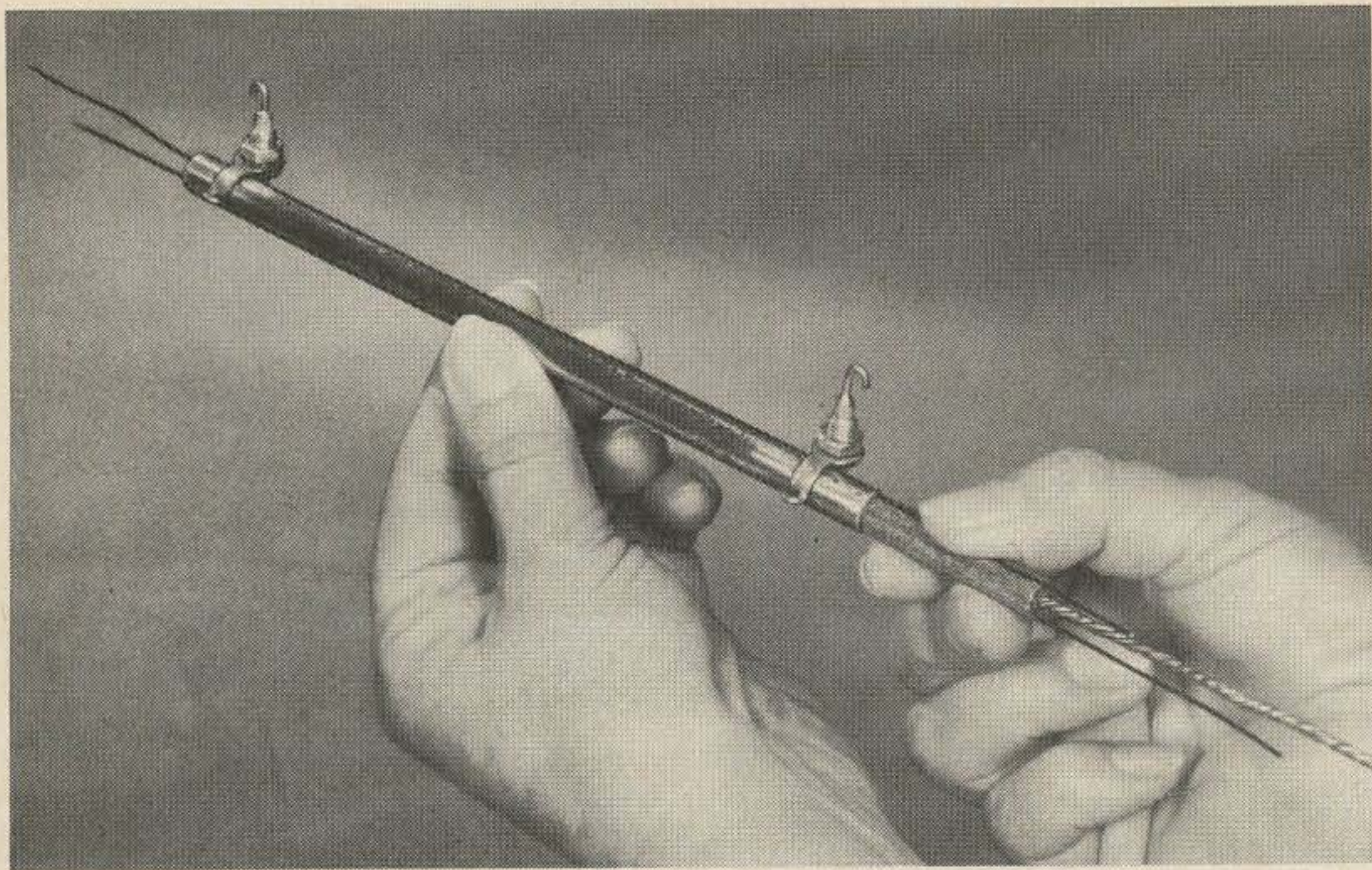

Fig. 4 Assembling the inner components into the brass tubing.

mits careful soldering of the capacitors to the lugs without danger of also soldering the nuts in place.

Two small grooves are now cut 180 degrees apart for the total length of the polyethylene insulation. A small wood carving gouge or carefully manipulated razor blade can be used for this purpose. These grooves provide a space for the enameled copper wire which is held in place when assembling as shown in Fig. 4. Prior to this operation, the wire should be stretched and work-hardened by jerking it between two pairs of pliers. Be sure that the plane described by the two wires lies at right angles to the chassis on which the unit is mounted. This permits all resistors and diodes to have equal lead lengths.

When the inner assembly has been tugged and shoved into place within the brass tubing, the #22 wire ends are trimmed, stripped and soldered to their respective resistors and diodes. Much care should be exercised at this point to prevent melting the insulation or damaging the near zero-length component leads.

### Application

A completed sensing unit for the VSWR meter is shown mounted on a typical chassis in Fig. 5. It will be noted that no conventional box or housing is used because the total outside of the unit is at ground rf and dc potential, save for the component connections at each end. By mounting the bypass capacitor in the chassis, the low-voltage rectified current fed to the meter switch is isolated from high-power rf on the other side of the chassis. It can readily be seen that the finished sensing unit occupies no more space than would be used by a coaxial lead running from an antenna relay to the antenna connector on the chassis.

A further refinement is shown in Fig. 6. Complete isolation of the high-power rf is provided by the coaxial hood. Impedance discontinuity is also minimized by use of the hood, which was designed for this purpose and is readily available.

### Length of sensor

The dimensions given for the length of the sensor element, including its outer tub-

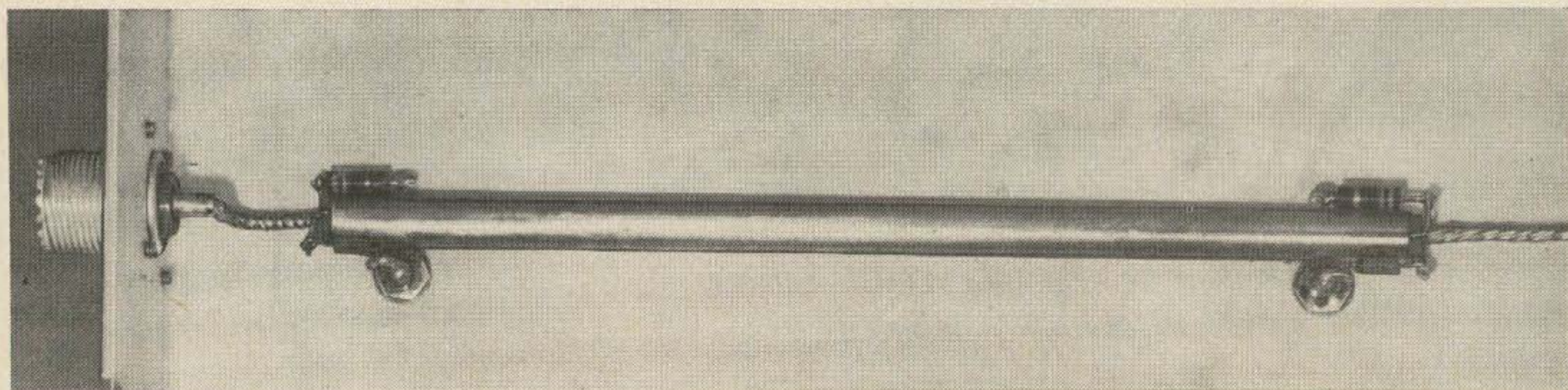

Fig. 5 Finished VSWR sensing unit mounted on a typical chassis.



ing and inner conductor, are not critical. They are, however, directly related to the power of the transmitter with which the VSWR meter is used. For example, with a one kilowatt high-frequency CW transmitter and a 0-1 millimeter as the indicating meter, the length of the sensor can be as short as 2-3 inches. A sensor which is constructed approximately 7 inches long, as illustrated in this article, will work fine with the same meter on a 25-200 watt high frequency transmitter. If meters with higher current ratings are used, a longer sensor is required, and, conversely, a more sensitive meter would provide adequate full-scale deflection with a shorter sensor element. Obviously, it is impracticable to vary the length of the sensor element in order to vary the sensitivity of the VSWR meter as a whole. It is for this reason that the adjusting resistor is provided in series with the meter. For VHF use, the sensor can be shorter.

All that has been said above can be depicted graphically. Fig. 7 shows the generalized relationship between the sensor length and transmitter power with which it is used. The two curves represent different meter sensitivities. A 0-1 millimeter offers a good compromise. With a 5-7 inch long sensor and the proper series resistor, all powers normally encountered in amateur work can be handled. However, if space requirements so dictate, a shorter sensor unit can be employed with some small sacrifice in accuracy.

Fig. 7 The approximate relationship between sensor length and transmitter power is shown for two commonly used meter movements. Other meter values may be used as discussed in the text.

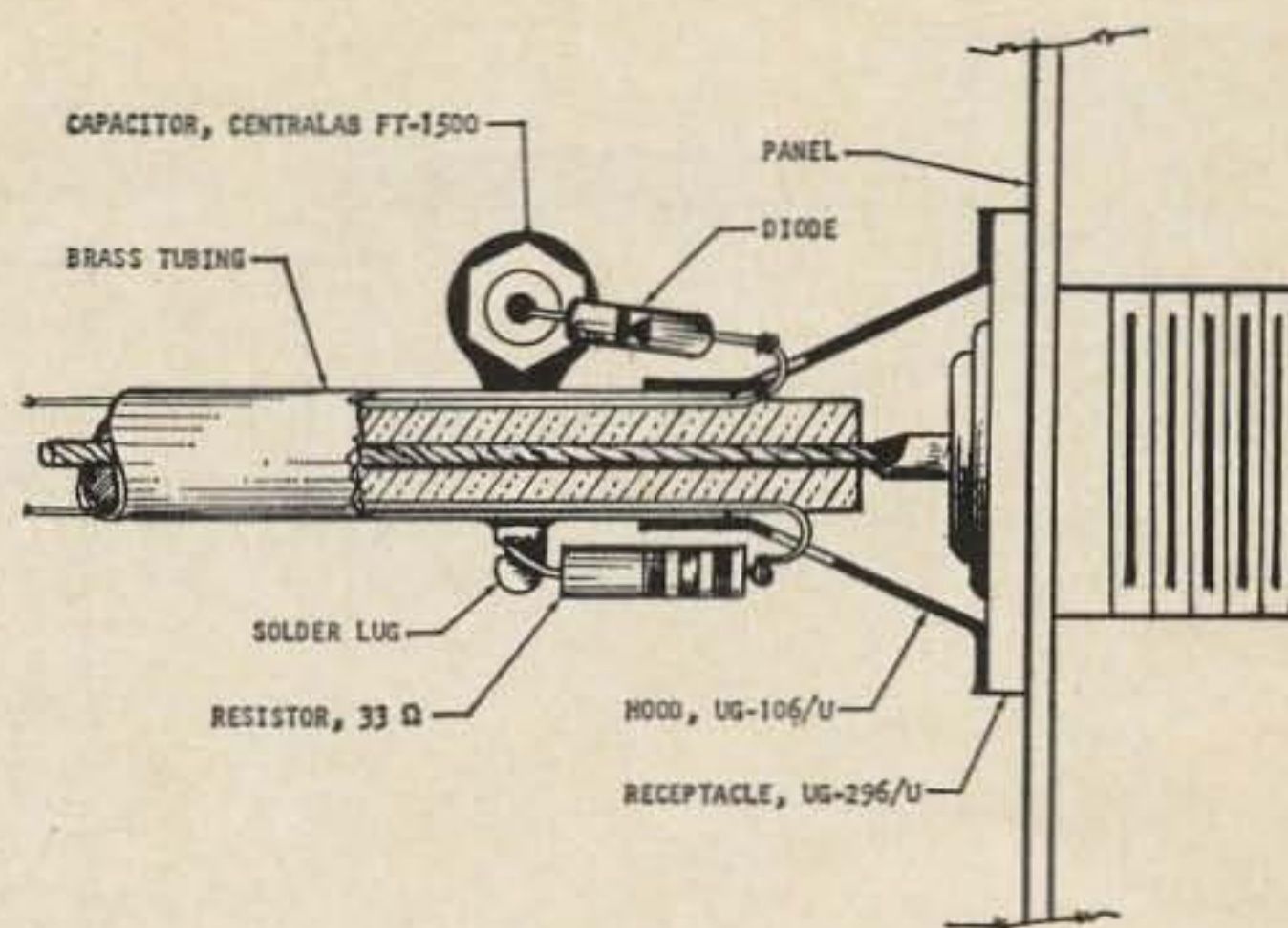
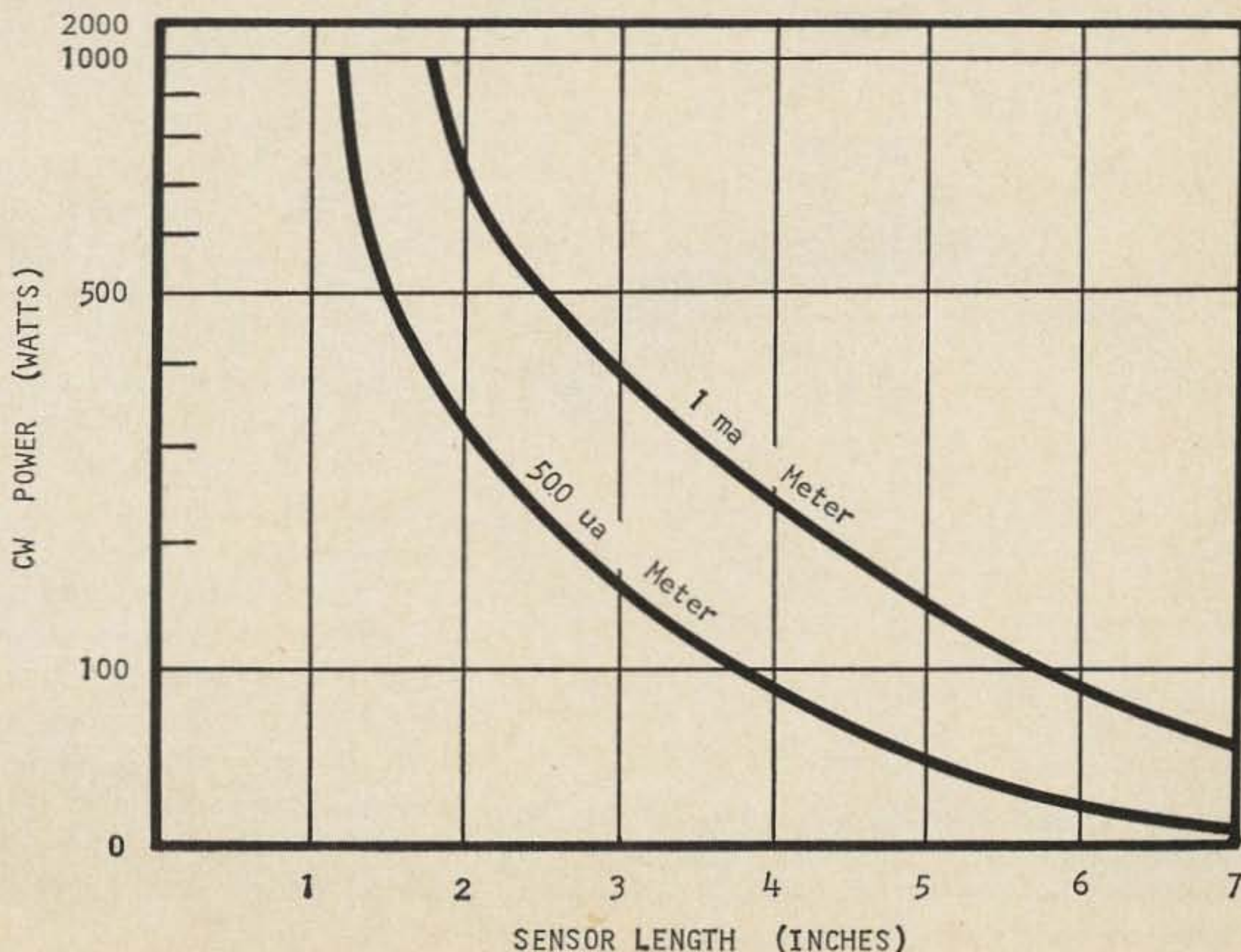

Fig. 6 Recommended chassis connection for output of VSWR meter sensing unit.

### Terminating resistor

Small variations in mechanical construction and lead dress will have an effect on the value of the terminating resistors,  $R_1$  and  $R_2$ . Also, a carbon resistor does not display the same reactance at high frequencies as its measured resistance at dc. The value of the 33-ohm resistor was therefore determined empirically.

To verify the proper value of the terminating resistors, the test set-up shown in Fig. 8 is used. A radio-frequency source of approximately 10 to 20 watts is required. A transmitter exciter stage operating on the 10-meter band is preferred for this purpose. Ten meters, or even fifteen meters, will provide better accuracy than one of the lower



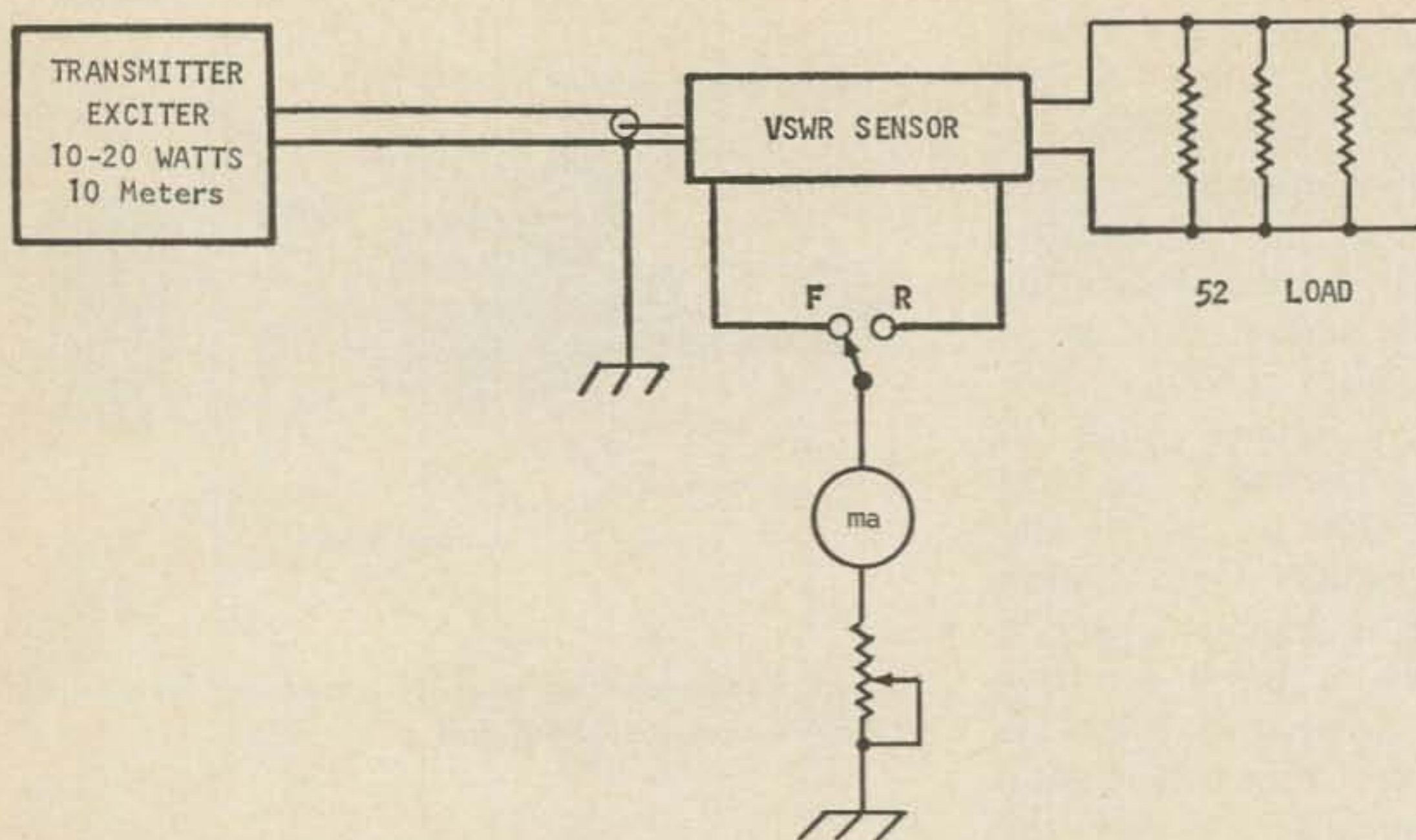

Fig. 8 Test set-up for verifying the proper value of the terminating resistors which are a part of the sensor unit. The value of the dummy load should match the characteristic impedance of the sensor unit and have a total wattage rating nearly equal to the source power.

frequency bands. A dummy load is also required. This load must be capable of dissipating the power of the radio-frequency source used in making the test. Three or four 2-watt carbon resistors of the proper value in parallel to provide 52 ohms will suffice if the power is not left on continuously.

In making the test, the selector switch is first placed in the "forward" position. With power applied, immediately adjust the sensitivity control so that the meter reads full scale. Upon switching to the "reverse" position, the meter should read near zero and be at or below the 1:1 calibration point on the meter scale. Several resistors may be substituted until the proper value is found. The important thing to remember is that both of

the resistors should be simultaneously substituted and that they must be as near identical as possible as measured on a reasonably good ohmmeter. Lead lengths should also be as short as possible and of identical length.

#### The dial scale

Using the standard formula for calculating VSWR, it is possible to calibrate the meter face as follows:

$$\text{VSWR} = \frac{\text{forward} + \text{reverse}}{\text{forward} - \text{reverse}}$$

Fig. 9 is a full-scale illustration of a meter face used with the *VSWR Supreme*. This scale fits the Triplet Model 327, as well as a number of other meters of the same size category. A word of caution—don't assume that the scale calibration, or linearity will be the same for all makes of meters. The individual meter movement selected should be checked by using the above formula and marking off radials representing 4-5 different VSWR values. With the scale from your meter at the center of an oversized radial(s) drawing, it is possible to verify the angular placement of each VSWR calibration point.

The *VSWR Supreme* is truly a novel approach to an old standby. Using the construction methods outlined in this article, it is possible to fabricate the sensor unit so that it occupies the smallest possible space. This sensor can now be built into a transmitter and take up no more room than the coaxial lead which it replaces.

... W4BRS

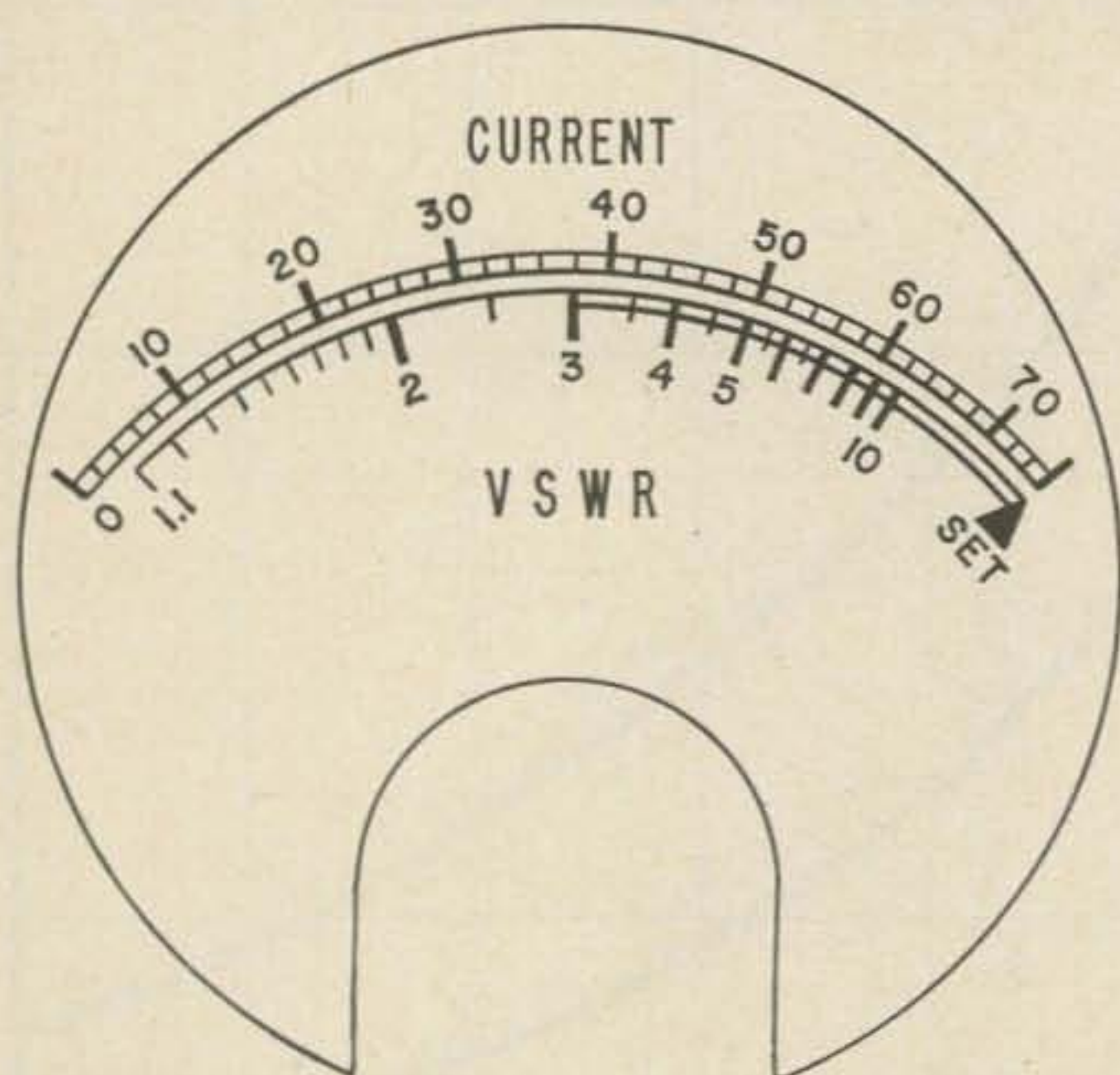

Fig. 9 Full-size photomaster of the VSWR meter dial. A multi-purpose meter was used in the author's transmitter so that the grid and plate currents could also be read on the upper scale.



# Want a high-pay career in Electronics?

## This free book may change your life

It tells how to go about getting the key to job success in the growing electronics boom—a Government FCC License

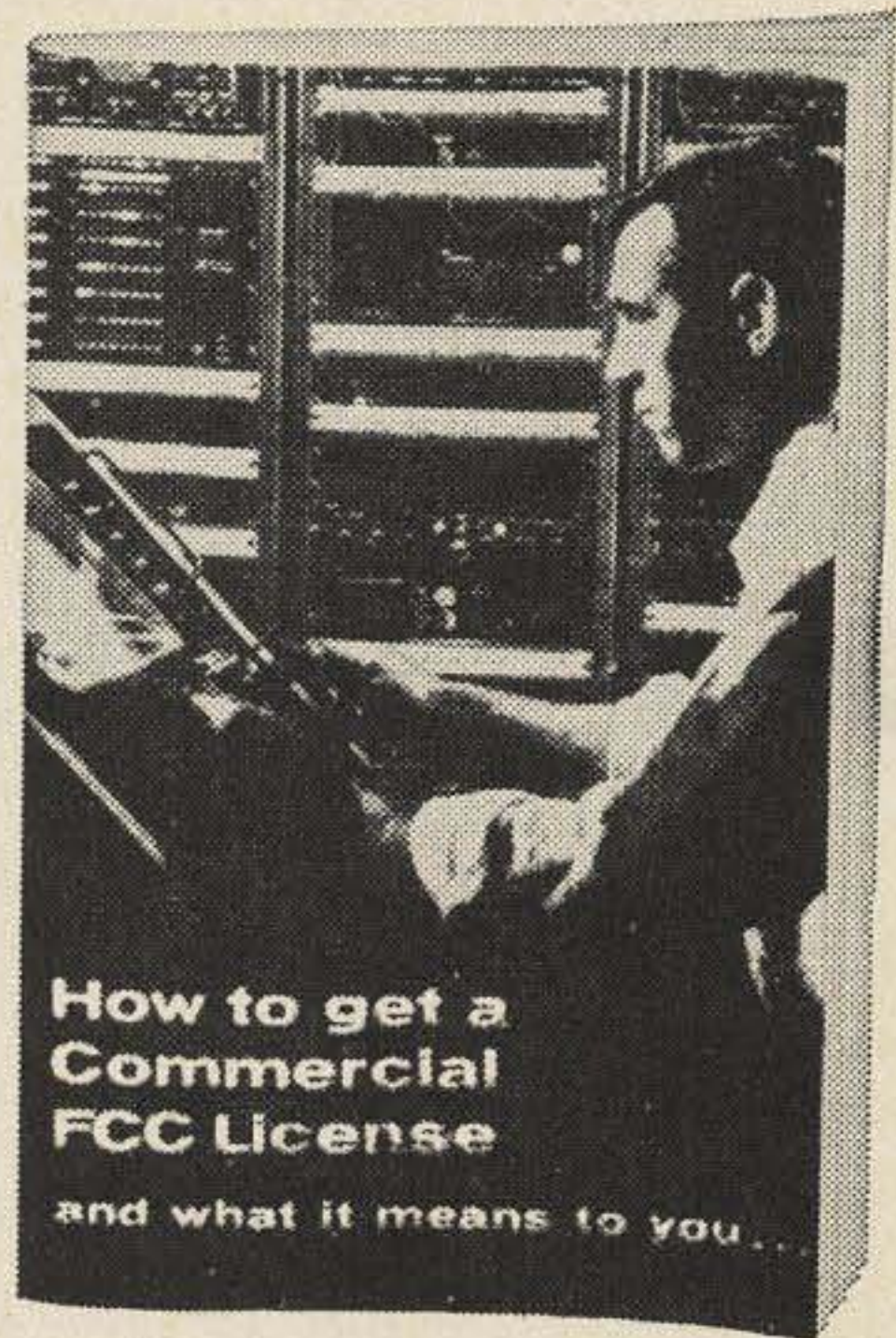

**T**HERE'S A BIG BOOM IN ELECTRONICS. And YOU can be part of it. You don't need a college education or any previous experience in electronics. The free book shown here tells you how.

In the last 15 years, the electronics manufacturing industry alone has grown from \$2.7 billion to \$17 billion, and is expected to hit \$24 billion by 1970.

Thousands of trained men are urgently needed to help design, manufacture, inspect, test, install, operate, and service electronics marvels that are making headlines. If you qualify, it means a secure, steady high-pay job with a real future to it.

Maybe you'd like to become a broadcast engineer . . . put famous radio disc jockeys and television entertainers "on the air." Or be your own boss servicing some of the more than a *million* two-way mobile radio systems in taxis, trucks, trains, etc. Or work alongside famous scientists developing and testing such electronics miracles as picture-frame TV, desk-top computers, pea-sized hearing aids, rocket guidance and control systems.

Regardless of which you choose, the secret of "getting your foot in the door" is getting a Government FCC (Federal Communications Commission) License. It's government-certified *proof*, respected by employers everywhere, that you have passed a standard Federal exam on the fundamentals of electronics—that you're not just an electronics handyman, but a real "pro." Many jobs legally require it.

Now, because of the importance of getting your FCC License, Cleveland Institute of Electronics has prepared a valuable 24-page book telling you how to go about it.

### ENROLL UNDER NEW G.I. BILL

All CIE courses are available under the new G.I. Bill. If you served on active duty since January 31, 1955, OR are in service now, check box in coupon for G.I. Bill information.

You will find out why the Commercial FCC License is often called the "passport to success." You'll see how and why the Government issues these licenses. You'll learn how you can get your license . . . and qualify for top opportunities in Electronics.

With this book, you will receive a second free book, "How To Succeed In Electronics." It's the catalog of the Cleveland Institute of Electronics . . . first organization to offer an FCC License Warranty. (CIE will refund all of your tuition if you don't pass the FCC exam . . . on your first try . . . after completing the course designed to prepare you for it.) You will learn why better than 9 out of 10 men with CIE training get their FCC Licenses, even though 2 out of 3 without this training fail.

To receive both books without cost or obligation, just mail the coupon below. If coupon has been removed, write to: Cleveland Institute of Electronics, 1776 East 17th Street, Dept. ST-15, Cleveland, Ohio 44114. Do it now—it may change your whole life.

### MAIL COUPON FOR 2 FREE BOOKS

 **CIE** Cleveland Institute of Electronics  
1776 East 17th Street, Cleveland, Ohio 44114

Please send me, without cost or obligation, your 24-page book, "How To Get A Commercial FCC License," together with your school catalog, "How To Succeed In Electronics," of license-preparation courses.

Name \_\_\_\_\_  
(please print)

Address \_\_\_\_\_

City \_\_\_\_\_ State \_\_\_\_\_ Zip \_\_\_\_\_

Occupation \_\_\_\_\_ Age \_\_\_\_\_

Check here for G.I. Bill information.

Accredited Member National Home Study Council  
A Leader in Electronics Training . . . Since 1934 ST-15



## Dual-Band Use of Single-Band Beams

W2EEY describes several ways the driven element of a single-band beam can be used on a higher frequency band without affecting beam performance on the band for which the beam is designed.

With the number of sunspots rapidly growing, many amateurs want to be able to use their present antennas on a higher band. Particularly, those with a 20-meter beam with a center-fed driven element might desire to have a radiator available on 15 or 10 meters and those with a 15-meter beam to have a 10 meter capability.

The purpose of this article is to present some simple ideas on how the center-fed driven element of a beam can be converted for use as an effective radiator on a higher band without in any way affecting performance on the basic band. Only the driven element is effected; no attempt is made to convert the entire beam to a dual-band affair. Methods of making dual-band beams have been well described before and the simple

conversions mentioned in this article are meant only to give capability on a higher band perhaps as a preliminary step to later erecting another beam.

Basically, all that is done is to use the half-wave driven element as a three-quarter or full-wave element on a higher band with a simplified feed system. The three-quarter and full wave dipoles have a very minor amount of gain (about 1 to 2 dB), but the directivity is enough to make rotation worthwhile. With the exception mentioned later, a 20 or 15 meter wire dipole can also be converted for use as a dual-band antenna.

As shown in Fig. 1, as the ratio of the diameter of a linear conductor from which an antenna is constructed increases as compared to wavelength, the characteristics of the in-

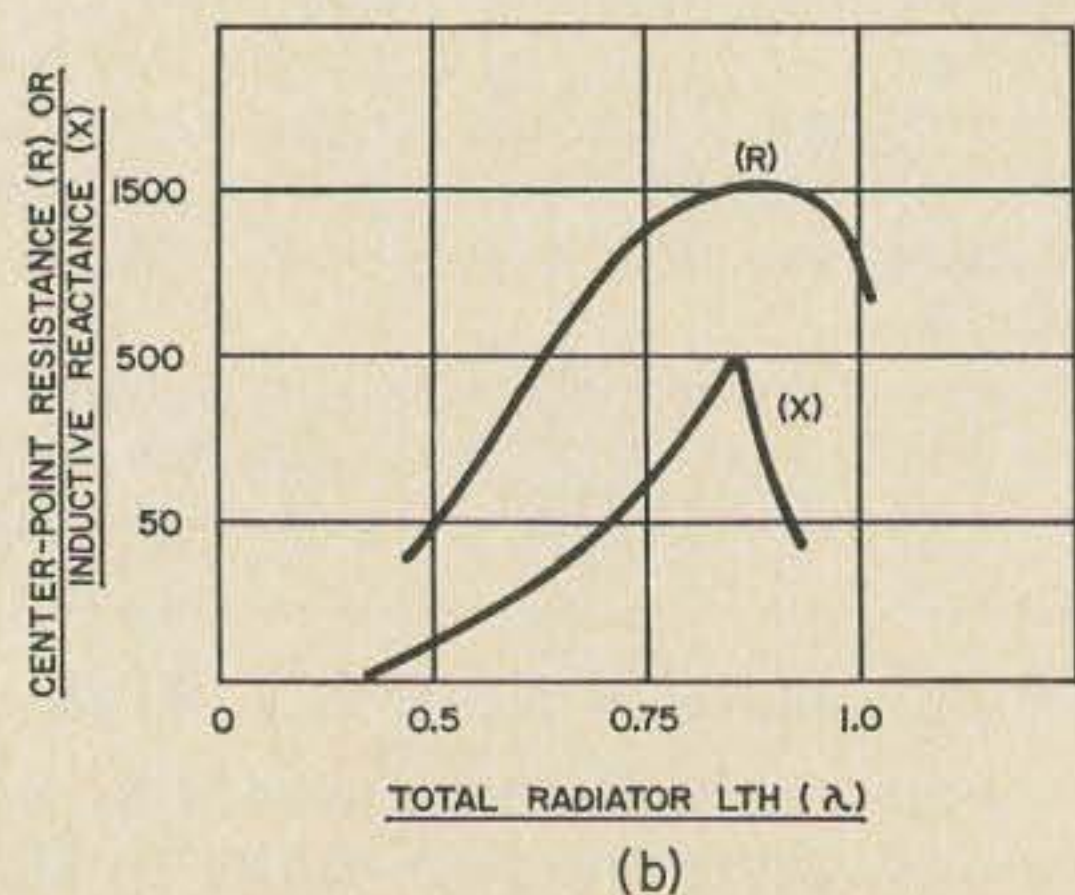
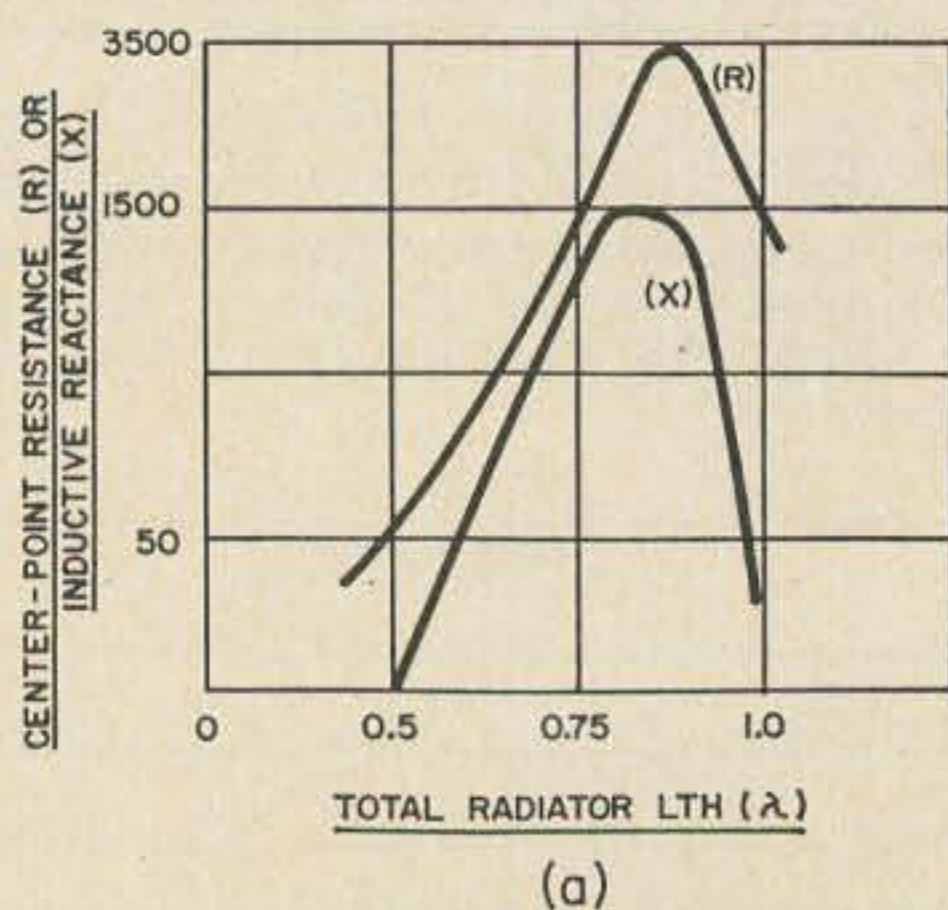

Fig. 1. The center-point impedance of a radiator for wavelength/conductor diameter ratios of  $\lambda/1000$  (a) and  $\lambda/100$  (b).



put impedance change. The resistive portion of the feed point impedance decreases in value and the peaks of the response broaden out. The reactive portion of the impedance decreases even more rapidly than the resistive portion and exhibits a sharper peak. There are also shifts in the exact radiator wavelength values at which the peaks occur but these are minor for the two wavelength/conductor ratios considered— $\lambda/100$  and  $\lambda/1000$ .

Most of the tubing used for beam construction on 20 and 15 meters will have wavelength/diameter ratios between these two extremes. Single wire antennas will have higher ratios—approximately  $\lambda/10,000$  for number 14 wire. In order to utilize the dual-band feed system mentioned in this article, the ratio must be reduced by using two or more wires on each side of the dipole which are fanned out to at least a foot separation between them at the ends.

Matching a transmission line to the impedance presented at the center point of a dipole which is  $\frac{1}{2}$  wave long on one band and  $\frac{3}{4}$  wave long on another band can be done in several ways. A double stub matching system can be used to produce an almost exact match to a transmission line on two bands but the adjustment procedure is unduly tedious, especially for the amateur who wants just occasional usage of an antenna on a higher band. The matching system actually used is a simple quarter-wave linear transmission line transformer. Such a transformer will not cancel the inductive reactance which a  $\frac{3}{4}$  center fed dipole presents. It can only match a transmission line to the resistive portion of the antenna impedance. However, as the wavelength/diameter ratio becomes reasonably large, the reactive portion of the impedance comes down to a value which can be accepted by most transmitter output circuits and the SWR will be a reasonable value on the higher band.

Fig. 2 shows a 15-meter dipole which can also be used on 10 meters. Since the matching section is cut to  $\frac{1}{2}$  wavelength on 15 meters, the antenna terminals see exactly the same impedance as the coaxial transmission line and 15 meter performance is not changed in any manner. On 10 meters the matching section becomes approximately  $\frac{3}{4}$  wave long (actually  $.7 \lambda$  on 28,500 kHz when cut to  $.5 \lambda$  on 21,000 kHz). The somewhat shortened length presents some capacitive reactance to

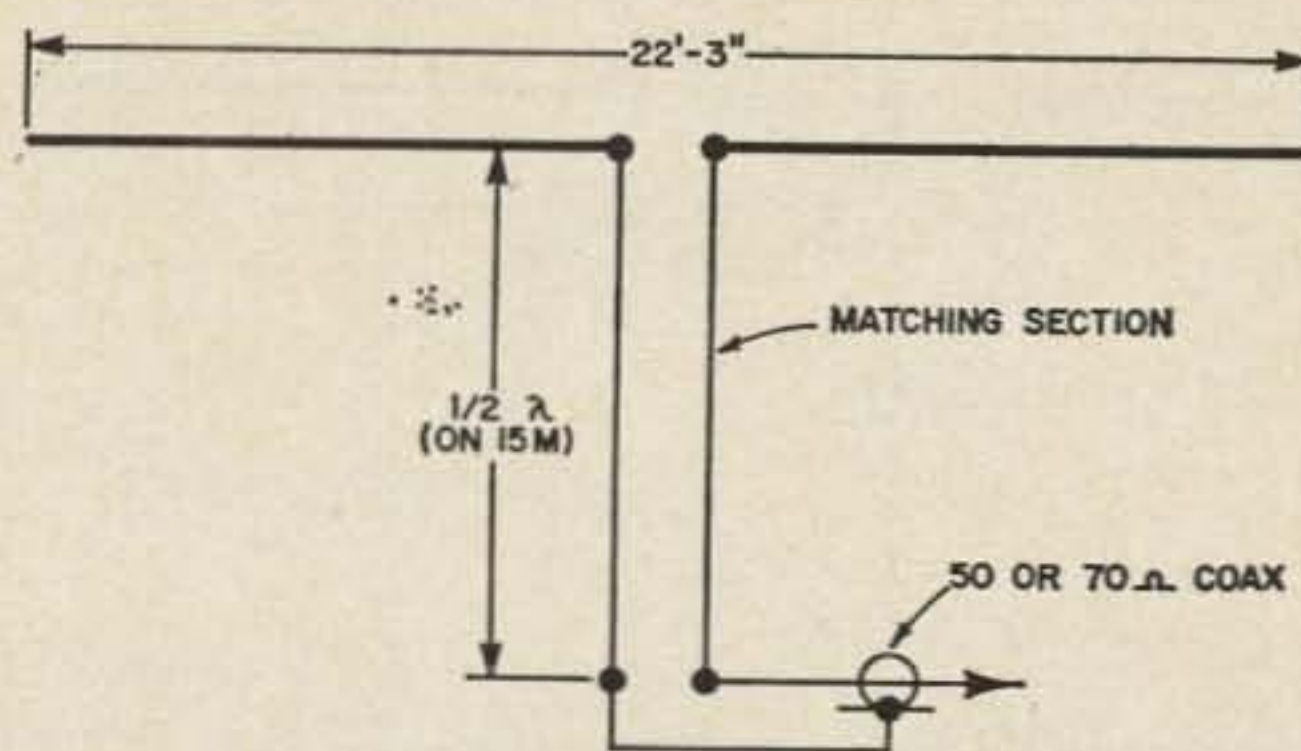

Fig. 2. A 15-meter dipole with a matching section for use on 10 meters. The impedance of the matching section depends upon the physical characteristics of the antenna as explained in the text.

the antenna terminals and seems to partly compensate for the inductive reactance of the  $\frac{3}{4} \lambda$  long flat-top on ten.

The impedance of the matching section is determined from the standard formula:

$$Z = \sqrt{Z(\text{coax}) \times Z(\text{ant})}$$

The impedance of the antenna on 10 meters can be estimated from Fig. 1 by taking the average antenna conductor diameter to estimate the wavelength/diameter ratio. For instance, for an average diameter of one inch, a matching section of 300 ohms would be used to match the approximate 2,000 ohm input impedance. In most cases, a 150 or 300 ohm matching section will suffice for the range of impedance encountered to produce a SWR of 2 to 1 or less on the higher band. The physical length of the matching section must take into account the velocity factor of the transmission line used (for instance, a  $\frac{1}{2} \lambda$  line of 300 ohm twinlead on 15 meters would be 17'2").

Using a 20 meter driven element on 15 meters presents almost exactly the same situation except that a  $\frac{1}{2}$  wave matching section on 14,000 kHz becomes almost exactly  $\frac{3}{4}$  wave on 21,000 kHz and no effective com-

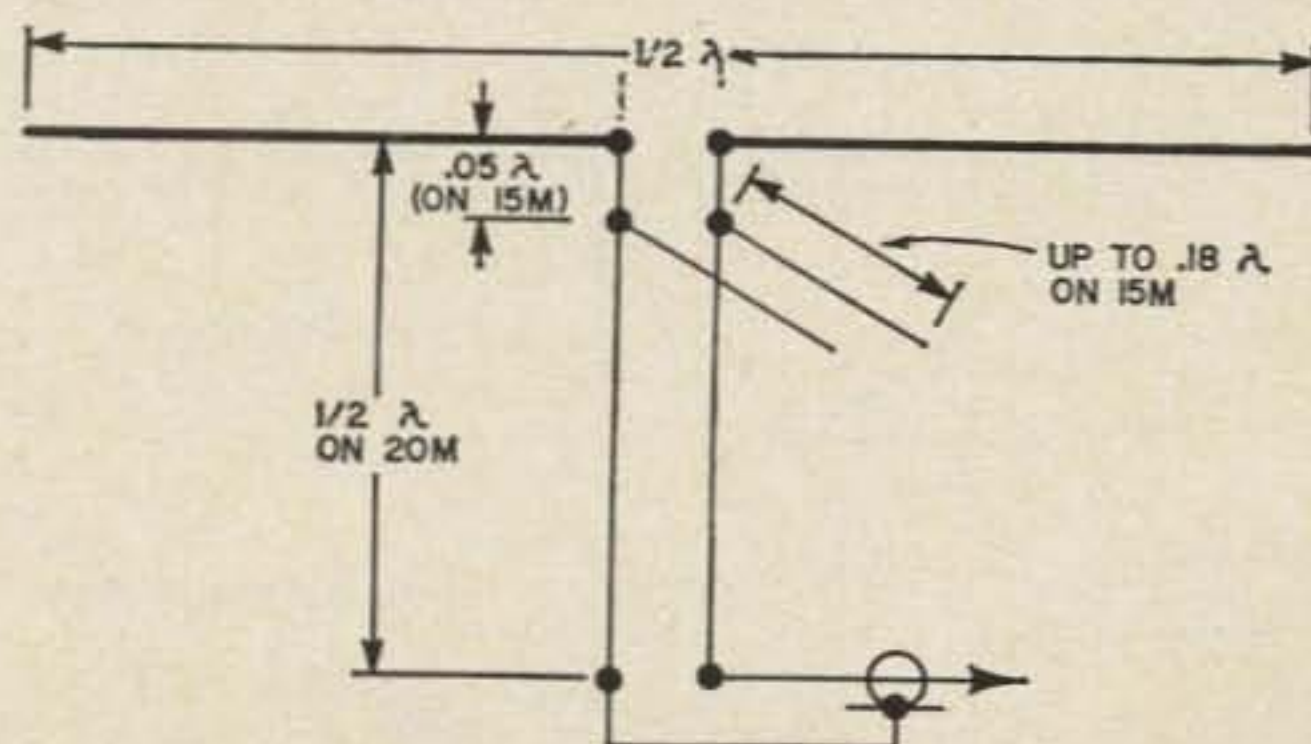

Fig. 3. The use of a 20-meter dipole on 15 meters may require the use of a small capacitive stub across the matching section.



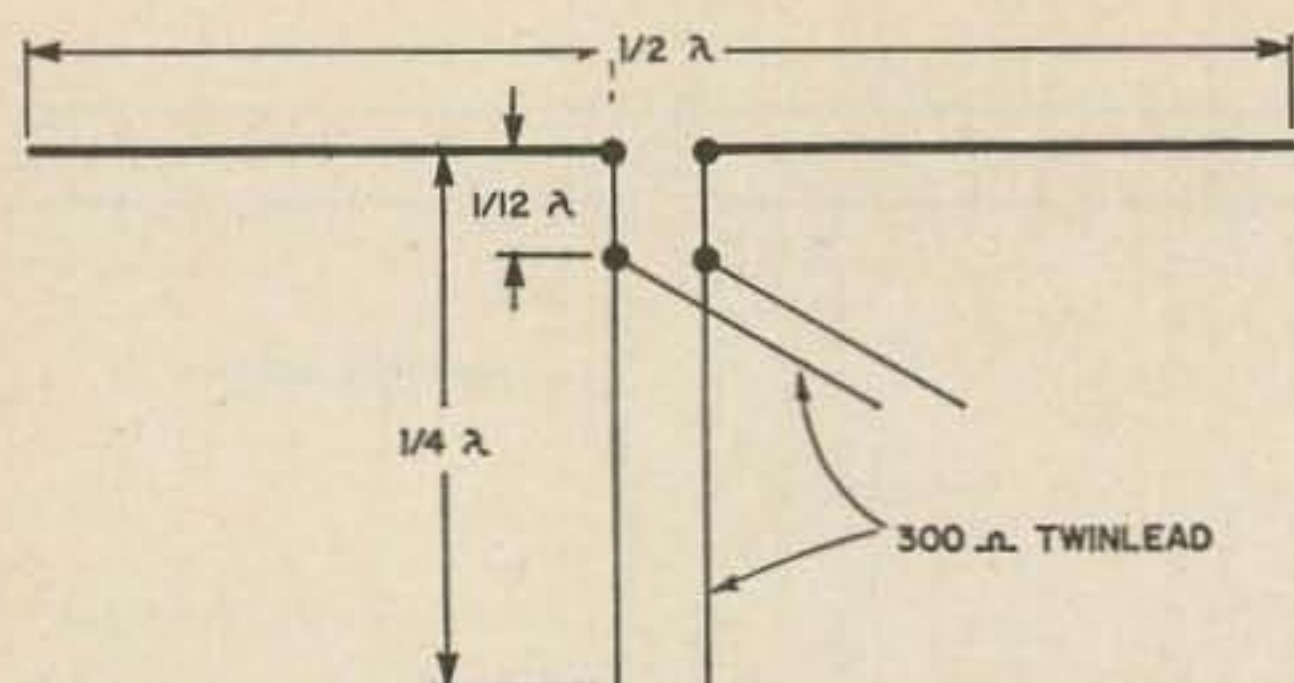

Fig. 4. Using a 20-meter dipole on 10 meters by matching with a  $\frac{1}{4} \lambda$  stub. The 300-ohm twinlead to the transmitter can be replaced with coaxial cable if a 4:1 wideband balun is used where the twinlead is attached to the stub.

compensation is provided for the reactive portion of the antenna impedance on 15 meters. Whether the reactance is sufficient to cause tuning difficulties depends upon the exact installation and operation of the transmitter output circuit. If difficulties are encountered, a stub of the same type line as the matching section can be added to the matching section as shown in Fig. 3 and trimmed for proper tuning. The position of the stub is not exactly correct as shown, but will suffice in most cases where antenna operation must not be effected on the fundamental frequency.

The use of a 20 meter dipole element on 10 meters cannot be accomplished by the use of a simple through-line  $\frac{1}{2}$  wave transmission line transformer because of the even multiple harmonic relationship of the two bands. Again, there would be various possibilities to match the antenna to the transmission line by use of multiple stub arrangements. However, the easiest scheme is an old one from the 1930's which gained popularity as a multiband antenna matching method, long before trap antennas were popularized.

A quarter-wave open stub is connected to the center of a half-wave dipole and the transmission line is connected across the stub one third the distance along it from the antenna. If the voltage and current distribu-

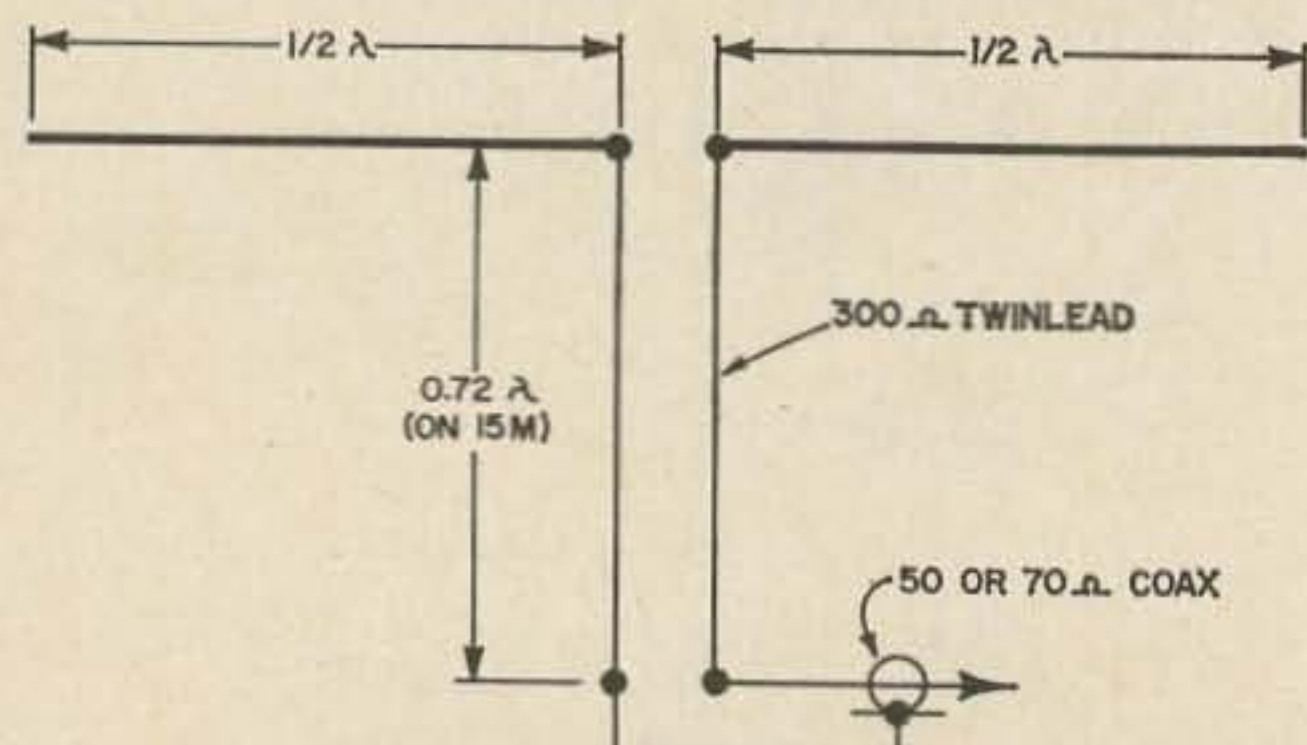

Fig. 5. A full-wave antenna for 15 meters can also be used on 10 meters if a  $0.72 \lambda$  matching section is used.

tions are drawn, it will be seen that almost the same impedance is presented at the one third point for the fundamental and all even harmonic frequencies; certainly for the fundamental and second harmonic, they are the same. Fig. 4 shows the arrangement using a 300 ohm transmission line. It should be noted that since essentially no reactance is present at the antenna terminals, the considerations regarding wavelength/conductor diameter ratio are not as important as in the previous matching methods.

A relatively simple matching system for a full-wave wire antenna for use on 15 and 10 meters can also be developed using a transmission line transformer in a fashion similar to our first scheme. Fig. 5 shows the matching arrangement. The matching section is cut slightly shorter than  $\frac{3}{4}$  wavelength on 15 meters and acts as a  $\frac{1}{4}$  wave transformer to match the low coaxial cable impedance to the high center impedance of the full-wave antenna. On 10 meters, the antenna flat-top portion becomes  $\frac{3}{2} \lambda$  long and the matching section is essentially  $1 \lambda$  long. Since the latter is a multiple of  $\frac{1}{2} \lambda$ , the low center impedance of the  $\frac{3}{2} \lambda$  flat-top is reflected directly to the coaxial transmission line.

It should be noted that although the  $\frac{3}{4} \lambda$  matching section performs as a  $\frac{1}{4} \lambda$  transformer ( $\frac{1}{2} \lambda$  section which performs no impedance transformation plus a  $\frac{1}{4} \lambda$  section which acts as the transformer), a  $\frac{1}{4} \lambda$  matching section cannot be used directly on the 10 meter band because its length ( $.35 \lambda$ ) would not be close enough to  $\frac{1}{2} \lambda$  to be suitable.

It should also be noted that since this antenna is  $\frac{3}{2} \lambda$  long on 10 meters, the horizontal radiation pattern changes from a maximum lobe broadside to the wire to a cloverleaf pattern. This is in contrast to the previously described antenna systems which produce a maximum length of  $1 \lambda$  so that a collinear array of two  $\frac{1}{2} \lambda$  elements was formed and maximum radiation remained broadside to the antenna, the same as for a  $\frac{1}{2} \lambda$  dipole.

The ideas presented in this article are not really new since transmission line transformers and stubs have been used for multiband antennas since the early 1920's. However, these ideas should enable most amateurs to at least quickly and simply provide themselves with a dual-band antenna from a simple one-band dipole.

... W2EEY/1



# New! The Most Modern Amateur Radio Spectrum Monitor Ever Offered



## Heathkit SB-620 "Scanalyzer" . . . . Only \$119.95

• New narrow fixed sweep function with crystal filter for single signal analysis — 10 kHz, 50 kHz, and variable control to 500 kHz • Increased sweep width capability for monitoring larger band segments — up to 500 kHz for IF's above 455 kHz, and up to 100 kHz for 455 kHz IF's • Matches SB-Series in style and performance • Operates with common receiver IF's up to 6 MHz • Both

linear and logarithmic amplitude displays • Long persistence CRT for optimum display • New improved voltage doubler power supply • Mu-metal fully shielded CRT • Simple connection to receiver • Plus all of the versatile performance and operating features already made famous by the HO-13 Spectrum Monitor.



**Analyzing Function** — 10 kHz preset sweep width — indicate carrier 100% modulated by 2 kHz tone-log scale.

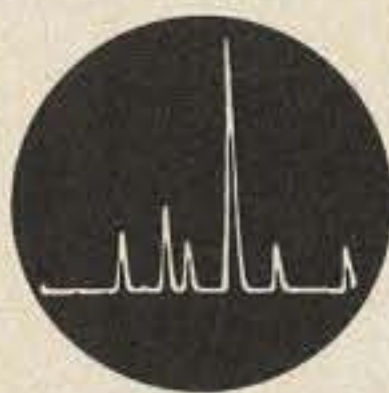

**Scanning Function** — approximately 250 kHz sweep width — indicates two signals above and three below the received signal, the strongest signal about 30 kHz down the band, down frequency being to the right.

The New Heathkit "Scanalyzer" Boasts Up To A Full 500 kHz Wideband Display — Plus 10 kHz Single-Signal Display. Displays up to 250 kHz either side of receiver tuned frequency (up to 100 kHz for 455 kHz IF's) . . . allows you to easily monitor band activity during contests or openings without going through the tedious hunt-and-tune procedure. The new SB-620 also brings accurate

**SB-620 SPECIFICATIONS** — **RF AMPLIFIER:** Input frequencies: One of the following; 455 kHz, 1000 kHz, 1600 to 1680 kHz, 2075 kHz, 2215 kHz, 2445 kHz, 3000 kHz, 3055 kHz, 3395 kHz, 5000 to 6000 kHz. **Frequency response:**  $\pm 0.5$  db at  $\pm 50$  kHz from receiver IF. **IF frequency:** 350 kHz. **Sensitivity:** Approximately 10 uv input signal provides a visible signal (40 db mark) at full pip gain setting. **Spectrum analyzer:** Test signal input frequencies up to 50 MHz. **HORIZONTAL DEFLECTION:** **Horizontal sweep generator:** Sawtooth sweep produced by neon lamp relaxation oscillator. **Sweep Rate (Approximate frequencies):** 10 kHz preset: 0.5 Hz. 50 kHz preset; 2 Hz to 2.5 Hz. Variable: 5 Hz to 15 Hz. **Preset sweep width:** 10 kHz preset: 10 kHz. 50 kHz preset: 50 kHz. **Variable sweep width:**\* 455 kHz (10 to 100 kHz); 1000 kHz (50 to 100 kHz); 1600 kHz (50 to 500 kHz); 1680 kHz (50 to 500 kHz); 2075 kHz (50 to 500 kHz); 2215 kHz (50 to 500 kHz); 2445 kHz (50 to 500 kHz); 3000 kHz (100 to 500 kHz); 3055 kHz (100 to 500 kHz); 3395 kHz (100 to 500 kHz); 5200 kHz (100 to 500 kHz); 6000 kHz (100 to 500 kHz). **Resolution:** 1 kHz. Note: Resolution is defined as the frequency separation between two equal adjacent signals such that the intersection between

signal analysis to amateur radio . . . allows measurement of carrier, sideband, and distortion product suppression. A quality test instrument. Styled to match the Heath SB-Series equipment, the SB-620 operates with practically all receivers (see specifications). Here is a useful prestige instrument for your amateur station.

**Kit SB-620, 15 lbs. . . . . \$119.95**

their respective pip indications is 30% below the apex amplitude. **Amplitude scales:** Linear: 20 db (10:1) range. Log: 40 db (100:1) range. —20 db Log: (Extends calibrated range to 60 db). **POWER SUPPLY:** Type: Transformer operated; fused at  $\frac{1}{2}$  ampere. **Low voltage:** Full-wave voltage doubler circuit, using four silicon diodes. **High voltage:** Full-wave voltage doubler circuit, using two selenium diodes. **Bias voltage:** Full-wave bridge circuit, using four silicon diodes. **Power requirements:** 120 or 240 volts AC, 50/60 Hz, 40 watts. **GENERAL:** **Tube complement:** (1) 3RP7 CRT, high persistence (yellow trace with screen filter). (1) 6AT6, detector vertical amplifier. (1) 6AU6, IF Log amplifier. (1) 6EA8, sweep oscillator, mixer. (1) 6EW6, RF amplifier. (1) 6EW6, IF amplifier. (1) 12AU7, horizontal, push-pull amplifier. **Diode complement:** (8) Silicon diodes, low voltage rectifier, DC filament rectifier. (2) Selenium diodes, high voltage rectifiers. (1) Silicon diode, voltage-variable capacitor. **Dimensions:** 10" W x 6 $\frac{5}{8}$ " H. x 10 $\frac{1}{2}$ " D.

\*These sweep widths are minimum values. Actual sweep width ranges will be greater than those listed, depending on the receiver IF frequency for which unit is wired.



### FREE 1967 CATALOG

Describes these and over 250 kits for stereo/hi-fi, color TV, amateur radio, shortwave, test, CB, marine, educational, home and hobby. Save up to 50% by doing the easy assembly yourself. Mail coupon or write Heath Company, Benton Harbor, Michigan 49022.

**HEATH COMPANY, Dept. 11-7**  
Benton Harbor, Michigan 49022



Enclosed is \$ \_\_\_\_\_, plus shipping.

Please send model (s) \_\_\_\_\_

Please send FREE Heathkit Catalog.

Name \_\_\_\_\_

(Please Print)

Address \_\_\_\_\_

City \_\_\_\_\_ State \_\_\_\_\_ Zip \_\_\_\_\_

Prices & specifications subject to change without notice.

AM-184



## Grounded-Grid Filament Chokes

Designing high-current rf filament chokes for grounded-grid amplifiers.

The grounded-grid amplifier is proving very popular with the ham fraternity for the amplification of SSB signals. An amplifier of this type is characterized by a comparatively low input impedance and relatively high driving power. Most SSB exciters in use today meet these requirements with ease, generally having a 50-ohm output at 100 watts or more. A disadvantage of the grounded-grid circuit is that the filament must be isolated for rf from ground.

Fig. 1 is a typical grounded-grid input circuit. Since the filament of the grounded-grid amplifier tube must operate at a rf potential above ground, it is necessary to iso-

late the filament from the transformer. A popular method of accomplishing this isolation is to place an rf choke between the tube filaments and the filament transformer.

In the construction of a choke for this application, the inductance of the choke must be such that the reactance is several times the input impedance. If the amplifier input is 50 ohms, the reactance of the choke should be about 250 ohms at the lowest operating frequency. The choke conductor must be large enough to carry filament current without excessive voltage drop. In addition, the choke must not have series-resonance points at any of the operating frequencies.

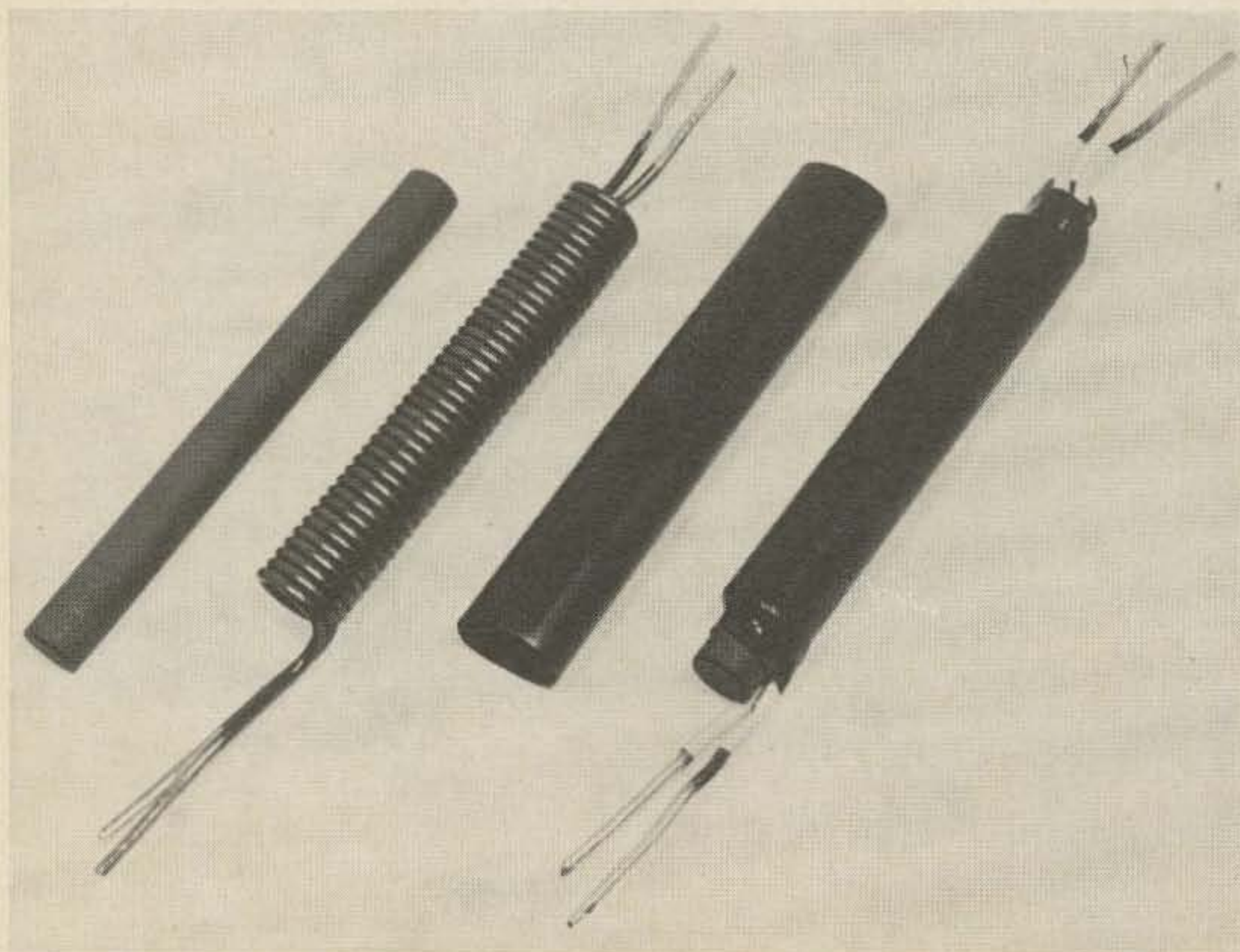

The complete bifilar wound, grounded-grid filament choke is on the right. From left to right respectively are the ferrite core, the bifilar-wound-coil and the heat-shrinkable tubing used for the outer cover.

Photograph by Bob Fleischman WA6WFE



The minimum required inductance can be calculated from the inductive reactance equation:

$$L = \frac{X_L}{2\pi F}$$

Where:  $2\pi = 6.28$

$$F = 3.5 \times 10^6 \text{ (3.5 MHz)}$$

$$X_L = 250 \text{ (desired reactance)}$$

$$L = \frac{250}{6.28 \times 3.5 \times 10^6} = 11.3 \mu\text{H}$$

The first requirement is to produce a coil having an inductance of 11.3 microhenries.

Before proceeding with winding the choke, it is necessary to determine the required wire size. This is based on the filament current. As an example, consider the 3-1000Z tube that requires 7.5 volts at 21 amperes. It can be seen that if 21 amperes flows through any appreciable resistance, considerable voltage loss will occur. In this case for example, one tenth of an ohm resistance will result in a voltage drop of 2.1 volts—this would result in only 5.4 volts at the filament terminals. The RCA transmitting tube manual indicates that operating voltages applied to the filaments should not be allowed to vary more than 5% from the specified values. It is best to operate the filaments as close to the specified value as possible. Using a 0.25 volt drop across the choke as an acceptable value, the resistance of the choke must not exceed .012 ohms. A copper wire table shows that number 10 wire has a resistance of 1.018 ohms per 1000 feet or .001 ohms per foot. If a choke is wound with 8 feet of number 12, the resistance would be .0128 ohms ( $8 \times .0016$ ) which slightly exceeds the required .012 ohms. It would be best to select number 10 wire where 8 feet would exhibit .008 ohms. A .008 ohm choke (dc resistance) with 21 amperes flowing through it would result in a voltage drop of .168 volts.

From Fig. 1, it may be noted that two rf chokes are required. These can be separate rf chokes, or they may be bifilar wound with both coils on the same form. The accepted practice has been to use a bifilar winding. Fig. 2 illustrates a section of a bifilar wound coil. Note that the turns are wound parallel to each other around the form. The eight feet of wire is divided into two four-foot lengths and wound on some convenient form. For example, if the coil is wound on  $\frac{1}{2}$  inch dowel rod, two four-foot lengths of wire (bifilar wound) will produce two coils, each

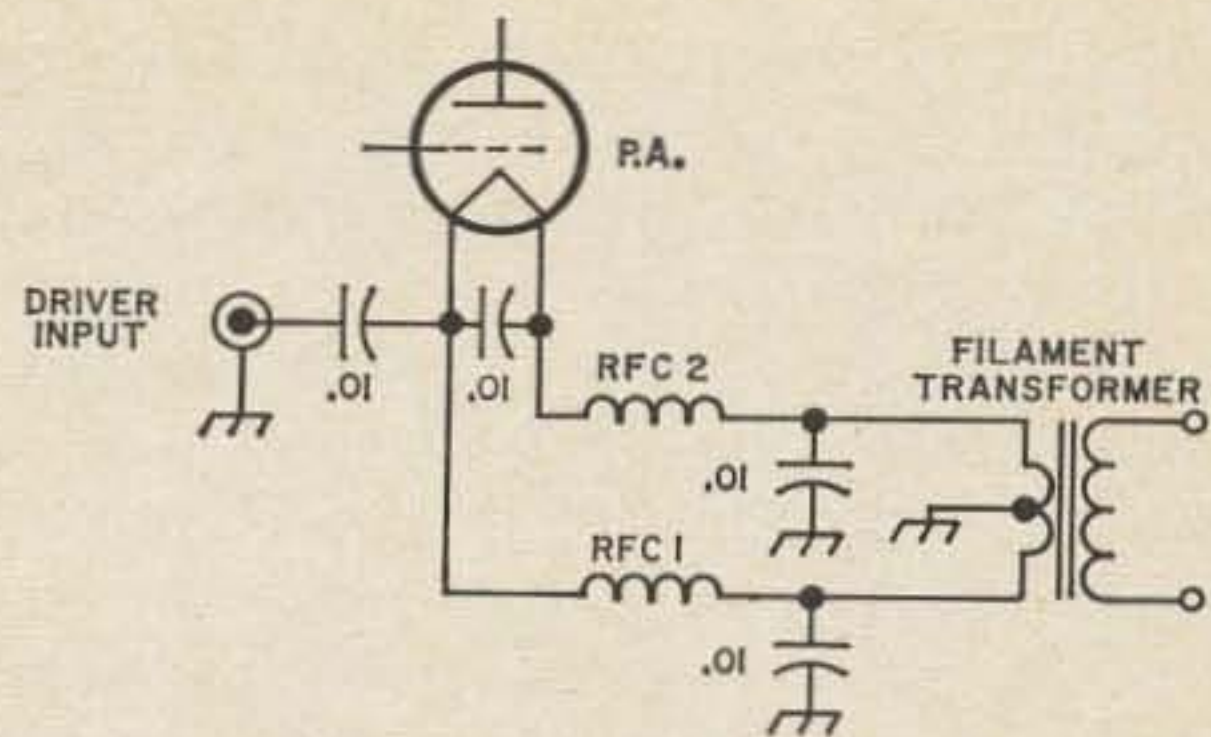

Fig. 1. Isolating the heated cathode of a grounded-grid rf amplifier with filament chokes RFC1 and RFC2.

having 23 turns with a coil length of 4.75 inches. However, a coil with these dimensions will have an inductance of only  $1.5 \mu\text{H}$ , far from the required  $11.3 \mu\text{H}$ .

Some means of increasing the inductance of the coil must be provided. This can be accomplished by removing the coil from the  $\frac{1}{2}$  inch dowel rod and slipping the coil over a  $\frac{1}{2}$  inch ferrite rod.<sup>1</sup> When a  $\frac{1}{2}$  inch ferrite rod is inserted into the coil, the inductance is increased to approximately  $20 \mu\text{H}$ . The inductance can be determined by locating a resonant frequency of one of the coils with a known capacitor connected across the coil. With a 36 pF capacitor across the coil, a GDO indicated a resonant frequency of 6.0 MHz. This frequency can be inserted into the equation:

$$L = 25330/F^2C = 25330/(6^2 \times 36) = 19.4 \mu\text{H}$$

Where F is MHz and C in pF.

Ferrite rod is quite hard and cannot be cut with a hacksaw. If it is desired to cut the rod, one method is to take a three-cornered file and file a small groove around the rod, place the rod in a vise with the groove at the edge, and with a quick hand motion, snap the rod off.

<sup>1</sup> Lafayette part number 32C6103, page 248, 1967 catalog.

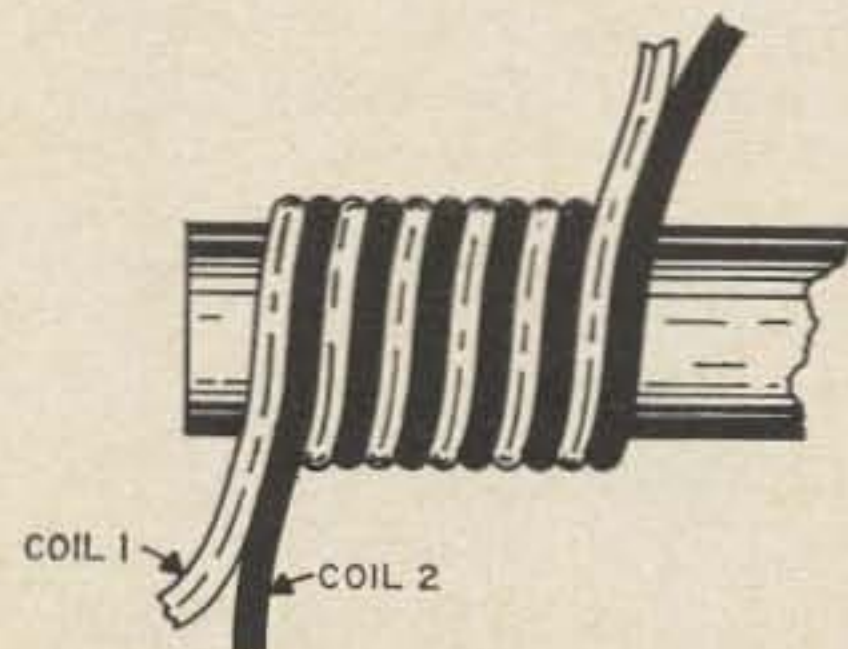

Fig. 2. Section of a bifilar wound coil. Note that the turns are wound parallel to each other around the form.



A check of the rf choke should be made to assure that no series-resonance points occur at the desired operating frequencies. It will be remembered that in a series-resonance circuit the inductive reactance and the capacitive reactance cancel, and the only impedance in the circuit is the dc resistance.

Since maximum current will flow in a series-resonant circuit, it is necessary to know that no series resonances occur at any of the operating frequencies. These may be determined by shorting the coil with a short piece of wire and checking with A GDO from 3 to 40 MHz for dips. A test of the rf choke shown in the photograph indicated no series-resonance points when tested on the bench or installed in a grounded-grid amplifier.

Although not required, the choke shown is protected with a length of  $\frac{3}{4}$  inch shrink-fit tubing.<sup>2</sup> If the coil does not fit snugly around

the ferrite core, place a few drops of adhesive on the core before slipping it into the coil. If shrink-fit tubing is used, it will hold the core in the coil.

The choke may be installed by soldering the choke leads directly to the filament transformer terminals at the tube socket or the choke may be mounted on tie points and then wired to the filament transformer and tube sockets. Wiring should be kept as short as possible and all excess transformer leads cut off to reduce introduction of additional resistance into the circuit.

One final point—in the event that the correct wire size cannot be obtained, the coil can be wound with a smaller size wire and the filament transformer voltage raised to compensate for the additional voltage drop in the choke.

. . . W6RET

<sup>2</sup> Beldon part number 68082.

## DL410—3690

When out motoring on our streets and highways, I see many other cars with mobile antennas swaying to and fro. Probably these fellows would like to have a QSO, but then comes the big question, does he have the rig turned on, and if so, where is he tuning? Many clubs and communities have a sign on the city limits stating the calling frequencies for mobile units in that area. This is a very good idea. My wife and I took a trip through 37 of our United States in 1963 and made good use of these signs.

Getting back to the mobileer, how can you figure out where he is tuning? Often you can tell what band is being worked by the size and shape of the mobile whip or coil. Unfortunately, many of the newer antennas look the same regardless of the band they're used on! Also, when you are whizzing along the freeway at over 60 miles per, it's pretty tough to inspect the other fellow's antenna coil.

Over the years I have developed a method of getting around all this guess work. This is to have a little sign that can be mounted both on the front and back of my car which contains only two lines of simple instructions—my call letters and the exact frequency that I monitor. When just buzzing around locally I keep the sign on the rear. If out on a longer trip both front and rear. I have

used painted signs on heavy cardboard for use inside the windows of the car, and more elaborate sheet metal signs which may be attached with wingnuts. The one I use now can be reversed so that one side says, "DL410 3690", and on the other side, "DL410 28500". You can put whatever you want on the sign, but it's best to keep it simple and to the point. Sometimes the other guy only sees it for a few seconds. My present sign uses three inch high letters and numbers made out of reflector tape. This makes it easier to see at night.

Once you have calling information posted on your car, results should not be long in coming. It's especially useful when away from home in strange territory. It helps fellows with the fixed stations, too. Just recently, while driving through a small village here in Germany, I saw a bicycle rider look at our car, do a double take and peddle off madly around the corner behind us. Not many minutes later there came a call on my monitored frequency from this same young fellow who had passed us on the street. He was very much out of breath from racing home and then running up four flights of steps to the ham shack. He elaborated at great length on how happy he was to see my sign and then make a QSO.

. . . Ken Bale W7VCB/DL410





# WHY SETTLE FOR HALF?

**GET THE ENTIRE BAND—BOTH CW AND  
PHONE WITH ONE TUNING ADJUSTMENT!**

## **10-15-20-40 METERS**

Only from HUSTLER will you receive the mechanical and electrical performance you want in a 4 Band Trap Vertical. Make the comparison and see for yourself.

### **Look what you get with Hustler!**

- Individually and precisely tuned traps!
  - Lowest SWR and Widest Band width!
  - Outstanding mechanical construction!
  - Heavy gauge heat treated aluminum!
  - Stainless and cadimium plated steel parts!
  - Base impedance nominal 52 ohms!
  - **WHOLE BAND OPERATION WITHOUT READJUSTMENT!**
- FOR 75-80 METER OPERATION ADD HUSTLER MOBILE RM 75 OR RM 75S RESONATOR ON TOP OF 4BTV. BAND WIDTH 60 TO 100 KC... UNDER 2 TO 1 SWR

**MODEL 4BTV**

**\$32.98**

# **FIXED STATION TRAP VERTICAL ANTENNAS**

**HUSTLER**



See your distributor or write for new catalog

**NEW-TRONICS corp.** / 3455 Vega Avenue  
Cleveland, Ohio 44113



## 200 Hertz CW Filter

A receiver with selectivity of 150 or 200 Hz should appeal to most CW hams. You can add this to your present receiver for a small sum and without any alterations. The filter shown here is connected between the 500-ohm output and your headphones. A by-pass switch is all that is needed, to cut it in or out as you wish.

The tonal quality of the received signal is only slightly sharper than the narrowest setting of the receiver. Background noise is attenuated considerably. Tuning will require a little more care, and in some cases the BFO may have to be peaked to the filter's center frequency. The selectivity of the receiver can be left in any setting.

There is a 3-dB loss through the filter, equivalent to one-half S-unit. Because of the lower background noise, weak DX signals can be heard, but require amplification to be worked. Also, individuals using a speaker will need an amplifier. It would probably be best to try out the filter as described and if found satisfactory, fit it to your requirements.

This filter is of the symmetrical type; that is, one half of it is a duplicate of the other. It has a bandwidth of 160 and 600 Hz at the 3 dB and 30 dB attenua-

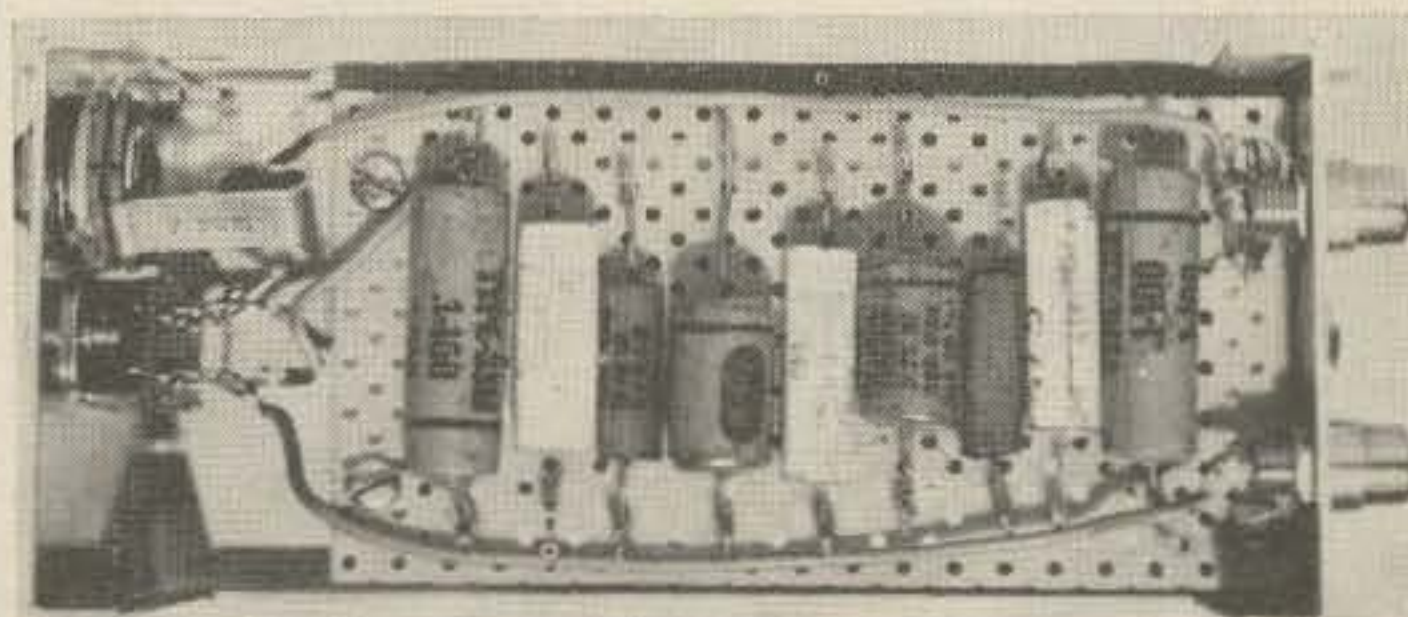

tion points, respectively. Its center frequency is set at 1000 Hz and it has an impedance of 500 ohms. Four 88 mH toroids of the unpotted type, and nine paper or mylar capacitors make up the filter. Mounting of the toroids is optional, but about one-quarter inch clearance must be allowed between each inductor and surrounding objects to prevent a change in their inductance.

If a different center frequency is desired, the capacitance values must be changed accordingly, assuming the toroids are untouched. The Q of the network will lower slightly as the center frequency is reduced.

At the indicated frequency, the reactance of these toroids is 553 ohms, giving C as

The 200 Hz CW filter is mounted in a 5 x 2½ x 2½ minibox. The 88 mH toroids are mounted on a threaded nylon rod; rubber grommets are used for spacers. The capacitors are mounted on a piece of punched Vector board.

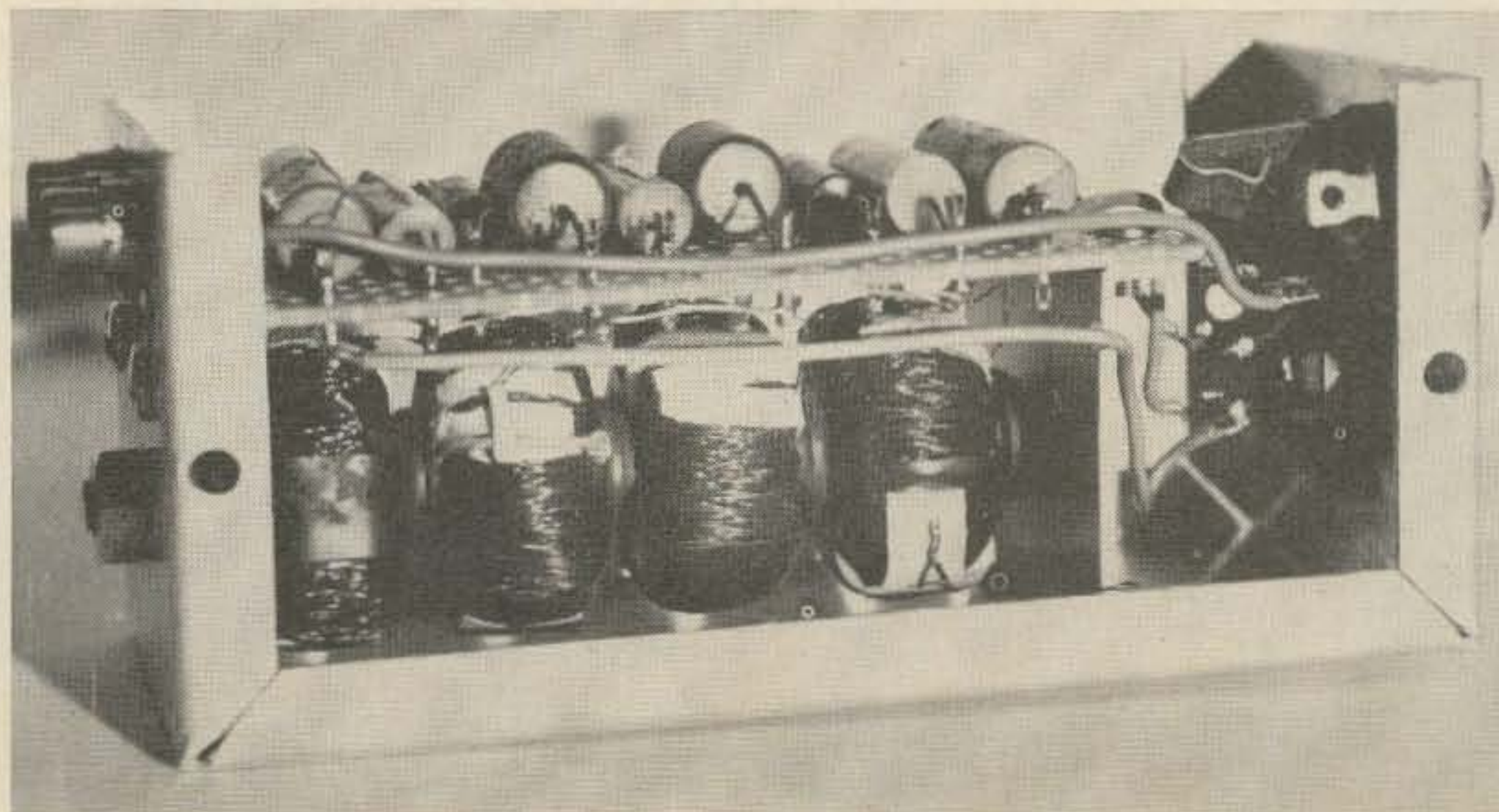



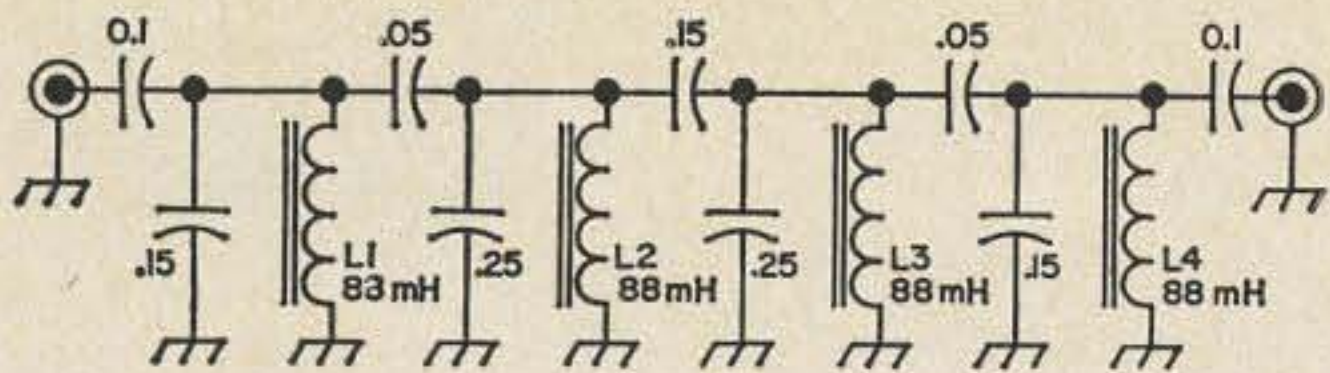

Fig. 1. Circuit of the 200 Hz CW filter. The coils are surplus 88 mH units. The capacitors were selected to proper passband response.

Attenuation	Bandwidth—Hertz
3 dB	160
6 dB	210
12 dB	260
18 dB	350
24 dB	460
30 dB	600

Passband response of the symmetrical type 200 Hz CW on a center frequency of 1000 Hz with input and output impedance of 500 ohms.

0.28  $\mu$ F. This value can be compared with Fig. 1. A signal generator and scope was used to determine the other capacitors, taking one toroid section at a time. Both the input and output were loaded by 500-ohm resistors during these tests.

The response curve of the first section will appear much like that of an *if* transformer. The two peaks will merge as more sections are added and sharpening of the skirts will be noted. Incorrect adjustment may cause one peak to "slide" down the slope instead, setting up two resonant points with resultant sub-harmonics. No further attenuation was obtained beyond four sections.

Due to the wide tolerance of capacitors, the values shown in the diagram must be considered as only nominal values. If a scope is not available, tests can be conducted with a VTVM.

This filter will add an additional selectivity position to your receiver and provide more enjoyable CW operation.

... K7UDL

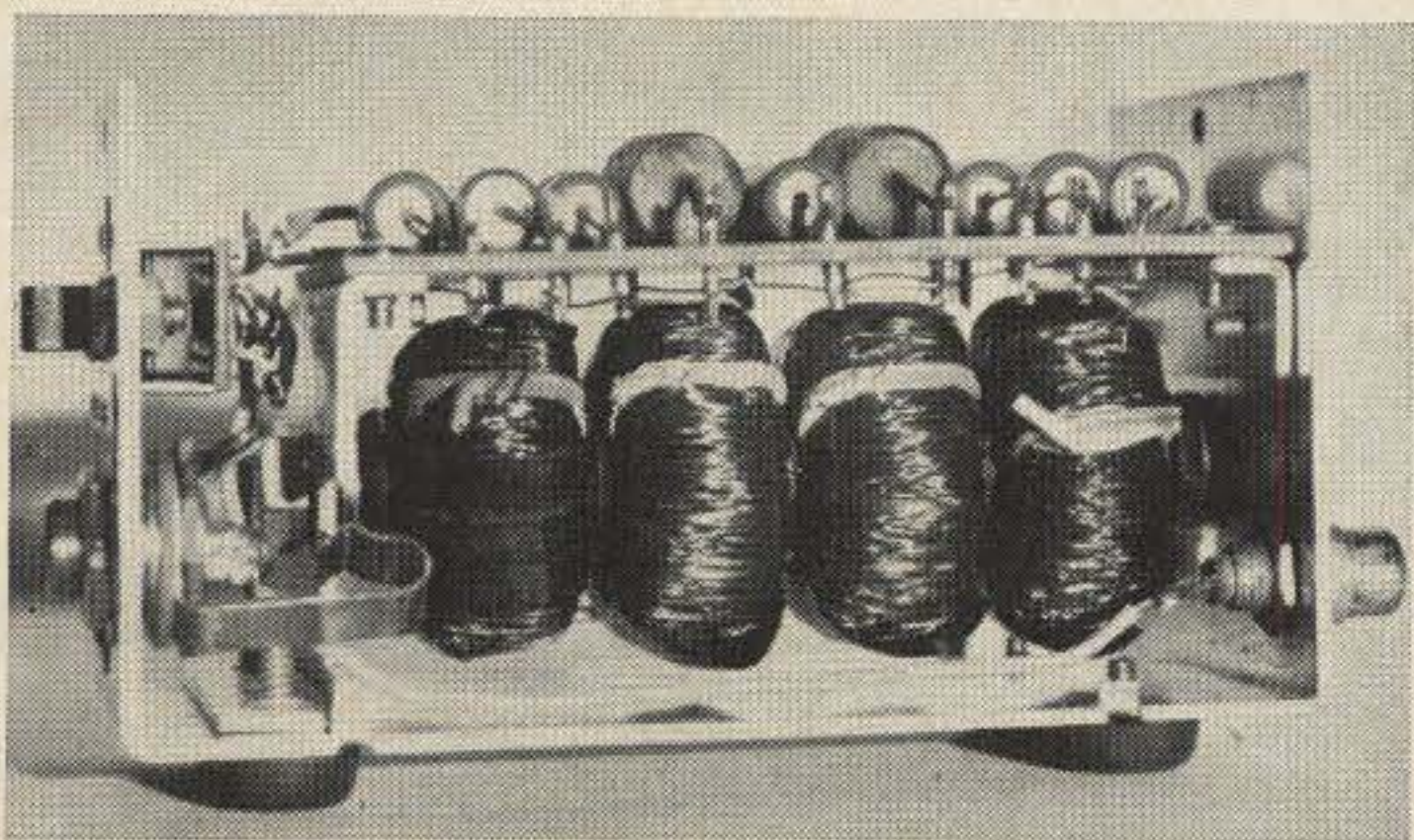

Compact version of the 200 Hz CW filter mounted in a minibox four inches long. The lugs on the slide switch had to be bent over to provide clearance.

## 6 METER TRANSCEIVER

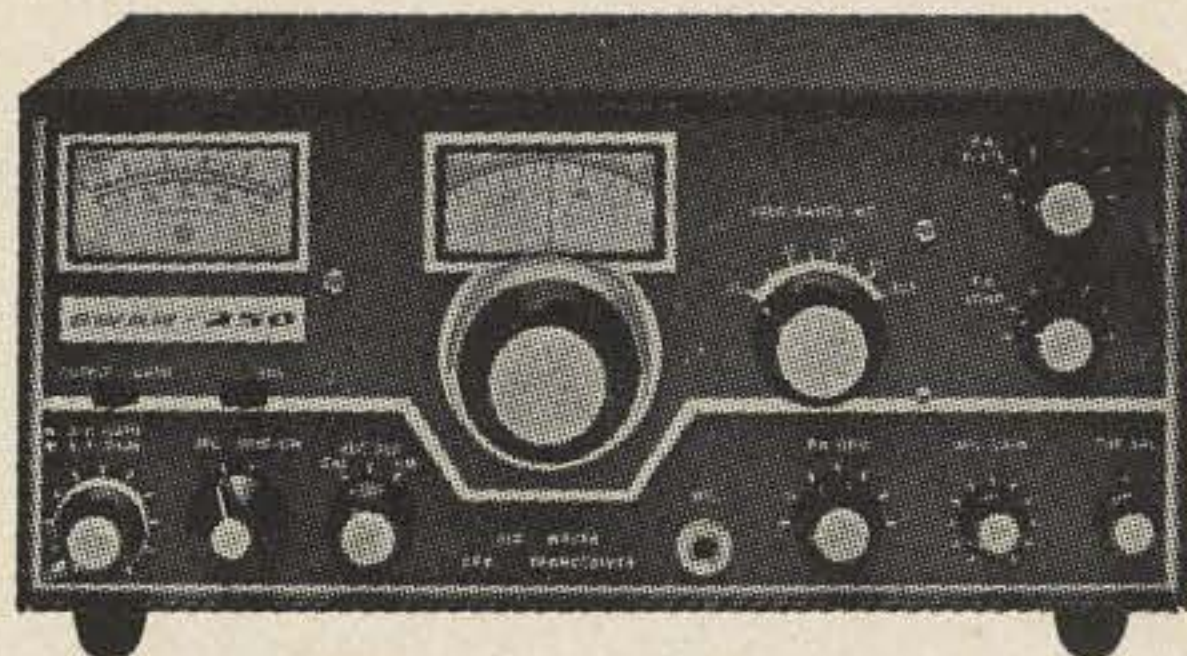

SWAN 250 \$325 PREPAID IN USA

# FREE

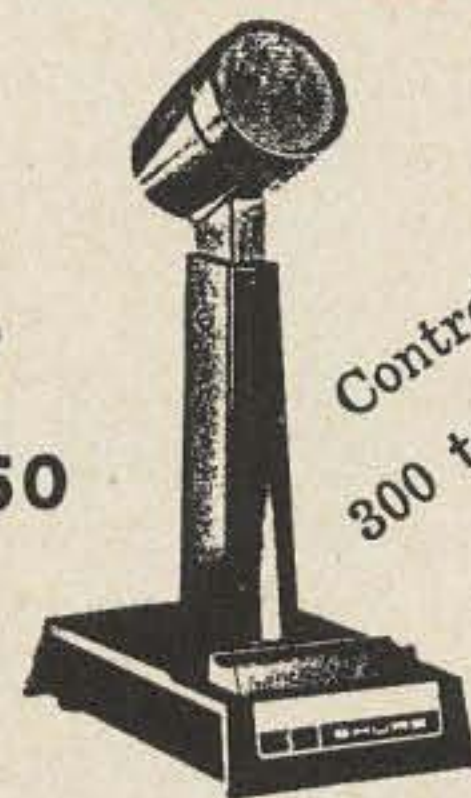

LIST  
\$42.50

Controlled Magnetic  
300 to 3,000 cps

**SHURE 444**  
SSB MICROPHONE WITH  
EVERY SWAN TRANSCEIVER

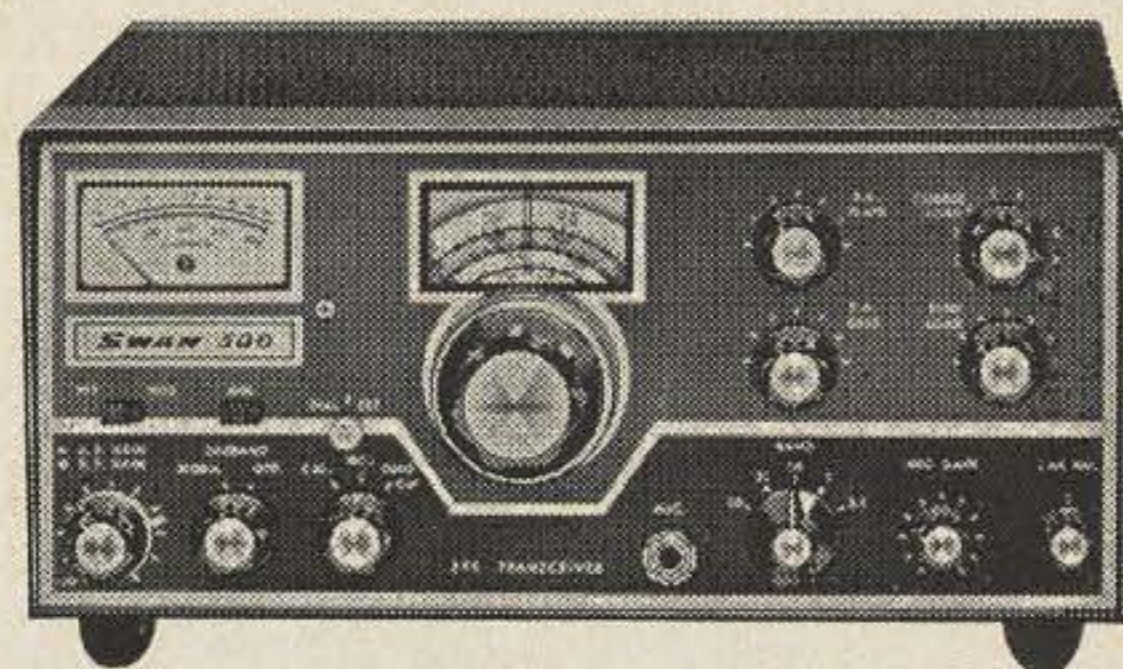

SWAN 500 \$495 PREPAID IN USA

IN STOCK AT

# QUEMENT ELECTRONICS

1000 SOUTH BASCOM SAN JOSE, CALIFORNIA  
"Northern California's Most Complete Ham Store"



## Observations of note by a VHF addict

Have you ever wondered where that #&\$%& is who gets so many sections and contacts? Especially while the band is dead at your QTH?? Take heart and read, VHF'er. I will try to clue you in on most of the suitable places in San Diego County (the best coverage, since my QTH is there) and other counties' mountains of note.

Since I am not particular on the elevation, so long as the propagation is good, I will include many small hills that are easy to get to and are of particular interest.

A little known mountain in San Diego County is Hot Springs Mountain. It is THE tallest mountain in San Diego County. It is 6533 ft. high and propagation is very good there. Communication with Arizona is easy since it is almost line-of-sight. Nevada is easy, also, although it would be wise to arrange skeds. Its location is just east of Warner Springs. To get to the top, which is usually locked, one would have to contact the U. S. Forestry District (Palomar) Office in Escondido, California. The road is not extremely dangerous, but it isn't particularly easy either. One hinderence about Hot Springs Mt. is that you would have

to turn your beam to work San Diego decently.

Another well-known mountain is Tecate, 3985 ft. high. This has a lot of nicities that Hot Springs lacks. Of course, propagation to the east and north east is diminished. Tecate Mtn. (state lookout) is located on the border, in fact,  $\frac{1}{3}$  is in Old Mexico. To get there, one would take highway (state) 94 east to the Tecate Turnoff, take the turnoff, and proceed until (about 2 miles) you see a sign saying Tecate Mtn. Lookout. Take it all the way. One word of caution: at the farm, at the very foot of the mountain, there are several dogs that just plain don't like hams. Keep doors and windows closed. If you want to go up outside of the fire season, you will have to get the key from the State Forestry District Office, in La Mesa. Tecate is one of my favorites. Once you get on top, you have a clear shot to L.A. and north. You set your beam towards L.A., and it's easy to work San Diego, slightly off to the side. On top, water is available and there is even a cement walkway to a nice facility.

Another well-known mountain is Lyons, just about 5-10 miles north of Tecate. It



Tecate Mountain — 3985 feet high. This mountain is located just north of the Mexican border in southern California. The "painted" mark to the left in the photo delineates the U.S.-Mexican border.



is surprising how useless this mountain is to VHF contesters. There are repeaters all over the summit. CD 2-meter phone closed-circuit stuff, etc. Also a person does not have as nice a shot north for L.A., etc. If you still want to go, you had better inquire at the U.S. District Forestry Station at Descanso, California.

One of the best mountains in San Diego County to go north is Mt. Otay. It is directly east of my QTH, north-west by west of Tecate. It is apx. 3600 ft. It has no facilities—bring your own water, etc. This is about the best mountain for S.D. and L.A. etc. work. It is pure line of sight for everything. It is leased privately, and it isn't easy to get the key. Inquire at the State Forestry Office in La Mesa.

A mountain known to just about everybody as Broucher Hill Lookout is fair for 6 and up work. It is on Palomar mountain, and if you have enough ops to post a couple as guards, you have it made. Another disadvantage is that if your beam is pointed to L.A., then you're 180° out from San Diego.

Cuyamaca Mountain is known hereabouts for snow in the winter time. I believe its elevation is about 5000 ft. It is also used as a repeater sight, but the real bugaboo is the Air Force radar installation there that causes images.

Los Pinos Mountain is about 7 miles south east of Cuyamaca, and about 500 ft. below. It isn't very good for L.A. communications for that reason. It gets quite cold on this one also.

Others in San Diego that you might want to check out are High Point and Black Mountain. They're U.S. Forestry lookouts, so inquire in Palomar District HQ, in Escondido.

Others of lesser note are Margarita, Woodson and Red Mountain lookout points. These are not recommended for various reasons.

Some mountains that one can drive up and operate mobile with very good results are Cowels, (I question my spelling) Helix, and Soledad. These are very good for evening operation.

Other very good mountain operating points in Southern California are Santiago (Riverside Cty): Santa Rosa Pk, 8046, (Riverside Cty), Pacific Mtn., 7124 ft., (L.A. Cty), Mt. Lowe 5593, (L.A. Cty) and Mt. Wilson,—ft., (L.A. Cty). Mt. Frazier, 8013

and Pines 8826, are both in Ventura County, with real good chance of getting Santa Clara Valley and San Joaquin Valley.

Well, now that I have given you an idea where everything is, I'll just comment about what to bring, and how.

If you intend to do a little hilltopping—GO PREPARED (voice of sad experience) PLAN EVERYTHING in advance. Murphy's Law and Harris' Theorem are infamous on these trips (I know). It isn't advisable to use tents. In the winter of 63-64, the roof of Tecate Lookout was blown off. And it wasn't put on with just glue either. Winds, at night, can very often get up to the hairy point . . . . but a little danger adds zest in one's life. The best operating shack would be a camper or station wagon. Make sure your car's full of water. An engine can really over heat on some of those climbs. Coffee: bring batches of it. Surprising how it perks one's spirit, and cold toes. Antennas . . . . bring the least wind resistant one you have . . . . that's any good. Don't sweat about a mast . . . . Get a broomstick and pound it in the rock-soil. You have a high enough mast under you anyhow. But do secure it. It's death if your big beautiful beam plunges off the side. (sob-voice of experience).

I hope some of you are interested. If you want to hilltop, you can get information from various sources—fellow hams . . . . gas station attendants, and forestry officials. A word to the wise . . . . be nice and courteous. Ask politely for the use of the mountain, etc. If you belong to CD, you might drop a couple hints about possible emergency tests—show him your license and CD card. But the best asset you have is to be kind and polite. I know. Most people think that teenagers are mostly brats or hoods. But even so, I have been able to get to many "no trespassing" places because I was polite. Also, leave EVERYTHING the way you found it. Remember, you might wish to come again. The ranger might not appreciate soda-beer cans all over the place, etc., and might put you on the "black" list.

Everybody is welcome and everybody has fun, so get out your gooney box and get on when there is a VHF contest. You'll be surprised how much activity there is and maybe you'll start hilltopping in earnest.

. . . . WB6JLC



## Mobile Installations

### The effect of SSB on battery drain and feed resistance

In discussing mobile operations, the question of battery drain usually rises very quickly. The prospective mobile operator is naturally concerned with the drain on his battery. He fully realizes that while the car is in motion the battery will be charged, but how long can he operate at a standstill?

One answer is, of course, that he can keep the engine running; and the development of alternators has facilitated this problem since they are capable of producing high charging currents at low engine revs. Nevertheless, many amateurs would rather operate when stationary without the engine running.

It is, of course, now possible to fit two batteries and by means of blocking diodes, reserve one for the radio and one for the car so that one will not be stranded with a flat battery unable to start the car. Still, the question arises, how long can one operate at a standstill on one battery without the engine running? This is where SSB is such a tremendous contribution to mobile operation. The duty cycle of SSB is so short that the *average* battery consumption bears little relation to the *peak* consumption.

To understand exactly what is meant by the short duty cycle, we have only to cast our minds back to amplitude modulation and to the various clippers and compressors which were developed to realize that speech consists of very high peaks of extremely short duration which far exceed the average amplitude.

When using AM from a mobile rig, the battery drain was continuous throughout the period of transmission in order to provide the carrier. The amplitude rose on positive peaks by as much as it fell on negative peaks but the average was the power required by carrier, and was continuous throughout the whole period of transmission.

SSB has removed the carrier. Now the power drain reaches its peaks only on the peaks of modulation. These only represent a very short time during normal speaking. The average power is very much lower than the peak power and, furthermore, any break between words or even between syllables instantaneously reduces the power required to very much lower levels. This has enabled reasonably high-power transmitters to be operated on SSB for considerable periods without flattening the battery.

I find that I can operate for 1½ to 2 hours with normal periods of transmission or reception with the Drake TR3 or TR4 on a normally good-sized car battery. Unfortunately, there is another side to the question. The current requirements during short periods can be quite high on the modern transceivers and though, as explained above, this does not seriously increase the battery drain, it does mean that the current flowing at certain periods from the battery to the mobile power supply is high and mobile installations must take this into account if good mobile communications are to be maintained.

I was recently told on several occasions that my signal was not as strong as it usually is. cursory examination of the transceiver and antenna, etc. did not disclose any obvious fault; the only symptom was that the rig didn't load as it had in the past. With the assistance of a friend and a voltmeter, the following tests were carried out:

The voltage at the battery terminals was measured with the transceiver in "transmit", carrier inserted, and this was compared with the voltage under similar conditions at the input terminals of the power supply. A drop of 1½ volts was noted between the battery terminals and the input terminals of the power supply. If we assume a current of



30 amps at that moment, this would mean that the voltage drop was due to a resistance of one-twentieth of an ohm, or  $0.05 \Omega$ , not exactly an enormously high resistance for the total of the contact resistances and the wire. If we assume that the current was only 20 amps, this would have made a resistance of 0.075 ohms, still not a very high resistance, but enough to materially detract from the performance of the transmitter.

By making certain alterations in the wiring, it was possible to achieve a voltage drop of only half a volt (still quite considerable) between the battery terminals and the input to the mobile power supply. This would mean a resistance of 0.025 ohms of one-fortieth of an ohm on a 20 amp load. On a 30 amp load it indicates a resistance of less than 0.017, or about one-sixtieth of an ohm. This resistance must cover the total resistance of the wire—both leads, positive and negative plus any contact resistance involved.

This gives some idea of the resistance in which we are interested when feeding a mobile power supply from a battery. It may help to explain why some mobile operators find difficulty in working over reasonably long distances from their mobile installations. It is certainly a factor which must be borne in mind when dealing with mobile installations.

. . . G3BID

### Stolen Equipment

Recently the Stanford Radio Club Station, W6YX, was broken into, and the following pieces of Collins Radio equipment were stolen:

Type	Description	Serial No.
32S-1	Transmitter	10790
75S-1	Receiver	3018
312B-4	Station Control	293
516F-2	Power Supply	3611
75A4	Receiver	5091

The cabinets of the S-line equipment were sprayed with red and orange paint. The 74A4 receiver had homebuilt crystal filters in place of the mechanical filters.

If you should have any information on the whereabouts of this equipment, please contact Victor R. Frank, Research Associate, Stanford Electronic Laboratories, Radio-science Laboratory, Stanford, California.

# radio amateur callbook

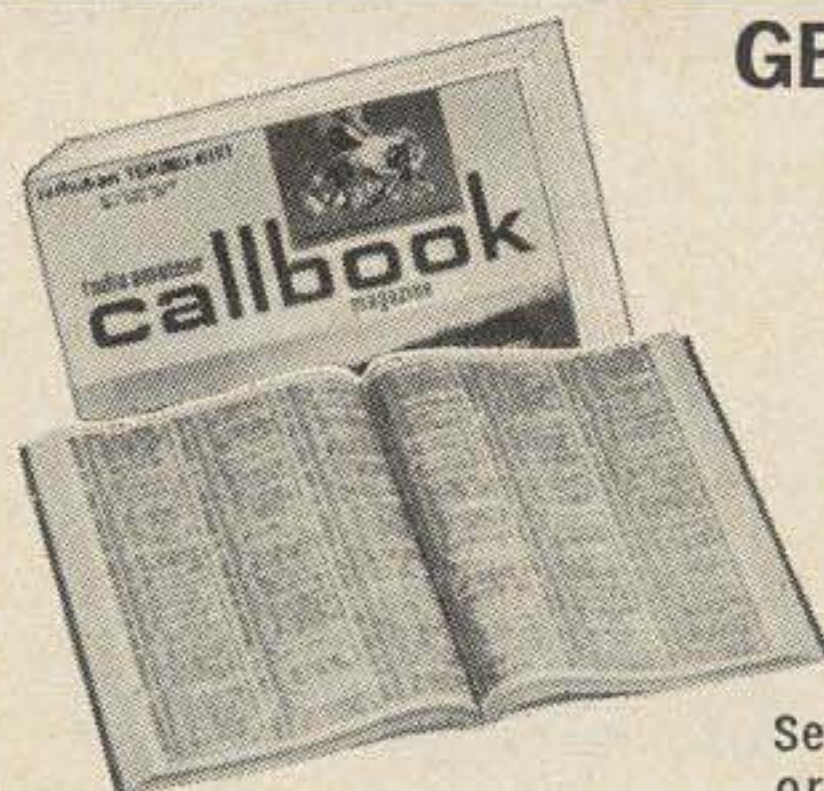

## GET YOUR NEW ISSUE NOW!

Over 283,000 QTHs  
in the U.S. edition  
**\$6.95**

Over 135,000 QTHs  
in the DX edition  
**\$4.95**

See your favorite dealer or order direct (add 25¢ for mailing in U.S., Possessions & Canada. Elsewhere add 50¢).

These valuable EXTRA features included in both editions!

- QSL Managers Around the World!
- Census of Radio Amateurs throughout the world!
- Radio Amateurs' License Class!
- World Prefix Map!
- International Radio Amateur Prefixes
- Radio Amateurs' Prefixes by Countries!
- A.R.R.L. Phonetic Alphabet!
- Where To Buy!
- Great Circle Bearings!
- International Postal Information!
- Plus much more!

**WRITE FOR  
FREE  
BROCHURE!**

RADIO AMATEUR  
**callbook** INC.  
Dept. B, 4844 W. Fullerton Ave.  
Chicago, Ill. 60639

## Acclaimed Throughout The World.... THE 'QUAD' AERIAL —Supreme for its size

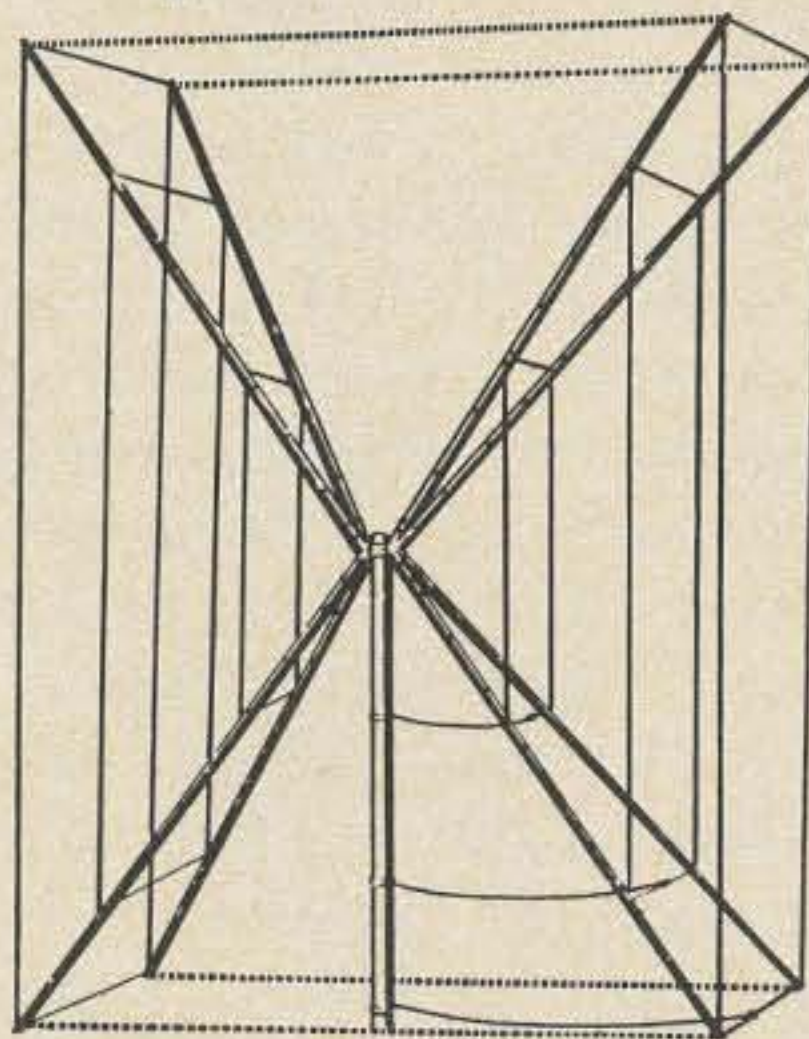

The Labgear 'QUAD' uses a spider construction providing optimum spacing on each band 10-15-20m. KITS AVAILABLE WITH OR WITHOUT BAMBOO ARMS.

Wonderful performance — no tuning adjustment necessary.

## Labgear

LABGEAR LIMITED  
CROMWELL ROAD  
CAMBRIDGE ENGLAND

Telephone 47301 · Telegrams Labgear Cambridge



Ralph E. Taggart WA2EMC  
Box 287  
West Milford, New Jersey 07480

## Getting a Start in Amateur Television

If you have been thinking about getting on ATV, this article outlines some of the simple techniques that can be used for getting started.

No matter what it is you would like to do, the biggest problem is always to overcome your own inertia and get started on the project. A great many amateurs, especially those who work the VHF bands, profess an interest in amateur television (ATV). Unfortunately, there always seems to be a host of problems, both real and imagined, which eventually prevent them from starting to actively experiment with this fascinating aspect of amateur radio. The purpose of this article will be to take a look at some of the problems and requirements facing the newcomer in ATV, and perhaps after we've thrown a little light on the subject, they won't seem quite so imposing.

Once you know the kind of equipment you need, one of the biggest problems is where

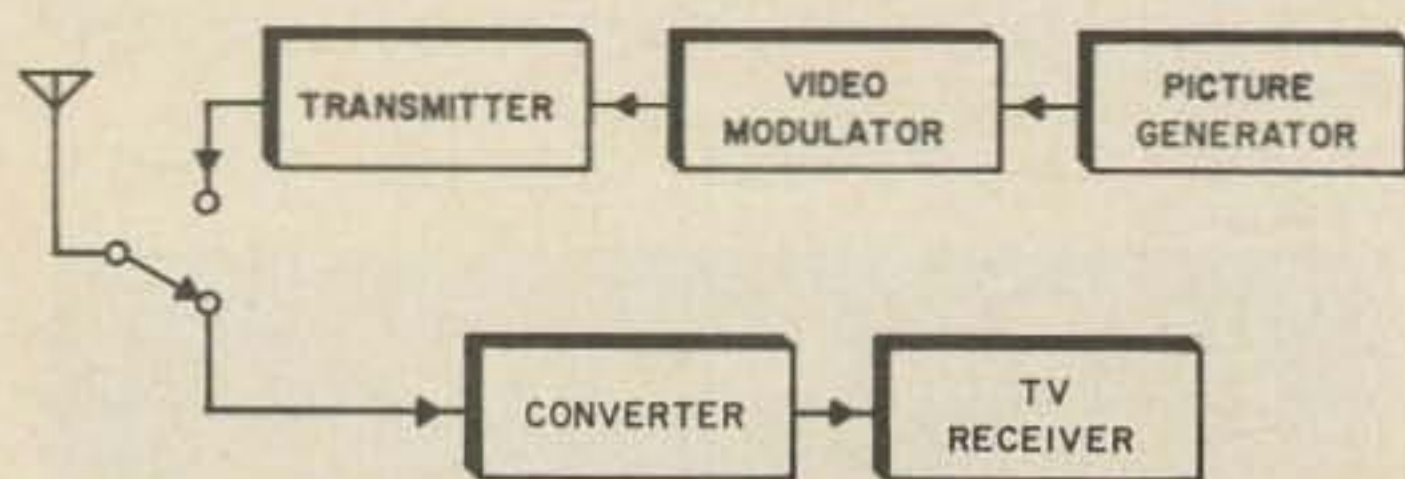

Fig. 1. Block diagram of the units required for a basic ATV station.

to go to find the information needed to put it together. The kind of references you need to make a start are available, but most amateurs don't know how to go about finding them. This article will have two purposes—first, to give you an idea of what you will need in the way of equipment, and secondly, to indicate where you can get the information you require. Each time we mention a specialized piece of equipment, you will find a number, referring to a reference at the end of the article, which should serve to get you moving in the right direction.

Unlike the situation in many areas of our hobby, you don't go out and buy items of chrome-plated equipment, bring them home with a few pieces of connecting cable, and suddenly find yourself on TV. ATV and a few other areas, such as RTTY, are still dominated by homebrew equipment. There are two basic reasons for this. First, there is a lack of amateur grade equipment on the market, and secondly, there is the cost factor. If you haven't already discovered that you can build a good piece of equipment for considerably less than its market value, you still have a lot to learn about this hobby of ours! This doesn't mean, however, that you have



to be an electronic genius to get on the air. There are simple circuits that are good for getting your feet wet, and more complex pieces of gear which can be tackled after a little experience. How many of us would be in amateur radio if we had to start by scratch building a SSB transceiver? Even the renowned "old timers" in this hobby started with crystal sets and regenerative receivers. The situation is quite similar with ATV. To generate the *best* possible signal using *any* mode requires sophisticated equipment, but this doesn't mean that you have to start that way. A lot of fellows have started in ATV, only to quit because they tried to begin too far up the ladder. You learn by moving up the ladder, and, in any area of the hobby, the guys who never learn anything are often the ones who start at the top with the store-bought goodies.

Fig. 1 shows a block diagram of a basic ATV system. The logical place to start our discussion is at the receiving end, particularly if you live in an area that may already have ATV activity. The TV receiver is the easiest part, for virtually any standard set will do the job. Generally the newer sets are more sensitive, and hence more desirable than some of the old clunkers. Most TV shops have a pretty good stock of used sets. Very often these sets are used strictly as a parts source, and they can often be picked up for next to nothing. If the set works well, you don't have to be concerned about how pretty it is.

You will also need a tunable converter, covering the 420 MHz band and feeding an unused TV channel in the set. You can homebrew one<sup>7</sup>, or you can pad down the tuning range of a commercial UHF converter. The UHF TV band begins at about 470 MHz and it is a simple procedure to pad most converters so they will cover at least the upper part of the 420 band.<sup>2, 5</sup> By gentleman's agreement, TV transmissions are usually confined between 436 and 450 MHz, which simplifies things considerably. Most of the simple converters consist of a tunable local oscillator driving a crystal mixer. These units are generally suitable for local work, and you can always add an outboard *if* or rf amplifier<sup>11, 13</sup> later, if needed.

The transmitting equipment can cover a complete range from the very simple to the very complex. Our basic requirements are a picture generator, a video modulator, and a



Fig. 2. Signal produced by WA8HZK/8's flying spot scanner transmitter as viewed on the receiver at his shack. The three-tube unit, designed by W2VCG, is capable of transmitting high resolution pictures of photographs and overlays, such as this identification slide.

transmitter. At the simplest end of the scale we have a little three tube rig designed by W2VCG<sup>4</sup> which will accomplish all of these functions. Using an old TV set as a sync and light source, this little rig will transmit pictures from transparent overlays and 35 mm slides for distances up to several miles, setting the average builder back to the tune of about \$30. A lot of fellows will drop this much on a microphone, so there doesn't seem too much monetary excuse for not giving it a whirl! If you build up more complex pieces of gear, it pays to do it in a modular fashion. This allows you to substitute or experiment at some points in the system without modifying others. This is the approach we used in

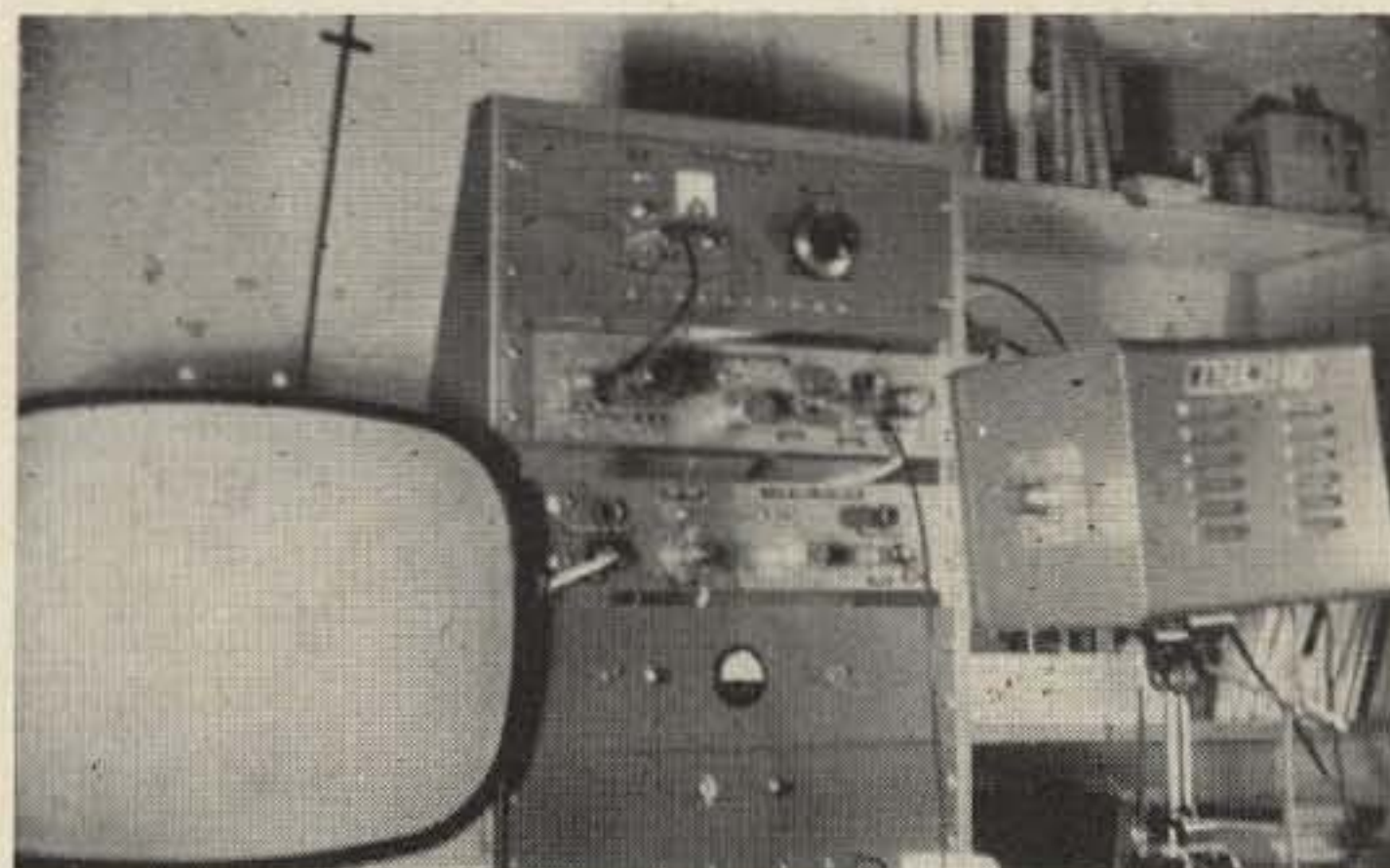

Fig. 3. The portable rig at WA2EMC/8. The TV receiver is on the left with the vidicon camera on the far right. The desk-top rack holds the rest of the video equipment in modular form, consisting (from the bottom up) of the camera power supply, the station power supply, an oral-subcarrier unit, the video modulator, and the transmitter. This is far from being a minimal installation of this type.



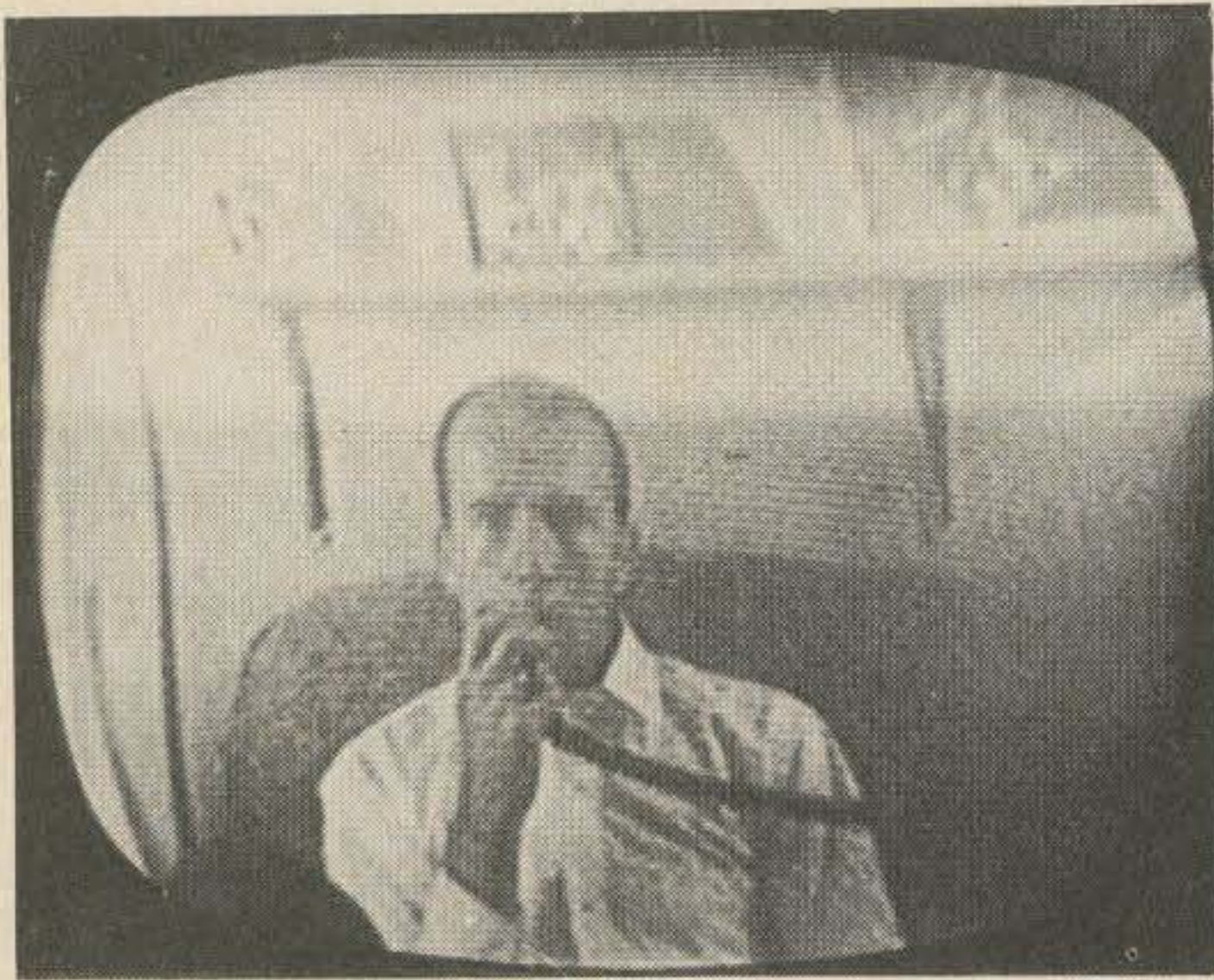

Fig. 4. Signal from WA2EMC/8 as received by WA8HZK/8, about a mile away, showing the author at the mike of the six-meter rig which was used for the audio link. Transmitter output from both stations was about one watt, with dipoles at both ends of the circuit.

building up the gear illustrated in Fig. 3.

Picture generators in most amateur stations fall into two general categories, the flying spot scanner (FSS) and the vidicon camera. The FSS, the principle of which is used in the W2VCG rig, is capable of producing high resolution pictures from transparent overlays or photographic slides. An example of this sort of transmission is illustrated in Fig. 2 with WA8HZK's ID slide. WØKYQ<sup>7</sup> has designed a very versatile FSS unit which is quite easy to build, and will give years of excellent service. FSS units essentially transmit still pictures, while a vidicon camera will give so-called "live" pictures. The FSS is usually easier to build and adjust than a vidicon, and I would recommend that a beginner start with a unit of that type. Even after you graduate to a vidicon, the FSS is still useful for transmitting station ID slides and routine picture material.

When you get to the point where you want a live camera, you have the decision as to whether you should buy or build. There are a large number of small cameras advertised in the catalogs these days, all of which will do a good job in ATV work. If you build, however, it's rather hard to keep from learning something about how the beast works, and I've always liked that idea! If you want to try a kit, there are increasing numbers becoming available. You will find units using either tubes or transistors advertised in magazines such as 73. For the scratch builder, it's hard to beat the five-tube camera designed by WØKYQ<sup>8</sup>. This unit is built from stand-

ard components, with nothing difficult or hard-to-find. This is the camera I use, and believe me, if I can build it, almost anyone can. ATV Research (see 73 ads) stocks manuals and lots of goodies for this camera.

### Modulators

Television is a wide-band mode, and the signal from the picture generator, whether vidicon or FSS, will have a bandwidth of from 2 to 5 MHz. Because of the bandpass required, conventional audio modulator circuits are not applicable. Special, although not complicated, circuits known as video amplifiers and modulators must be used. For strictly local work, it is possible to combine a modulator and low-power transmitter into units with as few as two tubes,<sup>3, 12</sup> although other circuits<sup>1, 6, 7, 10</sup> can be built in modular form and used with a wide variety of transmitters.

### Transmitters

Most fellows start with small single-tube oscillator transmitters. A 12AT7 unit, described by WØKYQ<sup>7</sup> is typical, and is used in the portable setup shown in Fig. 3. This transmitter also produced the picture shown in Fig. 4. Most of the higher powered transmitters are crystal controlled. If you already have a transmitter for 420, the chances are that it will be perfectly usable for ATV.

### Antennas

Antennas can make or break any station on 420, and even more so in the case of ATV. Virtually any antenna suitable for 420 may be used, just make it the best you can, depending upon individual circumstances.

### Audio

The easiest technique here is to use your station facilities for some other amateur band. Six or two meters is quite popular. You can use more sophisticated techniques such as separate 420 fm gear or aural subcarrier units so that the audio will come in on the TV along with the picture, but this is not the best way to start. Usually you have the problem of setting up initial contact on 420, and it's best to have a reliable audio link on a lower frequency.

I have included a number of photographs showing what you can reasonably expect to accomplish with a moderate investment of time and effort. The pictures were taken



during one of the many QSOs between WA8HZK and myself during the time we were both studying at Ohio University in Athens, Ohio. Neither of us is professionally interested in electronics, and Ron had had no prior ATV experience when he started work on the W2VCG FSS/transmitter unit which he was using at the time the photos were taken. Ron's TV gear was tucked away in his bedroom at his fraternity house, and I was operating from my rooming house across town. If two average hams, such as ourselves can do it under those conditions, there ought to be many groups all over the country who could do it even more easily. Granted, ATV is now primarily a short range affair, although you can work out as much as 30 miles over flat terrain, using small single tube transmitters. In hills, unless you're on top of them, the range drops fast, and increased power is required. You have to use a band and a mode in order to learn to get the most out of it. The fellows who worked five meters back in the "old days" were supposed to have many of the same limitations, but they dug in and improved the state of the art—if you don't believe it, look at the VHF bands today. Who wants to do the same sort of experimenting in one of the last frontiers we have in the hobby today?

... WA2EMC

References:

1. Baird, R. E. W7CSD, "High Level Modulation for Ham T-V," *73 Magazine*, Dec. 1964, p.30-31.
2. Forth, J. WA2TRT, "Modification of Commercial UHF Converters on the ATV Band." *ATV Experimenter Anthology*, p.77-78.
3. Grolla, K. H. WB2OSA, "Low Power 432 mc Video Transmitter," *ATV Experimenter*, Oct.-Nov. 1964. p.3-5.
4. Kaiser, M. L. W2VCG, "A UHF Television Transmitter," *CQ Magazine*, April 1962. p.26.
5. Kennedy, J. K6MIO, "Converting UHF TV Tuners for ATV," *ATV Experimenter Anthology*, p.80-81.
6. Mondine, A. K6TWF, "A High Performance High Level Modulator," *ATV Experimenter*, Apr.-May 1965. p.5-7.
7. Shadbolt, M. WØKYQ, *Ham TV*. 100p. 73 Magazine, Peterborough, N.H.
8. ———, "An Eleemosynary Vidicon Camera for Scroungers." *ATV Experimenter Anthology*, p.4-23.
9. Simpson, A. W6LYS, "Sony UHF Converter," *ATV Experimenter*, Oct.-Nov. 1964. p.11.
10. ———, "Video Modulators, Theory and Practice," *ATV Experimenter*, Aug.-Sept. 1964. p.10-14.
11. Taggart, R. E. WA2EMC, "A Grounded Grid Cascade Nuistor Preamp for ATV Reception," *ATV Experimenter*, Apr.-May 1965. p.3-4.
12. ———, "Quick and Easy ATV Transmitter," *ATV Experimenter Anthology*, p.24.
13. ———, "A Simple Solution to the Problems of RF/IF Amplification in ATV Reception," *ATV Experimenter*, Feb.-Mar. 1965. p.12.

The ATV Experimenter Anthology (1962-1964) is available from 73 Magazine, Peterborough, N.H. for \$3.00.

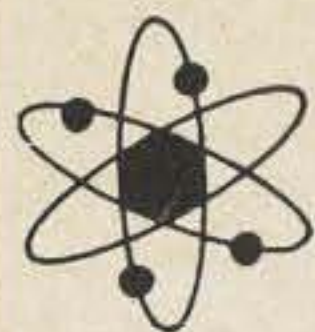

**stellar industries**  
DIV. OF STELLAR I, Inc.  
SALES AND SERVICE

**ELECTRONIC COMMUNICATIONS EQUIPMENT**

10 GRAHAM ROAD WEST  
ITHACA, N. Y. 14850  
TELEPHONE: AREA CODE 607 273-9333

**You already know these names:**



**Now we'd like you to know ours:**

**Stellar Industries — Dept. M**  
10 Graham Road West  
Ithaca, New York 14850

Please send me information

on.....

Send Used Equipment List

Name..... Call.....

Address.....

City..... State..... Zip.....

**These Lines  
And Others In Stock**

**Monitor 3.999 9-5:30 Mon. thru Fri.**

DAVID G. FLINN  
W2CFP/WB2QGK/KPQ7914  
President and Treasurer

DAVID E. BOWMAN  
K2MYC  
Sales Representative

ARTHUR J. HUBERT  
WA2UJM  
Sales Representative



L. Jacques Filion VE2AES/W6  
2226 N. Spruce Street  
Santa Ana, California 92706

## A Compact Linear Amplifier

A good antenna and a barefoot rig can do a lot for a ham, but sooner or later the bug will get him, and he will want to increase his power. Of course, if you already have a linear or all kinds of cash to go out and buy one, this article is not for you. On the other hand, if you are anything like me—that is, have a bigger junk box than available cash for that linear—and are prepared to roll up your sleeves, you would be surprised with what you can come up with. At least I was.

There isn't anything new under the sun regarding linears and this one really is no different. Many good articles have recently been published and very nicely demonstrate how a linear can be constructed at a low, low cost. Unfortunately, I did not have the 811's or 572B's recommended in these articles; but a pair of 7094's were gathering dust in the shack. Neither did I have three meters as many articles called for, but in the bottom of the junk box I found an O-1 mA meter with a bent needle and a broken glass. As for capacitors, plenty of 100  $\mu$ F at 450 Vdc were there for me to use and many other bits and pieces left over from the days when a ham was a born "scrounger" and

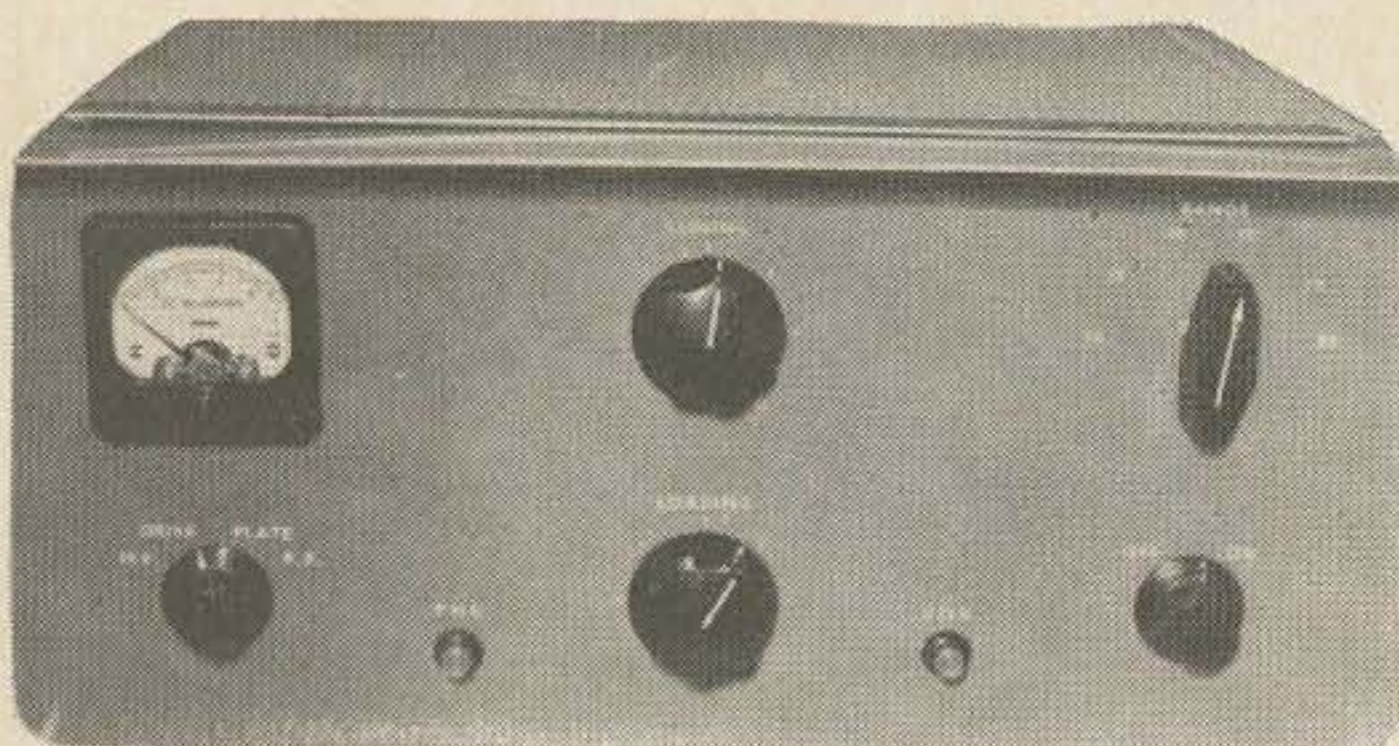

Front view of the linear amplifier. To maintain high efficiency with the tuning capacitor which was used, two positions are used to cover the 3.5 MHz band—one for 75 meters, the other for 80.

would build his own station from junk.

### Circuits and parts

The first thing was to consider the final appearance. For that, I spent the first twenty dollars. An LMB cabinet, Model CO-1, was purchased. This would take care of the appearance, plus match the "S-Line" very nicely. Secondly, after blowing all the dust from the components, I tried to fit all of them into the box in such a way that I would end up with a linear. After a few hours of eager work, I almost gave up. It seemed that I would have to put ten pounds of junk in a brand new, sleek, shiny box that would hardly accommodate a half-pound. Many hours of repositioning the components while burning the midnight oil didn't seem to help. I almost gave it up as a bad deal and put everything back on the shelf, plus a new cabinet, to gather new dust. Finally—eureka! A sub-chassis for the bottles would provide the badly needed room for the components and at the same time would make the linear quite versatile; inasmuch as all hams might not have 7094's like me, this sub-chassis provides sufficient space for almost any other tube lineup. What will happen when my bottles give up the ghost? I can dig all I want in my junk box, but I knew a spare could not be found. Possibly I could come up with another odd pair of tubes. To use them, all I would have to do is remove the sub-chassis and rewire a new one at very little expense. That, I must say, really appealed to me.

The circuit is the sum of all I could dig up on homebrew and commercial linears. Provided there was sufficient space, I tried to incorporate whatever features they had into this design. ALC was considered and finally discarded as impractical and complicated to adjust without proper instrumen-



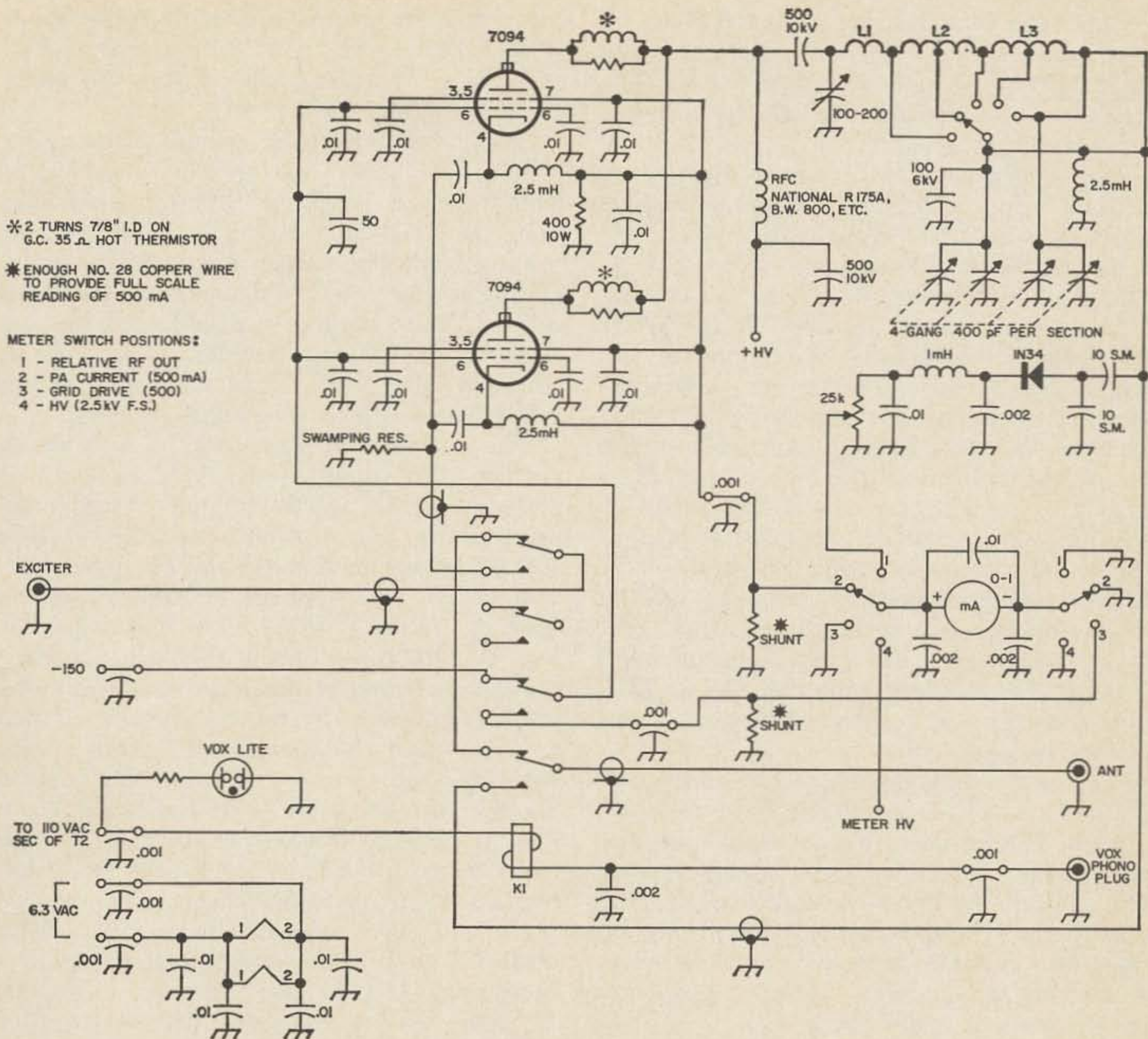

Fig. 1. The compact linear amplifier using two 7094's in the final.

tation. The 7094's are used in the popular grounded-grid configuration. The manufacturer rates these tubes at 400 watts maximum input per tube in grounded-grid. (ICAS maximum absolute rating is 2000 Vdc, 350 mA, or plate input of 400 watts). The beauty of these tubes is that they require only 15 watts of driving power for maximum output. On the other hand, if one has an exciter with a sizeable amount of input power and has very little control over it, it would be wise to consider the installation of a swamping resistor at the input of the linear.

Typical operation calls for 1750 Vdc at 200 mA on each plate, providing 210 watts of usable power into the antenna for each bottle. This meant that my dusty junk-box tubes would be capable of giving me a cool, conservative 3/4-gallon dc input without abusing them. Now is the time to start looking



The station at VE2AES. The compactness of the linear in the center can be noted by comparing its size to the transmitter and receiver.



in your own junk box to see what kind of tubes you can come up with. Between this article and those previously published, you should be able to dig out all the answers for your future linear.

The transformer for the power supply was purchased for ten dollars from a surplus house. It is an UTC H-89 with a secondary of 425-0-425 at 320 mA, or 525-0-525 at 300 mA continuous duty. In a voltage doubler I was able to get 1900 or 2250 Vdc under load, respectively. To complete my luck, I came across a "Diode, Inc." high voltage, full wave bridge rectifier pack (500 mA at 5000 Vdc). Unfortunately, one of the legs of the fullwave bridge was shorted. I guess this is what to expect for a dollar. I drilled out one of the connecting pins to which the defective string of diodes was attached. This broke the continuity of the bridge and disconnected the bad string. Best of all, it left me with two legs of good rectifiers that would handle 500 mA at 2500 Vdc. The hole was refilled with epoxy, completing the operation.

The remaining components are pretty well standard. If you do not have them on hand, a quick visit to the surplus store should cure the problem. The total cash outlay for me was around \$48.00, but duplication at full retail price would surely be much higher. Ingenuity and elbow grease are the order of the day if you want to get along with the big guns at a low price.

The output tank was built from a B&W 3905-1 inductor—I used 25 turns, tapped as indicated in the coil table (L3). For L2 ten turns of  $\frac{3}{16}$  inch copper tubing were wound

into a coil two inches in diameter with about  $\frac{1}{8}$  inch between turns. Coil L1 was wound with  $\frac{3}{8}$  inch wide copper strap— $3\frac{1}{2}$  turns  $1\frac{1}{8}$  inch in diameter.

Before the coils were wound, the copper tubing and strap was polished and silver plated with a powdered plating compound from the Cool-Amp Company\*. A word of caution here. Follow the instructions for the plating to the letter. Make sure the parts are cleaned and washed properly, leaving no trace of the plating powder. If you don't, you will find that it will oxidize and you will have to repeat the whole process.

The variable tuning capacitor is from an old BC-375 tuning unit. The capacity is 100 pF. A 150 or 200 pF unit would have been better, but I used what I had. If a 100 pF capacitor is used, the 10 meter portion of L1 will have to be so adjusted to resonate at 29.7 MHz with the capacitor set to minimum. This is the only way that the whole 10 meter band can be tuned. The same applies for the 80 meter band. I used a six-position band selector switch, with separate positions for 75 and 80 meters. Should you be faced with the same problem, it may be wise to make L2/L3 with more turns, trimming them to the exact frequency with a grid-dip meter. The taps on both coils were selected for a Q of 12 or better. The output loading capacitor is a four-gang, 400 pF per section, TRF type I found for \$4.50. You should have no trouble finding a duplicate. If worse comes to worse, a three gang unit should do very nicely.

Another point of interest with this circuit is that you cannot apply drive unless the filaments are lighted. Secondly, if a momentary power failure should occur when the high voltage is applied, a minute will be required to restore the linear to normal operation. Of course, with instant heating filament tubes, this would not be an asset. It is also worth noting that on receive, minus 150 Vdc is applied to the grids of the power amplifier to make certain that there is no idling current. Last but not least, the metering circuit for the high voltage is designed in such a way that it samples at the 300 Vdc level, minimizing potential danger with very little voltage seen at the meter. As for the method of measuring the power amplifier current and drive, it was picked

\*Cool-Amp Company, 8603 Southwest 17th Avenue, Portland, Oregon 97219.

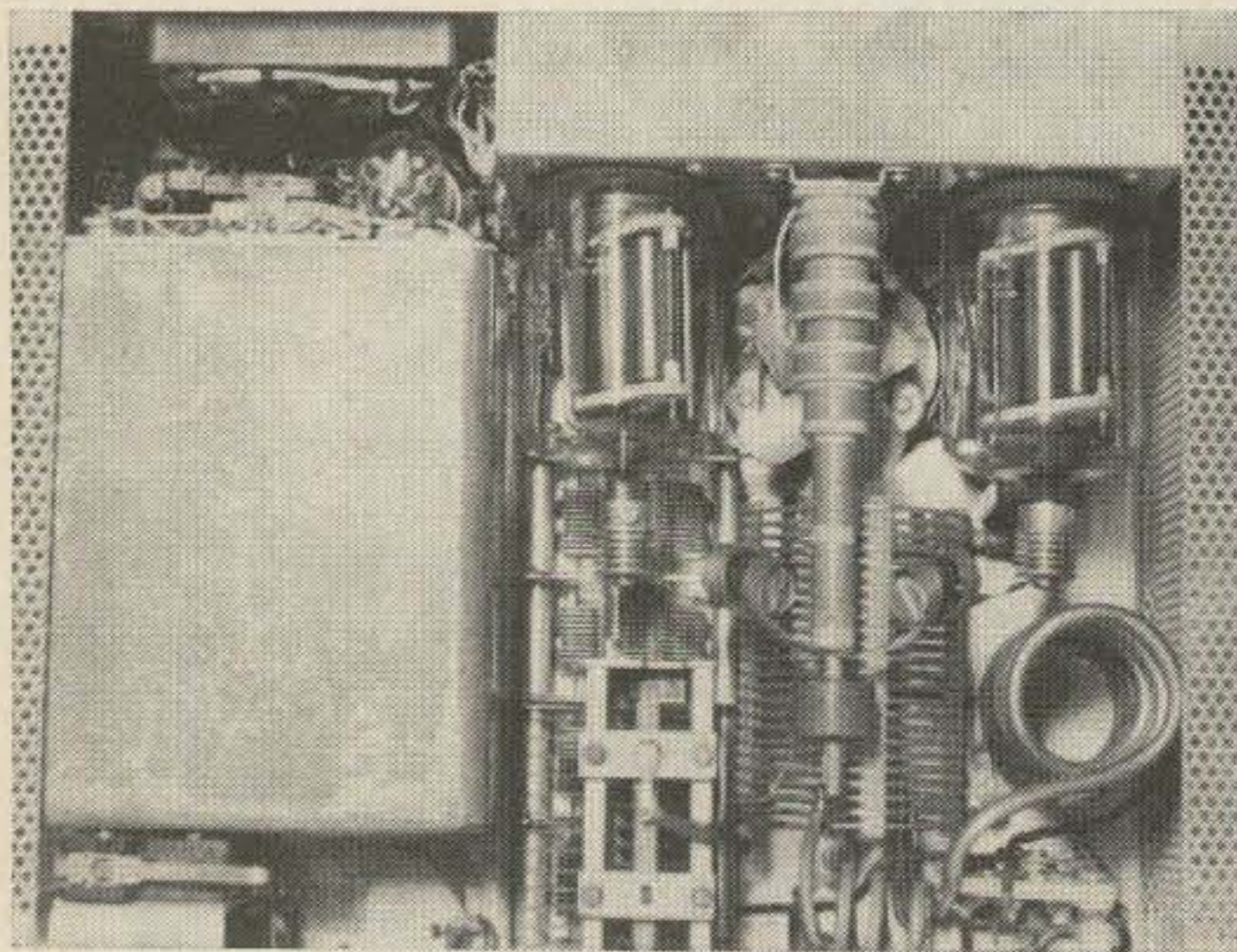

Interior of VE2AES's linear amplifier. The 7094's are mounted on a subchassis mounted on the rear panel of the cabinet. The power supply is mounted on the left-hand side.



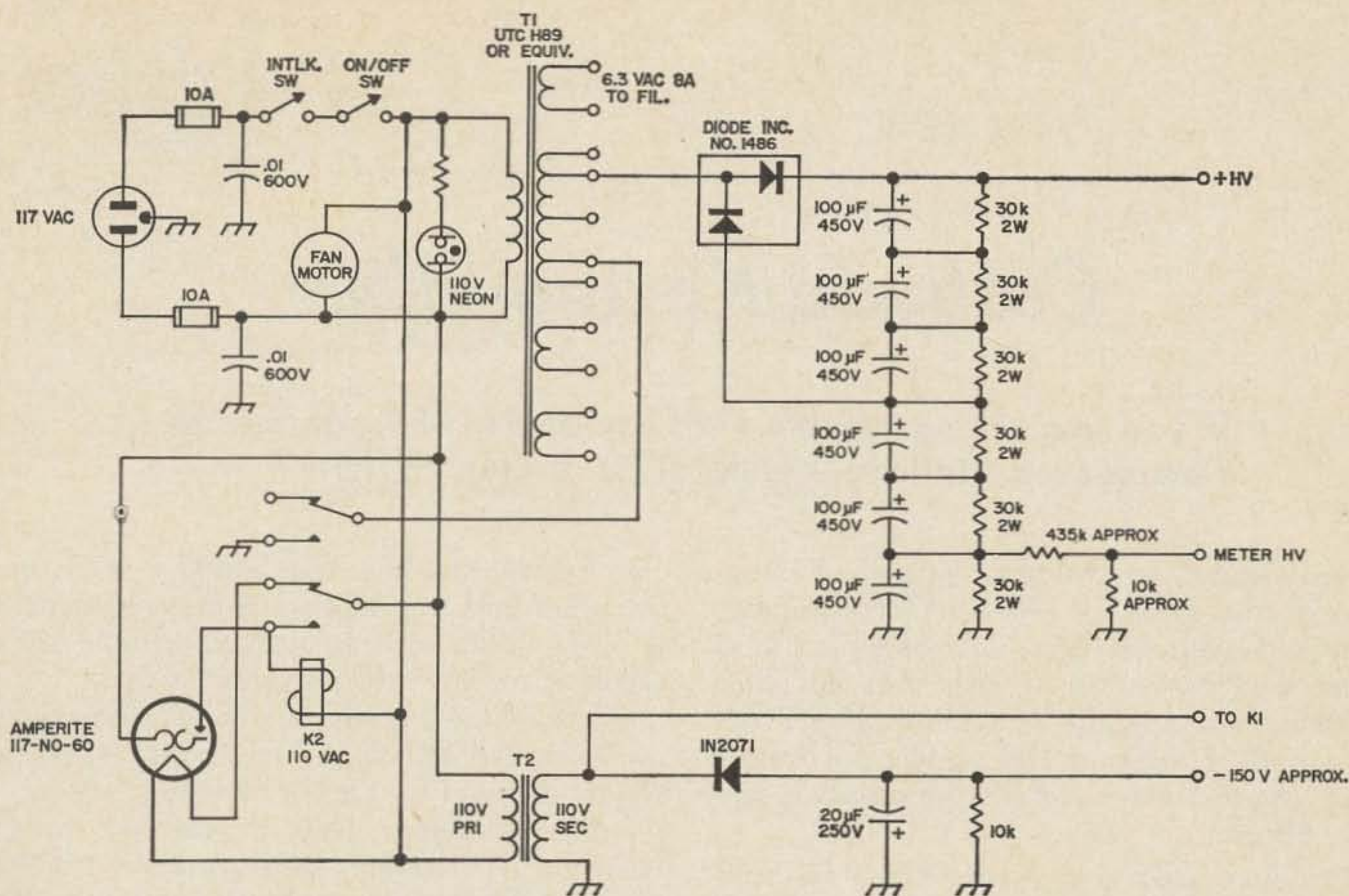

Fig. 2. Power supply for the compact linear amplifier.

up in *RCA Ham Tips* (Volume 19-3, August, 1959).

In this method, the plate and grid current are measured individually. Although the control grid and screen grid of the 7094's are connected in parallel for rf, the dc return is through their individual meter shunts. This arrangement permits a single milliammeter connected in the ground side of the circuit to measure either the plate or the grid current without switching the meter in or out of the high-voltage leads. It also minimizes the possibility of improper adjustments which could result if the meter were used to measure the total cathode current.

### Construction details

Many readers will probably wonder why two RFC's are used in the cathodes of the 7094's. The reason is simple. The ones I happened to have in the junk box would not carry the total current.

Apart from the 2 x 4 x 8 inch sub-chassis, one aluminum plate was bent in such a way that it would accommodate the transformer, which is mounted on the left side, leaving sufficient room underneath for the six capacitors and dividing resistors. The parasitic chokes consist of a strip of copper, .045" thick by 3/8 inch wide, formed into a two-turn coil

3/8 inch in diameter that will accommodate a 35 ohm thermistor (hot) mounted inside. These strips are also silver plated as described above.

### Tuning procedure

As in any linear amplifier, the meter is used primarily to check the operating conditions. The output indicator helps to achieve maximum output; but for a serious amateur, a monitoring scope with a two-tone generator is really the only way to optimize such an amplifier.

I run the 7094's with a maximum drive current of 160 mA and 400 mA plate current. Plate voltage under these conditions is 1900 Vdc—a little higher than what the manufacturer recommends. The plate current can be reduced to 380 mA to stay within manufacturer's recommendations. The tubes are still holding out very nicely and probably will be for a long time to come. The idling current without the bias is 90 mA. Neutralization was not required.

To those who venture into such a project, I feel assured that, omitting the pleasure of building such a piece of equipment, they will be repaid by at least one "S" unit. At times—not always—this will make the difference between being heard or not.

... VE2AES/W6



## Cathode Keying Filter

If you are having trouble with key clicks, why not try the time-proven cathode keying filter presented here?

Many gadgets have been described down through the years to solve clicky, thumpy, cathode keying problems. The simplest and most effective circuit is still the old filter choke system described in this article. From the sound of some of the signals on the air today, more fellows should be using a key click filter.

The filter used in this circuit can be built external to the rig in a small California Company box chassis #135, which is  $3\frac{3}{4}$  x 3 x  $2\frac{1}{8}$  inches in size. There is no need to go inside the transmitter and make changes which will devalue the price of the rig if it is resold. This system may be more inconvenient than some of the automatic keying systems, where just pressing the key turns the rig on and off, but it is cheaper and foolproof. A double-pole toggle switch can be used with

one half turning on the antenna relay and the other half turning on the crystal oscillator or VFO, either by breaking the cathode of the oscillator or the plate supply lead.

For best keying without chirps, the crystal oscillator or VFO should never be keyed, but should be on during the sending period to prevent frequency shift or causing chirps. Leaving the oscillator on during the sending period solves many problems and improves the sound of the signal.

Keying of the final amplifier or buffer by opening and closing the cathode prevents feedthrough from going out on the air, which might happen if blocked-grid keying is used and the amplifier is not blocked off enough. The system is simple, and there is much to recommend cathode keying if the pulse shape is rounded off to prevent clicks by using the simple filter shown in the schematic.

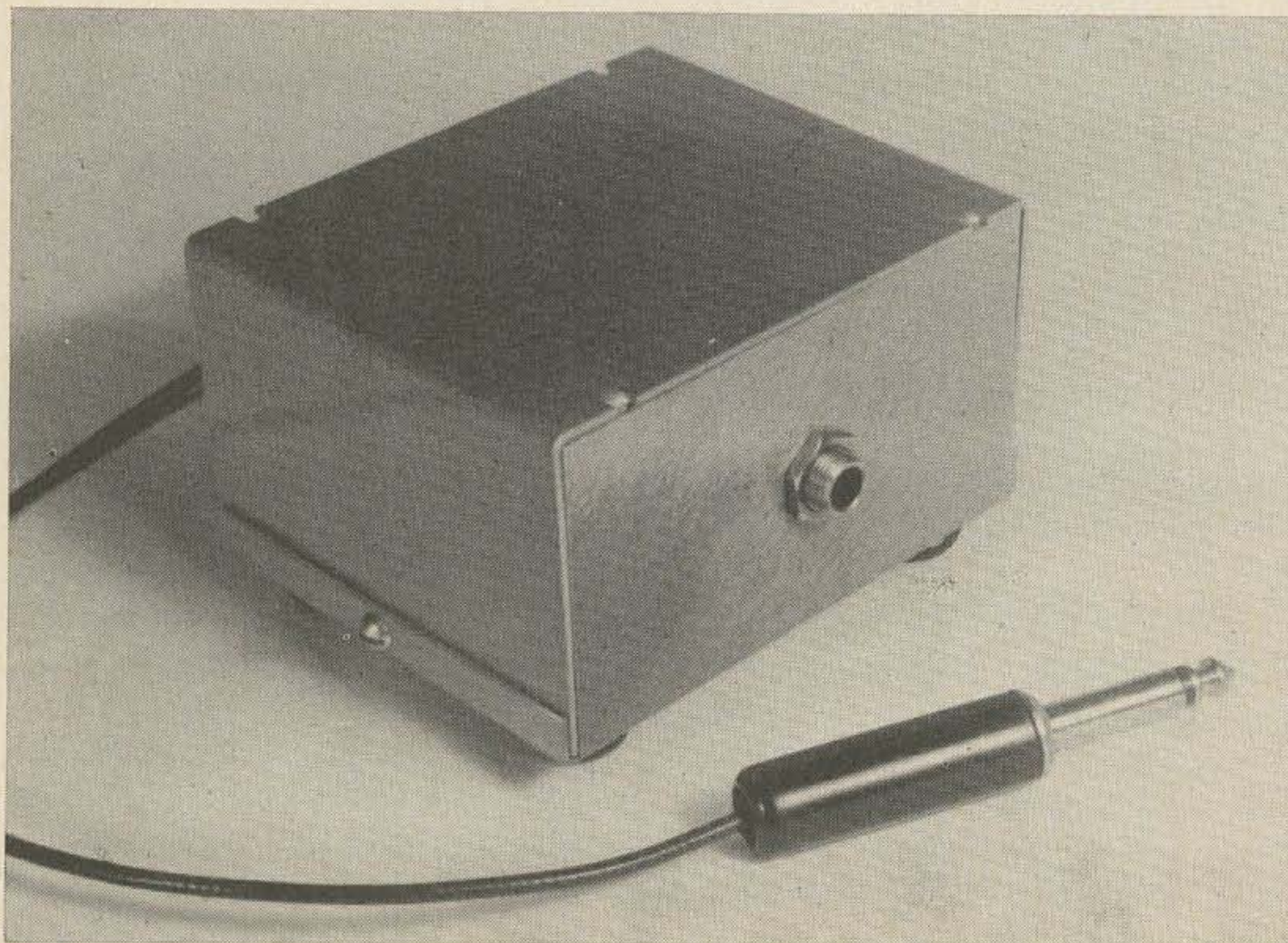

The cathode keying filter is housed in a small chassis box,  $3\frac{3}{4}$  x 3 x  $2\frac{1}{8}$  inches.



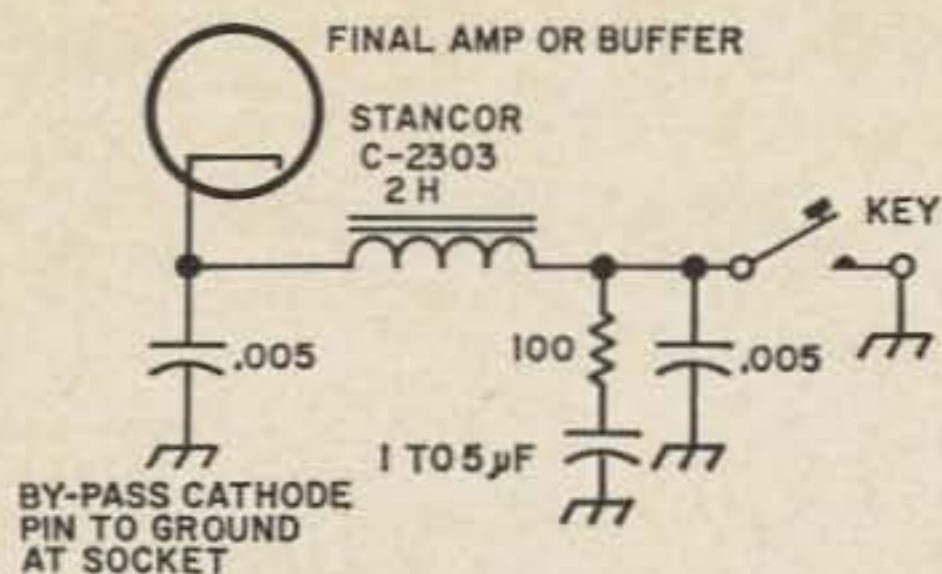

The simple cathode-keying filter.

If you are building a rig and intend to cathode key it, by-pass the cathode to ground at the socket with a .01 disc capacitor. If there is more than one cathode pin lead as in the 6146, use one for keying and by-pass the others with .005 mF disc capacitors. Also, ground pin 8 on 6146 tubes, because that is attached to the skirt which is a metal shield. In most instances the 6146 will not have to be neutralized when pin 8 is grounded. The key lead can be several feet long, but use RG-174/U or RG-58/U to the key. Place a .005 mF capacitor across the key to prevent arcing.

The filter choke used in series with the cathode for the filter should carry the rated current drawn by the tube. For a single 6146, a Stancor type C-2303, 150 mA, 2 H filter choke will work just fine. A 2 to 5 mF (oil filled) capacitor is placed across the key

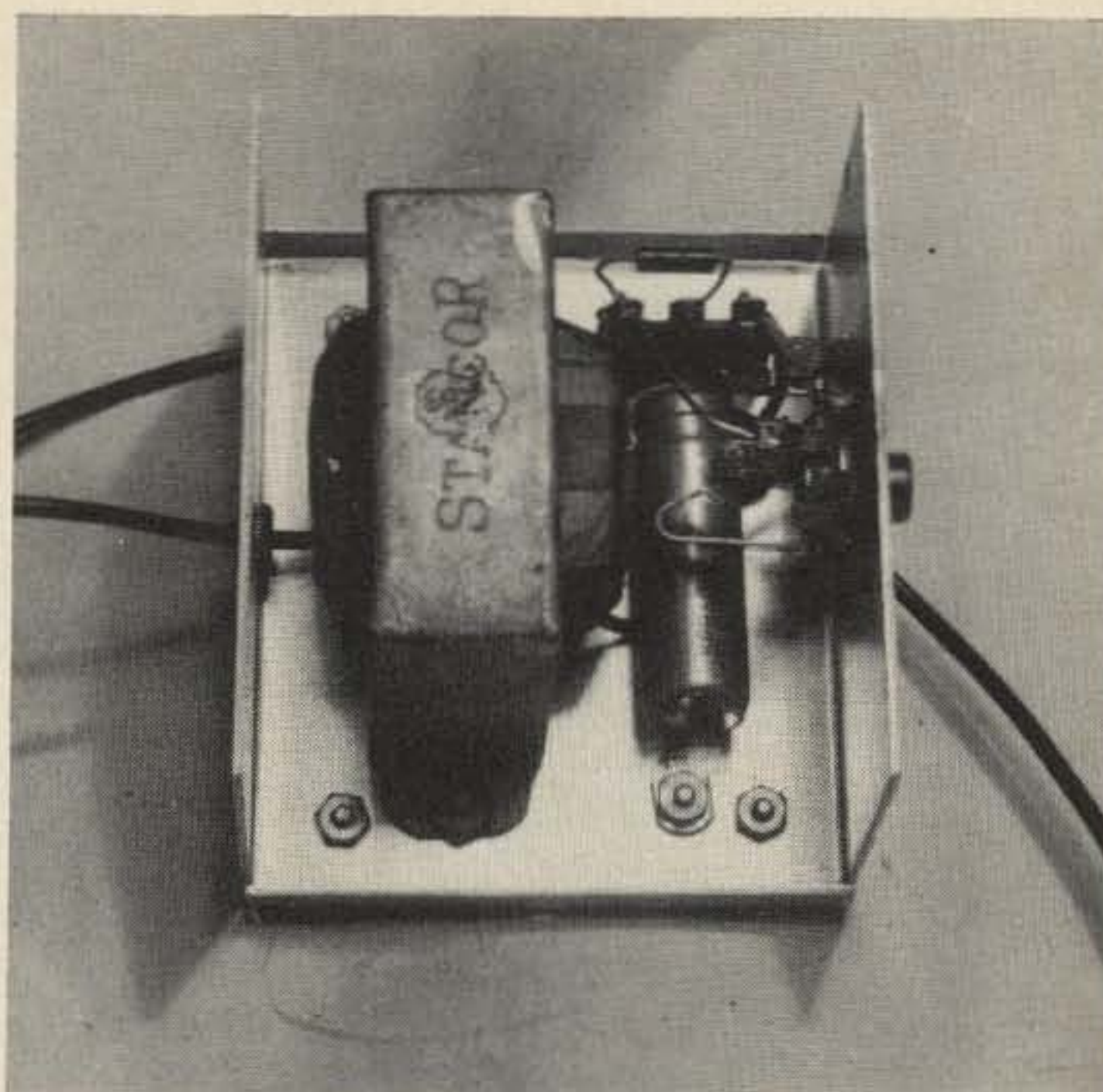

Inside the cathode keying filter.

in series with a 100-ohm resistor. The 5 mF value will be about the maximum value desired because the signal becomes rather "wing-wing sounding" if it is any larger. The operator can experiment with this value to see what is best for his tone.

Just give this old idea a try and see if it is not much simpler than some of the other circuits now in use.

... W6BLZ

## Increased Selectivity for the Twoer

This project was started in the hopes of increasing the selectivity of my Twoer in the simplest possible way. The results are fantastic and the total cash outlay was only two dollars.

In this simple circuit modification, four parts are removed—R10, C26, C27 and L6. A 10 pF capacitor, a 3.3 megohm resistor, a 30 pF trimmer and a new coil are substituted in their place as shown in the schematic. The 30 pF trimmer should be set for complete coverage of the two-meter band with the variable tuning capacitor, C28. You will find that adjustment of this trimmer is fairly tricky. A grid dipper is useful here, but not a necessity if there is plenty of two-meter activity in your area.

After this modification the sensitivity is slightly lower, but this is made up by the amazing selectivity which results from the new detector circuit. If you want more sensi-

tivity, you can add one of the many nuvistor preamplifiers that have been described. Selectivity is estimated to be in the neighborhood of 100 kHz, but will depend upon the strength of the received signal.

... Wayne Montague VE3FYL

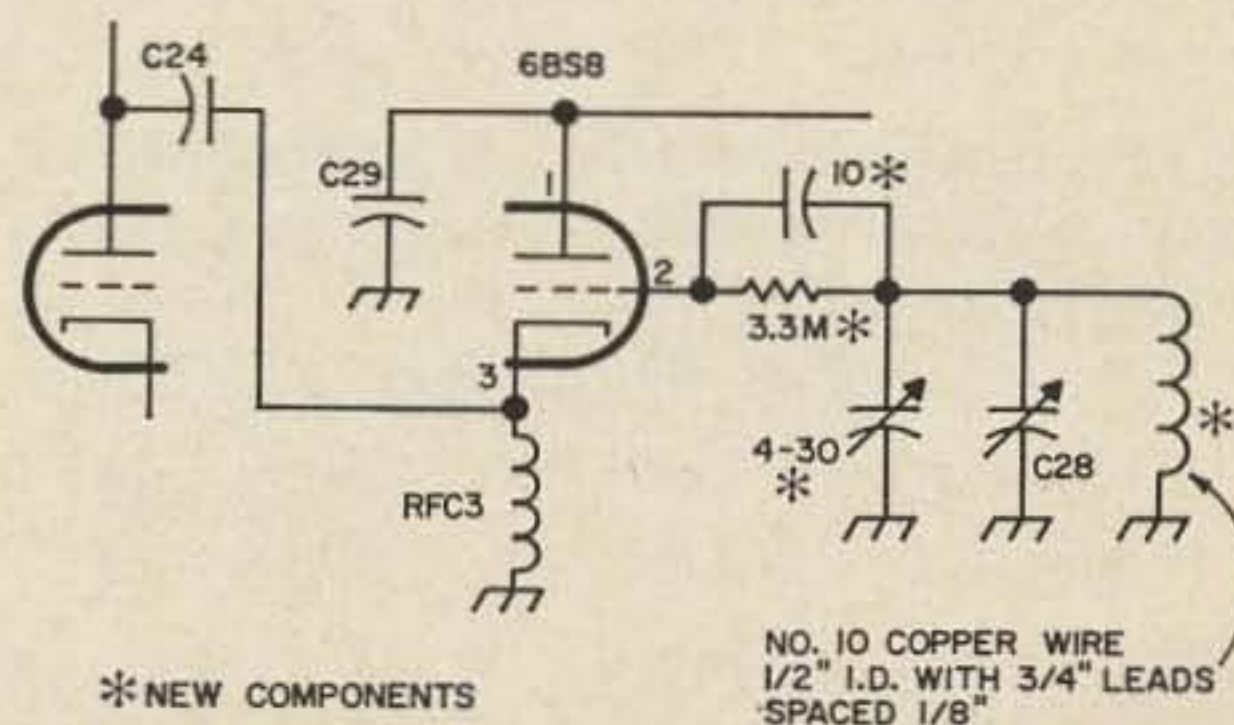

Modified Twoer circuitry for greater selectivity. The 30 pF trimmer should be set for complete coverage of the two-meter band with C28. A grid-dip meter is useful for this adjustment, but not necessary if there is a lot of 144 MHz activity in your area.





## LINEAR AMPLIFIER

2 KW PEP SSB—1000 DC Watts CW-AM-RTTY. 21 important advanced features. New HD tank gives more output, especially on 10 meters. 65 Watts will drive to full output. 220/115 VAC operation. Write for list of features.

Complete with Eimac 3-1000Z **\$895<sup>00</sup>**

## SERVICE TESTED EQUIPMENT

FREIGHT FREE WITH CASH REMITTANCE IN CONTINENTAL USA.

### CENTRAL ELECT.

20-A SSB xmtr \$89  
458 VFO for same 29

### COLLINS

75A-2 rcvr \$189  
75A-3 rcvr 229  
75S-1 rcvr  
w/noise blktr 369

### CLEGG

22'er xcvr \$199  
66'er xcvr 179

### DRAKE

I-A rcvr \$119  
T-4 reciter 219

### EL-MAC

PMR-7 rcvr \$39  
PMR-8 rcvr 59

### GONSET

G-50 6 mtr xcvr \$169  
G-66B mob. rcvr 39

G-77 mob. xmtr 49  
G-77A mob. xmtr 69  
GSB-100 xmtr 169  
GSB-201 linear 199  
500-watt linear 99  
Comm. II, 6 mtr 79  
Comm III, 6 mtr 99  
Comm IV, 2 mtr 249  
Mob. FM conv. 39  
Sidewinder,  
2 mtr SSB 199

### HALLICRAFTERS

S-40 rcvr \$49  
SX-99 rcvr 65  
SX-101 Mk 3 139  
HT-37 xmtr 229  
HT-32A xmtr 299

### HAMMARLUND

HQ-145XC \$169  
HQ-160 rcvr 165  
HQ-170C rcvr 199  
HQ-170A rcvr 249  
HQ-180AC rcvr 389  
HX-50 xmtr 239  
SP-600-JX rcvr 229

### HEATH

DX-35 xmtr \$19  
DX-40 xmtr 39  
HA-20 6 mtr lin. 95  
HR-10 rcvr 65  
HR-20 rcvr 89  
MT-1 xmtr 39  
HG-10 VFO 24  
HP-20 P/S 25  
MP-1 P/S 19  
HW-10 6 mtr xcvr 129  
HA-14 mob. lin. 89  
HP-14 mob. P/S 69  
HW-12 75 mtr  
SSB xcvr 89  
HW-32 20 mtr  
SSB xcvr 99  
AJ-10 Warrior lin. 169  
HO-10 scope 65  
VHF-1 Seneca 129  
SB-200 lin. 209  
SB-400 xmtr 289  
SB-600 w/HP-23 P/S 75

### JOHNSON

Navigator xmtr \$69  
6 & 2 mtr mtr 79  
Invader 200 SSB xmtr 199

### LAFAYETTE

HE-45 6 mtr xcvr \$49  
HE-45A 6 mtr xcvr 59  
HE-45B 6 mtr xcvr 69

### NATIONAL

NC-60 rcvr \$39  
NC-98 rcvr 59  
NC-270 rcvr 119  
NCL-2000 lin. 399  
VX-501 w/calib 169  
HRO-50T w/5 coils 149

### SONAR

40 mtr xcvr \$99  
DC P/S for same 49

### SWAN

SW-120 20 mtr xcvr \$119  
SW-175 75 mtr xcvr 129  
600 VDC P/S for same 49

### SIDEBAND ENGINEERS

SB-2-LA lin \$199  
SB-3-DCP lin P/S 189

I will ship in the 48 states freight free! Write to me for top trade-in allowance!

Bill Hullquist K6LOS

# MISSION HAM ELECTRONICS

3316 Main Street  
Riverside 3, California 92501  
Phone 833-0523 (area code 714)

ORDER  
TODAY

### MISSION HAM ELECTRONICS

3316 Main Street, Riverside, Calif. 92581

- SHIP ONE "STONER" RT-1 CONVERTER:
- Send spec sheet on BTI Linear.
- QUOTE Trade allowance for my.....
- Please send latest HAM flyer.
- Put me on your mailing list.

Name ..... Call .....

(please print)

Address .....

City ..... State ..... Zip .....

(Calif. orders add 4% tax)



A. E. Blick VE3AHU  
 Box 204  
 Amherst View, Ontario  
 Canada

## A Simple Resistance Bridge

Every ham that has done any homebrewing, amateur style, has been faced with the problem of calculating resistance. You have just set the bias on that transistor amplifier using a variable pot and now your Scotch soul rebels at leaving it in the circuit when a five-cent composition type would suffice. If only you could get an exact replacement—the circuit calls for two 1,000 ohm resistors, matched to within 1% and all you have is the normal dozen junk-box variety; and on and on!

Many years ago, long before the advent of ham radio, this problem was solved by a man called Wheatstone who designed the Wheatstone resistance bridge. It can be found in nearly every electronics lab where precise measurements are required but is a costly item due to the precision of its parts and the exceedingly high quality of its components. For ham work such very high precision is not necessary and with the current availability of precision multiturn pots and dial counters, a suitable type for our use can readily be made in the workshop.

Fig. 1 shows the schematic of the type I built. With it you can measure, with a high degree of accuracy, resistances from 1 megohm down to 0.01 ohm. This will cover just about any value that the average ham experimenter will want to measure. The equation used for measurement is  $R_u =$

$$R_1 \times \frac{R_a}{R_b}$$

and by switching in different values of precision resistors for  $R_a$  and  $R_b$ , a large range of values can be measured.  $R_1$  is a 1,000 ohm precision ten-turn potentiometer with a turns-counting dial. Two flashlight batteries are used for the voltage source, and a standard VTVM, adjusted to read centre scale at rest on its lowest voltage scale, is used for the indicating meter. A sensitive galvanometer could also be used.

I used the high-impedance voltmeter described by K3LCU in the July 1966 issue of 73.

Measuring resistance is simple. Plug in the meter and set it to centre scale, attach the unknown resistance to the  $R_u$  terminals, turn on switch S-2 and manipulate S-1 and  $R_1$  until the meter balances at centre scale. Read off the value from  $R_1$  and multiply this by the factor given by S-1. For example, if the reading from  $R_1$  is 492 and S-1 is at X1, then  $R_u$  would be 492 ohms; if S-1 is at X1000, then  $R_u$  would be 49,2000; if S-1 is at X0.01,  $R_u$  would be 4.92 ohms, etc.

Layout of parts is not critical, but keep all wiring short and direct, using heavy gauge wire for the arms of the bridge to decrease errors that may crop up when measuring very low values of resistance. Due to the relatively high values of the resistances used for  $R_a$  and  $R_b$ , contact resistance in switch S-1 will not affect the readings.

... VE3AHU

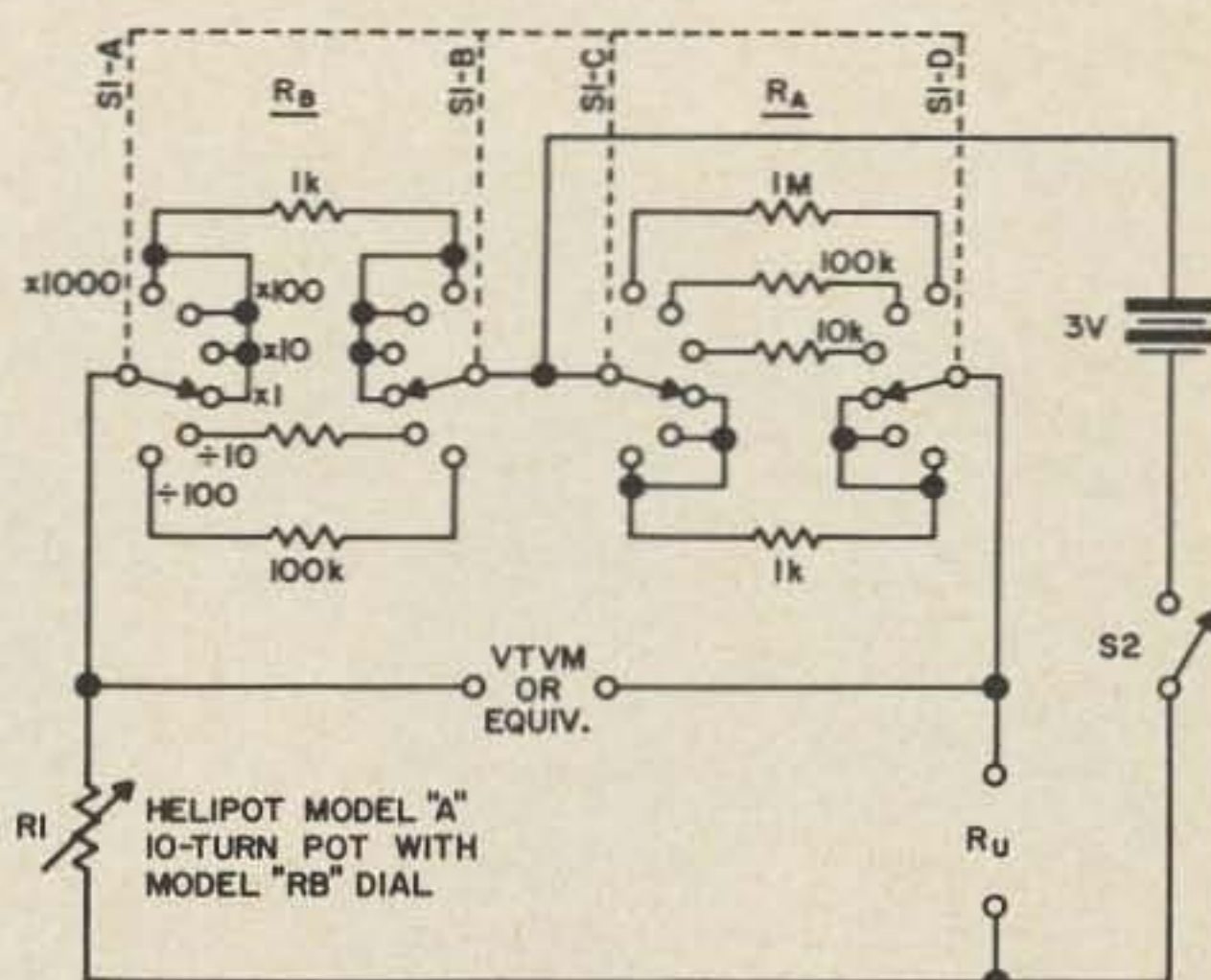

NOTE - ALL RESISTORS 1%.

Circuit of the simple resistance bridge. S1 is a Centralab PA2011 rotary switch, S2 is a SPST slide switch and R1 is a precision, ten-turn 1000 ohm potentiometer such as the Helipot model A. The unknown resistance is placed across terminals "RU".



## Compact Heat Sinks

Simple but effective heat sinks using standard copper pipe caps.

With the increasing use of solid-state devices as power rectifiers, voltage regulators, and power amplifiers, there is the problem of getting rid of excess heat. If this heat is not conducted away from the junction, internal temperature soon rises to the danger point, and another expensive rectifier, transistor, or Zener diode goes *kaput*.

In much experimental equipment, solid-state devices that can have the "hot" (thermally) side grounded are bolted to the chassis, which makes a fairly good heat sink. Insulated mountings of this type are also sometimes possible, by use of mica or other washers which are good conductors of heat, and very poor conductors of electricity.

In much finished equipment, heat sinks are made from sheets of copper, usually  $\frac{1}{16}$ " thick, which are stood edgewise, to facilitate convection, and insulated from surroundings as needed. These, if of sufficient area, are most effective, but take up a lot of chassis

space.

Although some "tailor made" heat sinks have appeared on the market, they are usually hard to get outside of large electronic centers such as New York, Chicago, and Los Angeles. A number of experiments and computations show that a cup-shaped heat sink, of suitable material, has excellent heat-dissipating properties. In addition, it takes up relatively little chassis space. A number of them were made up, tested, and found most satisfactory. At about this time, while trying to wangle some more copper sheet at the supplier's, it was found that the copper cups needed for these heat sinks were already made commercially. They are sold as copper pipe caps, and come in a variety of sizes. Shape of a standard copper pipe cap is illustrated in Fig. 1.

Sizes and area factors for these copper pipe caps are shown in Table 1. As might be

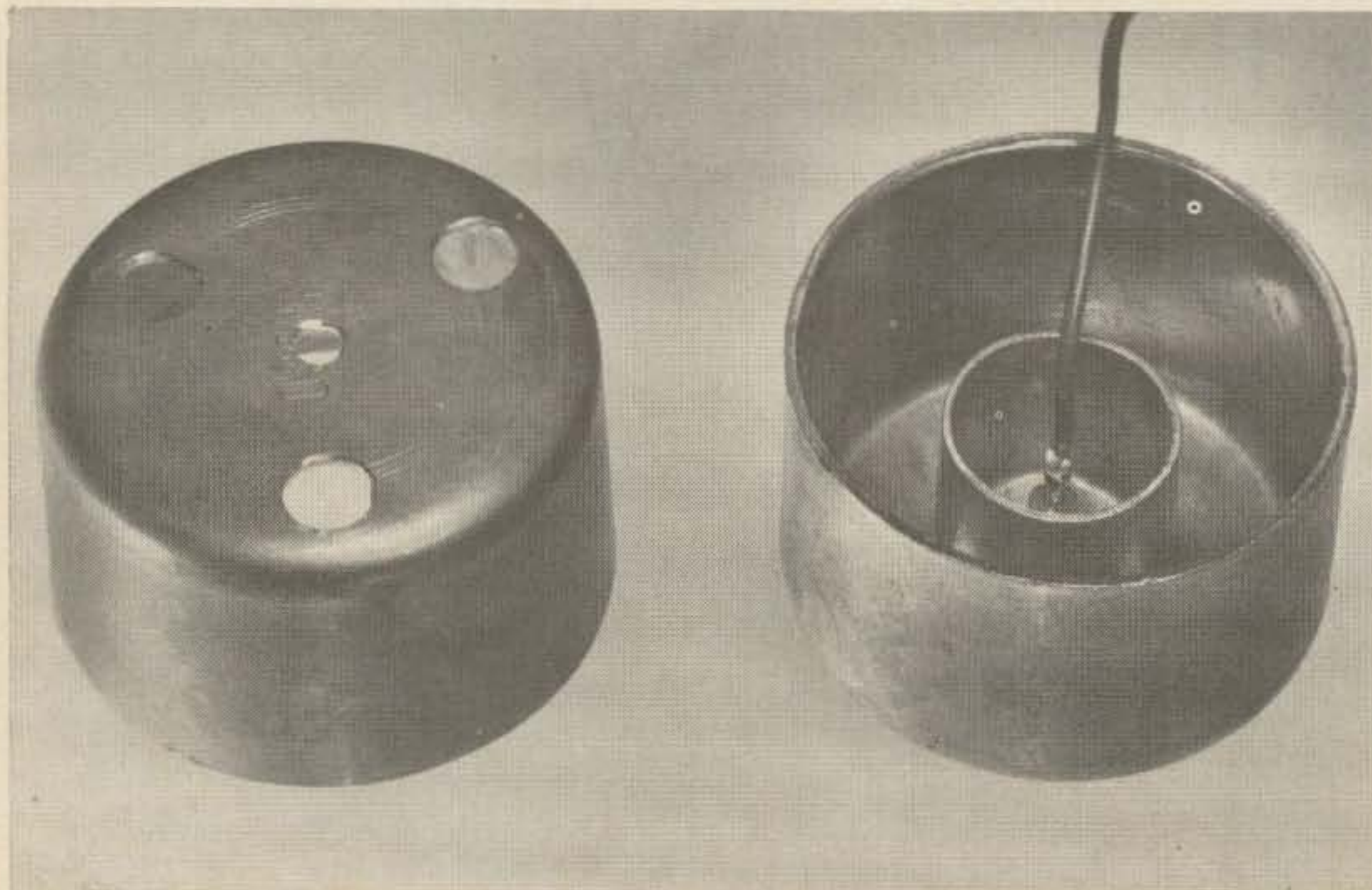

The copper pipe-cap heat sinks. The unit on the left shows the placement of the vent holes. The unit on the right uses "nested" construction for greater heat dissipation.



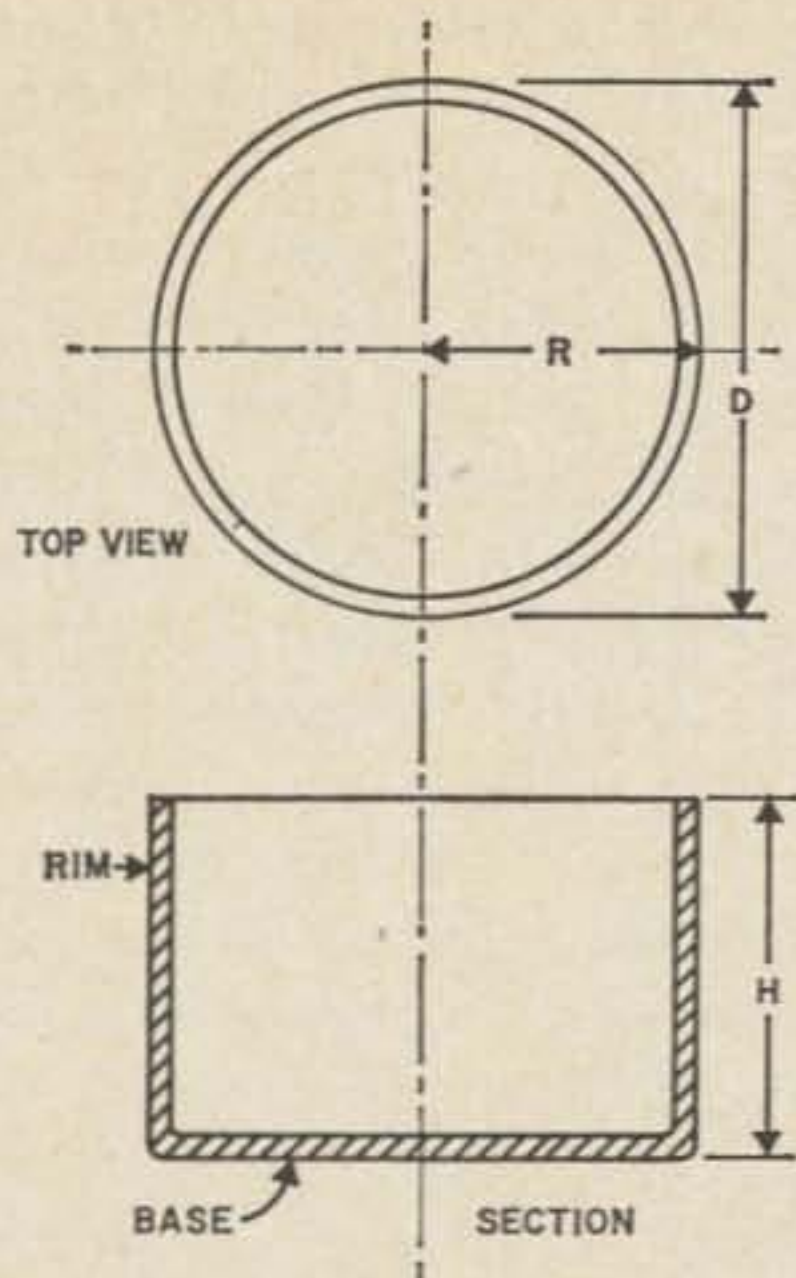

Fig. 1. Standard copper pipe cap. The standard sizes and area factors for these caps is given in Table 1.

expected, the radiating ability of these caps was not a simple function of surface area, and the effective radiating area was considerably increased, in the larger sizes, by suitable venting, which permits convective cooling of the inner surface of the cup. Arrangement of vent holes, and empirical data on their sizes, are shown in Fig. 2. Vent holes smaller than about  $\frac{1}{16}$ " in diameter are almost completely ineffective. Vent holes that are too large are also somewhat ineffective, as they reduce the heat conducting area of the flat portion of the pipe cap. Heat conduction away from the center of the pipe cap tends to be somewhat better than that in a flat plate having the same thickness as the rim of the pipe cap, as the base tends to be considerably thicker than the rim.

Vented pipe-cap sinks cool best when they are mounted above the chassis to allow free circulation of air through the holes. If the heat sink must be mounted close to the chassis, or if absolute maximum cooling is desired, suitable vent holes in the chassis are desirable. These should be at least as large as the holes in the heat sinks—preferably

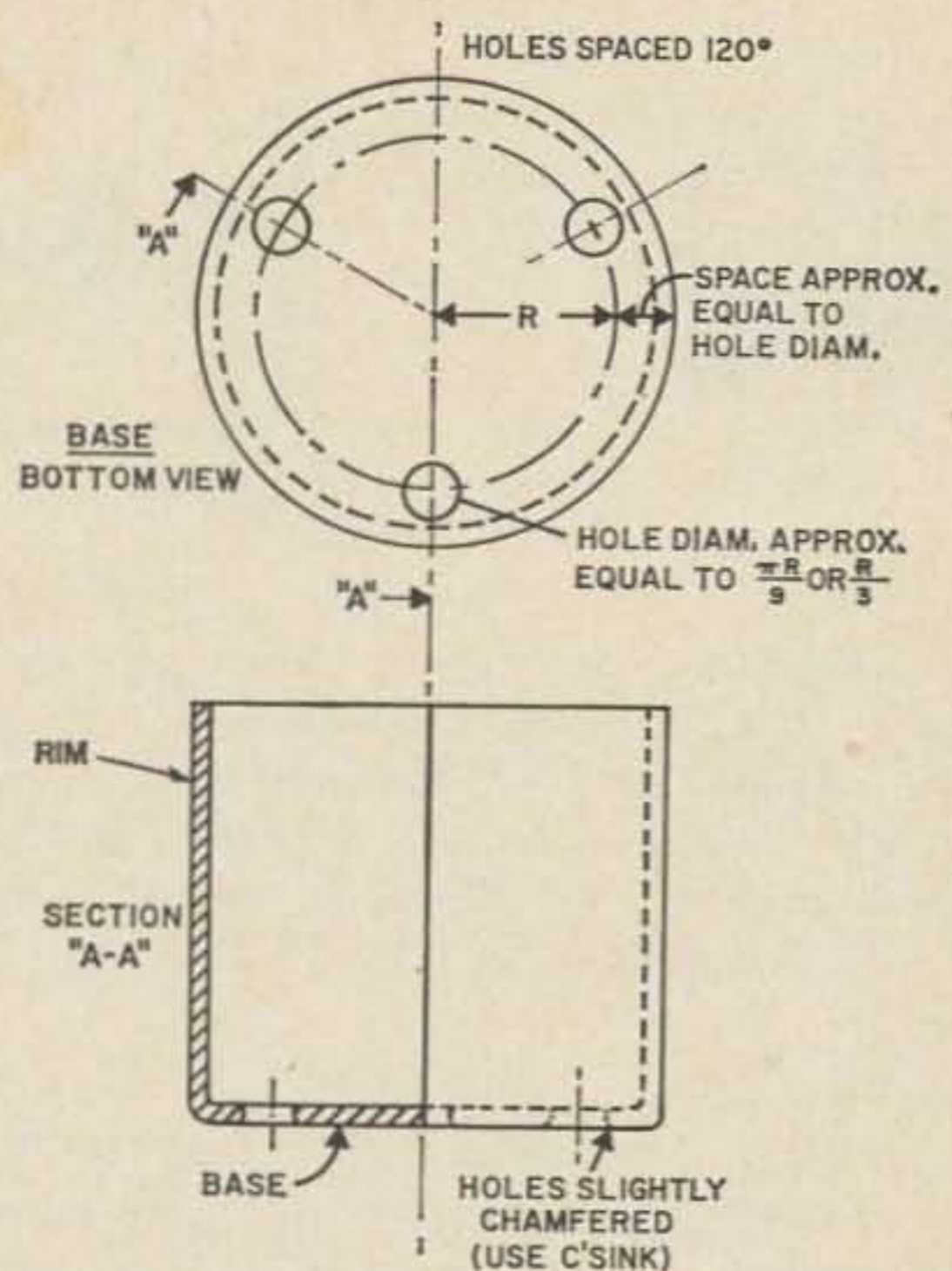

Fig. 2. Arrangement of vent holes in the copper pipe cap heat sinks.

somewhat larger—and lined up with them to permit free air motion. Quite obviously, the chassis should not be hermetically sealed, or air circulation will be impeded.

To permit free conduction of heat from the semiconductor to the sink, the semiconductor must be in intimate contact with it. Good results are usually obtained if the base of the semiconductor fits smoothly and tightly to the heat sink. Use of thermally-conductive "gunk", such as Dow-Corning DC-100 silicon grease, will improve heat conduction somewhat. CAUTION: Do not use a mercury amalgam to improve heat conduction between the semiconductor and the heat sink. This does improve conduction in some instances, but mercury vapor, which is emitted slowly at room temperature, and quite rapidly at higher temperatures, is extremely toxic, and produces irreversible physiological damage.

Possible combinations of pipe caps, to produce heat sinks or large area and small bulk, are numerous, but only a few of them

nominal size inches	h inches	d inches	r inches	outside area square inches	Effective Area square inches	
					unvented	vented
1/2	.6250	.6875	.3437	1.70	2.04	2.05
3/4	.8750	.9375	.4687	3.20	4.10	4.23
1	.8750	1.250	.6750	5.13	6.60	7.05
1 1/2	1.1875	1.750	.8750	8.85	12.40	13.70
2	1.3750	2.250	1.125	12.46	18.70	21.60
2 1/2	1.500	2.275	1.137	17.00	27.20	32.30

Table 1.



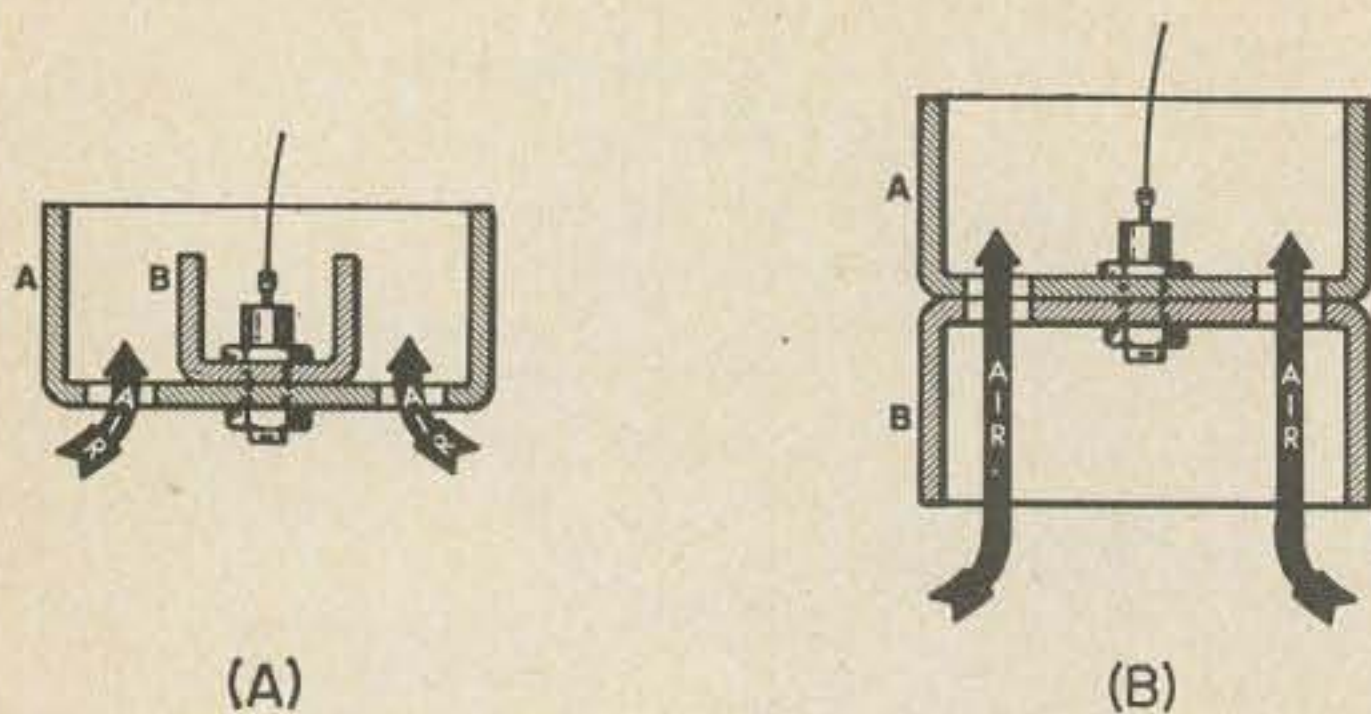

Fig. 3. Combining two copper pipe cap heat sinks to increase the effective heat radiating area. The effective cooling area of the nested arrangement in A at 25° C above ambient is 1.05 [A (vented) + B (unvented)]. The effective cooling area of B at 25° above ambient is 0.95 [A (vented) + B (vented)].

work well. When radiating surfaces are too close together, radiation carooms back and forth between them, and cooling is nowhere as rapid as the areas involved would indicate. Likewise, if the mechanical spacing is too close, convective air circulation is retarded, and cooling, again, is not what you might expect. Two effective combination formats are shown in Fig. 3, with approximations of their cooling properties.

The "nested" format, shown here, is also shown in the photographs. This, in many respects, is the best of the combination formats. The heat sink shown, made from a vented 2" pipe cap, into which is nested an unvented ¾" pipe cap, has an effective radiating area approximating 26 square inches,

roughly equivalent to a sheet of ¼" copper 3.56" square, or a circle of ¼" copper 4.1" in diameter.

According to data given by most manufacturers, and verified by tests, this is adequate to cool a 10-watt Zener diode or a 5-ampere rectifier. Because of the greater mass of copper close to the shank of the semiconductor, it furnishes greater protection against the thermal effects of short-term high currents than does a heat sink made of copper sheet.

Although most physics books state (correctly) that a black surface is a most effective radiator, painting these heat sinks black with ordinary paint, such as Krylon, does not improve their radiating properties. Most paints are pretty good thermal insulators, and painting a heat sink black may very well reduce its cooling properties. For most purposes, radiation will be at a maximum if the clean copper surface of these heat sinks is allowed to darken by normal oxidation. A slight increase in radiation can be produced by chemical blackening, or by painting with special radiating paints, such as black "radiator paint."

On the basis of a number of careful, but necessarily crude, tests, it appears that heat sinks made from standard copper pipe caps are a most satisfactory and inexpensive solution to the problem of getting more cooling area in less chassis space. ■

## Simple Test Leads

With each new piece of test equipment, the problem of test leads increases by at least two. This ever-increasing tangle of wires is bad enough, but when you start interconnecting equipment or try to use the leads from one instrument on another, you often hit a snag.

The solution, at first, looked simple: convert all equipment to accept one type of lead. I settled on a banana plug on one end and an alligator clip on the other. This worked for a while, but I soon found I needed a clip on both ends of some and plugs on both ends of others.

After many hours of study, I stumbled onto the fact that the tails of some alligator clips were just the right size to take banana plugs. With this fact in mind, my test leads now have plugs on both ends, and with six or eight clips, I can make the

lead to suit the job.

This procedure has even been carried to test prods. Now, if the situation calls for clipping a voltmeter lead to a wire, it is a simple matter to change the prod to a clip.

The simplest way to convert your test prods is to use a commercial plastic banana jack, file it to fit your prod, attach a wire, and glue the jack in place. Another method is to drill the handle so that you can just force the tubular end of the alligator clip into the prod. Then remove it, break it off, solder a wire on, and drive this into the plastic handle.

This system is well worth the small amount of time and work involved. Give it a try and see if it doesn't help clean up your workbench jungle.

. . . John Foster KØFEG



## B-500-SSC TRANSCEIVER — The Complete Big Station In One Little Box

This is the World's Most Advanced Transceiver, utilizing techniques that significantly extend the state of the transceiver art. A completely self-contained unit, it provides superb, high-efficiency performance on SSB, CW and AM.

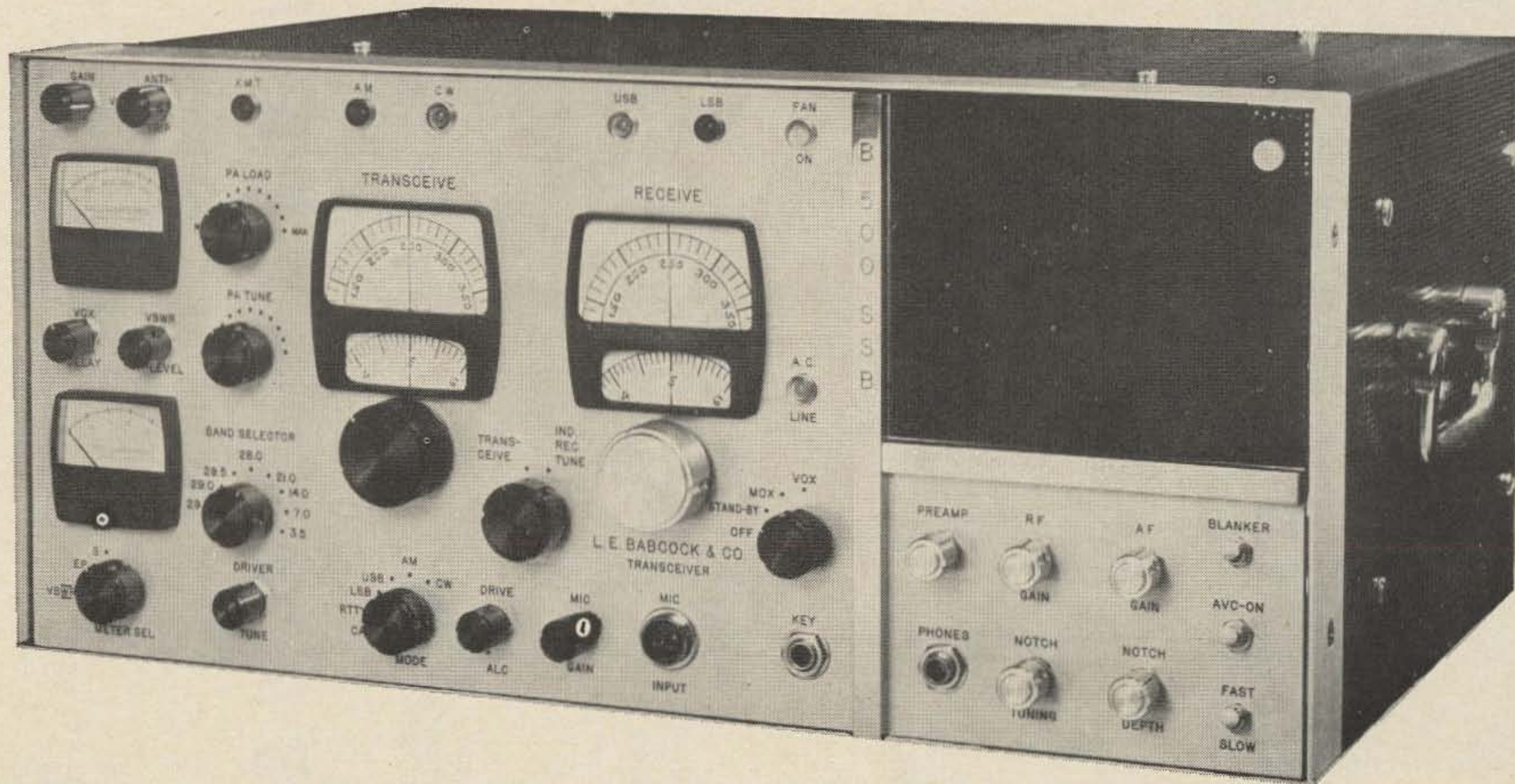

The B-500-SSB uses a rugged Eimac 4CX250B. Power input is 600 watts PEP class AB1 on SSB, 500 watts PEP input class C on CW and 500 watts PEP input class C with high-level plate modulation on AM. The B-500-AM plate modulator is an accessory. 3.5 thru 30 MHz in 8 500 kHz segments. See full details in 73 Magazine for April, 1967, and November, 1966. Price \$1195.00. Available, December 1967.

28 Durant Ave.

# L. E. BABCOCK & CO.

Maynard, Mass., 01754



Robert Brickey W7QAG  
Electronics Instructor  
Utah Technical College  
349 N. 250 E.  
Orem, Utah 84057

## *Evaluating Antenna Feed Systems with Time Domain Reflectometry*

Although you are not apt to find a time domain reflectometry system in the average ham shack, it is extremely useful and informative as W7QAG shows here.

Transmission line impedance measurements made with a standing wave bridge, directional coupler, or similar device, yields information on the cumulative effect that the various components in the feed system have on the impedance of the point being measured. Only with a knowledge of the characteristics of all parts of the system can the effects of a particular portion be ascer-

tained. Even with all of this information, which is frequently unobtainable to the necessary precision, the computations are quite involved if the system is very complex.

Time domain reflectometry offers a powerful tool for use in evaluating antenna feed systems, and in some cases characteristics of antennas as well. With this technique it is possible to single out the various elements

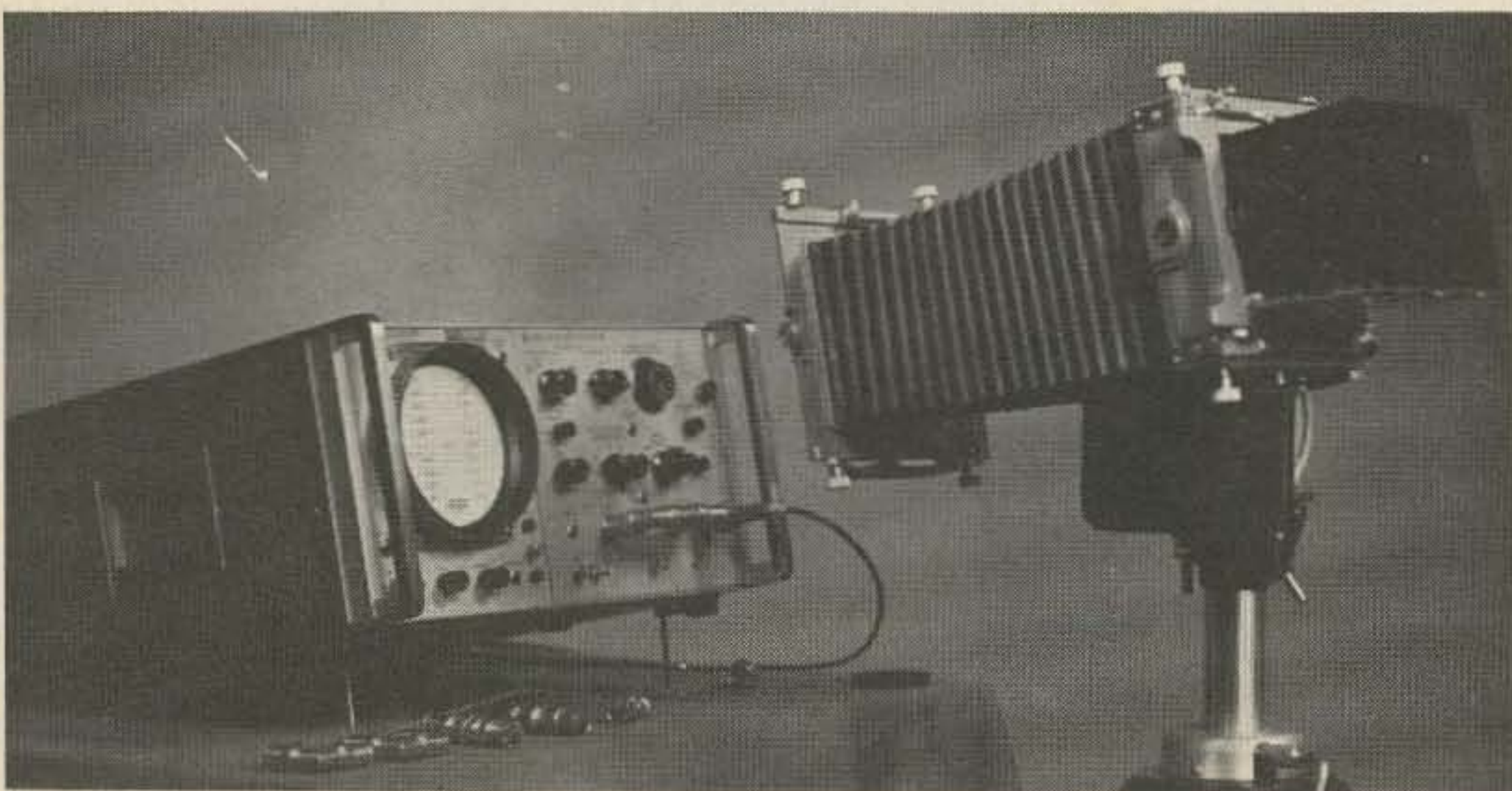

Fig. 1 The Hewlett Packard "time domain reflectometer" installed in the 140A oscilloscope and the "view camera" used in making the scope trace photographs.



of a system and evaluate them individually.

### How it works

In operation this system of measurement is somewhat analogous to a simple radar system. A pulse of energy is transmitted through the system being evaluated and the returning echoes give information on the electrical characteristics of any discontinuities in the system. Since echoes from different points return to the measuring equipment at different times, it is possible to isolate and evaluate the individual effects of each component.

The pulse reflection method of locating faults in a transmission system is not new. In fact, it is a proven technique which has been in use for many years for locating troubles in long lines.

Why then all this concern about an old measuring system? With the development of methods for generating pulses of energy with rise times less than one nanosecond, and oscilloscope sampling techniques which provide undistorted observation of these rapid pulses, it is now possible to make a system which has less than one inch resolution as compared with the older systems which could isolate the trouble only to within several yards. Because of the high degree of distance resolution of the new measuring systems, an oscilloscope presentation can be generated which shows an accurate impedance profile of a short radio-frequency transmission system.

### The equipment

Hewlett-Packard manufactures a "time domain reflectometer" plug-in unit which is designed to be used with their Model 140-series oscilloscopes and it has the necessary characteristics for accurate measurements in high-frequency systems. This equipment, along with the "view camera" used in making the photographs in this article, is shown in Fig. 1. Of course, sophisticated equipment of this type is well beyond the budget of most radio amateurs, and I am certainly not suggesting that all well-equipped stations shouldn't be without one. While it is doubtful, because of the expense, that you will be able to use time domain reflectometry yourself to analyze your own antenna systems, an understanding of the techniques applied should give you a better insight into the behavior of transmission lines in general.

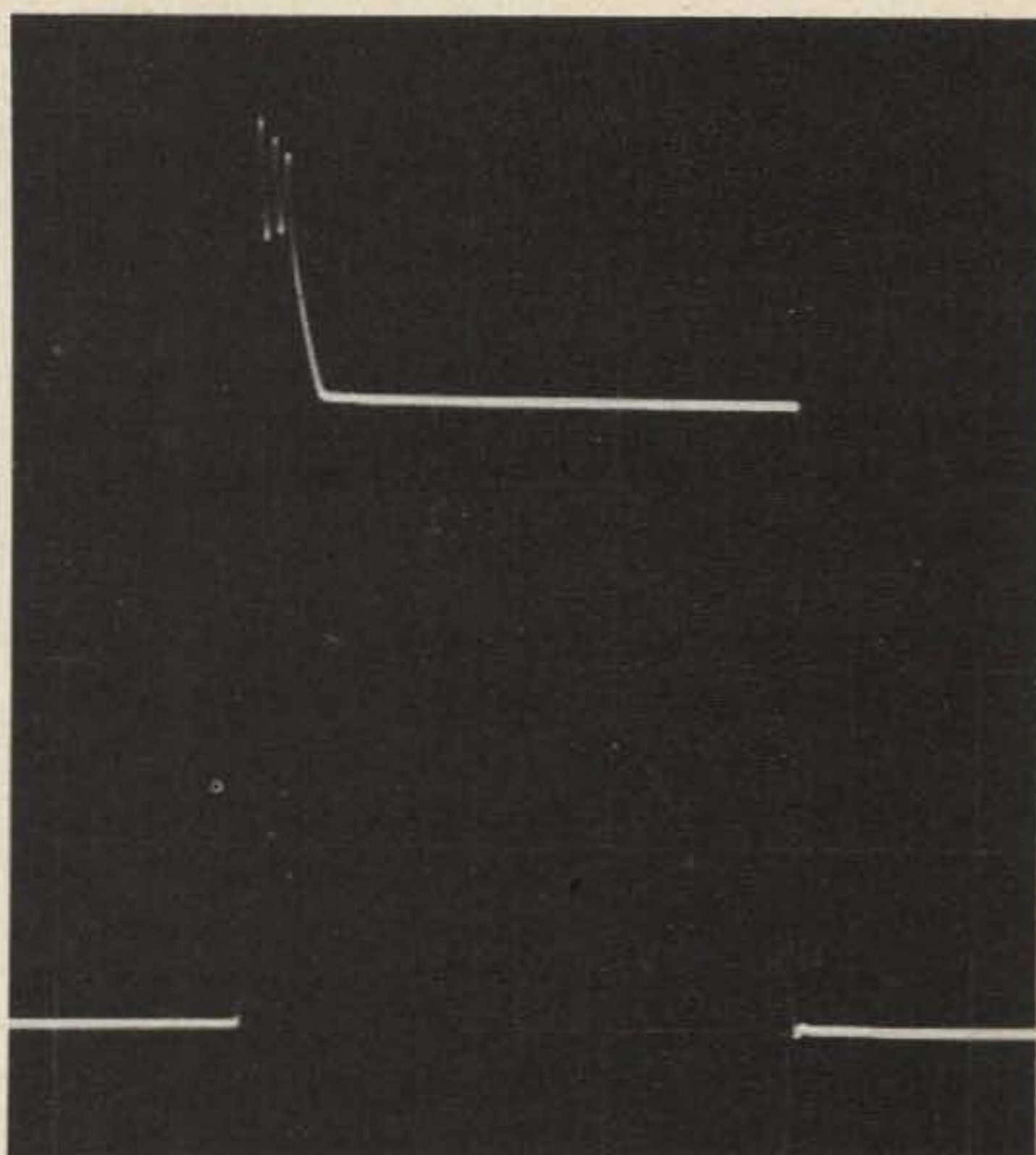

Fig. 2 A photograph of the voltage step output of the "time domain reflectometer" as displayed on a Tektronix type 564 storage scope. The rise time of the pulse is approximately 50 psec.

I have included scope trace photographs of impedance profiles of a number of different feed system components which are widely used by radio amateurs.

### The Voltage step

The pulse of energy applied to the transmission system under test by the "time domain reflectometer" is shown in Fig. 2. This pulse has a rise time of approximately 50 picoseconds, a repetition rate of about 150 kHz, and an amplitude of approximately .25 volts into a 50-ohm load or

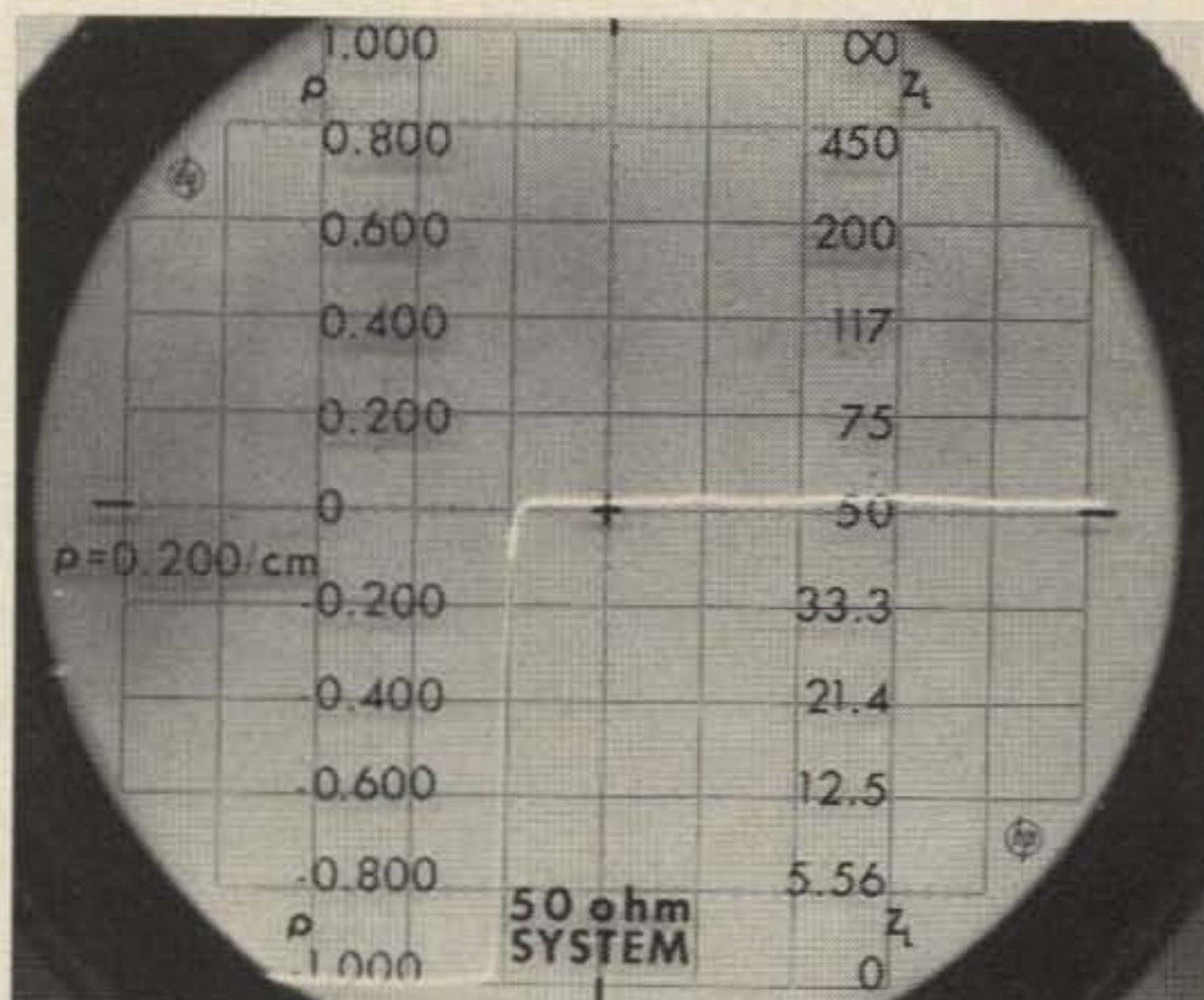

Fig. 3 The scope trace when the reflectometer is connected to a 50 ohm resistive load. As there is no reflection the load appears the same as an infinite length of transmission line.



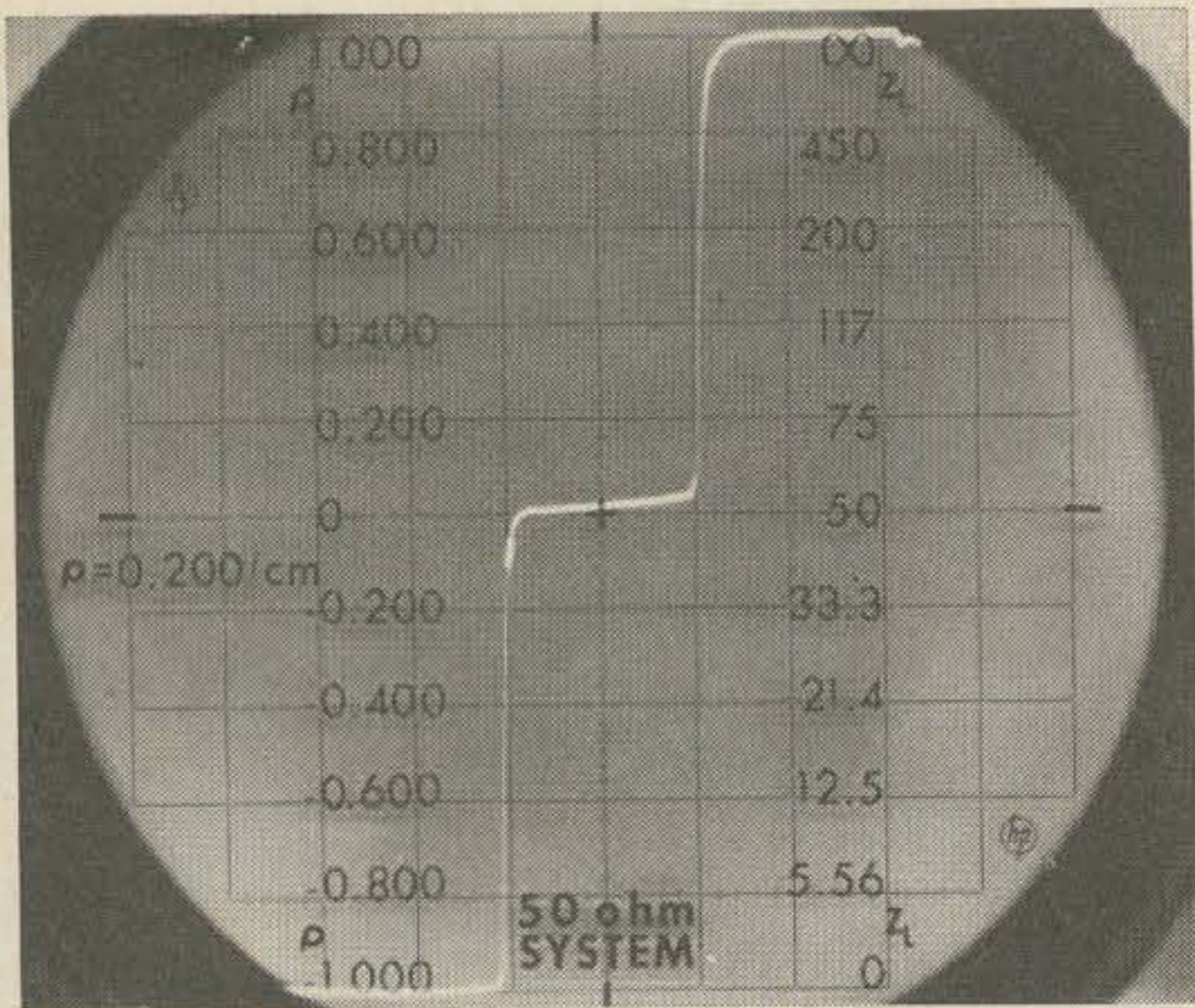

Fig. 4 The impedance profile of a piece of coax cable which has a propagation time of 10 nsec. The far end of the cable was open. The horizontal scale is 10 nsec per division. The voltage step takes 10 nsec to reach the end of the cable and another 10 nsec to return.

.50 volts into an open circuit.

When this pulse reaches the line discontinuity, it is reflected back to the measuring oscilloscope where it is added to the incident pulse. If the discontinuity is resistive and has a value larger than the line impedance, a step of the same polarity is reflected, and if the resistance of the discontinuity is less than the line impedance, a step of the opposite polarity is reflected. Reactive discontinuities also reflect spikes which indicate the polarity of the reactance, inductive or capacitive.

#### A 50-ohm dummy load

If the output of the time domain reflectometer is connected to a 50-ohm resistive

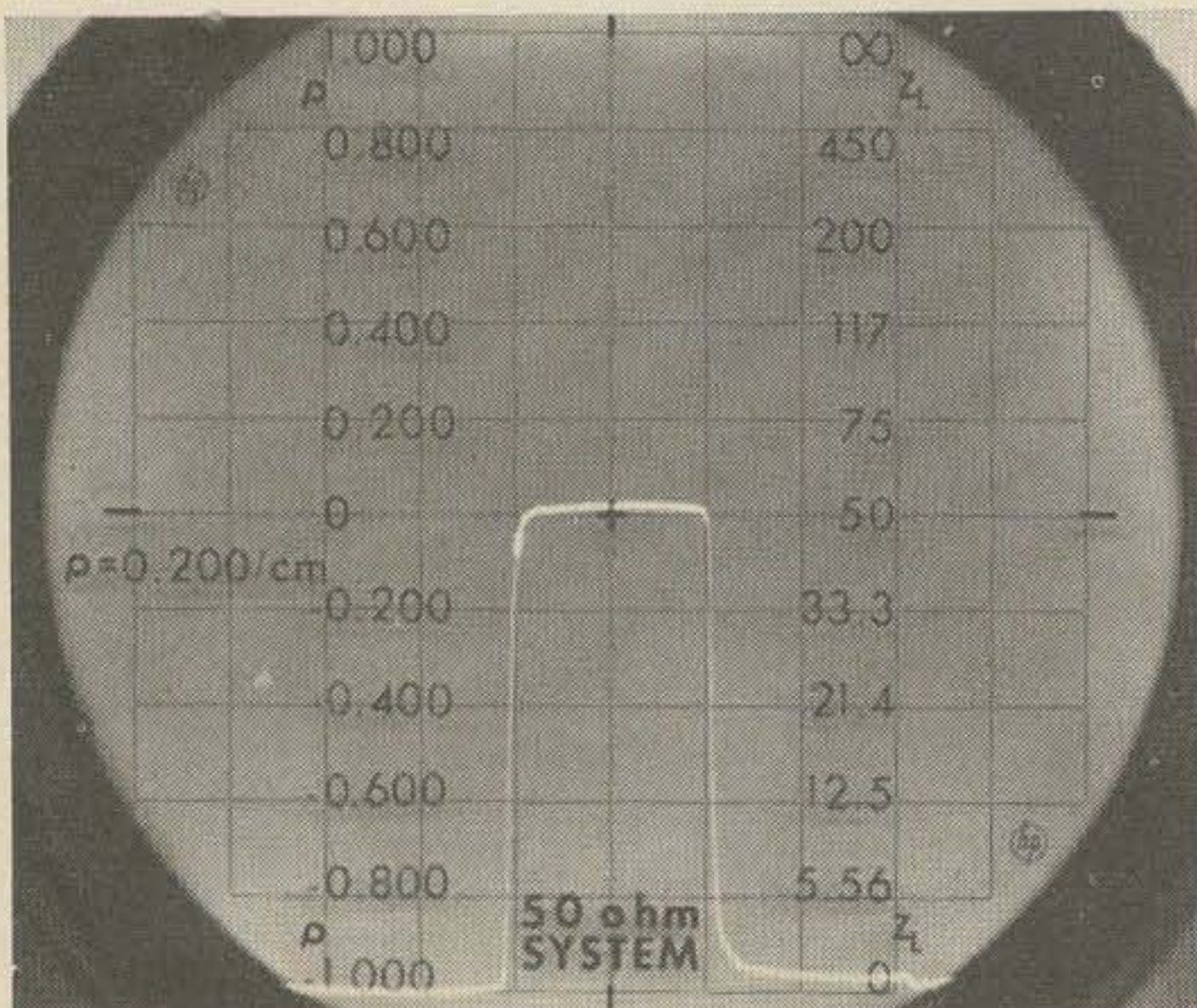

Fig. 5 The same cable with the far end shorted. Notice the trace doesn't quite go to zero on the far end as explained in the text.

termination, it appears as an infinitely long transmission line with no discontinuities to the reflectometer. This is shown in Fig. 3. Note that the impedance scale on the left goes from zero ohms at the bottom of the scope to infinity at the top. On the left the reflection coefficient is given. As you will see in later photographs, this scale can be adjusted so that the discontinuities on the order of fractions of an ohm can be measured.

You will also notice that the voltage step is delayed from the time the scope is triggered so that the beginning of the distance measurement is visible on the scope screen.

#### Open and shorted lines

If the input impedance of a transmission line, with the far end mismatched, is measured by means of a standing wave bridge, the measured impedance will depend upon the electrical length of the line as well as its characteristic impedance. If time domain reflectometry is used to make the measurement, this problem is greatly reduced as can be seen in Fig. 4 and 5. The line used in making Fig. 4 had a propagation time of 10 nsec\* and was left open at the far end.

The horizontal time scale used is 10 nsec per centimeter of deflection. You can see that 10 nsec was required for the voltage step to propagate to the end of the line and another 10 to return, making the 50 ohm portion of the trace 2 centimeters long. In this manner not only can the impedance characteristics of a line be determined, but also its electrical length. If the physical length of the line is known, this information can be converted into velocity factor.

Fig. 5 shows the same piece of coax cable with the far end shorted. You will notice that the voltage step return time is still the same. Notice, however, that the shorted portion at the far end of the line does not cause the scope trace to register zero ohms. This is because of the attenuation of the cable. The returning echo from the short is not arriving back at the reflectometer with the same intensity with which it left.

This effect can be used to determine the dc attenuation of the cable. It can also result in erroneous impedance profiles if the attenuation is excessive. In most cases, however, the attenuation of short rf lines is low

\*nsec = nanosecond =  $1 \times 10^{-9}$  second or one-billionth second.



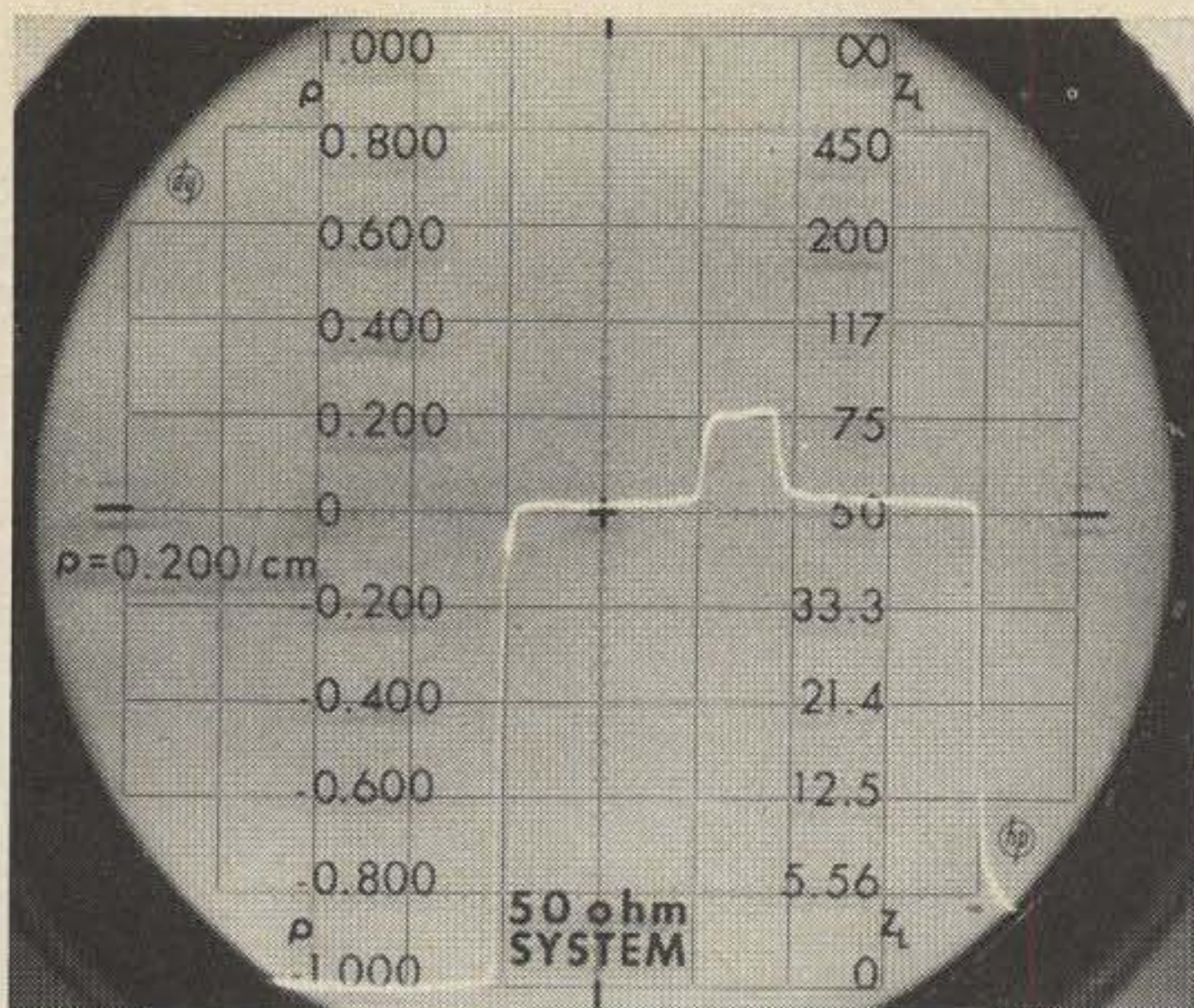

Fig. 6 A 75-ohm coax cable spliced between two 52-ohm cables. The far end was shorted.

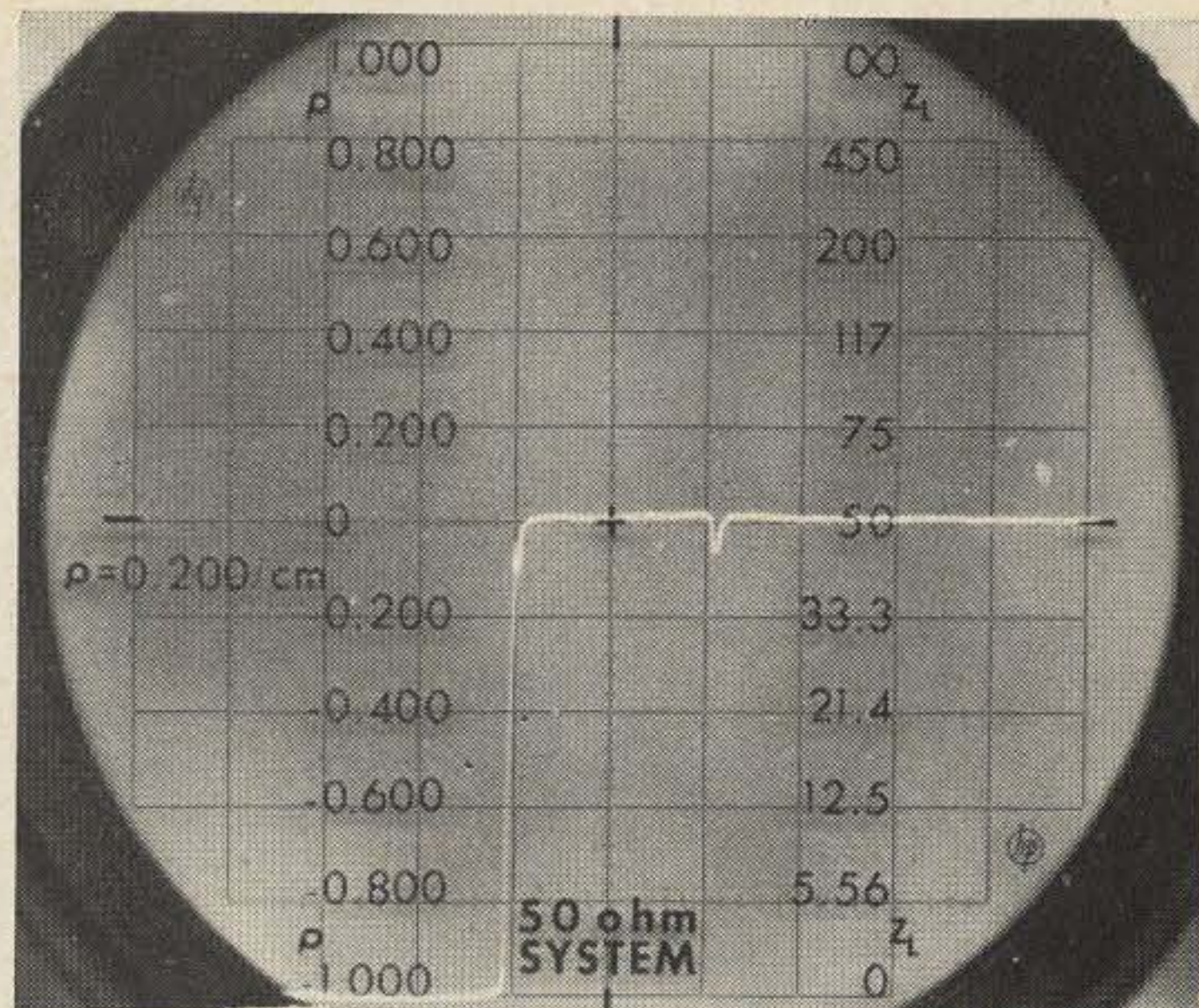

Fig. 7 Two 52 ohm coax cables spliced together with standard UHF coax fittings. The connectors appear as a series inductor.

enough so it can be neglected when interpreting the impedance profiles. Where the losses are excessive, of course, they must be taken into account when evaluating the profile.

### Multi-impedance lines

The impedance profile shown in Fig. 6 was made by splicing a short section of 75-ohm coax in between two 52-ohm lines. The far end of the combination was shorted.

You will notice that the line attenuation has increased—this is indicated by the trace as it starts to straighten out in the lower right-hand corner before reaching the zero impedance line.

This picture shows very well how time domain reflectometry can be used to look selectively at various parts of a feed system and not simply at the total combined effect at the feed point. The electrical lengths of the various sections can be readily determined as well as their impedances.

### Transmission line connectors

Next, two sections of RG-8/U coaxial cable were spliced together by means of ordinary UHF male and female connectors. These are the same fittings used on most amateur equipment. You can see the results of this splice in Fig. 7. The fittings appear as a series inductor in the line.

Fig. 8 is the same combination as Fig. 7 except that a UHF 90° elbow connector was inserted between the male and female connectors. It is obvious that impedance bumps such as these could have disastrous effects on a feed system operated in the VHF, or especially, the UHF region.

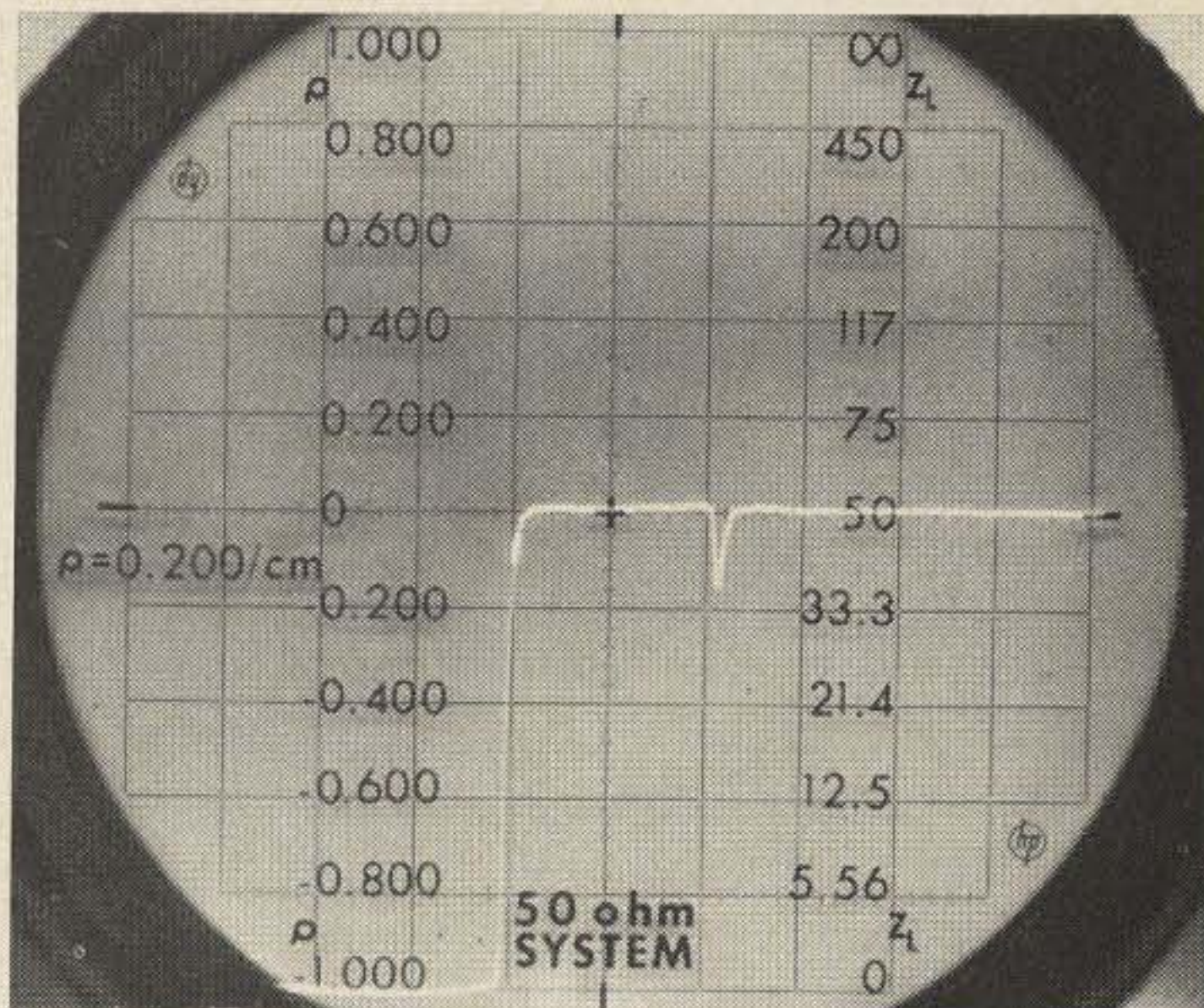

Fig. 8 The same as Fig. 7 only a 90° elbow connector has been added.

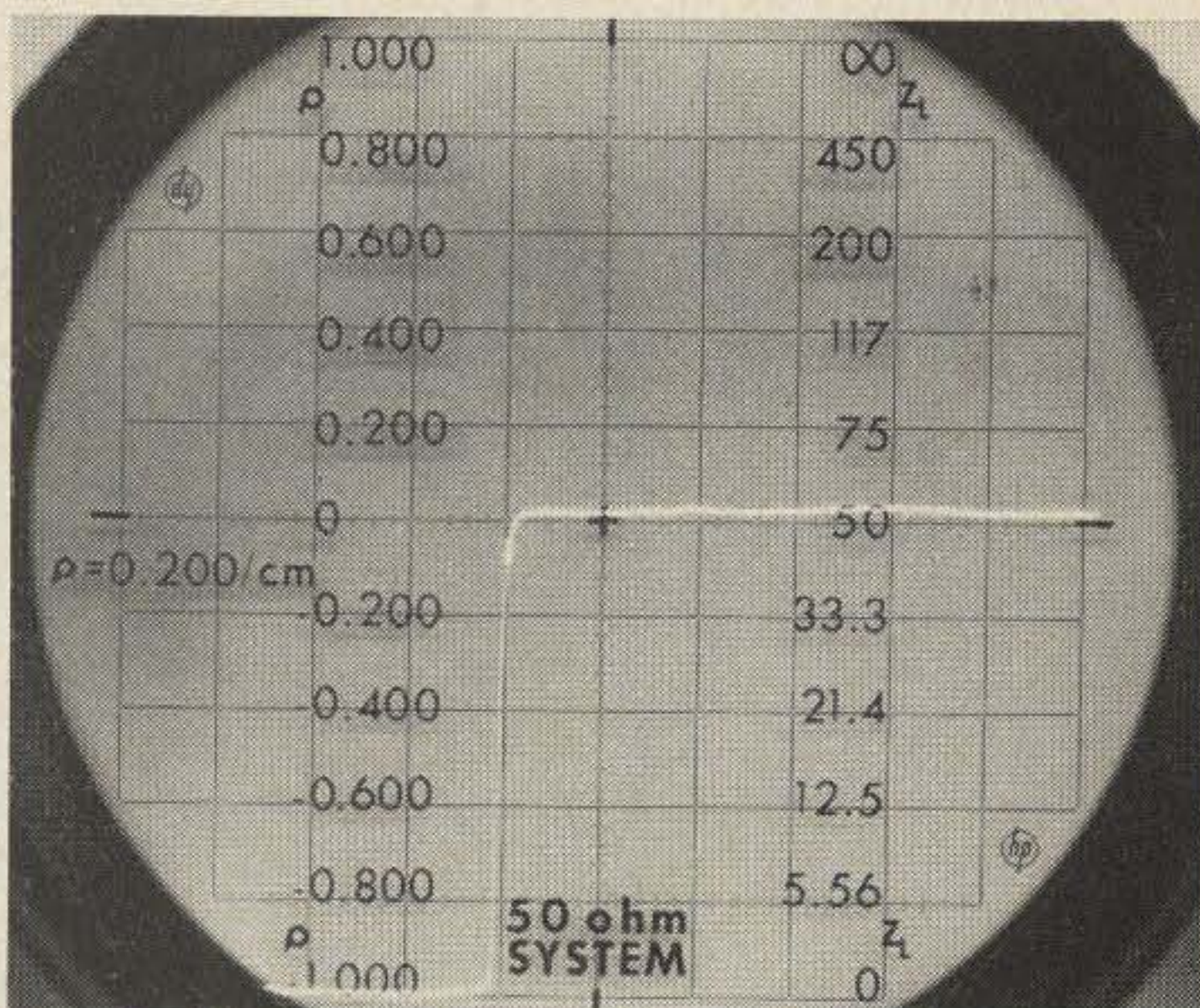

Fig. 9 The same two cables spliced together with General Radio type connectors.

Fig. 9 shows the same two coax cables spliced together with General Radio type connectors. The superiority of these con-



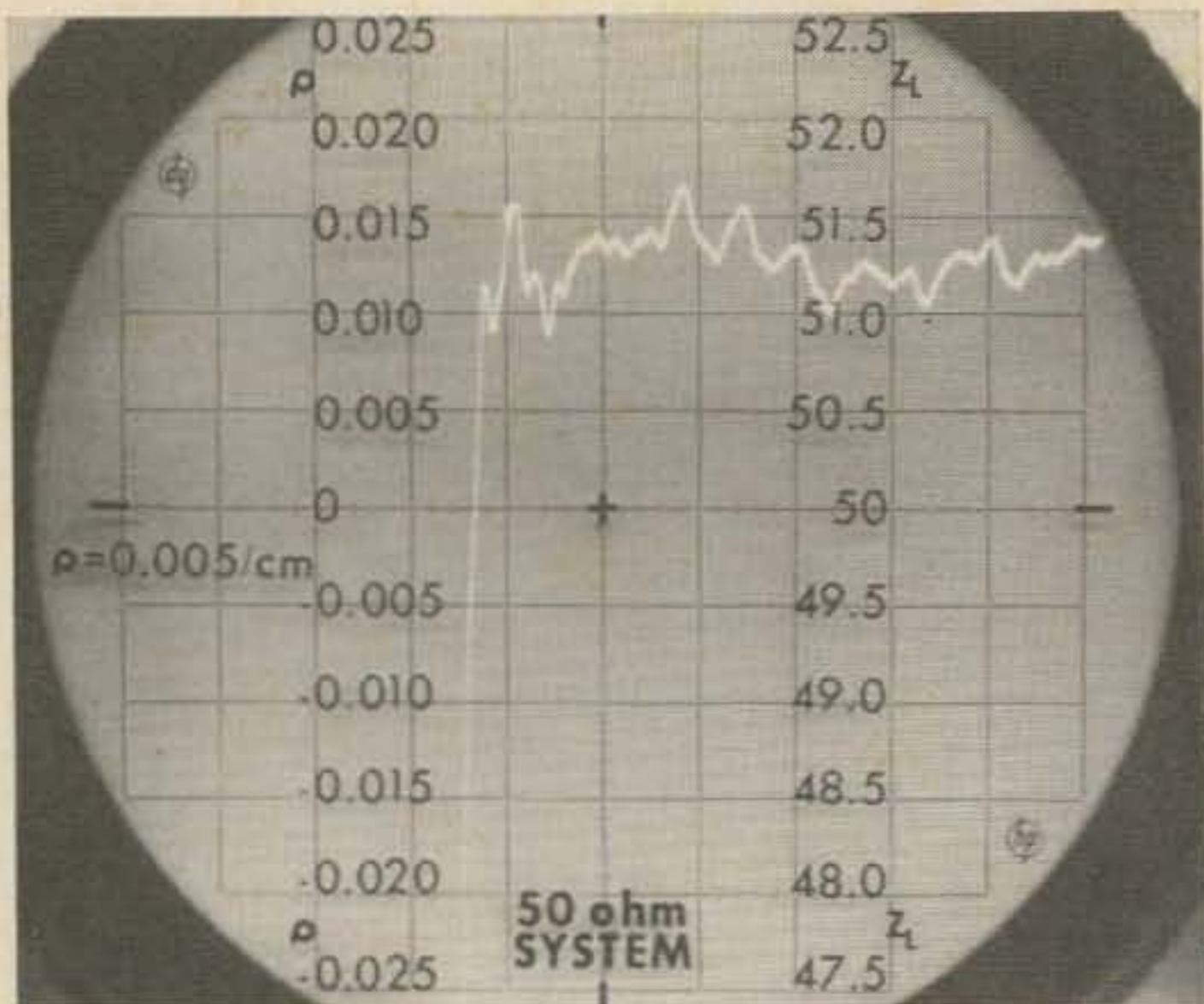

Fig. 10 An expanded view of the impedance variations in a section of coaxial cable.

nectors is obvious.

### Increased sensitivity

When the vertical gain of the oscilloscope is changed to increase its sensitivity to impedance variations, some very interesting results are obtained. Fig. 10 is an impedance profile of a piece of RG-58/U coax cable. The sensitivity has been increased to the point where full vertical scope deflection represents only 5 ohms.

As you can see, the impedance of the cable is *not* uniform throughout its length but varies more than  $\frac{1}{2}$  an ohm. If the cable is squeezed or bent sharply to distort its inner geometry, it causes an impedance bump that is very evident. Usually when a cable has been compressed or bent in this fashion, the impedance bump remains even after the pressure is relieved, since

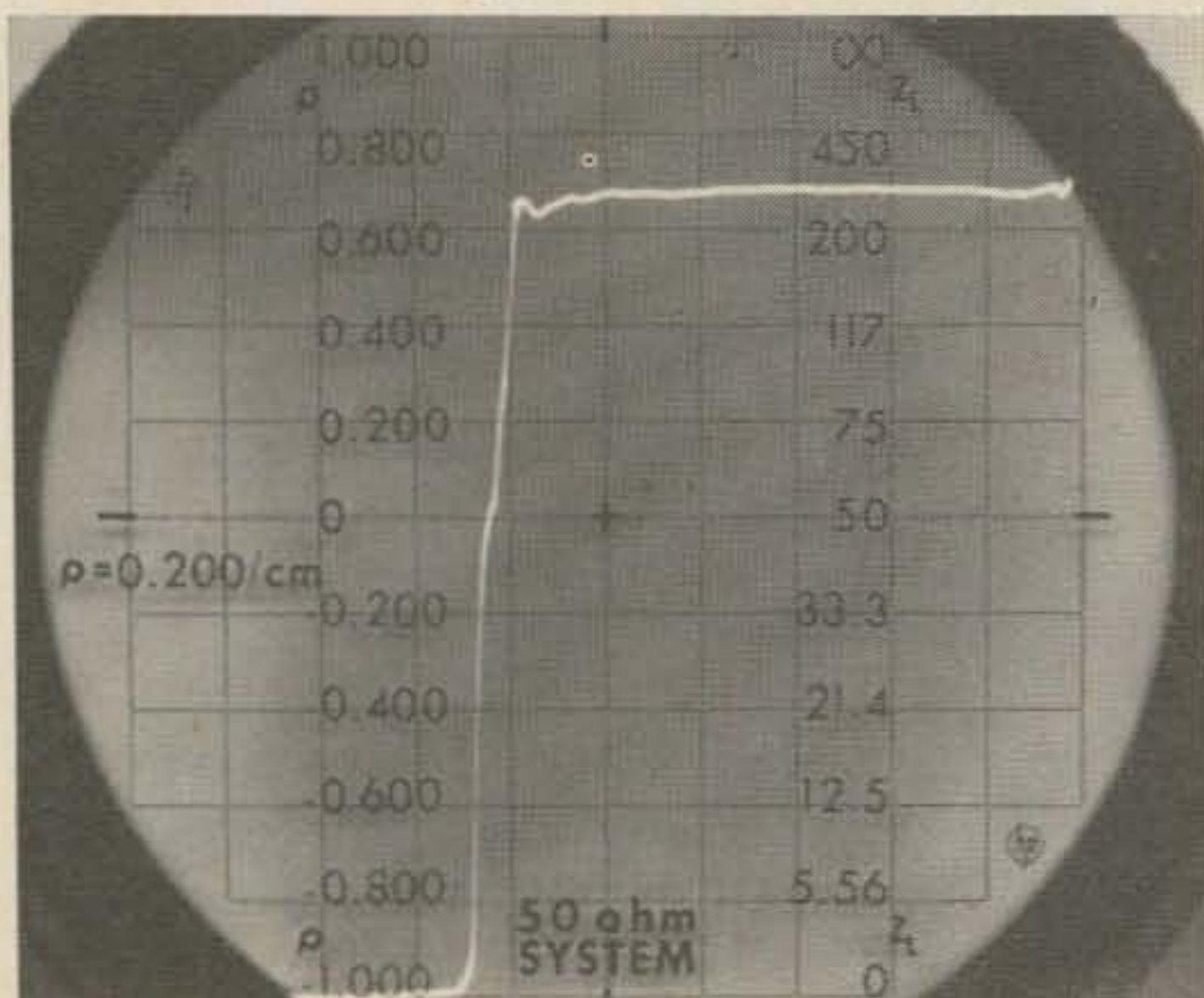

Fig. 12 The impedance profile of a section of 300 ohm twin lead spaced several inches away from metal objects. The slight impedance "bump" at the beginning of the line is explained in the text.

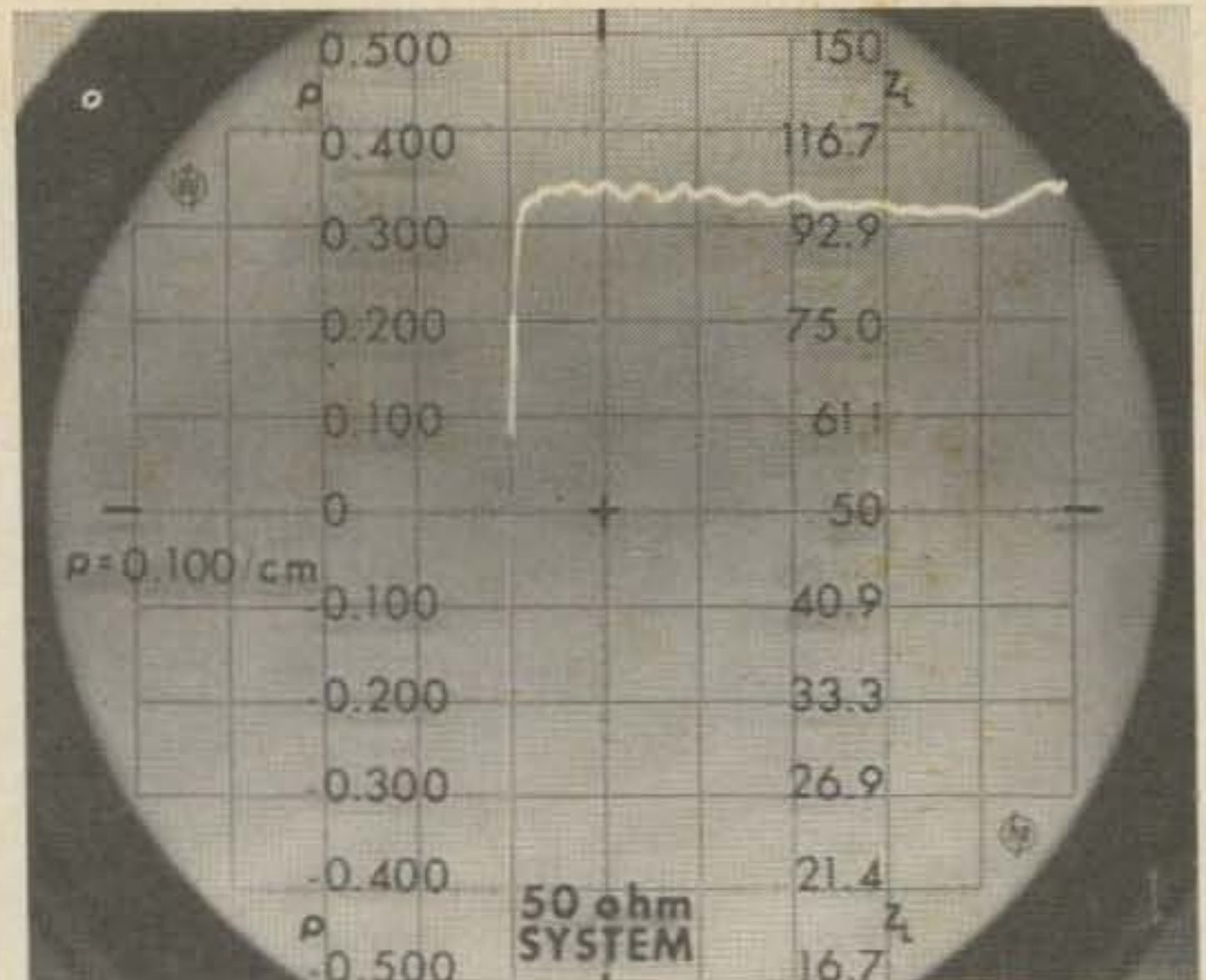

Fig. 11 A scope trace showing the impedance variations in a piece of ordinary "zip cord".

the cable dimensions do not quite return to normal.

Variations in cable impedance of about  $\frac{1}{2}$  ohm can be produced by simply waving the cable back and forth slightly between two end supports. While variations of this magnitude are not usually significant, at least in amateur applications, it is very interesting to observe them on the scope.

Fig. 11 was made by connecting a random length of ordinary 120 Vac "zip cord" to the output terminals. The vertical sensitivity has been reduced, but impedance variations, probably caused by irregular spacing of the conductors, is still quite apparent.

### What? Your feed line goes down the mast!

The last set of photos was included primarily to show the detrimental effects of improperly installed twin-lead feed lines.

For the purpose of the demonstration, I used a section of ordinary 300-ohm television feed line. Fig. 12 shows the profile obtained when the line was connected to the output terminals and suspended several inches away from any metallic objects. You will notice a slight impedance bump at the beginning of the line caused by the balanced feed line being connected to the unbalanced coaxial output of the time domain reflectometer. Otherwise, the trace shows a uniform impedance characteristic near 300 ohms.

Fig. 13 shows what happened when the I grasped the line with my hand near the far end. In the affected section the impedance dropped to almost half of its normal value.

The line was then threaded through a short piece of 1" water pipe. This simulates



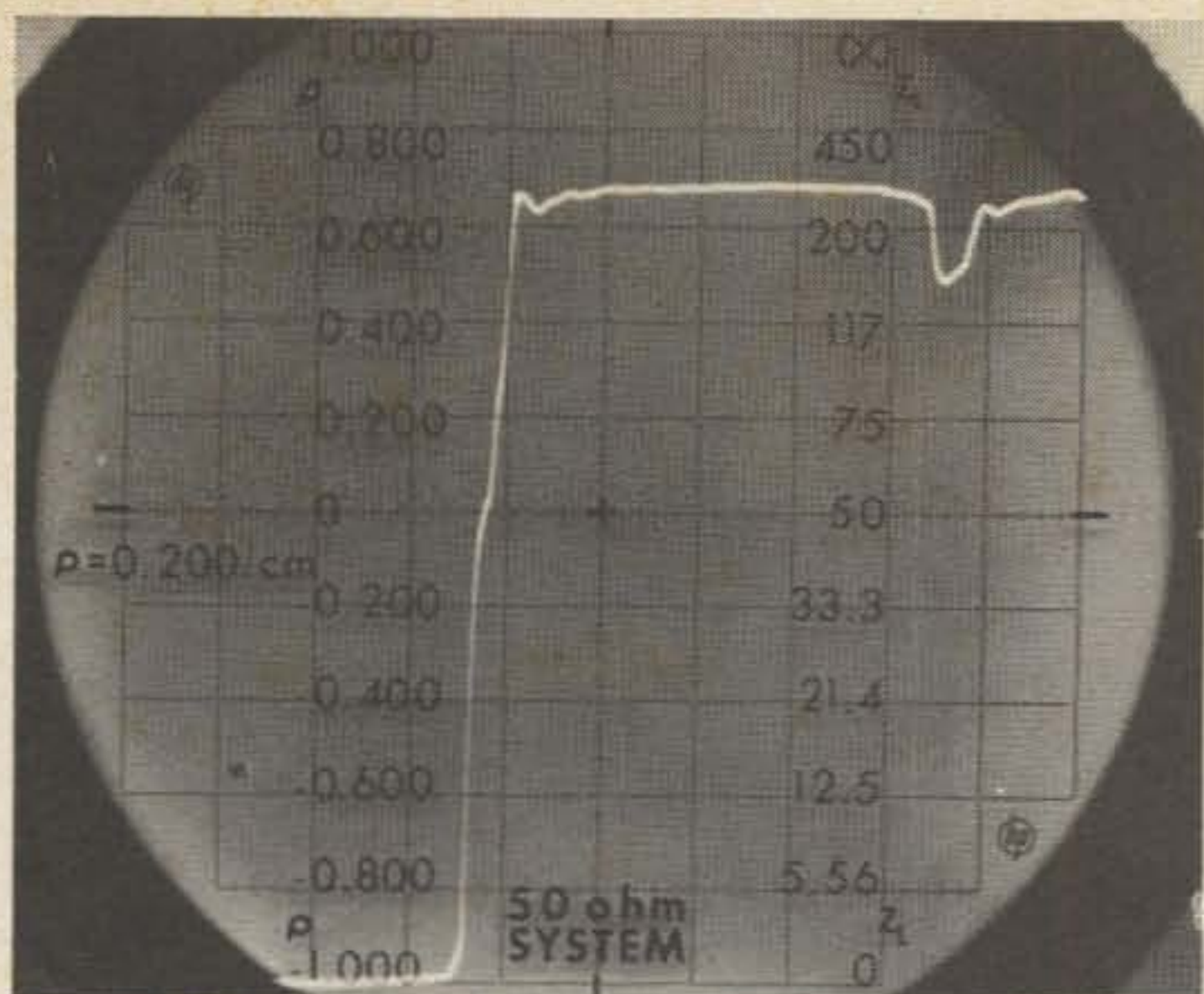

Fig. 13 Impedance "bump" caused by grasping the 300 ohm twin lead with the hand.

the effect caused by running an antenna feed line down through the center of an antenna supporting mast. The impedance in this section was below 200 ohms, and incidentally, varied considerably as the line was moved around within the pipe. See Fig. 14.

What if you put the feed line on the outside of the mast rather than running it down inside? In Fig. 15 the line was taped to the outside of a piece of 1" pipe every few inches. Enough said about that.

When a feed line is a little longer than necessary, it is always tempting to just coil up the surplus rather than cut the line. Fig. 16 was made by wrapping the line into a neat coil about 6" in diameter. At one point this caused the line impedance to go almost to infinity. It would obviously be much better to cut the line to the proper length and splice it in the future if necessary.

### Summary

There are a great number of other applications for the time domain reflectometer. It is very useful for such things as adjusting the lengths of phasing sections in multi-element antennas, checking the characteristics of broad-band impedance matching devices, measuring the impedance characteristics of wide band antenna systems, etc.

I hope that the examples I have presented will serve to increase your interest in this valuable measuring technique and also help you to appreciate some of the things which happen in amateur radio antenna feed systems.

... W7QAG

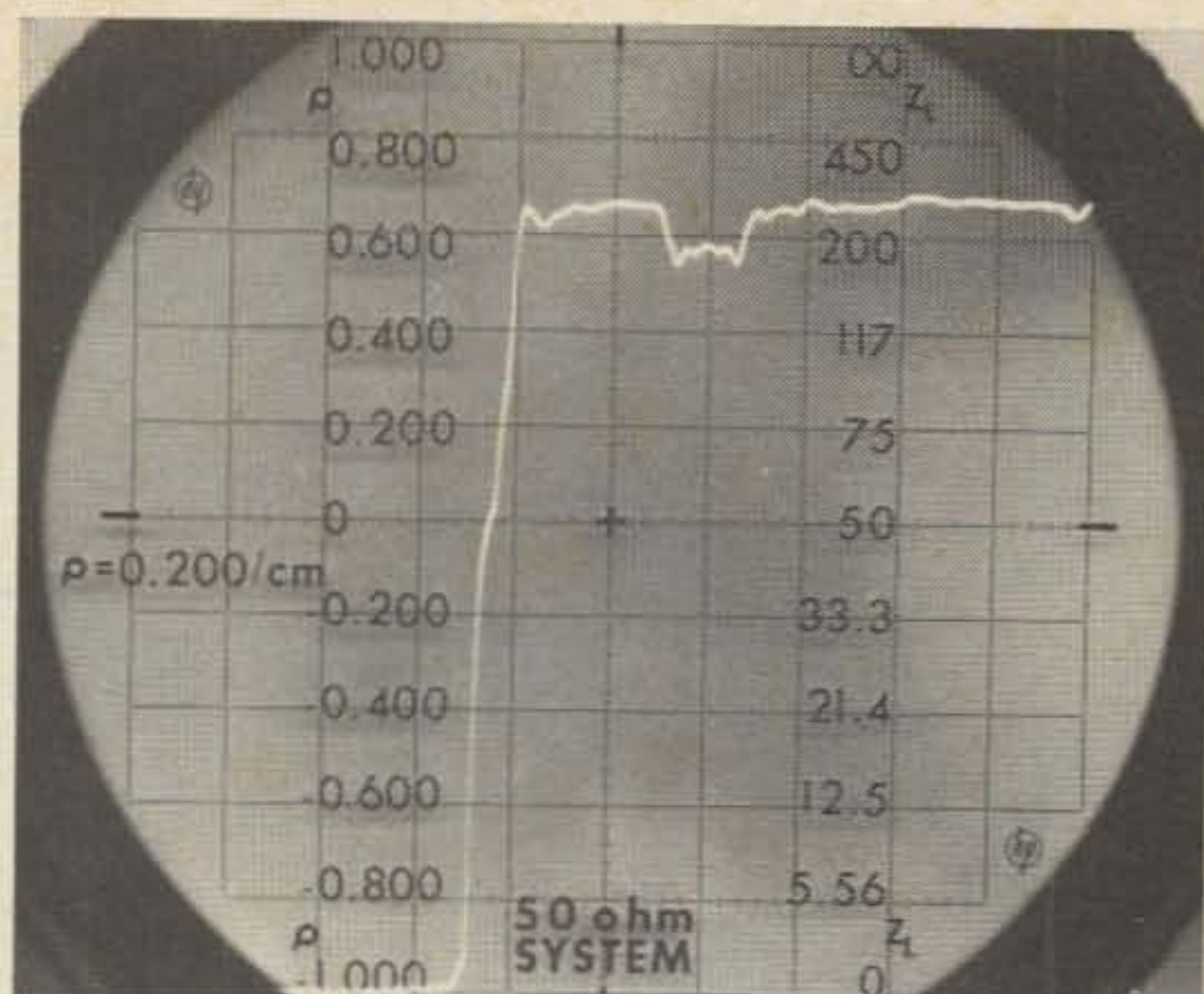

Fig. 14 When the 300 ohm twin lead was passed through a 1" water pipe it's impedance dropped sharply to less than 200 ohms.

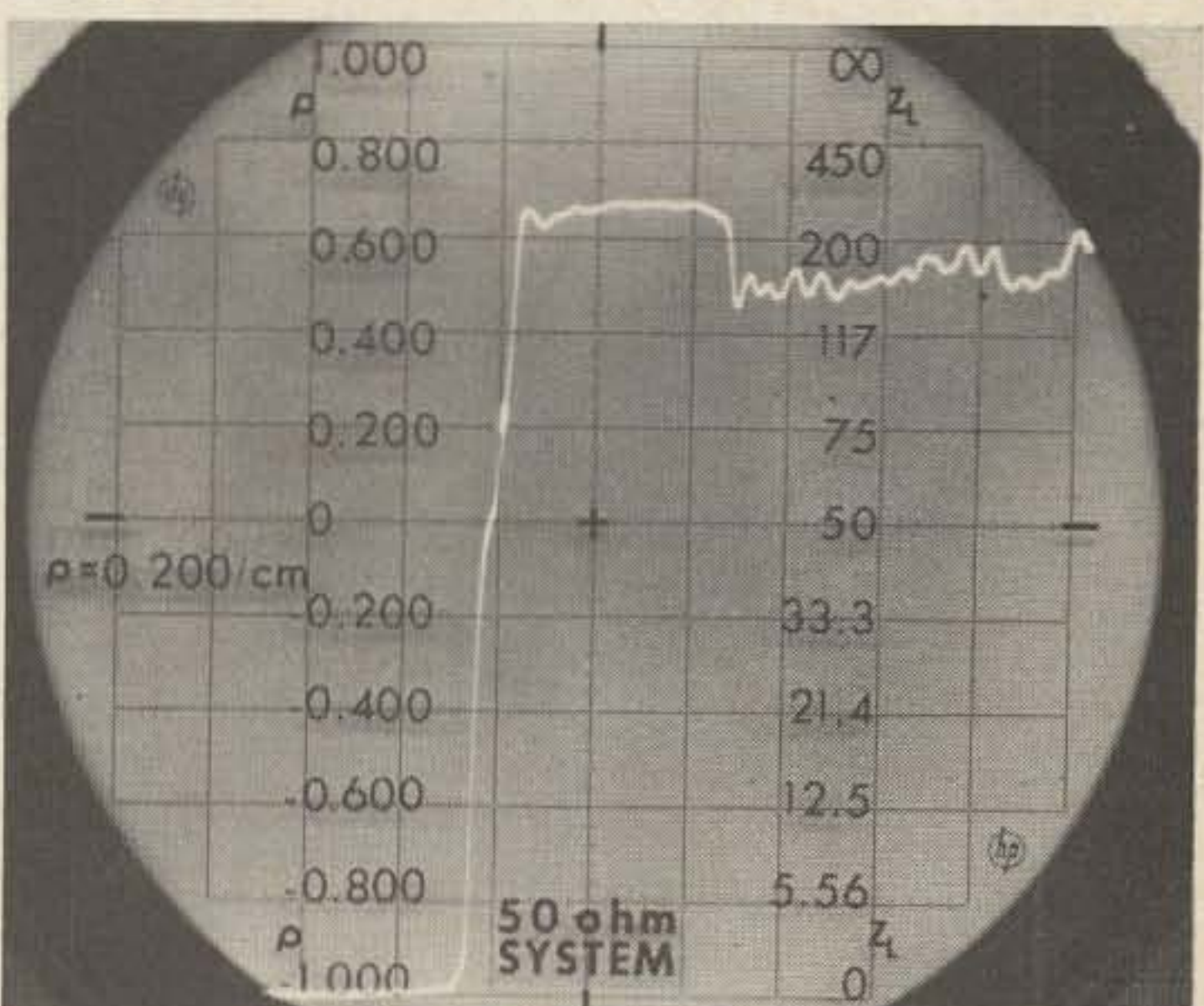

Fig. 15 Part of the 300 ohm twin lead was taped to a 1" pipe every few inches. The impedance of the taped section varied considerably and was less than 200 ohms.

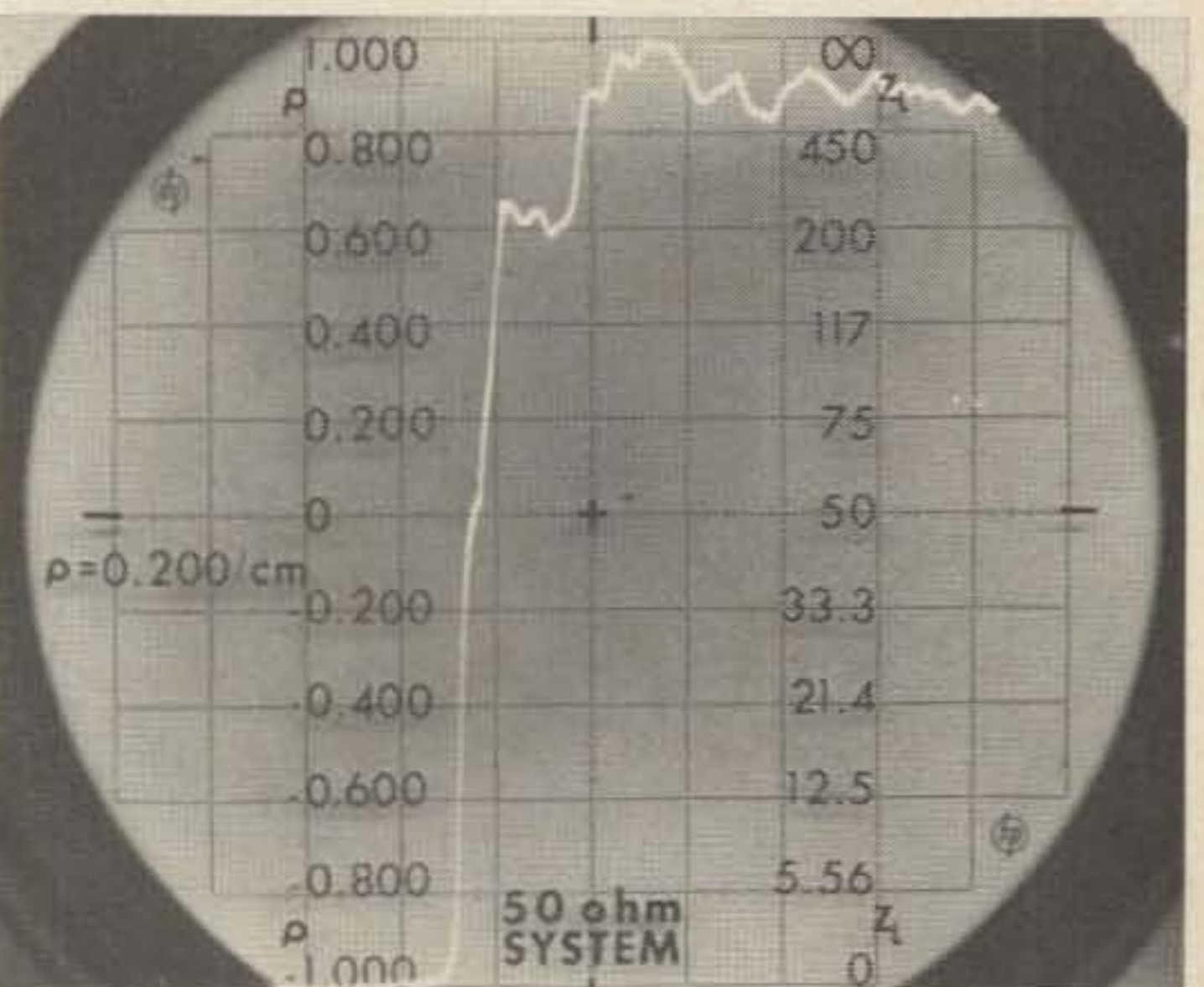

Fig. 16 Impedance changes caused by coiling 300 ohm twin lead into a neat 6" diameter coil. Notice that at one point the impedance is almost infinite.



## Cheapskate's "On The Air" Sign

Novices, attention! Are you troubled by all sorts of in-shack QRM? Do you miss that other guy's call because your wife is yelling her head off trying to get you to take her shopping? Well, this is the one article that might be able to relieve the above disturbances.

The **On-The-Air** sign I'm about to describe is about the cheapest one around. It shouldn't cost you more than, oh, say, six bits at the most and can be assembled in close to two hours. The materials used can probably be found around the house.

First get a small cigar box the size, approximately, of a 3" x 5" index file. I had one that held imported cigars. Next, get a piece of glass that will fit snugly into the opening of the box. While you're getting the glass cut, pick up a small ceramic bulb socket and a couple of feet of appliance cord.

Now, get hold of some stencils about 3/4" long. Lay out three guide lines on the glass so each word, *on*, *the*, and *air* are on sepa-

rate lines. Place the stencils on the glass backwards and reverse order because you will be painting the glass from the back. See Fig. 1.

When you have all the letters stencilled out, get some red enamel paint. Paint around the letters, not in them. The light will shine through the words and not the background. See Fig. 1.

While you are waiting for the paint to dry, take the socket and fasten it with epoxy cement to the side of the cigar box. Set the box on end to let it dry overnight. When the cement dries, drill a 1/4" hole in the bottom center of the box to pass the cord through.

Take a small wattage bulb, about ten watts, and screw it into the socket. Take the glass and check the fit in the end of the box. If it fits ok, place a little bit of epoxy cement around the outer edge of the glass

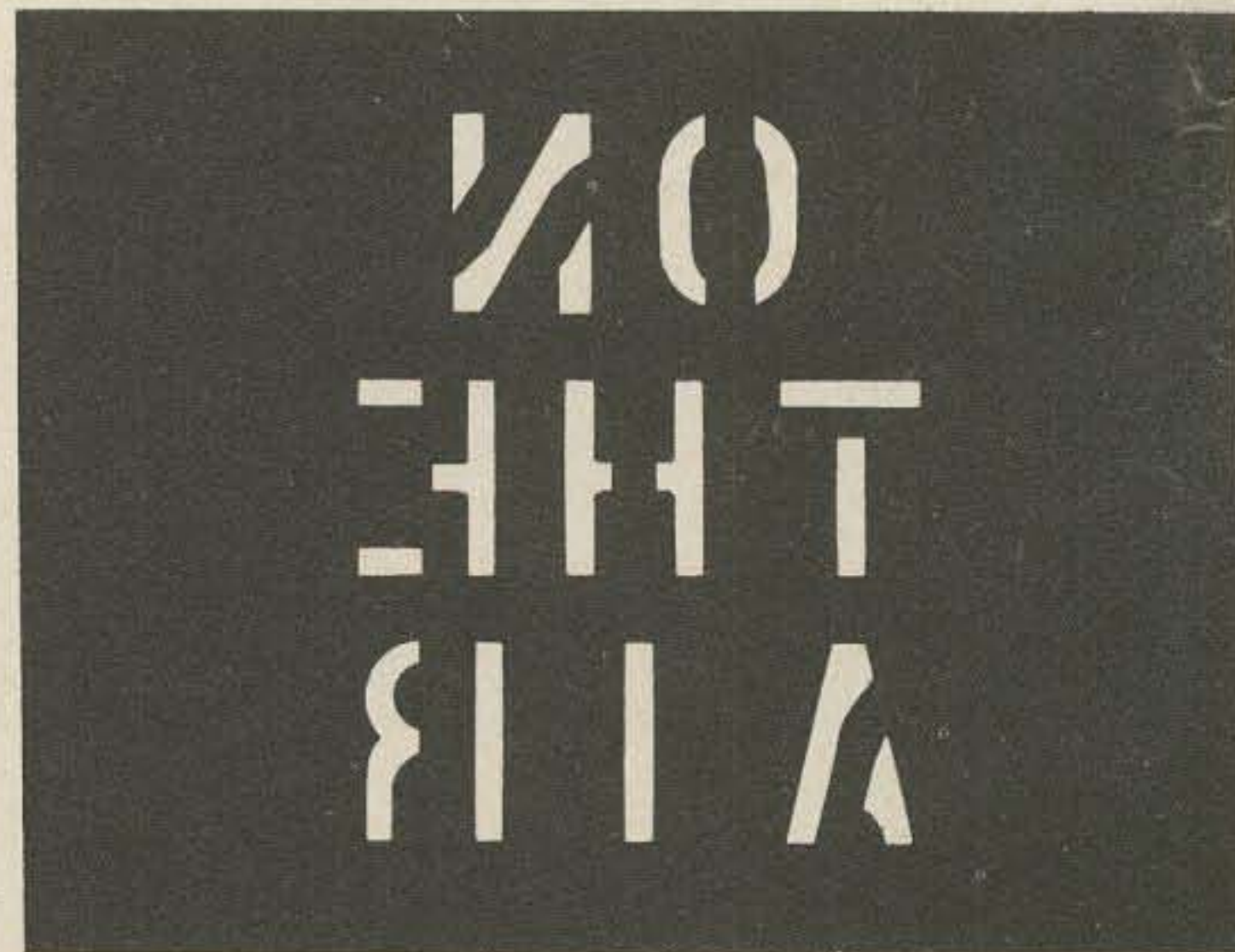

LETTERS MUST BE REVERSE-STENCILLED. PAINT AROUND LETTERS WITH RED PAINT.

BACK OF GLASS SHOWN



and gently place it into position in the box. This step can be facilitated by placing the glass face down on a clean flat surface and lowering the box onto it from overhead. When the cement dries for a day or two you can finish the box in any color to match your rig.

Now to hook it up to the rig. I have an accessory socket on my T-60, so all I had to do is connect the wire ends to the 117 volt pins on the accessory socket. The sign lights up whenever I turn the rig to AM or CW. If you don't have an accessory socket on your rig, wire a SPST switch in series with one of the leads and mount it somewhere inside the box before you position the glass. Then tap into your power line.

One more thing. When I first used the sign, I was able to see the inside of the box through the stencilled letters. I got a 3" x 5" index card, trimmed it to fit the glass plate, and placed it on top of the paint before it dried. When the paint did dry the card stayed in place. Try the box with the light on before you stick on the glass and see if you have need for an index card.

With the **On-The-Air** sign glaring at your "QRM", she will get the message and pipe down until you QRT, or the other guy's wife makes him take her to the store. But before you sign off with the latter, tell him about this sign. Maybe he could use one for his disturbances.

... WN3EWW

## Mobile Installation Without Drilling

With the present trend toward mobile installations, car dealers have a good excuse to lower the trade-in value of your car if it is full of holes because of a mobile installation. Also, the little woman may be a lot happier if she knows you are not drilling a lot of holes in the new car.

Let's start with the antenna, which can be mounted with any good bumper mount, or one of the new deck mounts that requires no holes. Be sure to follow instructions. This is not the ultimate in antenna installations, but no holes are required. The feed line can be routed through the trunk. The gasket around the trunk lid will usually give enough to allow it to close on the cable without damage. Then route the cable under the back seat, under the carpet and on to the front. Be sure to keep the cable away from sharp edges on moulding, seats, and other hardware.

Next comes the transceiver. Obtain two small electrician's beam clamps and fasten them to the transceiver's gimbel bracket as

shown in Fig. 1. Position the bracket under the dash in the desired position, and tighten the set screws. If the set has a self-contained power supply, speaker, etc., you are almost in business, as power can be obtained from the ignition switch. However, if your rig has a separate power supply, locate a rubber feedthrough grommet (on the firewall or under the carpet) and feed the power cable into the engine compartment. Carefully select a place for the power supply, so that it will not be exposed to extreme heat. In addition, you may be able to use existing holes to mount it. As a last resort, holes can be drilled to mount the supply—car salesmen seldom look under the hood for holes!

Bonding of hood, tail pipe, and all ignition suppression should be taken care of at this time. The rest of the installation is handled in the normal manner. When the time comes to trade the old buggy off, not a sign of mobile installation.

Happy mobiling.

... Forrest Thomas K9MRL

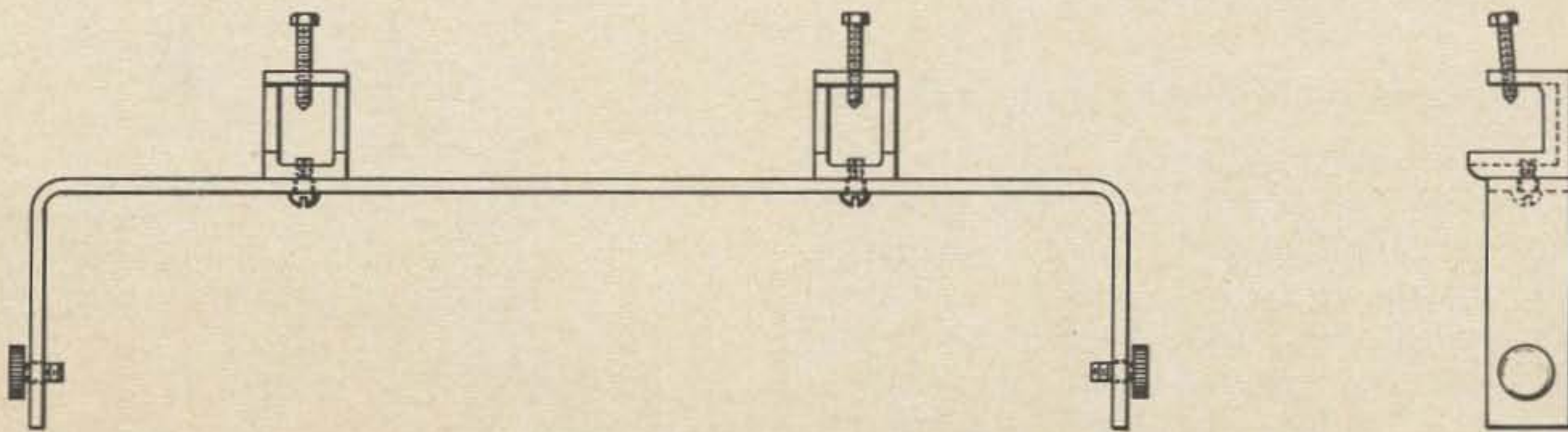

No-holes mobile mount using electrician's beam clamps attached to the transceiver gimbel mount.



Murray Ronald VE4RE/3C4RE  
 Box 974  
 Brandon, Manitoba  
 Canada

## Relay Energization In Fixed And Mobile Equipment

The antenna and power switching circuits in fixed/mobile transmitters and transceivers should meet several requirements. First of all, for safer mobile operation and for convenience when fixed, they should be activated by a single control. If the switching system is electronic or electro-mechanical in nature, it should be foolproof, consume a minimum of electrical power and be such that it may be activated by either the dc or ac power supply.

Most amateur equipment employs a relay as the switching device, the relay being operated indirectly by voice or manually by a switch. The former is known as the VOX system, the latter as the PTT (push-to-talk) system. When building a six meter transceiver recently, I decided on a push-to-talk system, feeling that it would best meet the criteria discussed above. I was surprised at the number of methods used to energize the relay, some of them not too popular in amateur designs but yet ideally suited for fixed/mobile equipment. A review of some of these methods is worthwhile. The last, and incidentally the simplest, method was used in my transceiver with a novel system to reduce power consumption.

### Energization from filament supply voltage

A typical relay switching system of this type is illustrated in Fig. 1. Notice that this hookup is suitable only for a negative ground system. If battery polarity were reversed, the diode would require reversing, and the positive terminal of the electrolytic would be placed at ground potential. In fixed operation the half-wave rectifier recti-

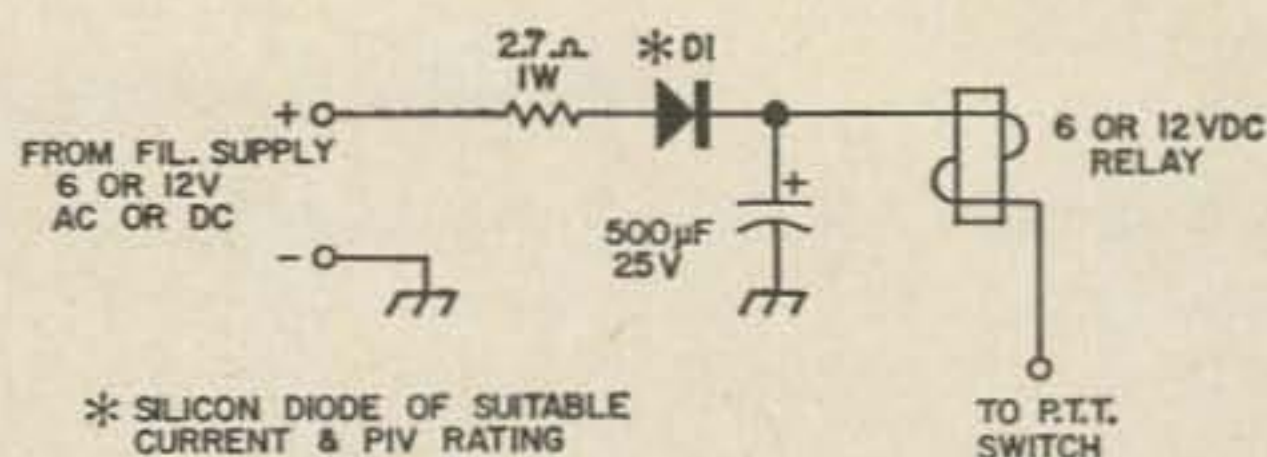

Fig. 1. Relay energization from a 6 or 12 volt filament supply.

fies the usual ac filament voltage. Considerable filtering is usually necessary to prevent relay chatter.

### Insertion in the cathode circuit of modulator or rf stage

As shown in Fig. 2, the relay is energized by the static plate current of the modulator stage. The relay resistance should approximate the proper cathode resistance value. This hookup is especially suited for the use of surplus low-resistance dc relays.

### Energization in the plate circuit of a low power transmitter stage

Fig. 3 is useful for dc relays in the 1000

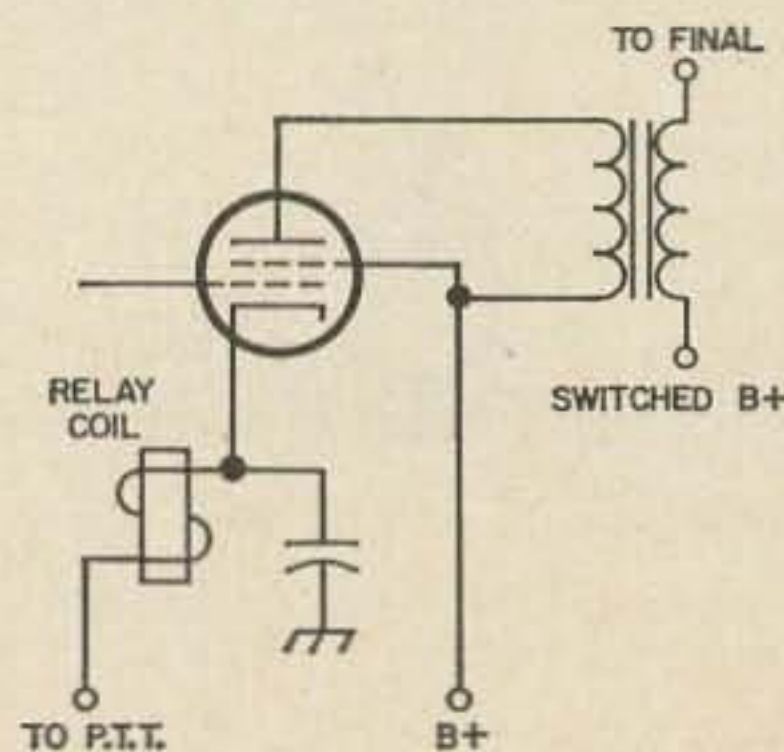

Fig. 2. Controlling a relay by mounting it in the cathode circuit of a single-ended modulator stage.



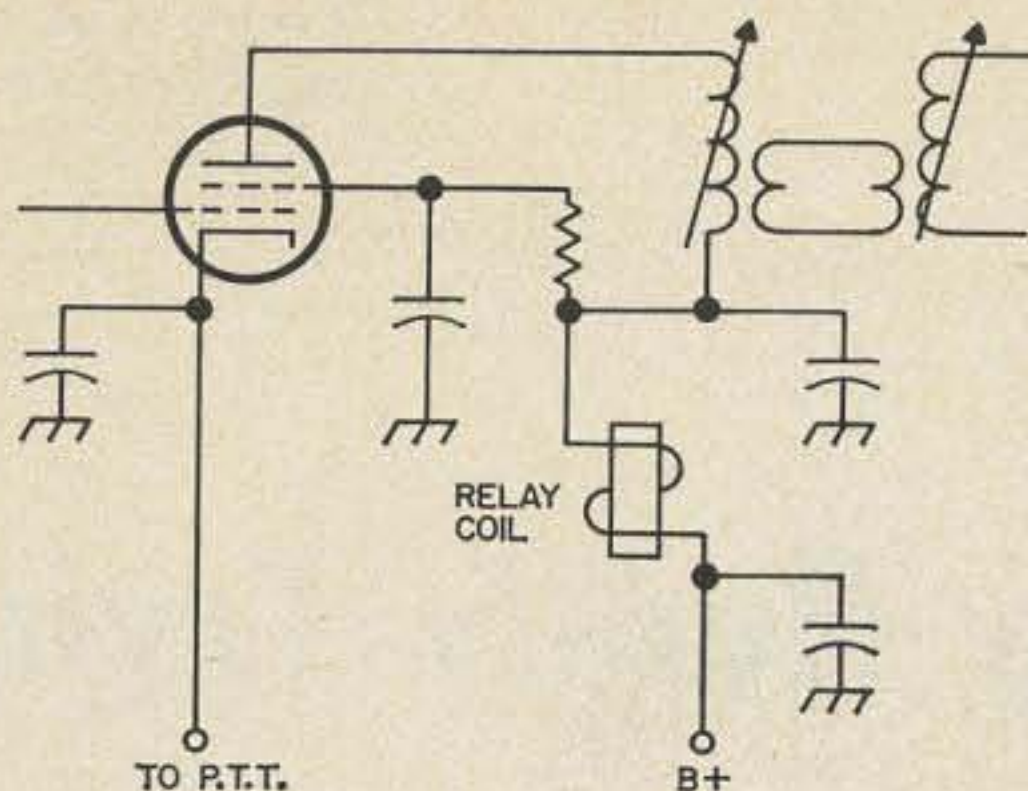

Fig. 3. Picking up and controlling a relay by wiring it into the plate circuit of a low-powered transmitter.

to 6000 ohm range. Although the relay will function as a plate-dropping or isolation resistor, the design should ensure that the relay coil does not overheat from excessive current flow through it.

#### Energization from the dc plate supply

Fig. 4A illustrates a conventional circuit with the relay coil and associated dropping resistor in series with the PTT switch. The arrangement of Fig. 4B shows a method for reducing the power consumed by the relay. It is based on the fact that the hold-in current for most relays is much less than the current for pulling in the armature.

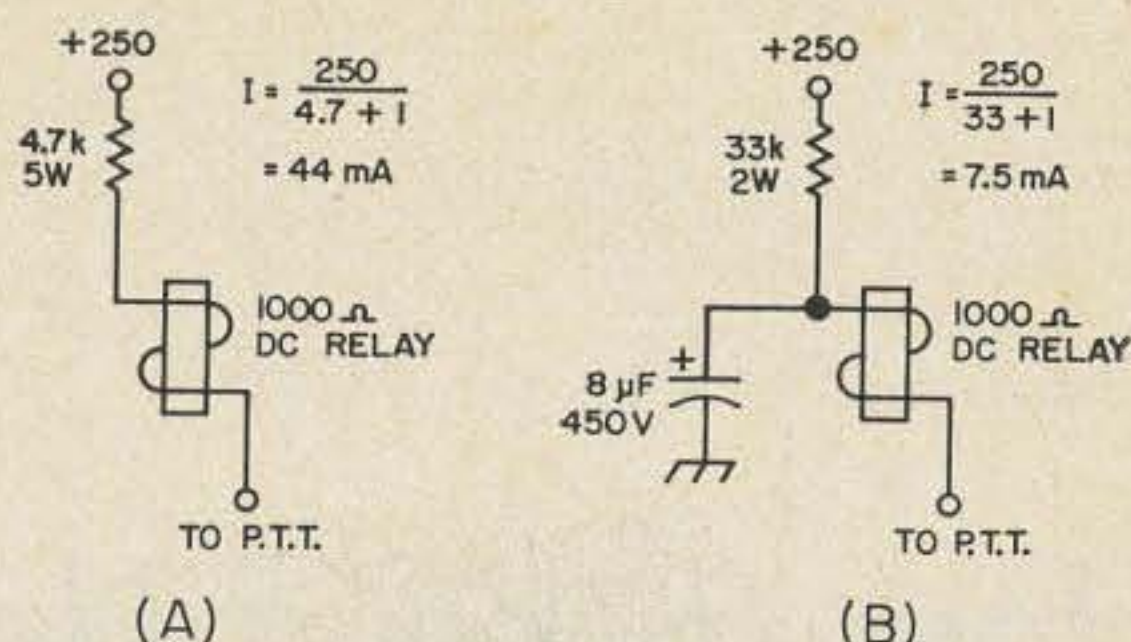

Fig. 4. Using the high-voltage dc plate supply to control a relay.

When the PTT switch is open, the capacitor charges to the value of the high voltage. Should the PTT switch be closed, partial discharge of the capacitor creates enough additional current to cause the relay to pull in. After this initial surge, the current drops to a value just sufficient to hold in the relay. For comparison purposes, the resistance value in each case was increased to a point where the relay would just snap in and hold. The reduction in current would certainly be a consideration in many cases.

I hope some of these ideas can be incorporated into that new piece of gear you are planning or that old mobile transmitter with all those switches.

... Murray Ronald VE4RE

## ANNOUNCING . . . THE KEYS WITH A MEMORY! the MICRO-ULTIMATIC MODEL K1



#### THE ONLY KEYS OFFERING:

- Dot and Dash Memories
- Squeeze Paddle Operation
- Integrated Circuit Construction
- Linear Speed Control 10-60 Wpm
- Built-in Monitor and Amp
- Unconditional Guarantee

#### SPECIFICATIONS:

Speed, 10-60 WPM in one linear range. Input; 3-wire key paddle (not supplied). Output (model K-1R): high-speed reed relay; model K-1G, 150-volt blocked-grid keying transistor. Construction: 1/8-inch thick black anodized aluminum cabinet; glass-epoxy board. Internal monitor oscillator/amplifier, jack for patching to receiver. Power: 105/125 VAC, 60 cycles, 8 watts. Circuitry: all digital, employing monolithic integrated circuits. Shipping weight, 4 1/2 pounds.

The Micro-Ultimatic is the most advanced electronic keyer available. It was first described in June, 1966, 73 magazine. Now completely redesigned and improved, it offers an ease of operation which is unsurpassed. Independent dot and dash memories permit "squeeze" (independent) paddle operation if desired. High-speed operation at 40-60 WPM is completely practical; yet, smooth, tape-like code at 10 WPM is generated with an ease which is surprising. The design and construction of the K-1 are first-quality, and an unconditional one-year guarantee assures your satisfaction. More details are available in a free brochure.

The Micro-Ultimatic is in limited production now. Orders are handled first-in-first-out. Send check or MO for \$85.00 plus shipping. Sorry, no CODs.

**PICKERING RADIO CO. • Box 29 • Portsmouth, R.I. 02871**



## How to be a Ham—By Really Trying

This is a ham article designed for those of you who are *not* hams. How's that you say? Well, it's designed to talk you into becoming a ham. But you'll say, "There have been lots of articles designed to do that."

This one is different because it was written by an expert in procrastination, a ham who took ten years to become a ham. A ham who knows, or thinks he knows, why you don't become one. The reason is simple and direct. You are lazy! That's right, lazy. There is no other word for it.

"The code is too hard." "The theory is too tough." My ears ache when exposed to Morse." I know the excuses—I've used them all. The trouble is, they all decipher down to, "I'm too lazy!"

I'll give you a little credit. I don't really mean mental laziness, the kind that means you cannot be bothered learning, or even moving over to the book rack to pick up a theory book. I mean the subconscious, confidence-robbing laziness that you don't even know you have. This well-hidden mental monster is the worst kind. Not only is your ambition handicapped, worst of all, your will to even start is limited.

Here is a real monster, far more serious than other handicaps—fingers that can't possibly write "Morse" and ears that have 57 dB attenuation to the code. What's worse, you don't even know it's there, but it is, working continually, keeping you from becoming a ham.

Whether we know it or not, we all suffer from self-defeatism. We are beaten before we start. The man who said, "A journey of a thousand miles begins with a single step," really knew what he was talking about. The biggest part of any job is the *start*. Start something and you have about an 80% chance of finishing it. If you don't start at all, you don't have a chance.

Starting a project of any significance can be compared to the laws of motion and energy. To start an automobile moving requires about nine times the energy required to keep it moving at a constant speed. The hardest part by far is the start. We are constantly being defeated in our ambitions by this simple fact. Our projects are defeated before they get started because they are never begun.

I was "all hot" to become a ham at the tender age of fourteen. However, even at this age the passive procrastinator was already well formed. As everything else came hard for me, I reasoned that becoming a ham would be no easier.

I could not possibly master the Morse code. You have to be some kind of mental marvel to do that, like my friend up the street, Cristofer Codepopper. Or my long-time buddy, Moris Muddle, who was known as the ten-word whiz because he got his ten words so fast. These were real men. I knew they were exceptional because they had learned the code. Obviously I wasn't as smart as they. How could I compete with that attitude?

That is how I went, for years and years. "Are you a ham? Boy—it must be something to know Morse; I wish I could learn." During all this time I tried all the tricks I knew to become a ham. I tried to get the rules changed, thought about pirating, and the like. I did everything but one thing—try. Oh, I came close once, I became very determined and tried to listen to Morse on the air. I even set a deadline—I would learn code in three months or know the reason why.

However, I soon reasoned that I was one of those poor unfortunate people who just didn't have the aptitude for code. I was un-codable. The mental monster, procrastination, had won the first round.



Finally, as misery is a lonely old soul and likes company, I met others who also could not master Morse. We formed a club—the un-codables.

Funny thing about a club, it builds incentive even though you know you are only as stupid as the next fellow. You know darn well that you cannot master Morse any better than he can, but somehow you must have something more on the ball than this guy. If you could possibly learn the code, it would sure make him look ridiculous, wouldn't it? Likewise, if he got his Morse first it would sure make me look stupid.

For the first time you begin to think dangerously. You think, "Maybe I could learn this Morse code." You begin doing very strange things like sitting down and really applying yourself. You listen to WIAW every night without fail. You attend regular code practice at the club. You honestly try to copy code on the air. A more realistic time limit is set. There is no hurry. Ham radio is on the move, but it is not going anyplace. Figure on a year. The only important thing is regular practice and study. This *means* regular. Even ten minutes a day, but every day.

Most important—decide that you *can* do it and that you are *going* to do it. Make that first important move—start! You can do it. How do I know? Well, I did it and I am no genius. All I have ever done is learn Morse—and anyone can do that.

... VE3GLX

### Poor Mans Antenna Switch

When several antennas are to be used on one transmitter, it becomes quite a task screwing and unscrewing PL-259 fittings. After a while the threads give up, so pliers and cuss words are in order.

**Solution:** Take a sleeve from an old PL-259, saw off the back end about 1/16 inch to remove the small ring that keeps it from pulling off the fitting. Bevel the inside corner slightly with a knife. Saw four slots from the back down to the threads. Flatten the thread end very lightly so it will be a snug fit when screwed on the chassis fitting. Screw the modified sleeve on the deck fitting, unscrew the sleeves from the coax lines, push back and tape to the lines for future use. Your antenna can now be changed with the same ease that is used in plugging in a set of headphones. □

## QUADS

Worked 42 countries in two weeks with my Gotham Quad and only 75 watts . . . W3AZR

**CUBICAL QUAD ANTENNAS**—these two element beams have a full wavelength driven element and a reflector; the gain is equal to that of a three element beam and the directivity appears to us to be exceptional! **ALL METAL** (except the insulators)—absolutely no bamboo. Complete with boom, aluminum alloy spreaders; sturdy, universal-type beam mount;

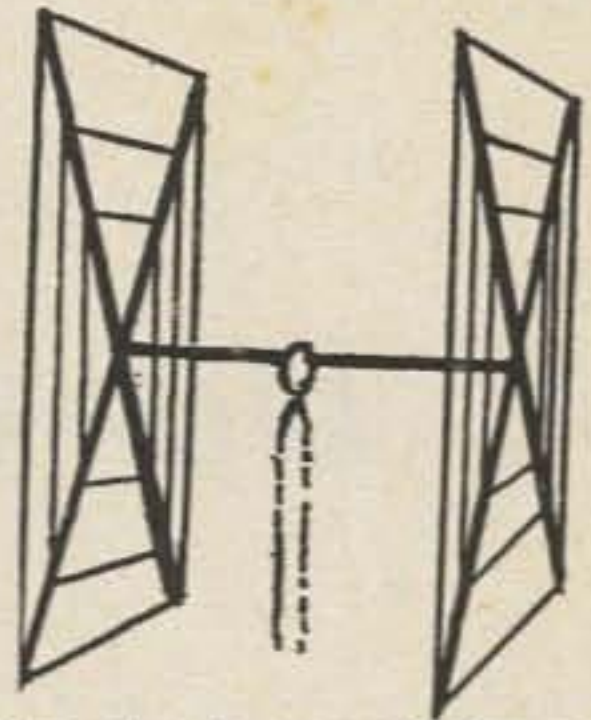

uses single 52 ohm coaxial feed; no stubs or matching devices needed; full instruction for the simple one-man assembly and installation are included; this is a fool-proof beam that always works with exceptional results. The cubical quad is the antenna used by the DX champs, and it will do a wonderful job for you! Remember: These are absolutely complete!

10-15-20 CUBICAL QUAD .....\$35.00

10-15 CUBICAL QUAD ..... 30.00

15-20 CUBICAL QUAD ..... 32.00

**BEAMS:** new complete with boom and hardware; SWR 1:1; handles 5 KW; adjustable entire band; 3/8" and 1" alum. alloy tubing; single coaxial feedline:

4 EI 20 .....\$32.*	2 EI 15 .....\$12.
3 EI 20 ..... 22.*	6 EI 10 ..... 28.*
2 EI 20 ..... 16.	4 EI 10 ..... 18.
5 EI 15 ..... 28.*	10 EI 6 ..... 32.*
4 EI 15 ..... 25.*	4 EI 6 ..... 15.
3 EI 15 ..... 16.	*Has 20' steel boom

ALL BAND VERTICAL V80 (6 thru 80) .....\$16.95  
ALL BAND VERTICAL V160 (6 thru 160) ..... 18.95

Remit with order; shipped charges collect.

GOTHAM, 1805 Purdy Ave., Dept. 73, Miami Beach, Fla. 33139



### HOTEL and APARTMENT SUITES

On world famous Wilshire Blvd. Newest and finest accommodations. California contemporary styling. Every room equipped with TV and AM - FM radio. FREE PARKING. Completely air - conditioned. Large swimming pool and plenty of patio for lounging in the sun just outside your door.

Luxurious comfort combined with all modern conveniences. THE BEST ADDRESS in

**LOS ANGELES**  
**CALIFORNIA**

10587 Wilshire Blvd.  
Los Angeles 24, Calif.  
GRanite 4-3511



## Do-It-Yourself Mobile Mount

Having decided to try mobiling for a change, I purchased a used transceiver with power supplies but with no mobile mount. Looking into possible kits for installing this equipment, led to the conclusion that one could be fabricated quite easily from material on hand.

A piece of  $\frac{1}{2}$  inch plywood  $10\frac{1}{2}$  x 17 inches was selected for the base to carry the transceiver. The corners were rounded

at one end, and at the other end I tapered each side as indicated in the drawing. The small end was then contoured to fit over the drive shaft tunnel in the middle of the floor. A small metal bracket was then attached to the center of this contour so the base could be secured to the floor with a metal screw.

Holes about  $\frac{1}{4}$  inch larger than the feet of the transceiver were bored at each corner

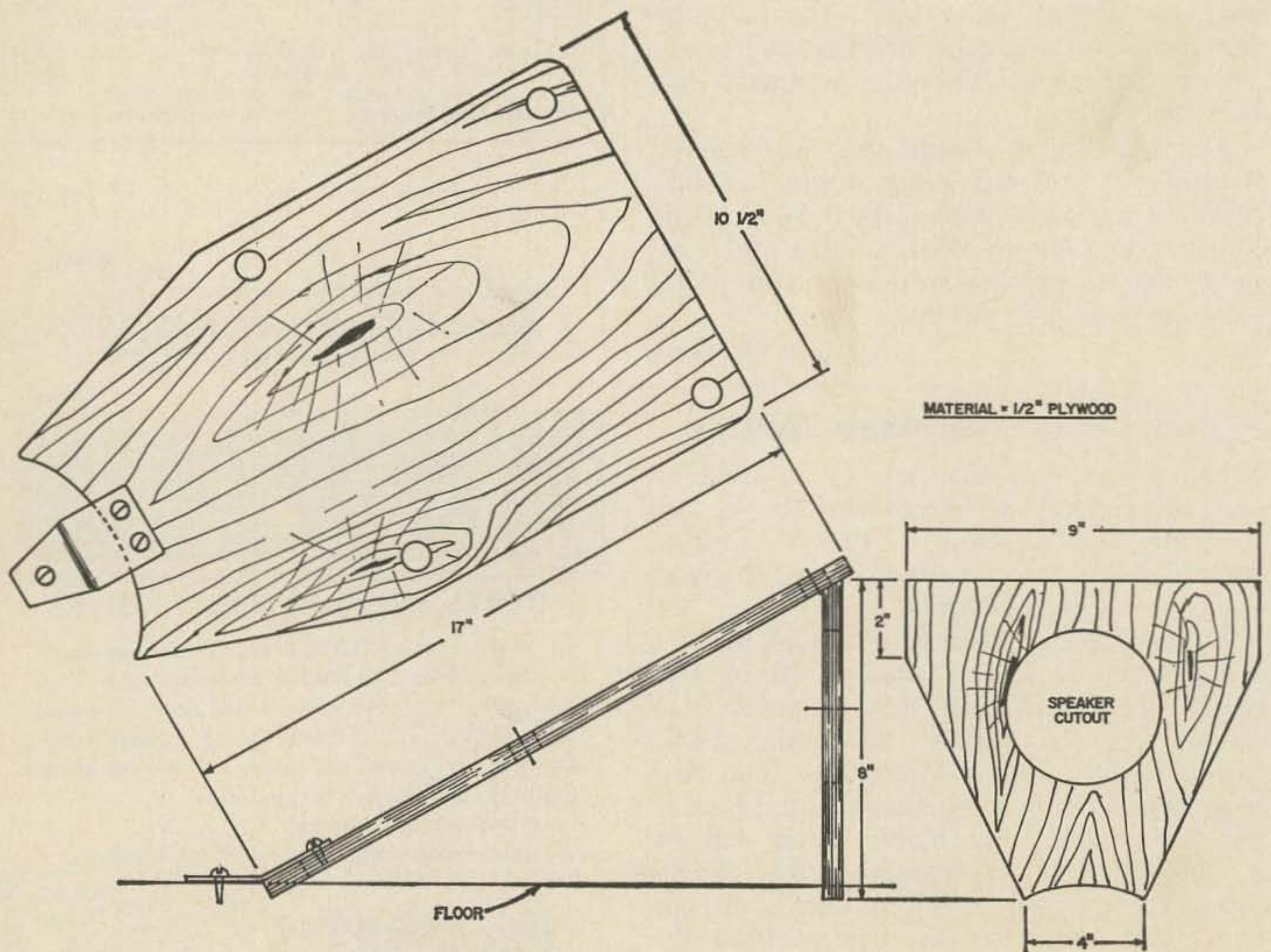

Fig. 1. Do-it-yourself mobile mount constructed from one-half inch plywood. The transceiver is force-fit into the four feet-mounting holes drilled in the top board. The speaker is mounted on the front. The bottom of the mount is contoured to fit over the drive-shaft tunnel in your car.



of the base to accept the feet. The edges of the holes were thoroughly sanded. Four discs of 1/8 inch felt approximately 2 inches in diameter were cut out. These felt discs were placed under the feet of the transceiver and pressed down with the set to form a secure socket, resilient and secure.

The base with the mounted transceiver was then placed in the car and temporarily propped up to the desired operating position. A template of cardboard was made for the bracket to support the front of the base and speaker, as shown in Fig. 1. A flange was turned over at the top to the

proper angle and fastened to the front of the base. A four-inch hole in the upper portion of this bracket accommodates a speaker.

After all was assembled, the base was thoroughly sanded and the edges slightly rounded. The completed mounting base and transceiver case was then sprayed antique gold to match the car interior—this was a wife pleaser! Although this exact design may not be duplicated exactly because of different transceivers and cars, this unit has proved very satisfactory for me.

... W6APE

## Tuning RTTY Shifts With a Piano

Obtaining reference frequencies for setting up mark and space shifts on RTTY equipment can be quite a problem, but if a piano, which is in relatively good state of tune, is available, it will provide a close reference.

The easiest method is to tune in your FSK VFO on the receiver and zero beat the note with "mark" condition. Count up to the fifth "G sharp" from the bottom of the piano keyboard. This note is very close to 850 Hz and by adjusting the shift on "space" to match the note (leaving the receiver untouched) the desired 850 Hz shift will be obtained.

If overload or "pulling" makes it difficult to obtain a good zero beat on your receiver, an alternate method may be used: the highest C sharp is approximately 2125 Hz, and the

highest F sharp is approximately 2975 Hz. If the mark and space are matched to them when monitored on the receiver, you will arrive close to the correct shift. In this case, adjust the receiver to match frequency to the lower note on "mark" condition, and then, without shifting any receiver adjustments, match the "space" tone to the higher note.

This might be used in conjunction with an electric organ, but only if the keyboard has the standard 88 keys. Otherwise you could wind up with the wrong notes. The piano method is sure fire . . . except in extreme cases of "tin-ear".

... Tom Park W6SYX

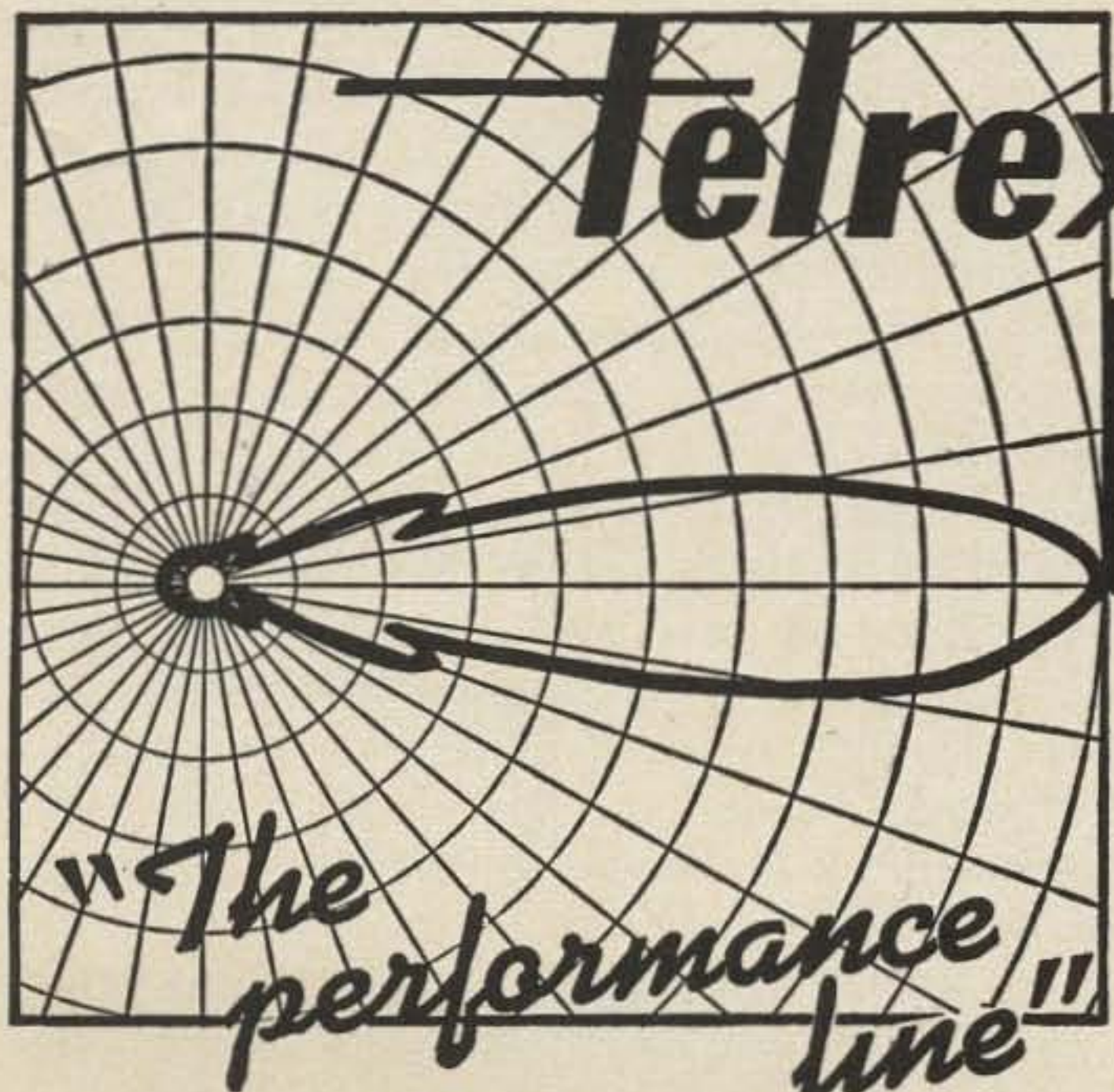

— with a MATERIAL DIFFERENCE!

Use, is one of the most dependable testimonials of endorsement, and Telrex products are in use in 139 Lands

## "Beamed-Power" ANTENNAS, "BALUNS" I. V. KITS and ROTATOR SYSTEMS!

Most Technically-Perfected, Finest Communication Arrays in the World! Precision-Tuned-Matched and "Balun" Fed for "Balanced-Pattern" to assure "TOP-MAN-ON-THE-FREQUENCY" Results

Enjoy, World renown TELREX performance, value and durability! Send for PL67 tech. data and pricing catalog, describing professionally engineered communication antenna systems, rotator-selsyn-indicator systems, "Baluns", I.V. Kits, Towers, "Mono-Pole", "Big-Berthas", accessories, etc., etc.

COMMUNICATION SYSTEMS SINCE 1921 **telrex** Laboratories  
 ASBURY PARK, NEW JERSEY 07712, U.S.A.



Robert C. Green W3RZD  
3304 Collier Rd.  
Adelphi, Md. 20783

## Wash Out Your (Antenna) Shorts

Last spring I purchased a four-wheel-drive truck and since it didn't have a broadcast radio in it I installed one. Due to the shape of the front fender the antenna had to be mounted on the side of the vertical section. There was another panel on the inner side of the fender so the antenna had to be mounted below this inner panel and because of this the coax cable plug was exposed to the weather inside the wheel well. A short time later I mounted a six meter whip on the opposite front fender, but this time I used a regular mobile mount complete with spring and backing plate. Both antenna plugs were sprayed with TV high voltage dope, in the hopes it would waterproof them, but the back side of the plugs couldn't be reached with the spray.

Spring turned into summer, summer into fall and all was ok except at times there was some noise in both receivers during a rain

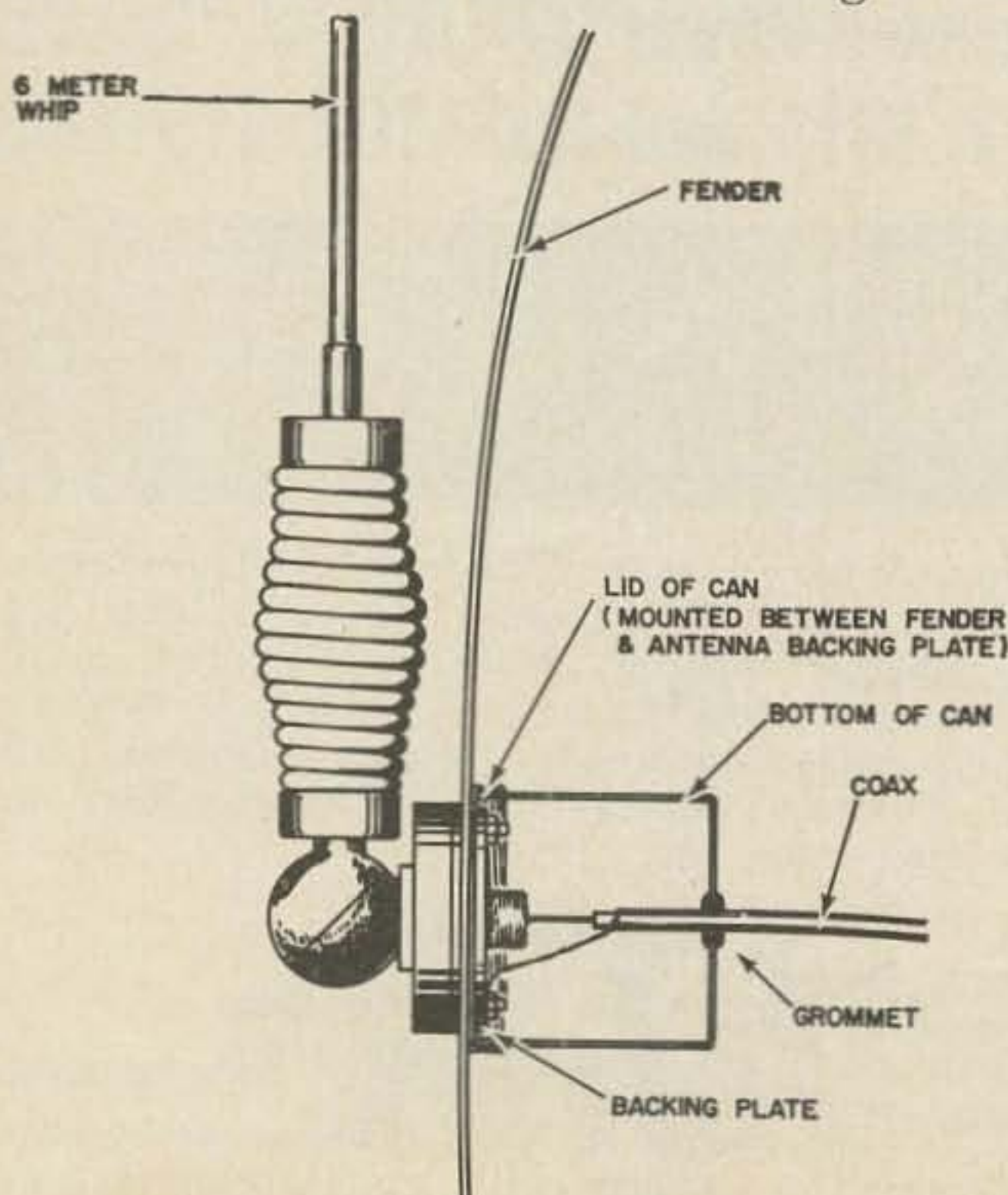

storm, but it was blamed on rain static and outside interference. Finally fall turned to winter and then the noise really started, especially during and after a snow storm. Also it was noticed that the six meter transmitter was acting up and "not getting out". I was beginning to think it wasn't outside noise at all, but right in the truck. So I started checking and found that both antenna coax cables, after a rain or snow, had between 400 and 1500 ohms resistance when measured at the receiving end. Evidently the front wheels were throwing rain or slush up under the fenders where it would collect on the antenna plugs. Of course during snows the good city fathers would order the salting trucks out, and the salt with the snow really did a good job of shorting.

It was decided that these plugs would have to be made more weather proof, and the best way should be some kind of a metal housing. Well, the solution was simple but I had to wash my hands a couple of times before I found it. I needed a can with a screw on lid, and there on the sink counter was such a can—waterless hand cleaner. The can was about four inches in diameter and three inches high. After a hurried trip to the store for another can and dumping the contents of both cans into an empty peanut butter jar, I cleaned the outside of the lids with sandpaper. I thought this might be better for grounding, if it was necessary. The paint was left on the sides of the can for protection, and besides, who was going to look up your fender anyway.

I removed both antennas and cut a hole in the lid of one can, just large enough to pass the BC whip's single feed through insulator. On the lid of the other can I centered the backing plate of the six meter whip and cut out the large center hole and the



bolt holes. In the bottom of each can a hole was drilled to hold a grommet that would fit snugly around the coax.

The six meter antenna was remounted with the backing plate on the inside of the can lid and the can was screwed up tight to the lid. Now to the BC antenna—here I ran into a wee bit of trouble, the antenna was sloppy after tightening up the mount. The lid of the can was acting as an “anti-friction washer” and would allow the antenna mount to swivel slightly. The can lid needed more friction between it and the fender wall. A hammer and nail solved the problem. The lid was laid on a board with the outside of it next to the board, then the nail was used to puncture a lot of small holes in the lid. When the antenna was remounted the burrs from nail holes dug through the undercoat and into the metal of the fender and held the antenna solid. The burrs also provided good grounding for the outside shield of the coax.

A friend who had a whip mounted on the rear fender of his car complained that several times he had broken the center lead of the coax when loading or unloading the trunk. I showed him my brain child and told him it would solve his problem as well as it solved mine. Later I heard he stopped at the store, on his way home, for a can of hand cleaner; but I never did find out if he had an empty peanut butter jar.

... W3RZD

### Antenna Coil Protection

In order to prevent the antenna rf coil in your receiver from burning out when a transmit-receive relay fails, solder a grain of wheat neon bulb (#NE-2) between the antenna connection and ground (chassis) of the receiver. If rf hits the receiver, the path is to ground, not to the antenna coil. Insurance is cheap . . . antenna coils are expensive.

... Jack Weatherly K1ZYG

### Sharpening Chassis Punches

Lacking a grinding wheel, a round chassis punch can be sharpened equally well on an oilstone. Use the first and second fingers to grasp the “flats” on the back of the punch, applying pressure with the thumb on the forward stock. It is best to count the strokes so as to equally sharpen each side of the punch.

... Ray Ezelle WP8JJQ

Watts  
on your  
mind . . .



**relax!**  
get COMDEL'S NEW  
"In Line" WATTMETER

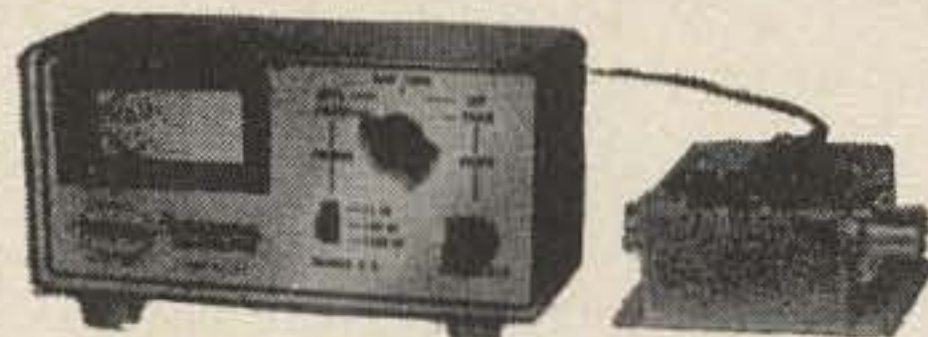

\$95.00 postpaid U.S.A.

- ▶ Measures absolute power with 1db accuracy in 50\*  $\Omega$  systems.
- ▶ Operates at all frequencies between 1.5 and 60 MHz.
- ▶ Calibrated 0.2 to 1500 watts in three ranges.
- ▶ Doubles as VSWR meter without the use of charts.
- ▶ Features antenna tune function for maximizing output from fixed load transmitters.
- ▶ Has negligible insertion loss, less than 0.02 db.
- ▶ Is simple to use, two switches select power range and function.

\*Other impedances available on special order.



beverly airport  
beverly, mass.



Alexander Ross WA2BCX  
1409 Milford Terrace  
Teaneck, New Jersey

## A Polarity Sensitive Meter for the Sightless

Here is a simple polarity-sensitive meter which may be used for checking diodes, capacitors, and within a limited range, resistors. It may also be used for testing continuity or as a code practice oscillator.

This article describes an easily constructed meter for checking capacitors, rectifiers, resistors, and general continuity testing. The device consists of a Mallory Sonalert oscillator connected in series with two miniature 9-volt batteries. The Sonalert and batteries are mounted in a plastic box, 6 x 3¼ x 2 inches. The output terminals are marked in Braille to allow easy polarity identifications.

The procedure in testing a rectifier is as follows: connecting the tester leads to the rectifier will indicate the anode and cathode by listing for the audio tone. If the tone is

heard, the positive lead of the tester is connected to the anode and the negative lead to the cathode. Turning the test leads around will produce no signal. If the signal is heard in both directions the rectifier is shorted; if no signal is heard in either direction the rectifier is open.

It is possible to tell the approximate capacitance of a capacitor by noting the length of the audio signal that is heard as the capacitor charges. The larger the capacitor, the longer it takes for the capacitance to

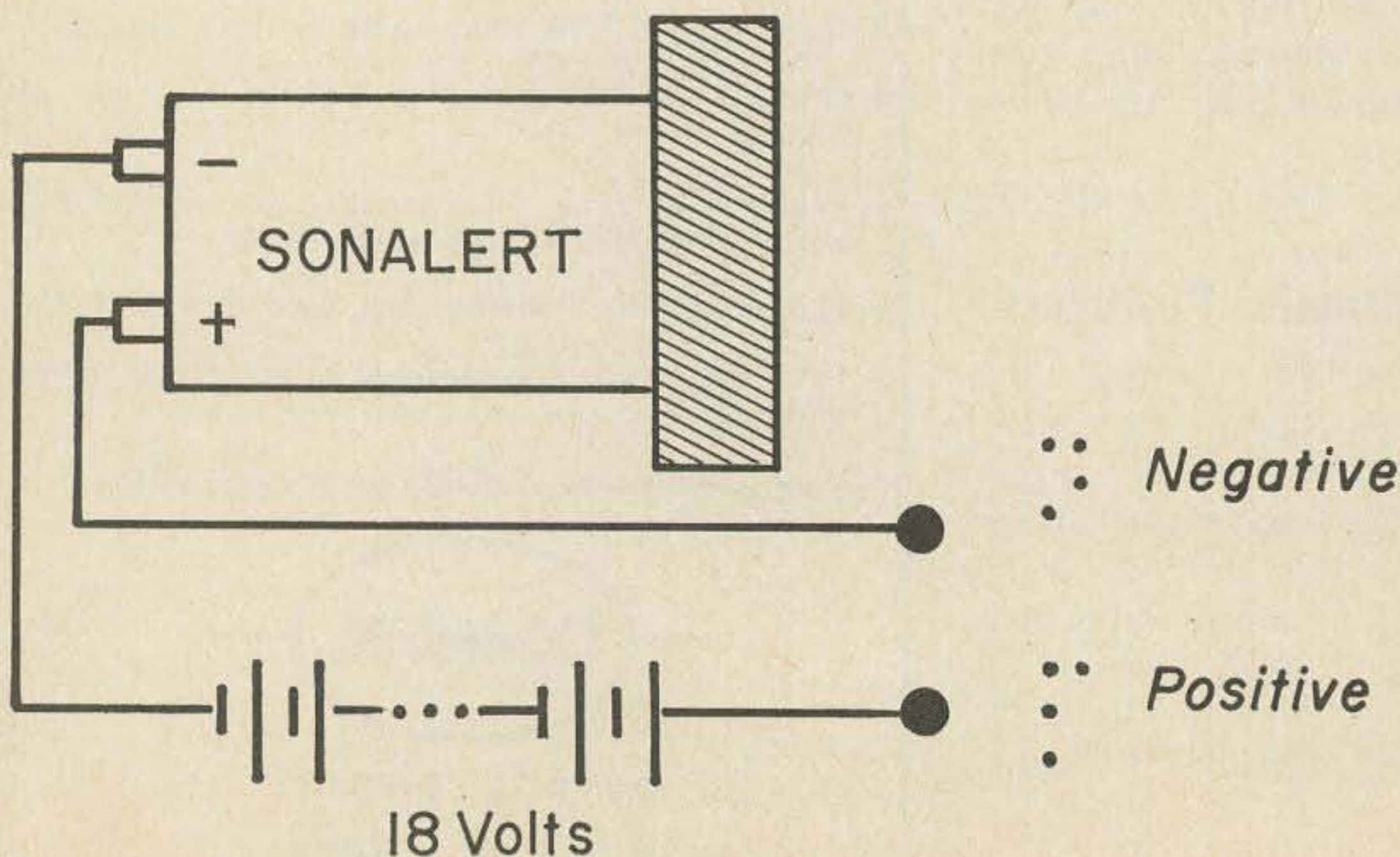

Circuit diagram of the polarity-sensitive meter. The entire unit is housed in a small plastic meter box.



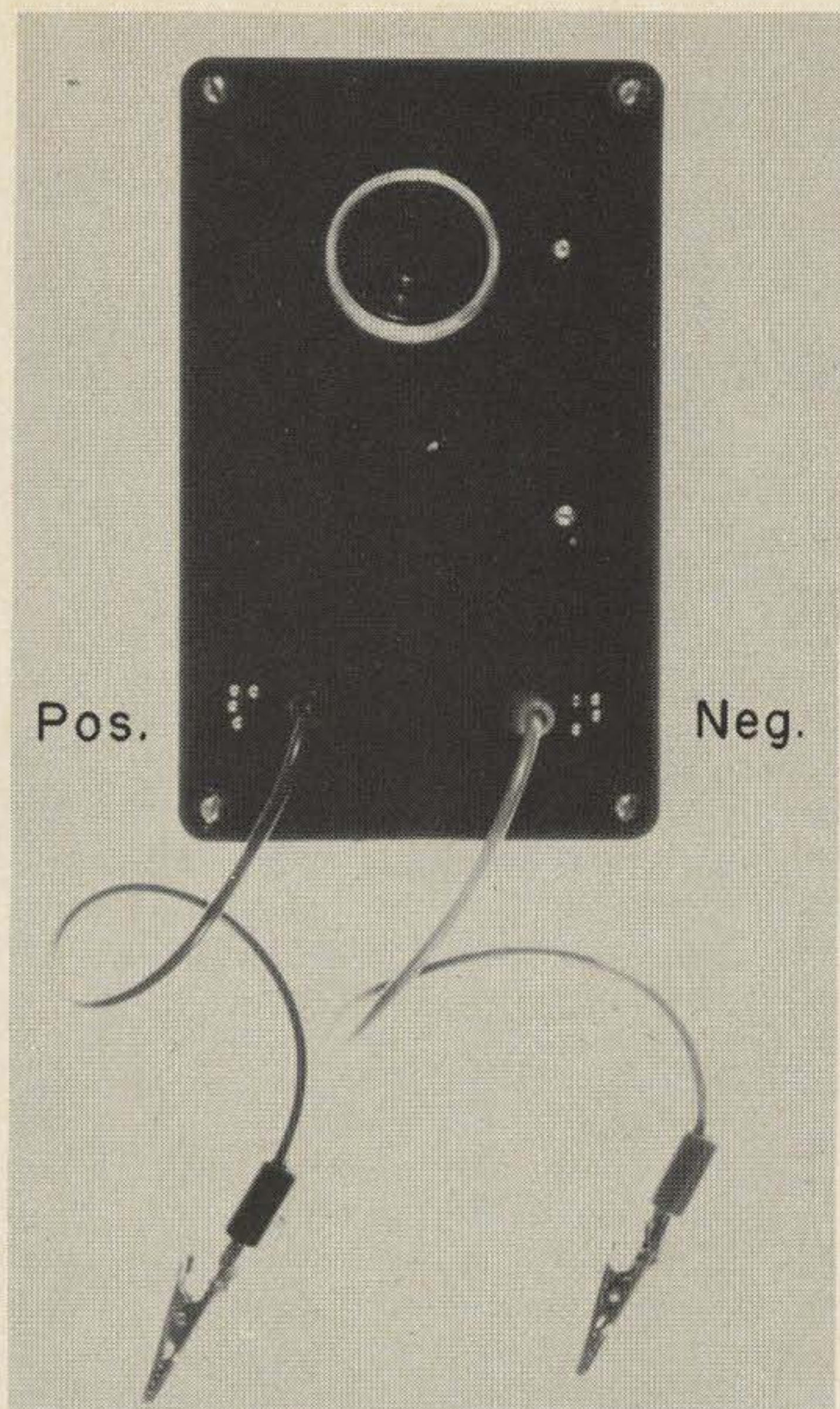

This audio polarity-sensitive meter uses a Mallory Sonalert module and may be used for checking rectifiers, capacitors and resistors. The output terminals are marked in Braille.

charge. This device is good for capacitors down to 0.01 mF. Electrolytic capacitor polarity can be obtained in the following manner: if the positive side of the capacitor is connected to the positive lead of the tester, and the negative capacitor lead to the negative side of the tester, the capacitor will charge and a brief tone will be heard. If the leads are reversed the tone will be continuous indicating wrong polarity.

The approximate value of a resistor can be obtained with this method; the greater the resistance the weaker the audio tone. Resistors above 20k ohms will give no audio tone and cannot be checked.

This unit can also be used as a code practice oscillator, or the Sonalert can be used by itself as a grid bias alarm. This versatile gadget has many potential uses for the sightless as well as sighted radio amateur.

. . . WA2BCX



VANGUARD  
MODEL 501  
Made in USA.

**\$279.95**  
SHIPPING COLLECT  
COMPLETE WITH LENS

SUB-MINIATURE SOLID STATE  
**TV CAMERA**  
FOR CLOSED CIRCUIT OR AMATEUR TV

THE VANGUARD 501 is a completely automatic closed circuit television camera capable of transmitting sharp, clear, live pictures to one or more TV sets of your choice via a low-cost antenna cable (RG-59U) up to a distance of 1000 ft without the need for accessories or modifications on the TV sets. The range can be extended indefinitely by using line amplifiers at repeated intervals or by using radio transmitters where regulations permit.

There are hundreds of practical uses in business, home, school, etc. for any purpose that requires you or anyone chosen to observe anything taking place anywhere the camera is placed. Designed for continuous unattended operation, the all-transistor circuitry of the 501 consumes only 7 watts of power.

**SPECIFICATIONS:**

- Measures 2 $\frac{3}{4}$ " x 4" x 7" (excluding lens and connectors).
- Weighs 3 $\frac{1}{2}$  lbs.
- Operates on 100-130 volts 50 or 60 cycles, 7 watts.
- Tested at 10° to 125° F.
- Advanced circuitry utilizing 35 semi-conductors most of which are silicon.
- Field effect input circuit for minimum video noise.
- Resolution guaranteed to exceed standards set by 525 line TV receivers.
- RF output 30,000 microvolts adjustable for channels 2 to 6.
- Video output 1.5V p-p composite with standard negative sync (random interlace).
- Viewable pictures obtainable with illumination as low as 1 ft. candle.
- Vidicon controlled light compensation; 150/1.
- Adjustable iris on lens enables use in bright sunlight.
- New long life, sub-miniature vidicon with spectral response similar to Type 7735A.
- Electronically regulated power supply and thermally compensated circuits eliminate change in picture quality when line voltage and temperature fluctuate.
- All parts guaranteed for 1 year (except for open filament on vidicon or breakage).
- Fast, low-cost service always available from our factory in Hollis, N.Y.

Pre-set adjustable controls include the following: Video gain, video compensation, pedestal level, target voltage, beam voltage, beam alignment, electrical focus, horizontal frequency, horizontal size, vertical frequency, vertical size, vertical linearity, modulation and RF frequency output.

Send your order direct to our factory

**VANGUARD LABS**  
196-23 Jamaica Ave. Dept. H Hollis, N.Y. 11423



Howard Pyle W70E  
3434 74th Avenue, S.E.  
Mercer Island, Washington 99040

## Climbing the Novice Ladder: Part X

FN offers Joe and Judy sage advice.

On the appointed Saturday, Judy and Joe trekked out to FN's place, reluctantly leaving their own cozy shacks where the never-ending thrill of contacting other stations was most exciting. Judy reported seven states already QSO'd for her eventual WAS award; most of these had been relatively local in the 80 meter band. As her confidence had

mounted though, she had ventured into the 40 meter group having first picked up a suitable crystal for this band. Two locals had answered her first CQ's here but the thrill came when she had called a California station, conversed with him for half an hour and added him to her WAS list. Joe too, had not been idle; he had finished his T-60 kit, Larry had checked his work and Joe had then taken the rig to FN for inspection before putting it on the air. With a couple of suggestions for minor wiring re-routing, FN pronounced it a satisfactory job, plugged it in and gave it an on-the-air test. It loaded nicely and FN's field strength meter indicated that for a 60-watt rig it was putting a pretty fair wallop into the air.

After a few minutes of small talk FN said, "Well, suppose we get at the meat of this meeting; we were going to talk about clubs, magazines and operating procedures, remember? I know you're both itching to get back to your shacks and pound the key, but there are other considerations in ham radio that you should know and that's what we're going to talk about today . . . let's start with clubs.

"Both of you already belong to your local club; that's as it should be. Be as active as you can and participate in as many of their activities such as field day, national and local contests and the like, as often as you can. Attend as many meetings as you can manage and keep your ears open for what the usually excellent speakers have to say . . . learn as you go in other words. You will have the local club situation well in hand then and can begin to consider what you want to do about clubs and organizations of wider scope.



"Judy works on the WAS award . . ."



Of all such groups open to all types of hams and would-be hams all over the world, the American Radio Relay League, familiarly referred to as the ARRL, is the oldest and best known. The word 'relay' in their name, while kind of a misnomer these days, dates back to their founding in 1914 when the spark hams of that time generally had to reach distant stations with messages by 'relaying' through one or more other hams. 'DX' as we know it now, was then unheard of . . . several hundred miles at best was the average transmitting range of the most powerful of the early ham stations, although a number of greater distance records were occasionally hung up, but they were the exception rather than the rule. Something like about one third of the approximately 300,000 hams in the world today, belong to the League. Taken all in all, it's a good organization, although they are, like any other group of their magnitude, subject to criticism, some of which is deserved. Personally, I don't accept all of their policies, lock, stock and barrel and I am not alone in this, but that doesn't prevent us from maintaining membership. So much then for the ARRL; let's look at a few other groups.

Probably one of the first and best for you to affiliate with is the QRP AMATEUR RADIO CLUB—International. This is a group of some 3000 amateurs scattered throughout the world who are dedicated to low power operation as their contribution toward relieving the tremendous amount of QRM now existing on all bands. With your power restriction of 75 watts as novices, the QRP club is practically tailored to fit. And, as a very large majority of novices are in the juvenile age groups which ordinarily makes economics very much a factor, *life* membership in this organization costs only *two dollars* which imposes no hardship on teen-age budgets. They also publish a quarterly News Letter which contains a lot of meat on their activities, contests and much more; you receive the first years' issue of this paper free when you join; a dollar a year after that if you want to continue it.

There are a number of other clubs and organizations for the ham, although the doors of some are automatically closed to you at this time. You could hardly be considered for membership in the QUARTER CENTURY WIRELESS ASSOCIATION for example where a background of 25 years as a licensed amateur is a requisite to member-

ship. Even less open to you are the portals of the OLD, OLD TIMERS' CLUB where, instead of 25 years, 40 or more years of licensed hamming must be proven to make you eligible to this elite group.

"Suppose now that we take up the matter of magazines; you are going to want to keep up on ham affairs in general and the very best way to do it is to read the monthly periodicals devoted to the ham. Of these there are three which treat with amateur radio exclusively. One of these, *QST*, published by the American Radio Relay League, you can have only by becoming a member of the League. Copies are not available on the newsstands nor can you subscribe without becoming a League member. The other two, *73* and *CQ* are both available in single monthly copies at most electronic stores catering to the ham. All three stores in town here for example, carry both of them. You'll make a substantial saving and always be assured of receiving your copies regularly if you subscribe by the year to either or both . . . your economic status will have to determine that.

"The three I've mentioned are, as I've said, devoted exclusively to ham radio. There are a number of other publications which often carry a number of first-class articles for the radio ham and to which you should give



"FN discusses the matter of ham publications."



more than a passing thought. Two that come to mind right at the moment are *RADIO-TV EXPERIMENTER* and *ELEMENTARY ELECTRONICS*. While the contents are not confined to the ham reader alone, there is a great deal of electronic information of general nature which is of considerable value to the radio amateur; constructional articles cover both ham radio gear and related electronics equipment such as hi-fi, sound recorders, record players and such miscellaneous products. *ELECTRONICS ILLUSTRATED* and *POPULAR ELECTRONICS* are another pair with similar content. Then there is *RADIO ELECTRONICS* and *ELECTRONICS WORLD*. The former is directed more toward the radio/TV service technician although it often includes a number of hints and tips of value to the ham. *ELECTRONICS WORLD* is slanted more toward the upper brackets of electronic readers and goes rather deeply into the engineering phases of the science of electronics. A good part of it is college level reading and offers much of interest to the ham who has progressed to that academic status and is seriously considering electronics as a career. The magazines I've mentioned are but a few of the current offerings and you'll find others on the newsstands. Aside from the strictly amateur class magazines, 73 and CQ, you ordinarily won't find other electronic magazines at your local ham stores but they are usually available at drug and supermarket newsstands. I'd say that you should take a little time now and then to thumb through these and make your own choice of those which may appeal to you. Whatever you choose is bound to teach you something, so you won't go wrong on any of them.

"Before we close this discussion of magazines though, suppose we examine their contents a little more in detail. In the three ham magazines the balance between construction articles and those of more general ham interest is about equal. Unfortunately, the larger proportion of their offerings is somewhat above the novice level of understanding although all of them try to devote a small number of their pages to a few elementary construction and discussion articles within the novice grasp. A strictly novice magazine does not exist . . . it probably could not exist were there such. A ham is a novice for a year at most, during which time he acquires sufficient knowledge to accept an increasing number of the more complicated articles with a

better understanding. He would then lose interest in a purely novice type of publication and quit buying or subscribing to one. Among the general class of electronic magazines, about the same situation exists; a considerable number of articles somewhat over the novice head. They too however, frequently run a construction article or two descriptive of something which the novice can readily build. To sum it up, my suggestion would be that you get one or more of the ham publications each month, preferably by subscription if you feel that you can afford it. Then round out your reading by doing a rather thorough thumbing through of the general electronics magazines on your local newsstands, buying those which seem to contain something of interest to you and perhaps even subscribing to one or two a bit later if they seem to offer you something of interest pretty consistently every month. So much for magazines then . . . let's look at something else.

"The 'something else' I'm talking about is your practical, daily novice operation on the air. You both have your feet wet now and have made a number of contacts. That indicates that basically you are on the right road, but ten to one you're doing a number of things which will earmark a recently graduated novice the minute he legally enters the General class bands. For one thing, practically all novices overdo the 'period'. This is desirable while you are a *novice*; use every single character of the code that you can in your daily contacts to familiarize yourself with them thoroughly; you need not carry this over into your general class operation though. Most generals ignore the long series of characters making up the period; either they simply leave it to the other guy to know where one thought ends and another begins or they use a simple 'dit dit . . . dit dit' or a 'BT' to separate the thoughts. However, should you handle any third party messages, as in traffic net operation, you must transmit such messages *exactly* as written by the sender; if a period appears, it must be included. The majority of traffic nets however, rather than using the long drawn out characters of the period, substitute the letter 'X'. This is by common agreement and is well understood and interpreted by traffic handlers. In a message physically delivered to the addressee, the period should appear written as the conventional 'dot' however; not as an 'X' which could



# CLEARANCE SALE

## Back Issues of 73

\$1 per year

\$1 per year

That's right, only one dollar for each year.

We want to clear our shelves so here is your opportunity to get those back issues you have missed.

Some years are complete, some lack one or two issues. If there are less than ten available for a year we will fill in from another year.

Send your name, address, a dollar for each year, and indicate which year or years we should send.

- 1961 . . . January and March are out
- 1962 . . . June is out
- 1963 . . . Complete, at present
- 1964 . . . Complete, at present
- 1965 . . . Complete, at present
- 1966 . . . Not available on this deal
- 1967 . . . Forget it.

The back issues of 73 make fascinating reading. Each year is like a complete handbook with from 200 to 300 technical and construction articles. Nothing much to get old in 73 . . . none of that who-worked-who jazz, just good live articles.



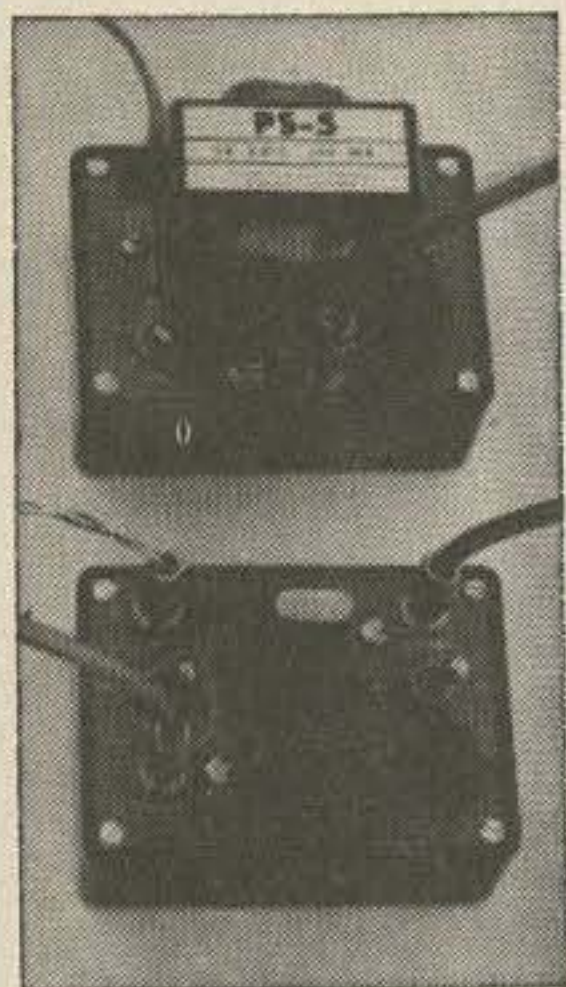

# LT-5

\$35.00 Wired

\$24.00 Kit

5 Watt 40-80 Meter Transmitter

# PS-5

\$34.00 Wired

\$22.00 Kit

Regulated AC Supply for the LT-5

Send for Data Sheet

Distributor

Inquiries Welcome

## OMEGA ELECTRONICS COMPANY

10463 ROSELLE STREET

SAN DIEGO, CALIFORNIA 92121

easily mystify the addressee.

"Another thing the novice is inclined to work to death is the 'CQ' call. "CQ, CQ, CQ . . ." on and on and on, instead of getting you a reply is more liable to find a disgusted listener tuning for someone else who doesn't bore him to death by constant repetition. A generally accepted procedure, known as the 'three by three' call, is: "CQ CQ CQ de WN7-WN7-WN7-" repeated three times and ending with an 'AR' or simply a 'K' after the last group of three. Even this is sometimes a little long and you'll get just as many replies if you use it this way: "CQ CQ CQ de WN7- WN7 -WN7-, CQ CQ de WN7-WN7-, CQ de WN7-'AR'." Catch on? CQ

and your call three times, then CQ and your call *twice* and finally only once followed by the 'AR' or 'K'. Try training yourself this way . . . you'll gain more respect and more frequent replies from the generals when you enter their ranks. True, you'll find some of the experienced generals who are flagrant CQ'ers also but the rest of the gang generally pass them up as being 'too long winded' and they lose a lot of otherwise good QSO's they might have had.

"There is another habit which seems to be a popular but asinine novice practice . . . oh I've heard it among a few generals as well; that is the childish habit of ending a QSO with an attempt at facetiousness by sending, "dit . . . dit dit dit . . . dit . . ." then waiting for the other guy to come back with 'dit . . . dit'. That's kids' play; don't do it. And, one more criticism of average novice operation and I'll be through with this 'one man lecture' panning you kids! That is the practice of acknowledging anything the other guy sends whether you get it or not by saying 'R . . . R . . . R . . . OK . . . OK', not only too many times but following it with, ". . . except I didn't get your handle and QTH, please repeat . . ." or words to that effect. When you send an 'R' it means that you received *everything* he sent; if you didn't get it *all*, don't say 'R' or 'OK'. Start right out after calling him by saying, "Sorry OM, missed a bit. Your handle and QTH again please" or words to that effect . . . make sense?"

FN then rose from his comfortable rocker saying, "Well; that was quite a session, wasn't it? Sorry I had to make it so one-sided but what I gave you were a lot of little points which should help you keep going in the right direction. Now here are some leaflets I dug up for you which explain some of

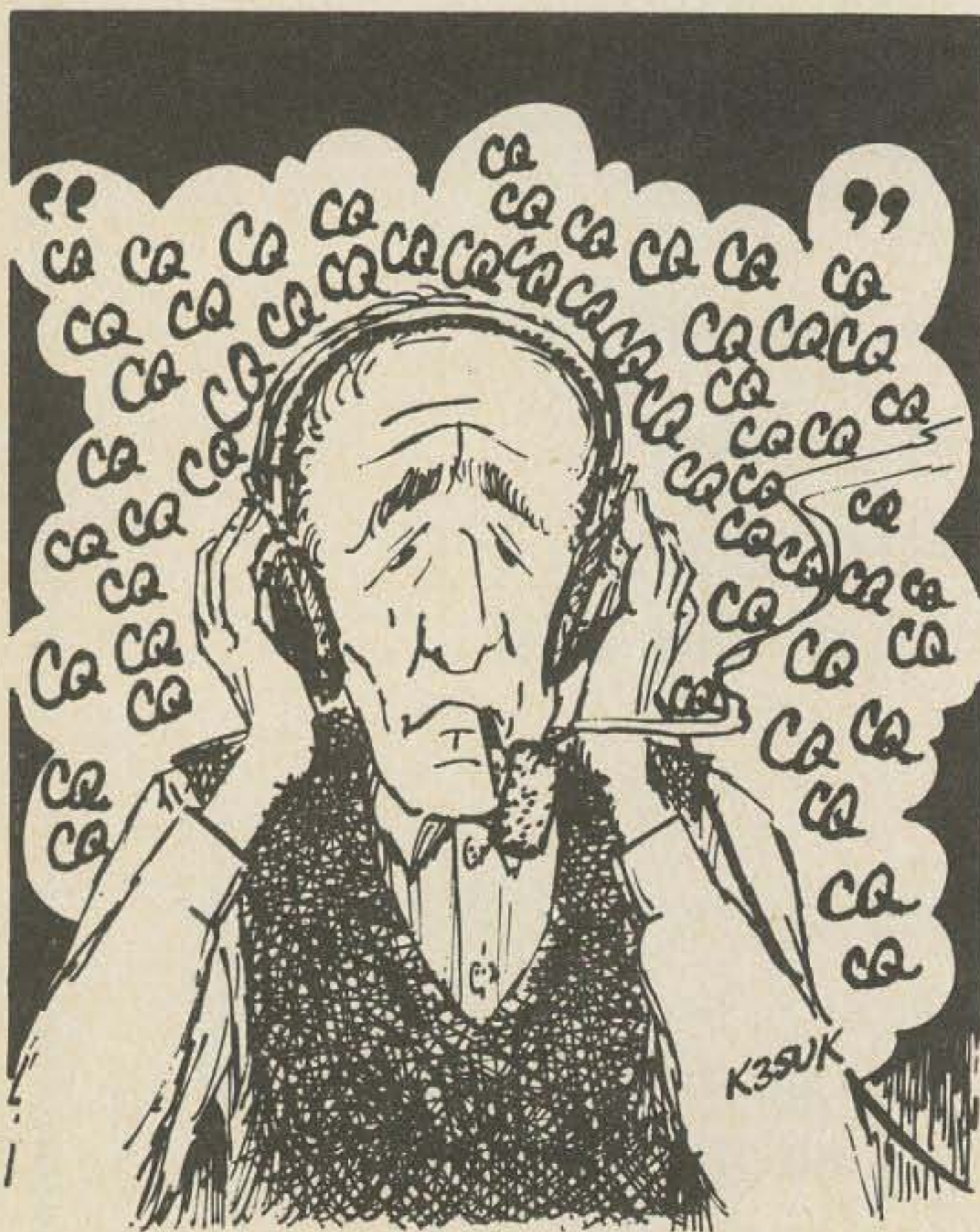

"The novice is inclined to work the CQ call to death . . ."



the clubs I was telling you about; how to join, cost, etc. Study them over and make up your own minds which if any, you'd like to join. Paw through the magazines at the corner drug store and look over the 73 and CQ at the ham shops down town. I've gone about as far as I can now to indoctrinate you into progressing up the novice ladder to the general class goal at the top. You're both more or less on your own now, but feel free to come out here any time; I'll be glad to see you, hear about your progress and help you with your little problems in any way you feel I can. So, run along now and get back to pounding out those CQ's but make 'em short and skip the 'monkey business' on the air; get your teeth into some really serious communication . . . OK? I'll tune in on your frequencies every now and then so watch out you don't rile me" he finished laughingly. The kids then took off for their respective shacks and the novice field was richer by two new members in their ranks who had just had their ears pinned slightly back!

And so ends the saga of two new devotees to the glorious hobby of ham radio. In their climb up the novice ladder they had innoculated Judy's Dad with the 'hamitis' bug and he was successful in passing *his* novice exam after four months of what study he could manage between his family and job obligations. Judy and Joe continued their studies and at FN's suggestion, both faithfully followed the code practice sessions on the air from W1AW until they had acquired formal Code Practice Certificates from the ARRL at 15 words per minute. Both then appeared together at the FCC examining point for their general class license. Judy made it the first time but Joe flubbed his sending; he came through on top after the required 30 day wait. So . . . eight months scratch until Judy was a General . . . nine months for Joe! And, to carry the seed of ham radio even farther afield, Judy and her Dad undertook on their summer vacation to Aunt Emma's Kansas farm, to start Cousin Clara, a wheel chair invalid, up the novice ladder. Having adequate time to practice and study, Cousin Clara made her novice ticket in seven weeks and became a General class ham in seven more months and established weekly schedules with Judy and her Dad! Let's leave them all now to the continued enjoyment of the glories of ham radio . . . shall we?

. . . W7OE

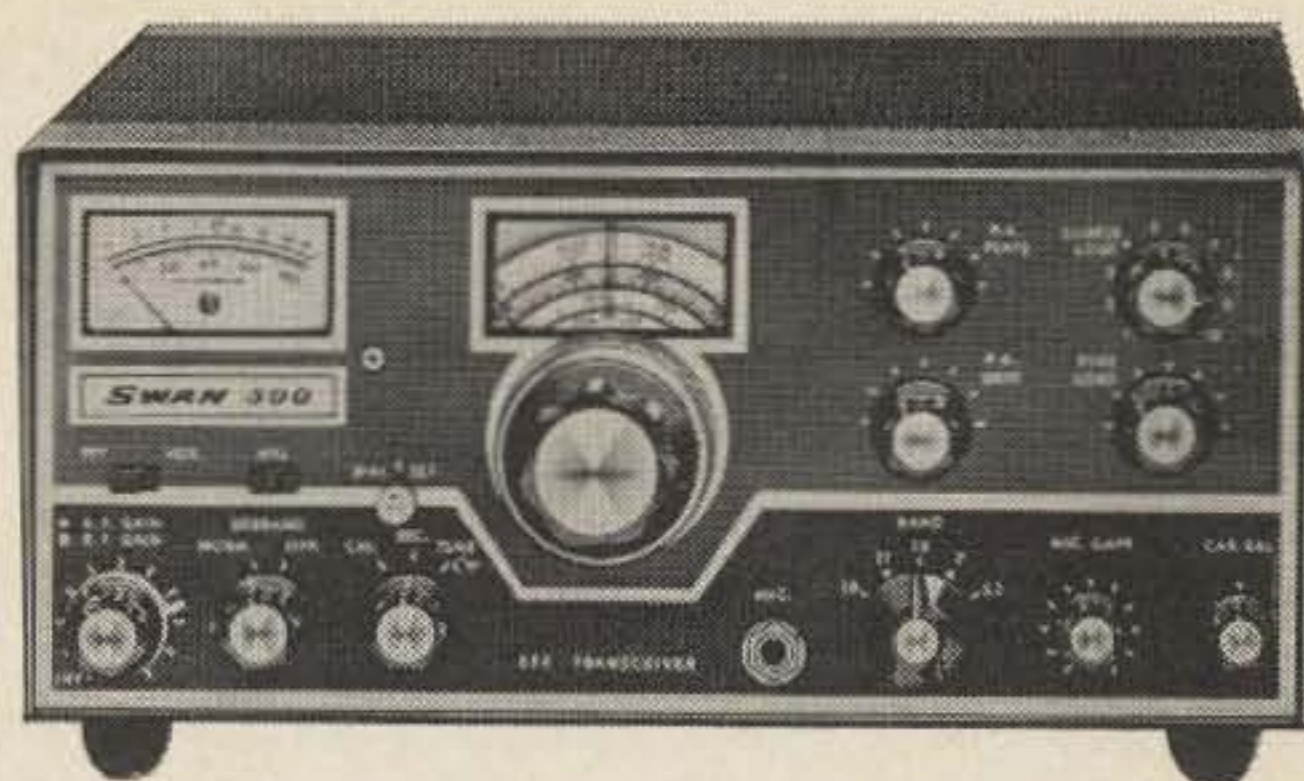

## SWAN 500

5 BAND—480 WATT SSB TRANSCEIVER  
FOR MOBILE—PORTABLE—HOME STATION

### ACCESSORIES:

Full Coverage External VFO. Model 410 .....	\$ 95
Miniature Phone Band VFO. Model 406B .....	\$ 75
Crystal Controlled Mars Oscillator. Model 405X ...	\$ 45
Dual VFO Adaptor. Model 22 .....	\$ 25
12 Volt DC Supply, for mobile operation.	
Model 14-117 .....	\$130
Matching AC Supply. Model 117XC .....	\$ 95
Plug-in VOX Unit. Model VX-1 .....	\$ 35

**S** COTT RADIO SUPPLY, Inc.

266 ALAMITOS AVENUE  
LONG BEACH, CALIF. 90802

**PLEASE INCLUDE YOUR ZIP CODE  
WHEN YOU WRITE 73.**

### NOVICE CRYSTALS \$1.25 EACH

FT-243 HOLDERS, FUNDAMENTAL FREQUENCIES.

80 meters—3705-3745 kc.

40 meters—7155-7195 kc.

15 meters—7033-7083 kc.

Add postage per crystal: 5c first class, 10c airmail. Specify frequency desired and nearest available will be sent. Other frequencies in stock. Free list. Dealer and club inquiries invited. Satisfaction guaranteed.

NAT STINETTE, Box Q, Umatilla, Fla. 32784

## ALL BAND TRAP ANTENNA !



Reduces Interference and Noise on All Makes Short Wave Receivers. Makes World Wide Reception Stronger. Clearer on All Bands!

For ALL Amateur Transmitters. Rated at 1000 Watts AM 2000 SSB PINet or Link Direct Feed. Light, Neat, Weatherproof.

Complete as shown total length 102 ft. with 96 ft. of 72 ohm balanced twinline. Hi-impact molded resonant traps. You just tune to desired band. Excellent for ALL world-wide short-wave receivers and amateur transmitters. For NOVICE AND ALL CLASS AMATEURS! Eliminates 5 separate antennas with excellent performance proven. Inconspicuous for Fussy Neighborhoods! EASY INSTALLATION! Thousands of users.

75-40-20-15-10 meter bands. Complete .....

40-20-15-10 meter. 54 ft. (best for swl's). Complete .....

SEND ONLY \$3.00 (cash, ch., mo) and pay postman balance

COD plus postage on arrival or send full price for postpaid delivery. Free information.

MIDWAY ANTENNA • Dept. A8-1 • Kearney, Nebr. 68847



# WTW Report

Things are progressing right along with the new WTW DX Award these days. If it's any indication of the interest in WTW, I am glad to report that the WTW country/tally sheets are going out at the rate of about 6 to 10 every day. If all these fellows are going out for the WTW certificates, there most certainly will be a lot of them issued in the future. If you are not already one of them, why not drop me a line, inclosing 20¢ in stamps, and I will send you a pair of the country/tally sheets so that you will more easily be able to keep your scores up to date. There is room after each prefix for a 10 year record for each of them. If everyone uses this standard report form, it will make our task a little easier, too, and thus eliminate the chances of making mistakes as more and more people qualify.

At the same time, each of the various QSL check points (they were listed in last month's report) will be using the same type of record keeping, so if it happens that some of them ever want "out", they can pass their records over to some other DX Club without the usual confusion of such a transfer of records from one group to another. Of course we at 73 Magazine hope none of them ever "wants out". The following stations have qualified since last month:

W4CRW-	-WTW-100-	14MHz	CW
W4FPW	-WTW-100-	14MHz	PHONE
DL5HH	-WTW-100-	14MHz	PHONE
W4JVU	-WTW-100-	14MHz	PHONE
W4BYB	-WTW-100-	7MHz	CW
K9OTB-	-WTW-100	14MHz	PHONE
K9PPX-	WTW-100-	21MHz	PHONE

In the above you will note there are two "Firsts"—The first non-USA WTW certificate goes to DL5HH (home call is WA4RMX) and there is Certificate #1 for 7 MC WTW-100 for W4BYB—Congrats to both of these stations.

Still wide open is certificate number one for any 28 MC operation, and certificate number one for both 3.5 MHz CW and 75 meter phone. At the rate the fellows are get-

ting on the band wagon it won't be long before someone gets these certificates. Better get in there and try for number one for these—they are QRX for the first one who qualifies!

I again inform you that along with each application you must inclose \$1.00 to cover costs of the certificates, application forms, mailing of the certificate, etc. In addition to this, you must also send along enough postage for the return of your QSL cards—whatever amount you send that's how we will return your cards to you. Otherwise, they will be returned to you at the cheapest rate possible. This means very slow delivery and, at times, uncertain delivery—so don't blame us if something happens to your cards after they leave us on their way back to you. You can find out the exact cost when you send them to us, and for the safest possible way to get your cards back, send them by *registered* mail. The next best way is by *certified* mail, and after this is the old stand-by first class mail which costs you 5¢ per ounce. Please keep all this in mind when sending us your QSL cards.

We are still mulling over the idea of accepting QSL cards of less than multiples of 100. It would certainly make the listings more interesting, I am sure. Of course there would be more of a bookkeeping problem, but problems have always been something to overcome as they arise.

I am still waiting for some pictures of some of the fellows who have qualified for the WTW so we can tell the other fellow about you and your station. Make them good black and white pictures, fellows, since in the process of printing pictures, a little is always lost. Color reproduction is financially out of the question. The process of color separation is very expensive, so we are just sticking to good old black and white.

This is it for this month, fellows. Better get in the WTW and have yourself a "ball" and at the same time get a very low serial number on your WTW certificate, something you will be proud of as more awards are issued and the serial numbers get higher.

. . . W4BPD



*Our message to the  
amateurs of the world  
is simple:*

# **We believe the new 2K-2 is the finest linear amplifier ever made for the amateur service**

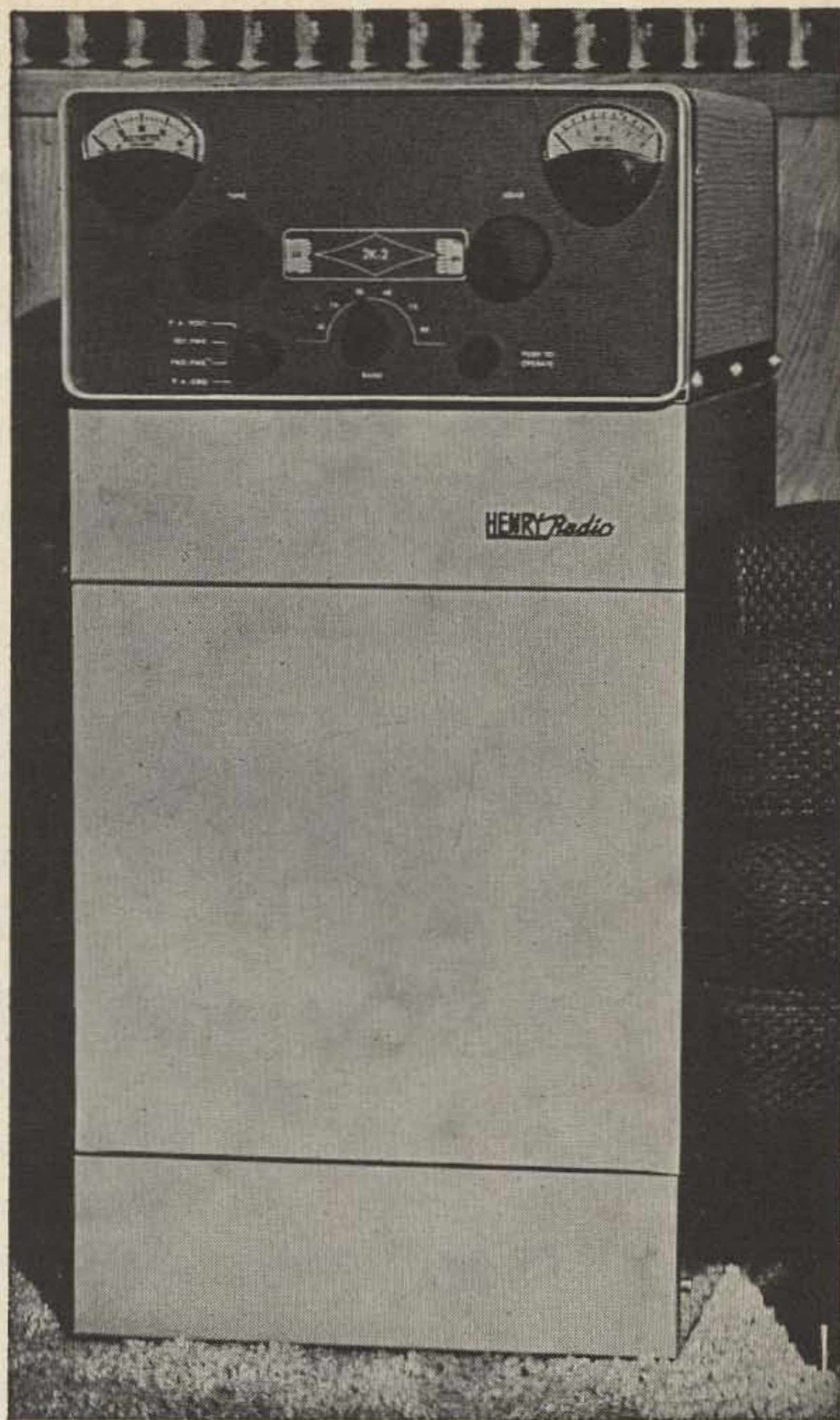

2K-2 FLOOR CONSOLE \$675.00

The new 2K-2, Floor Console, 2KD-2 Desk Model and 2KR-2 RF Deck are destined for greatness. Following the pattern of excellence established by the world famous 2-K, the new 2K-2 reaches previously unattainable levels of achievement. Its exceptional simplicity of design, extraordinary concern for reliability, superb linearity with attendant signal sharpness, remarkable power output and modern design all combine to make the 2K-2 the finest linear available to the amateur today.

Wouldn't you like to own the finest? Write today for full information.

6% FINANCE CHARGE • 10% DOWN OR TRADE-IN DOWN • NO FINANCE CHARGE IF PAID IN 90 DAYS • GOOD RECONDITIONED APPARATUS • Nearly all makes & models. Our reconditioned equipment carries a 15 day trial, 90 day warranty and may be traded back within 90 days for full credit toward the purchase of NEW equipment. Write for bulletin.

TED HENRY (W6UOU)

BOB HENRY (W0ARA)

WALT HENRY (W6NRV)

**Henry Radio Stores**

CALL DIRECT . . . USE AREA CODE

Butler 1, Missouri, 64730 816 679-3127

11240 W. Olympic, Los Angeles, Calif., 90064 213 477-6701

931 N. Euclid, Anaheim, Calif., 92801 714 772-9200

6116 N. 27th Ave., Phoenix, Ariz., 85017 602 AM 4-3895

East Coast Rep.: Howard Laughrey, 2 Elizabeth St., Chappaqua, N.Y. 10514, (914) CE 8-3683

*"Worlds Largest Distributors of Short Wave Receivers"*



Jac Rocha Jr PY2BZD  
R. Costa Carvalho 156  
Sao Paulo 9, Sao Paulo  
Brazil

## Trindade Island DXpedition



At 8 o'clock in the morning September 10, 1965, I landed on Trindade Island with my ham equipment, courtesy of PY2PA, PY2PE, PY2PC, PY2QT and PY2BIK. This was the climax of a five year fight to operate from this rare spot in the middle of the South Atlantic Ocean.



Jac, PY2BZD/Ø on Trindade island.

At 3 o'clock in the afternoon the first CQ was sent and contacts were made on SSB with PY2PA, TU2AA, YV5BNW and PY2CYK. In the next four hours many European and stateside stations were worked—first stateside were W2MES on CW and WB2EPG on SSB.

Every operator was very excited and I knew they had been patiently tuning my frequencies day and night since September the first, awaiting my appearance on the air. I did everything to have as many QSO's as possible and in the first day of operations 161 stations from 23 countries and 4 continents were contacted.

Conditions were very fair during all 23 days of operations and the total QSO's reached 3200 with 108 countries. I hope on the next trip that the total number of stations contacted will be better and more hams will have a first DX QSO with Trindade!

### Trindade Island

Trindade is a small rocky island on latitude 20° 30' S, longitude 29° 22' W, about 600 miles east of Brazil. The island has a volcanic nature and is shaped of high mas-



No—this is not St. Peter and St. Paul Rocks—it's Trindade Island near Ponta do Paredao.



sive mountains with very little vegetation. The highest point, Pico Desejado, is situated about the middle of the island and has 600 meters height. The coast is abrupt and embroidered most of its length with coral reefs and erupted matter where the ocean harps impetuously. It was first discovered by Juan da Nova (a Spaniard working for Portugal) in 1501. He named the island "Ascensao", but later Estevao da Gama changed the name to Trindade. The British raised their flag on it several times (1700, 1781 and 1895) but in 1895 by mutual consent, the dispute between Great Britain and Brazil was submitted for arbitration to the King of Portugal, who decided in favor of Brazil.

The Brazilian Navy occupied the island several times during the first and second world wars. The island was abandoned a long time because there are many difficulties to land. During the Geophysical Year the Brazilian Navy built an Oceanographic station which is sustained by the Hydrography and Navigation Department.

Trindade is a rich fishy area and its sea has many kinds of fishes. The easiest to fish are the grouper, cavalla, badejo (similar to sea bass) and sharks. The fish "Pufa" or "Por-favor-me-pegue" (Please get me) is an ordinary fish and can be fished with a bucket or fish hook without bait!

In 1894 the island gained a momentary celebrity through the announcement by Baron Harden Ptickey who created himself "Prince of Trindade" but the Brazilian government made him desist of his plans.

### The Pirates Treasure

According to legend, Lord Dundonald, commandant of the Chilean fleet, stole gold, silver and precious stones from the Lima Cathedral, but a pirate ship kidnapped Dundonald and fled into the Atlantic Ocean. Later the pirates were arrested and hanged

in Habana, Cuba, but they did not tell where they had hidden the treasure. Everyone believed that they hid it on Trindade. From 1822 to 1899 about twelve ships visited Trindade looking for the treasure but they had no success.

In September 1965 I landed but I did not discover the pirates' treasure either. I did convince my wife that I should come back to Trindade again to find it (a good reason to be out from home one more month to make the QSO's without any XYL-QRMMMM)!

### Acknowledgment

Thanks are expressed to the Brazilian Navy authorities and radio hams PY2PA, PY2PE, PY2PC, PY2QT, PY2BIK, PY2CRJ, PY1BMH, K2HLB, WB2CKS and others, for their very considerable help (equipment, QSL's and encouragement) and guidance, without which this DXpedition could never have been possible.

... PY2BZD

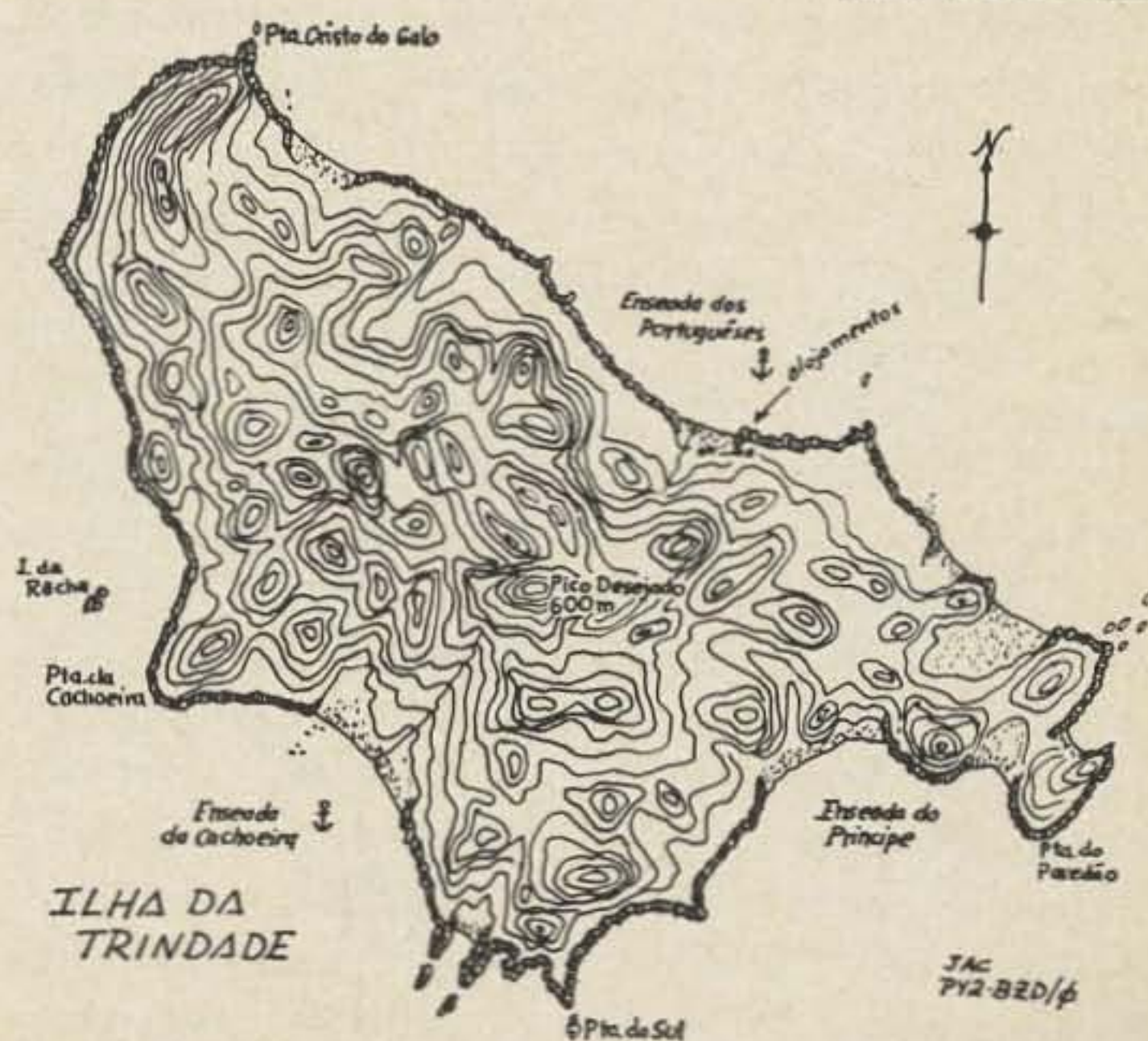

Map of Trindade Island. PY2BZD/PYØ was located on the north side of the island as indicated by the arrow.



# Gus: Part 27

## Gough Island

Away we were now for Gough Island, some 300 or 400 miles further south towards that *cold* Antarctic continent. As we went south, a very noticeable cooling off of the temperature was noticed. I spent many hours on the air that night telling the fellows, "it won't be long now". We were going to be at Gough Island for a number of days.

Late the next afternoon I again noticed the thickening of birds on the horizon and about an hour later, Gough Island was in sight. It was almost a duplicate of Tristan except the high plateau looked a bit higher and the mountains seemed higher too. The birds were very numerous. Lots more than on Tristan. At sundown we anchored a few miles offshore. The water was too deep for anchors to do any good, so during the night the engines were run every now and then since we were drifting toward the island with no place to anchor. That was one night the radar and depth finder came in handy. They were both watched closely all night.

I was on the air telling the fellows where we were and saying I hoped the next day to be on land so I could give them a new country. I was very anxious to get on solid ground and get going with the "Gus Watchers" as they called each other.

The next morning we went ashore to see the weather station which was located down in a deep gulch between two mountains. It seemed like an odd place for a weather station to my way of thinking. I guess they had come to the same conclusion, as we had three pre-fabricated buildings on board which were to be unloaded at a spot about a mile south from the old station. The new location was right smack on top of a flat plateau, some 300 feet straight up from the water's edge. A knocked down derrick was unloaded from the ship in pieces and this was to be *walked* to the spot where they were going to build the new weather station. Eight men, 4 from the weather station and 4 from the ship, were going to walk that old,

beat up, rusty derrick across that rough terrain. They had a walkie-talkie with them to keep in touch with the ship's radio officer.

We all went back to the ship after looking around the island a little. We saw a number of seals, sea elephants (very dirty looking animals), and a few penguins here and there down at the water's edge. The penguins were rather wild and would head for the water when we approached. They would dive under and not come up until they were far out to sea. The old sea elephant was groaning and wailing away all the time and would snap at us if we got too close to him.

We had lunch on board the ship and then got in touch with the derrick crew to see how they were progressing. They said it would take all the rest of that day just to get the parts of the derrick to the place where it would be installed. I could see there would be no operating from land that night.

In order for the land crew to see where the ship was, they left the lights burning on board. This was a bad thing to do. Around midnight a crew member knocked at my door and told me to come out on deck if I wanted to see something unusual. Out we went and I saw the doggondest bloodiest sight I have ever seen. There must be millions of night birds around Gough Island and they were attracted to the lights. The lights were apparently blinding them as they were crashing into the shielded lights and the sides of the ship. Birds were scattered all over the deck with broken necks, broken wings, some had their heads knocked off. There was blood all over the place. It was very smelly and sickening to see those birds slaughtering themselves. The next day the whole ship had to be hosed down from stem to stern and the decks scrubbed to get rid of that fishy smell.

They finally got the derrick put together about 4 PM but by now the wind had changed and it was impossible to go ashore so I spent another night aboard the ship. I know the guys were disappointed and so was I. Man, I was itching to get on solid ground



and operate rather than just/MM.

Finally the next morning all was set and I was given the opportunity to be the first one ashore. We loaded the gear into the landing craft. All the suitcases with the radio equipment were well wrapped with oil cloth that W8PQQ had sent me months earlier. After a quick breakfast consisting mostly of Rock Lobster (I was beginning to get enough of that stuff by now), the landing craft was lowered and away I went. As we approached those straight up cliffs, they looked higher and higher. Finally I was right underneath them and they really did look high then.

We had the little walkie-talkie and called up to the fellows with the derrick and told them to let her down. Then sent down a big wire cage measuring about 12' x 12' with a veneer floor. This cage was opened up and I, along with all my junk, was loaded inside. Then the cage was locked from the top and could not be opened from inside. The signal was given from the top of the cliff to raise me up. Away I went. I was at least on my way to good solid ground. I wasn't too sure I was going to make it, though. I had noticed that the steel cable on the derrick was quite rusty looking, and boy . . . what a lot of creaking and groaning that thing made as it was being raised up. Here I was like a wild animal, locked inside a cage being raised by a pre-historic looking derrick, on a strange island in the South Atlantic. Sometimes these fellows on a DXpedition will do almost anything to give the guys a "new one". I am sure this DXpedition would have come to a sudden stop if that cable had broken while I was being lifted ashore. Was I afraid? You said it, Ole Buddy, I *was!* And that is putting it mildly, too.

On the way up, I had a chance to notice all the bird caves in the side of the cliff. There seemed to be a million of them. In each one, there was a bird or two and they looked out at me and let out a few squawks as I went by. I waved at them just to be sociable. When I was about halfway up, I looked down at the ship. It looked very small and far down. The wire cage sure would have made a big splash if that cable had broken and had sunk to the bottom of that rocky lagoon. For me, it would have been "goodbye world".

It seemed to take forever to bring me to the top. I guess it was really only a couple of minutes, but it seemed much longer. When the cage finally reached the top it was swung

away from the water; it was sure good to be over dry land again. I was lowered and stepped out of the cage as it was unlocked. At last I was on solid land and the QSOs I was to have would count for the DXers again. The men on shore were all interested in what I was doing even though they could not understand why I went to all that trouble just to put a ham station on the air from Gough Island. I explained to them that I could use a little help in putting up my tent and erecting the 40 foot sail mast I had taken ashore. They all pitched in and in a couple of hours I was ready to go.

I tuned up the rig, did a little juggling of the lengths of the ground plane wires to get the SWR down. On 40 meters from 7000 to 7200 it was not higher than 1.2:1 and it was even better on 20 and 15. I had found that by cutting two ground plane wires to resonance on each band, this was not hard to do. The signals from ZS and LU sounded like locals. I had just finished tuning up on 14065 and didn't even sign my call when Marge, ZS1RM tapped her key a few times just saying, "Gus?" Back I came, and gave her the first QSO from ZD9AM. She was 599+. From then on, I worked them like mad. First a batch of ZS stations and after them quite a number of LU's, PY's, and then all over Europe. After that the W/K stations had their turn. It was like shooting doves in a baited field. The band sure was in great shape considering the sun spots were down. In fact, the band came near to staying open all night, ending with a few QSOs with VE8 and some KL7's. I could see things were going to be very FB from this location and hoped they would continue the same when I got further south in a week or so.

When the sun went down it got downright chilly. A damp southwest wind would start blowing and it felt like it was coming directly from the South Pole to me. I had brought a pair of red insulated long handles with me, so I stayed pretty comfortable.

The cooking chores were taken care of by the crew who were there to install the new weather station. These South Africans are heavy eaters, and they took to the Rock Lobster like ducks to water. As for myself, I got to the point where I didn't want that white meat all the time. That's when I began eating some of the canned goods I had brought along with me. I did not think pork and beans could taste so delicious and a few



cans of those beans with little franks were "out of this world"!

I stayed up almost every night all night long and slept most of the day. Quite a nice way for a fellow who likes DXing as much as I do to spend the time. The funny part is, I never did get tired of this even though after a while it took on the aspects of a "job". But it was an enjoyable job, I must say.

The stay at Gough was supposed to have been for 5 or 6 days, since this was the time required to assemble those pre-fab houses we brought from Capetown for the weather station and the staff. The bad weather had not been considered at all in their plans. Every morning just at the break of day, the sea looked very fine, but before the first barge could be filled with parts of the pre-fab buildings, the wind shifted and increased to the point that landing the barge and loading up the wire cage with material was impossible. This thing kept up for 17 days. During this time they could only bring in a barge once in a while. Finally, everything was ashore and put together and we were all glad it was over. I had just about worked the bands dry and even had to call CQ two or three times to get a contact. When it gets like this, it is time for a DXpeditioner to move on, and that is just what I wanted to do.

The night before the departure I got the message to be ready to depart from the island 30 minutes after sun up the next day. I packed up all the equipment and got things torn down and was ready when the ship sent the landing barge to pick me up from the wire cage. Again I took the trip in the cage and again I was very much afraid the cable would break and end the DXpedition. But, I made it and was much relieved to set foot on the barge safe and sound. I was sure glad to leave Gough Island and the birds there.

There was some question about our going to Bouvet Island, since the Captain of the ship had been requested to tow a disabled lobster boat back to Capetown. It looked as if Bouvet was going down the drain until I contacted Brian—ZS6ANE. I asked Brian if he had any pull with the big man in Pretoria. He told me not to worry and made a schedule for five hours later. When the sked time came, Brian was right there and said he had good news for me. We were definitely going

to Bouvet. This was confirmed by the First Mate who told me we were now headed for the island after all. This was great news for me. I immediately got on the air and told the fellows the news. Then I pulled the switch to the rig and wandered up to the poop deck to chat with the man at the wheel. When I first entered, he told me we had changed direction and were headed for Bouvet, which he called the land of ice and snow. He said I had better have lots of warm clothing . . . as much as I could walk in. He said it was the most unhealthy and the coldest place in the world. He told me he wouldn't go there for a thousand dollars and I was in for a rough time if I planned to land. I told him landing on Bouvet was the reason I had come on this trip and nothing was going to stop me. This little talk with this man made me want to go there more than ever. I like these challenges.

When the sun went down that afternoon, I went on deck to watch the stars and I could see the Southern Cross had risen a little higher in the sky. The winds became a little colder and more brisk and the dark blue of the sky even looked clearer and had a sort of cold look about it. The waves were even more choppy than usual.

Oh yes, before I forget, let me tell you of one incident which happened while I was on Gough Island. After I had been on the island a few days, three Russian Whalers anchored a few miles from our ship. With field glasses we could see they were watching us. The radio operator on our ship tried calling them a few times but couldn't get any answer. After a while he called an imaginary group of American whalers supposedly coming to Gough Island. He gave them a line about OK . . . we'll be expecting five ships here tomorrow morning. The result was the Russian ships departed before morning. So, you see, hams are not the only ones who have QSOs with "ghost" stations. I remember one time when the band was dead and just for the heck of it I called AC4YN and had a "QSO" with him. When I signed there were 5 stations calling him. Two of them were fellows who were near the top of the DXCC Honor Roll, too! One of them called me and asked me if AC4YN had come back to him! There are always interesting things on the band if you listen for them.

. . . W4BPD



So good it defies comparison...

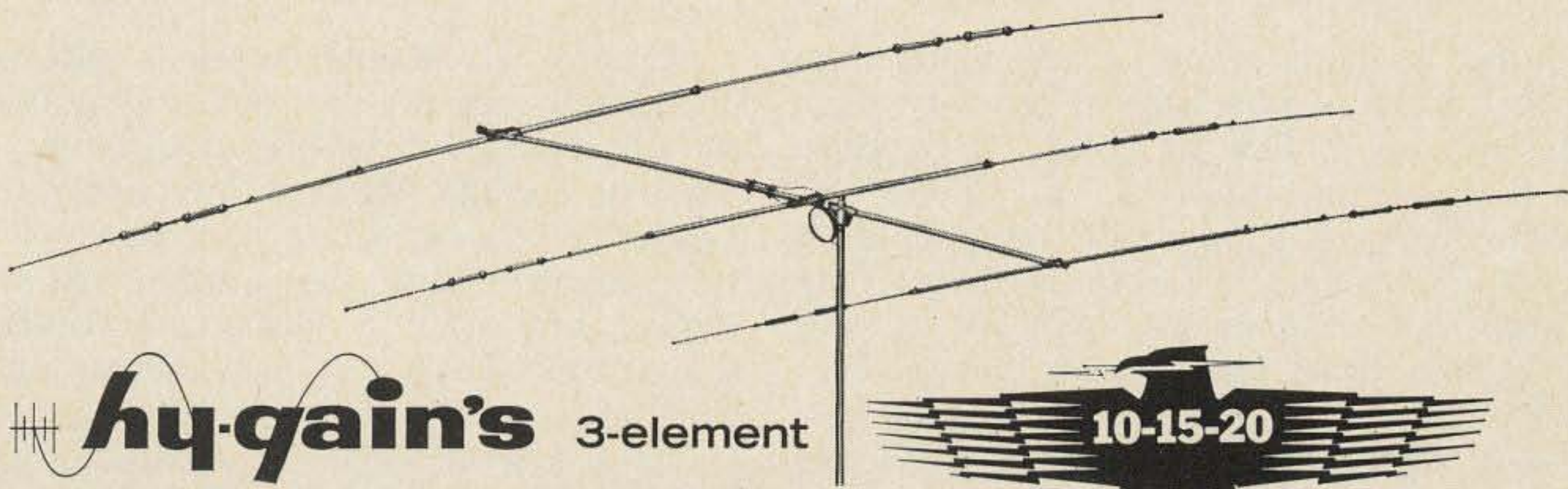

Hy-gain's 3-element  
**THUNDERBIRD**  
TRIBANDER MODEL TH3Mk2



- Delivers uncompromised full-sized performance on 10, 15 & 20 meters
- Takes maximum legal power
- Exclusive time-proven Beta Match

Try as you may, you just won't find another three-element tribander for 10, 15 and 20 meters that will even begin to compare with Hy-Gain's Model TH3Mk2. Some say it's the individually tuned, large diameter Hy-Q traps that make the difference by providing full-sized performance on each band. Others say it's the spacing of the elements on the 14 foot boom. Still others claim it's the ex-

clusive, time-proven Beta Matching System that provides the optimum gain and maximum F/B ratio you get with the Model TH3Mk2. Actually, it's a combination of all of these factors plus rugged heavy gauge, taper-swaged seamless aluminum construction...solid aluminum trap housings using air dielectric capacitor...weather impervious molded high impact cyclac insulators... and Hy-Gain's over-all engineering excellence, that makes the Model TH3Mk2 so good it defies comparison. Get the best in 3-element tribanders — get a Model TH3Mk2. Model TH3Mk2..... **\$114.95** Net

Other Hy-gain Thunderbird TRIBANDERS...

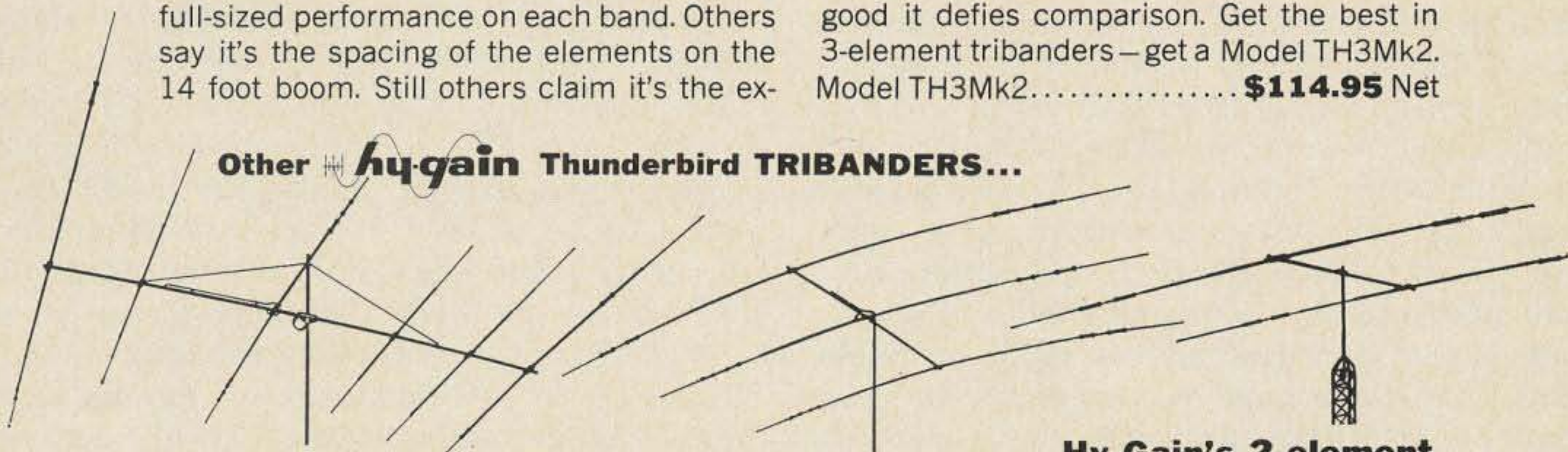

**Hy-Gain's 6-element DX THUNDERBIRD**  
Provides the very ultimate in tribander performance. Takes maximum power. 24' boom. Exclusive Hy-Q traps and time-proven Beta Match. Model TH6DX **\$149.50** Net

**Hy-Gain's 3-element THUNDERBIRD JUNIOR**  
Fantastic performance in limited space. Takes 600 watts P.E.P. 12' boom. Exclusive Hy-Q traps and Beta Match. Rotates with heavy duty TV rotator. Model TH3Jr. . . . **\$74.50** Net

**Hy-Gain's 2-element THUNDERBIRD**  
Installs most anywhere. Delivers outstanding performance. Takes maximum power. 6' boom. Exclusive Hy-Q traps and time-proven Beta Match. Model TH2Mk2 **\$74.50** Net

Available now from your Hy-Gain distributor or write...

Hy-gain **ELECTRONICS CORPORATION**

Dept. AB-9 Highway 6 • Lincoln, Nebraska 68501



## DX'ing

If you haven't gotten into the DX game yet, but would like to start, here are some techniques that will get you off on the right step.

DX'ing is, with many, much more than a hobby, it is an obsession. They buy their houses in good DX locations; they have jobs that permit them to stay home on occasion to catch a rare new country; their vacations are planned for times when they are sure that no new ones will be on, and even nights out to visit friends can be cancelled at the last minute if something new is heard on the bands. Most ham's wives suffer, but the wife of a DX chaser suffers the most.

Working DX means different things on different amateur bands. On the very high frequencies a contact over 100 miles may often be the cause of great rejoicing. On the short waves a contact with the other side of the earth is a mundane occurrence. The great bulk of the serious DX hunting is done on the twenty meter band. Next comes fifteen meters, then ten meters, then forty, eighty and, finally, one hundred sixty meters.

Let's talk first about twenty meters. Here the DX game means, in essence, contacting as many different countries as possible. There are the easy ones and there are the hard ones. Countries like Germany and England, with thousands of licensed amateurs, are no problem, except that they often are around in such profusion that they may obscure some of the rarer countries. Some countries are so small or backward that they have no amateurs in residence. Some have just one. With perhaps 20,000 amateurs playing the DX chasing game, a single amateur in a country is kept extremely busy providing even one contact with everyone that wants him.

We'll talk later on about what an operator in a rare country can do to keep things orderly and protect himself from being called by hundreds of stations all at once. Whether the situation is one of order or chaos is entirely in the hands of the operator in the rare country.

Perhaps we should consider motivations just briefly here. To some operators just the contacting of stations in different countries is enough. Others are interested in having a chance to sit and chat with the rare country. But the great bulk of the DX'ers are after a QSL card confirming the contact which they can display on their wall and send in for an award.

There are hundreds of awards available. As a matter of fact there is one fellow who publishes a quarterly bulletin listing the new awards. And there is a Certificate Hunters Club made up of fellows who are trying to get as many awards as possible. The two main awards today are the DXCC, the DX Century Club, and the WTW, Worked The World. The DXCC is awarded by *QST* magazine and WTW by *73* magazine. Both require the contacting of 100 different countries for the basic award. And then there are further awards as more and more countries are contacted. We'll give you the detailed rules for these two awards later.

If you stop and give the matter some thought, you can probably see one of the basic difficulties that these awards have brought out. This is the question of what is and what is not a country. This has gotten to be a very involved situation and has, as yet, not been satisfactorily resolved. *QST* makes its own decisions as to what they will count as a country for their award. *73* leaves the decision up to the national radio societies around the world. So we have the rather ridiculous situation of little reefs that come out of the water at low tide in various spots around the world being counted as new countries. And we, of course, have amateurs rushing by boat to these wet reefs to set up their stations for a few days and give everyone contacting them a contact with this new country. Who pays for this? Why, the overjoyed fellows who have upped their country score, naturally. It is all on a donation basis, to be sure,



so the chap sitting on the wet rock is not technically receiving remuneration for his trip.

### The station equipment

Let's suppose now that you are interested in winning one of those wonderful DX awards. It stands to reason that the better station you have, the easier it will be to get your 100 or more QSL cards. Oh, you can manage it with low low power, a poor antenna and only a few minutes a day. But you may be a lot older than you are right now when you finally make it. If you are like the rest of us you are impatient. You want to get right at this challenge. You don't want to spend years doing a few weeks work.

You're going to need four things if you are going to make a name for yourself in the DX world. You're going to need a good rig, a good antenna, a good location, and enough time. We'll take those on one at a time.

Despite the many kilowatt rigs on the market, most of the amateurs are still running a lot less than the legal maximum. Some feel it is more sporting . . . some are saving money . . . some have just been putting off buying the new rig. I think I should level with you about a fact of amateur radio life: you need all the power you can get. Please don't start arguing with me. You'll have more than enough problems even after you've come up with one of the outstanding signals from your area. You want everything going for you that you can control. Look here, I've operated from over there . . . and believe me, if you are running any less than the full book and a good beam you just aren't going to be heard most of the time. In Afghanistan you can hear the loud stations six nights out of seven. You hear the medium powered stations one night out of seven. And you hear the low powered stations just a few nights a year. How long do you want to have to wait to work Afghanistan?

### The rig

You may prefer a separate transmitter and receiver. For my part, I find that the bulk of the contacts are worked right on my own frequency and thus a transceiver is a lot handier than separate units. You can waste a lot of time zeroing in on your

receiver when a rare one has just called a CQ or signed with someone else. You could miss him. There are times when you want to be able to split your transmitter and receiver, so be sure that your transceiver will do this and spend the few dollars extra for the remote VFO.

Some of the transceivers today run 300 to 400 watts. Don't for a minute think that this is going to be enough. You want a good solid kilowatt linear on the end of that transceiver. There are several excellent units on the market. As a rule of thumb, the larger the linear, the more power it will run. Once you have one of the big babies you will have to be careful . . . they are capable of running a little more than the legal limit. Keep one eye on the final plate meter and don't let it get up above 2000 watts PEP. If you forget it for a while you may find yourself talking into the mike a little louder than usual and the meter going on up to 5000 watts PEP. Shame! You don't have to run overpower if your antenna is perking satisfactorily.

Did I hear someone complaining that this is getting too expensive? Come on now. A good transceiver, complete with calibrator, power supply and remote VFO can run a bit under \$600. That's brand new, and not counting any trade-ins or discounts. The linear might run \$700. \$1300 for the pair. About what you might spend for a good camera or a small boat. Even a couple of good guns would run you that. There just aren't very many hobbies where you can be a top gun for such a modest investment. Statistics show that the average amateur has over \$3000 invested in his station . . . the problem usually is that it wasn't invested to the best advantage. You can blow a lot of money foolishly in ham radio too, with not much to show for it in results.

You're not finished yet. There is still the matter of the beam. And that beam should be up there about 70 feet in the air. Please don't bug me with verticals or anything like that. You want a signal that is going to be heard. This means that you're going to have to put up a three element quad or a three element beam. If you are willing to settle for just one band then I'd favor a full size three element beam for 20 or a four element for 15 meters. Unless you are going to have an awful lot of time available for DX'ing you might just as well settle down on 20 meters. This one band



will keep you plenty busy. Besides, you certainly don't want to mix countries worked on different bands. A three element full sized 20 meter beam costs about \$70. That isn't too bad, is it? You can get by for less with a quad or a home made affair. And if you do for some obstinate reason insist on working two or three bands then you might do very well to consider the quad. Tribander yagi beams do work out well, but usually a single bander will over-ride them.

Figure about \$20 per ten feet for the tower. That's about \$120 for the 60 footer plus some extra change for guy wires and accessories. And another \$100 for the rotator. \$300 will pretty well take care of your beam, tower and rotator.

There you go. For about half the normal ham investment you can have an outstanding station capable of working the world . . . one that will get you through the QRM most of the time. Even on the rare ones you won't have to wait very long . . . unless some more fellows happen to heed this.

### The QTH

Not very many operators are going to move to a better location just because they've contracted the DX bug. But it seems to me that I saw figures once which showed that, on the average, everyone moves about once every five years. Our experience with address changes for 73 seems to back this up . . . and the *Callbook* magazine agrees that hams, too, do move around a lot. At any rate, when you do make that five year move you might give some consideration to the location of your new house from the DX standpoint. It might be prudent not to say anything out loud about this aspect of your selection, to keep down friction with the wife.

We still have some things to learn about ideal hamming locations. It should be fairly obvious though that you are going to be at a disadvantage if your antenna is pointing into the side of a large mountain or a building. If you are going to have to live in a metropolitan area you can subtract at least one S-unit from your signal reports . . . and from the received signals. The buildings and pavement will absorb that much. You'll probably have fits with the noise all those other people generate too. The garbage on your dial at night can

bring you to tears . . . television oscillators . . . diathermy . . . electric razors . . . heating pads . . . the supply of noise is endless. There really is a lot to be said for the suburbs.

Keep an eye peeled for a house with a big enough yard to contain a full sized twenty meter beam. And if you are renting, don't forget to get written permission for your tower. And check to see if there are any restrictions in the neighborhood against towers . . . many communities have these.

An ideal spot would be on top of a good sized hill with a high water table, a good clear shot in all directions, and no neighbors for a mile or so in every direction. See what you can do about that. Sell your wife on the fabulous privacy. Better be sure you're not too close to a main highway either, you don't want all that ignition interference. It is safer for your dogs and cats too.

If you do have to live in the city . . . and most of us do . . . then how about moving into an apartment that will let you put your beam on the roof. Get it in writing. The last one I rented was all cooperation until I had signed the lease and then the landlord had no further recollection of any beams or ham antennas.

Some fellows believe in leaving nothing to chance and take the time to check out the proposed new location with a mobile receiver to see if it is going to work out OK. This can be helpful. You could just accidentally pick a site on top of a dry hill or even one filled with ore and wonder where the signals went. I remember the summer I set up a ham shack in a fabulous location up in northern New Hampshire. There were acres for antennas, only one house within miles, and it was at the end of a long road, way away from the highway. This should have been a hams heaven. I put up long wires, dipoles, and even a rhombic trying to get signals in and out of that spot. I worked out better with my mobile from downtown Manhattan than I did from that beautiful mountainside in New Hampshire. On twenty meters I did, using the rhombic, manage to contact England. On ten meters I got an S-2 from Australia once. On 75 meters I worked for weeks to get a contact down in New York. Talk about frustration.

Funny thing about that place. Back in the 30's WICUN used this same shack.



I suspect that he may have suffered the same difficulties I did, for he became one of the pioneers of ten meters. Was it frustration that drove him up to ten?

The water table is high at my present location and the ground is good. You have to be careful not to stamp too hard or the dent fills with water. I work out incredibly . . . and I strongly suspect that this has a lot to do with it. When I was W4NSD down in Virginia I had the same sort of ground and I managed all sorts of interesting DX from there with a simple dipole thrown into a tree about ten feet off the ground.

The way I look at it is this . . . ham radio is a hobby that usually sticks with you for your lifetime. Now, if you are going to be enjoying ham radio for years why not make the extra effort when you buy a house to give yourself the best possible advantage? When you move next time get yourself a good DX'ing location.

#### Time

It takes time to work 300 countries . . . a lot of time. You have to be pretty dedicated to get this many worked. But if you have a good signal and can put in two or three hours a day on weekdays and perhaps six or eight a day on weekends, you should be able to work your first 100 countries in about two weeks. By the end of a year you should be well over 200. Your success from then on depends on how avid you are. The rarer ones don't come by accident. You have to keep in touch with the other DX'ers and find out when they will be on, their frequency, and so forth. You have to subscribe to the DX bulletins and use their info as a guide in listening for new ones.

When we announced the WTW award we set a starting date of May 1966 and all contacts had to be after that date. The first fellow to turn up with 100 countries contacted and QSL'ed was Gay Milius W4NJF and he managed this within two months. W5KUC turned in cards for 200 countries contacted and QSL'ed after only six months. This shows what you can do if you put your mind to it and have a reasonable signal to back up your determination. One year after the start of WTW at least two stations had contacted 300 countries and only a few straggling QSL's were between them and the certificate.

Fortunately for those of us that have to work for a living the best DX'ing hours don't conflict too seriously with bread-winning. On twenty meters you can get most of your best DX'ing in during the evening hours. It doesn't hurt to get on in the morning too for an hour or so before breakfast. The DX pattern changes with the seasons. At one time of the year you will hear South Africa in the late afternoons, at others it will be Europe or the middle East. A few days on the air and you get used to the pattern and have a good idea of when you can work where and which way to point the beam.

Luckily, weekends are the busiest times all over the world on our bands and you will find that weekend time devoted will usually give you more results than weekdays. DX'peditions usually try to operate over the weekends too.

It does pay to keep track of the various times around the world. The bands are open to a lot of areas that we don't work merely because no one happens to be on there at the time. If you have a clock that indicates the time at different spots around the world it will be helpful to you. The fellows will, usually, be on the air at around 6 pm their local time. There is little to be gained in trying to work them at 4 pm their time for they are still at work. And after 11 pm most of them are in bed. When a good strong DX'pedition station opens up from a rare spot we appreciate this factor for we find that we are able to work him almost around the clock. Of course his high power makes a big difference on this too. In my travels around the world I've tried to encourage DX stations to put on as much power as they can. Most of them are not really aware of the difference that high power makes in the number of hours that the band would be open for them. They haven't really realized why it is that they can hear my signal for 16 hours a day, but can only get through to me for two or three hours. This can be extremely frustrating for the DX operator. Imagine yourself in some out-of-the-way spot where you know that thousands of stations would give their eye teeth for even a ten second contact with you . . . and absolutely no one comes back to your CQ calls or to your attempts to call stations who are in QSO. They just aren't hearing you.

. . . W2NSD





**\$149.50**  
less vidicon

\* Made in USA - Model XT-1A, series c

## THE FIRST and ONLY SOLID-STATE TELEVISION CAMERA KIT!\*

**LOW COST**

- Vidicon • 400 line resolution • Automatic light compensation • Video and RF outputs (ch. 2-6) • Connects without modifications to any TV set • Complete, EASY-TO-FOLLOW construction manual • Time-tested, straightforward circuitry • Fully Guaranteed • Ready for immediate shipment!

Field and lab tested for thousands of hours. Perfect for industrial, educational and amateur applications. Designed to run continuously. Completely self-contained, single printed circuit board construction. Get all the details (including pictures) in our BRAND NEW 20 page closed-circuit TV catalog. It's FREE, write TODAY! Also included is a full complement of tube and transistor "starter" kits, focus-deflection coils, lenses, economical vidicons, tripods and other essential TV items. FACTORY-DIRECT prices.

**13th & Broadway**

**ATV RESEARCH**

**Dakota City, Nebr. 68731**

### Propagation Chart

SEPTEMBER 1967

ISSUED JULY 5

J. H. Nelson

**EASTERN UNITED STATES TO:**

	00	02	04	06	08	10	12	14	16	18	20	22
ALASKA	14	14	14	7A	7	7	7	7A	14	14	14	14
ARGENTINA	21	21	14	14	7A	7	14	14	21	21	21	21
AUSTRALIA	14	14	14	14	7B	7	7	7A	7A	7B	14	14
CANAL ZONE	21	14	14	14	14	7	14	14	14	14	21	21
ENGLAND	14	14	7A	7A	7	14	14	14	14	14	14A	14A
HAWAII	14A	14A	14	14	7	7	7A	14	14	14	14	14
INDIA	14	14	14	7B	7B	7B	14	14	14	14	14	14
JAPAN	14	14	14	7B	7B	7B	14	14	14	14	14	14
MEXICO	14A	14	14	14	7	7	14	14	14	14	14A	14A
PHILIPPINES	14	14	14	7A	7B	7B	7A	14	14	14	14	14
PUERTO RICO	14A	14	14	7A	7	7	14	14	14	14	14	14A
SOUTH AFRICA	7B	7B	7B	14	14	14	14	14A	21	21	14	14
U. S. S. R.	14	14	14	14	7A	14	14	14	14	14	14	14
WEST COAST	14A	14A	14	14	7	7	7A	14	14	14	14	14

**CENTRAL UNITED STATES TO:**

ALASKA	14	14	14	14	7A	7	7	7A	14	14	14	14
ARGENTINA	21	21	14	14	7A	7	14	14	21	21	21	21
AUSTRALIA	14	14	14	14	14	14	7	7A	7A	7B	14	14
CANAL ZONE	21	14	14	14	14	7A	14	14	14	14	21	21
ENGLAND	14	14	7A	7A	7	7	14	14	14	14	14	14A
HAWAII	14A	14A	14	14	14	14	7A	14	14	14	14	14A
INDIA	14	14	14	14	7B	7B	7B	14	14	14	14	14
JAPAN	14	14	14	14	7B	7B	7B	14	14	14	14	14
MEXICO	14	14	14	7A	7	7	7	14	14	14	14	14
PHILIPPINES	14	14	14	14	7A	7B	7B	7A	14	14	14	14
PUERTO RICO	21	14	14	14	7	7	14	14	14	14	14A	14A
SOUTH AFRICA	7B	7B	7B	7A	7B	14	14	14	14	14	14	14
U. S. S. R.	14	14	14	14	7	7	7A	14	14	14	14	14

**WESTERN UNITED STATES TO:**

ALASKA	14	14	14	14	7A	7	7	7	14	14	14	14
ARGENTINA	21	21	14	14	7A	7	14	14	21	21	21A	21
AUSTRALIA	21	21	21A	21	14	14	14	7A	7A	7B	14	21
CANAL ZONE	21	14	14	14	14	7	14	14	14	14	21	21
ENGLAND	14	14	7A	7A	7	7	7	14	14	14	14	14
HAWAII	21	21	21A	21	14	14	14	14	14	14	14	21
INDIA	14	14	14	14	14	7B	7B	7A	14	14	14	14
JAPAN	14	14	14	14	14	14	7B	7A	14	14	14	14
MEXICO	14A	14A	14	14	14	7	7	14	14	14	14A	14A
PHILIPPINES	14	14	14	14	14	14	7B	7A	14	14	14	14
PUERTO RICO	14A	14A	14	14	7A	7	7A	14	14	14	14	14
SOUTH AFRICA	7B	7B	7B	7A	7B	14	14	14	14	14	14	14
U. S. S. R.	14	14	14	14	7	7	7B	7B	14	14	14	14
EAST COAST	14A	14A	14	14	7	7	7A	14	14	14	14	14

A. Next higher frequency may be useful this hour.  
 B. Very difficult circuit this hour.

- Good: 1, 4, 5, 8, 9, 11, 12, 20-25, 28, 30
- Fair: 3, 6, 7, 10, 13-15, 17, 26, 27
- Poor: 2, 16, 18, 19, 29
- VHF: 22-25, 30



Jim Fisk WIDTY  
RFD 1, Box 138  
Rindge, N. H. 03461



## *Knight KG-663* **Regulated DC Power Supply**

If you're experimenting with transistors and integrated circuits these days, you need a good reliable variable dc source—regulated, stable and usually, pretty *stiff*. The new Knight KG-663 Regulated DC Supply fills all of these requirements plus several interesting features not usually economically available to the amateur or experimenter: current limiting, short-circuit protection, and remote programming and sensing.

The KG-663 features variable voltage from zero to 40 volts and *variable* current limiting up to 1.5 amperes with a completely solid-state circuit. The basic power supply consists of a dual full-wave rectifier and capacitive filter system and a series regulator. A dual potentiometer across the output is used to adjust the voltage; the dual feature permits both *coarse* and *fine* control of the output voltage. The voltage adjust pots actually control the base bias on the error detector transistor. The emitter of this transistor is maintained at 0.9 volts by a bias reference source. Once the voltage adjust knob is set, any change in output voltage is detected by the error detector, amplified by the error-amplifier transistor, and adjusts the series-regulating transistors to compensate for the change.

Since this action is almost instantaneous, the regulator action provides additional filtering action and reduces ripple on the output to a very low level. Capacitors connected across the voltage-adjusting pots make the error detector much more sensitive to ac ripple components. The result is a supply which exhibits less than 0.6 millivolts rms (0.0006 V rms) ripple, even at the full-rated load of 1.5 amps.

If the output of a regulated supply is short circuited, the regulator tries to main-

tain the output voltage present before the short occurred. Since the current quickly reaches very high values with a short circuit across the output terminals, the supply will burn out if it is not protected in some way. Fuses have been used for this purpose, but their action is usually so slow that the semiconductors in the supply will be destroyed before the fuse blows.

In the KG-663 this sad series of events is curtailed by a current-limiting circuit. The current-limit transistor samples the output current and is normally cut off. If a short circuit occurs with the current-limit control set to maximum, the current-limit transistor is turned on, removes control from the error detector and error amplifier transistors, and biases the series regulator transistors down to the point where two amps is maintained. This is a safe current level for a limited time. When the short circuit is removed, the output voltage returns to its preset value. With this circuitry, the KG-663 supply is not damaged by external short circuits. The current limit control permits the maximum current to be adjusted from two amperes down to 100 to 200 milliamperes.

In addition to current limiting, protection is also provided for reverse voltage. A diode connected across the output terminals protects the electrolytic capacitors and series regulator transistors from externally applied reverse voltages. This reverse voltage diode is particularly important where two or more supplies are connected in series for higher supply voltages. If, in this case, the ac power is removed from one of the supplies and not the other, the protective diode prevents damage to the unenergized supply which would result from a reverse



**Our 1968 catalog of  
precision quartz crystals  
and electronics for  
the communications industry  
is now available.**



**It will cost you nothing.**

SENTRY MANUFACTURING COMPANY

1634 Linwood Boulevard, Oklahoma City, Oklahoma 73106

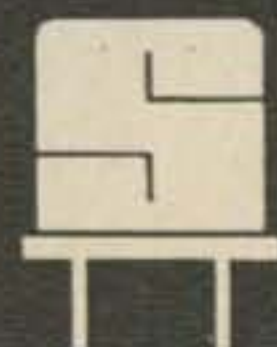



polarity.

If two or more KG-663 power supplies are connected in parallel to provide more output current, the series-regulator transistors must be protected from reverse voltages. This is accomplished with a diode connected across them. The only other requirement for operating these supplies in parallel is to connect a 0.1 ohm, 1 watt resistor in the positive lead of each supply. Then each of the supplies must be adjusted to exactly the same output voltage. This may be confirmed by connecting the positive leads together—there should be no deflection of either voltmeter.

Two interesting features incorporated into the KG-663 supply are remote error sensing and programming. These items are usually found only in very expensive commercial units. For most applications the load is connected to either the front-panel binding posts or the rear output terminals, but in some cases the load must be separated from the power supply by a relatively great distance. In this case the remote sensing feature can be used if precise voltage regulation is required.

The regulator will maintain the voltage at the output terminals, but if long leads are required to the load and the current is high, there may be a significant voltage drop. To maintain the desired voltage at the load itself, external voltage sensing leads may be connected across the load. These leads are connected directly to the voltage adjusting controls and error detector transistor. Since they only carry about 10 milliamps, 22 gauge or larger wires are sufficient. With the external sensing connected, the power supply compensates for line loss due to lead resistance and a constant voltage is maintained at the load.

In some applications it may be desirable to control the output voltage from a remote point. This may be accomplished with the KG-663 through the remote programming feature. Basically, an external 4000-ohm voltage-adjust potentiometer is connected across the remote programming terminals at the rear of the supply. If desired, both the remote programming and remote error sensing may be used simultaneously.

Although the current-limiting circuitry provides sufficient current regulation for most applications, in some cases precise current regulation is required. This may be obtained in the KG-663 with an external

#### Knightkit KG-663 Specifications

<b>Output voltage:</b>	0-40 volts.
<b>Output current:</b>	0-1.5 amperes.
<b>Output load regulation:</b>	Less than 60 millivolts (0.6 V) from no load to full-rated load.
<b>Line regulation:</b>	Less than 0.3 volts change under all load conditions.
<b>Ripple:</b>	Less than 0.6 mV rms at full load.
<b>Output impedance:</b>	Less than 0.1 ohm from dc to 10 kHz; less than 0.5 ohm to 100 kHz.
<b>Current limiting:</b>	Continuous, adjustable from front panel.
<b>Short-circuit protection:</b>	Continuous dissipation type.
<b>Features:</b>	Remote error sensing, remote programming, precise current regulation, positive or negative ground, may be stacked for series or parallel operation.
<b>Semiconductors:</b>	6 transistors, 11 diodes.
<b>Meters:</b>	Voltage and current.
<b>Size and weight:</b>	7 $\frac{3}{4}$ x 7 $\frac{1}{2}$ x 10 $\frac{3}{4}$ inches. 16 pounds.
<b>Power requirements:</b>	110-130 volts, 50/60 Hz, 20 watts at no load; 110 watts at full-rated load.
<b>Price:</b>	\$99.95 kit; \$149.00 factory assembled.

current-sensing resistor and the external sensing feature.

Assembly of the Knightkit KG-663 is very straight forward and only requires three or four evenings work. The instruction manual is well laid out, well illustrated and easy to follow. If you have not assembled a Knightkit before, you will be pleased with the ease with which they go together and the high quality components used. For example, instead of providing several rolls of hookup wire, Knightkit furnishes labor-saving pre-cut and stripped lengths. Wiring errors are practically eliminated by the pre-power resistance checks and preliminary tests outlined in the construction manual.

The KG-663 variable dc power supply is a very versatile unit which should find a lot of use on the amateur's bench. The 1.5 ampere capability of the supply is particularly useful when breadboarding integrated circuit projects. The 0-40 volt output meets almost every requirement for transistor work. In addition, the current-limiting circuit may save that expensive transistor circuit you're working on. These features, coupled with the remote error sensing and programming, comprise a power supply that's hard to beat in terms of versatility, regulation, convenience and cost.

... WIDTY





Mort Waters W2JDL  
82 Boston Avenue  
Massapequa, Long Island  
New York 11758

## Heathkit SB630 Control Console

The old saying about good things coming in small packages could have been written with Heathkit's SB630 console in mind. There are four operating conveniences in this one compact unit—SWR bridge, hybrid phone patch, 24-hour digital clock and an entirely independent 10-minute timer which reminds you when it's time to identify. This last provides you with a choice of a brightly lit *identify* on the panel, or the internal buzzer may be switched on so that light and sound both remind you that it's time for a station break.

Styled to match the rest of the ever-growing Heathkit SB-family, the SB630 can, of course, be used with any gear. Panel height is identical with the other Heath units, but a variety of feet come with the kit to let you change it to whatever suits you best.

### SWR bridge

The hardware and circuitry of the built-in bridge appear to be identical to the HM-15 SWR meter. Two sets of resistors are supplied with the kit, allowing use with either 50-52 ohm or 70-75 ohm transmission lines. It's a good idea to keep the unused resistors handy; you can tape them to the chassis in

case you decide to change feedlines.

For full scale forward deflection on 75 meters, 70 watts of output are required but as frequency rises, less power is needed. At 6 meters only 2 or 3 watts pin the needle when the sensitivity pot is wide open. Despite these requirements, the bridge can be used at lower power levels too, with some slight loss of accuracy. If for example, the forward reading is only 50% of full scale, the indication of reflected power is proportional.

Perhaps even more important than any discussion of the bridge's characteristics is the manual's lucid and concise explanation of SWR and line losses, and what they mean to the amateur.

### Phone patch

The SB630's meter has two functions—SWR, as already mentioned, and the indication of phone line listening level. When the mode switch is turned to **phone patch**, the meter reads accordingly.

In addition, there's a two-position slide switch on the rear apron. At the **monitor** position, which is where you'll normally use it, the meter indicates signal level on the phone line, so you can set the gain to avoid



crosstalk on the line. The other position, null, is optional if you want to work patches with VOX control; even then you only use it once, following a simple null adjustment procedure described in the manual. In this position of the switch, meter sensitivity is increased, making it easier to find the null. Once set, it should need no further attention.

#### Ten-minute timer

The circuit of the identification timer is very interesting. Three resistors and two capacitors comprise an RC network with a very long charge time. When this charge reaches a critical point, it causes a neon bulb to conduct, sending a positive pulse to the grid of a 6EW6 relay control tube, energizing the relay. Several things then occur.

One set of contacts lights the pilot lamps (and sounds the buzzer—if the front panel switch has selected this option). Another set of points lets a capacitor discharge through a pair of resistors to hold the grid positive for about a second, the time in which *identify* lights up and the buzzer sounds. In passing, I found this cycle too short to suit me, but it took only a few moments to add another capacitor across C25 to increase the hold-in time. I could have changed a resistor (R27) for a higher value to get the same results, but the capacitor was easier to get at.

A third pair of contacts discharges the timing capacitors. When the contacts re-open, the 10-minute timing cycle begins all over again. You expect a regulated voltage source in this circuit if there is to be any accuracy. There is one—an OA2 gives you 150 volts of regulated voltage.

Adjustment of the timing is simple and quick. There's a "coarse" control you set once. Then touch up a "fine" adjustment until you have a cycle of exactly 10 minutes. Although broadcast studio precision isn't a necessity, you can get it easily. On the very first try, I got the cycle to 9 minutes, 57 seconds. Two touchups later I had it right on the nose. As this is written, following about 3 weeks of use, it has held its calibration perfectly.

To use the timer, touch the reset button on the panel at the beginning of each QSO, to start the 10-minute cycle. The 24-hour clock runs all the time, of course, completely free and independent of the ten-minute timer.

... W2JDL

## “*the NEW* Vacationer” PORTABLE ANTENNA with Non-Shatterable Base

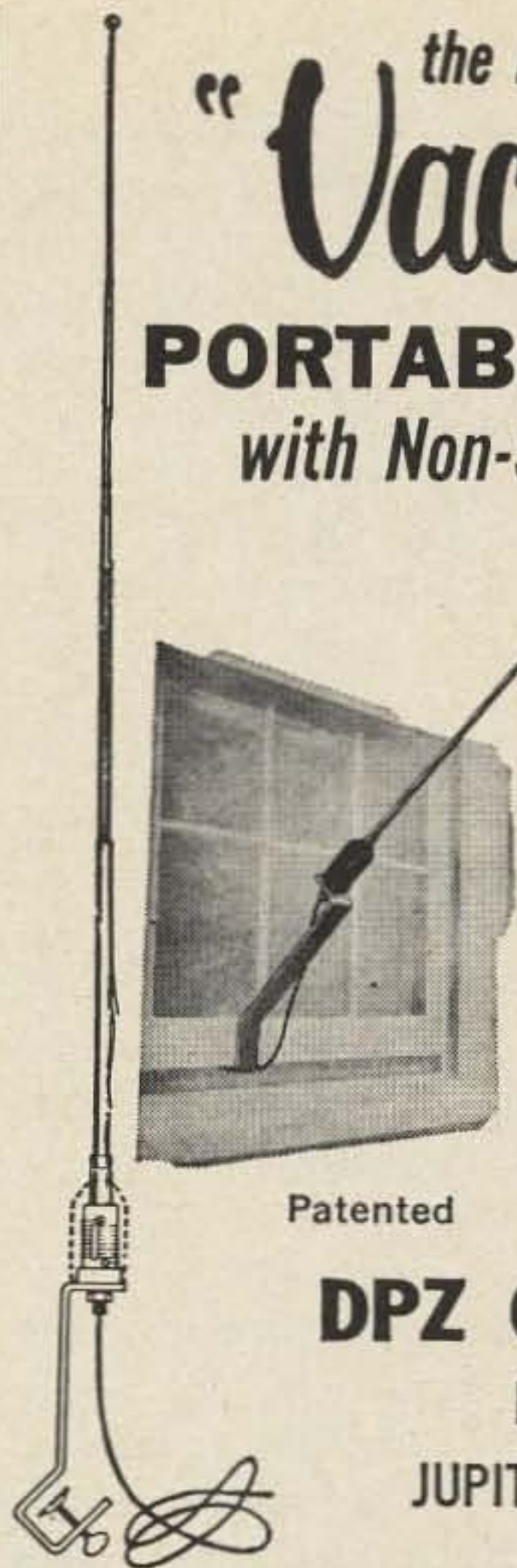

- 20-15-10-6-2- Meters
- Very Low SWR
- Folds to 19 inches
- Weighs only 2 pounds
- Complete for 5 Frequencies

**\$24.50**

ask your local dealer  
or

Patented

**DPZ CORPORATION**

P. O. BOX 1615

JUPITER, FLORIDA 33458

### MORE RANGE . . . with NO NOISE

FOR ALL  
MOBILE UNITS



ELECTRO-SHIELD

CUSTOM SYSTEMS  
KITS • ACCESSORIES

ELIMINATE IGNITION NOISE  
**ELECTRO-SHIELD®**  
YOUR ENGINE

FROM \$44.95

**ESTES ENGINEERING CO.**

1639 W. 135th St. Gardena, Calif. 90249

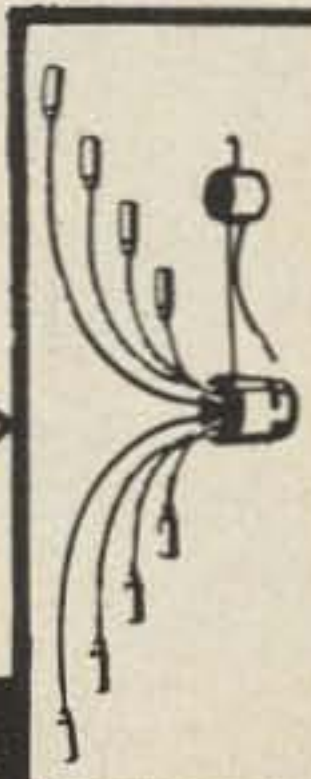



*(Continued from page 4)*

Raju (VU2NR) and Colin (G3MUR) were waiting for me when I staggered out of customs. Colin had his car and drove us first to his place for a lunch and then on to the Janpath Hotel where they had reserved a room for me. The room, with breakfast, was \$3.60 a day and it was nice. It was air conditioned, thank heavens, and had a small dressing room, shower and fairly large bedroom with a fan built into the ceiling, like in the movies.

After I had unpacked we drove on to Raju's house on the outskirts of New Delhi. Delhi is an enormous city, consisting of about seven cities in a cluster, each a little newer. The newest section of this thousand year old group is New Delhi. It has wide streets and modern buildings. The great bulk of it was built by the government and I gather that most of the people living in the houses are, like Raju, government servants. Raju services the electronic equipment for the airlines. He has a quad on the roof, but is afraid to put up anything lasting because he expects to get a raise before long and then he will be moved to a new apartment.

Raju is one of the few Indian amateurs active on SSB. He, like most of the others, built his own equipment from surplus. The receiver is a converted Command Receiver; the kind we buy here for about \$5. The transmitter was all home made and most of the parts looked as if they had been used many times before they came to Raju. Amazingly enough, it works. I went on the air and made a few contacts, just to see how it went.



Dar VU2BX, Karnik VU2CK, Raju VU2NR, Amar VU2CZ, and Verma VU2OP, officials of the Amateur Radio Society of India.

A reception had been arranged for the evening so we stopped off at the hotel and I put on a white shirt with long sleeves. I always take along a white shirt, tie and jacket on my trips in case I get into something where my usual sport shirt isn't quite right. Most of the active amateurs in Delhi were there for the reception, along with some of the government officials. I had a good chance to explain about amateur radio in America and point out to them the importance of encouraging amateur radio in India if the country were to build up the technicians it would be needing for the development of electronics and communications in the future.

Dr. Sarwate, the Secretary General of the ITU, was there and we had quite an interesting chat. I suggested the possibility of a set of amateur radio regulations being drawn up as an ITU standard which could be suggested for the newer countries. This would put amateur radio on a more official basis with the ITU, and could give us a standard set of regulations which would be world-wide. Dr. Sarwate thought this would be an excellent idea and hoped that the ITU might be able to set up a committee for such a program. He was very interested in my explanation of the basic importance of amateur radio to emerging nations and said that although he was aware that amateur radio was of importance for emergency communications and for the development of new ideas and inventions, he hadn't appreciated the possibilities it had for the training of technicians.

Mr. Lal, the head of the PTB, the Indian counterpart of our FCC, was there, and he also was interested in this aspect. I made arrangements to get together with him later for more discussions along this line and to see if we could start things going for the possible helping of Indian amateurs with American ham gear. I also talked about this idea with Colonel Rai, the president of the Amateur Radio Society of India (ARSI), as he drove me back to my hotel.

A large buffet dinner was served, but I was so busy talking that I didn't get much of a chance at it. It was probably just as well, for everything was very highly seasoned with red pepper and I might have succumbed to "Delhi-Belly" even earlier than I did if I'd loaded up on it. I like the food, but my stomach is only used to medium hot curries, not the scorching curries they serve. If you'd like to approximate an



Indian amateurs and radio officials at reception in New Delhi. The late Dr. Sarwate, then Secretary General of the ITU is seated in the center of the front row.



Indian curry, then add two spoons of red pepper for every spoon of curry when you make it. Have you watched Mr. Terrific on a color set?

### Taj Mahal

Raju and Karnik (VU2CK), the only Indian amateur I'd managed to talk with from home before the trip, had arranged to go with me the next morning down to Agra, about 150 miles south, to see the Taj Mahal. We were going to go down by train, but they arrived a little late and we decided to take a taxi instead.

Frankly I was no little alarmed at this turn of events. I knew, somehow, that it was the rich American who would pay for this. And the idea of having to pay for a 300 plus mile fourteen hour taxi ride probably upset me as much as any of the food I ate on the trip.

Driving through Delhi is an experience which is hard to describe. There are bicycles by the thousands . . . coming at you, going away, and just crossing the streets. Then there are scooters, motorcycles, pedicabs, motorcycle cabs, taxis, cars, trucks, buses, donkey carts, oxcarts, bullock carts, cows, sheep, goats, hand pushed carts, men staggering under immense loads, women with several things balanced on their heads, children about 18" high running back and forth across the street, horses, horse drawn cabs, and water buffalo, all in profusion filling the streets and roads. The cars . . . particularly the taxis . . . drive through this mass as fast as they can, honking their horns steadily . . . though I saw no sign of anyone paying the slightest attention to horns. Everything is missed by inches. I would expect the man on the Lambretta, with his wife and three children hanging on behind him, to make an effort not to be

run down. I was wrong. We drove through these crowds, shoving people and animals out of our way as we drove.

Along about half way to Agra the driver stopped for his lunch while the three of us sat in the taxi and waited for him. I passed the time by taking pictures of a snake charmer and his cobra, a trained bear on a leash, and a fellow with an eight foot python.

We arrived in Agra about 10:30 and, after trying to find Les King, VU2AK, who happened to be out of town that day, we stopped for breakfast. The omelet, coffee, toast and pastries all around were my treat . . . \$1.30 for the three of us complete. Raju and Karnik complained about the prices . . . twice as much as Delhi . . . gouging the tourists. It was a good meal and I felt great in spite of the 100° temperature.

We stopped for a minute while Raju got a wad of betel nut to chew. He thoughtfully got one for me too. They take a large leaf and paint it with a brown goo, drop a few chunks of betel nut in it, sprinkle some ground spices on it, fold it up and then you pop this mouthful into your mouth and chew. It tasted medicinal, but I gamely chewed away at it. You can spot betel nut chewers by their permanently red lips and mouth. It is supposed to help your digestion. It didn't help mine.

Just a few minutes from town, we pulled up in front of a large palace type of building and got out of the taxi. I just made it to a nearby hedge with the mouth full of betel nut . . . whooey! The combination of the long trip, the oppressive heat and the betel nut had me dizzy and reeling, but I grabbed my wide angle and telephoto cameras and went through the archway, fighting off the hordes of people pleading and begging to guide me or sell me some-



thing.

There, in front of me, was the Taj Mahal . . . sure enough. Just like all the pictures. In a daze I took pictures of the Taj, Raju, and Karnik . . . we took off our shoes and walked up to the pure white building . . . blinding in this sun. Translucent marble with millions of intricate designs carved and set with colored stones. The dome inside is so perfect that you can hear an echo for over five seconds. The building took 18 years to finish and apparently kept the country so busy that they didn't have time for wars. It was built 700 years ago.

In spite of frequent infusions of orange soda, ice cream and pineapple juice, I was just able to keep going in the heat. A half mile away we went through the Red Fort, a huge palace where the king used to live and run the country. Then came another palace, about twenty miles away, built by the father of the chap who built the Taj Mahal. He made a little mistake. When they got through building the palace there, they discovered that there was no water locally and it all had to be brought in. So they eventually gave up and built the Red Fort near the river, and used that.

We stopped in town for dinner. The curried food . . . and everything except the milkshake was curried . . . tasted good, but hit my stomach like live coals and burned its way on down during the interminable drive back to Delhi. The milkshake was like nothing I've ever tasted before . . . buffalo milk, I think, sweet and *cold* . . . I didn't complain.

Along most of the road between Delhi and Agra I noticed a ditch about the width of the road, filled with water. What is? That's where they got the dirt for the road. Simple solution.

During most of the trip back, I added to my discomfort by trying to figure out how much this little taxi ride was going to cost me. Lordy, imagine what something like that would cost in America! We pulled up in front of the hotel a little after eight o'clock and I got the word . . . 140 rupees. Whew! That's about \$14. Over 300 miles plus fourteen hours for the driver for a total bill of \$14. With great relief I staggered to my room and to bed for the night.

### Old Delhi

At 5:30 the next morning, I was on my way to see Raju and try to keep a schedule

with Jim Fisk back at my home station. Raju had written the instructions for a taxi driver to find his place, but I worried. I'd been through this bit before where a driver looks at instructions, drives off confidently and then ends up driving all over the place, lost. All on the meter, of course. Then they talk excitedly to me in their own language and eventually, several dollars later, return me to my hotel to look for a smarter taxi driver.

I lucked out this particular morning and found Raju's apartment quickly. Only YV's coming through. Not a whisper from the states. Raju's wife served an Indian breakfast . . . something like a curried potato salad with Indian bread . . . tasted great, but don't they get a lot of heart burn from all that pepper in every meal? My lips burned and I drank quite a bit of water and coffee. Good coffee. Obviously the band isn't going to open this morning.

Along about eight we took a taxi downtown and dropped in on Dar VU2BX. Dar had an SX-28 and a very old, low powered, AM transmitter. No wonder we don't hear him in the U.S. Amar VU2CZ arrived, and we all went out to see old Delhi in Dar's car. As we got into the older section of town, the shops were mere stalls and jumbled all over one another . . . some in the street, some on the sidewalk, and some back a ways. People everywhere, like Christmas in Macy's. We drove right through the mass of people, animals and wheeled things . . . I said how about stopping so I can take some pictures of this . . . sure, anywhere you like, said Dar, driving madly on . . . STOP, right here . . . oh, we can't here . . . and on he went. I think I screamed.

Dar stopped in surprise and I jumped out before he could sort out his gears and get going again. I snapped pictures in all directions, running through a whole roll of film before the heat (and breakfast) got to me. Aha, just ahead was a cold drink stand with Gold Spot orange soda . . . boy, do I need some of that! I offered to buy them all a bottle . . . it costs about 3c a bottle. oh, no, come over here. No, I want an orange . . . no, come this way. Reluctantly I let myself be dragged away from the cold drinks and into a small dark booth where there were piles of very old World War II surplus radio gear, most of it in terrible shape. We were in an Indian sur-



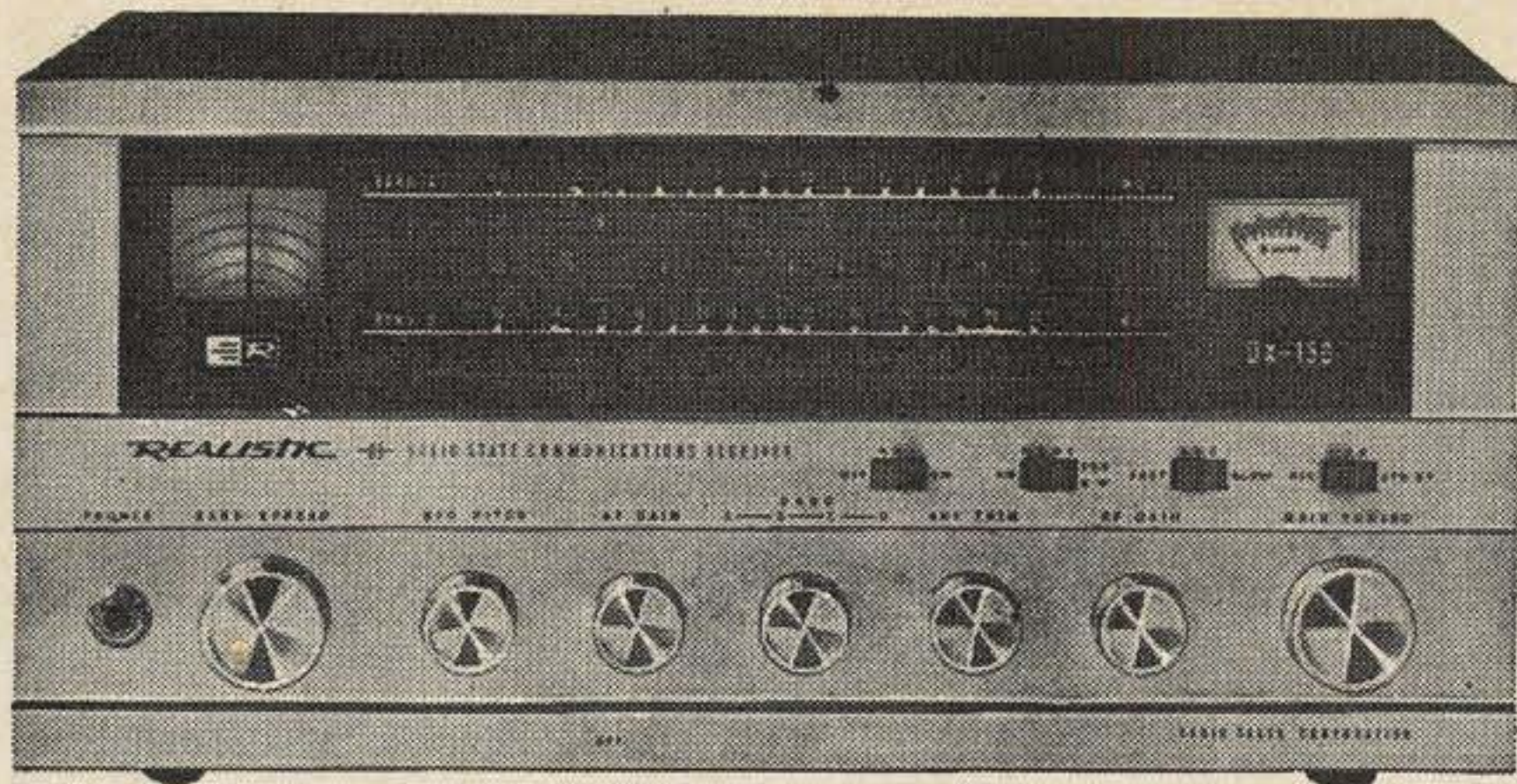

RADIO SHACK  
**BREAK THRU!!**  
 ALL  
 SOLID STATE

# The World's First 117V/12V All-Transistor Communications Receiver Is Available Now In 150 Radio Shack Stores Coast to Coast!

## THE *REALISTIC*® DX-150

- Over 30 semiconductors — no tubes, no nuvistors — the DX-150 is 100% solid state!
- SSB/CW/AM reception, covering 535KC through 30MC in 4 slide-rule bands!
- Product detector for SSB/CW, plus fast and slow AVC; variable-pitch BFO!
- Illuminated electrical bandspread fully calibrated for the Amateur and CB bands!
- Cascade RF stage; ANL for RF and AF; zener-stabilized; OTL audio; illuminated "S" meter!
- Built-in monitor speaker plus front-panel jack for external (optional) matching speaker!

**ONLY**  
**119<sup>95</sup>**

New, big, exciting, professional — the Realistic DX-150 obsoletes tube receivers and warm up, banishes forever your dependence on house current to stay in operation. For example: the DX-150 will run 100 hours on 8 D-cells if current fails, or isn't available, or on field day. Additionally, it will operate from a car's cigarette lighter or any other mobile or base 12VDC source! Of course a 117VAC power supply is built in. DX-150 is a husky brute: 14 1/8 x 9 1/4 x 6 1/2", with a massive silver extruded front panel, solid metal knobs, grey metal cabinet, 14 pounds of quality.

### A NEW STANDARD OF RECEIVER VALUE!

Priced Radio Shack's way (factory-to-you) the DX-150 saves you about \$100 off traditional pricing methods. Yet it offers 11 front controls; dual power supply; 12 1/4" slide-rule dial in 5 colors; continuous coverage from 535KC through 30MC, including 160 through 10 meters; separate detector circuits for AM (diode, and SSB/CW (4-diode bridge); sensitivity good to 0.5µv at 30MC. Nobody but nobody but 44-year-old Radio Shack could have created this unique product for \$119.95. You better believe it!

### THERE'S A STORE NEAR YOU!

- |   |  |
|---|--|
| ARIZONA — Phoenix   | MICHIGAN — Detroit   |
| ARKANSAS — Little Rock  | MINNESOTA — Minneapolis, St. Paul  |
| CALIFORNIA — Anaheim, Bakersfield, Covina, Downey, Garden Grove, Inglewood, La Habra, Long Beach, Los Angeles, Mission Hills, Mountain View, Oakland, Pasadena, Pomona, Reseda, Sacramento, San Bruno, San Diego, San Francisco, Santa Ana, Santa Monica, Torrance, West Covina | MISSOURI — Kansas City, St. Joseph, St. Louis  |
| COLORADO — Denver   | NEBRASKA — Omaha   |
| CONNECTICUT — Hamden, Manchester, New Haven, New London, Orange, Stamford, West Hartford  | NEW HAMPSHIRE — Manchester   |
| FLORIDA — Jacksonville, Orlando   | NEW JERSEY — Pennsauken  |
| GEORGIA — Atlanta   | NEW MEXICO — Albuquerque   |
| ILLINOIS — Chicago  | NEW YORK — Albany, Binghamton, Buffalo, New York, Schenectady, Syracuse  |
| KANSAS — Wichita  | OHIO — Cincinnati, Cleveland   |
| LOUISIANA — New Orleans   | OKLAHOMA — Oklahoma City, Tulsa  |
| MAINE — Portland  | OREGON — Portland  |
| MARYLAND — Langley Park   | PENNSYLVANIA — Philadelphia, Pittsburgh  |
| MASSACHUSETTS — Boston, Braintree, Brockton, Brookline, Cambridge, Framingham, Lowell, Medford, Natick, Quincy, Saugus, Springfield, Waltham, West Springfield, Worcester   | RHODE ISLAND — Providence, East Providence   |
|   | TENNESSEE — Memphis, Nashville   |
|   | TEXAS — Abilene, Arlington, Austin, Brownsville, Corpus Christi, Dallas, Fort Worth, Houston, Lubbock, Midland, San Antonio, Sherman, Waco |
|   | UTAH — Salt Lake City  |
|   | VIRGINIA — Arlington, Virginia Beach   |
|   | WASHINGTON — Seattle   |

### REALISTIC DX-150 CUSTOM ACCESSORIES

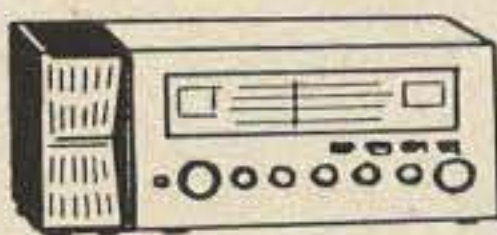

Exact-match external Voice-Frequency speaker cuts out built-in monitor, includes lead and plug. 20-1500: \$7.95 (4 lbs.)

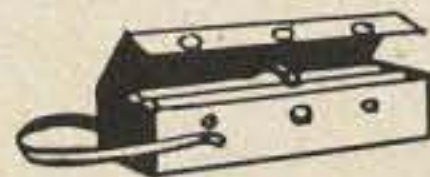

12VDC portable pack with all cables, plugs, 8-long-life batteries; includes plug-to-plug and plug-to-lighter cord sets. 20-1501: Only \$7.95 (wt. 4 lbs. w/batteries)

### ORDER BY MAIL! IN PERSON! FREE FOLDER!

**RADIO SHACK**

East: 730 Commonwealth Ave., Boston, Mass. 02215  
 West: 1515 So. University Dr., Ft. Worth, Tex. 76107  
 Dept. SV

Please rush me the item I've checked below.

I enclose \$\_\_\_\_\_, plus 50¢ for postage and handling:

- |  |   |
|--|---|
| <input type="checkbox"/> FREE 1968 Catalog           | <input type="checkbox"/> Matching Speaker, 20-1500, \$7.95* |
| <input type="checkbox"/> FREE DX-150 Folder          | <input type="checkbox"/> 12 VDC Power Set, 20-1501, \$7.95* |
| <input type="checkbox"/> Receiver, 20-150, \$119.95* | * Plus Shipping Cost:<br>14 lbs., 4 lbs., 4 lbs.            |

Name (print) \_\_\_\_\_  
 Street \_\_\_\_\_  
 City \_\_\_\_\_ State \_\_\_\_\_ Zip \_\_\_\_\_



plus store.

Dar said something to the proprietor and he went out for a minute and came back with four bottles of Gold Spot. The first went down in one gulp. The second I drank slowly, beginning to perk up a bit. Raju was looking for some small resistors and the shop keeper was looking through old candy boxes of junk trying to find the right values. The parts looked as if they had been pulled from a third hand radio. With old carbon resistors at about \$2 each, comparatively, the hams can't afford to buy many parts.

Back in the car, we lurched along passing one remarkable sight after another. I sure would like to take a picture of that. Dar drove on. Can I get a picture of that? Sure, we'll be back later and stop. I screamed again. When they got me calmed down, we parked and set out on foot, my cameras snapping.

Weakened, the heat got to me quicker this time and I began to wilt. Dar and Raju climbed a long long staircase to a mosque . . . tremendous place. They wanted me to take off my shoes and go in . . . I could see acres of hot burning stones ahead and the blazing sun overhead. I leaned against the wall and said absolutely no . . . no more mosques. They lamented that all foreigners wanted to see was the Taj Mahal and all other mosques were ignored. I agreed . . . now let's get back to the car; I'm beginning to reel.

We went around a circle and found another surplus store with the parts spread out over the sidewalk in boxes. More incredible junk by our standards. Raju kicked at it a bit, to show his contempt, before asking the price. He had to send out for some orange sodas too . . . I gulped down a couple more, coming back to life just a bit. The proprietor, anxious to set up a good atmosphere for business, passed out some little seeds to Dar and Raju . . . Dar passed along a couple to me. After the betel nut experience I was wary. Sure enough, ugh! I waited for them to turn away for a minute so I could get rid of them. After several painful minutes I deposited them behind a BC-375 tuning unit, and spitting bright yellow, I started looking over the gear for sale. The storekeeper was not out of tricks yet. He whipped out a handful of seeds for Raju and Dar. They tried everything they could to get me to try them . . . what

are they? Anise. No thanks, I know anise, not now. Our host was frustrated. He next brought out some tiny foil pellets . . . here chew one of these. I gave up and tried it. What is it? Cardamom, the same as you had before. Yep, that's what it was alright. Ptooeey. They led an almost unconscious Wayne back to the car.

After a little nap, a shower, and an Indian lunch at the hotel, Dar and Amar picked me up and drove me to the Ministry of Communications to talk with the Secretary to the Ministry. Colonel Rai was there with Lal. We all went in and talked with the Secretary for about a half hour. I explained what I had in mind . . . the gathering of radio parts and equipment in the U.S. for shipment to India for the amateurs and amateur radio clubs. I explained the importance of amateur radio to the development of India and he was quite enthusiastic and anxious to get the project started. I said that as soon as I had a letter from him making it official that the equipment could be imported duty free, I would start work on my end. I felt that if we in the U.S. were going to help out by donating gear, the least India could do was allow it to enter the country without charging their usual prohibitive duty.

During the afternoon I wandered through some of the tourist stores near the hotel and bought a few knick knacks.

That evening I had dinner with the ARSI officers. Most of the evening was spent with the fellows arguing with Dar, so I didn't get a word in edgewise. He had strong opinions on everything brought up and didn't seem to feel any need for facts or reason to support his arguments.

In the paper it was mentioned that one man was making 75 rupees a month after 15 years on the job. Another was making 125 rupees after 25 years. Karnik is doing very well at 1000 . . . upper class. A rupee, remember, is worth about ten cents.

#### VU2JM

The next morning my hotel phone started ringing early and by 9 I had a morning planned with Raju, lunch with Minoo Patel VU2JM and dinner with Rai. Raju and I went shopping. I bought some spotted mink gloves for \$2.50 a pair . . . and leopard gloves were \$5. Things were so low priced that it was difficult to hold back.

Minoo picked me up for lunch in his Mercedes 180. We ate at the Imperial Hotel,



very impressive, and then on to his office for a cup of tea and a little business. Mino is a brigadier and is treated with considerable respect and pomp. Then on to his house, a beautifully modern one, complete with charming wife and Coca-Cola in ice. I sat down at his SX-111 and Johnson Valiant for a few short contacts. I worked a couple VK2's and then 9N1MM called in to say hello. I told Father Moran that I would be on schedule, arriving tomorrow afternoon.

That evening I had dinner with Rai and his wife. It was a delicious Indian meal. We talked over the problems involved with bringing in ham gear and Rai suggested that the Institute of Telecommunications Engineers, the Indian counterpart of our IEEE, act as the importing agent and take care of distributing it to the amateurs and clubs. He said he had an OK on this from the Secretary of the Institute. That sounded like a fine idea and it would get around the problems they are having in the ARSI. It is a lot better to have a third agency in charge of distribution.

Between the heat and the curry, Delhi did wear me down a lot. Delhi-belly set in. Fortunately my flight to Nepal was delayed a day and I had a chance to rest up and recuperate before facing Father Moran and Katmandu.

It is now almost a year later and I'm still waiting for that letter from Jain, the Secretary of the Ministry of Communications. I did get a call from the Indian Embassy in Washington along in January, but nothing more since then. Perhaps I'm wrong in this, but I feel that they should make some sort of effort to be helped.

Next month . . . the mountains of Nepal.

## Montreal

Despite the fact that I am about as popular with the officials at an ARRL convention as a case of the plague, I did consider attending the recent National at Expo. The basic problem that I present is that the League wants to keep a lot of things secret and I insist on spilling the beans. It does not make me popular with them.

Lin, my new wife, and I drove up to Montreal for the Mensa Annual Gathering, figuring that we might stay on for the ARRL deal the following weekend. We were dismayed to find ourselves living in a small hastily constructed box assigned by LogExpo

at \$22 per night. We drove on to Expo and found the signs took us to a \$2 parking lot plus \$2 more for a boat ride to Expo itself across the river from the parking lot. Then add in \$5 for the two Expo "passports" and you have a basic bill of \$31 a day plus meals, rides and gizmos that the XYL buys at the hundreds of little stores spread all through Expo. We stopped off at a little Austrian restaurant and had a simple lunch . . . \$10. I figure Expo cost us about \$70 a day with everything.

Now \$70 a day isn't too bad . . . if it is for *one* day. But if this goes on for a week . . . ! Some of Expo is good fun . . . a lot of it is a dreadful bore. The lines, sometimes hours long, kept me out of most of the better exhibits. By the third day we figured that we had seen all that we could see without long waits and, remembering the \$70, drove back to Peterborough and cancelled any thoughts we had of staying on for the ARRL convention.

Suggestions: after a while you begin to get the swing of Montreal. You can avoid the LogExpo system by driving into Montreal and looking for signs in windows of homes that take roomers. This costs less than half and usually includes a nice breakfast. Then you can take the Metro to Expo from town and not have to drive in, as we did, from a suburban plywood box development. Expo tickets come as low as \$1.50 each if you shop around. I can see where a couple bound on economy could get by for as little as \$25 a day complete. This would mean lunches of hot dogs or buffalo burgers, to be sure. And not too many rides in the amusement area.

By the way, if you do visit Expo, stop in at the ham shack over in La Ronde and put VE2XPO on the air for an hour or so while your feet are recovering. I made a few contacts on twenty, but it cost me plenty. Lin went out and found a handbag at the Moroccan boutique which I might have steered her by if I had been with her instead of talking.

Sorry if I missed you at the convention, but we're going to have to have a whole lot more subscribers to 73 before I can hack that \$70 a day jazz.

## More DXCC Deletions

In the July issue of 73 I reported on the hassle between Don Miller and the ARRL.

The latest bulletin is dated July 6th and it deletes credit for working Miller at St.



Peter and Paul's Rocks (PYØXA), Chagos (VQ9AA/C), and Heard Island (VK2ADY/Ø). The League claims it has not received "reasonable documentation concerning the manner in which travel was accomplished" for the first two, and that there is a question of authorization by the Australian government on the third. They go on to define what they expect in the way of documentation . . . "a running log showing arrival and departure times at each port and stopping point, name or number of aircraft or vessels employed, and receipts for transportation and lodging."

There is a great bitterness spreading around the world as a result of this latest announcement. Thousands of amateurs spent a lot of time and effort to snag Miller at the five spots the ARRL has so far discredited retroactively . . . no, make that seven, for we can't completely forget the Ebon Atoll and Cormoran Reef DXpeditions that ARRL gave credit for at first and then later cancelled.

The first serious question of determining whether a station was really situated exactly where he said he was came up over ten years ago. There was no secret about this at the time. One fellow signed the calls of several countries he may not have actually visited. I discussed this problem with League staff and know that they were well aware of it.

It was not until Miller had the audacity to refuse to contact some of the top DXCC honor stations that ARRL swung into action. The first happened not long before credit was retracted for Ebon and Cormoran. Miller continued to avoid operators whom he considered were operating contrary to the ARRL DX operating code and the result has been the distressing mess I reported in July.

The League should, when the problem first came up, have established guidelines for DXpeditions to be credited for DXCC. This would have been a simple matter and would have avoided the further complications.

All this is not meant to imply that we do not have any reservations about some of Don's expeditions. To the contrary, we have some very serious doubts that we would like to have dispelled.

### Burma

On September 22, 1965 I contacted Don as XZ2TZ in Burma. I have a QSL for this contact. This was quite a coup because the

stations in Burma had been off the air for about three years at this time and there didn't seem to be any possibility for them to get back on again. I didn't know how Don managed to get into this country or how he was able to get permission to operate when the local amateurs were not. He was there, so I knew he had succeeded. I thought nothing more about it.

Then came my own visit to Burma one year later in September 1966. My suspicions were aroused when I found out how difficult it was to get into the country. They did not diminish when I found that the country was now a military state under strong influence of the Chinese, as I will report when I tell you the full story of my incredible visit to Burma in my editorial in a month or so.

You can be sure that I asked a lot of questions when I got in touch with local amateurs. Not one had heard of Don Miller being in Burma. Not one believed that he could have managed to bring in any radio equipment or gotten permission to operate it. In a small country like Burma they felt sure that they would have heard all about anything like that.

Don's story to me was that he and Chuck had been mistaken for CIA men and that Burma had rolled out the red carpet for them. When I suggested this to a man from the British embassy, he laughed and said that no CIA man would ever be allowed to get off a plane in the country.

Frankly, I left Burma with a strong suspicion that Don had not actually been there during the XZ2TZ expedition. This would be simple to verify by a photostat of the page in Don's passport where the dates that he entered and left must be indicated. I, for one, would like to see this positive proof that he actually was in Burma during the expedition period.

My discussions in Bangkok raised similar questions about K7LMU/HS. The active amateur whom I talked with there said that local operators had not been able to hear Don and Chuck during this operation.

### St. Peter and Paul Rocks

Many of the questions that come up about the Miller expeditions involve circumstantial evidence. For instance on the PYØXA trip we have reports from Brazil that the station seemed to be in the direction of Guyana instead of almost 90° away, from the Rocks.





# NUVISTOR LOW NOISE PREAMPLIFIER

For 27 (CB), 28, 50, 144 or 220 MC. (Also available for 150-170 MCS)

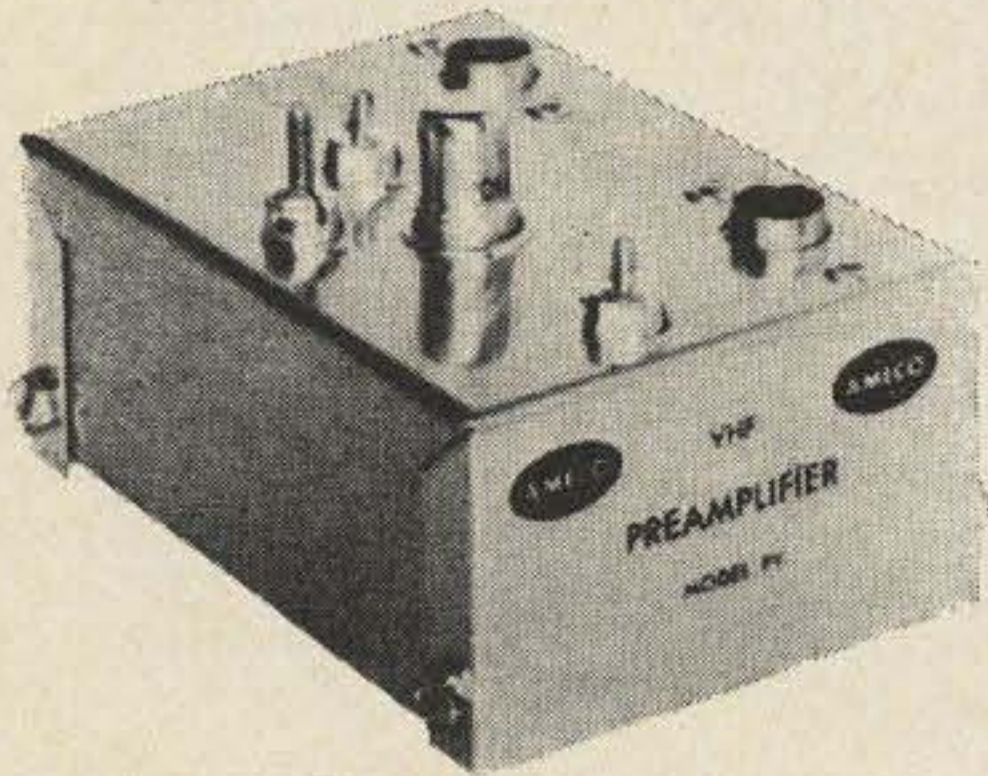

Add this Ameco Nuvistor Preamplifier to your receiver (or converter) to improve the sensitivity and noise figure. Two tuned circuits also improve rejection of image and spurious frequencies. Compact, easily connected and low power requirements, wired and tested with tube.

Model PV 27 ..... \$11.95  
Models PV 28, 50, 144 & 220 ..... \$13.95

Write for details on 150-170 mcs and others.

**Ideal for improving performance of surplus FM Two-Way equipment for "NET" operation on the 2 and 6 meter bands.**

**MANUFACTURERS OF FM AND AM TWO-WAY RADIO, SSB AND ISB COMMUNICATIONS, CONTROLATOR FUEL CONTROL AND DATA EQUIPMENT, AMECO\* HAM, CB AND SHORT WAVE LISTENING EQUIPMENT.**

## AMECO EQUIPMENT CORP.

**A SUBSIDIARY OF AEROTRON, INC. ■ P. O. BOX 6527 ■ RALEIGH, N. C. 27608**

Then there is the question of how a 58 foot power boat was able to go for almost 4000 miles without refueling, from Cayenne to the Rocks and back.

### Heard Island

Two problems have cropped up with this one. First there is the matter of the lack of authorization to land on Heard and then there is a bit of doubt in my mind as to where Don actually was during this expedition. You see, I have it second hand, but from a good source, that Don was positively in Vancouver, B.C. the day before the operation went on the air from "Heard." Since this is the antipodes to Heard the beam headings could be OK for many stations. But it is difficult for me to understand how Don was able to move 12,000 miles in one day to a very remote island not far from Antarctica.

### Others, Too

Similarly strong circumstantial evidence raises questions about Niue Island, where locals insist that no expedition has operated in recent years. And then there is Minerva

Reef, 1M4A, where Don operated for 48 hours of the DX contest. The problem here is that, as far as I know, this reef is under water, three feet of water, except during extreme low tide. The only identifiable landmark on the reef is the hulk of an old fishing boat. This, strangely, was missing from Don's pictures of the reef.

We've all watched too many Perry Mason mysteries to convict someone on circumstantial evidence, no matter how incriminating. But I do think that we are due incontrovertible proof that the countries which are supposed to count for WTW have been the actual sites of the operations. I think ARRL is due the same for credit for their DXCC. And aren't the fellows who made his trip possible by donating thousands of dollars also due a complete and well documented report on the operations?

Rather than continue this battle between Miller and the ARRL where the League makes an accusation and Miller then refutes it, let's clear up all this nonsense once and for all with a detailed and officially documented report on the whole expedition.

. . . Wayne



## NEW BOOKS

### **Single Sideband: Theory and Practice**

Most amateurs operating on the high-frequency bands today are using single sideband; on VHF and UHF its use is increasing all the time. In addition, the majority of commercial communications stations have adopted ssb for maximum use of the usable spectrum. This new book by Harry Hooton W6TYH is an essential text for those interested in single sideband communications and equipment.

"Single Sideband: Theory and Practice" covers the origin of single sideband in the early days, the derivation of ssb signals, carrier suppression techniques, sideband selection, carrier generators, speech amplifiers and filters, ssb generators, balanced mixers and converters, low-power ssb transmitters, linear power amplifiers, ssb communications receivers, transceivers, tests, and measurements. Each of the sections is well illustrated with practical circuits and emphasizes basic principles and circuitry rather than mathematics. If you are having trouble understanding the fundamentals of ssb, W6TYH's presentation is straight forward and easy to understand.

The sections on the design, construction, and adjustment of linear amplifiers contain enough information so that any amateur can build his own equipment. In addition to the illustrations contained in the text, there is a foldout section in the rear which contains detailed schematics of many of the popular amateur ssb receivers, transmitters and transceivers. If you operate single sideband and/or want to know more about it, this is a very useful volume. \$6.95 from your local electronics distributor or write to Editors and Engineers, Ltd., New Augusta, Indiana 46268.

### **Ten Minute Test Techniques**

How many times have you had to return your rig to the factory for repair? Or turned the household TV or radio over to a serviceman? If you have, you should have a copy of Elmer Carlson's "Ten Minute Test Techniques" in your shop. This new equipment servicing guide approaches electronic troubleshooting from a new and unique angle—that

every circuit is essentially an amplifier or rectifier. With this fact in mind, and some common sense, even the most complex electronic equipment can be easily tested and analyzed with basic test equipment and simple servicing procedures.

The volume is profusely illustrated and describes several specific methods which can be used to analyze either tube or transistor circuits in all types of electronic equipment, including power supplies, amplifiers, oscillators and transmitters. Step-by-step test techniques are outlined which may be used for localizing troubles and pinpointing defective components without delving into involved theoretical discussions.

If you are ever required to fix that receiver, transmitter or transceiver, this book can save you a lot of sweat and tears. More than 25 years of experience have gone into it and many time and temper savers are included, with practical hints for solving troubles fast and eliminating repeat failures. \$6.95 from your local book store or write to TAB Books, Drawer D, 18 Frederick Road, Thurmont, Maryland 21788.

### **Slide Rule in Electronics**

If you work with electronic circuits, design them or analyze them, the rapid, accurate calculations available with a slide rule simplify matters considerably and save a lot of time. It has yet to be surpassed, even by a computer, in terms of weight, size, speed and variety of calculations and simplicity of operation. The slide rule is especially useful to the amateur and technician because most of the ordinary electronics math encountered can be easily calculated.

"Slide Rule in Electronics", by Don Carper, teaches you how to use the slide rule for making quick, accurate calculations in electronics. The book is divided into twelve lessons covering multiplication, division, placing the decimal point, reciprocals, squares, cubes and roots, ratios and proportions, folded scales, trig functions, and logarithms. Each lesson, in turn, is divided into sections containing practice problems and exercises. It shows you how to calculate resistance, reactance, impedance, current and voltage relations, frequencies, phase angles, and many other quantities.

\$4.25 from your local electronics parts store, or write to Howard W. Sams & Company, Inc., 4300 West 62nd Street, Indianapolis, Indiana 46206.



## Transistor Substitution Handbook

If you're using transistors in your projects these days, and are trying out various new circuits, you have undoubtedly run into the problem of what transistor to use when the one specified is not available. This new book from Howard W. Sams & Company was compiled by a computer and is one of the most complete listings of transistor substitutes available. The substitutions were selected by comparing the electrical and physical parameters of each transistor with a computer.

For the past several years about 1,000 new transistor types have been introduced each year. In some cases specific types are no longer manufactured and it is impossible to obtain an exact replacement. Furthermore, because there are several type-numbering systems in use besides the stand and 2N- system, it is sometimes difficult to determine whether a different unit will serve the purpose.

In addition to the computer selected substitutions, this handbook lists all the major-line, general-replacement type transistors in accordance with the manufacturer recommendations. Information also includes the manufacturers, NPN and PNP polarities, germanium and silicon types, and basing diagram styles. If you work with transistors, you shouldn't be without this book. \$1.75 from your electronics parts distributor or write to Howard W. Sams & Company, Inc., 4300 West 62nd Street, Indianapolis, Indiana 46206.

## MF/HF Communications Antennas

Actually, the entire title of this government publication is "DCA (Defense Communications Agency) Engineering-Installation Standards Manual, Addendum No. 1, MF/HF Communications Antennas"! Like many other publications from the Government Printing Office, this jewel has an awful lot of information between its covers for a very economical price. The subject of course is antennas, their characteristics, design, siting, testing, and installation. In addition, there is information on electromagnetic theory, propagation and basic antenna theory.

If you want to know what antenna you should use for a given purpose, this book compares size, directivity, frequency range and cost. When you have decided what antenna you want to use, it will tell you how to design it. Complete design details are

given for rhombics, log-periodics, terminated-vees, yagis, dipoles and sloping antennas as well as compromise and compact designs. The field-testing section is particularly interesting, and covers tuning and matching devices and procedures, field strength measurements, VSWR and ground resistance. The installation section covers tower erection, guying and basic installation requirements. For the DX men there is a simple method of finding great circle distances and bearings. A best buy for antenna men at \$2.30 from the Superintendent of Documents, U.S. Government Printing Office, Washington, D.C. 20402. Order DCA 330-175-1, Addendum No. 1.

## New Sams Publications

Howard W. Sams has several new publications this month that are useful to the ham. First of all, "Slide Rule in Electronics" shows how to use the slip-stick for making quick, accurate calculations in electronics math. It tells how to calculate resistance, reactance, impedance, current and voltage relations, frequency, phase angles and many other quantities. Price is \$4.25.

For the beginner not acquainted with electricity or electronics, "Basic Electricity and an Introduction to Electronics" is an excellent starter text. It is written in a simple, easy-to-understand style, supplemented by liberal use of diagrams and illustrations and presents the basic fundamentals so simply and clearly that the subject does not seem difficult at all. This book covers the fundamentals of electricity and magnetism and follows up with coverage of electronic circuits, transistors and other semiconductors and television and industrial electronics. Price \$3.95.

The stereo buff and home fix-it man will be interested in "101 Ways to Use Your Hi-Fi Test Equipment". This book answers the basic questions most often asked about hi-fi instruments and places the emphasis on basic audio tests of hi-fi amplifiers and associated equipment. It covers the use of harmonic-distortion meters, audio wattmeters, tone-burst generators, and fm stereo-multiplex generators. Practical information as well as precautions and required equipment and connections are given for each test. Price \$2.95.

Each of these books may be obtained from your electronics distributor, or direct from the publisher, Howard W. Sams and Company, Inc., 4300 West 62nd Street, Indianapolis, Indiana 46206. ■



# Can The Patient Be Cured?

In the field of medicine there are dreaded words like cancer and arteriosclerosis. I am not alluding to medical problems. My patient is Ham Radio as it has existed these past fifty years. My client has the middle age bulge. He is apathetic and is so engrossed in his own little world that he cannot see the larger problems that are ready to overtake him. He won't face the fact that he is a sick man, and not being able to admit to a deficiency, you can hardly expect him to do anything about it. He is like the chain smoker who has been told about lung cancer and emphysema, but because it hasn't caught him yet, he continues his four packs a day.

Ham Radio is sick. You don't have to be a trained diagnostician to observe the symptoms. But to those of you who haven't thought much about it, let me enumerate some of the more obvious signs.

- A. A falling off of new hams.
- B. The reduction of sales outlets catering to hams.
- C. The relative lack of advertising revenues in the ham magazines and consequent financial ills of all three publishers.
- D. The statistics of those recording the vital facts on our gross ham business.
- E. The obvious reduction in respect afforded amateurs by our government.

If these are the signs of illness—what can the reasons for this sickness be? In my judgment there are at least five areas that collectively have caused our plight.

1. The announced need of incentive licensing without the reasonably quick surgery required. The FCC has taken altogether too long to do what should have been done.
2. The abiding concern most of us have had with respect to the Viet Nam war and the possibility that escalation would require a congressional declaration of war with the attendant prospect of our loss of ham operating rights.
3. The existence of C.B. radio. This simple way to "ham" without code or technical examination has taken the largest number of would-be hams away from our ranks, and with loose FCC enforcement of C.B. rules, has given a vent to those with an itch to communicate.
4. The science of our art has gone beyond our average ability to comprehend, and we have therefore not been able to keep up with the latest in SSB tech-

niques, in synthesis, in solid state circuits, or in mathematical filter design. What we understood very well in 1947 has become an enigma in 1967.

5. Because the sources of supply have largely disappeared, we as individuals can no longer build as easily as we once did, and therefore we place more reliance on store-bought preassembled rigs. Because we didn't build it, we don't really know the piece.
6. As a nation, more of us exist, with less physical space on which to erect antennas. More of us are moving than ever before, or are living in mobile homes. Certainly less chance to do things the way we used to. And as a corollary, we are more prone to *give in to* rather than fight TVI, for obviously there are more TV sets, more TV stations, more rabbit ears than there used to be. We are not as *determined* as we once were, probably because there are so many other things to do! Ham Radio has gradually lost its pre-eminent position in the community which it once had for disaster relief and emergencies. Nowadays competing services are better organized to step in and take over. Civil Defense organizations have matured, professional communication outfits exist such as police, public utility and fire departments with far more facilities than yesteryear, and many of these "pros" don't want us hams monkeying around.

These are the symptoms of our illness, but many other threats exist too. For example, the increased number of newly arrived nations will all want to control their own spectrum, to assert their own ideology with their short wave broadcasting stations. For example, there is a larger need for business frequencies, for space for millions of CB'ers, and for a larger government and military requirement. What this means is that despite technical progress, a larger demand on *our* frequencies will inevitably be made.

## SHOULD WE ROLL OVER AND DIE?

Emphatically NOT! Ham Radio is still king of all hobbies. The nation with a large ham population is still really the best prepared country. The Near East scrap was interesting. Israel, with 2,700,000 people, has nearly 400 hams. The U.A.R. and Syria and Jordan, with over 10 times the population, have between them scarcely 20 hams.



Surely this lesson is not going to be lost, but as hams, can't we see that the Prime Ministers, or other heads of state, obtain copies of the foreign Call Book and visualize this lesson while it is still fresh?

There are many other things to do. For example, why can't we beat incentive licensing to the punch and *up* our license grade *before we have to*? Wouldn't this prove that we care, to the FCC?

For example, why can't we infiltrate the ranks of CB radio, join their clubs and show them the difference between 5 watts and 500 watts, the difference between legal and illegal QSO's?

For example, why can't we foster more high school radio clubs, more church radio clubs, more Boy Scout radio groups? Why not let every ham club push for new beginners by offering classes and suitable incentives within our existing ham organizations?

For example, why can't the kit manufacturers, instead of just telling us to solder 3" of red wire between points A and B, explain their product's philosophy and circuit details in a better educational manner? Too many kits built, not enough knowledge gained in the process.

For example, why can't the Electronic Industry Association create a committee of Amateur Products manufacturers, said committee to study our problems and the attendant lack of motivation by those handling the sale of this material, and over a period of time, implement their suggestions as only the united strength of the EIA can do?

For example, if Ham Radio is the reservoir of trained operators that we are supposed to be, how about enabling legislation in the Congress that would give us tax exemption on the money spent for ham radio in each year? This is worth looking into. And, in a lesser vein, how about convincing your respective state governments that sales taxes should be levied on the difference value of your purchase, when you trade in your old gear? Here is discrimination that has a telling effect against us *hams*. We don't know how to lobby for useful gains—license plates for our cars, yes, but cash in our pockets, *no*.

For example, why not resolve to build something this year, even if it is only a phone patch or an RF monitor? Rolling your own does make it taste better. And, as Doug DeMaw used to say, "we learn by doing."

For example, why can't we make a determined effort to utilize more of our unoccupied 2 and 6 meter bands, before they are gone? Possession is supposed to be 9/10ths of the law.

For example, why can't more authors and more radio magazines concentrate on showing us how to knock down front end overload by enabling us to make our own filters? And why not special emphasis on tact and diplomacy in handling TVI problems? Must we always be Mr. Meek?

For example, how many revitalizing ham radio club activities? No imagination equals no attendance equals no club. In the same breath, let's have more small ham fests. These very large ones neither satisfy the visitor, the exhibitor, or the sponsoring group, and *oh*, my feet!

For example, let's all join the ARRL and support their cause, which is really our battle. Even though you may dislike them, or disagree with some of the things that are done—(we're not all perfect, you know)—your membership and support is the most logical way through which you can effect any change, not by leaving them and ranting from outside.

For example, as hams, why can't more of us join MARS—either Navy, Army, or Air Force, and prove to our government in the most telling of all ways, that our ham radio is a precious right, for *both* pleasure and public good, rather than something we take for granted like social security and medicare. God knows we've depended too much already on government and not done enough for ourselves!

Gee whiz, fellows—look in the mirror now. Is your face clean?

Herbert W. Gordon WIIBY  
P.S. Don't misunderstand me. I'm no angel! I am in the business of selling exclusively to hams. It's to my advantage to see Ham Radio healthy and pink—not with a white tongue the way it is today.

## HERBERT W. GORDON COMPANY

*"Helping Hams to Help Themselves"*

WOODCHUCK HILL, HARVARD, MASS. 01451

Telephone 617-456-3548



# "THE HAM'S HEAVEN"

## CRABTREE'S ELECTRONICS

PRESENTS

### GALAXY V MARK 2

5 BAND TRANSCEIVER



**NEW**

400 Watts Power

6 WAYS BETTER

STILL ONLY \$420

#### WE WANT YOUR BUSINESS

And we are prepared to offer King-Size trade-in allowances on your present gear. Also, we will give you a quote on any package combination you are looking for. The package price in this ad applies to both cash and charge orders.

*Bob Baker*

Crabtree's Electronics  
Phone 214-748-5361

**WRITE or CALL For Quotes or Trade-in Allowances**

#### ● MONEY SAVING PACKAGE

(DELUXE MOBILE)	Reg. Price
Galaxy V Mark 2 .....	\$420.00
DC35 12V DC Supply.....	99.95
CAL35 Calibrator .....	19.95
MMB Mobil Mount.....	7.95
DELUXE Ball Mount and Spring with 25' RG58 and connector.....	16.20
WEBSTER WMWD Mast and Top Section plus KW Coils 75 thru 10.....	49.45
TURNER 350C Mike and Connect....	8.25
Mobil Log Book.....	.50
<b>REG. TOTAL .....</b>	<b>\$622.25</b>

#### CRABTREE'S ELECTRONICS

2608 Ross Ave., Dallas, Texas 75201

Please ship me the following:

- Mobile Package — \$549
- Galaxy V Mark 2 — \$420
- Free 1967 Catalog with credit form
- Check or Money Order attached

NAME \_\_\_\_\_ CALL \_\_\_\_\_

ADDRESS \_\_\_\_\_

CITY \_\_\_\_\_ STATE \_\_\_\_\_

ZIP \_\_\_\_\_





**The View from Here**  
(Continued from page 2)

about spluttering and misadjusted SSB transmitters, but in many cases the trouble lies right in the complainer's own receiver. If he would put an attenuation pad in the transmission line so the front end wasn't overloaded, the spurious splutter signals would miraculously disappear.

Since single sideband is so much more efficient than AM, a little bit goes a long way, and when conditions are good, receiver overload can be a problem. So, before you accuse another operator of spluttering or broad signals, you had better check his signal on a scope—after turning off the AVC in your receiver.

If you have any other reasons why AM should not be removed from the ham bands up to ten meters, I'd be very glad to hear from you. But before you write, check your facts by reading the references given below.

Jim Fisk W1DTY

**References:**

1. E. W. Pappenfus, W. B. Bruene, E. O. Schoenike, "Single Sideband Principles and Circuits," pp. 3-8, 17-23, McGraw-Hill Book Company, New York, 1964.
2. S. Goldman, "Information Theory," pp. 212-216, Prentice-Hall, Inc., Englewood Cliffs, N.J., 1953.
3. H. D. Hooton, "Single Sideband: Theory and Practice," pp. 15-23. Editors and Engineers, Ltd., New Augusta, Indiana, 1967.



"We run 100 watts barefoot here, OM."

radio amateur  
**callbook**

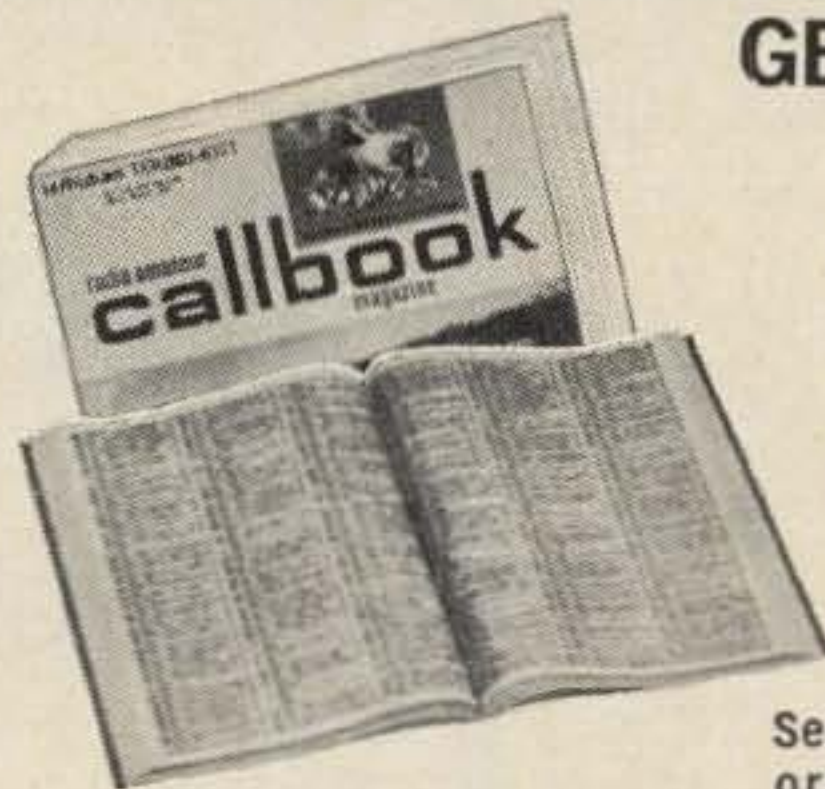

**GET YOUR NEW ISSUE NOW!**

Over 283,000 QTHs in the U.S. edition  
**\$6.95**

Over 135,000 QTHs in the DX edition  
**\$4.95**

See your favorite dealer or order direct (add 25¢ for mailing in U.S., Possessions & Canada. Elsewhere add 50¢).

These valuable EXTRA features included in both editions!

- QSL Managers Around the World!
- Census of Radio Amateurs throughout the world!
- Radio Amateurs' License Class!
- World Prefix Map!
- International Radio Amateur Prefixes
- Radio Amateurs' Prefixes by Countries!
- A.R.R.L. Phonetic Alphabet!
- Where To Buy!
- Great Circle Bearings!
- International Postal Information!
- Plus much more!

**WRITE FOR FREE BROCHURE!**

RADIO AMATEUR  
**callbook** INC.  
Dept. B, 4844 W. Fullerton Ave.  
Chicago, Ill. 60639

**SPACE AGE KEYS**

**Only \$67.50**



- Planar epitaxial *integrated circuits* for reliability. No tubes—No separate transistors.
- Precision feather-touch key *built-in*.
- Fully digital—Dot-dash ratio always perfect.
- No polarity problems—Floating contacts switch  $\pm 300\text{-V}$  @ 100-ma.
- Rugged solid construction—will not walk.
- Send QSL or postcard for free brochure.

**PALOMAR ENGINEERS**

BOX 455, ESCONDIDO, CAL. 92025



**U.S.A. FIRST!  
DOUBLE  
BONUS**

**\$25**

**FREE WORTH OF**  
• Transistors  
• Rectifiers  
• Condensers  
• Diodes  
• Knobs  
• Coils, etc.

Radio, TV Parts. Add 25¢ for handling

**PLUS**

**CHECK HERE**  
**CHOOSE ANY \$1 ITEM FREE**

**BOTH "GIFTS" FREE WITH \$10.00 ORDERS**

**SOLID STATE**

**24 volt 3 amp. DC**

ARC-5 power supplies! **995**  
in 117 VAC, /60

**MOVIN' Special!**

**BEST SELLING**

**1 AMP**



PIV	Sale	PIV	Sale
50	5¢	800	23¢
100	7¢	1000	40¢
200	9¢	1200	59¢
400	11¢	1400	69¢
600	19¢	1600	89¢

**2 AMP SILICON RECTIFIERS**  
• GLASS CAPS



PIV	Sale	PIV	Sale
50	7¢	600	19¢
100	9¢	800	29¢
200	12¢	1000	51¢
400	16¢	1200	69¢

**1. AMP 600 PRV TOP HAT 6 for \$1**

**SILICON RECTIFIERS**



**SILICON POWER STUD RECTIFIERS**

AMPS	Factory Tested	50 PIV	100 PIV	200 PIV
3	<input type="checkbox"/>	7¢	11¢	17¢
15	<input type="checkbox"/>	22¢	40¢	65¢
45	<input type="checkbox"/>	75¢	90¢	1.25
160	<input type="checkbox"/>	2.50	2.95	4.05
250	<input type="checkbox"/>	4.50	5.50	6.89

AMPS	400 PIV	600 PIV	800 PIV	1000 PIV
3	22¢	31¢	40¢	59¢
15	90¢	1.35	1.59	1.79
45	1.59	1.90	2.50	2.95
160	5.75	7.50	9.25	10.95
250	9.59	12.50	15.00	19.95

**FACTORY TESTED \$1 SEMI-KON-DUCTORS**

- 2-85 WATT 2N424 PLANAR, silicon. TO-53 npn ... \$1
- DUAL TRANSISTORS  PNP (2N2807)  NPN (2N2060) \$1
- 100 GERMANIUM & SILICON DIODES, no test ... \$1
- 3-40W NPN SILICON MESA 2N1648, transistor ... \$1
- 4 2N170 TRANSISTORS, by GE, npn for gen'l rf ... \$1
- 10 3 Amp RECT's, studs, silicon, to 800 V no test ... \$1
- 4-2N255 POWER TRANSISTOR EQUALS. ... \$1
- 10 PNP SWITCHING TRANS'TRS. 2N404, no test ... \$1
- 2N3088 "N" Channel FET'S Very High Input Z ... \$1
- 5 2N107 TRANS'TRS, by GE, npn, pop, audio pak ... \$1
- 5-2N1613 3W NPN SIL. 120 mc, by "Rheem" ... \$1
- 3-45 AMP POWER RECTIFIERS, stud, silicon ... \$1

**FACTORY TESTED \$1 SEMI-KON-DUCTORS**

- 10 2-6Amp RECT's, studs, silicon to 800 V no test \$1
- 10 PNP SWITCHING TRANSISTORS, no test. TO5 . \$1
- 4 2N43 OUTPUT TRANSISTORS, by GE, npn. TO5 . \$1
- 3 - "EPOXY" TRANSISTORS 2N3638, by Fairchild \$1
- 10 ZENERS REFERENCES stud, asst types ... \$1
- 25 TOP HAT RECTIFIERS, silicon, 750 ma, no test \$1
- 2-1000 MC-TRANSISTOR 2N918 NPN SILICON . \$1
- 4 2N333 NPN SILICON transistors, Transitron . \$1
- 4 BIDIRECTIONAL TRANSISTORS, 2N1641 ... \$1
- 10 NPN SWITCHING TRANS'TRS, 2N338 no test \$1
- 15 PNP TRANS'TRS, CK722, 2N35, 107, no test \$1
- 15 NPN TRANSISTORS, 2N35, 170, 440, no test \$1
- 30 TRANSISTORS, rf, lf, audio osc-ifs, TO5 no test \$1
- 10 FAMOUS CK722 TRANSISTORS, npn no test . \$1
- 30 TRANSISTORS, rf, lf, audio, no test. TO5 no test \$1
- 4 35-W. TRANS'TRS, 2N1434, CBS, TO10, stud... \$1
- 5 2N706 500MW, 300MC NPN transstrs. TO18 \$1

**SILICON CONTROLLED RECTIFIERS**

PRV	7 AMP	16 AMP	25 AMP
50	48¢	70¢	80¢
100	70¢	1.05	1.20
200	1.05	1.30	1.70
300	1.60	1.90	2.20
400	2.10	2.30	2.70
500	2.80	3.00	3.30
600	3.00	3.30	3.90

**HAM SILICON TUBE SPECIALS**

- 5U4GB ..... 2.39
- 5R4 ..... 4.39
- OZ4 ..... 2.39
- 6AU4GTA ..... 2.39
- 866A ..... 11.19

**1 AMP MICROMINIATURE SILICON RECTIFIERS**

PIV	Sale	PIV	Sale
50	5¢	600	19¢
100	7¢	800	25¢
200	9¢	1000	45¢
400	12¢		

**2N1100 \$1.99**  
VCB (volts) 120

**TRANSISTORS**  
**100 for \$2.98**  
Power, Audio, RF, untested

**ZENER RECTIFIERS**

Watts	Price
1-WATT	.49
10 WATTS	1.00
5.4	18
6.4	20
8.0	22
9.1	24
10	27
12	30
13	33
36	43
39	47
51	51
58	58
62	62
68	68
75	75
82	82
91	91
120	120
130	130
150	150
160	160
180	180
200	200

**GLASS AMP ONE AMP**

PRV may be exceeded without the rectifier breaking down.

PIV	Sale	PIV	Sale
50	5¢	600	19¢
100	7¢	800	29¢
200	9¢	1000	45¢
400	13¢	1200	59¢

**6-MONTHS' GUARANTEE**

Poly Paks, the only company of its kind in the world due to its tremendous purchasing power, quality and factory testing procedures, **GUARANTEES** all items AS ADVERTISED for 6 months or your money back. A 'FIRST' ANYWHERE

**10¢ FOR OUR "XMAS" BARGAIN CATALOG ON:**  
 Semiconductors  Poly Paks  Parts

**POLY PAKS**

TERMS: send check, money order, include postage—avg. wt. per pak 1 lb. Rated, net 30 days. CODs 25%

P.O. BOX 942 A  
SO. LYNNFIELD, MASS. 01940  
"PAK-KING" of the World



**2 1/4" 0-100 MICROAMMETERS**

**DC \$2.88**

**MONEY BACK GUARANTEE**



## Letters

### AM—Sideband Feud

Dear 73,

I just finished reading your "View From Here" in the June issue of CQ. (Sic) Here is my view from Southern California. I think you have expressed your personal opinion without giving much thought to the other side of the page.

I retired about 8 years ago at the age of 70, and for the next four years I spent the most lonely and purposeless life imaginable.

Then a Nephew suggested that perhaps amateur radio would be interesting. He gave me an ARC-2 transceiver and some ARRL books, and after 3½ months of intensive study, I passed the General exam . . . and began having the greatest pleasure I had ever experienced.

. . . After a time, I managed to procure a used communications receiver and a Johnson transmitter. SSB equipment was out of my reach. This equipment has brought me more happy hours than I can tell you and has made the life of an old man seem very worth while.

Every day I talk to many hams who have to get along with used AM equipment for financial reasons.

If you feel that the bands are unnecessarily crowded, why not instigate a campaign to educate the SSB operators in the proper operation of their equipment. Any time of the day or night, SSB can be heard splattering over much more of the spectrum than is necessary . . . sometimes as much as 10 kHz.

Have you ever stopped to think that not a single commercial station, fire dept., police dept., or any organization that wants to get a message through without using phonetics are using SSB?

No one has a SSB rig of the usual 200-300 watts P.E.P. for very long before they want to hook a 2000 watt linear on it and use full power even for a very short-haul QSO. This is totally unnecessary and not in compliance with FCC regulations.

The last paragraph of your editorial about the state of the art is amusing. How many of the SSB operators do you honestly believe are operating in accordance with the state of the art?

. . . I have been a reader and subscriber of 73 since January 1964 and believe you have the best amateur radio magazine published. I have dropped the other two, but I don't think your editorial was in the best interest of amateur radio.

I have never heard Wayne Green make any such statements.

This has been a very long reply to your View From Here, but I believe it has done me some benefit to get it off my chest. I expect it to receive waste basket filing.

Arthur M. Smith WB6MTI  
Riverside, California

Dear 73,

Well, well, I just received my first subscription copy (June 67) to 73 and lo and behold I find in "The View from Here" advocacy of policy which led me to forsake QST.

Your reference to AM and the reasons for eliminating it in favor of SSB suggests that you are confounding the broad purposes of amateur radio by confining it to rag chewers, traffic handlers, and appliance operators. I agree that the AM stations should not complain of SSB QRM or vice versa. I am convinced however, through my experiences in the

industry, that for the sake of the country and its technological resources, the ham experimenter is the largest potential contributor. To maintain his interest, the bands must be available without selected restrictions.

I have a KW of SSB, AM, RTTY and VHF (all home brew) and apply each as the occasion demands.

In 1938 two other stations and my own, were, to my knowledge, the only stations on SSB and we were practically run off the air. How the tides turn!

W. H. Grosselfinger W2ATQ  
Lloyd Harbor, N. Y.

Dear 73,

You've missed one point. There are some of us that simply don't have the price of "a good communications receiver a decade ago." I'm all for SSB, and I'll get it someday, but in the mean time I have a family to support too. Something is better than nothing.

J. Bradley Flippin K6HPR  
Falls Church, Va.

Dear 73,

Don't you feel a more favorable approach to the situation of AM and SSB would be to shorten the CW band and allocate frequencies for both modes? You know as well as I do that a strong SSB signal will take out a weak one and a large percent of SSB fellows don't have their rigs adjusted properly anyway. AM activity has really increased in the past several weeks . . . Wonder why?

Warren C. Shook  
LaFayette, Ohio

Dear 73,

Yesterday I received my copy of June issue of 73 Magazine and after reading "The View from Here" by idiot Jim WIDTY I am most ashamed I am a reader of the magazine.

It is my belief that a magazine should not be so narrow minded as to issue such an article against AM transmission when Sideband had better clean its own doorstep first. They overmodulate and cover from 5 to 10 Kc with heavy linears. There is no courtesy among SB operators as among AM operators. SB at best sounds as though the person was talking with a mouth of hot mush. Not a thing like the clear, understandable reception of AM.

If SB is so great, why don't all broadcasting companies use it?

So I think you should rewrite that article and give AM its rightful place. I have Drake equipment on SB, and a Johnson Viking II on AM, of which will always be my first love.

Claude H. Keneaster WA5LFL  
El Paso, Texas

Dear 73,

Are you proposing that AM be outlawed? If so, I think you are making a big mistake. Please clarify your views.

You mention the contribution of amateurs to the state of the art. How, pray tell, does buying an SSB transceiver, as you suggested, contribute to the state of the art? A CB'er, buying transistorized transceivers also hastened the development of power transistors for use at 30 megacycles. Was this a contribution to the state of the art? If so, give CB'ers the credit.

. . . It was interesting to learn that AM wasn't compatible with SSB. I hadn't noticed. Some of the



**NEW! IMPROVED!**  
**SOLID STATE**  
**FREQUENCY CONVERTERS**



Priced from only **\$14.95** to \$39.95

OVER 5000 FREQUENCY COMBINATIONS FROM  
 .45 MC TO 475 MC AVAILABLE FROM STOCK.

MANY NEW MODELS TO CHOOSE FROM OFFERING A TOTAL OF THE FOLLOWING: Crystal control, variable tuning, UHF epitaxial transistors, FET transistors, noise figures as low as 2.0 db, full wave varactor diode transistor protection, sensitivity better than 2/10 microvolt, fully shielded oscillators and band-pass filters to eliminate spurious frequencies, zener diode voltage regulation, 6 to 12 volts positive or negative ground, slug tuned coils, double tuned R.F. stages, tuned mixer stages, wide band I.F. amplifiers. All this plus the highest quality components carefully assembled, tested, and guaranteed.

We have exactly what you want at a lower price and better quality than you can obtain elsewhere. See our new multiple oscillator converters for monitoring two or more frequencies simultaneously!

24-hour special delivery service available on many models.

Send for your free 1967 converter catalog.

**VANGUARD LABS**

Dept. H

196-23 Jamaica Ave.

Hollis, N. Y. 11423

operators aren't, but that is irrelevant.

If AM (advanced modulation) is outlawed, I shall either move back to CW or go QRT. I can't afford SSB for some time.

My subscription renewal awaits some acceptable explanation for "The View from Here" in June '67 issue. I want to subscribe but I feel that I can't support someone trying to kick me off the air.

Carl "Skip" Roby WB2TCV  
 Corning, New York

Dear 73,

Re your editorial (June '67) . . . your only legitimate reason given for SSB is spectrum clearance, which you promptly discount by suggesting DSB. The rest is mostly invective and high-flown phrases that mean little.

The point is that AM is frequently misused. There are still plenty who allow frequencies over 3 kc to get through the modulator, who run dead carrier, etc. However there are just as many badly adjusted SSB rigs, and properly adjusting an SSB rig, particularly a home-brew one, is tougher than getting good plate-modulated AM.

. . . As to 872 rectifiers, they work good, and don't cut loose on transients, like silicon stacks. They are also cheap if you know where to look.

On VHF, I believe in the dark horse; Future Modulation. There's room for it, and it'll give SSB trouble.

Incidentally, I know good AM when I see it. I'm a broadcast engineer.

Joel S. Look W1KCR  
 Claremont, N.H.

Dear 73,

Well the Editorial in June sounds like ARRL, pro RM 499, Docket 15328 or whatever it was.

May I suggest that the SSB operator who runs a kw that is not linear or is driving improperly is causing more QRM than any AM station ever thought of causing.

. . . I too think AM is a little too wide from the standpoint of spectrum space, but you haven't heard an AM station when told he had a problem, not immediately start looking for the cause and cure. Not SSB, no sir, there must be something wrong with your receiver OM and go right on yakking.

Check with an owner of the most popular SSB tranceiver on the market and see how wide some of the signals are.

I don't advocate anything except deterring the thought that SSB is superior in practice without specialized receiving equipment. By the way, the other SB and the carrier are transmitted along with the wanted SB, they are at a reduced level however.

Let's keep the story straight in 73 and not resort to Huntoon's (ARRL & Me Too) tactics.

If you really want to be narrow—return to CW.

K. Mulkey

Dear 73,

. . . You say AM is dead, when is the funeral? To save space why don't we scrap SSB also and make everyone use CW. Three signals in space of one SSB! And no quacks!

A. S. Johnson W6EPO  
 El Cajon, Calif.

Dear 73,

Mr. Jim Fisk, W1DTY, may be up on the latest transistor circuits, but he could stand a little bit of education in the stand point of amateur radio today. About his brutal beating of AM as a mode of communications, I couldn't be more in disagreement. Jim may be in love with SSB, so let him love it.

Sure side band is more efficient as a communicating mode, but so what? Consider if you will, the person interested in amateur radio. More than likely, he will obtain an inexpensive receiver without a BFO. So, he gets home, turns on his receiver, which is more often than not, a small transistor portable, and all



# HEY! HOW ABOUT THAT

## S.W.R. BRIDGE

- MODEL SWB-2
- READS FORWARD AND REFLECTED POWER SIMULTANEOUSLY
- "EASY READ" METERS
- USE FOR REFERENCE POWER METER
- DUAL 100-MICROAMP METER MOVEMENTS
- LOW INSERTION LOSS
- SIZE-5"X2"X2"

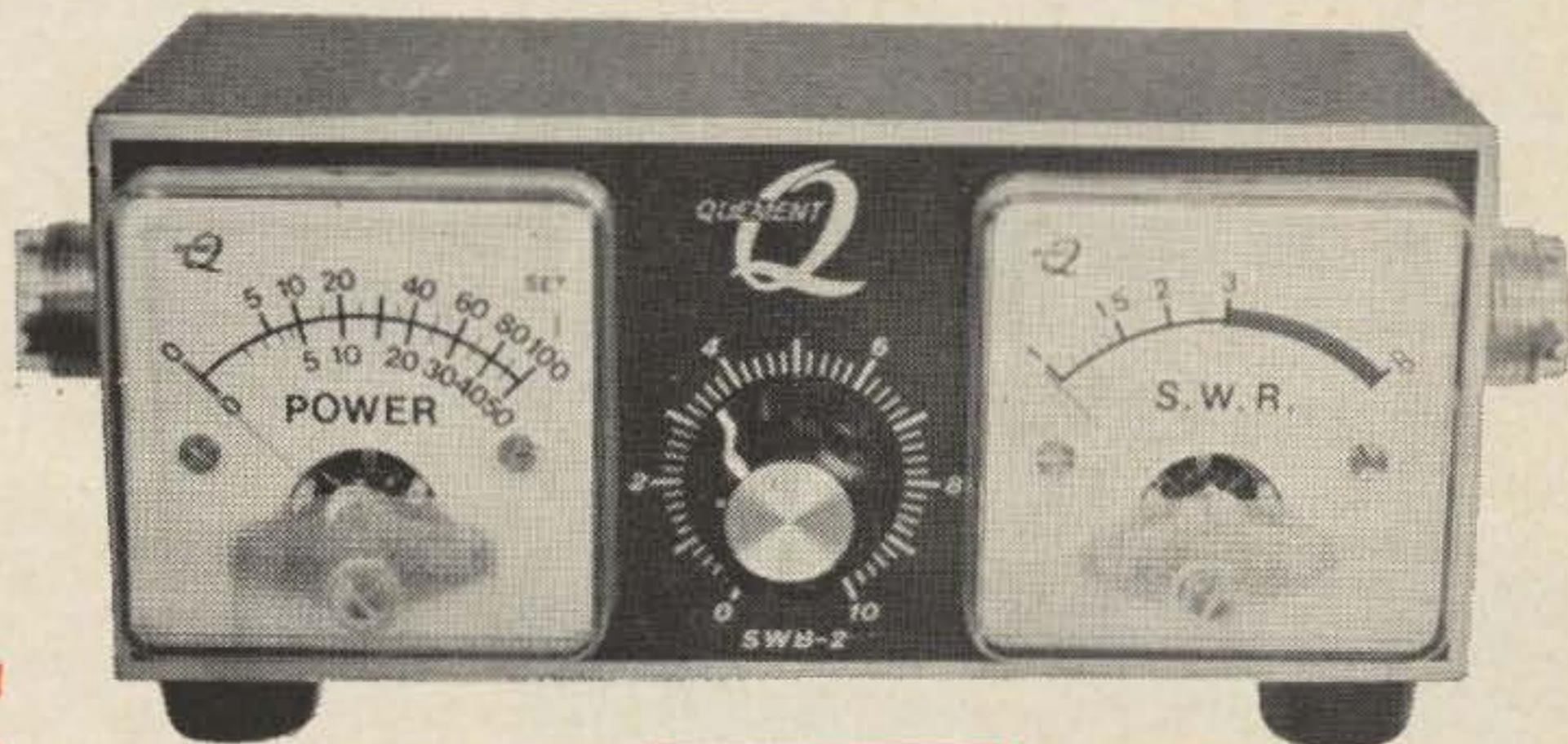

# \$15.95

Allow 50¢ for packing and shipping. California residents include 4% sales tax.

THE BEST VALUE WE HAVE EVER OFFERED!

MAY BE LEFT IN LINE, UP TO 2000 WATTS.

GOOD THROUGH 2 METERS

SINCE 1933

FAST SERVICE

Phone CY 4-0464

# QUEUMENT ELECTRONICS

1000 SOUTH BASCOM AVENUE

SAN JOSE, CALIFORNIA

"Northern California's Most Complete Ham Store"

## ILLUMINATED WORLD GLOBE only \$16.95

plus . . . . FREE . . . a two year subscription or extension to 73



- This 13" globe is just the right size for your operating desk.
- The globe gets you the beam heading for a country quickly.
- Keep it beside the rig and spin to the country you are working.
- Illuminated, makes the shack look really great.
- The lamp is easily changed if it ever burns out.
- For a small fee you can get a new globe to keep up with country changes.
- Complete with desk stand.
- Guaranteed by Hammond.
- Every home should have a world globe.

YES! Send me, immediately, one of those 13" illuminated world globes, with desk stand and lamp. And enter a two year subscription for me to 73.

\_\_\_\_\_ new sub. \_\_\_\_\_ extension of sub.

Name \_\_\_\_\_

Call \_\_\_\_\_

Address \_\_\_\_\_

City \_\_\_\_\_

State \_\_\_\_\_ Zip Code \_\_\_\_\_



## HW12(A), 22(A), 32(A) OWNERS

**New three band modification  
delivers the performance of your  
transceiver on five 200 kc band segments**

Featuring selectable upper or lower sideband, and selectable AVC.

Coverage: 3.8-4.0; 7.0-7.2; 7.2-7.4; 14.0-14.2; 14.2-14.4 Mc.  
Front panel key jack. New front panel and plastic dial included.

**COMPLETE KIT PRICE ONLY \$69<sup>95</sup>**

Send 50c for brochure.

## DYNALAB COMPANY

215-28 Spencer Ave. Queens Village, N.Y. 11427

## VHF-UHF

Converters and Preamps for 50 thru 432 Mc.  
Write for literature.

Send for a sample copy of the VHF'er, the only magazine for VHF and UHF hams.

**Parks Electronics, 419 S.W. First Beaverton, Ore.**

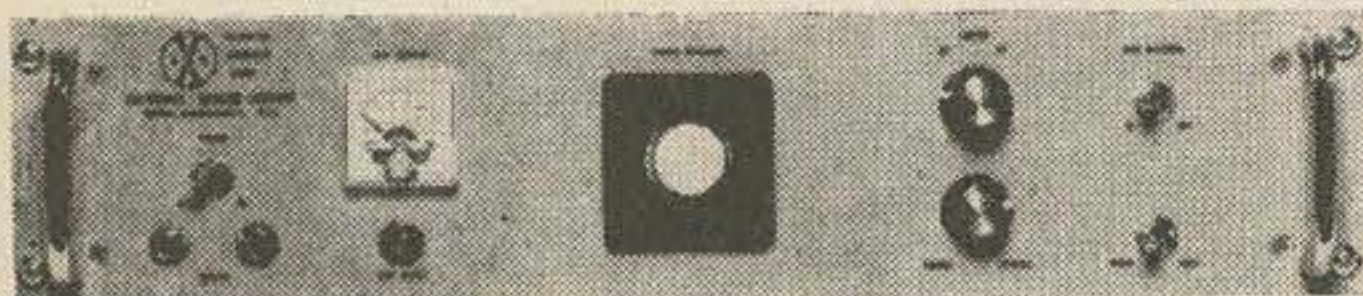

### ALLTRONICS-HOWARD MODEL L RTTY CONVERTER

Telewriter Model "L" frequency shift converter designed for two-tone AM or FM with limiter operation available by switch. Solid state ratio corrector compensates for fading signals. Permits copying on Mark or Space only. Selector magnet dc loop supply built-in with bias supply and octal socket for optional polar relay to key transmitter. 6W6 keyer tube. Plug-in discriminator for 850 cycle or other shifts. Cathode ray or dual eye indicator. Auto-start control system optional. Prices for 19" rack mounting: Model "L" with dual eye \$199. Model "L" with C. R. tube indicator \$279. Cabinet \$19.50

**ALLTRONICS—HOWARD CO.**

Box 19, Boston, Mass. 02101. Tel. 617-742-0048

### DON'T BUY TUBES

UNTIL YOU GET OUR LOWEST PRICES IN THE WORLD ON BRAND NEW SPECIAL PURPOSE, BROADCASTING, RECEIVING TYPES. ESTABLISHED 1920. SEND FOR OUR CATALOG.

**UNITED RADIO CO.**

56-B FERRY ST., NEWARK, N.J. 07105

## WE PAY CASH FOR TUBES

**Lewispaull Electronics, Inc.  
303 West Crescent Avenue  
Allandale, New Jersey 07401**

he hears is something that sounds like monkey chatter. So, having no way to decipher this stuff, he moves away. This is what would happen if AM is outlawed. I will not go so far as to say that if he could understand some of the characters on SSB he would be scared off just as quickly as if he had not been exposed to AM at all.

Don't try to kid me. I've heard several guys after they have been introduced to sideband. They have been changed, and far, far away from better. They go nuts with their power in SSB. These guys find an AM QSO in progress and interfere with it until it ends.

Amateur radio is in a downward fall as it is. A certain select group seems to want to bar all newcomers to the hobby and turn the bands into a huge Citizen's Band.

**Terry Climer  
Lebanon, Tenn.**

P.S. I'm a Novice and I'm proud of it!

*Come on Terry, you're not going to do much operating on the novice bands with a receiver that doesn't have a BFO!*

Dear 73,

Page 2 of the June issue has a very repulsive and untrue innuendo, directed at **amplitude modulation**. It is not Ancient, as you are trying to make your readers believe. It does have many uses, one of which is to introduce speech and music to any continuously generated radio frequency, such as a CW transmitter with 'key down', and also to do likewise to a single or double sideband transmitter with suppressed carrier. Therefore you have contradicted yourself by taking interest in DSB, where amplitude modulation is used, except for the suppression of the carrier. Double-sideband is the same as used by broadcasting stations, and is what I use. The only difference is in whether or not the carrier is present. By using suppressed carrier, and doing a proper job, the receiver has to have added circuitry, to take the place of the carrier frequency which is included in 'unsuppressed' carrier transmission. Otherwise the AM will not, generally, have the fidelity of unsupported carrier operation, and the person on the other end, does not sound the same as when conversing face-to-face.

By your attitude, I must assume that you don't believe in regenerative receivers. Incidentally, they are not obsolete, only the old, inefficient and unnecessarily large parts of such equipment have become obsolete. Spark and arc transmitters are still usable, but the space can be better utilized, and the broadness of transmissions have made the use of such 'early radio apparatus', impractical.

If you are so worried about spectrum space, reflect a moment on 75 and 20 meter phone, and the restriction of class A operators only on those bands. If FCC had different grades of licences, and the higher classes were allowed to operate in more bands than the lower classes, there would be some incentive . . . except for the high cost of getting a license. It used to be FREE.

I am shocked also that any genuine radio amateur would suggest that equipment can be purchased. Instead of being a hobby, it is big business now.

You have also said that AM requires more bandwidth, which is not true when related to the above comment. What isn't compatible is the single-sideband-suppressed-carrier, or in other words, the operation of AM transmitters without carrier, with the AM with-carrier. If suppressed-carrier operation is so wonderful, how come most of the stations need big, high power linear finals? Even SSB-SC does no better when the band goes dead, than conventional AM. They do not have freedom from interference; it inevitable, like death and taxes.

When the "state-of-the-art" becomes the technical standard for the Broadcasting Industry, I'm interested,



and right now that includes double-sideband, low-distortion, high-fidelity, and includes a carrier.

Robert P. Thayer W1PBE

*You're only trying to muddy the water—AM in conventional terms infers a DSB signal with carrier. The use of single sideband by the broadcast industry is not practical because of the millions of table top radios that would have to be scrapped. The fidelity of a properly adjusted SSB system can be just as good as an AM one, but not with the 300 to 3000 Hz filters used in communications equipment.*

Dear 73,

Well, the new Editor seems to have gotten to a rip-roaring start with his "The View from Here" in the June 67 issue. And here, as he predicted, is one of those cries from an isolated corner.

I take neither side in the AM-SSB matter. I have a low power rig of each type on six meters. However, it seems to me that this little essay doesn't fall too short of what might be called a scathing denunciation of any ham using what is a perfectly legal type of voice transmitter—a type being presently manufactured and sold by reputable companies, and described as construction projects in various publications.

Without questioning any of the advantages of sideband, I suspect that the ownership and use of sideband gear sometimes involves a touch of "status symbol" and social snobbery. It isn't that good. Nothing is.

But worst of all is the statement, "As our technology skyrockets forward, there doesn't seem to be an awful lot the backyard experimenter and amateur can contribute".

I imagine there were those who indulged in similar thinking when radio amateurs found it necessary to abandon spark and master the techniques of tube oscillators and amplifiers and when they found themselves shoved off the high end of the broadcast band into the uncharted short wave regions. Yet, who would you say, pioneered these high frequencies and later VHF and made them work? Maybe RCA? Seems to me there's been some pretty damned spectacular backyard skyrocketing going on. And still is.

And so, I take it, 73 editorial policy in this instance would recommend that the ham content himself with his store-bought appliance gear and leave the thinking to the manufacturers. Now what kind of a ham would that be?

Alden Fowler WA9KHM  
Greensburg, Ind.

*Very few hams are actually doing any pioneering work these days—a few yes, but not the number that were twenty or thirty years ago. How many hams have tried the laser, frequency synthesis, phase-lock loops, masers, parametric amplifiers and other such esoteric doodads? For that matter, how many hams could get through the Proceedings of the IRE these days and understand what they read?*

Dear 73,

. . . It appears that you have taken an extremely "anti-AM" stand. Let us look more closely at the arguments you proposed. You say, "Everyone else has gone to more efficient and compatible sideband". True, a lot of amateurs have indeed gone to sideband, but they were literally forced to. They had SSB jammed down their throats whether they liked it or not. If one examines sideband from its early beginning we see that in the late thirties and forties sideband was developed. It didn't catch on partly because of the real expensive equipment needed, partly because of WWII and mostly because there was no manufacturer building and pushing commercial ready built sideband equipment. Then came the fifty's when SSB began to catch on. It caught on because the manufacturers saw a gold mine in it. The manufacturers put on one of the most extensive advertising campaigns ever seen . . . The manufacturers are the real group responsible for the growth of SSB and not the tech-

### VHF FET CONVERTERS

50 and 144 MHZ Converters and Preamps presently available with higher bands soon available!

With commercial design and specs, these devices have low noise figures, low intermodulation and crossmodulation distortion and high image rejection. They are designed for the serious VHF'er and are competitively priced. You cannot buy these units until you've studied our specifications.

Write: TeleTec ASSOCIATES  
PO Box 808, San Luis Obispo, Calif. 93401

*"Your Friendly Supplier"*

FROM STOCK OFFERS

A COMPLETE LINE OF

**Hy-gain**

VERTICAL ANTENNAS

MODEL 18AVQ . . . A high-performance all-band vertical for under \$50.00 . . . You asked for it . . . HyGain built it. Automatic band switching all-bands 10 thru 80 meters. Features individually tuned Hy-Q traps that provide peaked performance on each band. Takes maximum legal power. Feeds with 52 ohm coax. SWR less than 2:1 on all bands. Simple to install on ground or rooftop. Withstands 100 MPH winds when properly guyed.  
Model 18AVQ \$49.95 NET

OTHER MODEL VERTICALS  
IN STOCK.

14AVQ 10 thru 40 Meters \$32.50  
12AVQ 10, 15 & 20 Meters \$24.50

ALSO CHECK WITH US FOR OTHER  
HYGAIN PRODUCTS.



**Evans RADIO**

P. O. BOX 312

CONCORD, N. H. 03301

FONE 603-225-3358

**C  
LINE  
VHF  
UHF**

**FOR THE BEST IN  
VHF-UHF**

- CONVERTERS
- PREAMPS
- EXCITERS
- LINEARS AMPS
- FILTERS
- VFO's

**E. T. CLEGG ASSOCIATES**

Box 376, Morris Plains, N. J. 07950

(201) 267-7414

### MACO QUAD — FOR 10-15-20

Uses SHAKESPEARE FIBERGLAS WONDER-SHAFT® Optimum spacing—.15 on all bands—  
(1) RG-8/U quad complete—\$99.95—WRITE FOR FREE BROCHURE

Maco Products

915 E. Cornell Ave., Springfield, Illinois 62703  
(telephone 217-544-5891)

See our previous ads in April, May and June 1966 73's.



# 10 - 15 - 20 METER MONOBEAMS

**FOR  
MORE  
DX PUNCH**

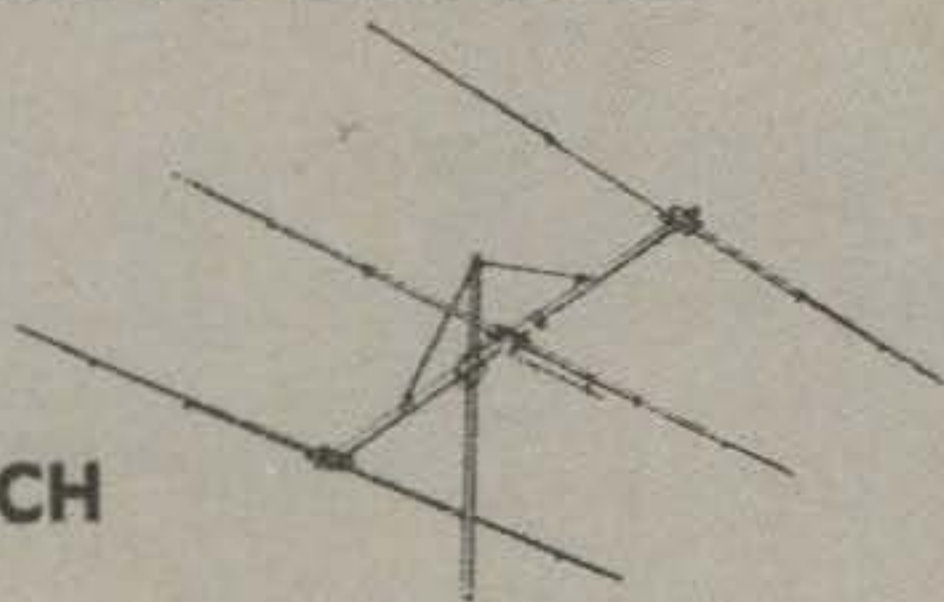

Cush Craft Monobeams combine superior electrical and mechanical features with the best quality materials and workmanship. They will provide reliable day to day amateur communications and that extra DX punch, when needed, for contest work or emergency communications.

A28-3	10 Meter, 3 Element, Boom 10'	\$31.95
A28-4	10 Meter, 4 Element, Boom 18'	42.95
A21-3	15 Meter, 3 Element, Boom 12'	39.95
A21-4	15 Meter, 4 Element, Boom 22'	59.95
A14-2	20 Meter, 2 Element, Boom 10'	49.95
A14-3	20 Meter, 3 Element, Boom 20'	77.50

SEE YOUR DEALER OR WRITE FOR CATALOG.

**Cush  
Craft**

621 HAYWARD STREET  
MANCHESTER, N.H. 03103

## SSB's—SWAN 500's NOW IN STOCK—\$495.00

KWS-1	.....\$795.	Viking 500	.....\$375.
KWM-2	.....795.	NCX-3	.....199.
Poly-Comm 62	.....225.	Eleo 753	.....159.

LARGE STOCK OF USED EQUIPMENT ON HAND  
**FRECK RADIO & SUPPLY CO., INC.**

38 Biltmore Ave., Asheville, N. C. 28801  
Ph. 704-254-9551  
T. T. Freck, W4WL

CLOSED SATURDAYS  
Sandy Jackson, WN4AAL

## COLLINS VFO's

Send For Data Sheet

Type	Used In	Tuning Range	Dimensions	Price
70E-24	75A-4	1.95-2.955 MHz	5x2½" diam.	\$39
70E-23	KWS-1	2.75-3.75 MHz	5x2½" diam.	\$39

Terms cash, full refund if you are not satisfied within 10 days.

**RICHARD E. MANN**

430 Wilmot Road, Deerfield, Illinois 60015

## DXERS and DXERS-TO-BE

Want to keep up to the minute of what's happening DXwise? Subscribe to Gus Browning W4BPD's new weekly **DXERS MAGAZINE**. 16 pages of DX events, coming up DXpeditions, QSL info, pix, etc. Rates, US surface \$8.50. US air mail \$10, West Indies \$16.50, S. America and Europe \$19, rest of world \$28.

**The DXERS MAGAZINE**  
c/o W4 BPD

Route 1, Box 161-A,  
Cordova, S.C., U.S.A.

nical advantages of SSB or the dedication of any individual SSBer.

"Maximum utilization of the bands available" can and will include the use of AM. Is the SSB equipment so poorly made and designed that it can not reject the carrier? If so, then there is a drastic need for improving the SSB equipment and not for forcing or outlawing the AMer off the air.

... As far as AM transmitters being "ineffective" I don't think so. ... Any high level plate modulated AM transmitter can come within a few dB of a SSB transmitter. However you cannot compare a screen modulated or grid modulated transmitter with SSB. There is no comparison. SSB will win every time. When an ultra-modulated AM transmitter is used it can beat an SSB transmitter when both run the same rf power input ... on ultra-modulated AM we can modulate over 100% with little distortion or spluttering. We could modulate 300%. This would give us 4500 watts of audio in the sidebands, which is perfectly legal. Ultra-modulated AM beats SSB all to heck.

... AM is indeed compatible. True it is not compatible with SSB but neither is SSB compatible with AM. SSB hasn't done much for the "state of the art" either. A well designed AM rig is efficient and it is very effective.

If ever AM should be discontinued it should be done by consent of only the AM operators. The editor used the word "eliminated" which is a rather ominous and threatening word. The choice of that word was a big mistake. It will solidify the AM'ers and not destroy them. AM will be around for a long time to come, and I will be operating it.

Ronald Zurawski WA8FVD  
Menominee, Mich.

*You'd better take another look at the textbooks—AM is not as efficient nor as effective as sideband, ultra-modulation or not.*

Dear 73,

Read your article from here to now. Partly I'll agree with you. I am an old timer who returned to the ranks of ham radio a little over two years ago as a Tech. I used to be W8BZT in the 20's, but let my ticket get away from me. I decided to return, failed the code twice and was ready to give up when the FCC officer suggested that I get the Tech., so I did.

I have been having a lot of fun on 50 MHz but one thing bugs me. If you want to get on the low bands, you must have a kW SSB or you don't make many contacts.

We are not hams anymore but appliance operators. In the old days, you had to build your own gear, antennas, and all. Now days, 80% of the new comers don't know how to build anything. All they need is money. Building is part of the fun and I still do some but I doubt if I could build a SSB rig and make it work.

... I would like to see the Techs get to use 80, 40, and 15 meters for CW. Maybe then there would be more chance to get a general. Maybe I'm getting old, but I think a lot of the fun has been taken out of ham radio by commercial building of ham gear. When a hobby begins to cost too much money, it ceases to be a hobby and becomes a burden. There may be a lot of hams that won't agree with me, but most of the old timers will. Ham radio isn't what it used to be. I know as I started out on the 200 meter band in 1923.

Keep up the good work. Maybe ham radio will come back.

G. M. Cooley WA4JYR  
Dunedin, Florida

*I agree, hams should do more building. And, if you can build a communications receiver, you can build a sideband transmitter.*



## Bouquets and Such . . .

Dear 73,

. . . This past year I have been taking 73, QST and CQ, however, I think 73 is the only one of the three worth the subscription fee. I have built several projects from your very fine construction articles and have been well pleased with all of them. Keep up the fine work and 73 to all at 73.

Roy Hook WN8UHB

Dear 73,

I have been reading 73 regularly for a year and it seems that your magazine is getting better every time. The May issue on Quads was very good, and the toroid article in June just fabulous.

I noticed in an ad for the Davco transistorized receiver that your report on this receiver came out almost a year before the report in CQ and almost a year and a half before the report in QST, so you are absolutely right when you say your articles are up-to-date.

I just thought I'd say thanks for a job very well done and keep up the excellent work!

Bob Zulinski WA8MAN  
Berkley, Mich.

Dear 73,

The March issue of 73 was tremendous!! I would like to see you have an article on a transistorized transceiver (80 - 6 meter, SSB - CW) or separate transmitter/receiver, using FETs. Also, how about a column for the beginning ham (simple antenna matches, etc.). Anyway, when I saw the cover on my last issue, I pushed the panic button and here is my five bucks for another year of 73.

John Ray WB4BFS  
Athens, Tennessee

Dear 73,

Yes, my subscription to 73 Magazine expired, and I let it die right there. Today I was in Bud Electronics Supply to get some coax, and there on the counter was your current issue.

. . . The ad placed by Newsome Electronics . . . with some 6 meter gear was worth the price of the magazine, but . . . the page after page of ramblings by Gus bored me stiff . . . he even tells what he ate, and goes on to try and convince me that there are MDs who leave the operating table to make a QSO with him . . . how silly.

Then we get the page after page of your fan mail. Sooo, I felt you might like to know what I had for supper. I had a hot black coffee as soon as I got home, then about 6 p.m. sat down to some big fat hamburgers, good corn and mashed potatoes, plus some meal bread with apple butter on top, and a glass of milk.

Do you want some copies of my fan mail. I get them in my line of work too, and will be glad to run off some copies for you . . . I'm sure you'd find them of similar interest.

Don't worry . . . I can't go on much longer missing out on my own personal copy of 73, and my subscription will be forthcoming.

Bud Sunkel  
Rossville, Illinois

Do you call those letters on the past few pages fan mail?

Dear 73,

I have been reading and re-reading my April 73 for several weeks now, and am convinced that 73 is the best magazine for the builder and the ham who is interested in keeping up with the state of the electronic art.

. . . Although I am a League member, I think that the staff at 73 has a good thing going for them, and I sincerely hope you keep up the good work.

In the April 73, I was particularly interested in your

## ANTENNA SPECIALS

Hy-gain	was	Special
5BDT	39.95	24.50
4BDT	29.95	17.50
3BDT	19.95	12.50
2TD traps	14.95	9.00
TH-2 Beam	74.50	50.00

## H C J ELECTRONICS

E. 6904 Sprague Ave.  
Spokane, Wash. 99206



### TUNAVERTERS!!

10 to 2 meters for HF & VHF AM-FM Marine, SW, and Police, Fire, etc! Tunable RF converters.

For all auto and home radios! Transistor & 6-l tuning!

(See Complete listing in Apr. '67 73 ad, page 107.)  
Dept. 79, Woodsboro, Texas 78393

HERBERT SALCH & CO.

## SURPLUS NEEDED

Guaranteed highest prices. Shipping paid. We'll buy, trade or give you new equipment of your choice. Send list or telephone for immediate quote. Payment in 24hrs

**MILITARY ELECTRONICS CORP.**

SPACE ELECTRONICS DIVISION

4178 PARK AVE., BX., N. Y. 10457 • (212) CY 9-0300

### SUMMER BONUS SPECIAL

Free Matching AC Supply with the Following Rigs	
Galaxy V Mk II ..\$420.00	Ham-M w/c .....\$ 95.00
Drake TR-4 ..... 599.95	Hy-Gain 204BA ... 100.00
Swan 500 ..... 495.00	Ily-Gain 18HT .... 125.00
Swan 350 ..... 420.00	Mosley Classic .... 109.00
R4-A & T4-X .... 799.00	Turner 454X Mike.. 17.00

SAVE EVERY DAY AT

**EVANSVILLE AMATEUR RADIO SUPPLY**

1629 S. Kentucky Ave., Evansville, Indiana 47713  
Bill Ogg—WA9RMO Dave Clark—WA9RFK

## oscillator/monitor

- a sensitive broadband RF detector gives audible tone signal in the presence of any RF field from 10mw to 1 kw and 100kc to 1000mc
- a CW monitor with positive "RF" switch uses only 8" pickup antenna and NO connection to rig or key
- a code practice oscillator with adjustable tone & built in speaker
- high gain 4 transistor circuit powered by long life AA pencil
- 16 gauge aluminum cabinet in white & black epoxy finish, 3 1/2" by 2 3/8" by 1 1/4", weight 8 ounces
- 100% US made and guaranteed



**1295** (batt incl)  
ppd usa & can  
send cert ck or m.o.  
ny res add 5% tax

**the James research company**  
11 schermerhorn st., brooklyn n.y. 11201



### VHF SPECIALISTS

featuring  
VHF-UHF Converters  
High Power Linear Amplifiers  
Custom IF Strips and Local Oscillators  
Reasonable Prices

#### Contact VHF SPECIALISTS

P.O. Box 474, Port Hueneme, Calif. 93041  
Phone (805) 649-9058

## FREE ARCTURUS CATALOG

**A Trusted Name in Electronics Since 1925**  
Electronic parts, tubes. Wholesale.

Thousands of items. Unbeatable prices.

### ARCTURUS ELECTRONICS CO.

502 - 22nd St., Dept. ST, Union City, N. J. 07087

**BARBER TRAVEL . . .** we like to think of ourselves as the ham's travel agency. For Ham-Hops, personal tours, or DX-peditions or make it a fly-drive tour (we loved it). You pay no more for expert assistance, and you don't have the headaches.

**BARBER TRAVEL** — Ruth Barber K1IIF — Jack Barber K1PRT. 711 Cottage Grove Road, Bloomfield, Conn. 06002 (203) 242-2279.

### Interested in VHF?

Then why not send for a free sample of the VHF'er Magazine. It's devoted entirely to serious VHF and UHF hamming. It contains articles by well-known and capable VHF'ers. All who want to improve their knowledge of VHF are invited to subscribe.

### The VHF'er

Parks Laboratories  
419 SW First, Beaverton, Oregon

## A. R. C. Sales

**Variable Capacitor.** Four section. 7.5-425 mmf. per section. 30-1700 mmf. overall. 3½" w x 1⅞" h x 6⅞" long plus ½" for ¼" shaft. Wt. 3 lb. . . . . \$4.95  
**Filament and Bias Transformer.** 115v. 60 cyc. pri. Sec. 1—12.6v C.T. @ 7.5 amp. Sec. 2—185v @ 50 ma. Wt. 7 lb. . . . . \$4.50  
**Plate Transformer.** Pri. 117v. 60 cyc. Sec. 690v @ 450 ma. No C.T. Will double to 1700 volts. Wt 19 lb. . . . . \$3.95  
**Plate Transformer.** Pri. 117v. 60 cyc. Tapped Sec 1200v C.T. @ 200 ma. and 740v C.T. @ 235 ma. Wt. 12 lb. . . . . \$3.25  
**Heavy Filament Transformer.** Tapped Pri. 115-125v. 57-63 cyc. Sec. 1—6.3v C.T. @ 15 Amp. Sec. 2—6.3v C.T. @ 5 Amp. Wt. 10 lb. . . . . \$3.50  
All items are new and F.O.B.. Worthington, Ohio

### A.R.C. Sales

P. O. Box 12, Worthington, Ohio 43085

comments on the ARRL, and the difficulty with which ham gear is obtained in various foreign countries. . . . . why not have a column in 73 devoted to matching foreign operators, wishing to set up stations, with American hams who wish to help them get started. I feel sure that many of our number would be interested in this, as it would help to insure that we will be able to keep our present bandspace, even in the face of commercial competition.

I hope to hear from you on this idea in a future edition of 73.

Ken Vincent WA7EFP

Dear 73,

Just wanted to say thanks to Jim Fisk, W1DTY, for a very nice "The View from Here" in July 73. It is the most sensible thing I have read in 73 in a long time.

We need to help and train more new hams, but not let the gate down for them to get in. We just had that experience and you can see what happened.

Herman Whatley W5IJQ  
Pampa, Tex.

Dear 73,

I was very pleased to find in the July issue of 73 Jim Fisk's article on public relations in ham radio. I hope many hams read this article and take it seriously because Jim spoke the truth. As president of our local high school radio club, I hope to initiate a drive for more public relations in our area. If you have any literature or suggestions that might help, they would be appreciated.

Rick Acuncius WA9SOF  
Bunker Hill, Ill.

Dear 73,

. . . . . You don't have to be a graduate of M.I.T., or a slip-stick artist to use the articles in the magazine. That is the best part of it.

Regarding your article on the decline of ham radio, I would also say that the "DX business, especially on 20 meters" is also hurting ham radio. When you listen on that band a bit, you commence to get a sea-sick feeling over the hello-goodbye, send your QSL to my agent, type of stuff. Since when does a ham operator have to have an agent like a movie star and do they get ten percent commission? Everyone to his own choice, I guess, but for my money it is more pleasure to deliver a message from some overseas man to his relatives and hear the heart-felt thanks you get, than all the QSL cards in the world . . . and I have enough cards to paper the shack.

P. B. Dunn W6WPF  
Northridge, California

### Thank You

Dear 73,

. . . . . I wish to offer my sincere thanks to two particular (ham) operators in Wellesley and Hingham, Mass. My wife died of a heart condition while visiting our son who is attached to the Embassy in Santo Domingo.

My only contact with him down there was by these two operators who even were nice enough to call my home by telephone and let me listen to all the details! I will be forever grateful to these two men who in my bereavement put themselves out of their way to keep me in contact. I wrote down their names and stations, but somehow during that time, I mislaid it. Hoping that they read this in your magazine, I remain gratefully.

William F. Leary  
Hyde Park, Mass.

*Thanks should go to Sylvester Connolly W1MD in Hingham, Al Graf W1OQP in Wellesley and HI8XDC in Santo Domingo.*



**New Use for Old Tubes**

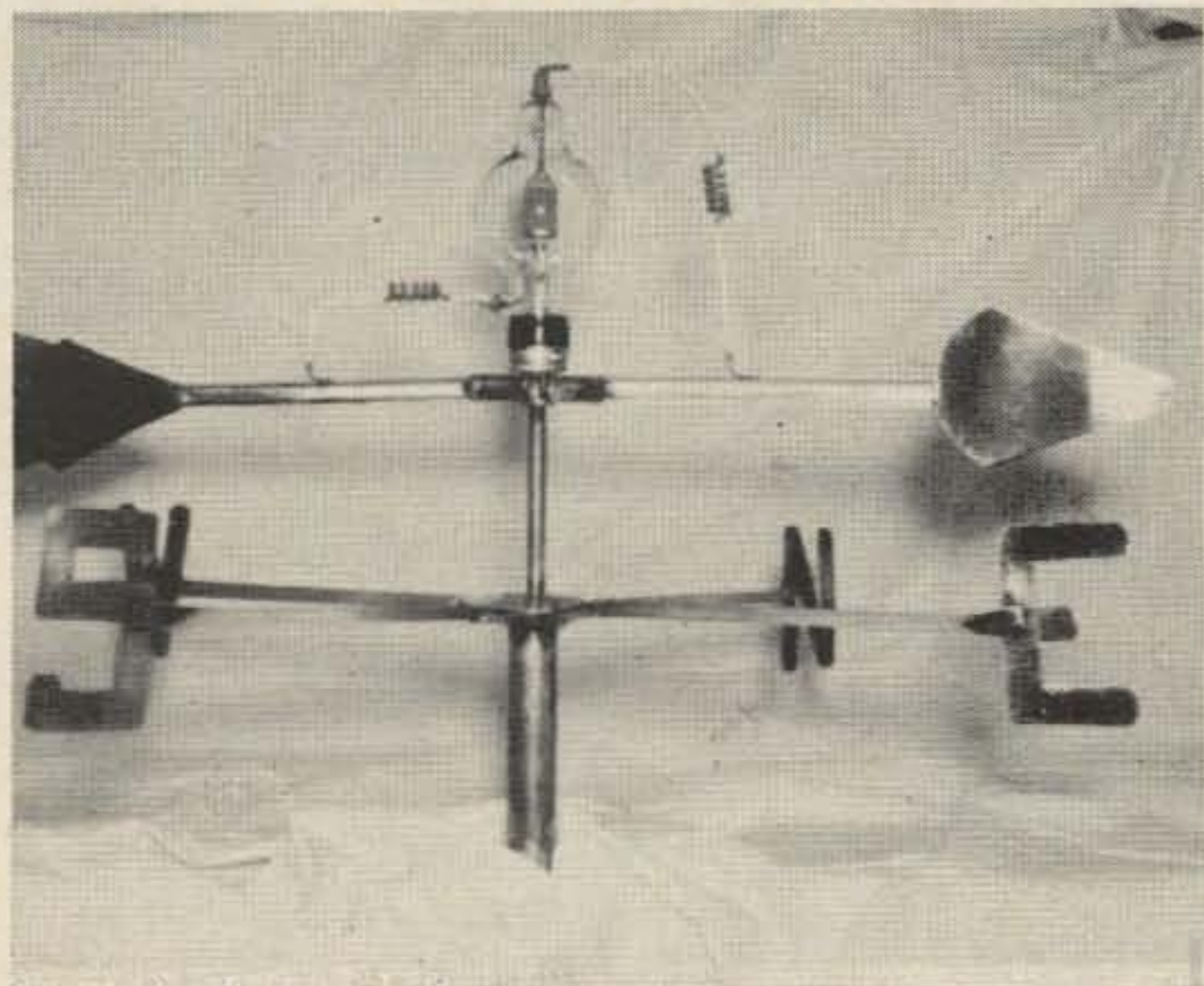

Dear 73,

Enclosed find a picture of a weather-vane I built for a fellow ham to mount on his tower. It is of copper, and stainless steel with 100th wired on top!! Hi . . .

A new use for the 100th?

Joseph Strolm  
Norwalk, Conn.

**Far-East Phone Patches**

Dear 73:

I am aboard a destroyer stationed in the South China Sea. About once a month the ship ties up in Subic Bay, Philippines. So far I have found no amateurs in the area. Could you please pass on to me information about amateurs in the Subic Bay-Manila area who could handle phone-patch traffic back to the states?

Bruce Adams  
Asst Commo Officer  
USS Brush (DD-745)  
c/o FPO San Francisco 96601

Can anyone put Bruce in touch with a MARS station in the Philippines?

**Gravity**

Dear 73:

The Mahlon Loomis Scientific Foundation, P. O. Box 6318, Washington, D. C. 20015, devotes a major portion of its activity to investigation including communication and motivation. Hams interested in more information should write to Mr. Thomas Appleby, Director.

Howard Pyle W7OE  
Mercer Island, Washington



"How about killing the plate power while I'm neutralizing the final?"

**FOR THE FIRST TIME**

**A COMPLETE LINE OF  
BROADBAND BALUNS**  
From The Quality Leader

**NEW LOW PRICES**

Model	Impedance* Ratio	Power (PEP)	Price Ppd. in USA
6010	50U-50B	2 KW	\$15.95
6011	50U-200B	2 KW	15.95
6012	50U-200U	500	14.95
6020	75U-75B	2 KW	15.95
6021	75U-300B	2 KW	15.95
6022	75U-300U	500	14.95

\*U—Unbalanced  
B—Balanced

All Units are Rated at Full Power from 2-32 mc  
Complete with Hardware & Mating Connector

**NEW**

- Model 615 Toroidal Filament Choke—3-30 mc —15 amp cont.
- Completely encased and ready for mounting
- Now used in the Henry 2K and 4K amplifiers!

**ONLY \$10.95 PPD. USA**

TRANSLAB INC.

Creative Concepts in Communications



4754 FEDERAL BLVD. SAN DIEGO, CALIF. 92102 TELEPHONE 714/263-1876

GUARANTEED RECONDITIONED



HAM GEAR

Phone: (415)  
DI 2-5737

**ELECTRONICS**

WRITE NOW  
FOR MONTHLY  
FLYER.

999 HOWARD AVE-BURLINGAME, CAL.

**SALE**

- BC-611 Walkie-Talkies, used good, w/o batts, ....\$15 ea.
- Bendix 3611 Interphone, new w/tubes & dynamotor, ..\$4 ea.
- BC-458 transmitter, certified ..... \$7.50 ea.
- Transistorized Wireless Intercom., 110/220 VAC  
50/60 cycles, per pair .....\$20.00
- Transistorized Telephone Amplifier .....\$10.00 ea.

**TALLEN CO. INC.**

300 7th Street, Brooklyn, N.Y. 11215, Phone 212-499-6300



*Gateway  
Tower Co.*

7530 BIG BEND  
ST. LOUIS, MO. 63119  
(314) 644-1500

**ALUMINUM TOWERS**

Send postcard for Literature



Hundreds of Bargains

# ...SO WHY PAY MORE FOR THE BEST!

Instant Credit, Instant Shipment On Time Payments & Cash Orders



Trigger Electronics is as near as your phone



...or your mailbox



Trigger—for the most complete inventory of amateur and CB equipment. Everything in stock for your convenience!

Trigger has cut the red tape of time-consuming credit delays. Just pick up the phone and call us (no collect calls, please) and your goodies will be on their way—usually the same day!

another important TRIGGER service:  
**WE BUY USED HAM GEAR FOR CASH**  
 PROMPT SERVICE...  
 PROMPT CASH!



No company processes foreign orders and inquiries with greater dispatch than Trigger

TRIGGER Attn: W9IVJ

7361 North Avenue  
 River Forest, Illinois

RUSH THE FOLLOWING:

Amount  
 Enclosed

NAME \_\_\_\_\_

ADDRESS \_\_\_\_\_

CITY \_\_\_\_\_ STATE \_\_\_\_\_ ZIP \_\_\_\_\_

ORDER BLANK TO: trade ur present gear, order equipment, sell ur gear for cash.

STORE HOURS Weekdays 11:00 A.M.—8:00 P.M.  
 (CENTRAL TIME) Saturdays 9:00 A.M.—3:00 P.M.

ALL TELEPHONES (312) 771-8616

## WHY IT WILL PAY YOU TO DEAL WITH TRIGGER

- Amazing Trades
- No Down Payment Required
- Low Budget Terms
- Midwest Bank Credit Cards Accepted
- Fast, Efficient Service
- No Waiting
- 20 Minutes From Downtown Chicago Or O'Hare Airport
- Near Junction Of Routes 64 & 43
- Plenty Free Parking
- Open Weekdays Until 8:00 PM
- COME IN, BROWSE AND GET ACQUAINTED, AND SEE THE MOST COMPLETE INVENTORY OF HAM AND CB GEAR—ATTRACTIVELY DISPLAYED.

## NEW EQUIPMENT ON LOW BUDGET TERMS

Ameco	Hallicrafters	Numechron
Astatic	Hammarlund	Regency
B & W	Hy-Gain	S B E
C D R	Johnson	Shure
Cush-Craft	Mark Mobile	Swan
Dow Key	Millen	Trimm
Drake	Mosley	Vibroplex
Eico	National	Waters
Finco	New-tronics	Weller

and many other major brands

## LIKE-NEW EQUIPMENT ON LOW BUDGET TERMS

- Ten-Day Trial
- 30-Day Guarantee

Tops in performance and appearance, thoroughly and beautifully reconditioned, and clean as a pin. Alignment, calibration as good as new, and frequently better. Listed below are but a few of the hundreds of items and accessories currently available. Write for complete listing and prices.

### LIKE-NEW BARGAIN SPECIALS FOR SEPTEMBER

DRAKE TR4.....\$519	SX111.....\$147	GALAXY 36 AC...\$239
DRAKE R4A..... 339	SX115..... 379	HQ100A..... 134
DRAKE T4X..... 339	SX122.....209	HQ145C..... 169
SWAN 350..... 299	SX130..... 127	HQ170AC..... 279
SBE 34..... 349	SX140..... 77	SP600JX..... 399
SB2LA LINEAR... 199	NC109..... 79	SB300..... 199
CLEGG 66ER..... 149	NC125..... 89	DX100B..... 87
INTERCEPTOR... 257	NC183D..... 199	HX10..... 219
JOHNSON RANGER. 89	NC303..... 239	SENECA VHF1.... 177
KNIGHT T150A... 87	NCX3..... 179	HA14 & HP24.... 137
AMECO TX62..... 119	NCX5..... 389	CENTRAL 100V... 379
S108..... 74	NCL2000..... 499	PSH LA400C.... 119
SX110..... 79	GONSET G77A.... 77	HICKOK 752A.... 249

### LIMITED QUANTITY NEW EICO KITS

753K SSB TRANSCEIVER \$149.95  
 751AC or 752DC \$59.95  
 720-90 WATT CW \$67  
 723-60 WATT CW \$39  
 722-VFO W/AC SUPPLY \$34

SPECIAL

SPECIAL

A SMALL DEPOSIT WILL HOLD ANY UNIT ON LAY-AWAY.

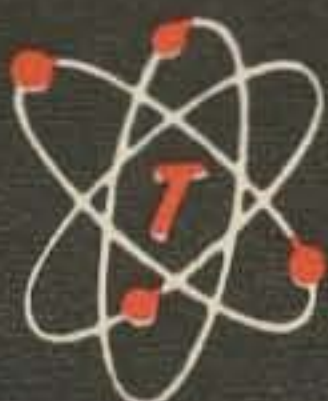

**TRIGGER** Electronics  
 7361 NORTH AVE. • RIVER FOREST, ILLINOIS 60305  
 (WEST SUBURBAN CHICAGO)

SUNDAY TELEPHONE SERVICE  
 11 A.M.—3 P.M.



## Caveat Emptor?

- ★ Price—\$2 per 25 words for non-commercial ads; \$5 per 25 words for business ventures. No display ads or agency discount. Include your check with order.
- ★ Type copy. Phrase and punctuate exactly as you wish it to appear. No all-capital ads.
- ★ We will be the judge of suitability of ads. Our responsibility for errors extends only to printing a correct ad in a later issue.
- ★ For \$1 extra we can maintain a reply box for you.
- ★ We cannot check into each advertiser, so Caveat Emptor . . .

**VOTE! VOTE! VOTE! HAMS!** National incentive licensing poll! Vote for or against, signing your call and handle on QSL or postcard. Now! Results petitioned to FCC. Spread the word fast. Vote today. Rush your vote to SCCARC, Dept. 73, Box 685, Moravia, N.Y. 13118.

**CONVERTERS.** World's largest selection of frequencies. Ham TV vidicon cameras and parts at low factory-direct prices. See them now in our full page ad in this issue. Vanquard Labs, 196-23 Jamaica Ave., Hollis, N.Y. 11423.

**RTTY GEAR FOR SALE.** List issued monthly. 88 or 44 mHy torroids 5 for \$1.75 postpaid. Elliott Buchanan & Associates, Inc., 1067 Mandana Blvd., Oakland, California 94610.

**LICENSE PLATE** call letters only \$1.00. With reflective paint \$1.50. Special club rates. Guaranteed. Permanent. Impressive. E. L. Crouch, K4ANE, 2040 Broad St., Paducah, Kentucky.

**TELETYPE EQUIPMENT** for sale: Polar relays, \$2.50; PR sockets \$1.75; 3-headed TD with sync motor \$60.00; Sync motor \$10.00; Other parts available. B. L. Ferris, K4AWR, Box 672, East Flat Rock, N.C. 28726.

**W9 DX CENTURY CLUB** will hold this year's meeting on September 16 at Holiday Inn of Chicago—O'Hare, Schiller Park, Illinois. G2MI, RSGB QSL Bureau, will be guest DX personality.

**HY-GAIN 18-AVQ**, brand new in original box. Going for full size 80-meter vertical. Delivered prepaid, \$39.50. WØRA/1, Box 115, Greenfield, N.H. 03047.

**LOUISVILLE HAM KENVENTION:** September 8-9, 1967. Beautiful Executive Inn Motor Hotel, Waterson Expressway at State Fair Grounds, Louisville, Kentucky. Participate in the technical sessions, forums, prizes, banquet and flea market. Bring XYL for day of women's activities. For information write Louisville Ham Kenvention, Box 20094, Louisville, Kentucky 40220.

**TEKTRONIX 511AD** 10-MHz scope. Clean with book. Usually \$200 or more from dealers, \$150.00. Popular TS-47A Test Oscillator, 40-500 MHz. CW, AM, Pulse modulation. See June 65 73. Perfect for antenna work and converter alignment, \$75. Knight C-577 compressor, \$10. Power devices regulated power supply, 100-400 V at 200 mA, \$15. Turn on with a three-channel solid-state color organ. Wild for parties, \$75. CushCraft 16 element colinears for 2 and 432, \$10 and \$5. Coveya 6—the six-meter antenna that looks like a TV antenna, but gives 10-dB gain, only \$20. Paul Franson WA1CCH, 38 Heritage Road, Acton, Mass. 01720, 617-263-3184.

**KNOB FOR COLLINS 75A** receivers, 6 to 1 reduction, \$7 postpaid. Jules Wenglare, W4VOF, 1517 Rose St., Key West, Florida 33040.

**CLEGG VENUS** mint condition. Hy-Gain beam. Alliance rotator. Expenses force sale. \$400. John Mrozinski, WB2EXI, 155 Eckford St., Brooklyn, N.Y. 11222.

**CENTRAL ELECTRONICS 20A** like new with 458 VFO, \$75.00. HQ-129X with speaker and Q multiplier, \$50.00. Dick Acker, W9TOK, 5434 S. Kostner Ave., Chicago, Illinois 60632.

**SPECIAL SALE:** Three-transistor converters, 50-54 mc in, 14-18 mc out. Wired, tested, printed circuit. Crystal controlled, \$6.00. Tuneable, \$5.00. Syntex, 39 Lucille, Dumont, N.J. 07628.

**RITTY MODEL 14** transmitter distributor wanted. Please write me. Dave Deatrick, WA8OLD, 2940 Hickory Lane, Ann Arbor, Mich. 48104.

**QSL CARDS????** America's finest samples 25¢ Deluxe 35¢. Sakers Printers, W8DED, Holland, Michigan 49423. (Gospel QSL samples 25¢).

**VIKING 500, \$225.** Viking SSB adaptor, \$135.00. SX-101-A, \$175.00, excellent condition. W6FZB, Lou Brummel, 2620 Aragon Way, San Jose, California 95125.

**WANTED: HRO-5**, good mechanical shape, with coils. Also, Burnell S-15000 50kc SSB filter. John Fredericks, K7GGJ, 314 S. 13th Ave., Yakima, Washington 98902.

**SALE:** Collins KWM-2, 516F, 30L1, with speaker and phone patch, including cables and manuals, complete, \$1200.00. W4DNT, D. F. Fleshren, 7305 Valleycrest Blvd., Annandale, Virginia 22003, phone 703-560-3604.

**THE FRIENDLY FAVORITE:** Warren, Ohio, A.R.A. Hamfest, August 27th, Newton Falls. Follow arrows from route 534 and Turnpike exit 14. Contests, swapshop, XYL-YL program.

**WANTED:** All types of aircraft, ground radios and tubes, 4CX1000A's, 4CX5000's, 304TL's, etc. 17L7, 51X, 618S, 618T, R388, R390A, GRC units. All 51 series. All Collins ham or commercial items. Any tube or test equipment, regardless. For fast, fair action. Ted Dames Co., W4KUW, 308 Hickory St., Arlington, N.J. 07032.

**DUMMY LOAD** 50 ohms, flat 80 thru 2 meters, coax connector, power to 1 kw. Kit \$7.95, wired \$11.95 pp Ham KITS, Box 175, Cranford, N.J.

**WANTED:** Tubes, transistors, lab instruments, test equipment, panel meters, military and commercial communication equipment and parts. Bernard Goldstein, Box 257 Canal Station, New York, N.Y. 10013.





## Master Code

the sure and easy way

**TELEPLEX METHOD** Code Instruction gives you training that makes you proud of your accomplishment. The greatest pleasure derived from any hobby is an exhibition of your

skill. Shaky speeds of a few words per minute may be gained in most any haphazard, hit-or-miss system. Professional skill will be gained only from professional training. Brochure 7-5 is free—it gives you the facts.

### TELEPLEX COMPANY

739 Kazmir Court, Modesto, Cal. 95351

**LARGEST SELECTION in United States  
AT LOWEST PRICES—48 hr. delivery**

**JAN  
CRYSTALS**

Thousands of frequencies in stock. Types include HC6/U, HC18/U, FT-241, FT-243, FT-171, etc.

SEND 10¢ for catalog with oscillator circuits. Refunded on first order. 2400B Crystal Dr., Ft. Myers, Fla. 33901

## WANTED ALIVE

all your surplus  
**VACUUM TUBES**  
&  
**SEMI-CONDUCTORS**

cash in on your left over stock,  
production over runs & design  
obsolescence.

### REWARD-CASH

WRITE, WIRE or PHONE  
for our **TOP DOLLAR** quotation

(201) 351-4200

**UNITY Electronics**

107 Trumbull St.,  
Elizabeth, N.J. 07206

## GO COMMERCIAL . . .

That's right. Get your FCC commercial operator's license, and then work, at good pay, in your "hobby" field—radio and electronics. We prepare you by correspondence, under our "get your license or your money back" warranty. Get full details in our free "FCC License Course Brochure". Write:

**Grantham School of Electronics, Dept. R.  
1505 N. Western Ave., Hollywood, Calif. 90027**

**SELECTRONIX AUDIO FILTER**, use between receiver and speaker or phones, cuts monkey chatter and narrows band pass to about 1000 Hz. Some QSO's possible only with this in circuit. \$24.95 pp. WØRA/1, Box 115, Greenfield, N.H. 03047.

**NOVICE AND TECHNICIAN HANDBOOK** by W6SAI and W6TNS. Limited quantity for only \$2.50 each. 73 Magazine, Peterborough, N.H. 03458.

**WANTED:** Military, commercial, surplus. Airborne, ground, transmitters, receivers, testsets, accessories. Especially Collins. We pay freight and cash. Ritco Electronics, Box 156, Annandale, Va. Phone 703-560-5480 collect.

**"SAROC"** Sahara Amateur Radio Operators Convention 4-7 January, third annual fun convention hosted by the Southern Nevada Amateur Radio Club. Designed for exhibitors and participants at Hotel Sahara, Las Vegas, Nevada. MARS seminar, Army, Airforce and Navy representatives. Ladies luncheon with crazy hat contest, hat should convey amateur radio theme. Plus fabulous entertainment only Las Vegas can present. Registration fee includes three cocktail parties, Hotel Sahara show, hunt breakfast, technical sessions, admission to leading manufacturers and sales exhibits. Advance registration closes one January. QSP QSL and ZIP and telephone number for details to Southern Nevada Amateur Radio Club, Box 73, Boulder City, Nevada 89005.

**MONCTON AREA AMATEUR RADIO CLUB**, is sponsoring Atlantic Centennial Amateur Radio Convention, at the Brunswick Hotel, Moncton, New Brunswick, September 2-4. Contact Mrs. Audrey Hughes, Chairman of the Registration Committee, at P. O. Box 115, Moncton, New Brunswick, Canada. U.S. Hams planning to attend this should waste no time writing the Department of Transport, Ottawa, Canada, to arrange a permit to operate when there.

**MOTOROLA** new miniature seven tube 455 kc if amplifier discriminator with circuit diagram. Complete at \$2.50 each plus postage 50¢ each unit. R and R Electronics, 1953 South Yellow-springs, Springfield, Ohio.

**TOROIDS—DIODES—COAX—CONNECTORS.** 88 mH toroids—45¢ each, 5/\$2.00. 1000 PIV 1 Amp Top-Hat Diodes—55¢ ea, 2/\$1.00. Connectors, PL259, SO-239, M359—45¢ ea, 10/\$4.00. Button feed-throughs (while they last) 500 pF @ 500 V. 20/\$1.00. Add sufficient postage. R & R ELECTRONICS, 1953 S. Yellow-spring Street, Springfield, Ohio.

**VARIACS**—General Radio and Ohmite. 60 cycles, Input 120V—output 0-280 V. 1 amp or input 240 V—output 0-280 V. 2 amp. **PULLOUTS IN GUARANTEED EXCELLENT CONDITION** \$6.95 plus postage. Shipping weight 10 lb. R & R ELECTRONICS, 1953 S. Yellow-spring Street, Springfield, Ohio.

### CQ de W2KUW

**5% BONUS!!**

**Paid over any top offer for any piece of aircraft or ground radio units, also test equipment. All types of tubes. Particularly looking for 4-250 • 4-400 • 833A • 304TL • 4-1000A • 4CX5000A et al. 17L • 51X • 390A • ARM • GRM • GRC • UPM • URM • USM units.**

**TED DAMES CO. • 310 Hickory St., Arlington, N.J.**



**FAIRBANKS, ALASKA CENTENNIAL EXPOSITION,** KL7ACS is official exposition station. Visitors call in on 3866 or 145.35. Informal get-togethers, Kings Kup, Noble Street, noon Saturdays. Comemorative QSLs sent. Exposition runs May 27 through September 21st.

**ELECTRONIC PARTS:** Components, transistors, diodes, kits, relays and many special items. Guaranteed. Send 25¢ for 100-page catalog. General Sales Co., P.O. Box 2031-F, Freeport, Texas 77541.

**CTK's BARB'D WIRE ANTENNA.** \$1 brings pictures and instruction sheet for this unique antenna. WA6CTK, Box 444, Montebello, California.

**TEKTRONIX 511AD** scope, 10 MHz bandwidth, good shape with instruction book. \$150. Paul Franson, WA1CCH, 38 Heritage Rd., Acton, Mass. 01720.

**COMPLETE CONVERSION** instructions for the AN/VRC-2, just \$1 while the supply lasts. 73 Magazine, Peterborough, N.H. 03458.

**NOVICE CRYSTALS,** all bands, \$1.30 each. Also other freqs. Free list. Dealer and club inquiries invited. Nat Stinnette, Umatilla, Fla. 32784.

**WANT TO CORRESPOND** with Hams and SWLs in USA and other parts of the world. Would also like to receive club magazines from radio clubs. K. Harvant Singh, 31, (774), Upper Museum Rd., Taiping, Perak, West Malaysia, Malaysia.

**WANTED:** Copies of VHFER magazine, years 1963 and 1964 for personal collection. W1DTY, RFD 1, Box 138, Rindge, N.H. 03461.

**1963 BOUND VOLUMES OF 73.** \$15 each from 73, Peterborough, N.H. 03458.

**SIX ASSORTED ISSUES** at ATV Experimenter, circa. '64-65, \$1 from 73 Magazine, Peterborough, N.H. 03458.

**LAFAYETTE HA-230;** Knight T-150. Work and look new. You ship if over 100 miles. Kenneth Mann, 3241 Jackson St., Shreveport, Louisiana 71109.

**WRL's used transceiver bonanza!** Guarantee—trial—terms. Without trades: SR-150—\$299.95; G-76—\$129.95; SR-46—\$129.95; KWM-1—\$249.95; Thor 6 and AC—\$219.95; Galaxy III—\$179.95; Galaxy V—\$269.95; Galaxy 300—\$149.95; Eico 753—\$149.95; NCX-3—\$179.95; SB-34—\$284.95; Utica 650 and VFO—\$129.95. Hundreds more. Free list. WRL, Box 919, Council Bluffs, Iowa 51501.

**HT-32A \$250;** 2B/2BQ/50 & 100 kc cal. \$200; KW Kompact/AC PS \$105; All parts for pr 3-400Z's linear & PS \$200. Dave Windisch, K3BHJ, 3402 Oakenshaw Pl., Baltimore, Maryland 21218 Call 301-235-0466.

**73 Magazine**  
**CUMULATIVE INDEX**  
 October 1960-December 1966  
 Now available for 25¢  
**73 Magazine**  
 Peterborough, N.H. 03458

**SPECIAL**

Canadian headsets: includes 2 earphones, two cushions, adjustable headband, cord & plug; also has hand microphone with push-to-talk switch, 2000, brand new, each .....\$1.50  
 \* \* \* \* \*

Command set transmitter BC-458/ARC-5, 5.3 to 7.0 Mc. Scavenge for parts or convert to SSB exciter, VFO or 100-W transmitter. Tubes: 2—1625's (12v. 807's); 1—1626 (VFO); 1—1629 tuning eye, (for calibration), plus crystal for calibrating VFO. Loads of parts. New, only .....\$9.50  
 \* \* \* \* \*

Bendix 3611 telephone amplifier with dynamotor DS100, input 12v at 1.2A, out 220V ac .060A. Also 2 tubes 6SJ7 and 6V6. 250 of each NEW .....\$6.50  
 \* \* \* \* \*

Telephone repeater type EE89. 40 NEW @ .....\$2.50  
**TALLEN CO. INC.**  
 300 7th St., Brooklyn, N.Y. 11215, 212-499-6300

**MORE MISCHUGA**

F250A20 Collins mechanical filter 250 KC. Band width at 6 dB, 2KC; at 60 dB, 4.3KC. New, 4 for \$25 ..... \$6.50 ea.

239 KC IF for BC command receiver, easily adjusted to 250KC with 2 APC's. 4 for \$1.85 ..... 50c ea.

**JFD PISTON TRIMMERS**

1/2 - 8 or Red plastic covered, 1/4" diam. 3/4" long plus adjusting screw. Solder terminals. NEW. Choice, 6 for \$1.00 ..... 18c ea.

1 - 5 pF 5-deck, 18-position SOLID SILVER SWITCH CONTACTS similar to CRL JV9017, 2 1/2"x2"x6 1/2" long, plus 1/2" for 1/4" shaft. NEW. 4 lbs. 4/\$10.50 ..... \$2.75 ea.

3 - 15 pF ERIE N650 miniature ceramic trimmer, latest type 1/4" diam. 1/4" thick. NEW. 5/\$1.00 ..... 23c ea.

12 MFd Tubular lytic 1" diam. 4" long, wire axial leads. NEW. 1/2 lb. 4/\$3.00 ..... 79c ea.

700 VDC OHMITE plate choke, 5 1/2 mHy, 8 1/2 ohm, 1 amp. 40 to 120 mHz. BILLIOUS GREEN. NEW ..... 10 for \$2.00

Z - 1

**FILAMENT TRANSFORMERS**

24 V Pri. 115V 60cy. Fully shielded saddle mount, wire leads (1 secondary soldered to shield, easily cut) 2 1/2"x2 1/2"x2 1/4", 2 lbs, NEW, 4 for \$6.50 ..... \$1.75 ea.

**HAMFEST SCHEDULE**

Findlay, O., Sept. 10; Peoria, Ill., Sept. 17; Cincy, O., Sept. 24.

All orders, except in emergency, or I'm at a hamfest, shipped same day received. For free "GOODIE" sheet, send self-addressed, stamped envelope—PLEASE, PLEASE include sufficient for postage, any excess returned with order. I carry private (Travelers) parcel post insurance, for domestic parcel post. For items too heavy, or too large for parcel post, I suggest bus parcel express. Please advise name of bus line, and city, where you can pick up the shipment.

**B C Electronics**  
 Telephone 312 CALumet 5-2235  
 2333 S. Michigan Avenue Chicago, Illinois 60616

LEARN RADIO CODE

THE EASY WAY!

- No Books To Read
- No Visual Gimmicks To Distract You
- Just Listen And Learn

Based on modern psychological techniques—This course will take you beyond 13 w.p.m. in LESS THAN HALF THE TIME!

Album contains three 12" LP's 2 1/2 hr. Instruction Also available on magnetic tape. See your dealer now!

\$9.95

EPSILON [E] RECORDS

206 East Front Street, Florence, Colorado



## INTEGRATED CIRCUITS

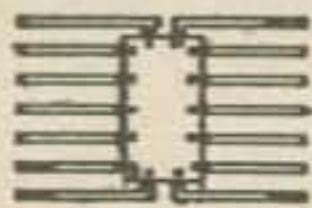

SR Flip Flops .....	\$ .90
SRT Flip Flops .....	\$1.15
Expandable OR Gates .....	\$1.00
JK Flip Flops .....	\$1.15
Dual Nand Nor Gates .....	\$1.00

They come complete with schematic, elect. characteristics sheet and some typical applications.

### Silicon Control Rectifier

PRV	3A	7A	20A
50	.35	.50	.80
100	.50	.70	1.35
200	.75	1.05	1.90
300	1.25	1.60	2.45
400	1.50	2.10	2.85
500	1.75	2.80	3.50
600	2.00	3.00	
700	2.25	3.50	
1000		5.00	

Terms: FOB Cambridge, Mass. Send check or Money Order. Include Postage, Average Wt. per package 1/2 lb. Allow for C.O.D. Minimum Order \$3.00.



POST OFFICE BOX 74C  
SOMERVILLE, MASS. 02143

featuring transistors,  
rectifiers and components

SEND FOR  
OUR LATEST CATALOG

### Top Hat & Epoxy 1 AMP

PRV	
100	.07
200	.09
400	.12
600	.20
800	.25
1000	.50
1200	.65
1400	.85
1600	1.00
1800	1.20

## TRIACS

5 AMP—T0-66

PRV	
100	.90
200	1.40
300	1.75
400	2.25
500	2.50

**EICO** 753 transceiver, \$150. AC or DC supply \$50 each. All units factory built with latest modifications. Also ART-13, \$49. WAØLJM, Box 138, Mayville, North Dakota 58257.

**SHORTWAVE LISTENER DX GUIDE**, 1967 edition, \$2.50. Aircraft, Maritime, Spacecraft, CB, Ham information. Send to Shortwave Listener DX Guide, Box 385, Berwick, Penna. 18603.

**HAM TV:** RCA TM6-B monitor, excellent, with console, also excellent film camera (RCA) with good I.O., also TA-5 stab amp., WP-33 and 580D power supplies. RTTY one excellent, model 19 complete \$100, 2-mainliner TU's with built in scopes, 125.00 ea, also one new condition SX-115 receiver \$300.00. W4AIS, 7 Artillery, Taylors, S.C. 29687.

**VHF:** TX-62, VFO621 150.00; NC-300 \$110.00 clean. Ameco 6 meter converter & preamp \$15.00. Mohawk 417A 2 meter converter \$25.00. All for \$275.00. WA9RDZ, 406 W. Rudisill, Ft. Wayne, Indiana, 219-745-7279.

**HRO RAS** receiver \$40. Atwater Kent model 55C, RCA Radiola 66, Philmore crystal set, plus parts of DC sets \$75. 3 antique wall telephones \$75. WA9IYF, Box 22, Milan Ind. 47031.

**FT-243 CRYSTALS:** 3500 to 8700 kc .01% setting, \$2.00 each. Novice 1.00 each ± 2 kc. Denver crystals, 776 S. Corona, Denver, Colorado 80209.

**COLLINS** 30L-1 linear, new, still packed, \$475. 75S-3 receiver with 200 cycle filter, \$479. 32S-1 transmitter, excellent condition, \$375. Leslie Acton, RR2, Box 234, Indianapolis, Indiana 46231. Phone 317-839-4124 after 5:00 P.M. or W.E.

**HY-GAIN 18HTB HY-TOWER**, new model, 10-80 meter vertical, complete, never installed, \$110. Leslie Acton, RR2, Box 234, Indianapolis, Indiana 46231. Phone 317-839-4124.

**DISCOUNT PRICES** and time payments. New equipment in factory sealed cartons at discount prices. Pay only 10% down, monthly payments as low as \$10. Swan SW-350, \$365; SW-500, \$430; SW-250, \$286; Ham-M, \$99.95; Drake TR-4, \$511; R-4A, \$349.50; T-4X, \$349.50; L-4, \$599; Galaxy V Mark II, \$365; SB-34, \$360; SBE Linear, \$219; Save up to 25%. Write for quote before you purchase. Reconditioned bargains: NCX-3, \$199; SW-240, \$179; Eico 753, \$159; SB-33, \$159; SW-350, \$299; Galaxy V, \$299; HT-37, \$179; HT-32, \$179; GBS-100, \$125; SX-117, \$199. Send for list. Bryan, W5KFT, Edwards Electronics, 1320-19th Street, Lubbock, Texas or call 806-762-8759.

**CASH IN** on your ideas. Inventors—hobbyists—gadgeteers. Send for free brochure. No obligation. West Coast Enterprises, Box 906, Pomona, California 91769.

**HICKOK DMS-3200** digital measuring system complete with DP-100 and DP-150 plug-ins. DMS-3200 main frame accepts all new plug-ins as released. Full 3-digit numerical read-out with over-range and wrong polarity indicators. DP-100 D.C. voltmeter measures 99.9 millivolts to 1.4 killivolts (using 40% over-range capability) with ±0.1% full scale accuracy. Input 10 megohms. DP-150 measures frequency to 1.2 MHz, period to 999 seconds. Over-range capability allows 7-digit resolution, accuracies to ±0.001%, with 10 millivolt sensitivity. Factory calibrated last fall. \$450 takes all, now \$690 for comparable new system. Will ship. John Leeder, 430 Dumbarton, Richmond Heights, Ohio 44124.

## \*TWO-WAY\* COMMUNICATION CRYSTALS

AMERICAN CRYSTAL CO.  
PO BOX 2366 KANSAS CITY, MO.



### MAKE MONEY BY PHONE!!

YES! You can make BIG MONEY by calling us collect—today!—if you have any of the following equipment. We urgently need and must buy:

TED Radio Transmitters, RT-67 and RT-68/GRC Transceivers, PP-109/GR Power Supply, R-110/GRC Recvr., C-433 and C-434/GRC Controls, AN/URR-13 and -35 Radio Recvrs., AN/ARC-27, -34, -52 Transceivers, PLUS any hi quality military or commercial TEST EQUIPMENT. We pay the most—fastest!—with a smile! CALL TODAY!

**COLUMBIA ELECTRONICS, Dept. 7**  
4365 West Pico Blvd., Los Angeles, Calif. 90019  
Phone: (213) 938-3731



**TELETYPE TEST SET I-193-C.** Brand new surplus. Tests RTTY transmitters, converters, relays. \$24.95, FOB Harrisburg, Penna. Telemethods International, P. O. Box 18161, Cleveland, Ohio 44118.

**HALLICRAFTERS SR-500** with mobile power supply, brackets, mike and speaker. Excellent condition. \$275.00. WAØIMK, Bill Brogdon, 13720 Vincent Ave., Burnsville, Minnesota 55378.

**REED RELAYS SPST-N.O.** Coil rating: 2.9 volts at 12 ma. Contacts rated for 12 VA; max. 300 volts or 0.50 amp. Sample usage circuits included. Body size 1" x 1/2". New low price \$2.35 plus 25¢ handling and postage. Airstar Products, P. O. Box 323, Marion, Iowa.

**GREATER BAY AREA HAMFEST** will be held again this year at the Edgewater Inn, Oakland, California, on October 14 and 15, 1967. For full information write to Greater Bay Area Hamfest, P. O. Box 545, Hayward, California 94543.

**HEATHKIT:** HW-22 40-meter SSB transceiver \$70. HP-13 mobile supply \$40.00. IM-32 VTVM \$25. IG-42 RF generator \$30. Millen 90662-A GDO \$35. Hallicrafters TO keyer \$45. Vibroplex key \$15. Ten TF transistors including several 1-watt out 400 mc \$10. K7AZB/6, 1837 Clarke Ave., Apt. 13, Palo Alto, California 94303.

**CALL LETTER BILLFOLDS:** Hand tooled men's economy \$7.00; ladies' or men's deluxe \$8.50; key cases \$3.00 and \$5.00, PPD U.S.A. Jane Freestone, Route 1, Box 122, Hardy, Arkansas 72542.

**TRADE 4-1000A** tubes excellent for Ruger 22 single six, High Standard or Colt automatic, also 22 Ruger rifle. W6WGJ/5, 4215 Darwood Drive, El Paso, Texas 79902.

Minni-Fan 6 or 12Vac/60 Cys \$2@ 3/\$5  
4X150 Ceramic Loktal \$1.25@.....4/2  
Line Filter 200Amp/130VAC \$5@...5/\$20  
DC 3 1/2" Meter/RD/800Ma \$4@...2/\$7  
DC 2 1/2" Meter/RD/30VDC \$3@...2/\$5  
DC 4" Meter/RD/1Ma/\$5@.....2/\$9

Socket Ceramic 1625 Tube...4/\$1, 10/\$2  
Socket Ceramic 4X150/Loktal .....4/\$2  
**Wanted 304TL - Top \$\$ Paid!!**  
2.5M H PiWound 500Ma Choke..3 for \$1  
Knob Spin-Crank BC348 \$1@...3 for \$2  
MiniFan 6 or 12 VAC \$1.50@...4 for \$5  
Beam Indicator Selsyns 24VAC..2 for \$10  
Precision TLI47 Feeler Relay Gage...\$1

Fuse 250Ma/3AG.....50 for \$1, 300/\$2  
XMTTG Mica Condsr .006@ 2.5Kv..2/\$1  
W.E. Polar Relay #255A/\$5@...2 for \$9  
W.E. Socket for #255A Relay.....\$2.50  
Toroids 88Mhy New Pckg \$1@.....6/\$5  
6.3VCT @ 15.5A & 6.3VCT @ 2A \$5 @,  
200 KC Freq Std Xtals \$2@...2/\$3, 5/\$5  
Printed Ckt Bd New Blank 9x12" \$1@

Klixon 5A Reset Ckt Breaker \$1@...10/\$5  
Line Filter 4.5A@115VAC.....5 for \$1  
Line Filter 5A/@125VAC.....3 for \$1  
866A Xfmr 2.5V/10A/10Kv/Insl.....\$2  
Choke 4HY/0.5A/27Ω\$3@.....4/\$10  
Stevens Precision Choppers \$2@...3/\$5  
Helipots Multi Ten-Turn@.....\$5  
Helipot Dials \$4@...3/\$10

2500V@10Ma & Fil \$2@.....3/\$5  
1100VCT @ 300Ma, 6V 8A, 5V @ 3A &  
125V Bias abt 1200VDC \$5@ .....4/\$15  
2.5V@2A \$1@.....3 for \$2  
6.3V @ 1A \$1.50@.....4 for \$5  
"Bruning" 6" Parallel Rule @.....\$1  
PL259A & S0239 CO-AX M&F Prs..3/2\$  
Phone Patch Xfms Asstd.....3/\$1

Insltd Binding Posts.....20/\$1  
Sun-Cells Selenium Asstd.....6/\$1  
.01 Mica 600WV Conds.....6/\$1  
.001 to .006 Mica/1200WV Cdsr.....4/\$1

# "TAB"

"TAB" \* SILICON ONE AMP DIODES  
Factory Tested & Guaranteed

Piv/Rms	Piv/Rms	Piv/Rms	Piv/Rms
50/35	100/70	200/140	300/210
.05	.07	.10	.12
400/280	600/420	800/560	900/630
.12	.18	.25	.40
1000/700	1100/770	1700/1200	2400/1680
.50	.70	1.20	2.00

\*All Tests AC & DC & Fwd & Load!

1700 Piv/1200 Rms@750Ma..10/\$10
2400 Piv/1680 Rms@750Ma..6/\$11

SILICON POWER DIODES STUDS  
& P.F.\*\*

D. C. Amps	50Piv 35Rms	100Piv 70Rms	200Piv 140Rms	300Piv 210Rms
3	.10	.15	.22	.33
12	.25	.50	.75	.90
18	.20	.30	.75	1.00
45	.80	1.20	1.40	1.90
160	1.60	2.90	3.50	4.60
240	3.75	4.75	7.75	10.45

D. C. Amps	400Piv 280Rms	600Piv 420Rms	700Piv 490Rms	900Piv 630Rms
3	.40	.50	.60	.85
12	1.20	1.50	1.75	2.50
18	1.50	Query	Query	Query
45	2.25	2.70	3.15	4.00
160	5.75	5.75	Query	Query
240	14.40	19.80	23.40	Query

We Buy! We Sell! We Trade!—

"TAB" TERMS: Money Back Guarantee! Our 23rd Year. \$5 Min. Order F.O.B., N. Y. C.

111 ML Liberty St., N.Y.C., 10006, N.Y.  
Phone 732-6245

Send 25c for Catalog  
PHONE 732-6245

\* TRANSISTORS \* SCR'S \* ZENERS!!!

## NEW UNIQUE IS ANTENNA SPACE YOUR PROBLEM?

The "fat dipole" theory permits full performance with an antenna 1/8 wavelength shorter than normal size.

For full particulars, including instruction details, send \$1 to C. Leroy Kerr, Box 444, Montebello, California, 90641. Or, if you prefer readymade antennas, they are shipped prepaid in USA as follows: 80/75 meter, \$21, 40 meter, \$10. 20/10 or 15 meter, \$6.

Full Leads Factory Tested & Gtd!  
PNP150 Watt/15 Amp HiPwr T036 CASE  
2N141, 442, 277, 278, DS501 Up To  
50/VCBO \$1.25@, .....6 for \$5  
2N278, 443, 174, Up to 80V \$3@...2/\$5  
PNP 30 Watt/3A, 2N115, 156, 235, 242  
254, 255, 256 257 301 392, 40e@ 3 for \$1  
PNP 2N670/300MW 35e@, .....5 for \$1  
2N1038/2N6F1@1 Amp.....4/\$1  
PNP 25W/TO 2N538, 539, 540....2 for \$1  
PWR Finned Heat Sink 180 SQ" \$1.50  
PWR Finned Sink Equip. 500 SQ"....\$5  
SILICON PNP/T05 & T018 PCKG  
2N327A, 332 to 8, 474 to 9,  
541/3, 935/7 .....7/\$2  
MICA MTG KIT to 36, T03, 30c @ 4/\$1  
ANODIZED TO PWR 30c@ .....6 for \$1  
ZENERS 1 Watt 6 to 200V.....\$1 Each  
ZENERS 10 Watt 6 to 150V...\$1.25 Each  
STABISTOR up to 1 Watt.....10 for \$1  
GLASS DIODES Equip IN34A...20 for \$1

18 Amp PWR Pressfit Diodes to  
100 Piv .....5 for \$1  
MICRO-MUSWITCH 35 Amp AC DC  
CASED ALUM(SI) .....5 for \$1

SCR-SLICON-CONTROL RECTIFIERS!  
PRV 7A 25A PRV 7A 25A  
100 Q \$1.10 500 2.50 3.75  
200 Q \$1.50 600 3.25 4.25  
300 1.80 2.25 700 4.00 500  
400 2.00 2.90 800 4.75 5 65

SCR 50 PIV/25A 80c@, .....8/\$5  
SCR 50 PIV/7A 49c@ .....12/\$5

2 RCA 2N408 & 2/IN2326 Ckt Bds  
IN2326 Can Unsolder.....4/\$1

DISCAP .002 Mfd@6KV.....6 for \$1  
DISCAP @ 1KV.....10 for \$1  
DISCAP Asstmnt up to 6KV...20 for \$1  
6 or 12VAC Minifan & Blade .....\$1  
Bandswth Ceramic 500W 2P/6Pos..\$3@  
5Hy-400Ma Choke \$4@.....2/\$5  
6Hy-500Ma \$5/@ .....2/\$6  
250Mfd @ 450 WV Lectlytic 4/SSB \$3@  
Cndsr Oil 10Mfd x 600 \$1@...4/\$3, 12/\$5  
Cndsr Oil 6Mfd@1500V \$4@...5 for \$10  
880 Vet @ 735Ma for SSB \$12@...2/\$22  
480 Vet@40Ma & 6.3@1.5A CSD..\$1.50  
10 Vet@5A & 7.5 Vet@ \$5@.....2/\$9  
Wanted Transistors, Zeners, Diodes!



# LIBERTY PAYS MORE!!

**WILL BUY FOR  
CASH  
ALL TYPES**

- ELECTRON TUBES
- SEMICONDUCTORS

**WILL BUY FOR  
CASH  
ALL TYPES**

- Military Electronic Equipment
- Test Equipment

**WIRE, WRITE, PHONE COLLECT! WE PAY FREIGHT ON ALL PURCHASES**

## Liberty Electronics, Inc.

548 Broadway, New York, New York 10012, Phone 212-925-6000

### TCS EQUIPMENT

#### NAVY TCS RECEIVER AM



1.5 MC to 12 MC in two (2) bands. Variable freq. oscillator & crystal control on four (4) preset channels in the entire freq. range. Audio output 1.5 watts into 500 ohm load; uses tubes 12SK7 RF A., 12SA7 converter, 2/12SK7 IF A., 12SQ7 detector BFO, 12A6 oscillator, 12A6 audio Amp. 456 KC IF Freq. Large vernier & spin dial, audio gain, AVC, BFO and all controls on the front panel. Voltages required: 12 VDC & approx. 220 VDC 100 MA. Size: 11 1/4" x 11 1/4" x 13 3/4". Wt.: 37 lbs. **USED: \$44.95**

Checked for Operation — \$10.00 extra.

#### NAVY TCS TRANSMITTER AM—

1.5 MC to 12 MC in three (3) bands, CW 40 watts, voice modulation 20 watts, master oscillator variable and crystal control on 4 preset channels in the entire freq. range. Uses 3/12A6 in oscillator & buffer-doubler, 4/1625 in modulator & power amplifier stages, 2 1/2" meters for PA Plate 0-200 DC RF meter 0-3, all tuning and operating controls on front panel. Voltages required: 12 VDC & 400-440 VDC 200 MA. W/tubes. Sizes: 11 1/4" x 11 1/4" x 13 3/4". Wt.: 41 lbs. **USED: \$34.50**

Checked for Operation — \$10.00 extra.

Antenna Loading Coil #47205 ..... Used: \$ 6.95  
 Remote Control Box w/Speaker #23270 .... Re-New: 9.95  
 Dual Dynamotor Power Supply 12 V. #21881 Re-New: 14.95  
 D-401 Transmitter Dynamotor 12 V. .... New: 6.95  
 D-402 Receiver Dynamotor 12 V. .... New: 4.95  
 CABLE—Receiver to Power Supply ..... New: 2.75  
 CABLE—Transmitter to Power Supply ..... New: 2.75  
 Connector Plugs for Remote Control Box ..... New: 1.50  
 A C POWER SUPPLY—115 V. 60 cycle (Not Government Surplus). Receiver: \$20.00—Transmitter: \$35.00.  
 Shock Mounting for Receiver or Transmitter.... Used: 2.95  
 Noise Limiter Conversion Kit—W/6H6 tubes ..... 2.00  
 Parts available for Rec. and Trans. Advise us of your needs!  
 Prices F.O.B. Lima, O—25% Deposit on COD's—BIG CATALOG—Send 25c (stamps or coins) & receive 50c CREDIT on your order.

#### FAIR RADIO SALES

DEPT. 73 — P. O. Box 1105 — LIMA, OHIO 45802

### INDEX TO ADVERTISERS

- |                                      |                                  |
|--------------------------------------|----------------------------------|
| Alltronics-Howard, 116               | Lewispaol Electronics, 116       |
| Ameco Equipment, 105                 | Liberty Electronics, 128         |
| American Crystal, 126                | Maco Products, 117               |
| Amrad Electronics, 121               | Mann, R. E., 118                 |
| Arcturus Electronics, 120            | Midway Antenna, 79               |
| A.R.C. Sales, 120                    | Military, 119                    |
| ATV Research, 92                     | Mission Ham Electronics, 50      |
| Babcock Co., L. W., 55               | Mosley Electronics, 16           |
| Barber Travel Svc., 120              | National Radio Co., Back Cover   |
| B C Electronics, 125                 | New-Tronics Corp., 33            |
| Clegg Associates, 117                | Omega Electronics, 78            |
| Cleveland Institute, 25              | Palomar Engineers, 111           |
| Columbia Electronics, 126            | Parks Electronics, 116           |
| Comdel, Inc., 71                     | Pickering Radio Co., 65          |
| Crabtree's Electronics, 110          | Poly-Paks, 112                   |
| CTK's Barb'd Wire Ant., 127          | Quement Electronics, 35, 115     |
| CushCraft, 118                       | Radio Amateur Callbook, 39, 111  |
| Data Corp., 77                       | Radio Shack, Inc., 101           |
| DPZ, Inc., 97                        | Rohn Mfg. Co., 4                 |
| DX'er Magazine, 118                  | Salch Co., Herbert, 119          |
| Dynalab Company, 116                 | Scott Radio, 79                  |
| Editors & Engineers, 11              | Sentry Mfg. Co., 93              |
| Electronic Center, 15                | Solid State Sales, 126           |
| Epsilon Records, 125                 | Stellar Industries, 43           |
| Estes Engineering, 97                | Stinnette, Nat., 79              |
| Evans Radio, 117                     | T A B, 127                       |
| Evansville Amateur Radio Supply, 119 | Tallen Co., Inc., 121, 125       |
| Fair Radio Sales, 128                | Teleplex Company, 124            |
| Freck Radio, 118                     | TeleTec Associates, 117          |
| Gateway Tower Co., 121               | Telrex Comm. Eng. Labs., 19, 69  |
| Gordon Co., H. W., 108               | Translab, Inc., 121              |
| Gotham, 67                           | Trigger Electronics, 122         |
| Grantham School, 124                 | United Radio, 116                |
| H C J Electronics, 119               | United Transformer Co., Cover 11 |
| Heath, 29                            | Unity Electronics, 124           |
| Henry Radio, 81                      | Vanguard Labs, 73, 114           |
| Hotel Del Capri, 67                  | VHF Specialists, 120             |
| Hy-Gain, 87                          | VHF'er Magazine, 120             |
| International Crystal, 3             | Waters Mfg. Co., 5               |
| James Research, 119                  | World Radio Labs, Cover 111      |
| J A N Crystals, 124                  | 73 Magazine, 115, 125            |
| Labgear, Ltd., 39                    |                                  |



**WRL gives you a FREE 2-week trial**

**ON THE  
Great NEW**

# **GALAXY V MARK 2**

**5 BAND TRANSCEIVER NOW — even Better than Ever!**

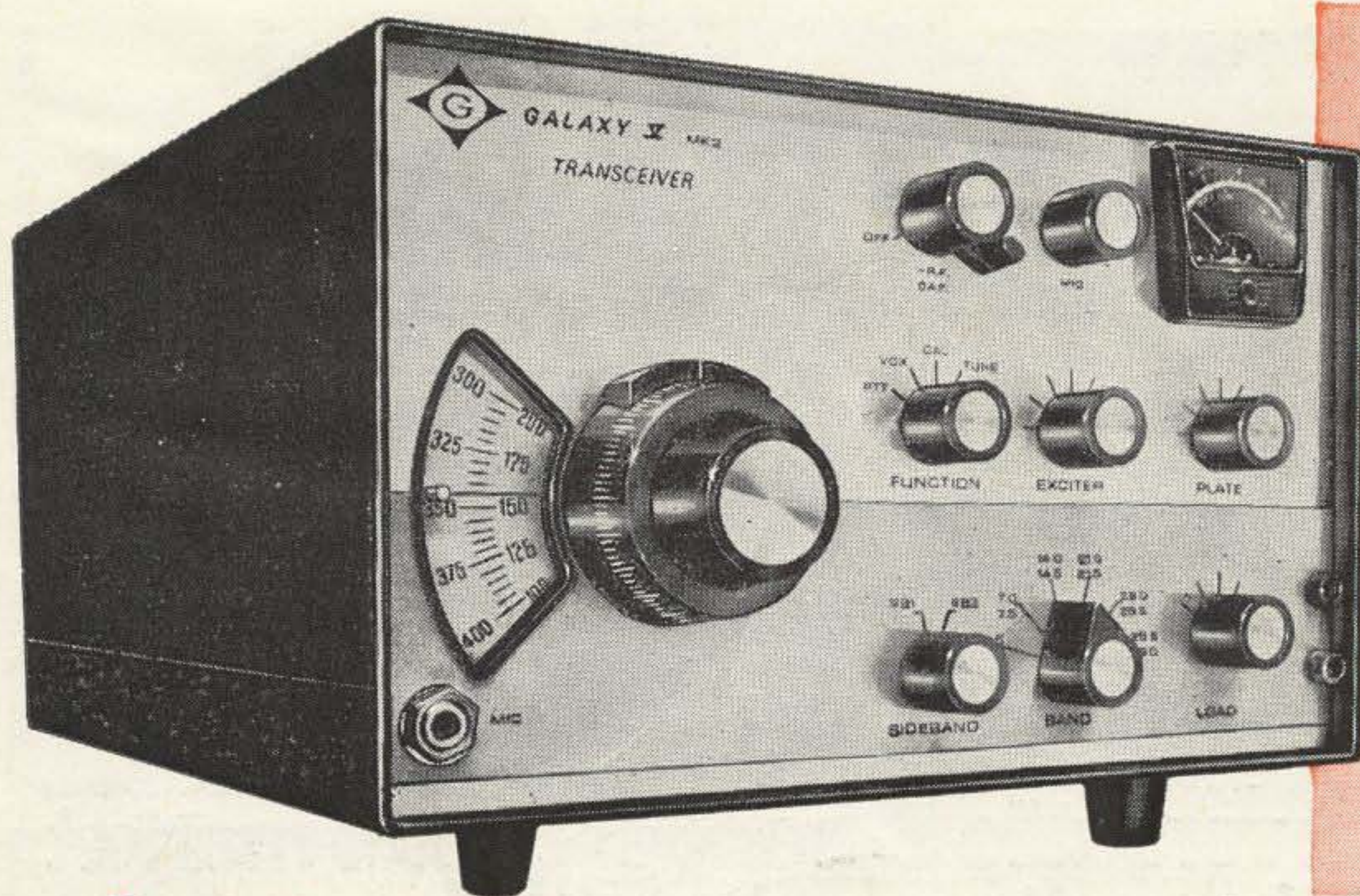

## **6 NEW Features:**

- New 400 Watt Power
- New Precise Vernier Logging Scale
- New Solid State VFO
- New CW Sidetone Audio
- New CW Break-In Option
- New CW Filter Option

## **6 WAYS BETTER —**

Yet Still **\$420<sup>00</sup>**  
Only

## **Satisfaction Guaranteed! (Serving Amateurs over 31 years!)**

■ We have the great new Galaxy V Mark 2 in stock, and we're so confident you'll like it that we're going to make it easy for you to step up to this powerful 80 through 10 meter transceiver on a "no risk" two-week FREE trial! Just

mail the coupon in for details. Remember, we give the highest trade-in on your present equipment...offer an easy monthly payment plan (*no finance company — you deal directly with us*).

Send in the coupon today, just check off your interests and mail.

**"The House the HAMS Built!"**



**Leo I. Meyerson  
WØGFQ  
President**



### **WORLD RADIO LABORATORIES**

3415 West Broadway, Council Bluffs, Iowa Zip 51501

73-S21

*Please send me the following:* (F.O.B. Council Bluffs, Iowa)

- |   |   |
|---|---|
| <input type="checkbox"/> Information on 2-week trial      | <input type="checkbox"/> A.C. SUPPLY — \$79.95                    |
| <input type="checkbox"/> Galaxy V Mark 2 Brochure         | <input type="checkbox"/> Quote me a trade                         |
| <input type="checkbox"/> GALAXY V Mark 2 — \$420.00       |   |
| <input type="checkbox"/> Fixed Station Package — \$597.55 |   |
| <input type="checkbox"/> Mobile Package — \$606.50        | <input type="checkbox"/> FREE WRL 1967 Catalog                    |
| <input type="checkbox"/> Enclosed is my Money Order       | <input type="checkbox"/> Check <input type="checkbox"/> Charge it |

Name \_\_\_\_\_ Call \_\_\_\_\_

Address \_\_\_\_\_

City \_\_\_\_\_ State \_\_\_\_\_ Zip \_\_\_\_\_



# Join the National 200 club

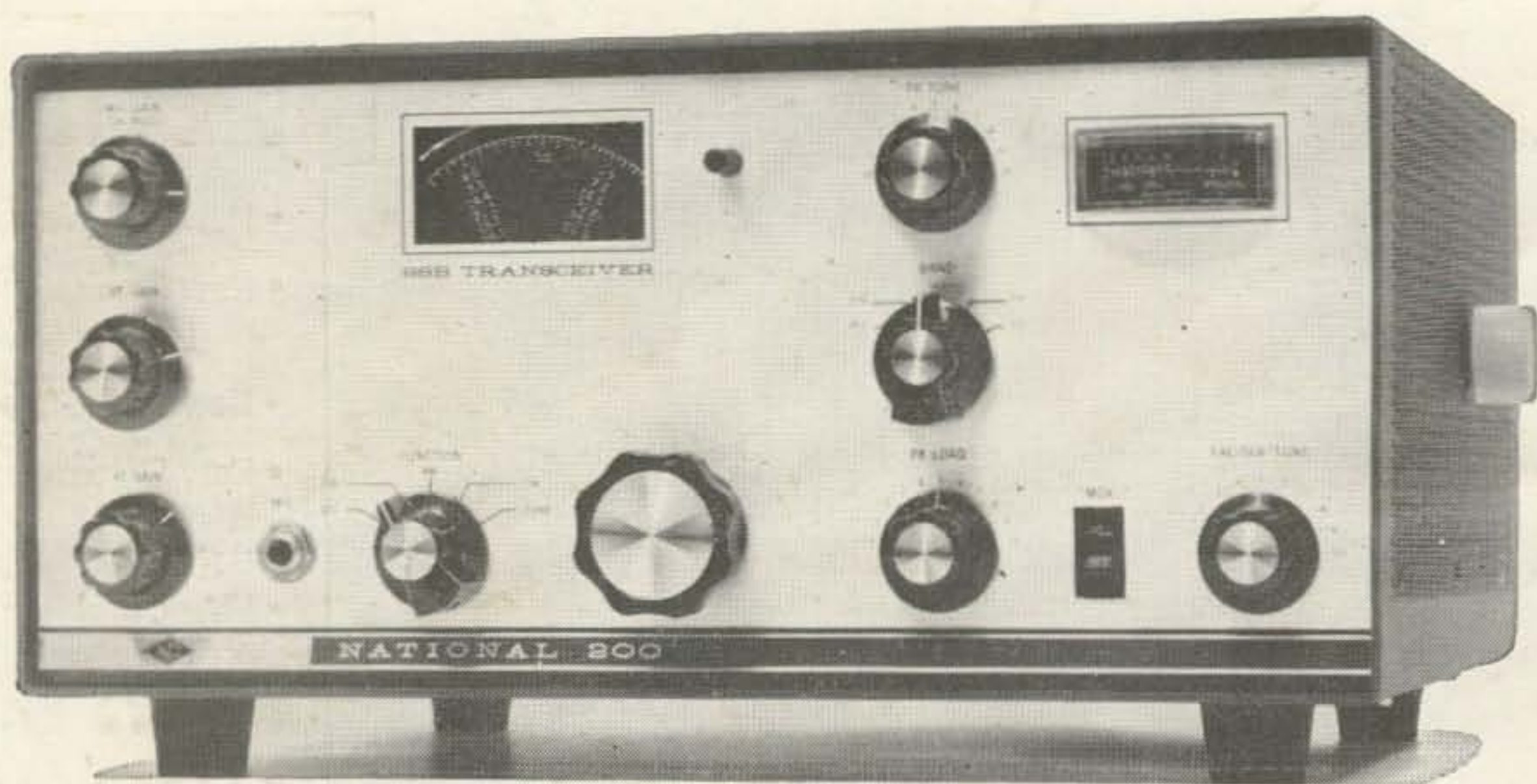

## Own the most versatile 5-bander on the market ...priced even lower than a kit rig!

National's new 200 is fast becoming the most popular 5-bander on the market . . . and it's no wonder! Here's an ideal rig for mobile, portable, or home operation . . . the fastest way to move up from single band or triband. The price? . . . an amazingly low \$359! Performance? . . . here's what Jim Fisk WIDTY said in a recent issue of a noted amateur radio publication: "When National came out with their new model 200 transceiver a few months ago at a lower cost than any other five band transceiver on the market, I just couldn't believe that it would perform as well as the more expensive models. But — after using it for several weeks in chasing DX, I find that they have done a superb job and it performs right along with the best of them. The sensitivity is fine, the selectivity afforded by the steep-sided crystal filter is excellent, and the audio reports, if I am to believe the fellows on the other end, have all been good. Reports of, 'tremendous audio quality,' 'really sounds good,' and 'very clean and crisp,' have been normal reports during the time I have had the 200 on the air."

Feature this for \$359! ■ Complete coverage of the 80 through 10 meter bands. ■ 200 Watt PEP input on SSB, plus CW and AM. ■ Separate product and AM detection plus fast-attack slow-release AGC. ■ Crystal-controlled front end and single VFO for high stability, and identical calibration and tuning rate on all bands. ■ Crystal lattice filter for high sideband suppression on transmit, and rejection of adjacent QRM on receive . . . plus solid-state balanced modulator for "set-and-forget" carrier suppression. ■ Operation from new low-cost AC-200 supply or from NCX-A or mobile power supplies. ■ ALC. ■ 45/1 planetary/split gear tuning drive. ■ Automatic carrier insertion in AM and CW modes. ■ Panel meter automatically switched to S-units on receive. ■ Universal mobile mount included.

**\$359.**  
ONLY  
with National's full  
One-Year Guarantee

 **National Radio Company**  
37 Washington Street, Melrose, Massachusetts 02176