

73

SEPTEMBER 1964

A Picayune 40c

Amateur Radio



HB9RF
See page 62

LINEAR STANDARD™



AUDIO TRANSFORMERS

BROADCAST HI-FIDELITY HAM COMMERCIAL

For over 30 years UTC has been the leader in advancing the art and technology of iron core inductance devices . . . The Linear Standard (LS type) units are the highest quality, non-hermetic, high fidelity transformers of their type. This series includes transformers designed for tube, transistor, hybrid, modulation and matching applications.

With the ever increasing use of wide range equipment, the point has been reached where the major limiting factor is the frequency range of the transformers employed. These LS components represent the closest approach to the ideal transformer from the standpoint of uniform frequency response, low wave form distortion, high efficiency, thorough shielding, and dependability.

IMMEDIATE DELIVERY
From Stock

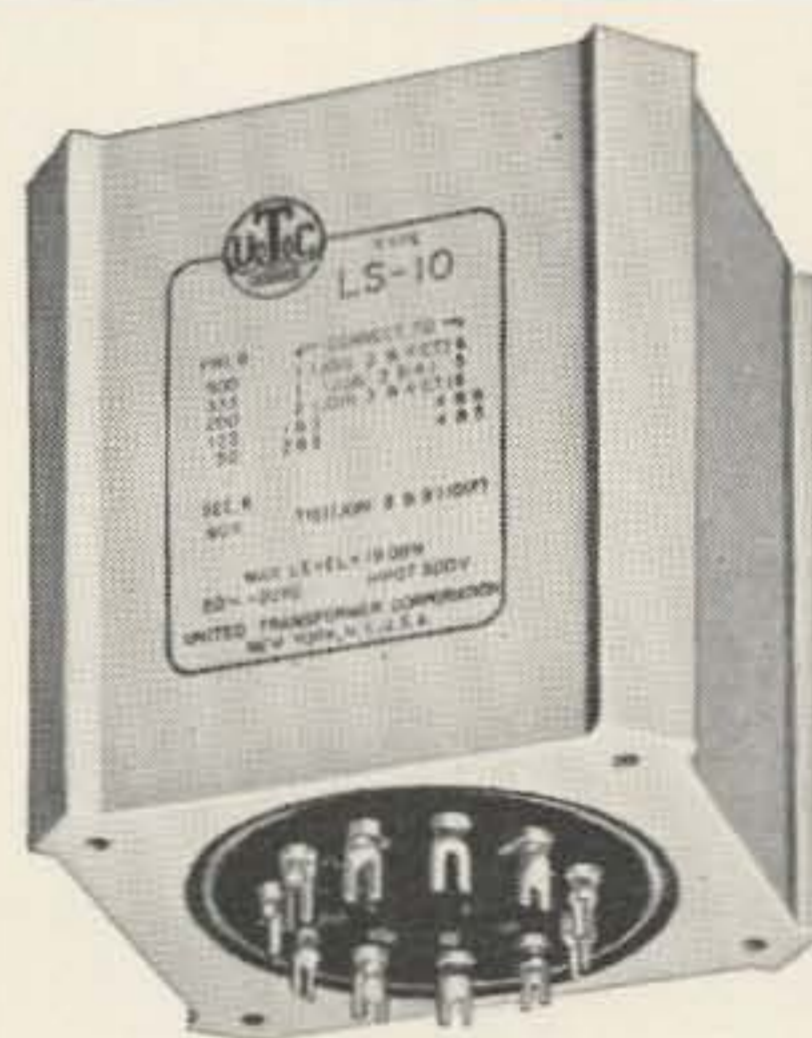

LINEAR STANDARD
HIGH SHIELDING
DIE CAST CASES
TOP & BOTTOM MTG.

LS-1 CASE

Length 3 1/8"
Width 2 5/8"
Height 3 1/4"
Mounting 1 15/16 x 2 7/16"
Screws 6-32
Cutout 1 7/8" dia.
Unit Weight 3 lbs.

LS SERIES

TRANSFORMER TYPES	Pri. Range Ω	Sec. Range Ω	Freq. Range ± 1 db	Max. Level Range
Low Imped. to Grid and Mixing and Matching	2.5 to 5,000	50 to 120,000	7 ~ to 50 KC	+ 15 dbm to + 23 dbm
Interstage and Driver	5,000 to 30,000	50,000 to 135,000	10 ~ to 20 KC	100 mw to 40 W
Hybrid and Repeat Coils	150 to 600	150 to 600	20 ~ to 40 KC	+ 15 dbm to + 18 dbm
Plate, Crystal, Photocell, and Bridging to Line	4,000 to 30,000	50 to 600	7 ~ to 50 KC	200 mw to 400 mw
High Level Matching	50 to 600	1.2 to 600	10 ~ to 40 KC	20 W to 40 W
Output to Line and Voice Coil	8 to 10K	500 to 1.2	7 ~ to 50 KC	20 W to 60 W
Modulation	3K to 10.4K	6000 to 1.2	10 ~ to 50 KC	20 W to 2500 W

Write for latest catalog of over 1,200 STOCK ITEMS with UTC high reliability

UNITED TRANSFORMER CORP.

150 VARICK STREET, NEW YORK 13, N. Y.

PACIFIC MFG. DIVISION: 3630 EASTHAM DRIVE, CULVER CITY, CALIF.

EXPORT DIVISION: 13 EAST 40th STREET, NEW YORK 16, N. Y.

CABLE: "ARLAB"



73

Magazine

Wayne Green W2NSD/1
Editor, etcetera

September, 1964

Vol. XXIII, No. 1

Linears for the Two'er	K1CLL	6
Linear for the Sixer	K1CLL	11
Portable Six Meter Station	W100P	16
Now That You Ask Me	W71DF	29
More on the 6DQ5	K5JKX	32
SJS Receiver	K5JKX	34
Another Antenna of Note	W2RWJ	40
Tuned Line Tank Circuits	WA4EPY	42
Six the Easy Way	WA9CZQ	50
Simple Squelch	K5JKX	53
Souping the TCS	K7CJJ	54
Varicap Phase Modulator	W7CSD	56
Friendly Silicon Rectifiers	W2RWJ	58
Moonbounce in Switzerland	HB9RF	62
The Heath SB-400	K1RPB	64
Save Ten?	WA4HWH	66
SB-10 and the ARC-2	W6PDD	68
RF Hazard	W2QCI	70
How to Raise a Beam	W2RWJ	72
Power for DC Motors	W4WKM	76
Gonset Sidewinder	W2NSD/1	82
Rubbish Wire Long Sky	K5HVZ	84
Bagpipes and the Phone Men	W1JKZ	87
Propagation	Nelson	96

Letters	10, 65, 84	CB Rules	73
Cartoon	57	IoAR	61
New Products	80	Clean Contacts	81

73's Advertising Rates

	1-5 times	6-11 times*	12 times*
2 pages	\$520	\$488**	\$456**
1 page	268	252**	236**
1/2 page	138	130	122
1/4 page	71	67	63
1/8 page	37	35	33
1/16 page	20	19	18

Add fractional page prices for sizes not listed.
 $\frac{3}{8} P = \frac{1}{4} P + \frac{1}{8} P$.
 *We must have a written contract for frequency discount.
 **No extra charge for second color for full page ads on contract.
 Second color (usually red, but our choice) . . .
 \$25 per page or fraction.
 Half or full page bleeds are 10% extra.
 No special positions can be promised for color pages.

73 Magazine is published monthly by 73, Inc., Peterborough, N. H. The phone number is 603-924-3873. Subscription rates \$4.00 per year, \$7.00 for two years, \$10 for three years world wide. Second class postage is paid at Peterborough, New Hampshire and at additional mailing offices. Printed in the U.S.A. Entire contents copyright 1964 by 73, Inc. Postmaster: please send form 3579 to 73 Magazine, Peterborough New Hampshire.



de
W2NSD/1

never say die

Do It Yourself?

In all of the tumult over incentive licensing, there is one item that seems to be generally accepted: it would be nice if things were better. We all wish that operating in our lower bands wasn't quite so hectic, that more operators would be considerate, that more public service was being accomplished, that more of us would try building equipment and that we would all continue to improve technically. Not necessarily in that order.

All of these goals are worth tackling. Amateur radio will be the better for their success and our enjoyment of it will be just that much more enhanced.

The question is, shall we go after these objectives voluntarily, putting our own personal enthusiasm into them, shall we do it with a gun stuck in our back, or shall we just leave everything alone and let things fester?

My own belief is that we can accomplish all this ourselves without the FCC wielding a big stick.

Ham radio is one of the greatest hobbies in the world. Not only do we get entertainment from the use of it, but we are ready to help out in any emergency or disaster. Perhaps it is time that every one of us took a good deep look into ourselves to see what we can do to be a better amateur and to make amateur radio better. This means all of us, from the oldest old timer to the newest Novice. All of us can help ourselves and ham radio.

What can *we* do? Let's take another look at those goals:

- Courtesy
- Wider use of available bands
- Technical improvement
- Home construction
- Public service

Courtesy. Perhaps consideration would be a better term. All of us can devote time and effort to this, not only in being sure that our own behavior is impeccable, but in teaching others what is right and what is wrong on our bands. It takes great courage to speak up when someone has done wrong . . . and great diplomacy. Diplomacy is not a born ability, it is learned through bitter experience. I find that few fellows get angry when I suggest an improvement in their equipment or techniques. I believe that the single greatest improvement possible to ham radio would be universal consideration.

Bands. To all practical purposes there is no QRM on the six and two meter bands. Neither is there any lack of activity. If you'll give them a try you'll find quite a few refugees from the furies of 20-40-80 up there. Ten needs you too.

Though all of these goals can be reached on a personal basis, many of them can be more effectively implemented through the group effort of an amateur radio club. Group action is the backbone of our hobby. Very few amateurs live beyond driving distance of a ham club. If every amateur would make it his business to attend club meetings and encourage his club to achieve the above goals we would enter a new era in our hobby.

Club discussions of operating practices are certain to be lively.

A club channel on ten, six or two would certainly open new horizons for many of the members stranded in the jungles on 75 or 20. Group efforts might even get activity going on 432 mc, which is increasing in popularity rapidly these days.

Every club meeting should include a short technical session where some phase of radio is discussed. The technical topic can be as-

INTERNATIONAL FREQUENCY METERS



designed for servicing!

Equip your lab or service bench with the finest . . .

Discover new operating convenience.

FM-5000 FREQUENCY METER 25 MC to 470 MC

The FM-5000 is a beat frequency measuring device incorporating a transistor counter circuit, low RF output for receiver checking, transmitter keying circuit, audio oscillator, self contained batteries, plug-in oscillators with heating circuits covering frequencies from 100 kc to 60 mc. Stability: $\pm .00025\%$ $+85^{\circ}$ to $+95^{\circ}$ F, $\pm .0005\%$ $+50^{\circ}$ to $+100^{\circ}$ F, $\pm .001\%$ $+32^{\circ}$ to $+120^{\circ}$ F. A separate oscillator (FO-2410) housing 24 crystals and a heater circuit is available. Dimensions: FM-5000, 10" x 8" x 7 $\frac{1}{2}$ ".

FM-5000 with batteries, accessories and complete instruction manual, less oscillators, and crystals. Shipping weight: 18 lbs. Cat. No. 620-103 \$375.00
Plug-in oscillators with crystal \$16.00 to \$50.00

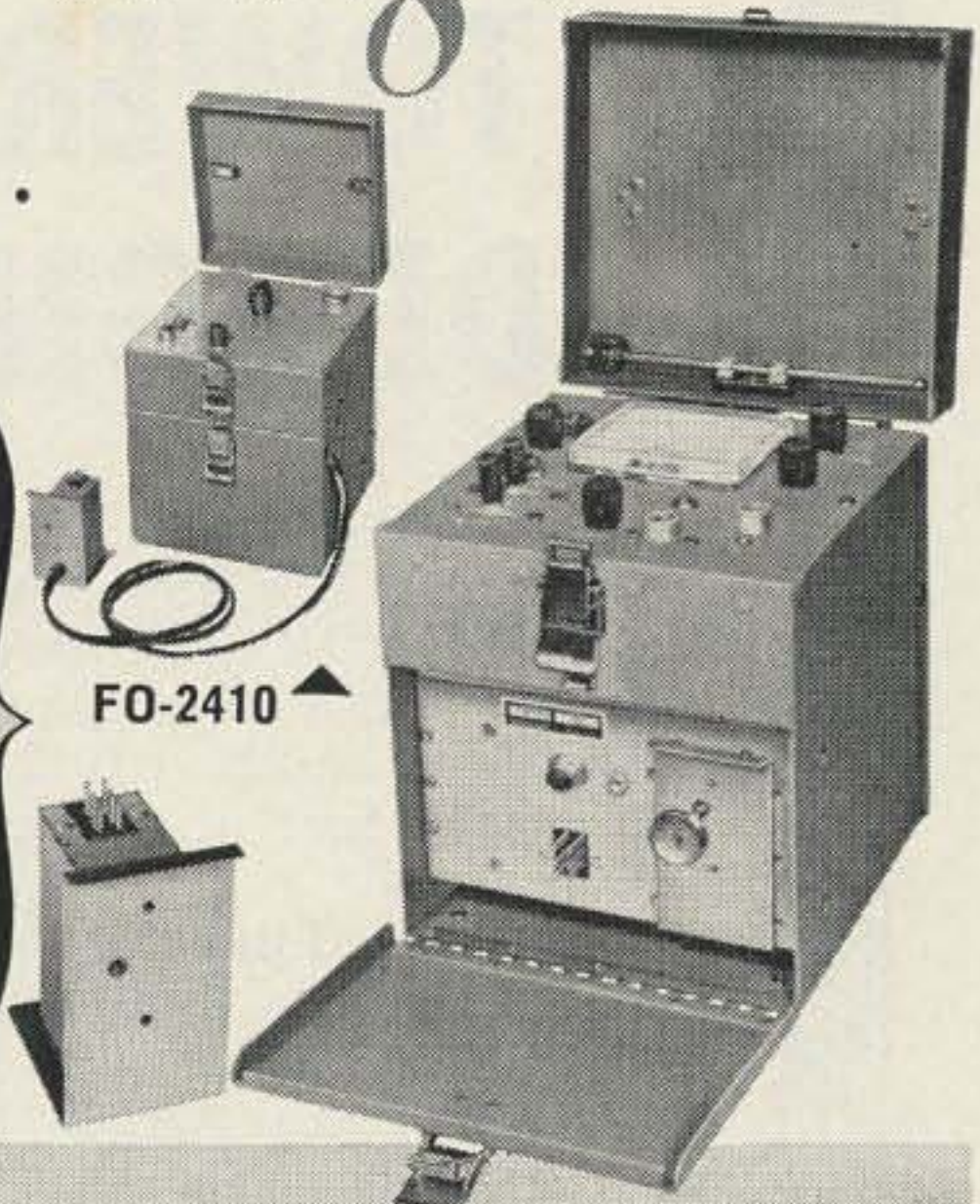

C-12B FREQUENCY METER For Citizens Band Servicing

This extremely portable secondary frequency standard is a self contained unit for servicing radio transmitters and receivers used in the 27 mc Citizens Band. The meter is capable of holding 24 crystals and comes with 23 crystals installed. The 23 crystals cover Channel 1 through 23. The frequency stability of the C-12B is $\pm .0025\%$ 32° to 125° F, $.0015\%$ 50° to 100° F. Other features include a transistorized frequency counter circuit, AM percentage modulation checker and power output meter.

C-12B complete with PK (pick-off) box, dummy load and connecting cable, crystals and batteries. Shipping weight: 9 lbs. Cat. No. 620-101 \$300.00

C-12 CRYSTAL CONTROLLED ALIGNMENT OSCILLATOR

The International C-12 alignment oscillator provides a standard for alignment of IF and RF circuits 200 kc to 60 mc. It makes the 12 most used frequencies instantly available through 12 crystal positions 200 kc to 15,000 kc. Special oscillators are available for use at the higher frequencies to 60 mc. Maximum output .6 volt. Power requirements: 115 vac.

C-12 complete, but less crystals. Shipping weight: 9 lbs. Cat. No. 620-100 . . \$69.50



C-12M FREQUENCY METER For Marine Band Servicing

The International C-12M is a portable secondary standard for servicing radio transmitters and receivers used in the 2 mc to 15 mc range. The meter has sockets for 24 crystals. The frequency stability is $\pm .0025\%$ 32° to 125° F, $\pm .0015\%$ 50° to 100° F. The C-12M has a built-in transistorized frequency counter circuit, AM percentage modulation checker and modulation carrier and relative percentage field strength.

C-12M complete with PK (pick-off) box and connecting cable, batteries, but less crystals. Shipping weight: 9 lbs. Cat. No. 620-104 \$235.00
Crystals for C-12M (specify frequency) \$5.00 ea.

KEEPING YOU ON FREQUENCY IS OUR BUSINESS...

Write today for our FREE 1964 CATALOG

**INTERNATIONAL
CRYSTAL MFG. CO., INC.**

18 NORTH LEE OKLAHOMA CITY, OKLAHOMA

the LEADER in CRANK-UP TOWER DESIGN



The full-strength Hercules 66-3 has diagonal bracing—a unique feature in all E-Z Way Towers. It's designed to support a large 20 m or 40 m beam; 4 el. Du-band; or 6 el Triband Wind area 22 feet at 66 feet in 60 MPH winds.

The 3 sections of the Hercules telescope from a minimum height of 30 feet to a maximum 62 feet.

A worm gear winch tilts the tower over for easy access to your beam.

Only
\$955.00

MODEL TORBZ 66-3

WIND LOAD CHART

Model	Ant. Wind Area	Full Hgt.	Height MPH	Half Hgt.	Height MPH	Min. Hgt.	Height MPH
TORBZ 66-3	22.2	66	60	50	86	32	125
TORBZ 66-3	13.2	66	75	50	90	32	140
TORBZ 66-3	8.2	66	90	50	100	32	150
TORBZ 75-3	17.0	75	60	55	86	33	125
TORBZ 75-3	10.0	75	75	55	100	33	140
TORBZ 88-3	12	88	60	65	86	38	140

NEW E-Z WAY HERCULES

DELIVERS THE ULTIMATE IN TOWER POWER

HERCULES	Painted	Galvanized
TORBZ 66-3	955.00	1,095.00
TORBZ 75-3	1,055.00	1,240.00
TORBZ 88-3	1,187.50	1,393.50

100' 115' Heights available

MOTOR WINCH

The E-Z Way Motor Winch raises and lowers towers to any height without guys. When towers are motorized a larger beam can be used because the tower is normally lowered to safer elevations. Standard features: Combination worm gear drive; totally enclosed motor and gear box; remote control switch; spiral grooved winch drum; positive crank down and limiter switches. Assembled complete with hardware and instructions, just \$389.50 for TORBZ 66-3; \$399.50 for TORBZ 75-3 and \$495.00 for TORBZ 88-3.



**E-Z WAY
TOWERS, INC.**

**5901 E. BROADWAY
TAMPA, FLORIDA**

signed at the previous meeting and should be something that all members can bone up on . . . perhaps a technical article in QST or 73. Clubs that are interested in using any of the many such technical articles published in 73 can buy bulk copies of back issues at our cost plus postage. That's the least we can do. You'll find a list of suggested issues on page 86.

Club projects for building identical units is fun and profitable. The club can take advantage of bulk buying savings . . . individual members can be sure that there will be someone to help them out of self inflicted difficulties. Turn to the back issues and handbooks, fellows. Construction is considered by many as one of the most exciting aspects of amateur radio. How about giving it a try?

Public service is easy. Club members should be able to come up with more suggestions than you can ever tackle. And don't forget to toot your horn when you turn in a good job . . . write an article for the local paper.

Tithe

Your excuse is the same as mine, I just don't have time. What little time I have to spare I like to use to get on the air. This is just an excuse, a rationalization. Actually there are darned few of us that cannot spare one night a month to attend a club meeting . . . and fewer yet that cannot spare a half hour or so a week to do some building and technical reading. If a fellow isn't interested enough in improving ham radio so that he is willing to invest one tenth of his hobby time in our common goals, how valuable an asset is he to the rest of us . . . or to his country . . . or to himself?

Please give some serious consideration to devoting a tithe of your time to bettering yourself and amateur radio.

Big Blow

One of the club events of which I most highly approve is the yearly "Big Blow" by the Windblowers VHF Society. This Northern New Jersey group takes to the mountains once a year for a day and sets up two meter stations in four states. If you can work all four of them you get a nice certificate. This year you'll hear the Blow on September 26th from 1400-2400 hours EDT, operating from New Jersey, New York, Pennsylvania, and Connecticut.

Current Events

No news is bad news on WA2USA.

No news is good news on RM-499.

No 73 at the ARRL National Convention.

Letter from K1YVB saying he was not per-
(Turn to page 91)

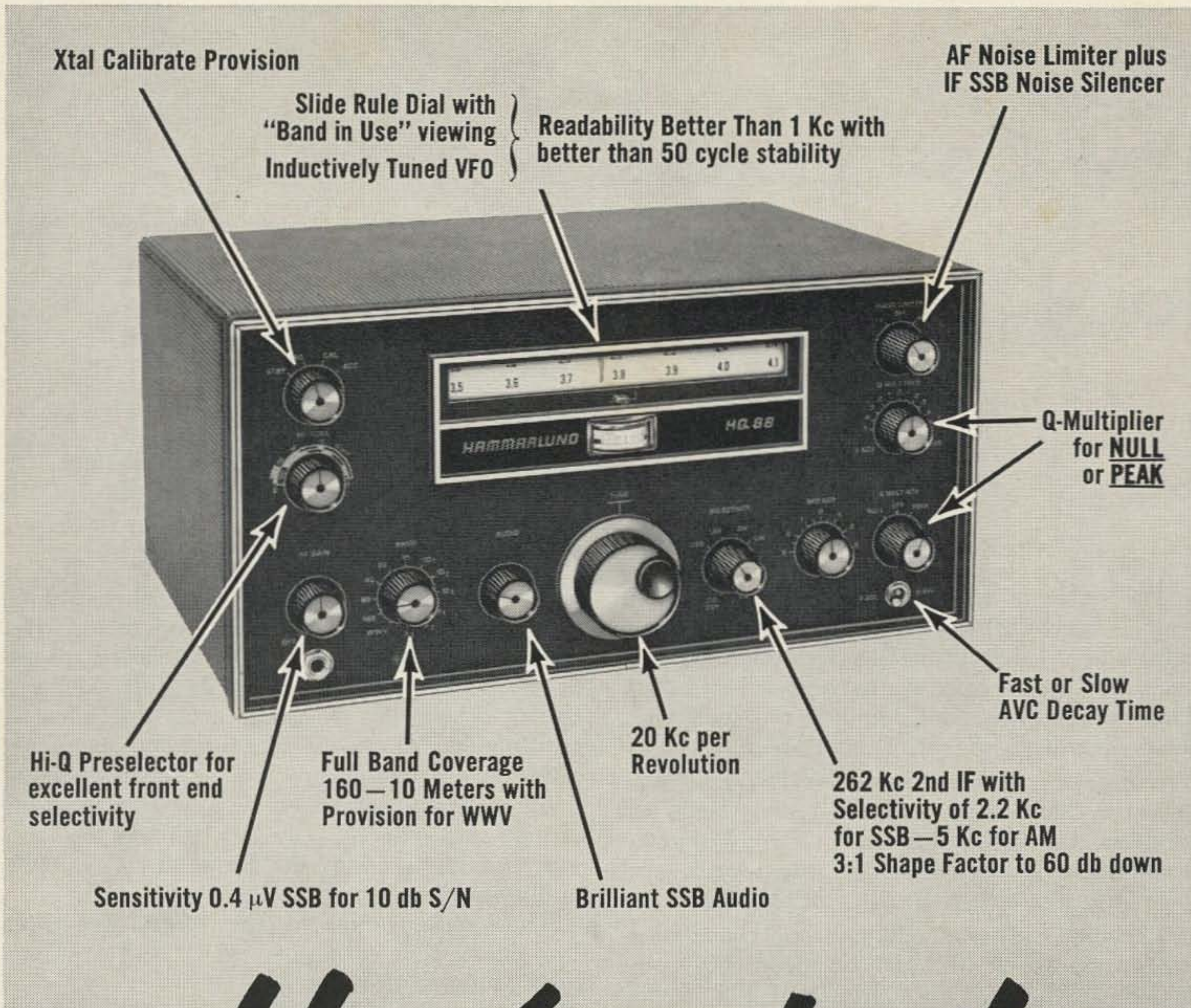

Here's why!

the ALL NEW HAMMARLUND HQ-88

has created a new set of performance standards for Hi-Stability receivers

FEATURES: ■ Separate diode AM detector and SSB Product Detector ■ Accessory Socket ■ Coax Input ■ 3.2 and 500 ohm audio output ■ Dimensions: 15" W x 7³/₄" H x 10¹/₂" D.

\$299⁰⁰

Thermal drift on the "88" is rated at no more than 50 cycles after warmup. See and test this high stability receiver at your nearest Hammarlund Distributor Today!



HAMMARLUND MANUFACTURING COMPANY
 A GIANNINI SCIENTIFIC COMPANY
 53 West 23rd Street, New York 10, New York

Low Cost Linears for the Two'er

Bill Hoisington K1CLL
83 Bellevue Ave.
Melrose, Mass.

The extreme UHF capabilities of the 100 watt 2C39, "Full power to 2500 megacycles," certainly justifies its use at 432 mc but does keep the surplus price up between \$5 and \$10. This perhaps does not coincide too well with the economical concept of the Two'er.

Contacts on the air with the Two'er linear, however, have demonstrated a *very* large interest in such an addition providing it can be done at reasonable cost. So the search and work was started—with interesting results.

The first trial was a logical one. Your present writer back in 1946 ventured into print in QST with "Getting Started On 420," using the 8012-8025 tubes. This little red-hot (temperature-wise) bottle had at least one interesting feature. I worked on 420 mc! You could run a good 50 watts to it. You can buy it today for 50 cents. Let's see why.

The 8012-8025 Tubes

The 8012 has three flexible leads for the filaments and center tap, and two grid leads and two plate leads. These last are what counts on 432 mc, and do no harm on 144

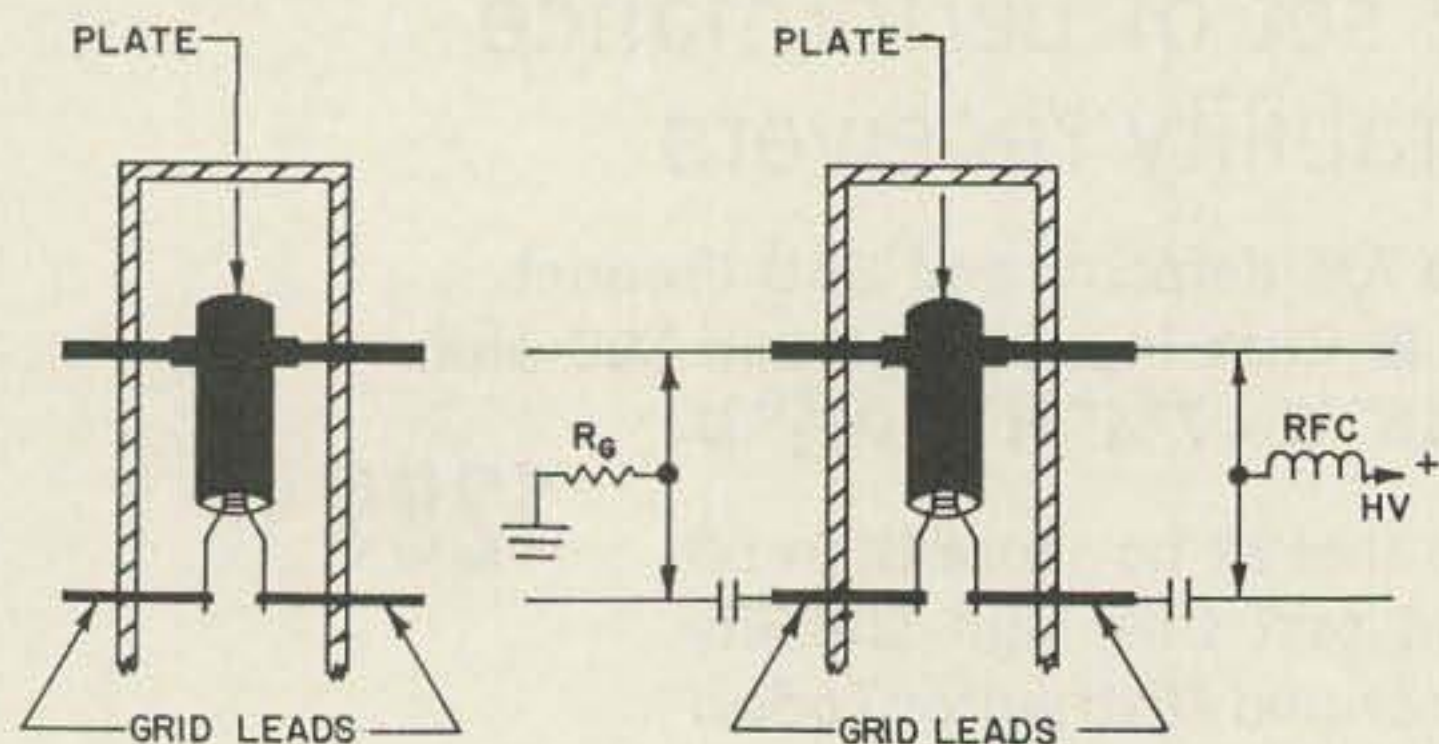

Fig. 1

Fig. 2

Fig. 1—8012 double lead detail

Fig. 2—8012 double line UHF oscillator

mc either. The principle of more than one lead is a great one as you go up into UHF. Certain low-cost tubes use this feature to get to UHF. The 6AM4, 6AN4, and 6AF4A, among others. As an example of the effect of multiple leads, one of those tubes was being used as an oscillator with grid and plate lines of heavy copper wire. Just the addition of a second wire, in parallel with the first one was enough to jump the frequency from 400 to 600 megacycles.

The configuration of the 8012 (see Fig. 1), shows this capability also, with its two plate and two grid pins.

Fig. 2 shows how this may be used to advantage at UHF, as an oscillator. With lines on both sides, it would go to 500 megacycles. With lines on only one side you're stuck on the 220 mc band.

On two meters, Fig. 3 shows what can be done as a "rugged" 2 meter linear amplifier. Unfortunately the required drive power for this tube is not to be found in the Two'er. Fig. 3 works FB, but *not* with the Two'er as a driver. It neutralizes and tunes great, but the 8012 tube gain was not sufficient to operate successfully on the less-than-one-watt of rf from the Two'er. As they said in Paris, my residence from 1927 to 1934, "On a pour son argent." Literal English: "One has for one's money." So much for the 8012 today and its twin the 8025, dressed up with buttons and a 4 pin base for the filament.

The 815

So on we went, the choice getting narrower and narrower. The tube must be *good* on 2 meters but not expensive. It should not, if possible, be described in the RCA Technical series as "This tube is used principally for

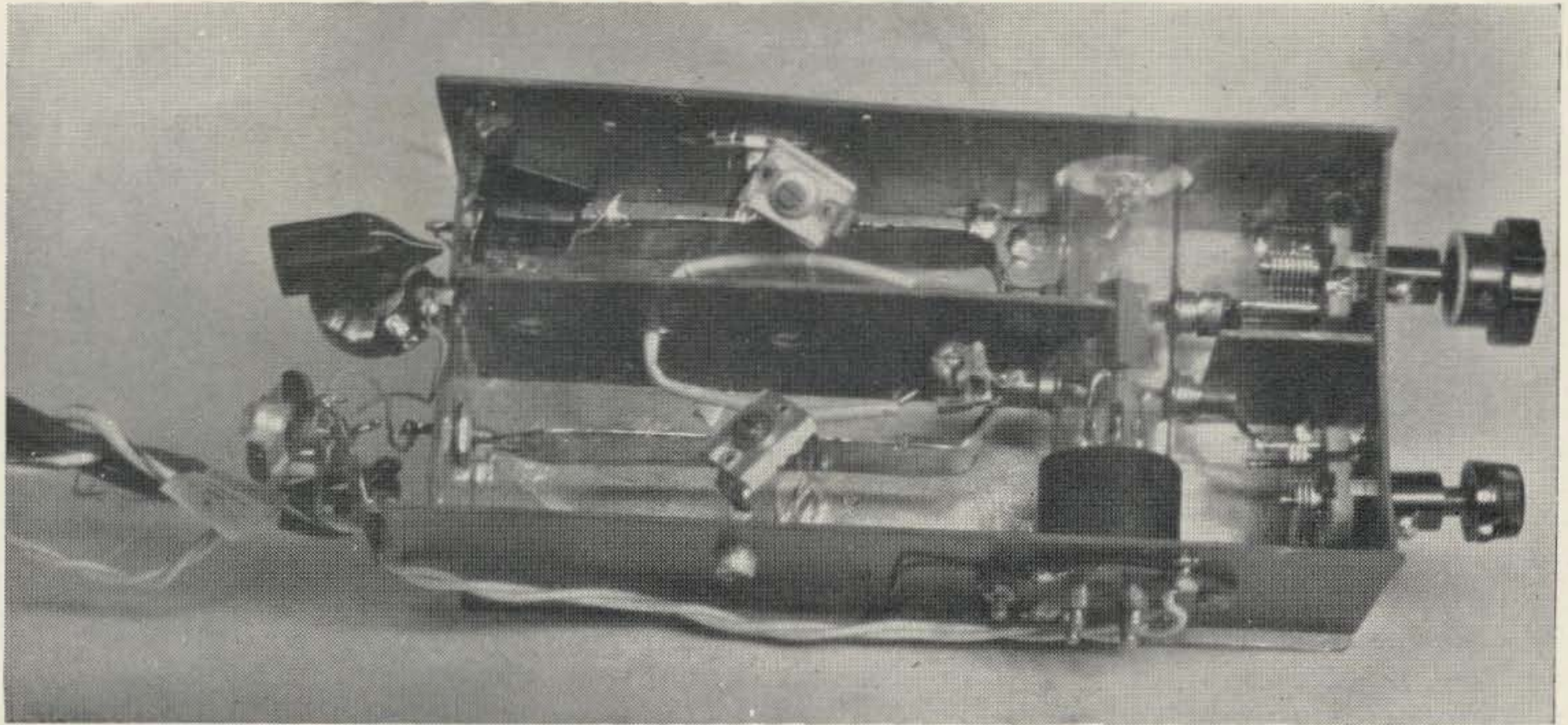

renewal purposes." Or worse, "This is a discontinued type listed for reference only." Regardless of the tube manufacturers reasons for not pushing a good tube like the 815, among which may well be the desire to sell more \$20 double pentodes, there appear to be as many as one hundred thousand or more young lads who just *cannot* pay such prices but who *do* want some *power* on VHF-UHF!

What does RCA say about the 815? First, "Twin Beam Power Tube." This sounds good. What does it mean? The twin part is easy. There are two identical tubes in one glass envelope. They may or may not have some common elements. The 815 does.

How about the "Beam Power" business. This is real tricky but it sure helps! In non-beam power tubes, tetrodes or pentodes, some of the available electrons are collected by the *screen* and thus do not produce power at the plate. In beam power tubes the grid and screen wires are so arranged that most of the electrons pass *between* the screen wires on their way to the plate. These negative charges, on which the entire electronic world depends, do not put any energy into the plate tank and thus on into your antenna when they stop and chew the fat on the screen! Nuff on that. Next.

"May be used at full input to 125 mc."

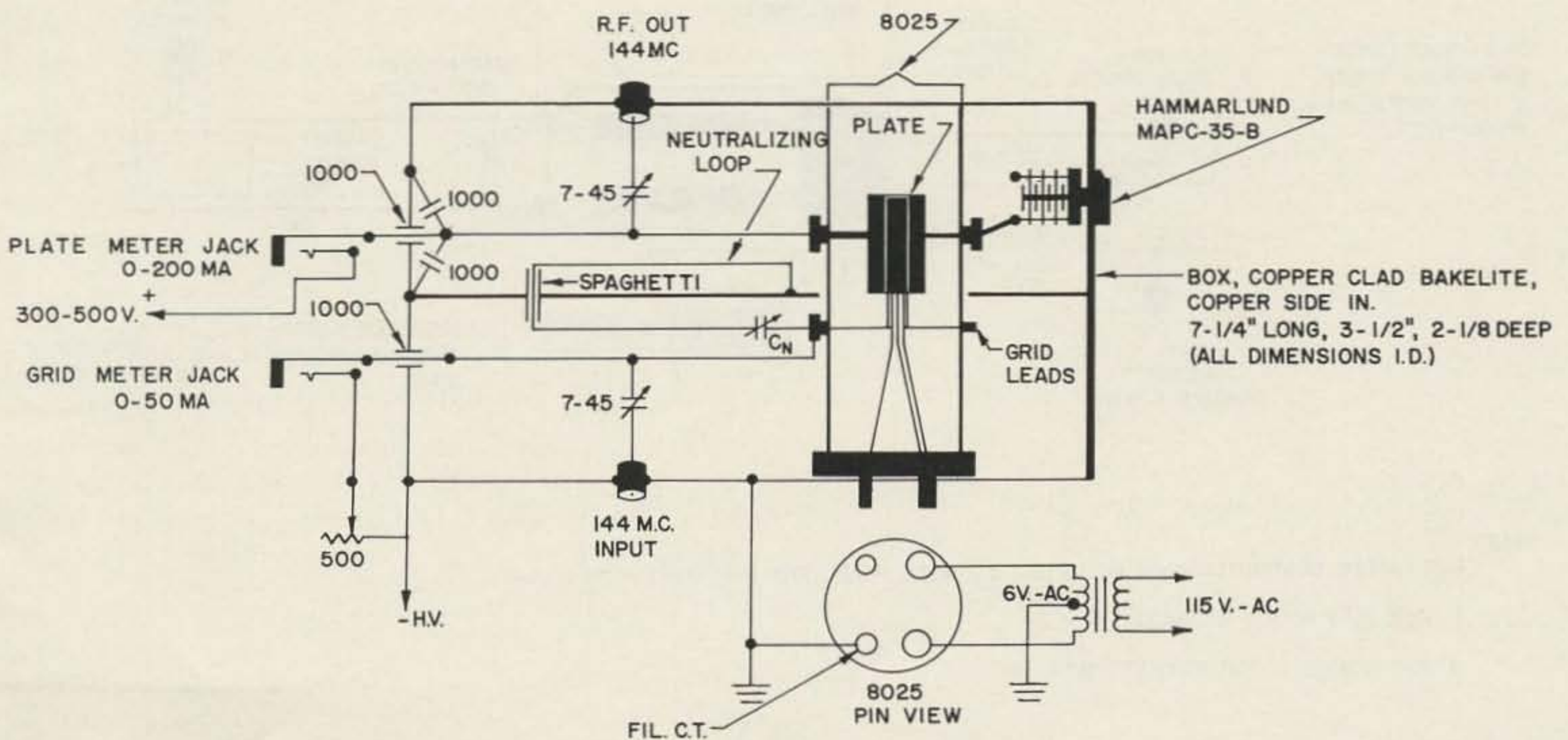
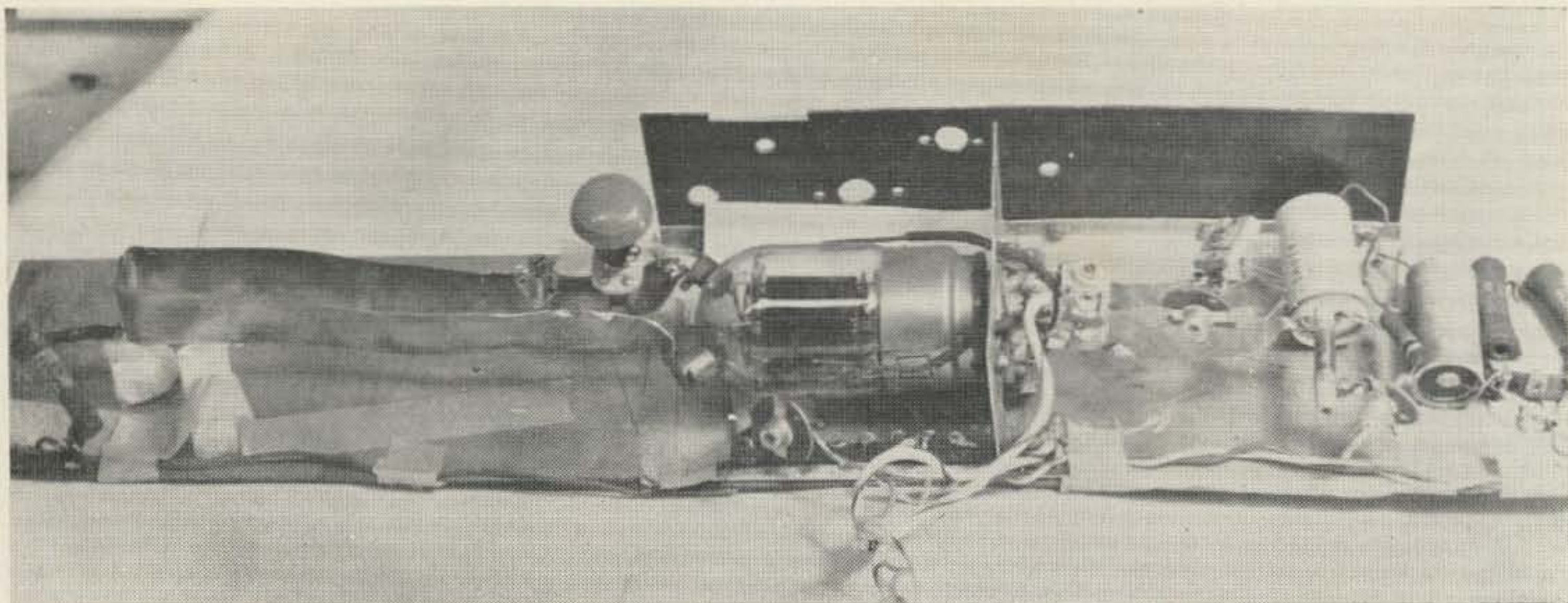

FIG. 3

8025 linear amplifier, 144 mc



"For operation at 175 megacycles plate voltage and input should be reduced to 80% of maximum." Looks like about 90% for 144 megacycles. Ratings for 200 mc are also shown, which is good, because listed operation at 200 mc means better capabilities at 144.

The allowed wattage looks good too. 75 watts input. More than we need but it's nice to have a little reserve. As a matter of fact, due to "grid circuit losses" and other nasty little deals, that 75 watts is *not* more than we need!

What about driver power? As a class C amplifier it works on only .16 watts! As a class AB2 job which is close to the desired class B linear type, .36 watts is indicated. And output? Using more drive than the Two'er has, I have lit a 50 watt bulb to full brilliance on

144 mc. So relax and let's see what it actually *does* put out when driven by a Two'er.

Fig. 4 shows the pictorial basic diagram. Copper strap is used in the grid and plate lines for the maximum electromagnetic momentum effect. The more copper you can use *properly*, the more momentum you will have. Which helps FB to get a high Q.

Experience has shown that the Q of a pair of lines in a $\frac{1}{2}$ wave circuit can be raised by locating them near a "ground plane," or in this case, a flat copper-clad sheet. The 815 socket can be located flat on a vertical wall on the copper-clad base. Grounds, filament, and screen bypasses, etc., are soldered close to the socket.

A good grid circuit is obtained with the $\frac{3}{4}$ inch wide copper strap which is needed to serve what little input power you get from

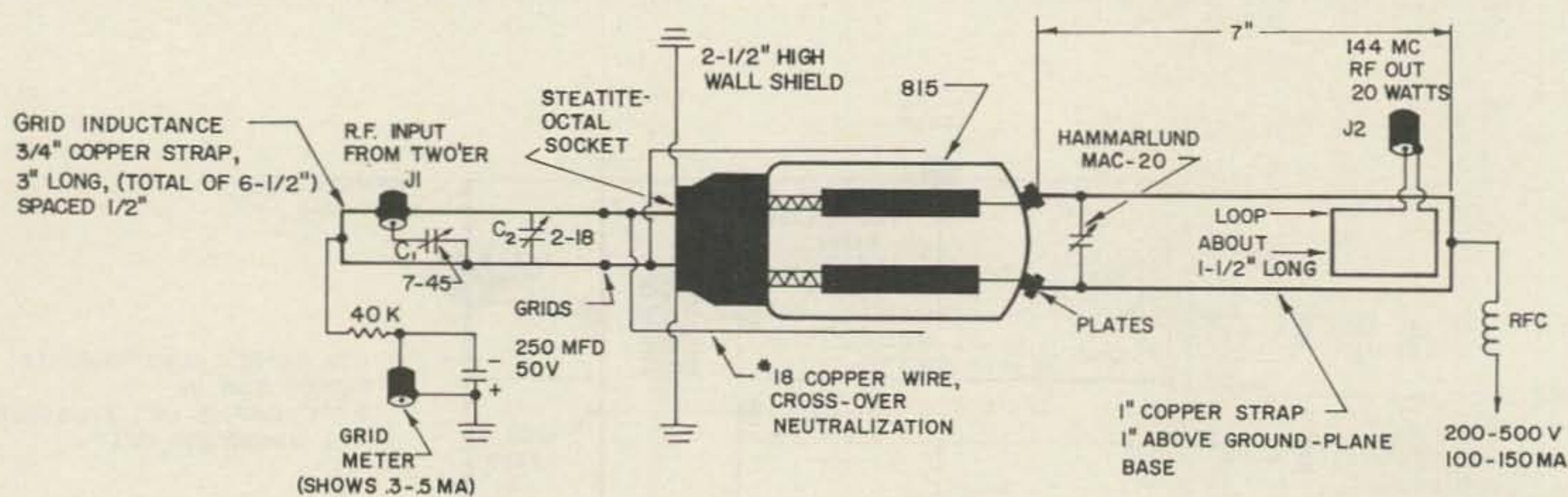

NOTES:

1. J1 OUTER CONDUCTOR CAN BE INSULATED WITH SMALL 1000 MMF DISKS IF NECESSARY.
2. GRID BIAS ABOUT 15 VOLTS.
3. SEE FIGURE 5 FOR SOCKET DETAILS.

FIG. 4

Fig. 4—Top view, 815 double beam-power pentode, 144 mc linear amplifier
Note 1: J1 outer conductor can be insulated

with small 1000 mmfd discs if necessary.
Note 2: Grid bias about 15 volts. Note 3: See Fig. 5 for socket details.

"SS-1R in a class by itself"

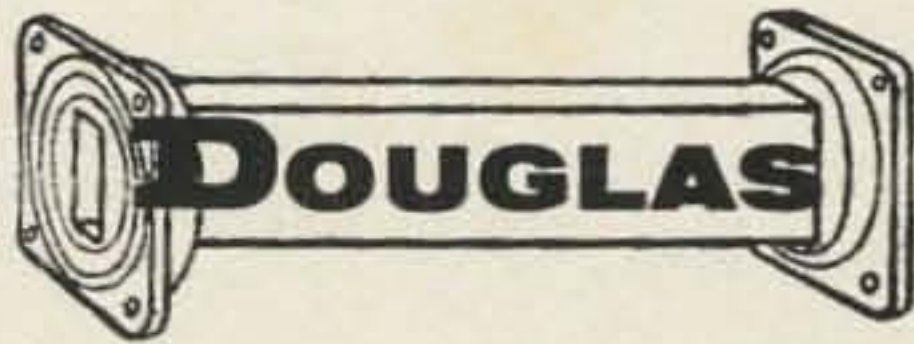

DOUGLAS MICROWAVE CO., Inc.

252 EAST 3rd STREET • MOUNT VERNON, N. Y. 10550 • 914 MOUNT Vernon 8-6900

CABLE - DOUGMICRO

June 3, 1964

Mr. Richard Marder, Sales Manager
Squires Sanders Inc.
475 Watchung Avenue
Watchung, New Jersey

Dear Mr. Marder:

I have now had my SS-1R (and SS-1S silencer) for a month and can now evaluate it, both from an operational as well as from a purely technical viewpoint. There is no question in my mind that the SS-1R is so outstanding that it is in a class by itself. In all my years as a radio "ham", going back to 1932, I have seen (and used) the "latest and newest", from the simplest (SW-3), to the HRO, to the Super-Pro, to the present Collins line. The SS-1R is as far ahead of them all as to be in a class by itself. This is one time when the expression "Sales is two years ahead of engineering" definitely does not apply; your engineering department is years ahead of your sales department. In my opinion you do not extoll strongly enough the real advantage of the SS-1R over anything else presently available. I am referring, of course, to the superb anti-cross-modulation front end design.

Having the good fortune (?) to be surrounded, within a radius of one mile, by at least three 20 meter, single sideband 1 Kw stations, I had been plagued by unusable wide sections in the band whenever these stations were on. I can honestly state now that the only time I am troubled with them is when I tune to within about 10 Kcs or less of their frequency.

It almost goes without saying, but, nevertheless, I must comment on the digital readout dial, the frequency stability and the ease of tuning; the receiver is superb and outstanding in all these features.

I have saved my comments on the noise silencer for the last. I recall, wayback in the late '30s, watching and hearing Jim Lamb demonstrate his I.F. noise limiter. In the twenty-odd years since then I had never seen (or heard) a noise limiter, clipper or silencer to better his original design; your SS-1R and SS-1S have now revised this opinion, but definitely! Again I feel your advertising of this feature is understated.

Being blessed with a good R.F. laboratory which makes it possible to check out equipment over the frequency range of 5 cycles to 90 Kilo megacycles (90 Kmc), it was with a great pleasure I saw the results when I ran the receiver through its paces: signal to noise ratios were met easily; dial accuracy was exceeded (averaging 1/4 to 1/2 Kc error, but never getting close to your stated 1 Kc max. error); frequency stability, as measured with a Hewlett-Packard counter, never exceeded a maximum of 80 cycles, from a cold start over a two hour "warmup" period.

In conclusion, I leave you with this thought: If Collins is considered the "Cadillac" of receivers, your SS-1R should be considered the "Rolls-Royce".

Very truly yours,

DOUGLAS MICROWAVE CO., INC.

R. Harry Douglas
President
W2VRU

RHD: jr

P.S. Very Important-Please rush through the SS-1T transmitter; I am anxious to put it on the air.

Squires-Sanders, Inc.
475 WATCHUNG AVENUE, WATCHUNG, N.J.

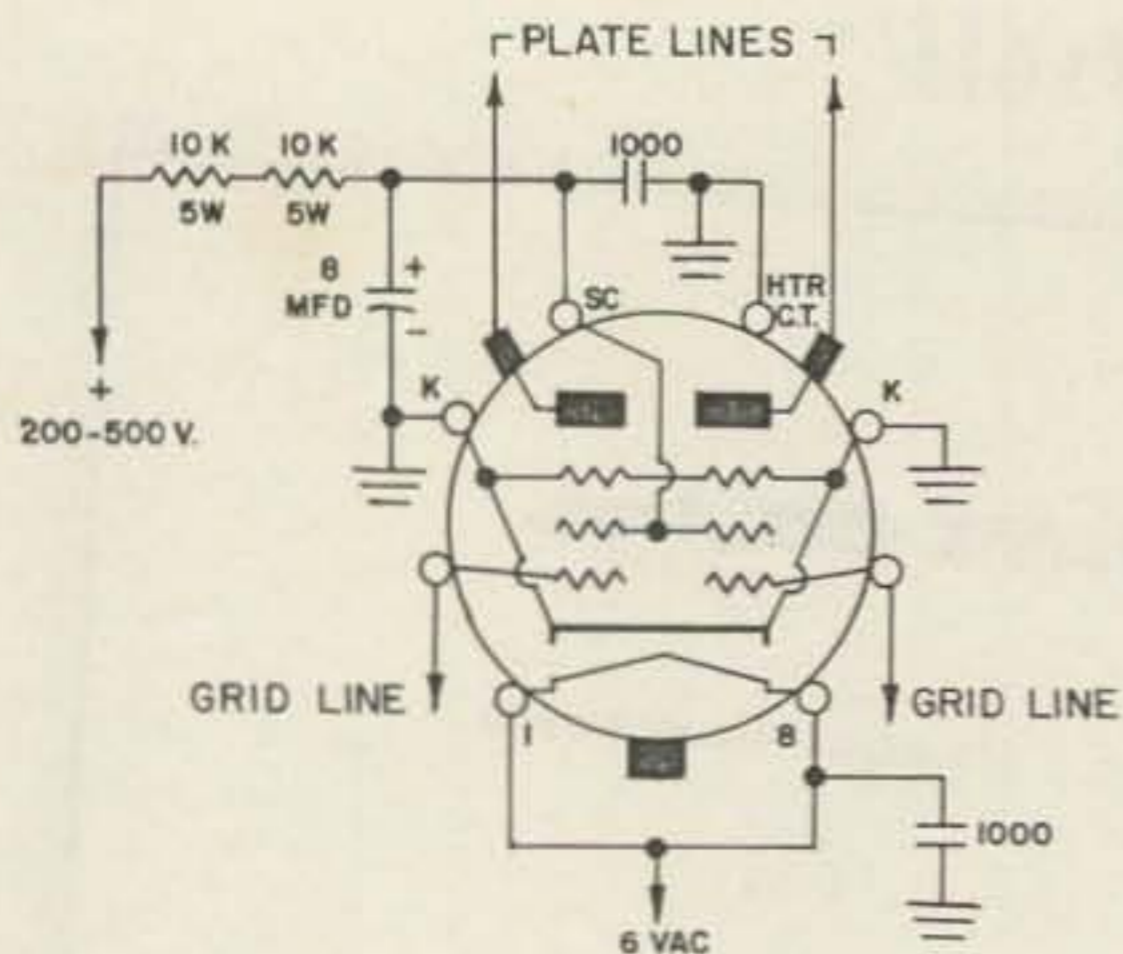

FIG. 5

Socket details, 815

the Two'er, because after all, it is a limited output unit. Three inches on each side for the grid line is not bad at 144 megacycles, considering the listed 13.3 mmfd input capacity of the 815 and the parallel tuning used.

Grid bias of minus 15 volts is listed for class AB2, and this just about what we wind up with finally. Putting a very large capacity across the grid resistor takes care of a sufficiently "stiff" bias for an AM linear, to an astonishing degree. My first contact with this amplifier was in West Bath, Maine, some 135 away Down East, airline miles. He reported, "Modulation very fine. Filling carrier. Even in deep fade to noise could still read you." I was running about 20 watts out then. After all, this is just a single \$1.75 tube driven by an unmodified Two'er.

The screen is a nice place for a power control if you would like one. Put a high power pot (five or ten watts rating) in place of the screen resistor indicated. Actually what are we worrying about? At these power levels? Tee Vee's run 200 to 300 watts all day long with—in my opinion—morons watching them for the most part, so the 40 to 50 watts input of our little "booster" linear is OK for my money. After all, it does operate around 60% efficiency on maximum Two'er modulation. SSB linears call for a "stiff" screen supply voltage. Do we need one here? Let us see just how rigid this must be for an AM linear which does *not* operate in the same fashion as an SSB linear. Checking the screen voltage under modulation with just an 8 mfd to ground for regulation, we find practically no variation in voltage. It should be remembered that in an AM linear stage with symmetrical modulation voltage, the average plate current remains constant. The proper positioning of the drive and bias is more important here, as

we will see, although the whole rig appears remarkably *uncritical*. In fact, as you listen to it while varying screen voltage and grid bias, there isn't much difference. The rf drive has perhaps the greatest effect. I finally settled for 20K series resistor in the screen; putting 190 volts on it with 450 volts on the plate and 40K in the grid, which puts some 12 to 15 volts bias on it. Again, remember that information on how to operate a linear for SSB does not apply here. That is, not *all* of it. In SSB, no rf is applied (if your carrier is really suppressed) til you talk. With an AM linear the carrier is always there.

As shown "flat-out" the unit is some 15 inches long. The plate lines may be run back over the tube if a good shield of copper-clad bakelite is installed over the tube and under the "bent-back" plate lines (not shown). In this case the length could be kept under 8 inches. If you really want to make it small, this can be done, but the Q, output, and rf filtering effect may drop a little.

A diagram of two-switch send receive operation is shown in a previous section in the 2C39 linear article.

On the Air Tests

Settling down with a steady 20 watts output, driven by the unmodified (as-yet!) Two'er into the little 4 element beam, results were almost identical to operation with the 2C39 linear. "Modulation sounds excellent"; "If I had a Two'er I would get right to it"; "Sounds great."

Personally, I'm getting quite interested in trying this rig out mountain-topping, my favorite recreation.

... K1CLL

Letter

Dear Wayne:

Perhaps I missed the corrections, or perhaps you missed the errors.

In the article "Let's Keep It Simple" (Jan. '64), the 100 microhenry choke should connect to the collector rather than the emitter. This was compounded by VE2AUB's statement that "the circuit may appear strange at first." Hi. A similar circuit appeared in "Hints & Kinks" a while back. For me, both circuits had the same defect. The crystal signal seems to swamp the signal from the antenna. Any suggestions?

In the sweep generator article "A New Broom" by K6JHJ (May '62), the oscillator grid leak was omitted. Anything else?

A very practical accessory for the "Broom" can be found in the Oct. '61 issue of "CQ." A two tube logarithmic amplifier and detector circuit can be "lifted" from the "Spectrum Analyzer" by K2BAJ and W2QZJ.

Gordon C. LaGrange, W5AKQ

The Sixer Linear

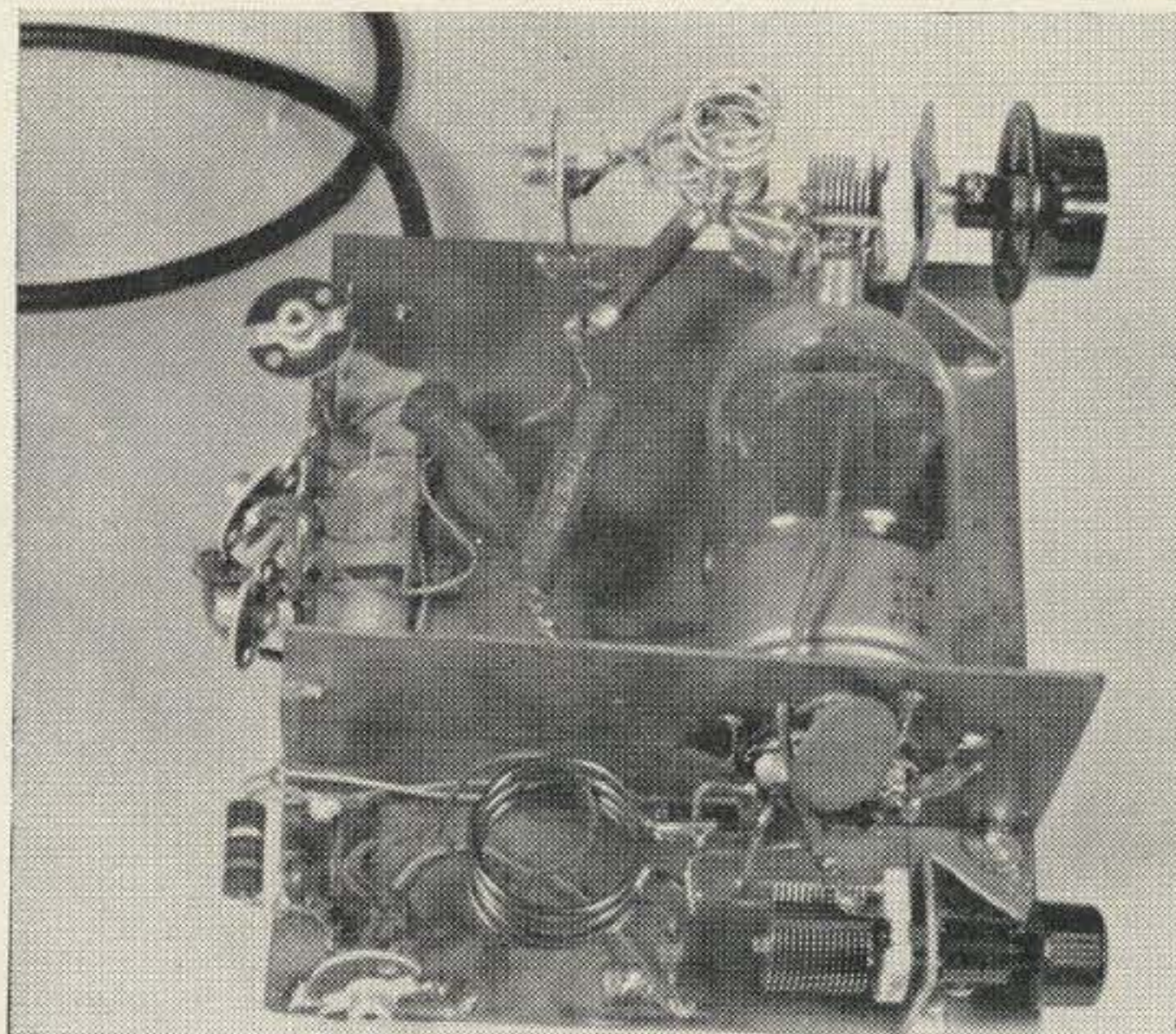

Bill Hoisington K1CLL

Design Philosophy AM Linear Operation

We will plunge right into the thick of AM linear theory without delay because I feel that the young starting out amateur (I was one once, too) has been had on this question. For the life of me, I can't understand why, but maybe you can form your own conclusions. Let's see.

Most of my amateur life I have shied away from AM linears because "everybody" said they were "only 30% efficient." It wasn't until I really delved into the subject recently and actually built several on 2 meters and on 6, that I began to wonder "what cooks here?"

Starting in naturally with "The Radio Amateurs Handbook," there is about two columns on the linear AM amplifier to be found on pages 296-7. What does it say? "The plate efficiency of the amplifier (linear AM) varies with the instantaneous value of the modulation envelope. The efficiency at the unmodulated carrier level is only of the order of 30-35%." "Because of this low efficiency, linear amplifiers have not had much application in amateur transmitters," ". . . . and only about one-third (of the input power, dc) is converted to useful carrier output."

There are some odd things about the above. The part about the 30% is true, but *only* for an unmodulated carrier, which "Who needs?" The second part is an opinion only. The fact is, a "sin of omission" has apparently been committed, for many long years.

For example, what does Terman say? "The linear amplifier is a form of Class B amplifier, and its most important use is as a power amplifier of modulated waves." Now read the next *carefully*. "The plate efficiency at full output is usually of the order of 50 to 65 percent under practical conditions. The peak power that can be developed by a tube operating as a linear amplifier is approximately the same as the power that can be developed by the same tube in class C operation." At about this point I began to realize the "why" of some of the on the air reports I had been getting. Any more? Yep! "The linear amplifier is a class C amplifier modified by adjusting to make the output proportional to the exciter voltage. Such amplifiers are used extensively in the amplification of modulated waves since they preserve the modulation without distortion." Well! Also, no wonder! "With the maximum allowable excitation the plate efficiencies of linear amplifiers normally lie between 50 and 65 per cent" So that's why I got those reports on the air! Any other "Authorities" on the subject? Yes. The Radio Corporation of America puts out a useful little tome, "Technical Manual TT5." This handbook "will be useful to engineers, . . . amateurs, and many others technically concerned with transmitting tubes." On page 19 we find ". . . class B amplifiers are particularly suitable for use as output amplifiers employing "low-level" amplitude modulation." ". . . the maximum efficiency varies from approximately 33% for an unmodulated carrier, to approximately 66 per cent for a fully modulated carrier."

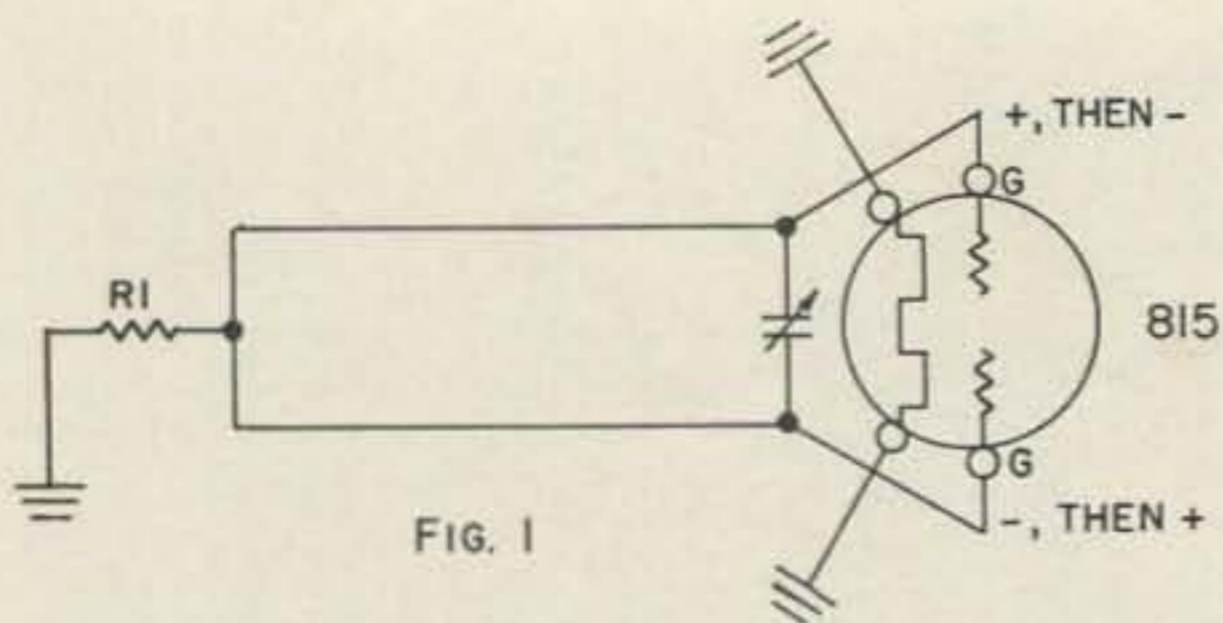

FIG. 1

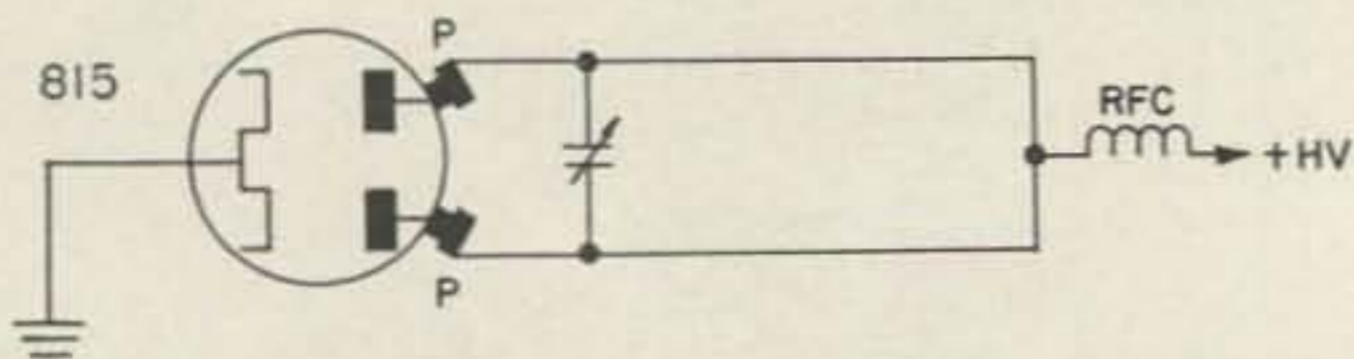

FIG. 2

Without further ado let's get on with the deal and look at the electricity consumed, cost, what tube, circuit, and on the air reports. You can judge for yourself, it won't cost you much.

Just wait till you hear some beefed-up Sixers on the air, if you haven't already. I was astonished myself and my first license was dated 1921, 2BAV. Wait till I go mobile and mountain-topping with *this* one!

Furthermore, as you will see, "automatic" class B can be used, without any regulated supplies at all. The rush to SSB by some people has greatly confused the linear amplifier question also, aided by some who have not seen, or don't care to see, the difference between a linear with an SSB driver, and a linear with an AM driver.

The handbooks are full of SSB linears. In the author's desire to find and be identified with new equipment, and to show off his erudition, he fills pages with descriptions of how to "tame" certain new tubes, what high voltage to use, how to obtain carefully regulated screen and bias supplies, how to suppress all kinds of "parasitics," regeneration, etc., in order to get "stability," without which he states, linear operation is "impossible." With certain popular type tubes a lot of this *is* needed for SSB, but not for an AM linear.

Cost

A persistent topic of typical VHF rag-chewers today concerns the absence of good low-cost rigs in the 50 to 75 watt class for the developing VHF amateur of the do-it-yourself type. These are for the young lads who save pennies, not dollars, until they get enough to send away for a Sixer, (personally I hope they send for a Two'er, since that's my favorite band) or maybe a used Gonset for six meters. They would like quite a bit more power if they could afford it. Several things get in the way though. First, what to buy, or build.

What to Build

Here there are all kinds of choices, generally leading into high voltage, an expensive modulation transformer, and what final? Well, to put your mind at rest right now, there is a tube selling for \$1.75 that can do the job practically all by itself, without a modulation transformer and with a reasonable HV supply of some 300 to 400 volts. This is the 815 Beam Power Double-Pentode run as an AM linear. It is a "surplus tube." It is a well tried design and one I used on 5 and 2½ meters before World War II, to be strictly honest. What happened to it? WW 2 came hurrying along, driven by the mad paper-hanger, and the 832 and the 829 were rushed into being and served well in the Armed Forces.

The 815, with its slightly reduced rating at 144 mc, took a back seat and apparently has stayed there. However, it still is *not* listed as "For renewal purposes only" or "discontinued type." Briefly, it is listed at 25 watts dissipation and will put out a good 25 watts also, cool. Being a double tube with parallel dc operation, it does this with voltages (300-400) that can be obtained from a power transformer from almost any old Tee Vee box. I found several of these recently that had been thrown away! Suit yourself on that.

The 815 is one of the first, successful Twin Beam Power tubes. The heater is either 6 or 12 volts, which is handy for mobile. It has an octal socket which is good because low cost, and because the plates are on the *other end* of the tube with two plate caps.

This business of single-ended versus double-ended tubes has been played up and down across the radio world for many decades. I used to use the 201A back in 1925-26. Then you could work ZL's and such using a single tube receiver (with the 201A) and a single tube transmitter. I had a Western Electric 212B, with 2000 volts ac on the plate. Then people got rf amplifier conscious, and out came the type 24 tube, double ended. Then a little later on the service people kicked about handling plate or grid caps as well as shielding, and an ever-growing family of single-ended tubes started up again. Now they had trouble with feedback from grid to plate, and various little tricks were used, like a center pin type shield, sockets with a little shield in the middle, building a shield out of mica capacitors across the socket, etc. As far as any power was concerned, except maybe for straight audio, transmitter tubes were still double-ended, like the 815.

The 815 is somewhat like two good 6L6's in one envelope with plate connectors on top,

common screen, common cathodes, with the suppressors internally connected to the cathodes. It has always been a good low voltage high current rf tube. The beam power is a name, and a good one for the use of grid and screen wires so lined up that most of the electrons reach the plate, and do not hit the screen on their way over. This is particularly useful just at the time it is needed most. That is, when developing power the plate should swing way down near zero. At that time the plate is more negative than the screen and electrons would tend to be more attracted by the screen were it not for the beam effect.

The formation of a "space-charge" helps too. This little electronic trick is a concentration of electrons near the plate, which being negative, (the concentration, that is) tends to repel secondary electrons from leaving the plate. If electrons left the plate it would go positive just at the time you want it to go negative. These nuisance secondary electrons are the result of the primary electrons, the ones you get from the cathode and want to use, going "Hot-Rod," at some 67 million miles per hour, and hitting the plate at that speed, which causes "electron splatter" (I should think so!). Of course, you *want* them to reach the plate but you don't want the secondaries to leave the plate. When as many secondaries are leaving the plate as primaries are arriving, you don't produce much power!

There is a much more complicated and important deal that enters the picture too, even more so at UHF, but we will look deeper into

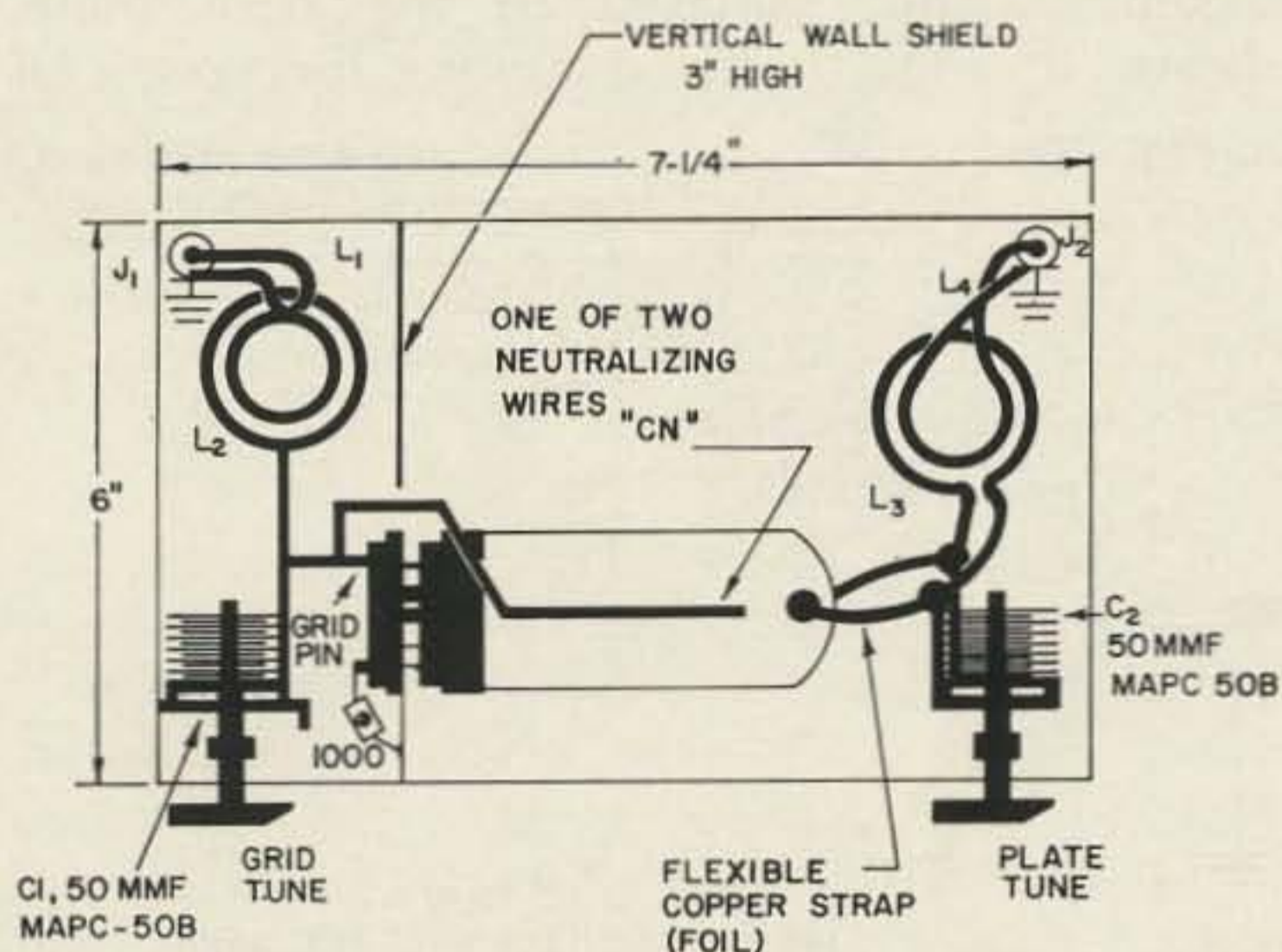

FIG. 4

- L1 6 T #18, 5/8" long, 5/8" O.D.
- L2 5 T #22, covered, 1/2" long, 1/2" O.D.
- L3 2T #22, covered, closewound, 1/2" O.D.
- L4 3T #22, covered, closewound, 3/8" O.D.
- L5 3T air wound, 16 per inch, 1/2"
- L6 4T #14, 5/8" long, 5/8" O.D.
- Ln 4T #22 plastic covered, 3/8" O.D., 1/2" long inside L6
- L7 2T #18 covered, 3/8" O.D., adjustable coupling to L6

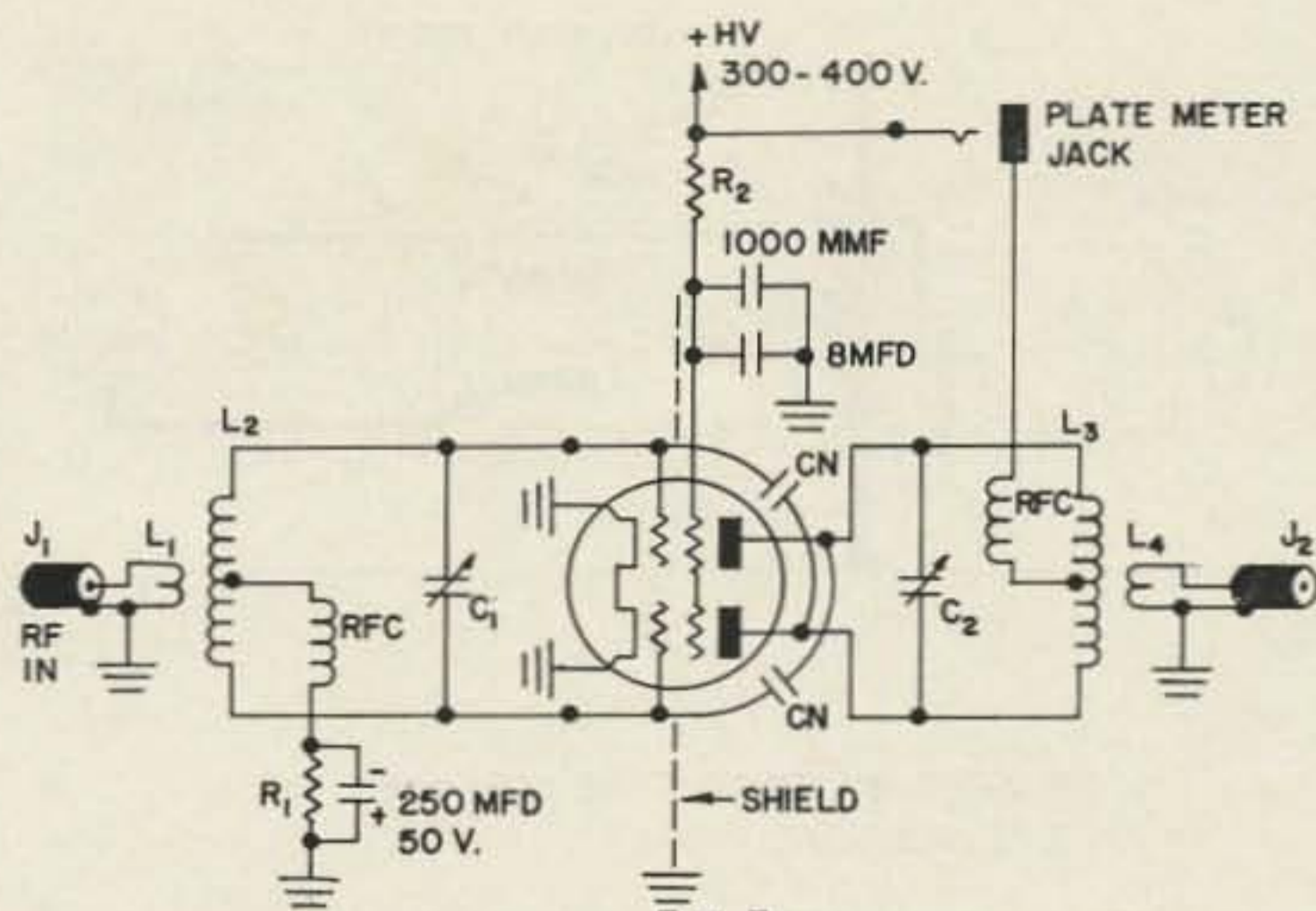

FIG. 3

- L1 3 T interleaved near middle
- L2 4 T heavy copper wire, #12 at least, 3/4" long 1 1/4" O.D.
- L3 6 T #14, 1 1/4" long, 3/4" O.D.
- L4 3 T #18, interleaved, 1/2" long, 1/2" O.D.
- C1 & C2 50 mmfd Hammarlund MAPC-50B
- Cn See text
- R1 5K
- R2 20K, 5W

that later on. This is the very great difference between the flow of electrons in a tube, at some fraction, say one twentieth, the speed of light for a plate voltage in the few hundreds, and the flow, or rather progress, or speed, of the electromagnetic *wave* along the plate strap, line, or cavity wall, which is practically at the speed of light.

So now we have the electrons at the plates of the 815, first on one plate then on the other, as the tube runs best in push-pull, and it really develops power. As mentioned, a good 25 watts output at 144 mc, or on 50 mc in this case.

Fig. 1 shows a big advantage of push-pull action at VHF. With a single grid the rf must be applied between grid and cathode. With push-pull the rf is applied to the two symmetrical grids, so that automatically there is a large and properly phased voltage between each grid and the cathode. The same effect applies to the plates, only more so, and a little different. As you can see in Fig. 2, electrons will arrive first at one plate then at the other. The electromagnetic wave, which is the type of energy you are interested in getting into the antenna and over to the other fellows antenna, travels back and forth on the U shaped inductance and does *not* have to be bypassed back to the cathode, as you can see.

Briefly, and exaggerating a little, for a 500 volt HV supply, first one plate gets a glop of electrons from the cathode as its grid goes toward positive. These negative charges cause the plate to drop near zero, providing of course that everything is working right, and also re-

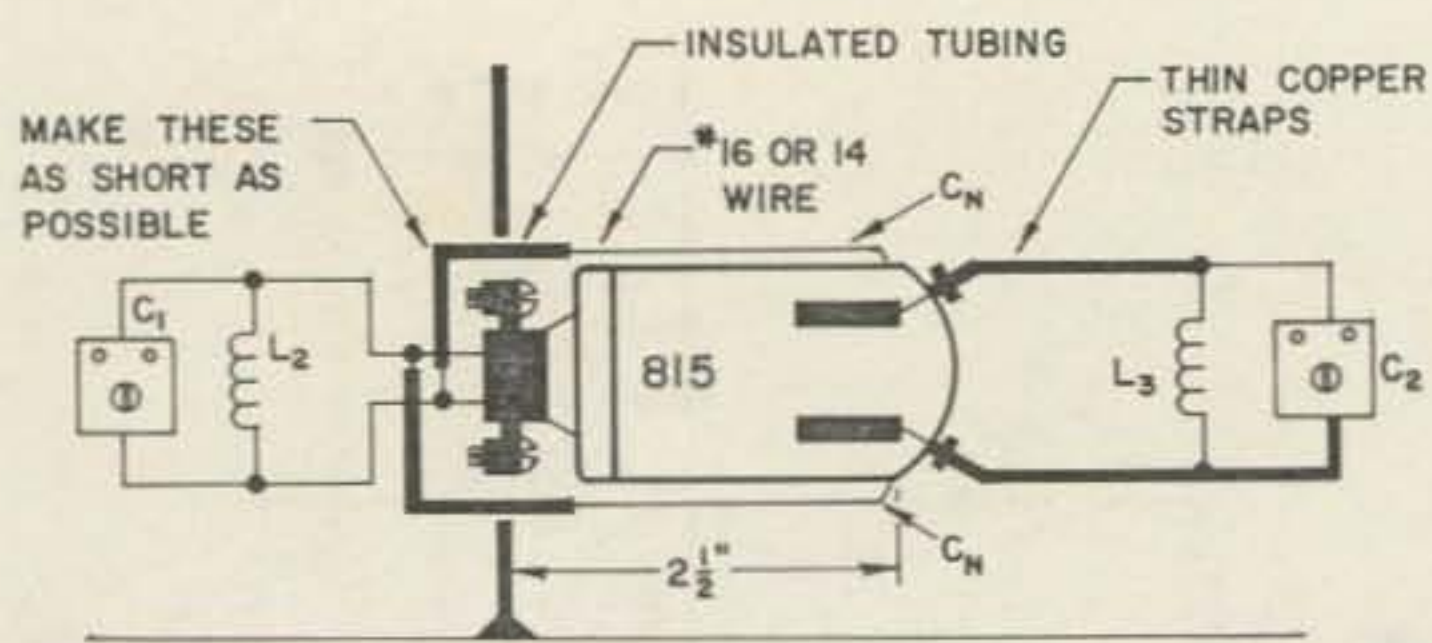

NOTES:

1. CAPACITOR MOUNTING STRIP NOT SHOWN.
2. C₁, C₂, SEE TEXT.

FIG. 5

membering that it takes a certain number of rf swings to reach the point of operation. The next instant (rf-wise) the electrons stop arriving at that plate and it "bounces" back positive again. It does not necessarily stop at 500 volts though, but may go much higher. In fact, you can get an interesting purple arc across the tank capacitor with no loading! Same action at the other plate, but of course a 1/2 cycle later. Fig. 2 shows plainly the "turning fork" or resonance effect that takes place between each plate and that there is no bypass needed back to the cathode. There is of course a steady average potential difference of 500 volts between both plates and the cathode. Remember though that this only an average, or dc difference. At one moment, rf-wise, it may be zero, the next moment 1,000 volts difference.

So, enough on push-pull. It works. You can use coils of course instead of straps. I did in this unit on 50 mc, for convenience.

Time was, on 5 meters "long-line" plate

tanks were quite the thing. You went to someone's shack and there up on the wall or stretched out on a table were some three feet or so of double copper tubing, side by side, as in Fig. 2. You can also wind up the copper strap into coils. I find myself using more and more C and less L in these 50 mc tanks. Some day I'll check to find out just how little L you can use. Sure cuts down on harmonics.

The Circuit and Tune-up

Fig. 3 shows the complete circuit. It is quite simple really and similar to class C amplifiers you find in the books. Except it doesn't need a modulator. While grid circuit "swamping resistors" are recommended for SSB linears, I could find no advantage here in the AM linear. Not only that, but remember that the Sixer does not have unlimited rf power output.

The 815 is mounted horizontally on a vertical wall of copper-clad bakelite. I'm sorry to be continually repeating about this material, but until someone shows me something better for experimental rigs, that's for me. Fig. 4 is a bird's eye view of the assembly. Fig. 5 is a front view of same, and Fig. 6 shows a pictorial of the 815 socket wiring.

Providing you use a good shield-wall to mount the socket on, and follow the simple neutralizing instructions, you can probably use a more compact assembly, or a different one, to suit your construction needs.

In Fig. 5 the grid and plate tuning capacitors are shown without mounts, I used the same bakelite again, soldered to the base plate, shown in Fig. 5, for mounting brackets. Of

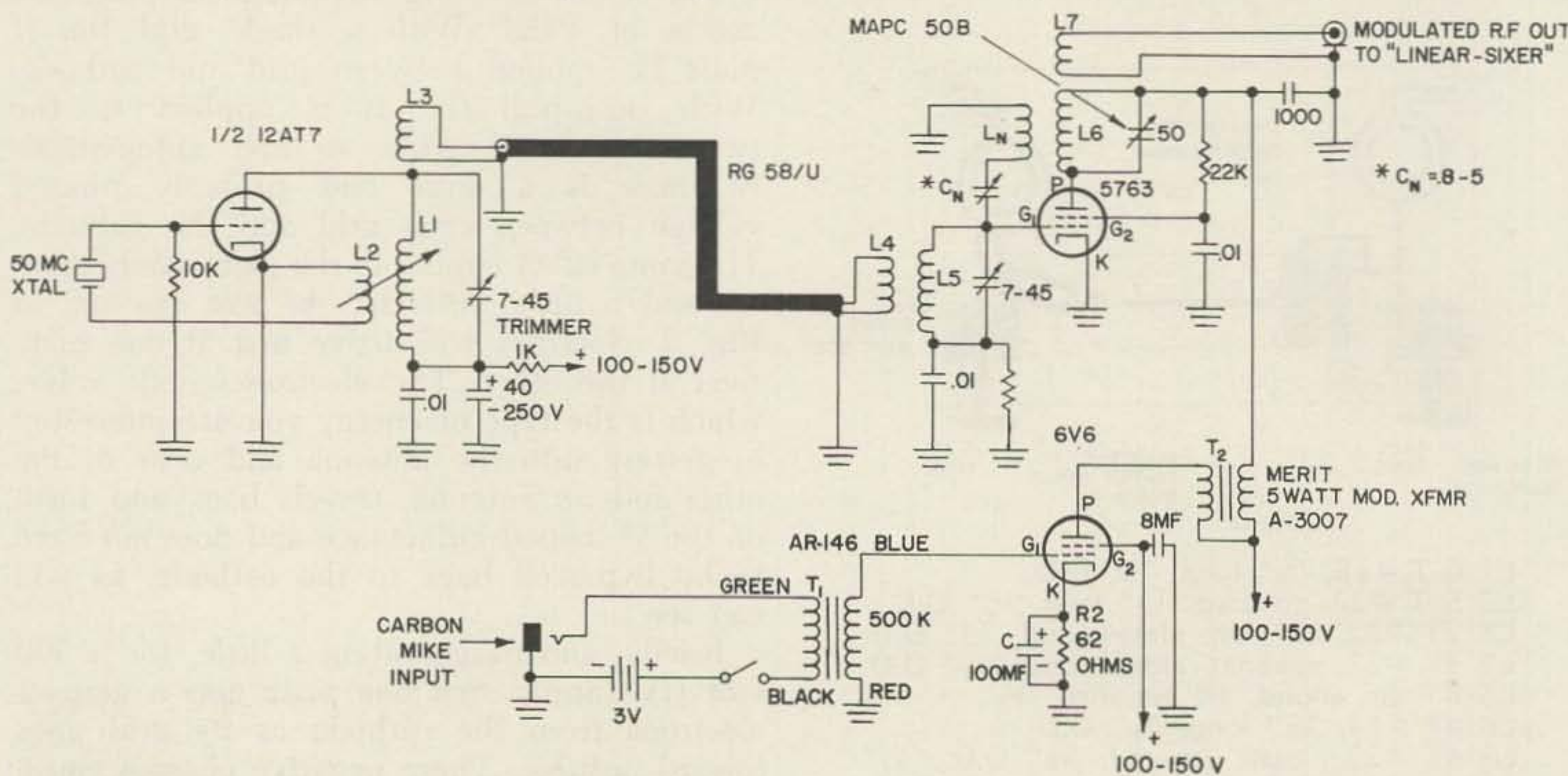

FIG. 7

Driver modulator for linear

815

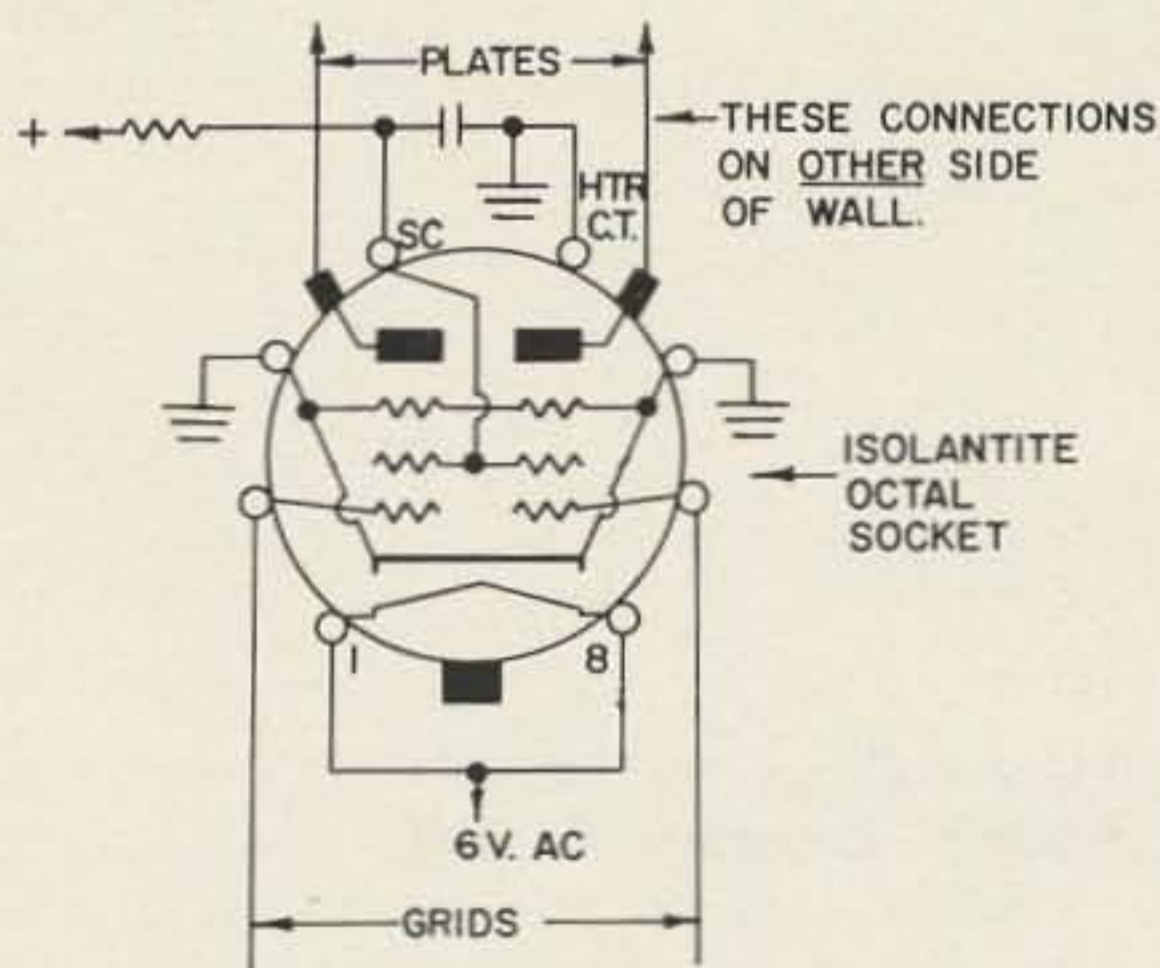

FIG. 6

course, if you want to use heavier non copper clad bakelite with metal angles, nuts, and bolts, go ahead. In any case, use insulated shaft extensions.

Incidentally, in Fig. 5 I did something for which I could be thrown in the clink. I used ordinary capacitors instead of symmetrical butterfly ones! It still works, but be sure and use butterfly capacitors and you will get a better balance in the L2 and L3 circuits. Hammarlund BFC-50's are recommended.

Fig. 5 also shows the neutralizing circuit. This is important but not critical, so don't worry about it. It acts very clean and neat. With the complete set up as in Fig. 3, apply filament voltage but no screen or plate voltage. Then, with rf drive from the Sixer or other driver applied to J1, some 15 to 20 volts should develop across R1. A diode detector tuned to 6 meters should be plugged into J2. Do *not*, I repeat, *not*, turn on the plate and screen voltage of the 815 unless you own a *lot* of diodes!

Some rf should show in the detector, unless you just happened to have neutralized the 815 on wiring to the dimensions shown by good luck. Fig. 6 shows exactly 2½ inches of wire for the cross-over neutralizing "capacitors." The way I did it was to make them a little longer and then trim them down near the right length. Then, watching the diode meter for the neutralizing null, which will be very evident, trim the wires for that null. You can bend them a little, leaving the wire tip pressed against the tube glass for rigidity. Once done you can leave them years.

Further checks can be used, although of a less precise nature. First, tune the plate circuit through resonance, without plate or screen voltage, and watch for absence of reaction on the grid circuit. A voltmeter across R1 will show movement if the tube is not neutralized. The above is with rf drive from the exciter.

(Turn to page 92)

SENSATIONAL!!

COVĒYA-6

The first 6 meter beam in this configuration. A cardioid pattern without side nulls. Perfect for round table QSO.

by **NEW-TRONICS**
the home of originals

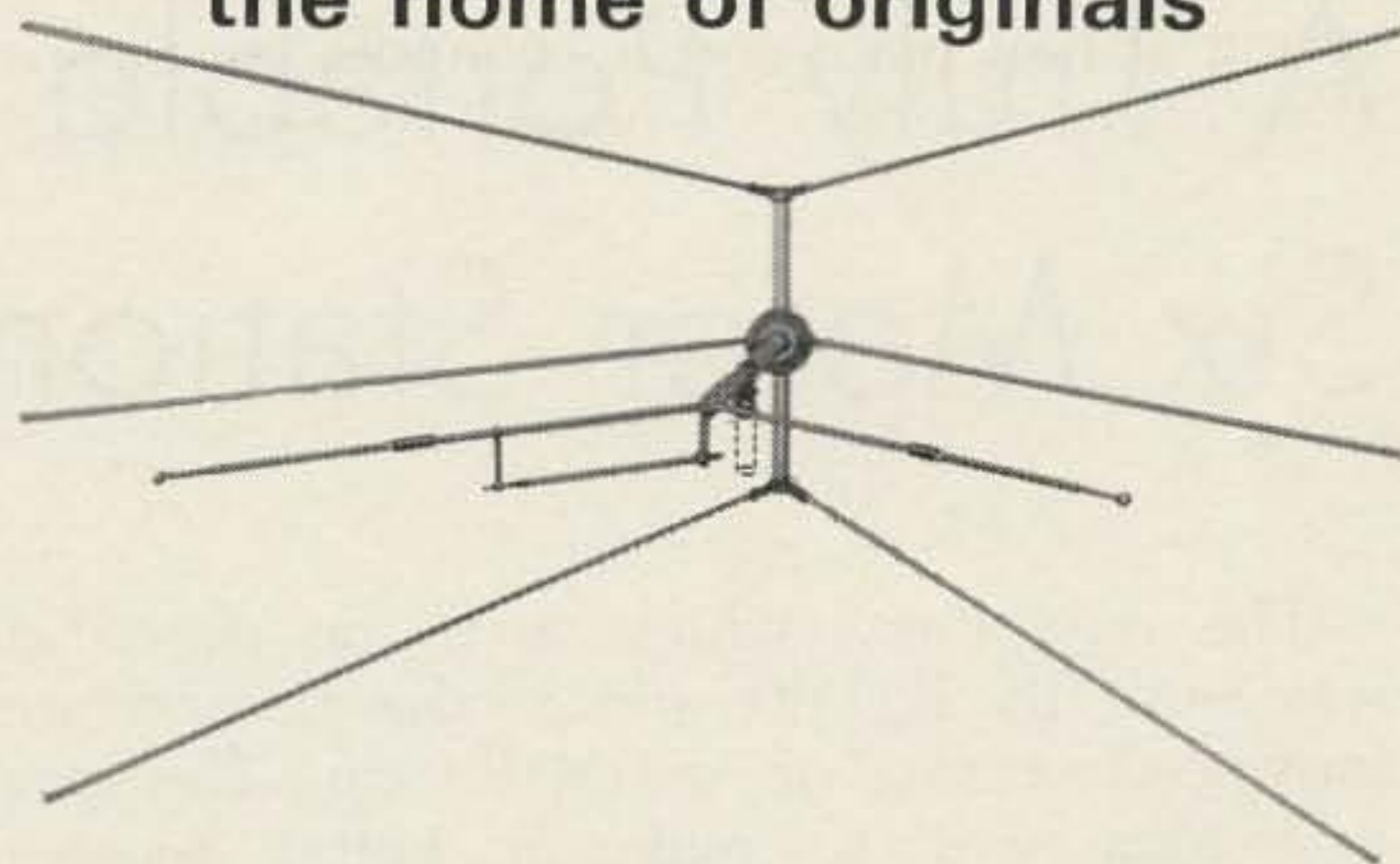

Look at these great features:

- 10DB gain over ½ wave dipole
- 25DB front to back ratio
- VSWR at resonance: 1.1 to 1
- Band width — 1000 KC with VSWR under 2 to 1
- Gamma matched
- 52 ohm coax feed line
- Adjustable for center frequency, 50 to 54 mc.
- Power capacity — 1 KW.
- Made entirely of seamless heat treated aluminum tubing
- Aluminum castings and hardware are iridited
- Weight 8½ lbs.
- Boom length 34"
- Turning radius 55"

Model COV-6.....\$39.90

See this sensationally new 6 meter beam at your distributor or write for literature.

NEW-TRONICS CORPORATION
"the home of originals"

3455 Vega Ave., Cleveland, Ohio 44113



Henry Cross W1OOP
Robert Lothrop K1IWI

A Truly Portable Six Meter Station

The equipment which is to be described was built by K1IWI and is the revised and improved version of W1OOP's rig. The original idea was to make a better receiver which could be used in conjunction with the Springfield CD Walky-talkies, for net operation at sports-car hillclimbs, at spots not suitable for parking a car. When the receiver was finally done, there was so much room that we put in a transmitter also. With the right hill under you, it can be a lot of fun to use, and the battery life is long enough for a full day of operating.

The set consists of a crystal-controlled converter, a tunable *if* receiver covering 7 to 11 mc/s which is also handy for listening to CHU, a crystal-controlled transmitter taking 25 mc crystals, and a class-A modulator with clipping. There are 17 to 20 transistors, depending on whether you incorporate the optional final, BFO and squelch. The drain on receive is under 20 ma at 12 volts, and on transmit about 250 ma. With eight MN1500 penlite cells (\$2.64 worth) you are set for a long day of hamming, or about 30 hours' net operation with a loudspeaker. Two F4BP lantern batteries (\$1.58 total) will go about three times as long. The ten-cent penlight cells will poo out after a half dozen transmissions, so don't bother with them. K1IWI goes mountain-topping with a pair of hot-shots and claims they last forever.

The receiver, so far as we can tell, is good

enough. There is some cross-modulation from strong local stations, but many "tube" receiving setups are as bad. The sensitivity is good, about 5 db noise figure including the losses in the protective circuit. The selectivity of the prototype was at one time adjusted to be 3 kc wide at 6 db down and 20 kc at 60 db, about the same as the early HRO's, but the coupling was later modified to make the receiver a little wider for net operation, by increasing the coupling capacitor between the pair of *if* coils to the value shown. It's still more selective than the older Gonsets.

Receiver drift is small, and what there is, is not caused by the transistors. Regulated voltage is used on the tunable (second) oscillator and its associated mixer to get away from battery voltage shift as the cells recover from a transmission. Transmitter drift is much less than found in tube transmitters using the same crystals, although the circuit was set up for maximum output.

The transmitter makes as much noise as can be expected from flea power. With a two-element portable beam Bob talked to five states from the top of Mt. Monadnock (the one you walk up) while W2NSD/1 was not using the ether. It is even fun to work W4's and W9's when you are about a watt—and hard, too. The point is that there are many spots where you can go with a lightweight portable and not find a bus-mounted kilowatt there ahead of you.

DOW-KEY



New DK72

SINGLE POLE THREE THROW COAXIAL SWITCH

Weatherproof coaxial relay for remote switching of r.f. sources. Designed for mounting on mast and remote switching up to 3 antennas. Not a rotating or stepping switch. Simplify installation, save money by running one cable instead of several to your antenna array.



See your dealer for catalog sheet and complete specifications, or write:

MODEL DK72 with UHF Connectors	\$22.95
With type N, BNC, TNC or C connectors	\$26.95

DOW KEY CO., Thief River Falls, Minn.

SOLDES

Si certains numéros de 73 vous manquent, voici une excellente occasion de compléter votre collection. Pour 5 F au lieu de 8, nous vous enverrons 4 numéros à votre choix (postérieurs à février 61). Si vous désirez recevoir une année complète nous vous enverrons toute la série pour 13 F alors que le prix normal est de 20 F. (A la rigueur nous accepterons 14 F au lieu de 13 si vous êtes superstitieux!)

Pour vous faciliter les choses, vous pouvez virer la somme due à F2 BO.

J-P CATALA, CCP 9372-41, Paris.

GELEGENHEIT

Falls Ihnen einige Exemplare von 73 fehlen, bieten wir Ihnen die Gelegenheit, diese Lücke auszufüllen. Für 4 DM statt 6, können Sie 4 Nummern Ihrer Wahl erhalten (ab Februar 1961). Wenn Sie einen ganzen Jahrgang wünschen, können wir diesen für 10 DM anstelle 16 DM übersenden.

The antenna tends to be heavier than the transceiver. Hi-Par makes a portable beam (we don't have one) which should be fine. For walk-around use, like at hamfests, a center-loaded piano wire whip does the job. In any case, there is a problem setting up the transmitter, and you should have a sensitive tuned field strength meter with some provision for monitoring with headphones. Currents don't change much with tuning, but modulation quality is critically dependent on the tuning of the final. There is sidetone provided to the earpiece of the WE handset, but it only tells you that the modulator is working. Rf power transistors for use at 50 mc are a bit of a problem. Since both the driver and final have modulation applied, the required breakdown voltage is a little less than four times the battery voltage for each stage—say 48 volts for BV_{CER} . If BV_{CBO} is what the manufacturer specifies, it should be over 60, in our experience, i.e., type 2N1506 performed ok but 2N1505 and 2N2297 appeared to break down on modulation peaks, causing flat-topping. (A Tektronix 545A with suitable plug-in will allow you to view the rf envelope across a 50-ohm load, if you feed the audio in as an external trigger.) The high-frequency performance of types used for 27-mc CB

UNMARKED SWITCHES? RATS NEST OF CORDS AND CABLES? Clean up the mess with A NAME-O-MATIC TAPE EMBOSSER



Wide and narrow self-stick strips, makes one or two raised line professional style labels. (Drop a hint to the XYL for XMAS!) You can mark anything from guns to keys or suitcases.

\$5.95 Postpaid in USA

EXTRA 23 FOOT TAPE PACKET \$1

Send Check Today to:

GRACE SPITZ

Box 4095, Arlington, Virginia 22204

rigs is seldom good enough, but it might be worth while to try a few dozen to find a good one. In general the ratings on rf transistors don't include AM, but a type rated at 1 watt out at 28 volts at 70 mc should be good for a quarter watt AM carrier output at 14 volts at 50 mc if you have enough drive (typically at least 110 mw.). When better transistors are made, you can expect that we'll try to use them at even higher frequencies (where as usual they won't work very well!)

The reason both final and penultimate stage are modulated is that with low gains and what is roughly class-B operation, modulating one stage doesn't seem to work. Also, neither the final nor the driver should be loaded for carrier conditions, but (like a Gonset linear) they should be tuned and loaded for best "upward" modulation. Since the transistor gain is much higher at, say, ten mc than at 50, there is a good chance of having parasitics at several mcs, though not much likelihood of trouble above the output frequency. A trick peculiar to transistors comes when the collector (in these NPN's) swings in a negative direction as the base goes positive to the point that current flows from base to collector, and for an instant in the rf cycle the output and input are connected. In one instance, this was

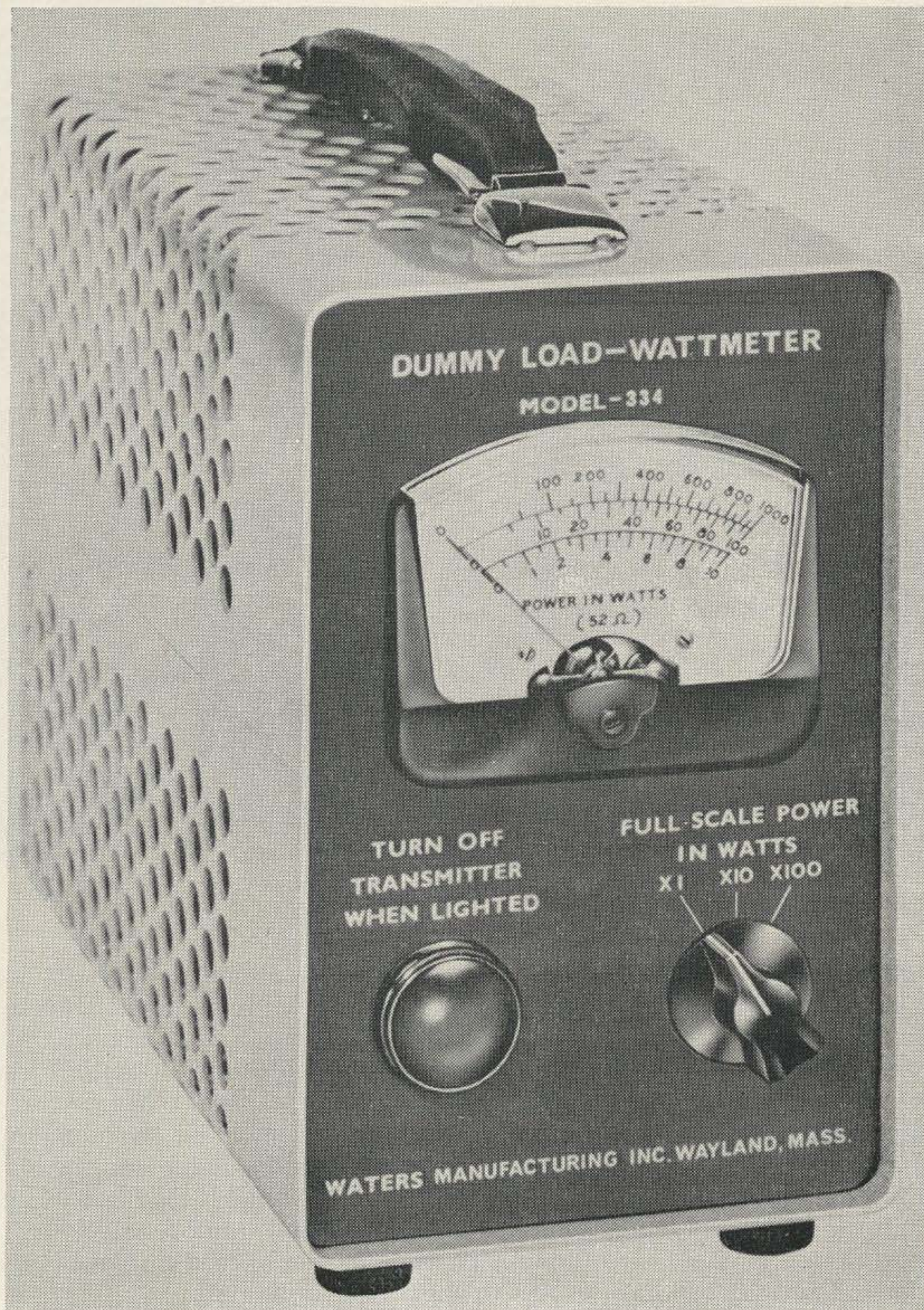

Specifications
 2-230 mc
 Non-inductive
 Oil Cooled
 Hermetically
 sealed
 52 ohms
 250 watts
 continuous
 1000 watts
 intermittent
 SO-239 connector
 4³/₄"W - 9"H - 10¹/₄"L
 12 Pounds
 Overload
 Warning Light

\$79.75

DUMMY LOAD WATTMETER

We also make these:

Q-Multiplier Notch filters to fit all Collins equipment. Channelator.

Coax Switches now available in four models — SPDT, DPDT, SP6T, Transfer.



Hybrid Coupler
 Compression Amplifier
 Phone Patch and Tape Recorder Patch.



Electronic Vernier Tuning for KWM-2/2A.

Little Dipper

WATERS MFG. INC. WAYLAND MASS.

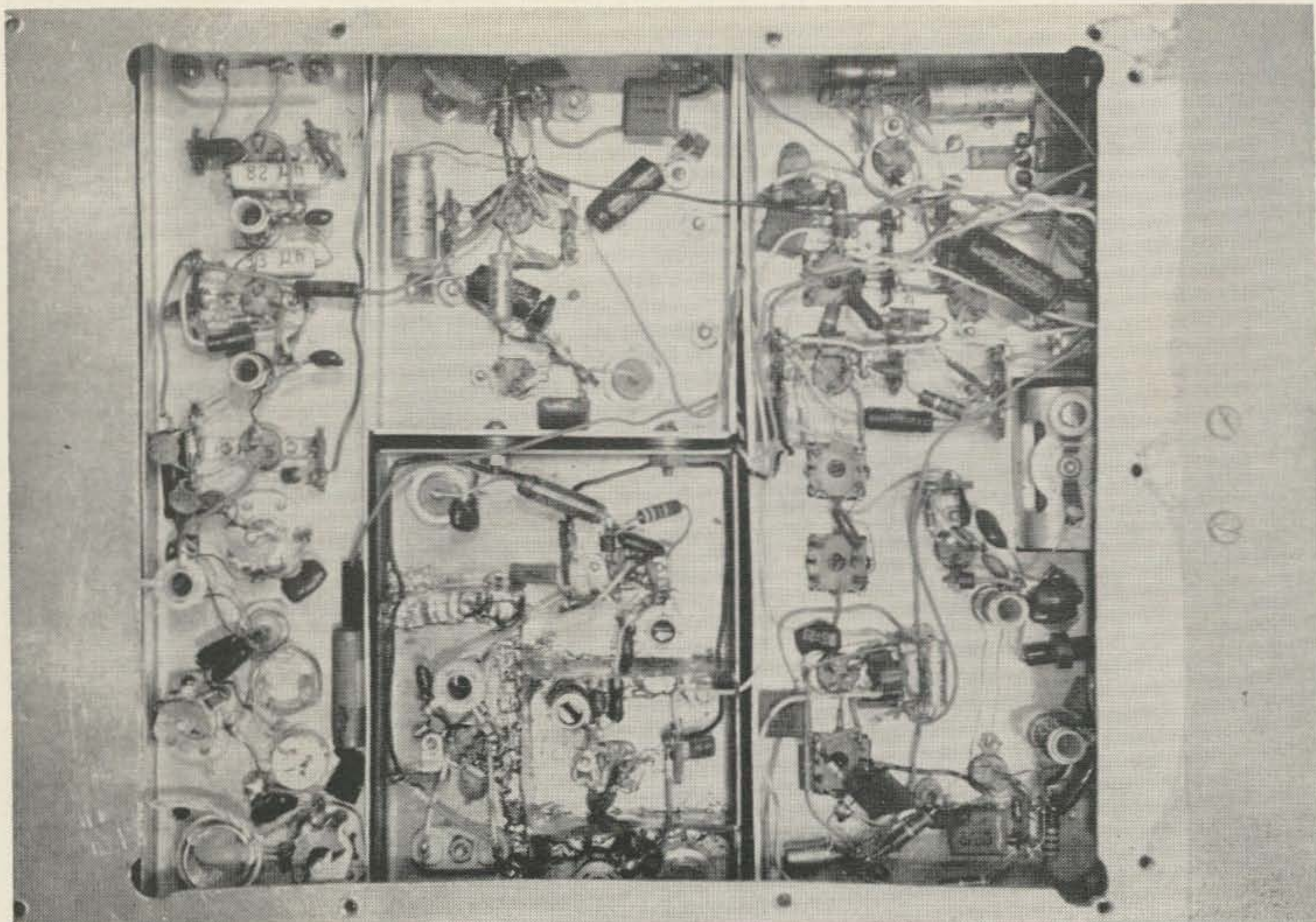

Transmitter

Modulator
Converter

Receiver

8 × 12 × 3 aluminum chassis. The smallest face becomes the front panel. Four chassis were built up to fit the available space, with the receiver full width next the panel, then two half width units for the modulator and the converter, and finally the rf section in a chassis about an inch and a half by eight. Batteries went in the rear, but the photos show the fourth stage on the transmitter, with external batteries being used.

As the photos show, the open side of the chassis was fitted with a cover plate, while the other face was mostly hacked away to allow access to the other side of the subassemblies without removing them.

The main mechanical problem is to get adequate tuning precision and mechanical stability in the receiver; it should be fitted so as to make sure the dial and tuning capacitor line up right, which is best done by first mounting the dial, then connecting the T C, and then spotting where the tuning capacitor mounts on the chassis. Send-receive switching is done with a wafer switch. Only two poles are really needed, as the audio amplifiers are separate.

Heat and heat-sinks. The silicon transistors in the rf section will work satisfactorily with-

out any heat radiator, although they get hot. Thermalloy #2211 heat sinks (in Lafayette's catalog) help quite a bit, and it wouldn't hurt to put the same type on the audio output transistors, if TO-5 size are used. The modulator power transistor is mounted on the aluminum chassis with the mica insulator supplied (at least it is with Delco types) for electrical insulation. Check for and remove all burrs in the area covered by the mica. Run your tongue over it to check for smoothness.

Components. The individual units were made up on .040 aluminum chassis to simplify grounding and shielding problems, except the converter, which was made of 0.031 brass, so that shields could be soldered in place. Sockets were used for the transistors, a great convenience when there is a desire to try various types. We used saddle mount sockets (Elco 05-3301) with four pins which would accept TO-5 transistors directly, as well as TO-40, 2N43, 2N78, 2N270 and TO-11. Other types such as TO-7, which has a shield lead, TO-44 which has leads close together, TO-1, TO-18 and such can be plugged in by arranging the leads properly. The sockets were mounted with 2-56 brass hardware. Solder lugs for no. 2 were made by using the small

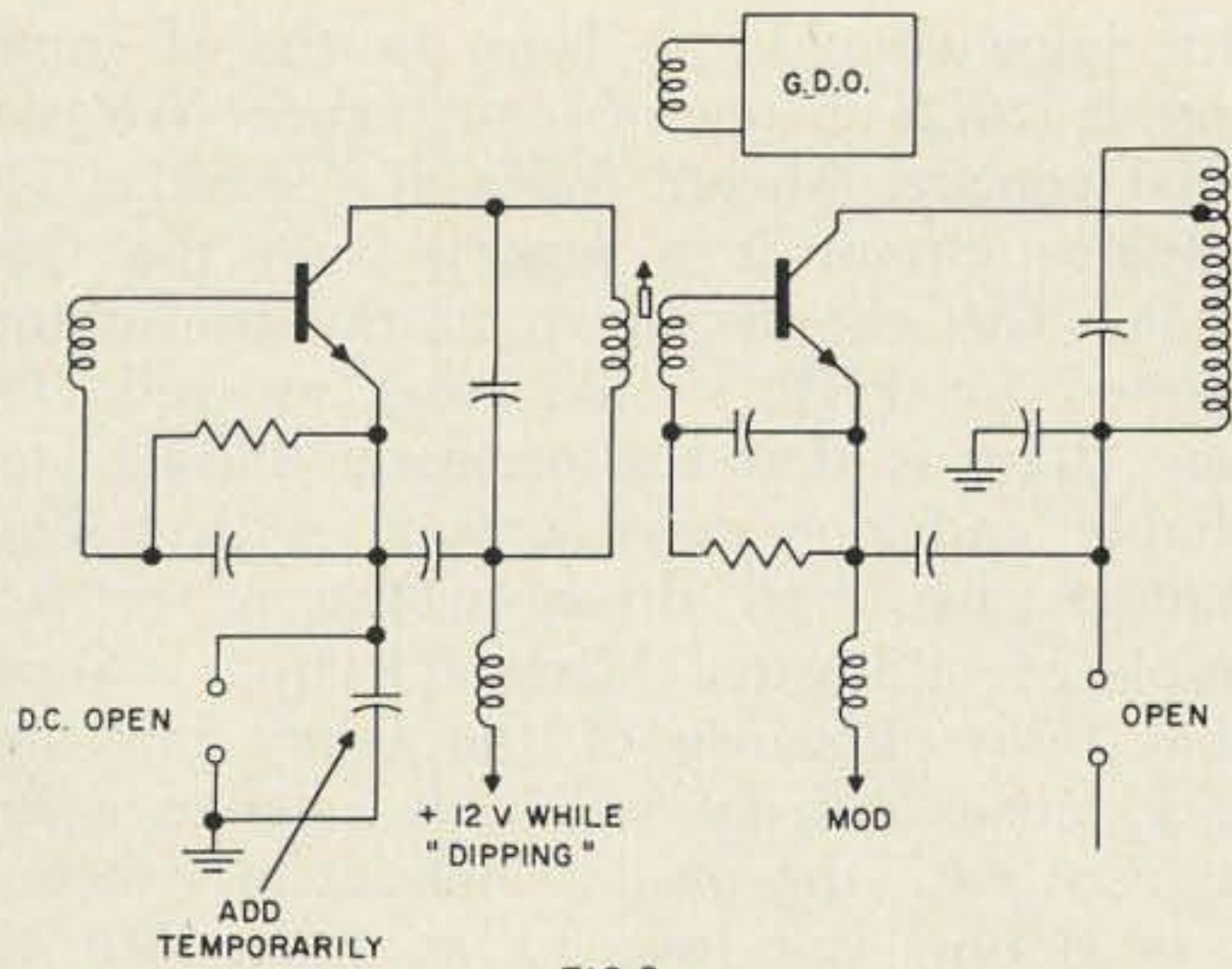

FIG. 2

To tune up a transistor interstage with a grid dipper, you apply collector voltage to the previous stage, make sure the base return (coil or whatever) is in place, and disconnect the emitter lead. The driven stage should have collector voltage disconnected. Now you have 12 volts or so between collector and base of the previous stage, so the C-B capacitance is approximately what it will be when things are going, and the next stage has zero bias. Couple loosely to get a sharp dip; if the GDO signal is more than a few hundredths of a volt current will be drawn and the capacitance will be changed. A transmitter interstage set up to dip is shown here.

end from standard size solder lugs. Model railroad hobby shops have the small bolts and nuts.

Resistors. We used several styles. Our advice is to use ohmite (Allen-Bradley) QUARTER watt types. The half watt use too much space, the tenth watt type are impossible to wire without tweezers and a jeweller's loupe—and the color code is hard to see—but the quarter watt size is just fine. Lafayette had some Japanese desposited-carbon resistors which were very fragile, and the small Global resistors came apart when the soldering iron got them too hot. An Ungar pencil iron on a Variac worked well, but the smallest GE iron with a resistor in series (cut out by a foot switch) was even more convenient.

Capacitors. The electrolytics were C-D type NLW (easy on the leads, some broke off first bend) or assorted Japanese. The coupling and AGC electrolytics might be Mallory TAM or similar, though the aluminum type is satisfactory. The rf and if bypasses were mostly 75-working-volt ceramic types from Lafayette, with some 10-w.v. ceramics used as base-return-to-emitter bypasses where there normally is no more than two volts. You've never heard a noisy component until you put 12 volts on a 10-volt ceramic capacitor. Like frying bacon.

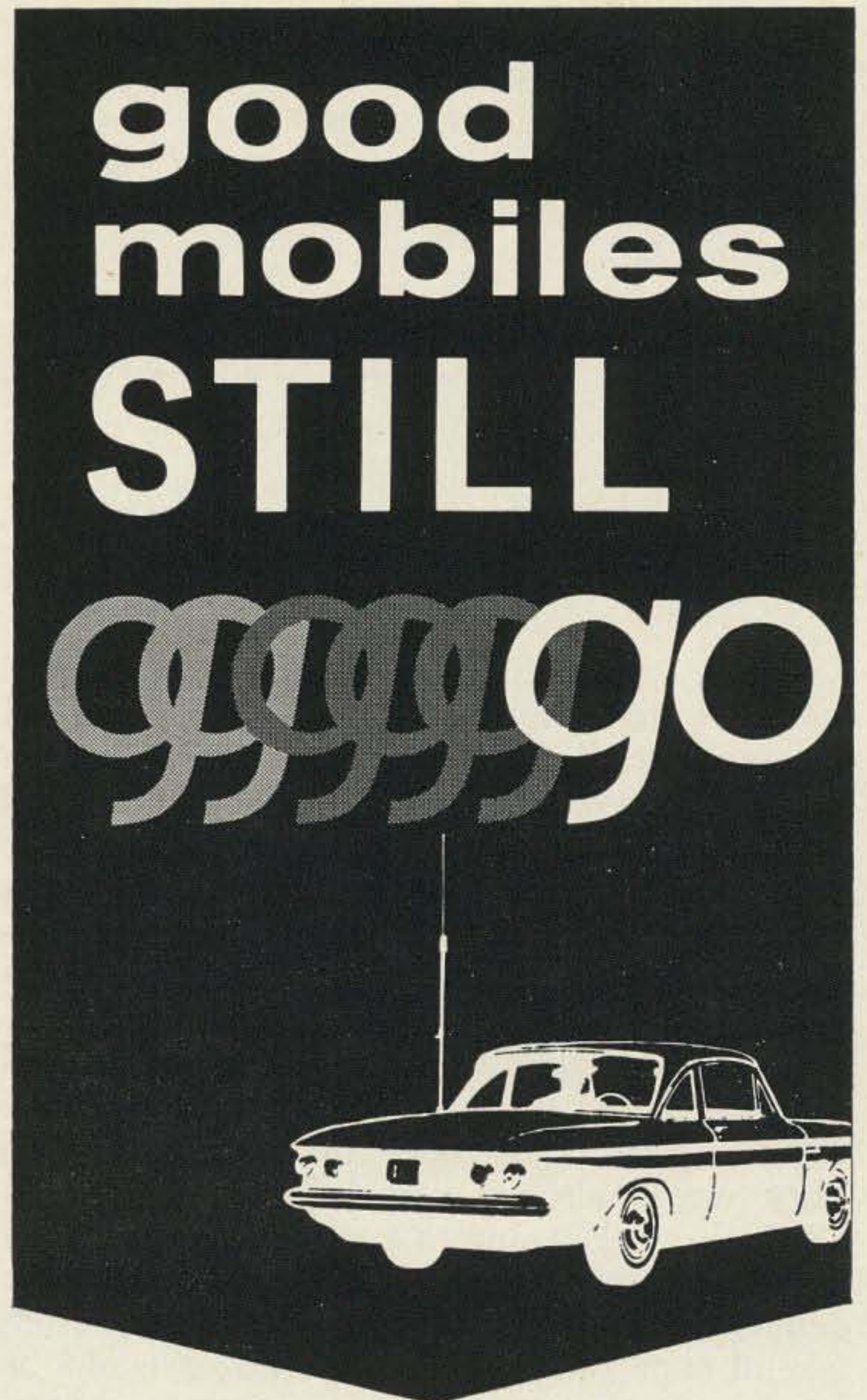

HUSTLER

by NEW-TRONICS
the home of originals!

HUSTLER is the mobile antenna that has won the widest praise from everyone that has used it. For really reaching out, and for exceptional results on every band, the HUSTLER has no equal. For unbiased opinion of performance, ask any HUSTLER user... there are thousands of them.

See the HUSTLER at your dealer or write us for literature.

NEW-TRONICS CORPORATION

"the home of originals"

3455 Vega Ave., Cleveland, Ohio 44113

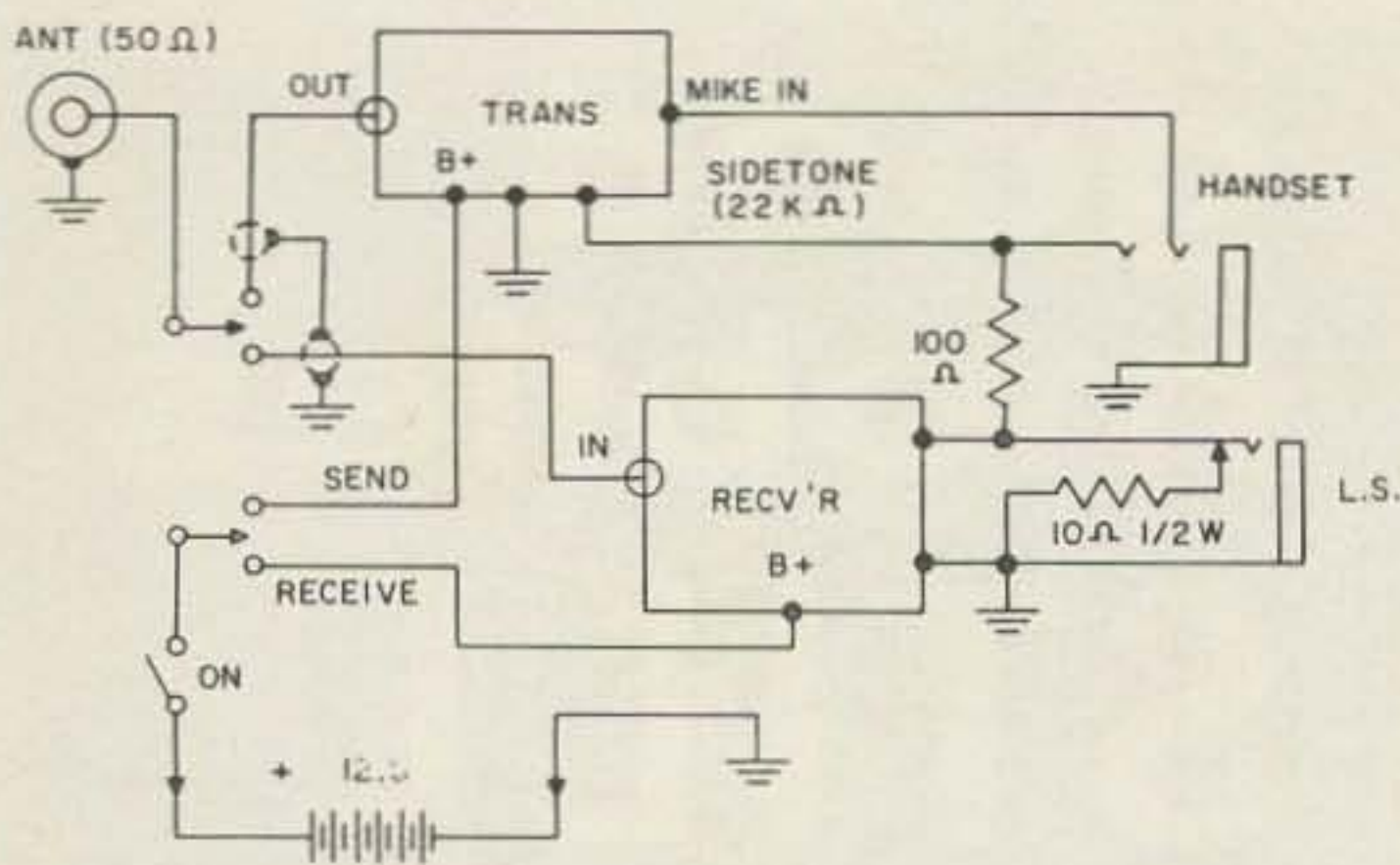

FIG. 3

Battery mounting. If internal penlite-sized batteries are to be used, they may be mounted in commercially available clips which hold a group of two to four cells, bolted to a wall of the case. We have had trouble with these after rough handling (the transceiver is just the right size to drop!) from the batteries getting askew and not making good contact. It is suggested that the batteries should be accessible for voltage check under load or physical inspection *without a screwdriver*. A piece of insulating material held in place over the clips would also prevent cells coming loose. With the F4BP lantern batteries there should be no problem, since it is easy to keep the binding posts tight. Certain types of closed-circuit type plugs or the equivalent could be used to hook into an external power source. The MN1500s appear to take several partial "recharges," so maybe it would help to plug into the car battery with the internal cells still connected: a blocking diode (1N91) is suggested to avoid trouble from reversed polarities or low external voltage.

Converter. (Fig. 5.) The 50 to 7 mc converter was originally adapted from a QST article. Like most such, there were enough changes that there is no justice in involving the original author. The main thing is to remember that there is no substitute for a good transistor in the first stage. The rf amplifier is used grounded-base, for reasons now only a dim memory. A silicon computer diode (not just any type, check the numbers) is used as a limiter at the input in hopes that strong 50-mc signals will not immediately melt the first transistor. Transmitter leakage is not bad, but what if the transceiver with whip attached is carried by a mobile just when he goes on transmit? A good check on the diode is that it should make no difference on weak sigs, on or off.

The double-tuned coupling helps keep Radio Moscow off six meters, but if some oscil-

lator juice should get back to the rf input, there is still a chance of interference. We used 0.010 copper (sheet? foil?) for shields. The oscillator circuit is a legacy from the QST article. The circuit shown in the transmitter, adapted for PNP, should work as well. The main thing is that the oscillator should start reliably and not move around with voltage changes. Required drive to the mixer is a couple of milliwatts. Mixer injection is somewhat fussy. Because of the fancy bias network, mixer current will only change a few per cent with the proper amount of injection. If in doubt, use less, so as to reduce the birdies and the spurious responses.

Roughly speaking, the 50-mc input impedance is the same grounded-emitter or grounded-base, about 30 ohms at the usual currents. The rf stage might as well be a premium type (still under three dollars) and the rest can be any type recommended for TV or FM use. See the section on the transmitter for tips on grid-dipping. The mixer plate lead feeds a pi-section low pass filter which is intended to reduce the quantity of 43 mc signal delivered to the 7-11 receiver. If this is very strong, it will combine with harmonics of the second oscillator in the second mixer to give birdies (in pairs) each time the 2LO harmonic gets 455 kc away from the 1LO frequency. The pi-section interstages are also intended to reduce the transmission of 43 mc. Tapped-coil coupling, used in the prototype, was quite bad in this respect, as the taps seemed to resonate in the 40-50 mc region.

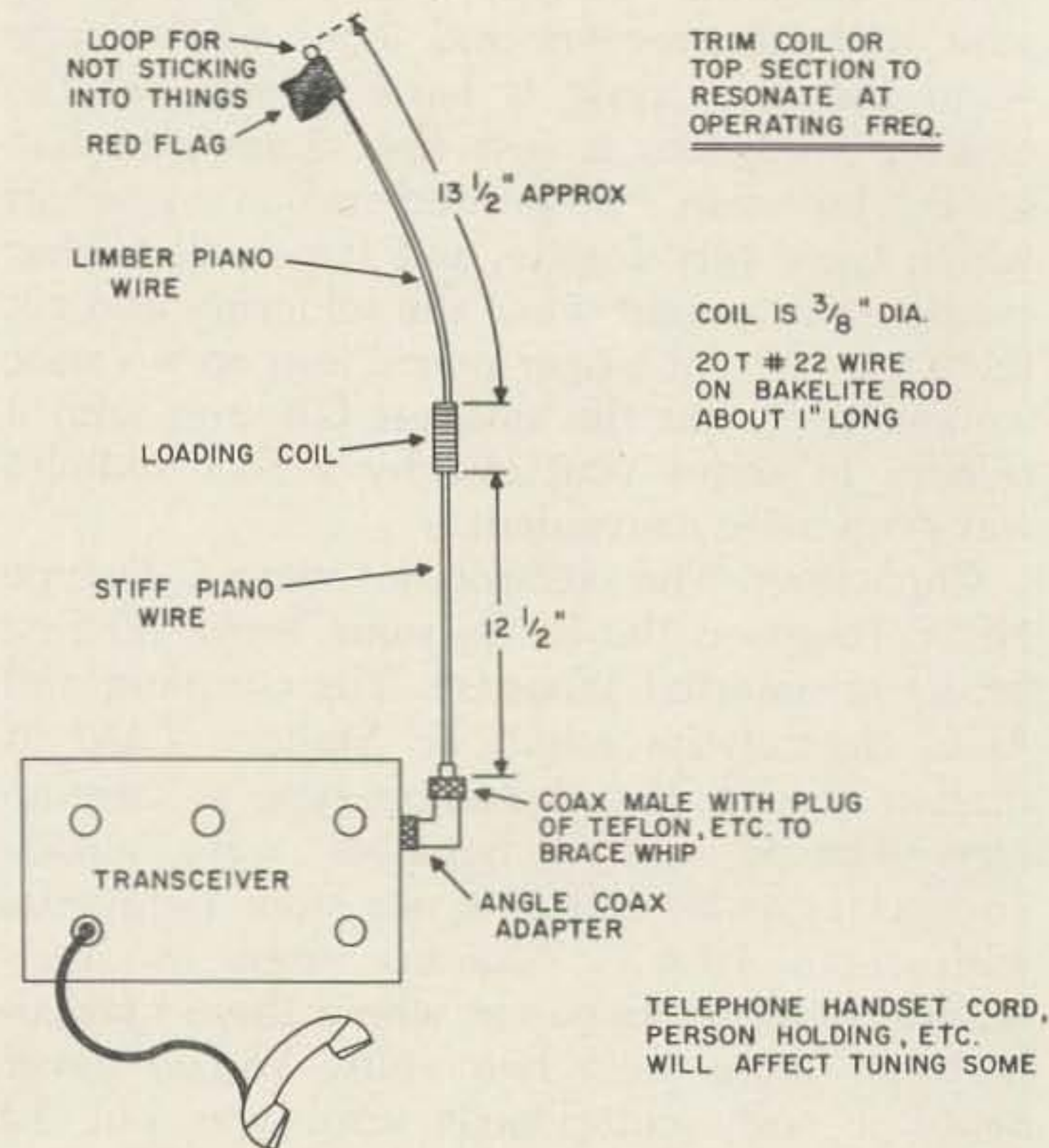

FIG. 4

NEWS

B & W OFFERS AMAZING Model 6100 TRANSMITTER FACTORY DIRECT!

NEW LOW
PRICE!



NOW ONLY

\$495⁰⁰

NO
TRADES

FOB FACTORY

**Here's why B & W's Model 6100 has been called
the "Most Amazing Transmitter of Our Time"!**

- The Barker & Williamson Model 6100 Transmitter has been engineered and built to give the discriminating operator the ultimate in SSB, CW and AM communications.
- The 6100 uses the B & W crystal controlled frequency synthesizer, producing an order of stability which up to this time has been available only in costly military and commercial communication systems.
- The crystal lattice filter method of sideband generation is employed. Superior sideband suppression results.
- Solid state rectifiers are used.
- Dual automatic level control (ALC) with adjustable threshold prevents overdrive of output stages.
- Digital Dial System offers a high degree of dial accuracy.

WIRE, WRITE OR PHONE - FACTORY DIRECT - DEPT. M

BARKER & WILLIAMSON, Inc.

A SUBSIDIARY OF RENWELL INDUSTRIES, INC.

Complete Radio Communication Systems and Equipment

Beaver Dam Road, Bristol, Pa., • 215 768-5581

See us at the National ARRL Convention



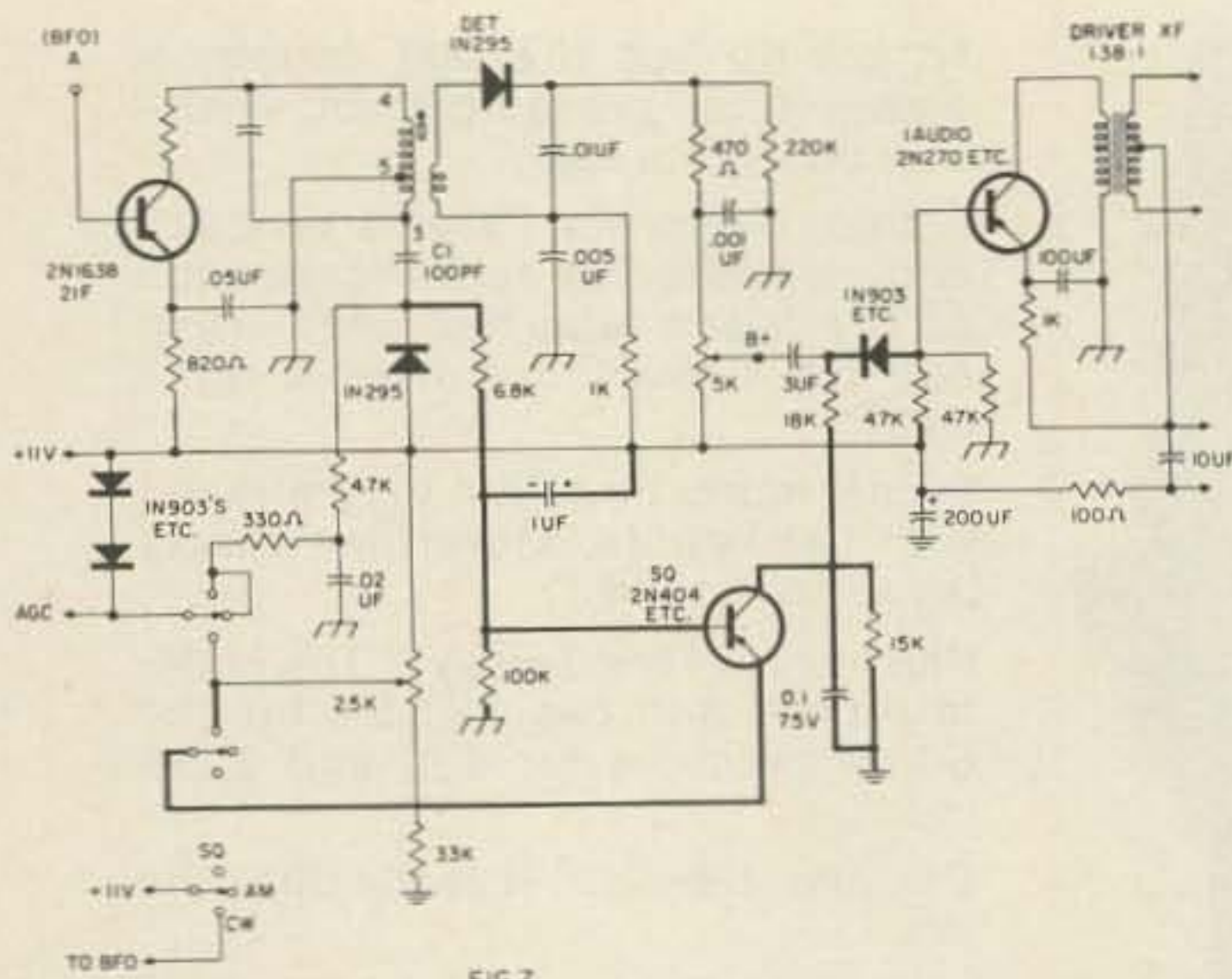

FIG. 7

C1 may be changed to 150 or 200 mmfd if strong locals still overload or block on AM.

Changes shown in heavy lines.

* RF gain in CW pos.—sq. in sq. pos.

the gain or collector current of the second *if*, as all the power it can deliver is sometimes needed. In order to get good AGC action with transistors, the last *if* amplifier must deliver enough power to the AGC rectifier to allow it to develop sufficient voltage to buck out the forward bias normally applied to the base circuits of the various *rf* and *if* amplifiers. For a 50 K ohm bias divider the required current is $12.6/50,000$ or about 250 microamps. 250 ua through 5,000 ohms (4,700 plus 330) is 1.25 volts. The power needed is thus about 1/3 milliwatt under carrier conditions or 1.25 mw peak. If the last *if* stage is running 1 ma of collector current at about 11 volts, there is a maximum of 5 mw *rf* power output available class A into a 10K load. If one fourth of the theoretical maximum is needed to develop the DC for AGC use (assuming a perfectly efficient rectifier, which is not likely at one volt out) things are pretty thin, and we cannot afford to cut the collector current of the second *if* stage at all. If the taps on the last transformer are wrong, no signal, no matter how strong, will develop cutoff bias, and the receiver will wipe the modulation off strong local signals. If there is some doubt, feed the BFO into the last *if* input full strength and see if the emitter current of the first *if* (as measured by the voltage drop across the 1K resistor) can be forced to zero and beyond. The "beyond" is to allow for modulation peaks.

The control voltage in the absence of a signal is clamped by a couple of silicon diodes to about 1.1 volts forward bias. When the AGC starts working, the diodes unclamp, but the *if* voltage at the AGC rectifier has to be about a half volt before this takes place, that

is, the AGC is "delayed." Any good silicon junction diode—power, top hat, alloy, diffused, or planar—will work here as the AGC clamp. The types suggested are small. The detector and AGC rectifiers are 1N295, similar to 1N34 but small and tested as a detector.

When a squelch is used, it is desirable to set things so the squelch opens before the AGC starts to work. When the BFO is turned on, the AGC must be disabled, and to do this we shift the line to a manual gain pot. The clamps still function to limit the maximum-gain forward bias to a safe value.

The oscillator circuit is a modified Colpitts. It is not as easy to get going as a vacuum tube oscillator because there is not any amplitude-controlling mechanism in a transistor oscillator equal to the grid-leak-and-condenser we are used to in tubes. Because the oscillator is around 7 mc, and a good oscillator transistor should be suitable for much higher frequency (so that the transit time, which varies with voltage and current and temperature, will be small compared with ninety degrees at operating frequency) there is danger of parasitics at higher frequencies, so a parasitic choke was put in.

As in the first mixer, the amount of drive is critical, and a bit of fiddling with the one-turn pickup coil (move it along the form to vary injection) will be needed. The oscillator runs on the low side with the values shown.

The *if* amplifier as drawn has effectively five tuned circuits. The Clevite TF-01A resonant emitter bypass has about as much rejection of off-frequency signals as another transformer. If you can't get one, use an 0.1 mf capacitor in place of it. The *if* transformers are small ferrite-core jobs, apparently U.S. made, which have an unloaded "Q" of about 140 at 455 kc. As the drift transistors have higher output impedance than the alloy types which were common when these were designed, we have our choice of more gain (by tapping the collectors up) or more selectivity (by using the former collector tap).

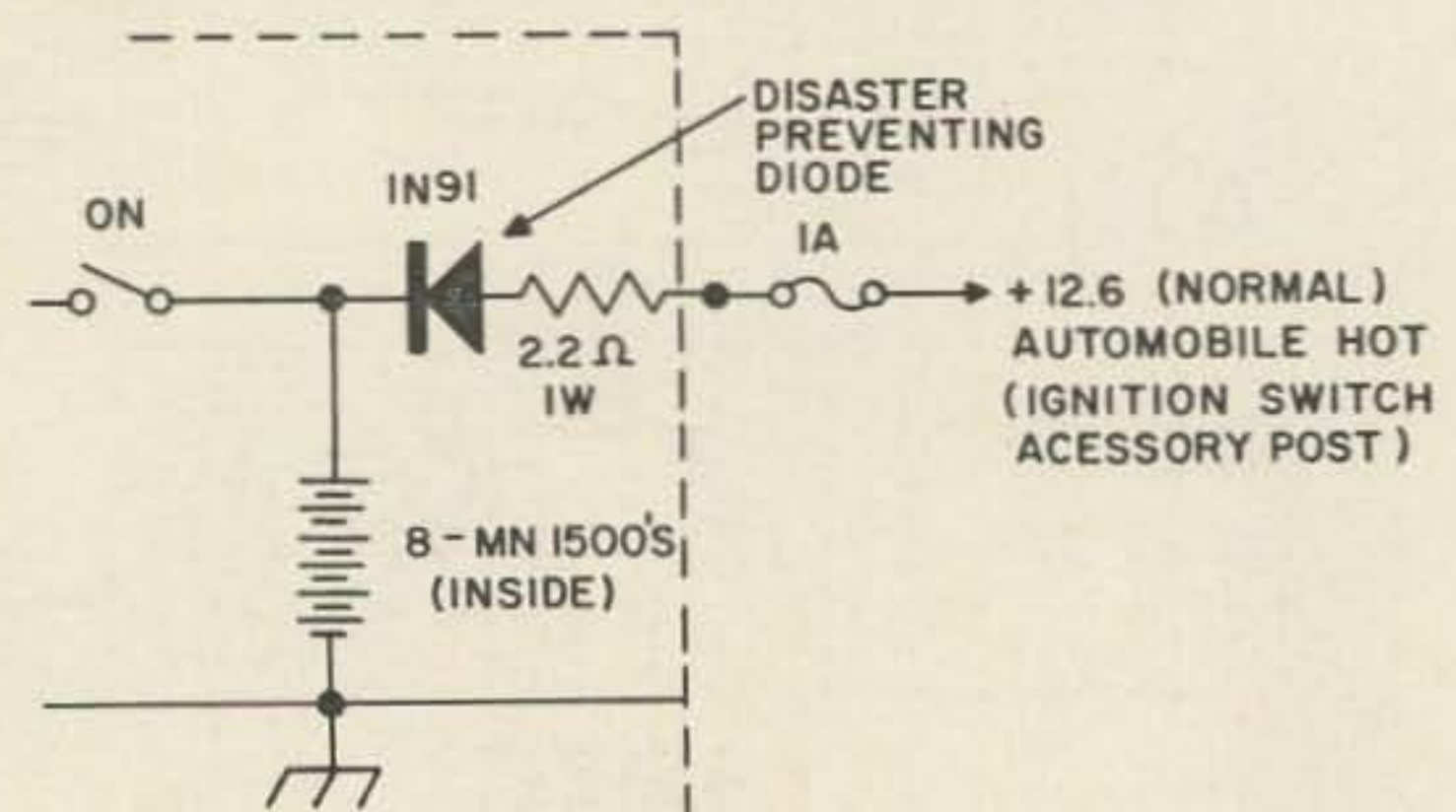

FIG. 8



SBE

powerful, peak performance pair

SB-33/SB1-LA... diminutive duo... four-band (80-40-20-15) SSB transceiver/exciter and high power linear amplifier. Bright, state-of-the-art version of a full thumping kilowatt... entirely self contained, including all power supplies... in two tiny cabinets! The only "extras" needed are microphone... antenna... two lineal feet of mounting space... and a strong desire for a clean-cut big signal. And when you look at the photograph above, (the 664 dynamic does look big in comparison to the linear amplifier behind it) consider that the SB-33 transceiver on the right also includes an outstanding receiver capable of solid-copy reception of the DX that is bound to be stirred up by the KW signal from your powerful pair.

Aside from the use of advanced solid-state circuitry and techniques, there are at least 37 other good reasons why SB-33 can be so small and still deliver in such a convincing manner—18 transistors, 18 diodes and 1 zener diode! (The heavy-duty work is done by two rugged PL-500 beam tetrodes and a 12DQ7 driver). The SB1-LA linear uses 6—6JE6's for 1000 watts-P.E.P. on 80-40-20 and 750 watts P.E.P. on 15, achieves its small size in part by careful design and by the use of an all-solid-state voltage-multiplying power supply.

See these best buys at your SBE distributor—compare them fully with anything else available, feature-wise, price-wise. (Remembering that SB-33 has 4-bands—panel selectable sidebands—Collins Mechanical Filter—built-in 117V AC power supply and loudspeaker, is 5½"H, 11¾"W, 10¼"D, weighs 15 pounds.

SB-33
TRANSCEIVER

389.50

SB1-LA LINEAR
AMPLIFIER

279.50

Please send full information on SB1-LA Linear and SB-33 Transceiver.

NAME _____

NUMBER STREET _____

CITY _____ ZONE STATE _____

SBE

SIDEBAND ENGINEERS

317 Roebing Rd. So. San Francisco, Calif.

An operation of Webster Manufacturing

Model SB2-DCP
DC to AC INVERTER
for SB-33 (only)
Quiet... entirely
solid-state.



Export sales: Raytheon Company, International Sales & Services, Lexington 73, Massachusetts, U.S.A.

We went for selectivity, except in the last transformer, which is heavily loaded by the diodes. Most 455 kc transistor *if* cans found in small six-transistor radios can be used in place of those specified; the connections are fairly standard. If more selectivity is needed, two coils coupled by a capacitor could also be used between the mixer and first *if*, with only a small reduction in overall gain. The coupling capacitor between the paired coils is run to the tap, so that a larger, easier to control capacitance can be used.

To align the *if* amplifier, a signal may be "stolen" from another receiver, by wrapping a wire around the last *if* plate lead in your HQ 129 or whatever, and tacking it to the base lead of the mixer in the transistor receiver. Tune the HQ 129 to a nice strong broadcast station and start twiddling screws. The single-tuned coils are just peaked for maximum output measured with a Simpson, etc. across the audio gain control (about one volt at most) and the double-tuned pair is adjusted by clipping about 100 mmf across the primary terminals of one can and trimming up the other, then moving the 100 mmf to the primary terminals of the other can and peaking the first.

The audio amplifier is conventional. It differs from most small transistor radio audio amps in that it runs on 12 volts and puts out half a watt rather than 9 volts and a quarter watt. The idling current of the class-B amplifier should be about 2 ma. Less gives scratchy quality, more uses too much electricity. The diode gives a no-signal bias which varies with temperature in the right way to compensate for the thermal characteristics of the output transistors. If a 1N2326 is not available any cheap alloy PNP transistor may be used, connecting to the base as cathode and hooking collector to emitter for anode. A small adjustment in the idling current can be made by changing the value of the emitter resistor in the first audio stage.

The BFO circuit shown will work with almost any alloy transistor, but the loading on the signal circuits will be a little less with the drift unit specified. Any interstage *if* transformer will work. The BFO is tuned to band center. No pitch control is provided.

If squelch is desired, it is inserted as shown in Fig. 7. The manual rf gain pot is used to set the squelch level, when that function is in use.

In the first model, one transistor was switched between BFO and squelch. The BFO was too near the front end of the re-

ceiver, and BFO harmonics were all over the dial. Segregating the BFO fixed this: in the photos the BFO assembly is tacked on above chassis. In the receiver shown in the photos, a transistor is in the squelch socket, but the socket is not wired.

A list of possible transistor types for the receiver is given in Table 2. The recommended types cost from fifty cents each for some audio types to about a dollar each for the 7-11 rf and two and a half for the hot six-meter rf stage. You may find something satisfactory in your pickle jars full of slightly surplus semiconductors, but it's not too likely. The types used in Japanese AM (not AM-FM) radios will not be suitable. Required collector breakdown voltage is at least 20, and 30 is better.

. . . WIOOP

Table of Transmitter Transistor Types

- A. Silicon NPN RF Power transistors
 Oscillator: Some 2N697, 706, 707, 708 some 2N718, 753, 759, 760, 913, 914, 915, 916, 957, 2N834, 2N1338, 1505, 1506, 2297.
 Doubler: 2N707, 708, 915, 1505, 1491, 2297. If modulated, may have voltage breakdown problems. 2N1506, 2N1492, 2N1493, 2N1342, 2N2218, 2N3118 should be O.K. modulated.
 250-milliwatt final: 2N1506, 2N2876, 2N2631, PT531, TA2084, 2N1978, 2N3118. Nothing more than five years old.
 1.5-watt final: 2N2876, TA2084, PT657.
 NPN AF amplifier: 2N35, 78, 167, 169, 214, 388, 445, 634, 635 etc.
 PNP AF driver: 2N43, 188, 241, 270, 396, 404, 407 and many more.
 Modulator: 2N1172, 2826, 2827, 2N301, 176, 276, 342, 553, 554.

Table of Receiver Transistor Types

- Converter-RF 2N1742, 2N2494, 2495, PADT-28, 2N502A, RCA 2N2873, Philco T 1694, 2N1177 (last choice)
 Mixer 2N1743, 2089, 1177, 1179, 2N1745, 2N1517
 Osc. 2N1744, 1743, 1178, 2084, 1517, 1745, 1868, 2N501
 7-11 RF 2N2089, 1180, 1517, 2084, 2N384, 370, 2N1726, 1747
 mixer 2N2089, 1180, 1517, 2084, 2N372, 2N274, 2N247
 oscillator 2N371, 1526, others will work, may need changes in feedback.
 IFs, 2N1638, 2N2092, any listed above, for RF or mixer
 BFO almost any computer or drift transistor, 2N1631, 1637, 247, 274. Squelch-anything.
 AF driver & af output 2N270, 241A, 188A 525, 2N43A 2N1413, 2N1924, 2N1192
 Zener diode = 1N200, or any up to 1½ watts, 6.8 to 8.2 volts nominal.

Note on transmitter transistors: The types used are Silicon NPN. If suitable transistors are not available on a beg, borrow, or buy surplus basis, it may be advisable to consider using the Amperex 2N2786 PNP germanium unit, announced some time after these transmitters were built. (Amperex Electronic Corp., 230 Duffy Ave., Hicksville, N. Y. has report #S113 on how to use it.) The main disadvantage is that the 2786s we have tested had roughly 30 volt collector breakdown, so that AM at 12 supply volts is not practical. The proper solution is to use series modulation from a 12v supply, or NFM, or a collector supply dropping resistor, adjustable so as to set up for maximum collector voltage that the transistor will stand and still modulate properly. The Amperex report suggests that 2N2207's can be used in the driver stages. The driver transistor costs under two dollars, the 2N2786 under five. Carrier output level for AM would be about 140Mw. For NFM, about half a watt out could be obtained.

Now that you
ask me . . .

Ken Cole W7ID
P.O. Box 3
Vashon, Wash.

The readers of a certain magazine, which I won't identify further—except to point out that it receives mail at a New Hampshire post office—found in their August '63 issue a thought-provoking ballot. Some of the thoughts provoked might surprise the editor. Polling of readers by editors is commonplace, and often enough the readers are pleased by the implication of interest and indulge the editor in return. But the question should deal with the issue simply and specifically, and in the cited case I think the phrasing was oversimplified and unspecific. How can anyone be in favor of, or against, restricted phone bands unless he knows the conditions—what, why, where, when, and most of all—who?

This was annoying to me because Wayne Green's dedication and energy are invaluable to us, and I think the ham community is in trouble. I would like to see more polling of opinion by 73 on current and future problems, but only following upon a lively discussion of each issue, and then by ballots spelling out the saner proposals and free of ambiguity. The fact that the editor of 73 projects his personality rather eloquently may leave some readers thinking he isn't vitally interested in reflecting our opinions. He is. But he can't read your mind. This is our opportunity; let's have more views and then more ballots. In this prickly mood I hope to use up some space in 73 to disagree with the editor on one item, agree on another and invite comment (!) on a third.

Perhaps we can dissipate some of the heat arguing terms and save the light to illuminate the issues. Labels should be exact or they become worse than useless. In our own time heedless loyalty to reckless orators has led whole nations to disaster, so while we have an open forum for the exchange of opinion we had better use it. It's good practice, and a reminder that our favorite form of government is based on responsible debate.

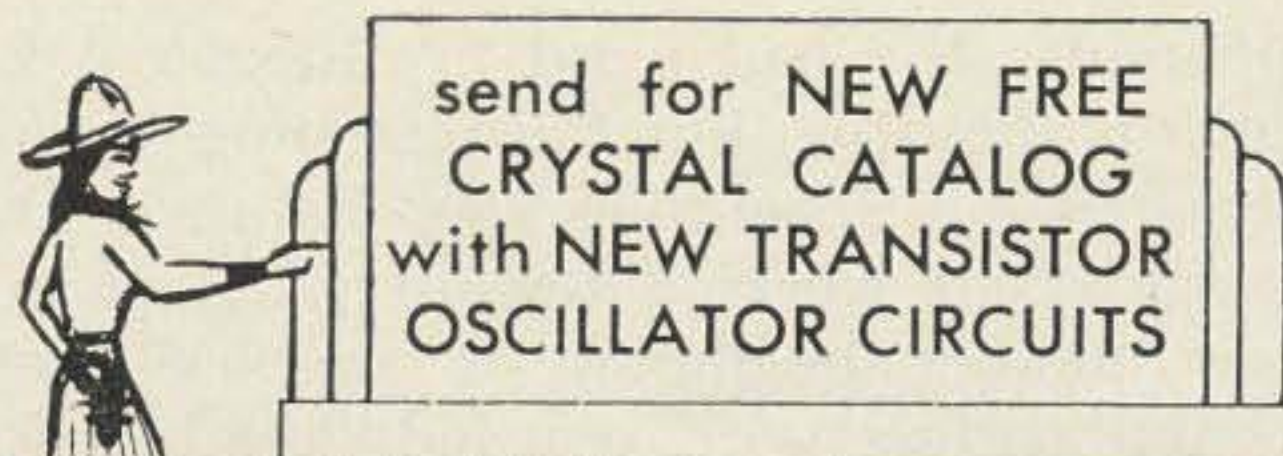

3 BIG MODERN PLANTS TO SERVE YOU BETTER

2 in Fort Myers

1 in Los Angeles



HERMETICALLY SEALED PRECISION GROUND CUSTOM-MADE NON-OVEN CRYSTALS

Top performance assured with quality controlled throughout manufacture. Gold or silver plating acts as electrodes. Crystals are spring mounted and sealed under vacuum or filled with inert gas. Very high frequency stability. Max. current capacity is 10 milliwatts—5 for overtone type. Conformity to military specifications guaranteed.

1000KC to 1600KC (Fund. Freq.)	-----	Prices on Request
1601KC to 2000KC (Fund. Freq.)	-----	\$5.00 ea.
2001KC to 2500KC (Fund. Freq.)	-----	4.00 ea.
2501KC to 5000KC (Fund. Freq.)	-----	3.50 ea.
5001KC to 7000KC (Fund. Freq.)	-----	3.90 ea.
7001KC to 10,000KC (Fund. Freq.)	-----	3.25 ea.
10,001KC to 15,000KC (Fund. Freq.)	-----	3.75 ea.
15MC to 20MC (Fund. Freq.)	-----	5.00 ea.

OVERTONE CRYSTALS

15MC to 30MC Third Overtone	-----	\$3.85 ea.
30MC to 40MC Third Overtone	-----	4.10 ea.
40MC to 65MC Third or Fifth Overtone	-----	4.50 ea.
65MC to 100MC Fifth Overtone	-----	6.00 ea.

DRAKE 2-B Receiver Crystals\$4.00
(All Channels—Order by Freq.)

OVEN-TYPE CRYSTALS

For Motorola, GE, Gonset, Bendix, etc.

Add \$2.00 per crystal to above prices

SUB-MINIATURE PRICES slightly higher

CITIZEN BAND Class "D" Crystals\$2.95
Over 50,000 CB crystals in stock for all sets and channels, both HC6/U and miniature types. To insure proper correlation and correct freq. operation, order by manufacturer model number and channel.

NOW . . . 48 HOUR SHIPMENT

ALL TEXAS CRYSTALS are made to exacting specifications, quality checked, and unconditionally guaranteed!

Send for new Citizen Band Crystal Interchangeability Chart with Texas Crystals Code System.

ORDER FROM CLOSER PLANT

TEXAS CRYSTALS

DEPT. 73-9
1000 Crystal Drive
FORT MYERS, FLORIDA
Phone 813 WE 6-2109

Division of

AND
4117 W. Jefferson Blvd.
LOS ANGELES, CALIF.
Phone 213-731-2258



Apparently the bad word in "Incentive Licensing" is incentive but the reasoning behind this escapes me. Incentives keep us alive. Our years are spent working toward goals of one sort or another—beginning, I suppose, with food, and ending with our individual definitions of a state of grace. Success is an occasional thing and inconclusive; "pursuit of happiness" was astute phrasing—the striving is life itself. Incentives are here to stay, I hope.

If the restricting of certain privileges (sideband and portions of twenty are speculations I hear most often) to a specific grade of license is the point of controversy, I'm for it. And if anyone loses ground in the shuffle he can catch up at his own convenience, if he's interested, by earning the grade carrying the authorization he wants. Our licenses confer privileges, not franchises, and in the light of what has happened on the electronic scene in the last few years a reappraisal of our qualifications may be in order. If you doubt it, listen to the bickering on 75 and the clang of swords on 20. Check stabilities and bandwidths, and reflect on the proliferation of phasing, filtering, VOX, elastic linears, compacted kilowatts and the five-dollar-down boom.

We worked for our ham tickets for many reasons. My original incentive derived simply from the concept of instant communication with unseen strangers. The mystique of private access to an invisible world was irresistible, but had it been free for the asking I doubt that hamming would have long competed successfully with the many interests that fascinate and plague most adolescents, for learning the code was tedious and theory a big, black hole. The self-discipline requisite to serious studying was new to me, but what I had failed to learn about it in high school came in the effort of getting that first ham ticket. It was a good lesson.

A-3 on 75 and the challenge of moving up a step provided the next incentive. Evolving curiosity and the acquisition of new privileges led automatically to a wider technical horizon and renewed effort. It would seem that, so long as a subject holds one's interest, this simple escalation by response to incentive describes an ideal educative situation. The goals are clearly defined and progress is timed to the applicant's own schedule. In my own case, and I inflict this recital on you because I've heard too many operators moan that some licenses are beyond their ability, Amateur Extra, First Phone and First Telegraph were difficult to get for I have had no technical training; at the sound of the word "mathematics" my brain squeaks in fright and skitters out of sight, and

finally, I learn very slowly. Not slowly for a turtle, but very slowly for a human being. If the system worked for me it will work for anyone, and here and now I dedicate retroactively to Incentive Licensing—administered under various governmental auspices—my aeronautical, marine, marriage and radio privileges and I'll throw in for good measure the prerequisites of a hatful of Bar Pilot Licenses granted with contrasting carelessness by seaport saloonkeepers. Reflecting now on the hours of study these certificates represent I'm surprised that I'm still not smart. But I'm happy—and that's what counts in a democracy. What we need is more incentives.

To avoid being accused of claim-jumping by another magazine, I have refrained from referring to Incentive Licensing as "The American Way"; however, the subject of other magazines having now been rather lamely introduced I would like to drop a curtsy to a third publication, QST, and file a wordy little disclaimer here to the effect that my touting of Incentive Licensing does not imply support of ARRL policy on the issue and I'm sure they couldn't care less. I may labor the point but I beg indulgence on the grounds that non-conformists are jealous of their isolation and picky about circumstantial alignments. Incidental to the subject of alignment, I was surprised to learn from five local hams questioned that one smokes filter-tips, three smoke cigarettes, four use a popular pain-killer—blended not buffered—and all five are ex-members of the ARRL. Their reasons for separation vary from my own in detail, but agree on the simple proposition that the League is not representative of our interest in amateur radio. After determining that their independent positions were not products of the ARRL stand on any one matter, and provoking some suspicion of the motives behind my curiosity, I pedalled away with studied nonchalance.

Certainly the League does speak for many thousands of hams; the ARRL is indeed large, reputable and impressive, and it has my respect—but I claim the right to differ with it. And this brings me to "The Amateur's Code," a canon prominently displayed in "The Radio Amateur's Handbook." Item one includes the dictum: "He abides by the pledges given by the ARRL in his behalf to the public and the Government." Item two: "He owes his amateur radio to the American Radio Relay League, and he offers it his unswerving loyalty." After mulling this over enough times I realized that as an occasional dissident I did not fit the mold, and I had better reserve my all out pledge-abiding, debt attesting and unswerving loyal-



TECHNIMATIC^{*}

TUNING



The
**WORLD WIDE
SYSTEM
OF REMOTE CONTROLLED
COMMUNICATION**
AS USED WITH OUR FAMILY OF
DDR-5 RECEIVERS

THE TECHNIMATIC^{*} TUNING SYSTEM permits an operator to tune both transmitters and receivers remotely to frequencies and various modes of operation on an automatic and pre-programmed basis by means of pre-cut tapes, cards, memory systems or manual selection and provides a readback of information to the operator showing him that the selected tuning functions have, in fact, been performed.

The system is unique in that manual override is provided at the receive site; however, any change in the positioning of the controls at the receive site would automatically be indicated on the remote controller's console. Tuning functions of transmitters and receivers, including the selection of frequency, audio and RF levels, sideband selection are controlled at this console. Readback indication of the frequency to which the remote units have been tuned to is presented by 1" illuminated digital display at the operator's console. Other tuning functions are displayed on illuminated indicators.

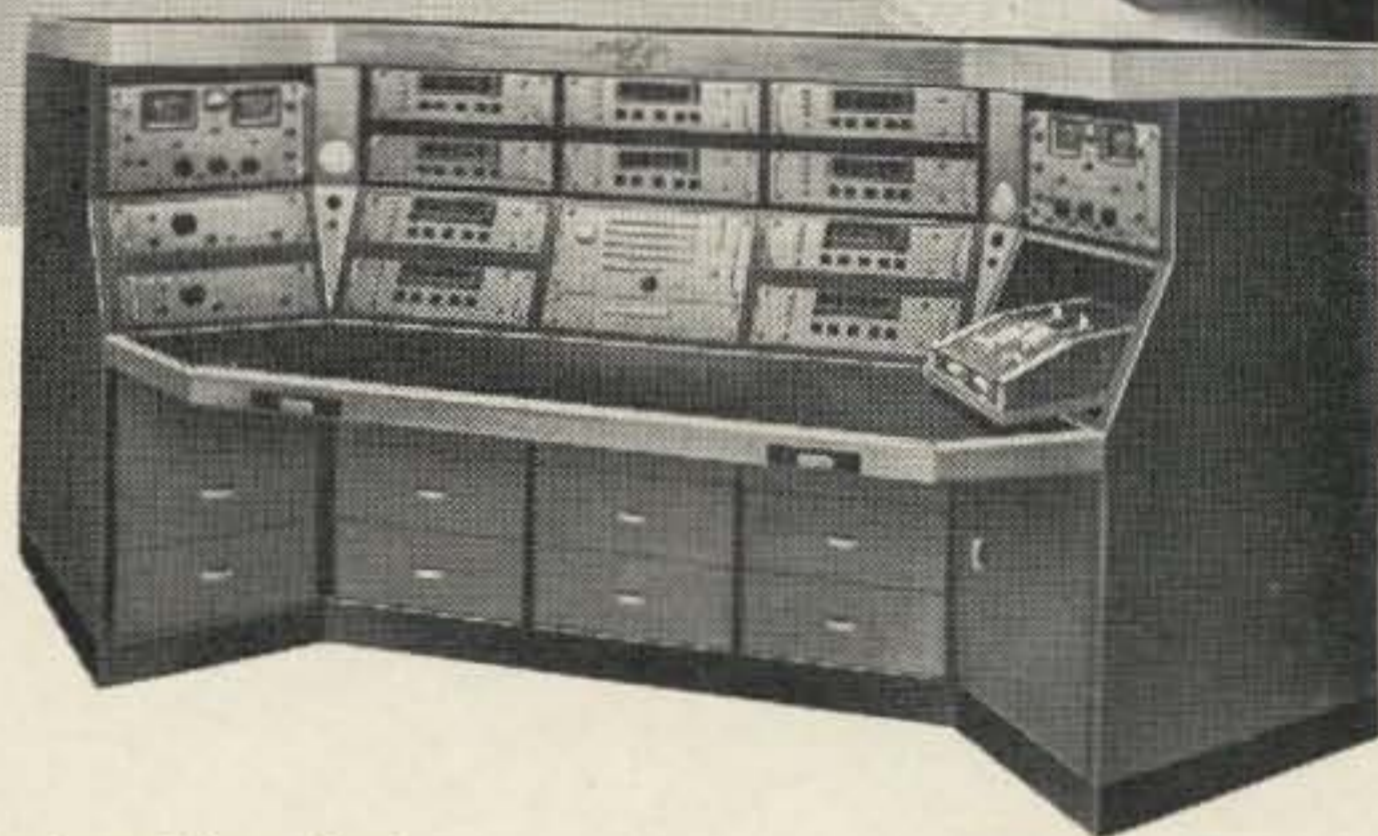

Illustrated above is a "run" of DDR-5 receivers assembled from our production line for photographing. A wide selection of receiver combinations and capabilities are discussed in our DDR Brochure available on request. Insetted at the lower right is a typical TECHNIMATIC control console. We invite your inquiry.

^{*}TM APPLIED FOR

WRITE FOR
BULLETIN 4012

THE TECHNICAL MATERIEL CORPORATION

MAMARONECK, NEW YORK

and Subsidiaries

OTTAWA, CANADA • ALEXANDRIA, VIRGINIA • GARLAND, TEXAS • OXNARD, CALIFORNIA
SAN LUIS OBISPO, CALIFORNIA • LUZERN, SWITZERLAND • POMPANO BEACH, FLORIDA



ty to other entities—such as my wife, and Uncle Whiskers, both of whom have in the past found occasion to exact fealty on equally sweeping terms, but for somewhat more vital reasons.

The more I thought about it the more it seemed that an incorporated group which refers to itself with some justice as “powerful and prosperous,” and works to influence legislation in Washington, and treaties in Geneva, should advertise its assumption of mandate less grandly, and consider a code more responsive to the ferment of opinion in its membership. Monolithic qualities in an organization indicate rigidity, not vitality; and not an enduring firmness, but a hardening of corporate arteries.

On one subject, thank goodness, I find myself in complete agreement with Wayne Green—licensing fees. I even go along with his reasoning and that should take care of the subject, except that as a prospective fee-payer I naturally want to make stupid suggestions about how my money should be used. To clear the air (inside joke) and give everyone really interested a fair shake I think the FCC should

re-examine every licensee in return for the first renewal fee. And subsequently an examination with every other renewal shouldn't be too painful a test of an amateur's interest in the art. Electronic progress has been wild, and a decade is a long time in our field and our age. Re-examination would mean to me getting out the lead and the books, or getting off the air, and it might turn out to be all three, but it would keep dilettantes from exploiting an international medium already suffering from its own population explosion, and the incentive and privileges would still be there for everyone whose interest is serious. The art would gain proportionately and it would be a pleasure again to listen to the ham bands.

Incentive Licensing is logical; re-examination would make reasonable frequency and emission restrictions fair and invigorate the community, and last but not least, “grandfather clauses” are pious abominations. If you have any interest in these matters, and I presume you do, I hope you will write, for or against, to 73 and the FCC.

... W7IDF

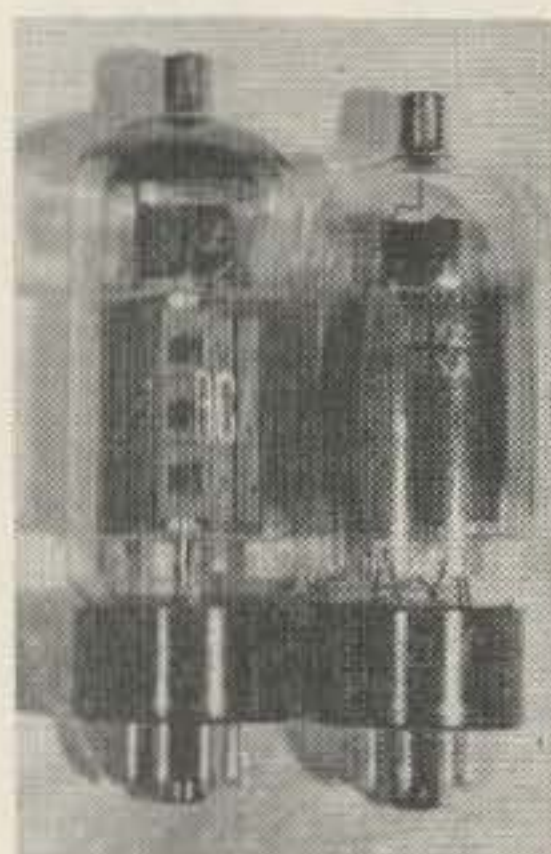

Jim Kyle K5JKX
1236 N. E. 44th St.
Oklahoma City, Okla.

More Notes on the 6DQ5

One of the more popular 100-watt-output final amplifier tubes around these days is the 6DQ5; this happy little horizontal-output bottle operates at approximately the same ratings as a 6146, but delivers nearly half again more RF output.

And with such a bonus built in, quite a few designers of commercial gear have also latched onto the Dog Queen Five as a natural. The Swan transceiver is one notable example of this.

However, it has recently come to our attention that the Dog Queen Five has another characteristic not shared by other tube types—and this one is bad rather than good. A 6146 is

a 6146 is a 6146, regardless of who made it; the same is not true of a 6DQ5.

The tube manuals bring this out clearly, but we hesitated to believe it since the whole idea of tube type numbering is to ensure that all tubes with the same type number are electrically interchangeable.

All 6DQ5's have the same base wiring, and *approximately* the same ratings in TV service; however, the similarity ends there.

Before we get specific and start naming names, let us hasten to point out that no slight is intended toward the manufacturers involved. Our purpose is rather to avoid possible complaints from unhappy 6DQ5 users. After all, the manufacturers still don't rate this tube for RF service, so it's quite possible none of them have become aware of the differences yet!

Now, if you have a copy available, turn to page 199 of RCA Receiving Tube Manual RC-19 and take a look at the set of curves numbered “92CM-9311T.” These are for the 6DQ5 at zero grid bias, with screen voltage varied. What we're looking at is the position of the “knee” or sharp change in direction of the curve.

With 100 volts on the screen, the knee occurs at about 35 volts on the plate, and 260 ma of plate current. With screen voltage upped to 125, the knee moves to 45 volts and 520 ma; with screen at 150, the knee is at 50 volts and 700 ma.

Now get a copy of the detailed G-E speci-

fication sheet on the 6DQ5; the one we're using is dated November, 1962, and the set of curves is numbered "K-55611-TD181-2."

Check the knee points. With 100 volts on the screen, the knee is at 60 volts and 410 ma. At 125 volts, the knee moves to 70 volts and 550 ma. And at 150 volts on the screen, the knee is at 75 volts, 720 ma.

It doesn't take an Einstein to figure out that the G-E version of the tube has a knee voltage about half again higher than that of the RCA variety. The higher knee voltage, in turn, means reduced power output is available even though the G-E tube does draw more current at the knee. The RF power available at the plate is equal to the plate voltage *swing* (from B+ voltage down to the knee point) times the average plate current (knee value divided by four) times a constant 0.862 which allows for conversion from peak pulse values to RMS power out.

Thus with 600 volts on the plate and 150 on the screen, the RCA 6DQ5 would deliver about 83 watts of power output while drawing 175 ma. The G-E version would deliver only 81 watts while drawing 180 ma.

This doesn't sound like much difference, but plate-dissipation ratings enter at this point to limit the maximum power input to the tube with lower efficiency, thus extending the difference.

In practice, W5PPE reports a power output drop of about 15 to 20 percent when replacing the RCA version with the G-E type. This was in a Swan.

And before too many feelings are hurt at G-E, we must hasten to add that Sylvania and Tung-Sol also make 6DQ5's to this same specification. It appears, then, that the RCA 6DQ5 can only be replaced by another from RCA.

But we wouldn't want to make that a flat statement, since we haven't examined all the Dog Queen Fives on the market.

The physical differences between the "low-knee" and "high-knee" versions of the tube are easily distinguished. The photo shows one of each type side by side for comparison. The low-knee version, at left, is about 1/4-inch taller, has the getter at the top of the tube, and carries three perforations in each side of the anode structure.

The high-knee version, at right, has the getter at the side, and the anode structure is solid.

In audio and TV service, both perform equally well and are as interchangeable as you would expect. But at RF, watch out. The power you lose will be your own.

. . . K5JKX

SPECIFY SAXTON

For Antenna Wire

Copperweld #6-#18
Solid Copper #12-#14
Stranded Copper 7x22 - 7x26

For Guy Wire

Galvanized Steel 4x20 - 7x18 -
12x20
Aircraft temper aluminum 7x18
Copperweld 6x20 - 8x18
Tiller Cable 3/32"

For Feeder Wire

Twin Lead
Open Wire
Coax
Open Twin Lead

Ground Wire

Solid dead soft aluminum #6 - #8
Rotor Cable - Mike Cable - High Voltage Wire. Plus dozens more types of wire and cable . . . AND MIL SPEC WIRE AND CABLE WITH CERTIFICATION.

Send for our catalog

Saxton Wire and Cable

4121 Park Avenue
Bronx 57, New York

The SJS Receiver

Part 1

Satisfied with your receiver? You're a most unusual ham if you answer yes! But with the present high cost of new equipment, and the apparent complexity of modifying the present rig, you're probably resigned to struggling along with what you have.

In the past couple of years, a number of excellent articles have appeared in the various ham magazines describing homebrew receiver projects. To cite just a few, there have been Ted Crosby's HBR units in QST, and the several fine units described in these pages by John Wonsowicz, W9DUT.

But most of these homebrew receivers appear to have two points in common (*besides* fine performance): they seem a bit too complex for the newcomer to homebrewing, and they all look more than a little expensive.

That's why the SJS was born; to be a simple, inexpensive receiver capable of serving as the only receiver at K5JKX, and still having enough quality to provide satisfactory performance.

To achieve these ends, a rather unusual looking device evolved. Simplicity was achieved by going to a modified modular type of construction, and the expense department was taken care of by raiding the surplus bins and the junkbox quite freely.

The result in terms of performance: stability is almost unsurpassable. From a cold start, checking against the 15 mc transmission of WWV, no drift was detectable after two minutes. Another check 10 minutes after turn-on showed the frequency to be about 200 cycles low; the receiver was again tuned to zero-beat and let run another half hour. It was still product-detecting the WWV signal with no change in audio note at the end of that time. This is frequency-meter stability, after the 10-minute warmup.

Selectivity is excellent although it could stand a bit of improvement for DX pileups on the lower ends of 20. The selectivity curve is fixed at approximately 4 kc, with steep enough skirts to do an effective job of deciphering DSB.

Sensitivity is determined entirely by the outboard converters used. On 50 mc, sensitivity is approximately 0.1 microvolt. On the lower bands, antenna noise is easily evident and no detailed checks were made.

You may have deduced by now that this is a multiple-conversion unit following the basic Collins approach, so the next question ought to be "How about birdies?" I have found two, neither objectionable. At first, there were many more, but if you follow the schematic and article you shouldn't have to chase them the way I did here!

And finally comes the question of image rejection. It's possible to find some images, but by proper tuning techniques they can be kept 40 db or more down; the kilowatt across town may pop up out of the band, but you won't find many commercials!

So now that you have the description of performance, let's take a look at the SJS itself.

Physically, it consists of two 3¼ inch relay rack panels plus an assortment of "miniboxes" hanging inside the rack. One of the panels contains the tuning/audio unit while the other contains the "intermediate converter". The miniboxes house the various outboard converters.

The tuning/audio unit began life as a BC-453 "Q-5er," but any resemblance between the present unit and the original command set is purely accidental. I used a "junker" 453 which had been given to me to get it off the shelves. The only parts of it retained are the capacitor gang, the rf-mixer-oscillator coil assembly, the three *if* transformers, and the bfo coil assembly. If the bypass capacitors are good you can use them too; I used several and substituted new Mylars for the rest.

The original circuit of the 453 was discarded and a new circuit (Fig. 1) was designed in its place. The new circuit uses a 6BA6 rf stage, hooked up conventionally, feeding a 12-AT7 mixer in the "Like New" circuit (73, October, 1961, page 32). The oscillator is a triode-connected 6AK5. The two *if* stages are both

6BA6's and are completely conventional. They feed the AM detector through the final *if* can; this detector is the Makino circuit (Ultimate ANL, VHF Horizons, July, 1962). In addition, the last *if* plate feeds a shunt-diode AVC detector, and provides signal to the 6BU8 product detector.

Audio from the AM detector and from the product detector are both applied to the front-panel function switch; this switch also controls B+ to the bfo grid of the 6BU8, and switches a padding capacitor into or out of the bfo tank to select USB or LSB operation. This trick, incidentally, was borrowed from Alan Margot, W6FZA, and his article in the January, 1962, QST.

Audio from the function switch goes through a 12AX7 cascaded amplifier with voltage gain of approximately 1000, and drives a 6AQ5 power amplifier.

In the avc circuit, a diode and several resistors are combined to get a fast-attack variable-release action; the front-panel avc switch gives fast, slow, and manual action. The rf gain control is in the cathodes of the two *if* stages and the rf stage; the audio gain control is between the function switch and the first audio stage. The speaker switch merely opens the voice-coil leads to mute the unit for standby.

The power supply for this unit is also enclosed in the chassis; it provides approximately 120 volts at 50 ma, using a silicon diode and a tiny TV-booster transformer. The ac switch is on the rf gain control. The low voltage was chosen after studying Bill Barnard's article in the Command Set Handbook on "Repackaging

the Command Set" for cool operation and lowest noise.

This tuner/audio unit may not sound so simple in the written description, but it shouldn't take more than 8 to 10 hours to wire it as all wiring is straightforward, point-to-point. The hardest part of all is installing the tuning capacitor gang and hooking up the front end. Detailed instructions will be given later.

As you can see by now, the tuner/audio unit takes rf energy in the range from 190 to 550 kc and gives you audio output. To be very useful, an "intermediate converter" is necessary, and that's the next unit.

W6FZA's article mentioned earlier describes an excellent "intermediate converter" he uses with a BC-453 to bring the 14 mc region down to the 453's tuning range; he reported (in private communications following appearance of his article) that he had no complaints after two years' service, and if 14 mc and higher is your prime interest, this would make a good unit to go ahead of the tuner.

However, I wanted to be able to listen on 40 as well, which would have required major redesign of the W6FZA unit. In addition, I wanted my "intermediate converter" to match the tuning unit in general size and appearance. Therefore, I designed my own.

It consists of a 6BJ6 rf stage, operated grounded-grid (idea from W6AJF's VHF Handbook), with a tunable band-pass circuit in its place. This stage feeds a 12AT7 "like new" mixer, while a second 12AT7 serves as crystal oscillator and cathode follower for output.

The front-panel controls are band-pass tuning (at left) which operates just like an an-

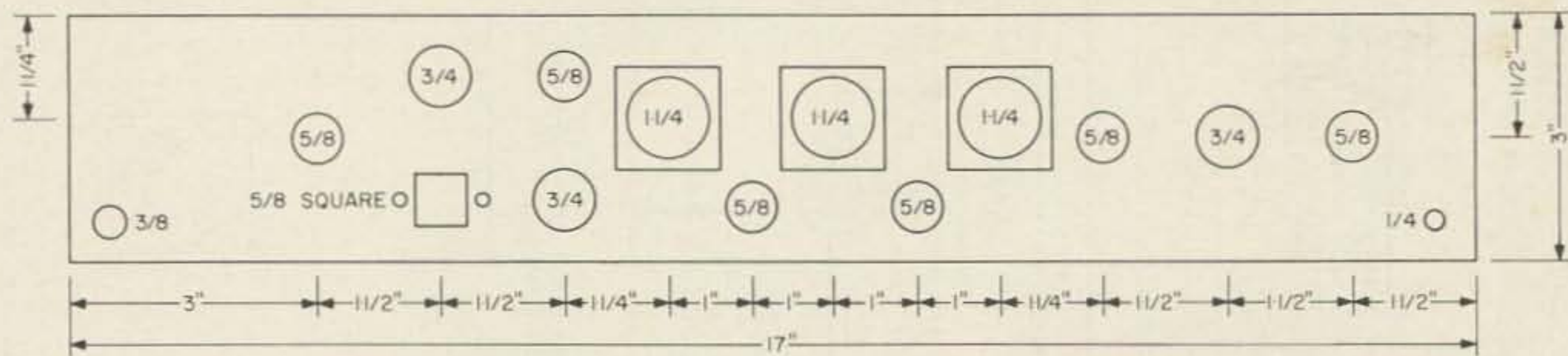

FIGURE 2
REAR-PANEL LAYOUT

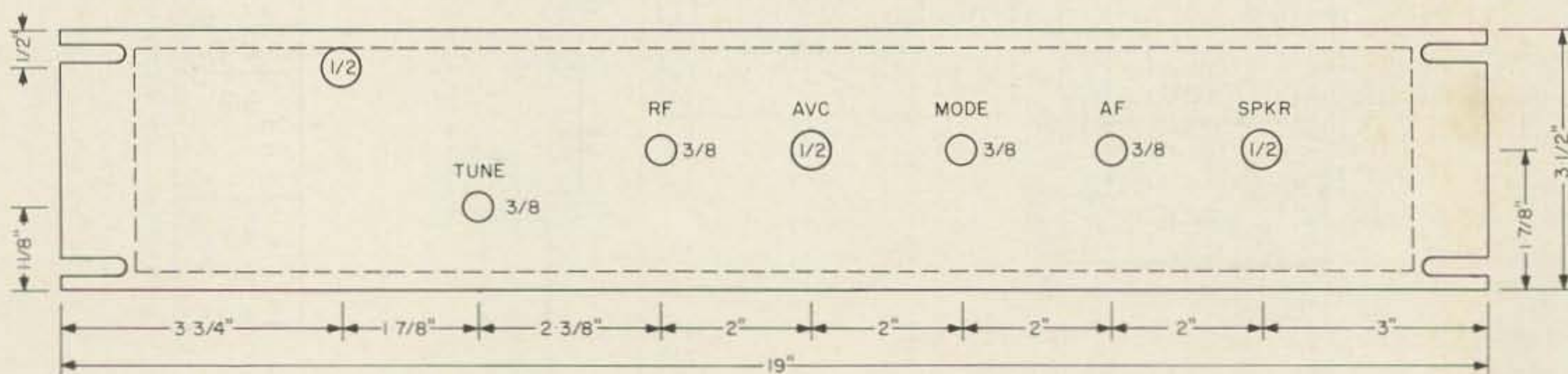

FIGURE 3

tenna trimmer, to peak up the rf stage and mixer at the same time; the bandswitch, which selects one of three crystals (6800, 7150, or 7500 kc) for the oscillator and simultaneously pads the band-pass circuit to the right region, the converter switch, which selects one of five outboard converters as the input, and the power switch.

For this unit, a 250 volt power supply was chosen and built in; this supply powers not only the intermediate converter, but any outboard converters which do not include their own supplies. Regulated 150 volts, unregulated +250, and filament voltage are available on back-panel connectors. Filament voltage is always on, while both B+ voltages are switched by the converter switch.

The intermediate converter covers the range 7 to 8.05 mc with no outboard converters attached, allowing direct listening on 40 meters. In addition, any frequency coverage desired can be achieved by putting a converter with 7 mc output ahead of it. As this is written, I am using a 50 mc converter on position 1. Position 2 is vacant. A 14.9-15.9 mc converter (International Crystal KB-1 board with 7900 kc rock) is in position 3 for WWV checking (and some SWL activity), and position 4 connects directly to a 40-meter antenna. Position 5, like position 2, is not in use.

While it might appear from this description that operation would be complex, it isn't. To turn the rig on, the tuner rf gain and the intermediate-converter power switch are both rotated clockwise. When the unit warms up, the band of interest is chosen by the converter switch, and is tuned by the tuning knob on the tuner. The desired signal is peaked with the band-pass tuning control. If a signal peaks with this control clockwise while it is tuned at the low-frequency end of the range, you are on an image. It will go away if you simply move the band-pass tuning to correspond with the main tuning control.

Ready to build it (or a similar device with some of your own modifications)? Let's go!

The starting place is the tuner/audio unit, since this can be used in Q-5er fashion with your old receiver until you complete the intermediate converter. Gather your junk BC-453, a 6 x 3 x 17 chassis, appropriate tube sockets and hand tools, and let's get to work.

First, strip the necessary parts from the BC-453. Start by removing the *if* cans; they come out easily from their plug-in sockets after you remove the two small screws (top of chassis) at the corners. Next, remove the two screws at the sides of the chassis and unplug the front-end coil assembly. Now you can re-

ROHN

sets the standard



**for
CRANK-UP
TOWERS**

**Why settle
for less
than the best?**



K7ASK

TWO CATEGORIES TO CHOOSE FROM

Standard Duty Guyed in
Heights of 37 - 54 - 88 - 105
and 122 feet

Heavy Duty Self Supporting
and Guyed in Heights of
37 - 54 feet (SS)
71 - 88 feet (guyed)

ROHN has these 6 IMPORTANT POINTS:

Ease of Operation—roller guides between sections assure easy, safe, friction-free raising and lowering. **Strength**—welded tubular steel sections overlap 3 feet at maximum height for extra sturdiness and strength. Unique ROHN raising procedure **raises all sections together**—uniformly with an equal section overlap at **all heights!** **Versatility**—designed to support the largest antennae with complete safety and assurance **at any height desired!** **Simple Installation**—install it yourself—use either flat base or special tilting base (illustrated above) depending on your needs. **Rated and Tested**—entire line engineered so you can get exactly the **right** size and properly rated tower for **your** antenna. The ROHN line of towers is **complete**. **Zinc Galvanized**—hot dipped galvanizing a standard—not an extra—with all ROHN towers! Prices start at less than \$100.

SEND FOR ROHN TOWER HANDBOOK

—\$1.25 Value

—**ONLY \$100** postpaid (*special to readers of this magazine*). Nearest source of supply sent on request. Representatives world-wide to serve you. Write today to:



ROHN Manufacturing Co.

P. O. Box 2000

Peoria, Illinois

"World's Largest EXCLUSIVE Manufacturer of Towers; designers, engineers, and installers of complete communication tower systems."

move the bfo coil assembly by removing four screws (don't lose them!) and all bypass capacitors. Check the bypasses with a neon bulb and a 150 volt source to make certain they aren't leaky or open. A good one will let the bulb blink once, but no more. Any glow, or lack of the initial blink, indicates a bad bypass.

We've saved the hardest part, removing the capacitor gang, till last. Remove the tuning dial. Behind it, you will find four small screws on the panel. Loosen them but do not remove them yet. Now check the connections to the capacitors. The rf and mixer connections can be removed at the capacitor, but you want to retain as much of the original oscillator wiring as possible. On mine, a No. 12 wire ran down to a feedthrough on the chassis, and disconnecting it from the feedthrough let me lift the whole unit free. When you are certain you have the wires under control, remove the four screws and lift the capacitor free.

Next step—and if it's late in the evening wait till tomorrow because it's really the hardest part of the whole job—is to drill and shape all the holes in the chassis. The rear-skirt layout (Fig. 2) and the panel template (Fig. 3) should be of help here. After all holes are drilled or punched, smooth off all burrs and mount the tube sockets.

Now the wiring begins. Run the filament line first. After it is complete to all sockets, add the 6AQ5 output stage components, including the audio output transformer. Now, wire in the power supply in the space between the output transformer and the 6AQ5 socket (and as you do this, you will understand why this order was prescribed—the 6AQ5 socket is inaccessible after the power supply is installed!).

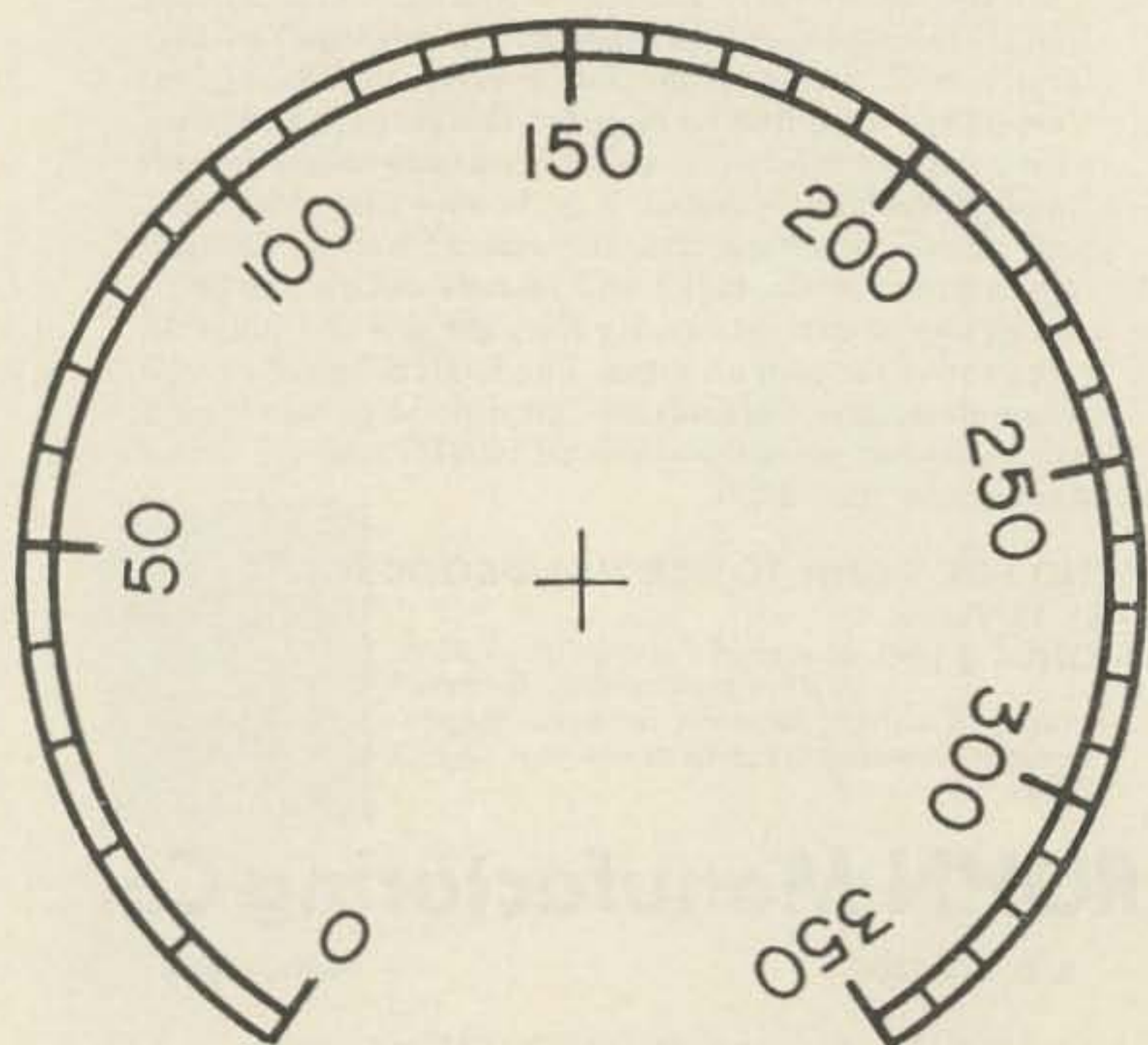

Tuning dial, full size tracing

After checking to see that all filaments light properly, remove tubes and disconnect ac power (short out the filter capacitors, too, for safety). Install the "W2EWL" transformer and wire all B+ lines, dressing the wires and decoupling components as close to the chassis as possible. Now you can finish up the 12AX7 audio stage, and reinsert the two audio tubes for a checkout. If all is well so far, you should be able to get a loud hum by touching the input grid of the 12AX7 with a screwdriver.

At this stage, add the volume control and speaker switch on the front panel and connect them in. You now have a fine audio amplifier ready for service; the next few steps will turn it into a receiver.

Next step is to wire the 6BU8 stage, and insert the last *if* transformer in its chassis hole and connect it. The Makino-limiter/AM detector is hooked up separately on a five-point tie strip and installed after this wiring is completed.

The other *if* transformers can be mounted now; hold them in place with 4-40 screws and nuts through the mounting lips, and connect by soldering directly to the "sockets" on the bottoms of the coils. Install the rf gain control, the avc switch, and the function switch on the front panel, and wire the *if* stages and the controls into the circuit.

The avc components can be added conveniently at this stage also. They fasten to a tie point on the bottom of the chassis, to the tube socket, and to the avc switch.

All that remains is the front-end wiring. Make all possible connections to the tube sockets. Connect generous lengths of insulated wire to all tube-socket pins which have any connections to be made to the coil assembly or capacitor, since you won't be able to get to them later.

Now angle the tuning capacitor into position. Before installing it permanently, you'll probably want to add a dial as I did—just trace off the calibration from the original dial plate, except that the old "200" mark becomes "O" on the new dial and you go up from there, so that the dial reads from 0 to 350. I used "letra-set" lettering and copied the final tracing with an office-copy machine, then glued the copy to drafting board and forced the board into place on the threaded hub of the tuning capacitor.

The hairline indicator behind the viewing hole in the front panel was made by scratching a line on a piece of lucite. The whole works is held in place by masking tape against the inside of the chassis, and a No. 47 bulb across

NEW

Cush Craft

SQUALO*

6-10-11-15-20 or 40 METERS

Cush Craft's continuing research produces another first —THE SQUARE HALO. Squalo is a full half wave, horizontally polarized, omnidirectional antenna. Outstanding all around performance is achieved through a 360° pattern with no deep nulls. Full size and compact dimensions provide a low Q for broad band coverage. Direct 52 ohm Reddi Match feed gives an SWR of 1.5-1 or less from 50 to 51 Mc.

The 6 and 11 meter Squalos are packaged complete with rubber suction cups for car top mounting and a horizontal support for mast or tower mounting. The 10-15-20 and 40 meter Squalos are designed for mast or tower mounting where space does not allow for larger antennas. Squalo is ideal for net control, monitoring, or general ham coverage.

Whether you are a beginner, apartment dweller, or serious DX man the space saver Squalo is for you. You can buy one for each band and build a Squalo Tree!

Model No.	Description	Net Price
ASQ-6	6 meter 30" square	\$12.50
ASQ-10	10 meter 50" square	19.50
CSQ-11	11 meter 50" square	19.50
ASQ-15	15 meter 65" square	23.50
ASQ-20	20 meter 100" square	29.50
ASQ-40	40 meter 192" square	66.50

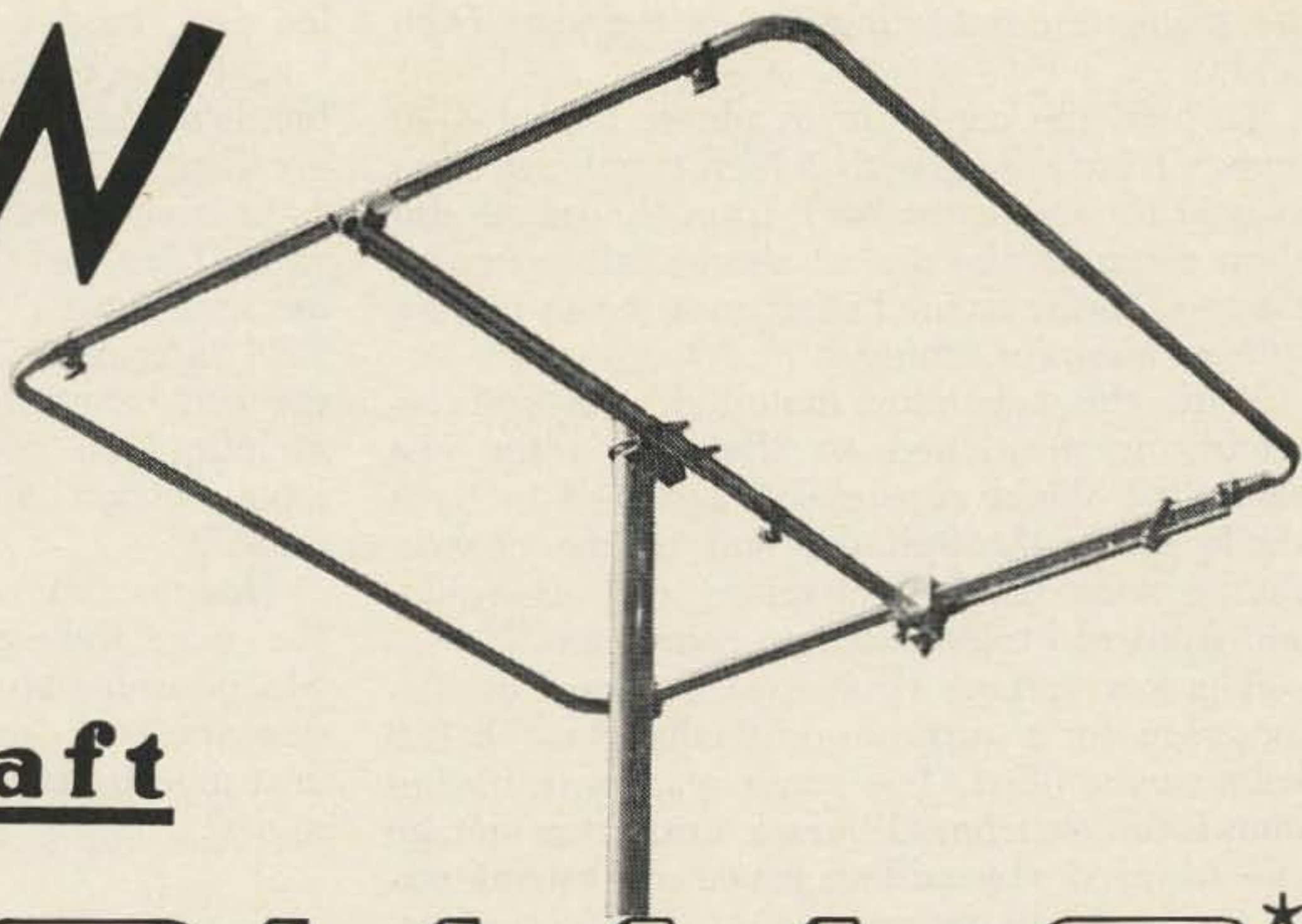

ON YOUR CAR

OUT A WINDOW

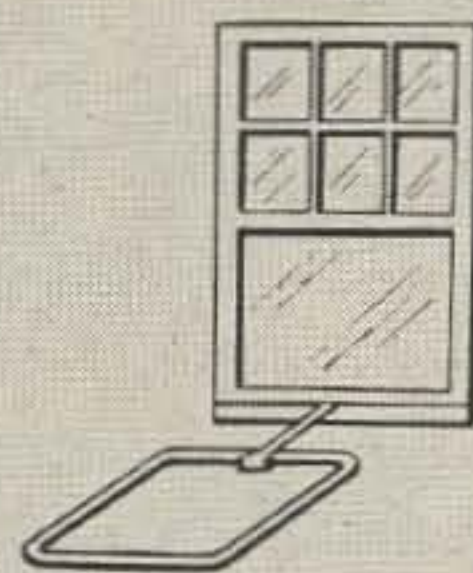

ON A MAST

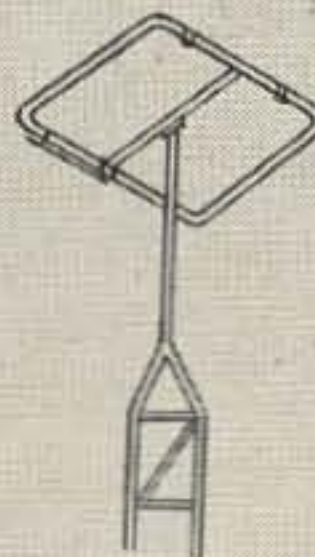

*Pronounced Squaylo

Cush Craft

621 HAYWARD ST.
MANCHESTER N. H.

BUY FROM YOUR
DISTRIBUTOR OR WRITE
FOR FREE LITERATURE

the filament circuit illuminates the dial from below.

To hold the capacitor in place, I used 4-40 screws 1 inch long, with $\frac{3}{4}$ inch tubular spacers to hold the capacitor back from the panel and allow room for the dial. A short shaft extension clamped to the splined shaft runs out to the big spinner knob for tuning.

With the capacitor mounted, the coil assembly is positioned so that the rotor just clears the shield case and is fastened in by a single screw through the end of the chassis. Connections to the capacitor, coil assembly, and front-end tubes are then completed.

The low voltage applied to the local oscillator is low for a purpose; originally, the full 120 volts was applied. The result was more birdies than I had ever heard before. Oscillator voltage was lowered (by adding series resistance) until the birds disappeared. Gain was not affected. Thus, if you should find a bird or two, try increasing resistance in the oscillator plate supply line and they will undoubtedly go away.

Now, after checking all your wiring, you're ready to fire up your tuner/audio unit and try it out. Connecting directly to an antenna will let you hear radio range stations operated by FAA and the military, and you can check frequency calibration against these. Don't be mis-

led by "bassy" audio though; these stations feed high-Q antennas and they lose the sidebands at the transmitter. Audio quality will be excellent with the unit in use on higher bands.

As mentioned earlier, you can use this unit as a Q-5'er, or (if your interests are all at 14 mc and above) you can put together the W6-FZA intermediate converter. Other intermediate converters already in print for this range include Don Stoner's "Novice Q-5'er" and a later version in his "New Sideband Handbook."

However, if you want to follow this unit all the way through, you'll want to build the SJS intermediate converter. It's a little long to describe here—so we'll break at this point until next month. And in the meantime, happy listening!

References

- Crosby, Ted, W6TC, "The HBR-16 Communications Receiver," QST, October, 1959.
Ericson, "The BC-453 as a Tunable IF in a Multiband Receiver," QST, February, 1961.
Wonsowicz, John, W9DUT, "Tri-Mode VHF Receiver," 73, November, 1960.
Wonsowicz, John, W9DUT, "Quad Mode Monitor," 73, August, 1962.
Margot, Alan, W6FZA, "A High-Performance Tuner for VHF Converters," QST, January, 1962.
Bernard, W. B., K6EUS, "The ARC-5 Repackaged," Command Sets, Cowan Pub. Corp.
Stoner, Don, W6TNS, "The 1959 SSB Q-5'er," New Sideband Handbook, Cowan Pub. Corp.

Fred Haines W2RWJ
123 Roberta Dr.
Liverpool, N. Y.

Another Antenna of Note

or Why did we ever move off the olde farm?

Having more wire than brains, and being of unsound mind (at least I was told this more than once), a monstrous idea formed in my mind one day, and unlike most of such, it was actually carried out. The 20 meter VEE beam has been described in the literature (73 Magazine for March, 1962) and one would be quite sure it was enough to dampen my enthusiasm for any more antenna projects. Wrong! That beam wouldn't load up on 80 or 40 worth two cents. For years a roll of #18 copper coated steel wire had been kicked about under the workbench and had been almost chucked out many times. One afternoon, while sitting at the operating position biting my fingernails to the quick and wishing I could get on 80 meters (all the good DX on 20 had already been worked twice that day) I spied that miserable roll of old wire. The rest is history. . . .

The handbooks were again consulted for some rule-of-thumb guides as to antenna lengths. As every Novice knows, or should, a $\frac{1}{2}$ wave on 80 meters is about 132 feet long, and once cut will also load up on 40 and other bands. Having spent my last thin dime on the 20 meter VEE beam, I was looking for something simple and this couldn't be much simpler. One end was attached to the peak of the house and the other end was run out to . . . ? And that's how the thing got started. There just wasn't any kind of a sky hook in the 132 foot range.

A tear welled up in one eye, and the idea was about to be dropped and a new hobby pursued, when by chance a hawk flew overhead. I idly watched that hawk as he glided and soared effortlessly overhead and finally as if guided by providence he flew in a line from

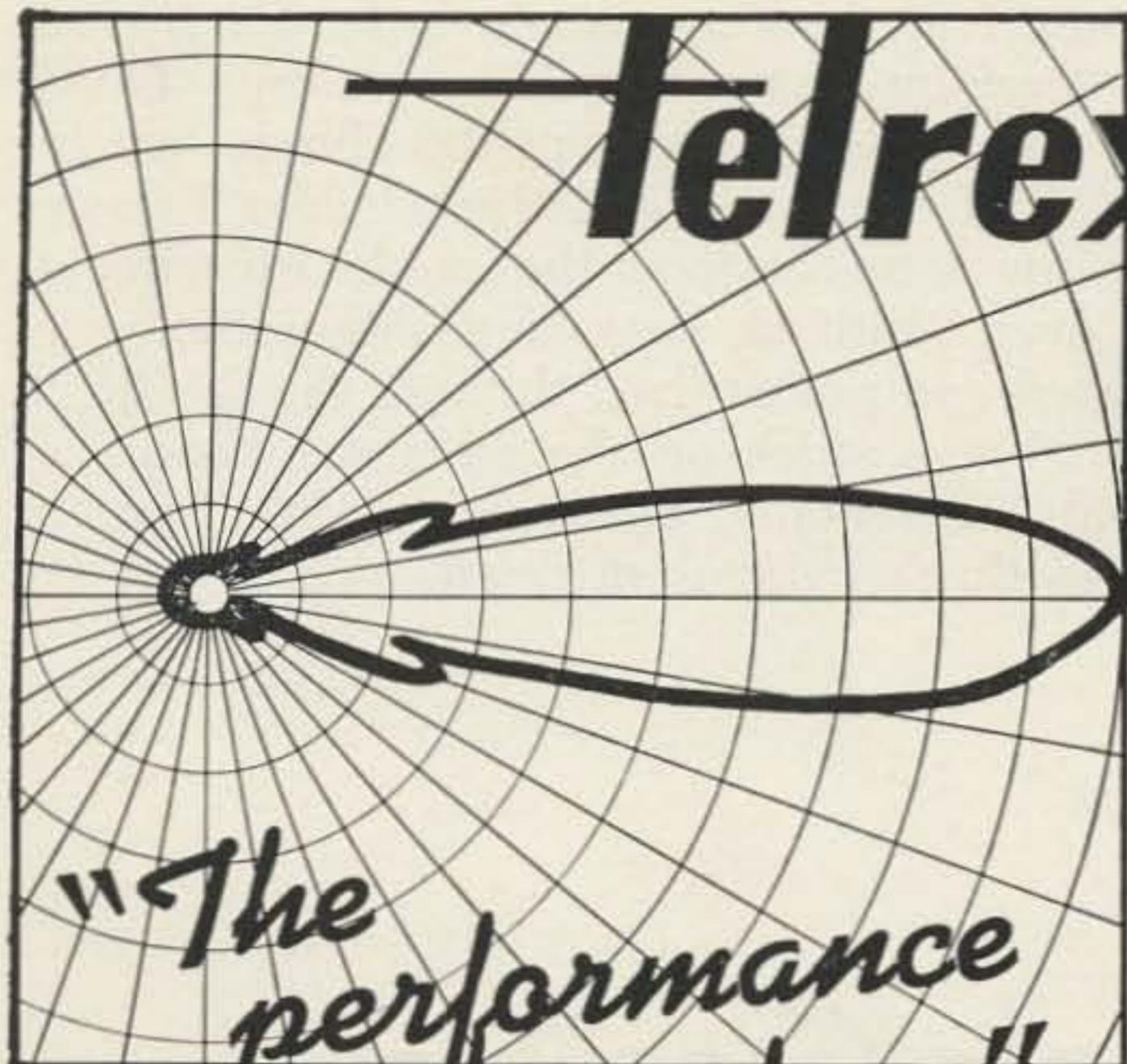

"BEAMED-POWER" ANTENNAS and ANTENNA SYSTEMS

The Choice of the Discriminating
Communication Engineer . . . the
Man who Never Settles for Any-
thing Less than THE-VERY-BEST!

You too—can enjoy world renowned TELREX performance and value! Send for PL65 condensed data and pricing catalog, describing the lowest priced antennas on the market, in relation to materials and performance! Expanded data sheets—including your favorite band, are also available.

"The performance
with a line"

**MATERIAL DIFFERENCE
—IN USE IN 135 LANDS!**

ANTENNAS

SINCE
1921

COMMUNICATION SYSTEMS
telrex LABORATORIES

ASBURY PARK 25, NEW JERSEY, U.S.A.

over the peak of the house in the direction my wire was lying on the ground, due east. As my eyes followed him he flew about 500 feet due east and alighted in the top of a tree growing at the top of a 150 foot hill.

My interest in ham radio and antennas dropped to a low level as I became interested in finding out if that bird had a nest in that tree. I started out on a trot for the tree on yon hill, and after about five minutes of puffing along had reached my goal. The bird had by that time flown off, and I set out to climb the scrub oak as it turned out to be. From my perch about 25 feet up I surveyed the countryside all around and was suddenly struck by a stupendous idea! Why not run my antenna from the house to the tree I was ensconced in?

A pulley was mounted in the tree and fitted out with some rope and the antenna wire was pulled skyward. With a wire 545 feet long there was some question in my mind if the stuff could even support its own weight without breaking, let alone keep from being so sway-back in the middle that a center support would be required. Lo and behold though, due to the small gauge wire used, it was apparently light enough to almost float on the breeze. The tree, being on a 150 foot rise was high enough so that the wire never came closer than about 30 feet from the ground at any point, and actually sloped down hill to the house. When the wind would blow vigorously, one end of the wire might be rising while the other end could be dropping, or one end could be still while a local gust at the other end was whipping the deuce out of the far insulator. Small

birds produced a curious reaction, which I chose to call the Banjo Effect. The first bird to alight on the wire caused a mild trauma in our household. The wire, it seemed, was resonant at some medium audio frequency, and when excited by the bird's feet, would produce a loud note, which was amplified by the walls of the house. You will recall the house was one of the antenna supports. When more than one bird landed simultaneously on the antenna, a strange symphony of atonal music would be produced, and I must admit in the middle of the night it was rather spooky.

Then there was the South Wind Effect. A south wind would cause a continuous pure note to be emitted at approximately A above middle C! The effect was similar to tuning in WWV at loud volume and leaving it that way for hours.

Now, to say that this antenna was popular with the rest of the family was not quite accurate. They couldn't seem to sacrifice at all for the sake of some outstanding 80 meter contacts, which incidentally were quite remarkable.

Then came the day I was up on the roof tightening up the monster. You see it stretched out about 1 inch per week, and required pulling up frequently. I calculated that at that rate it would have lasted for at least 5.78 years, but as we shall see it didn't reach that critical old age. It was nearly dark as I stood up there twisting the wire back through the insulator, and as far as I could see it was perfectly clear except for some clouds miles away on the horizon. Suddenly I was jolted out of my skin

by a shock which seemed to have more kick than the day I fell across my 700 volt plate supply and passed out on the bed! I almost leaped off the roof! But luckily I was able to hold on and regain my composure. Then out of curiosity I watched the clouds on the horizon some miles away. A flash! And a funny noise from the antenna insulator! That heat lightning some 10 miles or more away was inducing current in that long wire.

Some fast thinking was in order . . . what if a near-by storm should come up? Good grief, the rig and perhaps the house would melt! In I went and out the window I came with my wire cutters; the noble experiment was over. With an agonizing slither the wire dropped and pulled itself through the hay field. Again I was stuck on the 20 meter band.

Oh! Incidentally, the hawk didn't have a nest in that scrub oak after all.

Tuned Line Tank Circuits

Joseph Marshall WA4EPY
Ozone, Tenn.

A tuned-line makes a very efficient tank circuit for VHF transmitters. Moreover, since it can be made of inexpensive materials obtainable at any auto supply or hardware store, it can often be the most convenient and cheapest tank. Finally, with proper design it can provide operation on two bands at no additional cost worth mentioning.

In view of all these advantages, tuned-lines ought to be widely employed in home brewed transmitters. Unfortunately, many hams are scared off because tuned-lines seem to be a mystery to them. Actually, no great knowledge is required to design a tuned-line tank and it is rather easier, if anything, to prune and adjust than the conventional coil-condenser tank.

Let's take a look at Fig. 1A, the circuit of

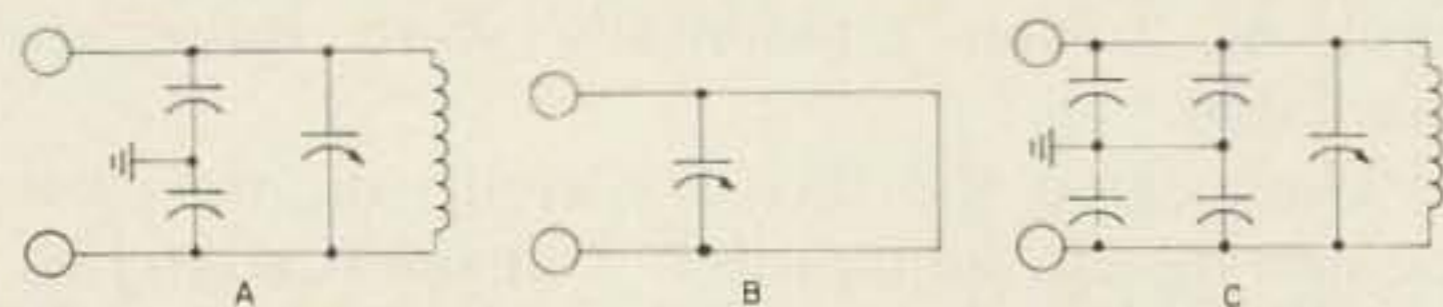

FIG. 1

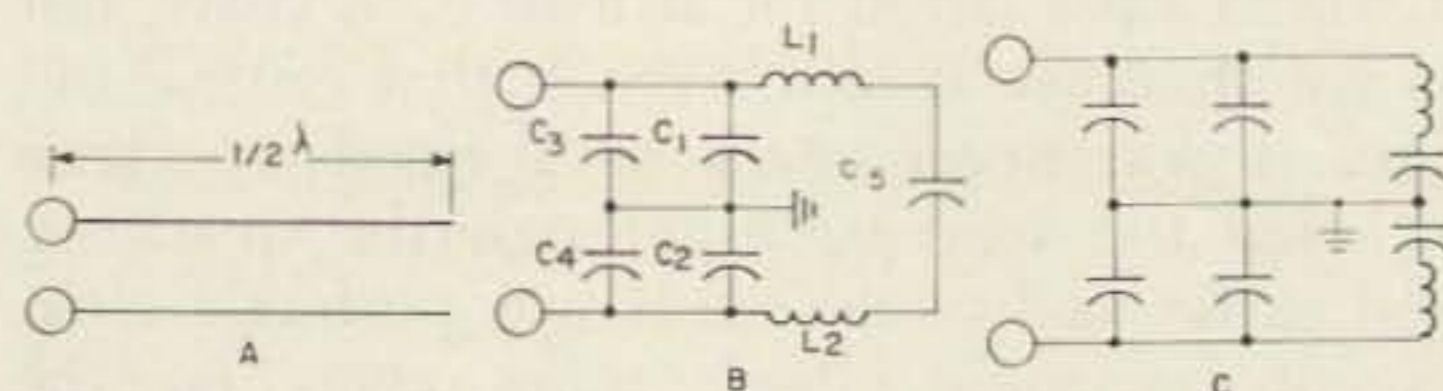

FIG. 2

a closed-end quarter-wave transmission tank. Then look at Fig. 1B which is the circuit of an amplifier with a conventional coil-condenser tank. If we unwound the coil and stretched it out to make a hairpin loop, it would look exactly like the closed-end transmission line. Conversely, the transmission line is basically identical to the circuit of the coil-condenser amplifier. The line can represent the wire in the coil. There is capacitance between the two conductors of the line, between each conductor and ground, and finally, there is capacitance within the tube from each plate to ground. Substituting all these in an equivalent electrical circuit we get the diagram of Fig. 1C which, obviously, is identical with that of the coil-condenser circuit. Thus we can say that a coil is merely a closed-end transmission line folded to a small dimension. A closed-end quarter-wave line is a coil or inductance stretched to its greatest dimension. In any event, a closed-end transmission line will behave exactly like a parallel-resonant circuit at a frequency for which the line is *effectively* a quarter wavelength long.

So far so good, but ordinarily we want to operate over a range of frequencies—say from 50 to 54 mc or 144 to 148 mc. How are we going to vary the frequency of the tuned line? Exactly the same way as we vary it in a coil-condenser tank—either by varying the inductance or the capacitance. We can change the in-

ductance by stretching or shortening the line. This can be done by making the line long enough to resonate at the lowest frequency, and then shortening it by moving a shorting bar across the far end. Much more simply, however, we can also vary the capacitance simply by adding a variable capacitor across the line.

It happens that an open-end line a half-wave long also behaves exactly like a parallel resonant coil-condenser tank; the only difference being that the tank is split. Fig. 2B shows the equivalent circuit. Here L1 and L2 are the inductances of the two conductors of the line; C1 and C2 are the capacitances between each conductor and ground; C3 and C4 are the capacitances of the output tubes to ground; and C5 is the capacitance between the two conductors of the line. Transposing this to a more familiar form we get the circuit of 2C which is equivalent to that of a split tank parallel resonant circuit. How do we change frequency? We can stretch or shorten the line, and at the same time vary the capacity, by connecting a variable capacitor from each end of the line to ground or across the open end of the line. You can look at the effect of this capacitor in either of two ways: simply as an added capacitance across the inductances in the circuit, or as a device which stretches or shortens the line by changing the reactance the signal faces.

One thing remains. To work out a completely practical circuit. We must feed the two amplifiers with input power. The proper point at which to feed such a circuit is the electrical center. In the case of the closed-end tuned line the electrical center is in the center of the line. Hence, we can feed dc voltage at this point. Thus we get the practical quarter-wave tuned line circuit of Fig. 3A.

In the case of a half-wave open end line the wave pattern along the line is such that the rf cold point is just about at the electrical center of each conductor. Therefore, we will feed the dc at this point through a pair of chokes and hence the practical half-wave open-end tuned line circuit looks like Fig. 3B.

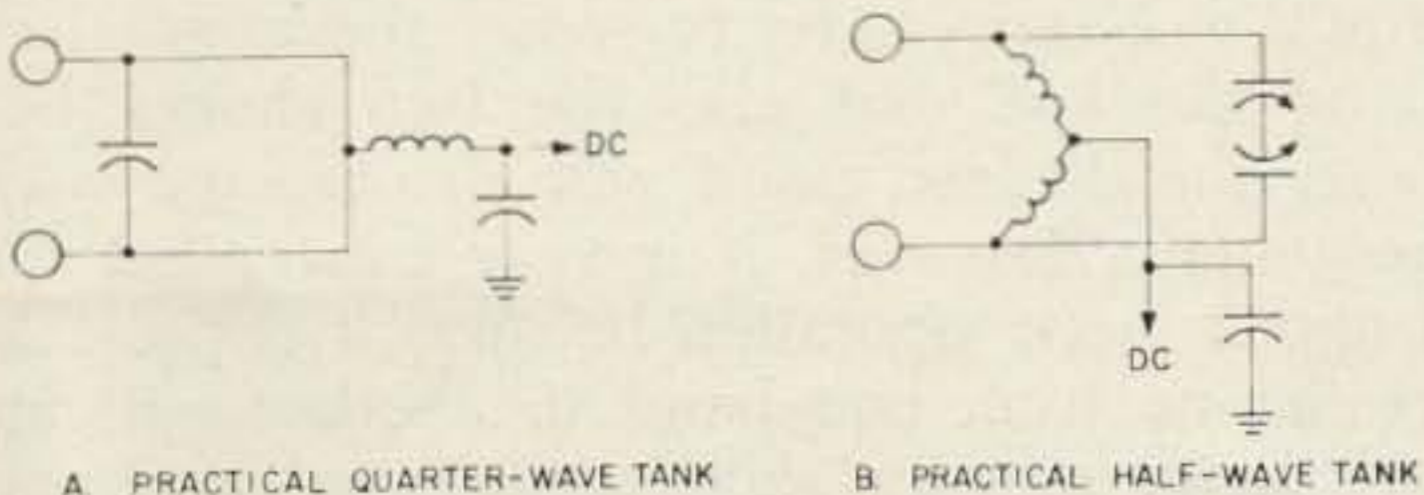
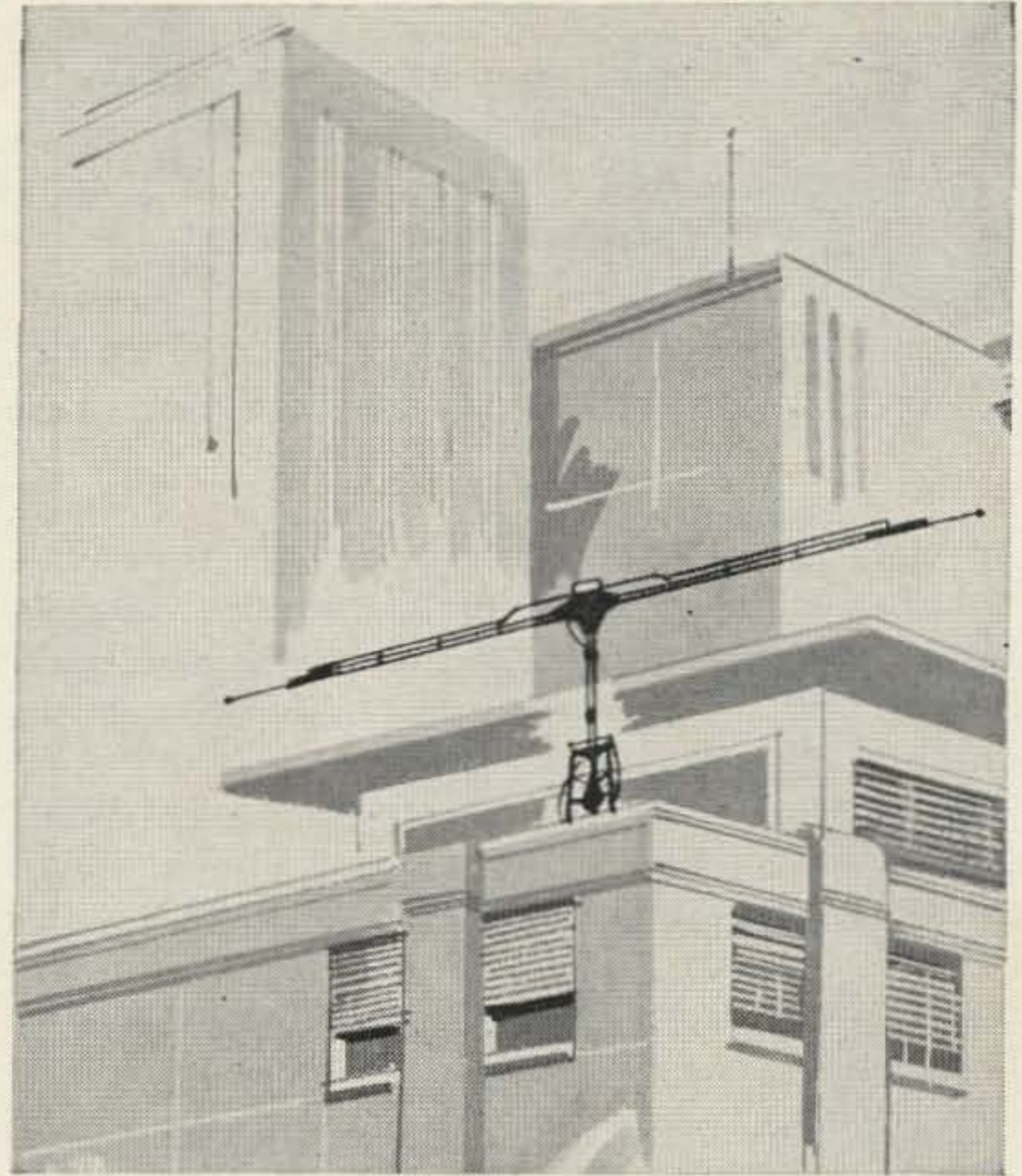

FIG. 3



CLIFF-DWELLER by *NEW-TRONICS* the home of originals

**FIRST
and
ONLY**

Remotely tuned
ROTATABLE DIPOLE
for 40 and 75 meters
also 10 meters

If you live in a congested area or on a small lot you can still operate beautifully on these two popular bands with a CLIFF-DWELLER CD 40-75. Band switching and tuning are performed on the control unit located at the transmitter. Extremely flat VSWR of 1.1 to 1 over entire band. This antenna is a MUST for thousands.

Model CD 40-75..... \$ 129.50

See the CLIFF-DWELLER at your distributor or write for comprehensive literature.

NEW-TRONICS CORPORATION
"the home of originals"
3455 Vega Ave., Cleveland, Ohio 44113



TELREX ROTATOR-INDICATOR SYSTEM MODEL TS238-RIS

Mast Feeds Thru Rotator For Safe, Easier, Installation

- 1300 IN/LBS ROTATION TORQUE
- SELF LOCKING BY STURDY WORM GEARS
- SELSYN AZIMUTH INDICATION
- ACCOMMODATES 2" O.D. MASTING
- MALLEABLE CAST MASTING CLAMP SUPPLIED
- OUTPUT SPEED APPROX. 1 RPM
- WILL FIT INTO OR ONTO A 6" SIDED TOWER

Write for FREE PL64 Describing Rotators and Antennas **TELREX LABS.** ASBURY PARK, N.J.

A Really Sturdy
ROTATOR-INDICATOR SYSTEM—
NOT a Modified TV Rotator!
Designed To
Out-Perform, Outlast!

\$23800 F.O.B.

ALSO:
TB278-RIS \$278.00
TS345-RIS \$345.00
TS435-RIS \$435.00
TS535-RIS \$535.00



Two-Band Operation

Before getting down to the practical aspects of designing and adjusting a tuned line tank, let us first see how it is possible to operate such an amplifier on two bands.

First take the case of the closed-end quarter-wave line. Obviously we can make the line long enough to resonate in the lower of two bands, and then move the shorting bar to shorten the line so it resonates on the higher band.

In the case of 6 and 2 meter operation, we can take still another approach. With the end closed as we have looked at it up to this point, we can design the line to resonate in the 2 meter band. Now suppose we open the line by removing the shorting bar at the end, and replace the shorting bar with a center tapped coil. The two sections of the line will be connectors connecting the coil to the condenser and the condenser to the tube plates. They will have some inductance which will add to the inductance of the coil but since they have a relatively large cross section, the inductance will be quite small. If the coil we put at the end is properly designed we can tune the circuit to the 6 meter band, with the same tuning capacitor we used to tune the line to 2 meters. Actually, to make the circuit most practical, we make the line just a little longer than necessary for 2 meters and fasten the 6 meter coil permanently in place. This is our 6 meter tank. For 2 meter operation we put in the shorting bar at the proper point, just in front of the coil, to make the line itself resonant on 2. Thus by removing the shorting bar we get 6 meter operation, and with the shorting bar in place we get 2 meter operation. The shorting bar, of course, shorts out the coil, but the choke still feeds the electrical center of the circuit with dc current.

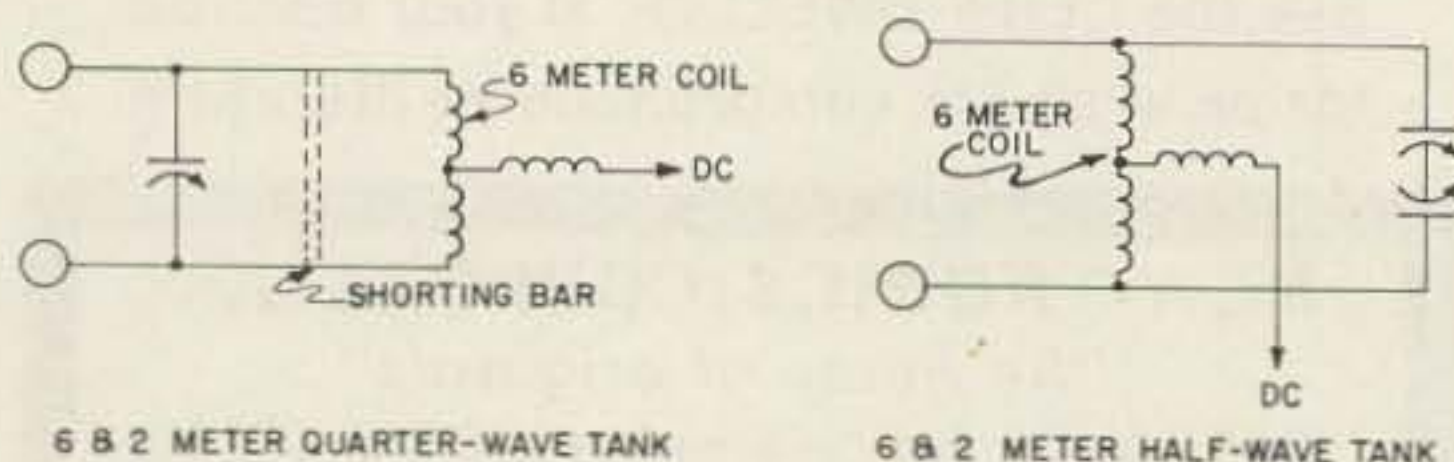

FIG. 4

The necessity for adding or removing the shorting bar is eliminated with an open-end half-wave line. Again we design the line to resonate as a half-wave open-end line in the 2 meter band. All we have to do to provide for 6 meter operation is to substitute a split tank coil for the two chokes at the dc feed point. The coil, with the inductance of the line and the capacitor at the far end, forms a parallel resonant coil-condenser tank on 6, or a lower band for that matter, if the coil is of a suitable size. The coils simply act as chokes on 2 meters. Thus this tank will deliver output either on 6 or 2 depending on the excitation. With 6 meter excitation it will deliver 6 meter power; with 2 meter excitation it will deliver 2 meter power. All we have to do to change bands is to change excitation.

Thus a tuned line gives us as a bonus, without much added complication, operation on two bands instead of one. We can design a transmitter with the primary idea of 6 meter operation and still provide for efficient two meter operation or vice versa.

So much for theory. Now let's get down to practical considerations. The first decision that you will have to make is whether to use the quarter-wave or half-wave line. This will depend partly on the available space, and partly on convenience in band-changing. A quarter-wave line is obviously shorter and will occupy less space in the transmitter. The quarter-wave line is the simplest choice until we get into the UHF range where it may be too small to provide a good arrangement. The quarter-wave line may be used on two bands either by moving the shorting bar or by removing the shorting bar and substituting a coil resonant in the circuit on the lower band.

The half-wave line cannot be used conveniently as a tuned line on two bands. We would not only have to move the condenser along the line, but also the two chokes because the dc feed point will also change with frequency. However, it is very convenient for 6 and 2 meter operation because it is possible to change from one band to another without switching, moving shorting bars or anything else—merely by changing the excitation fed into the amplifier.

WOW!

HERE IS THE UNIT THAT HAS THE
WHOLE INDUSTRY EXCITED!

"AND WE'RE EXCITED TOO"

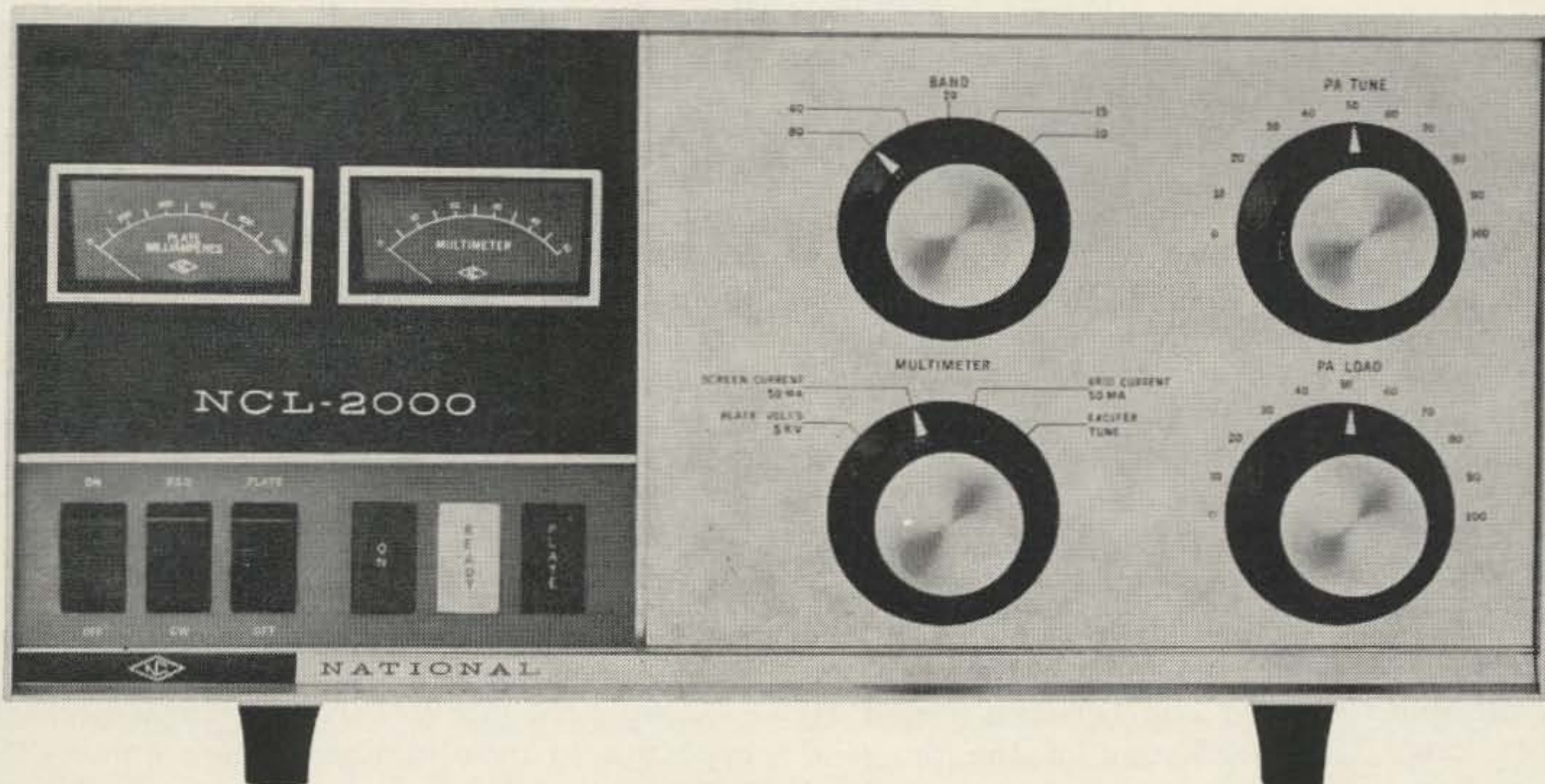

(PREPAID IN U.S.A.)

In Stock at Quement's! We're Shipping Now!

NOTICE NCX-3 OWNERS!

Write today for very informative data regarding the new NCL-2000 and how you may improve your signal quality. This will be of value to you.

FREE — WRITE TODAY

NATIONAL
NCL-2000 LINEAR

\$585

USE OUR EXCLUSIVE



PAYMENT PLAN

WE STOCK EVERYTHING FOR THE AMATEUR

• 10 HAMS TO HELP YOU

See our "KEY DOWN" NCL-2000 Demonstration at ARRL Pacific Division Convention, Sept. 25, 26, 27, in Sacramento, Rooms 178 and 179.

SINCE 1933

• FAST SERVICE

• Phone CY 4-0464

QUEMENT ELECTRONICS

1000 SOUTH BASCOM AVENUE

SAN JOSE, CALIFORNIA

"Northern California's Most Complete Ham Store"

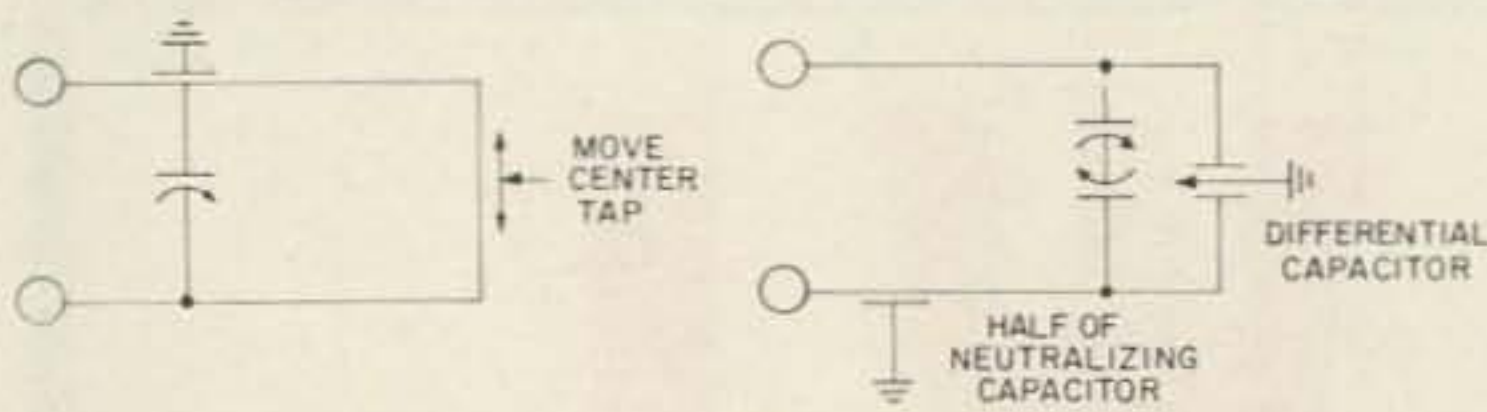

FIG. 5 BALANCING THE LINE

How Long a Line

The formula for transmission line lengths is the same as for antennas. A half wave line would be:

$$\frac{492}{F \text{ in mc}}$$

and a quarter wave line would be:

$$\frac{246}{F \text{ in mc}}$$

However, a practical tuned line tank is always very much shorter than this. This is because the capacitances shorten the line, and there is always a certain amount of inductance in the leads from line to tubes and in the capacitor. As a rule the half-wave line will be only about a quarter-wave long and the quarter-wave line will be roughly an eighth-wave long.

For example, a half wave line at 144 mc according to the formula would be some 34 inches long. A quarter-wave line some 17 inches long. In practice—with typical transmitting tubes, tuning capacitors and layout arrangements—the half-wave line will be something between 14 and 20 inches long and the quarter wave line between 7 and 10 inches long. This shortening of the practical line makes a quarter-wave line quite practical on 6 meters since it would be some 20 to 30 inches long instead of the 50 to 60 inches that you might expect from the formula.

It would be possible to determine the actual length mathematically, but it is much more simple to do it by cut and try. For example, take the case of a half-wave line to be used in a combination 6 and 2 meter transmitter. For a good Q on 6, where the circuit will be a coil-condenser tank, the capacitance ought to be between 15 and 25 mmfd. So we chose a split stator or butterfly variable condenser in this range. For the first trial we can take two pieces of tubing or strap about 20 inches long, or longer, if you want to play safe. With appropriate temporary straps, connect one end of each piece of tubing to the stators of the condenser, and the other end to the plates of the amplifier tubes (being sure that the cathode of the tube is grounded so that the plate-to-ground capacitance will become part of the circuit). This can be done in a temporary breadboard arrangement on a

table or bench top. Take your grid dip oscillator and couple it to the line in the middle. Turn the tuning capacitor to nearly minimum capacitance and tune the gdo to resonance as indicated by the dip on its meter. The chances are that the dip will occur at a frequency lower than 144 mc, indicating a line that is too long. Cut an inch off the ends of the tubing and try again. Keep this up until the gdo shows that the line resonates at around 148 mc with the tuning capacitor near minimum capacitance. Tuning the capacitor to high capacitance will lower the frequency and you should get enough spread to cover the entire 144-148 mc band. You now have approximately the right length of line. You can prune it exactly when you mount the tubes, condenser, etc., on the chassis.

Pruning a quarter-wave line is easier. Start with the line about 12 or even 14 inches long. The most convenient tuning capacitor is a neutralizing capacitor taken apart and mounted on the two lines so that the two discs are between the two lines and can be moved toward each other for tuning. The capacitor is mounted as close to the tube end of the line as is convenient without getting the capacitor too close to the tubes or other components. If you use bar stock or strap, the normal kind of capacitor can be mounted on top of or below the straps and directly to them.

Couple the gdo to this line. Turn the tuning capacitor to near minimum capacitance. Take a piece of metal and short the far end of the line. Resonate the gdo. If, as is most likely, the line resonates at a frequency below 144 mc, move the shorting strap to shorten the line; repeat resonating with the gdo until you find the point where the line resonates at 148 mc with the tuning capacitor near minimum capacitance. Now tune the capacitor to see if you get coverage of the full 2 meter band. Cut the line about an inch longer than indicated to provide a safety factor for final pruning and also, if you are going to use the circuit on 6, space for mounting the 6 meter coil.

Finding the Electrical Center

With the line of approximately the right length, you can now arrange your parts on the chassis and mount the tubes, condensers,

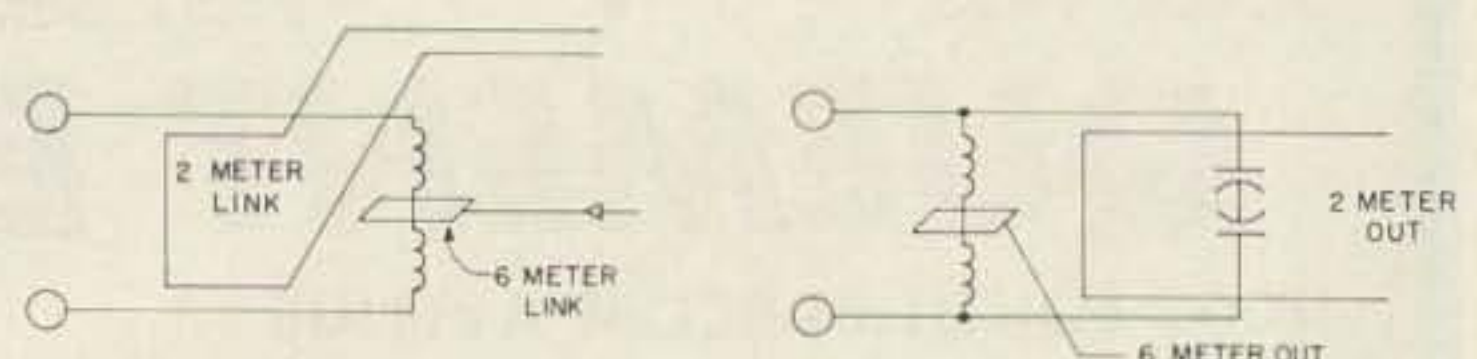

FIG. 6 LINKS

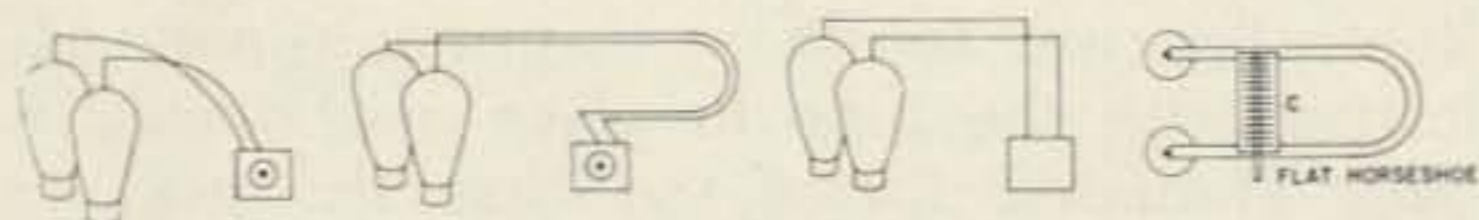

FIG 7. VARIOUS ARRANGEMENTS OF TUNED LINE TANKS

etc. The line can be bent if necessary to provide a suitable arrangement or to save space. Though circular bends are preferred, you can use right angle bends if they are necessary.

When you have everything in place you can do the final pruning with the gdo so that you can cover the entire 2 meter band with the range provided by the tuning capacitor. Having done this and fastened everything down in final form, couple the gdo to the line (not too tightly). Resonate the line to about 146 mc as indicated by the dip on the gdo. In the case of the quarter-wave closed-end line, the electrical center should be in the center of the shorting bar. You can check this by taking a long screwdriver, and touching the chassis with one end and the shaft to the center of the bar. If the tank is balanced, doing this will not change the reading on the gdo meter. If it is *not* balanced exactly, the meter needle will move up or down. Move the screwdriver to one side or the other of the center. Find the point at which the meter reading is the same when you touch the shorting bar with the screwdriver as it is when the screwdriver is removed. This is the precise electrical center. You can if you like, attach the dc feed point here. Or, you can balance the line, so that the feed point does come at the center of the shorting bar.

The line can be balanced in several ways. You can prune one of the tubes or bars slightly. Or you can skew the shorting bar slightly so that one line is shorter. Or, you can add a balancing capacitor. This can be a strip of copper or aluminum strap grounded at one end and mounted so that the other end is close to one conductor, and can be moved closer or farther away from it by bending. The balancing capacitor should be on the side of the line that is shorter. By adjusting this capacitor you can move the electrical center until it comes exactly in the middle of the shorting bar.

When the quarter-wave line is used with a coil for 6 meter operation, the electrical center should be at the center tap of the coil with the shorting bar in place. You can move the tap on the coil, or balance with the capacitor as above. At any event, the point is to have the dc feed point at the precise electrical center so the two sides of the circuit will be balanced and, also, so that the choke will be at the rf

null and hence will not be heated by an unbalanced rf voltage.

In the case of the half-wave line, the procedure is a little different. Having done your final pruning of the line so that it covers the desired band with the capacitor, couple the gdo and resonate the line in the middle of the band. Now take a lead pencil and run the point along one of the conductors. Watching the gdo meter you will note that the reading will change as you move the pencil along the line. At one point, however, the meter reading will be exactly the same whether the pencil touches the line or is removed. This is the electrical center of that side of the line. Mark it exactly. Do the same thing on the other line and mark the electrical center there. These two points should be opposite each other if the line is balanced. If it is not balanced you can add capacitance to one side with the piece of copper or aluminum strap until the two centers are opposite each other. These are the points where you will feed the dc and, in the case of a 6 and 2 meter amplifier, where you will have your 6 meter coil. In any event you can arrange to mount the chokes or the coil at exactly these two points.

The fact that you can so easily balance a tuned-line tank is one of the reasons why a tuned line can deliver high efficiency. A balanced tank will deliver most of the power to the load, whereas an unbalanced one will dissipate a good deal of power in the tank or choke.

If you are going to operate on one band only, you can connect your chokes to this electrical center and get on with the job. But if you want to operate on the lower band, the next step is to provide the coil for the lower band.

In the case of the quarter-wave line, remove the shorting bar. Make a trial coil and attach it to the end of the line, grounding the center of the coil through a .0005 to .001 capacitor. Couple the gdo to the coil, set the tuning capacitor for about $\frac{1}{4}$ capacitance and dip the gdo. You want to hit 54 mc. Prune the coil by adding or removing turns, by compressing or expanding the turns, until the combination does resonate at 54 mc—somewhere between $\frac{1}{4}$ and $\frac{1}{2}$ the range of the tuning condenser. You should be able to hit 50 mc with the capacitor advanced to higher capacitance. When you have a coil that provides this range with enough capacitance to provide a good Q, change the gdo range to the region of 150 to 400 mc. Sweep the range to make sure that the line does not resonate at

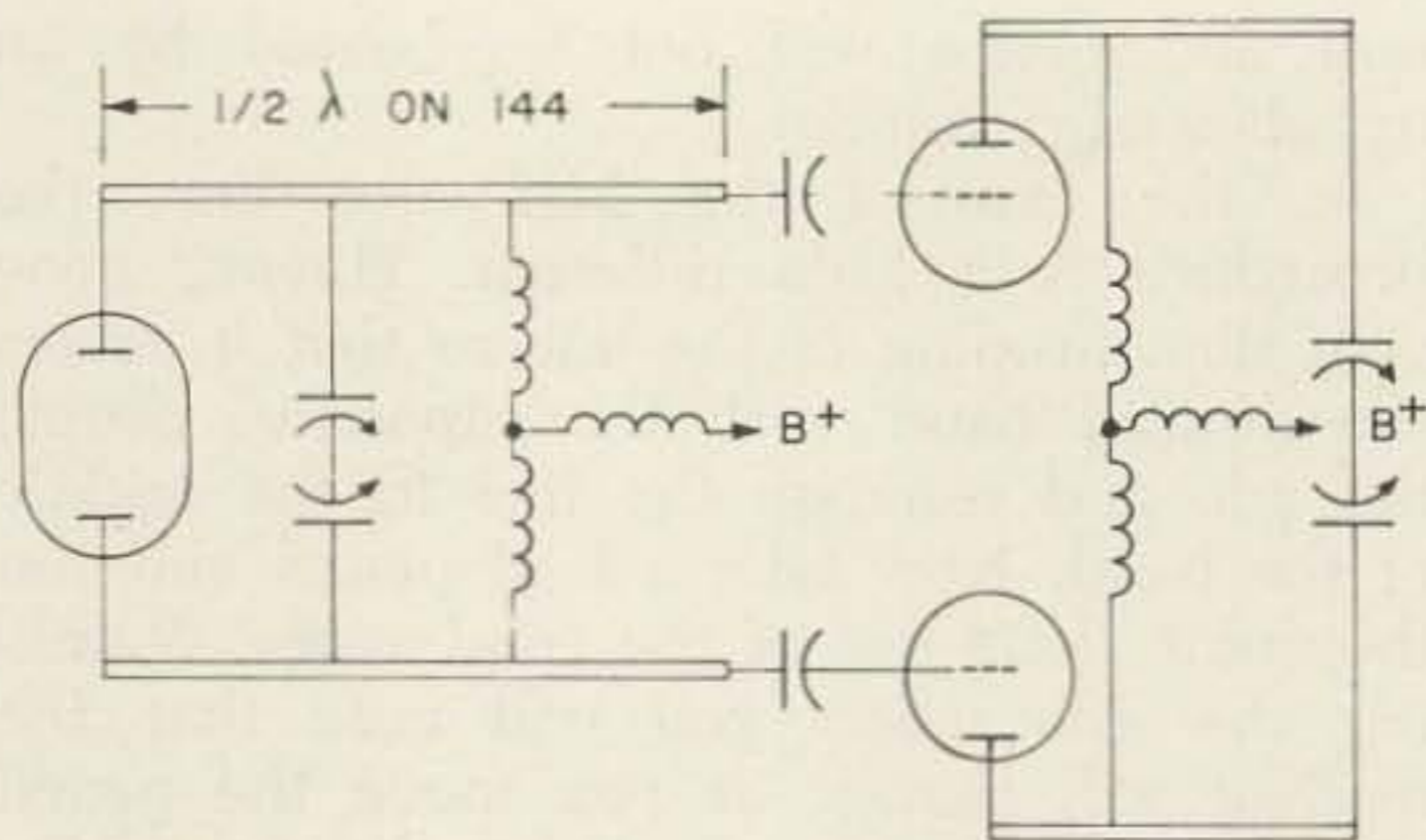

FIG. 8 HALF-WAVE LINE COUPLING OF DRIVER AND FINAL

some harmonic of 50 mc. If it should resonate at the same setting of the capacitor at the 6 meter fundamental and a precise harmonic of it, change the coil by adding or reducing inductance so this will not happen. Actually this is not likely to be the case, but it should be checked so that you will not be accentuating an illegal harmonic.

With the coil pruned, put the shorting bar in place. The circuit should still resonate in the 2 m band. The circuit is right when you can cover the whole 2 m band with the shorting bar in place and the full 6 m band with the bar removed.

In the case of the half-wave line, the procedure is similar. Having tuned the line to cover the 2 m band, wind a trial 6 meter coil and connect it at the electrical center points of both lines, with the center tap to ground through a condenser. Couple the gdo to the coil and prune the coil until you can cover the 6 m band with the proper range of the capacitor. Remember that you should have enough capacitance in the circuit to keep the Q good. A half-wave line could well resonate at the third harmonic of a 50 mc signal, so be sure that when the circuit resonates in the 6m band, the line itself resonates well below 150 mc. If you prune the line to resonate at 148 mc with almost minimum capacitance, and the coil so it resonates in the 6 m band with half capacitance or more, you will eliminate this possibility.

When you have your final coils in place, check the balance of the line. Balance it if necessary with the added capacitor as pointed out earlier.

Tuned lines can be used in grid or plate circuits or both. You can use a quarter-wave line in the plate circuit and a half-wave line in the grid circuit, or vice versa, as convenience dictates. You can also use conventional coil-condenser tanks in the grid and tuned lines in the plate circuits.

The adjustment of tuned grid lines is exactly the same as the adjustment of plate

lines. Be sure to do your pruning and adjusting with the tube in place and the cathodes grounded for rf, so that the grid to ground capacitance is part of the circuit.

Tuned lines are most conveniently made of copper or brass tubing which is available in diameters from 1/8th to more than 2 inches. The size depends on the power in the circuit and the efficiency desired. The larger the tubing the smaller the skin-effect losses, and therefore, the higher the efficiency. Tubing of 1/2 inch inner diameter (or larger) will serve for amplifiers up to the full gallon. Tubing with an inner diameter of 1 1/4 inches is especially convenient to use with 4 x 150's and 4 x 250's. If one end is slotted by making two or more hack saw cuts about an inch deep, it will slip right over the radiator-anodes of these tubes and can be clamped tight with an automobile radiator hose clip. The cooling air, after passing through the cooling fins, will go through the lines and out the far end—so be sure that the air can escape the far end without obstructing the air-flow.

The lines should be spaced about 3 1/2 to 4 times their diameter for highest efficiency but this spacing is not too critical and a small variation or departure for convenience in layout arrangement will not make a big difference.

An elegant way to balance a tuned line is with a small differential capacitor as shown in Fig. 8. This is easily done in grid lines since the voltages are low and small differential capacitors can be used. In plate lines where the voltages are high, suitable differentials may run into money and, for that matter, may not be available at all. One of the discs from a disc type neutralizing condenser makes a fine balancing capacitor.

The entire tuned line, with its condenser, tubes, etc., should be shielded. Otherwise it will radiate power. Perforated cane metal make a satisfactory shield for small lines. However, a solid metal shield may be preferable for larger lines because the cane metal shielding may vibrate and change the capacitance from line to ground—thus changing the resonant point or the balance or both. Final adjustment and pruning should be done with the shield in place.

Links

Tuned lines are usually coupled to the antenna or a preceding driver or exciter through a link. The links are hairpin loops placed close to the tuned lines at a high voltage point. Coupling is varied by moving the links closer or farther away from the lines. This

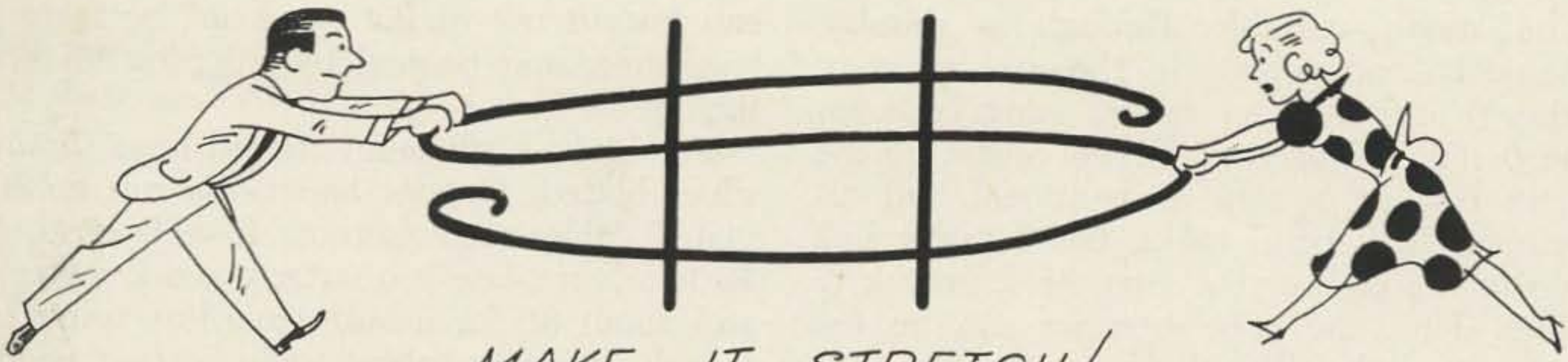

MAKE IT STRETCH!

Yes OM here is a rare opportunity to make your dollars stretch. This month we again offer those real down to earth prices on fully reconditioned and fully guaranteed equipment. **ACT — WRITE NOW!**
73 Stan Burghardt WØBJV

CASH/NO TRADE

AMECO CN NUVESTOR 2 Meter Convertor and Power Supply 28-32 MC IF	\$ 35.00
CENTRAL ELECTRONICS 20A Rack Mount with QT-1 factory wired	125.00
CENTRAL ELECTRONICS Deluxe VFO 160-15	25.00
CENTRAL ELECTRONICS 100V Exciter	395.00
CLEGG ZEUS Transmitter Complete (like new)	399.00
CLEGG INTERCEPTOR Receiver (like new)	319.00
COLLINS 75A-1 Receiver	159.00
COLLINS 75A-4 Receiver with speaker	369.00
COLLINS 75S-3 Receiver (like new)	475.00
COLLINS 75S-3 Receiver (very good)	419.00
COLLINS 312B-4 Console	129.00
COLLINS KWM-2 Transceiver	745.00
DRAKE 2B with speaker	209.00
DRAKE 2B with speaker & calibrator	219.00
DRAKE TR-3 Transceiver	445.00
ELDICO SSB100A Exciter	195.00
GALAXY 300 & PSA300 Deluxe Supply	295.00
GLOBE CHIEF 90 Novice Xmitter	29.00
GONSET GSB100 Exciter	195.00
HALLICRAFTERS S38E Receiver	24.00
HALLICRAFTERS S40B Receiver	49.00
HALLICRAFTERS SX110 Receiver	99.00
HALLICRAFTERS SX111 Receiver	149.00
HALLICRAFTERS SX101-3A Receiver	179.00
HALLICRAFTERS CB5 Transistorized 5 Watt CB Transceiver	99.00
HALLICRAFTERS S119 Receiver	25.00
HALLICRAFTERS HT32 SSB Transmitter	299.00
HALLICRAFTERS HT37 SSB Transmitter	279.00
HAMBOARDS 2 Meter Transistorized Converter 28-32 M.C. IF	25.00
HAMMARLUND HQ100 Receiver	99.00
HARVEY WELLS TSB-50D Deluxe Xmitter with Matching AC Supply	49.00
HEATH UT1 AC Power Supply	19.00
HEATH MT-1 Cheyenne Xmitter	49.00
HEATH VF-1 VFO	15.00
HEATH HP 10 Mobile DC Supply	19.00
HEATH DX35 Novice Transmitter	35.00
JOHNSON 250-20 LP Filter	10.00
JOHNSON 122 VFO	25.00
JOHNSON 6N2 Factory Wired (like new)	109.00
JOHNSON RANGER (PTT & Sequence Keying)	149.00
JOHNSON VALIANT—A Powerhouse	179.00
KNIGHT HE40 Receiver	35.00
KNIGHT R100 Receiver with Speaker	59.00
LAFAYETTE HE35 6 Meter Transceiver	39.00
NATIONAL NC88 Receiver	59.00
SBE-1LA Linear (like new)	199.00
TECRAFT CC50 6 Meter Convertor 14-18 M.C. IF	19.00

WE OFFER CONVENIENT TIME PAYMENTS ON PURCHASE OF NEW GEAR.

Collins, Drake Hallicrafters,
National, SBE, Swan in stock
for shipment today!

Write for our Special
Transceiver Packet

NATIONAL NCL 2000 LINEARS
arrive. This one is the "tops" of all.
We are dropping high on this one.
We need your linear. You need this
one. Let's make a deal now.

HALLICRAFTERS Demo Package
— Can't tell from new:

SR 150	Regularly	898.50
P150AL	This one only	\$695.00
P150DC		
MOUNTING RACK		

COLLINS Package:

75S3 Receiver	FULLY GUARANTEED Worth \$950 Easily WE ASK \$845.00
32S1 Transmitter	
516F2 Power Supply	
302C Watt Meter	

LIMITED OFFER: Thru Oct. 31, 1964 with outright purchase of any new sideband transceiver and at least one power supply we will furnish free 35.00 of antenna equipment fixed or mobile—your choice

BRAND New Hallicrafters HA2 or HA6 Transverter complete with P-26 ac supply regular 449.00 Value—Special Only 199.00. Limited Supply

WRITE FOR LATEST REVISED BULLETIN
ISSUED MONTHLY
AMERICA'S MOST RELIABLE DEALER

BOX
37A

Burghardt
RADIO SUPPLY, INC.

PHONE
886
5749

WATERTOWN, SOUTH DAKOTA

can be made variable through a suitable mechanical arrangement. In the case of combination 6 and 2 meter tanks, using coils for 6, the 6 meter link goes to the center of the 6 meter coil as in any conventional coil arrangement. In 2 band tanks, the 6 meter link can go to the coil, and a separate 2 m link to the line. Thus the two antennas can be fed by separate links. The links to the line (or coil for that matter) can be single-ended or balanced. The 6 meter link can be single-ended to feed a coax cable. The 2 meter link can be balanced to feed a 300 ohm line. Similarly, the links on the grid tank can be arranged to provide separate 2 and 6 m excitation. A half-wave line may be used between the driver and final without links as indicated in Fig. 10. It can work both on 6 and 2 with 6 m coils in the center; in which case the driver can work straight through on 6 and triple on 2 by changing bias.

Lines can also be made of bar stock, or heavy strap cut from copper or aluminum plate. Grid lines especially, are conveniently made from 16 to 18 gauge copper or aluminum strap from $\frac{1}{2}$ to $1\frac{1}{2}$ inches wide. On the $1\frac{1}{4}$ m and higher bands, a quarter-wave line

can be cut out of flat stock in the form of a horseshoe, and pruned by snipping off bits of the open end.

For highest efficiency, tuned lines should be silver plated. Copper and brass can be silver-plated, aluminum cannot. It will cost about \$3 to silver plate a quarter-wave 2 meter line, and about \$6 for a half-wave line using up to 1 inch diameter tubing. The plating need not be heavy; a coating which covers the entire surface is enough.

When lines are used with high power, it is best to silver solder any joints. Soft solder joints, if they should happen to be a point of high rf potential, could melt out—especially when the tank is tuned without a load and has to dissipate the entire rf output of the transmitter.

To summarize, tuned lines are very efficient tanks at VHF and UHF. They make possible convenient and inexpensive two band operation. They can be designed and adjusted quite simply with the aid of a gdo. If you're thinking of a new 6 meter rig, why not get some copper tubing from your auto supply dealer and try a tuned line tank, so that you can have 2 meter operation as a bonus.

I Absolutely Refuse To Give Up Ten Meters

Dale Ulmer WA9CZQ
1733 N. 40th Street
Milwaukee 8, Wisconsin

Long ago, before I lost all my senses and began pouring all of my money into ham gear, I was fascinated by TV DX. For that matter, I still am. I suppose the six meter band's proximity to the TV bands is what prompted my interest in 50 mc work. At any rate, a few weeks ago I found myself faced with a mad desire to get on six for the summer E-skip openings, but only a Viking II, an SX-99, a Knight VFO, and an assortment of low frequency antennas.

This collection was not at all abetted by the strange lightness in my left rear pocket caused by deficit spending. The situation became a bit less desperate when I recalled W4WKM's article in the October, 1962 "73" describing the use of a Standard Coil TV tuner as a VHF converter.

After ripping apart an old Admiral TV set, I discovered my problem was rapidly diminishing. I found that almost no work was needed to use the tuner as a converter. Not to discredit Roy's fine work, it was merely necessary to connect the tuner's *if* output to the antenna post on the receiver through a length of coax, ground the AGC lead, apply power, and adjust the channel 2 oscillator slug.

Six meter signals came roaring in between 22 and 26 mc on the SX-99. Stability is not spectacular, but in all other respects the tuner seems to be the equal of most low priced commercial converters. (A few days later I discovered that putting an OA2 VR tube in the B plus line made the converter as stable as Gibraltar after just a few minutes warm

NEW! LAFAYETTE 10-80 METER DUAL-CONVERSION AMATEUR RECEIVER Model HA-350 with MECHANICAL FILTER for HIGH SELECTIVITY



18950

99-2524WX

In the HA-350, Ultra-Sharp Selectivity is Achieved by Means of a True Mechanical Bandpass Filter in the 455 kc IF Section. The Filter Consists of 3 Sections—an Input Transducer, a Mechanically Resonant Filter, and an Output Transducer.

- 5 Ham Bands plus WWV
- Complete with Crystals for 80, 40, 20, 15 and 10 Meters
- Product Detector-Selectable Upper/Lower Sideband Reception
- 100 Kc Crystal Calibrator and Crystal BFO
- 12 Tubes
- "S" Meter
- Automatic Noise Limiter
- Imported.

FREE!



LAFAYETTE
RADIO ELECTRONICS
1965 CATALOG No. 650

Over 500 Pages
Featuring Everything
in Ham Gear
from the
"World's Amateur &
Electronics Center"

Mail the Coupon for your
FREE 1965 Lafayette Catalog.

See the Largest
Selection in
Our 44-Year
History:

BUY ON TIME—Use Lafayette's famous Easy-Pay Credit Plan . . . up to 24 Months to Pay

HAM GEAR . . . for receivers, transmitters, as well as the smallest accessory amateurs everywhere make Lafayette their headquarters for all their gear.

plus

CITIZENS BAND • STEREO HI-FI
• TEST EQUIPMENT • TAPE RECORDERS
• P.A. EQUIPMENT • TOOLS • BOOKS • and MUCH MORE

Lafayette Radio Electronics
Dept. 73-1-4 P. O. Box 10
Syosset, L. I., N. Y. 11791

\$..... enclosed; send me #..... (Prices do not include shipping charges).

Send me the FREE 1965 Lafayette Catalog 650

Name

Address

City State..... Zip.....

THE BIG SIGNAL!



ask the ham who owns one! SEE THE SWAN 400 AT YOUR SWAN DEALER NOW!

SWAN

ELECTRONICS CORP.
Oceanside, California

up.) Anyway, I was now hearing six meter signals. (Incidentally, the TV set cost \$2.50. Not bad for a converter and a junk box, eh?)

For some reason, I thought getting a signal out was going to be a little more difficult. I designed a little rig based around parts out of the same TV set. Unfortunately, I still had to buy some parts to get the rig working.

Now, my XYL is very understanding when it comes to unfeminine metal objects invading our sleeping quarters, but she is partial to eating three square meals a day. The six meter rig met with a violent veto.

After a week or so of feeling sorry for myself, I got into a QSO with Phil W9GCG, who had recently converted his Viking I to six meter operation.

"No," I screamed, "I absolutely refuse to give up ten meters!"

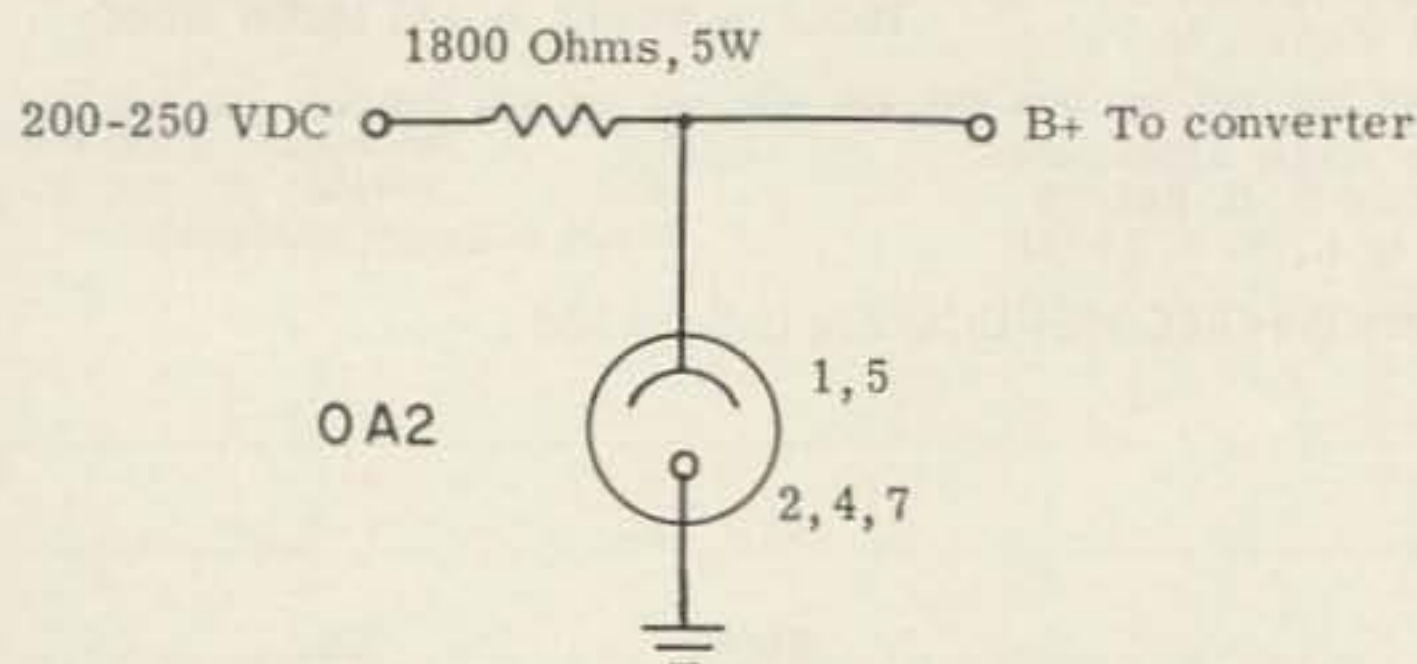

Regulated voltage for the TV tuner converter

Well, Phil calmed me down by announcing that it wasn't necessary to lose any coverage. After about ten minutes worth of experimenting, I came up with even a simpler conversion than Phil had offered. It should be of interest to Viking I and II owners, and of course the principles are applicable to most rigs that have ten meter coverage and adequate grid drive.

The conversion takes a great deal longer to describe than to accomplish. The Viking rigs have a small coil for ten meter tuning mounted at the rear of the pi-network tuning mechanism. Shorting out this coil allows the final to double 25 mc signals (easily produced when the bandswitch is in the ten meter position) and still perform normally on all other bands. (The pi-network arrangement on most other rigs being a bit simpler, shorting out the ten meter coil would of course effectively short out the entire inductor. A few turns should be left unshorted on rigs other than the Viking I and II. The exact number is easily determined experimentally. On these rigs the short should be made removable in order to allow ten meter operation.) The only precaution necessary is that of watching for the correct dip (the Viking will dip at ten meters at about 90 on the pi-net scale and at about 100 for six. The six meter dip is not

nearly as pronounced as the dip on the lower bands). Tuneup on six is the same as on all other bands. Since the final is doubling, reduce the dc input a bit.

I encountered one minor difficulty that will probably vary from rig to rig. The parasitic chokes present too much reactance for six meter operation. The Viking II worked beautifully when the number of turns was halved.

Since I was still broke, and crystals cost money—in fact lots of money when one considers that they only work on one frequency—I began thinking about converting the Knight VFO. The Johnson and Heath VFO's have eleven meter coverage with six mc output which is easily converted for six meters, but the Knight lacks that feature.

Luckily, I found that the 80 meter section (fundamental at 160 meters) could easily be adjusted to oscillate all the way up to 2.25 mc. This multiplied by twenty-four is 54 mc.

After a bit of recalibration the VFO tunes eighty at the low end of the scale and six at the high end. (This modification may not be necessary. The Knight VFO oscillates in the 160 meter range. The seventh harmonic falls around 12.5 mc. Theoretically, this is unusable, but my Viking II doesn't know it, so it works very well with the unmodified VFO.) Tune the first stage of the transmitter to 12.5 mc, the multiplier to 25 mc, the final to 50 mc, and you're in business.

Incidentally, I have no six meter antenna, but since the six meter band is an odd harmonic of forty meters (the seventh) my forty meter antennas function very well on six.

Considering my total investment of two and a half dollars, and only a small portion of that was used in the rig, I am forced to conclude not only that I am a genius, but that getting on six meters can be cheap, fast and easy.

Jim Kyle K5JKX
1236 N.E. 44th St.
Oklahoma City, Okla.

A Simple Squelch Circuit

Like the idea of a sensitive, sure squelch circuit to be added to your present receiver with a minimum of fuss and commotion?

A couple of years ago we featured a roundup of all known types, but most required some outboard circuitry. Those that didn't either had limited sensitivity, or suffered distortion on weak signals.

But here's a little-known one which hadn't been published at the time of the earlier article, which requires only 8 components and can be added to virtually any receiver. It's the brainchild of E. Dusina, of Hollis, N. H., and first saw print in Electronic Design magazine, an engineering-level publication with restricted circulation. We're showing it here because it's too good to be passed up.

The schematic shows how to hook it up, but what it does and how it works may not be too clear.

First let's look at the screen voltage of the if amplifier tube when no signal is coming in. AVC voltage is nil, which means screen current is at its highest point, so the screen voltage is fairly low. In an SP-600JX this is somewhere around 55 to 60 volts.

If "squelch" pot R3 is set so that its arm provides about 65 volts, the diode will be reverse biased because it has only 60 volts (screen level) on its anode but 65 on the cathode. Under these conditions, no signal passes through the diode. The diode appears to be a resistance of about 20 megohms, so that incoming audio goes into a voltage divider of 40/1 ratio which is equal to some 30 db attenuation. And at normal settings of the volume control, this is the same as "no signal".

Now when a signal comes in, avc voltage

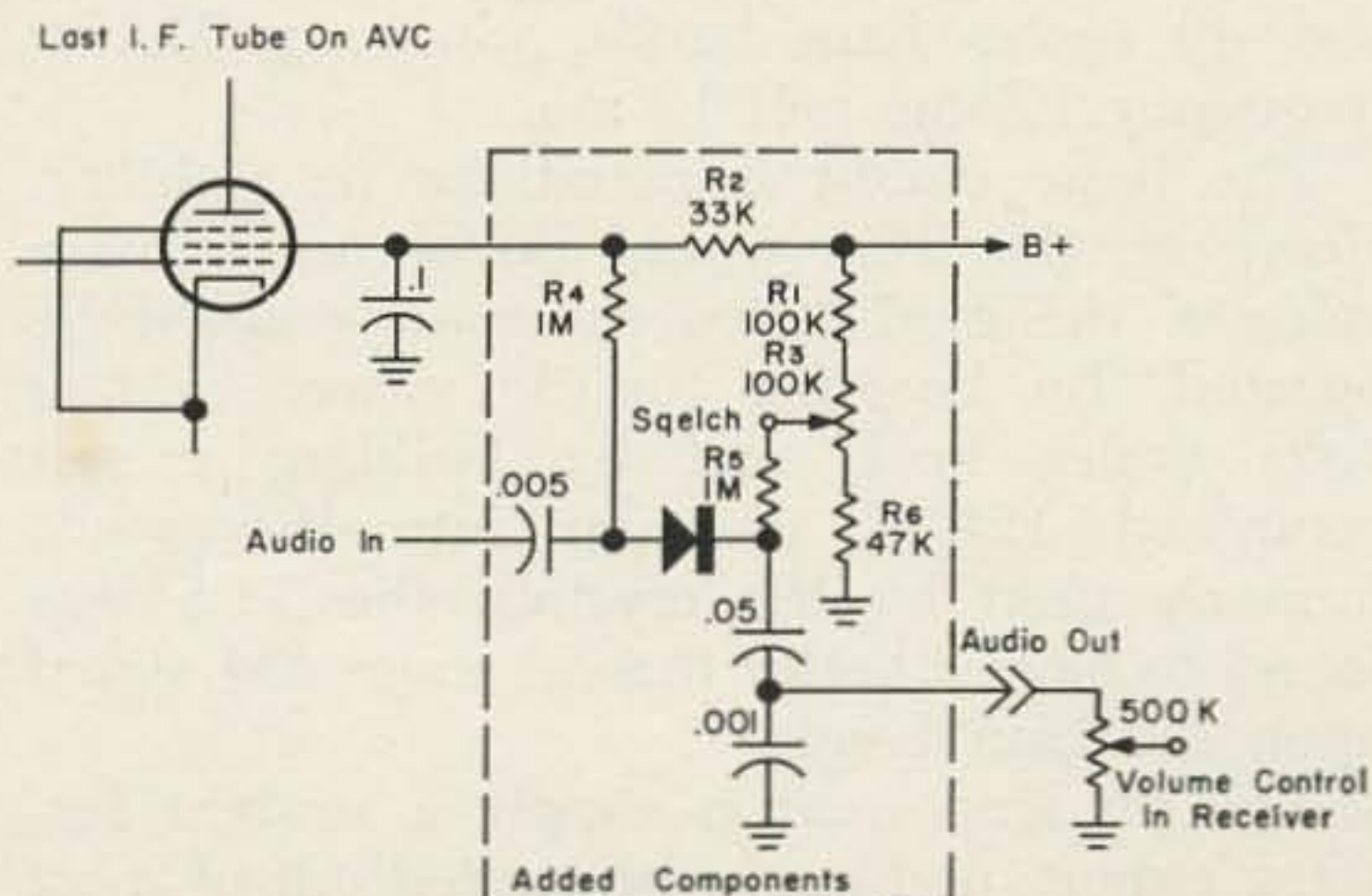

is developed which applies additional grid bias to the tube. The screen current falls and screen voltage rises. When the voltage rises to 70, the diode is thoroughly forward-biased and its resistance drops to somewhere near 10K ohms. The voltage divider ratio then becomes 25/26, which is less than 1 db attenuation of the audio.

The two 1-megohm resistors R4 and R5 serve to isolate the audio from the screen-grid circuit while maintaining dc levels desired; they also prevent loss of audio voltage through shunting in the control network.

Note that the last *if* tube amplifies the swing of the avc voltage as well as the signal; thus the required 10-volt swing for switching of the diode is obtained with less than 2 volts swing of avc level.

By proportioning R1, R3, and R6 so that the upper and lower voltage extremes of R3 are 10 volts above and 10 volts below the extremes expected at the screen grid, the control will allow squelch to be turned off at any time, or set so that the receiver will not turn on even with strong signals. This, in turn, allows the squelch to be used to filter out interfering signals which are only slightly weaker than the desired one, even if the interference is S9 in strength.

Improved performance might result from substitution of a hand picked silicon power rectifier with extra-high back resistance (around

1000 megohms) instead of the 1N459 specified. A VTVM should be satisfactory for resistance measurement here as the operating voltage on the diode will be approximately 1 to 10 volts.

Squelch chatter can be prevented by placing the squelch after the ANL; this cannot be done with many squelch circuits since they are intimately connected with the detector circuitry. However, this circuit can be inserted between any two audio stages so long as the signal level is less than 5 volts peak-to-peak.

The circuit acts as rapidly as the avc voltage when a signal comes in, and holds on after the signal ceases only as long as the avc; for elimination of noise bursts at the end of each received signal, avc release time constants may need to be shortened.

The circuit may also be used to provide CW of constant pitch regardless of tuning. To do this, use a SPDT switch to take audio input to the squelch from either the receiver detector or from an external audio oscillator. With input from the oscillator, and with receiver avc operating, the squelch will open on each dit or dah and allow the oscillator tone to pass through to the speaker or phones. AVC time constants may need modification to avoid "tailing", but for operators who prefer constant-pitch tones the result might well be worthwhile.

. . . K5JKX

Souping Up The TCS Audio

Bob Harris K7CJJ/WA6UMU
96 Carlton Drive
Monterey, California

The TCS transmitter has always been a rather dependable article to have around the ham shack. It can be used on the 160, 80-75, and 40 meter ham bands, plus any MARS frequency 1.5 mc and 12 mc.

The basic circuit is noted for its stability. However, the TCS would be of much more value if the modulation percentage could be boosted. By boosting the dc power to 600 volts under load, and by building a self contained 12AT7 pre-amp into the space formerly used by the crystals, the TCS was found to have a better than average AM signal upon the ham bands.

The pre-amp used is simply a straight forward circuit, and could be copied out of most

of the ham publications, but the novel feature of the arrangement is found in the way the pre-amp is coupled into the existing circuit. This is simple, and is done by using the secondary of the input transformer to act as a coupling device and also act as an auto-transformer to match the grids of the modulator tubes. Many eyebrows should flicker on this one, because basically it is not considered good practice, but the proof of the pudding is in the reception at the other end. Actually, there is no valid reason why this same coupling device couldn't be used in any of the surplus gear on the market that uses a carbon mike coupled into a push pull grid circuit.

Using a ceramic microphone of the tape re-

hallicrafters HT-41

Linear Amplifier

\$269.00 NEW

WAS \$395.00

World's Best Terms

6% finance charge

10% down or trade-in down

No finance charge if paid in
90 days

- CAN BE DRIVEN BY ANY EXCITER DELIVERING 20 TO 100 WATTS OUTPUT
- 80 THROUGH 10 METERS
- HIGH POWER PAD BUILT IN
- 1200 WATTS P.E.P. INPUT
- 900 WATTS INPUT ON CW
- 2-7094 AS FINALS 2-866AX RECTIFIERS

Call us direct

"Use Area Code"

Butler 1, Missouri

813 679-3127

11240 West Olympic, Los Angeles, Calif.

213 477-6701

913 North Euclid, Anaheim, Calif.

714 772-9200

431 East Green St., Pasadena, Calif.

213 684-0861

ORCHARD
GRANITE
PROSPECT
MURRAY

Henry Radio Stores

"World's Largest Distributors of Short Wave Receivers"

order variety in the circuit pictured, I found that the audio power matched the carrier, and that the reception was loud and clear at the other end. The signal was so clean that the receiving station was able to pull it through very bad QRM, simply because of its clarity. Signal reports of over 5 plus from a thousand miles away on 75 meters, and over seven hundred miles away on 160 were reported. The clarity of the audio was always the outstanding feature. Using the transmitter on AM I called into SSB roundtables and most of the SSB boys didn't realize that I was on AM! They thought that I was still on the just-sold 100 V.

The only critical wiring was found to be in the input rf choke, with its bypass capacitor and input resistor. These were mounted on a terminal board by the input jack. All other components were mounted in the space normally used by the crystals. It is possible to remove the old crystal sockets, and by mounting two octal sockets for the four crystals, and the 12AT7 socket on any suitable board found in the ham shack that will fit the space, the original circuitry can be still used.

A second key jack was mounted adjacent to the mike input jack, and wired in parallel. This was found to be a very convenient way to key the relay without a push to talk mike.

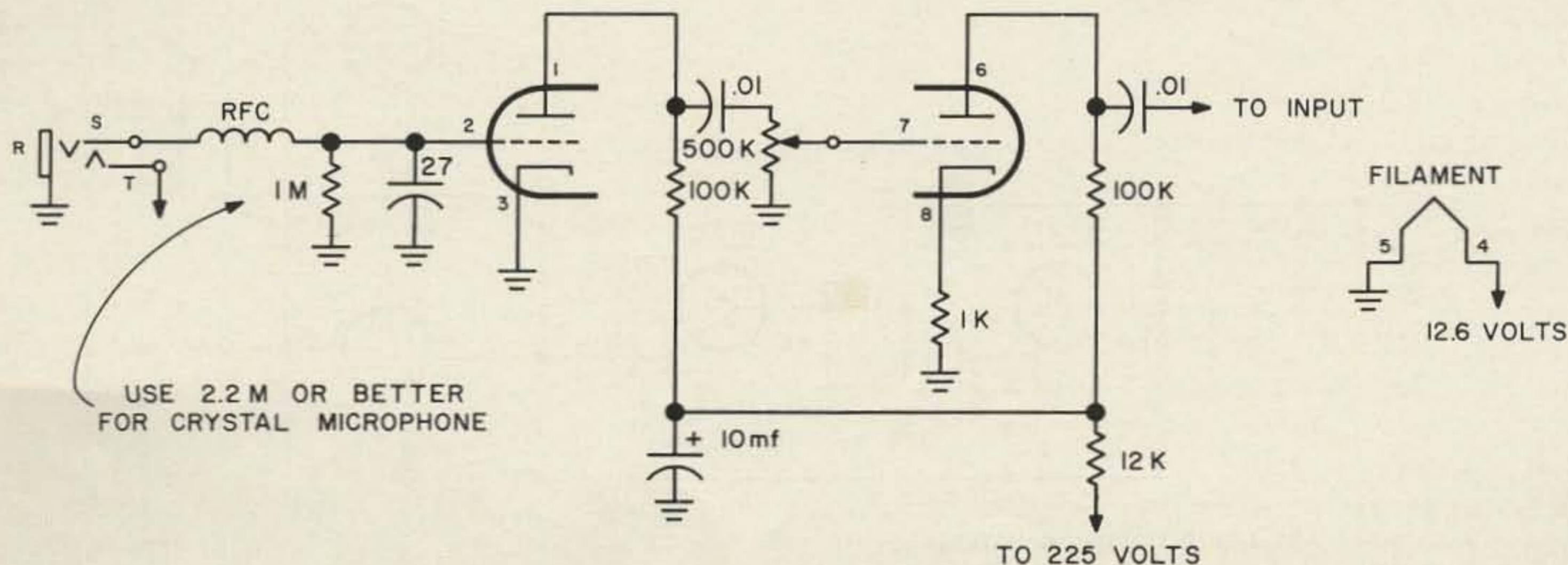

The power off-on switch was removed, and the volume control was placed in this opening. The control was used, as various mikes act in various ways. If one mike is to be used continuously, this control could be replaced with a one megohm resistor. This has been done in the present TCS in use at this station, and has been found to be very satisfactory.

It should be noted that the input resistor was picked for a ceramic mike. To use a crystal mike, it is suggested that a 2.2 megohm resistor be substituted.

One word of caution is to note that the plate voltage should be taken from the relay center terminal. If the plate voltage is taken from the keyed side, there will be tails on the signal from the 10 mfd capacitor discharging.

The input to the TCS is made at terminal #3 of the transformer T101, with a .01 mfd capacitor acting as the coupling device. Make sure that shielded wire is used for all audio leads.

If the job is to be done with baling wire, there will be no need to disturb any of the TCS parts. If a crystal and 12AT7 socket board is to be installed, it will be necessary to remove the back panel to accomplish this feat. Actually the time spent was small compared to the satisfaction gained in logging the signal reports received. Go to it. Those surplus transmitters are still worth the time, if the ham wants to work them over to fill the bill. Good luck.

. . . K7CJJ

Robert Baird W7CSD
3740 Summers Lane
Klamath Falls, Oregon

A Varicap Phase Modulator

We still receive questions about the original varicap FM modulator, published in the first issue of 73 October 1960; in fact we have made up a ditto sheet to send out because many hams don't know where they can find an Oct. 60 73. The varicap FM modulator still works as good as ever and still causes considerable wonderment to the beholders.

Unfortunately home brew mobile VFOs generally leave something to be desired as far as stability is concerned. And a lot of the mobile home brewers prefer to stick with crystal control. So herewith is a crystal controlled varicap modulator. Whether it is phase

modulation as the title suggests or maybe direct FM doesn't much matter. It works and can be readily detected by slope detection and does give the added stability of a crystal oscillator. We think it has more talk power per watt drawn from the battery than AM.

The crystal oscillator will seem familiar as something like circuits found in many handbooks. We actually extracted it from a military handbook and modified it as per Fig. 1. The varicap a VC 100 made by Pacific Semiconductors gets its bias by virtue of being across the emitter resistor which runs about 4 volts. There are perhaps numerous transistors

N.C.—Two pieces of plastic covered hook up wire twisted—neut with scope.

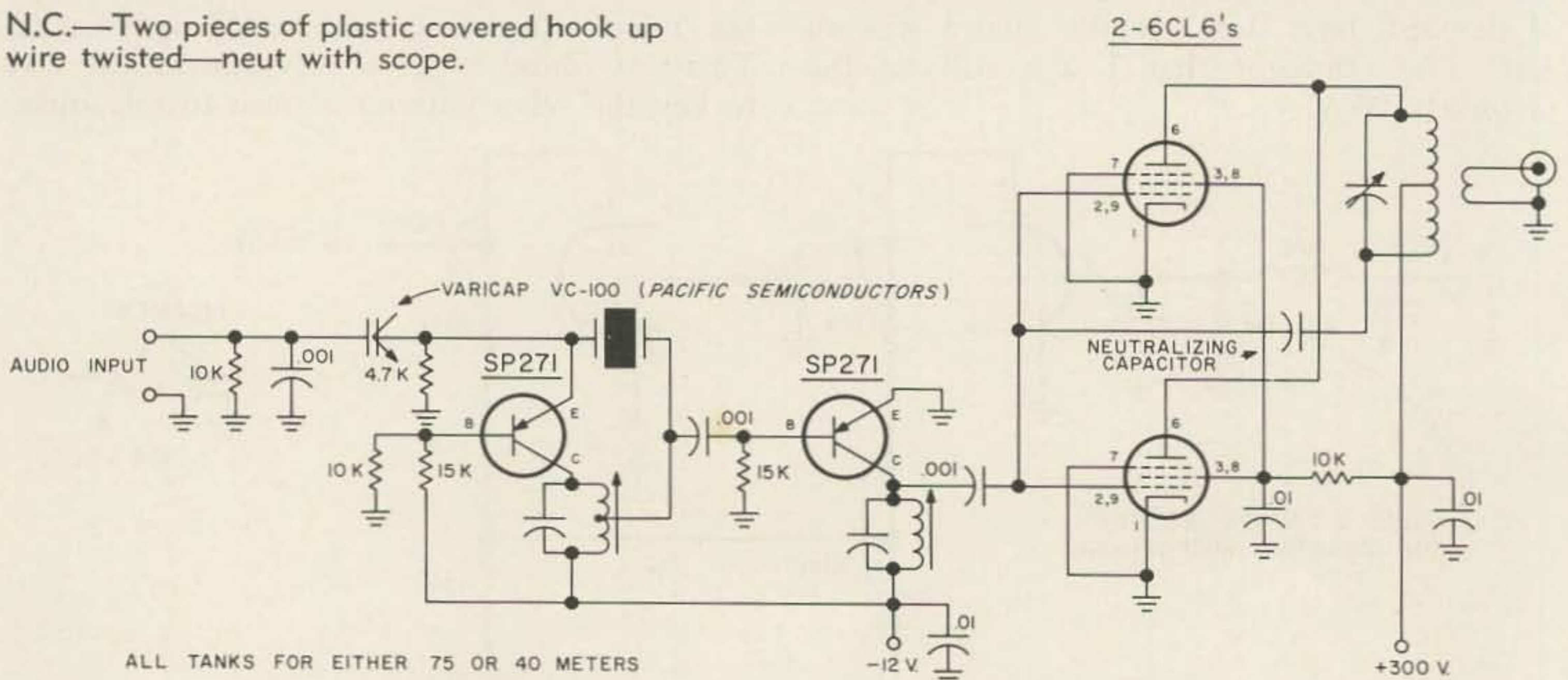

that will work in this oscillator. We tried a 2N1195, a 2M741A and a couple other fairly high priced ones but they worked no better than a Lafayette SP271 selling for 87c. Likewise an SP271 is used in the buffer stage. The use of slug tuned circuits and fixed capacitors make for small size. The final amplifier consists of a pair of 6CL6 tubes in parallel and plate neutralized. The transistor exciter does an adequate job for these tubes and a 300 volt supply was all that we had available. If higher power is desired a single 6CL6 in an intermediate PA would be necessary. Then a pair of 6146s or something of that size could be put in the final.

No audio is shown in the circuit diagram because we still have the varicap driver from the original February 61 73. There would be room on the chassis illustrated to put in a two stage transistor amplifier if desired. Possibly a *sound powered* telephone type mike might do the job alone. Our experimentation with this little rig was quite successful. One word of warning—it works fine on a storage battery but if you use a lightly filtered rectified ac supply it is pretty rough. We thought we had a real lemon until we connected on 12 volts of honest to goodness DC.

One very important discovery was made—a back biased epoxy or top hat silicon rectifier worth 30c will work almost as good as an expensive varicap. A little more audio voltage may be necessary. The Q is no doubt lower but the effect as far as operation is about the same.

... W7CSD

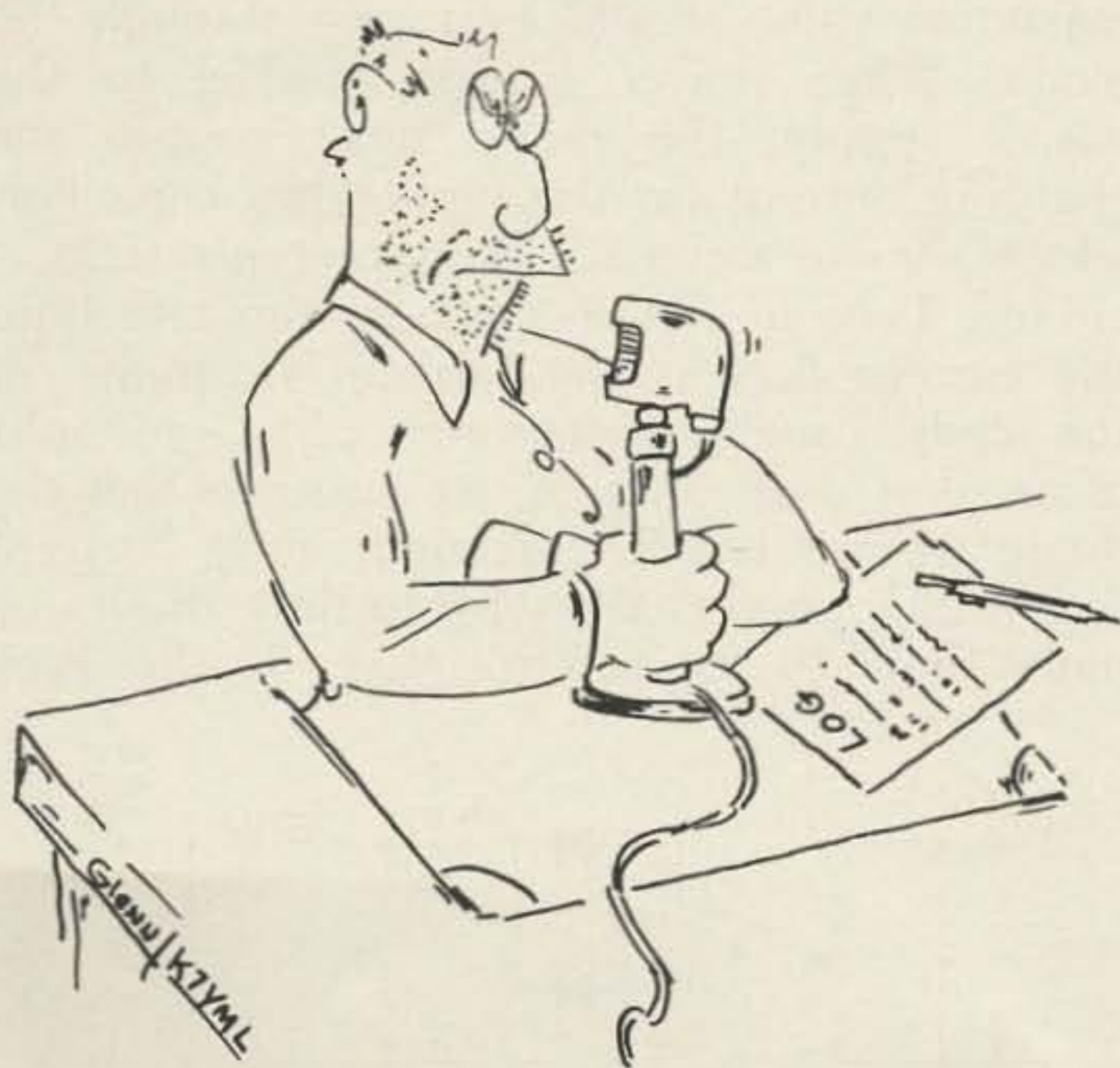

Hi Hi

NEW callbook

**HOT OFF
THE
PRESS!**



**Over 60% of listings
changed in only a year!**

PLUS THESE EXTRA FEATURES:

- Great Circle Bearings
- Great Circle Charts
- Prefixes by Countries
- "Q" and "Z" Signals
- World Time Chart
- Int'l. Postal Rates

United States Listings...\$5.00
DX Listings..... 3.00

**ORDER THESE USEFUL
AMATEUR RADIO AIDS TODAY!**



Radio Amateur DX Guide—62 pages of vital data; 291 Great Circle Bearings for 22 major U.S. cities; Prefix Map, Time Conversion Table, DX Log, plus other features postpaid \$2.00



World Prefix Map—Full color, 29" x 42", shows prefixes on each country . . . DX zones, time zones, cities, cross referenced tables postpaid \$1.00



World Atlas—Only Atlas compiled for amateurs. Polar projection, six continents, prefixes on each country . . . full color, 16 pages postpaid \$1.00

**WRITE FOR
FREE
BROCHURE!**

RADIO AMATEUR

callbook INC.

Dept. B, 4844 W. Fullerton Ave.

Chicago, Ill. 60639



See your favorite dealer or order direct (add 25¢ for mailing)

The Friendly Silicon Rectifier

Fred Haines W2RWJ
123 Roberta Dr.
Liverpool, N. Y.

Since the advent of the high voltage silicon power rectifier several years ago, it seems to have gained an unenviable reputation as an undependable, on again-off again, no account component, not worth taking a chance with in the ham shack. In the meantime however, the semiconductor boys have been trying hard to figure out just what seems to be the trouble in applying silicons in practical power supply circuits. You know the story. . . . "Throw away those old outmoded antique 866's and replace them and their big power-mad filament transformers with these new small cool efficient marvels of modern technology." Well, many of us did just that, but ended up holding the bag. The reason, we now know, was that we didn't realize some of the finer nuances of the care and feeding of these beasts. We weren't to blame though. . . . It's a fact that even the semiconductor manufacturers didn't know enough to publish any helpful literature. Now they do, and we should forgive them and make a new try with this truly amazing little rectifier.

The first trouble to cause the early demise of a silicon rectifier is a filter circuit with a capacitor input. When power is first applied to the circuit, the capacitor charging current is great enough to destroy the rectifier on the first half cycle or so of the very first sine wave. Poof! There goes \$1.20! Good grief.

Fig. 1 shows the path of the destructive charging current. The remedy is simple, and has but one drawback as we shall see. Merely

place a current limiting resistor in series with the diode, and the current during the initial charging period of the filter capacitor cannot exceed that specified as maximum by the diode manufacturer. Note that this negates one of the advantages of the silicon rectifier: low forward drop and, thus, better power supply regulation. This isn't too serious though, because with a capacitor input filter, the advantage of low forward drop doesn't contribute very much to regulation. The big thing is, we *have* eliminated the hot old rectifier tube and its transformer winding. In my experience, this circuit will operate practically forever without a burned out diode. See Fig. 2.

To figure out a rule of thumb for calculating the series resistance required, we could reason in a sloppy way as follows. . . . The manufacturer usually specifies the "peak one cycle surge current" for a rectifier. To be safe we should assume that no current greater than $\frac{1}{2}$ of the maximum value should ever pass through the diode. When power is first applied to the power supply, the diode must supply the charging current for the input filter capacitor, which we can assume is an instantaneous short circuit. Thus in Fig. 1 the only thing to limit the current flow is the forward resistance of the diode; usually of the order of a few tenths of an ohm. For example, let's assume that the diode in use has a maximum surge current rating 20 amperes. We wish to limit this to no more than 10 for safety's sake. If the *Peak*

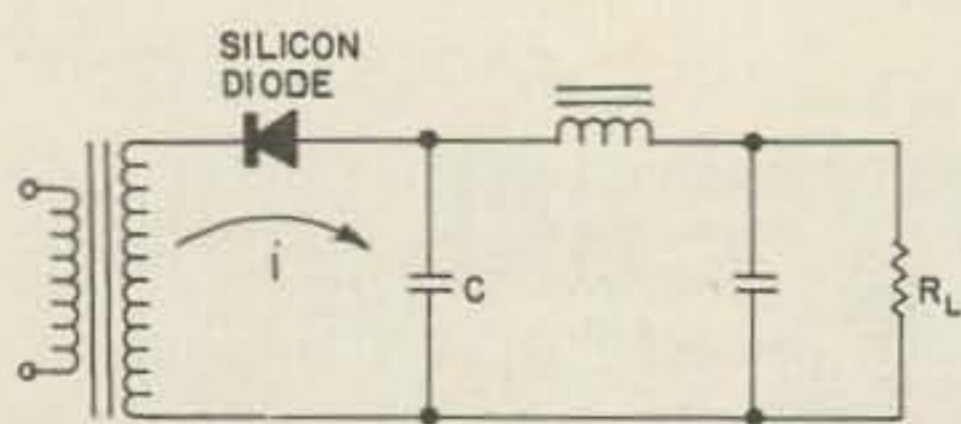

FIG. 1

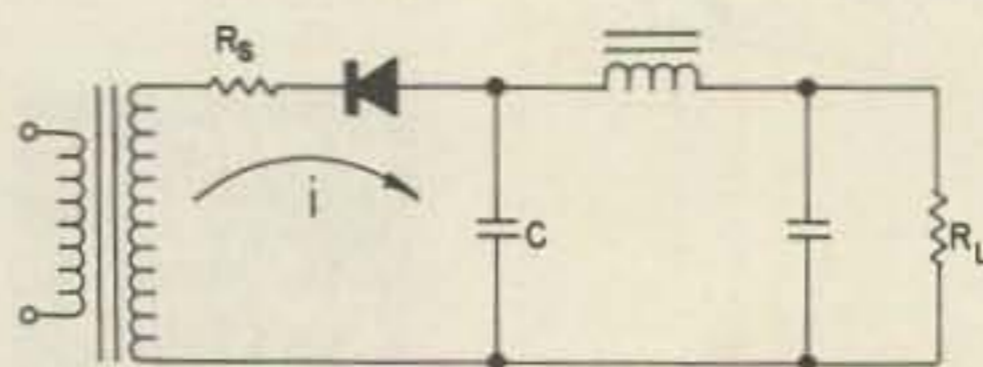

FIG. 2

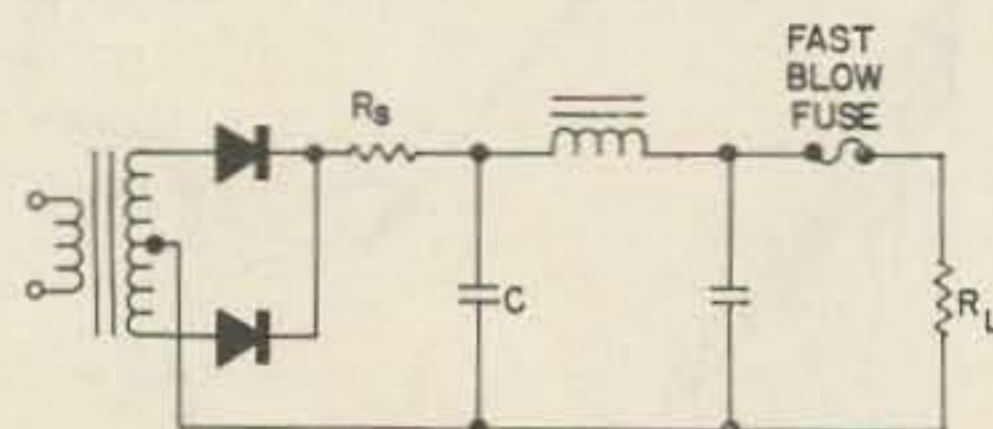
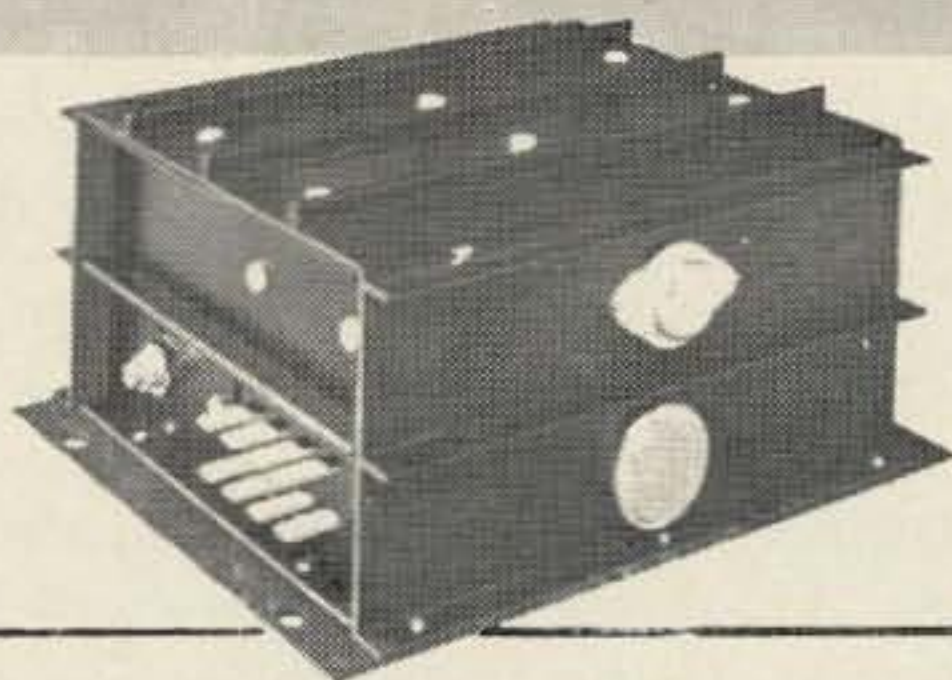

FIG. 3

YOU KNOW ABOUT THE **CENTURY** **MOBILE POWER SUPPLIES**

You know about the advanced circuitry* used in the design of the CENTURY to provide the most outstanding D-C transistorized converter on the market today. Now in widespread use with commercial and amateur transceivers, the CENTURY is proving daily to be "the best supply money can buy".



MODEL
400-12
\$145

A Few of the Features Include:

- POWER OUTPUT — 400 W SSB — 300 W AM
- EFFICIENT — Over 90%
- TOTALLY ENCLOSED
- COOL — Only 25°C Rise
- REVERSE POLARITY PROOF
- REGULATION — 8% No Load to Full Load
- QUIET — No Hash or Audible Noise Generated
- COMPACT — 6 x 7 x 3 1/2 — 7 lbs.
- CIRCUIT BREAKER PROTECTED

BUT DO YOU KNOW

that **LINEAR SYSTEMS**
now has the

STELLAR

series of Frequency Stable 60 Cycle
POWER INVERTERS based on the
revolutionary design* of the **CENTURY**?

Did you know that prior to the development of the STELLAR, truly frequency stabilized inverters were very expensive and that to run a tape recorder, clock, etc. from a conventional inverter was impractical due to the frequency instability?

Did you know that the STELLAR series of **Frequency Stable** Inverters maintain a stability of 0.5 cycles over the voltage/load range?

And of course the STELLAR Inverters are of exclusively Solid State construction, eliminating the necessity of using tuning forks or vibrators.



MODEL
12-1000SM
1500 W PEAK

The **STELLAR Frequency Stable** Inverters are available with power output ranging from 10 to 2000 VA and output voltages at 115 or 230 V.AC. Priced from \$60 (Model 12-10S, 15 VA Synchronous Motor Drive).

WRITE FOR FULL INFORMATION ON YOUR SPECIFIC REQUIREMENTS TO:



LINEAR SYSTEMS INC.

*PAT. APPLD. FOR

605 UNIVERSITY AVENUE
LOS GATOS, CALIFORNIA

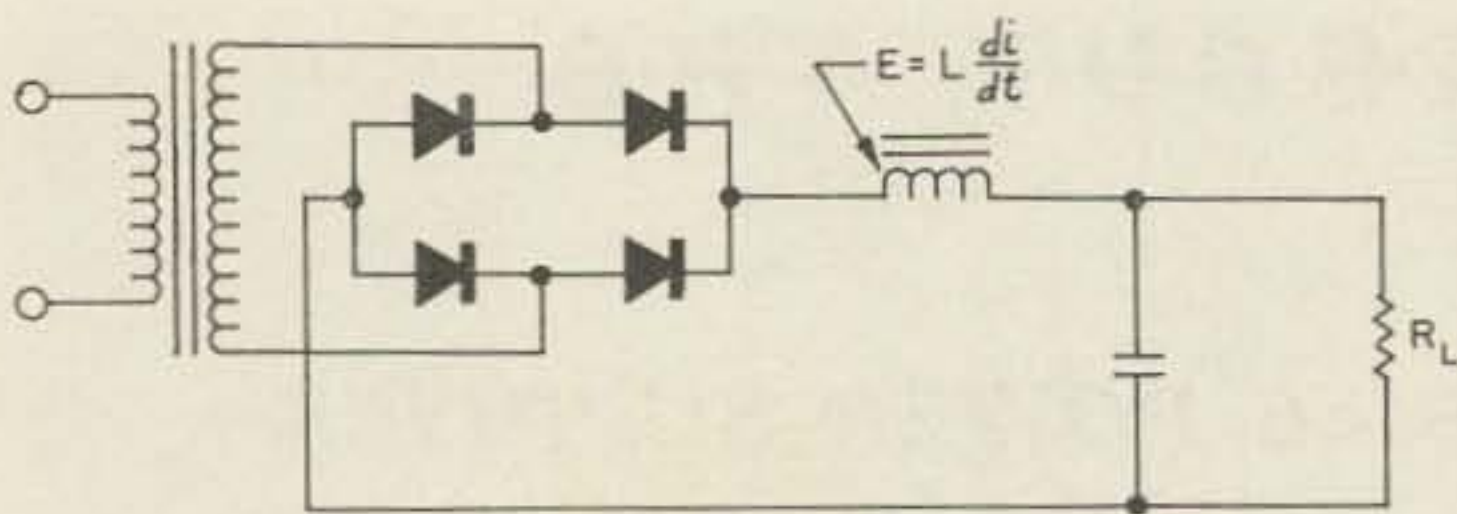

FIG. 4

voltage of the transformer secondary is 10 volts, then a resistor in series with the diode

of 1 ohm will do the trick. $R = \frac{E}{I} = \frac{10}{10} = 1$.

We have assumed here that the transformer secondary has no ohmic resistance, which of course is not true. If the transformer measures 1 ohm or more, you may get away without the series resistance in some cases, but since the transformer secondary resistance is mixed up with some inductance too, it may be safer to ignore it and rely upon a separate resistor. It's better to err on the good side. The simple procedure outlined here can be adapted to any capacitor input filter with a silicon rectifier.

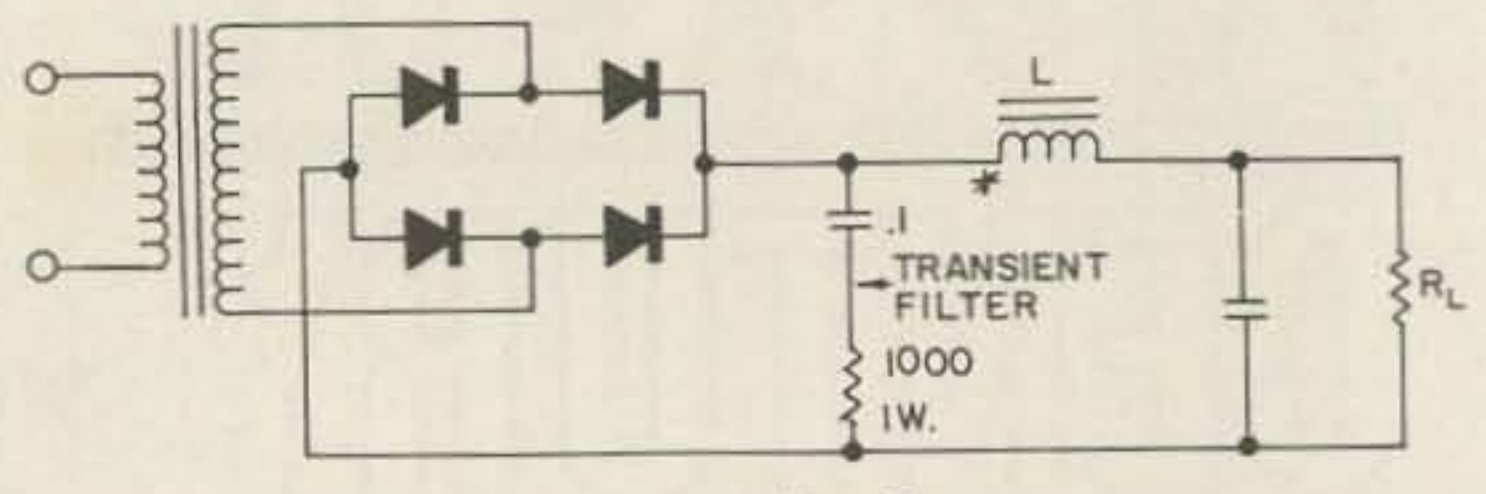

FIG. 5

* Voltage rating must be 1.5 times or more dc voltage at this point.
750 vdc, 300 ma supply

$L \frac{di}{dt}$! Well . . . what's that, you may ask if you

aren't an expert with the calculus. It amounts to a large voltage being developed across an inductance if a large, rapidly changing current flows through it. In the case of the choke input filter shown in Fig. 4, a large voltage transient is developed across the filter choke when the power is first applied to the supply. That transient can reach terrific peaks; as much as a thousand volts not being uncommon!

A good precaution against rectifier popping in this case is an RC time constant filter as

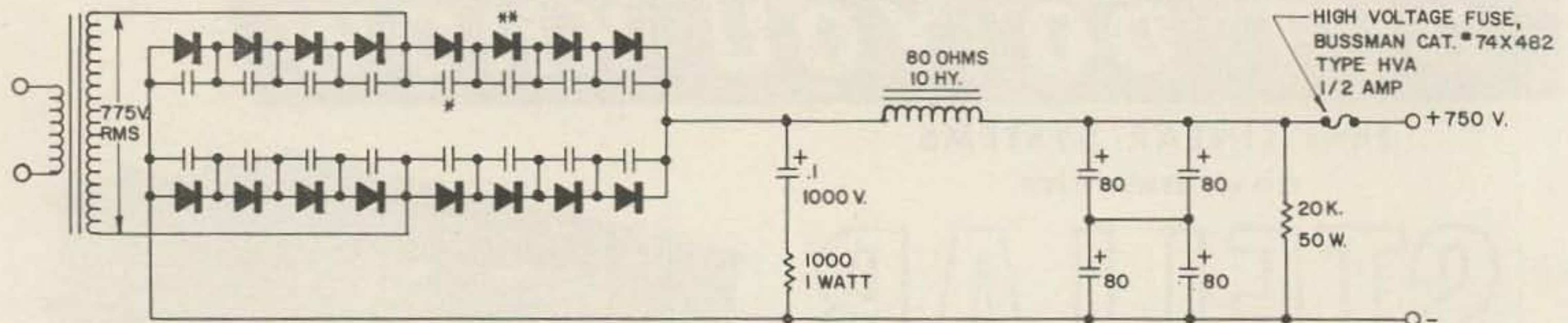

FIG. 6

* All .01, 600 volt rating. ** All G-E Co. 1N1695 silicon diodes. All filters are 450 volt units.

The second trouble to cause the fast death of silicons is improper or no overload protection. The best inexpensive protection is the fast-blow fuse wired in after the filter, as shown in Fig. 3. Supplies with such a fuse have been shorted out with screwdrivers purposely as many as 100 times without any trouble that 100 new fuses couldn't remedy. If the circuit supplied by the power supply has a large capacitor across the dc supply line, the fuse may blow whenever the circuit is energized. In this case, put the fuse in the device to be operated by the power supply *after* the large by-pass capacitor.

The third trouble to be considered in our silicon rectifier health program is called

shown in Fig. 5 connected from the junction of the rectifiers and the filter choke to ground. Many diodes have been saved by this simple circuit. A series resistor is not required in the case of a choke input filter, since the filter choke has a high enough ohmic resistance to limit the peak one cycle current through the diode or diodes to far less than the rating.

Fig. 6 illustrates a 700 volt supply of conservative design using silicon rectifier diodes. The supply has been in use for a couple of years at W2RWJ and the original diodes are still in service. Notice the surge by-pass capacitors across the diodes. These should always be employed whenever diodes are connected in series to prevent transient damage.



telrex "BALUN" FED INVERTED "V" ANTENNA KITS

SIMPLE-TO-INSTALL, HI-PERFORMANCE ANTENNA SYSTEMS:

1 KW P.E.P. Mono-Band Kit . . . 1KMB1V/81K . . . \$14.95*

2 KW P.E.P. Mono-Band Kit . . . 2KMB1V/81K . . . \$18.95*

*Kit comprises, encapsulated, "Balun," copperweld, insulators, plus installation and adjustment instructions for any Mono-band 80 thru 10 Meters. Also available 2, 3, 4, 5 Band Models.

Mfd. under Pat. 2,576,929

Write for TFLREX PL 6-5

TELREX LABORATORIES
ASBURY PARK, NEW JERSEY

For best results, select diodes of the hermetically sealed variety to insure long life. The General Electric 1N1695 and the RCA 1N3195 are good examples of high quality sealed units at moderate price.

. . . W2RWJ

IoAR News

The Founding Membership of the Institute of Amateur Radio is now almost 600! The ten dollars dues is a lot of money and represented a hardship to many of the Founding Members, but the tremendous importance to amateur radio of this money at this time overshadowed personal problems.

Harry Longerich W2GQY/4 reports that supplies and an Institute flag are available to members who would like to represent the Institute at hamfests and conventions. Please write to Harry at the Institute of Amateur Radio, 5219 Seventh Road, South Arlington, Virginia. He has information booklets, IoAR buttons, the flag and application blanks.

Founding Members all should have received, in addition to their large golden membership certificates and gold plastic membership cards, a copy of the FCC Part 97, the amateur radio rules and regulations. These are sometimes hard to find (and expensive to buy from the government) when you need them so the Institute has printed them up and distributed a copy to all Founding Members. A copy of the recent FCC release on the new Citizens Band regulations and the new RTTY identification rules has also been sent to each Founding Member. The first 400 Founding Members, whose calls were published in the July issue of 73, apparently have been given a free subscription to the *W. Amateur Radio News*, for which I suspect we can thank the ARRL.

The Institute held off sending newsletters to Congress during the K3UIG convention, but resumed them when everyone had returned to Washington.

News is a little scarce during the summer, what with vacations and all.

Wayne Green W2NSD/1

DOW-KEY DK60 SERIES COAXIAL RELAYS

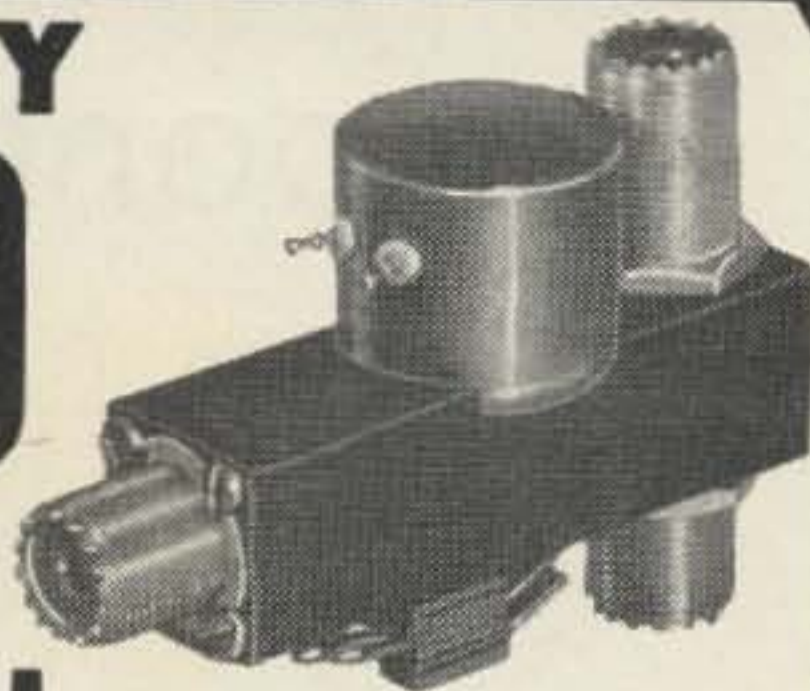

Size
2 1/4 x 3 1/4 x 1 1/2
Less than 9 oz.

DK60-G2C

4 Standard Models, AC or DC,
UHF, N, BNC, TNC or C Conn.

Outstanding favorite for amateurs . . . Versatile combinations for industrials! Low VSWR less than 1.15:1 from 0 to 500 mc. LOW LOSSES . . . High Contact Pressures. LOW CROSS-TALK through use of patented "isolated connector" arrangement. HIGH POWER RATING. All coils encapsulated in epoxy resin for quieter operation and resistance to moisture.

- ★ UNCONDITIONAL GUARANTEE for one year. (We will repair if faulty within 1 year.)
- ★ See one of our 700 dealers and distributors in U. S. and Canada for catalog sheets or write:
- ★ All Relays available in weatherproof boxes for exterior installation.
- ★ Ganged, multiple position switch arrangement available for remote control selection of antennas.

STANDARD RELAYS: DK60, DK60-G, DK60-2C and DK60-G2C —

PRICED FROM . . . \$12.45

DOW-KEY CO., Thief River Falls, Minn.

We stock Cushcraft's
new SQUALO

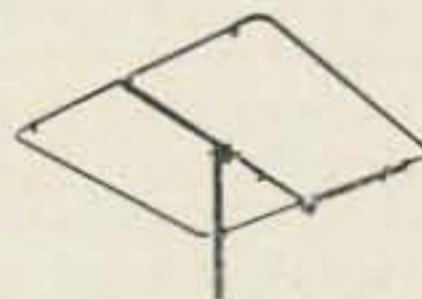

for 6-10-11-15-20 or 40 meters

Open 10-6 daily, Tues. and Fri. 'till 9, Sat. 9-4

LAFAYETTE RADIO
ELECTRONICS

319 Central Ave.
Dover, N. H.
603-742-3895

TONS OF AMATEUR EQUIPMENT IN STOCK

WESTERN RADIO

SAN DIEGO

1413 India Street BE 9-0361
MON - FRI 8:30 to 8:00 SAT 8:30 to 5:00

VHF-UHF

Converters & Preamps.
50 thru 432 Mc.

Write for literature

Parks Electronics, Rt. 2, Beaverton, Ore.

Moonbouncing in Switzerland

Dear OM Editor:

I am very glad to give you some details of our Moon-Bounce activity here in Switzerland.

The Crew consists of 5 Hams which are: HB9RG Hans, DL9GU Ed, DJ4AU Jurgen, HB9RF Johnny, and DJ3EN Kurt.

The successful MB-QSO East- to Westcoast of USA back in 1960 encouraged us to jump into this new field of Amateur-Radio.

In 1961 we got a 10 foot dish from the German Post-Administration. The big difficulty now was: How to get it free of duty over to Switzerland. (Unfortunately tariff of duty depends on weight in Switzerland).

Immediately we constructed a polar mount and in the same winter we began also to build up all the necessary parts, a paramp for our converter and a new final amplifier.

After a hard series of tests, problem number one was the tracking-system. We were able to ask Sam Harris, W1BU, to send us some signals. This first test was negative. Some minor modifications on the parametric amplifier and the dish brought us our first success. On the 22nd April, 1962 we received our echo from the Moon. Since then we tried again with W1BU, but never got the signals through.

In spring 1963 we enlarged the dish to 17 feet and replaced the RG-17 coax by $\frac{7}{8}$ inch Heliac. Our only partner in 1963 was the sun. New Varactors in the paramp brought us more stability on the receiver side.

In our latest test in spring 1964 we managed to hear the sun just over the receiver noise with the converter alone. Connecting the paramp ahead improved the reading by 6 db.

Our station for 1296 mc: The heart of the transmitter is a transistorized oscillator, 7 feet under ground in my garden, well isolated to keep a steady temperature. The crystal is 8 mc and it can be moved to the exact frequency by a varactor. On 24 mc we compare the accuracy of our frequency by an oscilloscope with Droitwich (Broadcast station on 200 kc in England). Conventional multiplier stages are used to 144 mc. From there cavities with 3CX100A5 bring the signal to 1296 mc. Two paralleled



HB9RG



HB9RF & HB9RG putting 432 dipole in.

cavities with 3CX100A5 work as driver stages with an output in the order of 100 watts. The final output is an RCA 7650 with indicated power of 400 watts. Power and SWR are permanently watched in a Micro-Match coupler. A dipole with reflector is the feed of our system. 18 feet of nitrogen pressurized Heliac link the rig with the antenna. On the receiver side we use a parametric amplifier constructed after details given in QST Jan 1961. For the moment the varactor is a Microwave 4294, pumped at 9 mc with a 2K25. A mixer 1N21F brings us the signal to the first if of 144 mc. Behind that comes a two meter converter to 28 mc which finally is followed by a Collins R-390A.

For the test with KP4BPZ on 432 mc we used: The same antenna with adapted dipoles. 32S3, 62S1 followed by cavity tripler and driver with 3CX100A5. The same final cavity as on 1296, where it works on $\frac{3}{4}$ Lambda, we have been lucky to get it working on $\frac{1}{4}$ Lambda on 432 mc.

The receiver was a normal converter with 7 db noise figure. In lack of time (we have been informed only 10 days before the test) we were not able to build a better adapted station.

On the 13th June, 1964 at 1842 GMT we heard the first CQ of KP4BPZ. In peaks the signal was 15 db over the noise level. KP4BPZ was logged and recorded in contact with: W1BU RST 589; W9GAB 469; HB9RG 579; W9HGE 459; W1FZJ SSB and G3LTF.

I think it is not necessary to tell you how happy we were to be the first Europeans working 70 cm over the ocean. Our QSO seems to beat the world-record on 432 mc.

We noticed that Moon Bouncers in USA are much more interested in 70 cm EME-work and we intend to improve our system by a parametric Amplifier.

Inclosed you will find some pictures and we hope that this story in my poor English will be a help for you to show to your readers how Moon Bouncers in Europe are working.

HB9RF "Johnny"
HB9RG "Hans"
P.O. Box 114,
Zurich 33, Switzerland



12 NEW AMATEUR BEAMS

from

FINCO[®]

**ALL GOLD CORODIZED
ALL GAMMA MATCHED**

- 3 New combination 6 & 2 meter beams**
- 5 New 6 meter beams**
- 3 New 2 meter beams**
- 1 New 1¼ meter beam**

**SEND FOR NEW
TECHNICAL INFORMATION
CATALOG #20-226**

THE FINNEY COMPANY

34 West Interstate • Bedford, Ohio

The Heath SB-400

William J. Hall K1RPB
36 Maple Street
N. Wilbraham, Mass.

Last year it became my misfortune to sell a well stocked ham station in order to purchase a new home. This turned out to be a blessing in disguise, since it gave me a chance to become reacquainted with the family, get a lot of house fixing done and play a few rounds of golf to boot. This spring, the financial picture was again being painted black, the family had seen enough of me and my golf score wasn't improving much. It was time!

I had been keeping a close eye on the rapid development of new equipment being offered on the amateur market. There were single and multiple band transceivers, high and low powered transmitters etc., etc. One thing was sure. It had to be SSB and definitely offer provisions for good ol' CW. It seemed like a tough decision, but Benton Harbor had again come up with something which offered the highest ratio of performance to price. I therefore took the plunge and ordered the new "SB" line and waited impatiently for the goodies to arrive.

Construction

After a somewhat lengthy wait (or so it seemed) the SB-400 finally arrived. I locked the ham-shack door and eagerly began to piece it together. The kit was completed in slightly less than 50 hours.

Construction was simplified considerably through the use of two circuit and two terminal boards. The instruction book was apparently well planned, minimizing difficulty in placing the tightly packed components. Heath even

supplied the solder. The finished product, which bears a faint resemblance to a high priced Brand X was plugged in and worked right off the bat. Alignment was completed in approximately ½ hour and required only the use of a VTVM and rf probe. I did have a little difficulty in producing sufficient drive near 28.5 mc but resolved this by tightly dressing down all of the coil leads in the grid and plate circuits of the 6CL6 driver.

Circuit Description

The transmitter design can be broken down into four separate systems, an exciter, a vfo, a heterodyne oscillator and an amplifying stage. First, the LSB, CW, and USB signals are produced at 3393.4, 3395.4 and 3396.4 kc. This is mixed with the variable frequency oscillator (LMO) which operates between 5 and 5.5 mc. Using a little arithmetic we find a mixer product varying between 8.395 and 8.895 mc. This in turn is mixed with a signal from another crystal controlled oscillator to produce the desired transmitting frequency. The signal is finally amplified through a 6CL6 driving a pair of AB₁ 6146s. We end up with full 80-10 meter coverage, (all crystals supplied, gentlemen) with approximately 100 watts output.

The circuit design also features such important items as an automatic level control (ALC) system. This allows a higher level of talk power without risking attendant flat-topping and distortion. It increases one's signal effectiveness considerably. In addition, an audible sidetone is generated in the CW function to allow for self monitoring. This also trips the VOX system allowing for semi-break-in keying. In the SSB position, one has the choice of push to talk or straight VOX operation. The antenna changeover relay is built in, although provisions for an external changeover are there for those who prefer it. The power supply makes good use of tiny semiconductor rectifiers. Separate medium and high voltage windings eliminate the need for power robbing dropping resistors and voltage regulators on the 6146 screens.

Operating Performance

After using the rig for a little while, one gets used to it and wonders "what else can they possibly come out with?". I have used the SB-400 with a Drake 2B and more recently, the companion SB-300 receiver. The transmitter is a dead mirror image of the latter. I have operated it in both the transceive and separate transmit/receive functions. All one has to do is change a couple of cables, which takes no

time at all and adds great versatility to the line. Tuneup amounts to resonating the driver and final and choosing the desired mode. The CW signal is removed one kc from the USB frequency. Therefore, in the transceive position, one tunes in the desired CW note at 1 kc, which centers it in the receiver 400 cycle band pass. This places the transmitter on dead zero beat. The meter is switchable between grid and plate current, plate voltage and relative power output.

Reports on distortion, signal width and side-band and carrier suppression have been excellent. There is no frequency drift that I have been able to detect, even from a cold start. My own scope measurements have confirmed the very fine comments on signal quality. To sum it up, gang, it would be mighty tough to beat this deal at twice the price of \$325.

Letter

Dear Wayne:

For these past eleven months I've been reading and quietly checking your efforts on behalf of the General licensees, and your healthy opposition to the QRM from QST headquarters. Your July appraisal of your efforts seemed to reflect a sense of discouragement and defensive thinking. I hope I read this incorrectly, Wayne. Perhaps the amateur body has not responded as readily and as freely as you had anticipated. Many are more than ready to give lip service, Wayne, but cash is another matter. It's pretty hard, in a lot of cases, to let go of the ten bucks for the IoAR, or even for shoes for the kids, for that matter. There seem to be many hams who just aren't in a position to send ten dollars. Would it be wise to appeal for lesser amounts? My membership in the ARRL expired on January 1 this year, and I did not renew it on the grounds that I did not want the crew at the ARRL to interpret my renewal and subscription to QST as a "yes" vote on all the crackpot or insane proposals they could dream up, and appealed to them to instill a bit of democracy in the organization by submitting serious questions to a vote of membership. I got the standard reply of "If a republican form of government is good enough for America, it is good enough for the ARRL." Perhaps I'm wrong, and you're wrong, and those who take the position we have taken are wrong, but I cannot help but wonder. The ego that makes for disregard of the opinions of the membership of a group can only lead to revolution by the members, and the ARRL does not have the means of control to suppress an uprising. I should say also, that not all hams are members, and not all hams care. To many hams, the final disposition of the ham bands is not of great importance. Ham radio is still a hobby, as it should be, and not a way of life. I'm afraid to continue, Wayne, to write in this vein, as it only leads to a reflection on injustice as it seems to be practiced by the government of the ARRL. The upshot of all this writing is that, enclosed, find two checks: one for the renewal of 73, and the other for my IoAR membership. I was going to send you money for the QST magazine too, but I'm still mad at them, but leaning toward rejoining so I can vote against the director, although what good that would do, I'm at all sure.

At any rate, Wayne, I am only one of many who hope you can be successful in your fight for justice—justice without discrimination for or against any amateur.

Richard C. Mack, KØIVD

Want High Efficiency and Small Size?

6 10 15 20 METERS
MINIATURIZED-4-BANDS

- ★ 500 Watts AM.
- ★ Turning Radius - 7'
- ★ Total Weight - 11 lbs.
- ★ Size - 5' x 11'

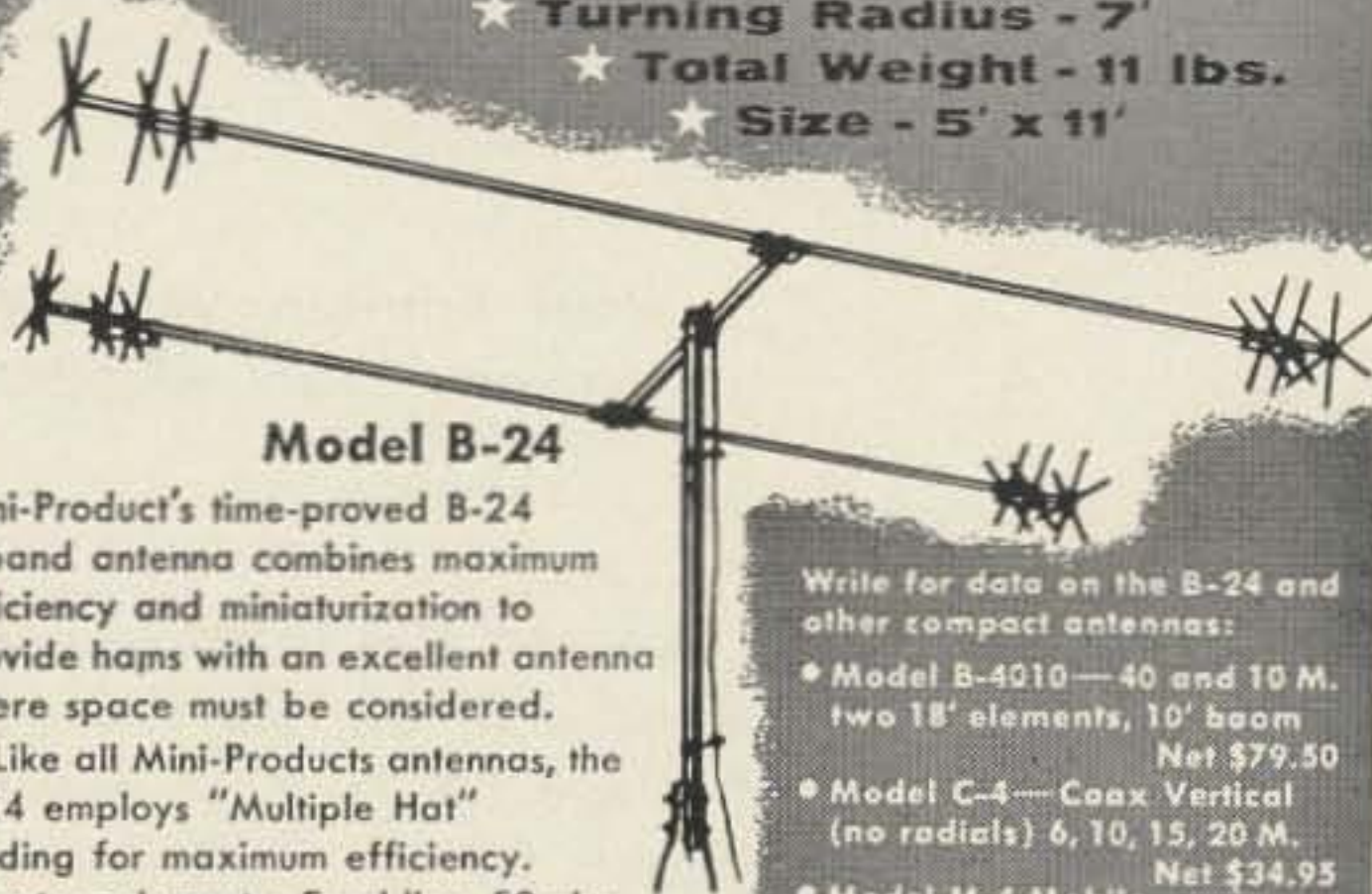

Model B-24

Mini-Product's time-proved B-24 4-band antenna combines maximum efficiency and miniaturization to provide hams with an excellent antenna where space must be considered.

Like all Mini-Products antennas, the B-24 employs "Multiple Hat" loading for maximum efficiency. TV rotor adequate; Feed line, 50 ohm coax; SWR 1.5:1.

Amateur Net
\$59.95

Mini-Products, Inc.

1001 WEST 18th STREET • ERIE, PENNSYLVANIA
See your local distributor or order direct from factory

Write for data on the B-24 and other compact antennas:

- Model B-4210—40 and 10 M. two 18' elements, 10' boom Net \$79.50
- Model C-4—Coax Vertical (no radials) 6, 10, 15, 20 M. Net \$34.95
- Model M-4 Mobile 6, 10, 15, 20 M. Net \$16.95

Patents pending

DOW-KEY

DK2-60B
NEW COAXIAL
TRANSFER SWITCH

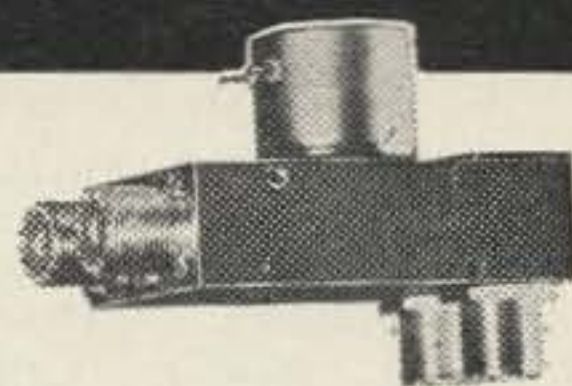

A DPDT unit internally connected in the de-energized position, ideal for switching in and out a power amplifier between an exciter and an antenna.

1 kw power rating to 500 mc; VSWR 1.15:1 to 500 mc; Isolation 60 db @ 1 mc; All standard AC and DC coil voltages available.

See your dealer for catalog sheet or write:

DK2-60B with UHF Connectors ... \$19.00
DK2-60B-2C with UHF Connector and DPDT auxiliary contact \$20.95

(BNC, TNC, N and C slightly higher)

DOW KEY CO., Thief River Falls, Minn.

TRANSTENNA 102A

A PRESELECTION SECOND TO NONE AND A T-R SWITCH BEYOND COMPARISON

Pat. Pndg. U.S.A. & Canada

MODEL 102A

\$69.45 (Add \$7 for Sidetone—either model)
15 DAY TRIAL

Return For Full Refund If You Burn It Out Or Are Not FULLY PLEASSED

- Std. coax coupler (xmtr to feedline)
- No TVI or Suck out
- 30 DB Min. Gain (10-80 mtrs)
- No Effect on Transmission
- Monitored switching
- Full Legal Input
- Burnout Proof
- CW Sidetone (optional)

Write for Free Literature

Improved 102A Adjustable Mute Circuit Breaks Any Xmtr-Rcvr Between Dots & Dashes Without Clicks. Improved Semiconductor Through-Position Switch Switches Rcvr Directly to Antenna for Unity Gain 6-80 Mtrs.

102B, \$59.00 like 102A exc. rcvr. muting

FICHTER ELECTRONICS
33 Myrtle Avenue
Cedar Grove, N. J.
Tel: CEnter 9-6412

Save Ten?

Paul Franson WA4HWH
Wayne Green W2NSD

During these long days of the quiet sun our poor old ten meter band will be, for the most part, a mighty dead place. A lack of activity on any band is bad news for us, and one like ten is particularly bad because it is so desirable to others. Perhaps we can do something to bring it back to life.

With the release of the new CB regulations there is likely to be quite a number of CB rigs floating around. Why not put these to work on ten meters? This would not only provide a good use for presently unused CB rigs, but would do a lot toward sparking activity on ten.

I propose a national calling frequency of 28.600 mc. Let's call this Channel A. I propose working channels of 28.65 and 28.7 mc, Channels B & C. Most CB rigs will cover these frequencies with just a little retuning. Those with continuous tuning receivers can be re-tuned simply. Crystal controlled receivers aren't much more of a problem.

I've written to all CB manufacturers telling them of my plan. Many answered and these are listed here along with any important comments or suggestions that they may have made.

Many of the CB sets can be souped up to 10 more watts. I'll be interested in any ideas that can be passed along on this. Also, if anyone has any particular trouble and conquers it, I am sure that all other owners of that type set would want to know what to do.

Since all of the CB rigs are crystal controlled, there is the problem of crystals. Fortunately at least two of the crystal companies are willing to go along with our plan and have agreed to make crystals available for Channels A, B, and C. Texas Crystals will send you a crystal for any of these channels for \$2.95 postpaid. Be sure to specify what model and make of rig it is for. Write to Texas Crystals, 1001 Crystal Drive, Fort Myers, Florida. International Crystals will supply their .01% tolerance crystals out of stock for \$4.40 for the fundamental type crystals and \$3.30 for the overtone type. You'll have to check and see which type your rig uses. If the frequency stamped on the top of the crystals is in the 8-14 mc range you can be reasonably sure that it uses fundamental crystals. Write to International Crystal, 18 North Lee, Oklahoma City, Oklahoma.

Since Channels A and C are on even 100 kc points there should be little problem in getting everyone adjusted right on the channels. The crystals can be padded onto frequency when you find someone with a 100 kc standard.

Since FCC is cracking down on the CB hobbyists we may shortly have an influx of two things into our hobby: used CB gear at bargain prices and used CB'ers trying to become hams. Both *can* help amateur radio. Proper instruction from old hams in the art and attitudes of amateur radio can help produce new hams who are neither ignorant nor indifferent lids. Help them become hams and you can shape their interests and actions. Ignore them and they will get their tickets anyway, but we may be treated to "10-4's" on six meters.

No matter how the CB'ers turn out, we



SETS DX CONTEST RECORD WITH CUBEX MK III QUAD

With your antenna I made the highest score ever made . . . in the ARRL 1959 DX Contest . . . has not been matched since. (2/16/62) A. W. Hingle K6UOM (ex-W4FVR)

Famous CUBEX MK III 3 BAND QUAD gives you 3 full size, full efficiency beam antennas with separate full wave driven elements on each band in **half the space** required by a 3 el, 20 mtr. beam.

See Article — "How DX Kings Rate Antennas," QST, Jan. 1964 issue, pg. 75.

Prices
Fiberglass Model \$99.50
Std. MK III Model \$67.50
Other models from \$27.50



CUBEX COMPANY P.O. Box 732 Altadena, California

should receive a boon in equipment. Most CB transceivers are well built, well designed and modern. (They should be. For the past few years, manufacturers who used to concentrate on ham equipment have been chasing the pot of green at the bottom of the CB rainbow.) Most CB transceivers can be easily adapted to ham use on 10 meters. They can provide a cheap reliable source of equipment for local rag chewing, mobile use and emergency nets. Many of the rigs are crystal controlled in receive (all are in transmit, of course). This may seem a handicap at first, but it is an advantage for the applications described above. Virtually all CB rigs include squelch so you can leave the receiver on with the squelch turned down. If anyone comes on, you're already on frequency so there's little possibility of missing them. Obviously, everyone must monitor the same frequency to make this work. We suggest 28.6 mc (channel A) as the primary frequency for monitoring. This frequency is low enough so that most CB rigs will reach it with no trouble. In many areas more frequencies will be needed. 28.65 (B), 28.7 (C) would make good secondary channels.

There is a temptation to go farther up the band, but these three channels should provide enough frequencies for a starter. In addition, they are spread out over only 100 kc. The CB band is 290 kc wide, so you should be able to jump from channel to channel without touching the internal adjustments. However, make sure that the receiver is left on channel A for monitoring when the rig is not in use. When you want to make a contact, you can call on A, then switch to another channel if desired.

Use of these CB transceivers should provide us with a little more activity on 10 meters and help keep down the QRM on 75. There is usually nothing to the modifications necessary to get on 10. For crystal controlled receivers, new crystals and a slight retuning is all that should be necessary. It might be necessary to remove a turn of wire or reduce a capacitor in some cases. It may even be possible to make the receiver tune continuously by plugging a tuned circuit in a receiver crystal socket. Tunable receivers will require a little juggling of adjustments in the front end. Transmitters are even easier to adjust. Plug in a new crystal, retune the final and you should be in business.

If you are interested in this we might just bring activity back to ten meters, provide considerable activity for clubs, and make mobiling around the country a lot more fun. How about it? Will we be seeing you on Channel A?

(Turn page)

CRYSTALS FOR CHANNEL A

* Most CB rigs can easily be retuned for ten meter operation.

* Channel A will help bring activity back to ten meters.

* Put your CB rig on Channel A with a Texas Crystal.

Texas Crystals is making special crystals for all popular makes of CB rigs so they can operate on:

CHANNEL A . . . 28.60 mc

CHANNEL B . . . 28.65 mc

CHANNEL C . . . 28.70 mc

These crystals would normally sell for \$3.85, however, in the interests of encouraging activity on these channels, we are making them available for only:

\$2.95 postpaid

When ordering please specify channel and make and model of CB rig you are using so we can match the crystal to your particular rig.

ORDER DIRECT from:

TEXAS CRYSTALS,
1000 Crystal Drive,
Fort Myers, Florida

(Save \$10 continued)

The following manufacturers have indicated that their equipment will operate on 28.6 mc. Unless otherwise indicated, the only changes required are new crystals and retuning of the coils in the rf stages of the transmitter and receiver.

Browning Labs R-27 Receiver. Replace first osc. crystal with a 33 mc 3rd overtone crystal.

S-23 Transmitter. Use 3rd overtone 28.6 mc miniature wire-in crystal. **Drake M-506.** Use 6235 kc crystal.

Drake M-523. Use 23,960 3rd overtone wire-in and 24,415 mc fundamental.

e.c.i. Fleet Courier.

General Radiotelephone Company MC6. Receive crystal is 28.6 mc minus 452.1 kc in 3rd overtone. Transmit crystal is 14.3 mc fundamental.

Hallicrafters CB-3A, CB-5 and CB-7, CR-23U crystals. Transmitter is 28.6 mc. Receiver is 28.6 mc plus the

if of the unit. Hallicrafters makes a kit to make the CB-3A or CB-7 receiver tunable.

Hallmark Instruments Model 512.

Heath Company All models. Transmitter uses 3rd overtone crystal. Receive crystal is 455 kc higher.

Maxwell Electronics Radiocom transceivers. Transmit frequency is 28.6 mc. Receive frequency is 455 kc above 28.6 mc.

Polytronics Labs PC "N". Polycom also makes a 10 meter version for CD use. They sell a continuous tuning attachment for receive, the Poly Tuner.

Radio Electronics Designs Model 10/2. Transmit crystal is 28.6 mc divided by three. Receive crystal is third overtone 455 kc below 28.6 mc.

Tram Electronics Receive: Replace 31.5 mc crystal with 33.3 mc parallel resonant 3rd overtone crystal. Use a 4700 kc crystal in receive socket. Transmit crystal is 14.3 mc.

Utica Communications MC 27. Transmit crystal is 3rd overtone. Receive crystal is 1680 kc above 28.6 mc.

Vanguard Electronics Labs Mark 1 and Mark 2.

Vocaline Company Model ED-278.

Webster Manufacturing Company Models 440 and 412.

SB 10 and the ARC-2

Bob Street W6PDD
1543 Los Altos Dr.
Burlingame, Calif.

Recently there has been quite a bit of activity over the ARC2 Transceiver. I have one more to add to the ARC2 field.

The conversion of the ARC2 is for SSB use as well as AM and CW. The conversion is not difficult and should not take more than a few hours.

The conversion consists of biasing the final stage to class AB1, breaking the drive lead to the grids of the final, installing two BNC coax connectors for the drive leads, and grounding the output of the receiver during transmit periods to prevent feed back and VOX lock up.

The change of operation from AM, SSB, CW or Cal, is controlled by the function switch. The old position marked MCW now performs the side band functions in conjunction with some of the existing relays with slight wiring modifications.

1. Rear section of MOD PA compartment: At the rear panel next to the rear modulator tube mount two BNC type coax connectors. These connectors will be used for a break in the drive, where the SB10 will be tied in, or a short piece of RG58 with appropriate connectors for class C operation for phone or CW use.

Mount these connectors near the base of the tube, be sure they clear the snap lock for the tube.

Drill a $\frac{3}{8}$ inch hole between the modulator tubes for the coax leads from the BNC connectors. Be sure not to drill through the existing wiring on the bottom side of this section.

Drill another $\frac{3}{8}$ inch hole between the PA tubes, this hole will accommodate the wiring for the bias switching for the PA tubes.

Make a small mounting bracket for a pair of OB2 regulator tubes and mount it in front of the front generator bracket.

Make a wooden mounting plate for a 22½ volt battery. The mount will fit into the front generator bracket and be secured by the tightening screw on the bracket. Ground the positive end of the battery, negative is bias.

2. At relay K107, AM-MCW relay location:
a) Remove wire No. 26A2 from No. 2 of relay. Remove wire No. 63A1 from No. 1 of relay. Tie these two wires, No. 26A2 and 63A1 together, solder, tape, and tuck

them into the harness.

Remove wire No. 25A1 from No. 3 tape and tuck this wire into the harness.

Disconnect wire No. 83A1 from No. 4, and wire No. 16A1 with No. 16A2 from No. 5.

a) Tie Nos. 25A1, 83A1 and 16A2 together solder, tape, and tuck them into the harness.

b) Run a wire from No. 1 of the relay to ground. Run a wire from No. 2 to the ground end of the bias resistor, R108, a 15K in the final compartment near the front. Remove the ground strap from the ground end of R108.

Run a wire from No. 3 of the relay into the generator compartment for the bias supply, tie it to the negative 22½V. The above changes modify K107, to AM, SSB mode selection under control of the function switch S115, a real dog to get to. One modification must be made on this switch.

3. Run a wire from the anode end of the VR tube string to R109. Tie the wire to the end of R109 farthest from the rear of the chassis, the end near the feed through insulator for the plate of V122 the rear modulator tube.

Run a wire from the cathode end of the VR string to No. 5 of K107, and a ground to No. 6. This connects the regular tubes in the screen grid circuit for linear operation.

4. At K105 keying and receiver disabling relay: On No. 8, wire No. 29A1, disconnect and tape this wire back.

Run a wire from No. 8, the side of the relay coil that is to be keyed, to K102. K102 is the second relay from the front right chassis near the top. Run the wire to the coil contact that is easiest to reach. K105 relay operation will ground the output of the receiver during transmit.

Remove wires No. 27A1, 27A2 and 15A2 from 4 and 5 of K105. Tie these wires together solder, tape and tuck them behind the relay coil. These wires provide the keying path from the key and mike jacks.

At S115 the functions switch: Section "A" of this switch, section nearest the front panel, No. 9 is strapped to No. 10. Strap No. 8 to No. 9. This will turn on the bfo in SSB function position.

NEW STORE HOURS

Spencer Amateur Radio

145 Main St. Spencer, Mass.
1PM to 9PM Mon.-Fri. 1PM to 5:30 Sat.
All leading brands, Time payments, Trade-ins etc.
W11TX (Indian take an ex-lax) K1HDM

BUILD A TV CAMERA!!

~ EXPERIENCE THE FUN OF HAM RADIO'S NEWEST FRONTIER ~

New low cost vidicon focus & deflection coils now make it possible to construct your own budget priced TV camera. Each coil kit comes complete with assembly instructions plus an "easy-to-build" 5 tube camera schematic. Complete kit only \$19.90. Postpaid delivery in U. S. and Canada.

Send 10c in coin for further information.

ATV RESEARCH, Box 396, South Sioux City, Nebraska

ACHTUNG 75A-4 USERS

A Collins Noise Blanker installed in your 75A-4 will extensively reduce ignition and other noise up to 5000 pulses per second.

New Collins 136C-1 noise blankers with simple installation, regular net \$124 now only \$49 while they last.

Richard E. Mann, 7205 Center Drive, Des Moines, Iowa

LOOKING? SHOPPING? TRADING? TRYING TO SAVE MONEY?

Write Bob Graham for Special Deals on New and Re-conditioned used gear. Cash or Budget.

Graham Radio

Dept. C., Reading, Mass.

Tel: 944-4000.

GUARANTEED RECONDITIONED HAM GEAR



Phone: (415)
DI 2-5757

ELECTRONICS

WRITE NOW
FOR MONTHLY
FLYER.

999 HOWARD AVE-BURLINGAME, CAL.

ELIMINATE MOBILE VIBRATOR NOISE

Revolutionary device outmodes noise-creating vibrator. Completely transistorized unit plugs directly into vibrator socket. No moving parts. Smaller than vibrator. 12 volts, Neg. Gnd. Not a kit. Comes completely encased, wired, ready to plug in. State whether pin one on vibrator socket is positive or grounded. Or, send schematic which we will return. \$12.95 PPD.—\$5.00 deposit on all C.O.D. orders

Tel-Trol Systems

2180 Bronx Park East

Bronx, New York 10462

TV CAMERA

We have the lowest prices and complete stock of all components for making your own Ham TV or closed circuit TV camera plus exclusive VANGUARD printed circuits and incredibly low prices on F1.9 lens with focusing mounts. Complete ready-to-operate cameras also available at the lowest prices you'll ever find.

For more information, price list, and photos, send 10c coin or stamps.

VANGUARD ELECTRONICS LABS, Dept. H-9
190-48—99th Ave. Hollis, N. Y. 11423

DX QSO Recorder

W1HOZ

NUMBER OF COUNTRIES CONTACTED NUMBER OF COUNTRIES CONFIRMED

DX CHASERS

HEAVY 8X10 QSO RECORDER IS BEST DX AWARD FOR WALL. SIMPLY TURNING SPINNERS ALWAYS SHOWS EXACT NUMBER COUNTRIES QSOED AND QSLD. ALSO, EXPLAINS DX CHASING TO VISITORS AT A GLANCE. \$2.50 PPD.

VIKING PRODUCTS



ALL HAMS UR CALL AND NAME GOLD EMBOSSED ON HANDSOME PEN AND PENCIL SET. IDEAL GIFT FOR THE CHIEF OP. SPECIFY RED, BLUE, WHITE OR BLACK. REQUEST SPECIAL PRICE ON QUANTITIES WITH DUPLICATE LETTERING FOR GROUP EVENTS. PRINT NAME AND CALL CLEARLY. PEN OR PENCIL ONLY \$2.75 PPD. PAIR \$4.50 PPD.

DEPT. B-3, 196 SO. MAIN ST., ORANGE, MASS.

5. Grid Drive for Final: In the compartment under the rf tubes disconnect the coax from pin No. 5 of V104, and run it through the hole previously drilled to one of the BNC connectors.

From the other BNC connector run a short piece of RG58 back to where you disconnected the above mentioned drive lead.

6. All that is left is to plug the SB10 to the in and out jacks turn on the power and;

side band with the ARC2.

Now if someone can tell me how to clean up the selectivity of the ARC2 without adding an external appendage, something that will track the tuning I'll feel my time wasn't wasted. The thing that makes it difficult is the variable *if* that is tuned from 1 to 1.5 Mc throughout each band.

Next project for the ARC2 is how to key the P.T.O. for NBFM and RTTY, that is to do it and maintain the stability.

Bob Rooney W2QCI
251 Price Street
Lockport, New York

RF Hazard

With the possibility that one kilowatt stations may soon make their first appearance on the amateur band 420-450 mc it may be timely to consider the often discussed hazard of radio frequency radiation on the UHF bands. Although this subject has been given considerable study by companies engaged in UHF communications, comparatively little has been learned as to how much radio radiation actually constitutes a hazard. We are reminded however, that a hazard does exist by frequent news of injury to technicians working with high power radar transmitters.

Nor is this hazard restricted to the microwave range. A rather recent study conducted by Dr. Pearce Bailey of the National Institute of Health indicates that over ten monkeys

have been killed from less than five minutes exposure to relatively low power radiation in the range 380-390 mc. Radiation is measured (in this case) in watts/ sq cm with the following levels generally considered as reference values.

0.01 watt/ sq cm is representative of the radiation level in a typical radar room. It is considered a safe value for day-to-day exposure. This value is equivalent to 60 volts/meter.

0.1 watt/ sq cm is considered safe for only limited exposures of a few hours. It is equivalent to 190 volts/meter. At this level the blood does not provide adequate cooling for the heat created by the radiation. This level must be regarded as dangerous.

1.0 watt/ sq cm is an extremely dangerous level of radiation for all but momentary exposures. This is equivalent to 600 volts/meter. Extended exposure will very likely cause brain damage at UHF.

Now let's consider some of the cases that may occur at amateur stations operating in the band 420-450 mc if the FCC grants final approval to the 1 kw power limit on this band. An example of the maximum power station on 420 mc is the case of a transmitter *delivering* 500 watts to a stacked array with a gain of 19 db. This works out to be an antenna gain of 79. (Antenna gain = anti log of db gain/10). To find the effective radiated power (ERP) we multiply the power input to the antenna

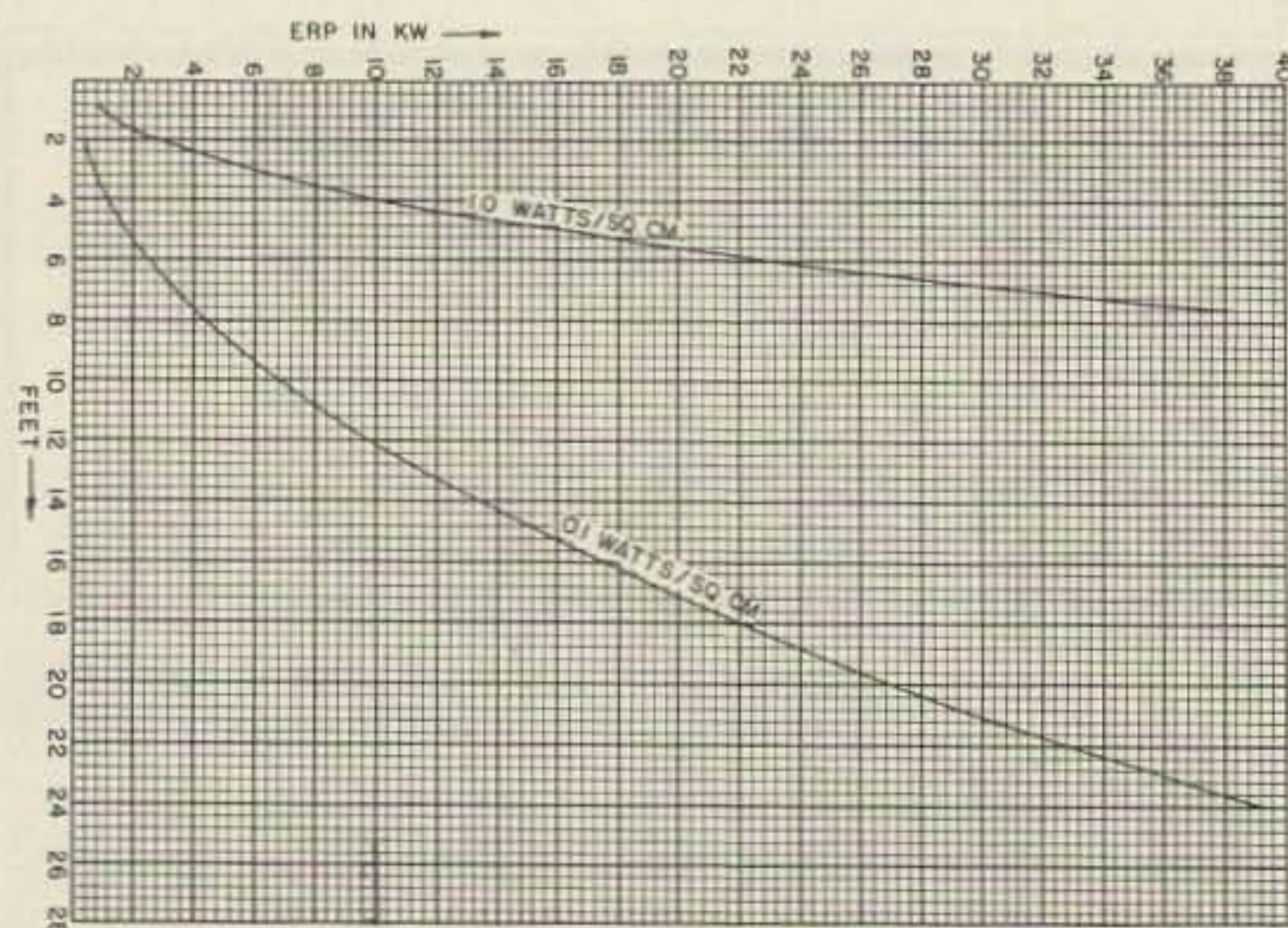

Distance of dangerous rf fields as a function of ERP.

by the gain which results in 39,500 watts ERP for this station in the forward direction of the beam. The problem now is to calculate at what distances the values of 0.01, 0.1, and 1.0 watt/sq cm will occur from an antenna radiating 39,500 watts ERP. For this, a handy formula has been derived which can be summarized as follows:

0.01 watt/sq cm occurs at (12.1 times the square root of the ERP in kw) feet.

0.1 watt/sq cm occurs at (3.82 times the square root of the ERP in kw) feet.

1.0 watt/sq cm occurs at (1.21 times the square root of the ERP in kw) feet.

Substituting our value of 39.5 kw ERP we find that 0.01, 0.1, and 1.0 watts/sq cm will occur at 76.0, 24.0, and 7.6 feet respectively. From the foregoing it can be concluded that working near a beam delivering 39.5 kw ERP can be quite dangerous. If beam adjustments are being made from a rooftop or from a tower, it is therefore advisable that the adjuster retire to ground level when the transmitter is energized.

Now let's consider a more typical case of the serious 420 mc operator who only runs medium power. This would be in the range of 3,700 watts ERP. Such power would be radiated by a transmitter delivering 150 watts to a 8 over 8 stacked array with a 14 db gain. In this case, the danger levels of 0.1 and 1.0 watts/sq cm exist at 7.41 and 2.35 feet respectively from the front of the beam. Still powerful enough to keep your distance when the transmitter is energized.

Finally we consider the case of the low power station. This station delivers 25 watts to an antenna with 11 db gain. This results in 315 watts ERP. The 0.1 and 1 watt/sq cm fields appear respectively at 2.14 and .678 feet from the forward direction of the antenna. Even at this level it is best to back off the antenna when power is applied.

When working with these reference levels of radiation we should consider two important factors. The first is that our calculated values apply only to the forward beam direction in the same plane as the boom of the beam. In any other direction the radiation will naturally be reduced. Our second consideration is the very high attenuation of UHF signals by obstacles. For example, a brick wall will reduce a UHF signal at least 10 db and this would probably reduce the radiation to a safe level with any power level the amateur would encounter. This should relax those who might be concerned about radiation entering a house in the path of the antenna beam.

It should be realized that although the

MAKE YOUR HEATH SIXER OR TWOER A SELECTIVE SUPERHET

No power supply changes
No cable changes
All circuits inside
original case

SIXER MOD. KIT \$34.85
TWOER MOD. KIT \$29.50

(incl. illustrated manual)

**LAWRENCE
ENGINEERING CO.**

36 LAWRENCE RD., HAMDEN, CONN. 06518

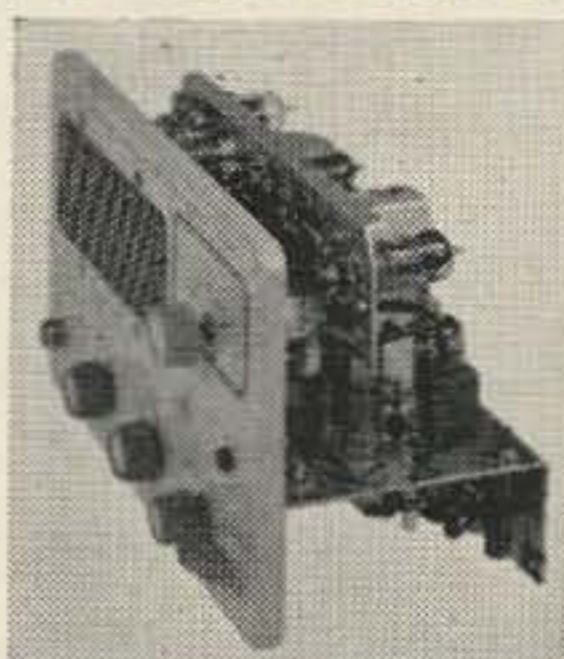

CONVERTER SALE

New model series 300 with 3 VHF transistors, crystal, and more than 30 high quality parts. Carefully assembled and tested. Measures only 3" x 2 1/4" x 2". Low noise and better than 1 microvolt sensitivity. Made in USA and guaranteed. Available in the following models for 12 volts DC:

Model	Input mc.	Output mc.	Price
300-A	26.965-27.255	1.0-1.255	\$10.95 ppd.
300-B	50-51	.6-1.6	\$10.95 ppd.
300-C	50-54	14-18	\$10.95 ppd.
300-D	144-148	50-54	\$12.95 ppd.
300-E	144-145	.6-1.6	\$12.95 ppd.
300-F	144-146	28-30	\$12.95 ppd.
300-G	14.0-14.35	1.0-1.35	\$10.95 ppd.
300-H	5.0 (WWV)	1.0	\$10.95 ppd.
300-X	Choice of 1 input freq & one output freq between .6 & 160 mc		\$14.95 ppd.

Note: All above converters have a tuned R.F. Stage.

Order now while prices are still low.

All above converters are supplied with Motorola type connectors. For two SO-239 connectors instead, add 75c. N.Y.C. residents add 4% sales tax.

VANGUARD ELECTRONICS LABS Dept. H-9
190-48-99th Ave. Hollis 23, N. Y.

Reyco Multiband Antenna Coils

Traps for dipoles . . . high strength . . . moisture proof guaranteed to handle a full KW. Model KW-40 coils will, with a 108 foot antenna, provide operation on 10-15-20-40-80. \$12.50 set.

For information on other models write:

**FRED L. REYNOLDS W2VS, 492 Ravenswood Ave.,
Rochester 19, New York**

TEST EQUIPMENT

TEKTRONIX, H.P., G.R., MEASUREMENTS,
MILITARY TEST SETS, WAVEGUIDES, ETC.

BUY—SELL—TRADE: SEND FOR CATALOG

J. R. Tucker, Box 206, Garland, Texas

Panoramic Indicator IP69/ALA-2 See June 73 for conversion data shipping wt 18 lbs, September special

\$17.50 unused

RTTY RELAY TEST SET I-193-B for 255 etc \$27.50

Send self addressed envelope for listing

ARROW SALES-CHICAGO, INC.

2534 S. MICHIGAN AVENUE
CHICAGO 16, ILLINOIS

values given for radiation at a distance are quite accurate, the effects they produce on the human body are in part dependent on frequency and can not be stated to any large degree of precision. At higher frequencies than 420 mc these effects are much more serious. At lower frequencies the radiation is not nearly as dangerous. When high gain antennas are used it should also be understood that even low power can produce a high ERP.

Because of the many "unknowns" which still exist in this field, the amateur should always be careful when working with UHF radiation and allow a generous safety margin.

... W2QCI

References

- The American Radio Relay League, *The A.R.R.L. Antenna Book*, West Hartford, 1955.
 Gihring, H. E., "Antennas for Television Broadcast" in the *NAB Engineering Handbook*, ed. by A. Prose Walker, New York, 1960.

How to Raise a Beam

Fred Haines W2RWJ
 123 Roberta Dr.
 Liverpool, N. Y.

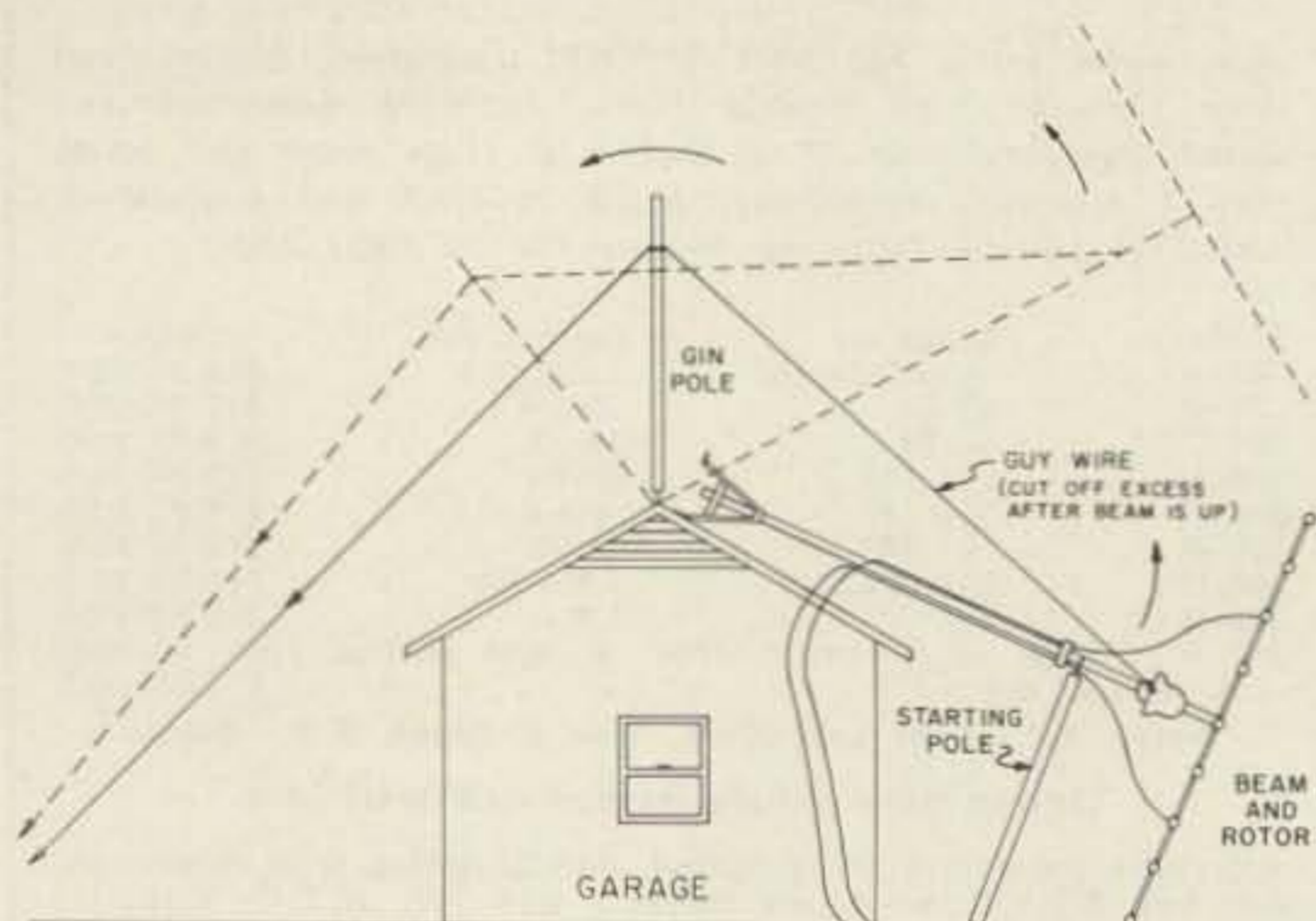

The antenna base is a TV antenna tripod about two feet tall. Bolt two hinged feet to roof first, then third. The dotted lines illustrate the path of the antenna as it is raised. The starting pole is used to lift the antenna above the horizontal, after which two men on the wire can raise the beam.

After purchasing a combination six and two meter Yagi last fall with a rotator and assembling it on the ground, it occurred to us that some difficulty might be encountered in raising it up on the roof and placing it on top of a 20 foot pole. A trip to the top of the 15 foot garage roof confirmed the suspicion. The old legs and also the confidence went to pot at this modest height, the back yard sure looked far away.

With blind determination however, we forged ahead and placed the assembled beam, rotor, guy wires, and 20 foot pole in the driveway. All connections to the feed lines were made tight and sprayed with lacquer and the guy wire eye bolts were screwed into the house at the proper points. The bottom of the

pole was handed up to me on the roof by the XYL and the plan was to bolt it into the tripod base on the roof and swing it skyward. Ha! It was impossible! The assembly wouldn't budge an inch.

The VHF fever was biting pretty hard though and a way would be found somehow. The accompanying diagrams illustrate the solution I worked out. Once up, the beam was over forty feet above the average surrounding terrain, and this height has been the biggest factor in the excellent 2 meter results I have had at W2RWJ. Others in the vicinity with higher power and lower beam height have not worked out as well. The effort was well worth expending.

... W2RWJ

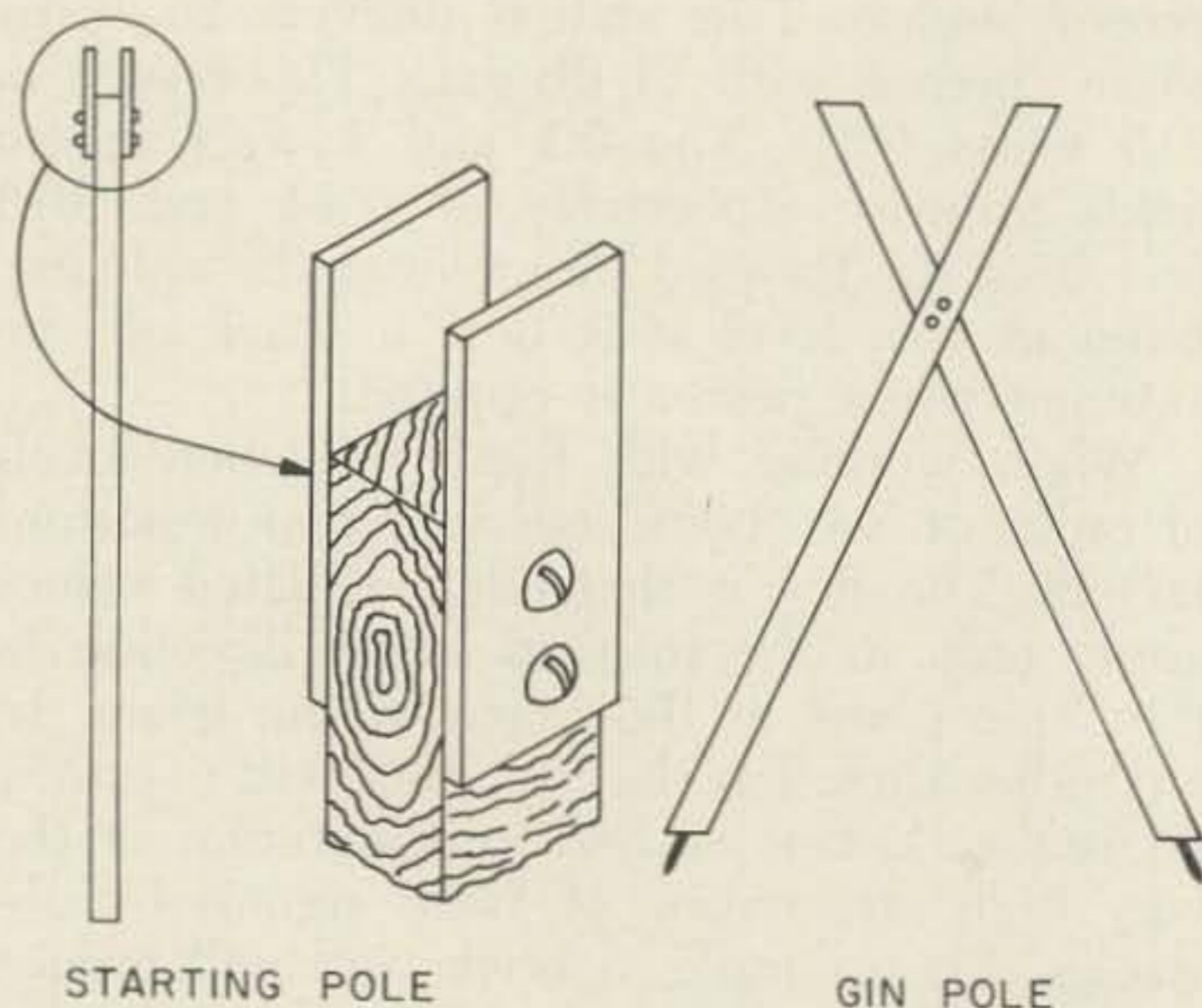

STARTING POLE

GIN POLE

Starting pole: 2 x 2 fir, 12 feet long with two mending plates bolted at top.
 Gin pole: 2 x 2 fir, 8 feet long nailed together as shown. Note spikes made from headless nails inserted in drilled holes. These pierce roof shingles to provide firm footing. Patch roof later with two dabs of roofing cement.

Citizens Radio Rules Tightened

After considering the more than 2,500 comments filed in Docket 14843, and other related information before it, the Commission adopted a Report and Order amending Part 95 (formerly Part 19) of its rules governing the Citizens Radio Service, effective Nov. 1. A major purpose of the rule changes is to clarify the permissible and prohibited communications and uses of citizens radio stations. The rule changes relate principally to operations of Class D stations in this service.

The Citizens Radio Service is designed to provide useful short-distance radiocommunication to meet the business and personal needs of a large segment of the public. The desirability of permitting hobby-type operation has been given particular consideration and earlier determination that the public interest would not be served by permitting such activity has been reaffirmed. Licensees are specifically prohibited from engaging in radiocommunications as a hobby or diversion; that is, operating the radio station as an activity in and of itself.

The Commission notes that the trend on the part of many Class D citizens licensees to use their stations for hobby-type operations has grown to the extent that the utility of the service for its original purposes has been substantially impaired. While anticipating that the rule amendments will assist the conscientious licensee to operate in accordance with the spirit and intent of the rules and thereby lessen enforcement problems, the Commission warns that if there is a continued misuse of operating privileges, it will consider again the fundamental question of whether the public convenience, interest or necessity is served by the continuance of the service.

Some of the significant provisions of the amended rules are:

1. The primary purpose of the Class D citizens authorization as a means of communication between units of a single licensee is emphasized.

2. Communication between units of different Class D stations (interstation) is permitted only under certain stated conditions and is restricted to seven designated frequencies (Citizens channels 9, 10, 11, 12, 13, 14 and 23).

3. All interstation communications are limited to no more than 5 consecutive minutes with a silent period of at least 5 minutes before another transmission is permitted.

4. The rules are modified to make it clear that call sign identification shall be made on each frequency used and identification shall include the station being called. Licensees commencing a communication on one frequency and then switching to another channel must give the proper identification of its station on each channel.

5. In general, all users of citizens radio equipment are required to obtain their own licenses and operate under their own call signs. Thus, except in the case of a station used solely for the control of certain remote objects or devices by radio, a citizens radio station may be operated only by the licensee, by members of his immediate family living in the same household, or by employees of the licensee acting within the scope of their employment.

6. The former provision of the rules which prohibited the operation of a citizens radio transmitter under more than one station license has been deleted. Accordingly, radiocommunication for such organizations as civil defense agencies, volunteer fire departments and auxiliary police should, in the future, be conducted under a single station license issued to the organization rather than under licenses issued to individual members of such organizations.

7. The practice of licensees "loaning" their call signs to other persons in order that the latter may operate radio apparatus pending the filing of and action on an application is specifically prohibited by Section 301 of the Communications Act and Sections 95.83(c) and 95.87 of the Commission's rules.

\$5.00 FREIGHT ALLOWANCE :



WRITE FOR ANTENNA PACKAGE INFO

NO MONEY DOWN

SAVE

BUY FROM WRL

WRL SPIRE SPAULDING TOWERS

SELF-SUPPORTING

3 SIZES 32', 40', 48'

All self-supporting with large tribander or other beams. May be extended to 120 ft. with proper guying.

3 MOUNTING BASES

(a) Rigid concrete mount. (b) Concrete mount with hinge base. (c) Earth anchor with hinge base (no concrete).

- ★ Fully galvanized
- ★ Aircraft riveted
- ★ Streamlined appearance
- ★ Includes rotor mount for Ham-M, AR22, etc.

\$58⁸⁵

32 FOOT RIGID CONCRETE MOUNT

All shipments are via truck, collect, with \$5.00 frt. allowance.

"By Demand - Most Popular Tower in the USA"

WRL World Radio Laboratories, Inc.
3415 W BROADWAY • PHONE 328-1851
COUNCIL BLUFFS, IOWA

8. A new section has been adopted in the rules which spells out various prohibited uses. Some of them are:
- (a) Activities in violation of law.
 - (b) Carrying communications for hire.
 - (c) Communications containing obscene, indecent or profane words, language or meaning.
 - (d) Communications in the nature of a broadcast or those not directed to specific persons.
 - (e) Malicious interference.
 - (f) Transmissions of music, whistling, sound effects, etc.
 - (g) Communications to stations of other licensees relating to technical performance, capabilities, testing of any transmitter, including transmissions concerning signal strength of frequency stability of transmitters.
 - (h) Communications advertising or soliciting the sale of goods or services.
 - (i) Communications to another station over a distance of more than 150 miles. (This new limit is far beyond the groundwave communications range under normal conditions. Normally the groundwave range would not exceed 25 miles.)
 - (j) Person engaged in selling citizens radio apparatus shall not allow customers to operate under the seller's station license.
9. An individual whose own radio station license has been revoked or cancelled is prohibited from operating another licensee's station of the same class until he is again issued a license of that class by the Commission.
- Because there are now some 700,000 citizens radio stations, the Commission is unable to furnish copies of the revised rules to meet requests of individual licensees. However, all citizens licensees are now being required to maintain a current copy of Part 95 of the rules covering this service, hence the subscription method afforded by the Government Printing Office entitles subscribers to receive a copy of these and subsequent citizens rule changes. Meanwhile, the text of the new rules will be published in an early issue of the Federal Register, which may be purchased from the Government Printing Office, Washington, D. C. 20402.

SERVICE TESTED EQUIPMENT

from



HERE IS A PARTIAL LIST OF OUR QUALITY RECONDITIONED HAM GEAR, FULLY GUARANTEED, AND SHIPPED PREPAID WITHIN THE CONTINENTAL U. S. WITH CASH ORDERS.

RECEIVERS

Collins 75A-1	\$169.50	Elmac AF-68	129.00
Collins 75A-4	425.00	Globe Chiefs	27.50
Collins 75A-4 (late Ser. #)	475.00	Globe Scouts	45.00
Collins 75S-1	369.50	Gonset G77	99.00
Collins 75S-3	565.00	Gonset GSB-100	219.00
Elmac PMR-6A	39.50	Hallicrafters HT-32A	359.00
Elmac PMR-8	119.50	Hallicrafters HT-37	275.00
Gonset G-66B	79.00	Hammarlund HX-50	275.00
Gonset 3 way Power Supply	15.00	Heath Apache	179.00
Hallicrafters S-76	85.00	Heath Warrior Linear	219.00
Hallicrafters S-99	89.00	Heath DX-40	39.00
Hallicrafters SX-101	199.00	Heath SB-10	59.00
Hallicrafters SX-101A	239.00	Johnson Ranger	119.00
Hallicrafters SX-110	129.00	Johnson Valiant	219.00
Hallicrafters SX-140	89.00	Johnson Valiant	219.00
Hallicrafters S-120	54.50	Johnson Valiant II	335.00
Hammarlund HQ-100	119.00	Johnson Invader 200 (new)	499.00
Hammarlund HQ-110	109.00	Johnson Invader 2000	695.00
Hammarlund HQ-145-C	199.00		
Hammarlund HQ-170-C	219.00		
Hammarlund HQ-180-C	319.00		
National NC-173	75.00		
National NC-170	189.00		
National NC-270	149.00		
National NC-300	189.00		
National NC-303	275.00		
RME DB-23 Preselector	27.50		

TRANSCEIVERS

Gonset G-76 w/Power Supply	\$275.00
Hallicrafters SR-150	495.00
Hallicrafters PS-150 AC Sup.	79.50
Swan SW-140	159.00
Swan SW-140	159.00
Swan SW-175	165.00

TRANSMITTERS

B & W 5100	\$149.00
B & W 6100 (new) Reg. 875.00	595.00
Central Electronics 20-A	119.00
Collins 32S-1	449.00
Collins 32S-3 w/516F1 P/S	675.00
Elmac AF-67	59.00

VHF EQUIPMENT

Gonset 6M Comm III	\$159.00
Gonset 6M Comm IV	219.00
Gonset 2M Comm IV	259.00
Heath "Sixer"	39.50
Poly-Com PC-2	249.00
Poly-Com PC-6	279.00

"THE STORE OPERATED BY HAMS FOR HAMS"
K6LOS, K6GCD, K6DXD, K6EF, K1SFQ, W600E

MISSION HAM SUPPLIES

3316 Main Street
Riverside 3, California 92501
Phone 683-0523 (area code 714)

ORDER
TODAY

Mission Ham Supplies

3316 Main Street, Riverside 3, Calif. 92501

Attn: Bill Hullquist, K6LOS Ship me the following:

\$ enclosed. Cash orders prepaid within continental United States.

Name _____ Call _____

PLEASE PRINT

Address _____

City _____ Zone _____ State _____

Put me on your mailing list. Calif. Add 4% Tax

Quement

ELECTRONICS

"YOUR COLLINS HEADQUARTERS"

C-O-O-L BARGAINS



ROTRON MUFFIN FANS

110V AC 60 cycle (Like New Used)

4⁸⁸

EACH
Allow 50c for packing and shipping. California residents include 4% sales tax.

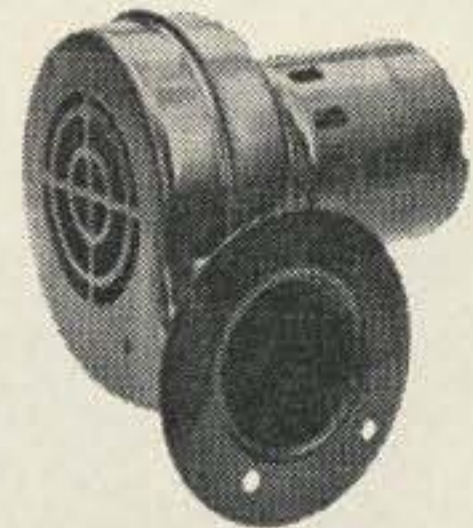

SQUIRREL CAGE BLOWERS

2 1/4" vent—approx. 100 cfm—220V AC 60 cycle
Simply parallel the two windings for 110V AC
(LIKE NEW USED)

TIMER MOTOR

CLUTCH DRIVE FOR RESET
MAKE CLOCKS or 10-MINUTE TIMERS

Hundreds of Uses

BUY SEVERAL
Allow 25c each for shipping



48c
EACH

1/60 RPM
110V AC
60 cycle

3⁸⁸

Allow 50c shipping
Collapsible
2 METER
GROUND PLANE
ANTENNA

Broad Band
"N" connector furnished



LOOK!

20,000 OHMS per VOLT DC
1% Precision Resistors

RANGES:
AC volts: 0-10-50-250-1000
DC volts: 0-5-25-125-500-2500
DC current: 0-250 mil, 0-50 microamp
OHMS: 0-10,000 & 1 meg.
Expanded low-ohm scale.
DB: -20 to +22

Test Leads
Leather Carrying Case



9⁹⁵

Allow 50c for packing & shipping. Calif. residents include 4% sales tax.

S.W.R. BRIDGE and FIELD STRENGTH METER

9⁹⁵

Allow 50c for packing and shipping. California residents include 4% sales tax.

MAY BE LEFT IN LINE, UP TO 2000 WATTS.

GOOD THROUGH 2 METERS



THE BEST VALUE WE HAVE EVER OFFERED!

THE IDEAL MOBILE MIKE

HIGHEST OUTPUT CERAMIC MICROPHONE AVAILABLE — AVERAGE LEVEL — 48 db. TWICE THE VOLTAGE OUTPUT OF ANY OTHER CERAMIC MIKE. RESPONSE CURVE TAILORED FOR MAXIMUM INTELLIGIBILITY 300 to 4000 CYCLES.

- Rugged Hi-Impact cyclac, take-apart case.
- Shock-resistant internal construction.
- Extra heavy duty push-to-talk switch can be rewired for special applications.
- Heavy duty rubber covered coil cord. 3 conductor, 1 shielded, 12" retracted, 6' extended.
- Spring retainer hang up clip.

5⁸⁸

Allow 50c for packing & shipping. Calif. residents add 4% sales tax

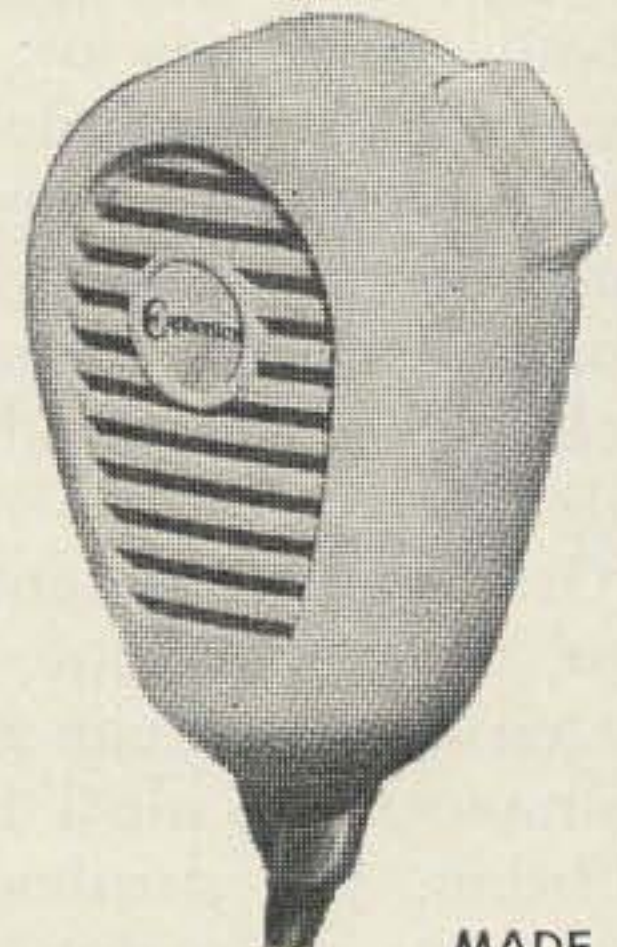

MADE IN U.S.A.

QUEMENT ELECTRONICS
1000 SOUTH BASCOM AVE. SAN JOSE, CALIF.

"NORTHERN CALIFORNIA'S MOST COMPLETE HAM STORE"

Low Cost Power for Surplus DC Motors

Roy Pafenberg W4WKM
316 Stratford Ave.
Fairfax, Virginia



This view of the blower panel using surplus dc blowers shows mounting details of the 20 ampere silicon diode mica insulators insulate the diode from the aluminum mounting plate which serves as a heat sink.

Direct current motors designed for 24 volt aircraft use are a drug on the military surplus equipment market. Not only are the basic motors available in a wide range of types and sizes, but many types of complete motor-driven assemblies are also available. Although prices are extremely low, only those units which meet a "hot" requirement have proven popular. Examples are the prop pitch motor for beam rotator use and surplus motor driven switches such as those featured in a recent 73 Magazine article.¹

Other amateur motor requirements include fans, blowers, remote tuning drives and motor driven band-switching systems. Many available dc motors are ideal for these applications. In addition, the surplus market is loaded with low cost, dc motor driven assemblies which were custom designed to meet these precise requirements. The problem is to adapt these motors for operation from the ac line.

The ideal source of operating power for all

¹ "A Surplus Motor Driven Coaxial Switch," W4WKM, August, 1962.

of these motors is a rock-solid, well regulated dc supply. Such an ac operated supply would consist of a substantial power transformer feeding a full-wave bridge rectifier with a modicum of filter. However, provision of such a supply for amateur applications would probably wipe out any cost advantage in the use of the surplus motors.

Most of the available 28 volt dc motors are of two general types: permanent magnet field motors and series wound units in which the field and the commutated armature windings are connected in series. For the permanent

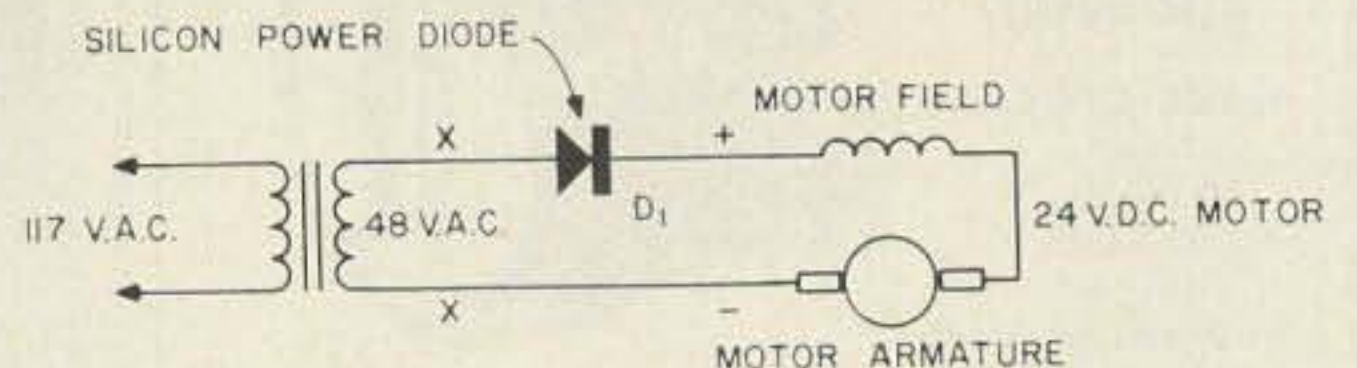

FIGURE 1A

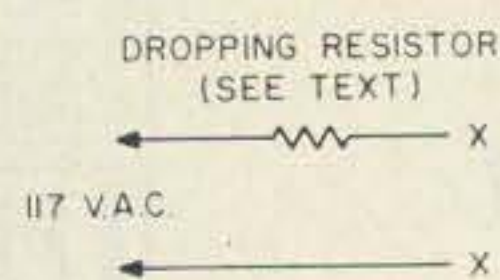

FIGURE 1B

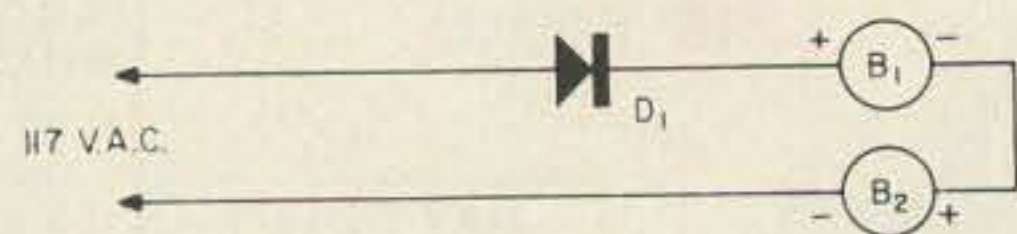

FIGURE 1C

1a Basic circuit for operating 24 volt dc motors from an unfiltered half wave rectifier. 1b Alternate voltage dropping circuit for use in Fig. 1A. Delete the power transformer and connect at points X.

1c Schematic diagram of the blower panel shown in the photographs. D1 is a 20 ampere, 400 PIV silicon diode, Lafayette Radio type SP-269. B1 and B2 are identical, 24 volt dc aircraft blowers.

FIRST AND ONLY TRANSISTORIZED 2 METER SSB-AM-CW TRANSCEIVER FOR MOBILE, PORTABLE AND FIXED COMMUNICATIONS

The totally new Gonset Model 900A *Sidewinder* is the first and only transistorized SSB-AM-CW transceiver (except mixer, driver, final stages in transmitter) to provide complete coverage of the 2 meter amateur band in 4 segments 1 MC wide. Yet it's so compact it fits quickly under the dash of the newest cars! Transistor design makes possible a primary power requirement in the receiver of less than 1/2 amp! Separate power supply accessories snap-fasten to back of transceiver, or may be used for remote installation. Here's the trouble free, solid state transceiver with power to spare for any fixed, portable or mobile application!

For complete information, visit your Gonset Distributor, or write Dept. _____.

CHECK THESE HIGH-PERFORMANCE SPECIFICATIONS:

TRANSMITTER: Transistorized (except for mixer, driver, final states)
• Frequency Range: 144-148 MC • Power Input: 20 watts PEP SSB, 6 watts AM, 20 watts CW • Spurious Suppression: -50 db • Carrier Suppression: -50 db on SSB • Unwanted Sideband Suppression: -40 db • Features include VFO low frequency 1st conversion, with crystal controlled high frequency 2nd conversion for stability, filter type side-band generation and broadband circuits for easy operation.

RECEIVER: All-transistorized • Frequency Stability: Highly stable; utilizes same VFO as transmitter • Sensitivity: 1/2 microvolts or better for 10 db $S+N$ • Selectivity: 3.5 kc filter for both receiver and transmitter • Audio Output: 3.0 watts • Spurious Suppression: -50 db or better • Image Rejection: -50db (receiver and transmitter utilize double conversion) • Full RF amplifier with three tuned circuits for low noise figure, good selectivity. Separate RF and AF gain controls.

TRANSCEIVER: Both the receiver and transmitter are dual conversion, using 15 MC and 9 MC frequencies with a hermetically sealed crystal lattice filter. Dimensions: 8 7/8" W., 4 7/8" H., 7 1/6" D. • Wt.: 10 lbs.-8 oz. POWER SUPPLY: Dimensions: (AC or DC) 8 7/8" W., 4 7/8" H., 5 1/6" D. • Wt.: 13 lbs.-8 oz.

PRICE: TRANSCEIVER: \$399.50 Amateur Net; POWER SUPPLY: AC-\$67.75 Amateur Net • DC-\$79.50 Amateur Net



© ALTEC LANSING CORPORATION

GONSET, INC.

ALTEC LANSING CORPORATION

LTV A Subsidiary of Ling-Temco-Vought, Inc.

1515 S. MANCHESTER AVENUE, ANAHEIM, CALIFORNIA

magnet field motors, dc operating power is an absolute requirement. Operating power requirements for series wound motors are dependent on motor design and conditions of use.

As a general class, series wound motors may be operated from either ac or dc power sources. Special design characteristics are required for use on ac power. These features include use of laminated magnetic materials to reduce hysteresis losses, special winding design and selection of proper brush material. For any particular motor, the speed and torque developed will be greater on dc than on ac. Voltage requirements for ac-dc motors can vary considerably. As an example, I have in front of me a surplus band switching motor which carries a name plate rating of 50 volts dc or 110 volts ac, 25 to 60 cycles. So-called universal motors are specifically designed to operate from either ac or dc power of approximately the same voltage to produce approximately the same output speed and torque.

Now back to the surplus 28 volt dc motors. First of all, almost all of these motors are specifically designed for dc use and as a result have unlaminated magnetic poles and frames and the brushes and windings are designed for dc use. This does not rule out the use of ac power for such motors if they are to be operated intermittently and/or at reduced voltage and output load. The continued successful use of prop pitch motors in beam rotator applications proves this point. If you have such an intermittent or light duty application, then use ac to power your surplus motor. Operating voltage and maximum load must be determined experimentally. Start with reduced voltage and load and gradually increase the voltage until excessive motor heating is observed. Hopefully, the desired speed and torque will be obtained before excessive heating is observed. Good luck!

If ac operation results in excessive heating and a well regulated dc supply is prohibitive, there is still another way around the problem.

ZEUS®

Portable Electric Generator

World's simplest, most reliable power generator

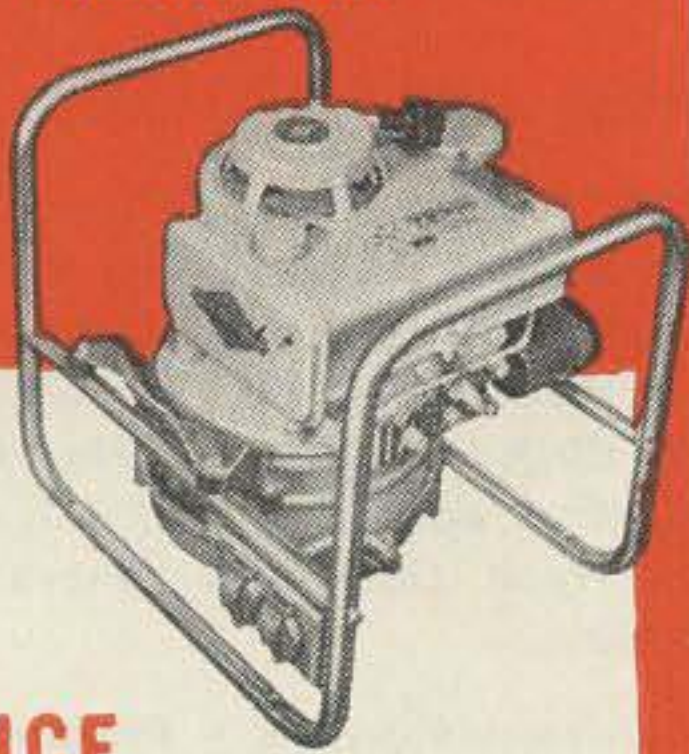

VIRTUALLY ELIMINATES RADIO INTERFERENCE

- Exclusive Permanent Magnet Alternator is the only moving part—no brushes, slip rings, bearings, commutators, etc., to produce irritating generator noise common to ordinary portable units.
- 115/220 volts, 60 cycle, AC, 1250 watt continuous rating.
- Gasoline powered—quickly adaptable to liquid propane
- Burn-out-proof against overloading or sudden surges.
- Compact—one man can handle.

Three models — 1000—1250—3000 watts

Available now from your local electronic parts distributor

the antenna specialists co.

12435 Euclid Ave., Cleveland 6, Ohio
Exp. Div. 15 Moore St., New York 4, N.Y.



This compact transmitter blower panel uses a single silicon diode to power two series connected, 24 volt dc axial-vane aircraft blowers from the 117 volt ac line.

As was pointed out in the referenced article,¹ a single, low cost silicon diode may be used as a half wave rectifier to supply operating power to dc motors. Fig. 1 shows how this is accomplished. Since no filter capacitor is used, the silicon diode, D1, provides the dual function of supplying the required dc operating power and also gives an effective 50% voltage reduction. Thus, for 24 volt dc motors, a 48 volt transformer is required. However, for many applications a dropping resistor may be used to supply power directly from the ac line. The effective 50% voltage drop across the silicon diode will, for many light duty applications, allow the use of a reasonably low wattage resistor. The value of such a resistor must be determined experimentally since it will be dependent on the motor load and the characteristics of the motor. For short duty cycle operation the resistor may be substantially overloaded without damage. For continuous duty applications, the usual power dissipation requirements apply. The silicon diode should have a minimum peak inverse rating of 400 volts. With the low cost of power diodes today, a substantial maximum current safety factor to accommodate the motor starting surge current can be economically provided.

Fig. 1C and the photographs show a rather unusual application of the techniques described above. The blowers shown are axial vane aircraft blowers designed to operate from 24 volts dc. These units operate at 14,200 RPM and use 1/12 HP motors designed for continuous duty use. Operating current is 4.7 amperes and each blower is rated at 60 CFM. As shown in Fig. 1C, the motors are wired in series with the silicon diode and connected directly to the ac line. The silicon diode is a

CLIP AND MAIL

FREE!

EXCLUSIVE HAM CATALOG

Now! the most complete amateur catalog ever compiled.



HAM/CB

- 100's of Bargains for the Ham, CB'ers & experimenter.
- Exclusive WRL "Charge-A-Plan" Application.
- The best prices available anywhere!

WORLD RADIO LABORATORIES

3415 West Broadway, Council Bluffs, Iowa

Rush my Free WRL 1965 Catalog

NAME _____

ADDRESS _____



CITY _____ STATE _____

SEND FOR IT TODAY FREE

CLIP AND MAIL

FEEDLINE RIOT! *

TWIN LEAD

Economy (7 strand)	100'	\$1.00	3 lbs
	250'	2.25	5 lbs
Crusader (10 strand)	100'	1.25	3 lbs
	250'	2.50	5 lbs
Heavy Duty (20 strand) Deluxe Copperweld	100'	1.98	3 lbs
	250'	4.75	6 lbs
Spongee 	100'	3.30	5 lbs
	250'	8.00	12 lbs
Tubular 	100'	2.00	3 lbs
	250'	4.75	8 lbs
Classic (41 strand)	100'	2.50	5 lbs
	250'	6.00	12 lbs

Price and efficiency are closely allied. If you want the lowest loss possible you would do well to use Classic or Spongee Lines. The formula is simple: the more copper and the better dielectric used, the more expensive the line.

COAX

RG-8/U 52 Ohm Foam	100'	\$12.50	12 lbs
RG-11/U 75 Ohm Foam	100'	11.00	10 lbs
RG-58/U 53 Ohm	100'	4.75	4 lbs
RG-59/U 73 Ohm Foam	100'	5.00	4 lbs

OPEN WIRE LINE

300 Ohm Copperweld	100'	\$2.15	3 lbs
	250'	4.85	5 lbs
300 Ohm Copper Formvar (insulated)	100'	3.50	3 lbs
	250'	8.50	5 lbs
450 Ohm Copperweld	100'	2.75	3 lbs
	250'	6.00	5 lbs
450 Ohm Copper Formvar	100'	3.50	3 lbs
	250'	8.50	5 lbs
450 Ohm Copperweld (#12 wire, 2" space)	100'	7.50	5 lbs
	250'	18.00	13 lbs
450 Ohm Insulated (Type INS-500)	100'	4.00	5 lbs
	250'	10.00	12 lbs

STANDOFFS

5 1/2" Nail type	10/\$1.50	1 lb
7 1/2" Wood screw	10/\$1.50	1 lb
7 1/2" Pole clamp	10/\$1.75	1 lb
INS-500 type	5/\$1.50	1 lb

These standoffs have slots for 300, 450, 600 Ohm wires

ORDER DIRECT AND SAVE

Minimum order \$5. Please enclose postage as below.

Postage	300 mi	600 mi	1000 mi	1400 mi	1800 mi	beyond
First 2 lbs.	.35	.39	.45	.51	.58	.64
Ea. add'tl lb.	.06	.08	.10	.13	.16	.19

REDLINE JEFFREY N. H.

* "Violent or wild disorder or confusion," says the dictionary, and this describes our warehouse perfectly.

low cost Lafayette Radio unit rated at 20 amperes and 400 PIV. This stud-mounted diode carries the part number of SP-269 and sells for \$2.98. Lower current units are available at correspondingly lower prices. This particular blower panel was assembled on a 7" × 11" aluminum plate to fit the bottom of a transmitter amplifier chassis. This little unit moves a fantastic volume of air. Vibration is negligible although the acoustical noise level is quite high. As a point of interest, all the neighborhood kids have been in the house at least once to see the "wind tunnel" in action. The blast of air, dimming of the lights (measured 5.5 amperes with 25 volts impressed across each motor) and the sound effects combine for a rather awe inspiring demonstration.

There are a few precautions to be observed in the use of dc motors on ac power, particularly if they are operated directly from the ac line. **WARNING:** *Many surplus dc motors have one terminal of the power input connected to the frame of the motor. Before use, check with an ohmmeter. If such a ground ex-*

ists, disassemble the motor and suitably insulate the circuit before operating from the transformer-less supplies shown in Figs. 1b and 1c. In some instances this ground will be obtained with a strap connection and in others it will be caused by the use of an uninsulated brush-holder. Remove the strap and/or suitably insulate the brush-holder to isolate the wiring from the frame of the motor. Electrical noise from the brushes is quite severe with such motors. While very difficult to completely eliminate, this noise can generally be reduced to tolerable levels by connecting .01 mmfd disc ceramic capacitors directly from the brush holders to the frame of the motor. Room can usually be found to install them inside the motor housing.

If your previous interests have been light construction with drive fabrication limited to fastening the knobs to the control shafts, get with the gears and motor drives. The low cost of drive components and motors on the surplus market makes possible amateur equipment automation limited only by your imagination.

... W4WKM

New Products, Etc.

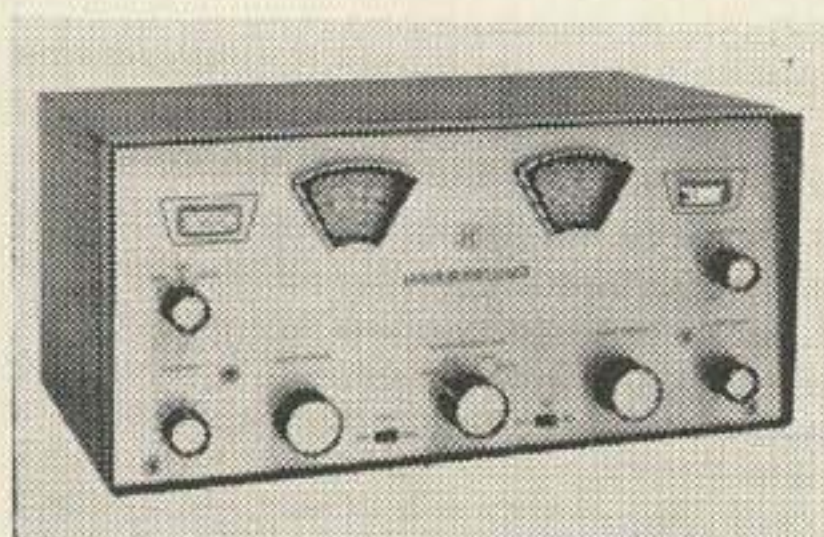

HQ-66

Hammarlund has announced a new general coverage receiver which tunes from 540 kc to 30 mc with calibrated electrical bandspread for the ham bands. The high frequency oscillator is temperature compensated for excellent stability; there is a built in automatic noise limiter; the selectivity varies to produce hi-fi on the broadcast band and a sharp response

on the short waves. The front panel is conservatively styled. Price is \$159.95. For further info write to Hammarlund, 53 West 23rd Street, New York 10, N. Y.

50th Anniversary

Truthfully, these 50th anniversaries have left me a little cool. It isn't my fault I'm a youngster, is it? National is celebrating its golden anniversary this year, though I guess they have been somewhat eclipsed by ARRL's ditto. This is unfortunate, for National has been an important part of ham radio and they deserve some lauding.

National had been around for 23 years when I first got started in ham radio in 1937. At that time their SW-3 was very popular and many of the shacks that I visited sported this excellent regenerative receiver. The NC-100's and NC-101's were in all the ads, but I knew few hams that had *that* kind of money. I remember that the deep voices on those exclusive 75 meter nets were using HRO's, but we peons didn't see much of them except in photographs.

So now here we are in 1964 and National is announcing a new HRO, the "500." Gone are the plug in coils . . . gone are the tubes . . . gone is the old PW dial. The HRO-500 is a solid state frequency synthesized phase lock receiver. I suspect, when we see it, that it will

be as far ahead of its day as the HRO was when it came out in 1933.

One product of this magnitude is usually all a company can get ready for production at any one time . . . but National has also announced their NCX-5, a new five band side-band transceiver!

The way they're going, if ham radio continues for another 50 years, National will be right there on top of the heap. Watch for the NCP-KW, the self-powered automatic calling self band selecting satellite communicator.

Mobile Gallon Coils

The Webster company has been making their compact Band Spanner for over 14 years. It helped make mobile operation respectable eliminating the monstrous whip and loading coil that used to give the XYL apoplexy. A few years ago they brought out the Top Sider with easily replaceable coils for quick band changes. Now the transceivers are in a power race, so Webster has a new line of inductors for the Top Sider, the Gallon series. Now you can run power and not have your car look like a WW2 jeep. The coils are rated at 1000 watts PEP and are about twice the size of the standard (300 watt) size. For more information, write Webster Manufacturing, 317 Roebing Road, South San Francisco, California.

Clean Contacts

George P. Oberto K4GRY

To keep that bug or straight key in good working shape its keying contacts should be kept clean. Relay cleaning tape, type K. S. 6528 is available from Hope Webbing Co., Inc. or can be gotten from electrical and electronics places that deal with relays and Teletype.

Every so often a clean tape is run between the keying contacts with the keying contacts closed once the tape is put between the contacts. Pulling on the tape will really clean those dirty contacts. Pull again with another clean tape if the first one gets dirty to make sure the contacts are good and clean. This takes about half a minute. A package of relay cleaning tape will last for years and of course the tape comes in handy for cleaning contacts on RTTY keyboards, TD's relays and so on.

. . . K4GRY

Redline Electronic Keyer Super-Kit



- ★ Gives perfect code, from 5 to 50 wpm
- ★ Built in speaker for sidetone monitoring
- ★ Built in transformer power supply with silicon diodes
- ★ 4" wide, 5½" high, 8½" deep, 5 pounds
- ★ Sockets and terminal strips riveted in place
- ★ High performance, stable computer circuits
- ★ Plug-in high speed mercury contact relay
- ★ Kit is complete with aluminum chassis, blue-gray cabinet, all parts, and complete detailed step by step instructions. Less tubes (four 12AU7, OA2, OB2, NE-2, NE-51) and key lever.
- ★ This is the finest keyer ever designed for amateur use.
- ★ Introductory price is \$39.95, subject to change without notice. Postpaid.

REDLINE

JAFFREY, N. H.



The Gonset Sidewinder

Wayne Green W2NSD/1

Since sideband is still in the early stages of use up on two meters I was quite surprised to see the ads for the Gonset two meter Sidewinder a few months back. I didn't expect to see anything like that for a couple more years. I think that all of the regular two meter denizens will join me in stating that we are all happy to see this piece of equipment available.

Sideband is just as advantageous on two meters as it is down on 20. Back in the days when it was possible to have a clear channel on 20 (I'm *old*, eh?), the early users of sideband were able to appreciate the unbelievable way we could get out, even with low power. If you've done any listening to the sidebanders on two meters you know that they are able to work over extraordinary distances.

Which brings us to the Gonset Sidewinder. This is a far cry from the old Gonset Communicator I. With this package you not only have an AM transmitter (6 watts input and receiver, but also a sideband transceiver (20 watts PEP) and everything except the higher power transmitter stages is transistorized. The power supply unit snaps right on the back of the transceiver. They have both twelve volt dc and 115 vac supplies, but I think I would go for the 12 volt job and then make a small power pack to deliver the 12 vdc at 8 amps required for shack use rather than buy both supplies. Then you could whip it into the car whenever you wanted.

The Sidewinder is small enough to fit in even a sports car. Bless transistors. And the power it requires shouldn't hurt your car. I counted 21 transistors and three tubes, ending up with a 6360 in the output. I.F.'s are on 15 mc and 9 mc.

That's all fine and good, but how does it work? Shortly after the Sidewinder was delivered up here in the wilds of New Hampshire I was heading for 73 Mountain to see what would happen. I hooked it up to a spare two meter antenna and listened around. I am not sorry to report that my 417A converter had a slight edge over it in sensitivity. Transistors may be pushing Nuvistors at two meters these days, but the 417A still can do a little better. No matter, there were darned few stations that I couldn't hear quite well on the Sidewinder. The stability of the receiver isn't important on AM, but it is greatly appreciated on SSB.

I tuned to 144.1, where the SSB gang hangs out, and called a quick "break" at the first opportunity. W2LVQ was on the channel having a round table with a station in Plaistow, New Hampshire and Boston. He came right back when I spoke up . . . not bad for 20 watts PEP at 200 miles, eh? All three critically listened to the signal and gave it a clean bill of health. Since then many SSB stations have been worked down into Southern New Jersey, over 300 miles from here. I don't do an awful lot better than that with my kilowatt on AM.

Gonset has worked out the tuning system well. There is a switch for selecting the megacycle and both fast and slow tuning of the main dial for plain tuning and zeroing in on SSB.

The Sidewinder sells for \$399.50. The dc power supply is \$79.50 and the ac supply is \$67.75. This is pretty remarkable when you consider that the Communicator IV was up over \$400! For not much more you have everything you had in the IV plus stability, SSB and CW! I suspect that the Sidewinder will put a lot more fellows on two meter sideband.

Letter

Dear Wayne:

Your competition sure has put much needed life and renewed vigor into previously decaying ARRL. Keep up your good work. Heretofore ARRL has had a monopoly in the amateur radio business and therefore had a tendency to go dead at the top. In any field of endeavor competition is usually the best productive process upon final analysis. ARRL should not be allowed to have a monopoly in the field of ham radio. Don't let the ARRL hounds get too close to your tail. Good luck.

African Hams

Name of Country and Prefix	Permanent licences.	National society	Licences granted to Visitors
BURUNDI (9U5)	Less than 10	No	Yes
CAMEROUN (TJ8)	None	No	Yes
CENTRAL AFRICAN REPUBLIC (TL8)	Less than 10	No	Yes
CONGO REPUBLIC (9Q5)	Over 120	U.C.R.A. Leopoldville	Yes
DAHOMEY (TY2)	Less than 5	No	Yes
GABON (TR8)	Less than 10	No	Yes
GHANA (9G1)	About 50	G.A.R.S. Accra	Yes
GUINEA (7G1)	None	No	Occasionally
IVORY COAST REPUBLIC (TU2)	Less than 20	No	Yes
MALI (TZ)	None	No	Occasionally
MAURETANIA (5T5)	Less than 10	No	-
NIGERIA (5N2)	About 40	N.A.R.S. Lagos	-
NIGER REPUBLIC (5U7)	Less than 10	No	'Dxpedition' operation discouraged
REPUBLIC of the CONGO (TN8)	About 25	Closely linked with R.E.F.	Yes
RWANDA (9X5)	Less than 20	No	Occasionally
SENEGAL (6W8)	Less than 25	Closely linked with R.E.F.	'Dxpedition' operation discouraged
SIERRA LEONE (9L1)	Less than 10	No	Administration favourable to Amateur Radio
SOMALI REPUBLIC (60)	Less than 20	No	Yes
SUDAN (ST)	None	No	-
TCHAD (TT8)	Less than 10	Closely linked with R.E.F.	No knowledge of visitors obtaining licences. Visitors have obtained licences in the past.
TOGO (5V)	None	No	" "
UPPER VOLTAIC REPUBLIC (XT2)	Less than 5	No	" "

(credit to I.A.R.U. Region 1 Bulletin)

FROM IBM COMPUTORS

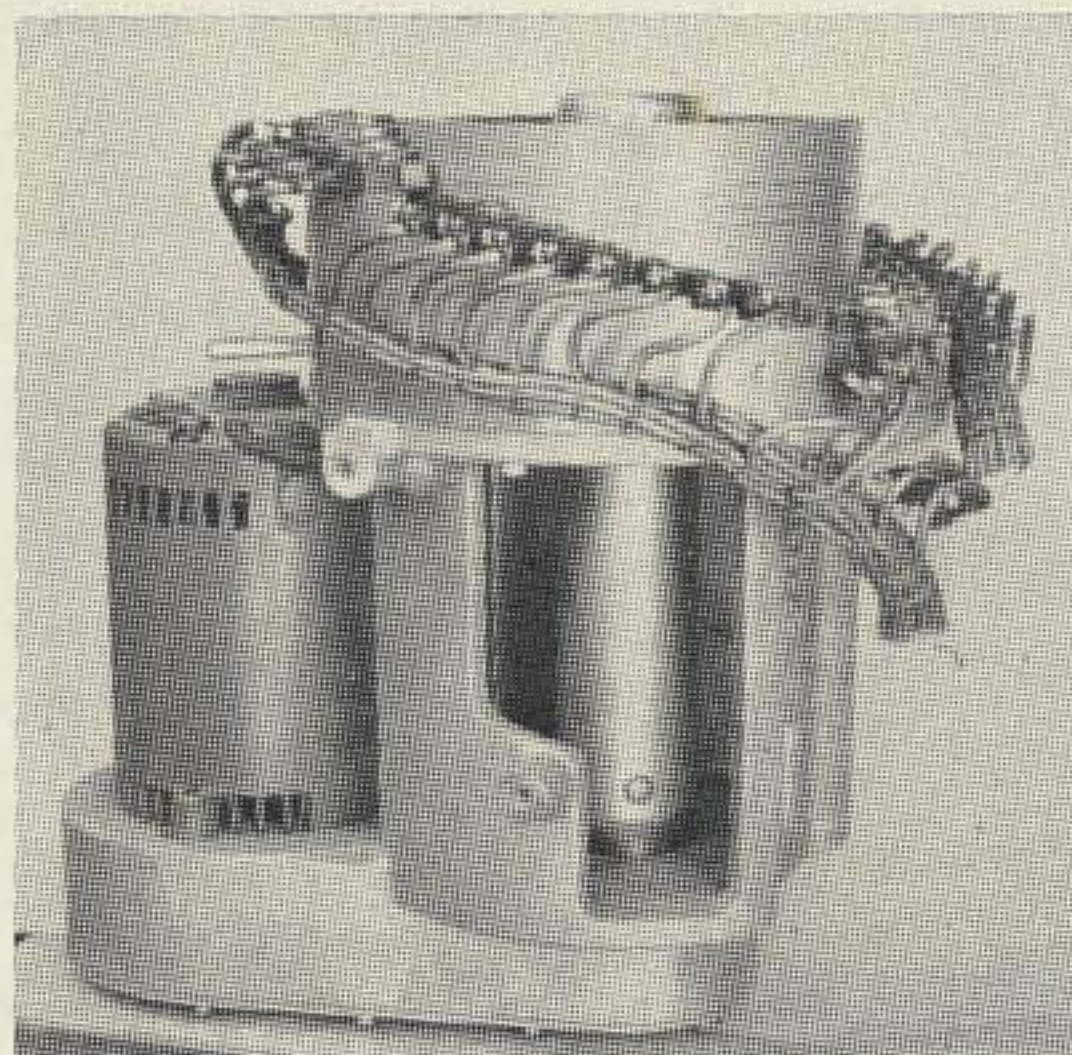

\$100.00

MEMORY DRUM, approx. 40 read-write heads, 115 volt 60 cycle motor.

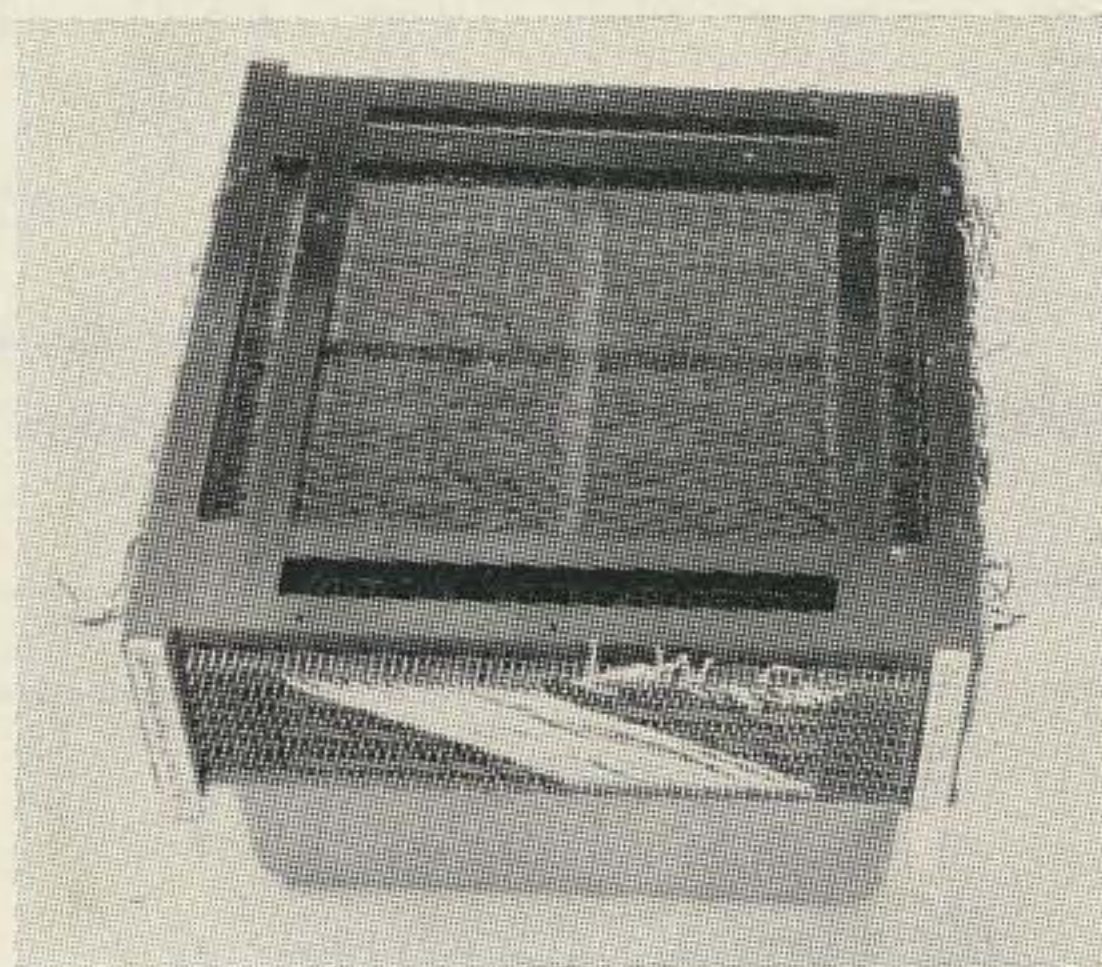

\$100.00

MEMORY PLANE STACK, WIRED, 10,000 cores per frame, 8 frames per stack, with cooling fan.

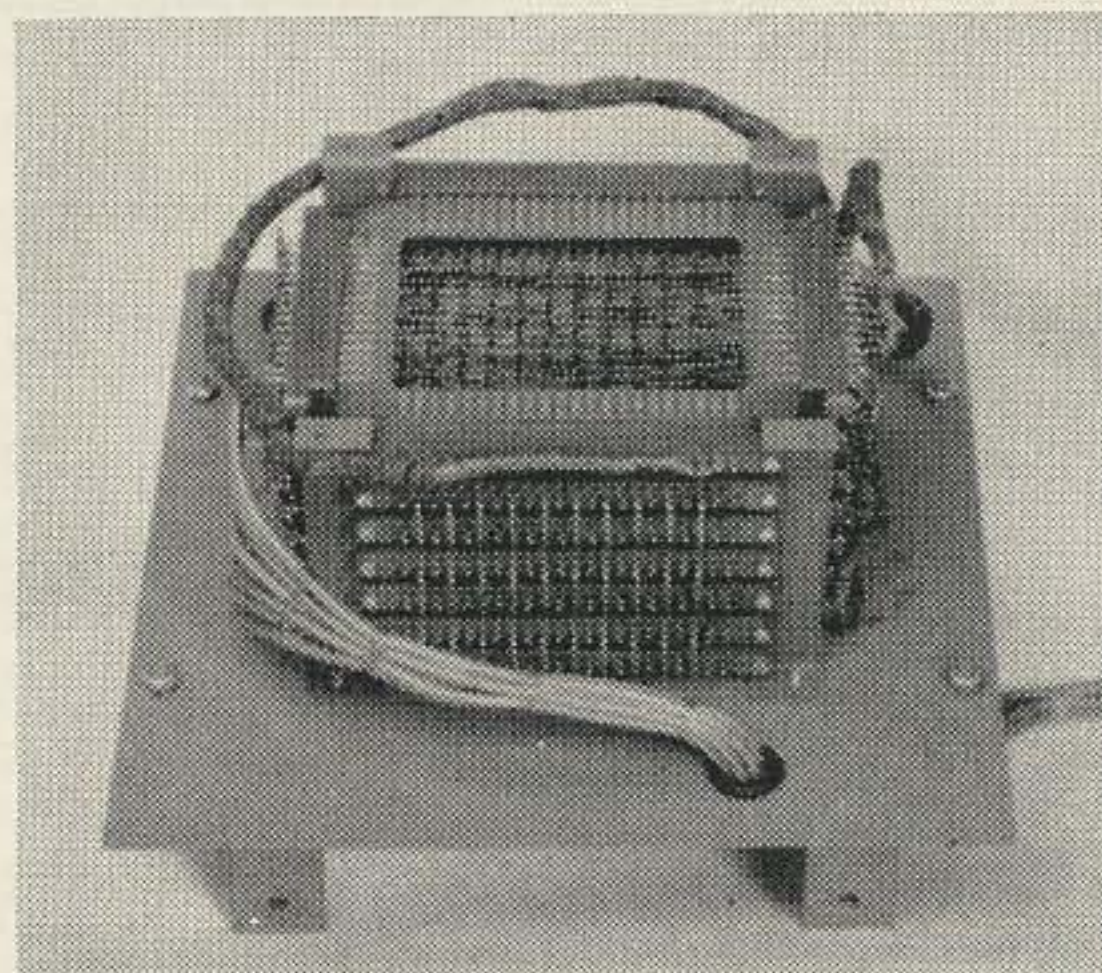

\$25.00

MEMORY PLANE STACK, WIRED, 100 cores per frame, 7 frames per stack.

JOHN MESHNA, JR.
19 ALLERTON ST. LYNN, MASS.

TECH MANUALS

original unabridged manuals with service info and schematics. Prices include postal charges

ALR-5 \$7.50	ARN-7 8.50	TT-7, 8 .. 9.00
APA-6 7.50	ARN-8 5.00	Mod. 14
APA-10 6.50	ARN-12 5.50	TTY 9.00
APA-11 7.50	ARN-18 6.50	BC-1060A .. 6.50
APA-16 7.50	ARN-14, 14c .. 10.00	CV-62 6.50
APA-17a .. 8.50	ARN-14a .. 10.00	CV-172 6.50
APA-38 7.50	ARN-14b, d .. 10.00	FGC-1 6.50
APA-81 7.50	ARN-21 10.00	ATK-ARK
APG-30 15.00	ARR-2 8.50	TV 12.00
APN-1 5.00	ARR-5 7.50	PRC-6 5.00
APN-9 10.00	ARR-7 7.50	PRC-17 4.00
APN-11 8.50	ARR-15 10.00	TG-7a, b .. 6.50
APQ-2a 7.50	ARR-16b .. 6.50	LM-2 7.50
APR-1 7.50	ARR-26 8.50	LM-7 7.50
APR-2 7.50	ART-13 10.00	LM-13 7.50
APR-4 7.50	ART-26 8.00	LM-14 7.50
APR-12 12.00	ART-28 7.00	LM-18 7.50
APS-2 15.00	ATD 7.50	GO-9 7.00
APS-3 15.00	RAX-1	DU-1 5.00
APS-4 15.00	MN-26C	DZ-1 5.00
APS-42b .. 30.00	LP-5	I-177 4.00
APX-6 8.50	LAF-2	TS-323 6.50
APX-6b 8.50	BC-1306 .. \$7.50	TS-297 3.00
APX-7 8.50	BC-611 6.50	TG-34 keyer 2.00
ARB 7.50	BC-610 10.00	TS-352 5.00
ARC-1 8.50	BC-221 7.50	USM-24c .. 9.00
ARC-1a 7.50	BC-348 specify letter .. 7.50	USM-29 .. 15.00
ARC-2 8.50	SCR-274N .. 8.50	TS-67 8.50
ARC-5 LF .. 8.50	BC-733 6.50	TS-174 6.50
ARC-5 VHF ... 8.50	BC-603, 604 5.00	TS-175 6.50
ARC-12 8.50	BC-620 5.00	51J3 10.00
ARC-27 8.50	BC-779 7.50	R-389 10.00
ARC-28 6.50	TT-5, 6 .. 8.50	R-390 10.00
ARC-44 8.50		R-392 10.00
ARN-5 7.50		URC-4 6.00
ARN-6 8.50		BC-312, 342 5.00

"write about any manual not listed. Over 200,000 in stock, we may have the one you need."

WE BUY TOO—send us your lists of excess publications.

PROPAGATION PRODUCTS COMPANY
P. O. BOX 242, Jacksonville 1, Fla.

Subscribe to 6up
Devoted exclusively
to VHF

73

Peterborough, N. H.

Letter

Dear Wayne:

Congratulations on the July issue. It came just at the right time here as interest in the vhf bands is starting to put a hammer-lock on me. The VHF Buyer's Guide added the finishing touch. I very much like the idea of running special issues with numerous articles pertaining to one phase of amateur radio, such as these last two issues have been.

CQ is setting a record I bet you will never beat, Wayne. They are sending my copy later each month, this time 9 days behind QST and 14 days behind 73. I simply had

to wait until I had laughed my way through their editorial before writing this letter. It turned out rather wishy-washy, but this was probably due to the fact that a new editor is at hand for CQ. Its misrepresentations, twisted facts and just plain lies smell of Arne Trossman, but the whole tone and style of the work is foreign to other ZB columns, such as the May masterpiece. When you get right down to it, the author seems to be spoon feeding his message to the readers with the too frequent use of the word—they—instead of who we know the editor meant. Is this a preview of K2MGA?

But the grabber of the issue was the letter box! . . . Congratulations on making CQ once again a responsible voice in ham radio. . . . Factual, to-the-point, hard hitting . . . you speak purely for the cause of TRUTH . . . tests of NC-300 with a SteamRoller . . . (it was actually an NC-109; Mr. Oliver seems to have lost his memory along with his sense of humor) . . . echhh to all of the above comments. I must also thank WA2TGC for his expose of Goat Boy's identity, previously unknown to the amateur public; I feel sorry for you Ted, with friends like WA2TGC, enemies must be a luxury.

Although CQ did print one letter against the May editorial, I really wish it had been one of the ones they received that tore into the deceptions of the article, piece by piece. I also noticed that one reader plans on blaming you for any frequencies lost at the next ITU Conference. Hmmm, I suspect that you are the direct cause of my brother getting grey hair at the age of 13, too.

Bill Orr misnamed his article; it skimmed on predictions of Amateur Radio Tomorrow and gave us a history of the ITU and past Conventions, something we could have gotten from past issues of QST.

Back to the editorial of CQ for July, in the middle of the fifth paragraph, the sentence starting—They will accuse ARRL officials of being corrupt . . .—one of the most exposing essays on the corruptness of the League was written by one of CQ's own column authors, K6BX, in his "Doyle Dairy" letter. QST said nothing at all on this paper, and it must be assumed that the ARRL could not deny the accusations of Clif's.

Before ending, one question Wayne, what was the outcome of your poll on RM-499? And(ha), did any ARRL officials show up to count the ballots?

Bob Sverstedt, WA6VAT

No, Bob, no one has hown up yet. The ARRL HQ gang knows that the 73 poll was accurate, so why on earth would they waste time coming up here to be embarrassed? Re CQ, I was under the impression that Cowan was writing the editorials. Re WA2TGC, since "Cuke" never has been a 73 reader he didn't know that I had not ever identified Goat Boy.

Long Sky
Rubbish Wire

Mrs. Harry Pennington, Jr. K5HVZ
134 E. Agarita
San Antonio, Texas

When a rare DX YL turns out to be your own daughter, it is indeed rare DX. VR4CM, Mary Pennington Cowmeadow, formerly K5HVX, is now living in the Solomon Islands. Her first radio contact was with, of all people, her parents, this week. Naturally, her delirious parents had planned it that way, but who could tell how long it would take to erect

an antenna on the top of a 35 foot bamboo pole, over an exotic red blooming Royal Poinciana tree to the back landing of their transient quarters in Honiara, Guadalcanal.

Mary and her husband, Arnold Cowmeadow, a Crown officer in the Forestry Service of Great Britain, will be stationed in the Solomon Islands for the next two years. They met last year while they were both students at the University of Edinburgh in Scotland. Mary came back to the University of Texas last fall to finish her senior year. Arnold arrived here around Thanksgiving. They were married in December. Arnold then went on to the Solomon Islands and Mary stayed to finish the semester and followed him to the Islands in February. Since then they have been in the jungle most of the time. His work is to enumerate and survey the forests. They have recently been assigned a new houseboat and launch, which will soon sprout a Zed L Special beam to her transceiver.

Mary's ham adventures in the South Pacific began before she got out of Texas when her plane taking off from Dallas had to dump 3000 gallons of gasoline from the air. The retractable landing gear had refused to retract, forcing an emergency landing on a foamed runway. Her fear was not in whether or not they would get the plane down safely but would she now be able to make her connections on New Guinea's weekly plane to Guadalcanal. Another plane was brought into Dallas and they flew out to San Francisco making up more than thirty minutes. She had a breathless connection with the QANTAS flight to Hawaii, Fiji and Sydney. Meanwhile back to the home ham shack, we K5HVW and K5HVZ were frantically calling for Vince, VK2VC and Ed, VK2EN in Sydney, Australia. Vince and Ed, several years ago, made a trip around the world and stayed with us for three days while in the United States. They met Mary at the Sydney Airport at the unearthly hour (for hams especially) of 7 AM. For the next thirteen hours of her layover, they were marvelous hosts, showing her all of the sights of beautiful Sydney. At nine o'clock that evening they took her back to the airport. As the officials were checking her passport, it was noticed that she did not have a visa to land in Guadalcanal. No amount of persuasion from Vince and Ed could get her on the only flight that would connect with the weekly plane out of New Guinea. Here indeed, are ham friends at their best. Ed's wife, Mary Hulme graciously invited Mary to stay with them in their lovely Pacific beach home. For the rest of the week they drove her around Southern Australia.

They helped her straighten out her visa problem. Ed took her to his electronics plant in Sydney and they inspected his brick kiln. She went bowling with Ed's family and swam in the Pacific (in February-summer?). She was able to make contact with Arnold in Guadalcanal who arranged to meet her in Munda, New Georgia, where the surveying party would begin their jungle trek.

Some years ago when the girls were teenagers, we had almost consecutive calls: K5HVW, K5HVW, K5HVX and K5HVZ. As the girls went off to college in Virginia, Randolph Macon Woman's College, we were able to maintain regular schedules. Barbara, our older daughter, now Mrs. Ben G. Bailey, lives in Atlanta, Georgia. We have twice weekly schedules with her and her new call WA4KFC and the two year old granddaughter. Granddaddy already has that look in his eye: "I wonder if she is too young to learn code?"

Mary has now been in the jungle with Arnold on four different trips lasting from three weeks to a month each time. Once she was quite alone in her tent when she realized that her solitude has been interrupted by a four foot long iguana. Several days ago she reported that even the native boys were panicked when they

ATV
EXPERIMENTER

ANTHOLOGY 1962-64

ARTICLES FROM THE FIRST TWO VOLUMES OF THE ATV EXPERIMENTER

ATV EXPERIMENTER EDITED BY MEL SHADBOLT WØKYQ
ATV ANTHOLOGY EDITED BY PAUL FRANKLIN WA4HWH

HAM TELEVISION



\$3

a 73 publication

Finally available in book form—the technical and construction articles from the first 2 years of the ATV Experimenter. ATV—edited by Mel Shadbolt WØKYQ—is the only American magazine devoted to the fascinating hobby of amateur television. WA4HWH has compiled the best articles from the first two volumes (12 issues) into a fully illustrated 96 page book. Some of the more than 50 features:

- Bibliography of ATV articles
- Complete inexpensive vidicon camera
- Quick and easy ATV transmitter
- Off the air pulse generator
- Converting ATK/ATJ to a vidicon camera
- Surplus video monitor
- Monoscope camera
- Aural subcarrier
- Camera lens—theory and practice
- Complete improvements on the Parker camera
- Image orthicons
- Narrow band TV
- Bar generator
- Converting commercial UHF converters to ATV
- Glossary of ATV terms

Price \$3. Special for ATV subscribers: \$2 Include the code number on your ATV or \$2 for a one year subscription to ATV with your order.

Send to 73 Inc.

Peterborough, N. H.

Specials for Early Autumn
Be prepared for those long winter nights: Get the 73 Six-Pack!



Get all of these 73 books for only \$2 regularly \$1
 Frequency Measuring 50c
 Math for the Ham Shack 50c
 Coils \$1
 CW Manual \$1
 Care and Feeding of the Ham Club \$1
 Mickey Miker 50c

A \$4.50 value for only \$2.50
Order the Special 6-Pack

Is your collection of 73's incomplete? Are your copies of 73 so dog-eared from use and re-use that they're falling apart? Do you have a friend who doesn't have back copies of 73? Back issues usually sell for 50c but look at this special offer: **Any 4 back issues of 73 (except 1960, Jan, Feb, Mar of 1961, and June 1962) for only \$1 postpaid.** Give second choice in case we have to substitute. Order from 73 Inc., Peterborough, N. H.

Club Special

One of the most important functions of a ham club is to help its members grow technically. A good way to do this is to have technical discussions at club meetings. Many articles in QST and 73 make excellent texts for these discussions. While we can't speak for QST, we are making copies of 73 available at a special price for clubs and other groups who are interested in studying technical topics. 10 or more copies of the same issue of 73 may be purchased at the special price of 5 for a dollar. Among the articles especially recommended are the following, but most other back issues since March 1961 are also available for this purpose. Be sure to mention the club name when you order.

May 61 How High the Fi
 June 61 Powerhouse Pros Part I
 July 61 Powerhouse Pros Part II
 September 61 Crystal Oscillators
 October 61 VFO Circuits
 March 62 Modulation
 September 62 Synchronous Detection
 November 62 Those Different Diodes
 May 63 Diode Modulators
 July 63 Active SSB Modulators
 September 63 UHF Cavity Design
 December 63 Sideband Linears
 April 64 Waveguide Simplified

killed a three foot poisonous sea snake on the deck of their houseboat. She said as they docked in a village port, she was bewildered to find that the sick villagers lined up in front of their boat expecting medical care. Since she has been back in Honiara (home of the winds) she has been studying daily at the hospital under a doctor and Fijian nurse for a course in first aid and out-patient care. She reported last night that she had given her first penicillin shot and observed (without fainting) the sewing up of a woman's foot that had been chopped with an ax.

Mary is fast becoming fluent in Pidgin English. A car is called a "schooner belong bush". A headache is "sore leg belong head." Even the newscasts are given in pidgin; as well as a daily medical care program that is broadcast through out the Islands in pidgin.

The day her ham gear arrived, she rounded up a collection of houseboys (calico lap laps) to help with her antenna erection. She had the guy wires attached to a 35 foot bamboo pole, then she signaled for everybody to lift. It became increasingly obvious as the pole stalled that the guy wires were too short, so down it went for modifications. With the new longer guys spliced in and a second erection about to begin, a car rounds the corner and unseeingly becomes impaled in her wires. This time it was really (bugger up finish) and less than an hour before her schedule with her parents. Extracting what was left of the guys and antenna, she again started over; obviously the long awaited first schedule would again be delayed. This time a land rover arrived filled with forestry department personnel. They fell on the project with efficiency and speed and had her (rubbish wire long sky) in place five minutes before schedule time. (Rubbish is the opposite of number one.)

Mary signed out last night with "I love getting DX, but *being* DX is the greatest!"

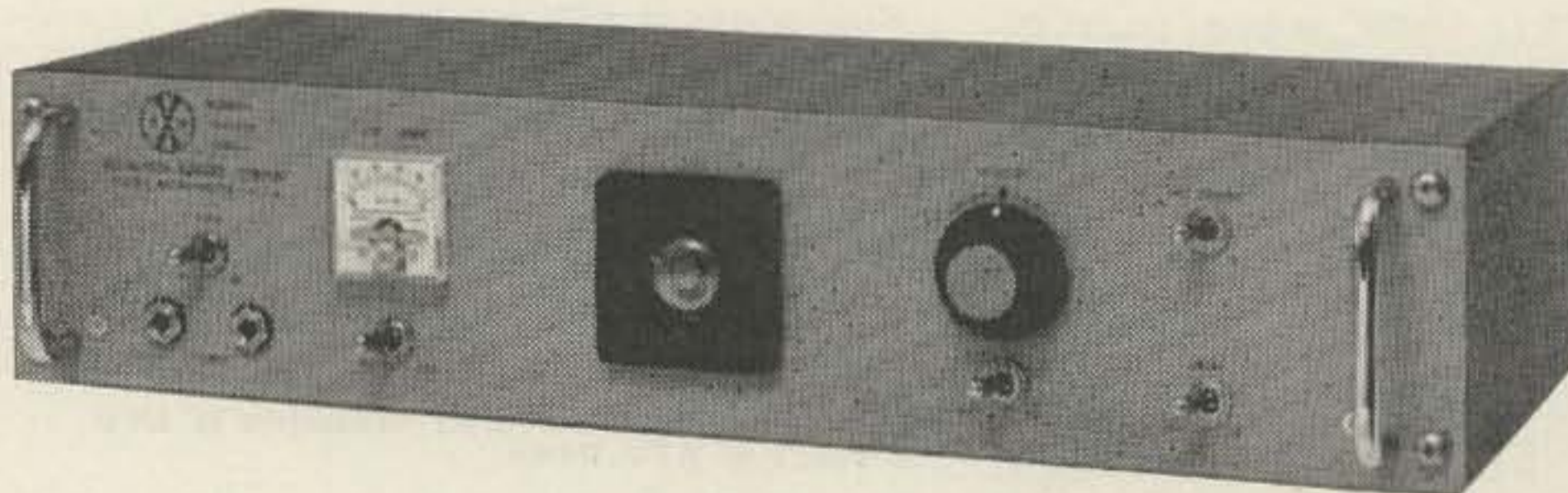

**TELEWRITER
 MODEL "L"
 FREQUENCY
 SHIFT
 CONVERTER**

\$199 (dual eye indicator)
 \$279 (CR tube indicator)
 \$14.50 cabinet

Audio input. Scope or dual eye indicator. Plug-in inductors for wide or narrow shift. Axis restorer & Limiter can be switched in or out of circuit, to suit conditions of fading or interference. Copies on Mark only or Space only automatically Mark hold circuit. Loop & Bias supply for optional polar relay for keying transmitter. Keying tube keys magnet. Terminals on chassis for external keying relay & scope indicator.

ALLTRONICS-HOWARD CO., Box 19, Boston 1, Mass.

Bagpipes and the Phone Men

Hector French W1JKZ
9 Davidson Road
Wakefield, Mass.

A lot of phone men are proud of their crisp, clean audio, even when it isn't. The circuit fanatics will even give you a blow-by-blow account of what's going on in their speech department, all the way from the mike to the antenna. That's fine—but does anyone know where this speech energy comes from in the first place?

If you ask a medical-style Doctor, he'll reply that speech comes from the interaction of complex groupings of neuro-muscular systems, under the control of the brain. Then he'll charge you nine dollars.

Well . . . I'm not sure that this reply does much good, and in the second place I didn't understand it, and in the third place it wasn't worth nine dollars in the first place.

"73" readers will therefore be happy to learn that they can save those nine dollars, and buy a three year subscription instead, because this issue of "73" is about to answer that old, old question: "Why is the phone man?"

The answer is clear. Here it is: The great American phone man is built like a bagpipe, and works the same way.

Does he sound like one? Read on.

The leather wind-bag under the piper's arm, for instance. This furnishes the air for the pipes. The piper keeps the bag full of air, through a blow-pipe he holds in his mouth.

The phone man works in just the same way. His lungs are like the bag of wind, and he forces out the air with his respiratory muscles. You're probably not conscious of these muscles if you've been breathing regularly lately, but you can feel them working by imitating the ho-ho-ho of Santa Claus.

"RW" September Bargains

- I-81 SELSYN INDICATORS—Xlnt for antenna beam direction indicator with 12v 60cy power. 360° dial marked 0-36. Used Good \$1.95 ea. 2/\$3.00
 BC-604 TRANSMITTER—20 to 27.9MC FM. 30watts, 10 Xtal channels, 7 tubes & schematic. Like New \$6.95
 SET 80 CRYSTALS Type-241 for BC-604 Xmtr. \$7.95
 BC-457A COMMAND TRANSMITTER 4-5.3MC. Xlnt for 80M or VFO. NEW \$8.95
 ARC-1 TRANSMITTER—100 to 156MC, AM, 10 channel. Complete with 29 tubes, IF crystal 24vDC dynamotor & orig. large schematic. Used, Xlnt \$24.95
 FIELD STRENGTH METER 100 to 156MC Calibrated Dial. Xlnt for aircraft or 2M bands. Requires 1.5v & 45v batteries. Used less batteries \$6.95
 HIGH VOLTAGE PROBE—Rated for 50kv with VOM or VTVM. Has 500 megohm Hi-Voltage resistor. Large, high quality probe that sells for over \$12.00 Brand New \$2.95
 CARBON PILE RHEOSTAT—Heavy duty compression type 1500 watts 0.01 to 2 ohms with 53 carbon plates 3"x3". Brand New \$24.95

Send money order or check with order
 PLEASE INCLUDE POSTAGE—Excess promptly refunded
 Minimum C.O.D. order \$10.00 with 25% deposit

R. W. ELECTRONICS, INC.

2430 So. Michigan Ave.
 Chicago, Illinois 60616

Dept. 378
 Phone CALumet 5-1281

- RT82/APX6 Get on 1215-1296 mc the EASY way . . . NEW 24.75
 TS726/UPM8 Tests APX6. W/27 Tubes, 10 Diodes. GOOD 14.50
 RT247/APS31B W/4J52A Magnetron, 2-2K25 Kly . . . EX 38.00
 RT18/ARC1 100-156 mc X'ceiver. 832A final . . . EX 22.75
 MT230/ARC Mounting for ARC1, ARC4 and ARC12 . . . EX 2.85
 RT58/ARC12 225-350 mc.W/42 tubes, 2-2C39A's . . . EX 29.75
 C45 Control Box For ARC1 and ARC12 X'ceivers . . . GOOD 1.35
 ARN6 R'ceivr 100-1750 kc. Four band Superhet . . . EX 19.25
 MT273 or MT274 Mounting for ARN6 Receiver . . . GOOD 2.85
 C403A/ARN6 Contr Box, Binding Post connections . . . EX 6.75
 T465/ALT7 X'mittir 168-352mc 100 watts output . . . EX 22.50
 Schematic for T465/ALT7 with parts values . . . 1.00
 6161 Tube 100 watts @ 900mc, 63 watts @ 2000mc . . . EX 7.25
 Socket Air System Type for 6161 tube, used . . . EX 1.25
 SWR Bridge 200W 50-1000 mc.W/Diodes and Meter . . . EX 8.25
 RE2/ARC5 Ant Relay W/Meter & Vacuum Capacitor . . . EX 1.85
 Blower, Axivane Type 60 c.f.m. 12-24V AC/DC . . . EX 6.75
 Set of 120 Xtals, Type FT243 5675 kc thru 8650 kc in 25 kc increments, US tested & packed . . . 120/17.75
 HV Probe 50 kv insulation, 500 meg series res. . . NEW 2.45
 RT91/ARC2 Transceiver 2-9 mc in four bands . . . EX 34.75
 C732/ARC2 Control Box for RT91/ARC2 Transceivr. . . EX 1.75
 Meter, Weston Model 843 500-0-500 microamp. 3" . . . EX 3.85
 Meter, Weston Model 840 0-1 ma, 0-10 scale. 2 1/4" . . . EX 2.55
 I-82-A Navigators Indicator. Five inch . . . GOOD 3.50
 BD100 Sw'board W/10 BK27A Polar Relays, Meter GOOD 24.75
 ID59/APA11 W/3BP1 & 16 tubes EX for Panadaptr. EX 17.50
 APX1 less tubes. A Warehouse of parts. 30 lbs. . . GD 2.75
 TN8 or TN90 Tuning Unit for APX1 w/3 tubes . . . GOOD 1.00
 TS155C Signal Generator 2700-3400mc. W/Book . . . EX 75.00
 APN1 Xceivr 420mc W/Wobulator. Less tubes . . . GOOD 3.85
 UCCS Receiver-TESTER in Fiberglass trunk . . . GOOD 34.00
 Rt.Angle Drive W/Gears & Universal, 1/4" shaft . . . EX 1.00
 PRS-3 Sunken or hidden metal locator; 53 Mod. . . . NEW 37.50

E. C. HAYDEN

BOX 294 Bay Saint Louis
 Mississippi

Shipment: FOB Bay Saint Louis.

Terms: Net, Cash.

— WANTED —

TCS-110V. AC POWER SUPPLIES

TCS-24V. DC POWER SUPPLIES

UPX-1A, UPX-6, UPA, UPM, TS, PRC,
 GRC, COLLINS TYPES, BENDIX TYPES, ETC.
 WE WILL PAY HIGH PRICES FOR GOOD,
 CLEAN MATERIAL

— TELEMARINE —

COMMUNICATIONS
 142 West B'WAY, NEW YORK 13, N. Y.
 PHONE: COrtland 7-5444

When you try out this ho-ho-ho (without the wife and kids around; they'd think you'd just blown your cork), stand up to do it—don't sit down. And be sure to make it a vigorous one. When you do this, you may find—and you will find, if you've done it with plenty of that old enthusiasm—that you're forcing out the air by using all of the muscles from your chest down to your abdomen.

Now try it again—but this time sitting in your chair, with your feet up on the table. See the difference? Standing, your voice can sound like the pipes calling the clans. Seated, all scrunched up, your voice is more apt to sound like a two-bit harmonica, under a blanket, in the rain.

So who wants his QSOs standing up? Not many; I know I don't. But at the very least, keeping to a good seated posture is guaranteed to improve the clarity of your voice, to help you get through the QRM, and to project a better image of the person behind the mike.

So let's go back to the bagpipes again. I've spoken of the wind in the leather bag. This wind is forced out through a double-reed sort of affair at the wind-bag end of the chanter, or chanter. These double-reeds have just enough room between them for the air to pass through. As it does, this air sets the reeds into vibration, to modulate the air stream and form some of the sounds which eventually come out as music. (My neighbor says that the wind from a bagpipe will never be music, but that's his opinion.)

The phone man works in just the same way. His larynx (Adam's apple; voice box) contains a pair of muscles which have just enough room between them for the air to pass through, just like the double-reed in the bag-pipe. When the air passes through, it sets these muscles into vibration, to modulate the air stream and form some of the sounds which will eventually be shaped into speech.

There's one important difference, though,

between the reeds in the pipes and the muscles in the larynx. The bagpipe reeds are merely a pair of reeds, and that's all. The muscles in the larynx are under the control of the speaker. He can change their tension and spacing, to help determine the frequency and waveform of his vocal noises.

This difference makes for a lot of trouble, as far as a 100% QSO is concerned. Here's why: these two muscles aren't the only ones in this part of the throat and neck. All it takes is a little tension, or fatigue, or bad speech habits, and these other muscles will tighten up to give a tensed, pinched, flat, unpleasant tone of voice. Singers and wind instrument musicians have to learn how to keep these other muscles relaxed, so they won't interfere with their tone production. If I tighten up these other muscles, my clarinet tone and intonation go all to pot. Wouldn't it be logical to assume that something similar applies to a radiophone conversation, so that a more efficient formation of the speech sounds would result in a more efficient use of the modulation capabilities of the rig?

Here's a little experiment you might want to try. It not only demonstrates what happens when you relax these other muscles, but it will help you learn where they are, what they feel like, and how to relax them. This time, have the XYL on hand to listen; she probably heard you going through that ho-ho-ho routine, anyhow.

Here's what you do: sit in a comfortable chair, one that lets you relax, but still gives you a firm support, for a good seated posture. It should support you to your shoulders; there should not be a head rest.

Now speak a few sentences to the XYL as a standard of comparison. Recite "Mary Had a Little Lamb," or read off the index to this issue of "73," or recite any familiar sentence or verse.

Are you relaxed? Fine. This experiment is

YOUR ONE COMPLETE SOURCE
for HAM-TV, ATV, CCTV
Equipment . . .

Test Monotrons type
1698 only \$9.95 pp

FREE FLYER
#771 . . . Full of
Bargains!!!!

CATALOG 50c
#1273 . . . "How To Build
Low Cost TV Cameras"

Catalog #1273 plus
LARGE Size schematic \$1.50

Phone: 203-875-5198

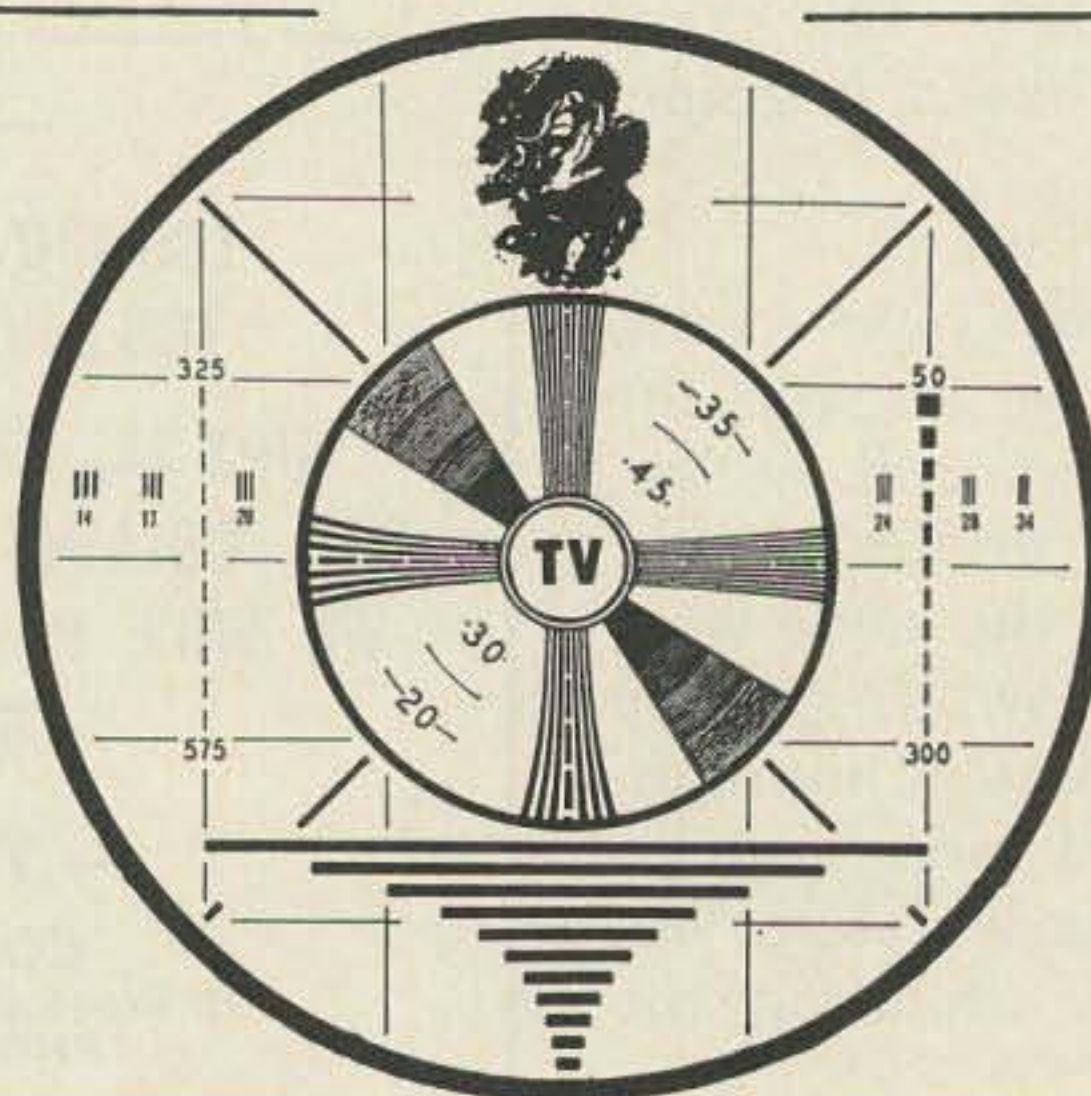

VIDICONS: \$34.50 up
1" electromagnetic or
2" electrostatic, your
choice: Grade C: \$34.50
Grade B: \$60.00
Grade Ham A: \$100.00
All types Ham-TV
equipment Bought-Sold-
Traded . . . **WRITE!**

**DENSON
ELECTRONICS
CORP.**

Rockville, Connecticut

actually an exercise; take about ten seconds to go around the circle once.

First, you let your head roll forward by its own weight, until your chin is just about touching your chest. Don't force it; let it go of its own accord. Then roll your head slo-o-owly over to the right, until it is resting on your right shoulder. Don't stop; roll your head along smoothly towards the back, until you're looking up toward the ceiling. (Don't force; let it go by itself). Keep going . . . over on your left shoulder . . . forward to your chest . . . relax a moment, then raise your head.

Now repeat the same sentence or verse you gave before. Surprised?

I had a friend try this whose voice usually sounds like a nervous breakdown looking for someone to happen to. After going around this circle exercise just once, his voice changed completely—for a couple of minutes, anyhow, until his regular speech habits took over again. His voice had turned big and deep, and as relaxed as a wet noodle. The kind of voice that commands respect on the air, and anywhere else, for that matter.

But I'm getting away from the bagpipes. When I left off, the air was going through the double-reeds, which were vibrating to modulate the air stream, and make a noise which the piper will control to make his music. To do this, the chaunter through which this modulated air stream passes has a series of holes along its length. The piper places his fingers on these holes and plays the chaunter like an oboe, to form the series of notes, trills, shakes, cuts, and warblers known as bagpipe music.

The phone man, now . . . the noises from his larynx are just that: noises. Just as with the piper, the phone man must control these noises, to form the sounds of speech. He does this by the tension and spacing of the muscles in his larynx (just described), and by the positions of his tongue, jaw, and lips.

Here's where the phone man runs into his most common fault: lazy pronunciation. He's apt to share the great American speech malady of "the mumbles." He doesn't open his mouth wide enough, for the sound to get out; he doesn't waggle his jaws as much as the syllables require; he doesn't bother making his tongue nimble enough to form his vowels and consonants so they don't all sound alike.

Here's where the XYL can help in some more experiments, this time in trying to improve your percent intelligibility by a more careful formation of words. What you'll do is this: leave on a couple of radios and the TV,

FREE Catalog

OF THE WORLD'S FINEST
ELECTRONIC GOV'T
SURPLUS BARGAINS



HUNDREDS OF TOP QUALITY ITEMS—Receivers, Transmitters, Microphones, Inverters, Power Supplies, Meters, Phones, Antennas, Indicators, Filters, Transformers, Amplifiers, Headsets, Converters, Control Boxes, Dynamotors, Test Equipment, Motors, Blowers, Cable, Keys, Chokes, Handsets, Switches, etc., etc. Send for Free Catalog—Dept. 73.

FAIR RADIO SALES
2133 ELIDA RD. • Box 1105 • LIMA, OHIO

PSYCHIATRIST WANTED!

Everybody says that the people at COLUMBIA ELECTRONICS need their head examined for paying such ridiculously high prices for used surplus electronics!

Be smart! Get YOUR share of the loot NOW! They are drooling at the mouth to latch on to BC-610 (models H and I preferred), SP-600, R-388, R-390, TED, TCS, TRC, CV43/APR-9, TN-131/APR-9, ARC-34, -52, GRC, PRC, SG, Test Equipment, etc. Tell COLUMBIA what you have!

If you hurry, you can beat the man with the white coat! They even pay freight!

COLUMBIA ELECTRONICS

4365 WEST PICO BLVD., LOS ANGELES 19, CALIF.

6 METER CONVERTER WITH NUVISTOR PRE-AMP

Unbeatable performance at an unbeatable price. Only \$10.00 ppd.! Complete with 6U8A, 6CW4 tubes and choice of 36 mc. crystal for 14-18 mc. output or 49.4 mc. crystal for broadcast band output. Fully assembled, tested and guaranteed. Sensitivity .1 microvolt. Noise figure 2.5 db.
VANGUARD ELECTRONICS LABS
190-48—99th Ave.

Dept. H-9
Hollis 23, N. Y.

to give some QRM. Find a pair of locations where the XYL can hear only about 80% of what you're saying, when you read to her from the paper, for example. Then when you've a good idea of how much she misses when you're speaking normally, try using this more vigorous word formation, and see if it helps. Look for more motion of lips, jaw, and tongue, not for more volume.

You might run into a little trouble here if you concentrate on your mouth motions too much—you'll end up like the caterpillar that starved to death because he couldn't figure out which foot to move next. What may happen to you is that all this concentration starts to interfere with a procedure which should be automatic, to the point where your voice starts to sound artificial, and not like yourself at all.

There's a simple cure for this tendency: whisper the words first. When you're whispering, you use a much more complete word

73 Products and Publications

6UP Magazine. The only fullfledged monthly devoted to VHF. Invaluable to the Technician and the VHF/UHF DX'er and experimenter. Activity reports on all band openings. Wide band FM news. Six meter news. Two meter news . . . 220, 432, 1296 . . . etc. Construction articles, antennas, etc. K5JKX editor. \$2 per year. Don't miss a single copy of this interesting magazine.

ATV Bulletin. The Amateur Television Experimenter is the only publication devoted to ham-TV. Circuits, operating news, conversions of surplus gear, ads for TV gear, discussions. WØKYQ editor. \$2 per year, published bi-monthly.

Binders. Bright red leather gold stamped with 73 and year. Specify 1960-1, 1962, 1963, 1964. \$3.00 each.

Bound Volumes. Only a few left. 1960-1, 1962, 1963. A very few. Beautiful red leather. \$15 each.

WØKYQ editor. \$2 per year, published bi-monthly. **Impedance Bridge.** Full scale construction prints for the bridge described in the August 1961 issue of 73. Comes complete with a reprint of the article. Watch out General Radio! \$1.00

SSB Transceiver Schematic—W6BUV. Giant size schematic of the transceiver that appeared in the November 1961 issue of 73. Complete with extra November issue. \$1.00

73 Inc
Peterborough, N. H.

formation with your mouth, since you don't have any sound from your larynx to work with. Then, when you've found out by whispering how you should have been forming these words all along, speak it out loud the same way and see if the XYL notices an improvement in intelligibility.

There's another trick to improving your intelligibility that vocalists and orators use all the time. Bagpipes don't need it, because when you hear a bagpipe, you know what it is—but a vocalist has to be able to cut through the QRM of a whole team of musicians competing with her at something like 30 db over S9, and make sure you get every word. Seems just the thing for phone, doesn't it?

Here's the trick: just form the words as far forward in your mouth as you can. I can't tell you how to do it by analyzing what goes on inside your mouth; you'll just have to try it yourself until you get it. Your voice will have a new ring and clarity, with a slight flavor of coming down with a cold, since you're now including the very-important resonant chambers of head and nose in your speech production. This front-of-mouth word formation has a lot to do with the ability of some amateurs to be heard and understood at a signal-to-noise ratio that leaves everyone else down in the mud.

Then, if the XYL is still listening, try them all out on her: body relaxation, for a freer use of the breathing apparatus; throat relaxation for a relaxed, bigger tone; more vigorous use of mouth, jaw and lips, together with word formation toward the front of the mouth, for improved clarity. Try it out on yourself with a tape recorder, feeding in known amounts of QRM. Try it out on the air to see if you get reports of improved audio, or of cutting through the QRM any better.

One last item; very important. It's this: there's a lot more to it than just cutting through the QRM and making contact. There's also the matter of courtesy, of making the other fellow sound as though you're interested in the QSO. Why should he bother listening if your voice doesn't sound interested, either? A firm, clear voice commands respect, on the air as well as anywhere else; tune over the band some night and see if this isn't so. Remember, when you're on the air, your voice isn't just a medium of communication: your voice is you.

So have fun. Here's to good rag-chewing, and lots of DX.

And if you know where I can get a good bagpipe, let me know.

. . . W1JKZ

(W2NSD from page 4)

mitter to operate K2US. Letters from several other visiting hams, some permitted to operate, some not.

There seems no question now that the Washington Amateur Radio News, ARRL's unofficial hate sheet dedicated to the downfall of the Institute of Amateur Radio, is being sent to all IoAR members listed in the July issue of 73.

Here At 73

With the closing down of the Parts Kits program and the Radio Bookshop, we've been able to get to work on other projects. One of the first was the printing of the amateur regs for the Institute. Next we printed a good sized book of articles that have appeared in the past issues of the ATV Bulletin, most of which are long out of print. This book is a must for all of you interested in ham TV . . . \$3. Next our little press swung into action and turned out a book on test equipment and how to use it. You can do a lot of things with your test gear you never thought of. Then we printed a book on Parametric Amplifiers which VHF men should find invaluable. Paramps are getting down to where you can build them yourself and get them working. This book shows you just how to do it.

The press hasn't had a chance to cool for quite a while. As soon as the Paramp book was done we put out 6-UP and started printing our VHF/UHF Antenna Handbook. Our Receiver Handbook is on the way and should be done before the end of August. All this printing has been made possible by our acquisition last spring of a 3000 pound paper cutter and a huge paper folder.

Though I really haven't had the time, I've been going up to 73 Mountain two or three nights a week and operating on six and two. Six was opening up frequently during early July and late June and I worked about 600 different stations in some 40 states. The best DX was California. The 500 watts and 16 element Cushcraft Colinear made DXing a snap.

The real thrill was down on two meters. Here I had a 336 element Cushcraft Colinear-Yagi antenna and 500 watts. The results are almost beyond belief. On a normal evening of operation I contact between 80 and 100 different stations during a four hour stint. Most contacts are hello-goodbye, but sometimes I get wound up answering questions and talk for a half hour or more. It takes me from two to three hours to tune from one end of the band

ALL-BAND SSB RECEIVER BARGAIN: R-45/ARR-7 has 2 stages RF, 2 stages 455 kc IF, separate Local Osc. w/VR AF, S-Meter, Noise-Limiter, Crystal & non-crystal IF Pass in 6 pass selections . . . and now we add **PRODUCT DETECTOR** in the empty socket left by removal of the reradiation suppressor preceding the 1st RF. Goes on when BFO is flipped on, works like a charm! **CONTINUOUS TUNING 550 KC to 43 MC!** Voice, CW, MCW. With 120/230 v. 50/60 cy power supply, ready to plug in and use **HOT and SHARP!** With book 90 lbs fob LA **199.50**

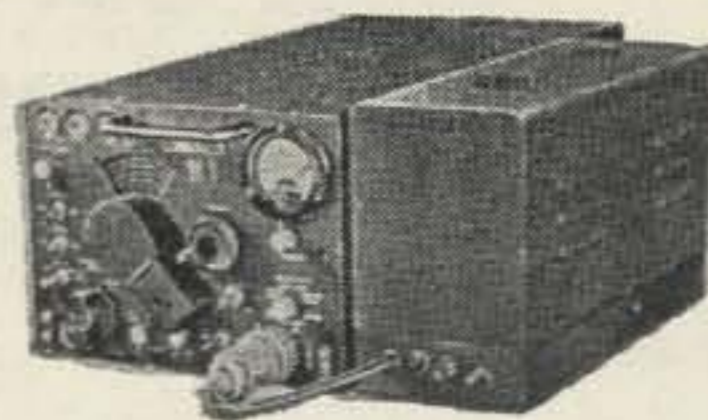

Same but without the SSB addition fob San Antonio **179.50**

TIME PAY PLAN: Any purchase totalling \$160.00 or more send us only 10% for Down Payment!

LM FREQUENCY METERS 125 kc-20 mc, with Cal. bk. plug, xtl, instruct., gorgeous **57.50**

TS-175/U FREQUENCY METER 85-1000 mc, crystal calibrated, with serial-matched Calk Bk. & Handbook, exc. condition! **150.00**

MAKE POWER SUPPLY for LM's and/or TS-175 by modifying brand new EAO 60 cy portable power supplies with Instructions and Silicon Diodes we supply. 47 lbs. fob San Diego **9.95**

FM XMTR-RCVR base station, Farnsworth AN/FRC-6A, puts 50 W into antenna, 30-40 mc, Voice. 120 v 60 cy pwr sply, speaker, meters, etc. in rack cabinet **99.50**

AN/APR-4 RECEIVER SET w/Tuning Units TN-16 & 17. 38-300 mc, checked 100% OK, w/plug & Handbook **149.50**
(Write for prices on AF/FM type and on other tuning units, up to 4 kmc.)

R-111/APR-5 RCVR 1-3 kmc AM has 115 v 60 cy pwr sply built in, exc. for SPEC-TRUM ANALYSIS **79.50**

A Model goes to 6 kmc **99.50**

A Model in rack w/30 mc Pandapter RDP, also 115 v 60 cy, displays ± 5 mc, plus other material, useful also for APR-4 Set above which also has 30 mc. I.F. **199.50**

NEW LOW PRICE on latest-type **MINE DETECTOR:** AN/PRS-3 has waterproof Search head, coils embedded in plastic, drag under water or use above ground, find **PIRATE'S GOLD** or **PLUMBER'S PIPES!** Exc. cond., with all parts & Handbook in Fiberglass Suitcase, 40 lbs. fob Tacoma, Wn., only **19.95**

NEW LOW PRICE on ungraded **SILICON DIODES**, various PIV's & Currents, some good, some bad, you grade them with Instruction included. 100 for only **2.95**

GRD CONDITION TELETYPE right off operating line, all w/SYNCH motors. No pwr splies. Clean, oiled, no rust. We will send you any repair parts you need **FREE** except window glass if you specify part Nos., so get the books too.

Mod. 15 send/rcve plus hi-base Typing Reperforator plus #14 Trans-Distr, all in operator's console cabinet w/paper storage, etc. Made of panels which open out on piano hinges for ready access to all machines **175.00**

Same except machine is Mod. 19 **195.00**

Mod. 14 Trans-Distrib. with cover **37.50**

Books (TM11): —352 on Mod. 15 \$7.50. —2222 on #14 TD, \$8.50. —2223 on #14 Typing Reperf. \$9.00. —2216 on Mod. 19, \$12.50.

ARC-3, ARC-27, ART-13 TECH. MANUALS each **10.00**

TEKTRONIX SCOPES grtd OK & gorgeous, w/books: #514A or #514D: DC to 10 mc; sensit. 30 mv/cm; sweep calib. uv/cm; calib. deflection **395.00**

#514AD **450.00**

#524D: For TV Station engineers **550.00**

GERTSCH RATIOTRAN PT-5R AC Voltage Divider .001% accurate, 50-10,000 cy. 5 decades plus final interp, slidewire, rack mtg **175.00**

w/ST-200 xfrmr & sw. to reverse polarity **200.00**

Measurements Corp. Model 80. General Radio #1021A series. General Radio #805-C. Navy LP, TS-413/U. Boonton AM/FM, etc. **STANDARD SIGNAL GENERATORS GALORE!** All completely checked out and certified OK ready to use. **ASK FOR LIST!** Also **LINE VOLTAGE REGULATORS.** Regulated Power Supplies, etc. & **TELL US YOUR NEEDS!**

LEEDS & NORTHUP: Kelvin-Varley Volt. Divider .01%, 20K ohms, 4-digit **49.50**

#4760 4-dial .1% DC Wheatstone Bridge **100.00**

#2310-c pointer galvan. for above **27.50**

WESTON #440 pointer galvanometer **37.50**

#5430A, similar above, galvo built in **125.00**

#4725 5-dial DC Wheatstone Bridge .05% **275.00**

#2430-c Lamp & Scale galvo for above **150.00**

RUBICON galvo very similar to above **125.00**

#5365 Power Cable Fault Bridge + Rheost. **275.00**

PLENTY MORE WONDERFUL MATERIAL! Ask for your needs! We **ALSO BUY** your excess mdse.

R. E. GOODHEART CO., INC.
Box 1220-GC BEVERLY HILLS, CALIF. 90213

Phones: Area 213, office 272-5707, messages 275-5342.

CLOSE OUT ON THE FOLLOWING KITS

Limited supply. Don't delay.

TRANSISTOR POWER SUPPLY. April 63. W11SI	\$22.50
QRP TRANSMITTER. March 63. W1MEL	\$5.00
SW CONVERTER FOR HAM RECEIVER. Au- gust 62. W2LLZ	\$11.00
RECEIVER DECEIVER. January 64. W2RWJ	\$15.00
SIX METER CONVERTER. May 63 No xtal. WA2HVK	\$15.00
QRP KILOWATT. March 63. WA4DQS	\$5.00
CAST IRON BALUN. September 63. W4WKM	\$3.00
NUVISTOR PREAMP FOR 15-20 METERS. April 63. W6SFM-1	\$4.00
CW NOISE LIMITER. September 63. W6SFM-2	\$3.00
PORTABLE 40M TRANSMITTER. March 63. K6LJY-1	\$22.50
PORTABLE 40M RECEIVER. March 63. K6LJY-2	\$15.00
TWO METER ANTENNA COUPLER-SWR BRIDGE. July 63. W6TKA-1	\$9.50
BOURBON S-METER. September 63. W6TKA-2	\$6.00
TONE MODULATED XTAL STANDARD. October 62. W9DUT-3	\$12.00
NOISE GENERATOR. April 63. Thomas	\$9.00
COIL EVALUATOR. June 63. WφQWY	\$8.00
40w TRANSISTOR MODULATOR. September 62. VE7QL	\$25.00
NOISE GENERATOR. Invaluable test instru- ment for tuning up rf stages, converters, etc., voltage regulated by a ener diode. Kit in- cludes even the battery and mini-box. K9ONT	\$5.00
TRANSISTOR TRANSCEIVER. One of the most popular kits we've ever assembled is this six meter miniscule transistorized transceiver. Really works. Hundreds built. See page 8 in the May '63 issue. Five transistors. K3NHI	\$25.00
TWOER MODIFICATION. Increase your selec- tivity considerably by installing a new triode 7587 nuvistor stage. This is our best selling kit to date. Everything you need for the modification is included. See June '63 page 56 K6JCN	\$7.50
CW MONITOR. Connects right across your key and gives you a tone for monitoring your bug. Page 44, June '63. WA2WFW	\$4.25

73 Inc.

Peterborough, N. H.

to the other, working stations as I tune up the band. The bulk of the contacts are down in the New York City-New Jersey area, but they go right on down to Hampton, Virginia. K1IED/4 in Hampton calls me almost every night that I operate and lets me know how my signal is doing down there. Normally it runs around S-6, but he has heard it 25 db over 9!

Under normal conditions I have no great problem in working fellows in New York City with Twoers and a five element beam. I've worked Twoers all the way down to Baltimore.

When I first got on with the Big Signal I figured that I would work fellows as fast as I could and that eventually I would have given everyone a contact with New Hampshire that wanted it. Then I could settle down and rag chew. Haw! I've contacted over 800 different two meter stations so far in the last six weeks and there is no sign of my running out of new contacts. I may *never* get to rag chew on two. I'm not complaining.

I sure would like to work some fellows down in North and South Carolina. I'll try to be on every Tuesday and Saturday night on about 145.000 mc at 2300 local time on CW and listening for calls around that frequency or between 144.0-144.1. I'll be on as many Fridays and Sundays as I can too.

. . . Wayne

(Sixer Linear from page 15)

Then cut off the rf input drive, apply plate and screen voltage and tune C1 and C2 over their ranges. No self-oscillation should occur. It is assumed that everything is in good working order, that the grid and plate circuits tune well above and well below the 50 mc band. Actually these tests above are *final* ones. The whole process should be repeated several times in order to be sure that everything is in good shape.

Linear Tune-up

The rig should work OK if you make it up as shown. However, I advise you to check with a 25 watt bulb as a dummy load first. With between ½ watt and a watt input, you should get 20 to 25 watts output, using 350 to 450 volts and 100 to 150 mils on the plates. Be sure and *overload* the plate coupling! Linears like that! Without load you should get a good 50% plate dip in current, and good fat smoky sparks with a pencil (wood!) on the plates.

Listening with the diode, transistor amplifier, and padded earphones, you *should* hear the kind of modulation you like to hear. Overdrive the grid circuit and see if you can make it distort. It *should* when you go up much over a watt on the driver output. You then reduce

it back to where it sounds good. Your Sixer may not be able to drive it that hard. You will easily find the input level that should not be exceeded. Incidentally, though not surprisingly, the drive can be increased if more plate and screen voltages are applied to the linear. You can go up to 500 volts if you really insist. Just watch those plates for color! I could not see any color at 60 watts input. With 25 to 30 watts output without modulation, and more with modulation.

On The Air Tests

I put up a portable four element 6 meter beam about 10 feet over the roof with RG-8/U feed line. Using close coupling between L3 and L4 and *no* plate dip, I listened in with the diode for linear results. Sounded OK, so I stood by on the band. A heavy call came on, "I've been listening to you Bill ever since you put that carrier on. Sounds great." That was encouraging. Worked around 1/2 dozen stations until a lot of QRM from Florida and Iowa started up. (Yes, on 50 megacycles!) Of course, if you've been on 6 working locals and such for weeks on end, DX is alright.

Comparisons between the "bare-foot" driver and the same with the linear added shows quite a difference alright. On distant stations, like Lyndboro, N. H., 47 miles airline, the signal at one watt is near the noise level with a Sixer, but with the linear added reports were "Solid copy, S 9." Well, you know those S-meters!

The whole business of an AM linear boils down to this; you've got a \$1.75 tube dissipating some 20 to 25 watts and putting out a fully modulated signal of some 30 watts, with quite a bit more on modulation. This is driven by a less than one watt signal from the Sixer or other little unit.

Just remember, to repeat, as it says on page 19, RCA TT5, "The maximum efficiency of an AM linear varies from approximately 33% for an unmodulated carrier (who needs one) to an approximately 66% for a fully modulated carrier."

What more do you want from a \$1.75 tube and a one watt modulator?

... KICLL

902A	2" CRT, P-1 phosphor, BRAND NEW (an AF goof, made in Jan. 1963), 600v DC max, on deflection plates. Fits octal socket. Shipping weight 3 pounds, each	\$3.50
RANGE FILTER	"POOR MAN'S Q-5er." Navy type, black crackle finish, sloping front, with two jacks, cord with PL-55, three position switch-range passes 1020 cycles, phone rejects 1020 cycles, both no filter action. Shipping weight 3 pounds. BRAND NEW	\$1.95
3 MFD 4000v DC	Oil filled, SPRAGUE, 4 1/2 x 3 x 6 1/2", with 1 1/2" ceramic terminals. Shipping weight 8 pounds. BRAND NEW. ea.	\$6.95
8 MFD 1500v DC	(Guaranteed for 2250v DC), 3 1/2 x 2 1/2 x 5 1/2" with 1/4" button terminals. Shipping weight 5 LBS. NEW	\$3.75
15 MFD 1000v DC	Good, clean, take-outs. 3 5/8 x 2 1/2 x 4 1/2" with 1/4" button terminals. Shipping weight 4 pounds	\$1.25
10 MFD 600v DC	Good, clean, take-outs. 3 1/4 x 1 1/2 x 4 1/2", with 1/4" button terminals. Shipping weight 2 pounds, ea.	89c
POWER TRANSFORMER	Straps, for last three above, with order, 15c pair. 117v 60 cycle tapped primary: 370-0-370 at 165 ma; 6.3v at 3 1/2 A, 5v at 3A secondaries. Open frame, color coded wire leads, hypersile core. 3 x 3 3/4 x 3". Shipping weight 7 pounds. 4 for \$12.50 NEW	\$3.50
FILAMENT TRANSFORMER	117v 60 cycle primary; two 2 1/2v CT at 9A each. 1780v DC test. Use as 5.0v CT 9A or 2 1/2v CT 18A. Cased 3 3/8 x 3 1/8 x 5", with 5/8" ceramic terminals. Shipping weight 7 LBS. BRAND NEW. 4 for \$18.50	\$5.00
5763 884	Tubes, pull-outs from new military sets, not tested but fully guaranteed. Any 4 for \$3.75	\$1.00

Hamfest Schedule: Findlay, Ohio Sep't 13; Peoria, Ill. Sep't 20; Cincinnati Stagfest Sep't 27.

B C ELECTRONICS
Telephone 312 CALumet 5-2235
2333 S. Michigan Ave. Chicago, Illinois 60616

ALL BAND TRAP ANTENNA!



Reduces Interference and Noise on All Makes Short Wave Receivers. Makes World Wide Reception Stronger. Clearer on All Bands!

For ALL Amateur Transmitters. Guaranteed for 600 Watts AM 1200 SSB Pi-Net or Link Direct Feed. Light, Neat, Weatherproof.

Complete as shown total length 102 ft. with 96 ft. of 72 ohm balanced twinlead. Hi-impact molded resonant traps. (Wt. 3 oz. 1" x 5" long). You just tune to desired band for beamlike results. Excellent for ALL world-wide short-wave receivers and amateur transmitters. For NOVICE AND ALL CLASS AMATEURS! NO EXTRA TUNERS OR GADGETS NEEDED! Eliminates 5 separate antennas with excellent performance guaranteed. Inconspicuous for Fussy Neighbors! NO HAY-WIRE HOUSE APPEARANCE! EASY INSTALLATION! Complete Instructions.

75-40-20-15-10 meter bands. Complete\$15.95
40-20-15-10 meter. 54-ft. (best for swl's) Complete\$14.95

SEND ONLY \$3.00 (cash, ck., mo) and pay postman balance COD plus postage on arrival or send full price for postpaid delivery. Complete installation & technical instructions furnished. Free information on many other 160-6 meter antennas.

Available only from:
WESTERN RADIO • Dept. A7-9 • Kearney, Nebraska

F M		2 METER		F M		6 METER		F M	
Hiband G.E.—ES1B	1 pc	20 watt	\$45	12a1	1 pc	10 watt	\$55	16a1	1 pc
16a1	1 pc	30 watt	\$65	13a1	1 pc	50 watt	\$65	Motorola—5V	1 pc
Motorola—5V	1 pc	10 watt	\$45	40V	1 pc	10 watt	\$55	41V	1 pc
41V	1 pc	10 watt	\$65	80DU	1 pc	30 watt	\$85	Loband G.E.—8th mo	2 pc
Loband G.E.—8th mo	2 pc	30 watt	\$65	Motorola walkie Talk		60 watt	\$85	Link 2365	1 pc
Link 2365	1 pc	30 watt	\$25	41v	1 pc	12 watt	\$55	Motorola—5V	1 pc
Motorola—5V	1 pc	10 watt	\$45	Receivers 13v			\$25	80D	1 pc
80D	1 pc	30 watt	\$85	Base Sta	2 pc	50 watt	\$75	T44a6a	1 pc
T44a6a	1 pc	18 watt	\$85	CMV2B	1 pc	30 watt	\$35	RCA Base Sta	2 pc
RCA Base Sta	2 pc	30 watt	\$35						
		Accessories \$20							

25% with order FOB Ft W

F M HAM SALES P.O. Box 1574 Fort Worth, Texas

INDEX TO ADVERTISERS

To aid you in finding ads which are not running in this issue we have listed the last ad run by each company in 73.

Oct. 63	Aaron	Aug. 64	Gem Electronics	July 63	QTH MAPS
Cover 2	Adcom	June 64	Glass, J. J.	July 64	Quaker
Jan. 64	Adirondack	77	Gonset	45, 75	Quement
Oct. 63	A & F Electromart	91	Goodheart	Aug. 64	Radio Bookshop
Sept. 63	Alco	69	Graham Radio	Apr. 64	Radio Ham Shack
Mar. 64	Alcom	Jan. 64	Groth	Apr. 63	Radio Industries
Oct. 63	Alden	Nov. 63	Grove	Nov. 63	Radio Publications
June 64	Algeradio	Aug. 63	Ham Trader	May 64	Rand
Aug. 64	Alliance	May 64	Hallicrafters	May 64	Ready Radials
Sept. 63	Allied	5	Hammarlund	79, 81	Redline
86	Alltronics-Howard	Nov. 63	Harrington	Sept. 63	Reed
July 64	Amateur Elect. Supply	Mar. 63	Harrison, Ivan	June 63	Rex
Feb. 63	Amateur Radio Exchange	87	Hayden	71	Reyco
Nov. 63	Amber	May 64	H CJ	Apr. 63	Ritco
July 63	American Crystal	July 64	Heath	Apr. 64	Roberts
May 63	Amperex	Aug. 64	Heed	37	Rohn
July 64	Amplidyne	Aug. 64	Hefron	Nov. 63	Rowe
69	Amrad	55	Henry	Dec. 63	R & S
78	Antenna Specialists	Aug. 64	Hi-Par	87	RW Electronics
Apr. 63	Arrow Electronics	Aug. 64	Hi-Way	Sept. 63	Sams
June 63	Arrow Sales, Cal.	Oct. 63	Holstrom	33	Saxton
71	Arrow Sales, Chi.	Aug. 64	Hornet	Feb. 63	Schober
July 64	Atlantic	Aug. 63	Howard	Aug. 64	Scientific Assoc.
85	ATV Book	Nov. 63	Hunter	Apr. 64	Seatronics
69	ATV Research	Aug. 64	Hy Gain	Aug. 64	Sideband Engineers
Oct. 63	Badges	Aug. 64	Hy Que	Apr. 63	S. J. Electronics
Sept. 63	Bald Eagle	Jan. 64	Identoplate	Mar. 64	Skylane
93	BC Electronics	May 63	Instructograph	Mar. 64	Slep
July 64	Bell	3	International Crystal	Aug. 64	Space
Apr. 64	Best	Aug. 64	IoAR	69	Spencer
Oct. 63	BF	Feb. 64	Irving Electronics	17	Spitz
Oct. 61	British Radio	Aug. 64	Jaro	Nov. 63	Sprague
49	Burghardt	Oct. 63	Jays	9	Squire-Sanders
23	B & W	Aug. 64	Jefftronic	June 63	Star
Apr. 64	Byron Airpack	Nov. 63	Johnson	95	Subscriptions
57	Callbook	July 64	Joseph's	Apr. 64	Super-Q
Aug. 63	Candee	Jan. 63	Kar-Tenna	May 64	Surplus Spec
June 64	C & H	Aug. 64	Kit-Kraft	52	Swan
July 63	Charter Oak	Nov. 63	Kniper	June 64	T A B
July 64	Chemung	Mar. 64	Knox	Feb. 63	Technical Manuals
9	Clegg	Sept. 63	KTV Towers	31	Technical Materiel
Apr. 64	Cleveland Institute	June 63	Ladd	87	Technical Syst.
July 63	Collins	61	Lafayette, N. H.	87	Telemarine
89	Columbia	51	Lafayette Radio	Feb. 64	Telemethods
May 63	Columbia Products	71	Lawrence Eng	41, 44, 60	Telrex
May 64	Comaire	59	Linear Systems	69	Teltrol
25	Cornell-Dubilier	Apr. 64	L R Electronics	July 64	Tepabco
Jan. 64	Coral Cliffs	Apr. 64	Mach	29, 67	Texas Crystal
66	Cubex	July 64	Madison	Feb. 64	Thermoelectric D.
39	Cushcraft	69	Mann	July 64	Topaz
Jan. 64	Dames	July 63	Maps	Aug. 64	Transistors Ult.
Apr. 64	Dayton Hamvention	Aug. 64	Master Mobile	Jan. 64	Trans Pro
Apr. 63	Delta	July 64	McCoy	Nov. 63	Trice
July 64	Denver Crystals	83	Meshna	Nov. 63	Tri-Ex
88	Denson	May 64	Metro	June 63	Tri-State
17, 64, 65	Dow Key	May 63	Metrodynamics	71	Tucker
Aug. 64	Dow Radio	May 64	Midwest	Aug. 63	United
Aug. 64	Drake	June 63	Miller	Feb. 63	US Crystals
Mar. 63	Ebco	65	Mini-Products	Cover II	U. T. C.
Apr. 64	Editors & Engineers	74	Mission	Apr. 63	Valley
Feb. 63	Ed-U-Cord	July 64	M & M	69, 71, 89	Vanguard
Mar. 63	Electro-com	Jan. 63	Mor-Gain	Oct. 63	Verns
June 63	Electronic Servicecenter	July 64	Mosley	July 63	Versatronics
July 64	Electronic Specialists	Cover IV	National	Feb. 63	Vesto
Oct. 63	Emrad	Apr. 64	Newark	July 64	V & H
May 64	Epsilon Records	May 63	New Products	July 64	VHF Associates
95	Evans	15, 21, 43	Newtronics	Jan. 63	Vibroplex
Feb. 64	E-Z Etch	July 63	North American	69	Viking
4	E-Z Way	Feb. 64	Northwest	Oct. 63	WA6DUW
89	Fair	Dec. 62	Nortronics	19	Waters
July 63	Fairbrother	Aug. 63	Ole's	Sept. 63	Webster
65	Fichter	May 63	Out-O-Door	61	Western (Calif.)
63	Finney	Jan. 64	Ontario	93	Western (Neb.)
Aug. 64	F-M	June 63	Palmer	Jan. 64	Wildcat Press
93	FM Ham Sales	61	Parks	July 64	Woodruff
Aug. 63	Foreign Projects	Jan. 64	Pauls Surplus	73, 78,	World Radio Labs
17	Foreign Subs	Mar. 64	Pausan	Cover III	
July 64	Fulton	Apr. 64	P & H	Apr. 62	Zalytron
July 64	Gain, Inc.	Apr. 64	Petrilak	95	73 Subscriptions
July 64	Galaxy	June 64	Poly-Paks	90	73 Products
Feb. 63	Gam	Mar. 63	Polytronics	92	73 Parts Kits
Mar. 64	Gavin Instruments	84	Propagation Products	84	6 Up

JUST PUBLISHED!

The Test Equipment Handbook by James G. Lee W6VAT

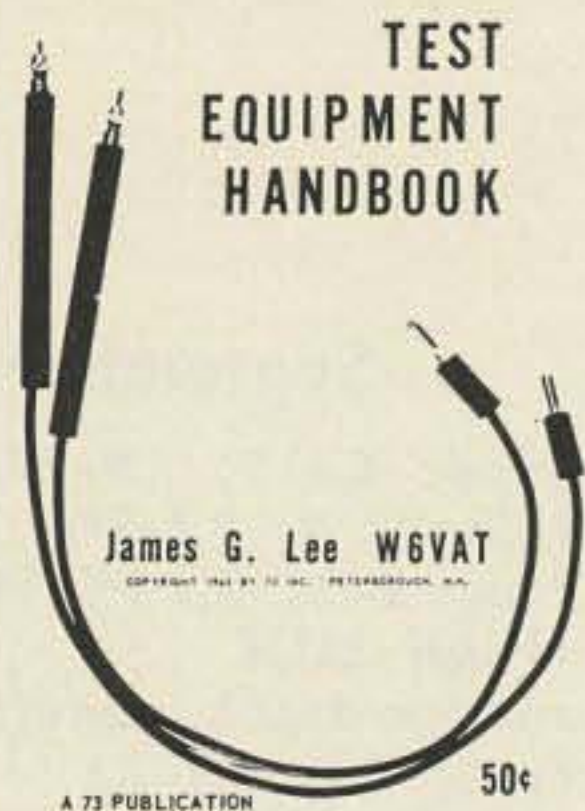

Test gear for the ham: Practical construction plans and complete information for a transistor VOM, SWR-power meters, dummy loads, and other pieces of ham test equipment.

Fully illustrated. 32 pages. Price: 50c.

Published by 73 Inc., Peterborough, N. H.

"Your Friendly Supplier"

FROM STOCK!

OFFERS

A COMPLETE "LINE-UP" OF ALL THE POPULAR TRANSCEIVERS



KWM-2

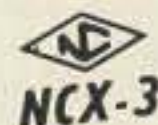

NCX-3



SIDE BAND ENGINEERS SB-33



SWAN-100

DRAKE TR-6

hallicrafters SR-160 SR-150

For Additional Information, Write for our "Transceiver Portfolio" #73T

Going Mobile??? Good Mobiles Go **HUSTLER**

We Stock Complete Line of NEW-TRONICS Antennas.

We maintain the largest stock of used equipment in the Northeast — Engineering Department — Time Payment Plan available.

WRITE FOR LATEST COMPLETE LIST

Evans RADIO

P.O. BOX 312

PHONE 603-225 3358

CONCORD, N. H.

Subscriptions

If you like 73 we'd appreciate your help in getting more fellows to subscribe. The big difficulty is to overcome inertia and actually get them to sit down to get it done. We try to make it as simple as possible on our end. The price is a simple (and low) \$4. Our address is simple: 73, Peterborough, N. H.

MASTER ORDER BLANK

73 Subscriptions

Name _____ Call _____

1 yr \$ 4.00 _____

Address _____

2 yr \$ 7.00 _____

City _____ Zone _____ State _____ Zip _____

3 yr \$10.00 _____

One year subscriptions

LIFE \$50.00 _____

6up \$2 _____ ATV \$2 _____

New sub. _____

Renewal sub. _____ loAR Membership 1 yr \$10 _____

Start with _____

Back issues (50c each) _____

Propagation Chart

EASTERN UNITED STATES TO:

GMT -	00	02	04	06	08	10	12	14	16	18	20	22
ALASKA	14	7*	7	7	7	7	7	7	7*	14	14	14
ARGENTINA	14	7	7	7	7	7	14	14	14*	21	21*	21*
AUSTRALIA	14	14	7	7	7	7	7	7*	7	7	14	14
CANAL ZONE	14	7	7	7	7	7	14	14	14	14*	21	21
ENGLAND	7	7	7	7	7	7*	14	14	14	14	14	7*
HAWAII	14	14	7	7	7	7	7	7	14	14	14	14
INDIA	7	7	7	7	7	7	7	14	14	14	14	7*
JAPAN	14	7*	7	7	7	7	7	7	7	7	14	14
MEXICO	14	7*	7	7	7	7	14	14	14	14	14*	14*
PHILIPPINES	14	7	7	7	7	7	7	7	7*	7*	7	14
PUERTO RICO	14	7	7	7	7	7	14	14	14	14	14*	14
SOUTH AFRICA	7*	7	7	7	7	14	14	14	14*	14*	14*	14
U. S. S. R.	7	7	7	7	7	7	14	14	14	14	7	7
WEST COAST	14	14	7	7	7	7	7	14	14	14	14	14

September 1964

Good: 6-11, 18-21, 26-28
 Fair: 1, 4, 12-14, 17, 23-24, 29
 Poor: 2-3, 5, 15-16, 22, 25, 30
 (High MUF
 and/or freak conditions)
 Es: 7-12, 19-21

CENTRAL UNITED STATES TO:

ALASKA	14	14	7	7	7	7	7	7	14	14	14	14
ARGENTINA	14	7	7	7	7	7	14	14	14	14*	21	21*
AUSTRALIA	21	14	7*	7	7	7	7	7*	7	7	14	14
CANAL ZONE	14	7*	7	7	7	7	14	14	14	14*	21	21
ENGLAND	7	7	7	7	7	7	14	14	14	14	14	7
HAWAII	14	14	14	7	7	7	7	7	14	14	14	14
INDIA	7	7	7	7	7	7	7	7*	14	14	7*	7*
JAPAN	14	14	7	7	7	7	7	7	7	7	14	14
MEXICO	14	7	7	7	7	7	7	14	14	14	14	14
PHILIPPINES	14	14	7	7	7	7	7	7	7*	7	7	14
PUERTO RICO	14	7	7	7	7	7	14	14	14	14*	21	21
SOUTH AFRICA	7*	7	7	7	7	7	14	14	14	14	14	14
U. S. S. R.	7	7	7	7	7	7	7	14	14	7*	7	7

WESTERN UNITED STATES TO:

ALASKA	14	14	7	7	7	7	7	7	7*	14	14	14
ARGENTINA	21	14	7	7	7	7	7	14	14	14	21	21*
AUSTRALIA	21	21	14	7*	7	7	7	7	7	7	14	14
CANAL ZONE	14*	14	7	7	7	7	7	14	14	14	14	21
ENGLAND	7	7	7	7	7	7	7	14	14	14	14	7
HAWAII	21	21	14	7	7	7	7	7	14	14	14	14
INDIA	7	14	7	7	7	7	7	7	14	14	14	7
JAPAN	14	14	14	7	7	7	7	7	7	7	14	14
MEXICO	14	14	7	7	7	7	7	14	14	14	14	14*
PHILIPPINES	14	14	14	14	7	7	7	7	7*	7	7	14
PUERTO RICO	14	7	7	7	7	7	7	14	14	14	14*	14
SOUTH AFRICA	7*	7	7	7	7	7	7	14	14	14	14	14
U. S. S. R.	7	7	7	7	7	7	7	7	14	14	7	7
EAST COAST	14	14	7	7	7	7	7	14	14	14	14	14

J. H. Nelson

* Means next higher frequency may be useful.

COMPARE

WRL OFFERS YOU THE FINEST HAM EQUIPMENT ON THE MARKET AT PRICES YOU CAN AFFORD!!

TOP TRADE-IN ALLOWANCE ON YOUR PRESENT GEAR FOR NEW OR USED EQUIPMENT

OVER 1200 PIECES OF RE-CONDITIONED UNITS AT BEST PRICES AND 4-WAY GUARANTEE

SEND FOR FREE "BLUE BOOK" LISTING ON RECONDITIONED EQUIPMENT

SEE WRL FOR ALL YOUR AMATEUR NEEDS

FREE NEW 1964 WRL HAM CATALOG

**WORLD RADIO LABORATORIES
3415 WEST BROADWAY
COUNCIL BLUFFS, IOWA 51504**



The House the Hams Built

NOW! ORDER YOUR GALAXY TRANS-CEIVERS FROM WRL!

**GALAXY III
80-40-20 METERS
ONLY... \$349.95**

NO DOWN PAYMENT ONLY \$17.00 MONTHLY ON WRL CHARG-A-PLAN

**GALAXY V
80-40-20-15-10 METERS
ONLY... \$469.95**

NO DOWN PAYMENT ONLY \$21.00 MONTHLY ON WRL CHARG-A-PLAN

**GALAXY OF FEATURES (III & V)
BOTH MODELS - THE BEST IN MOBILE & FIXED STATION OPERATION.**

Handsome styling - functional design. Brushed aluminum panel with 4-color etchings. Flat black knobs and perforated steel cabinet with hinged top.

- 300 WATTS SSB/CW INPUT conservatively rated
- FULL COVERAGE ALL BANDS
- BEST FILTER AVAILABLE exceptional 2.1 KC filter stays 60 db down - with 1.8:1 shape factor
- MOST COMPACT 300-WATT TRANSCEIVERS - size, 6" x 10 1/4" x 11 1/4". Weighs only 13 lbs.
- SELECTABLE USB OR LSB with illuminated indicators
- ALC CIRCUIT BOOSTS TALK POWER

TWO-WEEK FREE TRIAL*

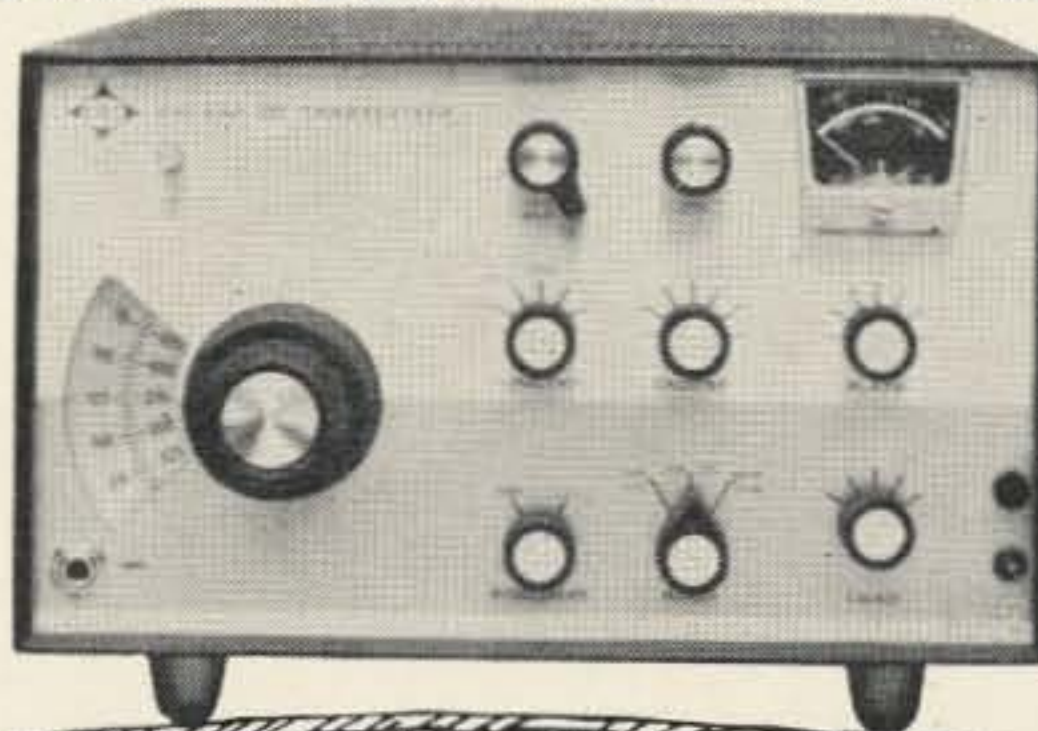

WRL WORLD RADIO LABORATORIES
3415 WEST BROADWAY
COUNCIL BLUFFS, IOWA

- Enter order on attached sheet. Send Galaxy III & V brochure. * Send trial terms.
 Quote trade allowance on attached sheet.
 Send FREE "Blue Book" sheets. Send FREE WRL Ham Catalog.

Name _____ Call _____

Address _____

City _____ State _____

NEW NCX-5 ALL-BAND TRANSCEIVER FROM NATIONAL — \$585

... The Finest Money Can Buy At Half The Cost of Closest Comparable Equipment

The new NCX-5 transceiver is dramatically superior in features and performance to the finest equipment previously available, yet, at only \$585, sells for the price of ordinary transceivers.

The NCX-5 was designed as a total amateur station for the 80, 40, 20, 15, and 10 meter bands, without compromise for either mobile or fixed station operation. Accordingly, the NCX-5 incorporates a linear solid state VFO with essentially no warmup drift — NCX-5 stability from turn-on is equal to the best tube type oscillators after "warm-up", and is unaffected by large excursions in temperature or voltage input. Dial calibration is by means of a technique previously found in only the most expensive military equipment — a digital counter read-out accurate to one kilocycle on each band with additional counter calibration to 100 cycles.

To make comparison with existing equipment even more difficult, NCX-5 transmit and receive selectivity is by means of National's new 8-pole crystal lattice filter; superior to filters of any type ever manufactured for amateur use. Filter bandwidth is 2.8 Kc. at 6 db with a 6-60 db shape factor of 1.7:1.

Selectable upper or lower sideband is included, together with a new Transceive Vernier control to provide up to ± 5 Kc. separation of receiver frequency from the transmitter.

Other important features are VFO input for optional VFO console VFO console incorporates split-frequency crystal channels as well as tunable VFO functions, with sharp selectivity and sidetone oscillator for CW operation Built-in ALC (10 db) with ALC input for NCL-2000 2 KW amplifier Two R. F. stages in receiver New separate AM detector as well as product detector Front panel choice of built-in VOX, PTT or new MOX operation Easy access hinged cover 200 watt input on SSB or CW, 100 watts AM Break-in grid block CW Fast-attack slow decay AGC S-meter/plate meter May be operated from NCX-A or NCX-D power supplies Optional XCU-27 100 Kc. calibrator Mobile mount included National's One Year Warranty.

Delivery of National's new NCX-5 transceiver will be in September. Call or write your authorized National dealer today for trade-in information on your present rig, and make certain you're first in line for delivery!

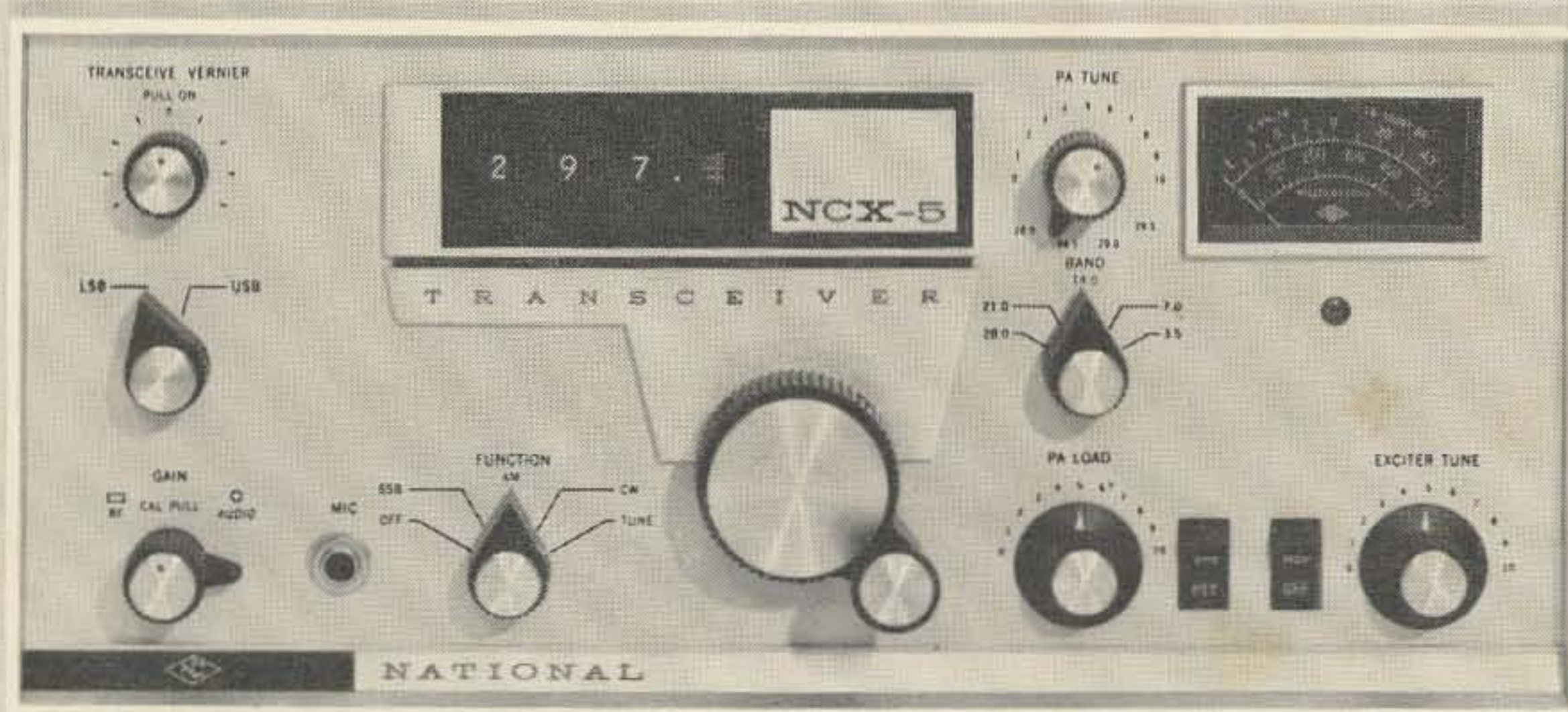

ADDITIONAL NCX-5 SPECIFICATIONS — Frequency Range: With crystals supplied 3,500 to 4,000 Kc., 7,000 to 7,300 Kc., 14,000 to 14,500 Kc., 21,000 to 21,500 Kc., 28,500 to 29,000 Kc. (Three additional crystals required if coverage of entire 28,000 - 30,000 Kc. band is desired). Types of Emission: SSB (selectable upper or lower sideband), AM, CW. Output Impedance Range: 40-60 ohms, Pi network. Frequency Determination: Double conversion with crystal-controlled high frequency oscillators and tunable second oscillator. Dial Accuracy: One kilocycle over entire 500 Kc. tuning range on all bands. Dial Calibration: 100 cycles on all bands. Tuning Ratio: Identical on all bands; 10 Kc. per 360° rotation of main tuning control. Frequency Stability: Not more than 100 cycles variation in any ten-minute period from turn-on including variation in input voltage of $\pm 10\%$. Suppression: Carrier -50db, unwanted sideband -50db, 3rd order distortion products -30db at full output. Receiver Sensitivity: 0.5 uv for 10 db S/N in SSB mode. Audio Output: Better than 2 watts; 3.2 ohms. Microphone Input: High Impedance. Tube and Semi-Conductor Complement: 20 tubes, 15 semi-conductors, 41 functions; Parallel 6GJ5's in P.A. Dimensions: 6-5/16" H, 13-5/8" W, 11-5/8" D. Shipping Weight: 26 pounds. Power Requirements: 700 V.D.C. @ 300 Ma., 280 V.D.C. @ 160 Ma., -80 V.D.C. @ 10 Ma., 12.6 V. @ 5 A.



NATIONAL RADIO COMPANY, INC.  37 WASHINGTON STREET, MELROSE, MASS. 02176

World Wide Export Sales: Ad Auriema Inc., 85 Broad St., N.Y.C.; Canada: Tri-Tel Associates, 81 Sheppard Ave. W., Willowdale, Ontario