

AMATEUR RADIO

73

August 1962

40¢

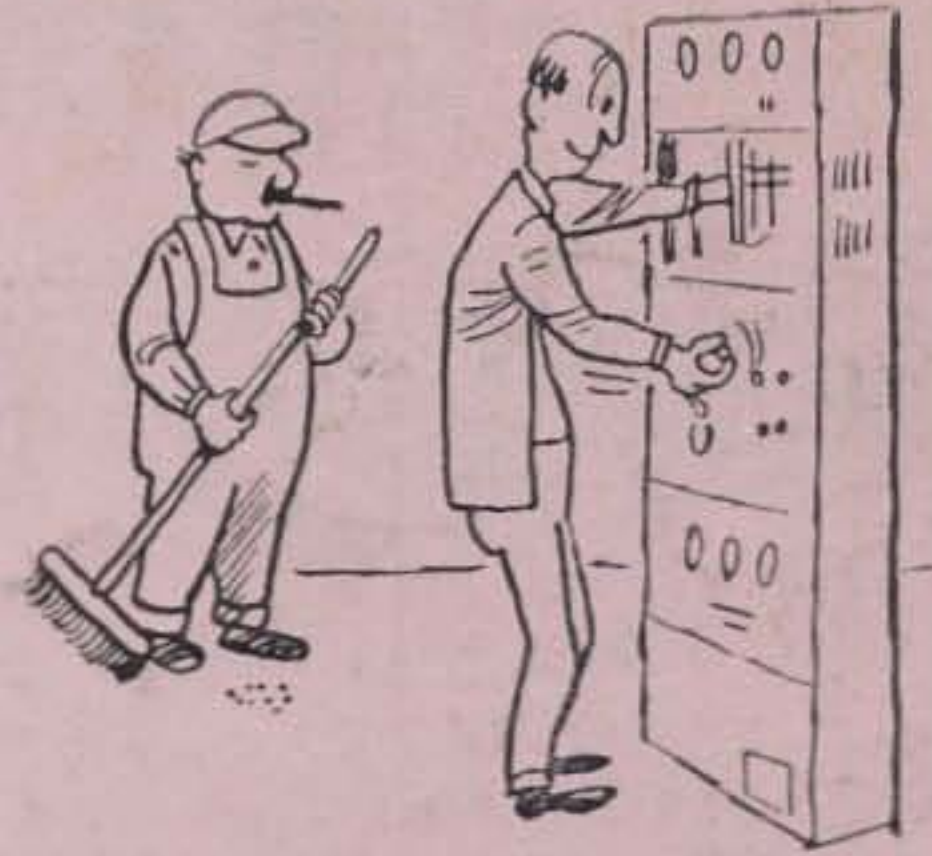
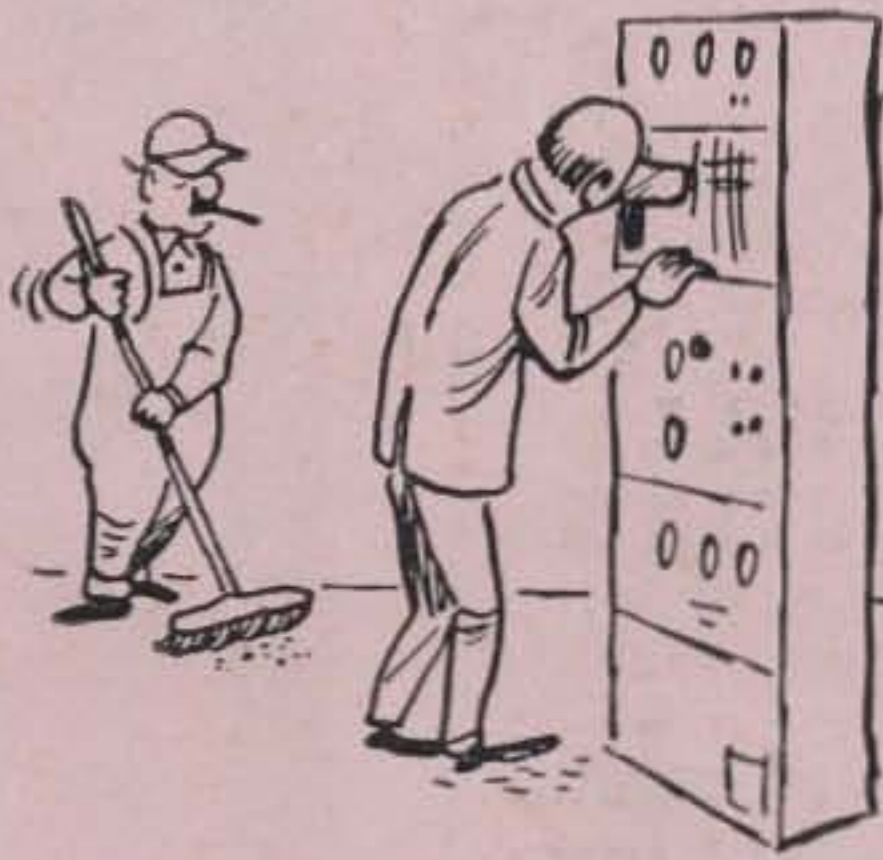

B. EDGERS



INTERNATIONAL AMATEUR CRYSTALS

Amateurs throughout the world depend on International crystals for precision frequency control.

Manufactured by the same highly skilled craftsmen who produce International commercial crystals for the broadcast industry, two-way radio communication, and our space and missile program.

International Amateur Crystals
1000 kc to 137 mc — .01% tolerance

Wire mounted, plated and hermetically sealed in metal holders. FA-5 and FA-9 are HC/6U pin type. The FM-9 is an HC/18U pin type.

Priced from \$3.30 to \$10.00

the **PERFECT** combination

for **FREQUENCY CONTROL**



INTERNATIONAL CRYSTAL SWITCHES

When you design or build . . . combine International crystals and crystal switches. Switches available from 3-position to 24-position. For antennas and laboratory work use International coaxial switches.

Priced from \$2.75 to \$19.50

1. S-121 Triple Socket Crystal Switch. Cat. No. 150-126.
2. AC-44 Single Pole, 24-Position Crystal Switch. Cat. No. 150-131.
3. 12-Position Crystal Switch. Cat. No. 150-163.
4. 3-Position Coaxial Switch. Cat. No. 100-112.

Write today for International's Free catalog of precision made crystals and equipment.

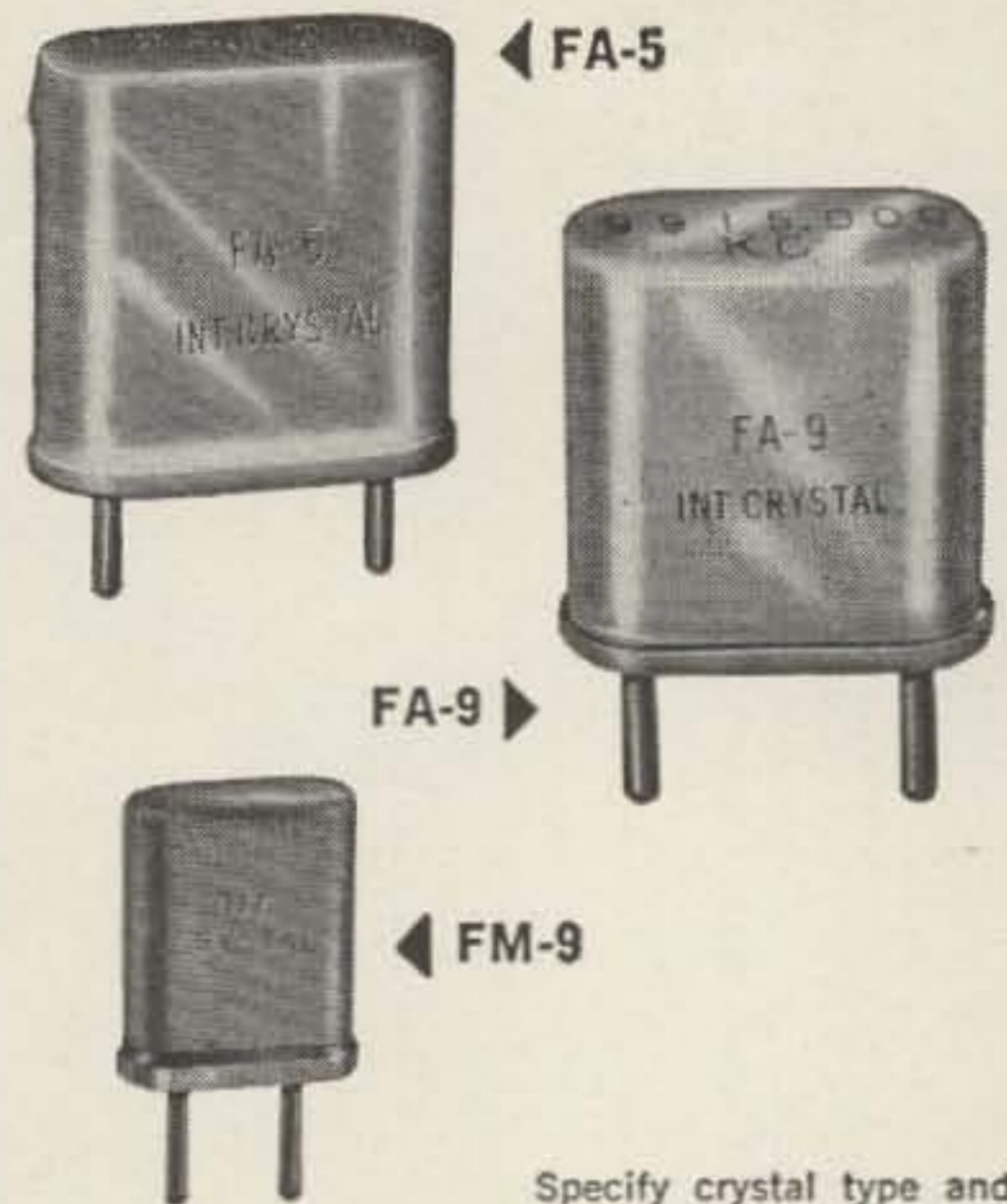

Specify crystal type and frequency when ordering.

	FA-5 and FA-9	FM-9
Fundamental	<ul style="list-style-type: none"> * 1000 - 1499 kc * 1500 - 1799 kc * 1800 - 1999 kc 2000 - 9999 kc 10000 - 14999 kc 15000 - 20000 kc 	<ul style="list-style-type: none"> Not available Not available Not available 8000 - 9999.999 kc 10000 - 15000 kc 15001 - 19999.999 kc
Overtone (3rd)	<ul style="list-style-type: none"> 10 - 14.99 mc 15 - 29.99 mc 30 - 59.99 mc 	<ul style="list-style-type: none"> Not available 20 - 39.99 mc 40 - 59.99 mc
Overtone (5th)	<ul style="list-style-type: none"> 60 - 75.99 mc 76 - 99.99 mc Not available 	<ul style="list-style-type: none"> 60 - 89.99 mc 90 - 100 mc 101 - 109.99 mc
Overtone (7th)	100 - 137 mc	110 - 137 mc

* Allow three to four day processing.

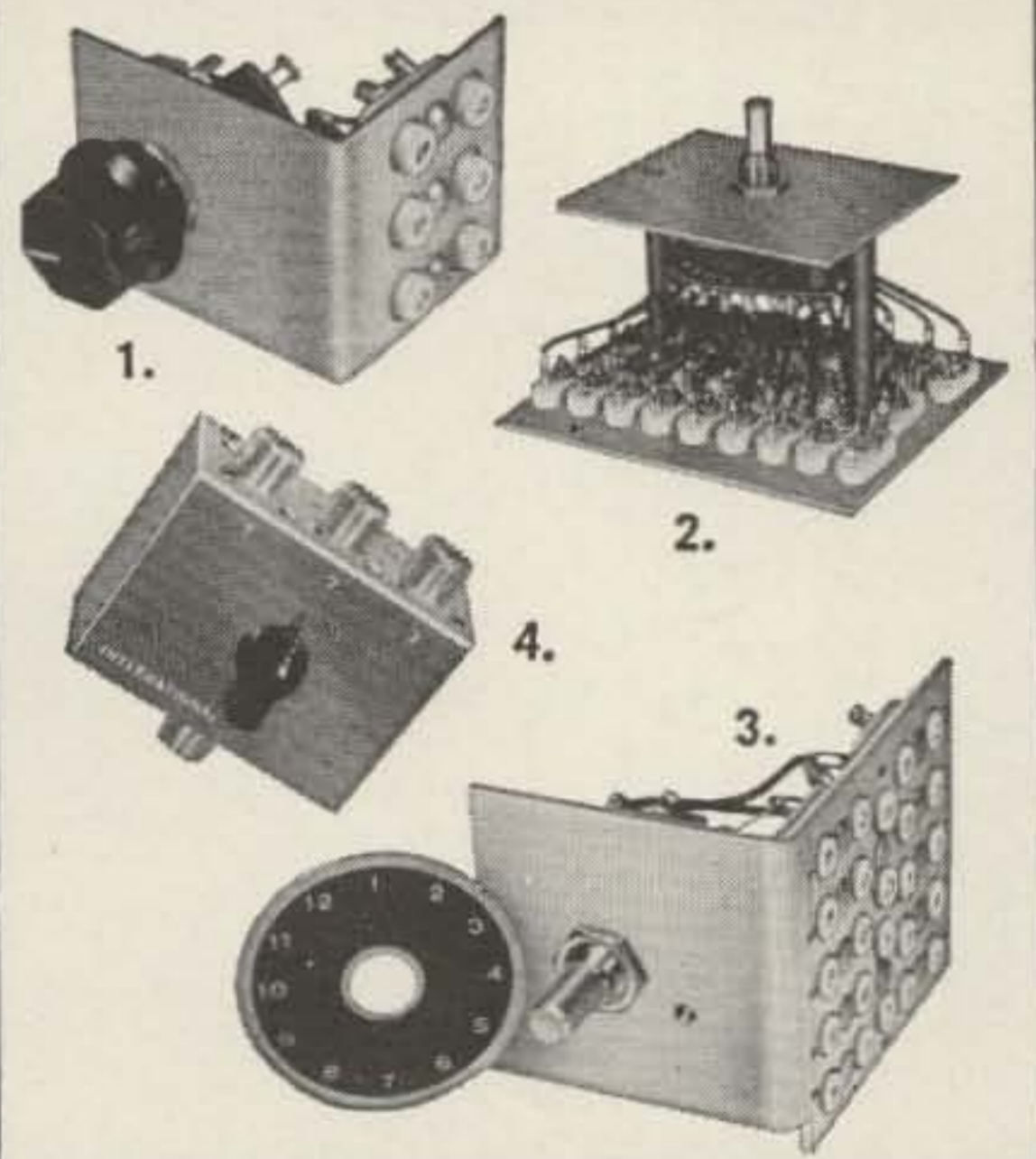

INTERNATIONAL CRYSTAL MFG. CO., INC.

18 NORTH LEE • OKLAHOMA CITY, OKLAHOMA

Coaxial line UHF Pre-amp.	Ronald Vacaluke W9SEK	6
420 mc Nuvistor preamplifier, pretty important at these frequencies.		
Improving the CC50	Larry Levy WA2INM	7
Blow the dust off and bring it up to date.		
VHF with RDR	Martin Kaiser W2VCG Raymond De Vos W2TAM	8
Navy surplus conversion. Covers 220 mc band rather well.		
Six Meter Coaxial Antenna	Abe Ringel W6KVO	12
Not for DX'ing, but it is simple, inexpensive and omnidirectional.		
The UNI	John Cleary W2VSP	14
Code practice oscillator.		
More on Crystal Oscillators	Murray Baird W6LWE	18
Part II of the crystal oscillator article in September 1961.		
Of RTTY and Transistors	Frank Van Brunt W3TUZ	22
Attention all RTTY bugs.		
Crystal Ball	Jim Kyle K5JKX	28
Measures crystal activity overtone activity, frequency spotting, etc.		
Quad Mode Monitor	John Wonsowicz W9DUT	31
An ultimate sort of receiver.		
Mobile Scope	Robert Williams K9DYS	36
Why not?		
More Fun from a Receiver	Elliott Weyer W2LLZ	38
General covering ham-band-only receivers.		
TT-180 Five Bander	Frederick Haines W2RWJ	42
Transmitter.		
Instantaneous Dissipator Tube	Robert Baird W7CSD	49
Medium power final amplifier with unusual power supply and interesting voltage regulator.		
Management Terminology	Roy Pafenberg W4WKM	54
Ha.		
CW Man's Monitor	Don Wherry W6EUM	56
One 6C4 and a simple circuit.		
T-60 Modifications	Roy Pafenberg W4WKM	58
Break-in and push-to-talk for the Knight T-60.		
Panel Markings	Jim Kyle K5JKX	62
Professionalizing home brew gear		
Potato Face	Sylvia Margolis XYL G3 NMR	66
Fiction		
Mounting the BC-625	Dick Griffen WA6MLI	74
The 522 will never die.		
Surplus Coaxial Switch	Roy Pafenberg W4WKM	76
Motor driven.		
Letter	26	Decades
		35
		Novice VFO
		65
Associate Editors W3UZN, W4API, W4WKM		
Canadian Representative: Robert J. Buckland Co. VE3AQE, P. O. Box 563, Chatham, Ont. Ph.: (519) EL 4-3106		
Western Representative: Jim Morrisett WA6EXU, 2103 India St., Los Angeles 39, Calif. Ph.: (213) NO 4-7840		
Cover: Cartoon by Bobby Rogers		

73 Magazine is published monthly by Amateur Radio Publishing, Inc., 116 Main Street, Norwalk, Connecticut. Please note that the address of the business office where you are to send all correspondence, subscriptions, submitted articles, etc., is at the top of this page. The telephone number is here too and we dare you to try to get it from the phone company. Subscription rates, while covered rather completely in the regular subscription ad, are: U.S.A. and possessions, APO, FPO, Canada and Mexico; one year for \$3.50, two years \$6.50, three years \$9.00. Foreign: One year \$4.00. Second class postage paid at Norwalk, Connecticut and at additional mailing offices. Printed in the U.S.A. Entire contents copyright 1962 by Amateur Radio Publishing, Inc. Postmaster: Please send form 3579 to 73 Magazine, Peterborough, New Hampshire.

de W2NSD/1

never say die

The moving of offices that was casually referred to in the last editorial turned out, when reduced to practice, to be quite a process. It is a big deal for an ordinary family to move across town. Your imagination would be staggered at the amount of ham gear that I have gathered down through the years. I was staggered when I looked it over. And all this had to be packed up and moved 250 miles!

One of the commercial movers came out to give me an estimate. He blanched. I had expanded to fill three and half garages, all of a seven room apartment and a good deal of a full sized house. He calculated \$2000 if we did all the packing, but I got the idea that this might turn out to be low once they found out how solidly packed those garages were and how heavy radio equipment is. I started calling rental truck companies.

U-Haul seemed to have one of the best prices so I rented one of their 16-foot vans and started loading. It held a lot more than I thought it would. Even with Virginia, me, our subscription man and two local hams pitching the stuff in, it still took a full day to fill it up. Perhaps we were a little too enthusiastic in the loading for when we stepped back to survey the results we noticed that the truck springs were bent backwards and the six tires almost flat from the weight. It was obvious that the truck could never make it.

It did come close though. It got to within one half mile of the house in Peterborough before one of the tires exploded. Luckily the tire vaporized right in front of the local Gulf station, winning them the job of trying to locate a jack strong enough to allow repairs. It was a warm day and the first jack sank into

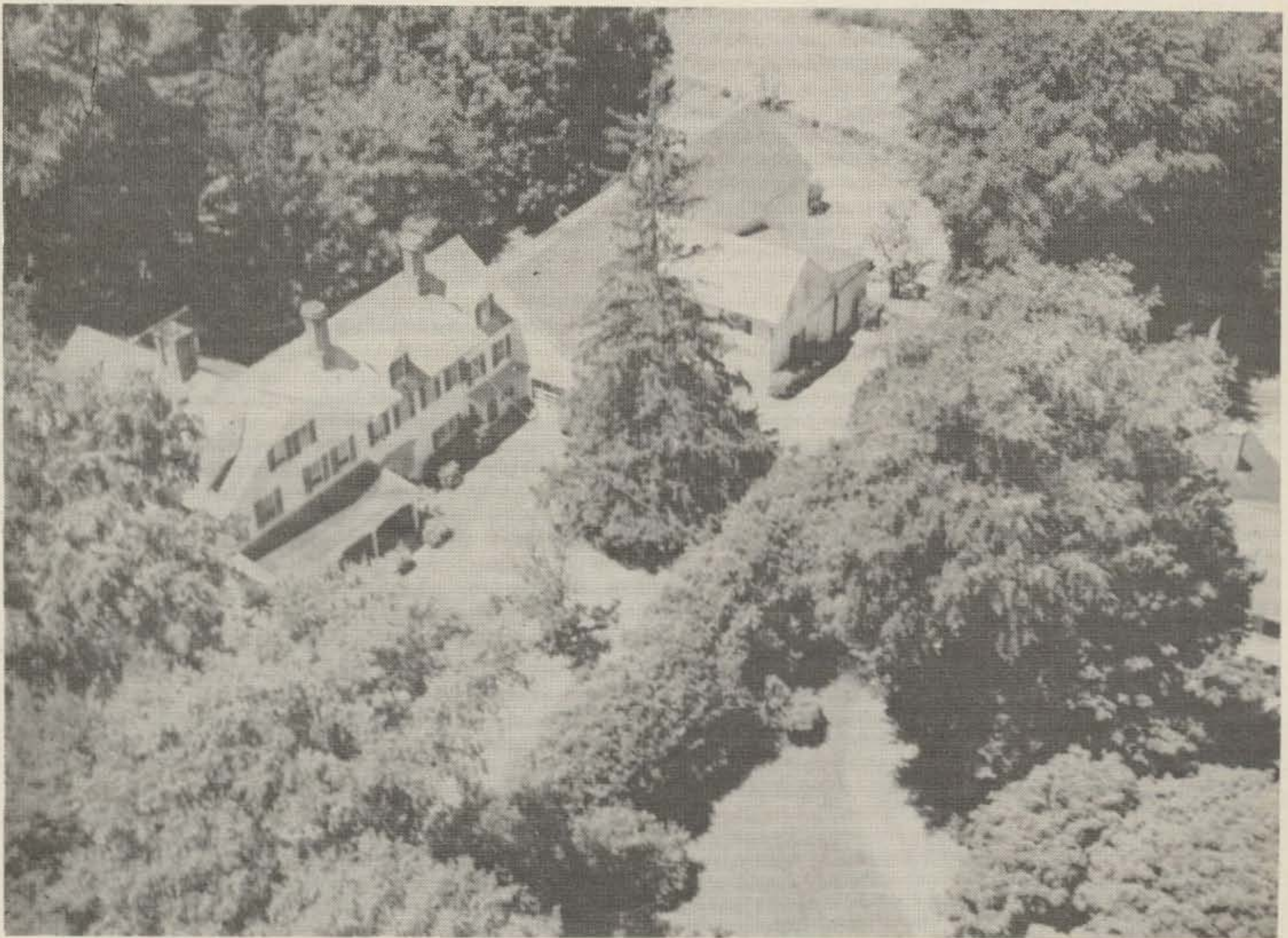

New Headquarters Building

LAFAYETTE RADIO

FOR BIGGER VALUE—PROGRESSIVE DESIGN

Announcing
the NEW STARFLITE™
90 WATT PHONE
and CW TRANSMITTER KIT



MADE
IN USA

COMPARE QUALITY!
COMPARE PRICE!

82⁷⁵
 NO MONEY DOWN

- 90 Watts Phone or CW on 80 Thru 10 Meters • Built-in 3-Section Low-Pass Filter • Clear, Chirpless Grid Block Keying

Dollar for dollar you can't beat this new Lafayette Starflite transmitter. Easy to build and operate, it glistens with quality and performance all-over. Features in addition to those listed above: 5 crystal positions and provisions for external VFO, illuminated edgewise panel meter and pin-net work output for proper antenna match. Buy one now — we know you'll be satisfied with it.

KT-390 Net 82.75

THE LAFAYETTE HE-30

Professional Quality
 Communications
 Receiver



99.95

- TUNES 550 KCS TO 30 MCS IN FOUR BANDS
- BUILT-IN Q-MULTIPLIER FOR CROWDED PHONE OPERATION
- CALIBRATED ELECTRICAL BANDSPREAD ON AMATEUR BANDS 80 THRU 10 METERS • STABLE OSCILLATOR AND BFO FOR CLEAR CW AND SSB RECEPTION • BUILT-IN EDGEWISE S-METER

Sensitivity is 1.0 microvolt for 10 db, Signal to Noise ratio. Selectivity is ± 0.8 KCS at -6db with Q-MULTIPLIER. TUBES: 6BA6—RF Amp, 6BE6 Mixer, 6BE6 OSC., 6AV6 Q-Multiplier—BFO, 2-6BA6 IF Amp., 6AV6 Det-AF Amp. ANL, 6AQ5-Audio output, 5Y3 Rectifier.

TOP VALUE COMMUNICATIONS RECEIVER

KT-200
 in Kit Form
64.50

HE-10
79.95
 WIRED AND TESTED
 NO MONEY DOWN



- SUPERHET CIRCUIT UTILIZING 8 TUBES AND RECTIFIER TUBE • BUILT-IN "S" METER WITH ADJUSTMENT CONTROL • FULL COVERAGE 80-10 METERS • COVERS 455KC TO 31 MC • VARIABLE BFO AND RF GAIN CONTROLS • SWITCHABLE AVC AND AUTOMATIC NOISE LIMITER

The Communications Receiver that meets every amateur need—available in easy-to-assemble kit form. Signal to noise ratio is 10 db at 3.5 MC with 1.25 microvolt signal. Selectivity is -60 db at 10 kc, image reflection is -40 db at 3 MC. Tubes: 3-6BD6, 2-6BE6, 2-6AV6, 1-6AR5, 1-5Y3.

NEW! LAFAYETTE HE-45A DELUXE 6-METER TRANSCEIVER

- Highly Sensitive Superheterodyne Receiver Section for 50-54 Mc
- Effective Series Gate Noise Limiter
- 3-Stage, 12-Watt Transmitter with 2E26 Final
- Illuminated Panel Meter for Plate Current and "S" Readings
- Pi-Network Transmitter Output
- Built-in 117 VAC and 12 VDC Power Supplies
- Push-To-Talk Ceramic Microphone

Provides maximum convenience and flexibility in either mobile or fixed operation.

LAFAYETTE HE-50 10-METER TRANSCEIVER
 Similar to above except for 10 meter operation 109.50



Made in
U.S.A.

114.95
 NO MONEY DOWN

FREE!

SEND FOR
 LAFAYETTE'S
 SUMMER CATALOG
 SUPPLEMENT

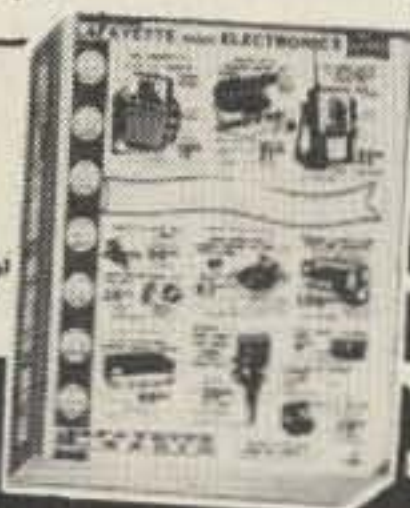

LAFAYETTE RADIO, DEPT. 73F-2
 P.O. BOX 10
 SYOSSET, L. I., N. Y.

Send FREE 1962 SUMMER Catalog Supplement featuring the full line of Lafayette Amateur Equipment. enclosed for Stock No.

Name.....
 Address.....
 City..... Zone..... State.....



"Sixty for Six"

WRK 6M at...

MODEL 60-46

60 Ft. - NO GUYS!

Here's a real cloud buster! 60 ft. of tower, E-Z Way quality, that will put you way out in front on 6 meters.

COMPLETE
2 Men - 2 Hours
INSTALLATION TIME

E-Z installation? You bet! This one goes up like a rocket. . . and it is only a two man job. All the space needed is one sq. ft. Crank up to 60 ft. and down to 21 ft.

only \$199.50
Model BA-60-46P

Model
BA-60-46G...\$259.50
GP-60-46P... 264.00
GP-60-46G... 324.00

If triband or 20 M operation is desired, this model may easily be converted to a Medalist "40"!

Freight prepaid anywhere 48 U. S. A.

For free information write Department "B"

E-Z WAY TOWERS, Inc.
P.O. BOX 5767 TAMPA 5, FLORIDA

the pavement instead of raising the truck. A larger jack was found and pressed into service. This one did better. It got the truck up high enough for the two wheels to be removed (the inside tire blew out, of course) and then crumpled, dropping the truck on it axel and almost toppling the whole works. By the next day they had enough jacks rounded up to get the truck up and a new tire in place. They had quite a time of it.

The second truckload was much lighter, being mostly office desks and furniture. This truck made it all the way to Springfield, Mass., before quietly expiring by the roadside. Oil leak. After a few long distance calls U-Haul scouted up another truck as a replacement and provided a man to help us change the load.

I decided to have a try at changing my luck. The third load went up in an Avis truck and made it without incident. That was worth a lot more than the \$10 difference in rental rates. The fourth load also went via Avis. This leaves one more load yet to go. What an accumulation! It is a monument to years of buying bargains in the local radio stores.

Open House August 19th

We're real proud of this new 73 home and would like to have you come on up and say hello. Since we are still going to continue short handed for some time it will be a bit unhandy for us to have people visiting at random . . . we work a 16 hour day seven days a week and still only get half the things done that we should . . . it will be much more convenient if the visiting takes place sort of between our press dates when we have a little more breathing time. The best time for us would be on Sunday, August 19th. I doubt if we will have much straightened up by that time, but at least there will be room for you to get from one place to another and we see what we're up to. Come on up. If you can't make it on the 19th, but find yourself in the area, drop in anyway.

The house is located right on Route 101, just East of Route 202. You can't see it very well from the road due to the high hedge around it. You turn up Pine Street and then right in the first driveway. We'll have some sort of sign up for you. Please, no gifts. I'd like to serve some sort of refreshments, but since I have no idea whether there will be two or two hundred visitors I guess there is no way to do it!

(Turn to page 70)

NEW *hy-gain*

DUOBANDER

for the popular 20-40 meter bands

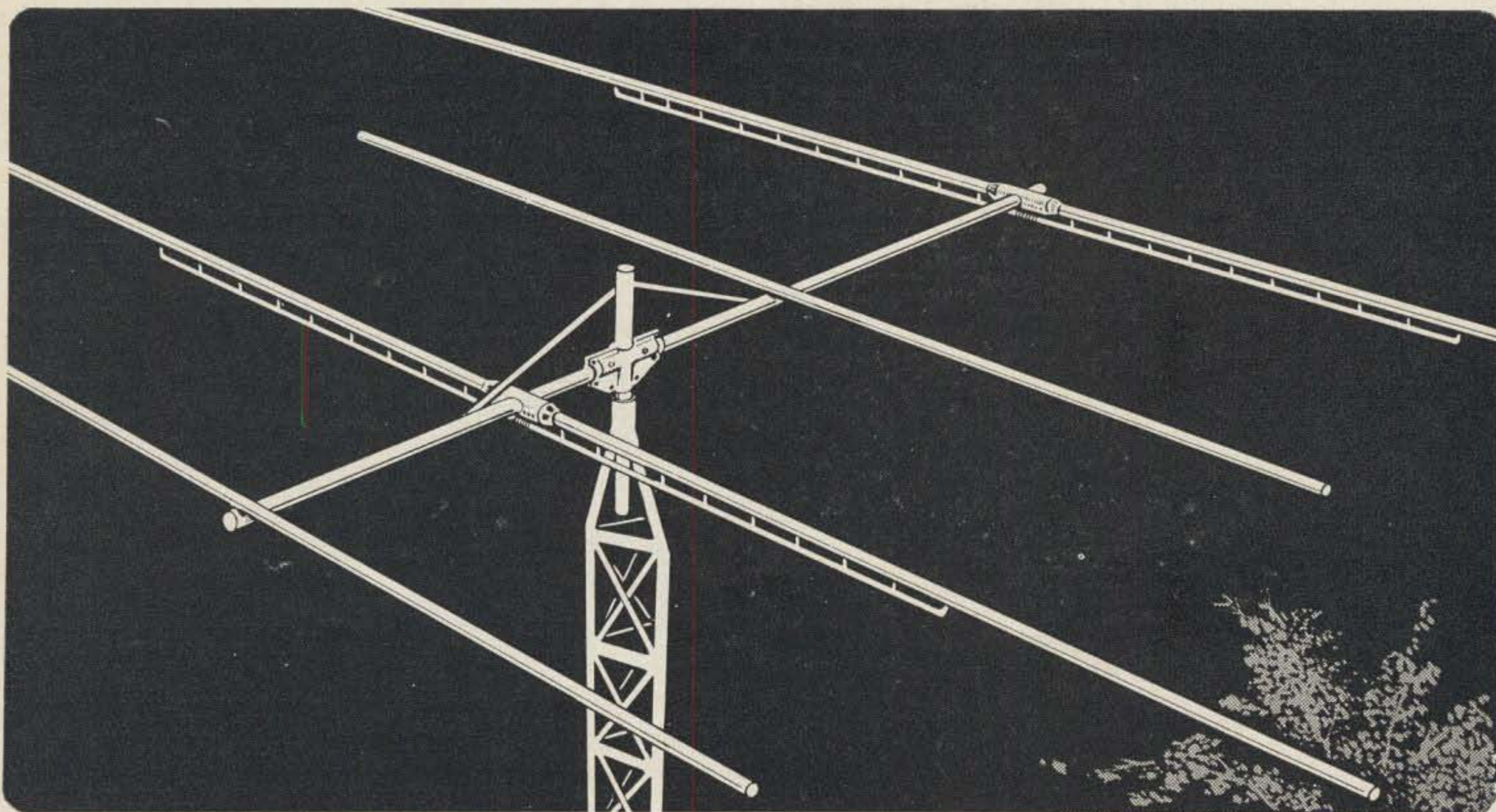

New compact lightweight unit features Linear Decoupling Stub and Beta Match

The 20-meter and 40-meter bands are becoming more and more popular with amateurs because of more room for expansion and low sun spot activity. That's why the Hy-Gain engineering staff has designed this important new antenna. The Hy-Gain Duo-bander has three full-sized elements on 20 meters and two reduced-size elements on 40 meters. It's compact, lightweight, highly practical—and priced right.

Through the exclusive Hy-Gain development, the linear decoupling stub, the ordinarily outsize 40-meter element is reduced to about $\frac{2}{3}$ of the normal size. This makes the Hy-Gain antenna practical, usable where others won't work out, but keeps performance standards high.

The exclusive Hy-Gain advancement of the linear decoupling stub makes two-band operation possible. You do away with inductance and capacity traps, yet the Duobander elements sections can be decoupled very efficiently. The linear loading principle, another Hy-Gain exclusive, does far better than a loading coil in reducing antenna size.

A proven Hy-Gain development—THE BETA MATCH makes possible maximum gain and low standing wave ratio

into a single 52 ohm coaxial feed line. For perfect pattern symmetry, a broad band balun is an integral part of the matching system.

SPECIFICATIONS

ELECTRICAL

Forward Gain over a tuned dipole 20 meters 8.1 DB
Forward Gain over a tuned dipole 40 meters 4.9 DB
Front to back ratio 20 meters 20-30 DB
Front to back ratio 40 meters 15-20 DB
VSWR at resonance (typical) 1.2:1
Nominal impedance 50 ohms
Power Capability..... 5 KW P.E.P., 3 KW AM

MECHANICAL

Net Weight 54 lbs.
Boom Length 24 ft.
Element Length Approx. 40 ft.
All aluminum construction—Alloy 6063T832—
Tensile strength 45,000 PSI
All hardware iridite-treated to military specifications; all plastic
high impact Cylolac
Wind surface area 6.9 sq. ft.
Turning Radius 24.2 ft.

price \$169.50

**See your local Hy-Gain dealer or
write for Duobander Bulletin.**

***hy-gain* antenna products**
8406 NE HIGHWAY 6, LINCOLN, NEBRASKA

Coaxial Line UHF Preamp

using nuvistors

Ronald M. Vaceluke W9SEK
Buckhorn Ranch Trailer Park
Lot B39
Des Plaines, Illinois

ALTHOUGH nuvistors have been on the market but a short period of time, they have been very popular in ham construction due to their high performance at low cost. However, as frequency rises, so do the problems involved. At 420 mc it becomes difficult to get the control grid at rf ground potential. This is because the familiar 6CW4 has but one grid connection and it is small in area. RCA obviously recognized this fact and brought out the latest nuvistor, the 8058. This gem has the control grid connected to the small indexing lug on the tube and becomes grounded when the tube is inserted into the socket. Due to the design, the 8058 is rated

job which fits into a $\frac{1}{2}$ inch hole and is held in place with two set-screws. The "cold" end of the inner conductor (L1) is soldered to one end of this feed-thru. The plate end of L1 has a $\frac{1}{4}$ inch hole drilled into it and, along with cross saw slots, makes a very usable plate connection. The plate tuning capacitor is a surplus unit much like a small Johnson type "M." It has four stator and five Rotor plates. The two stator support rods are cut so they partially straddle the inner conductor and are soldered to it. When soldering, be sure the

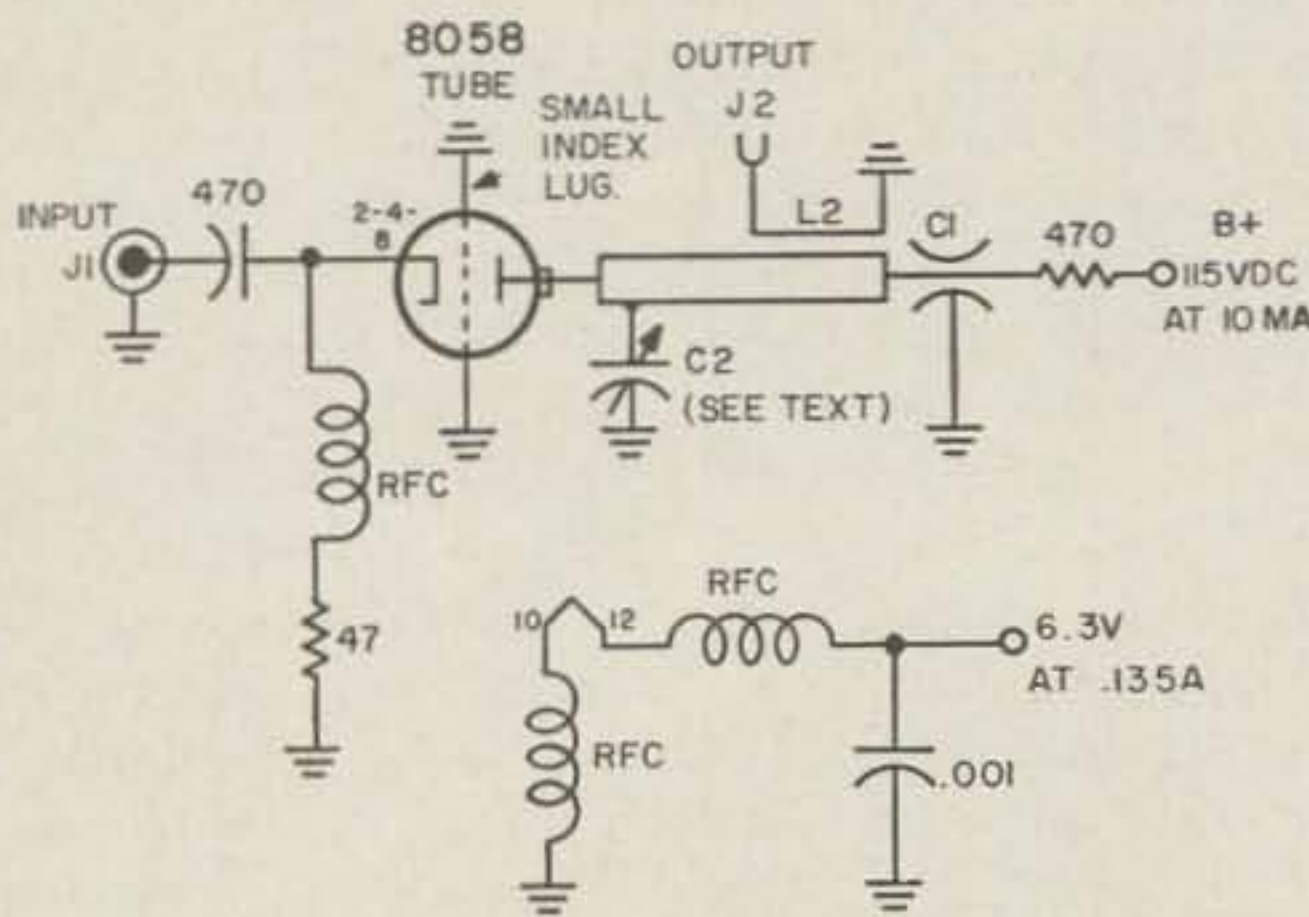

to 1200 mc and lends itself to coaxial tank circuit configurations. With this in mind, I set out to build a pre-amp for 432 mc.

Construction

The general construction features can be seen from the photos and sketch; however, a few additional words are in order. The major portion of the tank circuit is constructed of brass. The two end pieces are $\frac{1}{4}$ inch thick and turned to size on a lathe. The far-end piece has a hole made to fit the plate by-pass capacitor. A mica feed-thru was used for the sake of simplicity. The one used is a surplus

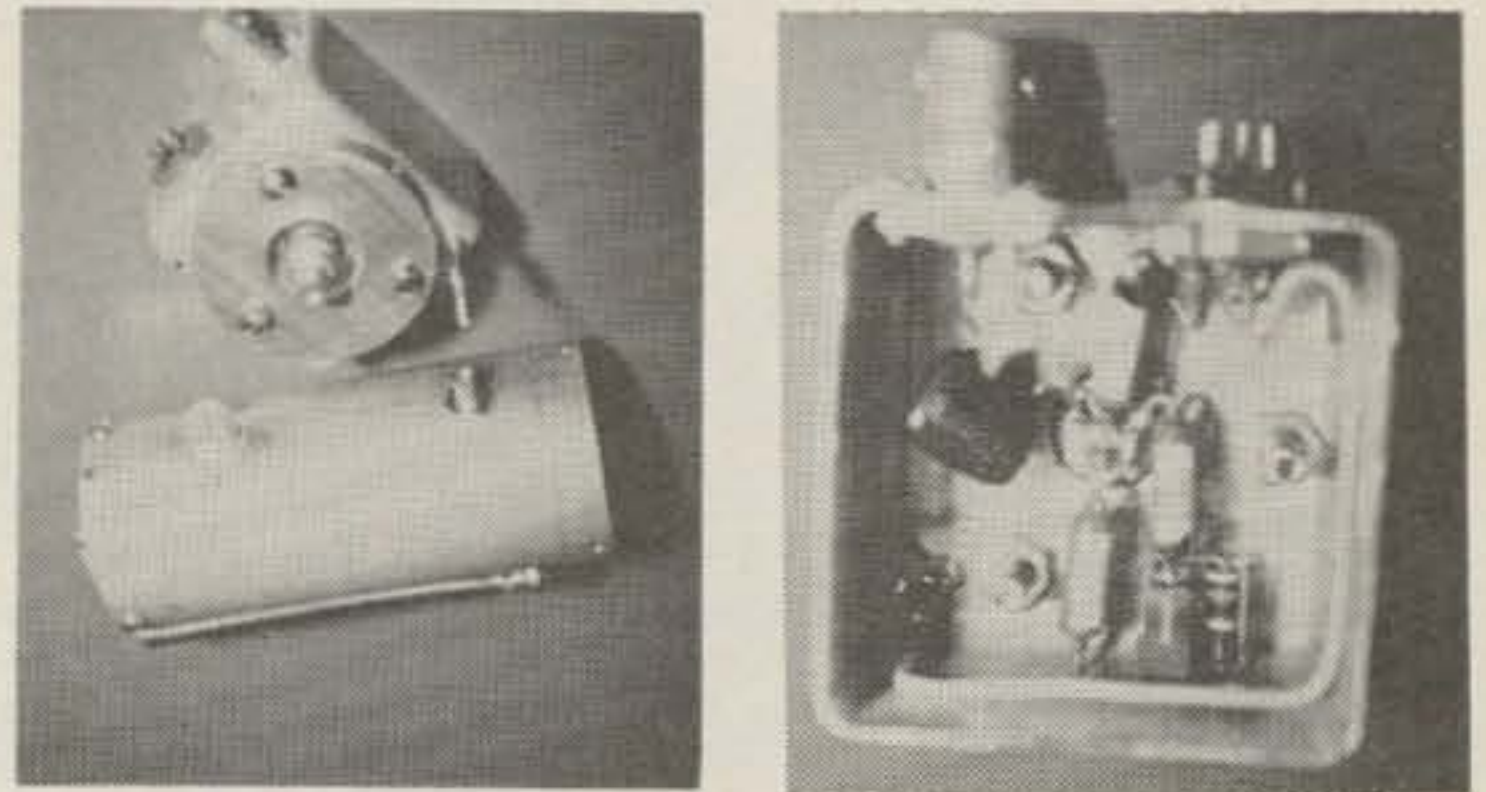

line L1 is centered within the tank. This provides alignment for the tube plate cap when assembling the unit. The end piece near the tube has a $\frac{3}{4}$ inch hole drilled thru it to pass the nuvistor. Both end-pieces are fastened to the outer line with three 6-32 screws on 120° centers.

The tube, socket, and all other associated circuitry is in the chassis (LMB #MO-18) which measures 2" x 2" x $1\frac{1}{4}$ ". The socket must be soldered to the chassis to be sure of a good rf ground. Parts layout can be seen from Photo #3. All power connections are made through the connector (Amphenol #126-010). The means by which the dc plate connection is made can be seen from Photo #2. A small feed-thru capacitor is soldered to a corner of the chassis with a phone pin plug soldered to the capacitor. A mating phone pin jack is soldered to the outer shell of the tank. When the tank is removed from the chassis for tube replacement, the B+ is dis-

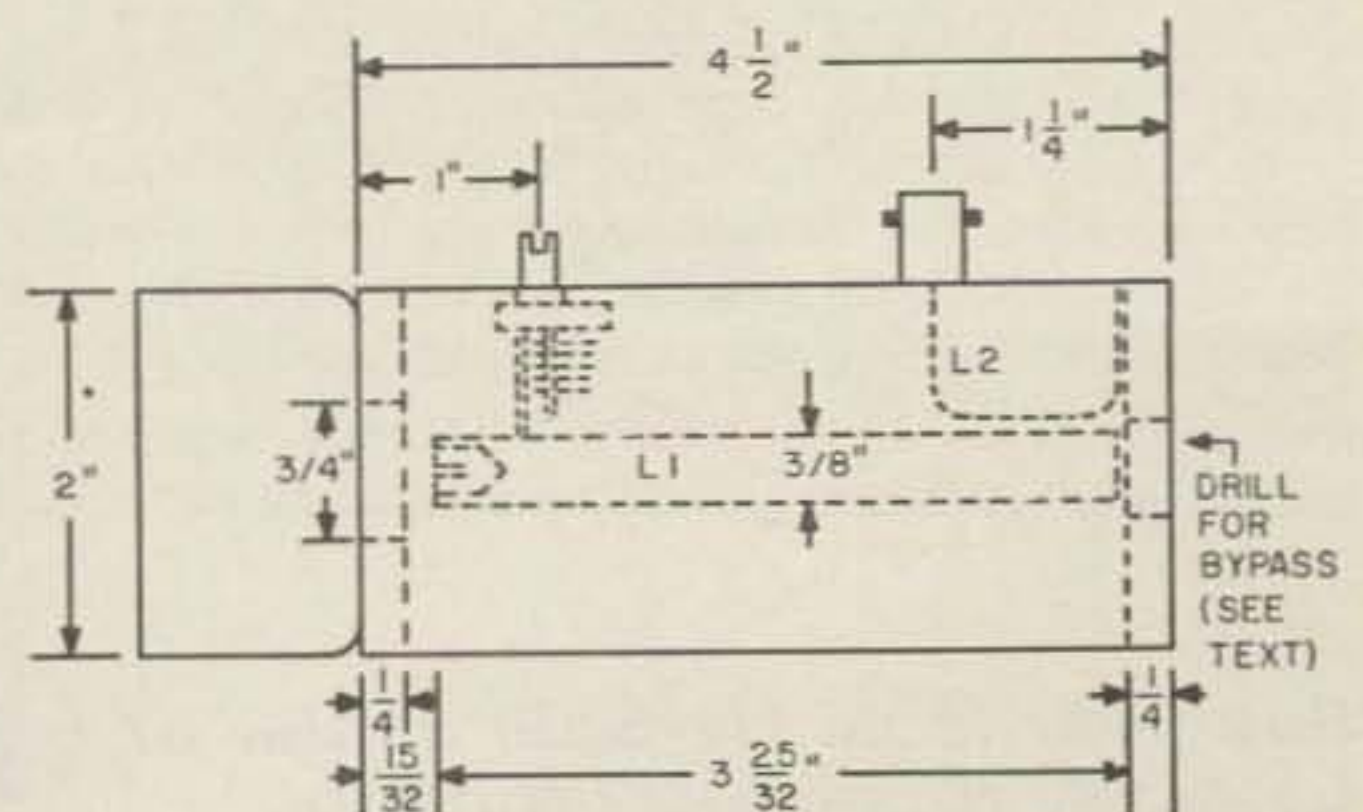
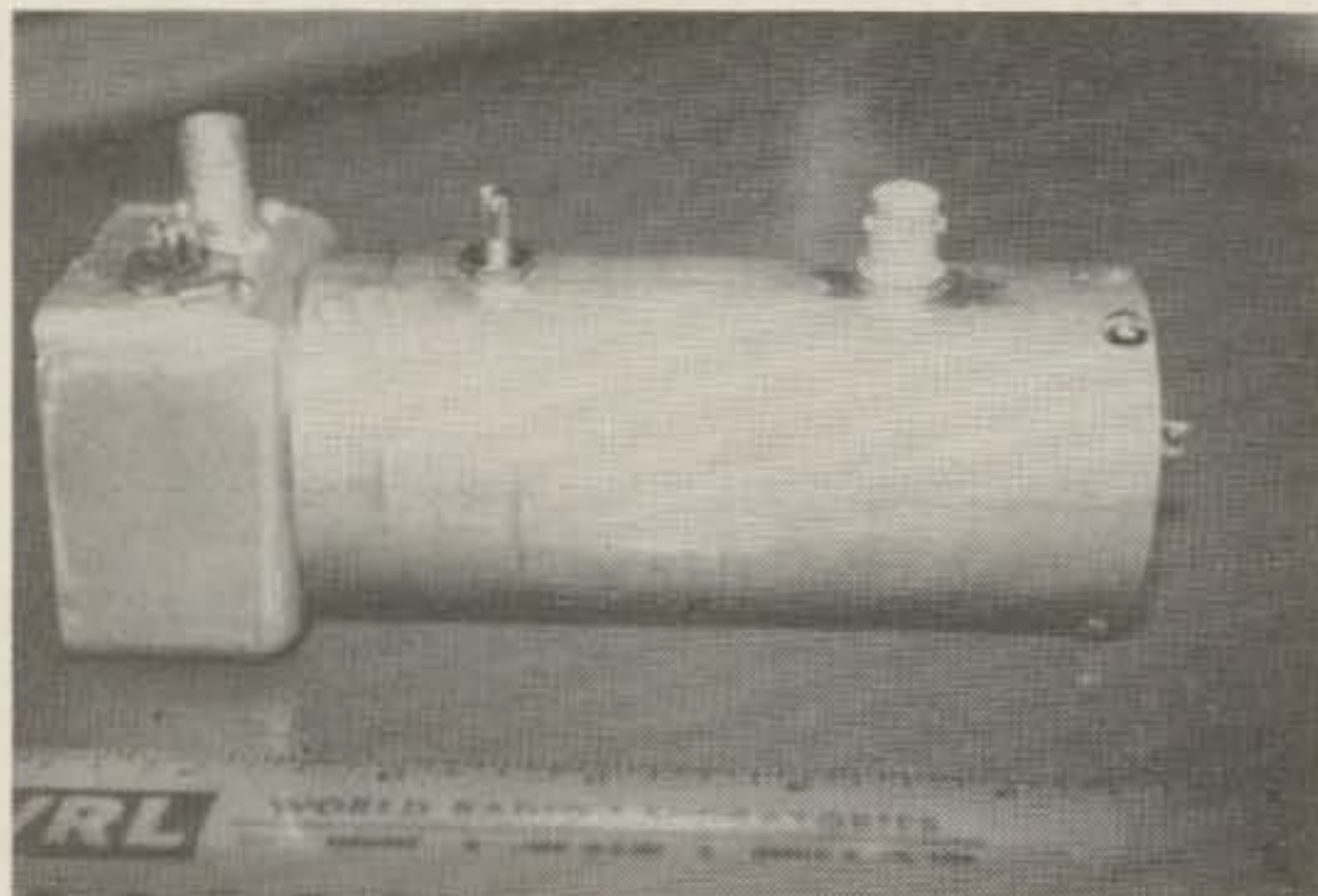

connected. This saves having to unsolder connections for servicing.

This may seem like a difficult way to get a pre-amp for UHF, but it is more satisfactory than lumped constants. No guesswork is used in finding the sizes of the tank configuration as this is calculated easily by mathematics. Many may rebel at the thought of machine work, but most hams, I'm sure, must have do-it-yourselfers as friends that can do the work. My thanks to my father for his assistance and machine work.

... W9SEK

C1—mica feed-thru
 RFC—Ohmite Z-460
 L1—Inner line $\frac{3}{8}$ " x 3-25/32"
 L2—Output link, 1" long near L1
 J1—BNC, UG-290/U
 J2—BNC, UG-625B/U
 Socket—Cinch #133 65 10 001
 Chassis—LMB #MO-18

Improving the CC50

Larry Levy WA2INM

Like many other hams who read only the price tag when they are shopping for a piece of equipment, I found myself with problems when I got home and tried out my new possession. In this case it was a Tecraft CC50 converter with which I had hoped to get into the DX race for WAS on 6 meters

This item may do well up in Maine, but down in Brooklyn the strong locals rode in over every signal and ruined my disposition for almost a week. I finally decided that these fellows were not going to get off the air just because I had problems, so I got out the tools and soldering iron to see what could be done.

While I had it apart, I also devoted some time to improving the noise figure, which looked like it could stand some improvement. I am happy to report that with only a few modifications, the CC50 turned into a satisfactory converter.

The front end was first. C1 and R2 were removed and the hot end of the antenna coil was connected directly to the grid. The substitution of an Amperex 6922 for the 6BZ7 really

made an improvement. The 6922 is a dual triode using frame grid construction (see 73, November, 1960 for more information on frame grid tubes). Both gain and noise figure were improved. (The transconductance of the 6922 is over 12000 and the noise figure was considerably lower than the 6BZ7). The 6922 shouldn't present any problems with neutralization. Although the 6922 costs slightly more than the 6BZ7, it is a worthwhile investment and it will probably outlast several 6BZ7s. (It is one of the Amperex PQ 10,000 hour tubes). It usually is a good investment to spend the extra money for tubes like this as the cost per hour of useful life is lower than ordinary tubes. The only circuit change needed for the 6922 is that the value of R1 be changed to 680 ohms.

This left me with a converter that had a better noise figure but still had susceptibility to cross modulation. In this converter the cross modulation takes place in the mixer stage. To overcome this problem, I decided to change to a triode mixer using slightly higher bias. The triode mixer will also have a slightly lower noise figure, although it is debatable if this will help reception of weak signals as the mixer is preceded by two stages of rf amplification. A 6AB4 was chosen for a mixer tube because they work well at the higher frequencies and also because I had one in the junkbox. Change the coupling capacitor (C2) to about 27 mmfd if it is any smaller than that value. (For some reason, several of the converters I have seen have different values for that condenser). Increase the value of the gimmick capacitor used for oscillator injection (C3) by twisting the wires around a few more times. The other values should be changed according to the schematic. The coils resonate without change. This reduced the cross modulation to a very low level.

It is well worth the time spent in this conversion, the amount being about one-half hour. Although this conversion only covers the CC50, there is no reason why these modifications could not be employed in similar converters, or for converters for a different band.

... WA2INM

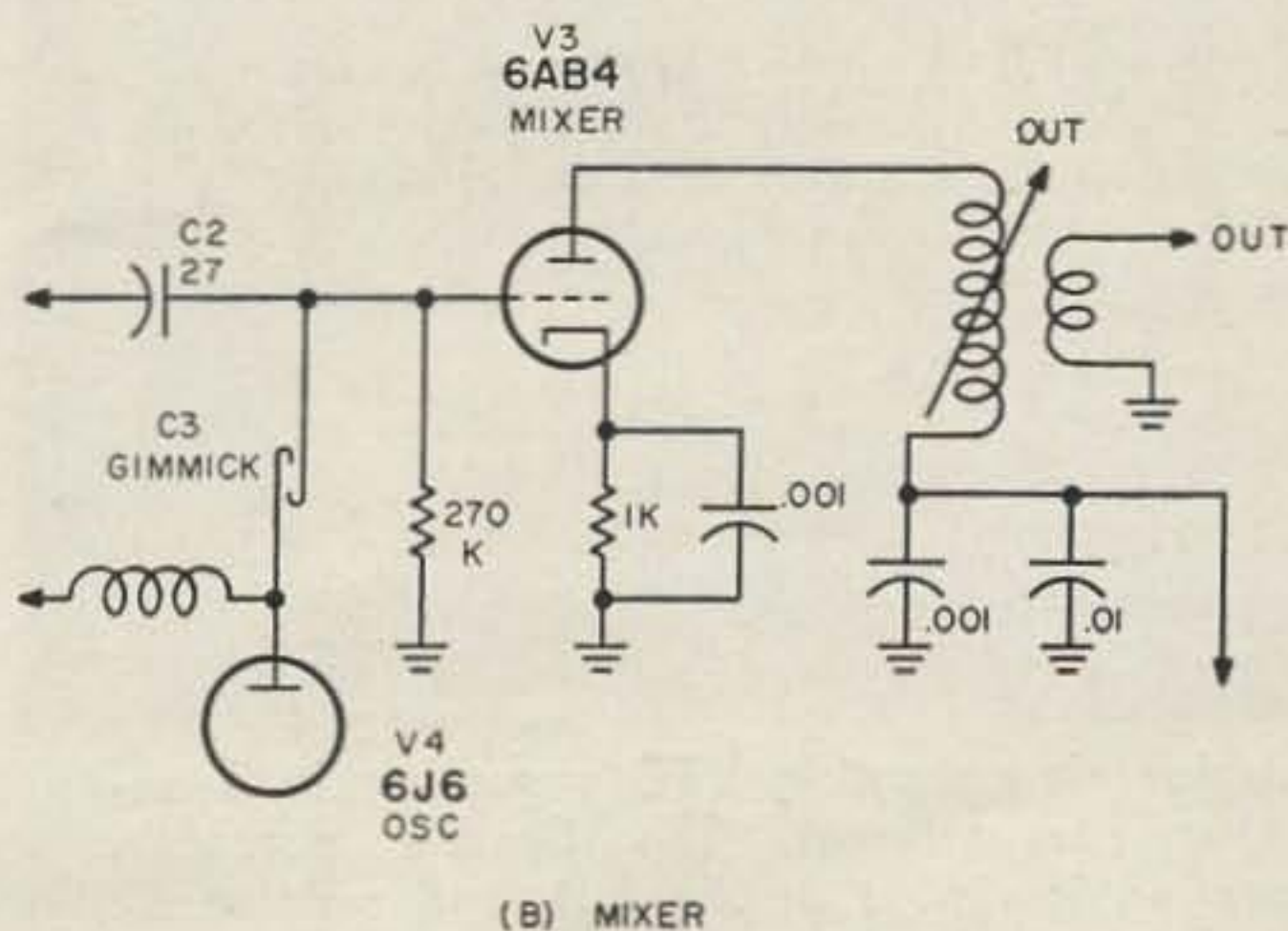
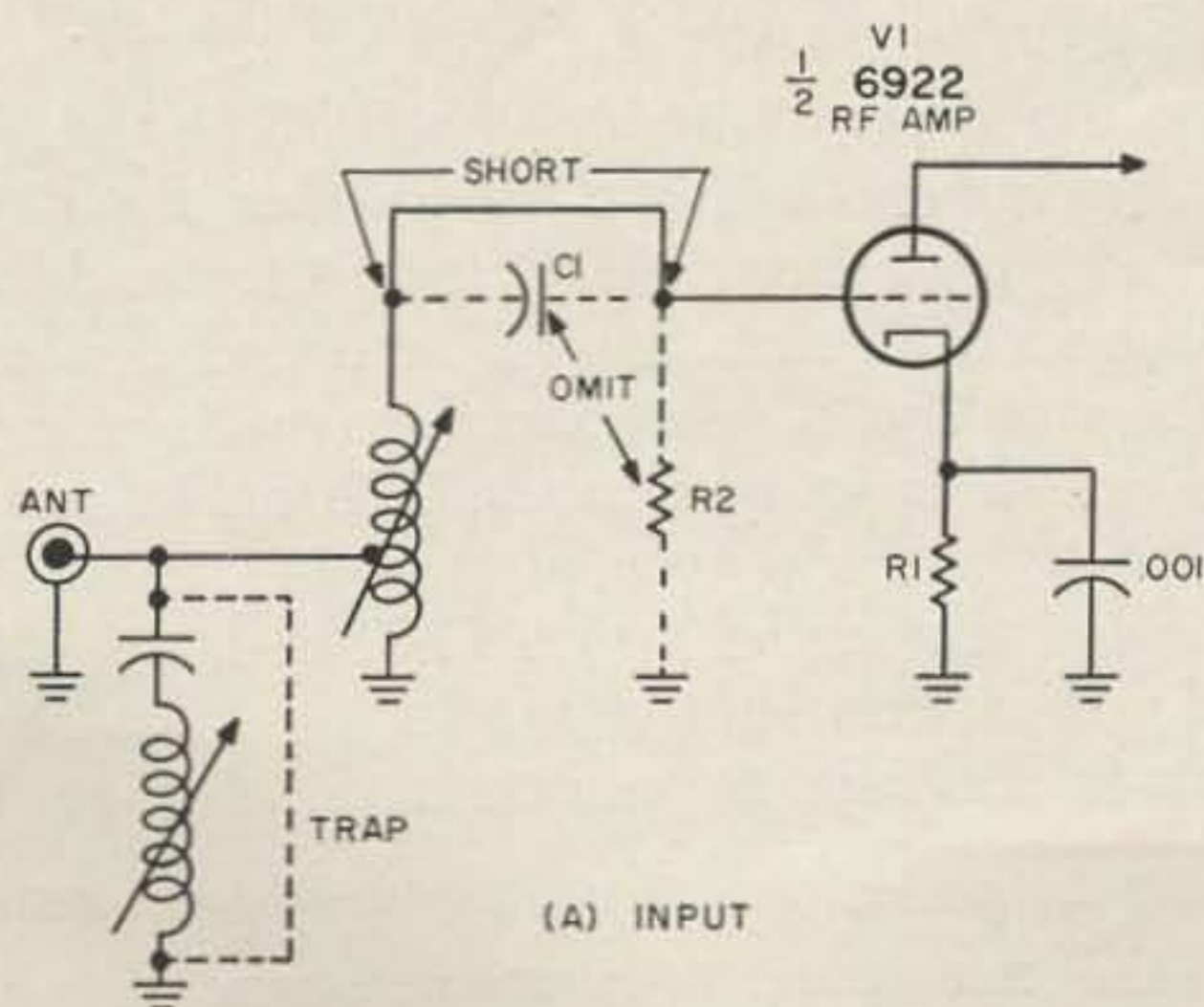

VHF with RDR

Martin Kaiser W2VCG
Raymond De Vos W2TAM
140 Summit Avenue
West Trenton, New Jersey

IN keeping with the general increased interest in the VHF bands, it is only fitting that any suitable and available surplus equipment should be brought to the attention of fellow amateurs in order to further occupancy of these bands. The unit in question is the Navy Model RDR receiver. This receiver was a companion unit for the MAR radio equipment and anyone fortunate enough to own the complete MAR equipment can connect the furnished cable from the RDR to the MAR power supply and he is in business. For others, a separate power supply will have to be built. The RDR is a crystal controlled superheterodyne receiver with a given range of 225mc to 390mc with the crystals supplied, but by the use of other crystals it is possible to cover the entire 220 mc amateur band without difficulties. Input voltages are 13V dc

or ac and 375 V dc for the plates. Antenna input is approximately 50 ohms which makes it suitable for the standard multi-element beams fed with RG/8U, RG/11U or RG/14U. Size of the receiver is 21 x 16 x 9 and weight as sold, uncrated, is 45 lbs. Removal of the dynamotor lightens the unit considerably. The dynamotor, by the way, is an excellent 13V dc input job with 385V at 500ma out and could very well be used to power

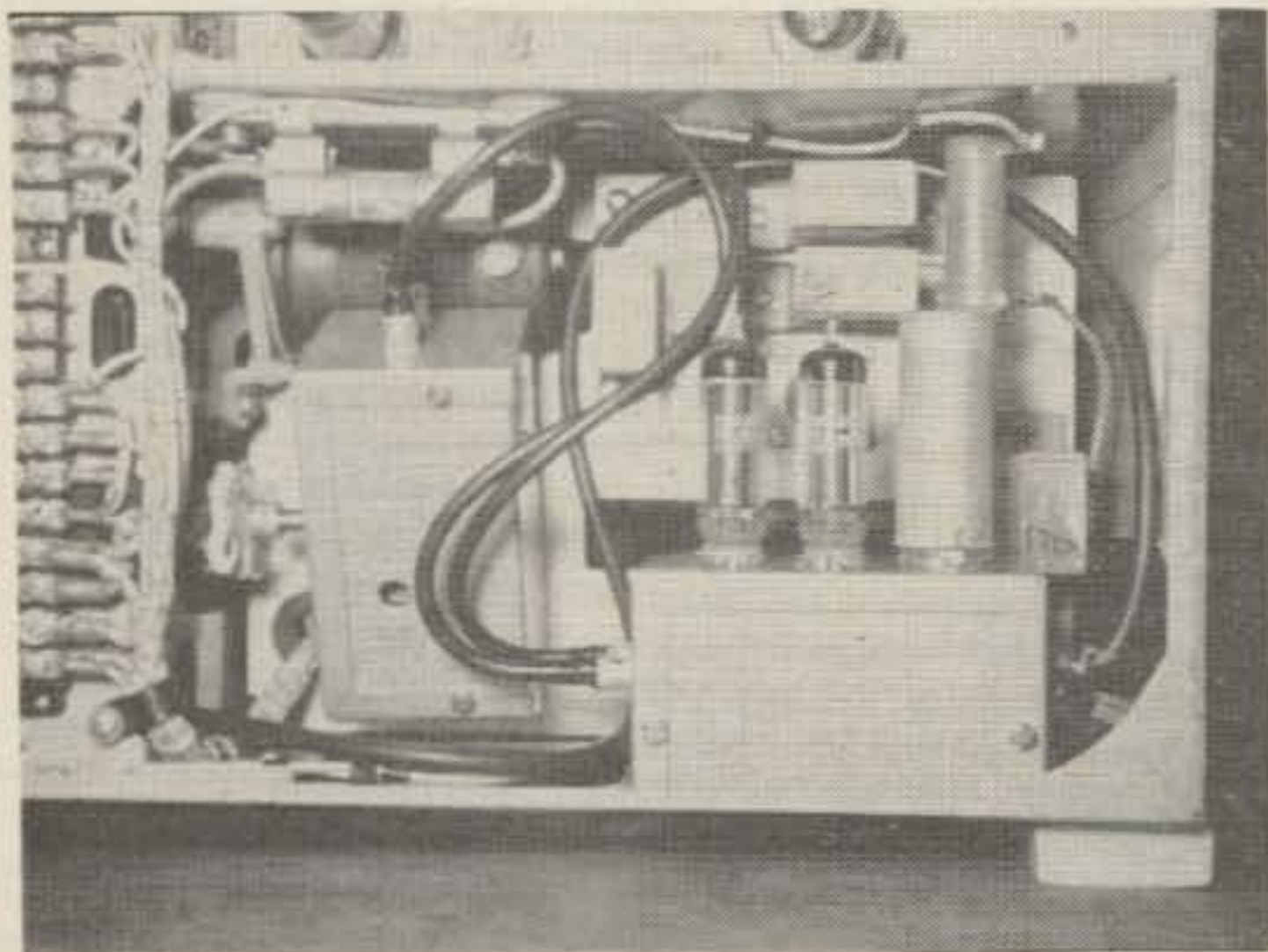

Interior view showing VFO mounting in dynamotor compartment. The flexible porcelain coupling is visible at the left, and resistor R2 can be seen above the tube shield of the 6417.

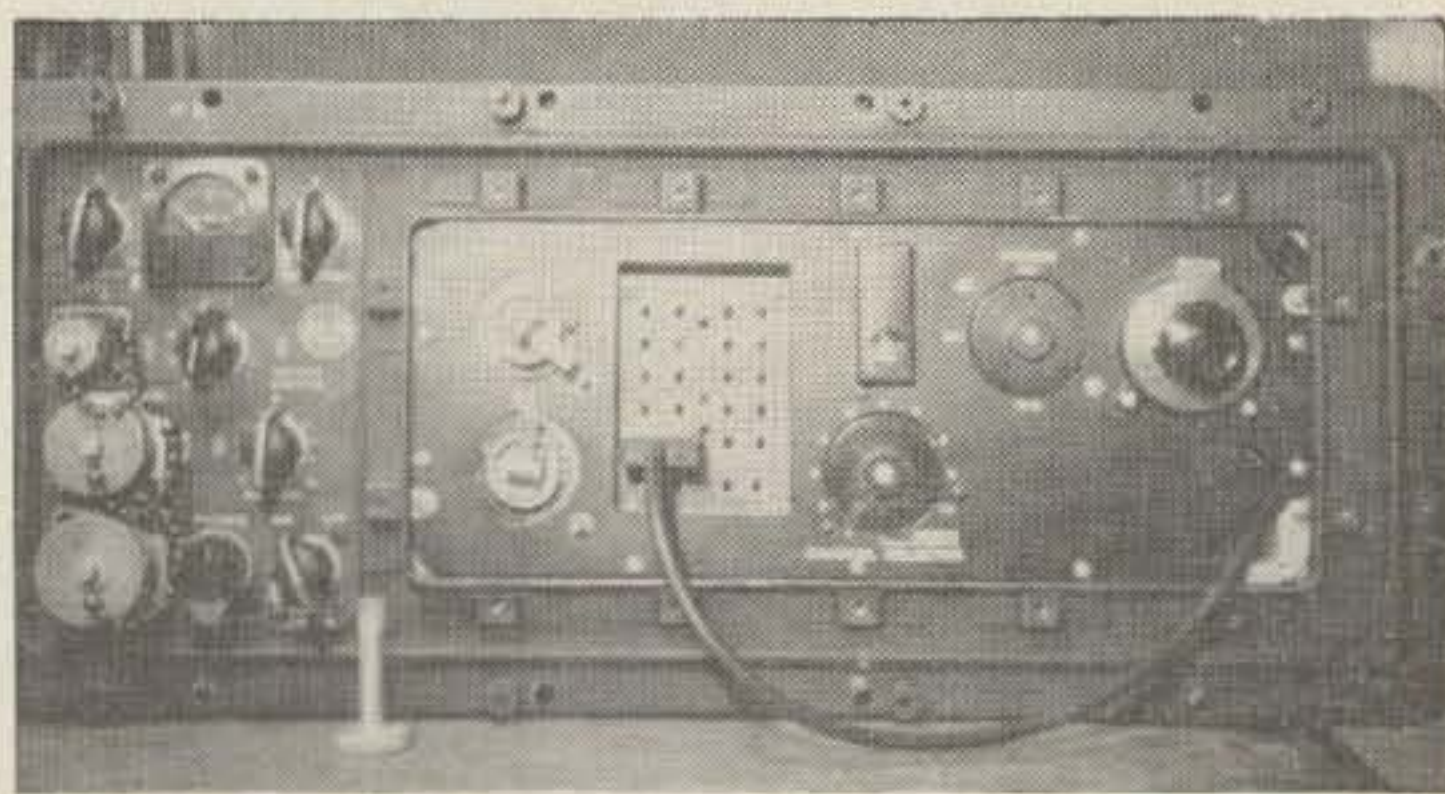

Front view of RDR showing VFO vernier dial at right, output cable with DC-30 holder plugged into #1 crystal socket in the center, and vernier tuning knob in front at the left.

some mobile equipment. The RDR in the present day market can be bought for about \$25 plus shipping from MDC industries and from Meshna Enterprises. It will be found that most units are brand new complete with manuals and crystal oven and tubes. The only item not included is the power plug, and that can be obtained by ordering AN3106A-16-9S from any radio parts supply house.

It is difficult to understand why so few

MDC Industries, 933 North Schiller Street, Philadelphia, Pa.
Meshna Enterprises, Lynn, Massachusetts

CLIMBING TO INFINITY...



SAM HARRIS (W1FZJ) NEVER LOOKS DOWN!

It is because of this fact that TELco is progressing so far, so fast . . . so steadily. Sam is our Chief Engineer, and it is his guidance that enables TELco to produce the ultimate in VHF - UHF - SHF spectrums.

SAM HARRIS, W1FZJ-W1BU

Design Engineer in Parametrics, Varactor Harmonic Generation, Solid States, and a Pioneer in Moonbounce.



FLIP THE SWITCH . . . and you're on 6 . . .
It's here at last . . . the TELco SB-50 6 meter Heterodyne Transmitting Converter is absolutely the finest way to get on 6. It takes the output of your 20 meter gear (AM, CW, or SSB) and gives you 30 watts output on 6. It has a powerful 6146 final, requires only 5-10 watts of drive, is stable as a rock, and a cinch to tune. Available from stock immediately, so rush your check now.

NOW ONLY... \$85⁰⁰

POSTPAID TO YOUR DOOR



TAPETONE ELECTRONIC LABORATORIES, INC.

99 Elm Street

West Newton 65, Mass.

VHF amateurs have latched on to this gem, unless the crystal control feature has been the deterrent. Crystal control is not the most desirable receiver arrangement, but this article will show how to make this a completely tunable receiver without altering the original arrangement. The operator will then have the choice of either a tunable receiver or a ten channel crystal controlled receiver. It should be added at this time that the conversion described is by no means the final one. The VFO unit could be reduced in size and could be housed in one box. The power supply could conceivably be made small enough to fit into the remaining space vacated by the dynamotor, the *if* system could be returned to narrow the band-pass and a nuvistor preamplifier might work wonders as far as sensitivity is concerned. As can be seen, there is still plenty of room for improvement and none of it overly difficult. A glance at the schematic of the VFO unit will show it to be straightforward. The unit as built and shown in the photograph is in two miniboxes. This was intended as an aid to stability, but in view of the fact that the entire unit is in an enclosed area the two box design perhaps adds very little to overall performance as compared to a single box. Power for the VFO is taken directly from the barrier strip located toward the front of the receiver. Terminal #8 for B plus and terminal #2 for the 13V filament circuit. The ground return wire can go to any convenient spot on the chassis. The dial hole, already drilled, is the one in which the knurled vernier tuning knob was stored. By

drilling the rivets from the retaining spring clips and removing them, the surface is disengaged. Over this hole is mounted a 2" vernier dial of the type currently sold by all supply houses. In order to get proper alignment a flexible porcelain coupling is used to connect the tuning capacitor C1 and the dial mechanism together. The coupling will take care of any strains due to misalignment. After the VFO has been assembled and installed, locate the range of 4.5kc to 5 kc. This may require adjusting the trimmer C2. The 220mc to 225mc band falls within this VFO range. Using a signal generator with output on 220mc, and the VFO at the low end, or 4.63kc, with Multiplier dial and rf dial on the receiver set near zero, it should be possible to tune in this signal. Once the signal has been located the rf dial may be locked in position. It will be necessary, however, to move the multiplier dial one division when going from the low end to the high end of the 220mc band. This dial will have to be locked when going from crystal position #1, or VFO, to any other crystal position with autotune mechanism. Crystals used should be in a type DC-30 holder and the frequency is calculated by the following formula: Crystal (or VFO) frequency x 18 minus 10.066mc x 3 equals receiving frequency. Good luck, and see you on 220mc. . . . W2TAM & W2VCC

- C1—Johnson 9M11
- C2—8-50 mmfd rotary ceramic
- C3-C4—1000 mmfd silver mica
- C5-C7-C8—.001 mfd disc ceramic
- C6—.005 mfd disc ceramic
- L1—50 turns #24 closewound on 3/4" form
- R1—51K 1/2 watt
- R2—1800 25 watt
- RFC1 } 2.5 mhy
- RFC2 }
- VI—6417
- V2-V3—OB2

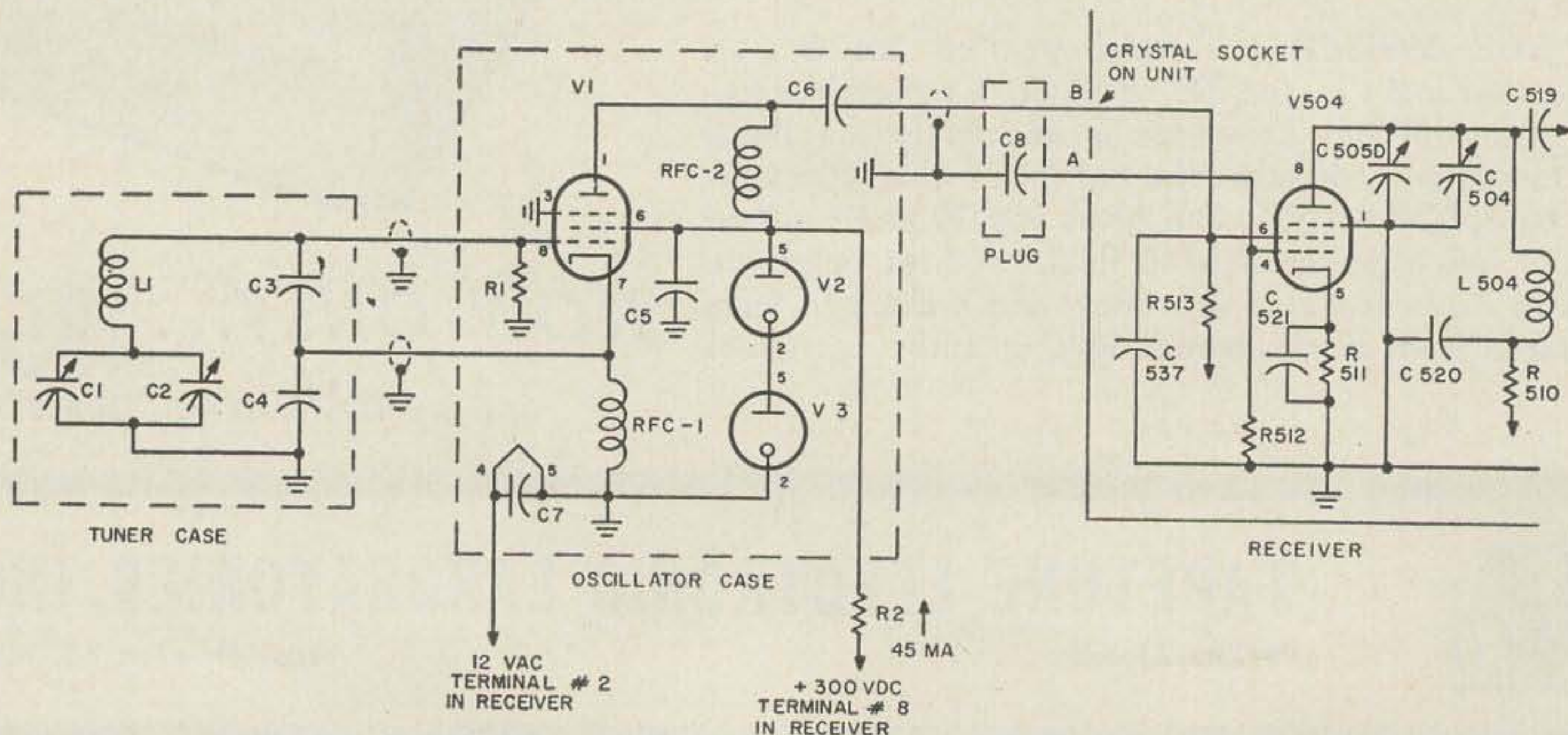

For DX or contests . . . for scatter, aurora or satellite tracking . . .
for "rock-crusher" reports or just plain "chewing the rag" . . .



HERE'S THE VHF COMBINATION THAT BEATS 'EM ALL!

Put yourself behind this power-packed Clegg VHF ham station . . . we guarantee you'll "out-talk", "out-receive" any other commercially-built amateur VHF transmitter and receiver now available!

Take, for instance, Clegg's ZEUS VHF Transmitter. It gives you full coverage of the amateur 6 & 2 meter bands and associated Mars frequencies, with maximum TVI suppression. Automatic modulation control with up to 18 db of speech clipping provides magnificent audio with "talk power" greater than many kilowatt rigs. This beautiful unit with its ultra-stable VFO is the ultimate in VHF equipment for amateur and Mars operation.

Clegg's all new INTERCEPTOR VHF Receiver, designed for the serious operator on these bands offers performance features unmatched by presently available equipment for these frequencies. Exactly matching the famous Zeus Transmitter, the Interceptor offers reception with virtually no cross modulation. Nuvistor RF stages provide an extremely low noise figure with high sensitivity. Stability is ideal for the exacting requirements of SSB and CW.

Amateur Net Prices:

ZEUS, \$695.
INTERCEPTOR, \$473.
99'ER, \$159.95

99'er TRANSCEIVER FOR 6 METERS

Here's a Transceiver that is ideal for both fixed station and mobile operation. Small in size, low in cost, and tops in performance, the 99'er offers operating features unequalled in far more costly equipments. The double conversion superhet receiver provides extreme selectivity, sensitivity and freedom from images and cross modulation. The transmitter section employs an ultra-stable crystal oscillator which may also be controlled by external VFO. An efficient, fully modulated 8 watt final works into a flexible Pi network tank circuit. A large S meter also doubles for transmitter tune-up procedure.



Write for Complete Information!

Clegg LABORATORIES

OAKWOOD 7-6800

An Inexpensive Six Meter Coaxial Antenna

Abe Ringel W6KVO
5648 Bowcroft Street
Los Angeles 16, California

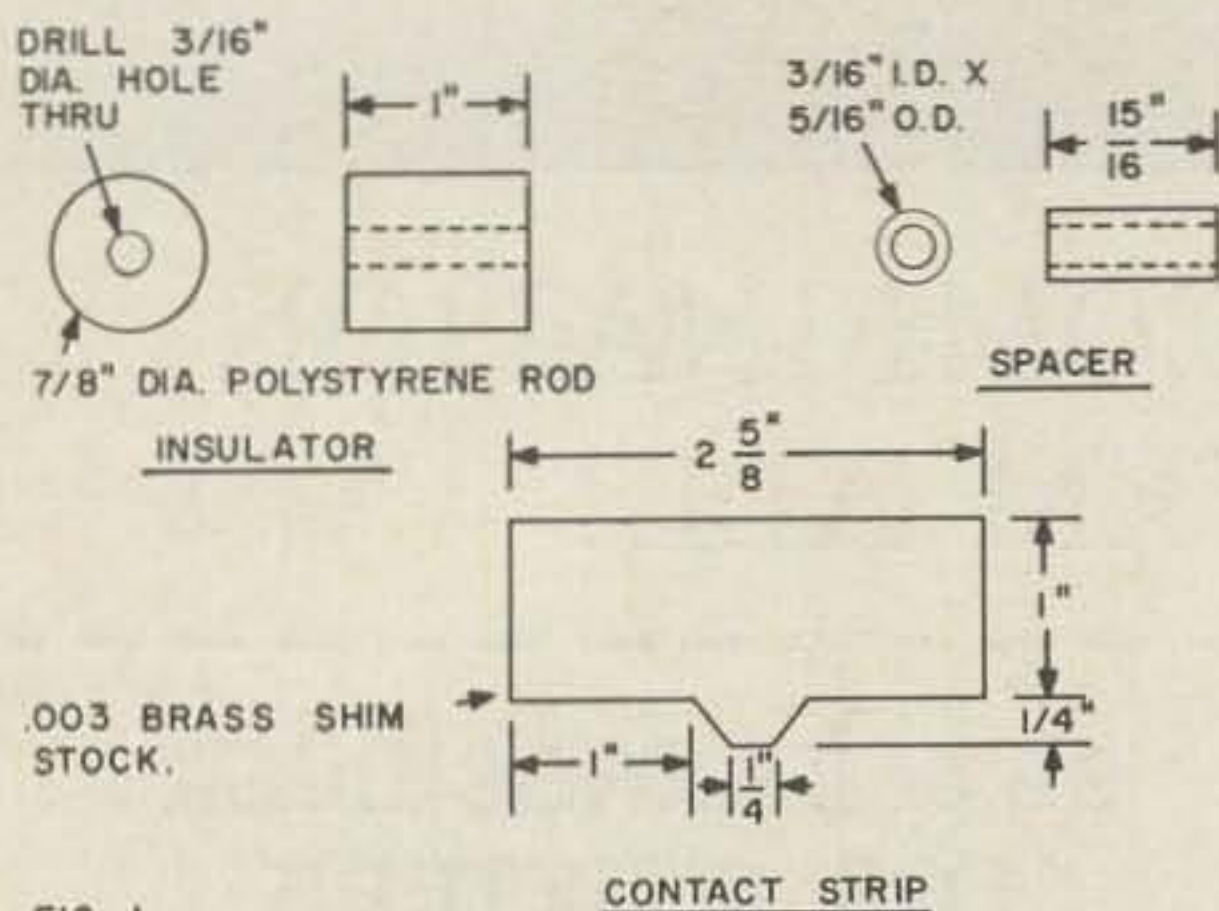

FIG. 1

THIS antenna was born of a lack of space, money and a desire for simplicity; the article to satisfy the pleadings of many of my ham friends, for whom I didn't have the time to make individual copies of the plans for this antenna. The majority of the materials are airplane surplus and the total cost of the antenna is less than five dollars.

Basically, this 50 to 54 mc antenna is a half-wave vertical radiator fed at the center. It consists of a projecting upper quarter-wave section called the whip, and a lower quarter-wave section called the skirt. The feedline

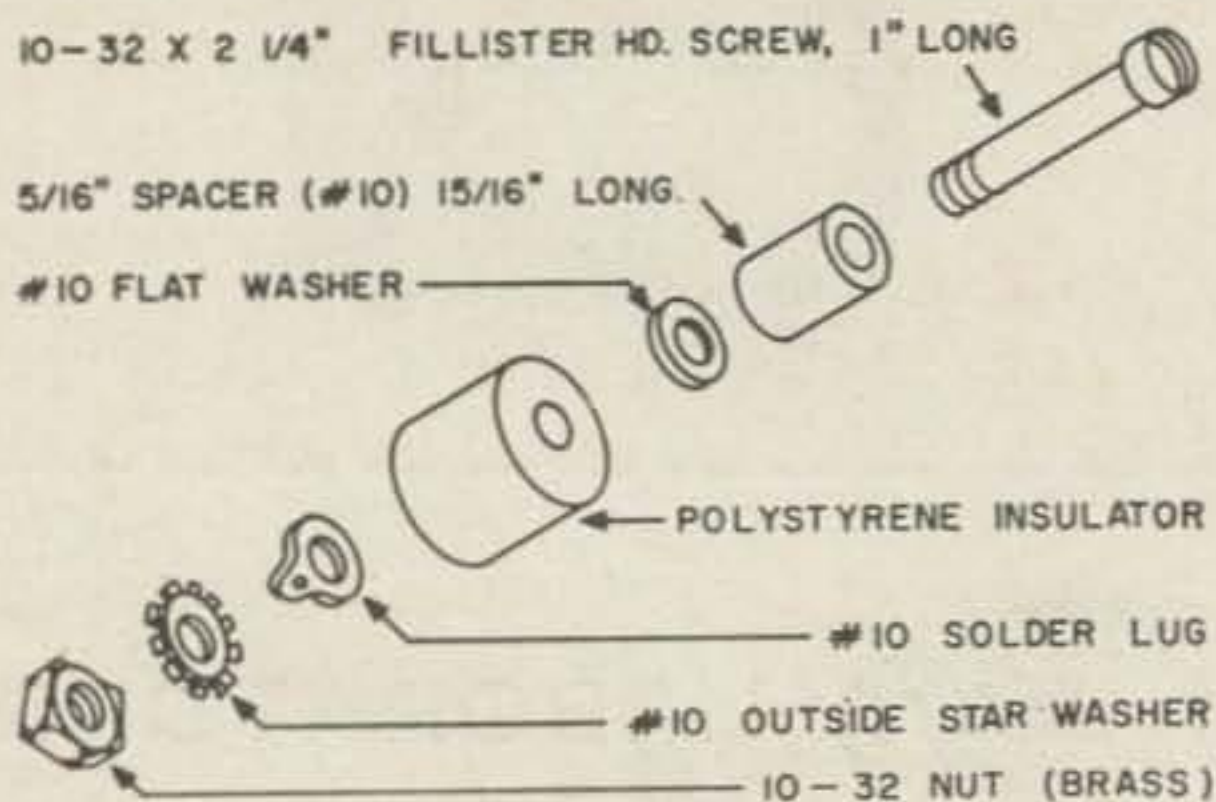

FIG. 2. INSULATOR ASSEMBLY

passes up through the skirt to the center insulator. The center conductor of a 72 ohm (RG 59/U) coaxial feedline is connected to the whip and the shield is connected to the skirt. This is accomplished by the special design of the center insulator.

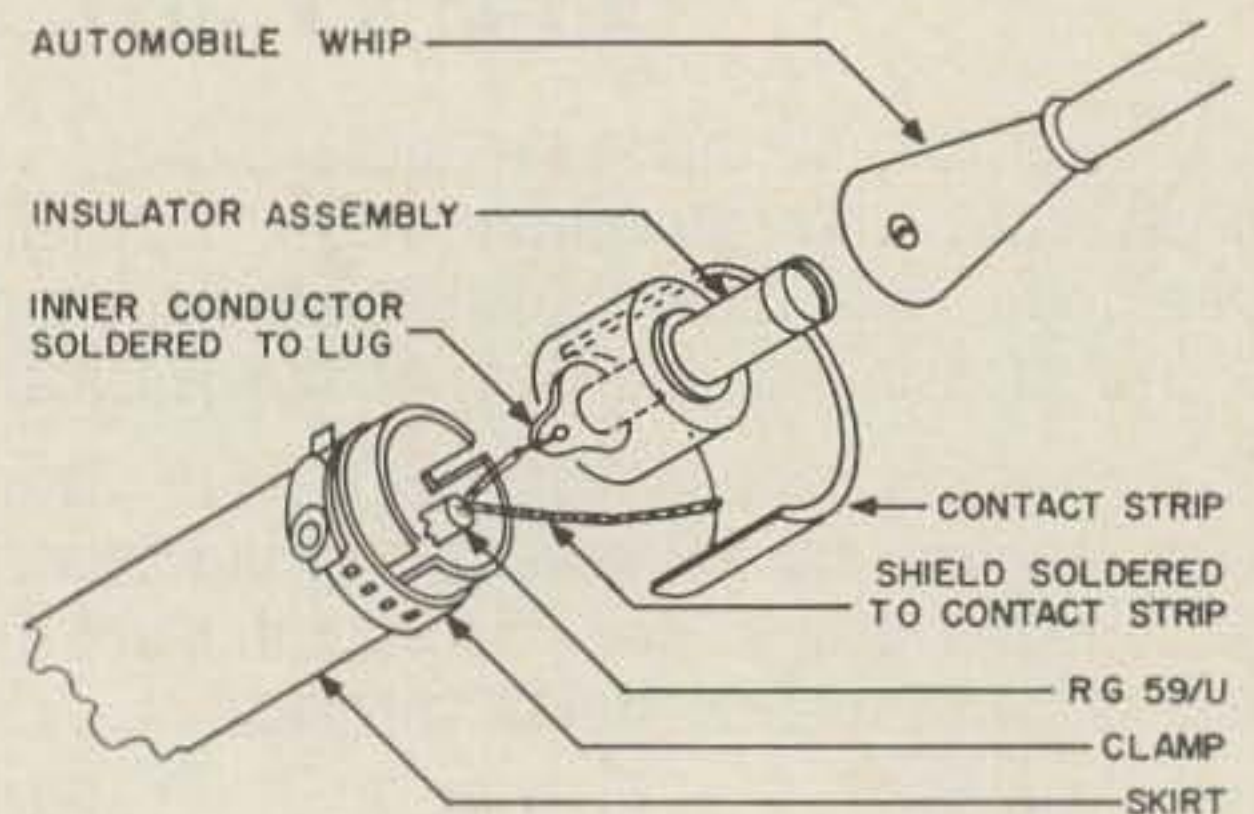

FIG. 3

The skirt of the antenna serves a two-fold purpose. Since it is half of the radiator, or one quarter-wave length, it also behaves as a trap providing an infinite impedance such that no appreciable current flows back down the feeder.

The whip is a commercially manufactured automobile replacement antenna, which when fully extended has an overall length of 58 inches. The skirt is made of 1 inch diameter aluminum tubing with a wall thickness of 0.049 inches.

A 6 foot length of tubing is cut to 55 inches for the skirt and the remaining 17 inches is used for the support tube. Both ends of the skirt and one end of the support tube are slit across the diameter of the tubing with a hacksaw containing a 1/16 inch blade to a depth of 1 1/8 inches.

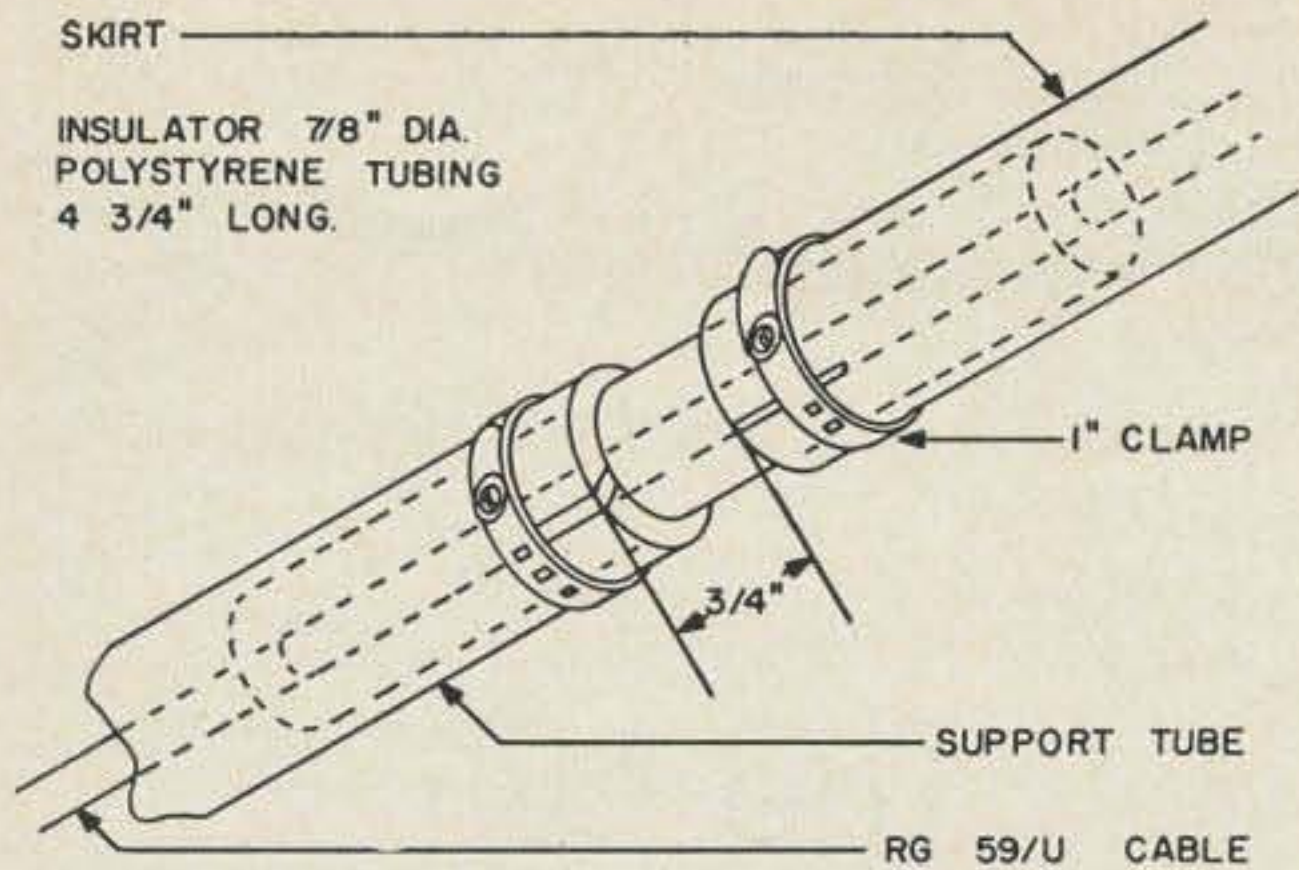

FIG. 4, INSULATOR AND SUPPORT TUBE ASSEMBLY.

The insulator is made from a 1 inch length of $\frac{7}{8}$ inch diameter polystyrene rod with a $\frac{3}{16}$ inch diameter hole drilled length-wise through the center (See Fig. 1). The insulator assembly (See Fig. 2) is made with the insulator, 10-32 x $2\frac{1}{4}$ inch fillister head screw, spacer (1 inch long, $\frac{5}{16}$ inch diameter) no. 10 flat washer, no. 10 solder lug, no. 10 outside star washer, and a 10-32 brass nut.

A contact strip is made from 0.003 inch brass shim stock (See Fig. 1) which is wrapped around the insulator before inserting into the end of the skirt. A 78 inch length of RG 59/U coaxial cable is used for the internal feedline. The RG 59/U cable is stripped at one end and the outer connector (shield) soldered to the tab on the contact strip, with the center conductor soldered to the lug on the insulator assembly. The other end of the cable is passed through the skirt with the insulator and contact strip inserted into the skirt end. A 1 inch clamp is slipped over the end of the skirt and fastened tight to hold the assembly firm (See Fig. 3).

The support tube insulator is a $4\frac{3}{4}$ inch length of $\frac{7}{8}$ inch diameter polystyrene tubing with a $\frac{1}{8}$ inch wall thickness. The tubing is slipped over the end of the coax cable and inserted 2 inches into the lower end of the skirt. A 1 inch clamp is positioned over the end of the skirt and tightened to secure the insulator. The support tube is slipped over the remaining free end of the insulator allowing $\frac{3}{4}$ inch spacing between the skirt and the support tube. A 1 inch clamp is positioned at the top of the support tube tightened securely (See Fig. 4). The antenna is completed by installing a PL 2 59 connector to the end of the cable and fastening the whip to the insulator assembly. The antenna can be mounted with any standard TV antenna mounting hardware.

Using the Gonset Communicator and this antenna the writer has received many excellent reports. . . . W6KVO

D. S. B.—A. M. TRANSMITTER

Sideband On Six!!

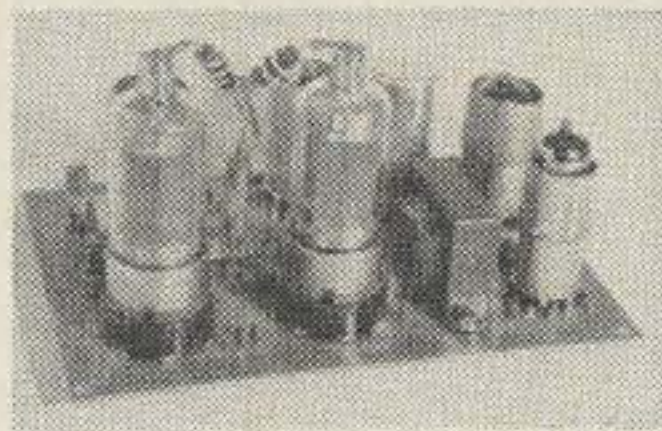

Audio tone generator
VOX controlled operation
5"x7" Fibreglass P.C. board
6 Sheets of drawings

\$7.50 plus 15¢ postage

Ohio Residents add 3% Sales Tax

See Article page 10, last issue.

C-Y ELECTRONICS

3810 E. 365th STREET, WILLOUGHBY, OHIO

NEW

from

P & H



MODEL DI-1 RF DISTORTION INDICATOR

- Specifically designed for correct adjustment of linear amplifiers, SSB exciters or transmitting converters.
- Displays RF trapezoid or RF envelope patterns. Uses 3" scope tube with full mu-metal shield. Green filter provides unusually sharp display, even in bright light.
- Trapezoid pattern compares detected envelope of exciter with RF envelope of amplifier or transmitting converter.
- The accessory Two-Tone Plug-In oscillator Model TT-1 provides the signal when making adjustments to the amplifier or transmitting converter.
- No modifications or internal attachments to exciter or amplifier required. Rear connections provided for 50-70 ohm coax lines.
- Operates 160 thru 6 meters. NO TUNING required. Handles any power 5 watts to 2 KW PLUS.
- Built-in, hum free power supply for 117 VAC.
- Comes completely wired and tested, with all tubes and ready to operate.

Amateur Net Price.....MODEL DI-1...\$99.95
MODEL TT-1...\$19.95

P & H

ELECTRONICS INC.

424 Columbia Lafayette, Ind.

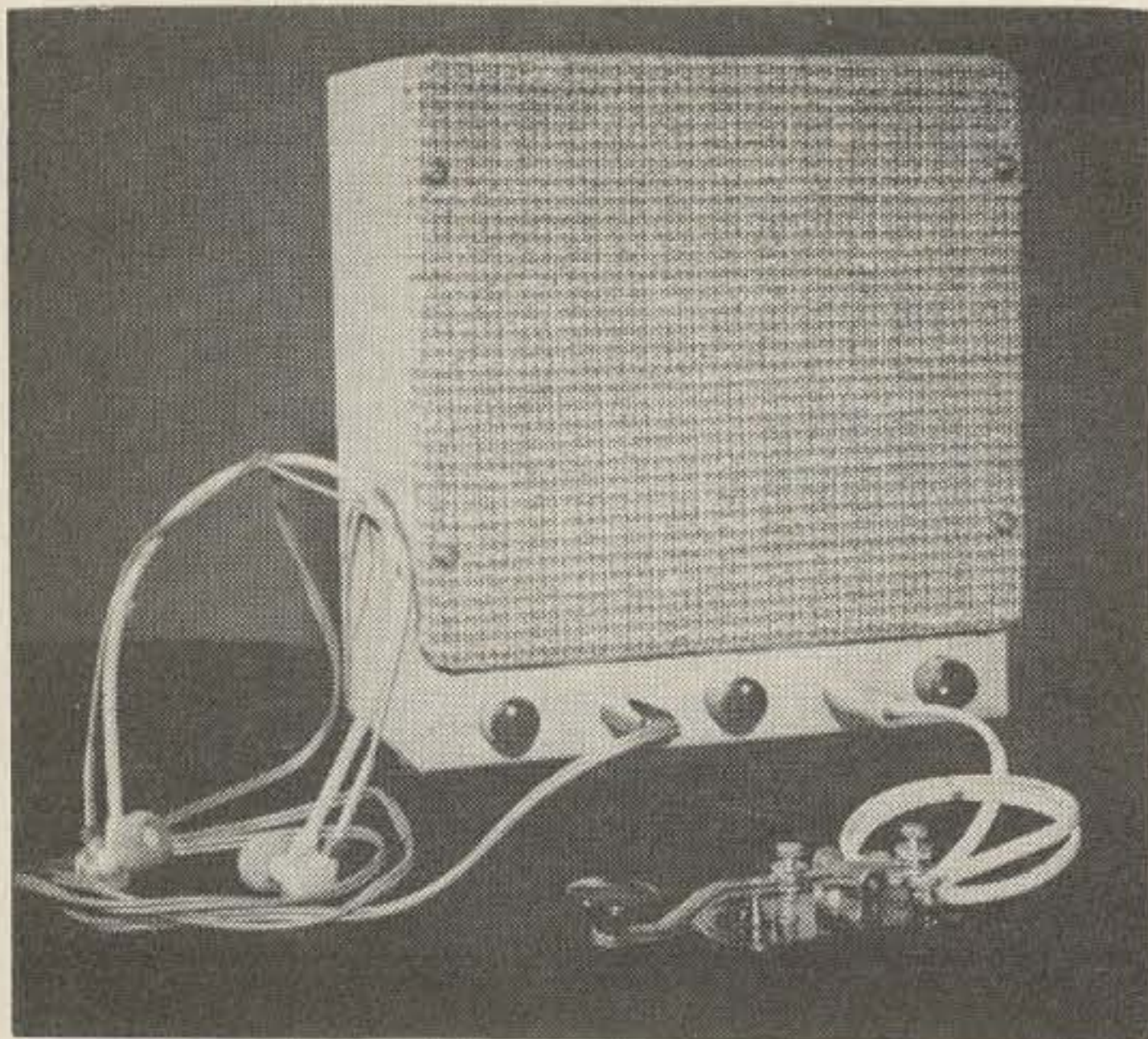

John Cleary W2VSP
 General Electric Company
 Syracuse, New York
 Semiconductor Products Department

The Uni Transistor

Code Practice Oscillator

THE "Uni" is the result of what started out to be a simple and quickly constructed code practice oscillator using a single transistor to drive the ham shack loudspeaker. The original plan was to have a little gadget handy, and always ready, so when things got dull around the shack, or when fancy struck, it would be a simple matter to give the ole fist some practice. But like the fellow who decided that a little red paint on the trim of his white house would really look sharp and then ended up painting the whole house red, so too the "Uni" ended up being painted red, so to speak, and got the complete treatment. As things stand now the "Uni" doubles as the shack loudspeaker as well as a complete portable code practice oscillator.

"Uni" was chosen as a name for two reasons: first, a single transistor only drives an 8" loudspeaker to reasonably loud volume; and second, the transistor doing the driving is a Unijunction, or UJT. The UJT (2N2160) is an unusual transistor. Although it is similar to other transistors in outward appearance, it is, in its own right, unique. Even the symbol is unique as can be seen in Fig. 1(A).

The Unijunction transistor, like most transistors, is a three terminal device. It is different than most, however, in that it displays a negative resistance characteristic between its emitter (E) and base-one (B1) terminals. Some UJT electrical characteristics resemble the gas thyratron, but here the similarity with other devices, tube or semiconductor, stops. The remaining electrical characteristics are unique and the Unijunction transistor has no exact counterparts either among solid state

or vacuum tube devices.⁽¹⁾ Although the Unijunction is available in a variety of types to meet a variety of needs, and at higher cost than the amateur likes to pay for a transistor, the 2N2160 is a low cost type well suited for amateur experimental work. Because of the unique characteristics such applications as oscillators, timing circuits, trigger circuits, and bistable circuits become simple to design, easy to construct, and precise in operation.⁽¹⁾

The Unijunction transistor relaxation oscillator shown in Figure 1(B) is the basic oscillator from which many interesting circuits can be derived. In fact, the "Uni" was the outcome of replacing R1 with a loudspeaker and adjusting RtCt for medium to high frequency oscillation. By keying the +V1 battery line, current is drawn only during key-down

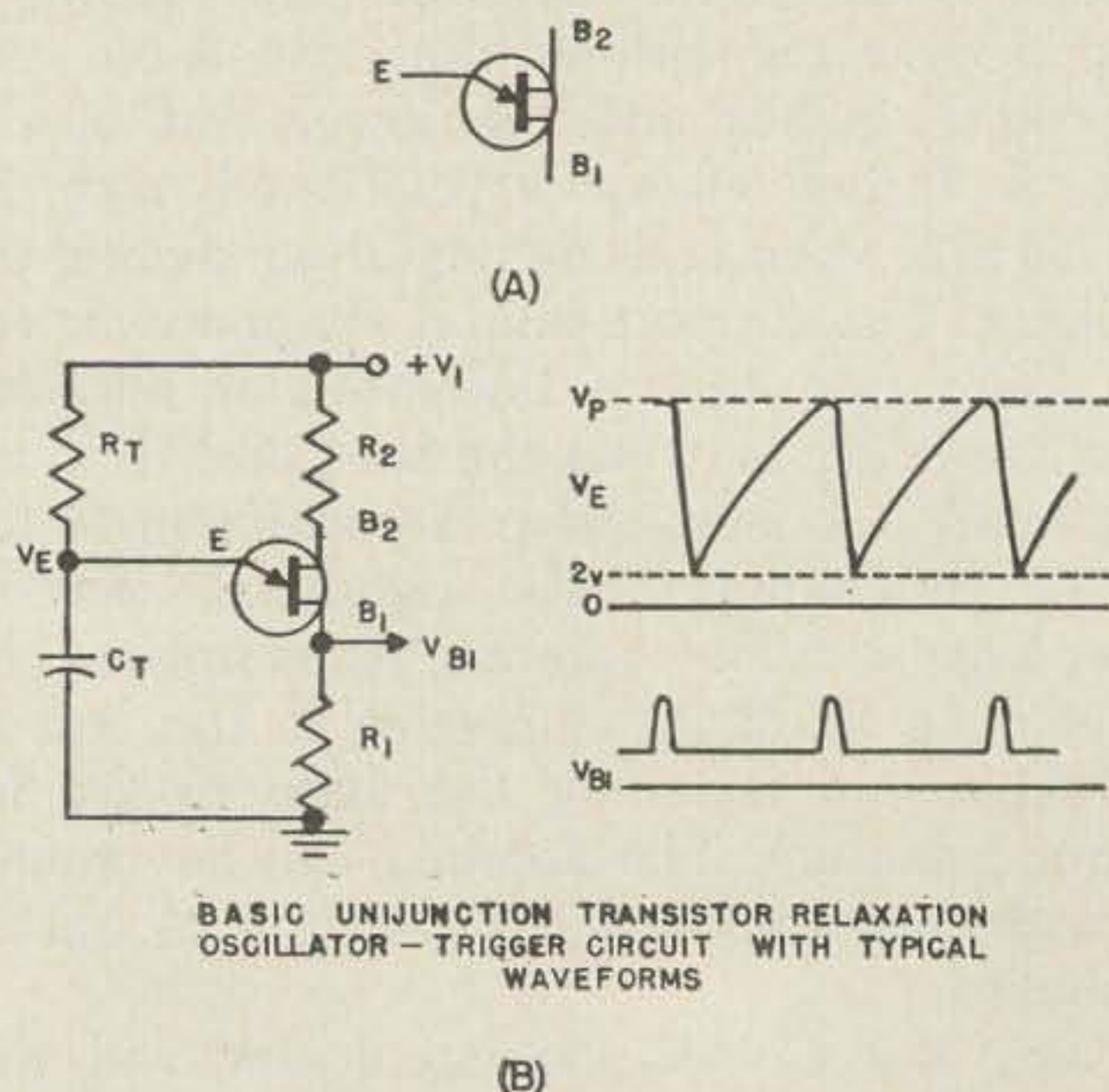

BASIC UNIUNCTION TRANSISTOR RELAXATION OSCILLATOR - TRIGGER CIRCUIT WITH TYPICAL WAVEFORMS

FIGURE 1.

periods and the result is an extremely simple and economical code practice oscillator consisting of speaker, two resistors, one capacitor, a battery, and a UJT 2N2160. How simple can a circuit get!

Let's look at Fig. 1(B) and briefly go over how the UJT basic relaxation oscillator works. At the beginning of the operating cycle the emitter is non-conducting since no operating voltage is being applied. Applying voltage at +V1 terminal allows capacitor CT to charge through resistor RT. As the emitter voltage at point VE rises exponentially towards the level of +V1, the supply voltage, a point VP, the emitter's peak point voltage, is reached. At this instant the dynamic resistance between the emitter and base-one drops to a low value.

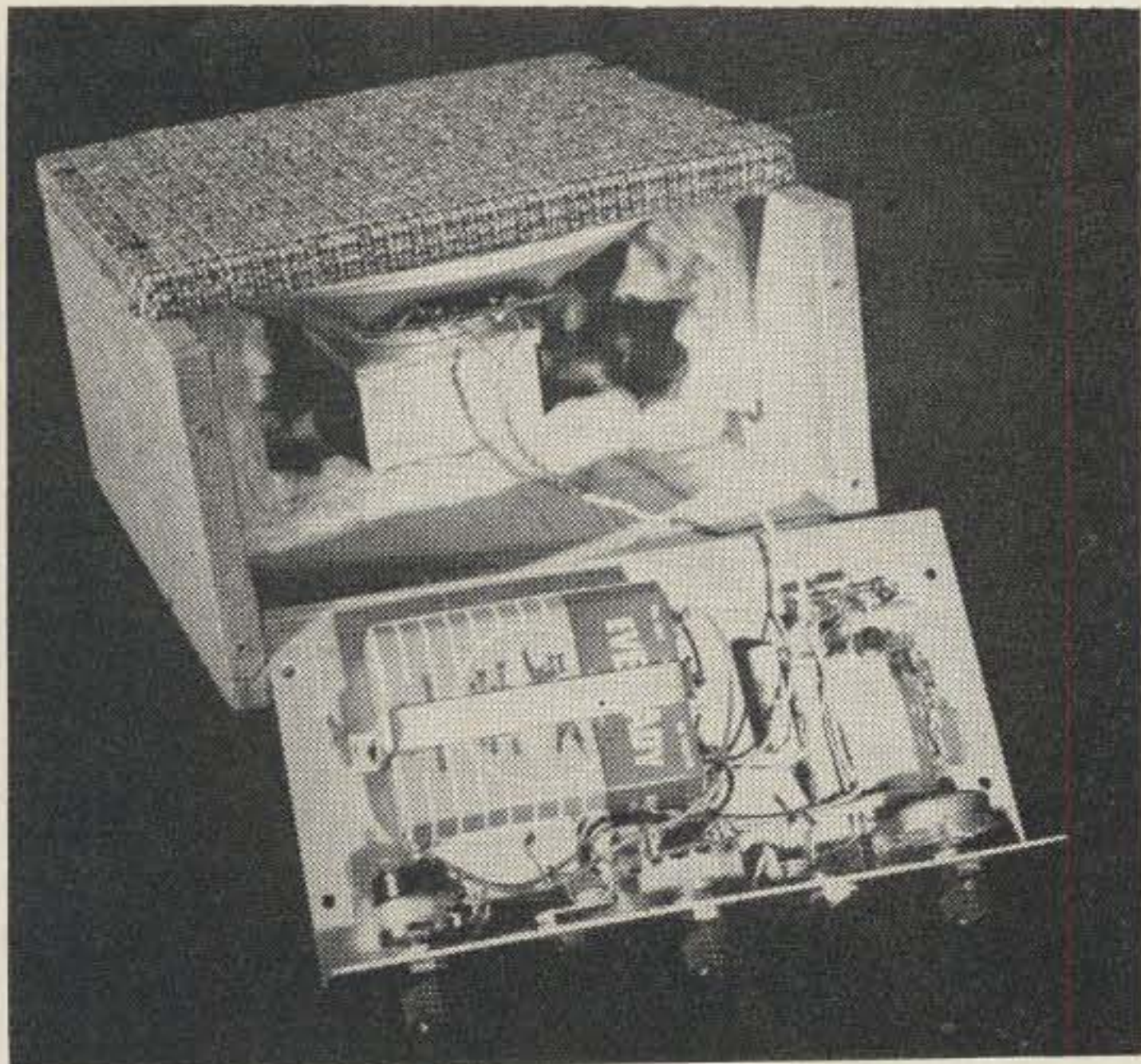

Capacitor CT then discharges through the emitter and through R1 to ground. As the emitter voltage VE approaches 2.0 volts the emitter no longer conducts and the cycle is repeated. The resulting series of pulses are shown as VB1.

Frequency is determined by RT, CT, and the voltage across the UJT. By including R2 in base-two the effective voltage across the UJT is stabilized with respect to temperature. Excellent frequency stability can be obtained from the UJT basic oscillator when R2 is between 50 and 500 ohms. Those interested in pursuing the UJT further can refer to the biography. Detailed theory of operation and specific applications of the UJT far beyond the scope of this article are treated by the authors in the papers listed. This being a construction article, let's get to building the "Uni."

Fig. 2 shows the completed "Uni." It goes without saying that you need not duplicate the circuit as shown. By replacing the tone

NOW!

TWO ANTENNAS IN ONE*

*another *FIRST* from *FINCO*

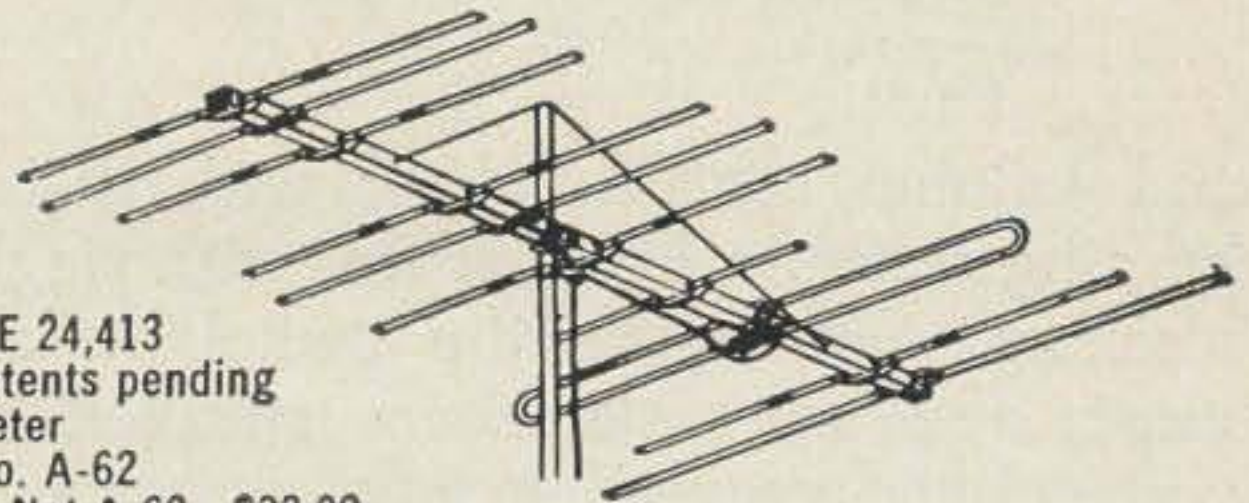

Patent RE 24,413
Other patents pending
6 & 2 Meter
Model No. A-62
Amateur Net A-62 \$33.00
Stacking Kit AS-62 \$2.19

The Only Single Feed Line

**6 & 2 METER
COMBINATION YAGI ANTENNA**

from **FINCO**[®]

- Heavy Duty Square Aluminum Boom, 10 Ft. Long
- All Elements are Sleeve Reinforced And Completely Pre-assembled With "Snap-Out" Lock-Tite Brackets
- Boom Suspension Rods Are Supplied Completely Pre-assembled, Ready To Be Snapped Into Upper End Of Mast

ON 2 METERS:

- 18 Elements
- 1—Folded Dipole Plus Special Phasing Stub
- 1—3 Element Collinear Reflector
- 4—3 Element Collinear Directors

ON 6 METERS:

- Full 4 Elements
- 1—Folded Dipole
- 1—Reflector
- 2—Directors

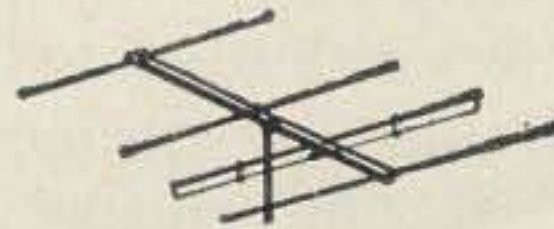

A6-4 6 Meter 4 Element
Amateur Net \$17.16
Stacking Kit AS-6 \$2.19



A2-10 2 Meter 10 Element
Amateur Net \$11.88
Stacking Kit AS-2 \$1.83



A1 1/4-10 1 1/4 Meter 10 Element
Amateur Net \$11.88
Stacking Kit AS-1 1/4 \$1.26

**See Your FINCO Distributor
or write for Catalog 20-226 to:
THE FINNEY COMPANY
Dept. 20, 34 W. Interstate St., Bedford, Ohio**

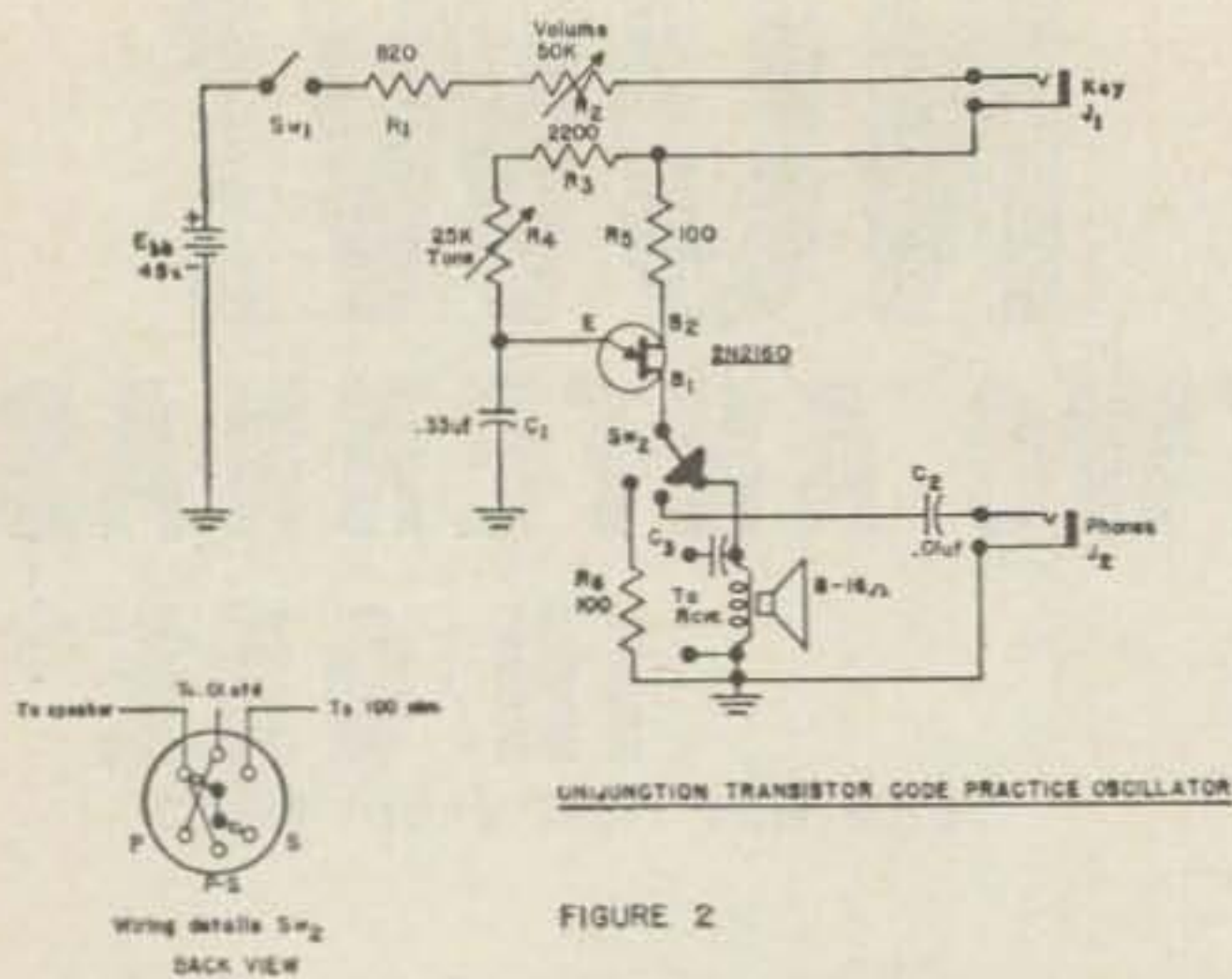

FIGURE 2



Wiring details SW₂
BACK VIEW

and volume controls along with their series limiting resistors, R1 and R3, with single fixed resistors, eliminating the switching arrangement, and using the shack speaker, an economical and simple but satisfactory code oscillator will be yours. Volume and tone will be fixed but this is more than compensated for by the few parts used.

A 45 volt B battery is used to power the "Uni." The battery selected, an RCA No. 455, was readily available and fits with ease into the cabinet. This can be seen in the photograph. A clamp is used to secure the battery in place. The clamp allows for spacing the battery 1/4" from the chassis surface by shimming with a scrap piece of wood or plexiglass. This allows the battery terminals to clear other surrounding terminals and components. Actually 45 volts is more than required for the 2N2160 and in order to limit the base-to-base voltage to the manufacturer's recommendation of 30 volts maximum, an 820 ohm limiting resistor in series with the 50 K volume control must be used. Some slight change in tone will be noted when the volume control is rotated from one end to the other. Limiting resistor R3 prevents excessive voltage being applied to the emitter when tone control R4 is adjusted to minimum. Battery drain, depending on volume setting, is from a half milliamperes to 10 ma.

Switch SW1 is strictly a precaution to save the battery from being drained by curious little hands when the Chief Operator is not around to supervise. Considering that the oscillator is keyed in the B+ line, and when the key is up the oscillator draws absolutely no current, SW1 could be left out. Selector switch SW2 allows for three modes of listening: phones alone, phones and speaker together, and speaker alone. Wiring details of the two circuit-three position switch is also shown in Fig. 2. Although the basic UJT oscillator circuit, because of its simplicity and

few components, can be stuffed into almost any space, some may wish to build the "Uni" as shown. Cabinet size will naturally depend on the size of the loudspeaker. An 8" General Electric Model 850D loudspeaker is used in the "Uni" here shown, but just about any loudspeaker may be used with equal results.

A word about C3. C3 acts as a dc blocking capacitor when the "Uni" is connected to the home receiver. This capacitor prevents the low resistance winding of the receiver's output transformer from dc shunting the speaker voice coil. Should this happen a serious decrease in volume from the "Uni" will result because of the current pulse from base-one splitting and flowing through the two parallel paths. C3 prevents this. Low audio frequency roll-off will result from using C3, depending of course, on the value used. A 2 mfd, or larger, capacitor should not cause too serious a roll-off in most ham installations.

To date the "Uni" has seen service at the recent ham family picnic, taking part in the QLF contest. It was loud enough to be heard at a good distance with a crowd surrounding the contestants. It has also been used to teach several code groups. In each instance it has come back home with flying colors, accompanied by such comments as, "Plenty of volume—pleasant tone—how about a copy of the circuit?" To say the least we're glad we gave the "Uni" the complete treatment. It was worth it!

... W2VSP

BIBLIOGRAPHY (1)

- L. E. Garner, Jr., "Using the Unijunction," *Radio-Electronics*, July 1957, pages 91-96.
- R. A. Stasiar, "How to Use the Unijunction Transistor," *Automatic Control*, February 1957, pages 24-25.
- S. R. Brown, T. P. Sylvan, "The Silicon Unijunction Transistor," *Electronic Design*, January 8, 1958, pages 56-59; January 23, 1958, pages 30-33.
- T. P. Sylvan, "Applications of Unijunction Transistor Relaxation Oscillators," *Electronic Equipment Engineering*, May 1958, pages 51-56.

Parts List

- C1—.33 μ fd
- C2—.01 μ fd
- C3—See text
- Battery—45 V "B" Battery. RCA No. 455 or equivalent
- J1—Open circuit key jack
- J2—Open circuit earphone jack
- R1—820 ohm 1/2 w.
- R2—50 K volume control with SPST Switch
- R3—2200 ohm, 1/2 w.
- R4—25 K Tone Control
- R5—100 ohm, 1/2 w.
- R6—100 ohm, 1/2 w.
- Sw1—SPST switch mounted on R2
- Sw2—2 circuit, 3 position rotary switch (Mallory Type 3123J)
- Speaker—8—16 ohm 8" speaker
- Misc. 3 single mounted terminal strips
 - 1 two lug screw type terminal strip
 - 4 Rubber feet
 - 3 5/8" dia. knobs
- Transistor—2N2160 Unijunction

SSB, AM, CW ON SIX METERS AT A REASONABLE COST FROM CONTINENTAL ELECTRONICS

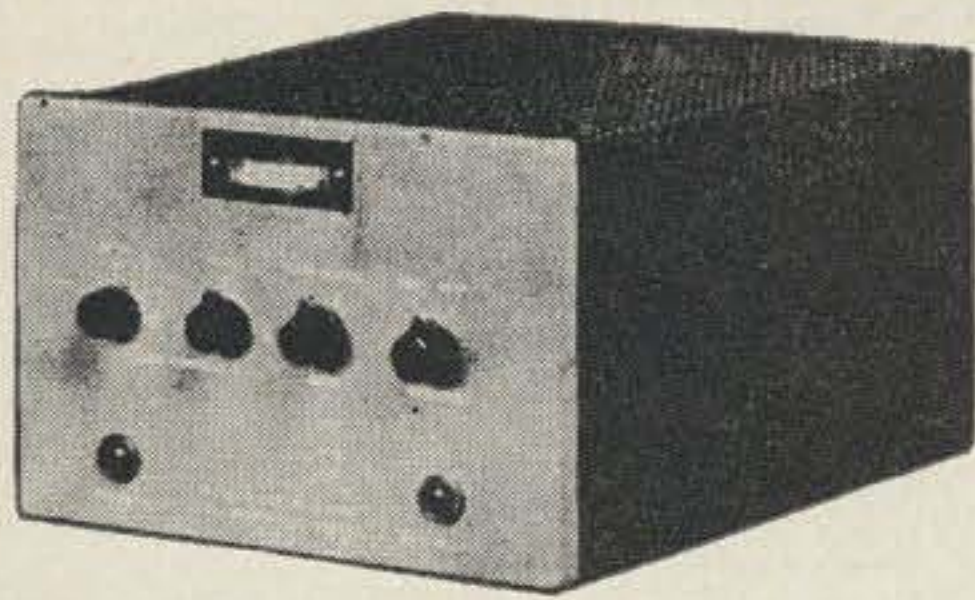

"Where Quality Counts First"

THE CONTINTAL "SIX" TRANSMITTING CONVERTER

\$99.95

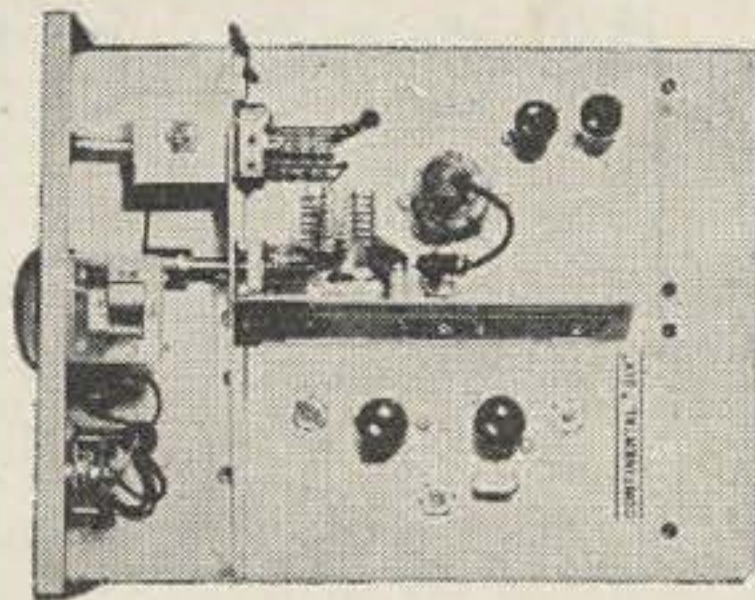

HERE'S A RIG BASED ON THE DESIGN OF K4RLX (See August 1961 VHF Magazine). 36 STATES CONFIRMED ON 6 METER TWO-WAY SSB.

FEATURES:

- Low drive requirements—Can be driven by any AM or SSB exciter with 20 meter output, such as 20-A, 10-B, DX-35, HT-37, KWM-2, etc.
- Power Requirements: 400 volts @ 75 mils, 150 volts regulated, 6.3 volts filaments.
- 30 Watts P. E. P. SSB, reduced output on AM.
- Horizontal meter reads PA plate and relative RF output.
- Uses minimum of operating adjustments when changing frequency.
- Extremely high "Q" circuit, high stability, excellent shielding and straightforward design to provide many hours of trouble-free operation.
- Modern two-toned grey low temperature cabinet, only 5 3/4" high, 8 11/16" wide, 11 1/4" deep, and exceptionally lightweight.
- Individually factory aligned and tested.

SEPARATE POWER SUPPLY AVAILABLE, WILL MATCH CONTINENTAL "SIX".—COMING SOON: THE CONTINENTAL "SIXTY-ONE" 100 WATTS P.E.P. ON SIX METERS AND THE CONTINENTAL "TWO" 175 WATTS P.E.P. ON TWO METERS.

Order Direct From: CONTINENTAL ELECTRONICS — Sumter, S. C.

HEADQUARTERS FOR SIX METER FM GEAR

—Contact Us—

FORT WAYNE ELECTRONICS SUPPLY, INC.

3606 Maumee Ave., Fort Wayne, Ind.



H
I
V
E
R
T
E
R

50

Extends use of your present 14 Mc SSB, AM and CW Transmitter to 50 Mc Band. With Tubes and xtal, less PS **\$99.50**



KITS
MAILED POSTPAID
ANYWHERE IN USA.



Send for free list of more than 80 printed circuit kits.

Let's "kit" Together
Use YOUR Parts & PAPPY'S wiring

IRVING ELECTRONICS CO

POST OFFICE BOX 9222 SAN ANTONIO 4, TEXAS

LOW
ANGLE

HIGH
GAIN

the
HOTTEST
on 6!

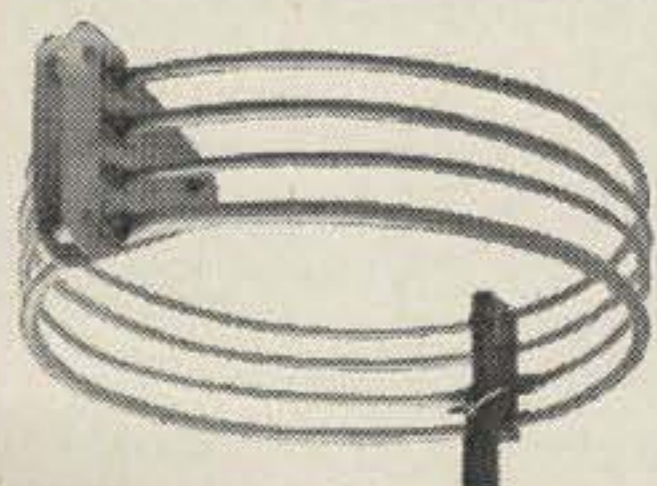

The EBCO
"446"

EBCO
Antennas

\$19.95

P. O. Box 23
Stoneham 80,
Mass.

P. O. Box 895
Los Amigos Sta.
Downey, Calif.

More on Crystal Oscillators

Murray Baird W6LWE
1231 10th Street
Manhattan Beach, California

THE crystal oscillator article in 73 Magazine, September 1961, did a fine job of surveying the countless ways of tickling those fascinating little quartz slabs into doing their duty. To my mind, though, it skipped rather lightly over the Colpitts family of oscillators. Since this basic circuit is rapidly becoming the favorite of a goodly number of designers, some added remarks on its care and feeding might be in order.

The Colpitts offers a number of advantages which are difficult, if not impossible, to obtain in a group from other circuits. Most important, I suppose, is that no critical adjustments are needed to obtain oscillation; turn it on and it plays. It's adaptable to either series or parallel resonance operation, overtone crystals and performs well up to 75 mc or more. Since the plate circuit is at rf ground, the door is open to any number of special-purpose applications. Another important feature that will appeal to those poor souls who have battled inter-stage feedback is that one side of the crystal is grounded. This reduces stray-capacity effects. The grounded crystal lead enables even more modifications to suit your particular need.

Refer to Fig. 1. C1 and L1 form a parallel resonant circuit at some frequency *lower* than the crystal frequency. This provides the correct phase of reactance to support oscillation.

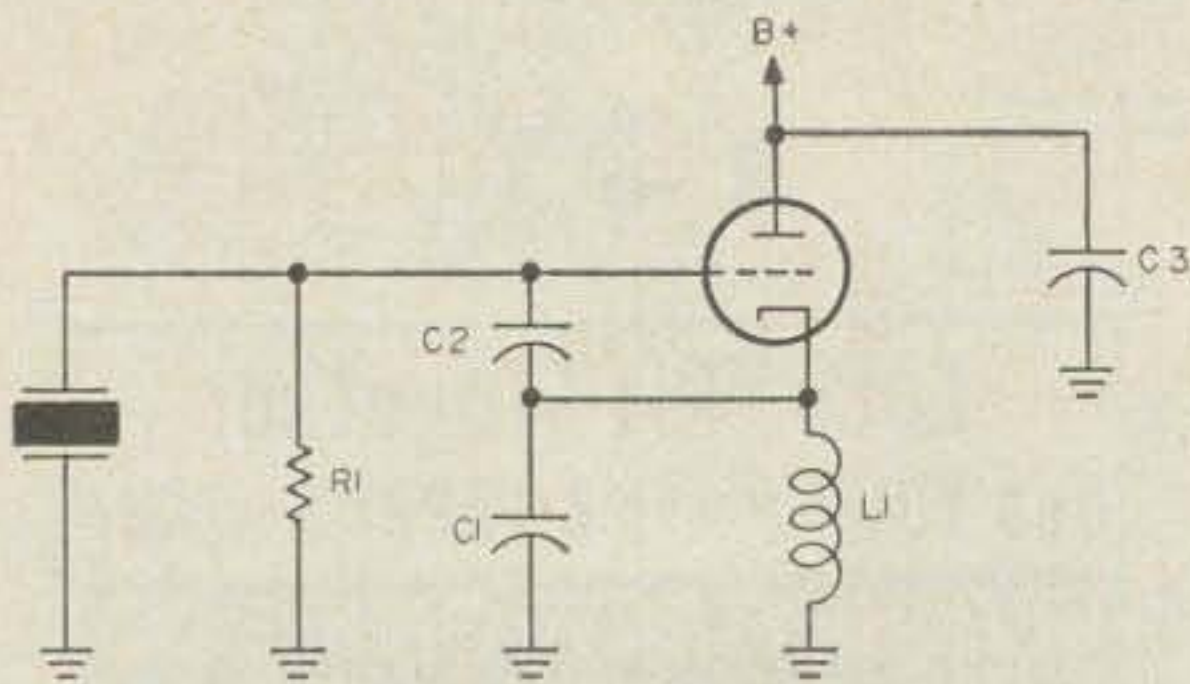

FIG. 1

Notice this is opposite of that required for the Miller (tuned-plate) oscillator which requires that the tuned-tank be tuned to a frequency *higher* than the crystal frequency. It all comes out even when you remember that a phase reversal occurs between grid and plate of the tube, but not between grid and cathode.

The actual value of C1 is not particularly critical; between 1 and 2 mmfd per meter will do fine. Remember that there is about 5 mmfd heater-to-cathode capacity built into the average small tube so when C1 and L1 resonate at a lower frequency than your trusty reactance chart would indicate it needn't necessitate a visit to the local head-shrinker.

Maximum feedback will occur when L1 and C1 resonate just below the crystal frequency. Also, here is where they have the strongest pulling effect on crystal frequency. Therefore, be wise and keep them at least ten percent away from the crystal frequency.

Capacitor C2 provides feedback between grid and cathode. At VHF the grid-to-cathode capacity of the tube itself is quite often adequate. The easiest way to find out is to try a couple of micro-micro farads; if the output increases you need it—if not, leave it out. If you like rules of thumb, make C2 two times the square root of the wavelength in meters. This applies throughout the MF-HF spectrum.

The rf path from plate to ground is pro-

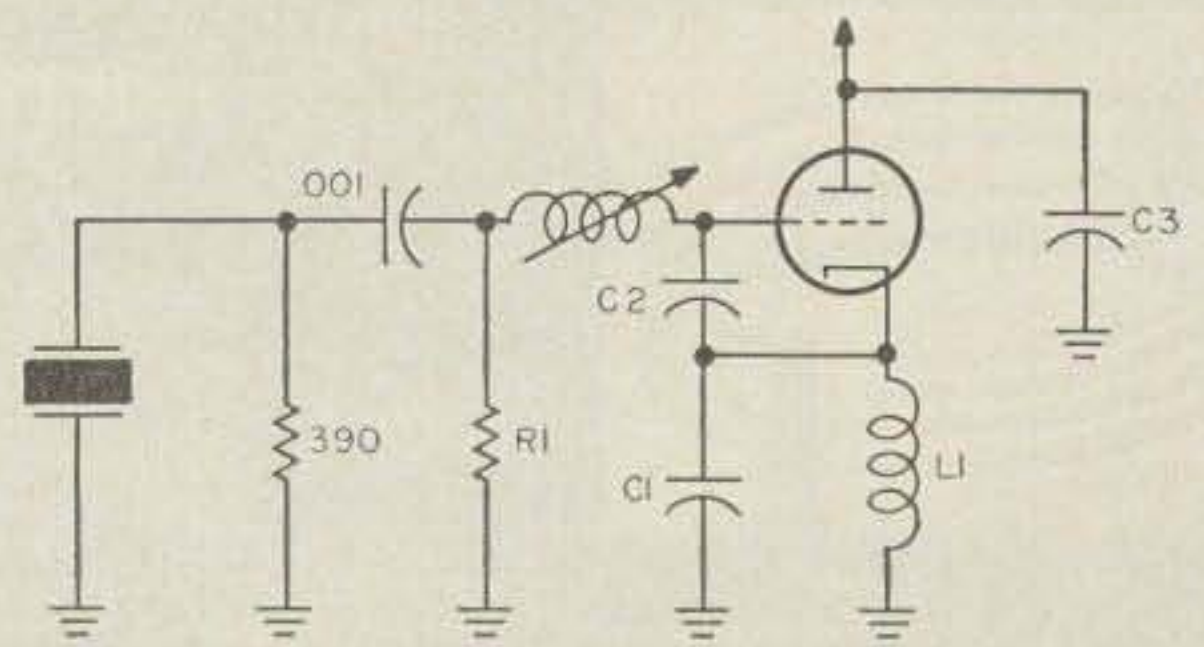

FIG. 2

vided by C3, the least critical component of the bunch. A .01 mfd disc will do nicely through 10 mc. Above that use a .001 mfd disc until you get into the VHF range. 50 mc and higher calls for a good low-inductance mica, 100 mmfd or more.

The grid resistor R1 has a moderate effect on power output and, to some extent, harmonic content in the output. If you want to keep harmonics down, keep R1 low in value and, more important, keep the plate voltage as low as possible. On the other hand if you want best efficiency in the circuit (low power drain with best output) a higher value of R1 is called for. In any case it usually will be between 10K and 100K ohms. If you choose a value lower than 22K, put a small rf choke in series with the resistor. This prevents the resistor from becoming an rf shunt across the crystal. Above 22K the choke doesn't buy you anything.

All of the above design rules have been and will continue to be violated for one reason or another, but if you observe them you will be assured of a reliable, trouble-free oscillator that will operate right off the bat.

At this point all our problems are solved except for one minor detail—how to get some output from the rascal. Well, as the fellow says, it all depends. If you are going into a buffer stage tie the buffer grid directly on the oscillator cathode (be sure to provide some cathode bias for the buffer stage). If the oscillator is used to inject a receiver mixer, couple from the oscillator cathode to the mixer grid through a very small capacitor. You can even get low impedance output by lifting the ground lead of C1 and inserting a coax cable in series with C1 to ground. In any event, avoid coupling to the grid since the frequency stability will surely suffer.

Now, with all this groundwork under our belts, let's look into some applications. Right away I hear somebody mention overtone crystals. Easiest thing in the world. All you have to do is set the values of L1 and C1 such that they resonate about 10% lower than the overtone frequency desired. Be sure to check it with your grid-dip meter before you plug the crystal in or turn on the power. The crystal will be operating in the parallel resonance mode with this lash-up. If your crystal is calibrated for series resonance operation and you don't want to put up with the slight frequency shift that occurs when operated parallel resonant, it will cost you three more parts. See Fig. 2. By inserting a small coil between R1 and C2 we now have a form of impedance-

THE NOGOTON TWO METER RECEIVER

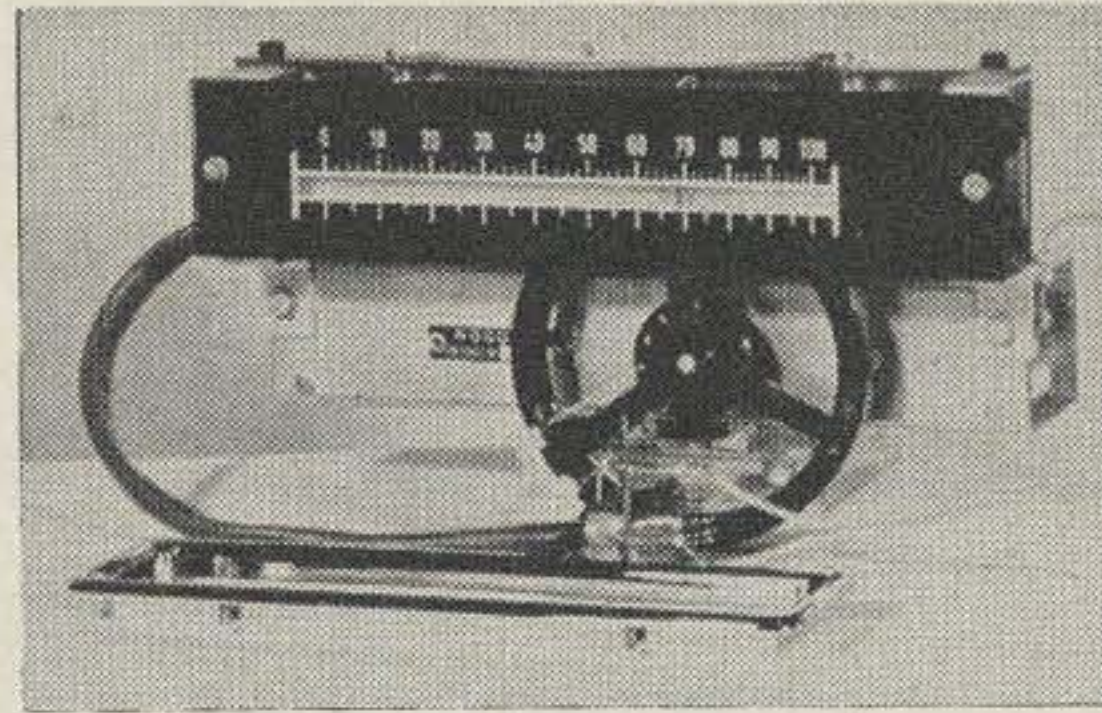

This five tube unit consists of a complete two meter receiver foundation, requiring only the addition of a power supply and an audio stage to provide you with a fabulous receiver. Using only 200 volts DC at 38 ma. and 6.3 volts at 2 amperes for the filaments. Sensitivity is better than one microvolt for full output with a bandwidth of 20 kc. All tubes are included, and it is fully wired, not a kit, but rather a working unit ready to install in your cabinet. Postpaid\$59.95

A deluxe model, incorporating triple conversion, Automatic Frequency Control and squelch with provisions for both a frequency deviation and an "S" meter giving one tenth microvolt sensitivity with 5 KC bandwidth using 7 tubes. Postpaid.....\$164.95

All units are made in West Germany by NOGOTON and use standard American available parts and tubes. All units fully guaranteed. Dealers' inquiries invited.

SEACOR, Inc. P. O. Box 134
Fleetwood Sta., Mt. Vernon, N.Y.

Looking for Service?

Factory Parts & Service for:

Amateur & Commercial transmitters & receivers

Test Equipment

Marine Radio

Power Supplies

Citizens Band

Hi-Fi

Stereo

Antenna Systems and Installations

AMATRONICS, INC.

(formerly Eastern Communications)

91-46 LEFFERTS BOULEVARD
RICHMOND HILL 18, NEW YORK

Phone: Hickory 1-7890

CB crystals in stock

40 FT. CRANK-UP TOWER

At

68 MPH

*At 40 Feet

USING A TRI-BAND 10-15-20 METER BEAM

Assembled Weight—20 lbs.
Wind Surface Area—4.9 sq. ft.
Wind Load—86 lbs.
Maximum Element Length—26'8"
Boom Length—12'
Turning Radius—14.9'

OR

148 MPH

with your Tri-Bander at 25'

WORLD'S
FINEST

SUPREME

COMMUNICATION TOWERS

*Certified by Reg. Prof. Eng.

\$119⁵⁰

Model 40-1

F. O. B.

WITH HEAD MOUNT

PLANT

BRACKET MTG. KIT \$9.50

Tilts over on a heavy base plate for access to motor and array.

Horizontal bracing throughout.

Available from your local distributor, or direct from manufacturer.

SUPREME ELECTRONICS INC.

FRONT & MAIN STS.
UPLAND, PENNA.

inversion oscillator. Don't let this scare you—it's quite simple. The Colpitts circuit needs a high impedance between grid and ground. A crystal operating in the series resonance mode is a very low impedance. So the problem boils down to inverting the low crystal impedance to the high impedance the grid is pinning away for. If you have delved into transmission lines very much you know that a shorted quarter-wave line will show a high impedance at the far end. If we wanted to coil up a mess of coax line, tying the crystal across one end and the grid on the other we would have ourselves an impedance-inversion oscillator. The little coil between R1 and C2 does the same job, and a heck of a lot neater. It's an artificial quarter wave line. All we have to do is make it the right size. Here's where you need your grid-dip meter again. Most overtone crystals have a capacity of about 10 mmfd measured in the socket. Our little coil must be resonant at the overtone frequency with this capacity. So wind yourself a little slug-turned coil, hook a 10 mmfd capacitor across it and prune it to the desired frequency with the slug somewhere in the middle of its range. After installing it (don't forget to remove the 10 mmfd capacitor) adjust for maximum oscillator output and you're in business series-resonant. The 390 ohm resistor prevents parallel-mode oscillation. The .001 capacitor prevents the grid being shorted by the 390 ohm resistor.

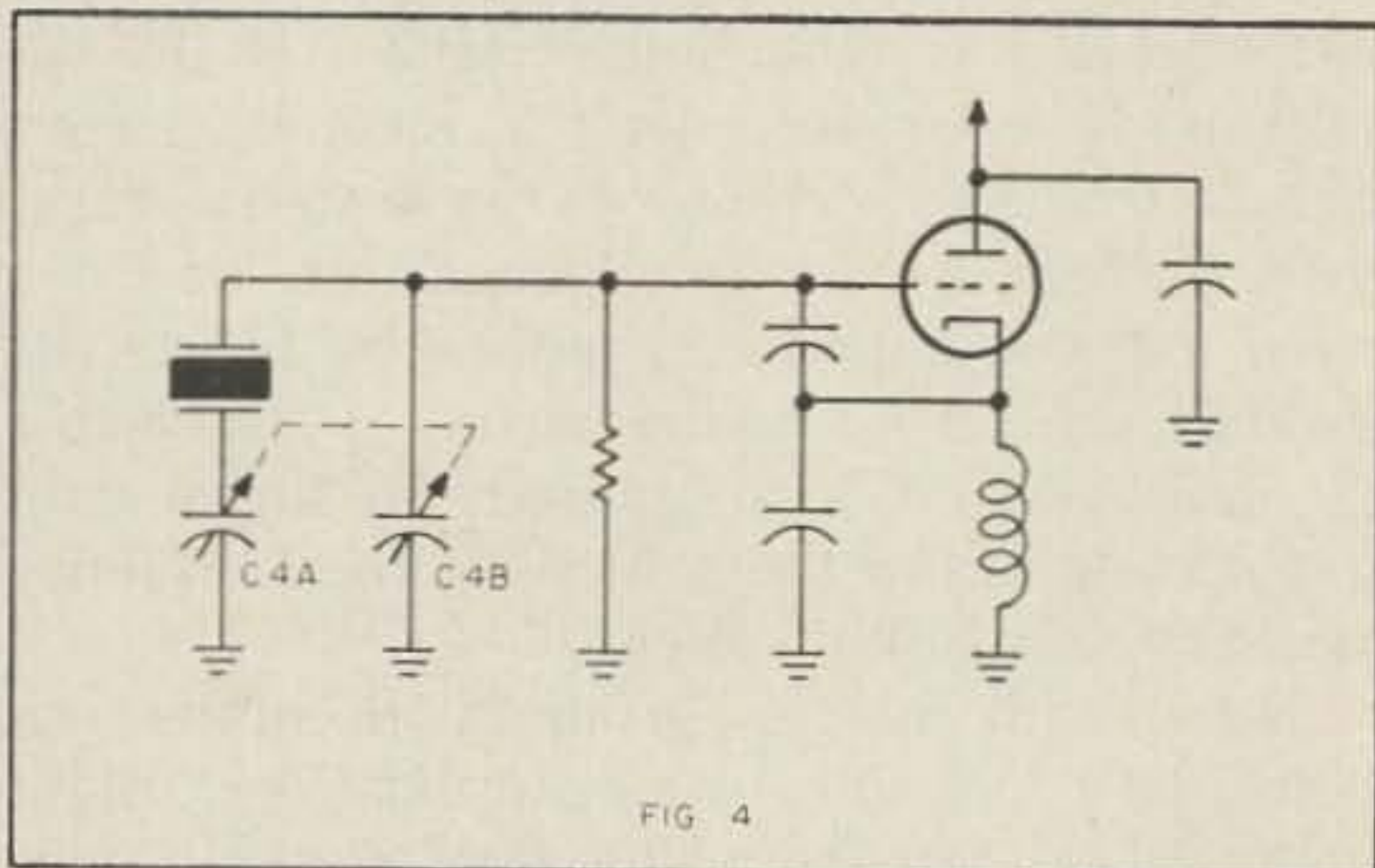

If you are using overtone crystal you're probably a VHF hound and you will be wanting to multiply even higher than the overtone frequency. Go ahead. All you need is a parallel resonant tank tuned to the desired multiple. Insert it between the plate and C3. It looks like a low impedance at the crystal frequency but a goodly amount of harmonic component will appear across it. Sort of a poor man's Tri-tet. Working as a doubler, there's plenty of drive for any of the high-transconductance pentodes (12BY7, 6CL6, etc) working straight through or multiplying. Matter of fact the type 6CX8 tube, triode as an oscil-

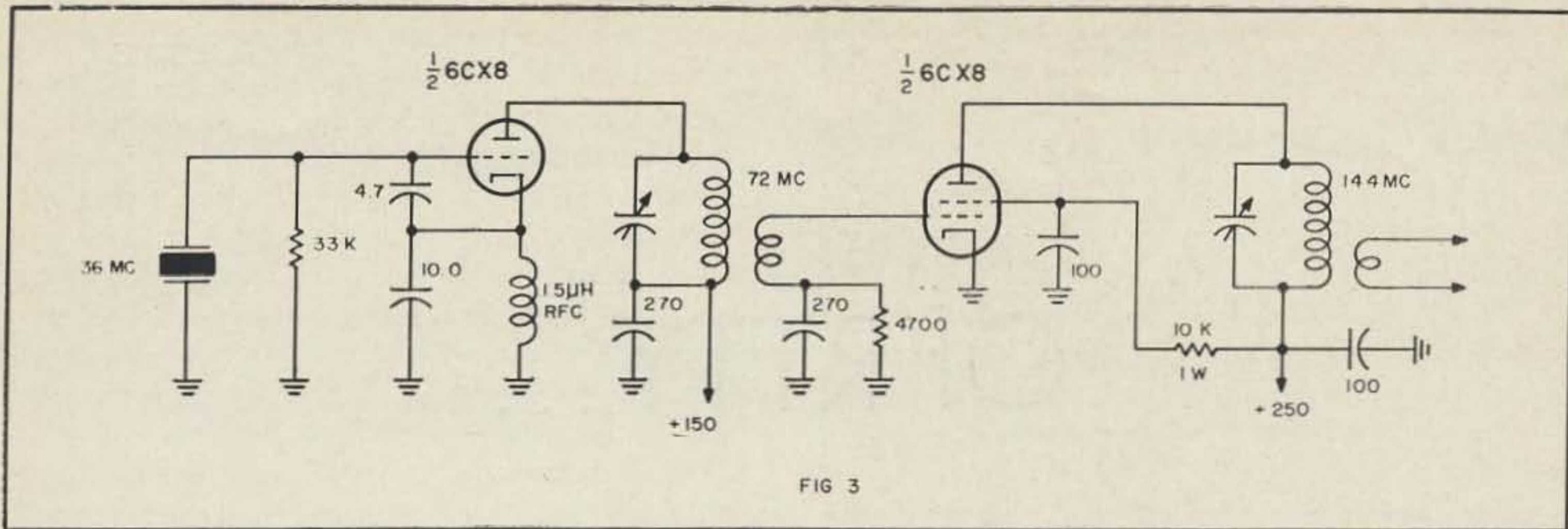

FIG 3

lator-doubler, pentode doubling, will deliver close to a watt at 144 mc with a 36 mc crystal. That's a lot of performance from a single envelope. The circuit is given in Fig. 3.

If you read the crystal oscillator article as carefully as you should have you now know that the crystal frequency can be lowered to some extent by a trimmer capacitor across the crystal, provided that it is operating parallel resonance. (Nothing will move it appreciably in the series resonance mode.) Anyway, to extend this line of scheming, you can just as easily *raise* the frequency from the nominal value by means of a trimmer capacitor in series with the crystal ground lead. By combining the two effects a frequency shift of better than 1 kc per megacycle can be obtained. The big advantage over other methods of rubbering crystals is that no external elements are introduced that will degrade the frequency stability except the trimmers, and they are pretty darned stable in themselves. Also, there is no question as to whether the oscillator is being crystal controlled or not; either the crystal is running the show or there's no show at all. The circuit ends up shown in Fig. 4.

C4 is a two-gang, 100 mmfd per section capacitor of good construction. It must be of the straight line capacity (semi-circular rotor plates) type. Pick one that can be disassembled. The rotor plates must be modified so that they end up quarter-circular. This means cutting them down the center and removing 90 degrees from each plate. The remaining 90-degree sections on each gang are spaced a quarter circle apart. The object is to end up with both C4a and C4b unmeshed at the high frequency end of the dial, C4a meshed and C4b unmeshed at the middle, and both C4a and C4b meshed at the low end of the dial. The oscillator will usually quit somewhere before you reach the high end but will continue to run to the low end if your crystal is average in activity.

Fig. 5 is another example of modifying the

Colpitts to suit a particular requirement. The problem here was to operate a transmitter at the same frequency as the receiver was tuned to. Crystal frequency f_2 is the same as the receiver *if*. Frequency f_1 is supplied by the receiver local oscillator. The crystal operates in the push-pull version of the Colpitts circuit. Its frequency is far removed from that of the plate tank circuit so that practically no f_2 appears in the output. Since the circuit is push-pull, even harmonics of f_2 are cancelled. Only the odd harmonics can cause trouble. F_1 , the local-oscillator signal, is parallel fed to the grids so it gets cancelled in the plate circuit also. In effect, only the sum or addition of f_1 and f_2 comes boiling through. Does this give you some thoughts for that little portable you've been thinking about?

If you get the idea that I'm sold on the Colpitts, you're right. In applying it over the years, I can recall only one disadvantage over other arrangements. The rf voltage on the cathode has a nasty habit of leaking out on the heater leads. This calls for adequate heater chokes if you need the ultimate in isolation. Other than that, for flexibility, ease of design, and overall reliability, brother, you can't beat the Colpitts.

... W6LWE

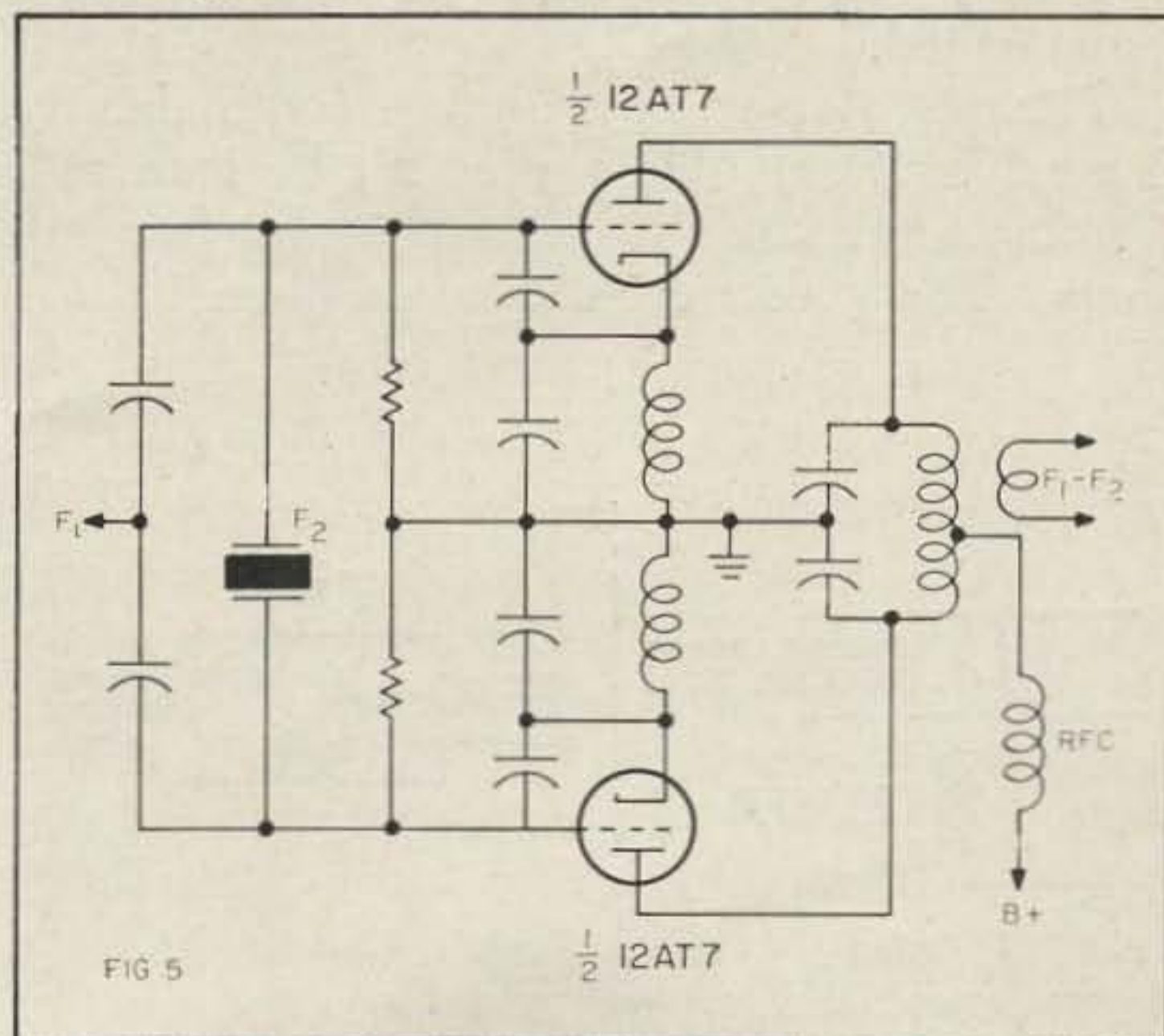

FIG 5

Of RTTY ...

and transistors

MY introduction to RTTY came when I acquired a Model 15 machine, in relatively good working order, albeit, without a cover. A phone call to a local RTTY nut (i.e., a ham who was in deeper, and far more experienced) elicited the information that the device required 60 ma through the selector magnet to operate. While strictly speaking it is indeed true, by itself this constitutes by all odds the understatement of the year! Further information indicated that there were two sections to this magnet and with the sections in series the resistance was about 200 ohms and the required current was 60 ma, or one could connect the sections in parallel (50 ohms) and use 120 ma. Simple calculations thus suggested that either 12 v at 60 ma or 6 v at 120 ma (total power of .72 watts) would do the trick! Alas, would that it were true. It is a longish tale, but read on—travel the road in print with me, and if all goes well, you may be spared some of the trauma I experienced.

The next step was acceptance (with alacrity, I must confess) of his offer of the loan of a terminal unit in first class. A number one shape. The gods were indeed smiling. I drove

over and there it was, relay rack panel, 10½" high, and weighing on the order of 60 pounds. All this to use two audio tones to turn this miniscule magnet current off and on. The keying tube was a 6L6, with more than 250 volts for the B supply. Here was almost 6 watts of heater power and over 15 watts of plate power used to deliver the .72 watts to the magnet.

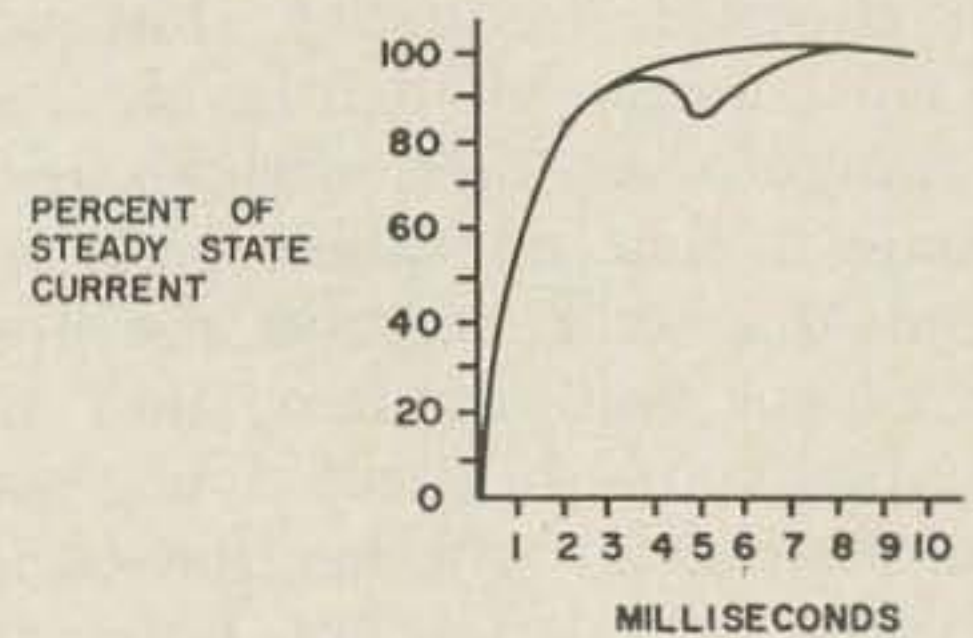

FIG 2

Somehow, this reminded me of the lad who used a steamshovel to transplant petunias! But there is an old saw regarding gift horses and teeth, so off I went, staggering under the load. I got it home, hooked it up and it worked, and well, indeed, but I could not escape the feeling that there should be an easier way to do the job.

The obvious approach was to use transistors. As current operated devices, they should indeed be fine for switching the magnet current off and on. In other portions of the circuit they should be equally good. The highest frequency in the unit was 2975 cps and most of the circuitry would be dealing with 22 millisecond pulses—certainly no fancy transistors would be needed for those frequencies. So the Mark I transistor terminal unit was built, by merely substituting a transistor stage for each tube stage in the circuit (which as a general propo-

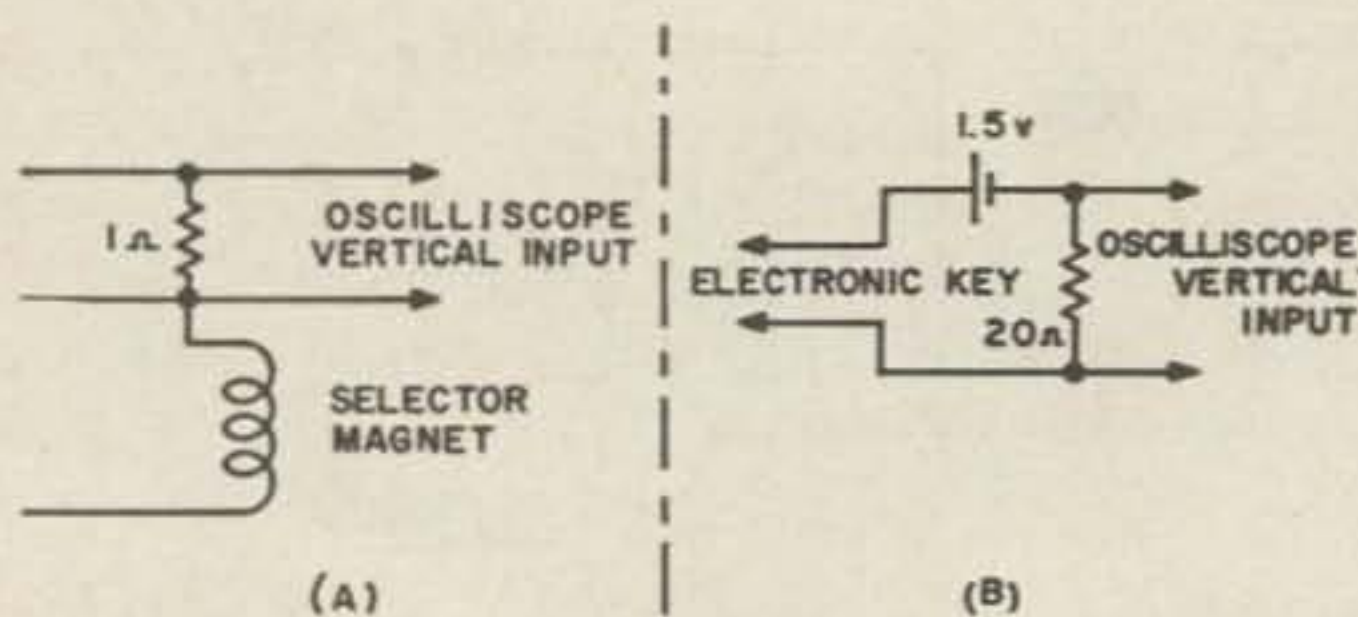
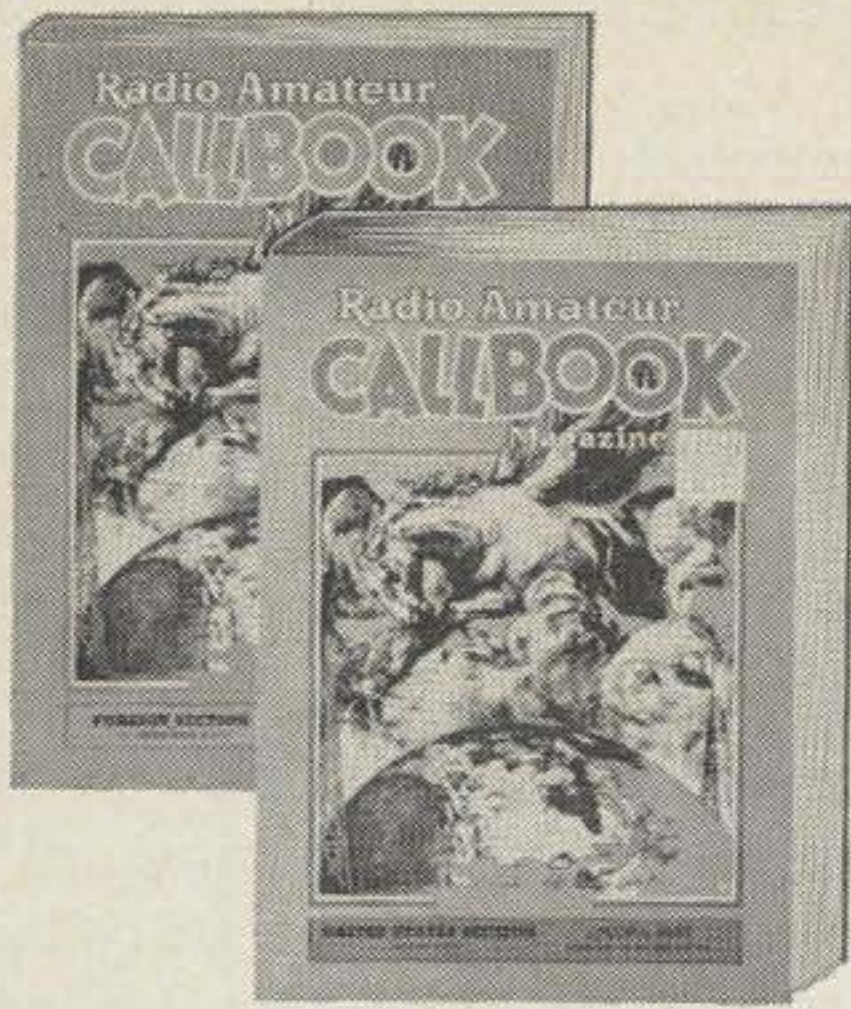

FIG 1



SUMMER 1962 CALLBOOKS

The SUMMER issues of the CALLBOOK are now on sale at your favorite radio parts store. Be sure to ask for your copies of the latest edition. Or order direct by mail from the publisher:

United States Section, per copy\$5.00 plus 25¢ for mailing.
(All K & W calls)

Foreign Section, per copy\$3.00 plus 25¢ for mailing.
(All countries outside U.S.A.)

RADIO AMATEUR CALLBOOK, Inc.
4844 Fullerton Avenue, Chicago 39, Illinois, Dept. ST-6

sition is the easiest but not the best way to design equipment). It worked, but the performance was less than sparkling. The next step was to design a unit following a block diagram of the functions desired; the result was a complete FSK unit using only three transistors. It worked better, and in fact, a fair number of copies of this unit have been built. It performed fairly—but, to be candid, not as well as the tube unit. The feeling persisted, however, that it should be feasible to build a transistor unit that would perform as well as the tube unit, and do it in a simpler, more compact, and more efficient manner.

An article in RTTY NEWS put me on the right road. There was a discussion and illustrations of the current rise shape in the magnet produced by a terminal unit. We promptly hooked up a scope to monitor the current and fed in 22 millisecond pulses. This is easily accomplished, just put a 1 ohm resistor in series with the selector magnet of the machine and connect the scope input across this resistor; the voltage across the resistor will be a function of the current through the selector magnet and the extra resistance will have a negligible effect on the operation. (See Fig. 1A). One word of caution, a dc scope is an absolute necessity—the frequencies involved are low enough so that practically all ac coupled scopes will distort the wave shape. If there is any question in your mind on this point, use a relay, a battery and a resistor—key the relay at the pulse rate, connect the scope across the resistor, and observe the wave shape—if it isn't square, it is the fault of the scope. (See Fig. 1B). Incidentally, if you have an electronic key, it's a fine square wave generator; just set it for dots at about 22 or 23 dots per second and you are in business. Alternatively, 4 or 6 volts ac into a polar relay will do the job.

There ensued a number of evenings looking at traces which were intended to be square

waves, and missed the mark in varying degrees. The root of the problem is the selector magnet. We are applying a voltage to a device which consists of a resistance and an inductance. If the inductance is fixed, you get the smooth curve in Fig. 2. However, the inductance in a teleprinter is not a fixed value. When the armature is not against the pole piece, the inductance is about 2 henries; when current is applied, the magnet charges, and as the field increases, the armature is drawn in. The physical movement of the armature is accompanied by an increase in the inductance. For purposes of analysis, this is convenient, since this change in inductance causes a jog in the current curve, and gives a visual indication on the scope of the point at which the mechanical transfer from mark to space occurs (See Fig. 2). All the wave shapes here have a time base on the horizontal axis and selector magnet current on the vertical axis.

As a starting point, consider the basic land line printer circuit for the Model 15, with a supply voltage of 120 volts, selector magnet sections series connected, and a resistance of approximately 1800 ohms to limit the current to 60 ma. The time constant of the circuit in milliseconds is the inductance in henries divided by the resistance in ohms (the limiting resistance plus the resistance of the selector magnet). In this case the time constant is 1 millisecond, which means that in 1 millisecond the current will rise to 63 per cent of its steady state value, in 2 milliseconds it will rise to 86 per cent of its steady state value, and in 3 milliseconds it will rise to 95 per cent. By using even higher voltage we can increase the series and thus achieve a still shorter time constant, however, we have a mechanical motion of the armature involved and beyond a certain point, an even shorter electrical time constant will not give significantly faster mechanical movement. Hence, any efforts in this case will result only in an

increase in power consumption without any corresponding gain in performance.

What happens mechanically under these conditions is that there is a delay of about 3 milliseconds between the closing of the circuit and the mechanical transfer, and at the end of the pulse, if the spring tension is properly adjusted, there is also a 3 millisecond delay in the return to the resting position. This adjustment gives the maximum range for the machine. The effects of less than optimum magnet currents are obvious from the family of curves in Fig. 3. At lower current levels the delay in the mechanical transfer becomes progressively longer and the action slower—and, in fact, it is possible to have a current level such that the delay equals the pulse length! The result is that the range of the machine becomes progressively smaller and the operation correspondingly less reliable. It might be noted that for the relatively slight decreases, it is possible to adjust the spring tension, and thus the delay or drop out to compensate for the increased initial delay. However, for optimum performance, it is far better to accept the manufacturer's word on the optimum current value.

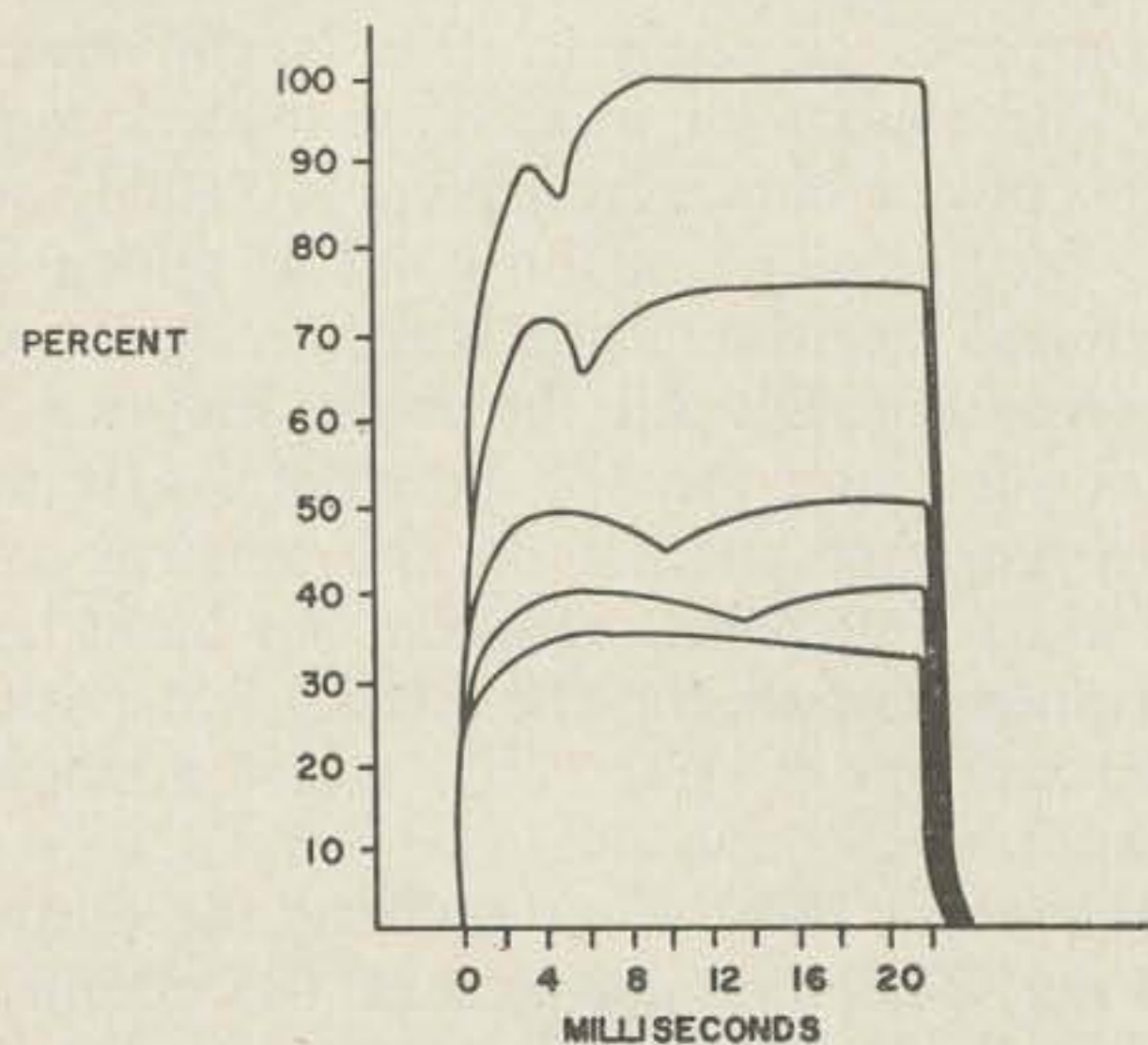

FIG 3

With regard to this process of lengthening the drop out time to compensate for slow rise time, we ran across an interesting commercial application. One of the commercial units that is marketed as a solid state replacement for the polar relay was tested and gave the current wave shape pictured in Fig. 4. The rise time is slow but the circuit has been designed to give a correspondingly slow fall time. The result is that the range of the machine remains about the same. With a machine which is not properly adjusted, this might even increase the range. In on the air tests this was more sensitive to interference and gave poorer performance than either the best

tube units or the transistor circuit we eventually used.

In a typical electron tube terminal unit that provides magnet current through a keying tube, we normally have 250 volts or more and a tube such as a 6L6 or 6Y6, which can handle the current satisfactorily. The variable series resistance and the plate resistance perform the current limiting function. The time constant is even shorter than that of the manufacturer's recommended circuit, and if properly driven by a square wave input, the performance is indeed good. A tube having a sufficiently high perveance should perform well with a 120 volt supply, although no tests have been made on such units.

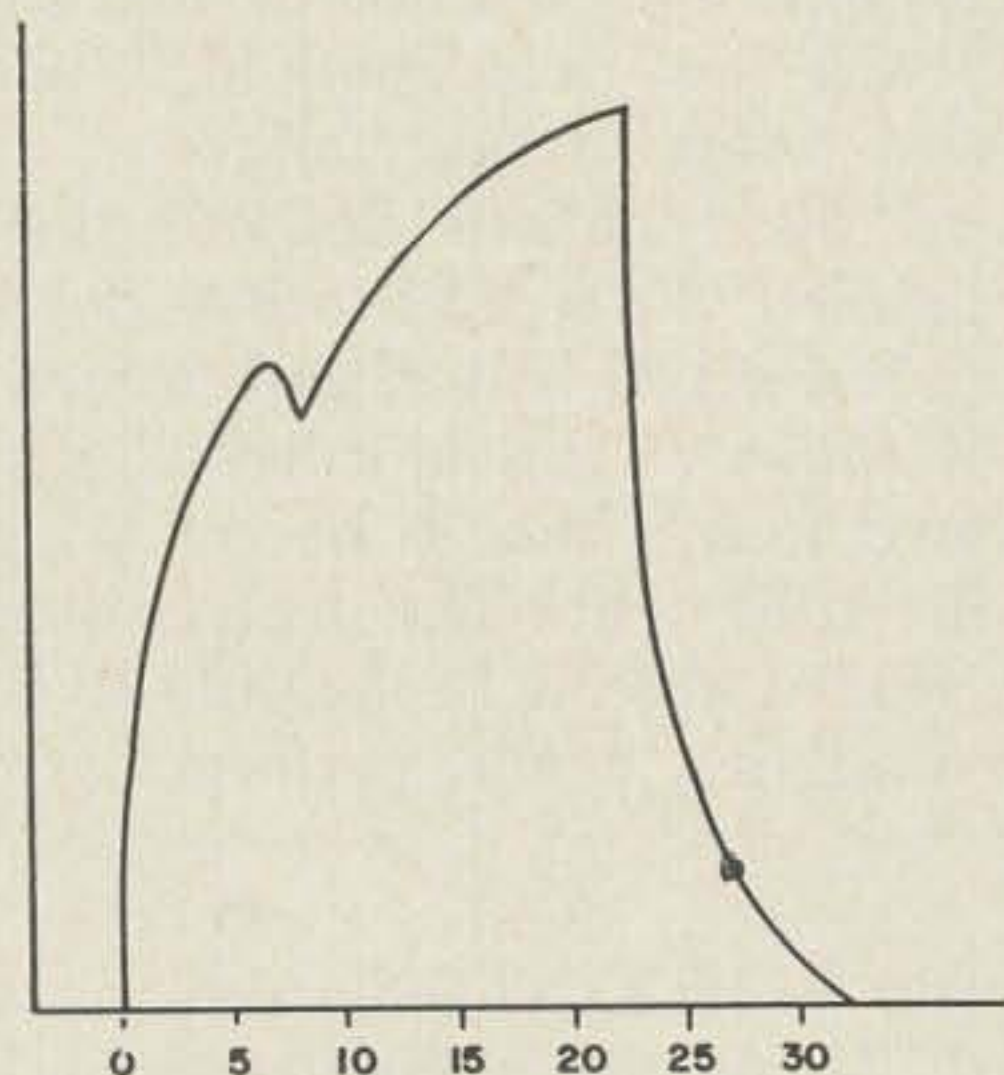

FIG 4

Next, consider the case of a transistor. If we merely replace the switch or relay in the conventional keying circuit with a transistor, the performance should be practically the same as the manufacturer's recommended circuit. The transistor, having a far lower saturation resistance than a tube should do better than a tube. If you start pricing transistors that will operate comfortably at 120 volts, you immediately conclude that theory and pocket-book don't always agree. In addition, the other transistors in the unit don't need voltages of this order, so you would either have large dropping resistors or need two separate power supplies—neither alternative is particularly appealing.

An example of this approach has been published which uses a grounded base high voltage transistor (this helps on the voltage capability side, but makes driving the device far more difficult) and requires three different power sources. Another effort to beat the rap has been published which uses three 45 volt transistors in a complex series arrangement. Neither of these alternatives are particularly attractive. The next step you might try (we did) is to see what will happen with a pedes-

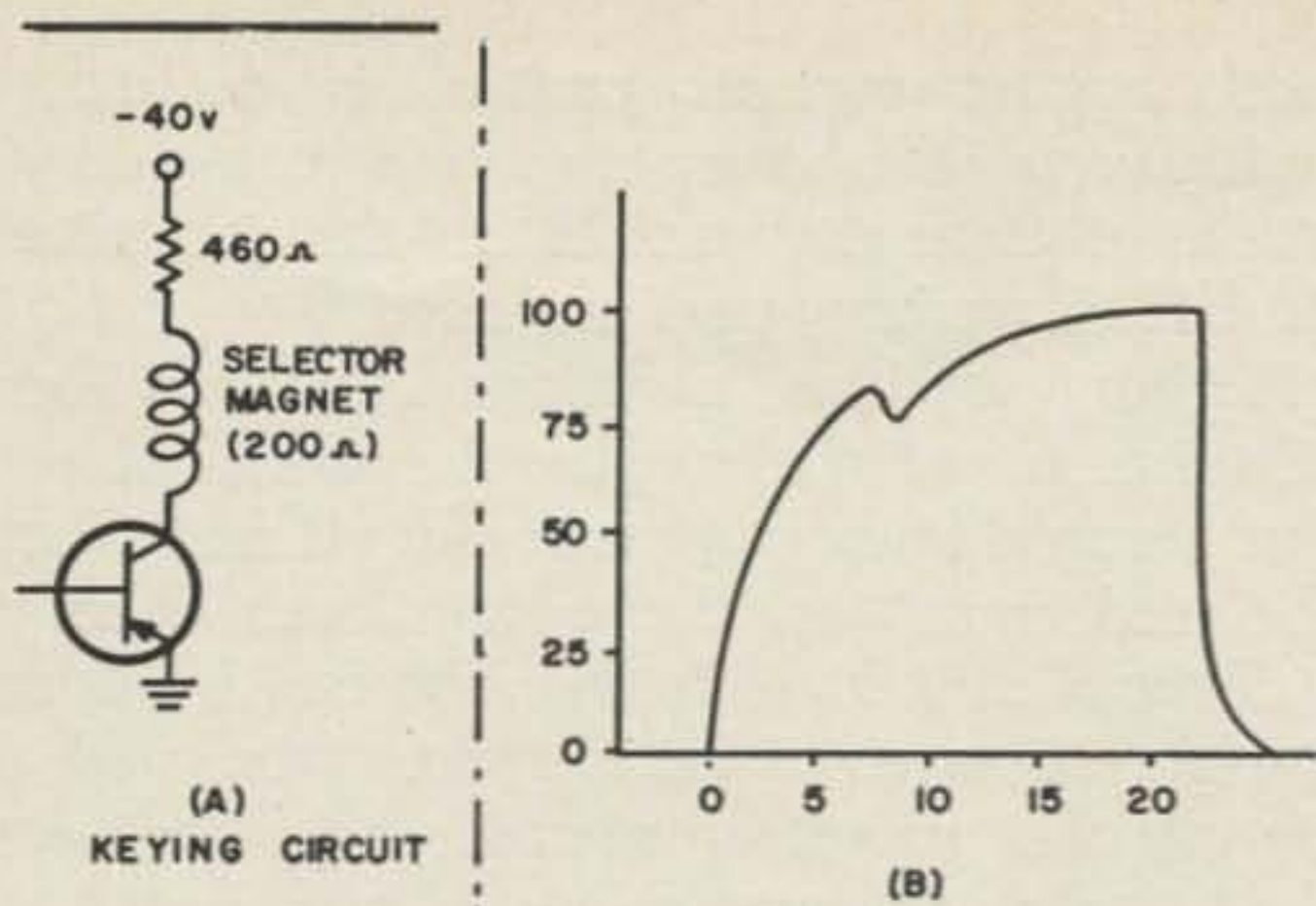

FIG 5

trian transistor and a 40 volt supply. The discouraging results are reported in Fig. 5. This will give copy, but it will not give good range or compete with the better tube terminal units.

The next step along the path was ridiculously simple. If we use 60 ma through each section of the magnet for satisfactory operation, we can do it with 60 ma and the sections in series, or 120 ma and the sections in parallel. Now when we put the sections in parallel, we have .5 inductance rather than 2 henries. Consequently, with 60 volts at 120 ma we have the same time constant and the same performance that we had with 120 volts and 60 ma. The increased current is easily handled by a transistor, whereas a tube to do this would be a fairly substantial bottle! At this point we were on the way, we'd cut the voltage requirement by a factor of two, but 60 volts was still too high for convenience i.e., a reasonably priced transistor. We really wanted something that would operate in the 30 to 40 volt region (with a bridge rectifier circuit and 15 to 20 volts available for the signal processing circuitry) and would yield all the performance of which the complex machinery was capable.

The next step was a closer look at the basic keying circuit. (Fig. 5A). This was not really what was desired. Better performance would be possible if the resistance could be made a direct short while the magnet was charging, and when the current reached the desired level, the resistance increased in value to that necessary to limit the current. It not only had to do this, but should be sufficiently fast acting so that an added time constant is not superimposed on the one we are struggling to reduce. While we did not come up with a device that would shift from zero resistance to the desired value, we did indeed find a solution that approaches this desired end!

This solution is a current limiting circuit which uses a transistor, a zener diode, and two

resistors. (Fig. 6). In this circuit R_2 is chosen so that the voltage drop across it with full operating current is equal to the zener voltage of D_1 . For a 3.5 volt zener diode this required a 30 ohm resistor. When the current is less than the required current, transistor Q_1 is in effect a very low resistance; when the current reaches the desired value, the effective transistor resistance increases and the voltage drop across the transistor increases to that necessary to maintain the desired voltage.

If we compute the time constant, it would appear paradoxically that we have increased it—but the computed time constant would be that which is required to reach a steady state value limited only by R_2 plus the resistance of the selector magnet. This current is about 500 ma and what concerns us is only the first 24 per cent of this value. In actual practice the rise time is quite fast. The actual measurement was 2 milliseconds to reach 90 percent of the final value. This is faster than the computed values for the recommended 120 v, 60 ma condition, which are 63 per cent in 1 millisecond and 85 per cent in 2 milliseconds. The measured rise time for an ex-

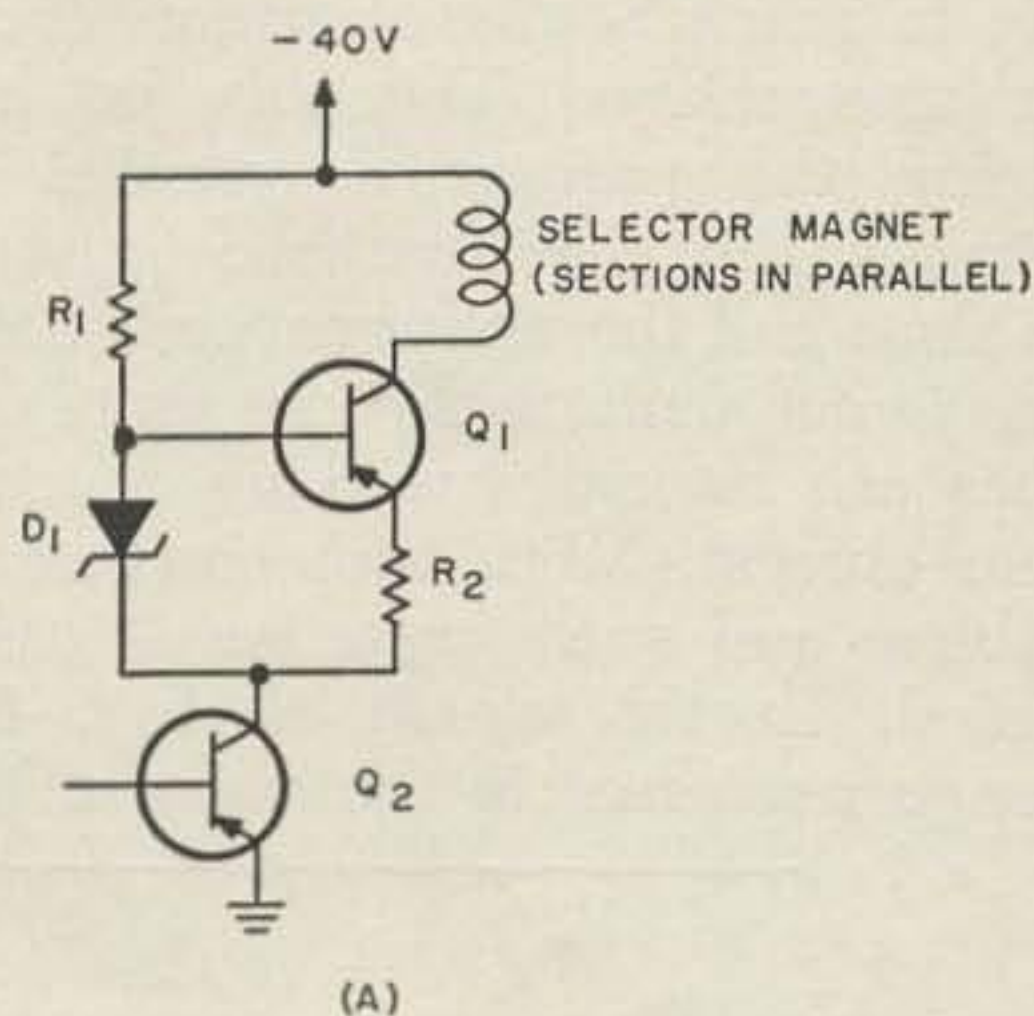

(A)

(B)

FIG 6

cellent tube terminal unit was 87 per cent in 2 milliseconds—also better than that of the suggested circuit. The resulting current rise curve is given in Fig. 6B.

This then was the performance we were looking for—a circuit using transistors, operating at a reasonable supply voltage, and giving performance equal or better than the manufacturer's suggested circuit, and the best tube units. This circuit, using two transistors, requires less total power than that needed to light the filament of a 6L6. The final result was incorporated in a terminal unit a small fraction of the size of the original rack mounted monster, which performs fully as well, but that is another tale for another day.

A word of caution should be added on the usual practice of patching in an extra machine by the simple expediency of putting the second printer in series with the first. It is convenient and usually only requires an adjustment of the series resistance to bring the magnet current up to normal value. However, a moment's thought and it is obvious that this doubles the inductance of the circuit—and doubles the time constant. The wave form only confirms the sad news, it takes twice as long to reach a given current level and performance suffers. This can be avoided by placing the printers in parallel instead of series; in this case the time constant remains the same and the performance is not degraded. This is not done with tube units because the tubes are normally working at nearly maximum current. With transistors current is no problem and such operation is easily accomplished. In the circuit in Fig. 6 the only change necessary is the value of R_2 . If sep-

arate magnet current control is desired, a duplicate of the circuit with a common Q_2 switching transistor would do the job nicely without degrading performance.

Nothing has been mentioned thus far about fall time. In actual practice this does not constitute a problem. In practically all units, both tube and transistor, the current was down to an insignificant level in 2 milliseconds or less. In no case were voltage spikes observed on any of the waveforms observed. One case where a slow fall was observed was during the testing of various transistors in the circuit of Fig. 5. Transistors ranging from 300 mw up to high power 15 amp. varieties were tested and almost all performed nicely. Even high power units such as 2N174's and 2N277's worked well. The only failure was an archaic 25 amp. unit which took about 6 milliseconds to fall to the 10 per cent level.

With regard to this process of lengthening the drop out time to compensate for slow rise time, we ran across an interesting case. As for practical values, if you want to give it a try R_1 is 5K or 10K. R_2 in practice is either trimmed to the precise value to give the desired current and left alone—or if like most of us you have an insatiable desire for knobs, use a 50 ohm potentiometer in series with a fixed 22 ohm limiting resistor. The diode should be a low voltage zener on the order of 3 or 4 volts. Those used have been 1N703 or 1N466. Theoretically, the lower the voltage the better, but 6 and 7 volt units have been tried and performed nicely. For transistors try a 2N251, 2N538 or any 40 or 50 volt unit, the higher the beta, the better.

... W3TUZ

Letter

Dear Wayne:

Not long ago you autographed #17 of the bound volumes covering the first fifteen issues for me. If this act had not been akin to lighting a slow fuze on a keg of black powder, I wouldn't be writing you now.

I am new to ham pleasures, Novice March '61—Tech—July and General in October. I have subscribed to Brand X for several years. Brand Y for a year or so, as well as several of the others in electronics generally. I had heard of 73 vaguely but hadn't seen it until about 3 or 4 weeks ago at a local informal gathering when I had a chance to get my hands on the March issue. I made appropriate notes and you subsequently received my subscription, and as I like to keep things neat and tidy, an order for January and February so my file would start at the first of the year.

I don't know just when I began to realize how new 73 was and that for \$14.98 plus 2¢ postage I could really tidy things up and go back to the very beginning, but it must have crept in sometime.

Anyway I eventually found time to do more than peruse the January and February issues and directly started hunting for fifteen clams. Such a magazine

never grows old and if all fifteen issues compared at all with the two I had in hand at that time, have them I must.

You know the rest from the checks you have read, etc. and in due course the bound volume arrived.

To date I've been mostly a kit builder but have always looked forward to going home brew and would, if necessary, discount a little quality for the fun. So your viewpoint is refreshing to say the least.

Can you guess dear editor what happened next? Do you and the others who have looked on 73 as individual copies of a monthly magazine, who have sipped its nectar in delight, have any idea what an orgy of fifteen copies all at one time can do to a guy?

I have problems. A 2 meter converter. What would the Finney 6 & 2 antenna really do? etc. etc. Now I only have one problem after I sober up, and that is where the heck do I begin?

You can quote me on this, Wayne, the fifteen for that bound volume buck for buck ranks with any I've ever spent. All late comers should be so advised.

Jack Morgan, K1RHP
Sharon, Mass.

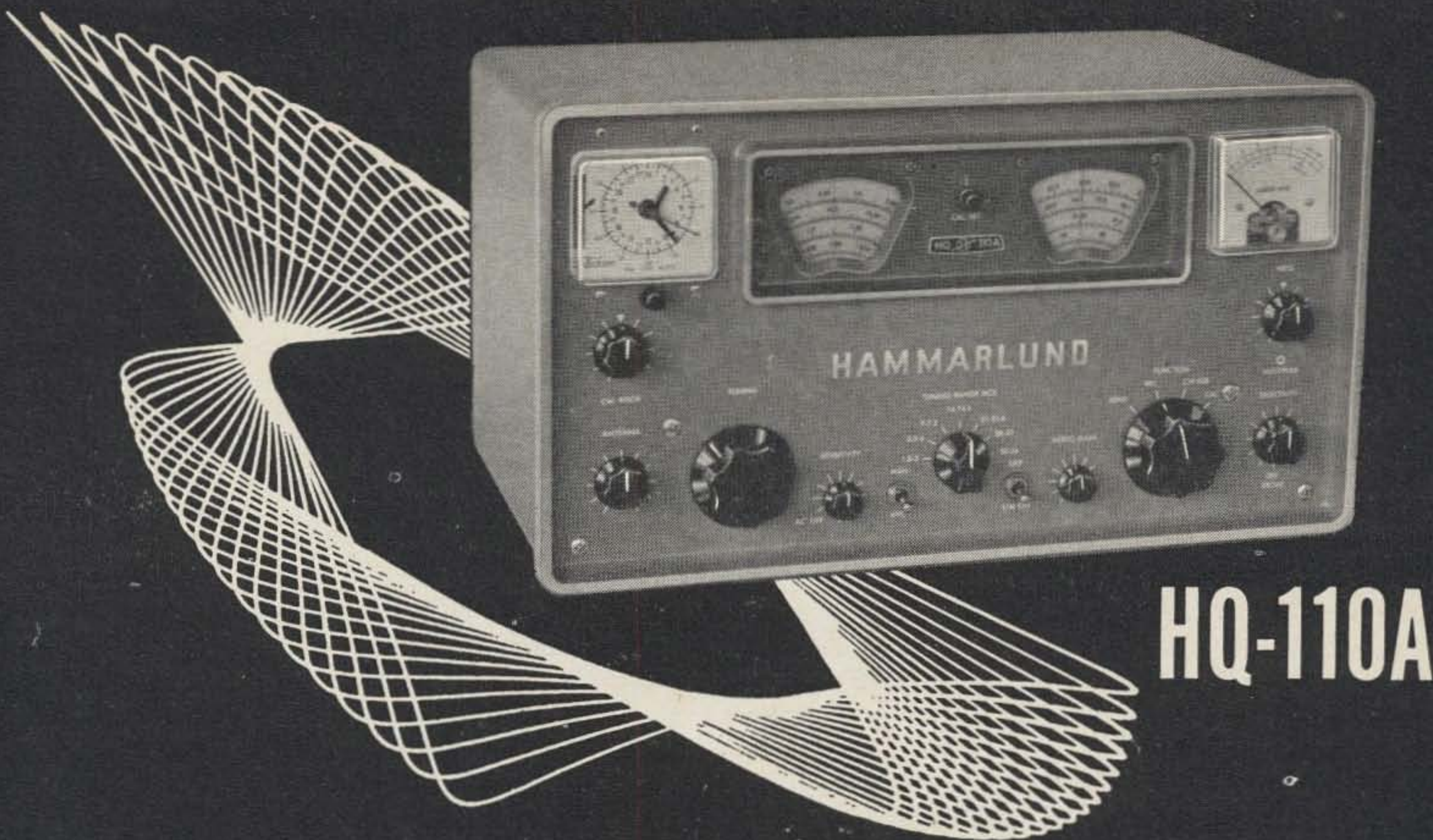

HQ-110A

A New Dimension in Amateur Radio

The Hammarlund HQ-110A looks like the 110—but basic design changes create the subtle difference between excellent and exquisite! A joyful performer as the HQ-110, the new HQ-110A reaches new heights of operating pleasure by including such extras as:

- Significantly tighter mechanical and electrical stability
- Accessory socket for pre-amp or converter application
- Expanded dial—with 144-148 MC calibrations for use with 2 meter converters
- Separate 6 meter coax input for rapid shift from VHF to LF operation

This 12 tube, dual-conversion superheterodyne receiver covers all amateur bands, from 160 to 6 meters—with optimum reception of CW and SSB signals through a separate linear detector.

You have to try this receiver to see just how good it really is—but if you can't—send for the new, informative brochure on the HQ-110A—or pick one up at your local Hammarlund distributor.

Still only
\$249⁰⁰

24 hour clock timer \$10 optional

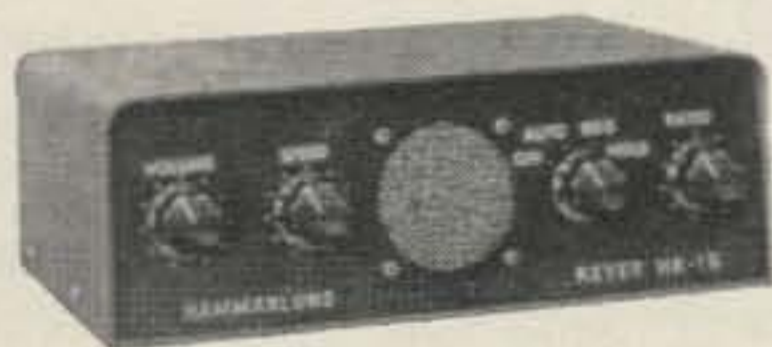

**"Personal Touch"
Electronic
Keyer—HK-1B**

Twice the value—half the cost. The all-transistorized HK-1B is comparable feature-for-feature with keyers costing **twice as much**. Adjustable "personal Touch" ratio for dots/dashes. Suitable for automatic, semi-automatic (bug) or straight key operation.

only **\$39.95**
(less battery)



Established 1910



HAMMARLUND

MANUFACTURING COMPANY, INC.

A Giannini Scientific Company

53 West 23rd Street, New York 10, N. Y.

The Crystal Ball

Jim Kyle K5JKX

OCCASIONALLY, a multiple-purpose gadget comes along with specifications that sound like an ancient ad for patent medicines. You know, the kind that grow hair on bald heads, cure colds, remove warts, and relieve insomnia.

Here's one of those kind of gadgets; containing only one crystal diode, two capacitors, a meter, and miscellaneous wire and sockets, this device will:

Measure activity of transmitter crystals, both at the fundamental and at all usable overtone frequencies;

Compare crystal frequencies, as in selection of crystals for sideband filter use;

Mark any number of spot frequencies when connected to the output of a VFO-equipped transmitter, acting as a marker at both band edges and at any number of frequencies within the band; and

Determine usability of an individual crystal at a specified overtone.

The circuit of the gadget is shown in Fig. 1. You can see that it consists, essentially, of a sensitive rf voltmeter made up of the diode, two capacitors, and meter, in series with a crystal socket and an rf signal generator.

When a crystal is placed in the socket, incoming rf from the signal generator must pass through the crystal to reach the voltmeter. This can happen only at a series-resonant frequency for the crystal concerned; the amount

of rf which gets through is proportional to the individual crystal's activity.

Thus, the meter will indicate upscale only when the input frequency is the same as one of the crystal's series resonances, and the amount of upscale deflection will indicate crystal activity (the greater the deflection, the higher the activity).

That's how it works, but to use it in all the ways listed earlier the basic connections must be changed slightly. We'll go into that, but first, let's look at construction details.

For maximum convenience, the "Crystal Ball" should be housed in a small minibox; the "input" connection shown on the schematic should consist of a coax connector, for either a coax jumper or a small loop of wire (for coupling to a grid-dip meter to serve as a signal generator).

To hold expense to a minimum, you can use one *octal* and one *loctal* base wafer sockets (approximately 10¢ each) as the crystal sockets. Connect pins 1 and 7 of each socket together (pin 1 of octal to pin 7 of octal, thence to pin 1 of loctal, and then to pin 7 of loctal) and pins 3 and 5 of both sockets together in the same manner. Thus, two FT-243-type crystals may be inserted in the octal socket at the same time, and two of the newer small-pin crystals may be placed in the loctal socket. If you need more crystals than this (for frequency spotting), use two or three of whichever type socket you need, connecting them all the same way.

Sensitivity of the entire device is determined by the meter. A 50-microamp unit is recommended (Lafayette Radio sells a 50-microamp "tuning meter" which has no calibrations, for \$2.95. This works admirably in this circuit) but you can get by with a 100-microamp unit if you must.

Naturally, shielding of the entire circuit is essential to confine all stray rf. This is particularly important if you're using it as a frequency spotter.

Now, let's look at the four main uses of the Crystal Ball:

To measure crystal activity, connect a signal generator such as the Heath SG-8 to the input

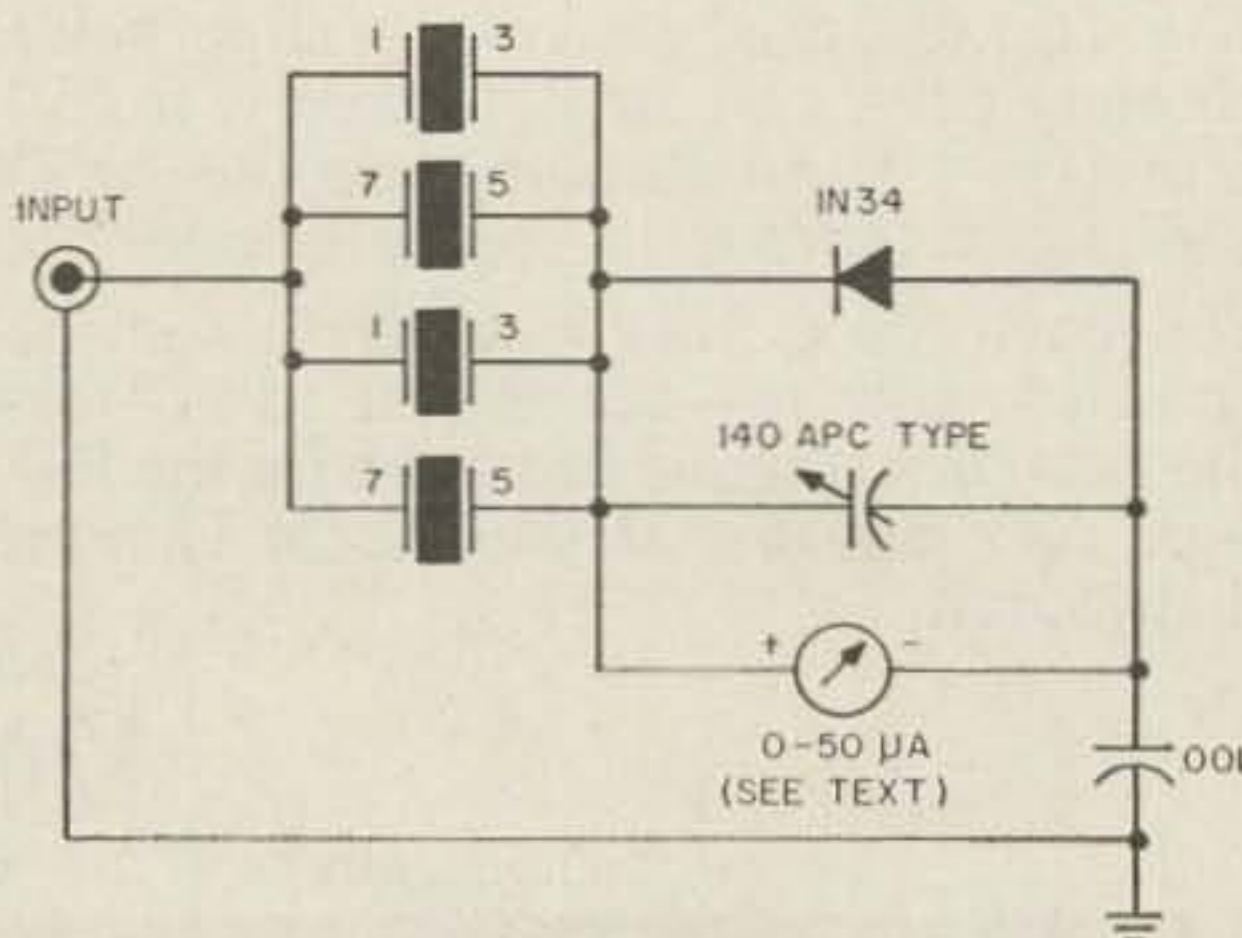
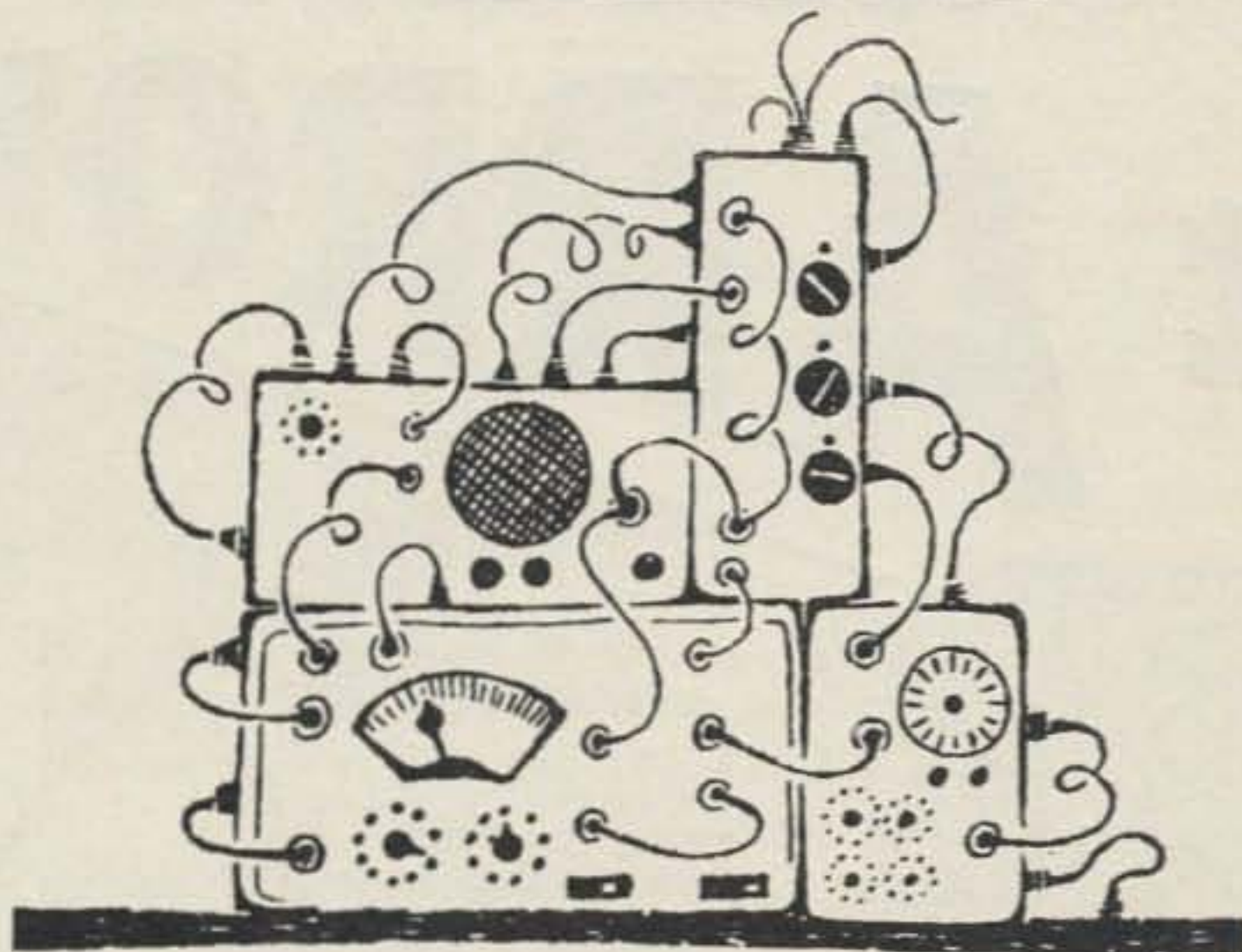

FIG. 1

WATERS UNNETTLES RIGS

COAXIAL SWITCHES



connector. Plug in the crystal you want to measure. Tune the signal generator slowly until the needle peaks (this peak is extremely rapid; you may miss it if you tune rapidly). When the needle peaks, the deflection is proportional to crystal activity. If the needle goes offscale, reduce capacity of the variable capacitor. Now, you can compare the activity of this crystal with others by substituting the other crystals and noting whether their peaks are greater or lesser.

To measure activity at an overtone, follow the same procedure. If one crystal's activity is measured at several overtones, you can select the overtone at which the unit gives greatest output (but signal-generator output should be reasonably uniform over the frequency range used for results at widely separated frequencies to be comparable).

To compare crystal frequencies, the same procedure is followed except that a calibrated receiver should be used to measure exact frequency of the peak of each crystal unless the signal generator calibration is extremely accurate.

To use the Crystal Ball as a frequency spotter, disconnect the signal generator. Connect a tee fitting to your transmitter's antenna connector, and connect a coax jumper from this fitting to the input connector of the Crystal Ball. If you're running more than about 50 watts power, it's best to insert a 50-mmfd capacitor in series with this line (place the capacitor in a shielded box, with the box located in the center of the jumper) to protect the marker crystals from excessive rf voltage. Plug "marker" crystals of the frequencies you want to spot into the gadget. Whenever the transmitter is tuned to one of these frequencies, the meter will deflect upscale. The VFO dial will tell you which of the marker spots you're at, unless you pick two so close together than calibration of the dial is uncertain.

Finally, to determine usability of a crystal at a specified overtone, go back to the activity-measuring setup. Set the signal generator to the approximate overtone frequency desired and "rock" the generator dial until you see a meter indication. If you get a good, healthy upswing, the crystal is usable at that overtone; if the upswing is weak or missing, the crystal won't work at that particular overtone. However, this does not mean that the same crystal won't work at *other* overtones, either lower or higher. Frequently, crystals perform nicely at high overtones when they won't work at all at lower ones.

The basic idea behind this gadget, incidentally, is probably almost as old as the quartz crystal itself; a variant, using a magic-eye tube instead of a meter, was used in all the WW2 Command-Set transmitters as a calibration technique. However, like many old ideas, it's worth repeating. . . . K5JKX

SWITCH IN, SWITCH OUT, OR DO THE 6-WAY SWITCH IF YOU'RE A HAM WHAT AM WITH A WATERS COAXIAL SWITCH.

Designed for panel mounting, and featuring in-line orientation of the coaxial connectors, these compact units occupy a minimum amount of space with ready access for connecting and disconnecting. The Waters Coaxial Switches have a negligible insertion loss, low standing-wave ratios (less than 1.1 up to 150 mc.), and a power carrying capacity of 1 kw. They come in two models complete with mounting screws, knob, and escutcheon plate with provision for erasable markings.

COAXIAL TRANSFER SWITCH — MODEL 336. A double-pole, double-throw (internally strapped) unit for in-and-out switching of a Power Amplifier between an exciter and antenna. Connections are made to 4 standard SO-239 UHF connectors. Amateur Net: \$11.45

COAXIAL SELECTOR SWITCH — MODEL 335. A single-pole, 6-position switch used for selection of RF sources, antennas, etc. Connections are made to 7 standard SO-239 UHF connectors. Amateur Net: \$12.95 Available at leading distributors

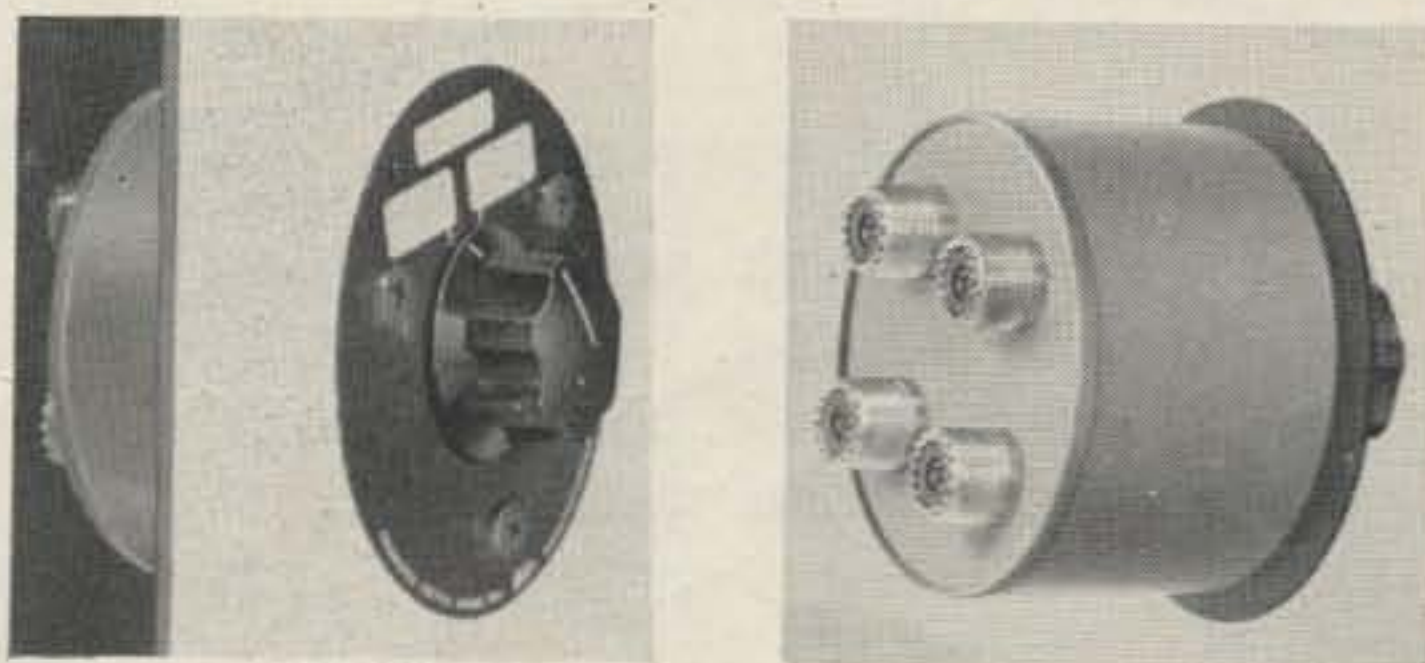

COAXIAL TRANSFER SWITCH — MODEL 336

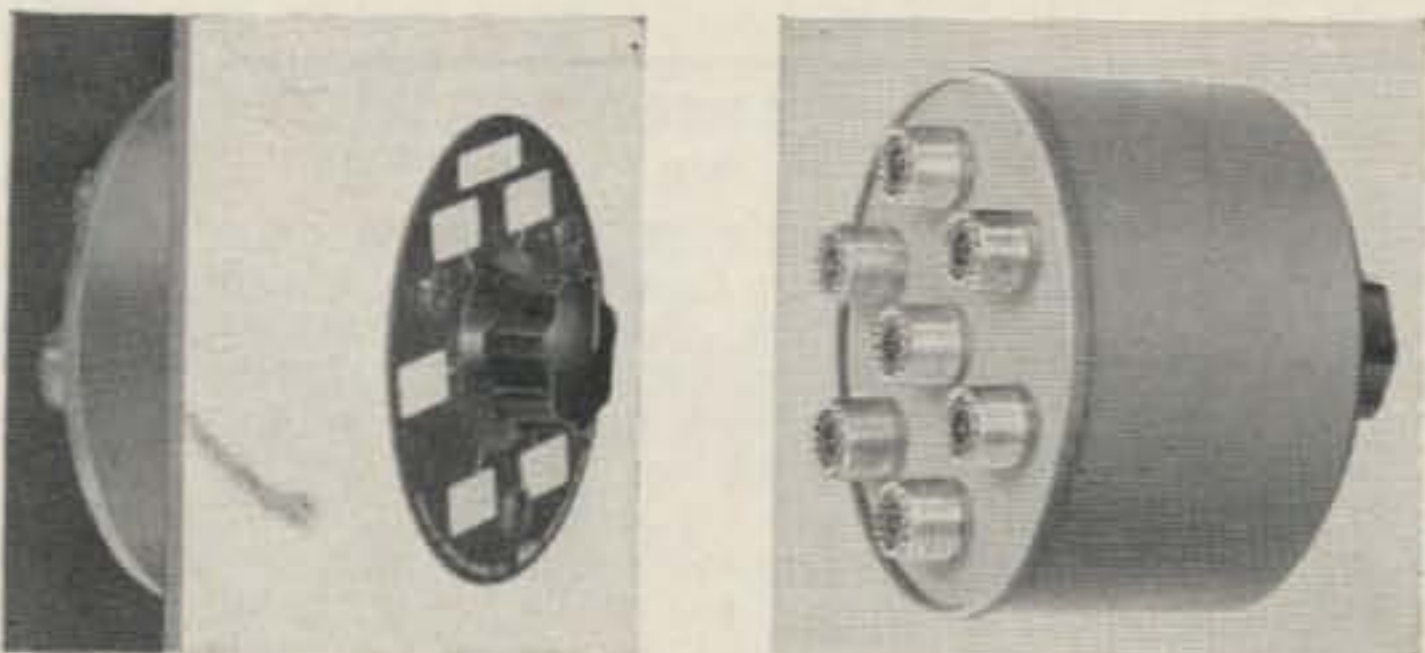

COAXIAL SELECTOR SWITCH — MODEL 335

**WATERS MANUFACTURING, INC.
WAYLAND, MASSACHUSETTS**

BULLSEYE BUYS at ARROW!



99'er 6 Mefer TRANSCIVER

A true ham station, ideal for both fixed station and mobile operation. Double conversion superhet gives you extreme selectivity and freedom from images and cross modulation.

Transmitter section has an ultra-stable crystal oscillator which also may be controlled by external VFO. Efficient, fully modulated 8 watt final works into flexible Pi network tank circuit. Large S meter serves for transmitter tune-up procedure.

Amateur Net \$159.95

PRECISION PLANETARY-VERNIER for exceptionally fine tuning

Superb craftsmanship by Jackson Bros. of England. Ball bearing drive, 1/4" dia. shaft, 1 1/8" long, 6:1 ratio, V_y FB for fine tuning. Easily adaptable to any shaft. Comparable value — \$5.95.

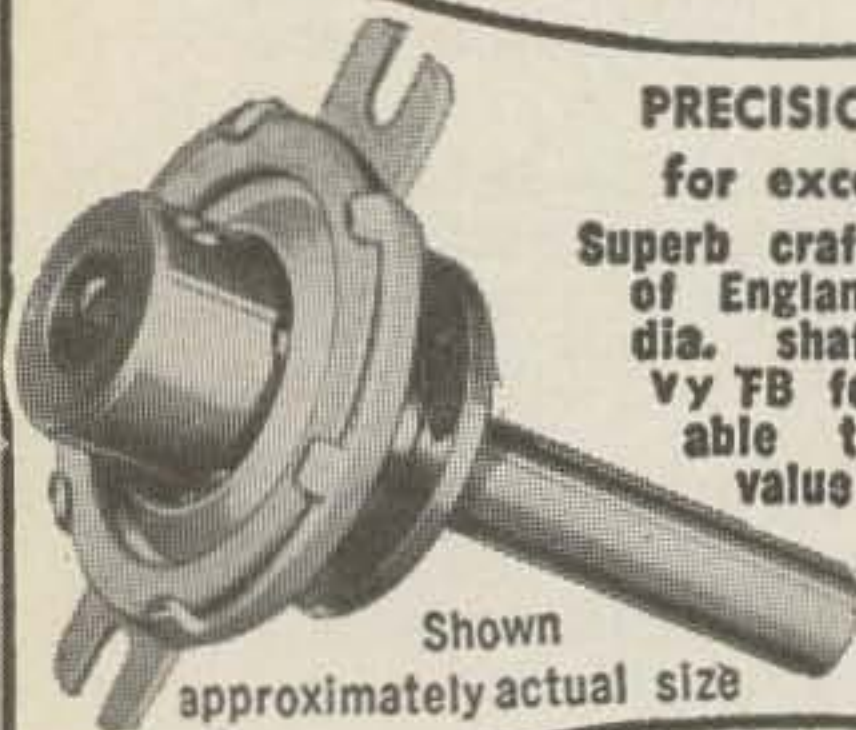

Shown approximately actual size

Amateur Net \$1.50 ea.
10 for \$13.50

PRECISION BALL DRIVE DIAL

Another superb product of Jackson Bros. of England. 4" dia. dial with 6:1 ball drive ratio. Fits standard 1/4" shaft. For that velvet touch...

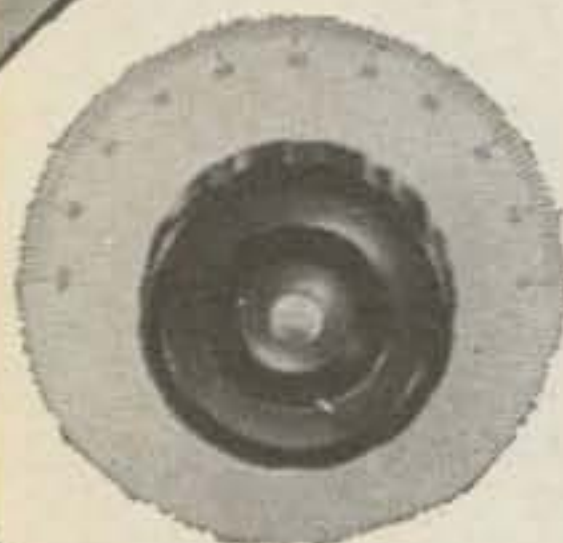

Amateur Net \$3.95

AMECO NUVISTOR PREAMPLIFIER

FOR 50, 144 or 220 mc. Over 20 db gain plus a lower noise figure, 2 tuned ckt's, 6CW4 Nuvistor completely neutralized. Noise figure is 2.5 db @ 50 mc, 3.0 db @ 144 mc and 4.0 db @ 220 mc. Power requirements: 100-150 v. @ 8 ma, and 6.3 v. at .13 amps. Specify frequency desired.

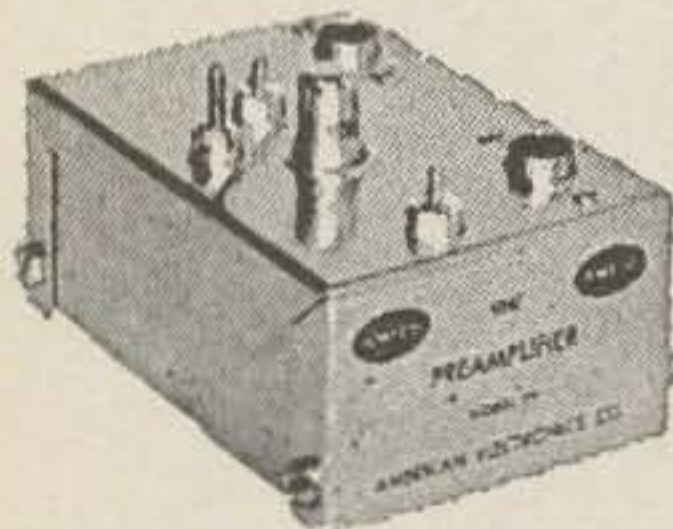

Also available for 27 mc Citizens band.

Mod. PV, wired & tested \$13.95

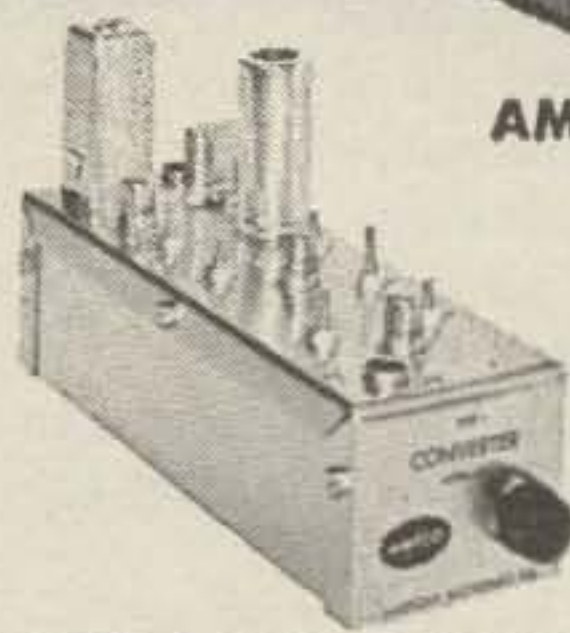

AMECO NUVISTOR CONVERTERS

Choice of separate models for 50, 144 or 220 mc bands. Output frequency easily changed for present and future requirements. Three RCA 6CW4 Nuvistors used, two as RF amps, one as mixer with 6J6 oscillator. Noise figure: 2.5 db for 50 mc model, 3.0 db for 144 mc, and 4.0 db for 220 mc model. Image, spurious and IF rejection better than 70 db. Power required: 100-150 V @ 30 ma, 6.3 V @ 1 amp.

Specify desired IF output for converter model selected.

Kit: CN-50K, CN-144K, or CN-220K, each \$34.95

Wired & Tested: CN-50W, CN-144W or CN-220W, each \$49.95

Versatile Miniature Transformer

Same as used in W2EWL SSB Rig — March 1956 QST. Three sets of CT windings for a combination of impedances: 600 ohms, 5200 ohms, 22000 ohms. (By using center-taps the impedances are quartered.) The ideal transformer for a SSB transmitter. Other uses: interstage, transistor, high impedance choke, line to grid or plate, etc. Size only 2" h. x 3/4" w. x 3/4" d. New and fully shielded.

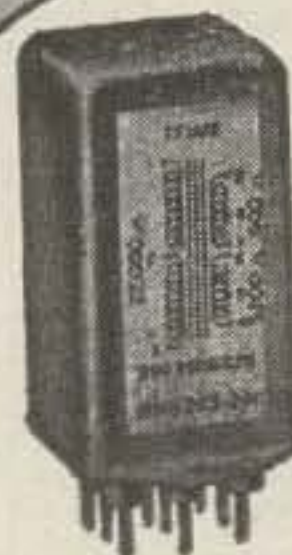

3 for \$3.49

Amateur Net \$1.39

10 for \$10.75

ARROW Authorized distributor of HEATHKIT equipment

HAMMARLUND "personal touch" ELECTRONIC KEYER HK-1B

The new Hammarlund 'Personal Touch' Keyer is a compact, fully transistorized code generator that combines all of the desirable features of electronic sending with distinctive dot/dash control to give messages your 'personal touch'. Usable with any of the key paddles available, the HK-1B generates smooth, effortless code transmission for the novice and expert alike.



Amateur Net (less battery) \$39.95

MAIL ORDERS PROMPTLY PROCESSED
SAME DAY SHIPMENT FROM STOCK

ARROW ELECTRONICS, INC.

65 Cortlandt Street, New York 7, N. Y. • Dlgy 9-4730
525 Jericho Turnpike, Mineola, N. Y. • Ploneer 6-8686

New Branch: Norwalk Connecticut
225 Main Street ★ Victor 7-5889

TO SAVE C.O.D. CHARGES, PLEASE INCLUDE SUFFICIENT POSTAGE WITH YOUR ORDER. ANY EXTRA MONEY WILL BE RETURNED.

ALL PRICES F.O.B. N. Y. C.
Arrow's Export Dept. Ships To All Parts Of The World!
Prices Subject To Change Without Notice.

Send for Arrow's New 1962 Catalog **FREE**

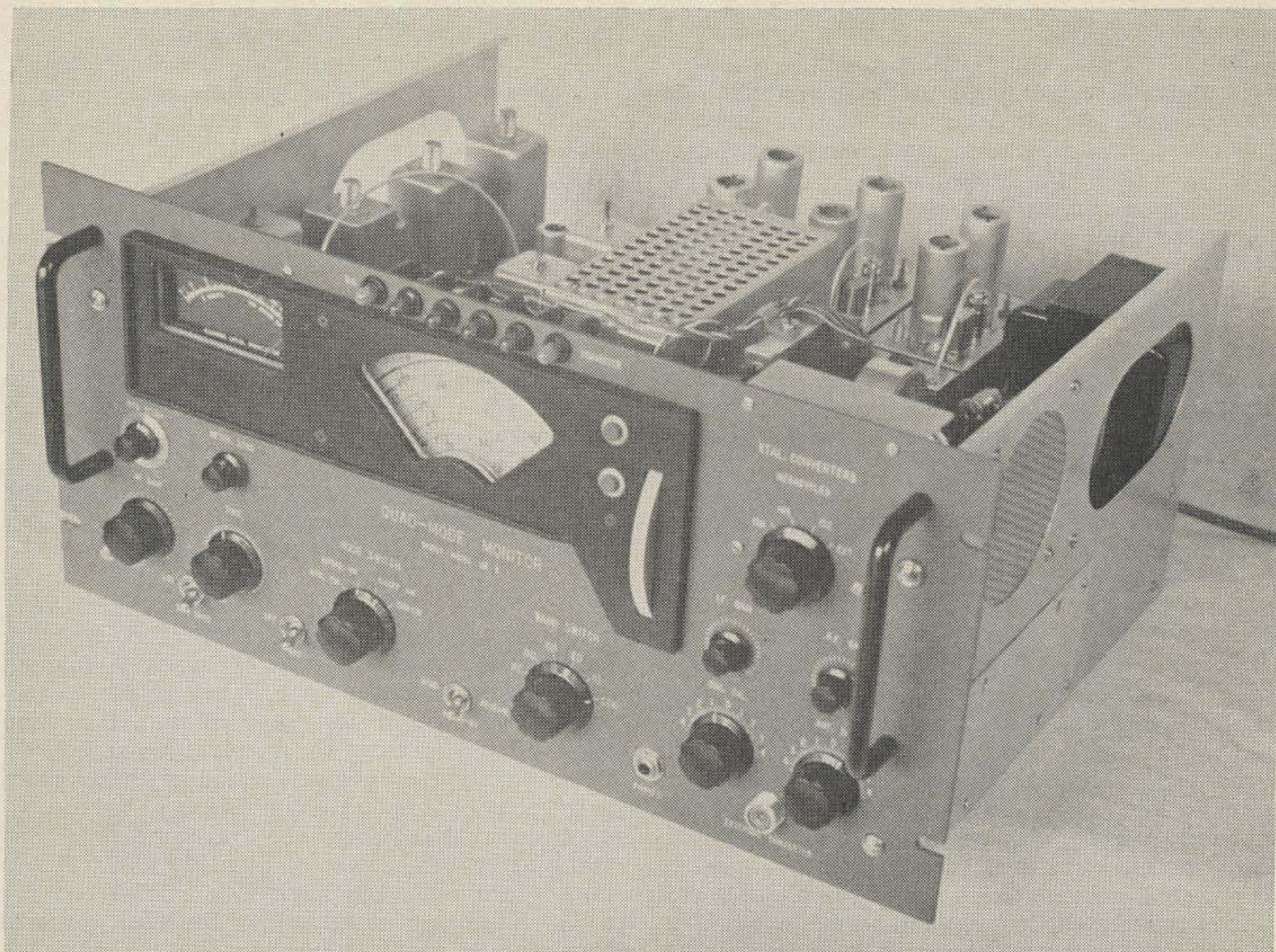

Angle View showing location of built-in speaker, and the access to the rf coils which is covered by the

small plate just below the speaker. Reference made to this effect in the manuscript.

Quad Mode Monitor

John Wonsowicz W9DUT
4227 North Oride Avenue
Norridge 34, Illinois

Interested readers at one time or another undoubtedly have had the pleasure of investigating some fine commercial communication receivers, or even some unusual home-brew design squawk boxes with features that were quite appetizing to an average ham. Perhaps some of these features were so good that the desire of owning such a hearing-aid was so strong that it required all the will power one could muster to be torn away from not mortgaging the family car and purchasing the beaut. Well, if you're among those reaching for the finest, with disregard for the sweat of your brow and the imposition on your bank account, here is your chance to be the proud owner of such a unit. Of course you must have determination and perseverance to

follow through, because this project requires more time than the usual converter or a small transmitter; but once finished, you can relax and enjoy the pleasures of your masterpiece for years to come.

In summarizing the advanced and exclusive features of this "Quad-Mode Monitor" as it is called for the four modes of reception, the goodies incorporated there-in are as follows: Modular construction, motor tuning, reception of NB FM, broad AM, sharp AM, upper and lower SSB, and CW, built-in VHF xtal converters, built-in auxiliary speaker, wide range of frequencies, large illuminated translucent dial, big illuminated S meter, tone control *if* gain control, rf gain control, etc., all this and more built on a standard 3" x 17" x 13"

aluminum chassis with a standard 8 $\frac{3}{4}$ " x 19" relay rack panel.

In design and construction of this receiver, no compromise had been made in material or workmanship to achieve the utmost in performance and pleasing professional appearance; so only the finest quality of coils, *if* transformers and ceramic coil forms were used as specified in the parts list or indicated in the schematic, and these were obtained from J. W. Miller Co.

To lessen the difficulty in construction of such a project, standard parts were used as much as possible. However, needless to say that a project of this kind requires a number of specialties that must be pieced together and fit into their respective niche, so many parts had to be machined. Fortunately, my access to a fine machine shop made this project materialize without imposing on my friends, and was completed in a record time of 8 months.

Mechanical

It is surprising to say the least that commercial receiver manufacturers haven't latched on to the very handy way of building ham receivers, which is the module construction as seen in the photo. This type of fabrication is not only simple, convenient and more economical, but also uniform; for each module when completed mechanically can be phased and optimized on the bench before securing it in place. Such construction was used in this receiver and modules developed are as follows:

Complete front-end with all coils, tuning capacitor, band switch and motor drive.

25 volt dc power supply for the drive motor.

High frequency (1600 kc) *if* strip.

Low frequency (85 kc) *if* strip.

Beat frequency oscillator (85 kc).

Converter switch.

Xtal controlled converters, and

Converter plug-in assembly with power receptacles.

To begin with, the main aluminum chassis was modified by the cut-outs for some of the above mentioned modules and the side brackets were bent on a hand brake and fastened to this chassis by 4-40 machine screws, as shown on the photo.

The right hand side of the aluminum bracket houses a 4" PM speaker as indicated by the round speaker grill near the front panel. Under the speaker is an opening for access to the rf coils. This is covered with a 3" x 6" aluminum plate. The far side of both brackets have oval hole cut-outs to substitute for carrying handles. Rectangle design of brackets instead of the usual triangle type shown in most catalogues were used for ease of handling and the ability of setting the receiver up-side down when working on the underside of the chassis, thus eliminating possible damage to components mounted on top. The dial escutcheon was machined from a piece of 5" x 11" x $\frac{1}{4}$ " aluminum plate with the back side milled out for a $\frac{1}{8}$ " plexiglass window for the dial. Around this plate a rectangular bar of aluminum $\frac{1}{2}$ " x $\frac{1}{8}$ " was secured with flat head 2-56 machine

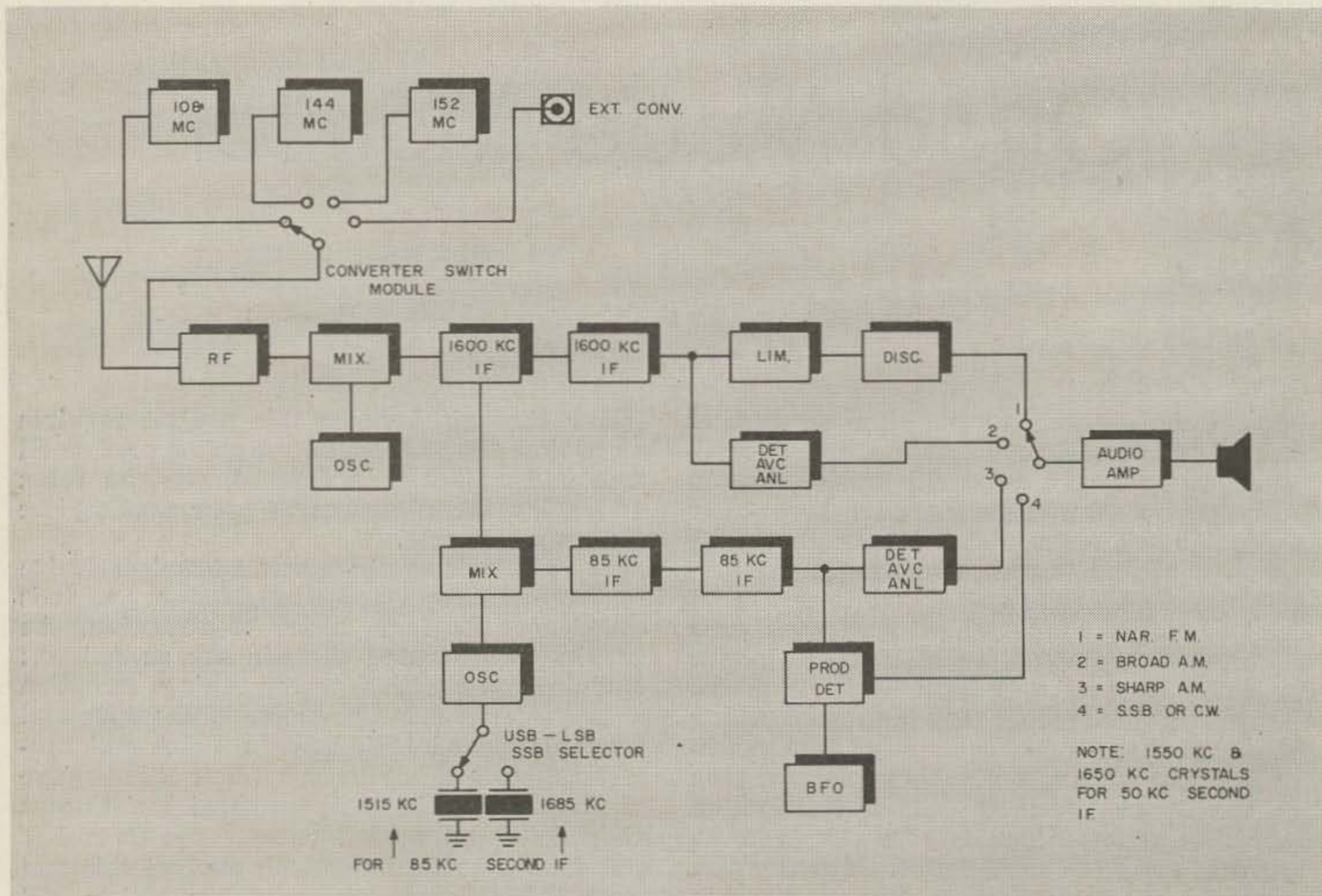

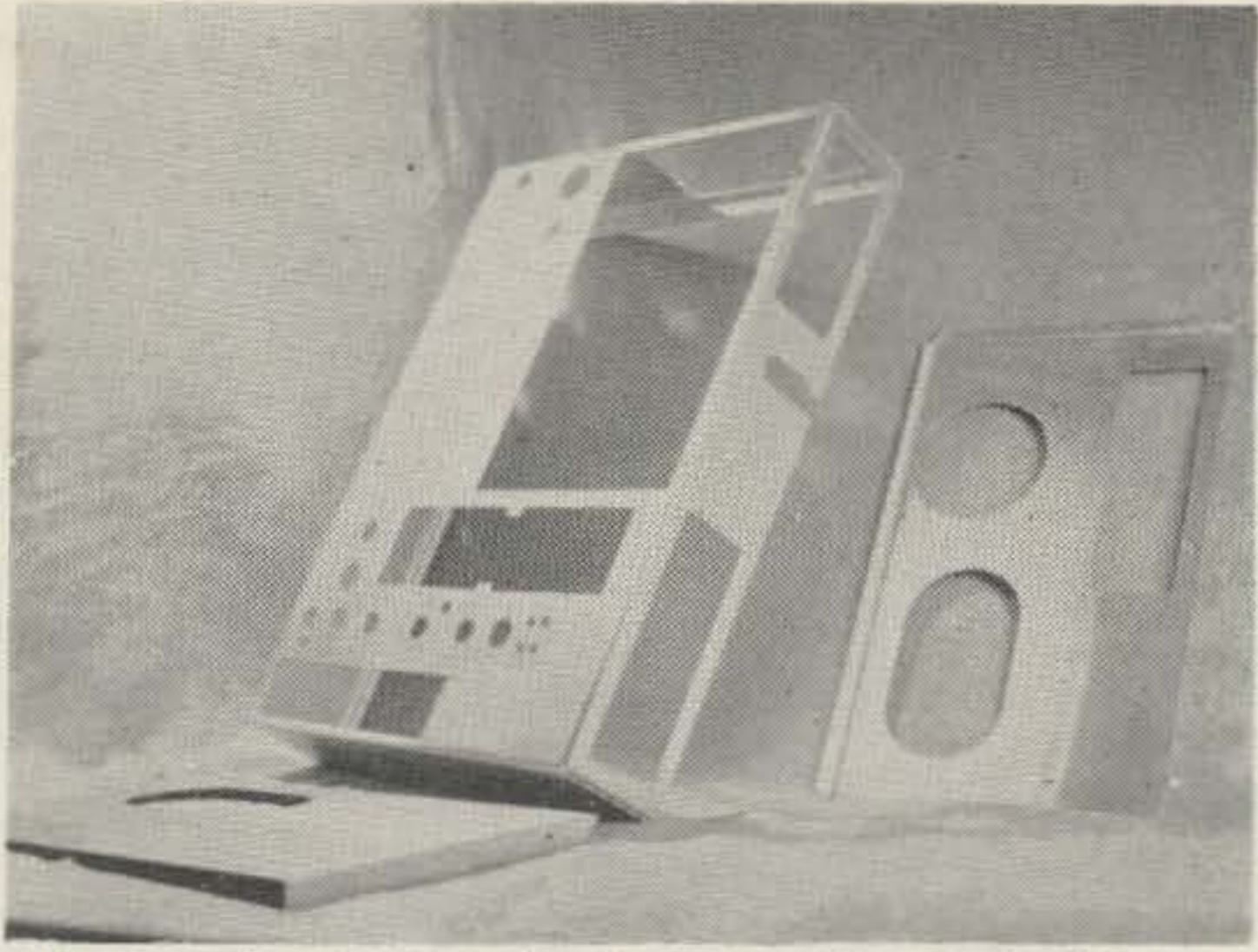

Main Chassis. Standard 3" x 13" x 17" aluminum chassis showing cut-outs for modules and front panel mounted controls.

Aluminum side brackets 8" x 13" with exposed ends bent for stiffening.

screws to form a pleasing three sided frame. After the cut-outs were made for the dial and the S meter, the assembly was sprayed with black crackle varnish to give it a professional look and to match the rest of the trim.

Front panel of this receiver required some study for the controls had to favor the best wiring practice and at the same time look neat and professional like; but after a few sketches and a little study, the design was frozen and all controls were fitted onto a 8 $\frac{3}{4}$ " x 19" standard relay rack panel which is crackle gray aluminum. All associated dials were matched and nomenclature engraved.

The six lights above the escutcheon plate are used to indicate the band in use and are switched in with the band switch. They are miniature neon panel lites and operate from 110 volt ac through a 10K- $\frac{1}{2}$ W isolation resistor. Black aluminum handles were provided for ease of removal from the cabinet, also to protect the dials from damage if the receiver is ever placed on it's face.

Electrical

Before going into details of circuitry and placement of components let's look briefly into the outstanding features of this receiver. Actually, this hearing-aid was designed for highest sensitivity possible, contrary to some engineers belief that sensitivity below .5 micro-volts is stretching it too far and is only good for noise reception. This may be quite true in some noisy locations and especially if such high sensitivity cannot be controlled. However, in this unit which has a usable sensitivity of .1 micro-volt and better on band 4 and below, and .2 micro-volt on band 5, it is controlled by the incorporated rf and *if* gain controls brought out to the front panel that can be varied to suit every condition.

Looking down the home stretch, this receiver is a double conversion super on all bands up to 30 mc if so desired and operated in the sharp AM or SSB mode. It becomes a triple



DON'T RETURN THIS COUPON

WALTER ASHE RADIO COMPANY
 Dept. S-8-62
 1125 Pine Street, St. Louis, Missouri
 Ok—Wake me up! I am interested in _____
 What is the Ashe "Surprise" allowance on _____
 Name _____
 Address _____
 City _____ Zone _____ State _____
 Send New Catalog
 Send Reconditioned Bulletin

Want to lie awake at night? That's what happens to the people who write for our trade in quote before they are ready to go.

Don't let our quotes disturb your sleep! Don't clip the coupon unless you can stand the best trade in offer in the business.

PLEASANT DREAMS!

(Quotes confined to gear made since 1945)

Anxious? Call us at Chestnut 1-1125

WALTER ASHE RADIO CO.

1125 Pine St., Dept. S-8-62, St. Louis 1, Missouri

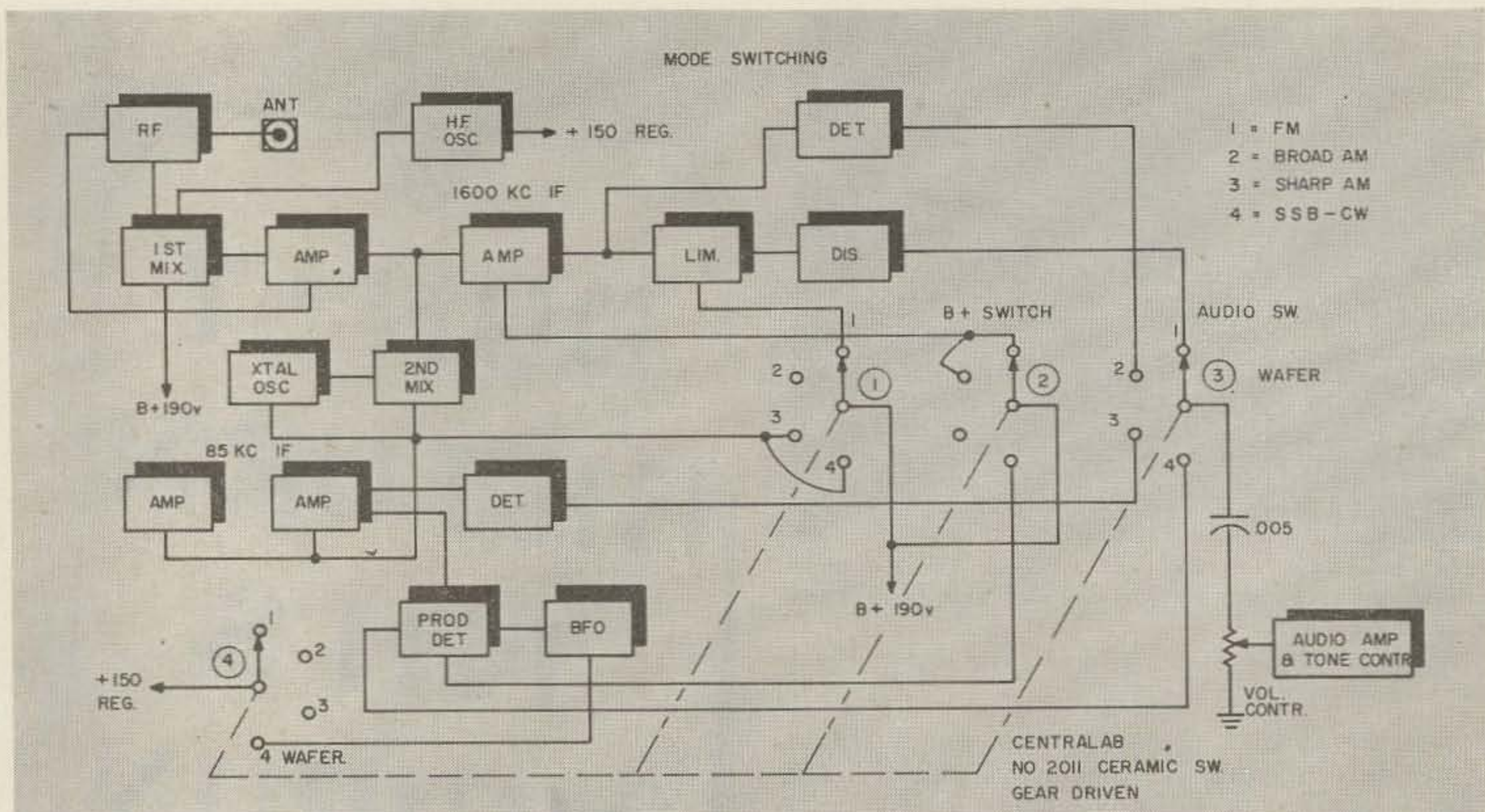

conversion device when used with the built in xtal converters, or a single conversion type when used in the broad AM or FM mode.

First *if* Amplifier

The selection of intermediate frequency depends on factors such as good image rejection and selectivity. But don't overlook the fact that powerful commercial stations near-by may feed into the wiring of a high gain amplifier completely ignoring the path of the front end. For this reason it is worth the effort to familiarize oneself with the bothersome local stations and select an *if* frequency at least 100 kc away. Of course a high intermediate frequency only gives good image rejection but poor selectivity, so one must resort to dual conversion and choose a second *if* that will suffice in separating the stations in the now congested bands. Usually a 50 kc up to 262 kc is good second conversion, depending on how much selectivity one needs for his particular operation. For high frequency AM and SSB, the lower the frequency the better, but for VHF operating using xtal converters, too much selectivity can be detrimental due to unknowingly passing stations while tuning.

After due consideration, the first *if* was selected as 1600 kc and the first *if* module built consists of two stages as amplifiers, one stage as a limiter and one stage as the FM discriminator. In the broad AM position the selectivity of this receiver is in order of 10 kc at 6 db down.

Front End

A lot of consideration must be given to the "front end" since that is the head of the table; a mediocre choice in design may hamper the overall performance of the completed unit. Many books were written on why's and why not's, peaks and pitfalls of tubes and circuitry

involving rf amplifiers, mixers and oscillators, but if you're like I am the more you read the stuff the more confused you get. The surest way out of the dilemma (assuming that you have a good signal generator and a VTVM) is the soldering iron and a hand full of parts together with some notes on progress made. From these notes as an embryo the front-end module took shape and consists of a 6AK5 rf amplifier, 6BE6 mixer with separate injection using a 6C4 triode as a Hartley HF tunable oscillator operated with 150 volts on the plate from a VR 150 volt regulator.

The image rejection of this front end measured through the first *if* is better than 60 db; being comparable to the finest in communication receivers. Frequency coverage of this front end are as follows:

- Band 1—500 kc to 800 kc
- Band 2—2.8 mc to 5.7 mc
- Band 3—5.7 mc to 10.4 mc
- Band 4—10.4 mc to 18.4 mc
- Band 5—18.4 mc to 30.0 mc

Band 6—switches band 4 into converter position and grounds the antenna input to band 4 to prevent signals from beating with the converter. This will be explained later in the article.

Second *if* Amplifier

Upon completion of the front end unit, the low frequency *if* strip came up for consideration. This module was viewed from the point of selectivity and question of frequency selection was obvious since an old surplus receiver using fine 85 kc intermediate frequency transformers was on hand. The old transformers were removed, taken apart, cleaned and re-assembled and three of these transformers with two 6BA6 pentodes are used in this module. To keep excessive gain down to a reasonable level, this strip is operated at re-

duced voltage. The overall selectivity of this strip is 2 kc at 6 db down. Being quite satisfactory for reception of AM and SSB.

Xtal Converters

In as much as this is a complete package embodying everything including the proverbial kitchen sink, the converters had to be included; and since they became part of the main chassis, a switch had to be designed for ease of control. The switch module incorporates the switch and miniature coax connectors to select any of the three converters, or the coax connector on the front panel for an external converter with an *if* frequency of 10 to 18 mc. Converters with *if* frequency of 3 to 30 mc can be fed into the antenna coax connector on the back of the chassis.

Frequency coverage of the built-in xtal converters is calibrated on the main dial and is as follows:

No. 1—107 mc to 109 mc

No. 2—143 mc to 148 mc

No. 3—152 mc to 157 mc

Detectors

Since it was a simple matter in wiring detectors, space was provided for them on the main chassis so that each of the four detectors was close to their *if* strip and the audio amplifier.

The detectors are as follows: FM discriminator, 1600 kc AM detector with built-in ANL, the 85 kc AM detector also with built-in ANL and a product detector for SSB and CW with separate BFO injection.

BFO

The beat frequency oscillator is a module built on a 2 $\frac{3}{4}$ " x 2 $\frac{1}{8}$ " x 1 $\frac{5}{8}$ " mini-box and uses a Miller 50 kc modified transformer with a 6C4 triode connected in a Hartley circuit. Cathode output is used which is brought out to a miniature coax connector.

Xtal Oscillators

Good communication receivers of today are selectable sideband receptors, and since this unit falls into that category, two crystal oscillators are used in the conversion to the low frequency *if* for the selection of upper or lower sideband. These oscillators are controlled from the front panel by a single pole double toggle switch.

Tone Control

A phenolic strip with all necessary components constitute the tone assembly. A pot, being the variable tone control is mounted on the front panel and wired with miniature coax cable to the phenolic tone assembly. This simple but worth while device adds pleasing tone quality when listening in the broad AM or FM mode.

Other controls brought out to the front panel are, antenna trimmer, BFO pitch, osc.

calibrate, meter zero, stand-by switch, and of course the main tuning. The main tuning is operated by thumb action for vernier tuning or by the push buttons mounted in the escutcheon for rapid excursions with motor drive. Tuning ratio through the worm drive is 50 to 1, making motor tuning very desirable.

Next month we'll have complete information on the construction of this receiver.

... W9DUT



Decades

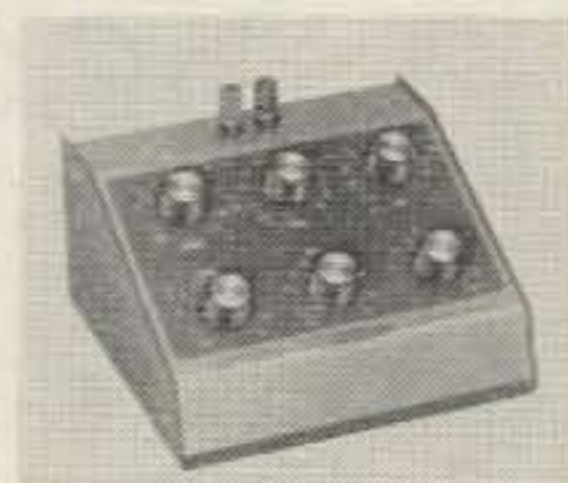

Anyone who has done much experimental work has felt the need of a good resistance or capacity decade. Many of us have gone to the trouble to build up our own since the commercial models heretofore have been rather expensive. Heath has done it again with their new IN-11 and IN-12 decade boxes which sell for only \$24.95 and \$17.95 respectively.

What do you do with these after you've bought 'em and assembled 'em? Well, there are many circuits that can be calculated by Ohms Law for a rough approximation, then you either have to build in a potentiometer to allow for individual variations in the circuit or else you have to connect one temporarily, adjust it for best operation of the circuit and then replace it with a resistor of an equal value. With the decade box around you can hook it in the circuit, adjust and then read the desired resistance from the dials. It is a lot handier to use than a flopping pot.

Or maybe you hook up a bridge circuit now and then for some particular application. With this decade you can assemble a bridge by means of a few clip leads, make your measurements, take it apart again . . . and get the accuracy that you wanted.

If you do any tuning of filters it is difficult to get along without a decade.

All in all, no test bench is really even half complete without a set of decades at hand. Like inside plumbing, you never really appreciate it until you have one of your own.

Mobile Monitor Scope

Robert Williams K9DYS
7 Willows Place
Rantoul, Ill.

Photographed by S/Sgt. John Matheson, USAF

DURING the course of experimenting with transistorized mobile modulation systems, the desire for a means of monitoring performance of the rig on the road led to the adoption of the miniature scope shown here. The 1" screen is mounted out of the way on the dash and can be seen without turning your head from the road. It can be used for either AM or SB. The power requirements are so small the scope can be run from flashlight batteries.

The scope tube is an RCA 913. The high

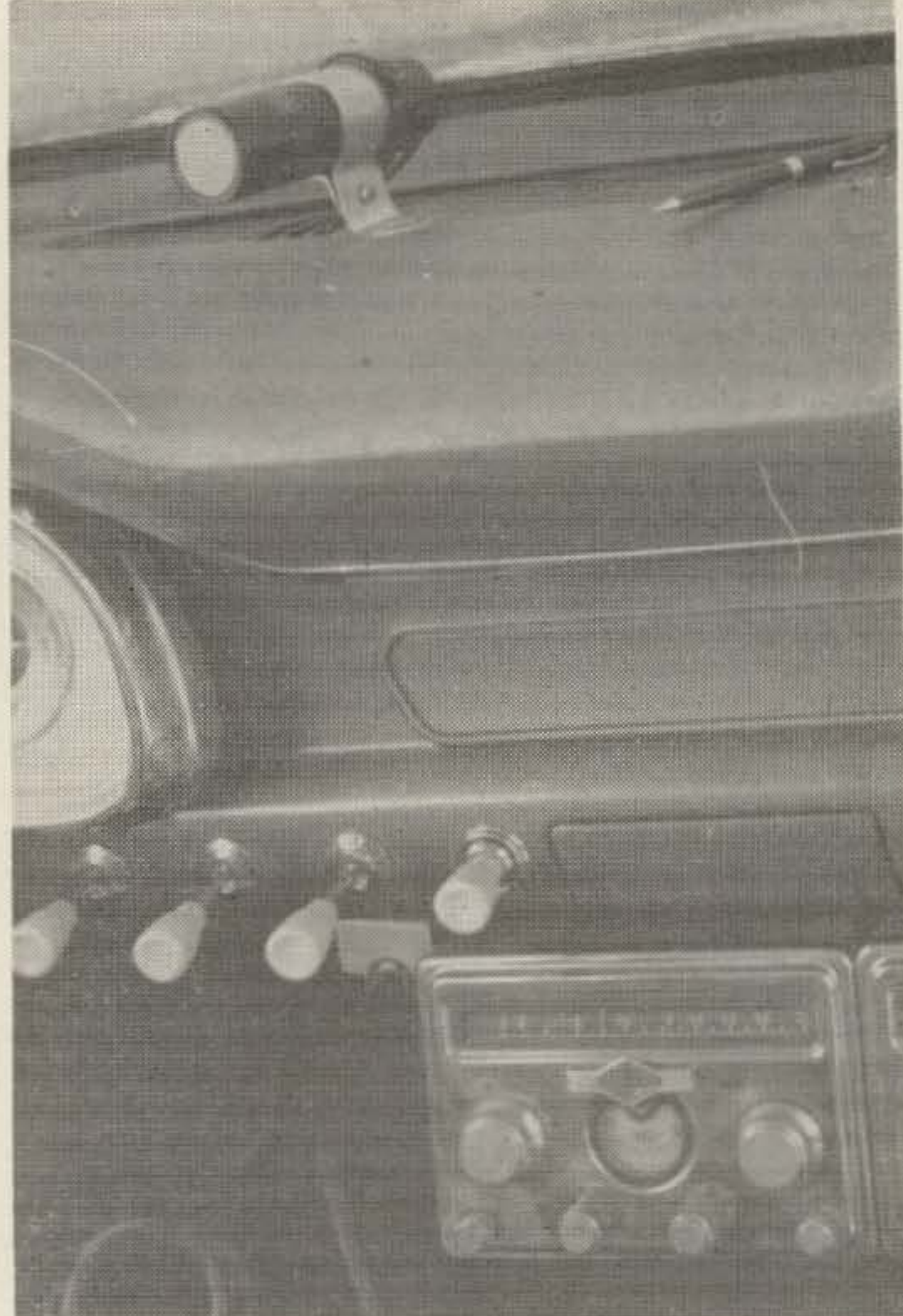

voltage requirement is supplied by a small transistor oscillator putting out 300 to 400 volts at approximately 100 micro amps.

The 913 filament is turned on by the transmitter on-off switch. To prevent a bright spot from burning the screen during stand-by the power supply is turned on with the push-to-talk system, thus the screen is dark during stand-by.

Construction

The power supply and controls are built into a 2¼ x 2¼ x 5" Bud Mini box which is

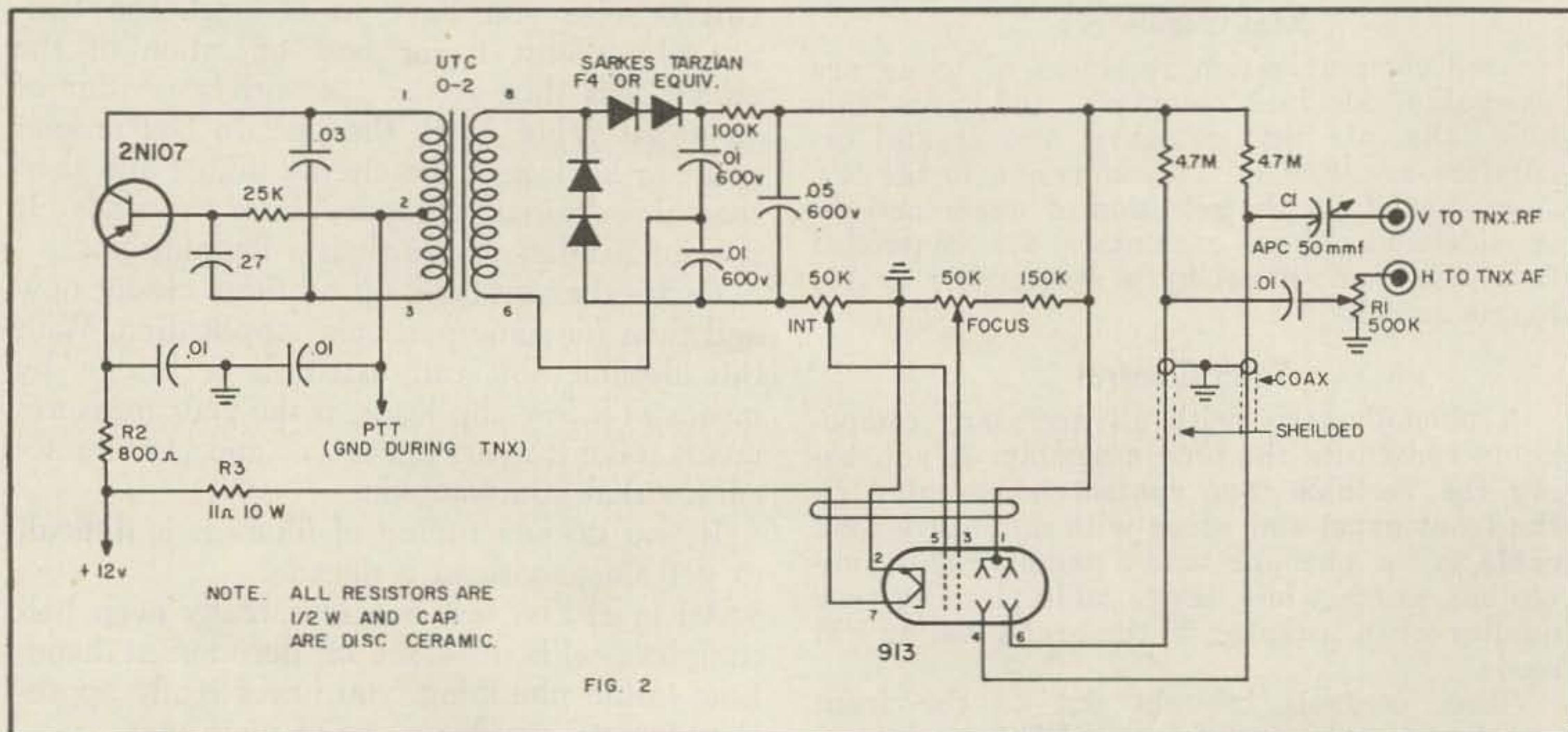

mounted out of sight under the dash. Only the tube and its socket are visible. The only important thing to remember about construction is that the oscillator must be shielded from the other components to prevent undesirable traces. The 913 can be replaced by a 2AP1, but it is somewhat large for dash mounting. The 2AP1 requires a different value filament dropping resistor.

The audio is brought into the scope by a shielded lead from a capacitor connected to the PA side of the modulation transformer. Rf is obtained from a tee connector on the transmitter's antenna plug. Coax cable is used for the rf leads. Connections shown in Fig. 1 are for a trapezoidal pattern.

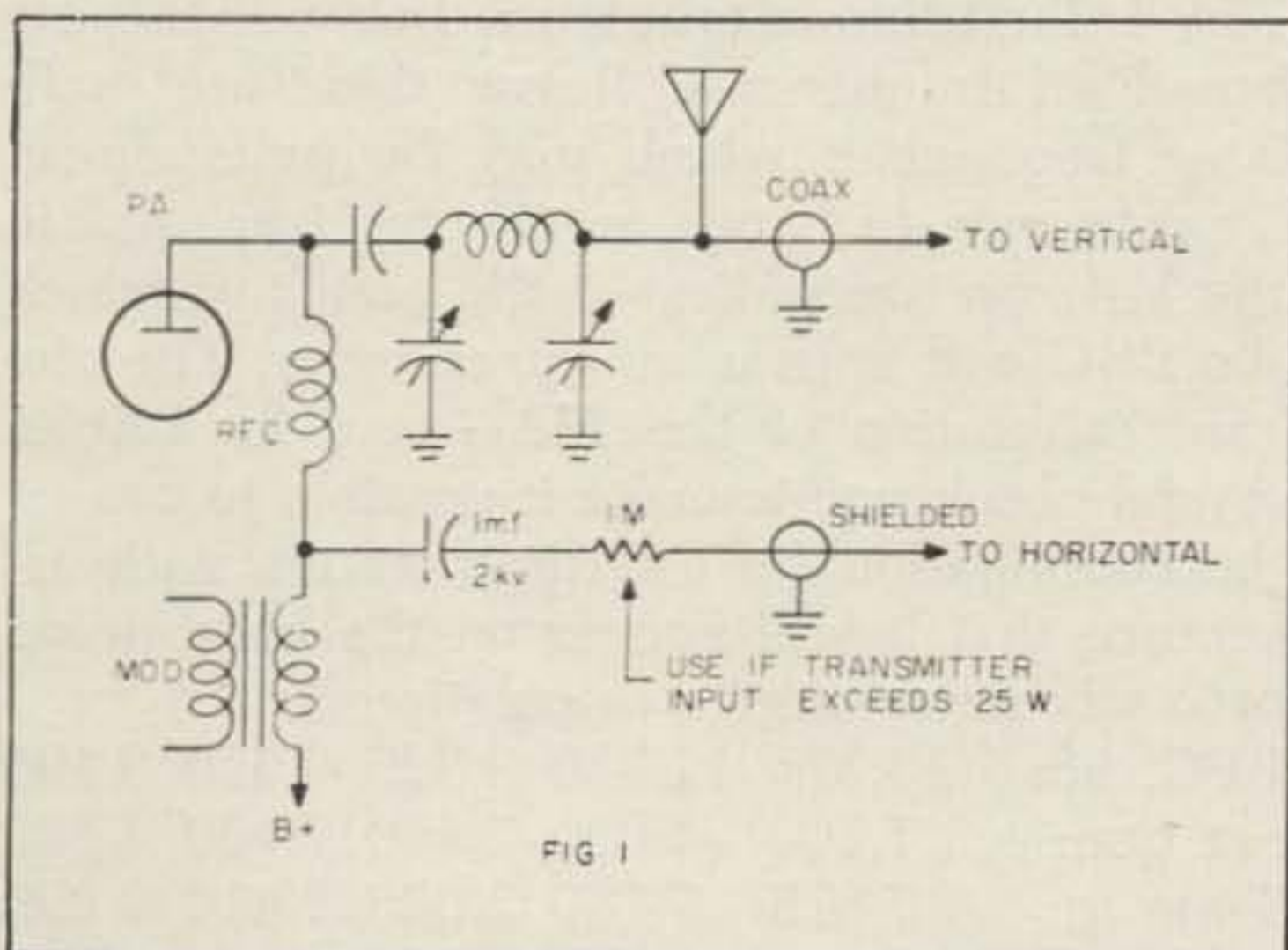

The aluminum bracket, holding the CRT, was made from scraps around the shack and is held in place by one of the bolts in the speaker grill.

Operations

If it is desired to make the scope completely self contained for portable use only a few changes are required. Increase the chassis size to accommodate the 913 and a 6 volt battery, 4 size D cells or a 6 volt lantern battery such as RCA VS040s. Remove the filament dropping resistor R3, for the 913 and remove R2 in the power supply. The brightness, although decreased, should still be sufficient.

After tuning the transmitter, adjust C1 with an insulated screwdriver (the rotor of C1 is hot) for a narrow line that fills about $\frac{3}{4}$ of the 913 screen. This is done without modulation and indicates carrier magnitude. Next loosen the CRT clamp and rotate the tube until the line is vertical.

Now apply modulation and adjust R1 for proper horizontal size and you are in business.

The pattern should be a trapezoid which is used here. For interpretation of the pattern refer to the ARRL Handbook.

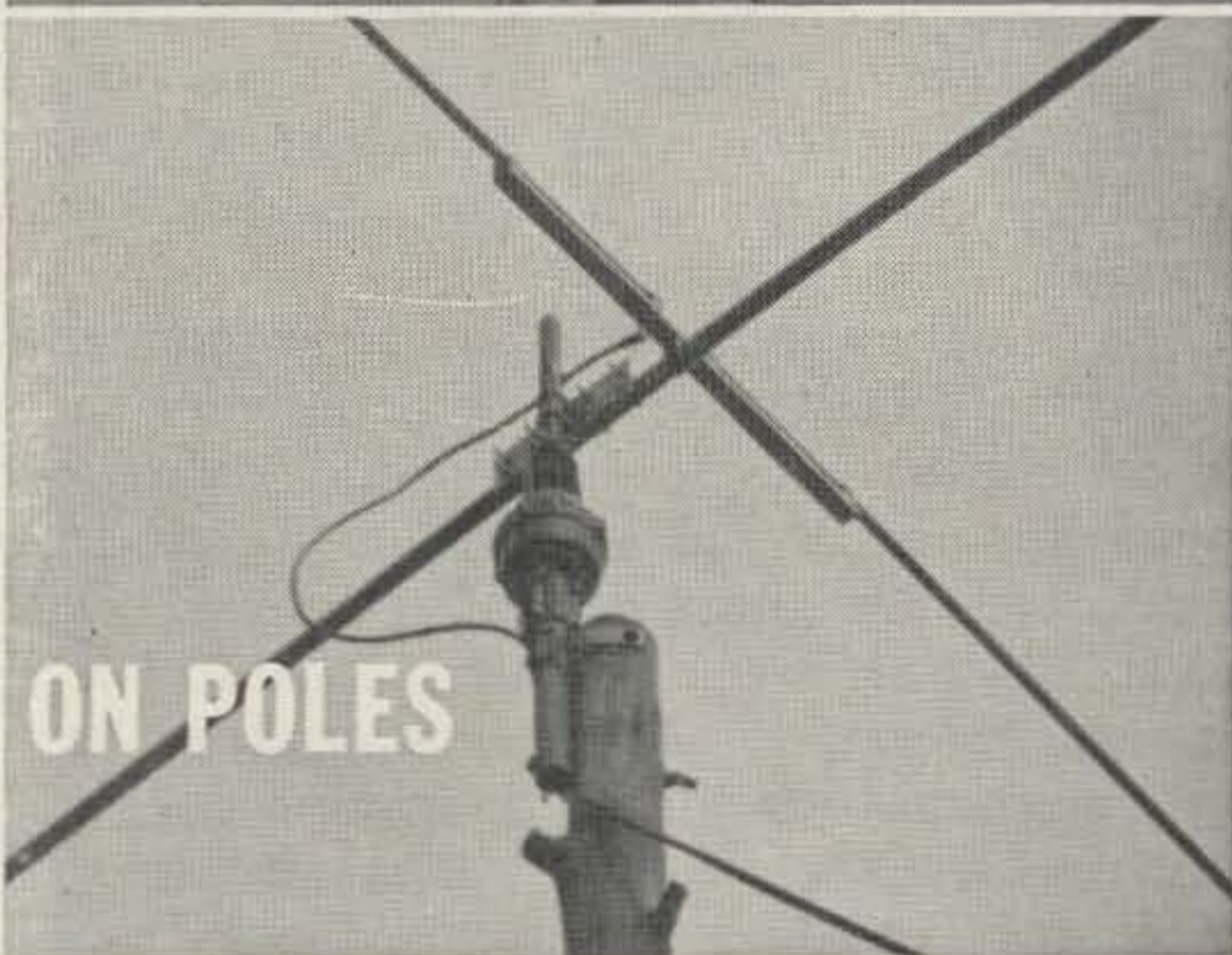

TALK ABOUT MOUNTABILITY!

Anyway you want to mount your antenna rotator, the HAM-M is the most versatile around! No special parts to buy! (Even the otherwise difficult inside tower mount can be accomplished with some angle iron and a hack saw) . . . Mountability like this is just one more reason why, at \$119.50 amateur net, you just can't top the HAM-M! Ask your local CDE Radiart Distributor for all details.

CDE **CORNELL-DUBILIER**

CORNELL-DUBILIER ELECTRONICS, DIV. OF FEDERAL PACIFIC ELECTRIC CO., 50 PARIS ST., NEWARK 1, N. J.

During the experimental stages, the 913 was mounted on the steering column and the pattern could be seen reflected on the windshield without obstructing vision. This worked quite well, but the combination of XYL, harmonics and HV at the CRT plug, put the monitor on top of the dash.

More fun with a Communications Receiver

Elliott Weyer W2LLZ

THE real purpose of a good ham receiver is to provide efficient reception on the amateur bands; however, there may be times (transmitter breakdown?) when there is an urge to use a great receiver in other than its intended rôle—Short Wave Listening! Current trends in communication receiver design are in the direction of less band-coverage and toward narrower frequency response—restrictions which make the 75A-4, for example, almost as useless for SWL as for bird watching. On the other hand, the precise calibration of the 75A-4 makes it possible to locate an out-of-bandspread station with unfailing accuracy, and then to enjoy a foreign broadcast with excellent quality reception.

To achieve these results, a simple converter is part of the story. The rest is only for those who believe in high fidelity, and consists in removing one of the Mechanical Filters from its rack and bridging the *if* “straight through” with “U’s” of wire inserted in the socket as shown. (Please do not throw away the filter).

Transistor bugs will go their minuscule way, but we have had very satisfactory results with a one-tube oscillator-mixer circuit, very simple to construct. The oscillator circuit with its padder will sweep the frequencies from about

The monitor has been in use for almost a year, and I am quite pleased with it.

Now I can adjust the rig at anytime for 100% modulation without using those often inadequate signal reports. Also, I can tune the rig without taking my eyes off the road.

... K9DYS

4.0 mc up to about 8.25 mc putting within easy reach most of the important short wave broadcasting stations of the world as well as other services too numerous to mention, but probably including for the first time—Sputniks!

Consider, for example, the overseas broadcast stations of the BBC. It will be noted that none of them may be tuned directly on the 75A-4. First line in tabulation below lists those broadcast frequencies. Below them are oscillator frequencies which may be precision-set by reference to bands on the receiver, and in the last row are indicated the points at which the BBC will appear on the receiver. The elegant calibration of the 75A-4 and its 100 kc crystal check points make it possible to pre-set the combination for a desired station with assurance that it will appear on the bandspread precisely according to calculations.

BBC, kc:	15.375	11.780	9.825	9.510	6.195
Set Osc:	7.700	4.000	7.800	7.100	4.100
Tune to:	7.675	7.780	2.025	2.410	2.095

Newcomers to the field of heterodynology will be rudely jolted by the obvious fact that in beating one frequency against another, the resultants are *two*—the sum of, and the difference between, the two frequencies. Hence, some strange bedfellows are bound to turn up. However, it is usually possible with simple mathematical juggling to get just what you are looking for, and get it without QRM. Of course, if it's the domestic broadcast band you want, it is there too, and not afraid to assert itself.

The 75A-4, its kin and issue share many qualities of good receivers for this purpose,

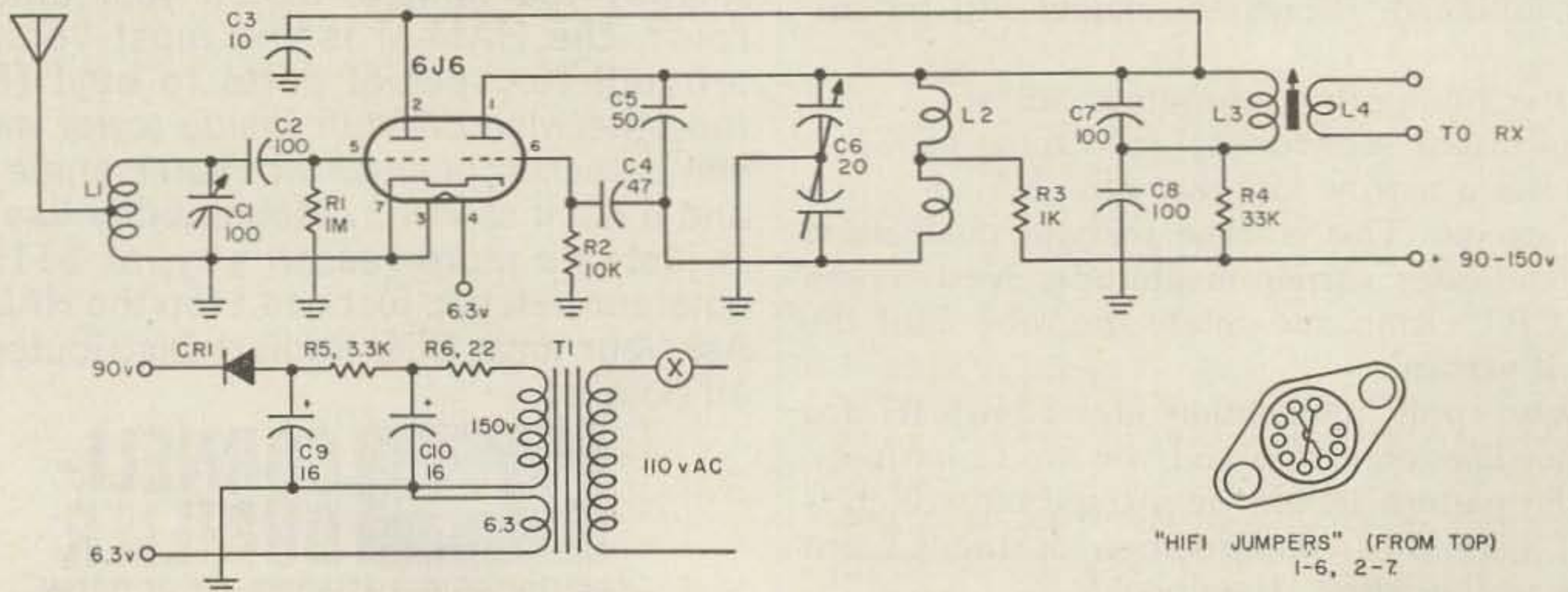

among them the fact that without an antenna, they hear almost nothing. Lesser breeds, which will pick up signals by osmosis as well as through the usual channels, will make the past-time even more sportive.

The Converter

All parts of the simple circuit are easily mounted on and in a standard 5 x 7 x 2" aluminum chassis. A geared-down drive for the split-stator capacitor is almost a "must" to facilitate exact oscillator tuning, although no dial or calibration are necessary, or would they mean anything anyway in view of the padding condenser. There is ample room within the chassis for the miniature power supply, if it is not desirable to "borrow" power from the receiver.

C₅, C₆, L₂ and 6J6 are on top of the chassis; all other parts are below deck. The converter is fitted with RCA input and output jack and plug, and in use, converter is inserted in a break in the coax from antenna to communications receiver. (The break in coax is so fitted that continuity may be restored after your transmitter is again in working order).

In using the converter, the following routine will become almost automatic: 1) Obtain frequency of desired station in megacycles,

2) Using the coverages of the bands of the communication receiver, select two tunable points such that their sum or difference will result in the desired (but otherwise unattainable) frequency.

3) Set receiver for reception exactly on one of these frequencies using crystal calibrator at nearest check point for accuracy.

4) Without connecting the converter to receiver "swish" around with C₅, and finally C₆, to zero-beat converter oscillator with receiver BFO.

5) Tune receiver to other of the frequencies derived by computation in 2) above; insert converter in antenna coax, and listen to your station.

"Tuning around" may be performed by either the bandsread of the receiver or the oscillator of the converter of course. Is it a Barrel of Monkeys or Pandora's Box?

... W2LLZ

T1—Small light-weight transformer of (isolation type—surplus) 110 v. in, 150, 6.3 v. out.

CR1—Selenium rectifier, 20 ma. capacity.

C6—Split-Stator "butterfly" or two opposed section; total about 20 mmf.

L1—1" of Miniductor 1/2" in diameter, 16 turns/in. air-wound; tap 4 turns fm. gd.

L2—16 turns #26 Enamel closewound on 1" form, center-tapped.

L3—24 turns #26 Enamel on 3/8" slug-tuned form.

L4—4 turns #26 Enamel at ground end of L3 above.

All resistors 1/2 Watt; all fixed capacitors (except electrolytics) ceramic disc.

GOOD MOBILES GO

HUSTLER

MOBILE ANTENNA 10-15-20-40-75-METERS

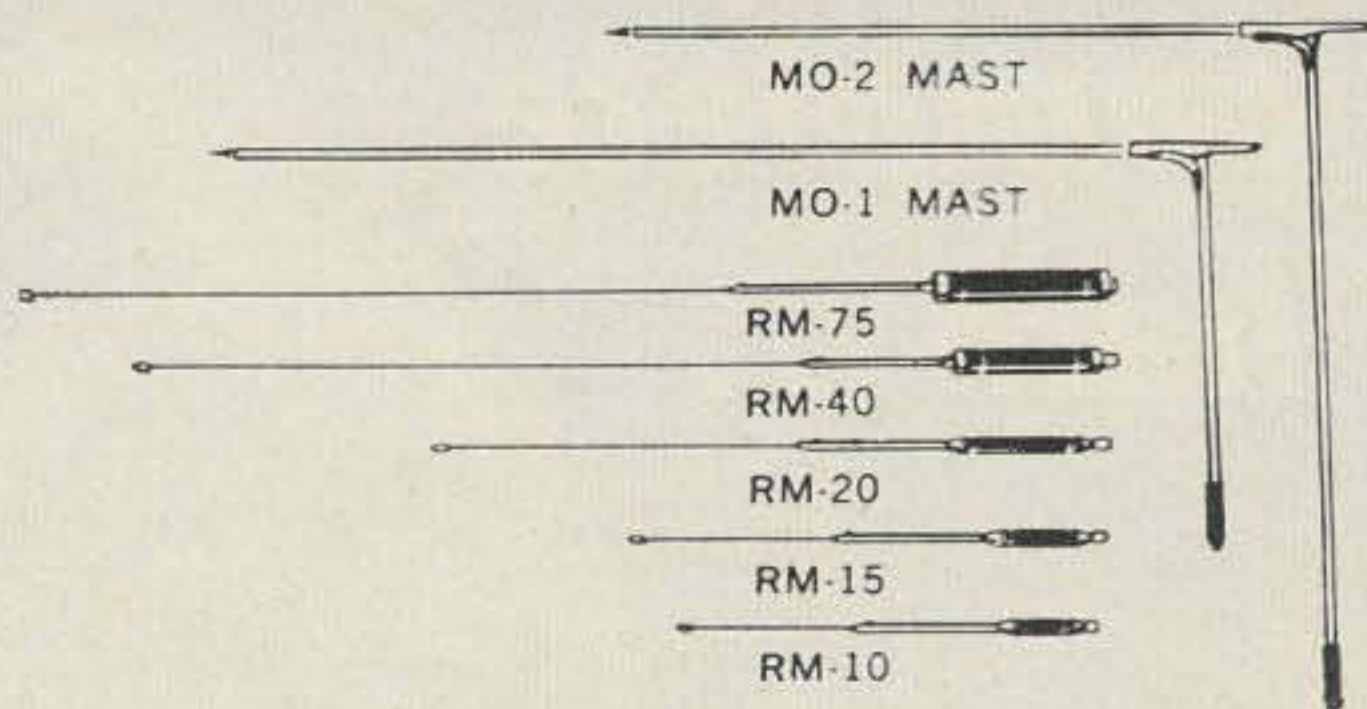

Buy only the mast and resonators for the bands you operate. NO NEED FOR MATCHING DEVICES, NO FEED LINE LENGTH PROBLEMS. Use any length of 52 ohm cable. New, efficient concept of center loading. Each resonator has a coil specially designed for maximum radiation for a particular band. Center frequency tuning is by an adjustable stainless rod in the resonator. The fold-over aluminum mast permits instant interchange of resonators. Mast folds over for garage storage. Mast has 3/8-24 base stud to fit standard mobile mounts, but will perform better with New-Tronic mounts. Power rating is 75 watts dc input A.M. - 250 watts PEP input for SSB.

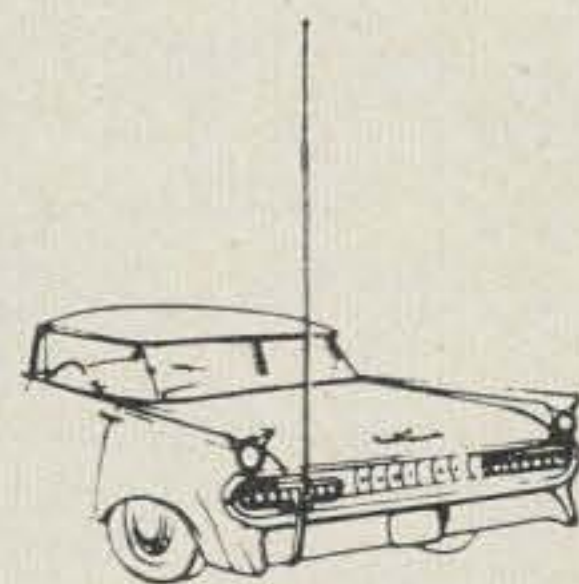

Mast and resonator in mobiling position



Mast and resonator folded over

RESONATOR WILL WORK PROPERLY ONLY IF USED WITH MO-1 OR MO-2 MASTS. ANTENNA ASSEMBLY CONSISTS OF 1 MAST and 1 RESONATOR.

MODEL	DESCRIPTION	TOT. HGT. of ASSY.	NET
MO-1	54" mast folds at 15" fr. base	Rear deck or fender	\$ 7.95
MO-2	54" mast folds at 27" fr. base	Bumper	7.95
RM-10	10 meter resonator	80" max. - 75" min.	5.95
RM-15	15 meter resonator	81" max. - 76" min.	6.95
RM-20	20 meter resonator	83" max. - 78" min.	7.95
RM-40	40 meter resonator	92" max. - 87" min.	9.95
RM-75	75 meter resonator	97" max. - 91" min.	11.95

ANY MAST OR RESONATOR MAY BE PURCHASED SEPARATELY

MODEL BM-1 BUMPER MOUNT

Flat alloy steel strap fits any shape bumper, large or small. "J" bolts require only 1/4" clearance between top of bumper and car body. Heavily chrome plated 1 1/2" die cast Zamak ball has 3/8"-24 thread. Adjustable for true vertical position. Gray Cyclocac base. Heavily cadmium plated... \$6.95



Ask your distributor to show you these and other fine NEW-TRONICS products. Write for literature on the complete NEW-TRONICS line.

NEW-TRONICS CORP.

3455 Vega Avenue

Cleveland 13, Ohio

**the
complete
ham...**



equips his shack at half-price with

Wise Amateur Radio operators know that they can depend upon Heath for quality, dependability and performance at lowest cost! Savings realized through easy, do-it-yourself kit construction, make it possible for the radio amateur to equip his station with complete facilities at savings of up to 50%! You also enjoy latest engineering design and features for top performance and convenient operation. Whatever your need, whatever your interest . . . "Mobile", "Fixed", AM, CW or SSB . . . there's a Heathkit product to fill it! The handy accessories shown above are only a few of the many money-saving Heathkits available to make better contacts, more conveniently, and with added fun.

1. MONITOR SCOPE: Specially designed for Amateur use! Displays envelope, AF and RF trapezoid patterns. Ideal for checking "flat-topping" and non-linearity in SSB linear amplifiers, observing modulation characteristics of AM & SSB transmitters plus quality of received signals. Use on amateur bands 160 through 6 meters. Built-in two tone test generator. 10 lbs.
Kit HO-10...no money down, \$6 mo.....**\$59.95**

2. REFLECTED POWER METER: Checks efficiency of antenna system by measuring forward and reflected power or standing wave ratio. Handles a peak power of well over 1 kilowatt and may be left in the antenna system feed line at all times. Matches 50 or 75 ohm lines. Covers 160 through 6 meters. 2 lbs.
Kit HM-11.....**\$15.95**

3. 100 KC CRYSTAL CALIBRATOR: Perfect for checking VFO's, receivers and other communications gear! Provides precise output every 100 kc from 100 kc to 54 mc. Circuit is transistorized and battery powered for complete portability. .005% crystal included. 1 lb.
Kit HD-20.....**\$14.95**

4. RF POWER METER: Samples RF radiation near antenna to give continuous indication of relative power output of transmitter. Sensitive 200 ua meter. Requires no external source of power for operation. Covers 100 kc to 250 mc range. 2 lbs.
Kit PM-2.....**\$12.95**



easy-to-build Heathkits

5. "CANTENNA" TRANSMITTER DUMMY LOAD: Permits testing or servicing transmitting equipment "off-the-air" . . . no TVI, QRM, or FCC violations to worry about! Handles up to 1 kilowatt I.C.A.S. with less than 1.5 V. S. W. R. up to 300 megacycles. Features oil-cooled resistor (oil not included). 2 lbs.

Kit HN-31 **\$9.95**

6. "TUNNEL DIPPER": Exclusive with Heath! . . . a solid-state grid dip oscillator. Hundreds of uses in amateur radio work. Covers 3 to 260 mc. Color-matched coils and dial scales. Battery powered, use it anywhere! Complete with rugged, epoxy coated coils, protective cover. 3 lbs.

Kit HM-10 . . . no money down, \$5 mo. **\$34.95**

7. VARIABLE FREQUENCY OSCILLATOR: Provides complete coverage of amateur bands, 80 through 2 meters. Rugged, reliable and loaded with special features for top performance and stability. Use with most transmitters designed for grid-block or cathode keying. All connecting cables furnished. 12 lbs.

Kit HG-10 . . . no money down, \$5 mo. **\$34.95**

FREE CATALOG:

Send today for your free 100 page Heathkit Catalog. Over 250 different quality kits to choose from. Save up to 50% with Heathkit.



HEATH COMPANY
Benton Harbor 11, Michigan

Please send Free Heathkit catalog

NAME _____

ADDRESS _____

CITY _____ ZONE _____ STATE _____

The TT-180

Five Bander

Frederick J. Haines W2RWJ
123 Roberta Drive
Liverpool, New York

A few months ago I decided to return to the air after a period of inactivity. The inclination was to build something fast and simple, perhaps a 6AG7-6L6 crystal controlled rig on an old-fashioned breadboard.

At this point judgment began to prevail over impulsive action. Wouldn't it be rather silly to build a transmitter for one or two bands, when all that hard-earned dough had just been shelled out for a new all-band receiver?

Several weeks were spent developing a set of specifications for the new rig, and after some preliminary design work, it was clear that construction of an all-band medium-power transmitter isn't as formidable a task as had been assumed.

The resulting unit is a five band, seven tube, bandswitching rig, with a dc power input of 180 watts into a twin tetrode final amplifier.

Technical Summary

Power. 117 volts ac at approximately 60 watts for tube heaters and blower. 600 volts at 300 ma or 750 volts at 240 ma and 360-375 volts at 100 ma, all dc. For AM phone the final requires 600 volts at 224 ma.

Signal. Internal crystal - controlled oscillator (VFO-CRYSTAL switch on chassis). Any VFO with an output of a few tenths of a watt to drive the input stage, V1.

AM Modulation. Any modulator delivering 65 watts of audio at an impedance of approximately 3800 ohms will 100% modulate the transmitter at a final amplifier input power of 134.5 watts.

Outputs, measured at 3.5 mc.

CW Telegraphy. 600 plate volts, 125 watts output (180 watts input); 750 plate volts, 130 watts output (180 watts input).

AM Phone. 600 plate volts, 100 watts output (134.5 watts input).

Impedance. The pi-network output circuit

matches 50 or 75 ohm coaxial transmission lines to antenna tuner or antenna.

Circuit

A type 5763 pentode functioning as a modified Pierce crystal oscillator or an amplifier-doubler is employed at V1. The plate tank circuit, L1-C3, tunes to either 80 or 40 meters depending upon the position of the exciter bandswitch S2. When an 80 meter crystal or VFO is used, V1 provides output on either 80 or 40, acting as a doubler for 40 meters. When starting with a 40 meter crystal or VFO the stage amplifies straight through on 40.

C6 pads the V1 tank circuit down to the 80 meter band when S2 is in the 80 meter position. The screen grid of V1 is controlled by the EXCITATION control R4 to allow the final amplifier grid drive current to be set at the correct value.

V2 serves to double the 40 meter output from V1 to 20, or to triple to the 15 meter band when S2 is in the 20/15 meter position. The plate circuit of V2 is arranged to tune to both 20 and 15 meters, thus eliminating the need for separate 20 and 15 meter multiplier stages.

When 10 meter output is desired, V3 is switched into the circuit and doubles 20 meter output from V2 to 28 mc.

The function of C15 is to make the grid circuit of V3 present the same capacitance as the final amplifier grid circuit. This provides resonance at 20 meters at a single setting of C11 whether V2 drives the final grid or the grid of V3.

Drive from V1, V2, or V3, is coupled to the grids of the parallel 6146's final amplifiers through a section of the EXCITER BAND-SWITCH, S2C. The coupling capacitors are C7, C8, C16, or C21, the one in use depending upon the setting of S2. M1 monitors the PA

grid current and indicates resonance of the driver tank circuits.

V4 and V5 were found to be miserably normal as far as parasitic oscillations were concerned. They were quite willing to produce spurious output with no encouragement. R12 and R13 were found to be "musts" as well as R14 and R15 in the screen leads. R16 and R17 with RFC-6, and RFC-7 will be recognized as the usual plate parasitic networks.

In order to allow keying of the driver stages, the final amplifier screen grid circuit incorporates the usual clamp tube V7, a type 6V6. When grid drive is removed from the final grid, the bias of V7 falls to zero and the tube draws current heavily through R19, the screen dropping resistor. When V7 conducts through R19, the voltage at the plate of the "switch" tube, V6, falls below the value required to maintain ionization and V6 extinguishes. At this point the final screens are actually disconnected from the screen supply and final plate current drops to a very low value.

A bonus advantage of the "switch" tube is that the gas requires a time to ionize, providing a measure of shaping of the CW keying characteristic, tending to "soften" the keying and minimize key clicks that otherwise might be radiated.

The plate tuning capacitor, C31, in combination with the plate inductor L6-L9 tunes to the five Amateur bands between 3.5 and 29.7 mc. The PA BANDSWITCH S3 shorts out turns progressively to provide the proper amount of inductance for each frequency band. This system of fixed inductance value for each band eliminates the usual inconvenience found whenever a rotary inductor is employed. No turns counter is required and band-changing is greatly simplified. In addition, the best circuit Q possible is built into the transmitter and is automatically selected by the operator without consultation of tuning charts.

Both COARSE and VERNIER LOADING controls were provided in the original model of the transmitter. If it is desired to simplify the circuit and minimize the mechanical complexity, the VERNIER LOADING capacitor, C32, may be omitted, and the COARSE LOADING switch rewired as shown in schematic.

It was found necessary to neutralize the final amplifier on the three higher frequency bands. The amplifier did not oscillate without neutralization, but it was found that maximum rf output did not coincide with minimum plate current as the final tank was tuned through resonance. Due to the long leads required and also because the final amplifier grid circuit doth not have its own coils and tuning capacitors, it would have been impossible to use the popular capacitive bridge method of neutralization. A search of the handbooks revealed a simple and effective but little used method of neutralization. As will be noted on the schematic diagram, two link neutralizing cir-

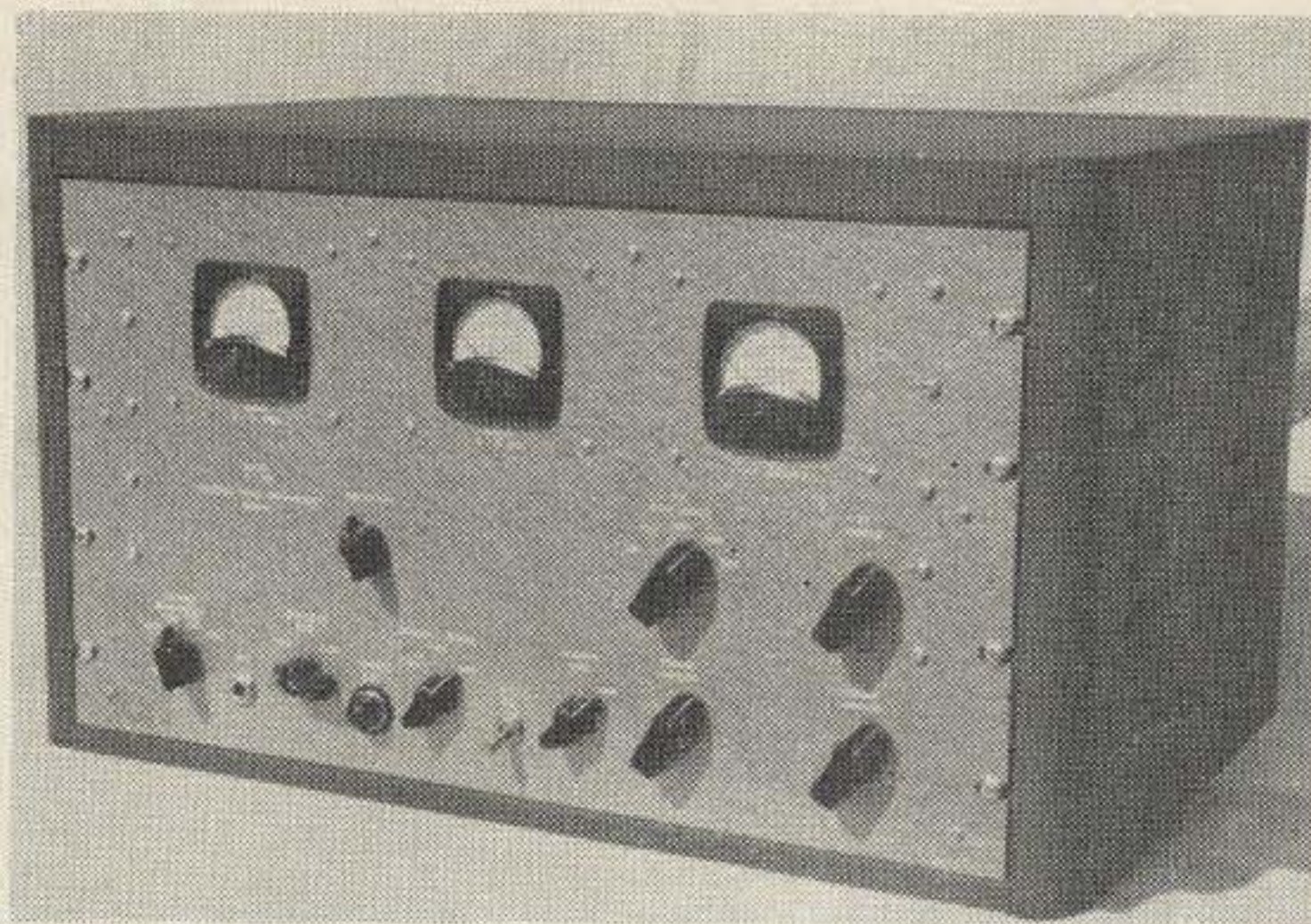

cuits are used. L5 and L7, connected together by a twisted pair of hook-up wire, couple some final amplifier plate tank energy back to the 10 meter doubler tank, L4. On ten meters the final amplifier grid tank is actually the V3 plate tank. When L5 and L7 are properly phased and the amount of rf coupling optimized, complete neutralization is obtained on the ten meter band. L3 and L8 accomplish the same for the twenty and fifteen meter bands. In the latter case however, one link coil is placed between the 20 and 15 meter portions of the plate tank coil and neutralization of both bands is accomplished simultaneously.

TVI Precautions

The major factors contributing to the freedom from TVI enjoyed with TT-180 transmitter are the excellent shielded enclosure and adequate by-passing of all leads entering and leaving the rig. Use of a link-coupled antenna tuner or a low-pass, low-impedance filter is absolutely required if TVI is to be minimized. Installation of C23, C36, C37, C40 through C46, C38 and C39 must be accomplished as outlined in the chapter on TVI of the Radio Amateur's Handbook.

Layout

The sides, top, bottom, and rear shield plates which make up the TVI shield enclosure were fabricated from 20 gauge sheet aluminum. They are mounted on a framework of $\frac{1}{2}$ x $\frac{3}{8}$ -inch aluminum bar stock, tapped for 6-32 screws about every two inches. Wherever the chassis and side plates contact the rear of the front panel, the paint was removed from the panel to insure good contact and to minimize TVI.

The area directly over the 6146 final amplifier tubes was cutout approximately $4\frac{1}{2}$ by 6 inches and covered from the bottom side with perforated sheet aluminum for ventilation. The area over the XTAL-VFO switch was also cut out, about $3\frac{1}{2}$ by $5\frac{1}{2}$ inches to allow access to the switch and the exciter tubes. The edges of the hole were lined with Eimac contact finger stock to provide a leak-proof removable

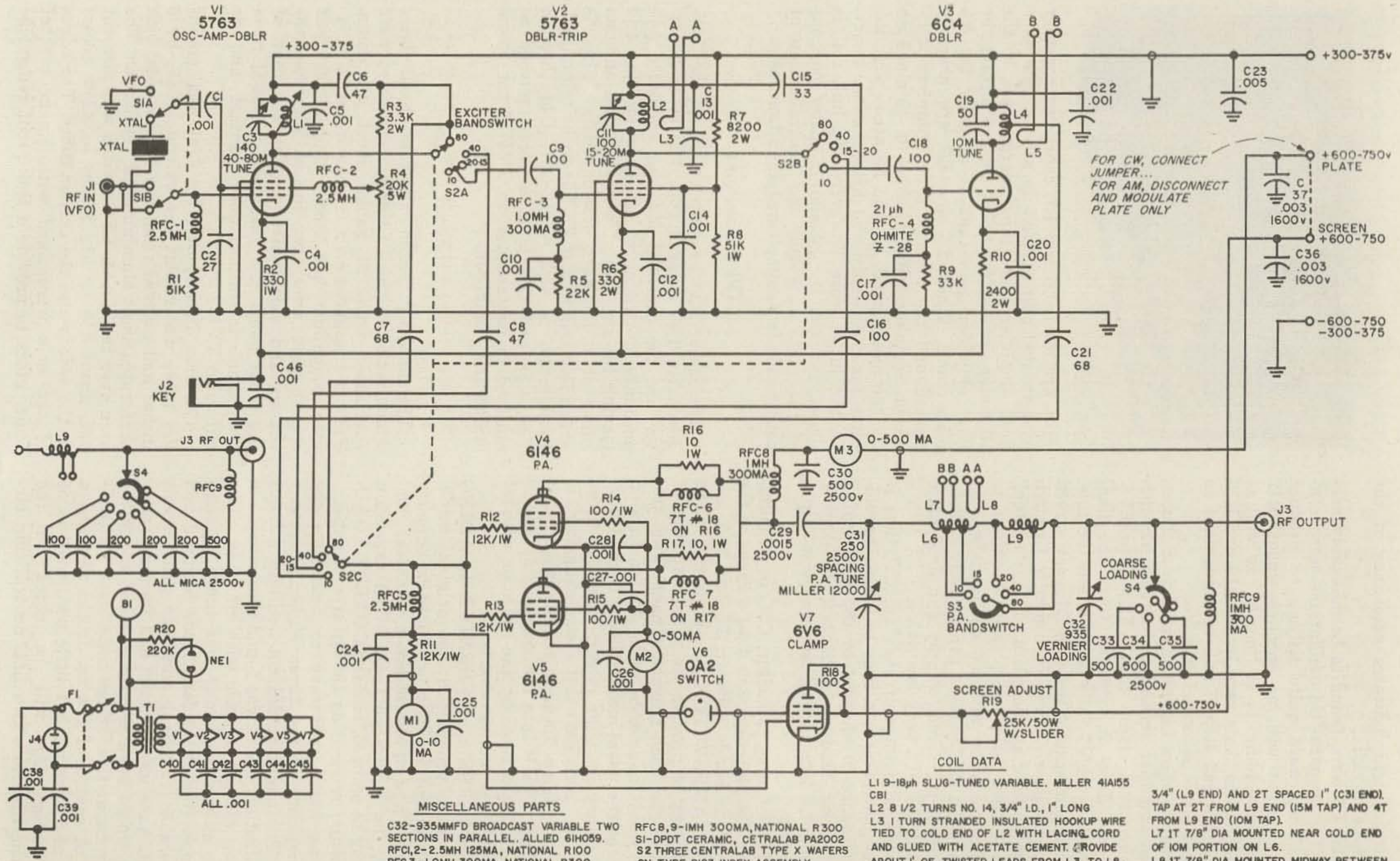

FOR CW, CONNECT JUMPER...
FOR AM, DISCONNECT AND MODULATE PLATE ONLY

MISCELLANEOUS PARTS

C32-935MMFD BROADCAST VARIABLE TWO SECTIONS IN PARALLEL. ALLIED 61H059.
RFC1,2-2.5MH 125MA, NATIONAL R100
RFC3-1.0MH 300MA, NATIONAL R300
RFC4-21μH, OHMITE Z28
RFC5-2.5MH 125MA
RFC6,7-7 TURNS NO. 18 SOLID WOUND OVER FULL LENGTH OF R16 & R17.

RFC8,9-1MH 300MA, NATIONAL R300 SI-DPDT CERAMIC, CETRALAB PA2002
S2 THREE CENTRALAB TYPE X WAFERS ON TYPE PI23 INDEX ASSEMBLY.
S3,4- CENTRALAB PIS PROGRESSIVELY SHORTING CERAMIC SWITCH SECTION. TYPE PI21 INDEX ASSEMBLY.

COIL DATA
L1 9-18μH SLUG-TUNED VARIABLE. MILLER 41A155
CBI
L2 8 1/2 TURNS NO. 14, 3/4" I.D., 1" LONG
L3 1 TURN STRANDED INSULATED HOOKUP WIRE TIED TO COLD END OF L2 WITH LACING CORD AND GLUED WITH ACETATE CEMENT. PROVIDE ABOUT 1' OF TWISTED LEADS FROM L3 TO L8.
L4 5 1/2 NO. 12 SOLID, 3/4" I.D., 1" LONG. TAP IT FROM 'TOP END FOR C21 CONNECT.
L5 SAME AS L3 BUT ATTACHED TO L4.
L6 6T NO. 12, 1 1/2" ID, 1 3/4" LONG. 4T SPACED

3/4" (L9 END) AND 2T SPACED 1" (C31 END).
TAP AT 2T FROM L9 END (15M TAP) AND 4T FROM L9 END (10M TAP).
L7 1T 7/8" DIA MOUNTED NEAR COLD END OF 10M PORTION ON L6.
L8 1T 7/8" DIA MOUNTED MIDWAY BETWEEN 20 AND 15M SECTIONS OF L6.
L9 22T NO. 16 1 1/2" DIA 2" LONG, B&W JEL-40 WITH LINK REMOVED. TAP 11T FROM END (40M TAP).

ALL RESISTORS ARE 1/2 WATT UNLESS OTHERWISE NOTED. ALL CAPACITORS ARE 500 VOLTS UNLESS OTHERWISE NOTED.

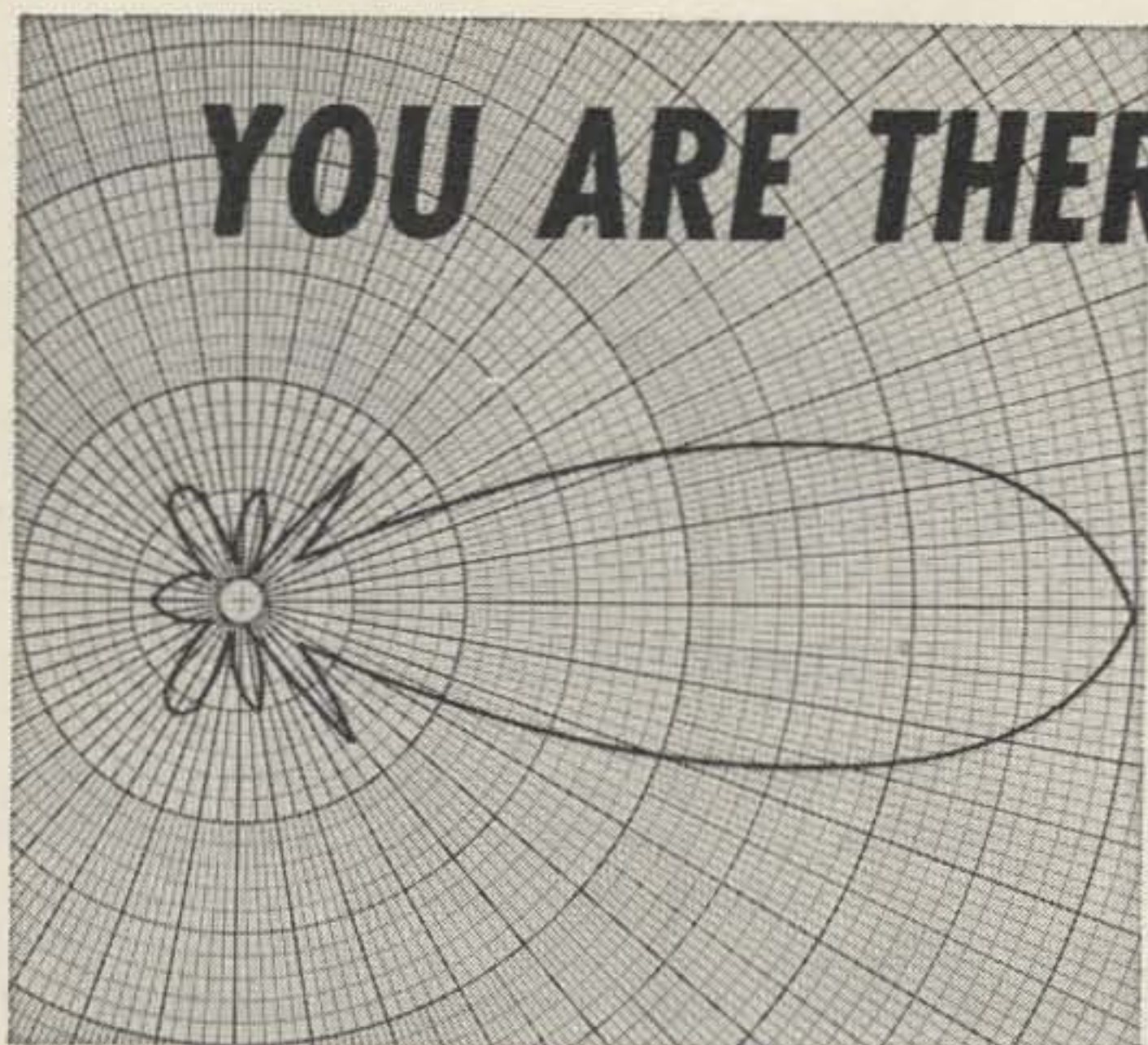

YOU ARE THERE!

with **telrex**
 —“the-performance-line”—
 with a “MATERIAL” difference!

NOW! A Broad-Band ‘Balun’ for your
 10, 15 and 20 Meter Tri-Band

\$16⁸⁵

MODEL BA1430/1-1

For **TOP-MAN-ON-**
THE-FREQUENCY results...

Install a Telrex antenna...dollar for
 dollar better in every way! Antenna
 systems from \$6.95 to \$12,000.00

ANTENNAS

SINCE
 1921

Communication and TV Antennas
telrex LABORATORIES

ASBURY PARK 40, NEW JERSEY, U.S.A.

cover plate which is fastened by two 6-32 wing
 nuts for fast removal.

The three panel meters are shielded from
 the rear by 4X4X2 inch aluminum utility boxes
 bolted to the rear of the front panel. Again,
 the areas under the edges of the meter shield
 boxes are scraped free of paint to insure good
 contact. Holes are drilled in the bottoms of the
 meter boxes to allow the meter leads to pass
 through rubber grommets.

Across the front of the chassis are the three
 tank capacitors for the tank circuits of V1,
 V2, and V3. The three tubes are located near
 their respective tuning circuits. The EXCITER
 BANDSWITCH, S2, is located to the rear of
 the exciter tube socks under the chassis and
 runs parallel to the front panel, being driven
 through a right-angle drive mechanism. Suit-
 able “L” brackets are made to support the
 drive mechanism (Millen type 10012) and the
 switch assembly. The tuning capacitors, C3,
 C11, and C19, are mounted to the panel so
 their shafts protrude through $\frac{3}{8}$ ” clearance
 holes. This is required because the capacitor
 shafts are at 360-375 volts dc. In order to
 insure against shock, the knobs used here must
 have deep-set set screws, and the set screw
 holes should be filled with glazing compound
 after the screws are tightened to prevent any
 possibility of contact with the set screws. The
 capacitors used for C3, C11, and C19 do not
 come equipped with $\frac{1}{4}$ -inch shafts for knobs.
 To remedy this, $\frac{1}{2}$ ” lengths of $\frac{1}{4}$ ” diameter
 brass rod were cut and soldered to the existing
 capacitor shafts.

The final amplifier tank components are
 mounted above the chassis on the right side,
 the tank tuning capacitor, C31, being to the
 front of V4 and V5 nearest the front panel.
 A shaft coupling and a quarter inch aluminum
 shaft were employed to extend the capacitor

shaft through the front panel bushing. To the
 left of C31 is the PA BANDSWITCH, S3,
 mounted on an aluminum “L” bracket whose
 height is chosen so the shaft of S3 comes
 through the front panel at the same height as
 the shaft of C31. Immediately behind S3 is the
 COARSE LOADING switch, S4. In order to
 maintain a functional grouping of front panel
 controls, S4 is mounted vertically through the
 chassis and driven through another Millen
 right-angle drive mechanism. Another im-
 portant reason for this mounting arrangement
 is to keep all final amplifier circuit elements
 above the chassis to prevent feedback to the
 grid circuit components which are all below
 the chassis.

If it is decided to use the VERNIER LOAD-
 ING capacitor, C32, note that it is mounted to
 the left and rear of S4 and driven through two
 holes in the chassis by a dial cord. The dial
 cord in turn is driven by a $\frac{1}{4}$ -inch shaft below
 the chassis supported by two panel bushings,
 one at either end. The capacitor was obtained
 from a discarded broadcast receiver and came
 equipped with a large dial cord pulley and
 spring tension device. Two clearance holes
 were made in the chassis to pass the dial cord.

The plate RFC, RFC-8, is mounted between
 V4 and V5, with plate by-pass C30 mounted
 with the shortest possible leads from the bot-
 tom terminal of the choke to the chassis. An
 octal socket-size hole was punched through the
 chassis near the ground connection of C30 to
 provide a short rf path from the plate circuit
 through the chassis to the cathode terminals of
 the final tubes under the chassis. This was
 found to be important in terms of TVI sup-
 pression.

The exciter portion of the rig, V1, V2, and
 V3, is wired by the point-to-point method, all
 disc ceramic capacitors being connected with

leads about $\frac{1}{4}$ " long or shorter. The unused terminals on the EXCITER BANDSWITCH, S2 were used to provide terminal connection points for many components, notably, R2, R3, R6, R7 and the 360-375 volt dc line. All of the coupling capacitors associated with the band-switched circuits were mounted directly on the bandswitch, S2.

The exciter tank coils, L2 and L4 are soldered directly on their tuning capacitors, C11 and C19. L1, a stud-mounted slug-tuned coil, is on the chassis near the connections of C3 and near V1.

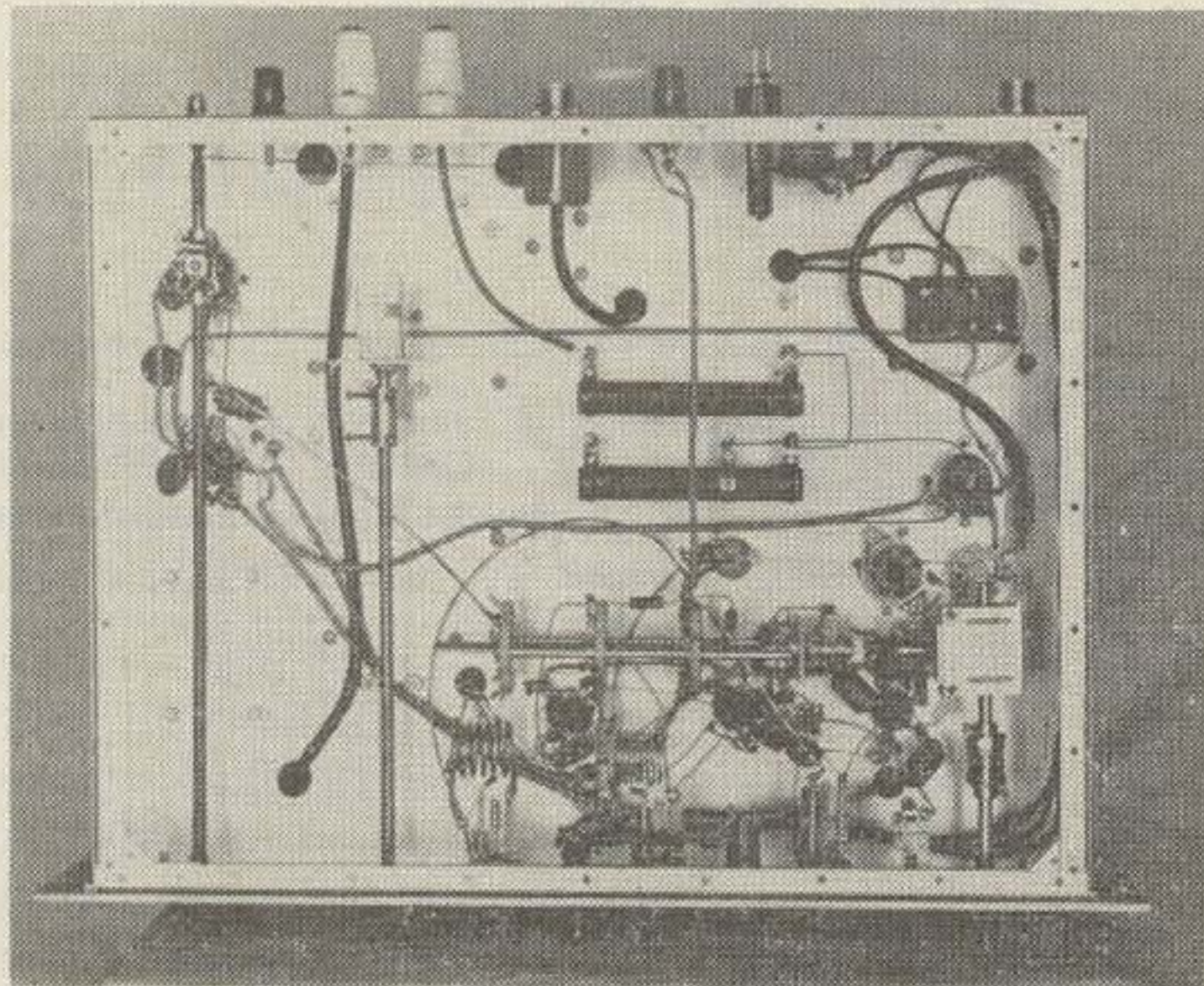

The neutralizing coils, L3 and L5, are made from single loops of flexible hook-up wire and are made up with twisted leads about 18 inches long to extend through grommet lined holes in the chassis up to the final tank coil area. The coils are tied to the "cold" ends of L2 and L4 with lacing cord and then cemented with acetate cement. L7 and L8 are supported by two-terminal tie strips atop $1\frac{1}{4}$ " high ceramic spacers near L6, and the twisted leads from L3 and L5 are trimmed to length and connected to L7 and L8.

The grid parasitic suppressors, R12 and R13, are mounted as close to the tube sockets as possible, as are the screen suppressors, R14 and R15. C28 and C27 are mounted as closely to the resistors as possible and grounded through $\frac{1}{8}$ " leads for low-impedance screen grounding.

The final tank coils and coupling capacitor, C29, are mounted on $1\frac{1}{4}$ " high ceramic spacers threaded for 6-32 screws at both ends. The coil connections to the PA BANDSWITCH are made with strips of copper sheet $\frac{1}{4}$ " wide to minimize rf losses at the higher frequencies.

All power wiring, including the high voltage leads was done with shielded cable, RG-59/U coax being used for all leads carrying in excess of 400 volts. The shields were grounded at both ends of each run.

It is important to connect all cathode pins of V4 and V5 together with heavy solid wire and to ground pins 1, 4, and 6 to the socket ground lugs. The rotor lead from S2C to the final grid circuit is made with a length of num-

ber 14 solid wire.

The leads entering the meter shield boxes must be shielded and the shields grounded just *before* the leads enter the boxes to prevent harmonic currents from flowing inside the boxes and on out to the front panel surface.

The loading capacitors associated with the COARSE LOADING switch, S4, are run down from the switch directly to ground lugs on the chassis.

Adjustment and Operation

After all wiring is complete and has been double checked for wiring errors, connect the ac cord to the chassis and turn on the HEATERS switch, S5. Check for blower operation and be certain all tube heaters are lighted.

Next, connect the 360-375 volt dc power (do not connect the high voltage) and place the EXCITER BANDSWITCH, S2, in the 80 meter position. With an 80 meter crystal in the crystal socket and S1 in the XTAL position, depress the key and tune C3 until grid drive is registered on M1. 80 meter drive should be obtained with C3 nearest to maximum capacitance. With C3 at resonance and the EXCITATION control, R4, at maximum clockwise position, the grid current meter should register at least 10 ma of grid drive. Do not leave the key down for more than a few seconds with grid drive in excess of 5 or 6 ma in order not to damage the final amplifier tubes.

Change the EXCITER BANDSWITCH to the 40 meter position and again depress the key and tune for final grid drive. The oscillator stage is now doubling from 80 to 40 meters and drive in excess of 10 ma should be found. If output on 80 and 40 are not obtained as outlined above, change the setting of the tuning slug in L1 (a grid dip meter is useful here) until both 80 and 40 meter outputs are obtained. 80 meter resonance should occur at about "2 o'clock" and 40 meter resonance at about "10 o'clock." The decals are installed in the proper positions to indicate the approximate knob settings for resonance on either band.

If a VFO is used, repeat the above procedure using a VFO with 80 meter output fed into J1. Set the XTAL-VFO switch to the VFO position. If it is not planned to operate on 80 meters then a VFO with output on 40 may be employed. In either case, the EXCITER BANDSWITCH must be set to the appropriate band.

With V1 set up as above to deliver 40 meter output, switch S2 to the 20/15 meter position and with the key depressed resonate C11 to the 20 meter position, near "2 o'clock" on the dial. Grid current in excess of the required 5 or 6 ma should flow. Note that C11 allows doubling to 20 or tripling to 15 meters at the same EXCITER BANDSWITCH position. Grid drive on 15 should be found near the "10 o'clock" position of the C11 knob. A grid dip

50 OHM

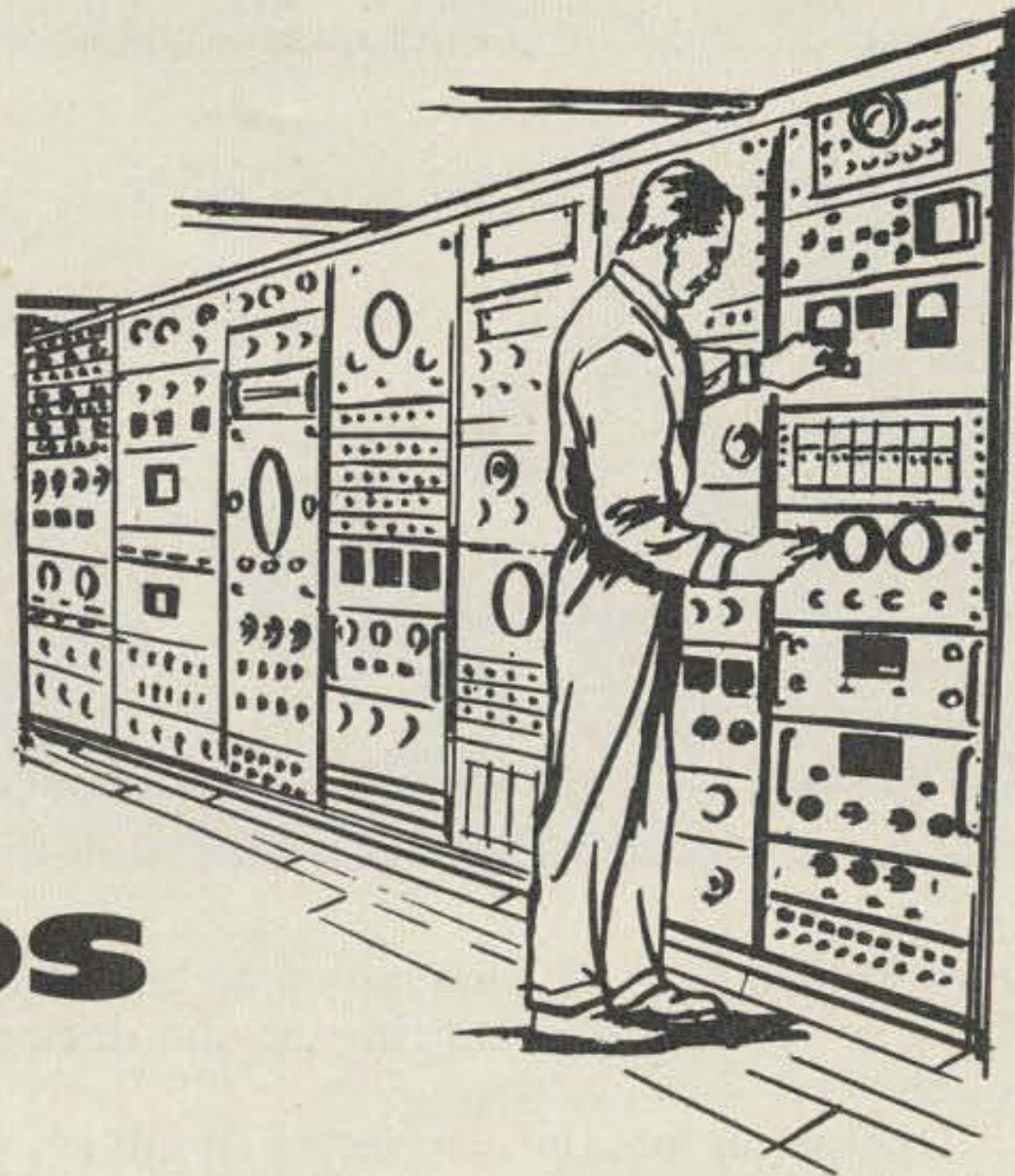
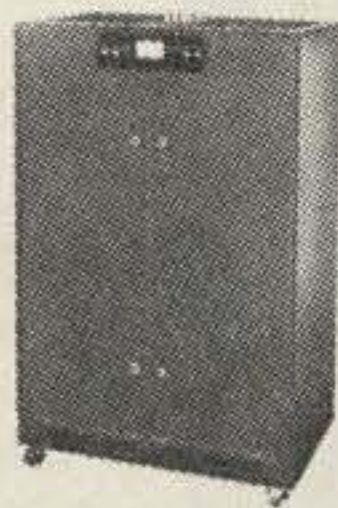

DUMMY LOADS

TMC MODEL NUMBER	MILITARY NOMENCLATURE	FREQUENCY RANGE	AVERAGE POWER (In watts)	PEAK ENVELOPE POWER (In watts)
TER-250-300 U		DC to 30 mc	250	500
TER-500-70 U		DC to 30 mc	500	1000
TER-500-600 B	DA-199/U	DC to 30 mc	500	1000
TER-1800-300 U		DC to 30 mc	1800	3600
TER-3500-70 U		DC to 30 mc	1750	3500
TER-3500-600 B	DA-200/U	DC to 30 mc	1750	3500
TER-5000-50U	DA-209/U	DC to 30 mc	5000	10,000
TER-5000-70 U	DA-210/U	DC to 30 mc	5000	10,000
TER-5000-300 U		2-30 mc	5000	10,000
TER-5000-600 B	DA-201/U	DC to 30 mc	5000	10,000
TER-18KA-50 U		DC to 30 mc	18,000	36,000
TER-18KC-50 U		DC to 30 mc	18,000	36,000
TER-18KA-70 U		"	18,000	36,000
TER-18KC-70 U		"	18,000	36,000
TER-18K-600 B		4-28 mc	18,000	36,000
TER-18K-600 BF		4-28 mc	18,000	36,000
TER-25KA-50 U		DC to 30 mc	25,000	50,000
TER-25KC-50 U		"	25,000	50,000
TER-25KA-70 U		"	25,000	50,000
TER-25KC-70 U		"	25,000	50,000
TER-25K-600 B		4-28 mc	25,000	50,000

To meet an increasing requirement, a 5 KW Average power (10 KW PEP) dummy load at 50 ohm with measured VSWR of 1.1 to 1 has been added to

TMC **TER** SERIES

Other models feature:

- 50 ohm, 70 ohm, 300 ohm and 600 ohm termination
- DC to 30 Mcs coverage
- Operating ambients of -40°C . to $+75^{\circ}\text{C}$
- Low VSWR
- Weather proof cases

Request Bulletin 8009



The **TECHNICAL MATERIEL CORPORATION**
MAMARONECK, NEW YORK

and Subsidiaries
OTTAWA, CANADA • ALEXANDRIA, VIRGINIA • GARLAND, TEXAS
LA MESA, CALIFORNIA • POMPANO BEACH, FLORIDA

For companion RF Broadband Transformers refer to Sales Service Bulletin #8015.

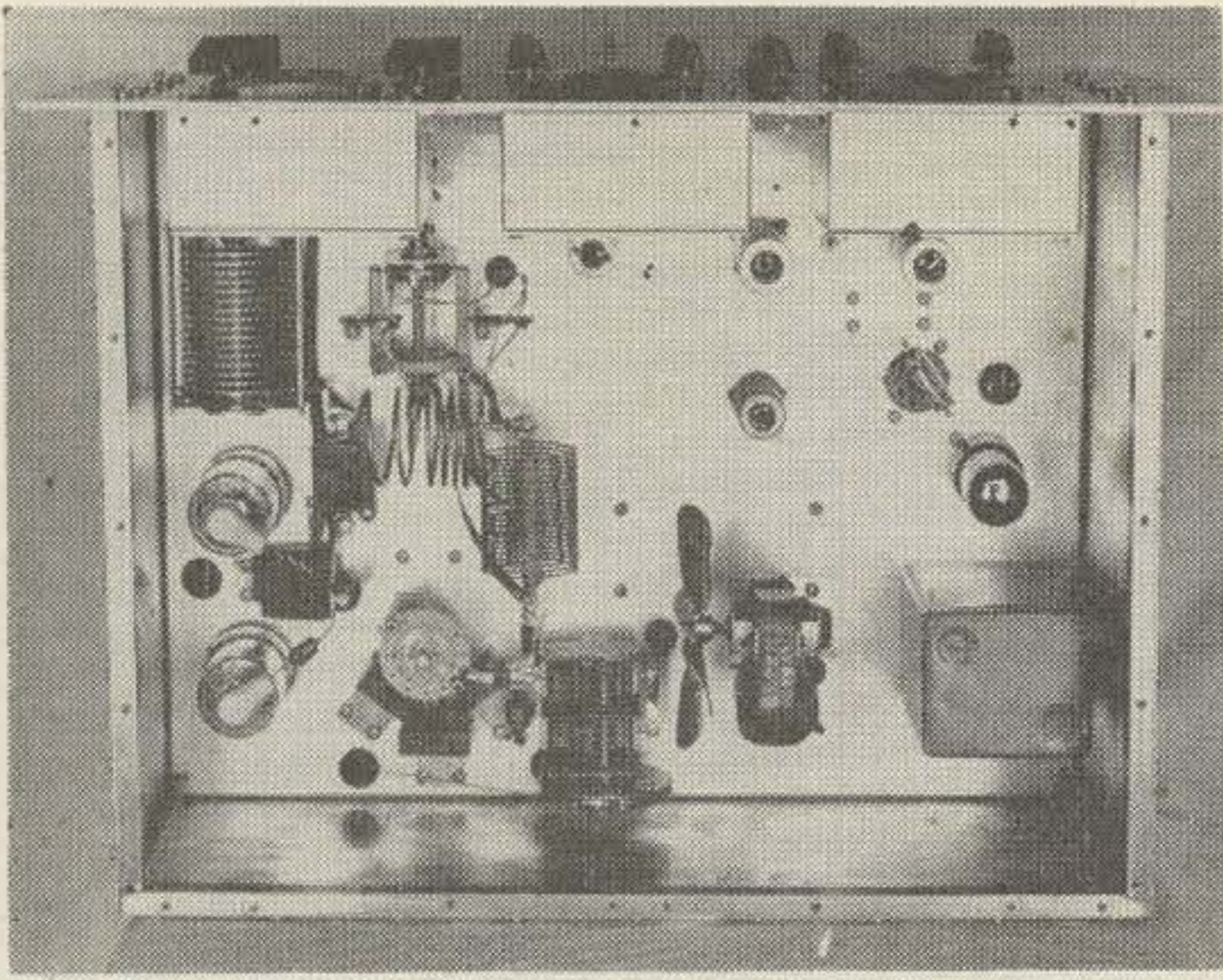

meter is useful at this point to make certain that resonance is occurring at the desired frequencies.

Operation of the 10 meter doubler, V3, is checked with V1 set for 40 meter output, V2 set up for 20 meter output, and the EXCITER BANDSWITCH in the 10 meter position. Resonate C19 for 10 meter grid drive.

Neutralize the transmitter as follows. With the RF OUT jack, J3, connected to ground through a 75-ohm $\frac{1}{2}$ watt resistor (no high voltage), and both bandswitches in the 10 meter position, obtain a grid drive of 6 ma on M1. Rotate the PA TUNING capacitor slowly through the resonance and note whether M1 "flicks" slightly as the resonant point is passed through. Adjust the position of L7 with relation to L6 until no variation of M1 occurs as the PA TUNING is moved through 10 meter resonance. For the most sensitive indication, set S4 for minimum capacitance. If neutralization cannot be obtained, interchange the wires from L5 where they connect with L7 and try again. The proper position of L7 is directly over the 10 meter tap of L6 at the "cold" end of the 10 meter section of the coil.

Repeat the above procedure with first 20 meter grid drive and the PA BANDSWITCH in the 20 meter position, and then 15 meter grid drive and the PA BANDSWITCH in the 15 meter position. Adjust L8 for minimum grid current variation as the PA TUNING is passed through resonance on the two bands. Note that the adjustment of L8 is a compromise between the two bands and that the position of L8 is halfway between the 20 and 15 meter taps of L6.

When the exciter portion of the rig has been checked out and the rig has been neutralized as outlined above, make up a dummy load consisting of a 150 watt light bulb connected to a short length of coaxial cable with a rf connector to connect the RF OUT jack, J3.

Before connecting the high voltage to the rig, set the COARSE LOADING switch, S4, for maximum capacitance and adjust R19 with an ohmmeter for a resistance of approximately 15,000 ohms. Next set up the exciter to provide

6 ma of 80 meter grid drive to the final. Now connect the high voltage lead (power turned off!) and with the 80 meter position indicated by the PA BANDSWITCH, turn on the high voltage supply. Note the reading of the PLATE meter, M3, which should not read more than 40 ma or so. Depress the key and immediately rotate the PA TUNING control until the resonant dip of plate current is found. Do not hold the key down for more than a few seconds until resonance is positively established to avoid overdissipating the final amplifier tubes.

Advance the COARSE LOADING control a step at a time while maintaining resonance with the PA TUNING control until a final plate current of about 240 ma (if 750 plate volts) or 300 ma (if 600 plate volts) is obtained. The VERNIER LOADING control can be used to trim the current to the exact value. At this point the 150 watt light bulb should be burning at near full brightness. When the key is released, the screen "switch" tube, V6 should go out, and the plate current should drop to 30 or 40 ma.

Using proper caution against shock, measure the screen grid voltage with the key depressed and the rig fully loaded into the dummy load. If 600 plate volts is used, adjust R19 for a screen voltage of 180. If 750 plate volts is used, adjust R19 for 160 screen volts. If the rig is to be plate modulated, the plate voltage must be no higher than 600 and the screen voltage must be 150 volts.

Repeat the tuning procedure for each of the remaining bands with the exciter set up to deliver grid drive on each band and the PA BANDSWITCH and PA TUNING adjusted accordingly. All bandswitching should be done with the high voltage turned off in order to prevent burning of the switch contacts. If the key is left up bandswitching can be done with the high voltage left on.

Note that the loading controls provide maximum loading at the minimum capacitance position.

The screen grid total current on M2 should be between 18 and 22 ma when the final voltages currents and loading are correct.

When plate modulating the transmitter, disconnect the jumper between the plate and screen high voltage terminals at the rear of the chassis. Feed modulated high voltage to the plate and unmodulated to the screen. A modulator output impedance of about 3800 ohms is correct with 600 plate volts and the recommended 224 ma of plate current. With plate modulation, the grid drive current must be higher than for CW operation, about 6.5 to 7 ma.

Operation, stability, and results have been particularly gratifying with the TT-180 in the several months this rig has been on the air at W2RWJ. Reports have been consistently above average, and I am quite pleased that the 6AG7-6L6 combination went by the board. Good luck with your TT-180!

. . . W2RWJ

The Instantaneous Dissipator Tube

A Versatile Medium Powered Final Amplifier Using An Unusual Power Supply And A Special Voltage Regulator

Robert Baird W7CSD
3740 Summers Lane
Klamath Falls, Oregon

THE purposes of this article are threefold. First will be the use of the voltage doubler circuit for a medium high voltage power supply. Second will be a special voltage regulator to be added to the power supply which will work under the difficult working conditions of a single side band linear. Third will be the amplifier itself which though not entirely unique, can be used in several modes of operation with all band operation and it fills out the complete picture of the three units working together.

The Power Supply

There are all kinds of chunky TV replacement transformers available to hams at the present time. Being the proud owner of a couple of these I began to wonder how I could use them for a ham power supply. 350 volts isn't very much and 700 out of a bridge has its limitations, but you might really be able to do something with 1400. So I began to speculate about using a voltage doubler circuit. For the past several years I have used a pair of 5R4GY's in a voltage doubler using existing filament windings on one of these TV transformers and it isn't hard to get 1500 volts at 100 ma. This gets both bulky and hot and you worry about the insulation in the filament windings. Now comes the day of the cheap silicon rectifier. Just what the doctor ordered.

A common mistake among hams is to assume that they can stick in a couple of 400 volt inverse peak silicons in place of a 5U4 in just any old power supply and everything will be just dandy. So they turn on the juice and POOOOF! Nope, they *were* good rectifiers. You just didn't use the old bean. Take a gander at Fig. 1.

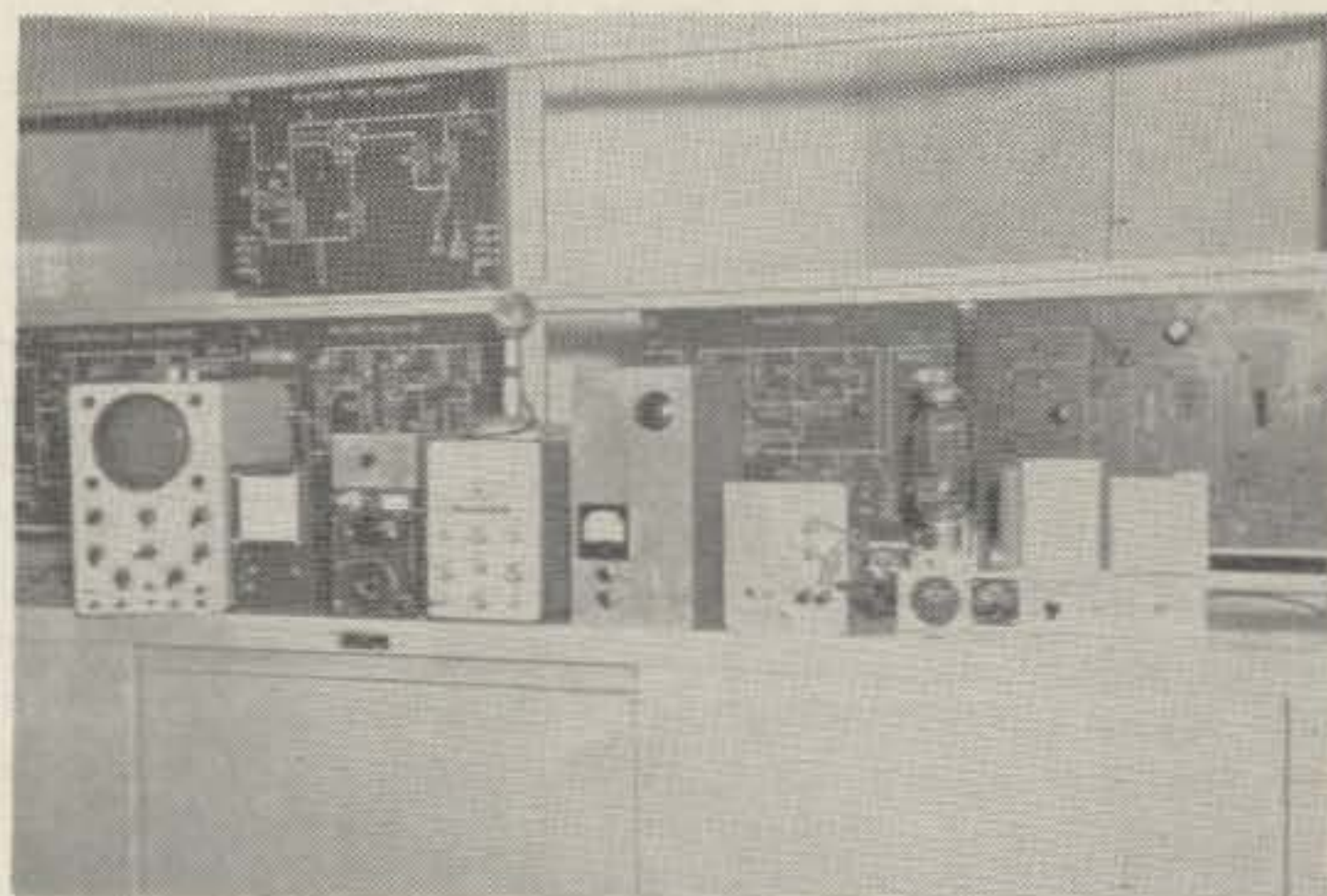
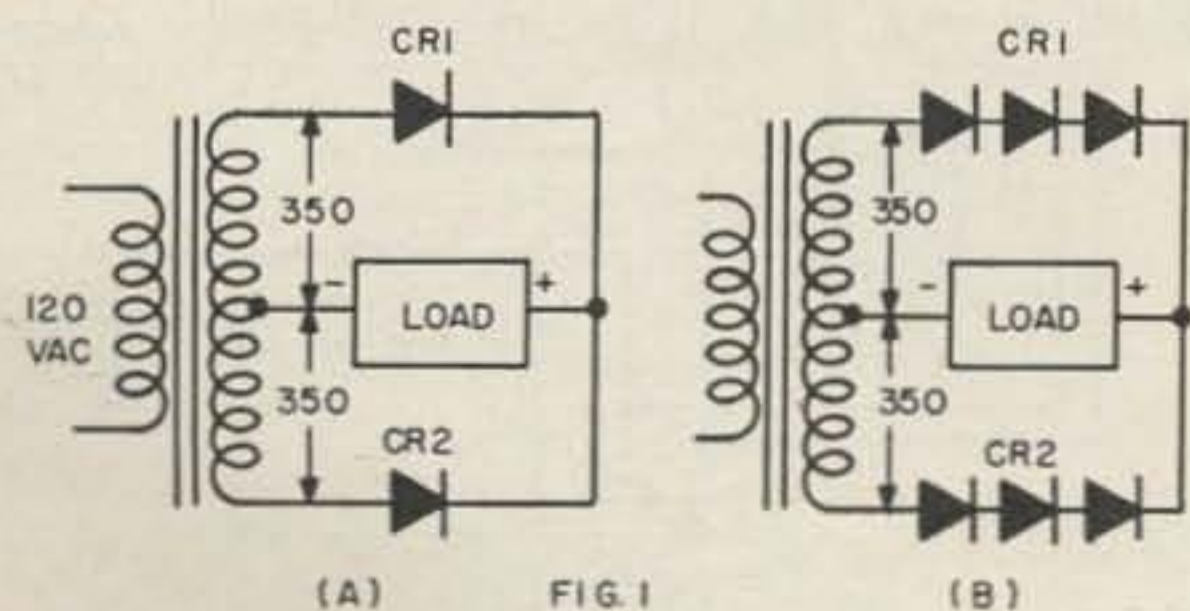

In the first place the 350 volts is RMS so the peak voltage is 350×1.414 or nearly 500 volts. In the second place let's consider rectifier CR_1 in the conducting condition and CR_2 in the non-conducting condition: If CR_1 is conducting there is very very little drop across it; therefore, the entire voltage of both halves of the secondary is across CR_2 in the nonconducting or inverse direction. At the instant of peak voltage this amounts to approximately 1000 volts. Small wonder that your 400 volt inverse peak rectifier went POOOOF! Thus it can be seen that to be on the safe side three of these silicon rectifiers should be in series on each side of the circuit. Fig. 1b.

Now the interesting part of the voltage doubler circuit is that you need exactly the same number of rectifiers to get 1400 volts as you need to get 350. See Fig. 2.

It can be seen that each set of rectifiers is working across the entire secondary separately or 700 volts RMS (1000 volts peak) which is the inverse voltage situation for the 350 volt full wave supply. In the voltage doubler case the capacitors charge up separately to 700

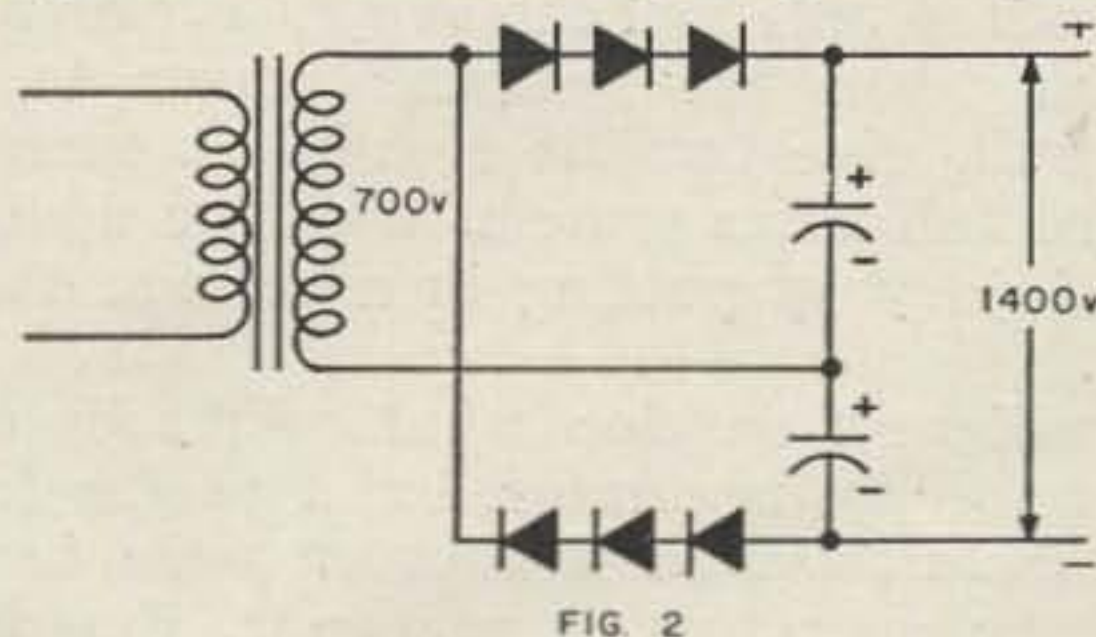

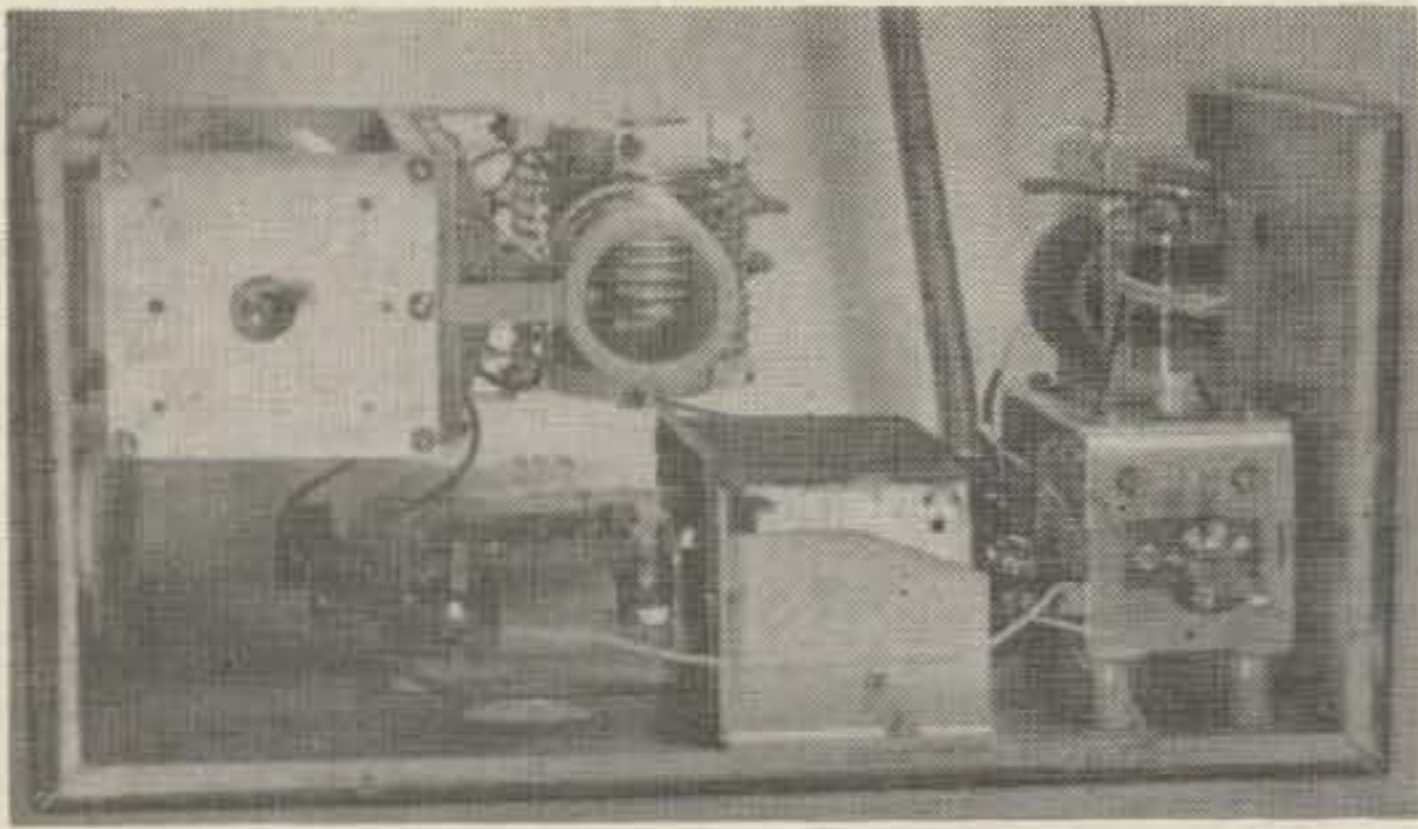

volts each (between 700 and 1000 depending on the load) and discharge in series a total equal to the sum of the two. This may be on the order of 1400 to 1600 volts with a 200 ma load. Of course you would probably put in a filter choke and another filter capacitor in actual operation. If you use 10 mfd 1000 volt leader condensers and a 10 henry choke followed by another 4 to 8 mfd at 2000 volts, you have a good 1500 volt power supply for a constant load. It takes up a minimum of space too. If you are only interested in AM phone or possibly NBFM you can stop right here. But you better think twice if you anticipate CW or SSB operation. If you take off the load as you do when you lift the key or when you stop talking on SSB, your voltage will go sky high up to the peak double voltage. This is likely to lead to chirps or poor phone quality. Also if you have overrated your filter capacitors they may blow up.

The Instantaneous Dissipator Tube

For many years the voltage regulated power supply in the 300 to 400 volt range has been very common. These involve a regulator tube in series with 500 or 600 volts and can be designed to give extremely good voltage regulation. Very little application of this principle has been made for high voltage power supplies. Actually about all that has been done on high voltage supplies is to put in a fairly heavy bleeder to keep the voltage from going too high when the key is up or when the operator stops talking into a SSB rig.

Having listened to some of the high power SSB boys I have come to one conclusion. The stations that do not sound good probably have about 30% to 40% voltage regulation in the power supply furnishing power for the final linear amplifier. If they are close to class B the plate current excursion could run to several hundred mils and the supply is practically unloaded when the operator ceases to talk. This would give terrible regulation even to a standard full wave system. We have added insult to injury by putting in a voltage doubler system.

We will now develop what might be called a shunt voltage regulator, but I prefer to call it the *instantaneous dissipator tube* because this is the operation it performs. Essentially

this is what the instantaneous dissipator does. When there is no excitation to the final amplifier either due to key up conditions or no speech on SSB, the tube is biased so that it will draw the same current as the amplifier would under peak conditions. When the amplifier is operating at peak condition the dissipator tube is cut off and draws no current. At intermediate points the combination of amplifier plate current and dissipator plate current add up to a total of the amplifier peak current. Thus under this condition, idealized, the power supply always has a constant load and consequently constant voltage would prevail. In practice this can be closely approximated.

This type of system calls for a big tube capable of dissipating the entire final amplifier input power at least for short periods of time. There are numerous surplus tubes on the market capable of serving this purpose. You can't buy 304TL's for 75 cents any longer, but I have seen 211's for about a dollar. And most hams have a half dozen dead Indians in the junk box. I came up with an HF-200, liberated from an obsolete diathermy machine some years ago. It was the first try and it worked. A couple of 211's should work equally well.

Now how do we get it to work? First determine the bias necessary for the dissipator tube to draw the right amount of current with transmitter at zero current. This can be done experimentally with a battery or if you have a separate filament transformer for the dissipator tube, cathode bias can be used. Find the proper size of resistor to put between the center tap and the B—. In my case the HF-200 drew 240 ma. at 1400 volts, which was approximately the current of the final, with zero bias. This looks like too much dissipation, but it takes quite a while for the tube plate to get red under these conditions and under talking or CW conditions it works fine. The next problem is supplying additional bias as the final draws more and more current. This

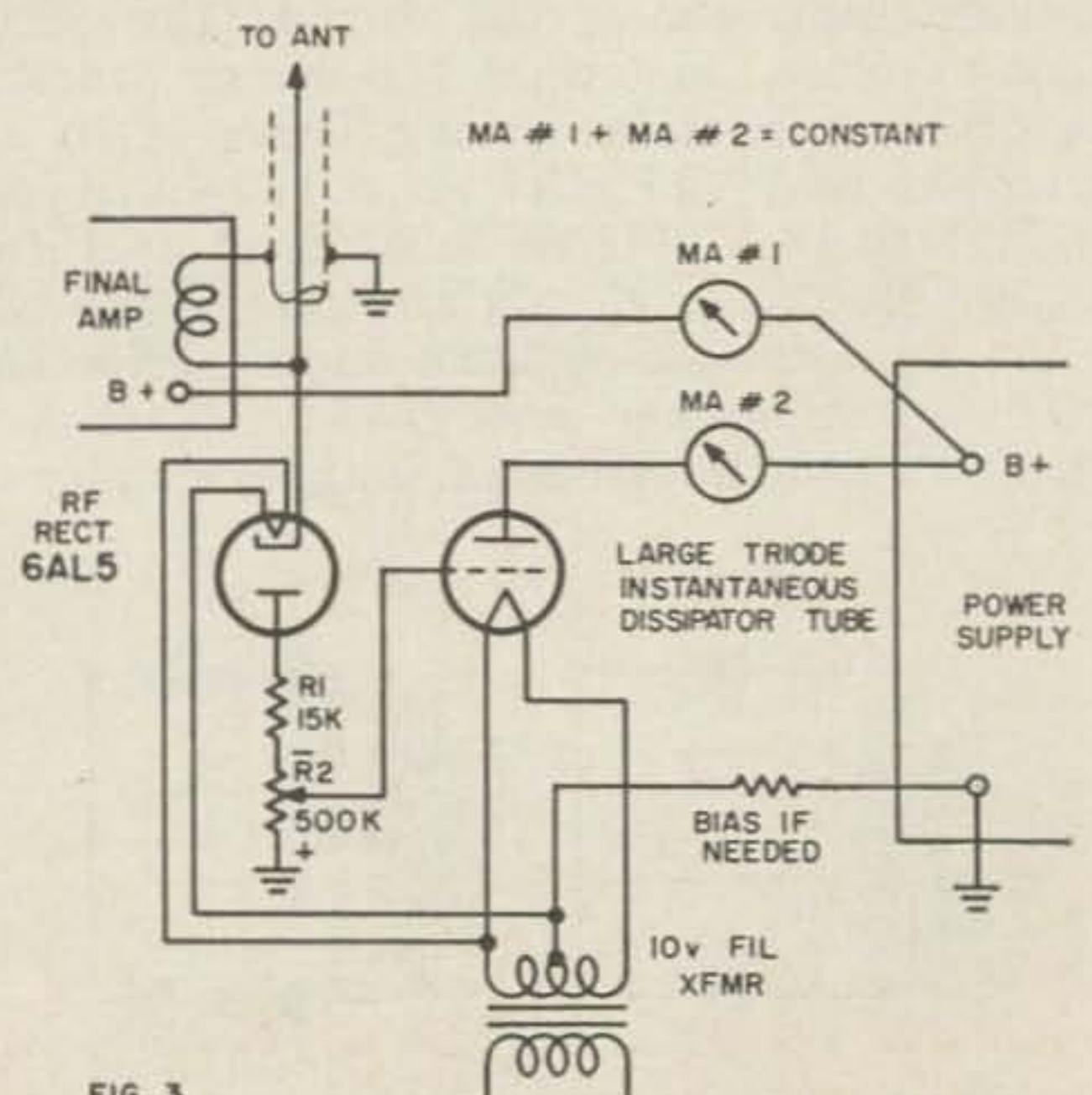

FIG. 3

is accomplished by using a diode detector connected right to the final amplifier output as can be seen from Fig. 3. The 6AL5 furnishes a negative voltage proportional to the rf output of the amplifier. If the amplifier is operated at peak or CW output you can adjust the 500K pot R₂ so that the dissipator tube draws no current. (I actually run it at about 20 milliamps to improve linearity at intermediate points.)

The question arises, why not use a semiconductor instead of the 6AL5? I tried it and two troubles appeared. First, semiconductors in general were not designed to rectify 100 volts or so of *rf* and they heat up, causing the bias to drift badly. Secondly, between no load and full load the results are very non-linear. In my case the current drawn from the power supply varied from 240 mils down to nearly 100 mils at the worst point. Using the 6AL5 with filament on one half of the 10 volt filament transformer I get a current differential of less than 30 mils in 240.

Using the system in Fig. 3, and the final later to be described I was able to get a voltage regulation of about 30 volts in 1400. This was observed by manually adjusting the excitation between zero plate current and maximum in the final. On SSB very little fluctuation of a voltmeter on the plate circuit can be observed.

Obviously the instantaneous dissipator tube may be used with any power supply. The fact

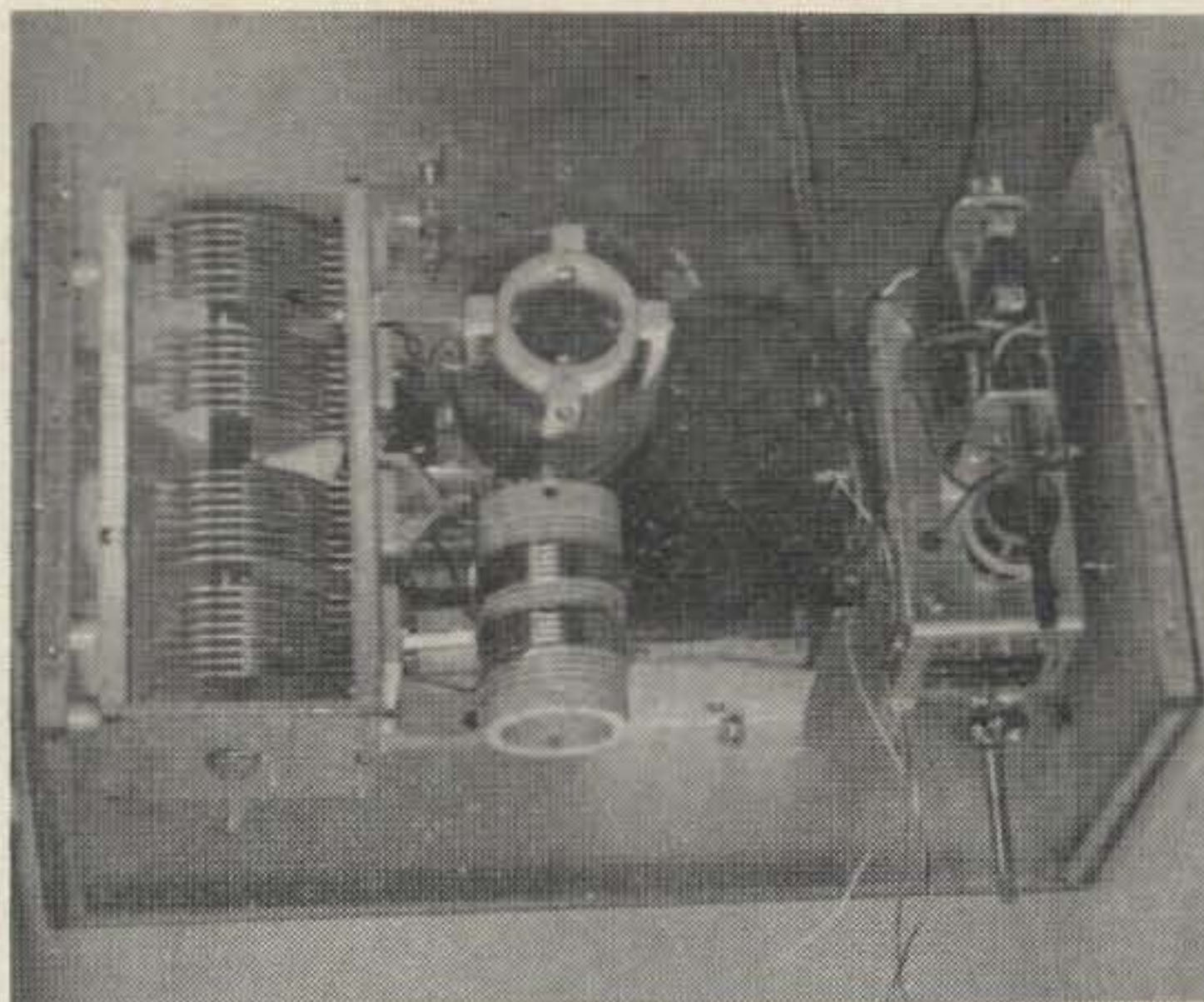

that it works this well with a voltage doubler circuit indicates it would work even better in a standard full wave supply. The advantages to the SSB man or CW man should be self evident.

The final amplifier is an integral part of this whole project as is the exciter. ¹ Although nothing startling has been developed in the final, some readers might be interested in what the foregoing power supply with instantaneous dissipator was working into. I had long wanted an all band medium powered final and had several WE-312A tubes at about the time National All Band Tuners became available at

EXCLUSIVE

SAVINGS ON NEW SEMICONDUCTORS !!

ZENER DIODES		RECTIFIERS		RECTIFIERS	
3/4 watt 20% 4.3piv	\$1.15	100ma 1000piv hi-V silicon	\$1.70	2amp 50piv axial lead	\$0.15
3/4 watt 20% 6.2piv	1.15	100ma 1500piv hi-V silicon	2.25	2amp 100piv axial lead	.27
3/4 watt 20% 8.5piv	1.15	100ma 2000piv hi-V silicon	2.95	2amp 200piv axial lead	.40
3/4 watt 20% 15. piv	1.15	100ma 3000piv hi-V silicon	4.45	2amp 400piv axial lead	.85
3/4 watt 20% 22. piv	1.15	500ma epoxy, similar 1N2069	.30	2amp 600piv axial lead	1.20
1 watt 20% 4.3v	1.35	500ma epoxy, similar 1N2070	.40	2amp 800piv axial lead	1.60
1 watt 20% 6.2v	1.35	500ma epoxy, similar 1N2071	.70	2amp 1000piv axial lead	2.80
1 watt 20% 8.5v	1.35	750ma 50piv replaces 1N599	.11	2amp 1500piv axial lead	4.30
1 watt 20% 15. v	1.35	750ma 100piv replaces 1N600	.20	2amp 2000piv axial lead	6.00
1 watt 20% 22. v	1.35	750ma 200piv replaces 1N602	.33	12amp 50piv replaces 1N1199	.75
Double anode 6.3v ±20%	.50	750ma 300piv replaces 1N603	.39	12amp 100piv replaces 1N1200	1.20
		750ma 400piv replaces 1N604	.48	12amp 200piv replaces 1N1202	1.75
		750ma 500piv replaces 1N605	.60	12amp 400piv replaces 1N1204	2.60
		750ma 600piv replaces 1N606	.75	12amp 600piv replaces 1N1206	3.75
		750ma 700piv	.95	12amp 800piv	6.90
		750ma 800piv	1.25	12amp 1000piv	9.50
		750ma 900piv	1.50	20amp to 400piv	14.00
		750ma 1000piv	1.95	25amp 50piv replaces 1N248A	1.50
		750ma 1500piv	3.25	25amp 100piv replaces 1N249A	2.50
		750ma 2000piv	4.15	25amp 200piv replaces 1N250A	3.70
		2amp 50piv replaces 1N2026	.17	25amp 400piv replaces 1N2136A	4.75
		2amp 100piv replaces 1N347	.30	25amp 600piv replaces 1N2138A	7.75
		2amp 200piv replaces 1N2027	.45	25amp 800piv	10.00
		2amp 400piv replaces 1N2029	.90	50amp 25piv	2.70
		2amp 600piv replaces 1N2031	1.35	50amp 50piv similar 1N411B	3.98
		2amp 800piv replaces 1N1236	1.75	50amp 100piv similar 1N412B	5.98
		2amp 1000piv replaces 1N3366	2.90	50amp 200piv similar 1N413B	6.50
		2amp 1500piv replaces 1N3371	4.70	50amp 400piv	9.75
		2amp 2000piv	6.50	50amp 600piv	16.00
		2amp — similar 2N1600	3.50		

NOTE: All semiconductors listed above are NEW-CLEAN! Fully guaranteed. Subject to your approval. AMERICAN MADE and individually tested to meet above ratings.

SEND FOR FREE CATALOG
Available direct or through
your local distributor

ALCO ELECTRONICS

21 SO. BROADWAY
LAWRENCE, MASS.

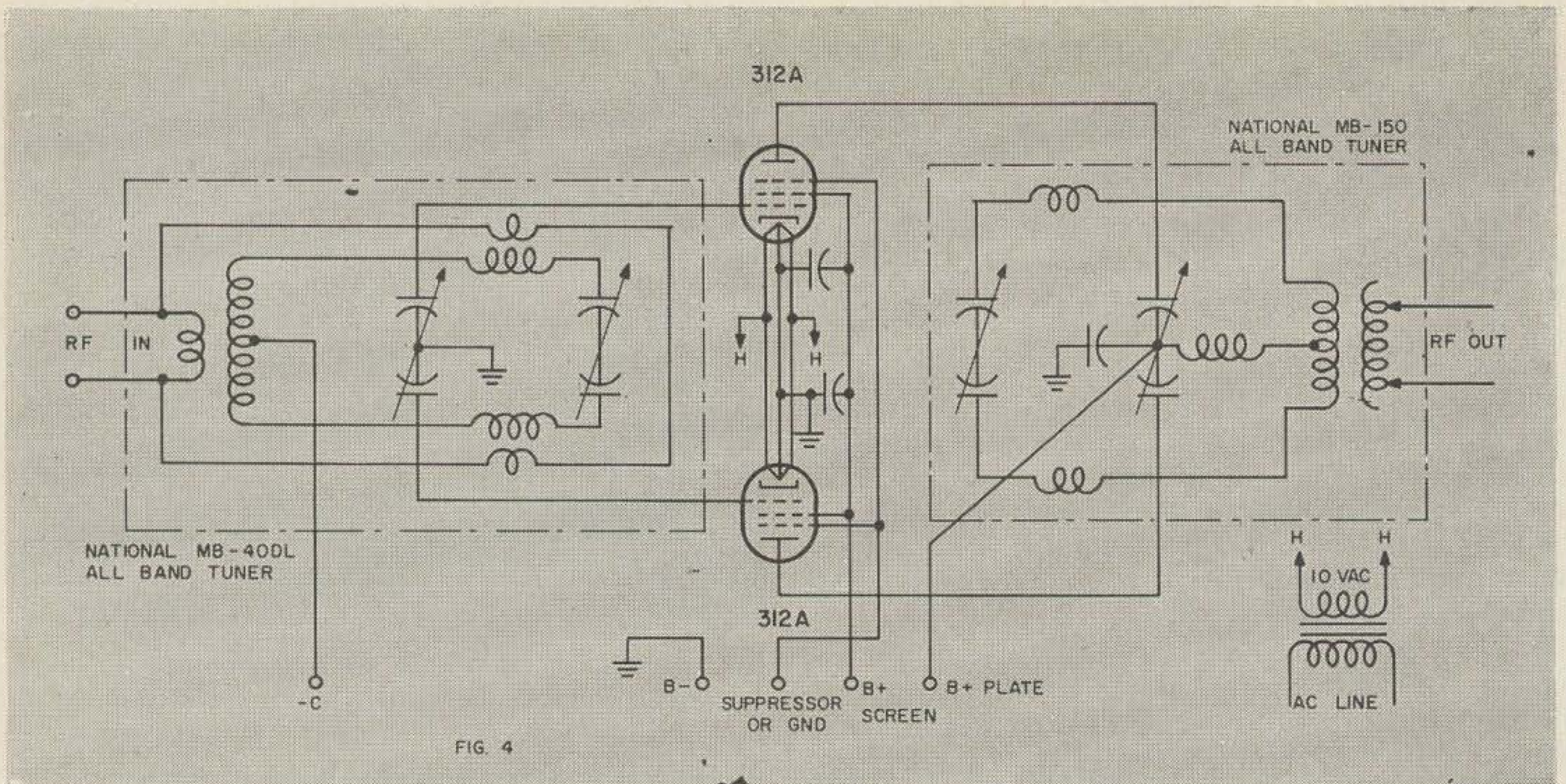

FIG. 4

bargain prices. This explains the reasons for the particular final here explained.

I followed the well known philosophy of hams, and sometimes I suspect even commercial manufacturers, of finding first a box and then designing the equipment to fit the box. I wound up with the grid circuit lying side ways in the bottom, the tubes mounted in an old GF-11 coil can, and the plate tuner hung upside down from the top of the can. The meter is a two scale 0 — 30 and 0 — 300 millimeter and not one that most people would be likely to have; so the circuit diagram is drawn with two meters. The circuit is straight forward push pull. It has no neutralization and no parasitic suppressors and so far works fine on 80, 40, 20, 15, and 10 meters. Maybe I was just lucky. 312A's have been available on the surplus market although 814's might be just as good. The 312A does have a suppressor grid and is a very fine suppressor grid modulated tube (handbooks rate them at 23 watts output or 46 for a pair). With suppressor grid modulation at 1500 volts I have been able to get about 65 watts out. The tubes show quite a bit

of color, but otherwise work fine. On straight CW you can easily triple this. Peak power in on SSB can run about 400 watts. That assumes proper bias for a linear. The bias connections are brought out to the power supply so that any kind of bias may be used.

Though I do not yet own an SB-10, the proceeds from this article may make that possible. The SB-10 shown in the illustration was borrowed from and with the experimental cooperation of W7VW. Experiments seem to bear out the fact that the exciter will adequately drive the SB-10 and that the SB-10 will adequately drive the final. Reports indicate the quality of the SSB to be definitely superior.

Although the method of using the instantaneous dissipator tube here outlined was for medium power, it would work equally well for the kilowatt final. More and larger dissipator tubes would be necessary. A whole string of surplus bottles of one kind or another would work. To those who still have a couple of 304TL's kicking around they would fill the bill excellently. What ever arrangement you can come up with it certainly pays off in better quality.

... W7CSD

1. See article on exciter (What ever issue of the mag it may be)

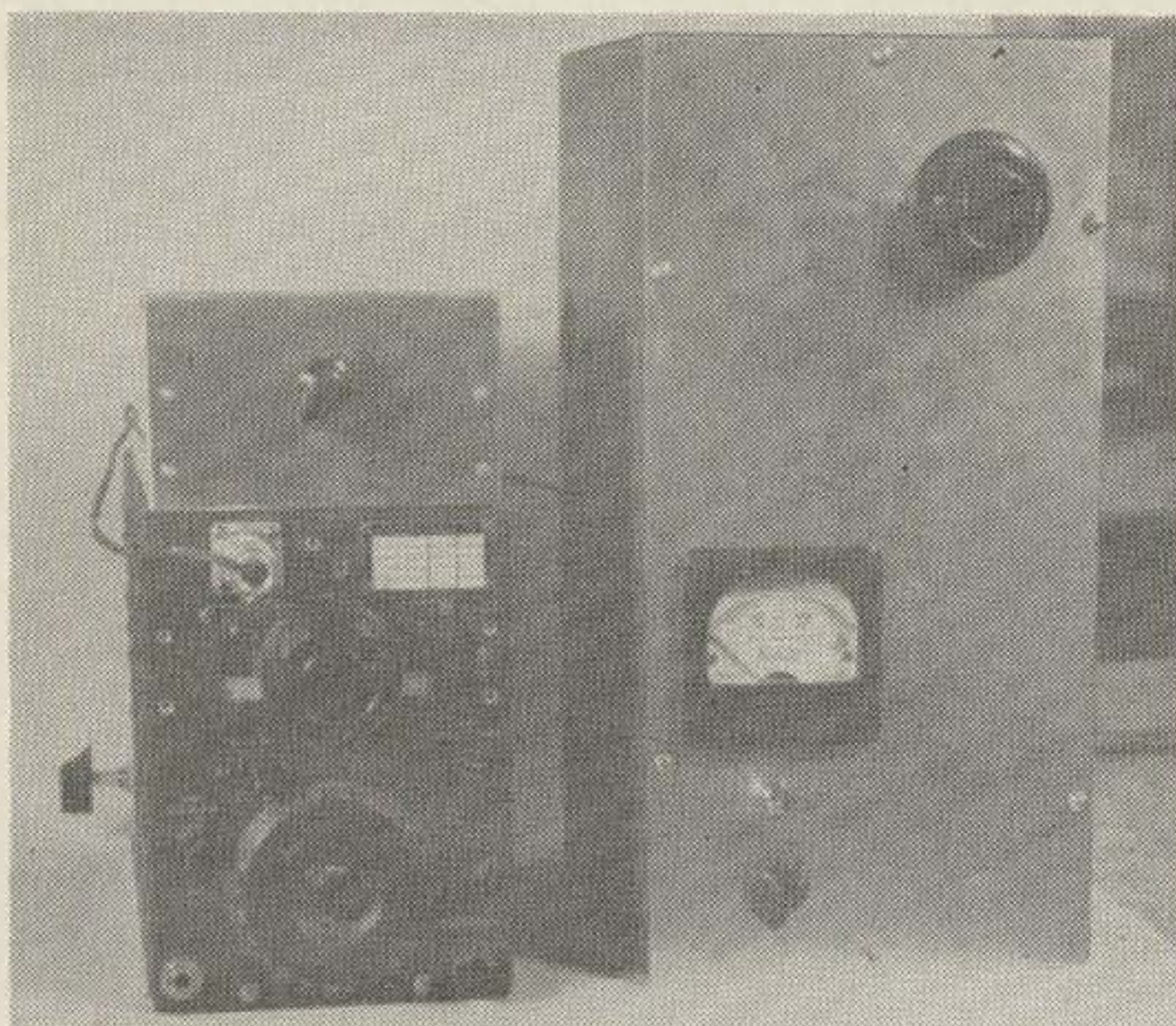

Club Subscriptions

\$3.00 each

in groups of

5 or more

ATTENTION HAMS!

6 GOOD BUYS FROM WRL

Prepaid* (Continental U.S.A.)



WRL SPIRE SPAULDING TOWERS SELF-SUPPORTING

3 Sizes - 32', 40', 48'

Self-supporting with large tribander or other beams. May extend to 120' with proper guying.

3 MOUNTING BASES

(a) Rigid concrete mount. (b) Concrete mount with hinge base. (c) Earth anchor with hinge base (no concrete).

- ★ Fully galvanized
- ★ Aircraft riveted
- ★ Includes rotor mount for HAM-M, AR22, etc.

WRITE FOR ANTENNA PACKAGE INFO

NO MONEY DOWN

\$49.95 32 FOOT RIGID CONCRETE MOUNT
*Prepaid via rail frt. or optional truck collect shipment with \$5.00 ship. allowance.



WRL Exclusive!

VERTICAL ANTENNA KIT MODEL WVG

- ★ Cont. Cov, 3.5-30 Mc. HAM-MARS-CAP
- ★ Matches 52-75 Ohms
- ★ Fully Self-Sup. — Radials not Required
- ★ No Traps — Mts. Anywhere
- ★ 23' Overall Height
- ★ Takes Full 1 KW AM (2 KW P.E.P.)

Model WVB similar except for side mt. \$12.95

Only \$14.95 (Express Only)

WRL Exclusive!

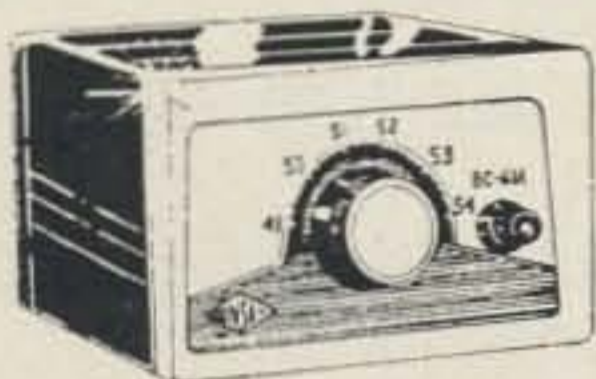

Nationally Advertised for **\$74.50**

12VDC - No high voltage - 49-54 Mc. Plugs into car radio. Built-in ANL. 6x8x4" Triple Conversion W/Car Radio Full 90-Day Warranty

BRAND NEW!

GONSET TUNABLE
6M Converter #3275

WRL Special **\$49.95**

WRL World Radio Laboratories, Inc.

3415 W. BROADWAY COUNCIL BLUFFS, IOWA PHONE 328-1851

NEW IMPROVED

TC6-A
6 METER
TRANSCIVER

\$39.95 KIT
LESS P.S.



**MOST COMPACT
IN ITS FIELD!**

5"x9 1/4"x6"

TRANSMITTER FEATURES

- 5W. input
- Use 8MC Xtals
- Built-in P.T.T. relay
- Plate modulation
- Use Hi-Z mikes

TCA KIT (115VAC/PS) **\$15.95**

RECEIVER FEATURES

- Superhet receiver
- Vernier tuning 49-54MC
- RF stage
- ANL
- Selective (20KC at 6 DB)
- Built-in speaker
- Drift, less than .01%

TCD-12 KIT (12VDC/PS) **\$24.95**

NEW! EXCLUSIVE! "MULTI-PAK"

A.C. Power Supply
LOWEST COST
in its field!



Only \$24.95 Kit Form

Available customized! For Swan, Gonset, Elmac, Heath

DUAL VOLTAGE

600VDC @ 300MA plus 300VDC @ 300MA, or 210W combined. Also delivers up to 95VAC for bias and 6V @ 10A or 12V @ 5A. Approx. wt. 15 lbs. Size: 11 1/4 x 4 3/4 x 6".

WRL EXCLUSIVE \$25.00 Value

KW Pi Variable Condenser
A Real Fine Condenser for that Linear. Pull outs, good condition.

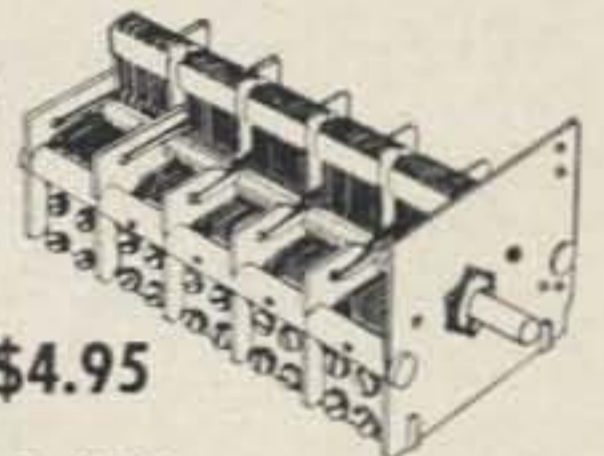

- 5 Gang
 - 2,010 Mmfd Max.
 - 100 Mmfd Min.
 - 160-10M Cap.
 - .020" Spacing, Adequate for 1 KW
 - Steatite Insulation
 - 3/8" O.D. 1" Shaft
 - 6" long, 3 1/4" wide, 2 3/4" high, 5 lbs.
- For shaft reducer 3/8" to 1/4", order #1D119, 17c ea.

Only \$4.95

Order X914

WORLD RADIO LABORATORIES, INC.

3415 West Broadway Council Bluffs, Iowa 73-8

Send: WRL Spire Vertical Gonset 3275
 KW Pi Condenser TC6-A Multi-Pak

Use WRL's Charg-A-Plan. No money down.

Name _____ Call _____
Address _____
City _____ State _____

F.O.B. WRL Except Spires

Management Directives

Roy Pafenberg W4WKM

MANY amateurs are employed in the electronics industry and assigned both technical and management responsibilities. Mountains of paperwork in both job areas generally prevent him from devoting full time and attention to purely technical matters. A very convenient aid to the proper understanding of obscurely worded technical literature has been published in 73 MAGAZINE¹ and this public service action has been the subject of many favorable comments.

Even more important to the practicing electroneer is the need to properly interpret management directives. In fact, his continued employment may very well depend on the correct interpretation and understanding of such writings. The following glossary should prove quite valuable in this respect and is printed here for the benefit of all 73 MAGAZINE subscribers whose continued employment and financial well being are of deep concern to 73 management:

As Written

Meaning

"A searching analysis reveals"	A spot check of incomplete reports.
"A survey is being made of this"	We need more time to think of an answer.
"Act at your discretion"	Go ahead, stick your neck out.
"Additional information received indicates" ..	Some of the reports were late.
"Additional information will be supplied at a later date"	Much later—after you ask for it again.
"Administrative oversight"	We goofed.
"All policies of the former management will remain in effect"	I haven't read them yet but will change them at the earliest opportunity.
"Attention is invited"	For Chrissakes, wake up!
"Authority is delegated"	If this thing works, I'll take the credit. If it flops, you get the blame.
"Budgetary considerations preclude"	No money.
"Expedite"	Compound confusion with commotion.
"For planning purposes, the following assump- tions are made"	You are required to prepare firm and intelli- gent plans on a series of unfounded assump- tions which will all be changed prior to the execution of your plans.
"Functional control"	You tell him what to do and he'll tell you where to go.
"Give us the benefit of your present thinking"	We'll listen as long as it doesn't interfere with what we've already decided to do.
"Growing body of opinion"	Two company officials agree.
"In due course"	Never.
"Information available in this office indicates"	This is the first inkling we've had but we'll take a guess.
"It is suggested"	Things would be different around here if I had anything to say about it.
"It is the policy of this company"	No reason for it. It's just our policy.
"It will be remembered"	You have forgotten, if indeed you ever knew.
"Let's get together on this"	I'm assuming you're as confused as I am.
"Note and initial"	Let's spread the responsibility for this.

"On an 'austerity' basis"	No materials.
"Opinion widely held"	Three company officials agree.
"Overriding priority is assigned"	We should have written this six months ago.
"Pending results of a survey now in progress"	We are trying to hire a man to make the survey.
"Present indications are"	One wild guess is as good as another.
"Program"	Any assignment that can't be completed by one phone call.
"Project"	Any assignment the office boy can't complete by one phone call.
"Research"	Dragging data out of an inaccessible place, tabulating it and then filing it in an equally inaccessible place.
"Research work"	Hunting for the guy who moved the files.
"Results, not methods, are what count most" ..	The greatest reversal since Serutan.
"Returned for reconsideration"	Did you think you'd get away with this one?
"See me and let's discuss"	Come down to my office, I'm lonesome.
"Status quo"	The mess we're in.
"This office is concerned with"	Knock it off. We're wise to you at last.
"Under active consideration"	Will have a shot at the files and see if we can find it.
"Under consideration"	Never heard of it.
"Within the framework of current instructions"	I don't know what they are. You look them up.

W4WKM

¹ "How To Read What The PhD Writes," K5JKX/6, March '61, 73 MAGAZINE.

EDITORS NOTE: The author and your editor have devoted considerable time and effort in attempting to identify the anonymous writer of the source document from which this glossary was developed. Evidence points toward a still unidentified, itinerant Navy Officer. This Officer was stationed in the Philippine Islands several years ago but has been presumed lost at sea since the date the document came to the attention of the Navy Department.

YOU could be the 1 out of 4

that **CANCER** strikes

strike back with dollars

The American Cancer Society

A CW Man's Monitor

Don Wherry W6EUM
2121 Grandview Drive
Camarillo, California

FOR those of us who use CW, some kind of a keying monitor is a must, particularly so if we are using high power, which invariably blocks the receiver. Even with low power it is not always convenient to use your receiver as a monitor, and to send intelligent code with an automatic key without hearing what you are doing is next to impossible.

During the past years many types of such keying monitors have been described, using everything from batteries to rf energy for oscillator power. The unit to be described here (Fig. 1) is an AC powered monitor and probably is the simplest which can be built and still furnish a good positively keyed tone. The only prerequisite to its use is that you have a transmitter which uses a negative voltage to block off one or more of its tubes when the key is up. Transmitters of this type, which include a large percentage of the commercial types and most of the kits and home construction, bring out a negative grid blocking voltage to the key which, when depressed, grounds out the blocking bias, removing it from the tubes concerned and allowing normal operation of the transmitter.

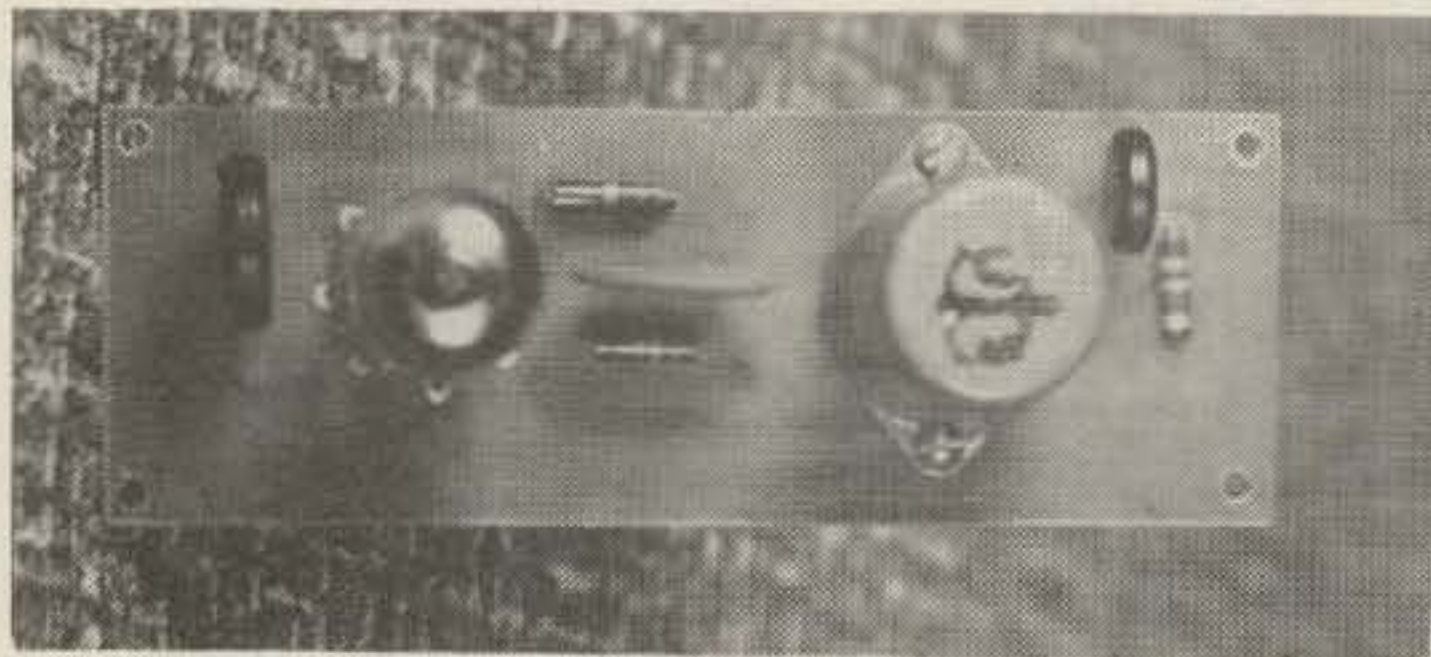

The monitor unit shown in Fig. 1 (schematic in Fig. 2) uses this negative voltage to key a 6C4 oscillator tube in a transformer coupled feedback circuit, oscillating at some desired audio frequency. The monitor is keyed in step with the transmitter by connecting the normally grounded end of its grid resistor to the hot side of the transmitter key. This means that, when the key is up, the normal grid blocking voltage of the transmitter is also applied to the grid of the oscillator tube, thus cutting off the monitor's oscillations. When the key is closed the transmitter grid blocking vol-

tage is grounded thereby removing it from the monitor and grounding the oscillator grid in the normal manner which allows oscillation to start.

One of the problems connected with such a monitor keying system is that of time delays in the blocking voltage build-up. These delays are built into the transmitter circuit to allow proper sequence keying and usually show up at the key as a slow voltage build-up when the key is opened. This feature will cause "tails" to appear on the monitor keying, sometimes to a prohibitive extent and always to an annoying extent. This characteristic is avoided in this monitor by the action of the oscillator tube itself. By using an oscillator circuit such as this, the feedback is very heavy, causing a large grid excitation signal and a large bias voltage to develop. This means that when the grid resistor is lifted from the direct ground by the opening of the key contacts the plate current of the 6C4 tube is rapidly cut off by the blocking action of the grid circuit. Before this grid blocking voltage can dissipate through the transmitter keying network the regular transmitter blocking voltage has built up and holds the monitor in a "outoff" condition until the key is again depressed. This allows good clean positive keying of the monitor. Another thing which should be considered before hooking a monitor onto the key of a transmitter using grid block keying is that you must not add a path from the "hot" side of the key to the ground. When the key is up, even though this path has a high resistance it will invariably upset the open key grid bias on your transmitting tubes and cause trouble.

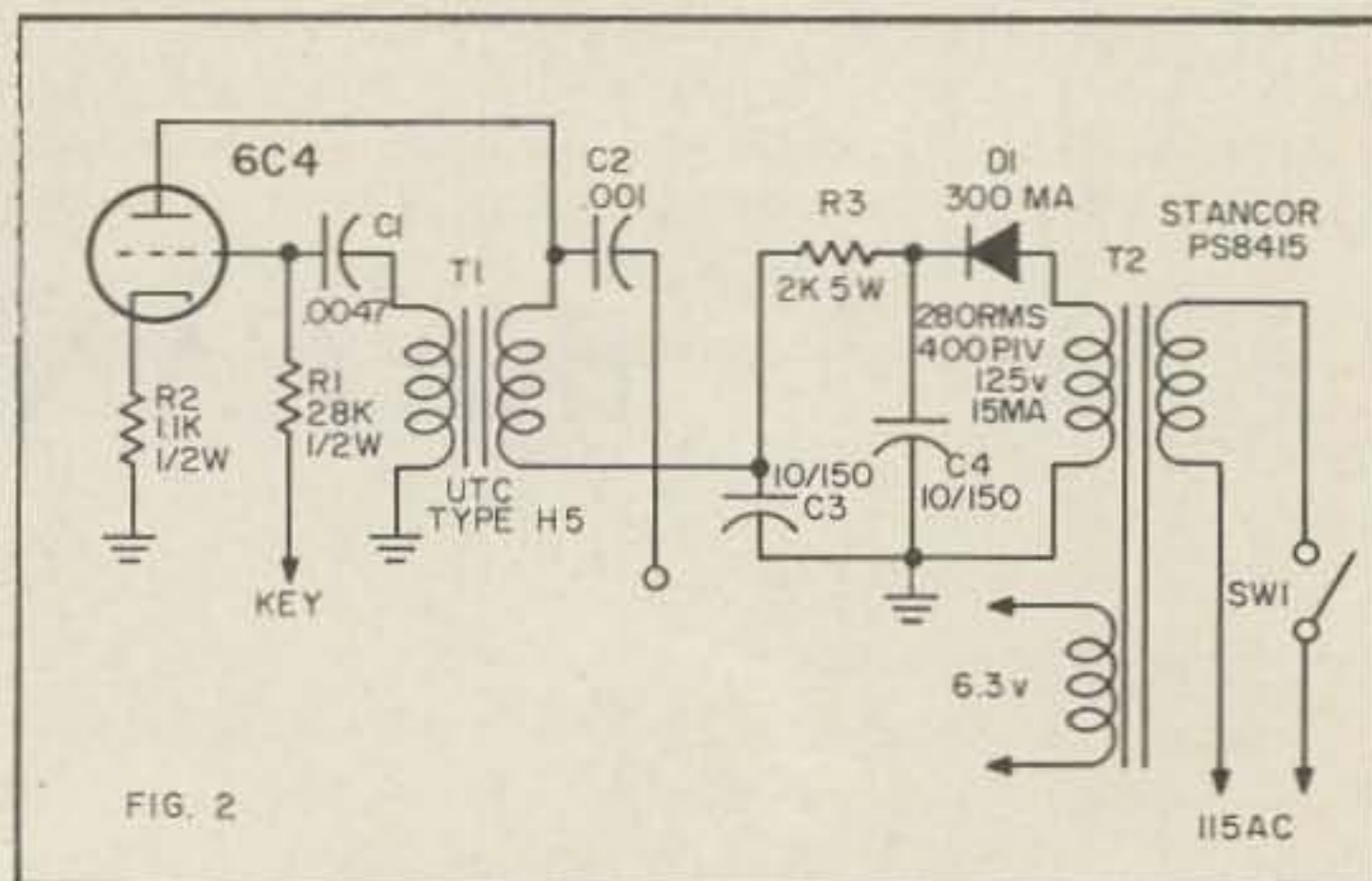

FIG. 2

The feedback transformer in this unit is a UTC miniature audio interstage type of the "H" series. The one shown in this unit is a surplus unit which I believe is identical to the commercial model H-5. Any audio transformer of the interstage type will operate in this circuit however so dig into your junk box.

The only thing to consider in this type of feedback circuit is the phasing of the audio

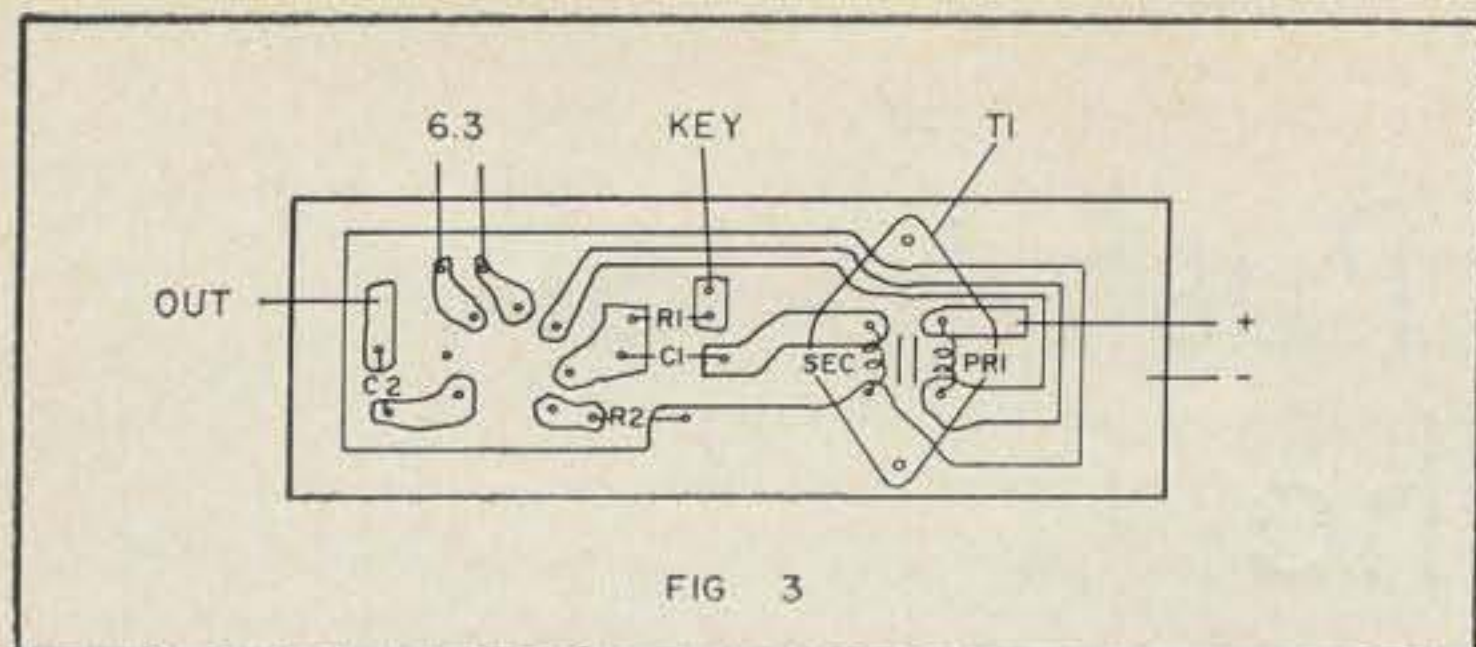

FIG 3

transformer winding. If the windings are not connected in the proper phase relationship the feedback voltage will be degenerative instead of regenerative, in which case no oscillations will be obtained. So if another transformer is used, be sure you know how it should be connected before you lay out your circuit board assembly.

The only adjustment which might be necessary to make to the oscillator is one to set the audio tone to suit the individual operator's taste. Lowering the capacity of C1 will raise the tone frequency and vice versa. This tone frequency can also be lowered by shunting a small capacitor across either winding of T1 or by decreasing the value of R1.

For headfone operation the output of the unit is mixed with the audio output of the receiver by paralleling the monitor output with that of the receiver. If the monitor is too loud, a resistor, or potentiometer, can be connected in series with C2 until the output level is of the correct value. In case it is desired to put the monitor on the receiver's speaker a small capacitor connected to the grid of the audio output will do the trick. Usually a few turns of wire twisted around the grid lead to the audio output tube will be enough capacity without a condenser, however.

The unit shown here is constructed on a printed circuit board, a layout of which is shown in Fig. 3. This is a "to scale" drawing and can be used as a template to trace on your board if you so desire. The handling of printed circuit boards has been described too often to repeat here. If you have any questions look back in past issues of your 73.

The power supply is normal, the only value which should be selected is that of R3. Select this resistor to give from 80 to 100 volts at C3.

In this installation the unit is mounted on a small chassis (Fig. 4) which also contains some antenna and transmitter controls along with a receiver output filter (see June issue of 73). Of course, it could be mounted as an integral unit on a small chassis of its own if so desired. By adding another stage of amplification, a standard volume control and one of these small miniature speakers it could be used

OPERATING DESK

Industrial Steel 18 Ga. 8 Sq. Ft. Masonite Top
\$35.00



Back Stop, Drawer, Lower Shelf, Plenty of leg room. 48½" W. x 33" H. x 24" Deep. Shipping wt. 25 lbs. Easily Assembled. Cash with order. No C.O.D.

MESCO, INC.

Electronic Laboratory

333 Ensminger Road
 Tonawanda, New York

NEW CLEGG 99er's

NEW PRICE \$159.95

SPECIAL
WHILE OUR PRESENT STOCK LASTS **\$139⁹⁵**

GRAHAM RADIO, INC.

505 Main Street, Reading, Massachusetts

Tel 944-4000

as a monitor with no connections to the normal receiver output circuit at all.

As a monitor it oscillates strongly, has a pleasing tone, rich in harmonics and keys beautifully. As mentioned it can be mounted in its own box which may be small and easily tucked away some place on your operating table out of the way if so desired. It is simple, cheap to build and above all it works, so if you're in need of a monitor, try it. . . . W6EUM

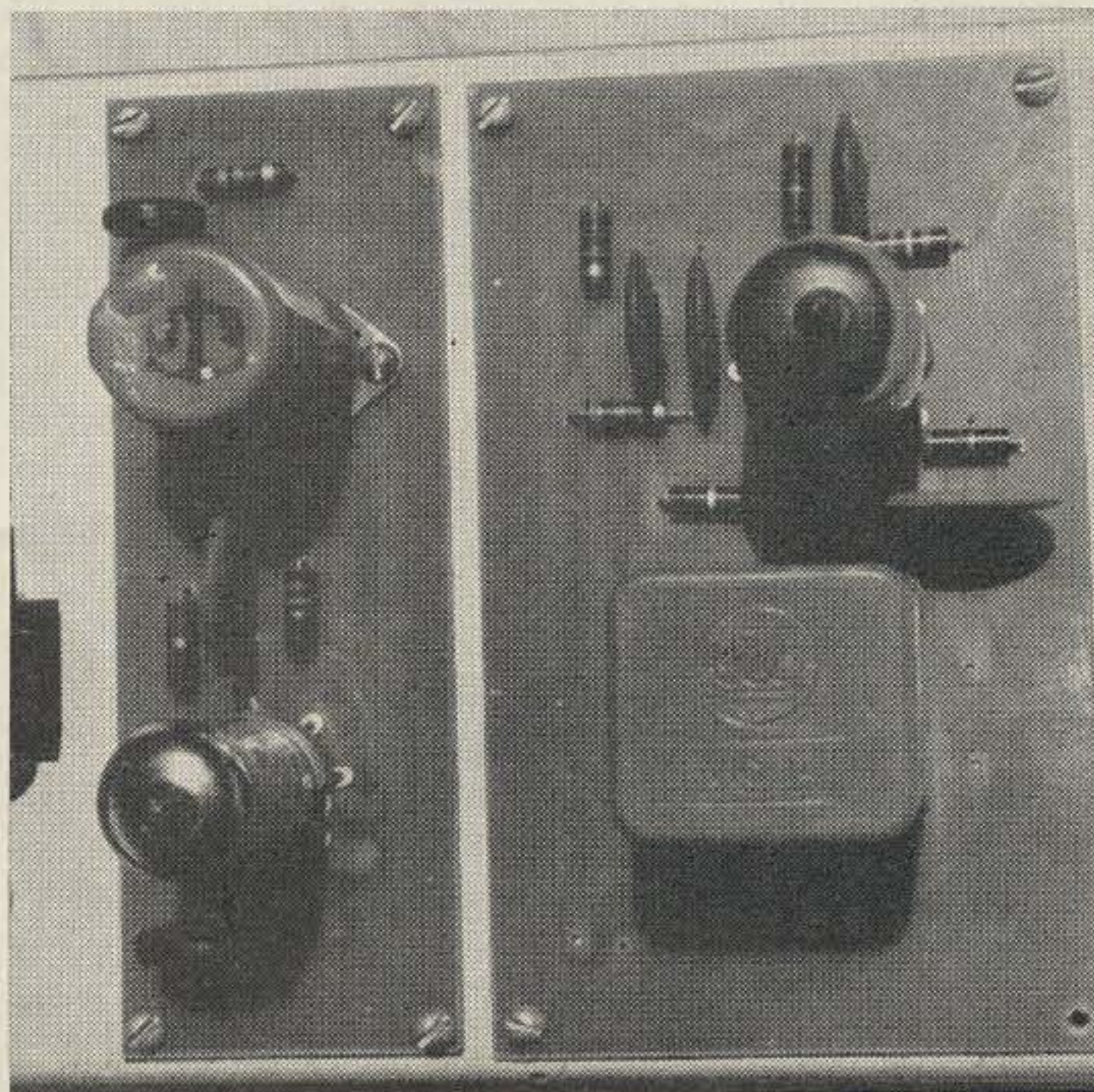

Break-in and Push-to-talk for the Knight T-60

Roy E. Pafenberg W4WKM
316 Stratford Avenue
Fairfax, Virginia

Photos: Morgan S. Gassman Jr.

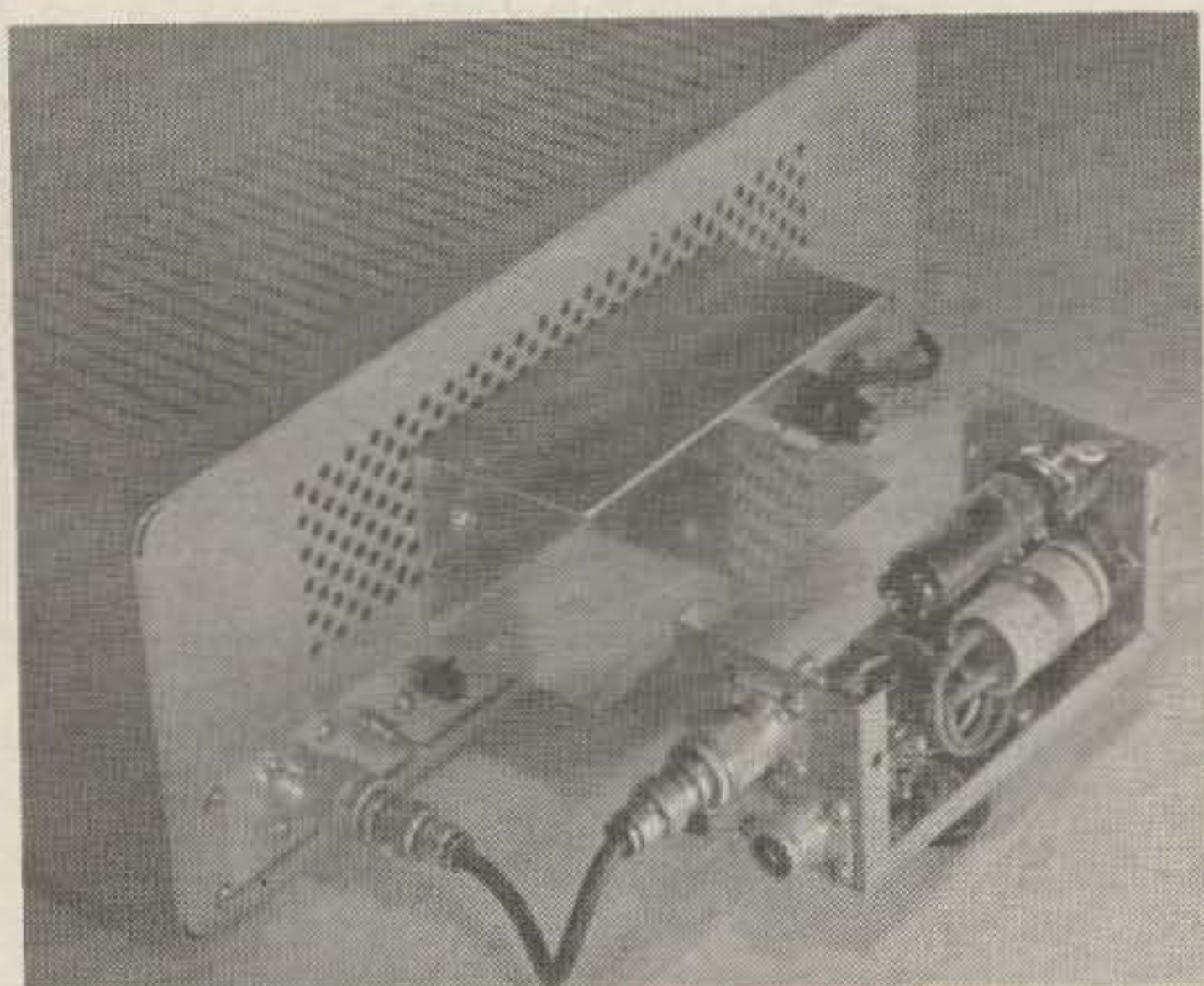

THE Knight T-60 Transmitter has proven to be very popular as a first transmitter for the Novice and many are now on the air throughout the country. While this Allied Radio kit meets the requirements of the newcomer admirably, the phone operator and the more experienced CW operator will find manual switching from send to stand-by condition a trifle inconvenient. The convenience and efficiency of push-to-talk phone and break-in CW operation cannot be argued. Fortunately, the Knight T-60 is so wired and constructed as to make post-assembly installation of these features a snap.

Amateur literature was searched for a suitable circuit with the desired simplicity and which could be adapted to the T-60. No circuit could be found which was entirely satisfactory from the standpoint of transmitter changes required. After considerable experimentation, the basic circuit shown in Fig. 1 was devised and it works like a charm. The circuit is directly applicable to many commercial transmitters and offers several advantages in home constructed equipment.

The relay is a sensitive, high resistance unit with the series resistor selected to provide the rated relay current. When the key is closed,

there is a slight delay while the shunt capacitor charges and the relay then operates. The relay contacts mute the receiver, switch the antenna from the receiver to the transmitter and complete the cathode keying circuit. The relay contacts are adjusted to make in the order stated to minimize receiver switching noise and to insure that the transmitter is not keyed until the antenna is transferred. Each key closure recharges the capacitor and this charge holds the relay closed during the normal intervals between characters and words. The diode passes the cathode current to ground but isolates the circuits so that, once the relay is closed, current from B+ to the floating cathode circuit will not hold the relay closed.

The salient features and circuit details of the Knight T-60 Transmitter were discussed in the original article¹ and only the circuitry affected by the modification will be treated here. Actual modification of the T-60 proper is very minor and consists of installing a three conductor mike jack, conversion of the external transmit-receive switching from ac to dry contact and removal of one resistor in the keying circuit. The relay and other components required in the break-in circuit are installed in a small metal case secured to the rear of the transmitter. All required circuit points already appear at the T-60 accessory socket and a short cable is used to interconnect the units.

Fig. 2 shows the changes in the transmitter proper. Remove the transmitter from the cabinet and locate J3, the mike connector. Carefully unsolder the two resistors, R8 and R9, from J3 and fold them out of the way. Remove and retain the mounting hardware and discard the connector. Ream the center hole to $\frac{3}{8}$ " and remove the burrs, being careful to keep the filings out of the chassis wiring. Reinstall the mounting screws, cutting them off flush with the nuts. Install a Switchcraft S-13B

¹"73 TESTS THE KNIGHT T-60 TRANSMITTER," W4WKM, MARCH, 1962, 73 MAGAZINE.

jack in the $\frac{3}{8}$ " hole, leaving the mounting nut loose until the wiring is completed.

Carefully remove and retain R7 which is connected between Pins 1 and 3 of J1, the key jack. Unsolder the bare ground lead from Pins 1 and 2 of J1 and route directly to Pin 1, leaving Pin 2 vacant. Solder an insulated lead to this lug and solder the other end to the tip contact of the new jack. Connect, but do not solder, a bare lead between the sleeve and shorting switch contacts of the new jack. Connect the free end of R8 to the ring contact and the free end of R9 to the sleeve contact and solder all connections on the jack. Turn the jack as required to avoid shorts and to present a neat appearance and tighten the mounting nut.

The new mike jack accepts the PL-68 type plug which has the third contact for push-to-talk operation. The push-to-talk circuit of the mike jack and the key jack have been wired in series and, with neither plug inserted, the keying circuit is closed. When a plug is inserted in either jack, grounding the tip contact will complete the circuit. R7 has been removed to avoid conflict with the relay circuit and will be relocated in the add-on unit. Normal operation of the transmitter is possible except that the open key contacts are at an uncomfortable and possibly dangerous potential. Connect power to the transmitter and check for normal operation.

The next step is to convert the external control circuit from 115 volt ac to dry contact switching as shown in Fig. 2. Unsolder the gray lead from Pin 8 of J2, the accessory socket, and pull free to where it terminates on Terminal 3 of TS-2. Clip this lead close to the terminal and discard. Clip, from Terminal 2 of TS4, the white with red tracer lead which runs to Terminal 2 of SW2. Route this lead to J2 and solder to Pin 8. This completes the transmitter wiring changes by connecting the stand-by switch contacts between Pins 7 and 8 of J2.

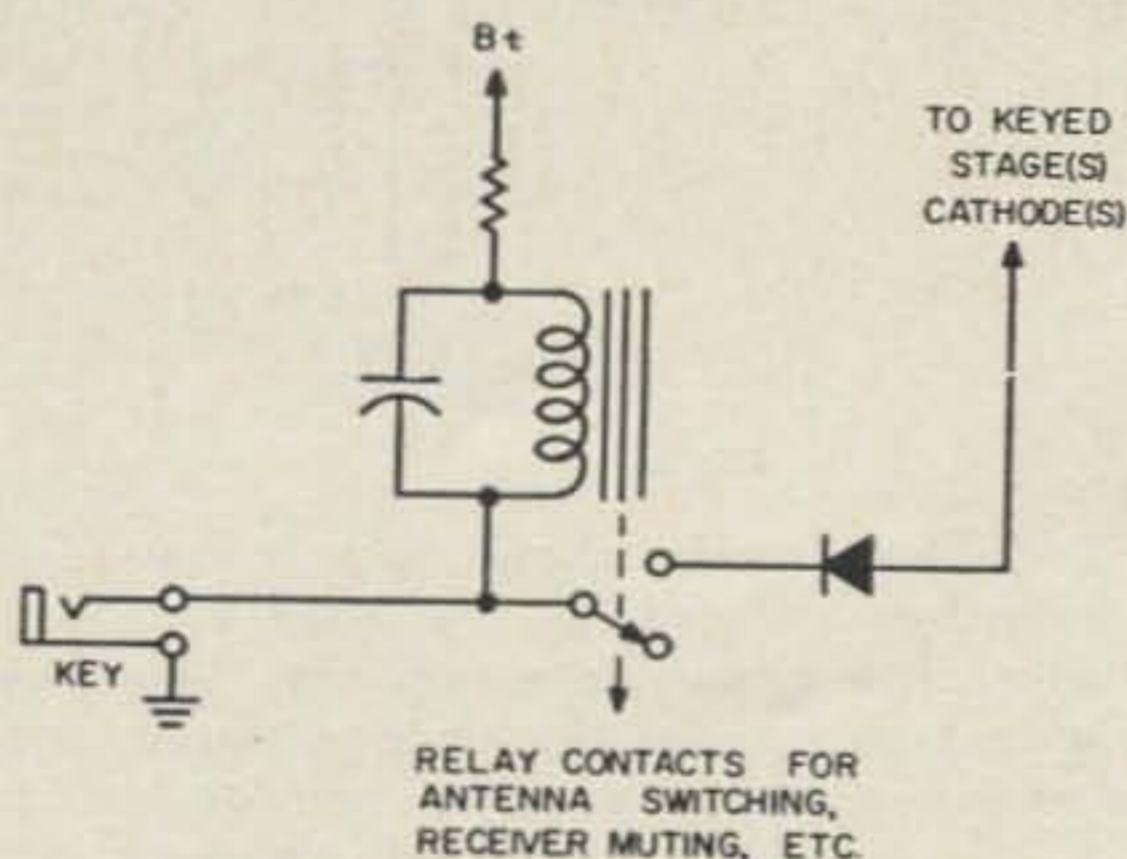

FIG. 1

Fig. 1 This basic break-in keying circuit has application in other equipment. The capacitor across the relay charges when the key is closed and holds the transmitter on during the intervals between characters and words. The diode provides isolation between the relay and cathode circuits.



GC-105
2 Meter

Go VHF! Get my
**FANTASTIC
DEAL**
on a GONSET
"GOONEYBIRD"

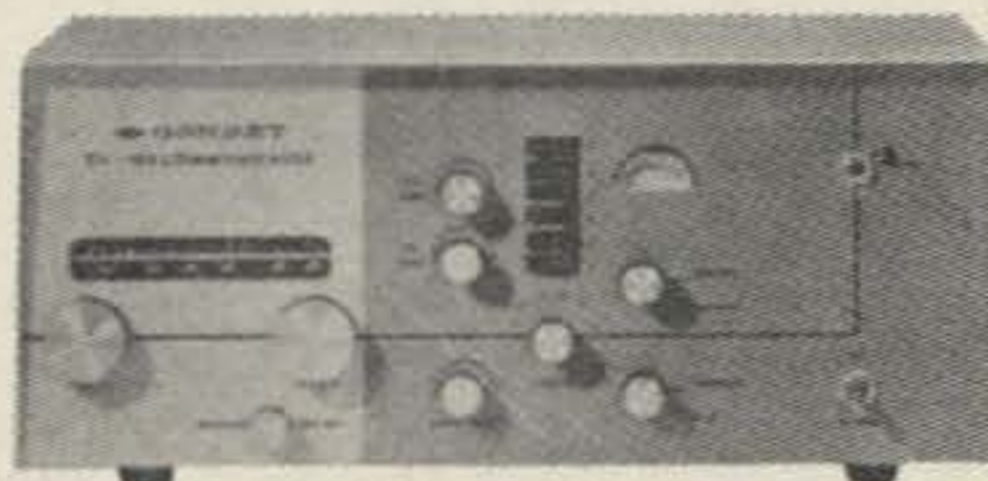

**\$500
DOWN**
\$9.22
A MONTH
(three years)

Fixed or mobile, this is a terrific complete 2 meter V H F transceiver. Silicon diodes save current drain; low noise tubes make operating a pleasure. All tunable circuits controlled from front panel. Input: 6/12 V DC or 115 V AC. Power cables included. Output 6 watts nominal. Ham net **\$259.95.**

WHAT DO YOU HAVE TO TRADE?
It's worth TOP DOLLAR to Me!

(list and monthly payments to be supplied by Terry)

NEW GONSET EQUIPMENT

	PRICE	MONTHLY PAYMENTS
3341 2 Meter Comm. IV	\$389.95	\$13.90
3342 6 Meter Comm. IV	389.95	13.90
3357 VFO 2, 6 Meter & 220 Mcs.	74.95	2.24
3221 G-50, 6 Meter Comm.	349.95	12.45
GC-102 All Band Transceiver, 180W-PEP	849.95	30.51
G-76, 100 Watt-Transceiver	429.95	15.34
3261 Super 12	89.95	3.42
GR-211 Receiver	69.95	2.34
GR-212 Receiver	109.95	3.79

REMEMBER \$5.00 DOWN IS ALL YOU NEED!

Above terms for three (3) year contract. Minimum order for one (1) year financing \$60; two (2) years \$120; three (3) years \$180.

Stay on the Air! Why go off the air? — Deal with Terry and you use your trade-in until your new equipment arrives.

AMATEUR ELECTRONIC SUPPLY

MILWAUKEE: 3832 W. Lisbon Avenue
CHICAGO: 6430 Milwaukee Avenue

Amateur Electronic Supply—Mail Order Dpt. 73-8
3832 W. Lisbon Avenue, Milwaukee 8, Wisc.

Ship me

I enclose.....I will pay the balance in
 1 year 2 years 3 years

I want to buy.....and want to trade
What's your deal?

Name

Address

City State.....

— Send reconditioned equipment bulletin.

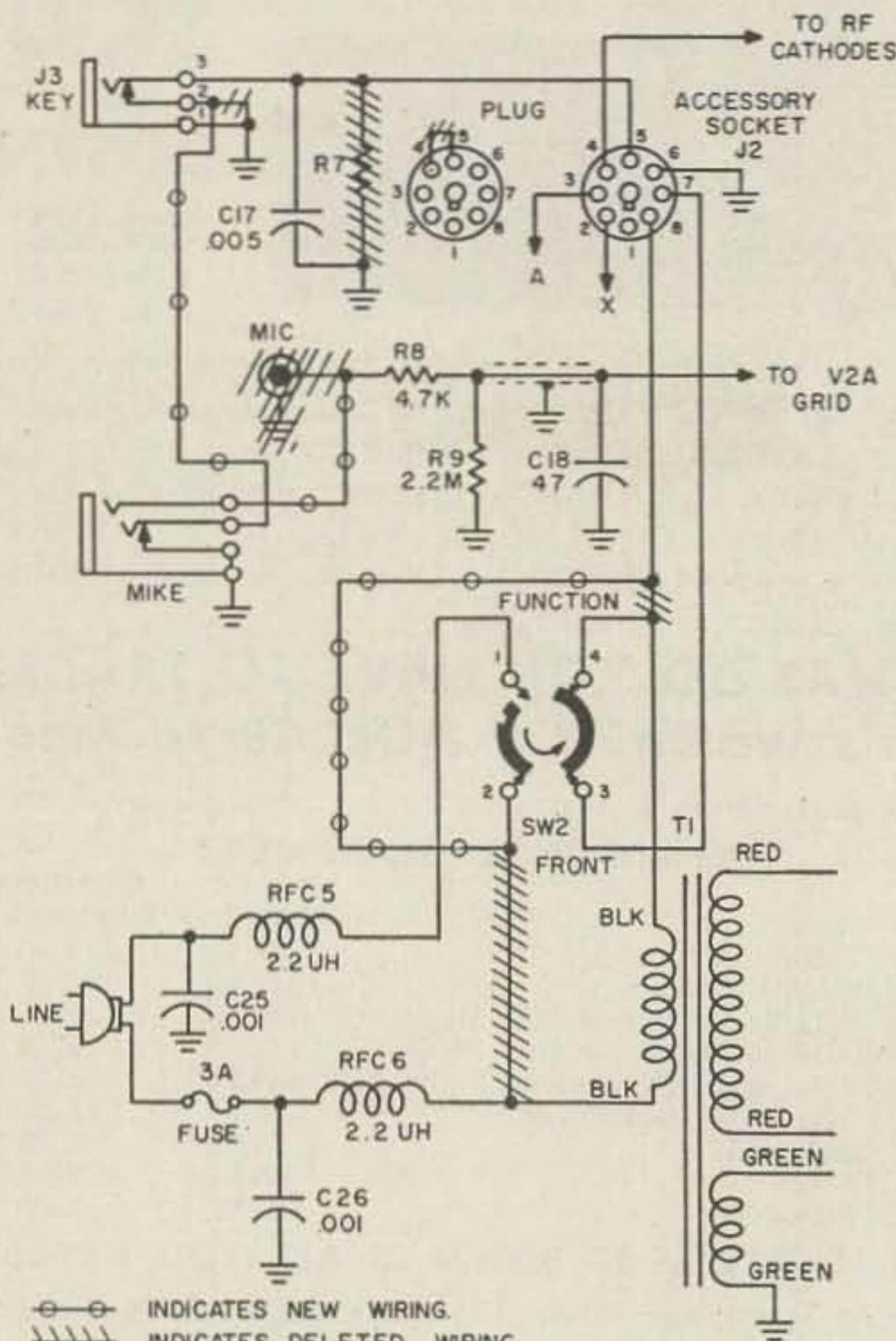
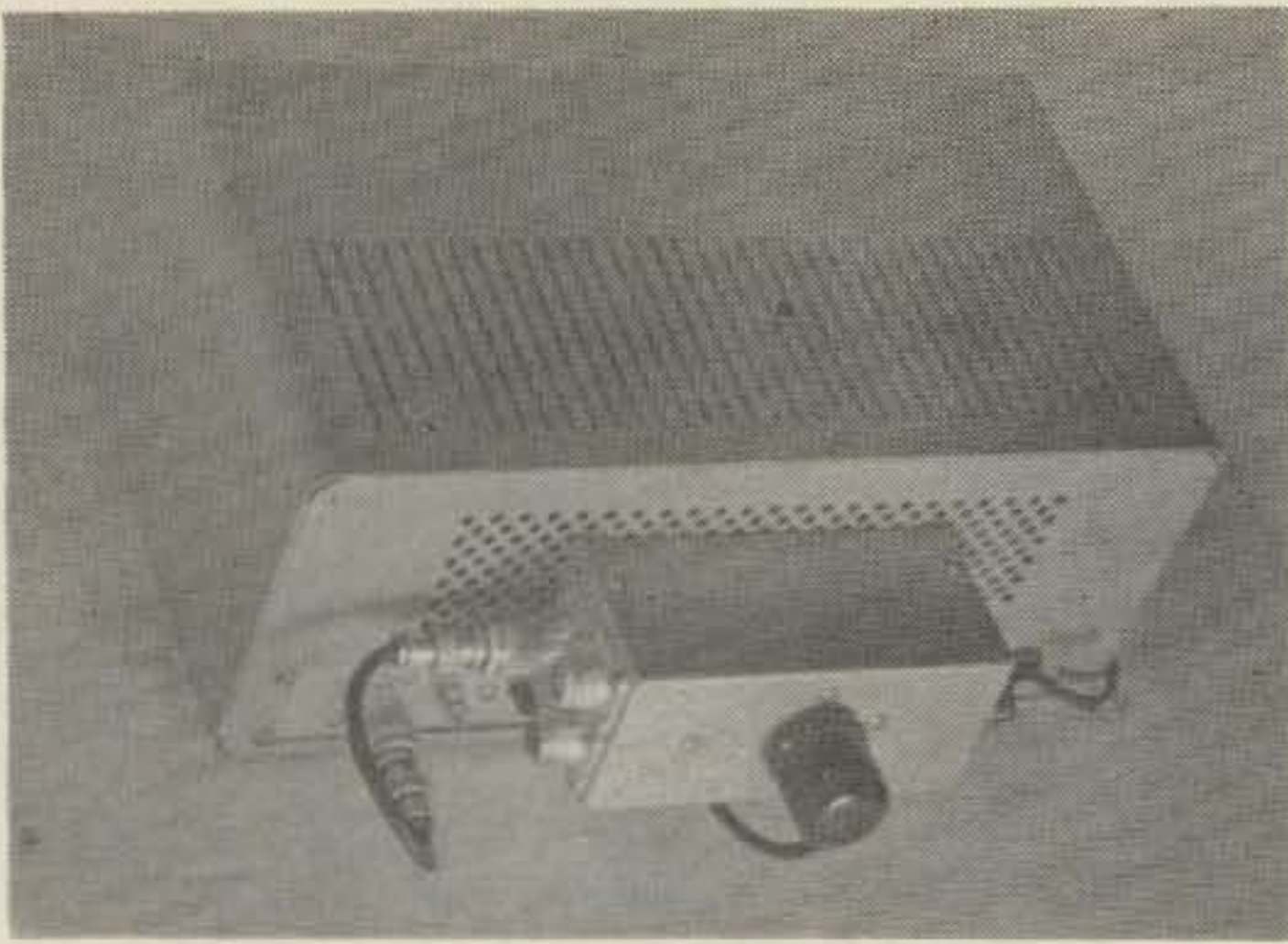

FIG. 2

Fig. 2 Only minor wiring changes are required in the transmitter proper. A new mike jack is installed and ac is removed from the external control switch circuit.

The balance of the break-in circuit, shown in Figure 3, is housed in a small box secured to the rear of the transmitter cabinet. A Premier type PMC-1004 miniature aluminum case, measuring 5" x 2 1/4" x 2 1/4", was used in the prototype. Using short screws and nuts, mount the box cover to the back of the transmitter cabinet and reinstall the transmitter. The photograph shows the location and method of mounting.

The circuit in Fig. 3 is essentially that of Fig. 1, with the rf bypass capacitors and additional relay contacts accounting for most of the increased complexity. One added feature is the voltage regulator tube. This tube fires in the open key condition, holding the voltage

across the key contacts to a safe 150 volts. When the key is closed, the voltage at Pin 5 of the OA2 drops to below 150 volts and the tube is extinguished.

Considerable latitude exists in the selection of components. The heart of the system is, of course, the control relay, K101. The unit used in the prototype is a Potter & Brumfield type KCP14, a 3 pole relay with a 10,000 ohm coil. The plastic case is discarded in this application. This relay was selected since it has large contacts with adequate spacing, good sensitivity and is reasonable in cost. With the Potter & Brumfield relay, a 40 mfd, 150 volt capacitor as C101 provided a delay compatible with the normal range of keying speeds. Relay characteristics affect the drop out delay and thus the value of C101. If in doubt, and a stock of various value capacitors is not available, purchase a multiple section unit such as a 40-40-40 mfd at 150 volt capacitor and use as many sections as required to achieve the desired delay.

Assembly of the unit is not difficult and no problems should be encountered. Install the 3 coaxial fittings of your choice on one end of the box. Remove the relay from the plastic case and position for the shortest leads to the coaxial connectors. The common contact leads of the 3 relay sections pass through holes in the contact terminal board and are soldered directly to the relay plug. Insert eyelets in these holes and solder the leads to these terminals. Now is the time to check the relay contact adjustment. Move the relay armature through its travel and observe the contacts.

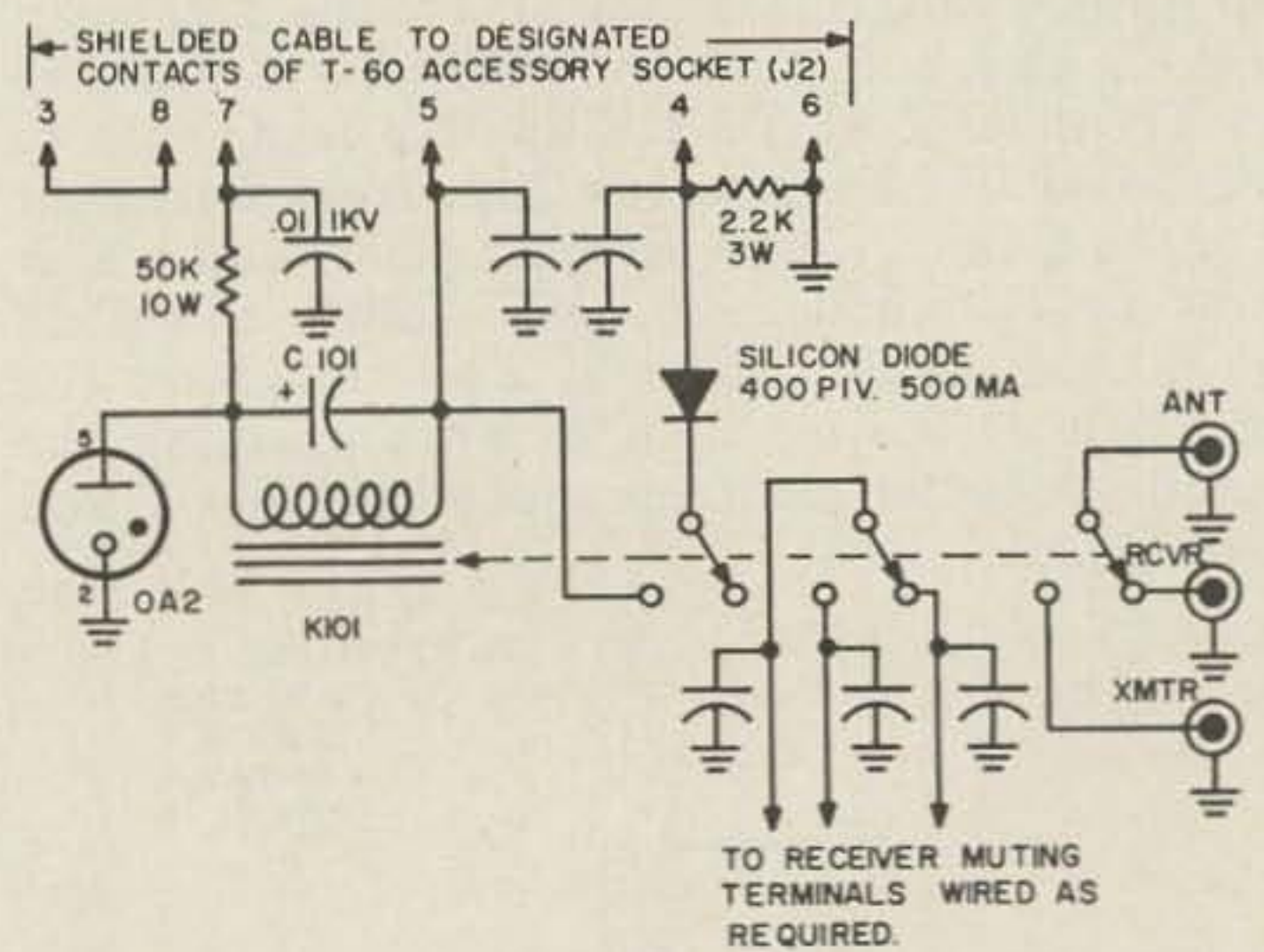

FIG. 3

Fig. 3 The circuitry shown here is housed in the utility box secured to the back of the transmitter. The circuit is essentially that shown in Figure 1 except for the voltage regulator which is required to reduce the voltage across the open key to a safe value.

Notes: See text for discussion on value of C101. All other unmarked capacitors are .001 mfd disk ceramic units. K101 is 10,000 ohm 3 pole relay. See text for discussion. Rf connectors are UHF type SO-239. Transmitter cable and receiver muting connectors were octal sockets in the prototype with extra terminals used as tie points.

Carefully adjust, by bending the stationary contacts, so that the receiver muting, antenna switching and keying contacts make in the order and break in the reverse order indicated.

Some may object to the use of this type relay in an rf switching application. However, the contact spacing, relay insulation and contact size are adequate for the power levels employed in the T-60 if the normal precautions are observed. Never operate the transmitter without an antenna and be certain of the relay contact operating sequence before power is applied.

The balance of the components may now be mounted, keeping them as far removed from the relay and rf wiring as possible. The photograph shows the details and this layout is suggested. Octal sockets are used for the T-60 cable and the receiver muting connectors, with the unused terminal lugs employed as tie points for other parts. The OA2 tube socket is mounted on stand-off posts as shown. Complete the metal work, mount the components and wire as shown in Fig. 3. The rf bypass capacitors should be wired, with short leads, directly to the socket terminals and ground saddle.

Remove the jumper between Pins 4 and 5 of the accessory socket plug and install the jumper between Pins 3 and 8. Use the plug and a second similar plug to make up the cable which connects the break-in unit to the transmitter. The photographs and Fig. 3 give the details. Install this cable and a short coaxial cable between the T-60 ANTENNA and the break-in unit TRANSMITTER coaxial connectors. Connect a 100 watt lamp to the ANTENNA connector and a neon lamp to the RECEIVER connector.

Switch the T-60 to STANDBY and connect power. Install a crystal and plug in an open key. Switch the transmitter to TUNE and observe the OA2 VR tube which should glow blue between the elements. Close the key and, after a momentary delay, the relay should operate. Tune the transmitter normally, switching to CW to complete the tuning. The lamp load should light when the transmitter is tuned properly. Open the key and, after a delay of a second or so, the relay should release. Send a test with the key at your normal operating speed. The relay should close after a slight delay and remain closed between characters and words. Increase the value of C101 if the relay delay is insufficient. Check to see that the neon lamp does not light at any time. If the lamp flashes it indicates that rf would be applied to the receiver input and that the relay contact switching sequence requires adjustment as previously described.

Remove the key, plug in a high impedance microphone with push-to-talk switch and switch the T-60 to AM. Operate the mike switch and the relay should close and remain closed for a second or so after the switch is released. When the unit is operating to your satisfaction, remove the lamps and secure the

GENERALIZE YOURSELF! LEARN RADIO CODE

The EASY WAY

No Books To Read—No Visual Gimmicks To Distract You. Just listen and learn

Based on modern psychological techniques — This course will take you beyond 13 w.p.m. in

LESS THAN 1/2 THE TIME
Available also on magnetic tape
See Your Dealer Now!



PRICE
\$9.95

Album Contains
Three 12" LP's
2 1/2 Hr.
Instruction

**EPSILON
RECORDS**

2769 CAROLINA
REDWOOD CITY, CALIF.

**DKC-
RFB**



SIGNALS 'POP OUT'

WITH DOW'S PREAMPLIFIER

Get signals you didn't hear!

Not a gimmick, but a tested and proven accessory. Precision made, fully backed by Dow-Key's traditional Factory Warranty.

HELP YOUR RECEIVER!

The DKC-RFB Booster is a 50 to 70 ohm impedance matching "broadband pre-amplifier" guaranteed to increase the over-all gain by 1 to 6 "S" units on all bands (1.5 to 30 mc). To improve sensitivity, work with DX, and bring up weak unintelligible signals, you'll want a DKC-RFB. Designed for receivers up to the \$300 class.

price . . . \$10.75

DOW-KEY COMPANY • THIEF RIVER FALLS
MINNESOTA

BLITZ-BUGS

COAXIAL LIGHTNING ARRESTER

1. MODEL LAC-1 with one male and one female Type 83 connectors; install directly to equipment. **PRICE \$3.95 NET**
 2. MODEL LAC-2 with double female Type 83 connectors for "in - the - cable" installation. **PRICE \$4.45 NET**
 3. MODEL LAC-2N with double female Type N connectors for commercial "in - the - cable" installation. **PRICE \$5.95 NET**
- BLITZ-BUGS provide lightning protection for amateur, citizen-band, two-way and all other coaxial cable systems.

See Your Distributor or Write for Catalog

Cush 621 Hayward Street
Manchester, N. H. **Craft**

box to the cover mounted on the transmitter. Connect the antenna to the ANTENNA connector of the break-in unit and install a cable between the RECEIVER connector and the station receiver. Wire in the receiver muting contacts as dictated by the receiver standby or muting switching requirements and you are ready to go on the air.

The convenience of having no controls to operate between the transmit and receive conditions must be experienced to be appreciated. The small cost and effort required to construct the break-in unit is well rewarded in operating pleasure. Such refinements as this make the difference between an expensive assemblage of hardware and a smoothly operating communications facility.

. . . W4WKM

Panel Markings

Jim Kyle K5JKX

AN interesting byproduct of the rise in "do-it-yourself" gear is the corresponding rise in interest in methods of making the finished product look "commercial." Within the past year, at least three different techniques for producing professional-looking dial plates and panel markings have been described in the literature; these techniques use methods borrowed from engineering-documentation practice, and can produce nameplates on either paper or metal.

However, they share two common drawbacks: the nameplate is limited in color to black and white, and the processes (unless expensive camera work is resorted to) produce only negative images.

Here's another, little-known technique which produces nameplates on clear plastic film, in your choice of 19 colors, and which can produce either negative or positive images (whichever you desire) with no camera work at all. Most of the materials are available at any well-stocked art supply firm; all are readily available across the country.

The basis of the technique is the diazo process, widely used in industry to produce "blue-line" reproductions of engineering drawings. This is a completely dry process; it makes use of paper coated with a special material. This coating includes a diazonium salt, a "coupler," and a mild acid.

In the absence of the acid, the diazonium salt

TOPAZ 250 WATT CONVERTERS



- Short circuit protected
- Compact — only 3 $\frac{15}{16}$ " x 4 $\frac{3}{8}$ " x 6 $\frac{1}{8}$ "
- Epoxyed magnetic components
- Epoxy fiberglass printed circuit board
- Accessible resistors, condensers and transistors
- Regulated drive power for extra long life and high efficiency
- Unconditionally guaranteed against defects in materials and workmanship for a period of 6 months

MOBILE POWER AT EXCEPTIONALLY LOW COST

Topaz Static Converters operate the majority of mobile transmitters and receivers. Through new concepts in converter circuitry* these units deliver more watts per dollar than any comparable unit. In addition, they are smaller and lighter in weight, and higher in efficiency. This means increased savings through longer life of batteries and generators.

New models are now available designed specifically for or adaptable to the following applications:

specifications:

*Model C10WDG** For Swan (all models), also adaptable to Collins KWM-1 and KWM-2.*

Outputs: 600 VDC (maximum .415A)
300 VDC (maximum .5A)
0-120 VDC (plus or minus, 50 VA maximum)
Internal primary power turn-on relay

\$99.50

GENERAL SPECIFICATIONS FOR ALL MODELS:

Input Requirements: 11-15 VDC, 13 volts nominal
Weight: Approximately 7 lbs.
Power Output: 250 Watts (Model C10XDG, 260 Watts)

Fused
Efficiency: 85%

Model C10WG: Same as above less turn-on relay..... **\$89.50**

Model C10W: This unit has accessory 120 VAC, 400 CPS, 50 VA output. Other specifications same as above less relay, bias..... **\$79.50**

Model C10WDD For Gonset "G-76"

Outputs: 650 VDC (.385A max.)
270 VDC (.13A max.)
LC Filter
Turn-on and High B+ Relays

\$119.95

Model C10XDG For Collins KWM-1 & KWM-2

Outputs: 800 VDC (.325A max.)
280 VDC (.21A max.)
LC Filter and Relay
—50 to —90 VDC Bias

\$134.95

*Patent Pending.

**SW12A (Swan part number) is made by Topaz for Swan Engineering for use with Swan Transceivers. Order from your local Swan dealer.

California Residents Add 4% Sales Tax to unit price. Enclose \$2 for Insured Parcel Post. No C.O.D. Orders.



TRANSFORMER PRODUCTS, INC.

3802 HOUSTON ST., SAN DIEGO 10, CALIFORNIA - CYPRESS 7-4815

Order from local electronics distributor — if unavailable order factory direct.

and the "coupler" combine to form a densely colored dye. Until the acid is removed, the coated stock has a pale yellowish cast.

To use this process, the coated paper is placed in firm contact with a translucent "master" containing opaque-line drawings, lettering, or other information, and is exposed to either sunlight or an arc lamp.

Where ultraviolet light passes through the "master," the diazonium salt is converted to an inert material; where the opaque lines block passage of light, the diazonium is left unchanged.

The exposed stock is then exposed once more, this time to ammonia fumes. These fumes neutralize the acid, allowing the dye image to form.

The process is known commercially by a number of names, including "Ozolid." As usually used, it produces blue lines.

However, the basic process is not limited to either blue lines or to the use of paper stock for the print. The Technifax Corporation, Holyoke, Mass., produces diazo sensitized stock on clear plastic film, in 10 dense and 9 pastel colors (including, in each case, black). This stock is known as "Diazochrome Foil." ("Diazochrome" is a registered trade mark of the Technifax Corporation.) This material is available from any of the firm's 51 branches throughout the country, and is the material used in this process.

To show how it works, let's take a comparatively simple example first. Let's suppose you're making a tuning dial for your new receiver; you would like to indicate, on the dial, if possible, the various sub-bands (phone, CW, Novice, etc.).

The first step, naturally, is to make a pencil rough by taping a piece of paper where the dial will be and marking calibration points, in pencil, on that paper.

Next, place the paper on a smooth surface and tape it in place. Then tape a sheet of tracing paper or "vellum" over the pencil rough. Using a compass and straightedge, trace the calibrations in ink. Make sure that all your lines are of equal density; uneven line weights will become obvious in later steps.

Now, working in subdued light (40-watt bulb or smaller, no direct sunlight or fluorescent), cut a piece of *black* Diazochrome foil to the same size as the dial plate. Keep track of the emulsion side of the foil when you cut; this is the side of the sheet which faces you when the

(Turn to page 64)

TONS OF AMATEUR EQUIPMENT IN STOCK

WESTERN RADIO

SAN DIEGO

1331 India Street

BE 9-0361

MON - FRI 8:30 to 8:00 SAT 8:30 to 5:00

Amateur/CB/ or industrial —
You can't go wrong with HORNET.



Model TB 1000-4

Cash Price \$112.50

Only \$10.50 per month

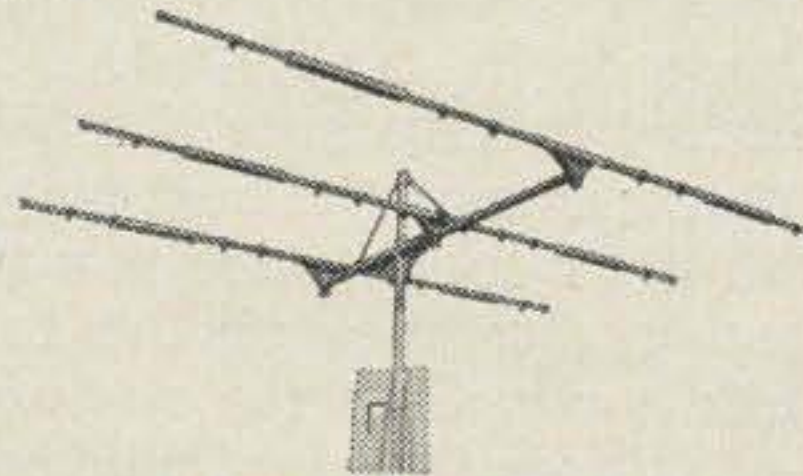

Model TB 1000

Cash Price \$89.75

Only \$8.35 per month

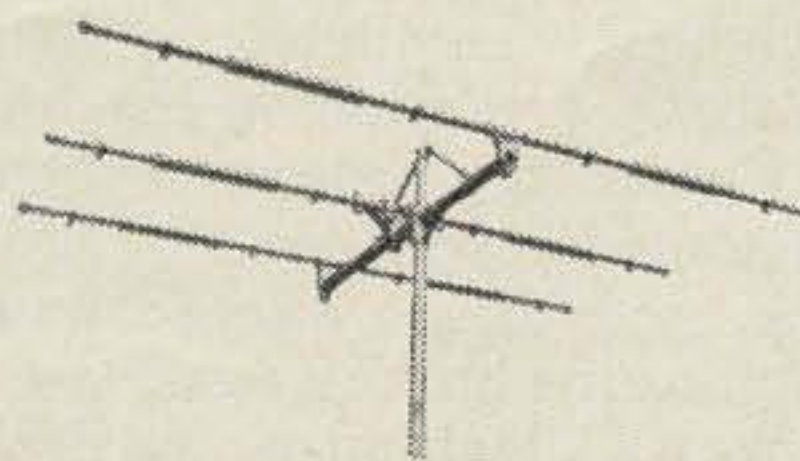

Model TB 750

Cash Price \$67.50

Only \$6.30 per month

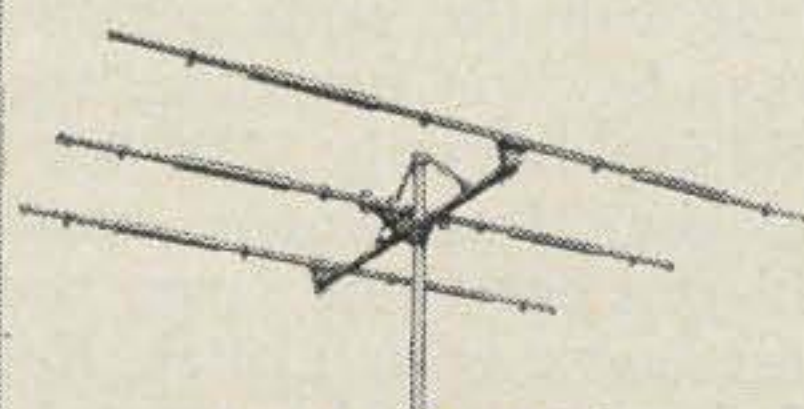

Model TB 500

Cash Price \$55.95

Only \$5.20 per month

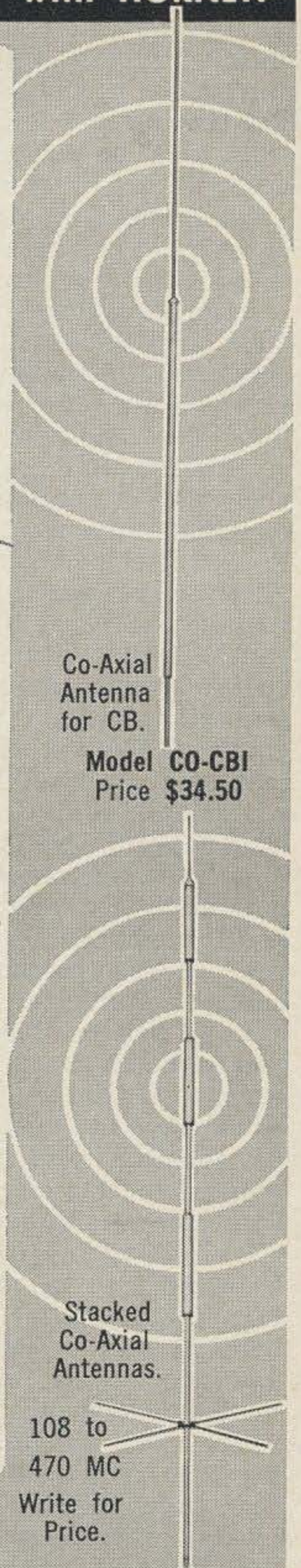

Co-Axial
Antenna
for CB.

Model CO-CBI
Price \$34.50

Stacked
Co-Axial
Antennas.

108 to
470 MC
Write for
Price.

MAIL YOUR ORDER TODAY

HORNET ANTENNA PRODUCTS CO., INC.
BOX 808, DUNCAN, OKLAHOMA

Please rush the Hornet Antenna indicated below for a 10-day trial. If not satisfied, I agree to return the antenna prepaid within 10 days without obligation.

- I prefer shipment to be c.o.d. 25% is inclosed.
- Payment in full is inclosed.
- I wish to use your Time Payment Plan.

Model	Description	Price

Name _____ Call Letters _____
Address _____
City _____ State _____

SATISFACTION GUARANTEED

notch is in the upper right-hand corner and on the top edge. Clamp the ink tracing you made in step two in contact with the foil, under glass. A picture frame, or better yet, a large photographic contact printing frame, is ideal. The tracing and foil must be in close contact.

At this point, expose the foil-and-tracing sandwich to direct sunlight for approximately one minute. Keep track of the exposure time by using a watch with a sweep-second hand, in case you have to make another print.

After exposing the foil, return to the subdued light and unclamp the sandwich. At this point, the foil should be completely transparent except where the ink lines shaded it; these lines should be pale yellow and barely visible.

Now, the foil is ready to be developed. Development is accomplished by exposing the foil to strong ammonia fumes; one of the best ways to do this at home is to get a large, wide-mouth glass jar, such as those used to pack pickles for commercial users (ask your favorite restaurant). In the bottom of the jar, place a sponge; on the sponge, put a few drops of commercial-strength ammonia (26%). Then roll the foil, emulsion side out, enough to get it into the jar and clamp on the lid. The image should appear within four to five minutes. When it stops getting darker, development is complete.

If the image is too light, you exposed the foil to sunlight too long. Repeat the process, exposing for only half as long as you did the first time. If it's too dark, you didn't expose long enough; double the exposure on the next try.

If all you wanted was a black-on-white dial, you would be nearly finished at this point. However, to indicate the sub-bands in color, a few more steps are necessary. The first is to either cut from the foil you just made, or trace on separate sheets of paper, the dial scale portion for each of the sub-bands. For instance, the "Novice" tracing would include only 3750-3800 kc, 7150-7200 kc, and the 21mc Novice band of 21,100-21,250 kc. If you cut these from the original foil, tape them down with Scotch No. 310 tape to a sheet of clear celluloid or acetate in their proper positions.

To check the tracings, sandwich them all together. When all are properly registered in the sandwich, it should look just like the plain black-and-white dial you already made. If it does, the register is good and you can proceed. If one or more fails to line up, re-do it until it does come into line.

Now, decide what colors you want to indicate what. For instance, you might like to have phone bands in green, Novice bands in red, CW

in blue, and the kc markings and legends in black.

A tip at this point—to get the legends in black, they must appear on a separate tracing all by themselves, and must *not* appear on any other tracing.

With the four tracings needed for this example prepared, expose a sheet of the proper color of Diazo chrome foil through each as you did before. Development also is identical to the procedure already described. You should come up with four foils, one bearing the Novice regions in red lines on a completely clear background, one bearing the phone bands in blue lines, one with CW bands in blue, and one black foil bearing only the numbers and letters you want on the dial.

Now, sandwich these four together so that the lines match properly, just as you did when checking the tracings earlier. It works best if you register two foils first, then tape them together and register the third on the taped pair, tape the third in place, and register and tape the fourth. Presto, a four-color dial.

At this point, of course, it's on a transparent background. You can cure this in either of two ways: you can back the sandwich up with a sheet of heavy white paper, or you can spray the back of the sandwich white with white spray enamel. Either works fine.

Of course, you're not limited to only four colors. A total of 19 different colors of foil are available, and you can use as many as you like. In addition, since the colors are transparent and the primary colors are included in the selection, you can blend colors by shading to produce any result you want.

Earlier, we said this technique made it possible for you to have either negative or positive dial plates without camera work, yet all we've mentioned so far is the positive plate (colored lines on white or clear background).

To get a negative dial, you proceed in the same manner except that you use a sheet of special "negative" Diazo foil; this material produces a reversed image, which will be clear lines on a colored background. It's available only in sepia, which prints like black, but the foil you get from it can then be used to produce dial plates in any color you desire.

The materials used are relatively inexpensive—a 4x10 inch dial in four colors costs only about 50¢ to make—but they are available only in comparatively large quantities. The smallest package available in Diazo chrome foil contains 25 sheets of foil, each 8½ by 11 inches, and sells for \$6. To get four colors, four pack-

DX-100 OWNERS

Increase power by 50%.

Run 240 watts AM-300 watts CW or SSB. Complete kit and instructions for adding another 6146 to final only \$19.95. Similar kit for TX-1. Order or write. W4KUV-W4NZS.

BEST RADIO SERVICE

610 N. Madison

Goldsboro, N. C.

WALKIE-TALKIE RADIOPHONES

FROM \$59.98

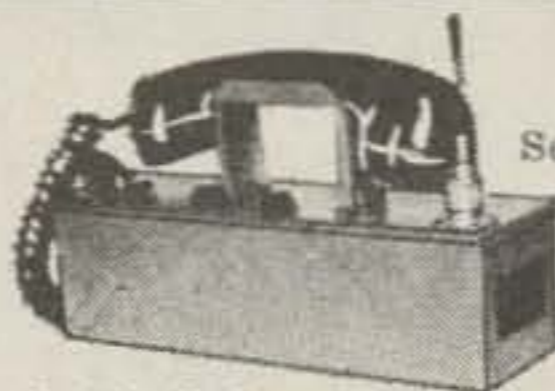

Dept. H-8

Send for FREE literature on the complete line of VANGUARD radiophones, for industry, Civil Defense, CAP, Citizens and Amateur bands. Made in the U.S.A. and guaranteed 5 years.

VANGUARD ELECTRONIC LABS.
190-48 99th Ave., Hollis 23, N. Y.

ages would be required. However, each package would make 50 dial plates of the size mentioned earlier, so if you do much homebrewing, and especially if you can find several other hams also interested in the idea to help defray the initial expense, the cost becomes quite low. The only other item you might have difficulty locating, the commercial-grade ammonia, is available at most drug stores at very reasonable rates.

.... K5JKX

Novice VFO

Gary Huff K9AUB

ALTHOUGH FCC regulations specifically state that Novices shall control the frequency by crystal control, and VFO's are outlawed, it is still possible for a Novice to use crystal control and have limited control of his frequency as if he were using a VFO. The idea described here is not new, and has appeared in such commercial transmitters as the Lysco 600.

Basically, it consists of placing a coil and capacitor in series with the crystal. The coil-capacitor combination will "rubber" the crystal a few kilocycles above and many kilocycles below the normal resonant frequency of the crystal. Of course, this effect is greatly increased as the frequency is increased. A 15 meter crystal will "rubber" three times as far as a 40 meter crystal.

The circuit is actually a VFO in series with the crystal. The coil and capacitor may be built into the transmitter if space permits, or may be added externally in a small utility box. Construction is not too critical, and the same practice as one would use in building a VFO should be followed. Once it is determined how far a crystal will rubber and still oscillate, the Novice may purchase several crystals far enough apart so their frequencies will overlap, and quite a large segment of band may be covered.

A word of warning. With crystals close to the band edge, it is quite easy to rubber yourself right out of the band, so be extremely cautious in setting the crystal frequency so that you don't get caught outside the band.

... K9AUB

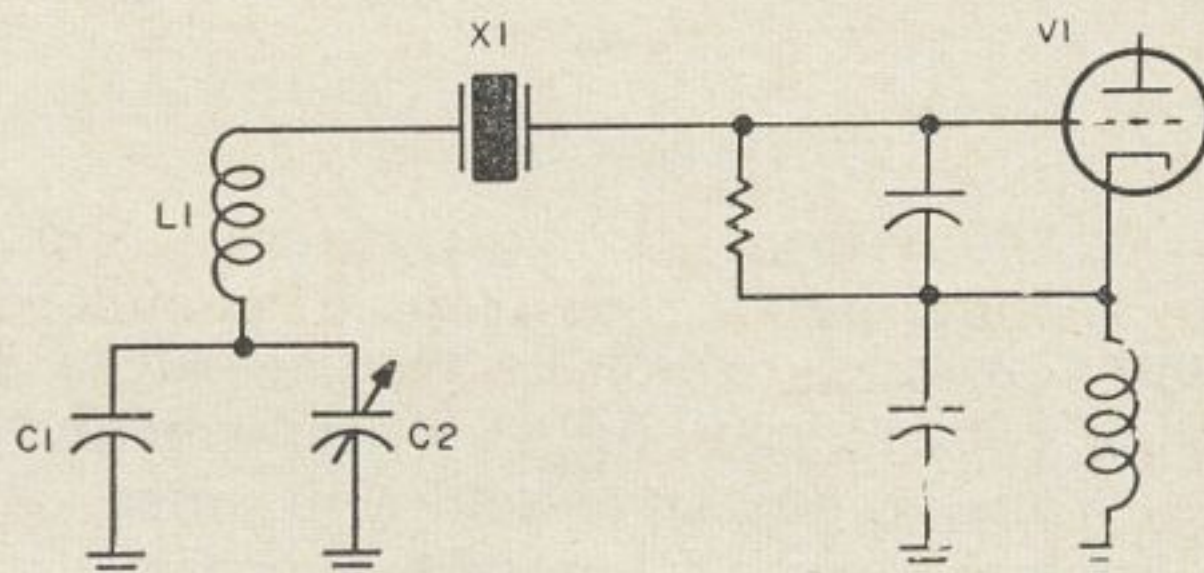

FIG 1

- L1. .Conventional VFO coil to resonate at crystal frequency with C1 and C2.
- X1. .Crystal
- VI. .Present crystal oscillator tube in transmitter

for
the

no-QSB QSO

Space Raider brings you the amazing *Polarized Diversity Beam* designed by K6CT and proven by DX men the world over. P. D.* virtually eliminates the 80% of QSB caused by polarization shift. P. D. Beams offer vastly improved forward gain, front-to-back and side rejection ratios. Space Raider beams priced from \$44.50. Write for particulars.

P. D. Beams Available for 20, 15, 10, 6 and 2 Meters

Space-Raider

1076 E. WALNUT ST., PASADENA, CALIF.

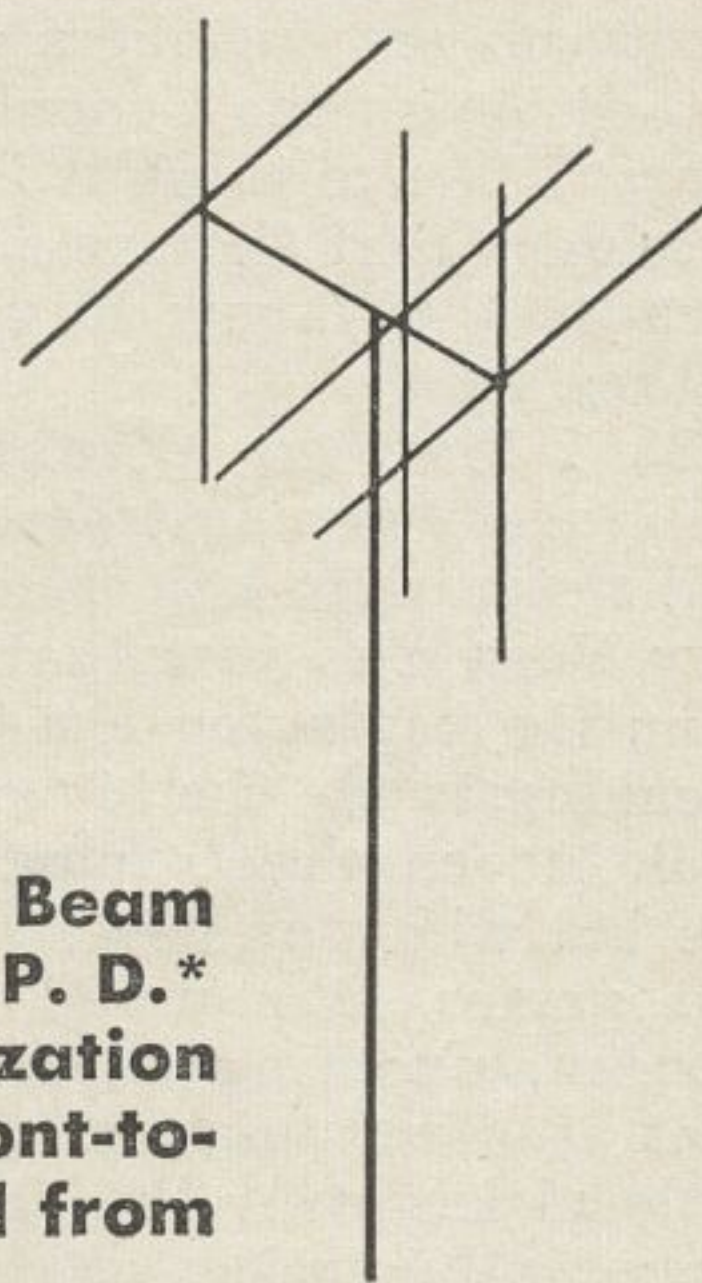

P.D.*

*Polarized Diversity

Potato Face

Sylvia Margolis XYL-G3NMR

I OFTEN wonder which is worse—for a man to be downright ugly or a woman. My friend, Vera, could have told you, once.

I'd known Vera all her life. Her father and I grew up together. As kids we built our first crystal sets together, back in the very early days. We lived as neighbors and friends and, when I became President of our local radio club, he was one of my ablest Committee men. I've been President now for more years than I like to admit. Ours is a fine little club, with plenty of new members coming in each month but, although the Committee changes with the years, I like to think it is because I am a good President that they re-elect me each year, not because they know it would break my heart if they didn't.

So I watched Vera grow up. Even as a child she was unattractive. Her elder brother and sister were homely enough kids but somehow Vera was just that much too plain. And from the beginning she knew it. It was heart-breaking to see the bitter truth twist her baby soul. At children's parties Vera was always the kid who was never chosen to take part in the games. She would sit them out with a wooden, uncaring expression, trying to show that it didn't matter really, while the other little girls, lovely in organza and ribbons and long white socks, quickly became the cruel teenagers who left Vera out of their invitation lists. At high-school parties Vera would spend the evening out in the yard, petting the host's dog, curled up into an ungainly lump of sensitive misery. At picnics it was Vera who could be relied on to look after the food efficiently. Nobody wanted to walk her by the river.

My own kids adored Vera, with her big, lumpy face, her thick clumsy body and sparse, mousy hair. A vicious neighbour named her "Potato Face" and Vera knew it, but that potato face could come alive when she was telling

a bed-time story, or comforting a fretful child.

Hers was a lonely life and perhaps it was lucky that her job as schoolteacher so filled her working hours that the emptiness of her leisure could, with kindness, be called "relaxation." When she was twenty her parents died suddenly, within weeks of each other. I lost my best friend and I was left as a kind of unofficial guardian with his daughter. Her brother and sister had married and moved away, so Vera clung to my family and we always welcomed her into our full and boisterous home.

One Christmas Eve I stepped across the street to the old house where she now lived alone. It was lucky that my wife had sent me over with the invitation to Christmas Dinner the day before Christmas Day. Otherwise I would have been too late and Vera would have finished the job. As it was I was just in time to drag her out of the gas-filled room. I called a medico friend whom I knew to be discreet and there was no scandal. When the fuss was all over my wife and I were faced with a problem. It was no easy task to persuade Vera to re-enter the utterly empty and lusterless life which she had tried to quit. Then I thought of amateur radio and suggested that she take up her father's life-long hobby. At first she was unresponsive and cynical, but her quick brain soon mastered the essentials and bit by bit her interest was aroused. Within a year she was on the air. We put together a real fine station for her, using some of her father's old gear and some of the new commercial equipment which she insisted on buying because, as she said, what else was there to spend her money on? Some of the club boys helped me fix up a good high beam, for this was our first local lady amateur.

Ours is a wonderful hobby for lonely people and it made all the difference to Vera. Now

CUTS WIRING COSTS!

**PLUG-IN
MASTER POWER
CONTROL
BOX**

MODEL 24
\$8.50

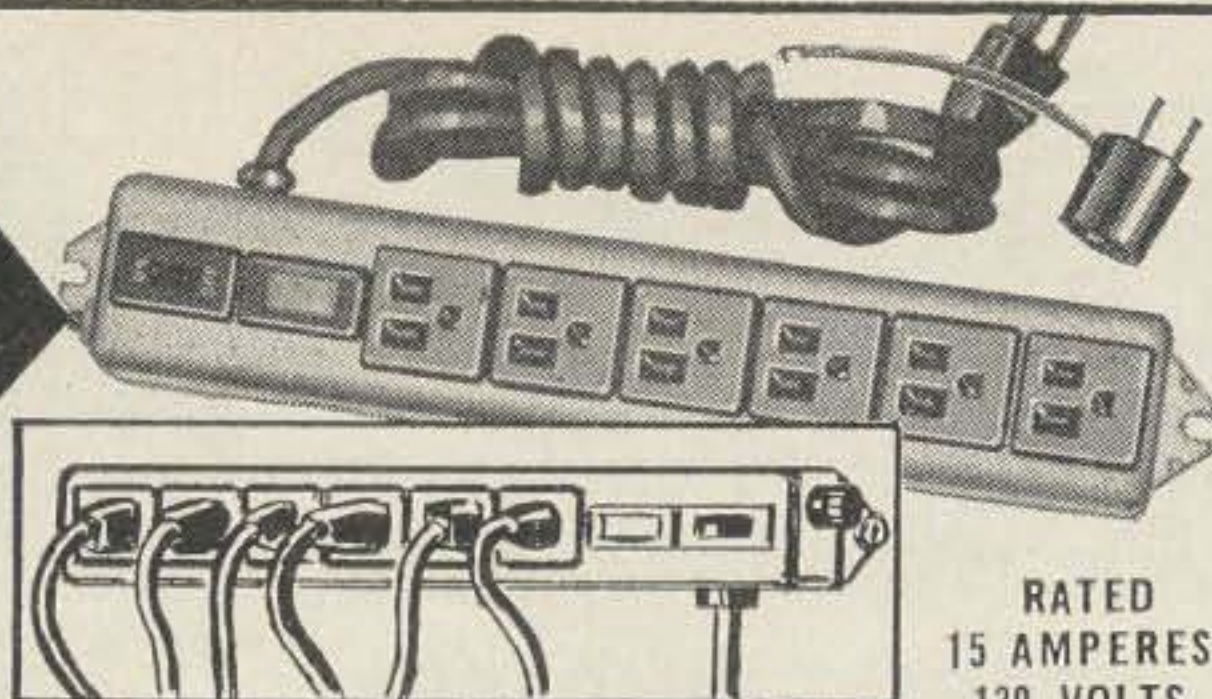

RATED
15 AMPERES,
130 VOLTS.

OFFERS YOU 6 SOCKETS WHERE YOU NOW HAVE 1

Heavy duty features insure long-life and complete utility for use on equipment or in shop or plant!

SEND FOR LITERATURE

QUOTATION FOR SPECIAL UNITS ON REQUEST

WABER ELECTRONICS, INC.

Hancock & Somerset Sts. Phila. 33, Pa.



- Panel Mounted Fuse
- On-Off Switch
- Pilot Light
- Tough U. L. Cordset
- Molded Plug
- U. L. Approved Components
- Mounting Ears
- Silver Gray Seamless Hammertone Case
- "U" Ground Receptacles
- Adaptor Free

Model 24CB (Circuit Breaker Type) \$10.50

it no longer mattered that she was left out of the skating parties, the moonlight barbecues, the dances that the other young people organized. There would always be a contest or a schedule to fill the gap. Gradually the current set of young people became younger and younger and Vera was beyond it all, an old maid of thirty, who had never been anything else. School filled her days—Vera was a marvellous teacher—and radio her nights.

It was the DX she liked best. I think she was always afraid to get involved in local nets for fear that the QSO's would lead to personal meetings, with the inevitable let-down and mumbled politeness and practised sliding-away that she had come to know so well. So Vera made friends in Athens and Leningrad and Paris, where the operators were not to know that the YL with the rather lovely voice and the charming mike manner was the more-than-homely butt of our little town, Fat Potato-Face, on whom the gathering years made no improvement. Vera never put her picture on her QSL's—no sir—but she did learn to flirt gently over the air with men she would never meet.

Her first contact with Harry was quite casual—a dead band, a venturesome CQ and straightway back came a W1—the only one around, it seemed, crisp and clear, with no QRM, as if some ionospheric Cupid were putting in overtime that night. It started off as a rubber-stamp QSO—callsigns, reports, QTH, WX, run-down on the rig. But when all that was over the band was still miraculously clear. Each was attracted by the other's voice—Harry's was deep, with a New England twang. So they began to gossip a little, shyly and awkwardly at first, but with neither wanting to end the contact.

She told him she taught school in Ipswich. He replied that he came from Vermont, but was living and working as a sound engineer in Boston, which might be a big city, but was certainly the lonely, and what a blessing ama-

teur radio was. Then up came the QRN and it was with something like panic that Vera lost contact. But the next night there he was again and seemed delighted to hear her once more. This time they discussed antenna systems and she helped him make some comparative tests, then they began to talk a little about their own lives. He told her about his dog and she agreed that dogs were nice things to have about the house. Then they discovered a mutual love for serious music. He described a recent concert he had heard at Boston's Symphony Hall. He had been told by an Englishman—no less—that this was the finest concert hall in the world.

Somehow after that it seemed natural for Vera to listen out for her new American friend. A regular schedule developed, but then, with the advent of Summer, the band went out. Regretfully Vera came up once more to the surface of life and didn't like it one bit. Normally most reserved and reticent, she took a chance on a letter to Harry. Life had accustomed her to personal hurt and rebuff but still she was bitterly disappointed when weeks passed before he replied, then his letter was a brief, stilted, type-written note. She didn't write again. But that Fall there was Harry again and apparently overjoyed to renew the friendship.

Vera seemed to blossom in the winter months that followed. She remained the fine and conscientious teacher she had always been, but little else in her existence had any substance. All that were real and tangible were the shack and the precious magic hours in contact with Boston. At Christmas Vera had to excuse herself early from our dinner table to keep their Christmas-Day schedule. She was so very proud to have to do this—to have a real date with a real beau, even though he be three thousand miles away. Harry was unmarried and over forty and to her he was everything.

(Turn to page 69)

BOUND VOLUME \$15

We have had a tough job getting enough volumes of 73 bound to meet the demand, even at the price of \$15. This may be because so many fellows have seen one around and have a hankering for the bright red cover and the first fifteen issues of the magazine that are bound inside.

YEARLY BINDERS \$3.00

These are also in bright red and are stamped either 1960-1 or 1962. You tell us which you want. We managed to get some 1960-1 binders that will hold 14 copies of the magazine. This makes for a better fit if you don't have all 15 issues. Specify large or small binder for this year.

MRT-90 CONVERSION: 50c

This booklet gives complete conversion instructions for converting the little pack-set surplus units into a fine two meter walkie-talkie. An article appeared in 73 on this unit in the October 1961 issue.

HAM-TV \$3.00



TV is one of the newest and most exciting phases of ham activity. This book gives clear and simple instructions for getting an operating TV station on the air for under \$50 outlay! It is no wonder that hundreds of fellows are rushing to get on the air. The interest has been so high that a bi-monthly bulletin has now been started to keep everyone up to date on the advances and latest stations to get into operation.

IMPEDANCE BRIDGE \$1.00

Here is a complete set of full scale drawings of the parts for the Impedance Bridge which was featured in the August 1961 issue of 73. This bridge is one of the most useful pieces of test equipment that you could possibly build. It would cost you hundreds of dollars to buy this unit commercially made. This set of plans comes complete with a reprint of the original article.

SSB TRANSCEIVER SCHEMATIC \$1.00

There have been many requests for a giant sized schematic of the wonderful little transceiver that appeared in the November 1961 issue of 73. This schematic comes complete with a spare issue of the magazine in case you missed it.

73 Magazine Peterborough, New Hampshire

INDEX TO SURPLUS

INDEX TO SURPLUS \$1.50

This is a masterful compilation of all articles that have ever been printed on surplus conversions, complete with a brief run-down of the content of each article.

TV BULLETIN \$1.00 per year

The first issue of the TV Bulletin is now ready for mailing. This is a bi-monthly bulletin designed to keep all fellows interested in Ham-TV up to date on technical improvements in Ham-TV gear and on all activities. In the first issue of the Bulletin there is a list of all known hams who are reported to be getting on the air on TV. The Bulletin is edited by Mel Shadbolt, WØKYQ, the author of the popular HAM-TV book. Get in on this from the first issue and have a complete set of information at your fingertips. The present plans call for six issues of the Bulletin per year, with at least 12 pages per issue.

MICKEY MIKER 50c

This is the first of our small booklets to come off the press. It is a complete description of the construction and operation of a little device which will measure capacity to a high degree of accuracy. This is a gadget that can be built out of most junk boxes and will forever be a handy item to have around when you are building something new or fixing something old.

BACK ISSUES

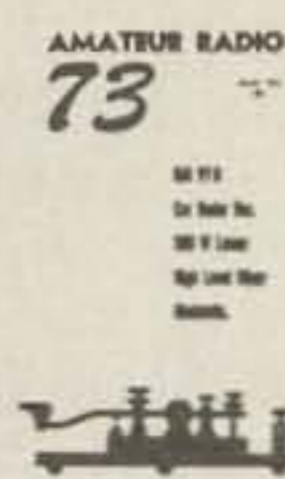
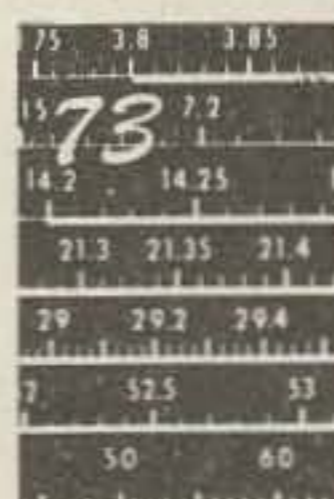

We have a diminishing stock of all back issues except January 1961. We are willing to part with this stock for only 50¢ each. How about that!

(Potato Face from page 67)

Forgotten were the misery and humiliation of childhood and adolescence, the feeling of not mattering to anybody. She proudly showed us the get-well card he sent when she was sick. It stood on her dresser for weeks.

One day in the Spring she rushed into our house to sob incoherently that it was all over. We calmed her down a little and she told us that Harry was to visit from the States. My wife and I were too intimate with her to make any pretence of how nice that would be. There was a sense of catastrophe. I suddenly remembered that dreadful Christmas Eve long ago and the reek of gas and how I had been just in time.

"I'll take a vacation—I'll go away!" she moaned and burst into tears again, thick blubbering ugly sounds. Few women can cry prettily and poor Vera's plain face had never seemed so unlovely. She showed me the short letter. Harry's firm was sending him to London for a month to study some new techniques in sound reproduction. He was looking forward very much to that personal QSO.

There was no way out. It just had to be. Vera, who had always had a raw deal from life, was all prepared for yet another blow. How could it have lasted? Who was she to expect her fool's paradise to go on forever?

The next weeks were shocking. She went to a

(Turn to page 70)

FREE Catalog OF THE WORLD'S FINEST ELECTRONIC GOV'T SURPLUS BARGAINS



HUNDREDS OF TOP QUALITY ITEMS—Receivers, Transmitters, Microphones, Inverters, Power Supplies, Meters, Phones, Antennas, Indicators, Filters, Transformers, Amplifiers, Headsets, Converters, Control Boxes, Dynamotors, Test Equipment, Motors, Blowers, Cable, Keyers, Chokes, Handsets, Switches, etc., etc. Send for Free Catalog—Dept. 73.

FAIR RADIO SALES
2133 ELIDA RD. • Box 1105 • LIMA, OHIO

ALL BAND TRAP ANTENNA !



Reduces Interference and Noise on All Makes Short Wave Receivers. Makes World Wide Reception Stronger. Clearer on All Bands!

For ALL Amateur Transmitters. Guaranteed for 500 Watts Power for Pi-Net or Link Direct Feed. Light. Neat. Weatherproof

Complete as shown total length 102 ft. with 87 ft. of 72 ohm balanced feedline, Hi-impact molded resonant traps. (Wt. 3 oz. 1" x 5" long). You just tune to desired band for beamlike results. Excellent for ALL world-wide short-wave receivers and amateur transmitters. For NOVICE AND ALL CLASS AMATEURS! NO EXTRA TUNERS OR GADGETS NEEDED! Eliminates 5 separate antennas with excellent performance guaranteed. Use as Inverted V for all band power gain. NO HAYWIRE HOUSE APPEARANCE! EASY INSTALLATION! 80-40-20-15-10 meter bands. Complete.....\$14.95
40-20-15-10 meter bands. 54-ft. ant. (best for w-w swl's) 13.95
20-15-10 meter bands. Dual Trap. 24-ft. antenna..... 19.95
SEND ONLY \$3.00 (cash, ck., mo) and pay postman balance COD plus postage on arrival or send full price for postpaid delivery. Free information.

Available only from:
WESTERN RADIO - Dept. A7-7 - Kearney, Nebraska

- 23 TRANSISTORS
- 13 SEMICONDUCTOR DIODES
- 5 CERAMIC TRANSFILTERS®

- 1 COLLINS MECHANICAL FILTER
- 12 QUARTZ CRYSTALS

and a couple of hundred other things

That's what goes into each DAVCO DR30 communications receiver.

Small wonder that it's taken us so long to get them on the market. No surprise at all that the performance is so outstanding. Only thing that just doesn't seem reasonable is the price . . . and we're working overtime to keep it as low as it is.

Some people might wonder what we've been doing. We certainly haven't been able to answer all your letters; we haven't done any advertising lately; we've passed up some hamfests we had planned to visit.

It just happens that we *don't* think that amateurs should have to pay for serving as guinea pigs for new products. We *do* think that an investment should be as safe as possible. We didn't want to bring out a model which might have to be improved in just a few months, simply because we might have been in a hurry or may have overlooked something.

So, we've been busy.

WE'VE:

- tested units under almost ridiculous environmental extremes;
- waited for new, better components from some manufacturers;
- searched for suppliers who could meet our strict specifications;
- incorporated suggestions from some of your letters;
- tested, double checked and re-examined everything we've done;

and managed to make some truly significant improvements in the whole system—things like increasing the power of our DT20 SSB transmitter, and improving the sensitivity of the DR30 receiver, and adding 6-meter coverage (some people say this is downright revolutionary: VHF coverage without external converters), and still more.

Two and a half years of development is a long time. We're proud of the results, though, and think that you'll agree with us that the time has been worth it.

Thanks for being so patient!

Missed our previous ads and wondering what this is all about? Drop a QSL or post card and you'll be put on our mailing list. Meanwhile:

The DR30: a double conversion ham-band receiver with mechanical filter selectivity, superlative performance, excellent stability, and features not found in other units at any price. It costs \$289.50 complete with all crystals, etc. The matching DT20 SSB-AM-CW transmitter-exciter is available in two models: the DT20A for independent use at \$345.00 including power supply, and the DT20, which shares xtal oscillators and mechanical filter with the DR30 receiver and is designed for use with it, when it provides all functions of the DT20A including separate VFO's or transceive operation (\$215.00 including power supply). Each unit is 7½x4x5 inches. All are imminently suited for fixed, portable and mobile operation by the most demanding amateurs and are wired, tested, and fully guaranteed.

davco electronics company
113 Norwood Avenue • Asheville, North Carolina

Just Arrived... Big Truckload Shipment!

FABULOUS TRADE-IN

allowance on NEW

HALLICRAFTERS

HT-37



"You won't believe my offer!
Rush coupon today... I'll send
FREE gift ball point pen with
my trade-in offer on HT-37"
King of Traders... Terry (W9DIA)



HAM \$
NET **495**

\$5 DOWN
TAKE UP TO FULL 3 YEARS
TO PAY THE BALANCE

We just received a fresh new truckload of HT-37's... we *MUST* move them during the next 30 days. You'll never get a better deal than *right now* on this precision CW/AM/SSB xmitter. 70-100 watts P.E.P. output CW or SSB. 17-25 watts output AM. Ideal CW keying; full voice control system. 52 ohm pi-network output for harmonic suppression.

OUR GOAL THIS YEAR IS \$1,000,000 IN HAM EQUIPMENT SALES! THAT'S WHY WE'RE GIVING YOU THE BEST DEAL AND BEST SERVICE ANYWHERE!

AMATEUR ELECTRONIC SUPPLY

Milwaukee: 3832 Lisbon Avenue (WEst 3-3262)

Chicago: 6450 Milwaukee Avenue (RO 3-1030)

Amateur Electronic Supply
3832 W. Lisbon Ave., Dept. 73-8
Milwaukee 4, Wisconsin

**MAIL COUPON
TODAY**

Terry: I have a _____ to
trade. What's your deal on the HT-37?
Be sure to send FREE Ball Point Pen, too!

Name _____ Call _____

Address _____

City _____ Zone _____ State _____

(Potato Face from page 69)

beautician and came away with her eyebrows a different shape and her lank hair corrugated into unfamiliar curls which somehow seemed to accentuate all the more her homeliness. She lost weight with worry, but her great heavy body seemed the same uncompromising gawky mass it had always been. We never left her alone. My wife even took a trip to stay with a friend, so that we should have an excuse to ask Vera to come over and run our home for a week, for then she would have no time to herself.

The dreaded day arrived. Vera begged me to meet Harry at the plane, for she couldn't face the horrifying meeting in the public arena of an airport lounge. I have had few minutes more soul-searing than those watching the big plane scream to a halt and waiting to meet the visitor. The little knot of passengers came across to the lounge and then I saw Harry.

I knew all at once a great surge of triumph and joy and sadness and pity for the whole human predicament. I greeted him, then, while he was checking his baggage, I excused myself to rush to a phone and call Vera.

I just had to tell her about Harry's white stick.

(W2NSD from page 4)

VHF Publications

There are now three offset printed bulletins catering to the VHF enthusiast, all leaning heavily on station activity reports. The newest, scheduled for a May debut and now reported to be out, is published by CB Horizons in Oklahoma City. I'll have more info on this when I get a copy. The editor is erstwhile 73 author Jim Kyle K5JKX. The oldest bulletin is VHF Amateur published by K2ZSQ. Bob pulled a sneak attack on Horizons by using the Horizon cover logo from their prepublication hoopla and making his latest issue look just exactly like the expected bulletin from Horizons. One of the bulletins that you Technicians should be sure to support is "The Technician" published by Armond Nebel K7MFA, Box 465, Billings, Montana at \$2 per year. This is a friendly and interesting bulletin.

Citizens Band

Bah!

I knew no good would come of that darn thing. Now I keep hearing more and more talk of their expanding the CB into our ten meter band, or maybe into the top half of six. This is ridiculous. I know, I know, they're

crowded and need more than 22 channels. If they'd cut out all the monkey business and get the frustrated would-be hams off the CB channels they would probably eliminate most of their QRM problems. Some fellows have suggested a new ham ticket for these chaps which would allow them into our VHF bands with no code and little technical requirements, which license would serve to ease the strain on the CB channels and keep our VHF bands busy enough to fend off raids from neighboring services.

The proposed encroachment on ten meters is based upon our non-activity in this region as much as it is on the overcrowding of the eleven meter Citizens Band. Why are we letting these frequencies go by the board? Why are we letting ourselves into another eleven meter situation again? With 250,000 hams in this country do you mean to tell me that we can't scare up a handful of fellows to keep these bands alive? Rats.

For example, Brooklyn probably has a ham population on the order of 7000 licensed amateurs. Still, if I tune across ten meters any evening, I am lucky to hear two or three QSO's in progress. Many times all is silent. A ten meter antenna is simple and all of the all-band rigs work fine there, so where is everyone? Probably watching TV after an unsuccessful battle with the QRM on 75. I don't suppose that there is any way to get fellows to invest a half hour a day in the preservation of our bands. If the 7000 hams in Brooklyn would each devote a half hour a day to getting on one of the "unoccupied" bands there would be so much activity that no one would think of taking away our frequencies.

How about it? Will you take a few minutes a day to keep the wolf from our door? Just get fired up on ten now and then, get something going on two this weekend and lure fellows up to the upper end, and once you've gotten set up on these then see what you can do to set up some nets in the high end of six meters. You don't have to blast away at the bands with a KW to have fun, a simple Sixer, Tenner or Twoer will do it, as will any of the many simple rigs we have run in 73 or that you will find in the Radio Handbook or the ARRL Handbook.

Reciprocation

Senator Magnuson will be holding hearings on the Reciprocal Licensing Bill in the near

(Turn to page 72)

TELETYPEWRITER EQUIPMENT • COLLINS

51J2, 51J3, R-390A/URR Receivers (.50-30.5 MC). Teletype Printers #14, #15, #19, #20, #26, #28. Kleinschmidt Printers #TT-4A, TT-76, TT-98, TT-99, TT-100, GGC-3. Teletype Frequency Shift Converter. For general information & equipment list, write to TOM, WIAFN, ALLTRONICS-HOWARD CO., Box 19, Boston 1, Mass. Richmond 2-0048.



DOW-KEY CONNECTORS

PANEL MOUNT

Durable, silver plated, precision made. Only 3/8" hole is needed, no screws.

ea.70

DOUBLE MALE

Favorite everywhere. Precision made, rugged locking type. Silver plated.

ea.1.25



DOW-KEY COMPANY, Thief River Falls, Minn.

Tri-State Amateur Radio Society Hamfest Ecco Valley on the Vanderburgh-Posey county line

Indiana Highway 66, west of Evansville, Indiana

Grand Prize, HT-37, many others

Registration \$2.00 • Dinner \$1.35

August 26, 1962



TV CAMERA

Build at

LOW COST

Details 50¢

DENSON ELECTRONICS CORP.
Box 85 Rockville, Conn.

EQUIPMENT FOR SALE

CLEGG ZEUS \$450, would prefer not to ship except by bus.
TAPETONE TC144, TC220, 50mc IF, \$75 ea., both spotless.
GLOBE CHIEF DELUXE, factory built, 12 xtals, \$40.
KWM1 NOVICE ADAPTER, 7 15mtr xtals \$20, never installed.
LW51 2mtr 12 volt with AC supply, \$90 used less than 2 hours.
HALLICRAFTERS METER KIT \$10 new. KNIGHT RF GEN. \$10 good.
All FOB K4YBL 2616 BARCELONA DRIVE, FT. LAUDERDALE, FLORIDA

10-15-20M QUADS

*PRE-CUT *PRE-TUNED *TRIBAND
\$59.95 DEPT. C \$99.95
Bamboo Fiberglass
WRITE FOR FREE LITERATURE EXTRA PARTS AVAILABLE

Skylane PRODUCTS 406 BON AIR DR
TEMPLE TERRACE FLA

DB Meter 3 1/2" Rd HS -10 to +6db, 1mw @ 600 ohm. NEW \$3.50
M-359 Coax Angle Connectors. FIVE yes 5 for. 1.00
600 Ohms 300 Watt Non-Inductive resistors. 2.50
M-15/UR microphones Noise cancelling type similar to T-17 14.50
Bird Model 74 COAX switch 6 posn like new. 22.50

SPACE ELECTRONICS CO.

218 West Tremont Ave., Bronx 53, New York
TRemont 8-5222

future. If you have anything cogent to say in the behalf of this bill you might make it your business to find out just when the hearings will be and be there. If you haven't anything cogent to say in behalf of this bill then you haven't been paying much attention to what is going on. Let's keep the Senator busy fellows. You can bet that I am going to make it my business to get down there and I want to see that place jammed with hams.

Conventions

This changing of QTH's is taking so much of my time that it is impossible for me to get around to any conventions or hamfests this year. Even if I had the time there is the financial strain since conventions just do not bring in enough in subscriptions to pay for themselves. It is a lot of fun putting out a ham magazine the way I think it should be published, but I do have to keep one eye on the till. Maybe by next year we will be doing well enough so Virginia and I can get to some more hamfests.

For some reason known only to yourself you are continuing to buy products that are not advertised in 73. Thusly encouraged, these manufacturers continue to not advertise in 73 and we continue to have to raise our subscription rates in order to meet the increasing bill from our printers and the post office. Just a few more pages a month of ads and we wouldn't have to raise our rates. I don't expect you all to sit down and write angry letters to non-advertisers, but you might chide them at the next convention and add it to any correspondence that you may have with them. You might take a quick look through the magazine and notice those major manufacturers who are obviously missing.

Don't forget us on the 19th. Come on up for a visit to beautiful New Hampshire in the famous Monadnock Region. Bring some VHF gear and try out Mount Pack Monadnock, just five minutes from our house. It is reachable by car and is one of the most popular VHF contest spots in the country. Where is Peterborough? About midway across the state and just above Massachusetts.

Wayne

SUBSCRIPTIONS

Whether you buy 73 on the newsstand, at your local parts distributor, or wherever, you really should be subscribed. Not only do you save a bit of money and are assured that you will get your copy each month, but also it will make us all very happy and might even leave a copy at your supplier for someone else to discover the magazine. You want us to be happy in our new headquarters, don't you? By the way, our sub rates will have to go up soon and we may not give you much warning.

.....

name call

.....

address (QTH)

.....

city zone state

\$3.50 one year \$40 LIFE

\$6.50 two years Renewal

\$9.00 three years New subscription

Start with: current issue next issue

.....

name call

.....

address (QTH)

.....

city zone state

\$3.50 one year \$40 LIFE

\$6.50 two years Renewal

\$9.00 three years New subscription

Start with: current issue next issue

73 Magazine

PETERBOROUGH,
NEW HAMPSHIRE

73 Magazine

PETERBOROUGH,
NEW HAMPSHIRE

Radio Bookshock

We'll have a lot better summer of it if you'll make a slight enlargement of your radio library. Order copiously.

4—RADIO AMATEUR CALL BOOK—Summer Edition. \$5.00

5—ANTENNAS—Kraus (W8JK). The most complete book on antennas in print, but largely design and theory, complete with math. \$12.00

13—REFERENCE DATA FOR RADIO ENGINEERS. Tables, formulas, graphs. You will find this reference book on the desk of almost every electronic engineer in the country. Published by International Telephone and Telegraph. \$6.00

18—SO YOU WANT TO BE A HAM—Hertzberg (W2DJJ) Second edition. Good introduction to the hobby. Has photos and brief descriptions of almost every commercially available transmitter and receiver, plus accessories. Lavishly illustrated and readable. \$2.95

21—VHF HANDBOOK—Johnson (W6QKI). Types of VHF propagation, VHF circuitry, component limitations, antenna design and construction, test equipment. Very thorough book and one that should be in every VHF shack. \$2.95

22—BEAM ANTENNA HANDBOOK—Orr (W6SAI). Basics, theory and construction of beams, transmission lines, matching devices, and test equipment. Almost all ham stations need a beam of some sort . . . here is the only source of basic info to help you decide what beam to build or buy, to install it, how to tune it. \$2.70

23—NOVICE & TECHNICIAN HANDBOOK — Stoner (W6TNS). Sugar coated theory: receivers, transmitters, power supplies, antennas; simple construction of a complete station, converting surplus equipment. How to get a ham license and build a station. \$2.85

24—BETTER SHORT WAVE RECEPTION—Orr (W6SAI). How to buy a receiver, how to tune it, align it; building accessories; better antennas; QSL's, maps, aurora zones, CW reception, SSB reception, etc. Handbook for short wave listeners and radio amateurs. \$2.85

28—TELEVISION INTERFERENCE—Rand (W1DBM). This is the authoritative book on the subject of getting TVI out of your rigs and the neighbors sets. \$1.75

32—RCA RADIOTRON DESIGNERS HANDBOOK—1500 pages of design notes on every possible type of circuit. Fabulous. Every design engineer needs this one. \$7.50

40—RADIO HANDBOOK, 15th EDITION—(W6SAI). Scads of amateur radio construction projects. \$8.50

45—CURTA COMPUTER. The world's smallest computer. Send for detailed information. Makes the slide rule look sick. Like a big Monroe computer only hand size. \$125.00

52—HOW TO READ SCHEMATIC DIAGRAMS—Marks. Components & Diagrams; electrical, electronic, ac, dc, audio, rf, TV. Starts with individual circuits and carriers through complete equipments. \$3.50

53—BASIC ELECTRONIC TEST PROCEDURES—Turner. This book covers just about every possible type of electronic test equipment and explains in detail how to use it for every purpose. Testing: audio equipment, receivers, transmitters, transistors, photocells, distortion, tubes, power . . . etc. \$8.00

55—TRANSISTOR CIRCUIT HANDBOOK—Simple, easy to understand explanation of transistor circuits. Dozens of interesting applications. \$4.95

63—G.E. TRANSISTOR MANUAL 6th EDITION. \$2.00

66—DESIGN MANUAL FOR TRANSISTOR CIRCUITS BY CARROLL. Tested transistor circuits for design engineers. Interesting reading too. \$9.50

67—TRANSISTOR CIRCUIT ANALYSIS AND DESIGN by Fitch. Written primarily as a college text to teach circuit design. \$13.00

68—HANDBOOK OF TRANSISTOR CIRCUIT DESIGN BY PULLEN—This is a handbook which teaches a systematic system for transistor circuit design. Highly recommended by radio schools. \$13.00

74—HANDBOOK OF ELECTRONIC TABLES & FORMULAS—Formulas & laws, constants, standards, symbols and codes. Math. tables, misc. data. \$2.95

QAN—SECOND CLASS RADIOTELEPHONE HANDBOOK—Noll (W3FQJ). Everything you need to know to pass the FCC exam and get started servicing two-way equipment. Much more than just a Q & A manual \$3.95

76—MODERN OSCILLOSCOPES & THEIR USES—Ruiter. Second edition. Shows what a 'scope is, what it does and how to use it for radio, TV, transmitters, etc. 346 pages. \$8.00

79—TRANSISTOR PROJECTS—Skip the theory and start having fun. Radios: self powered, shirt pocket, regenerative, carrier-power, headphone. Instruments and accessories: sine-square wave generator, preamps for VTVM's, gain checker, shortwave calibrator, phase shifter, substitution box. Plus remote transistor ear, electronic compass, simple oscillator, lamp control, multi-impedance amplifier, electronic counter, portable power supply . . . etc. \$2.95

G94—TRANSISTORS. Selected articles from Radio Electronics on how to test transistors and how to build all-transistor test equipment. \$1.95

731—HAM—TV—W4KYQ. This is the only book available on this fascinating branch of ham radio. Describes complete ham TV station that costs under \$50. \$3.00

734—INDEX TO SURPLUS—Bibliography of all surplus articles printed in all radio magazines to date. Brief description, etc. \$1.50

735—BOUND VOLUME—October 1960 through December 15 issues (Vol. 1). \$15.00

R235—RADIO CONTROL FOR MODEL BUILDERS—Winter. One of the best and newest books available on RC. \$4.25

R245—HOW TO USE GRID-DIP OSCILLATORS—Turner (K6AI). Construction & uses, an important book. \$2.50

MMD—ELIMINATING MAN MADE INTERFERENCE—What makes it, how to find it, how to cure it in homes, factories, automobiles, aircraft, boats, etc. Or maybe you haven't been plagued lately. 160 pages. \$2.95

NHP—BUILDING UP YOUR HAM SHACK—Pyle (W7OE). A practical discussion of points to consider when you are buying ham equipment, complete with descriptions of much of the available commercial gear. It's just possible that Pyle might keep you from making a mistake which would cost a lot more than his book. \$2.50

Circle the book numbers you wish to order. Please include cash, check, money order . . . or something we can deposit in the bank.

Name Call

Address

City State

RADIO BOOKSHOP
1379 East 15th Street, Brooklyn 30, N. Y.
(N.Y.C. add 3% tax)

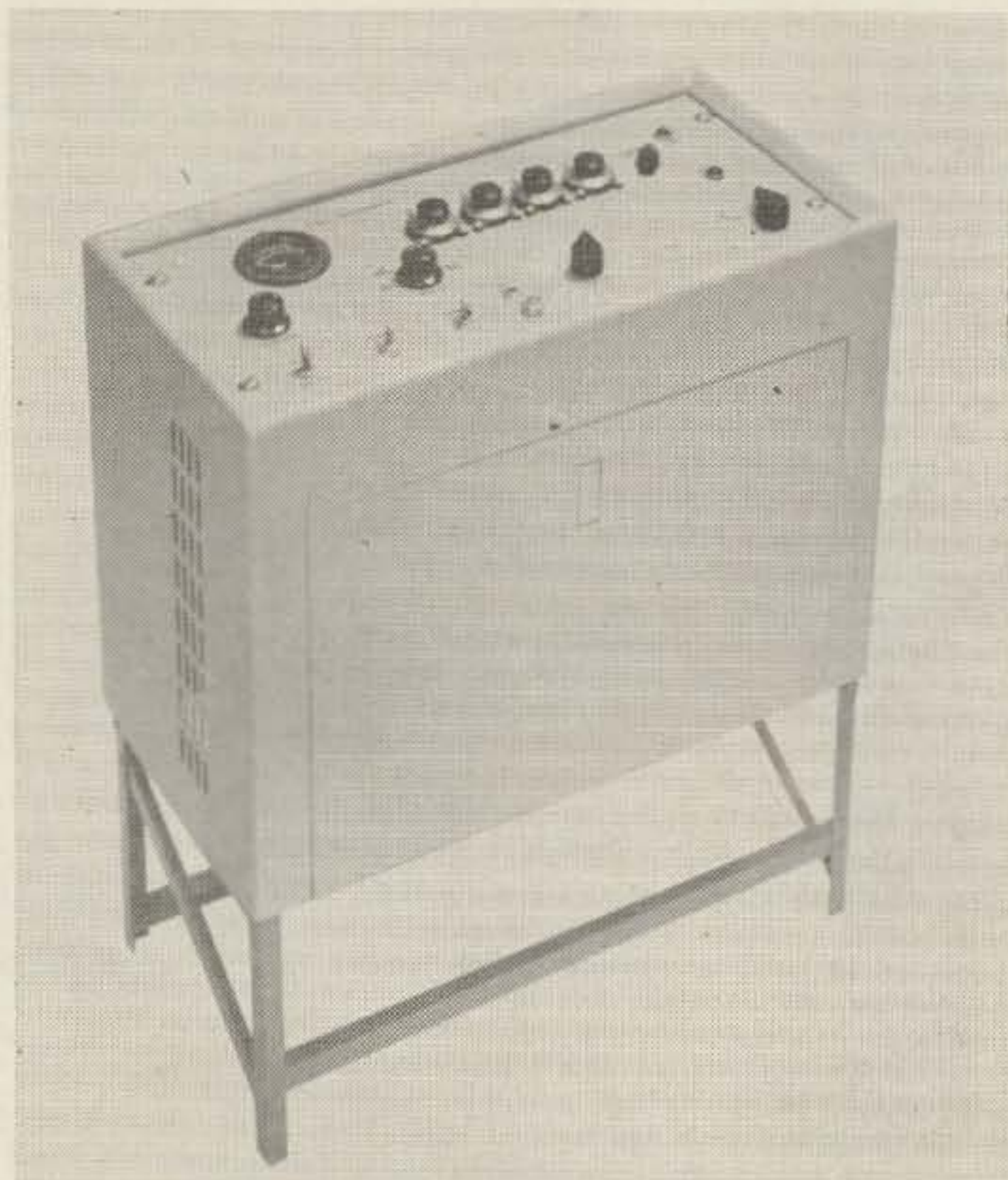
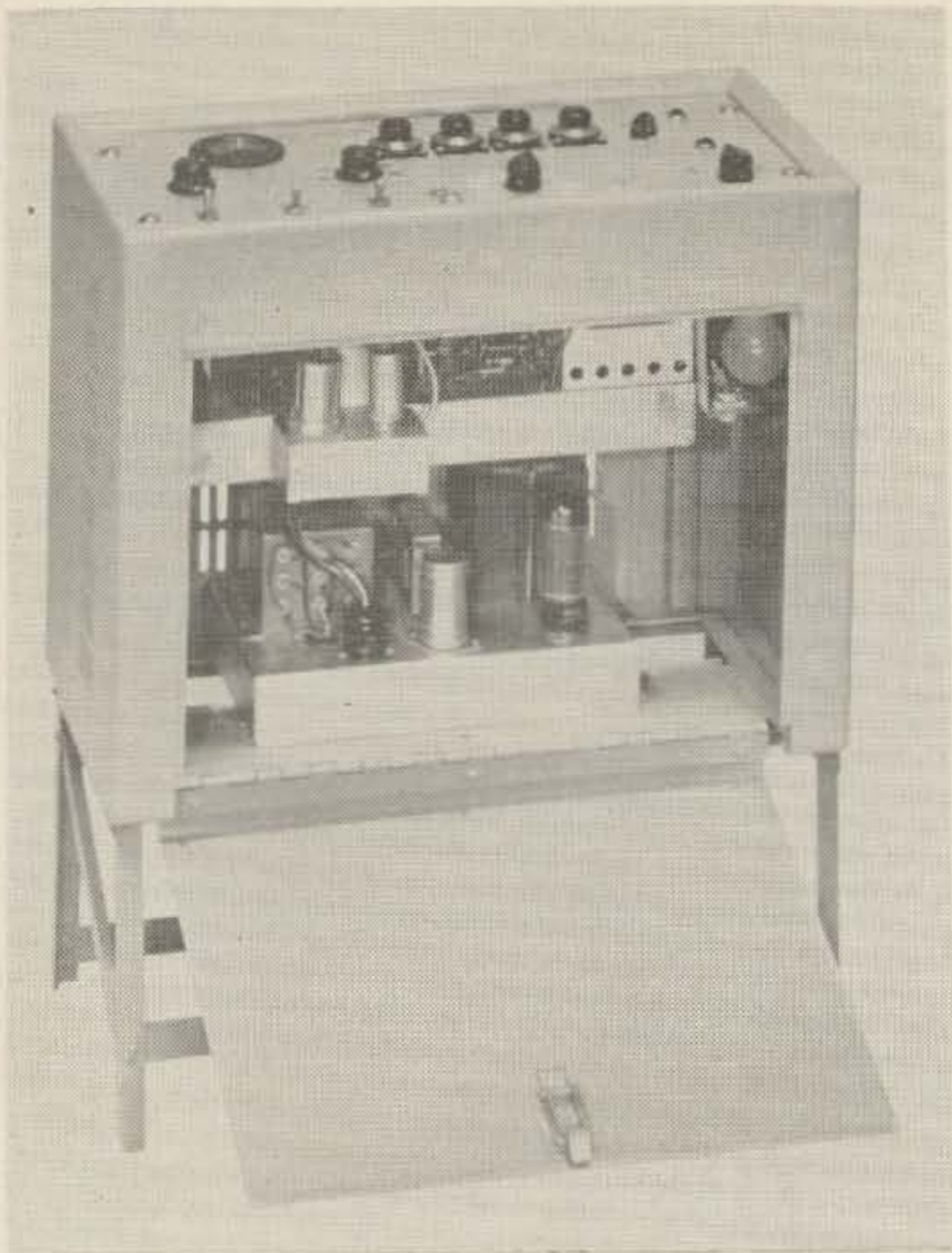

Mounting the BC-625

W A G M L I ♦

RADIO _____
 CONFIRMING QSO OF _____
 AT _____ GMT, YOUR _____ MC.
 _____ SIG RST _____
 XMTR. VIKING II _____ W INPUT
 RECEIVER, KNIGHT R-100
 WITH HOME BREW PRESELECTOR
 ANTENNA
 HORNET 3EL BEAM _____ TRAP VERT. _____
 PSE. QSL TNX. 73c



DICK GIFFEN 13716 ANOLA ST WHITTIER, CALIF USA

Dear Wayne,

First of all you probably looked at the pictures first and I must warn you that this is not another surplus conversion. The 522 has been done to death, rather this is just a novel way to mount a BC-625. Some time ago you asked for pictures of home brew and converted gear. Well, when I decided to "Do"

a 522 I had to figure some way to mount it that wouldn't take up any desk space. The result, Armchair Console, the unit stands to the left of the operators chair against the wall in front of the desk. By mounting the panel "Upside down" in the cabinet and making aluminum angle legs, I have a drop front cabinet that makes access to tubes a real snap. The conversion is the usual as done in the Conversion manuals, with the exception of the Quartz VFO, a surplus 16 position switch with 16 of the most used frequencies hereabouts. I have an antenna relay and ant. selector switch incorporated. A conventional 12AU7 mike pre amp completes the rig. The power supply is made from scavenged TV's, and a surplus xformer. All parts including cabinet (\$2), are surplus or junk box with the exception of the rack panel and vernier dials. Total investment about \$20, input 20 Watts. I have photographed it both vertical and horizontally mounted. I hope you can use some of it. I think the Armchair Console, idea may prove as handy to other crowded shacks as it did to mine.

Also included is my QSL, also home brew. I have had real good luck on returns using this type. With all the Amateur Photogs that are also Hams there should be more of this type of card. Need an article? The big drawback to cards of this type for hams who like to build and modify, is that they go out of date and have to be redone every few months. I now have a Drake 2-B between the Viking and the Knight, and the Homebrew keyer, and

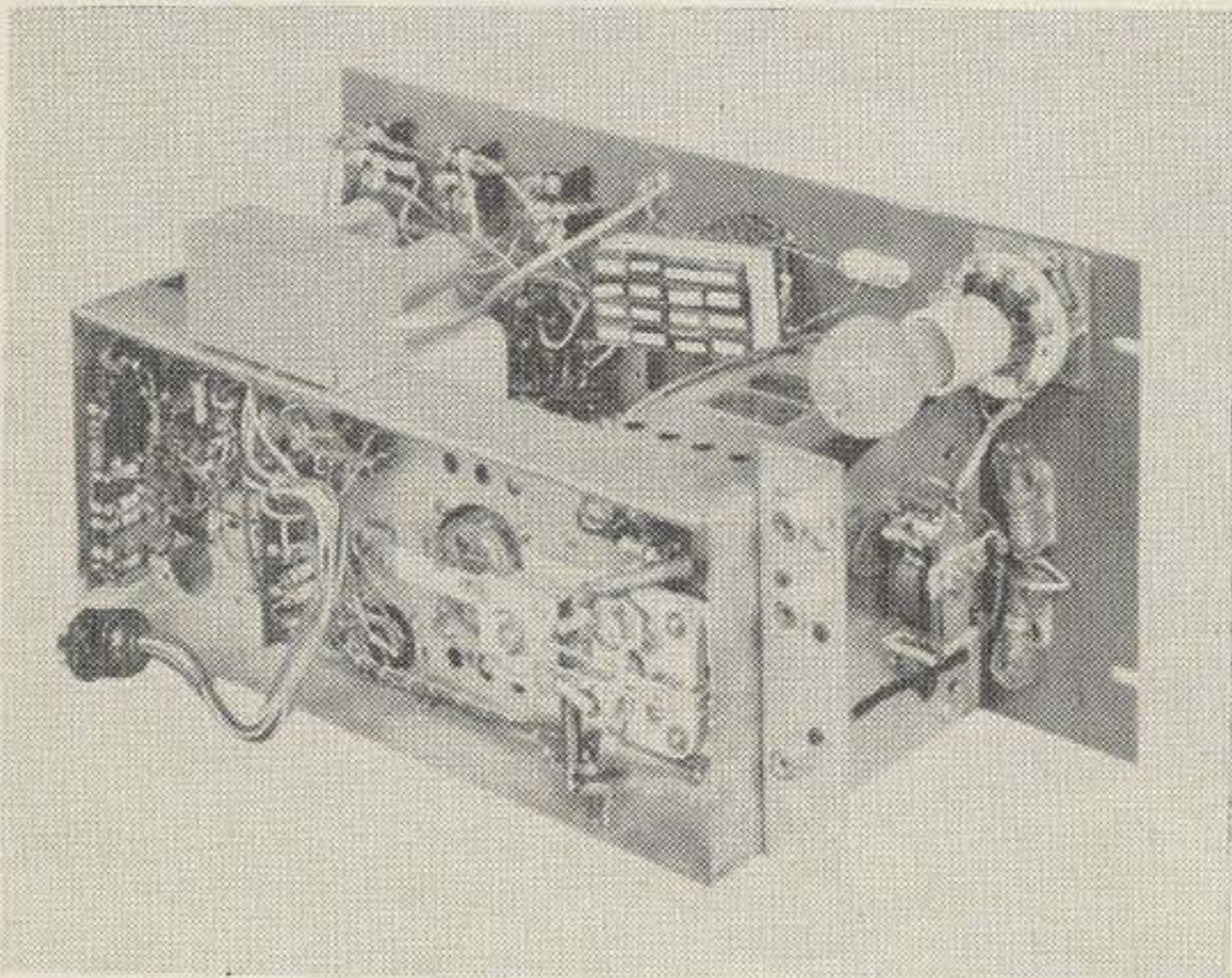

preselector are on top of each other, and I'm using the Knight for an I-F with a H. B. Nuvistor converter on 2. New card coming up soon. Vocation here is commercial photographer. I sure like the magazine Wayne, don't change a thing unless you make it bigger and more technical-builder type.

... Dick Giffen WA6MLI

FREE PARKING
COME IN FOR OUR SATURDAY SPECIALS
THOUSANDS OF ITEMS
— THOUSANDS OF BARGAINS
WRITE FOR NEW CATALOGUE

- APX-6—UHF transponder, perfect for 1215 mc. Very little conversion needed—complete w/tubesNEW \$18.95
- ATK/BC-1211—TV camera w/iconoscope and all tubes. At about 1/3 last surplus price and 5% of government price. For closed circuit TVL/NEW 99.50
- AXR—Receiver-Monitor for ATKEXC 29.95
- ATX—Xmtr u/w ATK-camera, incl. antennaEXC 39.95
- I-196B—Sig. Gen. 150-230mc—terrific buyNEW 1.45
- PE-103 — Dyn w/filter and start relay. In 6 or 12v @ 21a/11a; Out 500v @ 150maEXC 10.00
- BC-617—RCVR 30-50mc, FM, xtal controlledEXC 22.45
- ASB—Transmitter 515mcNEW 17.50
- ASB—Indic'r. Scope w/5BPI, easy conv.NEW 15.45
- ID-6/APN-4—5" Loran Scope, easily conv.EXC 11.95
- TS-239—Famous lab scope by Lavoie..Special..EXC 119.45
- SCR-522—XCVR 100-156mc, 832 final, 30 Watts. EXC 18.45
- BC-620—XCVR 20-27-9mc, w/tubesL/NEW 7.50
- BC-1158—XMTR 50-97mc, 815 final AM—few left—
NEW 24.45
- BC-458—XMTR 5.3-7mc, can run 120 WattsEXC 6.95

GO-9—XMTR 0.3-18mcs, 100 Watts, 2 803's final.
 Phone Transmitter, VFONEW 45.00

- BC-604—XMTR 20-27-9mc, 30w, 10ch—bargain. NEW 9.45
- H-63/U—Headset & Boom Mike . . . low priceEXC 4.50
- T-26—Mobile chest carbon "mike"NEW 4/4.00 1.25
- J-5—Flameproof keybuy twoNEW 2/1.25 .69
- A-62—Phantom ant. 20-29mc, handles 50wNEW 1.25

NEW, UNUSED SURPLUS TUBE SPECIALS—GUARANTEED

4X150A ..\$12.00	707B1.50	829A4.00
3E294.95	8032.95	8371.00
307A2/1.00	8071.10	6SH712/1.00
3AP12.00	5CP14.50	16265/1.00
3BP11.75	7BP73.50	169821.00
5BP44.00	16253/1.00	90048/1.00

- Dummy Antenna—Telescope w/SO239 fitting 1.00
- Antenna Dish—Parabol reflector, 30 inch 4.95
- Circuit Breaker—117 Vac, 3 Amp., Curve 1 1.00

All prices FOB Linden, N. J. Some quantities limited.
 Prices subject to change without notice. Min. order \$4.00.

U. S. #1 ELECTRONICS

1920 E. Edgar Road Linden, New Jersey
 on Highway U.S. 1 — across from Esso Research Labs

- 850 WATT MODULATION TRANSFORMER, Chicago Xfmr Co., FS-type frame. Pri. 10,000, Sec. 3750 and 7550 ohms \$32.00
- MATCHING CHICAGO PLATE TRANSFORMER, FS frame as above, 5 KVCT 400 MA \$32.00
- CHICAGO FILAMENT XFMR, 115V 60 cyc, sec. 5V @ 15A, 5KV AC hipot \$7.50
- MULTI-TAP FILAMENT xfmr, pri. 210-240V 60 cyc in 5v steps, sec. 5/7.5/10/11V @ 35A, common CT \$19.95
- FILAMENT XFMR, 115V or 220V 50/60 cyc, sec. 5V @ 20A CT, 35kv ins. \$12.00
- FILAMENT XFMR, 117V 50/60 cyc, two 10V 13A @ 12.5KV, one 10V 13A @ 7.9KV, one 6.3V 1A . . . \$11.00
- CAPACITOR 8MF 2KV, Cornell-Dubilier, with brackets \$3.15
- CAPACITOR 4MF 3KV, Goodman, with brackets. \$3.75

V E R N ' S 7701 S. Normandie
 Los Angeles 44, Calif.
 All Orders FOB L. A. — Phone (213) PL 1-0278

A Surplus Motor Driven Coaxial Switch

Roy Pafenberg W4WKM
316 Stratford Avenue
Fairfax, Virginia

Photographs by Morgan Gassman, Jr.

A NUMBER of motor driven coaxial switches have appeared on the surplus market in recent years. Of these, the SA-325/U is typical in design and construction. The switch is a 4 position unit, designed for remote operation from the usual 28 volt dc aircraft supply. Except for the dc voltage requirement and the lack of technical information, these units are ideal for amateur application.

This article is designed to solve both of these problems. Fig. 1 shows the schematic diagram of the SA-325/U RF Coaxial Switch. Negative battery is supplied to Pin "A" of the connector and positive battery is supplied to one of the Pins, "B" through "E". The motor turns the switch sections and the rf switch unit until the open switch segment reaches the stator contact used to supply positive battery. The motor then stops and the rf switch rests in the selected position. This "open seeking" type of remote positioning is a very simple servo system that is widely used. Its major disadvantage is that one control lead is required for each switch position.

To prevent overtravel of the rf switch, a

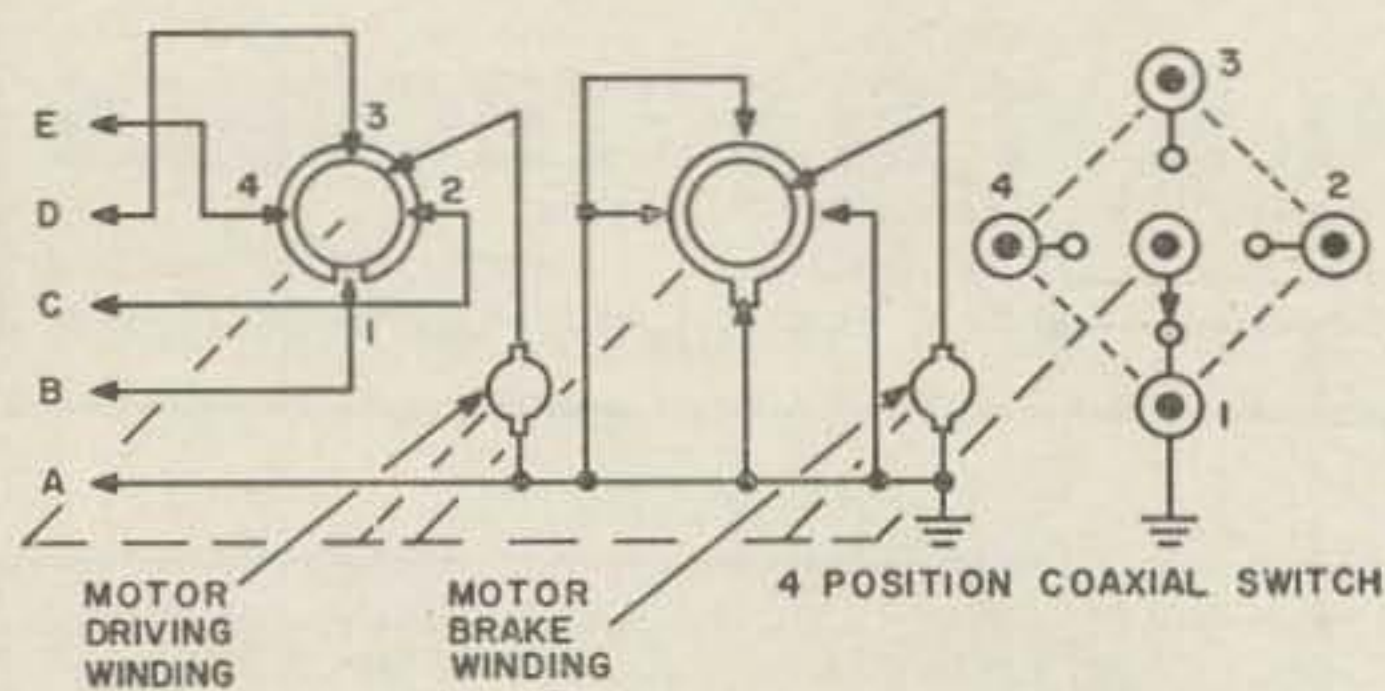

braking winding and commutator are used in the small PM drive motor. The rf switch mechanism is coupled to the gear drive by a loose fitting yoke. The rf switch is equipped with a strong detent which, as each position is approached, causes it to overtravel the motor drive. At the same time, and at each detent position, the motor brake winding is shorted by one of the switch sections. If the "open seeking" switch section finds an open, the slowed down motor stops quickly without moving the rf section past the detent. If the open is not found, the motor speeds up and goes through the cycle until the open is found.

The specifications in Table I for the rf switch cover only VHF and microwave applications but the switch may be used from dc to the maximum rated frequency.

The PM drive motor will operate from a dc source of between 20 and 30 volts. The simple approach for amateur application is to install a dropping resistor and silicon rectifier in series with the ac power line and operate the motor with the pulsating dc current. This system was tested and found to work very well. There is, however, one precaution that must be observed if this method is used. In the SA-325/U, Pin "A" of the connector is grounded, along with the motor brushes and the brake winding switch contacts. THESE GROUNDS MUST BE LIFTED, REPLACED WITH INSULATED LEADS, AND THE ENTIRE CIRCUIT INSULATED TO WITHSTAND THE FULL AC LINE VOLTAGE.

Table I

Frequency Range	30-11,000 mc
VSWR	1.1:1 Maximum between 100- 1,500 mc 1.2:1 Maximum between 1,500- 4,000 mc 1.3:1 Maximum between 4,000-11,000 mc
Insertion Loss	0.5 DB average at 7,000 mc
Attenuation Between Connectors.....	60 DB average at 7,000 mc
Characteristic Impedance	51.5 Ohms
Power Rating	100 Watts CW at 3,000 mc
Voltage Rating	1,000 Volts RMS

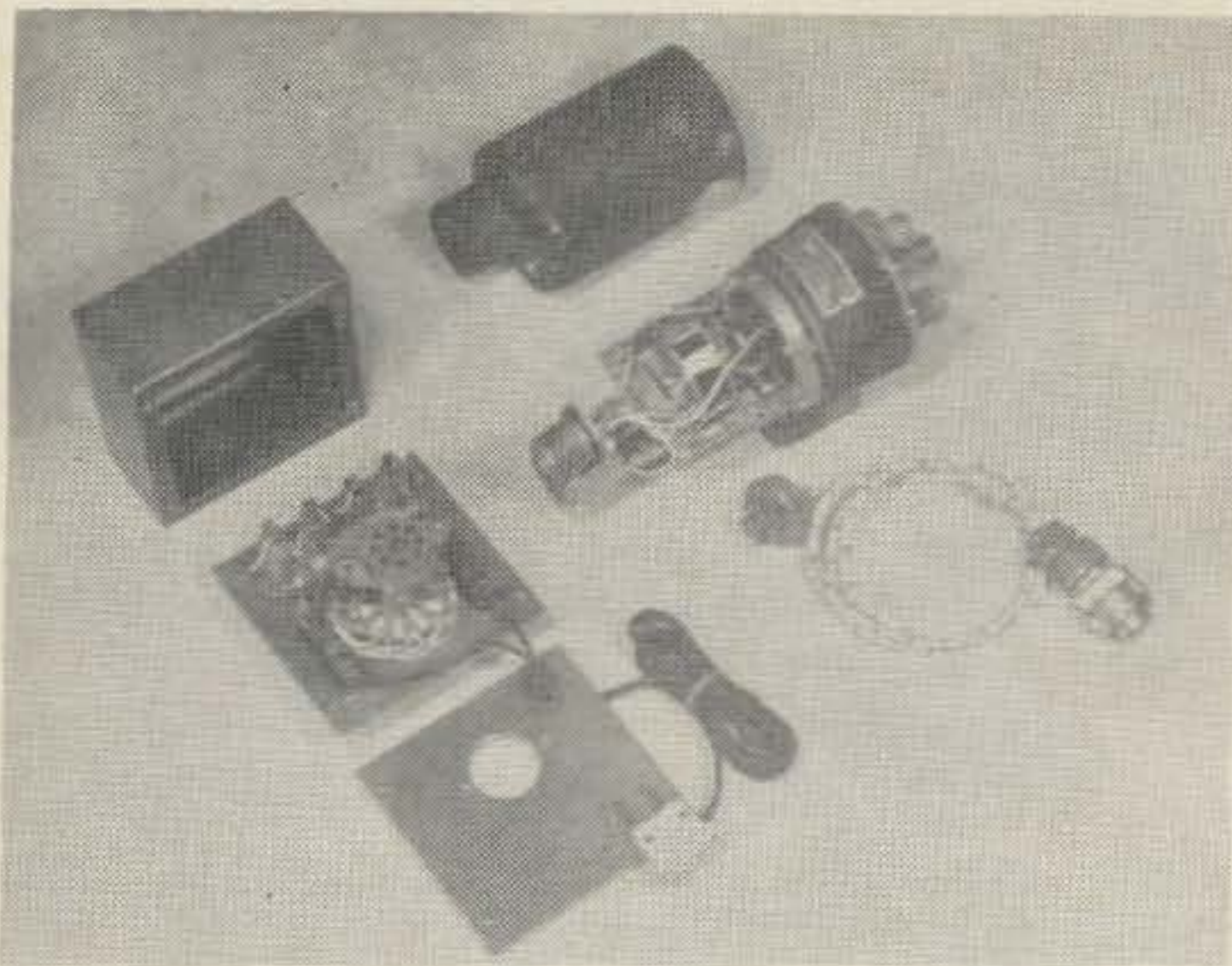

An exploded view of the surplus SA-325/U coaxial switch and the home built control unit with power supply.

This poses no problems except in the case of the grounded motor brush holder. A lead is soldered to the brush support bar and the area where this bar passes through the insulator plate built up with epoxy cement. After the cement is thoroughly dry, the bar is cut at the point where it is staked into the motor casting and the ends dressed to provide adequate clearance. A strong, well insulated assembly results and no difficulty has been experienced.

The control unit, shown in Fig. 2, is quite simple. While it is unconventional to fuse both sides of the ac line, it was considered desirable in this case. The 20 ohm dropping resistor supplies between 20 and 30 volts, measured with a dc meter, to the silicon diode and the motor winding. Although the 25 watt resistor is greatly overloaded in this application, the switch cycles through all 4 positions in less than 5 seconds. Because of the short duty cycle, no undue heating occurs.

The same considerations apply to the silicon diode. A .75 ampere, 400 PIV unit is used and no problems have been encountered. Once again, the switching cycle is completed before excessive heating occurs. If this gross overloading is considered objectionable, stud

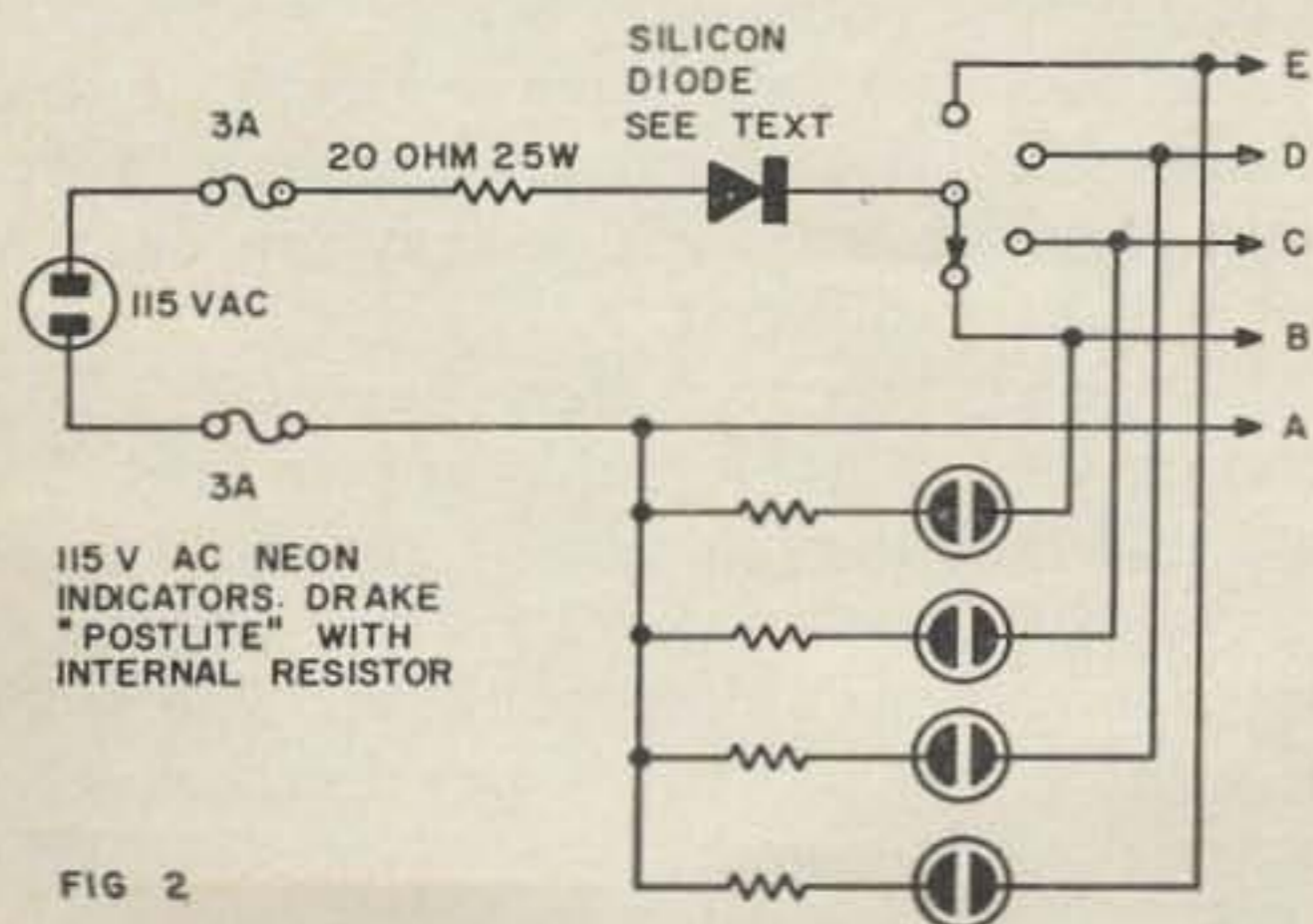

FIG 2

- PARABOLIC ANTENNA, AN-134A, steel, O. D. color, aluminum cast stationary x-mtg. 4 feet diameter.
NEW \$79.50@
- DELUXE METAL CABINET standard 19" width 12 1/4" panel space gray crackle finish, Bud #CR-1742-G.
NEW boxed \$11.50@
- ARN-6 MAINTENANCE MANUAL, NEW \$4.50@
- ARC-27 MAINTENANCE MANUAL, NEW \$6.50@
- FL-5 FILTER w/own x-mtg. switch.... \$1.35@

"SATISFACTION GUARANTEED"

HIWAY CO. 1147 Venice Blvd.
Los Angeles 15, Calif.

WE WANT TO BUY

PRC or GRC EQPT
accessories and parts

e.g. RT-66 RT-67 RT-68 RT-70 etc.
PRC-6, 8, 9, 10 etc.

Will buy in small or large quantities.
Advise quantity, price and condition.

WRITE, WIRE OR PHONE:
We pay the freight.

AMBER INDUSTRIAL CORP.

75 VARICK ST., N. Y. 13, N. Y. • CAnal 6-7455

Amateur & CB Crystals

\$3.00 2500 kc to 15,000 kc, fundamental frequencies 15 mc to 30 mc, third mode

\$3.50 30 mc to 50 mc



All crystals for amateurs are set at 20 mmfd, hermetically sealed, with pins optional: .125" (CR-1); .093" (FT. 241/3); .050" (HC-6); 1/2" centers.

Citizens Band transmitter crystals in stock for the following equipment: JR-800, 761A, CD1, GW10, CD5, CD100, CD100A, TR330, C27, AT20, Messenger, MK7, R2700, TR910, 27C2, ED27, CR117, CDD5, CT1, RP115, CD27, TECT. Guaranteed .004% of nominal: \$3.00.

AMERICAN CRYSTAL CO.
P.O. BOX 2366 • KANSAS CITY 42, MO.

KEEP CANDEE HANDEE!!

CHECK OUR BARGAINS

in this year's issues of 73. Goodies, every one, right? So clean out our stock so we can run a whole new line of

FALL BARGAINS

next month. OK? And don't forget,

★ ★ ★ WE'LL HORSE TRADE and give you Top \$\$ Dollar \$\$ for your PRC, GRC, VRC & Test Equipment!

J. J. CANDEE CO.

509 No. Victory Blvd., Burbank, Calif.
DDD area 213 - VI 9-2411

FL-8 FILTERS FL-5F

Amazing! See

article July 62 CQ, March '62 73, page 57, Nov. '57 CQ page 60. Order now while these low prices hold!

Please send..... FL-8;..... FL-5F @ \$2.49 each + 25¢ postage.

NAME

ADDRESS

CITY..... STATE.....

SEG SALES

1306 Bond Street, Los Angeles 15, Calif.
Calif. orders, include 4% sales tax.

COLUMBIA GEMS!

FREE! Send for Columbia's New 48-Page Catalog of Surplus Electronic Bargains!

Name..... Call.....

QTH

City..... Zone..... State.....

Please Rush Me the New Columbia Catalog!

COLUMBIA ELECTRONICS

4365 WEST PICO BLVD. LOS ANGELES 19, CALIF.

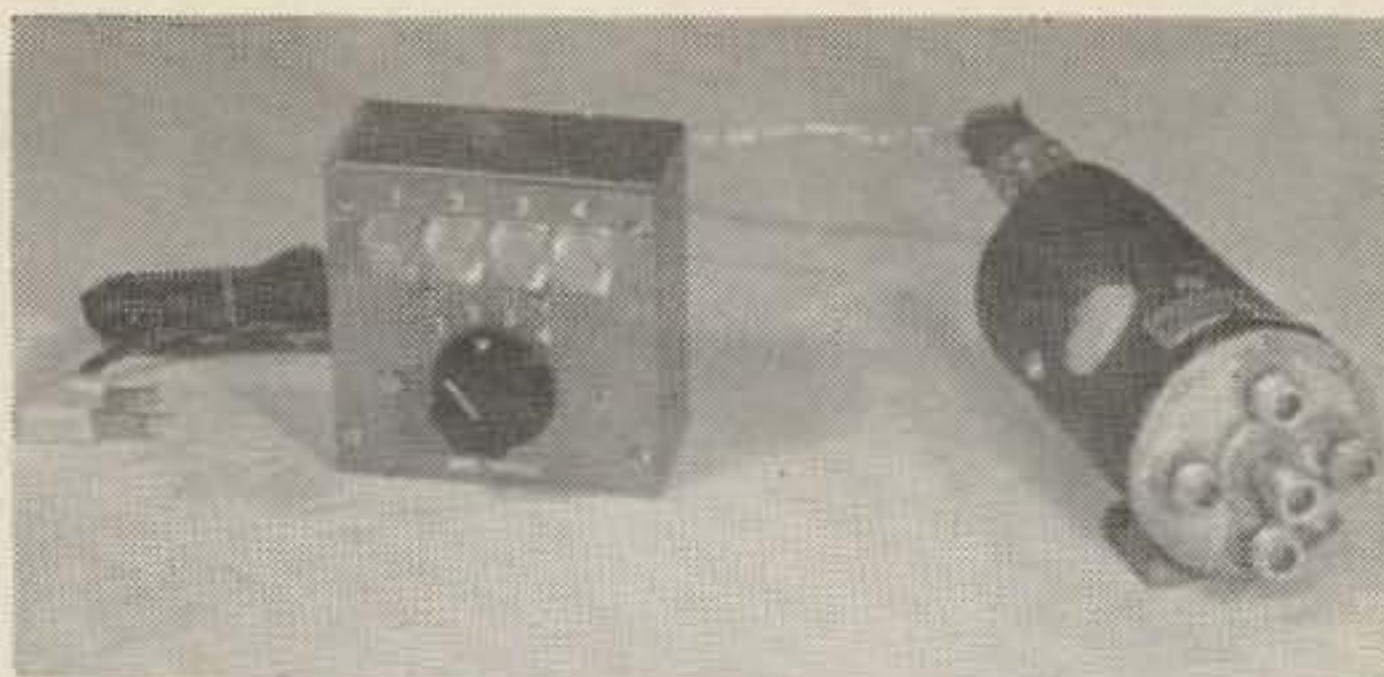

The completed project is shown in this view. The modified surplus switch and the control unit operate from the ac line.

mounted units are now quite reasonably priced. TAB of New York (index) lists 2 ampere, 200 PIV units at 55c, 300 PIV units at 80c and 400 PIV units at \$1.00.

The complete control unit and power supply is housed in a 2" x 4" x 4" utility box and it all fits nicely. The photographs show the construction details and the completed system. The selector switch connects power to one of the 4 contacts in the SA-325/U. The pilot lamps are connected to each of the contacts and returned to the negative power lead. The lamps are extinguished until the motor circuit is opened. At this time, 115 volts pulsating dc is applied to the appropriate lamp. This feature is quite convenient since the lamps light only after the remotely located switch has completed its cycle.

An octal socket is mounted on the rear of the box and is used to connect the 5 conductor cable to the SA-325/U. The connector on the SA-325/U is a common AN or MS type. The mating cable connector is an MS3106A14S-5S. An AN3057-6A cable clamp with bushing completes the connector. You can probably save money by visiting your surplus dealer for the connector.

If manual operation of the rf switch is desired, remove the motor shell and remove the 4 screws which hold the motor drive to the switch. The switch may be chassis mounted on the original mounting feet. A splined shaft extends from the switch and a standard 1/4" flexible coupling may be attached to the shaft. Add an extension shaft through a bushing in the equipment panel, add a knob and you are in business. Restrain your curiosity and do not open the rf switch unit proper. A very strong spring is used which may flip out. Assembly is very difficult.

All in all, these remotely operated coaxial switches are valuable additions to any ham shack. When modified and installed as described, they provide a low cost answer to many antenna switching problems. The switch and control unit can easily pay for themselves in coaxial cable saved.

... W4WKM

Advertisers

Alco	51
Allied	80
Alltronics—Howard	71
Amateur Electronics	59, 70
Amatronics	19
Amber	77
American Crystal	77
Arraw	30
Ashe	33
Best	64
Callbook	23
Candee	78
Century	Cover III
Clegg	11
Columbia	78
Continental	17
Cornell-Dubilier	37
Cushcraft	61
C-Y	13
Davco	69
Densen	71
Daw Key	61, 71
Elico	17
Epsilon	61
E-Z Way	4
Fair	69
Finney	15
Fort Wayne	17
Graham	57
Hamfest	71
Hammarlund	27
Heath	40
Hi-Way	77
Hornet	63
Hy-Gain	5
International Crystal	Cover II
Irving	17
K4YBL	71
KTV	79
Lafayette	3
Mesco	57
Mini-Products	79
National	Cover IV
Newtronics	39
P & H	13
Radio Amateur Callback	23
Radio Bookshop	73
Seacor	19
S. E. G.	78
Skylane	71
Space	71
Space Raider	65
Subscription	72
Supreme	20
Tapetone	9
Tecnical Material Corp.	47
Telrex	45
Topaz	62
Tri-Ex	55
Tri-State	71
U. S. #1	75
Vanguard	64
Verns	75
Waber	67
Waters	29
Western (Neb.)	69
Western (Calif.)	63
World Radio Labs	53
73 Products	68

LEADERS IN COMPACT ANTENNAS

Now... **40** plus 10
MINIATURIZED

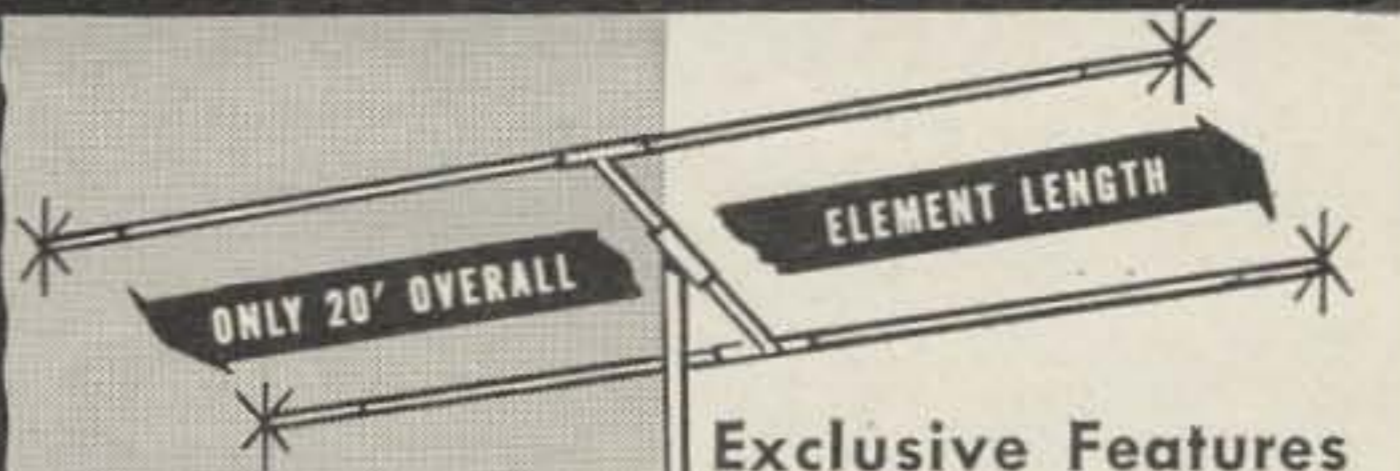

Other Mini-Products
Compact Antennas
for 6-10-15-20 meters

- Model B-24
Two Element Beam
Net — \$54.95
- Model C-4
Coaxial Vertical
(no radials)
Net — \$34.95
- Model M-4 Mobile
4-band — 5' 3" high
Net — \$16.95

*Patents pending

Exclusive Features
of Model B-4010
40 plus 10 meters

- New end loading for maximum radiation efficiency*. No center loading employed.
- Element length only 20'; boom 10'.
- About 22 lbs. in weight.
- Feed line 50 ohm coax.
- SWR . . . 1.5:1.
- Rated for full 1000 W.-A.M.

Model B-4010 Amateur
Net —
\$79.50

Mini-Products, Inc.

1001 West 18th Street • Erie, Pennsylvania
Order direct from factory . . . or from your favorite distributor

KTV HY-TRACK TOWERS

The biggest improvement in crank-ups yet — you crank up the antenna and not the tower. It takes a minimum of space, is fast to erect, and you can never fall off! Makes it a snap to change beams or make adjustments whenever you please. You can even crank the beam up to the best height for current propagation conditions. See the photos on page 15 of the March '62 73 for a better idea of what this is all about. Government and commercial installations a specialty. Send for literature and prices:

**KTV TOWERS
SULLIVAN
ILLINOIS**

**SMASHING
VALUE**

ALLIED

**RECONDITIONED
EQUIPMENT**

SALE!



MOBILE EQUIPMENT SPECIALS

Gonset	
G-66B Receiver.....	\$129.50
G-77A Transmitter.....	169.00
3175 6-Meter Converter.....	49.00
Super-6 Converter.....	29.00
Commander Transmitter.....	49.00
Eico	
720 Transmitter.....	69.00
Heath	
Cheyenne Transmitter.....	89.00
Comanche Receiver.....	99.00
Morrow	
560A Transmitter.....	119.00
Falcon Receiver.....	89.00
Multi Products	
AF-67 Transmitter.....	99.00
PMR-7 Receiver.....	89.00

NOVICE/SWL BARGAINS

Globe	
Chief 90A Transmitter.....	44.95
Scout Deluxe Transmitter.....	124.00
Hallicrafters	
S-20R Receiver.....	25.00
S-85 Receiver.....	79.00
SX-99 Receiver.....	99.00
SX-110 Receiver.....	109.00
SX-140 Receiver.....	99.50
HT-40 Transmitter.....	74.00
Hammarlund	
HQ-105TR (comb. SW Receiver and CB Transceiver).....	189.00
HQ-140X Receiver.....	149.00
HQ-129X Receiver.....	119.00
Heath	
DX-35 Transmitter.....	35.00
DX-40 Transmitter.....	45.00
Johnson	
Adventurer Transmitter.....	29.00
Ranger I Transmitter.....	179.00

Knight	
R-55 Receiver.....	\$ 59.00
R-100 Receiver.....	79.00
T-60 Transmitter.....	49.95
V-44 VFO.....	19.95
Lettine	
240 Transmitter.....	39.00
Millen	
50-Watt Transmitter (w/pwr supply built-in).....	29.00
National	
NC-88 Receiver.....	89.00
NC-109 Receiver.....	109.00
NC-188 Receiver.....	89.00
NC-190 Receiver.....	189.00
NC-270 Receiver.....	189.00

SSB EQUIPMENT VALUES

Central Electronics	
MM-1 Scope.....	69.95
Collins	
30S-1 KW Linear.....	995.00
32S-1 Transmitter.....	449.00
75S-1 Receiver.....	395.00
KWS-1 Transmitter.....	895.00
Drake	
2A Receiver.....	229.00
Gonset	
G-28 10-Meter Transceiver.....	159.00
Globe	
DSB-100 Transmitter.....	89.00
Hallicrafters	
HT-31 500-W Linear.....	99.00
HT-32 Transmitter.....	350.00
HT-33 Linear.....	289.00
SX-100 Receiver.....	179.00
SX-101 MK1A Receiver.....	199.00
SX-101A Receiver.....	289.00
Heath	
SB-10 SSB Generator.....	79.00
Hammarlund	
HX-500 SSB Transmitter.....	479.00
HQ-170 Receiver.....	259.00

VHF EQUIPMENT

Gonset	
Communicator IV 6-Mtr.....	\$289.00
Communicator III 6-Mtr.....	179.00
Heath	
Seneca (6 & 2 Meter) Xmtr.....	169.00
Lincoln	
6 Meter Transceiver.....	39.00
RME	
VHF-126 1 1/4, 2 & 6 Mtr. Converter.....	179.00
Hallicrafters	
S-95, 152-174 mc FM Receiver.....	49.00
SR-34, 6 & 2 Mtr. Transceiver Universal Model.....	299.00

OTHER USED GEAR SPECIALS

Collins	
310B Exciter/Transmitter.....	99.00
32V-1 Transmitter.....	189.00
Eico	
730 Modulator.....	49.00
Hallicrafters	
SX-42 Receiver.....	129.00
SX-71 Receiver.....	119.00
SX-96 Receiver.....	129.00
Hammarlund	
SP-400 Super-Pro Receiver..	165.00
HQ-160 Receiver.....	239.00
Johnson	
KW Matchbox (standard model).....	89.00
Valiant I Transmitter.....	289.00
National	
HRO-60.....	369.00
RDF-66 Direction Finder.....	12.95
RME	
HF-10/20 Converter.....	39.00
4300 Receiver.....	119.00
4350 Receiver.....	129.00
Sonar	
SRT-120 100 W. Phone & CW Transmitter.....	95.00

NO MONEY DOWN

Allied's Credit Fund gives you bigger buying power—up to 24 months to pay.

90-DAY WARRANTY

Allied reconditioned equipment is covered by the full 90-day new gear warranty.

SALE ENDS SEPT. 15!

Quantities Limited—
Order today—use the coupon.

ALLIED RADIO

ALLIED RADIO, Dept. 432H
100 N. Western Ave., Chicago 80, Ill.

Attn: Don Koby, W9VHI. Ship me the following:

\$..... enclosed (or buy on our No Money Down Credit Fund)

Name _____
PLEASE PRINT

Address _____

City _____ Zone _____ State _____

**ORDER
TODAY**

SSB FILTER



CF14S CRYSTAL FILTER

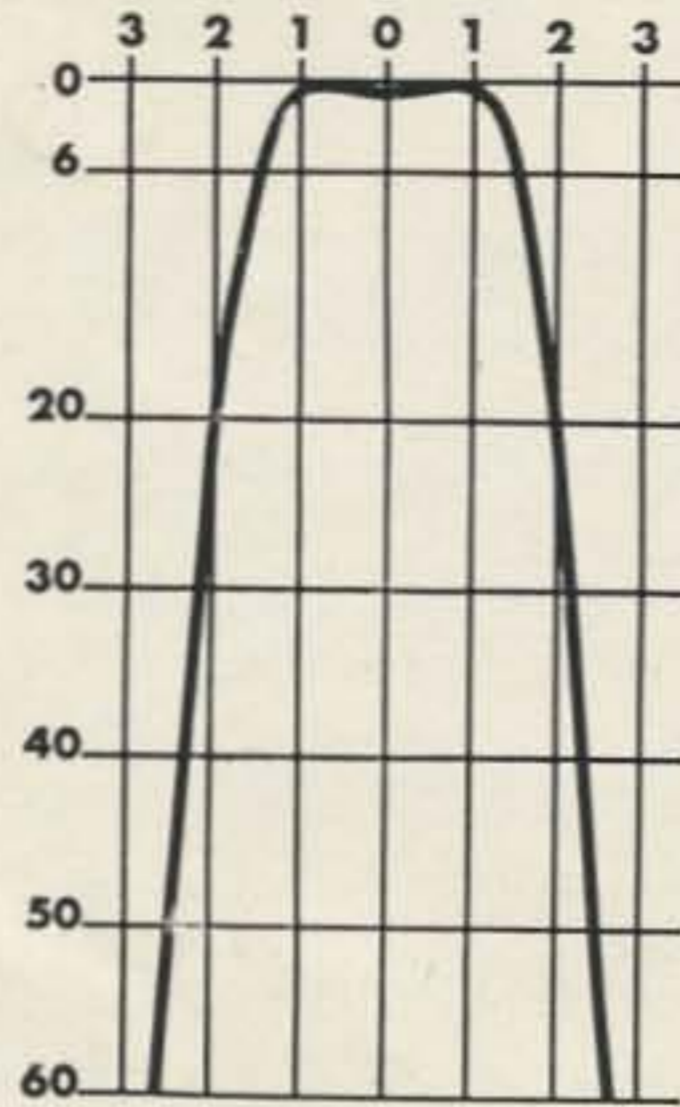

Center frequency: 455KC.
 Passband: 3KC at 6 DB; 5.5KC at 60DB.
 Shape factor: 1.8:1
 Sideband rejection: 50 DB.
 Carrier suppression: 20DB.
 Passband ripple: $\pm 1/2$ DB.
 Input impedance: 560 OHMS, and 33K.
 Output impedance: 33K.
 Mech. size: 1 13/16 x 1 x 7/8.

- Lowest priced SSB filter on the market.
- Only SSB filter on the market with five year guarantee.
- Uses high quality gold plated MIL Spec. crystals.



GUARANTEED

Guaranteed for five years against electrical and mechanical failure under reasonable environmental conditions.

Price \$18.95

PRICE INCLUDES FILTER, FT241 UPPER AND LOWERSIDEBAND CRYSTALS, APPLICATION DATA, AND RECOMMENDED CIRCUITS.

TO ORDER

Send check or money order to
 We require 25% down on C.O.D.

CENTURY COMMUNICATIONS CORP.
 P.O. BOX 445
 WESTMINSTER, CALIFORNIA

Californians add 4% state sales tax.

Application data and recommended circuits sent on request.



CENTURY COMMUNICATIONS CORP.

P.O. BOX 445, WESTMINSTER, CALIFORNIA

The National NC-303

*is not for
every amateur...*

Frankly, the NC-303 is an expensive receiver. And not every ham is willing to spend \$449 to enjoy the maximum in receiving convenience and performance. The NC-303 is not a "compact" light weight. It's packed with 78 pounds of husky components to provide a little bit better reliability and performance than the next receiver. The NC-303 offers certain advantages. Sensitivity, for example, is an honest 1.0 microvolt or better for 10 db AM signal-to-noise ratio (this is not a misleading CW measurement or one based on a 6 db S/N), and the NC-303 is quiet — no operator fatigue from background noise bursts.

Selectivity is remarkable (six tuned circuits at 80 KC result in extremely steep skirts on SSB and CW) . . . and the '303 offers the widest selectivity range available on any hamband receiver — 400 cycles through 8 KC. Stability, both mechanical and electrical, is quite out of the ordinary. No need to tip-toe around the shack. In fact, tune a CW signal and employ the classic "drop test" to see for yourself. Incidentally, we consider 100 cycle thermal drift after a short warm-up to be unusual. "This is all very well", you may say, "but not a great deal better than competitive receivers". We

agree — for four hundred and fifty dollars you should expect much more than this, and so we give more to you. The most expensive dial drive in the industry to provide smoother inertia tuning than any receiver on the market, regardless of price. The NC-303's band switch mechanism even employs a Geneva movement . . . you just start it on its way . . . it does the rest of the job by itself. No wiggling back and forth to make sure every contact is engaged. This switch snaps in with a satisfying clunk and stays there. (Try tuning a signal on one band, then flip to another band and back again.)

Other extras include complete coverage from 160 (by the way, the '303 is the only SSB hamband receiver now on the market which incorporates 160) through 1 1/4 meters with separate 12" slide rule drum dials for each band, and accessory converters are available for the three VHF bands. Even a separate converter input is provided. Dial calibration is to 1 KC on the lowest band, to 2 KC through 15 meters.

The '303 also offers the best SSB AVC you've ever heard. No pops, thumps or distortion . . . just a constant gain level through local or DX QSO. There's an audio response control for CW peaking or VHF scatter work . . . an active nulling Q multiplier for 50-60 db notches, complete with depth control . . . an unusual noise limiter which cuts impulse noise without signal distortion, plus adjustable CW/SSB limiting. Even external provision for RF gain control for CW break-in operation and an accessory socket for receiver accessories or adapters are included.

The NC-303 was not designed to meet competitive price or performance, but to provide maximum hamband performance for every type of operation. Not just SSB, not just AM, not just CW . . . but every mode. As a result, it costs more than the average ham receiver. On the other hand, if your requirements are for more than "the average", perhaps the '303 should be your next receiver. Why not operate one soon and find out?

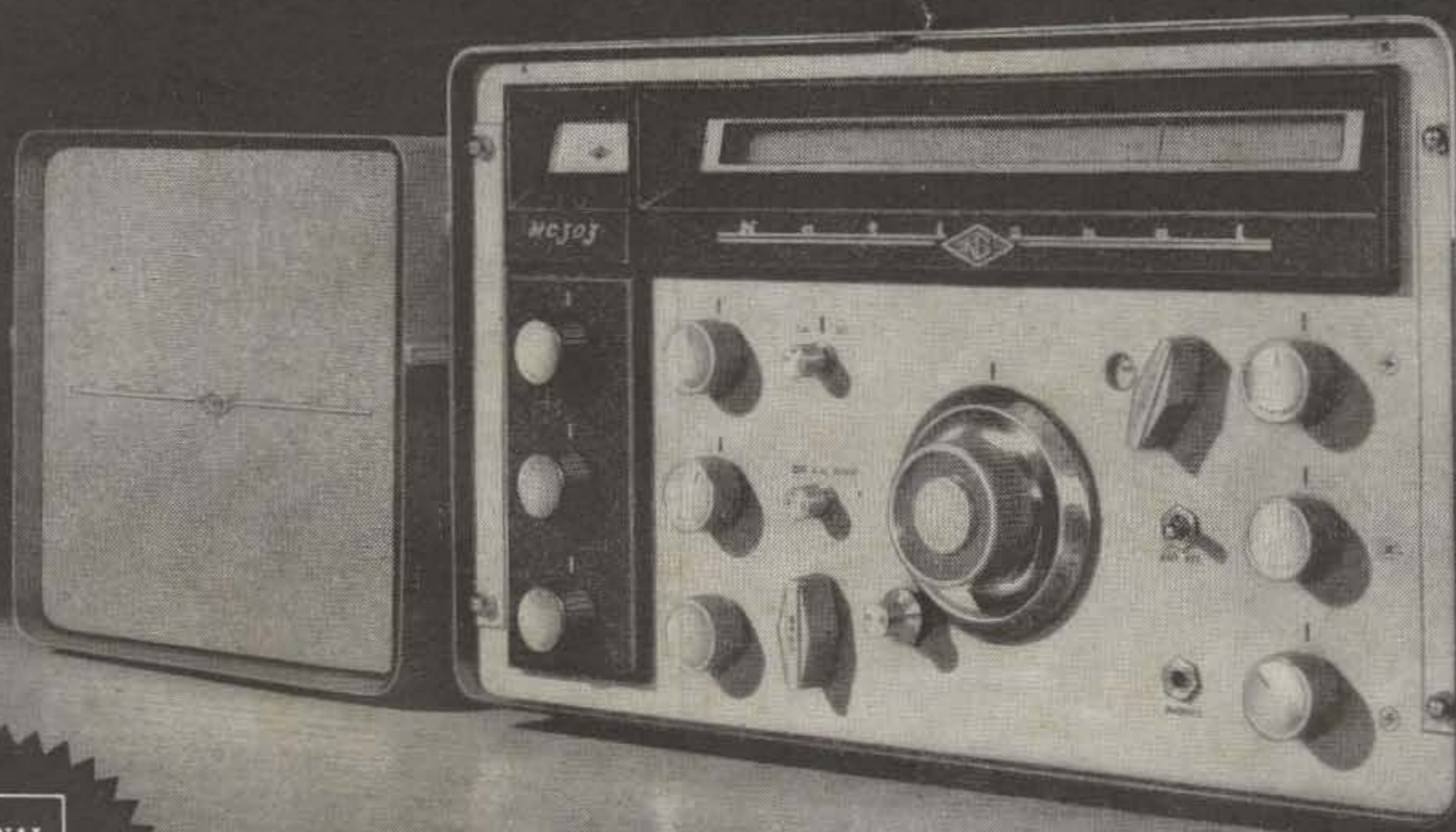

**NATIONAL
ONE
YEAR
GUARANTEE**

NATIONAL RADIO COMPANY, INC.

A wholly owned subsidiary of National Co., Inc.

MELROSE 76, MASS.

Export: Ad Auriema, Inc.,
85 Broad St., N.Y.C.

Canada: Tri-Tel Assoc., Ltd.,
81 Sheppard Ave., Willowdale, Ont.

