

**RADIO • TELEVISION
ELECTRONICS
DICTIONARY**

1X-4



NATIONAL RADIO INSTITUTE • WASHINGTON, D. C.

RADIO - TELEVISION - ELECTRONICS
DICTIONARY



PREPARED BY THE STAFF
OF
NATIONAL RADIO INSTITUTE
WASHINGTON, D.C.

HOW TO USE THIS DICTIONARY

This dictionary has been completely revised and rewritten to cover more than 6500 subjects in the fields of radio, television and electronics. Where a particular term has more than one possible meaning, only the technical definition is given.

Terms in this dictionary are listed according to their actual usage rather than by subjects. For example, the term "ABSORPTION MODULATION" will be found under the heading "ABSORPTION" rather than under the heading "MODULATION". This type of construction makes it very easy to locate any given term quickly and eliminates, to a large extent, duplicate definitions and confusing cross references.

The second word of any two-word term, such as "MODULATION" in "ABSORPTION MODULATION", is indented slightly making it easy to locate specific terms under one given heading. All defined terms are printed in easy-to-read bold face type for rapid location of terms.

In addition to the extensive coverage of technical definitions, there are five appendixes included for ready reference.

Appendix I contains currently accepted abbreviations used in technical fields.

Appendix II covers vacuum tube symbols and terminology. The often confused symbols for ac and dc electrode voltages and currents are clearly shown on charts and diagrams.

Appendix III covers transistor symbols and terminology. This appendix is similar to the preceding section on vacuum tube terminology except that it covers transistors.

Appendix IV is a chart which shows commonly used modulation symbols. In addition, this chart gives a brief description of each modulation process.

Appendix V is a listing of currently accepted graphic symbols used in schematic drawings. These symbols conform to standards set by the IRE, ASA, and AIEE.

COPYRIGHT 1962 BY NATIONAL RADIO INSTITUTE, WASHINGTON, D.C.

A

abampere. The unit of current in the cgs system of electromagnetic units. One abampere is equal to 10 amperes.

A battery. The source of filament current for the tubes in a battery-operated vacuum-tube circuit.

abcoulomb. The unit of quantity of electricity in the cgs system of electromagnetic units. One abcoulomb is equal to 10 coulombs.

abfarad. The unit of capacity in the cgs system of electromagnetic units. One abfarad is equal to 1,000,000,000 farads.

abhenry. The unit of inductance in the cgs system of electromagnetic units. One abhenry is equal to .000000001 henry.

abohm. The unit of resistance in the cgs system of electromagnetic units. One abohm is equal to .000000001 ohm.

AB power pack. A combination of batteries or other power-supplying devices in a single housing, used to supply filament and plate voltages for receivers, especially portable sets.

abscissa. The coordinate value specifying distance in a horizontal direction from the vertical reference line on a graph. Also, the horizontal reference line along which these values are indicated.

absolute

delay. In loran, the interval of time between the transmission of signal from the "A" Station and transmission of the next signal from the "B" Station.

units. A unit of measurement derived from fundamental units of length, mass and time.

value. The value of a number without regard to sign. Thus, the absolute values of +9 and -9 are both 9. In algebraic expressions, vertical lines on each side of a quantity are used to specify that the absolute value is to be used. Example: the absolute value of x is written $|x|$.

zero. The temperature at which all thermal motion ceases, and at which an ideal gas would reach zero volume. This temperature, -273.15°C (-459.67°F), is theoretically the coldest temperature obtainable, and is the 0° point on the absolute, or Kelvin (K) temperature scale.

absorption. Dissipation or loss of electromagnetic energy (radio waves) or

acoustic energy (sound waves) in the medium through which the energy travels, or the extraction of electrical energy from one circuit by another coupled to it.

coefficient. A measure of the ability of a material to absorb energy, especially from sound waves.

loss. That part of the transmission loss due to the dissipation or conversion of sound energy into other forms of energy (e.g., heat), either within the medium or attendant upon a reflection.

modulation. Modulation produced by absorption of signal power from the antenna or rf system of a transmitter by a closely-coupled af system.

trap. A tuned circuit coupled to another circuit for the purpose of absorbing and attenuating undesired signals.

wavemeter. A device for measuring the wavelength or frequency of a radio wave, loosely coupled to a signal source so that it extracts enough energy to operate an indicator.

abvolt. The unit of potential in the cgs system of electromagnetic units. One abvolt is equal to .000000001 volt.

ac

erasing head. In magnetic recording, one which uses alternating current to produce the magnetic field necessary for erasing.

generator. Any device that produces an ac voltage, such as an oscillator or an electric generator.

magnetic biasing. In magnetic recording, magnetic biasing is accomplished by the use of an alternating current, usually well above the signal frequency range.

plate current. The alternating component of the plate current of a tube. It is equal to the ac plate voltage divided by the total impedance in the circuit.

plate resistance. The opposition offered by the plate-cathode path of a tube to the flow of alternating current. With no load in the circuit, it is equal to the change in plate voltage divided by the resultant change in plate current, or to the ac plate voltage divided by the ac plate current.

receiver. A receiver designed to operate only from an ac power source.

accelerating electrode. An electrode to which a potential is applied to increase the velocity of the electrons or ions in the beam.

acceleration. The time rate of change of velocity.

accelerometer. An instrument that meas-

ures one or more components of acceleration.

accentuation. Amplifying or emphasizing any band of frequencies in the audio spectrum over other audio frequencies.

acceptor. A type of material, such as indium, which has 3 electrons in its valence shell and, when added to a pure semi-conductor, leaves holes in the lattice structure.

circuit. A circuit offering minimum impedance to a desired frequency or band of frequencies, and high impedance to all other frequencies.

access time. (1) The time interval between the instant information is requested of the memory and the instant this information begins to be available in useful form. (2) The time interval between the instant information is available for storage and the instant it is effectively stored.

accessible terminal. A network node available for external connections.

accumulator. A device which stores a number and, upon reception of a new number, adds it to the previous contents and stores the sum. An accumulator may have properties such as sensing signs, clearing, complementing, etc.

accuracy. Freedom from mistake or error; exactness.

ac-dc receiver. A receiver that will operate from either an ac or dc power source. It has no power transformer. A universal receiver.

achromatic

color. Color that does not elicit hue.

lens. A combination of two or more lenses, the curvature of one serving to correct the chromatic aberration of the others.

locus. (achromatic region) Chromaticities which may be acceptable reference standards under circumstances of common occurrence are represented in a chromaticity diagram by points in a region called the "achromatic locus."

acorn tube. A small tube resembling an acorn in size and shape, designed to have low internal capacities, thus permitting its use in ultrahigh-frequency applications, up to about 400 mc.

acoustic. Pertaining to the production, transmission, reception or effects of sound.

capacitance. The capacitance of a

sound medium is the volume displacement per dyne per square centimeter. The unit is centimeter per dyne.

compliance. The reciprocal of acoustic stiffness.

dispersion. The separation of a complex sound wave into its various frequency components, usually caused by a variation with frequency of the wave velocity of the medium. The rate of change of the velocity with frequency is used as a measure of the dispersion.

feedback. Transfer of energy from the sound waves coming from the loudspeaker to any preceding part in the same amplifying or broadcasting system in such a way that the current in the circuit is modulated, producing howling or squealing.

generator. A transducer which converts electric, mechanical, or other forms of energy into sound.

horn. A tube of varying cross section having different terminal areas which provide a change of acoustic impedance and control of the directivity pattern.

impedance. The acoustic impedance of a sound medium on a given surface is the sound pressure on that surface divided by the flux through the surface.

mass. (acoustic inertance) The quantity which, when multiplied by 2π times the frequency, gives the acoustic reactance associated with the kinetic energy of the medium.

memory system. A system using acoustic time delay in a circulating path to obtain time separation between a sequence of digits, thereby producing a dynamic form of storage.

ohm. An acoustic resistance, reactance, or impedance has a magnitude of 1 acoustic ohm when a sound pressure of 1 dyne per square centimeter produces a volume velocity of 1 cubic centimeter per second.

pickup. (sound box) A device which transforms groove modulations directly into acoustic vibrations.

radiating element. A vibrating surface in a transducer which can cause or be actuated by sound waves.

radiometer. An instrument for measuring sound intensity by determining the unidirectional steady-state pressure caused by the reflection or absorption of a sound wave at a boundary.

reactance. The imaginary component of the acoustic impedance. The commonly used unit is the acoustical ohm.

refraction. The variation of the direction of sound transmission due to spatial variation of the wave velocity in the medium.

resistance. The real component of the acoustic impedance. The commonly used unit is the acoustical ohm.

- scattering.** The irregular and diffuse reflection or diffraction of sound in many directions.
- stiffness.** The quantity which, when divided by 2π times the frequency, gives the acoustic reactance associated with the potential energy of the medium or its boundaries. The unit commonly used is the dyne per centimeter to the fifth power.
- transmission system.** An assembly of elements adapted for the transmission of sound.
- acoustical.** When used as a qualifying term is related, pertaining to, or associated with sound, but not having its properties or characteristics. Examples: acoustical engineer, school, glossary, unit.
- labyrinth enclosure.** A loudspeaker enclosure in which partitions are used to increase the length of the air path of the rear radiation of the loudspeaker.
- ohm.** An acoustic resistance, reactance, or impedance has a magnitude of one acoustical ohm when a sound pressure of 1 microbar produces a volume velocity of 1 cubic centimeter per second.
- units.** In acoustics, the cgs system of units is at present predominantly used; but some practical units such as English and metric system units of length are also being used; the watt is commonly used for designating acoustic power.
- acoustics.** The science of sound. The study of the cause and effect of audible vibrations. Also the characteristics of a room or space that affects sound propagation and sound travel.
- acoustimeter.** A device for the electrical measurement of sound, having an output indicator calibrated in db or in units of sound intensity. A sound-level meter.
- action.** In the automatic field it refers specifically to control action. It is that which is done to regulate the controlling element in a process or operation. The action ranges from the familiar "on" and "off" movements to not so familiar derivative and rate types of action.
- active**
- lines.** The television image lines actually visible on the screen; those of the 525 image lines not blanked out.
- transducer.** A modulating transducer.
- actuating signal.** In control systems, the reference input minus the primary feedback.
- Adcock antenna.** Two or more vertical conductors for reception or transmission of radio waves, arranged so that the interconnecting horizontal wires have little or no pickup.
- adder.** A device that can form the sum of two or more numbers, or quantities, impressed upon it.
- circuit.** Circuits that perform the addition of two numbers, by electrical means, in an electrical computer.
- additive color mixture.** Superposition or other nondestructive combination of light of different chromaticities.
- address.** Information (usually a number) which designates a particular location in a memory or storage device.
- part.** In an instruction, any part that is usually an address. See instruction code.
- A-display.** In radar, a pattern in which targets appear as vertical deflections from a line representing a time base. Target distance is indicated by the horizontal position of the deflection from one end of the time base. The amplitude of the vertical deflection is a function of the signal intensity.
- adjacent**
- channel.** The channel immediately above or below the reference channel.
- channel interference.** Interference originating in the channels on either side of the one to which the channel is tuned. Interference from any channel near the desired one.
- channel selectivity.** The ability of a receiver to reject the signals of stations on either side of the channel carrying the desired signal.
- adjustable**
- resistor.** A wire-wound resistor having a movable tap that can be clamped at any desired point along the resistor.
- voltage divider.** A wire-wound resistor having three or more terminals, at least one of which is movable to permit its being clamped at any desired point to adjust the voltage division.
- admittance.** (Y) A measure of the ease with which an alternating current flows in a circuit. The reciprocal of impedance, measured in mhos. The word mho is ohm spelled backwards, indicating it is a reciprocal.
- aeolight.** A glow lamp employing a cold cathode and a mixture of permanent gases in which the intensity of illumination varies with the applied signal voltage.
- aerial.** See antenna.

aerodynamic missile. A military weapon requiring the use of aerodynamic forces to maintain its flight path.

aerophare. In air operations a name for radio beacon.

afterglow. The continued emission of light by a phosphorescent material after excitation ceases.

aided-tracking. A tracking system in which the manual correction of the tracking error automatically corrects the rate of motion of the tracking mechanism.

AI radar. (airborne intercept) An airborne radar used for searching and tracking other aircraft.

air

capacitor. A capacitor having air as its dielectric.

-cell battery. A nonrechargeable wet-cell battery delivering about 2.5 volts when new, used chiefly in 2-volt battery-operated home receivers. Its carbon electrodes are porous, and absorb oxygen from the air for depolarization purposes.

core. A magnetic circuit consisting only of air and other nonmetallic materials.

-core transformer. A transformer having a core (magnetic circuit) of air or other nonmetallic materials so that the magnetic lines of force travel only through these nonmagnetic materials.

gap. A path for electrical or magnetic energy through air between two objects, as between the electrodes of a spark gap or the core sections of an iron-core transformer.

-position indicator. An airborne computing system which presents a continuous indication of the aircraft position on the basis of aircraft-heading, air speed and elapsed time.

speed. The rate of motion of a vehicle relative to the air mass.

traffic control. A system established by the CAA for issuing information and instructions to aircraft. At or near an airport it is called Airport Traffic Control and along the airways, Airways Traffic Control.

airplane dial. Popular name for a circular receiver dial with a rotating pointer, resembling the dials and pointers of airplane instruments.

airport

runway beacon. A radio signal used to indicate the approaches to an airport.
surface detection equipment. A radar for observation of the positions

of aircraft on the surface of an airport.
surveillance radar. A radar operating at or near an airport, and used for observation of the positions of airborne aircraft. It is primarily employed in the control and organizing of local traffic.

Afford loop. A multielement antenna, having approximately equal and in-phase currents uniformly distributed along each of its peripheral elements, producing a substantially circular radiation pattern in the plane of polarization (originally developed as a four-element, horizontally-polarized vhf loop-antenna).

align. To adjust tuning circuits so they respond to the designed frequency or band of frequencies. Also, to line up holes in two or more parts so a bolt can be passed through the holes, or to line up parts by positioning them in a straight line.

aligning tool. A small screwdriver or socket wrench, constructed partly or entirely from nonmetallic materials, used for making neutralizing or aligning adjustments in radio receivers. The use of nonmetallic materials eliminates body capacity that would affect the accuracy of the adjustments if a metallic wrench or screwdriver were used.

alignment. The process of adjusting the tuning circuits in a receiver or transmitter so they respond to the desired frequency or band of frequencies.

chart. A chart giving manufacturer's alignment instructions.

alive. Energized by being connected to an operating voltage source.

alligator clip. A long-nose clip with spring-controlled jaws and meshing teeth, used on test leads for making quick temporary connections.

alloy. A mixture of two or more metals. For example, bronze is an alloy of copper and tin.

junction. (semiconductor) A junction formed by alloying one or more impurities to a semiconductor crystal.

all-pass network. A network designed to introduce phase shift without introducing appreciable attenuation of any frequency.

all-wave

antenna. A receiving antenna designed to pick up stations over a wide range of carrier frequencies, including short-wave bands and broadcast bands.

- receiver.** A receiver capable of receiving stations on all commonly used radio bands. The most common all-wave receivers have a range from 500 kc to 30 mc.
- signal generator.** A test instrument capable of generating any of the radio-frequency signals needed in aligning or servicing all-wave receivers (approximately 100 kc to 30,000 kc).
- alnico.** An alloy of iron, aluminum, nickel, and cobalt, that holds magnetism indefinitely, used in permanent magnets for loudspeakers, motors, dynamotors, meters, and motor-generators. There are several kinds of alnico, differing in magnetic characteristics, identified by a number, as alnico III, alnico V.
- alpha.** Designated by the Greek letter α this term is used to indicate the current amplification factor of a transistor. Alpha may be defined as "the ratio of the change in collector current for a specific change in emitter current at a constant collector voltage".
- cutoff frequency.** The frequency at which the alpha of a transistor has fallen to 0.7 (3db) of its low frequency value.
- particle.** The nucleus of the helium atom.
- alternating current.** A periodic current the average value of which, over a period, is zero.
- alternation.** One half of a cycle, consisting of a complete rise and fall of current in one direction. Thus, 60-cycle alternating current has 120 alternations per second.
- alternator.** A dynamoelectric generator for producing ac voltages.
- altimeter.** A device for measuring altitude or elevation above sea level. The electronic form employs radar principles.
- aluminized picture tube.** A cathode-ray picture tube in which a thin layer of aluminum has been deposited on the back of the fluorescent surface to improve the brilliance of the image and prevent ion-spot formation.
- amateur.** Any person who operates and experiments with short-wave transmitters as a hobby rather than for profit. Often called a "ham."
- bands.** Bands of frequencies assigned to radio amateurs.
- ambient.** Encompassing on all sides. Commonly used to describe the following: ambient temperature is the average or mean surrounding temperature, e. g., the temperature of the air surrounding a transistor; ambient noise level is the mean surrounding noise level.
- ambiguity.** In navigation, the condition obtained when navigation coordinates define more than one point, direction, line of position, or surface of position.
- ammeter.** An instrument used for measuring current flow in amperes.
- ampere.** The practical unit of electric current flow. The current present if a one-ohm resistance is connected to a one-volt source. The movement of approximately 6,280,000,000,000,000 electrons past a given point in a circuit in one second.
- hour.** A current of one ampere flowing for one hour; a unit used chiefly to indicate the amount of electrical energy a storage battery can deliver before it needs recharging.
- hour meter.** An instrument that indicates or records the number of ampere-hours of energy drawn from a storage battery.
- turn.** A unit of magnetomotive force, or the strength of the magnetic field produced by a coil. The number of ampere-turns is equal to the coil current in amperes multiplied by the number of turns in the coil. One ampere-turn is equal to 1.257 gilberts.
- amplidyne.** A motor generator used to amplify the effect of a low-current control system. The field excitation of the amplidyne generator is varied by the control, and the amplidyne output energizes the field of the controlled generator.
- amplification.** General transmission term used to denote an increase of signal magnitude.
- factor.** A rating indicating the theoretical maximum amplification that can be provided by a given vacuum tube. It is the ratio of the plate-voltage change to the grid-voltage change with a constant cathode current.
- amplifier.** A device whose output is an enlarged reproduction of its input.
- feedback.** The process of applying a fraction of the output of an amplifier to the input terminals of the amplifier in such polarity as to oppose (degenerative), or aid (regenerative), the normal input signal that is being applied to the terminals.
- operating angle.** That part of the grid signal voltage cycle during which plate current flows.
- amplify.** To increase; to enlarge.

amplitude. The amount of variation of a quantity from a reference value, usually zero. The amount of vertical displacement above or below a horizontal reference line on a graph. Also, the displacement of a phonograph record groove from its average or unmodulated position.

balance control. In navigation, that portion of a system which may be varied to adjust the relative output levels of two related signals.

discriminator. A circuit, the output of which is a function of the relative magnitudes of two signals.

distortion. The result of nonlinearity of an amplifier with respect to signal amplitude. This results from driving a tube beyond the linear portion of its characteristic so that, for example, a two-fold increase of input-signal amplitude will not double the amplitude of the output. Since this type of distortion introduces harmonics not present in the input, it is also known as harmonic distortion.

modulation. A system of transmission, in which the amplitude of the transmitted signal varies in accordance with the instantaneous amplitude of the intelligence signal, at a rate corresponding to the frequency of the intelligence signal. This process produces sideband frequencies above and below the assigned carrier frequency.

response. (camera tubes) See square-wave response.

separation. Separation of two or more signals of different amplitudes by arranging a circuit to pass signals that are either above or below a predetermined level. Specifically, separation of the synchronizing signal from the video component of a TV signal.

separator. The clipper or sync separator stage in a television receiver.

-suppression ratio. A measure of the ability of an FM receiver to limit or remove AM variations. The ratio of the undesired AM output to the desired FM output.

analog. (electronic computers) A physical system on which the performance of measurements yields information concerning a class of mathematical problems.

computer. A physical system together with means of control for the performance of measurements (upon the system) which yields information concerning a class of mathematical problems. In an analog computer, quantities are represented without explicit use of a language.

and-gate. A gate whose output is energized

when and only when every input is in its prescribed state. An and-gate performs the function of the logical "and." Often called, and-circuit; and-switch.

angle. The figure formed when two straight lines meet at a point. The lines are called the sides of the angle and the point is called the vertex. An acute angle is less than 90° . An obtuse angle is more than 90° . A right angle is 90° .

of beam. The angle enclosing the greater part of the energy transmitted from a directional antenna.

of deflection. In a cathode-ray tube, the angle between the two positions of maximum deflection of the electron beam.

of divergence. In a cathode-ray tube, the angle between the deflected electron stream and a longitudinal line through its center.

of incidence. The angle between a ray of light falling on a surface and the perpendicular to the surface at that point.

of radiation. The angle between the earth and the strongest part of the wave radiated from a transmitting antenna.

of refraction. The angle formed with respect to the normal when a ray of light passes from one medium to another.

angstrom unit. A unit of wavelength measurement equal to one hundred-millionth of a centimeter. The wavelength of visible light is between 4000 and 7000 angstrom units.

angular

frequency. The frequency expressed in radians per second. It is equal to the frequency in cycles per second multiplied by 2π .

phase difference. The phase difference expressed in radians or degrees.

velocity. The speed of a rotating body measured by an angle whose vertex is the center of rotation and through which any point of the body moves in a given time. The angular velocity of a current or voltage is equal to 2π times the frequency.

anion. An electrochemical term for a negative ion that moves toward the anode.

annealing. A process of softening metals by first heating and then cooling gradually.

annunciator. A visual signaling device, operated by relays, which indicates conditions of associated circuits.

anode. A tube electrode, commonly called the plate, and usually at a high positive potential with respect to the cathode.

Identified on diagrams by the letter P.
breakdown voltage. (gas tubes) See breakdown voltage.

current. See electrode current.

strap. (of a magnetron) A metallic connector between selected anode segments of a multicavity magnetron, principally for the purpose of mode separation.

voltage. See electrode voltage.

voltage drop. See tube voltage drop.

A-N radio range. A radio range providing four radial lines of position identified aurally as a continuous tone resulting from the interlocking of equal amplitude "A" and "N" International Morse code letters. The sense of deviation from these lines is indicated by deterioration of the steady tone into audible A or N code signals.

antenna. A means for radiating or receiving radio waves.

array. Two or more antennas coupled together so as to improve transmission or reception in a desired direction.

coil. The coil in a receiver through which the antenna current flows, usually directly connected to the antenna and ground terminals.

coupler. A device in a transmitter for transferring rf energy from the final plate tank to the antenna. It may also serve to match the plate-tank impedance to the impedance of the transmission line.

current. The current flowing in the antenna.

effect. The error in the direction-indicating characteristic of a loop antenna due to capacity between the antenna and ground. In radio direction-finders, the antenna effect is cancelled out by the balancer.

form factor. The ratio of the effective height of an antenna to its actual physical height.

gain. The effectiveness of an antenna in a particular direction as compared to some standard antenna. The ratio of the power that must be supplied to the given antenna to that supplied a standard antenna to produce the same field strength in a desired direction. Antenna gain in db is equal to 10 times the log of this power ratio.

power. The product of the square of the antenna current and the antenna resistance at the point where the current is measured.

power gain. The square of the ratio of the root-mean-square free space field intensity produced at one mile in the horizontal plane, in millivolts per meter for one kilowatt antenna input power to 137.6 mv/m. This ratio should be expressed in decibels. If specified

for a particular direction, antenna power gain is based on the field strength in that direction only.

resistance. The total resistance of the transmitting antenna system at the operating frequency calculated at the point of maximum current.

antilogarithm. The number corresponding to a logarithm. Usually written antilog. Example: The logarithm of 87.9 is 1.9440, and 87.9 is the antilog of 1.9440.

anti-resonant circuit. A parallel-resonant circuit.

anti-tr switch. A gas-discharge switch, employed when a common transmitting and receiving antenna is used, which automatically decouples the transmitter from the antenna during the receiving period.

aperiodic

antenna. An antenna with a constant impedance over a wide range of frequencies.

circuit. A circuit with no definite time period of oscillation because its resistance is large enough to prevent natural oscillations, or because its capacity and inductance are of such values that they will not resonate in the tuning range.

aperture. A hole in a plate or other device used to control the diameter or position of an electron beam or a light beam.

apparent power. In an alternating current circuit, the effective voltage in volts multiplied by the effective current in amperes, without consideration of phase relations. The apparent power is, therefore, not the true power if the circuit contains any reactance.

applicator. Appropriately shaped conducting surfaces between which is established an alternating electric field for the purpose of producing dielectric heating.

approach

navigation. Navigation during the time that the approach to a dock or runway is of immediate importance.

path. That portion of the flight path in the immediate vicinity of a landing area where such flight path terminates at the touchdown point.

aquadag. A suspension of graphite particles in water, used to deposit a carbon coating on the glass envelopes of vacuum tubes and cathode ray tubes for any of several purposes, such as shielding the electrodes from light, absorbing

heat, or collecting stray electrons. By extension, the coating itself.

arc. A discharge of electricity through a gas, normally characterized by a voltage drop approximately equal to the ionization potential of the gas.

-back. The flow of a principal electron stream in the reverse direction owing to the formation of a cathode spot on an anode, which results in a failure of the rectifying action.

converter. An rf oscillator utilizing an electric arc and a tank circuit to generate a pulsating or alternating current.

-drop loss. (gas tubes) The product of the instantaneous values of tube voltage drop and current averaged over a complete cycle of operation.

-through. (multielectrode gas tubes) The loss of control resulting from the flow of a principle electron stream in the normal direction during a scheduled nonconducting period.

argon. A gas used in some rectifier tubes and electric lamps. It gives off a purple glow when ionized.

arithmetic unit. That part of a computer which performs arithmetic operations.

armature. The part of a motor or generator that includes the main current-carrying winding. In dc machines the armature is the rotating part but in ac machines it may either rotate or be stationary. Also, the pivoted or spring-mounted iron portion of a magnetic loudspeaker, vibrator, buzzer, relay, or magnetic phono pickup.

contact. Sometimes used for movable contact.

reaction. The reaction between armature flux and field flux causing a redistribution of flux lines in a dynamoelectric motor or generator.

relay. A relay operated by an electromagnet which, when energized, causes an armature to be attracted to a fixed pole.

travel. The total distance traveled during operation by a point on the armature which is nearest the pole-face center when the relay is operated.

Armstrong oscillator. An oscillator with a tuned circuit either in the plate or grid circuit using inductive coupling (tickler winding) or regenerative feedback from plate to grid.

array. See antenna array.

arrester. See lightning arrester.

artificial line. A network which simulates

the electrical characteristic of a transmission line.

aspect ratio. In television, the ratio of the frame width to the frame height.

astable multivibrator. A multivibrator which has no stable state; a free-running multivibrator.

astatic. Without polarity.

galvanometer. A sensitive galvanometer using two very small magnetized needles arranged parallel to each other with north and south poles adjacent and suspended inside the galvanometer coil. The two needles reduce the effect of the earth's magnetic field.

astigmatism. A defect of a lens or other optical system in which rays coming from one point of an object are not all brought to the desired focal point. In an electron-beam tube, a focus defect in which electrons in different axial planes come to focus at different points.

A supply. Filament voltage supply of a vacuum tube circuit such as an A battery or a filament winding on a power transformer.

asynchronous. Not synchronous.

computer. An automatic computer in which succeeding operations are started by signals indicating the completion of the previous operation rather than by signals from a master synchronizer.

AT-cut crystal. A low temperature drift crystal, cut at a 35° angle to the Z axis.

atmosphere. A complex mixture of gases, principally oxygen and nitrogen, surrounding the earth for a distance of nearly 100 miles, and exerting a pressure of 15 psi at the surface of the earth, which value is a unit of pressure called one atmosphere.

atmospheric

duct. An almost horizontal layer in the troposphere, extending from the level of a local minimum of the modified refractive index as a function of height, down to the level where the minimum value is again encountered, or down to the earth's surface if the minimum value is not again encountered.

interference. Crackling and hissing noises caused in the receiver by electrical disturbances in the atmosphere. These disturbances radiate electromagnetic waves that are picked up by antenna systems. Also called static

interference, and particularly noticeable during thunderstorms.

pressure. The barometric pressure of air at a particular place on the earth's surface. The nominal, or standard, value of atmospheric pressure is 760 mm Hg (14.7 psia).

radio wave. A radio wave that is propagated by reflections in the atmosphere. It may include either or both of the components, ionospheric wave and tropospheric wave.

atmospherics. Unwanted, extraneous, disturbing currents induced in wire-line circuits, which result from dust, lightning, and snow storms, are sometimes referred to as atmospherics. The term is, however, more properly used to indicate natural disturbances encountered in radio transmission. See static.

atom. The smallest particle into which matter may be divided by chemical means. An atom has a nucleus consisting of protons, neutrons, etc., with electrons revolving around the nucleus. Each of the known elements has a different number and arrangement of electrons and protons in its atoms.

atomic weight. The weight of any atom as compared to the weight of the oxygen atom, which is set at 16.

attenuation. General transmission term used to denote a decrease of signal magnitude.

band. See rejection band.

constant. For a traveling plane wave at a given frequency, the rate of exponential decrease of the amplitude of a field component (or of the voltage or current) in the direction of propagation, in nepers or decibels per unit length.

equalizer. A network of resistors, coils, and capacitors designed to change the current amplitude in the circuit so that it varies in a desired way with frequency, without regard to phase.

attenuator. A device, usually an arrangement of variable resistances, that reduces the strength of a signal a desired amount without appreciable distortion.

altitude. The position of a vehicle as determined by the inclination of its axes to some frame of reference. If not otherwise specified, this frame of reference is fixed to the earth.

audibility. The strength of a sound or signal as compared to the strength required to produce a sound that can just barely be heard.

audible. Capable of being heard; actually heard.

audio. Pertaining to currents or frequencies corresponding to normally audible sound waves.

amplifier. A vacuum tube or transistor stage that increases the voltage or power, or both, of an audio-frequency signal.

band. Usually used to designate the range of audio frequencies passed by an amplifier, receiver, transmitter, etc.

frequency. Any frequency corresponding to a normally audible sound wave.

frequency meter. An instrument for measuring audio frequencies.

-frequency peak limiter. A circuit used in an audio-frequency system to cut off peaks that exceed a predetermined value.

-frequency transformer. An iron-core transformer used for coupling audio-amplifier circuits.

oscillator. An oscillator that generates audio-frequency voltages.

range. The range of frequencies to which the human ear will respond. This range varies with individuals, age, state of health, etc., and is approximately 16 to 16,000 cycles.

signal. The electrical equivalent of sound.

transformer. Audio-frequency transformer.

audiogram. A graph showing hearing loss, per cent hearing loss, or per cent hearing as a function of frequency.

audiometer. An instrument for measuring hearing acuity. Measurements may be made with speech signals; usually recorded or with tone signals.

audion. The three-electrode vacuum tube invented by Lee de Forest.

aural. Pertaining to hearing.

harmonic. A harmonic generated in the auditory mechanism.

-null direction finder. A direction finder receiver in which a loop antenna is rotated until minimum sound is heard in the headphone; bearings are read from a compass scale associated with the loop antenna control.

radio range. A radio range station providing lines of position by virtue of aural identification or comparison of signals at the output of a receiver.

transmitter. The radio equipment for the transmission of the aural signal only.

auto alarm. An automatic device for maintaining a continuous watch for dis-

ness signals, consisting of a receiver tuned to the international distress frequency, and a selector that will respond only to the international auto alarm signal.

autodyne reception. A system of heterodyne reception in which one tube acts both as an oscillator and a detector.

automatic. Self-acting.

bass compensation. A resistor and capacitor circuit used in some receivers to make low audio-frequency notes sound more normal at low volume-control settings. The circuit automatically compensates for the poor response of the human ear to weak low-frequency sounds.

brightness control. A circuit that automatically keeps the average brightness of the reproduced image constant in a television receiver.

chrominance control. A circuit which automatically controls the magnitude of the chrominance signal, such as in a color receiver.

circuit-breaker. A device that automatically opens a circuit when the current become excessive.

contrast control. A circuit that varies the bias on one or more tubes so that the contrast of the television picture is maintained at a constant average level.

controller. A device that measures the value of a variable quantity or condition and operates to correct or limit deviation of this measured value from a selected reference. An automatic controller includes both the measuring means and the controlling means.

control system. Any operable arrangement of one or more automatic controllers connected in closed loops with one or more processes.

direction finder. A direction finder which automatically and continuously provides a measure of the direction of arrival of the received signal. Data is usually displayed visually.

frequency control. A system which controls the frequency of a source of oscillations by comparing it with that of a reference signal and supplying correction voltage to the controlled source. Sometimes applied to systems controlling both frequency and phase.

gain control. A circuit arrangement which adjusts the gain in a specified manner in response to changes in input.

grid bias. Use of the voltage drop across a resistor in the grid or cathode circuit of a tube as the C bias voltage for the grid of the tube, eliminating the need for a separate C bias voltage source.

phase control. A system which controls the phase of a source of oscillations

by comparing it with that of a reference signal and supplying correction voltage to the controlled source. An apc system controls frequency also.

pilot. (autopilot) Equipment which automatically stabilizes the attitude of a vehicle about its pitch, roll and yaw axes.

record changer. An electrically operated device which automatically feeds, plays, and rejects a number of records in sequence. Consists of a motor, turntable, pickup arm and changer mechanism.

regulator. A device for regulating a system so that changes in its functioning are carried out electrically or mechanically rather than manually.

tuning. An electrical or electromechanical system that tunes a receiver automatically to a predetermined station when a button or lever is pushed.

voltage regulator. A device or circuit which maintains a constant voltage.

volume control. A circuit to maintain a preset audio output level.

volume expansion. A special audio circuit that increases the volume range of a radio program or phonograph record by making the weak passages weaker and loud passages louder.

automation. The technique of making a process or system automatic. Automatically controlled operation of an apparatus, process, or system, especially by electronic devices.

autoregulation induction heater. An induction heater in which a desired control is affected by the change in characteristics of a magnetic charge as it is heated at or near its Curie point.

autosyn motor. See selsyn motor.

autotransformer. A transformer in which the primary and secondary are combined as a single coil.

available line. In facsimile, the portion of the scanning line which can be used specifically for picture signals.

average. The average of a number of quantities is obtained by dividing the sum of the quantities by the number of quantities involved.

absolute pulse amplitude. The average of the absolute value of the instantaneous amplitude taken over the pulse duration.

brightness. The average illumination in the television picture.

electrode current. The value obtained by integrating the instantaneous electrode current over an averaging time

and dividing by the average time.

power output. The radio-frequency power delivered to the output terminals of an amplitude-modulated transmitter, averaged over a modulation cycle.

pulse amplitude. The average of the instantaneous amplitude taken over the pulse duration.

aviation channels. Frequency bands assigned for radio communication between aircraft and ground stations. They are both above and below broadcast-band frequencies.

azimuth. Direction in the horizontal plane. Normally used in designating direction of a radio beam.

B

back electromotive force. A voltage developed in an inductive circuit by a changing or alternating current whose polarity is such that it opposes the change in current that produces it. Also called counter electromotive force.

background. The average illumination of a television scene, contained in the dc component of the video signal.

control. See brightness control.

noise. 1. Noise heard along with a received program, due to atmospheric interference or to circuit noises. 2. In recording and reproducing, the total system noise independent of whether or not a signal is present. The signal is not included as part of the noise. 3. In receivers, the noise in the absence of signal modulation on the carrier.

returns. (radar) See clutter.

voltage. In a radio direction finder, any voltage induced in the loop other than the desired signal voltage.

backlight. Illumination applied to the rear of the iconoscope in a film pickup to provide a minimum light level and thus assist in controlling shading.

backplate. (camera tubes) The electrode to which the stored charge image is capacitively coupled.

back porch. That portion of a composite picture signal which lies between the trailing edge of a horizontal sync pulse and the trailing edge of the corresponding blanking pulse.

back-porch tilt. The slope of the back porch from its normal horizontal position. Positive or negative refers, re-

spectively, to upward or downward tilt to the right.

back-shunt signaling. A signaling system in which energy is delivered to the antenna when a telegraph key is closed, and to a "backshunt" non-radiating circuit when the key is open.

back-to-front ratio. A ratio used in connection with antennas, metal rectifiers, or any device in which signal strength or resistance in one direction is compared to that in the opposite direction.

backward wave. (in a traveling-wave tube) A wave whose group velocity is opposite to the direction of electron stream motion.

backwave. A signal heard from a telegraph transmitter with the key open because of improper neutralization of the transmitter amplifier.

baffle. A shielding structure or partition used to increase the effective length of the external transmission path between two points in an acoustic system, e.g., between the front and back of an electroacoustic transducer.

balanced

circuit. A circuit, the two sides of which are electrically alike and symmetrical with respect to a common reference point, usually ground.

currents. (on a balanced line) Currents flowing in the two conductors of a balanced line which, at every point along the line, are equal in magnitude and opposite in direction.

line. A balanced or "metallic" line or circuit utilizing two conductors or components, instead of one conductor or component and ground (common conductor). A balanced line is usually preferred when minimum noise and crosstalk values are desired.

modulator. A circuit used to generate the sidebands of an amplitude modulated wave and suppress the carrier.

termination. For a system or network having two output terminals, a load presenting the same impedance to ground for each of the output terminals.

voltages. (on a balanced line) Voltages (relative to ground) on the two conductors of a balanced line which, at every point along the line, are equal in magnitude and opposite in polarity.

balancer. The portion of a radio-direction finder used to eliminate the antenna effect due to loop-ground capacity.

balancing capacitor. A capacitor used

as part of a balanced circuit; a neutralizing capacitor. The capacitor that makes both sides of a direction-finding loop equal in capacity to ground when the antenna is set for minimum signal pickup.

ballast

resistor. A resistor that has the characteristic of greatly decreasing its resistance when current decreases, and increasing its resistance when current increases, thereby maintaining essentially constant current over a considerable range of voltage variation.

tube. A ballast resistor mounted in an evacuated glass or metal envelope to improve the automatic voltage regulating action by reducing the radiation of heat from the resistor element. Also, a line-dropping resistor housed in a tube envelope.

ballistic galvanometer. An instrument for measuring a momentary discharge or pulse of energy. It is a microammeter having a coil with a high moment of inertia and no retarding spring so that, when energized, the indicator is free to rotate until stopped by friction. The total movement of the pointer until it comes to rest is proportional to the energy being measured.

balun. An impedance-matching device for antennas; used between equipment and transmission lines or transmission lines and antennas.

band. Limited continuous region which is part of a more extended region. Used in connection with frequencies and pressures; the group of rotating tracks on a magnetic drum storage system. The digits of a word are stored in parallel on the tracks of the band.

elimination filter. Filter network which rejects a given band of frequencies while passing frequencies to either side of this band.

pass. Number of cycles per second expressing the difference between the upper and lower frequencies at which the desired fraction (usually half-power) of the maximum output is obtained.

selector. A band switch that permits selection of any one of the bands in which a receiver or transmitter is designed to operate.

switch. A switch that simultaneously changes all tuning circuits of a radio receiver or transmitter to a desired band of frequencies.

bandspread tuning. Tuning by means of a gang of low capacity capacitors con-

nected in parallel with the main tuning gang. After tuning to the desired band with the main gang, it is possible to "spread" that band over the bandspread dial because the small capacities give a smaller frequency change per degree of rotation. Also, a mechanical system for achieving the same result by using a vernier tuning knob having a high drive ratio, so that many turns of it are needed to move the main capacitor gang appreciably.

bandstop filter. A filter having characteristics inverse to those of bandpass; barring frequencies within a defined band and offering low attenuation to those outside.

bandwidth. The difference, expressed in cps, between two frequencies that: are the upper and lower limits of a band of frequencies; are the highest and lowest frequencies at which the response does not fall below some specified amount of the maximum response.

bar.

generator. A generator for producing pulses equally separated in time that are synchronized so they produce a stationary bar pattern on a television screen for test purposes.

magnet. A magnetized straight bar of steel serving as a permanent magnet.

pattern. A pattern of identical repeating bars on a television screen. The spacing between the bars is used to determine the degree of linearity of the horizontal or vertical scanning systems.

relay. A relay so designed that a bar actuates several contacts simultaneously.

barium. A chemical element used in photoelectric cells.

Barkhausen-Kurz oscillator. An oscillator of the retarding field type in which the frequency of oscillation depends upon the electron transit time within the tube.

barrier. (in a semiconductor) See depletion layer.

barrier-layer. See depletion layer.

base. One element of a transistor. The center section of the junction and surface-barrier types and the main or largest section of the point-contact type. The base can be compared to the grid of a triode vacuum tube.

electrode. (of a transistor) An ohmic or majority carrier contact to the base region.

- region.** The interelectrode region of a transistor into which minority carriers are injected.
- station.** The station in a land mobile system which remains in a fixed location and communicates with mobile stations.
- baseline.** In navigation the line joining the two points between which electrical phase or time is compared in determining navigation co-ordinates.
- base-loaded antenna.** A vertical antenna, having an inductance in series at the base for loading the antenna to secure a desired electrical length.
- basic**
- frequency.** The frequency of the component considered to be the most important.
- repulsion rate.** In loran, the lowest pulse repetition rate of each of several sets of closely-spaced repetition rates employed by loran.
- research.** The theoretical or experimental study directed toward the increase of knowledge.
- bass.** Low audio frequencies, generally considered to be those frequencies below 300 cycles per second.
- boost circuit.** A circuit designed to emphasize low audio frequencies.
- compensation.** Any means for offsetting the natural drop in the response of the human ear to low audio frequencies at low volume levels.
- control.** A manually-adjusted control provided on a receiver for the purpose of emphasizing or de-emphasizing low audio frequencies.
- reflex enclosure.** A loudspeaker enclosure consisting of a closed-back box having an opening in addition to the one behind the speaker. The additional opening, known as a port, is generally located directly beneath the loudspeaker. The volume of the enclosure and size of the port are such that the sound waves emitted from the port and from the speaker opening are in phase at the low frequencies, thereby improving the low-frequency response.
- response.** The ability of a loudspeaker or amplifier to handle low audio notes, or the sensitivity of the human ear to low audio notes.
- bath tub capacitor.** A capacitor enclosed in a metal can with rounded corners resembling a bathtub.
- battery.** One or more dry cells or storage cells connected together to serve as a dc voltage source.
- bat wing antenna.** A structure of open-spaced tubing resembling a bat's wing in shape. Adapted from the basic dipole, this antenna is characterized by a uniform current distribution and large physical area. These features provide the uniform radiation field and broad bandwidth required by TV and FM transmitting antennas.
- baud.** A unit of signaling-speed derived from the duration of the shortest code element. Speed in bauds is the number of code elements per second.
- bay.** One complete section of a number of amplifiers or other transmitter units mounted on racks. Also a section of a complex antenna array.
- bayonet base.** A type of tube and lamp base having two projecting pins on opposite sides that engage in corresponding slots in the bayonet-shell socket. Electrical contact is made by means of pins or rings on the bottom of the base.
- bazooka.** A quarter-wave shield used at the end of a coaxial transmission line to raise the impedance of the outer conductor to permit connecting to a balanced transmission line. A line balance converter.
- B battery.** A battery having many small cells connected in series, used for supplying dc voltages to the plate and screen-grid electrodes of radio tubes used in battery-operated equipment.
- B-display.** In radar, a rectangular display in which targets appear as blips with the bearing indicated by the horizontal coordinate, and the distance by the vertical coordinate.
- beacon.** See radio beacon.
- course.** The equisignal zone or beam of an aircraft radio beacon, designating a course through the sky.
- beam.** The stream of electrons passing from the cathode to the fluorescent screen of a cathode ray tube. Also, a constant radio signal transmitted for guidance of aircraft. Also, radiated energy that is concentrated and directed in a particular path.
- alignment.** (camera tubes) An adjustment of the electron beam, performed on tubes employing low-velocity scanning, to cause the beam to be perpendicular to the target at the target surface.
- angle.** The angle enclosing a greater part of the energy transmitted from a

- directional antenna.
- antenna.** An antenna whose radiation is practically confined to a narrow beam extending in a definite direction.
- bender.** See ion trap.
- bending.** (camera tubes) Deflection of the scanning beam of the electrostatic field of the charges stored on the target.
- current.** The current in the stream of electrons in a cathode-ray tube.
- deflection tube.** An electron-beam tube in which current to an output electrode is controlled by the transverse movement of an electron beam.
- indexing color tube.** A color picture tube in which a signal, generated by an electron beam after deflection, is fed back to a control device or element in such a way as to provide an image in color.
- of light.** A group or pencil of light rays.
- power tube.** An electron-beam tube in which use is made of directed electron beams to contribute substantially to its power-handling capability, and in which the control grid and the screen grid are essentially aligned.
- rider guidance.** A scheme of guidance in which the missile follows a radar beam to the target by means of on-missile computers and controls which are sensitive to radar beams.
- switching tube.** A trochotron in which an electron beam can be formed and switched to any one of several (usually 10) positions.
- bearing.** A term used to designate the direction of one point with respect to another or to the points of a compass.
- beat**
- frequency oscillator.** An audio-frequency oscillator whose output is obtained by combining and rectifying two known higher-frequency signals generated by or obtained from separate circuits. Also, an oscillator used to provide a beat signal when its output is mixed with an incoming cw signal, so that an audible output can be obtained.
- note.** The wave of difference frequency created when two sinusoidal waves of different frequencies are supplied to a nonlinear device.
- beating.** A phenomenon in which two or more periodic quantities of different frequencies produce a resultant having pulsations of amplitude.
- bel.** The unit for logarithmic expression of ratios of power, voltage, or current, named after Alexander Graham Bell, inventor of the telephone. The number of bels is the common logarithm of the power ratio. In radio work, a smaller unit, the decibel, is used instead of the bel; a decibel is one-tenth of a bel.
- B eliminator.** A power pack that converts ac power line voltage to the pure dc voltages required by plate and screen-grid circuits of radio tubes, thereby eliminating the need for B batteries.
- bellows.** A pressure-sensing element consisting of a convoluted metal cylinder closed at one end; a pressure difference between the outside and inside of the cylinder causes it to expand or contract along its axis.
- bell wire.** A common name for the cotton-covered No. 18 copper wire used for making doorbell and thermostat connections in homes.
- bend.** In a rectilinear navigational system, the departure of a defined course line from a straight line.
- benllo.** A cw navigational system in which the distance to an aircraft is determined on the ground by a phase-difference measurement of an audio signal transmitted from the ground and re-transmitted by the aircraft. Bearing information is obtained by ground direction-finding of the aircraft signals.
- beta.** Designated by the Greek letter β , this term is used to indicate the base-to-collector amplification; symbol for transport factor; the fraction of the output fed back to the input of an amplifier.
- beta rays.** Rays consisting of negatively-charged particles or electrons.
- Beverage antenna.** A directional antenna of low height, having a length some multiple of the received wavelength.
- B-H curve.** A curve showing the relationship between magnetic flux density (B) in a magnetic path and the magnetic force per unit length (H) in that path.
- bias.** Electrical, mechanical, or magnetic force applied to a relay, vacuum tube, or other device, for the purpose of establishing an electrical or mechanical reference level for the operation of the device; dc potential applied to the control grid of a vacuum tube; average dc voltage between the control grid and cathode of a vacuum tube.
- cell.** Dry cells in the grid circuit of a vacuum tube to provide C-bias voltage.
- resistor.** The cathode resistor that provides a C-bias voltage for a tube.
- bidirectional.** In two directions, one op-

- posite the other. An ordinary loop antenna is bidirectional, picking up energy from two opposite directions.
- antenna.** An antenna which radiates or receives power in two directions.
- microphone.** A microphone in which the response predominates for sound incidences of 0° and 180° . See principal axis.
- pulse.** A pulse in which the variation of the normally constant value occurs in both directions.
- bifilar winding.** A transformer in which the primary and secondary windings are wound together, side by side, in the same direction. Near unity coupling results from this type of winding. Thus, there is a very efficient transfer of energy from primary to secondary.
- bilateral.** Having two sides.
- antenna.** An antenna that radiates or receives radio waves best in two directions; 180° apart.
- area track.** A photographic sound track having the two edges of the central area modulated according to the signal.
- network.** A network in which a given current flow in either direction causes the same potential drop.
- transducer.** A transducer capable of transmission simultaneously in both directions between two terminations.
- billboard array.** An antenna array consisting of stacked dipoles $1/4$ to $3/4$ wavelength apart with a large sheet-metal reflector behind the dipoles.
- bimorph cell.** A cell consisting of two crystal elements cemented together, used in crystal headphones, microphones, pickups, and loudspeakers.
- binary.** The number system that is based on a radix of two, and hence employs two digits, 0 and 1. See positional notation.
- cell.** An information-storing element which can have one or the other of two stable states.
- code.** Composed of a combination of entities, each of which can assume one of two possible states and which is identifiable in time or space.
- coded decimal.** A system for representing decimal numbers in which each decimal digit is represented by a combination of four binary digits.
- number system.** A number system which uses two symbols (usually denoted by "0" and "1") and has two as its base, just as the decimal system uses ten symbols (0, 1, . . . , 9) and the base ten.
- point.** The radix point in the binary system.
- binaural.** A sound-reproducing system for duplicating the realism of the original sound by providing a separate signal for each ear. The sound is picked up by two microphones spaced a short distance apart to represent the two ears of the listener. The signals are amplified separately and ultimately applied to a pair of headphones, one signal to each unit. Because of the inconvenience of headphones, loudspeakers are often substituted. This, however, is no longer a pure binaural system since sound from the "left-ear" loudspeaker can reach the right ear of the listener and vice versa.
- effect.** The effect of sound on both ears. The difference in the two sound-path lengths makes it possible for a person to determine the direction from which a sound is coming.
- binding post.** A terminal to which wires may be attached by screws or clamps for making quick electrical connections.
- binomial array.** A directional antenna array for reducing minor lobes and providing maximum response in two opposite directions. This array consists of a number of single turn loops fed in phase and stacked vertically above each other, and with the current distributed between successive elements according to a binomial expansion whereby the center radiators get more current than the outer ones.
- bipolar.** Possessing two poles.
- birdie.** A beat note having a high audio frequency. A high-pitched whistle.
- bistable.** A device, such as a direct-coupled multivibrator (flip-flop), that has two equilibrium positions, such as one tube cutting off and the other heavily conducting, or vice versa.
- bit.** (in electronic computers) An abbreviation of "binary digit." A single character of a language employing exactly two distinct kinds of characters. A unit of storage capacity. The capacity, in bits, of a storage device is the logarithm to the base two of the number of possible states of the device. See storage capacity.
- position.** The location of a bit in the make-up of a word.
- black compression.** (black saturation) The reduction in gain applied to a picture signal at those levels corresponding to

dark areas in a picture with respect to the gain at that level corresponding to the mid-range light value in the picture.

level. In television, the voltage representing the color black. Usually it is not greater than 80% of the maximum television signal amplitude.

peak. The maximum excursion of the picture signal in the black direction at the time of observation.

recording. In an amplitude-modulation system, that form of recording in which the maximum received power corresponds to the maximum density of the record medium. In a frequency-modulation system, that form of recording in which the lowest received frequency corresponds to the maximum density of the record medium.

signal. The signal in a facsimile system produced by the scanning of a maximum density area of the subject copy.

transmission. In an amplitude-modulation system, that form of transmission in which the maximum transmitted power corresponds to the maximum density of the subject copy. In a frequency-modulation system, that form of transmission in which the lowest transmitted frequency corresponds to the maximum density of the subject copy.

black and white. See monochrome.

blacker-than-black region. That portion of the video signal above the black level. It contains the synchronizing pulses.

blanking. The process of applying negative voltage to the control grid of the cathode-ray tube to cut off the electron beam during the retrace or flyback period.

level. The level of the front and back porches of the composite video signal.

pulse. The signal introduced into the complex video signal at or above the black level, used to blank out video signals during the transmission of synchronizing signals.

blasting. A distortion of sound caused by overloading a microphone, loudspeaker, or some other part.

bleeder

current. A current drawn continuously from a power pack or other voltage source to improve voltage regulation or to increase the voltage drop across a resistor.

resistor. A resistor used to draw a fixed bleeder current from a power pack.

bleeding whites. In TV, a condition in which white areas appear to flow ir-

regularly into black areas.

blemish. (in charge-storage tubes) An imperfection of the storage surface which produces a spurious output.

blip. (PIP) On a radar display a deflection, or a spot of contrasting luminescence, caused by the presence of a target.

blister. A housing for a radar antenna.

block. A group of words considered as a unit.

block diagram. Simplified plan of an electronic system. The several stages or sections are shown as rectangles.

blocked

-grid keying. Method of keying a telegraph transmitter by applying sufficient bias to block tubes when the key is open. Closing the key removes the bias, allowing plate current to flow.

impedance. The input impedance of a transducer, when the output impedance is made infinite.

resistance. That part of the resistance in a loudspeaker due to electrical losses. It can be measured only when the moving elements in a loudspeaker have been blocked so they cannot move.

blocking. Stopping of operation, as by applying a high negative bias to the grid of a tube to cut off plate current.

capacitor. A capacitor used in an electronic circuit to prevent the flow of direct current while allowing ac signal currents to pass.

oscillator. A vacuum-tube oscillator operating intermittently, with grid bias increasing during oscillation to a point where it stops the oscillation, then decreasing to a point at which oscillation can be resumed.

blooming. Increase in spot size in a cathode ray tube resulting from abnormal brilliancy. Also, increase in picture size due to oversweeping because of reduced high voltage.

blow-out magnet. A permanent magnet or an electromagnet located in such a position as to place a magnetic field in the space where an electric circuit is to be broken. This field causes the arc to be displaced, thus lengthening it and helping to extinguish it more rapidly.

bobbin. A spool upon which a coil is wound.

body capacity. The capacity existing between the human body and a piece of radio apparatus.

bombardment. The striking of electrodes or other parts by ions or electrons.

bonding. Connecting metal objects together with heavy wire or metal straps so they will be at the same potential (usually ground potential).

book capacitor. A two-plate capacitor hinged like the pages of a book. Capacity variation is obtained by changing the angle between the plates.

Boolean algebra. A form of algebraic representation of logical propositions, invented by George Boole, in 1847.

boom. An adjustable mechanical arm for holding a camera or microphone in a number of different positions.

booster. A preamplifier connected between the antenna and receiver to increase the signal strength at the receiver input.

bootstrap

circuit. A single-stage amplifier in which the output load is connected between the negative end of the plate supply and the cathode, the signal voltage being applied between the grid and the cathode. The name bootstrap arises from the fact that a change in grid voltage changes the potential of the input source with respect to ground by an amount equal to the output signal.

region. That portion of memory reserved for instructions that load (read in and store) programs; usually the first or the last storage locations available.

bounce. Rapid, irregular changes in brightness of a TV picture. Irregular up and down movements of the picture.

boundary, p-n. A surface in the transition region between P-type and N-type material at which the donor and acceptor concentrations are equal.

bourdon tube. A pressure-sensing element consisting of a curved tube, closed at one end and having a flattened elliptical cross-section. A positive pressure difference between the inside and outside of the tube tends to straighten the tube.

branch

arm. 1. A portion of a network consisting of one or more two-terminal elements in series. 2. Synonym for conditional jump.

of control. An operation that alters the sequential path of a digital program in accordance with conditions existing in the equipment.

point. See node.

breadboard construction. Layout of radio parts and wiring so parts may be easily changed during experimental work. Originally on a wooden board but now usually on a metal chassis.

break cycle. An interruption of the computational or data-processing program, executed to permit the transfer of information between memory and input, output, or auxiliary storage devices.

breakdown. In a gas tube, a runaway increase in an electrode current.

transfer characteristic. A relation between the breakdown voltage of an electrode and the current to another electrode.

voltage. 1. The voltage of an electrode at which breakdown occurs to that electrode. Note 1: The breakdown voltage is a function of the other electrode voltages or currents and of the environment. Note 2: In special cases where the breakdown voltage of an electrode is referred to an electrode other than the cathode, this reference electrode shall be indicated. 2. The voltage at which the insulation between two conductors will become conductive.

break-in

keying. A method of operating a radio telegraph communication system in which the receiver at the transmitter location is capable of receiving signals during transmission spacing intervals.

operation. A type of radio communication in which the receiving operator can interrupt the transmitting operator.

break point. A place in a routine at which a special instruction is inserted which, if desired, will cause a digital computer to stop for a visual check of progress.

breathing. Amplitude variations similar to bounce but at a slow regular rate.

breezeway. In NTSC color, that portion of the back porch between the trailing edge of the sync pulse and the start of the color burst.

bridge

circuit. A circuit consisting of four resistances or impedances connected in series to form a square, with a voltage source connected between one pair of opposite junctions, and an indicator (usually a galvanometer) between the other pair. The bridge is said to be balanced when it is adjusted so no current flows through the indicating meter.

rectifier. A four-element rectifier cir-

cuit connected in the characteristic four-cornered arrangement of a bridge circuit. AC voltage is applied to one pair of opposite corners, and dc voltage is obtained from the other pair.

bridged-T network. A T-network with a fourth branch connected across the two series arms of the T, between an input terminal and an output terminal.

bridging. 1. A term used to describe a contact transfer in which the movable contact touches the normally open contact before leaving the normally closed contact during the transfer action, thus never completely opening the circuit of the movable contact. 2. The shunting of one electrical circuit by another.

amplifier. An amplifier requiring negligible input power that can be connected across another circuit without disturbing that circuit's normal function.

gain. The ratio of the power a transducer delivers to a specified load impedance under specified operating conditions to the power dissipated in the reference impedance across which the input of the transducer is bridged.

loss. The ratio of the power dissipated in the reference impedance across which the input of a transducer is bridged, to the power the transducer delivers to a specified load impedance under specified operating conditions.

bright level. The voltage representing white, the brightest part of a TV image, usually set at about 15% of the maximum TV signal amplitude.

brightness control. In a television receiver, the control that varies the average illumination of the image.

brilliance. Degree of reproduction of the higher audio frequencies. Also, the brightness of a TV picture.

brilliance control. Same as brightness control.

British thermal unit. An English unit of measure of heat quantity. It is the heat required to raise the temperature of one pound of water at its maximum density, 1° F.

broadband

antenna. A transmitting or receiving antenna which operates with essentially uniform efficiency over a wide band of frequencies without requiring readjustment. Such antennas are characterized by a low Q and low efficiency.

rf amplifier. An rf amplifier which operates with essentially uniform effi-

ciency over a wide band of frequencies without requiring readjustment.

broadcast

band. The group of frequencies assigned to broadcast stations. In the U. S., the standard AM broadcast band is from 550 kc to 1600 kc; the FM broadcast band is from 88 mc to 108 mc.

interference. Interference produced by any transmitter with any broadcast reception; interference of amateur radio transmitters with reception on standard broadcast receivers.

station. A radio station used for transmitting programs to the general public.

broadside directional antenna. An antenna array whose radiation is substantially at right angles to the line along which its elements are arrayed.

broad tuning. A characteristic of a receiver wherein the pass band of the tuning circuits is wide.

brush. A metal or carbon block used to make contact with a moving part in an electrical circuit; a wiper.

discharge. Visible ionization occurring at sharp points, corners, or bends of conductors charged to high potentials. Corona discharge.

brute-force filter. A low-pass filter depending on large values of capacity and inductance rather than on resonant effects to block ac components while passing direct current.

B supply. Any power supply connected in the plate circuit of a vacuum tube.

bucking coil. A coil whose magnetic field opposes that of another coil.

buffer. 1. An isolating circuit used to avoid reaction of a driven circuit upon the corresponding driving circuit. 2. A circuit having an output and a multiplicity of inputs so designed that the output is energized whenever one or more inputs are energized. Thus, a buffer performs the circuit function which is equivalent to the logical "OR."

amplifier. An isolating amplifier in which the reaction of output load impedance variation on the input circuit is reduced to a minimum.

capacitor. A capacitor used to reduce voltage surges that might affect following parts.

gate. See "OR" switch.

bug. A semi-automatic code transmitting key in which movement of a lever to one side produces a dot or a series of dots of equal duration and spacing, and move-

ment to the other side produces a single dash. Also, a slang expression for a defect or trouble.

bulb temperature pickup. A temperature transducer in which the sensing element is enclosed in a metal tube or sheath for protection against corrosive liquids or other contaminants.

bulk eraser. A 117-volt ac device used to erase an entire reel of magnetic tape without running it through a recorder. A strong magnetic field neutralizes the magnetic patterns on the tape.

buncher grids. The elements in a velocity-modulated tube, such as a klystron, whose potentials vary the electron velocities so that bunches of electrons are formed in the drift space.

bunching. The action in a velocity-modulated electron stream that produces an alternating convection-current component as a direct result of the differences of electron transit time produced by the velocity modulation.

angle. (in an electron stream) In a given drift space, the average transit angle between the processes of velocity modulation and energy extraction at the same or different gaps.

of electrons. Application of rapidly alternating fields to a uniform beam of electrons so that their velocities will be modulated. After a proper interval of travel, the faster electrons overtake preceding slower ones and bunches are formed that can be used to deliver energy to a resonant cavity.

parameter. One-half the product of (1) the bunching angle in the absence of velocity modulation and (2) the depth of velocity modulation. Note: In a reflex klystron the effective bunching angle must be used.

burned-in image. An image that persists in a fixed position in the output signal of a camera tube after the camera has been turned to a different scene.

burnishing surface. In mechanical recording, the portion of the cutting stylus directly behind the cutting edge which smooths the groove.

burst. See color burst.

gate. A keying pulse used in coders to gate in the color bursts on the back porch following each horizontal sync pulse. In receivers, to gate the bursts into the color-sync circuit. A burst flag.

bus. In electronic computers, one or more conductors which are used as a path for

transmitting information from any of several sources to any of several destinations.

bars. The heavy copper bars used on switchboards to carry current. Also, an uninsulated copper wire of about 12 or 14 gauge.

bushing. A tube or washer used as a bearing or as a lining for insulating a hole in a chassis.

butterfly

capacitor. A variable capacitor whose movable plates resemble the shape of a butterfly.

tank. A vhf resonant circuit using the mechanism of a butterfly capacitor in such a way that the rotor varies both the inductance and the capacity, thus giving a wide tuning range.

butt joint. A connection between two waveguides which provides physical contact between the ends of the waveguides in order to maintain electrical continuity.

buzz. A rasping sound ranging in frequency between a hum and a squeal. For example, an audible disturbance in the sound output of a television receiver due to synchronizing signals that get through the sound channel.

"B" wind. Magnetic tape wound on the reel with the dull oxide-coating side of the tape toward the outside. It is seldom used today. The wind can be changed from an "A" wind to a "B" wind by putting a half twist in the tape and re-winding on the recorder.

BX cable. Flexible metal conduit used to protect power line wiring in buildings and in high-power radio apparatus.

bypass

capacitor. A capacitor used to provide a low-impedance path for radio or audio signals around a resistor or between a circuit terminal and ground.

filter. A filter which provides a low attenuation path around some other equipment as, for instance, a carrier-frequency filter is used to bypass a physical telephone repeater station.

C

cabinet. The wood, metal, or plastic housing in which electronic equipment is placed.

resonance. The acoustical resonance of the loudspeaker enclosure.

cable. A transmission line or group of transmission lines mechanically assembled in compact flexible form.

caesium. (cesium) An alkali metal used in some photoelectric cells.

cage antenna. An antenna whose conductors are groups of parallel wires in a cylindrical arrangement.

cake wax. A thick disc of wax upon which an original mechanical disc recording may be inscribed.

calculator. 1. A machine that performs mathematical operations. 2. One that calculates or computes.

calibrate. To determine by measurement or comparison the true values for each scale division of a meter or other instrument. To determine and record the settings of a control that correspond to particular values of frequency, voltage, current, or some other characteristic.

calibration. A tabulation which gives the average output of a specific instrument in terms of the input values at various calibration points over the range of the instrument.

accuracy. Finite degree to which a device can be calibrated. (Influenced by sensitivity, resolution, and reproducibility of the device itself and the calibrating equipment.) Usually it is expressed in percent of full scale.

curve. A smooth curve connecting a series of calibration points.

markers. In radar, calibration marks on the display to delineate bearing, distance, height or time.

call letters. Government-assigned identifying letters for a radio or TV station.

calorie. The unit of heat energy in the metric system. One calorie is the amount of heat energy required to raise the temperature of one gram of water one degree Centigrade. There are 252 calories in a British thermal unit (btu).

calorimetric wattmeter. An instrument for microwave power measurements in which the rf energy is changed to heat and the amount of heat is measured.

cam. A rotating or sliding part used to convert rotary motion to linear motion, or vice versa, or to transfer motion from one direction to another.

camera. The part of a television transmitting apparatus in which the image of the scene to be televised is converted

into equivalent electrical impulses.

chain. The group of amplifiers, monitors, and the sync generator associated with a TV camera; all signal equipment between camera and transmitter.

preamplifier. A video amplifier, mounted in or very near the camera, for providing enough amplification to offset losses in the cable leading to the control room.

tube. An electron tube for the conversion of an optical image into an electrical signal by a scanning process.

candle. The unit of luminous intensity. One candle is defined as the luminous intensity of 1/60 square centimeter of a blackbody radiator operating at the temperature of solidification of platinum. Values for standards having other spectral distributions are derived by the use of accepted luminosity factors.

candlepower. Luminous intensity expressed in candles.

candohm. A wire-wound resistor, usually tapped, wrapped in heavy fiber insulating paper and then encased in metal. Used for bleeder resistors and voltage divider applications.

capacitance. See capacity.

capacitive

coupling. Coupling in which a capacitor provides a path for signal energy between two circuits.

loudspeaker. A type of loudspeaker consisting of two closely spaced metal plates, one rigid and the other thin and flexible. The audio signal is applied to these plates in series with a steady dc potential known as the polarizing voltage. As the flexible plate becomes alternately positive and negative, it is alternately attracted and repelled by the fixed plate. The flexible plate corresponds to the cone of a conventional loudspeaker, and its vibration sets up sound waves. Also known as an electrostatic loudspeaker since it operates on the principle of electrostatic attraction and repulsion.

pickup. A pickup element containing two metal plates, one stationary and the other actuated by the stylus. As the stylus rides in the groove, its movements are coupled to the movable metal plate. In this way, the plate spacing and capacitance vary in accordance with the modulation of the groove.

reactance. The reactance in ohms a capacitor offers to ac. It decreases as either frequency or capacity or both are increased. Capacitive reactance is measured in ohms, and is equal to the

reciprocal of the capacitance in farads multiplied by the frequency in cycles, times 2π . The formula of capacitive reactance is: $X_C = 1/2\pi fC$.

capacitor. A device consisting essentially of two conducting surfaces separated by an insulating material or dielectric such as air, paper, mica, glass, or oil. A capacitor stores electrical energy, blocks the flow of direct current, and permits the flow of alternating current to a degree dependent on the capacitance and the frequency.

split-phase motor. An induction motor using a series capacitor to produce the rotating magnetic field required to bring an induction motor up to synchronous speed when operated from a single-phase ac source.

capacity. (C) The ratio of the charge stored in a capacitor to the voltage producing the charge. The unit of capacity is the farad; a capacity of 1 farad exists when a change of 1 volt per second produces a current of 1 ampere. In radio work, capacity is measured in microfarads (μfd) and micromicrofarads ($\mu\mu\text{fd}$); 1 μfd is equal to 1,000,000 $\mu\mu\text{fd}$.

bridge. A bridge for precise measurements of capacity.

capstan. The spindle or shaft, often the motor shaft itself, which rotates against the tape, pulling it along at a constant speed on recording and playback.

carbon. An element used in the construction of radio parts such as resistors, dry cells, and microphones.

granules. Small particles of carbon used in microphone buttons.

microphone. A microphone which depends for its operation upon the variation in resistance of carbon contacts.

pile regulator. A device the resistance of which decreases in accordance with the pressure or compression applied; used to regulate the output of small generators.

-pressure recording. Electro-mechanical facsimile recording in which a pressure device acts upon carbon paper to register upon the record sheet.

resistor. A resistor made of carbon particles and a ceramic binder usually molded into a cylindrical shape, with leads attached to opposite ends.

carbonized. Pertaining to an insulator that has been converted to a partial conductor by being burned by an arc, so that the residue of carbon acts as a conducting medium.

anode. An anode in a vacuum tube that

has been blackened with carbon to increase heat dissipation by radiation.

cardioid pattern. A heart-shaped pattern representing the response or radiation characteristics of certain antennas or the response characteristics of certain microphones.

carriage. The overhead feed mechanism of disc sound-recording equipment that carries the cutting head.

carrier. 1. A wave suitable for being modulated. Note: Examples of carriers are a sine wave, a recurring series of pulses, or a direct current. 2. In a semiconductor, a mobile conduction electron or hole.

beat. The undesirable heterodyne of signals each synchronous with a different stable reference oscillator causing a pattern in received copy. Where one or more of the oscillators is fork controlled, this is called fork beat.

controlled approach system.

(CCA) An aircraft carrier radar system providing information by which aircraft approaches may be directed via radio-communications.

current. The alternating current associated with a carrier. Also, the rf carrier current sent over power lines for communication purposes.

frequency. The frequency of the original unmodulated wave produced by a transmitter.

-frequency pulse. A carrier, amplitude modulated by a pulse. The amplitude of the modulated carrier is zero before and after the pulse.

-frequency stability. A measure of the ability of a transmitter to maintain an assigned frequency.

level. The strength of a carrier, expressed as power or voltage, usually applied to an unmodulated carrier.

line. Any transmission line used for multiple channel working by the carrier method.

loading. Inductive lump loading in the cable section of a transmission line specifically designed for carrier transmission. Loading serves to minimize impedance mismatch between cable and open wire and to reduce the cable attenuation.

noise level. The noise level produced by undesired variations of a radio-frequency signal in the absence of any intended modulation.

-operated noise suppression.

(CONS) A system in which the receiver is silenced (to eliminate noise) until the carrier exceeds a certain strength, set to be sufficient to override the noise. Used in communications systems in

which the transmitter carrier is turned off and on frequently.

repeater. An assemblage of equipment designed to raise carrier signal levels to such a value that they may traverse to a succeeding line section at such amplitude as to preserve an adequate signal-to-noise ratio. While the heart of a repeater is the amplifier, or amplifiers (one- or two-directional), necessary adjuncts are filters, equalizers, level controls, etc., depending upon the operating methods, all considered a part of the repeater.

signaling. The method by which necessary supervision, i.e., busy signals, ringing or dial signaling relays are operated by the transmission of a carrier frequency tone. The frequency of a carrier employed for carrier signaling may lie either inside the range assigned to the speech channel, may lie between channels, or a group of such tones for a number of signaling circuits may be put in a voice band or a half band assigned for the purpose.

suppression. A method of transmission in which the carrier wave is not transmitted.

transfer filters or sets. A group of filters arranged as a carrier-frequency crossover or bridge between two transmission circuits.

wave. The unmodulated component of a signal wave, usually called simply the carrier. It carries the sound, picture, code, or facsimile signals from the transmitting station through space to receivers.

carry. 1. A condition occurring in addition when the sum of two digits in the same column equals or exceeds the base of the number system in use. 2. The digit to be forwarded to the next column. 3. The action of forwarding it.

carry. (end-around) In subtraction, the digit carried to the order above that for which the computer is designed, and is instead "carried around" to the units order, to be added there.

carrying capacity. The maximum current strength a conductor can safely transmit without overheating.

cartesian coordinates. Cartesian coordinates of a point are its rectangular or oblique coordinates. They were named in honor of the French mathematician Des Cartes who first introduced the idea of coordinates as a basis for the analytic study of geometry.

cartridge. In a pickup, the unit which converts the motion of the stylus into a corresponding electrical signal.

fuse. A fuse enclosed in a cartridge in the shape of a rod or cylinder, with contacts at the ends.

cascade. The connecting of two or more devices in chain-like fashion, such as the output of one amplifier to the input of a second amplifier. The two amplifiers are said to be connected in cascade or "chain".

control. An automatic control system in which the control units, linked in chain fashion, feed into one another in succession, each regulating the operation of the next in line. Sometimes called "piggy-back" control.

limiter. An FM limiter system using two or more limiter tubes in series, or cascade, to improve operation for both weak and strong signals.

cascode amplifier. A two-stage triode amplifier consisting of a grounded cathode input stage feeding a grounded grid output stage. Used primarily as a VHF amplifier because of its relatively high gain and low noise.

catcher grids. The elements in a velocity-modulated tube, such as the klystron, used to extract the energy contained in the bunched electrons.

cathode. The electron-emitting electrode of an electron tube or semiconductor device.

coating impedance. The impedance, excluding the cathode interface (layer) impedance, between the base metal and the emitting surface of a coated cathode.

current. The total current passing from the cathode to the other electrodes in a vacuum tube.

follower. A circuit in which the output is taken between cathode and ground, providing high-impedance input with low-impedance output.

glow. A luminous layer which covers all or part of the cathode in a glow-discharge tube.

heating time. The time in seconds required for the cathode of a tube to reach normal operating temperature after normal voltage is applied to the heater.

interface capacitance. A capacitance which, in parallel with a suitable resistance, forms an impedance approximating the cathode interface impedance.

interface impedance. An impedance between the cathode base and coating. Note: This impedance may be the result of a layer of high resistivity or a poor mechanical bond between the cathode base and coating.

interface resistance. The low frequency limit of cathode interface impedance.

- keying.** Method of telegraphic transmission in which the key is connected in the plate return lead to the cathode or filament center tap.
- luminous sensitivity.** (photocathodes) The quotient of photoelectric emission current from the photocathode by the incident luminous flux, under specified conditions of illumination.
- modulation.** Amplitude modulation in which the modulation is applied between the cathode and ground, thus varying the grid bias and plate voltage simultaneously.
- preheating time.** The minimum period of time during which the heater voltage should be applied before the application of other electrode voltages.
- radiant sensitivity.** (photocathodes) The quotient of the photoelectric emission current from the photocathode by the incident radiant flux at a given wavelength, under specified conditions of irradiation.
- ray.** A ray or beam of electrons emitted from a cathode.
- ray oscilloscope.** A test device using a cathode-ray tube. The most common uses are showing waveforms of voltage or current on a time basis and comparing two signals as to frequency or phase.
- ray picture tube.** The cathode-ray tube used in television receivers to reproduce the scenes being transmitted.
- ray tube.** An electron-beam tube in which the beam can be focused to a small cross section on a surface and varied in position and intensity.
- ray tube screen.** The fluorescent material covering the inside surface of the picture end of a cathode-ray tube.
- ray tuning indicator.** (magic eye) A small cathode-ray tube that indicates visually whether an apparatus, such as a radio receiver, is tuned accurately to a station.
- spot.** (of an arc) An area on the cathode of an arc from which the electron emission density is extremely high.
- cation.** An electrochemical term for a positive ion that moves toward the cathode.
- cavitation.** The formation of local cavities in a liquid as a result of the reduction of total pressure.
- cavity.** In certain types of tubes and circuits, the metallic enclosure within which resonant fields may be excited at the microwave frequency to which the cavity is tuned.
- filter.** Applies to a selective tuned device with proper coupling means to insert in a transmission line in order to attenuate unwanted off-frequency signals.
- gap impedance.** The impedance of a cavity resonator across the gap.
- magnetron.** A microwave generator made up of a cylinder of copper around the inner diameter of which a series of identical key holes have been cut with the narrow slot opening into the center hole. In the center of the body is placed a cathode.
- resonance.** The characteristic of a cavity, determined by its dimensions, that cause it to have maximum response at a particular frequency.
- resonator.** (in waveguides) A resonator formed by a volume of dielectric bounded by reflecting walls.
- resonator frequency meter.** A cavity resonator used to determine frequency of an electromagnetic wave.
- C battery.** The battery used for supplying a negative C bias to the control grid of a vacuum tube.
- C bias.** An applied voltage used to make the control grid of a vacuum tube negative with respect to the cathode.
- C-display.** In radar, a rectangular display in which targets appear as blips with bearing indicated by the horizontal coordinate, and angles of elevation by the vertical co-ordinate.
- celestial navigation.** A form of navigation using the stars for reference. In missile terminology, a system wherein a guided missile, suitably instrumented and containing all necessary guidance equipment, may follow a predetermined course with reference primarily to the relative positions of the missile and certain preselected celestial bodies.
- cell.** 1. A single unit capable of serving as a dc voltage source. A primary cell, such as a dry cell, cannot be recharged when exhausted. A secondary cell, such as the cell of a storage battery, can be recharged by passing a current through it in the reverse direction. The term "cell" is also used to designate a light-sensitive tube (photoelectric cells and selenium cells). 2. An elementary unit of storage; e.g., binary cell, decimal cell.
- type tube.** (TR, ATR, and Pre-TR tubes) A gas-filled radio-frequency switching tube which operates in an external resonant circuit. A tuning mechanism may be incorporated in either the external resonant circuit or the tube.
- cent.** The interval between two sounds whose basic frequency ratio is the twelve-hundredth root of two. Note: The inter-

val, in cents, between any two frequencies is 1,200 times the logarithm to the base 2 of the frequency ratio. Thus 1,200 cents = 12 equally tempered semitones = 1 octave.

center frequency. In frequency modulation, the frequency of the unmodulated carrier. With modulation, the instantaneous frequency swings above and below the center frequency. The average frequency of the emitted wave when modulated by a symmetrical signal.

centering control. Control used for positioning the image on the screen of a CRT, by either changing the dc potential on the deflection plates in the electrostatic system or by changing the direct current flowing through the deflection coils in the magnetic system.

centigrade. (C) The metric scale of temperature in which 0 is the freezing point and 100 is the boiling point of water at sea level.

centimeter. (cm) In the metric system of measurements a unit equal to one hundredth of a meter, or approximately .39 inch. There are 2.54 centimeters in one inch.

-gram-second. (cgs) A system of physical units based on the centimeter, gram, and mean solar second as standard measure of mass, length and time.

ceramic. A clay-like material, consisting mainly of aluminum and magnesium oxides which, after molding and firing, is used as insulation. Glazed ceramic is porcelain.

capacitor. A capacitor whose dielectric is ceramic.

pickup. A pickup cartridge using the piezoelectric properties of a ceramic material such as barium titanate. The stylus movement applies a twisting motion to the ceramic element which translates this motion to a corresponding voltage variation. Ceramic pickups are practically unaffected by temperature and humidity.

changeover switch. A switch at a two-way communications point, used to shift from sending to receiving and vice versa.

channel. 1. A band of frequencies including the assigned carrier frequency within which a station is required to keep its modulated carrier signal in order to prevent interference with stations on adjacent channels. Also, one branch or path over which signals may travel.

2. In electronic computers, that portion

of a storage medium which is accessible to a given reading station. See also track.

separation. An expression in db of the unwanted presence of one channel of a stereo system in the other channel. A channel separation of 25 db means, for instance, the level of Channel B signal in Channel A is 25 db below the level of Channel A signal.

character. (in electronic computers) One of a set of elementary marks or events which may be combined to express information.

characteristic. The first part of a logarithm (to the left of the decimal point). Example: In $\log 461 = 2.6637$, the characteristic is 2. The characteristic of a number greater than 1 is positive and is one less than the number of digits to the left of the decimal point. The characteristic of a number less than 1 is negative, and is one more than the number of zeros immediately to the right of the decimal point.

curve. A curve plotted as a graph to show the relation of changing values. For example, a curve showing how the plate current in a vacuum tube changes with respect to a change in grid voltage.

impedance. The impedance in ohms at the input of an infinitely long line, or of a practical line with its far end closed by a matching impedance, equal to L/C of the line for all but very low frequencies.

charge. A quantity of electrical energy held on an insulated object. The electrical energy stored in a capacitor. The act of supplying electrical energy to a metal object, to a capacitor, or to a storage battery. When an object has more electrons than normal, it has a negative charge, when it has less electrons than normal, it has a positive charge.

storage tube. A storage tube in which information is retained on a surface in the form of electric charges.

charger. A device for supplying direct current for charging a storage battery.

chassis. Assembled parts on a metal frame or base, not including the housing or cabinet. Also, the metal frame itself.

base. The metal framework on which parts are mounted. The chassis.

punch. A tool for making round or square holes in sheet metal.

chatter. Chatter is a sustained rapid opening and closing of contacts caused by variations in the coil current, mechanical vibration and shock or other causes.

check

automatic. A check performed by equipment built into the computer specifically for that purpose, and automatically accomplished each time the pertinent operation is performed. Sometimes referred to as a built-in check. Machine check can refer to an automatic check, or to a programmed check of machine functions.

problem. A problem whose incorrect solution indicates an error in the operation or programming of a computer.

Child's Law. An equation stating that diode current varies directly with the three-halves power of the anode voltage, and inversely with the square of the distance between the electrodes. Also known as Langmuir's equation, or the three-halves power equation.

chip. In mechanical recording, the material removed from the recording medium by the recording stylus while cutting the groove.

chirp. The undesirable change in frequency of a radiotelegraph signal as the transmitter is keyed on or off. The received signal sounds somewhat like the chirping of a bird.

choke

coil. A coil used to limit the flow of alternating current while allowing direct current to pass.

joint. A connection between two waveguides which provides effective electrical continuity without metallic continuity at the inner walls of the waveguide.

chopper. A device for interrupting a current or ray of light at frequent and regular intervals.

chromatic aberration. In optics, a lens defect that affects the sharpness of optical images by focusing light rays of different wavelengths at slightly different points in the focal plane.

chromaticity. The color quality of light definable by its chromaticity co-ordinates, or by its dominant (or complementary) wavelength and its purity taken together.

diagram. A plane diagram formed by plotting one of the three chromaticity co-ordinates against another.

chromaticness. Hue and saturation, taken together, expressive of the quality of color sensation as distinguished from its intensity.

chrominance. The colorimetric difference between any color and a reference color of equal luminance, the reference color having a specified chromaticity.

-carrier reference. A continuous signal having the same frequency as the chrominance subcarrier and having fixed phase with respect to the color burst. This signal is the reference with which the phase of the carrier chrominance signal is compared for the purpose of modulation or demodulation.

channel. In a color television system any path which is intended to carry the carrier chrominance signal.

demodulator. A demodulator used in color television reception for deriving video frequency chrominance components from the chrominance signal and a sine wave of chrominance subcarrier frequency.

modulator. A modulator used in color television transmission for generating the chrominance signal from the video frequency chrominance components and the chrominance of a color.

signal. (carrier chrominance signal) The sidebands of the modulated chrominance subcarrier which are added to the monochrome signal to convey color information.

subcarrier. The carrier whose modulation sidebands are added to the monochrome signal to convey color information.

chuck. A clamping device that holds the stylus or needle of a phonograph pickup. Also, a device that holds a drill bit, as in a hand drill or drill press.

cipher. A zero. Also, a secret code.

circuit. A network providing one or more closed paths.

breaker. An electromagnetic device that opens or breaks a circuit automatically when the current rises above a set value.

-disturbance test. A professional servicing technique widely used for isolating the defective stage in a dead receiver. It depends on the fact that a disturbance introduced in any receiver stage will reach the reproducer only if all stages between the point of disturbance and the reproducer are in operating condition. The disturbance is introduced in each stage in turn, working from the reproducer toward the antenna; the first stage at which no response is obtained is the defective stage.

efficiency. (of the output circuit of an electron tube) The ratio of the power at the desired frequency delivered to a load at the output terminals of the output circuit of an oscillator or amplifier to the power at the desired fre-

quency delivered by the electron stream to the output circuit.

circular

mil. A unit of area used chiefly in specifying the cross-sectional areas of wires. The area of a circle whose diameter is one mil (.001 inch).

-mil-foot. A unit of wire measure having a cross-sectional area of one circular mil and a length of one foot.

circularly polarized wave. An electromagnetic wave for which the electric and/or the magnetic field vector at a point describes a circle. Note: This term is usually applied to transverse waves.

circulating register. A register consisting of a means for delaying information and a means for regenerating and reinserting the information into the delaying means.

citizens' radio service. A service established to provide for private short-distance radiocommunication, signaling, and the control of objects or devices by means of radio.

clamp. 1. A device for compressing or holding together two or more parts. 2. See clamping circuit.

clamping circuit. A gated dc restoring circuit capable of restoring a dc potential of either polarity. See also dc restorer.

Clapp oscillator. Also called a series tuned Colpitts oscillator, the Clapp oscillator frequency is little affected by changes in tube potentials and circuit capacitance changes.

class

A amplifier. An amplifier in which the grid bias and alternating grid voltages are such that anode current in a specific tube flows at all times.

AB amplifier. An amplifier in which the grid bias and alternating grid voltages are such that anode current in a specific tube flows for appreciably more than half but less than the entire electrical cycle. Note: The suffix 1 is added to the letter or letters of the class identification to denote that grid current does not flow during some part of the cycle. The suffix 2 is used to denote that grid current flows during some part of the cycle. While these suffixes can be used with any class amplifier, they are usually found only with Class AB.

B amplifier. An amplifier in which the

grid bias is approximately equal to the cutoff value so that the anode current is approximately zero when no exciting grid voltage is applied, and so that anode current in a specific tube flows for approximately one half of each cycle when an alternating grid voltage is applied.

C amplifier. An amplifier in which the grid bias is appreciably greater than the cut-off value so that the anode current in each tube is zero when no alternating grid voltage is applied, and so that anode current in a specific tube flows for appreciably less than one half of each cycle when an alternating grid voltage is applied.

clear. To restore a storage or memory device to a prescribed state, usually that denoting zero.

clearance. 1. In navigation, the depth of modulation differences at various elevations or bearings. 2. In instrument landing systems, the deviation indicator current produced at various elevations or bearings.

click filter. See key-click filter.

clip. A small spring clamp used for making a readily removable connection.

clipper

circuit. Circuit arranged to clip or delete the amplitude of a waveform that exceeds a certain desired magnitude.

-limiter. A device whose output is a function of the instantaneous input amplitude for a range of values lying between two predetermined limits but is approximately constant at another level, for input values above the range.

clipping level. The amplitude level at which a waveform is clipped.

clock. A primary source of synchronizing signals.

close coupling. Coupling provided by an rf or i-f transformer when the primary and secondary windings are as close together as possible.

closed

-circuit-television. Television signals which are not broadcast but are transmitted over a closed circuit and received only by interconnected receivers; such as for industrial or surgical instruction purposes.

loop. See feedback control system.

ring circuit. A cascade combination of a ring of triggers in which the last trigger actuates the first trigger, thereby

causing the ring to operate continuously.

cloud pulse. (In a charge-storage tube)
The output resulting from space charge effects produced by the turning on or off of the electron beam.

clutch. In facsimile, the mechanical element which allows the synchronous motor to rotate while the phasing mechanism is stopped. This allows the facsimile machine to be phased without stopping the synchronous drive mechanism. Also called "slip-friction clutch."

clutter. In radar the display of a conglomeration of unwanted echoes.

coarse chrominance primary. In the color television system at present standardized for broadcasting in the United States, that one of the two chrominance primaries which is associated with the lesser transmission bandwidth.

coaxial

antenna. An antenna that is a quarter wavelength extension of the center conductor of a coaxial cable, with the outer conductor connected to and covered with a quarter-wave-length "skirt" or sheath.

loudspeaker. Two loudspeakers mounted on the same longitudinal axis, usually one within the other. One of these speakers is smaller and is designed to reproduce the higher audio frequencies.

transmission line. A transmission line consisting of two coaxial cylindrical conductors. Coaxial cable.

cobalt. A metallic element often combined with iron and steel to make alloys used in permanent magnets. It is less magnetic than iron, but retains its magnetism at temperatures as high as 1100° C.

co-channel interference. Interference between two signals of the same type in the same radio or TV channel.

codan. Coined from Carrier Operated Device, Anti-Noise. A squelch circuit.

code. 1. A system of dot and dash signals used in the transmission of messages by radio or wire telegraphy. The International Morse Code (also called the Continental Code) is used everywhere for radio telegraphy. The American Morse Code is used commonly for wire telegraphy. It is also a system of sending secret messages. 2. A system of symbols and rules for use in representing information. 3. Loosely, the set of characters resulting from the use of code. 4. To express given information by means of a code.

distinguishability. The quality of a coded radio beacon which permits it to be distinguished from all other emissions from the beacon such as those giving distance.

recorder. An instrument that makes a permanent record of code messages.

coded program. A description of a procedure for solving a problem by means of a digital computer. It may vary in detail from a mere outline of the procedure to an explicit list of instructions coded in the machine's language.

coding delay. In a Loran system, an arbitrary time delay in the transmission of pulse signals from the "B" Station to permit the resolution of ambiguity that comes in certain cases.

coefficient. Any factor of a product can be called the coefficient of the product of the remaining factors. Examples: In $2xy$, 2 is the coefficient of xy ; x is the coefficient of $2y$; y is the coefficient of $2x$. Usually, however, only the numerical part of an expression is called the coefficient. If there are no numbers in the expression, the coefficient is assumed to be 1.

of coupling. The ratio of the mutual inductance, M , between two inductors, to the maximum possible value of mutual inductance. This ratio is commonly designated by the symbol K .

$$K = \frac{M}{\sqrt{L_1 L_2}}$$

coercive force. The amount of opposite magnetomotive force necessary to eliminate residual magnetism.

coil. A number of turns of wire offering considerable opposition to alternating current at the frequencies for which it is designed.

form. The tubing or solid object on which a coil is wound. It can have any shape and can be made from any insulating material, such as paper, cardboard, fiber, bakelite, a plastic or ceramic material, glass, or wood.

coincidence counter. A device for counting pulses that occur in separate circuits at precisely the same time.

cold

cathode. A cathode that does not depend upon heat for electron emission. The cold cathode of a photo-electric tube emits electrons when exposed to light, and in a rectifier tube such as the OZ4 the electrons are pulled out of the cold

cathode when a sufficiently high voltage is applied to the anode to ionize a path between the two.

-cathode tube. An electron tube containing a cold cathode.

collector. 1. An electrode that collects electrons or ions which have completed their functions within the tube. 2. In a transistor, an electrode through which a primary flow of carriers leaves the interelectrode region.

current. Under transistor ratings, this value may be considered the maximum allowable current to pass through the collector circuit and should never be exceeded.

cutoff current. This is the collector current drawn under conditions of zero base current with a dc voltage applied between emitter and collector. Value is usually listed only for junction transistors.

junction. (of a semiconductor device) A junction normally biased in the high-resistance direction, through which the current can be controlled by the introduction of minority carriers.

rings. See slip rings.

voltage. Under transistor ratings, this value may be considered the maximum allowable voltage as measured between emitter and collector and should never be exceeded.

collinear antenna array. An antenna array in which all the elements lie in the same straight line.

color. The visual sensation produced when light enters the eye. The color perceived depends on the wavelength of the light. A wavelength of 4000 angstrom units is perceived as violet and a wavelength of 7000 angstrom units as red with all other color wavelengths between these limits. White is seen whenever the three primary light colors or two complementaries are present in equal proportions.

balance. Proper proportioning of phosphor efficiencies and/or electrical and optical characteristics so that the scale of neutral grays in the image is reproduced achromatically. Faulty color balance results in a colored overcast when receiving a color picture.

bar. A bar of color produced on a picture tube by a suitable signal. Usually several bars of different colors are produced at the same time.

breakup. Any fleeting and partial separation of a color picture into its display primary components caused by a rapid change in the condition of viewing.

burst. That portion of the composite color signal, comprising a few cycles of a

sine wave of chrominance subcarrier frequency, which is used to establish a reference for demodulating the chrominance signal.

carrier. See the preferred term chrominance subcarrier.

cell. In a repeating pattern of phosphors on the screen of a color picture tube, the smallest area containing a complete set of all the primary colors contained in the pattern.

center. (color picture tubes) A point or region (defined by a particular color-selecting electrode and screen configuration) through which an electron beam must pass in order to strike the phosphor array of one primary color.

code. Any system of colored markings used to indicate the electrical value of a part or to identify terminals and leads.

coder. In color television transmission, an apparatus for generating the color picture signal (and possibly the color burst) from camera signals and the chrominance subcarrier.

contamination. An error of color rendition due to incomplete separation of paths carrying different color components of the picture.

decoder. In color television, an apparatus for deriving the signals for the color display device from the color picture signal and the color burst.

difference signal. An electrical signal which, when added to the monochrome signal, produces a signal representative of one of the tristimulus values (with respect to a stated set of primaries) of the transmitted color.

encoder. See color coder.

fidelity. The ability of a color television system to reproduce accurately the colors in the original scene.

field. Scanning through the picture area once in the selected scanning pattern and in each of the primary colors. In the line-interlaced scanning pattern of two-to-one, it means the scanning of the alternate lines of the picture area once in each of the primary colors.

field corrector. A device located external to the tube producing an electric or magnetic field which affects the beam after deflection as an aid in the production of uniform color fields.

flicker. That flicker which results from fluctuation of both chromaticity and luminance.

frame. Scanning all the picture area once in each of the primary colors. In the line interlaced scanning pattern of two-to-one, a color frame consists of two color fields.

fringing. Spurious chromaticity at boundaries of objects in the picture.

gamut. Group or range of colors, particularly those falling within a given

area on a chromaticity diagram, which can be matched by a given set of primaries.

killer. A device which disables the chrominance channel when receiving a monochrome transmission.

phase. The phase, with respect to the chrominance-carrier reference, of that component of the carrier chrominance signal which corresponds to one of the chrominance primaries.

picture signal. The electrical signal which represents complete color picture information, excluding all synchronizing signals.

purity magnet. A magnet in the neck region of a color picture tube to alter the electron beam path for the purpose of improving color purity.

response. The relative sensitivity of photoelectric cells, TV camera tubes, and the human eye to light of various colors.

saturation. The lack of dilution of a hue by white.

signal. Any signal at any point in a color television system, for wholly or partially controlling the chromaticity values of a color television picture.

subcarrier. See chrominance subcarrier.

sync signal. See color burst.

temperature. Temperature of the complete (blackbody or Planckian) radiator required to produce the same chromaticity as the light under consideration.

transmission. The transmission of color television signals which can be reproduced with different values of hue, saturation, and luminance.

triad. (of a phosphor-dot screen) A color cell of a three-color phosphor-dot screen.

triangle. A triangle drawn on a chromaticity diagram, representing the entire range of chromaticities obtainable as additive mixtures of three prescribed primaries, represented by the corners of the triangle.

colorimetric purity. The colorimetric purity of a sample is the ratio of the luminance of the single-frequency component (which, mixed with the reference standard produces a color matching the sample) to the luminance of the sample.

colorimetry. The techniques for the measurement of color and for the interpretation of the results of such measurements.

Colpitts oscillator. An oscillator in which a parallel-tuned tank circuit is connected between grid and plate, with the tank capacitance containing two voltage-dividing capacitors in series, with their

common connection at cathode potential and the necessary feedback voltage being obtained across the grid-cathode capacitor.

command. 1. In computers, one of a set of several signals (or groups of signals) which occurs as a result of an instruction; the commands initiate the individual steps which form the process of executing the instruction. 2. In servomechanisms, an independent signal from which the dependent signals are controlled according to the prescribed system relationships. 3. In control systems, the input which is established or varied by some means external to and independent of the feedback control system under consideration.

guidance. A system of guidance in which the vehicle is directed in its flight path by radio commands from a ground station.

communications

band. The active band of frequencies produced by modulation or keying of a particular transmitter. The ideal communications band is narrower than a channel, to prevent interference between stations having adjacent frequency assignments.

receiver. A receiver designed especially for reception of code or voice messages transmitted by radio communications services.

community TV. A type of closed circuit TV used in areas where reception is poor. A single antenna system is connected by means of coaxial cables and amplifiers to the receivers of paying subscribers.

commutating poles. Small poles set between the main poles of a generator or motor to produce sparkless commutation.

commutation. In a dc generator, the process of changing the generated ac voltage to a pulsating dc voltage by means of a commutator and brushes.

switch. Device used to execute repetitive sequential switching.

commutator. 1. A device used on electric motors or generators to maintain a unidirectional current. 2. A device used in a multiplex system to connect the line to various channels.

compactron. Trade name for a compact, glass envelope, twelve-pin button base series of vacuum tubes. Two or more independent tube sections with a common heater are usually incorporated in a single envelope.

comparator. A circuit which compares two signals and supplies an indication of agreement or disagreement.

compensated

amplifier. An amplifier with a frequency response adjusted to fit a special need.

attenuator. An attenuator with associated resistors and capacitors, arranged to obtain or maintain a required frequency response while the amplitude is being varied.

volume control. A device in a radio receiver that changes the tonal balance of the loudspeaker output for different output levels, to compensate for corresponding variations in the response characteristics of the human ear.

compiler. In computers, a program that constructs new programs, using a symbolic program and a library of sub-routines.

complement. A number whose representation is derived from the finite positional notation of another by one of the following rules: (a) True complement: Subtract each digit from the radix less 1, then add 1 to the least significant digit, executing any carries required. (b) (Radix-1) complement: Subtract each digit from the radix less 1.

complementary colors. Two colors of light which, when properly combined, produce white light. Yellow and blue are complementary colors.

complex number. An expression consisting of a real number, plus or minus an imaginary number. Examples: $R + jx$; $7 - j16$. The value following j is the imaginary component.

compliance. A measure of the ability of an object to give or stretch when a force is applied, equivalent in a mechanical system to capacity in an electrical system. Usually used in radio in referring to the springiness of a loudspeaker moving system.

component. Any part of a whole considered by itself. Examples: the ac portion of a pulsating current; any of the resistors, condensers, or other parts of a receiver.

components of a vector. The distances which determine the position of a vector with respect to reference lines. The horizontal component is the projection of the vector upon a horizontal line, and is equal to the magnitude of the vector multiplied by the cosine of the angle which the vector makes with the horizontal. The vertical component is the projection of the vector upon the

vertical line, and is equal to the magnitude of the vector multiplied by the sine of the angle that the vector makes with the horizontal.

composite

color signal. The color picture signal plus blanking and all synchronizing signals.

color sync. The signal comprising all the sync signals necessary for proper operation of a color receiver. This includes the deflection sync signals to which the color sync signal is added in the proper time relationship.

sync signal. The portion of the television signal consisting of the horizontal, vertical, and equalizing pulses.

video signal. The complete video signal. For monochrome, it consists of the picture signal and the blanking and synchronizing signals. For color, additional color-synchronized signals and color-picture information are added.

compound. A combination of two or more elements.

motor. A dc motor which has two separate field windings. One, usually the predominating field, connected in parallel with the armature circuit, the other connected in series with the armature circuit.

winding. A two-section field winding for a motor or generator, one section in series and the other in parallel with the armature.

computer. 1. A machine for carrying out calculations. 2. By extension, a machine for carrying out specified transformations on information.

analog. A system, usually of electrical circuits, set up to simulate the actual physical arrangement of the device under study. The electrical simulating system is thus the analog of the actual system, and answers obtained in the electrical system will apply to the actual system.

digital. A system which performs its operations with symbols representing numbers. It adds, subtracts, multiplies, and divides one by the other as called for in an initial programming procedure instituted by the human operator, and ends up with an answer in symbol (number) form.

concentric. Having a common center.

cable. Coaxial cable.

line. A coaxial cable.

-line oscillator. An oscillator whose grid and/or plate tank inductances are formed by the elements of a concentric line. Used in ultra-high-frequency work.

- wound coils.** Coils which have their windings placed radially, one on top of another.
- condensed-mercury temperature.** The temperature measured on the outside of the tube envelope in the region where the mercury is condensing in a glass tube, or measured at a designated point on a metal tube.
- condenser.** See capacitor.
- conditional**
- jump.** An instruction which will cause the proper one or two (or more) addresses to be used in obtaining the next instruction, depending upon some property of one or more numerical expressions or other conditions.
- transfer.** (of control) In digital computing, an instruction which will, depending upon some property of a given number (or numbers), cause the proper one of two other instructions to be executed. See conditional jump.
- condor.** A cw navigational system similar to Benito, which automatically measures bearing and distance from a single ground station. The distance is determined by phase comparison and the bearing by automatic direction finding. Distance and bearing are displayed on a cathode ray indicator.
- conductance.** (G) The characteristic of a body that allows electricity to flow through it. The unit of conductance is the mho. Conductance is the reciprocal of resistance; that is, when resistance is lowered, the conductance is proportionally increased.
- conduction**
- band.** A range of states in the energy spectrum of a solid in which electrons can move freely.
- current.** A current formed by movements of electrons only (not ions).
- electrons.** The electrons in the conduction band of a solid which are free to move under the influence of an electric field.
- conductive pattern.** A design formed of any conductive material.
- conductivity.** The conductance of a unit cube of a material.
- modulation.** (semiconductor) The variation of the conductivity of a semiconductor by variation of the charge carrier density.
- modulation transistor.** A transistor in which the active properties are derived from minority carrier modulation of the bulk resistivity of a semiconductor.
- conductor.** A material that offers little opposition to the flow of electric current. A wire or metal structure that provides a path for electric current between two points.
- conduit.** A metal pipe through which electrical conductors are run.
- cone resonance.** The increased response of a loudspeaker at the natural frequency of vibration of its cone. This frequency is determined by such factors as cone size, shape, suspension, etc., and produces a peak in the response curve of the loudspeaker. In some cases this peak can be used to fill in the hole or low spot in the response of associated equipment.
- confetti.** The effect of random noise on the reproduced picture in color TV. Corresponds to snow on a black-and-white picture.
- conical**
- antenna.** An antenna consisting of two cones, placed apex to apex, or two pairs of wires arranged in a flattened X to resemble the outlines of such cones.
- horn.** A horn whose cross-sectional area increases as the square of the axial length.
- connector.** 1. Any device that joins or couples two or more parts. 2. (telephone) The name given to the switch or relay group systems that finds the line being called as a result of digits being dialed. This switch also has the function of causing interrupted ringing voltage to be placed on the called line or of returning a busy tone to the calling party if the line is busy.
- console.** A large receiver cabinet designed to rest on the floor rather than on a table. Also, the desk on which are mounted the controls of a transmitter.
- constant.**
- current characteristic.** The relation between the voltages of two electrodes with the current to one of them as well as all other voltages maintained constant.
- current generator.** A tube circuit in which the ac plate resistance is high compared with the plate load resistance, with the result that the current is practically independent of load variations.
- current modulation.** Amplitude modulation in which the output circuits of the modulator and the modulated am-

plifier are coupled by a common inductor that has high impedance to the signal frequencies and which, therefore, maintains the common plate supply current of the two circuits constant. The signal-frequency voltage appearing across the common inductor appears as modulation of the plate supply, to the modulated amplifier, with corresponding modulation of the carrier output.

-current transformer. A transformer designed so that the current at the secondary remains constant under varying loads when a constant voltage is supplied to the primary.

-K filter. A type of filter design characterized by a constant ratio between two of the circuit impedances.

-voltage transformer. A transformer delivering a fixed voltage regardless of input voltage variations over a limited range.

constantan. An alloy of approximately 60% copper and 40% nickel, used in the construction of precision resistors, rheostats, and measuring instruments.

contact. A terminal to which a connection can be made. A junction of conductors to permit the flow of electrical current.

emf. See contact potential.

microphone. A microphone designed to pick up mechanical vibrations directly and convert them into electrical impulses.

potential. A small voltage that is established whenever two conductors of different materials are brought into contact. It is due to the difference in work functions or the ease with which electrons can cross the surface boundary in the two directions.

rectifier. Two different solids in contact, in which rectification is due to greater conductivity across the contact in one direction than in the other.

resistance. The ohmic resistance between the contacts on a switch or relay.

contactor. A heavy-duty relay which controls electrical circuits.

contacts. Current-carrying parts of a relay which engage or disengage to make or break electrical circuits.

continuity. The property of having a continuous or complete dc electrical path.

-transfer contacts. Same as Make-Before-Break contacts.

continuous

commercial service. (CCS) A transmitting tube rating in which long tube life and reliable performance under continuous operating conditions are of prime importance.

duty relay. A relay which may be energized with its rated coil voltage or current at rated contact load for a period of three hours or more without failure and without exceeding its specified temperature requirements.

duty rating. Classification of a part, indicating the conditions under which it is capable of uninterrupted use or operation.

wave. (cw) A radio wave in which successive cycles are identical (constant in amplitude) under steady-state conditions.

contrast. The range of light and dark values in a picture or the ratio between the maximum and minimum brightness values. For example, in a high-contrast picture there would be intense blacks and whites whereas a low-contrast picture would contain only various shades of gray.

control. An adjustment for increasing or decreasing the range of light intensities of an image by varying the amplitude of the picture signal. Contrast control in the television receiver corresponds to gain control in a sound receiver.

control. 1. Usually, those parts of a digital computer which effect the carrying out of instructions in proper sequence, the interpretation of each instruction, and the application of the proper signals to the arithmetic unit and other parts in accordance with this interpretation. 2. Frequency, one or more of the components in any mechanism responsible for interpreting and carrying out manually-initiated directions. Sometimes called manual control. 3. In some business applications of mathematics, a mathematical check.

accuracy. The degree of correspondence between the ultimately controlled variable and the ideal value.

characteristic. A relation, usually shown by a graph, between the critical grid voltage and the anode voltage in a gas-filled tube.

electrode. An electrode used to initiate or vary the current between two or more electrodes.

elements. The portions of the feedback control system that are required to produce the manipulated variable from the controlled variable.

grid. A grid, ordinarily placed between the cathode and an anode, for use as a control electrode.

precision. The degree of reproducibility of the ultimately controlled variable for several independent applications of the same reference input under the same operating conditions.

room. A room in a station, from which

the engineers and production men monitor and control the program, usually partly or completely enclosed in glass and located next to the main studio. **signal.** The energy applied to the device which makes corrective changes. **system.** An assemblage of control apparatus coordinated to execute a planned set of control functions.

controlled

carrier modulation. Compound modulation in which the carrier amplitude is varied in accordance with the degree of modulation as averaged over a short period of time. When the modulation is small, the carrier amplitude is small, but when the modulation is increased, the carrier is increased accordingly, so that the percentage of modulation, or modulation factor, remains relatively constant regardless of the amplitude of the signal.

system. (or process) The body, process, or machine, a particular quantity or condition of which is controlled. The collective functions performed in and by the equipment in which a variable is to be controlled.

variable. That quantity or condition of the controlled system which is directly measured and controlled.

convection

current. In an electron stream, the time rate at which charge is transported through a given surface.

-current modulation. The time variation in the magnitude of the convection current passing through a surface, or the process of directly producing such a variation.

converge. To bring together, as to focus light rays or radio waves to a single point.

convergence. 1. A condition in which the electron beams intersect at a specified point. 2. In a tricolor kinescope, the meeting or crossing of the three electron beams at a common point. For proper reproduction, convergence must be maintained over the entire scanned area.

electrode. An electrode whose electric field converges two or more electron beams.

magnet. A magnet assembly whose magnetic field converges two or more electron beams.

plane. A plane containing the points at which the electron beams appear to experience a deflection applied for the purpose of obtaining convergence.

surface. The surface generated by the point of intersection of two or more

electron beams during the scanning process.

conversion

transconductance. The quotient of the magnitude of the desired output-frequency component of current by the magnitude of the input-frequency (signal) component of voltage, when the impedance of the output external termination is negligible for all of the frequencies which may affect the result.

transducer. (frequency conversion transducer) A transducer in which the input and useful output frequencies are different.

voltage gain. (of a conversion transducer) The ratio of the magnitude of the output-frequency voltage across the output termination, to the magnitude of the input-frequency voltage across the input termination of the transducer.

converter. 1. The section of a superheterodyne receiver that changes incoming rf signals to a lower frequency known as the intermediate frequency. 2. A device, usually rotary, for changing electrical energy from one form to another, as ac to dc. 3. A device for changing the frequency of incoming signals to frequencies that can be tuned in by the receiver.

noise. Noise generated in the mixer-first detector of a superheterodyne receiver.

tube. An electron tube that combines the mixer and local-oscillator functions of a heterodyne conversion transducer.

coordinate. Any of two or more magnitudes that determine the position of a point with respect to reference lines. Ordinary graphs use rectangular coordinates, in which the horizontal reference line is called the X axis or the axis of abscissa, and the vertical reference line is called the Y axis or the axis of ordinates. In polar coordinates, position is determined with one vector magnitude and the angle the vector makes with the horizontal reference line or X axis.

copper. A metallic element widely used in electrical equipment. It is one of the best conductors of both electricity and heat.

copper-oxide

rectifier. A rectifier made up of discs of copper coated on one side with cuprous oxide. The discs allow current to flow in one direction but allow very little current flow in the reverse direction.

rectifier-type meter. An instrument

for measuring ac voltages and currents, using a copper-oxide rectifier to convert ac to dc to actuate a dc-indicating d'Arsonval type meter.

core. 1. The material or space about which a coil is wound; by extension, the material through which flows the major portion of the magnetic flux. 2. In mechanical recording, the central layer or basic support of certain types of laminated media.

losses. The losses in an iron-core coil or transformer due to eddy currents and hysteresis in the iron core.

type induction heater or furnace.

A device in which a charge is heated by induction and a magnetic core links the inducing winding with the charge.

coreless type induction heater or furnace.

A device in which a charge is heated by induction and no magnetic core material links the charge. Note: Magnetic material may be used elsewhere in the assembly for flux guiding purposes.

corner

enclosure. A loudspeaker enclosure designed to be used in the corner of a room.

reflector. In radar, three conducting surfaces mutually intersecting at right angles designed to return electromagnetic radiations toward their sources, and used to render a position more conspicuous to radar observations.

corona. The discharge of electricity that appears on the surface of a conductor as a glow of colored light when the potential gradient (voltage per unit length) exceeds a certain value. It is due to ionization of surrounding air by the high voltage.

corrosion. A chemical action, oxidation or rusting, which causes a gradual wearing away of metal.

cosecant. A trigonometric function. The cosecant of an acute angle of a right triangle (written $\csc \Theta$) is equal to the hypotenuse divided by the opposite side.

cosecant-squared pattern. An antenna field in which the signal-power pattern in the vertical plane, above a prescribed angle of elevation, varies as the square of the cosecant of the elevation angle.

cosine. A trigonometric function. The cosine of an acute angle of a right triangle (written $\cos \Theta$) is equal to the adjacent side divided by the hypotenuse.

cosmic rays. Rays originating outside the earth's atmosphere having extremely high frequency and penetrating power.

cotangent. A trigonometric function. The cotangent of an acute angle of a right triangle (written $\cot \Theta$) is equal to the adjacent side divided by the opposite side.

coulomb. Measure of the quantity of electricity that passes a given point in a circuit in a given time. One coulomb is equal to a current of one ampere flowing for one second.

Coulomb's Law. The force of attraction or repulsion between two charges (or magnetic poles) is directly proportional to the product of the charges (or pole strengths), inversely proportional to the square of the distance between them, and is modified by the dielectric constant (permeability) of the material between them.

count down. In a transponder, the ratio of the number of interrogation pulses not answered to the total number of interrogation pulses received by the transponder.

counter. An electronic circuit which will count pulses.

counter emf. See back electromotive force.

counterpoise. A system of wires directly below a transmitting antenna, insulated from and replacing the ground where the ground conductivity is poor, or where the terrain prevents the use of sunken wires.

coupled circuits. Separate circuits that are made to influence one another.

coupler. 1. An inductive, capacitive, or resistive device used to transfer electric power from one circuit to another. 2. In navigation, that portion of a navigational system which receives signals of one type from a sensor and transmits signals of a different type to an actuator; i. e., a transducer.

coupling. 1. The means by which signals are transferred from one radio circuit to another. Coupling can be direct through a conductor, electrostatic through a capacitor, or inductive through a transformer. Optimum coupling or critical coupling is that which gives maximum transfer of signal energy. Tight coupling is the closest possible coupling under a given set of con-

- ditions. Loose or poor coupling gives little transfer of signal energy. 2. A device for connecting two shafts together end to end. 3. (induction heating usage) The percentage of the total magnetic flux produced by an inductor which is effective in heating a load or charge.
- aperture.** Aperture in wall of waveguide or cavity resonator designed to transfer energy to or from an external circuit.
- capacitor.** A capacitor used to couple two circuits together.
- coefficient.** A numerical rating between 0 and 1, specifying the degree of coupling between two circuits. Perfect coupling is 1, and no coupling is 0. For inductive coupling, the coupling coefficient is equal to $M + \sqrt{L_1 L_2}$, where M is the mutual inductance in henrys, and L_1 and L_2 are the inductance values in henrys of the individual coils.
- condenser.** See coupling capacitor.
- loop.** A conducting loop projecting into a waveguide or cavity resonator designed to transfer energy to or from an external circuit.
- probe.** A probe projecting into a waveguide or cavity resonator designed to transfer energy to or from an external circuit.
- transformer.** A transformer used to couple two circuits together by means of mutual induction.
- covalent bond.** A pair of electrons shared by two neighboring atoms.
- C power supply.** Any power-supply device connected between the cathode and grid of a vacuum tube so as to apply a grid bias, such as a C battery or grid bias cell.
- crater.** The cavity formed in the positive carbon electrode of an electric arc. The highest light intensity is emitted in the region of the crater.
- lamp.** A neon lamp having a cup-shaped light source, providing a spot source of light.
- crest factor of a pulse.** The ratio of the peak-pulse amplitude to the rms pulse amplitude.
- critical**
- angle.** The angle of incidence beyond which rays of light are no longer refracted (bent) into a transparent medium, but are totally reflected from its surface.
- anode voltage.** (multielectrode gas tubes) Synonymous with anode breakdown voltage (gas tubes.)
- coupling.** Coupling that produces maximum transfer of energy.
- damping.** Introduction into a series LC circuit of that value of R that will cause a transient to die out within a half cycle, without producing oscillations.
- frequency.** The limiting frequency below which a magneto-ionic wave component is reflected by, and above which it penetrates through, an ionospheric layer at vertical incidence.
- inductance.** For a given load resistance, the value of inductance of a choke input filter below which the inductance ceases to function as a filter element. This value of inductance may be approximated by dividing the load resistance by 1000. ($L_C = R/1000$)
- viewing distance.** The distance at which the line structure of a television image becomes indiscernible.
- crocodile clip.** A long-nosed clamp with spring-controlled jaws, one of which is smaller than the other so that the teeth do not mesh, used on test leads for making quick, temporary connections.
- cross**
- modulation.** Modulation of a desired signal by an undesired signal.
- neutralization.** A method of neutralization used in push-pull amplifiers whereby part of the plate-cathode ac voltage of each tube is applied through a neutralizing capacitor to the grid-cathode circuit of the other tube.
- section.** The area of that part of an object that is contained in any plane at right angles to the object length.
- talk.** Interference in a given channel originating in another channel of the same system.
- crossband transponder.** In navigation, a transponder which replies in a different frequency band from that of the received interrogation.
- crossover**
- area.** In an electron gun, a region in the first lens system where emitted electrons are brought together under the influence of electric (and sometimes magnetic) fields.
- frequency.** The frequency at which equal power is applied to both loudspeakers of a two-loudspeaker system.
- network.** The filter circuits used to separate the audio signal according to frequency and to feed the separated frequencies to two or more loudspeakers, each designed to operate in a specific portion of the audio spectrum.
- point.** The point at which converging light rays or electron beams cross and begin to diverge.
- crystal.** 1. A piece of natural quartz or similar piezoelectric material that,

when set in vibration, will generate a voltage at a desired radio frequency. A quartz crystal is used in radio transmitters to generate the assigned carrier frequency of a station, and in filters of radio receivers to improve the selectivity of the i-f amplifier. 2. The material, usually Rochelle salt, used as the pickup element in some cartridges. The crystal is piezoelectric and generates voltages in accordance with the movement of the stylus.

cartridge. A case or shell containing a piezoelectric crystal, usually of Rochelle salt, used in a phonograph pickup to convert mechanical movement of the needle into electric energy.

control. Use of a quartz crystal to maintain operation of a radio station at its assigned frequency within the limits prescribed by law.

cutter. A cutter in which the mechanical displacements of the recording stylus are derived from the deformations of a crystal having piezoelectric properties.

detector. A detector consisting of a crystal such as silicon, germanium or galena in contact with a pointed wire.

earphone. Very similar to the crystal microphone in construction, the crystal earphone is often used in stereo headsets and earpieces for hearing aids and transistor receivers.

filter. A highly selective tuning circuit using a quartz crystal, sometimes used in the i-f amplifier of a communications receiver to improve selectivity.

headset. A headset in which the mechanical forces acting on the diaphragm result from the vibration of a crystal element.

holder. A device to hold a quartz crystal in a definite position and provide proper electrical contacts for it. Some holders have a variable air gap so the frequency of oscillation can be varied over a limited range.

microphone. A microphone in which changes in the shape of a piezoelectric crystal caused by sound waves generate the output voltage.

oscillator. A vacuum-tube oscillator stage whose frequency is determined by a piezoelectric (quartz) crystal.

oven. A small electrically heated oven in which the quartz crystal of a transmitter is mounted. The oven and crystal are kept at essentially constant temperature by automatic temperature controls to prevent frequency drift with temperature change.

pickup. A pickup in which changes in the shape of a piezoelectric crystal by movements of the stylus generate the output voltage.

current. The movement of electrons through a conductor. Current is measured in amperes, milliamperes, and microamperes.

amplification. 1. The ratio of the magnitude of the current in a specified load impedance connected to a transducer to the magnitude of the current in the input circuit of the transducer. 2. In multiplier phototubes, the ratio of the signal output current to the photoelectric signal current from the photocathode.

amplifier. An amplifier capable of delivering considerable current at a low voltage.

antinode. A point along a transmission line or antenna at which current is at a maximum.

attenuation. The ratio of the magnitude of the current in the input circuit of a transducer to the magnitude of the current in a specified load impedance connected to the transducer.

-carrying capacity. The maximum current which can be continuously carried without causing degradation of electrical or mechanical properties of the printed circuit board, or attached temperature-sensitive component parts.

density. The amount of an electric current per unit cross-sectional area of a conductor.

feed. A method of exciting a transmitting antenna by feeding current to it at a point of minimum impedance.

feedback. A form of degeneration in which the feedback is proportional to the plate current.

generator. A two-terminal circuit element with a terminal current independent of the voltage between its terminals. Note: A current generator has zero internal admittance.

-limiting resistor. A resistor used in a circuit as a protective device against overload during voltage surges.

loop. See current antinode.

node. Any point in a transmission line or antenna that has zero current.

relay. A relay which is designed to operate at a particular rated coil current rather than at a given rated coil voltage.

transformer. A transformer connected into a high-current circuit to permit measurement. A meter is connected across the secondary winding, and is calibrated or read in terms of current flowing in the primary.

curve. The line on a graph that connects plotted points and shows the relationship of one variable to another.

curvilinear cone. A curved loudspeaker cone having the general form of a pa-

rabola, used to secure pure piston action. A para-curve.

cutoff.

frequency. That frequency beyond which no appreciable energy is transmitted. It may refer to either an upper or lower limit of a frequency band.

voltage. 1. In a vacuum tube, the grid-bias voltage value at which plate current ceases to flow. 2. In a selective circuit, the frequency above or below which an amplifier or circuit fails to respond. 3. The lowest frequency a waveguide can transmit.

wavelength. The ratio of the velocity of electromagnetic waves in free space to the cutoff frequency.

cutout. Any arrangement by which a circuit is automatically opened when the current flowing through it exceeds or drops below a certain set value. Usually an electromagnetic device like a relay.

cutter. An electromechanical transducer which transforms an electric input into a mechanical output, typified by mechanical motions which may be inscribed into a recording medium by a cutting stylus.

cutting

angle. Angle between the vertical cutting face of the stylus and the record surface.

head. The stylus (and its actuating mechanism) used to cut the grooves on a disc recording.

stylus. A recording stylus with a sharpened tip which, by removing material, cuts a groove into the recording medium.

cyan. A blue-green color complementary to the red primary.

cybernetics. The field of science which attempts to relate the operation of automatic devices to the functioning of the nervous system in the human body.

cycle. 1. One complete positive and one complete negative alternation of an alternating current. 2. Complete set of any recurrent values. 3. Commonly used to mean cycles per second, which is the measure of frequency.

timer. A controlling mechanism which opens or closes contacts according to a preset cycle.

cycling. A rhythmic change of the factor under control at or near the desired value.

vibration. Sinusoidal vibration applied to an instrument and varied in such a

way that the instrument is subjected to a specified range of vibrational frequencies.

cyclotron. An apparatus that uses electromagnetic and electrostatic means for imparting tremendously high speeds to electrified particles. Cyclotrons are used to bombard the nuclei of atoms so as to change atomic structure or artificially produce radioactivity.

frequency. The frequency at which an electron traverses an orbit in a steady, uniform magnetic field and zero electric field. It is given by the product of the electronic charge and the magnetic flux density, divided by 2π times the electron mass.

cylindrical

antenna. See coaxial antenna.

wave. A wave whose equiphase surfaces form a family of coaxial or confocal cylinders.

damped

oscillation. An oscillation which, because the driving force has been removed, gradually dies out; each swing being smaller than the preceding in smooth regular decay.

waves. Radio waves that progressively decrease in amplitude during successive cycles.

dampen the studio. To increase the absorption of sound in a studio by using sound-absorbing equipment such as monk's cloth screens, drapes, or rugs; or by bringing more people into the studio.

damper tube. In television, a tube connected across the horizontal deflection coils to cut off shock-excited oscillations when the magnetic field collapses.

damping. 1. Reduction of energy in a mechanical or electrical system by absorption or radiation. 2. Act of reducing the amplitude of the oscillations of an oscillatory system; hindering or preventing oscillation or vibration; diminishing the sharpness of resonance of the natural frequency of a system.

factor. 1. In oscillatory R-L-C circuits, the quantity

$$\frac{-Rt}{2L}$$

2. In audio, the ratio of loudspeaker impedance to the output impedance of the amplifier. 3. In instruments, the ratio of the deviations of the pointer (or marking device) in two consecutive swings from the equilibrium position,

the greater deviation being divided by the lesser.

dark

current. See electrode dark current.

spot defect. Dark areas in the reproduced television image caused by electron clouds in front of the mosaic screen in the camera tube at the transmitter.

d'Arsonval meter movement. The meter movement most commonly used in direct-current measuring instruments. It consists essentially of a small coil of wire supported on jeweled bearings between the poles of a permanent magnet, with a spiral spring holding the coil and the attached indicating pointer at the zero position on the meter scale. When the current to be measured is sent through this coil, the magnetic fields of the coil and magnet interact to cause rotation of the coil and pointer.

dashpot. A damping device, sometimes adjustable. It usually comprises a cylinder and piston, relative motion of which displaces air, oil, or other fluids.

data. Facts used in a logical process. The plural of datum.

handling capacity. In navigation, the maximum number of unit situations that can be handled within a specified period without deteriorating the performance below certain minimum values.

handling system. To the control engineer, automatically-operated equipment engineered to simplify the use and interpretation of the bewildering mass of data gathered by modern instrument installations. This equipment, for example, can automatically handle information fed to it from thousands of widely scattered points in a plant. (Engineers, with their tendency for "two-for-one" terminology, also refer to this as a Data Reduction System).

processor. A machine for handling information in a sequence of reasonable operations.

reduction. Transformation of information into useful, ordered, or simplified intelligence.

stabilization. In radar, stabilization of the display of signals with respect to a selected reference regardless of changes in radar-carrying vehicle attitude, e. g., azimuth-stabilized PPI.

dbm. A symbol for power level in decibels with reference to a power of one milliwatt (0.001 watt).

db meter. An ac voltmeter designed for use across a specific impedance whose scale is calibrated to read decibel

values. Used with audio amplifiers particularly to indicate volume level in broadcast and public address work.

dc

amplifier. A direct-coupled signal amplifier that will pass the dc component along with ac.

component. The part of the video signal caused by the average background illumination of the scene being televised. Also, the dc portion of any pulsating current.

erasing head. In magnetic recording, one which uses direct current to produce the magnetic field necessary for erasing.

generator. A rotating machine that converts mechanical energy into direct-current electric energy.

inserter stage. A television transmitter stage that introduces a dc component (the pedestal level) into the television signal. Synchronizing pulses then swing the signal in one direction from the pedestal level, while picture elements swing the signal in the other direction, thus making it possible to separate the two at the receiver.

magnetic biasing. In magnetic recording, magnetic biasing accomplished by the use of direct current.

plate resistance. The opposition to dc offered by the plate-cathode space of a vacuum tube, equal to the average or dc plate voltage divided by the average or dc plate current.

reinsertion. The process of re-establishing the dc level or base line of a waveform after it has been wiped out by ac-coupled video stages. Clamping.

resistance. The opposition offered by a circuit or component to dc current flow, measured in ohms.

restorer. A circuit used to reinsert the dc component of the video signal lost during amplification. A clamper.

transmission. The transmission of a television signal with the direct current component in the picture signal.

voltage. A voltage that sends a direct current through a circuit, and hence forces electrons around the circuit in the same direction all the time.

D-display. In radar, a C-Display in which the blips extend vertically to give a rough estimate of distance.

dead

-center position. The position in which a brush would be placed on the commutator of a dc motor or generator if there were no distortion of field flux by armature reaction.

end. The part of a radio studio that has the greatest sound absorption. Also the

portion of a tapped coil through which no current is flowing.

reckoning. The procedure of advancing a known position to give a position at a later time by addition of one or more vectors representing courses and distances. Note: In air navigation, it is customary to allow for wind when determining dead reckoning positions; however, the best marine usage now excludes effects of wind, currents, etc. and considers a dead reckoning position as one determined by advancing a known position for course steered and speed through the water. The expression "estimated position" is used in marine navigation when allowance is made for the wind and current.

room. A room which is characterized by an unusually large amount of sound absorption.

spot. A region in which signals from certain stations are received poorly or not at all.

time. 1. In radiation counters, the time interval after the start of a count, during which a radiation counter is insensitive to further ionizing events. 2. A fixed interval of time between the impression of an input on an element or system and the undistorted response to the input. 3. The minimum interval following a pulse during which a transponder, or component circuit thereof, is incapable of repeating a specified performance.

deathnium. The process of recombination of holes and electrons in a semiconductor device.

layer. Recombination at the surface. For small volume devices this is the dominant recombination process.

decade box. A system of series-connected resistors of such values that any desired amount of resistance from 1 ohm to the maximum of the system can be obtained in 1-ohm steps.

decay. (in charge-storage tubes) The reduction in magnitude of stored charge by any cause other than erasing.

curve. A curve showing the rate of decrease in power voltage or current in a circuit in which energy is being dissipated.

time. (in a charge-storage tube) The time interval during which the magnitude of the stored charge decays to a stated fraction of its initial value.

decca. A cw radio aid to navigation using multiple receivers to measure and indicate the relative phase difference of cw signals received from several synchronized radio stations. The system

provides differential distance information from which position can be determined.

decelerating electrode. (electron-beam tubes) An electrode, the potential of which provides an electric field to decrease the velocity of the beam electrons.

deci. A decimal prefix designated by the symbol d meaning 10^{-1} .

decibel. The decibel is a unit of relative power, either acoustical or electrical, and is numerically equal to 10 times the logarithm of the ratio of the two powers. Equipment is often rated in decibels with respect to some established reference level, commonly 6 milliwatts across 600 ohms.

decimal. Consisting of, or characterized by, 10 things or parts.

fraction. A proper fraction in which the denominator is some power of 10, usually expressed by a period (decimal point) placed at the left of the numerator.

number system. The method of positional notation using ten as the radix.

point. The radix point in the decimal system.

prefixes. A common method of expressing very large or very small numbers as powers of ten.

FACTOR	PREFIX	SYMBOL
10^{12}	Tera	T
10^9	Giga	G
10^6	Mega	M
10^3	Kilo	K
10^2	Hekto	h
10^1	Deka	dk
10^{-1}	Deci	d
10^{-2}	centi	c
10^{-3}	milli	m
10^{-6}	micro	μ
10^{-9}	nano	n
10^{-12}	pico	p

Use of nano and pico is preferred to millimicro and micromicro.

decineper. One-tenth of a neper.

deck. A set of punched cards.

switch. A gang switch in which sets of contacts are arranged at different levels on insulating rings, with the contact points or fingers on discs attached to a shaft.

decoder. A network or system in which a combination of inputs is excited at one time to produce a single output. Sometimes called Matrix.

decoding. Process of obtaining intelligence from a code signal.

decoupling. Means taken to prevent coupling between stages or circuits of a stage.

circuit. A network of resistors or coils and capacitors used to separate and bypass signals that would ordinarily flow in a common circuit.

de-emphasis. The reduction of some part of a signal, as the restoration of a pre-emphasized signal wave to its original form.

circuit. A circuit that reduces some part of a signal, as an RC filter in an FM receiver that decreases to normal proportions those high audio frequencies that were emphasized in transmission to obtain a better signal-to-noise ratio.

de-energize. Remove from the power source.

definition. The fidelity with which the detail or an image is reproduced by a television receiver, facsimile receiver, or electron microscope. Also called resolution.

deflecting

coil. A coil of wire used to control, by electromagnetic means, the movement of the electron beam in a cathode-ray tube in an oscilloscope, television camera, or television receiver. Also called a deflecting yoke.

electrode. An electrode, the potential of which provides an electric field to produce deflection of an electron beam.

plates. See deflecting electrodes.

deflection. A movement of an object away from its normal position, such as deflection of a meter pointer or an electron beam in a cathode-ray tube.

factor. 1. In electrostatic-deflection tubes, the voltage required between a pair of deflection plates to produce unit deflection. Usually expressed in dc volts per inch. 2. In magnetic-deflection tubes, the current required through a definite deflection yoke at a definite point on the tube to produce units deflection. Usually expressed in milli-amperes per inch. 3. In cathode-ray tubes, the reciprocal of the deflection sensitivity.

sensitivity. (cathode-ray tubes). The quotient of the displacement of the electron beam at the target or screen by the change in the magnitude of the deflecting field. Note: Deflection sensitivity is usually expressed in milli-

meters (or inches) per volt applied between the deflecting electrodes, or in millimeters (or inches) per ampere in the deflecting coil.

voltage. A potential difference between two deflection plates that deflects the electron beam passing through toward one plate or the other.

yoke. An assembly of one or more electromagnets to produce deflection of one or more electron beams.

-yoke pull-back. 1. Color. The distance between the maximum possible forward position of the yoke and the position of the yoke to obtain optimum color purity. 2. Monochrome. The maximum distance the yoke can be moved along the tube axis without producing neck shadow.

defocusing. Adjustment of the electrode voltages in a cathode-ray tube that causes the electron beam to spread out from its minimum cross-sectional area and to produce a larger spot on the screen.

degaussing. Neutralizing the magnetic field, as of a ship, so that if it passes over a magnetic mine, the striker on the mine will not act and the mine will not explode.

degenerate modes. A set of modes having the same resonance frequency (or propagation constant).

degeneration. The feeding back of an out-of-phase signal so that the effective amplification is reduced. Deliberately introduced in inverse feedback circuits because it reduces distortion.

deionization. Reversion of ions in a glow or arc to their original condition as neutral atoms and molecules.

time. (gas tubes) The time required for a tube to regain its pre-conduction characteristics after anode-current interruption. Note: See recovery time.

deka. A decimal prefix designated by the symbol dk meaning 10^1 .

delay. The time which elapses between the instants at which any designated point of a transmitted wave passes any two points of a transmission circuit between which the delay is measured or specified. Such delay is primarily determined by the constants of the circuit, and is measurable in milliseconds or microseconds.

distortion. That form of distortion which occurs when the rate of change of phase shift with frequency of a circuit or system is not constant over the frequency

range required for transmission. See envelope delay.

equalizer. A device which adds delay at certain frequencies to a circuit in such a manner as to reduce the delay distortion.

line. (in electronic computers) 1. Originally, a device utilizing wave propagation for producing a time delay of a signal. 2. Commonly, a device for producing a time delay of a signal.

-line memory. Synonym for delay-line storage.

-line register. An acoustic or electric delay-line, usually one or an integral number of words long, together with input, output, and circulation circuits.

-line storage. A storage or memory device consisting of a delay line and means for regenerating and reinserting information into the delay line.

relay. A relay that is intentionally designed for a time delay between the energizing or de-energizing instant and the time that the relay contacts open or close.

delayed avc. An automatic volume control circuit that does not begin to act until signals reach a certain strength. It permits reception of weak signals even though they are fading, whereas normal avc tends to make signals weaker.

delta

antenna-matching transformer. A means of matching the impedances of an open-wire transmission line and a half-wave antenna by spreading out the upper ends of the line and connecting them directly to the antenna to form a triangle like the Greek letter delta (Δ).

circuit. A network of three resistors or impedances connected in the form of a triangle like the Greek letter delta (Δ).

connection. Connections forming a triangle like the Greek letter delta (Δ).

demodulation. The process of recovering the modulating wave from a modulated carrier.

denominator. The part of a fraction written below the line. Example: In $1/2$, the denominator is 2.

density. 1. A measure of the concentration of matter in a material, in which case density is equal to mass divided by volume. Current density is the total current divided by the cross-sectional area of the conductor. 2. In facsimile, a measure of the light-transmitting or light-reflecting properties of an area. It is expressed by the common logarithm of the ratio of incident to transmitted or

reflected light flux. Note: There are many types of density which will usually have different numerical values for a given material; e.g., diffuse density, double diffuse density, specular density. The relevant type of density depends upon the geometry of the optical system in which the material is used.

depletion layer. A layer of ionized atoms at a junction, formed when free electrons from the N region diffuse across the junction into the P region, forming a layer of negatively charged ions, and holes from the P region diffuse across the junction into the N region, forming a layer of positively charged ions. These charged layers repel the majority carriers away from the junction. See barrier layer or potential layer.

depolarization. Removal of the gases that form at the electrodes in a battery as a result of the chemical action involved in producing current.

depolarizer. The chemical used in a primary cell to reduce polarization by removing the hydrogen gas formed at the carbon electrode.

depth

of heating. (dielectric heating) The depth below the surface of a material in which effective dielectric heating can be confined when the applicator electrodes are applied adjacent to one surface only.

of modulation. In a radio guidance system, obtaining directive information from two spaced lobes in a directional antenna system, the ratio of the difference in field strength of the two lobes to the field strength of the greater at a given point in space.

derivative. The rate of change in one variable in a functional relationship with respect to the other variable in this relationship.

detail. Refers to the most minute elements in a picture which are distinct and recognizable. Similar to definition or resolution.

detection. The process of obtaining the desired intelligence from a modulated carrier. Also, frequency conversion as in a superheterodyne receiver. See demodulation.

detector. The stage in a receiver in which demodulation or detection takes place.

detent. A mechanism used on indexed rotary switches to hold the switch firmly in

position. Generally consists of a spring-loaded ball that falls into place in indentations on a plate that rotates with the switch shaft.

deviation

distortion. Distortion in an FM receiver caused by inadequate bandwidth, inadequate amplitude-modulation rejection, or inadequate discriminator linearity.

ratio. The ratio of maximum frequency deviation to the highest audio frequency in an FM signal.

diagram. A plan or layout for a receiver, transmitter, or other apparatus. In a schematic circuit diagram, schematic symbols represent radio parts. In a pictorial circuit diagram, actual sketches of radio parts are used. In a block diagram, entire circuits, stages, or sections are represented by labeled blocks.

dial. Any means for indicating the value to which a control knob has been adjusted.

cord. The braided cord or flexible wire cable used to make a tuning knob control the position of the pointer or dial that indicates the frequency or channel to which a receiver is tuned.

light. The pilot lamp that illuminates the tuning dial of a receiver.

diamond stylus. A recording or reproducing phonograph stylus which is diamond-tipped.

diaphragm. A thin, flexible sheet that can produce sound vibrations (as in a head-phone) or can be moved by sound waves (as in a microphone). In photography and in television cameras, an adjustable device used to reduce the effective area of a lens so as to control the amount of light passed by the lens.

diathermy. Therapeutic use of a high-frequency current to generate heat within the body. Diathermy machines are actually short-wave transmitters and often cause serious radio and TV interference.

dielectric. The insulating material between two conductors. Specifically that between the plates of a capacitor.

constant. The ratio of the capacity of a capacitor using a given substance for a dielectric to the capacity of the same capacitor with air for a dielectric.

heating. The heating of a nominally insulating material in an alternating electric field due to its internal losses.

loss. Energy loss in the form of heat in the dielectric of a capacitor, due to an action similar to hysteresis in a magnetic circuit.

strength. The maximum potential gradient that a material can withstand without rupture.

waveguide. A waveguide consisting of a dielectric structure.

difference detector. A detector circuit in which the output is a function of the difference of the peak amplitudes or rms amplitude of the input waveforms.

differential

equation. An equation involving not only the variables, such as x and y , but also their derivatives.

gain. The amplitude change, usually of the 3.6-mc color subcarrier, introduced by the over-all circuit, measured in decibels or percent, as the subcarrier is varied from blanking to white level.

gain control circuit. That portion of a system which adjusts the gain of a single radio receiver or circuit to obtain desired relative output levels from two or more sequential unequal input signals. For example: The circuits in the Loran receiver which adjust the gain between successive pulses.

phase. The phase change of the 3.6-mc color subcarrier introduced by the over-all circuit, measured in degrees, as the subcarrier is varied from blanking to white level.

selsyn. A selsyn in which both rotor and stator have similar windings that are spread 120° apart. The position of the rotor corresponds to the algebraic sum of the fields produced by the stator and rotor.

differentiating circuit. A circuit in which the voltage amplitude at the output is proportional at any instant to the rate of change of voltage amplitude at the input. Specifically, such a circuit used in a TV receiver to segregate the horizontal sync pulses from the vertical sync pulses after clipping. A high-pass filter.

differentiator. (in electronic computers) A device, usually of the analog type, whose output is proportional to the derivative of an input signal.

diffracted wave. When a wave in a medium of certain propagation characteristics is incident upon a discontinuity or a second medium, the diffracted wave is the wave component that results in the first medium in addition to the incident wave and the waves corresponding to the reflected rays of geometrical optics.

diffraction. The spreading of an electromagnetic wave or light beam into the region behind an obstacle.

diffuse

reflection. Process by which reflected energy is distributed over a wide range of angles.

sound. In a given region, sound which has uniform energy density and is such that all directions of energy flux at all parts of the region are equally probable.

diffused junction. In semiconductors, a junction which has been formed by the diffusion of an impurity within a semiconductor crystal.

diffusion. 1. Scattering of light or electromagnetic waves. 2. The random motion of electrons or holes in a doped semiconductor due to the energy of the material.

digit. One of a definite set of characters which are used as coefficients of powers of the radix in the positional notation of numbers.

digital

computation. The process of calculation employing discrete digits and using arithmetic operations.

computer. One in which information, numerical or otherwise, is represented by means of combinations of characters in such a way that the number of distinguishable combinations is much greater than the number of distinguishable characters. Thus, a digital computer is one which makes explicit use of a language.

voltmeter. A vacuum tube voltmeter whose display is digital in form, rather than the usual moving pointer-scale display.

dihedral base. A 14-pin tube base used for cathode-ray tubes.

dimmer. A device by means of which lights may be gradually dimmed or brightened.

diode. A device having two electrodes, the cathode and the plate or anode.

characteristic. (multielectrode tubes) The composite electrode characteristic taken with all electrodes except the cathode connected together.

-pentode. A vacuum tube having a diode and a pentode in the same envelope.

-triode. A diode and a triode in the same tube envelope.

diopler. A unit expressing the power of a lens, equal to the reciprocal of the focal length in meters.

diplexer. A coupling unit that allows two transmitters to operate simultaneously into the same antenna.

diplex operation. Simultaneous transmission or reception of two signals using a specified common feature, such as a single antenna or a single carrier.

dipole. An object oppositely charged at two poles, especially an antenna shorter than a half wavelength. Loosely, an antenna whose length is approximately one-half of the electromagnetic wavelength to which it is resonant.

dip soldering. A technique where printed-circuit boards are immersed in, or floated on the surface of, molten solder for the purpose of simultaneously soldering component parts of printed wiring.

direct

colorimetry. Color matching in a colorimeter for the purpose of numerical specification of color. See indirect colorimetry.

coupling. That type of interconnection between tubes in amplifiers or other electronic equipment wherein the plate of the preceding tube is connected directly to the grid of the following tube.

current. A unidirectional current in which the changes in value are either zero or so small that they may be neglected.

-view. A television receiver in which the image is viewed on the face of the cathode-ray tube. Distinguished from the indirect-view or projection-type receiver, in which the image is optically projected from the cathode-ray tube to a special viewing screen.

wave. A wave propagated through space without being reflected.

direction. The position of one point in space relative to another without reference to the distance between them. Note: Direction may be either three-dimensional or two-dimensional. Direction is not an angle, but is often indicated in terms of its angular difference from a reference direction.

finder. (DF) A radio aid to navigation that determines the direction of arrival of a radio signal by measuring the orientation of the wave-front or of the magnetic or electric vector of a radio wave.

-finder deviation. The difference between the observed bearing and the true (corrected) bearing of a direction finder.

of polarization. The direction of the electric field component in an electromagnetic wave. For example, a vertically polarized wave is one having the electric field component in a vertical

(up and down) plane with respect to the earth's surface.

directional

antenna. An antenna that radiates or receives radio waves better in some directions than others.

coupler. A four-branch junction consisting of two waveguides coupled together in a manner such that a single traveling wave in either guide will induce a single traveling wave in the other; direction of the latter wave being determined by direction of the former.

filters. In many carrier systems, a certain range of frequency is used for east-to-west paths, and a certain other range for west-to-east paths. The filters provided to separate these two frequency ranges are known as directional filters, or directional separation filters. Directional filters may be conventional low-pass, high-pass, or bandpass filters, the "directional" appellation indicating only the usage.

microphone. A microphone, the response of which varies significantly with the direction of sound incidence.

pattern of an antenna. A special graph (polar characteristic) that indicates the intensity of the radiation field of a transmitting antenna at a fixed distance in different directions in space. In the case of a receiving antenna, it indicates the response of the antenna from different directions to a signal having unit field intensity.

directivity. The antenna characteristic that causes it to radiate or receive more power in certain directions than in others.

directly proportional. Varying in the same direction as some other value. For example, if one increases, so does the other.

director. In a directional antenna system, the parasitic element in front of the antenna that increases the radiation or reception along a line passing through it to the antenna.

disc. A phonograph record or blank. Also, the rotating element of a mechanical television scanning system.

recorder. A mechanical recorder in which the recording medium has the geometry of a disc.

discharge. A release of stored energy from a capacitor, or the drawing of current from a battery.

tube. 1. A tube biased to cut-off so that no current flows until triggered by a positive pulse. A capacitor is placed in

the plate circuit and allowed to charge during cut-off and discharge during periods of current flow. The tube may be either vacuum or gaseous. 2. Any tube containing gas or vapor which is capable of being discharged by ionization.

discriminator. A circuit in which the output is dependent upon how an input signal differs in some aspect from a standard or from another signal.

dish. A reflector, usually in the shape of a paraboloid, which reflects the radio energy leaving or entering a microwave antenna.

dispersion. The separation of white light into its component colors, as in a prism. Also, the scattering of electromagnetic waves.

displacement of porches. Refers to any difference between the level of the front porch and the level of the back porch.

display. Visual presentation of a signal.

dissector. A pickup tube used in the television camera, more properly an image dissector.

tube. See image dissector tube.

dissipation. Energy expended in the form of heat in the resistive elements in, or associated with, a circuit.

distance measuring equipment. A radio aid to navigation which provides distance information by measuring total round-trip time of transmission from an interrogator to a transponder and return.

distortion. Improper reproduction of sound or image because of changes occurring in the waveform of the intelligence signal somewhere in the path it takes through the transmitting and receiving systems, or through an amplifier system.

distress

frequency. The frequency allotted by international agreement to distress calls. For ships at sea and aircraft over the sea, it is 500 kilocycles.

signal. By code: SOS; by radiotelephone: "MAYDAY," from "m' aider" (French) meaning "help me."

distributed

capacity. Capacity distributed between conducting elements, as distinguished from capacity concentrated in a capac-

itor. Usually, the small capacity existing between the turns of wire in a coil.

constants. Constants that exist along the entire length or area of a circuit, such as distributed capacity or distributed inductance.

inductance. The inductance that exists along the entire length of a conductor, as distinguished from self-inductance concentrated in coils.

distribution. The degree of linearity of scanning in a television system. When scanning is linear, distribution is good.

amplifier. Amplifier, either rf or audio, having one input and two or more isolated outputs.

control. The control that varies the amount of correction applied to the sawtooth wave in a television receiver, so as to give the desired linear scanning of lines.

disturbance. 1. An unwanted current which degrades communication by producing noise in the telephone, false signaling, or otherwise interferes with the normal operation of the system. 2. An undesired command.

divergence loss. That part of the transmission loss which is due to the divergence or spreading of the sound rays, in accordance with the geometry of the system (e.g., spherical waves emitted by a point source).

divergent. Spreading out from a point of origin, as of light rays or radio waves.

beam. Beam consisting of rays that spread out (diverge from a point).

diversity reception. Reception of radio signals so as to overcome fading by means of two or more antennas separated by several wavelengths or differing in polarity.

dividend. The number to be divided by the divisor.

dividing network. A frequency selective network which divides the spectrum to be radiated, into two or more parts. See crossover network.

divisor. The number by which another number or quantity is to be divided. Example: In $1400 \div 70 = 20$, the divisor is 70. (The dividend here is 1400, and the quotient is 20).

dog house. The structure at the base of a transmitting antenna that houses the antenna tuning equipment.

Doherty amplifier. An amplifier circuit in which one tube supplies unmodulated carrier power, and a second tube, feeding the same load as the first, is biased so no plate current flows until the rf grid voltage (modulated carrier signal) exceeds its bias. When this happens, the second tube feeds power to the load, and the effective impedance of the load is lowered. This results in an increase in power from the first tube.

dolly. A perambulator or carriage upon which a camera is mounted.

dominant

mode of propagation. In wave transmission, the mode of propagation of the dominant wave.

wave. (uniconductor waveguide) The electromagnetic wave which has the lowest cut-off frequency.

wavelength. The wavelength of light of a single frequency, which matches a color when combined with suitable proportions in a reference standard light.

donor. A type of material, such as arsenic, which has 5 electrons in its valence shell, and which when added to a pure semi-conductor donates easily freed electrons.

impurity. (in a semiconductor) An impurity which may induce electronic conduction.

doorknob tube. A doorknob-shaped tube designed for ultra-high-frequency work by the elimination of a base and reduction of interelectrode capacities.

dope. To add an impurity to pure germanium.

doped junction. (semiconductor) A junction produced by the addition of an impurity to the melt during crystal growth.

doping. Addition of impurities to a semiconductor or production of a deviation from stoichiometric composition, to achieve a desired characteristic.

compensation. Addition of donor impurities to a P-type semiconductor or of acceptor impurities to an N-type semiconductor.

Doppler

effect. An apparent change in the frequency of a sound or electromagnetic wave reaching an observer. Caused by motion of the source toward or away from the observer, by motion of the observer, or both.

radar. Any form of radar which detects motion of a distant object, away from a radar set, by means of the change in

radio frequency of the echo signal due to the motion of the object.

shift. The magnitude of the change in the observed frequency of a wave due to the Doppler effect. The unit is the cycle per second.

system. In radar, any system utilizing the Doppler effect for obtaining information.

dot

-bar generator. A color TV test unit that generates either a dot pattern for adjusting convergence, or a standard NTSC color-bar pattern for adjusting chrominance circuits.

interlacing. A method of scanning in which alternate picture elements are scanned during each field. In color systems, every third element is scanned in one color in one field.

sequential. In color TV, the process of scanning one picture element in one primary color, the next in another color, and the third in the third color. By dot interlacing, each element is scanned in a different color in different fields, so that when a complete frame has been scanned, each element has been scanned in all three colors. A similar system of scanning picture elements in some regular, repetitive pattern may be used in black and white TV.

double

-button carbon microphone. A carbon microphone having two buttons or containers for carbon granules, one on each side of the diaphragm, to secure a push-pull action for increased signal output.

conversion superheterodyne. A receiver in which the received signal is changed to a first intermediate frequency which is, in turn, changed to a second, usually lower, intermediate frequency. This results in a marked improvement in selectivity and image response over the single conversion superheterodyne. Especially useful for receiving the shorter wavelength signals.

diode. Two diodes in the same tube envelope. A duodiode.

-hump resonance. A condition in which two circuits normally resonant to the same frequency, are closely coupled, or are detuned so that they resonate to frequencies on either side of the original resonant point, thus producing a response curve having two humps.

modulation. The process in which a carrier wave of one frequency is first modulated by the signal wave, and is then made to modulate a second carrier wave of higher frequency.

pole-piece magnetic head. A magnetic head having two separate pole pieces in which pole faces of opposite polarity are on opposite sides of the medium. One or both of these pole pieces may be provided with an energizing winding.

-pole switch. A switch that simultaneously changes connections in two separate circuits or in both sides of the same circuit.

sideband transmission. A system in which both sidebands, one on either side of the carrier, are transmitted. It is the standard AM broadcast transmission.

-throw switch. A switch that connects one terminal to either of two other terminals.

triode. Two triodes in the same tube envelope. A duotriode.

doubler. A vacuum-tube or transistor circuit in which the output signal is twice the frequency of the input signal. Also a voltage doubler.

doublet antenna. An antenna system, independent of the earth, usually a half wavelength long or some multiple of this length. Also describes a shorter antenna, called a dipole.

downward modulation. Modulation in which the instantaneous amplitude of the modulated wave is never greater than the amplitude of the unmodulated carrier.

Dow oscillator. An electron-coupled oscillator circuit.

drain. The current being taken from a voltage source.

D region. The region of the ionosphere up to about 55 miles above the earth's surface.

dress. To position wires or parts in an exact manner so as to prevent or reduce undesired feedback.

drift. The type of conduction produced when a potential is connected across a semiconductor. In an N-type material this is by means of electrons; in a P-type material, it is by means of holes.

mobility. (in a homogeneous semiconductor) The average drift velocity of carriers per unit electric field. Note: In general, the mobilities of electrons and holes are different.

rate. (voltage regulators or reference tubes) The slope, at a stated time of the smoothed curve, of tube voltage drop with time at constant operating conditions.

space. 1. In an electron tube, a region substantially free of externally applied alternating fields, in which a relative repositioning of the electrons takes place. 2. The space between the buncher and catcher grids in a Klystron in which the electrons actually bunch because of their differing velocities.

drive

belt. A belt used to transmit power from the driving to the driven device.

control. A service adjustment on TV receivers which controls the amplitude of the signal from the horizontal oscillator to the horizontal amplifier.

holes. Holes spaced around in the center hole of a recording disc to engage a drive pin in the turntable, preventing the disc from slipping during recording or playback.

pattern. Density variation caused by periodic errors in the position of the recording spot. When caused by gears, this is called gear pattern.

pin. In disc recording, a pin similar to the center pin, but located to one side thereof, which is used to prevent a disc record from slipping on the turntable.

driven element. Any antenna array element that receives power directly from the transmitter or is connected directly to the receiver.

driver. 1. That portion of a projection-type speaker (trumpet) or horn-loaded tweeter that contains the magnet, voice coil, diaphragm and coupling chamber. 2. A woofer is sometimes called a driver. 3. That portion of an AF or RF amplifier used to provide excitation to the power output stage.

driving signals. Signals that time the scanning at the pickup device.

drop. Voltage drop. Reduction of voltage due to an increase in current.

repeater. A microwave repeater that is provided with the necessary equipment for local termination of one or more circuits (service channel is always available).

drop-out

current. That value to which the current through a relay coil must be reduced before the armature will be released.

values. The drop-out current, voltage, or power is the maximum value for which the contacts of a previously energized relay will always assume their unenergized positions.

dropping resistor. A resistor used to decrease the voltage in a circuit.

drum. A magnetic storage device which consists of a cylinder coated with a magnetic material and driven by an electric motor. Data is recorded on and read back from the surface of this cylinder by means of electromagnets called drum heads.

recorder. A facsimile recorder in which the record sheet is mounted on a rotating drum or cylinder.

speed. The number of scanning lines per minute in a facsimile system.

switch. A series of contacts on a rotating drum that make contact with fingers fastened to an insulated support. Used for complex circuit changes.

transmitter. A facsimile transmitter in which the subject copy is mounted on a rotating drum or cylinder.

dry

battery. A group of dry cells connected in various series, parallel, or series-parallel arrangements to get desired voltage and current values.

cell. A type of primary cell in which the electrolyte is in the form of a paste rather than a liquid.

-disc rectifier. Dry contact rectifier. A rectifier consisting of discs of metal and other material in contact under pressure, such as a copper-oxide rectifier or a selenium rectifier.

electrolytic capacitor. An electrolytic capacitor in which the electrolyte is a paste rather than a liquid, to permit using the capacitor in any position without danger of leakage of the electrolyte.

dual

capacitor. Two capacitors in a single housing.

-diversity receiver. A radio receiver designed to receive signals from two different receiving antennas and use whichever signal is the stronger at any instant, in order to offset fading.

frequency induction heater or furnace. A heater in which the charge receives energy by induction, simultaneously or successively, from a work coil or coils operating at two different frequencies.

modulation. The process of modulating a common carrier wave or subcarrier by two different types of modulation (e.g., amplitude- and frequency-modulation) each conveying separate information.

networks. See structurally dual networks.

-track recorder. Usually a tape recorder with a recording head that covers half the tape width, making it possible to record one track on the tape, then turn the reels over and record a second

track in the opposite direction. Sometimes called a half-track recorder.

-track recording. A tape recording technique that doubles the playing time of a given length of tape. As the tape passes through the recording head, the magnetic patterns are recorded on only half the tape width. The tape may then be reversed and the recording continued on the unused half-width.

duct. An atmospheric phenomenon consisting of two layers between which electromagnetic waves are channeled and, as a result, reflected toward the earth at a greater range than normal.

dummy

antenna. A device which has the necessary impedance characteristics of an antenna and the necessary power-handling capabilities, but which does not radiate or receive radio waves. Note: In receiver practice, that portion of the impedance not included in the signal generator is called "dummy antenna."

load. A dissipative but essentially non-radiating device having the impedance characteristics of an antenna or transmission line.

duodiode. A vacuum tube having two diodes in the same envelope.

-pentode. A vacuum tube having two diodes and a pentode in the same envelope. Also called double-diode pentode.

-triode. A vacuum tube having two diodes and a triode in the same envelope. Also called duplex-diode triode.

duotriode. A vacuum tube having two triodes in the same envelope. Also called double triode.

dupe. Sometimes called a dub or dubbing. A copy of a tape recording made by recording on one machine what another machine is playing. Tape recordings are easy to duplicate by re-recording and there is a minimum loss in quality from the original to the copy.

duplex. A method of operation of a communication circuit where each end can simultaneously transmit and receive. Ordinary telephones are duplex. When used on a radio circuit, duplex operation requires two frequencies.

operation. Simultaneous transmission and reception of radio signals.

duplexer. A device which permits the use of the same antenna for both transmitting and receiving. Not to be confused with the diplexer.

duralumin. An alloy of aluminum com-

parable in strength and hardness to soft steel.

duty

cycle. The duty cycle is the rated working time of a device compared to its idle time.

factor. 1. The ratio of the average pulse duration to the average pulse spacing.
2. The product of the pulse duration and the pulse repetition rate.

ratio. In a pulse radar or similar system, the ratio of average to peak pulse power.

dynamometer. A device for measuring magnifying power.

dynamic

behavior. Describes how a control system or an individual unit carries on with respect to time.

characteristic. A graph showing the operating conditions for a tube.

convergence. (multibeam cathode-ray tubes) The process whereby the locus of the point of convergence of electron beams is made to fall on a specified surface during scanning.

focusing. (picture tubes) The process of focusing in accordance with a specified signal in synchronism with scanning.

loudspeaker. A loudspeaker in which the diaphragm or cone is attached to a small coil that is mounted so that it can move within a constant magnetic field. Audio frequency currents flowing through this coil produce a varying field that interacts with the fixed field, causing the coil to move in and out, thereby causing the cone to reproduce sound waves.

microphone. A microphone having a moving coil mechanism similar to that in a dynamic loudspeaker. Sound waves move the diaphragm, causing the attached voice coil to move in and out of a fixed magnetic field produced by a permanent magnet. An audio output voltage is thus induced in the moving coil.

pickup. A type of pickup cartridge containing a coil and a magnet. Movements of the stylus cause the coil to move in the magnetic field. The voltage thus induced in the coil is the cartridge output.

range. The ratio between the softest and loudest sounds a tape recorder or other device can reproduce without undesirable distortion. Usually measured in db.

dynamo. An electric motor or generator.

dynamometer. An apparatus for measuring power.

dynamotor. A rotating device acting both as a motor and generator, used to change a dc voltage to an ac voltage or to a higher dc voltage.

dynatron. A tube circuit arranged so that secondary emission from the plate causes plate current to decrease as plate voltage is increased.

oscillator. An oscillator in which energy is delivered to a tank circuit because the tube is made to have a negative resistance characteristic.

dyne. The cgs unit of physical force. A dyne is equal to 1/980 gram.

per square centimeter. The unit of sound pressure. The term "bar" was formerly used to mean a sound pressure of the dyne per square centimeter, but the term is being dropped in acoustics.

dynode. An intermediate electrode between the cathode and plate of an electron-multiplier tube. The dynode emits many secondary electrons for each incident electron striking it.

E

earphone. An electroacoustic transducer intended to be closely coupled acoustically to the ear.

earth. Same as ground. Used in the United Kingdom.

eccentric

groove. (eccentric circle) In disc recording a locked groove whose center is other than that of the disc record. (Generally used in connection with mechanical control of phonographs).

spiral. The blank spiral groove leading from the end of the recorded part of a phonograph record to the eccentric groove.

eccentricity. In disc recording, the displacement of the center of the recording groove spiral, with respect to the record center hole.

echo. 1. A wave which has been reflected or otherwise returned with sufficient magnitude and delay to be perceived in some manner as a wave distinct from that directly transmitted. 2. In facsimile, a multiple reproduction on the record sheet due to the same original facsimile signal arriving at different times from transmission paths of different lengths. This may be caused by

multipath transmission on radio circuits or reflections on wire circuits.

3. In radar, the portion of energy of the transmitted pulse which is reflected to a receiver.

area. The effective cross-sectional area of a radar target, resulting from scattering of the reflected beam.

box. In radar, a calibrated resonant cavity which stores part of the transmitted pulse power and gradually feeds this energy into the receiving system, after completion of the pulse transmission.

chamber. A reverberant room used to add hollow effects and echoes to radio programs.

suppressor. In navigation, a circuit which desensitizes the equipment for a fixed period after the reception of one pulse, for the purpose of rejecting delayed pulses arriving from indirect reflection paths.

eddy current. Current induced in conducting materials by varying magnetic fields in such a way that power is dissipated within the conductor in the form of heat.

Edison

base. The standard screw base used for ordinary electric light bulbs in the United States.

cell. A storage battery using nickel and iron plates and an alkali electrolyte.

E-display. In radar, a rectangular display in which targets appear as blips with distance indicated by the horizontal coordinate, and elevation by the vertical coordinate.

effective

acoustic center. Of an acoustic generator, the point from which the spherically divergent sound waves, observable at remote points, appear to diverge.

antenna length. The length which, when multiplied by the current at the point of maximum current, will give the same product as the length and uniform current of an elementary dipole antenna at the same location, and give the same radio field intensity in the direction of maximum radiation.

band. (in facsimile) The frequency band of a facsimile signal wave equal in width to that between zero frequency and maximum keying frequency. Note: The frequency band occupied in the transmission medium, will in general be greater than the effective band.

current. The value of alternating current that will cause the same heating effect as a given value of direct current. Also called rms current.

- height.** An antenna rating equal to the height of a perfect antenna giving the same field strength.
- radiated power.** The product of the antenna input power and the antenna power gain. This product should be expressed in kilowatts and in decibels above one kilowatt (dbk).
- resistance.** In an ac circuit, the average power dissipated divided by the square of the effective current.
- value.** The rms value of an alternating cycle of current, voltage, or power.
- efficiency.** The ratio of energy output to energy input, usually expressed as a percentage.
- of rectification.** The ratio of the dc output power to ac input power of a rectifier.
- elasticity.** The ability of a substance to return to shape after being stretched or otherwise deformed.
- E layer.** An ionized layer in the atmosphere, capable of reflecting or bending radio waves back to earth. The E region extends between about 55 and 85 miles above the earth's surface.
- electralloy.** A soft iron alloy used for radio chassis construction.
- electret.** A dielectric that retains a charge after the charging field is removed, much as a permanent magnet retains magnetism.
- electric.** Containing, producing, arising from, actuated by, or carrying electricity, or designed to carry electricity and capable of so doing. Examples: electric eel, energy, motor, vehicle, wave.
- displacement density.** Electric flux density.
- eye.** 1. A cathode-ray tuning-indicator tube used in some radio receiving sets. It consists of a fluorescent screen with a dark sector that varies in direct proportion to the strength of the incoming signal. 2. A popular name for a photoelectric cell.
- field.** A region or space traversed by electric lines of force.
- field strength.** The magnitude of the electric field vector.
- lines of force.** Imaginary lines used to designate the direction and amount of force produced by an electric charge.
- reset.** A qualifying term applied to a relay indicating that following an operation its contacts must be reset electrically to their original positions.
- shield.** A housing of metal, usually aluminum or copper, placed around a radio circuit. The housing prevents interaction between circuits by providing a low-resistance and reflecting path to ground for high-frequency radiations.
- telemetering.** Telemetering performed by deriving from the measurand or from an end device a quantitatively related separate electrical quantity or quantities as a translating means.
- transducer.** A transducer in which all of the waves concerned are electric.
- electrical.** Related to, pertaining to, or associated with electricity, but not having its properties or characteristics. Examples: Electrical engineer, handbook, insulator, rating, school.
- angle.** A phase angle expressed in degrees.
- bandspread.** Tuning by means of a gang of low-capacity capacitors connected in parallel with the main tuning gang of a short-wave receiver. After tuning to the desired band with the main gang, it is possible to "spread out" that band over the complete rotation of the bandspread dial because the small capacitances give a smaller frequency change per degree of rotation.
- center.** The point approximately midway between the ends of an inductor or resistor that divides it into two equal electrical values, as to voltage, resistance, inductance, or number of turns.
- forming.** (semiconductor devices) Process of applying electrical energy to a semiconductor device in order to modify permanently the electrical characteristics.
- inertia.** Inductance; opposition to change in current flow.
- interference.** Interference caused by the operation of electrical apparatus other than radio stations. Also called man-made interference.
- length.** The physical length expressed in wavelengths, radians, or degrees.
- transcription.** A recording made expressly for broadcast purposes.
- electricity.** A fundamental quantity in nature characterized by the fact that it gives rise to a field of force possessing potential energy, and that when moving in a stream (electric current) it gives rise to a magnetic field with which kinetic energy is associated.
- electroacoustic.** Pertaining to a device whose functions involve both electric current and sound-frequency pressures.
- transducer.** A transducer for receiving waves from an electric system and delivering waves to an acoustic system, or vice versa.

- electrochemical recording.** Recording by means of a chemical reaction brought about by the passage of signal-controlled current through the sensitized portion of the record sheet.
- electrode.** 1. (electron tubes) A conducting element that performs one or more of the functions of emitting, collecting, or controlling, by a varying field the movements of electrons or ions. 2. (of a semiconductor device) An element that performs one or more of the functions of emitting or collecting electrons or holes, or of controlling their movements by an electric field.
- characteristic.** A relation between the electrode voltage and the current to an electrode, all other electrode voltages being maintained constant.
- current.** The current passing to or from an electrode, particularly that through the space inside a vacuum tube.
- dark current.** The current that flows when there is no radiant flux incident on the photocathode of a phototube. Since dark current may change considerably with temperature, temperature should be specified.
- dissipation.** The power dissipated in the form of heat by an electrode as a result of electron and/or ion bombardment.
- voltage.** The voltage applied between another electrode and the cathode in a vacuum tube.
- electrodynamic loudspeaker.** A dynamic loudspeaker in which the magnetic field is produced by an electromagnet.
- electrodynamometer.** An instrument having two coils, arranged so the interaction of their fields actuates an indicator, used to measure dc and low-frequency ac currents.
- electroluminescence.** Emission of light by certain substances due to the application of an alternating electric field.
- electrolysis.** 1. Corrosion caused by a current flowing in and out of the surface of a conductor when resistance develops in a joint in the normal current path, or conductivity develops in adjoining insulation. 2. Chemical decomposition by the action of an electric current.
- electrolyte.** The chemical liquid or paste used between the electrodes of a dry cell, storage battery, or electrolytic capacitor.
- electrolytic capacitor.** A fixed capacitor containing a liquid or paste electrolyte, in which the dielectric is a thin film formed on the surface of one electrode.
- cell.** A cell containing two electrodes used to dissociate an electrolyte into its components.
- recording.** That type of electrochemical recording in which the chemical change is caused by ionization in the recording medium. This is usually a chemically-moistened paper.
- electromagnet.** A core of magnetic material surrounding by a coil and magnetized by a current flowing through the coil.
- electromagnetic deflection.** The process of bending or altering the path of an electron stream by means of a magnetic field created by the passage of current through coils.
- field.** The combined electric and magnetic fields produced by the flow of electrons through a wire or coil.
- focusing.** Control of the cross sectional area of the electron beam in a cathode ray tube by means of a magnetic field produced by a focusing coil.
- induction.** The action that causes a voltage to be induced in a conductor when the number of magnetic lines of force linking the conductor is changed.
- relay.** A relay whose operation involves the use of a magnetic field which is produced by an electromagnet.
- units.** (emu) A system of electrical units of measurement derived from basic cgs units, assuming the magnetic permeability of air as 1.
- wave.** A wave in which there are both electric and magnetic fields at right angles to each other. Electromagnetic waves are known as radio waves, infrared rays, light, x-rays, etc., depending on the frequency.
- electromagnetism.** Magnetic effects produced by electric currents.
- electromechanical.** Pertaining to a combination of mechanical and electric forces.
- recording.** Facsimile recording by means of a signal-actuated mechanical device.
- transducer.** A transducer for receiving waves from an electric system and delivering waves to a mechanical system, or vice versa.
- electrometer.** An instrument for measuring charge, usually by mechanical forces exerted on a charged electrode in an electric field.
- tube.** A high-vacuum tube having a very low control-electrode conductance to

facilitate the measurement of extremely small direct current or voltage.

electromotive force. (emf) The force causing motion of electrons. Voltage.

electron. The elementary particle of negative electricity. Some electrons are closely associated with atoms of matter; others, called free electrons, move readily between atoms under the influence of electric or magnetic fields, or are emitted under the influence of heat. The movement of electrons through a conductor constitutes an electric current.

beam. A stream of electrons, such as in a cathode-ray tube or in a klystron.

-beam tube. An electron tube, the performance of which depends upon the formation and control of one or more electron beams.

-coupled oscillator. An oscillator circuit using a screen-grid or pentode tube in which the oscillator transfers energy to the output circuit through the stream of electrons from the cathode, instead of through direct coupling.

coupling. A method of coupling in which an electron stream transfers energy from the anode grid of the oscillator to the plate load circuit.

device. A device in which conduction is principally by electrons moving through a vacuum, gas, or semiconductor.

drift. The actual movement of electrons when current flows.

emission. The release of electrons from the surface of a material into surrounding space due to heat, light, high voltage, or other causes.

focus. Use of an electrostatic or electromagnetic field to converge the electron beam in a cathode-ray tube to a small spot on the screen.

gun. An electrode structure which produces and may control, focus, deflect, and converge one or more electron beams.

microscope. A device that directs a beam of electrons on the object being examined, magnifies the resultant shadow visibly on a fluorescent screen, or records it on photographic film.

multiplier. A structure, within an electron tube which employs secondary electron emission from solids to produce current amplification.

-ray tuning indicator. A vacuum tube with a fluorescent screen used in receivers to indicate when a station is tuned in accurately.

tube. An electron device in which conduction takes place by electrons moving through a vacuum or gaseous medium within a gas-tight envelope.

volt. The energy possessed by an elec-

tron that has undergone a change of potential of one volt.

electronic. Accomplished, operated or actuated by the action of electrons. Of or pertaining to devices, circuits, or systems utilizing electron devices. Examples: electronic control, electronic equipment, electronic instrument, and electronic circuit.

control. The control of a machine or condition by apparatus using electron tubes. Electronic safety devices are examples of electronic control. Also called electronic regulation.

data processing. (EDP) The assimilation, manipulation, classification, and printing of data by electronic and electromechanical means.

key. A circuit that automatically produces dots and dashes of uniform size.

keying. A method of telegraphic keying in which the keyed stage is controlled by a tube that in turn is made to function by a manually operated key.

lens. An arrangement of electrodes and/or magnetic deflecting and focusing coils used to control the direction and size of a beam of electrons.

optics. That branch of electronics dealing with the control of the movements of electrons by the application of electrostatic and electromagnetic forces.

raster scanning. That method of scanning in which motion of the scanning spot in both dimensions is accomplished by electronic means.

television. A television system in which the scene to be transmitted is scanned and reconstructed by electron beams in cathode-ray tubes, rather than by mechanical means.

tuning. The process of changing the operating frequency of a system by changing the characteristics of a coupled electron stream. For example, characteristics involved are velocity, density or geometry.

tuning range. The frequency range of continuous tuning between two operating points of specified minimum power output for an electronically-tuned oscillator. Note: The reference points are frequently the half-power points but should always be specified.

tuning sensitivity. At a given operating point, the rate of change of oscillator frequency with the change of the controlling electron stream. For example, this change may be expressed in terms of an electrode voltage or current. See pushing figure.

electronics. That field of science and engineering which deals with electronic devices and their utilization.

- electroplating.** A process for applying a coating of metal to a conductive surface by means of an electric current.
- electroscope.** An instrument for detecting static charges of electricity.
- electrosensitive recording.** That type of recording where the record image is produced by passage of electric current into the record sheet.
- electrostatic.** Pertaining to static electricity, charges, and potential differences.
- charge.** An electric charge in a capacitor or on the surface of an insulated object.
- coupling.** The coupling of two circuits by a capacity, so that one circuit influences the other through capacitor charges and discharges.
- deflection.** The process of bending the electron stream in a cathode-ray tube by the use of an electrostatic field.
- field.** See electric field.
- focusing.** A method of focusing an electron beam by the action of an electric field.
- induction.** Accumulation of an induced charge on a conductor as a result of placing a charge in the vicinity. If a negative charge is brought near an uncharged conductor, electrons in the conductor will recede, producing an induced positive charge.
- loudspeaker.** (capacitor loudspeaker) A loudspeaker in which the mechanical forces are produced by the action of electrostatic fields.
- memory.** A memory device utilizing electrostatic charge as the means of retaining information, involving usually a special type of cathode-ray tube together with associated circuits.
- memory tube.** An electron tube in which information is retained by means of electric charges.
- recording.** Recording by means of a signal-controlled electrostatic field.
- scanning.** The deflection of an electron beam to form a raster by means of an electrostatic field.
- shield.** A grounded piece of metal or a grille consisting of vertical or horizontal wires but not both, used to prevent an electric field from transferring energy. See Faraday shield.
- spring shields.** Metallic shields between two relay springs to minimize capacitance between them.
- units.** (esu) A system of electrical units of measurement derived from basic cgs units, assuming the dielectric coefficient of air as 1.
- voltmeter.** A voltmeter that operates on the principle that two like charged bodies will repel each other. Such a voltmeter has two plates opposite each other, one free to move. As the voltage applied to the plates is increased, the movement increases, and a pointer connected to the movable plate indicates the voltage applied.
- electrothermal recording.** The type of electrochemical facsimile recording in which the chemical change is produced principally by heat.
- element.** One of the known basic forms of matter that make up the universe. Also the component parts of a device; thus, the cathode, grid, and plate are the elements of a triode vacuum tube.
- eliminator.** A device that replaces batteries as a source of current and voltage.
- elliptically polarized wave.** At a given frequency a radiated wave for which the component of the electric vector in a plane normal to the direction of propagation describes an ellipse.
- embossed**
- foil printed circuit.** A printed circuit formed by embossing.
- recording.** A method of sound recording on discs or film by mechanical pressure. Modulation grooves are formed by pressure displacement of the recording base material, instead of by cutting out the material.
- embossing stylus.** A recording stylus with a rounded tip which displaces the material in the recording medium to form a groove.
- emission.** Giving off of electrons. Also, the radiation of energy into space as from an antenna.
- characteristic.** A relation, usually shown by a graph, between electron emission and some factor controlling the emission, such as the temperature, voltage, or current of the filament or heater.
- efficiency.** The amount of electron emission from a cathode per watt of heating power.
- velocity.** The initial velocity with which electrons emerge from a cathode surface.
- emliron.** Terms applied to one British version of a television camera tube.
- emitter.** One of the end sections of a transistor. The emitter-base junction is always biased in a forward direction. Function can be compared to that of the cathode in a vacuum tube.

- junction.** A junction normally biased in the low-resistance direction to inject minority carriers into an interelectrode region.
- emphasizer.** A series of components connected in a circuit to increase signal amplitude at certain audio frequencies.
- empirical.** Based on experience or observation.
- enabling pulse.** A pulse which prepares a circuit for some subsequent action.
- enameled wire.** Wire coated with an insulating layer of baked enamel.
- encoder.** A network or system in which only one input is excited at a time and each input produces a combination of outputs. Sometimes called matrix.
- end**
- around carry.** See carry.
- device.** The final system element that responds quantitatively to the measurand and performs the final measurement operation.
- effect.** The effect of capacitance at the ends of an antenna. Also, the effect of inductance at the end of a coil.
- fire antenna array.** An array in which the elements are side by side, parallel, and all lying in the same horizontal plane.
- point control.** Quality control through continuous, automatic analysis. In highly automatic operations, final product is analyzed; if there are any undesirable variations, the controller automatically brings about the necessary changes.
- energize.** To energize a relay is to apply rated voltage to its coil.
- energy.** Ability to do work.
- gap.** (semiconductor) The energy range between the bottom of the conduction band and the top of the valence band.
- envelope.** Two curves, one drawn through the negative, and the other through the positive peaks of a graph of a waveform of an rf signal. Also the glass or metal housing of a tube.
- delay.** The time of propagation, between two points, of the envelope of a wave. Note: The envelope delay is measured by the slope of the phase shift in cycles plotted against the frequency in cycles per second. If the system distorts, the envelope delay at the specified frequency is defined with reference to a modulated wave which occupies a frequency bandwidth approaching zero.
- environmental conditions.** External conditions of heat, shock, vibration, pressure, moisture, etc.
- E plane.** The plane of an antenna in which the electric field lies, perpendicular to the H plane.
- equalization.** The process and result of designing an amplifier that will compensate for nonlinearities introduced by other components of a sound-reproducing system. For example, high-frequency signals are boosted during disc recording to increase the signal-to-noise ratio. The playback amplifier must therefore have a frequency characteristic that will reduce the high-frequency signal to its correct relative amplitude.
- equalizer.** A component or circuit used to produce a flat electrical or acoustical frequency response over a desired frequency range for changing the response to satisfy particular requirements.
- equalizing pulses.** In TV, pulse trains in which the pulse-repetition frequency is twice the line frequency and which occur just before and just after a vertical synchronizing pulse. Equalizing pulses minimize the effect of line-frequency pulses on the interlace.
- equation.** A mathematical statement that two numbers, quantities, or expressions are equal. Examples: $P = EI$; $7^2 = 49$; $(a + b)^2 = a^2 + 2ab + b^2$. A formula is an equation because it involves equality, but an equation is a formula only when it expresses a scientific fact, law, or principle.
- equipotential.** A conductor with all its parts at a single potential. The cathode of a heatertube is equipotential whereas the voltage of a filament varies from one end to the other.
- cathode.** See indirectly heated cathode.
- line.** An imaginary line in space along which all points have the same potential.
- equisignal**
- radio-range beacon.** A radio-beacon station that transmits two distinctive signals, these being received with equal intensity only along certain paths that constitute the route of airplanes.
- sector.** The on-course region in which the two different signals from an equisignal radio-range beacon are received with equal intensity.
- equivalent**
- circuit.** An arrangement of resistors, coils, and capacitors to simulate or

- electrically replace a more complicated circuit to permit analysis.
- loudness level.** The intensity level in decibels of a 1000-cycle pure tone equivalent in loudness to the sound under consideration.
- noise resistance.** A quantitative representation in resistance units, of the spectral density of a noise-voltage generator at a specified frequency.
- plate voltage.** A theoretical voltage in the plate circuit equal to the ac grid voltage multiplied by the amplification factor of the tube.
- resistance.** A lumped or concentrated resistance that would cause the same loss as a smaller resistance value distributed throughout an entire part or circuit. Used chiefly for convenience in computations or for determining circuit actions.
- erase.** 1. To remove previously recorded information. 2. To destroy information at any address in a storage system in order to enable new information to be stored at this address. 3. In charge-storage tubes, to charge or discharge storage elements to eliminate previously stored information.
- erasing head.** A device for obliterating any previous recordings. It may be used for preconditioning the magnetic media for recording purposes.
- speed.** (charge-storage tubes) The rate of erasing successive storage elements.
- E region.** The region of the ionosphere between about 90 and 160 kilometers above the earth's surface.
- erg.** The basic unit of work in the cgs system. The work done by a force of one dyne acting through a distance of one centimeter.
- error.** 1. In mathematics, the difference between the true value and a calculated or observed value. 2. In a computer or data-processing system, any incorrect step, process, or result. In addition to the mathematical usage, in the computer field the term is also commonly used to refer to machine malfunctions as "machine errors" and to human mistakes as "human errors."
- escutcheon.** The ornamental wood, metal, or plastic framework for a dial, tuning indicator, or other panel-mounted part in a receiver or amplifier.
- etchant.** The solvent used to dissolve the unwanted portion of a layer of material bonded to a base.
- etched printed circuit.** A printed circuit formed by etching.
- etching.** A process consisting of chemical, or chemical and electrolytic, removal of the unwanted portion of a layer of material bonded to a base.
- ether.** The medium that was once supposed to fill all space, and through which radio, heat, and light waves were supposed to travel.
- Eureka.** The ground transponder of Rebecca-Eureka, a secondary radar system.
- E waves.** Electric field waves.
- excess 3 code.** A code for numerical data in which each decimal digit, d , is represented by the binary number $(d + 3)$.
- excitation.** Application of a signal to the input of an amplifier stage, or application of signal power to a transmitting antenna. Also, application of voltage to the field coils of a motor or generator, or to the field coil of an electrodynamic loudspeaker.
- anode.** Auxiliary starting electrode of a mercury arc rectifier.
- excited field loudspeaker.** A loudspeaker in which the steady magnetic field is produced by an electromagnet.
- exciter.** In a directional transmitting antenna system, the part directly connected to the transmitter. In a transmitter, the exciter is the crystal oscillator or self-excited oscillator that generates the carrier frequency. Also, the small auxiliary generator used to provide field excitation for some large generators.
- lamp.** An incandescent lamp having a concentrated filament used in recording and reproducing all types of motion picture film sound tracks.
- exciting current.** The current through the primary winding of a power transformer when there is no load connected to any secondary winding.
- expansion.** A process in which the effective gain applied to a signal is varied as a function of the signal magnitude, the effective gain being greater for large than for small signals.
- exploring coil.** A small coil used in measuring a magnetic field.
- exponent.** A number written at the right of and slightly above another number to

indicate how many times the number is to be multiplied by itself. The result is the power of the number. Examples: 5^4 means $5 \times 5 \times 5 \times 5$, and is pronounced "5 to the fourth power." The result, 625, is the fourth power of 5. 1^2 means 1×1 , and is pronounced "1 squared" or "1 to the second power." A negative exponent means to find the reciprocal of the number with a positive exponent. Example:

$$b^{-3} = \frac{1}{b^3}$$

A fractional exponent indicates the root of a quantity. Example:

$$x^{\frac{1}{2}} \text{ means } \sqrt{x}$$

$$x^{\frac{1}{3}} \text{ means } \sqrt[3]{x}$$

$$x^{\frac{5}{3}} \text{ means } \sqrt[3]{x^5}$$

exponential

horn. A loudspeaker horn whose flare is such that the cross-sectional area increases exponentially with the distance from the throat. This is a mathematical way of saying that the horn flares out like a bell rather than being straight-sided like a cone.

transmission line. A two-conductor transmission line whose characteristic impedances vary exponentially with electrical length along the line.

extended

cut-off. See remote cut-off tube.

play. A disc recording where the recorded portion is extended toward the center to increase the playing time.

extension spring. See restoring spring.

extinction potential. The lowest value to which the plate voltage of a gaseous triode can be reduced, without stopping the flow of plate current.

extract. 1. To remove from a set of items of information all those items that meet some arbitrary criterion. 2. To form a new word by juxtaposing selected segments of given words.

extraordinary wave. One of two components into which a radio wave is split in the ionosphere by the earth's magnetic field. Sometimes called the X wave. The other component is the ordinary wave.

extrinsic

properties. (semiconductor) The properties of a semiconductor as modified

by impurities or imperfections within the crystal.

semiconductor. A semiconductor with electrical properties dependent upon impurities.

F

facsimile. (in electrical communications)

The process, or the result of the process, by which fixed graphic material including pictures or images is scanned and the information converted into signal waves which are used either locally or remotely to produce, in record form, a likeness (facsimile) of the subject copy.

receiver. The apparatus employed to translate the signal from the communications channel into a facsimile record of the subject copy.

receiving converter. A device which changes the type of modulation from frequency shift to amplitude. (FS to AM converter)

recorder. That part of the facsimile receiver which performs the final conversion of electrical picture signal to an image of the subject copy on the record medium.

signal. A signal voltage or current produced by scanning the subject copy in a facsimile system.

-signal level. The maximum facsimile signal power or voltage (rms or dc) measured at any point in a facsimile system. Note: It may be expressed in decibels with respect to some standard value such as 1 milliwatt.

system. An integrated assembly of the elements used for facsimile.

transmission. The transmission of signal waves produced by the scanning of fixed graphic material, including pictures, for reproduction in record form.

transmitter. The apparatus employed to translate the subject copy into signals suitable for delivery to the communication system.

transmitting converter. A device which changes the type of modulation from amplitude to frequency shift. (AM to FS converter.)

factor. If two or more numbers are multiplied together, each of them, or the product of any combination of them, is a factor of the product. Example: 2, x, y, 2x, 2y, and xy are all factors of 2xy.

fade. To change gradually. A program is faded in by making it gradually louder or brighter, and is faded out by diminishing its volume or brilliance gradually to zero.

fadeout. Intentional, gradual disappearance of a movie or television scene prior to showing a different scene. Also, the failure of radio waves to arrive at a location because of magnetic storms or atmospheric disturbances.

fader. A device for electrically fading a program in or out. Also, a control that gradually reduces the volume of one signal while gradually increasing the volume of another signal.

fading. The variation of radio field strength caused by changes in the transmission medium with time.

margin. The number of decibels of attenuation which may be added to a specified radio frequency propagation path before the signal-to-noise ratio of a specified channel falls below a specified minimum.

Fahnestock clip. A spring-type terminal to which a temporary connection can readily be made.

Fahrenheit temperature scale. A temperature scale based on the mercury-in-glass thermometer, with the freezing point of water defined as 32°F and the boiling point as 212°F , both under conditions of normal atmospheric pressure (760 mm of mercury).

fail-safe control. A system of remote control to prevent improper operation of the controlled function in the event of circuit failure.

fall-in. (synchronizing) A synchronous motor delivers no power except when running exactly at synchronous speed. Synchronous motors are usually started by auxiliary motors. The instant the synchronous motor reaches synchronous speed it is said to "fall-in" to synchronism. Sometimes called "drop-in" or "lock-in."

fan antenna. An antenna in which the elements are in a vertical plane and spread out fanwise from a common junction.

farad. The basic unit of capacity. A capacitor is said to have a capacity of 1 farad when a change of 1 volt per second across it produces a current of 1 ampere. A microfarad equals one millionth of a farad. A micromicrofarad equals one millionth of a microfarad.

Faraday

effect. When a plane polarized beam of light passes through certain transparent substances in a direction parallel to the lines of a strong magnetic field, the

plane of polarization is rotated a certain amount.

shield. A network of parallel wires all interconnected at the same end like a comb, to provide electrostatic shielding. The end that connects to all conductors is grounded, and the entire assembly is placed between two coils to eliminate stray capacity, or around a loop aerial to eliminate electrostatic pickup of signals. A Faraday screen.

Faraday's Laws. 1. In electrolysis, the quantity of a substance deposited in a given time is proportional to the current. 2. In electrolysis, the quantities of different substances deposited by the same current in the same time are proportional to their electrochemical equivalents. 3. In electromagnetic induction, the electromotive force induced in a circuit is proportional to the rate at which the flux linkages of the circuit are changing.

fast groove. (fast spiral) In disc recording, an unmodulated spiral groove having a pitch that is much greater than that of the recorded grooves.

F-display. In radar, a rectangular display in which a target appears as a centralized blip when the radar antenna is aimed at it. Horizontal and vertical aiming errors are respectively indicated by the horizontal and vertical displacement of the blip.

Federal Communications Commission. (FCC) A board of commissioners appointed by the President, with power to regulate all U. S. communication systems, including radio, television, telegraph, cable, and telephone.

feed. To supply electric energy to one part or stage from another part or stage.

feedback. The process of returning a portion of the signal voltage to a preceding point of the circuit. The signal so returned may be either in phase or out of phase; that is, it may either reinforce or oppose the signal at the point of feedback. Aiding the feedback is said to be positive or regenerative; opposing, it is negative or degenerative. Negative feedback is often used in audio circuits since it improves frequency response, reduces harmonic distortion and improves the stability of the amplifier.

control loop. A closed transmission path, which includes an active transducer and which consists of a forward path, a feedback path, and one or more mixing points arranged to maintain a

prescribed relationship between the loop input signal and the loop output signal.

control system. A control system in which the controlled quantity is measured and compared with a standard representing the desired performance. Any deviation from the standard is fed back into the control system in such a sense that it will reduce the deviation of the controlled quantity from the standard.

cutter. In sound recording, a cutter in which a voltage generated by movement of the cutting stylus is fed back into the amplifier system, for the purpose of reducing distortion and stabilizing frequency characteristics.

elements. The portion of the feedback control system that establishes the relation between the primary feedback and the controlled variable.

path. In a feedback control loop, the transmission path from the loop output signal to the loop feedback signal.

feeder. A wire or set of wires supplying energy from a source to a load.

fermi level. The value of the electron energy at which the fermi distribution function has the value one-half.

ferrite core. A chemical mixture or oxides, including that of iron, which exhibits magnetic properties.

ferroelectric. A chemical mixture involving titanium (titanates) that exhibits a hysteresis loop and permanent electrification when made the dielectric of a capacitor, just like permanent magnetism in ferromagnetic substances, such as steel.

ferromagnetic. Magnetic in a high degree, like iron.

fiber. A hard, tough material made of wood pulp, compressed into sheets, rods, or tubes, and used in radio for insulating and supporting purposes.

fidelity. The degree with which a system, or a portion of a system, accurately reproduces at its output the essential characteristics of the signal which is impressed upon its input.

field. In black-and-white television, the area covered during one vertical sweep of the scene; consequently, in double-interlaced scanning, the field is one-half the area of the scene. In color television, scanning through the picture area once in the chosen scanning pattern and in one of the primary colors; con-

sequently, in 2-to-1 line-interlaced scanning of alternate lines once in a single color. Also, a general term describing the space surrounding an electrically charged object or magnet. See electric field, magnetic field, and color field.

coil. In an electrodynamic loudspeaker, electric motor, or generator, the coil or coils that produce the magnetic field.

emission. The liberation of electrons from a solid or liquid by a strong electric field at the surface.

free emission current. The electron current emitted by a cathode when the electric field at the surface of the cathode is zero.

frequency. In television systems using interlaced scanning, the number of times per second the frame area is scanned by a downward sweep of the electron beam.

gain. The ratio of the field intensity of a multi-element antenna to that of a simple half-wave antenna fed with the same power.

intensity. The effective (rms) value of the electric or magnetic field produced at a point by radio waves from a particular station. It is usually expressed as electric field intensity in microvolts per meter or millivolts per meter. Also, the amount of magnetic flux produced by an electromagnet or permanent magnet.

of view. The area included in a televised image as "seen" by the camera.

period. In television, the length of time required to scan one field, equal to 1 divided by the field frequency.

pole. The structure of magnetic material on which a field coil is wound in a motor, generator, loudspeaker, etc.

repulsion rate. See field frequency.

rheostat. A variable resistance used to regulate the current flowing through the field coils of a motor or generator.

sequential. In color television, an arrangement in which an entire field is scanned in one primary color before it is scanned in another color.

strength. See field intensity, electric field strength.

figure-of-merit. 1. The ratio in any electrical circuit, of reactive power to real power. 2. For reactive circuits this may be expressed as the ratio of the reactance to the resistance (X/R) and is called the "Q" of the circuit. 3. For vacuum tube amplifiers this is expressed as either the ratio of transconductance to the total input and output capacitance (gm/C_t) or the ratio of transconductance to the total input

and output capacitance times 2π ($gm/2\pi C_T$). The latter is perhaps more useful since it is directly the gain-bandwidth factor.

filament. The resistance wire through which current is sent in a vacuum tube to produce the heat required for electron emission. When electron emission is from the surface of the filament wire itself, the filament also serves as the cathode.

circuit. The complete circuit through which current flows from the filament voltage source to the filaments of radio tubes.

current. The current supplied to the filament of a vacuum tube for heating purposes.

emission. The process by which electrons are given off from a heated filament in a vacuum tube.

rheostat. A variable resistance used to limit the flow of current through the filaments of vacuum tubes.

saturation. See temperature saturation.

voltage. The voltage that must be applied to the filament terminals of a vacuum tube in order to send the rated value of current through the filament.

winding. A separate secondary winding provided on a transformer for use as a filament voltage source.

film

reproducer. An instrument in which film is the medium from which a recording is made.

scanning. The process of converting movie film into electrical signals that can be transmitted by a television system.

sound recorder. Equipment which uses film as the recording medium.

filter. 1. A selective network designed to pass signals within a certain range of frequencies, while reducing considerably the amplitudes of signals at undesired frequencies. A filter consists of some combination of resistors, coils, and capacitors, sometimes also with a crystal. 2. A substance that absorbs or blocks certain colors of light while allowing others to pass.

capacitor. A capacitor used in a filter system.

choke. A coil in a filter system.

finder. The name given to the switch or relay group in switching systems that selects the path which the call is to take through the system. Operates under the control of the calling station's dial.

line tuning control. A control on the receiver that permits varying the fre-

quency of the local oscillator over a small range to compensate for drift and permit accurate adjustment to a station's carrier frequency.

pins. Radial sheets or disc of metal attached to a power tube or other component for dissipating heat.

firing. The process of gas ionization and the start of current flow in gas or vapor-filled tubes.

point. The voltage at which the gas or vapor in a tube ionizes and current begins to flow.

potential. See firing point.

first

audio stage. The first stage in the audio amplifier of a receiver to which audio signals are fed.

detector. The stage in a superheterodyne receiver in which the incoming modulated rf signal and the rf signal from the local oscillator are combined to produce the i-f signal.

fishbone antenna. A directional antenna consisting of a number of doublets attached to a transmission line, with all doublets making the same angle with the line to form a herringbone pattern.

fishpaper. A specially treated fiber paper used to insulate transformer windings.

fixed

bias. A constant value of bias voltage.

capacitor. A capacitor having a definite capacity value that cannot be varied.

frequency transmitter. A transmitter designed for operation on a single carrier frequency.

resistor. A resistor having a definite ohmic value that cannot be varied. A fixed resistor with intermediate connections or taps is known as a tapped resistor.

station. A permanently located station which communicates with another fixed station.

flange. A rim or lip on a waveguide section specially shaped to permit coupling to another section, so that the two sections will be properly matched.

flare. The rate of growth of a loudspeaker horn or cone; the rate at which the area increases per unit length.

factor. The outward curvature of a loudspeaker horn, expressed numerically.

flash. 1. Momentary interference to the picture of a duration of approximately one field or less, and of sufficient total magnitude to distort the picture infor-

mation. In general, this term is used alone when the impairment is of such short duration that the basic impairment cannot be recognized. Sometimes called "hit". 2. The excess material generated at the edge of a record or transcription after the molding is completed.

flashover. A disruptive discharge around or over the surface of an insulator, or between two charged surfaces not in contact with each other.

flat

-leakage power. (TR and Pre-TR tubes) The peak radio-frequency power transmitted through the tube, after the establishment of the steady-state radio-frequency discharge.

spot. In navigation, a point of zero incremental deviation sensitivity occurring with the crossover region.

top. The horizontal portion of an antenna.

-top response. A broad frequency response such as that obtained by tuning primary and secondary trimmers of an i-f transformer to slightly different frequencies. Band-pass response.

F layer. An ionized layer in the F regions of the atmosphere. In the daytime, two layers exist, the F_1 layer and F_2 layer.

F_1 layer. The lower of the two ionized layers normally existing in the F region in the day hemisphere.

F_2 layer. The single ionized layer normally existing in the F region in the night hemisphere; the higher of the two layers normally existing in the F region in the day hemisphere.

Fleming valve. Early name for a two-electrode vacuum tube.

flexible

coupling. A connector for joining two shafts end to end and permitting rotation, even though the two shafts are not aligned.

resistor. A non-rigid resistor made by winding Nichrome resistance wire around a length of asbestos or other flexible heat-resistant cord, then covering the winding with a pliable braided insulation.

shaft. A shaft that transmits rotary motion at any angle up to 90 degrees.

flicker. The erratic movement or wavering light perceived when a series of images is presented at a slow rate.

flip-flop. 1. A device having two stable states and two input terminals (or types of input signals), each of which corresponds with one of the two states. The

circuit remains in either state until caused to change to the other state by application of the corresponding signal.

2. A similar bistable device with an input which allows it to act as a single-stage binary counter.

floating

battery. A storage battery connected permanently in parallel with another power source, normally handling only small charging or discharging current, but assuming the entire load upon failure of the main supply.

grid. A vacuum-tube grid not connected to any circuit. See free grid.

-point system. A system of number notation in which two sets of digits are used, the added set being included to denote the location of the radix point.

flock. Finely divided felt used on phonograph turntable surfaces, underneath microphone stands, and in similar places where a nonscratching surface is desired.

flow

chart. See flow diagram.

diagram. (In electronic computers) A graphical representation of a program or a routine.

fluorescence. Light emitted as a result of electron bombardment or as a result of absorption of radiation from some other source.

fluorescent

lamp. An electric discharge lamp in which ionization of gas produces radiation, activating the fluorescent material on the inside of the glass tubing, thus creating visible light.

screen. A coating of chemical material that glows when bombarded by electrons. In a cathode-ray tube, the coating is on the inside surface at one end of the glass envelope of the tube.

flush printed circuit. A printed circuit in which the outer surface of the reproduced conductive pattern is in the same plane as the outer surface of the insulating base.

flutter. In communication practice, (1) distortion due to variations in loss resulting from the simultaneous transmission of a signal at another frequency, (2) a similar effect due to phase distortion, or (3) distortion which occurs in sound reproduction as a result of undesired speed variations during the recording, duplicating, or reproducing.

echo. A rapid succession of reflected

pulses resulting from a single initial pulse.

flux. Magnetic or electric lines of force. Also, a substance, such as rosin, used in soldering to free the surfaces of oxides and thus promote their union.

density. The total number of magnetic or electric lines of force per unit of area.

guide. (induction heating) Magnetic material to guide electromagnetic flux in desired paths.

linkage. The coupling between one circuit and another by means of magnetic or electric lines of force.

-meter. An instrument used to measure the number of magnetic lines of force passing through a given area.

flyback. Retrace, or return time; the period during which an electron beam that has concluded one scanning sequence returns to the starting point.

supply. A high-voltage supply of a cathode ray tube circuit, by which energy is obtained from pulses occurring in the primary of the horizontal sweep output transformer during the retrace period.

flying spot. The spot of light that moves across or scans the object being televised by a mechanical television system using a scanning disc for indirect scanning.

flywheel effect. The manner in which a shock-excited resonant circuit in an oscillator or class C amplifier maintains continuous operation by producing a continuous wave signal.

FM-PM. A system in which the several frequency modulated subcarriers are used to phase-modulate a second carrier.

FM stereo multiplex. Broadcasting simultaneously both channels of a stereo program by one FM station.

f number. A number obtained by dividing the focal length of a lens by the effective diameter of the lens. The lower the f number, the brighter the image.

focal

length. The distance between the optical center of a lens and its principal focal point at which light rays coming from an infinite distance meet.

point. The point to which a lens or mirror focuses light rays.

focus. Influencing a ray of light or a stream of electrons so that it converges to a spot of the desired size.

focusing. The process of controlling the electron paths within one or more beams, for the purpose of obtaining a desired image or current density distribution.

and switching grille. (color picture tubes) A color-selecting-electrode system in the form of an array of wires including at least two mutually-insulated sets of conductors in which the switching function is performed by varying the potential difference between them, and focusing is accomplished by maintaining the proper average potentials on the array and on the phosphor screen.

coil. An electromagnetic coil placed around a cathode ray tube or television camera tube, for the purpose of controlling the cross-sectional area of the beam at the fluorescent screen. Also, loosely applied to a permanent magnet used for the same purpose.

control. In a cathode-ray oscilloscope or television system, the control that adjusts the size of the visible spot produced on the screen.

electrode. An electrode to which a potential is applied to control the cross-sectional area of the electron beam.

magnet. See focusing coil.

foil. Very thin, pliable sheets of aluminum, lead, tin, or other metals used extensively in radio for plates of fixed capacitors and sometimes for shielding.

folded dipole. An antenna consisting of two half-wave elements arranged parallel to one another and with their ends connected together.

following blacks. (trailing blacks) A term used to describe a condition in which the edge following a white object is over-shaded toward black. The object appears to have a trailing black border. Also called "trailing reversal."

foot-candle. A unit of measurement of intensity of illumination. One foot-candle is the intensity of illumination on a surface located 1 foot from a 1-candlepower source.

foot lambert. A unit of luminance equal to $1/\pi$ candle per square foot, or to the uniform luminance of a perfectly diffusing surface of one lumen per sq. ft.

foot-pound. A unit of energy equal to the work done in raising a mass of one pound a distance of one foot.

force. Any physical cause that can produce motion, or change the motion of a body.

fork

beat. See carrier beat.

oscillator. An oscillator which uses a tuning fork as the frequency determining element.

form factor. The ratio of the effective to the average current. Also used to describe the shape (diameter/length) of a coil.

formica. A phenolic compound having excellent insulating qualities.

forming. The process of preparing the thin film on the surface of the positive electrode of an electrolytic capacitor. Also, the processing of lead plates for use in storage batteries.

formula. A scientific fact, law, or principle, expressed as an equation by means of letters, symbols, and constant terms. Examples: $Z^2 = R^2 + X^2$; $E = IR$. A formula is an equation because it involves equality, but an equation is not always a formula.

forty-five rpm record. A record recorded and reproduced at 45 revolutions per minute, having a center hole 1.5 inches in diameter.

forward

bias. Connection of a battery across the junction so that its polarity aids the flow of current across the junction.

path. In a feedback control loop, the transmission path from the loop actuating signal to the loop output signal.

transadmittance. The complex quotient of the fundamental components of the short-circuit current induced in the second of any two gaps and the fundamental component of the voltage across the first.

wave. (traveling-wave tube) A wave whose group velocity is in the same direction as the electron stream motion.

Foster-Seeley discriminator. A phase-discriminator type of FM detector. It uses synchronously tuned primary and secondary windings, the latter being center tapped, feeding identical diode detector circuits. It is sensitive to amplitude variations and must therefore be preceded by one or more limiters.

four-address code. See instruction code.

Fourier

series. A series of sine and cosine terms of integral-multiples of frequency used in evaluating the coefficients of harmonics of complex waves.

theorem. Any finite periodic motion may be analyzed into components, each of which is a simple harmonic motion of definite and determinable amplitude and phase.

four-wire

circuit. A two-way circuit using two paths so arranged that communication currents are transmitted in one direction only on one path and in the other direction on the other path. The transmission paths may or may not employ four wires.

repeater. A repeater which provides for transmission in opposite directions on two pairs of wires, or two transmission paths.

terminating set. A hybrid arrangement by which four-wire circuits are terminated on a two-wire basis for interconnection with two-wire circuits.

fraction. An indicated division, commonly representing a number less than 1. Example: 1/2.

frame. 1. In black-and-white television, one complete scanning of every part of the field of view being transmitted. 2. In color TV, a "frame" is scanning all of the picture area once in a single color. 3. In facsimile, a rectangular area, the width of which is that of the available line length, and the length of which is determined by the nature of the facsimile service. 4. In a relay, the structure on which the coil and contact assembly are mounted. 5. One cycle of a cyclically recurring number of pulses.

frequency. The number of frames per unit time.

roll. A momentary roll.

synchronizing pulse. A recurrent signal establishing each frame.

framer. A device for adjusting facsimile equipment so that the recorded elemental area bears the same relation to the record sheet as the corresponding transmitted elemental area bears to the subject copy.

framing. The adjustment of the picture to a desired position in the direction of line progression.

control. See horizontal hold control.

signal. A signal used for adjustment of the picture to a desired position in the direction of line progression.

Franklin antenna. A short-wave antenna in which several half-wave sections are used one above the other, with coils between the sections.

free

- electron.** An electron that is not closely bound to an atom, but is free to move about in the material. It is a negative carrier.
- field.** A field (wave or potential) in a homogeneous, isotropic medium free from boundaries. In practice, a field in which the effects of the boundaries are negligible over the region of interest.
- grid.** See floating grid.
- impedance.** Of a transducer, the impedance at the input of the transducer when the impedance of its load is made zero.
- motional impedance.** Of a transducer, the complex remainder after the blocked impedance has been subtracted from the free impedance.
- oscillation.** Oscillation that continues in a circuit after the signal voltage has been removed.
- point tester.** A test instrument in which a tube from a receiver is transferred to a socket on a test panel, which in turn is connected to the receiver socket from which the tube was removed. Voltage and current measurements for each tube electrode are then made quickly by plugging a meter into appropriate jacks on the test panel.
- progressive wave.** (free wave) A wave in a medium free from boundary effects. A free wave in a steady state can only be approximated in practice.
- running frequency.** The frequency at which a normally synchronized oscillator operates in the absence of a synchronizing signal.
- space field intensity.** The field intensity that would exist at a point in the absence of waves reflected from the earth or other reflecting objects.
- space radiation pattern.** The radiation pattern an antenna would have in free space, where there would be nothing to reflect, refract, or absorb the radiated waves.
- freezing point.** The temperature at which any particular liquid changes from the liquid to the solid state.
- F region.** The region of the ionosphere above the E region.
- frequency.** The number of complete cycles an alternating electric current, a sound wave, or a vibrating object undergoes per second.
- band.** A continuous range of frequencies extending between two limiting frequencies.
- changer.** A device for changing the frequency of alternating current.
- conversion.** The process of changing the original frequency of a signal to some other frequency by combining it with a second frequency.
- converter.** A circuit or device that changes the frequency of an alternating current.
- departure.** The amount of variation of a carrier frequency or center frequency from its assigned value.
- deviation.** In frequency modulation, the amount by which the instantaneous carrier frequency of the signal differs from the resting frequency. Also, the amount by which a carrier frequency differs from its assigned frequency.
- deviation meter.** A meter that measures the drift from a specified reference frequency.
- discrimination.** Distortion occurring when different frequency components in a signal are given unequal amplification.
- discriminator.** A circuit that extracts the intelligence signal from a frequency-modulated signal. Also, a circuit that produces a dc voltage proportional to the frequency difference between the carrier frequency and its assigned frequency.
- distortion.** A type of distortion that occurs when a circuit or device fails to amplify, attenuate, or transmit equally all frequencies present in a signal.
- divider.** A device delivering output voltage at a frequency that is a fraction of the input frequency. A flip-flop circuit.
- division multiplex.** A system of sending two or more signals on one carrier by causing each modulating signal to modulate different sub-carriers, all of which in turn modulate the main carrier.
- doubler.** A circuit arranged so that the frequency of its output is twice that of its input. Usually it is a class C, amplifier-adjusted so that the plate circuit will have strong harmonics of the input signal, with the plate tank circuit tuned to the second harmonic of the input. It may also be a full-wave rectifier feeding a tank circuit tuned to the second harmonic of the input.
- drift.** Detuning due to time, temperature, humidity, or other influences.
- interlace.** In television, the relationship between the frequency spectrum of an essentially periodic interfering signal and the spectrum of harmonics of the scanning frequencies. This relationship minimizes the visibility of the interfering pattern, by altering its appearance on successive scans.
- interleaving.** See frequency interlace.
- meter.** An instrument for measuring frequency. A wavemeter.
- modulation.** (fm) Angle modulation of a sine-wave carrier in which the instantaneous frequency of the modulated

wave differs from the carrier frequency by an amount proportional to the instantaneous value of the modulating wave. Note: Combinations of phase and frequency modulation are commonly referred to as "frequency modulation".

modulation deviation. Peak difference between the instantaneous frequency of a modulated wave and the carrier or reference frequency.

monitor. An instrument that indicates the amount of frequency deviation.

multiplex. Technique for the transmission over a common path of two or more signals, each characterized by a distinctive reference frequency or frequency band.

multiplier. A stage or section used to increase the frequency of a signal, such as a doubler, tripler, etc.

overlap. In a color television system, that part of the frequency band which is common to the monochrome channel and the chrominance channel.

pulling. A change of the generated frequency of an oscillator caused by a change in load impedance.

range. (of a device) The range of frequencies over which the device may be considered useful with various circuit and operating conditions. Note: Frequency range should be distinguished from bandwidth, which is a measure of useful range with fixed circuits and operating conditions.

record. (test record) A recording of various known frequencies at known amplitudes, usually for the purpose of testing or measuring.

regulator. A device that maintains the frequency of a signal source at a predetermined value.

response. The manner in which a circuit or device handles the frequencies falling within its operating range.

response characteristic. Variation with frequency of the gain or loss of a device or a system.

response curve. A graph showing the frequency response of a radiopart, circuit, or system.

-response equalization. (equalization) The effect of all frequency discriminative means employed in a transmission system to obtain a desired over-all frequency response.

separator. The television receiver circuit that separates the horizontal synchronizing pulses from the vertical synchronizing pulses.

shift. A change in the frequency of an oscillator or transmitter.

shift keying. That form of frequency modulation in which the modulating wave shifts the output frequency between predetermined values and the output wave is coherent with no phase discontinuity.

spectrum designation.

vlf very low frequency.....Below 30 kc
 lf low frequency.....30 - 300 kc
 mf medium frequency .. 300 - 3,000 kc
 hf high frequency ... 3,000 - 30,000 kc
 vhf very high frequency... 30 - 300 mc
 uhf ultra high frequency
 300 - 3,000 mc
 shf super high frequency
 3,000 - 30,000 mc
 ehf extremely high frequency
 30,000 - 300,000 mc

stability. The ability of a transmitter, signal generator, or other signal source to maintain a given frequency. Usually expressed as a percentage of deviation within which the frequency is maintained.

stabilization. The process of controlling the frequency so that it does not differ more than a prescribed amount from that of a reference source.

standard. A highly stable, accurate signal source which generates a frequency to which, or to the harmonics of which, other frequencies can be compared.

swing. The instantaneous departure of the frequency of the emitted wave from the center frequency resulting from modulation.

tolerance. The maximum permissible amount of variation in either direction from the assigned carrier frequency.

tripler. A device delivering output voltage at a frequency three times the input frequency.

fresnel zone. A cigar-shaped region surrounding the axis of a symmetrical beam antenna. The sum of the distances from any point on the boundary of the first fresnel zone to each antenna is one-half wave length longer than the direct path between antennas.

frictional

error. As applied to pickups, the difference in values measured in percent of full scale before and after tapping, with the measurand constant.

loss. Energy expended in overcoming friction between moving parts.

friction tape. Cotton tape impregnated with a sticky moisture-repellent compound, used chiefly to hold rubber-tape insulation in place.

fringe howl. A squeal or howl heard when some circuit in a receiver or amplifier is on the verge of oscillation.

front

contact. Sometimes used for the stationary contact of single-pole normally open contacts.

porch. That portion of the composite picture signal which lies between the leading edge of the horizontal blanking pulse and the leading edge of the corresponding sync pulse.

-to-back ratio. 1. The ratio of the resistance of a crystal to current flowing in the normal direction to the resistance to current flowing in the opposite direction. A term used in connection with checking crystals used as mixers in microwave receivers. 2. The power ratio of a directional antenna between the front and the rear. Also called front-to-rear ratio.

fs to am converter. See facsimile receiving converter.

full

adder. A complete circuit for adding the digits in each order and also adding the carries to the appropriate orders.

scale. The maximum value of the rated range of an instrument.

-scale cycle. A complete transversal of the range of an instrument from minimum reading to full scale and back to minimum reading.

-wave rectifier. A radio tube or other device that rectifies an alternating current in such a way that both halves of each input ac cycle appear in the pulsating rectified output. A full-wave rectifier tube contains two separate diode sections: one passing current during one alternation, and the other passing current during the opposite half-cycle.

function. If for each value of a variable "x" there is a corresponding value of "y," "y" is said to be a function of "x."

generator. A generator which produces a voltage whose variation with time is similar to the manner in which one variable, such as y, varies with respect to another variable, such as x.

potentiometers. Potentiometers whose electrical output (for a constant applied input) is the same function of its physical adjustment, that a given variable is of another variable.

switch. A network or system having a number of inputs and outputs and so connected that signals representing information expressed in a certain code, when applied to the inputs, cause output signals to appear which are a representation of the input information in a different code.

fundamental

component. The fundamental frequency component in the harmonic analysis of a wave.

frequency. The lowest frequency com-

ponent in a complex signal having harmonics. The lowest or natural resonant frequency of a part or circuit.

tone. 1. The component in a periodic wave corresponding to the fundamental frequency. 2. The component tone of lowest pitch in a complex tone. See fundamental frequency.

wavelength. The wavelength corresponding to the fundamental frequency.

fuse. A protective device consisting of a short piece of wire or strip of metal that melts and breaks when the current through it exceeds the rated value of the fuse. Fuses are inserted to open a circuit automatically in case of serious overload, thereby preventing damage to parts.

block. An insulating base on which are mounted fuse clips or other contacts for holding fuses.

clip. A spring contact for holding a fuse in position and providing a connection.

link. The metal portion inside a fuse that melts at the rated current value.

wire. Wire made from an alloy that melts at a relatively low temperature.

fused junction. In a semiconductor, a junction formed by recrystallization on a base crystal from a liquid phase of one or more components and the semiconductor.

G

gage. Alternate spelling of gauge.

gain. In an amplifier stage or system, the ratio of output to input, sometimes expressed in decibels.

control. A control connected so that it can change the over-all gain of an amplifier or system. A volume control or contrast control.

crossover. A point in the plot of loop ratio at which the magnitude of the loop ratio is unity.

margin. The amount by which the magnitude of the loop ratio of a stable system is different from unity at phase crossover. It is frequently expressed in decibels.

of an antenna. A rating expressing how much better one transmitting or receiving antenna is than another. For constant transmitted power level, the measured gain is the ratio of the signal powers produced at the input terminals of a receiver by the antennas under comparison.

time control. See sensitivity time control.

- turn down.** In a transponder, the automatic receiver gain control incorporated for the purpose of protecting the transmitter from overload.
- galena.** Lead sulphide, a shiny, bluish-gray mineral once widely used as the crystal in crystal detectors.
- galvanometer.** A current-indicating meter, usually having a scale indicating relative deflection or degrees of deflection, from which the amount of current can be calculated. When the meter has a current scale indicating milliamperes or amperes, it is called a milliammeter or ammeter.
- recorder.** (for photographic recording) A combination of mirror and coil suspended in a magnetic field. The application of a signal voltage to the coil causes a reflected light beam from the mirror to pass across a slit in front of a moving photographic film, thus providing a photographic record of the signal.
- gamma.** The ratio of the contrast of any two elements of the picture to the original contrast of these same elements in the scene being televised.
- correction.** The introduction of a non-linear output-input characteristic for the purpose of changing the effective value of gamma.
- ray.** An electromagnetic radiation similar to x-rays, but of shorter wavelength.
- gang.** A number of similar pieces of apparatus mounted so they can be simultaneously adjusted by a single control.
- switch.** Two or more rotary switches mounted on the same shaft and operated by a single control.
- tuning capacitor.** Two or more variable tuning capacitors mounted on the same shaft and operated by a single control.
- gap.** In a device in which a ferromagnetic substance provides most of the path for magnetic flux, the gap is that portion of the magnetic circuit in which there is no ferromagnetic material. Also, the space between the surfaces of two electrodes.
- arrestor.** An antenna lightning arrester in which there is an air gap between two metal points that, in turn, are connected to the antenna and ground. The gap arcs over when the antenna is struck by lightning, grounding the charge.
- coding.** In navigation, a process of communicating information by so interrupting the transmission of an otherwise regular signal that the interruptions form a telegraphic-type message.
- length.** In longitudinal magnetic recording, the physical distance between adjacent surfaces of the poles of a magnetic head. See magnetic head.
- garter spring.** A spring which is fastened around the circumference of the drum of the facsimile machine, to hold the record sheet or subject copy on the drum.
- gas**
- amplification.** The ratio of the charge collected to the charge liberated by the initial ionizing event.
- amplification factor.** (of a gas phototube) The ratio of radiant or luminous sensitivities with and without ionization of the contained gas.
- current.** A positive-ion current produced by collisions between electrons and residual gas molecules in a vacuum tube.
- filled counter tube.** A gas tube used for detection of radiation by means of gas ionization.
- flow counter tube.** A radiation-counter tube in which an appropriate atmosphere is maintained by a flow of gas through the tube.
- focusing.** Focusing of the electron beam in a cathode ray tube by the action of ionized gas.
- magnification.** The increased electron flow in a gas-filled photocell due to ionization of gas.
- ratio.** The ratio of the ion current in a tube to the electron current that produces it.
- tube.** An electron tube in which the contained gas or vapor performs the primary role in the operation of the tube.
- gaseous**
- conduction.** The conduction of electricity through a gas, due to ionization of the gas by collision of electrons with gas molecules.
- tube.** An electronic tube into which a small amount of gas or vapor is admitted after the tube has been evacuated. Ionization of the gas molecules during operation of the tube gives greatly increased current flow.
- tube generator.** A power source comprising a gas-filled electron tube oscillator, a power supply, and associated control equipment.
- gasket.** A ring or washer used for packing or insulating.
- gasoline-driven generator.** An ac or dc generator operated by a gasoline engine.
- gassing.** The production of gases when a current is passed through a chemical

solution. Specifically, the liberal production of gas in a storage battery when charging is continued after the battery is completely charged.

gassy tube. An imperfectly evacuated tube, one in which a small amount of gas accidentally remains. A "soft" tube.

gate. 1. In electronic computers, a circuit having an output and a multiplicity of inputs so designed that the output is energized when, and only when, certain input conditions are met. Note: Sometimes "gate" is used for "and-gate."
2. A square-wave voltage which switches a circuit on or off electronically, by energizing the grid or cathode of the control tube. See and-gate; or-gate.

tube. A thermionic tube which is operative only while two signal voltages, derived from two independent circuits, are applied simultaneously to two separate electrodes.

gated sweep. A sweep in which the duration, as well as the starting time, is controlled to exclude undesired echoes from the indicator screen.

gating. The process of selecting those portions of a wave which exist during one or more selected time intervals or which have magnitudes between selected limits.

gauge. A standard of measurement; a device for measuring.

pressure. The pressure of a liquid or gas measured relative to the ambient atmospheric pressure.

gauss. The unit of flux density equal to one magnetic line of force per square centimeter. The term gauss has also been used as a unit of magnetic field intensity, equal to one gilbert per centimeter.

G-display. In radar, a rectangular display in which a target appears as a laterally-centralized blip when the radar antenna is aimed at it in azimuth, and wings appear to grow on the blip as the distance to the target is diminished. Horizontal and vertical displacement of the blip.

gear pattern. See drive pattern.

Geiger counter. Any of several devices for detecting and measuring radiation, as the Geiger-Mueller counter.

Geiger-Mueller counter. A device for measuring radiation, containing a gas-filled tube con-

sisting of a metallic cylindrical sheath having a slender wire running axially through its center. Radiation such as from x-ray, gamma rays, beta rays, and alpha rays, traversing the gas causes ionization of the gas thus permitting a pulse to actuate an amplifying or counting circuit.

counter tube. A radiation counter tube designed to operate in the Geiger-Mueller region.

region. (radiation counter tube) The range of applied voltage in which the charge collected per isolated count is independent of the charge liberated by the initial ionizing event.

threshold. The lowest applied voltage at which the charge collected per isolated tube count is substantially independent of the nature of the initial ionizing event.

Geissler tube. A long gaseous tube that gives off colored light when a suitable voltage is applied to the electrodes which are at opposite ends of the tube.

genemotor. A small motor-generator set, generally employed for plate voltage supply in mobile radio installations.

general number. A letter or symbol used for representing quantities. Thus, R is a general number (sometimes called a literal number) used to represent resistance.

generation rate. In a semiconductor, the time rate of creation of electron-hole pairs.

generator. A machine that converts mechanical energy into electrical energy. It usually consists of a number of conductors mounted on an armature rotated in a magnetic field produced by field coils. A series generator has the armature, field, and load all in series. A shunt generator has the armature, field, and load all in parallel. A compound generator has two fields, one in series with the armature and the other in parallel with the armature. Also a device, such as an oscillator, that develops an ac voltage at a desired frequency when energized with dc or low-frequency ac power.

geodesic. The shortest line between two points measured on any specified surface which includes the points.

geometric
distortion. Non-linear aberrations in a TV picture's raster, such as keystoneing.
mean. The square root of the product of two quantities.

geometrical

error. In navigation, systematic error due to calibrating a system on the basis of spherical rather than oblate spheroidal earth; sometimes used as a synonym for ionospheric height error.

factor. In navigation, the ratio of the change in a navigational co-ordinate to the change in distance, taken in the direction of maximum navigational-co-ordinate change. That is, the magnitude of the gradient of the navigational-co-ordinate.

geometry. The branch of mathematics that deals with the relations and measurements of solids, surfaces, lines, and angles.

germanium. A grayish-white, brittle, metallic element having semiconductor properties. Used in semiconductor diodes and transistors.

diode. A rectifier or detector using metallic germanium crystal.

german silver. An alloy of copper, zinc and nickel.

getter. A material which is included in a vacuum system for the purpose of absorbing the residual gas.

ghost. In television, an undesired duplicate image appearing a fraction of an inch to one side of the desired image, due to reception of a reflected signal along with the signal coming directly from the television station.

signals. 1. In loran and gee, identification pulses which appear on the display at less than full repetition rate; 2. In loran, signals appearing on the display which have a basic repetition rate other than the rate being observed.

gilbert. The unit of magnetomotive force. One gilbert equals 0.796 ampere-turn.

Gill-Morrell oscillator. A retarding field oscillator in which the frequency of oscillation is dependent not only on electron transit time within the tube, but also on associated parts values.

gimmick. A capacitor formed by twisting two wires together.

glide

path. The path an airplane is to follow when using an instrument landing system. It is formed in space by two intersecting field patterns radiated in such a way that the glide path is the equisignal zone.

-slope. An inclined surface which includes a glide path and which is gen-

erated by an instrument-landing facility.

-slope deviation. The difference between the projection in the vertical plane of the actual path of movement of a vehicle and the planned slope of the vehicle; expressed in terms of either angular or linear measurements.

glitch. A form of low-frequency interference appearing as a narrow horizontal bar moving vertically through the picture. Also observed on an oscilloscope at field or frame rate as an extraneous voltage pip moving along the signal at approximately reference-black level.

glow

discharge. A discharge of electricity through a gas characterized by: 1. A space potential in the vicinity of the cathode that is much higher than the ionization potential of gas; 2. The presence of a cathode glow.

discharge tube. A gas tube that depends for its operation on the properties of a glow discharge.

-discharge voltage regulator. A gas tube whose resistance varies between about 5000 and 30,000 ohms, depending on the amount of applied voltage; used to maintain a constant voltage supply.

lamp. One in which light is produced by a glow discharge between two electrodes in an evacuated envelope into which a small quantity of gas or vapor has been introduced.

switch. A small gas discharge tube consisting of a pair of contacts, one actuated by a bimetallic strip, in a glass bulb containing a rare gas such as neon or argon. The tube and an inductance are connected in series with a fluorescent lamp for starting purposes. In starting, a glow discharge heats the thermostatic strip and bends it to close the switch contacts. The closed contacts apply filament current to the fluorescent lamp. The thermostatic strip cools quickly, its contacts open, and the resulting inductive surge strikes the arc in the lamp. If the arc does not strike the first time, the contacts quickly open and close again automatically until it does start.

goniometer. An rf transformer used with a direction finder. It has two primaries at right angles, each connected to a loop antenna, and coupled to a rotary secondary. Rotating the secondary coil has the same effect as does rotating a loop antenna.

gradient. 1. The rate of increase or decrease of a variable magnitude. 2. The

- curve representing such a rate of change.
- microphone.** A microphone, the output of which corresponds to a gradient of the sound pressure.
- gram.** A unit of mass and weight in the metric system. One pound is equal to 453 grams.
- graph.** A pictorial representation of the relation existing between two or more quantities.
- graphite.** A soft form of carbon, used as a lubricant.
- Grapholine.** A lubricant containing carbon; used where conductivity must be maintained.
- grass.** 1. In radar, a descriptive colloquialism used to refer to the indication of noise on an "A" or similar type display. 2. The video information of the composite video signal in TV.
- gray scale.** A scale of brightness values.
- Greenwich Mean Time.** (GMT) The time along the zero meridian of longitude which passes through Greenwich, England.
- grid.** An electrode having one or more openings for the passage of electrons or ions.
- bias.** The voltage used to make the control grid of a vacuum tube negative with respect to the cathode.
- bias cell.** A cell used in the grid circuit of a vacuum tube.
- cap.** A spring clip used to make an easily removable connection to the cap terminal located at the top of some radio tubes.
- cathode capacitance.** The capacitance between the grid and the cathode inside a vacuum tube.
- characteristic.** The graph plotted with grid voltage values as abscissas and grid current values as ordinates.
- conductance.** The ratio of the change in grid current to the change in grid voltage producing it, under the condition of constant plate voltage.
- controlled thyratron.** A gaseous tube in which the grid determines when plate current starts to flow, but not how much current will flow.
- current.** The current passing to or from a grid through the space inside a vacuum tube.
- detection.** Detection taking place in the grid circuit of a vacuum tube. (grid leak detection)
- dip oscillator.** An oscillator with a sensitive current meter connected in its grid circuit. When the oscillator is coupled to a resonant circuit, a sharp change in the meter reading indicates that power is being drawn from the oscillator and the two are in resonance.
- driving power.** The average product of the instantaneous value of the grid current and the alternating component of the grid voltage over a complete cycle.
- emission.** Emission of electrons or ions from a grid, usually due to the impact of electrons going from cathode to plate in the vacuum tube.
- leak.** A resistor of high ohmic value connected between the control grid and the cathode in a grid-leak capacitor detector circuit, for automatic biasing.
- leak detector.** A circuit in which detection occurs in the grid of a tube, as the result of the diode action of the grid and cathode.
- limiter.** A circuit in which the plate current cannot increase appreciably with signal increases, because once the signal exceeds a critical value, grid current flows through a resistor in the grid circuit, thus producing an automatic bias that opposes further signal increases.
- modulation.** Modulation produced by introduction of the modulating wave into a grid circuit in which the carrier frequency wave is present.
- neutralization.** Neutralizing an amplifier by shifting part of the grid-cathode ac voltage 180° and applying it to the plate-cathode circuit through a neutralizing capacitor.
- plate capacitance.** The capacitance between the grid and the plate within a vacuum tube.
- return.** The connection that provides a path for electrodes from the grid circuit to the cathode.
- suppressor.** The resistor connected between the control grid and the tuned portion of the grid circuit of a radio-frequency amplifier to prevent oscillation.
- swing.** The total variation of grid voltage from positive peak to negative peak of the applied signal.
- voltage.** Total voltage between grid and cathode.
- grommet.** A washer made of an insulating material used to prevent a wire or part from touching the sides of a chassis hole.
- groove.** In mechanical recording, the track inscribed in the record by the cutting or embossing stylus, including undulations or modulations caused by the vibration of the stylus.

angle. In disc recording, the angle between the two walls of an unmodulated groove in a radial plane perpendicular to the surface of the recording medium.

shape. In disc recording, the contour of the groove in a radial plane perpendicular to the surface of the recording medium.

speed. In disc recording, the linear speed of the groove with respect to the stylus.

velocity. The rate of motion of a phonograph needle from side to side in the groove.

ground. 1. The earth to which a connection is made by means of a buried conductor for radio purposes. 2. The chassis of a receiver when it serves as the return path for signal circuits.

absorption. The loss of power in transmission of radio waves due to dissipation in the ground.

-controlled approach. A ground radar-system providing information by which aircraft approaches may be directed via radio communications.

-controlled interception. A radar system by means of which a controller may direct an aircraft to make an interception of another aircraft.

plane antenna. A vertical antenna combined with a turnstile element to lower the angle of radiation, and having a concentric base support and center conductor that together serve to place the antenna at ground potential even though it may be located several wave lengths above ground.

position indicator. A computer, similar to an air position indicator, with provision for taking account of drift.

potential. The potential of the earth. A chassis, circuit, or terminal is at ground potential when it is electrically connected to the earth.

-reflected wave. The component of the ground wave that is reflected from the ground.

system. The portion of an antenna system closely associated with the ground, including the earth itself and any wires buried in it.

wave. A radio wave that is propagated along the earth's surface.

wire. A wire used to make connection from electronic apparatus to a grounded object.

grounded. Connected to earth or to some conducting body that serves in place of the earth.

-cathode amplifier. A vacuum tube amplifier with cathode at ground potential at the operating frequency, with input applied between control grid and ground, and the output load connected

between plate and ground. This is the "normal" amplifier connection for broadcast-band frequencies.

-grid amplifier. A vacuum tube amplifier circuit in which the control grid is at ground potential at the operating frequency, with input applied between cathode and ground, and output load connected between plate and ground.

-plate amplifier. A vacuum tube amplifier circuit in which the plate is at ground potential at the operating frequency, with input applied between control grid and ground, and the output load connected between cathode and ground. Also known as a cathode follower.

group velocity. The velocity of propagation of rf energy when confined between reflecting mediums, such as the walls of a waveguide, between which it is bounced back and forth. The path travelled is consequently longer than the distance from the point of origin to the point of reception, so that the speed with which the signal is received is less than that of the wave components along the reflected path.

growler. An electromagnetic device used for locating short-circuited coils in dynamo, genemotor, or motor armatures.

grown junction. In a semiconductor, a junction produced during growth of a crystal from a melt.

guard

band. A frequency band provided at either end of a channel to prevent interference between adjacent channels.

circle. The closed innermost groove of a disc recording. The guard circle prevents the pickup arm from swinging into the center of the record.

digit. A period of time equal to one digit time in which no information is transmitted to allow the circuits to reach a steady state before new information is transmitted.

guy

anchor. The buried weight or mass to which the lower end of a guy wire is attached.

wire. A wire used to brace the tower of a transmitting or receiving antenna system.

gyroscope. A device consisting of a wheel so mounted that its spinning axis is free to rotate about either of two other axes perpendicular to itself and to each other; also the wheel of this device. The characteristic of a gyroscope to maintain

equilibrium makes it a useful component for many aircraft instruments.

H

hairpin

pickup coil. A hairpin-shaped, single-turn coil used in vhf work to transfer energy from an rf generator, oscillator, or transmitter to an antenna lead-in or to a succeeding stage.

tuning bar. A hairpin-shaped metal bar inserted between the two halves of a doublet antenna and used to vary the over-all electrical length of the antenna.

halation. Spreading of light to produce a ring of illumination surrounding the impact point of electrons on a fluorescent screen.

half adder. A digital computer circuit that performs addition and generates the carries but does not dispose of them.

half-wave

antenna. An antenna whose length is approximately equal to one-half the wavelength to be transmitted or received.

line. A line electrically equivalent to a half wavelength at the operating frequency.

rectification. Changing only one half of each ac cycle into unidirectional current.

rectifier. A tube or other device that converts ac into pulsating dc by allowing current to pass during only one half of each ac cycle.

halo. Most commonly, a dark area surrounding an unusually bright object, caused by overloading of the camera tube.

ham. Slang term for an amateur radio operator.

hand-reset. A qualifying term applied to a relay indicating that following an operation the contacts must be reset manually to their original positions.

hard

copy. A copy or record on paper in ordinary language. In digital computer terminology, the record is either produced by an electric typewriter, a line printer or similar output devices.

tube. A vacuum tube that has been evacuated to a high degree.

harmonic. A sinusoidal quantity having a

frequency which is an integral multiple of the fundamental frequency of a periodic quantity to which it is related. For example, a wave, the frequency of which is twice the fundamental frequency, is called the second harmonic.

analyzer. An instrument that measures the component pure sine waves of a complex wave.

antenna. An antenna whose length is an integral multiple of the wavelength or the half-wavelength with which it is used.

attenuation. The elimination of a harmonic component of a signal.

conversion transducer. (frequency multiplier, frequency divider) A conversion transducer in which the output-signal frequency is a multiple or sub-multiple of the input frequency.

detector. A voltmeter circuit that measures only a particular harmonic of a fundamental frequency.

distortion. Nonlinear distortion characterized by the appearance in the output of harmonics other than the fundamental component when the input wave is sinusoidal. Sometimes called amplitude distortion.

filter. An electronic circuit designed to attenuate harmonics in a particular piece of electronic equipment.

generator. A vacuum tube or other generator used to produce a signal having many strong harmonics.

suppression. The prevention of the generation of harmonics, or their attenuation after generation.

Hartley oscillator. A vacuum tube oscillator circuit that has a tapped winding connected between the grid and the plate of the vacuum tube, with the tap going to the cathode.

hash. Interference produced by man-made devices, such as that produced by vibrators that have excessive sparking at the contact points.

head. 1. The cutting head in a recorder; a mechanism for cutting modulated grooves on a blank disc. 2. A rectifier built in a probe, used for measuring rf voltages without upsetting the circuit. 3. A device having coils around a laminated core of high magnetic permeability, for the purpose of writing or sensing information. 4. The ring-shaped electromagnet across which the tape is drawn and which magnetizes the iron-oxide-coated tape in a series of patterns. Most tape recorders use a combination record-playback head and also an erase head. Some professional machines also have a monitor head for listening to the recorded sound a split

second after it has been put on the tape.

header. The part of a hermetically sealed relay through which the electrical terminals pass.

heading. The horizontal direction in which a vehicle is directed, expressed as an angle between a reference line and the line extending in the direction the vehicle is headed; usually measured clockwise from the reference line.

headphone. See earphone.

headset. A pair of earphones attached to a headband to hold the phones snugly against the ears.

heater. An electric heating element for supplying heat to an indirectly heated cathode.

coil. See load coil.

current. The current supplied to a vacuum tube filament used only for heating purposes.

voltage. The voltage applied between the terminals of a vacuum tube filament used only for heating purposes.

Heaviside layer. A layer of ionized gas which exists in the region between 50 and 400 miles above the surface of the earth, and which reflects radio waves back to earth under certain conditions. Also called the Kennelly-Heaviside layer.

heelpiece. The part of a relay magnetic structure at the end of the coil opposite the armature. It generally supports the armature and completes the magnetic path between the coil core and the armature.

height control. The control in a television receiver that adjusts the picture size in a vertical direction. Also called the vertical size control.

error. See ionospheric height error.

markers. (radar) See calibration markers.

Heising modulation. Method of modulating a carrier wave in which the plates of both the radio-frequency oscillator or amplifier and modulator tubes are fed through a common inductor having a high impedance. The inductor prevents any change in total plate current drawn by the two tubes together; hence, audio-frequency plate-current variations in the modulator tube produce similar but opposite audio-frequency variations in the plate current of the radio-frequency oscillator or amplifier tube.

helical. Having the shape of a helix or coil; spiral.

helix. A coil wound in spiral form; the shape of a machine screw thread.

Helmholtz coil. A phase-shifting network consisting of fixed and movable coils. With a constant input, fixed in phase, the output may be continually shifted in phase from 0° to 360° . Used to determine range in certain radar equipment.

henry. The unit of inductance. A device has an inductance of 1 henry when an electromotive force of 1 volt is induced in it by a current changing at the rate of 1 ampere per second.

heptode. A seven-electrode electron tube containing an anode, a cathode, a control electrode, and four additional electrodes that are ordinarily grids.

hermetically sealed. Sealed to be airtight.

Hertz antenna. An antenna that is electrically independent of the ground.

heterodyne. Pertaining to the production of sum and difference frequencies and their associated harmonics, by combining two frequencies.

conversion transducer. (converter) A conversion transducer in which the output frequency is the sum or difference of the input frequency, and an integral multiple of the local oscillator frequency.

frequency. A frequency, produced by combining two other frequencies, which is their numerical sum or difference. A beat frequency.

frequency meter. See heterodyne wavemeter.

harmonic analyzer. A circuit in which a complex input voltage is examined by beating it with a variable frequency oscillator signal, and filtering the resultant beats to separate the harmonics.

interference. Interference between two stations transmitting on nearly the same frequencies, so their waves produce a beat note that causes an audible tone in receivers.

reception. A process of changing the carrier frequency of an incoming signal by combining it with a locally generated signal. Usually called superheterodyne reception.

wavemeter. A wavemeter used to determine the frequency of a signal by heterodyning the known frequency of its internal oscillator with the received rf frequency, and tuning the internal os-

cillator to produce a zero beat. Also called heterodyne frequency meter.

whistle. A steady squeal heard in a receiver due to a beat formed by heterodyne interference between stations having nearly equal carrier frequencies.

hexode. A six-electrode electron tube containing an anode, a cathode, a control electrode, and three additional electrodes that are ordinarily grids.

high

-angle radiation. Radiation from a transmitting antenna in a vertical or nearly vertical direction.

definition. The television or facsimile equivalent of audio high fidelity, in which the reproduced image contains as nearly as possible all picture elements, accurately reproduced, with each detail clearly visible.

fidelity. The ability of an audio component, amplifier, or system to reproduce with a minimum of distortion the full audio range of frequencies.

-frequency induction heater. (furnace) A device for causing electric current flow in a charge to be heated, the frequency of the current being higher than that customarily distributed over commercial networks.

-frequency resistance. The total effective resistance of a circuit to high-frequency currents.

-frequency trimmer. In a super-heterodyne receiver, the trimmer capacitor that controls the calibration of a tuning circuit at the high-frequency end of a tuning range.

-level detector. See power detector.

-level modulation. Modulation at a point in a transmitter where the power level is approximately the same as at the output of the transmitter.

-mu tube. A tube having a high amplification factor.

-pass filter. A filter network designed to pass all frequencies above a cut-off frequency value, while attenuating or rejecting lower frequencies.

Q. High ratio of reactance to ac resistance for any resonant circuit or coil.

-resistance voltmeter. A voltmeter having a very high resistance, so that little current is drawn by the meter from the circuit in which a measurement is made.

-tension. A term applied to circuits handling thousands of volts.

-vacuum tube. A vacuum tube that has been evacuated so thoroughly that gaseous ionization cannot occur during normal operation.

-voltage power supply. Equipment designed to provide high voltage, as for

acceleration of the beam in iconoscopes or kinescopes.

highlight. Pictorially, a point of great illumination of the brightest parts of a reproduced image.

Hollerith code. A standard method of punching cards so that the position of holes may represent letters, numbers, or special symbols.

hissing. A noise encountered in sensitive radio receivers due to feedback or to circuit and tube shot effects.

H network. A network composed of five branches; two connected in series between an input terminal and an output terminal, two connected in series between another input terminal and output terminal, and the fifth connected from the junction point of the first two branches of the junction point of the second two branches.

hold. (in charge-storage tubes) To maintain storage elements at equilibrium potentials by electron bombardment.

controls. In a television receiver, the two manually adjusted controls that adjust the natural oscillating frequencies of the oscillators used in the horizontal and vertical sweep circuits. Also called speed or framing controls.

values. The hold current, voltage or power is the minimum value for which the contacts of a previously energized relay will always maintain their energized positions.

hole. A mobile vacancy in the electronic valence structure of the semiconductor which acts like a positive electronic charge with a positive mass.

home. A recorded spot on a drum to be used as a reference mark for all timing signals.

position. The trigger in an open ring that precedes the first ring trigger.

homing. 1. The process of approaching a desired point by maintaining constant some indicated navigational parameter (other than altitude). 2. In missile guidance, the use of radiation from a target to establish a collision course. 3. A qualifying term, applied to a stepping relay indicating that the wipers, upon completion of an operational cycle, are stepped around or back to the start position.

guidance. A system wherein a missile steers itself toward a target by means of a self-contained mechanism which is activated by some distinguishing characteristic of the target.

homodyne reception. A form of reception in which the carrier wave is locally supplied or reinforced relative to the side bands.

homopolar generator. A generator in which all the poles presented to the armature are of the same polarity. Direct-current machines usually have a single pair of poles, each pole completely surrounding the armature, so that the armature conductor always cuts magnetic lines of force in the same direction. A pure direct current is thus produced without commutation.

honeycomb coil. A coil wound in a criss-cross or basket-weave manner to reduce distributed capacity. Also called lattice-wound coil.

hookup wire. Tinned and insulated soft-drawn copper wire used in wiring radios, TV sets, switchboards, etc.

hop. In traveling from one point to another, an excursion of a radio wave from the earth to the ionosphere and back to earth. Also, a slang term for sensitivity.

horizontal. Level; from side to side.

afc. An automatic frequency control circuit used to lock the horizontal sweep of a TV receiver to the average of the sync pulses.

amplitude control. See width control.

bars. Relatively broad horizontal bars, alternately black and white, which extend over the entire picture. They may be stationary or may move up or down. Sometimes referred to as a "venetian-blind" effect. Caused by approximate 60-cycle interfering frequency or one of its harmonic frequencies.

blanking. The application of cut-off bias to a cathode ray tube during the horizontal retrace.

blanking pulse. The pulse that cuts off the electron beam while it is returning to the left side of the screen of a cathode ray tube.

centering control. A control provided in a television receiver or cathode ray oscilloscope to shift the position of the entire image from side to side. Also called horizontal positioning control.

deflecting electrode. One of the cathode ray tube electrodes to which voltage is applied to move the electron beam from side to side.

displacements. Describes a picture condition in which the scanning lines start at relatively different points during the horizontal scan. See jitter.

drive control. The control on an electromagnetically deflected television receiver that adjusts the grid input on the

horizontal output tube, thus affecting both the width and the linearity of the horizontal sweep. Also called horizontal peaking control.

flyback. In a television system, the right-to-left return motion of the electron beam from the end of one line to the beginning of the next.

frequency. In television, the number of times per second the spot sweeps across the screen in the horizontal direction. The horizontal repetition rate.

hold control. The control that adjusts the frequency of the horizontal sweep oscillator in a television receiver so that it can be locked in with the sync pulses. Also called the horizontal speed or framing control.

linearity control. In television, a control provided to adjust the uniformity of the distribution of picture elements in a horizontal direction.

resolution. The definition or clarity of a television image in a horizontal line.

retrace. See horizontal flyback.

ring induction furnace. A device for melting metal comprising an angular horizontally-placed open trough or melting channel, a primary inductor winding, and a magnetic core which links the melting channel with the primary winding.

size control. See width control.

speed control. See horizontal hold control.

sweep. In television, the circuit that produces the horizontal scanning voltage.

synchronization. Making the horizontal scanning at the receiver occur at the same relative time as the horizontal scanning at the camera.

synchronizing pulse. The pulse sent at the end of each line for controlling the horizontal sweep rate. The line synchronizing pulse.

horizontally polarized wave. A linearly polarized wave whose electric field vector is horizontal.

horn

arrester. A lightning arrester in which the spark gap has upwardly projecting diversion horns of thick wire, up which the arc travels as soon as it is formed. When the arc reaches the widest part of the gap, it extinguishes.

loudspeaker. A loudspeaker in which the radiating element is coupled to the medium by means of a horn.

mouth. Normally the end of a horn with the larger cross-sectional area.

radiator. A tapered metal box used as a guide for radiated waves.

throat. Normally the end of a horn with the smaller cross-sectional area.

horsepower. A unit of power, the rate of doing work. One horsepower is mechanically equivalent to 33,000 foot-pounds per minute or 550 foot-pounds per second, and is electrically equivalent to 746 watts.

horseshoe magnet. A magnetized steel bar bent into the shape of a horseshoe.

hot. Connected, alive, energized, not grounded. Heated.

cathode. (thermionic cathode) A cathode that functions primarily by the process of thermionic emission.

-cathode tube. A vacuum or gaseous tube in which the cathode is heated to provide electron emission.

-wire ammeter. An ammeter that depends for its action on the expansion of a fine wire under the influence of the heat produced in it by the passage of the current to be measured.

howl. An undesirable audio-frequency oscillation occurring in a radio or amplifier system, due to either electrical or acoustic feedback.

H pad. An attenuation network having its elements arranged like the letter H, with a constant input and output impedance.

H plane. The plane of an antenna in which the magnetic field lies perpendicular to the E plane.

bend. For a rectangular uniconductor waveguide operating in the dominant mode, a bend in which the longitudinal axis of the guide remains in a plane parallel to the plane of the magnetic field vector throughout the bend.

tee junction. For a rectangular uniconductor waveguide, a tee junction of which the magnetic field vector of the dominant wave of each arm is parallel to the plane of the longitudinal axes of the guides.

hue. The attribute of color perception that determines whether it is red, yellow, green, blue, purple, or the like.

hum. 1. A low audio frequency, having the same frequency as that of the power supply or a harmonic thereof, introduced into the signal paths by inductions, leakage, or insufficient filtering, and heard in the background of a received radio program, or appearing across a television image in the form of one or two horizontal bars. 2. As applied to relays, the sound caused by mechanical vibration resulting from alternating current flowing in the coil.

-bucking coil. An extra coil placed on

the center pole of an electrodynamic loudspeaker, and wired in series with the voice coil so that hum currents induced in both coils by the field coil will cancel.

modulation. Modulation of a radio-frequency or detected signal by hum.

hunting. 1. (power) Erratic engine operation caused by the inability of a governor to respond accurately to changes in engine speed. 2. (radar) Mechanical oscillation in a servo system due to improper adjustment of control voltage, servo amplifier, or feedback. 3. Operation of a selector in moving from terminal to terminal until one is found which is idle.

hydrometer. A device used to measure the specific gravity of a liquid.

hydrophone. An electroacoustic transducer which responds to water-borne sound waves and delivers essentially equivalent electric waves.

hygroscopic. Readily absorbing and retaining moisture.

hysteresis. 1. (magnetic) The response of a magnetic material to an alternating magnetic field, the lagging of the induced magnetism behind the magnetizing force. 2. Of an oscillator, a behavior that may occur in which multiple values of the output power and/or frequency will correspond to given values of an operating parameter. 3. In radiation-counter tubes, the temporary change in the counting-rate vs voltage characteristic) caused by previous operation.

error. The maximum difference in percent of full scale in readings obtained, by making a complete full-scale cycle of the measurand at a specific value of of the latter.

heater. An induction device in which a charge, or a muffle about the charge, is heated principally by hysteresis losses due to a magnetic flux which is produced in it. A distinction should be made between hysteresis heating and the enhanced induction heating in a magnetic charge.

loop. A graph showing the relation between magnetizing force and flux density over a complete cycle of magnetization and demagnetization.

loss. Energy loss in a magnetic substance exposed to a constantly changing magnetic field due to internal friction, appearing as heat.

motor. A synchronous motor without salient poles and without direct current excitation, which starts by virtue of the hysteresis losses induced in its

hardened steel secondary member by the revolving field.

I

iconoscope. A camera tube in which a beam of high-velocity electrons scans a photoemissive mosaic which is capable of storing an electrical charge pattern.

Ideal

noise diode. A diode that has an infinite internal impedance and in which the current exhibits full shot noise fluctuations.

transducer. (for connecting a specified source to a specified load). A hypothetical passive transducer which transfers the maximum possible power from the source to the load.

transformer. A hypothetical transformer which neither stores nor dissipates energy. Its self inductances have a finite ratio and unity coefficient of coupling. Its self and mutual impedances are pure inductances of infinitely great value.

value. The value of the ultimately controlled variable that would result from an idealized system operating from the same command as the actual system under consideration.

idealized system. One whose performance is agreed upon to define the relationship between the ideal value and the command.

identification. In radar, the process of determining the identity of a particular displayed target (who are you?) or the determination of which, of a number of blips, represents a specific target (where are you?)

of friend or foe. (IFF) A system of challenge and response by radar, involving transmission of coded signals.

i-display. In radar, a display in which a target appears as a complete circle when the radar antenna is correctly pointed at it and in which the radius of the circle is proportional to target distance. When not correctly pointed at the target, the circle reduces to a segment of a circle, the segment length being inversely proportional to the magnitude of the pointing error and its angular position being reciprocal to the direction of pointing error.

idle cycle. That part of an electronic cycle during which the machine performs no arithmetic operation.

idler

pulley. A pulley used to maintain tension on or to change the direction of motion of a belt or cord. Its shaft does not rotate any other part.

rollers. Rollers that press against the tape and hold it against the driver roller, while they rotate freely as the tape passes by them.

ignition interference. Interference produced by sparks or other ignition discharges, or equipment in which there are loose contacts or connections.

ignitor. An electrode made of highly resistive material, partly immersed in the mercury-pool cathode of an ignitron tube and used to activate the ignitron by starting the ionization process. See ignitor electrode.

current. See electrode current.

-current temperature drift. (TR, pre-TR, and attenuator tubes). The variation in ignitor electrode current caused by a change in ambient temperature of the tube.

discharge. (switching tubes) A dc glow discharge, between the ignitor electrode and a suitably located electrode, used to facilitate radio-frequency ionization.

electrode. (switching tubes) An electrode used to initiate and sustain the ignitor discharge.

firing time. (switching tubes) The time interval between the application of a dc voltage to the ignitor electrode and the establishment of the ignitor discharge.

interaction. (TR, Pre-TR, and attenuator tubes) The difference between the insertion loss measured at a specified ignitor current and that measured at zero ignitor current.

leakage resistance. (switching tubes) The insulation resistance, measured in the absence of an ignitor discharge, between the ignitor electrode terminal and the adjacent radio-frequency electrode.

oscillations. (TR, pre-TR, and attenuator tubes) Relaxation oscillations in the ignitor circuit.

voltage drop. (switching tubes) The direct voltage between the cathode and the anode of the ignitor discharge at a specified ignitor current.

ignitron. A half-wave mercury-vapor tube used as a high-power rectifier.

illuminance. (illumination) The density of the luminous flux on a surface; it is the quotient of the flux by the area of the surface when the latter is uniformly illuminated.

illumination. The amount of light flux

falling on a surface, usually measured foot candles.

sensitivity. (camera tubes or phototubes) The quotient of signal output current by the incident illumination, under specified conditions of illumination.

image. A reproduction of a person, object, or scene, such as that produced by a television receiver.

dissector tube. (dissector tube) A camera tube in which an electron image produced by a photo-emitting surface is focused in the plane of a defining aperture and is scanned past that aperture.

distortion. Faulty transmission or reproduction of the scene scanned by a television camera.

frequency. A frequency on the opposite side of the oscillator frequency from that of the desired frequency, and differing from the oscillator frequency by the $i-f$ value. For example, in a superheterodyne receiver in which the oscillator operates above the incoming signal frequency, the image frequency is equal to the sum of the oscillator frequency and the $i-f$ value. It is above the desired signal frequency by twice the $i-f$ value.

iconoscope. A camera tube in which an electron image is produced by a photoemitting surface and focused on one side of a separate storage target which is scanned on the same side by an electron beam, usually of high-velocity electrons.

interference. Interference in which two stations are heard at the same time, one being the desired station, and the other being an undesired station at the image frequency.

-interference ratio. A superheterodyne receiver rating indicating how effectively the rf tuned circuits ahead of the first detector can reject signals at the image frequency when tuned to a desired frequency.

orthicon. A television camera tube in which a low-velocity electron beam is used to pick up the image signal, then an electron multiplier in the tube is used to amplify it.

ratio. The ratio of the field strength at the image frequency to the field strength at the desired frequency, each field being applied in turn, under specified conditions, to produce equal outputs.

reconstructor. The picture tube or other device used in a television receiver to convert the received picture signals into an image of the scene originally televised.

response. The degree to which a superheterodyne receiver responds to an undesired signal at the image frequency while tuned to a desired signal.

tube. (image converter tube) An electron tube which reproduces on its fluorescent screen an image of an irradiation pattern incident on its photosensitive surface.

imaginary number. The square root of a negative number. In formulas the letter j indicates the square root of -1 .

impedance. The total opposition a part or circuit offers to the flow of alternating current at a particular frequency. A combination of resistance and reactance measured in ohms.

bridge. A device to measure the combined resistance and reactance of a part.

coupling. Coupling between stages by a circuit resembling resistance coupling, with one or both resistors replaced by choke coils.

match. A condition in which the impedance of a component or circuit is equal to the impedance of the source to which it is connected.

-matching transformer. A transformer used to provide an impedance match between two or more circuits.

implode. To burst inward, as does a television picture tube when cracked. The high vacuum causes the external pressure to be so great that the glass fragments are forced inward to a high velocity.

impregnate. To treat a component so as to make it moisture-resistant by filling the excess space in its container with a material such as wax or pitch. Also applied to the coating of a part with a similar material.

impregnated coils. Coils which have been permeated with a phenolic or similar varnish to protect the coils from mechanical vibration, handling, fungus and moisture.

impulse. See pulse.

noise. Random, sharp bursts of noise.

impurity. (chemical) An atom within a crystal which is foreign to the crystal.

inactive lines. The television image lines not visible on the picture tube screen, those of the 525 image lines that are blanked out between fields.

incident

light. Light falling on a surface.

wave. In a medium of certain propagation characteristics, a wave which impinges on a discontinuity or a medium of different propagation characteristics.

inclination. The angle a line or surface makes with another line or surface.

Incoherent scattering. When radio waves encounter matter, a disordered change in the direction of propagation of the waves.

increment. A change in the value of a variable.

Incremental

gain. See differential gain.

permeability. The permeability effective in a core when an ac fluctuation in current is superimposed on a dc current.

index. The small number in the angle of a radical sign, indicating the particular root to be extracted. Examples: In $\sqrt[4]{x}$, the index is 4; in $\sqrt[3]{64}$, the index is 3.

counter. An odometer type counter which makes it possible to note the location of any particular selection of a tape, thereby making it easier to find. Many late model tape recorders feature built-in index counters.

of refraction. A number indicating how much a ray of light will be bent out of its normal path when passing from one material into another. It is equal to the speed of light in one material divided by the speed of light in the other material.

indexing. The establishing of a reference point from which measurements are made. A means of automatically changing the address part of an instruction in order to increase the efficiency of programs that deal with large quantities of data in a repetitious manner.

holes. Indexing holes are holes placed in a printed-circuit base to enable the base to be positioned accurately.

notch. An indexing notch is a notch placed in the edge of a printed-circuit base to enable the base to be positioned accurately.

indication. The display to the human senses of information concerning the measurand.

indicator. An instrument that makes information available but in which there is no provision for storage of such information.

tube. An electron-ray tube, sometimes called a "magic eye", in which useful information is conveyed by the variation in cross sections of the beam at a luminescent target. Often used as a tuning indicator.

Indirect

colorimetry. Calculation of the tristimulus values for a sample with respect to a particular set of primaries from (1) the tristimulus values of the spectrum for the same set of primaries, and (2) the spectral distribution of radiance from the sample. See also direct colorimetry.

scanning. A method of scanning in which a beam of light is moved across a scene or picture and the light reflected from the illuminated scene is picked up by one or more photocells.

view. A television receiver in which the image is optically projected from the cathode ray tube to a large viewing screen.

wave. Sky wave.

Indirectly

controlled system. The body, process, or machine which determines the relationship between the indirectly controlled variable and the controlled variable.

controlled variable. That quantity or condition which is controlled by virtue of its relation to the controlled variable and which is not directly measured for control.

heated cathode. (equipotential cathode, unipotential cathode) A cathode of a thermionic tube to which heat is supplied by an independent heater element.

indoor antenna. A receiving antenna system located entirely inside a building.

Induced

charge. An electrostatic charge produced on an object by an electric field in the vicinity.

current. 1. A current due to an induced voltage. 2. (induction heating usage) Current in a conductor due to the application of a time-varying electromagnetic field.

voltage. A voltage produced in a circuit by changes in the number of magnetic lines of force linking or cutting through the conductors of the circuit.

inductance. (L) The property of a circuit or coil that causes an electromotive force (voltage) to be set up because of a change in current in the circuit or coil, or that determines how much electromotive force will be induced in one of two neighboring coils or circuits by a change in the other. Inductance is effective only when a varying or alternating current exists, and has no effect on direct current. The basic unit of inductance is the henry. A circuit has an inductance of 1 henry when a change

of current of 1 ampere per second induces an electromotive force of 1 volt.
bridge. A form of Wheatstone bridge circuit used to determine inductance values.

-tube modulation. Frequency modulation by means of an oscillator control tube that acts as a variable inductance in parallel with the tank circuit of an rf oscillator, causing the oscillator frequency to vary in proportion to the af voltage applied to the grid of the oscillator control tube.

induction. A coupling produced by magnetic lines of force whereby the variable flow of current through one coil produces a voltage in a nearby coil even though there is no electrical connection between the coils. Also, the production of a charge or of magnetism by the presence of an electric or a magnetic field.

coil. A device with some form of interrupter for changing direct current into high-voltage alternating current.

compass. A compass whose indications depend on a coil revolving in the magnetic field of the earth. An earth inductor compass.

field. The portion of the electromagnetic field produced by a transmitting antenna that acts as if it were permanently associated with the antenna. The radiation field, on the other hand, breaks away from the antenna to form radio waves.

heating. The heating of a nominally conducting material in a varying electromagnetic field due to its internal losses.

motor. An electric motor operated on the principle that a pivoted closed loop of wire will rotate essentially in step with a rotating magnetic field.

ring heater. A form of core-type induction heater adapted principally for heating electrically conducting charges of ring or loop form, the core being open or separable to facilitate linking the charge.

inductive

coupling. A form of coupling in which energy is transferred from a coil in one circuit to a coil in another circuit by induction.

feedback. Feedback of energy from the plate circuit to the grid circuit of a tube by inductive coupling.

reactance. Reactance due to the inductance of a coil or other part in an alternating current circuit. Inductive reactance is measured in ohms, and is equal to the inductance in henrys multiplied by the frequency in cycles, times the number 6.28. The formula of in-

ductive reactance is: $X_L = 2\pi fL$.

winding. An inductive winding, as contrasted with a non-inductive winding, is a coil having an inductance.

inductor. Inductance. Coil.

industrial television. The application of television principles for remote viewing of processes or operations; usually over cables, as contrasted with broadcasting to the public.

inert gas. One of a group of gases including helium, neon, argon, krypton, and xenon that will not combine with another element.

inertia. The property of matter that tends to prevent motion, or resists a change of motion.

inertial guidance. A system independent of information obtained from outside the missile.

infinite. Without limit.

baffle. A loudspeaker enclosure having no openings other than the one behind which the speaker is mounted. Originally applied to very large baffle areas, such as when speaker is mounted in the wall of a room; it is now often used to describe a relatively small, tightly closed box.

-impedance detector. See C bias detector.

line. An imaginary transmission line that has all the characteristics of an ordinary line, but is infinitely long.

infra

-black region. See blacker-than-black region.

-red rays. Rays of longer wavelength than visible light rays, lying just beyond the red end of the spectrum. Heat rays.

infrasonic frequency. (subsonic frequency) A frequency lying below the audio-frequency range. Note: The word "infrasonic" may be used as a modifier to indicate a device or system intended to operate at infrasonic frequencies.

inhibiting input. A gate input which, if in its prescribed state, prevents any output which might otherwise occur.

initial ionizing event. An ionizing event that initiates a tube count.

injection

grid. A grid element placed in a vacuum tube in such a way that it has reasonable control over the electron stream without causing interaction between itself

and the control grid.

molding. Injection molding is the process of molding a record or transcription by means of injecting into a die cavity a plastic liquified by heat.

ink

mist recording. In facsimile, that type of electromechanical recording in which particles of an ink mist are deposited directly upon the record sheet.

recording. That type of mechanical facsimile recording which employs helical scanning using an inked helix which marks the record sheet.

vapor recording. That type of recording in which vaporized ink particles are directly deposited upon the record sheet.

in phase. Having the same frequency and passing through maximum values at the same instant of time, exactly in step.

input. The current, voltage, or power fed into a circuit or device. Also, the terminals to which the incoming signal is applied.

admittance. The reciprocal of the impedance between the grid and the cathode of a tube, determined by the internal tube capacities and the coupling effects of the grid-to-plate capacity.

capacity. The sum of all the direct input capacities between the grid and all other electrodes of a vacuum tube, plus the grid-plate capacity as increased by the Miller effect.

gap. Gap in which the initial velocity modulation of the electron stream is produced in a klystron. The buncher gap.

impedance. The ratio of the ac voltage applied to the input terminals of a circuit or device to the alternating current thereby produced.

resolution. (between two variables of a system or element) The maximum change in the variable considered as the input which can be made without causing a change in the variable considered as the output. Resolution may be dependent upon conditions of operation and the operating point. If these are not specified, the maximum value of the resolution over the entire operating range and for all conditions of operation is implied.

transformer. A transformer used to deliver energy to the input of a device or amplifier.

insertion

gain. Resulting from the insertion of a transducer in a transmission system, the ratio of the power delivered to that part of the system following the transducer, to the power delivered to that

same part before insertion of the transducer.

loss. 1. The loss in load power due to insertion of apparatus at some point in a transmission system. It is measured as the difference between the power received at the load before insertion of the apparatus and the power received at the load after insertion. 2. The ratio, expressed in decibels, of the power received at the load before insertion of the apparatus, to the power received at the load after insertion.

instantaneous

companding. Companding in which the effective gain variations are made in response to instantaneous values of the signal wave.

frequency. The time rate of change of the angle of an angle-modulated wave.

power output. The rate at which energy is delivered to a load at a particular instant.

recording. A recording that can be played without further processing.

value. The value of an alternating current, voltage, or power at any one point in its cycle.

instruction. Information which, when properly coded and introduced as a unit into a digital computer, causes it to perform one or more of its operations. An instruction commonly includes one or more addresses.

code. A code for representing the instructions which a particular digital computer can execute.

digit. One of the two digits of the instruction code.

repertoire. The set of instructions or commands that designates the various types of operations and can be decoded by a digital computer.

instrument. Used broadly to connote a device incorporating measuring, recording, and/or controlling abilities.

approach system. In navigation, a system furnishing guidance in the vertical and horizontal planes to aircraft during descent from an initial-approach altitude to a point near the ground. Completion of a landing requires guidance to touchdown by other means.

landing system. As a general term: A system which provides, in the aircraft, the lateral, longitudinal and vertical guidance necessary for a landing.

multiplier. A highly accurate series resistor used to extend the voltage range of a meter.

relay. A relay, the operation of which depends upon principles employed in electrical measuring instruments such

as the electro-dynamometer, iron-vane and D'Arsonval.

shunt. A highly accurate low-value resistor connected in parallel with a meter to extend its current range.

instrumental error. In navigation, the error due to the calibration, limited course sensitivity and other inaccuracies introduced in any portion of the system by the mechanism of translating path-length differences into navigation coordinate information.

instrumentation. Used to describe the application of industrial instruments to a process or manufacturing operation. Also describes the instruments themselves.

Insulated

carbon resistor. A carbon resistor encased in a molded ceramic, fiber, or plastic housing.

wire. A conductor covered with a non-conducting material.

insulating tape. Tape impregnated with insulating material, usually adhesive, and used to cover joints in insulated wire or cables. Also rubber tape.

insulation. Any material that has a sufficiently high electrical resistance to separate one electrical circuit, part, or wire from others. Cotton, silk, baked enamel, mica, porcelain rubber, and bakelite are a few of the common insulating materials used in radio.

resistance. The electrical resistance between two conductors separated by an insulating material.

insulator. An object that offers a great deal of opposition to the movements of electrons, used for supporting or separating conductors.

integer. Any whole number, without fractions or decimals.

integral. 1. The result of an integration either of a function or of an equation; an expression whose derivative is the integrand. 2. Relating to integers. 3. essential to completeness.

sign. The sign \int used in higher mathematics to indicate that the operation of integration (finding the sum of small elements or differentials) is to be performed.

Integrating

amplifier. An amplifier whose output represents the time integral of the input voltage.

circuit. A circuit whose output repre-

sents the time integral of its input.
network. (integrating circuit, integrator) A transducer whose output waveform is the time integral of its input waveform.

integrator. (in electronic computers) 1. A device whose output is proportional to the integral of an input signal. 2. In certain digital machines, a device for numerically accomplishing an approximation to the mathematical process of integration.

intelligence. Information conveyed to a machine or to an observer from a machine or transmission system.

sample. Part of a signal used as evidence of the quality of the whole.

signal. The electrical signal that corresponds to the information or intelligence being handled, such as sound waves, television scenes, or code; also known as the low-frequency signal.

Intensifier

electrode. An electrode causing post acceleration.

ring. A third anode in a cathode ray tube, consisting of a coating on the inside of the glass envelope. The application of a high positive potential to the intensifier ring increases the velocity of the electron stream, consequently increasing the intensity of the light.

intensity. Strength or value.

level. (specific sound-energy flux level) (sound-energy flux density level). The intensity level, in decibels, of a sound is 10 times the logarithm to the base 10 of the ratio of the intensity of this sound to the reference intensity. The reference intensity shall be stated explicitly.

modulation. The process of applying a voltage to the grid or cathode of a cathode ray tube to vary the intensity of the spot as it sweeps across the screen. Brilliance modulation, or Z-axis modulation.

of illumination. The brightness of an illuminated surface. Intensity of illumination is normally indicated in foot-candles and is inversely proportional to the square of the distance from the source.

Intercarrier

-noise suppression. A means for suppressing the noise otherwise heard in a high-gain receiver when it is tuned between station carriers. The audio input of the receiver is blocked automatically when no signals exist at the second detector.

sound. The method employed in those

television receivers which make use of the television picture carrier and the associated sound carrier to produce a frequency-modulated signal whose center frequency is equal to the difference between the two carrier frequencies.

Intercommunication system. An amplifier system that provides two-way communication between two or more points.

Interdigital magnetron. A magnetron having axial anode segments around the cathode, alternate segments being connected together at one end, remaining segments connected together at the opposite end.

Interelectrode capacity. The direct capacity that exists between two electrodes in a vacuum tube.

Interface connection. An interface connection is a conductor which connects conductive patterns on opposite sides of a printed-circuit base.

Interference. 1. Electrical disturbance which causes undesirable responses in electronic equipment. 2. Disturbance in radio reception caused by undesired signals, stray currents from electrical apparatus, etc. A current from a foreign source or a second communications line which in some way produces derogatory performance. Interference is sometimes spoken of as the current or power which causes noise in the telephone. 3. In a signal transmission system either extraneous power which tends to interfere with the reception of the desired signals, or the disturbance of signals which results.

control. The monitoring of radio frequencies assigned to a missile range for detection of interfering signals that could result in malfunctioning of missile-borne equipment, and the concerted effort to locate and terminate the source of interfering radiations.

eliminator. Any device designed for the purpose of removing or reducing interference.

filter. A device used on a source of interference or on a receiver to attenuate or eliminate noise.

guard bands. Bands of frequencies in which no signals are transmitted, existing on either side of a channel, providing separation between signals of stations having adjacent frequency assignments to prevent adjacent-channel interference.

pattern. Any interfering pattern seen on

a television screen, caused by hum, noise, etc.

Interlaced scanning. In television, a system in which every other line of the image is scanned during one downward sweep of the scanning beam, and the remaining lines are scanned during the next downward sweep of the scanning beam.

Interlock. A system that makes it impossible to open or close certain switches or relays until certain actions have taken place. For example, interlocking relays and switches may make it impossible to apply plate voltage to mercury vapor rectifier tubes until their filaments have reached operating temperature. Also, similar switches used on doors of transmitters or on television sets to automatically break the high voltage supply circuits when doors are opened or shields removed, to protect the operator or serviceman.

relay. A relay composed of two or more coils with their armatures and associated contacts so arranged that the freedom of one armature to move or its coil to be energized is dependent upon the position of the other armature.

Intermediate

frequency. The frequency produced by the heterodyne process, equal to the difference between the frequency of the local oscillator and the incoming signal.

-frequency amplifier. The section of a superheterodyne receiver designed to amplify signals with high efficiency at a predetermined frequency called the intermediate frequency of the receiver.

-frequency-harmonic interference. (In superheterodyne receivers) Interference due to radio-frequency-circuit acceptance of harmonics of an intermediate frequency signal.

-frequency response ratio. The ratio of the field strength at a specified frequency in the intermediate frequency band to the field strength at the desired frequency, each field being applied in turn, under specified conditions, to produce equal outputs.

-frequency transformer. A transformer used at the input or output of an i-f amplifier stage in a superheterodyne receiver for coupling purposes and for providing selectivity.

subcarrier. A carrier which may be modulated by one or more subcarriers and which is used as a modulating wave to modulate another carrier.

Intermittent

commercial and amateur service.

(ICAS) A transmitting tube rating in

which the transmitter design factors of minimum size, light weight, and maximum power output are more important than long tube life. Intermittent refers to operating conditions in which the operating or "ON" time does not exceed five minutes, followed by an equal or greater "OFF" time.

duty. Noncontinuous operation.

-duty rating. The rating of a device when operated for specified intervals of time other than continuous duty.

reception. A type of faulty reception in which a receiver performs normally for a time, then becomes dead or otherwise defective, with the process repeating itself at regular or irregular intervals.

intermodulation. The modulation of the components of a complex wave by each other in a nonlinear system.

distortion. A type of distortion resulting from nonlinearity in an audio system. As a consequence of this nonlinearity, the frequency components of the signal are beat together and produce sum and difference frequencies. Since these frequencies were not present in the original sound, they constitute distortion.

interference. Station interference that occurs when two undesired signals whose frequencies differ by exactly the i-f value of a superheterodyne receiver reach the first detector, and there produce an i-f beat signal without the aid of the local oscillator.

sound system. See intercarrier sound.

internal resistance. The resistance inside a battery, generator, or circuit component.

International

morse code. The dot and dash code used universally for radiotelegraphy, and for wire telegraphy in some European countries. The Continental Code.

temperature scale. A scale of temperature fixed by international agreement. Between -182.97°C and $+630.5^{\circ}\text{C}$, it is based upon the resistance of a standard platinum resistance thermometer in accordance with the Callendar-Van Dusen equation for resistance at a temperature (T).

interpolation. The process of estimating the value of a quantity between two known values.

interrogation. Transmission of a radio signal or combination of signals intended to trigger a transponder or group of transponders.

interrogator. The transmitting component of an interrogator-response.

-responzor. (IR) A radio transmitter and receiver combined to interrogate a transponder and display the resulting replies.

interrupted continuous wave. (icw) A continuous wave modulated by an audio-frequency tone, then code keyed.

interrupter. Apparatus for breaking up a continuous current into successive pulses.

interstage. Between stages.

transformer. A transformer used to provide coupling between two vacuum-tube or transistor stages.

interval timer. An electronic tube device used to measure time intervals.

Intrinsic

conduction. Conduction of electricity in a pure semi-conductor by hole-electron pairs. Formation of the hole-electron pairs is caused by outside energy such as light or heat.

impedance. The impedance of an electromagnetic field, expressed as a ratio of the strengths of the electric and the magnetic fields. In a loss-free material or free space, it is determined by the ratio of the permeability and the dielectric constant.

properties. (of a semiconductor) The properties of a semiconductor which are characteristic of the pure, ideal crystal.

semiconductor. A semiconductor whose electrical properties are essentially characteristic of the pure, ideal crystal.

temperature range. (in a semiconductor) The temperature range in which the electrical properties of a semiconductor are essentially not modified by impurities or imperfections within the crystal.

Inverse

electrode current. The current flowing through an electrode in the direction opposite to that for which the tube is designed.

feedback. Negative feedback, also called degeneration or stabilized feedback. A fraction of the output signal of an amplifier stage is intentionally fed back to the input so it is out of phase, thereby reducing distortion and noise, permitting greater undistorted power output. It also reduces amplification.

feedback filter. A resonance bridge circuit used at the output of a high-selectivity amplifier, in which the im-

pedance is adjusted so that the feedback output is zero for the resonant frequency but increases rapidly as frequency departs from this value.

limiter. A transducer, the output of which is constant for input of instantaneous values within a specified range and a linear or other prescribed function of the input for inputs above and below that range. Note: This term describes a device used generally to remove the low-level portions of signals from an output wave. It is sometimes used to eliminate the annoying effects of cross talk in a system at the expense of some distortion.

peak voltage. The highest instantaneous negative potential which, with respect to the cathode, the plate of a vacuum tube can acquire without danger of damaging the tube. Also, the highest instantaneous potential difference which exists between the electrodes of a half-wave rectifier during that half of the cycle when current does not flow.

inversely proportional. Related in such a way that when one value increases, the other decreases a proportionate amount, and vice versa.

inversion. Bending of a radio beam due to the upper part of the beam being slowed down by traveling through denser air. This may occur when a body of cold air moves in under a moisture-laden body of air.

Inverted

amplifier. See grounded-grid amplifier.

L antenna. The conventional antenna used for broadcast reception, having a long horizontal portion suspended between insulators, with the single-wire vertical lead-in connected to one end of the horizontal portion.

inverter. 1. A device used to change dc to ac. 2. A unit, such as a vacuum-tube stage, which reverses the polarity of a pulse.

switch. A combination of two inverters employing one common plate load resistor. Also sometimes called a negative coincidence switch.

ion. Electrically charged atoms formed when a neutral atom or group of neutral atoms loses or gains one or more electrons. If electrons are lost, the result is a positive ion; if electrons are gained, the result is a negative ion.

spot. 1. A spot on the fluorescent surface of a cathode-ray tube which is somewhat darker than the surrounding area because of bombardment by nega-

tive ions which reduce the sensitivity. (Ion burns) 2. (camera tubes or image tubes) The spurious signal resulting from the bombardment or alteration of the target or photocathode by ions.

trap. An arrangement of magnetic fields and apertures which will allow an electron beam to pass through but will obstruct the passage of ions.

Ionic-heated

cathode. A hot cathode that is heated primarily by ionic bombardment of the emitting surface.

-cathode tube. An electron tube containing an ionic-heated cathode.

ionization. An action whereby atoms or molecules of gas in an electronic tube are converted into electrically charged ions, which are attracted by charged electrodes. Ionization makes a gaseous tube more conductive than an equivalent vacuum tube.

current. Current flow between two oppositely charged electrodes in an ionized gas.

potential. The voltage at which sufficient current will flow to ionize the gas in a tube.

pressure. An increase in the pressure within a gaseous tube due to ionization of the gas.

time. The time between the moment of application of voltage and the ionization of the gas.

ionized layer. See Heaviside layer.

ionizing event. Any interaction by which one or more ions are produced.

ionosphere. That portion of the earth's atmosphere, beginning about 30 miles above the earth's surface which consists of layers of highly ionized air capable of bending or reflecting certain radio waves back to the earth. (This condition enables the transmission and reception of radio-frequency signals between two distant points.)

Ionospheric

error. In navigation, the total systematic and random error resulting from the reception of the navigational signal after ionospheric reflections. It may be due to (a) variations in transmission paths, (b) non-uniform height of the ionosphere, or (c) non-uniform propagation within the ionosphere.

height error. In navigation, the systematic component of the total ionospheric error due to the difference in geometrical configuration between ground paths and ionospheric paths.

storm. A period of disturbance in the ionosphere, during which radio waves are reflected in abnormal ways.

wave. A radio wave that is propagated by way of the ionosphere. Note: This is sometimes called a sky wave.

IR drop. Voltage drop produced across a resistor (R) by the flow of current (I) through it.

I²R loss. Power loss due to current flow through resistance.

Iron

-core coil. A coil wound on a form inside of which iron laminations are inserted.

-core transformer. A transformer in which iron makes up part or all of the path for magnetic lines of force traveling through the transformer windings.

loss. Power loss occurring in iron cores of electric machines, coils, transformers, etc., due to hysteresis and eddy currents.

-vane instrument. A meter in which the movable element is an iron vane, which is drawn into the magnetic field produced by the flow of the current being measured.

I signal. The chrominance signal corresponding to the wide-band subcarrier axis.

Isolantite. A high-quality insulating material used in the construction and mounting of radio parts, particularly those used in ultra-high-frequency circuits.

Isolation network. A network inserted in a circuit or transmission line to prevent interaction between circuits on each side of the insertion point.

Isotropic antenna. An isotropic antenna is one with a spherical symmetric radiation pattern. Although such an antenna cannot be constructed, it is a concept of great convenience due to its mathematical simplicity.

J

Jack. A plug-in spring terminal widely used in radio apparatus for temporary connections.

Jamming. Transmission of radio signals in such a manner as to interfere with the reception of signals from another station.

JAN specification. Joint Army Navy specification.

J antenna. A half-wave antenna, fed at the end by a quarter-wave line section so the two resemble the letter J.

J-display. In radar, a modified A-display in which the time base is a circle. The target signal appears as a radial deflection from the time base.

Jet. The exhaust stream or rapid flow of fluid from a small opening or nozzle.

vane. A vane made of some highly heat-resisting material (e.g., graphite) placed in the jet stream for use in guidance of a missile.

Jewel bearing. A small piece of natural or synthetic jewel, usually sapphire, carefully ground to form a bearing for the pivot of a meter movement.

Jitter. 1. Distortion in a received television or facsimile picture caused by momentary errors in synchronization between scanner and recorder. 2. Small rapid variations in a waveform due to mechanical disturbances or to changes in the supply voltages, in the characteristic of components, etc.

Johnson noise. See thermal noise.

Joule. The unit of electrical work or energy. One joule equals one watt-second.

Joule's law of heating. The heat produced in a conductor is proportional to the resistance of the conductor, the square of the current, and the time.

Jump. To cause the next instruction in a digital computer to be selected from a specified storage location.

Jumper. Any conductor used to connect two points together or short out a part temporarily.

Junction. 1. A joint or connection. 2. A point of contact between two dissimilar metals or materials. 3. The region of contact between P-type material and N-type material in a single semiconductor crystal.

box. A box into which wires or cables are led and connected.

diode. A crystal diode made up of two regions, one of N-type material and the other of P-type material.

P-N (in a semiconductor) A region of transition between P- and N-type semiconducting material.

point. See node.

station. A microwave relay station that

joins a microwave radio leg or legs to the main or through route.

transistor. A transistor having a base electrode and two or more junction electrodes.

just scale. A musical scale formed by taking three consecutive triads each having the ratio 4:5:6, or 10:12:15. Note: By consecutive triads is meant triads such that the highest note of one is the lowest note of the other.

K

k-display. In radar, a modified A-display in which a target appears as a pair of vertical deflections or blips instead of a single deflection. When the radar antenna is correctly pointed at the target in azimuth, the blips are of equal height. When not correctly pointed, the difference in blip height is an indication of direction and magnitude of azimuth pointing error.

keep-alive

anode. An auxiliary electrode in a mercury pool tube that keeps the mercury heated and thus ionized.

circuit. In a TR or Anti-TR switch, a circuit for producing residual ionization for the purpose of reducing the initiation time of the main discharge.

keeper. A piece of iron used to close the magnetic circuit of a permanent magnet to prevent loss in magnetic strength.

Kelvin

balance. An instrument for measuring current by sending it through a fixed coil and a movable coil attached to one arm of a balance, and comparing the resultant force between the coils with the force of gravity acting on a known weight at the other end of the balance arm.

temperature scale. A thermodynamic absolute temperature scale, having as its zero, the absolute zero of temperature (-273.15°C).

Kendall effect. A spurious pattern or other distortion in a facsimile record caused by unwanted modulation products arising from the transmission of a carrier signal and appearing in the form of a rectified baseband that interferes with the lower sideband of the carrier. Note: This occurs principally when the single sideband width is greater than half the facsimile carrier frequency.

Kennelly-Heaviside layer. See Heaviside layer.

Kenotron. A high-vacuum rectifier tube.

Kerr cell. A device used in some mechanical television systems to modulate a light beam with television signals. The cell rotates a beam of plane-polarized light in proportion to the voltage applied between the two plates of the cell.

key. A lever switch designed for rapid opening and closing of a circuit during transmission of code signals. Also, a lever switch used on telephone switchboards to control speech circuits.

-click filter. A filter that attenuates the surge produced when the keying circuit of a transmitter is opened or closed.

clicks. A noise caused by the sharp current change when a sending key is opened or closed.

keyer. A device that changes the amplitude or frequency of the output of a transmitter in accordance with the intelligence to be transmitted.

adapter. A device which detects a modulated signal and produces the modulating frequency as a dc signal of varying amplitude. This type of unit is used to provide keying signal for a frequency shift exciter unit for radio facsimile transmission.

keying. Forming of signals such as those employed in telegraph transmission by an abrupt modulation of the output of a direct-current or an alternating-current source, as, for example, by interrupting it or by suddenly changing its amplitude or frequency or some other characteristic.

chirps. Peculiar sounds accompanying code signals when the transmitter is unstable and shifts in frequency each time the sending key is closed.

signal. A periodic signal which keys on or activates a circuit so as to permit the production or transmission of another signal. See also gate.

Keystone

correction. To cause the horizontal sweep width in an iconoscope to increase when vertical scanning deflects the beam to the part of the mosaic nearest the electron gun, resulting in a rectangular rather than a keystone-shaped electron image.

distortion. A form of distortion in which the television image takes the shape of a trapezoid, because the electron gun is not at right angles to the mosaic. This makes the electron path to the top of the picture longer than that to the

bottom, and consequently the sweep is wider at the top than at the bottom.

distortion. (camera tubes) A distortion such that the slope or the length of a horizontal line trace or scan line is linearly related to its vertical displacement. Note: A system having keystone distortion distorts a rectangular pattern into a trapezoidal pattern.

-shaped image. A reproduced image wider at the top than at the bottom or vice versa.

keystoning. The effect produced when the electron gun of a cathode ray television camera tube is placed at an angle with the principal axis of the tube, resulting in a keystone-shaped scanning pattern.

kickback. The counter-electromotive force produced in a coil when the current through it is stopped and the magnetic field collapses.

power supply. See flyback supply.

kilo. A decimal prefix designated by the symbol K meaning 10^3 .

kilocycle. One thousand cycles.

kilogauss. A unit of flux density equal to 1000 gauss or 1000 lines of flux per square centimeter.

kilovolt. One thousand volts.

-amperes. A unit of apparent power, equal to 1000 volt-amperes.

kilovoltmeter. A voltmeter scaled in thousands of volts.

kilowatt. A unit of electrical power equal to 1000 watts.

-hour. A unit of electrical energy, equal to 1000 watt-hours. (watts \times hours + 1000.)

kinescope. A cathode ray tube used in television receivers for reproducing the scene being televised. A picture tube.

recording. A motion-picture-film recording of the presentation shown by a picture monitor. Also known as television recording (TVR), Vitapix, etc.

kinetic energy. The energy (ability to work) a moving object possesses by virtue of its motion.

Kirchhoff's

Current Law. A fundamental electrical law which states that the sum of all the current flowing to a point in a circuit is equal to the sum of all the currents flowing away from that point.

Voltage Law. A fundamental electrical law which states that the sum of all

the voltage sources acting in a complete circuit is equal to the sum of all the voltage drops in that same circuit.

klystron. A tube in which the speed rather than the number of electrons is controlled by the input signal. Elements called the buncher grids velocity-modulate the electron stream so the electrons collect in bunches in the drift space. The catcher grids then extract energy from the electron bunches.

oscillator. A microwave oscillator that uses a klystron to get considerable rf power at frequencies above 300 megacycles.

repeater. A klystron tube operated as an amplifier and inserted directly in a waveguide in such a way that incoming waves velocity-modulate the electron stream emitted from a heated cathode. A second cavity converts the energy of the electron clusters into waves of the original type but of greatly increased amplitude and feeds them into the outgoing guide.

knee. An abrupt change in direction between two fairly straight segments of a curve.

knife switch. A switch in which one or more flat metal blades, each pivoted at one end, make contact with gripping spring clips to complete the circuit.

of transfer characteristic. (image orthicons) The region of maximum curvature in the transfer characteristic.

L

labyrinth enclosure. See acoustical labyrinth enclosure.

lacquer

discs. (cellulose nitrate discs) Mechanical recording discs usually made of metal, glass, or paper, and coated with a lacquer compound (often containing cellulose nitrate).

original. (lacquer master) An original recording on a lacquer surface for the purpose of making a master.

recording. Any recording made on a lacquer recording medium.

ladder network. 1. An adjustable attenuator network of the step type in which the steps are of known attenuation, and the network presents a known and constant load to the signal source. 2. A sequence of L, T, H, or pi networks connected in tandem.

lag. 1. The difference between the time that two alternating quantities having the same frequency pass through corresponding values; the last one that reaches a particular point in a cycle is said to lag behind the other. 2. In camera tubes, a persistence of the electrical charge image for a small number of frames. 3. Preferred engineering term for delay in response.

screw. A screw used for fastening objects to brick or masonry.

lagging current. An alternating current that is retarded by the inductance of the circuit, so that its changes occur after the voltage changes have occurred. When there is only inductance in the circuit, the current lags 90 degrees behind the voltage.

lambert. A unit of luminance equal to $1/\pi$ candle per square centimeter and, therefore, equal to the uniform luminance of a perfectly diffusing surface emitting or reflecting light at the rate of one lumen per square centimeter.

laminated. Made of thin layers, strips, or plates.

record. A mechanical recording medium composed of several layers of material. Normally, it is made with a thin face of surface material on each side of a core.

lamination. A thin layer, strip or sheet. Specifically one of iron or steel, used to build the core of a transformer or other device designed to operate at audio or power frequencies. Also, a thin layer of plastic-impregnated cloth, used in making insulating sheets or tubes.

lamp. An artificial source of light, infrared, or ultra-violet radiation.

lanac. (laminar navigation, anti-collision). An aircraft radio navigation system consisting of airborne interrogator and ground transponder equipments with height-coding of the airborne interrogator pulses.

land. The record surface between two adjacent grooves of a mechanical recording.

line. A telephone or telephone line.

L antenna. An antenna consisting of one or more horizontal wires with a vertical lead-in connected at one end. An inverted L antenna.

lap winding. A type of winding of an armature in which each coil terminates at the next adjacent commutator segment.

laryngaphone. A throat microphone.

LASER. (light amplification by stimulated emission of radiation). See maser.

latch. Pertaining to an operating characteristic of a double inverter connected to a cathode follower which, in turn, feeds the inverter. A signal input to the inverter thereupon circulates continuously through this circuit and furnishes a continuous output from the cathode follower. The action can be stopped by opening this closed loop at any point; a stable output is obtained in either the "ON" or "OFF" condition.

latch-in relay. A relay having contacts which lock in either the energized or de-energized position until reset either manually or electrically.

latent image. Stored picture information, such as that contained in the charged globule-capacitances of the iconoscope.

lateral

force. Force exerted from the side.

recording. A mechanical recording in which the groove modulation is perpendicular to the motion of the recording medium and parallel to the surface of the recording medium.

lattice. In navigation, a pattern of identifiable intersecting lines of position laid down in fixed positions with respect to the transmitters that establish it.

network. A network composed of four impedance branches connected in series to form a closed circuit, two nonadjacent junction points serving as input terminals, while the remaining two junction points serve as output terminals.

-wound coils. Coils in which the windings are criss-crossed.

launching. Transferring energy from a coaxial cable or waveguide to a surface wave transmission line.

law of

electric charges. Like charges repel each other; unlike charges attract each other.

magnetism. Like poles repel, unlike poles attract.

position. The relationship that exists between the focal length and the distances of object and image from an optical lens:

$$\frac{1}{P} + \frac{1}{Q} = \frac{1}{f},$$

where P = distance from lens to object,
Q = distance from lens to image, and

f = focal length of lens.

reflection. The angle of reflection is equal to the angle of incidence, both measured from the normal to the surface.

layer

-bull battery. A battery in which flat, waferlike cells are laid one on top of the other, eliminating waste space.

windings. A coil-winding method in which adjacent turns are laid side by side along the length of the coil form, then succeeding turns are placed over the first layer in the same side-by-side manner.

layout. A diagram indicating the placement of parts on a panel or chassis.

LC

product. Inductance multiplied by capacitance.

ratio. Inductance divided by capacitance.

L-display. In radar, a display in which a target appears as two horizontal blips, one extending to the right and one to the left, from a central vertical time base. When the radar antenna is aligned in azimuth at the target, both blips are of equal amplitude. When not correctly pointed, the relative blip amplitude indicates the pointing error. The position of the signal along the baseline indicates target distance. The display may be rotated 90 degrees when used for elevation instead of azimuth aiming.

lead. 1. Any connecting wire, such as a battery lead, a test lead, etc. 2. The opposite of lag. When two alternating quantities have the same frequency but do not pass through corresponding values at the same instant, the one which reaches a particular point in a cycle first is said to lead the other. 3. A soft gray metal used in storage batteries, solder, and for shielding cables.

cell. The common storage battery cell that uses plates of lead compounds for the positive and negative electrodes.

screw. In recording, the threaded rod that leads the cutter or reproducer across the surface of the disc.

-in. The portion of an antenna system that connects the main part of an antenna to the input of a receiver or to the disconnecting switches or instruments of a transmitter or its tuning house.

-in-groove. The unmodulated spiral groove at the beginning of a disc recording. This groove leads the stylus into the recorded grooves.

-in insulator. A porcelain tube inserted in a hole drilled through an outer wall

or window frame of a house through which the lead-in wire of the antenna is run.

-in spiral. See lead-in-groove.

-out groove. (throw-out spiral) In disc recording, a blank spiral groove at the end of a recording generally of a pitch that is much greater than that of the recorded grooves and which is connected to either the locked or eccentric groove.

-over groove. (crossover spiral) In disc recording, a groove cut between recordings of small durations which enables the pickup stylus to travel from one cut to the next.

leader and timing tape. Special, tough, nonmagnetic tape which can be spliced to either end of a tape to prevent damage or breaking off of the magnetic tape ends and possible loss of part of the recorded material.

leader cable. A navigational aid in which the path to be followed is defined by a magnetic field around a cable.

leading

blacks. A term describing a TV picture condition in which the edge preceding a white object is over shaded toward black. The object appears to have a preceding or leading black border.

whites. A term describing a TV picture condition in which the edge preceding a black object is shaded toward white. The object appears to have a preceding or leading white border.

leakage. Undesirable flow of current through or over the surface of an insulating material. Also, magnetic flux that takes a short-cut path so that it does no useful work. Also, the escape of a portion of an electromagnetic field along an undesired path.

current. A current flowing between two or more electrodes of a tube by any path other than that through space.

flux. The portion of the total magnetic flux that does not link with all the turns of wire in a coil or transformer.

inductance. The difference between the total inductance of a transformer winding and that used in transferring energy from one winding to another.

power. (TR and pre-TR tubes) The radio-frequency power transmitted through a fired tube.

radiation. Radiation from anything other than the intended radiating system.

reactance. Opposition to alternating current offered by the leakage inductance of a transformer.

resistance. The resistance of a path taken by leakage currents.

leaky. Having an abnormal resistance path so that undesired current flows.

Lecher

frame. An insulated support along which Lecher wires are stretched.

oscillator. A device for producing a system of standing waves along two parallel wires called Lecher wires used in measuring frequencies above 28 mc.

wires. Parallel wires coupled to a transmitter or receiver for measuring wavelength. The parallel wires form a transmission line along which standing waves appear. The wavelength is equal to twice the distance between any two consecutive current nodes.

Lectanche cell. A primary cell having a carbon positive electrode and a zinc negative electrode in an electrolyte of sal ammoniac and a depolarizer. The common dry cell.

left-handed elliptically polarized

wave. An elliptically polarized wave in which the rotation of the direction of displacement is counterclockwise for an observer looking in the direction the wave is travelling.

left-hand taper. Concentration of the resistance toward the clockwise end of the range of a potentiometer or rheostat, held with the shaft pointing toward the observer.

leg. The part or parts of a filter or an attenuator that form a parallel branch across the circuit.

lens. A transparent object, usually glass, having one or more curved surfaces designed to change the direction of rays of light. Also, a device for focusing radio waves. Also, an electric or magnetic field used to focus the electron stream in a cathode ray tube.

disc. A mechanical television scanning disc in which each opening is fitted with a lens for the purpose of securing greater brilliancy or light concentration.

speed. A measure of the amount of light a lens will pass, equal to focal length divided by diameter.

turret. A rotating lens mount on a television camera, to which are attached several lenses. It is used for rapidly switching lenses.

Lenz's law. The current induced in a circuit as a result of its motion in a magnetic field is in such a direction as to exert a mechanical force opposing the motion. Also called law of induced current.

level. 1. Signal amplitude measured in accordance with specified techniques. 2. A specified position on an amplitude scale applied to a signal waveform. 3. In charge-storage tubes, a charge value which can be stored in a given storage element and distinguished in the output from other charge values. 4. As applied to a stepping relay, the term level is used to denote one bank or series of contacts.

above threshold. (sensation level). Of a sound, the pressure level of the sound in decibels above its threshold of audibility for the individual observer.

indicator. A volume indicator.

light. Electromagnetic radiations having wavelengths between 4000 and 7000 angstrom units and, therefore, visible to the eye.

beam pickup. A phonograph pickup in which a beam of light is a coupling element of the transducer.

carrier injection. The method of introducing the carrier by periodic variation of the scanner light beam, the average amplitude of which is varied by the density changes of the subject copy.

chopper. A mechanical device for interrupting a light beam.

flux. The total amount of light produced by a source, usually measured in lumens. Sometimes used to describe invisible radiations such as infrared and ultraviolet rays.

microsecond. The distance a light wave travels in free space in one-millionth of a second. See electrical distance.

modulation. Variation in the intensity of light, usually at audio frequencies, for communications or movie soundtrack purposes.

modulator. The combination of a source of light, an appropriate optical system, and a means for varying the resultant light beam (such as galvanometer or light valve), so that a sound track may be produced.

ray. The direction or path of propagation of light, represented by a straight line.

relay. A photoelectric device in which a change in light intensity opens or closes a relay.

-sensitive cell. A device whose electrical characteristics are changed when the amount of light falling on it is changed.

valve. A device whose light transmission can be made to vary in accordance with an externally applied electrical quantity such as voltage, current, electric field, or an electron beam.

velocity. All electromagnetic radiations, including those of light, travel in space (in a vacuum) with the same

velocity, approximately 186,000 miles per second or 300,000,000 meters per second.

lighthouse tube. (So called from its supposed resemblance to the shape of a lighthouse.) A sealed-disc triode in which the grid is a flat wire mesh separated from flat cathode and plate surfaces by only a few thousandths of an inch. Transit time is reduced, permitting use at ultrahigh frequencies.

lightning

arrester. A protective device used to sidetrack lightning that strikes a receiving or transmitting antenna directly to ground.

switch. A switch with large current-carrying capacity used to connect an antenna to ground for lightning protection when the antenna is not in use.

limit bridge. A Wheatstone bridge used for testing resistors. Conformity within tolerances, rather than exact resistance, is determined.

limited

signal. In radar, a signal that is intentionally limited in amplitude by the dynamic range of the system.

stability. A property of a system characterized by stability when the input signal falls within a particular range and by instability when the signal falls outside this range.

limiter. A transducer whose output is constant for all inputs above a critical value. Note: A limiter may be used to remove amplitude modulation while transmitting angle modulation.

limiting. The action performed upon a signal by a limiter.

line. 1. One horizontal scan of the electron beam. 2. A transmission or power line.

-balance converter. A quarter-wave shield used at the end of a coaxial transmission line to raise the impedance of the outer conductor to permit connecting to a balanced transmission line. A bazooka.

cord. A two-wire cable terminating in a two-prong plug, used for making connection to an ac or dc wall outlet.

drop. The voltage drop between two points on a power line or transmission line, due to the resistance, reactance, or leakage of the line.

equalizer. A part or parts inserted in a transmission line to correct the frequency-response characteristic of the line.

filter. A device containing one or more

choke coils and capacitors, inserted between the line cord plug and the power line to block noise signals.

flyback. In a television system, the right-to-left return motion of the electron beam from the end of one line to the beginning of the next. Also called horizontal flyback or horizontal retrace.

frequency. The number of horizontal scans per second, nominally 15,750 times per second.

impedance. The impedance measured across the terminals of a transmission line.

interlacing. In television, a system of picture scanning in which odd-numbered lines are scanned as one field, and even-numbered lines are scanned as another field.

noise. Disturbing electrical pulses originating in a transmission line.

-of-sight distance. Straight-line distance from station to horizon. The transmitting range, under normal conditions, of high-frequency stations such as television, FM, and radar.

-scanning frequency. The number of lines scanned each second, equal to the number of scanning lines per frame, multiplied by the frame frequency.

-stabilized oscillator. An oscillator in which a section of transmission line is used as a sharply selective frequency-controlling element.

stretcher. A section of waveguide whose physical length is variable.

-synchronizing pulse. In television, the pulse added to the video signal for the purpose of controlling the horizontal sweep oscillator in the receiver.

voltage. The voltage existing at a wall outlet or other terminals of a power line system. In most of the United States, between 110 and 120 volts.

-voltage regulator. A device that delivers an essentially constant voltage to the load, regardless of minor variations in the input voltage.

linear. A linear relationship exists between two quantities when the change in one quantity is exactly proportional to the change in the other quantity.

amplification. Amplification over a straight portion of the characteristic curve.

amplifier. A stage operated over the straight portion of its characteristic curve. Specifically, a transmitter stage used to amplify the modulated wave.

control. A volume or tone control having uniform distribution of resistance along each unit length of the resistance element.

detection. Detection in which the audio-frequency output is directly propor-

tional to the radio-frequency input for all normal signals.

distortion. Distortion independent of the amplitude of voltage or current involved.

power amplifier. A power amplifier in which the signal output voltage is directly proportional to the signal input voltage.

rectification. Rectification in which the rectified current or voltage is proportional to the amplitude of the input wave over a wide range of input amplitudes.

transducer. A transducer for which the pertinent measures of all the waves concerned are linearly related.

varying-parameter network. A linear network in which one or more parameters vary with time.

linearity. 1. A relationship existing between two quantities when the change in one quantity is exactly and directly proportional to the change in the other quantity. 2. In television, the uniform distribution of picture elements along a line or over the total area of the image.

control. In television, a control whose adjustment makes the sweep more linear.

region. In an instrument approach and similar guidance system, that region in which the deviation sensitivity remains within specified values.

linearly polarized wave. A transverse wave in which the displacement has a constant direction at a point in space.

lines of force. Imaginary lines used to designate directions in which electric or magnetic forces act in space.

link. 1. The fusible and replaceable part used in some types of cartridge fuses. 2. A closed circuit containing one or more coils used to couple radio-frequency circuits. 3. A flat strip serving as a removable connector between two terminal screws. 4. A transmitter-receiver system connecting two locations.

coupling. The coupling of two circuits by a closed loop consisting of a few turns of wire coupled to an inductance in each circuit, and connected together by a pair of wires or a low-impedance concentric line.

linkage. Coupling together by lines of force that pass through both parts.

lip microphone. A microphone which is adapted for use in contact with the lip.

Lissajous patterns. Patterns obtained when alternating voltages of various

amplitude ratios, frequency ratios, and phase differences are plotted, mechanically traced, or applied to both pairs of deflecting plates in a cathode ray tube.

Litz wire. A special stranded wire made so that every strand is on the surface for the same distance. Used to reduce the tendency of high-frequency currents to flow near the surface of a conductor rather than through the center.

live. Having a voltage; energized.

end. The part of a radio studio that gives the greatest reflection of sound.

room. A room which is characterized by an unusually small amount of sound absorption.

L network. A network composed of two branches in series, the free ends being connected to one pair of terminals and the junction point and one free end being connected to another pair of terminals.

load. 1. The part or combination of parts into which power is fed to accomplish a desired result. 2. The amount of power taken from a circuit.

circuit efficiency. (Induction and dielectric heating usage) The ratio of the power absorbed by the load to the power delivered at the generator output terminals.

coil. (Induction heating usage) An electric conductor which, when energized with alternating current, is adapted to deliver energy by induction to a charge to be heated.

impedance. The impedance presented by the load to a transducer.

impedance diagram. (oscillators) A chart showing performance of the oscillator with respect to variations in the load impedance. Ordinarily, contours of constant power and of constant frequency are drawn on a chart whose coordinates are the components of either the complex load impedance or of the reflection coefficient.

leads. (Induction and dielectric heating usage) The connections or transmission line between the power source or generator and load, load coil or applicator.

line. A line drawn on transducer transfer curves to show what the operating conditions will be for a particular load in the output circuit.

matching. (Induction and dielectric heating usage) The process of adjustment of the load circuit impedance to produce the desired energy transfer from the power source to the load.

matching network. (Induction and dielectric heating usage) An electric network for accomplishing load matching.

matching switch. (Induction and di-

electric heating usage) A switch in the load matching network to alter its characteristics.

switch. (load contactor) The switch or contactor in an induction heating circuit which connects the high-frequency generator or power source to the heater coil or load circuit.

transfer switch. A switch to connect a generator or power source optionally to one or another load circuit.

loaded

antenna. An antenna with extra inductance or capacitance in series to increase its electrical length.

applicator impedance. (dielectric heating usage) The complex impedance measured at the point of application with the load material at the proper position for heating, at a specified frequency.

impedance. Of a transducer, the impedance at the output of the transducer when the output is connected to its normal load.

Q. The Q of a resonant circuit when an external load is coupled to the circuit.

loading. Most commonly used to designate the introduction of inductors in a transmission line. See carrier loading.

coil. A coil inserted in a circuit to increase its inductance but not to provide coupling with any other circuit.

lobe. One of the loops in the radiation pattern of an antenna.

switching. Changing the direction in which one or more of the antenna lobes point.

local

control. Radio-transmitter control in which the control functions are performed directly at the transmitter.

oscillator. An oscillator whose output is mixed with a wave for frequency conversion.

oscillator tube. An electron tube in a heterodyne conversion transducer to provide the local heterodyning frequency for a mixer tube.

localizer. A radio facility which provides signals for use in lateral guidance of aircraft with respect to a runway centerline.

locked groove. A blank, endless groove at the end of modulated grooves on a record, to prevent further travel of the phonograph needle. This groove is off-center on most modern phonograph records, to provide an in-and-out motion for actuating the tripping mechanism of an automatic record changer, in which case it is more generally called the eccentric groove.

lock-in. A term describing the condition that exists when a sweep oscillator is in synchronism with the applied sync pulses. Also, a loctal tube.

locking relay. A relay that locks into position when its coil is energized momentarily, thus eliminating the need of continual coil energization. A latching relay.

loctal tube. A tube with an 8-pin base that is locked into its socket by a groove on the centering key into which a spring ring in the socket fits. Also called a lock-in or loktal tube.

lodar. A direction finder with which the direction of arrival of loran signals is determined free of night effect by observing the separately distinguishable ground and skywave loran signals on a cathode ray oscilloscope and positioning a loop antenna so as to obtain a null indication of the component selected to be most suitable.

log. A list of radio stations. A record of stations with which a radio transmitter has been in communication; radio operators are required by law to keep this log. A detailed record describing the program being broadcast each minute of the operating day by a broadcast station. A record of the meter reading required by law to be taken at regular intervals in a broadcast transmitter and in certain other types of transmitters. Also, abbreviation for logarithm.

log⁻¹. Antilogarithm. To be read, "A number whose log is '-1'."

log_e. Logarithm of a number to the base e, which is 2.718 in the natural system of logarithms.

log₁₀. Logarithm of a number to the base 10, which is the common logarithm of a number.

logarithm. The common logarithm of a quantity is the exponent of the power to which the number 10 (the base of the common system of logarithms) must be raised in order to equal the quantity. Thus, 4 is the logarithm of 10,000 (log 10,000 = 4) because 10⁴ is equal to 10,000. In the natural system of logarithms, the base is 2.718, which is designated by the Greek letter ϵ .

logarithmic

horn. A horn whose diameter varies with

its length according to a logarithmic law.

scale. A scale for graphs, on which distances from zero of the scale are proportional to the logarithms of the numbers with which these points on the scale are labeled.

logger. An instrument which automatically scans conditions (temperature, pressure, humidity) and records or logs findings on a chart. Can come equipped with lights or alarms to signal danger points.

logging. Making a record of the exact dial setting at which a station is received, or making a written record of any other essential data.

logic. 1. A reasonable analysis of the procedures followed in solving a problem.
2. See logical design.

logical

design. 1. The planning of a computer or data-processing system prior to its detailed engineering design. 2. The synthesizing of a network of logical elements to perform a specified function. 3. The result of 1 and 2 above, frequently called the logic of the system, machine, or network.

diagram. In logical design, a diagram representing the logical elements and their interconnections without necessarily expressing construction or engineering details.

element. In a computer or data-processing system, the smallest building blocks which can be represented by operators in an appropriate system of symbolic logic. Typical logical elements are the and-gate and the flip-flop, which can be represented as operators in a suitable symbolic logic.

operation. 1. Any nonarithmetical operation. Examples are: Extract, logical (bit-wise) multiplication, jump, data transfer, etc. 2. Sometimes, only those nonarithmetical operations which are expressible bit-wise in terms of the propositional calculus or a two-valued Boolean algebra.

symbol. A symbol used to represent a logical element graphically.

long

distance navigation aid. A navigational aid usable at distances beyond the radio line of sight.

playing. Refers to a transcription or record having substantially longer playing time by reason of more lines per inch. See LP records.

waves. Wavelengths longer than the longest broadcast band wavelength of

545 meters. Long waves correspond to frequencies between about 15 kilocycles and 550 kilocycles.

-wire antenna. An antenna whose length is an integral multiple of a half-wavelength. A harmonic antenna.

longitudinal

current. The current which flows in the same direction in the two wires of a pair using the earth as its return path.

magnetization. In magnetic recording, magnetization of the recording medium in a direction essentially parallel to the line of travel.

waves. Sound, pressure and some seismic waves, transmitted through a material medium in which the individual particles of the medium move back and forth in the direction in which the wave progresses. The medium undergoes condensations and rarefactions. Radio waves are not longitudinal, but transverse.

loop. 1. A closed circuit or path. 2. On a graph, the plot of a variable that forms a hump or closed curved pattern. 3. Another name for antinode.

actuating signal. The signal derived by mixing the loop input signal and the loop feedback signal.

antenna. An antenna consisting of one or more complete turns of wire.

difference signal. The output signal from a summing point of a feedback control loop produced by a particular loop input signal applied to that summing point. Note: The loop difference signal is a specific type of loop actuating signal.

error. The desired value minus the actual value of the loop output signal.

error signal. The loop actuating signal in those cases in which it is the loop error.

feedback signal. The signal derived as a function of the loop output signal and fed back to the mixing point for control purposes.

gain. The total usable power gain of a carrier terminal or two-wire repeater. The usable gain of any "closed" system may be less than the sum of the enclosed amplifier gains because of the propensity of the system to oscillate or "sing." The maximum usable gain is determined by and may not exceed the losses in the closed path.

input signal. An external signal applied to a feedback control loop.

output signal. The controlled signal applied to a feedback control loop.

return signal. The signal returned via a feedback control loop to a summing point, in response to a loop input signal applied to that summing point, and sub-

tracting from the loop input signal. Note: The loop return signal is a specific type of loop input signal.

loose coupling. Sometimes referred to as insufficient coupling. A relatively low value of inductive coupling between two circuits, so that only a small part of the magnetic flux of one circuit links with the other circuit. Loose coupling is defined by a value of K of less than 0.1 where K is the coefficient of coupling and varies between zero and 1.

lorad. See lodar.

loran. (Coined from LONG RANGE Navigation) A navigational system which enables the operator to determine direction and position by measuring the time that elapses between the arrival of signals emitted by special fixed transmitting stations. The accuracy of the location depends on the distance from, and the direction of the fixed stations, and on other circumstances. It compares well on the whole with that of positions determined by astronomical observations. In operation, a loran position line is obtained by a time-difference measurement, and the point of intersection of the two position lines gives the position of the receiving station.

loss. 1. Energy dissipated without accomplishing useful work. 2. (transmission loss). General term used to denote a decrease in signal power in transmission from one point to another as opposed to transmission gain. Loss is usually expressed in decibels.

loudness. The intensity of an auditory impression on a scale extending from soft to loud. Note: Loudness is dependant upon the amplitude or intensity, frequency and waveform of the sound.

contours. Curves which show the related values of sound pressure level and frequency required to produce a given loudness sensation for the typical listener.

control. A frequency-compensated volume control. Such controls vary the frequency response of an amplifier when the volume level is changed. This control compensates for the change in frequency response of the human ear at different levels of sound intensity.

level. In phons, of a sound, numerically equal to the sound pressure level in decibels, relative to 0.0002 microbar, of a simple tone of frequency 1,000 cps which is judged by the listeners to be equivalent in loudness.

loudspeaker. (speaker) (loud speaker) An electroacoustic transducer usually intended to radiate acoustic power effectively at a distance in air. Note: The term "speaker" should be avoided where there is risk of ambiguity.

system. A combination of one or more loudspeakers and all associated baffles, horns, and dividing networks arranged to work together as a coupling means between the driving electric circuit and the acoustic medium.

voice coil. The moving coil of a moving coil loudspeaker.

louver. A loudspeaker grille construction in which sloping slats of a cabinet hide the loudspeaker yet allow sound waves to emerge unhindered. Also, a similar construction for ventilating or decorative purposes. Sometimes spelled louvre.

low

-capacitance contacts. A type of contact construction providing low intercontact capacitance.

-frequency induction heater or furnace. A device for inducing current flow of commercial power line frequency in a charge to be heated.

-frequency padder. In a superheterodyne receiver, a semi-adjustable capacitor placed in series with the oscillator tuning circuit to adjust the calibration of the circuit at the low-frequency end of the tuning range.

-level modulation. Modulation at a point in a transmitter where the power level is low compared to that at the output of the transmitter.

-loss construction. The use of materials or the manner of constructing parts so that there is a minimum of loss.

-pass filter. A filter network designed to pass all frequencies below a cut-off frequency value, while attenuating or rejecting higher frequencies.

tension. Low voltage.

-velocity scanning. The scanning of a target with electrons of velocity less than the minimum velocity to give a secondary-emission ratio of unity.

lower sideband. The lower of two frequencies or two groups of frequencies produced by an amplitude-modulation process. See sidebands.

lowest useful high frequency. The lowest high frequency effective at a specified time for ionospheric propagation of radio waves between two specified points. Note: This is determined by factors such as absorption, transmitter power, antenna gain, receiver characteristics, type of service, and noise conditions.

L pad. An attenuation network having its elements arranged to resemble the letter L. See L network.

LP records. Long-playing records. The increased playing time is obtained by a reduction of groove pitch. The LP record, therefore, has a greater number of grooves per inch than the standard record. A typical value for a standard disc is 100 grooves per inch, while an LP record may have from 225 to 300 grooves per inch. The grooves of an LP record are only about one-third as wide as those of a standard record and are known as microgrooves. LP records are made of vinylite and, therefore, have an extremely low noise level.

lug. A small strip of metal used as a terminal to provide a convenient means for making a soldered connection.

lumen. A unit of light flux. A light source of one candlepower emits 12.56 lumens of light.

luminance. The luminous intensity of any surface in a given direction per unit of projected area of the surface as viewed from that direction.

signal. A signal wave which is intended to have exclusive control of the luminance of the picture.

luminescence. Radiation of light by an object that has previously been exposed to strong light. Emission of light not directly due to heat.

luminosity. Ratio of luminous flux to the corresponding radiant flux at a particular wavelength. It is expressed in lumens per watt.

luminous

flux. The time rate of flow of light.

intensity. (In any direction) The ratio of the luminous flux emitted by a source or by an element of a source, in an infinitesimal solid angle containing this direction, to the solid angle.

sensitivity. (of a phototube) The quotient of output current by incident luminous flux at constant electrode voltages. Note 1: The term "output current" as used here does not include the dark current. Note 2: Since luminous sensitivity is not an absolute characteristic but depends on the spectral distribution of the incident flux, the term is commonly used to designate the sensitivity to light from a tungsten-filament lamp operating at a color temperature of 2870° K.

lumped

capacitance. Capacity concentrated in

a component, as distinguished from stray or distributed capacity.

constant. A single constant, equivalent electrically to all the distributed constants of that type that exist in a circuit.

impedance. Impedance concentrated in a component, as distinguished from stray or distributed effects.

inductance. Inductance concentrated in a component, as distinguished from stray or distributed inductance.

resistance. Resistance concentrated in a component, as distinguished from stray or distributed resistance.

M

mach number. The ratio of the speed of an object to the speed of sound in the undisturbed medium in which the object is traveling. Mach 1 is approximately equal to 760 mph at sea level.

magenta. Purple, complementary to the green primary.

magic

eye. See electron-ray tuning indicator.

magnal base. An 11-pin base used for cathode ray tubes.

magnesium copper-sulphide rectifier.

A dry-disc rectifier consisting of magnesium in contact with copper sulphide.

magnet. A substance or device that attracts other pieces of magnetic material and attracts or repels other magnets. A permanent magnet has this property indefinitely; an electromagnet only when current is flowing through its coil.

wire. Insulated copper wire in sizes commonly used for winding coils in electromagnetic devices.

magnetic. Pertaining to a magnetized substance, or to a substance capable of being magnetized.

air gap. A magnetic air gap is the non-magnetic portion of a magnetic circuit.

amplifier. A voltage amplifying device utilizing the unique magnetic properties of a transformer that can be saturated by the flow of current. No vacuum tubes are employed. Commonly used in motor-speed control systems.

armature loudspeaker. (magnetic loudspeaker) A loudspeaker comprising a ferromagnetic armature actuated by forces of magnetic attraction.

biasing. The simultaneous conditioning magnetic recording medium during re-

- cording by superimposing an additional magnetic field upon the signal magnetic field.
- cartridge.** A case or shell containing an electromagnetic device used in a phonograph pickup for converting mechanical movement of the needle into electric energy.
- circuit.** A complete path for magnetic lines of force.
- contactor.** A magnetically actuated device for opening or closing an electric power circuit.
- core storage.** Storage by magnetizing the iron core in one direction to represent a 1, and in the opposite direction to represent a 0.
- cutter.** A cutter in which the mechanical displacements of the recording stylus are produced by the action of magnetic fields.
- cycle.** One complete round of changes in the magnetization of an object, corresponding to one cycle of the alternating current producing the magnetization.
- damping.** Reduction or elimination of oscillation or vibration by the opposing force produced by eddy currents.
- deflection.** A method of bending the electron stream in a cathode ray tube by means of the magnetic field produced by coils placed around the tube.
- density.** The number of magnetic lines of force per unit cross-sectional area.
- field.** The space around a permanent magnet or a current-carrying conductor or coil where magnetic flux exists.
- field intensity.** Magnetizing force or magnetic force.
- figure.** A pattern showing the distribution of a magnetic field, made by sprinkling iron filings on a nonmagnetic surface in the field.
- flux.** Magnetic lines of force.
- flux density.** The number of magnetic lines of force per square unit of area.
- focusing.** A method of focusing an electron beam by the action of a magnetic field.
- freezing.** The sticking of a relay armature to the core, after de-energization, due to the residual magnetism of the core.
- head.** In magnetic recording, a magnetic head is a transducer for converting electric variations into magnetic variations for storage on magnetic media, for reconverting energy so stored into electric energy or for erasing such stored energy.
- keeper.** A bar of soft iron placed across the poles of a permanent horseshoe magnet to complete the magnetic circuit when the magnet is not in use, to prevent demagnetization.
- leakage.** Passage of magnetic flux outside of the path along which it can do useful work.
- lines of force.** Imaginary lines along which magnetic forces are acting in a magnetic field.
- microphone.** A microphone in which the output voltage depends upon variations in the reluctance of a magnetic circuit.
- oxide.** Microscopically small particles of ferric oxide dispersed in a liquid binder and coated on a tape backing. Red oxide is most common; some magnetic tapes use a dark green oxide. These oxides are magnetically "hard", that is, once magnetized, they remain magnetized permanently, unless they are demagnetized by exposure to a strong magnetic field.
- pickup.** A pickup cartridge using a magnetic field. See dynamic pickup and variable-reluctance pickup.
- plated wire.** A magnetic wire having a core of nonmagnetic material and a plated surface of ferromagnetic material.
- poles.** Regions in a magnet near which the field is concentrated.
- pole strength.** Force exerted on a metallic object by a magnetic pole, measured in unit poles. A unit pole is one that repels a similar pole at a distance of one centimeter with a force of one dyne.
- powder-coated tape.** (coated tape) A tape consisting of a coating of uniformly dispersed, powdered ferromagnetic material on a nonmagnetic base.
- powder-impregnated tape.** (impregnated tape) (dispersed magnetic powder tape) A magnetic tape which consists of magnetic particles uniformly in a nonmagnetic material.
- printing.** (magnetic transfer) (cross-talk) The permanent transfer of a recorded signal from a section of a magnetic recording medium to another section of the same or a different medium when these sections are brought into proximity.
- recorder.** Equipment incorporating an electromagnetic transducer and means for moving a ferromagnetic recording medium relative to the transducer for recording electric signals as magnetic variations in the medium. Note: The generic term "magnetic recorder" can also be applied to an instrument which has not only facilities for recording electric signals as magnetic variations, but also for converting such magnetic variations back into electric variations.
- recording.** A system of recording in which the recording signal is translated into corresponding magnetic patterns on a magnetic tape, disc or drum.
- recording head.** In magnetic record-

- ing, a magnetic head for transforming electric variations into magnetic variations for storage on magnetic media.
- recording medium.** A magnetizable material used in a magnetic recorder for retaining the magnetic variations imparted during the recording process. It may have the form of a wire, tape, cylinder, disc, and the like.
- recording reproducer.** Equipment for converting magnetic variations on magnetic recording media into electric variations.
- reproducing head.** In magnetic recording, a magnetic head for converting magnetic variations on magnetic media into electric variations.
- saturation.** A condition of a ferromagnetic material in which further increases in magnetizing force produce little increase in magnetic flux.
- sensitivity.** The amount of deflection of the electron stream in a cathode ray tube produced by a stated current through the deflection coil.
- shield.** An iron housing used with a radio part to prevent external magnetic fields from affecting the part or to prevent magnetic fields produced by the part from affecting other circuits and parts.
- storm.** A rapid and violent fluctuation in the intensity of the earth's magnetic field, disrupting radio and telegraphic communications.
- switch.** Sometimes used for relay.
- tape.** A magnetic recording medium having a width greater than approximately 10 times the thickness. This tape may be homogeneous or coated.
- tape storage.** Storage by magnetically recording on tape the digits of a number or word.
- vane meter.** An ac meter containing a metal vane pivoted inside a coil. The vane is magnetized by the coil's magnetic field with such polarity that the vane and attached pointer are caused to rotate to a position that indicates the strength of the alternating current flowing through the meter coil.
- wire.** A magnetic recording medium, approximately circular in cross section.
- magnetics.** The branch of science that deals with the laws of magnetic phenomena.
- magnetism.** The ability to attract magnetic materials and to influence moving electrons.
- magnette.** Lodestone.
- magnetization curve.** A curve showing the relation between the magnetizing force H (ampere turns or gilberts per cm) and the flux density B (lines per sq. centimeter). Also called B-H curve.
- magnetizing force.** See magnetomotive force.
- magnetomotive force.** The force that produces magnetic flux in a magnetic circuit. That which sets up and maintains a magnetic field.
- magnetostriction.** The change in the dimensions of a ferromagnetic object with change in magnetic field.
- loudspeaker.** A loudspeaker in which the mechanical displacement is derived from the deformation of a material having magnetostrictive properties.
- microphone.** A microphone which depends for its operation on the generation of an electromotive force by the deformation of a material having magnetostrictive properties.
- oscillator.** An oscillator in which the grid and plate circuits are coupled through a rod of magnetic material. The alternate expansion and contraction of the rod with changes in plate current governs the fundamental frequency of the oscillator.
- magnetostrictive.** Changing in size (dimensions) when placed in a magnetic field.
- magnetron.** An electron tube characterized by the interaction of electrons with the electric field of a circuit element in crossed steady electric and magnetic fields to produce ac power output.
- oscillator.** An oscillator using a magnetron, most generally one in which the tube contains cavities that are the circuit components.
- magnitude.** The amount or value of a quantity.
- main gap.** (glow-discharge tubes) The conduction path between a principal cathode and a principal anode.
- mains.** Ordinary power lines.
- major**
- cycle.** In a storage device which provides serial access to storage positions, the time interval between successive appearances of a given storage position.
- lobe.** The loop in the radiation pattern of an antenna that is the path of maximum radiation.
- majority**
- carrier.** The current carriers (holes or electrons) present in the greater numbers. In N-type material, electrons are the majority carriers; in P-type material, holes are the majority carriers.
- carrier contact.** (to a semiconductor)

- An electrical contact across which the ratio of majority carrier current to applied voltage is substantially independent of the polarity of the voltage while the ratio of minority carrier current to applied voltage is not independent of the polarity of the voltage.
- emitter.** (of a transistor) An electrode from which a flow of majority carriers enters the interelectrode region.
- manganin.** A metal alloy commonly used in rheostats and resistors, because it is not appreciably affected by changes in temperature.
- manipulated variable.** The quantity or condition that the controller applies to the controlled system.
- man-made static.** High-frequency noise signals produced by sparking in electrical apparatus or power lines and picked up by receivers.
- manometer.** A pressure-measuring gauge.
- mantissa.** The part of a logarithm to the right of the decimal point. It is always a decimal and always positive. Example: In $\log 461 = 2.6637$, the mantissa is .6637.
- manual tuning.** Tuning a receiver to a desired station by rotating the tuning-control knob by hand.
- Marconi antenna.** An antenna directly connected to ground or close enough to ground so that the ground plays an essential part in the radiation of energy.
- marginal**
- checking.** A preventive maintenance procedure in which certain operating conditions, e.g., supply voltage or frequency, are varied about their normal values in order to detect and locate incipient defective units. See also check.
- relay.** A relay which functions in response to predetermined changes in the value of coil current or voltage.
- testing.** Synonym for marginal checking.
- marker.** See radio marker beacon. Also, a bearing or range indication on a radar screen.
- pip.** A frequency index mark used in cathode ray oscilloscope alignment of TV sets and in conjunction with a sweep-driven signal generator. The marker pip is produced by coupling a fixed-frequency oscillator to the output of the signal generator.
- marking wave.** In telegraphic communication, the wave on which the code characters are being transmitted.
- MASER.** (microwave amplification by stimulated emission of radiation) That class of amplifiers which utilize the energy states of a molecule or atom for the generation or amplification of microwave energy.
- mask.** A plastic, metal, or wood covering used to conceal those portions of a picture tube face not being used for reproduction of the image.
- microphone.** A microphone designed for use inside an oxygen or other type of respiratory mask.
- masking.** (audio) The amount by which the threshold of audibility of a sound is raised by the presence of another (masking) sound. The unit customarily used is the decibel.
- audiogram.** A graphical presentation of the masking due to a state noise. This is plotted, in decibels, as a function of the frequency of the masked tone.
- disc.** A baffle used in an electron gun to restrict the cone of electrons to a small size to prevent spherical aberration.
- mass.** The property of a body that determines the acceleration it will have when acted upon by a given force.
- mast.** A vertical pole or structure supporting an antenna.
- master.** A metal part, normally derived from a disc recording by electroforming, which is a negative of the recording, i.e., a master which has ridges instead of grooves and thus cannot be played with a pointed stylus.
- clock.** The primary source of timing signals.
- control board.** The panel on which all the main operating controls of a broadcast studio or transmitter are located.
- drawing.** A drawing showing the dimensional limits applicable to any or all parts of a printed circuit, including the base. It is reproduced as necessary for use in preparing the master pattern.
- oscillator.** The oscillator that establishes the carrier frequency of a transmitter.
- oscillator power-amplifier.** A combination of a vacuum-tube oscillator followed by a radio-frequency amplifier stage.
- pattern.** An accurately constructed scaled pattern which is reproduced as necessary for use in producing the printed circuit within the accuracy specified in the master drawing.
- station.** The station of a synchronized

group of radio stations to which the emissions of other station or stations of the group are referred.

matched

load. A load whose impedance exactly equals the impedance of the source.

termination. (for a waveguide). A termination producing no reflected wave at any transverse section of the waveguide.

transmission line. See matched waveguide.

waveguide. A waveguide having no reflected wave at any transverse section.

matching. Connecting two circuits or parts together in such a way that their impedances are equal.

stub. Two wires or a section of transmission line of such a length that, when properly tapped, or when connected to the proper point along a transmission line, will match the impedances of the load and source.

transformer. A transformer for matching two or more impedances.

matrix. 1. A negative from which duplicate phonograph records are molded. 2. In electronic computers, any logical network whose configuration is a rectangular array of intersections of its input-output leads, with elements connected at some of these intersections. The network usually functions as an encoder or decoder. 3. A circuit for separating a group of incoming signals into another group of signals which contain specific percentage levels of each of the incoming signals.

unit. (matrix circuit). A device which performs a color co-ordinate transformation by electrical, optical, or other means.

MAVAR. (microwave amplification by variable reactance). A parametric amplifier.

maximum

available power. The power any device can deliver when its source and load impedances are matched.

rated carrier power. The greatest power at which a transmitter can be operated satisfactorily or safely.

retention time. (in charge-storage tubes). The maximum time between writing into and reading an acceptable output from a storage element.

undistorted output. (maximum useful output). For sinusoidal input, the greatest average output power into the rated load with distortion not exceeding a specified limit.

usable frequency. The upper limit of the frequencies that can be used at a

specified time for radio transmission between two points and involving propagation by reflection from the regular ionized layers of the ionosphere. Note: Higher frequencies may be transmitted by sporadic and scattered reflections.

maxwell. The unit of magnetic flux, equal to one magnetic line of force.

triangle. The equilateral-triangular form of chromaticity diagram in which the primaries are represented at the vertices of the triangle.

Mayday. The international distress call for radiotelephone communication. It is the phonetic spelling of the French "M'aider," meaning "Help me."

M-derived filter. A filter with infinite attenuation at some specific frequency, producing a sharper cut-off than can be obtained from a standard filter.

m-display. In radar, a type A-display in which target distance is determined by moving an adjustable pedestal signal along the baseline until it coincides with the horizontal position of the target signal deflection. The control which moves the pedestal is calibrated in distance.

mean

carrier frequency. The resting frequency or assigned carrier frequency of a frequency-modulation transmission system.

free path. For sound waves in an enclosure, the average distance sound travels between successive reflections in the enclosure.

pulse time. The arithmetic mean of the leading edge pulse time and the trailing edge pulse time. Note: For some purposes the importance of a pulse is that it exists (or is large enough) at a particular instant of time. For such applications the important quantity is the mean pulse time. The leading edge pulse time and trailing edge pulse time are significant primarily in that they may allow a certain tolerance in timing.

measurand. A physical quantity, property, or condition that is to be measured.

measuring means. Whatever is used to measure a condition. A thermometer is a measuring means for room temperatures.

mechanical

bandspread. The use of a vernier tuning dial to make a gang tuning capacitor rotate more slowly than is possible with the regular tuning-control

- knob, making station tuning easier in crowded short-wave bands.
- damping.** The use of rubber or plastic blocks with the moving parts of a recording cutter or reproducer to absorb undesired vibrations.
- filter.** An electromechanical device capable of sharp cutoff frequency discrimination.
- recorder.** An instrument for transforming electric or acoustical signals into mechanical motion of approximately like form and inscribing such motion in an appropriate medium by cutting or embossing.
- rectifier.** A vibrator.
- transmission system.** An assembly of elements adapted for the transmission of mechanical power.
- mega.** A decimal prefix designated by the symbol M meaning 10^6 .
- megacycle.** (mc) One million cycles per second.
- megatron.** See lighthouse tube.
- megger.** A high-range ohmmeter used for measuring leakage resistances and insulation resistances.
- megohm.** (meg) One million ohms.
- Meissner oscillator.** An oscillator in which the grid and plate circuits are inductively coupled through an independent tank circuit that determines the frequency.
- mel.** A unit of pitch. By definition, a simple tone of frequency 1,000 cps, 40 db above a listener's threshold, produces a pitch of 1,000 mels. The pitch of any sound that is judged by the listener to be n times that of the 1-mel tone is n mels.
- melting channel.** The restricted portion of the charge in a submerged resistor or horizontal ring induction furnace in which the induced currents are concentrated to effect high energy absorption and melting of the charge.
- memory.** A storage system for information in a computer or similar device that simulates the memory of a human being. See storage.
- capacity.** The maximum number of distinguishable stable states in which a memory device can exist is a measure of its capacity. It is customary to use the logarithm to the base two of that number as a numerical measure of the memory capacity. In this case, the unit of memory capacity is a binary digit.
- cycle.** The length of time allowed for information to be transferred into or from the internal memory of the computer.
- tube.** See storage tube.
- mercury.** A heavy, silver-colored metal that is liquid at ordinary room temperatures. When heated, it gives off a vapor that is highly conductive when ionized.
- barometer.** An instrument in which the pressure of the atmosphere is indicated by the height of a column of mercury.
- switch.** An electric switch made by placing a large globule of mercury in a glass tube having electrodes arranged in such a way that tilting the tube will cause the mercury to move and make or break the circuit.
- vapor tube.** A gas tube in which the active gas is mercury vapor.
- merge.** To produce a single sequence of items, ordered according to some rule (i. e., arranged in some orderly sequence), from two or more sequences previously ordered according to the same rule, without changing the items in size, structure, or total number. Merging is a special case of collation.
- meridian.** A great circle on the face of the earth, passing through both poles.
- mesh.** A set of branches forming a closed path in a network, provided that if any one branch is omitted from the set, the remaining branches of the set do not form a closed path. Note: The term "loop" is sometimes used in the sense of mesh.
- beat.** See *moiré*.
- meson.** A particle having a unit charge like an electron but a mass in between that of electrons and protons. Also called heavy electron, barytron, mesotron, penetron, X particle, etc.
- metal**
- clad base material.** A laminate which consists of metallic material bonded to one or both surfaces of an insulating base.
- detector.** An electronic device for locating metal objects.
- tube.** A vacuum tube having a metal envelope instead of a glass envelope. Electrode connections are made through glass beads fused into the top and the bottom of the metal envelope.
- metallic insulator.** A shorted quarter-wave section of a microwave transmission line that acts as an electrical insulator at the frequency for which its length is one quarter wavelength.

- metallized resistor.** A resistor made by depositing a thin film of high-resistance metal on the surface of a tube or rod made of glass or other insulating material.
- meteorograph.** An apparatus for recording simultaneously several meteorologic phenomena, such as temperature, moisture, etc.
- meter.** 1. The unit of length in the metric system. One meter is equal to 3.28 feet. 2. An instrument used for making electrical measurements. A voltmeter measures voltage; an ammeter or milliammeter measures current; a wattmeter measures power; an ohmmeter measures resistance.
- metric system.** A decimal system of measures and weights, using the meter and the gram as basic units. The system of units based on meters for length, grams for mass.
- mho.** The unit of conductance, which is the reciprocal of resistance.
- mica.** A transparent flaky mineral that splits readily into thin sheets and has excellent insulating and heat-resisting qualities, used extensively to separate the plates of capacitors, to insulate electrode elements of vacuum tubes, and for other insulating purposes in radio apparatus.
- capacitor.** A capacitor using sheets of mica as the dielectric material that insulates adjacent plates from each other.
- micro.** A decimal prefix designated by the symbol μ meaning 10^{-6} .
- microammeter.** A meter designed to measure extremely small currents.
- microampere.** (μa) A unit of current, one millionth of an ampere.
- microfarad.** (μfd) A unit of capacity, one millionth of a farad.
- microhenry.** A unit of inductance, one millionth of a henry.
- micromho.** A unit of conductance, one millionth of a mho.
- micromicro.** A prefix meaning one millionth of one millionth of. Abbreviated $\mu\mu$ or mm . The prefix pico can be used instead of micromicro.
- micromicrofarad.** ($\mu\mu\text{fd}$) A unit of capacity, one millionth of a microfarad; one picofarad.
- microphone.** An electroacoustic transducer which responds to sound waves and delivers essentially equivalent electric waves. See also telephone transmitter.
- button.** A button-shaped container filled with carbon particles. When attached to the diaphragm of a microphone, the resistance between the terminals of the button varies in accordance with movements of the diaphragm.
- cabie.** The group of wires connecting a microphone to an amplifier or mixer.
- preamplifier.** An audio amplifier that amplifies the output of a microphone so that the audio signal can be sent over a transmission line to the main amplifier.
- stand.** A table or floor stand used to support a microphone in a desired position.
- transformer.** The iron-core of transformer that couples the microphone to a microphone amplifier, to a transmission line, or to the input circuit of the main audio amplifier.
- microphonics.** Vibration of loose elements in a tube changes the characteristics and modulates its plate current. In effect, the tube acts as a microphone, hence the name microphonics. Sound from the loudspeaker may vibrate a microphonic tube, resulting in uncontrolled feedback and producing howls and squeals in the loudspeaker.
- microphonism.** (microphonics) (electron tubes) The modulation of one or more of the electrode currents resulting from the mechanical vibration of a tube element.
- microsecond.** One millionth of a second.
- microswitch.** A switch in which a very small movement of its actuating plunger suffices to change the switch from on to off or vice versa.
- microvolt.** One millionth of a volt.
- microvoltmeter.** A highly sensitive voltmeter that indicates differences of potential in microvolts.
- microvolts per meter.** A measure of radio field intensity, equal to the signal strength at the antenna in microvolts divided by the effective height of the antenna in meters.
- microwave.** A very short electromagnetic wave, having a wavelength less than one meter.
- early warning.** An early warning radar operating at a wavelength less than

- one meter; usually including a number of indicators of high resolution and having large traffic handling capacity.
- oscillator.** An oscillator that generates a frequency higher than 300 megacycles (less than one meter).
- radio communications relay.** A system of microwave repeater stations which is used to convey data over a prescribed path by successive reception and retransmission at intervals generally determined by the line-of-sight. Such a system generally has multichannel capability and may be used with voice, teletypewriter, of facsimile terminal equipment.
- television relay.** A system of microwave repeater stations used by the television networks to provide program material to broadcasters on a regional or nationwide basis.
- mil.** A unit of measurement equal to one thousandth of an inch (0.001 inch).
- foot.** A wire one foot long having a diameter of one mil.
- Miller**
- effect.** Increase in the effective grid-cathode capacitance of a vacuum tube due to the charge induced electrostatically on the grid by the plate through the grid-plate capacitance.
- integrator.** A circuit consisting of a typical RC charging network with a high-gain amplifier paralleling the charging capacitor. It provides extreme linearity of the generated sawtooth.
- milli.** A decimal prefix designated by the symbol m meaning 10^{-3}
- milliammeter.** A meter that indicates current in milliamperes.
- milliamperes.** (ma) A unit of current, one thousandth of an ampere.
- millihenry.** A unit of inductance, one thousandth of a henry.
- millimeter.** A metric unit of length, one thousandth of a meter. One millimeter is approximately equal to one twenty-fifth of an inch.
- millivolt.** A unit of voltage, one thousandth of a volt.
- millivoltmeter.** A voltmeter that indicates voltage in millivolts.
- milliwatt.** A unit of power equal to one thousandth of a watt.
- miniaturization.** The design and production of a miniature that will perform the same functions as the larger sized original.
- mini-groove.** A recording having more lines per inch than the average 78 rpm phonograph record and yet not enough lines per inch to be called "long-playing" or "microgroove".
- minimum.** Lowest, least, or smallest quantity.
- distance.** The shortest distance at which a navigational system will function within its prescribed tolerances.
- firing power.** (switching tubes) The minimum radio-frequency power required to initiate a radio-frequency discharge in the tube at a specified ignitor current.
- minitrack.** 1. A system for tracking artificial satellites by means of radio waves transmitted from the vehicle itself; several ground stations are required.
2. The track of a miniature transmitting set emitting telemeter-type signals.
- minor**
- cycle.** In a digital computer using serial transmission, the time required for the transmission of one word, including the space between words.
- lobe.** Any lobe except the major lobe in the radiation pattern of an antenna.
- minority**
- carrier.** The carriers (holes or electrons) present in fewer numbers. In N-type material, holes are the minority carriers; in P-type material, electrons are the minority carriers.
- emitter.** (of a transistor) An electrode from which a flow of minority carriers enters the interelectrode region.
- minuend.** The number from which the subtrahend is to be subtracted.
- minus sign.** A sign(-) used in mathematics to indicate subtraction or a negative value. Used in radio to indicate the negative terminal of a voltage source, or negative polarity.
- minute.** One-sixtieth part of a degree. One complete revolution of an angle-generating line is 360° , which is 360×60 or 21,600 minutes.
- mirror scale.** A scale having a mirror so located that the reflection of a knife edge is directly in line with the pointer when the eye is in the correct position to read the instrument. This is a means of avoiding parallax error.
- mismatch.** The condition in which the impedance of a source does not match or equal the impedance of the connected load.

mixed

-high frequencies. The part of the television color signal that carries the finer details (high frequencies) of the transmitted image.

highs. Those high-frequency components of the picture signal which are intended to be reproduced achromatically in a color picture.

-highs bypass. The mixed-highs signal that is shunted around the chrominance-subcarrier modulator or demodulator.

mixer. A device that permits combining the output signals of two or more signal sources in any desired proportion before these signals are fed to the input of the main af amplifier. Also called a mixer-first detector.

-first detector. The stage in a superheterodyne receiver in which the incoming modulated rf signals are combined with the local oscillator signals to produce the i-f signal.

tube. An electron tube that performs only the frequency-conversion function of the mixer-first detector when it is supplied with voltage or power from an external oscillator.

mixing. Feeding two or more signals to the same circuit.

point. In a block diagram of a feedback control loop, a symbol indicating the relationship of one output to two or more inputs, such that the value of the output at any instant is the function of the values of the inputs at that instant. Note: If a mixing device in practice contains dynamic elements, these shall be considered as transfer elements in one or more of the signal paths entering or leaving the mixing point.

mobile

receiver. A receiver designed to be operated while in motion.

relay station. A base station in which the base receiver automatically turns "on" the base station transmitter which re-transmits all signals received by the base station receiver. Used to extend the range of mobile units and requires two frequencies for operation.

station. A radio station operated from a movable location such as an automobile, fire truck, train, ship, or airplane.

systems. 1. (One way). A system consisting of a base station and mobile receivers only. Not used much now. 2. (Two way). A system consisting of a base station transmitter and base receiver with mobile transmitters and receivers. May be operated using one or two frequencies. 3. (Three way). Same as two way except provisions for

mobile to mobile operation. When used on a single frequency, a two way system automatically becomes three way; when a two way system is operated on two frequencies, an additional frequency must be included in the mobile transmitter to make it three way.

transmitter. A transmitter designed to be operated while in motion and normally so operated.

mobility. See drift mobility.

mode. A state of a vibrating system to which corresponds one of the possible resonance frequencies (or propagation constants).

filter. A selective device designed to pass energy along a waveguide in one or more modes of propagation and substantially reduce energy carried by other modes.

number. The number of whole cycles during which a mean-speed electron remains in the drift space of a reflex klystron.

of an oscillator. 1. (resonator mode).

A condition of operation corresponding to a particular field configuration for which the electron stream introduces a negative conductance into the coupled circuit. 2. (transit-time mode). A condition of operation of an oscillator corresponding to a limited range of drift-space transit angle for which the electron stream introduces a negative conductance into the coupled circuit.

of propagation. (transmission). A form of propagation of guided waves that is characterized by a particular field pattern in a plane transverse to the direction of propagation, which field pattern is independent of position along the axis of the waveguide. Note: In the case of uniconductor waveguides, the field pattern of a particular mode of propagation is also independent of frequency.

of resonance. A form of natural electromagnetic oscillation in a resonator, characterized by a particular field pattern which is invariant with time.

purity. (ATR tubes). The extent to which the tube in its mount is free from undesirable mode conversion.

separation. (in an oscillator). The frequency difference between resonator modes of oscillation.

transducer. (mode transformer). A device for transforming an electromagnetic wave from one mode of propagation to another.

transformer. See mode transducer.

modem. Contraction of the two words modulator-demodulator. The modulator and demodulator circuits of a carrier terminal are normally mounted together

on a single panel and may have common elements. For this reason the term "modem" is widely used in referring to this portion of a carrier terminal.

modified

constant-velocity recording. A disc recording technique that combines constant-amplitude and constant-velocity recording. Below a certain frequency (known as the turnover frequency) constant-amplitude recording is used. Above the turnover frequency, constant-velocity recording is employed.

index of refraction. In the troposphere, the index of refraction at any height increased by h/a , where h is the height above sea level and a is the mean geometrical radius of the earth. When the index of refraction in the troposphere is horizontally stratified, propagation over a hypothetical flat earth through an atmosphere with the modified index of refraction is substantially equivalent to propagation over a curved earth through the real atmosphere.

modular. Construction using modules.

modulate. To vary the amplitude, frequency, or phase of an oscillation; usually at a signal frequency rate.

modulated

amplifier. See modulated stage.

continuous wave. (mcw) In telegraphy, emission in which the carrier is modulated by a constant audio-frequency tone.

stage. A transmitter stage in which the frequency, phase, or amplitude of a signal to be modulated is changed in accordance with the modulating signal.

wave. A radio wave that varies either in frequency, phase, or amplitude in accordance with the waveform of the intelligence signal being transmitted.

modulating

electrode. An electrode used in a cathode-ray tube to control the beam current.

signal. (modulating wave) A wave which causes a variation of some characteristic of a carrier.

wave. See modulating signal.

modulation. The process or the result of the process in which the amplitude, frequency, or phase of a wave is varied with time in accordance with a wave.

capability. The maximum percentage modulation that is possible without objectionable distortion.

distortion. Distortion of a waveform due to a greater plate-current change on one half-cycle than on the other half-cycle.

envelope. A curve drawn through the peaks of a graph showing the waveform of a modulated rf carrier signal.

factor. The ratio of the maximum amplitude of the modulation envelope to the amplitude of the unmodulated carrier. Multiplying this factor by 100 gives the percentage of modulation. Same term used in FM.

grid. An electrode used between the cathode and focusing electrodes in a cathode-ray tube to control the amount of emission and thereby the brilliance of the spot.

index. 1. A measure of the degree of modulation for any type of modulation. 2. In frequency modulation with a sinusoidal modulating wave, the ratio of the frequency deviation to the frequency of the modulating wave.

monitor. An instrument used to provide a continuous indication of the modulation percentage at a transmitter.

noise. (noise behind the signal) The noise caused by the signal. The signal is not to be included as part of the noise. Note: The term is used where the noise level is a function of the strength of the signal.

percentage. The ratio of a modulating voltage to carrier voltage, expressed in percent.

modulator. A transmitter stage that supplies the modulating signal.

module. A one-package assembly of functionally associated parts so arranged as to be mounted together to function as a system or subsystem.

moiré. A wavy or satiny effect produced by convergence of lines. Usually appears as a curving of the lines in the horizontal wedges of the test pattern and is most pronounced near the center where the lines forming the wedges converge. A moiré pattern is a natural optical effect when converging lines in the picture are nearly parallel to the scanning lines. This effect to a degree is sometimes due to the characteristics of color picture tubes and of image-orthicon pickup tubes (in the latter, termed "mesh beat").

mold. In disc recording, a mold is a metal part derived from a master by electroforming which is a positive of the recording, i.e., it has grooves similar to a recording and thus can be played in a manner similar to a record.

molded capacitor. A capacitor cast in bakelite or other insulating material to keep out dust and moisture.

molecular theory of magnetism. The

theory that treats each molecule of matter as a complete permanent magnet. When a piece of material is magnetized, all the molecular magnets line up with like poles pointing in the same direction.

molecule. The smallest piece into which a substance can be broken without losing its chemical properties.

molybdenum. A metallic element of the chromium group used in the manufacture of tubes.

monitor. An instrument to measure continuously or at intervals a condition that must be kept within prescribed limits.

oscilloscope. An oscilloscope whose time base is permanently set at line or frame frequency, or a sub-multiple of either, for continuous indication of the video voltages of a transmission.

panel. A group of controls used to govern the level of sound signals from a studio, or of television video signals.

monitoring. The act of listening to or observing a program either during rehearsals or actual broadcasts, to check quality and set the levels for proper sound or visual effects.

monkey chatter. Garbled speech or music heard along with a program, occurring when the side frequencies of an adjacent-channel station beat with the desired station signal.

monochromatic. Of or pertaining to one color only.

monochrome

signal. 1. In monochrome television, a signal wave for controlling the luminance values in the picture. 2. In color television, that part of the signal wave which has major control of the luminance values of the picture, whether displayed in color or in monochrome.

signal bypass. A monochrome signal that is shunted around the chrominance-subcarrier modulator or demodulator.

transmission. In television, the transmission of a signal wave for controlling the luminance values in the picture, but not the chromaticity values.

monoscope. A signal-generating, electron-beam tube in which a picture signal is produced by scanning an electrode, parts of which have different secondary-emission characteristics.

monostable multivibrator. A multivi-

brator with one stable state and one quasi-stable state. The circuit requires an external trigger to perform one cycle.

monotron. A monoscope.

Morse Code. A system of dot and dash signals used in the transmission of messages by radio or wire telegraphy. The International Morse Code is used universally for radiotelegraphy, and the American Morse Code is used only for wire telegraphy in the United States.

Morse sounder. A telegraph receiving instrument that produces an audible sound at the beginning and end of each dot and dash. From these sounds a trained operator can read the message.

mosaic. The light-sensitive surface of an iconoscope, consisting of millions of tiny silver globules on a sheet of ruby mica, each globule treated with caesium vapor to make it photosensitive.

mother. A positive recording produced directly from the metal master or negative.

motional impedance. (loaded motional impedance) Of a transducer, the complex remainder after the blocked impedance has been subtracted from the loaded impedance.

motion-picture pickup. Use of a television camera to pick up scenes directly from motion-picture film.

motor. A machine that converts electrical energy into mechanical energy. It consists essentially of a large number of conductors mounted on an armature that rotates in a magnetic field.

board. Also called tape transport mechanism. The platform or assembly of a tape recorder on which the motor (or motors), the reels, the heads and the controls are mounted. It includes those parts of the recorder other than the amplifier, preamplifier, loudspeaker and case.

-driven relay. A relay which is actuated by the rotation of the shaft of some type of motor, for example, a shaded-pole, induction-disc, or hysteresis motor.

effect. The repulsion force exerted between adjacent conductors carrying currents in opposite directions.

-field control. A method of controlling the speed of a motor by means of a change in the magnitude of the field current.

field induction heater. An induction heater in which the inducing winding

typifies that of an induction motor of rotary or linear design.

-generator. An electric motor directly connected to one or more generators for the purpose of converting one voltage to another voltage or frequency.

reduction unit. A motor with an integral mechanical means of obtaining a speed differing from the speed of the motor.

motorboating. Regeneration occurring at a low audio frequency in a radio receiver or audio amplifier, resulting in putt-putt-putt sounds resembling those made by a motorboat.

mount. (switching tubes) The flange or other means by which the tube or tubes and cavity are connected to a waveguide.

mouth. The large end of a horn loudspeaker.

moving

-coil instrument. Any instrument in which the moving system is a coil that carries the pointer or mirror or other indicating device.

-coil loudspeaker. A loudspeaker in which the mechanical forces acting on the diaphragm are produced by interaction between the magnetic field of the moving conductors (voice coil) and the steady applied magnetic field produced by a field coil or permanent magnet.

-coil meter. See moving-coil instrument.

-coil microphone. (dynamic microphone) A moving-conductor loudspeaker in which the movable conductor is in the form of a coil.

-coil pickup. (dynamic reproducer) A phonograph pickup, the electric output of which results from the motion of a conductor or coil in a magnetic field.

-conductor loudspeaker. A loudspeaker in which the mechanical forces result from magnetic reactions between the field of the current in a moving conductor and a steady magnetic field.

target indicator. (MTI) A device which limits the display of radar information primarily to moving targets.

mu factor. The ratio of the change in one electrode voltage to the change in another electrode voltage when the current and all other electrode voltages are maintained constant. For example, the amplification factor.

Muller tube. A thermionic vacuum tube having an auxiliary cathode or grid connected to the main cathode internally through a high-value resistor.

multi-band antenna. An antenna that can

be used with satisfactory results on a number of frequency bands.

multicavity magnetron. A magnetron in which the circuit includes a plurality of cavities.

multi-channel transmitter. A transmitter having two or more complete radio-frequency sections capable of operating on different frequencies either individually or simultaneously.

multielectrode tube. An electron tube containing more than three electrodes associated with a single electron stream.

multi-frequency transmitter. A radio transmitter capable of operating on two or more selectable frequencies, one at a time, using preset adjustments.

multigrid tube. A vacuum tube having more than one grid electrode.

multimeter. A test instrument having provisions for measuring voltages, current, and resistance.

multipath. See multipath transmission.

reception. The reception of a direct wave from the transmitter accompanied by one or more reflected waves. See ghost and echo.

transmission. (multipath). The propagation phenomenon which results in signals reaching the radio receiving antenna by two or more paths. Note: In facsimile, multipath causes jitter.

multiple

-address code. (instruction). An instruction in general consists of a coded representation of the operation to be performed and of one or more addresses of words in storage. The instructions of a multiple-address code contain more than one address.

-break contacts. Multiple-break contacts are contacts so arranged that, when they open, the circuit is interrupted in two or more places.

connection. The connecting of two or more devices in parallel.

-contact switch. A switch in which the movable contact can be set to any one of a number of different fixed contacts.

modulation. A succession of processes of modulation in which the modulated wave from one process becomes the modulating wave for the next.

scanning. The process of scanning an image in two or more individual fields, each containing a fraction of the total picture information. Interlaced scanning.

- spot scanning.** The method in which scanning is carried on simultaneously by two or more scanning spots, each one analyzing its fraction of the total scanned area of the subject copy.
- tube counts.** (In radiation counter tubes) Spurious counts induced by previous tube counts.
- tuned antenna.** An antenna connected to ground through tuning coils or capacitors at more than one point, so that the total of the reactance in parallel will make the antenna resonant at the desired frequency.
- unit.** (semiconductor device) A semiconductor device having two or more sets of electrodes associated with independent carrier streams. Note: It is implied that the device has two or more output functions which are independently derived from separate inputs, e.g., a duo-triode transistor.
- unit tube.** An electron tube containing within one envelope two or more groups of electrodes associated with independent electron streams.
- multiplex operation.** Simultaneous transmission of two or more messages in either or both directions over the same transmission path. Permits time-sharing of a single transmission channel by several information sources.
- radio transmission.** The simultaneous transmission of two or more signals using a common carrier wave.
- multiplicand.** The number to be multiplied by the multiplier.
- multiplication.** The process of determining by a briefer computation the result of adding any given number or quantity a certain number of times. Thus 3×4 is 4 added together 3 times, or $4 + 4 + 4$. Multiplication is indicated by the sign \times . In algebra, the multiplication sign is usually omitted between general numbers (numbers expressed by letters), or the symbol is used to denote multiplication. Examples: $I \times R$, IR , and $I.R$ all mean that I is to be multiplied by R ; $2\pi fL$ means 2 times π times f times L . In algebra, the product of two numbers having like signs is positive. The product of two numbers having unlike signs is negative.
- point.** A mixing point whose output is obtained by multiplication of its inputs.
- multiplier.** 1. The number which is to multiply another number, called the multiplicand. 2. A resistor used in series with a voltmeter to increase the range of the meter. 3. In computer work, a device which has two or more inputs and whose output is a representation of the product of the signed magnitudes represented by the input signals.
- tube.** A tube in which emitted electrons are pulled along by increasingly higher potentials and are made to strike a number of plates (called dynodes) successively. At each plate, secondary emission occurs, resulting in a high current from the last plate and giving the effect of high gain.
- multiplying amplifier.** An amplifier whose output is some desired multiple of the input.
- multipolar.** Having more than one pair of magnetic poles.
- multirange.** Capable of being used for measuring through two or more ranges.
- multisegment magnetron.** A magnetron with an anode divided into more than two segments, usually by slots parallel to its axis.
- multi-tap pressure potentiometer.** A pressure potentiometer having the resistance coil tapped at intervals to permit the shaping of the output function of the instrument.
- multitrack magnetic recording system.** A recording system which provides, on a medium such as magnetic tape, two or more recording paths which are parallel to each other, and which may carry either related or unrelated program material in common time relationship.
- multivibrator.** A relaxation oscillator consisting of two tubes connected so that energy from the plate circuits is fed to the opposite grid circuits at the proper phase to produce the desired output signal.
- Musa antenna.** A multiple unit steerable antenna consisting of a number of stationary antennas, the composite major lobe of which is electrically steerable.
- muting.** Silencing or reducing in volume.
- switch.** Device used in automatic-tuning systems to silence the audio system while stations are being selected or tuned in.
- mutual conductance.** The ratio of the change in plate current to the change in grid potential producing it, under the condition of constant plate voltage. See transconductance.

Impedance. The ratio of the applied voltage at one part of a transmission line or network to the current at another part of the same system. Also called transfer impedance.

Inductance. The common property of two associated circuits that determines how much electromotive force will be induced in one by a change or current in the other. Mutual inductance is measured in henrys, and is designated by the letter M.

Induction. The generation of a voltage in one circuit by the varying current in another circuit when inductive coupling exists.

N

nano. A decimal prefix designated by the symbol n meaning 10^{-9} .

narrow-band axis. In phasor representation of the chrominance signal, the direction of the phasor representing the coarse chrominance primary.

National Electric Code. A set of rules governing construction and installation of electrical apparatus, as approved by the National Board of Fire Underwriters.

natural

frequency. In an undamped body or system, the frequency at which oscillations will continue after the applied force has been removed.

frequency of an antenna. The fundamental resonant frequency of an antenna alone (without added inductance or capacity).

wavelength. The wavelength corresponding to the natural frequency of a circuit.

nautical mile. The length of a minute along a great circle on the earth. A United States land mile is .8684 of a nautical mile.

navaglobe. A long-distance continuous-wave LF navigation system of the amplitude-comparison type, providing bearing information.

navar. A co-ordinated series of radar air navigation and traffic-control aids utilizing transmissions at wavelengths of 10 centimeters and 60 centimeters to provide in the aircraft distance and bearing from a given point, display of other aircraft in the vicinity, and commands from the ground; also providing

on the ground a display of all aircraft in the vicinity, as well as their altitudes, identities, and means for transmitting certain commands.

navarho. A long distance continuous wave LF navigation system providing simultaneous bearing and distance information.

navigation. The process of directing a vehicle to reach the intended destination.

n-display. In radar, a display similar to the type K-Display in which the target appears as a pair of vertical deflections or blips from the horizontal time base. Direction is indicated by the relative amplitude of the vertical deflections; target distance is determined by moving an adjustable pedestal signal along the base line until it coincides with the horizontal position of the vertical deflections. The pedestal control is calibrated in distance.

needle. See stylus.

pressure. See stylus force.

negative. 1. Having more electrons than normal, or more than some reference point. 2. In the numerical scale, a number below zero.

balance. Term referring to the data in the accumulator when negative. This condition can control branching of program routines.

bias. A voltage that makes the control grid of a radio tube negative with respect to the cathode.

charge. More than the normal number of electrons.

coincidence switch. A switch employing two or more inverters connected to a common plate load resistor. Also referred to as an inverter switch.

feedback. Degeneration, which decreases the amplification. Also called inverse feedback or stabilized feedback.

ghosts. Duplicate images that appear on a television screen with intensity variations opposite to those of the picture.

image. A reversed television image in which the dark portions of the televised scene appear bright, and the bright portions dark.

modulation. 1. In television a method of transmission in which a decrease in scene illumination causes an increase in the radiated power of the transmitter. 2. In an AM facsimile system, that form of modulation in which the maximum transmitted power corresponds to the maximum density of the subject copy. 3. In an FM facsimile system, the form of modulation in which the highest transmitter frequency corresponds to the

- maximum density of the subject copy.**
- picture phase.** A condition wherein increases in brilliancy make the television picture signal voltage swing in a negative direction.
- resistance.** A characteristic of an electric arc, or, to a limited degree, of vacuum tubes, wherein an increase in voltage produces a decrease in current.
- resistance oscillator.** A tube operated on its negative resistance characteristic so that it delivers energy to a tank circuit to produce oscillation.
- terminal.** A terminal having more than the normal number of electrons, or one having more electrons than another to which it is being compared.
- transmission.** The transmission of television signals in such a way that a decrease in initial light intensity causes an increase in the transmitted power.
- neon.** A gas used in electronic tubes. It produces a characteristic red glow when ionized.
- glow lamp.** A neon-filled gaseous tube having a glass envelope through which can be seen the characteristic red glow of neon when ionization occurs during operation of the tube.
- oscillator.** A relaxation oscillator using a neon glow lamp instead of a vacuum tube to discharge the capacitor.
- neper.** A unit of power gain or loss using the natural system of logarithms as its base, replaced by the decibel and volume unit.
- network.** 1. Any complex electrical circuit.
2. A group of broadcasting stations connected together by radio or wire telephone lines so that all stations can broadcast a program originating at one of the stations.
- neutral.** An object that has its normal number of electrons and, therefore, is uncharged electrically.
- relay.** A neutral relay, in contrast to a polarized relay, is a relay in which the movement of the armature is independent of the direction of flow of current through the relay coil.
- wire.** The middle wire of a three-wire, two-phase power line, usually grounded.
- neutralization.** Any process that balances out or prevents an undesirable effect. Specifically, preventing oscillation in an amplifier by introducing a voltage into the input equal in magnitude but opposite in phase to the feedback through the interelectrode capacitance.
- neutralizing capacitor.** A variable capacitor used in transmitting and receiving circuits to feed a portion of the ac plate voltage back to the grid circuit for neutralizing purposes.
- indicator.** A device for indicating the degree of neutralization of an amplifier.
- tool.** See aligning tool.
- voltage.** The ac voltage fed from the grid circuit to the plate circuit (or vice versa), deliberately made 180° out of phase with and equal in amplitude to the ac voltage transferred through undesired paths, usually the grid-plate tube capacitance.
- neutrodyne circuit.** A circuit in which a portion of the rf plate voltage is fed back into the grid circuit 180° out of phase to reduce the tendency toward oscillation.
- neutron.** An electrically neutral particle having about the same mass as a proton.
- nichrome.** An alloy of nickel, iron, and chromium that has a high resistance per unit volume and is capable of withstanding high temperatures.
- noctovision.** A television system using optically invisible rays, usually infrared, for scanning purposes at the transmitter.
- node.** A terminal of any branch of a network or a terminal common to two or more branches of a network.
- noise.** 1. Undesired sound. By extension, any unwanted disturbance within a useful frequency band such as undesired electric waves in any transmission channel or device. 2. Unintelligible signals in a communication system which tend to interfere with proper perception of the desired signals or speech. More loosely, noise is sometimes used as synonymous with the power which causes noise. 3. Unwanted energy (or the voltage produced), usually of random character, present in a transmission system due to any causes.
- current generator.** A current generator, the output of which is described by a random function of time.
- factor. (noise figure)** Of a linear system at a selected input frequency, the ratio of (1) the total noise power per unit bandwidth (at a corresponding output frequency) available at the output terminals, to (2) the portion thereof engendered at the input frequency by the input termination, whose noise temperature is standard (290°K) at all frequencies.
- filter.** A device inserted between a wall outlet and the power cord plug of a re-

ceiver to block noise interference that might otherwise enter the receiver. Noise filters are also placed between the power line and the device producing the noise, to prevent escape of the noise signals into the power line.

level. The strength of noise signals in a circuit, or of acoustic noise in a particular location.

limiter. A circuit that limits the effects of interfering noises by cutting off all noise peaks stronger than the highest signal peak being received.

quieting. Term used to describe the ability of a receiver to reduce noise background in presence of desired signal, usually expressed in decibels.

-reducing antenna system. An antenna system in which the only part capable of picking up signals is the antenna proper, this being erected high enough to be out of the noise-interference zone. The lead-in is a shielded cable of twisted two-wire line that can pass through the interference zone without picking up noise signals.

silencer. See squelch circuit.

suppressor. A part of a receiver circuit which reduces noise automatically when no carrier is being received. Also squelch.

-voltage generator. A voltage generator the output of which is described by a random function of time.

nominal

impedance. Impedance of a circuit under conditions at which it was designed to operate. Normally specified at center of operating frequency range.

line width. The average separation between centers of adjacent scanning or recording lines.

nomograph. A chart or graph containing a series of scales on which equations can be solved by placing a ruler on two known values and reading the answer where the ruler intersects the scale for the unknown value. Also known as a nomogram.

non-

bridging. A term used to describe a contact transfer in which the movable contact leaves one contact before touching the next.

conductor. Any material that offers very high opposition to the flow of electricity. An insulating material.

corrosive flux. Flux that is free from acid and other substances that might cause corrosion.

homing. A qualifying term applied to a stepping relay indicating that wipers, upon completion of an operational cycle, do not return to the home position, but

are at rest on the last used set of contacts.

homing tuning system. A motor-driven automatic tuning system in which the direction of motor rotation is reversed at the ends of the tuning range. When a station-selecting button is pressed, the motor will rotate in the direction in which it was last rotating. If the dial setting for the desired station is in the other direction, the motor will rotate the tuning mechanism to the end of the scale and will then reverse and proceed to tune the receiver to the desired station frequency.

nonconductive pattern. A design formed by holes or nonconductive material such as capacitor dielectric.

non-inductive

capacitor. A capacitor having practically no inductance. The layers of foil and paper are staggered in winding so that one layer of foil protrudes at one end, so the leads make contact to the entire edge of the foil strips rather than just one end.

circuit. A circuit having practically no inductance.

load. A load having practically no inductance.

resistor. A wire-wound resistor so constructed that the wire coil has practically no inductance. Used at high frequencies.

winding. A type of winding in which the magnetic fields produced by two parts of the winding cancel each other and provide a non-inductive resistance.

nonlinear. Not proportional.

detection. Square-law detection. Detection in which the operating point is at the point of maximum curvature of the tube characteristic.

distortion. Distortion caused by a deviation from a desired linear relationship between specified measures of the output and input of a system. Note: The related measures need not be output and input values of the same quantity; e.g., in a linear detector, the desired relation is between the output signal voltage and the input modulation envelope.

network. (circuit) A network not specifiable by linear differential equations with time as the independent variable.

nonlinearity. The crowding of television picture elements in the horizontal direction or crowding of lines at top or bottom due to a distortion of the sweep sawtooth.

nonmagnetic. Pertaining to materials such as glass, wood, copper, brass, and paper which cannot be magnetized.

nonplanar network. A network which cannot be drawn on a plane without crossing of branches.

nonresonant line. A transmission line of any length having terminating devices matching the surge impedance so that there are no reflected (standing) waves. Also a transmission line having a physical length much shorter than a quarter wavelength at the operating frequency so that the distributed voltage and current are practically uniform.

nonshorting contact switch. A selector switch in which the width of the movable contact is less than the distance between contacts.

nonstorage camera tube. A television camera tube that produces a picture signal proportional at any instant to the intensity of the illumination on the corresponding elemental area of the scene.

nonsynchronous vibrator. A vibrator that only interrupts a direct current, without rectifying the resulting stepped-up ac pulses.

normal. The perpendicular to the point of contact. Also, the expected or regular value.

position. The usual de-energized position, open or closed, of contacts due to spring tension or gravity.

sequence of operation. The normal sequence of operation is the sequence in which all the normally closed contacts open before closure of the normally open contacts of the assembly.

normalized

admittance. The reciprocal of the normalized impedance.

impedance. (with respect to a waveguide). An impedance divided by the characteristic impedance of the waveguide.

normally

closed contacts. Normally closed contacts are a combination of a stationary contact and a movable contact which are engaged when the coil is unenergized.

open contacts. Normally open contacts are a combination of a stationary contact and a movable contact which are not engaged when the coil is unenergized.

north pole. The pole of a magnet from which the magnetic lines of force leave.

north-stabilized PPI. An azimuth-stabilized PPI on which the reference bearing is north.

Novachord. An electronic musical instrument that creates the sounds by means of oscillator and amplifier circuits.

noval socket. A tube socket with openings for nine pins.

NPN transistor. A transistor in which the base is made of P-type material, and the emitter and collector of N-type material.

n-type

conductivity. The conductivity associated with conduction electrons in a semiconductor.

material. A semi-conductor material that has been doped with a donor material that gives an excess of electrons.

semiconductor. An extrinsic semiconductor in which the conduction electron density exceeds the hole density. Note: It is implied that the net ionized impurity concentration is donor type.

nucleonics. The science dealing with phenomena associated with the atom nucleus.

nucleus. The core of an atom consisting of one or more protons along with one or more neutrons. The plural is nuclei.

null. A minimum or zero value of current in an electrical circuit.

indicator. Any device that will indicate when the current is zero.

method. Any method of measurement in which the reading is taken at zero.

nullity. (degrees of freedom on mesh basis). The number of independent meshes that can be selected in a network. The nullity N is equal to the number of branches B minus the number of nodes V plus the number of separate parts P . $N = B - V + P$.

number. 1. Formally: An abstract mathematical entity defined by the rules governing the relations and operations to which it is susceptible. In this sense, a number is independent of the manner of its representation. 2. Commonly: A representation of a number as defined above, such as a "binary number," or a "decimal number," or a sequence of pulses. 3. In a digital machine, a word composed only of digits and possibly a sign.

numeral. One or more written or printed characters used to express a number. Example: Arabic numerals 1, 2, 3, etc. Roman numerals I, V, X, etc.

numerator. The part of a common fraction written above the line. Example: In $1/2$, the numerator is 1.

nutating feed. In a tracking radar an oscillating antenna feed for producing an oscillating deflection of the beam in which the plane of polarization remains fixed.

O

oboe. A particular radar navigation system consisting of two ground stations measuring distance to an airborne transponder beacon and relaying information to the aircraft.

obsolescence-free. Not liable to become out of date because of new developments or new inventions.

octal

base. A tube socket with openings for eight equally spaced prongs and a central aligning key.

socket. A tube socket with opening for eight equally spaced pins, and a slot for a central aligning key.

octave. The interval between two sounds having a basic frequency ratio of 2. By extension, the octave is the interval between any two frequencies having the ratio 2:1.

octode. An eight-electrode electron tube containing an anode, a cathode, a control electrode, and five additional electrodes that are ordinarily grids.

odograph. An automatic electronic map tracer used in jeeps and other mobile military vehicles for map making and navigation on land. It automatically plots on an existing map or on cross sectional paper the exact course taken by the vehicle. Phototubes and thyatron transfer the indication of a precision magnetic compass to a plotting unit actuated by the speedometer drive cable, causing a pencil to trace the course taken on roads or on cross country movements.

oersted. Unit of magnetic intensity or magnetizing force equal to one gilbert in one centimeter. Also, formerly the unit of magnetic force of one gilbert divided

by a flux of one maxwell.

offset. Describes the difference between the value or condition desired and that actually attained.

angle. In lateral disc reproduction, the offset angle is the smaller of the two angles between the projections into the plane of the disc of the vibration axis of the pickup stylus and the line connecting the vertical pivot (assuming a horizontal disc) of the pickup arm with the stylus point.

ohm. The unit of resistance. The resistance of a device is one ohm when a dc voltage of one volt will send a current of one ampere through that device. The Greek letter omega (Ω) is commonly used to represent ohm.

ohmic

contact. A contact between two materials, possessing the property that the potential difference across it is proportional to the current passing through.

value. The resistance in ohms that a part or circuit offers to the flow of current.

ohmmeter. A test instrument that measures and indicates directly the resistance of a part or the resistance between any two points in a circuit.

Ohm's Law. A fundamental electrical law that expresses the relationship between voltage, current, and resistance in a dc circuit, or the relationship between voltage, current, and impedance in an ac circuit. The three forms of the law in each case are given below, in which E is the pressure in volts, I is the current in amperes, R is the resistance in ohms, and Z is the impedance in ohms.

DC Forms	AC Forms
$E = I \times R$	$E = I \times Z$
$I = E \div R$	$I = E \div Z$
$R = E \div I$	$Z = E \div I$

ohms-per-volt. A sensitivity rating for meters, obtained by dividing the resistance (of the meter and multiplier resistors) by the full-scale voltage value. The higher the ohms-per-volt rating, the more sensitive is the meter.

omnibearing. A bearing indicated by a navigational receiver on transmissions from an omnirange.

indicator. An instrument which presents an automatic and continuous indication of an omnibearing.

selector. An instrument capable of being set manually to any desired bearing of an omnirange station and which controls a course deviation indicator.

omnidirectional. In or from all directions, as the radiation pattern of a vertical antenna.

antenna. An antenna which radiates equal power in all directions in a horizontal plane.

microphone. (nondirectional microphone). A microphone the response of which is essentially independent of the direction of sound incidence. Note: It should be noted that, in this case, omnidirectional refers to elevation as well as azimuth. In radio antenna practice this is not necessarily the case.

range. (omnirange). A radio facility providing bearing information to or from such facilities at all azimuths within its service area.

omnigraph. An instrument for producing Morse Code messages for instruction purposes by means of a buzzer and perforated tape.

on-course curvature. In navigation, the rate of change of the indicated course with respect to distance along the course line or path.

"one-shot" multivibrator circuit. A regenerative two-tube feedback amplifying circuit which can be triggered by an input voltage so as to assume conductivity in one tube and plate-current cutoff in the other tube, and by a second triggering pulse, can then assume the opposite condition.

O network. A network composed of four impedance branches connected in series to form a closed circuit similar to a squared letter "O."

opaque. Preventing the passage of light rays.

open. 1. Condition in which conductors are separated so that current cannot pass.
2. Break or discontinuity in a circuit which can normally pass a current.

circuit. A circuit that is not electrically continuous; that is, one in which current cannot flow.

-circuit jack. A jack whose circuit contacts are normally open and can be closed only through a properly connected plug.

core. An iron core inside a coil without an external path, so that the magnetic circuit has a long path through air.

course PPI. A PPI (Plan Position Indicator) in which the display of the initiation of the time base precedes that of the transmitted pulse.

loop. A control system in which there is no self-correcting action for "misses"

of the target value, as there is in a closed loop system.

transmission line. A transmission line formed by two parallel wires, held apart by spacers.

operand. The portion of stored information with which the arithmetic element performs its operation.

operate

time. Refers to the phase of computer operation when an instruction is being carried out.

operating

angle. In an amplifier, the portion of a cycle during which plate current flows.

characteristic. See dynamic characteristic.

frequency. The rated ac frequency of the supply voltage at which the relay coil is designed to operate.

life. The total number of one-third full scale operating cycles that an instrument can undergo without serious deterioration in performance.

point. The point on a family of characteristic curves of a vacuum tube or transistor where the coordinates of the point represent the instantaneous values of the electrode voltages and currents for the operating conditions under study or consideration.

power. The power that is actually supplied to the transmitting antenna.

temperature °C. Under transistor ratings, this value may be considered the maximum allowable operating temperature in degrees centigrade.

voltages. The dc voltages applied to the filament, plate, screen grid, and control grid elements of a tube to establish its operating characteristics.

operation

code. That part of an instruction which designates the operation to be performed.

part. In an instruction, the part that usually specifies the kind of operation to be performed, but not the location of the operands. See also instruction code.

time. The time after simultaneous application of all electrode voltages for a current to reach a stated fraction of its final value. Conventionally, the final value is taken as that reached after a specified length of time.

optical

pattern. (Christmas tree pattern). In mechanical recording, a pattern which is observed when the surface of a record is illuminated by a light beam of essentially parallel rays.

- sound recorder.** Equipment incorporating a light modulator and means for moving a light-sensitive medium relative to the modulator for recording electric signals derived from sound signals.
- sound reproducer.** A combination of light source, optical system, photoelectric cell, and a mechanism for moving a photoelectric medium (usually film), by means of which recorded variations on a sound track may be converted into electric signals of approximately like form.
- optics.** The science that treats of a phenomenon of light.
- optimization.** The approach to economically perfect plant operation accomplished, primarily, by analytical rather than hit-or-miss methods.
- optimum.** Best possible.
- bunching.** The bunching condition that produces maximum power at the desired frequency in an output gap.
- coding.** Where the access time of a word in the memory depends on its location, a method of coding in which instructions or numbers are so stored as to reduce or minimize delay caused by access time.
- coupling.** That amount of coupling between two circuits that gives maximum transfer of signal energy.
- inductance.** Twice the value of critical inductance.
- working frequency.** The most effective frequency at a specified time for ionospheric propagation of radio waves between two specified points.
- orange-cyan-wideband.** Property of a color television system (e.g., the U.S. standard system) which allots more detail capacity to the determination of shades varying from orange to cyan than it does to shades from green to purple.
- orbital multiplier.** A thermionic secondary emission tube in which electrons given off from the two sides of a disc cathode are accelerated and bent into two semi-circular paths that converge on a dynode from which the secondary electrons are collected on a plate.
- OR-circuit.** Synonym for OR-gate.
- order.** 1. Synonym for instruction. 2. Synonym for Command. 3. Loosely, synonym for operation part. 4. The power of the radix that appears in a given term of the number.
- ordinate.** The coordinate that specifies distance in a vertical direction on an ordinary graph.
- OR-gate.** A gate whose output is energized when any one or more of the inputs is in its prescribed state. An OR-gate performs the function of the logical "inclusive-or."
- orient.** To turn or adjust in a definite direction with respect to some reference.
- original master.** (metal master) In disc recording, the master produced by electroforming from the face of a wax or lacquer recording.
- OR switch.** A switch that produces an output signal if a signal appears on any one of the input lines.
- orthicon.** A camera tube in which a beam of low-velocity electrons scans a photoemissive mosaic capable of storing an electrical-charge pattern.
- orthogonal axes.** Axes which are mutually perpendicular to one another. With reference to an instrument, these axes are usually chosen so that they coincide with the axes of symmetry of the instrument.
- oscillating current.** A current that alternately increases and decreases in magnitude and reverses polarity with respect to time in a definite pattern.
- oscillation.** The condition of oscillating.
- oscillator.** A non-rotating device for producing alternating current, the output frequency of which is determined by the characteristics of the device.
- harmonic interference.** The result of interaction between incoming signals and harmonics of the local oscillator (usually the second harmonic) in a superheterodyne receiver.
- mixer-first detector.** A single stage that combines the functions of the local oscillator and the mixer-first detector in a superheterodyne receiver.
- padder.** An adjustable capacitor in series with the oscillator tank circuit of a superheterodyne receiver, used to make possible better tracking between oscillator and preselector at the low-frequency end of the tuning dial.
- oscillatory circuit.** A circuit containing inductance and capacity having values such that a voltage pulse will produce an oscillatory (alternating) current.
- oscillogram.** The recorded trace or per-

- manent record produced by an oscillograph.
- oscillograph.** A test instrument that records the waveforms of a varying current or voltage. Also, loosely, an oscilloscope.
- recorder.** A device capable of charting high speed variations in measured quantities, such as temperature or pressure, as found in aircraft testing, for example.
- oscilloscope.** A test instrument that shows visually on a screen the waveform of a varying current or voltage.
- tube.** (oscillograph tube). A cathode-ray tube used to produce a visible pattern which is the graphical representation of electrical signals.
- osophone.** A telephone receiver for use by the deaf. It applies sound vibrations directly to bones in the head.
- outer marker.** A marker facility in an ILS which is installed at approximately 5 miles from the approach end of the runway on the localizer course line to provide a fix.
- outlet.** A set of terminals to which a device may be connected. For example, the wall outlet from which electric power can be obtained.
- out of phase.** Having waveforms that do not pass through corresponding values at a particular instant.
- out of sync.** Not synchronized. Television or facsimile reception, in which the line or frame sweeps or both are not in step with the transmitted signals.
- output.** The useful electrical energy delivered by a signal or power source.
- capacitance.** The sum of the direct capacitances between the output electrode (usually the plate) and all other electrodes that connect directly or indirectly to the other side of the circuit.
- gap.** An interaction gap by means of which usable power can be abstracted from an electron stream.
- impedance.** The impedance presented by the transducer to a load.
- indicator.** A meter, tuning eye, or other device used to show changes in output.
- meter.** A meter connected to the output of a receiver or amplifier for the purpose of measuring the output signal strength.
- stage.** The final stage in a receiver or af amplifier.
- transformer.** An iron-core af transformer used to provide efficient coupling between the output stage of a receiver or af amplifier and its load. **tube.** See power output tube.
- over-all electrical efficiency.** (induction and dielectric heating usage). The ratio of the power absorbed by the load material to the total power drawn from the supply lines.
- overbunching.** The bunching condition produced by the continuation of the bunching process beyond the optimum condition.
- overcutting.** In disc recording, the effect of excessive level characterized by one groove cutting through into an adjacent one.
- overflow cycle.** A cycle of division in which the divisor is subtractively transferred to the counter, thereupon changing the sign of the counter balance and thus indicating that the divisor should be shifted to a lower order.
- overflow.** 1. The condition which arises when the result of an arithmetic operation exceeds the capacity of the number representation in a digital computer. 2. The carry digit arising from this condition.
- overhead cutter.** A cutting head assembly suspended above the disc as distinguished from a cutter mounted in the end of a swing-arm mechanism. The overhead cutter is mounted on a threaded shaft known as a lead screw, rotation of which moves the cutter from the edge of the disc toward the center.
- overlap.** The amount by which the effective height of the scanning spot exceeds the nominal width of the scanning line in a facsimile system.
- overload.** A load greater than that which an electrical device is designed to carry.
- capacity.** The current, voltage, or power level beyond which permanent damage occurs to an electrical device.
- relay.** An overload relay is a relay which is specifically designed to operate when its coil current reaches a predetermined value above normal.
- overmodulation.** Modulation greater than 100%, resulting in distortion because the carrier is cut off during portions of each modulating cycle.
- overshoot.** 1. A peak, spike, or sharp rise beyond the desired terminating point on a square or pulsed wave. 2. Results from an unusual atmospheric condition

that sets up variations in the index of refraction causing microwave signals to be received where they were not intended. 3. In control systems, it occurs when the process exceeds the target value as operating conditions change.

overtone. 1. A physical component of a complex sound having a frequency higher than that of the basic frequency. 2. A component of a complex tone having a pitch higher than that of the fundamental pitch.

overvoltage. (radiation-counter tubes). The amount by which the applied voltage exceeds the Geiger-Mueller threshold.

relay. A relay which is specifically designed to operate when its coil voltage reaches a predetermined value above normal.

O wave. Ordinary-wave component.

oxide. A combination of an element with oxygen. Rust is an oxide of iron.

-coated cathode. A cathode that has been coated with oxides of alkaline-earth metals to improve electron emission at moderate temperatures.

-coated filament. A filament coated with a metallic oxide to increase the electron emission.

oxygen point. The temperature, $+90.1^{\circ}\text{K}$ (-297.4°F) at which pure liquid oxygen boils when under a pressure of 760 mm of mercury. It is one of the four fixed points of the International Temperature Scale.

P

pad. A configuration of resistors designed to attenuate the signal without introducing an impedance mismatch.

electrode. One of a pair of electrode plates between which a load is placed for dielectric heating.

padder. In a superheterodyne receiver, the trimmer capacitor placed in series with the oscillator tuning circuit to control the receiver calibration at the low-frequency end of the tuning range.

pairing. A partial or complete failure of interlace in which the scanning lines of alternate fields do not fall exactly between one another but tend to fall (in pairs) one on top of the other.

pan. To move a television camera vertically and/or horizontally to keep it

trained on a moving object or secure a panoramic effect.

panel. A board on which the operating controls of a radio device are mounted.

panoramic receiver. A radio receiver that permits continuous observation on a cathode-ray tube screen of the presence and relative strength of all signals within a wide frequency range.

paper capacitor. A fixed capacitor consisting of foil plates separated by paraffined or oiled paper.

parabola. A wave shape in the form of a conic section resulting from the intersection of a cone with a plane parallel to its side. Also a parabolic reflector.

parabolic. When used to describe a function of time, means that the function is zero for zero and negative values of time, and has a constant second derivative for positive time.

antenna. An antenna with a radiating element and a parabolic reflector that concentrates the radiated power into a beam.

microphone. A microphone placed at the focal point of a parabolic sound reflector.

reflector. A device for collecting light, sound, or radio waves and focusing them to a single point, or for reflecting them in beams consisting of parallel rays.

parallax. The apparent displacement of the position of an object caused by a shift in the point of observation. To eliminate errors in meter reading due to parallax, the eye should be directly above the meter pointer.

parallel. 1. Connected so that current can flow through two or more paths. 2. Equally distant and never meeting, as parallel lines. 3. One of the imaginary circles on the surface of the earth parallel to the equator, marking latitude. 4. In electronic computers, pertaining to simultaneous transmission of, storage of, or logical operations on the parts of a word, character, or other subdivision of a word, using separate facilities for the various parts.

adder. An adder in which the various orders are added simultaneously, instead of in sequence (serially).

arithmetic unit. One in which separate equipment is provided to operate (usually simultaneously, on the digits in each column).

beam. A beam of light whose rays are exactly parallel to one another.

cut. A Y cut in a quartz crystal.

- digital computer.** One in which the digits are handled in parallel. Mixed serial and parallel machines are frequently called serial or parallel according to the way arithmetic processes are performed. An example of a parallel digital computer is one which handles decimal digits in parallel although it might handle the bits which comprise a digit either serially or in parallel. See also serial digital computer.
- elements.** 1. Two-terminal elements are connected in parallel when they are connected between the same pair of nodes. 2. Two-terminal elements are connected in parallel when any cut-set including one must include the others.
- plate oscillator.** A push-pull ultrahigh-frequency oscillator circuit in which two parallel metal plates form the tank circuit that determines the frequency.
- operation.** The operation of a computer in which the arithmetic calculations are performed simultaneously upon the various orders of a number.
- resonant circuit.** A tuning circuit consisting of an inductance and a capacity connected in parallel with the source.
- rod oscillator.** A microwave oscillator whose grid and plate tank circuit are formed of parallel rods.
- paramagnetic.** Having a magnetic permeability greater than that of a vacuum and essentially independent of the applied magnetizing force. In ferromagnetic materials, the permeability varies with the magnetizing force.
- parameter.** A variable (or changing quantity) that can be used to find other variables.
- Parametric amplifier.** A microwave amplifier that depends on the time variation of a circuit parameter such as a reactance for its amplifying qualities.
- variation.** A change in system properties not caused by the actuating signal which may affect the performance or operation of the feedback control system.
- paraphase amplifier.** An amplifier which converts a single input into a push-pull output.
- parasitic.** An undesired low or high frequency signal in an electronic circuit.
- element.** An antenna director or reflector that receives its excitation by induction or direct radiation from the driven element, and that re-radiates the energy in the proper phase relationship to get the desired results.
- oscillations.** Unintended self-sustaining oscillations or transient pulses in a current.
- suppressor.** A combination of inductance and resistance inserted in the grid circuit of an amplifier to suppress parasitic oscillations.
- part.** In electronics, a mechanical unit which cannot readily be subdivided. Assembled parts make up a component.
- particle velocity.** In a sound wave, the velocity of a given infinitesimal part of the medium, with reference to the medium as a whole, due to the sound wave. The commonly used unit is the centimeter per second.
- passive transducer.** A transducer whose output waves are independent of any sources of power which is controlled by the actuating waves.
- patch.** To connect circuits together temporarily by means of a cord, known as a patch cord.
- patchboard.** A panel containing a series of single or double jacks at which various circuits are terminated. The circuits are interconnected by short cables called patchcords.
- patchcord.** A short two- or three-conductor cable with male plugs at one end, used to interconnect various circuits terminated at a control panel, or patchboard.
- path.** In navigation, a line connecting a series of points in space and constituting a proposed or traveled route.
- p-display.** See plan position indicator (PPI).
- peak**
- amplitude.** The value of the maximum amplitude, voltage or current, of a wave.
- cathode current.** (steady state). The maximum instantaneous value of a periodically recurring cathode current.
- electrode current.** The maximum instantaneous current that flows through an electrode.
- forward anode voltage.** The maximum instantaneous anode voltage in the direction in which the tube is designed to pass current.
- inverse anode voltage.** The maximum instantaneous plate-cathode voltage in the direction opposite to that in which a tube is designed to pass current.
- load.** The maximum current consumed or produced in a stated period of time.

- plate current.** The maximum instantaneous plate current flowing in a tube.
- power.** The power over a radio frequency cycle corresponding in amplitude to synchronizing peaks.
- pulse amplitude.** The maximum absolute peak value of the pulse excluding those portions considered to be unwanted, such as spikes. Note: Where such exclusions are made, it is desirable that the amplitude chosen be illustrated pictorially.
- pulse power.** The power at the maximum of a pulse of power, excluding spikes.
- pulse power, carrier-frequency.** The power averaged over that carrier-frequency cycle which occurs at the maximum of the pulse of power (usually one half the maximum instantaneous power).
- response.** Maximum response.
- voltmeter.** A voltmeter that indicates the peak value of a voltage.
- peaking.** Providing more amplification for the high frequencies than for the low, used in compensating for loss of high frequencies.
- coil.** A small coil placed in an amplifying circuit to increase response at certain frequencies. Specifically, an inductance used in a video amplifier to resonate with the circuit capacitance beyond the upper limit of the band and thus compensate for high-frequency loss of gain and to correct the amplifier phase shift.
- peaks.** Momentary high volume levels produced during a program as a natural result of changes in pitch, accent or speech emphasis, causing the volume indicator to swing upward. Also rises in the response characteristic of an amplifier.
- peak-to-peak voltage.** The voltage amplitude between the maximum positive and maximum negative peaks of an ac signal. For a sine wave, this is twice the peak voltage or is 2.82 times the rms voltage.
- pedestal.** See blanking pulse.
- pencil**
- beam.** Emission, from an antenna, having the form of a narrow conical beam.
- tube.** A small tube designed especially for operation in the ultrahigh-frequency band. Used as an oscillator or rf amplifier.
- penetration frequency.** The highest frequency at which a radio wave traveling vertically upward will still be reflected regularly by a particular ionized layer of the ionosphere. See critical frequency.
- pentagrid converter.** A pentagrid tube used as a mixer-detector in a superheterodyne receiver.
- tube.** A tube having five grids.
- pentatron.** A five-electrode vacuum tube containing two anodes.
- pentode.** A five-electrode electron tube containing an anode, a cathode, a control electrode, and two additional electrodes that are ordinarily grids.
- percent ripple.** The ratio of the rms ripple voltage value to the average dc voltage value at the output of a rectifier or dc generator, multiplied by 100 to express it as percentage.
- percentage**
- beam modulation.** One hundred times the ratio of (1) the signal output current of an image orthicon for high-light illumination on the tube to (2) the dark current.
- modulation.** 1. In amplitude modulation, the ratio of half the difference between the maximum and minimum amplitudes of an amplitude, expressed in percent. 2. In frequency modulation, the ratio of the actual frequency swing to the frequency swing required for 100 percent modulation, expressed in percentage. 3. The modulation factor multiplied by 100 to express it as a percentage.
- modulation meter.** An instrument used to measure the percentage of modulation of a transmitter. It may be a meter or a cathode-ray oscilloscope.
- perfect dielectric.** A theoretical dielectric material without losses regardless of frequency or potential. A perfect vacuum is the only perfect dielectric.
- performance chart.** (of a magnetron oscillator). A plot on coordinates of applied anode voltage and current showing contours of constant magnetic field, power output, and over-all efficiency.
- perigee.** That point in an orbit nearest the earth. It is the opposite of apogee, or point in an orbit farthest from the earth.
- period.** In alternating current, the time required for one cycle or one complete change to take place.
- periodic.** Recurring at equal intervals of time.

electromagnetic wave. A wave in which the electric field vector is repeated in detail in either of two ways: (1) At a fixed point, after the lapse of a time known as the period, (2) At a fixed time, after the addition of a distance known as the wavelength.

pulse train. A pulse train made up of identical groups of pulses, the groups repeating at regular intervals.

Permalloy. An alloy of nickel and iron used as core material for high-quality audio-frequency transformers.

permanent

echo. In a primary radar system a signal reflected from an object fixed with respect to the radar site.

magnet. A piece of hardened steel or other magnetic material that has been artificially magnetized and retains its magnetism.

magnet loudspeaker. A moving-conductor loudspeaker in which the steady field is produced by means of a permanent magnet.

permatron. A thermionic vacuum tube in which the plate current is controlled by a magnetic field instead of a grid.

permeability. A measure of how much better a particular material is than the air as a path for magnetic lines of force. The permeability of air is assumed as 1.

tuning. A method of varying the inductance of an iron-core rf coil by moving an iron-core in or out of the coil.

permeance. The reciprocal of reluctance, magnetic conductivity.

perpendicular magnetization. In magnetic recording, magnetization of the recording medium in a direction perpendicular to the line of travel, and parallel to the smallest cross-sectional dimension of the medium. Note: In this type of magnetization, either single or double pole-piece heads may be used.

persistence. The measure of the length of time the screen of the cathode-ray tube remains luminescent after the excitation is removed.

of vision. The ability of the eye to retain the impression of an image for a length of time after the image has disappeared from view. The property of the eye that enables it to fill in the intervals between successive images and to produce the illusion of motion.

perveance. The quotient of the space-charge-limited cathode current by the

three-halves power of the anode voltage in a diode.*

phanotron. A hot-cathode gas-discharge tube in which no means is provided for controlling the unidirectional current flow. A type 866 mercury-vapor rectifier tube is a familiar example.

phantastron. An electronic circuit of the multivibrator type that is normally used in the monostable form. It is a stable trigger generator in this connection, and is used for gating functions and sweep delay functions.

phantom

circuit. A circuit superimposed on two other circuits. Used in telephone and broadcast work to make two pairs of wires provide three complete circuits.

target. See echo box.

phase. An expression of how much of the time period of one cycle of a regularly recurring quantity has been completed, usually measured from a reference time when the quantity passes through zero from negative to positive. The phase difference of two or more quantities can be determined by comparing their phases at the instant one quantity is at the reference time. Phase is usually expressed as a phase angle measured in degrees or radians.

angle. A means of expressing the phase of a regular recurring quantity in degrees or radians. Phase multiplied by 2π gives the phase angle in radians, and by 360, the phase angle in degrees. If a cycle has advanced from zero to maximum, $1/4$ of the cycle has passed, or the phase is $1/4$ and the angle is

$$\frac{1}{4} \times 360 = 90^\circ$$
$$\frac{1}{4} \times 2\pi = \frac{\pi}{2} \text{ radians}$$

When two or more quantities are being compared, either their phase difference can be converted into a phase angle, or the difference between their phase angles can be found, to express the angle of lead or angle of lag between them.

constant. Of a traveling plane wave at a given frequency, the space rate of decrease of phase of a field component (or of the voltage or current) in the direction of propagation in radians per unit length.

crossover. A point on the plot of a loop ratio at which its phase angle is 180° . In the transfer of a single frequency wave from one point to another in a system, the time delay of a part of the wave identifying its phase. Note:

- The phase delay is measured by the ratio of the total phase shift in cycles to the frequency in cycles per second.
- deviation.** Peak difference between the instantaneous angle of the modulated wave and the angle of the carrier.
- difference.** The amount by which the phase of one quantity leads or lags the phase of another. It is usually expressed as a phase angle in degrees or radians.
- discriminator.** A device in which amplitude variations are derived in response to phase variations.
- distortion.** A condition in which unequal frequency response causes time delays that shift the phase of components of a signal. Particularly important in video amplifiers because it changes the peak values of the video signal and thus alters the contrast and resolution.
- frequency distortion.** Distortion due to lack of direct proportionality of phase shift to frequency over the frequency range required for transmission.
- inverter.** See paraphase amplifier.
- localizer.** A localizer in which the localizer on-course line is centered in an equiphase zone, and right-left deviations from this zone are detectable as reversals of phase of one of the two radiated signals.
- margin.** The angle by which the phase of the loop ratio of a stable system differs from 180° at gain crossover.
- modulation.** (PM) Angle modulation in which the angle of a sine-wave carrier is caused to depart from the carrier angle by an amount proportional to the instantaneous value of the modulating wave. Note: Combinations of phase and frequency modulation are commonly referred to as frequency modulation.
- response characteristic.** The phase displacement versus frequency properties of a network or system.
- reversal.** A change in phase of one-half cycle or 180° .
- shift.** A time difference between the input and output signal of a control unit or system.
- shift microphone.** A microphone employing phase-shift networks to produce directional properties.
- shift oscillator.** An oscillator made by connecting between the output and the input any network having a phase shift of an odd multiple of 180° per stage at the frequency of oscillation.
- splitting circuit.** A circuit that produces from the same input waveform, two output waveforms that differ in phase from each other.
- velocity.** Of a traveling plane wave at a single frequency, the velocity of an equiphase surface along the wave normal.
- phasor.** In facsimile, a device for adjusting the equipment so that the recorded elemental area bears the same relation to the record sheet as the corresponding transmitted elemental area bears to the subject copy in the direction of the scanning line.
- phasing.** In facsimile or TV, the adjustment of picture position along the scanning line.
- signal.** In facsimile or TV, a signal used for adjustment of the picture position along the scanning line.
- Phasitron.** A tube producing frequency modulation. The cathode emits a rotating sheet of electrons, the outer edge of which is sinusoidally modulated. The amount of energy reaching the second anode is determined by the speed of the rotating sheet of electrons, which is modulated by the intelligence signal.
- phasor.** A complex number used in connection with a steady-state ac phenomenon. It can represent a voltage, a current, or an impedance. The length of a phasor can be taken to represent either the rms or the maximum value of a sinusoidally varying quantity.
- phon.** A term sometimes used in place of decibel to specify equivalent loudness levels.
- phonograph.** See record player.
- amplifier.** An audio-frequency amplifier for use with a phonograph pickup.
- oscillator.** An rf oscillator arranged for modulation by the output of a phonograph pickup, so that the resulting modulated rf signal can be radiated to the antenna and ground terminals of a radio receiver. This permits the playing of records without having to make any direct connection to the receiver.
- pickup.** (mechanical reproducer) A mechanoelectric transducer which is actuated by modulations present in the groove of the recording medium and which transforms this mechanical input into an electric output.
- phosphor.** A chemical that has the characteristic of emitting cold light, either from internal chemical action or from external excitation. Specifically, a chemical coating on the face of a cathode-ray tube that becomes luminous when bombarded with electrons.
- bronze.** A hard, springy alloy of copper, tin and phosphorous, widely used in radio for contact springs.
- phosphorescence.** Light emitted without tangible heat. Specifically, light given

off by a phosphor after the exciting light of the electron stream has ceased to grow. Persistence, afterglow.

photocathode. An electrode used for obtaining photoelectric emission when irradiated.

photocell. A device for converting variations of light intensity or color into equivalent electrical variations.

photoconductive cell. A light-sensitive cell whose ohmic resistance varies with changes in light falling on the cell.

photoelectric. Electricity sensitive to changes in light.

cell. A light-sensitive cell, which can be any one of three basic types, photoemissive, photoconductive, or photovoltaic. It converts variations in light into corresponding variations in voltage or current.

emission. The ejection of electrons from a solid or liquid by electromagnetic radiation.

photoemissive. Emitting electrons when struck by light.

cell. A light-sensitive cell in which a treated cathode, mounted in a glass envelope, emits electrons under the action of light, these electrons being collected by the anode.

photolionization. Ionization occurring in a gas as a result of a visible light or ultraviolet radiation.

photometer. An instrument for measuring the brightness of sources of light.

photomultiplier. Deprecated. See multiplier tube.

photophone. An instrument for transmitting sound over short distances by means of a beam of light.

photosensitive. Responsive to changes in light intensity.

recording. Recording by the exposure of a photosensitive surface to signal-controlled light beam or spot.

phototube. An electron tube that contains a photocathode, and has an output depending at every instant on the total photoelectric emission from the irradiated area of the photocathode.

relay. An electrical relay which operates mechanical devices, such as counters and safety controls, by the action of a beam of light on a phototube.

photovaristor. A varistor in which the cur-

rent voltage relation may be modified by illumination, e.g., cadmium sulphide or lead telluride.

photovoltaic cell. A light-sensitive cell that generates a voltage when illuminated, this voltage varying with the amount of light falling on the cell. Also called a self-generating cell.

pickup. 1. A device that converts a sound, scene, or other form of intelligence into corresponding electric signals e.g., a microphone, a television camera, or a phonograph pickup. 2. The minimum current, voltage, power, or other value at which a relay will complete its intended function. 3. Interference from a nearby circuit or system.

arm. (tone arm) A pivoted arm arranged to hold a pickup.

cartridge. The removable portion of a pickup containing the electromechanical translating elements and the reproducing stylus.

plco. A decimal prefix designated by the symbol p meaning 10^{-12}

pictorial wiring diagram. A diagram containing sketches of parts and showing the wiring between the parts.

picture

black. The signal produced at any point in a facsimile system by the scanning of a selected area of subject copy having maximum density.

element. In a television system, the smallest portion of a picture or scene that is individually converted into an electric signal.

frequencies. The frequencies which result solely from scanning subject copy. Note: This does not include frequencies which are part of a modulated carrier signal.

inversion. A process which causes reversal of the black and white shades of the recorded copy.

monitor. Refers to a cathode-ray tube and its associated circuits arranged to view a television picture.

signal. That portion of the composite video signal which lies above the blanking level and contains the picture formation.

tube. The image-reproducing cathode-ray tube in a television receiver.

white. The signal reproduced at any point in a facsimile system by the scanning of a selected area of subject copy having minimum density.

plc. One layer or section of a multisection winding. Sometimes written pi.

winding. A method of constructing coils

from a number of individual washer-shaped coils called pies. Also called pi winding.

Pierce oscillator. A form of crystal oscillator circuit in which the frequency-controlling crystal element is connected between grid and plate of the oscillator tube. It needs no tuned plate circuit, and therefore may drive a final amplifier or buffer stage with but one tuning control. Used primarily by amateur radio operators.

piezoelectric. Possessing the ability to produce a voltage when mechanical force is applied, or to produce a force when a voltage is applied, especially of a crystal.

pigtail. A flexible connection between a stationary terminal and a part or terminal that has limited motion. Also, the connecting leads on parts such as resistors and capacitors.

pilot

jewel. A clear or colored glass or plastic placed over or in front of a pilot lamp.

lamp. A small lamp mounted on the panel of a radio receiver to illuminate the tuning dial, or mounted on the panel of another radio apparatus to indicate when the apparatus is turned on.

regulator. A device for maintaining circuit transmission constant under varying attenuation conditions on the transmission media.

pi mode. The mode of resonance of a multicavity magnetron for which the phase difference between adjacent anode segments is π radians.

pin connections. Connections made to the pins of a vacuum tube. The following abbreviations are used to identify pin connections: NC, no connection; IS, internal shield; IC, internal connection (but no electrode connection); P, plate; G, grid; SG, screen grid; K, cathode; H, heater; F, filament; RC, ray-control electrode; TA, target.

pincushion distortion. (camera tubes or image tubes). A distortion which results in a monotonic increase in radial magnification in the reproduced image away from the axis of symmetry of the electron optical system. Note: For a camera tube, the reproducer is assumed to have no geometric distortion.

pine-tree array. Dipole antennas aligned in a vertical plane known as the radiating curtain with a second array containing

corresponding half-wave antennas parallel to and a quarter wavelength behind, forming a reflecting curtain.

pi network. A network of three impedances, two across the line and the third inserted in one line between the two so as to resemble the Greek letter π .

pin jack. A small receptacle into which is pushed a pin-like plug to complete a circuit connected to the two parts.

pip. A pulse or peak on a wave pattern. See blip.

piston action. The movement in or out as a unit of the cone or diaphragm of a loudspeaker when driven at bass audio frequencies.

pitch. That attribute of auditory sensation in terms of which sounds may be ordered on a scale extending from low to high, such as a musical scale.

Planck's constant. A constant appearing in many physical formulas, having the dimension of action (energy \times time) and having a numerical value of 6.547×10^{-27} erg-second. It represents the ratio of the energy of any radiation quantum to its frequency, and was first recognized by the German physicist M. Planck in 1900. Also called quantum of action.

plane. A flat surface.

earth factor. The ratio of the electric field strength that would result from propagation over an imperfectly conducting plane earth to that which would result from propagation over a perfectly conducting plane.

of polarization. For a plane polarized wave, the plane containing the electric field vector and the direction of propagation.

polarized wave. At a point in a homogeneous isotropic medium, an electromagnetic wave whose electric field vector at all times lies in a fixed plane which contains the direction of propagation.

wave. A wave whose equiphase surfaces form a family of parallel planes.

plan position indicator. (PPI) In radar technique, a cathode ray indicator on which blips produced by signals from reflecting objects and transponders are shown in plan position, thus forming a map-like display.

plasma. An electrically charged gas or body of gas, formed when the gas is subjected to very high temperature. A

mixture of ions, electrons, and neutral particles, may theoretically be held in magnetic bottles for the production of thrust. The plasma of deuterium has already been used experimentally in fusion machines.

plate. The principal anode in a tube, usually at a high positive potential with respect to the cathode to attract the electrons emitted by the cathode.

characteristic. See electrode characteristic.

circuit. A circuit including the plate voltage source and all other parts connected between the cathode and plate terminals of a tube.

current. The current flowing through the plate circuit of a tube and between the plate and cathode inside the tube.

detection. Rectification of the radio-frequency signals in the plate circuit of a vacuum tube.

dissipation. The power in watts expended as heat in the plates or anodes of tubes. It is the difference between the plate input power and the power delivered to the load.

efficiency. The ratio of power delivered to the load (ac) to the plate input power (dc).

impedance. See ac plate resistance.

input power. The product of the dc voltage applied to the plates of the tubes in the final radio stage and the total current flowing to these plates, measured without modulation.

keying. Keying a telegraph transmitter stage by interrupting the plate supply of a transmitter.

-load impedance. The total impedance connected between anode and cathode.

modulation. Modulation produced by introduction of the modulating wave into the plate circuit of any tube in which the carrier-frequency wave is present.

neutralization. A method of neutralizing an amplifier in which a portion of the plate-cathode ac voltage is shifted 180° and applied to the grid-cathode circuit through a neutralizing capacitor.

resistance. The resistance in ohms of the plate-cathode path in a tube. See dc plate resistance and ac plate resistance.

saturation. The condition in which further increase of the plate voltage will not result in an increase of the plate current because all of the electrons being emitted by the cathode are being collected by the plate. Also known as voltage saturation.

supply. The voltage source used in a vacuum tube circuit to place the plate at a high positive potential with respect to the cathode.

-to-plate impedance. The load im-

pedance measured between the plates of a push-pull amplifier stage.

voltage. The dc voltage existing between the plate and cathode terminals of a tube.

platinum resistance thermometer. A temperature measuring device which utilizes the change in resistance of platinum wire with temperature as the means for sensing temperature.

pilotron. A high-vacuum thermionic tube having one or more grid electrodes to control the magnitude of the unidirectional current flow.

plug. A device inserted in a terminal jack or outlet, used for conveniently making or breaking connections.

plug-in. 1. Act of connecting equipment into an electrical circuit by inserting a plug into a jack. 2. Also, a term applied to a component which is inserted in a socket or connector.

coil. A coil having as its terminals a number of prongs arranged to fit into a socket mounted on the radio chassis.

resistor. A filament voltage-dropping resistor mounted in a metal or glass enclosure and provided with a plug-in base.

plumbing. Popular term for microwave wave-guides and associated equipment.

plunger relay. A relay operated by energizing an electromagnetic coil which in turn operates a movable core or plunger by solenoid action.

PM dynamic loudspeaker. See permanent magnet dynamic loudspeaker.

PM erasing head. One which uses the fields of one or more permanent magnets for erasing.

PNP transistor. A transistor in which the base is made up of N-type material and the emitter and collector are made of P-type material.

point

contact. Pressure contact between a semiconductor body and a metallic point.

-contact diode. A crystal diode made up of either N-type or P-type material with a cat-whisker welded to it.

-contact transistor. A transistor having a base electrode and two or more point-contact electrodes.

-junction transistor. A transistor having a base electrode and both point-contact and junction electrodes.

- to-point communication.** Radio communication between two definite fixed stations.
- to-point resistance.** A method of testing wherein the resistance between given points in a set is measured and checked against expected normal values.
- pointer.** The part of a meter or tuning dial that moves over the scale; an indicator.
- poison.** In television or electronics, a substance that reduces phosphorescence in a luminescent material. Also, a contaminant that reduces emission.
- polar coordinates.** System of coordinates in which a point is located by its distance from a fixed point and the angle that the line from this fixed point to the given point makes with a fixed reference line called the polar axis.
- radiation pattern.** A graph showing how much sound is radiated from the cone of a loudspeaker in all directions in one place. Also a similar graph for radio waves from an antenna.
- relay.** A relay containing a permanent magnet that centers the armature. The direction of movement of the armature is governed by the direction of current flow.
- polarity.** 1. The quality of having one of two possible electric charges, negative or positive. 2. The quality of having one of two possible magnetic poles, north or south.
- of picture signal.** Refers to the polarity of the black portion of the picture signal with respect to the white portion of the picture signal.
- polarized.** Having polarity. Of waves, having electric and magnetic components in a fixed direction.
- cell.** A cell that has become inoperative because of the formation of hydrogen about its positive pole.
- light.** Light vibrating in only one direction, produced by passing the light through a piece of quartz, a nicol prism, or a special type of glass called polaroid.
- polarizing current.** The dc current of a circuit, which when it flows through an iron-core choke coil or transformer determines the permeability of the core and thus the value of inductance.
- pole.** One end of a magnet. One electrode of a battery.
- face.** The pole face is the part of the magnetic structure on the end of the core nearest the armature.
- piece.** A section of ferromagnetic material forming one end of an electromagnet or permanent magnet.
- polyphase.** Having more than one phase.
- polyplexer.** In radar, equipment combining the function of duplexing and lobe switching.
- Polystyrene.** A clear plastic material having excellent dielectric properties, especially at high frequencies.
- pool cathode mercury arc converter.** A frequency converter using a mercury arc power converter.
- port.** 1. A place of access to a system where energy may be supplied or withdrawn, or where system variables may be observed or measured. 2. An opening in a loudspeaker enclosure other than the one behind which the loudspeaker is mounted. See reflex baffle.
- portable receiver.** A completely self-contained radio receiver having the loudspeaker, batteries, and a loop antenna built into a compact carrying case. Terminals are sometimes provided for external antenna and ground connections.
- transmitter.** A complete radio transmitter designed so that it can be readily transported from place to place.
- positional cross-talk.** (multibeam cathode-ray tubes). The variation in the path followed by any one electron beam as the result of a change impressed on any other beam in the tube.
- notation.** One of the schemes for representing numbers, characterized by the arrangement of digits in sequence, with the understanding that successive digits are to be interpreted as coefficients of successive powers of an integer called the base of the number system.
- positive.** A term used to describe a terminal having fewer electrons than another. Also, numerically above zero.
- bias.** Positive voltage applied to the control grid of an electron tube.
- charge.** The charge on an object having fewer electrons than normal.
- feedback.** A feedback from a high level point to a low level point of an amplifier so phased as to increase the net gain of the amplifier.
- grid oscillator.** A Barkhausen - Kurz oscillator, one in which the frequency

is determined by the transit time of electrons oscillating back and forth about the grid.

ion sheath. Collection of positive ions on the control grid of a gas-filled tube.

modulation. In television, a method of transmission in which an increase in scene illumination causes an increase in the radiated power of the transmitter. In an AM facsimile system, that form of modulation in which the maximum transmitter power corresponds to the minimum density of the subject copy. In an FM facsimile system, that form of modulation in which the highest transmitter frequency corresponds to the minimum density of the subject copy.

picture phase. A condition in which increases in brilliancy make the television picture signal voltage swing in a positive direction.

positron. A natural elemental quantity of positive electricity having much smaller mass than a proton.

post acceleration. Acceleration of the beam electrons after deflection.

post-emphasis. See de-emphasis.

potential. The difference in voltage between two points of a circuit. Frequently one is assumed to be ground (zero potential).

barrier. See depletion layer.

difference. The difference in voltage between two points.

energy. The ability to do work possessed by a body by virtue of its position.

potentiometer. 1. An instrument for measuring an unknown electromotive force or potential difference by balancing it, wholly or in part, by a known potential difference produced by the flow of known currents in a network of circuits of known electrical constants. 2. A three-terminal rheostat, or a resistor with one or more sliding contacts, which function as an adjustable voltage divider.

powdered-iron core. A slug made of powdered iron mixed with a binder, used in the core of rf and i-f coils and transformers.

power. The rate at which electrical energy is delivered and consumed, measured in watts. Also, the result obtained when a number or quantity is multiplied by itself a particular number of times.

amplification. The ratio of signal output power to signal input power.

amplifier stage. An audio amplifier stage capable of handling a relatively

large amount of audio power without distortion. Also, an rf amplifier stage in a transmitter that serves primarily to increase the power of the rf carrier signal.

cord. The cord that carries power from a standard wall outlet. A line cord.

detector. A detector that can be operated at high values of input voltage without objectionable distortion.

factor. A percentage rating obtained by dividing the resistance of a part or circuit by its impedance at the operating frequency, then multiplying the result by 100. Also, the ratio of the true power to the apparent power, multiplied by 100 to express it as a percentage.

gain. The ratio of the power that a transducer delivers to a specified load, under specified operating conditions, to the power absorbed by its input circuit.

level. At any point in a transmission system, the difference of the measure of the steady state power at that point from the measure of an arbitrarily specified amount of power chosen as a reference.

-level indicator. An ac voltmeter calibrated to read in terms of audio power level.

line. A pair of wires carrying electric power from one location to another.

loss. The ratio of the power absorbed by the input circuit of a transducer to the power delivered to a specified load under specified operating conditions.

output tube. A vacuum tube designed for use in the output stage of an electronic system. It is capable of handling much greater current than the ordinary amplifier tube and of delivering high output power.

pack. The power supply unit of a receiver, amplifier, transmitter, or other apparatus. Its function is to convert the available power line or storage-battery voltage to the values required by filament, grid, and plate circuits.

rating. The power available at the output terminals of a device when operated according to manufacturer's specifications.

ratio. The ratio between power output and power input, used in calculating db gain and loss.

relay. The final relay that controls a power circuit or magnetic contactor.

sensitivity. An index of power amplifier performance. The ratio of the signal output power to the square of the effective input voltage, expressed as a conductance in mhos.

switch. Sometimes known as ON-OFF switch. The device through which power is applied to an apparatus.

transformer. An iron-core transformer having a primary winding connected across the ac power line, a high-

voltage secondary winding for the power pack rectifier tube, and one or more low-voltage secondary windings that supply the required ac voltages to the tube filaments.

tube. See power output tube.

PPI. See plan position indicator.

P-P junction. (In a semiconductor) A region of transition between two regions having different properties in P-type semi-conducting material.

preamble. That part of a radio message that contains the prefix, message number, office of origin, word check, time filed, and date.

preamplifier. 1. An additional amplifier preceding the main amplifier. The preamplifier is generally used to build up the signal from a microphone or pickup to a value sufficient to drive the main amplifier. The preamplifier is usually, but not always, built on a separate chassis and may have its own power supply. The program selector (AM, FM, television, phono, etc.), equalizer, loudness control and bass and treble tone controls are often located in the pre-amplifier. 2. In radio, an amplifier separated from the remainder of the receiver and located so as to provide the shortest possible input circuit path from the antenna so as to avoid deterioration of the signal-to-noise ratio.

precision. The quality of being exactly or sharply defined or stated. A measure of the precision of a representation is the number of distinguishable alternatives from which it was selected, which is sometimes indicated by the number of significant digits it contains. See also accuracy.

approach radar. A radar system located on an airfield for observation of the position of an aircraft with respect to an approach path and specifically intended to provide guidance to the aircraft in the approach.

net. (network) In a four-wire terminating set or similar device employing a hybrid coil, an artificial line so designed and adjusted as to provide an accurate balance for the loop and subscribers set or line impedance.

pre-emphasis. A process in a system to emphasize the magnitude of some frequency components with respect to the magnitude of others.

characteristic. See standard pre-emphasis characteristic.

preferred tube types. Types of tubes

recommended to designers of electronic equipment for general use to minimize the number of tube types required for stock supply.

preselector. The section ahead of the frequency converter in a superheterodyne receiver containing resonant circuits tuned to the desired frequency.

presence. That quality of a sound-reproducing system that creates the illusion of listening to the original sound rather than to its reproduction.

preset guidance. A technique of missile control wherein a predetermined path is set into the control mechanism of the vehicle and cannot be adjusted after launching.

pressing. In disc recording, a pressing is a record produced in a record-molding press from a master or stamper.

pressure. Force per unit area. Measured in pounds per square inch (psi), or by the height of a column of water or mercury which it will support (in feet, inches, or centimeters).

microphone. A microphone in which the electric output substantially corresponds to the instantaneous sound pressure of the impressed sound waves. Note: A pressure microphone is a gradient microphone (see gradient microphone) of zero order and is nondirectional when its dimensions are small compared to a wavelength.

pads. Felt pads mounted on spring-brass arms which hold the magnetic tape in close contact with the heads on some machines.

potentiometer. A pressure transducer in which the electrical output is derived by varying the position of a contact arm along a resistance element.

roller. Also called capstan idler or puck. A rubber-tired roller which holds the magnetic tape tight against the capstan by spring pressure to insure constant tape speed and prevent slippage.

sensing element. That part of a pressure transducer which converts the measured pressure into a mechanical motion.

transducer. An instrument which converts a static or dynamic pressure input into a proportional electrical output.

Pre-TR tube. A gas-filled radio-frequency switching tube used to protect the TR tube from excessively high power and the receiver from frequencies other than the fundamental.

primaries. The colors of constant chro-

maticity and variable amount, which, when mixed in proper proportions, are used to produce or specify other colors.

primary. 1. First in order of time, placement, development of importance. 2. The primary winding of a transformer.

battery. A battery of one or more primary cells.

cell. A cell in which the voltage is generated by permanent chemical changes in the cell material. A primary cell cannot be recharged.

colors. See primaries.

emission. Streams of electrons or cathode rays released by a heated or illuminated cathode.

feedback. A signal which is a function of the controlled variable and which is compared with the reference input to obtain the actuating signal.

flow. (of carriers) A current which is responsible for the major properties of the device.

relay. The relay that responds to the initial change in a sequence of operations.

standard. An exact quantity, size, or frequency deriving its characteristics from an absolute standard fixed by general agreement.

voltage. The voltage applied to the input terminals of a transformer.

winding. The input winding of a transformer.

prime. In charge-storage tubes, to charge or discharge storage elements to a potential suitable for writing.

number. A number that has no factor other than itself and 1. Examples: 5, 13, 17.

priming speed. (in charge-storage tubes) The rate of priming excessive storage elements.

principal axis. 1. An imaginary line extending from the center of a lens or mirror and passing through the focal point. 2. (of a transducer) Used for sound emission or reception, a reference direction for angular coordinates used in describing the directional characteristics of the transducer. It is usually an axis of structural symmetry, or the direction of maximum response; but if these do not coincide, the reference direction must be described explicitly.

printed

circuit. A circuit in which the connections and some of the components are printed or painted on a surface of an insulating sheet with conductive or resistive materials.

-circuit assembly. A printed-circuit board on which separable component parts have been added.

-circuit board. An individual separate printed circuit on a base, completely processed as far as the printed portion is concerned.

-component assembly. A printed circuit in which the printed portion consists primarily of printed component parts.

component part. A printed circuit, or a portion, thereof, intended primarily to provide an electrical or magnetic function, or both, other than point-to-point connections or shielding, e. g., printed inductor, printed resistor, printed capacitor, printed transmission line, etc.

contact. That portion of a printed circuit used to connect the circuit to a plug-in receptacle and perform the function of a pin in a male plug.

wiring. A printed circuit, or a portion thereof, intended primarily to provide point-to-point electrical connections or shielding.

-wiring assembly. A printed circuit in which the printed portion consists primarily of printed wiring.

prism. A solid whose bases or ends are similar polygons and whose sides are parallelograms; in optics, a body of this form, especially one with triangular bases, made of a transparent substance, used for breaking up light into its spectrum.

product detector. A low intermodulation heterodyne type detector for single sideband and cw telegraph signals.

profile chart. A vertical cross section drawing of a microwave path between two stations indicating terrain, obstructions, antenna height requirements, etc.

program. 1. A plan for the solution of a problem. 2. Loosely, a synonym for routine. 3. To prepare a program.

control. A control system which automatically holds or changes its target value on the basis of time to follow a prescribed "program" for the process. Setting the timer and thermostat in your oven at home is a simple example of this type of control.

level. The measure of the program signal in an audio system expressed in vu.

library. A collection of programs, routines, subprograms, subroutines and loops, used by digital computers.

signal. In audio systems and components, the complex electric wave corresponding to speech, music, and associated sounds, destined for audible reproduction.

- time.** The time in which the computer extracts the instruction word from memory, decodes the instruction, and initiates the execution of the instruction.
- programming.** In computers, the science of translating a problem to terms and instructions that a machine can understand and obey.
- projection**
- cathode-ray tube.** A cathode-ray tube designed to produce an image of sufficient brightness to permit projection by lenses or a combination of lenses and mirrors.
- receiver.** A television receiver in which the picture is enlarged by lenses and projected upon a viewing screen.
- propagation.** A term used to describe the manner in which an electromagnetic wave, such as a radar signal, timing signal or ray of light, travels from one point to another.
- constant.** For a traveling plane wave at a given frequency, the complex quantity whose real part is the attenuation constant in nepers per unit length and whose imaginary part is the phase constant in radians per unit length.
- time delay.** The time required for a wave to travel between two points on a transmission line. See delay.
- velocity.** The speed at which a radio wave travels. In free space, a radio wave travels at approximately 186,000 miles per second.
- proportional**
- band.** The range of values of the condition being regulated which will cause the controller to operate over its full range. Usually expressed by engineers in terms of percentage of instrument full scale range.
- control.** Control action related to the extent a condition being regulated is off-the-beam.
- counter tube.** A radiation counter tube designed to operate in the proportional region.
- region.** (radiation-counter tubes) The range of applied voltage in which the charge collected per isolated count is proportional to the charge liberated by the initial ionizing event.
- protective resistance.** A resistor used to limit current flow to a predetermined safe value.
- proton.** The natural, elemental quantity of positive electricity. The mass of the proton is 1849 times that of the electron. A proton has the same quantity of positive electricity as an electron has of negative electricity, hence one proton balances one electron.
- prototype.** A model suitable for complete evaluation of mechanical and electrical form, design, and performance. It is in final mechanical and electrical form, employs approved parts, and is completely representative of final equipment.
- proximity**
- effect.** The redistribution of current in a conductor brought about by the presence of another conductor.
- fuse.** A fuse designed to detonate a projectile, bomb, mine, or charge when activated by an external influence in the close vicinity of a target.
- P-type**
- conductivity.** The conductivity associated with holes in a semiconductor.
- material.** A semiconductor material that has been doped with an acceptor material that gives an excess of holes.
- semiconductor.** An extrinsic semiconductor in which the hole density exceeds the conduction electron density. Note: It is implied that the net ionized impurity concentration is acceptor type.
- pulling.** Forcing the frequency of an oscillator to change toward another frequency by some form of coupling or loading.
- pull**
- out torque.** The pull-out torque of a synchronous motor is the maximum sustained torque which the motor will develop at synchronous speed for 1 minute, with rated voltage applied at rated frequency and with normal excitation.
- up current.** The minimum current that will cause the armature of a relay to be pulled up against the relay core.
- pulsating current.** A current that changes in value but not in direction.
- pulse.** A variation of a quantity whose value is normally constant; this variation is characterized by a rise and decay, and has a finite duration.
- amplitude.** A general term indicating the magnitude of a pulse.
- bandwidth.** The smallest continuous frequency interval outside of which the amplitude of the spectrum does not exceed a prescribed fraction of the amplitude at a specified frequency.
- carrier.** A pulse train used as a carrier.
- decay time.** The time required for the instantaneous amplitude to go from 90% to 10% of the peak value.

- delay unit.** A unit having a long time constant for delaying the arrival time of a pulse.
- demoder.** (constant-delay discriminator) A circuit which responds only to pulse signals which have a certain spacing between pulses for which the device is adjusted. Contrast with Pulse-Moder.
- discriminator.** A device that responds only to a pulse having a particular characteristic, such as duration, amplitude, period. The latter is also called a time discriminator.
- doppler system.** A pulsed radar system which utilizes the Doppler Effect for obtaining information about the target (not including simple resolution from fixed targets).
- droop.** A distortion of an otherwise essentially flat-topped rectangular pulse characterized by a decline of the pulse top.
- duration.** (pulse length, pulse width) The time interval between the points on the leading and trailing edges at which the instantaneous value bears a specified relation to the pulse amplitude. Note: Frequently the specified relation is taken as 50%.
- duration coder.** In navigation a device which generates a code by the varying of the pulse lengths.
- duration discriminator.** A circuit in which the sense and magnitude of the output is a function of the deviation of the pulse length from a reference.
- duration modulation.** A form of pulse-time modulation in which the duration of a pulse is varied.
- duty factor.** The ratio of the average pulse duration to the average pulse spacing. Note: This is equivalent to the product of the average pulse duration and the pulse repetition rate.
- generator.** A device that generates pulses. Specifically, one for generating pulses for synchronizing purposes in a television system.
- interleaving.** A process in which pulses from two or more sources are combined in time-division multiplex for transmission over a common path.
- interrogation.** The triggering of a transponder by a pulse or pulse mode.
- interval.** See pulse spacing.
- interval modulation.** A form of pulse-time modulation in which the pulse spacing is varied.
- jitter.** A relatively small variation of the pulse spacing in a pulse train. Note: The jitter may be random or systematic, depending on its origin, and is generally not coherent with any pulse modulation imposed.
- mode.** 1. A finite sequence of pulses in a prearranged pattern used for selecting and isolating a communication channel. 2. The prearranged pattern.
- mode multiplex.** A process or device for selecting channels by means of pulse modes. Note: This process permits two or more channels to use the same carrier frequency.
- moder.** A device for producing a pulse mode. Contrast with Pulse-Demoder.
- modulation.** 1. Modulation of a carrier by a pulse train. 2. Modulation of one or more characteristics of a pulse carrier.
- modulator.** A device that applies pulses to the element in which modulation takes place.
- operation.** Method of operation in which the energy is delivered in pulses.
- position modulation.** (ppm) A form of pulse-time modulation in which the position in time of a pulse is varied.
- repeater.** A device used for receiving pulses from one circuit and transmitting corresponding pulses into another circuit.
- repetition frequency.** The pulse repetition rate of a periodic pulse train.
- repetition period.** The reciprocal of the pulse repetition frequency.
- repetition rate.** The average number of pulses per unit of time.
- rise time.** The time required for the instantaneous amplitude to go from 10% to 90% of the peak value.
- separation.** The interval between the trailing-edge pulse-time of one pulse and the leading-edge pulse-time of the succeeding pulse.
- separator.** A television receiver circuit that separates the horizontal and vertical pulses.
- shaper.** Any transducer used for changing one or more characteristics of a pulse.
- shaping.** Intentionally changing the shape of a pulse.
- spacing.** (pulse interval) The interval between the corresponding pulse times of two consecutive pulses. Note: The term "pulse interval" is deprecated because it may be taken to mean the duration of the pulse instead of the space or interval from one pulse to the next. Neither term means the space between pulses.
- spectrum.** (pulse frequency spectrum) The frequency distribution of the sinusoidal components of the pulse in relative amplitude and in relative phase.
- spike.** An unwanted pulse of relatively short duration superimposed on the main pulse.
- spike amplitude.** The peak pulse amplitude of the pulse spike.
- |||.** A distortion in an otherwise essentially flat-topped rectangular pulse

characterized by either a decline or a rise of the pulse top.

train. A sequence of pulses.

valley. The part of the pulse between two specified maxima. Note: Unless otherwise specified, it is to be understood that the maxima are the first and the last.

width. See pulse duration.

-width modulation. See pulse-duration modulation.

pulsed

oscillator. An oscillator which generates a carrier-frequency pulse or a train of carrier-frequency pulses. Note: These carrier-frequency pulses may occur as the result of self-generated or externally applied pulses.

-oscillator starting time. The interval between the leading-edge pulse-time of the pulse at the oscillator control terminals and the leading-edge pulse-time of the related output pulse.

pulsar. Electronic equipment for the production of high voltage pulses of extremely short duration occurring at definite recurrence rates.

pure tone. A sound produced by sinusoidal sound waves of a single frequency.

purity. In color TV, the reproduction of a fully saturated primary color without the presence of any other color.

push-back hookup wire. Tinned copper hookup wire covered with a loosely braided cotton insulation that can be pushed back from the end of a wire length to expose sufficient bare wire for a connection.

push-button

switch. A device that opens or closes a circuit by means of pressure upon a button.

tuner. A tuning unit that automatically tunes a receiver to a station when the button assigned to that station is pressed.

pushing figure. (of an oscillator) The change of oscillator frequency with a specified change in current, excluding thermal effects. See electronic tuning sensitivity.

push-pull

circuit. A two-tube circuit so arranged that both tubes operate simultaneously and their individual plate currents add in the common load to balance out all even harmonics that would otherwise cause distortion.

currents. Balanced currents.

microphone. A microphone which makes use of two like microphone elements actuated by the same sound waves and operating 180° out of phase.

oscillator. A balance oscillator with two similar tubes in phase opposition.

transformer. An iron-core af transformer designed for use in a push-pull amplifier circuit.

voltages. Balanced voltages.

push-push

circuit. A two tube circuit so arranged that the tubes operate alternately into a common load.

voltages. Voltages (relative to ground) on the two conductors of a balanced line which, at every point along the line, are equal in magnitude and have the same polarity.

Q

Q The merit (degree of perfection) of a coil or capacitor, equal to its reactance divided by its resistance.

signal. 1. One of the three-letter abbreviations starting with Q in the International List of Abbreviations, used to represent complete sentences in radiotelegraphy. When the question form of the sentence is intended, the code signal for an interrogation mark is sent after the abbreviation. Thus, QRM means "I am being interfered with," and QRM? means "Are you being interfered with?" Other common Q signals used in a similar manner are: QRN, Atmospheric interference. QRT, Stop sending, used to clear bands in emergency. QRX, Wait. QSY, Shift frequency. 2. The chrominance signal corresponding to the narrow-band subcarrier axis.

quadrature. Displaced 90° in phase angle.

quantum efficiency. (photocathodes) The average number of electrons photoelectrically emitted from the photocathode per incident photon of a given wavelength.

quarter-wave

antenna. An antenna electrically equal to one-fourth the wavelength of the signal transmitted or received.

transformer. A section of transmission line one-quarter wavelength long, used as an impedance-matching transformer.

transmission line. A transmission line that is an electrical quarter-wavelength of the frequency for which it is designed.

quartz. A natural crystalline material widely used as the source of piezoelectric crystals.

crystal. A thin slab cut from a natural crystal of quartz and ground to a thickness that will make it vibrate at the desired frequency when supplied with energy. It is used as the master carrier frequency source in the crystal oscillator stage of a transmitter.

lamp. A mercury-vapor lamp having a transparent envelope made from quartz instead of glass. Quartz resists heat, permitting higher current, and passes ultraviolet rays that are absorbed by ordinary glass.

quasi-optical. Having properties similar to light waves in their propagation; said of microwaves.

quenching. (In a gas-filled radiation counter tube) The process of terminating a discharge in a radiation counter tube by inhibiting reignition.

frequency. A locally generated frequency produced in a super-regenerative detector stage at regular intervals to prevent oscillation during reception.

quick-break fuse. A fuse that opens a circuit rapidly when it is overloaded, to prevent arcing.

quiescent

carrier telephony. A radiotelephony system in which the carrier is suppressed whenever there are no voice signals to be transmitted.

operating point. The value of voltage or current characteristic of a vacuum tube or transistor circuit when no signal is being transmitted or received.

quiet

automatic volume control. A noise limiter circuit that blocks an i-f or af stage until a certain signal strength is reached, and which does not therefore apply full amplification to background noise when tuning between stations.

tuning. A means of silencing the output of a receiver at all times except when it is accurately tuned to an incoming carrier wave.

quieting sensitivity. (In FM receivers) The least signal input for which the output signal-noise ratio does not exceed a specified limit.

R

radar. A general name for radio detecting

and ranging systems that determine the distance and usually the direction of objects by the transmission and return of electromagnetic energy.

equation. A mathematical expression which relates the transmitted and received powers and antenna gains of a primary radar system to the echo area and distance of the radar target.

performance figure. The ratio of the pulse power of the radar transmitter, to the power of the minimum signal detectable by the receiver.

pilottage equipment. Equipment utilizing primary radar techniques and carried on a vehicle for the purpose of determining bearing and distance of recognizable landmarks and for indicating the relative position of other vehicles.

shadow. In radar, a region shielded from radar illumination, by an intervening reflecting or absorbing medium; this region appearing as an area void of targets on a radar display.

radial. In navigation, one of a number of radial lines of position defined by an azimuthal radio navigational facility, and identified in terms of the bearing (usually magnetic) of all points on that line from the facility.

lead. A lead coming from the side of a component, rather than axially from the end.

radian. An angle which, when placed with its vertex at the center of a circle, intercepts an arc equal in length to the radius of the circle. A complete circle contains 2π radians, hence 1 radian is 57.2959° , and 1° is 0.01745 radian.

radiant energy. Energy in the form of electromagnetic radiation such as radio waves, heat waves, or light waves.

radiate. To emit electromagnetic or heat waves into space.

radiating

curtain. An antenna array of dipoles placed in a vertical plane to reinforce each other.

guide. An ultra- to super-high-frequency waveguide designed to radiate energy into free space.

radiation. 1. The process of emitting waves, as of radio waves from an antenna. 2. In nuclear work, the term is extended beyond its usual meaning to include moving nuclear particles, charged or uncharged, and electrons moving with sufficient speed to enter into nuclear processes.

counter. An instrument used for de-

- tecting or measuring radiation by counting action.
- efficiency.** A transmitting antenna rating, equal to the ratio of the power radiated to the total power supplied to the antenna at a given frequency.
- field.** Space containing electromagnetic lines of force.
- loss.** That part of the transmission loss due to radiation of radio frequency power from a transmission system.
- pattern.** A diagram indicating the intensity of the radiation field of a transmitting antenna at a given distance away from the antenna in all directions. In the case of a receiving antenna, it indicates the response of the antenna to a signal having unit field intensity and arriving from different directions.
- resistance.** That part of the total resistance of an antenna that causes energy to be radiated into space instead of being dissipated as heat loss at the antenna. It is equal to the radiated power (determined through field strength measurements) divided by the square of the antenna current at a point of maximum current.
- radiator.** That part of an antenna system from which radio waves are emitted.
- radical sign.** The sign $\sqrt{\quad}$, placed before a number to indicate that its square root is to be extracted. When some other root is to be extracted, the index number of that root is placed in the angle of the radical sign. Examples: $\sqrt{49}$ means square root of 49, which is 7; $\sqrt[3]{64}$ means cube root of 64, which is 4.
- radio.** The art of communication by means of radio waves traveling through free space, as in sound, television, facsimile, etc., as distinguished from wired radio, in which rf currents are transmitted over wire lines. Also, a receiving set capable of picking up radio waves and reproducing the intelligence they convey.
- altimeter.** A device for determining the altitude of an airplane, consisting of a transmitter sending pulses which are reflected from the earth to a receiver. The time between the sending and receiving of a pulse indicates the altitude.
- beacon.** A facility, usually a nondirectional radio transmitter, emitting identifiable signals intended for radio direction finding observations.
- channel.** A band of frequencies officially allotted to each station for radio communication or broadcasting purposes.
- compass.** A radio direction finder used chiefly in marine and aircraft radio stations for navigational purposes.
- control.** The control of moving objects such as airplanes, automobiles, ships, and torpedoes, by means of signals transmitted over radio waves from the transmitter location to special radio receiving equipment in the object being controlled. Also called remote control.
- direction finding.** Radiolocation in which only the direction of a source of radio emission is determined by means of a directive receiving antenna system.
- fadeout.** Partial or complete blocking of radio waves by a sudden ionospheric disturbance.
- field strength.** The electric or magnetic field strength at a given location resulting from the passage of radio waves. In the case of a sinusoidal wave, the root-mean-square value is commonly used. Unless otherwise stated, it is taken in the direction of maximum.
- frequency.** (rf) A frequency higher in the spectrum than audible frequencies but lower than light or heat frequencies. See spectrum.
- frequency amplifier.** A vacuum tube amplifier stage to provide amplification of radio frequencies.
- frequency choke.** A coil designed to have high impedance at radio frequencies.
- frequency converter.** A power source for producing electrical power at a frequency of 10 kc and above.
- frequency transformer.** A air-core or powdered-iron core transformer used in rf circuits.
- horizon.** The locus of points at which direct rays from the transmitter become tangential to the earth's surface. Note: On a spherical surface the horizon is a circle. The distance to the horizon is affected by atmospheric refraction.
- landing beam.** A radio beam that serves for vertical guidance of aircraft when landing during unfavorable weather conditions.
- link.** The carrying of a program (sound or television) from point of pickup to main studio by means of radio instead of telephone lines.
- marker beacon.** A radio beacon station used for marking the location of a point, a boundary or a small area, such as for aircraft blind-landing systems.
- navigation.** Use of radio signals for course-plotting.
- range.** A radio facility which provides radial lines of position by having special characteristics in its emissions recognizable as bearing information and useful in lateral guidance of aircraft.
- range station.** A radio beacon station that transmits waves in definite directions, in such a way that departures from a given course can be observed by aircraft or ships.
- receiver.** An instrument that amplifies

- radio-frequency signals, separates the rf carrier from the intelligence signal, amplifies the intelligence signal additionally in most cases, then converts the intelligence signal into sound waves.
- spectrum.** All the wavelengths or frequencies that can be used for the transmission of energy, communications, or signals by radio.
- station.** A station equipped to engage in radio communications or radio transmission of energy. A station includes all apparatus used at a particular location for one class of service. Radio stations are classified according to the nature of the service they furnish.
- telegraphy.** Radio communication by means of the international Morse Code.
- telephony.** The transmission of voice or music through space by means of modulated rf waves.
- transmitter.** A device for producing rf power for radio transmission.
- wave.** A combination of electric and magnetic fields varying at a radio frequency, and capable of traveling through space.
- wave propagation.** The transfer of energy by electromagnetic radiation at frequencies lower than about 3×10^{12} cycles per second.
- radioactivity.** The emission of radiant energy by an element or material, either spontaneously or under the influence of an activating device.
- radiophoto.** The transmission by radio of photographs, drawings, typewritten and printed material. Also called facsimile.
- radiotelephone transmitter.** A transmitter capable of sending voice and music, as contrasted with a radiotelegraph transmitter, which can send only code.
- radius.** The distance from the center of a circle or arc to any point on that circle or arc.
- radome.** A streamlined antenna housing used on airplanes.
- rain return.** In radar, clutter due to rain.
- remark.** A fixed facility which continuously emits a signal so that a bearing indication appears on a radar display.
- random**
- access.** Pertaining to a memory device which is not cyclic and from which all stored information is equally available at any particular time.
- errors.** Those errors which can be predicted only on a statistical basis.
- noise.** Noise due to the aggregate of a large number of elementary disturbances with nonregular occurrence in time.
- winding.** A winding made with no regard for the position of the turns or layers in reference to each other.
- raster.** The illuminated rectangular area scanned by the electron beam in a picture tube, visible when the brilliancy control is turned up with no signal.
- burn.** (camera tubes) A change in the characteristics of that area of the target which has been scanned, resulting in a spurious signal corresponding to that area when a larger or tilted raster is scanned.
- ratchet relay.** A stepping relay actuated by an armature-driven ratchet.
- rate**
- action.** A type of control action in which the rate of correction is made in proportion to how fast the condition has gone awry. Also called derivative action.
- grown junction.** (semiconductor) A grown junction produced by varying the rate of crystal growth.
- of decay.** The time rate at which the sound pressure level (or velocity level, or sound-energy density level) is decreasing at a given point and at a given time. The practical unit is the decibel per second.
- rated output.** The power, voltage, or current a device will provide when operated under specified conditions.
- ratio.** The value obtained by dividing one number by another.
- detector.** An FM detector that uses a pair of diodes connected in such a manner that the audio output is proportional to the ratio of the FM voltages applied to the two diodes.
- ray.** The path along which electrons or light waves travel in space.
- RC**
- circuit.** A time-determining network of resistors and capacitors in which the time constant is defined as the product of the resistance and the capacitance.
- coupling.** Resistor-capacitor coupling between two circuits.
- oscillator.** Any oscillator in which the frequency is determined by resistance-capacitance elements.
- reactance.** That part of the impedance offered to the flow of alternating current by the inductance or capacity of a

part or circuit. Reactance is measured in ohms, and depends upon the frequency of the alternating current as well as upon the value of inductance or capacity.

modulator. Device, the reactance of which may be varied in accordance with the instantaneous amplitude of the modulating wave applied. Electron tubes are widely used in this manner to effect phase or frequency modulation.

reactive. Pertaining to inductive or capacitive reactance.

volt-amperes. That component of the apparent power in an alternating-current circuit which is delivered to the circuit during part of a cycle but is returned to the source during another part of the cycle. Sometimes called wattless power. The practical unit of reactive power is the var, equal to one reactive volt-ampere.

reactor. 1. A device that introduces either inductive or capacitive reactance into a circuit. 2. An assembly capable of sustaining a fission chain reaction.

-start motor. A form of split-phase motor designed for starting with a reactor in series with the main winding. The reactor is short-circuited or otherwise made ineffective and the auxiliary circuit is opened when the motor has attained a predetermined speed.

read. To acquire information, usually from some form of storage. See also write.

around number. (In charge-storage tubes) The number of times priming, writing, reading, or erasing operations can be performed on storage elements adjacent to any given element without loss of information from that element. Note: The sequence of operations should be specified.

number. (In charge-storage tubes) The number of times a storage element is read without rewriting.

-out. The process of entering the output information or answers of a computer in a recorder, or on a page or card via the agency of a printer.

reading speed. (In charge-storage tubes) The rate of reading successive storage elements.

real

power. That component of the apparent power (volt-amperes) in an alternating-current circuit that represents true work. Expressed in watts. Equal to the volt-amperes multiplied by the power factor.

time. Simultaneous and concurrent action or activity; solving a problem or making decisions which will affect the

device (missile, etc.) while it is still operating on the same mission from which the data involved was received.

Rebecca. The airborne interrogator-responder of Rebecca-Eureka, a secondary radar system.

receiver. A device for receiving radio waves.

gating. The application of operating voltages to one or more stages of a receiver only during that part of a cycle of operation when reception is desired.

lockout system. In mobile communications, an arrangement of control circuits whereby only one receiver can feed the system at one time to avoid distortion.

receptacle. A socket or outlet into which a plug can be pushed or screwed for the purpose of making an electrical connection.

reciprocal. The reciprocal of a number is 1 divided by that number. Example: 1/R is the reciprocal of R.

transducer. A transducer in which the principle of reciprocity is satisfied.

recombination current. The current across a junction that does not reach the external circuit because the carriers recombine with carriers of the opposite polarity.

record

medium. The physical medium on which the recorder forms a record of the recording signal.

noise. Noise voltages produced as the stylus passes over the granular surface of the record. Record noise is also known as record scratch or surface scratch.

-player. A motor-driven turntable and an electric pickup used for converting the variations on a phonograph record into electrical signals.

recorder. An instrument that makes a record of a signal.

recording. 1. A record of a signal. 2. The process of making records or of registering the received signal upon the record sheet of a facsimile receiver or measuring instrument.

channel. The term refers to one of a number of independent recorders in a recording system or to independent recording tracks on a recording medium. Note: One or more channels may be used at the same time for covering different ranges of the transmitted frequency band, for multichannel recording, or for control purposes.

- disc.** An unrecorded or blank disc used for sound recording purposes. Also called a recording blank.
- head.** The device that cuts a groove on a disc, or magnetizes a steel wire or magnetic tape in accordance with the sound being recorded.
- level.** The db or vu output of an audio amplifier used for recording.
- loss.** In mechanical recording, the loss in recorded level whereby the amplitude of the wave in the recording medium differs from the amplitude executed by the recording stylus.
- playback-gap.** The tiny distance between the poles of the recording head, measured in mils. The head gap of home recorders may range from 1 mil (.001 inch) down to $\frac{1}{2}$ mil. The smaller the gap, the higher the frequency range of the tape recorder can be.
- spot.** (In facsimile) The image area formed at the record medium by the facsimile recorder.
- stylus.** A tool which inscribes the groove into the recording medium.
- recovery time.** 1. (of a radiation counter) The minimum time from the start of a counted pulse to the instant a succeeding pulse can attain a specific percentage of the maximum value of the counted pulse. 2. (gas tubes) The time required for the control electrode to regain control after anode current interruption.
- rectangular coordinates.** The two values that specify the position of a point on a graph with respect to two reference lines at right angles to each other.
- rectification.** The process of changing alternating current into a current that flows in only one direction, usually a pulsating direct current.
- factor.** The quotient of the change in average current of an electrode by the change in amplitude of the alternating sinusoidal voltage applied to the same electrode, the direct voltages of this and other electrodes being maintained constant.
- rectifier.** A device that changes an alternating current into a pulsating direct current.
- rectilinear scanning.** The process of scanning an area in a predetermined sequence of narrow, straight parallel strips.
- recurrence rate.** See repetition rate.
- redistribution.** (In charge-storage tubes) The alteration of charges on an area of a storage surface by secondary electrons from any other area of the surface.
- re-entrant cavity.** A resonant cavity with one or more sections directed inwards, so the electric field is confined to a small area or volume.
- reference**
- black level.** The picture signal level corresponding to a specified maximum limit for black peaks.
- input.** A signal established as a standard of comparison for a feedback control system by virtue of its relation to the command.
- level.** The starting or zero point from which a scale is laid out or from which measurements are made.
- volume.** The volume which gives a reading of 0 vu on a standard volume indicator.
- white level.** The picture signal level corresponding to a specified maximum limit for white peaks.
- reflectance.** Ratio of reflected to incident flux.
- reflected**
- impedance.** The effective impedance that appears across the primary of a transformer when a load is connected to the secondary.
- resistance.** The effective resistance that appears across the primary of a transformer when a load is connected across the secondary.
- wave.** The wave caused by the reflection of part of an incident or oncoming wave.
- reflecting curtain.** A vertical array of half-wave reflecting antenna elements, generally used behind a radiating curtain of a number of dipoles, to form a high-gain antenna array.
- reflection.** A change in the direction of waves after impinging on a surface.
- altimeter.** An aircraft altimeter depending on the reflection of radio waves from the earth for the determination of altitude. See radio altimeter.
- loss.** The power lost in a transformer or transmission line because of a difference in the impedances of the source and load.
- reflector.** 1. A single rod, system of rods, or solid metal sheet used to increase the directivity of an antenna. 2. A microwave reflecting surface (usually flat) placed in a radio beam to change the direction of the beam.
- voltage.** The voltage between the re-

flector electrode and the cathode in a reflex klystron.

reflex

baffle. A loudspeaker baffle in which a portion of the radiation from the rear of the diaphragm is propagated forward after controlled shift of phase or other modification, the purpose being to increase the over-all radiation in some portion of the frequency spectrum.

bunching. The bunching that occurs in an electron stream that has been made to reverse its direction in the drift space.

circuit. A circuit through which a radio signal passes both before and after a change in its frequency.

klystron. A klystron tube in which one set of grids is made to act both as the buncher and the catcher through the use of a reflector or repeller plate.

refracted wave. That part of an incident wave which travels from one medium into a second medium.

refraction. The bending of light, heat, sound, or radio wave passing obliquely from one medium into another, in which the velocity of propagation is different from that in the first medium.

loss. That part of the transmission loss due to refraction resulting from non-uniformity of the medium.

refractive index. Of a wave transmission medium, the ratio of the phase velocity in free space to that in the medium.

regeneration. 1. A method of securing increased output from an amplifier by feeding a part of the amplifier output back to the amplifier in such a way that the signal is in phase with the input. Also called positive feedback. 2. (In electronic computers) In a storage device whose information storing state may deteriorate, the process of restoring the device to its latest undeteriorated state. See also rewrite.

regenerative

detector. A vacuum tube detector in which intentional feedback of rf energy from the plate circuit to the control grid circuit produces regeneration, greatly increasing the useful amplification.

receiver. A radio receiver that uses controlled regeneration to increase the amplification provided by a vacuum tube stage.

repeater. A repeater which performs pulse regeneration.

register. 1. A device capable of retaining information which is usually a subset of the aggregate information in a digital computer. 2. The condition of accurate superposition of one or more partial pictures on another. 3. The relative position of one or more printed-circuit patterns, or portions thereof, with respect to their desired locations on a printed-circuit base or to another pattern on the opposite side of the base.

length. The number of characters which a register can store.

registry. The superposition of one image on another, as in the formation of an interlaced scanning raster.

regulated power supply. A power supply designed to have a constant voltage or current output under conditions of varying load or input power.

regulation. Ability to maintain constant output despite variations in load.

regulator. A device that accomplishes regulation within desired limits.

reignition. (of a radiation counter tube) A process by which multiple counts are generated within a counter tube by atoms or molecules excited or ionized in the discharge accompanying a tube count.

Reinartz crystal oscillator. A crystal-controlled vacuum-tube oscillator featuring a resonant circuit connected between cathode and ground, tuned to half the crystal frequency.

rejection band. (of a uniconductor waveguide) The frequency range below the cut-off frequency.

reinsserter. A circuit for establishing the dc level of a waveform.

reinsertion of carrier. The combining of an incoming suppressed-carrier signal with a locally generated carrier signal in the receiver.

rel. A unit of reluctance, equal to 1 ampere-turn per magnetic line of force.

relaxation oscillator. An oscillator circuit in which alternate charging and discharging of a capacitor through a resistance determines the number of pulses, so the frequency is determined by the time constant of the capacitor and resistor.

relay. An electromechanical device which is operated by variation in the conditions of one electric circuit to effect

the operation of other devices in the same or other electric circuits by either opening contacts or closing contacts or both.

station. A radio station which acts as an intermediate station in transmitting communication signals from one fixed station to another. See repeater.

transmitter. A transmitter that rebroadcasts television or sound programs to increase the service area. Often called repeater station.

reluctance. That property of a material which opposes the establishment of a magnetic field. Reluctance in a magnetic circuit corresponds to resistance in an electrical circuit.

reluctivity. The reciprocal of permeability.

remanence. The magnetic flux density remaining in a magnetic circuit after the removal of an applied magnetomotive force.

remote

control. Control of any device from a distance.

cut-off tube. A variable-mu tube in which the spacing of the control grid wires is wider at the center than at the ends. The amplification of the tube does not vary in direct proportion to the bias, and some plate current flows even at high values of negative bias on the grid.

pickup. Any program not originating in the studio.

repeatability. The difference between two successive output readings at the same input, taken under the same conditions and with the input applied from the same direction.

repeater. An amplifying station used to boost the volume on long telephone lines.

station. (radio) An intermediate station in a microwave system which is arranged to receive a signal from an adjacent station and amplify and retransmit the signal to another adjacent station. Usually performs this function in both directions simultaneously.

repeating timer. A timing device which upon completion of one operating cycle continues to repeat automatically until excitation is removed.

repeat point. A second position of a superheterodyne tuning dial at which reception of a given station recurs.

repeller. An electrode whose primary function is to reverse the direction of an electron stream. Note: The repeller is

sometimes called the reflector.

repertoire. A word used in digital computer terminology. See instruction repertoire.

repetition frequency. See repetition rate.

rate. The rate at which recurrent signals are transmitted.

reply. In transponder operation, a radio frequency signal or combination of signals transmitted as a result of an interrogation.

reproducer. A device for converting an electrical signal into some form capable of being perceived by the senses. Specifically, a loud-speaker, picture tube, or facsimile reproducer.

re-radiation. Return of energy to space by a device such as a receiving antenna that has extracted energy from space.

research. A process of scientific investigation prior to and during development. It has for its aim the discovery of new scientific facts, techniques, and natural laws; an extension of the "state-of-the-art."

reset. 1. To restore a storage device to a prescribed state. 2. To place a binary cell in the initial or "zero" state. See also clear.

residual

charge. The charge remaining on the plates of a capacitor after discharge.

error. The sum of the random errors and the uncorrected systematic errors.

gap. In relays, the residual gap is the length of the magnetic air gap between the pole-face center and the nearest point on the armature when the armature is in the energized position.

gases. The small amount of gas remaining in a tube after evacuation.

magnetism. Magnetism that remains in the core of an electromagnet after the electrical circuit has been broken.

resist. A material (ink, paint, metallic plating etc) used to protect the desired portions of the printed circuit from the action of the etchant.

resistance. The opposition a device or material offers to the flow of current, as a result of which electric energy is converted into heat or radiant energy. Resistance is the only opposition to dc. In an ac circuit, the total opposition is known as the impedance; where there is negligible reactance, the impedance

equals the resistance, but where there is appreciable reactance, the impedance is a combination of the two. Because of skin effect, losses in iron cores, etc., the resistance in a circuit may be somewhat higher for ac than for dc, and is called ac resistance to distinguish it from the lower dc resistance of that same circuit.

box. See decade box.

bridge. See Wheatstone bridge.

-bridge pressure pickup. A pressure transducer in which the electrical output is derived from the unbalance of a resistance bridge varied according to the applied pressure.

-capacitance coupling. The coupling together of two vacuum tube stages or circuits by means of resistors and capacitors.

coupling. Another name for resistance-capacitance coupling.

drop. The voltage drop occurring across a resistance when a current flows through it. An IR drop.

loss. See I^2R loss.

pad. A system of resistors used to reduce signal strength, change impedance, or isolate one circuit from another.

wire. Wire made from an alloy having high resistivity.

resistivity. The resistance of a unit cube of a material.

resistor. A radio part that offers resistance to the flow of electric current.

resolution. 1. In television, a measure of the ability to delineate picture detail. 2. In a pressure potentiometer, the number of wires on the winding.

chart. A television test pattern containing a number of converging lines. The point on the screen where these lines seem to merge into one, determines the maximum resolution of the image.

wedge. On a television test pattern, a group of gradually converging lines used to measure resolution.

resolver. A device for converting data obtained in polar form into rectangular form, and vice versa.

resolving time. 1. In radiation counters, the minimum achievable pulse spacing between counts. 2. The minimum time interval by which two events must be separated to be distinguishable in a navigation system, by the time measurement alone.

resonance. In a circuit containing both inductance and capacitance, a condition in which the inductive reactance is equal

to and cancels out the capacitive reactance.

bridge. See impedance bridge.

curve. A frequency response curve that shows in graphical form the manner in which any apparatus containing a resonant circuit handles or amplifies the various frequencies at or near the resonant frequency.

indicator. A device, such as a meter or neon lamp, that provides visual means of showing resonance in a circuit.

point. In connection with vibration testing, a frequency of vibration of a body or system at which mechanical vibration is "magnified".

resonant

circuit. A circuit containing inductance and capacitance. Specifically, a circuit in which the inductance and capacity values have been chosen so the circuit will resonate at a desired operating frequency.

current step-up. The increase of the current in a parallel resonant circuit at resonance, over the line current fed into it.

frequency. The frequency at which the inductive and capacitive reactances are balanced.

gap. (TR tubes) The small region in a resonant structure interior to the tube, where the electric field is concentrated.

line. A transmission line whose length makes it resonant at the transmitted frequency, or one tuned to such a frequency by adding the proper inductance or capacity to it.

-line oscillator. A self-excited ultrahigh frequency oscillator using parallel rods to form the grid and plate inductances.

resistance. The resistance offered by a parallel resonant circuit at resonance.

voltage step-up. The increase in voltage across each element of a series resonant circuit at resonance, over the source voltage.

resonate. To bring to resonance, as by tuning.

resonating cavity. A short wave guide adjustable in length and terminating at either or both ends in a metal piston, diaphragm, or other wave-reflecting device. It is used as a filter, as a means of coupling between guides of different sizes, or as an impedance network. See cavity.

resonator. A hollow chamber forming the tuned circuit of a microwave oscillator. See cavity resonator.

mode. See mode of an oscillator.

response. The amplification of a device at

- a particular frequency.
- characteristic.** A curve showing the response of a radio device, circuit, or system over a range of frequencies.
- speed.** See time constant.
- time.** (of a system or element). The time required for the output to first reach a specified value after the application of a step input or disturbance.
- responsor.** The receiving component of an interrogator-responsor.
- resting frequency.** The assigned carrier frequency of a radio station using the frequency modulation system of broadcasting. The resting frequency is radiated only during intervals when no sound waves are being transmitted.
- restoring spring.** A spring which, when the relay is de-energized, moves the armature to and holds it in the normal position.
- retarding-field oscillator.** An oscillator using a vacuum tube in which the electrons oscillate back and forth through a grid maintained positive with respect to the cathode and the plate. The field in the region of the grid exerts a retarding effect that draws electrons back after passing through it in either direction.
- retrace.** The path traveled by an electron beam from the end of one line or field to the start of the next line or field. Flyback.
- line.** The line traced by the electron beam in a cathode-ray tube in going from the end of the one line or field to the start of the next line or field.
- time.** The time required for the spot to return after each sweep. It is also referred to as return time or flyback time.
- return wire.** The ground or common lead.
- reverberation.** The persistence of sound at a given point, after direct reception from the source has stopped.
- chamber.** An enclosure in which all of the surfaces have been made as sound-reflective as possible. Reverberation chambers are used for certain acoustic measurements.
- time.** For a given frequency, the time required for the average sound-energy density, originally in a steady state, to decrease after the source is stopped to one-millionth of its initial value (60 db). Note: Usually the pressure level for the upper part of this range is measured and the result extrapolated to cover 60 db.
- time meter.** An instrument for measuring the reverberation time of an enclosure.
- reverse**
- bias.** Connection of a battery across a junction so that its polarity opposes the flow of current across the junction.
- emission.** (back emission) (vacuum tubes) The inverse electrode current from an anode during that part of a cycle in which the anode is negative with respect to the cathode.
- rewrite.** In a storage device whose information storing state may be destroyed by reading, the process of restoring the device to its state prior to reading.
- rf power supply.** A high-voltage power supply sometimes used in television receivers, consisting of an rf oscillator whose output is fed through a step-up transformer to a rectifier.
- rheostat.** A variable resistor having a movable contact controlled by a knob, so that the amount of resistance in use can be easily adjusted while the circuit is electrically alive.
- rhombic antenna.** A directional antenna consisting of four long wires arranged to form a rhombus (a parallelogram with all four sides equal, like a diamond).
- ribbon microphone.** A moving-conductor microphone in which the moving conductor is a single corrugated metal ribbon mounted between the poles of permanent magnets. Often called a velocity microphone.
- right-hand taper.** A concentration of the resistance toward the counterclockwise end of a potentiometer or a rheostat when held with the shaft pointing toward the observer.
- rim-drive.** A method of driving a phonograph or sound recorder turntable with a rubber-covered wheel in contact with the rim of the turntable.
- ring**
- around.** 1. In secondary radar, the undesired triggering of a transponder by its own transmitter. 2. In secondary radar, the triggering of a transponder at all bearings causing a ring presentation on a PPI.
- counter.** A loop of interconnected bistable elements such that one and only one is in a specified state at any given time and such that, as input signals are counted, the position of the one specified state moves in an ordered sequence around the loop.

- head.** A magnetic head in which the magnetic material forms an enclosure with one or more air gaps. The magnetic recording medium bridges one of these gaps and is in contact with or in close proximity to the pole pieces on one side only.
- oscillator.** An arrangement of two or more pairs of tubes operating as push-pull oscillators around a ring, usually with alternate successive pairs of grids and plates connected to tank circuits. Adjacent tubes around the ring operate in phase opposition.
- time.** In radar, the time during which the output of an echo box remains above a specified level. The ring time is used in measuring the performance of radar equipment.
- ringing.** An oscillatory transient occurring in the output of a system as a result of a sudden change in input.
- ripple.** 1. The ac component from a dc power supply arising from sources within the power supply. 2. In computers, the process of having the Carrys formed during addition pass from the lowest to the highest orders simultaneously with the process of adding the digits in each order, instead of waiting until such sums are first made.
- current.** The alternating-current component of a pulsating unidirectional current.
- factor.** The effective value of the alternating components of voltage or current divided by the direct or average values of the voltage of current.
- filter.** A filter that passes only frequencies below a critical cut-off frequency, used to reduce the ripple current of a rectifier or dc generator while allowing direct current to pass freely.
- frequency.** The frequency of the ripple current.
- voltage.** The alternating component of the unidirectional voltage from a rectifier or generator used as a source of direct-current power.
- rise time.** (of a system or element) The time required for the output to increase from one specified percentage of the final value to another, following the application of a step input. Usually the specified percentages are 10 and 90 per cent.
- rising-sun magnetron.** A multicavity magnetron in which resonators of two different resonance frequencies are arranged alternately for the purpose of mode separation.
- rms pulse amplitude.** (effective) The square root of the average of the square of the instantaneous amplitude taken over the pulse duration.
- Rochelle salt crystal.** A crystal of sodium potassium tartrate, having a pronounced piezoelectric effect, used in crystal microphones and crystal phonograph pickups.
- rocking.** A term applied to the back and forth rotation of the main tuning gang as the oscillator padder in a super-heterodyne receiver is adjusted at the low-frequency end of the dial.
- Roentgen ray.** The X-ray.
- roll.** A lack of vertical synchronization which causes the picture as observed on the picture monitor to move upward or downward.
- off.** A term used to describe the gradual decrease in gain of an audio system with either an increase or decrease in frequency. Originally applied only to high-frequency attenuation, now used for both high- and low-frequency characteristics.
- root.** A number which, when multiplied by itself a number of times, equals a given number. The radical sign $\sqrt{\quad}$ is used to indicate square root, and the radical sign with an index number in its angle is used to indicate any other root. Example: $\sqrt[5]{3125} = 5$ which means that the fifth root of 3125 is 5.
- mean square. (rms)** 1. The effective value of an alternating current. It corresponds to the direct current value that will produce the same heating effect. 2. The square root of the average of squares of values uniformly distributed throughout a cycle.
- sum-square.** The square root of the sum of the squares. Note: Commonly used to express the total harmonic distortion.
- rosin-core solder.** Solder that has as its core the correct amount of rosin flux for effective radio soldering work. The rosin is released automatically as the solder is applied to the heated joint.
- rotary**
- beam antenna.** A highly directional short-wave receiving or transmitting antenna system mounted in such a way that it can be rotated to any desired position either manually or by an electric motor drive.
- converter.** A rotating electric machine having a single armature containing both a commutator and slip rings. If driven by a motor or engine, both ac and dc

power may be obtained from it simultaneously.

generator. (induction heating usage) An alternating-current generator adapted to be rotated by a motor or prime mover.

spark gap. A type of spark gap using a rotating disc having studs from which sparks leap to one or more stationary electrodes when high voltage is connected between disc and stationary electrodes.

stepping switch. Same as stepping relay.

switch. Any switch that is operated by rotating a control knob.

rotating joint. A coupling for transmission of electromagnetic energy between two waveguide structures designed to permit mechanical rotation of one structure.

rotor. A rotating part, such as the rotating armature of an electric motor or generator.

plates. The movable plates of a variable capacitor.

round-off. To delete less significant digits from a number and possibly apply some rule of correction to the part retained.

error. Error resulting from rounding off.

routine. A sequence of operations which a digital computer may perform, or the sequence of instructions which determine these operations.

rumble. Low-frequency sounds introduced during recording (or during playback) by vibrations of the turntable or motor.

S

sabin. (square-foot unit of absorption) A measure of the sound absorption of a surface. It is the equivalent of 1 square foot of a perfectly absorptive surface.

safety factor. The ratio of the normal operating rating, to the maximum safe rating.

sampler. A switching arrangement used to connect circuits in rapid succession. In color television, the sampler of the transmitter switches in signals for each of three colors in a specified order. At the receiver, the sampler routes the three color signals in proper order to the reproducer.

sampling. The process of switching to get small segments of each cycle at a time.

gate. A device which extracts information from the input waveform only when activated by a selector pulse.

saturable reactor. (saturable core reactor) A magnetic core reactor in which a low value of current produces magnetic saturation of the core, thereby reducing the effective inductance and reactance above the saturation point. Sometimes called a nonlinear coil.

saturated signal. In radar, a signal of an amplitude greater than the dynamic range of the receiving system.

saturation. 1. In a magnetic circuit, the condition wherein increases in magnetomotive force produces negligible additional flux. Also see plate saturation and temperature saturation. 2. The "vividness" of a color described by such terms as pale, deep, pastel, etc. The greater the amplitude of the chrominance signal, the greater the saturation.

sawtooth. A voltage or current waveform that rises linearly to its peak and then drops rapidly back to its starting level.

generator. A relaxation oscillator providing an alternating voltage having a sawtooth waveform.

scalar quantity. A quantity that has only magnitude, and no direction.

scale. 1. A series of marks printed on a surface over which an indicator moves, or which moves past an indicator. 2. A musical scale is a series of notes (symbols, sensations, or stimuli) arranged from low to high by a specified scheme of intervals, suitable for musical purposes.

division. A region between one line and the next adjacent line on a scale.

factor. 1. In analog computing, a proportionality factor which relates the magnitude of a variable to its representation within a computer. 2. In digital computing, the arbitrary factor which may be associated with numbers in a computer to adjust the position of the radix point so that the significant digits occupy specified columns.

scaling. A method of allowing numbers of different magnitude to fit a particular register by the introduction of a suitable (scale) factor.

circuit. A circuit that actuates a counting device on receiving a predetermined number of pulses.

scanner. 1. The part of a facsimile transmitter that systematically translates the densities of the elemental areas of the subject copy into signal-waveform. 2. An instrument which automatically checks a number of measuring points and indicates which have wandered too far from their desired values.

scanning. The process of successively converting the amount of light present in each of the picture elements that make up the total area of a picture or scene into electrical signals for television or facsimile transmission. Also, the reverse process at the receiver.

line. A single continuous narrow strip, produced by the process of scanning in television or facsimile.

linearity. In television, the uniformity of scanning speed during the trace interval.

line length. The total length of scanning line is equal to the spot speed divided by the scanning line frequency. Note: This is generally greater than the length of the available line.

spot. The area viewed at any instant by the scanner in a facsimile system. Also, the cross-sectional area of the electron beam at either the camera or picture tube in a TV system.

scatterband. In pulse systems, the total bandwidth occupied by the frequency spread of numerous interrogations operating on the same nominal radio frequency. Note: The frequency spread is due to the fact that each interrogation is a pulsed transmission, and to the additional fact that not all transmitters in the group are exactly on the nominal frequency.

scattered reflections. Reflections from a region of the ionosphere, which interfere and cause rapid fading. They are variable in respect to time of occurrence, geographical distribution, intensity, and frequency range.

scattering loss. That part of the transmission loss which is due to scattering within the medium or due to roughness of the reflecting surface.

schematic diagram. A diagram that shows electrical connections of an electronic device by means of symbols used to represent the parts.

Schmidt system. An optical system used to produce large projection images. A large hemispherical mirror is used to project the image formed on a small picture tube onto a translucent screen. Optical distortion is compensated for

by interposing a corrector lens in the projection path.

Schmitt trigger. A cathode-coupled bistable multivibrator, the output of which will be a square wave independently of the shape of the input voltage waveform. A squaring circuit.

Schottky emission. The increased thermionic emission resulting from an electric field at the surface of the cathode.

scintillation. (also target glint or wander) On a radar display, a rapid apparent displacement of the target from its mean position.

counter. The combination of a phosphor photomultiplier tube and associated circuits for counting scintillations.

scope. A cathode ray oscilloscope.

scoring system. For motion picture production, a recording system used for recording music to be reproduced in timed relationship with a motion picture.

scrambled speech. Radio-telephone speech that has been made unintelligible to those not having the proper receiving equipment.

scratch filter. A filter circuit used in connection with a phonograph pickup to block those frequencies at the higher end of the audio range at which needle scratch is most prominent.

screen. The surface of a cathode-ray tube upon which the visible pattern is produced. Also a shield.

grid. A grid placed between a control grid and an anode, and usually maintained at a fixed positive potential, for the purpose of reducing the electrostatic influence of the anode in the space between the screen grid and the cathode.

-grid modulation. Modulation produced by introduction of the modulating signal into the screen-grid circuit of a multigrid tube in which the carrier is present.

-grid tube. A vacuum tube having a screen grid.

-grid voltage. The dc voltage applied between the screen grid and the cathode of a vacuum tube to make the screen grid positive with respect to the cathode.

persistence. The property of the fluorescent screen of a picture tube to continue the radiation of light for a short time after the electron beam causing the light spot has passed.

seal-disc tube. A tube in which the grid is a portion of a disc, sealed into the glass envelope. See lighthouse tube.

sealing

compound. Wax or pitch used in capacitor blocks and transformer housings to prevent air and moisture from reaching the parts.

off. Final closure of the glass or metal envelope of a vacuum tube or lamp after evacuation.

search

coil. A tiny exploring coil of wire used with a ballistic galvanometer or fluxmeter to measure flux density in a magnetic field.

radar. A radar employed to search for and initially locate objects as opposed to track radar which is used to track or follow objects.

searchlighting. The process of projecting a radar beam continuously at an object.

sea return. Clutter resulting from irregularities of the sea surface.

secant. (sec) A trigonometric function. The secant of an acute angle of a right triangle (written $\sec \theta$) is equal to the hypotenuse divided by the adjacent side. The secant is the reciprocal of the cosine.

second

anode. The electrode in a cathode-ray tube that is maintained at a constant positive potential and used to accelerate the electron beam.

detector. The stage of a superheterodyne receiver that separates the modulation from the intermediate frequency carrier signal.

secondary. A transformer winding that receives energy by electromagnetic induction from another or primary winding.

cell. A dc voltage source capable of storing electrical energy. When exhausted, it can be recharged by sending direct current through it in the reverse direction. Each cell of an ordinary storage battery is a secondary cell.

electron gap loading. The electron gap admittance which results from the traversal of a gap by secondary electrons originating in the gap.

electrons. Electrons emitted from a body due to the impact or bombardment of other electrons.

emission. The ejection of electrons from a solid or liquid as a result of charged-particle impact.

emission ratio. (electrons) The average number of electrons emitted from a surface per incident primary electron. Note: The result of a sufficiently large number of events should be averaged to ensure that statistical fluctuations are negligible.

grid emission. Electron emission from a grid resulting directly from bombardment of its surface by electrons or other charged particles.

voltage. The voltage across the secondary winding of a transformer.

sectoral horn. An electromagnetic radiator, two opposite sides of which are parallel, and the remaining two sides of which diverge.

sector display. In radar, a limited display in which only a section of the total service area of the radar system is shown. Usually the sector to be displayed is selectable.

selectance. The reciprocal of the ratio of the sensitivity of a receiver tuned to a specified channel to its sensitivity at another channel separated by a specified number of channels from the one to which the receiver is tuned.

selection check. A check (usually an automatic check) to verify that the correct register, or other device, is selected in the performance of an instruction.

selective

fading. Fading which is different at different frequencies in a frequency bank occupied by a modulated wave.

interference. Radio interference concentrated in a narrow band of frequencies. Some examples are other radio stations on the same or adjacent frequencies, or harmonics of other radio stations.

reflection. Reflection of waves of only a certain group of frequencies.

selectivity. The degree to which a receiver is capable of reproducing signals of one station while rejecting signals from all other stations on adjacent channels.

control. The device or circuit that changes the selectivity of a receiver.
of a receiver. That characteristic which determines the extent to which the receiver is capable of differentiating between the desired signal and disturbances of other frequencies.

selector. A device, mechanical, electronic, or electrical, for making connections to any one of a number of circuits at will.

pulse. A pulse which is used to identify for selection one event in a series of events.

relay. A relay capable of automatically selecting one or more circuits from a number of circuits.

selenium

cell. A photoconductive cell using some form of selenium as the light-sensitive material. The resistance of the cell varies with the amount of light falling on the cell.

rectifier. A dry-disc rectifier made of a crystalline selenium layer between two electrodes. A chemical barrier action between the selenium and one electrode produces a unidirectional current flow when ac voltage is applied.

self

-bias. See automatic grid bias.

-cleaning contacts. Contacts designed to close with a rubbing motion that keeps them clean.

-excitation. Supplying of field current to a generator from its own armature.

-excited oscillator. An oscillator that starts itself. Any change in plate current will induce a voltage in a tank circuit, which changes the grid voltage so that oscillations are developed and maintained.

-healing capacitor. A capacitor that repairs itself after dielectric breakdown.

-inductance. The property that determines how much electromotive force will be induced in a coil or circuit by a change of current in that same coil or circuit; often simply called inductance.

-modulated oscillator. See blocking oscillator.

-quenched counter tube. A radiation counter tube in which reignition of the discharge is inhibited by internal processes.

-quenched detector. A super-regenerative detector in which the time constant of the grid leak and grid capacitor is sufficient to cause intermittent oscillation above audio frequencies, stopping normal regeneration each time before it becomes squealing.

Selsyn motor. A synchronous motor that accurately follows the phase of the voltage fed to it.

semiconductor. A material midway between a conductor and an insulator. The electrons can be moved from their atoms when some external energy such as light, heat, or a voltage is applied.

device. An electron device in which the characteristic distinguishing electronic conduction takes place within a semiconductor.

diode. A two-electrode semiconductor, the average distance to which minority carriers diffuse between generation and recombination.

semiduplex. A method of operation of a communication circuit where one end is duplex and one end simplex operation. Sometimes used in mobile systems with the base station duplex and the mobile station simplex. Requires two frequencies.

semitone. (half-step) The interval between two sounds whose basic frequency ratio is approximately equal to the twelfth root of two.

semitransparent photocathode. A photocathode in which radiant flux incident on one side produces photoelectric emission from the opposite side.

sending. Transmitting, as Morse Code.

end impedance. The input impedance of a transmission line.

sense. To determine the state of a bistable or multistable device.

antenna. A non-directional antenna used with a direction finder to cause reception to be unidirectional rather than bidirectional.

finder. The portion of a radio direction finder that determines which of two opposite directions (180° apart) a radio wave is coming from.

sensing element. The part of a transducer mechanism which is in contact with the medium being measured and which responds to changes in the medium.

sensitive

relay. A relay requiring very small amounts of current for operation.

volume. (of a radiation counter tube) That portion of the tube responding to specific radiation.

sensitivity. 1. The ratio of the change in output of an instrument to the change in input. That is, the slope of the output-input curve. Expressed in volts/psi for a pressure potentiometer or ohms/degree for a resistance thermometer.

2. The least signal input capable of causing an output signal having desired characteristics.

control. A device that governs the gain of the rf or i-f amplifier stages of a receiver.

time control. (also called gain-time control or time-gain) That portion of a system which varies the amplification

of a radio receiver in a predetermined manner as a function of time.

sensitometry. The measurement of the light response characteristics of photographic film under specified conditions of exposure and development.

sensor. That portion of a navigational system which perceives deviations from a reference and converts these deviations into signals.

separation. Regarding multistage missiles, the time or place at which a burnt-out stage is discarded and the remaining missile continues on its way.

filter. As the name implies, a filter or, more accurately, a combination of filters used to separate one band of frequencies from another. Often used to separate carrier and voice frequencies for transmission over individual paths.

sequence

control. The automatic control of a series of operations in a predetermined order.

relay. A relay that controls two or more sets of contacts in a definite predetermined sequence.

sequential system. A system in which the colors are transmitted one after the other and which depends either on the retentivity of the eye or picture-tube storage (or both) to combine them. The respective elements have been produced as sequential fields, lines, or dots.

serial. Pertaining to time-sequential transmission of, storage of, or logical operations on the parts of a word, using the same facilities for successive parts.

arithmetic unit. One in which the digits of a number are operated on sequentially.

digital computer. One in which the digits are handled serially. Mixed serial and parallel machines are frequently called serial or parallel according to the way arithmetic processes are performed. An example of a serial digital computer is one which handles decimal digits serially although it might handle the bits which comprise a digit either serially or in parallel. See also parallel digital computer.

operation. The operation of a computer in which the arithmetic calculations are performed in sequence upon the various orders of a number, normally on the same piece of equipment.

transfer. A system of information transmission in which the characters of a word are transmitted in sequence

over a single line, as contrasted to parallel transfer.

transmission. See serial transfer.

series. An arrangement of parts in such a way that the same current flows through all of them.

connection. A connection in which the same current must flow through all of the series-connected parts.

elements. 1. Two-terminal elements are connected in series when they form a path between two nodes of a network such that only elements of this path, and no other elements, terminate at intermediate nodes along the path. 2. Two-terminal elements are connected in series when any mesh including one must include the others.

feed. Application of a dc operating voltage through a circuit carrying a signal current.

modulation. Modulation in which plate circuits of the modulating tube and the modulated amplifier tube are in series with the plate voltage supply.

motor. A commutator-type motor having armature and field windings in series. Characteristics are high starting torque, variation of speed with load, and extremely high speed on no-load.

peaking. The use of an inductance in series with the plate of a video amplifier tube to compensate for loss of high-frequency gain and to correct high-frequency phase shift.

resonant circuit. A circuit in which a coil and capacitor are connected in series with the source of voltage, or in which the exciting voltage is induced in the coil, and where the inductive reactance of the coil is equal to the capacitive reactance of the capacitor at the desired resonant frequency.

tee junction. A tee junction having an equivalent circuit in which the impedance of the branch guide is predominantly in series with the impedance of the main guide at the junction.

serrated

pulses. A series of equally spaced pulses within a pulse signal. For example, the vertical sync pulse is serrated in order to keep the horizontal-sweep circuits in step during the vertical sync-pulse interval.

rotor plate. A variable capacitor rotor plate having slots cut along its edge to divide the plate into sections that can be bent in or out to adjust the capacity during alignment.

service

area. The region around a station in which its signal strength is strong

enough to insure satisfactory reception at all times.

band. A band of frequencies allocated to a given class of radio-communication service, such as the broadcast band, a police band, etc.

oscillator. A test instrument used to generate radio-frequency oscillations for alignment and test purposes.

servo

system. 1. A complete electromechanical system for amplifying and transmitting accurate mechanical position from one point to another by electrical means. 2. A signal-transmitting system. The purpose of a servo is to reproduce a signal at a place or power level or form different from the original signal, but under its control. The servo signal is usually mechanical. The circuit elements are motors, gears, or the mostats.

techniques. Methods devised to study performance of servomechanisms or control systems.

servomechanism. A feedback control system in which one or more of the system signals represent mechanical motion.

servomotor. A mechanism to make force act at a distance, proportional to the force impressed upon it, as in gyro-control mechanisms which guide rudders on steered rockets. In particular, pneumatic or hydraulic cylinders used for this purpose.

sesqui-sideband transmission. The transmission of a carrier with one full sideband and half of the other. See vestigial sideband.

set-up. 1. The initial adjustment of a receiver or transmitter before it is placed in service. 2. The separation in level between blanking and reference-black levels.

seventy-volt line. (70-volt line) A line connected to the 70-volt tap on the output transformer of an amplifier. The position of this tap is such that it will provide 70 volts when the amplifier is delivering its rated power output. This system simplifies the mathematics of impedance matching since, with 70 volts taken as a standard, loudspeakers and matching transformers may be labeled in watts as well as ohms. Loudspeaker impedances are nonuniform; the lower wattage ones having highest impedance. With this constant-voltage system, impedance matching reduces to the rule: connect any number of loudspeakers to

the 70-volt line as long as their wattages add up to the rated power output of the amplifier.

shaded-pole induction motor. An induction motor utilizing field displacement caused by a small coil wound around a part of one field pole for initiating rotation.

shading. 1. In TV camera tubes, a brightness gradient in the reproduced picture, not present in the original scene, but caused by the tube. 2. A method of controlling the directivity pattern of a transducer through control of the distribution of phase and amplitude of the transducer action over the active face.

coil. Sometimes used for shading ring.

ring. 1. A large copper ring placed around the central pole piece of a loud-speaker field magnet to act as a shorted turn and buck out hum voltages. Also called shading coil, and used on part of one pole of small ac motors to produce a rotating magnetic field. 2. In relays, a shading ring is a shorted turn surrounding a portion of the pole of an alternating-current magnet, causing a delay of the change of the magnetic flux in that part, thereby preventing contact chatter.

signal. A signal that raises the gain of the amplifier of a television camera for those intervals of time when the electron beam is in a dark-spot area.

shadow

factor. The ratio of the electric field strength which would result from propagation over a sphere to that which would result from propagation over a plane, other factors being the same.

mask. (color picture tubes) A color-selecting-electrode system in the form of an electrically conductive sheet containing a plurality of holes which uses masking to effect color selection.

tuning indicator. A tuning meter having a small square metal vane mounted on a shaft, which in turn is connected to a meter movement. A pilot lamp is mounted behind the vane so that a shadow is thrown upon a glass screen. The meter is so constructed and connected into a radio receiver circuit that the shadow will be narrowest when the receiver is accurately tuned to a station.

shank. The portion of a phonograph or recording stylus that is clamped into position by a set-screw in the pickup or cutting head.

sharp. A term usually used to describe the selectivity of a circuit that will respond

- to a very limited range of frequencies or to a single frequency only.
- sheath.** The external conducting surface of a shielded transmission line. Also, the metal wall of a waveguide.
- shelf life.** See storage life.
- shells.** The regions around the nucleus of an atom in which the electrons are found.
- shell-type transformer.** A transformer whose external metal covering resembles a shell or a dish, and whose core has three legs, with the coils wound on the center leg. Contrasted with the core type which has the form of an "O" with coils wound on both sides.
- shield.** Material used to suppress the effect of an electric or magnetic field within or beyond definite regions.
- grid.** (gas tubes) A grid which shields the control grid from electrostatic fields, thermal radiation, and deposition of thermionic emissive material, and which may also be used as an additional control electrode.
- shielded**
- cable.** One or more insulated conductors surrounded by a metallic braid or tape covering.
- pair.** A two-wire transmission line surrounded by a metal sheath.
- transmission line.** A transmission line whose elements essentially confine propagated electrical energy to a finite space inside a conducting sheath.
- wire.** Insulated wire having around it a shield of tinned, braided copper wire.
- shielding.** Metal covering used on a wire, or the metal can, partition, or plates used around parts to prevent undesirable radiation, pickup of signals, magnetic induction, stray current, or ac hum.
- shift.** Displacement of an ordered set of characters one or more places to the left or right. If the characters are the digits of a numerical expression, a shift may be equivalent to multiplying by a power of the base.
- register.** In computers, a register in which it is possible to shift. Conversion from serial read-in to parallel read-out, or vice-versa, is possible.
- shifting accumulator.** An accumulator in which the number registered can be moved or shifted one or more orders to the right or to the left.
- shock.** Stimulation to the nervous system of an animal or to an electrical system caused by a discharge of electricity.
- excitation.** Production of oscillations in an oscillatory circuit by a sudden electrical discharge or pulse.
- shoran.** (Short Range Navigation) A precision position fixing system using a pulse transmitter and receiver on the vehicle with two transponders at fixed points.
- short**
- Circuit.** An undesirable current path, occurring accidentally or because of a component break-down, that exists between the two sides of a circuit or between any two circuit terminals.
- wave converter.** A radio device that can be connected between a broadcast receiver and its antenna system to convert high-frequency signals to a broadcast-band frequency that can be handled by the receiver.
- waves.** Wavelengths shorter than those included in the broadcast band, hence waves shorter than 200 meters. Short waves correspond to frequencies higher than the highest broadcast-band frequency of 1600 kilocycles.
- wave transmitter.** A radio transmitter that radiates short waves.
- shorting contact switch.** A rotary selector switch in which the width of the movable contact is greater than the distance between contact studs, so the circuit is never completely open. Also called a make-before-break switch.
- shot effect.** Noise caused by the random impact of electrons in a vacuum tube. This causes slight instantaneous variations in the output current of the tube.
- shunt.** A resistor placed across the terminals of an ammeter to allow a definite part of the circuit current to go around the meter. Also, any parallel-connected part, or the act of placing one part in parallel with another.
- feed.** The application of a dc operating voltage through a circuit parallel to and separated from the signal circuit. Parallel feed.
- peaking.** The use of an inductance in a parallel circuit branch of a video amplifier to compensate for the high-frequency loss due to the shunt circuit capacitance or to correct the high-frequency phase shift.
- tee junction.** A tee junction having an equivalent circuit in which the impedance of the branch guide is predominantly in parallel with the impedance of the main guide at the junction.

-wound. A motor or generator wound so the armature and field are in parallel.

shutter. A device for cutting off light.

side

circuit. One (either) of the two circuits employed for the derivation of a phantom circuit.

frequency. One of the frequencies of a sideband.

-lock. Control of an AFC system by a frequency component other than the carrier of the applied signal, resulting in stabilization of the oscillator frequency at a value different from this carrier.

sideband

attenuation. Attenuation in which the transmitted amplitude of some component or components of a modulated signal (excluding the carrier) is smaller than that produced by the modulation process.

power. The power contained in the sidebands. It is this power to which a receiver responds, not to the carrier power, when receiving a modulated wave.

sidebands. 1. The frequency bands on both sides of the carrier frequency within which fall the frequencies of the wave produced by the process of modulation. 2. The wave components lying within such bands.

sign. A symbol used to indicate a particular operation in arithmetic, algebra, or mathematics in general. Examples: +, ×, +, =. Also characters indicating polarity and positive and negative numbers.

digit. A character used to designate the algebraic sign of a number.

signal. A radio wave or alternating current that carries intelligence of any form.

contrast. (In facsimile) The ratio expressed in decibels between white signal and black signal.

frequency shift. In a frequency shift facsimile system, the numerical difference between the frequencies corresponding to white signal and black signal at any point in the system.

generator. A test instrument used to produce a modulated or unmodulated rf carrier signal having a known radio-frequency value, sometimes also at a known voltage.

level. At any point in a transmission system, the difference of the measure of the signal at that point from the measure of an arbitrarily specified signal chosen as a reference.

output current. (camera tubes or phototubes) The absolute value of the difference between output current and dark current.

plate. The metal plate on the back of the mica sheet supporting the mosaic of one type of cathode-ray television camera tube. A capacity exists between each globule and this plate, and as each globule loses electrons, the effect is relayed electrically to the signal plate through the mica dielectric.

strength. A measure of the signal level at a particular location, usually expressed as millivolts per meter of effective height of the receiving antenna.

-strength meter. A meter connected in the avc circuit of a receiver and calibrated in db or arbitrary units to indicate the strength of a received signal.

-to-noise ratio. The ratio of the magnitude of the signal to that of the noise. This ratio is often expressed in decibels.

tracer. A test instrument designed to indicate the presence of signals at any point in a receiver.

tracing. A receiver servicing technique that involves tracing the progress of a signal through an entire receiver, stage by stage, while the receiver is in operation. Measurements made during this procedure by a signal tracer indicate when the defective part or stage has been reached.

wave. A wave that conveys a signal.

signaling channel. A tone channel used for signaling purposes.

silent period. A period during each hour in which ship and shore radio stations must remain silent and listen for distress calls.

silicon. Non-metallic element which is a semiconductor and used as transistor material.

controlled rectifier. (SCR) A PNPN device which is the semiconductor equivalent of a gas thyatron.

silk-covered wire. Wire insulated with one or more layers of silk.

simple

scanning. Scanning of only one scanning spot at a time during the scanning process.

sound source. A source which radiates sound uniformly in all directions under free-field conditions.

target. In radar, a target having a reflecting surface, such that the amplitude of the reflected signal does not vary with the aspect of the target; e.g., a metal sphere.

tone. (pure tone) 1. A sound wave the instantaneous sound pressure of which is a simple sinusoidal function of the time. 2. A sound sensation characterized by its singleness of pitch.

simplex operation. Operation of a telegraph or radio system in only one direction at a time.

simulation. The representation of physical systems by computers and associated equipment.

simulator. The representation of a physical system by computers and associated equipment.

simultaneous system. A system in which the complete color information for a picture element is transmitted at one time. The U. S. approved system is a simultaneous color system.

transmission. A system of color television transmission in which all three primary colors are transmitted at the same instant over separate channels, and are superimposed one over the other at the receiver.

sine. (sin) A trigonometric function. The sine of an acute angle of a right triangle (written $\sin \theta$) is equal to the opposite side divided by the hypotenuse.

wave. The waveform of a single-frequency alternating current. A wave whose displacement is the sine of an angle proportional to time, or distance, or both.

single

-address code. (instruction) An instruction in general consists of a coded representation of the operation to be performed and of one or more addresses of words in storage. The instructions of a single-address code contain only one address.

-button carbon microphone. A microphone having a carbon-filled button on only one side of its diaphragm.

-ended. Using a single tube or tubes connected in parallel rather than in push-pull.

-ended stage. An amplifier in which only one tube is normally used, or if more than one tube is used, they are connected in parallel so that operation is not balanced with respect to ground.

-ended tube. A tube with all connections on the base (no top cap).

phase. A circuit or device that is energized by a single alternating voltage. Also, one of the phases of a polyphase system.

-pole switch. A toggle or knife switch

having only one movable contact arm or blade.

-sideband transmission. A method of broadcasting in which one sideband is suppressed. The carrier wave may be either transmitted or suppressed.

-signal receiver. A superheterodyne receiver equipped with a crystal filter usually located in the intermediate-frequency amplifier to provide single-frequency (code) reception. Also a set designed to receive only one station.

-throw switch. A toggle or knife switch of the ON-OFF type, capable of closing or opening only one circuit for each blade of the switch.

-tone keying. That form of keying in which the modulating wave causes the carrier to be modulated with a single tone for one condition, which may be either "marking" or "spacing", and the carrier is unmodulated for the other condition.

track. (standard track) In motion picture film recording a variable-density or variable-area sound track in which both positive and negative halves of the signal are linearly recorded.

-track recorder. A tape recorder which records only one track on the tape. Usually a full-track recording head is used which covers the full width of the 1/4-inch tape although some machines use a narrower, half-track recording head which records a single track down the middle of the tape. Output of a full-track recording is theoretically double that of a half-track recording, although actually it is only slightly greater because of improved half-track head design.

unit semiconductor device. A semiconductor device having one set of electrodes associated with a single carrier stream. Note: It is implied that the device has a single output function related to a single input.

sink. 1. (of an oscillator) The region of a Rieke Diagram where the rate of change of frequency with respect to phase of the reflection coefficient is maximum. Operation in this region may lead to unsatisfactory performance by reason of cessation or instability of oscillations. 2. Term sometimes used by telephone engineers to designate a load or power-consuming device.

sinusoidal. Having sine waveform.

vibration. A cyclical motion in which the object moves linearly. The instantaneous position is a sinusoidal function of time.

skew. (in facsimile) The deviation of the

received frame from rectangularity due to asynchronism between scanner and recorder. Skew is expressed numerically as the tangent of the angle of this deviation.

skiatron. 1. A dark trace oscilloscope tube (see dark trace tube). 2. A display employing an optical system with a dark trace tube.

skin

depth. For a conductor carrying currents at a given frequency as a result of the electromagnetic waves acting upon its surface, the depth below the surface at which the current density has decreased one neper from the current density at the surface. Note: Usually the skin depth is sufficiently small so that for ordinary configurations of good conductors, the value obtained for a plane wave falling on a plane surface is a good approximation.

effect. The tendency of a high-frequency current to flow near the surface of the conductor, rather than through the entire cross-section of the conductor. This decreases the useful diameter of the conductor, so it acts as if it has more resistance than it does to dc.

skip

distance. Distance between the transmitting antenna and the nearest point at which the reflected sky wave comes back to earth.

zone. A ring-shaped region around a transmitter within which there is no reception from the transmitter except that from ground waves. The outer edge of the ring is fixed by the skip distance.

sky wave. See ionospheric wave.

slave

station. In navigation, a station in which some characteristic of its emission is controlled by a master station.

sweep. A time base which is synchronized or triggered by a waveform from a source external to the time base. Used in navigational systems for displaying or utilizing the same information at different locations, or in displaying or utilizing different information with a common or related time base.

sleeve. The cylindrical metal contacting part immediately back of the tip in a telephone- or radio-type plug. Also, the insulating jacket that fits over the cone of metal-cone television kinescopes. Also, insulating tubing or spaghetti, used as a sheath over wire.

slide. A title or picture mounted for transparency projection.

rule. A device consisting of sliding ruler-like scales and a movable indicator, arranged to give a convenient mechanical equivalent of a table of logarithms. It is used for performing the operations of multiplication, division, squaring, cubing, extracting square roots, and determining trigonometric functions.

-rule dial. A tuning dial used on receivers, in which a vertical marker moves horizontally over long straight scales resembling the scales of a slide rule.

slider. A sliding type of movable contact.

slip. The difference between synchronous and actual speed in an induction motor.

rings. The rings of an ac motor or generator, corresponding to the commutator of a dc motor or generator, through which connection is made to the rotating member of the device.

slope. The trigonometrical tangent of the angle which the tangent line to a curve at any point, makes with the abscissa.

slot antenna. A radiating element formed by a slot in a metal surface.

slow-acting relay. A time delay relay in which an adjustable interval of time exists between energizing or de-energizing of the coil and attraction or releasing of the armature.

slug. A brass rod or powdered-iron core used in an rf coil. Also a heavy metal ring or short-circuited winding placed on the core of a relay to give a time delay in its operation.

tuner. A waveguide tuner containing one or more longitudinally adjustable pieces of metal or dielectric.

tuning. Varying the frequency of a resonant circuit by introducing a slug of material into either the electric or magnetic fields or both.

small signal depth of velocity modulation. The ratio of the peak amplitude of the velocity modulation of an electron stream, expressed in equivalent volts, to the electron-stream potential.

smear. A term used to describe a picture condition in which objects appear to be extended horizontally beyond their normal boundaries in a blurred, or smeared manner.

S meter. See signal strength meter.

smoothing

choke. An iron-core inductor used in a

- filter to remove pulsations in the unidirectional output current of a rectifier or direct-current generator.
- filter.** A filter composed of inductance and capacitance for removing ac components from the unidirectional output current of a rectifier or dc generator.
- snow.** Television slang for the effect of random noise on the reproduced picture. It has the appearance of a grainy, speckled pattern superimposed on the picture.
- socket.** A mounting device for tubes, plug-in coils, plug-in capacitors, plug-in resistors, and crystals, having holes with spring clips arranged to fit and grip the terminal prongs of the part being plugged in. Also, a bayonet or screw-type socket for pilot lamps.
- sodar.** A device, also known as acoustic radar which detects large changes in temperature overhead by the fact that the amount of sound returned is increased several times in volume when hot and cold air are intermingling violently. The device launches vertically upward from the ground a sound of low power that is in the range of human hearing. The echoes are received and changed into oscilloscope patterns that can be viewed.
- sofar.** An underwater sound system which makes it possible to locate air and ship survivors far at sea. The system utilizes a TNT charge dropped underwater by the survivor and timed to explode at a depth of 3000 to 4000 feet, which sets up underwater sound waves that are picked up by hydrophones at shore stations. Survivors can be located within a square mile of sea as far as 2000 miles from shore.
- soft tube.** A vacuum tube in which a small amount of gas is allowed to remain when the bulb is evacuated.
- software.** A terminology used in digital computer application. It means standard routines and subroutines on paper tape, magnetic tape or punch cards that are supplied by the computer manufacturer or that are developed at a data processing center. It contrasts "hardware" which means circuits and equipment.
- solder.** An alloy of lead and tin that melts at a fairly low temperature and is used for making permanent electrical connections between parts and wires.
- solderability.** The capability of a printed conductive pattern to be wet by solder.
- soldering connections.** Wiring connections made by the use of small screw clamps that firmly hold the wires to be joined.
- gun.** A soldering iron resembling a pistol. It has a fast-heating resistance element at the tip, that operates at high current and low voltage from a step-down transformer built into the unit.
- iron.** A device used to apply heat to a joint to be made permanent by soldering.
- pencil.** A soldering iron with a thin barrel and tip for soldering in small spaces.
- solenoid.** An electromagnet having a movable iron core.
- relay.** Sometimes used for a plunger relay.
- solid conductor.** A single wire. A conductor that is not divided into strands.
- sonar.** (SOUND Navigation And Ranging) A system for determining the direction and position of an object by means of reflected sound waves.
- sones.** A unit of loudness. By definition, a simple tone of frequency 1,000 cps, 40 db above a listener's threshold, produces a loudness of 1 sone.
- sonic.** Of or pertaining to sound, especially in aviation contexts, to the speed of sound. (Sound travels at different speeds through different mediums, and it travels at different conditions of temperature, etc. In air, under standard sea-level conditions, sound travels at approximately 1,100 feet per second, or 750 mph).
- sonne.** A radio navigation aid that provides a number of characteristic signal zones which rotate in a time sequence. A bearing may be determined by observation (by interpolation) of the instant at which transition occurs from one zone to the following zone.
- sort.** To arrange items of information according to rules dependent upon a key or field contained by the items.
- sound.** A general term used to specify a sound wave (a traveling vibration in air or some other elastic medium) or a sound sensation (the effect of this sound wave on human ears). Sound is sometimes defined as a vibration of a body or material at a rate that can be heard by human ears. The extreme limits of human hearing are 20 cycles and 20,000 cycles, but animals can hear still higher frequencies. Bats can hear sound waves

- as high as 50,000 cycles. Sound can travel through any medium that can vibrate; the resulting traveling vibrations are called sound waves.
- absorption.** The process by which sound energy is diminished in passing through a medium or in striking a surface.
- absorption coefficient.** (acoustical absorptivity) The fraction of incident sound energy absorbed by the surface or medium.
- analyzer.** An electronic apparatus, such as an oscilloscope, harmonic analyzer, or audiometer, used to measure sound levels and analyze frequency components in an audio signal.
- carrier.** The television signal carrier that conveys the audio part of the signal.
- field.** A region containing sound waves.
- gate.** The mechanism through which sound motion picture film passes for the purpose of converting the sound track on the film into audio signals.
- intensity.** The sound energy transmitted per unit of time in a specified direction through a unit area perpendicular to this direction. It is expressed in ergs per square centimeter or in watts per square centimeter. Also called flux density or sound-energy flux density.
- level.** At a point in a sound field, the weighted sound pressure level determined in the manner specified in the latest edition of "American Standard Sound Level Meters for Measurement of Noise and Other Sounds."
- level meter.** An instrument including a microphone, an amplifier, an output meter, and frequency weighting networks for the measurement of noise and sound levels in a specified manner; the measurements are intended to approximate the loudness level which would be obtained by the more elaborate ear balance method.
- panel.** Movable panels of rock wool for sound absorption, or hard surfaces for reflection.
- powered telephone.** A telephone operating entirely on current generated by the speaker's voice, requiring no batteries or power supply. A diaphragm, activated by sound waves moves a small coil through a magnetic field, producing a current in the coil.
- recording system.** A combination of transducing devices and associated equipment suitable for storing sound in a form capable of subsequent reproduction.
- reproducing system.** A combination of transducing devices and associated equipment for reproducing recorded sound.
- sensation.** The sensation produced in the human ear by a sound wave.
- track.** A narrow band, usually along the margin of a sound film, which carries the sound record. In some cases, a plurality of such bands may be used.
- wave.** A traveling wave produced by vibration of an elastic medium (air, metal, wood, etc.) at a rate that can be heard.
- sounder.** A telegraph receiving instrument.
- source.** The device which supplies signal power to a transducer.
- impedance.** The impedance presented by the source to a transducer.
- south pole.** The pole of a magnet at which the magnetic lines of force enter.
- space.** In telegraphic communications refer to the open circuit condition or the signal causing the open condition.
- charge.** The net electric charge within a given volume.
- charge debunching.** Any process in which the mutual interactions between electrons in the stream disperse the electrons of a bunch.
- charge density.** The net electric charge per unit volume.
- charge effect.** The repulsion exerted on electrons emitted from the cathode of a vacuum tube by electrons accumulated in space near the cathode.
- charge grid.** A grid, usually positive, that controls the position, area, and magnitude of a potential minimum or of a virtual cathode in a region adjacent to the grid.
- charge-limited current.** (of a vacuum tube) The current passing through an interelectrode space when a virtual cathode exists therein.
- charge region.** (pertaining to semiconductor) A region in which the net charge density is significantly different from zero. See also depletion layer.
- cloth.** Carbon-impregnated cloth used as a waveguide termination.
- current.** The current made up of electrons moving from the cathode to the plate and the other positive electrodes in a thermionic vacuum tube.
- pattern.** A geometrical pattern appearing on a test chart designed for the measurement of geometric distortion. Note: The RETMA Ball Chart is a specific example of a Space Pattern.
- spacing wave.** In telegraphic communication, the emission that takes place in between the code characters or when no code characters are being transmitted.
- spaghetti.** Heavily varnished cloth or

plastic tubing sometimes used to provide additional insulation of wires.

spark. A momentary flash due to an electric discharge through air or some other dielectric material.

coil. An induction coil used to produce spark discharge.

frequency. The number of sparks occurring per second in a spark transmitter.

gap. An arrangement of electrodes across which a spark will jump at a predetermined voltage.

-gap modulation. A modulation process that produces one or more pulses of energy by means of a controlled spark-gap breakdown for application to the element in which modulation takes place.

sparkling. Intentional or accidental spark discharges, as between the brushes and commutator of a rotating machine, or between contacts of a relay or switch.

voltage. The minimum voltage at which a spark discharge occurs. Also, the starting potential of a cold-cathode gas tube.

speaker. See loudspeaker.

specific resistance. The resistance of a unit conductor having a cross-sectional area of 1 circular mil and a length of 1 foot, a circular-mil-foot. Also called resistivity.

spectrum. All frequencies used for a particular purpose. Also, any series of radiant energies (or light), arranged in order of wavelength.

analyzer. A device for sweeping over a spectrum or band of frequencies to determine what frequencies are being produced, and the amplitudes of each such component.

color. Color of some part of the spectrum.

speech

amplifier. An audio amplifier.

clipper. An electronic circuit for the purpose of limiting the wave crests of speech frequency signals.

-frequency range. Audio frequencies from about 100 to 3000 cycles. In audio equipment, the frequency range necessary for intelligible speech.

spherical wave. A wave whose equi-phase surfaces form a family of concentric spheres.

spider. A highly flexible fiber ring that serves to center the voice coil of a dynamic loudspeaker between the pole

pieces and at the same time provide a restoring force, causing the voice coil to return to the same starting point after each movement. Also, a small metal cap used to couple the driving pin to the apex of the cone in magnetic speakers.

spike. A spurious pulse of relatively short duration, superimposed on the main pulse. See overshoot.

leakage energy. (TR and Pre-TR tubes) The radio-frequency energy per pulse transmitted through the tube before and during the establishment of the steady-state radio-frequency discharge.

splice. A joint between two wires that possesses mechanical strength as well as electrical conductivity.

split

-anode magnetron. A magnetron with an anode divided into two segments, usually by slots parallel to its axis.

-stator variable capacitor. A variable capacitor having a rotor section that is common to two separate stator sections.

sporadic

E layer. A portion of the normal E layer of the atmosphere that sometimes breaks away and exhibits special characteristics.

reflections. Sharply defined reflections of substantial intensity from an ionized layer of the ionosphere at frequencies greater than the critical frequency of the layer. They are extremely variable in respect to time of occurrence, geographic distribution, and frequency range.

spot. The luminous area produced on the viewing screen of a cathode-ray tube by the electron beam.

projection. The optical method of scanning or recording in which the scanning or recording spot is defined in the path of the reflected or transmitted light.

speed. The product of the length of scanning line and the number of scanning lines per second in a facsimile system.

spottiness. The effect in a television picture resulting from variations in the instantaneous light value of the reproduced image due to electrical disturbances between the scanning and reproducing devices.

spreader. The insulating cross-arm used to space aerial wires when more than one wire is used.

spring contact. A relay or switch contact mounted on a spring, usually of phosphor bronze.

spurious radiation. Any emission from a radio transmitter at frequencies outside its assigned communication band.

square. The product obtained by multiplying a number by itself. Example: 49 is the square of 7, because $7 \times 7 = 49$.

-law detector. A detector whose output current is proportional to the square of the rf input voltage.

-loop antenna. An FM antenna consisting of four dipoles arranged in the form of a square.

mil. The area of a square whose sides are .001 inch (one mil).

root. A number which, when multiplied by itself, equals a given number. Examples: 2 is the square root of 4; 13 is the square root of 169.

wave. A wave which alternately assumes two fixed values for equal lengths of time, the time of transition being negligible in comparison with the duration of each fixed value.

-wave generator. A signal generator for producing square or rectangular waves.

-wave response. (camera tubes) The ratio of (1) the peak-to-peak signal amplitude given by a test pattern consisting of alternate black and white bars of equal widths to (2) the difference in signal between large-area blacks and large-area whites having the same illuminations as the black and white bars in the test pattern.

squealing. A condition in which a high-pitched note is heard along with the desired radio program. It can be due to interference between stations.

squelch. To automatically quiet or reduce the output signal of a receiver when the applied input signal strength is less than a certain value.

circuit. An avc circuit that reduces the noise otherwise heard in a radio receiver between signals by blocking some stage when the signal amplitude is below a value called the squelch level.

squirrel cage

induction motor. A motor in which the secondary circuit consists of a squirrel cage winding suitably displaced in the secondary core.

winding. Permanently shortcircuited winding, usually uninsulated, having its conductors uniformly distributed around the periphery of the machine and joined by continuous end rings.

SS

-FM. This system of multiplex is one in which the several single sideband sub-carriers are used to frequency modulate a second carrier.

loran. A Loran system synchronized by sky waves instead of ground waves.

-PM. This system of multiplex is one in which the several single sideband sub-carriers are used to phase modulate a second carrier.

stability. The property of a system or element whose response to a stimulus dies down if the stimulus is removed.

stabilized

feedback. Another term for negative feedback, degeneration, or inverse feedback.

flight. That type of flight which obtains control information from inertia-stabilized references such as gyroscopes. Example: Flight in which the lateral, longitudinal, and vertical attitudes of an aircraft are maintained constant by a conventional automatic-pilot.

stacked

array. An array in which half-wave antenna elements are placed one above the other.

dipoles. Two or more dipole antennas arranged one above the other on a vertical structure.

stage. A circuit containing either a single tube or two or more tubes connected in push-pull, push-push, or parallel.

-by-stage elimination method. A method of servicing receivers similar to the circuit disturbance method except that the test signal is introduced by means of a test oscillator.

efficiency. The ratio of useful power delivered to the load (ac) and the plate power input (dc).

staggered tuning. Interstage coupling circuits of a video i-f amplifier are said to be staggered when they are tuned to different frequencies within a desired pass band. Staggered tuning is used to give broadband response.

standard

atmosphere. Standard values of pressure, temperature, density, etc., as a function of altitude.

beam approach. A vhf 40 mc continuous-wave low-approach system using a localizer and markers. The two main signal lobes are tone-modulated with the Morse Code Letters E and T, respectively. These modulations interlock to form a continuous "on-course" tone. The airborne equipment is instrumented for visual references but

the system may also be used aurally.

de-emphasis characteristic. The amount of de-emphasis necessary to correct standardized pre-emphasis. In FM, a response, decreasing as the modulating frequency increases, at a rate equal to that provided by a simple RC circuit having a time constant of 75 microseconds.

microphone. A microphone the response of which is accurately known for the condition under which it is to be used.

noise temperature. The standard reference temperature T_0 for noise measurements is 290°K.

pitch. The standard pitch is based on the tone "A" of 440 cycles per second.

pre-emphasis characteristic. A standardized amount of pre-emphasis. Especially in FM, a response, increasing as the modulating frequency increases, at a rate equal to that provided by a simple coil-resistor circuit in the modulating source having a time constant of 75 microseconds.

propagation. The propagation of radio waves over a smooth spherical earth of uniform dielectric constant and conductivity, under conditions of standard refraction in the atmosphere.

test output. The output power into a standard dummy load at which a receiver is tested. For receivers that can produce more than 1 watt of undistorted output power, it is .5 watt. For receivers that can produce no more than 1 watt, it is .05 watt.

standing

wave. 1. Distribution of current and voltage on a transmission line formed by two sets of waves traveling in opposite directions, and characterized by the presence of a number of points of successive maxima and minima in the distribution curves. Standing waves indicate that power is being lost in transmission, therefore efforts are made to keep standing waves to a minimum. 2. Sinusoidal distribution of current and voltage amplitudes along a transmission line as a result of the reflection of energy from a point where a mismatch of impedance occurs.

wave loss factor. The ratio of the transmission loss in an unmatched waveguide to that in the same waveguide when matched.

wave ratio. (SWR) The ratio of the voltage maximum to the voltage minimum along a transmission line.

stand-off insulator. An insulator used to support a wire at a desired distance away from the support on which the insulator is mounted.

start

record signal. A signal used for starting the process of converting the electrical signal to an image on the record sheet.

signal. A signal which initiates the transfer of a facsimile equipment condition from standby to active.

starter. (gas tubes) A control electrode, the principal function on which is to establish sufficient ionization to reduce the anode breakdown voltage.

breakdown voltage. (gas tubes) See breakdown voltage (of an electrode of a gas tube).

gap. (gas tubes) The conduction path between a starter and the other electrode to which starting voltage is applied.

voltage drop. (gas tubes) The starter voltage during conduction to the starter.

starting

anode. An electrode used to establish the initial arc or to prevent extinction in a mercury-arc rectifier or similar tube.

current. (of an oscillator) The value of electron-stream current through an oscillator at which self-sustaining oscillations will start under specified conditions of loading.

static. Interfering noises heard in a receiver due to waves created by atmospheric electrical disturbances such as discharges of lightning.

charge. An electric charge accumulated on an object, usually by friction.

eliminator. A device designed to attenuate the effect of static interference in a receiver or other electronic equipment.

station. An assembly of radio transmitting equipment and its transmitting antenna.

selector. The switch or tuning element in the receiver used to select the desired signal.

stator. The fixed set of plates in a variable capacitor. Also, the non-rotating part of an electric motor or generator.

steady-state

condition. Normal operation reached by a device after the transients produced as a result of turning it on have died out.

error. The error which remains after the transient has expired.

oscillation. (steady-state vibration) Steady-state oscillation exists in a system if the motion at each point is a periodic quantity. Note: This is frequently a special case of forced oscillation.

- steatite.** Soapstone talc. A mineral consisting chiefly of a silicate of magnesium, with excellent insulating properties.
- stenode circuit.** A superheterodyne receiving circuit in which a piezoelectric unit is used in the intermediate frequency amplifier to balance out all frequencies except signals at the crystal frequency, thereby giving very high selectivity.
- step-down transformer.** A transformer in which the secondary winding has fewer turns than the primary, so that the secondary delivers a lower voltage than is applied to the primary.
- step-up transformer.** A transformer in which the secondary winding has more turns than the primary, so that the secondary delivers a higher voltage than is applied to the primary.
- stepping relay.** A relay the contacts of which are stepped to successive positions as the coil is energized in pulses. Some stepping relays may be stepped in either direction. (The Stepping Relay is also called a Rotary Stepping Switch or a Rotary Stepping Relay.)
- stereophonic.** A sound-reproducing system designed to preserve some of the realism of the original sound by overcoming the point source characteristic of the loudspeaker. The number of loudspeakers used in the reproducing system is equal to the number of microphones, and the physical arrangement of these loudspeakers corresponds to the arrangement of the microphones. In this way, each loudspeaker reproduces the sound the listener would have heard had he been located at the position of the corresponding microphone.
- stop**
- record signal.** A signal used for stopping the process of converting the electrical signal to an image on the record sheet.
- signal.** A signal which initiates the transfer of a facsimile equipment condition from active to standby.
- storage.** 1. The act of storing information. (See also store.) 2. Any device in which information can be stored, sometimes called a Memory Device. 3. In a computer, a section used primarily for storing information. Such a section is sometimes called a Memory or a Store (British). Note: The physical means of storing information may be electrostatic, ferroelectric, magnetic, optical, chemical, electronic, electrical, mechanical, etc., in nature.
- battery.** One or more secondary or storage cells connected together, usually in series.
- capacity.** The amount of information that can be retained in a storage (or memory) device, often expressed as the number of words that can be retained (given the number of digits, and the base, of the standard word).
- cell.** A secondary cell, more specifically, one of the cells in the ordinary storage battery, capable of being recharged.
- element.** (In charge-storage tubes) An area of a storage surface which retains information distinguishable from that of adjacent areas.
- life.** The length of time that an instrument may be stored, non-operating, without deterioration or loss of performance.
- time.** (In charge-storage tubes) See maximum retention time.
- tube.** An electron tube into which information can be introduced and then extracted at a later time.
- type camera tube.** A television camera tube in which the elemental areas on the photosensitive plates build up their charges gradually, developing a picture signal proportional to the time of charging of the plates by light from the scene.
- store.** 1. To retain information in a device from which it can later be withdrawn. 2. To introduce information into such a device. 3. British synonym for Storage.
- straight-line characteristic.** Any action that can be represented by a straight line on a linear graph, that is, when one quantity varies in direct proportion to another.
- strain.** The change of shape, size, or form caused by applied force.
- gauge.** A measuring element (transducer) which can be used to convert a force, pressure, tension, etc., into an electrical signal. The signal is then fed to an instrument of measurement and, if desired, control.
- insulator.** An insulator designed to withstand the tension in a guy wire, antenna, or other stretched wire, used to break up the wire into insulated sections.
- pickup.** A pickup cartridge using the principle of the strain gauge. A strain gauge consists of a thin wire attached to a flexible backing. If the wire is stretched, it becomes thinner and longer and its resistance increases. When the

wire contracts, it becomes thicker and shorter and its resistance decreases. In the strain pickup, the strain-sensitive coating is applied to a thin, plastic backing. Movements of the stylus vary the resistance of the element and therefore modulate the current flow through it.

stranded wire. A number of small wires twisted or braided together and used as a single conductor.

stray

capacity. Capacity that exists between parts, between wires, or between a chassis and various parts and wires.

field. Stray inductance. Leakage magnetic flux that spreads outward from an inductor and does no useful work.

striking potential. The grid potential of a gas-filled triode at which plate current begins flowing.

stroboscope. A flashing light used to study rotating or reciprocating machinery by making it appear motionless. For example, if the flashing rate of a stroboscope is made equal to the rotating frequency of an electric fan, the blades will appear motionless. This is because the blades are in the same position each time they are illuminated.

disc. A disc, similar in shape to an ordinary record, used to check turntable speed. The disc, imprinted with a series of radial lines, is placed on the turntable and illuminated with a light flickering at the 60-cycle rate. The spacing of the radial lines is such that they appear stationary if the turn-speed is correct. Separate sets of lines or markers are used for 78, 45 and 33-1/3 rpm. Some stroboscopic discs have markings for 25- as well as 60-cycle illumination.

strobotron. A glow lamp that is made to produce accurately timed flashes of light that permit visual inspection of high-speed moving parts.

structural resolution. (color picture tubes) The resolution as limited by the size and shape of the screen elements.

structurally

dual networks. A pair of networks such that their branches can be marked in one-to-one correspondence so that any mesh of one corresponds to a cut-set of the other. Each network of such a pair is said to be the dual of the other.

symmetrical network. A network which can be arranged so that a cut through the network produces two parts

that are mirror images of each other.

stub. A shorted or open impedance path between the two conductors of a transmission line or in a waveguide. It is adjustable as to position so as to match the impedance of an antenna or transmitter to that of a transmission line. Also, a quarter-wave length of transmission line used between a transmission line and either its source or load, used for impedance matching by making connections at the proper points along its length. Also, an open quarter wave or shorted half wavelength of transmission line, connected across the antenna terminals of a receiver so as to act as a short circuit at the frequency of an interfering station.

studio. A room in which programs originate.

stylus. The needle of a recorder or playback unit. In the recorder, the stylus serves to cut material from the disc to produce the groove. In the playback unit, the stylus rides in the groove, imparting its motion to the cartridge where it is translated to a corresponding electrical signal.

alignment. The position of the stylus with respect to the record. Viewed from a head-on position, the stylus should be perpendicular to the surface of the record.

drag. The effect of the friction between the record surface and the reproducing stylus.

force. Effective weight of the reproducer or the force in the vertical direction on the stylus when in operating position.

subcarrier. A carrier which is applied as a modulating wave to modulate another carrier.

chromacity. The chromaticity which is intended to be displayed when the subcarrier amplitude is zero.

subharmonic. A frequency that is a fraction of the fundamental frequency. Thus, the second subharmonic is 1/2 the fundamental frequency; the third subharmonic is 1/3, etc.

submerged resistor induction

furnace. A device for melting metal comprising a melting hearth, a depending melting channel closed through the hearth, a primary induction winding and a magnetic core which links the melting channel and the primary winding.

submersion-proof. An instrument de-

signed so that it will continue to operate properly while completely submerged in water.

subminiature tubes. Electron tubes of very small size.

subscript. A small number or letter written at the right of and below another letter, for distinguishing purposes. Example: In X_L and X_C , the subscripts L and c serve to distinguish inductive reactance (X_L) from capacitive reactance (X_C); in $R = R_1 + R_2 + R_3 + R_4$, numeral subscripts serve to distinguish different resistor values. X_L is pronounced "X sub L"; R_3 is pronounced "R sub three".

subtraction. The process of finding the numerical difference between two quantities or numbers.

subtractive color system. A system in which a desired color is produced by removing or filtering the undesired colors from an originally white light.

subtrahend. The number that is to be subtracted from the minuend.

summing amplifier. An amplifier whose output represents the sum of several inputs applied simultaneously (in parallel).

super-control tube. See variable-mu tube.

superheterodyne receiver. A radio receiver in which the incoming modulated rf signal is mixed with a local oscillator signal in a frequency converter section where it is converted into a fixed, lower frequency signal called the intermediate-frequency signal of the receiver. This modulated i-f signal is given very high amplification in the i-f amplifier stages, then fed into the second detector for demodulation.

superhigh frequency. (shf) A frequency in the band between 3000 mc and 30,000 mc.

superimpose. To put one over another, as television images, in such a way that they may both be seen, intermingled.

superregeneration. The principle of the design of some special purpose radio receivers, in which a detector oscillates periodically at the received frequency and is then quenched by another oscillator at a frequency slightly above audible range.

superregenerative detector. A form of regenerative detector in which the feedback is periodically reduced by a quenching frequency to prevent oscillation and still maintain high sensitivity.

supersonic

frequency. A frequency above the audible range.

vibrations. Vibrations that cannot be heard by the unaided human ear because they are above the audible frequency range.

suppressed carrier transmission.

A system of transmission used in telephony in which the carrier component of the modulated wave is suppressed, only the side frequencies being transmitted.

suppressor. A resistor inserted in series with the spark-plug lead or the distributor lead of an automobile engine to suppress spark interference that might otherwise interfere with reception of radio programs in the auto radio set. Also, a resistor or choke coil used in a radio circuit to suppress oscillations.

grid. A grid placed between the screen grid and the plate of a vacuum tube and maintained at or near cathode potential, in order to force secondary electrons back to the plate.

surface

barrier. One of two areas in a surface-barrier transistor in which there are no carriers, because the free electrons have been driven out by a negative electrical charge built up by a layer of electrons gathered around the two cavities to which the emitter and the collector are connected.

-barrier transistor. A transistor made of N-type material in which the emitter and the collector are connected to cavities. Free electrons collect around the cavities, setting up regions of negative charge that repel free electrons and form a surface barrier, or region in which there are no free electrons.

defects. Defects readily visible on top of the radio chassis or in the connections to a radio, such as: tube top cap off; disconnected antenna lead-in; a dead tube, etc.

duct. An atmospheric duct for which the lower boundary is the surface of the earth.

noise. The noise reproduced in playing a record due to rough particles in the record material and/or irregularities in the walls of the groove left by the cutting stylus.

recombination rate. The time rate

at which free electrons and holes recombine at the surface of a semiconductor.

temperature resistor. A platinum resistance thermometer designed for installation directly on the surface to be measured.

surge impedance. The impedance in ohms at the input of an infinitely long line, or of a practical line with its far end closed by a matching impedance. It is equal to $\sqrt{L/C}$ of the line for all but very low frequencies. Also called characteristic impedance.

surges. Sudden increases of current in a power line or circuit.

surveillance. The operations of visual and radar searching from aircraft, ground and ship stations to determine that the range is free of shipping, other aircraft traffic, etc., and that safe conditions exist to permit missile launching. Also, the subsequent act of keeping the missile itself (as well as the range) under the watchful eye of the Range Safety Officer, through optical or electronic means, to assure that the missile travels its prescribed course or is destroyed.

radar element. (surveillance radar element). The radar of the GCA system used to direct traffic to a region where it may be observed by the PAR radar.

sustained oscillation. Continued oscillation due to insufficient attenuation in the feedback path.

sweep. The motion of an electron beam over the screen of the cathode-ray tube.

circuit. An oscillator circuit that generates a voltage having a sawtooth waveform suitable for making the electron beam of a cathode-ray tube sweep across or up and down the fluorescent screen.

generator. A generator of a radio-frequency signal, the frequency of which varies above and below the mean frequency at a rapid and constant rate.

oscillator. A signal generator in which the frequency is varied continuously over a predetermined range, the variation being repeated at a low frequency rate.

voltage. The periodically varying voltage produced by a sweep oscillator.

swinging choke. An iron-core choke operated with an almost saturated core, in order to make the inductance vary or swing as the average current changes.

switch. A device for opening and closing an electrical circuit, or for changing the connections between parts or circuits.

switchboard. An instrument or apparatus used where a number of circuits are to be combined, measured, controlled, and/or protected. The apparatus consists of a panel or panels on which are mounted switching, measuring, controlling and/or protecting devices, such as relays, phone jacks, switches, panel lights, dials, fuses, etc.

syllabic companding. Companding in which the effective gain variations are made at speeds allowing response to the syllables of speech but not to individual cycles of the signal wave.

syllable articulation. (per cent syllable articulation) The per cent articulation obtained when the speech units considered are syllables (usually meaningless and usually of the consonant-vowel-consonant type).

symbol. A simple design used to represent a part on a schematic diagram. Also, a letter used in formulas to represent a particular quantity.

symbolic logic. The method of presenting logical theorems or statements by means of standard symbols, thereby facilitating the reasoning process employed in obtaining a desired result or conclusion.

symmetrical. Balanced. Equal on each side of a normal or center line.

transducer. (with respect to specified terminations) A transducer in which all possible pairs of specified terminations may be interchanged without affecting transmission.

sync. See synchronizing.

clipper. In television, a vacuum tube or transistor circuit that is biased so as to remove the sync signals from the composite video signal.

compression. The reduction in gain applied to the sync signal over any part of its amplitude range with respect to the gain at a specified reference level.

generator. Electronic equipment designed to produce the driving, blanking, and synchronizing pulses necessary to the operation of a television system.

inverter. A vacuum tube circuit that produces a phase shift of 180° of the sync pulses to provide the necessary polarity for control of the scanning oscillator.

level. The level of the tips of the syn-

- chronizing pulses.
- limiter.** A vacuum tube circuit that produces sync pulses of uniform height.
- separator.** See sync clipper.
- signal.** (synchronizing signal) The signal employed for the synchronizing of scanning.
- synchro.** A type of wound-rotor ac motor used for repeating angular motion both as to speed and total angle. The name selsyn is often used synonymously with synchro, and is an abbreviation for the term self-synchronous, and indicates the normal use of the equipment.
- differential generator.** The synchro unit which receives at its primary terminals an order from a synchro generator, modifies this order mechanically by any desired amount by the angular position of the rotor, and transmits the modified order from its secondary terminals to other synchro units.
- differential motor.** A motor which is electrically similar to the synchro differential generator except that a damping device is added to prevent oscillations. Both its rotor and stator are connected to synchro generators, and its function is to indicate the sum or difference between the two signals transmitted by the generators.
- synchroguide.** A control circuit for horizontal scanning in which the sync signal, oscillator voltage pulse, and the scanning voltage are compared and kept in synchronism.
- synchronism.** The phase relationship between two or more periodic quantities of the same period when the phase difference between them is zero.
- synchronization.** The process of causing to be synchronous. Specifically, the process of keeping the image-reconstructing action of a television or facsimile receiver in step with the corresponding action at the transmitter.
- error.** In navigation, the error due to imperfect timing of two operations; this may or may not include signal transmission time.
- synchronized.** In step with.
- synchronizing.** 1. Causing two elements of a system to coincide in speed, frequency, relative position, or time. 2. (in facsimile). The maintenance of predetermined speed relations between the scanning spot and the recording spot within each scanning line. 3. (in television). Maintaining two or more scanning processes in phase.
- generator.** An electronic generator that supplies synchronizing pulses to television studio and transmitter equipment.
- pulses.** In television, the portions of the transmitted signal that control horizontal and vertical scanning of the receiver. See horizontal and vertical synchronizing pulses.
- separator.** The circuit that separates the control pulses from the video signals.
- signal.** (in facsimile) A signal used for maintenance of predetermined speed relations between the scanning spot and recording spot within each scanning line.
- signals.** Electrical pulses used to keep a television or facsimile receiving system in step with the transmitting system, so that the picture or scene will be reconstructed properly.
- synchronous.** Simultaneous in action and in time (in phase).
- capacitor.** A synchronous motor that is over-excited so that it produces a leading current, used to correct power factor where inductive loads are across the power line.
- demodulator.** (or synchronous detector) A demodulator or detector capable of deriving modulation components in phase synchronism with a local reference signal. As used in color television, it is called a chrominance demodulator.
- gate.** A time gate wherein the output intervals are synchronized with an incoming signal.
- induction motor.** A wound rotor induction motor to which direct-current excitation is supplied when it approaches rated speed, enabling it to start as an induction motor and operate as a synchronous motor.
- motor.** A synchronous machine which transforms electric power from an ac system into mechanical power. Synchronous motors usually have dc or PM field excitation, and will run at a speed which is directly related to the frequency of the power applied to the motor and is not dependent upon other variables.
- switch.** A circuit in which thyratrons control the operation of ignitrons in such applications as resistance welding.
- vibrator.** A vibrator that serves the dual function of converting a low dc voltage to a low ac voltage and at the same time rectifying a high ac voltage.
- voltage.** (of a traveling-wave tube) The voltage required to accelerate electrons from rest to a velocity equal to the phase velocity of a wave in the absence of electron flow.
- synthesis.** The building up of a whole out

of parts or elements, as a complex waveform by superimposition of harmonics on a fundamental frequency.

syntony. The condition in which two oscillating circuits have the same resonant frequency.

system

deviation. In servomechanisms, the value of the ultimately controlled variable minus the ideal value. The system deviation is the negative of the system error.

error. In servomechanisms, the ideal value minus the value of the ultimately controlled variable.

layout. A chart or diagram indicating number, type and terminations of circuits on a microwave system.

systematic errors. Those errors having an orderly character and which can be corrected by transmission time.

T

tabulating

card. A unit record card designed for the recording of data in the form of punched holes to be sensed by mechanical or electrical (including electronic) means.

machine. A machine or device used primarily in a tabulating system.

tachometer. An instrument for measuring rotational speed in revolutions per minute.

tailing. (hangover) The excessive prolongation of the decay of a signal.

talk-listen switch. A switch used in intercommunication systems to enable the operator to use the receiving loud-speaker as a microphone.

tangent. (tan) A trigonometric function. The tangent of an acute angle of a right triangle (written $\tan \theta$) is equal to the opposite side divided by the adjacent side.

galvanometer. A galvanometer consisting of a small compass mounted horizontally in the center of a large vertical coil of wire. The current through the coil is proportional to the tangent of the angle of deflection of the compass needle.

tank circuit. An LC resonant circuit capable of storing electrical energy at its resonant frequency.

tantalum. A refractory metal possessing the property of absorbing gases, used for grids and plates of power tubes.

T antenna. A flat-top antenna, the lead-in of which is taken from the center of the horizontal portion.

tap. A connection made somewhere along an inductance or resistance, other than at the ends.

tape

guides. Grooved pins of nonmagnetic material mounted at either side of the recording head assembly to position the magnetic tape on the head as it is being recorded or played.

loop. A length of magnetic tape with the ends joined together to form an endless loop. Used either on a standard recorder, special "message-repeater" type units or in conjunction with a cartridge device, it makes it possible to play back a recorded message repetitively without rewinding the tape.

-on surface temperature resistor. A surface temperature resistor installed by taping the sensing element to the surface with a piece of pressure-sensitive tape.

recorder. An electronic instrument for the recording and playing back of sound. An audiomodulated magnetic field influences the magnetization of particles of iron in a moving paper or plastic tape in accordance with the amplitude of the audio frequency signal. For playback, the tape is moved between the poles of the playback device, causing field fluctuations that can be amplified.

speed. Speed at which tape moves past the recording head. Standard tape speeds for home use are 3-3/4, and 7-1/2 inches per second (ips). Faster speeds are 15 and 30 ips. Slower speeds sometimes used are 1-7/8 and 15/16 ips. Faster speed makes possible improved high-frequency response, while slower speed means greater tape economy. If a tape is recorded at 3-3/4 ips then played back at 7-1/2 ips all sounds will be raised 1 octave in pitch. Cutting the speed in half lowers a tone 1 octave.

transmitter. A code-transmitting device actuated by pre-punched paper tape.

taper. Distribution of resistance over the range of rotation of a volume or tone control.

tapered waveguide. A waveguide in which a physical or electrical characteristic changes continuously with distance along the axis of the guide.

tapped

control. A volume or tone-control potentiometer having a fixed tap somewhere along the resistance winding for the purpose of providing fixed bias or automatic bass compensation.

resistor. A fixed resistor with extra terminals along the resistance element to provide various voltage values needed in voltage-divider applications.

target. 1. (camera tubes) A structure employing a storage surface which is scanned by an electron beam to generate a signal output current corresponding to charge-density pattern stored thereon. 2. In radar, specifically an object of radar search or surveillance. Broadly any discrete object which reflects energy back to the radar equipment.

capacitance. (camera tubes) The capacitance between the scanned area of the target and the backplate.

cutoff voltage. (camera tubes) The lowest target voltage at which any detectable electrical signal corresponding to a light image on the sensitive surface of the tube can be obtained.

voltage. (In a camera tube with low-velocity scanning) The potential difference between the thermionic cathode and the backplate.

tearing. An undesirable effect in a received television picture in which groups of lines are displaced, giving the appearance of a torn picture. Caused by unstable horizontal synchronization.

tee junction. A junction of waveguides in which the longitudinal guide axes form a T. Note: The guide which continues through the junction is the main guide, the guide which terminates at a junction is the branch guide.

telegraph

-modulated wave. A continuous wave that is varied in amplitude or frequency by means of telegraphic keying.

sounder. A telegraph receiving device that converts code signals into sounds.

telegraphy. Communication by code signals sent by electrical or electronic means, with or without connecting wires.

telemetering. Remote indication of values or readings of meters or gauges usually involving electrical transmission between points.

telemetry. 1. Technique of transmitting data over great distances. 2. Radiolink from a remote vehicle whereby information related to measurements is

transmitted to established receiving stations.

telephone. A device containing a microphone for converting sound waves into electrical signals, and an earphone receiver for producing sound from electrical signals.

receiver. An earphone for use in a telephone system. See also earphone (receiver).

transmitter. A microphone for use in a telephone system. See also microphone.

-type relay. Sometimes used for an armature relay with an end-mounted coil and spring pile-up contacts mounted parallel to the long axis of the relay coil.

telephony. An electrical method of reproducing sounds, especially those of the voice, at a distance.

telephotography. Radio or wire transmission of still pictures or photographs.

telephoto lens. A lens used to produce large pictures of an object quite distant from the camera.

teleprinter. A device which prints the letters of a message when actuated by a signal of the proper coding.

telex. (television and radar navigation system) A radar navigation system in which the positions of aircraft are determined by ground radar, the PPI being televised, superimposed on a map, and transmitted to the aircraft.

teletypewriter. A printing telegraph instrument having a typewriter keyboard for sending messages, and a motor-driven signal-actuated mechanism for printing received messages directly.

television. The transmission and reception of a rapid succession of images of fixed or moving objects by means of radio waves traveling through space or over wires.

broadcast band. The frequencies in the band extending from 54 to 890 megacycles which are assignable to television broadcast stations. These frequencies are 54 to 72 megacycles (channels 2 through 4), 76 to 88 megacycles (channels 5 and 6), 174 to 216 megacycles (channels 7 through 13, and 470 to 890 megacycles (channels 14 through 83).

channel. A band of frequencies 6 megacycles wide in the television broadcast band and designated either by number or by the extreme lower and upper frequencies.

- test chart.** A chart placed before the camera of the transmitter, having geometric patterns that enable the observer to determine the resolution and linearity of the receiver.
- transmission standards.** The standards which determine the characteristics of a television signal as radiated by a television broadcast station.
- telex.** A teleprinting system used in several European countries for the transmission of teletypewriter service over telephone wires.
- temperature**
- coefficient.** The change in characteristics of a substance for each degree centigrade change in temperature.
- coefficient of resistance.** The rate of change in resistance in an electrical conductor with respect to temperature.
- coefficient of voltage drop.** (glow discharge tubes) The quotient of the change of tube voltage drop (excluding any voltage jumps) by the change of ambient (or envelope temperature).
- compensating capacitor.** A capacitor used to compensate for reactance changes in oscillator circuits due to changes in temperature, being designed to change in capacity in the opposite manner so the reactance change will be cancelled.
- control.** A relay actuated by a thermostat.
- relay.** A relay that functions when the temperature of equipment associated with the relay changes to a predetermined value.
- saturation.** Also known as filament saturation. The condition in which increasing the temperature of the cathode does not increase the plate current because the space charge forces the excess electrons to return to the cathode as rapidly as they are emitted.
- sensitivity.** The amount by which the output of an instrument is affected by a change in temperature from the temperature at which the instrument was calibrated. Usually expressed as a percentage of full scale per degree F.
- tension.** 1. Potential difference or voltage.
2. A force causing or tending to cause extension.
- spring.** See restoring spring.
- tera.** A decimal prefix designated by the symbol T meaning 10^{12} .
- terminal.** 1. A fitting to which electrical connections are made. 2. The final station in a radio relay system.
- impedance.** The impedance measured at the input or output terminals of a device.
- repeater.** Two microwave terminals arranged to provide for the interconnection of separate systems, or separate sections of a system.
- station.** The microwave equipment and associated multiplex equipment used at the ends of a microwave system.
- terminated line.** A transmission line terminated in the characteristic impedance of the line.
- termination.** The load connected to a transmission line or other device. To avoid wave reflections it must match the characteristic of the line or device.
- terrestrial reference guidance.** A technique of missile control wherein the predetermined path set into the control system of a missile can be followed by a device in the missile which reacts to some property of the earth, such as magnetic or gravitational effects.
- tesla coil.** An air-core transformer having a few turns of heavy wire as the primary and many turns of fine wire as the secondary. The oscillatory discharge across a spark gap applied to the primary results in an extremely high value of high-frequency voltage across the secondary, which is capable of producing a brush discharge between widely separated electrodes in air.
- test.**
- board.** A board or panel provided with instruments, terminals and equipment for testing electronic apparatus.
- lead.** A flexible insulated lead used chiefly for connecting meters and test instruments to a circuit under test.
- oscillator.** A test instrument that will generate an unmodulated or tone-modulated radio-frequency signal at a desired frequency. Also called a signal generator or an all-wave signal generator.
- pattern.** A geometric design periodically transmitted by a television station intended to facilitate adjustment of a television receiver. See television test chart.
- prod.** A sharp metal point provided with an insulated handle and a means for connecting the point to a test lead. It is used for making a touch connection to a circuit terminal.
- tetrode.** A four-electrode electron tube containing an anode, a cathode, a control electrode, and one additional electrode that is ordinarily a grid.

- TE waves.** Transverse electric waves. Electromagnetic waves in a waveguide when the electric field waves are transverse and the magnetic field is in the direction of propagation.
- theremin.** An oscillator whose output frequency and amplitude are variable, and are controlled by capacity changes, as by moving one's hands with respect to a rod or loop. An electronic musical instrument.
- thermal agitation.** Tiny pulses of electron current produced by the random movement of free electrons in a conductor, due to heat.
- instrument.** An instrument in which current is measured by sending it through a fine wire, which is thereby heated, and the resulting expansion or sag of the wire is used to deflect the meter pointer. Also called hot wire instrument.
- noise.** The noise caused by thermal agitation in a dissipative body.
- relay.** A relay which is operated by the heating effect caused by an electric current.
- thermion.** An ion, either positive or negative, which has been emitted from a heated body. Negative thermions are electrons (thermoelectrons).
- thermionic.** Relating to electron emission under the influence of heat.
- emission.** The liberation of electrons or ions from a solid or liquid as a result of its thermal energy.
- grid emission.** (primary grid emission) Current produced by electrons thermionically emitted from a grid.
- tube.** An electron tube in which the heating of one or more of the electrodes is for the purpose of causing electron or ion emission.
- thermistor.** A thermistor is a temperature sensitive resistor employed in such a manner as to cause that property to perform some desired function.
- thermocouple.** A temperature sensing element that creates an electrical signal in proportion to the temperature at the element.
- ammeter.** An ammeter dependent for its indications on the voltage produced in a thermocouple when heated by the current to be measured.
- thermoelectric effect.** An electromotive force that results from a difference of temperature between two junctions of dissimilar metals in the same circuit.
- thermogalvanometer.** An instrument for measuring small high-frequency currents by their heating effect.
- thermometer.** An instrument for measuring temperature.
- thermophone.** An electroacoustic transducer in which sound waves of calculable magnitude result from the expansion and contraction of the air adjacent to a conductor whose temperature varies in response to a current input.
- thermopile.** A unit consisting of a number of thermocouples connected in series to increase the voltage sensitivity.
- thermostat.** A device used to open or close circuits with changes in temperature.
- third harmonic.** A sine-wave component having a frequency three times that of the fundamental frequency of a complex wave.
- thoriated filament.** Tungsten vacuum-tube filament to which a small amount of thorium has been added to improve emission. The thorium comes to the surface and is primarily responsible for the electron emission.
- thread.** The material cut from a phonograph disc by the recording stylus during recording. Also called chip.
- threading slot.** Slot in recording head assembly cover plate into which tape is slipped in threading up the reels for use of the recorder.
- three**
- phase current.** Current delivered through three wires, with each wire serving as the return for the other two and with the three current components differing in phase successively by one-third of a cycle, or 120 electrical degrees.
 - pole switch.** An arrangement of three single-pole switches coupled together to make or break three contacts simultaneously.
 - way loudspeaker system.** A sound reproducing system using three separate loudspeakers, each designed for a specific portion of the audio spectrum (high, low and mid-frequencies). The high-frequency loudspeaker is also known as a tweeter, and the low-frequency speaker as a woofer. Filter networks are used to channel the signal frequencies to the proper loudspeakers. These filters are called crossover or dividing networks.
 - wire system.** A direct-current or

single-phase alternating current system comprising three conductors, one of which (the neutral wire) is maintained at a potential midway between the potential of the other two.

threshold. The point just at the verge of observation by the senses or by an indicator, or the point at which a circuit action will be initiated.

of audibility. The amount of sound intensity just barely audible to the average person.

of feeling. That amount of sound intensity just barely painful to the average person.

signal. In navigation the smallest signal capable of effecting a recognizable change in positional information.

throat microphone. A microphone normally actuated by mechanical contact with the throat.

through transfer function. In a feedback control loop, the transfer function of the through path.

throw-out spiral. A blank spiral groove cut in an eccentric manner at the end of a recording; provided to actuate the mechanism of an automatic record changer.

thru repeater. A microwave repeater that is not equipped to provide for connections to any local facilities, other than the service channel. See repeater station.

thump. A low frequency disturbance to a voice circuit caused by the operation of telegraph or signaling circuits.

thyatron. A hot-cathode gas tube in which one or more control electrodes initiate, but do not limit, the anode current except under certain operating conditions.

tickler. A coil connected in the plate or grid circuit for the purpose of feeding a portion of the amplified signal current back into the grid circuit by induction for repeated amplifications.

tie point. An insulated terminal used for connecting a number of parts together.

tier array. An arrangement of antennas one above the other, used chiefly in ultra-high frequency work. See stacked array.

tight coupling. The closest possible coupling between two circuits under given conditions.

tilting. An up or down movement of a television camera.

time

constant. Time required for an exponential quantity to change by amount equal to 0.632 times the total change that will occur. In a capacitor-resistor circuit, it is the number of seconds required for the capacitor to reach 63.2 percent of its full charge after a voltage is applied. In an inductor-resistor circuit, it is the number of seconds required for the current to reach 63.2 percent of its final value. The time constant in seconds of an indicator having an inductance L in henrys and resistance R in ohms is L/R . The time constant of a capacitor having a capacitance C in farads in series with a resistance R in ohms is RC .

delay. The time that elapses between the time in action should occur and the time at which it actually does occur.

-delay circuit. A circuit that delays the transmission of a pulse, a signal, or a portion of a signal for a definite desired period of time.

-delay relay. A relay in which a delayed action is purposely introduced.

-division multiplex. A device or process for the transmission of two or more signals over a common path by using successive time intervals for different signals.

gate. A transducer which gives output only during chosen time intervals.

switch. A time-controlled switch. A timer.

timer. 1. That part of an electronic circuit which starts pulse transmission and synchronizes it with the beginning of indicator sweeps, timing of gates, range markers, etc. **2.** In navigational equipment, the programming unit.

timing

axis oscillator. An oscillator circuit that generates a sawtooth voltage for the horizontal deflecting plates or horizontal deflecting coils of a cathode-ray tube.

relay. A motor-driven time-delay relay.

tin. To cover with tin or solder to permit or facilitate soldering.

tinned wire. Copper wire that has been coated with a layer of tin or solder to simplify soldering.

tip. The contact at the end of a telephone-type plug. Also the soldering surfaces of a soldering iron.

jack. A small receptacle into which a metal plug can be inserted to complete a circuit.

plug. A small plug that fits into a tip jack.

TM waves. Transverse magnetic waves. Electromagnetic waves in a waveguide, when the magnetic field is transverse, and the electric field waves are in the direction of propagation.

T-network. A network composed of three impedance branches connected two in series with one side of a line, the third across the line between the other two.

to-from indicator. A sensing device to show whether the numerical reading of an omnibearing selector for an "on-course" indicator represents the bearing toward or away from an omnirange.

toggle switch. A small switch operated by means of a lever that is joined to the contact arm in a knee joint in such a way that the contact fingers move in the same direction as the force actuating the lever.

tolerance. The permissible variation from a rated or assigned value.

tone. 1. A sound wave capable of exciting an auditory sensation having pitch. 2. A sound sensation having pitch.

arm. In a record player, phonograph, or changer, the arm that contains the cartridge and stylus.

channel. An intelligence or signaling circuit utilizing a frequency (on-off or frequency shift) as a means of transmission (usually audio frequency).

control. A control, usually part of a resistance-capacitance network, used to alter the frequency response of an amplifier.

generator. An audio-frequency signal generator.

top cap. A metal cap sometimes placed on the top of a vacuum tube and connected to one of the electrodes.

-loaded antenna. A vertical antenna having the top structure enlarged to increase the apparent length.

toroid. Ring-shaped. A doughnut-shaped coil.

toroidal core. Ring-shaped or doughnut-shaped.

torque. The force that produces rotation.
amplifier. A device possessing input and output shafts and supplying work to rotate the output shaft in positional correspondence with the input shaft without imposing any significant torque on the input shaft.

T-pad. A resistive T-network used for providing attenuation and/or impedance matching.

TR cavity. (radar) The resonant portion of a TR Switch.

switch. A switch, frequently of the gas-discharge type, employed when a common transmitting antenna is used, which automatically decouples the receiver from the antenna during the transmitting period.

tube. A gas-filled radio-frequency switching tube used to protect the receiver in pulsed radio-frequency systems.

tracer. A thread of contrasting color in wire insulation that aids in identification and tracing of the wire during maintenance and servicing of the equipment.

track. 1. That portion of a magnetic tape or drum that passes under the read-write head. 2. In electronic computers, that portion of a moving-type storage medium which is accessible to a given reading station; e.g., as on film, drum, tapes, or discs. See also channel. 3. In navigation, the horizontal component of the path actually followed by a vehicle.

homings. The process of following a line of position known to pass through an objective.

tracking. 1. The maintenance of proper frequency relations in circuits designed to be simultaneously varied by gang tuning. 2. The process of keeping radio beams set on a target. 3. The following of a groove by a phonograph needle.

error. In lateral mechanical recording, the angle between the vibration axis of the mechanical system of the pickup and a plane containing the tangent to the unmodulated record groove which is perpendicular to the surface of the recording medium at the point of needle contact.

trailing edge. The major portion of the decay of a pulse.

trainer. The representation of an operating system by computers, associated equipment, and personnel.

transceiver. A radio device used for both transmitting and receiving.

transconductance. The effect on one electrode current of an ac voltage on another electrode. Mutual conductance. The most important is the control-grid to plate transconductance, measured by the ac grid voltage producing it.

transcriber. Equipment associated with a computing machine for the purpose of transferring input (or output) data from a record of information in a given language to the medium and the language used by a digital computing machine (or from a computing machine to a record of information).

transcription. An electrical recording.

transducer. A device for converting a signal or physical quantity of one kind into a corresponding physical quantity of another kind.

gain. The ratio of the power that the transducer delivers to a specified load under specified operating conditions to the available power of a specified source.

loss. The ratio of the available power of a specified source to the power that the transducer delivers to a specified load under specified operating conditions.

pulse delay. The interval of time between a specified point on the input pulse and a specified point on the related output pulse. Note: This is a general term which applies to the pulse delay in any electronic device, such as receiver, transmitter, amplifier, oscillator and the like.

transfer. 1. To transmit, or copy, information from one device to another. 2. To jump. 3. The act of transferring.

characteristics. 1. The relationship between output and input of an electronic amplifier or transducer. 2. In electron tubes, a relation, usually shown by a graph, between the voltage of one electrode and the current to another electrode, all other electrode voltages being maintained constant. 3. In camera tubes, a relation between the illumination on the tube and the corresponding signal output current, under specified conditions of illumination.

current. (gas tubes) The current to one electrode required to initiate breakdown to another electrode. Note: The transfer current is a function of the voltage of the second electrode.

relay. A relay controlled by and controlling other relays.

time. Transfer time is the total elapsed time between the breaking of one set of contacts and the making of another set of contacts.

transformer. Two or more coils mounted on a common support in such a way that the magnetic lines of force produced by the flow of alternating or pulsating direct current through one coil will pass through the other coil and induce

in it a corresponding ac voltage.

-coupled amplifier. An amplifier using transformers for coupling.

loss. The ratio of the power that would be delivered to a specified load impedance if an ideal transformer were substituted for the actual transformer, to the power delivered to the specified load impedance by the transformer, under the condition that the impedance ratio of the ideal transformer is equal to that specified for the transformer.

transient. The phenomenon which takes place in a system owing to a sudden change in conditions and which persists for a relatively short time after the change has occurred.

error. The difference between the system error at any time and the steady-state system error for a specified positive stimulus.

oscillation. A momentary oscillation occurring in a circuit during switching, or at a sharp change in the signal.

overshoot. The maximum value of the transient error.

response. The manner in which an electrical circuit responds to sudden changes in applied potential.

transients. Erratic changes in voltage or current. Also, a momentary voltage or current surge.

transistor. An active semiconductor device with three or more electrodes.

transit time. 1. The time taken by an electron to pass through some specific area. 2. Same as transfer time.

transitron oscillator. A negative-resistance oscillator similar to a dynatron, in which the inner grid is used as an anode, the outer grid as a control element, and the plate as a collector anode.

translator. A network or system having a number of inputs and outputs and so connected that signals representing information expressed in a certain code, when applied to the inputs, cause output signals to appear which are a representation of the input information in a different code. Sometimes called Matrix.

translucent. Permitting the passage of light, but so scattering the light rays that objects cannot be clearly seen.

transmission. 1. Transfer of electric energy from one location to another through conductors or by radiation or induction fields. 2. Transmission, as applied to photographic recording, is the

ratio of the light flux transmitted by the medium to the light flux incident upon it. Transmission may be either diffuse or specular.

line. 1. Any set of conductors used to carry rf or af signals or energy from one location to another. 2. A waveguide consisting of two or more conductors.

line input impedance. The impedance between the input terminals with the generator disconnected.

loss. 1. The power lost in transmission between one point and another. It is measured as the difference between the net power passing the first point and the net power passing the second. 2. The ratio in decibels of the net power passing the first point to the net power passing the second.

transmittance. Ratio of transmitted to incident flux.

transmitter. A comprehensive term applying to all of the equipment used for generating, amplifying, and radiating an intelligence signal into space.

transparent. Permitting the passage of light rays without scattering.

transponder. A transmitter-receiver facility the function of which is to transmit signals automatically when the proper interrogation is received.

transport factor. The fraction of the current from the emitter which reaches the collector.

transpose. To interchange position.

transposition. Interchanging the relative positions of wires to neutralize the effects of induction to or from other circuits. In two-wire parallel lead-ins for an antenna, to minimize radiation from the lead-in during transmission, or to minimize interference pickup by the lead-in reception.

trans-u-factor. (multibeam electron tubes) The ratio of 1) the magnitude of an infinitesimal change in the voltage at the control grid of any one beam to 2) the magnitude of an infinitesimal change in the voltage at the control grid of a second beam. The current in the second beam and the voltage of all other electrodes are maintained constant.

transverse

beam traveling-wave tube. A traveling-wave tube in which the direction of motion of the electron beam is transverse to the average direction in which the signal wave moves.

electric wave. (TE wave) In a homogeneous isotropic medium, an electromagnetic wave in which the electric field vector is everywhere perpendicular to the direction of propagation.

electromagnetic wave. (TEM wave) In a homogeneous isotropic medium, an electromagnetic wave in which both the electric and magnetic field vectors are everywhere perpendicular to the direction of propagation.

field traveling-wave tube. A traveling-wave tube in which the traveling electric fields which interact with the electrons are essentially transverse to the average motion of the electron.

magnetic wave. (TM wave) In a homogeneous isotropic medium, an electromagnetic wave in which the magnetic field vector is everywhere perpendicular to the direction of propagation.

magnetization. In magnetic recording, magnetization of the recording medium in a direction perpendicular to the line of travel, and parallel to the greatest cross-sectional dimension.

wave. A wave in which the displacement is crosswise to the direction of propagation.

trapezoidal. Having the form of a trapezoid, a plane four-sided figure with two of the sides parallel.

wave. 1. Waveform of trapezoidal shape. 2. Rectangular wave on which a sawtooth is superimposed. It is the voltage wave necessary to give a linear deflection current through the coils of a magnetic deflection cathode-ray tube.

traveling

plane wave. A plane wave each of whose frequency components has an exponential variation of amplitude and a linear variation of phase in the direction of propagation.

-wave magnetron. A traveling-wave tube in which the electrons move in crossed static electric and magnetic fields which are substantially normal to the direction of wave propagation.

-wave magnetron oscillations. Oscillations sustained by the interaction between the space-charge cloud of a magnetron and a traveling electromagnetic field whose phase velocity is approximately the same as the mean velocity of the cloud.

-wave magnetron type tube. A traveling-wave tube in which the electrons move in crossed static electric and magnetic fields which are substantially normal to the direction of wave propagation.

wave tube. A vacuum tube in which the signal is caused to follow a wire

helix. An electron stream directed down the center of the helix interacts with the electric field of the signal to cause bunching, which in turn amplifies the signal.

-wave tube interaction circuit.

An extended electrode arrangement in a traveling-wave tube designed to propagate an electromagnetic wave in such a manner that the traveling electromagnetic fields are retarded and extend into the space occupied by the electron stream.

treble. The higher audio frequencies. The higher audible tones.

triangulation. A method of fixing the position of an aircraft or surface vessel by taking bearings with a radiocompass on at least two fixed land stations.

trickle charge. The continuous charging of a storage battery at a low rate, approximately equal to the rate of internal loss, to maintain it in a fully charged condition.

tricon. A radio navigation system in which the airborne receiver accepts pulses from a triplet or chain of three stations pulsed in variable time sequence. The time sequences vary so that pulses arrive at the same time along paths of various lengths.

trigatron. An electronic switch in which conduction is initiated by the breakdown of an auxiliary gap.

trigger

circuit. A multivibrator circuit in which either of the two tubes can operate stably, but the triggering of either tube cuts off the current of the other. The flip-flop action is produced by a trigger pulse in the grid of either tube.

level. In a transponder, the minimum input to the receiver which is capable of causing a transmitter to emit a reply.

triggering. The pulsing of a system, such as a multivibrator, into the opposite state of equilibrium.

circuit. A circuit furnishing a pulse voltage which serves to actuate some other circuit, such as a "one-shot" multivibrator circuit.

trigonometric function. The ratios that exist between the various sides and angles of a right triangle.

trigonometry. A branch of mathematics that deals with the relations existing among the angles and sides of triangles.

trimmer capacitor. A small semiadjust-

able capacitor used in the tuning circuits of radio receivers and other radio apparatus to permit accurate alignment.

triode. A three-electrode electron tube containing an anode, a cathode, and a control electrode.

-pentode. A vacuum tube having a triode and a pentode in the same envelope.

triplet. In navigation, three radio stations operated as a group for the determination of positions.

tripping device. Any mechanical or electromagnetic device used to open a circuit breaker or starter, either when certain abnormal electrical conditions occur or when actuated manually.

tri-tet oscillator. A crystal oscillator using electron coupling to the output circuit, popular when amateur radio operators because it has strong harmonics that make it ideal for multiband operation.

tropopause. The boundary or transition zone between the troposphere and the stratosphere.

troposphere. The lower layer of the earth's atmosphere, extending from the surface of the earth to an altitude of 10 miles. Although the composition of the air remains more or less constant, its density decreases rather rapidly with altitude; 75% of the atmosphere's weight is found in the troposphere.

tropospheric wave. A radio wave that is propagated by reflection from a place of abrupt change in the dielectric constant or its gradient in the troposphere.

trough. In a modulated wave, the regions of minimum output. In the atmosphere the space between two ionized reflecting layers.

true power. The power measured by a wattmeter, taking phase into consideration. In a reactive circuit it is the product of voltage times current times a power factor.

tube. (electron) An electronic device in which conduction by electrons takes place through a vacuum or gaseous medium within a gastight envelope.

heating time. 1. The time required for a tube to reach normal operating temperature. 2. (mercury-vapor tubes). The time required for the condensed-mercury temperature to reach a specified value.

noise. Noise originating within a vacuum tube, such as microphonics and shot-effects.

tester. An instrument used to test the condition of radio tubes.

voltage drop. The anode voltage during the conduction period.

tubular capacitor. A paper or electrolytic capacitor having as its plates long strips of foil rolled into a compact tubular shape.

tuned. Adjusted to resonate at a specified frequency.

antenna. An antenna made to resonate at the desired operating frequency.

circuit. A resonant circuit, consisting of a coil and capacitor that are preset or can be adjusted to give resonance at a desired frequency.

filter. A resonant circuit used to attenuate signals at the resonant frequency.

-grid oscillator. An oscillator whose frequency is determined by a parallel-tuned tank in the grid circuit to which the plate circuit is coupled to provide the required feedback.

-grid, tuned-plate oscillator. A vacuum-tube oscillator having a parallel resonant circuit in series with the plate circuit and another parallel resonant circuit in series with the grid circuit. The grid resonant circuit is tuned to the operating frequency, and the plate resonant circuit is tuned slightly above the operating frequency, so as to act like an inductance. Oscillation is maintained by capacity feedback through the internal capacity of the tube.

-plate oscillator. An oscillator whose frequency is determined by a parallel-tuned tank in the plate circuit to which the grid circuit is coupled to provide the required feedback.

radio-frequency amplifier. An rf voltage amplifier circuit using tuned circuits in the coupling system.

radio-frequency receiver. A receiver in which rf amplification is provided by a number of vacuum tube amplifier stages, each of which has one or more circuits that are tuned to resonance at the incoming signal frequency by a section of the gang tuning capacitor.

radio-frequency stage. A stage of amplification, usually consisting of a vacuum tube and one or more tuned circuits that can be resonated to the received signal.

radio-frequency transformer. A transformer having one or both windings tuned; used for coupling two rf amplifier stages.

-reed frequency meter. See vibrat-ing reed frequency meter.

tuner. 1. A device capable of selecting the desired signal, and delivering rf, i-f, or demodulated information to some other equipment. 2. The portion of a receiver that contains circuits tuned to resonance at the received signal frequency and those tuned to the local oscillator frequency.

tungar bulb. A phanotron (hot-cathode, gas-discharge rectifier tube) having a heated filament serving as cathode and a graphite disc serving as anode in an argon-filled glass envelope, used mostly in battery chargers.

tungsten. A metal used for the filaments and other elements of radio tubes.

tuning. The process of varying the inductance or capacity in a coil-capacitor circuit to provide resonance at a desired frequency. Also, the process of setting all of the tuning circuits in a radio receiver simultaneously to a desired frequency by rotating the tuning dial or pressing a button of a push-button tuner.

eye. See electron ray tuning indicator.

tork. A two-pronged hard steel device that vibrates at a definite natural frequency when struck or when set in motion by electromagnetic means. Used in some electronic equipment as an accurately controllable source of signals because its vibrations can be transformed readily into audio-frequency signals by means of pickup coils.

indicator. A device that indicates when a radio receiver is tuned accurately to a radio station.

range. In cavity-type tubes, the frequency range over which the resonant frequency at the tube may be adjusted by the mechanical means provided on the tube or associated cavity.

stubs. Elements, usually adjustable, which are connected to transmission lines at intervals to improve the voltage distribution.

wand. A flexible rubber or fiber rod having a brass plug in one end and a powdered-iron core at the other end, used for checking receiver alignment.

tunnel diode. A semiconductor consisting of a PN junction which has been especially constructed to optimize the characteristics desired.

turn. In a coil, one complete loop of wire around the coil form.

turnover. When measuring ac, the difference in meter readings found when the leads of a vtvm are reversed, caused by unequal capacities between the vtvm circuits and ground.

U

- cartridge.** A pickup cartridge designed for use with 3-speed playback equipment.
- frequency.** In disc recording the frequency below which constant-amplitude recording is used and above which constant-velocity recording is employed.
- turns**
- per-volt.** The number of turns needed on the secondary winding of a transformer to give 1 volt of output voltage for a specified primary voltage.
- ratio.** The ratio of the number of turns in a secondary winding of a transformer to the number of turns in the primary winding.
- turnstile antenna.** A series of crossed horizontal doublet antennas, arranged vertically on a mast and fed 90° out of phase. Used where circular radiation patterns are desired.
- turntable.** In a record player or electric phonograph, the motor-driven disc on which the phonograph record is placed. In a sound recorder, the motor-driven disc on which is placed the disc to be cut.
- rumble.** Low-frequency vibration mechanically transmitted to the recording or reproducing turntable and superimposed on the reproduction.
- turret.** 1. A revolving plate sometimes mounted at the front of a television camera and carrying two or more lenses of different types, used to permit rapid interchange of lenses. 2. A rotatable device on which one or more pretuned circuits are mounted for use in receivers, transmitters, and signal generators. Rotating the device connects a different pretuned circuit into the circuit and disconnects the others.
- tweeter.** A loudspeaker designed specifically for the higher audio frequencies and used where one or more additional speakers are available to reproduce the other portions of the audio spectrum.
- twin**
- lead.** A transmission line consisting of two parallel wires, molded into and held apart by rubber or plastic insulation.
- triode.** Two identical triode tubes in a single envelope.
- wire.** A cable composed of two parallel-laid insulated conductors having a common covering.
- twisted pair.** Two insulated conductors twisted together, without a common covering.
- ultor.** In a cathode-ray tube, the electrode or combination of electrodes to which is applied the highest dc voltage for accelerating the electrons prior to deflection.
- ultra-audion oscillator.** A variation of the Colpitts oscillator circuit, in which the two voltage-dividing capacitances are the plate-to-cathode and the grid-to-cathode capacitances of the tube.
- ultrahigh frequency.** (uhf) A frequency in the band between 300 mc and 3000 mc. See radio spectrum.
- ultralinear.** A push-pull output circuit in which the screen grids are connected to taps on the primary winding of the output transformer. This circuit is characterized by increased power and linearity.
- ultrasonic.** Frequencies which lie just above the audible range. Sometimes called supersonic.
- coagulation.** The bonding of small particles into larger aggregates by the action of ultrasonic waves.
- cross grating.** (grating) A space grating resulting from the crossing of beams of ultrasonic waves having different directions of propagation. This may be two- or three-dimensional.
- delay line.** (ultrasonic storage cell) A contained medium (usually a liquid, e.g., mercury) in which use is made of the propagation time of sound to obtain a time delay of a signal.
- detector.** A device for the detection and measurement of ultrasonic waves. Note: Such devices may be mechanical, electrical, thermal, or optical in nature.
- frequency.** (supersonic frequency) A frequency lying above the audio frequency range. The term is commonly applied to elastic waves propagated in gases, liquids, or solids.
- generator.** A device for the production of sound waves of ultrasonic frequency.
- grating constant.** The distance between diffracting centers of the sound wave which is producing particular light diffraction spectra.
- light diffraction.** The formation of optical diffraction spectra when a beam of light is passed through a longitudinal wave field. The diffraction results from the periodic variation of the light refraction in the sound field.
- material dispersion.** The production of suspensions or emulsions of one material in another due to the ac-

- tion of high-intensity ultrasonic waves.
- stroboscope.** A light interrupter whose action is based on the modulation of a light beam by an ultrasonic field.
- ultrasonics.** The general subject of sound in the frequency range above about 15 kilocycles per second.
- ultraviolet.** A range of radiation frequencies beyond the visible spectrum at the violet, or high-frequency end.
- umbrella antenna.** An antenna in which the wires are guyed downward in all directions from a central mast or tower to the ground, somewhat like the ribs of an open umbrella.
- undamped oscillations.** Oscillations of an electromagnetic wave whose energy source constantly restores losses incurred by the load or resulting from radiations.
- underload relay.** A relay that operates when the current in a circuit drops below a minimum value.
- undermodulation.** Incomplete modulation at a transmitter.
- undervoltage relay.** A relay specifically designed to function when its coil voltage falls below a predetermined value.
- underwater sound projector.** A transducer used to produce sound in water.
- undistorted output.** The output associated with an arbitrarily low level of distortion established for a particular test or operation.
- unidirectional.** In one direction only.
- antenna.** An antenna which radiates most of its power in one direction.
- loop.** A loop that will pick up energy from one direction only.
- microphone.** A microphone which is responsive predominantly to sound incident from one hemisphere.
- uniform line.** A transmission line that has identical electrical properties throughout its length.
- unijunction transistor.** A three-terminal semiconductor with a single PN junction. Consists of two ohmic base connections and one emitter. Also called a double-base diode.
- unilateral.** One sided.
- area track.** A sound track in which one edge only of the opaque area is modulated in accordance with the recorded signal. There may, however, be a second edge modulated by a noise reduction device.
- bearing.** A bearing obtained with a radio direction finder having a unidirectional response.
- conductivity.** Conductivity in only one direction, as in a perfect rectifier.
- transducer.** A transducer which cannot be actuated at its outputs by waves in such a manner as to supply related waves to its inputs.
- unipolar transistor.** A transistor which utilizes charge carriers of only one polarity.
- unipotential cathode.** A cathode to which heat is supplied by an independent heater element, so there is no potential difference along it as a result of heater current flow. An indirectly heated cathode, or equipotential cathode.
- unit.** 1. A reference quantity for measuring purposes. 2. A portion or subassembly of a computer which constitutes the means of accomplishing some inclusive operation or function, as: arithmetic unit.
- pole.** A unit of measurement of magnetic strength. A unit pole repels a similar pole with a force of one dyne at a distance of one centimeter.
- step function.** A voltage or current function which changes abruptly from one steady state condition to another steady state condition.
- unity**
- coupling.** The condition in which all the magnetic flux of the primary passes through the entire secondary.
- power factor.** A power factor of 1.0 obtained when current and voltage are in phase, as in a circuit containing only resistance or in a reactive circuit at resonance.
- universal**
- motor.** Series-wound motor which may be operated either on direct current or single-phase alternating current at approximately the same speed and output.
- output transformer.** An iron-core audio output transformer having a number of taps on its windings to permit matching to a wide range of load impedances.
- upper sideband.** The higher of two frequencies or two groups of frequencies produced by a modulation process. See sideband.

V

vacuum. A space from which practically all air or gas has been removed.

tube. A tube evacuated to such a degree that its electrical characteristics are essentially unaffected by the presence of residual gas or vapor.

-tube keying. A telegraph keying system in which a vacuum tube is placed in series with the center-tap lead of the final stage, its grid being connected to its filament through the transmitting blocks and no plate current flows. Grounding the grid (closing the key) unlocks the tube, current flows, and a pulse is sent out.

-tube voltmeter. (vtvm) A test instrument that utilizes a vacuum-tube circuit for measuring voltages without greatly affecting the circuit to which the instrument is connected.

valence

band. The range of energy states in the spectrum of a solid crystal in which lie the energies of the valence electrons which bind the crystal together.

electron. An electron in the valence shell, not very closely bound to its atom.

shell. The outermost shell in an atom.

valve. British for radio tube.

Van de Graaf generator. An electrostatic generator which employs a system of conveyor belt and spray points to charge an insulated electrode to a high potential.

vane-type instrument. A measuring instrument utilizing the force of repulsion between fixed and movable magnetized iron vanes, or the force existing between a coil and a pivoted vane-shaped piece of soft iron, to move the indicating pointer.

V antenna. See vee antenna.

var. The unit of reactive power. One var is one reactive volt-ampere.

variable. A quantity that may assume a succession of values, some of which may be repeated.

capacitor. A capacitor whose capacity can be changed either by varying the space between plates (as in a trimmer capacitor) or by varying the amount of meshing between the two sets of plates (as in a tuning capacitor).

coupling. Inductive coupling of two or more coils that can be varied by moving

one or more in relation to the others.
density track. A sound track of constant width and usually, but not necessarily, of uniform light transmission on any instantaneous transverse axis and of which the average light transmission varies along the longitudinal axis in proportion to some characteristic of the applied signal.

-impedance tube. See reactance tube.

inductance. A coil whose inductance can be changed by varying the number of turns in use, or by moving a core made of powdered iron or brass.

-inductance pickup. A phonograph pickup which depends for its operation on the variation of its inductance.

-u tube. An electron tube in which the amplification factor varies in a predetermined way with control-grid voltage.

reluctance microphone. (magnetic microphone) A microphone which depends for its operation on variations in the reluctance of a magnetic circuit.

-reluctance pickup. A type of cartridge whose magnetic reluctance varies with movements of the stylus. The lateral movements of the stylus are imparted to a strip of magnetic material known as the armature. As the armature moves back and forth between two pole pieces, it varies the air gap and consequently the reluctance of the magnetic path. Since reluctance in a magnetic circuit corresponds to resistance in an electrical circuit, an increase of reluctance results in a decrease of magnetic flux, and a decrease of reluctance permits an increase of flux. The changing magnetic field cuts through a coil, inducing a voltage--the cartridge output. Although the variable-reluctance cartridge has a relatively low output, the frequency response is excellent.

resistance. A resistance that can be changed in value while in use.

-resistance pickup. A phonograph pickup which depends for its operation upon the variation of a resistance.

variac. A transformer whose output voltage can be varied over a wide range by means of a switch and a series of taps.

vario coupler. A variable rf transformer consisting of two independent windings, one stationary and the other adjustable with relation to the fixed element so the mutual inductance can be changed.

variometer. A variable inductance having a movable coil mounted inside a stationary one. The two coils are connected in series. The total inductance of the unit

can be varied continuously through a wide range of values by rotating the inner coil.

varistor. A device or assemblage of devices which has the property of changing resistance influenced by the voltage applied. A device which exhibits non-linearity between voltage applied and current which flows as a result of that voltage.

Varley bridge. A variation of the Wheatstone resistance bridge, used to determine distance from the bridge to the point at which a line is grounded.

v-beam radar. A volumetric radar system for the determination of distance, bearing, and height by the use of two fan beams.

vector. A straight line whose length is proportional to the magnitude or amount of a quantity, and whose arrow head points in the direction of motion or force of that quantity.

diagram. An arrangement of vectors showing the relations between alternating quantities.

quantity. A quantity that has both magnitude and direction.

vee antenna. A single-wire antenna arranged in the form of a "V". Also, an antenna consisting of four rods arranged to form two V's, lying in the same plane, with apexes pointing in the same direction, and with the corresponding sides connected in parallel.

velocity

microphone. A microphone in which the electric output substantially corresponds to the instantaneous particle velocity in the impressed sound wave.

-modulated oscillator. A vacuum-tube structure in which the velocity of an electron stream is varied in passing through a resonant cavity, called a buncher. Energy is extracted from the bunched electron stream as it passes through a second cavity resonator, called the catcher. Oscillations are sustained by coupling energy from the catcher cavity back to the buncher cavity.

modulation. 1. A system of varying the velocity of electrons in a stream so they bunch to form a modulated wave. 2. A television system in which the picture-tube beam current is maintained constant and the change in brightness of the reproduced picture is achieved by varying the horizontal velocity of the spot in both the picture and camera tube in accordance with the brightness of the

picture on the mosaic of the camera tube.

vernier. An auxiliary device used with a main device to obtain fine adjustment.

capacitor. A small variable tuning capacitor placed in parallel with a larger tuning capacitor for the purpose of providing a finer adjustment after the large capacitor has been set roughly to the desired position.

dial. A dial in which a large rotation of the control knob makes the controlled shaft rotate only a small fraction of a revolution, permitting fine and accurate adjustment.

vertical

antenna. A single vertical metal rod, suspended wire, or metal tower used as an antenna.

blanking pulse. In television, a pulse transmitted at the end of each field to cut off the cathode-ray beam while it is returning to start the next field.

centering control. A control provided in a television receiver or cathode-ray oscilloscope to shift the position of the entire image vertically on the screen.

deflecting electrodes. The electrodes of an electrostatic cathode-ray tube to which voltage is applied to move the electron beam up and down (from top to bottom) on the screen.

hold control. The control in a television receiver that adjusts the free-running period of the vertical sweep oscillator.

linearity control. In television, a control provided for adjustment of the uniformity of distribution of picture elements in a vertical direction.

oscillator. The sawtooth scanning generator that furnishes the required voltage or current wave for vertical scanning.

radiator. A conductor or system of conductors perpendicular to the earth, used as an antenna for transmitting or receiving.

resolution. The definition or clarity of a television image in the vertical direction.

retrace. The return path of the electron beam across the raster from bottom to top at the end of each field.

scanning. The movement of the beam on the picture tube in the vertical direction.

speed transducer. An instrument which furnishes an electrical output proportional to the vertical speed of the aircraft or missile in which it is installed.

sweep. The downward movement of the

electron beam, line by line, from the top to the bottom of a picture or scene being televised.

synchronization. Making the vertical scanning at the receiver occur at the same relative time as the vertical scanning at the camera.

synchronizing pulses. A series of pulses longer in time duration than the horizontal pulses, that occur between each field and that are used to synchronize the vertical scanning oscillator.

vertically polarized wave. A linearly polarized wave whose magnetic field vector is horizontal.

very high frequency. (vhf) A frequency in the band between 30 mc and 300 mc. See radio spectrum.

vestigial

sideband. The transmitted portion of the suppressed sideband.

sideband transmission. That method of signal transmission in which one normal sideband and the corresponding vestigial sideband are utilized.

vibrating reed frequency meter. A frequency meter consisting of a row of steel reeds, each having a different natural frequency, that are excited by an electromagnet fed with the alternating current whose frequency is to be measured. The reed that vibrates with the greatest amplitude is the one whose frequency corresponds most nearly to that of the current.

vibrator. An electromagnetic device that converts a dc voltage to pulsating dc or ac.

video. Television parts and circuits that handle picture signals, and to signals associated with the picture being transmitted.

amplifier. See video-frequency amplifier.

chrominance components. (or video-frequency chrominance components) Signals representing components of the chrominance information. These components may serve as input to a chrominance modulator or be delivered by a chrominance demodulator.

frequency. The frequency of the signal voltage containing the picture information resulting from the television scanning process.

-frequency amplifier. The amplifier stages after the video demodulator stage that build up video signal strength. Also any wide-band amplifier.

integration. A method of utilizing the

redundancy of repetitive signals to improve the output signal-to-noise ratio, by summing the successive video signals.

mapping. A procedure whereby a chart of an area is electronically superimposed on a radar display.

signal. The picture signal in a television system.

stretching. In navigation, a procedure whereby the duration of a video pulse is increased.

vidicon. A camera tube in which a charge-density pattern is formed by photoconduction and stored on that surface of the photoconductor which is scanned by an electron beam, usually of low-velocity electrons.

view finder. An attachment on a television camera to enable the cameraman to observe the area covered by the camera.

viewing screen. In a cathode-ray oscilloscope or picture tube, the screen that converts the useful energy of the electron beam into a visible pattern.

virtual

cathode. The space charge or electron cloud in front of the cathode in a vacuum tube.

height. The apparent height of an ionized layer determined from the time interval between the transmitted signal and the ionospheric echo at vertical incidence, assuming that the velocity of propagation is the velocity of light in a vacuum over the entire path.

voice

coil. A moving coil attached to the diaphragm of a dynamic loudspeaker, to which audio voltages are applied.

frequency. The essential frequency range of ordinary speech, from about 100 to 3000 cycles.

volt. The practical unit of voltage or electromotive force. One volt will send a current of one ampere through a resistance of one ohm.

-ampere. The unit of apparent power in an ac circuit containing reactance. It is equal to the voltage in volts multiplied by the current in amperes, without regard for phase.

-ohm-millimeter. See multi-meter.

voltage. The force causing motion of electrons, measured in volts. Electromotive force.

amplification. The ratio of the magnitude of output terminal voltage of an amplifier to the magnitude of input

terminal voltage which produced the voltage at the output.

amplifier. An amplifier designed primarily to build up voltage without supplying any appreciable amount of power.

attenuation. The ratio of the magnitude of the voltage across the input of the transducer to the magnitude of the voltage delivered to a specified load impedance connected to the transducer.

difference. See potential difference.

divider. A resistor having one or more fixed or adjustable contacts along the length of its resistance element in addition to the customary two end terminals, and desired portions of this voltage are obtained from any two terminals on the voltage divider. Also, two or more resistors connected in series to serve the same purpose.

doubler. A rectifier circuit that doubles the output voltage by charging a capacitor on one half-cycle and discharging it in series with the applied voltage during the next half-cycle.

drop. The voltage developed across the terminals of a radio part by the flow of current through the part.

feed. A method of exciting a transmitting antenna by applying voltage at a voltage loop or antinode.

feedback. A form of degeneration in which the feedback is proportional to the output voltage.

gain. Voltage amplification. A rating of an amplifier stage obtained by dividing the ac output voltage by the ac input voltage.

generator. A two-terminal circuit element with a terminal voltage independent of the current through the element. Note: A voltage generator has zero internal impedance.

jump. (glow-discharge tubes) An abrupt change or discontinuity in tube voltage drop during operation. Note: This may occur either during life under constant operating conditions or as the current or temperature is varied over the operating range.

multiplier. A precision resistor used in series with a voltmeter to extend its measuring range.

node. Any point that has zero voltage.

ratio. In a pressure potentiometer, the ratio of output voltage to input voltage as read at the terminals of the instrument.

reference tube. A gas tube in which the tube voltage drop is approximately constant over the operating range of current and relatively stable with time at fixed values of current and temperature.

regulation. The ability of a generator or other voltage source to maintain

nearly constant terminal voltage for all load values from zero to the maximum rated capacity.

regulator tube. A gas tube in which the tube voltage drop is approximately constant over the operating range of current.

relay. A relay that functions at a chosen value of voltage.

rise. A generated or source voltage.

saturation. The plate voltage at which all electrons emitted from the cathode are being collected by the plate so that further increases in plate voltage have no effect on plate current. Also known as plate saturation.

voltic cell. Any cell that produces voltage.

voltmeter. A meter used to measure electrical pressure or voltage in volts.

volume. The magnitude of a complex audio frequency wave in an electric circuit as measured on a standard volume indicator. The volume is expressed in *vu*. In addition, the term volume is used loosely to signify either the intensity of a sound or the magnitude of an audio frequency wave.

compression. Limitation of volume range so overmodulation will not take place.

control. A device that varies the output of a receiver or public address amplifier, thereby changing the volume of the sound produced by the loudspeaker.

expander. A manually adjusted audio circuit that can be set to increase the volume range of a radio program or phonograph record by making the loud portions of the program louder, thereby counteracting volume compression at the transmitter.

expansion. In a sound-reproducing system, the process of making the loud sounds still louder and the quiet sounds still quieter.

indicator. A meter that indicates the volume level of sound.

recombination rate. The time rate at which free electrons and holes recombine within the volume of a semiconductor.

unit. (*vu*) A unit specifying the number of db above a reference level of 1 milliwatt (.001 watt). When a level is given in volume units, there is no need to specify the reference level since it is implied in the definition of *vu*. A *vu* is equal to a db when changes in power are involved.

volumetric radar. A radar capable of producing three-dimensional position data on a multiplicity of targets.

vor. (vhf omnirange) A specific type of range operating at vhf and providing radial lines of position in any direction as determined by bearing selection within the receiving equipment.

W

w

socket. A socket in which the clips for gripping the tube prongs are mounted between two wafers or plates of insulating material.

switch. A switch whose fixed contacts are mounted in a circle on one or more plates of insulating material.

walkie-talkie. A small portable transmitter-receiver.

walls. The sides of the grooves in a disc recording.

water-cooled tube. A transmitting tube whose plate element is cooled by circulating water.

watt. The practical unit of electrical power. In a dc circuit, the power in watts consumed by a device is equal to the applied voltage multiplied by the current in amperes. In an ac circuit, however, the power value obtained in this manner must also be multiplied by the power factor of the device.

-hour. Unit of electrical energy. One watt expended for one hour equals one watt-hour.

-hour meter. A meter that measures and registers electric energy in watt-hours or kilowatt-hours.

-second. One watt acting for one second, equal to one joule.

wattage rating. A rating expressing the maximum power a device can safely absorb or handle.

wattmeter. A meter used to measure the power in watts or kilowatts that is being consumed by a device.

wave. A propagated disturbance or vibration in a medium, usually periodic, as an electric wave or sound wave; a single cycle of such a disturbance.

analyzer. See harmonic analyzer.

angle. The angle at which a radio wave leaves a transmitting antenna or arrives at a receiving antenna. The two angles needed to specify the direction of a radio wave are the azimuth angle (corresponding to a direction above the surface of the earth) and the deviation angle with respect to the surface of the earth.

antenna. An antenna approximately one wavelength long at the operating frequency.

band. A band of frequencies, such as that assigned to a particular type of communication service. Waves between two arbitrarily chosen wavelengths, including waves of all lengths between the lowest and highest chosen.

trap. A device sometimes connected to the aerial system of a receiver to reduce the strength of signals at a particular frequency.

velocity. The velocity of propagation of energy.

winding. A type of winding of an armature in which each coil is connected to segments on opposite sides of the commutator.

waveform. The shape of a wave as shown pictorially or graphically, usually with reference to changes in voltage or current. Also wave shape.

waveguide. A tubular conductor through which ultrahigh frequency electromagnetic waves are directed. More generally, any system of material boundaries capable of guiding radio waves.

attenuator. A waveguide device for the purpose of producing attenuation by any means, including absorption and reflection.

bend. A section of waveguide in which the direction of the longitudinal axis is changed.

connector. A mechanical device for electrically joining separable parts of a waveguide system.

phase shifter. A device for adjusting the phase of a particular field component (or current or voltage) at output of device relative to the phase of that field component (or current or voltage) at the input.

plunger. In a waveguide, a longitudinally movable obstacle which reflects essentially all the incident energy.

post. In a waveguide a cylindrical rod placed in a transverse plane of the waveguide and behaving substantially as a shunt susceptance.

resonator. (resonant element) A waveguide device primarily intended for storing oscillating electromagnetic energy.

stub. An auxiliary section of waveguide with an essentially nondissipative termination and joined at some angle with the main section of waveguide.

taper. A section of tapered waveguide.

transformer. A device usually fixed, added to a waveguide for the purpose

- of impedance transformation.
- tuner.** An adjustable device added to a waveguide for the purpose of impedance transformation.
- twist.** A waveguide section in which there is a progressive rotation of the cross section about the longitudinal axis.
- wavelength.** For a traveling plane wave at a given frequency, the distance along the guide between points at which a field component (or the voltage or current) differs in phase by 2π radians.
- wavelength.** In a periodic wave, the distance between points of corresponding phase of two consecutive cycles. The wavelength λ is related to the phase velocity, v , and the frequency f , by $\lambda = v/f$.
- wavemeter.** A device arranged and calibrated to measure or indicate the length of a radiated wave directly in meters, or its frequency.
- wax.** In mechanical recording, wax refers to a blend of waxes with metallic soaps. See also cake wax.
- original.** (wax master) An original recording on a wax surface for the purpose of making a master.
- weak coupling.** Loose coupling.
- wedge.** The convergent, fan-shaped pattern of equidistant black and white tapering lines on a television test pattern.
- weighting.** The artificial adjustment of measurements in order to account for factors which in the normal use of the device would otherwise be different from the conditions during measurement.
- weld-on surface temperature resistor.** A surface temperature resistor installed by welding the sensing element to the surface being measured.
- cell.** A cell in which the electrolyte is in liquid form.
- electrolytic capacitor.** An electrolytic capacitor that uses a liquid electrolyte.
- Wheatstone bridge.** An instrument invented by Sir Charles Wheatstone, English physicist, and used for accurate resistance, inductance, or capacity measurements. The balance between the known and unknown values is indicated by the absence of current in a wire that forms a bridge or path between opposite junctions of the circuit.
- wheel stalk.** In auto radios interference caused by friction between the tires and the pavement.
- white.** 1. The signal produced at any point in a facsimile system by the scanning of a selected area of subject copy having minimum density. 2. The brightest portion of a television image.
- compression.** (white saturation) The reduction of gain applied to a picture signal at those levels corresponding to light areas in a picture with respect to the gain at that level corresponding to the mid-range light value in the picture.
- noise.** A random vibrational or electrical spectrum having uniform energy distribution and instantaneous amplitude.
- wide**
- angle lens.** A lens having a short focal length, so as to give a wide field of view.
- band axis.** In phasor representation of the chrominance signal, the direction of the phasor representing the fine chrominance primary.
- width.** In television the horizontal dimension of the picture. Also, the time duration of a pulse (pulse width).
- control.** The control on a television receiver whereby the horizontal dimension of the picture is adjusted to fill the picture tube.
- Wien bridge.** A bridge circuit in which capacity can be measured in terms of resistance and frequency; also useful for measuring frequency and for finding power factor of capacitors.
- Williamson amplifier.** An audio amplifier with a single inverse feedback loop using triode voltage amplifier stages and a triode-connected tetrode power amplifier stage. The forefather of most present hi-fi amplifier circuits.
- Williams-tube storage.** A type of electrostatic storage.
- wiper.** A moving contact on a switch that makes contact with a terminal.
- arm.** In a pressure potentiometer, the movable electrical contact that is driven by the sensing element and moves along the coil.
- arm pressure.** The force with which the wiper arm presses against the coil.
- wiping contacts.** Contacts designed to have some relative motion during the

interval from the instant of touching until completion of the closing motion.

wire. A metallic conductor having essentially uniform thickness, used in radio chiefly to provide a path for electric currents between two points. Also, the act of making connections.

gauge. A system of numbers used to designate wire sizes (diameters). The American Wire Gauge or AWG (formerly Brown and Sharpe or B and S Gauge) is in common use in this country, and has numbers ranging from 0000 as the largest size to 40 and beyond for the smallest sizes.

-wound resistor. A resistor constructed by winding a resistance wire on an insulating form.

wirephoto. A process of transmitting facsimiles of pictures over telephone wires by converting them into and reconvert- ing from electrical signals.

wired radio. Communication by means of a modulated rf carrier signal traveling through wires instead of through space.

wireless. Radio.

record player. A motor-driven turntable and phono pickup mounted in the same cabinet with an rf oscillator. The phono pickup converts a recording into af signals that modulate the rf carrier of the oscillator. The resulting signal is radiated through space as a miniature broadcast signal, and can be picked up by any radio receiver in the same house merely by tuning that receiver to the broadcast-band frequency on which the wireless record player is operating.

wobbulator. A device used with a signal generator to vary the frequency between two values periodically.

woofer. A loudspeaker designed for low frequencies and used in conjunction with one or more other speakers designed for other portions of the audio spectrum.

word. An ordered set of characters having a meaning and considered as a unit. Digital computers commonly use a fixed word length (that is, a fixed number of characters) which is a characteristic of each computer.

time. Synonym for minor cycle.

work. The product of the force acting on a body and the distance through which the body is moved.

coil. See load coil (induction heating usage).

function. The minimum energy required to remove an electron from the Fermi

level of a material into field-free space. Note: Work function is commonly expressed in electron volts.

working voltage. The highest voltage that can be applied continuously to a capacitor without causing a breakdown of the dielectric.

wow. Cyclic variations of recorded or re- produced frequencies due to nonuniform motion of the turntable or capstan. A low frequency flutter.

write. 1. To introduce information, usually into some form of storage. 2. In charge-storage tubes, to establish a charge pattern corresponding to the input.

-in. The process of entering input data into a computer, such as in its high-speed memory system.

writing speed. (In charge-storage tubes) The rate of writing on successive storage elements.

wye junction. A junction of wave guides such that the longitudinal guide axes form a Y.

X

x

axis. A reference axis in a quartz crystal. Also, the horizontal axis of a graph, or the horizontal sweep path in a cathode-ray oscilloscope.

cut. A piezoelectric crystal or quartz plate cut in such a manner that the X axis is perpendicular to its faces. Sometimes called a Curie cut.

rays. Rays having frequencies between the higher ultraviolet frequencies and the lower gamma rays. They are produced by the striking of cathode rays on a solid and are capable of penetrating opaque objects.

X-Y graph. A graph drawn by a rotating-drum or flat-bed recorder in which the input variable is applied to one axis and the output variable to the other axis. Hence, a plot vs output for a transducer.

Y

yagi array. An arrangement of dipole antenna elements for television reception in which one element acts as the antenna and the others as parasitic elements (directors and/or a reflector) to

improve gain and directional reception pattern.

y

axis. In a quartz crystal, a line perpendicular to the two diametrically opposite parallel faces. It lies in a plane at right angles to the X axis. Also, vertical axis of a graph or the vertical sweep path in a cathode-ray oscilloscope.

cut. A piezoelectric crystal cut in such a manner that the Y axis is perpendicular to its faces. Also sometimes called a face-parallel cut or 30° cut.

network. A circuit of three resistors or impedances arranged in the form of a Y or star.

yoke. See deflection yoke.

Z

z

axis. The optical axis of a crystal, perpendicular to the X and Y axes.

-axis modulation. In a cathode-ray oscilloscope, the varying of the number of electrons in the beam so as to change the intensity or brightness of the spot on the screen.

Zener diode. A PN junction diode reverse-biased into the breakdown region; used for voltage stabilization.

Zeppelin antenna. An antenna one-half

wavelength long or a multiple thereof, fed at one end by one lead of a transmission line.

zero

-beat. A condition where no beat frequency results from combining two frequencies, because the two frequencies are exactly the same.

bias. Zero dc voltage between the control grid and the cathode of a vacuum tube, so that these two electrodes are at the same dc potential.

level. The reference level used when specifying a level in decibels.

zone

leveling. (pertaining to semiconductor processing) The passage of one or more molten zones along a semiconductor body for the purpose of uniformly distributing impurities throughout the material.

marker. (Z) A vhf radio station designed to radiate vertically and used to define a zone above a radio range station.

of silence. An area in which radio signals cannot be received.

purification. (pertaining to semiconductor processing) The passage of one or more molten zones along a semiconductor for the purpose of reducing the impurity concentration of part of the ingot.

refining. Removal of impurities by successive melting and refreezing of adjacent sections of a semiconductor material.

APPENDIX I

ABBREVIATIONS

a	ampere; angstrom	ecm	electronic countermeasures
abc	automatic brightness control; automatic bass compensation	eco	electron-coupled oscillator
ac	alternating current	edp	electronic data processing
acc	automatic chrominance control	ehf	extremely-high frequency
adf	automatic direction finder	EIA	Electronic Industries Association
af	audio frequency	emf	electromotive force
aic	automatic frequency control	emu	electromagnetic unit
agc	automatic gain control	esu	electrostatic unit
ah	ampere-hour	f	frequency
AIEE	American Institute of Electrical Engineers	FAA	Federal Aviation Agency
am	amplitude modulation	fax	facsimile
amb	ambient	fc	foot-candle
amp	ampere	FCC	Federal Communications Commission
ant	antenna	fm	frequency modulation
antilog	antilogarithm	fpm	feet per minute
apc	automatic phase control	freq	frequency
ARRL	American Radio Relay League	fsk	frequency-shift keying
asc	automatic sensitivity control	ft	foot; feet
asde	airport surface detection equipment	ftc	fast time constant
asr	airport surveillance radar	gca	ground controlled approach
atc	air traffic control	gci	ground-controlled interception
atr	anti-transmit-receive	GMT	Greenwich Mean Time
avc	automatic volume control	gnd	ground
ave	automatic volume expansion	gpi	ground position indicator
awg	American wire gauge	h	henry; hour (combining form)
back emf	back electromotive force	hf	high frequency
bc	broadcast; broadcasting	hp	high pass; horsepower
bci	broadcast interference	hr	hour
be	band elimination	icw	interrupted continuous wave
bfo	beat-frequency oscillator	id	inside diameter or dimension
bmews	ballistic missile early warning system	i-f	intermediate frequency
bp	band pass	iff	identification friend or foe
btu	British thermal unit	ils	instrument landing system
c	candle; cycle (combining form)	im	intermodulation
cc	cubic centimeter	in	inch
cca	carrier controlled approach	Intercom	intercommunication system
ccs	continuous commercial service	ips	inches per second
ccw	counterclockwise	ir	interrogator-responder; infrared
cgs	centimeter-gram-second	IRE	Institute of Radio Engineers
cm	centimeter	j	$\sqrt{-1}$; an imaginary number
co	cutoff; crystal oscillator	jnd	just noticeable difference
coax	coaxial; coaxial cable	kc	kilocycles per second
cos	cosine	kv	kilovolt
cot	cotangent	kva	kilovolt-ampere
cp	candlepower	kw	kilowatts
cpa	color phase alternation	kwh	kilowatt-hour
cps	cycles per second	l	lambert; length
cro	cathode-ray oscilloscope or oscillograph	lb	pound
crf	cathode-ray tube	lc	inductance-capacitance
csc	cosecant	lf	low frequency
cw	continuous wave; clockwise	lp	low pass; long play
db	decibel	luf	lowest useable frequency
dba	adjusted decibel	m	meter; mutual inductance
dbm	decibel referred to 1 milliwatt	madt	microalloy diffused base transistor
dbv	decibel referred to 1 volt	ma	milliampere
dbw	decibel referred to 1 watt	max	maximum
dc	direct current	mc	megacycle per second
deg	degree	mcw	modulated continuous wave
del	detector	megohm	megohm
df	direction finder	mew	microwave early warning
dme	distance measuring equipment	mf	medium frequency
dpdi	double-pole, double-throw	mfid	microfarad
dpst	double-pole, single-throw	mh	millihenry
dsb	double sideband	mike	microphone
dt	double-throw	min	minimum
dx	distance		

mm	millimeter	RTMA	Radio and Television Manufacturers Association
mmf	micromicrofarads	rx	receiver; receive
mo	master oscillator	scr	silicon controlled rectifier
mod	modulator	sec	second; secondary; secant
mopa	master oscillator power amplifier	shf	super-high frequency
mpcd	minimum perceptible chromaticity difference	sif	selective identification feature
mti	moving-target indicator	sin	sine
muf	maximum usable frequency	snr	signal-to-noise ratio
mult	multivibrator	spdt	single-pole, double-throw
mv	millivolt	spst	single-pole, single-throw
mv/m	millivolt per meter (sometimes microvolts per meter)	sq ft	square foot
mw	milliwatt	sq in	square inch
mx	multiplex	sr	saturable reactor
n	number of turns on a coil	ss	single signal
NAB	National Association of Broadcasters	ssb	single sideband
nc	no connection	stc	sensitivity time control
NEMA	National Electrical Manufacturers Association	superhel	superheterodyne receiver
NTSC	National Television System Committee	sw	short wave; switch
ocw	orange-cyan wideband	swbd	switchboard
od	outside diameter or dimension	swr	standing wave ratio
orth	orthicon	sync	synchronous; synchronizing
osc	oscillator	tan	tangent
owf	optimum working frequency	te	transverse electric
oz	ounce	tem	transverse electromagnetic
pa	power amplifier, public address	tm	transverse magnetic
pam	pulse-amplitude modulation	tpr	teleprinter
par	precision approach radar	tpig	tuned-plate, tuned grid
pbx	private branch exchange	tr	transmit-receive
pcm	pulse-code modulation; pulse-count modulation	trf	tuned radio frequency
pdf	post deflection focusing	tty	teletypewriter
pdm	pulse-duration modulation	tu	transmission unit
pf	power factor; pulse frequency	tv	television
phono	phonograph	tvq	time varied gain
pic	power-line carrier	tw	traveling wave
pm	permanent magnet; phase modulation	twx	teletypewriter exchange
po	power oscillator	tx	transmitter; transmit
pot	potentiometer	uhf	ultrahigh frequency
pp	peak to peak; push-pull	v	volt
ppi	plan-position indicator	va	volt-ampere
ppm	part per million; pulse-position modulation	var	volt-ampere, reactive; visual-aural radio range
pps	pulse per second	vf	voice frequency
preamp	preamplifier	vfo	variable frequency oscillator
prf	pulse-repetition frequency	vhl	very-high frequency
pri	primary	vid	video
prp	pulse-repetition rate	vlf	very-low frequency
psi	pounds per square inch	vpm	volt per meter
ptm	pulse-time modulation	vr	voltage regulator; variable reluctance
pu	pickup	vsb	vestigial sideband
pwm	pulse-width modulation	vswr	voltage standing wave ratio
pwr	power	vt	vacuum tube
rc	resistance capacitance	vivm	vacuum-tube voltmeter
rcvr	receiver	vu	volume unit
rdi	radio direction finder	w	watt
rf	radio frequency	wh	watt-hour
RMA	Radio Manufacturers Association, now RTMA	x	reactance
rmi	radio magnetic indicator	xmit	transmit
rms	root-mean-square	xmitr	transmitter
rpm	revolutions per minute	xtal	crystal
		y	admittance
		z	impedance

APPENDIX II

VACUUM TUBE SYMBOLS

1. Instantaneous values of quantities which vary with time are represented by lower-case letters (i for current, e for voltage, and p for power).
2. Maximum, average (dc), and effective or rms values are represented by upper-case letters (I, E, or P).
3. DC values and instantaneous total values are indicated by the subscript b in the plate circuit, and c in the grid circuit.
4. Varying component values are indicated by the subscript p in the plate circuit and g in the grid circuit.
5. If necessary to distinguish between maximum, average, or rms values, maximum and average values may be distinguished by the additional subscript m and av, respectively.

Examples of the notation above are:

- i_b = total instantaneous plate current
- i_{p} = instantaneous value of varying component of plate current
- I_b = average (dc) value of plate current
- E_g = rms or effective value of grid voltage
- E_{gm} = amplitude (maximum value) of grid voltage

6. Conventional current into the plate (or grid) from the external circuit is positive.
7. The first subscript designates the electrode at which the current is measured, or where the electrode potential is measured with respect to the reference electrode designated by the second subscript. When the reference electrode is understood, the second subscript may be omitted.
8. Supply voltage may be indicated by repeating the electrode subscript. The reference electrode may then be designated by a third subscript, if necessary. For example:

E_{bb}, E_{cc}, E_{cck}

9. In multigrid tubes, the grids are numbered starting at the cathode going toward the plate. In a pentode, for example, there are three grids: g_1 , the control grid; g_2 , the screen grid; and g_3 , the suppressor grid.

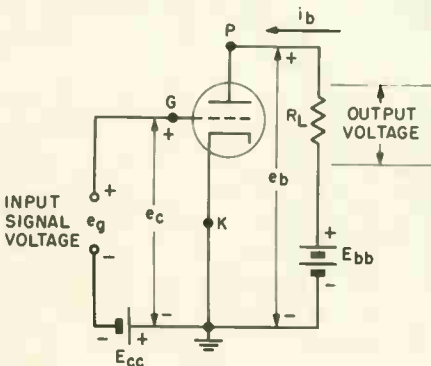

TABLE I

SYMBOLS			
	i, e, p	I, E, P	
Subscripts	g p k	Instantaneous Varying Component Value	Maximum or RMS Varying Component Value
	c b k	Instantaneous Total Value	Average DC Value

TABLE I. A handy reference for symbols and subscripts.

FIG. 1. A common (grounded) cathode vacuum tube amplifier with the proper terminology.

APPENDIX II (continued)

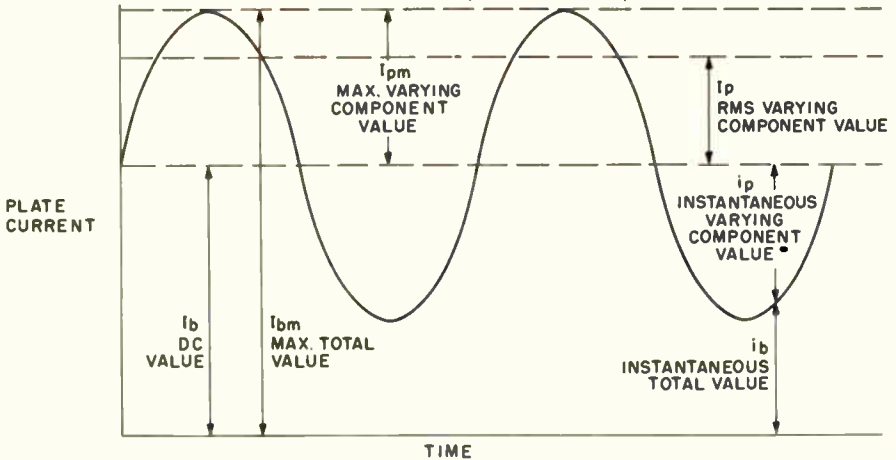

FIG. 2. Proper symbol usage for a typical plate current waveform.

APPENDIX III TRANSISTOR SYMBOLS

1. Instantaneous values of quantities which vary with time are represented by lower-case letters (*i* for current, *v* for voltage, and *p* for power).
2. Maximum, average (dc), and effective or RMS values are represented by upper-case letters (*I*, *V*, or *P*).
3. DC values and instantaneous total values are indicated by the upper-case subscript (*B* for base, *E* for emitter, and *C* for collector).
4. Varying component values are indicated by the lower-case subscript.

Examples of the notation above are:

I_E = total instantaneous emitter current

i_e = instantaneous value of varying component of emitter current

I_B = average or dc value of base current

I_b = rms value of varying component of base current

5. If necessary to distinguish between maximum, average, or rms values, maximum or average values may be represented by the additional subscript *m* and *av*, respectively. For example:

I_{bm} = maximum value of the varying component of base current

6. Conventional current into an electrode from the external circuit is positive.

7. The first subscript designates the electrode at which the current is measured, or where the electrode potential is measured with respect to the reference electrode designated by the second subscript. When the reference electrode is understood, the second subscript may be omitted.

8. Supply voltage may be indicated by repeating the electrode subscript. The reference electrode may then be designated by a third subscript, if necessary. For example:

$V_{EE}, V_{CC}, V_{BB}, V_{CCB}$

APPENDIX III (continued)

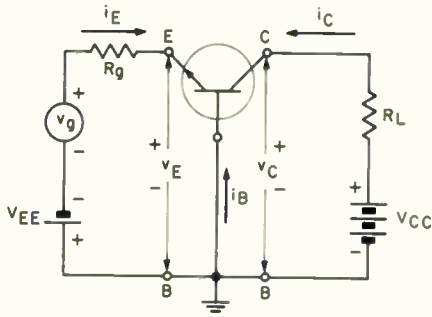

FIG. 1. A common base configuration with proper terminology.

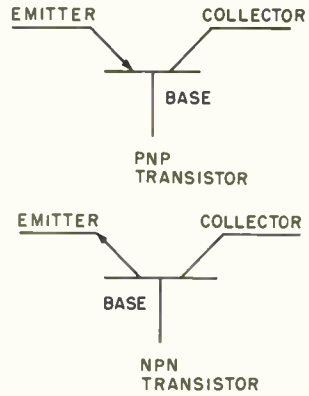

FIG. 2. Symbols for PNP and NPN transistors.

TABLE I

SYMBOLS		
	<i>i, v, p</i>	<i>I, V, P</i>
Subscripts	e Instantaneous	Maximum, RMS
	b Varying	Varying Component
	c Component Value	Value
Subscripts	E Instantaneous	Average DC
	B Total Value	Value
	C	

TABLE I. A handy reference for symbols and subscripts.

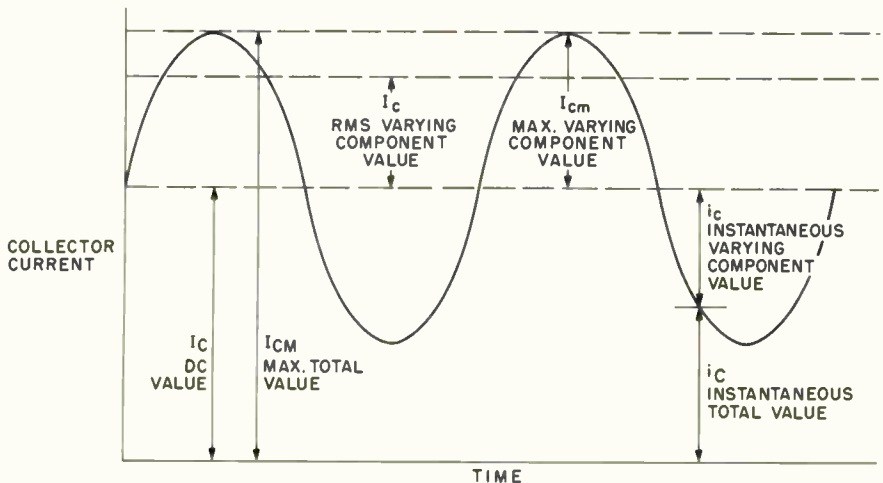

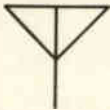
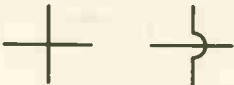





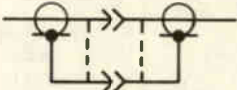

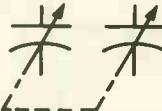

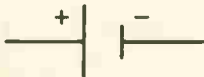





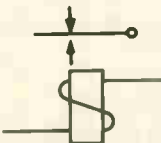



FIG. 3. Proper symbol usage for a typical collector current waveform.

APPENDIX IV MODULATION SYMBOLS











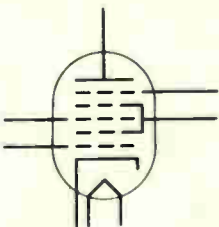
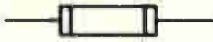

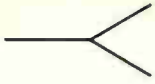
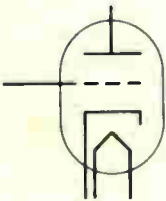
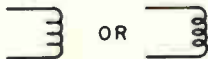
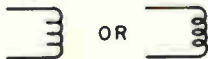
Type	Description	Other Characteristics	Symbols
Amplitude	Absence of any modulation	---	AØ
	Telegraphy without the use of modulating audio frequency (on off keying)	---	A1
	Telegraphy by the keying of a modulating audio frequency (or frequencies) or by keying of the modulated emission.		A2
	Telephone	Double sideband, full carrier Single sideband, reduced carrier	A3 A3a A3b
	Facsimile	---	A4
	Television	---	A5
	Composite transmission and cases not covered by the above	---	A9
	Composite transmission	Reduced carrier	A9c
	Frequency (or phase)	Absence of any modulation	---
Telegraphy without the use of modulating audio frequency (frequency shift keying)		---	F1
Telegraphy by the keying of a modulating audio frequency (or frequencies), or by keying of the modulated emission.		---	F2
Telephony		---	F3
Facsimile		---	F4
Television		---	F5
Composite transmission and cases not covered by the above		---	F9
Pulsed Emission		Absence of any modulation intended to carry information	---
	Telegraphy without the use of modulating audio frequency	---	P1
	Telegraphy by the keying of a modulated audio frequency (or frequencies), or by the keying of the modulated pulse.	Audio frequency or frequencies modulating the pulse in amplitude Audio frequency or audio frequencies modulating the width of the pulse Audio frequency or audio frequencies modulating the phase (or position) of the pulse	P2D P2e P2f
	Telephony	Amplitude Modulated Width Modulated Phase (or position) modulated	P31 P3e P3f
	Composite transmission and cases not covered by the above	---	P9

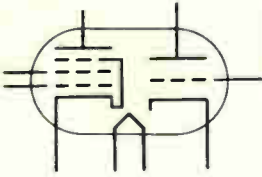
APPENDIX V

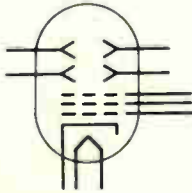
GRAPHIC SYMBOLS

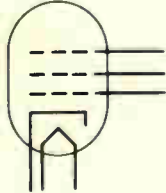
ANTENNA	MICROPHONE	PATH, TRANSMISSION
General 		 Connection No Connection
Dipole 	CAPACITOR Capacitor 	METHOD 1  Connection No Connection
Loop 	Adjustable or Variable 	METHOD 2 CONNECTOR  Coaxial Connector with Outside Conductor Carried Through
LOUDSPEAKER PM Loudspeaker 	Adjustable or Variable with Mechanical Linkage 	 Two-Conductor Switchboard Jack
BATTERY One Cell 	Feed-Through Capacitor 	 Two-Conductor Switchboard Plug
Multicell 	Split Stator Capacitor 	 Two-Conductor Nonpolarized Connector With Female Contacts
RELAY SPDT Relay 	GROUND Earth Ground  Chassis Connection 	 Two-Conductor Nonpolarized Connector With Male Contacts

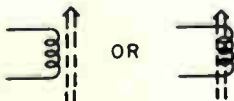
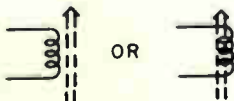
APPENDIX V (continued)

ELECTRON TUBE	FUSE	DEFLECTING ELECTRODE
 <p style="text-align: center;">Pentagrid Tube</p>	 <p style="text-align: center;">OR</p> 	 <p style="text-align: center;">MACHINE, ROTATING</p>
 <p style="text-align: center;">Triode Tube</p>	<p style="text-align: center;">INDUCTOR</p>  <p style="text-align: center;">OR</p>  <p style="text-align: center;">General</p>	 <p style="text-align: center;">Generator</p>  <p style="text-align: center;">Motor</p>
 <p style="text-align: center;">Triode-Pentode Tube</p>	 <p style="text-align: center;">Magnetic Core Inductor</p>	<p style="text-align: center;">METER</p>  <p style="text-align: center;">Ammeter</p>
 <p style="text-align: center;">CRT With Electrostatic Deflection</p>	 <p style="text-align: center;">Adjustable Inductor</p>	 <p style="text-align: center;">Voltmeter</p>
 <p style="text-align: center;">CRT With Magnetic Deflection</p>	 <p style="text-align: center;">Tapped Inductor</p>	<p style="text-align: center;">RECTIFIER</p>  <p style="text-align: center;">General</p>
	 <p style="text-align: center;">OR</p>  <p style="text-align: center;">Permeability - Tuned Inductor</p>	 <p style="text-align: center;">Metallic</p>

APPENDIX V (continued)

