



**RADIO RECEIVER
TROUBLESHOOTING**
Lesson TSM-1C



DeVRY Technical Institute

4141 W. Belmont Ave., Chicago 41, Illinois
Formerly DeFOREST'S TRAINING, INC.

RADIO RECEIVER TROUBLESHOOTING

4141 Belmont Ave.

COPYRIGHT 1955

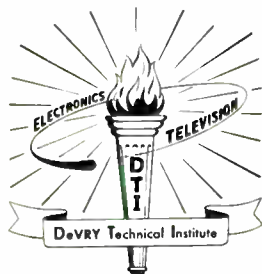

Chicago 41, Illinois

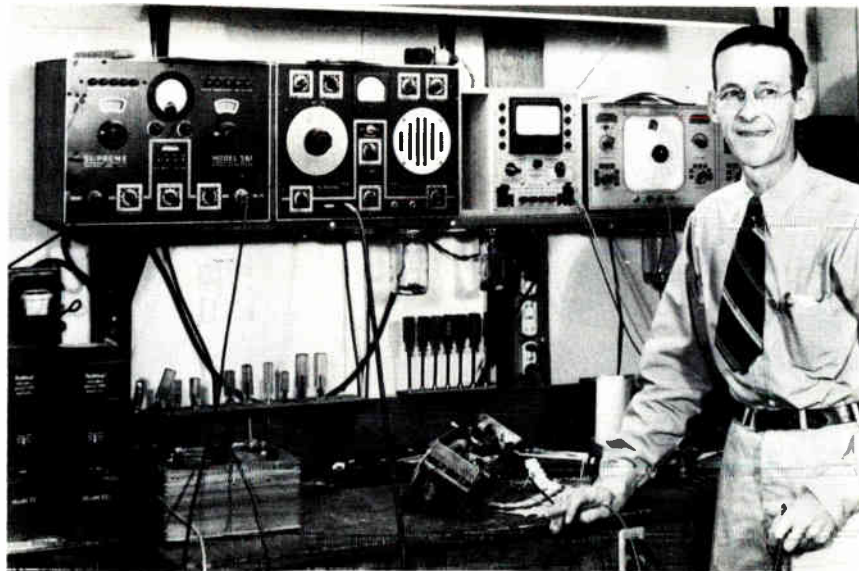

A well-designed radio service bench has instruments, tools, and service data located within easy reach along with ample illumination and a-c power outlets.

Courtesy John A. Jacobson

Television Service Methods

RADIO RECEIVER TROUBLESHOOTING

Contents

	PAGE
Identification of Tubes and Circuits	4
Questioning the Owner	6
Visual Inspection	7
Aural Check	9
Sectional Checks	10
A-F Section	12
I-F Section	13
R-F Section	13
Tube Testing	15
Dynamic Testing	16
Voltage and Resistance Testing	16
Types of Receivers	17
A-C Receivers	18
D-C Receivers	20
A-C/D-C Receivers	24
A-C/D-C Battery Portables	24
Component Troubles	26
Tube Troubles	27
Capacitor Troubles	27
Resistor Troubles	29
Transformer and Choke Troubles	30

Television is a powerful giant of science in need of recruits to swing it into action as a service to the public. The call goes out for captains of industry born with vision. Also for engineers, showmen, merchandisers, actors, scenic designers, scenario writers, producers, cameramen, directors, musicians and thousands of others required to stage such a multi-ringed circus in a medium that conveys sight and sound as fast as they are tossed to the camera and the microphone.

—Selected

RADIO RECEIVER TROUBLESHOOTING

No matter how well a piece of equipment is constructed, sooner or later certain components do weaken or break down. Hence, repairs and replacements must be made to restore proper operation. Since time is costly, to be successful, a service man must search for and repair these various defects quickly and correctly.

Very likely you have seen some rather complicated appearing test equipment. The impression sometimes given by these instruments is that it is only necessary to learn how to manipulate the equipment and it will do the troubleshooting. This is not so. No matter how elaborate, every instrument requires two things of the serviceman: (1) a knowledge of the techniques required to get accurate information quickly, and (2) a background of circuit theory with which to correctly interpret this information.

Since the circuit theory for radio and television receivers was thoroughly covered in earlier lessons, these lessons are devoted entirely to showing how this knowledge is used to locate and remedy faults in the receivers.

In fact, for the first two lessons, we shall rapidly survey the servicing field by showing how the knowledge presented in the previous lessons on receiver cir-

cuits, test equipment, static and dynamic testing, and circuit tracing can be combined for effective troubleshooting of simple broadcast radio receivers. Then, with these basic techniques in mind, the remaining lessons will describe the entire servicing procedure step by step as it is used by the successful television servicemen.

Since many service calls require only the replacement of tubes and other simple adjustments which can be accomplished without removing the chassis, it pays to make a preliminary inspection to make sure whether chassis removal is necessary or not.

IDENTIFICATION OF TUBES AND CIRCUITS

To make this preliminary check, the serviceman must be able to locate quickly the various tubes such as the a-f output tube, the rectifier, the i-f amplifier tubes, etc. Fortunately, all tubes are marked with their type numbers, and thus can be identified readily. Usually, this marking is about half way up on the bulb of the glass type tubes, and in a similar location on the metal tubes; although in some cases the type number is on the base of the tube.

Knowing the type number, one can determine the function of any tube by referring to a tube chart or manual. As experience is gained, it will be possible to recognize more and more tubes without referring to the chart. However, with the large number of types now in use, it is very difficult to memorize all of them, and therefore, a good tube manual must be considered an essential part of your equipment.

A study of the tube types also helps to identify the nature of the circuit used in the receiver. Practically all commercial radio receivers employ either a tuned radio frequency (trf) or a superheterodyne (superhet) circuit. The superhet employs a converter stage and one or more i-f transformers in addition to the circuits used in the trf receiver.

As an example, inspect the top view of the radio receiver chassis shown in the drawing of Figure 1. The chassis contains five tubes, marked 25L6, 6J7, 25Z6, 6K7, and W-46416. Reference to a tube manual shows that the 25L6 is classed as a beam power amplifier, the 6J7 can be used as a detector or audio amplifier, the 25Z6 is a half-wave rectifier or voltage doubler, while the 6K7 is classed as an r-f or i-f amplifier. The W-46416 does not appear in the ordinary tube table and actually is not a tube in the usual

sense of the word. Details on this unit are given a little later in the lesson.

The only tube with functions including detection is the 6J7, thus it can be concluded that this tube is the detector. Also, as no converter tube is included, the 6K7 can be assumed to be an r-f amplifier. From this information, we can reason that, insofar as the tubes are concerned, the signal passes from the antenna through the 6K7, the 6J7, the 25L6, and then to the speaker.

As the chassis of Figure 1 contains no i-f transformers, oscillator, mixer or converter tube, the receiver cannot be a superhet. It is evidently a trf. Also, since no power transformer is used, this receiver is likely an a-c/d-c unit. A further check of the tube table shows that all of the tubes require a heater current of .3 ampere, and thus can be connected in series as is in the a-c/d-c type circuits. The table shows also that the 25L6 and 25Z6 heaters each require 25 volts for proper operation, while the 6J7 and 6K7 heaters require 6.3 volts.

Therefore, the total drop is $25 + 25 + 6.3 + 6.3$ or 62.6 volts for the four tube heaters. The home lighting circuit is rated at 110 to 120 volts, but usually is considered as being 117 volts for calculations. Therefore, to make up the difference between 117 and

62.6 volts, a resistor must be connected in series with the tube heaters, and its resistance must be such that the voltage drop across it will be $117 - 62.6$ or 54.4 volts with a current of .3 ampere.

For the receiver of Figure 1, this resistor is mounted inside the W-46416 tube, which is known as a ballast. Once you become familiar with the regular tube types, there is no difficulty in identifying the ballast tubes, since their numbers are entirely different. Thus, when an a-c/d-c receiver contains an unusual tube number, you can be reasonably sure that this odd tube is a ballast.

As a second example, refer to the top view of the receiver chassis in Figure 2. For the tubes shown, a tube manual gives the recommended uses listed below:

formers generally is closely related to the path taken by the signal as it passes through the receiver. This fact further aids servicemen in identifying the tubes with regard to their respective functions.

QUESTIONING THE OWNER

Generally, it is a good plan to begin the troubleshooting by asking a few questions of the receiver owner. Many times the owner gives certain essential information which aids a great deal in determining the source of the trouble. For example, the serviceman may ask, "Does the set play at all?" If so, "In what way is its operation objectionable?" If not, "How did the set perform just before it stopped?"

Frequently, the owner of a radio prys into the mechanism in

<u>Type No.</u>	<u>Recommended Use</u>	<u>Probable function in this receiver</u>
6V6	Output audio amplifier	Output audio amplifier
6X5	Full-wave rectifier	Power supply rectifier
6J5	Detector, amplifier or oscillator	Local oscillator
6SA7	Converter	Mixer
6SK7	R-f or i-f amplifier	I-f amplifier
6SQ7	Combined det, amp, and avc tube	2nd det, and 1st audio amp.

In Figure 2 the oscillator and mixer tubes, as well as the i-f transformer, immediately identify this receiver as being of the superhet type. An important point, which should be noted at this time, is that the physical location of the various tubes and i-f trans-

an effort to determine the trouble before calling in a repairman. In some cases, they may actually have discovered the location of the trouble without knowing the remedy. For example, the owner may remark, "that big tube at the end gets red hot", and the

serviceman, noting that this is the rectifier tube, is well on his way toward finding the faulty component.

On the other hand, the owner may have tried to fix his radio, in which case the serviceman may find the receiver now has more troubles.

VISUAL INSPECTION

As his second step, the successful serviceman employs what usually is called a "visual inspection" of the set. However, besides his sense of sight, he also makes use of his senses of hearing, touch, and smell. For example, by looking carefully at a receiver, one should observe any broken or bent components, glass tubes in which the filaments are not lit, a glowing rectifier tube, etc. Also, the condition of the 117-volt a-c line cord and plug should be checked. By listening carefully to the hum, squeals, noise, or lack of sound in a speaker, often additional information on the nature or general location of the trouble can be determined. By feeling the various parts (this must be done cautiously), one can frequently determine whether any are overheated or loose, and the sense of smell will tell whether any parts have been heated sufficiently to burn or char the insulation.

Of the above checks, those which can be made without the

power on should be made first. Then, when the power is turned on, the rectifier tube should be watched closely for several seconds. Should the plate or plates of this tube turn red hot after a few seconds of operation, the power must be turned off immediately. This glow indicates that the tube is carrying an excessive current, and therefore, either the tube, the power transformer, or both, are in danger of permanent damage.



One of the first steps in a troubleshooting routine consists of checking the tubes either in a tube tester, such as the unit shown, or by replacement with known good tubes.

Courtesy The Jackson Electrical Instrument Co.

In the power supply circuit of Figure 3, excessive current in rectifier tube V_1 can be caused by a short between points X and Y as illustrated by the dashed line. Normally, the bleeder $R_1R_2R_3$ and the plate and screen circuits

of the other tubes of the receiver form the total load which has a resistance of several thousand ohms. At all times, this resistance plus that of choke L_1 and one-half of the transformer high voltage secondary winding are in series with V_1 , and limit the current to a safe value.

Should anything happen to produce a conductive path between the circuit connected to the rectifier filament and the chassis (ground) as indicated at X and Y, the short circuit produced contains only the resistance of the transformer winding and the tube V_1 . With the high voltage applied, this low resistance path permits an abnormally heavy current. Also, the low impedance of the secondary of T_1 is "reflected" to the primary, the applied 117 volts from the power line then produces excessive current in the primary winding, and this excess may cause the primary to burn out.

Hence, a short in the power circuit must be corrected before any other testing or inspection of the set can be done with the power on. However, a test can be made to determine whether such a short exists, by measuring the resistance between the rectifier socket filament contacts and the chassis with an ohmmeter as shown in Figure 4. These connections are equivalent to placing the ohmmeter test prods at points

X and Y in Figure 3. The measured resistance should be on the order of 10,000 ohms or more. Very often, a short in this part of the receiver power supply is due to a shorted input filter capacitor, C_1 , Figure 3. Although occasionally, a connecting wire or a transformer or choke winding will make contact with the chassis to create a short, in most cases the trouble is a defective capacitor.

When the operation of the rectifier tube has been observed and found to be normal, the power may be left on for a further inspection of the receiver. There is a wide variation in the step-by-step inspection procedure followed by different servicemen. Such things as personal preference, the type of receiver, personality of the customer, and general policies of the service shop all affect the actual routine.

Included in all routines, an important check consists of determining whether all the tube heaters or filaments are operating. With the receiver turned on, the glow of the operating heaters can be seen in the case of the glass tubes, while touching the metal tubes to see if they are warm after a few minutes of operation will provide the same information.

In making tests of this kind, it should be remembered that,

while a heater may be lit, this does not necessarily mean that the tube is in working order. Some of the elements may be shorted, or the emission may be low, etc., but at least the heater and its circuit are known to be in good condition.

The identification of the circuit is of benefit here, because for the series heater connection of the a-c/d-c receiver in Figure 1, any broken heater prevents all tubes from lighting. On the other hand, in the circuit of Figure 2 the tube heaters are in parallel; and therefore, when one is defective, it does not light, but the others do.

AURAL CHECK

For another test, the serviceman uses his ears to observe the nature of the sound coming out of the loudspeaker. Every receiver operating on a-c has a slight hum in the speaker when no signals are being received and the volume control is turned all the way down. Then, as the volume is turned up, there is a sort of "live" sound even when no signals are being received. The higher the volume control is turned, the louder this sound will be, until natural static and other disturbances are heard. In modern receivers with avc, these disturbances diminish greatly as each broadcast station is tuned in.

With the set turned on and the tubes warmed, place an ear close

to the speaker. If the set is absolutely dead with no trace of hum or live sound, it is safe to assume there is trouble either in the speaker, the output transformer, the plate circuit of the output tube, or the plate voltage supply. This diagnosis is made because the speaker is coupled to the plate circuit of the output tube, and if the circuits and coupling are in good order, at least a slight hum is heard.



Replacement power transformers as shown here are available in various sizes and mountings and with standard secondary voltages.

Courtesy The Halldorson Company

If you hear a hum, but no live sound or other noise when the volume control is rotated back and forth from low to high, it is a good indication of trouble in

the audio section of the receiver circuit. On the other hand, should the speaker have the live sound, and the intensity can be varied by operating the volume control, the audio amplifier is working and the signal is lost somewhere between the detector and the antenna.

Although these checks provide definite indications in the case of a receiver which is completely inoperative, they can be used also in a receiver which is operating poorly. For example, a low signal volume but high hum level indicates defective filtering, usually due to trouble in the filter capacitors. For example, in the power supply shown in Figure 5, the input filter capacitor, C_1 , exercises an important control over the d-c output voltage. Thus, if the capacitance of this unit diminishes due to age or other causes, not only is there less filter action, resulting in increased hum, but lower d-c output voltage as well which causes reduced signal volume.

In the case of loudspeakers which employ field coils, usually proper field excitation can be determined by placing an iron screw driver near the pole piece to observe whether any magnetic pull or force is being created.

As another example, distortion of the sound output can be caused by the loudspeaker voice coil rub-

bing against the pole piece. This possibility can be checked by turning the volume down low so that there is but slight tendency for such rubbing to occur. Then, if the distortion disappears, chances are that the voice coil is off center. However, if the distortion still exists, it is due most likely to some electric defect in the audio stages of the receiver.

SECTIONAL CHECKS

As mentioned, these preliminary tests are made in an attempt to localize the trouble to a particular section of the receiver. The following tests also follow this same basic plan. For convenience, a radio receiver can be divided into sections identified by the frequency of the signal in them. Thus, a trf receiver contains an r-f section and an a-f section, while a superheterodyne receiver in addition to these has an i-f section.

The a-f section can be checked by removing the first audio amplifier tube from its socket and replacing it quickly. When this is done, a loud click is produced in the speaker when the a-f section is active.

If the first audio tube has a grid cap, the test can be made by touching the finger to the cap. A violent howl or click should be heard if the a-f stages are functioning properly. This test re-

sults in a loud low frequency hum in the speaker in any building wired for a-c lighting if the a-f circuits are operating properly. If no sound is heard in the speaker except the slight hum due to the power supply ripple, trouble is indicated in the audio amplifier circuits.

proper condition. In this case, the trouble can be assumed to lie in the r-f section. If no click is heard, the trouble probably is in the i-f section.

In receivers in which the tube heaters are operated in series, the removal of any one tube

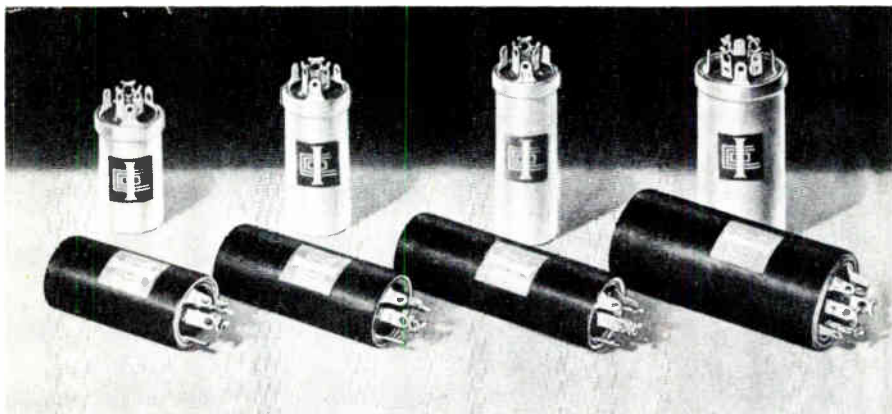

Self mounting electrolytic capacitors are available in a variety of sizes for replacement purposes.

Courtesy Illinois Condenser Company

In the case of a trf receiver, the trouble now has been isolated to either the a-f or r-f section. However, with a superheterodyne receiver, generally it is desirable to further isolate the trouble to either the r-f or i-f section when the a-f section is indicated to be operating properly. This check can be made by removing and replacing the mixer or converter tube in its socket. The procedure should produce a click in the speaker if the i-f section is in

opens the entire heater circuit. The remaining heaters usually remain hot long enough so that the disturbance does cause the desired click in the speaker. However, if a tube is left out of its socket too long, or if several tubes are pulled and replaced in rapid succession, all the heaters may cool down to a point where a false indication of improper operation is obtained, although the tube and stage being checked are in good condition.

A second method of making the r-f/i-f check consists of touching a screw driver blade to the stator plates of the tuning capacitor section which is connected to the signal grid of the mixer or converter tube. The fingers should make contact with the metal blade to obtain the full effect of the body capacitance. A click is heard in the speaker when the i-f section is operating properly.

A-F Section

In the event that the preceding sectional check has indicated trouble in the a-f section, the next step consists of further isolating the defect, if possible, to either the first a-f stage, the power amplifier stage, the loudspeaker or output transformer, etc. As a check has been made already at the input of the first audio tube, the second or output tube now can be pulled and replaced. When a loud click is heard in the speaker, the trouble is most likely in the first audio stage. If no sound is heard, the defect probably exists in the output stage or the speaker.

Except for a few of the older types, the audio power-amplifier tubes do not have grid caps. However, a test at this point in a receiver can be made by removing the tube, winding a turn or two of thin bare wire around the control grid prong, and replacing

the tube in its socket, with the free end of the wire projecting outward. Then, when this wire is touched, a loud hum or howl should be heard. If the hum is not heard, chances are that the trouble is in the output tube or circuit, rather than in the loudspeaker. Care should be taken that the wire does not contact the chassis, as this would ground the grid of the tube and give a false indication.

Occasionally, the reception is of an intermittent nature, that is, the set may operate perfectly for a while and then suddenly cut off completely, after a short interval it again resumes operation only to cut off again. This trouble is called "grid blocking" or "choking", and can be caused by an open or break in the grid circuit of some stage. Such a condition removes the grid return path and therefore the bias from the grid. Reception is heard until sufficient electrons gather on or near the grid to bias this element negative to a point which prevents the flow of electrons to the plate. When this cut off occurs, the tube becomes inoperative and signals cannot pass through the stage. The inoperative condition remains until enough electrons leak off the grid to reduce the bias to a voltage which again permits plate current. This entire action continually repeats itself. In some

cases the alternate intervals of operation and silence are so short that nothing is heard but a sputtering sound, and the receiver is said to be "motorboating" or "oscillating".

This trouble is very common in a-f stages, and usually is the result of an open grid resistor. To check for this condition, place one finger on the grid cap and another finger on the same hand to the chassis. This action completes the grid circuit through the resistance of the hand, and normal operation should be restored. For the tubes that do not have a grid cap, the arrangement with a piece of wire wound around the grid prong can be used as explained earlier, or this test can be postponed until later when the chassis is removed from the cabinet.

I-F Section

If the sectional check indicates the defect to be in the i-f section, an attempt is made to locate the exact faulty stage by removing and replacing in its socket each of the i-f amplifier tubes in turn, beginning in the last i-f stage and working toward the first stage. In each case, a click should be heard as the tube is pulled and replaced if the stage is not defective. That is, a faulty stage is indicated when the click is not heard. If the click is heard when the tube is pulled in the first i-f

stage, then the trouble can be assumed to be in the mixer or converter stage.

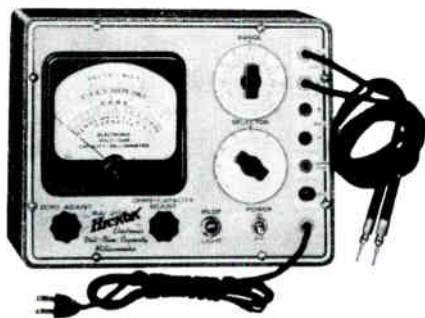

Generally, a large part of the troubleshooting may be performed with the use of a multi-meter. The unit shown measures voltage, resistance, capacitance, and current.

Courtesy The Hickok Electrical Instrument Co.

An open or break in the grid circuit of an audio amplifier results in grid blocking or motorboating as explained, when this condition occurs in an i-f or r-f stage, often the receiver continues to operate, but the volume is considerably lower than normal, and almost always the reception is accompanied by oscillations and tuning instability. However, a reliable check for an open grid circuit in the i-f section requires pulling the chassis and the use of test equipment, and therefore, it is made at a later point in the troubleshooting routine.

R-F Section

The r-f section of a receiver includes the antenna, the antenna transformer, one or more r-f am-

plifiers, the local oscillator, and the input circuit of the mixer or converter stage. When the defect has been isolated to the r-f section, often further localization may be obtained by disconnecting the antenna lead-in wire from the antenna post and successively attaching it to the various tuned stages until reception is heard. It may be necessary to rotate the tuning capacitor to pick up a signal from a powerful or nearby broadcast station.

If no outside antenna is employed with the set normally, a short portable one, or one installed in the service shop, can be used for this test. Often, the receiver gain is sufficient to permit obtaining reception merely by touching the input circuits with a finger, or with a screw driver as explained for the mixer test. For example, one such point of contact is the stator plates of the tuning capacitor section to which the r-f amplifier grid is connected. Other points are the ungrounded ends of the antenna transformer, and r-f transformer secondary windings.

When a point is found at which reception is obtained, it is then known that the trouble lies ahead of this point; that is, between this point and the antenna. This test forms a fairly quick method of locating a defective antenna or r-f coil, and is especially impor-

tant because such trouble is a rather frequent occurrence in many receivers.

If operation is being obtained to some extent, this test can be used also to determine whether or not, the tuned r-f circuits are properly aligned, since poor alignment may cause a drop in signal strength. By applying the lead-in first to the circuit following the suspected stage, and then to the input of this stage, the efficiency of the stage can be estimated roughly by noting the increase, if any, in output volume from the speaker. An r-f amplifier stage can be tested by removing and replacing the tube in its socket, in which case proper operation will be indicated by a click in the speaker, as explained for the tubes of the i-f and a-f sections.

The operation of a superheterodyne receiver depends upon the heterodyne action between the incoming carrier signal and the r-f output of the local oscillator. Therefore, if the oscillator is not operating, the i-f signal is not produced and the receiver is inoperative. As mentioned for the speaker listening tests, the live sound may exist which can be varied by the volume control, but there may be no signals reproduced.

While a positive test for oscillator operation requires test equipment, a rough test can be made

by placing a finger on the stator plates of the oscillator section of the tuning capacitor. This increases the capacitance of the circuit, and detunes it sufficiently to stop its normal operation. If the oscillator is operating, placing a finger on the stator of its tuning capacitor should cause a "soft" click or "plop" in the speaker. The term "soft" is used to distinguish this sound from the rather sharp click which is heard when the grids of the amplifier tubes are touched.

TUBE TESTING

The various preliminary tests described above are performed to locate the particular stage which contains the defective tube or other component. Due to the wide variety of troubles, these relatively simple checks do not always provide the information desired, and even when the defective section or stage is indicated, there still remains the problem of locating the precise component which is causing the trouble. Thus, generally further tests are necessary which require test equipment, or tubes and other parts for substitution, or both.

The tube test should be the first made after the preliminary checks are completed. The reason for this is that the largest percentage of troubles are due entirely to defective tubes. If the preliminary tests above have indicated a certain

stage or section to contain the defect, then the tube or tubes here contained should be checked in a tube tester. An alternative method consists of replacing each suspected tube with one that is known to be good.

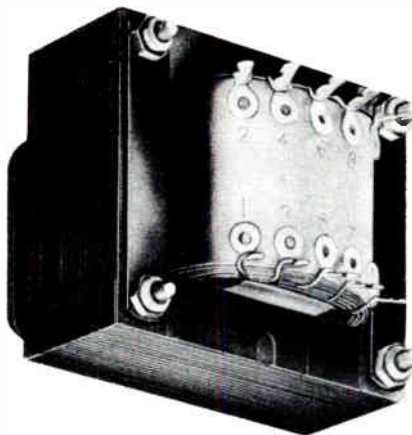

While some replacement power transformers have flexible color coded leads for making connections others have numbered lugs which also furnish mechanical support.

Courtesy SNC Mfg. Co., Inc.

It is a good idea to check with the service data for the receiver to see if the tubes now being used are the exact types for which the receiver was designed. For example, the types 6Q7, 6Q7-G, and 6Q7-GT are all very much alike and any one of them may work satisfactorily in most circuits. However, since these tubes differ as to internal shielding and inter-electrode capacitances, they cannot be interchanged for all circuits.

Even though the receiver may be restored to proper operation by replacing one or more defective tubes, or by some other simple repair or adjustment, it is a good plan to check all of the tubes, because certain ones, though operating at the moment, may be old and on the verge of failure. Regardless of any ideas or hunches you may have regarding the cause of the trouble in a particular case, the law of averages has shown that the greatest troubleshooting efficiency is attained by testing the tubes first.

DYNAMIC TESTING

When the faulty stage has not been located by the preliminary tests described, the desired isolation of the trouble may be attained by means of the type of tests known as dynamic tests. These tests consist of the signal tracing and signal substitution tests which were described in detail in earlier lessons. Also, as explained, these tests require a test instrument which is capable of either detecting or generating the signals used for the tests.

Briefly, the method consists of either checking for the presence of or injecting the test signal at various points, in the receiver. The defect then is assumed to be located in some circuit which is beyond the last point at which a satisfactory indication is obtained.

Dynamic testing is employed to reduce to a minimum the number of static tests which must be made. That is, with the faulty stage located, generally it is unnecessary to make voltage and resistance tests in the other stages of the receiver. Of course, these dynamic tests are omitted when the defective stage has been located by the preliminary tests explained above.

VOLTAGE AND RESISTANCE TESTING

Also described in detail in a previous lesson, measuring the voltages at various points with respect to a reference point such as the chassis of the receiver, and measuring the resistance of various components or between different points in the circuit are useful static tests. Generally, the potentials at the electrodes of the tubes are measured first, and the readings obtained are checked against the values specified in a service data sheet for the receiver. Ordinarily, tolerances of about plus or minus 20% are allowed in the readings because of variations in individual receivers of the same model, line voltage differences, and normal aging of components.

When an electrode voltage is found to be too low, too high, or absent entirely, then further voltage measurements are made in its

circuit at points between the electrode socket terminal and the power supply. Usually, these checks indicate one or more components or connections which, if defective, could produce the improper electrode voltage measured. Finally, with this information obtained, the power is turned off, and resistance measurements are made of the suspected components, wiring, etc.

In cases where the defect does not produce changes in electrode voltages greater than the usual tolerances allowed, the resistance must be measured between each electrode socket terminal and a reference point specified in the service data sheet. Then the measured resistances are compared with the readings given in the data sheet and, as before, tolerances of about plus or minus 20% are allowed. Any incorrect resistances obtained indicate faulty conditions, and further resistance tests must be made to locate the specific defect.

In a vast majority of the cases, the voltage and resistance tests need be made in only the stage or section which has been indicated as faulty by the preliminary or dynamic tests. However, in the event that the previous tests do not isolate the defect in any one section or stage, it may be necessary to make systematic static tests of the entire receiver until

the troublesome unit or connection is found.

Voltage and resistance tests of the complete receiver require a lot of time. Therefore, the preliminary and dynamic tests are made to eliminate, if possible, the making of static tests in the circuits which are not defective.

Finally, there are types of troubles which do not produce considerable changes, if any, in the voltages or resistances in a circuit, and therefore may not be located by means of the static tests. In such cases, the only means available is to isolate the faulty stage if possible with dynamic type tests, and then substitute suspected parts in succession with units known to be good. This substitution method is the most time consuming and expensive of all, and should not be employed except as the very last resort.

TYPES OF RECEIVERS

Of the various types of radio receivers, each is likely to develop certain troubles that are common to that particular type of set. Therefore, from a servicing point of view, it is convenient to identify the type of receiver before beginning the troubleshooting work. For the preliminary tests, receiver circuits were classified simply as trf or superhet. However, over 90 per cent of all commercial broadcast receivers are

of the superheterodyne type, and usually it is desirable to classify receivers further in accordance with other characteristics.

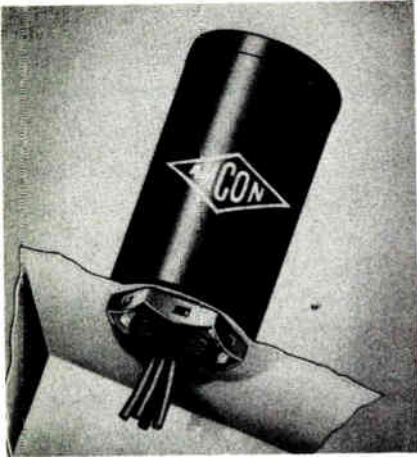

This electrolytic capacitor is secured to the chassis by means of the large mounting nut. As shown, the leads are brought out through the bottom.

Courtesy American Condenser Company

For service work, a practical basis for receiver classification has been found to be the differences in the various types of power supplies employed. Receivers grouped on this basis can be sub-divided according to whether they require a-c or d-c power, according to whether or not a power transformer is used, or according to the voltage (2, 6, 32, 117, etc.) which the source must supply. In whatever way this is done, it will be found that a few types of receivers fit into more than one category. For the purpose of the

following explanations, receivers are classed according to whether their power supplies require an a-c, a d-c, or either an a-c or d-c input.

A-C Receivers

Almost all a-c receivers have power supplies of the kind which employ power transformers. This form of power supply is illustrated in the diagram of Figure 5. The main units of the power supply are: the power transformer T_5 ; the rectifier tube V_5 ; the filter consisting of capacitors C_1 , C_2 , and the speaker field coil which serves also as a choke; and the voltage divider $R_6R_7R_8$, which supplies negative voltages for the various control grids.

When radio was first introduced commercially many years ago, receiving sets were powered by means of a number of batteries. The battery used to supply the tube filaments was called the "A supply", the one that supplied the plates and screen grids was called the "B supply", and that from which the control grid bias was obtained was termed the "C supply". With the exception of the battery-portable type radios, modern receivers now contain other arrangements for supplying the operating voltage to the various tube elements. However, the designations A, B, and C for the respective supply circuits are still in use as indicated in Figure 5.

In the a-c receiver of Figure 5, the A supply consists simply of a power transformer secondary winding having the required number of turns to provide the needed heater voltage, and having sufficient current carrying capacity to accommodate the total of all the individual heater currents. As indicated, the various heaters are connected in parallel, and hence their individual current requirements can differ. Being connected to the same secondary winding, however, they must all have the same voltage ratings. In receivers with tubes which operate at different heater voltages, the power transformer must contain more than one heater secondary winding.

The "B" supply in the receiver of Figure 5 is filtered by C_1 , C_2 and the speaker field, and provides a direct voltage output (B+) of 225 volts positive with respect to ground. Actually, there is a total of 275 volts as measured from the heater of V_5 to the center tap of the high-voltage secondary winding, that is, across C_1 . But, due to the current through the speaker field coil, there is a 50-volt drop across this coil, and thus there remain only 275-50 or 225 volts between the ground end of the field coil and "B+". That is, output capacitor C_2 is charged to a potential of 225 volts, and the plate and screen grid circuits of the various tubes are connected

in parallel with this unit. Since only the d-c circuits are of concern, most of the signal circuits have been omitted.

Although not employed in many receivers, the C-supply shown in Figure 5 provides a fixed bias for the control grids of the various tubes, and for the delayed automatic volume control diode of V_3 . As mentioned above, due to the IR drop across the speaker field coil, the end of this coil which is connected to the power transformer center-tap has a potential of 50 volts negative with respect to ground. By means of the voltage dividing resistors R_6 , R_7 , and R_8 , the various desired voltages are obtained by connecting to the junctions between these resistors as shown.

So far as obtaining bias from the negative leg of the power supply filter is concerned, this could be accomplished by the use of resistors R_6 , R_7 and R_8 connected as shown, but without the speaker field in parallel. However, the voltage divider resistors must then carry the total B supply current, have much higher wattage ratings, and therefore add considerably to the cost of the receiver. Thus, in the receiver of Figure 5, the B supply current is utilized to energize the speaker field, and this field coil eliminates the need of a regular filter choke. When connected as shown, the

field coil takes most of the B current so that the voltage divider resistors may be of the less expensive low wattage types.

A less common type of a-c receiver employs a voltage doubler circuit rather than a power transformer to provide the high voltages needed for the B circuits. A power-supply circuit of this type is illustrated by the diagram in Figure 6. Here, the A or heater circuit is connected directly across the 117-volt input line, and a ballast or series dropping resistor R_1 reduces the voltage to the total value of 74 volts required by the five heaters in series.

At first glance, this set might be mistaken for an a-c/d-c receiver because of the series heater connection and the absence of a power transformer. From the physical appearance, there is little to distinguish between the two types. A tube table shows the V_6 tube is a double-diode type which can be employed either as a half-wave rectifier in an a-c/d-c receiver, or as a voltage doubler. Therefore, it is necessary to examine the wiring and connections of any particular circuit to determine for which purpose a tube of this type is employed.

As Figure 6 shows, when this rectifier is used in a voltage doubler, the plate of one diode section is connected to the cath-

ode of the other diode. The filter capacitors, C_2 and C_3 are connected in series from the cathode of V_{6A} to the plate of V_{6B} . These tube elements form the positive and negative terminals, respectively, at the input of the B supply filter. The complete filter consists of C_2 , C_3 , the speaker field coil, and C_4 . When a double-diode tube like that in Figure 6 is used as a half-wave rectifier in an a-c/d-c receiver, its two plates are connected together, as well as the cathodes, and a single unit replaces the series capacitors C_2 and C_3 . For simplicity in Figure 6, all circuits have been omitted except those which show the d-c paths from B+ to the plates and screens of the various tubes.

D-C Receivers

The various types of radio receivers that are designed for d-c operation include: (1) automobile receivers, (2) battery portables, (3) sets which operate on 117 volts d-c only, and (4) those made to employ the output of motor-generator equipment, such as the 6 or 32 volt power supplies found in aircraft, on farms, etc. Of these, the automobile receivers are the type encountered most frequently by the serviceman working with commercial broadcast equipment.

An automobile radio uses a vibrator in its power supply, and is contained in a metal case to

shield the set from interference. As the vibrator produces r-f interference, usually the receiver is further shielded by a metal partition which separates the power supply components from the radio signal circuits.

A schematic diagram of a typical automobile receiver power supply is given in Figure 7A. Again the signal circuits are omitted, since this explanation is concerned mainly with the method by which the A and B currents are supplied to the various tube elements. The point labeled "6-volt d-c input" is connected to the "hot" side of the car battery (this may be either the + or - terminal). The other terminal is connected to the car frame by a heavy bonding strap. The receiver chassis or case is grounded to the dash by means of bolts, and thus the car frame acts as the common return lead.

This type of power supply operates as follows: The direct current from the car battery passes through the fuse, L_1 , SW_1 , and L_2 to the center tap of the primary of vibrator transformer T_1 . From this point, the path is alternately through the upper and lower halves of this winding, and through the contacts of vibrator V to ground. This current induces an emf in the secondary of T_1 , the voltages here being high because of the step-up

turns ratio of the transformer windings.

Then this high alternating voltage is applied to a rectifier tube, the d-c output of which is filtered by C_5 , R_1 , and C_6 . The B+ output terminal of the filter is applied to a voltage divider consisting of resistors R_2 , R_3 , R_4 , and R_5 . Various points on this divider supply the operating voltages for the plate and screen circuits of the r-f, converter, and i-f tubes, the plate circuit and cathode of the detector and 1st a-f tube, and the screen grid of the output tube. The plate of the output tube is supplied from point B++ at the filter input.

Connected in parallel, the tube heaters are supplied with d-c at 6 volts from the car battery. The complete heater circuit consists of the fuse, r-f choke L_1 , SW_1 , heater choke L_6 , and the parallel heaters. Also supplied with d-c is the speaker field coil, which is connected from the junction between L_2 and L_6 to ground.

Consisting of r-f energy generated by the ignition system of the automobile, interference is radiated from the wiring of the car electric system. As mentioned, the auto receiver is shielded from this interference by its metal case. To prevent the noise currents from entering the receiver through the hot battery lead, a filter network is employed at the

input to the power supply. In the circuit of Figure 7A, this filter consists of r-f chokes L_1 , L_2 , and L_6 , and capacitors C_1 , C_2 , C_3 , and C_4 .

Capacitors C_3 and C_4 have very low capacitance, and thus bypass r-f currents only. Therefore, noise energy of lower frequencies is filtered out by means of C_1 and C_2 . Although the latter units have low reactance for r-f currents, their connecting leads would serve as sources of r-f radiation inside the receiver case if these capacitors were depended upon for r-f filtering also. To prevent such radiation, C_3 and C_4 are of a special leadless type sometimes called "spark plates". A cross section of their construction is illustrated in Figure 7B.

As shown, the spark plate capacitor C_3 consists of a metal plate insulated from the chassis by a thin sheet of mica. The piece of metal is one plate of the capacitor, and the chassis is the other. With a hole in its center, the circular plate is mounted over a corresponding hole in the chassis, and the hot battery lead coming through the opening, is knotted to prevent strain on the joint where it is soldered to the insulated plate. Because of this special construction, usually these capacitors are indicated by the symbols shown in Figure 7A, and the lower or chassis plate of each

is at ground potential as indicated by the dash lines.

The continual making and breaking of the circuit at the vibrator contacts produces sparking which is a source of r-f interference in the receiver. This interference is known as "vibrator hash", and to prevent it from entering the signal circuits of the set, various hash filters are included in the circuit. In Figure 7A, resistor R_8 provides a low resistance path for current during the time the vibrator reed is traveling between contacts. This current reduces the intensity of the back-emf across the primary of T_1 , to decrease the amplitude of the contact spark and, therefore, the amount of hash produced.

Connected to the center tap of T_1 , chokes L_2 and L_6 and capacitor C_2 prevent hash from reaching the heater circuits and speaker field; while capacitors C_7 and C_8 absorb the high voltage surges across the secondary winding of T_1 . The back-emf produced in the secondary during rapid current changes is coupled back to the primary circuit of the transformer and also tends to produce sparking at the vibrator contacts. C_7 and C_8 are called "surge" or "buffer" capacitors. Usually, these are of the oil filled type, and have capacitance ranging from $.005 \mu\text{fd}$ to $.03 \mu\text{fd}$ with

a voltage rating of from 1,000 to 1,500 volts. In some cases, one capacitor is connected in place of C_7 and C_8 across the vibrator transformer secondary. This single unit must have a rating of twice the above value, or 2,000 to 3,000 volts.

As shown in Figure 7A, a rectifier of the heater-cathode type is required because, supplied by the auto battery, the heater, is at ground potential, while the cathode is at the high potential of the B supply output. In some automobile receivers, the power sup-

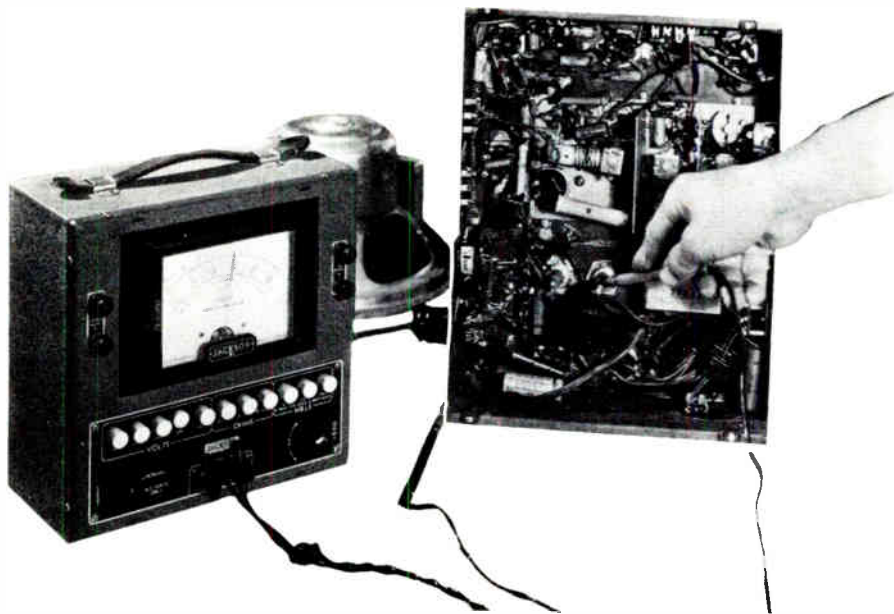

The multimeter indicates the voltage at the terminal of the filter capacitor to which the test prod is touched during the troubleshooting of a radio receiver.

Courtesy The Jackson Electrical Instrument Co.

As the inductance of the secondary winding of T_1 and the total capacitance of C_7 and C_8 form a resonant circuit, these capacitors form an important factor in the design of the power supply. Therefore, their values should not be changed when replacement is necessary in service work.

plies employ rectifiers of the cold-cathode type which do not contain heaters or filaments. These tubes contain a gas which ionizes when a high alternating voltage is applied, and thus permits the passage of electrons through the tube from cathode to plate. Cold-cathode rectifiers also produce r-f interference, and it is necessary

that circuits containing them include additional r-f filter elements to prevent this rectifier noise from affecting the receiver.

A-C/D-C Receivers

A relatively simple power supply circuit is shown in Figure 8. Employed in an a-c/d-c receiver, this supply requires an input of 117 volts, either a-c or d-c. It consists simply of a rectifier tube and a filter. Usually, the plate and screen current requirements are low in this type of receiver. Therefore, resistors R_2 and R_1 are used in place of inductive filter elements. The heaters are connected in series directly across the power line as shown. Since the a-c type receiver is distinguished by its power transformer, and the automobile receiver by its vibrator, the a-c/d-c set generally can be recognized by the absence of these units. Exceptions are certain voltage doubler type a-c receivers. Representative ratings of the B supply filter resistors and capacitors are indicated in Figure 8.

A-C/D-C Battery Portables

The power supply of a typical receiver designed to operate either from 117 volts a-c or d-c, or entirely from self-contained batteries, is shown in Figures 9 and 10A. Considerable difference in the circuit connections is brought about by the changing

of power selector switch S_1 - S_2 from a-c/d-c operation to battery operation. Therefore, Figure 9 shows the circuit connections when the switch is in one position, and Figure 10A shows the connections with the switch in another.

Figure 9 shows the circuit connections for battery operation, in which case section S_1 of the selector connects the plate and screen circuits to the positive terminal of the B battery. The negative terminal of this battery is connected to voltage divider R_1 - R_5 . The voltage drop caused by the B current in these resistors provides negative bias for the grids of the various tubes as indicated.

The filaments are connected in parallel and supplied through S_2 by the A battery. Tracing the individual filament circuits in the direction of electron flow, the paths are from the A battery negative to ground, and then: from ground through the 1S5 filament, to the right and through the right segment of S_2 to the A battery positive; from ground through the left segment of S_2 , to the left and through the 1R5 filament, over and through the right segment of S_2 to A+; from ground through S_2 as before, through the 1T4 filament, and through S_2 to A+; and from ground through S_2 , through the

two halves of the 3Q4 filament in parallel, by separate leads to S_2 , and then to $A+$. This completes the connections of the A, B, and C supply circuits as they exist when the receiver is battery operated.

When this receiver is operated on 117 volt a-c or d-c power, the selector switch is set so that the respective segments of S_1 and S_2 are rotated to the positions shown in Figure 10A. Now, the A and B batteries are disconnected from the receiver, while direct currents for both the A and B circuits are supplied by the rectified power line input. The selenium rectifier SR replaces tube V_1 of Figure 8. The pulsating d-c in this circuit is smoothed by the filter components R_1C_2 and R_2C_3 . The junction between R_2 and R_3 is connected through S_1 to C_3 , and thus C_3 constitutes the output filter capacitor so far as the B supply is concerned.

For the A supply there is a circuit from $B+$ (the junction between R_2 and R_3) through the voltage dropping resistor R_3 , and by means of S_2 through the tube filaments in series to ground. On tracing this circuit in detail, it is seen that resistor R_3 connects to the right segment of S_2 , from which point there is a path through the filaments of the 3Q4, 1T4, 1R5, and 1S5 tubes in series to ground. To complete the circuit, the lower wire (in the figure) of

the a-c power line is connected through the left segment of S_2 to ground.

With the positive lead opened by S_1 , there is no current in the B battery circuit, and therefore no voltage drop across R_4 and R_5 . Thus, connected to these resistors, the control grids of the various tubes are at d-c ground potential. The required grid bias voltages are obtained by virtue of the d-c voltage drops produced across the filaments by the filament current.

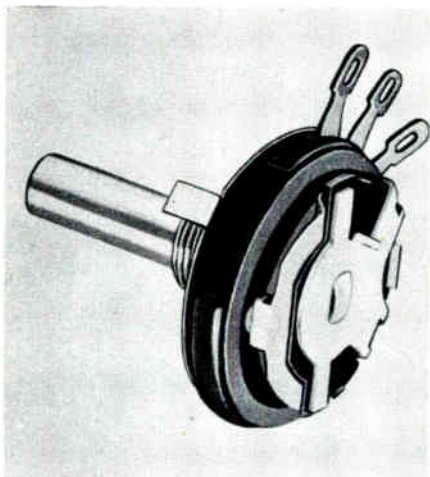

Shown here with the cover removed, a volume control can be the cause of intermittent operation due to the accumulation of dirt and corrosion between the sliding contact and the resistance element.

Courtesy The Allen-Bradley Company

Since the filaments are in series with the B circuits, the plate and screen currents also pass through the filament circuit. However, the

total B current does not pass through every filament, and unless properly compensated for, this condition would result in higher voltage drops across the filaments which carry the most B current. Therefore, to prevent an unequal voltage distribution, the resistances of some sections of the filament circuit are decreased by means of the shunt resistors R_6 and R_7 .

This arrangement is shown in Figure 10B. Here, resistor R_7 shunts all the filaments except that of the 3Q4, while R_6 is in parallel with the 1S5 filament. It may simplify matters somewhat to think of R_7 as providing a path for the 3Q4 B current, and R_6 as providing a path for the 1T4 and 1R5 B currents.

To maintain constant voltage drops across the respective sections of the filament circuit, the signal variations are absorbed by filter capacitors C_4 and C_5 , Figure 10A. When the switch S_1 - S_2 is set for battery operation, Figure 9, resistors R_6 and R_7 are merely connected in parallel across the A battery.

COMPONENT TROUBLES

Because of the many component parts contained in most electron devices, there are possibilities for an almost unlimited number of defects. However, on the basis of the types of components which

form the sources of trouble, almost all defects can be classified as being caused by:

1. Tubes
2. Capacitors
3. Resistors
4. Transformers and Chokes

Fortunately, most failures are caused by a single defect, but there are cases in which the original defect produces circuit conditions that cause a second and perhaps a third.

For example, in the power supply shown in Figure 3, an open in filter choke L_1 removes the load and allows the voltage across C_1 to rise. If the voltage rises sufficiently, the insulation of C_1 may break down and cause the capacitor to short. Therefore, the first defect could be the direct cause of the second.

Going further, the shorted capacitor might allow sufficient current to burn out the rectifier tube V_1 , or the high voltage secondary of T_1 . Thus, the second defect may be responsible for a third.

We mention this condition mainly because often it is puzzling to diagnose a case of trouble which has several defects, any one of which could prevent operation. However, the main job is to find and remedy the trouble no matter how many defects are present.

Tube Troubles

In general, tube troubles are low emission, interelectrode shorts, and microphonics. From earlier explanations, it is known that the action of an electron tube depends on the emission or stream of electrons thrown off by a heated filament or cathode. As the tube is used, the electron emitting properties of the filament or cathode decrease until there are not enough emitted electrons to permit proper operation. When this condition is reached, the tube must be replaced.

For proper functioning, very close spacing is required between the elements of the tube. Although usually they are well supported, mechanical vibration may cause one element to shift slightly and touch another to cause an internal short.

Microphonic tubes are those in which non rigid supports permit mechanical vibration of the elements which produces corresponding variations in the output. Some circuits are affected more easily by microphonic tubes than others. Therefore, often a satisfactory repair may be made by reversing the position of two tubes of the same type. When reversing the positions of several tubes of the same type does not remove the trouble, the microphonic tube must be replaced.

Capacitor Troubles

The main defects to be found in capacitors are opens and shorts. An open capacitor is one in which a lead wire has been pulled loose from one of the plates so that there is no contact. A leaky capacitor is one in which there is a comparatively high resistance conductive path between the two plates inside the capacitor. When the resistance of the conductive path is low or zero, the capacitor is said to be shorted.

A defect common to electrolytic capacitors is loss of capacitance. In an electrolytic capacitor, the action takes place between a metal plate and a conductive electrolyte, with a thin oxide film acting as the insulator or dielectric. For proper operation, the electrolyte must be moist, but as the capacitor ages, the electrolyte dries out, and the capacitance decreases.

Power Supply Filter: In the power supply circuit of Figure 3, capacitors C_1 and C_2 and choke L_1 form a filter for removing the a-c ripple from the $B+$ voltage. If either capacitor shorts, the output voltage is zero. In addition, damage to L_1 , V_1 , or T_1 could result. An open capacitor at C_1 results in lower $B+$ voltage and increased hum. An open at C_2 results in slightly lower $B+$ voltage, increased hum, and sometimes low frequency oscillation or motor-

boating because of insufficient filtering.

value of the grid resistor, usually the receiver output is lowered and distorted, or reduced to zero.

When a cathode bypass capacitor shorts, it removes the bias voltage from the tube, the plate current increases, and usually the output becomes distorted. On the other hand, an open capacitor leaves the cathode resistor unby-passed, and the resulting degeneration reduces the amplification, although the signal quality is unaffected.

When a screen bypass capacitor opens, the variations in screen grid current cause corresponding variations in screen grid voltage. A form of degeneration, this condition causes a decrease in output and, in some cases, oscillation or distortion.

A shorted screen bypass capacitor reduces the screen grid voltage to zero and generally cuts off the tube. Also, it connects the screen dropping resistor across the high voltage plate supply. The resulting excessive current overheats the resistor and, in most cases, causes it to become defective.

Often, plate bypass capacitors are connected between the plate and ground to bypass unwanted high frequency signals. If, in the a-f output stage, this capacitor shorts, the primary of the output transformer will be connected di-

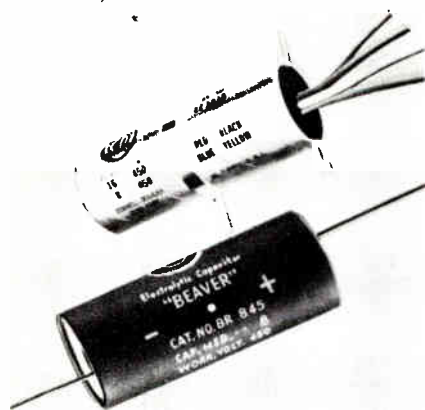

Two types of electrolytic copocitors used in power supply filters in radio receivers. The upper one is a dual unit with flexible leads. The metal brocket around the middle or those of the end may be employed for mounting. The lower unit is supported by meons of the stiff terminol wires projecting from the ends.

Courtesy Cornell-Dubilier Electric Corporation

When a coupling capacitor is open, very little or none of the signal reaches the grid of the next tube. As a result, the output of the receiver is very low or zero. If the coupling capacitor shorts, the high plate voltage will be applied to the grid, and generally the resulting heavy current in the grid circuit prevents the tube from operating. A leaky coupling capacitor and the grid resistor of the following tube form a voltage divider across the plate supply so that a positive voltage is applied to the grid. Depending upon the leakage resistance of the capacitor and the

rectly across the plate supply, from B+ to B-. Under these conditions, the plate voltage of the output tube is reduced to zero, and damage to the output transformer primary may result from the increased current.

In other output circuits, the plate bypass capacitor is connected between the plate and cathode. If the capacitor shorts, there is produced a conductive path from B- through the cathode resistor, the shorted capacitor, and the primary of the output transformer to B+. With this relatively low resistance path, the heavy current may damage the output transformer, cathode resistor, or both.

When a tuning capacitor shorts, it places a low resistance path between the coil terminals and the signal voltage cannot be developed across the circuit. When the tuning capacitor opens, it removes capacitance from the tuned circuit, and usually the resonant frequency changes sufficiently to make the circuit inoperative.

Resistor Troubles

Generally, defective resistors are found to be open, changed in resistance, or shorted. Resistors may open because of mechanical injury or electrical overload. Mechanical injury may break the resistance wire of wire wound resistors, crack the resistance ele-

ment of carbon resistors, or pull the pigtail leads loose from the resistance element of molded wire wound or carbon resistors. Electrical overload may cause the resistance wire of a wire wound resistor to burn out. Also, it may cause the resistance element of carbon or composition resistors to change in chemical composition, because of excess heat, and thus alter the resistance.

A resistor rarely shorts within itself. A short may occur between turns of some types of wire wound resistors and thereby reduce the resistance. Under some conditions, an electric overload on a molded insulated carbon or composition resistor may char the inside surface of the insulating covering so that the resistance is less than the original value.

A voltage divider consists of two or more resistors connected in series across a voltage source. The resistances are chosen so that the voltages at the junctions are some desired fraction of the total voltage available. If any of the resistors become defective, the voltages at the terminals change and may cause unsatisfactory operation of the circuits supplied from the divider.

If a plate load resistor becomes shorted, there is no resistance between the plate and B+, and the signal output is zero. An open resistor prevents plate current,

and again there is no output. Reduced output and distortion of the signal result from an increase or decrease in the plate load resistor.

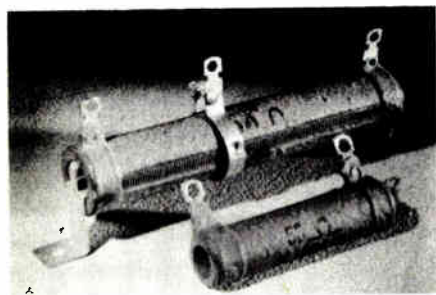

High wattage, wire wound resistors are employed as voltage dividers and bleeders. Opens are produced in these units when forced to carry excessive currents due to a short or other defective condition in the circuits of a receiver.

Courtesy Clarostat Mfg. Co., Inc.

Screen dropping resistors are connected in series in the electron tube screen circuits to provide the proper operating voltage for the screen grid. Here, an open resistor reduces the screen grid voltage to zero and cuts off the tube. If the resistance increases above its normal value, the screen voltage is lower than normal and the output decreases.

An open cathode resistor prevents plate current and thus makes the tube inoperative. An increase in the resistance produces a higher bias which may cause a reduction in the output and, in some cases, distortion. If

the resistor shorts, the bias is zero, and the output distorted.

When a grid resistor opens in the a-f circuits, the receiver may operate for a few moments after it has been turned on, and then stop. In other cases, the receiver will not operate at all. The reason for this action is that the signal causes the coupling capacitor to charge and, with the grid resistor open, there is no path by which the capacitor can discharge. The charged capacitor applies a negative bias to the grid and cuts the tube off. Turning the receiver off for a few minutes and then turning it on causes operation for a few moments before the tube is cut off again. On the other hand, a shorted grid resistor connects the grid to ground and thus prevents the signal from varying the grid voltage.

Transformer and Choke Troubles

All chokes and transformers are subject to the same faults. The windings may open, short, or ground. For example, an open in the primary of a coupling transformer prevents plate current in the tube to which it is connected, and no signal output is obtained. Likewise, signal current cannot be produced in the secondary if this winding is open, and the output is zero.

In the case of a power transformer, an open in the primary or any of the low voltage heater windings prevents operation of the electronic device in which the transformer is employed. If either half of the high voltage secondary is open, the B+ voltage is lower than normal and improper operation results.

A break in the winding of choke coil L_1 of Figure 3 opens the supply circuit so that no B+ voltage is available. Therefore the circuits connected to the supply remain inoperative.

Usually, a short is encountered in coils which have more than one layer of turns. It occurs when one or more turns of one layer short together, or to one or more turns of an adjoining layer, due to the breakdown of insulation. Depending on the number of turns shorted, this condition may either go unnoticed, cause improper operation, or cause operation to stop altogether.

For example, in the power transformer of Figure 3, a short between two layers of either the primary or high voltage secondary may allow sufficient current to overheat the transformer or blow a fuse in the power line. In

contrast, a short between two layers of an output transformer may not produce a noticeable change in the operation of the receiver. A partial short in an i-f transformer may be compensated by readjusting the trimmer capacitors.

A partial short of the winding of choke coil L_1 in Figure 3 reduces the filtering action so that the B+ voltage has a superimposed a-c ripple. When L_1 becomes completely shorted, almost all filtering action is removed, and the B+ voltage has a large a-c ripple component.

A complete short of any secondary of transformer T_1 in Figure 3 may allow sufficient current to overheat the transformer or blow a power line fuse. A completely shorted primary will cause the power line fuse to blow instantly. If any winding of an i-f or output transformer becomes completely shorted, no signal voltage can be developed, and the operation of the circuit is stopped.

Iron core transformer and choke coil windings may become grounded because of the breakdown of insulation between the windings and the core.



STUDENT NOTES

STUDENT NOTES

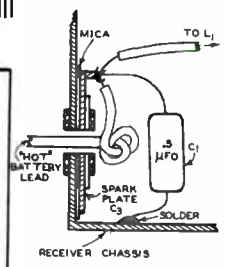
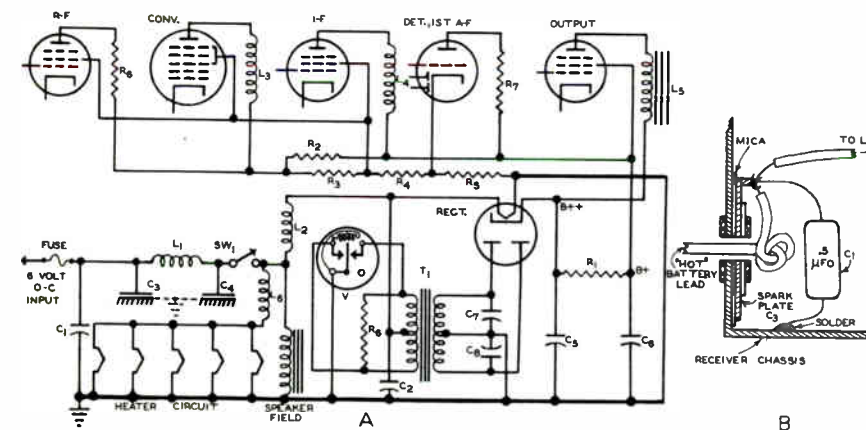
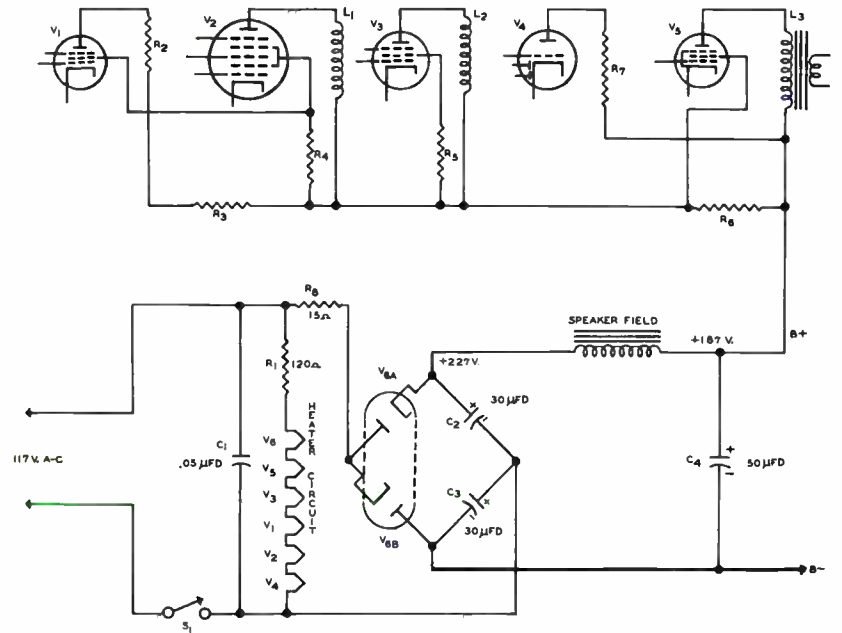
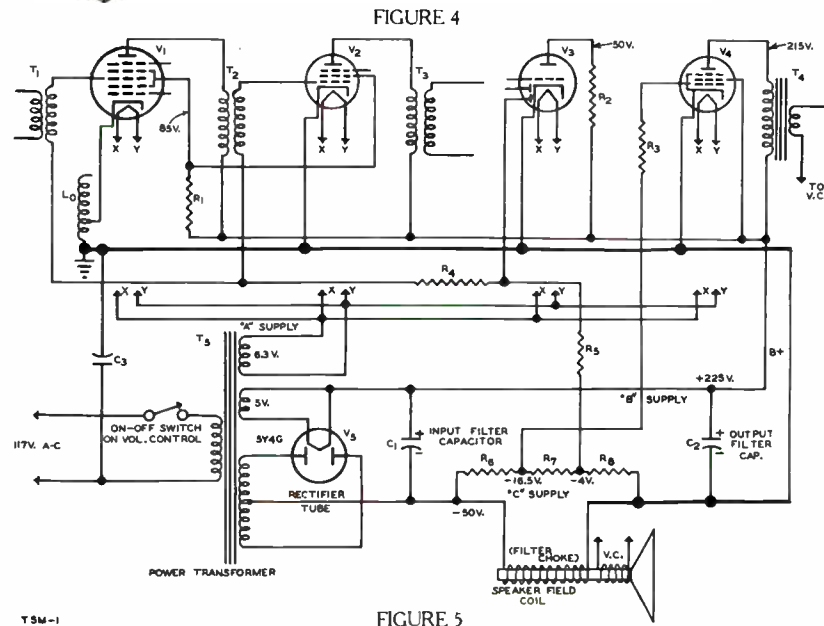
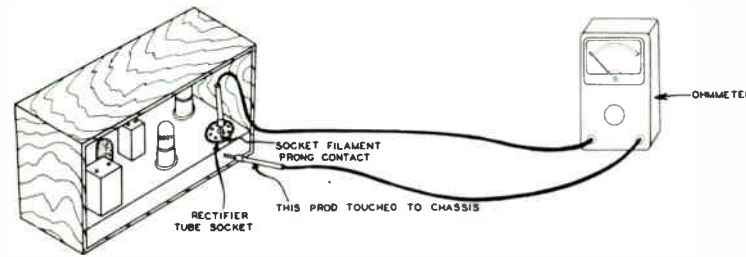
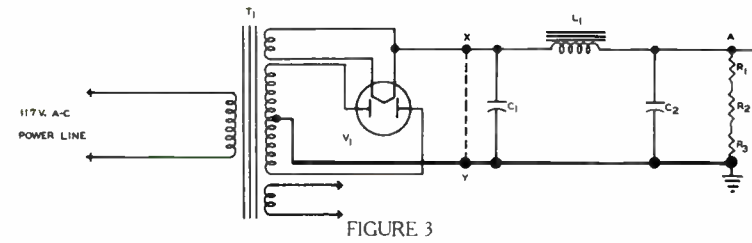
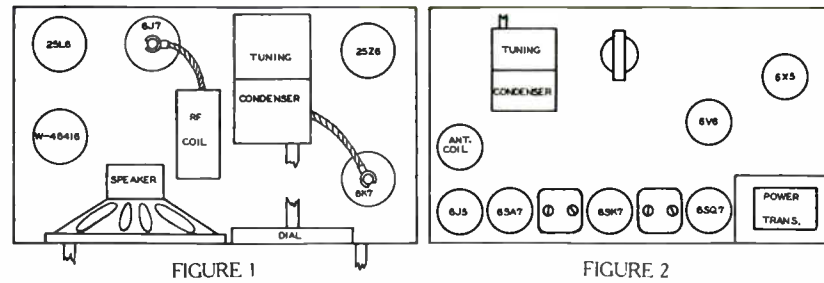

DeVRY Technical Institute

Formerly DeFOREST'S TRAINING, INC.

4141 WEST BELMONT AVENUE

CHICAGO 41, ILLINOIS

QUESTIONS

Radio Receiver Troubleshooting—Lesson TSM-1C

Page 35

1

How many advance Lessons have you now on hand?

Print or use Rubber Stamp.

Name Student No.

Street Zone Grade

City State Instructor

Write your answers on the "Ans." line below each question. If more space is needed use reverse side of this page.

1. List three types of d-c receivers.

Ans.

2. Besides visual inspection, what natural senses can be used to good advantage in the service procedure?

Ans.

3. Every test instrument requires what two things of the serviceman?

Ans.

4. When it is desired to isolate the trouble to a certain section of the receiver, what can be done to check the a-f section?

Ans.

5. What check can be made to isolate the trouble to either the r-f or i-f section of a receiver?

Ans.

6. Why is it a good policy to test the tubes as an early step in the trouble procedure?

Ans.

7. If the rectifier tube plates glow red soon after a receiver is turned on, what general type of defect in the voltage supply is indicated?

Ans.

8. What is a rough check that can be made for high frequency oscillator operation in a superheterodyne receiver?

Ans.

9. Assuming the receiver continues to operate, what may be the effect on the output when a cathode bypass capacitor becomes shorted?

Ans.

10. What defect in the power supply choke coil results in no B+ voltage available at the supply output?

Ans.

TSM-1C

FROM OUR *Director's* NOTEBOOK

BORN LUCKY?

An old saying puts it, "Some people are just born lucky. They always have money. They own better things; their friends are more influential. They get more because they have more."

Oh yeah?

Lucky means that a man got up earlier and plugged harder. Lucky means he made things happen by careful planning and had the gumption to push the plans through.

It means he lived on less than he made, that in life's daily struggle he was better informed, wiser, abler, and more persistent than his competitors.

Few people are born lucky. Good luck comes to those who know things and do things and never quit. Luck is the product of a persistent struggle toward the goal you have set.

Apply these principles when you establish your own business and maybe some day they'll say about you, "Oh, he was just born lucky."

Yours for success,

W. C. Healey

DIRECTOR

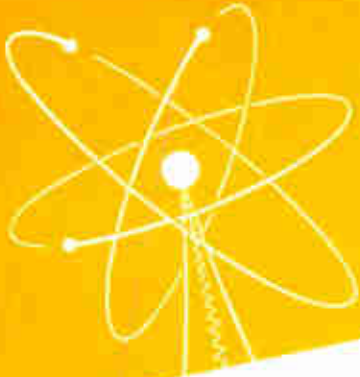

RADIO RECEIVER ALIGNMENT

Lesson TSM-2B

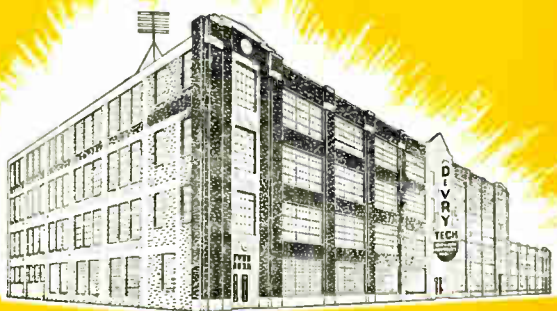

DeVRY Technical Institute
4141 W. Belmont Ave., Chicago 41, Illinois
Formerly DeFOREST'S TRAINING, INC.

RADIO RECEIVER ALIGNMENT

4141 Belmont Ave.

COPYRIGHT 1955

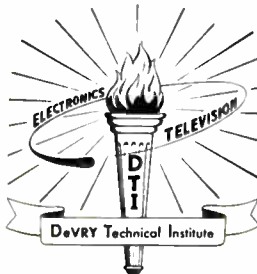

Chicago 41, Illinois

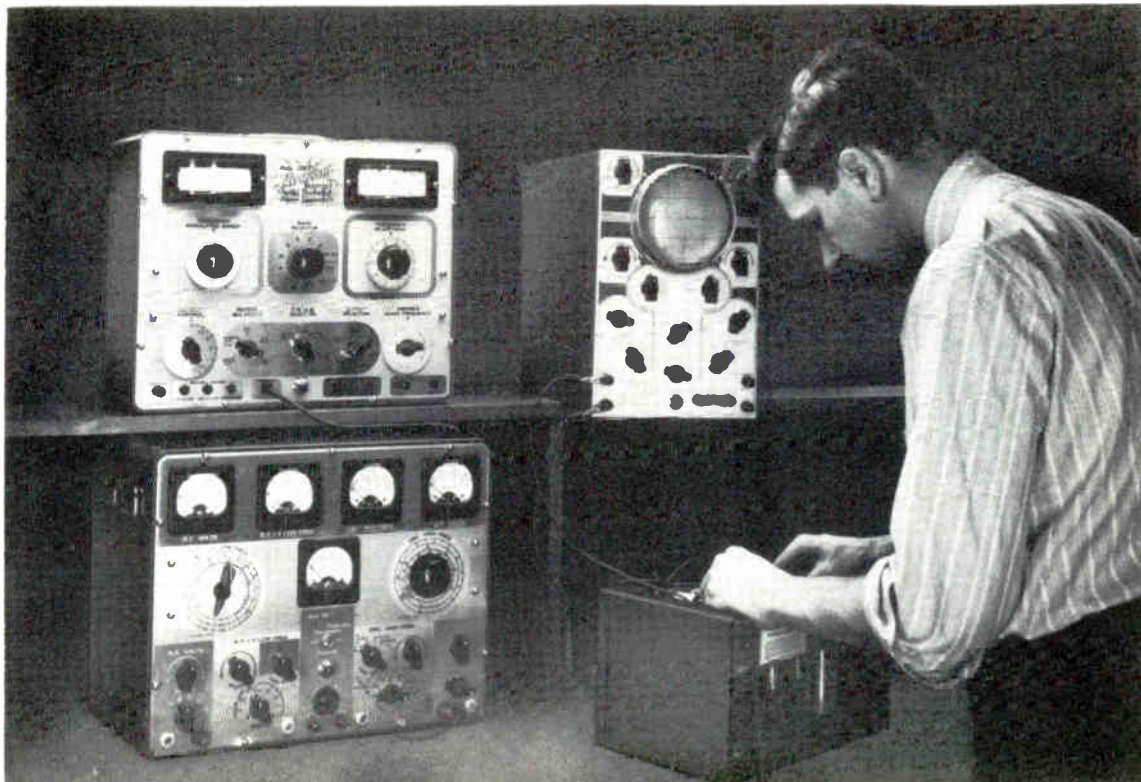

Using a sweep generator and an oscilloscope to align an FM receiver.

Courtesy Hickok Electrical Instrument Co.

Television Service Methods

RADIO RECEIVER ALIGNMENT

Contents

	PAGE
Receiver Repairs	4
Resistors	4
Capacitors	4
Transformers and Chokes	5
Wires	5
Alignment	7
Indications of Misalignment	9
Pre-alignment Checks	10
Provisions for Circuit Adjustments	10
Alignment of a TRF Receiver	10
Alignment of AM Superheterodyne Receiver	17
Alignment of FM Superheterodyne Receiver	23
AM Generator Alignment Procedure	23
Sweep Generator Alignment Procedure	27

A great deal of the joy of life consists in doing perfectly, or at least to the best of one's ability, everything which he attempts to do. There is a sense of satisfaction, a pride in surveying such a work—a work which is rounded, full, exact, complete in all its parts—which the superficial man, who leaves his work in a slovenly, slipshod, half-finished condition, can never know. It is this conscientious completeness which turns work into art. The smallest thing, well done, becomes artistic.

—William Mathews

RADIO RECEIVER ALIGNMENT

Insofar as electronic equipment is concerned, it is generally agreed that the important and difficult part of service work is in the location of the defect. However, after this has been done, the defective part must be repaired or replaced. While this part of the job is mechanical for the most part, electrical conditions must be preserved carefully to provide good operation.

RECEIVER REPAIRS

Whenever possible refer to circuit diagrams of the equipment being serviced. It saves time. Not only do manufacturers publish service data on their receivers, but several organizations publish service manuals which cover all popular brands of receivers. Most servicemen find that the time saved more than pays for the subscription cost for these manuals.

However, occasions do arise when the data is not available and there isn't sufficient time available to procure it. In these cases the serviceman must rely solely on the location and appearance of the various components to determine their purpose and values.

Resistors

For resistors, there are two important specifications, the re-

sistance and the wattage. Usually, resistors are color coded to show their ohmic value, but seldom are marked in respect to their wattage. However, with a little experience, an accurate estimate of the power dissipating ability of the common types of carbon resistors may be made by observing their size.

While the dimensions vary somewhat, the typical 1 watt resistor is from $\frac{1}{2}$ to $1\frac{1}{4}$ inches long, with a diameter of about $\frac{1}{4}$ inch, and the half watt size is from $\frac{3}{8}$ inch to $\frac{5}{8}$ inch in length, with a diameter from $\frac{1}{8}$ inch to $\frac{1}{4}$ inch. With dimensions proportionately smaller, $\frac{1}{2}$ watt and $\frac{1}{4}$ watt carbon resistors are used in some types of equipment. Although a few 2 watt carbon resistors are used, it is more common to employ wire wound types for higher wattage.

Capacitors

The two important capacitor specifications are the capacitance and the voltage. Most capacitors are marked with the capacitance either by color code or printed numbers. The paper and electrolytic types are marked with a test or peak as well as the working volts. For safety, the listed working volts should be about twice the normal circuit voltage.

For most bypass and filter circuits, both the capacitance and voltage rating of a replacement capacitor can be higher than the values of the original unit, but should not be lower. Exceptions are found in the signal circuits where an increase of capacitance can cause a change in frequency response. For example, a plate bypass capacitor has the same circuit location as a unit used for tone control, and an increase in its capacitance will cause a reduction of high frequency signals.

Transformers and Chokes

For iron core chokes, the specified inductance, current, and resistance are important, while for power transformers, the voltage across and the current to be carried by each winding should be known. Usually the turns ratio is of greatest importance in low frequency transformers, although the primary winding must provide sufficient impedance to load the plate circuit of the tube properly. For output transformers, the turns or impedance ratio and the power capacity in watts are the basic specifications. For high frequency transformers, the principal specification is the resonant frequency of the circuit.

Wires

All the circuit wires should be disconnected before dismantling a part mechanically. When this

is not done, the dismantled part hangs by the wires and its weight may break some of the connections.

To insure their rapid and correct replacement, all connecting wires should be identified before they are removed from a defective unit. Some men trust their memory because many of the wires have color coded insulations or the circuit arrangement may be quite obvious. However, should the work be interrupted, it may be difficult to remember all the details when the job is resumed.

A better plan is to tag each wire as it is removed, using the colors or positions as a method of identification. Generally, time is saved by checking the circuit first and making a pencil sketch of the parts when there are more than three connecting wires. Then, regardless of interruptions, the work can be picked up at any time with little chance of error.

Even when it is felt that a sketch is not necessary, it is well to identify the defective part electrically. Think of it as, "The plate resistor of the 1st a-f", "The screen bypass of the second i-f", "The cathode resistor of the output" or in similar terms which make its electrical location definite. This is a much easier and better method than one which depends entirely on mechanical

location, such as, "The third resistor to the left of the second socket from the right when the chassis is upside down and the power transformer is at the lower left as I face the bench".

When installing replacement parts, always complete the mechanical mounting first to provide a solid and permanent support for the electric connections. Of course, there are a few exceptions. The arrangement may not leave space to make these connections after the part has been mounted mechanically. In the case of parts like resistors and capacitors, the leads provide both the electric connections and the mechanical support. For these units, all joints should be secure mechanically before solder is applied.

When the replacement part is not an exact duplicate of the original, other problems may arise. For example, the windings of the original power transformer may be brought out to terminal lugs which support the circuit wires. The replacement unit may have flexible wire leads instead of lugs, thus eliminating the mechanical supports for the connections between the transformer windings and the circuits.

It is poor practice to splice the wires and allow the joints to hang loosely. It is better to install terminal strips along each

side of the replacement transformer. Then the original circuit wires are attached to the lugs of the strip, together with the proper lead wires from the transformer. To simplify future service work, always make replacements so as to retain the original circuit arrangement as closely as possible.

After a replacement is mounted, the wires are reconnected, one by one, in the reverse order to which they were removed, and only after each is checked against a diagram or some other means of identification. As the wires are connected, a continuity test of each should be made to make certain it has not been broken.

Precautions of this nature may seem to cause a needless delay in the work, but there is nothing more irritating than to find a completed job which will not work because one of the connecting wires has broken. Often this broken wire is difficult to replace and may make it necessary to remove other wires also.

To make sure of the replacement part, as well as the connections, the continuity tests should include more than one part of the circuit. For example, when a new output transformer is installed, include all of the plate supply circuit between the output of the power supply filter and the plate of the output tube in the test.

Electricians tape does not work well for insulating wire splices in electronic equipment. Not only is it bulky, but the increased temperature of operation causes it to dry out rapidly. When a joint requires insulation, slip a short length of insulated tubing or spaghetti over one of the wire ends, and then after the work is done, slide the tubing back over the joint.

Locating and replacing a defective part doesn't always complete a repair. When a fuse "blows" in a home lighting circuit, it may indicate trouble which a new fuse won't cure and a larger fuse may make worse. The proper procedure is to locate the trouble, then replace the fuse. The same general idea holds for electronic service. The defective unit, located by tests, may compare to the fuse of the home lighting circuit. Therefore, always analyze the conditions before proceeding with the repair. Try to determine the cause of the failure.

For example: "Did the defective resistor simply break down from age or was it subject to overload due to some other defect?", "Did the shorted bypass capacitor absorb enough moisture to weaken the dielectric or was it operating at an excessive voltage?", "Did the resistance strip of the gain control just wear out or

did some other defect cause it to carry excessive current?".

Knowing the nature and location of a defect, a rapid analysis of the circuit indicates which other components could have caused the trouble if they were defective. A careful test of these components is good insurance against "come back" repairs, for the replacement capacitor, resistor, or other part will break down quickly unless the cause is located and corrected.



R-f signal generator of the type employed for aligning tuned circuits in radios and other electron equipment.

Courtesy Superior Instruments Co.

ALIGNMENT

Tuned circuits are used in radio and television receivers to accept or reject energy at one band of frequencies. In every such circuit, there is a certain amount of response to signals

above and below the resonant frequency. The response falls off as the signal frequency increases or decreases from resonance. In practice, a tuned circuit is said to have a "response band" which includes all the frequencies at which the circuit response is equal to or greater than some given percentage of maximum. The circuit has a **CENTER FREQUENCY** which is that frequency midway between the upper and lower limits of the response band. When the circuit has symmetrical response (equal rate of fall above and below resonance), then the resonant frequency and center frequency are the same.

In cases where the response band limits have a frequency separation greater than 5 percent of the center frequency, the circuit is called a **BROADLY TUNED** or **WIDE BAND** circuit. A **NARROW BAND** or **SHARPLY TUNED** circuit is one in which the band limits have small separation relative to 5 percent of the center frequency.

In the event either the capacitance or inductance changes in a tuned circuit, the resonant frequency is altered accordingly. The circuit no longer has maximum response at the desired frequency, nor does it respond properly to all of the original frequency band. Also, with the response band thus shifted in the frequency spectrum, the circuit has in-

creased response to frequencies normally outside of its band.

When the L and C components in a tuned circuit are such that the circuit is resonant at the desired frequency, it is said to be **ALIGNED**, or in **ALIGNMENT**. Then, its response band covers the desired portion of the frequency spectrum. When the circuit is resonant to some frequency other than the proper frequency, it is **OUT OF ALIGNMENT**, or **MIS-ALIGNED**, and it is necessary to make the adjustments necessary to bring the circuits back into alignment. The term **ALIGNMENT** is employed also to designate the process of adjusting tuned circuits. It is this important process that the remainder of this lesson describes.

In this and other lessons on electron circuit testing, the general procedures and test instruments employed apply to most of the equipment used in the many branches of the electronic industry. However, in this lesson only radio receiver circuits are used for the various illustrative examples.

There are differences in the details of the procedures for aligning various makes and models of any given type of receiver. Most manufacturers supply the necessary data for the alignment of each particular model, and this data should be used whenever a

given unit is adjusted. Such alignment data may be obtained from the manufacturer or from a service manual such as those published to aid the servicing of radio and television receivers.

The basic arrangement employed for alignment is illustrated in block form in Figure 1. A signal generator supplies a test signal of the desired amplitude, wave-form, frequency, and modulation characteristics. For various purposes, the test signal may be either amplitude, frequency, or pulse modulated; or it may be unmodulated. The test signal is applied to some appropriate point such as the input terminals in the unit to be aligned, and adjustments made in the tuned circuits to produce resonance at the frequency of the test signal.

In some cases, the point of adjustment at which resonance is obtained can be determined by the nature of the output or the operation of the unit. However, usually some type of resonance indicator must be employed as shown in Figure 1.

For radio receivers, the signal generator consists of an r-f generator with controls which permit a choice of test signal frequencies, amplitudes, modulation, etc. The generator has a dial calibrated in output frequency, and usually an output attenuator which provides either continuous

or step control of output amplitude. Other controls permit variation of the percent of amplitude modulation, or the frequency deviation when an FM signal is used.

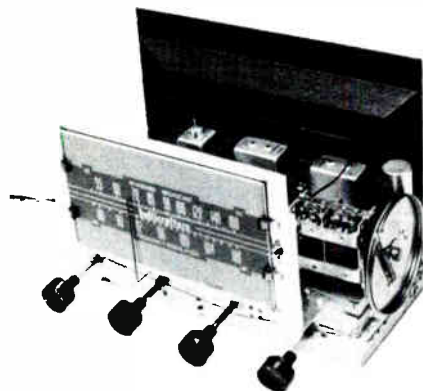

View of an AM/FM radio receiver shows the i-f transformers and tuning capacitor trimmers which are adjusted when the tuned circuits are aligned.

Courtesy The Hallicrafters Co.

The resonance indicator may be an ordinary service type a-c voltmeter, a vtvm, a cathode ray oscilloscope, or a tuning-eye tube may be used as an indicator in units which employ such tubes.

Indications of Misalignment

Although it is possible for one or more of the tuned circuits to become so far out of alignment that the unit will not function at all, such a condition is rare. Usually, the tuned circuits become only slightly misaligned so that the performance of the equipment falls below its original level.

Due to misalignment, a radio receiver loses sensitivity or produces a distorted output, or a television receiver may have a weak or smeared quality picture, distorted sound, or both.

Pre-alignment Checks

However, these symptoms sometimes are caused by circuit defects other than misalignment. In some instances, some other defect may exist along with misalignment, while in other cases the entire trouble may be due to another type of fault and alignment is not needed. Hence, in every case the tubes should be checked and all other types of repairs or adjustments made first. Then, if the symptoms persist, alignment is needed.

Regardless of the type of electronic equipment or the method of alignment to be employed, the unit and all test equipment to be used should be turned on and permitted to warm up for 15 minutes before beginning the alignment procedure. This makes it possible to align the receiver under normal operating conditions.

Provisions for Circuit Adjustments

Most radio receivers include variable capacitance or inductance components which form part of the frequency determining elements in the tuned circuits. Small

capacitors called trimmers are connected in parallel with the main tuning capacitors and designed so they may be adjusted with some type of alignment tool.

Usually having considerably more capacitance than trimmers, similar variable capacitors, called padders, are connected in series with the main tuning capacitor in the tuned circuit. Some h-f transformers have movable powdered-iron cores, or slugs, the relative position of which affects the permeability of the flux path, and the permeability determines the inductance of the coil. Tuning by means of such adjustable cores is known as PERMEABILITY TUNING.

ALIGNMENT OF A TRF RECEIVER

As a typical example of the alignment procedures, Figure 2 shows the schematic diagram of a tuned-radio-frequency radio receiver of the type employed for reception in the standard broadcast band. In this circuit, transformer T_1 couples the received signal from the antenna to first r-f amplifier V_1 , transformer T_2 couples the signal from V_1 to second r-f amplifier V_2 , and T_3 forms the coupling unit between V_2 and detector tube V_3 . From the plate circuit of the V_3 stage, the audio is coupled through C_{12} to the grid of output tube V_4 . Finally by means of output transformer T_5

the signal reaches the voice coil of the speaker.

Tube V_5 is the power supply rectifier, and dial lamp D functions as an on-off indicator. Located in the negative leg of the power supply, resistor R_5 produces a voltage drop to supply the negative bias needed for the grid of tube V_3 .

In the r-f coupling circuits, a three-section tuning capacitor is connected so that sections C_1 , C_2 , and C_3 resonate the secondary coils of T_1 , T_2 , and T_3 to the carrier frequency of the desired station. To permit alignment adjustments, trimmer capacitors C_4 , C_5 , and C_6 are connected across these tuned circuits. In the V_3 grid circuit, capacitor C_7 prevents shorting the negative grid-bias voltage to ground, but due to its large capacitance it offers very little reactance to signal frequency currents.

To align the receiver of Figure 2, the antenna is disconnected and the signal generator output leads connected to the receiver antenna terminals such that the "hot" lead connects to point A and the ground lead to point G. However, to simulate conditions of normal operation with an antenna, the manufacturer may designate that a system of components known as a DUMMY ANTENNA be inserted in series with the hot lead of the signal generator.

The components of the dummy antenna vary in number and in values as specified by the manufacturers of different receivers, and in some cases consist of but a single capacitor. Where a dummy antenna is specified but the circuit and values are not given, the standard RTMA arrangement of Figure 3 may be used. Here, coil L is 20 microhenries, mica capacitor C_1 is .0002 microfarads and C_2 is .0004 microfarads, and the composition type resistor R is 400 ohms.

When an a-c voltmeter is employed as the resonance indicator, it is referred to generally as an OUTPUT METER. Alternative connections for the output meter are shown in Figure 4. The method of Figure 4A is probably the most convenient so far as making connections are concerned, and when this system is used, the a-c voltmeter should be set on a low range because the voltage is low across the voice coil of the speaker. When the output meter is connected from the output tube plate to ground as shown in Figure 4B, the blocking capacitor C, equal to about .1 μ fd, 600 wv, is required to protect the meter from the B voltage in this circuit, and to insure meter readings which are directly proportional to the signal voltages. In many commercial multimeters, a blocking capacitor is inserted in the internal meter

circuit when the selector switch is placed in the "output" position.

Compared to the secondary voltage, the voltage across the primary winding of the output transformer is quite high, and an output meter must be set to a higher scale when connected as in Figure 4B. In general, the meter range used should read as high as about 50% of the d-c operating voltage on the plate of the receiver output tube. A third way in which the output meter may be connected is in series with a blocking capacitor from the plate of one to the plate of the other of the two tubes of a push-pull output stage. In this case the meter range used should read about as high as 100% of the d-c operating voltage on one tube.

With any of the above arrangements, the meter range used should be high enough so the pointer does not deflect off scale, but otherwise should be as low as possible so that changes in readings can be observed easily. That is, a change of 5 or 10 volts causes very little movement of the meter pointer on the 500 volt range, but results in a considerable change in pointer position when the 50 volt range is employed. Hence, when used on a lower range, the meter provides a more accurate indication of resonance.

With the output meter connected in the audio circuits of a radio

receiver, it provides a reading proportional to the demodulated output of the detector, since with a given percentage of modulation, the amplitude of the detector output is proportional to the strength of the r-f test signal at its input. With a given amplitude modulated r-f test voltage applied to the receiver antenna terminals, the intensity of the test signal reaching the detector input depends upon the alignment of the various tuned circuits. Therefore, the meter indicates to what degree the circuits are in proper alignment.

That is, when all circuits are aligned, maximum signal passes from point A to the grid of V_3 , Figure 2, and the resulting large audio signal in the a-f amplifier circuits causes maximum deflection of the pointer of the output meter. Since each r-f and a-f amplifier stage amplifies the signal, the test voltage applied to the receiver input must be very much smaller than the value indicated on the output meter. However, only the adjustments which produce the peak indication are of concern here, the actual voltages being unimportant so long as the input signal is maintained below the amplitude at which the amplifiers overload.

With the signal generator and output meter connected as explained, the receiver is turned on

and volume control P advanced to its maximum clockwise position. The tuning capacitor is set at or near the high-frequency end of the band, that is, with the plates completely out of mesh. A precise dial setting is not important, but should be one at which no station can be heard.

The signal generator is set to provide an amplitude modulated r-f signal in the broadcast range, and its frequency dial adjusted to the same frequency as that indicated on the receiver dial. Often, the percentage of modulation is fixed at some value such as 30%. If variable, the modulation intensity should be adjusted to give the clearest tone in the receiver speaker. The generator output should be adjusted to give a meter reading high on the scale used, without causing distortion of the tone in the speaker.

To make the alignment adjustments, the various trimmer capacitors, C_4 , C_5 , and C_6 are adjusted for maximum reading on the output meter. As the receiver is brought into alignment, the sound output from the loudspeaker increases also. However, these changes in sound volume provide only a rough indication, because the ear is relatively insensitive to the small changes in volume which occur near the exact resonance setting of each tuned circuit. Thus, the output meter

should be employed in every case because of the greater alignment accuracy which can be obtained.



Typical multimeter of the type employed as an output meter for aligning AM receivers.

Courtesy Precision Apparatus Co., Inc.

A typical ganged tuning capacitor is illustrated in Figure 5. Here, the three main tuning capacitor sections consist of sets of semi-circular rotor plates and rectangular stator plates, and the sections are separated from each other by large partitions. The rotor plates are all mounted on the same shaft through which they make electric contact to the frame of the unit and thus to the chassis of the receiver in which the unit is mounted. The stator plates are

insulated from the frame of the unit so that each set can be connected individually to the grid of the proper tube as shown in the diagram of Figure 2.

In the unit of Figure 5, the three trimmers are mounted above the stator plates of each tuning capacitor section, and as indicated, adjustment screws are provided to change the capacitance of the trimmers by varying the spacing between their respective grounded and ungrounded plates. The trimmers are electrically in parallel with the main tuning capacitor sections as shown in Figure 2. Therefore, when an adjustment screw is turned in, it moves the trimmer plates closer together. The trimmer capacitance increases to provide an increased capacitance across the coil of the corresponding tuned circuit. This increase in capacitance results in a lower resonant frequency. In like manner, the tuned circuit resonant frequency is raised due to the decrease in total capacitance when the adjustment screw is rotated to move the trimmer plates further apart.

The insulated aligning tools should be employed for any type of alignment work to minimize the added capacitance effect due to the proximity of the tool. For the same reason, after each adjustment, the aligning tool and hands should be removed from

the chassis before the output meter is read.

The trimmers are adjusted in turn, beginning with the one electrically nearest the detector, and working toward the front end of the receiver circuit. That is, in the receiver of Figure 2, trimmer C_6 is adjusted first, C_5 next, and C_4 last. As each circuit is aligned, the deflection of the output meter pointer increases, and it may be necessary to decrease the test signal amplitude to prevent the pointer from swinging off scale. The strength of the test signal should be reduced by decreasing the output from the signal generator. Only when a point is reached where further reduction in generator output causes distortion of the tone in the speaker, should the receiver volume control setting be reduced. Then the generator output is increased to give a suitable deflection on the output meter scale.

When the trimmers are adjusted or peaked properly, the output meter reading decreases when the adjustment screw is rotated in either direction from the correct setting. As a general rule, the trimmers should be adjusted for the lowest possible capacitance which provides the desired peak condition. If a particular tuned circuit is considerably out of alignment originally, a commonly used method consists of turning

the adjusting screw all the way in and then backing it off one full turn before starting the more exact or fine adjustments.

The final position of the adjusting screws should never be very tight, because in this position the full capacitance of the trimmer is added to the tuned circuit and may prevent the receiver from receiving signals in the high-frequency end of the band. After all trimmers have been peaked properly, final touch-up adjustments of each should be made, beginning with C_6 , as before, to make certain the exact correct settings have been obtained.

When the tuning capacitor has slotted end plates, after all trimmer adjustments are completed the signal generator is set at about 1000 kc and the receiver is tuned to this frequency as indicated by maximum sound output from the speaker. With this setting, the rotor is approximately in the position shown in Figure 5, with each end plate having a segment which is only partly in mesh with the stator plates. Adjustments are made by bending these segments toward or away from the stator plates to obtain maximum reading on the output meter. Each end plate segment is adjusted in turn, beginning with the detector section of the tuning capacitor and working toward the front end of the receiver.

Remove the hands from the plates each time a meter reading is taken. First, the meter reading is noted, and then the segment bent slightly either way. A second reading is made, and if higher than the first, the segment is bent further in the same direction, etc. If the second meter reading is lower than the first, then the plate should be bent in the opposite direction.

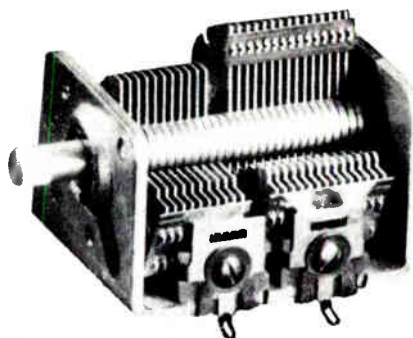

Two-section tuning capacitor used in superheterodyne receivers. Each section is equipped with a screw driver-adjusted mica trimmer for alignment.

Courtesy General Instruments Corporation

After the first set of segments have been adjusted for each section of the tuning capacitor, the signal generator is set at about 800 kc and again the receiver tuned for maximum sound volume. This adjustment brings the next segment of each end plate partly in mesh with the stator plates, and as before, each of these segments are bent in or out as required to produce a maximum reading on the output meter.

Finally, the signal generator is set to about 600 kc, and the receiver tuned to this frequency to bring the last set of segments into position. Again the segments are bent to give a maximum reading on the meter as explained above.

The above paragraphs have included all of the alignment adjustments which can be made on the simple trf receiver. However, usually the end plate adjustments are not necessary except where it is found that extreme misalignment exists due to some reason such as a segment having become bent accidentally to the wrong position. The necessary end plate adjustments usually are made during the original alignment or phasing at the factory. Ordinarily trf receiver alignment consists of adjusting the trimmer only.

When a receiver contains an avc circuit, this circuit functions to counteract changes in audio volume due to variations in carrier strength at the detector input. Thus, with an r-f test signal of sufficient strength to cause operation of the avc circuit, and the output meter connected in the receiver audio output stage as explained above, the trimmer adjustments are unable to produce sufficient variation in r-f input to the detector to provide enough change in the audio output volt-

age so that the meter can definitely indicate the resonance point.

Therefore, to align a receiver containing avc, it is necessary to modify either the connections or the procedure given above for the simple receiver of Figure 2. One method consists of connecting the signal generator and output meter the same as explained, but the generator output is kept below the value required to produce avc action. The percentage of modulation is increased until a suitable reading is obtained on the output meter, and trimmer adjustments are made as explained for Figure 2.

Another method consists of disconnecting the receiver avc lead from the output point of the avc circuit, and inserting a suitable fixed bias source, such as a small battery, between the avc line and ground. Then an r-f test signal of any satisfactory value may be used and the alignment performed the same as for a receiver without avc.

For a third method, a high-resistance voltmeter is connected across the output of the avc circuit, and the avc voltage is used to indicate resonance. Again, the input signal need not be maintained at a low level, and adjustments are made in the usual way.

Often the receiver dial is found to be out of CALIBRATION. When

the variation is small, it is customary to turn the dial until it reads the frequency of the signal generator and then adjust the trimmers for maximum output. When the variation is great, usually it is more practical to first tune the receiver to the test signal frequency as indicated by maximum sound output, and then, without changing the position of the tuning capacitor, mechanically loosen and rotate the receiver dial until its reading is correct.

ALIGNMENT OF AM SUPERHETERODYNE RECEIVER

The majority of modern receivers used in communications, broadcast, telemetering, and remote control purposes are of the superheterodyne type, and so for a further example of the alignment procedure, the method of aligning an AM superheterodyne radio receiver is given in the following paragraphs. The method consists of tuning all i-f tuned circuits to the receiver intermediate frequency, and then tuning the r-f stages so that the h-f oscillator TRACKS with the mixer and r-f amplifier. That is, the oscillator produces the i-f frequency by beating with the incoming signals at each position on the dial.

Most radio receiver i-f interstage coupling circuits are arranged on the plan illustrated in

Figure 6. That is, both primary and secondary coils of the i-f transformers are tuned by means of shunt capacitors, and to provide for alignment adjustments, either the capacitors are variable as shown in Figure 6A, or permeability tuning is used as in Figure 6B.

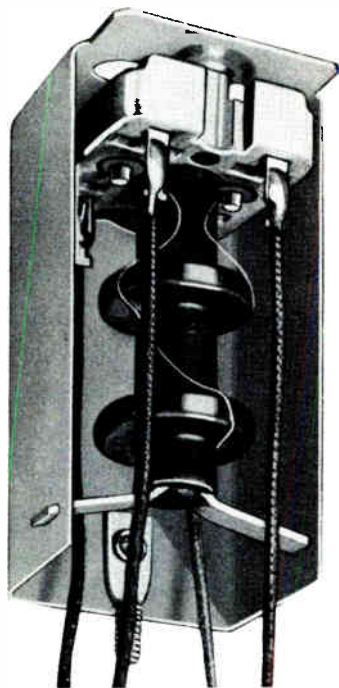

Cut-away view of a 455kc i-f transformer suitable for general replacement purposes in AM radio receivers.

Courtesy Stanwyck Winding Company

The cut-away view of Figure 7A shows the location of the trimmer capacitor adjustment screws just under the top of the

shield can of a typical i-f transformer. In the top of the can, two small holes permit insertion of the alignment tool. In various transformer designs, the adjustment screw has either a slotted or hexagon head, and thus requires either a screw driver or a socket wrench for making adjustments.

To conserve space, other transformer designs have the slotted screw for one trimmer placed inside a hollow, hexagon-headed screw for adjusting the other trimmer. This arrangement is quite common, and it is mentioned because at first glance it appears to be a single adjustment consisting of a slotted screw with a lock nut.

Some i-f transformers have only one adjustment screw which serves to adjust a single trimmer across either the primary or the secondary winding of the unit. Still other designs have one adjustment screw on top and the other below the transformer, and then the alignment tool must be inserted from below the receiver chassis to adjust the lower screw.

An example of a permeability tuned transformer is pictured in the cut-away view of Figure 7B. In the unit shown, a single slotted screw permits moving the transformer core in or out of the windings, and this screw is reached by inserting the align-

ment screwdriver through the hole in the top of the shield can. In general, the mechanical adjustments are performed in the same way, regardless of whether trimmer capacitors or permeability tuning is employed.

The receiver tuning capacitors vary the tuning of the r-f and oscillator stages, and are constructed with all rotors mounted on a single shaft like the unit of Figure 5. Trimmer capacitors are included for r-f alignment and for h-f oscillator tracking adjustments.

In some receivers, the oscillator circuit contains a padder capacitor to provide the required difference between the oscillator frequency and the resonant frequency of the r-f amplifier and mixer circuits. Connected in series with the oscillator tuning capacitor, the padder reduces the total tank circuit capacitance to provide the required oscillator frequency at any given tuning, and is variable to permit TRACKING adjustments.

In other models, a padder is not used, and the reduced oscillator tank circuit capacitance is obtained by employing a main tuning capacitor in which the oscillator section is smaller than the r-f sections.

The various r-f and i-f tuned circuits of an AM superheterodyne receiver are shown in the

partial diagram of Figure 8. Here, the secondary winding of T_1 and tuning capacitor C_1 form the tuned grid circuit of r-f amplifier V_1 ; the secondary of T_2 and capacitor C_2 are the tuned LC circuit in the number 3 grid circuit of converter tube V_2 ; and the oscillator tank circuit consists of T_3 and C_3 . As shown, the three tuned circuits are shunted by trimmers C_4 , C_5 , and C_6 . Permeability tuning is employed in the three i-f transformers, T_4 , T_5 , and T_6 , which couple the converter, i-f amplifiers V_3 and V_4 , and diode detector V_5 .

Before starting the alignment, the receiver tuning capacitor should be fully meshed and the position of the dial pointer observed. If the pointer is not at the proper reference mark as specified in the service manual for the particular receiver model, the necessary mechanical adjustment should be made to bring it to this mark. Usually, the instruction manual tells how this adjustment is made, such as by releasing the pointer clip on the dial or loosening the screws in the pointer drive pulley, setting the pointer to the mark, and re-tightening the clip or screws.

The i-f stages are aligned first, and to prevent unwanted beat notes due to interference from the receiver h-f oscillator, this oscillator should be disabled temporarily. A simple method con-

sists of connecting a $.01 \mu\text{fd}$ capacitor from the stator plates of the oscillator tuning capacitor to ground, across C_3 in Figure 8, to "short" the oscillator tank circuit.

The connection can be made readily if an alligator clip is fastened to each lead of the shorting capacitor. Then one lead can be clipped to a stator plate of the tuning capacitor and the other lead to a rotor plate or to the receiver chassis. If the receiver employs a separate oscillator tube, this tube may be removed, thus making the shorting capacitor unnecessary.

An output meter is connected across the speaker voice coil and set to a low range as explained above. Using the specified blocking capacitor (usually $.01$ to $.1 \mu\text{fd}$), a signal generator is connected to the proper input point as given in the alignment instructions in the service manual. Referring to Figure 8, various points at which the i-f test signal may be applied are the antenna terminals A and G, the control grid of V_1 and chassis, or grid No. 3 of V_2 and chassis.

The stator of the associated tuning capacitor, C_1 or C_2 , forms a convenient point on which to clip the hot test lead. The generator ground lead should be connected through a $.1 \mu\text{fd}$ capacitor to the chassis when the receiver is of the a-c/d-c type.

The receiver volume control is set to maximum, and with amplitude modulated output, the signal generator is set to the intermediate-frequency employed in the receiver, such as 455 kc. To prevent avc action, the generator output should be kept low enough so that the output meter never reads higher than about 0.4 volts.



Wave trap resonant to 455 kc prevents radiated i-f signals from passing through the input circuits of a radio receiver.

Courtesy Stanwyck Winding Co.

Beginning with the last i-f transformer, T_6 in Figure 8, the trimmer or core is adjusted to produce maximum indication on the meter. The peak indication points are not difficult to locate, since turning the adjustment screw in one direction causes the meter reading to increase until the peak point is reached, after which the reading decreases. Then the screw is rotated in the other direction until the peak reading again is obtained.

After T_6 is peaked, adjustments of the iron cores of T_5 and then T_4 are made in the same manner, reducing the signal generator output whenever necessary to main-

tain the output meter reading below the maximum mentioned. After the i-f transformers have been aligned individually, all adjusting screws should be given a final touch up check to make certain the exact peak conditions are obtained.

In a few cases, the i-f stages are so badly out of alignment that deflection cannot be obtained on the output meter even with maximum settings of all signal generator and receiver output controls. In this event, the test signal may be applied to the input of each individual i-f stage, beginning with the last and working toward the front end of the receiver.

That is, to align transformer T_6 , Figure 8, the signal generator "hot" lead is connected to the control grid of tube V_4 . If the meter reading is still zero, even with maximum output from the generator, the generator frequency should be adjusted slowly above and below the i-f value until a frequency is reached which results in a reading on the meter. Then, the generator should be adjusted a few kilocycles at a time, to the correct i-f, and each time the test frequency is changed, the i-f transformer is adjusted for maximum output. In this way, the transformer primary and secondary circuits finally are resonated at the desired intermediate frequency.

With T_6 aligned, the signal generator lead is removed from the V_4 grid and connected to the grid of V_3 to permit adjustments of T_5 . Finally, the test signal is applied to grid No. 3 of V_2 , the slugs of T_4 adjusted for maximum output, and the touch-up adjustments of all i-f transformers made as mentioned above.

With the i-f section alignment completed, the shorting capacitor is removed to restore the h-f oscillator to operation. The signal generator is connected through the specified dummy antenna, usually a $.00025 \mu\text{fd}$ capacitor, to the receiver antenna terminals, and set to the specified frequency, near the high end of the broadcast band, such as 1600 kc. The receiver tuning control is set so the dial pointer indicates this test frequency, and the h-f oscillator trimmer C_6 is adjusted for maximum reading on the output meter. Next, the signal generator is set to a somewhat lower frequency, such as 1400 kc, and the receiver tuning control adjusted to receive the generator test signal, even though the receiver dial pointer may not indicate the exact test signal frequency. Then the r-f circuit trimmers, C_4 and C_5 , are adjusted for maximum indication on the output meter.

Finally, if the receiver oscillator circuit contains a padder capacitor, the signal generator is

set to 600 kc and the receiver tuned to this frequency as indicated by maximum output of the audio tone from the loudspeaker. The padder is adjusted while the receiver tuning capacitor is "rocked" back and forth until a point of maximum output is obtained as indicated on the output meter.

This "rocking" procedure is employed to find that combination of tuning capacitor position and padder adjustment which give maximum output regardless of whether the receiver dial point falls exactly on the 600 kc mark.

Instead of a padder capacitor, permeability or slug tuning of the oscillator coil may be employed, in which case the slug adjustment is made at the 600 kc test frequency. Again, the tuning capacitor is rocked while the slug is adjusted to obtain maximum output.

When neither of the above oscillator circuits are employed, usually no check is specified at 600 kc. An exception is a receiver in which the tuning capacitor has slotted end plates similar to the unit of Figure 5. In this case, the tracking may be checked at 600 kc and, if necessary, corrected by bending the r-f section end plates to produce a maximum indication on the output meter.

As with the i-f section alignment, the signal generator output

should be kept low to prevent AVC action while all adjustments are being made in the receiver r-f section. However, if the AVC circuit is opened and a fixed bias substituted as explained for TRF alignment, the superheterodyne receiver may be aligned without the necessity of keeping the signal generator output at an extremely low amplitude.



A vacuum tube voltmeter often is used as the resonance indicator when an FM receiver is aligned.

Courtesy Sylvania Electric Products, Inc.

As another alternative, the system may be employed in which the direct voltage output of the AVC circuit is used to indicate the resonance adjustment of the various tuned circuits. In this case, a high resistance voltmeter, oscilloscope, or other voltage indicator is connected across the output of the receiver AVC circuit as mentioned for the TRF, and the

alignment adjusted for maximum AVC bias.

Carried by the wiring of the i-f section signal circuits, intermediate frequency energy may be radiated with sufficient strength to be picked up by the receiver antenna. Then, the i-f signal will be amplified in the r-f amplifier and mixer stages and re-applied to the input of the i-f section. This feedback action may result in undesired oscillation in the i-f circuits, and some receivers contain tuned trap circuits to prevent the i-f signal passing through the r-f circuits.

Figure 9A shows series resonant circuit, L_1C_1 , connected across the primary of antenna transformer T_1 to illustrate one arrangement frequently employed for the i-f trap. Tuned to resonance at the intermediate frequency, this circuit offers very low impedance and thus forms a short circuit across the receiver input so far as i-f energy is concerned.

A second trap is illustrated in Figure 9B. Here, parallel resonant trap L_1C_1 presents maximum impedance at the intermediate frequency. Therefore, practically all the i-f signal voltage applied to the input appears across the trap circuit, and very little across the primary of antenna transformer T_1 . A third arrangement consists of a series

resonant LC circuit which shorts the converter input grid to ground at the i-f, and is shown in Figure 9C.

During the alignment of a receiver containing an i-f trap, the variable component of the trap is adjusted just after the i-f transformers are aligned, and while the h-f oscillator is still inoperative. Set to the i-f carrier frequency, the signal generator is connected through a dummy antenna to the receiver antenna terminal or r-f amplifier grid, depending upon the location of the trap, and the trap is adjusted for minimum output meter reading.

ALIGNMENT OF FM SUPERHETERODYNE RECEIVER

In the case of an FM type superheterodyne receiver, the signal generator is employed with unmodulated output, and a high-resistance meter is needed as a resonance indicator. The general procedure is very much like the AM receivers except for a few additional readings taken to check the i-f bandwidth and the detector linearity.

The circuits of the last i-f or limiter stage and a discriminator type FM detector are shown in Figure 10. The FM, i-f signal is coupled by T_1 to the grid of limiter tube V_1 , and from the V_1 plate through T_2 to the plates of the discriminator diodes, V_2 and

V_3 . From the discriminator output, the audio signal is taken from the slider on volume control P and applied to the receiver a-f amplifier.

AM GENERATOR ALIGNMENT PROCEDURE

To align a receiver employing a discriminator detector, the signal generator is set to the receiver intermediate frequency, often 10.7 mc, and the hot test lead connected through a .01 μ fd capacitor to the grid of the limiter tube at point A in Figure 10. The generator ground lead is connected to the receiver chassis, point G.

With the high-resistance output meter on its d-c range, its test prod is connected through a 1 megohm isolating resistor to point B, and the ground lead to the receiver chassis. At this time, the voltage at point B may be either positive or negative with respect to ground. The output meter is set to a low range and the signal generator output adjusted to supply a test signal of about .1 volt to the grid of V_1 .

With the receiver tuning capacitor rotated so that the plates are fully open, the primary circuit of transformer T_2 is resonated at the i-f by adjusting C_4 to produce a maximum indication on the output meter. Then C_5 is adjusted for zero reading. As C_5 is ad-

justed, the voltage at point B reduces alternately from a positive value, through zero, to a negative value, and then back through zero to a positive again. Therefore, a zero-center meter will facilitate the adjustments at this point. When such a meter is not available, then the regular d-c meter may be reversed each time the voltage changes polarity at point B.

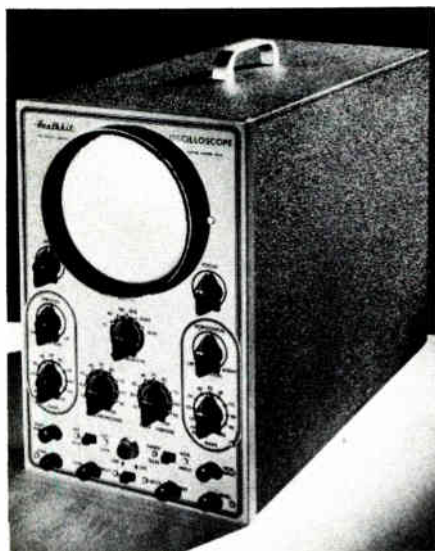

A 5-inch oscilloscope of the general service type suitable for application as a response curve indicator for "visual" alignment of an FM receiver.

Courtesy The Heath Company

Another method consists of using the zero adjust control to set the meter to some reference point near or at mid-scale. This setting may be made with the meter in either the +DC or -DC position. Then, when the voltage

at point B is positive, the meter pointer is deflected to one side of this reference point, and the pointer is deflected to the other side when the voltage at B is negative. Regardless of the direction of deflection at any instant, the secondary circuit of T_2 is adjusted to bring the meter pointer to the selected reference point, at which time the voltage will be zero at point B.

If the meter does not contain a zero adjust control, a voltage source such as a $1\frac{1}{2}$ volt dry cell may be connected in series with one of the meter test leads to make the meter read near the midpoint of its 3 volt range when the test prods are temporarily shorted together. The reading thus obtained then is employed as the "zero" reference for aligning the detector circuit. Any of these meter arrangements may be employed for adjusting the primary circuit trimmer, C_4 , of the detector transformer also, in which case adjustments are made to obtain maximum deflection away from the reference point—in either direction.

To check the linearity of the discriminator, a zero-center meter is used or the meter set to a mid-scale reference point as explained above and the readings obtained noted when the signal generator is set at frequencies which are lower and higher than the i-f by equal amounts. For ex-

ample, with an i-f of 10.7 mc, suitable pairs of check points are 10.675 and 10.725 mc, 10.650 and 10.750 mc, etc.

For each pair of check points, the meter readings should be equal and opposite with a zero center scale, or should increase and decrease by equal amounts from the mid-scale reference point. If this result is not obtained, the detector is not linear, and more careful alignment of the detector transformer is necessary.

There are three conditions under which the voltage is zero at point B: with the transformer secondary tuned (1) far below, (2) far above, and (3) exactly at the i-f. It is this last condition which must be obtained for proper operation.

When the detector transformer is properly aligned, the signal generator is returned to the exact original i-f test frequency by adjusting the generator dial to obtain a zero voltage indication at point B.

To align i-f transformer T_1 , the signal generator test signal is applied to the control grid of the preceding i-f amplifier tube, the output meter set to read $-DC$ volts, and its test prods connected to point C and ground. Trimmers C_1 and C_2 are adjusted for maximum deflection on the output meter.

Leaving the meter connected to points C and G, the test signal is applied to the grids of each i-f tube in turn to permit alignment of the other i-f transformers. Finally, the test signal is injected at the signal input grid of the mixer for alignment of the first i-f transformer. As with T_1 , the trimmers of each transformer are adjusted for maximum indication on the meter.

The last i-f stage and the balanced type ratio detector circuit of an FM receiver are shown in Figure 11. The bias components R_1 and C_3 are in the V_1 cathode circuit instead of the grid circuit. The secondary of T_2 connects to the cathode of detector diode V_2 and the plate of V_3 . The audio signal taken from the junction between capacitors C_6 and C_7 , passes through the de-emphasis filter R_4 and C_9 , and is applied to the receiver a-f amplifier as indicated. In this circuit, T_2 is permeability tuned, the junction between resistors R_2 and R_3 is grounded, and capacitor C_8 prevents output variations due to audio amplitude-modulation of the i-f signal.

To align a receiver employing an FM detector circuit like that of Figure 11, the signal generator is connected with its hot lead through a $.01 \mu\text{fd}$ capacitor to point A, and its ground lead to point G. The high-resistance voltmeter is set to read $-DC$ volts

and connected to point B and ground.

The signal generator is set to the i-f (10.7 mc), and its unmodulated output adjusted to give a reading of about 2 or 3 volts on the meter, as specified in the service manual for the particular receiver model. At the specified output, the ratio detector is operating at its normal level and will give the best indication of correct alignment.

The primary circuit of T_2 is tuned to resonance at the i-f by adjusting its slug to obtain maximum reading on the meter. Next, the meter test leads are connected to point C and ground, and the meter set to read on its zero-center scale, or operated with a mid-scale reference point as explained above. Then, the secondary circuit of T_2 is aligned by adjusting the secondary winding slug to obtain the zero reading which indicates the circuit is resonated at the exact i-f carrier frequency.

In the unbalanced type ratio detector circuit, a single, ungrounded resistor replaces R_2 and R_3 of Figure 11, and to permit alignment of the detector secondary circuit, the detector output must be balanced temporarily by connecting two 100K ohm resistors in series across the amplitude limiting capacitor, and grounding the junction between

them. This results in an arrangement of components connected like R_2 , R_3 , and C_8 of Figure 11. The output meter is connected to point C and ground, and the transformer secondary circuit adjusted for zero reading in the same manner as with the balanced detector of Figure 11.

To check the linearity of the ratio detector, the signal generator is set above and below the intermediate-frequency by equal amounts as explained for the discriminator circuit. If the detector is linear, point C will be made positive and negative by equal amounts with respect to zero or the mid-scale reference voltage, for each pair of test frequencies used.

To align the i-f stages in a receiver with a ratio detector, the output meter is reconnected to point B and ground, and the i-f test signal injected at the grids of successive tubes, i-f amplifiers and converter, working toward the front end of the receiver, and adjustments made for maximum deflection of the meter pointer on the -DC volts scale.

To align the r-f and oscillator circuits of the FM receiver, the antenna lead-in is disconnected from the receiver antenna posts, and the signal generator is connected through a dummy antenna to these terminals. At this point, a 300 ohm resistor forms the

dummy antenna and is connected in series with the hot test lead to one antenna post. The other post is connected by a jumper wire to the ground post to which the generator ground lead also is connected.

Another method consists of leaving both antenna posts ungrounded, inserting a 150 ohm resistor in series with each gener-

The signal generator and receiver dials are set to a test frequency near the high end of the band, such as 107 mc for an FM broadcast receiver. The generator output is set as specified in the service manual, and the oscillator coil, r-f transformer, and antenna transformer trimmers are adjusted for maximum meter deflection.

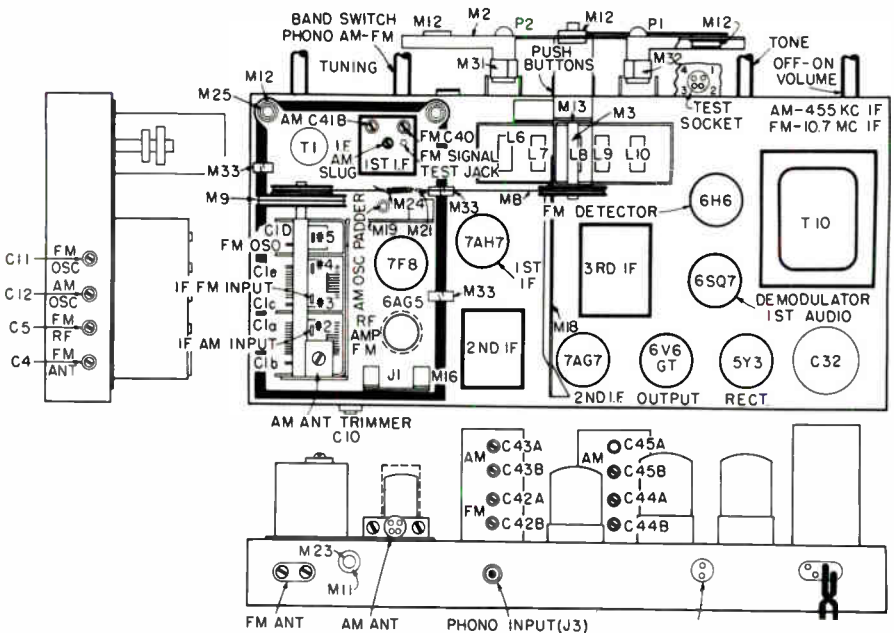

The various adjustments used in a receiver alignment can be located readily by means of a label pictorial. Most manufacturers include one in their service manuals.

ator lead, and connecting the leads to the antenna posts. The output meter is connected to the FM detector circuit, point C and ground in Figure 10, and point B and ground of Figure 11.

SWEEP GENERATOR ALIGNMENT PROCEDURE

In their service manuals, some FM receiver manufacturers include instructions for alignment

of the i-f circuits with a cathode ray oscilloscope and a sweep signal generator. The sweep generator is an r-f generator which provides suitable frequency modulated test signals, and the oscilloscope produces a visual pattern of the receiver response which may be observed by the alignment technician while adjustments are made. These instruments require about the same time to set up and connect as the AM generator and output meter.

Some sweep generators provide a sine wave or sawtooth time base voltage for application to the CRO horizontal input, while with others, the scope internal sweep is employed and synchronized by the sync voltage output of the generator. Thus, for the generator-to-scope connections in any given case, consult the instruction manual for the specific sweep generator used.

To align the detector transformer in the FM receiver, the scope ground lead is connected to the receiver chassis, and the vertical input lead is connected to point B in the discriminator circuit of Figure 10, or point C in the ratio detector circuit of Figure 11. The generator ground lead is connected to the receiver chassis, and in series with a decoupling resistor of several hundred ohms, the hot lead is connected to the control grid of the i-f amplifier or limiter tube immediately

preceding the detector stage. In Figures 10 and 11 for example, the generator leads are connected to points A and G.

The sweep generator is set to the receiver i-f and to produce a total sweep range of about 200 to 300 kc. If the scope employs a sine wave time base voltage equal to the generator sweep frequency, such as 60 cycles, an "S" pattern similar to the solid line curve of Figure 12A appears on the screen. In some cases, the curve will slope in the other direction, as indicated by the dashed line, or when a sawtooth time base equal to twice the sweep frequency is employed, an "X" pattern results, as indicated by both the solid and dashed line curves of Figure 12A.

In the case of the discriminator type of detector circuit, Figure 10, trimmers C_4 and C_5 are adjusted alternately to obtain either an "S" or "X" curve having maximum size vertically, and maximum linearity over the "straight" portion. With the "X" curve, adjustments are made also to make the crossover point correspond with the midpoint of each curve.

In the case of the ratio detector circuit, Figure 11, the primary of T_2 is first adjusted to obtain an "S" or "X" pattern of maximum height on the scope screen, and then the secondary is adjusted to obtain best linearity and to place the "X" pattern crossover at the center of both curves.

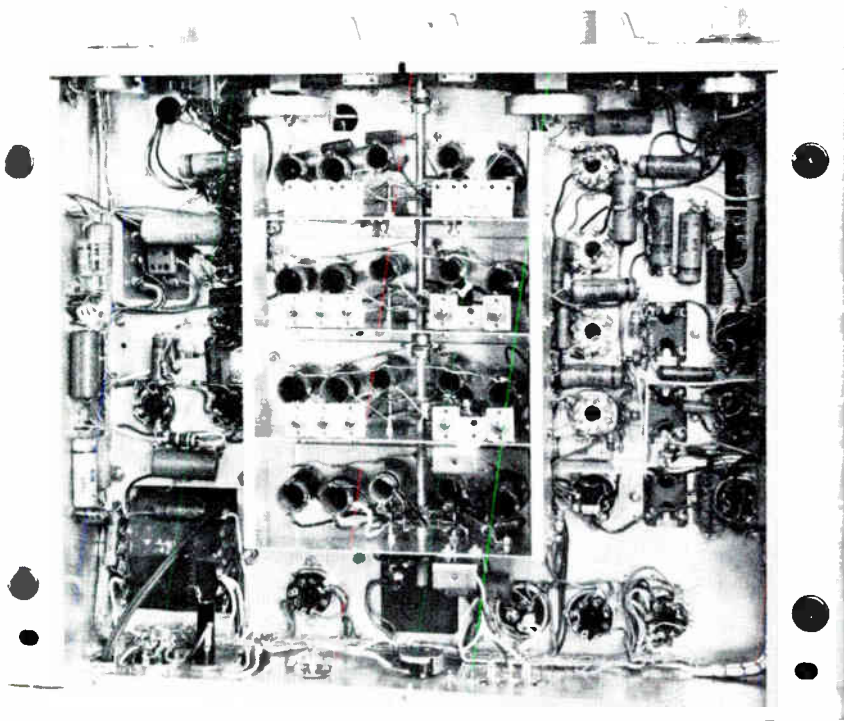

Under chassis view of a multi-band communications type receiver showing the mica trimmer capacitors which are adjusted to align the tuned circuits for the various bands in which the unit operates.

Courtesy The National Company, Inc.

To align the receiver i-f amplifier stages, the FM test signal is applied to the signal grid of the converter tube, and the oscilloscope connected to points C and G, Figure 10, in a discriminator receiver, and to point B, Figure 11, with C_8 temporarily disconnected, in ratio detector receivers. Then, beginning with T_1 (both types of receivers) and

working toward the front end of the set, alignment adjustments are made to obtain a pattern like in Figure 12B. Depending upon the CRO used, the observed pattern may be "upright" like that shown in the Figure, or it may be inverted. However, in either case, adjustments are made to obtain maximum vertical deflection and symmetry.

Due to causes inherent in the design, it is possible for a common service type sweep generator to produce an FM output in which the center frequency is considerably off the value indicated on its dial. To take advantage of the convenience provided by the visual pattern on the CRO screen, a sweep generator known to be inaccurate may be used if a preliminary rough alignment is made with an ordinary r-f generator and output meter as described above, and then the sweep generator and scope employed for final linearity adjustments.

When this system is used, the sweep generator frequency is adjusted to place the center of the response curve on the center of the CRO screen, regardless of the

frequency indicated on the generator dial. Final adjustments of the receiver detector and i-f transformer trimmers or slugs are then made to obtain the desired shape of the response curves, as shown in Figure 12.

After the FM receiver detector and i-f stages have been aligned with the sweep generator and scope, then an unmodulated r-f generator and high-resistance output meter are employed to align the r-f amplifier and converter stages as explained previously.

Although broadcast receivers were used as examples in this lesson, the same basic procedure applies to every radio receiver found in communications, television, or industrial electronics.



STUDENT NOTES

STUDENT NOTES

STUDENT NOTES

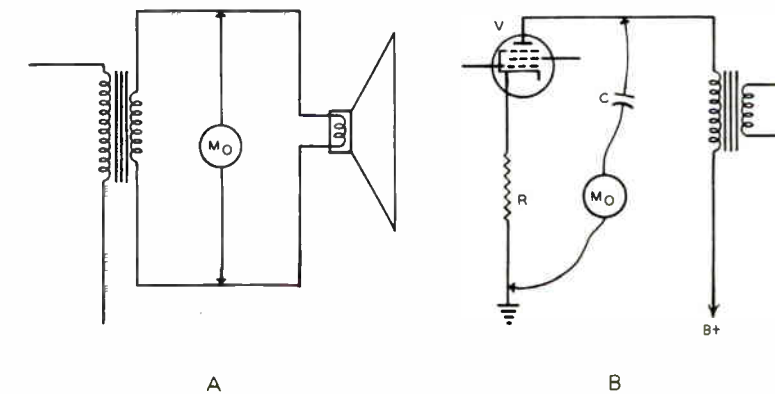
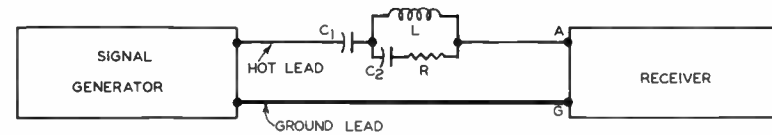
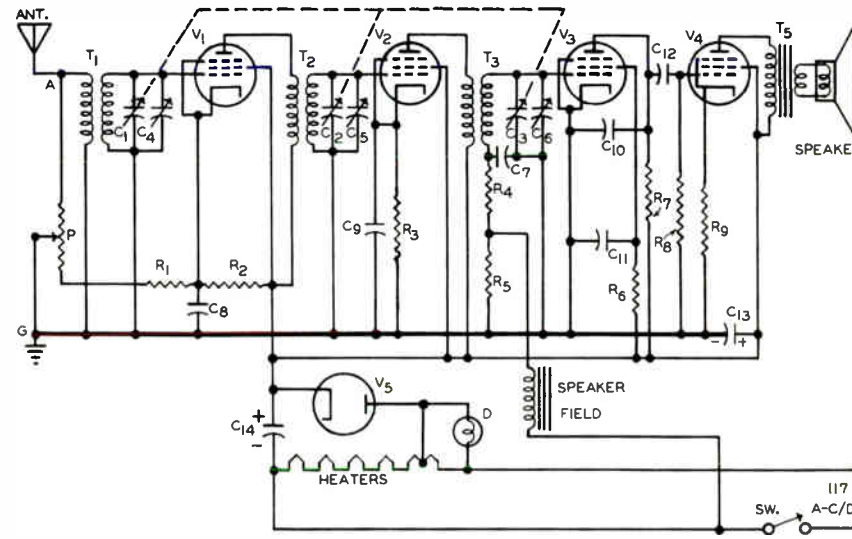
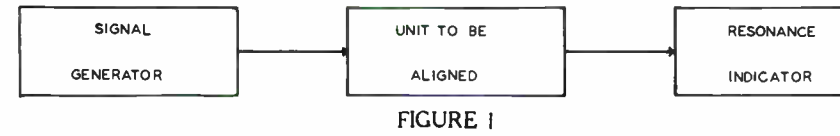

TSM-2

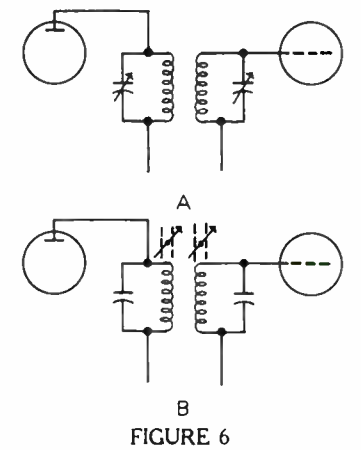
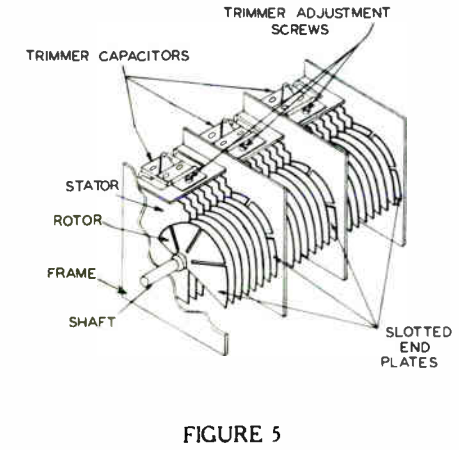

COURTESY J.W. MILLER CO.



COURTESY MEISSNER MFG. DIV.

FIGURE 7

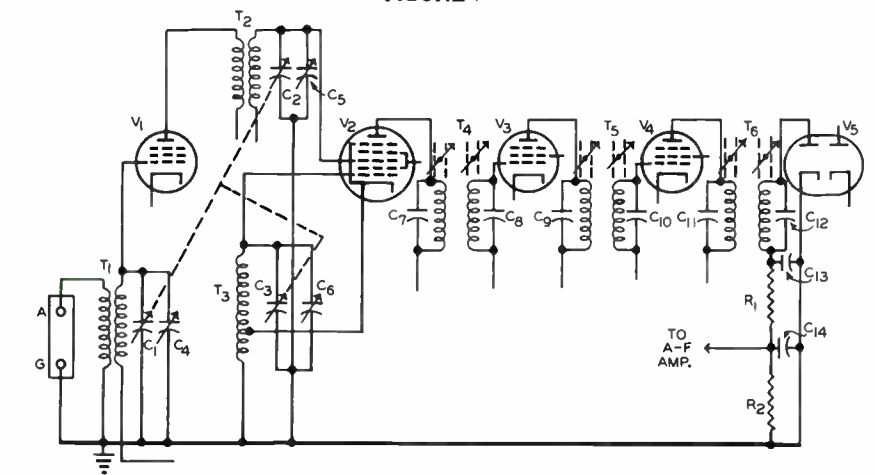

TSM-2

FIGURE 8

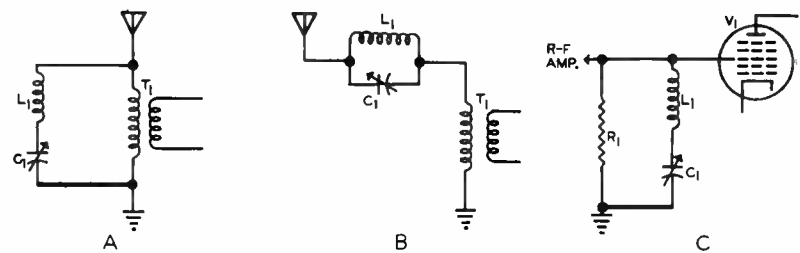

FIGURE 9

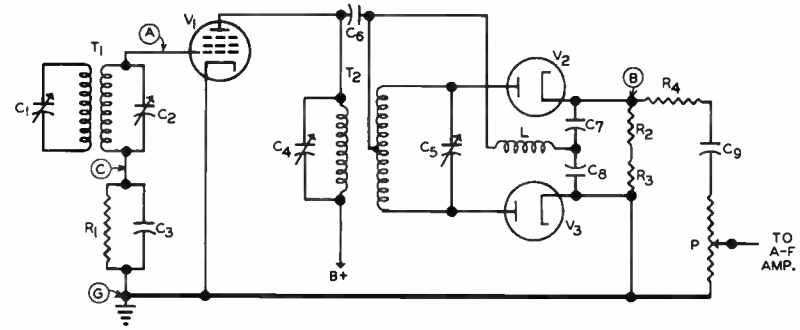

FIGURE 10

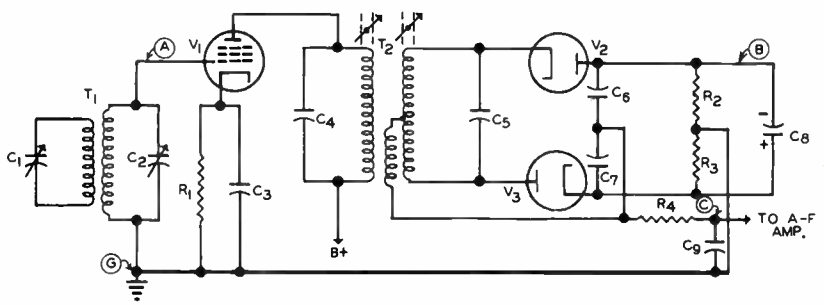

FIGURE 11

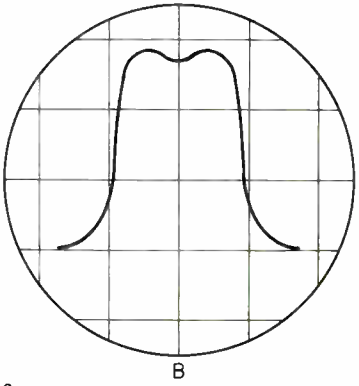
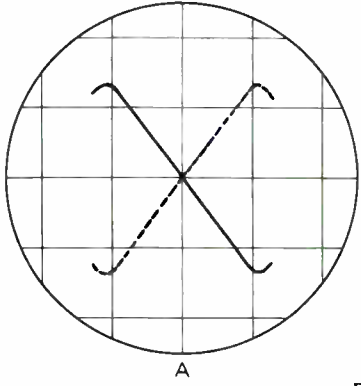

FIGURE 12

DeVRY Technical Institute

Formerly DeFOREST'S TRAINING, INC.

4141 WEST BELMONT AVENUE

CHICAGO 41, ILLINOIS

QUESTIONS

Radio Receiver Alignment—Lesson TSM-2B

Page 35

1

How many advance Lessons have you now on hand?

Print or use Rubber Stamp.

Name

Student No.

Street

Zone

Grade

City

State

Instructor

Write your answers on the "Ans." line below each question. If more space is needed use reverse side of this page.

1. What process is designated by the term alignment?

Ans.

2. What variable components, in tuned circuits, allow for alignment adjustments?

Ans.

3. In the partial circuit of Figure 4B, why is capacitor "C" required?

Ans.

4. When an a-c meter is employed and an output indicator, are the actual readings important?

Ans.

5. Why is the use of an output meter preferred to listening when making alignment adjustments?

Ans.

6. In order to align receivers with avc circuits, why should precautions be taken to prevent avc action when the output indicator is connected to a-f circuits?

Ans.

7. Why should the h-f oscillator be disabled during alignment of the i-f section in a superheterodyne type receiver?

Ans.

8. What precaution should be taken when connecting the output terminals of a signal generator to an ac/dc type receiver?

Ans.

9. Are the tuned traps, like those of Figures 9A and 9B, adjusted for maximum or minimum output indications?

Ans.

10. Why are i-f wave traps used in a radio receiver?

Ans.

TSM-2B

FROM OUR *Director's* NOTEBOOK

REACHING THE RIGHT MAN

How many times have you tried to reach someone by telephone in a large company—someone you knew could help you—if only you knew which one he was?

You probably get transferred from department to department, from person to person—and after considerable effort and repeats of your request, you may get the right person.

Now what if you went about applying for a job in the same manner? You'd be behind the eight ball in short order, wouldn't you?

Contrast this trial and error method with a readily available, everyday service that opens the door to the correct person the first time—Uncle Sam's mail system.

Yes, a good letter addressed to the Personnel Manager—giving a full outline of your qualifications . . . one that tells your story in an interesting and complete way—may pay many times more dividends than a telephone call asking if the company "is hiring these days."

Try it.

Yours for success,

W. C. DeVry
DIRECTOR

4-3

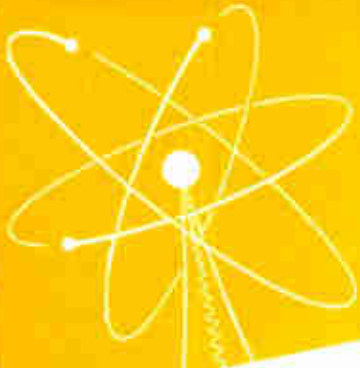

TV RECEIVER CIRCUITS

Lesson TSM-3B

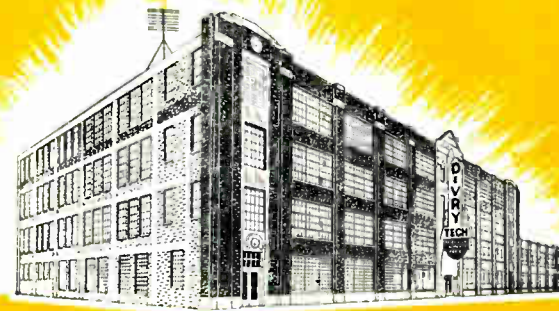

DeVRY Technical Institute
4141 W. Belmont Ave., Chicago 41, Illinois
Formerly D-FOREST'S TRAINING, INC.

TSM-3B

TV RECEIVER CIRCUITS

4141 Belmont Ave.

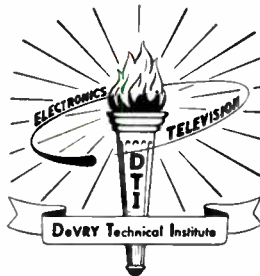

Chicago 41, Illinois

COPYRIGHT 1955



The modern television receiver is essentially two receivers thus providing simultaneous reception of both sound and picture from the studio to the viewer's home. Pictured above is a receiver indirectly viewed by means of a mirror mounted in the top cover.

Courtesy The Sparks Withington Co.

Television Service Methods

TV RECEIVER CIRCUITS

Contents

	PAGE
Motorola Television Receiver	5
R-F Section	6
Picture Channel	10
Sound Channel	13
Sync Circuits	13
Deflection Circuits	15
High Voltage Power Supply	16
Low Voltage Power Supply	18
Crosley Television Receiver	18
R-F Section	19
Picture Channel	20
Sound Channel	22
Sync Circuits	23
Deflection Circuits	24
High Voltage Power Supply	27
Low Voltage Power Supply	28

Television!

No word has ever been so filled with magic. Youngsters in school dream big dreams of futures in the field, as actors, as daring field cameramen, as powerful producers, or as station executives. Advertising officials fancy television as the final charge in saturating the market with their merchandise. Educators visualize magnificent advances in education and culture as television grips and molds the mentalities of our people. Idealists long for television to serve as the champion of society, eradicating interracial, international, and interreligious misunderstanding. It will fill the voids in our lives more effectively than does radio. Years of anticipation have whetted our appetities for television. Its name is magic.

—Selected

TV RECEIVER CIRCUITS

To serve as an aid in troubleshooting and other service work, many manufacturers make available complete sets of diagrams and data for each of their television receiver models. As previously explained, the block type diagrams are useful for determining the stages contained in the various sections of the receiver, and therefore, are helpful in locating the defective one. Tube layout charts permit locating any tubes which the technician may desire to check. Pictorial diagrams show the physical position of the other components and the various adjustment screws, etc.

However, to determine the electric connections and relationships of the various components in a circuit or stage, and to permit making systematic troubleshooting tests with a voltmeter, ohmmeter, etc., the electrical plan of the receiver is needed in the form of a schematic diagram. In the theory lessons of this course, various partial schematics were given to show the circuit connections in each of the receiver sections.

To show the connections between the various sections of complete receivers, and to illustrate the circuit diagrams furnished by the manufacturers, this lesson describes the complete

schematic diagrams of two commercial television receivers. However, since the various circuit actions were explained in detail in earlier lessons, they are described only briefly in this lesson. If some point seems vague, refer to the earlier lesson which describes that particular action in detail.

Although the schematic diagrams used here are of Motorola and Crosley receivers, the fundamental principles upon which the various circuits operate are common to other makes and models, any of which could have been used equally well as examples. These two receivers were chosen for the purpose of showing the major differences found in present day television receiver design. Most receivers are basically a composite of some of the circuits shown in these examples.

The one receiver uses channel switching in the tuner, inter-carrier i-f amplifiers, a ratio detector for sound and a crystal detector for the video, electrostatic sweep circuits, r-f high voltage power supply, and a transformerless voltage doubler for the low voltage supply.

In contrast, the other receiver has continuous tuning, dual channel i-f amplifiers, a Foster-Seeley discriminator for sound and a

conventional diode detector for video, electromagnetic deflection, a kick-back high voltage supply, and low voltage supply with a transformer.

MOTOROLA TELEVISION RECEIVER

The Motorola Models VT-71 and VT-73 television receivers employ the circuit shown in the schematic diagram of Figure 1. With the exception of its cabinet and antenna system, the receiver unit proper often is referred to as a CHASSIS. Thus, as indicated at the upper right in Figure 1, both of these Motorola models employ chassis number TS-4J. Differences in picture tube types, component part numbers, and circuit arrangement are reasons for different chassis designations of a given receiver make.

Also, various units of a given model may employ different chassis. For example, the Motorola Model VT-71 employs chassis TS-4B, C, D, E, F, G, H, or J. Therefore, when a particular television receiver is to be serviced, the technician should refer to a schematic diagram and other data which pertains to the correct chassis as well as the correct model.

A brief check of the block layout of a television receiver facili-

tates location of certain circuits or connections in the schematic diagram. Given in Figure 2, the block diagram of the TS-4J chassis shows this receiver to be of the intercarrier type and employing an r-f type high voltage supply.

Since the blocks contain the tube numbers corresponding to the similar designations in Figure 1, the various tubes sharing common envelopes can be located fairly easily in Figure 2. For example, the r-f oscillator and the converter employ respective sections of V-17, while one section of V-18 serves as an a-f amplifier and the other section is used in the deflection circuits. Finally, Figure 2 shows that the 4.5 mc sound i-f is separated from the video signals at the output v-f amplifier V-5 and from the same point, the video signal is applied to the picture tube and to the input of the sync clippers.

In the schematic diagram of Figure 1, the various sections have about the same general location as in the block diagram. That is, the r-f section is at the upper left in Figure 1, the sound channel is at the upper right, and the picture channel is at the center. From left-to-right across the bottom are the low voltage supply, sync circuits, deflection circuits, and high voltage supply.

R-F Section

The r-f section employs a type 6AG5 r-f amplifier, V-1, and the two sections of a type 12AT7 for the converter, V-17A, and the r-f oscillator, V-17B. At the extreme upper left of the diagram, the antenna posts A, G, and A connect to coil L-57 which provides a 300-ohm input impedance when the lead-in is connected across the two A terminals, and a 75-ohm input with the lead-in connected to the G and the lower A terminals, as indicated. Also shown is a small cross-sectional drawing of L-57 which indicates that a blue color-coded lead connects to the center tap at point 2.

The path of the incoming signal is from the upper end of L-57, through C-2 and the antenna coupling line to point A. Together L-57 and C-2 form a high-pass filter with a cutoff frequency of about 35 mc, to prevent passage of r-f energy with frequencies near that of the receiver i-f band. Located in the r-f amplifier grid circuit, sections A and B of station selector switch S-3 serve to place the proper inductance in the circuit for each of the 8 VHF channels made available by the tuner. Mounted on S-3, antenna coils L-60, 61, 62, 63, 14, 15, and 16 provide channel selectivity and also the correct impedance match between the antenna input circuit and the r-f amplifier tube V-1.

With S-3 in the position shown, the signal path is from point A through L-60, through the connected contacts of S-3A and S-3B, through L-16, L-15, L-14, and C-129 to the grid of V-1. Since point B is grounded, and C-1 forms a low reactance path from the center tap of L-57 to ground, it might appear that the signal voltage across L-57 is shorted out through C-1 and C-2. However, the connection between points A and B consists of a wire several inches in length which has appreciable inductive reactance at these VHF frequencies. Thus, this inductance, L-AB, prevents the shorting out of the signal.

To more clearly illustrate these relationships, the circuit of tube V-1 is redrawn in simplified form in Figure 3. Here, the inductance of the wire from A to B is represented by a coil in dashed lines, and the coils included between C-2 and C-129 are those employed when the station selector is in the position shown in Figure 1, as stated above. Other than the length of wire between points A and B, there are practically no high impedances presented by the connections between switch terminals, because the respective pairs of wafers are mounted back-to-back as shown by the pictorial side-view of S-3 in Figure 1.

In Figure 3, coils L-60, L-16, L-15, and L-14 form a series reso-

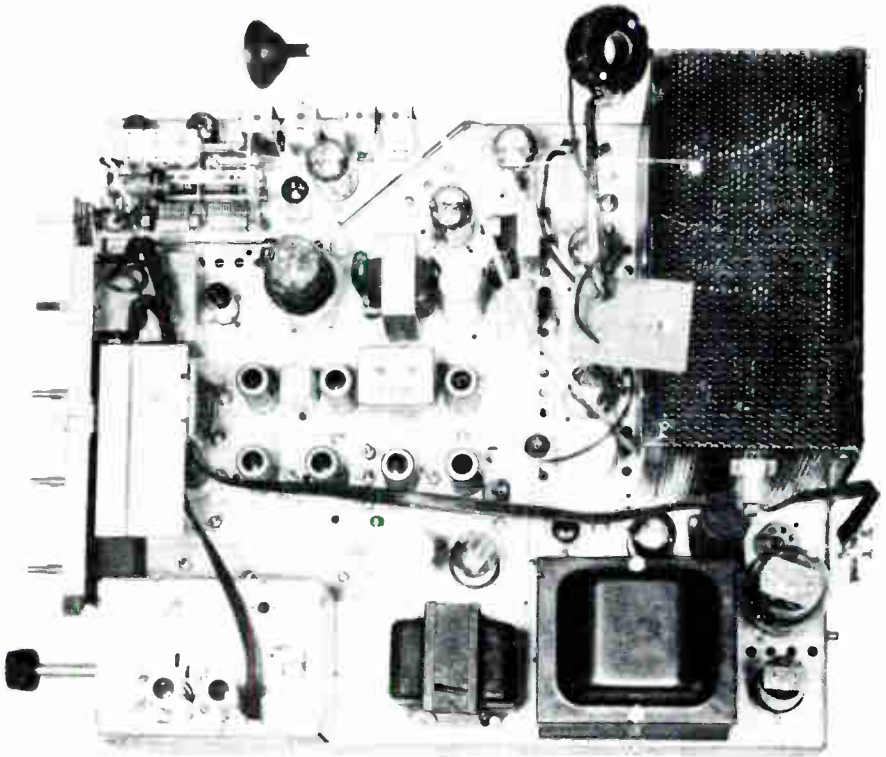

Top view of a receiver chassis which provides TV, FM, and AM reception. Thus, three tuners with the associated circuit must be included in the schematic diagram.

Courtesy Philco Corp.

nant circuit with C-2 and C-129 for the picture carrier on either channel 2 or 3, as determined by the setting of the adjustable core in L-60. As a series resonant circuit has low impedance at its resonant frequency, resistor R-2 is effectively in parallel with L-57 at the frequency of the desired carrier. However, the series LC circuit presents higher impedance to the frequencies of other chan-

nels, thereby preventing undesired signals being applied across R-2.

In like manner, coils L-81, L-30, L-31, L-32, and L-64 form a parallel resonant circuit with the output capacitance of V-1 at the desired carrier frequency. The core adjustment of L-64 permits this circuit to be tuned to resonance at the carrier frequency of the same channel (2 or 3) to which the grid circuit is tuned.

Since the V-1 input and output circuits are tuned to the two carrier frequencies, a resulting overall flat-topped wide-band response is obtained for the r-f stage.

As indicated by the curved arrows in Figure 1, the rotating contact on S-3A turns clockwise and that on S-3B counterclockwise when the receiver is tuned to higher frequency channels. Thus, when the station selector is set for channel 4, the contact on S-3A causes L-60 to be shorted out, while the contact on S-3B connects L-61 in series between point A and L-16. In like manner, coils L-62 and L-63 are substituted when the receiver is tuned to channels 5 and 6, respectively.

When the switch is set to channel 7, S-3B disconnects L-63, and couples L-16 through C-84 to point Y near the grounded end of wire AB. For Figure 3, this arrangement would be equivalent to opening the circuit at point X, and inserting a capacitor between points X and Y. In this case, the series resonant circuit now consists of C-2, the portion of L-AB between points A and Y, C-84, L-16, L-15, L-14, and C-129.

Referring to Figure 1, when S-3 is turned to the next position to receive either channel 8 or 9, coil L-16 is removed from the resonant circuit and capacitor C-84 connects to the junction between L-16 and L-15. To tune to

channels 10 or 11 and 12 or 13, coils L-15 and L-14 are removed in succession. Thus, for the highest channel, for example, the incoming signal has a path from the upper end of L-57 through C-2 and L-AB to point Y, and through C-84 and C-129 to the grid of V-1.

Although there are only eight switch positions, the receiver can be aligned to receive signals from all the stations that are assigned in the VHF band in any given locality. As only alternate channels are assigned in any area, and some of the tunable coils are designed so they can be adjusted for either of two channels, the receiver can be aligned to receive whichever group of channels are assigned to the area in which it is to be used.

Located in the plate circuit of the r-f amplifier, switch sections S-3C and S-3D function to select the proper coils in a way similar to that explained for S-3A and S-3B. Also, S-3E and S-3F select any one of the coils L-68, 72, 73, 74, 75, 76, 77, or 78 in the r-f oscillator circuit. The oscillator coils are provided with alignment adjustments for every channel, but with the exception of L-81, the coils in the r-f amplifier circuits can be aligned only on the lower channels. However, the remaining coils are factory tuned for resonance on the high band channels.

The V-17B section of the type 12AT7 tube is employed in a Colpitts r-f oscillator circuit. The respective coils are resonated by the distributed and other circuit capacitances as well as by trimmer C-169. Therefore, this capacitor and the movable cores of the coil form the means by which the oscillator may be tuned to the proper frequency for each channel.

The grid-cathode interelectrode capacitance and the plate-cathode interelectrode capacitance in addition to C-122 form the voltage divider across the tuned circuit, instead of using actual capacitors across the coil as is found in the conventional Colpitts circuit. Thus, the grid and plate have the r-f potentials of the opposite ends of the tuned circuit, while the cathode is connected to the junction of the capacitance divider.

With the selector switch in the position shown, oscillator coil L-68 connects to the movable contact on S-3F. As indicated in the Figure, this contact is connected to the contact on S-3E which, in turn, connects to C-7, C-8, and C-169. Therefore, for channel 2 or 3, L-68 is connected in parallel with C-169, and the tuned circuit is coupled through C-8 to the grid of V-17B, and through C-7 to the grid of the converter section V-17A. On S-3F, the curved contact serves to short out the high

channel coils to prevent undesired oscillations at harmonics of the low band frequencies.



A large screen table model receiver. The same receiver chassis may be used in various type cabinets, however, the chassis number does not change unless a change is made in the receiver circuits.

Courtesy Sentinel Radio Corp.

When the shaft of the station selector switch is rotated to higher channel positions, the rotating contact of S-3E and S-3F serve to disconnect L-68, and successively connect the other oscillator coils into the circuit. On channels 2 to 6, the r-f oscillator operates above the incoming carrier frequencies, while on channels 7 to 13 it operates below the carrier frequencies. This arrangement makes it possible to employ much lower oscillator frequencies for the high channels than would be necessary if the oscillator operated above the carriers at all times, and thus

permits oscillator stability to be obtained more readily.

Labeled CONVERTER in the schematic of Figure 1, the triode V-17A serves to mix the output of the r-f oscillator with the amplified carrier signals which are coupled by C-6 from the plate circuit of V-1 to the grid of V-17A. The resulting heterodyne action produces the desired intermediate frequencies which, present in the plate circuit of V-17A, are coupled by double-tuned transformer T-1 to the grid of the 1st. i-f amplifier, V-2.

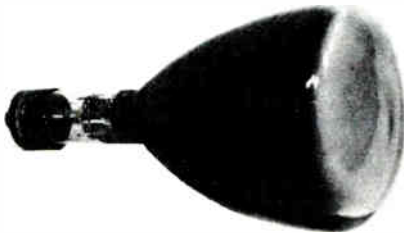

The 7JP4 electrostatic deflected picture tube is the type used in most electrostatic deflection receivers.

Courtesy National Union Radio Corp.

With the r-f oscillator operating above the carriers on the lower channels, a picture i-f of 26.2 mc and a sound i-f of 21.7 mc are employed. On the higher channels however, with the oscillator output below the r-f carriers, conditions are reversed in that the produced sound i-f of 27.4 mc is 4.5 mc above the picture i-f of 22.9 mc.

Picture Channel

Carrying both i-f signals, the i-f amplifier consists of three stages which contain tubes V-2, V-3, and V-4, respectively. The i-f interstage coupling circuits contain coils L-82, L-36, and L-37 which are stagger-tuned to provide the desired bandwidth. The over-all response is essentially symmetrical about a center frequency of approximately 24.6 mc. The picture i-f is near the upper limit of the i-f pass band for the lower channels, and near the lower limit for the upper channels as shown in Figures 4A and 4B. Thus, symmetrical response is necessary rather than the usual type which falls off at the high end such that it is reduced to 50% of maximum at the picture i-f frequency.

In this receiver, the converter output coupling transformer and the i-f amplifier coupling circuits are tuned so the over-all response is as shown by the curves in Figure 4. Here, "M" represents the maximum i-f response which is flat approximately 1.5 mc above and below the center frequency of 24.6 mc. Figure 4A shows the response is about .6 of maximum to the picture i-f frequency, and about .1 of maximum to the sound i-f when the receiver is tuned to a low-band channel. As shown in Figure 4B, when the receiver is tuned to a high-band channel, the

same relative response relationship is obtained, even though the sound i-f is now above the picture i-f.

The output of the i-f amplifier is coupled to the 2nd detector stage which employs a type 1N34 crystal rectifier and a low-pass filter composed of coils L-38, L-39, and capacitor C-24. The filter output is terminated by load resistor R-25 which carries the crystal direct current. The i-f voltage variations across L-37 are coupled through C-23 and C-119 to the detector, and the short-circuit effect of the crystal rectifier prevents the positive alternations of the signal voltage being impressed on the load circuit.

However, during the negative alternations of the signal, the crystal offers high resistance and permits these portions of the signal voltage to be impressed on the filter input. The filter attenuates the intermediate frequency components of the signal so that only the video frequencies are produced across R-25. From the upper end of R-25, the video signal is coupled through C-163 to the grid of the video amplifier tube, V-5.

The direction of the pulsating direct current in R-25 is such that the upper end of this resistor is negative with respect to B—. Filtered by R-145, C-13, and C-112, this negative voltage is applied to

the grid circuit of the 1st i-f amplifier V-2, to serve as automatic gain control. To apply a very small positive direct voltage to the grid of V-2, a voltage divider consisting of R-158, R-145, R-25, and R-96 is connected from the positive end of R-8 to B—. This positive voltage serves to delay the agc action so that the detector negative d-c output cannot affect the V-2 bias until it is greater in magnitude than the positive voltage at the junction between R-158 and R-145. Due to the drop across R-143, the V-2 cathode is always more positive than the grid so that normal operation of this tube is secured.

The picture and sound i-f's heterodyne in the crystal detector stage to produce a second sound i-f equal in frequency to 4.5 mc. Along with the v-f components, the 4.5 mc sound i-f is coupled through C-163 to the grid of V-5.

As explained, the detector d-c output is negative. That is, increases in the i-f amplitude causes the upper end of R-25 to become more negative with respect to ground. Therefore, corresponding to the lower i-f amplitudes, the picture signal components are positive with respect to the blanking and sync pulse components of the composite video signal. This v-f signal polarity is known as **POSITIVE PICTURE PHASE**. An advantage of a positive picture

phase signal at this point in the circuit is that high-amplitude noise voltages drive the video amplifier to cutoff, thus providing some noise reduction.

negative picture phase. This signal must be applied to the cathode of V-15, as shown, so that the reproduced image is a POSITIVE, and the blanking pulses reduce

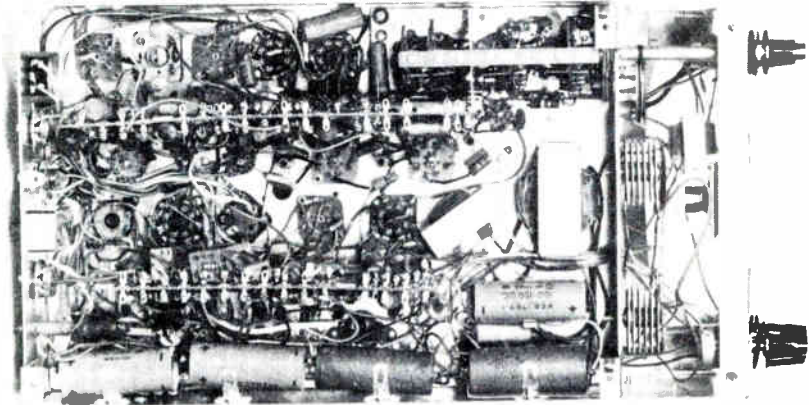

The under chassis view of a well known television receiver.

Courtesy General Electric Co.

In the plate circuit of V-5, coils L-79 and L-80, resistors R-138 and R-156, and the various circuit shunt capacitances form a low-pass filter which has a cut-off frequency of approximately 4 mc. Thus, the entire v-f band is coupled through C-63 to the cathode of the picture tube V-15, but the 4.5 mc sound i-f is attenuated by this filter.

In addition to amplifying the signal, the v-f amplifier serves as an inverter so that its output has

the electron beam to cutoff during the retrace intervals.

To provide for variation of the bias for V-5, and thus control its amplification, potentiometer R-155 serves as the contrast control.

As the signal is applied to the cathode of V-15, its control grid is connected to B- as shown in the Figure. Connected from B++ to B-, potentiometer R-100 serves as the brightness control. From

the variable arm on R-100, a positive voltage is supplied through R-124 to the V-15 cathode, the potential of which can be varied from zero to the full value of $B++$. This is equivalent to providing a corresponding negative bias for the grid of the picture tube, therefore the raster brightness can be controlled manually to any desired level.

Sound Channel

Amplified by V-5, the 4.5 mc sound i-f is coupled through the sound trap C-170, L-43, and C-31, to the grid of the limiter tube, V-6. The filter is peaked at the sound i-f by adjusting L-43 to resonance with C-170 and C-31 at 4.5 mc. The V-6 stage operates as an i-f amplifier and also as a limiter.

Plate, screen, and grid bias voltages are applied to V-6 such that the input signal swings the grid beyond cutoff and saturation. The action causes the signal peaks to be clipped, or removed, resulting in reduction in any existing amplitude variations.

The output of V-6 is coupled by transformer T-2 to the ratio detector, V-16. In the detector circuit, resistors R-105 and R-106 and capacitor C-101 form a filter which reduces the effect of amplitude variations of the input signal on the detector output. With frequency modulation of

the sound i-f, the a-f signal voltage variations are developed across capacitor C-123, and therefore, also appear across R-91 and R-92. From the sliding arm on potentiometer R-92, the audio signal is coupled through C-151 to the grid of audio amplifier tube V-18A. As indicated, R-92 serves as the volume control, while the upper portion of this potentiometer, resistor R-91, and capacitor C-133 act as the high frequency de-emphasizing filter.

From the plate circuit of voltage amplifier V-18A, the a-f variations are coupled by capacitor C-150 to the grid of the output tube, V-12. The output transformer T-3 couples the audio signal energy from the plate circuit of the power amplifier to the voice coil of loudspeaker SP-1.

Sync Circuits

The synchronization circuits include sync clippers V-10A and V-10B, transformer T-9, afc diode V-11B, and the two-section integrating circuit, R-44, C-47, R-45, and C-48. From the junction between L-80 and R-138 in the video amplifier plate circuit, the composite video signal is coupled through R-39 and C-44 to the grid of the 1st. clipper which operates with grid leak bias.

Since the applied signal has negative picture phase, the positive-going sync pulses cause grid

current in V-10A, and this current charges C-44. Between pulses, this charge leaks off through R-147 to produce a negative bias below the cutoff value so that the tube is held nonconductive except during the relatively positive sync pulse portions of the input signal. Therefore, plate current exists during sync pulse intervals only, to produce negative-going voltage pulses at the plate of V-10A.



The television receiver circuits in this large screen console receiver are designed to provide consistently good pictures.

Courtesy Sentinel Radio Corp.

The negative sync pulse output of the 1st. clipper is coupled through C-45 to the grid of V-10B which operates at zero bias. To provide wideband response to the high-frequency sine wave compo-

nents of the rectangular sync pulses, the relatively low value of ten-thousand ohms is employed for grid resistor R-42.

Amplified by V-10A, the sync pulses have sufficient amplitude to drive the grid of V-10B beyond cutoff, thus clipping any irregularities or noise variations from the negative peaks of the pulses. Inverted by V-10B, the pulses are positive-going in the output of the 2nd. clipper, and are applied through R-43 to the primary of T-9 as well as to the integrating filter in the grid circuit of the vertical sweep oscillator.

Automatic control of the horizontal sweep oscillator frequency is provided by the action of the V-11B triode operated as a diode. The primary of T-9 and capacitor C-153 form an LC circuit resonant to the horizontal sweep frequency, 15,750 cps. Shock excited by the horizontal sync pulse output of V-10B, this LC circuit develops a circulating current of sine wave-form, and the resulting voltage induced across the secondary is applied to the plate of V-11B. As shown, the cathode of this tube is connected to the junction between capacitor C-159 and resistor R-133 in the output circuit of the horizontal sweep oscillator tube V-11A. When V-11A conducts, the voltage across R-133 and that across the secondary of T-9 are both of a polarity to cause

conduction of V-11B, and this conduction charges capacitor C-154.

The charge on C-154 constitutes the negative bias on the grid of V-11A, and therefore affects the frequency of the oscillator. That is, the greater the charge on C-154, the greater its retarding effect on the oscillator action, and vice-versa. Determined by the average conduction time of V-11B, the magnitude of the charge on C-154 depends upon the phase relationship, and therefore, the frequency relationship between the incoming sync pulses and the horizontal sweep oscillator output.

Deflection Circuits

The horizontal sweep oscillator operates as a blocking oscillator and produces a sawtooth voltage which is applied in opposite phase to the respective horizontal deflection plates of the picture tube. Feedback from the plate to the grid of V-11A is provided by transformer T-8, and the oscillator free-running frequency is determined by the time constant of C-154, R-153, and R-154 in the grid circuit. Horizontal hold control, R-154 permits adjustment of the frequency for easy control by the incoming sync pulses. As explained, final control is provided by the afc diode circuit which functions to increase or decrease the charge on C-154 if the oscillator drifts in frequency.

To permit oscillator response to relatively slow changes in the charge on C-154, but not to individual sync pulses or noise voltages, C-156 and R-130 are employed across C-154. For relatively low frequency variations, the reactance of C-156 is high so that this capacitor and R-130 do not appreciably affect the circuit time constant.

However, at the high frequencies of the sync pulses and noise energy, the reactance of C-156 is so low that, effectively, R-130 is placed in parallel with C-154. Because the resistance of R-130 is so much lower than that of R-153 and R-154 in series, the circuit time constant is determined essentially by R-130 and C-154, and as this time constant is relatively short, the circuit bypasses the high-frequency variations.

During the intervals that V-11A is cut off, C-137 charges through R-55 and the upper winding of T-10. This charging current in the upper winding induces a voltage in the lower winding which produces a current to charge C-158. These capacitor charges are such that the ungrounded plate of C-137 is positive and the ungrounded plate of C-158 is negative. When V-11A conducts, both capacitors discharge in series through the tube. The sawtooth voltage thus produced across C-137 is coupled through C-147

to one of the horizontal deflection plates of V-15, and that across C-158 is coupled through C-148 to the opposite deflection plate of the picture tube.

In parallel across C-158, resistor R-133 and capacitor C-159 form an integrating circuit which changes the sawtooth wave to a parabolic wave for application to the cathode of the afc diode. This permits more uniform control action on either side of the center or correct frequency.

Although tube V-18B is labeled VERTICAL SWEEP OSCILLATOR in Figure 1, actually this oscillator is a multivibrator containing both V-18B and the upper section of V-8, which is referred to in this lesson as V-8A. The plate of V-18B is coupled to the grid of V-8A by capacitor C-55, and the plate of V-8A is coupled by means of C-57, R-125, and C-141 to the grid of V-18B. The vertical hold control, R-115, varies the time required for C-141 to discharge to the voltage which permits V-18B to begin conducting. Thus, this variable resistor provides for manual adjustment of the free-running frequency of the oscillator.

Coupled from the integrating filter through C-140 to the grid of V-18B, the 60 cps vertical sync pulses initiate the conduction of this tube at the proper instant for each cycle. Thus the multivibra-

tor is locked into synchronism with the field scanning frequency at the transmitting station.

In addition to being part of the multivibrator, tube V-8A serves as a sweep voltage amplifier. Capacitor C-56 charges slowly through R-139 and R-53 and discharges quickly through V-18B when this tube conducts, thus forming a sawtooth voltage. Applied through C-55 to the grid of V-8A, this sawtooth is amplified and coupled through C-166 to one of the vertical deflection plates in V-15.

From the plate of V-8A to B—, C-57 and C-142 form a voltage divider circuit, from the junction on which a portion of the V-8A output is applied through R-117 and R-58 to the grid of V-8B. Amplified and inverted by V-8B, the sawtooth voltage is coupled through C-167 to the opposite vertical deflection plate. Since C-166 and C-167 are too small to pass the sawtooth wave without distortion, resistor R-148 is employed to pre-distort the wave in the opposite direction so the resulting wave applied to the deflection plates is linear.

High Voltage Power Supply

Shown to the right of the picture tube in Figure 1, the r-f type high voltage supply contains a type 25L6GT tube as the r-f oscillator and a type 1B3GT/8016 tube as the high voltage rectifier.

The lower section of T-7 and capacitor C-68 form the oscillator tank circuit, and are tuned to produce a frequency of about 140 kc. T-7 is an autotransformer, and the r-f tank voltage is stepped up to approximately 6,000 volts across the entire winding and applied to the plate of the rectifier, V-14. Feedback is obtained by connecting the grid of V-13 to a spring wound around the rectifier envelope. This arrangement provides capacitive coupling between the plate of V-14 and the spring, the location of which is critical.

The rectified high voltage appears at the filament of V-14, and the r-f variations are removed by filter capacitor C-65. The high voltage supply output is applied across a voltage divider which, from the high voltage end to B-, consists of R-157, the two centering controls R-107 and R-142 in parallel, R-151, R-152, R-71, R-72, focus control R-74, plate load resistors R-149 and R-150 in parallel, and the two sections of V-8 in parallel. The vertical sweep output tube is supplied in this manner because the low voltage power supply output is insufficient to permit linear sweep variation over the range which it is necessary to swing the plate voltages of this tube. With the plate circuit serving as part of the high voltage divider, approximately 900 volts are applied at

the junction between R-149 and R-150.



Pictured is a table model television receiver with an indoor type antenna to provide reception of television signals.

Courtesy Motorola Inc.

As shown in the Figure, the potential at the left end of R-157 is applied to the second anode of V-15. Through isolating resistors, the sliders on R-107 and R-142 connect to one vertical and one horizontal deflection plate, respectively, while the taps on these controls are connected to the opposite plates. The picture tube focusing electrode is supplied a somewhat lower voltage from the slider on the focus control, R-74.

Low Voltage Power Supply

Shown at the lower left in the Figure, the low voltage power supply is a half wave voltage doubler employing two selenium rectifiers, E-2 and E-3. Voltage doubling is accomplished by rectifier E-3 and capacitor C-164 to provide a d-c voltage of about 260 volts across the input filter capacitor, C-77A. This voltage is filtered by R-159C to provide a d-c output of about 240 volts across capacitor C-78A. All the tube heaters are connected in a series-parallel arrangement across the a-c line, the current being limited by ballast resistors R-159B and R-159D.

The low voltage is divided by two busses, one marked B+ and supplying approximately half the available voltage; the other marked B++ and supplying full output voltage. The video amplifier tube, V-5 receives a slightly higher voltage from a connection ahead of filter resistor R-159C. The low voltage bus is obtained by a series parallel arrangement of the tubes. Tubes V-4, V-6, and V-10B are connected from B++ to the B+ bus, while tubes V-1, V-10A, and V-12 are connected from B+ to B-. The 60 μ fd capacitor, C-78B, connected from the common connection (B+) of these six tubes to B-, stabilizes the voltage from B+ to B- and the voltage remains constant at approximately 120 volts.

The tubes themselves serve as a voltage divider and, therefore, a high wattage voltage divider network is unnecessary. The only bleeder across the low voltage power supply is the low wattage network formed by resistors R-85 and R-87 (in the 2nd i-f stage) to obtain bias. The first and second i-f amplifiers, V-2 and V-3, are both type 6AG5 tubes and are connected in series from B++ to B-. Tubes V-11A, V-13, V-17A, V-18A and V-18B are connected from B++ to B- and receive the full 240 volts except for the drop due to the series circuit elements.

CROSLEY TELEVISION RECEIVER

As a contrasting example of a complete receiver circuit, the schematic diagram of the Crosley Models 9-403M and 9-413B receivers is given in Figure 5. Here, the r-f section is shown at the upper left, the low voltage power supply at the lower left, and the remaining sections are arranged one below the other on the central and right side of the Figure.

Arranged on the same general plan as the schematic, a block diagram of this receiver has been drawn for Figure 6. As shown here, the receiver is of the dual-channel type, with the picture and sound i-f signals being separated at the output of the common i-f amplifier, V1.

R-F Section

Referring to Figure 5, the receiver R-F UNIT is enclosed by dashed lines, and includes two 6J6 double triodes operating as r-f amplifier and oscillator, respectively, and a type 6AK5 pentode as the mixer. In the r-f stage, the two sections of V101 are operated in parallel with the grids grounded and thus this tube is employed as a grounded-grid amplifier. The antenna signals are coupled through C101 to the cathodes which provides a low impedance match for the transmission line.

From the plates of V101, the signals are coupled by the double tuned circuit to the control grid of mixer V102. In this coupling circuit, the coils L101 L102A and L104 L102B tune to the desired frequency with the respective tube capacitances and capacitors C105, C106, and C107. To provide the required wide band-pass, resistors R102, R103, and R104 are employed in shunt with the tuned circuits.

With one plate and one grid grounded, the remaining elements of V103 are employed in a Colpitts oscillator circuit, the tube interelectrode capacitances being used to couple the feedback energy from plate to grid circuit. In shunt with these capacitances and trimmer C111, the oscillator tank inductance consists of series coils

L102C and L105 in parallel with L103. From the grid end of the tank circuit, the oscillator r-f voltage is coupled by C112 to the grid of the mixer tube.

Continuous tuning over the range of 44 to 216 megacycles in the VHF band is provided by the three-section variable inductance arrangement consisting of L102A and L102B in the r-f mixer coupling circuit, and L102C in the oscillator tank circuit.

As the LC values are different in the oscillator tank circuit, this circuit tunes over a range 21.9 mc higher in frequency than the r-f carrier band, or from 65.9 to 237.9 mc. All three variable elements are mounted on a single shaft which is rotated by the station tuning knob on the front panel of the receiver.

Produced in the mixer stage, both picture and sound i-f signals are coupled to the first i-f amplifier by means of the coupled filter consisting of coils L1, L2, and L3, the output capacitance of V102, and the input capacitance of V1. In this circuit, the coils serve as an equivalent transformer of which L1 and L2 are the primary, L3 and L2 the secondary, and L2 is the mutual coupling inductance. Capacitor C1 serves to place the B+ end of L2 and its loading resistor R1 at r-f ground potential, while C2 prevents the B+ voltage being applied to the grid of V1.

Picture Channel

Following the common i-f amplifier V1, two additional picture i-f amplifiers, V2 and V3 are employed in the receiver picture channel. All three stages use type 6AG5, high gain, sharp cutoff pentodes, and each of the picture channel i-f coupling circuits consists of two adjustable coils, L4L5, L6L9, and L10L11 respectively, which are resonant with picture i-f at one side of center frequency. Between tubes V2 and V3, the coupling network consists of an "M" derived band-pass filter, the series arm of which contains parallel resonant traps L7C10 and L8C12 to block passage of the used channel and adjacent channel sound i-f's respectively.

The control grids of tubes V1 and V2 have d-c return paths to the slider on contrast control VR2, the ungrounded end of which connects through switch S2 (when S2 is in the TV position) to the junction between R62 and R63 in the negative leg of the low voltage power supply. Thus, with -14 volts d-c applied across VR2, this control serves as a means of varying the grid operating points, and therefore, the gains of the V1 and V2 stages.

Present across coil L11, the picture i-f signal is applied to the plate of diode V4A. The rectified diode current produced is in a

direction such that the left end (in the Figure) of L13 is negative with respect to the cathode of the diode. Since the cathode is grounded for r-f by capacitor C17, the video signal across load components L13 and R17 has positive picture phase, and is applied through L12 and R18 to the grid of the first video amplifier, the left hand section of V5. Coils L13 and L12 serve as peaking coils to improve the high frequency response of the detector output coupling circuit. R18 loads L12 to prevent a sharp peak in the response at some high frequency.

The circuits of the two triode sections of V5 form a two-stage v-f amplifier. The signal is coupled from the plate circuit of the first stage through capacitor C18 to the grid of the second triode section. In the plate circuit of the second stage, R22 and R23 form the total load resistance, and high frequency compensation is provided by peaking coils L14 and L15. Capacitor C19 forms a parallel resonant circuit with L15 at 4.5 mc to reduce the possibility of the beat frequency of the two i-f's being applied to the picture tube.

The first v-f amplifier grid bias is supplied in series with the detector circuit from the -2.9 volt point in the negative leg of the low voltage power supply. With

an i-f signal of normal strength applied to the detector, an average direct voltage of .7v is developed across the load, L13R17, to provide a total of -3.6 volts with respect to ground. As indicated, this voltage is applied through L12 and R18 to the grid of the first v-f amplifier tube.

teristic curve. In similar manner, an increase in i-f signal strength increases the direct voltage across L13 and L17 to cause the first v-f amplifier grid to operate at a lower point on the curve.

To hold the black level constant at the grid of picture tube V6, the grid circuit of the second v-f

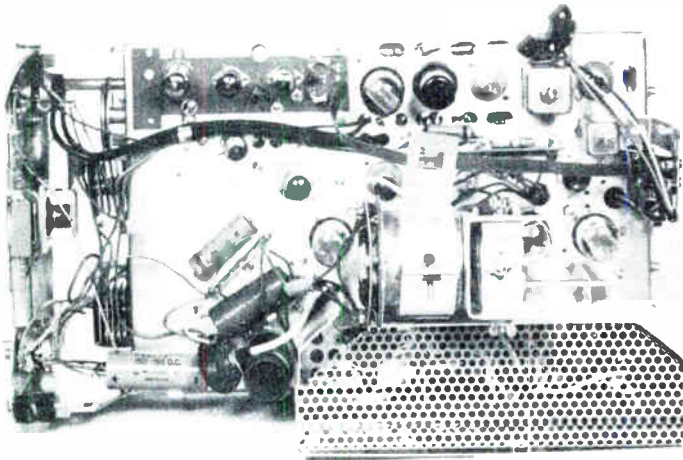

The top view of a TV receiver chassis with the picture tube removed. The various tubes may be quickly located when a tube layout chart is available.

Courtesy General Electric Co.

This arrangement provides automatic control of picture contrast, since a decrease in i-f signals strength reduces the average direct voltage across L13 and R17, and therefore causes the first v-f amplifier grid to operate at a higher point on the I_p - E_c charac-

teristic curve. The first v-f amplifier contains a 1 meg resistor R20 and coupling capacitor C18. These have a relatively long time constant such that grid leak bias is produced across R20 and varies in accordance with changes in the peak amplitude of the positive going sync pulses.

To retain the restored d-c component, the output amplifier plate is direct-coupled through peaking coil L15 to the grid of V6. This places the grid of V6 at the same operating voltage of +96 volts as the plate of the output tube, and provides a bias of 105-96, or 9 volts, between grid and cathode of V6. With an operating voltage of only 96 volts, the output tube V5 plate would not be able to swing over a sufficient range to provide the required video signal amplitude if the cathode of this tube were at or near ground potential. Therefore, the cathode is operated at -88 volts as indicated, thus providing an effective total plate voltage of $88 + 96$, or 184 volts for this tube. To obtain the proper negative operating voltages, the grid and cathode circuits of the v-f output tube are returned to the -90 volt point in the negative leg of the low voltage power supply.

Depending upon the receiver model, the picture tube is a type 10FP4 or a type 10BP4, both of which employ magnetic deflection and focusing. Connected to the +225 volt point of the low voltage supply, series resistors R93, VR1, and R24 form a voltage divider to ground. As shown, the V6 cathode is supplied +105 volts from the slider on VR1 which therefore functions as the brilliance or brightness control. Capacitor C20 forms a low react-

ance path from the cathode to ground for all v-f currents.

Sound Channel

As mentioned, i-f amplifier V1 passes both picture and sound i-f signals and, from the plate of this tube, the sound i-f voltages are coupled by capacitor C23 to the primary circuit of T1. The sound i-f amplifier consists of two stages in which the tubes V7 and V8 are type 6AU6 high gain sharp cutoff pentodes. The coupling transformers, T1 and T2, have their primary coils tuned to the sound i-f of 21.9 mc by capacitors C24 and C31, respectively, while the secondaries are resonated to the same frequency by capacitors C25 and C32.

As in the picture channel, alignment is accomplished by adjustment of the movable cores of the various windings. To remove variations in the i-f amplitude, V8 provides limiting action due to its being operated with relatively low screen voltage, and the grid leak bias developed across R31 and C30 in the grid return circuit.

To serve as automatic gain control, the negative voltage across C30 and R31 is applied through the two-section RC filter R30C33 and R26C26 to the grid circuit of V7. Since the grid leak bias voltage increases with signal strength, the gain of the V7 stage

is decreased due to the resulting more negative grid operating point when the signal strength is high. Conversely, the gain is increased when the signal strength is low.

To prevent oscillations due to undesired feedback in the sound i-f amplifier, a limited degenerative feedback is obtained by employing low resistance unbypassed resistors R27 and R32 in series with the cathode return leads, and by coupling a small signal energy from the high side of the cathode of V7 back through C27 to the grid.

The output of the sound i-f amplifier is coupled by transformer T3 to two diode plates of V9, a type 6T8 triple diode, high- μ triode which operates as a modified Foster-Seely discriminator circuit, while connected to pin 9 is the plate for the triode section of the tube.

Resistors R36 and R37 form the detector plate load, from across which the a-f signal is applied through de-emphasizing filter R38C40 and coupling capacitor C41 to the volume control, VR3. Connected to a tap on this control, R92 forms a tone compensating circuit with C78. From the slider on VR3, the a-f signal is applied to the grid of the triode section of V9. This grid is supplied a fixed bias of -1 volt from the junction of R89 and R90 which

form a voltage divider from the $-3.5V$ point in the low voltage supply negative leg to ground. From the plate of the first a-f amplifier, the signal is coupled through C43 to the voltage divider, R83R40, from the junction of which the signal is applied to the grid of output amplifier tube, V10.

Sync Circuits

The sync circuits include the sync amplifier and separator V11, the sync limiter V4B, and the horizontal control circuit which employs the left hand triode section of V13 in the Figure. In the plate circuit of the v-f output stage, the load resistance consists of two sections, R22 and R23, and the portion of the composite video signal voltage across R23 is coupled through capacitor C46 to the grid of the left hand section of V11. Employing a combination of fixed and grid leak bias to obtain a total negative grid bias of -4 volts, this triode section serves to amplify and invert the v-f signal, so that the signal has negative picture phase at the plate of the tube.

This signal, with positive going pulses, is applied through C48 to the plate of sync limiter V4B and the grid of the right hand section of V11. Conductive during the positive peaks of the applied signal, V4B causes C48 to be charged and, during the re-

mainder of each cycle, this charge leaks off through R46 to develop a high negative bias which is applied to the grid of the sync separator triode.

Because of this high grid bias, this section of V11 is held at cut-off at all times except when the relatively high amplitude sync pulses arrive and overcome the bias to cause conduction of the tube. With the sync separator conductive during the sync pulse intervals only, the plate current has the form of the sync pulses and causes corresponding voltage pulses to be developed across the cathode resistor, R45.

Any changes in the applied signal strength cause corresponding variations in the conduction of V4B, and therefore, the bias applied to the grid of the sync separator tube. Thus, a principal function of V4B is to limit to a common level the amplitude of the sync pulses produced across the cathode load resistor, R45.

From the upper end of R45, the sync pulses are applied to the three-section integrating circuit, R47C49, R48C50, and R49C51, which develops the 60 cps integrated vertical sync pulses to control the frequency of the vertical sweep oscillator. Also from the upper end of R45, the sync pulses are coupled through C60 and combined with the sawtooth voltage from the horizontal oscil-

lator and negative going pulses from the horizontal output circuit.

This combined voltage is applied to the grid of the left hand or control tube section of V13, the average plate current of which depends upon the phase relationships of the various components of the applied grid voltage. In the cathode circuit of this tube, the average plate current produces a corresponding charge on capacitor C64. Appearing across R73, a fraction of this voltage forms part of the grid bias of the horizontal oscillator. Capacitor C63A determines the amplitude of the combined voltages applied to the grid of the control tube.

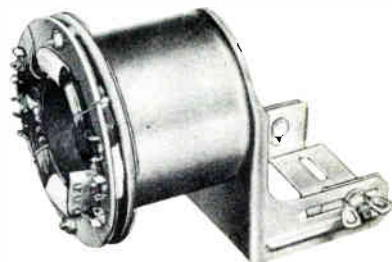

To obtain data on the TV receiver components, such as the deflection yoke above, reference may be made to the schematic diagram and associated data sheets supplied by most manufacturers.

Courtesy General Electric Co.

Deflection Circuits

The type 6SN7GT double triode tube V12 serves as the vertical oscillator, discharge tube,

and output amplifier, as indicated in Figure 5. The first and second functions are served by the left hand section, while the right hand section provides sufficient deflection power to properly drive the vertical coils of the picture tube yoke.

In addition to the tube, the blocking type vertical oscillator circuit consists of transformer T4, capacitor C52, resistors R95 and R96, vertical hold control VR7, resistor R78, and height control VR6. Developed across C51, the vertical sync pulses are inserted in series in the grid-cathode circuit of the oscillator. To produce a trapezoid voltage, capacitor C55 alternately charges slowly through R51, linearity control VR8, peaking resistor R53, R78, and VR6, and discharges rapidly through R53, C53D, the oscillator tube, and the plate circuit winding of T4.

Thus produced across C55 and R53, the trapezoid voltage is coupled through C54 to the grid of the amplifier section of V12. Carried by the primary of T5, the resulting trapezoidal plate current induces a voltage in the secondary which produces sawtooth current in the vertical deflection coil windings, T6A.

In the cathode circuit of the vertical output tube, C53D, VR8, and R51 produce a low amplitude, negative going sawtooth voltage which, applied to the cathode, acts

to supplement the grid voltage variations in such a way as to reduce non-linearity of the sawtooth plate current. The exact shape of the cathode voltage can be varied by adjusting the linearity control VR8.

Also a blocking oscillator, the horizontal deflection oscillator circuit includes the right hand section of V13, transformer T7, resistors R69, R75, and R73, and capacitors C63B and C66. This section of V13 acts as the discharge tube also, and its plate voltage is supplied through the upper winding of T7, R76, and R82 from the cathode of damper tube V15. V15 rectifies the voltage across the secondary of T8 and thus serves as a booster supply in series with the low voltage power supply.

Considering the junction of R82 and C53A as the output point of the booster supply filter, the sawtooth voltage is produced across C67 which charges slowly through R76 and discharges rapidly through the right hand section of V13 and the upper winding of T7. The sawtooth frequency is controlled mainly by C63B, adjustment of which varies the bias on the blocking oscillator grid. However, some frequency control is provided also by hold control VR5, which determines the operating voltage applied to the plate of the control tube section of V13.

In series from the upper plate of C67 to ground, capacitors C68 and C63C form a voltage divider, and the portion of the sawtooth voltage across C63C is applied through R81 to the grid of output tube V14. The amplitude of the input to V14 may be varied by adjustment of horizontal drive control C63C which affects both the linearity and amplitude of the horizontal deflection current.

Carried by the primary of T8, the V14 plate current induces a voltage in the secondary which produces sawtooth current in the horizontal deflection coil windings T6B. The complete path of the deflection coil current is from the upper end (terminal 4) of the larger secondary winding of T8, through T6B to the +270 volt point in the low voltage power supply, through R97 to the +280 volt point, to the tap (terminal 5) on the T8 secondary and through the upper portion of the winding to the top end.

Adjustment of width control L18 varies the reactance presented by the secondary circuit, and therefore, the amplitude of the sawtooth current in this circuit. Serving to prevent oscillations in the horizontal deflection coil circuit, damper tube V15 conducts heavily immediately after each flyback interval, and the diode current is employed to charge capacitor C72 to provide a source

of higher direct voltage than is obtainable at the output of the low voltage power supply. As mentioned, variations of this higher voltage are smoothed by filter components R82 and C53A for the plates of V13, while horizontal linearity control L19 and capacitor C71 are connected as a voltage divider across C72.

The portion of the booster output (pulsating d-c) which exists across C71 is applied through the lower portion of the T8 primary to the plate of V14. This same voltage is smoothed by filter components R80 and C53C, and applied to grid number 2 of the picture tube and through VR6, R78, and T4 to the plate of the vertical oscillator tube. Adjustment of L19 varies the phase of the booster output with respect to the deflection voltage cycle at the plate of V14, and thus varies the linearity of the sawtooth plate current.

The d-c voltages indicated at the plates of V13 and the left hand section of V12 are obtained when measurements are taken between these plates and the receiver chassis, or ground. However, they are not the total plate-to-cathode operating voltages, because the cathode and grid circuits of these tubes and of V14 are returned to the -90 volt point in the low voltage power supply. For example, the cathode of the horizontal oscillator is at 90 volts below

ground, while its plate is 47 volts above ground, as indicated, for a total plate-to-cathode difference of potential of $90 + 47$, or 137 volts.

High Voltage Power Supply

The high voltage supply is of the flyback type, with diode V16 employed to rectify the high amplitude pulses produced across T-8 during the return sweep portion of the deflection current cycle. The primary of T-8 acts as an autotransformer with the entire winding as the secondary, and the positive pulses at the upper end of this winding are applied to the plate of V16. The negative pulses produced across the deflection coil circuit winding of T8 also are applied in series with C76 to the filament of V16. Thus, the two pulses are series aiding to produce heavy conduction of the rectifier during the flyback interval, and charge C76 to a high voltage which is applied to the anode of the picture tube.

To show the various connections of the high voltage supply circuit to the picture tube and low voltage supply, the diagram of Figure 7 has been drawn. Here, coils T8_p and T8_s represent the primary and secondary windings, respectively, of transformer T8, and R97, R64, VR4, R65, R93, VR1, R24, R61, R98, R62, and R63 form the voltage divider across the low voltage supply.

For simplicity in Figure 7, the low voltage supply output filter is represented by C57B only.



The 10BP4 picture tube provides a small screen with electromagnetic deflection.

Courtesy Radio Corporation of America

As mentioned, when the deflection voltage pulses make the upper end of T8_p positive, the upper end of T8_s is made negative, and electrons flow from T8_s to the negative plate of C76, from the positive plate of C76 through V16 and T8_p to the positive plate of C71, from the negative plate of C71 to the negative plate of C57B, and from the positive plate of this capacitor through T8_s to complete the path. These short duration current pulses do not affect the charges on C57B and C71 to any appreciable extent because of the relatively large values of these capacitors.

However, C76 has a capacitance of only 500 micromicrofarads and, therefore, is charged to a high voltage by the pulse current of V16. Through filter resistor R88, the potential of the positive plate of C76 is applied to the anode of picture tube V6, the cathode of which is operated 105 volts above ground due to its connection to the slider on VR1 in the voltage divider circuit.

In conjunction with the anode coating, the grounded outer conductive coating of V6 serves as the high voltage supply output filter capacitor. As explained above, the first and second grids of V6 are operated at +96 volts and +130 volts, respectively.

Low Voltage Power Supply

Employing transformer T9 or T11, and two type 5Y3GT tubes, V17 and V18, in parallel, the low voltage power supply is of the conventional 60-cycle type. The supply provides direct voltages of 280, 270, 225, 135, -2.9, -3.5, -14, and -90 at various points on the output voltage divider. Located between the rectifier tube filaments and the divider, the main low voltage supply filter components consist of capacitors C56A, C57A, C56B, C57B, and

filter choke L16. Capacitor C58A provides additional filtering for the +225 volt output, while C59, and C58B serve in a similar manner for the +135v. and -90v. outputs.

As shown, focus coil L17 forms part of the low voltage supply bleeder circuit, and is connected across the divider components, R64 and VR4. Adjustment of focus control VR4 varies the ratio of resistance in this branch to that of the branch consisting of L17 and, therefore, the proportions of bleeder current carried by the two branches. That is, adjustment of VR4 results in changing the current in L17 to focus the picture tube beam.

As was done in the two typical examples of this lesson, by "reading" the schematic as furnished by the manufacturer of any receiver to be serviced, an understanding of the specific function of each circuit can be determined. This knowledge is important if efficient and satisfactory servicing of the receiver is to be accomplished. It makes the difference between blind, random probing and a directed and effective technique. That is, it can be the difference between a "fixer" and a good service man.



STUDENT NOTES

STUDENT NOTES

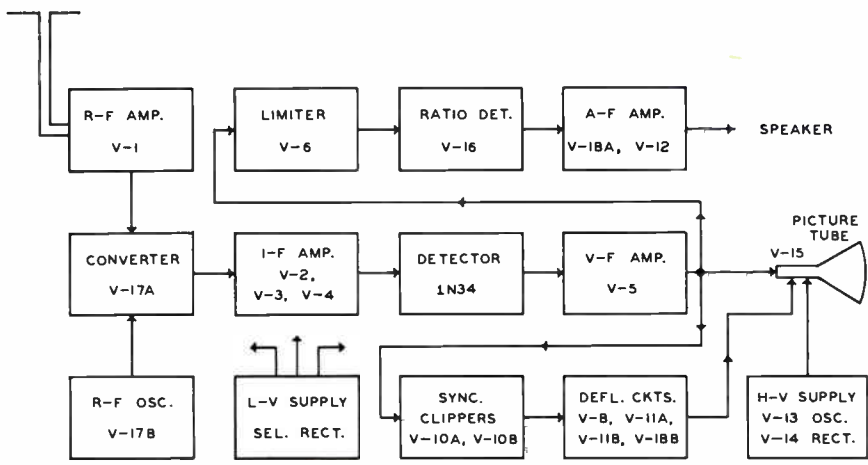

FIGURE 2

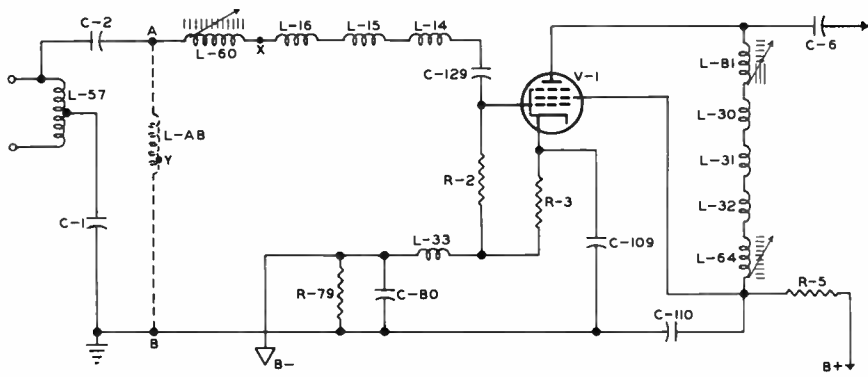

FIGURE 3

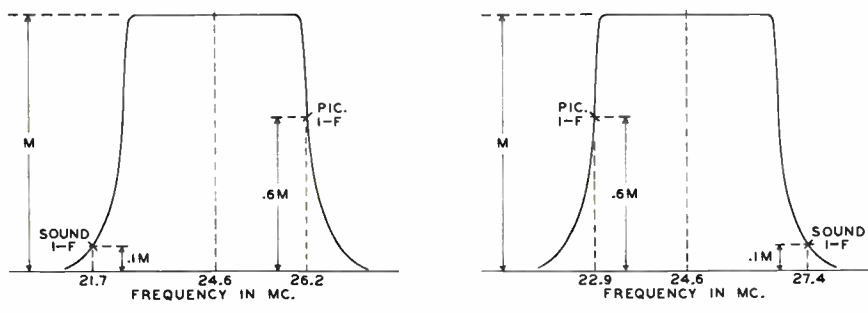

FIGURE 4

TSM-3

STUDENT NOTES

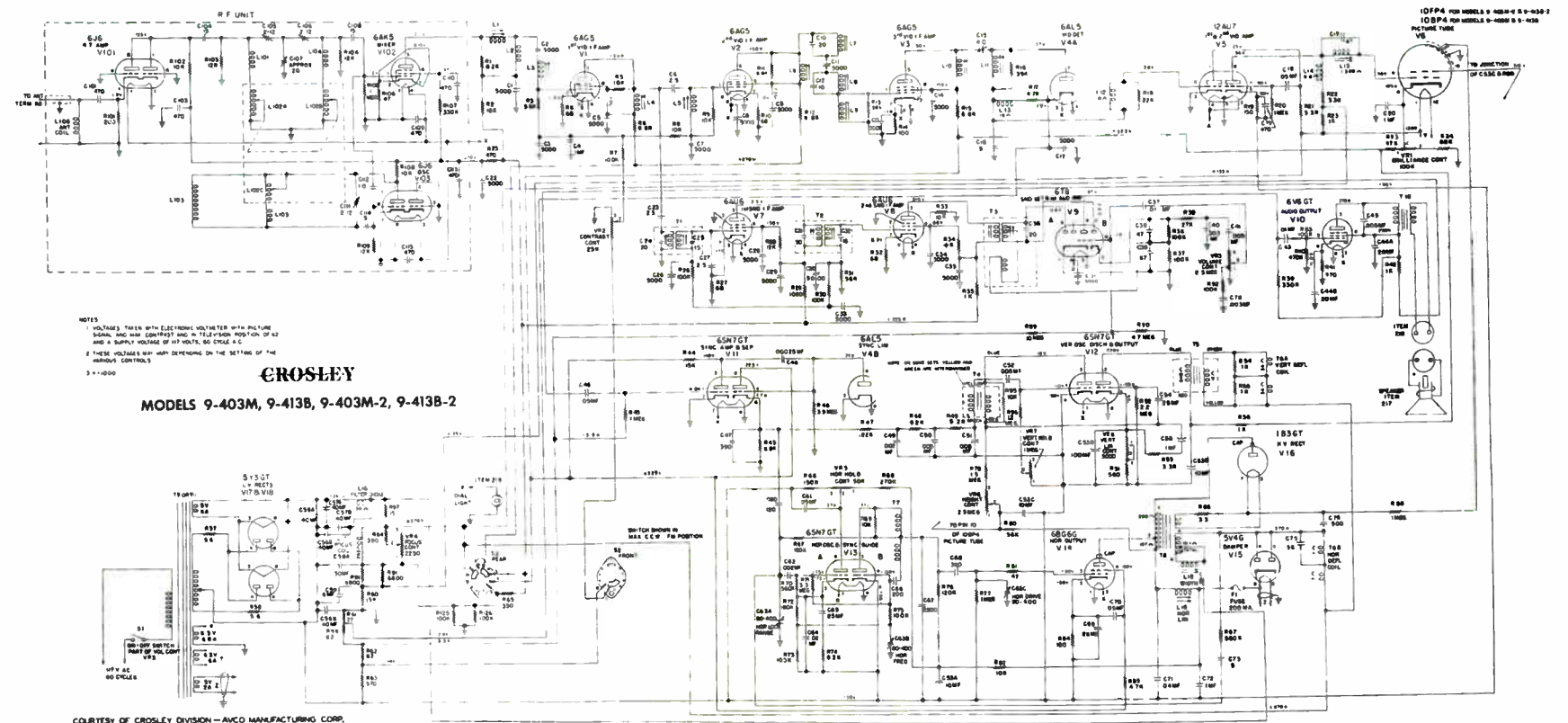

FIGURE 5

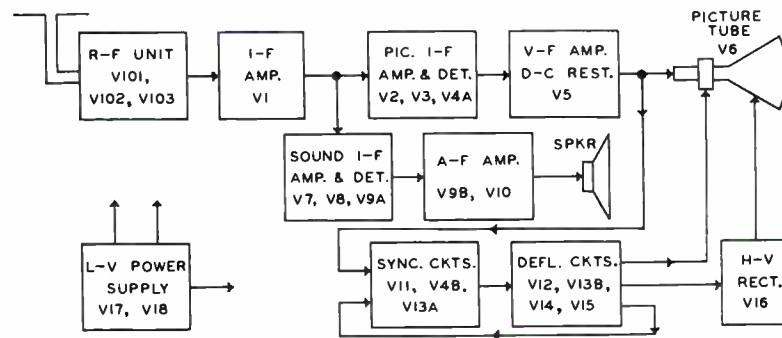

FIGURE 6

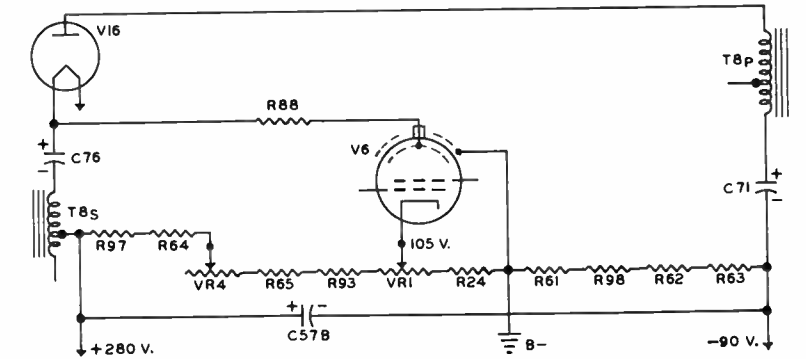

FIGURE 7

TSM-3

DeVRY Technical Institute

Formerly DeFOREST'S TRAINING, INC.

4141 WEST BELMONT AVENUE

CHICAGO 41, ILLINOIS

QUESTIONS

TV Receiver Circuits—Lesson TSM-3B

Page 35

How many advance Lessons have you now on hand?.....

1

Print or use Rubber Stamp.

Name Student No.

Street Zone Grade

City State Instructor

Write your answers on the "Ans." line below each question. If more space is needed use reverse side of this page.

1. Give two reasons for the use of different chassis designations for a given receiver make.

Ans.

2. In Figure 1, the respective coils in the V-17B r-f oscillator circuit are resonated by what capacitances?

Ans.

3. In the picture channel of Figure 1, why are coils L-82, L-36, and L-37 stagger-tuned?

Ans.

4. In the sound channel of the receiver of Figure 1, what is the purpose of the sound trap consisting of C-170, L-43, and C-31.

Ans.

5. In the horizontal deflection circuit, Figure 1, the time constant of what three grid circuit components determines the free-running frequency of the oscillator?

Ans.

6. In the low voltage power supply circuit of Figure 1, in what arrangement are the tube heaters connected.

Ans.

7. In the high voltage supply circuit of Figure 1, how is feedback obtained between the r-f oscillator and high voltage rectifier?

Ans.

8. In the r-f section of the receiver of Figure 5, what is the purpose of resistors R102, R103, and R104 with regard to frequency response?

Ans.

9. In the picture i-f channel, Figure 5, what is the purpose of the tuned circuits L7C10 and L8C12?

Ans.

10. In the horizontal deflection circuit of Figure 5, what is the total difference of potential between the plate and cathode of tube V13B?

Ans.

FROM OUR *Director's* NOTEBOOK

ON GETTING ADDED BUSINESS

When you are called to a customer's home to service a TV receiver, don't forget to ask if he has a radio which needs service.

The power of suggestion is great. Bring the radio tactfully to the customer's attention and, having just had his TV set properly repaired, he will be more apt to have the defective radio serviced too.

The casual question, "How are your radios operating?" may serve to recall a buzzing radio. The cost of traveling to and from the home already is paid for by the TV repair job, so the radio service is just added profit.

Thus, a "planted" reference to a radio—coming after a **good** TV repair job—can tap another source of income you now may be missing.

Yours for success,

W. C. DeVry

DIRECTOR



**CONTROL
ADJUSTMENTS**
Lesson TSM-4B



DeVRY Technical Institute
4141 W. Belmont Ave., Chicago 41, Illinois
Formerly DeFOREST'S TRAINING, INC.

CONTROL ADJUSTMENTS

4141 Belmont Ave.

COPYRIGHT 1955

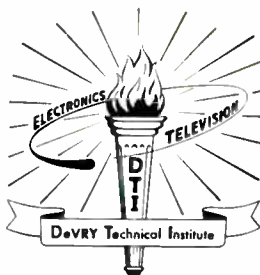

Chicago 41, Illinois



Covered by the name plate, the non-operating controls are readily accessible on the front panel of the television receiver when needed.

Courtesy Emerson Radio & Phonograph Corp.

Television Service Methods

CONTROL ADJUSTMENTS

Contents

	PAGE
Typical Test Pattern	4
Centering and Picture Size	4
Linearity	5
Focus	7
Resolution	8
Contrast	12
Brightness	13
The RTMA Resolution Chart	14
Receiver Control Adjustments	17
The Ion Trap	18
Brightness and Contrast	20
Channel Selector	21
Fine Tuning Control	21
Hold Controls	22
Tilted Picture	23
Focus	24
Interaction of Controls	24
Instructing the Owner	27

No field of endeavor ever proposed by man offers more or demands more from its patrons than does the creation and transmission of electronic pictures. If people engaged in television work disregard the idea of associated professions, they might nullify possible contributions to the art. No one person can feel that his knowledge of a specialty is in itself sufficient or that knowledge of the potentialities and problems of his colleagues are not required. Television is, in truth, a melting pot of the sciences, the arts, and the populace.

—Selected.

CONTROL ADJUSTMENTS

Regardless of some current advertising claims, every conventional television receiver is provided with about twelve important controls, all of which must be adjusted properly to provide the best possible reception. Some of these require adjustment only when the receiver is installed and at infrequent intervals when tubes are changed or other service is needed. Others, which can be identified as **OPERATING CONTROLS** must be manipulated by the owner as he tunes the desired programs.

All of these adjustments must be made accurately when the receiver is installed and equally important are the instructions which the technician gives the owner. Many return service calls, due only to the improper control adjustments by the owner, can be reduced in number by more complete and thorough instruction. However, to make the adjustments quickly and explain the actions of the controls, the technician must know the function of each and its location on the various makes and models of receivers.

In most cases, final adjustments are made while a picture is being received but the constant movements in the scenes of most programs make it extremely difficult to set some controls properly.

For this reason a few television stations transmit a stationary **TEST PATTERN** during certain hours of the day. When used to full advantage, these patterns not only simplify the control adjustments but aid greatly in diagnosing operational defects.

TYPICAL TEST PATTERN

There is no standard in general use at the present time, therefore television stations have designed their own test patterns. Although differing somewhat in appearance, these patterns consist mainly of circles, arcs, wedges, and shading blocks. A large number of receiver operating conditions can be checked by means of the test pattern and, although the following explanations are based on the NBC pattern of Figure 1, the principles and methods apply equally well to any of the others currently in use.

In making control adjustments, it is not necessary to follow any certain sequence because the starting point for adjustments is dictated by the specific distortion present in any particular receiver.

Centering and Picture Size

Two of the most easily discernible misadjustments of the receiver are off-center picture and incorrect picture size. In the

test pattern of Figure 1, the HORIZONTAL CENTERING and HORIZONTAL SIZE are correct when the two arcs of the large outer circle just touch the sides of the mask for receivers with rectangular viewing screens. For receivers with circular screens, the horizontal centering and size are correct when the large inner black circle touches the edge of the mask.

In either case, VERTICAL CENTERING and VERTICAL SIZE are correct when the black circle just fits in the screen from top to bottom. Correct 4:3 aspect ratio is indicated when the two arcs and the black circle are perfectly round.

Although the picture size may be adjusted perfectly for one program, occasionally a change of station, or a change in the program from the same station, may cause the picture to reduce in size and no longer fill the mask. Often as much as $\frac{1}{2}$ inch difference in picture height or width on a 21 inch receiver screen occurs when the station changes from one sync generator to another, or from a local to a relay program. This is due to the variation in the horizontal and vertical blanking time on different stations, or on different sync generators in the same station.

When the line voltage changes at the receiver, it also causes cor-

responding changes in the deflection voltages and the high d-c voltages, both of which affect the picture size. For this reason, a receiver adjusted for correct size in the service shop may be found to have a smaller or larger picture at the owner's home. Also, in some receivers the picture has a tendency to "grow" in size, or to drift in centering as the receiver warms up during the first hour of operation.

While most of the customers complain if the picture does not completely fill the mask, very few object if a small portion of the picture is hidden behind the mask. So, it is common practice to extend the picture slightly beyond the mask so such fluctuations are less noticeable. For these reasons, the various control adjustments should be made after the receiver has warmed up. This procedure will assure optimum adjustment for normal operating conditions.

Linearity

In reproducing the picture, the picture tube electron beam generates a spot of light on the face of the tube. The action of the deflection circuits is such that this spot is moved across the face of the tube from left to right and from top to bottom in a motion called scanning, as was described in detail in an earlier lesson. The video signal in turn, modulates or varies the intensity of the

beam, resulting in a changing brightness of the spot.

Should its speed change during the scanning of a line, the spot produces crowded picture elements where it is moving slowly and the elements are spread out where the spot is moving more rapidly. To make the spot move from left to right at uniform speed on the screen, the horizontal deflection circuit must produce a linear sawtooth voltage or current output.

Also, to provide equal spacing between the horizontal scanning lines, the output of the vertical deflection circuit must be linear so the spot will travel with constant speed from the top to the bottom of the screen. If the vertical speed of the spot is not constant, the scanning lines are crowded where the spot is traveling relatively slow and are widely spaced where the spot is moving downward fast.

Thus, poor LINEARITY of the output wave of either of the deflection circuits results in distortion of the test pattern or picture. The effect is to pull the pattern "out of round" so that the circles become egg-shaped and the "bull's eye" is off center.

As an example, if in a certain receiver the VERTICAL LINEARITY control is misadjusted then the pattern of Figure 1 may be reproduced such that the top part

of the black circle is flattened, and the bottom portion is drawn out and pointed. The bull's eye is moved to some point above center in the picture, and measurement of the two vertical wedges shows that the bottom wedge is considerably longer than the top. This means that the top part of the picture is compressed and the bottom part is expanded or spread out vertically over too great an area. In a scene distorted in this manner, an actor's legs will appear lengthened and the upper portion of the body will appear shortened.

During an interval when no test pattern is on, an alternative method of checking vertical linearity consists of advancing the brightness control until the raster lines appear, and observing the spacing between the lines. For example, if the spacing is greater between the lines near the top than at the bottom it indicates that the picture is spread out at the top and compressed at the bottom. Linearity adjustments should be made to obtain equal spacings between all of the lines on the screen.

Non-linearity of the horizontal deflection circuit is recognized by similar test pattern distortion. The bull's eye is pulled off center horizontally, circles are flattened on one side and drawn out to a point on the other, and horizontal wedges are not of equal length.

In most receivers using magnetic deflection, there is considerable interaction between HORIZONTAL WIDTH CONTROL, HORIZONTAL LINEARITY CONTROL, and HORIZONTAL DRIVE CONTROL. Adjustment of the horizontal size may provide proper picture width, but result in a non-linear test pattern image. Then, adjustment of either HORIZONTAL LINEARITY or HORIZONTAL DRIVE CONTROLS, or both, will improve linearity. However, it also will change the picture size, and therefore, it is necessary to readjust each of these controls several times before a good image is procured.

The number of linearity controls and their circuit actions differ with various receiver designs. Consequently, the service manual issued by the receiver manufacturer should be studied carefully, when available, for pertinent information regarding linearity adjustments for any particular receiver. Non-linearity is not always due to improper adjustment within the receiver, but may be due to non-linearity on the part of the transmitter. Therefore before making final adjustments, a good service technique is to check linearity on several stations.

Focus

FOCUS is a word used to describe the clearness or distinctness of the image. The focus of

the picture is dependent upon the size of the scanning spot, and to obtain a sharply focused picture with clear and distinct fine detail, the spot must be as small as possible.

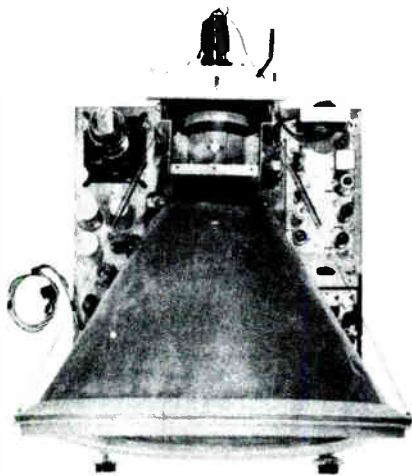

The top view of a receiver chassis showing the deflection and focus coil mounts. The small lever to the right of the CRT base is the picture centering control.

Courtesy Motorola Inc.

The test pattern of Figure 1 provides an excellent means of obtaining proper adjustment of focus. The procedure consists of looking at the vertical and horizontal wedges at points as far inward toward the narrow end as the lines are distinct, and adjusting the focus control until the lines appear sharpest and most clearly defined at the observed points. This method tends to bring the center portion of

subsequent pictures into sharpest focus. In the event the scanning spot is not perfectly round, the focus adjustment that is sharpest for the vertical wedges may not produce sharpest focus on the horizontal wedges. When this is the case, the adjustment should be made for best focus on the vertical wedges.

Resolution

Usually consisting of converging black and white lines as in Figure 1, the vertical and horizontal RESOLUTION WEDGES are probably the most informative parts of a test pattern. Commonly used interchangeably with the word DEFINITION, RESOLUTION is an indication of the fineness of detail a receiver is capable of resolving or reproducing. A picture in which small detail is clear and distinct is said to have good or high resolution. If the picture is smeared, the small detail is lost and the resolution is poor.

Due to the manner in which a television picture is reproduced, the resolving power in the vertical and horizontal directions is dependent upon different factors. Usually expressed as so many "lines", VERTICAL RESOLUTION IS THE NUMBER OF HORIZONTAL ALTERNATE BLACK AND WHITE LINES WHICH THE RECEIVER IS CAPABLE OF REPRODUCING distinctly when the entire picture consists of

many thin horizontal black and white lines.

In any receiver, the vertical resolution depends upon the number of usable scanning lines and the size of the scanning spot. The phrase, "usable scanning lines", refers to the fact that, of the 525 scanning lines per frame, approximately 7% occur during the vertical blanking interval, leaving 490 lines which are usable in picture reproduction. If the spot size is small enough so that there is no overlapping of adjacent scanning lines, then theoretically, 490 lines can be reproduced and represent the maximum vertical resolution.

The vertical resolution can be checked on a test pattern by observing the horizontal wedges. If the lines are clear and distinct toward the center, the vertical resolution is considered to be satisfactory.

In Figure 1, for example, the left-hand horizontal wedge is composed of 31 alternate black and white lines. We find by measurement that at its wide end, the width of the wedge is about one-fifth of the picture height. This point on the wedge then corresponds to a vertical resolution of 5×31 or 155 lines. At the narrow end, the width of the wedge is slightly more than one-twelfth of the picture height. If the lines are clear and distinct

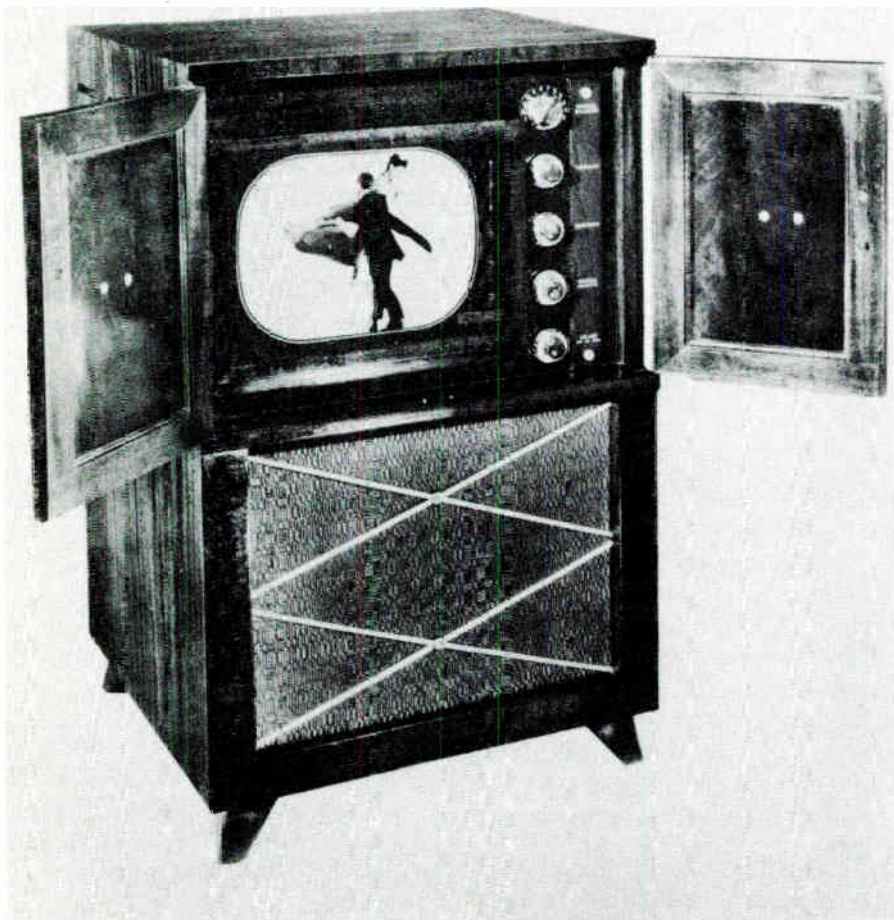

The operating controls are shown at the right of the screen of this television receiver. From top to bottom, these controls are the channel selector, contrast, brightness, vertical and horizontal hold, and the on-off volume control.

Courtesy Westinghouse Electric Corp.

and have the same contrast as the rest of the wedge at this point, it indicates a vertical resolution of 12 x 31 or 372 lines.

Suppose that the test pattern of Figure 1 is observed on a pic-

ture tube screen and, at some point on the horizontal wedge, the lines fade and are no longer distinct from that point inward. If, at that point, the width of the wedge is one-tenth the height of

the picture, then the vertical resolution is 10 x 31 or 310 lines.

The dots along the side of the wedges are markers of definite resolution values. For the pattern of Figure 1, the dots indicate resolution values of 200 and 250 lines respectively and the large and small ends of the wedge indicate 150 and 375 lines, respectively. When checking resolution, remember that, **VERTICAL RESOLUTION IS INDICATED BY THE HORIZONTAL WEDGES IN THE TEST PATTERN.**

In like manner, **HORIZONTAL RESOLUTION IS INDICATED BY THE VERTICAL WEDGES IN THE PATTERN.** It can be expressed in terms of lines also. However, the calculation of horizontal resolution is different due to the 4:3 **ASPECT RATIO** specified by the FCC. This aspect ratio means that the picture width equals four-thirds of the picture height, or its height is equal to three-fourths of its width.

It is desirable that there be a direct comparison between vertical and horizontal resolution, as expressed in lines. For example, 300 lines should indicate the same resolving power in both the vertical and horizontal directions. Therefore, horizontal resolution is the total number of vertical black and white lines that would be reproduced in three-fourths of the width of the

picture, that is, in a horizontal dimension equal to the picture height.

Suppose the test pattern of Figure 1 is observed on a picture tube screen, and black and white lines of the vertical wedge are clear and distinct in to a point where the width of the wedge is equal to one-tenth the picture height. The vertical wedge also contains 31 lines, so the horizontal resolution is equal to 10 x 31 or 310 lines.

Resolution, either horizontal or vertical, can be calculated for any test pattern by the use of the following relationship:

$$\text{resolution in lines} = \frac{H}{W} \times N$$

where: H = picture height

W = width of wedge where lines become indistinct

N = the total number of black and white lines in the wedge.

The dots alongside the top vertical wedge like those on the horizontal wedges are calibrations of resolution in lines. Those near the center indicate 250 lines while the dots further out are for 200 lines.

So long as the spot size is small enough, the **HORIZONTAL RESOLUTION OF A RECEIVER IS DEPENDENT ON THE FREQUENCY RESPONSE OF**

THE RECEIVER. For this reason, sometimes horizontal resolution is expressed in terms of the high frequency response limit of the receiver signal circuits.

The relationship between RESOLUTION IN LINES and RESOLUTION IN FREQUENCY can be determined as follows: The picture tube beam traces 15,750 horizontal lines per second, therefore, one horizontal line is traced in $1/15,750$ th of a second, or in 63.5 microseconds. Of this time, 10.2 microseconds are consumed in retrace. This leaves 53.3 microseconds as the time required for the beam to travel from the left-hand side of the picture to the right-hand side. As only three-fourths of this entire line is used for the calculation of horizontal resolution, the time required for the beam to travel this distance is $\frac{3}{4} \times 53.3$ or 40 microseconds.

Now, assume that the picture tube beam is reproducing a horizontal resolution of 80 vertical lines. This means that three-fourths of the picture width will contain 80 vertical black and white lines which are being produced by the spot on each horizontal trace.

Since the spot is the result of the electron beam striking the screen, to make the spot black the beam must be cut off, while to make a white spot the beam must be of maximum intensity. Ap-

plied to the control grid, the video signal modulates or controls the beam intensity at any instant.

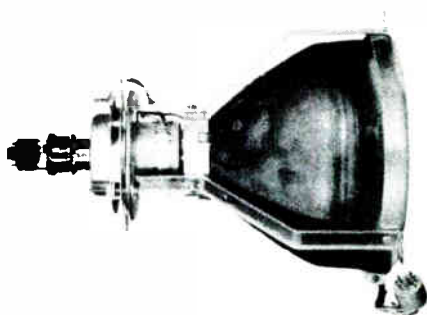

Circular picture tube with deflection coil, focus coil, and beam bender. The focus coil is positioned by means of thumb nuts and picture centering is adjusted by means of the sharp levers.

Courtesy Philco Corp.

Therefore to reproduce a portion of the trace from black line to white line to black line, the video signal has to vary from negative to positive and back to negative. This means that there must be one cycle of video signal for each pair of the 80 vertical lines, or 40 cycles during three-fourths of one complete left-to-right horizontal trace.

As mentioned, this portion of the horizontal trace is accomplished in 40 microseconds. Therefore, to produce a horizontal resolution of 80 lines, there must be 40 cycles of video signal occurring in 40 microseconds, or one cycle per microsecond, which is the same as 1 mc per second.

That is, a video signal frequency of one megacycle is required to reproduce a horizontal resolution of 80 lines.

In like manner a signal frequency of 2 mc produces a horizontal resolution of 2×80 or 160 lines, 3 mc produces 3×80 or 240 lines, and 4 mc produces 320 lines. These facts can be summed up in a general statement or relationship, as follows:

$$f_r (\text{mc}) \times 80 = r_h (\text{in lines}),$$

or

$$\frac{r_h (\text{in lines})}{80} = f_r (\text{mc})$$

where: r_h = horizontal resolution in lines

f_r = video frequency response
in mc.

Referring to the test pattern of Figure 1, the VERTICAL WEDGES not only INDICATE the horizontal resolution of the television system, but also serve as a quick visible means of checking THE HIGH FREQUENCY RESPONSE OF THE RECEIVER. So, by means of the dots along its sides, the bottom wedge is "calibrated" in frequency in megacycles. The wide bottom end of the wedge corresponds to approximately $1\frac{1}{3}$ megacycles, and from this end upward, the first pair of dots indicate 2 megacycles, the second pair 3 megacycles, the third 3.25 mc, and the fourth indicates 3.5 megacycles. Finally, the nar-

row end of the wedge represents 4 megacycles.

In like manner the HORIZONTAL WEDGES INDICATE THE LOW FREQUENCY RESPONSE OF THE RECEIVER. Since the wedge lines are practically parallel to the scanning lines, in fact the center line of each wedge is horizontal, it takes a relatively long time to cross from one line to the adjacent line of the wedge. Hence, it is reproduced by low frequency video signals. Therefore, good reproduction of the horizontal wedge is dependent on good low frequency response.

As a rule, the low frequency response of receivers is good, and the wedges are normally distinct to the center. So most interest is concentrated on the high frequency response indicated by the vertical wedge.

Contrast

On a television receiver screen, the entire picture is produced by the CONTRAST between light and shadow. The darker the shadows and the brighter the light portions, and provided the appropriate intermediate shadings are present, the greater the contrast, the more vivid and distinct the picture.

To supply a means of determining the degree of contrast, the test pattern of Figure 1 has light and dark areas at the outer ends

of the horizontal wedges, and a series of shading rings which vary from black through successively lighter shades of gray to white around the "bull's eye" at the center. These shading rings facilitate adjustment of the receiver contrast control.

Up to a certain point, the degree of contrast is proportional to the strength of the signal on the picture tube grid. If the signal is increased beyond this point, the black areas cannot become blacker, but the dark grays become darker and soon merge with the black. Thus, some of the intermediate shading is lost. Proper contrast is the maximum that can be obtained without loss of the dark gray shadings.

When the contrast control is not advanced sufficiently, the signal on the picture tube grid is too weak, and the entire pattern has a washed out appearance. That is, the black areas are gray, and the light gray areas blend with the white areas. As the contrast control is advanced to provide greater signal strength on the picture tube grid, the black areas of the pattern become darker and the light shading rings become more and more distinct.

To adjust the contrast properly, advance the control until the point is reached where the increase of contrast makes the darkest gray ring seem to blend

with the central black spot. Further increase of contrast does not improve the picture, but will increase the over-all contrast at the expense of the shading.

As determined by the test pattern, proper setting of contrast is the point at which all degrees of intermediate shading are most clear and distinct.



Two representative television controls. The top unit is used as an on-off volume control while the lower "pot" may be used as contrast, brightness, etc.

Courtesy International Resistance Co.

Brightness

There is a definite distinction as well as a definite relationship between contrast and brightness. CONTRAST IS THE DIFFERENCE IN THE DEGREE OF SHADING BETWEEN THE LIGHT AND DARK PORTIONS OF THE PATTERN. BRIGHTNESS IS THE AVERAGE LEVEL OF ILLUMINATION OF THE ENTIRE PICTURE. Therefore, contrast can increase brightness only to the extent of making the light areas of the image brighter.

The function of the brightness control is to vary the average beam intensity. For example, assume a raster is produced on a screen, but no signal is applied to the grid. In this case, the "picture" is an illuminated area made up of all bright portions. The intensity of the electron beam is determined by the setting of the brightness control, and therefore, the bias between grid and cathode.

Now, assume the picture is the test pattern of Figure 1. As the brightness is increased, the various areas become brighter due to increase in beam intensity. This improves the picture, but only to the point where the light gray shadings are not impaired. Here, the shading rings of the test pattern are of assistance again. As the brightness is increased, the shading rings should be observed closely and when the light gray and white areas tend to merge, the brightness control should be advanced no further. Further increase in brightness reduces the intermediate shading in the pattern, and eventually causes the black areas to fade so that the whole pattern appears washed out.

There is a considerable interaction between the contrast and brightness controls, such that adjustment of one necessitates adjustment of the other. For example, increase in the contrast may

make black areas darker and more distinct, but the picture may be lacking in light gray shading because the brightness level is too low. Then the needed adjustment of the brightness may cause the retrace lines to appear, making further adjustment of contrast necessary.

There is one precaution against advanced settings of either brightness or contrast. When the beam intensity is increased beyond a certain point, the scanning spot tends to "mushroom", or grow in size. This action reduces the picture detail, for the fineness of detail requires a small spot. If the distinctness of the fine details is improved by a reduction of contrast or brightness, it indicates that the spot was enlarged by excessive intensity of the electron beam.

Final adjustment of contrast and brightness may vary with individual taste or preference. Some receiver owners prefer extreme brightness even to the point of sacrificing contrast; while others like a picture of less average brightness but with more variation in intermediate shading.

THE RTMA RESOLUTION CHART

Developed by the Engineering Department of the Radio and Television Manufacturers' Association the test pattern of Figure

2 is of primary value in testing television transmitter operation. While, at first glance, this pattern seems to bear little or no resemblance to the one used by NBC, closer inspection shows considerable likeness, and both patterns contain parts which serve corresponding functions.

The chart of Figure 2 was prepared primarily for checking performance of transmitting equipment to reduce distortion to a minimum by adjusting for proper scanning, focus, shading, and to minimize low-frequency phase shift.

Useful to CRT manufacturers are the small concentric circles at the center of the chart and at the center of the resolution wedges in each corner. These small circles are not reproduced properly when the scanning spot is elliptical instead of circular.

For the scanning action to be correct, the equipment must be adjusted for proper picture size, linearity, and aspect ratio. To obtain the desired size, the camera is focused optically so that the chart covers the entire area scanned by the camera. The boundaries of the chart are indicated by the triangular arrow heads, two of which are located along each edge.

Marked "200", there are six groups of short horizontal bars in the pattern, and vertical linearity

is checked by comparing the spacing of the bars in the groups at the top and bottom of the pattern with those midway between. The "200" indicates that the vertical resolution must be equal to at least 200 lines for these bars to be distinct. Proper linearity is indicated by equal spacings in all six groups. Marked "200" for the same reason as above, the three groups of longer vertical bars are employed in similar manner to check horizontal linearity.

Forming a square which just fits in the large white circular area are strips known as gray scales consisting of variously shaded segments numbered from 1 to 10. If both vertical and horizontal scanning is linear, and the respective size controls are adjusted so that measurement shows the gray scales to form a perfect square, then the aspect ratio is correct.

In the large white circle, the four diagonal black lines are employed to check interlacing. These lines appear jagged when the interlaced scanning lines are "paired", not equally spaced.

Both the camera optical lens and the camera tube scanning beam are focused by adjusting for maximum resolution of the converging lines of the wedges. The camera shading is adjusted until the pattern background is an even gray and a maximum

number of shades can be "read" on all four gray scales.

Note that there are two heavy black bars above the top gray scale and below the bottom gray scale. Low-frequency phase shift is indicated by the presence of streaking to the right of any of these bars. After these various adjustments are made, the resolution of the system is determined by checking the horizontal and vertical wedges, both the large wedges in the central portion of the chart and those in the small circles in the corners.

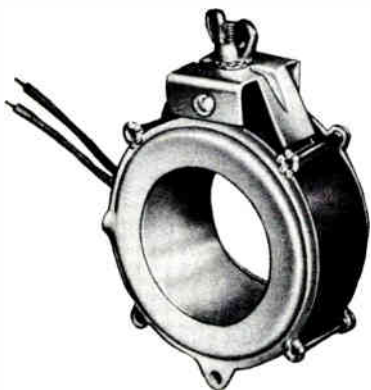

An electromagnetic focus coil. To permit quick and easy adjustment of position, a wing nut is provided for mounting the unit.

Courtesy General Electric Co.

As explained before, vertical resolution is indicated by the horizontal wedges, while the vertical wedges indicate horizontal resolution. To indicate resolution in lines, there are numbers rang-

ing from 200 to 600 along the large wedges in the center, and on concentric circles joining the small wedges in the corners. The lower large vertical wedge is marked off in megacycles as well as lines as shown.

Labeled 50-300 and 350-600, the two groups of single-line width marks are included to provide an accurate means of checking "ringing", or high-frequency oscillation in the equipment. If for any reason, there is oscillation occurring at some frequency, the frequency is indicated by one of these marks being reproduced several times to the right of its regular position.

The lower group of marks represent horizontal resolutions of 50, 100, 150, 200, 250, and 300 lines, respectively, and the upper group resolutions of 350, 400, 450, 500, 550, and 600 lines, respectively. Thus, the oscillation frequency can be determined by means of the conversion equation given above.

As an example, suppose ringing is indicated to the right of the fourth mark from the top in the lower group. As this mark represents horizontal resolution of 200 lines, the oscillation frequency must be in the neighborhood of $200 \div 80 = 2.5$ mc.

Any such ringing affects the vertical resolution wedges also, but the multiple lines produced in

the wedge are rather confusing, and it is more difficult to determine the exact resolution value to which they correspond.

RECEIVER CONTROL ADJUSTMENTS

There exists little standardization among television receiver manufacturers as to the name or location of the various controls. Some models include a large number of controls on the front panel and only a few on the rear of the chassis. In other models, the reverse arrangement is employed, while still others have layouts ranging between these extremes. To present the appearance of a minimum of front panel controls, many receivers have a small recess in front in which are located some of the non-operating controls and often a few of the secondary operating controls. This cavity is located just above, below, or between the exposed operating controls, and normally is fitted with a spring mounted or hinged cover to conceal these extra controls.

Examples of the wide variation in control locations are demonstrated in Figures 3 and 4. The controls on the front panel of a typical television receiver are shown in Figure 3A. At the left, the VOLUME CONTROL ON-OFF SWITCH and BRIGHTNESS CONTROL are mounted on concentric shafts so that the larger outer knob may

be rotated independently of the smaller inner knob. The same mounting arrangement is used for the two controls at right. Here, the BAND SWITCH selects the upper or lower television band, and the CHANNEL TUNING control permits continuous tuning over the selected band.

The controls at the rear of this receiver are shown in Figure 3B. The adjustment screws for CENTERING and FOCUSING are on the focus coil, and the HORIZONTAL SIZE and LINEARITY coils are located in the assembly beneath the picture tube socket. From left-to-right along the rear of the receiver chassis, the control adjustment screws and shafts are available for adjusting AGC, HORIZONTAL DRIVE, HORIZONTAL HOLD, CONTRAST, VERTICAL LINEARITY, HEIGHT, and VERTICAL HOLD.

As an example of a receiver with most of its controls on the front panel, Figure 4A illustrates the front panel of a popular combination receiver. Here, the radio and television tuning controls have large knobs located at each end of the panel, while six operating controls with medium size knobs are arranged in a row at the lower center of the panel. Except for the horizontal hold and brightness controls, all of these have the concentric mounting arrangement explained for Figure 3A. The cover is removed to show a recess at the upper center of

the panel, which contains the VERTICAL LINEARITY, VERTICAL HOLD, HEIGHT and FOCUS CONTROLS.

Only a few controls are located at the back of this receiver, as shown in Figure 4B. Here, the HORIZONTAL LOCK adjusts a tuned circuit which maintains the horizontal deflection oscillator at constant frequency. As indicated, the other three controls are contained in the horizontal deflection circuits, also.

As previously mentioned, there is considerable variation in the sequence used for control adjustments, depending upon the condition of the raster or image in each individual case. It would be next to impossible to include specific instructions for every possible situation and receiver model. Also, because such instructions would be so voluminous as to be unwieldy, they would be impractical.

Therefore, a single, generalized sequence is given to indicate roughly the order in which the controls should be adjusted in the extreme case where every control is out of adjustment to begin with. This extreme situation is assumed in order to include all controls, but in most instances at least a few controls are found to have correct settings, and therefore, the actual procedure employed will vary accordingly.

Before turning on a television receiver for the first time, it is advisable to rotate the contrast and brightness controls toward their minimum settings as this helps to keep the surge currents to a minimum throughout the receiver. Usually, the on-off switch is incorporated with one of the other controls, such as the volume, tone, or contrast control, and, after being turned on, the receiver should be allowed to warm up for a few minutes.

The Ion Trap

AN ION TRAP is an arrangement employed to prevent damage to the fluorescent screen due to ion bombardment in picture tubes employing magnetic deflection. In electrically deflected tubes, the deflection field causes the ions in the scanning beam to spread out over a greater area so that they do not produce an ION SPOT. Also, the magnetically deflected tubes with metallized screens are not damaged in this way because the metal coating protects the fluorescent material of the screen. Thus, an ion trap is not employed with either of the latter types of picture tubes. However, it is absolutely essential with the non-metallized screen, magnetically deflected types.

Briefly, the ion trap action is as follows: Produced by a certain configuration of the electron gun structure, a specially shaped elec-

tric field acts to deflect any negative ions in the beam from the axis of the tube so they strike and are collected by the No. 3 grid (second anode) of the gun. Called the ION TRAP MAGNET or BEAM

Should the tube be operated with the ion trap magnet considerably out of adjustment, damage may result within a relatively short time. Therefore, when a receiver has just been installed

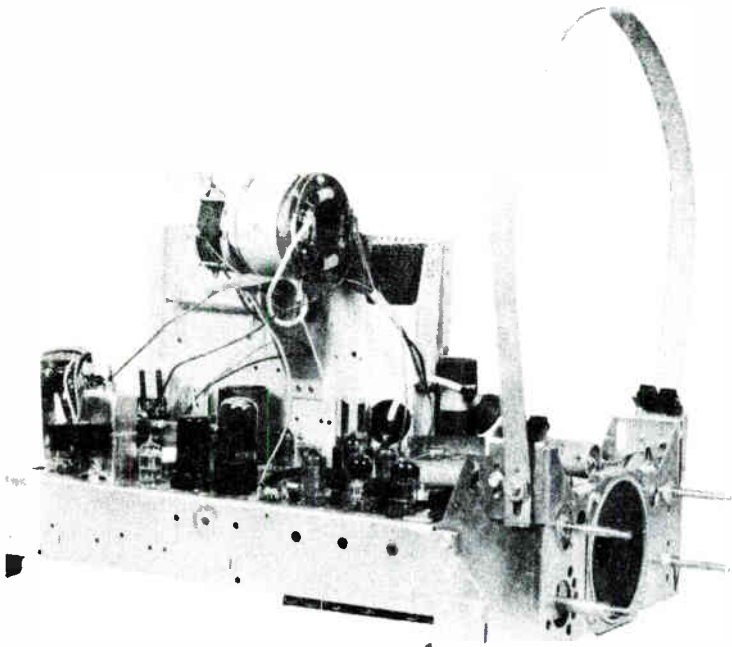

A side view of the television receiver chassis. The focus coil of the preceding illustration is shown mounted in back of the deflection yoke.

Courtesy General Electric Co.

BENDER an arrangement containing one or two magnets is situated around the outside of the tube neck, and its field or fields serve to separate the electron and ion beams so the electrons can be returned to the tube axis and continue to the screen.

and is to be operated for the first time, the position of the beam bender should be checked to make sure it is in the approximately correct position before the receiver is turned on. This approximate or initial position is indicated by pole pieces, called **FLAGS**,

projecting from the sides of the 2nd grid of the electron gun. Different manufacturers specify somewhat different procedures for initial ion trap adjustment, and the service manual instructions should be checked when possible for each particular receiver make and model.

In order for the ion trap to operate properly, the magnets must be located at the correct point along the neck of the tube. In the two-magnet types, both are assembled as a unit, and therefore are adjusted together. To make the proper adjustment the brightness should be turned up until the raster is just visible. With a turning motion, the unit is pushed forward and backward slowly to locate the point at which the raster is brightest.

If the raster becomes excessively bright, the setting of the brightness control is decreased and the ion trap magnet again is adjusted for maximum brightness. Never leave the magnet at any setting other than maximum brightness, for any other setting will cause the beam electrons to bombard and destroy the gun electrodes.

In the case of the single-magnet units, it is possible to locate two points at which the raster becomes bright, one of which is incorrect, and may result in eventual damage to the gun. This point

is nearer the bulb end of the tube neck, while the correct point is nearer the base end of the neck, and usually the correct point will produce a somewhat brighter raster than will the incorrect point.

Brightness and Contrast

With the BRIGHTNESS CONTROL adjusted until the raster is just visible, turn up the contrast control until a test pattern appears on the screen. If all the controls were out of adjustment originally, as assumed above, the received pattern will not have proper size, centering, linearity, or focus at this time. Since these adjustments are made best with a test pattern on the screen a channel should be selected on which a pattern is being transmitted.

As mentioned earlier in the lesson, certain television stations transmit test patterns during specific hours of the day only. If neither a pattern or a program picture is received when the contrast control is first turned up, there may be no station transmitting on that channel, and other channels should be tried in an attempt to obtain a test pattern.

As a single tone audio signal usually accompanies a test pattern, reception of the latter can be distinguished from a program image, even when only a meaningless jumble appears on the

viewing screen. If no test pattern is being transmitted, one of the received program pictures must be used for making the control adjustments.

The CONTRAST CONTROL is a variable resistance unit employed as either a potentiometer or a rheostat which controls the grid bias on one of the video amplifier stages or in one or more of the stages in the r-f and i-f sections of the receiver. This control of the grid bias permits varying the amount of signal amplification obtained in the controlled stages, and therefore, the strength of the video signal ultimately applied to the grid of the picture tube.

The positive portions of the applied video signal represent the light parts of the reproduced pattern, while the negative portions represent the dark areas. Therefore, the farther the contrast control is advanced, the greater is the peak to peak voltage of the video signal, and the greater is the brightness difference, or contrast, between the light and dark portions of the reproduced image.

Channel Selector

The channel selectors in current use are the push-button, rotary switch selector, turret, and continuous tuning types. Fundamentally, all do the same thing, that is, tune the resonant circuits of the r-f, mixer, and oscillator

stages to the correct frequencies for receiving the desired station.

Except for their mechanical differences, the push-button and rotary switch types are alike. They serve to remove inductance, capacitance or both from the respective tuned circuits, as the receiver is switched to successively higher channels. In turret tuners, the entire set of tuned circuits is replaced by a different set, as each station is tuned in. In the continuous tuning systems, variable inductance or capacitance elements are varied continuously over an entire band of television channels.

Fine Tuning Control

Generally, a variable capacitor or inductor, adjusted by the FINE TUNING CONTROL permits the receiver local oscillator to operate at the exact frequency required for the production of the correct picture and sound intermediate frequencies. For example, in a receiver employing a picture i-f of 45.75 mc, the local oscillator must operate at 123 mc when the set is tuned to receive channel 5, (76 to 82 mc). Thus, the produced picture i-f is $123 - 77.25$, or 45.75 mc, and the sound i-f is $123 - 81.75$, or 41.25 mc.

In a dual-channel type receiver the sound i-f circuits are tuned relatively sharply to the sound i-f band, therefore the sound i-f sig-

nals will fall outside this band if the local oscillator frequency is appreciably above or below its correct value. In the dual-channel receiver, the fine tuning control is adjusted for best sound quality.

In an intercarrier type receiver, the picture i-f and first sound i-f both pass through a common i-f amplifier, the tuned circuits of which are aligned to give the proper relative i-f response.

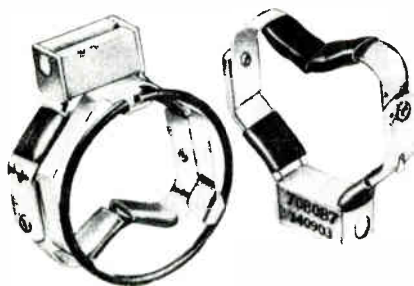

The proper adjustment of the beam bender or "ion trap magnet" is the point on the neck of the CRT at which the raster is brightest.

Courtesy Clorostat Mfg. Co.

If the local oscillator is mistuned so that the sound i-f amplitude is greater than about 10% of that of the picture i-f, then the 4.5 mc second sound i-f, produced in the video detector, is frequency modulated by the video signal, causing an undesirable VIDEO BUZZ in the loudspeaker.

In an intercarrier receiver, the fine tuning control is adjusted for best picture quality but sometimes it may be necessary to adjust to a point of less than maxi-

mum picture quality to reduce the video buzz to an acceptable level. Such a compromise adjustment results in inferior quality of picture and sound, and is not necessary when the receiver is aligned properly.

A few receivers do not use a fine tuning control, but rely on the stability of the local oscillator and its pre-set adjustment to produce correct sound and picture i-f's. This arrangement permits the manufacturer to advertise one less front panel control, but it may increase the number of service calls for adjustments which a fine tuning control makes unnecessary.

After the channel selector is set to receive the desired signal, the tuning is completed by adjusting the fine tuning control as explained above. In most cases, a test pattern is now visible on the receiver screen, although the pattern may be distorted in one or more ways as mentioned earlier. In the event the viewing screen contains a hopeless jumble, then some adjustment of one or both of the scanning frequencies is necessary.

Hold Controls

The so-called "hold" controls permit adjustment of the deflection oscillator frequencies over a limited range. The VERTICAL HOLD controls the 60 cycle scanning

frequency, and its misadjustment results in loss of vertical synchronism as illustrated in Figure 5A. The HORIZONTAL HOLD controls the 15,750 cycle scanning frequency, and Figure 5B illustrates the result when this control is misadjusted.

Notice that these and subsequent Figures show a number in front of the title. This number refers to the same Figure in lesson TSM-5. For example, Figure 5A reads 11. POOR VERTICAL SYNC. The "11" refers to Figure 11 of TSM-5. Since the illustrations in TSM-5 are larger, this reference number makes it easy for you to examine these larger pictures for details.

To obtain proper synchronism, the vertical motion of the pattern is stopped first by adjusting the vertical hold control. Usually, this adjustment results in the pattern being obtained with no adjustment of the horizontal hold being necessary. This is due to the fact that the line scanning action is locked in synchronism by the automatic sweep-frequency control circuit employed in the horizontal deflection system of most receivers. However, should the image continue to be a meaningless jumble, or if a distorted part of the test pattern is duplicated a number of times, then some adjustment of the horizontal hold control is necessary.

Besides the horizontal hold control, most receivers contain one or more additional controls for correcting the horizontal deflection frequency. These additional controls must be adjusted when horizontal synchronism cannot be obtained with the hold control only. Before changing the settings of these other horizontal frequency controls, it is a good plan to check whether synchronism can be obtained on another channel by means of the hold control only.

The procedure for making horizontal oscillator adjustments varies considerably with different receiver makes and models. Therefore, when such adjustments are required, reference should be made to the service manual which applies to the specific model being installed or serviced.

Tilted Picture

After the deflection circuits have been synchronized and a test pattern obtained, it may appear rotated or tilted in either direction from the normal position as shown in Figure 5C. For the magnetically deflected type picture tube, this condition is corrected by temporarily loosening the deflection yoke and rotating the yoke until the raster is square with the mask.

For the electrostatic deflection type picture tube, the entire tube,

socket and all, must be rotated to the correct position. In this case, the socket is mounted with a set screw adjustment which is tightened to hold the tube in place.

Focus

The receiver may be focused by adjusting the control and observing the fine details of the test pattern or by checking the setting at which the scanning lines are thinnest. Improper focus is illustrated in Figure 5D. With magnetically focused picture tubes, the setting of the FOCUS CONTROL determines the magnitude of the direct current carried by the electromagnetic focus coil, and therefore the strength of the magnetic focusing field.

In some receiver models, a PM focus magnet is employed, in which case adjustment screws or some similar arrangement is provided to permit focusing by changing the axial location of the magnetic focusing field or by varying an air gap in the magnetic field. For electrically focused tubes, the focus control determines the voltage applied to the focusing electrode of the electron gun. Some of these tubes require zero voltage on the electrode, and since it is so non-critical, these tubes are referred to as zero focus or self focus tubes.

It is desirable to obtain optimum focus over the largest pos-

sible area of the screen, and the resolution wedges of the test pattern may be employed to check horizontal versus vertical resolution as the focus control is adjusted. Maximum resolution will not always be obtained in both directions at the same setting at which the horizontal scanning lines are seen most clearly over most of the picture area.

In the event satisfactory focus cannot be obtained by adjustment of the focus control with a magnetically focused tube, it may be necessary to move the focus coil backwards slightly, away from the deflection coil, in order to achieve satisfactory focus over the largest area of the picture.

Interaction of Controls

Although properly rotated or oriented so that horizontal lines in the test pattern are parallel with the upper and lower edges of the receiver mask, the raster may be off-center horizontally as shown in Figure 6A, off-center vertically, or both, as shown in Figure 6B.

With receivers employing electrically focused picture tubes, centering of the raster sometimes is accomplished by adjusting the rotational position of the CENTERING MAGNET around the tube neck. In the case of magnetically focused tubes, some or all of the centering screws must be adjusted

on the focus coil until the desired raster position is obtained. In some cases, it may be necessary to loosen the focus coil mounting screws also.

Generally, loosening and adjusting the various screws will permit the focus coil to be tilted, moved slightly up or down, right or left, forward or back, or rotated about a vertical axis with respect to the picture tube neck.

Since changing the position of the focus coil affects the picture focus, adjustments for uniformity of focus should be made first by moving the coil along the neck of the tube, simultaneously adjusting the receiver focus control, after which the coil is adjusted to center the picture and the mounting screws tightened.

Other receivers contain CENTERING CONTROLS in the form of potentiometers which determine the magnitude and sometimes the direction of direct currents carried by the deflection coils, or the direct voltages applied to the deflection plates, depending upon whether magnetic or electric deflection is employed. These direct currents or voltages add unidirectional field components to the deflection field, thus determining the vertical and horizontal center lines about which the beam is deflected.

Generally, it is possible to obtain proper centering by the ad-

justment of these controls only. If the raster cannot be centered completely by means of the centering controls, or if a shadow exists across the corner of the picture, it may be necessary to adjust the physical position of the focus magnet or coil as explained above.

The size controls, HEIGHT and WIDTH, determine the amplitude of the sawtooth voltages on the deflection plates, or the sawtooth currents in the deflection coils, respectively, and therefore, the height and width of the raster produced on the receiver screen.

It is difficult or impossible to adjust the height and width controls properly before the raster is centered. Also, it may not be possible to complete the centering adjustments without making some adjustments of height, width, or both, especially when the height and width controls have initial settings which are too far advanced so that one or both of the raster dimensions exceed those of the mask.

The centering and focus adjustments are interdependent, therefore each should be rechecked, one or more times, until the best possible image is obtained. After the raster is centered and has approximately correct height and width, final adjustments of the focus control, or adjusting screw, should be made carefully to pro-

vide the optimum focus conditions as specified in the service manual for the particular receiver. Finally, the adjustment of the ion trap magnet should be checked to see that the brightest possible raster is obtained, as explained.

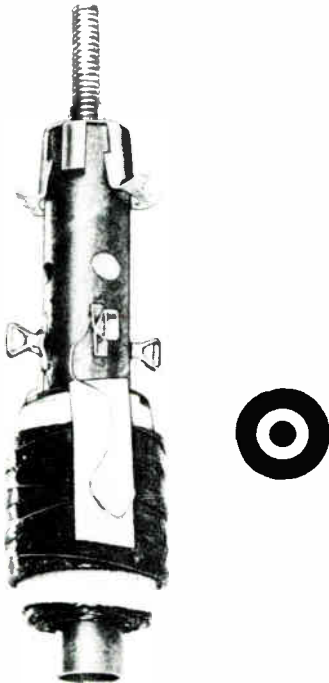

An inductance of the type used as horizontal linearity and width coils in the television receiver. A powdered iron core is used to vary the inductance over a small range.

Courtesy Merit Coil and Transformer Corp.

Insufficient height is illustrated in Figure 6C, and poor vertical linearity in Figure 6D. The vertical linearity control determines the curvature in the forward sweep portion of the vertical de-

flexion sawtooth wave-form. However, this control has considerable effect on the deflection voltage or current amplitude. Likewise, the vertical size or height control has most effect on the deflection amplitude, but its adjustment causes some change in the linearity of the wave-form. Therefore, when either of these controls is adjusted, usually it is necessary to adjust the other also.

The general procedure is as follows: Adjust the HEIGHT CONTROL until the raster just fills the mask vertically. Adjust the VERTICAL LINEARITY CONTROL until the distances are equal from the center to the top and bottom of the reproduced test pattern. Re-adjust linearity control, etc., until both the proper height and best over-all vertical linearity are obtained. After or during these adjustments, some slight re-adjustment of the vertical centering may be necessary.

Figure 6E and 6F illustrate insufficient width and horizontal non-linearity, respectively. Similar to the vertical circuit controls, the WIDTH and HORIZONTAL LINEARITY controls each have effect on both the amplitude and linearity of the horizontal deflection wave-form. The wave-form also is affected by the horizontal drive control which determines the amplitude of the deflection voltage applied to the grid of the horizontal deflection amplifier.

In addition to the deflection coils, the horizontal amplifier drives the flyback high voltage supply in many receivers. The brightness of the scanning spot is determined by the potential of the picture tube anode which obtains its positive voltage from the high voltage supply. Therefore, the raster brightness depends upon the output of the horizontal deflection amplifier, and this output is determined by the setting of the **DRIVE CONTROL**. However, besides the brightness, the drive control affects both the width and horizontal linearity of the raster. Advancing the setting of the drive control causes increase in brightness and width, while reducing its setting improves the linearity. Thus, all three are interdependent controls.

A good procedure for adjusting the width, drive, and horizontal linearity controls is as follows: Adjust the drive control for maximum raster width and brightness consistent with reasonably good linearity. Adjust the width control until the raster just fills the mask horizontally. Adjust the horizontal linearity control until the distances are equal from the center to the left and right sides of the test pattern. Alternately re-adjust the width and linearity controls until the desired width and linearity are obtained, at the same time re-adjusting the drive control if

necessary. After or during these adjustments, it may be necessary to make slight re-adjustments of the horizontal centering.

INSTRUCTING THE OWNER

Most of the various adjustments described need be made only when a receiver is first installed or when, for some reason, certain or all of the controls have been misadjusted. Generally, the television receiver controls can be classified as "operating" controls, and service or "non-operating" controls. Once properly adjusted, the non-operating controls do not have to be changed by the owner for normal operation of the receiver. As shown in Figure 4, the operating controls are usually available on the front panel, and are the only ones that the owner needs to use. However, to advertise simplicity of operation, some manufacturers locate certain of the less often needed operating controls at the rear of the receiver, as pictured in Figure 3, thus leaving fewer controls in sight on the front panel.

Except for a few absolutely necessary controls which appear on the front of every set, the particular receiver design determines which operating controls are needed most often. Thus, there are many variations in the combinations of front panel controls employed on different receiver makes and models. Because of

these variations, there are slight differences in the specific operating procedures recommended by the different manufacturers, and these procedures are given in the service manual for each model.

Too many television service calls are of the "unnecessary" type due to the fact that many people simply do not know how to operate their receivers. Probably dissatisfied with the picture quality because of his incorrectly set operating controls, often the receiver owner will begin to change the settings of the non-operating controls.

As explained in the section above on control adjustments, many of the non-operating controls are interdependent. Thus, the owner may not achieve the expected result indicated by the name of the first-non-operating control adjusted, and this may lead him to change more and more of these controls until so many are misadjusted that he is unable to obtain a picture which is acceptable at all. Then he concludes something is wrong with the receiver and calls the serviceman.

This situation is difficult to explain to the owner-customer, and it is far better that it be avoided in the first place by seeing to it that at least one member of the owner family is carefully instructed as to the proper opera-

ting procedure for that particular model at the time the set is installed.

Equal in importance to the operating procedure, the necessity of leaving the non-operating controls alone must be impressed upon the owner. Generally, this is easy to do because of the relative location of the two groups of controls. However, when one or more of the operating type controls are at the back of the receiver, their location should be pointed out carefully to avoid possible accidental misadjustment of the other controls.

The front panel of every television receiver contains an on-off switch, sound volume control, and a channel selector. In most cases, the on-off switch, and volume control are operated by the same knob. Thus, by rotating this knob about a half-turn clockwise, the receiver is turned on and an initial volume control setting is made. Setting the channel selector to the channel number of the desired station and resetting the volume control to provide the desired sound level completes the basic steps of the operating procedure, regardless of the make or model of the receiver. Also, when tuning from station-to-station, the fundamental steps consist of turning the channel selector to the desired setting and adjusting the volume control slightly if necessary. In some cases, these may

be all the adjustments necessary, even though the receiver has several other operating controls on its front panel.

control. In the event the volume control was advanced too far initially, its setting may have to be reduced to permit obtaining best

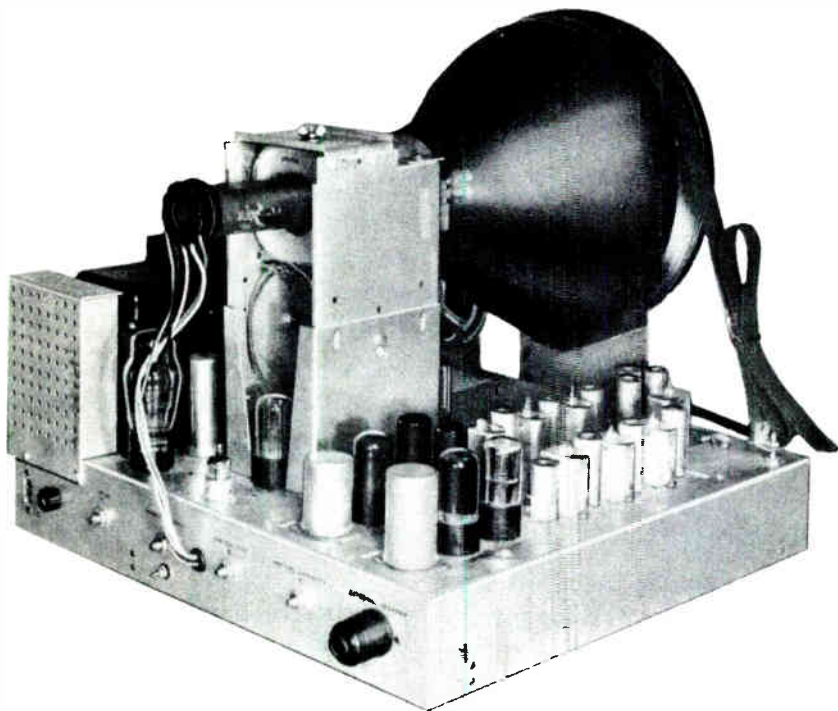

The non-operating controls are shown mounted on the back of this receiver chassis. From left to right, these controls are: focus, horizontal drive, vertical size, and vertical linearity.

Courtesy Meissner Mfg. Div., Moguire Industries, Inc.

Practically every receiver has either the fine tuning, contrast or brightness control, a combination of two, or all three as main operating controls on the front panel. With a dual-channel receiver, the fine tuning control is adjusted immediately after the setting of the channel selector, and before the final adjustment of the volume

sound quality with the fine tuning control.

Next, the contrast or brightness control, whichever is present, is set for the most pleasing picture. The appearance of the image when the contrast is too high is illustrated in Figure 6G, while Figure 6H shows the result when the brightness is too high.

With an intercarrier receiver, the fine tuning control is adjusted after the first adjustments of the contrast and brightness controls which are described below.

The effect of changing the contrast is similar to but not the same as changing the brightness, and when both of these controls are available, they will produce the best picture when their first adjustments are made as follows:

1. Rotate the contrast control fully counterclockwise.
2. Set the brightness control to the point where the screen just barely glows.
3. Advance the contrast control to the point of desired picture contrast.

If video buzz is heard at this point with an intercarrier receiver, reduce the setting of the contrast control until the buzz is inobtrusive. If retrace lines are visible reduce the brightness control setting until they disappear. With an intercarrier receiver, the fine tuning control is now adjusted for the sharpest and clearest picture. Finally, with either type of receiver, make final touch-up adjustments of the contrast and brightness controls.

A few television receivers include horizontal hold, vertical hold, and focus controls on the front panel. Usually, these do not have to be adjusted every time a

station is tuned in, and may be considered secondary operating controls. When hold control adjustments are necessary, they should be made just after the initial contrast and brightness control adjustments described above. Adjust the vertical hold until the vertical motion stops, and then the horizontal hold until a picture is obtained and centered. To obtain synchronization, it may be necessary to increase or reduce the setting of the contrast control somewhat.

The focus control can be adjusted after the desired contrast and brightness have been obtained. Finally, a slight re-adjustment of all three of these controls may further improve the picture quality.

If the receiver contains a tone control, it may be adjusted along with the volume control. Most tone controls affect the sound volume, therefore a final adjustment of the volume control usually is made after the desirable tone has been obtained. After a dual-channel type receiver has been in operation for 10 or 20 minutes, the local oscillator may have drifted sufficiently to impair sound quality so that re-adjustment of the fine tuning control is necessary.

A few receivers contain one or more controls or switches not mentioned above. One such control is the "FUNCTION" SWITCH

which permits selection of television, FM radio, AM radio, or phono in the combination type receivers. A high-low band-switch is employed in some designs which contain continuous tuning type r-f tuners. An antenna trimmer control permits tuning the antenna circuit for best reception in a particular channel, and an antenna switch permits selection of either the outdoor or built-in antenna.

A CIRCLE-NORMAL switch allows the raster to be changed from a rectangle to a circular screen pattern. For the rectangle raster, the diagonal is equal to the diameter

of the picture tube face. To produce a circular picture, the height of the raster equals the diameter of the picture tube. Although the picture ends and corners are lost, this latter arrangement increases the picture size.

Adjustment of the various controls forms one of the important steps in television installation and one of the initial steps in troubleshooting, regardless of the nature of the suspected trouble. Therefore, the adjustments explained above should be considered carefully, for correctly adjusted controls help to create a satisfied owner and a future customer.



STUDENT NOTES

STUDENT NOTES



FIGURE 1

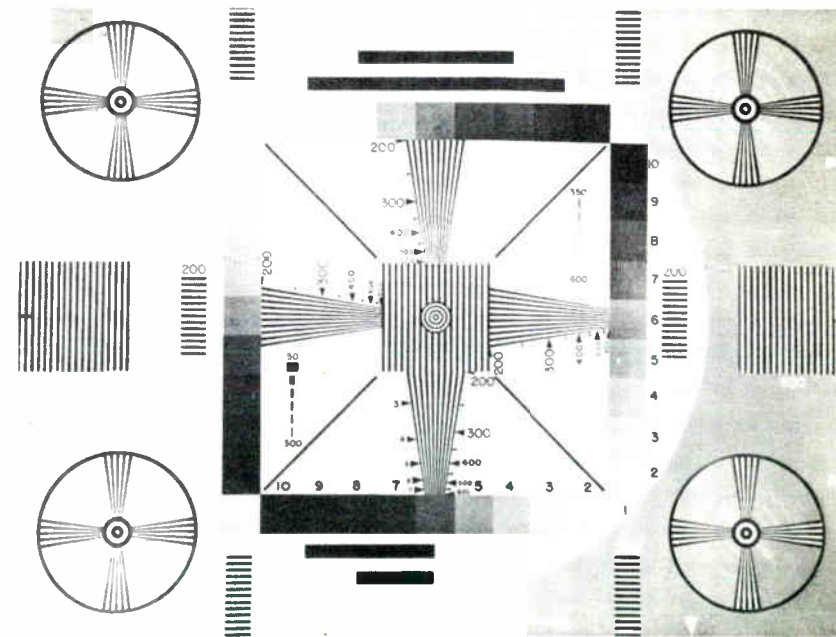
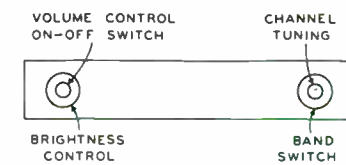
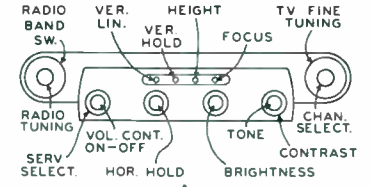

FIGURE 2

TSM-4



A



A

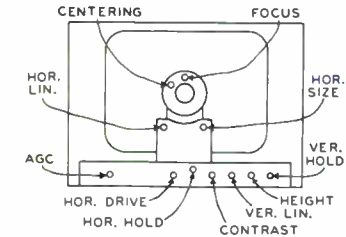

B

FIGURE 3

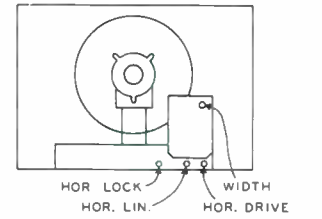

B

FIGURE 4

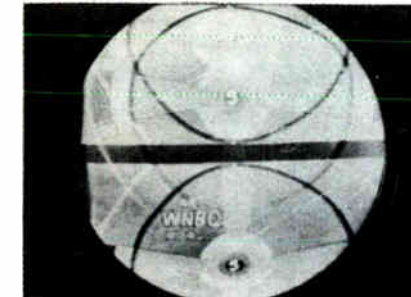

11. POOR VERTICAL SYNC.

A

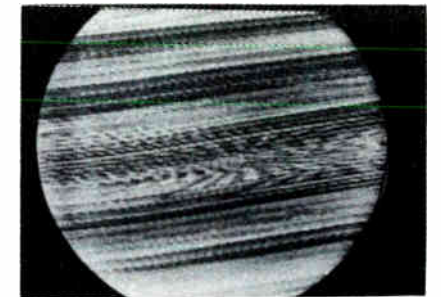

36. NO HORIZONTAL SYNC.

B



37. PICTURE TILTED

C



17. OUT OF FOCUS

D

TSM-4

FIGURE 5

COURTESY - FARNSWORTH



5. POOR HORIZONTAL CENTERING
A

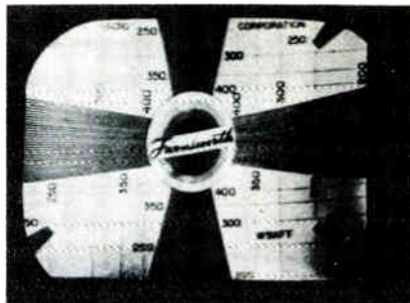

6. POOR CENTERING
B
COURTESY-FARNSWORTH

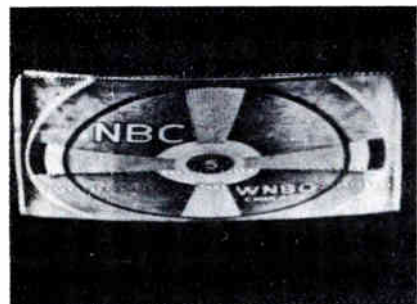

4. INSUFFICIENT VERTICAL HEIGHT
C



9. POOR VERTICAL LINEARITY
D



3. INSUFFICIENT HORIZONTAL WIDTH
E

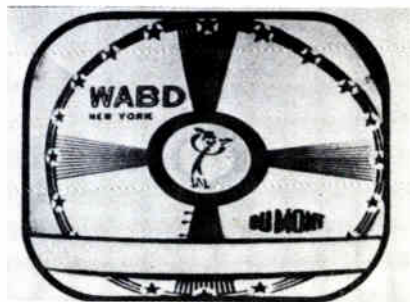

8. POOR HORIZONTAL LINEARITY
F
COURTESY-DUMONT

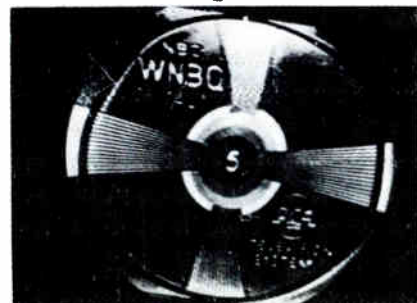

1. TOO MUCH CONTRAST
G



2. TOO MUCH BRIGHTNESS
H

DeVRY Technical Institute

Formerly DeFOREST'S TRAINING, INC.

4141 WEST BELMONT AVENUE

CHICAGO 41, ILLINOIS

QUESTIONS

Control Adjustments—Lesson TSM-4B

Page 35

1

How many advance Lessons have you now on hand?.....

Print or use Rubber Stamp.

Name..... Student No.....

Street..... Zone..... Grade.....

City..... State..... Instructor.....

Write your answers on the "Ans." line below each question. If more space is needed use reverse side of this page.

1. When no test pattern is being transmitted, what method may be used to check vertical linearity?

Ans.

2. What technique should be used to determine whether non-linearity is due to the receiver or to the transmitter before making final adjustments?

Ans.

3. With regard to the television image, what is the meaning of the word "focus"?

Ans.

4. With a test pattern, do you observe the vertical or the horizontal wedges to check vertical resolution?

Ans.

5. What portion of a test pattern provides a measure of the high frequency video response?

Ans.

6. On a given receiver screen, the entire pattern has a washed out appearance. Areas that should be black are dark gray, and those that should be white are light gray. This condition most likely is caused by improper adjustment of what control?

Ans.

7. With regard to the picture tube beam intensity, what is the function of the brightness control?

Ans.

8. What is a danger of operating the picture tube when the ion trap magnet is considerably out of adjustment?

Ans.

9. What is the procedure used for correcting a tilted picture in a receiver employing a magnetically deflected picture tube?

Ans.

10. At the time a television receiver is installed in a customer's home, what instruction should be given to avoid later service calls of the "unnecessary" type?

Ans.

TSM-4B

FROM OUR *Director's* NOTEBOOK

ACCENTUATE THE POSITIVE

When you apply for a job, a positive mental attitude can do more to achieve the results you want than any other approach. For one of the underlying laws of nature—of human behavior—is that things positive attract, influence, win over.

Remember you are offering a prospective employer something he wants. Otherwise he wouldn't consider you. He intends to use the know-how you have gained to help his company make a profit.

You have something to offer; the employer also has something to offer. Present a clear-cut, well organized explanation of your education and experience, emphasizing the things you do best which are needed on this particular job.

A positive attitude at this time toward your own qualifications—and how they can be of value to the employer—can help greatly in putting yourself across favorably and getting the job.

Yours for success,

W. C. Healey

DIRECTOR

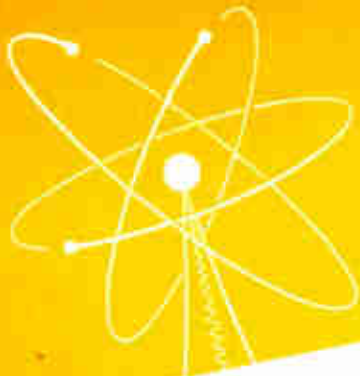

IMAGE ANALYSIS

Lesson TSM-5A



DeVRY Technical Institute
4141 W. Belmont Ave., Chicago 43, Illinois
Formerly DeFOREST'S TRAINING, INC.

ISOLATION OF TROUBLE

By Image Analysis

4141 Belmont Ave.

COPYRIGHT 1955

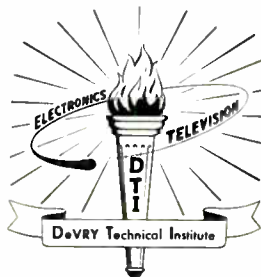

Chicago 41, Illinois

ISOLATION OF TROUBLE

By Image Analysis

PURPOSE OF LESSON

The purpose of this lesson is to show by actual photographs of patterns, some of the effects produced by numerous receiver faults or improper adjustments.

Fifty pictures have been taken for illustrations, and the amount of explanation has been reduced to a minimum. It would take many words to describe and explain the defects causing the faulty image reproductions that are illustrated by these photographs. By holding these statements to a minimum, a compact and more useful analysis of faulty receiver operation is the result.

In order to provide a reference to permit rapid selection of the photographs representing particular types of circuit faults, a brief table of contents is given.

Since these photographs merely provide a reference to permit rapid selection of typical faults, there are *no examination questions* on this assignment.

Instruction Department

DeVRY TECHNICAL INSTITUTE

Television Service Methods

ISOLATION OF TROUBLE

By Image Analysis

Contents

	PHOTOGRAPH
AC (60 and 120 Cycle)	18 to 22, 39, 41, 43
Alignment	12 to 16, 23, 32, 42, 44
Antenna and Transmission Line	12, 13, 16, 23, 38, 45 to 50
Control Adjustments	1 to 12, 14, 16, 17, 27, 30, 35, 36
Deflection Circuits	3 to 9, 20, 24 to 30, 33, 37
Interference	12, 13, 38, 44 to 50
Power Supply	20 to 22, 32, 34, 39 to 41, 47, 48
R-f and I-f Circuits	12 to 16, 31, 32, 42, 44
Synchronizing Circuits	10, 11, 20, 31, 35, 36
Video Amplifiers	1, 2, 10, 15, 18, 19, 22, 32, 43

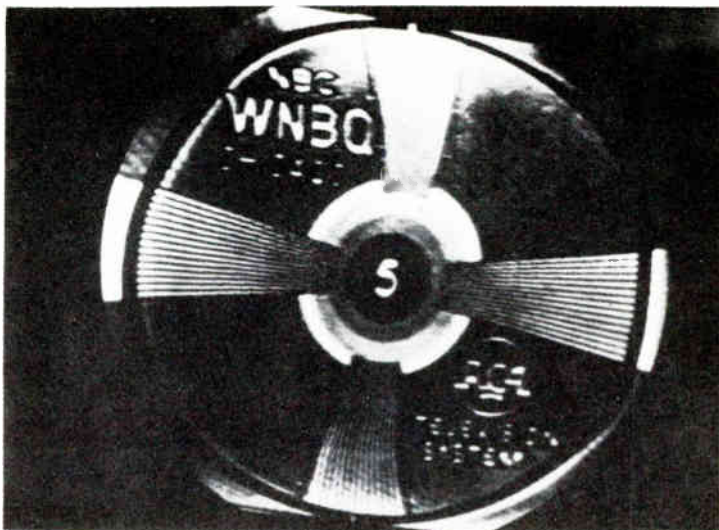

1. **Too Much Contrast. Insufficient Brightness.** Adjust contrast and brightness controls.

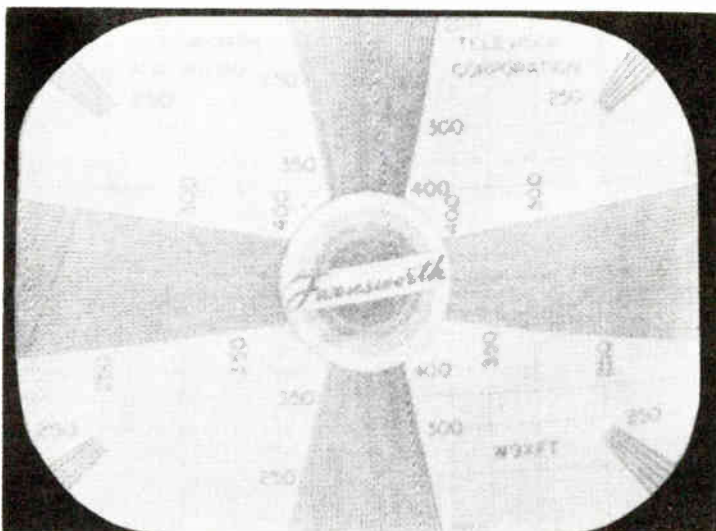

Courtesy—Farnsworth Television and Radio Corporation

2. **Insufficient Contrast. Too Much Brightness.** Adjust brightness and contrast controls.



3. **Insufficient Horizontal Width. Excessive Vertical Height.** Adjust vertical height and horizontal width controls. If not successful also adjust horizontal drive and linearity controls.

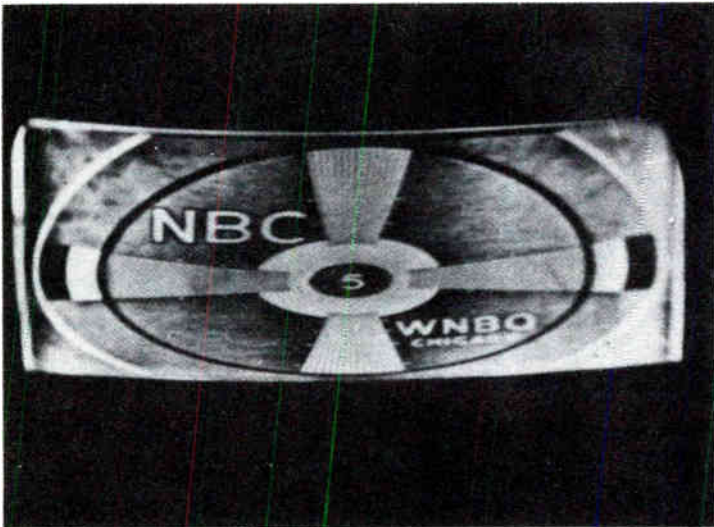

4. **Insufficient Vertical Height.** Adjust vertical height control.

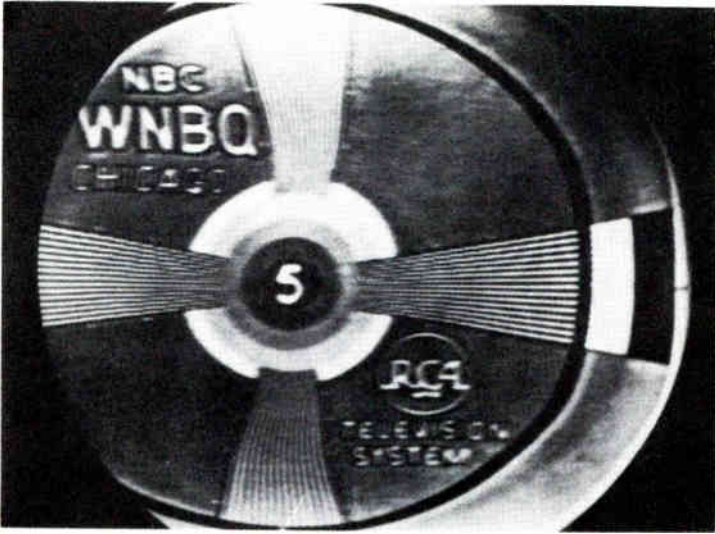

5. Poor Horizontal Centering. Adjust horizontal centering control.

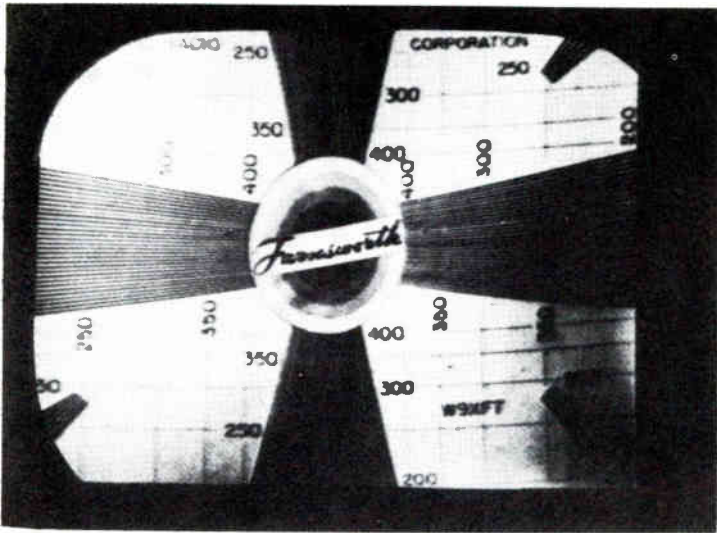

Courtesy—Farnsworth Television and Radio Corporation

6. Poor Centering. Adjust horizontal and vertical centering control.

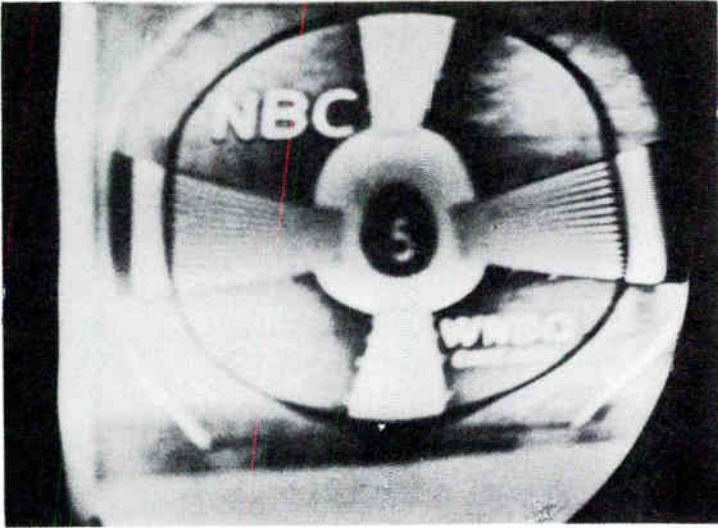

7. **Poor Focus, Poor Height, Poor Linearity.** Adjust focus height and linearity controls.

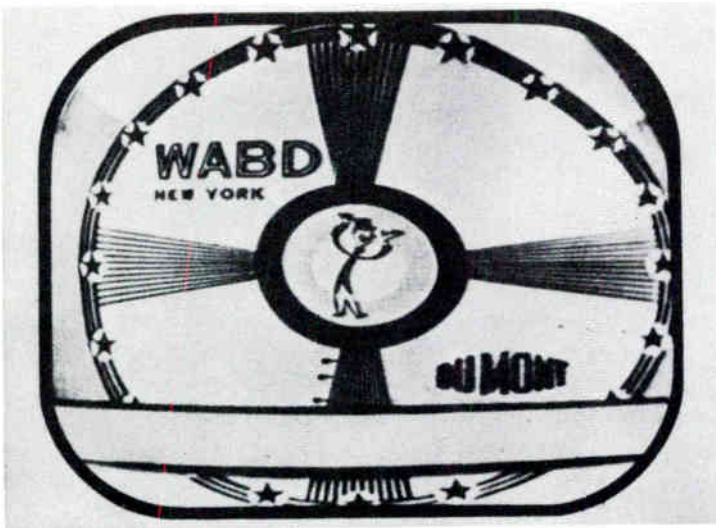

Courtesy—Allen B. Dumont Labs. Inc.

8. **Poor Horizontal Linearity.** Adjust horizontal linearity control.



9. **Poor Vertical Linearity.** Adjust vertical linearity control.

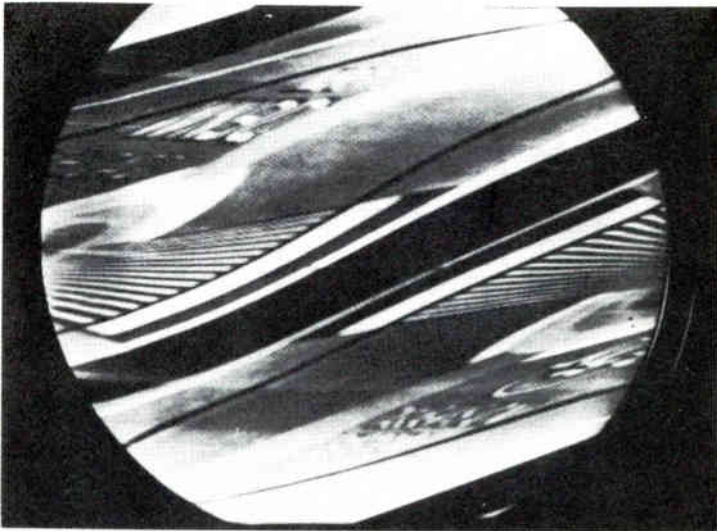

10. **Poor Horizontal Sync.** Adjust horizontal hold control. Reduce contrast.

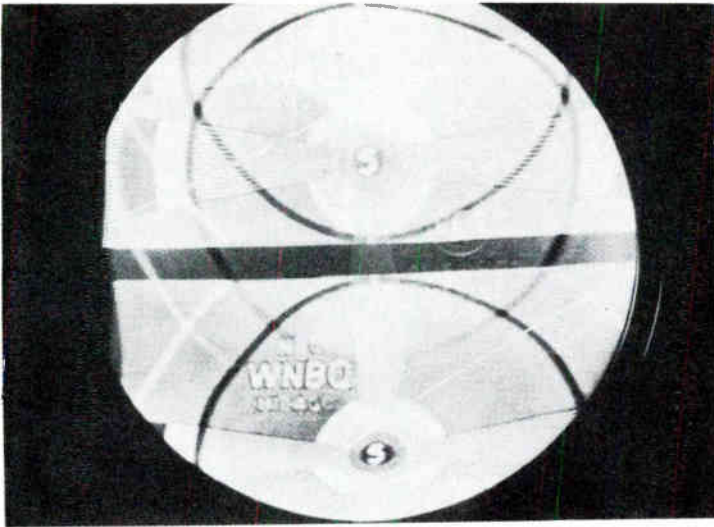

11. **Poor Vertical Sync.** Adjust vertical hold control.

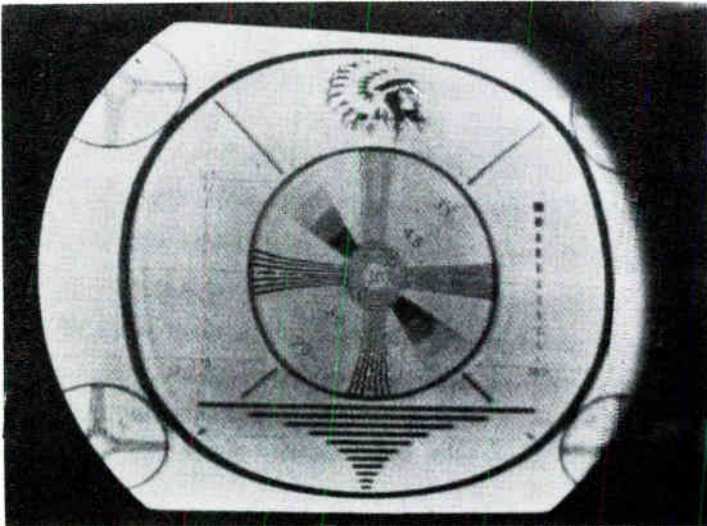

12. **Weak Signal. R-F Interference.** Check channel switch and adjust fine tuning. Possibly 4.5 mc interference on intercarrier receivers. Adjust sound traps.

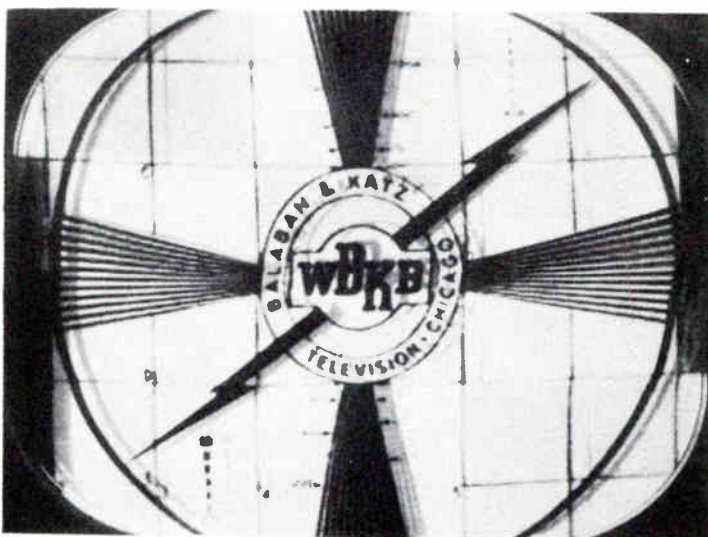

13. **Ghosts.** Check antenna, r-f, i-f alignment.



14. **Smear. Poor Detail.** Check fine tuning. R-f and i-f alignment.

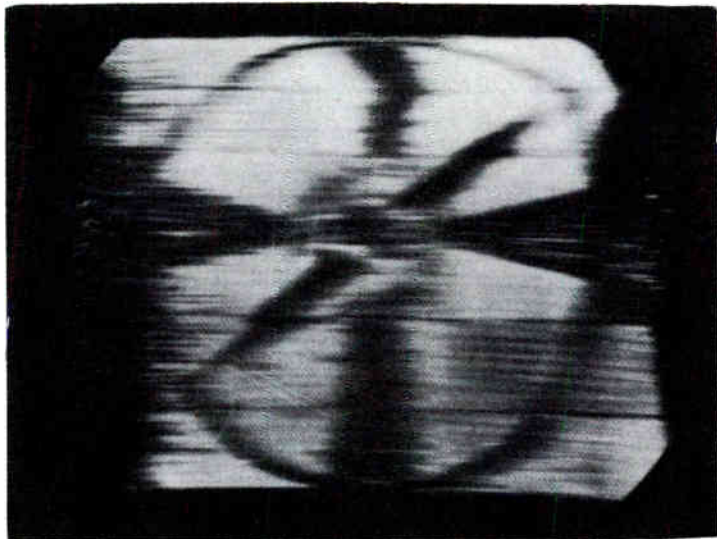

15. **Oscillations.** Check cathode resistors and all i-f and video decoupling networks. Alignment.

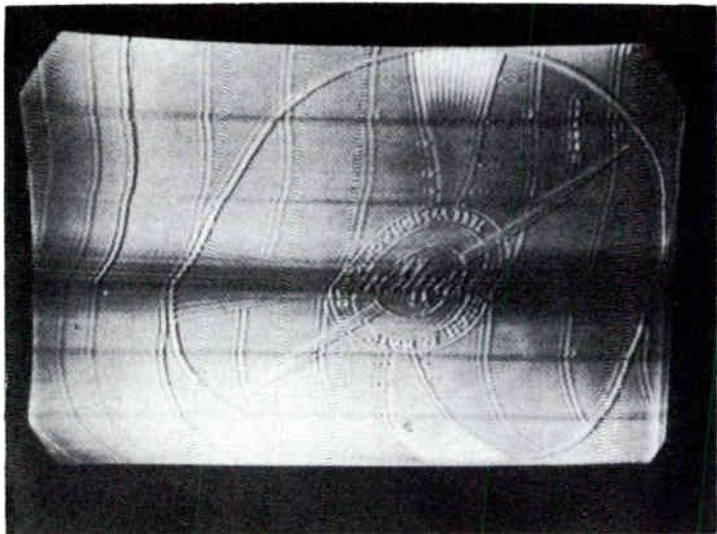

16. **Relief Picture. R-F Interference. Regeneration.** Check tuning, r-f and i-f alignment and decoupling.

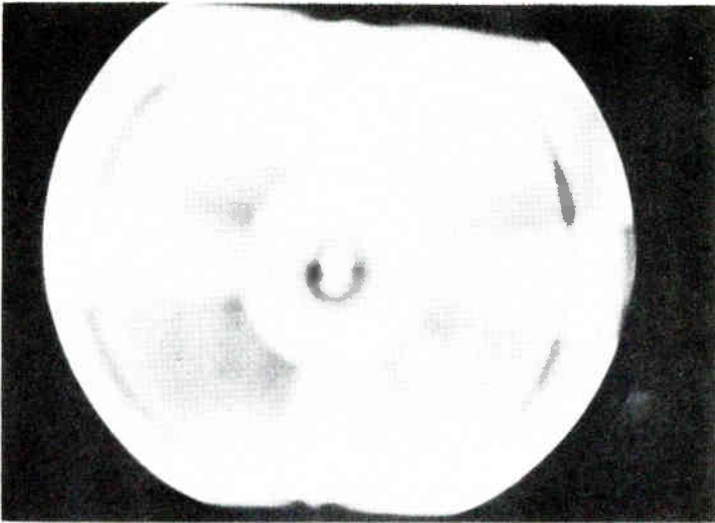

17. **Out of Focus.** Improperly adjusted focus control or defective focus coil.

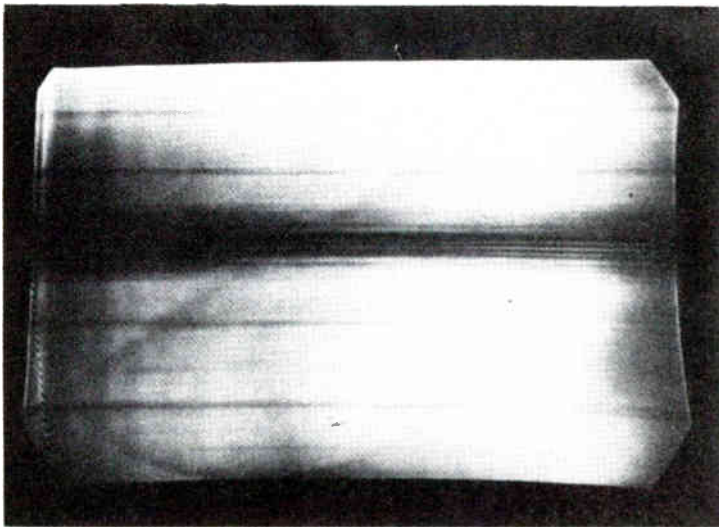

18. **60 Cycle in Video. Weak Video.** Cathode to heater short in video amplifier or picture tube.

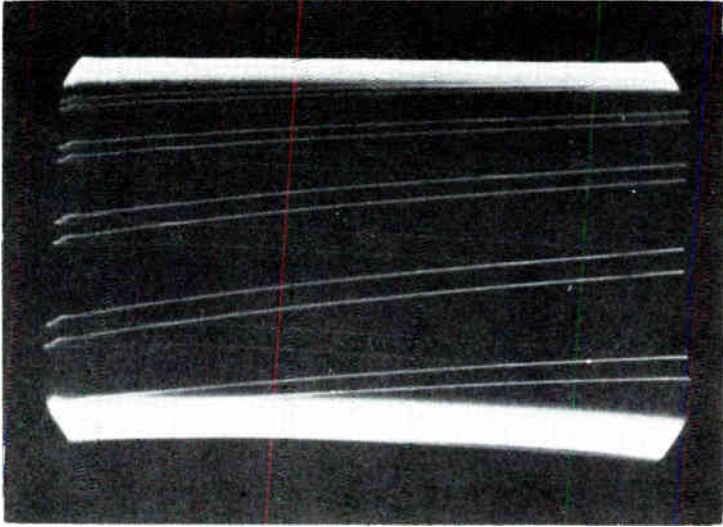

19. **60 Cycle in Video.** Cathode to heater short in video amplifier.

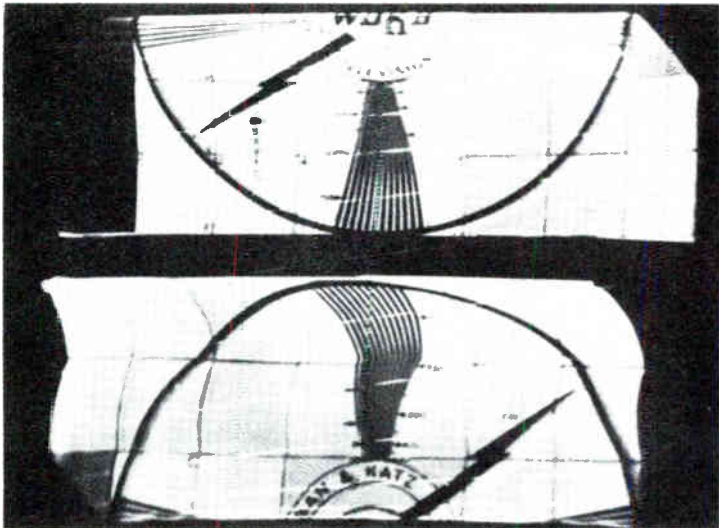

20. **Poor Vertical and Horizontal Sync.** 60 cycle hum in sync or deflection circuits.

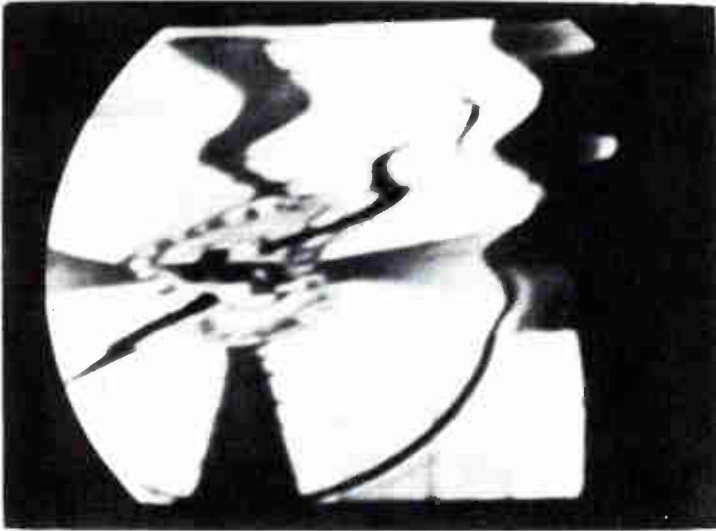

21. Out of Focus. Strong 120 Cycle Ripple. Open filter capacitor in B+.

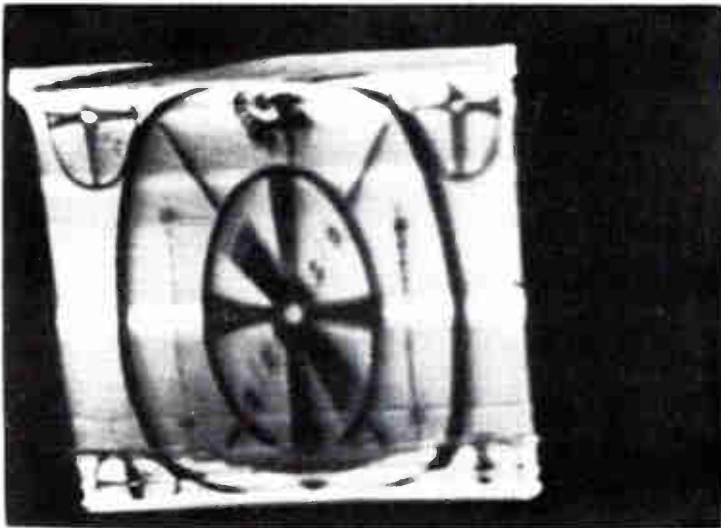

22. 120 Cycle in Video. Check power supply and video decoupling capacitors.

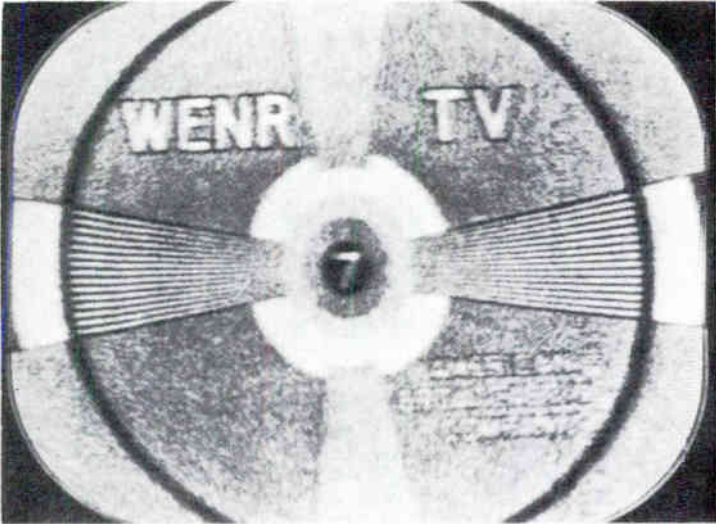

23. **Weak Signal. Heavy "Snow".** Defective antenna, lead in, r-f, or i-f amplifier tube or part.



24. **Horizontal Fold-over.** Shorted damper tube. Open capacitor in linearity control circuit.

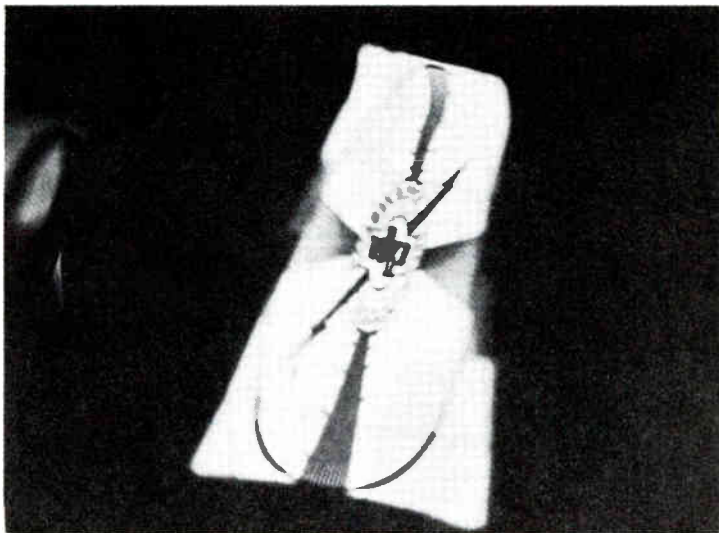

25. **Keystone.** Capacitor or Coil shorted in top half of horizontal yoke.

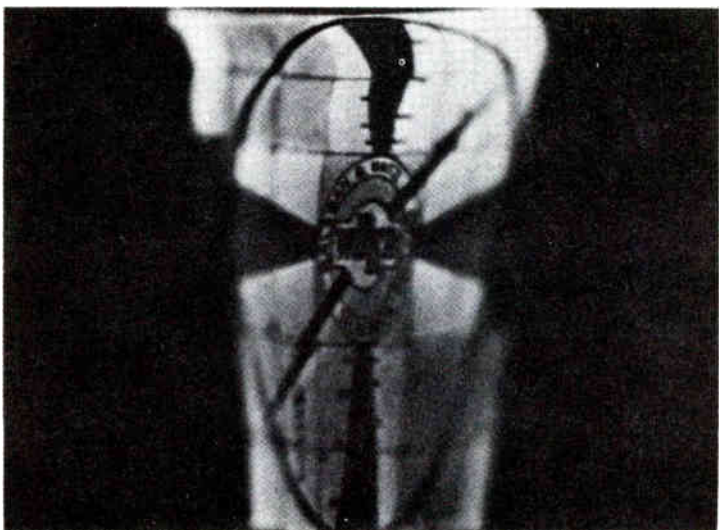

26. **Keystone.** Capacitor or Coil shorted in bottom half of yoke.

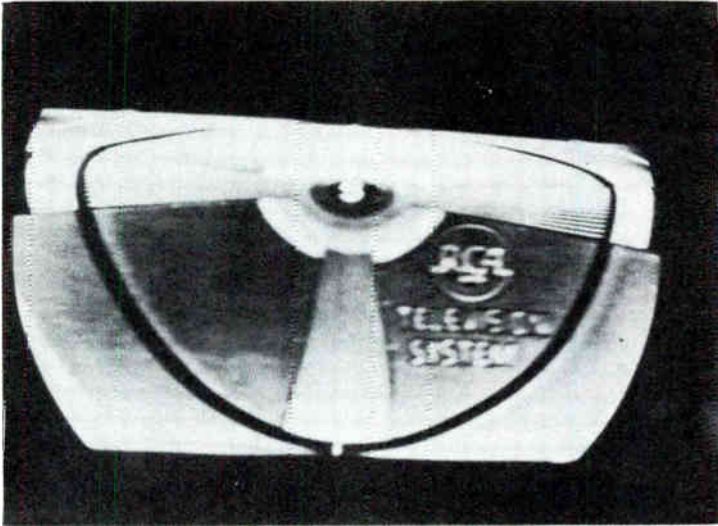

27. **Poor Vertical Linearity.** Improperly adjusted controls or defective parts in the vertical or height circuits.



28. **Defective Horizontal Sweep.** Leaky power feed back capacitor.
Faulty deflection yoke or yoke capacitor.

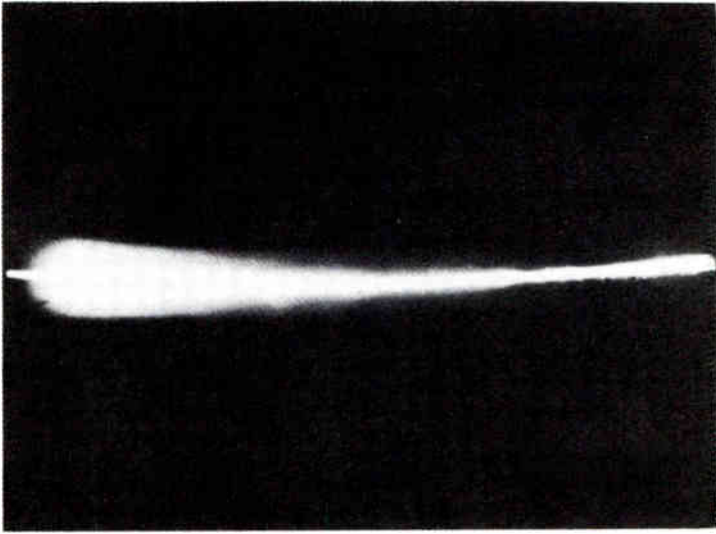

29. **No Vertical Sweep.** Check vertical oscillator and amplifier circuits and tubes.



30. **Poor Interlace. Poor Centering.** Adjust vertical sync and horizontal centering.

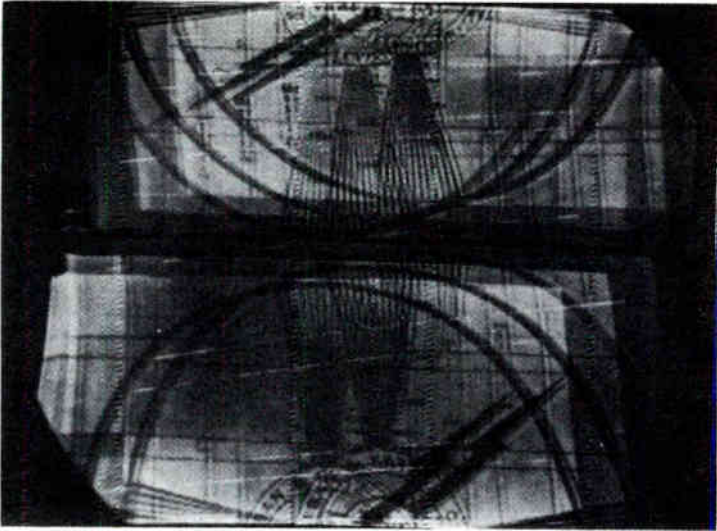

31. **No Vertical or Horizontal Sync.** Defective clipper. Open sync circuit coupling capacitor. Weak i-f tube.

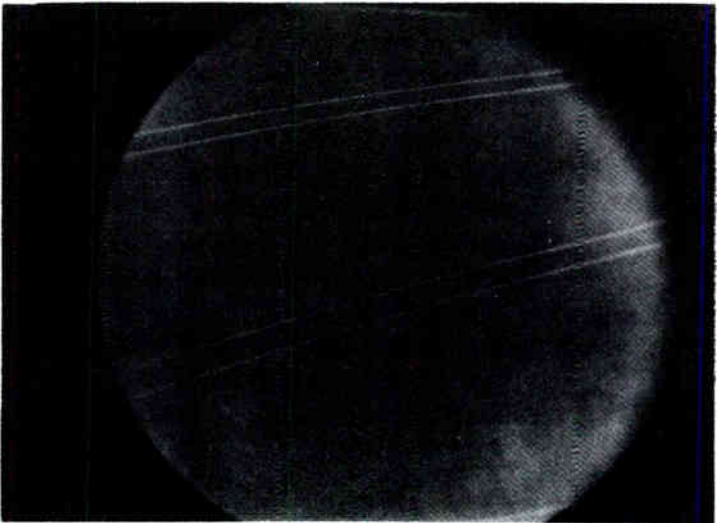

32. **Dull Raster. No Picture.** Check Power supply. Check antenna, tuner, i-f and video amplifiers.

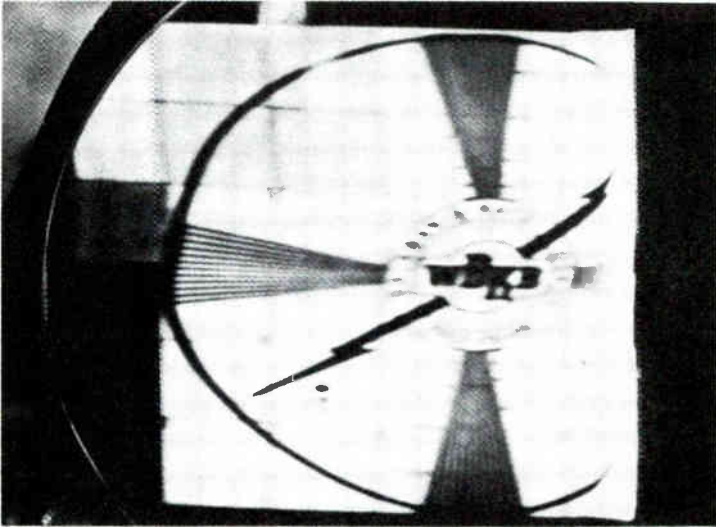

33. **Horizontal Fold-over.** Replace gaseous horizontal output tube.

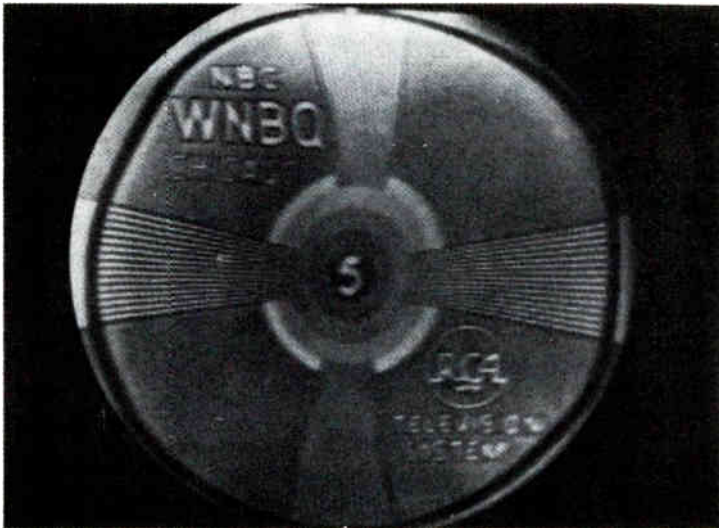

34. **Dull Raster. Normal Video.** Low second anode voltage. Check high voltage filter resistor and rectifier tube.

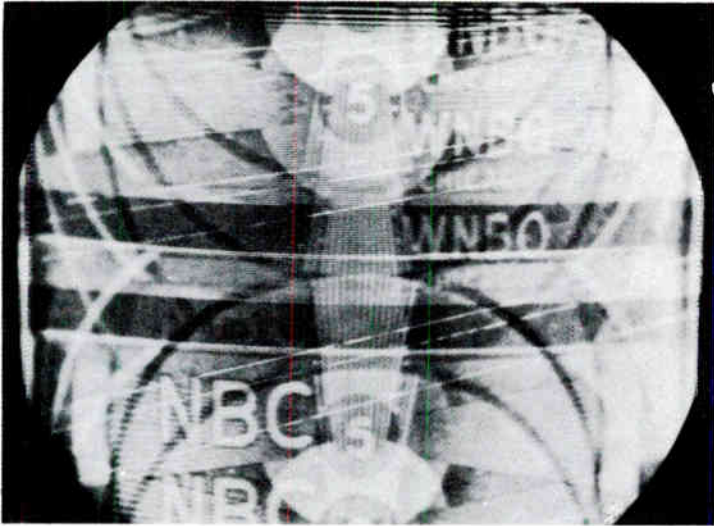

35. **No Vertical Sync.** Adjust vertical hold control. Check tube and parts in vertical sync circuit.

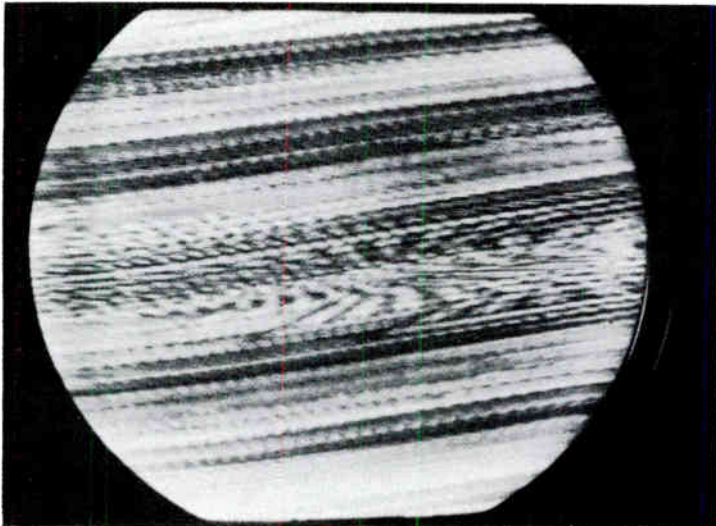

36. **No Horizontal Sync.** Adjust horizontal hold. Check tubes and parts in horizontal sync circuit.

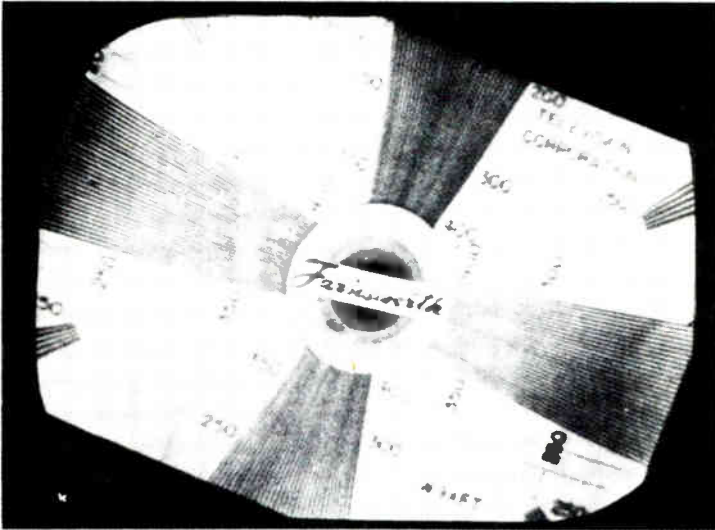

Courtesy—Farnsworth Television and Radio Corporation

37. **Picture Tilted.** Rotate deflection yoke.

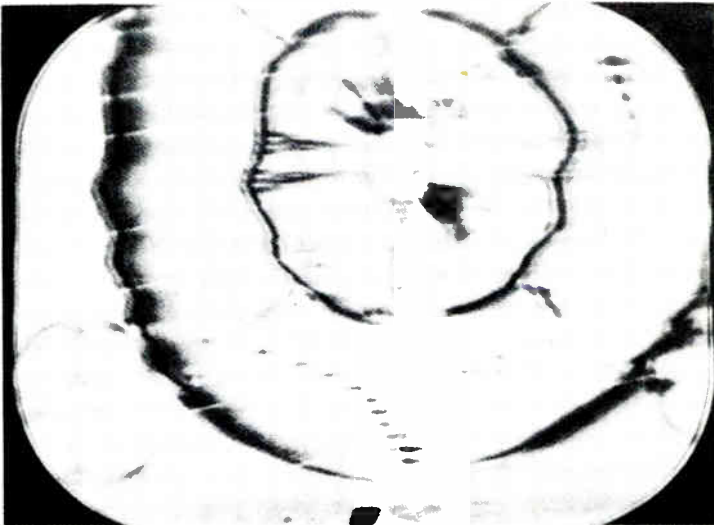

38. **Interference.** Strong High Frequencies that beat with local oscillator. Rotate antenna.

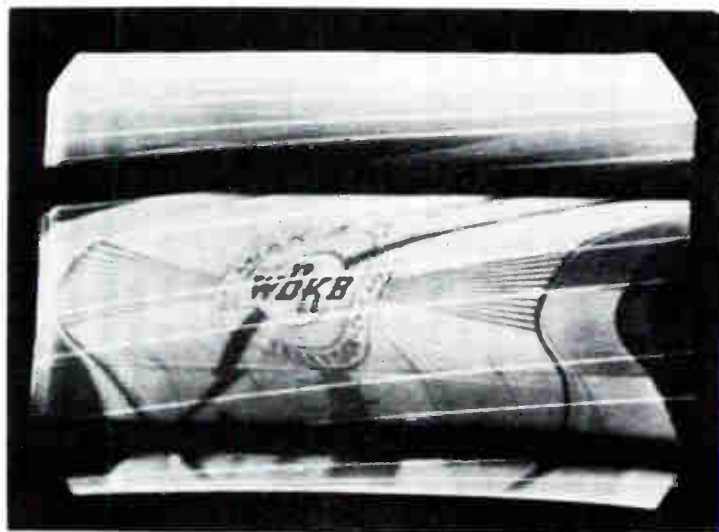

39. 120 Cycle Ripple. Open filter capacitor in power supply.

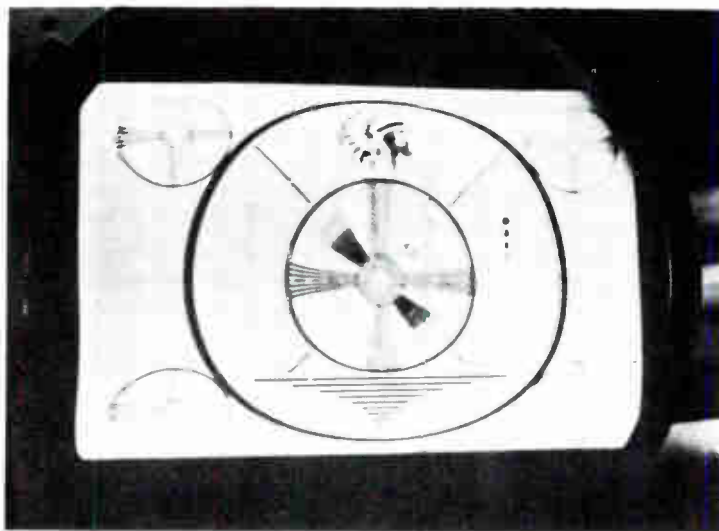

40. Decreased Vertical and Horizontal Sweeps. Low line voltage, defective rectifier tube or power transformer.

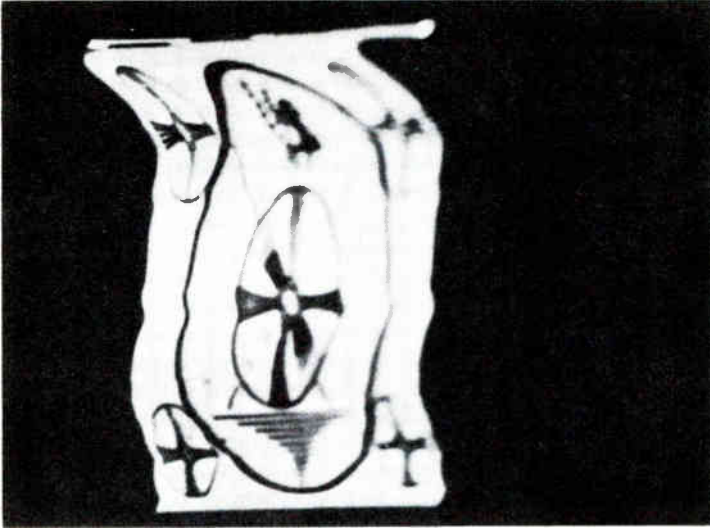

41. 60 Cycle Ripple. Check power supply filters.

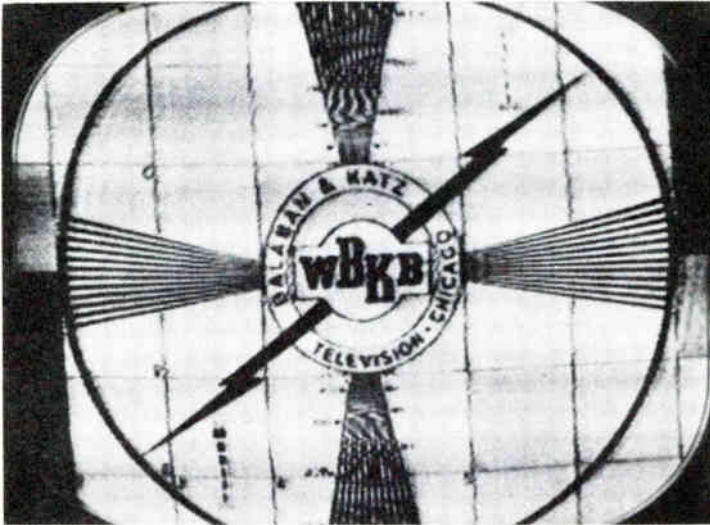

42. Video Regeneration. Check r-f and i-f tubes, decoupling capacitors. Alignment.

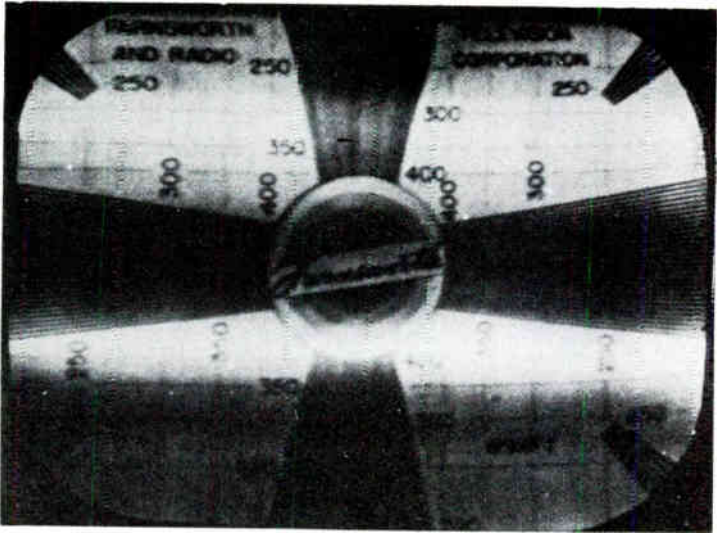

Courtesy—Farnsworth Television and Radio Corporation

43. **120 Cycle Ripple.** Check decoupling in r-f, i-f, and video amplifiers.

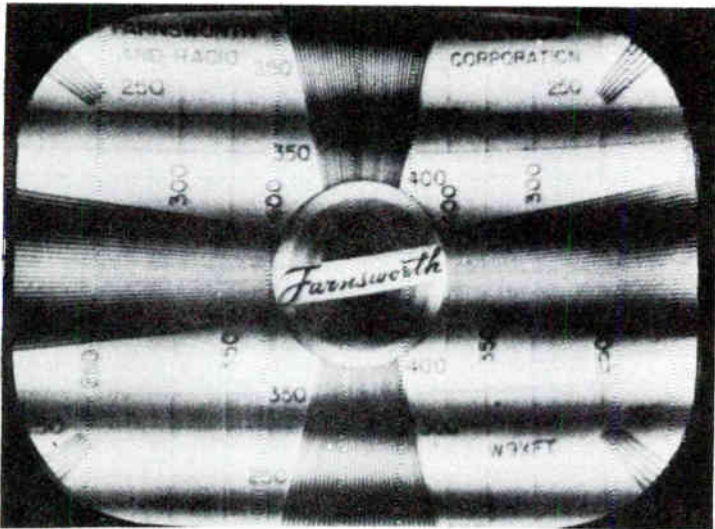

Courtesy—Farnsworth Television and Radio Corporation

44. **Sound Bars.** Check oscillator tube, sound traps and audio decoupling. Alignment.

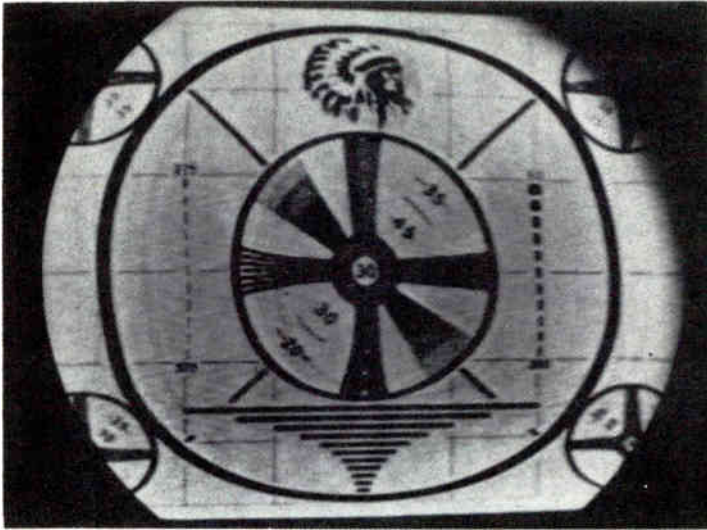

45. **High Frequency Interference.** Receiver not likely at fault. Try rotating antenna.

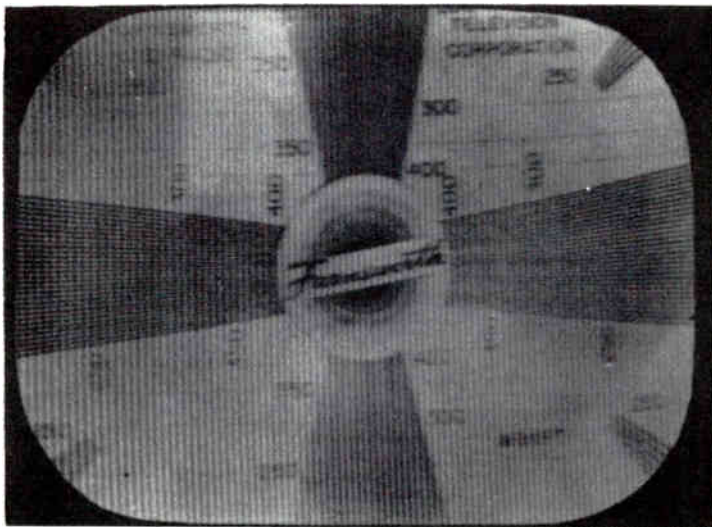

Courtesy—Farnsworth Television and Radio Corporation

46. **Beat Frequency Interference.** Receiver not likely at fault.

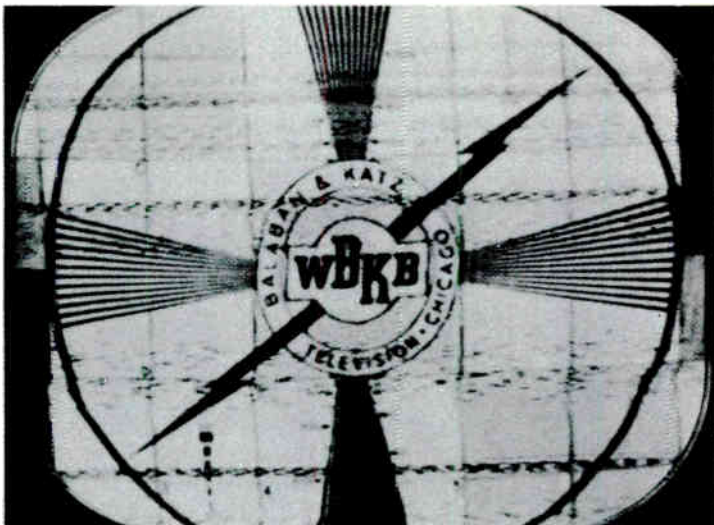

47. **Ignition Interference.** Possible arcing in high voltage supply.
Check for corona.

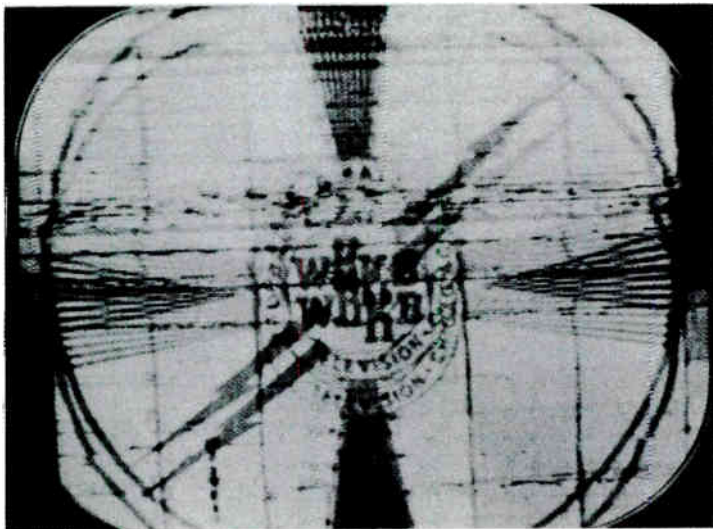

48. **Loss of Sync. Interference.** Check high voltage for corona. Check for small motors in vicinity.

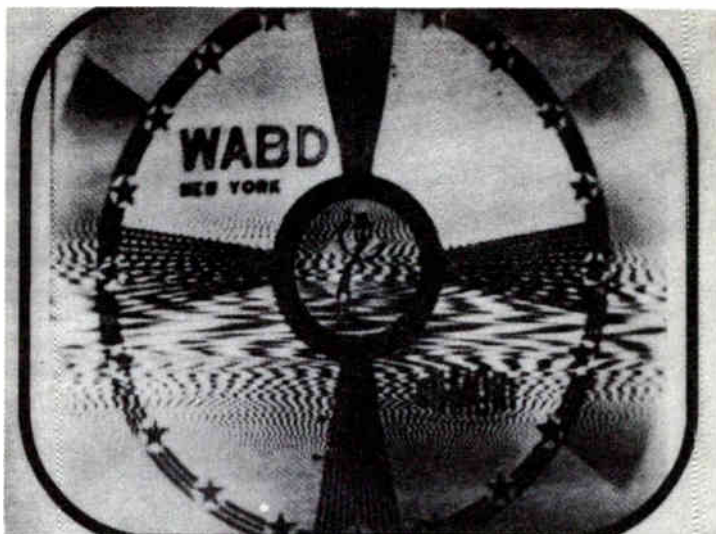

Courtesy—Allen B. Dumont Labs. Inc.

49. **Diathermy Interference.** Interference of strong local r-f source like diathermy machines and dielectric heaters.

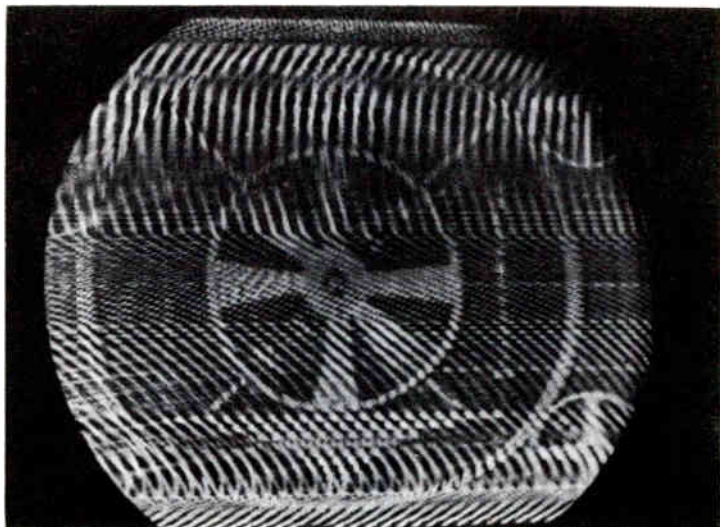

50. **Strong R-F Interference.** Check for local r-f sources.

FROM OUR *Director's* NOTEBOOK

"Putting SELL-O into Your Hello"

If you're planning a TV-Radio business of your own, the telephone can be a most important asset—IF YOU USE IT PROPERLY.

A good telephone personality is a decided advantage to a businessman. Often, first impressions with your customers are made by phone and good impressions mean a great deal of future business for you.

When you talk on the phone, your VOICE has to represent your entire personality. The person at the other end can't see your EYES, your SMILE, your GESTURES or any of these other "three dimensional" personality traits. Your voice alone does the selling.

How can you put that SELL-O into your hello? Well, you can start by being courteous. Improve your phone manners by speaking directly into the transmitter and slowing down your speech about one-third. Other helps: pitch your voice in the middle register, spell out proper names, repeat figures, instructions.

Adopt a persuasive phone attitude. Pick the right words and "say it with flowers" in your voice.

Yours for success,

W. C. De Vree

DIRECTOR

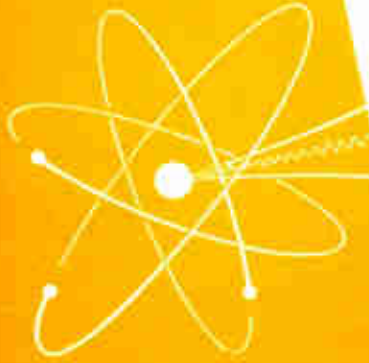

**INITIAL INVESTIGATION
AND ADJUSTMENT**
Lesson TSM-6A

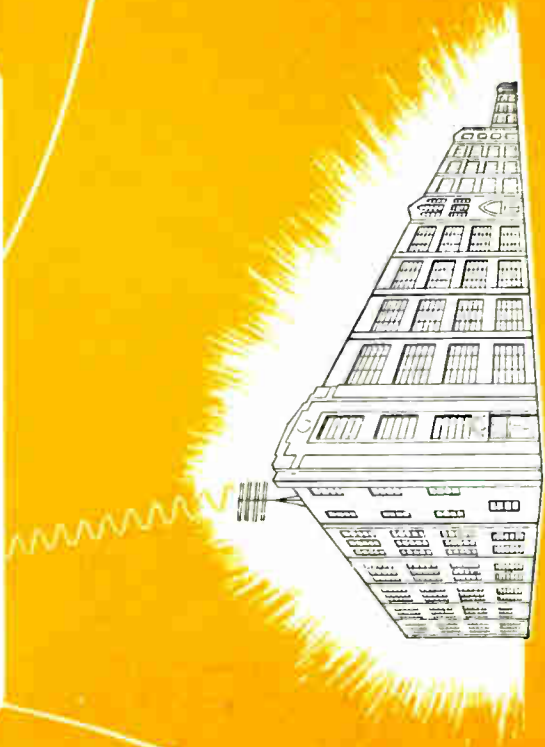

DeVRY Technical Institute
411 W. Belmont Ave., Chicago 41, Illinois
Affiliated with DEFOREST'S TRAINING, INC.

INITIAL INVESTIGATION AND ADJUSTMENT

4141 Belmont Ave.

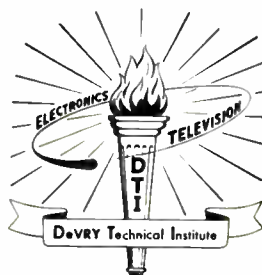

Chicago 41, Illinois



Electronic service work is highly interesting and profitable. To save time, all possible initial checks should be made before pulling the chassis.

Courtesy Radio Corporation of America

Television Service Methods

INITIAL INVESTIGATION AND ADJUSTMENT

Contents

	PAGE
Television Service Tools	4
Servicing Methods	5
Analyzing by Sense Indications	7
Analysis of Image and Block Diagram	8
Interference	10
Ghosts	11
Brightness and Contrast	11
Vertical Hold	12
Horizontal Hold	12
Width and Height	12
Non-Linearity	13
Tube Replacement	14
Tube Failures	16
R-F Section	17
Picture Channel	19
Sound Channel	21
Sync and Deflection Section	21
Power Supplies	22
Other Tests and Adjustments	24
Antenna System	24
Tuner	26
Controls	27
Low Voltage Supply	28
High Voltage Supply	29
Safety Precautions	31
Appendix A—Service Equipment and Supplies	34

Television, because of its eye and ear appeal, is radio in combination with motion pictures—radio with Broadway and the world of news and sports. Television's unlimited possibilities for service and employment is surpassed only by the complexity of its many riddles—economic, artistic, legal, financial and scientific.

—Selected

INITIAL INVESTIGATION AND ADJUSTMENT

In the preceding lessons we explained how image analysis and the adjustment of various controls are used to attain picture reception. These various adjustments generally are made at the time the television receiver is installed. However, some, or all, of these controls have to be adjusted during a service call at times other than that of the original installation. In fact, the first step in a service call should involve adjusting these controls to make sure that the fault is not just misadjustment. Therefore, they are referred to from time to time in these lessons concerned with the methods and procedures employed in servicing television receivers.

TELEVISION SERVICE TOOLS

There are two prime needs to any good service job, (1) the proper tools, and (2) the knowledge of how to use them. One is dependent upon the other. The most elaborate equipment is useless in the hands of the ignorant, and the most skilled serviceman is severely crippled without adequate equipment.

In a broad sense, the "tools" employed by a television service technician may be considered to

include his knowledge plus all test equipment, circuit diagrams and service manuals, as well as the actual tools such as a soldering iron, screwdrivers, and so on. On a specific service job, the tools used depend upon the nature of the existing trouble and whether the work is done in the customer's home or at a service shop.

Generally, the servicing equipment used for service calls is considerably less extensive than that available in the shop. For field service, usually the work can be done with a minimum of common tools, test equipment, and parts. However, for major troubles the chassis is removed and taken to the shop for further service.

Selected from several well known service company's lists, an outline of receiver parts, test equipment, and tools needed or useful in field service, shop, and installation is given in Appendix A. Naturally each shop differs from this list. All that it actually indicates are those items usually considered essential for servicing by efficient service organizations. Many of the items can be omitted in a particular shop, although the omission may mean more time spent on service calls. It is their time saving ability that rates these items as useful.

SERVICING METHODS

Although differing in details, the methods employed by various experienced television service technicians are basically similar. Because of their experience, often these men can tell from the symptoms which circuit contains the defective component even before making any tests or measurements. However, and herein lies the important likeness, when they don't know where the trouble is located, good servicemen employ definite and systematic troubleshooting methods.

The reliance on random knowledge of service techniques and television theory are characteristics of the "tinkerer" rather than the real service technician. This often results in doing more harm than good to the relatively intricate television receiver circuits. Therefore, we cannot emphasize too strongly the importance of a thorough understanding of the operation of the various television receiver circuits, as well as unvarying adherence to some well defined troubleshooting procedure.

There are a number of servicing methods which can be employed in troubleshooting any type of electronic equipment, including radio and television receivers. Depending upon the type of equipment to be serviced, the test equipment available, and the

preference of the individual service technician, various combinations of several or all of the service methods are employed in some definite sequence and thus form a given trouble-shooting procedure. For television receivers, most technicians employ a basic system consisting of the following three steps:

1. Determine in which section of the receiver the trouble is located.
2. Isolate the troublesome stage in the defective section.
3. Locate the faulty component or other trouble within the defective stage.

In the basic procedure outlined, the second and third steps constitute the procedure generally employed in servicing regular radio receivers, and are adapted directly to television work. However, due to the larger number of circuits involved in a television receiver, it is convenient to precede these with step 1 by thinking of the receiver as containing a number of sections which are groups of closely related stages.

The same general grouping may be used for all makes and models of television receivers although the actual divisions employed may vary with different individual servicemen. Based on the related functions of the tubes,

one example of a grouping often employed is as follows :

1. R-F Section : antenna, lead-in, r-f amplifier, r-f oscillator, and mixer.
2. Sound Channel: sound i-f amplifiers, audio detector, a-f amplifiers, and speaker.
3. Picture Channel : picture i-f amplifiers, video detector, v-f amplifiers, and picture tube circuits.
4. Sync Circuits: sync pulse clippers and amplifiers, and horizontal frequency control circuits.
5. Deflection Circuits : vertical and horizontal deflection oscillators, output amplifiers, and deflection coils.
6. High Voltage Power Supply: horizontal deflection circuit, high voltage rectifiers and filter; or r-f type, high voltage supply which includes oscillator, rectifier, and filter.
7. Low Voltage Power Supply: power transformer, rectifier tubes, filters, and heater circuits.

A block layout outlining the tubes involved in each section of the particular receiver being serviced also is desirable. Although all television receivers can be divided into the same sections, such

as those outlined above, the individual receivers do vary somewhat. To illustrate these differences, block diagrams of the two major types of receivers are given in Figures 1 and 2.

Figure 1 shows the layout of a dual-channel receiver which employs a common flyback type high voltage supply. Dashed lines are drawn around each of the seven sections listed, and as indicated, the deflection circuit and high voltage power supply sections overlap because the horizontal oscillator and amplifier may be considered parts of both sections.

With its sections outlined by dashed lines in a similar manner, the block diagram of an intercarrier type receiver is shown in Figure 2. Although an r-f high voltage power supply is shown, this illustration is not intended to indicate that all intercarrier type receivers employ r-f power supplies. At present, the fly-back type, high voltage supply is used in most receivers of either type. The receiver in Figure 2 is divided into the same seven sections as indicated for Figure 1, but there are differences in the circuits included in, and signals carried by, certain of these sections.

That is, in the receiver of Figure 2, the sound signal passes through most of the picture channel instead of being applied di-

rectly from the r-f section to the sound channel. Also, the r-f type power supply is independent of the sweep circuits in the receiver of Figure 2.

circuits are served by each supply. Due to these differences, it may be necessary to combine sections of Figures 1 and 2 to suit a particular receiver.

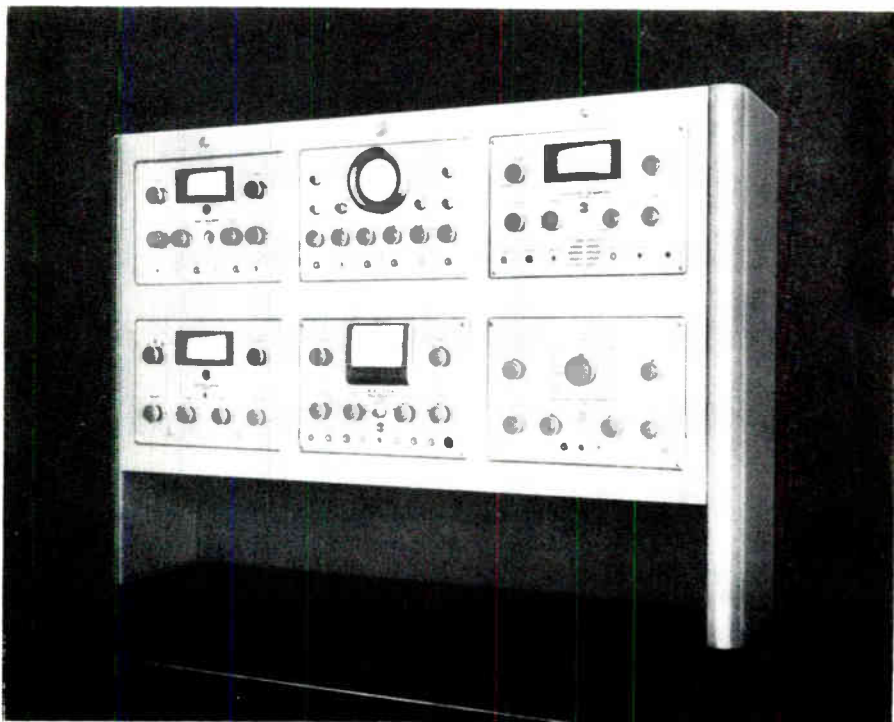

Designed for the service shop, the six piece test rack is equipped for AM, FM, and TV servicing. The rack includes a radio oscillator, oscilloscope, TV calibrator, test oscillator, vvm, and sweep generator.

Courtesy RCA Victor

Other design variations not indicated are receivers with more than one low voltage power supply, and receivers employing series-parallel heater circuits. With more than one low voltage supply, no one of these supplies make the entire receiver dead, and it is necessary to determine which cir-

Analyzing by Sense Indications

Complete alertness often saves valuable time, for four of the five natural senses: sight, hearing, touch, and smell often can be employed to obtain an indication of the type of source of trouble in a television receiver.

A visual inspection will reveal a disconnected power line plug or antenna lead-in, unlighted tube heaters, parts which are blistered or blackened from overheating; bent, broken, and other defects in components, controls, and wiring.

The aural inspection consists of listening for distorted sound output from the loudspeaker, and for hums, squeals, or other unusual sounds either from the speaker or some other part of the set.

Burned or burning components have distinctive odors which must be learned by experience. An example is that of a burned out transformer which, once detected, rarely is mistaken.

Tubes with metal envelopes can be felt to determine whether the heaters are operating. Touching other components; such as transformers, resistors, and capacitors, reveal overheating when this condition is not indicated by either appearance or smell. However, many components operate normally at a fairly high temperature which should not be mistaken for faulty operation.

Tubes, or other components, often have defects which cause trouble intermittently, or only under conditions of vibration. Usually such defects can be discovered by tapping various tubes and components with a finger, pencil, or a lightweight mallet

made for this purpose. Occasionally, tapping or wiggling a capacitor does not reveal its defective condition in which case success may be obtained by use of a small, slotted tool made of plastic. One at a time, the capacitor leads are inserted in the slot and then pulled, pushed, and twisted so that any existing defect is made evident by the effect on the receiver output.

Analysis of Image and Block Diagram

It should be pointed out here that one of the very first steps in servicing is to make sure that one of the controls isn't at fault. That is, following the methods described in the previous lessons, each control should be adjusted for optimum operation. Then, if the fault still persists, the nature of or lack of the picture on the screen along with a thorough knowledge of the function of each section is probably the best indication as to which television receiver section is defective.

Together with a check of the loudspeaker output, an analysis of the reproduced image provides considerable information as to the type of existing trouble. That is, regardless of the location of the fault in the receiver, some type of adverse effect is produced on either the picture, the sound, or both. In most cases, this effect is unique to the particular section containing the defect.

For example, the picture and sound signals are carried by the picture and sound channels, respectively, and both are carried by the r-f section. When the picture is lacking but sound is present, the picture channel likely contains the defect. When sound is lacking but the picture is present, the trouble probably lies in the sound channel. If both picture and sound are lacking but a raster is present on the screen, a section, affecting both picture and sound, must be defective.

The raster is produced by the deflection circuits, therefore any non-linearity or similar raster distortion indicates some defect in these circuits. Loss of vertical or horizontal synchronization of the scanning beam is likely due to trouble in the sync circuits or the deflection circuits, but also may be due to a defect in the r-f section or picture channel through which the sync signals are carried along with the remainder of the video signal.

For the raster to be visible on the screen, a high positive voltage must be on the picture tube anode. Thus, a complete absence of the raster, with sound present, is usually an indication of trouble in the high voltage power supply, in the horizontal deflection circuits of receivers employing fly-back type supplies. However, mis-adjusted beam benders or defec-

tive picture tube cathode circuits can produce a similar result.

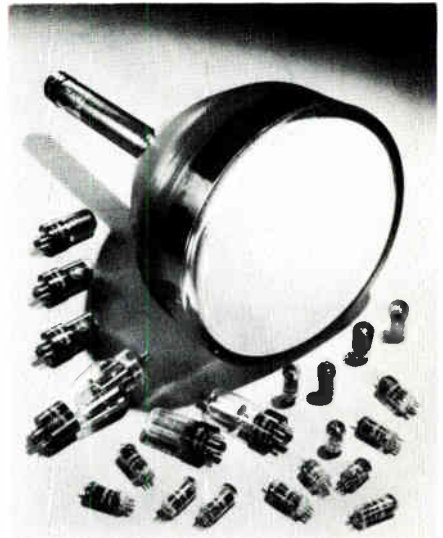

Shown are all tubes required for tests and replacement for one model television receiver.

Courtesy Tung-Sol Lamp Works, Inc.

A bright, horizontal line on the screen indicates a defective vertical deflection circuit, since the sawtooth output of this circuit is needed to move the spot up and down on the screen. In like manner a bright vertical line indicates an inoperative horizontal deflection circuit. However, a vertical line cannot be produced in this way in receivers employing fly-back high voltage supplies, unless the horizontal yoke is shorted out, because the spot requires the presence of a high anode voltage which depends upon the horizontal deflection circuit.

If the set is completely "dead", with no sound present and no picture or raster on the screen, most likely the fault is found in the low voltage power supply, for it is unlikely that separate troubles develop in two or more sections at the same time.

In addition to the symptoms described, the picture tube screen serves to indicate troubles due to sources outside the receiver, such as ghosts or patterns resulting from reception of reflected and other interfering signals by the antenna system, and pickup of noise energy by the antenna or power lines, etc.

The various causes of the different types of trouble are covered in detail in other lessons, but to illustrate the method, the more common of the mentioned symptoms are listed in chart 1 opposite the receiver sections in which they indicate the trouble most likely to be located.

To further determine the fault, a further examination of a test pattern or picture may reveal much. Just as the pictures of the previous lesson illustrated which controls were misadjusted; once adjustment has been attempted, these same pictures, or others like them, indicate which sections are at fault and to some extent the nature of the fault.

INTERFERENCE

Random bursts of radio frequency energy are produced by a large number of different devices or sources which may be in the vicinity of the receiver. This energy is radiated through space or carried by power lines to the receiver and thus is added to the desired signal to produce light spots or streaks as shown in Figure 3A. Typical of these sources are small motors, automobile ignition systems, or even arcing or corona within the receiver itself.

Chart 1

<u>Symptom</u>	<u>Defective Section</u>
No picture, raster, or sound	Low voltage power supply
No raster	High voltage power supply
Horizontal line on screen	Vertical deflection circuit
Vertical line on screen	Horizontal deflection circuit
No picture-raster normal	Picture channel after sound take-off point
No sound	Sound channel
No picture or sound-raster normal	R-f section, Picture channel before sound take-off point
Picture distorted	Deflection circuits
Loss of sync	Sync circuits, deflection circuit, picture channel, r-f section
Ghosts, streaks, crosshatch patterns	R-f section, pickup by chassis or power line

On the other hand, evenly spaced slanting or vertical lines, produced on the screen as shown in Figure 3B, are due to the pick-up of continuous r-f waves such as from interfering television or radio stations, nearby television or radio receivers, or other r-f equipment such as diathermy machines. The lines may remain stationary, or shift slowly in a clockwise or counterclockwise direction.

GHOSTS

As illustrated in Figure 3C, reflected waves travel greater distances than the direct wave between transmitter and receiving antenna, and so arrive a short time later to produce one or more images displaced slightly to the right of that produced by the direct wave. These undesired secondary images are called ghosts and are usually faint relative to the contrast of the direct image.

When energy in the audio frequency range enters the video signal circuits in some manner, the a-f voltage causes the picture tube beam intensity to vary at the audio rate to produce horizontal bars on the screen as shown in Figure 3D. Sound bars vary with the sound strength and frequency. This trouble may be due to the existence of unwanted coupling conditions, such as a microphonic oscillator tube or part, or some defective decoupling capacitor.

BRIGHTNESS AND CONTRAST

Figures 3E through 3H illustrate incorrect brightness and contrast. As shown in Figure 3E, when the brightness is not sufficient, the entire picture is too dark. Grey tones are darkened and driven toward the black level, and normally light or white areas become grey. Other effects include apparent loss of detail and irregular lighting of normally uniformly illuminated areas.

When the brightness is excessive, the entire image becomes too light as shown in Figure 3F. The grey tones are lightened and driven toward white, while the normally black areas become grey. Again a loss of fine detail results, accompanied by uneven shading and, if the brightness is very high, the image appears "washed out" and the vertical retrace lines are often visible.

Figure 3G shows the effect of too much contrast. This effect is similar to that of Figure 3E, except that in Figure 3G the white areas do not become grey. However, the normally grey areas are caused to appear black. The most apparent effect of this fault is the loss of most of the intermediate tones between black and white. Image details are lost and the image looks blurred. With a strong signal, phase distortion or tone reversals will result so that the

black areas of the image become white, and the white areas become black.

Similar to the effect of too much brightness, the image has an overall grey or washed out appearance when the contrast is not sufficient, as shown in Figure 3H. Fine details are lost, the grey areas become white, and the black areas become grey. To avoid wasted effort, a careful distinction should be made by the serviceman, between brightness and contrast. For if the fault is contrast, the trouble exists in one of the signal circuits. On the other hand, brightness is not necessarily affected by these circuits but is dependent on the picture tube high voltage, grid bias, or other electrode voltages, and these are determined by entirely different circuits.

VERTICAL HOLD

A loss of vertical sync is illustrated in Figure 4A. This condition causes the image to slide slowly up or down across the screen, or produces rapid vertical motion and the effect of overlapped images as shown. Whether the image moves up or down on the screen depends upon whether the vertical oscillator is too fast or too slow. This indicates trouble in the vertical oscillator or sync circuits, although occasionally this fault can be produced by 60 cycle ripple in a signal circuit.

HORIZONTAL HOLD

The loss of horizontal sync may cause a part of the image to break up in the form of a horizontal band or area of varying width, depending upon the extent of the fault, or the entire image may break up as shown in Figure 4B. Occasionally, improper hold results in the formation of a number of small pictures or images on the screen.

Usually the trouble can be found in the horizontal oscillator or sync circuits. However, improper contrast affects the vertical and horizontal synchronism. Since the sync pulses are part of the composite video signal, these pulses may be too weak to control the frequency of one or both deflection circuit oscillators if the contrast is not sufficient. On the other hand, if the contrast is excessive, the large amplitude pulses applied to the sync circuits may cause unstable operation of these circuits, and create random triggering of the deflection oscillators.

WIDTH AND HEIGHT

Insufficient width is illustrated in Figure 4C by the normally circular pattern having elliptical shape, with its length in the vertical direction. The inner large "circle" just touches the top and bottom edges of the mask, when the height adjustment is correct.

As shown in Figure 4D, a similar effect results when the height is excessive. Here, the inner large

should be made so that effort can be directed to the right sweep circuit.



The VTVM, oscilloscope, and signal generator are the basic essential test instruments for the television service shop.

Courtesy Philco Corp.

“circle” extends beyond the upper and lower edges of the mask, but the large outer “areas” just touch the sides of the mask to indicate that the width is correct. Various other pattern distortions which are similar in appearance should be studied and the differences noted carefully so that the faulty control settings are recognized immediately. Again a distinction

NON-LINEARITY

Image non-linearity in the horizontal direction is illustrated in Figure 4E. In this case, the pattern is squeezed together on the left and stretched out on the right. Variations of horizontal non-linearity include squeezing or bunching at either side with stretching at the other side, squeezing or stretching of one side only with

the other side normal, and squeezing or stretching at the center with both sides normal. Though the left side of the pattern of Figure 4E is similar to that of Figure 4C, the right side is not. In fact, it is due to the non-symmetrical pattern produced by either horizontal or vertical non-linearity that this defect can be distinguished from improper size control adjustments.

An example of vertical non-linearity is given in Figure 4F. Here, the top part of the image is stretched out, and the lower part squeezed together. Like horizontal non-linearity, vertical non-linearity may take various forms with regard to the stretched and squeezed portions of the image.

To decide whether the non-symmetrical image is due to horizontal or vertical non-linearity, remember that the former causes crowding and spreading of picture elements along each and every horizontal scanning line, while vertical non-linearity causes differences in the spacings between lines resulting in crowding and spreading of picture elements in the vertical direction.

When the width is excessive, the test pattern has an elliptical shape with its major axis in the horizontal direction, as shown in Figure 4G. Though distorted, this pattern is symmetrical, side-for-side and top-for-bottom. Similar

in appearance to the pattern of Figure 4G, the pattern of Figure 4H shows the result produced by insufficient height. Again, the normally circular pattern is made elliptical but, as in all cases of incorrect size control settings, the pattern is symmetrical. It is important to make a distinction, for linearity and size are both functions of the same circuits, but each is normally created by different component failures.

TUBE REPLACEMENT

A number of simple checks can be made to determine whether the trouble is due to a faulty tube, although in some cases the only test available consists of replacing the tubes in the defective section, one by one, and observing the result on the operation of the receiver. Before removing a tube from its socket to check it by replacement or in the tester, it is a good idea to first press it firmly into its socket to see if any improvement in reception can be obtained, for often faulty operation is caused by a tube making loose contact with its socket. Also, a tube tester may indicate the faulty tube when a replacement is not immediately available, although a reading of GOOD on the tester can be misleading.

Regardless of the method by which it has been located, any tube found to be defective should

be replaced by a new tube which provides operation of the receiver. In some cases it is necessary to try more than one new tube in a critical circuit, since there are appreciable differences in the characteristics of individual tubes of the same type number. These differences may produce vastly different results, even though all the tubes tried are GOOD. For this reason, a selection of tubes are listed with field service equipment rather than a tube tester.

Most tubes have a factory guarantee of one year, and each is marked in code with the date of manufacture. Various codes are used, but usually can be interpreted easily. For example, a tube marked 9-48 was manufactured

in the 48th week of 1949. Using a different code, another tube may be marked 194710 to show that it was manufactured in the 10th month of 1947.

An understanding of these codes will make it easy to determine whether the guarantee is still valid in a particular case, and thus whether the tube will be accepted by the factory for replacement. Of course, a tube must be returned to the distributor or manufacturer of that particular tube.

Chart 2 lists tube types which records show have failed most frequently over a period of several years. Included are the usual causes for the failure of each type, and one or more suggested means of correcting the trouble.

Chart 2

<u>Tube Type</u>	<u>Cause of Failure</u>	<u>Suggested Correction</u>
R-f Section 6J6 (osc.)	Microphonic	Select non-microphonic new tube or use lead shield.
12AT7 (conv.)	Fails to oscillate on high channels due to low Gm.	Sel. new tube that will oscillate.
Picture Channel 12AU7 (v-f amp.)	Microphonic	Sel. Non-mic. new tube.
Sync. Section 6SN7	Open heater, low gain, gassy or intermittent.	Replace with new tube.
Hor. Defl. Section 6BG6G and 19BG6B (output)	Gassy due to electrolysis action at top connection.	Replace with new tube of make having leaded glass envelope.
	Insufficient output due to reduced emission.	Replace with new tube which shows high sensitivity on tester.
	Barkhausen oscillations.	Replace tube or place magnet of ion trap type around tube.
Damping Tubes	Burnout due to flashover caused by heater sagging.	Replace tube.

TUBE FAILURES

Because of the time it takes to remove the chassis from the cabinet of any receiver, it is desirable to check the possible sources of existing trouble which may be corrected with the chassis in the cabinet, before removing or "pulling" the chassis. Thus, when a trouble of this type exists, the repair or replacement may be made without spending time and labor in unnecessary and time consuming removal of the chassis.



Reception faults due to built-in or indoor antennas may be corrected by installation of an outdoor type.

Courtesy The Ward Products Corp.

The records of various television service organizations kept over a period of several years show that tube replacement corrects the trouble in 25 to 40 per cent of all service calls and approximately one-fifth of these tube troubles consist of defective picture tubes. That is, picture

tubes have been replaced on an average of between 5 and 8 out of every 100 service calls.

When considering the cost of picture tubes, these replacements represent rather high maintenance expense to receiver owners were it not for that fact that about half of these picture tube failures occur within the 90 day warranty period given by most TV receiver manufacturers. Furthermore, the present trend is toward free or very low cost replacement by the manufacturer during the entire first year.

Although a large percentage of receiver troubles are due to tubes which are actually defective, certain other receiver conditions result in tube failure, even though the tube is still good as far as normal use is concerned. That is, many television receiver circuits are designed to operate certain tubes at or near the upper limit of their ratings. Hence, in these circuits, any change will reduce the capability of the tube to provide service equal to its original peak performance, and thus results in early tube failure.

For example, the cathode emission capabilities of tubes decrease as tubes age. Most receiver circuits are designed to allow for this decrease so that the tubes they contain are useful for a relatively long period of time. However, when used in a circuit re-

quiring the high emission of which only a relatively new tube is capable, any tube is useful during only the first portion of its rated life. After this period, the circuit will not perform properly. Satisfactory operation is restored only when a new tube is substituted for the old one.

As another example, due to aging under normal use, resistors and capacitors change somewhat in value. When such a change reduces either the signal or operating voltages applied to a tube in a critical circuit of this type, the output from this stage might be too low for proper operation of the receiver. By trying a number of replacement tubes of the same type, often a service technician will find one that has higher than average capabilities and, therefore, is able to supply sufficient output even with the lower applied voltages.

Often, the tube replacement method is employed even when the technician realizes that some other circuit condition is the actual cause of trouble. Although as many as half a dozen new tubes are tried before finding one that works satisfactorily in a particular set, this method still permits receiver operation to be obtained in less time than it takes to remove the chassis and replace the defective part, etc. In the long run, however, this usually proves

to be rather costly because of the repeated replacements necessary.

The previously mentioned service records show that from 1 to 15 per cent of all calls require work of some type on the antenna system, including re-orientation, repair, and changing the antenna arrangement. Other reasons for fairly large percentages of service calls are to repair or replace the tuner resistors, capacitors and other components.

Finally, a fair number of calls, from 4 to 15 per cent, are so-called "false" calls, made because the receiver owner thought something was wrong with his set or installation when actually there wasn't. Examples of this include trouble at the transmitter, temporary noise sources, and a-c power failures.

R-F Section

The r-f section of the receiver contains the r-f amplifier, the local oscillator, and the mixer tubes. Frequently, these tubes become microphonic and cause a high frequency squeal in the speaker. This squeal usually is generated when the receiver volume is high, and appears stronger and more frequently on the higher frequency channels. The oscillator tube is by far the worst offender insofar as microphonic troubles are concerned.

Often, the faulty tube is located by tapping each tube until the squeal appears or is modified. When the defective tube is found, it should be replaced by one which operates properly. It may be necessary to try several tubes before a satisfactory one is found. However, because a given tube is microphonic in a particular receiver this tube is not necessarily useless, but may work perfectly well in another circuit.

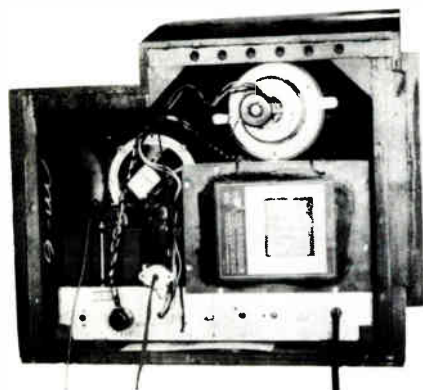

To provide adjustment, all controls are accessible to the service technician without removal of the chassis. Note this receiver has a tube layout chart posted on the high voltage coil.

Courtesy Philco Corp.

Replacing a defective oscillator tube may change the produced intermediate frequency to such an extent that the signal is not passed by the tuned coupling circuits of the i-f amplifier stages. When this is the case, the oscillator must be retuned to obtain the correct intermediate frequency. The oscillator tube shield should be replaced

before any such re-alignment is attempted, because the capacitance which it adds will throw the stage out of alignment if replaced after the adjustment is made. Also, whenever this shield has been removed for any reason, it is important that it be replaced when work on the receiver is completed, for it serves to prevent r-f radiation and reduces vibration of the oscillator tube.

“Noisy” tubes in the r-f section affect both the sound and the picture. Noise energy in the signal circuits results in horizontal streaks or flashes on the viewing screen. Tube noises are common in receivers using miniature type tubes, because these tubes have closely spaced elements which may touch more easily and cause high or low-resistance shorts. Some intermittent shorts produce noise effects in the receiver output, while others of a more serious nature cause the stage to be completely inoperative.

To check for a noisy tube, the various tubes are tapped lightly and the output observed to detect any resulting effect. This check may be misleading if the faulty tube is so sensitive that it operates erratically when other tubes near by are tapped. In this event, the only satisfactory check consists of replacing the tubes one by one until the defective one is located.

Picture Channel

The picture channel contains the tubes of the i-f amplifier, the video detector, the v-f amplifier, and the picture tube. In the i-f amplifier, tubes are the main source of trouble. Weak or noisy tubes are a common defect in this section, and cause an effect on the image similar to the illustration in Figure 5. The remedy for this condition is to replace the faulty tube.

Oscillation in the picture i-f section produces the effect shown in Figure 6. When this trouble is caused by a defective tube, it can be corrected by replacing the tube, but if it is due to some other faulty component, the receiver chassis has to be removed to permit further checks.

In any part of the picture channel, a weak tube sometimes will result in an image with reduced contrast as illustrated in Figure 7. This symptom is produced even when the video detector is weak, although this tube is not a very common source of trouble. In some receivers, a crystal detector such as a 1N34 is employed, and the same effect on the image is caused by a decrease in the forward conductance of this unit.

Tubes often will not light or heat because of an open heater. These may be detected easily by visual inspection or feeling to see

whether hot or not. However, certain tubes such as the video detector diodes, operate with very light currents, and therefore do not heat as much as other tubes. Thus, when this check is made, these normally lower operating temperatures should not be mistaken for a defect.

In the video amplifier stages, 60 cycle energy may be introduced into the signal circuits by a cathode-to-heater short, and create the effect illustrated in Figure 8. A similar symptom results when a cathode-to-heater short develops in the picture tube.

Illustrated in Figure 9, loss of sync control may be caused by weak sync or video amplifier tubes when this tube serves the dual-function of picture signal and sync pulse amplifier. In fact, a v-f amplifier tube can be weak enough to cause loss of sync, and yet have very little effect on the picture contrast. A similar effect is produced by interference such as arcing in the high voltage supply.

In some receivers, the last video amplifier is coupled direct to the picture tube without a d-c blocking capacitor. In this case, a weak or bad video output tube may allow the picture tube grid to become positive with respect to the cathode, resulting in cathode-to-grid electron flow in the grid circuit.

Indicated by a blurred picture when the brightness control is advanced, this trouble may result in eventual damage to the picture tube. Sometimes, a complete loss of the raster will result when the brightness control is turned to maximum with this defect present. To prevent damaging a new picture tube, a check for the possible existence of this circuit condition always should be made when the picture tube is to be replaced.

Should the vertical deflection circuit fail, the beam will trace a thin horizontal line on the screen as shown in Figure 10. In receivers in which the high voltage supply is independent of the horizontal deflection circuit, failure of the latter produces a vertical line, while a small bright dot will appear at the center of the screen if both deflection circuits fail. These conditions result in a brownish line or spot being burned into the screen if the receiver is left turned on for too long a period without proper beam deflection.

A discolored screen appearance which may be mistaken for either of the above conditions is that due to a collection of dust on the outside surface of the picture tube face. Attracted by the charged glass face, these dust particles will not wipe off easily and may give the impression of a

burned or decayed phosphor. This dust can be removed with some common glass cleaner such as a glass wax.

As with other tubes, picture tubes age with use. The cathode emission becomes weak and the screen material decays from continual electron bombardment, resulting in reduced brightness and a brownish tinge on the screen. When the picture tube heater is burned out there is no beam and, of course, no raster. If lighted, the heater should be visible near the tube base.

Also, the raster cannot be produced if the tube has developed a leak and filled with air. When the tube base has become loose but the tube is in good condition otherwise, it may be possible to return it to the manufacturer to have the base cemented on again.

Damage to the picture tube screen may result if the electron beam is not properly centered in the gun and cuts into the gun structure to knock small particles loose and hurl them against the screen. This condition can be caused by a misadjusted ion trap magnet. The same action may release gas from the electron gun electrodes. Usually, a gassy picture tube is recognized readily by the blurred and spotty screen appearance or possibly a negative picture, when the brightness control is turned up. When it pre-

sents this appearance, the picture tube should be replaced.

Also severe jarring can throw the entire electron gun out of line so the beam cannot be focused properly. In the case of picture tubes which employ electric deflection, the deflection plates can be jarred out of line so that the raster is distorted.

Sound Channel

In the receiver sound channel, defective tubes may be located by removing the tubes one by one and listening for the loud click in the speaker which indicates the stage to be in good condition. When this test is made, a weak click or no response indicates the trouble to be in the stage of the tube being removed, or in a following stage. If a loud click is heard when the tube is removed in the following stage, then the defect is in the stage which produced the soft click. If the trouble is not remedied when the tube is replaced by one known to be good, further troubleshooting of the circuit is necessary. This is true, of course, in any stage of the receiver.

Removal of the audio detector tube does not produce a noticeable click unless the tube contains a section which is used as an amplifier. Some symptoms of a defective detector tube are weak or distorted sound. When suspected

of being defective, a detector tube should be replaced.

Sync and Deflection Section

In general, any distortions of the raster, inability to adjust the controls for proper size, centering or linearity, or loss of sync may be due to defective tubes in the sync and deflection circuits of the receiver.

If the picture stops momentarily when the hold controls are adjusted, and then rolls on without being locked in definitely, it is likely that the sync circuits are not applying the sync pulses to the deflection oscillators or horizontal control circuit. This trouble may be caused by a defective tube in the sync section. However, a weak video or video i-f amplifier tube can cause similar instability in some receivers without impairing the contrast to a noticeable degree.

If the picture tears out horizontally but holds vertically, there may be a defective tube in the horizontal sync control circuit, or the horizontal deflection oscillator tube may be faulty. In like manner, a defective vertical oscillator tube may make it impossible to bring the picture to a stop, even when the hold control is turned as far as it will go.

Loss of synchronism also can be caused by a noisy tube in the r-f section, picture channel, sync

or deflection circuits, and often may be located by lightly tapping the various tubes. The same method may be employed to locate a tube in which a defect is causing intermittent loss of sync.

Horizontal non-linearity may result from a defective horizontal oscillator tube, discharge tube, or output tube. Defects in these same tubes may make it impossible to obtain sufficient raster width by adjustment of the width and drive controls.

Also, the damper tube may be a source of this trouble, but then usually the symptom is accompanied by a bright area on the left side of the screen, as illustrated in Figure 11.

In a similar manner, insufficient height or vertical non-linearity may be due to a defective vertical oscillator, discharge, or output tube. A defective vertical output tube can cause the raster to be too high or too low on the screen, while the raster may be off-center horizontally due to a defective horizontal output tube.

Known as **BARKHAUSEN OSCILLATIONS**, extremely high-frequency oscillations may be produced in the horizontal deflection circuit output tube and radiated so that the energy is picked up by the input circuits of the receiver. If the oscillations are strong enough, one or more black vertical lines may be produced on the screen as shown on the left hand side in

Figure 12. In this illustration it is most readily observed in the solid white area. When the oscillations are weak, or are not picked up to any great extent by the input, the produced lines may appear white and, if broadened, be mistaken for the effect of damping tube failure, Figure 11.

To determine the source of trouble in this area, a loop of the antenna lead-in may be placed around the horizontal output tube and, if the same white lines increase in intensity or become black, the cause is Barkhausen oscillation. The tube should be replaced with a new one which does not produce these oscillations. An alternative is to place a beam bender around the tube and adjust by rotation and axial motion for minimum oscillations.

Power Supplies

Power supply rectifier tubes must be in good condition to supply the various circuits with the required voltages and currents. Insufficient raster size, a weak picture, and reduced sound volume may be caused by a rectifier tube having low emission. In many receivers, the low voltage power supplies employ selenium rectifiers which are designed in such a way that they can be removed easily for replacement. Although mounted on top of the chassis in some models, in others

they are mounted below the chassis in which case they cannot be replaced without the chassis being removed from the cabinet.

In receivers employing transformerless type low voltage power supplies, usually the heater circuits are series-parallel connected

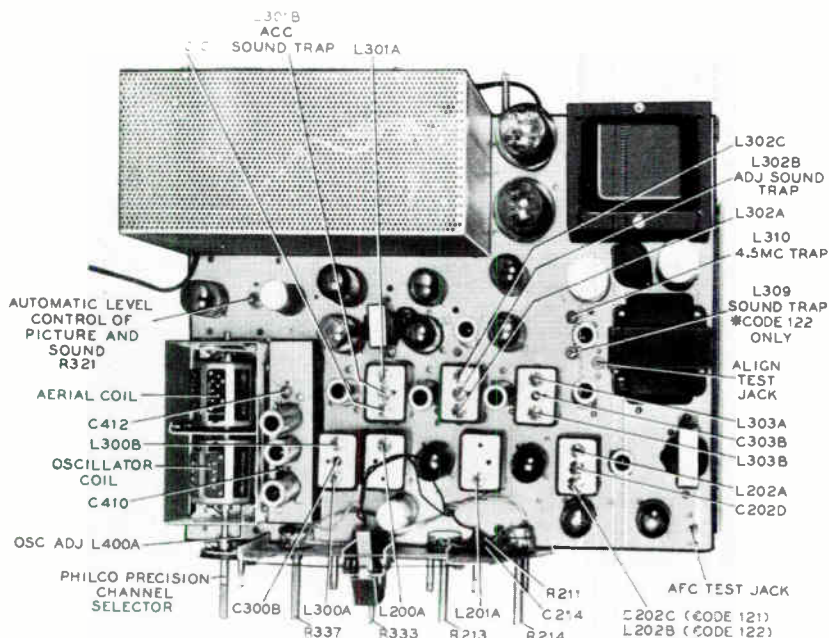

Top chassis view of the receiver shown in the preceding illustration. All adjustments made from the top of the chassis are indicated.

Courtesy Philco Corp.

Like the electron tube types, these rectifiers become weak with age and thus result in the same symptoms mentioned above. Often, defective selenium rectifiers produce a very disagreeable odor. This is caused by a severe overload due to a short circuit existing in the low voltage supply or in other circuits connected to it.

across the 117 v a-c line. With this arrangement, an open heater in one tube results in all tubes connected in series with the defective tube to remain unlighted. The high voltage compartment also contains tubes, and these should not be overlooked as a possible cause of trouble in the heater circuits. However, the high

voltage rectifier tube does not obtain its heater voltage from the a-c line, but from the high voltage transformer. Therefore, this tube can have an open heater without affecting the heater current in the other tubes.

Some receivers employ ballast tubes to drop the line voltage to the correct value for heater operation. Occasionally, one of the resistors in the ballast circuit is used as part of an RC network which serves as a filter in the low voltage power supply output. In the event this resistor is open, the tube heater circuit is not affected. That is, a ballast tube may be defective even though all of the receiver tubes are lit.

Red hot rectifier tube plates indicate that the power supply is being heavily overloaded due to a short or some other abnormal condition. As this condition can cause the rectifier to be damaged, the power should be turned off immediately whenever this symptom is observed.

Usually, the type of high voltage supply employed can be recognized by the tubes it contains. In the case of a flyback type supply, generally the horizontal deflection oscillator is a duo-triode such as a 6SN7, 12AU7, or a 12SL7, the horizontal output tube may be a 6BG6, 6BQ6, 6CD6, 19BG6 or a 50BG6, the damping tube usually is a diode such as a

5V4 or a 6W4, and the high-voltage rectifier a 1B3/8016 or a 1X2.

The r-f type supply contains an oscillator tube which generally is a power pentode such as a 6K6, 25L6 or 50L6, but occasionally may be a triode or a duo-triode such as a 6C4, 6SN7, or 12AU7. Again, the high voltage rectifier usually consists of a 1B3/8016 or a 1X2.

OTHER TESTS AND ADJUSTMENTS

In addition to tube replacements, there are a number of other tests, adjustments, and repairs which can be made without removing the chassis from the cabinet of the television receiver. Also, if one or more new stations have begun operating since the receiver was installed, proper reception on the new channels may not be obtained without adding channel strips to the tuner, a complete UHF converter, or changing the antenna system. These complaints do not involve a defect in the receiver proper.

Antenna System

The change may consist of re-orientation of the antenna, addition of a high or low-band VHF or a UHF unit, increase in height, or replacement by an entirely different type.

When troubleshooting the antenna system, observe closely

both the antenna and lead-in to detect any mechanical or electrical faults. A loose connection in the antenna or transmission line, a short circuit in either, faulty orientation or mounting, or contact with near-by conducting objects cause poor operation.

A broken transmission line may produce symptoms which vary with different stations. For example, ghosts may be seen on one channel, reception may be weak on another, while none at all is obtained on still another channel.

Ice formed on the antenna or lead-in, snow, sleet, rain, or dense fog sometimes result in a weak or fading signal input to the receiver, usually this trouble being more apparent on the higher frequency channels. The same effect can be caused by a transmission line which is not installed securely and sways with the wind.

Many receivers contain a built-in antenna and, although providing satisfactory reception in some areas, antennas of this type often result in the appearance of snow and ghosts when used in weak signal areas. In cases where an outdoor antenna cannot be installed for one reason or another, satisfactory reception may be obtained by employing a portable indoor type antenna instead of the built-in unit. The advantage of the portable type is that it can be oriented without regard to the position of the receiver cabinet.

A weak signal may be caused by a mismatch between the transmission line and receiver input circuit, and this condition can be corrected by the use of a matching stub. Such a stub consists of a length of transmission line connected to the receiver input terminals at one end and having its free end short circuited. In any particular case, the proper stub length may be determined experimentally as follows:



A handy tool which may be added to the service kit. It is used to remove tubes from the socket.

Courtesy Hytron Radio and Electronics Corp.

A piece of 300 ohm twin-lead about 60 inches long is connected to the receiver input terminals, and a razor blade or sharp knife used to short circuit the lead at various points by cutting through the insulation to make contact with both wires. A weak station is tuned in and, beginning at the free end of the lead, the short circuit is made at points successively closer to the receiver terminals while the screen is observed for resulting changes in the

picture. The position on the lead is noted at which the short results in the brightest picture.

Next, the same procedure is followed with the receiver tuned to each of the other channels because a given stub length may improve reception on one channel but impair it on another. The final length chosen may have to be a compromise. After the most desirable shorting point has been decided upon, the lead is cut just slightly beyond this point so that it forms a stub of the desired length after the wire ends are cleaned of insulation and soldered together.

If the picture is over contrasted and unstable, possibly the agc is inoperative. However, for short distance reception, sometimes the trouble is an over strong signal. This can be corrected by disconnecting one or both wires of the lead-in from the receiver input terminals. However, in many cases it has an adverse affect on reception from the weaker stations.

A second method consists of cutting the lead-in near the receiver and overlapping the two ends a few inches to provide capacitive coupling. Inserted into the antenna circuit, an attenuator pad will reduce the signal strength, and adjustable attenuators are available which permit the exact desired signal strength to be obtained.

Still another method consists of cutting a piece of solder several inches long and connecting it directly across the receiver input terminals. Although this may appear to be a direct short, actually the solder has too much impedance at the television r-f frequencies to permit excessive attenuation of the incoming signal.

Tuner

In the receiver r-f section, the tuning assembly is a common source of faulty reception. For example, a loss in i-f amplifier gain is caused by the frequency shift of the produced i-f band when the local oscillator has drifted in frequency. Correction for a small drift can be made by adjusting the fine tuning screws in the oscillator circuit. In many receivers, these screws are readily accessible and can be brought into view by removing the channel selector and fine tuning knob.

Before such an adjustment of the oscillator trimmers is made, the fine tuning control is set to mid-position. Then, a non-metallic alignment tool is used to adjust the oscillator screws for each channel until the best picture and sound are obtained. Usually, only a few turns of the screws are necessary. CAUTION should be exercised, for IF THEY ARE TURNED TOO FAR, THESE SCREWS MAY FALL FROM THEIR MOUNTINGS, thereby requiring removal of the chassis

for their replacement. Since the circuit arrangement can be such that the tuning is affected on the lower channels when adjustments are being made on the higher channel circuits, usually the best procedure is to start with the higher channels and work down.

Due to rotation of the channel selector vibration may cause the r-f oscillator adjustment screws on top of the chassis to shift position and result in a weak signal or no signal complaint. This trouble can be prevented by the application of a small amount of service cement to the alignment screws. Mixer and r-f stage tuning adjustments are located on top of the chassis also, and similar applications of cement to them prevents possible future misalignment due to shifts in their settings.

Some tuners have spring clamps which hold the movable parts in position. These clamps may break, slip from the mounting or lose tension and cause intermittent operation, and a visual inspection often indicates whether they are at fault.

Where UHF channel stations have recently "gone on the air" the set owner likely will want his receiver adapted to receive the program. This conversion is accomplished by one of two means: (1) the addition of a UHF converter, or (2) The insertion of

strips where the receiver has a turret tuner for which UHF strips are manufactured.

Installing the converter is simple. The unit is placed conveniently on top or beside the VHF receiver, twin lead is connected from the converter output to the receiver antenna posts, the twin lead from an all channel antenna or from VHF and UHF antenna are connected to the converter input. After plugging the power plug in, the installation is ready.

Installing UHF strips in the VHF turret tuner requires pulling the receiver chassis and inserting the strips in place of unused VHF channels. The manufacturer's instructions packed with the UHF strips indicate how this replacement should be made. Make sure the strips installed are for the right channel and for the right tuner make and model. As pointed out in a previous lesson, the same manufacturer may build tuners for different intermediate frequencies. Therefore the UHF strips installed must be designed to produce the same i-f output as the original VHF strips.

Controls

Frequently, the volume control causes the sound output to be noisy or intermittent due to the carbon disc having become dirty. This condition may be checked by rotating the control knob and

noting whether the changes in volume are uneven. Sometimes this trouble can be corrected by removing the knob and pouring a small quantity of carbon tetrachloride down next to the shaft. This liquid flows over the carbon disc, and the control is rotated to aid the cleaning action.

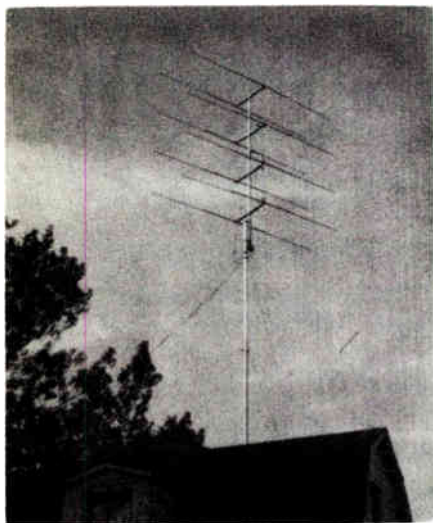

To provide good reception from all stations in the area, the antenna orientation is varied by a motor which is controlled by a switch at the receiver.

Courtesy LaPoint-Plascomold Corp.

The vertical or horizontal hold controls may cause intermittent or constant loss of sync if they become dirty, and often may operate properly if cleaned with carbon tetrachloride as explained above for the volume control. The same cleaning method can be used for the brightness control which, when dirty, may result in a no raster condition.

Low Voltage Supply

Many receivers include a fuse to protect the low voltage power supply. When this fuse has blown, it should be inspected to see if it is of the correct rating. If its rating is correct, then there must have been an excessive current drain or load on the supply to blow the fuse, and the cause of this overload should be investigated and removed before the fuse is replaced. A new fuse with the correct current and voltage ratings should be used to replace the blown unit.

Although an inspection of tube heaters indicates the heater circuits to be in good condition, the low voltage supply may not be providing the required d-c output. A rough check for this output consists of temporarily removing a tube from its socket in the sound channel. As the tube is removed, a click is heard in the loudspeaker if the low voltage supply is operating properly. However, if the click is not heard, the power supply may be defective, but this check is not complete, for in this case the trouble also might be in some circuit between the removed tube and the speaker, or in the speaker itself. If in addition to this indication, a faulty or no raster condition exists, then the low voltage supply is probably defective.

Although a fairly large transformer may be used in the low

voltage power supply, the normal load on this supply is quite heavy and will cause the transformer to become fairly warm. Excessive heating of this transformer is an indication of an abnormal condition in the supply, or in some circuit connected to the supply. Whether or not the transformer is too warm must be determined largely by experience, but a defect may be assumed to exist if the transformer appears so warm that there is definite danger of its insulation being damaged.

Measured across the prongs of the a-c line plug, a resistance reading will reveal a short circuit in the transformer primary, or in the line cord. If this reading is normal, between about 1 and 10 ohms, and the transformer appears overheated, then it is likely that trouble exists in circuits connected to one of the transformer secondary windings. Other than of the rectifier tubes, further checks require removal of the chassis.

Loose laminations in the power transformer produce a low pitched 60 cycle hum similar to that frequently heard in loudspeakers due to defective filters or other causes. Often, the hum may be varied by rotating the volume control if it is being produced in the speaker, but this control has no effect on the hum produced by the power transformer.

However, a more definite check may be made by temporarily disconnecting one of the speaker voice coil leads, or pulling out the speaker plug in the case of a PM speaker. Should the hum still persist, the transformer is the likely source. The condition can be corrected partially or completely by tightening the bolts which hold the transformer together.

Defective power supply filter capacitors can cause hum, but then the picture is affected at the same time. If the low frequency a-c voltage introduced into the video circuits has a frequency of 60 cycles, the picture tube screen will contain one light and one dark horizontal bar, or one light or dark bar across the middle with the two halves of the other bar above and below, respectively, as illustrated in Figure 8. If the introduced voltage has a frequency of 120 cycles, the screen will contain some combination of a total of two white and two dark alternate bars.

High Voltage Supply

A neon bulb may be used to make a quick check for operation of part of the receiver high voltage supply. If the horizontal output circuit is functioning, the bulb will light when held near the plate lead of the high voltage rectifier tube. To protect the high voltage supply circuits, most receivers contain a fuse which should be

checked when no high voltage is present. Often, a momentary surge of current will have caused it to blow, in which case its replacement is all that is needed to complete the service work. However, repeated blowing of this fuse may indicate a faulty component in the high voltage supply circuit, and such a possible cause should be looked for.

Another cause of loss of high voltage is arcing from a high voltage wire to the chassis, metal shield, or some low potential circuit component or wire. Usually, such arcing can be detected because of the frying or hissing sound which accompanies it, and if it continues long enough it may blow a fuse. To correct this trouble, after turning off the power, move the high voltage wire to a position where it has greater clearance.

In some cases, even though actual arcing may not occur, the air near the high voltage wire or other conductors may become ionized and thereby permit a type of discharge known as corona. Usually, no sound accompanies this discharge, but a blue haze is seen near the conductor when the receiver high voltage supply is inspected in a dark room. Sharp-pointed wire ends, rough solder joints and other irregularly surfaced conductors are all sources of corona discharge. To prevent corona, the solder joints should

be heated until the solder flows smoothly, and other rough points should be coated with a good grade of varnish or some type of service cement. Polystyrene cement is excellent for this purpose.

The receiver picture tube contains a conductive coating on its outer surface, and this coating forms part of the high voltage supply output filter capacitor. Therefore, it is important that the coating is connected conductively to ground. When spring type contacts are used to connect the tube coating to some grounded objects such as the deflection yoke mounting, these springs may become bent or lose tension so that they do not make good contact. This type of trouble may be indicated by a fine herring-bone pattern on the picture tube screen, and can be corrected by bending the springs so that a better contact is obtained.

Ion trap magnets may lose their magnetism and result in a no raster condition, even though the proper high voltage is applied to the picture tube anode. The magnet may be checked by touching it with a screwdriver or other iron object, and a very weak attraction indicates that the magnet should be replaced.

In some receivers employing the r-f, high voltage supply, a feed-back spring encircles the high voltage rectifier and serves

to feed energy in the form of pulses back to the oscillator circuit to maintain oscillations. Should the spring become located at the wrong position on the rectifier tube, the oscillations are weakened and the high voltage output reduced, causing a dim or no raster condition on the picture tube screen. The correct placement of the spring varies with different receiver makes, and the manufacturer's instructions should be consulted for the proper location in a particular case.

Also, in this type of supply, the filament loop of the r-f transformer may fall out of position or one end may open. This loop should be replaced in its exact original position, as an increase in the coupling may overload the rectifier filament, or reduced coupling may decrease the filament current to a value which does not provide sufficient heating of the filament, resulting in lowered d-c output voltage with poor regulation.

Low output voltage may be due to frequency drift of the oscillator in an r-f type high voltage supply, and may be restored to the proper value by adjustment of the oscillator trimmer capacitor. The capacitor can be adjusted through a small hole in the shield which surrounds the high voltage supply components. When a voltmeter is employed to measure the high voltage output, the

instrument used should be one which will not draw more than 50 microamperes so that the supply is not overloaded.

If the voltage is too high, the deflection circuits may not be able to provide sufficient raster size to fill the mask even with the height and width controls set to maximum. Therefore, these controls should be set to their mid-positions before the high voltage oscillator trimmer is adjusted, and then trimmer adjustments made to fill the entire screen. Finally, the size controls are adjusted for the proper aspect ratio and exact size desired.

In some receivers, a fuse is employed in the cathode circuit of the horizontal deflection amplifier tube. This fuse prevents excessive plate current due to loss of control grid signal in the event of failure of the horizontal deflection generator circuit. When no fuse is used, the defective circuit condition is indicated by a cherry red glow of the plate of the horizontal output tube. The trouble should be remedied before attempting to replace the tube.

SAFETY PRECAUTIONS

Although electrically similar to the other tubes in the television receiver, the picture tube presents definite hazards in handling because of its large surface area, high evacuation, and high anode

voltage required. The high evacuation produces a nearly "perfect" vacuum inside the tube so that the pressure approaches 15 pounds per square inch on the outer surface. For example, a tube with a total surface area of about 1,000

The trained service technician knows how to avoid shock from the high voltage circuits or contacts and the greatest danger here is to an unskilled person tampering with the receiver, such as the owner who is trying to

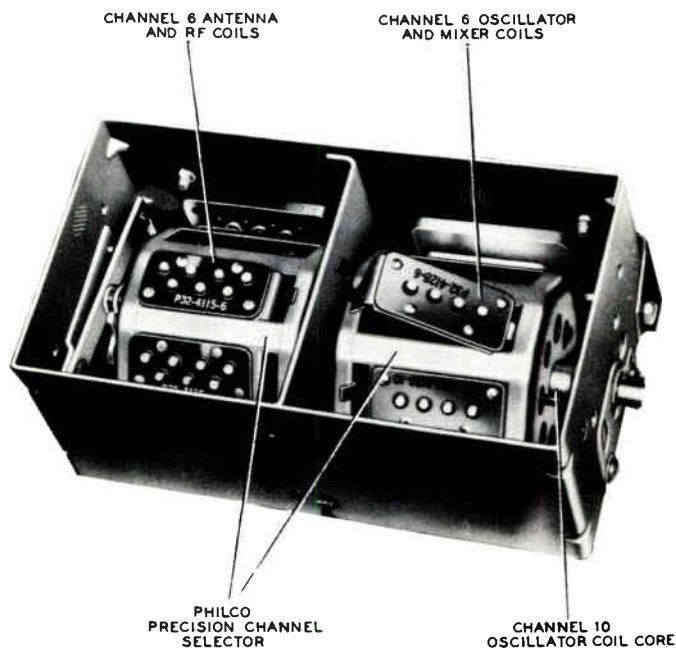

Accessible through the front of the receiver cabinet, the oscillator tuning core (indicated as channel 10) is adjusted for slight drifts in frequency.

Courtesy Philco Corp.

square inches has a total force of approximately $15 \times 1,000$, or 15,000 pounds pressing inward on the bulb. Therefore, picture tube breakage results in an implosion of such force that the glass flies in all directions with possible serious injury to nearby persons.

make his own repairs. Although the high-voltage shock is uncomfortable, its danger to life has been reduced because of the fact that modern receivers contain high voltage supplies of types that are incapable of delivering a lethal current. A much more

dangerous shock can be given by the low voltage supply. With large filter capacitors it is capable of supplying heavy currents. However, the real danger lies in the possible injury suffered by a person striking some sharp or hard object when his hand, arm, or head jerks away involuntarily as the shock is received.

The service technician has to remove, replace, and otherwise handle picture tubes from time to time, and to minimize the danger to himself as well as any persons who may be near by (in the same room), he should observe closely the following safety rules, as set up by the Radio and Television Manufacturers Association.

- (1) Don't remove replacement picture tube from packing carton until ready to use it.
- (2) Always wear goggles and gloves when handling a picture tube.
- (3) Keep other people away at a safe distance when a picture tube is exposed.
- (4) Place the used tube in the carton which contained the new tube, **AND TAKE IT AWAY.**

- (5) Always keep the picture tube in the protective container whenever possible.
- (6) To dispose of a used picture tube, one of the following methods may be employed:
 - (a) Place the old tube in a shipping carton, seal the carton and drive a crow-bar or similar object through the closed top of the container.
 - (b) To dispose of more than one tube at a time, the above method may be employed using a metal ash can with a plunger operated through the closed top.
- (7) Don't use regular picture tubes for display purposes. Obtain special display type tubes from a parts jobber.

Although not necessarily taken in the sequence presented in this lesson, the serviceman can quickly make the replacement or adjustments indicated necessary as described in this lesson. If the fault is remedied much labor has been saved, and if not, the chassis can be pulled with full assurance that it is a necessary and a justifiable use of servicing time.



APPENDIX A

SERVICE EQUIPMENT AND SUPPLIES

Field Service Equipment

A portable, metal tool box, or a fishing tackle box with several trays, provides a convenient means of carrying small tools, multi-meters, receiver parts, etc., when the service job is to be done outside the shop. To avoid extra trips, lost time, and unfavorable impressions, the tool box should be checked carefully before leaving the shop to make a call. A complete kit should contain most or all of these parts.

Tools—

screwdriver set ($\frac{1}{8}$ " to $\frac{1}{4}$ " blade)	wrench, crescent (6")
screwdriver, Phillips ($\frac{1}{4}$ ")	wrench, Allen, set
diagonal pliers (6")	wrench, spintight set
long nose pliers (6")	($\frac{3}{32}$ " to $\frac{3}{8}$ ")
gas pliers	knife
solder gun/iron (60 to 200 watts)	flashlight
	mirror, 4 x 5 inches

Parts and Tubes—

capacitors	supply of receiver type tubes
resistors	one or two picture tubes (of
beam benders	type used in set to be
	serviced)

Supplies (assorted)—

service manual	volt-ohmmeter
solder	rubber and friction tape
hook-up wire	neon bulb
assorted nuts and bolts	power cord
300 ohm twin-lead line	carbon tetrachloride
	cleaning cloths

The preceding lists cover most of the essential equipment. There are many desirable tools which may be added and, in time, become essential to the serviceman. However, the most essential is a vehicle, car or truck, in which to make field service and installation calls.

Shop Equipment

The planning of the service shop depends upon the location and space limitations. However, careful layout can turn a less than ideal space into an efficient shop.

The shop should contain a well wired and lighted test bench which is designed for convenient location of test equipment and tools; ample storage space and shelves for parts, reference data, and the receivers repaired as well as those waiting to be serviced.

The larger, more elaborate types of test equipment are left in the service shop. Thus, the receivers which require alignment, major repairs, or more extensive tests to locate the trouble are brought to the service shop.

The service shop's equipment includes many of the tools used for field and installation service. In this case, the equipment should be duplicated.

Listed below are suggested basic test instruments, tools, and replacement parts:

Test Instruments—

oscilloscope (with probe)	AM-FM signal generator
vacuum tube voltmeter	tube tester
sweep generator	

In addition to these basic items, there are other useful instruments which the serviceman may add to the above list. These are: high frequency and high voltage probe for VTVM, capacitor checker, audio generator, cross hatch generator, peak-to-peak scope calibrator, field strength meter, isolation transformer, and so on.

Tools—

electric hand drill $\frac{1}{2}$ "	iron
drill set ($\frac{1}{16}$ " to $\frac{1}{4}$ ")	solder
tool steel reamer	extension cord (100')
files, set	saw, hack (adjustable)
hammer, double face (3 lbs.)	saw, keyhole
hammer, claw (16 oz.)	screwdriver (6" blade)
center punch ($\frac{3}{8}$ " dia.)	screwdriver, Phillips
wrenches, open end set	chisel, cold $\frac{1}{2}$ "
socket punches ($\frac{5}{8}$ ", 1", $1\frac{1}{2}$ ")	chisel, wood $\frac{1}{2}$ "
vise	pliers, side cut 7"
allen wrench set	pliers, diagonal 7"
wrenches, spintight set	pliers, long nose 7"
screwdriver set ($\frac{1}{8}$ " to $\frac{1}{4}$ ")	pliers, gas
alignment tools, kit	electric grinder

Replacement Parts

Resistors—standard values of ½, 1, and 2 watts

3.3 ohms	680 ohms	22K	1.0 meg
10	820	27	1.2
15	1000	33	2.2
22	1200	39	3.3
27	1500	47	4.7
47	1800	56	10
68	2200	68	
82	2700	82	
100	3300	100	
120	3900	120	
150	4700	150	
220	5600	180	
270	6800	220	
330	8200	270	
470	10K	330	
560	12	470	
	15	560	
	18	680	
		820	

Capacitors—standard values mica (500 wv d-c)

10 μfd	330 μfd
27	390
39	470
47	680
82	820
100	1000
120	1500
150	3900
220	4700
270	5000

Capacitors—standard values paper—(450 to 600 wv d-c)

.001 μfd	.02 μfd
.002	.05
.004	.1
.005	.25
.006	.5
.01	1.0

Electrolytic—(single and dual)

20 μfd	60 μfd
40	80

Receiver tubes and picture tubes

1B3/8016	6BA7	6SK7	12BE6
1V2	6BC5	6SL7	12SN7
1X2	6BE6	6SN7	19BG6
5U4G	6BG6	6SQ7	19T8
5V4G	6BH6	6SV7	25BG6GT
5Y3GT	6BK7	6T4	25L6
6AB4	6BL7	6T8	25W4GT
6AC7	6BN7	6U5	25Z6GT
6AF4	6BQ6	6V6	35L6
6AG5	6BX7	6X4	35Z5
6AG7	6C4	6X5	35W5
6AH6	6CB6	6W4GT	50B5
6AK5	6CD6	6W6	50L6
6AK6	6H6	7B4	12LP4
6AL5	6J6	7B5	14BP4
6AL7	6K6	7B6	16AP4
6AN4	6L6	7C5	16GP4
5AQ5	6S4	7F8	16RP4
6AR5	6S8GT	7W7	16TP4
6AS5	6SA7	12AL5	17AP4
6AT6	6SC7	12AT7	17BP4
6AG6	6SG7	12AU6	19AP4
6AU6	6SH7	12AU7	20AP4
6AV6	6SJ7	12BA6	21EP4
6BA6			22AP4

Crystal diodes

1N37 1N34

Miscellaneous parts and supplies—

loudspeakers, 5", 6", 8", 12"	nuts and bolts (ass'td)
transformer, r-f, i-f, a-f	sockets, tube
transformer, power	power cord
transformer, deflection	stationery and office supplies
chokes, a-f, r-f	corona dope
deflection yokes	friction tape
focus coils	hook-up wire
beam bender	carbon tetrachloride
rectifiers, selenium	cleaning cloths

The preceding lists are intended only as a guide for the television service shops. The needs of a particular serviceman depends greatly upon the location, type of service, and the makes and models of the receivers to be serviced. To provide good service, an adequate supply of parts and tubes must be kept on hand. Generally, at least two of each type of replacement part is stocked, the common tube requirement is about ten, while for the more popular types it is well to keep fifty on hand.

STUDENT NOTES

STUDENT NOTES

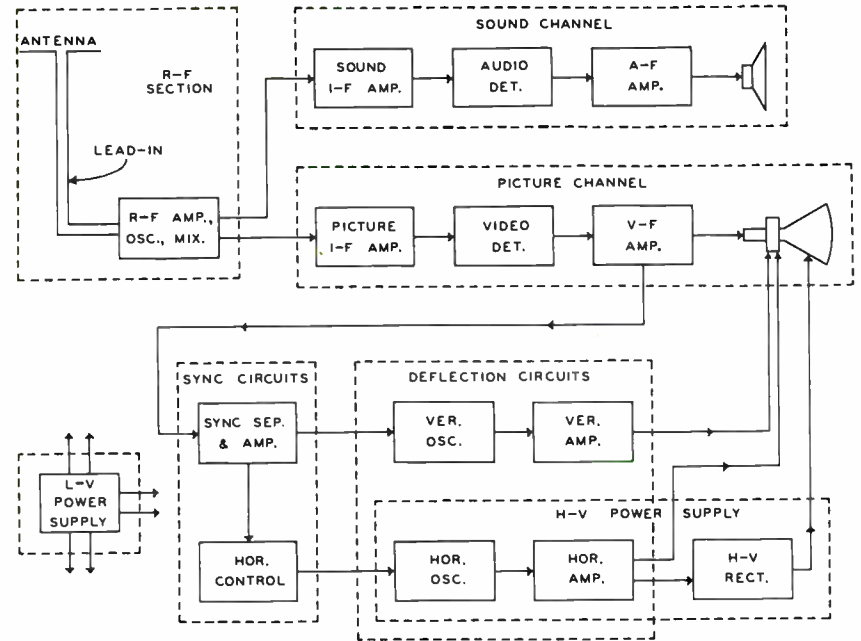
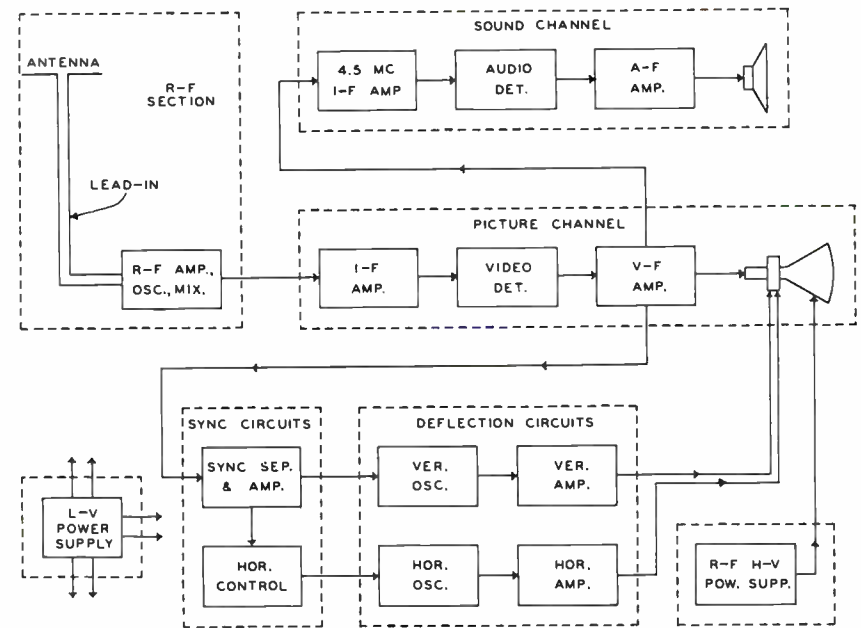

FIGURE 1



TSM-6

FIGURE 2

STUDENT NOTES



47. IGNITION INTERFERENCE
A

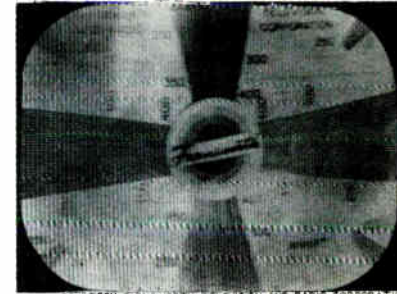

COURTESY FARNSWORTH TELEVISION AND RADIO CORPORATION
46. BEAT-FREQUENCY INTERFERENCE
B

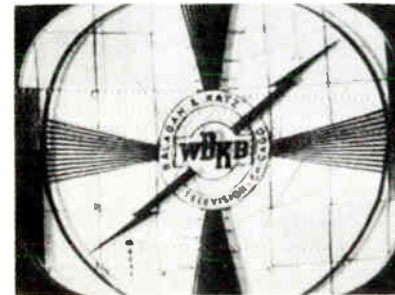

13. GHOSTS
C

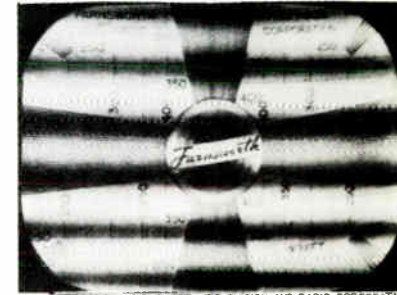

COURTESY FARNSWORTH TELEVISION AND RADIO CORPORATION
44. SOUND BARS
D



BRIGHTNESS TOO LOW
E

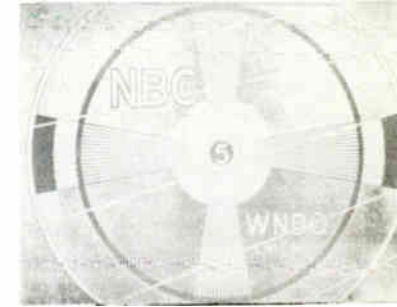

BRIGHTNESS TOO HIGH
F

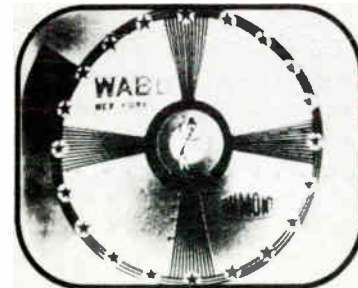

COURTESY A. B. DUMONT LABS., INC.
CONTRAST TOO HIGH
G



COURTESY A. B. DUMONT LABS., INC.
CONTRAST TOO LOW
H

TSM-6

FIGURE 3

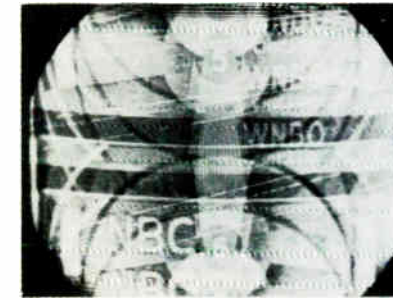

35. NO VERTICAL SYNC.
A



10. POOR HORIZONTAL SYNC.
B



3. INSUFFICIENT HORIZONTAL WIDTH.
EXCESSIVE VERTICAL HEIGHT.
C



COURTESY PHILCO CORPORATION
EXCESSIVE HEIGHT
D

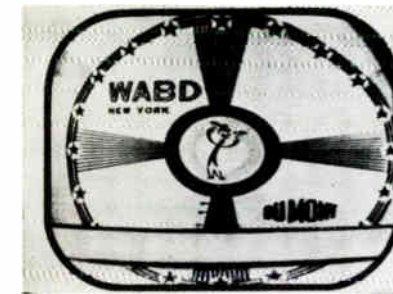

COURTESY A. B. DUMONT LABS., INC.
8. POOR HORIZONTAL LINEARITY
E

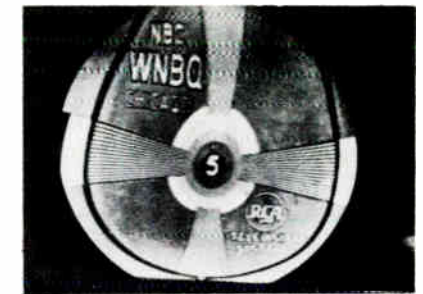

9. POOR VERTICAL LINEARITY
F

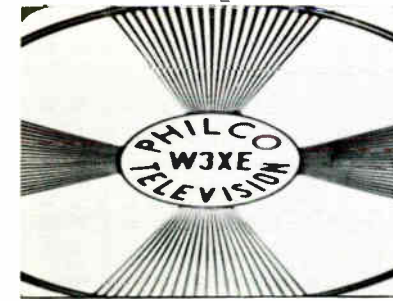

COURTESY PHILCO CORPORATION
EXCESSIVE WIDTH
G



4. INSUFFICIENT VERTICAL HEIGHT
H

TSM-6

FIGURE 4

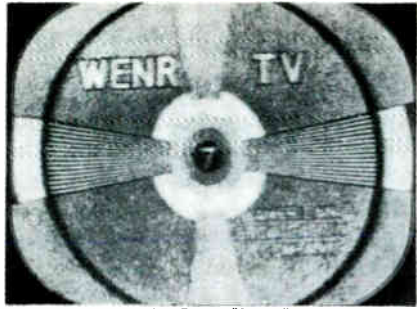

23. HEAVY "SNOW"
FIGURE 5

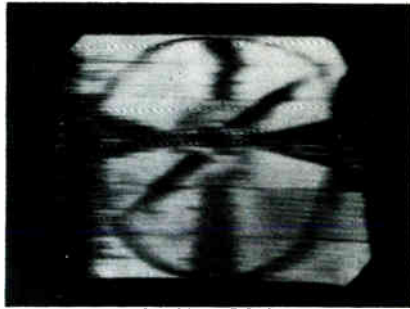

15. OSCILLATIONS
FIGURE 6



INSUFFICIENT CONTRAST
FIGURE 7

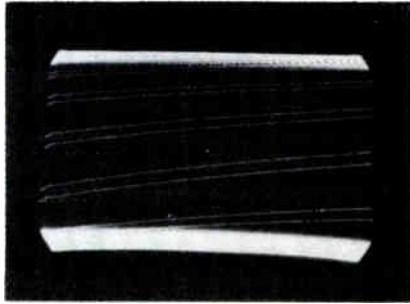

19. 60 CYCLE IN VIDEO
FIGURE 8

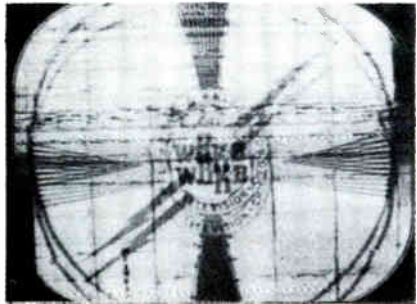

48. LOSS OF SYNC.
FIGURE 9

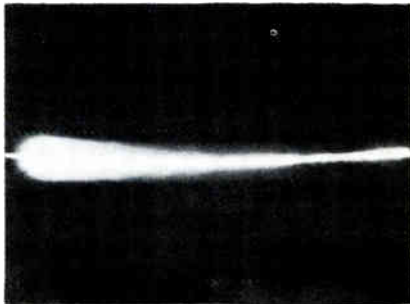

29. NO VERTICAL SWEEP
FIGURE 10



TSM-6
24. HORIZONTAL FOLD-OVER
FIGURE 11



BARKHAUSEN INTERFERENCE
FIGURE 12

DeVRY Technical Institute

Affiliated with DeFOREST'S TRAINING, INC.

4141 WEST BELMONT AVENUE

CHICAGO 41, ILLINOIS

QUESTIONS

Initial Investigation and Adjustment—Lesson TSM-6A

Page 43

2

How many advance Lessons have you now on hand?

Print or use Rubber Stamp.

Name.....	Student No.....
Street.....	Zone.....
City.....	State.....
	Grade.....
	Instructor.....

Write your answers on the "Ans." line below each question. If more space is needed use reverse side of this page.

1. In the initial investigation of a television receiver, what is the first step?

Ans.....

2. Why is a thorough knowledge of the function of each section of a television receiver essential?

Ans.....

3. What circuit is at fault when a bright horizontal line is observed on the CRT screen?

Ans.....

4. If a preliminary investigation reveals that a receiver is completely "dead", in what section is the fault most likely to exist?

Ans.....

5. What pattern is produced on the picture tube screen when an audio frequency voltage is coupled to the video signal circuits?

Ans.....

6. When a television receiver is microphonic, what tube is likely at fault?

Ans.....

7. What are two possible causes of the '60 cycle in video' illustrated in Figure 8?

Ans.....

8. Generally, what is the cause of horizontal fold-over as illustrated in Figure 11?

Ans.....

9. What is a quick check method of determining the existence of high voltage?

Ans.....

10. Why should the conductive coating of picture tubes be grounded?

Ans.....

FROM OUR *Director's* NOTEBOOK

THE "SOFT" JOB

Who **WANTS** a "soft" job anyway? I don't. And I'm pretty sure you don't either. It's just like a fellow hitting a soft section of a road. He bogs down. He gets nowhere.

The easy job—the one that is a snap—is the kind just about anyone can handle. It doesn't take much knowledge, experience or much of anything, for that matter, to hold down this sort of place in any organization.

Then too, it's no secret that the position just about every Tom, Dick and Harry can step into is the one that pays the poorest.

Soft job? That's for the fellow who hasn't had the training and experience advantages you've had. Let him have it. The road to better things in life is built on the firm ground of ambition and knowledge. That's where real progress is made.

Yours for success,

W. C. De Vree

DIRECTOR

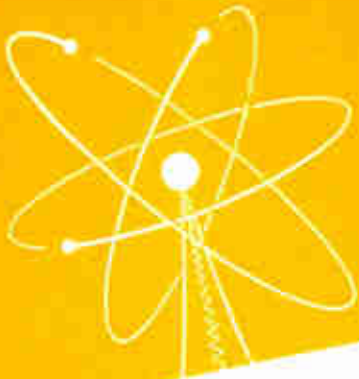

TEST PROCEDURES

Lesson TSM-7B



DeVRY Technical Institute

4141 W. Belmont Ave., Chicago 41, Illinois

Formerly DeFOREST'S TRAINING, INC.

TEST PROCEDURES

4141 Belmont Ave.

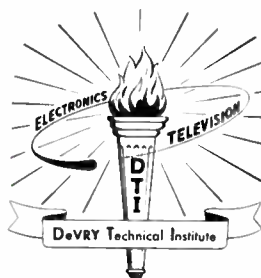

Chicago 41, Illinois

COPYRIGHT 1955

After building their television receivers, the students in DTI's design laboratory make a series of performance tests.

DTI Photo

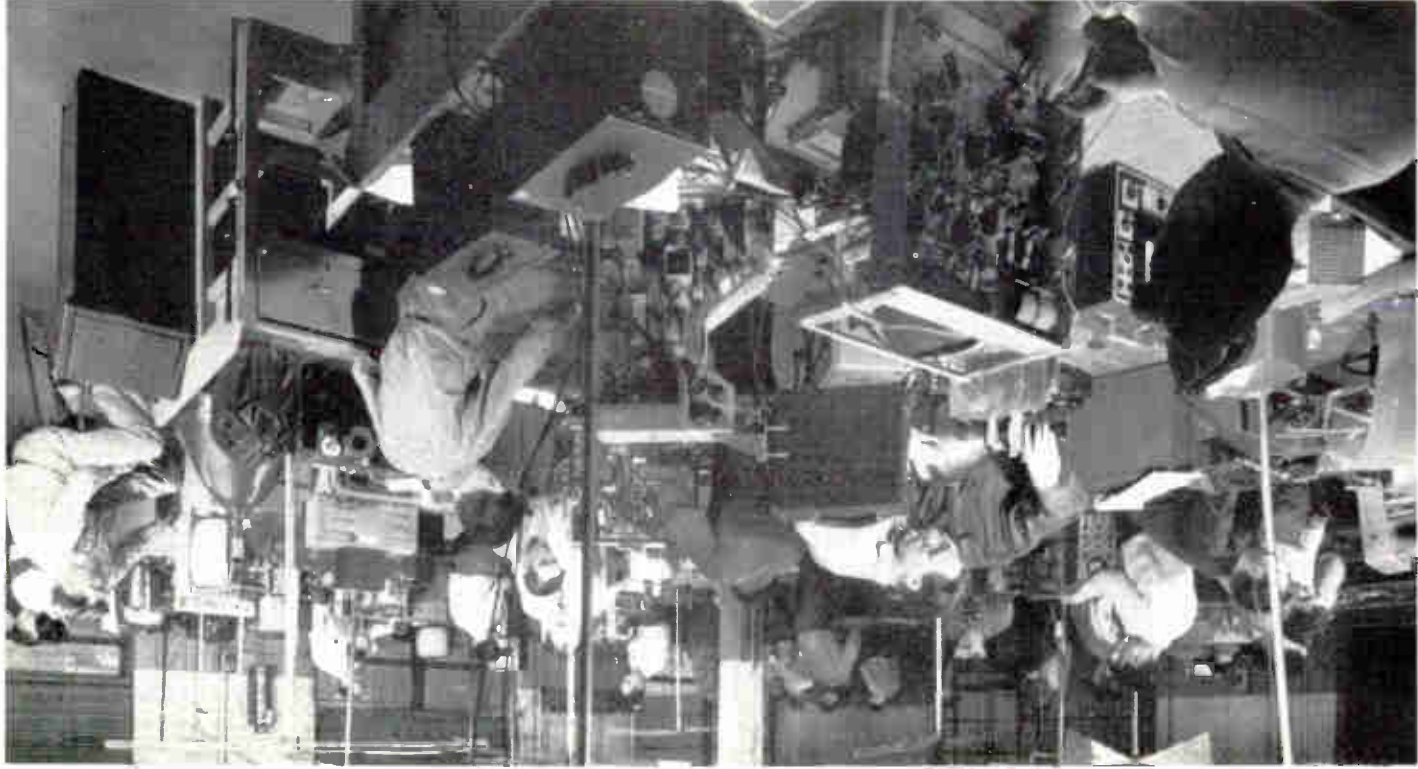

Television Service Methods

TEST PROCEDURES

Contents

	PAGE
Types of Tests	4
Television Test Equipment	4
Dynamic Tests	7
Disturbance Testing	7
Signal Substitution	9
Signal Tracing	14
Capacitor Bridging	20
Static Tests	20
Voltage Tests	21
Resistance Tests	26
Employing Tests in Troubleshooting	27

David Sarnoff may well be called the champion of television. He has the faith, stout heart, unyielding spirit and indomitable will to bring television into every home. As a veteran in the field he has seen radio and electronic research hurdle many barriers: He knows beyond doubt that television will do the same; there's no stopping it. To him, it is not the facts of yesterday but the progress of tomorrow that determines its destiny. Mr. Sarnoff predicts, "The advances of the next fifty years will make those of the last fifty pale into insignificance."

—Anon

TEST PROCEDURES

The usual procedure employed to find the source of trouble in a television receiver consists of combining various established troubleshooting methods in a definite sequence. In previous lessons we described in detail methods of observing sensual indications, analyzing the image, adjusting controls, and tube checking. These methods may locate the trouble. If not, usually they indicate the receiver stage or (at least the) section in which the defect exists. To further isolate and finally locate the fault, other methods of testing described in this lesson are employed.

TYPES OF TESTS

In general, these tests are classified into two types, DYNAMIC and STATIC. Any tests made of a receiver circuit's operating conditions are called dynamic tests, while static tests show the electric condition of the components, without regard to the effect which the circuit has on the signal, sync, or deflection voltages. The static tests include the taking of direct voltage readings, whether a signal is being received or not, and of resistance readings with the power turned off. On the other hand, signal substitution, disturbance testing, signal tracing, and wave-form observation are classed as dynamic tests because they

provide information concerning the manner in which a given circuit or stage is performing its designated function.

Generally, dynamic tests are made immediately following the tube tests and simple adjustments, and serve to isolate the faulty stage in the defective section. This procedure, of making dynamic tests before the static tests, has the advantage of reducing the total number of static tests that are necessary.

Occasionally, a particular symptom is indicative of trouble due quite definitely to a certain component in a receiver. In this case, static tests of this component or the circuit containing it are made first. Thus, they eliminate the need for dynamic testing when this component is the faulty one. However, as this situation represents an exception rather than the rule, the general explanations of this lesson are based on the procedure in which static tests follow the dynamic testing.

TELEVISION TEST EQUIPMENT

Although a minimum of test equipment is carried by the service technician on a call to the receiver owner's home, a number of the more bulky type instruments are needed in the service shop to

provide for alignment and other relatively extensive service work.

That is, the shop should contain at least one unit of every type of test instrument which is essential for the proper adjustment of the various tuned circuits in a receiver. Also, instruments are needed to permit every possible type of trouble to be located without expending more time than it is reasonable to charge the customer.

In fact, since the labor cost often is a large part of the service charge, the time required for locating the trouble generally constitutes a major part of the total time spent on a particular receiver. Certain instruments of the useful but not essential type may be desirable to aid in maintaining service charges within the limits determined by competitive service shops in the area.

In connection with this, it should be pointed out that the instruments themselves do not service the receiver. Unless the technician makes it his business to learn how to use each piece of test equipment effectively, he is unable to perform satisfactory or economical service work, regardless of how many instruments are available.

In an effort to determine which instruments are considered essential, useful but not essential, and

so on, a survey was made of a large group of technicians experienced in radio and television service work. However, as any individual generally considers equipment essential or useful only after he has become familiar with its operation and capabilities, there are changes from time to time in the results of such surveys as more and more service technicians become familiar with the newer types of test instruments.

Therefore, although the results of this survey are included here as an aid in choosing equipment on the basis of past experience, the relative value of these results should be kept in mind, as well as the fact that each technician has his own individual preferences with regard to the servicing methods and equipment used.

In this survey, the instruments indicated most essential are the electronic voltmeter, cathode ray oscilloscope, multimeter, r-f signal generator, tube tester, and the frequency-modulated or sweep signal generator. Instruments indicated as useful but not essential are the test pattern generator, cross-hatch generator, square wave generator, field strength meter, capacitance-resistance bridge, audio signal generator, oscilloscope voltage calibrator and, by a somewhat lower percentage of the group, the high

voltage voltmeter, and the Q meter.

The groupings given here are made on a broad basis of largest percentages, and the actual survey results show considerable overlapping of ratings such that no instrument mentioned above is considered essential by every individual, while at the same time every instrument is rated as useful by some appreciable percentage.

Of the instruments listed, all have been described previously except the test pattern generator, cross-hatch generator, and the oscilloscope voltage calibrator. As the name implies, the test pattern generator provides a signal which may be applied to the receiver r-f, i-f, or v-f circuits; and thus produces on the screen a test pattern similar to that transmitted by the television stations. Instead of the familiar test pattern, an image consisting of uniformly spaced horizontal and vertical lines, or rows of dots is produced on the screen by the output of the cross hatch generator. Both of these instruments make it unnecessary to rely on the transmitted patterns for making accurate adjustments of television receiver controls and circuits.

For troubleshooting the video, sync, and deflection circuits of television receivers, often it is desirable to investigate the wave-

form and amplitude of the output from the various stages. The wave-forms can be checked easily with the cathode ray oscilloscope, but the wide range of voltage amplitudes are difficult to check with a single calibration on the scope screen. In their service manuals, most television receiver manufacturers give the peak-to-peak voltages under test. Due to the unsymmetrical wave-forms of the voltages in these circuits, the usual service type voltmeters do not indicate readings which can be accurately expressed in peak-to-peak values.

To measure these amplitudes, a voltage calibrator can be employed in conjunction with an oscilloscope. One type of such a calibrator contains a square wave generator and a meter calibrated to read the peak-to-peak square wave voltage output.

To make a measurement, the voltage to be checked is applied to the oscilloscope in the usual manner, and the total number of vertical divisions of deflection noted. Then, the calibrator output is substituted for the unknown voltage, and the calibrator output control adjusted until the square wave covers the same number of vertical divisions on the scope screen as did the unknown voltage. The peak-to-peak voltage is now indicated on the calibrator meter.

To eliminate the need for continuous changing of test lead connections, each voltage to be checked is applied directly to a pair of input terminals on the calibrator, the output terminals of which are connected to the vertical input of the oscilloscope. Connected in the calibrator output circuit, a switch selects either the unknown or the square wave voltage.

DYNAMIC TESTS

It is necessary to remove the chassis from the receiver cabinet in order to make most of the various dynamic and static tests described in this lesson. Therefore, it is assumed that all preliminary tests possible while the chassis was still in the cabinet have been carried out. To give examples showing how these techniques are applied to a specific circuit, reference will be made from time to time to various points in the schematic diagram of Figure 1.

Disturbance Testing

Of the various dynamic testing methods, disturbance testing probably is the quickest, requires practically no equipment, and still gives reasonably accurate information with regard to a defective or dead stage. The only tools essential for disturbance testing are a screwdriver and a short piece of wire with an

alligator clip at one end and a 0.1 μ fd capacitor at the other.

To check the entire a-f section of the sound channel, a finger may be touched to the top or high signal potential terminal of the volume control such as the point between capacitor C_1 and potentiometer R_1 in the schematic of



Often an AM-FM signal generator is used to provide an operation test of the video and sound circuits of the TV receiver. An AM signal produces sound bars on the CRT screen and a tone is produced in the speaker by an FM signal.

Courtesy McMurdo-Silver Co.

Figure 1. This should produce a fairly loud, low-pitched hum in the speaker. If the volume control R_1 is in good condition, rotating the control should vary the intensity of the hum.

To check each a-f stage, the test lead is clipped to some tube socket lug at which the 6.3 volt a-c heater potential exists, which is not shown in Figure 1, for simplicity. Since most receivers have one side of the heater circuit

grounded, care should be exercised so that the clip lead is connected to the ungrounded, or "high" side of the 6.3 volt heater circuit to obtain the desired test voltage whenever this system is employed.

The free lead of the capacitor is touched to the grid socket lug of each a-f amplifier tube in turn, beginning with the output stage. In Figure 1 this would mean starting at the grid of tube V_2 and then moving back to the grid of tube V_1 . When the stages are functioning, a 60 cycle tone or hum is heard in the loudspeaker when the test is made, and should increase in intensity when each additional stage is added by moving the injection point toward the front end of the receiver circuit. If, for any given test point, the hum is not heard, or is not louder than at the preceding test point, then the trouble stage lies between these two test points.

As in the a-f section, 6.3 volts a-c may be taken off a heater socket lug with the clip lead and capacitor and fed to the grid of each tube in the video amplifier.

Since the picture tube circuit forms the last stage in the v-f section, the 60 cycle test voltage may be applied to either the grid or cathode of this tube, whichever is employed as the video signal input element in the receiver under test. To facilitate

applying a test signal to the picture tube input circuit, test clips are available equipped with a sharp spike or needle which will pierce the insulation of and thus make contact with the wire connecting to the grid or cathode terminal of the tube socket. For Figure 1 the grid is the input element of the picture tube V_5 and, therefore, the test signal is injected at the grid end of R_{10} .

The 60 cycle test signal should result in one black and one white broad horizontal bar on the receiver screen. In some cases, either the black or white bar is across the middle of the screen, with part of the remaining bar at the top and the other part at the bottom.

As the test signal injection point is moved forward to each v-f amplifier tube grid in succession, that is, from the grid of V_5 to the grid of V_4 and finally to the grid of tube V_3 , the bars on the screen should increase in contrast. Therefore, a defective stage is indicated when there is no increase in contrast or the bars disappear completely as the test signal input is moved to the grid of the tube in this stage.

The final test in the v-f section is made by applying the 60 cycle voltage to the high side of the detector load circuit, such as the detector side of capacitor C_{12} .

When the contrast control is contained in the v-f section, as shown in Figure 1 by R₁₆, rotating it at this time should result in contrast variations on the screen if the control is in good condition.

The deflection circuits can be checked by clipping the test lead to the high signal potential terminal of the audio volume control, such as the point between C₁ and R₁ of Figure 1, and touching the blocking capacitor lead to various points in the deflection amplifiers, discharge tube, and oscillator circuits. In Figure 1, this involves the plate and grid leads of tubes V₁₀, V₁₁, V₁₃, and V₁₄.

When these circuits are operating, a 60 cycle note is produced in the loudspeaker when the vertical circuits are checked. Adjustment of the various deflection oscillator frequency controls should produce slight variations in the pitch of the indicating tones. However, a high-pitched note (15,750 cps) may or may not be heard when the tests are made in the horizontal circuits. This is due to the fact that many persons cannot hear frequencies as high as 15,000 cycles. Also, the response of the a-f amplifiers may be so limited that this frequency is not passed. Therefore, other tests are required to indicate troubles in stages V₁₂ and V₁₃.

When the test lead is touched to the plates or grids in the sync clipper and amplifier stages, such as tubes V₆, V₇, V₈, and V₉, the 60 and 15,750 cycle tones should be heard in the speaker. However, for these tests, a station must be tuned in. A buzzing sound caused by the picture signal component of the video wave is added to the deflection frequency tones when the tests are made in the first stages of the sync section such as tubes V₆ and V₇.



The "Condenser Tester" is a useful test instrument and often is added to the essential shop equipment.

Courtesy The Jackson Electrical Instrument Co.

Signal Substitution

In the signal substitution method of dynamic testing, a signal generator is employed to supply a test signal of the desired type for insertion into the input of various stages of the receiver.

Of course, the type of test signal needed depends upon the receiver section in which the tests are to be made. To prevent interference from a received signal, the receiver station selector should be set to a channel which is not used in the area.

Compared to the disturbance testing method, signal substitution not only indicates whether or not a stage is operating, or is weak, but also it shows when a stage is distorting the signal applied to it. Furthermore, stage gain checks can be made with considerably more accuracy by using the signal generator as a signal source, and a voltmeter to indicate the output.

Either an audio oscillator or the audio voltage output of an r-f signal generator can be used to check the a-f section of the television receiver. Again reference is made to the circuits of Figure 1 as a typical example. When it isn't included in the generator output circuit, a blocking capacitor ($0.1\mu\text{fd}$) should be employed in series with the test lead to prevent application to the generator of any direct voltages in the circuits under test. The procedure follows the general plan of the disturbance testing method.

With the shield or ground lead attached to the chassis, the generator a-f output test lead is

touched to the high side of the receiver volume control R_1 . When the audio tone is heard in the loudspeaker, the generator output is reduced until the tone is undistorted with the volume control set at maximum. The operation of the volume control is checked by rotating it to reduce the volume of the speaker output. If all of these adjustments can be made satisfactorily, the trouble is not located in the a-f section of the sound channel.

However, if the above test produces no tone in the loudspeaker, or an undistorted tone cannot be obtained, a fault is indicated in the a-f section, and a stage-by-stage check should be made. The generator test lead is touched to the grid socket lugs of the a-f amplifier tubes, V_1 and V_2 beginning with the output stage V_2 . Greater output from the generator may be required to obtain an audible tone at this point, and the sound level should increase markedly when the test lead is shifted to the grid of the preceding stage.

The a-f signal may be inserted into the video circuits also, and causes a number of horizontal bars on the screen when these circuits are operating. For example, if an a-f test signal of 900 cps is employed, the television 60 field-per-second vertical scanning rate will result in $900 \div 60$ or 15

black and 15 white alternate bars on the screen, except for those occurring during vertical retrace. However, unless a square wave test signal is available, this check will not indicate how well the v-f stages are operating with regard to distortion, etc.

By applying the a-f test signal across the video detector load circuit first, that is across capacitor C_{12} , the entire v-f section may be checked. Trouble is indicated in this section by the absence of bars on the screen, or the produced bars lack contrast with the receiver contrast control fully advanced with at least two or three volts of signal supplied by the generator. Then a stage-by-stage check should be made, beginning at the input of the picture tube V_5 , and working toward the detector by injecting a signal into the grid circuits of V_4 and V_3 successively.

To provide proper contrast on the screen, the applied test signal must have greater amplitude for the later stages in this section. The required values will vary with different receivers, but in general about 30 volts peak-to-peak or more must be applied to the picture tube grid. At least 1.5 volts peak-to-peak is needed at the grid of the output tube, and about 0.5 volt peak-to-peak at the detector output when two v-f stages are employed.

Together with a vtvm, the signal generator may be employed to make amplifier gain checks in any of the amplifier sections. To check the v-f amplifiers of Figure 1 for example, the generator is set to any convenient frequency within the range over which the vtvm is usable. With the meter



The sweep generator provides an FM signal which, tuned to the sound i-f, may be used to test the sound section of the TV receiver.

Courtesy Precision Apparatus Co., Inc.

connected to its output terminals, the generator is set for an output of 0.5 volt, as read on the meter a-c scale. The receiver is tuned to an unused channel, and with a $0.01 \mu\text{fd}$ blocking capacitor in series with its lead, the meter is connected from the grid of the picture tube V_5 to ground. The receiver oscillator tube, or one of the i-f tubes may be removed, if necessary, to prevent readings on

the meter due to undesired pick-up of noise energy.

The 0.5 volt output of the signal generator is now applied to the grid of the video output tube V_4 and the reading on the meter noted. The stage gain is equal to this voltage divided by 0.5. For example, if the meter now reads 6 volts, the output stage gain is $6 \div 0.5$, or 12.

Before moving the test lead, the signal generator output is reduced until the meter again reads 0.5 volt. Leaving the vtvm connected to the picture tube grid, the signal generator lead is moved to the grid of the preceding v-f amplifier tube V_3 and the meter reading again noted. As before, the gain of this stage is equal to the present meter reading divided by 0.5. Similar gain measurements may be made in the r-f, i-f, and a-f sections of the television receiver.

Although indicating the gain at the frequency of the test signal employed, gain checks of this type do not indicate the response of the r-f, picture i-f, and v-f stages to the wide bands of frequencies over which they operate. A frequency-band response check requires the use of a sweep generator and an oscilloscope as is explained in the lesson on television receiver alignment.

Since for only a few occasions is the signal substitution method

applied to the r-f and i-f amplifiers, except as carefully described in a subsequent lesson on alignment, these circuits are omitted from Figure 1 to make it easier to find the points referred to. However, on occasion it becomes apparent from preliminary tests that the trouble occurs before the signal reaches one of the circuits included in Figure 1. For these situations one of the following tests usually locates the defective stage.

To check the receiver i-f stages by signal substitution, a modulated r-f signal must be applied to the grids of the successive i-f amplifier tubes, beginning at the last stage and working toward the first stage, as was illustrated for the audio and video amplifiers. In the sound channel, the test signal must be equal to the sound i-f carrier frequency, and must be frequency modulated with an a-f signal which, detected by the receiver audio detector, produces a corresponding tone in the loudspeaker. The sound i-f is always 4.5 mc in intercarrier receivers, but is determined by the manufacturer's choice in dual channel receivers.

In the picture channel, the test signal must have a frequency which falls in the picture i-f band, and it may be amplitude modulated with an a-f signal to produce horizontal bars on the

picture tube screen. In every case, the applied test signal should have amplitude no greater than is necessary to produce the desired output indication. Also, it should be necessary to reduce the test signal amplitude as each new injection point adds another stage of amplification between the signal generator and the receiver video or audio detector. When a test point is reached at which the proper output or amplification is not obtained, trouble is indicated in the circuits between this and the preceding satisfactory test point.

Amplitude modulated with an a-f signal, a test signal with a frequency equal to the center frequency of the channel to which the receiver is tuned may be employed to check the r-f section. Again, passage of the test signal by the stages between the point of injection and the output is indicated by light and dark horizontal bars on the screen. In this section, in order of their use the injection points consist of the mixer grid, r-f amplifier grid, and receiver input terminals.

In a dual-channel type receiver, the operation of the oscillator may be checked by employing a frequency-modulated test signal with a center frequency equal to the sound r-f carrier. With this signal applied to the receiver input terminals, it should be possible to obtain maximum sound

output from the loudspeaker when the receiver fine tuning control is adjusted to approximately the mid-point of its range.

If no sound output is obtained, even though this control is adjusted over its entire range, the oscillator may be operating, but considerably off frequency. Then the tuning control should be set to its mid-position, and the signal generator frequency changed until the desired speaker output, if any, is obtained. Should an a-f output be obtained in this way, the receiver oscillator is off frequency by the amount which it was necessary to change the test signal.

When it is suspected that the oscillator is not operating at all, is weak, or its output is not reaching the mixer grid, a check may be made by substituting the signal generator for the oscillator. For this test, the receiver is tuned to a channel in which a station is transmitting, and an unmodulated r-f test signal used, the frequency of which is equal to the receiver sound i-f plus the sound r-f carrier for that channel. This total is the frequency at which the receiver oscillator should be operating.

When the test lead is touched to the mixer grid, the test signal should heterodyne with the received carriers to produce the proper sound and picture inter-

mediate frequencies and result in reception of both picture and sound from the tuned station. Should such reception occur only when the r-f signal is injected, then the receiver oscillator circuit, or the oscillator-mixer coupling circuit is faulty.



The electronic volt ohmmeter often is used to make static tests of the receiver. Note, for voltage tests, the ground lead is always connected to B— and a switch (at lower left) reverses the meter reading.

Courtesy The Jackson Electrical Instrument Co.

Signal Tracing

Signal substitution is useful primarily in the various signal sections of the television receiver. Although the method known as signal tracing can be applied to these sections also, its greatest value lies in checking the video, sync, and deflection circuits. Instead of supplying a signal to various test points in the receiver circuit, the signal tracer consists of some type of indicating device

which provides the technician with information concerning the existence, amplitude, or waveform of the signal at the points in the circuit to which its test probe is touched.

Generally, the test procedure consists of beginning at the input of the first stage of the defective section, and progressing toward the output of the section, checking the nature of the signal from point to point. However, some individuals prefer to begin at the last stage and work toward the front end, as explained for the signal substitution method. Either system is satisfactory and, in both cases, the trouble is isolated to the circuits between two adjacent test points, one at which the signal is satisfactory and the other at which the signal is faulty.

Designed for troubleshooting AM radio receivers, commercially built signal tracers generally consist of one or more untuned r-f amplifier stages, a detector, and an output indicator such as a speaker, a-c meter, etc. Although useful, a comparable instrument for television troubleshooting would be practically a complete television receiver, and would be rather cumbersome.

However, the cathode ray oscilloscope serves as an excellent signal tracing device for the video, sync, and deflection cir-

cuits of the television receiver. The sync signals received from the transmitter, and the deflection produced in the receiver must have proper wave-form and amplitude, and these characteristics are best studied with the aid of the scope.

The signal tracing technique is based on the fact that so long as the signal is normal in wave-form and amplitude that particular circuit is functioning normally. Therefore, the serviceman needs to know what the normal signal is for each point in the circuit in order that the abnormal signal may be recognized and the associated defective circuit determined. To satisfy this need, many receiver manufacturers include photographs or drawings in their service manuals of the voltage wave-forms which exist at various points in the receiver circuits, and usually they indicate the peak-to-peak voltages. To illustrate this technique, various signal wave-forms are shown in Figures 2, 3, 4, and 5 for the circuits of Figure 1.

With the receiver tuned to a station and the scope coarse frequency control set to the range which includes 30 cps, the test lead is touched to the grid socket lug of tube V_3 , Figure 1. Then the scope fine frequency control is adjusted until the curve of Figure 2A is obtained. Since the

television field frequency is 60 per second, two cycles of the composite video signal wave are produced on the scope screen when the scope horizontal sweep is adjusted to 30 cycles per second.

In Figure 2A, the two large irregular white areas near the top represent the video signal components during the vertical scanning portions of each field. These areas are separated by the narrow blanking pulse which occurs during the vertical flyback interval at the end of each field. Projecting slightly below each blanking pulse is a very narrow white, vertical dash which represents the group of sync pulses, constituting the vertical sync pulse, which also occurs during the vertical flyback interval.

The wave shown in Figure 2A has positive picture phase, with the picture signal components on the top, and the pulses on the bottom. This wave would be shown inverted on the screen of those scopes in which downward deflection is produced by a positive signal applied to the vertical input terminals.

For the receiver of Figure 1, the wave of Figure 2A normally is 3 volts peak-to-peak. When the scope test prod is placed at the grid socket lug of the second video amplifier tube, V_4 , the wave on the scope screen has the ap-

pearance shown in Figure 2B. Comparison shows this to be about the same as that of Figure 2A, but inverted due to the action of the first v-f amplifier stage. Also, amplified by the first v-f stage, the video signal is 16 volts peak-to-peak at the input to V_4 , thus necessitating reduction of the setting of the scope vertical gain control to prevent the pattern going off-screen vertically.

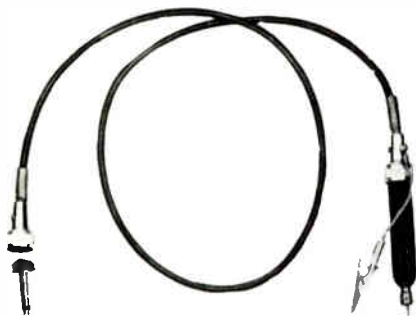

When used with a vtvm, the crystal detector probe permits measurement of r-f voltages.

Courtesy RCA Victor

The second v-f amplifier stage increases the signal level to 32 volts peak-to-peak and again inverts the wave so that, at the picture tube grid, it has the appearance shown by the scope pattern of Figure 2C. Here, the bottoms of the horizontal blanking pulses form slightly slanting, horizontal lines near the lower portion of the scope pattern, and below these a second set of similar lines are formed by the bottoms of the horizontal sync pulses.

As shown in 2A, the picture signal components of the video wave are at the top and the blanking and sync pulses project downward, or are negative going, to blank out the picture tube spot during retrace intervals. Only the bottom edges of the horizontal pulses are visible on the scope screen when the signal is viewed in this manner, the vertical sides of these pulses being invisible because of the very rapid deflection of the scope beam during the rising front and descending back of each pulse.

As shown in Figure 1, the video signal at the grid of V_4 is coupled through resistor R_{23} to the grid of the first sync amplifier V_6 . The voltage wave-form at the sync amplifier grid is shown in Figure 2D, and, though similar to that at the grid of V_4 is modified slightly due to the effects of the coupling circuit components.

To permit observation of individual horizontal scanning cycles of the video wave, the scope probe is held at the grid of V_6 , and the scope sweep rate set at 7,875 cycles per second to produce the curve of Figure 2E. As the scope sweep rate is now equal to one-half the television horizontal scanning frequency, two complete cycles are produced on the scope screen.

In this pattern, the picture signal produces the irregular,

broad white area near the bottom, and the triangular positive peaks represent the horizontal blanking and sync pulses. At this point in the circuit, the video wave has negative picture phase, thus both Figures 2D and 2E show positive going pulses.

The sync pulses are on top of, and are narrower than, the blanking pulses, but the pulse shapes seen on the oscilloscope screen depend upon the frequency response of the receiver and scope circuits. Therefore, they only approximate the ideal wave-forms illustrated in the theory lessons of this training.

With the scope sweep rate at 30 cps, the voltage wave-form at the plate of the first sync amplifier tube is shown in Figure 2F. Figure 2G shows the wave-form of this voltage during three horizontal scanning cycles, that is, with the scope sweep rate at one-third the line scanning rate, or 5,250 cps.

With the scope probe at the grid of the sync clipper tube V_9 , the observed wave-form should be as shown in Figure 2H when the scope sweep is at 30 cps, and as shown in Figure 2I when the scope rate is 5,250 cps.

When checking either vertical or horizontal frequency voltage waves, the choice of the scope sweep rate lies entirely with the individual service technician,

and will depend upon the number of cycles of the wave which it is desired to observe at various points in the receiver circuit. In some instances, more information can be obtained by viewing only one or two cycles, while three or more cycles are desirable in other cases.

As shown in Figure 1, the output from the sync clipper circuit is taken from the cathode of tube V_9 . The wave-form at this point has the appearance shown in Figures 2J and 2K, with scope sweep rates of 30 cps and 5,750 cps, respectively. As these curves show, the picture signal components have been removed, or clipped, and only the respective vertical and horizontal sync pulses remain. The clipper output is coupled through capacitor C_{20} to the input circuit of the horizontal afc tube, V_{12} and also through the three-section integrating network, $R_{31}C_{21}$, $R_{32}C_{22}$ and $R_{33}C_{23}$ to the grid circuit of the vertical oscillator tube, V_{10} .

Observed on the screen of the oscilloscope, the voltage wave-form at the grid of V_{10} has the shape shown in Figure 2L. This circuit is a blocking oscillator, and two cycles of its 60 cps output are seen when the scope sweep frequency is 30 cps. Following through the vertical deflection circuit, Figure 3A shows the voltage wave-form at the plate of V_{10} and Figure 3B shows

the wave-form at the grid of the vertical amplifier tube V_{11} . Figure 3C is the wave-form at the plate of V_{11} , and finally, the wave-form at the upper end of the secondary winding of vertical output transformer T_3 appears like Figure 3D.

The horizontal sync pulses combine with the sawtooth and pulse outputs of the horizontal deflection circuit to form the wave-form of Figure 3E across the horizontal lock capacitor, C_{30} . For this pattern, the scope sweep rate is 7,875 cps. Employing tube V_{13} , the horizontal oscillator operates as a blocking oscillator and, checked at the junction between the two windings of transformer T_4 , the output of this circuit has the wave-form shown in Figure 3F.

With the scope sweep at 5,250 cps, the voltage wave-form across the sawtooth forming capacitor C_{39} is shown in Figure 3G, while that across horizontal drive capacitor C_{41} is shown in Figure 3H. Finally, with the scope probe at the lower end of the primary of horizontal output transformer T_5 , and the sweep at 7,875 cps, the wave-form obtained should be like that of Figure 3I.

With the aid of an audio oscillator, the oscilloscope may be employed to check the operation of the television receiver a-f stages also. In this case, the sta-

tion selector is set to a channel not used by a station in the area, and the audio oscillator signal applied across the detector load circuit. The receiver of Figure 1 contains an a-f input plug, PL_1 , to permit using the receiver audio section in conjunction with some external a-f source such as a phono or radio tuner. Thus, this plug serves as a convenient means of injecting the test signal which may have any desired frequency such as 400 or 1000 cycles per second.

With the test signal applied and the oscilloscope sweep set to one-half the frequency of the test signal, the scope probe is touched to the grid of the first a-f amplifier tube, V_1 . Two cycles of sine wave-form should be obtained on the scope screen, as shown in Figure 4A. The same wave-form, but with greater amplitude and inverted should be obtained with the scope probe at the grid of the a-f output tube, V_2 . Finally, inverted and amplified again, the sine wave voltage should be obtained at the plate of V_2 .

Any troubles existing in the a-f circuits result in some type of modification of the normal wave-form, or test signal amplitude. For example, should grid resistor R_2 be open, the results illustrated in Figure 4B are obtained when the scope probe is

touched to the grid of V_1 . Clipping of the positive or negative peaks of the waves is produced if some defect is causing the wrong operating voltage to be applied to a tube element. For example, observed at the grid of V_2 , the positive peak clipped waves shown in Figure 4C are caused by a decrease in the V_1 screen voltage. The reduction of the V_1 screen voltage may be caused by an increase in the resistance of R_3 . With the scope probe at the V_2 plate, the waveform of Figure 4C may be observed due to an undesired increase in the V_2 grid bias. Either condition causes the tubes to operate too near to cutoff so that the negative peak of the signal drives the grids below cutoff.

On the other hand, when the grid bias is reduced, the positive peaks of the input signal drive the grid positive, resulting in clipping of the negative peaks of the signal at the plate of the tube. Severe overdriving of any amplifier produces clipping of one or both peaks of the output wave even when all operating voltages are correct. Therefore, to prevent obtaining a false indication of trouble, the applied test signal amplitude should not be too great.

The distorted wave of Figure 4D may be produced at the plate of V_2 , Figure 1, when the input coupling capacitor C_6 is leaky,

while the wave-form of Figure 4E is produced at the plate when the cathode bypass capacitor C_7 is leaky. To check for open cathode and screen bypass capacitors, the scope test lead is placed at the tube socket lugs of these respective tube elements. Normally, practically no alternating voltage should be indicated at these points. Hence, when the signal wave, Figure 4A is found to exist at the cathode or screen grid, most likely the corresponding bypass capacitor is open.

Occasionally, undesired feedback conditions exist which permit oscillation in a-f amplifier circuits. These oscillations may occur at a-f or at higher frequencies. Figure 4F shows the appearance on the scope screen of such a generated h-f alternating voltage which is amplitude modulated by the applied test signal.

Examples of voltage waveforms which may exist in the circuits of the low voltage power supply are shown in Figure 5. Referring to the low voltage supply circuits in the lower portion of Figure 1, practically no alternating voltage should exist at the junction between choke L_0 and capacitor C_{51} , as this is one of the output terminals of the supply. Thus, with the scope test lead touched to this point, a nearly straight horizontal line

should appear on the scope screen even with the vertical gain control fully advanced. However, with the scope set for 60 cycle sweep, the wave of Figure 5A should be obtained when the test lead is applied to the input of the filter, that is, to a filament lug of the rectifier tube socket.

With the test lead at this point, the voltage wave has the shape shown in Figure 5B when the input filter capacitor, C_{50} , is open. Also checked at the filter input, the voltage wave-form is like that shown in Figure 5C when the filter choke L_9 is open.

Capacitor Bridging

When previous tests have indicated the likelihood of a capacitor being open, a further check can be made simply by holding a new unit of the same capacitance so that its leads touch the leads of the suspected capacitor. This is done with the receiver turned on and tuned to a station. When the original capacitor is open, receiver operation is restored or improved when this check is made. The unit employed for the test should have a voltage rating at least equal to the one in the receiver, and proper polarity should be observed in the case of electrolytic capacitors.

Generally, it is necessary to bend the leads of the test unit to make the desired contacts, and,

since the receiver must be on to make this test, the leads should be bent before they are applied to the circuit. Also to avoid shock, the test capacitor should be held so that the fingers do not touch the metal leads while the bridging test is made.

In the case of the high voltage circuit capacitors, the receiver should first be turned off, and then the leads of the test capacitor wrapped tightly around those of the suspected unit. Then with hands free of the circuit, the receiver can be turned on and its operation observed. Before removing the test capacitor, turn off the receiver and short across both the test unit and the high voltage filter capacitor to discharge them.

This type of check will not indicate whether the suspected capacitor is leaky or shorted. The possibility of these defects must be investigated by means of the voltage or resistance checks described for static tests.

STATIC TESTS

With a few exceptions, all of the testing methods explained up to this point have been of the type which are employed to isolate the trouble first to a section of the television receiver, then to a single stage in the defective section and, in some cases, to the defective circuit or circuit com-

ponent. As explained previously, these checks are made in order to permit locating the trouble in a minimum time by making as small as possible the needed number of static tests.

Troubleshooting must be completed by making voltage or resistance tests which should show quite definitely the electric condition of the suspected circuit or component.

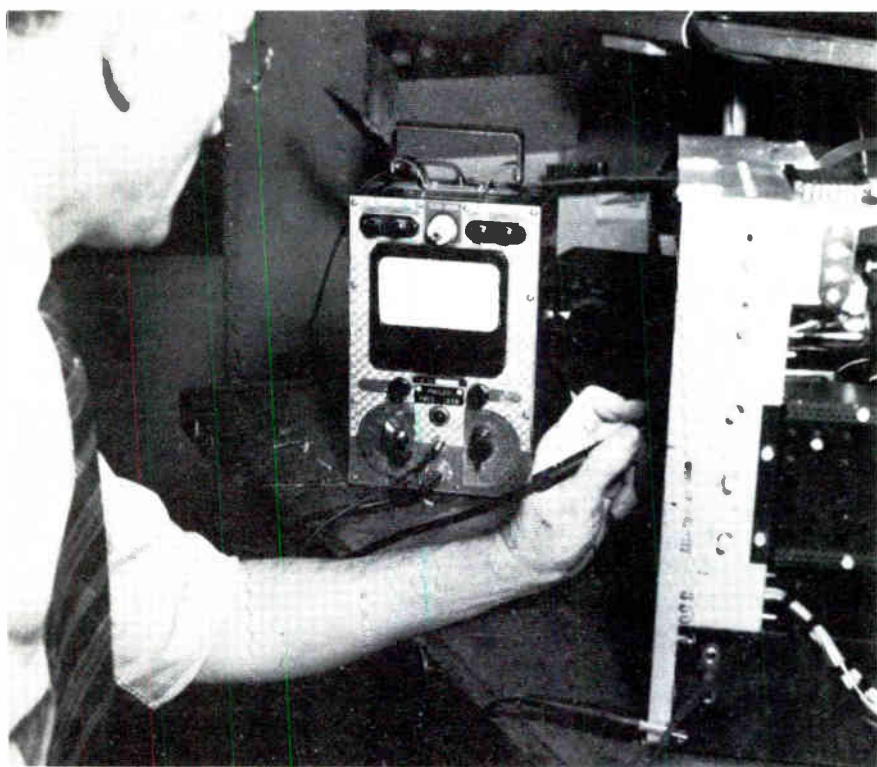

An electronic volt ohmmeter is being used to make static tests in the TV receiver chassis.

Courtesy Philco Corp.

However, though useful for the purpose mentioned, these various dynamic tests indicate only the likely location of the trouble, or that some certain component is probably at fault. Therefore, the

Voltage Tests

Along with wave-form charts most television receiver manufacturers include charts which give the normal direct voltages applied to the various elements of

each tube in the receiver. Usually, such charts indicate the corresponding tube base pin numbers to facilitate the checking of these voltages. Voltage measurements are further facilitated when a socket layout diagram is included, as generally these diagrams are labeled with regard to the base pin numbers, the corresponding tube elements, or both.

In some cases, the voltage chart and socket layout diagram is combined with the proper voltages indicated at the socket terminals. This arrangement makes it necessary to refer to only one chart to determine the desired points to apply the voltmeter test prod and to check the proper voltage.

In connection with the voltage chart, the manufacturer includes information concerning the type of voltmeter which was employed to take the readings given in the chart, the amplitude and frequency of the line voltage which was applied to the receiver and the settings of the various receiver controls when the chart was made. All of these factors affect the voltages read and, therefore, must be adhered to or otherwise taken into account when a voltage test is made.

The manufacturer also specifies whether the chart represents those values present when the receiver is operating with or without a signal applied to its

input. When the readings are for a no signal condition, which usually is the case, the antenna lead-in should be disconnected from the receiver input terminals, and the terminals short-circuited. If a signal input is to be used, the specified test signal should be employed. Finally, unless otherwise specified, voltage readings are taken between the indicated base pin and the receiver chassis.

Tube element operating voltages should lie within about 20 percent of whatever values are specified, regardless of the function of the circuit containing the tube. Voltage testing in the circuits of a television receiver is about the same as that explained in earlier lessons concerning voltage tests for electron circuits in general.

As an example, to check the plate voltage of the first sync amplifier tube, V_6 , Figure 1, the voltmeter negative test prod is placed on the receiver chassis, and the positive lead touched to the socket terminal connected to the pin corresponding to the plate of this tube. Inspection of the circuit diagram shows the plate of V_6 is returned to the + 90 volt terminal of the low voltage power supply, the cathode is returned to the -50 volt terminal, and the grid returns to ground.

For the receiver of this example, plate, grid, and cathode oper-

ating voltages of $+80$, -20 , and -15 volts, respectively, are specified. To check the grid and cathode voltages, the voltmeter positive test prod is placed on the receiver chassis, and the negative lead touched to the V_6 grid and cathode socket terminals in turn. When a vtm is used, the ground lead is always attached to the chassis and positive or negative readings are taken with the other lead. When the meter doesn't read in both directions, usually a switch is provided to reverse the meter readings.

Often, it is desirable to test voltages at points in the circuit other than at tube socket elements. Sometimes, the normal voltage at various points are indicated on the schematic diagram for the receiver. However, when they are not available, it is necessary to estimate the approximate correct voltages from an inspection of the diagram.

Voltage tests may be employed to check for leakage of coupling capacitors such as C_{18} between the plate of V_6 and the grid of V_7 , Figure 1. With C_{18} leaky, there exists a conductive path from ground, through R_{26} , C_{18} , and R_{25} to the $+90$ volt terminal of the power supply. The resulting electron flow in this direction causes the upper end of R_{26} to be positive with respect to ground.

However, this condition can be caused also when V_7 is gassy. Therefore, to make this check, V_7 is removed from its socket and the voltmeter leads placed across R_{26} . If C_{18} is not leaky, the meter will read zero, but if a direct voltage is found to exist across this resistor, then C_{18} is leaky. Since a capacitor sometimes becomes leaky only when a sufficiently high voltage is applied to it, this method is better than connecting an ohmmeter across the capacitor. Also, an accurate check with an ohmmeter requires that one lead of the capacitor be disconnected from the circuit and, finally, the ohmmeter test only indicates leaky capacitors when they are very leaky or shorted.



The high voltage probe is designed to permit readings with the service type voltmeter. Note the heavy insulation and safety flanges for protection of the serviceman. The multiplier resistor is visible inside the plastic tube near the tip.

Courtesy RCA Mfg. Co.

For measuring the high direct-voltages in the picture tube anode and high voltage supply circuits, a number of high voltage test probes are available commercially.

These probes contain the needed multiplier resistors to permit high voltage readings with ordinary service type voltmeters. Some of these probes are for use with vacuum tube voltmeters, and others are for non-electronic type voltmeters with 20,000 ohms-per-volt sensitivity. All such probes have special high voltage insulation, and usually include safety flanges to prevent the service technician's fingers touching the metal tip on the probe.

By employing a suitable arrangement of series resistors, the technician can construct a multiplier which, together with a current meter, can be used for high voltage measurements. Special high voltage resistors are obtainable for this use.

If ordinary 1 or 2 watt carbon resistors are employed in a series string, the voltage across each resistor in the string should be limited to a maximum of 500 volts to prevent flashover because the momentary heavy current may damage the meter. For example, if a total of 600 megohms are required in a multiplier to permit measurement up to 30 kv, a minimum of $30,000 \div 500$ or 60 resistors of 10 megohms each are required.

To prevent losses due to corona, all terminals and soldered joints should be free of sharp edges and points and there should be

no sharp bends in the wiring. A liberal coating of good wax such as Cerese or Ceresin (but not paraffin) should be applied to the multiplier to prevent surface leakage, and the completed unit mounted inside an insulated case. High voltage insulated leads should be used to connect the multiplier to the meter and test probe.

The total resistance needed for the multiplier depends upon the current required for full scale deflection of the meter employed, and upon the highest voltage which the unit is being designed to measure. As television receiver high voltage supplies normally deliver extremely small currents at the rated voltages, the test voltmeter should be one that requires a minimum of current for its operation so it will not place an undue load upon the high voltage circuit.

For various standard current meter sensitivities, the multiplier resistance required to read voltages up to 10,000 or 30,000 volts are given in table 1.

TABLE 1

Current Meter Sensitivity in Microamps	Multiplier Resistance in Megohms for :	
	10 kv full scale	30 kv full scale
20	500	1500
50	200	600
100	100	300
200	50	150
500	20	60
1000	10	30

As you know, the most sensitive and accurate current meters are those which require the smallest current for full scale deflection. For example, when the meter and multiplier combination is employed to measure the output of a high voltage supply having a 1 megohm series filter resistor, and with the receiver in operation, the accuracy of the reading obtained ranges from about 89 percent with the 1000 microammeter to about 99.8 percent with a unit using a 20 microammeter.

To increase the accuracy of the high voltage reading, regardless of the meter sensitivity, the test should be made with the receiver brightness and contrast controls at minimum settings so that the picture tube screen is dark. Then, the picture tube anode current is approximately zero and, in place of the picture tube, the meter circuit loads the high voltage supply. As the meter circuit passes approximately the same current as the picture tube anode circuit during normal operation, the meter reading closely approximates the actual operating voltage applied to the anode.

In addition to these adjustments, the focus, width, horizontal drive, horizontal centering and horizontal linearity controls should be set at least approximately to the correct positions. When an image or raster does

not exist on the screen, these controls can be set at about the midpoint of their range.



The oscilloscope used as a signal tracer provides information concerning the video signal, sync, and deflection voltage amplitude and wave-forms at various points in the circuit. Note: the r-f probe permits signal tracing in the i-f circuits.

Courtesy Supreme Instrument Co.

To make a high voltage measurement, the receiver is turned off, the high voltage anode lead disconnected from the picture tube bulb contact, and a short length of stiff wire inserted through the rubber insulating jacket and twisted tightly around the grip-connector sleeve. Then the high voltage lead is reconnected to the bulb contact. The negative test lead of the voltmeter is clipped to the receiver chassis or B-, and should not be held onto when the receiver is turned on. With the receiver turned on, a high voltage reading is taken by touching the meter test probe to the end of the protruding wire.

When using a high voltage meter which has been constructed from a current meter, multiplier resistor string, and high voltage insulated flexible leads as described above, BOTH TEST LEADS SHOULD BE CLIPPED TO THE PROPER TEST POINTS (PROTRUDING WIRE AND CHASSIS) BEFORE THE RECEIVER IS TURNED ON. Then, the receiver is turned on and the meter reading noted. UNDER NO CIRCUMSTANCES SHOULD THE TEST LEADS BE HANDLED WHILE THE RECEIVER IS ON. After the reading is taken, THE RECEIVER IS TURNED OFF BEFORE THE TEST LEADS ARE REMOVED.

example, never make two-handed high voltage measurements, but instead observe the time-honored rule: KEEP ONE HAND IN YOUR POCKET WHILE MAKING HIGH VOLTAGE MEASUREMENTS.

Even when using a commercially designed high voltage probe of the type described above, do not toy or dawdle with the measurement. First connect the negative test lead to the chassis or B-, then turn the receiver on, take the reading, quickly remove the test probe and switch the set off. Grasp the probe so that the fingers are farthest removed from the contact end, but do not allow any portion of your hand or any other part of your body or clothing to come into contact with the flexible leads.

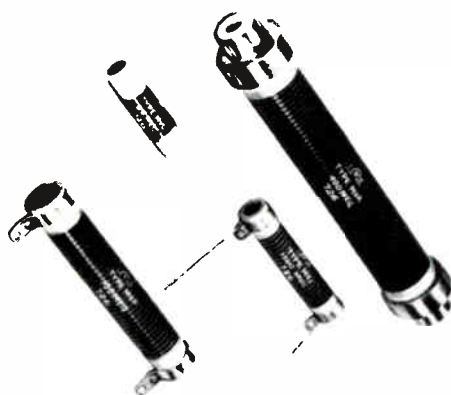

High voltage resistors.

Courtesy IRC

Even though the television high voltages are generated by poorly-regulated, low-current power supplies, they should be treated with proper respect and caution. For

Resistance Tests

Frequently resistance testing requires disconnecting component leads or other wiring to prevent obtaining false readings due to parallel circuits. Generally an attempt is made to locate the trouble definitely by means of voltage testing first, if this is possible, to eliminate the necessity of making resistance tests. However, there are many cases in which it becomes absolutely necessary to check resistance of various circuits or components, and such checks are then made in the same general way explained in an earlier lesson on

continuity tests. Continuity tests constitute the type of testing in which it is desired to determine the resistance of the component or circuit under test, in addition to establishing whether or not continuity exists between the test points.

Besides disconnecting one lead of the component to be checked when there is any possibility of parallel connected components or circuits, you must remember to keep your fingers from coming in contact with the metal tips of the ohmmeter test leads, because your body will act as a parallel path of only a few hundred thousand ohms or less. Finally, to prevent damage to the ohmmeter, NEVER MAKE RESISTANCE OR CONTINUITY TESTS UNLESS THE RECEIVER POWER HAS BEEN TURNED OFF.

EMPLOYING TESTS IN TROUBLESHOOTING

The above paragraphs have described the various types of testing methods as applied to the receiver in general. However, as explained previously, usually testing is necessary in only one section of the receiver in any particular case, depending upon the nature of the trouble as indicated by the initial analysis. That is, for each individual case, only a few of the many tests described above are necessary. Basically

all cases are alike from the standpoint of the general over-all procedure of: (1) locating the defective section, (2) locating the defective stage, and (3) locating the defective component or connection.

As an example of the manner in which the different types of tests are applied to troubleshoot a typical defect, suppose, when a receiver is turned on, it is found that the screen contains neither picture nor raster, but that the sound is normal.

Both contrast and brightness controls are adjusted, and it is found that, with the contrast control at maximum, there exists only one setting of the brightness control at which a very dim picture can be obtained, and at all other settings the screen is blank. Furthermore, at the setting where the picture is visible, it does not fill the mask horizontally, but the right side of the picture contains a bright vertical line and ends about 3 inches short of the right side of the mask. Finally, adjusting the horizontal drive control makes the picture disappear.

On the basis of this information, it is reasoned that to produce proper sound, and distorted but properly "synced" picture, all sections of the receiver must be operating properly except the deflection circuits. Since the distortion affects each horizontal

scanning line alike, and full vertical sweep is obtained, the horizontal deflection circuits must be defective.



A non-electronic multimeter may be used to make stotic tests in the TV receiver. Note this meter has a sensitivity of 20,000 ohms-per-volt d-c.

Courtesy Weston Electrical Instrument Co.

All tubes in the horizontal deflection circuit are replaced, and since the receiver employs a fly-back type high voltage supply, the damping tube and high voltage rectifier are replaced also. The tube check results in no improvement, therefore the chassis is removed from the cabinet. The horizontal deflection circuit portion of the receiver schematic diagram as shown in Figure 6 is referred to in making a wave-

form check with an oscilloscope. The circuit shown includes the horizontal oscillator, V_1 , horizontal discharge tube, V_2 , horizontal output amplifier, V_3 , damping tube V_4 , and the high voltage rectifier, V_5 .

In the upper section of Figure 7 are shown the wave-forms and the peak-to-peak voltages which, according to the service manual, should exist at points A, B, C, D, E, and F, respectively, in the circuit of Figure 6. The scope check shows the actual wave-forms of these voltages to be as given in the lower section of Figure 7. Since the observed wave-forms are correct at points A and B, it is assumed that the horizontal oscillator circuit, including tube V_1 , is operating properly.

The first point at which an incorrect wave-form is produced is at the plate of the discharge tube, V_2 , therefore, further investigation of this circuit is made. Here, C_5 is the sawtooth forming capacitor, and R_6 and R_7 serve to produce the negative spike of the trapezoid voltage. R_5 is the resistor through which the C_5 charging current passes when V_2 is cut off, while C_4 and R_8 couple the developed trapezoid voltage, Figure 7D, to the grid of amplifier tube, V_3 . C_6 and R_9 serve to improve the linearity of the sawtooth portion of the trapezoid wave. As the voltage at the plate

of V_2 is the same as that on the upper plate of C_5 , any of the above circuit components can affect the shape of the produced trapezoid voltage.

Voltage measurements are then taken in the horizontal discharge tube circuit. It is found that the applied B+ voltage is + 275 volts, and the voltages at the elements of V_2 are: $E_p = -75$ volts, $E_k = -138$ volts, and $E_k = -100$ volts with respect to ground. As indicated in Figure 6, all of these are normal except that at the plate of V_2 . The lowered voltage at this point can be caused by an increased drop across R_5 due to excessive current in this resistor, or a large increase in its resistance. However, an increase in the resistance of R_5 would cause C_5 to charge more slowly, use less of its charging curve, and therefore remain on the linear portion of the curve. The sawtooth portion of the trapezoid wave, Figure 7C, would not be curved as indicated by the scope check.

Excessive current would be caused by V_2 conducting too heavily, but this possibility is ruled out by the fact that the grid voltage is correct, and the tube check has shown the tube to be in good condition. Therefore, if there is excessive current in this circuit, then some other conductive path must exist from the

upper end of R_5 to the -100 volt terminal on the low voltage power supply. One possible path includes C_4 and R_8 , and another consists of C_5 , R_6 , R_7 and R_9 . In either case, the included capacitor must be shorted or very leaky.

To check C_4 , tube V_2 is removed, the negative test lead of the voltmeter held at the grid of V_3 , and the positive lead to ground. A reading of -100 volts is obtained, indicating that there is no leakage current in the circuit from the -100 volt supply terminal through R_8 , C_4 and R_5 to the +275 volt terminal. The indicated -113 volts is present only with V_2 in its socket and the circuit in normal operation.

With V_2 still out of its socket, a voltage measurement taken at the junction of R_5 and C_5 shows -86 volts. Thus, it is concluded that a leakage current exists in the circuit containing C_5 because, with V_2 out, if C_5 were good there would be no current in R_5 , and the full B+ of +275 volts would be obtained at this test point.

With the receiver turned off, one lead of C_5 is disconnected, and a resistance reading across its terminals shows this capacitor to be shorted. Finally, C_5 is replaced and, with V_2 back in its socket, normal operation is restored.

In addition to showing how the various types of tests are combined in the complete troubleshooting procedure, the above example illustrates the way in which the technician's knowledge of circuit theory must be used to interpret the various test results, and in deciding which possible faults are eliminated by each result.

This example is not intended to indicate that the symptoms described are always caused by a shorted sawtooth forming capac-

itor. In fact, any of several other defects could have produced equivalent electrical conditions in the horizontal deflection circuit. Rather, it was intended to demonstrate the proper approach to a typical troubleshooting problem. It should be observed in particular that although the blank screen obtained initially tended to indicate high voltage trouble, further organized investigation showed that the low high voltage was a secondary result of the actual trouble.



STUDENT NOTES

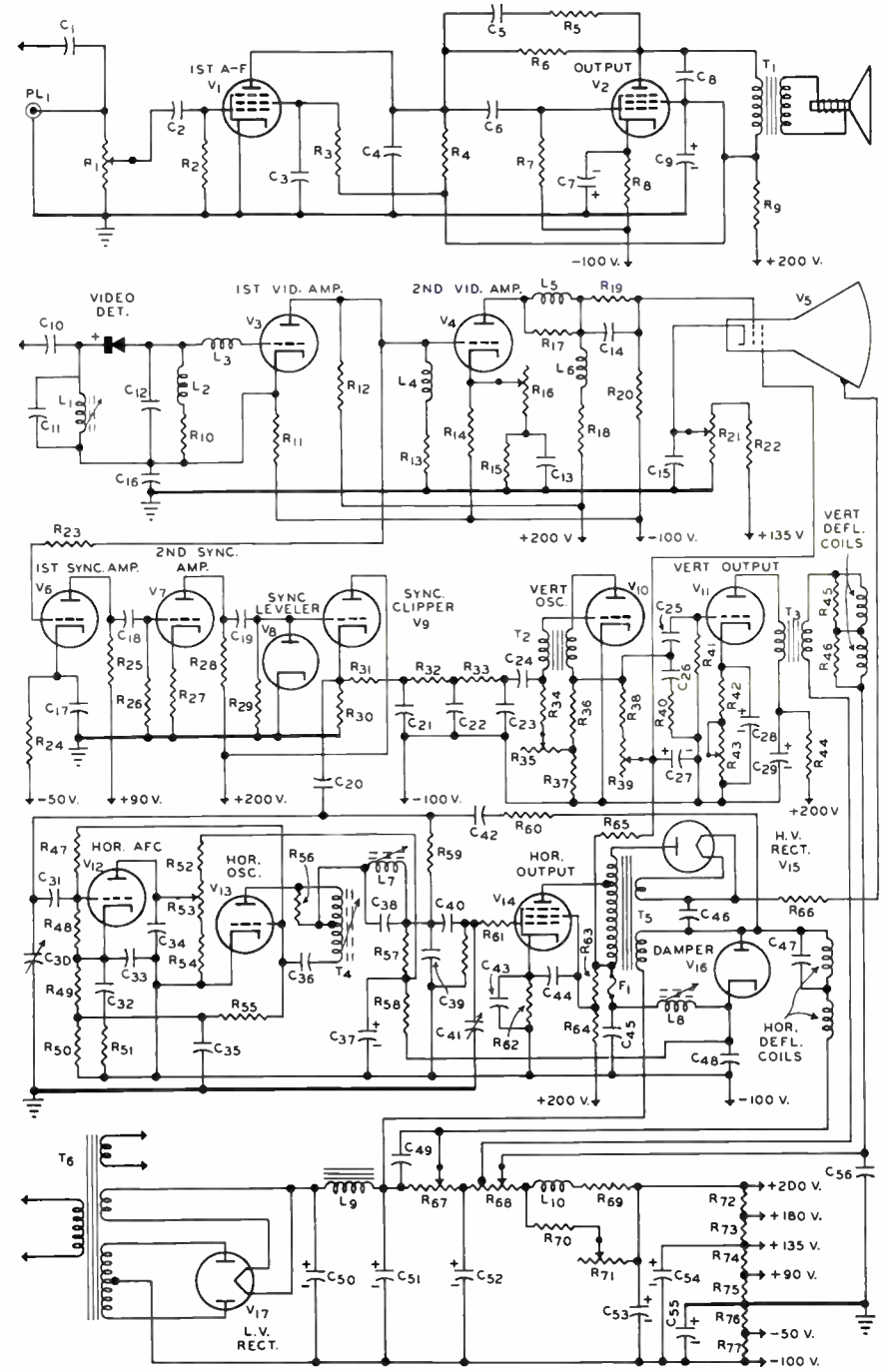

TSM-7

FIGURE 1

STUDENT NOTES

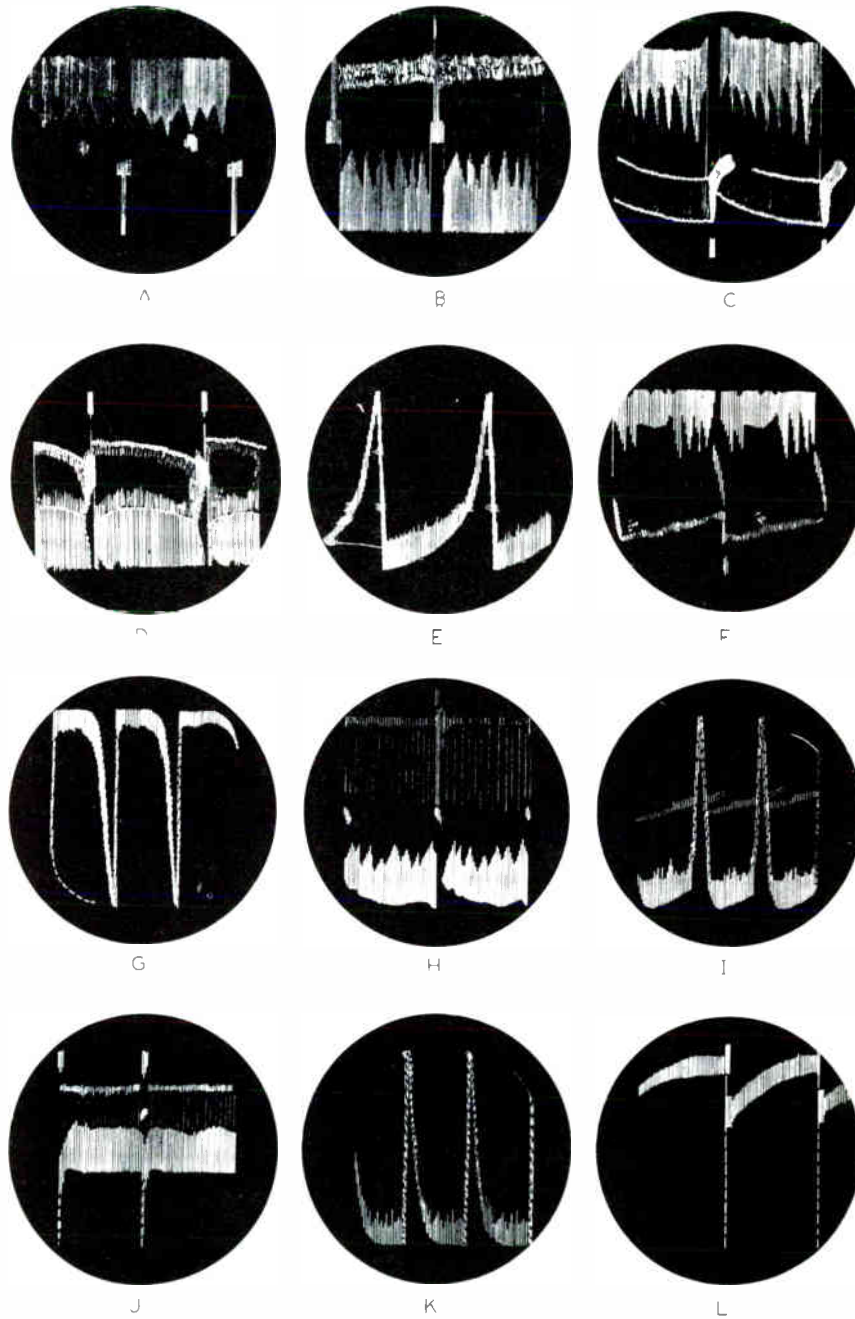

TSM-7

FIGURE 2

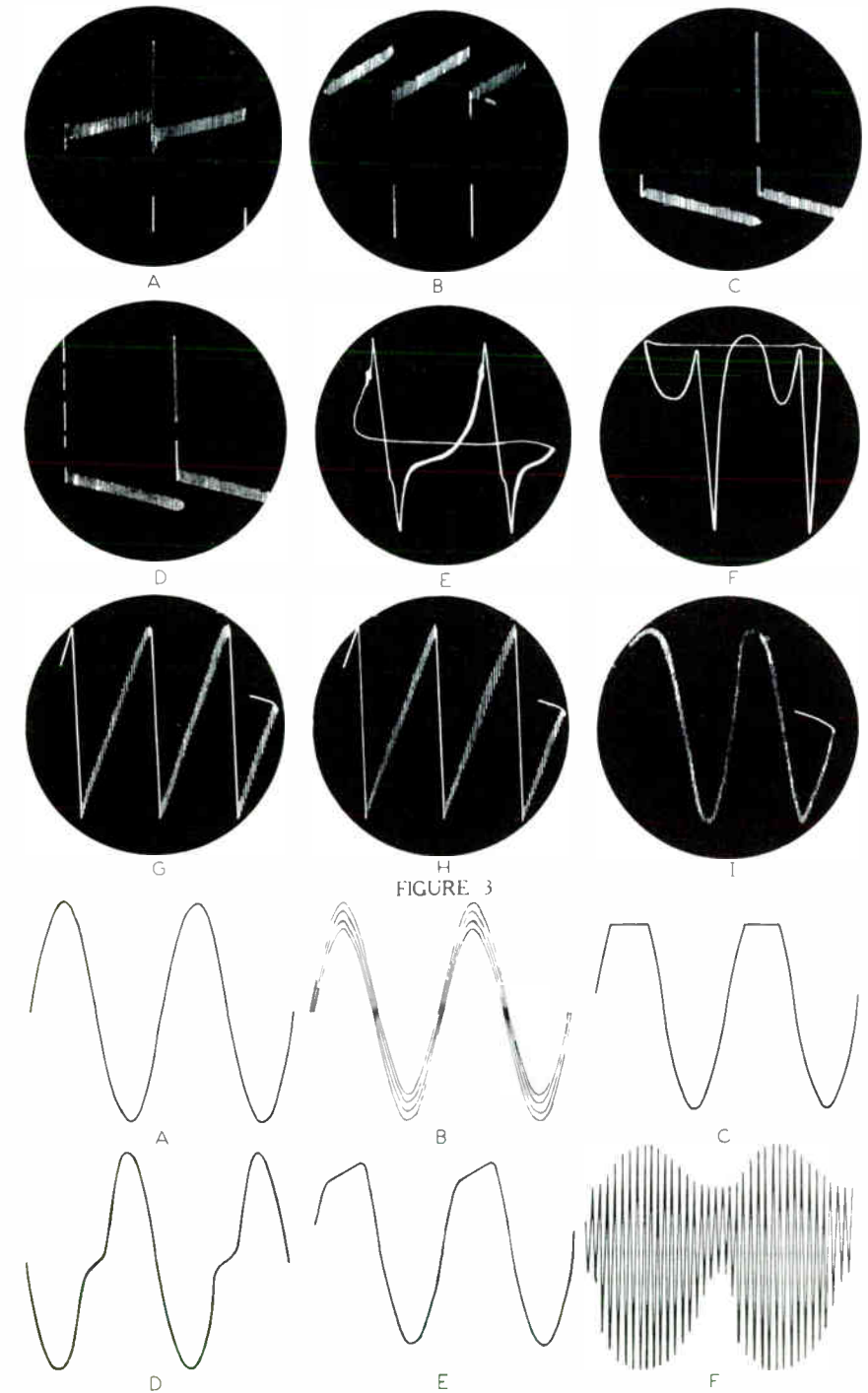

FIGURE 3

TSM-7

FIGURE 4

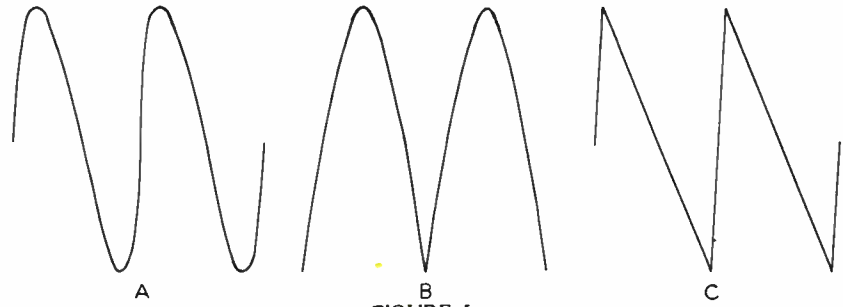

FIGURE 5

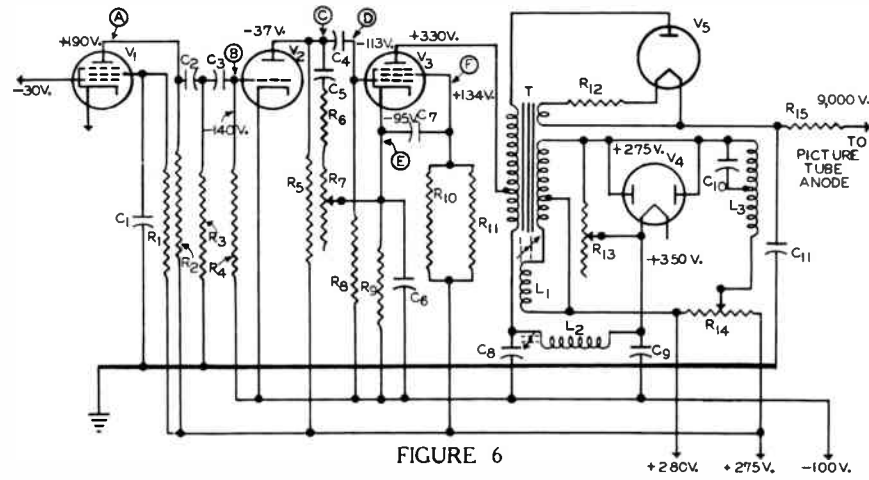

FIGURE 6

POINT	A	B	C	D	E	F
NORMAL WAVE FORMS						
AMPLITUDE	225v. PP	100v. PP	78 v. PP	78v. PP	11.5v. PP	9v. PP
OBSERVED WAVE FORMS						

FIGURE 7

TSM-7

DeVRY Technical Institute

Formerly DeFOREST'S TRAINING, INC.

4141 WEST BELMONT AVENUE

CHICAGO 41, ILLINOIS

QUESTIONS

Test Procedures—Lesson TSM-7B

Page 35

3

How many advance Lessons have you now on hand?.....

Print or use Rubber Stamp.

Name..... Student No.....

Street..... Zone..... Grade.....

City..... State..... Instructor.....

Write your answers on the "Ans." line below each question. If more space is needed use reverse side of this page.

1. What is meant by a dynamic test?

Ans.....

2. What general type of trouble is revealed by a disturbance test?

Ans.....

3. How can a quick check be made of the audio and video stages of a television receiver by using a signal?

Ans.....

4. Compared to the disturbance testing method, what are two advantages of signal substitution?

Ans.....

5. Can a (television) signal generator be used to check the operation of a h-f oscillator in a television receiver?

Ans.....

6. When the oscilloscope signal tracing method is employed, what must the technician know?

Ans.....

7. In the circuit of Figure 1, and with respect to ground, at what point should the wave-form of Figure 3E occur?

Ans.....

8. When capacitors are used in bridging tests, what are the requirements for the capacitor used?

Ans.....

9. When television manufacturers supply voltage charts with their receivers, what additional information must be known concerning the readings?

Ans.....

10. When making high voltage measurements, what "hand" rule should be followed?

Ans.....

FROM OUR *Director's* NOTEBOOK

THE CUSTOMER'S IMPRESSION OF YOU

The fellow who pays the bill, the customer, is a mighty important man in your life when you have your own service shop. He's your reason for being in business; he's the fellow who keeps you in business.

The impression you make on your "meal ticket" is important, right from your first contact with him to the present time. Your own personal appearance and that of your shop . . . the way you answer the phone . . . the way you go about your service work, especially in the customer's home . . . your method of handling customers, whether they be complaining or merely inquiring . . . in fact, everything about your business operations—these are all important to the customer.

When you are determined to give your customer your best efforts, you're bound to give the impression of being a good, solid businessman. That's what keeps your customers coming back. And that's what a lasting business is built on.

Yours for success,

W. C. De Vry
DIRECTOR



TSM-8

INSTALLATION PROCEDURES

Lesson TSM-8A



DeVRY Technical Institute
4141 W. Belmont Ave., Chicago 41, Illinois
Formerly DeFOREST'S TRAINING, INC.

TSM-8A

INSTALLATION PROCEDURE

4141 Belmont Ave.

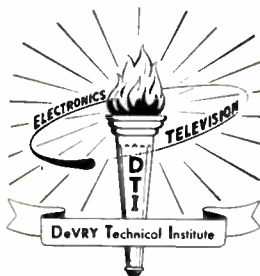

Chicago 41, Illinois

COPYRIGHT 1955

DeVRY Technical Institute



The complete installation includes placing the receiver in the most desirable location in the home and mounting the antenna where it provides consistently good reception.
Courtesy Emerson Radio & Phonograph Corp.

Television Service Methods

INSTALLATION PROCEDURE

Contents

	PAGE
The Importance of the Antenna System	5
Factors Determining Television Reception	7
Line-of-Sight Transmission	7
Signal Strength	8
Ghosts	9
Interference	10
Antenna Bandwidth	11
Directivity Requirements	11
Polarization of Carrier Waves	12
Multiple Outlets	13
Choosing the Antenna	13
Installation Equipment	14
Pre-Installation Survey	15
Basic Installation Procedure	16
Locating the Receiver	16
Installing the Antenna	17
Masts and Towers	21
Installing the Lead-In	25
Impedance Matching	27
Final Check and Instructing Owner	29
Signal Strength Indicators	30
Safety Precautions	31
Appendix A—Installation Tools and Supplies	33

“Stripping away the blinders of distance and darkness,
building a bridge across space, television is bringing the
world right into your living room.”

—General Electric Company

INSTALLATION PROCEDURE

All technical fields and industries can be separated into the general divisions of theory and practice. In most fields, and especially television, a rather complete understanding of "theory" is essential for intelligent and successful "practice". Therefore, the preceding lessons of this training program have described the more general aspects of the television system and the theory of operation of the most common types of television receiver circuits.

The following lessons explain the practice and show why a knowledge of theory is essential for the installation, adjustment, maintenance, and repair of television receivers. Also, they contain detailed instructions of "how" practical work is done, and whenever necessary, include explanations of "why" certain procedures and tests must be followed.

All practical work can be considered on the basis of CAUSE and EFFECT. As a common example, the effect of an excessive circuit current is a "blown" fuse. The practical man must be able to locate the defective fuse and know "how" to replace it. But that is not all. He must determine "why" the fuse blew and be able to locate and cure the cause of the excessive current.

In television, the customer's complaint and a preliminary inspection of his defective receiver indicates only the "effect" of the trouble. The knowledge of theory will permit a rapid diagnosis of the probable "causes" and finally, practical procedures locate and correct the defects. Therefore, in the study of these practical procedures it is a good idea to review the previous explanations of theory in order to keep clearly in mind the functions and operation of the various stages of a complete receiver.

The subject matter of this series of lessons is arranged so that, in a general way, it follows the television technician or serviceman's work during the life of an average receiver. Starting with the details of the original installation, the explanations follow the normal sequence through the instructions to the owner and subsequent service calls.

The described complaints also follow the normal sequence from simple improper adjustments by the owner through tube and component parts failures to the more serious circuit defects. To make the information more complete, the descriptions of the various defects include details of the procedures and equipment required for their correction.

THE IMPORTANCE OF THE ANTENNA SYSTEM

From the customer's standpoint, the first service job consists of the installation of the receiver in his home. This is the technician's first contact with the new customer, and a good impression should be made by carrying out the installation in as efficient and businesslike way as possible. It is at this time that the customer's confidence in the serviceman's ability must be gained, and the surest way of accomplishing this is for the serviceman to proceed with his work in a systematic manner, having a definite reason for everything that is done, so that the desired results are obtained in a minimum time. When the customer is confident that he is receiving a job of professional quality, he is more willing to listen sympathetically to explanations concerning any unusual reception conditions which may be encountered. On the other hand, if such explanations are employed merely to cover up the inability to achieve perfection, when perfection is possible, eventually these "explanations" backfire at the expense of the installer.

The complete installation includes placing the receiver in the most desirable location in the room in which it is to be used, connecting the lead-in wire from the antenna to the receiver, and

setting up the antenna in an arrangement which provides a strong, distortion-free signal. The antenna arrangement is by far the most time consuming and important part of the entire installation.

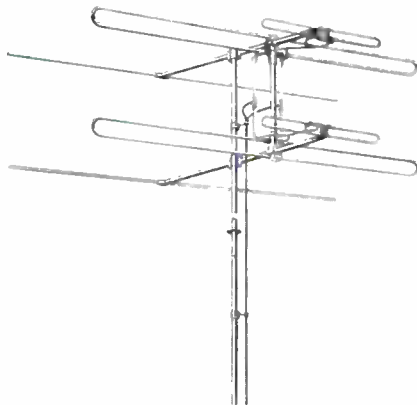

Stand-off insulators, shown mounted on the mast, provide the required space separation of the transmission line and mast. Shown is a Hi-La, stacked array VHF antenna with reflectors.

Courtesy American Phenolic Corp.

It is the function of the receiving antenna to collect as much of the radiated signal as possible and supply it to the receiver. Regardless of how high the quality of the receiver, its picture and sound output cannot be better than the signal supplied by the antenna system.

In the case of most AM broadcast receivers, installation consists simply of delivering the set to the customer's house and plugging in the power cord. Even with

those receivers providing all-wave reception, the design and installation of the antenna usually is left up to the customer. Although television is related to radio, the difference between them is considerable—and important.

The television system employs extremely short radio waves which act quite differently from the comparatively long waves of AM broadcast radio. Therefore, just any piece of wire strung up in any position cannot be used for a television antenna. The dimensions and positioning of a television antenna are critical and determine not only the quality of the reproduced picture, but whether or not a picture is obtained at all.

The television receiver is sensitive and easily disturbed by stray noise energy. Therefore, the television transmission line cannot consist of any type of wire. It must be carefully designed for correct impedance, have low loss, be balanced or adequately shielded, and it must be installed in such a manner that minimum loss and interference are introduced.

It is not enough that the installation technician be aware of these facts. The dealer for whom he works as well as the sales personnel must understand these things and **AT THE TIME THE SALE**

OF A SET IS MADE should point out to the customer that:

1. Each individual installation is a different problem.
2. The solution is not always a cut-and-dried affair.
3. The time and materials needed for his installation might be more than required for his neighbor or competitor.
4. Further adjustments may be necessary in the future when new stations come on the air.

The importance of a good television antenna installation was shown when a leading New York receiver manufacturer, running down complaints of faulty set operation, found that **NINETY PER CENT** of the troubles were due entirely to incorrect installations! Almost of equal significance is the fact that many of the dealers involved frankly admitted that they couldn't understand the reason for painstaking, time consuming television installations.

Besides these general considerations, the installer must possess a working knowledge of the more technical factors involved in the transmission and reception of television signals so that he may be able to recognize readily the various types of defective reception which are encountered from time to time, and to apply the proper remedy.

FACTORS DETERMINING TELEVISION RECEPTION

The problem of installing any particular antenna system generally consists of most, if not all, of the following factors:

Line-of-Sight Transmission

The radio-frequency carrier waves radiated from the transmitting antenna would spread out indefinitely in all directions were it not for the modifying effects of the earth's surface, the atmosphere, and various objects such as buildings, trees, and water towers.

Besides being propagated in a horizontal direction, these waves travel upward away from the earth. The ionized layer of the upper atmosphere, which is known as the **IONOSPHERE**, causes the paths of the radio waves to be bent by an amount directly proportional to their wavelengths. Because of this, the paths of the longer waves are bent sufficiently so that the waves return to earth and may be picked up by a receiving antenna located at the point of return. This action accounts for the long-distance reception of the lower frequencies, such as the broadcast band, and is illustrated by path 1 in Figure 1.

The high-frequency short waves employed as television carriers usually do not have their paths

bent sufficiently by the ionosphere to cause them to return to earth. Thus they continue on through the ionized layer, as shown by path 2, and are lost as far as reception is concerned. The only waves which are useful for dependable television reception are those which travel near the surface of the earth as indicated by path 3. Waves which travel by paths 1 and 2, etc. are called **SKY WAVES** while those which follow path 3 are termed **GROUND WAVES**.

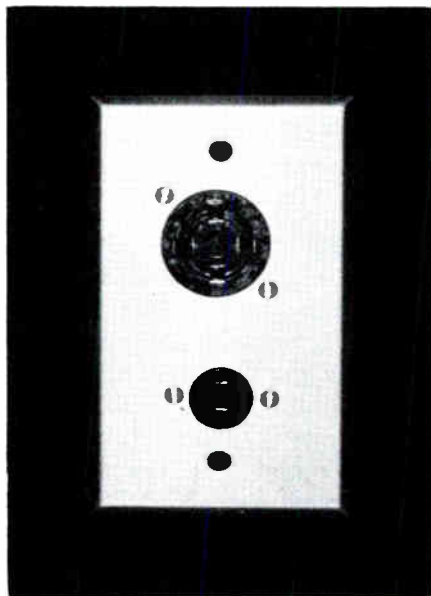

Typical wall outlet for antenna systems. The four prong receptacle is used for TV and the two prong receptacle for AM receivers.

Courtesy Intra-Video

High-frequency television carriers act like light waves in that they travel in straight lines.

Thus, although the signal reaches the receiver by path 3, Figure 1, it is unable to reach point "x" because of its inability to bend around the curved surface of the earth.

The distances from the respective transmitting and receiving antennas to the horizon limit the range of television reception by direct waves. This is known as LINE-OF-SIGHT transmission, meaning the transmitting antenna is "visible" from the receiving antenna position. The total distance, from antenna to antenna, depends upon the respective heights of the antennas, and, at the present time, averages somewhere between 50 and 70 miles in level country.

Of course, even though topographical and atmospheric conditions, etc. are ideal, it is not possible to actually see the transmitting antenna with the naked eye from this distance because of the normal acuity of vision. Furthermore, in traveling through the air, radio waves are bent or "refracted" slightly toward the earth and therefore the "radio horizon" is considered to extend some 15 per cent beyond the "optical horizon".

These various relations are given by the chart of Figure 2. This "nomograph" is calculated for a smooth spherical earth and with the transmission station and

receiver at the same heights above sea level. H_T represents the height in feet of the transmitting antenna, H_R the height in feet of the receiving antenna, D_o the total optical, or line-of-sight distance in miles, and D_R the total direct-wave radio transmission distance in miles.

For example, with a transmitting antenna 1000 feet high and a receiving antenna 50 feet high, the maximum distance over which regular reception normally can be expected is about 53.5 miles, as indicated by the point where the dotted line drawn from 1000 on H_T to 50 on H_R crosses the D_R scale.

These distances represent the maximum theoretical limits within which dependable reception can be expected. However, reception varying from dependable to extremely sporadic due to various conditions, is actually obtained at considerably greater distances in practice. This is described more fully in a later lesson.

Signal Strength

At a given distance from the transmitting antenna, the strength of the radiated television signal will depend upon a number of things such as the power output of the transmitter, the attenuation of the signal along its path, the directivity characteristics of

the transmitting antenna, and the nature of the intervening terrain in regard to hills, etc.

Each receiver requires some minimum signal voltage at its input terminals for satisfactory operation. Therefore, the antenna system must be designed to provide at least this minimum input to the antenna terminals of the receiver to which it is connected. Of course, it is possible for the signal strength to be so weak at the receiver location that satisfactory reception cannot be obtained even though the most efficient antenna system is used and it is well within the line-of-sight distance from the transmitter.

Ghosts

A ghost may be defined as an undesired image which is displaced either to the right or the left of the desired image. The amount of displacement varies for different cases and usually the ghost image is weaker, or less intense, than the desired image. One or more ghosts may be present at the same time, and are due to signals arriving at the receiver either sooner than or later than the desired signal.

When the undesired signal arrives sooner than the desired one, the ghost is displaced to the left and is called a "leading ghost", whereas, when the undesired signal arrives later than the desired

one, a "lagging ghost" is produced at the right of the desired image.

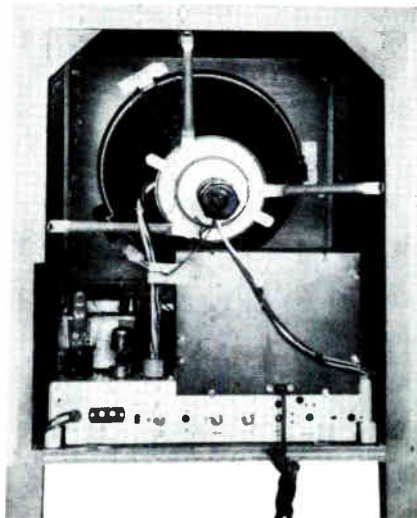

One of the requirements of a good installation is the proper adjustment of the non-operating controls. The rear view of the receiver is shown in the illustration.

Courtesy Philco Corp.

The lagging ghost is the most common. Usually the cause is some condition equivalent to that illustrated in Figure 3. The waves which produce the desired image travel by a direct path from the transmitting station to the receiving antenna, and thus cover the shortest possible distance between these two points. These waves, carrying the same modulating signal are radiated in all directions, and some may be reflected from the surfaces of large objects

such as buildings, mountains, lakes, rivers, etc.

The receiving antenna may intercept both the direct wave and a reflected wave, so that the desired and ghost images are produced on the receiver screen. All radio waves travel at approximately the speed of light in free space. Therefore, having left the transmitting antenna at the same time as the waves of the direct signal, the waves of the reflected signal travel a greater total distance and, consequently, arrive at the receiving antenna later than the direct path waves.

After the desired image has been formed by the modulating energy brought by the direct wave, the picture tube scanning spot continues moving to the right for a period of time equal to the difference in travel time between the two waves, after which the second, or ghost, image is produced by the modulating energy brought by the reflected wave. Usually the displacement of the two images is so slight that most objects in the picture overlap their corresponding ghosts.

A second cause of lagging ghosts is impedance mismatch between the transmission line and receiver and between the line and the antenna. When the impedance of the source is equal to that of the load, a maximum of energy

transfer takes place, but when the respective impedances are not equal, part of the energy is reflected back into the source.

When the transmission line's surge impedance is not equal to the input impedance of the television receiver, part of the received signal is reflected and travels back up the line to the antenna. If a mismatch exists at this point also, part of this energy again is reflected and travels back to the receiver. Thus, it arrives at the receiver's input terminals later than the original signal by a time equal to that which was required to travel the length of the transmission line twice. Therefore, this twice reflected energy produces a ghost image displaced to the right of the desired image.

A leading ghost is produced when the direct signal is picked up by the transmission line and, therefore, arrives at the receiver input terminals sooner than the energy from the antenna proper.

Interference

Besides undesired signal energy from various reflected waves from the "tuned" station, interfering signals may be received from other television stations in the same channel or in other channels, from FM stations, from government or commercial communication stations, and from amateur stations.

In addition to these various radio signals, interference in the form of noise energy may be picked up due to the proximity of such sources of r-f as diathermy equipment, neon signs, fluorescent lighting, electric motors, trolley cars, automobiles, etc. Such energy may be introduced into the television antenna, the transmission line, the wiring or chassis of the receiver itself, or it may be picked up by the house wiring and transferred into the receiver through the power supply.

The local oscillator signal of one television receiver may be in some way coupled to the set's antenna and thus radiated into space and picked up by the nearby antenna of a second television receiver.

Antenna Bandwidth

The five channels of the lower VHF television band extend from 54 mc to 88 mc, while those of the higher VHF band extend from 174 mc to 216 mc. Thus, to receive channels 2 through 6, the antenna system must be broadly resonant over a band at least 34 mc in width, and over a band 42 mc in width to receive channels 7 through 13. Also, an all-channel VHF antenna system must be designed for uniform response over a band $216 - 54 = 162$ mc wide.

In the UHF band, channels 14 through 83 extend from 470 to

890 mc. Thus, to receive the 70 UHF stations the antenna system must be broadly resonant over a band 890 - 470 or 420 mc wide. Finally, an antenna system designed to receive channels 2 through 83 must have a band width of 836 mc.

Noise energy is generally fairly even in distribution over the entire frequency spectrum. For this reason, the wider the bandwidth for which amplitude modulated radio equipment is designed, the greater its susceptibility to noise pickup, and the lower the signal-to-noise ratio in its output. Thus, the television antenna system should tune broadly enough to receive all the stations from which reception may be expected, but not more broadly than is absolutely necessary because of the importance of maintaining the signal-to-noise ratio as high as possible.

Directivity Requirements

The directive characteristics of the antenna system employed in any particular installation depend upon the location of the various stations from which reception is desired, relative to that of the receiver. Other determining factors are the locations of any undesired stations (operating on the same channels as the desired stations) and the directions from which any undesired reflected signals may be arriving. Thus, for

various reception situations, the antenna systems used may have to be omnidirectional, bidirectional, or unidirectional, etc., and, usually must be oriented, or rotated, to the optimum position for the desired reception.



In fringe areas, for good reception, the height of the antenna is important due to line-of-sight transmission characteristics. Shown is a 40 ft. tower and mast designed for roof installation.

Courtesy Wind Turbine Co.

Polarization of Carrier Waves

An r-f wave consists of two components; an electric field and a magnetic field. These two fields are at right angles to each other, and one or the other—or both—are perpendicular to the direction of wave travel.

The way in which a wave of this type is propagated through space is illustrated in Figure 4. Here, the large diagonal arrow indicates the wave to be traveling from the “source” toward point “X”. The electric field is represented by the solid vertical lines, the magnetic field by the horizontal dotted lines, and their direction at any instant by their respective arrows.

As indicated by the curves, these **LINES OF FORCE** have been drawn only at the points of maximum field intensity in each direction. However, the electric and magnetic fields are continually changing in intensity and direction as the wave travels along.

The electric lines of force are not always vertical nor the magnetic lines horizontal. They may be just the reverse, or they may be at some angle other than 90° to the earth’s surface. In any event, they are always at an angle of 90° to each other, and one field at least is always at an angle of 90° to the direction in which the waves are traveling.

When applied to electromagnetic wave propagation, the word polarization is used to describe the direction or orientation of the electrostatic component of the wave. Thus, the wave illustrated in Figure 4 is described as being vertically polarized, and is the form employed in AM radio broad-

casting. The polarization imparted to a radiated wave is determined by the physical position of the transmitting antenna, and for best reception, the receiving antenna should be mounted in the same position.

For television, horizontal polarization is employed and to achieve this, the transmitting antenna is mounted with its long axis in a horizontal plane. For this reason, the receiving antenna is normally mounted in a horizontal plane also. However, due to various conditions along its path of propagation, the originally horizontally polarized television wave may be rotated to some extent so that its electric field is no longer in a horizontal direction. When such is the case, reception may be improved by mounting the receiving antenna at an angle to the horizontal.

Multiple Outlets

Finally, it may be found necessary to operate several or possibly a large number of receivers from the same antenna system. Examples of this are: where a dealer desires to operate several makes or models simultaneously so his customers may make their choice on the basis of relative performance, and where it is desirable to permit many or all of the various occupants of a large apartment building or hotel to have television service.

A large number of individual antennas crowded on one roof usually results in so much mutual interaction that satisfactory reception is impossible on many if not all of the receivers. Furthermore, not only does a forest of different shaped antennas subtract from the "beauty" of the building, it also is a fire hazard, and generally is not permitted by the landlord, manager, or a city code.

Hence, in these apartment buildings, the antenna system employed must be one which is capable of supplying sufficient r-f energy to the input of each receiver, isolates the receivers to prevent interaction, and consists of a trim and simple array of elements on the roof of the building.

CHOOSING THE ANTENNA

Because of the large number of different specific reception problems which may exist due to various combinations of any group or all of the factors described above, the antenna system or arrangement decided upon often is evolved during the course of the installation process. Experience with previous installations of the same general type, and in the same vicinity, will usually provide a basis for the selection of the antenna type needed, but the discovery of unexpected reflections or other undesired condi-

tions often necessitates some modification of the arrangement.

Of course, it is possible for conditions to be so extreme at a particular location that the antenna system required may be entirely different from any of the others in the surrounding neighborhood, and in rare cases, may even necessitate rather "unorthodox" installation practices. On the other hand, reception conditions may

nas. Because of this situation, no practical rules can be formulated for choosing an antenna system which are applicable to all cases. Rather, the antenna types designed especially for various reception problems are mentioned when these problems are taken up in the following lessons.

INSTALLATION EQUIPMENT

To do work of professional quality and with a minimum expenditure of time, it is necessary that the installer possess and know how to use the correct installation tools. The various working tools and supplies required are listed in Appendix A.

For determining the exact point where it is most desirable to mount the antenna, it is convenient to make an initial check at various points by means of a lightweight portable dipole antenna, having a short mast, and which is connected by a temporary lead-in to the receiver. Usually it is easier to carry this test antenna about on the roof than the actual unit to be used in the final installation.

Two men are required to install the antenna expediently, one on the roof and the other at the receiver. To provide for communication between them, some type of inter-phone system must be used. The sound-powered type is the most convenient, as no battery or other power source is



The VHF TV booster, designed to mount on the antenna mast, improves the signal-to-noise ratio for fringe area reception.

Courtesy Electro-Voice Inc.

be so favorable that satisfactory performance can be obtained with any type of standard commercial antenna, including indoor anten-

needed, and the antenna lead-in may be used as the telephone line. The observer at the receiver hooks his phones across the lead-in at the receiver antenna terminals and the technician on the roof connects his phones across the terminals of the antenna. In each phone, an armature, located between the poles of a permanent magnet, is driven by voice power, thus developing current which drives the receiver diaphragm in the ear piece of the phone at the other end of the line.

When battery powered phones are employed, a separate two-conductor telephone line must be strung between the operators on the roof and at the receiver. Typical connections of the equipment used for this type of system are shown in Figure 5.

When the distance between the receiver and antenna is greater than about 200 feet, an intercommunication system containing an amplifier may be necessary. The serviceman can design his own from an ordinary low power audio amplifier circuit, or he may purchase any of several commercial systems which are available for this purpose.

PRE-INSTALLATION SURVEY

A technician should make a preliminary visit to the site at which an installation is to be

made for the purpose of determining the general type of antenna system that is needed. This will reduce the equipment which has to be carried to the location by the installing personnel. Also, the technician can consult the owner with regard to the size or complexity of the arrangement which he will permit on the roof of his home.

Some people do not like the appearance of an outdoor antenna, in which case the technician should check the possibility of obtaining satisfactory reception with an indoor antenna. Useful for this purpose, as well as for determining the signal strength in the area, is a portable television receiver using any of several commercial type indoor antennas. In many cases satisfactory reception cannot be obtained with an indoor antenna, and, in a few rare cases, is even unobtainable with an outdoor installation.

Experience has shown that it is far better not to make a sale of a television receiver than to make an installation which will result in repeated owner calls for service and possibly end with his request for removal of the set from his home. One such unwise installation can have a more damaging effect on the reputation of the seller than can be counter-balanced by many successful installations.

Besides signal strength, other points which should be checked at the time of the pre-installation survey are:

1. The distance and direction of television stations serving the area; their channels, transmitted power, and time of operation.
2. Make and model of receiver purchased by the customer.
3. Nature of surrounding and intervening terrain, trees, buildings, water towers, railroad trestles, and other objects which might hinder reception or cause reflections, etc.
4. Possibility of interference due to nearness of power lines, electrical machinery or signs, doctor's offices, or heavily traveled streets.
5. Nature of reception at other installations in the neighborhood; type of defects if any.
6. City or landlord objections to outdoor antennas or height of masts, towers, or large arrays.

This survey is important to the prospective customer, the dealer and his sales staff, as well as to the installation man. It can serve as a basis for agreement between the customer and the person making the sale. The installer, by analyzing the findings of the survey, can plan and carry out the

installation more rapidly, thereby helping to gain the desired customer satisfaction.

BASIC INSTALLATION PROCEDURE

In the following paragraphs is outlined the basic procedure which applies generally to all television receiver and antenna installations. No problems of a specific nature are included in this outline, but the points in the procedure at which the more complex problems occur are indicated. The possibilities of the existence of a large variety of special or undesirable reception conditions have been mentioned, and the specific methods of dealing with these various conditions are taken up in following lessons.

Locating the Receiver

It is a good idea to make a performance test of the receiver in the service shop and make any necessary adjustments before delivering it to the customer's home. By following this plan, it is reasonably certain that any troubles which appear at the site are installation defects and not the fault of the receiver.

Upon arrival at the customer's home, the first step is to decide upon a suitable location for the receiver. In most cases this site is chosen by the customer, however, it is the duty of the installer to

point out how, if possible, the choice may be improved. The customer should be told to take into consideration the viewing of the screen by his whole family plus a group of friends because he will not appreciate having to shift all the furniture in his living room to accommodate guests.

When possible, guide his choice to avoid placing the receiver where bright light falls upon the screen or where reception of interfering signals from electrical appliances or units within the home affect the picture. The final location depends largely upon the space available and it should be called to the customer's attention that the optimum viewing distance is from four to ten times the picture height and that a cleared area of this size in front of the receiver is to his advantage.

The receiver should not be placed in a closet or wall recess, since provision for ventilation and accessibility for adjustments must be considered. Finally, convenience to an a-c power outlet is important as power cord extensions are to be avoided.

When these considerations are mentioned before the owner is asked to designate a location the chances are he will cooperate willingly. If he is asked to make this decision first, and these arguments are used to show where he is

wrong, he may tend to stick to his first choice regardless of its faults. A bad choice of receiver location by the customer, who is the boss, may add difficulties to the installer's job.

When the location has been selected, estimate the distance from the receiver to the nearest appropriate window, skylight, air duct or other means of access to the roof. Outside, estimate the distance from the tentatively chosen point of entry to the part of the roof most remote from this point.

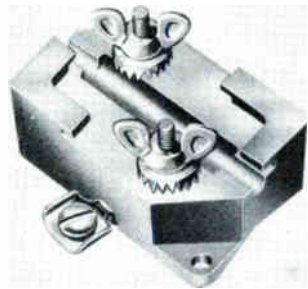

VHF-UHF Lightning Arrestor. Designed for use with Flot, Open, or Tubular Twin Leads. Courtesy of JFD Mfg. Co., Inc.

The total of these two estimated distances is the approximate length of 300 ohm twin-lead transmission line which is needed for the antenna location process.

Installing the Antenna

Before connecting this lead-in, the receiver may be given a brief

preliminary check to make certain it is in operating condition by using suitable wires to make a temporary connection to the dipole inside the house. In most cases it should be possible to obtain some kind of picture on the screen and a few adjustments of the front panel controls will indicate the condition of the receiver.

After the set is seen to be in working order, this arrangement is disconnected and the regular lead-in connected to the receiver and then run out through a window or other opening. Outside, the portable antenna is connected to the lead-in and taken to the roof or wherever the regular antenna is to be mounted.

The next step consists of determining at what point on the roof the antenna must be located and the angle of rotation, or orientation, necessary for proper reception. These two requirements must be determined simultaneously by means of a process known as "probing". The receiver is tuned to a station and one technician "walks" the antenna around the roof while the other observes the picture on the screen of the receiver. The operator at the receiver reports the quality of the picture to the man on the roof who systematically explores the area, moving slowly from point to point continuously rotating the mast until a position and orientation is found which provides good

reception. This procedure is followed through on one station at a time, and the points noted at which satisfactory operation is obtained for each station until a position is found at which reception of all desired signals can be obtained. Of course, there is considerable variation in the time required to find the optimum antenna location for different individual cases.

It is during the probing operation that most of the existing reception difficulties are encountered. Since more than one often is present at the same time, the problem may appear quite complex and formidable. That is, the existing troubles may result in any one or any combination of two or more of the following conditions on the screen: (1) ghosts, (2) snow, or faint pictures, (3) interference streaks, patterns or flashes, and (4) distorted or tearing pictures.

Manufacturers' service and installation organizations, as well as large independent specialist television installation organizations, have learned that a successful installation is obtained most quickly by applying one of the most fundamental rules of radio and electronic troubleshooting. This rule is: **TROUBLESHOOT FOR ONE TROUBLE AT A TIME.** Obvious as this procedure may seem, often it is overlooked by the inexperienced installer.

As mentioned, the methods employed to correct the various troubles are explained in later lessons. Therefore, assuming the best antenna location has been found and all reception troubles remedied, the next step consists of the mechanical mounting of the antenna. The antenna to be used is now substituted for the probing dipole, if this has not already been done during whatever troubleshooting procedure may have proved necessary.

The antenna kit normally includes a mount for the antenna mast. However, as the structure of the building at the desired location may be any of many forms, a variety of mount types, or some type of universal mount, should be carried. When practical from the standpoint of good reception, a chimney serves as a convenient mounting point. The antenna mast may be secured to the chimney by means of brackets similar to those illustrated in Figure 6A, or by brackets held by metal straps that encircle the chimney as in Figure 6B. Another object useful for rooftop mounting is a vent pipe, and brackets of the correct size and shape for this use are available. Also commercially available are a variety of types for wall mounting such as those shown in Figure 7. A simple gable mounting may be accomplished by means of a board

about six feet in length and two brackets as in Figure 8.

For mountings like those of Figures 6A and 7, it is necessary to drill holes to accommodate some type of expansion fittings. It is important that the holes be made in the bricks themselves and not in the cement between the bricks. Drilling into the cement will permit water to leak into the holes and the resulting expansion due to freezing in cold weather will produce cracks which allow the brackets to pull free.

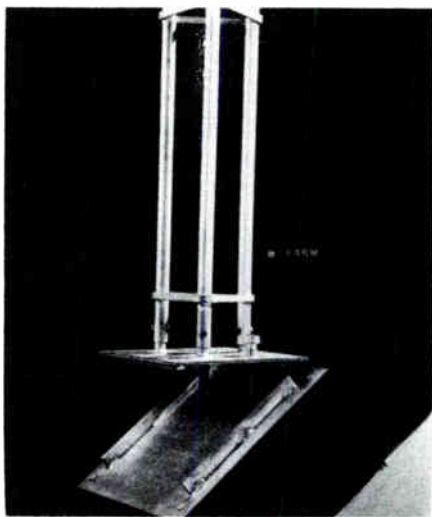

Antenna base plate for masts or towers. Note that this unit is designed to mount on both flat and slanting roofs.

Courtesy Penn Boiler Mfg. Corp.

The bricks, of course, are much harder to drill into, and when an electric drill is to be used, a hole

should first be made with a rawl tool. Then, when the hole is enlarged with the electric drill, there is less danger of overheating the expensive masonry bit. When an electric drill or power is not available, the holes may be made with a star drill and hammer.

Consisting of a cone-shaped copper nut encased in a soft lead sheath, an expansion screw anchor next may be fitted into each hole, after which a setting punch is used to spread the lead inside the hole. The anchor should be put into the hole so that the large end of the copper nut goes in first, as shown in Figure 9. The antenna mast brackets may now be mounted to the wall or chimney by means of one-quarter inch machine screws which fit into the expansion fittings.

For protection from lightning, steel or aluminum antenna masts should be grounded by means of a ground clamp connected to a heavy wire which is run by the shortest path possible to the nearest well-grounded object. If made of metal (not tile) a sewer vent on the roof forms a good grounding point. Another grounded object is the garden hose faucet on the side of the house. **THE GROUND LEAD SHOULD NEVER BE CONNECTED TO HOT WATER PIPES, GAS PIPES, OIL PIPES, UNGROUNDED VENT PIPES, RAIN GUTTERS, OR HOT AIR DUCTS.** If a convenient ground

cannot be found, a spade-end stake designed for the purpose may be purchased and driven into the ground to a depth of at least 4 feet. The ground lead from the antenna mast may then be clamped to this stake.

An antenna mast mount for mounting the antenna on a peaked roof is shown in Figure 10A, and an arrangement that may be used on a flat roof is shown in Figure 10B. In general, guy wires should be employed whenever the antenna mast is more than 10 feet high, regardless of the type of mounting employed. The guy wires should be spaced 120° apart and broken by insulators at intervals which are shorter or longer than the length of the antenna to prevent the guy wires from resonating at the frequency to which the antenna is tuned.

Rooftop installations which require that the mounting bolts or screws puncture the roof surface should be avoided if at all possible. Such an arrangement may permit rain to leak through and rot the wood base or damage the plaster on the ceilings of the rooms below. Many times a roof has been guaranteed by the roofer and any deliberate damaging of its weather-proofing qualities automatically voids the warranty. The owner's permission should always be obtained before an installation of this type is made.

Masts and Towers

Due to straight line propagation of r-f waves and to the curvature of the earth's surface, the higher the antenna, the stronger the received signal. Also, a high antenna, reduces the possibility of noise pickup. However, as cost is usually a limiting factor, the height of the antenna mast or

should be selected and erected with the greatest of care, for there is a certain peril to property and person when masts or towers are not sufficiently sturdy to withstand high winds, ice loads, etc. Substantial damage can result from an installation being blown down. A suitable erection site must be selected where the

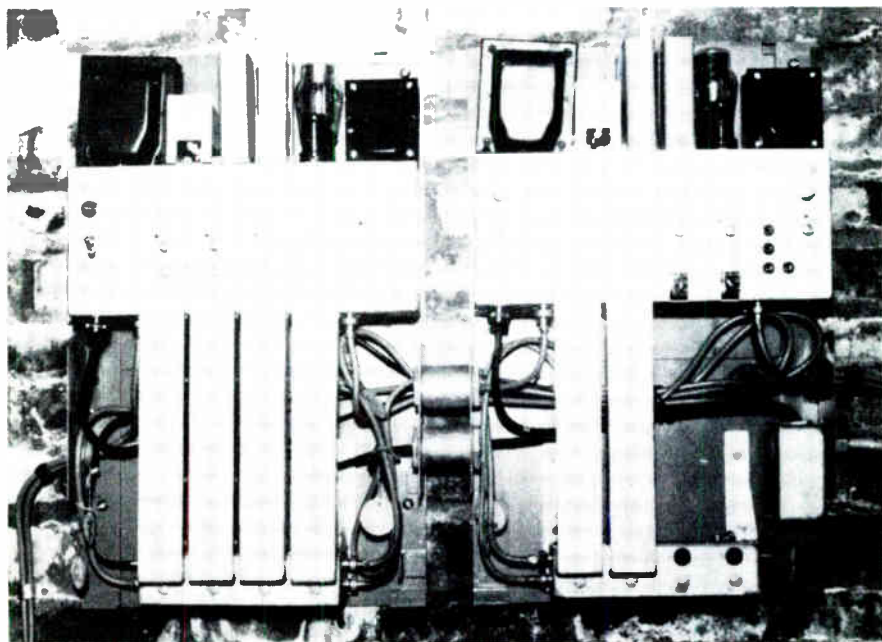

Typical booster installation for six channels used in an apartment building.
The units are shown with covers removed.

Courtesy Intra-Video

tower is generally held to the minimum required for satisfactory reception.

The mast upon which the television antenna is to be mounted

particular mast for a given height can be erected. When towers as high as 60 feet or more are required, they should be erected a distance at least equal to their

height away from the house or other buildings. While this may require a longer lead-in, the slight increase in expense is negligible. It is not recommended that chimneys be depended upon to support masts which are over 10 feet high.

For heights up to 30 feet, a guyed pipe mast is safe. The pipe which may be used depends upon the size of the array to be mounted on it. Galvanized iron pipe is strong and durable, with $\frac{3}{4}$ inch to $1\frac{1}{2}$ inch sizes being the average requirements. Although more expensive, aluminum has the advantage of being lighter in weight and, therefore, is easier to handle and erect.

Where a pipe mast is used, guy wires of heavy galvanized steel or bronze should be spaced every ten feet up the entire length of the mast and spread out as far as possible at the base.

When masts are required which are 30 feet in height, it is necessary to join shorter lengths together since pipe and tubing come in standard sizes up to 12 feet long. Great care should be taken with these joints, or otherwise they will present a weak spot in the construction with possible danger of breaking. As with base mounts, special couplers and mast extension connectors are available for properly joining lengths of pipe and tubing of all sizes. Reference to plumbing, electrical,

and hardware catalogues disclose many other items that prove useful in mast construction.

Although wood masts can be used, such as those made of 2x2 or 2x3 lumber, they present a fire hazard, and do not last as long as metal ones. However, wooden masts do afford the advantage of being inexpensive and easy to work with. Properly guyed, heights up to 36 feet can be obtained with the mast construction shown in Figure 11. When the lumber selected is knot-free and painted with a good outside lead base paint, a wooden mast of this type should last for several years.

When heights greater than 30 feet are desired, usually a commercially manufactured tower is best. These come in a number of different styles, as shown in Figures 12 and 13. The four post, self supporting type such as a windmill tower is most desirable, but usually the three post, guyed type is less expensive.

In many rural locations there may be present a windmill tower which is ideally suited for supporting large arrays. Silos, water towers, and barns also may be used for this purpose, but usually these are located at a considerable distance from the house, necessitating an excessively long lead-in.

When erecting a mast or tower, care should be taken with the base

mounts. Not only should the base be secure, but, if it is mounted on the roof, the use of roofing pitch to avoid water leakage is essential. The market offers a wide selection of special fixtures and base mounts for use on peaks, flat, and sloping roofs.

The erection of the mast or tower will present problems of varying degrees of difficulty depending upon the type of unit to be used and the nature of the location at which the mounting is to be made. It is suggested that a professional "rigger" be consulted, or it may be best to have him do the actual tower erection. He not only knows best how to do the job, but also has the necessary tools and equipment for doing it. However, if the installation technician and crew must do the job themselves, the following information is useful.

Tools required are very much the same as described in this lesson for the installations in primary service areas. The main additions are ropes, pulleys, and "gin" poles. Other parts and equipment that is needed are listed as follows:

1. Guy wire: For pipe or tubing masts up to 30 feet high, number 12 galvanized iron wire, solid or stranded, will be satisfactory. Bronze is more expensive but better since it does not rust. No. 8, 6, or 4

wire is necessary for use with towers up to 100 feet in height. The manufacturer usually recommends the proper size to use with different heights of his particular type of tower.

2. Turn buckles: These are usually necessary to take up the slack in guy wires and keep them taut. A 6 inch turn buckle should be used with the guys of masts up to 50 feet in height. Larger sizes may be necessary with the towers of greater height.
3. Strain insulators: These are used to break up the length of guy wires to prevent undesirable resonant effects in those guys which are attached to the top of the mast near the antenna.
4. Large bolts: Used to fasten base mounting plate to roof. In most cases, $\frac{1}{2}$ inch by 6 inch carriage bolts are needed. Generally, the necessary bolts are supplied with the tower.

A tower may be erected either by assembling it completely and then raising it from the roof or ground, or by building it up piece by piece. The former method is the easiest way to put up a pipe or tubing type mast. The usual procedure is to first join the separate length of pipe together and then attach the guy wires which have been cut and assembled with

strain insulators. With lead-in connected, the antenna array is assembled to the mast and the guy wire tie points located around the roof or ground. With the base plate bolted firmly in position, the mast can then be "walked" and pulled up in place. While one or more men hold the mast, others can tie the guy wires to the various tie points.



Installation of a television antenna and tower. The illustration shows the use of a platform, rope, and pulley. Note a safety belt is worn by the installer.

Courtesy Wind Turbine Co.

In the case of masts near or exceeding 35 feet in height, it may be necessary to use either a gin pole or a "scissors" to aid in the erection. The drawings of Figure 14 show methods of using

such devices. At every ten feet on the pipe three guys, 120° apart, usually will prove sufficient. In some cases it may be impossible to fasten them at this angle.

Shown in Figure 13, is a 100 foot aluminum tower which must be erected by the building up method. Most towers of this type come in ten foot sections with full instructions and all necessary hardware for assembly. The general procedure is to first locate points for anchoring the base and guy wires. If the guys are to be anchored in the ground, they may be attached to six foot lengths of pipe driven into the earth with the upper end pointing at an angle away from the tower.

For very heavy poles, however, the "dead-man" type of guy anchor may be necessary. These consists of heavy planks, rails, or other large heavy objects buried about three or four feet in the earth, after a short length of doubled guy wire is attached to afford a means of connecting the tower guys.

With the base located solidly, the tower is built up, a section at a time, with the guy wires installed at regular intervals. This work is dangerous and a safety belt should be used by the man climbing the tower. The antenna is mounted last and may require an outrigging as well as ropes and pulleys to get it in place.

The self-supporting type of tower, shown in Figure 12, necessitates that the legs be firmly fastened to the roof or ground. For roof installations, large bolts of sufficient size and length should pass through the roof, with a steel plate washer on the underside. Usually, this type of tower is built up a section at a time, but can be pre-assembled for ground installation and erected with block, tackle, and gin poles.

In certain locations, such as near airfields, it may be necessary to employ tower lighting. Often, CAA rules requires that beacon lights be employed on towers 100 feet or more in height. The flasher timing and other specifications depend upon the local code and should be investigated.

Installing the Lead-In

After the antenna is in place, the next step is to permanently secure the lead-in. The lead-in installation process follows a downward route from the antenna to the receiver, avoiding pipes and other large metal objects as much as possible. When such objects must be approached, the lead-in should not run parallel to their length for any great distance. While the line is being installed, a technician at the receiver observes images on the various channels to detect any distortions which may appear.

To minimize attenuation of the signal, as short a route as possible is desirable but it must be altered if necessary to eliminate any such interference or other extraneous effects. Also, it should be kept in mind that most people do not like to have wires run down the outside of their house front.

It is important that the antenna-transmission line connection be a good, low-resistance contact. When the connection to the antenna requires that the lead-in wires be soldered to terminal lugs, only rosin core solder should be used and the residue wiped away with alcohol or carbon tetrachloride. As the various parts of such connections contain different metals, moisture and salt in the air will cause a battery action to take place, resulting in fairly rapid corrosion of the joints. To prevent such action, after being cleaned, the joints should be covered with a thick coating of lacquer or glyptal.

A simple method of preparing the end of coaxial cable for attachment to the antenna terminals is illustrated in Figure 15. First, the outer insulation is removed from about six inches of the end of the cable. A scribe or an icepick is then used to make an opening in the braid, as shown in Figure 15A. This opening is carefully enlarged to a length of one

to two inches after which the inner conductor is pulled through as shown in Figure 15B. The braid is stretched to its full length and then twisted to form a flexible conductor, and about one inch of the insulation is removed from the end of the inner conductor. Finally, solder lugs are attached to both conductors, Figure 15C, and the cable is ready to be connected to the antenna.

Many antenna manufacturers provide transmission line supports attached to the antenna mast. In the case of systems employing coaxial cables, these supports prevent the antenna terminals from having to hold the weight of the line, while in the case of twin-lead line the correct line-balance is provided by such a support. If none are contained in the antenna kit, various types of such supports may be obtained from radio parts suppliers.

To assure good space separation from surfaces likely to become wet during bad weather, the lead-in should be mounted by the use of stand-off insulators similar to those shown in Figure 16. Those of Figures 16A, B, and C are for twin-lead line and that of Figure 16D for "coax". The unit of Figure 16C is not threaded, being designed to be driven in with a hammer. Installation of these insulators in brick or concrete structures may be accom-

plished by piercing a hole with a rawl tool, inserting a rawl plug and then twisting or nailing the insulator fitting into the plug.

After all stand-off's, etc. have been mounted, the transmission line is threaded through the antenna mast supports and permanently attached to the antenna. If a coaxial cable is used, the threading is continued, proceeding from the antenna to the point where the line is to enter the house. In the case of twin-lead, the line is dropped from the roof and then inserted into successive eyelets, beginning at the antenna mast. To reduce the amount of noise pickup, twin-lead should be twisted about one turn per foot along its entire run.

If at all convenient, twin-lead should be brought into the building through a window nearest the receiver. Insulated staples should be used to neatly tack the lead to the window frame so as to conform to the shape of the molding. The window can be notched at the bottom so as not to pinch the line when closed. Coaxial cable may be brought in by drilling a hole under the window sill. The hole should be drilled from the inside out and at a downward angle to prevent water from running into the building. The hole should be just large enough to allow the cable to fit, and if the line does not completely fill the hole, the

hole should be filled with caulking compound after the line is installed. This arrangement is illustrated in Figure 17. In the case of a stone or cement sill, or a metal window frame, the hole may be made in the frame at the side of the window and near the bottom.

When the location of the receiver is such that, from the point of entrance at the window, the transmission line run inside the house is difficult due to doorways, fireplace, etc., or if the owner does not want a hole drilled in the window frame, an alternative method is to bring the line down the outside wall and in through a hole or notch in the frame of the basement window. Then insulated staples or nailit knobs may be used to run the line along the basement ceiling to the point where the receiver is located. Here, a small hole can be drilled in the floor and the line brought up to the set, or to a transmission line socket mounted on the baseboard behind the set.

When the line has been brought in near a window, it is next strung along the desired path to the receiver. Cable clips which fasten directly into the moulding at the top of the base board and do not require a screw are available and provide a fast and easy method of permanently securing the line. Insulated staples may be used for

this if care is taken that they do not puncture or squeeze the line and cause a short. At the receiver, enough slack should be left in the line to permit the set to be moved for cleaning or service work without it being necessary to unplug or disconnect the lead-in.

To connect the line to the receiver, the wires need only be stripped and placed around the antenna post screws when twin-lead ribbon is used. In the case of a coax line, the end should be prepared with solder lugs as explained above for Figure 15. Again, a good, low-resistance contact is important.

Impedance Matching

To prevent standing waves on the line, it is very important that the proper impedance match between the transmission line and the receiver input be obtained. Although most sets are designed to have the standard 300 ohm input impedance, some manufacturers prefer to design their receivers for use with the unbalanced 73 ohm coaxial cable because of the better signal-to-noise ratio obtainable with the coaxial type line. Still other makes have input circuits designed to accommodate either coax or 300 ohm twin-lead ribbon, and, in all cases, the service data for the particular model being installed should be consulted to make certain the proper connection is made.

For example, in the Motorola Model TS-901 television receiver, the lead-in is to be connected to a plug which fits into the antenna receptacle in the chassis. The plug prongs to which the wires of the lead-in are attached depend upon whether a 300-ohm balanced or a 73-ohm unbalanced input is desired, as shown in Figure 18. With the 300-ohm connection, the transmission line is across the entire antenna coil, and across one-half the coil in the case of the 73-ohm connection. This provides the correct match for either case, since the impedance of the winding is proportional to the square of the turns.

When it is desirable to use a transmission line which does not match the input impedance of the receiver, and a choice of connections is not provided at the input terminals, a matching transformer may be used so that proper operation is obtained. The circuit of such a transformer is shown in Figure 19A. The unit is held in a metal container which is mounted and grounded on the chassis of the receiver. It may be employed to match a 73-ohm cable to a 300-ohm receiver, or a 300-ohm* line to a 73-ohm receiver.

However, while the first arrangement provides a 2-1 signal step-up, the second gives a 2-1 step-down and should not be used if the signal strength is weak. A

73-ohm cable may be matched to a 300-ohm balanced input receiver by means of the resistor network shown in Figure 19B. This also results in a 2-1 step-down of voltage, and should be used only where the signal strength is sufficiently strong.

After the transmission line is mounted and connected, a lightning arrestor should be installed. Several types specially designed for use with twin-lead ribbon are commercially available. Two-terminal arrestors should not be used with twin-lead line because they offer a lightning path to ground from only one conductor.

A type which is easy to install is shown in Figure 20. The arrestor is mounted close to the lead-in entrance hole and leads run from it and the mast to ground while the line is placed in the slot provided for it. The line is held onto the arrestor by pronged clamps which bite through the polyethylene insulation and make electric contact to the conductor. Advantages of this type of unit are that the wires of the transmission line do not have to be cut or spread apart (spreading effects the line impedance), nor does the insulation have to be stripped off at the point of connection.

For coaxial cable, a two-terminal type of arrestor may be used, and should be installed at the time that the cable is being

connected to the antenna. For connection to the arrestor, the cable has to be cut, and the ends prepared in the manner explained for Figure 15.

Final Check and Instructing Owner

When the performance check is made, it is a good plan to make a

the quality of reception from one or more stations. The record of the original performance will indicate to the serviceman whether the receiver or antenna installation has become defective, or reception is about as good as originally and any improvement possible likely will necessitate some change in the antenna system, etc.

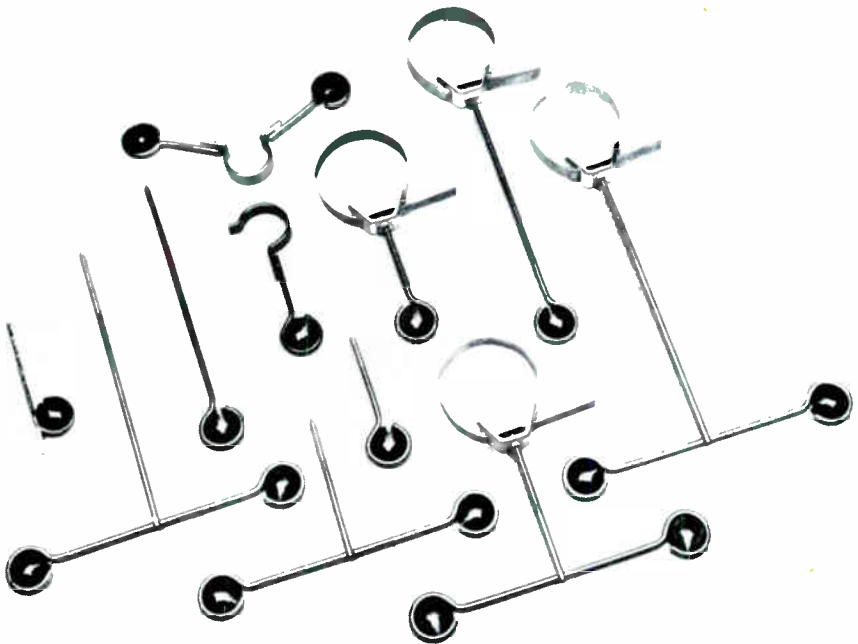

Stand-off insulator designed for various mounting problems. The fibre inserts are shaped to hold coaxial cable, flat or tubular twin-lead.

Courtesy JFD Mfg. Co., Inc.

written record of the nature of the reception from each station. This may be useful later if the serviceman is called in by the owner and requested to improve

The last step of the installation procedure consists of checking the operation on all channels on which reception can be obtained and of making sure that at least

one member of the owner's family understands the purpose of all the "operating" controls.

Instruction of the owner in the proper operation of the receiver controls must be done in a thorough manner, with the utmost patience on the part of the installer, for the number of "unnecessary" service calls is in exact proportion to the owner's inability to tune his set. This may be one of the most difficult parts of the entire installation procedure, for the owner's attitude will be anywhere from that of complete cooperation to actual resentment of the installer's assumption that he, the owner, doesn't know how to tune his own set.

In every case, diplomacy must be employed by the installer, for even the most cooperative (originally) owner will come to resent being "talked down" to, or otherwise treated as inferior. At the same time, the use of technical terms and explanations should be avoided. Instead, the various controls should be explained in terms of their effect on the appearance of the picture and on the sound.

After explaining the purpose of the various controls, the installer should go through a simple but adequate tuning procedure for several or all of the stations which can be received. This should be done slowly while the owner watches, and all his

questions answered after each demonstration.

Finally, the owner is asked to tune each station while the installer watches, and corrective suggestions made after each trial. This last step is probably the most important of all, and for more complete learning it would be desirable that the owner demonstrate his ability to tune the receiver at intervals of increasing time duration up to several hours. However, such a situation will seldom, if ever, be practical. Therefore, it is all the more important that the original instruction be made as simple and easy to follow (and remember) as possible.

SIGNAL STRENGTH INDICATORS

In addition to the standard installation equipment listed in Appendix A, some type of FIELD STRENGTH METER often proves to be a very useful instrument in making the pre-installation survey. This device usually consists essentially of a battery operated receiver tunable over the television carrier frequency range and containing an output meter to indicate relative field strength. Commercial units usually have the meter calibrated in microvolts, indicating the strength of the signal at the input terminals of the instrument.

A similar instrument, which makes use of the amplification of the installed receiver, has been designed to make it possible for a single installer to successfully locate and orient the antenna without the aid of an observer at the receiver. This unit consists of a rectifier circuit which is connected to the modulated electrode (grid or cathode) of the receiver picture tube and connected by an extension cord to the indicating meter which is held in the hand of the technician at the antenna.

The schematic diagram of this device is shown in Figure 21. In use, the "ground clip" is connected to the receiver chassis at some convenient point, and the "high clip" to any wire which connects directly to the picture tube's modulated element. The "high clip" contains a needle point which pierces the insulation of the wire, thus avoiding the necessity of finding an exposed terminal or scraping off insulation.

The meter unit is temporarily plugged into the rectifier plug, and the receiver gain control set for a reference reading on the meter, the set having been connected to the antenna, (which is in a tentative location) and tuned to a weak station. Then the extension cord is inserted and the meter unit carried to the roof where its variations can be ob-

served by the installer as the antenna is moved about and rotated, etc.

Maximum readings are obtained when the antenna location and orientation are such that the strongest signal is being picked up. The presence of ghosts are indicated when the reading does not show uniform drop-off as the antenna is rotated either way from the maximum setting.

Of course, a reading on a meter can never tell as much about the character of the reception as the actual image on the screen of the receiver, and the final check is always made at the receiver. Also, whenever any particularly troublesome reception difficulties are encountered, continual observation at the receiver screen is almost essential to a satisfactory installation.

SAFETY PRECAUTIONS

The danger associated with television installation work might be said to be directly dependent upon the amount of common sense employed by the installing technicians. That is, while the work might be extremely hazardous to the thoughtless, the observance of a few simple safety rules will reduce the chance of accident to the point where little or no danger is incurred. Examples of such rules are as follows:

1. Wear rubbers or rubber-soled shoes whenever any climbing is involved.
 2. When working on steeply-pitched, gabled roofs, use a safety rope which is tied around some solid object such as the base of a chimney. Move slowly and carefully.
 3. When a ladder is used, it should be one which inspection shows to be in good condition and is equipped with feet to prevent slipping.
 4. The ladder should be placed so that it has a firm footing and at an angle such that the distance from the wall to its base is one-quarter of its extended length.
 5. Always keep one hand free when carrying the antenna or tools up the ladder; face the ladder going up or down; do not carry heavy objects up or down a ladder, use a hand line.
 6. Do not place a ladder in front of a door which opens towards it unless the door is locked, blocked, or guarded by another person.
 7. Do not stand on the edge of the roof when elevating or installing the antenna. Use a safety rope or have someone hold onto your feet when it is necessary to lean over the edge of the roof or out of a window.
 8. Avoid contact with power wires, either directly or by means of the transmission line, antenna structure, guy wires, metal ladder, etc.
- In the following lesson, a discussion is given of the various types of antennas and where they can be used best.



APPENDIX A

INSTALLATION TOOLS & SUPPLIES

Many of the tools used for antenna installation are used for field service and need not be duplicated where the technician does both types of service. These additional small tools should be carried in a kit separate from service equipment.

TOOLS:

ladder (50' adjustable)	saw, hack; keyhole
pipe wrench 12"	screwdriver (heavy duty)
rope (100' x $\frac{3}{8}$ ")	screwdriver (Phillips)
extension cord	center punch ($\frac{3}{8}$ " dia.)
(200' with multiple outlets)	rawl tool
masonry drill set	ratchet wrench, box type
piloted setting punch	($\frac{1}{2}$ " x 9/16")
hammer (heavy construction)	ratchet wrench, box type
chisel set (cold)	($\frac{3}{8}$ " x 7/16")
chisel, wood $\frac{1}{2}$ "	flashlight (right angle) and/or
phone set (sound powered)	electric lantern
brace	gas pliers
electric drill (portable,	claw hammer (16 oz.)
$\frac{1}{4}$ " and/or $\frac{1}{2}$ " chuck)	diagonal pliers 7"
bit (5/16" and $\frac{1}{2}$ " electrician's)	long nose pliers 7"
iron (200 watts)	steel tape rule (50 ft.)
hammer (double face, 3 lb.)	paint brush 1"
file (2) 8"	putty knife

INSTALLATION SUPPLIES:

antennas (assorted)	ground clamps
parasitic elements	roofing compound
mast	insulated tacks or staples
mast extension and connectors	guy wire (6 strand steel wire)
bracket mounts (chimney, wall,	clamps, guy ($\frac{3}{4}$ " and 1")
adjustable wall, base mounts)	expansion shields (for $\frac{1}{4}$ " bolts)
coaxial cable (73 or 75 ohm)	emery cloth
twin-lead (300 ohm) (1,000')	bolts, spring toggle
tubular twin-lead (500')	bolts, lag (5/16" x 1 $\frac{1}{2}$ ")
insulators, stand-offs	bolts, lag (5/16" x 2")
(4" and 8")	bolts, stove ($\frac{1}{4}$ " x 2") ($\frac{1}{4}$ " x 1")
insulators, mast stand-offs	tape, friction
lightning arrestors	tape, rubber
wire, ground (#14 copper or	
#18 aluminum)	

STUDENT NOTES

STUDENT NOTES

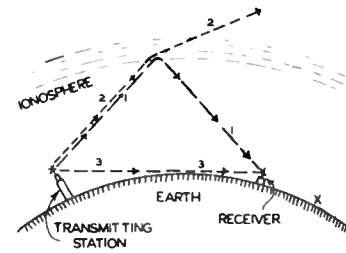

FIGURE 1

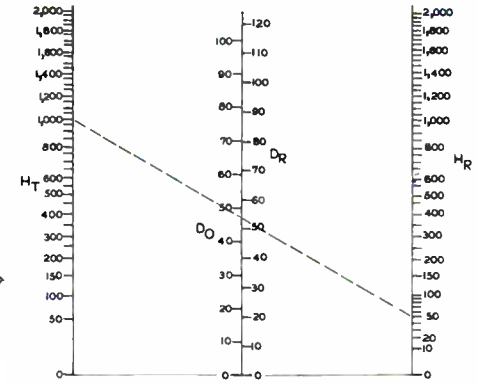

FIGURE 2

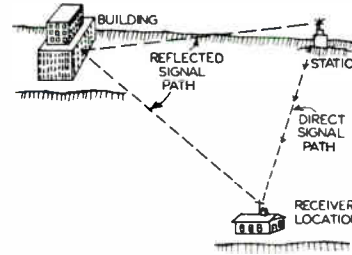

FIGURE 3

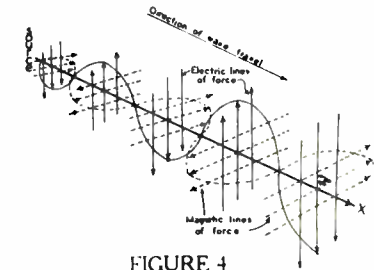

FIGURE 4

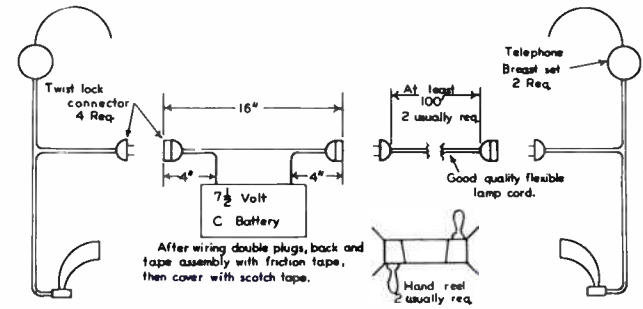
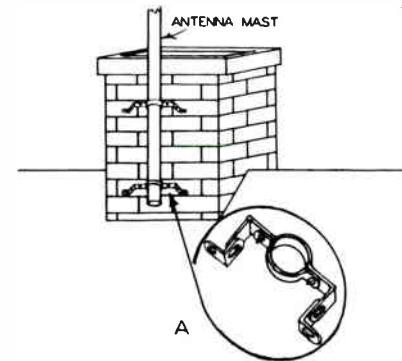

FIGURE 5



TSM-8

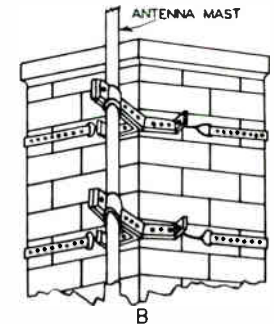

FIGURE 6

STUDENT NOTES

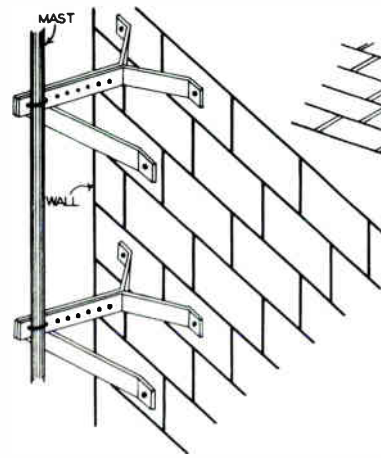

FIGURE 7

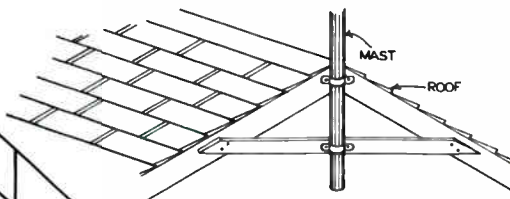

FIGURE 8

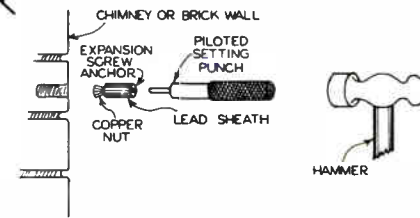
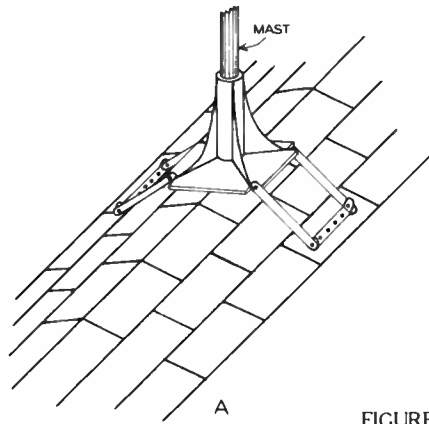
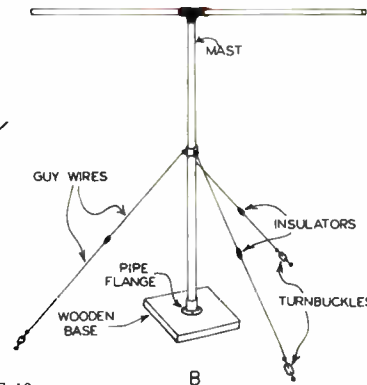

FIGURE 9



A



B

FIGURE 10

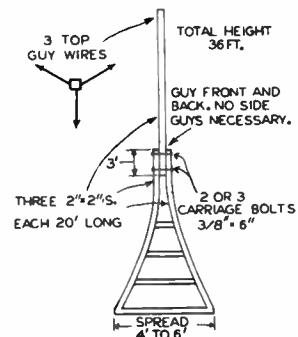

TSM-8

FIGURE 11



FIGURE 12



FIGURE 13

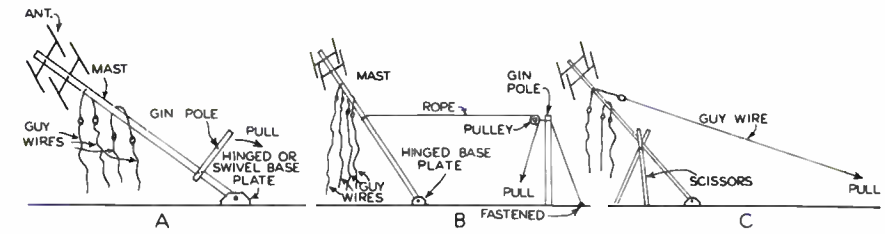
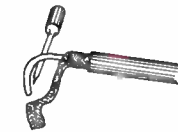

FIGURE 14



A



B



C

FIGURE 15



TSM-8

FIGURE 16

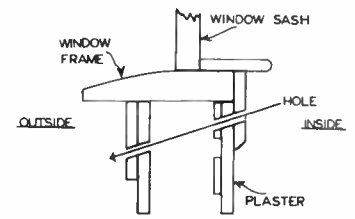

FIGURE 17

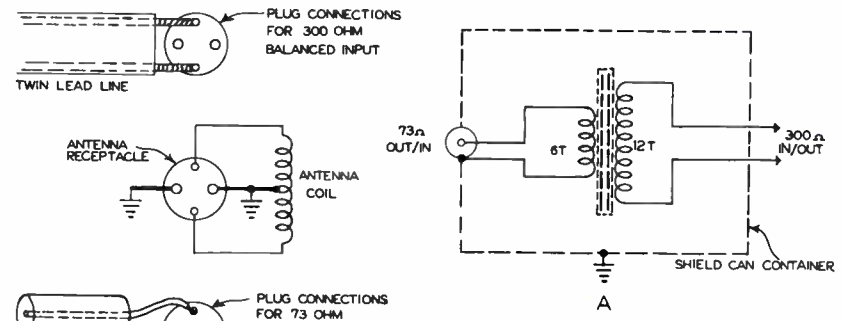

FIGURE 18

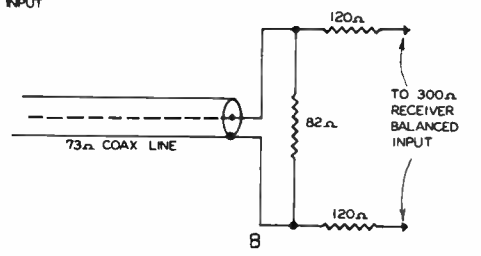

FIGURE 19

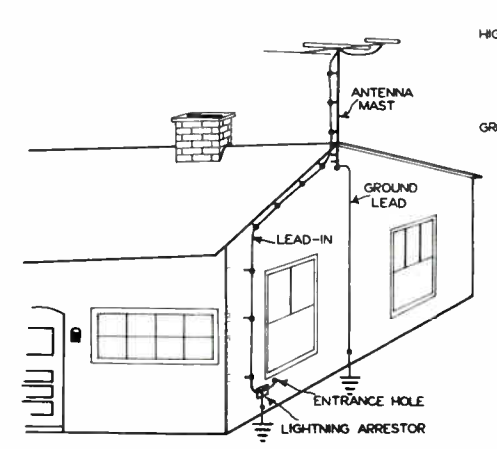

FIGURE 20

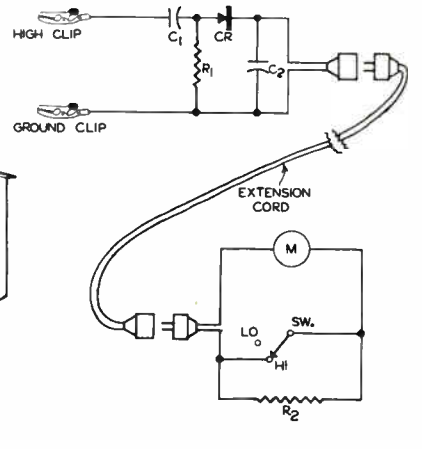

FIGURE 21

TSM-8

DeVRY Technical Institute

Formerly DeFOREST'S TRAINING, INC.

4141 WEST BELMONT AVENUE

CHICAGO 41, ILLINOIS

QUESTIONS

Installation Procedure—Lesson TSM-8A

Page 39

3 How many advance Lessons have you now on hand?.....

Print or use Rubber Stamp.

Name..... Student No.....

Street..... Zone..... Grade.....

City..... State..... Instructor.....

Write your answers on the "Ans." line below each question. If more space is needed use reverse side of this page.

1. In a complete television installation, what arrangement is the most important?

Ans.....

2. What is meant by a "lagging ghost"?

Ans.....

3. What are two common causes of "lagging ghosts"?

Ans.....

4. What is the importance of providing an antenna system with a bandwidth only broad enough to receive desired stations?

Ans.....

5. What does the word "polarization" describe?

Ans.....

6. What is meant by "probing"?

Ans.....

7. To mount antenna brackets, why is it preferable to drill holes in the bricks of the wall rather than in the cement between the bricks?

Ans.....

8. Why should guy wires be "broken" by insulators?

Ans.....

9. Why is a twin lead transmission line twisted about one turn per foot of its entire run?

Ans.....

10. Should a lightning arrestor be a part of the antenna installation?

Ans.....

TSM-8A

FROM OUR *Director's* NOTEBOOK

BE SPECIFIC

No employer is interested in a man who can "do ANYthing." He wants someone who can "do SOMETHing."

So be specific when you're asked what your qualifications are. "My training has been in TV servicing," or "I've done a bit of troubleshooting on radio receivers," are much better answers than, "Oh, I can handle almost anything in electronics."

The fellow who can do ANYthing is liable to end up on the business end of a broom, instead of on a job he has really prepared for.

Outline your qualifications carefully during an employment interview. You never can tell in advance when one particular phase of your training or experience might be just the very thing the employer is seeking.

Be specific. It pays!

Yours for success,

W. C. Healey

DIRECTOR

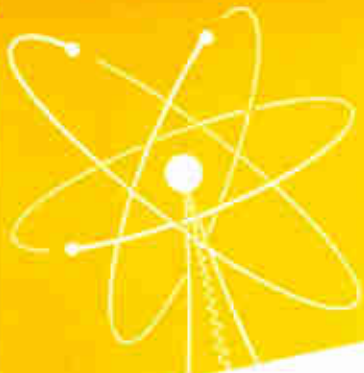

RECEPTION PROBLEMS

Lesson TSM-9A

1-9



DeVRY Technical Institute

4741 W. Belmont Ave., Chicago 47, Illinois

Formerly DeFOREST'S TRAINING, INC.

RECEPTION PROBLEMS

4141 Belmont Ave.

COPYRIGHT 1955

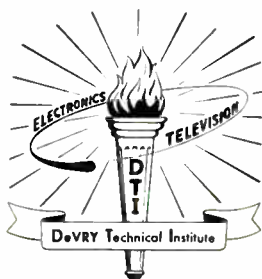

Chicago 41, Illinois



The owners of large screen television receivers expect good reception. Often a carefully designed and installed antenna is required.

Courtesy Stewart-Warner Corp.

Television Service Methods

RECEPTION PROBLEMS

Contents

	PAGE
Directivity Problems	4
Single Channel Reception	6
Multiple Channel Reception	7
Wide-Band Antennas	7
Long-Wire Antennas	8
High and Low Band Combinations	9
VHF-UHF Combinations	10
Connecting Transmission Line to Two Antennas	12
Weak Signal Areas	14
Gain Requirements	14
Antennas for Fringe Area Reception	16
Masts and Towers	22
Transmission Lines	23
Boosters	24
Rotation of Wave Polarization	25
Multiple Outlet Distribution Systems	26
Master Antenna System	27
Pre-Amplifiers	28
Receiver Isolation	29
Complex Systems	30
Indoor Antennas	30

Though Electronics is already a nearly indispensable factor in our daily lives, it is as yet only an infant science whose mature power can only be guessed at in the light of what has already been achieved.

Joseph Leeming
Peaks of Invention

RECEPTION PROBLEMS

In the previous lesson the mechanics of the normal antenna installation were described and, at the same time, it was pointed out that a large variety of antennas are available for the various reception conditions.

Since an almost unlimited number of reception problems exist it is impractical, if not impossible, to list each one separately and prescribe a rigid procedure to follow.

Instead, in this lesson various types of antennas are described along with proper applications of them to common, typical reception conditions. It then should be possible to go out, survey the reception conditions involved, and intelligently select and install a satisfactory antenna system.

DIRECTIVITY PROBLEMS

It was suggested in the previous lesson that, during the pre-installation survey, the approximate directions of arrival of the signals from the various stations serving the area should be determined; as well as undesired signals, such as a station occupying the same channel as a desired local station. Not only will these directions be determined more accurately during the "probing" operations, but also the directions from which reflections or other

interferences are arriving. However, with the survey information on hand, it is possible to decide what general directional characteristics are needed by the selected antenna system.

Four typical receiving situations are illustrated in Figure 1. In each case the block containing the letter "R" represents the location of the receiver, and the circles containing the letter "T" show the respective locations of the desired television transmitters.

In Figure 1A, the transmitters are all in the same general direction with respect to the receiver, and best reception may be expected with some type of uni-directional antenna such as a straight or folded dipole with one or more parasitic elements as shown in Figure 2. When no ghost or other interfering signals are present, and the signal strength is sufficiently high, a dipole or folded dipole without reflectors or directors can be used. However, a system which has additional elements similar to those illustrated generally is preferred, since it provides a voltage gain of from 1.5 to 2 times that obtained with the straight dipole.

To obtain reception from sources 180° apart, as pictured in Figure 1B, the bi-directional characteristics of a straight dipole or

folded dipole, without parasitic elements, can be used. In this case, an arrangement like Figure 2 is not desirable as the parasitic elements prevent sufficient signal pickup from one of the two stations. If needed, some increase in pickup from both directions may be obtained by employing two or more such dipoles in a stacked array, and either straight or folded dipoles can be used in this manner.

A receiver location such that the desired signals arrive from four directions is illustrated in Figure 1C. Providing reflections and noise signals, etc. are not troublesome, the simplest solution is an omni-directional antenna, two types of which are illustrated in Figure 3. Known as **turnstile antennas**, their radiation patterns are circular at the resonant frequency, but change to approach that of a dipole for signal frequencies above and below resonance. These units provide less pickup than a straight dipole, and should be used singly only in areas of relatively high signal strength. For greater pickup, either of the turnstile types may be used in a stacked array.

Figure 1D represents the situation where two desired signals arrive from sources approximately 90° apart, and either the signal strengths are not high, interfer-

ence is present, or both. In this case, none of the antenna arrangements so far described are satisfactory. Therefore, acceptable performance requires the use of two separate antennas oriented for maximum pickup from each station using the arrangement pictured in Figure 4. Parasitic elements are used to increase signal pickup and reduce interference and ghosts, and usually the antennas are mounted on the same mast, but spaced as far apart as possible, as shown.



The TV booster often is used to improve fringe area reception. One control provides continuous tuning for all VHF channels.

Courtesy Alliance Manufacturing Co.

Where more than two widely separated stations are involved, as in Figure 1C, and the signal strengths are not high, it may be necessary to use antennas for each, mounted on a single mast in the same general manner as illustrated in Figure 4.

Always use a transmission line whose impedance is approximately equal to that of the antenna. The impedance of an antenna array varies with the number of elements, their arrangement and spacing employed, etc. Chart 1 lists the impedances for the antenna systems mentioned.

tenna-selector switch box on the panel of which the appropriate call letters indicate the respective stations.

SINGLE CHANNEL RECEPTION

Up to this point, the explanations have assumed a commercial

CHART 1

VHF Antenna or Array	Type of Transmission Line	
	Straight Dipole	Folded Dipole
Single Element	75 ohm coax cable	300 ohm twin-lead
1 reflector	50 or 75 ohm coax	300 ohm twin-lead
1 refl. and 1 director	50 ohm coax	75 ohm coax or 95 ohm twin-coax
2 elements, stacked	50 ohm coax	150 ohm twin-lead
2 elements and refl., stacked	50 ohm coax	95 ohm twin-coax or 150 ohm twin-lead
Turnstile	50 ohm coax	150 ohm twin-lead
Separate antennas	Individual lines; which depend upon the type of antennas used.	

In Figure 3A, the transmission line is connected directly to one dipole and to the other dipole by means of a quarter-wave matching section consisting of a piece of 75 ohm coaxial cable which is equal to approximately 0.9 the length of one rod of the antenna. A similar arrangement is used with the unit of Figure 3B, in which case the matching section is made from 300 ohm twin-lead.

Where several individual antennas are used, the different transmission lines may run to the receiver by the same route. At the receiver, these lines are connected to the input terminals of an an-

type antenna which has been designed to resonate somewhere near the center of either the high or the low VHF television band or the UHF band so as to receive any station in the band. An antenna of this type, or a system capable of receiving in both VHF bands and the UHF band is necessary in areas served by several stations. On the other hand, in many regions only one station can be received, in which case it is often advantageous or even absolutely necessary that the system be designed to give maximum performance on a single channel.

Tuning the antenna to the center frequency of the channel occupied by the desired station will increase the signal input to the receiver and also improve the signal-to-noise ratio. The element lengths required for the various VHF channels for a three-element parasitic array are given in Figure 5. The spacing values are calculated for quarter wavelength spacing between elements, but spacings greater or less than those given often may be found by experiment which result in more gain, that is, better pictures at a given setting of the contrast control.

Final tuning is accomplished by adjusting the distance or spacing between the inner ends of the dipole element, the point at which the transmission line is connected, for maximum picture brightness. These methods of increasing signal pickup may also be used for each unit where several separate antennas are employed as explained for Figure 4.

MULTIPLE CHANNEL RECEPTION

Where several television stations serve an area, usually there is one or more operating in both the high and low VHF bands and in the UHF band. Thus, the receivers installed in the area will need to be equipped with an antenna system having adequate re-

sponse over these bands. This may be done by using two antennas, one which is broadly resonant over a range from 54 to 216 mc and the other resonant over a range from 470 to 890 mc. Or a three unit system may be used consisting of two antennas for the high and low VHF bands and one for the UHF bands.

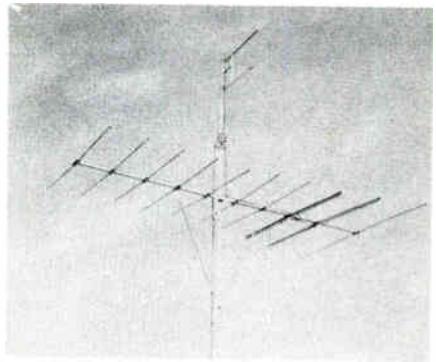

In weak signal areas, high gain antennas are required. Shown is a stacked UHF yagi joined with a low band VHF yagi. Note the antennas are oriented in different directions and a cross-over network is used to prevent inter-action.

Courtesy JFD Manufacturing Co., Inc.

Wide-Band Antennas

The response of a straight dipole is broadened to some extent by employing an intentional mismatch with the transmission line, such as by using a 300 ohm twin-lead. However, this arrangement has the disadvantages of loss of energy transfer to the line and possibility of ghost images due to reflections on the line.

In the case of any dipole antenna, the Q is inversely proportional to the diameter, or the "effective diameter" of the rods or wires. A folded dipole forms the equivalent of a flat sheet of metal one-half wavelength long, and therefore has greater effective diameter, and lower Q , than a straight dipole. Because of its lower Q , the folded dipole has a broader frequency response, as shown by the curves of Figure 6. Curve D represents the response of a straight dipole and curve F the response of a folded dipole with reference to the percent of the frequency to which each is "cut" or tuned.

The bandwidth of the dipole can be increased still further by the use of rods having the form of large cylinders, or of cones, as illustrated in Figures 7A and 7B, respectively. Due to their large surfaces, both of these are rather impractical because of the likelihood of damage by wind. This danger is greatly reduced with the antenna construction shown in Figure 7C. Here, each cone consists of twelve wires attached at evenly spaced points on a ring at the outer ends, and brought together for connection to the transmission line at the inner ends. The response obtained with a unit of this type is shown by curve C in Figure 6.

A number of commercial models which have the general ap-

pearance of the antenna shown in Figure 7 have been designed to provide broadband reception. A number of these units consist of 4 quarter-wave rods, arranged as shown, and are actually simulated conical antennas. They are often referred to as "Double-V" or "X" type antennas.

Another type useful for broadband reception is the Di Fan antenna in Figure 8 which also has characteristics much like those of the cone antennas.

Long-Wire Antennas

Since the various antennas described in this section are all basically of the half-wave dipole type, their directional patterns are about the same as that of the straight dipole. However, when an antenna length is a wavelength or more, it is known as a LONG-WIRE antenna, and the direction of maximum pickup is no longer broadside to the axis of the antenna. As a general rule, the greater the length of the antenna compared to the wavelength of the signal to be received, the smaller the angle becomes between the direction of maximum pickup and the axis.

For example, a straight or folded dipole which is a half wave-length long on channels 2 to 6 is one and one-half wave-lengths long for channels 7 to 13, and therefore, will operate in

both high and low VHF bands. However, in the low band its horizontal directional pattern is as shown in Figure 9A, while in the high band, the antenna will function as a long-wire antenna having the characteristics illustrated by Figure 9B. Although there are minor lobes at right angles, the greatest pickup is at angles of approximately 45° .

antenna, depending upon the locations of the respective low and high band VHF stations, and may result in ghost problems due to pickup of reflected signals.

High and Low Band Combinations

In many cases, the desirable all-wave antenna arrangement is one which has the same direction-

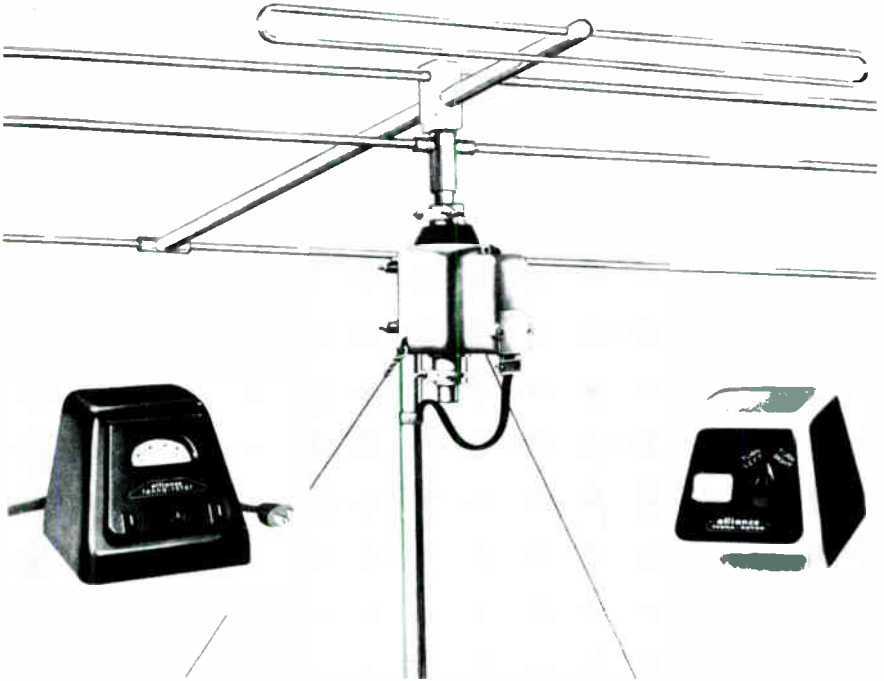

The rotating antenna can be re-oriented for each station in the area, thus correcting this type of reception problem. Note the motor turns the antenna clockwise or counter-clockwise through an arc of 365° .

Courtesy Alliance Manufacturing Co.

This change in the directional pattern may either simplify or complicate the orientation of the

al characteristics on both VHF television bands. These characteristics are approached by both the

conical and the Di Fan type antennas. Another arrangement, illustrated in Figure 10A, is an antenna called a CONICAL V BEAM which has a directivity pattern similar to that of a dipole on the low band while on the high band its pickup is like a type known as a "V" antenna.

This use of the words "V antenna" should not be confused with that used to describe the physical appearance of other types of antennas, such as the simulated conical antenna of Figure 7D, or the adjustable angle dipoles often employed as indoor antennas.

A V antenna consists of two long wire antennas which are combined to form a V in a horizontal plane so that their main lobes reinforce along the line bisecting the V, and thus result in a very effective directional antenna. That is, if the long wire antenna of Figure 10B is properly combined with that of Figure 10C, their respective directional patterns combine to give the resultant shown in Figure 10D.

In the commercial unit of Figure 10A, the V antenna action has been achieved by bending the rods of the driven element forward. It is a stacked array consisting of two conical V dipoles with reflectors to produce a uni-directional pattern.

Two other commercial types designed for all-channel reception

are shown in Figure 11. Figure 11A consists of a long thin dipole mounted close to a short thick dipole, and has a bi-directional directivity characteristic which remains substantially the same for all 12 VHF channels. The Bat Wing antenna of Figure 11B functions as an ordinary folded dipole for reception of the low band channels, but has a six lobed pattern for the high band with somewhat greater gain on the side on which the short modifying Bat-Wing elements are mounted.

Dual-band VHF antennas consisting of a high band unit and a low band unit mounted on a common mast are shown in Figure 12. Figure 12A is called an In-Line antenna because the high and low band VHF folded dipoles and reflector are all on the same horizontal plane. This antenna is uni-directional on both bands. The long folded dipole and the reflector are used for reception of low band signals, while the long dipole acts as a reflector for the short dipole in the high band. Figure 12B provides for individual orientation by using a separate array consisting of folded dipole and reflector for each band.

VHF-UHF Combinations

Where both VHF and UHF stations serve an area, the desirable antenna system is one which permits all-channel reception. Four commercially available antennas

which have the necessary broad-band and directional characteristics are shown in Figures 13 and 14. They are referred to here as the DOUBLE VEE, TROMBONE, ULTRA VEE, and ULTRA FAN.

The double vee antenna consists of two V's in the horizontal plane and its characteristics are determined to a great extent by the angle between the elements. As shown in Figure 13A, with elements in position 1 which is an angle of approximately 90° the antenna gives best results for VHF only. Position 2, 60° , is optimum for VHF-UHF and position 3, 45° , for UHF only.

The main lobe is in the direction of tilt and thus provides good gain in this direction. A disadvantage is that minor lobes exist slightly to each side of the feed point and at the back of the antenna proper. This condition leads to ghosts where reflections are encountered.

Similar to the double vee, the trombone shown in Figure 13B has adjustable elements, also. This antenna has lower gain than the double vee in both the VHF and UHF bands. The directivity pattern of the trombone has the main lobe in the direction of tilt. The amplitude of the side and back lobes are lower than the double vee and, therefore, provides greater rejection of ghosts.

Providing good UHF gain with low VHF gain, the ultra vee, shown in Figure 14A, can be used in areas of high or low UHF signal, as well as high VHF signal. On the high channels, the main lobe of the directivity pattern is quite narrow which makes orientation fairly critical. This is of value in locations where ghosts are a problem. The low channel pattern is quite broad permitting easy orientation.

The ultra fan shown in Figure 14B consists of an all-channel UHF antenna combined with an all-channel VHF antenna. To prevent interaction between the UHF triangular dipole and the VHF fan elements, connections to the transmission line are made through a two stage filter not visible in this drawing.

In operation, the VHF fan elements serve as a sheet reflector for the triangular dipole for UHF reception. For channels 7 to 13, the unit operates as a large diameter V antenna and for channels 2 to 6, operates as a conical or fan antenna with reflector.

The directivity pattern of the ultra fan has the major lobe in the direction of tilt with small secondary lobes at the sides and back. This antenna has good gain over all channels 2 through 83 and also provides good rejection of ghosts due to reflections.

Connecting Transmission Line to Two Antennas

When the installation consists of two antennas, as in Figures 12A and 12B, some means must be employed to connect them both to the single input of the receiver. In most cases, when a commercial type antenna is used, the proper transmission line connections are included in the installation instructions. If they are not, or if the antenna system is custom built, then the installer must employ whatever method of connection is most satisfactory from the standpoint of picture quality and practicability.



An antenna-rator controller which may be used with the antenna shown in the preceding illustration. The dial pointer indicates the direction of antenna orientation.

Courtesy Alliance Manufacturing Co.

Whenever possible, it is desirable to connect both antennas to a single lead-in which is then run to the receiver, rather than use

two lead-ins. The simplest method available consists of connecting the two antennas with a piece of transmission line of any convenient length, and running the lead-in from the terminals of one of the antennas to the receiver.

When this arrangement gives good reception from all stations that can be received, then it is the one to use. However, in many cases it is found that this system does not result in good picture quality because the two antennas tend to interfere with each other. That is, they both pick up as much signal as possible in both bands and distortion of the picture is produced if both antenna signals reach the receiver input.

The high band VHF antenna may be prevented from loading the low band unit by the method employed with commercial designs of the type illustrated in Figure 12A. In this case, the piece of 300 ohm twin-lead line connecting the two folded dipoles has a length of about 12 to 14 inches. The combined length of this line and the high band antenna serves as a shorted quarter-wave stub at the low band frequencies.

Since such a stub is equivalent to a parallel resonant circuit, the arrangement results in the high band antenna acting as a high impedance circuit at the point

where the stub joins the low band antenna. Therefore, the low band unit is not loaded by the high band antenna when a station on a low band channel is being received.

Often employed with antenna combinations like that of Figure 12B is an isolating arrangement called a "harness" which serves to prevent loading of the low band antenna by the high band unit, and to effectively eliminate the low band unit when a high band signal is being received. The connections of this harness are shown in Figure 15A. Here, an open-end "stub" is connected to the terminals of the low band antenna. From 12 to 13 inches in length, this stub is a quarter wavelength long at a frequency near the upper end of the high band.

An open-end stub acts like a series resonant circuit and, therefore, serves to short-circuit the terminals of the low band antenna, at high band frequencies. This antenna must be connected to the lead-in, but in such a way that the lead-in is not shorted by the open end quarter-wave stub.

This requirement is accomplished by means of a piece of connecting line equal in length to any odd number, N , of quarter-wave sections at the same high frequency to which the shorting stub is tuned. Since its antenna

end is effectively shorted at the high frequencies, this connecting line is the equivalent of a shorted quarter-wave stub, insofar as the lead-in is concerned. Therefore, it presents the high impedance of a parallel resonant circuit to the lead-in when a high band station signal is being received.

By means of a connecting line, the high band antenna is prevented from loading the low band unit, as explained for Figure 12A. In Figure 12B, the proper value of this line may be determined experimentally for best results, beginning with a line 14 or 15 inches in length. All connecting lines, stubs, and the lead-in are made with 300 ohm twin-lead line.

For extremely stubborn cases, the antennas may be connected with twin-lead transposed once, in each side of which is inserted a filter unit, Z , as shown in Figure 15B. These filters consist of parallel tuned circuits, Figure 15C, made up of five and one-half turns of #18 wire wound on a $5 \mu\text{fd}$ ceramic capacitor.

Where both VHF and UHF antennas are mounted on a single mast, a CROSSOVER NETWORK may be used to provide a single lead-in connection to the receiver. As shown in Figure 16A, a short length of transmission line connects each antenna element to the network and through a single

lead-in to the receiver. Usually, these connecting lines are 300 ohm tubular twin-lead.

The schematic diagram of the crossover network is shown in Figure 16B. The network consists of a band-pass filter across each input. By thus presenting low impedance to frequencies outside the pass band, these filters prevent inter-action between antennas.

When none of the above methods are successful, it becomes necessary to run individual lead-ins to an antenna switch at the receiver as explained for Figure 4.

WEAK SIGNAL AREAS

Generally speaking, a weak-signal area" may be defined as any area in which the signal intensity is so low that satisfactory reception cannot be obtained by means of the usual antenna system. With some receivers, a picture of reasonably good quality may be obtained when the input signal level is as low as 50 microvolts. However, a minimum of at least 250 microvolts is usually necessary for a clear picture and freedom from "snow" on the screen. The FCC specifies a signal input level of 500 microvolts as being the minimum required for satisfactory reception. In areas where considerable noise is present, signals of several

thousand microvolts intensity may be required to over-ride the noise energy.

In some instances, receiver locations quite close to the transmitter may be characterized by low signal strength due to intervening mountains, or buildings, etc. However, for most cases low signal intensity is due to distance, such as 25 to 150 miles, between the transmitter and receiver locations. The latter type of weak signal areas are known as FRINGE AREAS or as SECONDARY SERVICE AREAS, while the regions within 25 miles of the transmitter are called the PRIMARY SERVICE AREAS. To provide for satisfactory reception in a weak-signal area, some type of special antenna arrangement normally has to be installed, and in extreme cases, a BOOSTER amplifier must be added.

Gain Requirements

Boosters and antennas which are especially designed for weak-signal area reception are generally rated in terms of db gain relative to the signal input derived from a simple straight dipole at a given frequency. In order to determine the approximate gain, and therefore, the type of system that is required for a particular installation, it is necessary to know the sensitivity rating of the receiver and the strength of the signal from the

weakest station which it is desired to receive.

The receiver sensitivity, in microvolts, may be given in the service manual for the model to be installed, or may be obtained from the manufacturer. An approximate sensitivity may be derived by comparing the set with other receivers of known sensitivity, care being taken that each is checked under the same conditions.

During the pre-installation survey, the signal strength in the area may be measured with a field strength meter and a temporary dipole antenna. Although in areas classified as "weak", the signal strength is usually on the order of 50 microvolts or more, it may be as low as 5 or 10 microvolts in certain locations.

With experience, a serviceman is able to estimate the approximate signal strength with a temporary dipole and a portable receiver if a field strength meter is not available. If desired, a meter calibrated in MICROVOLTS INPUT may be connected to the output of the video detector stage so that the test receiver indicates signal strength as well as the quality of the pictures obtained.

The signal intensity increases with height above ground, and it often is desirable to elevate the test antenna by some means to de-

termine whether the increased pickup so obtained will justify the erection of an antenna tower. One means of doing this is to employ one of the several commercially available, sectional aluminum tubing masts which can be assembled very quickly and temporarily guyed with rope.

CHART 2

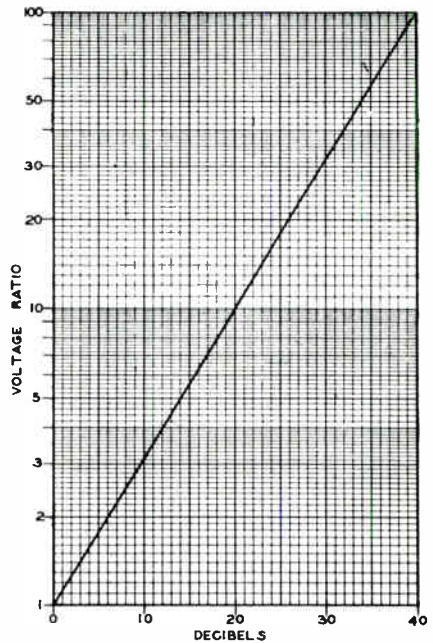

With this signal strength information on hand, the minimum db gain required of the selected antenna system can be found in Chart 2 by calculating as follows :

$$\text{Voltage Ratio} = \frac{E_r}{E_s}$$

where:

E_r = receiver sensitivity in microvolts.

E_s = signal strength in microvolts.

This can be best demonstrated with an example. Suppose a certain receiver with a sensitivity rating of 100 microvolts is to be installed at a location where the signal strength is 50 microvolts at 30 ft. from the ground. Applying these two values to the equation it becomes:

$$\text{Voltage Ratio} = \frac{E_r}{E_s} = \frac{100}{50} = 2.$$

Now by looking up the voltage ratio of 2 on the vertical scale of Chart 2, and following this line across the chart until it intercepts the diagonal line, and dropping down to the horizontal scale, it shows that the antenna must have a minimum gain of 6 decibels (6 db) in the direction of the weakest station.

Antennas for Fringe Area Reception

Various types of high gain antennas are available for use in low signal areas. Each has advantages and disadvantages and, although theoretically, some types are better than others for particular applications, generally a serviceman will develop his own special likes and dislikes as he gains experience with the various types.

Besides the technical factors involved, the selection of the antenna system used also may depend upon the customer's desires. Some individuals will insist on minimum cost, in which case the best antenna will probably be one which is just electrically adequate to give a satisfactory picture. Other customer's are quite sensitive about the appearance of their antenna installation and, unable to understand that their location is much better than that of their neighbors so that a less elaborate antenna can be employed, they feel that they are being slighted. For this reason many servicemen adopt a policy of using only one very good antenna type wherever possible in all weak-signal area installations.

The most numerous of the weak-signal cases are those installations in rural areas near a large city, where a number of stations operate on both VHF and UHF channels. Usually, these stations have their transmitters and antennas located atop the taller buildings within a small area in the heart of the city.

The receiver installations must include an antenna system which has sufficiently high gain as well as broad response so that signals from all stations serving the area are supplied with sufficient

strength to the receiver. Since all the signals arrive from practically the same direction, the antenna employed may have a uni-directional pickup pattern.

For medium long distance VHF reception, such as 25 to 50 miles, relatively simple dual-band antennas of the type shown in Figure 12 may be used. These units have a gain of approximately 2 to 4 db over that of a straight dipole at the center frequencies of the respective high and low VHF television bands. A gain of 4 to 6 db can be obtained by use of two three-element parasitic arrays, one for each band, mounted one above the other on the plan explained for Figure 4, but oriented in the same direction.

However, this may result in poor reception of some low band stations because of the narrow frequency response of this type of array. Although resulting in a slight loss in gain, the frequency response may be broadened somewhat by tuning or cutting the low band reflector for the lowest channel to be received, the dipole to the center of the band, and the director to the highest low-band channel desired. As the elements of an antenna are essentially tuned circuits, this procedure corresponds to stagger-tuning the i-f coupling circuits in a receiver to increase the over-all bandwidth.

As an example, suppose a particular area is served by stations occupying channels 2, 4 and 5. The limits of this band are 54 mc and 82 mc. The geometrical mean frequency is:

$$f_g = \sqrt{f_a \times f_b} = \sqrt{54 \times 82}$$

$$= \sqrt{4428} = 66.5 \text{ mc (approx.)}$$

Dipole length in inches is equal to 5549.8 divided by its resonant frequency in megacycles. Therefore, to tune it to 66.5 mc, the dipole length is:

$$L_{in} = \frac{492 \times .94 \times 12}{f_g(\text{mc})} = \frac{5549.8}{66.5}$$

or 83½ inches (approx.).

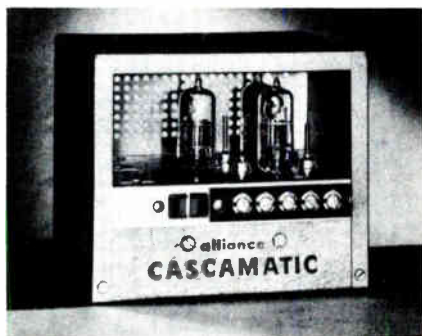

A television booster designed to mount on the back of the receiver. This three stage unit operates on all VHF channels and requires no controls.

Courtesy Alliance Manufacturing Co.

The table of Figure 5 gives lengths of 102 inches for a reflector tuned to channel 2, and 67.3 inches for a director tuned to channel 5.

In the case of the high band array, stagger tuning is unnecessary because the ratio of the bandwidth to center frequency is lower and when cut for channel 10, the three-element array will have fair response over the band. However, if the signal from one station is weaker than those from the others, it may be desired to tune the array to favor the weak station instead of the center frequency of the band.

An alternative method is to employ two antennas like that of Figure 11A, arranged one above the other in a stacked array. This provides reception on all VHF channels and the gain obtained is from 4 to 5 db over that of a dipole. Besides increasing the gain, the stacked array antenna provides better vertical directivity which is advantageous in decreasing the pick-up of noise energy from above and below the antenna.

For greater distances, antenna systems with still higher gain must be used. Giving a gain of from 6 to 7 db, one common unit is the stacked, folded dipole-reflector array shown in Figure 17. Other advantages of this unit are broader response than the three-element array and better vertical directivity. However, this type of antenna does not have broad enough response to give satisfactory operation over all 12

VHF channels. When stations in both bands are to be received, separate stacked arrays with reflectors should be used, designed for the low and high bands, respectively. The two arrays may be mounted on the same pole, but should be separated vertically as much as possible.

A high gain, all-channel antenna which may be used for reception of both VHF and UHF stations is that shown in Figure 14B. Compared to a dipole, this unit has a gain of from 5 db on channel 2, to 5 db on channel 13 and 4 db on channel 14 to 6 db on channel 83.

For still greater distances, a YAGI array may be used in which all elements are cut and spaced for maximum gain in the channel for which the array is designed. A unit of this type is capable of gains from 8 to 10 db or more, and the one illustrated in Figure 18 consists of a folded dipole "A", a reflector "R", and three directors "D₁", "D₂", and "D₃".

For VHF, an antenna of this type is good for reception on one channel only and, therefore, is most useful in areas which are served by a single station. If the signal strength of stations on adjacent channels is high enough, it is possible to secure satisfactory reception from them, although if more than one channel is to be received, it is generally

better to employ a separate array for each. The separate arrays should not be coupled to the same transmission line. Instead, separate lines must be run from each and connected to the receiver with a switch as suggested for Figure 4.

Advantages of this antenna, are that it is fairly easy to construct and, in many cases it has proved equal or superior in performance to commercial stacked arrays costing several times as much. The folded dipole element may be made of $\frac{3}{8}$ " O.D. hard brass tubing having .025" wall thickness, the reflectors and directors of $\frac{1}{2}$ " O.D. aluminum or dural tubing, and the supporting arm of $1\frac{1}{4}$ " O.D. aluminum tubing. The dipole should be plated with chrome on a silver base to prevent corrosion, and insulated from the support arm by means of $\frac{3}{8}$ " I.D. polystyrene tubing.

Due to the difficulty of bending brass tubing, the dipole ends may be made from short lengths of $\frac{5}{16}$ " solid brass rod of the type sold by welding shops for brazing, these being bent into "U" shapes on a $\frac{7}{8}$ " radius and inserted two or three inches into the brass tubing. These ends then may be adjusted until the exact desired dipole length is obtained, and then soldered in place.

Mounted in $17/32$ " holes drilled through the support arm, the various antenna elements are held in place with set screws. Those set screws which are holding the dipole element must be tightened carefully to avoid cracking the polystyrene tubing. The vertical mast may be made from a 10' length of $1\frac{1}{4}$ " thin wall conduit, and a standard 300-ohm twin-lead transmission line connected directly to the folded dipole. If the materials and method of assembly described above are employed, the actual dimensions required may be determined by reference to Figure 5 when all spacing measurements are made from the center of one element to the center of the adjacent element as pictured in Figures 5 and 18.

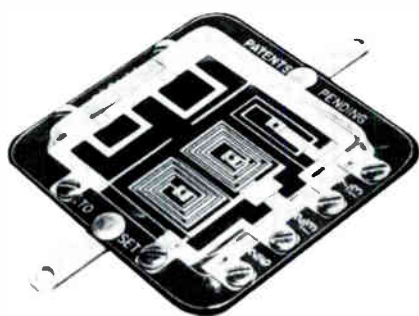

The cross-over network is a printed circuit designed to prevent inter-action between VHF and UHF antennas connected to the same transmission line.

Courtesy JFD Manufacturing Co., Inc.

To permit reception on more than one channel, a less selective antenna is needed, such as a di-

pole-reflector stacked array similar to that illustrated in Figure 19. This type of unit has a gain of 8 or 9 db or more and, like the antenna of Figure 17, provides reasonably uniform response over either but not both of the VHF television bands. However, the particular model illustrated in Figure 19 actually consists of two separate antennas—one for the low band and one for the high band. Corresponding elements are mounted one-on-another and insulated, and a special matching section is employed to match the antennas to any transmission line between 50 and 60 ohms.

A top view of what is known as a RHOMBIC antenna is shown in Figure 20. This is another long-wire antenna, and each of its "legs" has a length L equal to 2 or more wavelengths at the center-band or design frequency. A gain of about 10 db may be obtained when L is equal to 2 wavelengths, about 13.5 db when $L = 4$ wavelengths, and about 16 db with $L = 6$ wavelengths.

The rhombic antenna is unidirectional and rejects reflected signals from the front as well as from the back due to its narrow directivity pattern. Rhombics with legs 2 wavelengths long have a useful horizontal beam width or acceptance angle of approximately 13 degrees, while

those with legs 4 wavelengths long have a beam width of 8 degrees.

The greatest disadvantage of this type of unit for VHF is the large space required to accommodate it. However, as well as high gain, the rhombic has a broader frequency response than the arrays of Figure 17 and 19, and providing sufficient space is available, a rhombic antenna may be the best type for certain very weak signal areas.

Other advantages of this antenna are that it is relatively easy and inexpensive to construct and the supporting poles on which it is mounted do not have to be more than 30 or 40 feet high. Although broad, its response is not adequate for two-band coverage, and when this is desired, a high-band rhombic can be strung inside the larger low-band unit and thus supported by the same poles. The separation is sufficient to avoid undesirable interaction.

The design data given in Chart 3 for $L = 4$ wavelengths and $L = 6$ wavelengths results in decreased gain and directivity in order to obtain a slight spread in station directions, or where space restrictions will not permit the use of the longer leg units. The values listed are for the L , S , and D dimensions indicated in Figure 20.

CHART 3

Wavelength of each Leg	2	4	6
Low Band			
L	28' 10"	57' 7"	86' 5"
S	35' 6"	53' 3"	64' 7"
D	45' 5"	102' 2"	160' 2"
High Band			
L	10' 2"	20' 5"	30' 7"
S	12' 6"	18' 10"	22' 11"
D	16' 1"	22' 11"	56' 8"
UHF Band			
L	3'	6'	9'
S	2' 7"	3' 2"	7' 10"
D	5' 5"	10' 10"	16' 1"
Inclination Angle	30°-40°	20°-25°	10°-15°
DB Gain	7	10.5	12.5

The wire employed for the legs of the rhombic antenna may consist of No. 12 hard drawn copper wire. The forward end of the rhombic antenna must be terminated in a non-reactive resistor of approximately 800 ohms. A 300 ohm twin-lead transmission line may be connected directly to the rhombic antenna, the impedance of the antenna being on the order of 700 to 800 ohms. The signal voltage loss due to this mismatch is only about 10 per cent, but may be avoided at some desired frequency by the use of a quarter wave matching section.

The antenna dimensions are not critical, nor is its exact location critical so long as it is "in the clear". However, due to its sharp directivity, the direction in which the rhombic is pointed must be determined very precisely by experimentation, especially

for the long leg units. The forward, or resistor terminated end should be mounted not less than 15 feet above the ground, and the entire unit inclined upward at the angle indicated in the above table.

There are many fringe locations where reception of two, three or more stations is possible, but from different directions. Although an antenna system such as described for Figure 4 may be practical when distances are not too great, a system of arrays arranged in this manner for long distance reception would have to be more elaborate and, therefore, rather cumbersome and expensive.

This problem may be solved by means of a motor or other device employed to rotate a stacked or parasitic array until it points toward the station from which reception is desired at any particular moment. The rotating mechanism may be remotely controlled by means of a switch located at the receiver.

Commercial antenna rotators are available which operate from low voltage, such as 24 v a-c, so that a relatively inexpensive 3 or 4 wire rubber covered control cable can be used between the switch and rotator motor. All such units are reversible in direction of rotation so when the 3 position switch is in one position the antenna turns clockwise, and

turns counterclockwise when the switch is in the opposite position. In the center switch position, no power is applied and the antenna remains stationary.

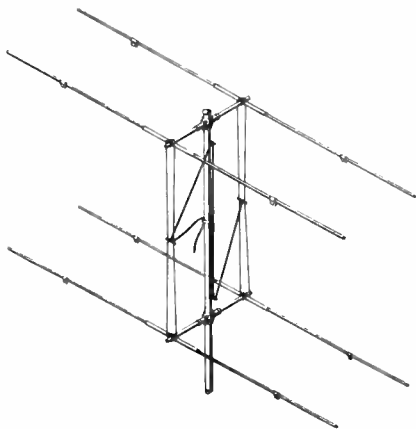

The correct phasing or match between the elements of this antenna is provided by the length of transmission line connected between the front and back elements.

Courtesy Cole-Worner Corp.

Masts and Towers

The height of the antenna is an important consideration in low signal areas. This is due to line-of-sight transmission of VHF and UHF signals. Normally, for VHF reception, the higher the antenna, the stronger the received signal. A slightly different approach must be considered for UHF.

In rural areas, the antenna may be mounted on windmill towers, silos, barns, etc. as explained in a previous lesson. Al-

though the required height is obtained, the location of the antenna may require long lead-ins. In this case, the signal strength at the antenna must be greater than is required at the receiver due to transmission line losses.

When a commercially built tower or mast is used it can be located near the house to permit short lead-in. As cost is a limiting factor, generally the height of the tower is held to the minimum required for satisfactory reception. Therefore, the location must be selected which provides the strongest signal.

The propagation characteristics of the UHF signal is somewhat different from those of the VHF. Two effects occur in the UHF band which require more careful selection of the antenna location: (1) increased reflections, and (2) cancellation of signal.

With antennas designed for UHF only, distant reception is possible over flat terrain or in line of sight locations. In locations where reflections are encountered, due to hills, buildings, etc., often the reflected signal is stronger than the direct signal. Thus, the antenna may be oriented to receive the reflected signal.

To prevent ghosts due to reflections the antennas must have a high front-to-back ratio. This is the ratio of signal received with

the antenna directed toward the station to the signal received with the antenna directed away from the station. The "bow tie" antenna shown in Figure 21 has a front-to-back ratio of 5 to 1 and a forward gain of 5 db.

The "corner reflector" shown in Figure 22 has a gain of 8 db with good rejection of reflections. Providing a gain of 9 db, the yagi shown in Figure 18 often is used in fringe areas.

As explained, increasing the height of the VHF antenna increases the signal. For the UHF antenna an increase in height may or may not increase the signal due to cancellation. This is due to two signals arriving from the transmitting antenna by two paths. At various heights from the ground, these signals add or cancel.

This is illustrated in Figure 23. When signals A and B are in phase they add to produce an increased output from the antenna. Out of phase signals tend to cancel reducing the antenna output. Thus, by moving the antenna, up or down and in a horizontal plane, as much as three feet may double or even triple the antenna output.

Obstructions in the path of the signal cause much greater attenuation at UHF than at VHF. Trees produce a serious loss in signal especially when the leaves appear in the signal.

The vibrations of the UHF antenna cause variation in the signal level at receiver terminals. In some cases these variations cause the picture to flicker. Therefore, to eliminate the flicker, the antenna and mast must be mounted rigidly.

Transmission Lines

In weak signal areas, where high antennas and long transmission lines are required, the line losses become important. It should be remembered that as the frequency increases the transmission line losses increase also. The same problems found in VHF installations also are found in UHF, except that they are more severe.

The 300 ohm, flat twin-lead employed for television is not entirely satisfactory, even for low band VHF under certain conditions. During wet weather, excessive attenuation may result from the film of moisture on the web between the wires. For UHF, the 300 ohm flat line losses become excessive when wet even for strong signals.

A tubular type 300 ohm line greatly reduces the losses due to moisture. The losses in coaxial transmission lines remain the same under both wet and dry conditions. However, since coaxial line losses are high, it shouldn't be used except in high noise areas where the shielding definitely improves the signal to noise ratio.

A comparison of the losses of these transmission lines is shown in Chart 4. The losses of each type of line are shown for both wet and dry conditions. Also, note that these losses are greater for 700 mc in the UHF band.

CHART 4

Line Type	Loss in db/100 ft.			
	100 mc		700 mc	
	Dry	Wet	Dry	Wet
300 ohm twin-lead	1.2	7.3	3.6	26.5
300 ohm tubular	1.2	2.5	3.6	8.2
73 ohm coax	3.7	3.7	11.7	11.7
75 ohm coax	1.9	1.9	6.2	6.2

In installation, the transmission line must be kept clear of all objects which absorb energy from the line and thus, results in attenuation of the signal. For line carrying UHF signals, the minimum distance should be six inches between the object and line.

Where signal losses become excessive due to line length, boosters can be used. These units may be located at the receiver or where noise voltages are induced in the transmission lines, best results are obtained when the booster is mounted near the antenna.

Boosters

In weak signal locations where even the most elaborate antenna

array is inadequate, or when an elaborate array is impractical or undesirable for some reason, a "booster" may be used to increase the strength of the television signal. This device is merely a pre-amplifier consisting of one or more stages of r-f amplification, and tunable over the entire band of television carrier frequencies. There are many types of commercial units available on the market, and it proves less expensive to purchase one of these than attempting to build one.

A typical television all-channel VHF booster is connected in the transmission line by terminals provided for the lead-ins from the antenna and to the receiver. A three-position switch permits use of the booster on either the high or low VHF television bands or on neither. That is, in the off position of this switch, the antenna lead-in is connected directly through the booster to the receiver lead-in. A channel-selecting switch, similar to that used on the television receiver, permits selecting the proper tuned circuits for the desired station.

Most boosters contain one or two stages, while three stages are considered the practical limit because of signal-to-noise ratio considerations. Noise energy is developed by thermionic emission in a tube and amplified by following stages.

Furthermore, as well as amplifying the signal, the booster also increases the amplitude of any noise content in the input signal from the antenna system. Thus, although a booster can give some gain and often produces a picture where none was obtained before, its useful gain is somewhat limited by the corresponding increase in the absolute noise level. This noise level would not be increased if the same gain was realized by means of an improved antenna system.

For this reason, the most frequent use for boosters is in those locations in which all reasonable efforts to improve the antenna system have resulted in a picture which is still not quite good enough. The booster will then provide the small additional gain necessary to obtain satisfactory reception.

While not having as much gain as those using conventional pentode circuits, boosters employing neutralized or grounded grid triodes for amplifiers may result in a better signal-to-noise ratio. The pentode types are usually less expensive and more readily obtainable in a variety of models.

Boosters can be cascaded for greater gain. That is, the output of one booster is connected to the input of the other so that two or more units are in series. The antenna lead-in is connected to the

input of the first unit while the output of the last booster is applied to the input of the television receiver.

In some cases however, this arrangement is found to result in a tendency toward instability and oscillation, especially on the higher channels. Any such tendency results in a tremendous increase in noise level. Often, oscillation of cascaded boosters may be prevented by using units of different makes.

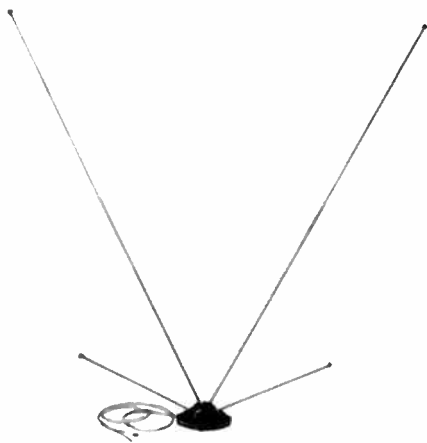

The adjustable indoor antenna often is used in strong signal areas where an outdoor type cannot be mounted on the building. Generally, it provides better reception than a built in antenna.

Courtesy American Phenolic Corp.

ROTATION OF WAVE POLARIZATION

The need for the receiving antenna to be mounted in the same plane as the electric component of the carrier wave, as well as the

fact that certain conditions in the propagation path may result in a change or rotation of the wave polarization was described in the previous lesson.

To permit compensation for this condition, some commercial antennas are designed to tilt from the horizontal when necessary, and thus provide for maximum signal pick-up. An adjustable angle dipole array of this type is illustrated in Figure 24.

Although this unit is intended for outdoor use, the rotation of wave polarization phenomenon is frequently encountered with indoor antenna installations, and several makes of indoor antennas have been designed to permit similar adjustment. Although an adjustable unit like that shown in the Figure is convenient, it is possible to tilt any type of array, which has the mechanical construction that permits it to be mounted at an angle to the horizontal.

MULTIPLE OUTLET DISTRIBUTION SYSTEMS

One of the greatest television reception problems is that of providing satisfactory signal input to all the receivers in an apartment building, hotel, or any other multiple family dwelling found within the metropolitan areas. Many building owners forbid the erection of separate outdoor an-

tennas for each individual apartment because such a maze of antennas adds an unsightly appearance to the building, decreases property values, presents the possibility of the owner being financially liable in the event of an accident due to faulty installations.

To overcome this problem, the television industry has developed multiple outlet distribution systems. This method is not original, however. Some years ago many newly erected apartment buildings had broadcast receiving antenna systems built into the walls of each apartment, with a convenient outlet for connecting radios. Also, in more recent years a similar system was adopted for FM reception, with only one master antenna on the roof. The various multiple outlet distribution systems employed for television follow the same basic idea.

A good television multiple outlet distribution system should perform the following functions:

1. Provide sufficient signal strength to the receivers on all channels for clear reception without snow or ghosts.
2. Prevent interaction between receivers.
3. Provide for later addition of receiver outlets and new stations on present and future frequencies.

4. Give satisfactory operation automatically and unattended for a long period of time.

The various types of distribution systems employed differ from each other according to the number of receivers that are to be served. More complex arrangements generally are needed when a large number of receivers are involved.

action, resistance networks and filters are incorporated in the wall outlets for each receiver.

Illustrated schematically in Figure 25 is one arrangement of a resistance network by means of which several receivers may be connected to a single transmission line. In series with the receiver lines, the resistors R_2 are used for impedance matching purposes.

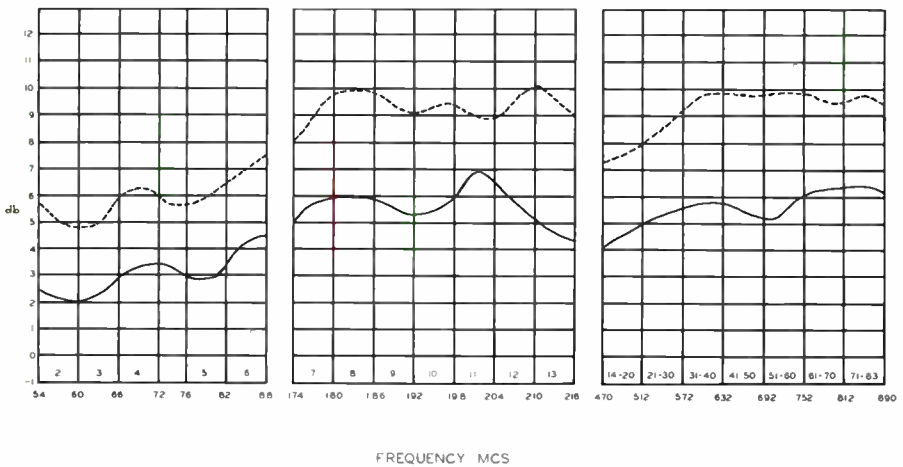

Gain Chart of the VHF-UHF combination antenna shown in Figure 14B. The solid line curve is for a single bay and the dashed line for a stacked bay.

Master Antenna System

The simplest arrangement is the master antenna system of which there are a few variations. The method generally employed consists of one broad-band antenna on the roof and a cable distribution system to the individual apartments. To prevent upsetting of the line impedance and minimize the effect of receiver inter-

Connected across the respective lines when the receivers are detached, the resistors R_1 are equal to the receiver input impedances.

The substitution of the receiver input by the terminating resistors R_1 may be accomplished by means of the double pole-double throw switches, illustrated in the Figure, or by plug-in arrangements, etc. This circuit is for use

when all receivers have the same input impedance and this impedance is equal to that of the lead-in. The resistors R_2 may be calculated from the following formula:

$$R_2 = \frac{R_1 (N - 1)}{2}$$

where R_1 is equal to the impedance of the transmission line and receiver input, and N is the number of receivers to be connected to the line.

A typical system of this type is shown in the diagram of Figure 26. Though appearing somewhat complex, this arrangement follows a rule of impedances which states that when two identical impedances are connected in parallel, the resultant impedance is equal to half of that of one. A pair of 300 ohm branch lines are connected in parallel to match each of the two 150 ohm riser lines, which in turn are paralleled to match the 75 ohm main line connecting to the antenna.

All of the individual outlet boxes are the same and contain a resistance network like that shown at the lower part of the Figure. It is not necessary that various branch lines contain the same number of outlet boxes, and the number connected to each may vary from 1 up to a maximum determined by the antenna signal strength.

In each box in this case resistor R_1 is equal to 300 ohms, and is connected into the circuit when the television receiver is not. In any one branch circuit, all the resistors R_2 are equal, their resistance being determined by the number of outlets to be incorporated in that branch. The resistors R_2 may be calculated from the formula given above for Figure 25, and in the case of the four outlets illustrated in Figure 26, $R_2 = 450$ ohms each. Thus, the total resistance of the two resistors R_2 plus the input impedance of the receiver is equal to $450 + 450 + 300 = 1200$ ohms. Connected in parallel across the branch line, the four 1200 ohm outlet boxes have a total equivalent impedance of 300 ohms which matches the line.

Since the signal present in the antenna and lead-in system is in the form of electric power, and each outlet box resistance and receiver input circuit is a power consuming device, there is a limit to the number of outlets that can be served by such a system, depending upon the strength of the received signal.

Pre-Amplifiers

In cases where a master antenna distribution system does not provide enough signal power for satisfactory operation of a large number of receivers, an arrangement employing pre-amplifiers will give better results.

Perhaps the simplest method is the use of a commercial booster in the main feed line to amplify the signal directly from the antenna. This requires a booster having extremely wide bandwidth if signals received on a number of different channels are to be amplified.

Since such a booster cannot provide very much amplification, it is more practical to use separate boosters for each channel, with their inputs and outputs common to the main feed line. However, a single booster is useful where only one station is to be received.

Where many receivers are to be served, another, more elaborate system uses separate high gain amplifiers with separate antennas for each channel. Usually, such an installation is manufactured and installed by companies specializing in this type of work. Like boosters, the characteristics to be considered with these multiple system amplifiers are gain, band-width, and signal-to-noise ratio.

The better types use low-noise circuits and have gains up to about 48 db with a bandwidth of 6 megacycles. If the simpler master antenna type system is already installed but not giving satisfactory results, usually amplifier units and additional antennas can be added, and the existing antennas and cable distribution with outlet boxes retained.

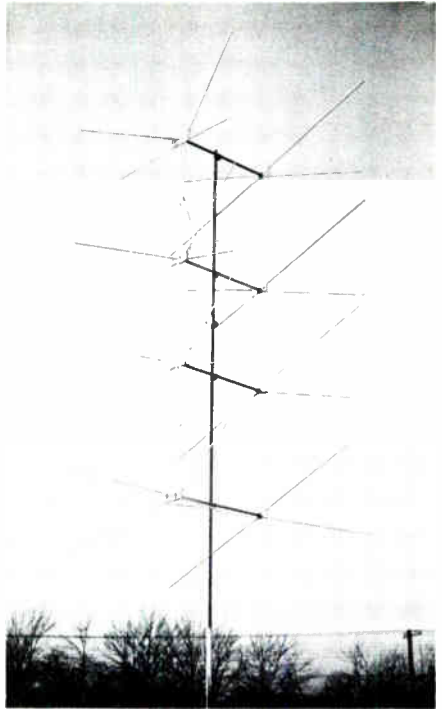

An array of VHF conical antennas stacked 4 high for good fringe area reception.

Courtesy Telerec Corp.

Receiver Isolation

With multiple outlet distribution systems, the main trouble encountered is the receiver interaction caused by the various local oscillators radiating energy into the common lead-ins. One method of overcoming this trouble is the use of special isolating transformers designed for the purpose. Called DISTRIBUTION TRANSFORMERS, the units employed in one commercial system provide isolation of approximately 100,000 to 1, or 50 db.

Another way of overcoming receiver interaction is the use of a separate cathode follower circuit between the lead-in and each receiver. The cathode follower serves the purpose of an isolating device, and also affords a method of matching the line impedance to that of the receiver input. When the signal strength is sufficient, cathode followers can be used with the master antenna system without pre-amplifier, but most often are used with the systems containing amplifiers.

Complex Systems

Figure 27 shows a complex distribution system employing separate antennas and pre-amplifiers and containing distribution transformers (D.T.) for isolation and impedance matching purposes. Systems of this type employ a separate antenna and pre-amplifier for every channel being used in the area, and the illustration shown is for reception on channels 4, 5, 7, and 9.

Even though a single broad band antenna could be used, separate units can be tuned and oriented for best results with each station. Also as shown, the system includes antennas and amplifier units for FM and AM broadcast and short-wave reception. The cost of these additional components is small compared to that of the complete installation.

The diagram of Figure 27 shows the outputs of the various amplifiers connected to a common line which is connected to the input of the first distribution transformer. From this unit, the four outputs are connected to the input circuits of four distribution transformers, each of which has four outputs connected to the inputs of four more distribution transformers, although the connections of only one branch line are shown in the drawing. That is, if all the units were included in the drawing, the lower line of distribution transformers would contain a total of 16 units.

Finally, the outputs of each of these lower distribution transformers connect to four receiver outlets, so that a total of 4 x 16 or 64 receivers can be served by this system. The input of each channel booster amplifier contains a potentiometer to compensate for varying signal levels from the different stations serving the area.

INDOOR ANTENNAS

A number of receiver models either have antennas built into their cabinet, or are intended to operate with some other type of indoor antenna. As mentioned above, many apartment house owners, etc. do not permit the installation of outdoor antennas in which case the television set

owner's only recourse is an indoor antenna or possibly some type designed to be mounted on a window sill.

A method of making a simple folded dipole from a length of 300 ohm twin lead transmission line has been described in an earlier lesson. However, to further fill the need for indoor antennas, a number of commercial types have been placed on the market.

A common type consists of two rods mounted in the form of a V, on a ball-type base. The unit is self-supporting and usually may be stood on the top of the receiver cabinet or any convenient table, etc. The telescoping dipole rods can be adjusted in length for tuning to the desired channel, and the entire assembly is rotated by hand for maximum signal pickup.

Another type, known as a SLIDE RULE FOLDED DIPOLE, has a physical appearance much like that of the steel measuring tape used by carpenters. That is, the element consists of metal ribbons which slide horizontally in and out of the mounting base. The unit is extremely compact and its retracting feature provides easy portability. Being a folded dipole, the antenna matches a 300 ohm transmission line, and settings are marked on the ribbon for each of the 12 VHF

television channels as well as for FM reception.

Still another arrangement employs the 117 volt power line as the antenna, and has a capacitor to couple one side of the line to the receiver antenna post. It provides low impedance to the r-f signal it couples from the power line to the receiver input. A choke coil, located in the power line lead between the power supply transformer primary and the point where the coupling capacitor is connected, prevents r-f signals from entering the receiver through the transformer.

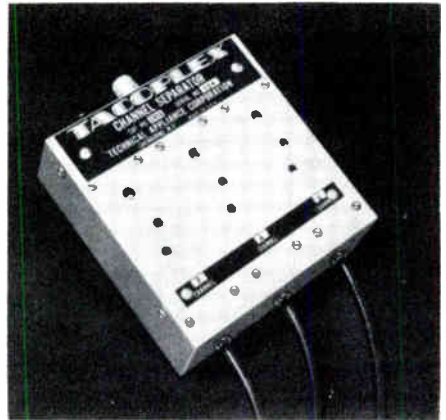

The channel separator is used to separate the various signals, from a single antenna in a master antenna system before amplification.

Courtesy Technical Appliance Corp.

Because of the relatively small energy which an indoor antenna can pick up, usually it is advisable to employ an indoor antenna only in the immediate vicinity of

the transmitter where the signal strength is very high. However, it is possible to employ an indoor antenna in an area of somewhat lower signal strength if a booster amplifier is used. Also, the practicability of the latter arrange-

ment will depend upon the noise present at the particular location. One manufacturer has designed a combination unit consisting of a booster and an adjustable "V" antenna similar to that described above.



STUDENT NOTES

STUDENT NOTES

STUDENT NOTES

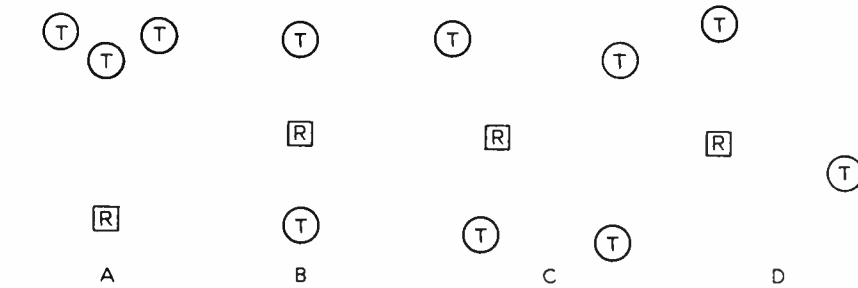

FIGURE 1

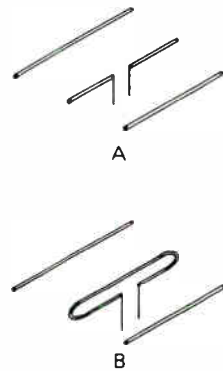

FIGURE 2

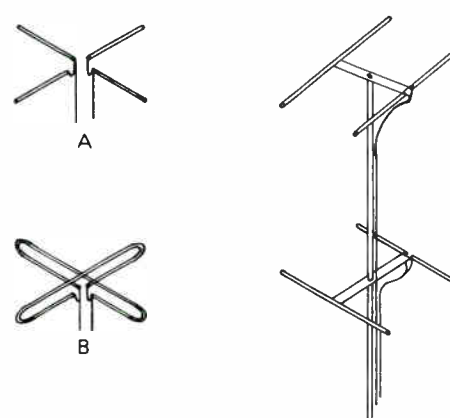

FIGURE 3

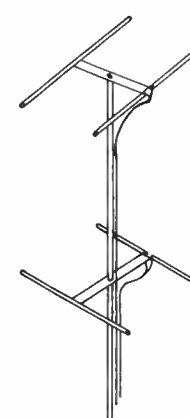

FIGURE 4

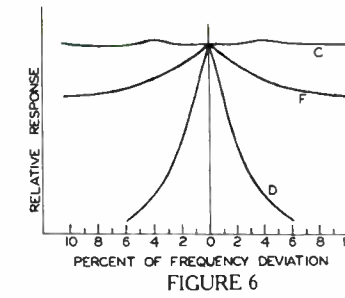

FIGURE 6

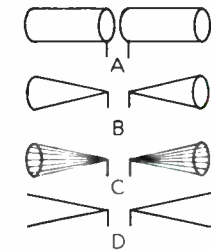

FIGURE 7

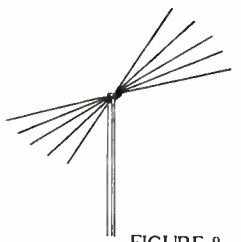

FIGURE 8

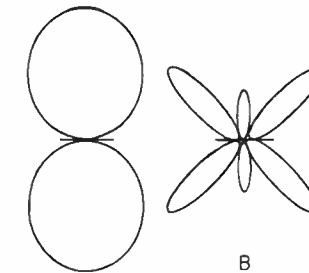
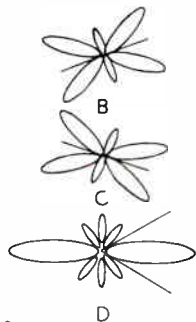

FIGURE 9



FIGURE 10



B

C

D

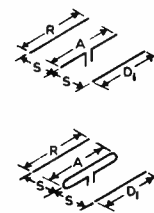

Channel No.	Element Length in Inches				Element Spacing in Inches		
	A	R	D ₁	D ₂ & D ₃	S	S _r	S _b
2	97.2	102	93.3	92.5	50.5	31.0	21.25
3	88.0	92.3	84.4	83.75	45.7	28.0	18.75
4	80.0	84.3	77.0	76.5	41.7	25.75	17.25
5	70.0	73.6	67.3	66.75	36.4	22.25	15.0
6	65.2	68.2	62.5	62.0	33.9	20.75	13.75
7	31.2	32.8	30.0	29.75	16.2	10.0	6.75
8	30.2	31.8	29.0	28.75	15.7	9.75	6.5
9	29.2	30.8	28.1	28.0	15.2	9.5	6.25
10	28.4	29.8	27.2	27.0	14.7	9.0	6.0
11	27.6	29.0	26.4	26.0	14.3	8.75	5.75
12	26.8	28.2	25.7	25.5	13.9	8.5	5.625
13	26	27.3	24.9	24.75	13.5	8.25	5.5

FIGURE 5

TSM-9

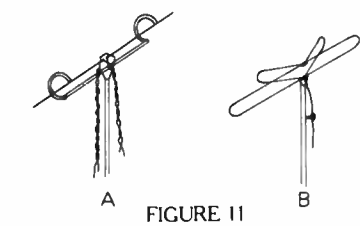

FIGURE 11

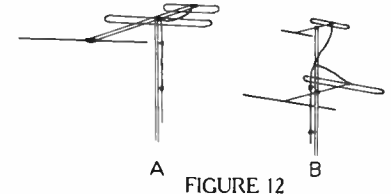
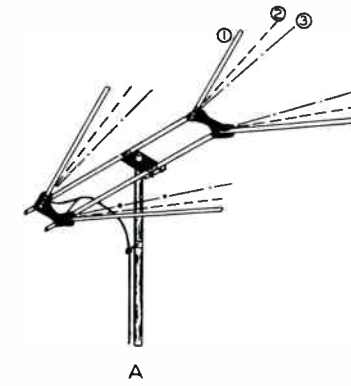

FIGURE 12



TSM-9

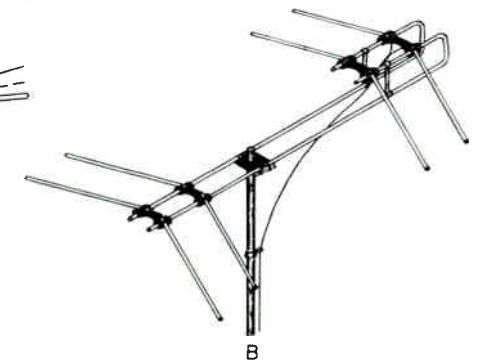
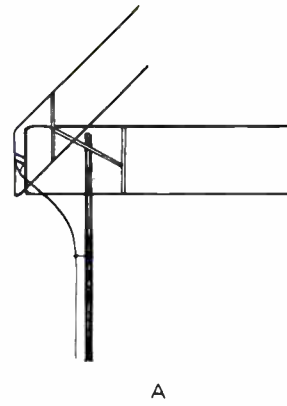
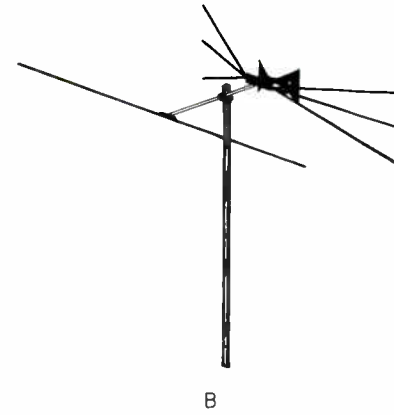

FIGURE 13

STUDENT NOTES



A



B

FIGURE 14

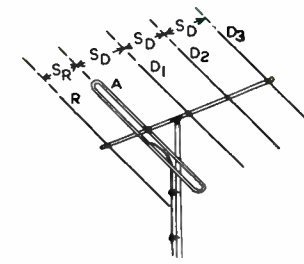

FIGURE 18

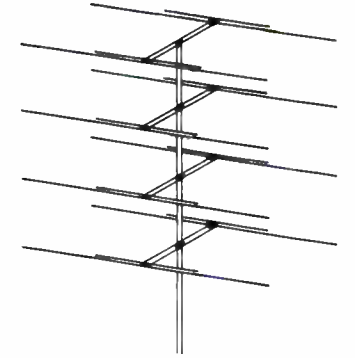
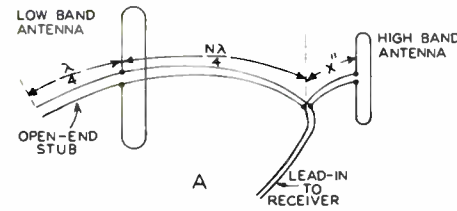
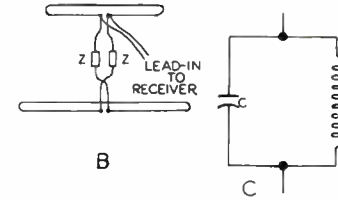

FIGURE 19



A



B

C

FIGURE 15

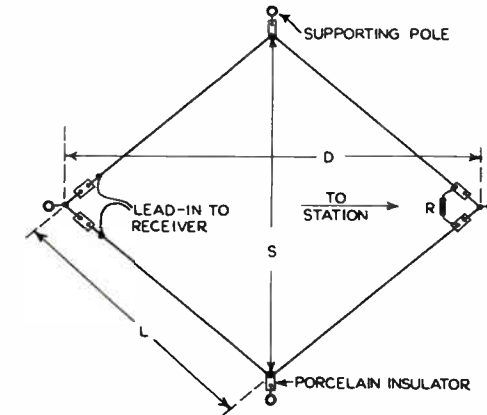

FIGURE 20

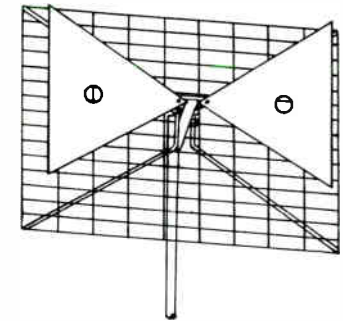
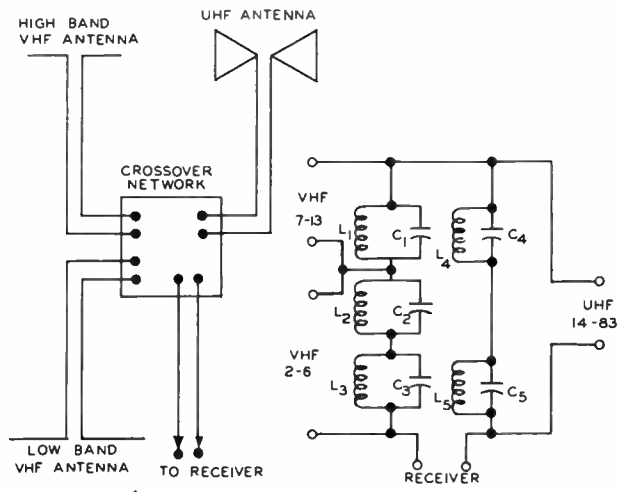

FIGURE 21



A

B

FIGURE 16

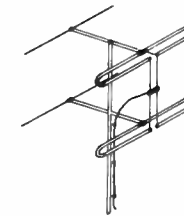
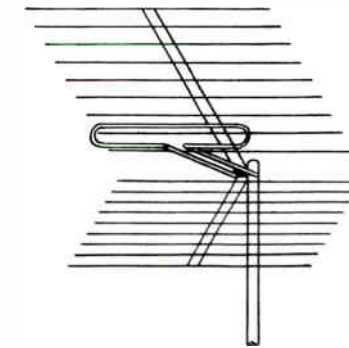

FIGURE 17



TSM-9

FIGURE 22

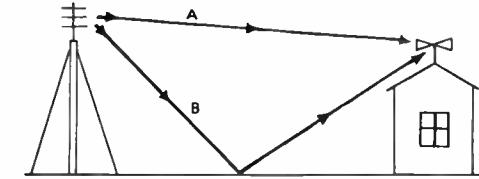

FIGURE 23

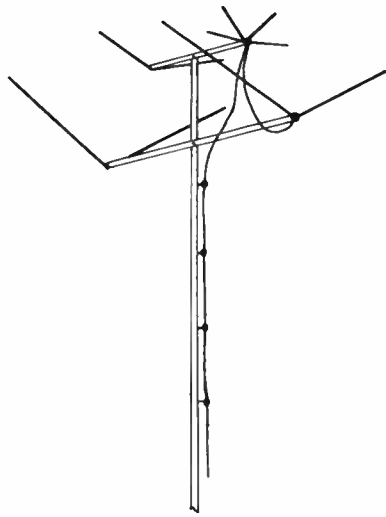

FIGURE 24

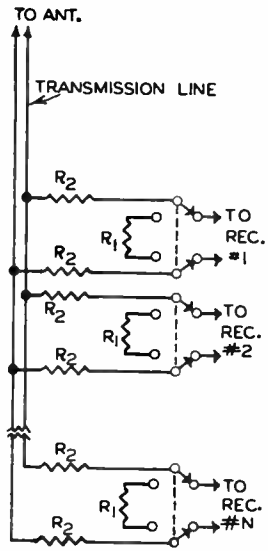
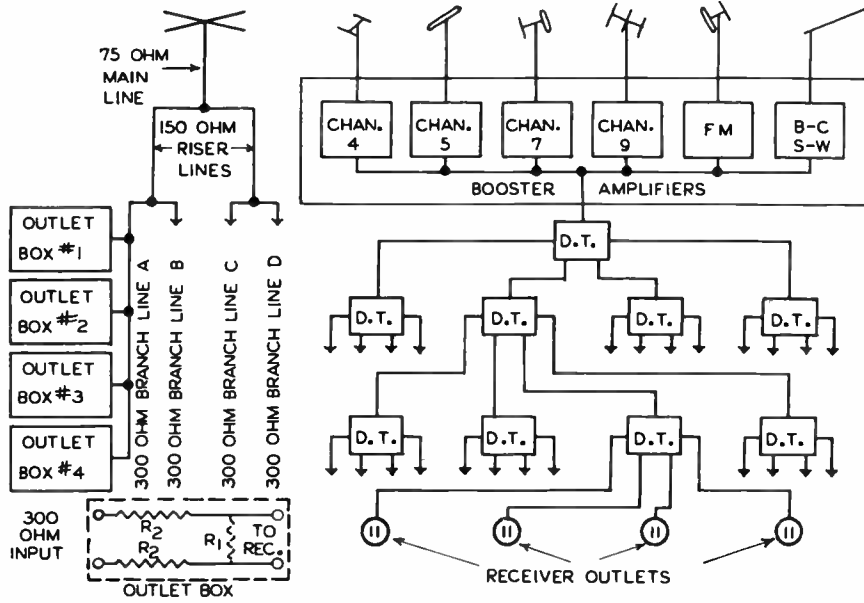

FIGURE 25



TSM-9 FIGURE 26

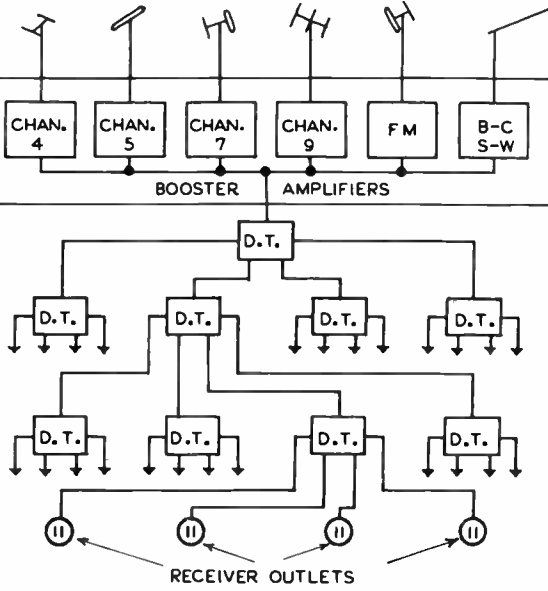

FIGURE 27

DeVRY Technical Institute

Formerly DeFOREST'S TRAINING, INC.

4141 WEST BELMONT AVENUE

CHICAGO 41, ILLINOIS

QUESTIONS

Reception Problems—Lesson TSM-9A

Page 39

3

How many advance Lessons have you now on hand?.....

Print or use Rubber Stamp.

Name..... Student No.....

Street..... Zone..... Grade.....

City..... State..... Instructor.....

Write your answers on the "Ans." line below each question. If more space is needed use reverse side of this page.

1. What is the advantage of tuning an antenna to the center frequency of the channel received?
Ans.....
2. What is the advantage of a folded dipole antenna over that of a straight dipole?
Ans.....
3. When high and low band VHF and UHF antenna elements are connected to a single transmission line, why is a special connecting arrangement required?
Ans.....
4. What is meant by "primary" and "secondary or fringe" service areas?
Ans.....
5. Determine the db gain that must be provided by an antenna located in a signal strength area of 40 microvolts for satisfactory operation of a receiver having a sensitivity of 100 microvolts.
Ans.....
6. Use the method followed in the example on page 17, column 2, to determine the required length each for the dipole, reflector, and director elements of a single antenna, like that of Figure 2A, which will cover channels 3 through 6, inclusive? (HINT: Check FCC Standards for channel allocations, find mean frequency, and then check with Figure 5.)
Ans.....
7. What effect may a vibration of the UHF antenna have on the picture?
Ans.....
8. What limits the number of stages that may be employed in a TV "booster"?
Ans.....
9. Referring to Figure 26, two television receivers each with 300 ohms input are to be connected to a 300 ohm transmission line. What is the resistance of R_1 and R_2 ?
Ans.....
10. In multiple outlet distribution systems, what are two methods of isolating the effects of one receiver upon another?
Ans.....

FROM OUR *Director's* NOTEBOOK

WHILE IN THE CUSTOMER'S HOME

One of your most important considerations, when performing a service job in the customer's home, should be NEATNESS. Your own personal appearance is important, but so is the way you do your work.

When you pull a TV chassis from the cabinet, there is usually a certain amount of dust and dirt which could soil the rug. Use a drop cloth to prevent this and also to provide a convenient place for your tools and parts. Make sure your tools are clean and your kit orderly.

If you have room, carry a small hand vacuum cleaner to remove dust from the chassis and cabinet. A bottle of glass cleaner and some clean rags for polishing the picture tube face and glass screen will also be helpful.

When you have finished the job, be sure to clean up thoroughly before you leave. Remember, the TV set to the customer is an expensive unit and you should treat it—and the customer's home—accordingly.

Your thoughtfulness and thoroughness will be greatly appreciated by your customer—helping to make your services more and more in demand as your reputation spreads. Yes—neatness is just good . . . smart business.

Yours for success,

W. C. Healey

DIRECTOR

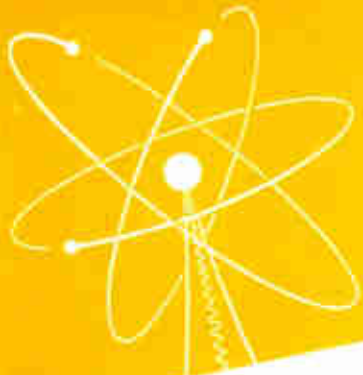

DISTORTED SOUND

Lesson TSM-10A

TSM-10



DeVRY Technical Institute

4141 W. Belmont Ave., Chicago 41, Illinois
Formerly D-FOREST'S TRAINING, INC.

TSM-10A

DISTORTED SOUND

4141 Belmont Ave.

COPYRIGHT 1955

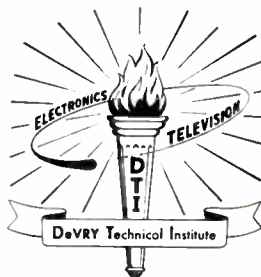

Chicago 41, Illinois



When the picture is reproduced perfectly as shown here, but the sound is distorted, then the troubleshooting is concerned with those circuits which can affect the sound only.

Courtesy General Electric Co.

Television Service Methods

DISTORTED SOUND

Contents

	PAGE
Sound Channel Circuits	5
Isolating the Defect	6
Sound Channel Troubles	8
Output Stage and Loudspeaker	8
Voltage Amplifier	11
Detector Stage	12
I-F Amplifier and Limiter Stages	16
Troubles Common to Dual-Channel Receivers	17
Troubles Common to Intercarrier Receivers	18

A great deal of the joy of life consists in doing perfectly, or at least to the best of one's ability, everything which he attempts to do. There is a sense of satisfaction, a pride in surveying such a work—a work which is rounded, full, exact, complete in all its parts—which the superficial man, who leaves his work in a slovenly, slipshod, half-finished condition, can never know. It is this conscientious completeness which turns work into art. The smallest thing, well done, becomes artistic.

—William Mathews

DISTORTED SOUND

Should you check over the previous lessons of this series, it would become rather apparent that we have resolved the troubleshooting of a television receiver into a systematic procedure, by explaining methods for making initial investigations and by making a study of the various types of television receiver circuits, test equipment, and efficient servicing techniques. Following this, a group of lessons, including the present one, classifies practically every reception difficulty or receiver fault which normally is encountered. In fact, every aspect which makes possible a logical step by step solution of the problem at hand is being considered.

Moreover each step is designed to either eliminate a whole group of possible troubles or to conclusively isolate the existing trouble. Nothing is to be done without reason. To aimlessly "try" different things can result in many hours of futile efforts. An intelligent use of a method moves the troubleshooting progressively toward a solution in a minimum number of steps. The result is an efficient use of time.

This efficiency is very important because, in the final analysis, the serviceman is selling his time. The value of the time is directly proportional to the rapidity with

which the serviceman isolates the trouble and corrects the fault. No matter how long it takes to locate the trouble, the serviceman cannot successfully charge more than the job is actually worth, for to build his business soundly with satisfied customers, the serviceman must keep his service charges within reason. Therefore, to make it a paying proposition, it is imperative for the serviceman to ferret out each new trouble with an alert and methodical approach.

This lesson is concerned with the troubleshooting of a television receiver that has a distorted sound output, although its reproduced picture is normal. This description immediately eliminates many of the receiver circuits as possible sources of trouble. Only those circuits are involved through which the sound signals must travel in one form or another. Those circuits through which both the picture and the sound signals pass are eliminated except for cases of misalignment.

Since the respective signals differ only in frequency, there is little possibility that a tuner or i-f stage could pass a normal picture signal and not a normal sound signal. Hence, nearly all of the troubleshooting will be concerned with the audio amplifier,

sound detector, and in a few cases, the i-f stages. The only remaining section involved in any way with the processing of the audio signal is the power supply. However, with a normal picture, the possibility of the trouble being in the power supply is fairly remote.

SOUND CHANNEL CIRCUITS

Television receivers are classified on the basis of their sound channel arrangement. In the dual channel type of receiver, the sound i-f signal is separated from the video i-f signal at some point between the mixer and video detector stages, and then it passes through one or more stages of sound i-f amplification before being applied to the sound detector.

In the intercarrier type of receiver, the original sound i-f and the video i-f signals are not separated, but are permitted to heterodyne in the video detector. Employed as the second sound i-f signal, the resulting 4.5 megacycle beat frequency is passed through the sound i-f amplifier and applied to the sound detector. The respective advantages and design details of these two types of receivers have been explained in previous lessons and so will not be repeated here.

The circuit diagram for the sound channel of the Sentinel model 411 television receiver is shown in Figure 1. This circuit

contains a type 6AU6 sound i-f amplifier, a type 6AL5 employed as a ratio detector, the triode section of a type 6SQ7 operating as the first audio or voltage amplifier, and a type 6AR5 power output tube.



Distorted sound output may result from changes in resistance of carbon resistors due to heavy current overloads or to aging.

Courtesy Allen-Bradley Co.

The receiver is indicated as the intercarrier type by the fact that the input to the audio channel is taken from a point following the receiver video detector: namely, the plate circuit of the video amplifier. Also indicating this type of receiver is the fact that transformers T_1 and T_2 resonate at 4.5 megacycles as labeled.

Representative of the dual channel type is the RCA model 8T241 television receiver for which the sound channel circuit diagram is shown in Figure 2. Here, the input to the sound channel is taken from a point preceding the receiver video detector:

namely, the secondary of the third picture i-f transformer T_1 . As indicated, the secondary of this transformer is tuned to the sound i-f frequency of 21.25 megacycles and, taken from the tap on this secondary winding, the signal is passed through two stages of i-f amplification and applied to a type 6AL5 tube operating as a discriminator. The triode section of a 6AV6 tube serves as the first audio amplifier, while a type 6K6GT is employed as the power output tube. The diode sections of the 6AV6 are used in the agc circuit.

ISOLATING THE DEFECT

Since the trouble already has been localized to the receiver sound channel, the procedure should consist of isolating the fault to a particular stage in the sound channel, and then locating the particular defective component or connection, etc. For this work, it will be necessary that the receiver chassis be removed from the cabinet, it being assumed that all the preliminary type tests, including tube checking, have been made and the cause of the trouble remains undiscovered.

First, a dynamic type of test should be made to determine whether the fault lies in or before the audio amplifier circuit. One method of accomplishing this test consists of tuning the receiver to

a channel in which no station is received, and applying an audio signal to the input of the a-f amplifier. For this test, an audio signal having a minimum of distortion is needed and should be obtained from an audio oscillator if such an instrument is available. If an a-f oscillator is not available, then a phono pickup or a radio tuner will serve, providing its output is of sufficient good quality to assure easy detection by the listener of any distortion produced in the audio circuits under test.

The test signal should be applied across the receiver volume control, as this control normally forms the input circuit of the audio amplifier. For example, for the receiver of Figure 1, one generator test prod is touched to ground, and the other prod applied to the R_6 terminal to which C_{10} is connected. In the receiver of Figure 2, the second test prod is applied to the R_{10} terminal which connects to C_{14} . Then, the signal generator output control is turned down to the point where the signal does not overload the receiver speaker.

When some other source of signal is being employed, this adjustment may have to be done by means of the receiver volume control. If, with the normal signal level, the output from the speaker is distorted, the trouble exists at

some point following that at which the test leads are being applied. If the output is not distorted, then the trouble must be at some point preceding that at which the signal is injected.

In the event the above test has determined that the trouble lies in the audio amplifier, the defect may be isolated to a particular stage or circuit by touching the audio oscillator test prod to various test points in the circuit. Examples of such test points are the grid of the first audio amplifier, the grid of the output tube, and the output tube plate. The latter point makes it necessary to use a blocking capacitor.

Another method of isolating the defective stage or circuit is by the use of a signal tracer. When this instrument is employed, the receiver is tuned to receive a station and its volume control set at a normal volume level. Beginning at the input to the sound channel and working toward the speaker, the signal tracer test prod is applied to successive test points until the distortion appears. The fault then lies somewhere between this point and the one previously tested.

After the dynamic test has isolated the trouble to a certain stage or circuit, the exact component or connection, etc., which is causing the trouble may be found by means of voltage and

resistance testing. First, the voltages appearing at the various tube elements are checked against the values given in the manufacturers service manual.



Tube used in the audio power output stage of television and radio receivers. Considerable distortion in sound output may be produced by a weak power output tube.

Courtesy Sylvania Electric Products, Inc.

For convenience in voltage testing, some manufacturers print these values right on the

schematic diagram. Although most plate, screen grid, and cathode voltages may be checked with ordinary voltmeters, an instrument having high input impedance such as a vacuum tube voltmeter is needed to obtain accurate readings of very low voltages or in high resistance-low current circuits.

After the voltage tests have indicated the trouble to be due to some faulty component or other circuit defect, the receiver is turned off and resistance tests made. Since the methods for making these tests have been explained in detail in previous lessons, they will not be repeated. However, an important rule that should be kept in mind is that, when there are one or more circuits in parallel with a component to be resistance tested, one of the latter's leads should be disconnected from the circuit. Also, it should be remembered that certain components, usually capacitors, break down when high voltage is applied to them during operation of the receiver, even though the same unit appears to be in good condition when tested with an ohmmeter.

SOUND CHANNEL TROUBLES

Except for the intermediate frequency employed, the sound channel of a television receiver is prac-

tically identical to the corresponding section of an FM radio receiver. Furthermore, with the exception of the FM sound detector stage, both the i-f and a-f sections of television receivers and FM receivers are about the same as those of AM receivers. For this reason, the troubleshooting methods as well as the types of troubles found are similar to those described for radio servicing. For general reference purposes, a few of the more common causes of distortion in the sound channel are given in the following paragraphs.

Output Stage and Loudspeaker

In any loudspeaker, distortion of the sound output results from a rubbing voice coil, or a cone whose shape has changed due to warping, etc. In the case of an electro-magnetic type speaker, distortion may be caused if the field excitation voltage is low. Various noises, rattles, etc. due to speaker defects often are hard to distinguish from actual distortion of the signal. Such noises may be due to the speaker cone being torn, a loose spider, the cone being loose from the basket rim, a loose or rubbing voice coil, or grit and dirt in the field gaps. Less frequent causes of the same trouble are a loose dust cap or loose speaker mounting screws.

Abnormally low plate voltage is a frequent indication of trouble

in the power output stage. Usually, this reading is the result of an excessive plate current due to insufficient grid bias. One cause of insufficient grid bias is a shorted or partially shorted cathode resistor, such as R_{11} in Figure 1. In this particular circuit, the resistor is unbypassed. Therefore, the fault must be in the resistor itself, or in the leads by means of which it is connected to capacitor C_{15} , the cathode, or to ground. However, other circuits, such as that in Figure 2, contain a cathode bypass capacitor. As shown, cathode resistor R_{20} is bypassed by capacitor C_{18} . Should this capacitor break down, it will reduce the cathode circuit resistance since the cathode resistor and capacitor are in parallel. Most often, the capacitor is the faulty unit, and its condition may be checked by disconnecting one of its leads. Now, if a normal voltage reading is obtained at the plate of the amplifier tube, the capacitor may be assumed to be defective and should be replaced.

A condition of insufficient grid bias may exist even though the amplifier tube cathode circuit is operating normally. This condition could be due to a leaky interstage coupling capacitor, such as capacitor C_{13} in the circuit of Figure 1. Normally, the output tube control grid bias should be anywhere from about -7 to

about -20 volts. The higher bias will be found in receivers which employ higher plate voltages on the output tube. The grid voltage, however, should be practically the same as that measured across the cathode resistor.



Potentiometers of the types used as volume controls in receiver a-f circuits. Noise produced in the speaker when the volume control is adjusted generally is due to dirt which has collected inside the control.

Courtesy Stockpole Carbon Co.

In the event the coupling capacitor is leaky, this grid voltage may be much less negative or even somewhat positive. For example, in the circuit of Figure 1, with capacitor C_{13} leaky, there is electron flow from ground through grid resistor R_{10} , through C_{13} , and through R_8 , R_9 , and R_{12} to $B+$. This current causes the grid end of R_{10} to be positive with respect to ground. Being in

series opposition to the voltage $E_{R_{11}}$, voltage $E_{R_{10}}$ results in a lower than normal total bias between the grid and cathode of the tube.

Should heavy leakage of C_{13} cause $E_{R_{10}}$ to be greater than $E_{R_{11}}$, then the grid will be positive with respect to cathode. Again, a simple check is to unsolder one lead of the coupling capacitor. If the plate voltage then returns to normal, it may be assumed that the coupling capacitor is at fault, and should be replaced.

Occasionally, the grid resistor of the audio output stage opens. This leaves the grid "floating" with no bias applied to it. As in the case of the shorted cathode circuit, this condition may result in heavy conduction by the tube, and an abnormally low plate voltage. This trouble is indicated if the plate voltage returns to normal when a resistor of the correct value is bridged temporarily from the control grid lug of the tube socket to ground.

Another cause of low plate voltage is the existence of undesired high resistance in the plate circuit of the output tube. For example, the primary of the output transformer should have a direct voltage drop across it of no greater than about 10 volts. If the drop across this primary is excessive, a resistance check

of this winding should be made. Another possibility is a high resistance short in the wiring of the plate circuit. Should both the plate and screen grid voltages be low, then the trouble may be due to a faulty decoupling resistor or capacitor, such as R_{12} and C_{16} of Figure 1.

If the plate voltage of the output tube measures abnormally high, then low or no plate current is indicated. This condition may be due to low screen voltage, or excessive negative grid bias.

In most receivers, the screen grid of the output tube is connected directly to the B+ end of the output transformer, as shown in Figures 1 and 2. For this reason, low screen voltages are not encountered very frequently. Should a low screen voltage reading be obtained however, cold soldered joints, broken leads, or defective tube sockets should be looked for.

Excessive grid bias may be due to an increase in resistance of the cathode resistor or the grid resistor. Any undesirable increase in the value of the latter due to age, heat, etc., may result in grid leak bias being developed. This bias adds to that across the cathode resistor so that the plate current is reduced.

Certain output stage defects can result in distortion of the sound even though the various

tube element voltages are normal. Examples are, an open cathode bypass capacitor, an open plate bypass capacitor, or a mismatched replacement output transformer or loudspeaker.

Voltage Amplifier

As in the case of the output stage, low plate voltage in the audio voltage amplifier indicates any of a number of circuit defects. For example, in the circuit of Figure 1, if plate load resistor R_8 and decoupling resistor R_9 are rated at the same resistance, then they should have equal voltage drops across them since the same current passes through them. Any considerable difference in the respective voltage drops indicates a fault. The resistors should be checked with an ohmmeter and, if either has changed sufficiently in resistance, a replacement should be made.

It is possible for the decoupling resistor to have correct resistance, yet still have an excessive voltage drop across it. This occurs when there is a short in the decoupling capacitor, C_{14} in Figure 1, or a short to the chassis where this capacitor and the two resistors are tied together. A very large voltage drop across both R_8 and R_9 may be due to a leaky coupling capacitor, C_{13} , a shorted r-f bypass capacitor, C_{12} , or tube socket defects or shorts.

As with the output tube, low plate voltage on the voltage amplifier tube may be due to breakdown of the decoupling capacitor, C_{10} , Figure 1. This assumption is based on the fact that the output of the power supply, at the B+ end of resistor R_{12} , is normal, since the supply also provides B+ voltage for the video section of the receiver, and it has been stated previously that the reproduced picture is normal.

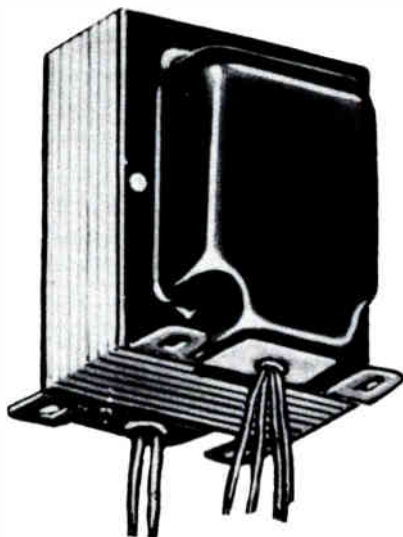

Distorted sound output may result if there are shorted turns in the audio output transformer.

Courtesy Stoddard Transformer Corp.

If load resistor R_8 or decoupling resistor R_9 becomes shorted, the voltage amplifier tube will have excessive plate voltage. This high plate voltage may cause distortion in the sound output.

With the tube element voltages normal, distortion of the signals is caused by a shorted or leaky coupling capacitor, C_{11} , in Figure 1. Occasionally, a receiver employs a pentode instead of a high mu triode as the audio voltage amplifier. In this case, the troubleshooting of this stage must include tests for possible defects in the screen grid circuit.

Detector Stage

If the dynamic test shows the audio amplifier to be in good condition, and that the trouble is in some stage preceding the audio section, then further checks are made to isolate the fault to a particular stage. In any type of television receiver, distortion may be caused by misalignment of the ratio detector or discriminator, misalignment of the i-f amplifier, or by a defective component in one of the circuits.

In the intercarrier type of receiver, a check for misalignment can be made by removing the high frequency oscillator tube and applying the output of a signal generator to the control grid of the i-f amplifier. For example, the signal generator ground lead would be connected to the chassis and its hot lead to the tube socket terminal for the control grid of tube V_1 in the receiver of Figure 1. A d-c voltmeter is then connected to read the voltage across the r-f bypass capacitor, C_8 , and

the frequency of the signal generator varied from 4.525 megacycles up to 4.475 megacycles. If the sound detector is aligned properly, the voltmeter will read zero at 4.5 megacycles, while the readings will be equal in magnitude but opposite in polarity at 4.525 and 4.475 megacycles, respectively.

If these desired readings are obtained, then the alignment of the i-f amplifier may be checked by applying the signal generator output to the grid of the video frequency amplifier or to the video detector input. With the voltmeter across C_8 , the test signal is varied through the same frequency range as above and similar readings should be obtained if alignment is correct. That is, the readings should be zero at 4.5 megacycles and equal but opposite at 25 kilocycles above and below 4.5 megacycles.

In the event the ratio detector, Figure 1, is out of alignment, a 4.5 megacycle unmodulated signal should be applied to the grid of the sound i-f amplifier, V_1 , and the d-c voltage reading taken across the electrolytic capacitor C_7 . The primary core of the ratio detector transformer T_2 should be adjusted for a maximum reading. Then, with the voltmeter across C_8 , the secondary core of T_2 should be adjusted for zero reading.

It is very important to have an accurate signal generator for this purpose. No tuning of the receiver can be made to compensate for any signal generator error. The 4.5 megacycle input must be correct. For lack of an accurate signal generator, it is better to tune in a strong station and align the detector transformer with the voltmeter as described in the previous paragraphs. A station transmitting a test signal is preferred for these adjustments.

If aligning the ratio detector does not clear up the distortion, or adjusting the transformer secondary coil will not cause the meter reading to drop to zero, a defective circuit component is indicated. With the signal generator applied to the V_1 input as above, and a 4.5 megacycle test signal, an electronic voltmeter should be used with an r-f probe to check the detector transformer. The probe should be placed first at the V_2 cathode and then the plate which are connected to the secondary winding of T_2 . If equal readings are obtained at these two points, it may be assumed that the transformer is good. Next, a check should be made for a leaky electrolytic capacitor, C_7 . Following this, a check should be made of the load resistors R_3 and R_1 , the r-f bypass C_8 , and the de-em-

phasis filter components R_5 and C_9 .

In the case of the dual channel type receiver, distortion may be due to any of the three causes mentioned above, improper functioning of the limiter stage when a discriminator type second detector is used, or misalignment of the high frequency oscillator. Another possible cause is that the gain of the i-f amplifier may not be sufficient to properly drive the limiter stage.



A rectangular picture tube with a "black" face to reduce glare is employed in this table model receiver.

Courtesy DeWald Radio,
United Scientific Lab., Inc.

First, the gain of the i-f amplifier should be checked by removing the high frequency oscillator tube, applying the output of a signal generator to the first i-f amplifier grid, and measuring the d-c voltage developed in the avc circuit. To make this meas-

urement, the voltmeter is connected across the bias components in the limiter grid circuit as shown in Figure 3. The signal generator should be set at the sound i-f frequency, which in the case of the circuit of Figure 2, is 21.25 megacycles. If the gain of the i-f amplifier is correct, a direct voltage should be measured in the avc circuit with very low test signal input to the receiver.

tain such a bias circuit, a parallel resistor and capacitor can be inserted temporarily. Suitable values are 150,000 ohms for the resistor and .01 microfarad for the capacitor.

If the i-f gain is satisfactory, then the proper functioning of the limiter stage may be checked by applying the output of the signal generator to the first i-f amplifier grid, and measuring the

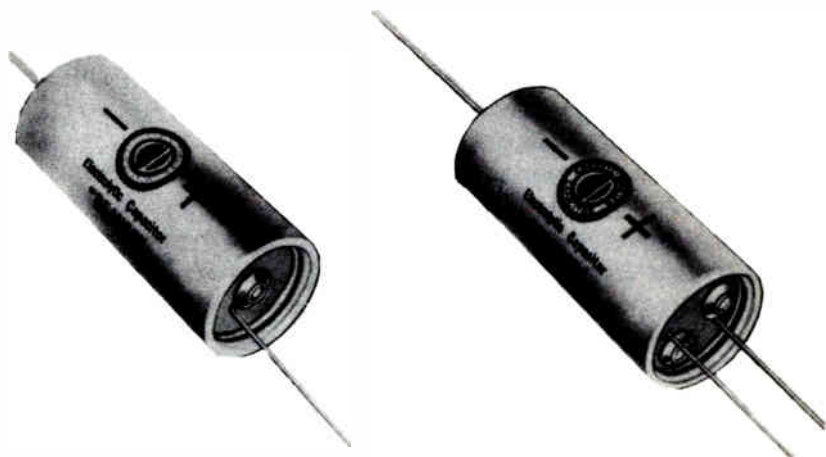

Electrolytic copocitors such as these ore employed to byposs the colhode resistor in the audio output stoge of o receiver. When defective, the result is distorted sound output.

Courtesy Cornell-Dubilier Electric Corp.

Some receivers do not have an avc circuit, as in the case of the receiver of Figure 2. However, the voltmeter can be connected across the bias circuit, R_3C_6 in Figure 2, to make the measurement. If the limiter does not con-

d-c voltage across the r-f bypass capacitor, C_{12} , Figure 2. The test signal should have a frequency either higher or lower than the sound i-f frequency. The amplitude of the input signal should be increased gradually, and after

the input to the limiter has reached a specified threshold voltage, the discriminator d-c output measured on the voltmeter should remain essentially constant as shown by the curve of Figure 4. When the discriminator output is like the curve of Figure 4, the limiter stage is operating properly.

With proper limiter operation, as indicated by the above test, the trouble may be due to misalignment of either the discriminator or the receiver oscillator. To check for misalignment of the detector or the oscillator, replace the oscillator tube in its socket and tune in a station. With the voltmeter connected across the r-f bypass capacitor C_{12} , it should be possible to make the meter swing to zero by adjusting the fine tuning control, if neither the detector nor the oscillator are misaligned.

If this check indicates misalignment, the tuning of the discriminator may be checked by again removing the oscillator tube and applying the signal generator signal to the grid of the first i-f amplifier. Assuming, for example, an i-f frequency of 21.25 megacycles, the signal generator output should be swung from 21.225 megacycles to 21.275 megacycles. Equal and opposite readings should be obtained at the extremes of this frequency range, while a

zero reading should be obtained at 21.25 megacycles.

Next, the signal generator should be swung through the same frequency range again with the voltmeter connected across one of the detector load resistors, such as resistor R_7 , Figure 2. In this case, a maximum d-c voltage reading should be obtained as the generator is swung through the 21.25 megacycle point.

When all of the readings obtained are correct, the discriminator is aligned properly, and the trouble lies with the high frequency oscillator. The alignment of the oscillator should then be carried out as described in the manufacturers service manual.

If, on the other hand, the detector output voltage does not swing through zero when the check is made, the detector is in need of alignment. This can be done with a test signal of 21.25 megacycles (for the receiver of Figure 2) applied to the grid of the first sound i-f amplifier and the voltmeter connected across the detector load resistor R_7 . The primary core of the discriminator transformer T_3 should be tuned for maximum meter reading.

Next, the voltmeter should be connected across C_{12} , and the discriminator transformer secondary core adjusted for zero meter reading. If proper alignment has

been obtained, a 25 kilocycle deviation above or below the 21.25 megacycle reading on the signal generator dial should result in equal and opposite voltage readings on the meter.



Sometimes distorted sound is due to mechanical defects in the loudspeaker.

Courtesy Oxford Electric Corp.

If, after careful alignment, the discriminator output will not reduce to zero or swing an equal amount plus or minus from zero, a faulty part is indicated. As before, the discriminator transformer can be checked by placing the r-f probes of an electronic voltmeter in turn at both ends of capacitor C_{11} , Figure 2.

Equal readings should be obtained at these points. Load re-

sistors R_7 and R_8 should be checked with an ohmmeter, and should have values well within a 20% tolerance. Any inequality here should be corrected. The coupling capacitor C_{14} , can be checked by replacing it temporarily with one of equal capacitance.

I-F Amplifier and Limiter Stages

If low i-f amplifier gain has been indicated, it may be due to misalignment of this amplifier, or the existence of a defective component. Voltage and resistance checks should be made in the i-f circuits in a manner similar to that explained for the audio amplifier and detector circuits. If all circuit components are in good condition, then the i-f amplifier transformers should be aligned according to the directions in the manufacturers service manual.

The limiter tube is operated so that, when the grid swings negative, cutoff is reached quickly, while the positive swings are limited by the loading due to grid and plate current. These operating conditions are met by using sharp cutoff pentodes with low screen and plate voltages. Often, poor operation of the limiter stage is due to some component such as a screen or plate resistor changing value to increase the plate or screen voltage above those specified for proper operation.

TROUBLES COMMON TO DUAL-CHANNEL RECEIVERS

More often, distortion of the sound output of dual-channel receivers is caused by mis-tuning than it is by a defect in components. This is due to the fact that the bandwidth occupied by the television sound signal is extremely narrow with respect to the sound i-f carrier frequency and the high frequency oscillator frequency. The television sound carrier deviates only plus and minus 25 kilocycles, while the sound i-f carrier frequency is, for example, 21.25 megacycles. Thus, the total band occupied by the sound signal sideband is 50 kilocycles, this being only a little over .2% of the 21.25 megacycle carrier.

Because of this, a relatively small change in the frequency of the i-f carrier may be sufficient to move the sound signal sideband partly or even completely above or below the range to which the sound channel transformers are tuned.

As you may recall, the i-f carrier is produced by the heterodyning of the output of the local high frequency oscillator and the incoming r-f carrier. Since the latter is maintained substantially constant by the transmitter, normally any changes in the i-f carrier frequency are due to the receiver local oscillator operating



Miniature type h-f amplifier tube. In a television receiver, a faulty tube in an r-f or i-f stage sometimes produces distortion of the sound.

Courtesy Radio Corporation of America

off frequency. In the dual-channel receiver, the fine tuning control permits adjustment of the oscil-

lator frequency. This control must be adjusted very carefully, almost precisely, so that the correct oscillator frequency is generated and the exact i-f carrier frequency produced each time a station is tuned.

Besides misadjustment of the tuning control, changes of the high frequency oscillator output frequency may result due to slight changes in values of certain oscillator circuit components due to temperature changes with warm up, etc. In like manner, the tuning of the i-f amplifier and discriminator tuned circuits may change slightly for the same reason. Often, severe changes result in the sound output being greatly distorted or disappearing entirely. Normally, this condition can be corrected simply by re-adjusting the receiver fine tuning control. Because of the wide band occupied by the video signals, this minor adjustment of the oscillator frequency causes no apparent change in the quality of the reproduced picture. In fact, it is normal procedure to tune this type of receiver for undistorted sound.

TROUBLES COMMON TO INTERCARRIER RECEIVERS

While sharp tuning is required, and undesirable results are produced by frequency drift in the

dual-channel receivers, the mistuning of an intercarrier type receiver does not result in this type of distortion. However, it does often produce a 60 cycle buzz known as "video buzz". Video buzz has a certain harshness and should not be confused with the familiar 60 cycle hum.

As is known, the 4.5 megacycle sound i-f frequency is generated by beating together the amplitude modulated video signal and the frequency modulated sound signal. Since the beat note (sound i-f) is a difference frequency of the two signals, it is frequency modulated also. The amplitude of a beat signal is equal to the weaker of the two signals producing it. Since amplitude modulation of the sound i-f by the video is very undesirable, it is important to keep the sound signal weaker than the weakest video signal so that the sound signal at all times determines the amplitude of this beat note.

It is common practice for television stations to permit their transmitters to be modulated downward as much as 90%. For this reason, the strength of the sound signal applied to the receiver video detector must be kept less than 10% of the unmodulated video signal strength.

This important relationship between the amplitude of the two signals is determined mainly by

the receiver video i-f amplifier response. The ideal video i-f response is represented by the curve of Figure 5A. As shown here, the 25.75 megacycle video i-f signal comes in at the half power point as required for a well-balanced picture, and the 21.25 megacycle sound i-f signal is passed through at a point barely up on the response curve. This results in the respective signals having the needed 10 to 1 amplitude ratio.

signal is no longer the required 1/10th of the amplitude of the video i-f signal, but is practically equal to it in amplitude. Hence, when the video signal is modulated, it will momentarily drop down to 1/10th of its normal value and cause modulation of the 4.5 megacycle beat note with the 60 cycle vertical sync and blanking pulses.

Referring again to Figure 5A, should the local oscillator be mis-

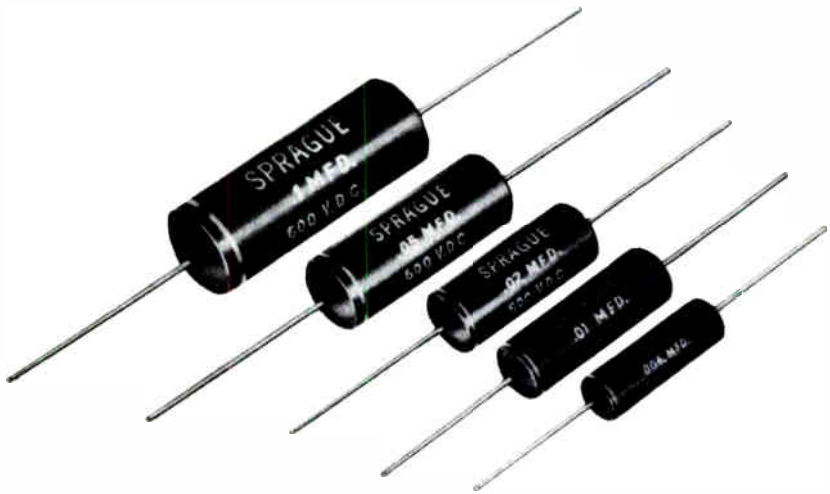

Copocitors of the types used for coupling and bypass purposes in television receivers. Poor sound quality results when such units become leaky, shorted, or open.

Courtesy Sprague Electric Co.

In Figure 5B, the curve shows the response of a video channel which is too broad. In this case, the 21.25 megacycle sound i-f

tuned until the 21.25 megacycle signal appears at point A and the 25.75 megacycle signal appears at point B on the curve, the situa-

tion will be similar to that of Figure 5B. The 10 to 1 ratio between the two signals will have been destroyed and the video buzz will be heard as a result of this mistuning.

On the other hand, if one should adjust the fine tuning control in an attempt to correct the fault of Figure 5B, the 21.25 megacycle sound i-f signal would appear at point C and the 25.75 megacycle video i-f signal would be up to point D. Often, the fine tuning control is not adjustable to this extent, and therefore, the buzz does not disappear over the tuning range. When such adjustment can be achieved, with the video carrier at point D on the response curve, the picture detail is impaired.

Hence, when the fine tuning control is adjusted, if the buzz does not disappear before the picture loses quality, it is quite probable that the video i-f amplifiers need alignment. This alignment is explained in another lesson.

Another common source of video buzz is the mistuning of the sound trap. Improper tuning of the sound trap permits some of the video signals to pass through the sound i-f channel. These video signals mix in the sound i-f amplifiers with the sound carrier to produce undesirable amplitude modulation of the sound signal.

A further source of video buzz is the overdriving of an amplifier stage when the contrast control is turned too high. Receiver owners do this on strong stations. When this control is advanced too far, it results in the over-driving of the first video i-f amplifier tube, in which case the buzz may be made to disappear by reducing the contrast to a proper level. The buzz also may be produced by the over-driving of the final video i-f amplifier tube, and often this will be due to the fact that the agc circuit is supplying inadequate bias to this tube. A fault of this kind can usually be traced to a bad agc diode, an open resistor, or a short to ground in the agc line.

If sufficient amplitude modulation of the sound signal is permitted by any of these means, the tuned circuits of the sound trap and sound i-f amplifier stages will produce phase shift of the amplitude modulation sidebands sufficient to produce **FREQUENCY MODULATION**. Once this occurs, neither the limiter nor a carefully tuned detector can reject the buzz. The only remedy available is correction of the cause of the amplitude modulation.

Occasionally, it might be found that an audio circuit lead is too close to the vertical sync circuit. Thus, the sync pulse frequency buzz is induced into the audio lead. Another cause of leak of the

sync signal is an inadequately decoupled power source. In fact, the buzz signal may exist on any of the leads from the power supply to the audio amplifier, i-f amplifier, or the local oscillators.

Finally, it is important that the ratio detector or discriminator be properly aligned to prevent video buzz from passing through the sound channel. For, even though one or more sound traps are employed, and all of the circuits are operating properly, some amplitude buzz components still exist. The complete elimination of the buzz depends on the AM rejection qualities of the sound detector, and buzz free operation is obtained only when the detector is properly tuned. Some intercarrier type receivers operate a sound i-f amplifier stage as a limiter to fur-

ther reduce the amplitude modulated interference.

It was mentioned earlier that some drift in the tuning of the sound detector circuit may occur due to changes in circuit components with change in temperature, etc. This, of course, will result in video buzz and can be corrected only by tuning the detector circuit. Although an adjustment of the fine tuning control would correct for such detector circuit drift in the dual channel type receivers, in the case of the intercarrier system, the 4.5 mega-cycle i-f beat note frequency is determined at the transmitter and tuning of the receiver local oscillator cannot be made to compensate for detector circuit frequency drift. Hence, the components used for replacement in this circuit should be stable over normal temperature ranges.

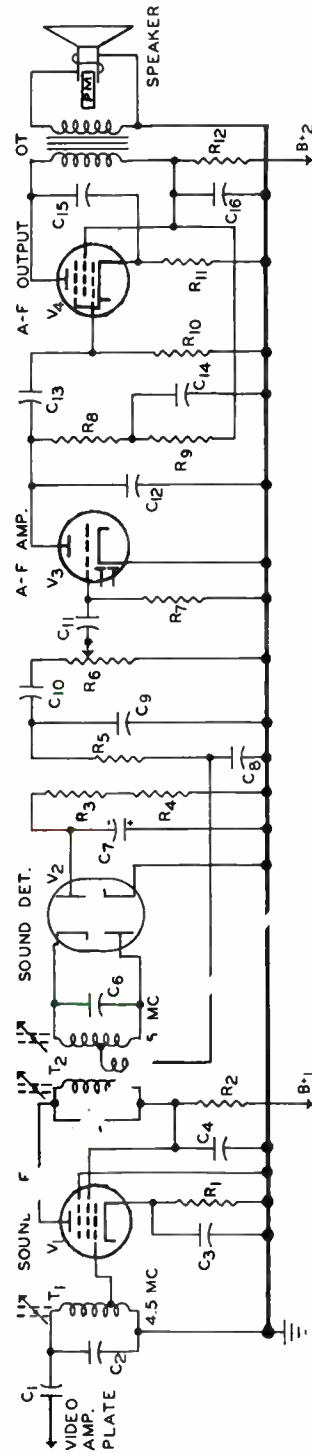

FIGURE 1

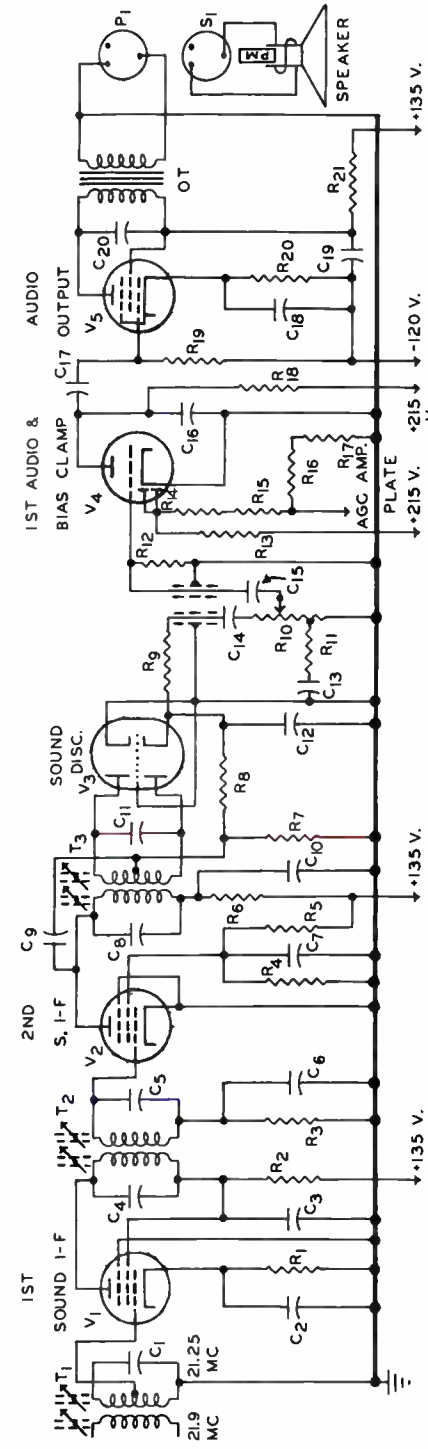

FIGURE 2

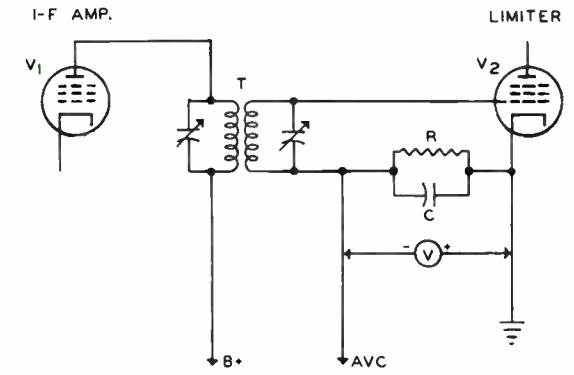

FIGURE 3

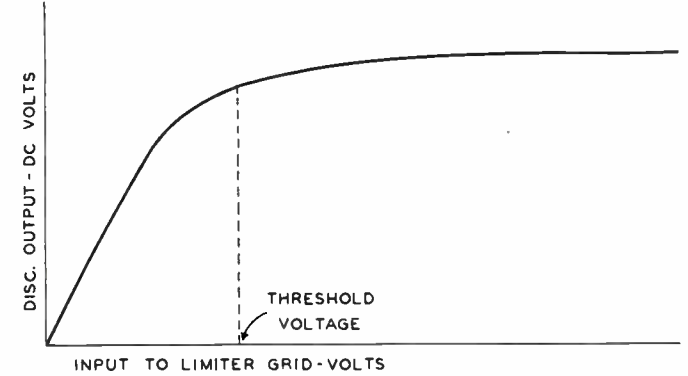

FIGURE 4

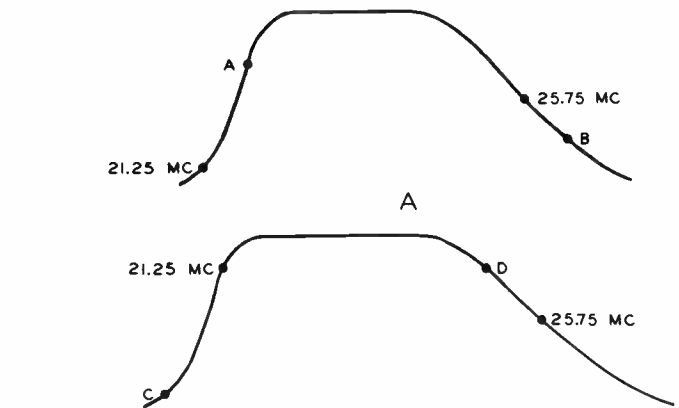

FIGURE 5

DeVRY Technical Institute

Formerly DeFOREST'S TRAINING, INC.

4141 WEST BELMONT AVENUE

CHICAGO 41, ILLINOIS

QUESTIONS

Distorted Sound—Lesson TSM-10A

Page 23

3

How many advance Lessons have you now on hand?.....

Print or use Rubber Stamp.

Name..... Student No.....

Street..... Zone..... Grade.....

City..... State..... Instructor.....

Write your answers on the "Ans." line below each question. If more space is needed use reverse side of this page.

1. What stages of the television receiver are likely at fault for normal picture and distorted sound?

Ans.....

2. In a dual receiver, between what two stages are the sound and picture i-f's separated?

Ans.....

3. Name five loudspeaker defects which cause distortion?

Ans.....

4. With regard to operating voltages, what would indicate a leaky cathode bypass capacitor C_{18} in Figure 2?

Ans.....

5. Coupling capacitor C_6 is detached from the grid of tube V_5 in Figure 2 when insufficient bias was indicated, what would be the likely fault if the bias becomes normal?

Ans.....

6. What is the normal voltage drop across an output transformer winding?

Ans.....

7. In Figure 1, what is the function of capacitor C_0 ?

Ans.....

8. In Figure 1, suppose resistors R_1 and R_0 measure correct resistance, but the voltage drop across R_0 is excessive, what component is likely at fault?

Ans.....

9. Why is it important to employ an accurate generator for tuning a 4.5 mc discriminator?

Ans.....

10. Why will a strong 60 cycle video buzz override both a limiter and a carefully tuned ratio detector?

Ans.....

FROM OUR *Director's* NOTEBOOK

CLIMBING THE LADDER

The general who leads thousands of troops was once a cadet or a buck private. The president of a large corporation probably was an office boy, junior engineer or a clerk. Practically every man who reaches the top position in his line of work has had to climb the ladder of success.

That's why it's no disgrace to start near the bottom of the ladder. The fact that you have had the benefits of D. T. I.'s training or have had some experience in this field puts you far ahead of the unskilled man, but it doesn't eliminate the need for climbing that ladder of success. It just makes climbing faster and easier.

Now I don't mean you should start by sweeping floors with the hope that you'll be placed in a job for which you are qualified. Set your sights as high as possible—but remember that you can't expect to start in the top spot.

Your employer wants to know that you're able to apply your know-how to his particular problems, and that's where training really pays off. When he finds out you CAN do the job, then he will talk in terms of higher salaries.

The important first step is to GET STARTED on the rungs of the ladder. Then keep climbing as fast as possible.

Yours for success,

W. C. De Vree
DIRECTOR



NO RASTER

Lesson TSM-11A

A-11

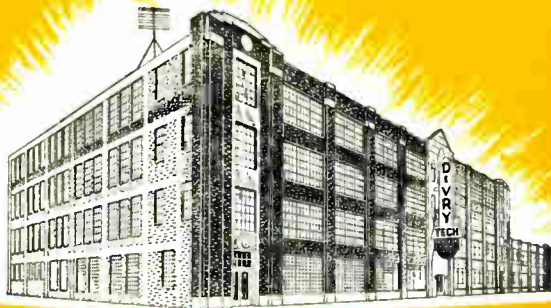

DeVRY Technical Institute
4141 W. Belmont Ave., Chicago 41, Illinois
Formerly DeFOREST'S TRAINING, INC.

TSM-11A

NO RASTER

4141 Belmont Ave.

COPYRIGHT 1955

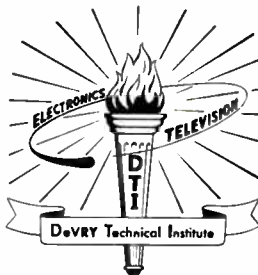

Chicago 41, Illinois



Remote control of the channel selector is provided with this combination model.
Courtesy Gorod Electronics Corp.

Television Service Methods

NO RASTER

Contents

	PAGE
Typical Faults	4
Types of No Raster Conditions	4
No Raster—No Sound	5
Question the Owner	5
Check for Shorts	7
Continuity Checks	8
No Raster—Sound Normal	9
No Light on Screen	10
Check for Shorts	11
Check High Voltage	12
Check Oscillator	13
Check Picture Tube	18
Check Picture Tube Circuits	22
Horizontal Line on Screen	24
Vertical Line on Screen	26
Single Point on Screen	27

Without arguing the point, let it be assumed that our economic system is capable of supporting a widespread television service, if it proves to be of considerable value to the community. This assumption is undoubtedly in accord with fact.

Television will contribute to our standard of living in at least three ways. First, through its cultural and educational value; second, as a source of entertainment; and finally, as an extension of our senses.

—Selected

NO RASTER

The general procedures employed in television troubleshooting were outlined and the methods of making the various types of tests were explained in the previous lessons. Although a great number of different defects can occur in a television receiver at some time or other, they all result in characteristic symptoms which may be grouped under a comparatively few headings. In addition, each of the various symptoms is the result of trouble in some specific section or sections of the receiver. Thus, to locate the defective section, the troubleshooting is started by classifying the existing symptom under one of these headings.

TYPICAL FAULTS

Any convenient grouping of troubles may be employed so long as each heading describes symptoms which differ in some respect from those described by the others. This and several lessons to follow describe the methods of troubleshooting typical receiver faults by employing the various test procedures previously explained. These faults are grouped according to the symptoms produced, as follows: No Raster, No Picture—No Sound, Distorted Picture, Ghosts, External Interference, Internal Interference, Intermittent Troubles, and Distorted Sound.

Because they are briefly worded, certain of these headings may seem to include identical troubles. However, as you know, the receiver circuits which function to produce a raster on the picture tube screen are different from those which carry the r-f, i-f, v-f, and a-f signals. Thus, although no picture can be produced when there is no raster, sound may or may not be present.

On the other hand, even though a raster is present, either the picture, sound, or both may not be produced, as indicated by the second heading. The third includes all picture distortions other than those due to reflections and interference.

Intermittent troubles are particularly hard to locate because they are present only part of the time. Therefore, troubleshooting for intermittents is taken up separately even though the symptoms are the same as those produced by most of the other troubles. Finally, distorted sound covers all defects which produce this symptom only, but not those which produce other symptoms in addition.

TYPES OF NO RASTER CONDITIONS

There are several types of defects which cause no raster condi-

tions in television receivers, and these may be placed in either of two categories, depending upon whether or not sound is present. If sound is not present, then, with neither picture nor sound, the receiver appears to be quite "dead".

If sound is present, the no raster condition may exist in any of several forms. There may be no light at all on the screen, there may be only a bright horizontal or vertical line, or, there possibly might be only a single point of light on the screen. Defects in different sections of the receiver are responsible for each type of situation. For this reason, the various no raster causes are taken up separately in the following paragraphs.

NO RASTER—NO SOUND

In any television receiver, the production of the raster on the viewing screen depends directly upon the proper operation of the deflection circuits, H.V. supply, and picture tube circuits. Also, production of sound depends directly upon the loudspeaker and all circuits which carry the sound signals. However, to produce a condition of no raster and no sound due to trouble in these circuits, there must be a defect in one of the circuits which produce the raster, and another defect in a circuit through which the sound signals pass.

Although possible, this situation is unlikely, and usually these symptoms are caused by trouble in the low voltage power supply. Because the operation of all the receiver circuits depends upon the low voltage supply; therefore, it affects the production of both raster and sound.



In this table model television receiver, the rectangular screen occupies almost the entire front of the cabinet.

Courtesy CBS-Columbia

Question the Owner

When the service technician is called to repair a television receiver for which the complaint is no picture (raster) and no sound, the owner should be questioned as to whether his receiver stopped working suddenly, or gradually, and how it performed just before it stopped, etc. His answers often provide helpful information as to the possible source of trouble. For instance, the weakening or wear-

ing out of a tube may be indicated if the sound volume and raster brightness decreased gradually before disappearing altogether.

The power switch should be checked to see whether it is turned off or has been left on. This check is mentioned because often it is puzzling to diagnose a receiver which has several defects, any one of which could cause the no signal complaint. Fortunately, most failures are caused by a single fault, but there are cases in which the original failure causes a second and perhaps a third defect.

If the power switch is turned off when the first defect occurs, others are not produced. However, the owner usually waits to see if the set will begin operating again, and then may forget to turn off the switch.

As an example, suppose an open developed in the B+ output circuit causing the receiver to stop working. With the power supply still in operation, one of the filter capacitors might become charged to an excessively high voltage, due to the low current drain from the supply, and finally break down. In turn, the punctured capacitor will permit a heavy current, and possibly result in damage to the filter choke, focus coil, filter resistor, or the rectifier tube.

To make certain the trouble is in the receiver, a check should be made at the a-c power outlet. This can be done with a neon glow tester, or by plugging in the line cord from some table or floor lamp in the room.

Before turning the receiver on, the technician should remove the safety cover from the back of the receiver, and make a quick, visual inspection of the upper side of the chassis. The accumulation of dust on the tubes and other components will indicate whether or not the receiver has been worked on recently.

Sometimes the lack of dust or presence of finger marks will contradict the owner's story that no one has touched his set. However, no matter what appears to be wrong, correction of the trouble is the serviceman's objective, and even when the owner's story is contradictory to the evidence, it is a very poor business policy to argue the point.

Instead, the serviceman should take a somewhat sympathetic attitude and encourage the owner to tell details. The complete story in conjunction with the inspection usually provides a fairly accurate history of the trouble, and while not strictly technical, information of this nature often is helpful in making a complete diagnosis and repair.

Check for Shorts

With the back cover off, it is necessary to employ an adapter cord ("cheater") with the appropriate connector to apply a-c power to the receiver. With the adapter in place, the power switch is turned on, and the L.V. supply rectifier tubes watched closely. If the plates of one or both of these tubes begin to glow, the power should be turned off immediately, for this glow indicates a short in or affecting the L.V. supply.

If the rectifier plates do not glow, the power may be left on, and a check made for the odor which indicates an overheated transformer, choke coil or focus coil. Also, odor indicates a shorted condition in the L.V. supply, regardless of whether the rectifier plates are glowing.

Figure 1 shows the low voltage supply circuit of a typical television receiver. With a short in C_1 or C_2 , in the load circuit connected to point A or B, or in a heater circuit, there is a heavy current in the corresponding secondary as well as the primary of transformer T_1 .

Moreover, in case of a short in C_2 , or in a load circuit connected to point B, the focus coil L_1 , and resistors R_1 and R_2 carry heavy currents. Finally, a short between any of the elements of V_1 or in the wiring of the rectifier tube circuit permits a heavy a-c in

this circuit, and therefore, in the primary of T_1 .

Thus, if an odor is detected, the power should be turned off immediately to prevent damage to the power transformer or other expensive circuit components. Next, unless one of the above checks indicates a short, the rectifier tube or tubes should be removed, and another check for shorted low voltage supply circuits made by taking a resistance reading, with the power off, between the cathode socket contacts for each rectifier and B-.



When it becomes shorted or leaky, a filter capacitor reduces the power supply output voltage and may thus result in loss of both raster and sound.

Courtesy Sangamo Electric Co.

Usually, B- is connected to the receiver chassis, and one ohmmeter test prod can be touched to the chassis for this check. In a receiver where the chassis is not at B- potential, the power switch may be closed, with the a-c plug out of the wall receptacle, and the ohmmeter prod touched to the plug prong which connects to B- in the receiver. The other prong

will result in a reading of "infinity". A reading of about 10,000 ohms or higher should be obtained between the rectifier lugs and B-. If a lower reading is obtained, a short very likely exists.

If the resistance check shows that no short exists, the rectifier tubes may be replaced with new tubes and the power turned on. If the no raster—no sound condition still exists, a check should be made to determine whether the heaters are lit in all tubes.

Continuity Checks

In receivers with series connected heaters, an open in the heater of one tube will prevent operation of all tubes in that series string, and may result in a no raster—no sound condition, even though the heaters are lit in tubes which are not part of the affected string. With an ohmmeter, the heater continuity should be checked for any tubes which are not lighted, or warm, in a receiver of this type.

In receivers with parallel connected heaters, other than the L.V. supply rectifiers, there is not likely to be any single tube which, when faulty or inoperative, will prevent the production of both raster and sound.

If a short is indicated by one of the checks explained above, or if the heater circuits and rectifier

tubes are in good condition and the original symptoms are still present with no short indicated, the chassis must be removed from the cabinet for further tests.

With the receiver power on and all tubes in their sockets, voltage tests of the power supply should be made to determine the magnitude of the various B voltages. Also, make a check across the heater windings of the power transformer. Any abnormal readings obtained should be followed by resistance checks of the suspected components.

In the circuit of Figure 1, checks should be made first at points A and B. If both positive voltages are correct, then checks of the heater voltages should be made. If the voltage at point A is normal, or only slightly low, and that at point B abnormally low, the trouble likely exists in the load circuits connected to point B. If the voltage reading at point A is very low, and that at point B is zero, either C₂ is shorted, or there is a short across the external load at some point on the +320v line. If the reading at point A is zero, either C₁ is shorted, or there is a short across the load circuits connected to point A.

If the reading at point B is very low, and that at point A higher than normal, there may be an open in focus coil L₁. With L₁ open, resistors R₁ and R₂ carry

all the current for the load circuits connected to point B. The increased drop across these resistors lowers the potential available at point B, and thus decreases the load currents. With less current in the $+320\text{v}$ circuits, C_1 is discharged less by these circuits, and therefore, charges to a higher average potential.

A more elaborate type of L.V. power supply is illustrated in the diagram of Figure 2. Here, circuits of rectifier tube V_2 are about the same as those of V_1 in Figure 1, except that in Figure 2, coil L_1 is a filter choke only, while L_1 of Figure 1 has the dual functions of filter choke and focus coil. A third positive voltage supply is provided by the circuits of rectifier tube V_1 in Figure 2.

As in the previous power supply, the positive output voltages at points A, B, and C should be checked first. If correct, the heater voltages should be checked. As before, troubles are indicated by absent or abnormal voltages. However, in this supply, the $+155$ volt output of the V_1 circuit is affected very little by troubles in the V_2 load circuits. Also, the $+360$ and $+340$ volt outputs are nearly independent of troubles in the V_1 load circuits.

For any L.V. supply, if both the heater and direct voltage outputs are low, either the a-c line voltage may be low, the power transform-

er primary may have shorted turns, or there may be a high resistance connection in the primary circuit. When both heater and B+ voltages are zero, there may be an open in the primary winding of the power transformer, a blown fuse, broken leads or connections, poor or no connections of the contacts of the power switch, etc.



A no raster condition results when there is an open in either of the vertical or horizontal coils of the deflection yoke.

Courtesy Triad Transformer Mfg. Co.

NO RASTER—SOUND NORMAL

There is no single section in a television receiver other than the L.V. power supply which will result in loss of both raster and sound, except where the final video amplifier tube of an inter-carrier receiver is directly coupled to a picture tube cathode. However, this defect is described later in the lesson with reference

to Figure 7. As mentioned before, defects in more than one section at the same time could cause this trouble, but this situation is unlikely. Therefore, for the following explanations of no raster conditions, we shall assume that the sound is normal in each case.

NO LIGHT ON SCREEN

When there is no light on the screen, the trouble may be due to: (1) insufficient or no high voltage on the picture tube anode, (2) a fault in the circuits which supply the other electrodes of the picture tube, or (3) a defective picture tube. Of these possibilities, the first is fairly common, relatively easy to check, and therefore should be examined first.

The high voltage for the anode is produced by a low current, H.V. supply circuit, the most common of which is the flyback type illustrated in Figure 3. Here, the entire horizontal deflection circuit is included, since it is the source of the a-c voltage applied to the plate of the H.V. rectifier V_3 . That is, horizontal oscillator V_1 develops a trapezoid voltage which is amplified and inverted by horizontal output tube V_2 . The a-c plate voltage of V_2 is stepped up by the autotransformer winding of transformer T_2 . As shown, the high voltage end of this winding connects to the plate of rectifier V_3 .

The deflection coil secondary winding of T_2 applies a higher voltage to the plate of damper tube V_4 than is needed to drive the deflection coils, and the circuit arrangement results in the production of a booster voltage across filter capacitor C_{10} . As shown, this booster voltage is applied through the fuse F_1 and resistor R_3 to the plate of V_1 , and through the fuse F_1 , the linearity coil L_1 , and the primary of T_2 to the plate of V_2 .

The alternating voltage applied to the plate of V_3 is rectified by the tube so that a high direct voltage of the polarity indicated is produced across capacitor C_{11} . Smoothed by additional filter components, R_8 and C_{12} , this high-voltage is applied to the picture tube anode as indicated.

Also, grid No. 2 of the picture tube is connected to the high a-c side of the deflection coil circuit, so that the deflection voltage is applied to this electrode, in series with the L.V. supply +290v output. With this arrangement, the negative alternations of the deflection voltage temporarily reduce the potential of the No. 2 grid, causing the scanning spot to be blanked during the horizontal return sweeps. Thus, the horizontal return traces do not appear on the screen even when the receiver contrast and brightness controls are set incorrectly.

An example of the r-f type H.V. supply is shown in Figure 4. Here, V_1 is the r-f oscillator, the output of which is coupled by transformer T_1 to the plate of rectifier tube V_2 . The rectifier action produces the required high voltage across the filter capacitor C_7 which, along with the filtering components R_4 and C_8 , applies this high voltage through a divider circuit to the proper electrodes of the picture tube.

The divider consists of resistors R_5 , R_6 , R_7 , R_8 , R_9 , R_{10} , potentiometer P_3 , R_{11} , and a parallel section. Each branch of the parallel section contains a plate load resistor and tube, $R_{12}V_3$ and $R_{13}V_4$ respectively, of the vertical deflection circuit output stage. Finally, the divider circuit is completed from the cathodes of the vertical amplifier tubes, through the L.V. supply circuit to ground.

In parallel with series resistors R_5 and R_6 , the respective vertical and horizontal centering controls are connected so that opposite deflecting plates can be made negative or positive with respect to each other, but all four plates are at approximately the same potential as the anode of the picture tube.

Check for Shorts

With a receiver using either of the above types of H.V. supplies, when the complaint is no light on the screen (no raster—sound

normal), one of the questions that is asked of the owner is whether he heard a sound that may be interpreted as arc-over, or smelled something burning when the receiver was used last. If so, then the receiver should not be turned on, but resistance tests should be made to check for a short in the H.V. supply circuit.

If neither of the above indications were noted, the receiver may be turned on, and a check made for these symptoms as well as for the existence of red hot plates in any of the rectifier tubes. Checks for shorts should be made with the power off, if any such symptoms appear. If they do not, the power may be left on, and the brightness control rotated to its maximum setting while the receiver screen is observed for any visible trace or glow. Also, the screen is observed while the centering controls are rotated through the entire range of adjustment. If no indication of light or raster is seen, these controls are reset to the approximate mid-positions.

With the power turned off, the back is removed from the receiver cabinet, and the cover removed from the H.V. supply shield can. With the power turned on, the high voltage rectifier heater should glow if the proper a-c values are present in the primary and heater windings of the hori-

zontal output or r-f supply transformer.

Check High Voltage

This glow may be present, but with reduced intensity, if some defective condition is causing lower than normal currents in one or both of these windings. The proper intensity of the rectifier heater glow will be learned by experience, but a rough check can be made by turning off the power, shorting the rectifier cap connector to ground, removing the cap connector and the tube, and applying a 1.5 volt dry cell to the heater pins of the tube. The glow produced in this way indicates approximately the normal intensity.

If no glow is obtained with the dry cell, the rectifier heater is open. A new tube should be placed in the receiver, the cap connector replaced and, with the power on, the heater of the new tube should be watched carefully.

If the heater glow becomes too bright, the power should be turned off, and a check made to determine whether the transformer heater winding has moved from its correct position. If this winding is not in the proper location, it may be over coupled and producing too much current in the rectifier heater.

If the heater glow is dim, this winding may be so loosely cou-

pled that the reduced heater current cannot produce sufficient emission for proper operation of the rectifier tube.

If this heater does not glow at all when the receiver power is turned on, a check of the horizontal output transformer fuse should be made at this time if this unit is located in the high voltage cage. In the circuit of Figure 3, the fuse, F_1 , is located electrically between the cathode of V_4 and the horizontal linearity coil L_1 . Physically, this fuse may be either above or below the chassis. On the other hand, many receivers are not fused at all in this circuit.

When a fuse is blown, replace it with another of the same current rating and turn the receiver power on. If the new fuse blows, checks for other troubles should be made before any more fuses are inserted. If it does not blow, operation of the receiver may be restored but should be observed for a period of time.

When the original fuse is found to be good, the high voltage rectifier tube should be replaced. If this does not correct the trouble, and the rectifier tube heater glows when checked with a dry cell as explained above, but not when the tube is in the receiver, a neon bulb should be held near the rectifier plate cap with the receiver power turned on. The neon bulb will glow if the high a-c voltage



A television receiver, FM and AM radio receivers, and a phonograph with 3-speed record changer are included in this combination.

Courtesy Stewart-Warner Electric Div., Stewart-Warner Corp.

is being applied to this cap; that is, if the horizontal deflection circuit or the high voltage r-f oscillator is operating, whichever is employed in the receiver being serviced.

Check Oscillator

With receivers having flyback type high voltage supplies, ab-

sence of a glow in the neon bulb indicates trouble in either the horizontal output circuit, horizontal oscillator circuit, or the deflection coil and damping tube circuit. In any convenient order, the tubes in these circuits, V_1 , V_2 , and V_4 , Figure 3, should be replaced. If the no raster condition still exists, the d-c operating voltage

at the plate cap of the horizontal output tube should be checked.

If a zero reading is obtained, the power should be turned off, and a resistance test made from the plate cap of the output tube to the B+ end of the output transformer primary. In the circuit of Figure 3, this check could be made with the ohmmeter prods at the plate cap of V_2 and the positive plate terminal of C_9 . The correct resistance is given in the service manual for each individual receiver; usually it is between 20 and 200 ohms.



The picture tube can be the cause of a no raster condition. However, all other possible causes should be investigated before this relatively costly item is suspected.

Courtesy Rodio Corporation of America

When the proper voltage is found at the plate cap of the horizontal output tube, the d-c voltage at the plate cap of the high voltage rectifier should be checked. A

zero or low reading here indicates an open or high resistance in the upper portion of the autotransformer winding of T_2 , Figure 3. This possibility may be checked by making a resistance test from the plate cap of V_2 to the plate cap of V_3 .

Again the correct values are given in the various service manuals, and usually are less than 500 ohms. If the resistance reading obtained is considerably higher than the specified value, or is infinite, for either this check or the one explained above, the output transformer should be replaced.

With receivers having r-f type high voltage supplies, such as that of Figure 4, absence of a glow in the neon test bulb indicates trouble in the high voltage r-f oscillator circuit. The oscillator tube should be replaced, and if the trouble is not corrected, continuity checks of the various windings of the h-f transformer should be made. The high voltage secondary winding may be checked by placing one ohmmeter test prod on the V_2 plate cap, Figure 4, and the other on the receiver chassis.

In some receivers, the high voltage r-f oscillator feedback arrangement consists of a spring or tinfoil band which encircles the high voltage rectifier tube and is connected directly to the oscilla-

tor tube grid. This arrangement provides capacitive feedback, and if the spring or band is incorrectly positioned on the rectifier, the amplitude of the oscillations may be greatly reduced, or the oscillations may stop altogether. Therefore, the position of this element should be checked.

When its correct position is not specified in the service manual, the spring or band should be moved to different positions in an effort to increase the amplitude of the oscillations, after noting the point at which it is located originally. If this moving does not increase oscillations in the circuit, the feedback element is returned to its original position.

Whenever any such adjustments or changes of any kind are to be made in the high voltage supply, the power should be turned off first and the high voltage filter capacitors discharged with a heavily insulated shorting wire.

For receivers with either type of high voltage supply, if the high voltage rectifier heater glows with proper intensity when the power is turned on, the high voltage supply may be operating properly, or there may be trouble in the output circuit of the supply.

The position of the ion trap magnet should be checked, and slight adjustments made in an effort to obtain light on the

screen. A magnet in a wrong position or one that is weak can prevent a raster from appearing on the screen. Test the magnet with a screwdriver. If the attraction seems weak, try a new magnet.

Whether or not the rectifier heater glows, if the neon test bulb glows when held near the rectifier tube plate cap, it will be necessary to make a high voltage measurement to determine whether the proper high voltage is produced by the supply and applied to the anode of the picture tube.

With a kilovoltmeter, or voltmeter and multiplier probe, the potential at the picture tube anode should be measured in the manner explained in the lesson on test procedures. As mentioned in that lesson, extreme caution should be observed when any high voltage measurements are made, as well as when any other work or testing is performed with the receiver high voltage circuits in operation. Occasionally, shorted wiring or defective components will result in the presence of high voltage at points in the receiver which are not at high potential normally. Thus, a high voltage shock may be obtained even though contact is not made directly with the high voltage supply circuits.

When insufficient or no high voltage is present at the picture



Rectifier tube of the type most employed in the flyback H.V. supply of television receivers. When this tube is defective, no voltage is applied to the second anode of the picture tube, and consequently no raster appears on the screen.

Courtesy Radio Corporation of America

tube anode cap, the power should be turned off, the H.V. filter capacitors discharged, and a resistance check made from the high

side of the input filter capacitor to the picture tube cap connector which has been removed from the anode cap.

In the circuit of Figure 3, C_{11} is the input filter capacitor, therefore, this measurement will include the resistance of R_n . In supplies of this type, the filter resistor usually has a resistance of about 1 megohm but, in each case, the schematic diagram and part values list should be checked for the receiver under test. Since practically all of the a-c component of the H.V. supply output is attenuated across this resistor, internal arcing and radical changes in resistance are common in this unit.

If the test shows the resistance of R_n , Figure 3, to be considerably changed, the unit should be replaced by two or three series resistors, the total of which approximately equals the correct resistance of R_n . For example, if $R_n = 1$ meg, it may be replaced by two half-meg units, or three resistors of 330,000 ohms each. With this arrangement, the a-c voltage across each resistor is only half or one-third the total a-c voltage component of the supply.

In the circuit of Figure 4, C_7 is the input filter capacitor, and in this case, the resistance check includes resistors R_4 and R_5 . If

replacement of either of these resistors is necessary, the correct values must be adhered to closely, because both units are in series with the H.V. divider, and it is necessary that the various voltage drops are correct so that the proper operating voltages are applied to the picture tube and deflection amplifiers.

For both types of supplies, if the above resistance check is satisfactory, the input filter capacitor should be disconnected, and the voltage checked at the picture tube end of the H.V. anode lead. When no change is noted, make a measurement with the output filter capacitor disconnected. If d-c voltage exists at the cap connector, or is higher than before, when either capacitor is disconnected, replace the capacitor with a new one.

With receivers having a glass picture tube with an external conductive coating, this coating serves as the grounded plate of the H.V. output filter capacitor. With the receiver power off, a reading of less than 5,000 ohms should be obtained when one ohmmeter test prod is touched to the picture tube coating and the other to the chassis.

In the event the neon test bulb glows, but the H.V. rectifier heater does not, although the latter glows properly when tested with

a dry cell, the rectifier tube should be removed and an ohmmeter used to check the continuity of the rectifier heater circuit. For this test, the test prods may be inserted into the rectifier heater socket terminals. This reading should be on the order of two or three ohms when the circuit contains the H.V. transformer heater winding only, as in Figures 3 and 4. However, in some receivers a current limiting resistor is employed in series with this winding, and generally has a resistance of 3 to 5 ohms.

If the reading is abnormally high, and the current limiting resistor is available above the chassis, the ohmmeter test prods should be placed at either terminal of this resistor to check its resistance. If this unit has opened or increased in resistance, it should be replaced. If the current limiting resistor checks good, or none is used in the circuit, and the heater winding is correctly positioned, the winding is probably open, and the H.V. transformer should be replaced.

When the correct high voltage is present at the picture tube anode cap, then the picture tube socket should be removed, voltage measurements made at the control grid, cathode and second grid terminals, and the readings checked against the voltages specified in the service manual. An

incorrect value indicates trouble in the corresponding circuit.

If all voltages are correct at the various picture tube electrodes, then a check of the picture tube itself should be made.



Table model television receiver employing a 20-inch rectangular picture tube.

Courtesy The Hallicrafters Co.

Check Picture Tube

Even though the various checks described above may seem to have eliminated every possible trouble except a defective picture tube, it is a good idea to make sure this tube is faulty before condemning it. Picture tubes are relatively costly items compared to other tubes and components in the receiver. Also, completion of the service job must wait a period of time when a new tube of the type required is not readily available.

Finally, although a fair percentage of receiver troubles are due to defective picture tubes, it is still more likely that any given no raster condition is caused by other circuit or component defects than by the picture tube. When a good picture tube of the type used in the receiver is on hand, the check simply consists of substituting the good tube in the receiver and noting whether the trouble is corrected.

However, if such a replacement tube is not at hand, then the suspected tube can be checked by means of a 0-1 d-c milliammeter mounted on an insulating panel as shown in Figure 5, a jumper cable like that shown in Figure 6, a kilovoltmeter, and a voltmeter.

For the meter of Figure 5, the panel may be of lucite and of such dimensions that there is a minimum of two inches between the meter and edge of the panel. The base and back may be made of bakelite. Insulated crocodile or alligator clips should be connected to the ends of the 30 kv type test leads, and a $.1 \mu\text{fd}$ 500 volt mica capacitor should be connected across the meter terminals to prevent damage to the meter by surge currents.

For the jumper cable of Figure 6, color coded wires should be connected from the indicated ter-

minals of a duo-decal type picture tube socket to the corresponding base pins of a duo-decal base from a discarded picture tube. This type base is employed with almost all picture tubes now in use, although similar jumpers for other type bases can be made as needed. Approximately a half inch of insulation should be removed from each wire of the cable, the bared points being "staggered" to prevent shorting.

To check the picture tube, the tube socket is removed, and the socket of the jumper cable connected to the tube base. The jumper cable base is inserted in the picture tube socket of the receiver. The positive test lead of the voltmeter is connected to the bare section of the jumper cable wire from socket terminal No. 10, the negative lead to the bare section of the wire from terminal No. 11.

The positive test lead of the kilovoltmeter is connected to the anode cap connector of the H.V. lead, and the negative test lead to the receiver chassis. The positive test lead of the milliammeter is clipped to the connector of the receiver H.V. lead, and the negative test lead to the anode cap of the picture tube.

With the contrast and brightness controls at minimum settings, and the receiver power turned on, the kilovoltmeter

should read about 8,000 volts for most 10 inch picture tubes, about 10,000 volts for most 12 inch tubes, 12,000 volts for the 16 inch tubes, 14,000 volts or more for the 19, 20, and 21 inch tubes. This increase continues with the size of the tube until 22,000 volts are required with the 30BP4.

Important exceptions are tubes using electrostatic deflection, and the tubes used in projection type receivers. The voltmeter should indicate a second grid potential of at least 225 volts for practically every type of picture tube, and the milliammeter should indicate zero anode current.

In the event a very high anode current is indicated, and cannot be reduced by adjustment of the brightness control, a check should be made of the control grid-cathode bias voltage. By rotating the brightness control, it should be possible to vary this bias from zero to its maximum negative voltage, as specified in the service manual. A check of the socket connections should be made also, and if these connections are good and the grid bias correct, the tube is likely gassy and should be discarded.

If the correct milliammeter reading of zero is obtained with the above control settings, the brightness control should be advanced until a reading of .2 ma is indicated in the anode circuit.

The ion trap magnet should be adjusted as soon as the anode current is equal to .1 ma.

When the current has been increased to .2 ma, the kilovoltmeter should indicate an anode voltage of about 7,000 volts for 10 inch tubes, 8,500 volts for 12 inch tubes, 9,000 volts for 16 inch tubes, and 10,000 volts for 19 and 20 inch tubes. The second grid voltage should not drop below 220 volts when the brightness control is advanced to the .2 ma anode current point.

When all the voltages are correct, but an anode current of at least .2 ma cannot be obtained within the range of the brightness control rotation, the tube should be returned to the manufacturer for adjustment. Should the .2 ma reading be obtained, but there is a weak or no raster produced, check to determine whether the grid-cathode bias approaches or reaches zero at maximum setting of the brightness control. If it does not, the tube is partially cut off due to a defect in the grid or cathode circuit. Also, a re-check of the setting of the ion trap magnet should be made, or a new magnet substituted.

In the event the anode current suddenly snaps off scale soon after the brightness control advance is started, a check of socket connections should be made and,

if correct, a gassy picture tube is indicated.

When the various above tests indicate the trouble to be located in a circuit beneath the chassis, or do not locate the defect, the chassis will have to be removed from the receiver cabinet for further tests. If the defective stage or circuits have not been indicated previously, this information may be obtained by measuring the d-c voltage at the cathode of the damper tube, V_4 , Figure 3, in receivers with flyback type H.V. supplies.

Any defect in the horizontal oscillator or amplifier circuits will result in lower than normal voltage at the damper cathode. If the voltage is correct at this point, the defect must be in the H.V. circuit proper, therefore additional voltage and resistance tests should be made of the components, leads, and connections in this circuit.

If the voltage at the cathode of V_4 is lower than normal, check the fuse, F_1 , if it has not been checked previously. If the fuse is good, or none is employed in the receiver, check the voltage from grid to cathode of the horizontal output tube, V_2 , Figure 3. This value may be anywhere from about -12 to -70 volts, depending upon the receiver model. In some cases, a cathode resistor is employed, and the ab-

solute grid-to-ground and cathode-to-ground voltages, specified in the service manual, must be added to obtain the total correct grid-to-cathode bias.

If the reading obtained is very low or zero, the voltage at the grid of the horizontal oscillator, V_1 , should be checked. Again depending upon the receiver model, this voltage may be between about -20 and -80 volts. If this oscillator grid bias is zero or abnormally low, the circuit is oscillating improperly, or not at all. Hence, other voltage and resistance tests should be made in this circuit to locate the defect.

When the voltage reading is correct at the grid of V_2 , then voltage and resistance tests should be made in the amplifier circuit. To check the screen bypass capacitor, this unit may be bridged with another capacitor of equal size and rating. If the V_1 and V_2 plate voltages are not correct, the booster circuit capacitor C_{10} should be checked, as well as the linearity circuit coil L_1 and capacitor C_9 .

The horizontal oscillator may be operating, but producing an output which does not have the correct wave-form. To check this possibility, an oscilloscope should be employed as described in a previous lesson to make wave-form checks in the horizontal deflection circuit. If the wave-form

is incorrect at the grid of V_1 , Figure 3, and all voltage and resistance readings are correct, transformer T_1 should be replaced. If the wave-form is correct at the grid of V_1 , but incorrect at the grid of V_2 , checks or successive replacement of the various components between the V_1 plate and V_2 grid should be made.

Finally, if all components, voltages, and resistances have been checked in the horizontal deflection and H.V. output circuits, and found to be correct as far as test meter readings and wave-form tests are concerned, and there still is no high voltage at the picture tube anode cap, the horizontal output transformer should be replaced. Even though a resistance test of this unit shows a correct reading, proper operation may be prevented if there is only one shorted turn such as can be caused by internal arcing.

For receivers with r-f type H.V. supplies, such as that of Figure 4, voltage and resistance tests should be made in the oscillator circuit if either the V_2 heater or the check with the neon bulb has indicated the oscillator to be inoperative, or weak. First, a high resistance voltmeter should be employed to check the control grid to cathode voltage of V_1 . If this bias is low or zero, it indicates that either the circuit is

oscillating only weakly, or not at all.

When previous checks have indicated the H.V. oscillator to be operating, but there is either incorrect or no high voltage at the picture tube anode, then tests should be made in the rectifier output circuit, and when electrostatic deflection is employed as in Figure 4, these tests should include certain of the divider circuit components. For example, an open in R_5 would cause a considerable reduction in the potential applied to the picture tube anode, since the anode would then be supplied through R_6 from the junction between P_1 , P_2 , and R_7 .

Also, if R_6 were open, there would be no bleeder current in R_5 and R_6 , and the voltage applied to the picture tube anode would be higher than normal. However, having higher resistances than R_5 and R_6 , the centering controls P_1 and P_2 will have a greater voltage drop across them, so that lower than normal voltages will be present at all lower points in the divider circuit. Operating at this lower potential, the picture tube focusing electrode may reduce the scanning beam intensity sufficiently to cause a weak or no raster condition.

An open in R_7 , R_8 , R_9 , R_{10} , or the upper portion of P_3 would

result in zero voltage on the picture tube focusing electrode, thus causing a no raster condition. Also there would be no bleeder current, and the reduced voltage drop across R_5 would result in a higher than normal potential on the picture tube anode.

When voltage checks at the picture tube socket terminals have shown an incorrect voltage to exist at the cathode, control grid, or second grid, then further tests of voltage and resistance should be made in the picture tube circuit after the chassis has been removed from the cabinet.

Check Picture Tube Circuits

Examples of television receiver picture tube circuits are shown in Figures 7 and 8. In Figure 7, tube V_1 is the video output amplifier, from the plate circuit of which the 4.5 mc sound i-f signal is coupled by transformer T_1 to the sound i-f amplifier, while the video signal is coupled to the cathode of picture tube V_2 by means of the low-pass filter consisting of coils L_1 , L_2 , L_3 , associated circuit capacitances, and resistors R_3 , R_4 , and R_5 .

The cathode of V_2 is supplied its operating potential through L_3 and R_5 from the junction between L_1 and L_2 . With the exception of an open between this point and $B+$, anything that prevents or reduces the V_1 plate

current causes this junction and the V_2 cathode to be abnormally positive because of the reduced voltage drops across R_4 and L_2 . With the picture tube cathode too positive, and the control grid at its normal potential, the grid-cathode bias may be increased sufficiently to cut off the beam and thus result in no raster on the screen. Also, in this receiver, if the current through V_1 is reduced sufficiently, there will be no sound.

In the circuit of Figure 7, the no raster condition can be caused by a defect in V_1 , an open in R_1 , L_1 , or the primary of T_1 , a short or leakage in C_1 , increase in resistance of R_1 or R_2 , or high resistance connections in the plate or screen circuits of V_1 .

The control grid of V_2 is supplied its operating voltage from the slider on brightness control P_1 , and any open in R_6 or in P_1 to the right of the slider causes the full -90 volts to be applied to the grid, cutting off the beam. Increase in the resistance of R_6 may make the voltage drop across this resistor so great that it is impossible to reduce the grid-cathode bias sufficiently by adjusting P_1 to permit normal operation of V_2 .

Operating voltage for the V_2 second grid is obtained from the junction between resistors R_7 and R_8 , as shown. These resistors

form part of a voltage divider from the booster circuit positive terminal to ground, the remaining components of which are resistors R_9 and R_{10} and the horizontal deflection coils. Therefore, trouble in the booster circuit or in any part of this divider results in an incorrect operating voltage, or no voltage, on the second grid of V_2 . Also, this voltage will be abnormally low or zero if capacitor C_5 is leaky or shorted.

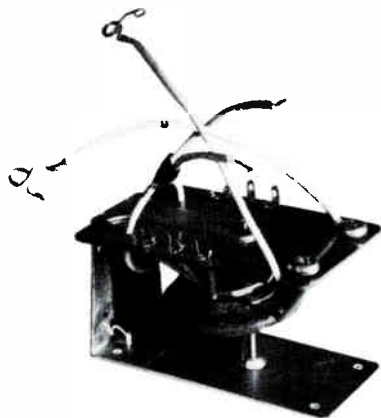

When the flyback transformer is defective a no raster condition may result.

Courtesy Allen B. Dumont Labs., Inc.

In the circuit of Figure 8, the video signal is coupled through capacitor C_5 from the plate of video output tube V_1 to the grid of picture tube V_3 . Tube V_2 and its associated components serve as a d-c restorer and also as a sync pulse clipper. The conduc-

tion of V_2 during sync pulse intervals results in the production of negative-going pulses across R_{10} and C_7 , and these pulses are applied to the input of the sync amplifier, as indicated in the Figure.

There is a d-c path from the V_3 grid, through R_7 and R_8 to ground. However, between sync pulses, electrons flow from ground up through R_8 and R_7 to the negative plate of C_5 , and produce a voltage drop across these resistors such that the upper end of R_7 , and therefore the grid of V_3 , is positive with respect to ground.

This positive potential on the V_3 grid depends upon the applied video signal and the d-c restorer action. However, the grid to ground voltage is only a few volts, and the major part of the grid-cathode bias is obtained by means of the cathode connection to the slider on potentiometer P_1 , which point is positive with respect to ground. Therefore, in the circuit of Figure 8, defects in the video output stage do not affect the picture tube grid-cathode bias sufficiently to cut off the beam and cause a no raster condition.

On the other hand, failure of the d-c restorer tube, V_2 , will prevent the proper discharge of C_5 during sync pulse intervals, and at low bias settings of P_1 ,

the positive portions of the video signal may swing the grid of V_3 positive to produce cathode to grid electron flow and, therefore, develop grid-leak bias across R_7 and R_8 of sufficient magnitude to cut off or partially cut off V_3 .

As in the circuit of Figure 7, any defects in the voltage divider $R_{12}P_1R_{13}$, Figure 8, will change the operating voltage applied to the V_3 cathode, and if this voltage is made sufficiently positive, the scanning beam is cut off, resulting in no light on the screen. Finally, the second grid is supplied through R_{11} . When this resistor is open it removes the operating voltage from this grid, and thus result in a no raster condition.

HORIZONTAL LINE ON SCREEN

Whereas the no light on screen symptom explained above may be due to troubles in any of several sections of the television receiver, each of the other types of no raster-sound normal troubles are due to a defect in only one specific section. Of these, the most common is the case in which a single horizontal line of light is present on the viewing screen.

A horizontal line of light on the screen is the result of a fault in the vertical deflection system. When this symptom is encountered, the height or vertical

size control should be adjusted first in an attempt to obtain vertical deflection. If this adjustment does not correct the trouble, a similar adjustment of the vertical linearity control should be made. Finally, the height, vertical linearity, and vertical hold controls should be adjusted throughout their ranges to determine whether vertical deflection can be obtained at some setting of these controls. If any vertical deflection is obtained, it may indicate the nature of the existing defect.

When none of these adjustments result in a deflection, the controls should be set approximately at their mid-positions, and the vertical oscillator, discharge, and output tubes replaced in succession. If the control adjustments or tube replacements have not corrected the trouble, the chassis must be removed from the cabinet for further tests.

At various points in the vertical deflection circuit, the voltage wave-forms should be checked with a CRO. If an oscilloscope is not on hand, a headphone may be employed to check for the presence of the 60-cycle vertical deflection voltage. In series with a $.1 \mu\text{fd}$ capacitor, the headphone is connected from the grid of the vertical output tube to ground. When the vertical oscillator is



A small size service type oscilloscope which is suitable for checking voltage wave-forms in deflection circuits during troubleshooting work in the home.

Courtesy Waterman Products Co.

operating, a low-pitched, 60-cycle buzz is produced in the headphone. If this buzz is not heard, voltage and resistance checks should be made in the oscillator circuit to locate the trouble.

When the buzz is heard, the headphone test leads should be connected across the secondary winding of the vertical output transformer. Should the buzz not be heard here, voltage and resistance checks of the output stage should be made, including the transformer. If the test with the headphone shows the vertical deflection voltage to be present across the output transformer secondary, resistance checks should be made of the vertical deflection coils as well as any components connected across these coils.

In the event the buzz or low-pitched tone in the headphone is very weak so that there is doubt about whether the desired deflection voltage is present in the circuits under test, a cathode ray oscilloscope must be used to check the voltage wave-form at the points mentioned above, and, if necessary, at the grids of the vertical oscillator and discharge tubes.

VERTICAL LINE ON SCREEN

A single vertical line of light on the television receiver screen is caused by a defect in the horizontal deflection circuit such that the desired sawtooth current is not present in the horizontal coils of the deflection yoke. With receivers employing flyback type

high voltage supplies, a horizontal deflection circuit defect which prevents production of the deflection current also will result in a no high voltage condition. Therefore, the scanning spot isn't produced on the viewing screen and a single vertical line of light cannot be formed in the case of a receiver of this type.

However, in any receiver which employs a high voltage supply other than the flyback type, the existence of the scanning spot does not depend upon the operation of the horizontal deflection circuit, and a single vertical line on the screen results when no horizontal deflection voltage or current is produced.

When this symptom is present, adjustments of the horizontal size, drive, linearity, and hold controls should be made to correct the trouble or produce some amount of horizontal deflection. If these adjustments do not provide proper operation, the horizontal oscillator, discharge, and output tube should be replaced, one by one, and any change in deflection noted. The nature of the trouble may be indicated by the type of deflection produced by the adjustment of the controls, or by the change in this deflection when the new tubes are substituted in the receiver.

If the trouble is not corrected by the above checks, the chassis

should be removed and an oscilloscope or a headphone employed to determine whether the horizontal deflection voltage is present at various check points in the circuit, in the same manner described above for the vertical deflection circuits. As the horizontal deflection voltage has a frequency of 15,750 cps, the headphone produces a high-pitched note. If the high note is heard, it indicates the deflection voltage is present. However, due to its high frequency, the deflection voltage may be beyond the response range of the headphone used. Also, the frequency of 15,750 cycles may be above the upper limit of the range over which the ear is responsive. Therefore, the fact that the note is not heard should not be considered conclusive evidence that the deflection circuit is inoperative. If the test does not provide conclusive indications, wave-form checks with an oscilloscope must be made in the horizontal deflection circuits. When the above checks have isolated the trouble to a single stage, voltage and resistance tests should be made in this stage to locate the defect.

SINGLE POINT ON SCREEN

A rarely encountered symptom, a single point of light, is produced on the receiver screen only when some defect causes inoperation of both vertical and horizontal de-

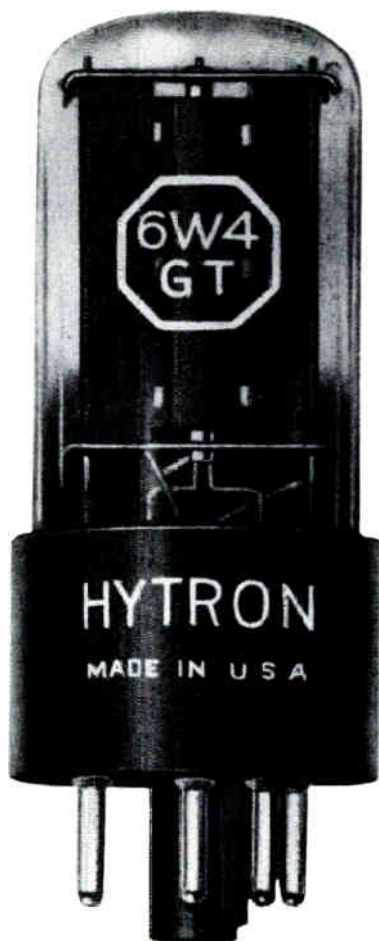

One type of rectifier commonly employed as a damper tube in horizontal deflection circuits. A defective damper can result in a no raster condition.

Courtesy Hytron Radio & Electronics Corp.

flection circuits, or two defects exist simultaneously, one in each of these circuits. Furthermore, since the presence of the spot depends upon the operation of the horizontal deflection circuit in re-

ceivers with flyback high voltage supplies, the single point of light symptom rarely exists in receivers of this type.

Two simultaneous defects (one in the vertical and one in the horizontal deflection circuit) are very unlikely. Therefore, after checking the adjustment of the various deflection circuit controls, the schematic diagram of the receiver should be studied to determine the location of the few components or connections, if any, which can affect the operation of both deflection circuits, but not the sound signal circuits.

When this trouble does exist, it is most likely due to a defect in some circuit by means of which operating voltage or heater current is supplied to some part of both deflection circuits. Most defects of this type are found in the

receivers which employ more than one low-voltage supply, or in which the tubes have series connected heaters.

Of course, if sound signal circuits are affected by the defect in the d-c supply or heater circuit, the single point of light symptom may be accompanied by a no sound condition. In any case, when a single point of light appears on the screen, voltage and resistance checks should be made in circuits in which a defect could affect both deflection circuits only, before a search is made for more than one defect.

The "no raster" condition is only one of the several troubleshooting problems encountered in television servicing. The following lessons explain how similar troubleshooting techniques are employed to find other common faults.



DeVRY Technical Institute

Formerly DeFOREST'S TRAINING, INC.

4141 WEST BELMONT AVENUE

CHICAGO 41, ILLINOIS

QUESTIONS

No Raster—Lesson TSM-11A

Page 31

3

How many advance Lessons have you now on hand?

Print or use Rubber Stamp.

Name Student No.

Street Zone Grade

City State Instructor

Write your answers on the "Ans." line below each question. If more space is needed use reverse side of this page.

1. What are the two categories of "no raster conditions"?

Ans.....

2. When servicing a "dead" television receiver, what circuits should be checked first?

Ans.....

3. What is the most common fault of "no light on the screen"?

Ans.....

4. In the circuit of Figure 3, what voltage source provides blanking of the horizontal return traces?

Ans.....

5. In high voltage power supplies of the flyback or r-f type what observation of the rectifier tube indicates an a-c voltage in the transformer?

Ans.....

6. What simple test procedure may be employed to determine the presence of high a-c (rectifier) supply voltages on the rectifier plate?

Ans.....

7. If measurements show the proper high voltage is developed by the power supply but there is insufficient high voltage at the anode of the picture tube, what component is probably at fault?

Ans.....

8. What measurement can be made to determine whether a picture tube is gassy?

Ans.....

9. If a single horizontal line of light is observed on the screen, in what section does the fault occur?

Ans.....

10. Besides an oscilloscope, what simple test circuit arrangement may be employed to determine whether or not the vertical horizontal oscillators are operating?

Ans.....

TSM-11A

FROM OUR *Director's* NOTEBOOK

PROFESSION OR TRADE?

Is the TV-Radio technician a skilled tradesman or a professional man? The dictionary says he can be either one, but you'll be much better off if you put your work on a professional basis.

Here's why:

When a tradesman completes his training or apprenticeship, he needs only a blueprint or other specific details to carry out a required job. He works almost entirely with his hands, using "cut and try" methods of repair.

However, the professional man's training also provides him with the broad principles of his field, teaches him to work with his HEAD as well as his hands, and gives him the ability to find specific data when needed.

In contrast to the mechanic, the professional service technician delves into fundamentals, makes tests and measurements and solves the problem with "headwork"—in much the same way as a doctor when he diagnoses illness.

When you charge for the work you do with your hands, you compete with every hourly wage laborer on a price basis. When you charge for the work at your BRAIN there is little competition. The ceiling for earnings is fixed only by your ability, honesty, and fairness.

Yours for success,

W. C. DeVry

DIRECTOR

TSI

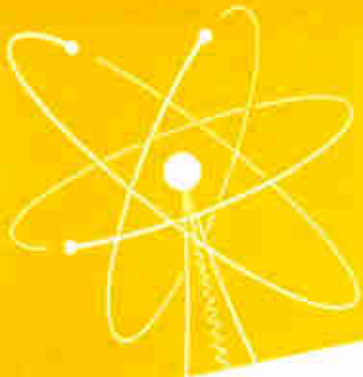

**NO PICTURE
NO SOUND**
Lesson **TSM-12A**

-12

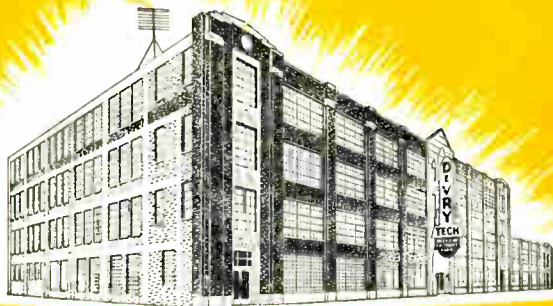

DeVRY Technical Institute
4141 W. Belmont Ave., Chicago 41, Illinois
Formerly DeFOREST'S TRAINING, INC.

TSM-12A

NO PICTURE—NO SOUND

4141 Belmont Ave.

COPYRIGHT 1955

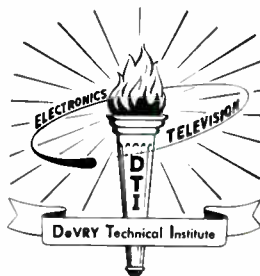

Chicago 41, Illinois



This blond mahogany cabinet houses a television receiver, AM and FM radio receivers, and a phono player.

Courtesy Majestic Radio & Television Div. of The Wilcox-Gay Corp.

Television Service Methods

NO PICTURE—NO SOUND

Contents

	PAGE
No Picture—Sound Normal	4
Dual-Channel Receiver	6
Intercarrier Receiver	9
Stationary Retrace Lines	10
No Sound—Picture Normal	11
Dual-Channel Receiver	11
Intercarrier Receiver	13
No Picture or Sound	14
Dual-Channel Receiver	16
Intercarrier Receiver	19

Television commands 100% active attention from its audience, as against a given percentage of passive attention received by many other media. Out of a given potential audience, television will often obtain a higher actual audience than sound programs because television, having sight, sound, motion and immediacy, has more appeal than sound alone. In addition, there are fewer simultaneous television programs on the air to split the audience.

—Electronics

NO PICTURE—NO SOUND

In a television receiver, the raster on the viewing screen is produced by the action of the receiver deflection circuits, and therefore, its existence does not depend upon the operation of the various signal circuits. Providing the various components and connections in the power supplies, deflection circuits, and picture tube circuits are in proper operating condition, a raster will appear on the receiver screen whether or not a signal is being received, or whether or not it is being passed properly by the signal circuits.

Hence, even with a raster present on the screen, one of several no-signal conditions may exist. There may be no picture produced, although the sound is normal, neither picture nor sound may exist, or the raster cannot be synchronized. The line and field scanning rates of a particular station must be received, passed by the signal circuits of the receiver, and the detected sync pulses applied to the inputs of the sync and deflection circuits.

Since the particular circuits in which defects can cause these conditions differ in the dual-channel or intercarrier type receivers, each is covered separately in the subsequent text.

Any applicable preliminary checks should be made in the manner explained in previous lessons, and should include questioning the owner, visual and aural inspections, etc. However, for simplicity, only the receiver sections involved, control adjustments, and tubes to be checked are mentioned in this lesson. Unless otherwise specified, voltage and resistance checks are to be made with the chassis removed from the receiver cabinet.

NO PICTURE—SOUND NORMAL

In the case of no picture-sound normal, the proper sound is reproduced for each station as the selector knob is rotated through the various channel positions, but no video information appears on the screen. Only a normal pattern of the fine horizontal scanning lines of the raster is seen. With the station selector set to a channel on which sound is received, the contrast control should be advanced toward maximum in an attempt to bring in the picture. If the adjustment does not correct the trouble, or results in only a weak picture, then a defect exists in some portion of the signal circuits which carry the picture signals only.

Further isolation of the fault can be accomplished with a station tuned in and the brightness control advanced until the ver-

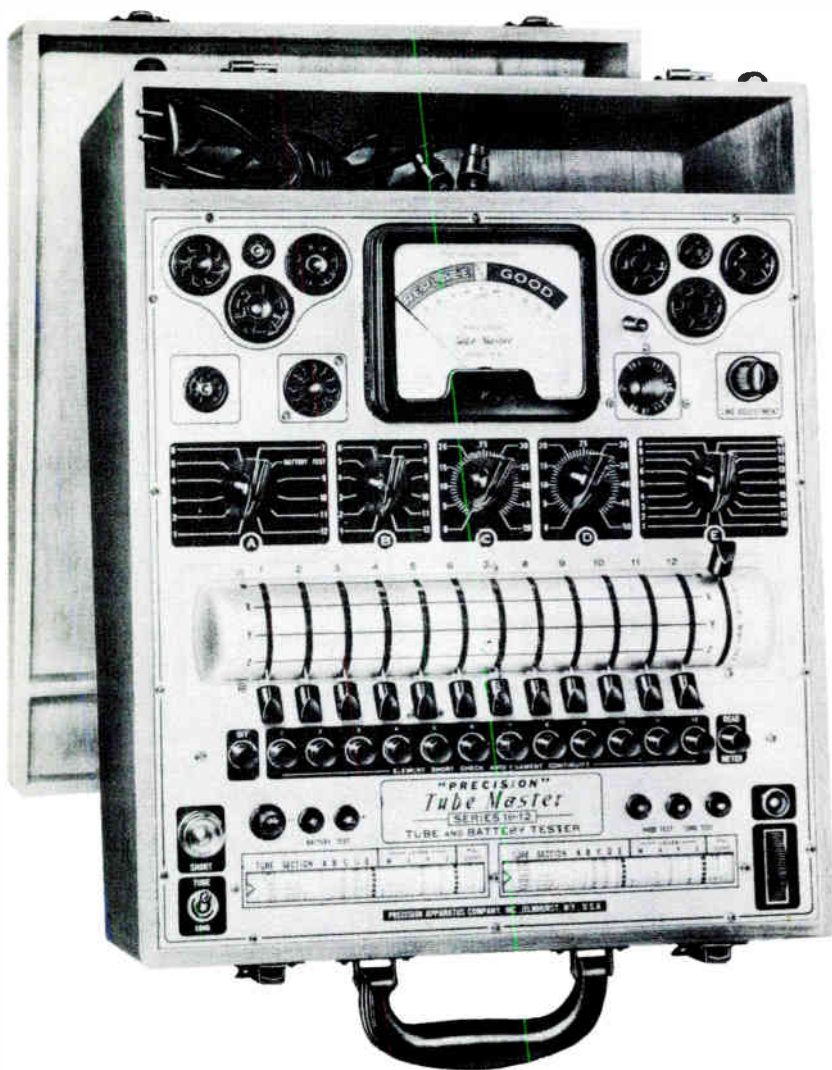

Modern tube testers permit making a variety of checks on all types of receiving tubes.

Courtesy Precision Apparatus Co., Inc.

tical retrace lines are visible. The raster should be inspected to see whether these lines are stationary or are moving vertically on the screen. If the retrace lines are moving, then the sync pulses are not being applied to the receiver sync circuits, and the trouble must be located at some point ahead of the sync pulse take-off. That is, the defect must be somewhere between this point and that at which the sound and video signals are separated. There may be several or few stages between these two points, depending not only upon whether the receiver is of the dual-channel or intercarrier type, but also the particular design of the manufacturer.

Dual-Channel Receiver

In the case of a dual-channel receiver, the sound and video signals are separated at the mixer output or at the output of the last common i-f stage, while the sync pulses are taken off at some point between the video detector output and picture tube input. Therefore, in a receiver of this type, the defect may be in any of one or more picture i-f amplifier stages, the video detector, or one or more v-f amplifier stages. To illustrate the circuits involved, the picture channel of a typical dual-channel television receiver is shown in Figure 1.

Here, the picture i-f signal is coupled from the mixer plate, through L_2 and C_1 to the grid of the first video i-f amplifier tube V_1 . Four i-f stages are employed, containing tubes V_1 , V_2 , V_3 , and V_4 , respectively, and the amplified signal is coupled from the plate of tube V_4 , through capacitor C_{23} to the cathode of the video detector tube V_5 . Appearing across the detector circuit load components L_{12} and R_{22} , the detected video signal is amplified by the v-f amplifiers V_6 and V_7 , and direct coupled from the plate of tube V_7 , through resistor R_{36} to the control grid of picture tube V_8 .

To provide good amplitude and phase response at low frequencies, direct coupling is employed in the entire v-f section, from the plate of detector tube V_5 to the control grid of the picture tube V_8 . Proper operating voltages for the various tube elements are supplied from different points on voltage dividers across the L.V. power supply. Potentiometer P_1 permits a service adjustment of the voltage supplied to the V_6 cathode circuit, while R_{30} and P_2 are the receiver contrast and brightness controls.

In the tube V_7 grid circuit, the video signal at the grid end of R_{28} is coupled through resistor R_{26} to the sync separator, as indicated by the arrow. Thus, if in this case the retrace lines are moving when a no picture—sound nor-

mal condition exists, the trouble must exist in some stage between the mixer plate and the grid of the v-f amplifier V_7 .

In any given sequence, each of the tubes, V_1 through V_7 , should be replaced in turn. Even though the trouble has been indicated to lie ahead of the V_7 stage, this tube itself could contain the defect.

If all tubes are in good condition and the trouble still persists, the chassis should be removed and a disturbance test made to determine whether the trouble is located before or after the detector stage.

In most receivers, this may be done by placing a screwdriver at the plate of the detector, and touching the screwdriver blade with the finger. A 60 cycle pattern, one pair of dark and light bars, should appear on the picture tube screen if the circuits following the test point are operating properly.

With the direct coupled circuits in the video section of the receiver such as in Figure 1, the plate of V_6 is at a high negative potential with respect to ground, and a $.1 \mu\text{fd}$ blocking capacitor connected to a clip lead should be used to apply 6.3 volts a-c to the detector plate from the ungrounded heater lug of some convenient tube socket.

If the 60 cycle pattern is produced when the above disturbance test is made, then the trouble lies in the i-f section, and further disturbance tests should be made in this section to isolate the faulty stage. With the contrast control at maximum, and the brightness control adjusted so the raster barely can be seen, the blocking capacitor lead is clipped to some high positive terminal of the L.V. power supply. To make the tests, the capacitor lead is tapped rapidly on the cathode pin of the second detector, V_5 , Figure 1, and if this stage is operating the raster should get brighter in step with the tapping. The momentary current produced in the cathode coil, L_{10} , creates a test signal which causes the changes in brightness on the picture tube screen.



When disturbance tests fail to isolate the defective stage, an audio oscillator may be employed to check a-f and v-f circuits by the signal substitution method.

Courtesy Sylvania Electric Products, Inc.

If this check indicates the detector to be operating, then similar tests should be made at the grids of the i-f amplifier tubes,

V_4 , V_3 , V_2 , and V_1 in this order, until the absence of a light flash on the screen indicates the faulty stage. These tests should be ob-

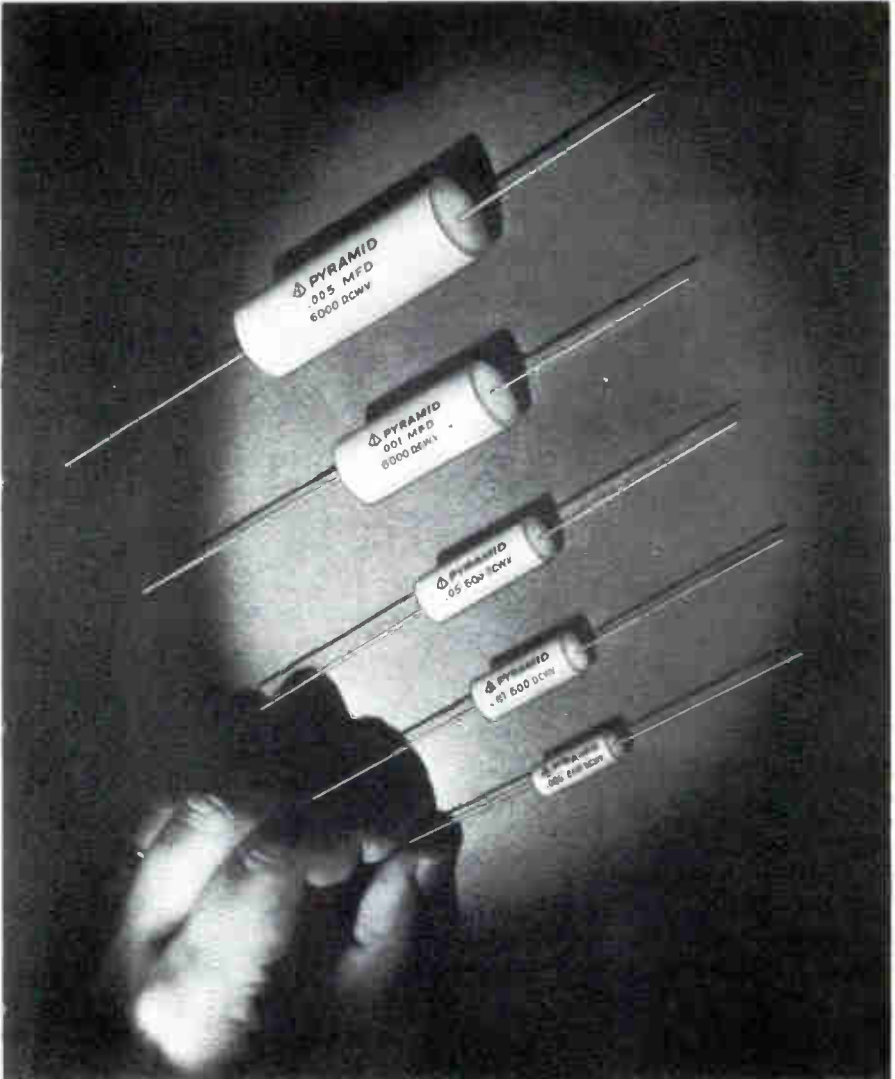

Capacitors used for interstage coupling and bypass purposes. A no-picture with sound normal condition can be produced by defective capacitors or other components located in the video circuits following the sound and sync signal take-off points.

Courtesy Pyramid Electric Co.

served carefully, for even the faulty stage may cause some displacement of the raster, although the screen does not become brighter.

In the event the defective stage cannot be located by means of these disturbance tests, further checks of this type may be made by means of the signal substitution method. As explained in an earlier lesson, an audio frequency test signal is inserted at the input of each stage of the picture channel, in turn, and the resulting bars observed on the receiver screen, or the test note is produced in the loudspeaker by connecting the v-f output tube plate through a blocking capacitor to the input of the receiver a-f amplifier.

When the defective stage has been located, voltage and resistance checks should be made in the stage to locate the trouble. In the event, the 60 cycle pattern is not produced on the screen when the first disturbance test at the plate of the video detector tube is made, then the trouble must be between this plate and the sync take-off point, that is, in the tube V_6 stage for the receiver of Figure 1. Voltage and resistance tests should be made to determine the defective part in this stage.

No attempt should be made to obtain an indication on the screen by tuning of the picture i-f stages. It is very unlikely that they should drift so far out of adjustment that the signal is unable to pass through at all, for these circuits are broadly tuned and quite stable; they seldom require re-adjustment.

Intercarrier Receiver

In an intercarrier receiver, the sound and video signals are separated at some point following the video detector and, therefore, only a few circuits or components can be responsible for a no picture—sound normal condition. In fact, with the retrace lines moving in the raster, the trouble must lie somewhere between the respective sync and sound take-off points. After any tubes between these points have been checked, and the trouble still is not corrected, disturbance or signal substitution tests may be omitted, and voltage and resistance tests applied immediately in these circuits.

For illustration purposes, the video output, sync detector, and picture tube circuits of a typical intercarrier receiver are shown in Figure 2. Here, the 4.5 mc sound i-f signal is coupled by L_2 and L_3 from the plate circuit of the video output tube, V_1 , to the input of the sound i-f section as indicated. In this case, how-

ever, the sync take-off point is at the upper end of resistor R_3 , in the plate circuit of the preceding v-f amp. stage.

Thus, in the receiver of Figure 2, both v-f amplifier stages must be operating properly when the sound is normal, and the no picture and moving retrace lines condition probably is caused by a defect in the V_2 stage which operates as the d-c restorer as well as sync detector. The video signal applied through C_6 and R_9 to the grid of V_2 causes a grid-leak bias to be developed which permits conduction of V_2 only during the positive sync pulses.

Produced at the plate of V_2 , the negative going sync pulses are applied to the input of the sync pulse amplifier, as indicated. Due to V_2 cathode circuit current, a d-c voltage is developed across R_{11} and C_7 , and applied through R_8 to the grid of picture tube V_3 for d-c restoration.

Defects such as an open in the tube V_2 cathode circuit or a short in V_2 could produce the trouble symptoms mentioned in the receiver of Figure 2.

However, very few other defects if any, would cause these exact symptoms. For example, an open in capacitor C_5 would prevent application of the video signal to the grid of tube V_3 , but would not interfere with the operation of the receiver sync circuits,

since the sync pulses are coupled to tube V_2 through capacitor C_6 .

Stationary Retrace Lines

In either type of receiver, if the retrace lines are found to be stationary in the raster when there is a no picture—sound normal condition, proper operation of the sync circuits is indicated, and the trouble must be located in the video section, in some circuit following the sync take-off point.

Therefore, in the dual-channel receiver of Figure 1, proper operation must exist up to and including the grid circuit of the v-f output tube V_7 , since the sync signal is taken off at this point. However, the trouble could be caused by a defect in V_7 , in picture tube V_8 , or in the other circuit components or connections in the output and picture tube stages.

For the receiver of Figure 2, the v-f amplifiers and the sync detector stages must be operating properly to provide normal sound and a synchronized raster, therefore the trouble must be in the signal circuits of the picture tube. In addition to the picture tube itself, possible causes here are an open or shorted coupling capacitor C_5 , an open in R_8 , and a short in C_8 . Because of the few possible sources of this trouble in either the dual-channel or intercarrier receivers, disturbance or signal substitution tests are unneces-

sary. The tube checking may be followed immediately by voltage and resistance tests in the circuits following either the sound or sync signal take-off point, whichever is nearest the output of the receiver.

NO SOUND—PICTURE NORMAL

When the picture is reproduced properly on the screen of the television receiver, but no sound is obtained, trouble is indicated in the sound channel following the point at which the sound and video signals are separated. In an intercarrier receiver, the possible defective stages include the 4.5 mc i-f amplifier, audio detector, a-f amplifiers, and loudspeaker.

In a dual-channel receiver, the trouble may be in any of two or more sound i-f stages, the limiter stage, audio detector, a-f amplifiers, and speaker. In either type of receiver, the picture is affected to some degree if the defect is in any stage ahead of the point at which the sound and video signals are separated. Therefore, with normal picture, the fault must exist in the sound channel after the picture-sound separation point.

Dual-Channel Receiver

When the no sound—picture normal condition exists in a dual-channel type receiver, the serviceman should set the station selec-

tor to a channel in which a program is received, and with the volume control set at maximum, rotate the fine tuning control carefully through its range. If this adjustment does not bring in the sound, the tubes in the sound channel should be replaced, one by one.

To illustrate the circuits in which a defect could produce the no-sound condition, the sound i-f, detector, and a-f stages of a typical, dual-channel television receiver are shown in Figure 3.



A 21-inch rectangular picture tube of the self-focusing type. With roster and sound present, loss of picture may be due to a defect in the picture tube circuits, or in the tube itself.

Courtesy Allen B. DuMont Laboratories, Inc.

Here, tubes V_1 and V_2 are i-f amplifiers, tube V_3 operates as an i-f amplifier and limiter, tube V_4 is a discriminator type FM detector, and tubes V_5 and V_6 are the audio

voltage and power amplifiers, respectively.

The diode sections of tube V_5 are employed to develop a voltage for the receiver agc circuits. Also, as indicated, a total of 280 volts is applied to the tube V_6 plate-cathode circuit due to the fact that the cathode circuit is returned to the -135 v terminal of the receiver L.V. power supply.

When the trouble still exists after all of the sound channel tubes have been checked, a disturbance test should be made to determine whether the defect is in the i-f and detector section or in the a-f section. The check may be made by placing the finger or the shank of a screwdriver with the finger touching it on the high terminal of the volume control, potentiometer P in Figure 3. By the "high" terminal of a unit is meant that terminal at which the signal potential is highest with respect to ground. In Figure 3 it is that terminal of P to which capacitor C_{17} is connected.

When this test is made, a fairly loud 60 cycle hum is heard in the loudspeaker when the circuits following the volume control are operating properly. This hum indicates the trouble to be in some sound channel stage preceding the volume control, that is, in the V_1 , V_2 , V_3 , or V_4 stages in Figure 3. Therefore, disturbance tests should be made in the i-f section to locate the defective stage.

These tests may have the form of any of those previously described; such as, scratching the grid socket lugs with a screwdriver, removing and reinserting tubes in their sockets, using a test lead and capacitor, or, the modulated test signal from a signal generator may be inserted at the grid of each i-f amplifier. In any case, the production of the corresponding signal or noise in the loudspeaker indicates operation of all circuits between the test point and the speaker.

The first test is made at the grid of the last i-f amplifier V_3 in Figure 3. If the desired indication is not obtained, the trouble may be in either the V_3 or the V_4 stage, and voltage and resistance checks should be made in these stages. If the test is satisfactory at the V_3 grid, tests at the grids of V_2 and V_1 should be made, in turn, and voltage and resistance tests made to locate the fault in whichever of these stages the trouble is indicated.

If the 60 cycle hum is not heard in the loudspeaker when the disturbance test is made at the high end of the volume control, the trouble is in the a-f section and further tests should be made to isolate the trouble to either of the a-f amplifier stages. By means of a signal generator or a capacitor and clip lead, a test signal should be applied to the grid of the output tube V_6 in Figure 3. If the

test note is not heard in the loudspeaker, an a-c voltmeter should be connected across the secondary of output transformer T.

When no reading is obtained on the voltmeter with a test signal applied to the V_6 grid, the defect is either in T or in some other component in the V_6 stage, and should be located with voltage and resistance tests.

If a reading is obtained on the a-c voltmeter, with no sound in the loudspeaker, then the speaker is defective. The strength of the speaker field may be checked by placing the shank of a screwdriver near the speaker and noting the pull. If the normal field is present, a resistance check of the voice coil should be made, with one lead to the output transformer disconnected.

If the test note is heard in the loudspeaker when the test signal is applied to the grid of V_6 , then the signal should be applied to the grid of V_5 . If no sound is produced, trouble in the V_5 stage is indicated. However, if the test note is heard, then there must be a defect in capacitor C_{10} , or in the volume control P. In every case, voltage, resistance tests, or both, should be made to check the condition of circuits or components indicated defective by the disturbance or signal substitution tests.

Intercarrier Receiver

For an intercarrier receiver, the circuits in which defects can cause a no sound—picture normal condition are shown in Figure 4. Here, tube V_1 is the 4.5 mc sound i-f amplifier, V_2 is a ratio detector type FM detector, V_3 the a-f voltage amplifier, and tube V_4 the a-f output amplifier. Similar to tube V_3 in Figure 3, V_1 in Figure 4 operates as a limiter as well as an i-f amplifier, with the necessary grid-leak bias being developed across resistor R_1 and capacitor C_3 in the grid circuit.

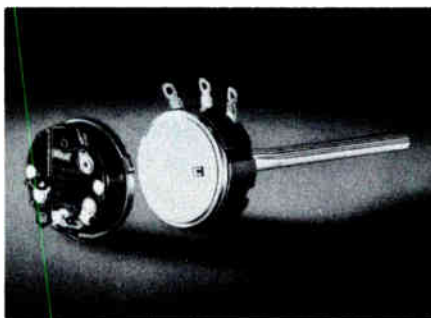

Replacement type volume control and line switch. A defective volume control can produce no sound—normal picture conditions.

Courtesy Centrolab, Div. of Globe Union, Inc.

With the receiver tuned to a station, and the fine tuning control adjusted for the best picture, the picture and sound will have the correct frequencies in the i-f stages preceding the video detector. Therefore, unless these common i-f stages are badly misaligned, it may be assumed that sufficient energy of the sound i-f

is being passed by these stages and that the proper 4.5 mc carrier is being produced and applied to the input of V_1 in Figure 4. Hence, the no sound condition in intercarrier receivers is not often corrected by adjustment of the fine tuning control. After checking the volume control, the service technician may proceed to check the tubes in the circuits of Figure 4.

When the trouble persists after all tubes have been replaced, a disturbance check should be made

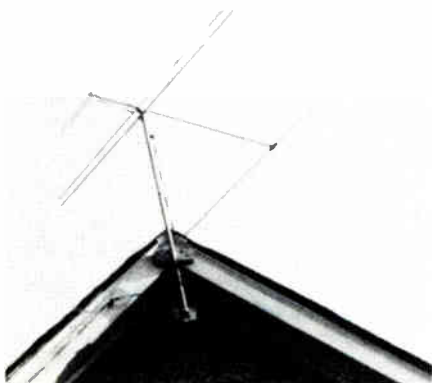

As they form part of the television receiver r-f section, the antenna and transmission line should be checked when neither picture nor sound is obtained.

Courtesy American Phenolic Corp.

at the high end of the volume control P, to isolate the trouble to either the 4.5 mc i-f or the a-f section. If the hum is heard, the audio amplifiers are operating normal and the i-f amplifiers or detector must be at fault. On the

other hand, no hum indicates a defect in the audio amplifier stages. As explained for the dual-channel receiver, this disturbance test should be followed by others necessary to isolate the defective stage, and then voltage and resistance tests are used to locate the actual fault.

NO PICTURE OR SOUND

When neither picture nor sound is reproduced, but a raster is present on the television receiver screen, a defect is indicated in some portion of the signal circuits which carry both picture and sound signals. Of course, it is possible that two defects exist, one in the picture channel and one in the sound channel, that is, in circuits not common to both signals. However, since this condition is unlikely, the trouble generally is found in the least time by assuming that a single fault exists in some circuit through which both signals pass. Then, in the event that the common stages prove to be operating properly, the separate portions of the picture and sound channels are investigated.

It is possible also, for a defect in one channel to affect the power supply circuits such that the other channel is rendered inoperative too, but usually a trouble of this type affects the deflection circuits also, and thus prevents the proper production of the raster on the receiver screen.

The exceptions are receivers with two low voltage power supplies. Other possibilities are L.V. power supply or agc circuit defects which prevent proper operation of the circuits which carry both picture and sound signals, and thus indirectly produce the same symptoms as are caused by defects in these signal circuits.

Antenna tests should be made in either type of receiver, since both picture and sound signals are carried by the r-f section, of which the antenna system is part. Thus, if adjustment of the tuning, contrast, and volume controls produces neither picture nor sound, a disturbance test should be made to determine whether the trouble is in the receiver proper or in the antenna system. The test may be made by removing the lead-in connections to the receiver, and drawing a screwdriver blade across the receiver input terminals. Flashes on the screen and noise in the speaker are produced when the r-f section is operating.

If the flashes and noise are obtained, then the trouble is in the antenna system. A portable or temporary test antenna and transmission line may be substituted for the regular antenna system by disconnecting the installed lead-in from the receiver and connecting the test line to the input terminals. In low-signal strength areas it may be necessary to locate the test antenna at some ele-

vated point, such as on the roof. If picture and sound are obtained in this way, then the trouble definitely is located in the installed antenna system.

A check of the lead-in may be made by touching the test prods of an ohmmeter to the two conductors at the receiver end of the line. In the case of a folded type antenna, continuity of the line is indicated by a very low or zero reading. This same reading indicates a short in the line when the antenna is of the straight dipole, or conical type, etc. To check line



An r-f generator is needed for checking r-f and i-f stages by signal substitution. This generator provides modulated or unmodulated r-f output over a total range from 170 kc to 124 mc.

Courtesy Coastwise Electronics Co.

continuity with a straight dipole, the lead-in conductors may be shorted together at the receiver end, and a measurement taken with the ohmmeter at the antenna end of the line. A very low or

zero reading indicates proper continuity.

Finally, to check for a shorted line with a folded dipole type of antenna, the lead-in conductors should be left unconnected at the receiver end, the line disconnected from the antenna, and an ohmmeter reading taken at the antenna end of the line. A short is indicated by a very low or zero reading. Although it makes no difference electrically, the method of making the ohmmeter reading at the antenna end of the line has an advantage because then it is unnecessary to make a second trip to the roof to remove the short from or reconnect the end of the line after the reading is taken.

If either a shorted or open line has been indicated by the above checks, a visual inspection usually reveals where the trouble is, such as at some point where the line is brought around obstructions or into the building, etc. When the antenna system is being checked, inspection should be made to see that the lead-in makes a good, low-resistance contact to the terminals of the antenna. A high resistance at this point easily can prevent sufficient transmission of signal energy to the receiver.

When the above mentioned disturbance test is made, if the flashes and noise are not obtained, then the trouble must be in the receiver proper. In the case of a

dual-channel receiver, the no picture or sound symptom may be caused by a defect in the front end or r-f section, or in any common i-f stages which the receiver may contain. In an intercarrier receiver, both picture and sound signals are carried by the r-f section, the common i-f section, the video detector, and usually one or more of the v-f amplifiers. Thus, for this type of receiver, any of the listed sections may contain a defect which will give the no picture—no sound symptom.

Dual-Channel Receiver

The r-f section of a dual-channel receiver is shown in the schematic diagram of Figure 5. As indicated, the antenna terminals connect through a set of contacts to antenna coil L_1 , from which the input signals are coupled by secondary L_2 to the grid of r-f amplifier tube V_1 . In the plate circuit of tube V_1 , the r-f signals are coupled by L_3 and L_4 to the grid of mixer tube V_2 . Tube V_3 is the h-f oscillator, from which the r-f energy is coupled by L_5 and L_4 to the grid circuit of V_2 .

From the plate circuit of the mixer stage, the picture i-f is coupled through L_6 to the picture i-f amplifier, and the sound i-f is coupled by L_7 and L_8 to the input of the sound i-f amplifier. As the dotted rectangles indicate, the complete set of r-f, mixer, and oscillator coils are changed each

time the receiver station selector is rotated to a different channel position.

The oscillator circuit is a common cause of trouble in an r-f tuner. Therefore, a check should be made to determine whether this circuit is operating. To do this, near the oscillator tube V_3 , Figure 5, hold a lead which connects to the input of an oscilloscope or any other indicator which may be operated by a very low r-f input voltage. If no indication is obtained the oscillator tube should be replaced. If the oscillator stage is operating, the r-f amplifier and mixer tubes, V_1 and V_2 should be replaced.

When the tube replacement does not correct the trouble, or the oscillator still appears not to be operating, then the chassis must be removed from the receiver cabinet for further tests. Disturbance tests which may be helpful here include shorting the grid of V_3 to ground with the blade of a screwdriver. If the oscillator is operating, this shorting changes the plate current in the tube and thus produces an instantaneous signal which is heard as a noise in the loudspeaker. No sound will be heard if the oscillator is inoperative.

The mixer stage may be checked by removing and replacing the r-f amplifier tube V_1 in its socket quickly several times. The elec-



A defective tube in the r-f or i-f circuits of a receiver which carries both the picture and sound signals may result in loss of both picture and sound.

Courtesy Hytron Radio & Electronics Corp.

tric disturbance thus caused will be passed by the mixer and heard as noise in the speaker if stage V_2 is operating. If both oscillator and mixer are operating, the trouble is likely in the r-f stage.

In the event the disturbance tests are inconclusive, signal substitution tests may be used to locate the faulty stage. Set to the required oscillator frequency for the channel to which the receiver is tuned, a signal generator may be substituted for the h-f oscillator by applying the signal to the grid of the mixer tube V_2 , or to the junction between resistors R_5 and R_6 .

severe detuning of the oscillator, and the incorrect beat frequencies produced are not being passed by the receiver.

If the oscillator functions properly, remove V_3 from its socket, apply the signal generator probe to the grid of V_2 , and vary the generator audio modulated output through the i-f range of the receiver. If the mixer stage is oper-

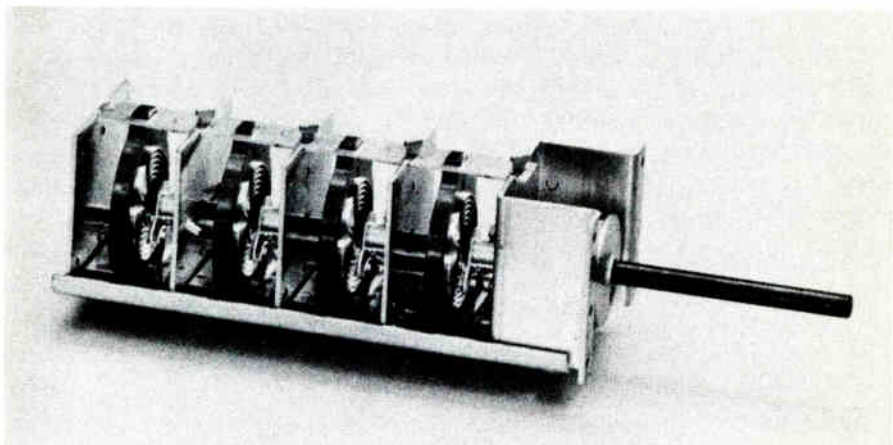

A 4-section, variable inductance tuner used in the VHF band. As the tuner circuits are common to the picture and sound signals, tuner troubles may cause reduction in strength, distortion, or complete loss of both signals.

Courtesy P. R. Mallory & Co., Inc.

To correct for errors in dial calibration, the generator dial is rocked slowly above and below the indicated frequency, and if picture and sound are obtained, the receiver oscillator is either inoperative or its output is not being applied to the mixer. A third possibility is that a defect in the oscillator stage is causing

ating, horizontal or vertical bars should appear on the screen, and the audio tone heard in the speaker when the generator is tuned to the sound intermediate frequency.

If bars are not produced on the screen, or sound in the speaker, when the modulated test signal is applied to the mixer grid in a

receiver containing one or more common i-f stages, then the test signal should be applied to the grids of the i-f amplifiers in turn, beginning with the first. When a point is reached at which the bars appear, the trouble is indicated to be between this point and the one previously tested.

If proper indications are obtained when the check is made at the grid of V_2 , Figure 5, then, with V_3 back in its socket, the signal generator should be set to either the picture or sound r-f carrier frequency for the channel to which the receiver is tuned, and the test probe applied to the junction between L_4 and C_4 , Figure 5. This is a test of both oscillator and mixer and, if both are operating, either the bars or audio tone will be obtained, depending upon the test frequency selected.

If both the V_2 and V_3 stages are functioning, the generator test probe should be moved to the grid of the r-f amplifier V_1 . Again, either the sound or bars on the screen will be obtained if this stage is operating.

When the faulty r-f section stage has been located, voltage and resistance checks should be made to locate the defective component, switch contact, or connection. Among the first of the voltage tests should be checks of the B+ voltage supplied and the agc voltage input in order to prevent

possible, unnecessary disturbance of the r-f section circuits.

Intercarrier Receiver

For an intercarrier receiver, the circuits in which defects can cause the no picture or sound symptom are shown in Figure 6. Here, two stages of r-f amplification are employed, containing tubes V_1 and V_2 . A double triode consists of mixer tube V_3 and oscillator tube V_4 . In this receiver, capacitive tuning is employed, with the three section tuning capacitor $C_{11}C_{17}C_{26}$, used to tune the r-f amplifier, mixer, and oscillator circuits to the required resonant frequencies.

A two-position switch places coils L_1 , L_2 , L_6 , L_8 , and L_{10} into the respective circuits for operation on the low-band VHF channels, while coils L_3 , L_4 , L_5 , L_7 , and L_9 are switched in for the high-band VHF channels. By means of L_{11} and L_{12} , the picture and sound i-f signals are coupled from the plate circuit of the mixer to the input of the common i-f amplifier, which contains the three tubes, V_5 , V_6 , and V_7 .

Operating as a diode, tube V_8 is the video detector, and the video signal output is passed along with the 4.5 mc second sound i-f carrier through the two-stage v-f amplifier containing tubes V_9 and V_{10} . From the plate circuit of V_{10} , the 4.5 mc signal is coupled by

means of L_{23} and L_{24} to the input of the sound i-f amplifier, as indicated. Also, the video signal is coupled through C_{43} to the receiver picture tube.

As explained for the dual-channel type receiver, some type of indicator may be employed first in an effort to determine whether or not the h-f oscillator is operating in the circuit of Figure 6. When no indication is obtained, the oscillator and mixer tubes should be replaced. If the oscillator is functioning, or replacing V_3V_4 does not correct the trouble, the remaining tubes shown in Figure 6 should be replaced, one at a time.

If the trouble remains after all tubes are replaced, or the previous check indicates the oscillator is inoperative, the chassis must be removed for further checks. First, disturbance or signal substitution tests should be made, in the manner explained in the above sections, to isolate the fault to either the v-f, i-f, or r-f section.

In the circuits of Figure 6 for example, the first test may be made at the plate of tube V_8 , and thus indicate the trouble to be either in the v-f section or ahead of the detector plate circuit. When indications are that the v-f section is operating, a test at the grid of V_5 will show whether the

trouble is in the i-f section or in the r-f section. Finally, further tests of this type should be made to isolate the faulty stage in the indicated section and then, voltage and resistance tests are made to locate the actual part at fault.

Work on any critical circuit of a television receiver should be conducted with a great deal of care to avoid detuning or misalignment of the circuits. This precaution is especially important when work is done in the r-f section where the highest frequencies are involved. **TOO MUCH PRESSURE ON COILS OR ANY ACTION THAT WILL MOVE H-F LEADS TO NEW POSITIONS SHOULD BE STRICTLY AVOIDED.** The inductance of coils and stray capacitance of leads can be changed easily, and since these in large part tune the r-f circuits, rough handling impairs the alignment.

As in troubleshooting any other type of electronic equipment, a careful inspection should be made to discover any defective joints, or evidence of overload or breakdown of circuit elements. After the cause of faulty operation has been found and corrected, an operational check should be made to determine if other corrective measures are needed, such as alignment or sweep and sync adjustments of the touch-up type.

STUDENT NOTES

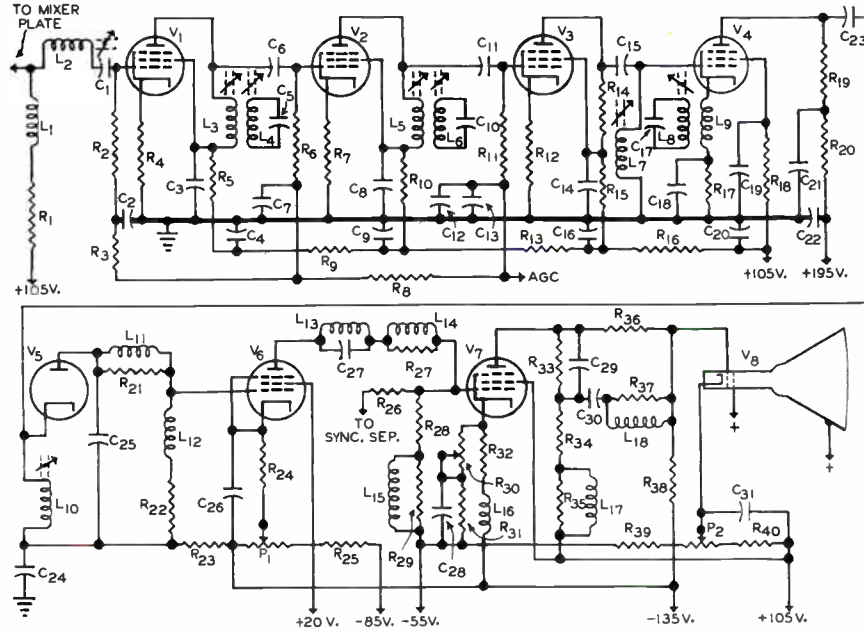

FIGURE 1

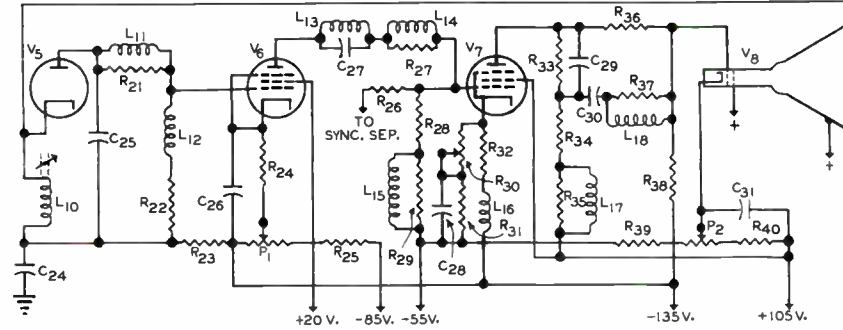

FIGURE 3

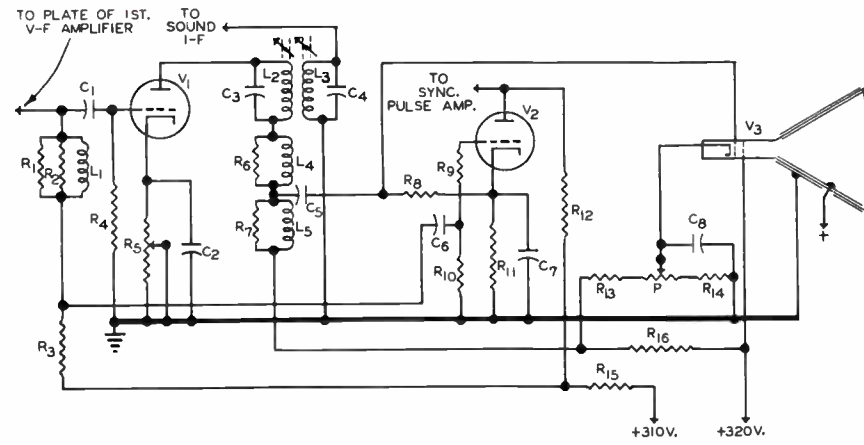
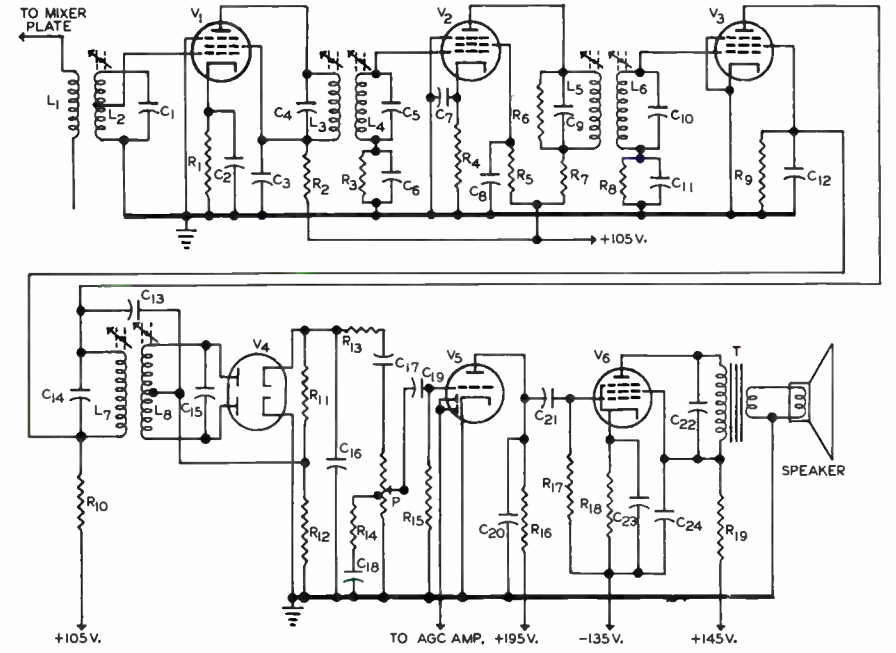
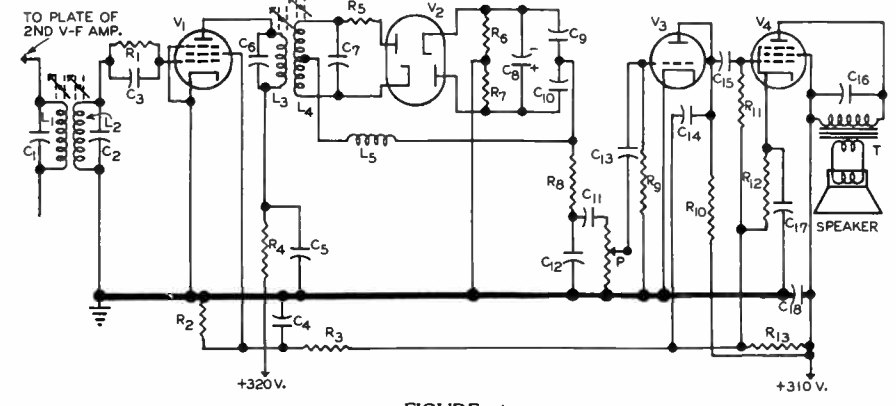

FIGURE 2



TSM-12

FIGURE 4



TSM-12

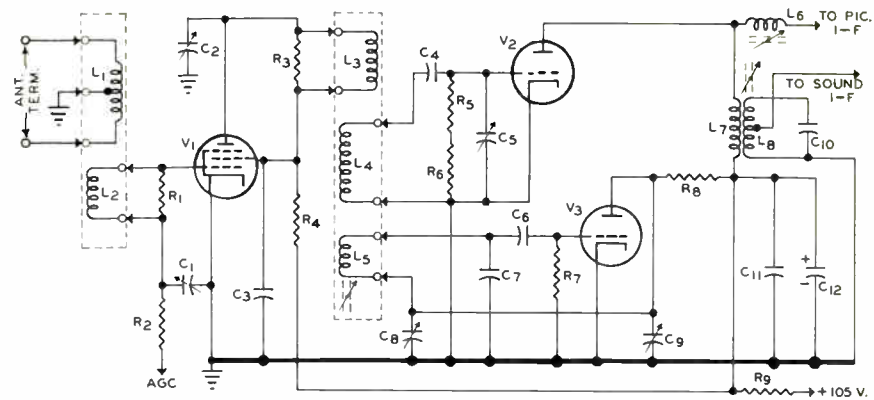
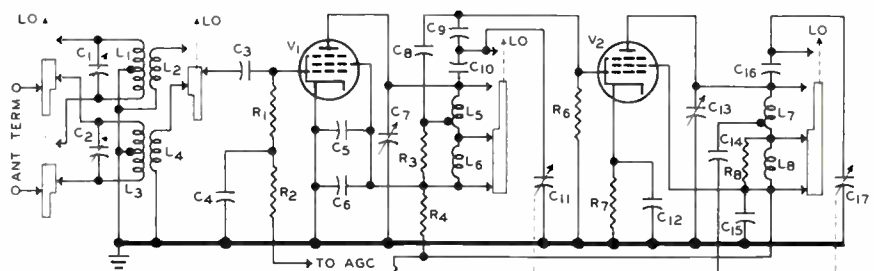
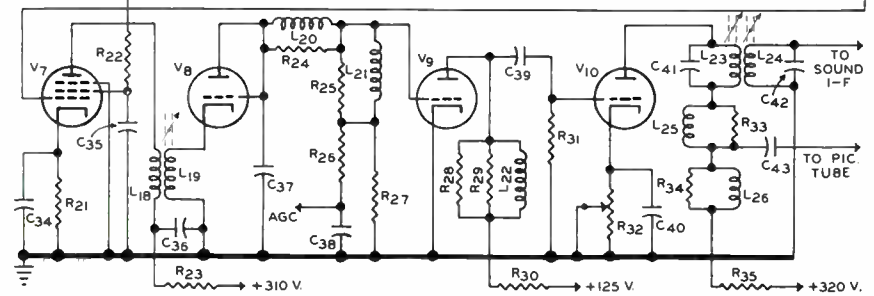
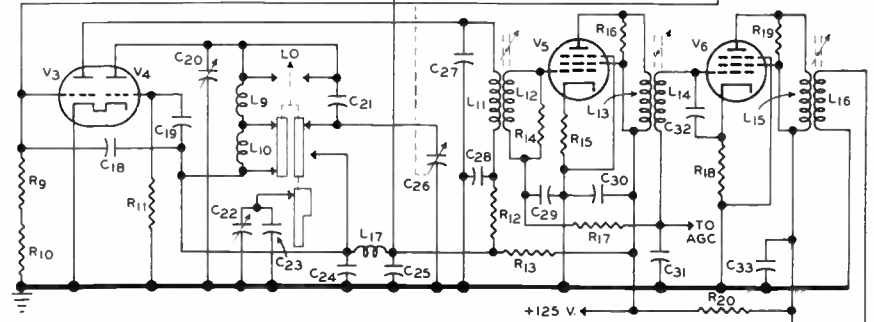

FIGURE 5



NOTE:
ALL BAND SWITCHES
SHOWN IN HI POSITION



TSM-12

FIGURE 6

DeVRY Technical Institute

Formerly DeFOREST'S TRAINING, INC.

4141 WEST BELMONT AVENUE

CHICAGO 41, ILLINOIS

QUESTIONS

No Picture—No Sound—Lesson TSM-12A

Page 23

3 How many advance Lessons have you now on hand?

Print or use Rubber Stamp.

Name..... Student No.....

Street..... Zone..... Grade.....

City..... State..... Instructor.....

Write your answers on the "Ans." line below each question. If more space is needed use reverse side of this page.

1. When a TV receiver is in normal working order, can there be a raster on the screen if the set is not tuned to a station?
Ans.....
2. For the condition of normal raster, proper sound, but no picture or a weak picture with the contrast at maximum, in which circuits is the trouble likely to be found?
Ans.....
3. In Figure 1, what is the purpose of using direct coupling between the video detector V_3 and the grid of the CRT V_1 ?
Ans.....
4. In a dual-channel TV receiver, as illustrated by Figure 1, could the condition of normal sound, no video, but a raster, with a lack of sync in the vertical retrace be caused by a bad video detector tube?
Ans.....
5. In an intercarrier type TV set, as illustrated by Figure 2, the first video amp. tube is defective. Which of the following symptoms of operation is NOT to be expected: normal raster, no picture, normal sound?
Ans.....
6. For a normal sound and raster, but no picture condition in a TV set, to what part of the video section is the trouble isolated if the sync circuits are operating as shown by steady retrace lines?
Ans.....
7. Where is the probable location of the trouble when the picture is normal but there is no sound?
Ans.....
8. With trouble in the sound section, what check can be made to isolate it to either the i-f or the a-f section?
Ans.....
9. Is it normally necessary to check the fine tuning control in an intercarrier set for a "No sound" indication?
Ans.....
10. For a no picture or sound condition with normal raster, what is the likely location of the defect?
Ans.....

FROM OUR *Director's* NOTEBOOK

IS BUSINESS SELFISH?

When you buy furniture, a car, food, or ANYTHING, you want your money's worth, don't you? So does an employer.

He wants a man who can offer the most for the salary he offers. He wants a man who will help him make a profit for the business. It's the very basis on which all business is conducted. If you don't make a profit, you don't stay in business very long.

When you are first hired, your employer will lose money on you. Later, as you progress, he'll break even. Finally, your efforts will begin to pay him a profit, and as you earn more you'll be expected to make more profit for the company.

So as you go after the "gold in them thar hills," don't expect to get it all out with a single blast. Start as high as your training and experience warrant, but remember that business is just selfish enough to want you to prove you're worth. You would feel the same way if you were the employer.

Yours for success,

W. C. Healey

DIRECTOR

TSM

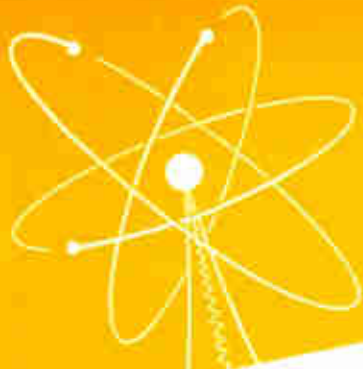

DISTORTED PICTURE

Lesson TSM-13A



DeVRY Technical Institute

4141 W. Belmont Ave., Chicago 41, Illinois
Formerly DeFOREST'S TRAINING, INC.

-13

TSM-13A

DISTORTED PICTURE

4141 Belmont Ave.

COPYRIGHT 1955

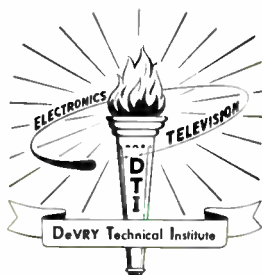

Chicago 41, Illinois

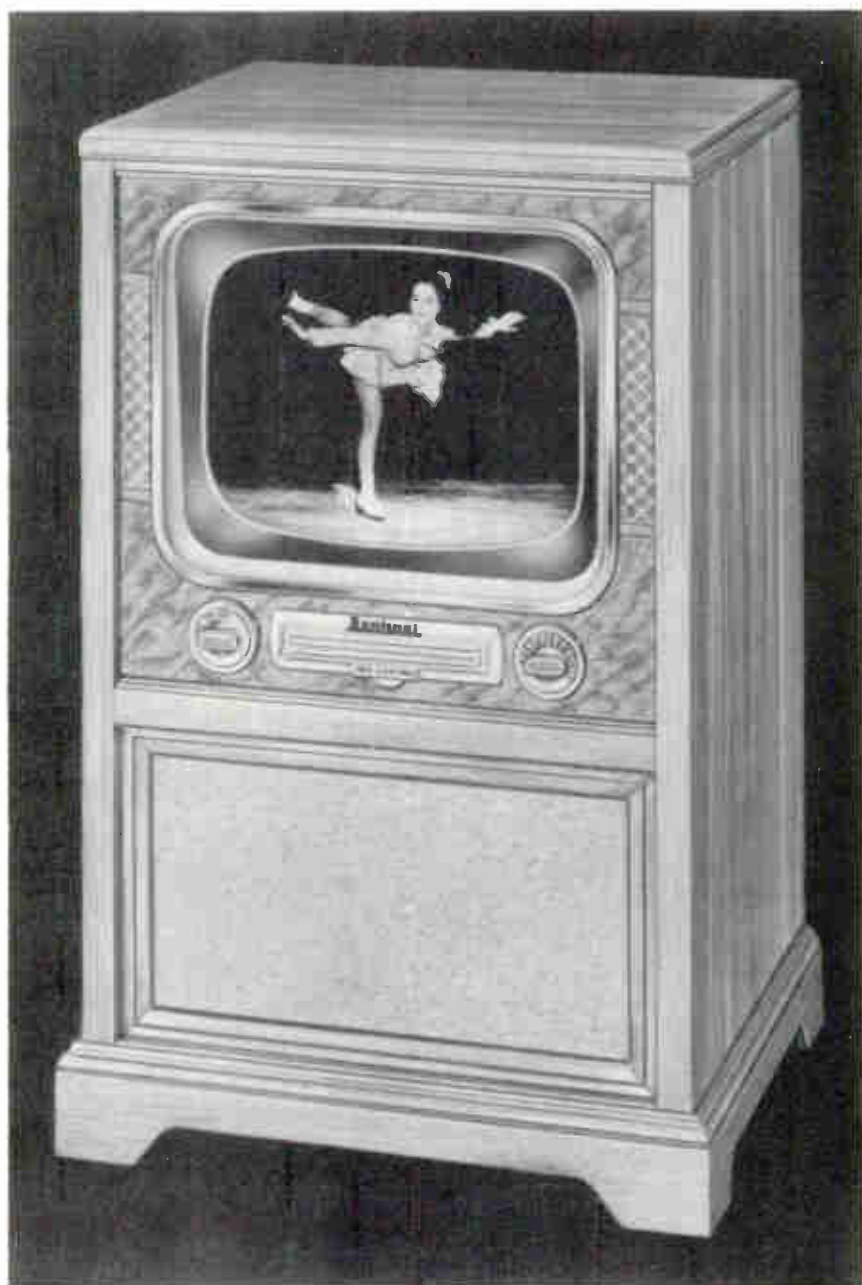

The modern television receiver owner expects a distortion free picture.
Courtesy Sentinel Radio Corp.

Television Service Methods

DISTORTED PICTURE

Contents

	PAGE
Incorrect Size	5
Nonlinear Sweep	6
Lack of Brightness	8
Loss of Sync	9
Frequency and Phase Distortion	15
Transient Response	16
Horizontal Pulling	16
Raster	16
Picture	17
Picture Tube and Circuit Defects	21

“One Picture is Worth 10,000 Words”.

—An Old Chinese Proverb

DISTORTED PICTURE

In this lesson we explain the various television receiver troubles which cause some type of picture distortion. In a broad sense, picture distortion may be taken to mean any deviation whatsoever from perfect reproduction of the scene being televised, and can be caused by defects in either the camera, transmitter, receiver, or transmitting medium.

Distortion also may be due to interfering signals, reflections, noise energy, etc. produced either external to or within the receiver. However, because of the large number of such troubles which are possible, the distortions due to interfering high and low frequency energy are covered in other lessons. The following paragraphs are concerned with troubles caused by defective circuits, tubes, and other receiver components.

Unlike most troubles, many of the various picture distortions may be due to troubles in any of several sections of the receiver, with the exception of the sound channel. In general, changes in linearity or raster size are produced by defects in the deflection circuits or power supplies, smearing and loss of definition by defects or mistuning in the signal circuits of the picture channel, and loss of synchronism by trou-

bles in the sync, video, picture i-f, or r-f circuits.

A fourth group of picture distortions are caused by defects in or misadjustments of components and circuits associated with the picture tube, or the tube itself. Finally, a large group of picture distortions such as weaving, bending and twisting, etc. result from troubles in all circuits except those of the vertical deflection and sound channel stages.

Although various types of distortions are illustrated in this and other lessons of this series, the patterns shown are only typical examples. Many variations are encountered in actual service work. These depend upon the makes and models of receivers, and the severity of the defect for the specific case.

Successful television servicing depends upon the technician's ability to recognize and correct the fault without unnecessary expenditure of time. Therefore, a careful study should be made of these distortion patterns and any others found in the trade literature so that the different types of trouble can be recognized as promptly as possible. For example, familiarity with the various symptoms usually will permit a quick decision as to whether the trouble is due to a defective component in the

receiver, or to interfering r-f energy. Also, by switching to a different channel and comparing the pictures, the serviceman can check on whether the trouble is in the receiver or the transmitter.

Much valuable time has been spent by television servicemen hunting for defects in the receiver before discovering that a distorted signal was being received from the transmitting station. Finally, as explained later, stray magnetic fields near the picture tube can cause a distorted picture, and a check for any possible source of such a field should be made before detailed work is spent on the receiver circuits.

INCORRECT SIZE

The deflection circuits and high voltage supply of a typical television receiver are shown in Figure 1. The vertical blocking oscillator employs transformer T_1 and triode V_1 , and controls the charge and discharge periods of capacitor C_3 which, with resistor R_5 , forms a trapezoid voltage. Applied to the grid of tube V_2 , this voltage is amplified and coupled by transformer T_2 to the vertical deflection coils, L_1 and L_2 , in which a sawtooth current is produced. In the V_1 stage, resistor R_2 is the vertical hold control, R_4 the height control, and R_8 forms the vertical linearity control in the output stage.

The horizontal deflection circuit consists of blocking oscillator tube V_3 and output amplifier tube V_4 , the output of which is coupled by transformer T_4 and capacitor C_{20} to the horizontal deflection coils L_3 and L_4 . In this circuit, V_6 is the damping tube, coil L_5 the width control, and inductor L_6 the horizontal linearity con-



Service cathode ray oscilloscopes are useful for checking the wave-forms of the sync pulse and deflection voltages in the circuits of a television receiver.

Courtesy Hickok Electrical Instrument Co.

trol. Stepped up by transformer T_4 , a high a-c voltage is applied to rectifier tube V_5 to produce the high d-c voltage across capacitor C_{19} needed for the picture tube anode.

In the circuits of Figure 1, certain components are variable to permit service adjustments as explained in earlier lessons. However, there are few if any components in these circuits which, when defective, do not have some affect on the linearity, size, or brilliance of the raster. Therefore, when adjustment of the appropriate control does not produce the desired correction, a tube or circuit defect is indicated.



A tilted picture, reversed picture, or keystone shaped raster, etc. can be produced by a deflection yoke which is improperly positioned, incorrectly connected, or shorted.

Courtesy Stondord Transformer Corp.

Certain of the various controls are interdependent, such as the size and linearity controls. For example, when the raster is reduced in size vertically and cannot be increased to normal size by adjustment of R_4 , Figure 1,

then an adjustment of R_8 should be made. When the adjustment of these controls does not correct the trouble, amplifier tube V_2 should be replaced.

Should the trouble still exist, then the chassis must be removed from the cabinet and an oscilloscope employed to make a wave-form check at the grid of V_2 . When the wave-form is correct at this point, then voltage and resistance measurements are made in the circuits of the V_2 stage to locate the defect.

In the event a short exists in or across one of the vertical coils, L_1 or L_2 of Figure 1, the raster is greatly reduced in size vertically, and has a KEYSTONE shape. Depending upon whether L_1 or L_2 is shorted, either the left or right side of the pattern is reduced more than the other. However, in either case, usually the short occurs deep within the winding, and replacement of the complete yoke is necessary.

NONLINEAR SWEEP

Trouble in the V_1 stage generally results in nonlinearity of the wave-form as well as a change in amplitude of the deflection voltage. Therefore, when the wave-form is not correct at the grid of V_2 , the tube voltage and resistance tests are made in the oscillator stage to locate the defect.

Of course, whenever a specific fault is indicated by the appearance of the picture or raster, this possibility should be investigated before other tests are made in the suspected stage. For example, in the vertical oscillator stage of Figure 1, if sawtooth forming capacitor C_3 develops d-c conductance (leakage), the raster is compressed at the bottom only, as shown in Figure 2. When the leakage is sufficient, it is impossible to correct the distortion by adjusting the height and linearity controls.

With the receiver turned on, a check for leakage in C_3 may be made by removing V_1 from its socket and placing the positive test prod of a voltmeter at the junction between C_3 and R_5 , with the negative prod to ground. A zero reading should be obtained if C_3 is not leaky.

In a like manner, a check for a leaky coupling capacitor, C_4 , may be made by placing the voltmeter test prods across R_6 , with the positive prod at the ungrounded end of R_6 . Again, a zero reading should be obtained. Whenever it can be employed, this method is better than using an ohmmeter to check the capacitor for often the leakage is appreciable only when sufficient high voltage is applied, such as under operating conditions. Instead of the bottom, the picture is reduced, compressed,

or flattened at the top in the event peaking resistor R_5 is shorted in the circuit of Figure 1.

Although a change in height can occur without affecting the linearity of the vertical deflection, usually both height and linearity are impaired by a defect in the vertical deflection circuits. In like manner, generally, defects in the horizontal deflection circuits result in both incorrect width and horizontal non-linearity.

In addition, usually troubles in the horizontal circuits cause a reduction in raster brightness. This is due to the fact that most receivers employ flyback type high voltage supplies which are operated by the pulse output of the horizontal amplifier. In the circuit of Figure 1, a shorted horizontal deflection coil, L_3 or L_4 , results in a keystone raster. Either the top or bottom of the raster is wider, depending upon which coil is shorted. In either case, the yoke should be replaced.

Other typical symptoms of defects in the horizontal circuits are: a slight increase in width with no noticeable change in brightness. In Figure 1, this may be caused by a shorted cathode bypass capacitor C_{14} , or an open in width control, L_5 . Also, with the brightness remaining about the same, the raster stretches to

the right on the screen when sawtooth forming capacitor C_{10} is open.



A distorted picture may be produced by the magnetic field which results when the metal envelope of a picture tube becomes accidentally magnetized.

Courtesy Allen B. Dumant Laboratories, Inc.

This effect may be accompanied by a thin bright vertical line near the left edge of the picture. Deflection is still obtained in this case because C_{11} and C_{13} charge and discharge in series to form a sawtooth voltage. Correct linearity should be restored when C_{10} is bridged with the proper capacitance. A similar effect is produced when horizontal drive capacitor C_{13} is misadjusted.

When an open occurs in linearity resistor R_{23} , the picture is stretched on the left side. This defect also causes a slight de-

crease in height, and both symptoms should be corrected when R_{23} is bridged with a good resistor.

LACK OF BRIGHTNESS

In a circuit like that of Figure 1, any trouble that causes a reduction in amplitude of the horizontal deflection voltage results in a lowered positive potential applied to the anode of the picture tube and, therefore, a decrease in brightness. Typical symptoms are loss of both brightness and width due to a weak amplifier tube V_4 . These symptoms plus an increase in height are caused by an increase in resistance of the V_4 screen circuit resistor R_{20} .

Insufficient brightness and non-linearity, with the picture stretched on the left side, can be caused by a leaky coupling capacitor, C_{11} . In this case, a strip about three inches wide along the right edge of the screen may have proper brightness. When one of the screen bypass capacitors, C_{15} or C_{16} , is leaky, the picture is dim, reduced in width, crowded on the left side, increased in height, and contains a thin bright vertical line near the left edge. On the other hand, an open in grid resistor R_{18} reduces the raster to about three-quarters normal width with only a slight loss in brightness.

As illustrated in Figure 3, the raster is darkened, decreased in width, and contains several vertical ripples along the left side when there is a leaky power feedback filter capacitor C_{18} of Figure 1. Any change in this capacitor causes a nonlinear raster with stretching at the left. Without the decrease in width and brightness, a similar ripple effect is produced by an open or change in the capacitance of the yoke capacitor C_7 . Leakage in this capacitor causes a reduction in width and brightness, and an increase in height of the raster.

A type of raster distortion known as HORIZONTAL FOLDOVER is illustrated in Figure 4. Here, the foldover is at the left side of the screen due to an open in capacitor C_{18} , Figure 1. In the event the horizontal output tube has become gassy, the foldover is at the right side of the screen.

Just like the vertical deflection circuit, if the trouble has not been corrected, after control adjustments and tube replacements have been made in the horizontal deflection circuit, wave-form checks should be made to isolate the trouble to either the oscillator or the output stage. When the faulty stage is found, the defective component is located by means of voltage and resistance tests.



Picture detail is lost due to a defective coupling capacitor in the video circuits of the TV receiver.

Courtesy Sangama Electric Co.

As shown in Figure 5, changes in raster brightness as well as both height and width, all at the same time, are caused by variations in the output of the low voltage power supply. These supply voltages vary due to changes in the a-c power line voltage because of varying load conditions. Generally, picture size and brightness are caused to vary directly with the line voltage changes which occur during certain parts of the day only. Other than installing a constant voltage line transformer or explaining the cause to the receiver owner, there is little that the service technician can do about this trouble. However, by increasing the setting of the size controls so that the raster fills the screen at all times, notice of this effect may be minimized.

LOSS OF SYNC

When deflection synchronism is lost in a television receiver, various symptoms result, and for simplicity, all may be considered as distorted pictures. Lack of

synchronism is due to three general types of troubles: (1) low gain, incorrect alignment, or other defects in the preceding stages through which the video signals pass, (2) pickup of hum voltages or other interference by the signal or sync circuits, and (3) defects in the sync or deflection circuits. The second type is covered in the lesson on internal interference, and the first and third are described in the following paragraphs.

When loss of either horizontal or vertical sync, or both, is indicated by the overlapping, tearing, or jumbling of the picture on the screen, the corresponding hold controls should be adjusted in an attempt to obtain proper sync. At the same time, the contrast control setting should be reduced. In many receivers, picture signal voltages are passed by the sync separator if the video amplitude is too high due to an advanced setting of this control.

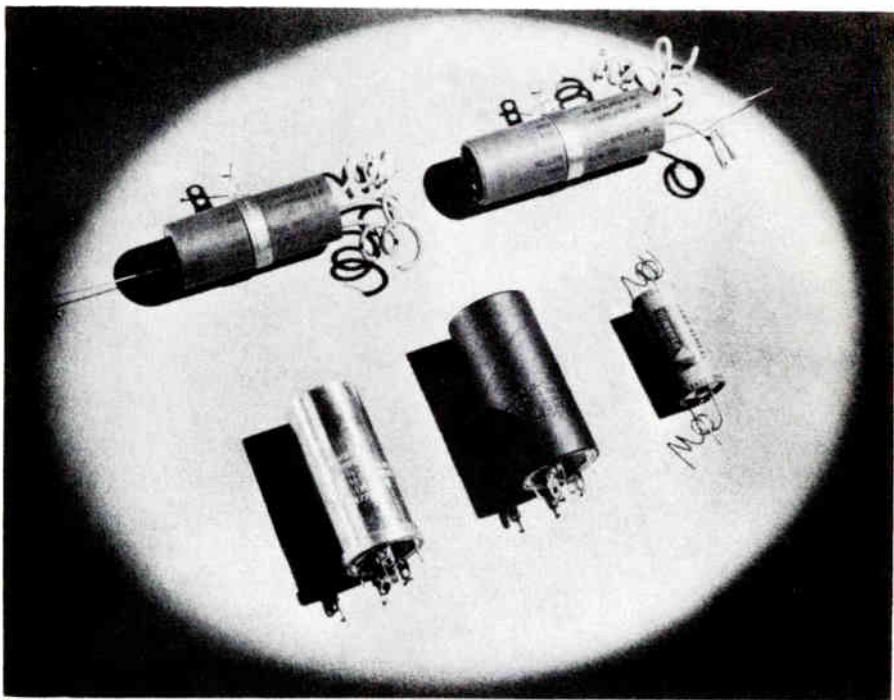

Raster pulling may result from the variations in the B+ voltage due to an open filter capacitor like these in the low voltage power supply.

Courtesy Pyramid Electric Co.

When present in the sync separator output, the picture signals interfere with the normal action of the sync pulses, and cause a loss of horizontal or vertical synchronism, or both.

When vertical synchronism exists, but horizontal synchronism cannot be obtained, then the horizontal afc tubes and the horizontal oscillator tube should be replaced. On the other hand, if only horizontal synchronism can be obtained, replace the vertical oscillator tube.

In the event neither vertical nor horizontal sync can be obtained, then the tubes in the sync circuits should be replaced. If loss in sync circuits is accompanied by weak picture reproduction, the tubes should be checked in the video stages and the picture i-f section. Finally, if these symptoms exist along with weak sound reproduction, the tubes in the r-f section need to be checked.

As before, if the control adjustments and tube checking do not result in correction of the trouble, the chassis must be removed and further tests made in the circuits of the suspected section. Since the methods of troubleshooting in the signal circuits are covered in other lessons, only the tests in the sync and deflection circuits are taken up at this time.

Figure 6 shows the sync amplifier, clamper, and separator circuits, using tubes V_1 , V_2 , and V_3 , respectively; the three-stage integrating network, R_6C_6 , R_7C_7 , and R_8C_8 , and the horizontal afc circuit, with tube V_4 , of a typical television receiver. As mentioned, if either horizontal or vertical synchronism only can be obtained, trouble is indicated roughly to exist at some point following point A in Figure 6.

However, with the chassis removed from the cabinet, a more definite indication can be obtained by employing an oscilloscope to check the wave-forms at point A. The wave-forms obtained should consist of both vertical and horizontal sync pulses, with no picture signal present.

The pulses should be examined with both 30 cycle and 7875 cycle time bases on the scope. When such data is available, they can be compared with the wave-forms specified by the receiver manufacturer. Whenever the wave-form check is made at any point near the input of a sweep oscillator, such as at point A, the oscillator tube or tubes should be temporarily removed to avoid mistaking the oscillator signal for the sync pulse.

When there is loss of vertical synchronism but the vertical

sync pulses have proper amplitude at point A, then the trouble is either in the integrating network or in the vertical oscillator stage. To further isolate the trouble, the vertical hold control R_2 of Figure 1 can be adjusted in an attempt to stop the picture momentarily. If the picture is stopped for an instant—even though it begins rolling immediately—the trouble is indicated to be in the integrating circuit, R_6C_6 , R_7C_7 , and R_8C_8 .

Defects here may take the form of opens, shorts, or changes in the resistance or capacitance of one or more of the integrator components. First, an oscilloscope can be employed to compare the amplitudes of the vertical pulses at the output of each section of the integrator. Normally, attenuation in each section is such that its output is approximately equal to 73% of the voltage applied to it.

Thus, in Figure 6, the pulse amplitude across C_6 should be about .73 of that at point A, the amplitude across C_7 is about $.73 \times .73$, or .53 of that at point A, and the amplitude across C_8 about $.53 \times .73$, or .39 of the input to the integrator.

With the scope test prods on point A and ground, the scope vertical gain control should be adjusted until the observed pulses fill exactly ten units on the

calibration scale. Then, with the prods placed across the integrator capacitors in succession, the pulse wave-forms on the scope screen should occupy approximately 7, 5, and 4 scale units, respectively. If the pulses have greater or less than the expected amplitude at any test point, check the resistance of the components in the preceding section of the integrator to locate the trouble.

When adjustment of the vertical hold control does not stop the picture for an instant, the trouble is likely in the vertical oscillator stage. Voltage checks should be made in this stage and, if necessary, resistance checks of the frequency determining components. In Figure 1, the main frequency determining components in the V_1 stage are T_1 , C_2 , R_1 , and R_2 . Also, C_1 and the preceding integrator components (not shown) may have some effect on the oscillator frequency.

By adjusting the horizontal hold control in an attempt to stop the picture momentarily, a similar check can be made to isolate the trouble to a single stage in the horizontal circuits. A loss of horizontal synchronism may exist even though the horizontal sync pulses have proper amplitude at point A, Figure 6. As before, trouble in the hori-

zontal oscillator is indicated when the picture cannot be stopped for an instant. If it can be stopped, the trouble likely is in the afc circuits, V_4 stage of Figure 6, and voltage and resistance checks should locate the defect in this stage.

In the event the observed sync pulses at point A do not have proper amplitude, or have picture signals or 60 cycle voltages associated with them, then the trouble is ahead of point A, and the scope test prod should be touched to point B, Figure 6. Since, in this example, the V_3 stage is the sync separator, the wave-forms observed at point B normally contain picture signal information. In receivers which employ this stage to amplify or invert the phase of sync pulses, separated from the picture signals in a previous stage, the wave-forms at point B should be the same as those at point A, except for possible 180° phase inversion.

When the check at point B is made, the sync pulse-to-video ratio should be noted. The video signal is represented in the drawing of Figure 7A in which are indicated the amplitudes, P of the sync pulses, and V of the complete video signal. The pulse-to-video ratio is equal to P/V , where P and V are both given in volts. Figure 7B shows the

actual appearance of the video wave-form on the screen of the typical oscilloscope employing a 30 cycle time base. Also, the amplitudes P and V are indicated.

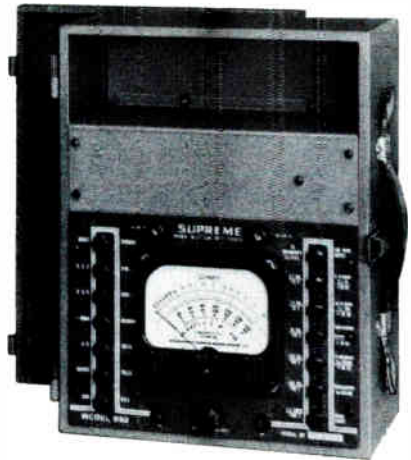

Service type multimeter. The high resistance ranges permit checking the leakage or interplate resistance of coupling and bypass capacitors.

Courtesy Supreme, Inc.

In the transmitted signal, the pulse-to-video ratio is about 1:5. However, in some receivers the video signal undergoes some limiting action before being applied to the sync separator. Due to clipping of the "white" regions of the signal by this limiting action, the P-to-V ratio may be as low as 1:3 at the grid of the sync separator tube. Generally, this ratio is not given in manufacturers' service data. Therefore, as a general state-

ment, it may be said that the P/V should not be less than 1:3 at point B, Figure 6. In the event the P/V is fairly low and picture signals are present in the sync separator output, the limiting action of the sync amplifier should be checked. Checks are made to locate the trouble in the V_3 stage when the wave-forms are correct at point B.

When the wave-form is incorrect at point B, a check at point C should be made. If the wave-form is normal at C, then there may be an open in C_3 , or R_3 may be shorted or a change occurred in its resistance. It is assumed all tubes in this section, including

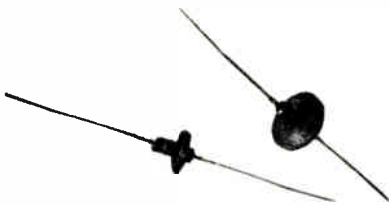

Picture detail is lost when an open peaking coil reduces the high frequency response of the video circuits of a television receiver.

D. T. I. Photo

V_2 , have been checked previously as mentioned earlier. Finally, point D is checked, and if the wave-forms are correct here but incorrect at C, then use voltage and resistance tests to locate the trouble in the tube V_1 stage.

Picture signals may be passed to some extent by the sync separator V_3 due to a fault in this stage or in some preceding stage. In this case, the picture signals corresponding to the darkest parts of the picture may have amplitude very nearly as great as that of the sync pulses. Therefore, they are able to trigger the horizontal deflection oscillator prematurely to cause raster tear-out in receivers which do not contain horizontal afc circuits.

In the vertical circuits, the relatively high-frequency picture signals do not affect synchronization to as great an extent as in the horizontal circuits. However, during successive field intervals, the picture signals may add different charges to the integrator capacitors so that the equalizing pulses are unable to discharge the integrator uniformly during the equalizing intervals. In this case, the vertical oscillator is not triggered at the exactly same point in each vertical cycle, and there is some loss of interlace.

When there is loss of interlace, successive scanning lines are paired, the result on the picture being as shown in Figure 8. At first glance, loss of interlace appears to be much like defocusing. However, close inspection shows that, whereas a defocused picture is not clear because of an overall fuzzing of the elements, the

elements stand out sharply when there is poor interlace, but lie on top of each other to produce a coarse picture.

FREQUENCY AND PHASE DISTORTION

The various troubles explained above distort the picture indirectly because of the effect they have on raster size, shape, brightness, or synchronism. In addition, there are many troubles which cause an abnormal video signal to be applied to the grid or cathode of the picture tube and, thus distort the picture more or less directly. These latter troubles occur in the signal circuits of television receivers.

The picture channel circuits of a typical receiver are shown in Figure 9. Here, the V_1 , V_2 , and V_3 stages make up the picture i-f amplifier, V_4 is the video detector and agc rectifier tube, V_5 the v-f amplifier, and V_6 the d-c restorer.

As shown in Figure 10, the fine detail is lost in the reproduced picture when, for any reason, the high video frequencies are being attenuated in the signal circuits. As the test pattern shows, this condition is indicated by a merging of the lines near the narrow ends of the vertical wedges.

In the V_4 and V_5 stages of Figure 9, poor high-frequency

response may be caused by shorted peaking coils, changes in load resistance, and undesirable circuit shunt capacitances due to components or leads moved from their normal location. Corresponding to the high video frequencies, the i-f components farthest removed from the carrier may be attenuated and result in loss of picture definition if the i-f circuits are misaligned.

Attenuation of the low-frequency picture signal components produces a result similar to that shown in Figure 11. This trouble may be caused by an open or a decrease in capacitance in coupling and bypass capacitors in the video circuits, or by attenuation of the components near the i-f carrier due to misalignment in the picture i-f circuits. Although less common, loss of either high or low frequencies may be caused by misalignment of the receiver r-f circuits. Also, the effect may be caused by h-f oscillator drift during the warm-up period just after a set is turned on. However, this latter cause is readily corrected by a slight re-adjustment of the fine tuning control.

The same circuit defects that cause attenuation of high or low frequencies also result in phase distortion. Phase distortion at low frequencies causes the production of light areas immediately to the right of dark objects.

Called **TRAILING REVERSALS**, several such areas are shown in Figure 11. Loss in clearness, due to distortion of the shape of the small picture elements, results from phase distortion at the high video frequencies.

Just as certain changes in v-f circuit components, etc., result in attenuation at the low or high video frequencies, other changes in these components cause greater than normal gain. Excessive low-frequency response produces horizontal streaks or a smearing effect following the larger objects in the picture. Excessive response at high-frequencies is indicated by a black smudge across the narrow end of the vertical wedges in the test pattern on the picture tube screen.

TRANSIENT RESPONSE

Transients, or momentary components of current exist in the v-f circuits due to the application of the various steep-sided wave fronts. These may have amplitudes great enough to produce temporary oscillations if the circuit is not adequately damped. In Figure 9 for example, the inductance and distributed capacitance of L_{10} may permit oscillations at some high frequency due to transient excitation in the event R_{10} opens or increases in resistance. An effect very similar to ghosts is produced on the receiver screen.

Improper transient response is indicated if the effect remains unchanged when the antenna is rotated, whereas the interfering images do change or disappear, when they are ghosts due to reflected signals.

HORIZONTAL PULLING

Certain bending or curving of the reproduced picture may be caused by a large number of different types of defects. Usually less severe than the symptoms caused by the various troubles explained above, these distortions are classed under the general heading of **HORIZONTAL PULLING**. On the receiver screen, horizontal pulling causes vertical objects such as doors, windows, and performers to have a bowed over, curved, or snaky appearance. This undesirable effect may be due to distortion of the raster itself, in which case it is known as **RASTER PULLING**. Also, it may be due to distortions in the picture, but not in the raster, in which case it is called **PICTURE PULLING**. Either type of pulling may remain constant or vary continually to produce a waver or weaving affect.

Raster

An example of raster pulling is shown in Figure 12 where the sides of the raster are wavy. This shows that the horizontal scanning lines are of unequal lengths due to variations in the amplitude

of the output of the horizontal deflection circuit. Because the receiver employs a flyback high voltage supply, the variations in scanning line length are accompanied by corresponding changes in brightness. The changes in line length affect the width of every picture element correspondingly to produce a distorted picture when a signal is received. In Figure 12, the two cycles of bending indicate a 120 cycle per second rate of change of deflection amplitude, such as would be caused by an open filter capacitor in the receiver low voltage supply circuit.

Other sources of raster pulling are: troubles in the horizontal deflection section, defects in the deflection yoke, and undesired magnetic fields near the picture tube. Since these sources cause pulling regardless of the nature of the signal voltage applied to the picture tube, raster pulling may be observed with or without a received picture.

Picture

Figure 13 shows an example of picture pulling. For this illustration, the picture has been moved to the left so that the edge of the raster can be seen to be straight. Here, the distortion consists of the video information shifted to the left on a group of scanning lines in the lower center part of the picture. Thus, the elements on



Horizontal pulling in the picture may be caused by a cathode-to-heater short in an r-f, i-f, or v-f amplifier tube.

Courtesy Hytron Radio & Electronics Corp.

each shifted line are produced to the left of their normal positions, causing the image to be bent, as shown. Also, the right-hand edge of the picture (the beginning of the horizontal blanking) is shifted

to the left, as is the darker area produced by the horizontal sync pulses. However, the raster itself maintains the proper shape because the deflection phase is controlled by the receiver afc circuit, and not by individual sync pulses. The picture pulling is due to phase modulation of the video signal, and causes the picture modulation, blanking, and sync information to shift in time-phase with respect to the constant amplitude scanning lines.

In the example of Figure 13, one complete cycle of variation per field appears, or 60 cycles per second. Therefore, the cause may be 60 cycle modulation of the video signal due to heater-cathode leakage in a tube in the v-f, picture i-f, or r-f section of the receiver. Other causes of picture pulling are: limiting action in the video amplifier; excessive or insufficient sync input to, or troubles in, the sync separator; poor low-frequency response in the r-f, i-f, or v-f amplifier; hunting action in, or extraneous signals coupled into, the horizontal afc circuits; very weak received signals; interference; and reflected signals.

Figure 14 shows picture pulling caused by limiting action in the video amplifier. This action reduces the amplitude of the sync pulses so that the sync separator cannot separate the sync from the

blanking and picture portions of the video signal. A similar effect is produced when a defect in the sync amplifier or sync separator circuits results in either too low or excessive amplitude of the horizontal sync pulses applied to the afc circuit.

Picture pulling due to poor low-frequency response in the r-f or i-f amplifier is illustrated in Figure 15. Since the sync signals are located near the low-frequency end of the v-f band, they are attenuated along with the picture lows when the r-f or i-f alignment is such that the carrier is located at a point which is too low on the over-all response curve. In this case, the picture pulling is accompanied by the other symptoms of poor low frequency response, such as poor reproduction of the large objects, and weak horizontal wedges.

The amplitude of the sync signals can be checked by adjusting the vertical hold control so that the picture rolls downward slowly out of vertical sync. This permits a comparison of the intensities of the picture, blanking, and sync signals, as they are applied to the picture tube. When the sync amplitude is correct, it should be possible to adjust the contrast and brightness controls to obtain the approximate relative intensities shown in Figure 16.

For this illustration, the lower part of one field is shown at the top of the screen, the large gray band across the middle is darkened due to the vertical blanking pulse between fields, and the upper part of the next field is at the bottom of the screen.

During the vertical blanking period, the scanning lines are further darkened by the short duration equalizing pulses near the middle of each of the first four lines, then by longer duration vertical sync pulses, and finally by a second group of equalizing pulses. As these pulses normally have greater amplitude than the blanking pulse, they cause the screen to be very dark gray, or black.

Although both blanking and sync signals make the screen black during normal operation of the receiver, for inspection purposes the brightness may be increased or the contrast decreased until the sync is dark gray instead of black.

An example of low sync pulse amplitude is given in Figure 17. Here, the sync pulse amplitude is reduced to about the same level as the portions of the picture signals corresponding to the darkest parts of the pattern. It is possible for the sync pulses to be wiped out completely (reduced to blanking level) by limiting action in the video amplifier. In such a case, synchronism is extremely

unstable, there is picture pulling at both top and bottom of the image, and the deflection oscillators may tend to sync with the leading edges of the blanking pulses.

An extreme form of horizontal pulling is illustrated in Figure 18. The entire image is distorted into an "S" shape due to 60 cycle modulation of the horizontal deflection oscillator. This symptom is caused by heater-cathode leakage in the horizontal afc tube V_4 , Figure 6. Electric hunting in the afc circuit, due to defective "anti-hunt" components, R_{10} or C_{12} of Figure 6, results in the horizontal pulling called COG-WHEEL effect, shown in Figure 19.

In trouble-shooting for horizontal pulling, first the edge of the raster is inspected to determine whether it is raster or picture pulling which exists. The raster may be moved to the left as in Figure 13, by means of the horizontal centering control, and its edge brought into view by adjustment of the contrast and brightness controls. The trouble is picture pulling if the edge of the raster is straight, but if the raster is curved also, then raster pulling exists.

In the event, with or without a picture, the shape of the raster is distorted, the exact nature of the distortion should be noted, as it may indicate the source of trou-

ble. For example, a defect is indicated in the low voltage supply filter by the presence of two cycles of bending accompanied by 120 cycle shading on the raster as in Figure 12. In a like manner, any other undesired a-c voltage which enters the horizontal deflection circuits produces curves and bars on the raster. The bars correspond in number to the frequency of the undesired voltage.

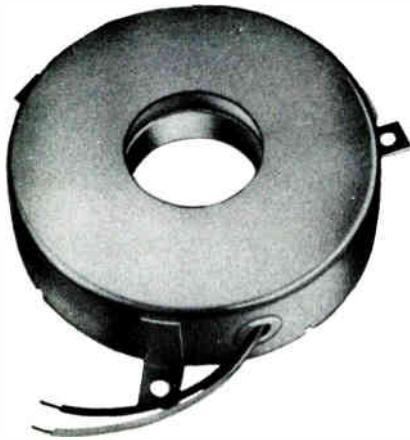

Often a distorted picture is a result of a mis-adjusted focus coil.

Courtesy Triad Transformer Mfg. Co.

Troubles in the deflection yoke produce various characteristic raster shapes such as keystone, pillow, pincushion, or barrel. To observe its shape, it is necessary to reduce the size of the raster by adjustment of the width and height controls. Usually these controls cause a change in line-

arity of the raster, and this should not be mistaken for yoke trouble. Also, misadjustment of the focus coil and ion trap magnet cause bending of the raster lines, therefore a check of these units should be made.

To determine whether raster pulling is due to yoke trouble or an external magnetic field, the thumbscrew on the yoke may be loosened and the yoke rotated about 90°. The raster is caused to turn also, but retains its original shape if the yoke is at fault. In the event an external magnetic field is causing the pulling, the raster changes in shape as the yoke is rotated.

In the case of picture pulling, to determine whether the cause is low amplitude sync signals, a check is made by observing the relative shading produced by the sync, blanking, and picture signals as explained for Figures 16 and 17. If the sync pulse amplitude is low, check the tubes in the v-f, picture i-f, and r-f sections.

When tube replacement does not correct the trouble, check the voltages and circuit components in the video amplifier. Lowered gain in this circuit most likely is due to a plate load resistor which has decreased in resistance or a coupling capacitor which is open or has decreased considerably in capacitance. Excessive limiting in the v-f stages may be caused by

higher than normal signal amplitude due to trouble or misadjustment in the afc circuit, or incorrect direct voltages on the plate, screen, cathode, or grid of the v-f tubes due to circuit defects.

If the v-f amplifier is operating properly, then a check of the alignment should be made in the i-f and r-f sections of the receiver, to determine whether the carriers are located high enough on the respective i-f and r-f over-all response curves.

When the shadings show the sync pulses to have sufficient amplitude, then the picture should be inspected to determine whether the trouble is in the afc circuit, or in the sync circuits ahead of the afc circuit. This is done by disconnecting capacitor C_5 of Figure 6 to remove the sync input to the afc circuit, and by setting the horizontal hold control R_{12} at its midposition. Then, by turning the horizontal oscillator frequency control, T_3 of Figure 1, the correct scanning frequency is obtained, as indicated by the momentary appearance of the complete picture on the screen.

After these adjustments are made, the horizontal oscillator is "free-wheeled" by continually adjusting the hold control to keep the picture stationary just long enough to observe whether the pulling is still present. If it is, the trouble is indicated to be in the

afc circuit, but if the pulling has disappeared, the trouble is more likely to be ahead of the afc stage. With C_5 reconnected, voltage and resistance checks are made in the indicated section to locate the trouble.

PICTURE TUBE AND CIRCUIT DEFECTS

In addition to the troubles in the various receiver sections, there are a number of types of distortions which may be produced by defects in the picture tube, or in the circuits directly connected to the picture tube.

A few troubles are inherent in the construction of the picture tube, and often there is little that can be done to remedy the situation. For example, a tube having appreciable curvature of the screen may cause the picture to look different when viewed from different angles, or show distortion at the edges of the picture. In this case, about all that can be done is reduce the size of the raster so the picture does not reach the edges of the tube.

Distortion may be produced if the electron gun is out of position relative to the screen, or the electrodes of the gun are out of alignment. Only replacement of the tube will remedy this trouble when the receiver centering adjustments cannot sufficiently compensate for the mis-alignment.

Defocusing over the entire screen may result from changes in operating voltages applied to the electron gun, or a gassy picture tube. If the deflection coils are unbalanced, or the deflection voltages unbalanced in the case of an electrostatic deflected tube, defocusing may appear in only some areas on the screen. What is known as trapezoidal distortion of solid areas in the picture is caused by loose, damaged, or misaligned deflection coils.

Due to refraction and reflection in the glass of the picture tube face, the scanning spot may be surrounded by a halo which reduces picture sharpness. This effect is called halation, and can be remedied to some extent by reducing the raster brightness.



When circuit components such as resistors change value, the resulting changes in the operating or signal voltages applied to a tube may produce picture distortion.

Courtesy Ohmite Mfg. Co.

Secondary emission from the electron gun or cold emission from the gun structures may cause illumination of the screen. Usually this emission has no relation to the regular scanning

beam, and produces irregular areas of unwanted light. Replacement of the picture tube is the only remedy for this trouble.

Television picture tubes gradually become deactivated with use, due to electron bombardment of the screen. Also, as with all tubes, the cathode emission decreases as the tube ages. Both of these factors cause a gradual reduction of screen brightness and, when the reproduced image is no longer acceptable, the tube must be replaced.

A cathode-heater short in the picture tube results in a light faded picture with retrace lines visible. Also, due to the resultant modulation of the cathode voltage, the 60 cycle light and dark bars are produced. In the case of a weak tube due to reduced emission, etc., the picture is uniformly faded over its entire area, and the retrace lines may not be visible. This latter symptom also is produced by a "soft" tube (tube in which the vacuum has reduced), or by a reduction of the voltage applied to the No. 2 grid. The picture appears dark with retrace lines visible, and rotation of the brightness control has no effect on screen brightness in the event an open exists in the cathode lead or base connection of the picture tube.

In a television receiver using a round picture tube, the screen

may contain a spot at or near the center as shown in Figure 20. This spot is produced by bombardment of the screen with the negative ions streaming from the electron gun. These ions are relatively heavy and, therefore, are not deflected to any great extent in magnetically deflected tubes. Therefore, they strike the screen in a relatively small area to cause deterioration of the luminescent material. In rectangular tubes the ion spot has an X shape, and is known as an "X" burn. Most tubes employ ion traps or aluminized screens to reduce or prevent the formation of an ion spot or burn.

A similar effect is produced due to electron bombardment of a small area of the screen for a short time immediately after the receiver is turned off. The deflection circuits are de-energized quickly, but the high voltage circuits discharge slowly and thus maintain a high potential on the picture tube anode for a considerable time. The cathode remains hot enough to emit electrons for a few seconds, therefore the electron beam continues to reach the screen but comes to rest near the center of the screen because of the absence of the deflecting field.

The beam soon dies out, but this action burns the screen a little bit each time the receiver is turned off. Whatever the cause of a burn on the picture tube face,

replacement of the tube is the only remedy.

Poor focus over the entire screen, and a shadow around part or all of the picture as shown in Figure 21, may be caused by several types of trouble. The deflection yoke may be too far back on the neck of the tube. It should be as close to the cone as it will go. The focus coil may be too close to the yoke. The ion trap may be improperly adjusted, or the electron gun improperly positioned in the tube. Use of a stronger ion trap magnet may compensate for the incorrectly positioned gun. At other times rotation of the picture tube will compensate for the poorly positioned gun.

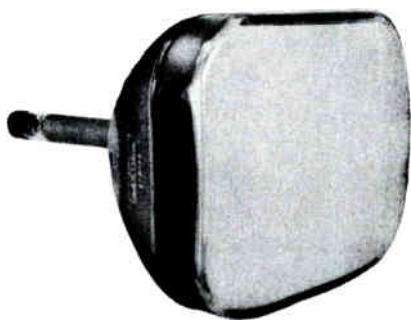

A 16 inch rectangular tube. The entire picture may appear out of focus if the picture tube is gassy.

Courtesy Federal Telephone and Radio Corp.

Various external magnetic fields cause raster distortions if they are near enough to the picture tube. For example, if a 60-cycle

transformer is located too close to the deflection yoke, one corner of the raster may be pulled toward or pushed away from the corner of the mask, and the entire picture may have a wavy appearance. With a magnet located too close to one side of the picture tube cone, the side of the raster may be curved inward resulting in a shape similar to that illustrated in Figure 22.

Similar distortions of the raster may result when the cone of a metal cone picture tube becomes magnetized accidentally due to being touched by a permanent magnet. As mentioned, distortions due to an external magnetic field form one type of raster pulling.

In Figure 23, the image is turned right for left and is caused by incorrect, right-to-left scanning of the electron beam. This could be due to transposing of the wires going to the horizontal coils of the deflection yoke, and could occur when the yoke has been replaced or repaired to correct some previous trouble.

If for any reason, the high-voltage anode lead or the cone of a metal picture tube arcs to ground, or is temporarily shorted to ground, the resulting heavy surge of current overheats the series resistor R_{24} , Figure 1, causing it to increase in resistance. Then, in operation, advance of the brightness control increas-

es the current in, and therefore, the voltage drop across R_{24} . This results in a lower voltage on the picture tube anode. With lower anode voltage, deflection is increased due to lower velocities of the electrons in the beam. As a result the raster expands both horizontally and vertically and loses focus to produce the "blooming" effect shown in Figure 24.

In addition, R_{24} forms the only series element of the high voltage supply filter, and practically the entire a-c ripple must be attenuated by this resistor. The ripple output of the high voltage rectifier may be as high as 1500 volts or more peak, therefore extremely high differences of potential exist within this resistor, and may cause internal sparking with radical changes in resistance.

This sparking causes variations in the high voltage applied to the picture tube anode resulting in various symptoms such as changes in picture brightness, size and focus, inability to obtain normal screen brightness, and difficulties in maintaining focus when changing brightness. To reduce the possibility of these troubles, when this resistor is replaced, two or more units should be used, the total of which approximates the original resistance of R_{24} .

Figure 25 shows severe smearing of the picture due to the effect

of undesired capacitance in shunt with the picture tube signal input circuit. Depending upon which element the signal is applied to, the capacitance is between the picture tube grid or cathode and ground. The trouble may be corrected by properly dressing the leads in the v-f amplifier output-picture tube input circuit.



STUDENT NOTES

STUDENT NOTES

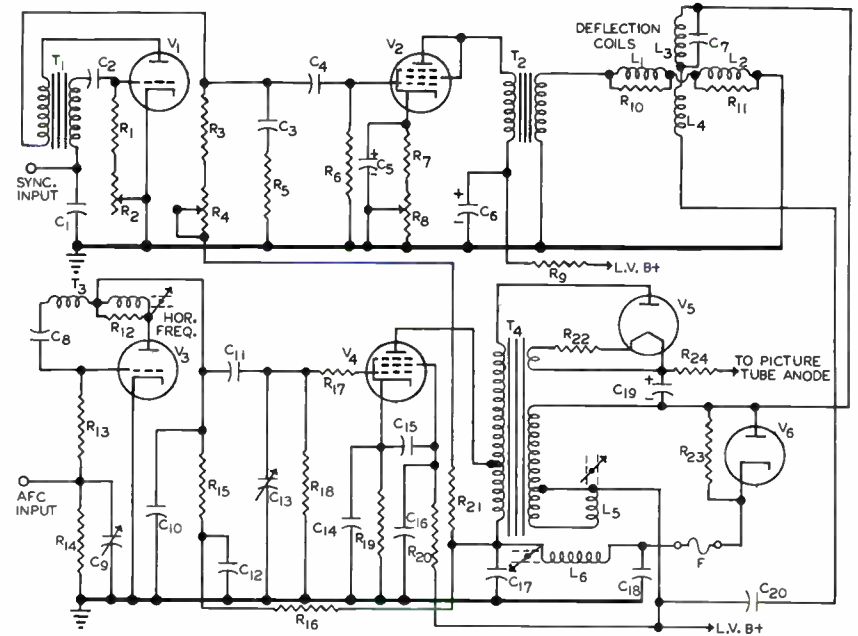
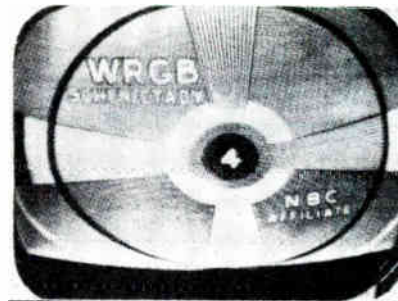
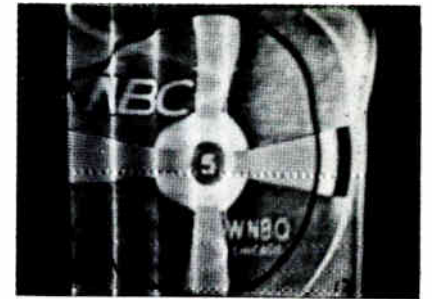

FIGURE 1



COURTESY GENERAL ELECTRIC CO.
REDUCED SIZE AT BOTTOM
FIGURE 2



28. DEFECTIVE HORIZONTAL SWEEP
FIGURE 3

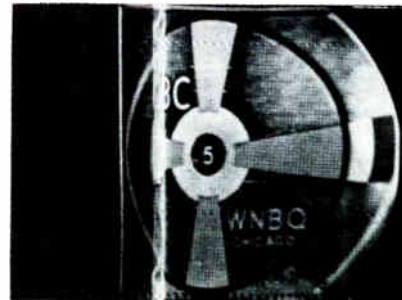

24. HORIZONTAL FOLD-OVER
FIGURE 4

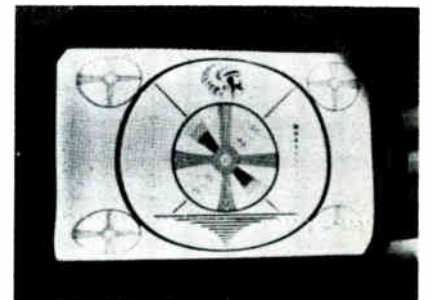

40. DECREASED VERTICAL AND HORIZONTAL SWEEPS
FIGURE 5

TSM-13

STUDENT NOTES

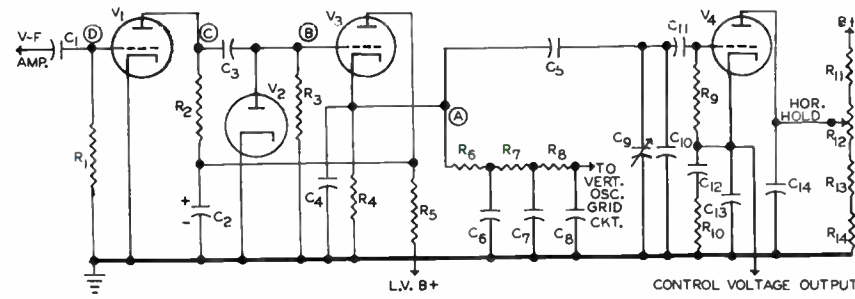

FIGURE 6

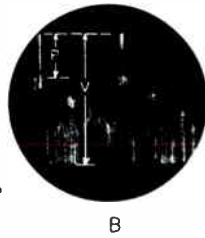
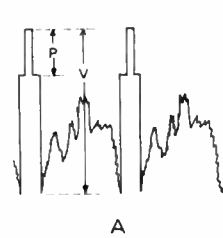

FIGURE 7

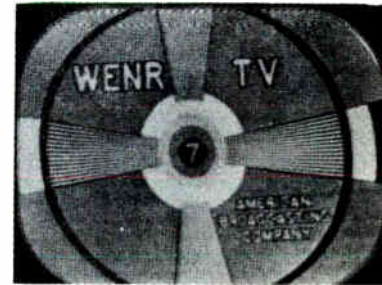

FIGURE 8

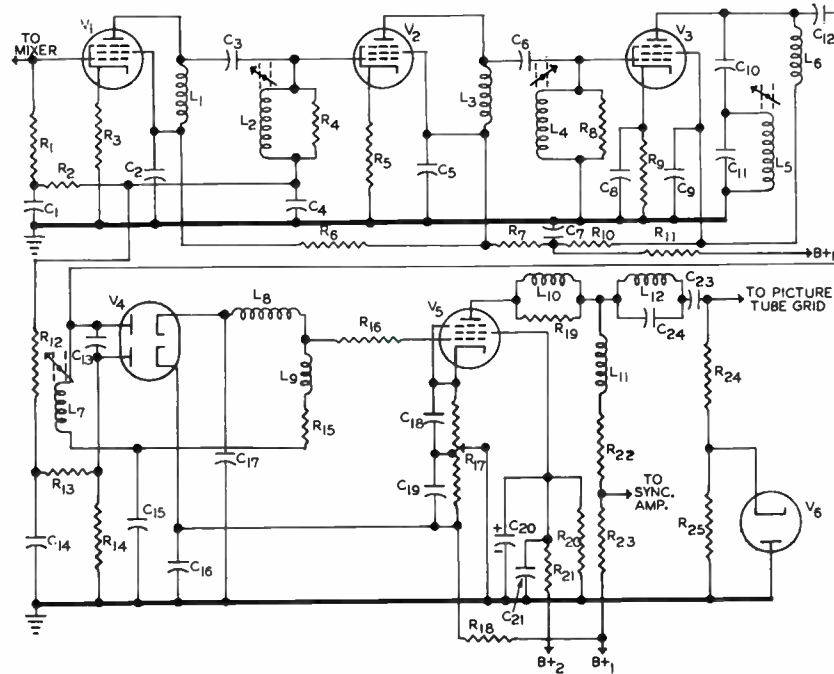
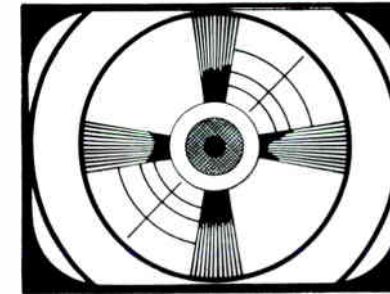
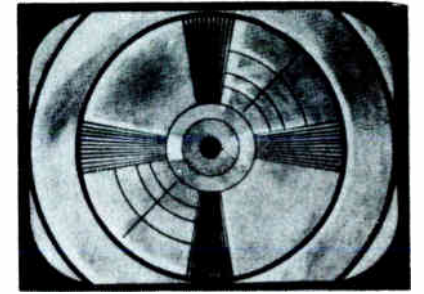

FIGURE 9



LOSS OF HIGH FREQUENCIES
FIGURE 10



LOSS OF LOW FREQUENCIES
FIGURE 11



COURTESY RADIO AND TELEVISION NEWS
RASTER PULLING
FIGURE 12



COURTESY RADIO AND TELEVISION NEWS
PICTURE PULLING
FIGURE 13



COURTESY RADIO AND TELEVISION NEWS
PICTURE PULLING
FIGURE 14



COURTESY RADIO AND TELEVISION NEWS
PICTURE PULLING
FIGURE 15

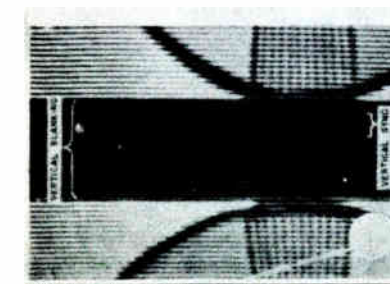

COURTESY RADIO AND TELEVISION NEWS
SYNC AND BLANKING PULSES
FIGURE 16



COURTESY RADIO AND TELEVISION NEWS
SYNC LEVEL REDUCED
FIGURE 17

TSM-13

TSM-13



COURTESY RADIO AND TELEVISION NEWS
PICTURE PULLING
FIGURE 18



COURTESY GENERAL ELECTRIC CO.
COG-WHEEL EFFECT
FIGURE 19

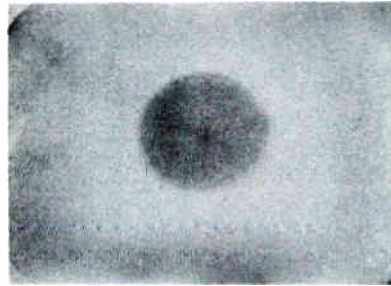

COURTESY GENERAL ELECTRIC CO.
ION SPOT
FIGURE 20

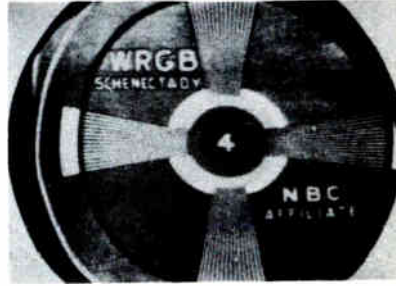

COURTESY GENERAL ELECTRIC CO.
NECK SHADOW
FIGURE 21

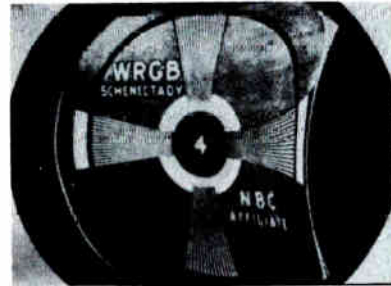

COURTESY GENERAL ELECTRIC CO.
SWEEP DISTORTION
FIGURE 22

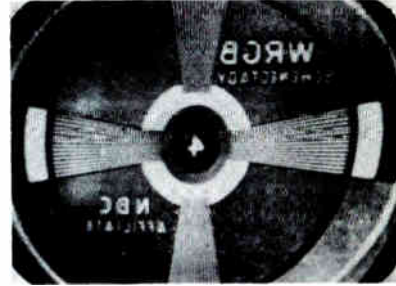

COURTESY GENERAL ELECTRIC CO.
RASTER REVERSED
FIGURE 23

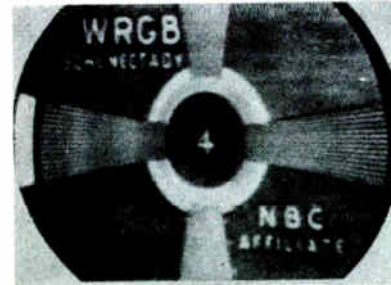

COURTESY GENERAL ELECTRIC CO.
BLOOMING
FIGURE 24

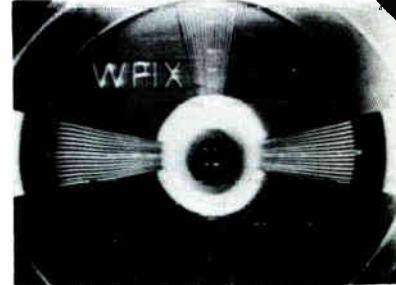

COURTESY PENNSYLVANIA ELECTRIC PRODUCTS, INC.
PICTURE SMEARED
FIGURE 25

DeVRY Technical Institute

Formerly DeFOREST'S TRAINING, INC.

4141 WEST BELMONT AVENUE

CHICAGO 41, ILLINOIS

QUESTIONS

Distorted Picture—Lesson TSM-13A

Page 31

3

How many advance Lessons have you now on hand?

Print or use Rubber Stamp.

Name..... Student
No.....

Street..... Zone..... Grade.....

City..... State..... Instructor.....

Write your answers on the "Ans." line below each question. If more space is needed use reverse side of this page.

1. In the circuit of Figure 1, what is the probable cause of the distorted picture illustrated by Figure 2?
Ans.....
2. Referring to the circuit of Figure 1, what is the probable cause of Horizontal Foldover illustrated by Figure 4?
Ans.....
3. When adjustment of the horizontal control stops the picture momentarily, then loses sync, what circuit is likely at fault?
Ans.....
4. What should be the approximate minimum ratio of sync pulse to video signal at the input of a sync separator stage?
Ans.....
5. What is the probable cause of loss of interlace?
Ans.....
6. In a picture channel circuit like that of Figure 9, list four possible causes of poor high frequency response illustrated by Figure 10.
Ans.....
7. What is the result of phase distortion at low video frequencies?
Ans.....
8. In troubleshooting for horizontal pulling, what check should be made first?
Ans.....
9. Associated with the picture tube, what two faults cause defocusing over the entire screen?
Ans.....
10. With operating voltages normal, what is an indication of a weak picture tube?
Ans.....

FROM OUR *Director's* NOTEBOOK

SAY WHAT YOU MEAN — MEAN WHAT YOU SAY

What you say and how you say it in your employment interview often spells the difference between getting the job and getting the "brush off."

When you are interviewed for a job, the employer has no way of knowing whether you are a good man for the job or not. You've had no chance to demonstrate your ability to him.

Hence, you must be able to put yourself across in words **FIRST** before you can have the opportunity of showing the boss you're the right man.

So speak clearly, use words you are familiar with, put together good, grammatical sentences and avoid stammering. Above all, say what you mean without overstatement—and **MEAN WHAT YOU SAY**. Sincerity is all-important for making a good impression.

Yours for success,

W. C. Ale Vrey

DIRECTOR

TSM



GHOSTS

Lesson TSM-14A

T-14

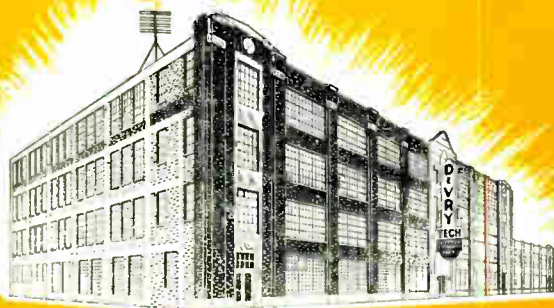

DeVRY Technical Institute
4141 W. Belmont Ave., Chicago 41, Illinois
Formerly DeFOREST'S TRAINING, INC.

TSM-14A

GHOSTS

4141 Belmont Ave.

COPYRIGHT 1955

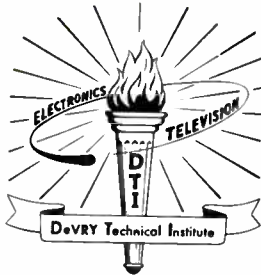

Chicago 41, Illinois



This combination television and FM receiver is styled especially for use in home game rooms, clubs, schools, lecture halls, etc. The unit can be placed on a shelf or on the matching base shown.

Courtesy Allen B. Dumont Laboratories, Inc.

[World Radio History](#)

Television Service Methods

GHOSTS

Contents

	PAGE
Types of Ghosts	4
Multipath Ghosts	5
Mismatch Ghosts	8
Tunable Ghosts	8
Line Pickup Ghosts	9
Identifying the Ghost	9
How to Obtain Ghost-Free Reception	12
Correcting Multipath Troubles	12
Transmission Line Impedance Matching	17
Correcting Other Ghosts	21

The story of the phototube is that of a modern miracle. Its accomplishments have been so numerous, so amazing, that they seem almost exaggerated. Yet what has been accomplished thus far is but a start; the future holds promise of developments and uses even more remarkable. We are on the threshold of the Electronic Age, the development of which will produce devices and accomplish results beyond our imagination. Phototubes will play an increasingly important part in that development.

—Selected

GHOSTS

In an earlier lesson, a ghost was defined as an undesirable image which is displaced either to the right or to the left of the desired image. Usually, the intensity of the ghost image is less than that of the main picture, although it can be brighter under certain reception conditions. In almost all cases, ghost images appear to the right of the desired image, and often more than one is produced on the screen.

Ghosts prove very annoying to the television viewer and, therefore, constitute one of the major problems encountered in satisfactory installation and performance of television receivers. It is the purpose of this lesson to explain the causes of ghosts, and to describe methods for either eliminating them or reducing them a satisfactory amount in those stubborn cases where complete elimination proves impossible.

TYPES OF GHOSTS

On the basis of their several causes, ghosts may be grouped into four general classes: (1) multipath, (2) mismatch, (3) tunable, and (4) line pickup ghosts. The ghosts may be classified in other ways. For example, various descriptive terms are employed according to their appearance on the receiver screen. Such

terms are: trailing, leading, positive, negative, fluttering, and multiple ghosts.

A **TRAILING GHOST** is one which is displaced to the right of the desired image on the receiver screen, due to the fact that the signal energy producing the ghost is arriving at the picture tube grid a short interval of time later than the signal which is producing the main image. Since the scanning spot moves from left to right on the screen, each picture element of the ghost image is produced from a fraction of a microsecond to a few microseconds later and, therefore, slightly to the right of the corresponding element in the desired image.

On the same basis, a **LEADING GHOST** is one which appears to the left of the desired image, for the signal producing it arrives at the picture tube grid a little sooner than that producing the desired image.

A **POSITIVE GHOST** image has light and dark areas which correspond directly with those in the main image. As in photography, positive and negative television pictures are the reverse of each other so far as light and dark areas are concerned. Thus, a **NEGATIVE GHOST** has light areas corresponding to the dark in the normal positive picture.

Under certain conditions, the ghost image may vary in intensity, appear and disappear, shift position on the receiver screen, and for this reason it is known as a **FLUTTERING GHOST**. As the term implies, **MULTIPLE GHOSTS** consist of two or more ghosts displaced from each other on the screen. Since the methods employed to eliminate ghosts differ with the various causes, the following explanations are grouped according to causes.

Multipath Ghosts

MULTIPATH GHOSTS are produced when the signal radiated by a given transmitter reaches the receiver antenna by more than one path. It is by far the most common type. Therefore, the trailing ghost image appearing on the screen due to the existence of one extra wave path is illustrated in Figure 1.

If there are no interfering objects between the transmitting and receiving antennas, the direct wave takes the shortest path and travels to the receiving antenna in a minimum of time. In general, any large object which reflects light will reflect the VHF and UHF television signals. Therefore, it frequently happens that the radiated waves travel from the transmitter to one or more such objects, and then are reflected to the receiving antenna. Thus, the antenna receives the waves by

the shortest or direct path, and also by one or more longer reflected paths.

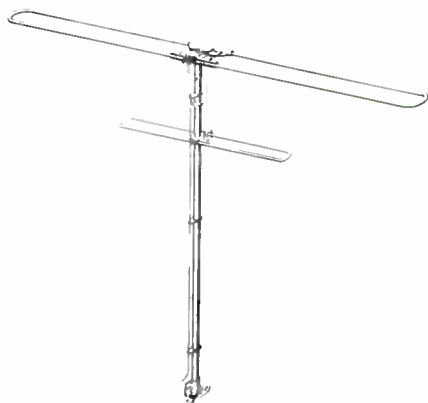

Folded dipoles, one for the low VHF band, and the other for the high band. A relatively simple arrangement such as this usually is suitable in ghost-free locations.

Courtesy The Ward Products Corp.

Any of a large number of different objects may serve as the reflecting medium, a few common examples of which are illustrated in Figure 2. Here, lines P_1 , P_2 , P_3 , P_4 , and P_5 indicate five paths by which the signals are radiated from the antenna of the transmitter. As indicated by the dashed lines, the television waves in path P_1 are reflected by a hill to the receiver location, the waves in path P_2 are reflected from a grove of trees to the receiver, path P_3 is the direct path, and waves in paths P_4 and P_5 are reflected from a water or gas tank and a building, respectively. Other common reflecting objects are bodies

of water, bridges, power and telephone lines, and moving objects such as automobiles, trains, and aircraft.

In the case of Figure 2, the signal energy arriving via the direct path P_3 is the one which produces the main or desired image on the screen, while four ghost images of various intensities will be produced by the signals of paths P_1 , P_2 , P_4 , and P_5 respectively. The total distance traveled by each ghost signal, from transmitter to reflecting object to receiver, is greater than the distance traveled by the desired direct-path signal. Therefore, each ghost signal requires more time than the desired signal to travel from transmitter to receiver, and consequently each arrives at the antenna later than the desired signal, to produce trailing ghosts on the screen.

The intensity of a ghost depends upon the efficiency of the reflecting action and the strength of the transmitted signal. Due to appreciable absorption by the reflecting object, the ghost usually has less intensity than the main image. However, in the event an object reflects a strong signal, and the direct signal is weakened by obstructions in its path, the ghost may be as bright as, or brighter than, the desired image.

The distance a ghost is displaced on the receiver screen depends upon how much farther the

ghost signal travels than the direct wave, and upon the width of the raster on the face of the picture tube. These relationships are shown graphically by the curves in Figure 3. Here, the figures along the left edge indicate how far the ghost image will be displaced from the main image for the various path length differences given along the bottom of the graph. As the displacement depends also upon the raster or sweep width, a curve is given for each of eight representative sweep widths.

As an example, suppose the receiver location is 7 miles, 1200 feet from the transmitter, in Figure 2, the total length of path P_2 , from transmitter to trees to receiver, is 7 miles, 3200 feet, and the receiver employs a 24 inch picture tube. Since the length of the direct path P_3 equals the distance between the transmitter and receiver, the path length difference in this case is:

$$\begin{aligned} 7 \text{ miles, } 3,200 \text{ ft.} - 7 \text{ miles } 1,200 \text{ ft.} \\ = 2,000 \text{ ft.} \end{aligned}$$

In Figure 3, the ordinate corresponding to a 2000 foot path length difference crosses the 24 inch picture tube curve at the abscissa corresponding to an image displacement of 0.8 of an inch. Therefore, the ghost due to path P_2 will appear about eight-tenths of an inch to the right of the main image on the screen.

Normally, it is not necessary to determine the path length differences of ghost signals and direct signals in service work but, in some instances, it might be desirable to determine fairly definitely whether or not a reflection is occurring at some particular object fairly near the receiving location. This is done by estimating the ghost image displacement on the receiver screen, and then using the graph of Figure 3 to determine the approximate difference in path lengths. This distance may then be checked against the estimated distance between the receiver and suspected reflecting object.

For example, suppose a displacement of about 0.26 of an inch exists between the ghost and desired images on the screen of a 20 inch picture tube. Referring to the graph of Figure 3, we find that the 0.26 inch displacement abscissa crosses the 20 inch tube curve at the ordinate corresponding to a path length difference of about 800 feet. Thus, the ghost may be due to some object so located as to increase the path by 800 feet.

If the path length difference is roughly one-twentieth or less of the distance between the receiver and transmitter and, drawn from the transmitter and suspected reflecting object to the receiver, imaginary straight lines form an angle of nearly 90° at the receiv-

ing location, then the distance from the receiver to the suspected object is practically equal to the indicated path length difference.



Often, ghosts are eliminated when the antenna front-to-back ratio is increased by adding parasitic elements such as the reflectors behind the dipoles as shown here.

Courtesy The Ward Products Corp.

However, as this angle increases, the distance to the reflecting object decreases. When the object is directly behind the receiver, the distance to the reflecting object is only one-half the difference in path lengths. On the other hand, as the angle is decreased from 90° , the object distance from the receiver becomes greater than the path length difference, and will be equal to many times the latter at very small angles. In this case, the location of the source of re-

flections is difficult if not impossible to determine.

A multipath condition which causes FLUTTERING GHOSTS on the receiver screen is that illustrated in Figure 4. Here, the solid line shows the direct wave path, and the dashed lines indicate various reflected wave paths made possible as the airplane moves along the flight path indicated by the dot-dash line.

Although but three possible reflected wave paths are shown in the figure, the actual number existing is infinite because the angle of the reflected path changes continuously with time as the airplane moves along. Therefore, the reflected path length changes continuously also, so that the carrier waves arriving at the receiver antenna by this path have a continuously changing phase with respect to the waves arriving by the direct path.

Due to these phase variations, the reflected waves alternately aid and oppose the direct waves so that the total or resultant signal applied to the receiver input becomes alternately stronger and weaker than the signal input when the reflected waves are not present. In turn, these signal strength variations cause corresponding contrast variations in the picture on the receiver screen. Because of the greater length of the reflected wave path, a trailing ghost

image is produced also, and the entire effect is that of a bobbing or bouncing of the picture, beginning slowly and increasing in speed and then stopping suddenly.

Mismatch Ghosts

MISMATCH GHOSTS are produced when the signal encounters a mismatch at the receiver. Due to the mismatch between the impedance of the line and that of the receiver input, not all of the energy is delivered to the receiver; instead a portion of it is reflected back along the line to the antenna. In turn, the antenna reflects part of the energy back to the receiver, producing a lagging ghost of diminished intensity. If the signal is sufficiently strong and the mismatch is severe, there will be repeated reflections resulting in a series of ghosts of decreasing intensity.

Tunable Ghosts

TUNABLE GHOSTS are produced due to oscillations in the picture i-f or video circuits of the receiver. If a defect or misadjustment exists such that these circuits do not attenuate properly the transients produced by steep wavefronts in the signal, the transients may excite damped oscillations which add components to the video signal such that one or more slightly displaced trailing ghosts are produced.

Line Pickup Ghosts

In some cases, especially where a relatively long lead-in is employed, the lead-in functions as an antenna, and thus supplies signal energy to the input of the receiver. This energy arrives at the receiver earlier than that picked up by the antenna, because of the difference in travel distances along the lead-in, and therefore, it results in a **LEADING GHOST**. That is, a ghost image displaced a short distance to the left of the desired image is produced due to the undesired line pickup.

Usually, this type of trouble merely causes the picture to be fuzzy or blurred because of the small amount of displacement due to the little difference in path lengths. A similar effect may be produced due to signal pickup by the chassis of the receiver.

IDENTIFYING THE GHOST

In correcting ghost troubles, the first step consists of determining the type of ghost which exists, since the type indicates the possible sources of trouble in each case. As always, the customer's story should be obtained before any troubleshooting work is done at the receiver or on the antenna installation. This is especially important in the case of fluttering ghosts due to reflections from passing airplanes, since, short of redesigning the

agc circuits in the receiver, little can be done to eliminate this trouble. Some receivers have agc circuits which are designed to prevent fluttering ghosts due to airplanes or similar sources of interfering signals.



Carried around the roof, a test antenna connected by a temporary lead-in to the receiver may be employed to find a ghost-free location to which the regular antenna may then be moved.

Courtesy The Ward Products Corp.

With the receiver tuned to a station, the screen should be observed to determine whether the ghost is leading or trailing, the displacement of the ghost image, and whether more than one ghost is present. If a stationary, trailing ghost exists, then it must be of either the multipath, mismatch, or tunable type. As tunable ghosts are very infrequent, either multi-

path or mismatch trouble may be assumed first, and further checks made to determine which of these is the actual cause in a particular case.

When it is possible to receive a station which is located in some direction other than that from which the ghost is being obtained, the receiver should be switched to this other station. If the ghost disappears completely, or an entirely different ghost condition exists, then multipath trouble is indicated. However, should the ghost remain unchanged when the receiver is switched to stations located in different directions, mismatch trouble is indicated.

In many cases, however, all the stations which can be received are located in the same general direction from the given receiving site, so that similar ghost conditions are produced by signals from all stations. When this situation exists, usually the channel switching test is inconclusive, and some other means is needed to distinguish between the multipath and mismatch types.

Such a means is provided by the following equation which gives the necessary lead-in length L , in feet, to produce a given ghost image displacement D , in inches on the receiver screen.

$$L = \frac{D \times k \times 26,100}{W}$$

in which:

W = raster width in inches, and
 k = the propagation constant of the lead-in wire.

To find the values needed for a particular case, the displacement D and raster width W can be measured, and the value of k taken from Table 1.

TABLE 1

Propagation Constants of Transmission Lines	
Type of Line	k
Twin lead, polyethylene insulated	
300 ohm	0.82
150 ohm	0.77
72 ohm	0.71
Coaxial cable, polyethylene insulated	
	0.66
Two conductor, air insulated	
Parallel wires	0.975
Parallel tubing	0.95

Then, with the appropriate values, of D , k , and W substituted in the above equation, the length L will be obtained for the lead-in necessary to cause the existing ghost. The actual length of the lead-in can be measured or estimated and compared with the calculated L . If the two values are reasonably close, then the ghost is likely due to mismatch trouble. However, in the event the value of L obtained from the equation is considerably greater or less than the actual length of lead-in employed, then multipath troubles are indicated.

As an example, suppose a ghost displacement D of 0.1 of an inch is produced on the screen of a receiver, measurement shows the raster to be 10 inches wide, and the coaxial cable is estimated to be about 175 feet long. From Table 1, the value of k is found to be 0.66 which, when substituted with the values of D and W in the equation, gives:

$$L = \frac{.1 \times 0.66 \times 26,100}{10}$$

$$= \frac{1722.6}{10} = 172.26 \text{ feet.}$$

Since the calculated value of L is reasonably close to the estimated length of the lead-in, it is reasonable to conclude that mismatch is the cause of trouble in this case.

To simplify the procedure, the graph of Figure 5 gives ghost image displacement versus lead-in length for several different sweep widths and two common transmission line types. As these curves are based on the above equation, it is necessary to adjust the receiver raster width to correspond with the nearest value given in the graph, measure the ghost image displacement on the screen, and use the graph to obtain the lead-in length required to obtain the measured ghost displacement. As before, this length then may be compared with that

which is actually employed in the installation, and the comparison will indicate the nature of the trouble causing the ghost.

To illustrate the use of the graph in Figure 5, let us assume that an installation employing 120 feet of 300-ohm twin lead transmission line has a ghost image displacement of 0.3 of an inch on the screen when the raster width is adjusted to 14" on the face of the receiver 16" picture tube. In Figure 5, the 0.3 inch displacement abscissa crosses the solid-line 14" sweep curve at the ordinate corresponding to a lead-in length of 460 feet.

Since the 0.3 inch displacement could not be produced by reflections on the 120-foot line actually used, the check indicates that the ghost is due to multipath conditions, rather than mismatch troubles. As an alternative check, the same 14" sweep curve crosses the 120-foot lead-in ordinate at the abscissa corresponding to a ghost image displacement of slightly less than .08 of an inch, this being the displacement which would exist if the ghost was due to mismatch trouble.

As Figure 5 shows, for lead-in lengths of less than about 100 feet, the ghost image displacements due to mismatch are quite small, especially for the smaller picture tubes. For such cases, the effect produced is more likely to

be a blurring of the picture than a distinct, clear-cut ghost. Also, when the signal is picked up by the transmission line or chassis to produce a leading ghost, usually the difference in path length is relatively small, and again the trouble is indicated simply by a blurring of the picture.



Sharp, clear, ghost-free reception such as this can be obtained only by careful, conscientious service work, in which the proper location, orientation and connection of the antenna is of major importance.

Courtesy Stewart-Warner Electric Div.,
Stewart-Warner Corp.

Though the produced symptoms may be alike for these two cases, mismatch trouble is by far the more frequent, and on this basis, the line-receiver input matching conditions should be checked first when either of these types of trouble is suspected.

HOW TO OBTAIN GHOST-FREE RECEPTION

Even though all existing ghosts may have been eliminated at the

time a particular receiver was installed, new conditions may have developed since then, the exact nature of which could not be foreseen when the installation was made. Examples are: new transmitting stations, changes in the neighborhood surrounding the receiver location, the substitution of a new receiver or transmission line by the owner without regard to impedance matching requirements, changes in antenna orientation by the owner, or the addition of antennas near the original unit.

The installer has no control over subsequent changes of this type even though aware that they may occur. Consequently, he must make the proper orientation adjustments and impedance matching connections according to the conditions existing at the time of the installation. When called, the service technician must make any necessary installation changes or adjustments to correct for the troubles due to the changed reception conditions.

Correcting Multipath Troubles

When the preliminary observations explained above indicate the ghost to be due to multipath troubles, then usually some change in the type of antenna, its location, or its orientation is necessary to restore proper reception. In most cases, the orientation has most to do with reception and rejection of

reflected signals and, therefore, should be checked carefully before more extensive changes are made in the installation. Generally, the installed antenna is located at a point where reception of adequately strong signals is obtained and at which fairly convenient mounting is possible.

With an assistant observing the picture on the screen of the receiver, the service technician may rotate the antenna experimentally in an effort to obtain ghost-free reception on all channels which can be received. Some means of communication must be employed between the observer and man on the roof so that the latter may be informed continually with regard to the results on the screen.

A two-way hand telephone system is very convenient for this purpose, but direct communication by shouting can be used when necessary. In the case of the latter method, a third person acting as liaison man may permit faster work, when such help is easily secured. In general, the more information given the man on the roof, the more he can accomplish in a given time.

Besides rotating the antenna in the horizontal plane, it may be found necessary to tilt the entire unit to some angle from the horizontal, or possibly to adjust dif-

ferent parts of the antenna to various angles with respect to each other. Also, the respective arms of the high and low band dipoles, reflector elements, etc. may have to be adjusted to unequal lengths to obtain the desired results.

These changes in angle or position and arm lengths are easy to make in the case of the adjustable indoor type antennas, and a few possible arrangements are illustrated in Figure 6. The two arms of the dipole are nearly vertical with a very small angle between them in Figure 6A. An angle of nearly 180° is used between the arms in Figure 6B, with the entire dipole tilted from the horizontal. In Figure 6C, both arms are tilted upward about the same amount, while practically vertical orientation is employed in Figure 6D.

In every case shown, the two arms of the dipole are adjusted to different lengths. Such unbalanced arrangements of dipole arm lengths and angles are necessary frequently in locations where an indoor antenna must be used, such as in certain apartment buildings, etc. In addition, often it is found that the location of the antenna is critical with regard to curtain rods, metal type venetian blinds, and hidden wiring and pipes.

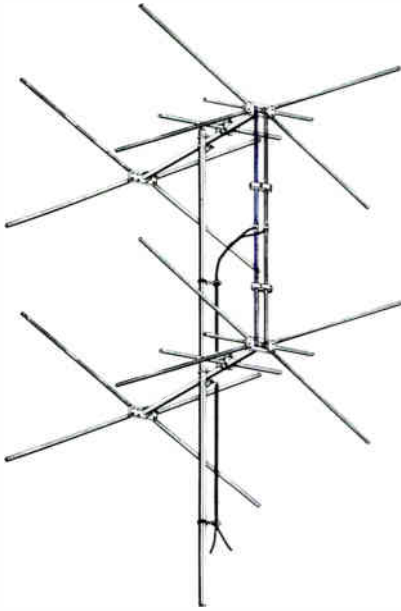

In some cases, a stacked array such as this is required to decrease the vertical angle through which the antenna is sensitive, and thus reduce pickup of signal energy reflected from points which are higher or lower than the antenna.

Courtesy Insuline Corp. of America

In the case of outdoor antennas, when proper reception cannot be obtained by making orientation adjustments only, it may be necessary to change the antenna receiving pattern in some way such as by adding directors or reflectors, or both, to the existing array. To prevent undesired pickup at vertical angles, another bay may be added above or below the existing antenna. However, such changes should not be made unless absolutely necessary, because the decreased angle of pickup so produced may reduce or prevent

entirely the reception from existing stations, or new stations which may begin operation in the future.

Some commercial antennas are designed to reduce the width of the lobes of the receiving pattern, and the desired ghost-free reception may be obtained by the substitution of one of these units.

Another method of changing the receiving pattern shape is afforded by the use of a PHASING DIPOLE as shown in Figure 7. Consisting of an aluminum rod or plated metal tubing, this dipole is mounted on the mast below the regular antenna, and in such a way that it can be moved up and down and rotated independently of the antenna. As indicated in the Figure, the antenna and phasing dipole connect through quarter-wave matching sections to the lead-in. The matching sections are tuned to the approximate center frequency of the band for which the antenna is designed.

The proper location and orientation of the phasing dipole is found experimentally by rotating it and moving it up and down on the mast until a height is found at which a maximum variation in screen contrast is produced when the dipole is rotated a half turn. That is, when the dipole can be rotated 180° between two points, one of which produces minimum and the other maximum signal

pickup by the system as a whole, the desired vertical location of the dipole has been found. Finally, the phasing dipole is rotated slowly until the ghost image disappears or is minimized.

When the trouble cannot be corrected by changes in orientation and structure of the antenna at its original location on the roof, it may be necessary to find a new location at which proper reception can be obtained. Such a location may be found conveniently by substituting a new temporary lead-in and a portable search dipole. The installed lead-in is disconnected from the receiver, and the temporary lead-in connected and run as far from the installed line as possible without having undue length.

Connected to the temporary lead-in, the search dipole is carried around the roof, while an observer at the receiver supplies a continuous report on the nature of the reception. Although a straight or folded dipole may be satisfactory for this purpose, in some cases a dipole with reflector may be needed.

To determine the effects of nearby metalwork with regard to causing or cancelling reflected signals, spot checks should be made by holding the dipole near roof flashing, rain gutters, and metal window sash or screening. Reflections can be caused by the guys

used to secure the antenna mast, and it may be necessary to guy with waterproof rope or plastic-covered clothesline. In certain difficult situations, it may be found that not only a new location but also additional parasitic elements and some unusual angle of tilt such as illustrated in Figure 6 are needed to prevent ghost interference on all channels.

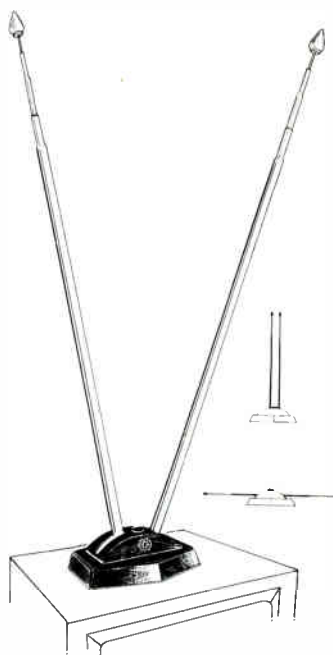

Indoor type of antenna which can be adjusted easily when desired to eliminate ghosts caused by reflection conditions which are different for different stations, etc.

Courtesy Insuline Corp. of America

When a satisfactory new location is found with the search dipole, then the installed dipole should be moved to this point and reinstalled with the necessary

length added to or removed from the installed lead-in. If there is considerable distance between the old and new antenna locations, a change in the routing of the installed lead-in should be made.

In some severe cases, there is no single point and orientation at which an ordinary antenna, with or without parasitic elements, can be positioned to give ghost-free reception on all channels.

One solution to this problem consists of using two or more differently oriented antennas connected to separate lead-ins. A switch is employed to connect the receiver input terminals to the proper lead-in for the channel to which the receiver is tuned at any given time. Usually the same location is suitable so that the various antennas can share a common mast.

A second solution is the employment of an antenna rotor, of which several commercial makes are available. Consisting of a motor driven antenna mount, remotely controlled, this unit can rotate the antenna as desired to obtain the best reception on each channel. It has the added advantage of permitting orientation adjustments to overcome the effects of changing reception conditions.

Proper reception may be obtained one day but ghost images may appear on the same receiver

the next day due to changes in weather conditions. In like manner, ghosts may appear where there were none before when a new building or other structure is erected in the neighborhood. In many cases such as these, slight rotation of the antenna by means of the rotor is all that is needed to restore proper reception.

However, many receiver owners are not satisfied with an installation in which an antenna adjustment must be made every time the receiver is tuned to certain channels, and the rotor should not be regarded as a simple cure-all for multipath problems in general. For most cases, sufficient and conscientious experimentation results in an arrangement consisting of a single stationary antenna, so constructed, located, and oriented that satisfactory, ghost-free reception is obtained for all channels used in the area.

In a few rare cases, when the direct wave signal is severely weakened due to obstructions, it may be necessary to orient the antenna so as to utilize a reflected wave to obtain an acceptable picture. However, this practice should be avoided whenever possible because the quality of a reflected signal changes from time to time depending upon the condition of the reflecting surface.

Transmission Line Impedance Matching

Although the transmission line can be matched to the input of the television receiver for operation on all channels, the line cannot be matched to the antenna over a wide band of frequencies because the antenna impedance changes with frequency. Fortunately, a match at the receiver input is all that is needed to prevent reflections on the line since, for such reflections to exist, there must be a mismatch at the receiver end of the line as well as at the antenna. Thus, when the preliminary checks explained earlier indicate mismatch trouble to exist, the service technician may correct the trouble by providing the proper impedance match between the lead-in and the receiver input.

A television receiver is designed to operate with either a two-conductor line or a coaxial cable connected to its input terminals. The first arrangement is known as a balanced input, and the second as an unbalanced input. For a balanced input, the two-conductor line may be unshielded, consisting of the commonly used twin-lead ribbon, or it may be shielded in which case either a pair of coaxial cables or a double conductor shielded line is used. A single coaxial line is the only type intended for use with the unbalanced input type of receiver.

Most receivers with balanced inputs have input impedances of 300 ohms, but a few have other input impedances such as 72 ohms and 100 ohms. Receivers with unbalanced inputs have impedances of 72 ohms for the most part, although a few have 300 ohm inputs. Twin-lead line is available with characteristic impedances of 75, 150, and 300 ohms, while coaxial cables in use for television have characteristic impedances of 53 and 75 ohms.



Often, elimination of all ghosts can be obtained only by orienting the low and high band antennas so that their main directions of reception are different.

Courtesy Oak Ridge Antennas
Div. of Video Television, Inc.

When the receiver is installed, a transmission line should be employed having characteristic impedance which matches the receiver impedance, unless there is some special reason for using a particular type of line as explained in the lessons on installation. However, the impedance match may no longer exist if the orig-

inal line has been replaced by a new one of different characteristic impedance, or a new receiver with different input impedance has been connected to the old line.

Regardless of the reason for the existing mismatch, if the condition results in ghost images, either of two corrective measures should be taken to provide the proper match: (1) replace the existing lead-in with one having characteristic impedance approximately equal to the input impedance of the receiver, or (2) insert a "pad" or network of resistors between the transmission line and the input terminals of the receiver.

Each method has certain advantages over the other. A pad usually requires less time and is easier to install, but attenuates the signal to some extent. A line with proper impedance eliminates the losses which result from mismatch, and does not introduce the "insertion" losses as in the case of a pad. Thus, in strong signal areas, pads may be used for matching lines to receivers, while new lines of the proper impedance are installed to obtain the proper match in weak signal areas.

Figure 8 shows pad arrangements for various combinations of transmission lines and receiver inputs. Connections for balanced inputs are shown in Figures 8A and 8B, while Figures 8C and 8D

show connections for unbalanced inputs.

For this explanation, an impedance is referred to as high or low with respect to the impedance to which it is to be matched. For example, a 150-ohm line has a high impedance compared to a 72-ohm receiver input, but a low impedance with respect to a 300-ohm receiver input. Thus, the arrangement used to match a high impedance line to a balanced low impedance receiver input is given in Figure 8A, while Figure 8B shows the method of matching a low impedance line to a balanced high impedance receiver input.

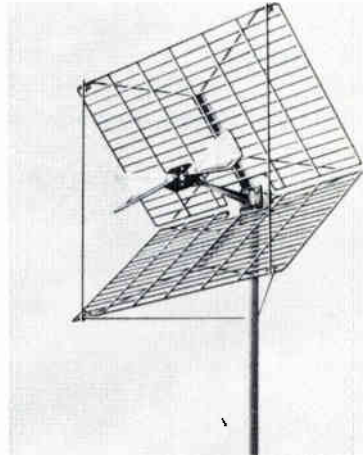

In this UHF antenna, the reflector increases pickup from the forward direction and shields the bow-tie dipole from unwanted signals, such as reflected waves, arriving from behind.

Courtesy JFD Mfg. Co. Inc.

The pad circuit for matching a high impedance line to an unbalanced low impedance input is

shown in Figure 8C. Figure 8D illustrates the method of matching a low impedance line to an unbalanced high impedance input. In every case, the shunt resistor R_2 is across the pad terminals which connect to the low impedance unit.

For matching various line impedances to different receiver input impedances, Table 2 gives the required resistance in ohms of the pad resistors R_1 and R_2 in the circuits of Figure 8.

8D is employed with a series resistor of $2R_1 = 2 \times 135$, or 270 ohms, and a shunt resistor $R_2 = 82$ ohms.

Instead of using a matching pad, usually the existing transmission line should be replaced by one having the proper impedance when ghosts are caused by a line-to-receiver mismatch in a weak signal area. However, this is only a general rule, and the method employed in any particular case should be determined by

TABLE 2

Receiver Input Impedance in Ohms	Transmission Line Impedance in Ohms			
	53	75	150	300
72	$R_1 = 18$ $R_2 = 100$	Pad not needed	$R_1 = 55$ $R_2 = 100$	$R_1 = 135$ $R_2 = 82$
100	$R_1 = 34$ $R_2 = 75$	$R_1 = 23$ $R_2 = 150$	$R_1 = 45$ $R_2 = 180$	$R_1 = 120$ $R_2 = 130$
300	$R_1 = 135$ $R_2 = 56$	$R_1 = 135$ $R_2 = 82$	$R_1 = 110$ $R_2 = 110$	Pad not needed

For the pads of Figures 8A and 8B, the two series resistors R_1 have equal resistance, the sum of which equals twice that given in Table 2. Therefore, since only a single series resistor is employed in the pads of Figures 8C and 8D, this resistor is made equal to two times the resistance of R_1 , as indicated.

For example, to match a 75-ohm line to a receiver with a 300-ohm unbalanced input impedance, the pad arrangement of Figure

various other considerations such as the type of line in use, type of line to be used, amount of mismatch existing, total length of the lead-in, and the amount of noise interference present.

As an example, suppose a receiver with a 72-ohm balanced input has a ghost image on its screen, and a check with the graph of Figure 5 indicates the trouble to be due to reflections on the lead-in which consists of 100 feet of 300-ohm twin-lead rib-

bon. The receiver is located in a weak-signal area, and the noise level is low enough to permit satisfactory reception without a shielded line.

With the existing mismatch of 300-to-72, or approximately 4-to-1, there is a signal power loss of 6.5 db due to the mismatch, plus a loss of about 1.5 db (per 100 feet) on the 300-ohm line at 144 mc, for a total loss of approximately 8 db.

Here, the use of a matching pad like that of Figure 8A will

eliminate the loss due to mismatch, but will introduce an insertion loss of 11 db, thus removing the ghost image but resulting in a total signal power loss of $11 + 1.5 = 12.5$ db. Since the signal level is already low at the antenna, the use of such a pad may decrease the signal-to-noise ratio to an unacceptable value.

A better solution here consists of replacing the 300-ohm line with a 75-ohm twin-lead line. Again the ghost trouble and mismatch loss are eliminated, and the total

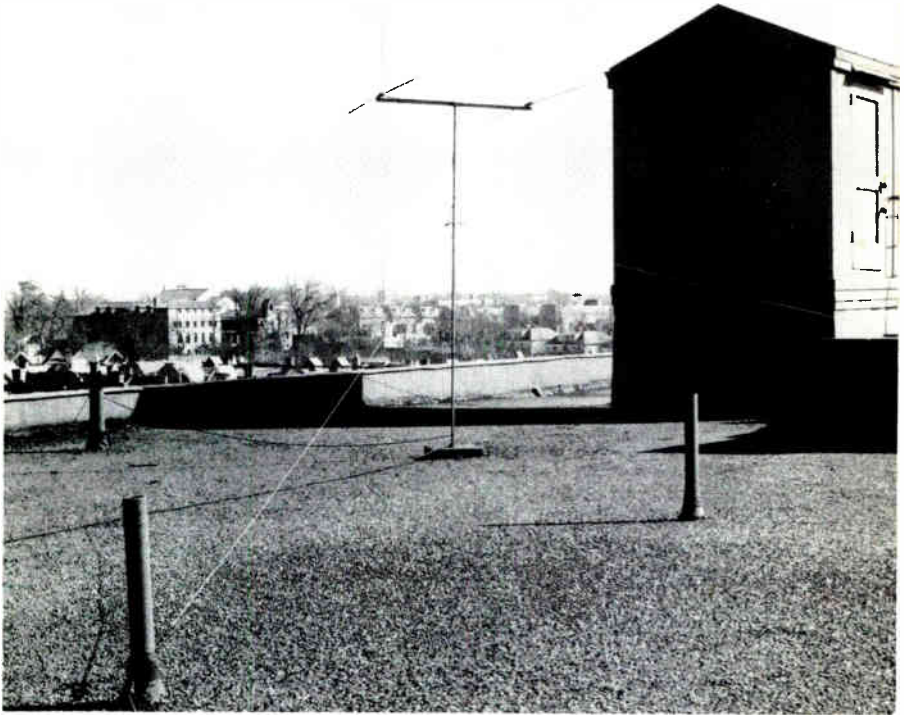

Reflections may be produced by guy wires, rain gutters, or other metal objects in the vicinity of the receiving antenna.

Courtesy Philco Corp.

loss is reduced to that of the 75-ohm line, or about 6.8 db at 144 mc.

However, suppose a considerably longer lead-in, 300 feet for example, is needed in the installation. The 75-ohm twin-lead line will then introduce a total loss of 3×6.8 , or 20.4 db at 144 mc, since its attenuation is 6.8 db per 100 feet at this frequency. In this case, a lower total loss will be produced by the use of a matching pad, because the 300-ohm line has less attenuation per 100 feet of length. Using the values given above, the losses will be 11 db pad insertion loss plus 3×1.5 , or 4.5 db for the 300 foot line, for a total loss of about 15.5 db.

Since either matching method results in a greater total loss than exists with the original mismatch conditions, in a case such as this it may be necessary to employ a booster at the antenna in order to obtain ghost-free reception with a satisfactory signal-to-noise ratio.

Correcting Other Ghosts

When one or more trailing ghosts exist, and there is no mismatch between transmission line and receiver input, then the ghost may be either of the multipath or tunable type. A check may be made by disconnecting the installed lead-in from the receiver and substituting a temporary line and search dipole as ex-

plained above in the section on multipath troubles. When this change is made, there should be a decided change in the ghost conditions if the trouble is due to multipath reflections.

If the ghost images remain unchanged, then they might be of the tunable type, and checks should be made of the voltages and components in the v-f and i-f circuits of the receiver, and of the i-f alignment to locate the source of the trouble.

When a definite leading ghost exists, the lead-in should be disconnected from the receiver, and a test lead-in and dipole substituted as above. If the ghost now disappears it is caused by transmission line pickup, but if the ghost remains unchanged, it may be due to pickup by the power line, the receiver chassis, or the chassis wiring.

The first cause may be eliminated by re-routing the installed lead-in, or replacing it with a shielded line if the trouble cannot be eliminated by re-routing. When the trouble is due to chassis pickup, the chassis may be shielded by grounded copper screening attached to the inside of the receiver cabinet. Often, signals picked up by the house a-c wiring are coupled to the receiver. This coupling may be prevented by connecting a .01 μ fd capacitor across the power cord, at the wall

socket, or some other point before the cord enters the receiver chassis.

When a blurred picture exists such that the trouble cannot be identified definitely as a leading ghost, the picture should improve as far as the blurring effect is concerned when a test line and dipole is substituted, if pickup is occurring. As before, re-routing the existing line, or installing a shielded line should correct the trouble.

If substitution of the test line and dipole does not change the blurred effect, the trouble may be due to chassis pickup, or it may be due to any of the many troubles which can distort the picture in this manner, and which were mentioned in the lesson on distorted picture troubles.

Finally, when changes of any type are made in the antenna, transmission line, or receiver for the purpose of eliminating ghosts, it should be kept in mind that there is little point in making changes which correct the trouble on one channel but allow it to remain or be introduced on another channel. Therefore, checks on the nature of the reception should be made from time to time on all channels in which signals can be received, when ghost elimination work is being performed, and especially before securing the antenna and transmission line in the final positions. Also, the nature of the picture should be checked from the standpoint of quality. In certain rare cases, some compromise must be made between best picture quality and ghost-free reception.



STUDENT NOTES

STUDENT NOTES

STUDENT NOTES

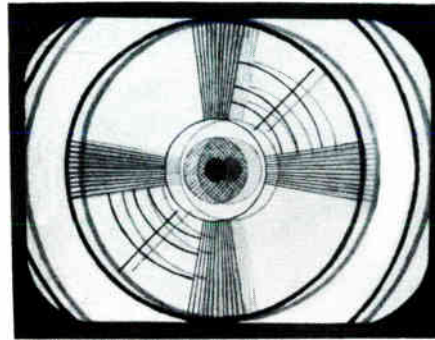

GHOSTS
FIGURE 1

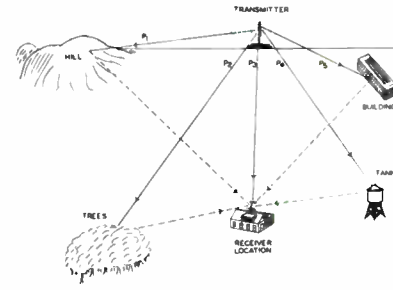

FIGURE 2

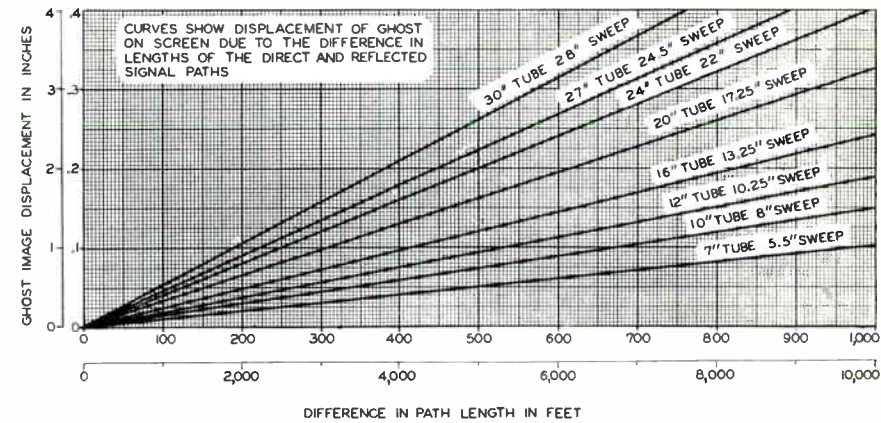

FIGURE 3

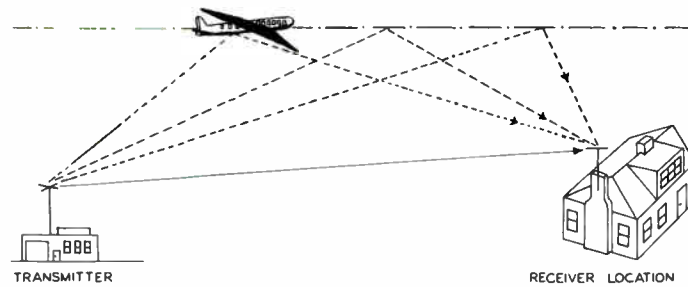

FIGURE 4

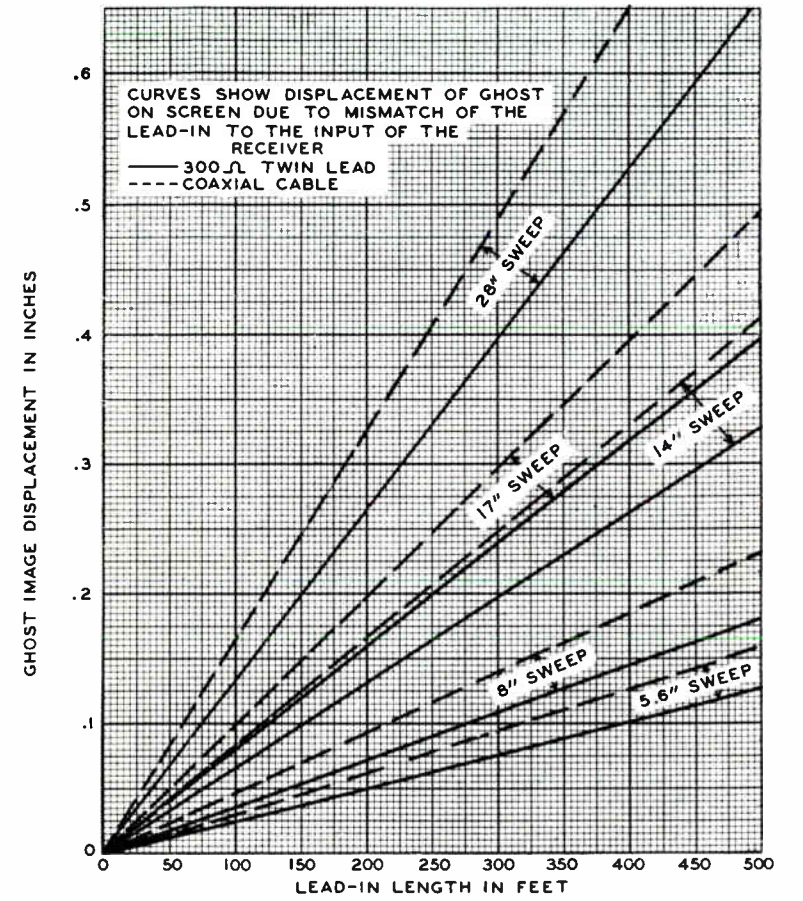

FIGURE 5

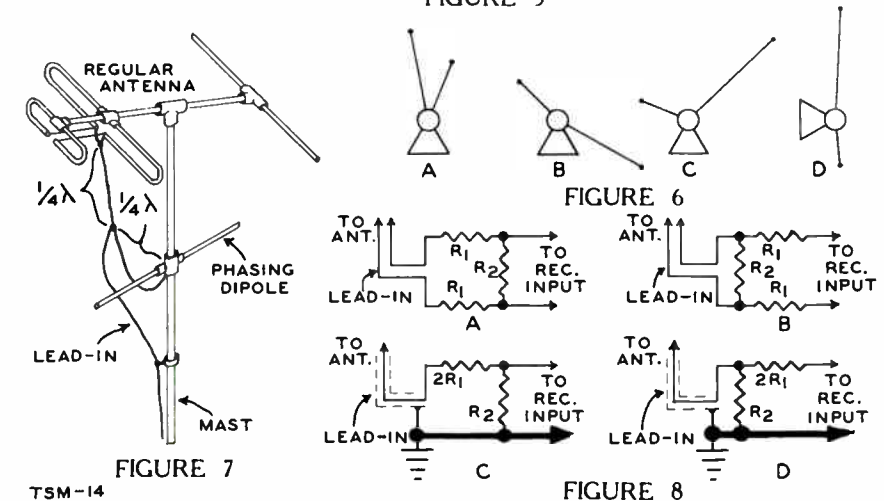

FIGURE 7
TSM-14

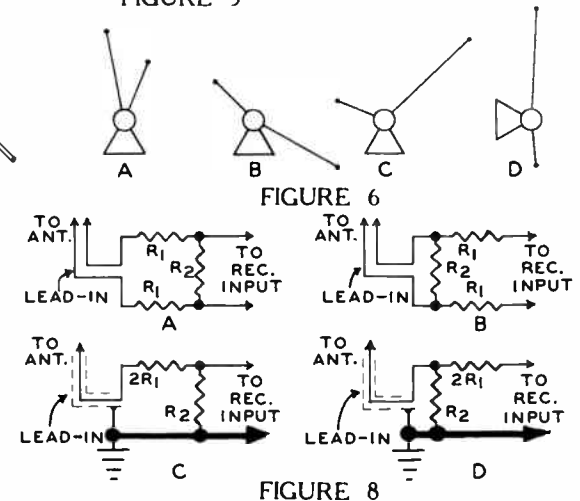

FIGURE 8

DeVRY Technical Institute

Formerly DeFOREST'S TRAINING, INC.

4141 WEST BELMONT AVENUE

CHICAGO 41, ILLINOIS

Ghosts—Lesson TSM-14A

QUESTIONS

Page 27

3 How many advance Lessons have you now on hand?.....

Print or use Rubber Stamp.

Name..... Student No.....
Street..... Zone..... Grade.....
City..... State..... Instructor.....

Write your answers on the "Ans." line below each question. If more space is needed use reverse side of this page.

1. On the basis of their causes, give the four classes of ghosts.

Ans.....

2. What is a negative ghost?

Ans.....

3. What causes multipath signals and trailing ghosts on TV?

Ans.....

4. How does an airplane cause fluttering ghosts?

Ans.....

5. Why is a ghost produced when the transmission line impedance does not match the input impedance of the receiver?

Ans.....

6. What causes tunable ghosts?

Ans.....

7. What is the direction of the picture displacement of a ghost resulting from line or chassis pickup?

Ans.....

8. A 17" sweep width TV picture shows a ghost displacement of .2 inch and the transmission line is a 200' length of coaxial cable. Using Figure 5, could this ghost be due to transmission line mismatch?

Ans.....

9. What is a remedy for ghosts due to multipath reception?

Ans.....

10. What two solutions are available to correct a mismatch between the transmission line and receiver input?

Ans.....

FROM OUR *Director's* NOTEBOOK

YOUR WORD AS A BUSINESSMAN

When you give your word, or make a bargain or set a policy as a businessman, remember that the success of your business, as well as your own personal reputation, depends upon your following through.

For, example, take the matter of shop hours. If you establish hours from 9:30 a.m. to 5:00 p.m., it is up to you to be available during those hours. Or, you must make arrangements to have someone on hand to carry on for you. Then, if a customer drops in without advance notice, his needs can be satisfied.

If you say you'll be at Mrs. Jones' home between 2:00 and 3:00 p.m., move heaven and earth to be there at that time. If you find you can't make it, call the customer, explain that you are detained, and set a new appointment. And keeping your word in financial matters goes without saying because your credit rating is at stake.

Yes—above all, try to do the things you say you will, for in doing so you are taking an all-important step toward making your business career long and profitable.

Yours for success,

W. C. Healey
DIRECTOR

REGISTERED U. S. P. A.

TSM



**EXTERNAL
INTERFERENCE**
Lesson TSM-15A

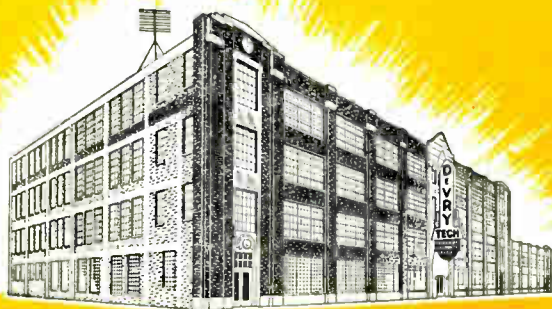

DeVRY Technical Institute
4141 W. Belmont Ave., Chicago 41, Illinois
Formerly D+FOREST'S TRAINING, INC.

EXTERNAL INTERFERENCE

4141 Belmont Ave

COPYRIGHT 1955

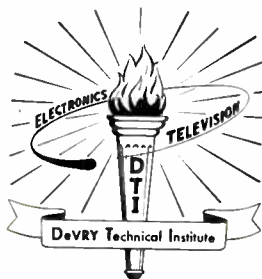

Chicago 41, Illinois



Radio frequency energy from the local oscillator of a television receiver may be coupled to the antenna and then radiate to cause interference in other receivers.

Courtesy DeWald Radio,
United Scientific Lab., Inc.

Television Service Methods

EXTERNAL INTERFERENCE

Contents

	PAGE
Television Interference	4
Identification of Interference	4
Arcing Noises	5
R-F Signals	6
Location of Source	9
Correction of Trouble	11
Noise Filters	12
Small Motors	15
Oil Burning Furnaces	16
Thermostats	16
Fluorescent Lights	17
House Wiring	18
Ignition Systems	18
Diathermy Interference	20
AM and FM Radio	21
Shielding	24

Patriotic talk is no proof of patriotism. Anyone can wave a flag. The real patriot lives his patriotism in everything he does.

—Maj. Gen. John M. Devine

EXTERNAL INTERFERENCE

TELEVISION INTERFERENCE

Interference constitutes not only one of the more difficult, but one of the most frequent television troubles with which the serviceman is confronted. The public has become accustomed to small static in the sound output of radio receivers. However, the eye is more quickly tired and annoyed than the ear, and therefore, imperfections in the television picture readily cause viewer dissatisfaction.

Many of the disturbances due to interference are far from slight, and so distract from the program being presented as to make the receiver practically useless on at least one channel. The more severe interferences cause the picture to lose synchronism, become distorted beyond recognition, or completely block the signal.

In any equipment designed to receive radio frequency waves, such as a television set, the signal-to-noise ratio is proportional to the selectivity, or Q , of the r-f tuned circuits. This is so because noise energy is fairly evenly distributed over the frequency spectrum. Therefore, the broader the band of frequencies accepted by the input or r-f

stages of a receiver, the greater will be the noise content.

In order to pass the standard 6 mc television channels, the input circuits of a television receiver are designed to have relatively low Q , and therefore, the signal-to-noise ratio in the first stage tends to be lower than in the first stage of the comparatively narrow band radio receiver. Furthermore, due to its broad selectivity, the television receiver is extremely susceptible to the many interfering signals whose fundamental and harmonic frequencies occur in and near the television channels.

IDENTIFICATION OF INTERFERENCE

Usually, television interference manifests itself in some form of disturbance or distortion on the screen of the receiver. Also, generally interference of the noise type is heard in the sound output. Although the FM sound channel is designed to eliminate much of it, noise energy which is strong enough to cause streaks to appear in the picture often passes through the sound channel. Although similar effects on the receiver screen are produced by interference energy generated within the receiver itself, the present lesson is concerned with

interference created by sources outside of the receiver.

The remedies employed for the various types of interference differ, and depend upon the source of the unwanted signal or noise energy. Thus, before employing a remedy, the serviceman must first identify and locate the source of trouble. To some extent, the identification may be made by observing the effects of the interference on the receiver screen since, generally speaking, different types of interference result in different effects on the screen.

Unfortunately, this method is limited due to the fact that several types of interference give practically identical patterns. Also, a single type of interference will result in patterns which vary considerably from one another depending upon the strength of the interfering signal. Because of this, and the fact that there are so many possible sources of interference, the troubleshooting is more time consuming than many other types of television reception difficulties.

Although practically all television interference exists in the form of high frequency energy which gets into the circuits of the receiver, it is convenient to classify it into two general types for purposes of analysis. One type, known as noise, is energy

which is distributed over a wide band of frequencies and generally is intermittent or discontinuous in nature. The second type consists of a single r-f wave which may remain constant in amplitude or frequency, or may be amplitude or frequency modulated.



A heavy industrial type electric motor such as this can be a source of strong interference when not provided with a proper filter.
Courtesy The Louis Allis Co.

Arcing Noises

Electric sparks, or arcs, are frequent sources of radio frequency interference which are radiated into space. Therefore, any electric appliance or equipment in which undesirable arcing occurs, or which depends upon an arc for operation is a source of the intermittent type of interference. Most radiation of this type diminishes rapidly in strength as the distance from the source increases.

The most common result of noise energy pickup is a series of randomly spaced black and white spots or flashes on the receiver screen. When the arcing occurs at a higher rate, black or white horizontal lines and streaks appear on the screen. The common sources of this type of interference are the ignition systems of automobiles, trucks, airplanes, streetcar trolley wires, etc. Another source is the ignition system of a fixed engine such as those used in lighting plants.

The general appearance of the disturbances resulting from ignition systems are illustrated by the pattern shown in Figure 1. As mentioned earlier, in any particular case the effect obtained may vary all the way from a hardly noticeable momentary fault to one in which the picture is thrown out of synchronism as illustrated in Figure 2. The length of time which a picture remains out of sync depends upon the source, severity, and duration of the noise energy.

Although the sources mentioned are the most common, effects practically identical to those illustrated in Figures 1 and 2 are produced by the noise energy generated by arcing in a large number of other types of equipment. In the order in which they are most frequently sources of trouble, the devices are: house-

hold appliances, heavy industrial electric motors and generators, air conditioning equipment, neon signs, flashing incandescent signs, fluorescent lights, traffic signal lights, electric power line leakage, overhead telephone lines, clicks from dial telephones, and incandescent electric lights.

The household appliances which may cause such trouble include many devices such as a refrigerator motor, oil heating unit motor and ignitor, electric stove, vacuum cleaner, toaster, doorbell, electric lights, electric razor, electric food mixer, electric space heater, electric blanket, electric coffeemaker, electric clock, and power tools.

The strength of the interfering signal mainly determines the nature of the visual interference symptoms. Therefore, differences in the effects cannot be relied on very heavily as indications of the type of source. However, experience with interference due to the various sources will provide the serviceman with some knowledge of slight differences between the effects of certain equipment.

R-F Signals

Where the interference consists of a signal generated by an r-f oscillator, the effect on the television receiver screen may be uniformly spaced, straight or

wavy, vertical or diagonal lines, an over-all herringbone pattern, an over-all cross hatch pattern, distortion of the picture with loss of blanking, or loss of synchronization.

which beats with the local oscillator and produces a beat frequency which lies within the range of the receiver picture i-f response, (3) an r-f signal, the harmonics of which beat with the

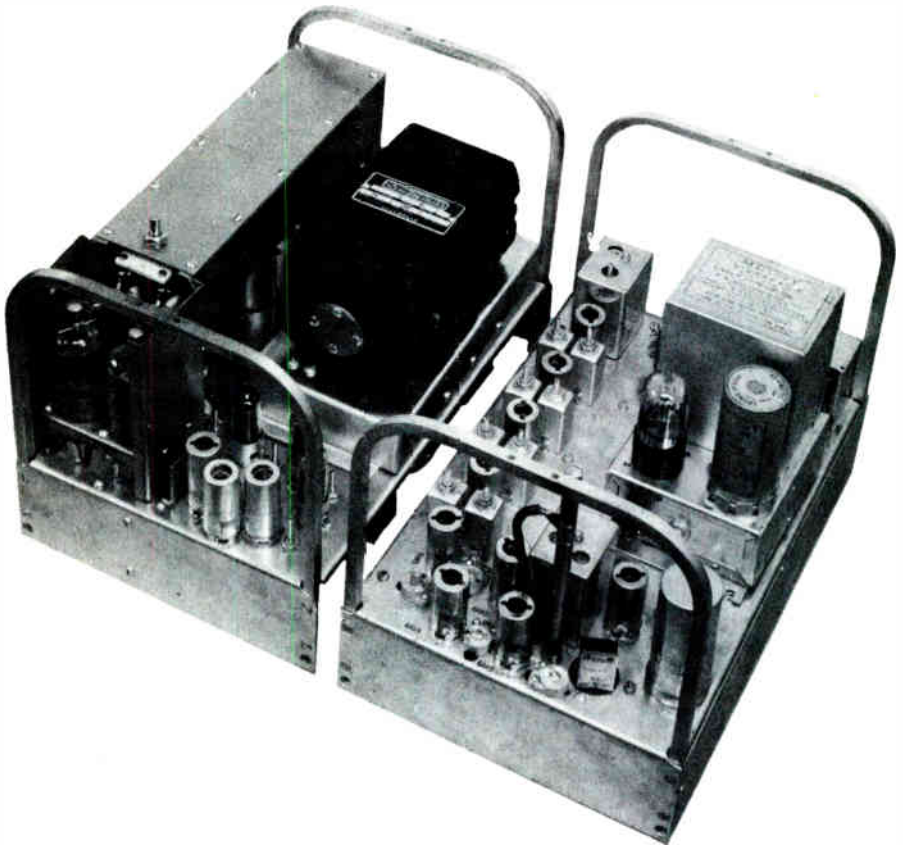

Occasionally, television receivers pick up a harmonic of the carrier wave employed by mobile radio communication equipment such as that shown here.

Courtesy Harvey Radio Laboratories, Inc.

This interfering signal may consist of any of the following: (1) any signal with a fundamental or harmonic which falls within the range of the receiver picture i-f response, (2) a signal

local oscillator to produce a beat frequency which lies in the range of the receiver picture i-f response, (4) a signal which beats with the 2nd harmonic of the local oscillator to produce a beat

frequency within the i-f response range, (5) a signal which beats with the desired carrier signal to produce a beat frequency lying within the i-f range, (6) an image frequency signal, and (7) a signal of frequency such that its harmonic falls within the image frequency range.

Although the total of the picture and sound i-f frequency ranges in any receiver is less than 6 mc, actually, the i-f tuned circuits will accept frequencies somewhat above and below this range. Therefore, any interfering signal between either 20 and 30 or 40 and 50 mc, depending upon the i-f used in the receiver, will pass through and cause a disturbance on the screen, in the sound output, or both.

Typical sources of such signals are commercial broadcast FM or AM stations, police and other government short-wave stations, amateur radio stations, local oscillators in other television or radio receivers, diathermy, induction heating, and X-ray equipment.

When due to a fixed frequency source, beat frequency interference produces fine light and dark slanting or vertical lines on the screen as shown in Figure 3. An interference pattern of this type is due to the beat note produced by the pick up of a comparatively

weak r-f signal such as that from an FM or AM broadcast station, ham station, or receiver local oscillator radiation. If the interfering source is an AM station whose signal is strong in the vicinity of the television receiver, the received picture may be distorted and turned to a negative as shown in Figure 4.

The most frequent form of interference of this type is that developed from nearby FM broadcasting stations. Although pickup of a weak FM signal results in lines like those shown in Figure 3, stronger FM pickup is characterized by broadly curved lines across the screen or by an overall herringbone pattern. In Figure 5 is shown distortion of the picture resulting from the pickup of a strong interfering FM signal, while an extremely strong FM signal may cause the picture to be completely torn up as shown in Figure 6. Although both Figures 5 and 6 happen to be examples of FM interference, similar results are obtained by an interfering AM signal of the same frequency.

Interference from diathermy and industrial induction or dielectric heating equipment most frequently causes a pattern distortion as shown in Figure 7. The most characteristic result of this type of interference is the apparent curvature or distortion

of the lines near the end of the horizontal wedges.

Closer inspection shows the entire wedges to contain lightly shaded curving lines, as well as a loss in contrast in the entire picture. In some cases the wavy lines will all be confined to a relatively narrow horizontal band across the screen while in other cases they cover the entire screen.

A weak signal from a source of this type may merely cause the picture to wave and distort as shown in Figure 8, although, here too, close inspection shows the horizontal wedges to contain the characteristic lightly shaded curved lines. A moderate signal from diathermy equipment, etc. may distort the signal to the point of "tear out" as shown in Figure 9.

Notice that quite different distortion is produced by the various strength signals, as shown in Figures 7, 8, and 9. These figures show that there are considerable differences in the results produced by weak, moderate, or strong signals from any one of these sources, and it is practically impossible to tell whether the interference is from a diathermy machine or from an r-f heating unit, etc. Also, as shown by Figures 3 to 6, whether the interfering signal is strong or weak makes much more difference in the effect on the re-

ceiver screen than whether the signal is from an FM or AM station, etc.

The local oscillator in a nearby television or radio receiver can cause radiation which affects the picture quality on the screen of another television receiver. Most often, this occurs when the offending unit is a television receiver tuned to a lower channel than that on which the interference is observed. When the interfering signal is weak, there is produced an over-all pattern consisting of diagonal or vertical lines as shown in Figure 3. The stronger signals from a local oscillator cause reduction in picture contrast, while very strong radiation can result in a negative picture as shown in Figure 10.

LOCATION OF SOURCE

After observation of the receiver screen has indicated which type of interference is causing the trouble, the exact source should be located. The serviceman should become familiar with the various interference problems in the area, such as the location of doctor's and dentist's offices, industrial concerns which may employ dielectric or induction heating equipment, or any buildings containing large electric motors and generators, etc. A knowledge of which stations have interfering frequencies also simplifies identification of the interference.

If the source of interference is a radio station and the interfering signal falls in the sound channel of the television receiver, the station may be identified by listening to the announcement of the call letters. If the radio station signal does not fall in the receiver sound channel, but rather in the video channel to affect the picture on the screen, the television receiver local oscillator may be tuned higher in frequency so that the video i-f signal is passed to the sound channel, then the interfering radio station may be identified by its call letters.

If the interfering station cannot be received by the television receiver sound channel, or the interfering signal is not from a radio station, then an accurately calibrated signal generator may be used to produce a beat with the interfering signal. When zero beat is obtained, the frequency of the signal generator is the same as the frequency of the interfering signal. This may be accomplished by simply operating the signal generator near the television receiver. If necessary, greater pickup of the generator signal may be obtained by loosely cou-

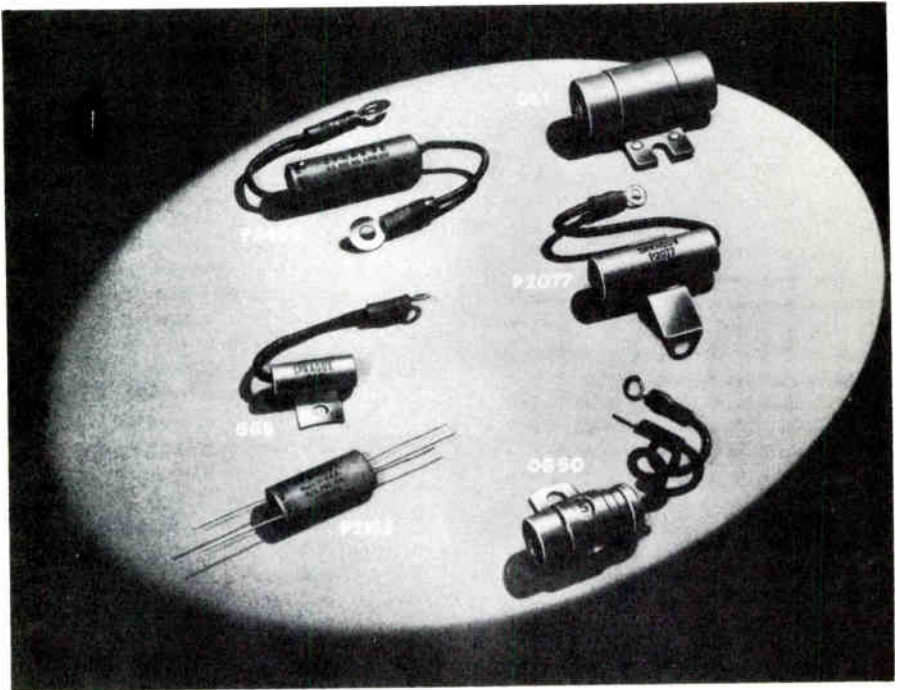

Copocitor types employed as filters in automobile ignition systems.

Courtesy Sprogue Products Co.

pling the generator output leads to the antenna lead-in.

Also, the search for the source of trouble may be easier if it can be determined in what way the interference is reaching the receiver. Interference may be passed into a receiver by one, or a combination, of three ways: (1) direct radiation from the interfering source to the receiver antenna or lead-in, (2) radiation from the house power wiring to the receiver antenna or lead-in, and (3) through the power line cord to the power supply circuits of the receiver, and thence by inter-circuit coupling to the signal circuits.

The interference energy in the house wiring is a result of the wiring picking up radiation from the interfering source or by means of the interfering units being connected directly to the wiring. If it is suspected that the interference is due to some household appliance, the exact unit may be discovered by turning on the various appliances, lights, etc., one at a time until the trouble appears.

Whether or not the interference enters by means of the antenna system may be checked by disconnecting the lead-in from the antenna terminals on the receiver. If the interference is not coming in this way, its effect will still be observed on the receiver screen, even though the picture is

absent. Should the interference disappear when this check is made, then the lead-in should be reconnected at the receiver and disconnected at the antenna end. If the interference now appears, it is being picked up by the lead-in. If it does not, it is being picked up by the antenna.

If, when the transmission line was disconnected at the receiver, the interference remained, then it may be entering through the power line. This may be checked by connecting an r-f filter in series with the receiver line cord. Several types of such filters are available commercially. Should the interference still persist, it may be entering the receiver by some other means, such as some exposed portion of the receiver chassis or wiring, etc.

The characteristic of interference that often betrays its source is its rhythm, or rate of occurrence. This rhythm may indicate a flashing sign, thermostat, etc., and should be noted as soon as the method of entry has been determined. By this means, often the source of trouble can be determined quite quickly.

CORRECTION OF TROUBLE

Whenever possible, corrective measures should be applied at the source of the interference. Of course, there are many cases



Interference is generated by the vibrator in equipment which employs the vibrator type of power supply.

Courtesy The Radiart Corp.

where this cannot be done, such as where the interference is from the ignition systems of automobiles, the arcs produced on trolley wires, and some commercial or government radio stations. Whenever an interfering amateur radio

station can be located, usually it will be easy to secure the cooperation of the amateur in reducing or eliminating any interference that his transmitter may be causing.

For the other types of interference sources listed, a number of more or less standard methods of correction are in common use. These methods consist of making some change in the television receiver antenna or transmission line or both, and in the use of tuned or untuned filter circuits inserted in series in the antenna transmission line or in the a-c power circuit.

Noise Filters

A wide variety of noise filters are available. The make-up and construction of these filters vary according to the type of interfering equipment with which they are to be used, and the severity of the interference produced.

Generally, the most effective place to install a line filter is between the noise source and the power line. Figure 11A shows the use of a single capacitor connected across the power line. Preferably, the capacitor should be as near the source of interference as possible. Generally, the capacitance needed must be found by experiment, and may be anywhere from .1 to .2 μ fd. To make the filtering

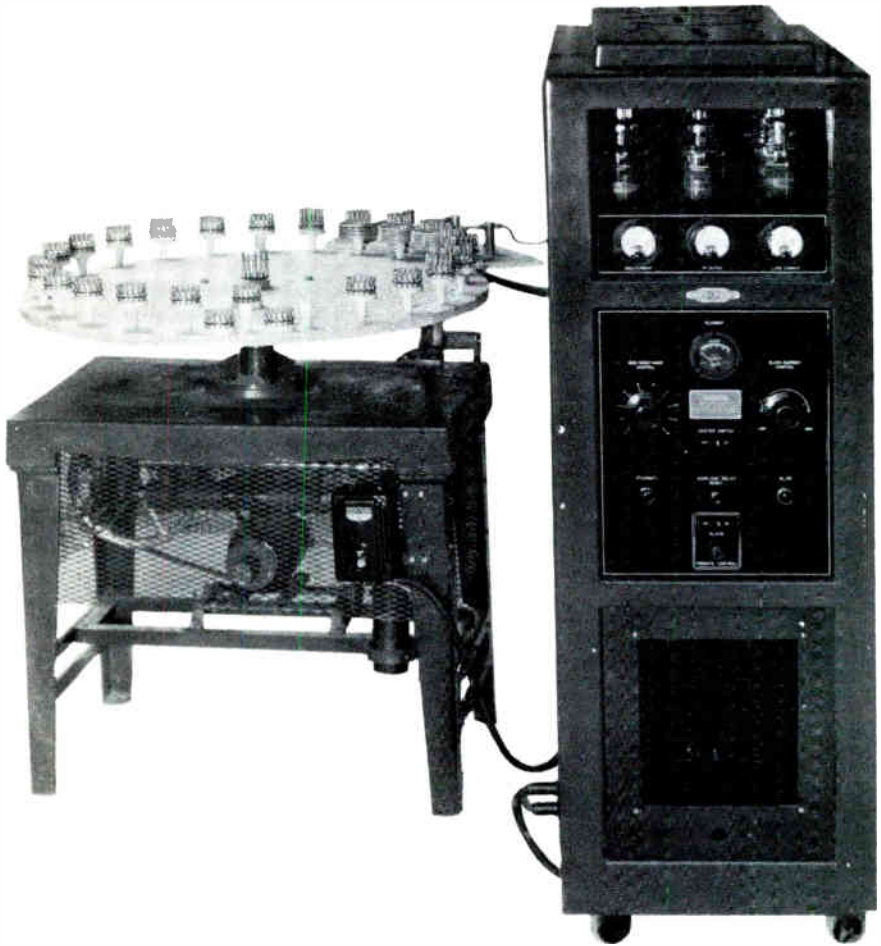

Induction heater employed to heat three units simultaneously. Industrial equipment of this type generates r-f energy which may interfere with local television reception.
 Courtesy Scientific Electric Div. of "S" Corrugated Quenched Gap Co.

action most effective, the capacitor leads should be as short as possible.

The filter requirements for various individual cases differ, and two capacitors in series across the line with their center point grounded provide a second fairly simple arrangement as shown in

Figure 11B. In the event the frame of the interfering apparatus already is grounded permanently, then the center point of the series capacitors may be connected to this grounded frame, as shown in Figure 11C.

Other effective arrangements are that in which the center point

of the series capacitors is coupled to the frame of the unit by a third capacitor, Figure 11D, and that in which one capacitor is connected across the line and a second, low capacitance unit is connected from the frame of the apparatus to one side of the line, Figure 11E. This second capacitor usually is on the order of .01 μ fd.

The capacitors employed in filter circuits of this type must be noninductive and have a working voltage rating depending upon the line voltage. The capacitor rating should be equal to or greater than the peak value of the line voltage.

Many commercial filters have the general appearance of a tubular capacitor with prongs at one end and a receptacle at the other end for convenience in installation. In use, the filter prongs are plugged into the 117 v wall receptacle, and then the power cord plug for the interfering unit is plugged into the filter.

Another common filter has the physical appearance shown in Figure 12A, and is connected for various uses as shown in Figures 12B, C, D, and E. This unit consists of three capacitors of .07 μ fd each, which are connected in a delta arrangement as shown within the dotted rectangles in Figures 12B to 12E inclusive.

Figure 12B shows the most common connection of this filter,

in which the two leads are connected to either side of the power line and the mounting strap, which also is a third terminal, is grounded to the frame of the equipment. The equipment frame should be connected to some earth ground. This arrangement is used, for example, with a fluorescent light.

The connection of the delta filter across the vibrator contacts of a battery charging unit are shown in Figure 12C. Again, the grounding strap must be connected to some point which is either directly or indirectly connected to earth ground. The employment of this filter to suppress the interference produced by a motor is shown in Figure 12D. Finally, the connection of the filter across the primary of the transformer of an oil burner ignition system is shown in Figure 12E.

When the interference is more severe, it may be necessary to use a filter which contains one or more r-f chokes, such as illustrated in Figure 13. Like in those of Figures 11 and 12, the filters shown in Figure 13 are for use between the interfering appliance and the 110 v outlet of the house wiring system.

Some of these filters which contain chokes are similar in appearance to the capacitor types, while others are larger and are contained in a metal box. The unit shown in Figure 13A is for use

with equipment which generally produces only medium interference such as electric razors, radios, and household appliances, while those of Figures 13B, 13C, and 13D, are for use with equipment which produces more severe interference.

The prices of these commercial filters are low, and generally it is not worth-while for the serviceman to construct such a unit. However, should it become necessary to construct an interference filter, the capacitors used should have the values mentioned previously, while the choke coils should be made in the form of the simple single layer solenoid such as used in the r-f circuits of radio receivers.

Coil forms measuring $1\frac{1}{2}$ to 2 inches in diameter may be used, and the wire size employed may be #16, #14, #12 or larger, depending upon the current to be carried. Iron core chokes are used very seldom. In general, the inductance needed is somewhere between .25 and 15 millihenries. The chokes should be installed in Underwriters Approved steel boxes.

Small Motors

The small motors used on washing machines, power tools, electric refrigerators, electric sewing machines, vacuum cleaners, food mixers, electric razors, etc. are common causes of interference.

The first step in correcting this type of interference is to make sure that the motor in question is in good electric condition. It is practically impossible to suppress the interference generated by a motor of this type that is improperly adjusted or has a defective commutator, brushes, etc. In case the serviceman is not equipped to handle the repair of the motor, he should make arrangements with someone who has experience with small motors to handle this part of the work.

After the motor is put in good condition, it may or may not still cause interference. If it does, quite often a simple filter such as those shown in Figure 11 will prove adequate. In all such cases, the best place to install the filter is right on the frame of the offending equipment. However, in the case of such appliances as food mixers and electric razors, etc. the owner may object to the appearance of such a filter, and it is necessary to employ the plug-in type of unit described above.

The interference produced by the small high speed brush type motors used in dentist's tools can usually be silenced by standard commercial r-f filters connected across the line, inside the cast iron pedestal, with the filter bracket grounded to the pedestal. In the event the motor frame is insulated from the main housing

and cannot be permanently grounded to it, or in a case where, between the motor and the point at which the filter is connected, the cord runs along the outside of the metal housing, the filter must be mounted on the motor itself.



Transceiver used in aircraft communication. A wave trap may be needed to prevent interference from an r-f source of this type.

Courtesy Horvey-Wells Electronics, Inc.

Oil Burning Furnaces

Interference from apparatus associated with oil burning furnaces may come from a number of different circuits. When the apparatus uses a high voltage transformer, a filter should be connected across the transformer primary as explained above for Figure 12E. This unit may have the form of a single capacitor with a capacitance of .1 to .2 μfd . Under no circumstances should capacitors be placed in the secondary circuit of such a transformer.

Interference from this equipment may also be reduced by placing a 25,000 ohm resistor in series with one or both of the high voltage leads. In cases where these methods are not sufficient, the high voltage leads should be shortened as much as possible, and then shielded, preferably by putting them in a small metal pipe.

Any interference from the motor of the system may be corrected as explained for small motors. In some installations, it may be necessary to bond together various types of apparatus by using ground clamps and grounding these bonded parts to a water pipe or to a rod driven into the ground. The wire used for this purpose should be #14 or larger.

Thermostats

Thermostats are employed in the home in space heating equipment, electric stoves, electric blankets, heating pads, flashers for Christmas tree lights, etc. Provided the thermostat is in good condition, the interference may be filtered out by connecting a .1 μfd capacitor across the line at a point as close as possible to the thermostat. In cases where the thermostat is defective, a continuous arc or spark will appear at certain periods in its opening and closing cycle, and the interference created may be impossible to filter. Then the thermostat must be repaired or replaced.

Fluorescent Lights

Often, it is found that interference from a fluorescent light is due to the fact that the unit has not been installed properly. For proper installation, the stator and ballast equipment should be enclosed in a steel channel, the wiring should be made with tight connections, the lamp and starters should be firmly installed in their sockets, and the fixture should be grounded. Connecting the fixture to gas pipes, metal lath, or metal ceiling outlets does not provide proper grounding. In fact, these often increase the interference.

is to replace the starter with a new one. If this does not change the noise level to any extent, it may be assumed that the capacitor in the original starter was operating satisfactorily.

Normally, the distance over which the radiations from a fluorescent lamp are effective in producing interference is less than 10 feet. Therefore, this interference is eliminated by separating the lamp and receiver by a distance greater than this. If the interference is reaching the television receiver by feedback through the a-c power line, then a filter of



These line filters prevent interference from feeding back into the power line from motors, dryers, lamps, etc.

Courtesy Pyromid Electric Co.

Standard fluorescent lamp starters include a small capacitor across the starter terminals for the purpose of eliminating interference. During normal lamp operation, this capacitor is in parallel with the lamp and aids materially in the prevention of radio and television noise.

After determining exactly which lamp unit or units are causing interference, the next step is to check the capacitors in the starters. Generally, the quickest way

the types described for Figures 11, 12, and 13 may be used in the power cord between the offending lamp or lamps and the power receptacle.

In some cases, the interference comes from several lamps, and it is cheaper to use a filter in the receiver power cord. Also, whenever the interference is reaching the receiver by means of the power line only, a filter in the receiver power cord is sufficient. However, the more frequent paths of inter-

ference energy are by radiation from the house wiring, and only filters used at the source prevent the interference from getting into the wiring in the first place.

House Wiring

Defective house wiring can be a prolific source of radio and television interference. Loose joints, defective sockets, lamps loose in their sockets, loose or corroded plugs on heaters, toasters, irons, etc., loose or corroded switches or fuse plugs, loose fuses in an electric range or other appliances, faulty extension cords, etc. all may cause interference.

A simple test for this interference can be made by removing the fuses for each circuit in the house, one at a time. If the interference is due to the house wiring, or any of the above causes, it will stop when the faulty circuit is disconnected. Of course, to check the circuit to which the television receiver is connected, it will be necessary to move the receiver a-c line cord plug to another circuit which has been tested previously.

Occasionally, interference is brought into the house by the wiring that supplies the electric power. If this is the case, a capacitor from each side of the line to ground, as close as possible to the point where the line enters the house may correct the trouble.

These capacitors should be from .1 to .2 μ fd, depending upon the severity of the disturbance.

Occasionally, it is found that the interference is originating in a neighbor's house. Usually the neighbor has a radio or television receiver also, and is anxious to have the interference cleared up. In this case, whoever owns the interfering equipment should be willing to pay the cost of the suppression measures necessary.

Situations arise where shopkeepers in residential areas have equipment, such as meat slicers, barber's clippers, cash registers, etc., which interfere with reception in the whole neighborhood. The shopkeeper's first reaction to the fact that he is creating interference may be that he doesn't care. However, when he realizes that this interference is bothering his customers, and may cause loss of good will, usually he is anxious to have it cleared up. The same situation is true when the interference is originating from doctor's or dentist's equipment.

Ignition Systems

The electric systems of automobiles, trucks, aircraft, etc. contain a number of units which generate interfering energy, the most troublesome unit of which is the ignition system. As with all radiated energy, the strength of the ignition noise falls off rapidly with

distance from the source. Therefore, since most ignition interference is due to vehicles passing on the street in front of the building in which the receiver is located, generally its pickup can be reduced by moving the antenna to a point on the roof near the rear of the building.

If a twin lead transmission line is used, it may be transposed or twisted, approximately one twist per foot, if this has not been done during the installation.

If the tests explained above indicate that much of the interference is picked up by the transmission line, then the line should be re-routed or, if necessary, the twin lead replaced by a coaxial cable. However, in weak signal areas, the coaxial cable may not deliver adequate signal power to the receiver, and so it will be necessary to employ a booster at the antenna.

If the interference is picked up by the antenna, often it is helpful to increase the height of this unit somewhat and make a slight change in its orientation. Whenever the location, height, or orientation of the antenna is changed, a check on the reception on all channels should be made to make certain that proper pickup of the desired signals is obtained. If the interference persists, the antenna can be converted to a stacked array. Normally, ignition inter-

ference, etc., comes from below the antenna, and a stacked array has less pickup in the vertical direction.



One of the many types of small motors used in household appliances which may cause TV interference. This particular unit was designed for sewing machines.

Courtesy Electric Motor Corp.

In the case of interference produced in the ignition systems of fixed engines, such as those used in gasoline engine driven generators, etc., the trouble may be eliminated by the use of commercial ignition suppressors such as used in automobiles. If the unit already contains suppressors, the suppressors may need to be replaced. Also, it may be necessary to enclose spark plugs in a grounded metal case. A heavy conductor should be run from the engine block to some grounded point such as a cold water pipe, etc.

In fact, any equipment using make and break contacts should have a good ground to its frame, as well as to the metal casing that encloses the equipment. Paint and corrosion often produce a high resistance in what appears to be a good ground return. Therefore,

all ground clamps and cable connections should be checked carefully.

Diathermy Interference

Diathermy machines operate on very high frequencies and, therefore, create more interference in the television and FM bands than in the AM broadcast radio bands. As with other interference sources, the best point to apply the remedy is that at which the interfering signals are being produced.

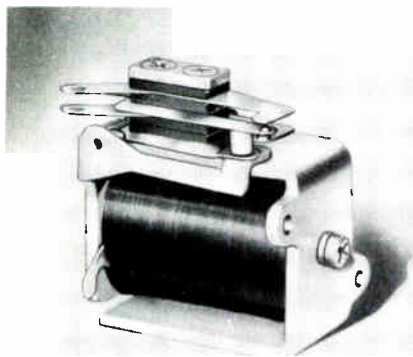

Interference may be generated due to arcing of contacts in a nearby relay.

Courtesy Cook Electric Co.

To prevent the diathermy interference getting into the a-c power lines, an r-f filter should be installed in the power line input to the equipment. Since power lines often pick up directly radiated noise energy, it may be necessary to employ an outlet filter in the power line connection to the television receiver.

In severe cases, it is necessary to screen the entire room in which the diathermy apparatus is housed. The portions of the diathermy casing should be bonded together and grounded with a direct ground connection. Further measures include installing r-f filters at each point where the a-c wiring enters the room in which the machine is located. A high-pass filter, designed to pass frequencies above 50 mc, may be installed in the receiver antenna lead-in. Providing the interference is not being picked up by the antenna system, a tuned r-f booster may be installed to increase the receiver signal-to-noise ratio. This arrangement makes it possible to turn down the receiver gain control to the point where the interference is not troublesome.

Generally, the X-ray machines used in hospitals and clinics create much less interference than they are blamed for. For example, in one case a number of complaints were lodged against interference supposedly coming from an X-ray machine used in a certain hospital, but the serviceman's investigation proved that the X-ray machine was practically noiseless.

Continued investigation finally disclosed that the real noise was simply a nearby tree limb rubbing against the power line. However, when it is determined that

an X-ray machine actually is the offender, generally an r-f filter installed in the power line to the machine will remedy the situation.

AM and FM Radio

To prevent interfering radio carrier waves from entering the receiver, tuned wave traps can be installed in the transmission line. Also, this interference can be reduced sufficiently in some cases by re-orienting or relocating the antenna, provided the same changes do not result in ghost images or decrease the signal-to-noise ratio to a point where reception is unsatisfactory.

A third method consists of increasing the antenna directivity by the addition of parasitic elements. However, this arrangement may not permit satisfactory pick-up on all channels when the various television stations are located in separate directions from the receiving site.

A number of tuned filter or "wave trap" arrangements are shown in Figure 14. Figure 14A shows a pair of traps tuned to the interfering frequency and inserted in series with the wires of a balanced transmission line to present maximum impedance to the interfering signal. The arrangement of Figure 14B shows the same type of wave trap used with an unbalanced type of lead-in.

Series tuned traps connected from the balanced line leads to ground are shown in Figure 14C, and Figure 14D shows the series tuned trap used with an unbalanced coaxial line. The type of trap which gives best results depends upon the particular installation. The traps of Figures 14A and 14C can be used either with the balanced transmission line lead-in, as mentioned, or in the power line cord.

When the interfering frequency is above 50 mc or so, a convenient wave trap is the quarter wave stub, consisting of a section of the same type of transmission line used for the lead-in and connected so as to hang from the receiver antenna terminals as shown in Figure 14E. This stub is left open at the terminal end, and its length is equal to a quarter wavelength at the frequency of the interfering signal. Although Figure 14E shows a twin lead type transmission line, a quarter wave section of coaxial line is used when the lead-in consists of coaxial cable.

Another source of television beat-frequency interference is the amateur radio station. The remedy at the receiver is the use of some type of wave trap like those shown in Figure 14. These traps can be tried in the receiver antenna terminals first, and then in the power line. In some cases,

wave traps are needed at both places.

If the amateur station can be located, then a number of interference elimination measures can be applied at the transmitter itself. These consist of: the use of wave traps, tuned to harmonic frequencies, in the transmitter antenna feeder line and in the oscillator and r-f amplifier stages; efficient shielding of the transmitter r-f circuits; key-click filters; and r-f filters in the transmitter power line.

Generally, amateurs are interested in eliminating interference from their transmitter, and are usually very cooperative in helping work out the details with the television service technician. Often, a slight change in the transmitter's operating frequency greatly reduces neighborhood interference. If all of these methods fail to eliminate the interference, it may be necessary to get the amateur to agree not to operate his unit during the hours that television programs are being broadcast, at least until the trouble can be found and remedied.

Flagrant interference can be reported to the nearest FCC office or the FCC headquarters office at Washington, D. C. However, a report should not be made unless it is impossible to get the amateur's cooperation in any other way, be-

cause such a report in itself is not a solution to the problem.

When the Commission receives a complaint, duplicate official notices are sent back to the interfering amateur and the complainant, telling each what he must do and stressing the need for cooperation. This returns the problem right back to where it was originally, thus, both parties must work together to solve the problem.

Occasionally, the beat frequency interference is due to some harmonic of the carrier used by the interfering station (commercial, government, or amateur). When this is the case, the wave trap must be tuned to the frequency of the interfering harmonic. In other cases, the trouble is due to the fact that the interfering fundamental signal is so strong as to completely block the normal operation of the television receiver. To prevent this trouble, the wave trap must be tuned to the interfering station's fundamental frequency.

These tuned filters or wave traps are available commercially, and the time involved in constructing them is generally so great as to make the cost of construction more expensive. One commercial wave trap unit which may be tuned to resonance at any frequency in the band from 40 to 60 mc, or the band from 80 to

115 mc, is illustrated in Figure 15. Whenever a commercial unit of this type is used, the instructions enclosed should be followed carefully. When a trap is to be connected in the antenna lead-in, a general rule to follow is to locate the unit as closely as possible to the terminals of the receiver.

The frequency of the interfering signal should be determined, and if it is desired to construct a wave trap, the specifications listed in Table 1 at the end of this lesson may be employed. The respective L and C values given are for each inductor and capacitor of the various wave traps shown in Figure 14. The variable capacitor employed should be preferably of the air dielectric type and a high quality dielectric coil form should be used for maximum stability and efficiency.

Although more simple to construct, the quarter-wave open stub type traps are too long for practical purposes at the lower frequencies. For this reason, values for lump type traps are given for the frequencies from 3.5 to 54 mc, and quarter-wave stub lengths are given only for the higher frequencies.

In the case of the lump type traps, the coils for the three lowest frequencies given (3.5 to 14.4 mc inclusive) are closely wound, while the turns on all of the others are spaced a distance equal to the

wire diameter. All of the coils may be wound using #16 or #18 wire, the heavier gauge being recommended when the trap is used for power line filtering.

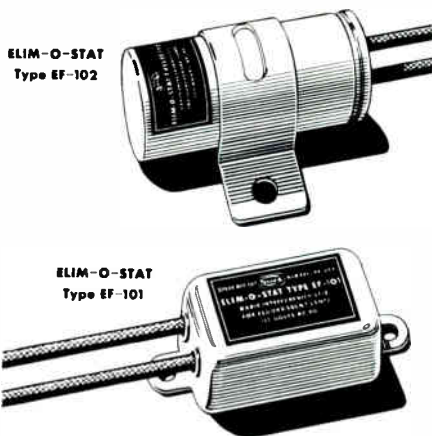

Filters designed to prevent interference generated in fluorescent lamps from passing into the power line.

Courtesy Solar Mfg. Co.

The dimensions for the quarter-wave open stub type trap are given in Figure 15 for the frequency limits of the respective bands. Intermediate frequencies require correspondingly different lengths. One method for adjusting the length is to cut a piece of line which is slightly longer than a quarter wave-length and trim off about a quarter inch at a time until maximum attenuation of the interfering signal is obtained. The exact length of stub needed for a particular frequency may be calculated from the following:

$$\text{Length in inches} = \frac{2952k}{f}$$

where:

k = velocity factor of the transmission line.

f = interfering frequency in megacycles.

For 300 ohm twin lead ribbon, k is equal to .82, and for coaxial cable, k equals .66. When the stub is made of twin lead, it should be run at right angles to the antenna lead-in, and in a reasonably straight line. To keep it out of the way, a coaxial type stub may be taped in parallel with the lead-in.

Shielding

Although the various methods described above are sufficient to remedy practically all cases of television interference, in certain stubborn cases it may be found that special measures are requir-

ed. For example, these methods may consist of unorthodox arrangements of antenna systems and lead-in, or both. Sometimes a tuned booster helps because its added selectivity results in amplifying the desired signal and, at the same time, attenuating the undesired one.

However, none of these means are completely effective—if at all—if the interference is being picked up directly by some receiver component, usually in the intermediate frequency channels. The cure for this trouble is shielding. A thorough job may be impractical, but an aluminum or copper bottom plate for the receiver chassis, and a lining of fine mesh copper screening for the inside of the receiver cabinet sometimes proves helpful.



TABLE 1

Interfering		Lumped Type Wave Trap		
Frequency MC	Service	L		C
		Turns	Diameter	$\mu\mu\text{fd}$
3.5 — 4.0	Amateur	32	1"	140
7.0 — 7.3	Amateur	19	1"	100
14.0 — 14.4	Amateur	12	1"	50
26.96—27.23	Amateur	9	1"	25
27.12	Scientific, Industrial, and Medical	9	1"	25
28.0 — 29.7	Amateur	9	1"	25
40.0 — 42.0	Scientific, Industrial, and Medical	8-9	1"	25
50.0 — 54.0	Amateur	8	0.5"	25

		$\lambda/4$ Open Stub Wave Trap	
		300-ohm Twin Lead	Coax
72 — 76	Public Safety, Industrial, Land Transportation, Marine, and Aviation	34" — 32"	27.5" — 26"
88 — 108	FM Broadcasting	27.5" — 22.75"	22" — 17.75"
108 — 132	Aeronautical	22.75"—18.35"	17.75"—14.75"
144 — 148	Amateur	17" — 16.5"	13.5" — 13.25"
148 — 152	Civil Air Patrol	16.5" — 15.9"	13.25" — 12.8"
152 — 174	Domestic Public, Land Transportation, Industrial, Public Safety, and Maritime Mobile	15.9" — 13.9"	12.8" — 11.2"
216 — 220	Telemetry	11.2" — 11"	9" — 8.85"
220 — 225	Amateur	11" — 10.75"	8.85" — 8.66"
328.6—335.4	Aeronautical navigation	7.36" — 7.22"	5.93" — 5.81"
400 — 406	Meteorological Aids	6.05" — 5.96"	4.87" — 4.8"
420 — 450	Amateur	5.76" — 5.38"	4.64" — 4.33"
450 — 460	Remote pickup broadcast, Industrial, Land Transportation, Public Safety, Domestic Public	5.38" — 5.26"	4.33" — 4.23"
460 — 470	Citizens Radio	5.26" — 5.15"	4.24" — 4.14"

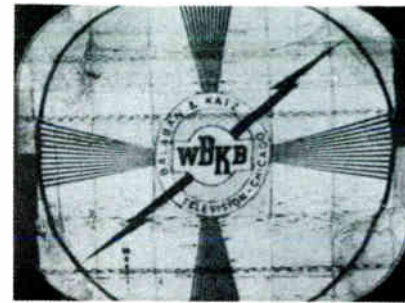

47. IGNITION INTERFERENCE
FIGURE 1

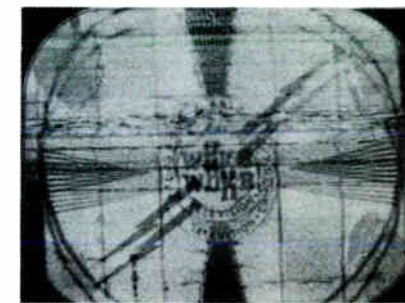

48. LOSS OF SYNC. INTERFERENCE
FIGURE 2

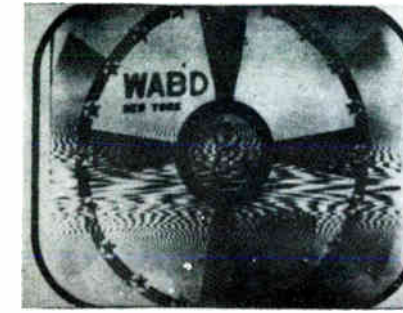

49. DIATHERMY INTERFERENCE
FIGURE 9



50. STRONG R-F INTERFERENCE
FIGURE 10

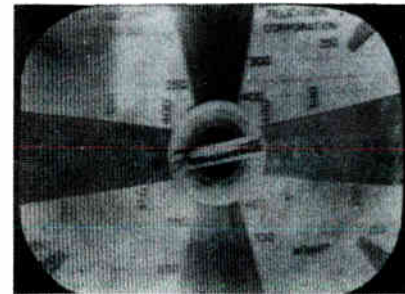

COURTESY-FARNSWORTH TELEVISION AND RADIO CORP.
46. BEAT FREQUENCY INTERFERENCE
FIGURE 3

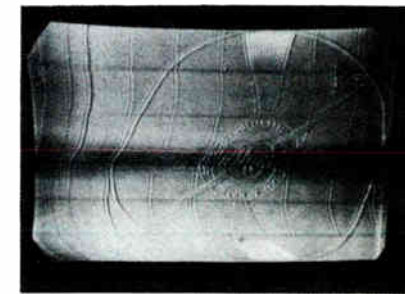

16. R-F INTERFERENCE
FIGURE 4

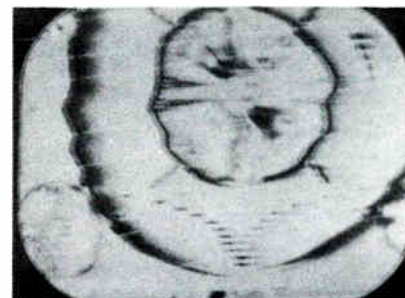

38. R-F INTERFERENCE
FIGURE 5

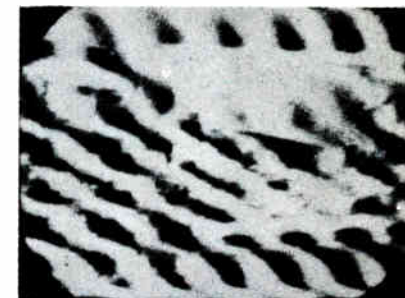

PICTURE TORN UP BY INTERFERENCE
FIGURE 6

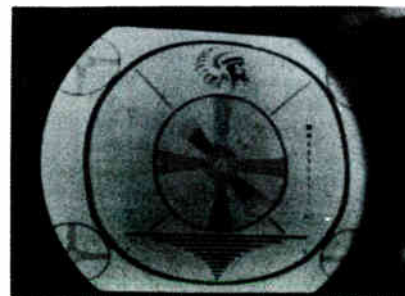

12. DIATHERMY INTERFERENCE
FIGURE 7

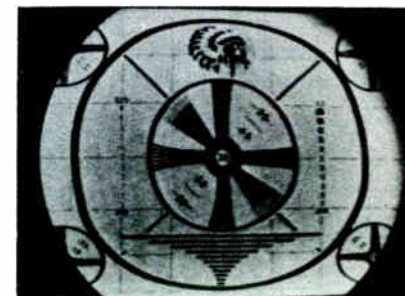

45. HIGH FREQUENCY INTERFERENCE
FIGURE 8

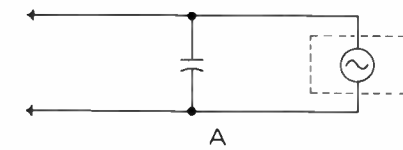

A

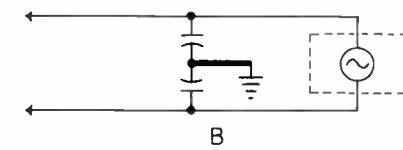

B

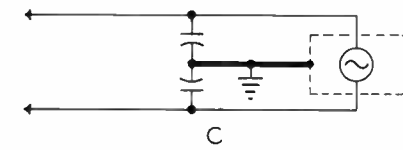

C

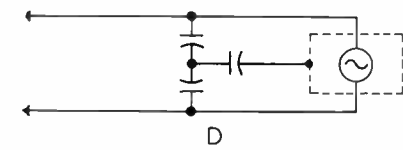

D

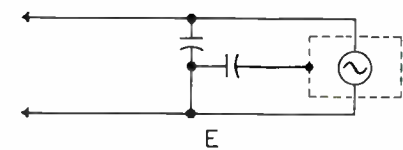

E

TSM-15 FIGURE 11

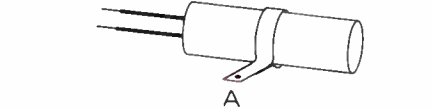

A

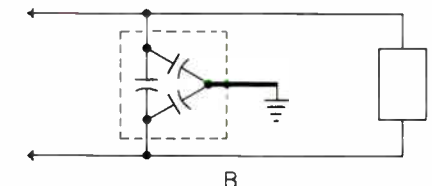

B

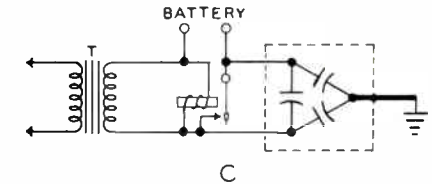

C

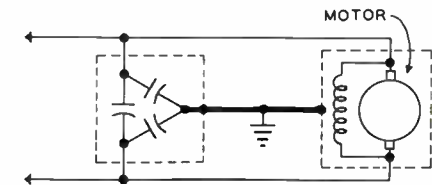

D

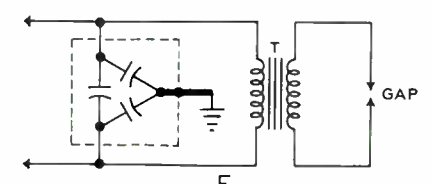

E

FIGURE 12

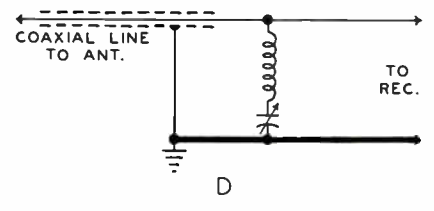
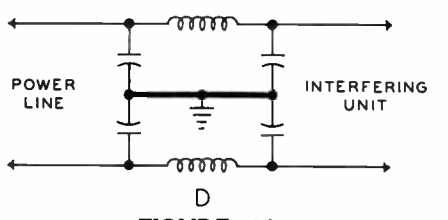
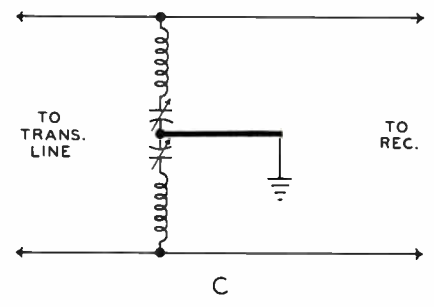
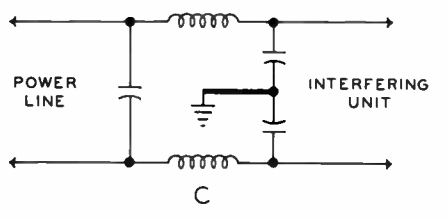
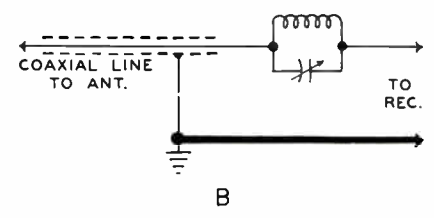
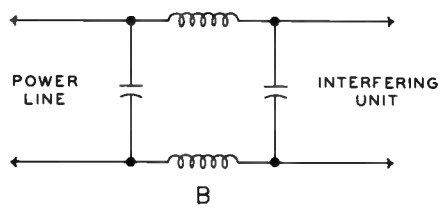
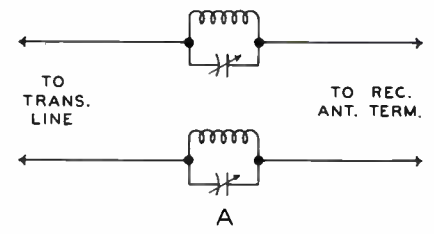
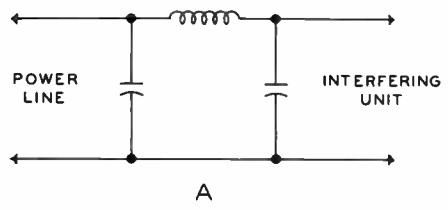
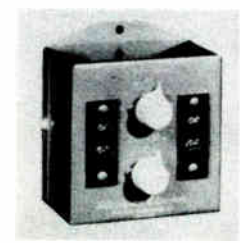

FIGURE 13



TSM-15 FIGURE 15

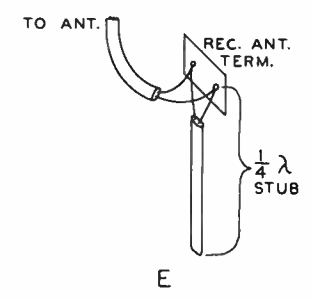

FIGURE 14

DeVRY Technical Institute

Formerly DeFOREST'S TRAINING, INC.

4141 WEST BELMONT AVENUE

CHICAGO 41, ILLINOIS

QUESTIONS

External Interference—Lesson TSM-15A

Page 27

3

How many advance Lessons have you now on hand?.....

Print or use Rubber Stamp.

Name..... Student No.....

Street..... Zone..... Grade.....

City..... State..... Instructor.....

Write your answers on the "Ans." line below each question. If more space is needed use reverse side of this page.

1. Before trying to remedy an interference, what should be done first?

Ans.....

2. In what two general types may external interference be classified?

Ans.....

3. How does interference due to arcing or a spark vary with distance from the source?

Ans.....

4. What mainly determines the nature of the visual interference symptoms?

Ans.....

5. In what three ways may interference enter the receiver?

Ans.....

6. What characteristic of interference often indicates its source?

Ans.....

7. Where are line filters most effectively installed?

Ans.....

8. How are capacitors most readily replaced in most fluorescent fixtures?

Ans.....

9. Give two things that can be done to prevent random noise entering by the antenna.

Ans.....

10. How may interference from radio stations be prevented?

Ans.....

FROM OUR *Director's* NOTEBOOK

FIRST IMPRESSIONS ARE ALL-IMPORTANT

The first moment a prospective employer lays eyes on you, he forms an opinion—often before he has said a word to you.

Now, if you appear before him with unkempt hair, dusty, dirty shoes, poorly kept clothes . . . if you present a generally "sloppy" appearance, he likely will think your work will be just as slipshod.

Make it a point to look your best. Be clean shaven, make sure you won't offend with perspiration odor, remove the "real estate" from under your fingernails, and see that your shoes have had a recent acquaintance with shoe polish. Pressed trousers, a clean shirt and a well-groomed appearance help you make that first impression a good one.

You don't have to be a fashion plate by any means. Just keep what clothes you have—old or new—looking nice. It is worth the effort.

Yours for success,

W. C. McVey
DIRECTOR

TSP

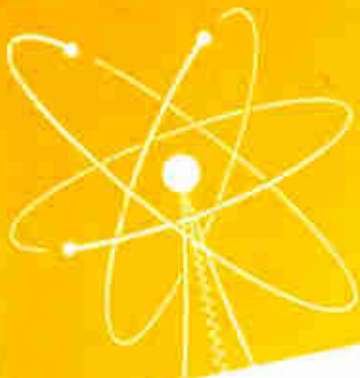

INTERNAL INTERFERENCE

Lesson TSM-16A



DeVRY Technical Institute

4141 W. Belmont Ave., Chicago 41, Illinois

Formerly DeFOREST'S TRAINING, INC.

TSM-16A

INTERNAL INTERFERENCE

4141 Belmont Ave.

COPYRIGHT 1955

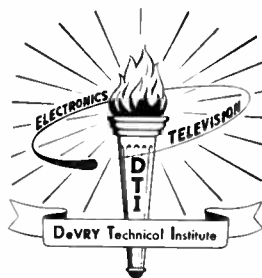

Chicago 41, Illinois

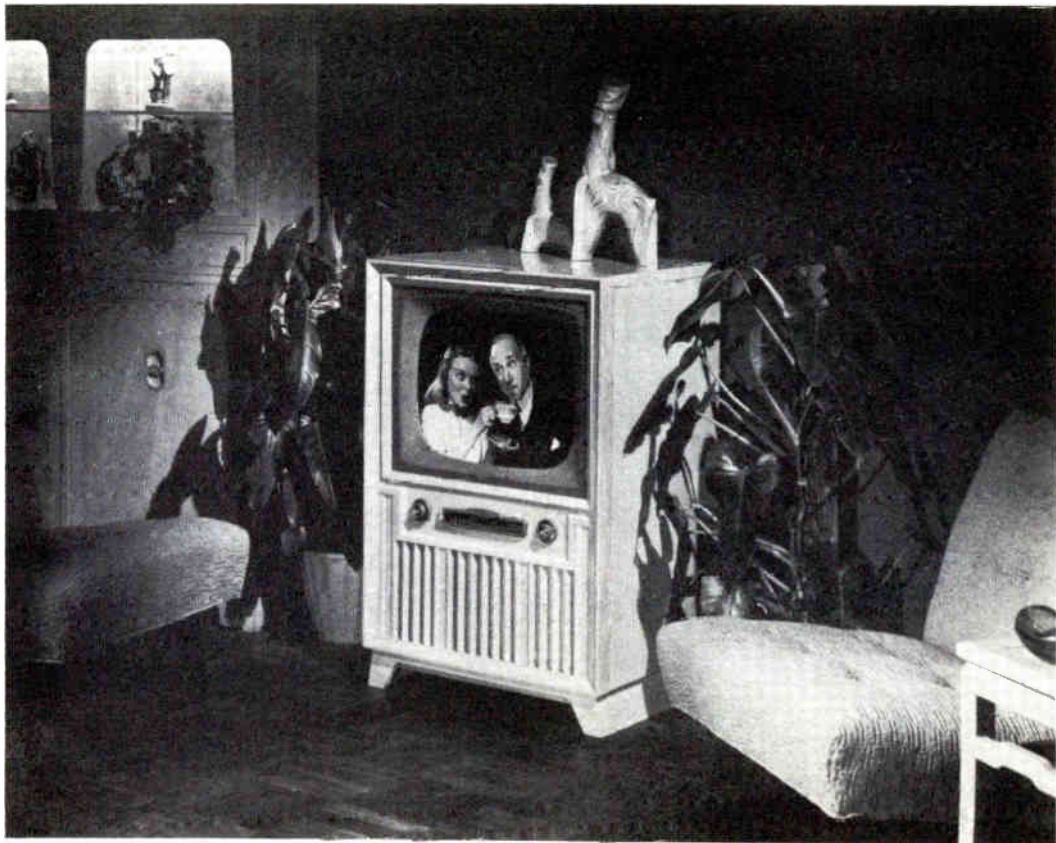

A modern 20 inch television receiver. Notice how the carefully designed cabinet harmonizes with the other furniture.

Courtesy Crosley Div. of Avco Mfg. Co.

Television Service Methods

INTERNAL INTERFERENCE

Contents

	PAGE
Low Frequency Disturbances	5
60 Cycle Voltages	5
120 Cycle Voltages	9
Sweep Frequency Interference	9
Audio or Adjacent Channel Video	11
High-Frequency Disturbances	17
Corona Discharge	18
Brush Discharge	18
R-F Power Supply	19
Microphonics	20
Picture I-F Oscillation	21
Barkhausen Oscillation	24
Faulty Components	25

No matter how big and tough a problem may be, get rid of confusion by taking one little step towards solution. Do something. Then try again. So long as you don't do it the same way twice, you will eventually use up all the wrong ways of doing it and thus the next try will be the right one.

—G. F. Nordenholt

INTERNAL INTERFERENCE

Previous lessons have been concerned with troubles resulting in no picture or sound, distortions of the picture due to failure of circuit components, and disturbances of the image due to pickup of interfering signals or noise energy from sources external to the receiver. In this lesson we shall take up the various picture disturbances which are the result of interfering energy from within the receiver.

Depending upon its source, the undesired energy may have the form of alternating currents or radiated waves of low or high frequency, and may be constant or varying in amplitude or frequency. In some cases, the disturbing signal is generated due to some defect, while in other cases, undesired voltage variations are coupled into the signal circuits of the receiver.

Circuits in which undesired modulating energy may be generated are shown in Figure 1. This diagram shows the picture channel, sweep, and power supply sections of a television receiver. The r-f section and the sound channel are infrequent sources of such trouble, and therefore are omitted.

The upper row of tubes includes a four-stage picture i-f amplifier, the video detector, a two-stage video amplifier, and the picture

tube. As shown in the upper left hand corner, the output of the converter is coupled to the input of the picture i-f channel by means of transformer T₁, the secondary of which is connected directly to the primary of the 1st picture i-f transformer, T101. The first two picture i-f stages carry both the sound and video i-f signals, with the sound i-f take-off being from a tap on the secondary of the third video i-f transformer T103.

The second line of tubes includes the agc rectifier and amplifier, sync separators and amplifier, limiter, vertical oscillator and discharge tube, and the vertical output amplifier. The lower group of circuits contains the horizontal oscillator and oscillator control tube, the horizontal output tube, the high-voltage rectifier, damper tube, and at the lower right, the low-voltage rectifier.

The disturbing energy existing in or produced by these circuits affects the picture in a variety of ways. For purposes of identification, it is convenient to group the various disturbances as being either of the low-frequency or high-frequency type, depending upon whether the currents or radiations causing them are within the audio frequency or the radio frequency ranges.

LOW FREQUENCY DISTURBANCES

By far the most frequent sources of low-frequency disturbances are the various circuits and components which carry currents at the power line frequency or twice the power line frequency. These disturbances correspond to the familiar 60 and 120 cycle hum produced in the loudspeakers of radio receivers. In a television receiver, the undesired voltages may modulate the video signal or the sweep voltages, or both.

60 Cycle Voltages

Since there are 60 television fields per second, a 60 cycle voltage will cause the picture tube control grid to be negative for half of one field and positive for the other half of the field. This results in half of the screen being dark and the other half being light. Thus, depending upon the phase of the 60 cycle voltage, the receiver screen may have a broad, light or dark band across the middle as shown in Figure 2. The upper half may be dark and the lower half light, or the upper half may be light with the lower half dark.

In either case, the condition indicates that 60 cycle a-c voltage is applied to the control grid of the picture tube. That is, to produce the horizontal bands on the screen, the 60 cycle signal must

exist in the video signal circuits, and it can be introduced into the video amplifier, the video detector, or even the r-f or i-f stages.

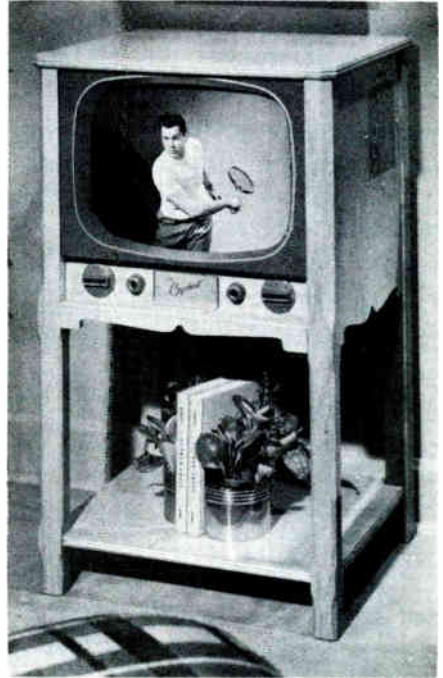

Every TV receiver owner desires to have a clear, sharp picture—free of interference.

Courtesy Capehart-Farnsworth Corp.

Frequently, the 60 cycle voltage is introduced as a result of heater-cathode leakage modulating an amplifier. By thermionic emission, electrons leave the insulating coating of the heater and travel to the cathode. This occurs especially in amplifiers which operate with cathode bias that is less than the highest voltage between the high voltage end of the heater and ground. That is, the voltage

across the heater causes the high voltage end of this element to be alternately positive and negative with respect to ground by the heater peak voltages.

When the high end of the heater is negative with respect to the cathode, electrons pass from the heater coating to the cathode and, when the high end of the heater is positive with respect to the cathode, electrons move from the cathode to the heater.

The action results in an alternating current in the heater-cathode circuit as indicated by the arrows in Figure 3. Since this heater-cathode leakage current passes through the cathode resistor R, the variations cause the cathode operating voltage to vary with respect to ground, at the rate of 60 cps.

This condition may be severe in a receiver employing series operated heaters when the offending tube is situated at the high end of the string. In this case, the high end of the tube heater varies positive and negative with respect to ground by a voltage equal to the total drop across all of the heaters in series with it. In fact, during heater current peaks, the entire heater of the faulty tube may be positive with respect to the cathode of the tube. Also, due to heater-cathode leakage, the a-c leakage current passes through the entire heater circuit and de-

velops an alternating voltage drop across the cathode resistor of the faulty tube. As mentioned before, this drop across the resistor varies the operating potential of the cathode which, insofar as the signal circuits are concerned, is the equivalent of varying the control grid of the tube at the 60 cycle power line frequency.

Although this trouble can occur in the r-f or i-f stages, the more common offenders are the video detector and the video amplifier tubes. In cases where the heaters are operated in series, the tubes to be tested must be replaced one by one. Otherwise, the faulty tube can be found simply by removing and reinserting the tubes. In the receiver of Figure 1 for example, if the heater-cathode leakage is taking place in the video detector, V105A, the horizontal bars will disappear when this tube is removed. Of course, the test pattern or picture cannot be obtained with this tube removed, but these are not needed for the check.

If the horizontal bars remain when V105A has been removed, then the trouble must be in the video amplifier tube V106. This tube may be checked by replacing V105A and removing V106. If now the bars disappear, then the video amplifier tube is definitely at fault. If not, then the 60 cycle energy must be entering the video circuits somewhere between the

video output tube and the picture tube.

If the horizontal bars disappear when V105A is removed, then the trouble is either in this tube, as mentioned, or in some preceding stage. To check the i-f section, the detector tube is replaced and V101 removed. If the bars remain, one of the picture i-f stages is faulty. In order, tubes V102, V103, and V104 are removed or replaced, and the defective tube or stage will be indicated by the disappearance of the bars.

In the event the bars disappear when V101 is removed, the trouble is indicated to be in this stage or in the r-f section. With V101 replaced, and the mixer tube removed, the bars will appear if V101 is faulty, but they will not be present if the trouble is in an r-f stage. Similar checks may be made in the r-f section, by removing the oscillator and r-f amplifier tubes, one at a time.

When it has been determined that the effect of Figure 2 is due to a faulty tube, the remedy consists simply of replacing that tube with a new one. However, in some cases, the location and correction of this trouble may not be accomplished immediately, because the effect takes place only after an initial heating period or only sporadically.

Therefore, it may be necessary to replace several defective tubes

to cure the trouble permanently without undue expenditure of time. On rare occasions, the new tube used to replace a bad one may have a similar defect, so that the "60 cycle" bars still appear on the receiver screen. After checking other possible causes of this trouble, it may be necessary to replace the old tube with a number of new ones before one is found which causes the bars to disappear.



A defect in a low voltage supply filter capacitor may be suspected when the raster shows the effect of 60 or 120 cycle ripple in the sweep circuits.

Courtesy Solar Capacitor Sales Corp.

When 60 cycle energy gets into the sweep section circuits, the image on the screen has a wavy appearance such as shown in Figures 4 or 5. As Figure 4 shows, the presence of 60 cycle ripple in the vertical sweep circuit causes the image on the screen to appear to bulge inward or outward.

If the receiver and the transmitting station are both obtaining power from the same company, then the distorted pattern remains stationary on the screen. However, if the receiver is obtaining power from a different company than that supplying the transmitter, and the two power supply companies are not operating in synchronism, then due to the difference in their frequencies, the pattern distortion drifts slowly up or down across the screen. In fact, during the course of a program, this 60 cycle distortion may move first in one direction and then in the other, sometimes standing still for appreciable periods of time.

Figure 5 shows the results of 60 cycle ripple in the horizontal sweep circuits. A slight ripple in these circuits barely causes the side of the picture to be wavy, but an excessive amount produces distortion of the entire picture, as illustrated.

To check for 60 cycle distortion of the sweep voltages, it is necessary that operation of both vertical and horizontal sweep circuits be maintained during the test. Therefore, the tubes of the sweep circuits may be checked by removing them and replacing with a good tube, one at a time.

A second common trouble which produces the effects shown in Figures 2, 4, and 5, is a de-

fective output filter capacitor in the low-voltage power supply. The input filter capacitor also can cause this trouble, and both capacitors should be checked by temporarily connecting a substitute capacitor across each in turn. In like manner, the various bypass capacitors should be checked in the stage in which it has been determined that the trouble is originating.

Often, an open develops in the grid circuit of some stage, resulting in an alternate build up and discharge of voltage at the open grid at a rate that is close to the power supply 60 cycle frequency, and may be mistaken for it. This condition can be checked by making continuity tests in the grid circuits of the various tubes. In the case of horizontal bars on the screen, the test is made in the stages that carry the video signal. The check is made in the grid circuits of the vertical or horizontal sweep circuit tubes when the distortion is like that of Figure 4 or Figure 5, respectively.

When grid or plate leads of the video detector, video amplifier, or deflection circuit tubes happen to be located near wires carrying 60 cycle current, such as filament leads, then the 60 cycle energy may enter the video or sweep circuits by means of induction between these leads.

Poor dressing of leads may exist due to the wiring having been disturbed during some previous service work on the set. In such a case, the trouble can be cured by moving the leads so that none of the signal or sweep circuit leads lie near any wires or components carrying 60 cycle a-c current.

AS A PRECAUTION, THE LEAD DRESSING AND PART PLACEMENT IN MANY OF THE TELEVISION RECEIVER CIRCUITS ARE QUITE CRITICAL, AND NO CHANGES SHOULD BE MADE UNTIL IT IS DETERMINED DEFINITELY THAT IMPROPER LEAD DRESSING IS THE CAUSE OF THE TROUBLE. For this reason, it is a safe plan to make a simple drawing of the existing lead placement at the point where an experimental change is to be made, and then return any changed leads to their original positions as indicated by the drawing, should the change not correct the trouble.

Although not occurring very often, another defect which produces the symptoms of Figures 2, 4, and 5, is poor filtering of the low-voltage power supply output due to a short in the filter choke. With both input and output capacitors temporarily replaced with units known to be good, the power supply output may be checked with an oscilloscope or pair of headphones. If considerable ripple output is in-

dicated, the d-c resistance of the filter choke should be checked. As indicated in Figure 1, filter choke L114 should have a resistance of 45 ohms, $\pm 10\%$, in this receiver. A similar check of focus coil L115 should be made, since this unit is in series with the power supply output in this receiver.

120 Cycle Voltages

Although these references have been for 60 cycle disturbances, if the low-voltage power supply employs a full-wave rectifier circuit as shown in Figure 1, its output ripple has a frequency of 120 cycles. In these cases, when the trouble is due to poor filtering of the power supply output, the disturbance frequency is 120 cycles and produces two dark horizontal bars on the screen. In a like manner, when the 120 cycle ripple affects the sweep circuits, the distortions obtained are similar to those shown in Figures 4 and 5, but the waves are double the number illustrated.

Sweep Frequency Interference

Horizontal pulling can be caused as a result of voltage surges in the vertical oscillator circuit being coupled into the horizontal afc circuit. This possibility can be checked by opening the circuit that couples the sync pulses into the vertical integrating network, and then free-wheeling the ver-

tical oscillator to keep the picture from rolling vertically.

oscillator and the horizontal sync input circuit.



A service type instrument for checking capacitors and resistors.

Courtesy Aerovox Corp.

For the circuits in Figure 1, this is done by disconnecting R151 from pin 6 of V109, and adjusting R158 continually to hold the picture in sync vertically. If this arrangement causes the horizontal pulling to disappear, then additional isolation is needed between the vertical

It is possible for an effect like that shown in Figure 2 to result due to video circuit pickup of energy from the vertical deflection circuit. Since this circuit operates at a 60 cps frequency, if conditions should be such that its output is applied to the grid of the receiver picture tube,

alternate light and dark horizontal bars are produced as shown.

For example, these bars may occur, when the leads of the vertical oscillator or amplifier run near the video signal circuit leads. Redressing of these leads usually cures the trouble. Should the disturbance persist, it may be necessary to suppress the vertical deflection circuit radiation to some extent. In the circuit of Figure 1, for example, this is accomplished by inserting a resistor (50 to 500 ohms) in series with coupling capacitor C149.

Audio or Adjacent Channel Video

Occasionally, due to some misadjustment or defect, a sound carrier signal is enabled to enter and pass through the receiver picture i-f circuits. When this occurs, the audio modulation is detected, amplified, and applied to the control grid of the picture tube. Applied to the picture tube, the audio signal produces horizontal bars on the screen like those shown in Figure 6. The number or intensity of these bars may remain constant, or may vary or be intermittent, depending upon the nature of the sound signal producing them.

Another common cause of this trouble is misadjustment of the receiver fine tuning control. For example, the receiver of Figure 1

employs a picture i-f of 25.75 mc and a sound i-f of 21.25 mc. When tuned to channel 3, the receiver high frequency oscillator operates at a frequency of 87 mc. Thus, the oscillator output beats with the picture r-f carrier of 61.25 mc and the sound r-f carrier of 65.75 mc to produce the intermediate frequencies mentioned.

In order not to pass the sound i-f, the picture i-f channel response is attenuated sharply below 22 mc and reaches a minimum at the 21.25 mc i-f sound carrier frequency. However, should the fine tuning control be misadjusted so that the local oscillator actually operates at 87.25 mc for example, this signal then would beat with the incoming r-f carrier signals to produce a picture i-f of 26 mc and a sound i-f of 21.5 mc. The sound i-f of 21.5 mc would be accepted to some extent by the tuned circuits of the video i-f channel and thus ride through to produce the disturbance shown in Figure 6.

The remedy is to adjust the fine tuning control for maximum sound output from the speaker. When this control is so adjusted, the sound bars disappear unless some other misadjustment or defect exists. The so-called "sound bars" appear in the picture due to mistuning of the oscillator in the case of the dual channel type

of receiver only. With the inter-carrier type of receiver, mistuning of the fine tuning control often is detrimental to picture quality, but regardless of the intermediate frequencies produced by the mistuned oscillator, they always are separated by 4.5 mc to which frequency the sound take-off trap in the video amplifier is tuned.

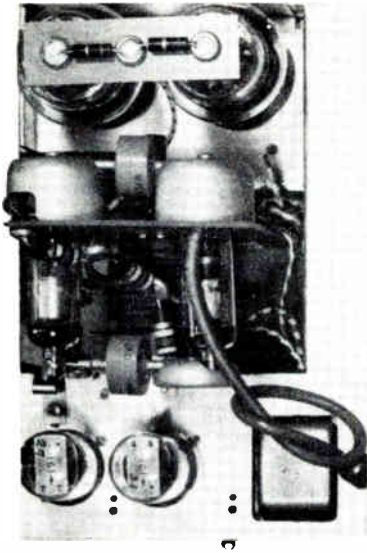

When corona or brush discharge is suspected, the high voltage supply should be observed with the receiver operating in a dark room.
Courtesy Allen B. Du Mont Laboratories, Inc.

Like other disturbing signals, the undesired audio can be picked up by the wiring, tubes, or components of the video i-f, detector, or video amplifier circuits. Therefore, a check of improper lead dressing or part placement should

be made, especially if the receiver has been serviced before.

Sound bars may result due to a defective decoupling filter capacitor in the plate supply circuit of the audio output amplifier. This tube carries considerable plate current and, if improperly filtered, the audio-frequency current variations may cause corresponding variations of the output of the low-voltage supply. As shown in Figure 1, the low-voltage supply provides operating voltages for the cathode and control grid of the picture tube and, when either of these elements varies with respect to the other, modulation of the screen intensity results.

In the dual-channel receivers, such as that of Figure 1, relatively sharply tuned filters or trap circuits are employed to separate the sound i-f from the picture i-f signals. If these traps become misadjusted for any reason, the sound i-f is not "trapped out" of the picture channel. Hence, some of the sound signal remains in the video circuits to produce sound bars.

In the receiver of Figure 1, an example of such a sound trap is the secondary circuit of picture i-f transformer T103. As indicated, this tuned circuit is resonated at the sound i-f frequency of 21.25 mc, and serves the double purpose of preventing passage of the sound i-f through the pic-

ture channel and of coupling the sound i-f signal to the input of the sound channel. Also employed to prevent the passage of the received channel sound i-f, another trap is located in the cathode circuit of tube V104, and consists of transformer T105 and capacitor C119.

As shown, a number of other traps are included in the circuits of the picture i-f amplifier, and are of importance when the receiver is used at a location where reception is possible from stations operating on adjacent channels. Generally, these traps are employed to prevent passage of the beat note produced by the local oscillator and the sound carrier in the lower adjacent channel, and the beat note produced by the local oscillator and the picture carrier in the higher adjacent channel.

With the receiver tuned to channel 3, the 59.75 mc sound carrier of channel 2 heterodynes with the 87 mc output of the local oscillator to produce a beat note of 27.25 mc. The beat note is modulated by the sound signal of channel 2, and the broadly responsive picture i-f tuned circuits do not have sufficient selectivity to prevent passing this audio modulated signal.

When such a signal passes through the picture i-f amplifiers, sound bars may be produced on

the receiver screen as shown in Figure 6, or a slightly degraded pattern may be produced as shown in Figure 7.



Often, disturbances in the television picture are caused by microphonic tubes, or tubes which are excessively noisy.

Courtesy RCA

To prevent a disturbance of this sort, the receiver of Figure 1 contains two sound traps tuned to this 27.25 mc beat frequency. One is located in the plate circuit of V101, and consists of the secondary of transformer T102 and capacitor C107. The other is in

the grid circuit of V104, and consists of the secondary of transformer T104 and capacitor C116.

It is fairly easy to distinguish between the interference or disturbance produced by the lower adjacent channel sound carrier and the sound i-f of the channel to which the receiver is tuned. In the latter case, the sound bars vary in accordance with the sound output heard from the loudspeaker.

For instance, when an actor is talking the sound bars are present, but disappear when he stops. Then, when he begins talking again, they reappear. On the other hand, when the disturbance is due to the sound from the lower adjacent channel, the bars move independent of the sound being reproduced by the loudspeaker, for they follow that being produced in the adjacent channel station.

Another clue to this identification is the fact that, normally, a steady tone is broadcast during the transmission of the test pattern, and the higher the audio note transmitted the larger the number of horizontal lines which appear on the screen. This fact is especially helpful when one of the stations is transmitting a test pattern and tone and the other station is transmitting a program.

If there is a station operating on the upper adjacent channel,

the picture signal carrier from this station and the receiver local oscillator signal will cause modulation on the screen if the produced beat note is able to pass through the picture i-f amplifiers. Though not strictly a low-frequency disturbance, this undesired signal results in the production of a fine cross line pattern, herringbone pattern, or other disturbances in the picture, similar to those described in the lesson on external interference.

Assuming the receiver of Figure 1 is tuned to channel 3, then the upper adjacent channel is channel 4. A station operating in channel 4 has a picture carrier frequency of 67.25 mc, and this signal mixes with the local oscillator 87 mc output to produce a beat note of 19.75 mc. This type of trouble can be as annoying as sound bars in the picture, and the receiver of Figure 1 employs two traps for the purpose of attenuating this beat note. Shown in the grid circuit of V101, the first 19.75 mc trap consists of capacitor C102 and a third winding on transformer T101. The second 19.75 mc trap is located in the cathode circuit of V105A, and consists of capacitor C123 and one winding of transformer T106.

Regardless of the channel to which the receiver is tuned, the various beat notes produced always have the same frequencies.

Thus, for any particular receiver a single setting of each of the respective traps serves for all channels. However, the beat frequencies depend upon the frequencies at which the local oscillator operates, which in turn depend upon the intermediate frequencies employed in the receiver. Therefore, since the various makes and models of television receivers use different intermediate frequencies, each model contains traps tuned to reject the particular beat frequencies produced, and so the actual trap frequencies may be the same or different from those in the circuit of Figure 1.

turbances which are similar to the type obtained when the video i-f amplifier trap circuits are out of adjustment. The possibility of the trouble being due to some such external source should be investigated thoroughly before any trap adjustments are made. Only when it has been established definitely that the trouble is due to misadjusted traps should they be tuned as explained in the lesson on television receiver alignment.

However, an important point to remember is, that any signal generator used for television alignment should be one which has been accurately calibrated. This point is particularly impor-

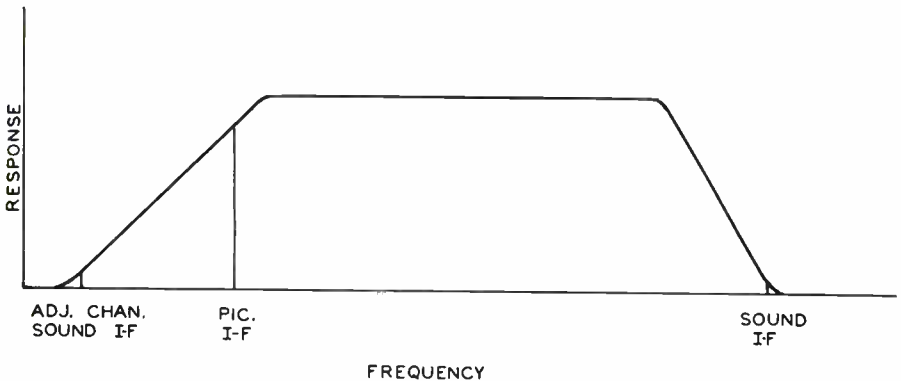

Due to misalignment, the picture i-f amplifier may have a response which passes the beat frequency produced by an adjacent channel carrier and the receiver local oscillator. This modulated beat note produces interference.

Often, interference of various types from external sources, such as X-ray machines, diathermy, or the harmonics of short wave stations in the vicinity, result in dis-

tant in the adjustment of the various traps, for the tuning of the trap circuits is very sharp and the exact frequencies must be used.

Occasionally, after the first of a pair of traps has been tuned, this trap absorbs so much energy at the test frequency that it is difficult to observe changes in the meter reading when the second trap is being adjusted. In the circuit of Figure 1, for example, if this condition makes it very difficult to tune the trap of T104, then the first 27.24 mc trap, at T102, can be bypassed by disconnecting the signal generator from the converter grid and connecting it to the control grid of V103. In other words, after the first trap has been tuned, the test signal may be injected at a point following this trap so that the second trap may be adjusted independently.

Since all of these traps consist of relatively high Q circuits, they can function with maximum trapping efficiency only when the fine tuning control is at the correct setting. If this control is set incorrectly, some of the energy of the undesired beat note passes through the i-f amplifier. Of these undesired beat frequencies, the strongest is the sound i-f of the used channel. This sound i-f heterodynes with the picture i-f in the video 2nd detector, in the same manner as in an intercarrier type of receiver. Of course, in a dual-channel type receiver like that of Figure 1, this action is undesired because the 4.5 mc beat note produces a "dot pattern" on the screen

if it passes through the video amplifier stages.

For this reason, the receiver of Figure 1 includes a 4.5 mc trap consisting of L104 and C128 connected in the plate circuit of the 1st video amplifier. This trap may be adjusted by tuning the receiver to a strong station and then detuning the receiver somewhat by means of its fine tuning control. If the trap is misadjusted, the beat note dot pattern now appears on the screen and L104 may be adjusted until this beat pattern is eliminated. If the "sound in picture" disturbance persists after all the other sources of this trouble have been investigated, including an adjustment of the various traps, then the alignment of the picture i-f amplifier should be checked.

If the i-f amplifier is out of alignment, its response curve may be such that the amplifier accepts too much energy at the frequencies of one or more of the various undesired beat notes. For these adjustments, the alignment procedure given in the service manual for the particular receiver should be followed. As this procedure is covered in the lesson on alignment, it will not be included here.

Finally, it is possible that the receiver local oscillator circuit is so far out of alignment that it is impossible to reach the correct

tuning point within the range of adjustment of the fine tuning control. Where this condition is evident after the traps and i-f amplifier circuits have been adjusted, then the alignment of the oscillator should be carried out in accordance with the manufacturer's directions.

circuit defects, defective components, etc. On the picture tube screen, often the results of these troubles are similar, thus making the trouble difficult to diagnose. Furthermore, often the disturbances are very much like those produced by the various sources of r-f energy which exist external

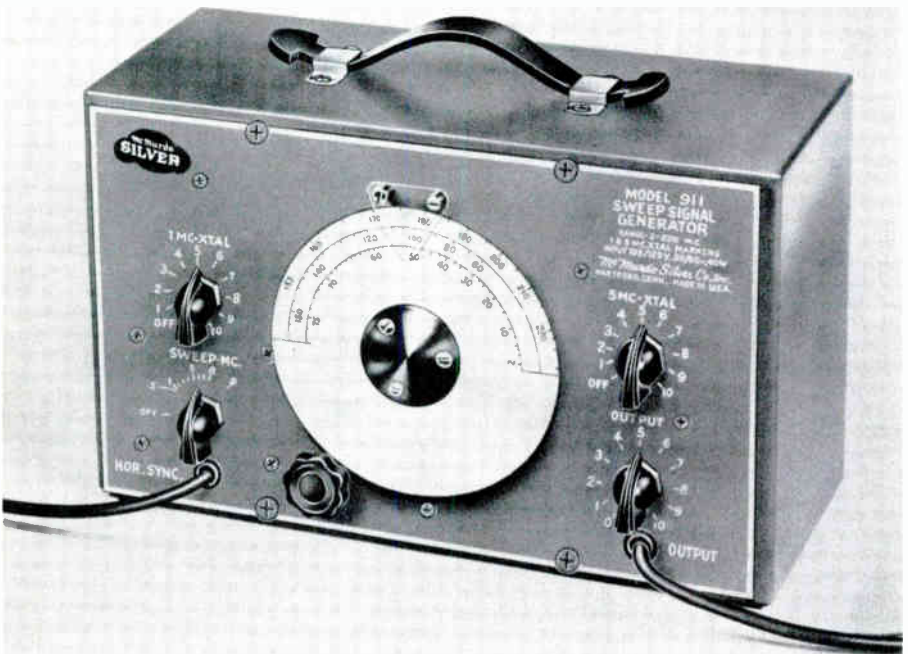

A sweep signal generator designed for visual alignment of a television receiver by a service technician.

Courtesy McMurdo Silver Co., Inc.

HIGH-FREQUENCY DISTURBANCES

Radio-frequency energy is created within the television receiver due to a number of causes such as

to the receiver. Therefore, the checks outlined in the lesson on external interference should be made to determine whether the disturbing energy is coming from within or outside the receiver.

When these tests indicate that the source is within the receiver, then careful observation of the screen should be made to reduce the total number of possible sources to be investigated. In the following paragraphs a rather rough grouping of these sources is made according to the general nature of the disturbances.

Corona Discharge

Under certain conditions, a discharge of electricity from a conductor into the surrounding air takes place. Such a discharge is known as CORONA. Corona occurs when the conductor is at a very high potential and has sharp edges, points, or curves. It results in the ionization of the surrounding air and, when viewed in a darkened room, appears as a glow of colored light on the surface of the conductor.

One of the effects of corona discharge is the production of r-f energy which, when picked up by the receiver signal circuits, produces flashes or streaks in the picture. Corona usually occurs in the high-voltage power supplies, especially the r-f type, and those used to provide picture tube anode voltages in the projection type television receivers.

Of greater importance than the disturbance produced on the receiver screen, are the effects which corona has on the conductor in

which it is taking place. For example, when corona is present in the windings of the r-f coil of an r-f type power supply, it results in the gradual destruction of the fine strands of litz wire. Generally, corona on this coil is due to the weakening of the varnish with which the coil has been impregnated. Because corona becomes greater in humid weather, often a coil which operates normally in a dry atmosphere breaks down and permits this type of discharge when the moisture in the air increases.

When corona is suspected, the receiver should be operated in a darkened room and a visual inspection made of the high-voltage power supply and any wiring or components connected to it, such as the external conductive coating used on some types of picture tubes. If corona discharge is occurring, a bluish glow can be seen at the point of trouble. A coat of service cement or a good grade of varnish applied at the point of corona normally clears up the trouble.

Brush Discharge

A flash-over or electric discharge between two points which have a high difference of potential is known as brush discharge. Often, this type of electric discharge is accompanied by a sound which, though not loud, may be described as a sharp "crack". Sometimes,

these discharges take place at a very rapid rate. When occurring through the air, brush discharges consist of visible streams of light accompanied by a hissing sound. When picked up by the receiver video circuits, a brush discharge produces r-f energy which may cause the whole picture to flash bright and then dark, intermittently. At other times, the disturbance produced has the same general appearance on the screen as that due to corona.

As with corona, the components in and connected to the high-voltage power supply are the sources of brush discharge, especially those having surfaces containing sharp points. Typical examples of locations of brush discharge are conductors having irregular surfaces, and carelessly made solder joints. To reduce brush discharge, all sharp bends in the high-voltage circuit wires should be eliminated, and the solder on all high-voltage joints should be flowed by being heated to the melting point with a soldering iron. Also, the application of varnish or service cement helps to cure this trouble.

Often materials normally considered to be good insulators become conductive and form leakage paths when subjected to high potential differences. Any discharges of this type represent power losses insofar as the power supply is concerned. In fact, the

conductivity of the leakage paths in insulation materials may become so great as to eventually produce considerable loading of the power supply. Due to glowing carbon, sometimes the burning path can be seen in an insulator. When the trouble has reached this stage, usually varnish or cement is of little benefit, and the only remedy is to replace the insulator or insulation material.

R-F Power Supply

The r-f type of high-voltage power supply operates at a frequency somewhere between 10 and 300 kilocycles. Normally, sufficient shielding is employed to prevent the r-f energy from radiating out of this circuit into the video circuits. However, if for any reason this r-f signal does enter the video section, it produces vertical lines on the screen. The number of lines produced depends upon the frequency at which the r-f power supply operates.

The introduction of the r-f energy into the video circuits may be due to pickup of direct radiation from the components or wiring of the high-voltage supply, or by conductive coupling due to the common connections to the receiver low-voltage supply. In the latter case, most likely the trouble is due to defective components in the low-voltage power supply filter.



Faint vertical lines on the receiver screen may be due to Barkhausen oscillation in the output tube of the horizontal sweep circuit.

Courtesy Radio Corporation of America

Video circuit pickup of radiation from the r-f supply may be due to the fact that the metal container or shield in which the supply is enclosed has not been properly replaced after the completion of previous service work.

Also, a check should be made to see that the power supply leads that carry r-f have been replaced in their correct location, such that they are not near any of the video circuits. Often, careful redressing of these leads is all that is necessary. In rare cases, additional filtering or shielding of the supply may be needed.

Microphonics

Streaks or splotches in the picture are caused by microphonic tubes, resistors, capacitors, or other components. Any vibration in the receiver causes these circuit components or the elements of the offending tubes to be set in motion, and this motion results in the generation of oscillating currents. Sometimes this condition exists only when the volume control is advanced, in which case, sound appears to be in the picture, as illustrated in Figure 6.

To locate the offending unit, each suspected tube and other component should be tapped lightly with the eraser end of a pencil or some similar light object. Sometimes it is necessary to replace the suspected tubes in succession until the microphonic one is found. An occasional source of microphonic trouble is a loose tuning core in one of the i-f transformers. In any case, when the offending component is located, it must be replaced.

When troubleshooting for the source of microphonic trouble, some servicemen tend to subject the tubes to more vibration or pounding than these tubes encounter during normal operation of the receiver. Certain television receiver tubes are operated under critical circuit conditions, and when subjected to abnormally severe pounding, produce distortions in the picture which are not generated under normal operating conditions.

The following set of rules or conditions have been suggested for use as a guide in determining whether or not a tube should be rejected as being microphonic.

1. Check to see that the chassis bolts are loose enough so the receiver chassis floats freely on its rubber mounting.
2. Set the sound volume control below the point where distortion of the sound occurs.
3. Do not reject a tube because it causes distortion due to severe shock, such as being pounded with a mallet. Use a light tap.

Generally, replacement of a tube does not improve the condition in the cases where the oscillations occur only immediately after the station selector switch has been turned to a new station.

Summarizing, *tubes should be rejected as being microphonic*

only when they fail to perform properly under normal operating conditions, or when very light tapping causes them to produce streaks or flashes in the picture.

Picture I-F Oscillation

Oscillations in the picture i-f circuits result in an over-contrasted and extremely distorted picture with long white streaks as shown in Figure 8. Such oscillations are caused by either defective i-f circuit components, or misalignment. In general, any component defects that increase the gain of an i-f amplifier stage may result in oscillation in that stage.

For example, a leaky coupling capacitor permits direct current in the grid resistor, and the voltage drop across this resistor has the polarity to reduce the negative grid bias and result in higher stage gain. Or, for an increase in resistance in a grid or plate circuit loading resistor, the Q of the circuit will increase, thus increasing the stage gain.

In the case of misalignment, the most common trouble is that of two successive i-f coils being tuned to the same frequency. However, since properly aligned i-f circuits are very stable and normally do not go out of alignment except under unusual conditions such as jarring or jolting of the receiver chassis, etc.; the

possible existence of defective i-f components should be investigated carefully first.

large increase in voltage across the detector load when the capacitor is removed from the grid

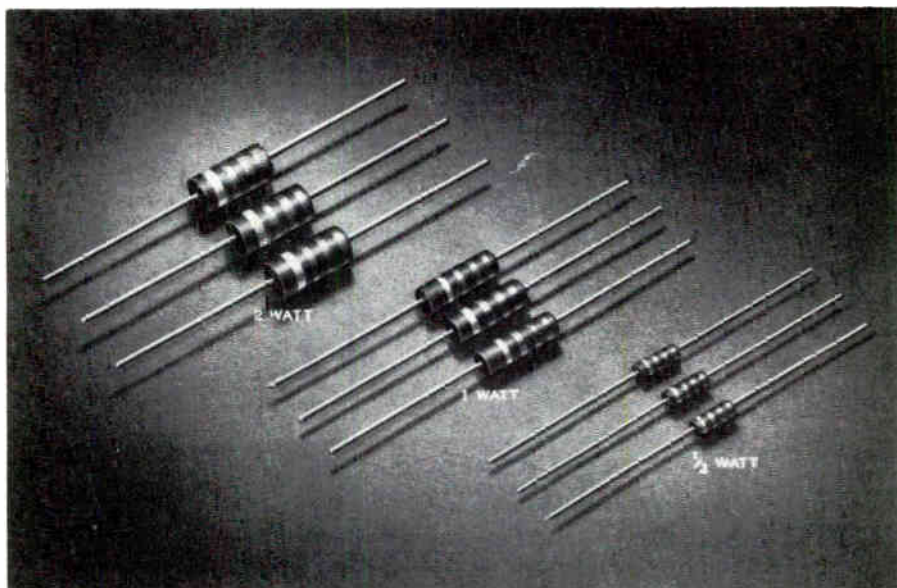

Resistors of various wattage ratings.

Courtesy Stackpole Carbon Co.

The receiver input terminals should be shorted and the picture i-f tubes replaced, one by one. If the trouble still remains, the chassis should be removed and .001 μ fd capacitors connected from each i-f tube grid to ground. This arrangement will stop the oscillations and, with a vtvm connected across the video detector load resistor, the .001 μ fd capacitors should be removed one at a time, beginning with the last i-f stage and working toward the front of the receiver. The stage in which the oscillations originate is indicated by a sudden,

circuit of the faulty stage. When there is no oscillation, the normal voltage across the detector load resistor is less than 1 volt when no signal is applied to the receiver input.

If tube replacement does not correct the trouble, check the operating voltages of the tube elements in the suspected stage, and bridge the bypass capacitors with units of corresponding values to check for opens. Bypass capacitors in the heater circuits should be checked, and any chokes used in these circuits

should be inspected to see if they have been bent out of shape. All leads should be returned to their proper position if they have been moved for testing or component replacements.

When a control grid is operating with less negative bias than specified in the manufacturer's service manual, a gassy tube or leaky coupling capacitor is indicated. Although the tubes were tested previously, a second check may be made by replacing the suspected tube with one or more new ones.

To test the coupling capacitor, the tubes in both the suspected and preceding stages are removed temporarily, and with the power on, voltage readings taken at both ends of the grid resistor in the suspected stage. If the capacitor is not leaky, the two readings should be the same. However, in those circuits to which the contrast control or agc bias is connected, there will be a slight difference in the readings if a low-resistance voltmeter is employed.

In the circuit of Figure 1 for example, the grid of V103 normally operates at $-.03v$. If a less negative, or a positive voltage is measured at this point, then with V102 and V103 removed, equal voltages should be obtained when readings are taken at the two ends of R110. If this

check shows the grid end of this resistor to be less negative, or more positive than the other end, leakage is indicated in C111.

Where checks in all suspected stages have not located the trouble, then misalignment is indicated. With a sweep generator, marker generator, and oscilloscope connected to the receiver to check the picture i-f over-all response curve as in alignment, a large peak in the observed response curve indicates the frequency at which the oscillations are occurring. A low output should be used from the sweep generator to avoid overloading the i-f stages.

When the receiver contrast control is connected to the picture i-f circuits, this control may be rotated toward minimum until oscillations cease, as shown by the pattern on the oscilloscope screen. If the oscillations stop after only a slight adjustment of the control, the trouble is likely in one of the stages connected to the control. If the oscillations remain while the control is adjusted over most of its range, possibly the trouble is in some stage not connected to the contrast control.

Turn the marker signal generator on and adjust its frequency until the marker pip is located at the same point as the oscillation peak on the response curve. The

marker dial now indicates the approximate oscillation frequency. Locate the i-f coil which normally is tuned to a frequency nearest to that of the oscillations, and adjust its core each way while observing the effect on the oscilloscope pattern. If this adjustment does not affect the amplitude of the oscillations, make similar adjustments of the other i-f coil cores in an attempt to stop the oscillations. Should none of these adjustments correct the trouble, complete re-alignment may be needed.

Before re-alignment can be accomplished, it is necessary to stop the oscillations. However, the shunting .001 μ fd capacitors cannot be used here because they would prevent proper tuning of the i-f coils. The operating frequency of each i-f coil should be determined by checking with the receiver schematic diagram or the alignment instructions in the service manual. Then the core should be turned all the way in on the coil which operates at the lowest frequency, all the way out on the coil which operates at the highest frequency, and set midway in its range on the coil that operates near the center of the receiver picture i-f band.

Depending on the operating frequencies, the cores on any other coils should be set about halfway between the others. Although a very wide i-f response

is produced by these adjustments, they also eliminate any tendency toward oscillation due to two coils being tuned too close to the same frequency. The regular alignment procedure is now followed as specified in the alignment instructions for the particular receiver.

Barkhausen Oscillation

A type of r-f generator known as a Barkhausen oscillator consists of a triode in which the grid is operated positive and the plate at zero potential or slightly negative with respect to the cathode. Leaving the cathode, electrons overshoot the positive grid and approach the plate. Repelled from the more negative plate, these electrons are drawn back toward the positive grid and again pass through it to approach the cathode. Before reaching the cathode, the electrons stop and then move toward and through the grid again.

After passing rapidly back and forth through the grid several times, the electrons are finally captured by the grid. However, by induction, the energy of the oscillating electrons is given to the external circuits of the tube which, therefore, is useful as a source of r-f voltage.

Under certain conditions, the horizontal output tube in a television receiver operates as a Barkhausen oscillator, in addition to

performing its function as deflection current amplifier. The h-f energy produced is radiated from the tube, or from leads connected to the tube elements. If picked up by the signal circuits of the receiver, this energy results in the production of thin gray, vertical lines on the left side of the picture tube screen, as shown in Figure 9. In the figure, these lines are most apparent in the solid white areas of the test pattern. When the oscillations are weak, or the energy is not picked up to any great extent by the signal circuits, the lines may appear white.

To determine whether the observed symptoms are due to Barkhausen or to some other type of interference, a loop of the antenna lead-in can be placed around the horizontal output tube. If the lines increase in intensity, the cause is Barkhausen oscillation. As mentioned in the lesson on simple adjustments, the trouble may be corrected by substituting a new tube which does not produce these oscillations, or by placing a beam bender around the existing tube and adjusting the bender by rotational and axial motion until the interference stops.

Faulty Components

Causing picture disturbances similar to those due to microphonics, other component defects result in the production of various

types of voltages generally classed as "noise". When produced by tubes, such noise voltages may be due to loose tube elements, or may be inherent in the normal operation of the tube. These inherent tube noises are produced by all normally operating tubes, but when it becomes so excessive as to cause objectionable disturbances in the reproduced picture or sound, the offending tube must be replaced.

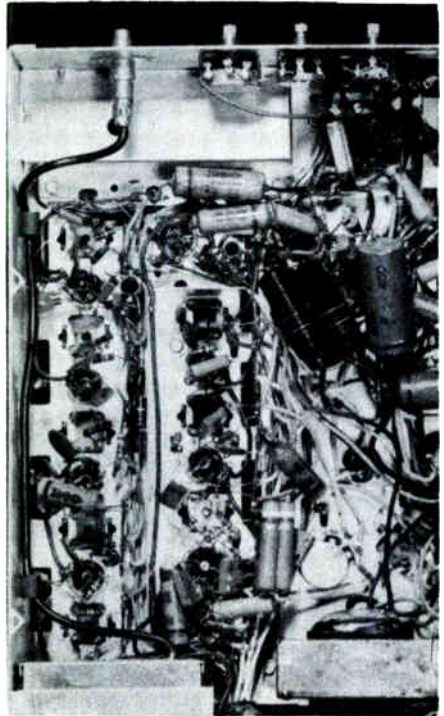

In the television receiver chassis, proper dressing of the wiring is important to prevent undesired coupling between circuits which may result in raster distortion or other disturbances in the picture.

Courtesy Allen B. Du Mont Laboratories, Inc.

The simplest check for noise is the replacement of the suspected tube by one known to be good. As in the case of microphonic trouble, a tube suspected of producing the noise voltages due to loose elements may be checked by tapping it with some light object.

Other component faults or circuit defects which result in the production of noise voltages are: corrosion in the windings of r-f and i-f transformers, peaking coils, etc.; broken connections; corroded joints; and conductive dirt accumulated in vital spots such as tube sockets, switch contacts, etc. Often, an unsoldered or poorly soldered connection, or a bit of solder or conducting material is the cause of the trouble, and may be difficult to locate because it is situated in some out-of-the-way place.

Troubleshooting for the source of noise should be conducted in an

orderly manner. First, place the signal grid of the 1st video-frequency amplifier at signal ground potential, and lightly tap all the components which are in the circuit between this point and the grid of the picture tube.

If this check does not reveal the trouble, remove the ground from the r-f amplifier grid, and ground the grid of the last picture i-f amplifier tube in the same manner, and tap all of the components located between this point and the 1st video amplifier. In this way, the cause of the trouble is searched for in successive stages or sections, working toward the front end of the receiver. Corrosion of the various coil windings may be checked by making an ohmmeter test of their d-c resistance. A corroded winding has a high resistance.



STUDENT NOTES

STUDENT NOTES

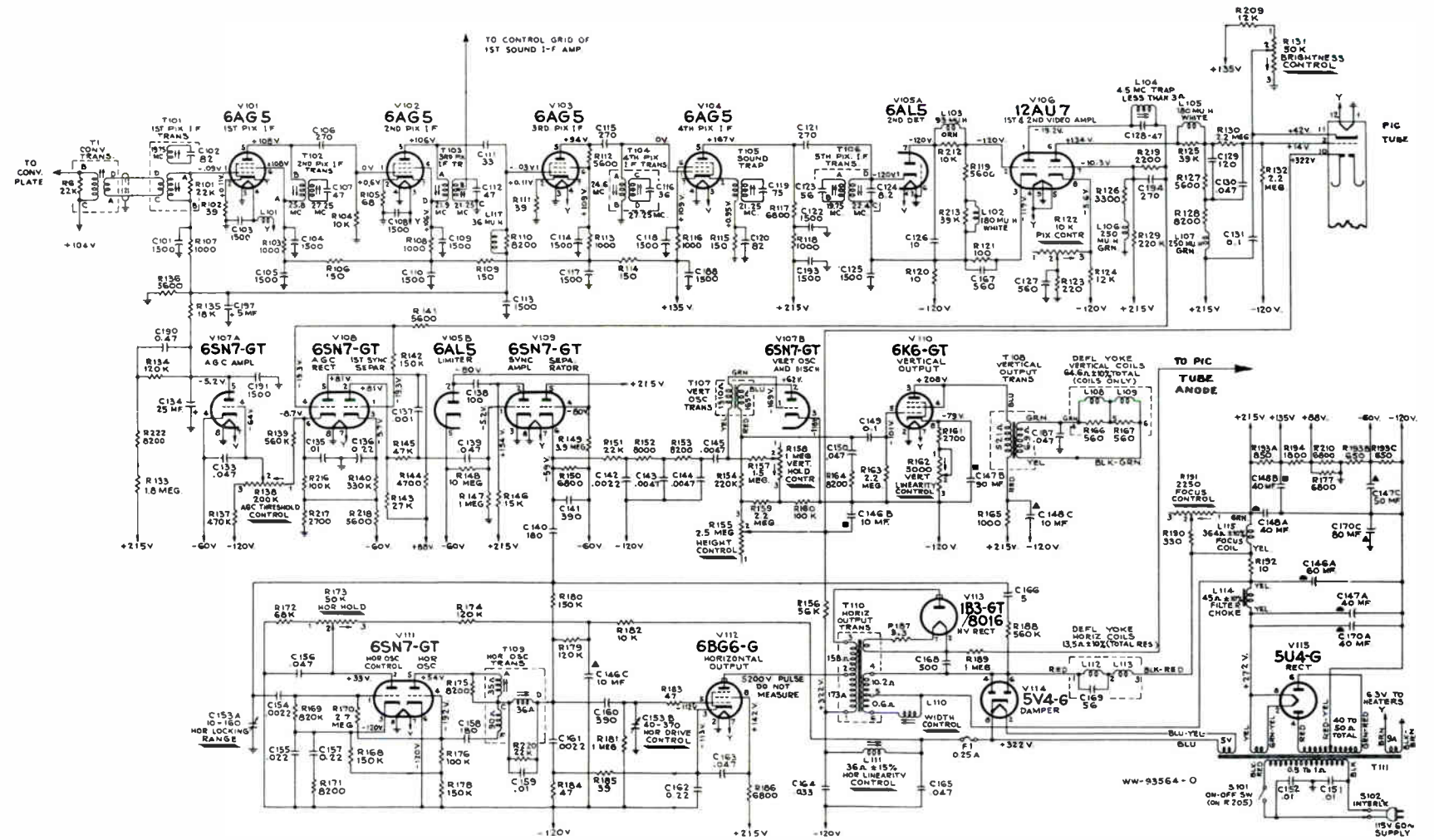

TSM-16

FIGURE 1

COURTESY OF RCA SERVICE CO.

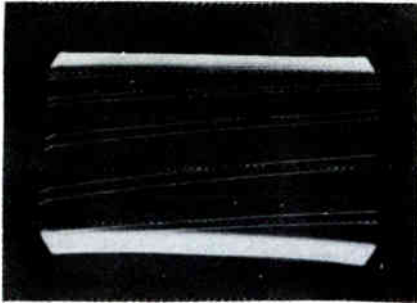

19. 60 CYCLE IN VIDEO
FIGURE 2

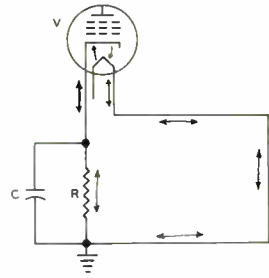
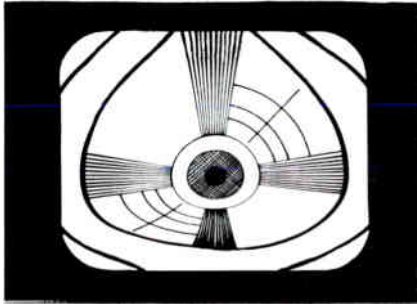
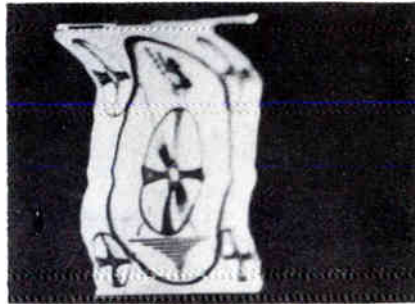

FIGURE 3



60 CYCLE RIPPLE IN VERTICAL SWEEP
FIGURE 4



41. 60 CYCLE RIPPLE IN HORIZONTAL SWEEP
FIGURE 5



44. SOUND BARS
FIGURE 6
COURTESY-FARNSWORTH

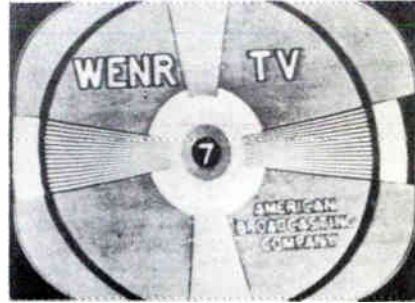

30. POOR INTERLACE
FIGURE 7



15. OSCILLATIONS
FIGURE 8
TSM-16

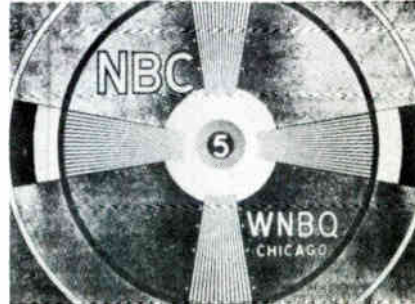

BARKHAUSEN INTERFERENCE
FIGURE 9

DeVRY Technical Institute

Formerly DeFOREST'S TRAINING, INC.

4141 WEST BELMONT AVENUE

CHICAGO 41, ILLINOIS

QUESTIONS

Internal Interference—Lesson TSM-16A

Page 31

3

How many advance Lessons have you now on hand?.....
Print or use Rubber Stamp.

Name..... Student No.....
Street..... Zone..... Grade.....
City..... State..... Instructor.....

Write your answers on the "Ans." line below each question. If more space is needed use reverse side of this page.

1. What is the general location and nature of the interference that produces a large dark band across the center of the picture?
Ans.....
2. What is the general location and nature of the interference that makes the picture appear to "bulge" at the top or bottom?
Ans.....
3. In a scene containing a vertical pole running from top to bottom of the picture, what is the nature and general location of the interference that distorts the picture and makes the pole look like the letter S?
Ans.....
4. What type of interference would a 120 cycle ripple in the video circuits produce?
Ans.....
5. What is the most probable cause of several horizontal bars across the picture which appear to move at random?
Ans.....
6. How can corona discharge be detected?
Ans.....
7. What remedies can be used to stop brush discharge?
Ans.....
8. How can a microphonic tube be detected?
Ans.....
9. What are the two basic causes for oscillations in the video i-f strip?
Ans.....
10. How is Barkhausen oscillation interference remedied?
Ans.....

TSM-16A

FROM OUR *Director's* NOTEBOOK

BUSINESS IS WHAT YOU MAKE IT

Why is it that one man does so much better than another in his own business? The fellow who sits around crying about how bad business is, usually ends up by closing up. He expends too much time and energy worrying about the lack of business, rather than doing something about getting business.

The successful one, on the other hand, finds many ways to increase business. He gets on the phone and calls up some of his past customers. He tells them he's checking to see if his last job was O.K. and asks if they need any further repairs.

Or, he sends out 500 or a thousand government past-cards to homes in his neighborhood (using a voting list as a source of names). A short, well-warded description of his services, or a special offer, usually does the trick. Or, he visits various department stores and appliance dealers nearby and tries to make arrangements for service work on a contract basis.

Use a little ingenuity . . . work . . . salesmanship . . . and you'll be able to keep your business moving at the same fast pace that the electronics field is now setting.

Yours for success,

W. C. DeVry
DIRECTOR



INTERMITTENT TROUBLES

Lesson TSM-17A



DeVRY Technical Institute

4741 W. Belmont Ave., Chicago 41, Illinois

Formerly DeFOREST'S TRAINING, INC.

INTERMITTENT TROUBLES

4141 Belmont Ave.

COPYRIGHT 1955

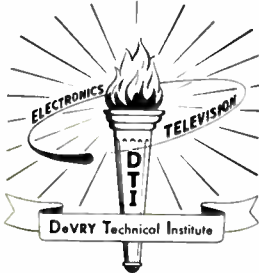

Chicago 41, Illinois



Intermittent operation can be caused by a defect in almost any of the large number of component parts and connections in a television receiver.

Courtesy Starrett TV Corp.

Television Service Methods

INTERMITTENT TROUBLES

Contents

	PAGE
Intermittent Operation Difficulties	4
External Troubles	5
Antenna and Lead-in	5
House Wiring	6
Receiver Defects	8
Tubes	8
Transformers and Coils	9
Capacitors	10
Resistors	10
Connections and Contacts	11
Troubleshooting Intermittents	12
Customer's Report	12
In the Home	12
In the Service Shop	15

The introduction of television sets means that the present radio serviceman will have to possess a good knowledge of television operating principles before any competent repair work on these receivers can be undertaken. It will also be required of other technicians, men and women, associated with the construction, operating and alignment of this type of set, to become familiar with the basic operation of television sets, the amount of knowledge required dependent upon the complexity of the job at hand. Present-day television receivers are intricate, critical mechanisms, and the person with insufficient technical knowledge will rapidly find the situation hopeless.

—Selected.

INTERMITTENT TROUBLES

All of the previous lessons were directed toward troubles of a continuous nature. That is, they are always there for the serviceman to methodically locate and remedy. In contrast, troubles which come and go can prove very time consuming to locate. Hence, intermittent troubles irk most servicemen more than any other type of trouble, for some of the causes of intermittent operation are so elusive and baffling that they appear to be the work of a mischievous hobgoblin.

A customer explains that his television receiver works fine for a while, and then either slowly or abruptly the picture drops to a low contrast level, the sound to a low volume level, or possibly both die out altogether. A sudden interruption or change in picture contrast or sound volume may accompany seemingly unrelated incidents such as: the turning on of a light, a refrigerator motor starting, or someone walking across a certain section of the floor. Often the owner has discovered that by slapping the cabinet, wiggling the antenna lead-in or the power cord, or turning the power switch off and on, normal operation can be restored.

INTERMITTENT OPERATION DIFFICULTIES

The fact that the receiver operates normally most of the time causes the owner to feel that the trouble is not serious, and that the serviceman should be able to find and repair the defect in a very short time. Usually however, the causes of this type of trouble take longer to locate than do the defects causing most of the other complaints. One reason is that the serviceman can test for the actual trouble only when the trouble exists.

Many times, a receiver which has intermittent trouble operates properly for hours, days, or even weeks without any indication of the trouble. Then, suddenly the signals die down or out every few minutes. Moreover, after hours have been spent waiting for the trouble to occur, the instant connections are made with the meter test prods, the signals may jump to normal and remain there, and another period of waiting becomes necessary.

Another fact adding to the perplexity of the matter is that, at some time or other, nearly any component part of a television receiver can be the source of intermittent operation. In many cases, the faults occur in some

apparently minor circuit element that ordinarily is not suspected. In such instances, where the trouble is due to some obscure condition within the receiver, no short-cut method of troubleshooting can be specified, for often it requires many hours of painstaking search and the checking of almost every component part in the receiver. In some cases it may be necessary to disconnect numerous units before they are tested. Moreover, the compensation received is rarely in proportion to the time and effort expended in locating the trouble.

EXTERNAL TROUBLES

In addition to the many possible causes of intermittent operation within the receiver itself, often the trouble can be due to conditions outside the receiver. These include faulty conditions in the antenna, lead-in, ground connections, or the house wiring system.

Antenna and Lead-in

Intermittent operation may be caused by variations in tuning or partial grounding of the antenna circuit due to the antenna or lead-in swaying in the wind. The swaying antenna or lead-in may touch the building or other object which absorbs the signal energy so that the receiver output is reduced in picture contrast or sound volume. In other cases, the same

thing may result in an increased output from the receiver, or in noisy reception, etc.

Other possible troubles include a poor contact at the point where the lead-in is connected to the antenna or to the receiver, poor insulation between the antenna and its mounting, or a corroded or broken lead-in such that the ends make contact intermittently.

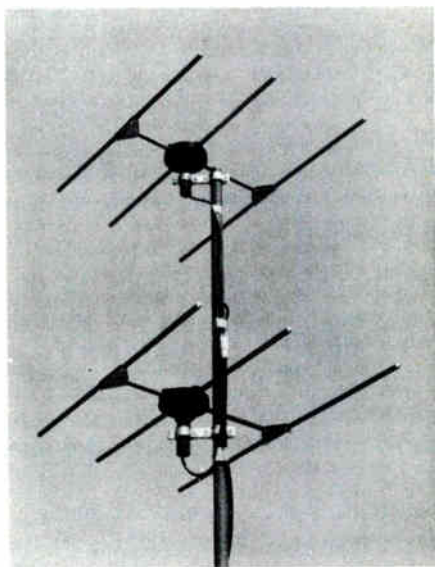

Rugged support and good connections are needed in antennas and lead-ins to avoid intermittent operation.

Courtesy The Workshop Associates, Inc.

The lightning arrestor terminal contacts may be corroded, or the mounting bolts may be loosened permitting the gap points to touch intermittently. Sometimes a special window lead-in strip is used, and this strip may develop

similar defects. Signal attenuation occurs when the lead-in is covered with moisture or a coating of ice.

House Wiring

Intermittent operation can be caused by a faulty condition of the 117 volt a-c line, anywhere between the receiver chassis and the point at which the power line enters the house. The receiver fuse clips may be corroded badly so that they offer a varying contact resistance. One of the line cord wires may be broken and making intermittent contact, or the wire may not be fastened securely under the screw in the line cord plug.

The plug may be loose in the receptacle, or the contact resistance may be high due to dirt and corrosion. The mounting screws may not be holding the receptacle tight in the outlet box, or the line wires may not be securely fastened under the terminal screws. To check these conditions it is necessary to remove the wall plate.

Often, the receiver output drops when an electric light or other appliance is turned on or off, this trouble being most pronounced when the appliance and receiver are on the same branch circuit. Usually, this condition can be corrected by establishing a good separate ground circuit. A

second solution consists of connecting two .01 μ fd 600 volt paper capacitors in series across the L.V. power supply transformer, as shown in Figure 1, if such capacitors do not exist already. The receiver chassis is connected to the junction between capacitors C_1 and C_2 . In cases where the effect is especially prominent for a certain light switch, the switch may be shunted with a .1 μ fd capacitor to correct the trouble.

Fairly slow variations in signal level can be caused by contact resistance at the point where the receiver is connected to ground. When the ground is made to a water pipe, the connection should be made as close as possible to the point where the pipe enters the earth. If it is not, the rust and corrosion at intervening joints may cause changes in resistance between the receiver and ground. When the grounding system consists of a metal rod or pipe driven into the earth, this ground circuit may be improved by saturating the earth surrounding the rod with a solution of salt water at frequent intervals.

Usually, the use of a gas pipe for the ground circuit is not satisfactory because such pipes are coated with a compound at the joints to prevent gas leakage. The joint compound is a poor conductor and, therefore, results in a high-resistance circuit.

If the intermittent operation occurs when someone walks across the floor, or a heavy truck on the street shakes the house, a complete inspection of the conduit and house wiring system may be necessary. The conduit may be touching a water or gas pipe, and when the house shakes, this contact is intermittently improved and broken. When a point of contact of this type is found, a piece of dry wood or asbestos should be placed between the two pipes.

Intermittent operation can be caused by a loose or badly corroded ground connection in the conduit or in one of the junctions or outlet boxes. If the cause of the trouble is not revealed by an inspection of the electric distribution system in the house, then the outdoor wires should be inspected. Swaying wires may be touching the branches of a tree, thus wearing off the insulation and causing an occasional arc to ground. When a defect in the outside wiring is located, the electric power company should be notified and requested to correct the trouble.

Frequently overlooked, another cause of intermittent operation is a variation in line voltage. Almost all power companies make every effort to maintain a uniform voltage, but local conditions may bring about sufficient changes

to cause troublesome variations in television reception. Depending upon their cause, such



Nearly worn out or defective tubes are frequent sources of intermittent troubles.

Courtesy General Electric Co.

changes may be gradual, sudden, or intermittent.

For example, in some localities, a large number of lights are used during the early evening hours, and the heavy load may cause a gradual reduction in line voltage. When this occurs, the result on the television receiver is a gradual decrease in picture size, brilliance, and sound volume.

Sudden changes in line voltage are caused by some electric device connected to the circuit. For example, electric refrigerator motors and oil burner motors draw a heavy current when starting. This momentary heavy load reduces the line voltage, dimming the house lights, and causing loss of vertical synchronism for an instant in the television receiver. Since this action does not occur frequently, it is a cause of complaint only occasionally. However, if a similar motor is started and stopped frequently, it may bring complaints. Examples are a nearby store with motor-driven cash registers, coffee grinder, etc., or a neighbor who has motor-driven tools in his workshop. Often starting and stopping these motors is the cause of noisy reception, and under certain conditions, they cause intermittent reception also.

RECEIVER DEFECTS

Most of the various symptoms described in previous lessons are

produced by intermittent troubles also, the only difference being that the symptom appears intermittently instead of continuously. In many cases, the actual defect is about the same except for some changing condition such that the receiver is permitted to operate properly between the trouble periods. In addition, there are other defects which cause intermittent troubles only.

Tubes, transformers, capacitors, resistors, switches, sockets, wires, connections, etc., are all capable of causing intermittent operation. The innumerable possibilities and unstable nature of these faults are responsible for the difficulties in locating them. Once the cause of the trouble is determined, usually the correction is not difficult, but often a great deal of time can be spent troubleshooting for the defect.

Tubes

Tubes cause intermittent operation due to high or low resistance shorts between elements, defective heaters, and heater-cathode leakage. Loose elements short intermittently when the receiver is jarred. Sometimes a tube heater opens after reaching a certain temperature, and, as the heater cools and emission stops, the stage becomes inoperative.

Depending upon the function of the stage, some type of trouble

symptom appears, such as loss of sync, picture, sound, etc. After the heater temperature drops to a certain point, the heater again closes the circuit, and the operation returns to normal for a period of time.

This cycle of events may continue indefinitely. When several heaters are connected in series, all tubes in the faulty branch are cut off while the defective heater is open, and if the heaters are all in parallel, only the faulty tube cools while the others remain hot.

Caused by heater-cathode leakage, 60 cycle interference effects appear as described in the lesson on internal interference. As with all intermittent troubles, the only difference here is in the persistence of the symptom. Intermittent bars on the screen or hum in the speaker, etc., result when the heater-cathode leakage varies from time to time to cause the undesired 60-cycle modulation to appear and disappear alternately.

A tube may deteriorate with age to the point where its proper operation is critical with regard to the B voltage supplied to it. Hence, if the a-c line voltage drops so that the power supply output is reduced below this critical voltage, the tube may operate defectively or stop altogether until the line voltage rises again.

If the h-f oscillator tube has subnormal transconductance, the

oscillations may stop when the B supply voltage reduces for any reason such as a drop in the a-c line voltage. Oscillations may stop due to excessive bias voltage across the grid leak resistor in this circuit. The excessive bias may be due to an increase in resistance of the resistor, a high-resistance connection in the grid leak circuit, or other incorrect operating conditions in the stage.

Transformers and Coils

In the receiver power supplies, leakage develops due to breakdown of insulation between the windings of transformers and filter chokes. Also, these units may open intermittently, as may the resistors of which the voltage divider-bleeder is composed. When a filter capacitor is leaky, variations in the leakage can cause intermittent operation.

Intermittent operation also can be caused by arcing and corona in the H.V. transformer and its connecting leads, as well as from any other element operating at high voltage. In a like manner, the voltage divider resistors across the output of the L.V. supply may permit arcing between adjacent units.

Similar intermittent leakage or opens may occur in the focus coil, in the coils of the deflection yoke, in the windings of the deflection oscillator transformers, deflection output transformers,

audio output transformer, speaker voice coil, video amplifier peaking coils, i-f transformers and trap coils, r-f and h-f oscillator coils, or in any r-f chokes employed in the receiver.

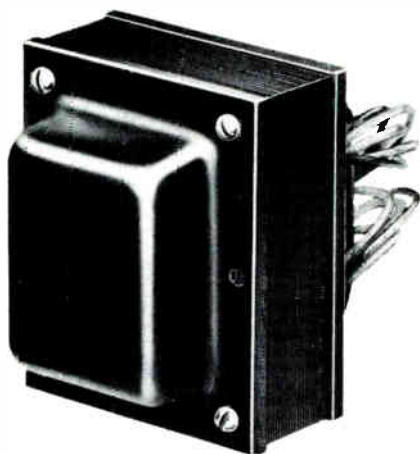

When the insulation breaks down and permits leakage between windings in a power transformer, intermittent operation often occurs.

Courtesy SNC Mfg. Co.

Often, intermittent operation is accompanied by a great deal of noise interference when the trouble consists of an r-f coil or lead from the coil making contact with the chassis or other grounded point. Such contact may be caused by jarring or shifting of the receiver, or even to slight vibration if the chassis is not floating freely on its rubber mounting.

Capacitors

A large percentage of intermittent troubles are caused by

periodic opening, shorting, or leakage of bypass capacitors in the r-f and i-f stages of the receiver. Also, interruptions of receiver operation may be caused by repeated opening of the capacitor or transformer coil which applies the h-f oscillator output to the mixer. Intermittent grounding of an i-f transformer may occur due to a lead from a winding touching the transformer shield can.

Resistors

In the video, audio, and sweep circuits, intermittent operation is caused by troubles in the variable resistance type controls. These include the contrast, brightness, audio volume and tone, sweep frequency, amplitude and linearity, and focus controls, etc. Generally, the trouble is caused by variations in continuity between the slider and resistance element due to corrosion.

Other common causes of faulty operation are defective resistors. Carbon resistors change in value as a result of heating, and also develop bad contacts at the terminal wires. Although the composition and wirewound types may not change in value as readily, they develop poor contacts where the terminal wires connect to the resistance elements.

One of the most common sources of trouble is the screen

grid resistor. Whenever resistors having minimum wattage ratings are found to be the cause of intermittent or other troubles, they should be replaced with units of higher wattage ratings provided this change can be made without upsetting critical inductances or capacitances in high-frequency circuits. When the wattage rating is too low, often the repeated expansion and contraction due to heating and cooling causes the small resistors to crack and crumble.

Connections and Contacts

Other frequent sources of intermittent troubles are high-resistance joints. For example, on a power transformer, a grounded terminal lug usually forms a convenient point for making additional grounds, and thus several wires may be supported by the same terminal. In the event the enamel insulation has not been removed entirely from the transformer lead, a high-resistance connection may exist even though the entire joint may be covered with solder. Due to changes in temperature, expansion and contraction may cause the resistance of such a joint to vary, thus resulting in cyclic operation of the receiver.

Similar troubles are caused by cold-soldered joints which were made in a hurry with parts not properly cleaned, or with an iron

that was not hot enough. Externally, these joints may look perfect. Actually, the solder has not run in and tinned the parts sufficiently to form a good, metallic connection.

A high-resistance contact may develop in the service selector switch in combination receivers, or in the speaker plug contacts, due to corrosion. A phono jack may have corroded contacts, or the contacts may have lost their tension.

In the r-f section, poor electric contacts in the channel selector switch are a common cause of intermittent reception. Such poor contact may be due to dirty or eroded switch contacts, worn contacts, or to improper mechanical operation of the unit. When a band switch is employed, similar defects may exist in this switch. Improper mechanical operation of the fine tuning control can cause intermittent shorts or opens in the oscillator tuning circuit.

A tube socket may have too much clearance in the contacts for the base pins. The bolts may be loose which fasten a unit to the chassis, thus forming a high resistance circuit to ground. Where parts are mounted with overlong leads, these leads may move together occasionally and short to cause intermittent operation.

TROUBLESHOOTING INTERMITTENTS

When the owner is questioned about the intermittent operation of his receiver, sometimes he will list a wide variety of seemingly unrelated events which cause the particular trouble to appear or disappear. Though his story may sound almost fantastic, usually the customer is telling exactly what has happened as well as he can observe and remember.

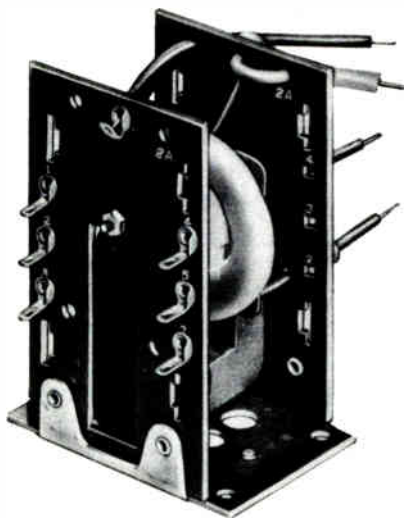

The flyback high voltage transformer may be a source of trouble due to intermittent breakdown of insulation between windings.

Courtesy Standard Transformer Corp.

Customer's Report

For example, the same effect may result from apparently opposite causes. At one time, the trouble may begin when a cer-

tain lamp is turned on, but may begin the next time when the same lamp is turned off. A certain event may cause interruption of reception at one time, but have no effect the next time it occurs.

In any case, all possible details should be observed, because the more information obtained with respect to the behavior of the receiver, the more accurate the diagnosis can be. Often, it seems that the trouble is especially "reluctant" to appear when the serviceman is present, in which case the information provided by the owner is all that can be obtained for making an immediate, preliminary diagnosis.

In the Home

After all possible information pertinent to the faulty receiver operation has been obtained from the customer, investigation should be made to determine whether the trouble lies within or outside the receiver. If this general location of the defect is not indicated by the customer's story, then an investigation of the antenna, lead-in, and ground system, if any, as well as the house wiring system should be made in an attempt to eliminate these items from the list of possible trouble sources. Although carefully made, this first inspection should be brief, since the trouble is found to lie within the

receiver in a large percentage of cases.

However, if the customer's story indicates the trouble lies outside of the receiver, then a detailed inspection should be made of the items mentioned. If this inspection reveals some condition which would be the source of the trouble, then, with the receiver operating, the suspected parts should be moved or jarred, etc., in an attempt to cause the symptom to appear.

Should this action produce a symptom which is recognized by the owner as that which caused his complaint, the faulty condition should be corrected, and the inspection continued. If no other suspicious condition is found, it may be assumed tentatively that the repair is completed.

However, it should be impressed upon the customer that the original cause of trouble may not have been located, and that he is being charged only for the time which has been spent up to this point in looking for the trouble. This explanation should be handled carefully, making sure the customer does not get the impression that the serviceman considers the case to be definitely closed, yet not so that the serviceman is likely to be held responsible for other types of trouble which may develop in the future.

In the event no possible source of trouble is found in the antenna system, the house wiring system, etc., or the customer's story indicates the trouble to lie within the receiver, then tests should be made in the receiver in an attempt to reproduce the symptom which caused the complaint.

A small bakelite rod may be used to tap each tube lightly, while other units such as transformers may be tapped with a slightly heavier tool. Various wires may be pushed, pulled, and wiggled, but not so vigorously that a break is produced where none existed before. Controls should be adjusted in an attempt to determine a setting at which the trouble occurs.



Three-deck band selector switch. Corrosion forming between the individual contacts and the contact ring is frequently the cause of intermittent operation.

Courtesy P. R. Mallory & Company

If these checks do not produce the symptom, then the chassis should be removed from the

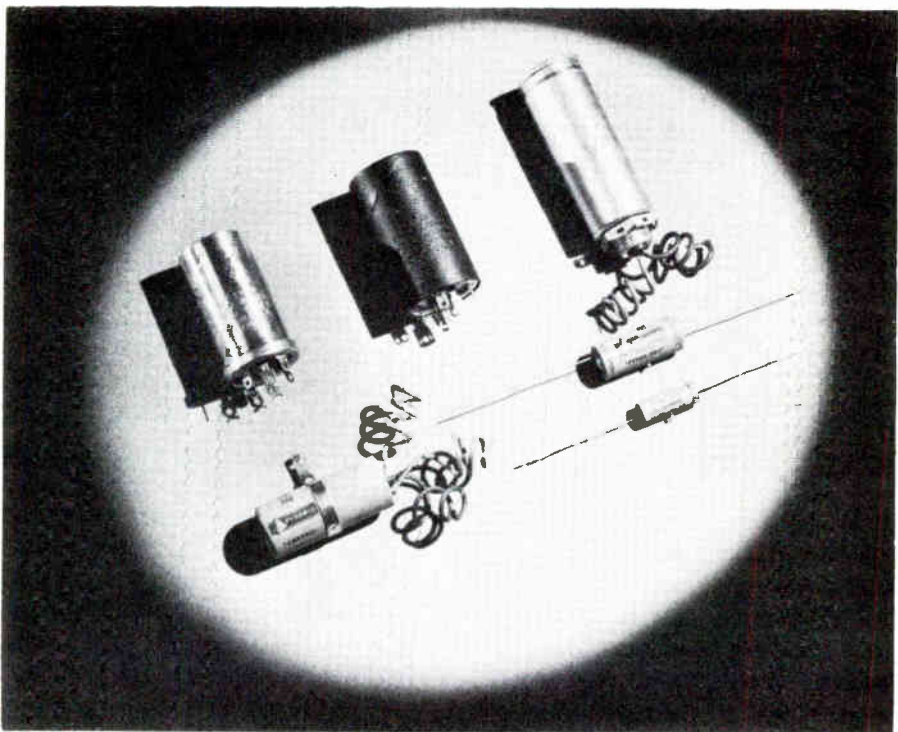

Periodic opening, shorting, or leakage in bypass and filter capacitors causes a large percentage of intermittent operation.

Courtesy Pyramid Electric Company

cabinet and further checks made of the components and wiring beneath the chassis. With the receiver in operation, all resistors, capacitors, connecting wires, soldered joints, etc. should be probed and tapped with a small bakelite or fiber rod. These checks may disclose any breaks or loose connections which may test correctly insofar as cold continuity is concerned, but which may change in resistance due to vibration or expansion with increased temperatures when the receiver is in

operation. The sources of many intermittent troubles can be found in this way because, when the defective part is tapped or moved, usually the trouble symptom is produced.

Some servicemen squeeze capacitors with pliers to check for intermittent troubles. However, capacitors can be spoiled if squeezed too hard, especially the paper types. Another tool which is handy for this testing consists of an ordinary straight pin fitted

with a handle. It can be made simply by clipping the head from a pin and inserting the blunt end of the pin into the end of a short stick of wood, such as a piece of dowling. In use, the pin can be inserted into small openings, such as where lead wires enter components, and then jiggled in an attempt to produce the trouble symptom.

In the Service Shop

If the above checks do not locate the source of the trouble, then tests of the dynamic type must be made. Most often, these tests involve observations extending over relatively long periods of time. Therefore, the receiver should be removed to the service shop for the completion of the work. This does not mean that all of the time is spent working on that particular receiver, because after a change has been made, several hours of observation may be necessary to determine whether or not the trouble has been corrected.

The customer should be informed of the time that may be required, and also what the charges are likely to be. Except in cases where the preliminary inspection reveals the cause of the trouble immediately, it is probably the best policy to take a service job of this nature on a time-plus-cost basis.

After the receiver has been brought into the shop, the first step is quite important in the troubleshooting procedure, because it may result in saving much time and effort. Even though an inspection has been made of the surroundings in which the receiver is operated in the home, there is always the possibility that some fault has been overlooked in the house wiring or antenna system. This is true especially in the cases where

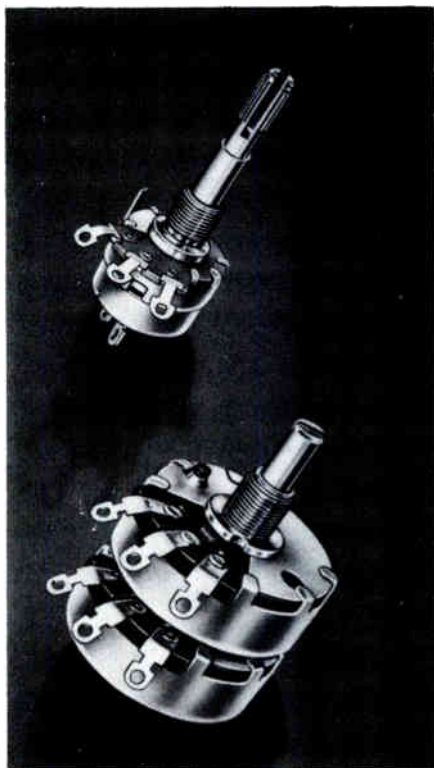

In the signal and deflection circuits, intermittent operation is caused by corrosion in the potentiometers.

Courtesy Stockpole Corbon Co.

only a brief inspection has been made of these systems because trouble within the receiver was indicated by the observed symptoms or by the customer's description of the trouble. Therefore, to avoid spending hours making tests on a receiver in which there is no defect, an operating test should be made before anything else is done to the receiver, to see whether the intermittent trouble occurs.

The operating test is made by tuning to a station which will be on the air during the entire observation period, and adjusting for low contrast and sound volume levels. The contrast and volume levels are important because many intermittent troubles occur at low signal strength levels only. The serviceman can then proceed with other work, while glancing at the intermittent receiver from time to time to check on whether the trouble symptom has appeared.

Various methods may be used to induce the appearance of the intermittent trouble during the operating test. One consists of placing an electric heater beneath the receiver chassis to raise the temperatures of the various components to higher than normal values within a short time, or at a faster than normal rate. Another consists of adjusting a spot light for sharp focus at

about 24 inches and allowing the spot to fall for several minutes on each of various capacitors. Sometimes the heat causes the defective unit to open.

When the symptom does not appear after several hours or days of operation, then, since various tapping and probing tests have been made previously, it is very likely that the fault is not located within the receiver. Before additional tests are made in the shop, the receiver should be returned to the customer's home where the operating test can be continued, and, at the same time, a more thorough inspection made of the house wiring and antenna system. Except when considered absolutely necessary, such return trips to the customer's home should not be made other than to deliver a repaired receiver, because they may cause loss of customer confidence due to his not appreciating the difficulties involved.

If the intermittent trouble appears during the operating test in the shop, then certain preliminary mechanical checks should be made. The chassis should be examined for the obvious defects such as loose shielding elements, tubes loose in their sockets, loose top caps, set screws, mounting bolts, and rivets.

As with other types of troubles, often the nature of the symptom

indicates the section in which the defect is located, and, if substituting tubes in this section does not correct the trouble, then a series of dynamic tests should be made to locate the faulty stage. In some cases the symptom disappears the instant the receiver is touched, and the tube checking and dynamic testing may both require a long time to complete.

of the "touch" nature of intermittent troubles. Every time something is done which jars the chassis even slightly, usually the trouble symptom disappears and a period of waiting is necessary until the next appearance of the symptom.

When an adaptor cable is available so that the picture tube can

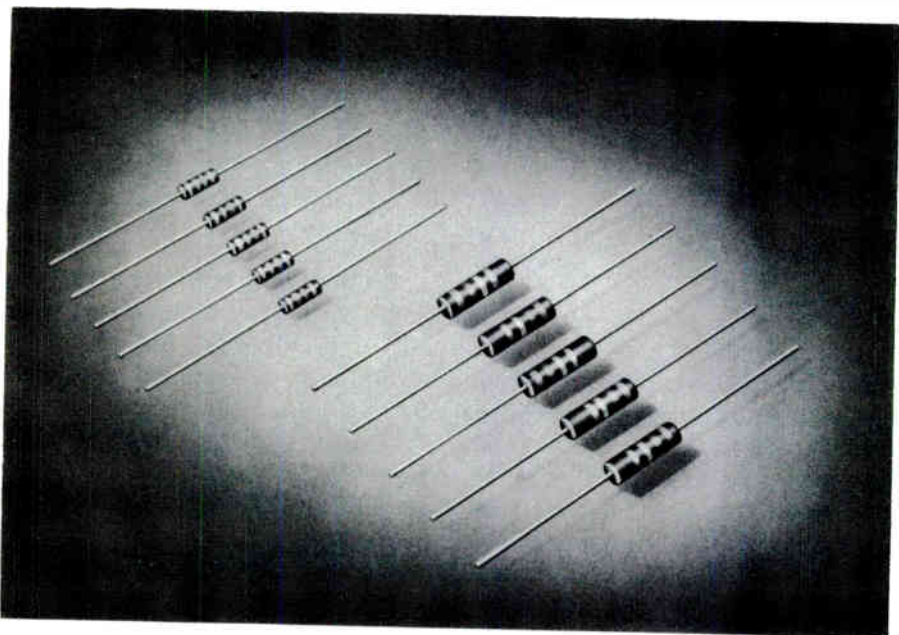

Replacement resistors should have the proper wattage rating. Repeated expansion and contraction causes resistors to crack and crumble when the wattage rating is too low.
Courtesy Stackpole Carbon Co.

That is, the essential difference between the various tests made for intermittent operation and those made for other types of troubles is that the former usually require much more time because

be operated off the chassis, it may be possible to make the intermittent trouble appear by giving the entire chassis a jolt or jar. Usually, this jolt is given by lifting the chassis one or two

inches and then dropping it to the service bench. This check often causes defects of a mechanical nature to show up. On the other hand, should the jolt dislodge loose pieces of solder or other materials, the defect may no longer exist.

As with other types of troubles, the various dynamic, voltage, and resistance tests may be carried out in a systematic manner to locate, in order, the defective stage, circuit, and component or connection, etc. For example, if the defect is in the picture channel, it can be isolated further by placing the a-c test prods of a vtvm to read the output voltage of the video detector, as shown in Figure 2.

If the meter shows the detector output to be unchanged when the intermittent trouble causes the picture to have low contrast, lose sync, or disappear entirely, then it may be concluded that the defect is located somewhere between the detector output and picture tube grid. To isolate the defective v-f stage, the vtvm may be connected to the control grid of the v-f output tube.

Usually, another period of waiting is then necessary, before the trouble reoccurs. When it does, a normal reading indicates the trouble to lie between this point and the picture tube grid. Finally, a similar check may be made with

the meter connected to the picture tube grid or cathode, whichever is the input element. For each case, trouble is indicated between the present and preceding test point, when occurrence of the intermittent symptom results in a change in the reading of the vtvm.

In the event the meter reading changes with appearance of the trouble when the test prods are across the video detector output, then trouble is indicated in some preceding stage of the video channel, and a rectifier probe may be employed with the vtvm to make checks in the i-f and r-f sections.

As another example, a cathode ray oscilloscope may be employed for dynamic tests in the sync circuits as illustrated in Figure 3, when the trouble consists of intermittent loss of sync. Here, tubes V_1 , V_2 , and V_3 are the sync amplifier, separator, and clipper, respectively, of a typical commercial television receiver.

To make the tests, the ground lead remains connected to the receiver chassis, and the high lead is clipped to various check points in succession, such as A, B, C, D, E, and F. At each point, the test lead is permitted to remain until the trouble occurs, at which time any change in the sync amplitude or wave-form is indicated on the scope. The defect can be assumed

to be located between two adjacent check points, at one of which the sync signal changes when the trouble appears.

In like manner, the scope can be employed for dynamic testing in the sweep and power supply circuits, in conjunction with an a-f generator in the video and audio circuits, or with a sweep signal generator or an audio modulated r-f generator in the receiver r-f and i-f sections.

Because of the relatively long time that may be consumed by tests of this type, the dynamic testing should not be continued any further than necessary to isolate the trouble to one single stage, or to a few circuits in the receiver. After this has been done, a close inspection of the wiring and soldered connections of the various parts included in this circuit should be made, and any observed mechanical defects corrected. Any loose nuts, etc. should be tightened, and tube socket contacts can be made tighter by squeezing them with pliers.

Voltage, resistance, and continuity tests now may be made, but it should be borne in mind that these tests are not positive indications of circuit conditions where intermittent operation is concerned. For example, the common type of test voltmeter with a sensitivity of 1,000 ohms per volt

has an internal resistance of 500,000 ohms on its 500 volt range.

Suppose in Figure 4, the normal resistance of R_3 is 470,000 ohms. In this case, with the meter connected across R_3 as shown to read the screen grid voltage, the resistance of the meter is substituted for the normal value of R_3 , and the circuit restored to normal operation even though R_3 is open.



Wirewound resistors of various sizes. Occasionally, such units develop high resistance of the points where the terminals connect to the resistance wire.

Courtesy International Resistance Co.

This action produces the effect of intermittent operation whether the faulty component opens only intermittently or is open continually. However, this result may be taken to indicate a defect in R_3 , and a further check made by replacing the resistor. As another example, pressing the voltmeter or ohmmeter test prods to a joint may result in proper continuity, even though this joint has high-resistance intermittently.

In transformers and coils, often the ends of the windings are wrapped around a terminal lug and soldered. Due to increased temperature while in operation, expansion of the parts may strain the wire sufficiently to cause a crack or complete break. However, when the coil is cool, the sides of the break may touch enough to permit the winding to pass the usual continuity test, and insulation or dope on the

wire may make the break invisible to the eye.

It is a good plan to bare the ends of the coil wires of a unit under test. In some units, the coil wires are joined to heavier flexible wires used for making connections to the circuit. Here, the joints should be examined carefully to locate slight breaks in the smaller, less flexible wires of the windings, and for poor soldering or corrosion.

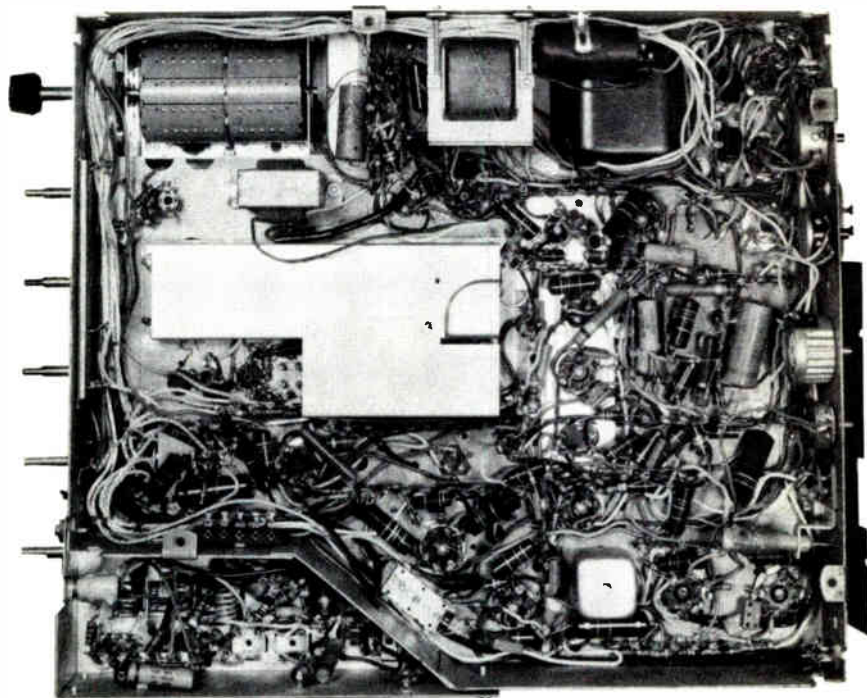

Underchassis view shows the hundreds of connections between the many components in a television receiver. Any one of these points may be a high-resistance connection, and thus a source of intermittent trouble.

Courtesy Philco Corp.

Continuity and resistance tests must be made with the receiver power off, but many intermittent shorts and opens in capacitors, breaks in resistors, etc., appear only when these components are hot due to the receiver being in operation. Therefore, except where continuity can be determined definitely with a voltage-drop check, often it is less expensive to replace all the components in a suspected circuit or stage than it is to spend the time necessary to make a large number of tests, the results of many of which are doubtful.

Often, the same line of reasoning is applied to suspected tubes. That is, when the trouble is intermittent, it may be far cheaper to replace the suspected tube, or all the tubes in the faulty section, than spend hours trying them out one by one. However, this method should not be employed for other types of trouble, because with these, the results of tests are definite, and when a faulty part is replaced, there is an immediate improvement in the receiver operation.

In cases of intermittent operation, another good plan followed by many experienced servicemen consists of applying a hot, well-tinned soldering iron to all of the points and connections of the sus-

pected circuit, or even the entire faulty section. This operation takes only a few minutes of time and insures that, if the trouble still exists, it is not due to cold-soldered joints.

For potentiometers and rheostats, good electric contact with the unit can be assured by cleaning the resistance wire with carbon tetrachloride, and then applying a thin coating of pure, white vaseline. However, if the control persists in causing noise and intermittent operation, it should be replaced with a new unit.

In very difficult cases, it may be helpful to consult the service department of the receiver manufacturer. Frequently, when intermittent operation is due to some defective part, it has appeared in numerous other receivers of the same make and series, and the service department has the information on record and is glad to pass it on.

Furthermore, the "tricks of the trade" articles in different service magazines should be watched and records kept, for this information is very valuable, and often contains a quick solution for the particular intermittent problem at hand.

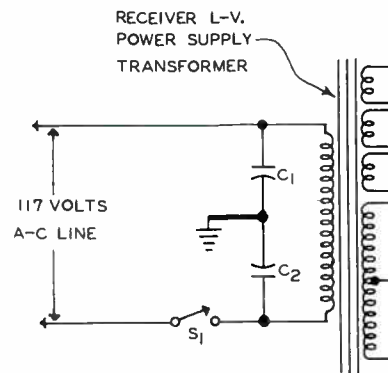

FIGURE 1

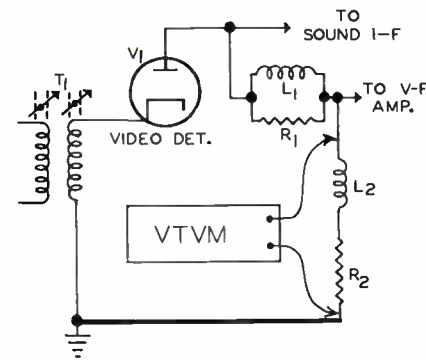

FIGURE 2

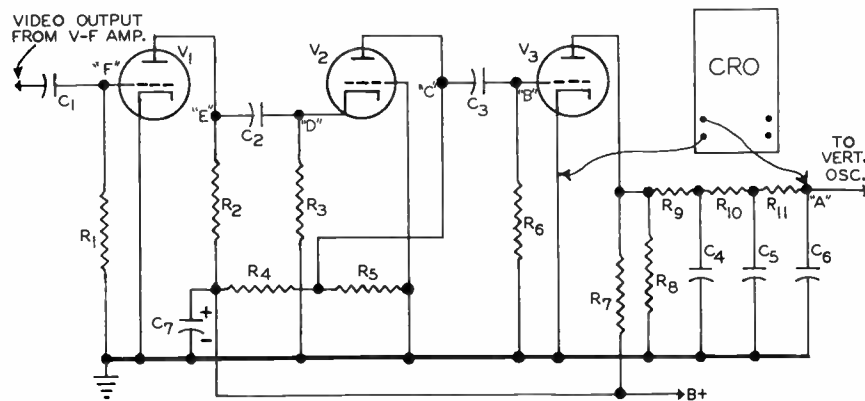

FIGURE 3

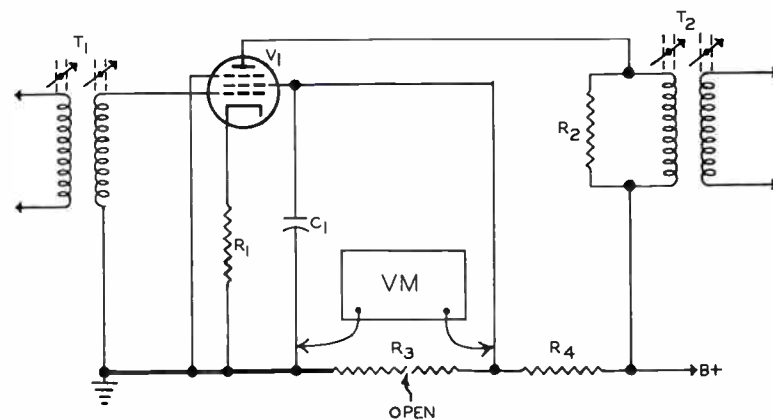

FIGURE 4

FROM OUR *Director's* NOTEBOOK

MONEY OR OPPORTUNITY?

Every person seeking a job has a decision to make right away: Should he take a dead-end job that pays more to start, or select the job that pays less in the beginning but promises much for the future?

A **thinking** man hesitates only for a moment over that decision. At best, the dead-end job offers occasional pay raises but little else. On the other hand, the job that may pay less in the beginning can provide the opportunity for working up the ladder into better positions with higher salary and other important personal benefits.

Don't settle for second best. Don't sell yourself short. Go after the job with something to offer in the years to come. Plan NOW for the future . . . look to the future . . . you're going to spend the rest of your life there.

Yours for success,

W. C. De Vry
DIRECTOR

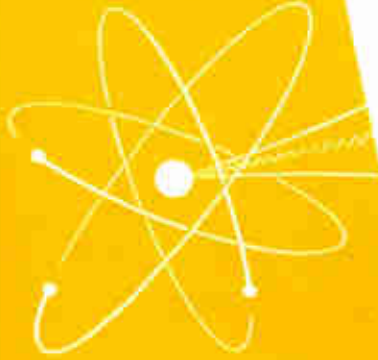

TV RECEIVER ALIGNMENT

Lesson TSM-18A

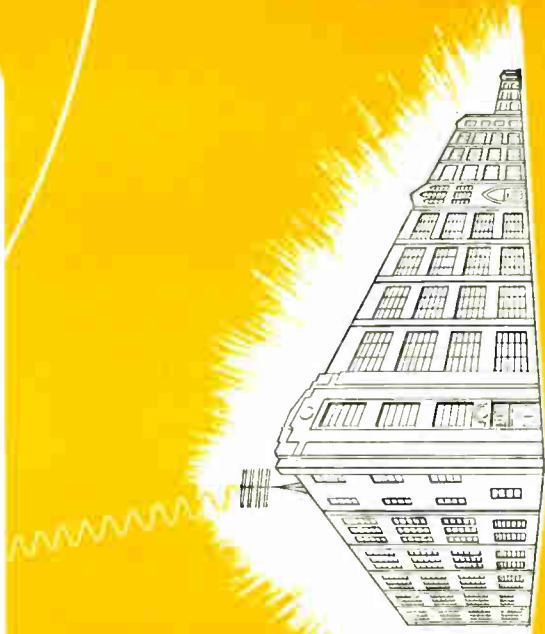

Devry Technical Institute
4141 W. Belmont Ave., Chicago 41, Illinois
Associated with DEFREEST'S TRAINING, INC.

TV RECEIVER ALIGNMENT

4141 Belmont Ave.

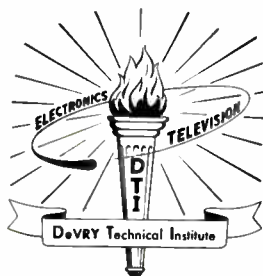

Chicago 41, Illinois



Students study the circuits and practice the alignment of various types of television receivers in the DTI laboratories.

DTI Photo

Television Service Methods

TV RECEIVER ALIGNMENT

Contents

	PAGE
Television Receiver Frequency Response	4
Receiver Sections Requiring Alignment	5
Indications of Mis-Alignment	6
Alignment Equipment	8
Alignment Preparation	13
Picture I-F Alignment	14
Sound I-F Alignment	20
4.5 MC Trap Adjustment	22
R-F Section Alignment	23
Oscillator Alignment	24
R-F Amplifier and Mixer Alignment	25
Touch-Up Adjustments	26
Alignment Difficulties	27
Stray R-F	27
Oscilloscope Response	28
Oscillations	29
R-F Amplitude	31

National networks for television programs are already in use. Networks to South and Central America and to other countries are scientifically, if not economically practicable today. Thus television might well bring about international languages and international thinking. During the war countries developed a tremendous capacity for international cooperation. Television's role in our civilization may prove to be a peacetime guard against war's imminence.

—Selected

TV RECEIVER ALIGNMENT

TELEVISION RECEIVER FREQUENCY RESPONSE

In the r-f section and picture channel of any television receiver, the interstage coupling circuits must be responsive to broad bands of frequencies and, at the same time, provide rejection to frequencies above and below the limits of these desired bands. The usual response of the r-f section is shown by the curve of Figure 1. Here, the response is essentially flat over a band of frequencies 6 mc or more in width as indicated, and is attenuated above and below this band.

However, the curve shows that the r-f circuits are not sharply selective. They pass considerable energy at the frequencies of the lower adjacent channel sound carrier and upper adjacent channel picture carrier. In addition to the undesired carriers, sideband components in the adjacent channels also are passed by the broadly tuned r-f circuits of the receiver. Thus, although contributing to the sensitivity of the receiver, the r-f section provides very little of the necessary selectivity.

The desired selectivity characteristic is obtained in the tuned circuits of the receiver i-f amplifier, as shown by the curve of Figure 2. Here, the pass band is reduced in width to 4 mc or less,

over which essentially uniform response is acquired, by sharp attenuation at the ends. This reduction is necessary to reject the intermediate frequencies formed by the oscillator output heterodyning with the various undesired adjacent channel signals passed by the r-f tuning circuits. The frequencies produced by the upper adjacent channel picture carrier, and that due to the lower adjacent channel sound carrier, respectively, are indicated in Figure 2 by broken lines.

In addition, the selectivity must be such that the response to the sound i-f carrier is only about 5 to 10 per cent of maximum, or less, to avoid video buzz. Finally, the slope at the high frequency end of the i-f response curve must be such that the response to the picture i-f carrier is about 50 per cent of maximum. This arrangement prevents the low frequency video components from having twice the normal amplitude due to their double-sideband transmission. Because of these exacting response requirements, the receiver i-f amplifier needs adjustment or alignment more frequently than the r-f section.

In general, the curve of Figure 2 represents the response requirements of the i-f amplifier circuits between the output of the mixer

and the input of the video detector in a television receiver, regardless of the type of picture and sound i-f channel arrangement. In addition to these circuits, the dual-channel receivers contain two or more stages of sound i-f amplification in which the tuned circuits have symmetrical response about the sound i-f carrier as shown in Figure 5B. The inter-carrier receivers contain at least one amplifier stage with tuned circuits having similar response for the second sound i-f carrier frequency, 4.5 mc. Finally, in both types of receivers, the audio detector stage has the "S Curve" response pictured in Figure 5C, as explained in the theory lessons on FM detectors.

RECEIVER SECTIONS REQUIRING ALIGNMENT

When a television receiver is assembled at the factory, alignment must be made of every section which contains tuned circuits, including the r-f section, picture i-f section, sound i-f section, and of the 4.5 mc traps, if any, in the video section. Included in the picture i-f section, one or more trap circuits also are adjusted at this time.

Once tuned, the r-f section seldom becomes mis-aligned, therefore, most of the later alignment adjustments are confined to those circuits following the mixer stage.

That is, in television receiver servicing, generally it is not necessary to perform a complete re-alignment of the entire receiver, but rather only of the particular section or sections which are out of alignment.



Sweep signal generator for aligning television receivers. The unit contains a marker generator and means for employing the signal from an external marker oscillator.

Courtesy Hickok Electrical Instrument Co.

In their service manuals, receiver manufacturers list the alignment instructions for each section separately, although the order in which the sections are listed usually indicates the sequence to be followed when more than one section is to be aligned. In some cases, alignment instructions for the r-f amplifier and mixer or the entire r-f section are omitted from the manual when these circuits are deemed to be sufficiently stable so realignment is rarely necessary.

Although there is some variation, the most common sequence employed in the receiver alignment is as follows:

1. Picture i-f Section
2. Sound i-f Section
3. R-F Section

In some cases, the service manuals specify that the oscillator should be aligned before the r-f amplifier and mixer, while in other cases the reverse order is suggested.

INDICATIONS OF MIS-ALIGNMENT

In general, mis-alignment of the television receiver tuned circuits results in poor picture quality, poor sound, or both. However, these same symptoms may be caused by other faults, or misadjustments, and checks for these causes should be made before the time consuming alignment procedure is begun.

Examples of faults which cause receiver operation similar to that produced by mis-aligned circuits are: faulty antenna installation, improperly set operating controls, incorrectly positioned ion trap, defective tuner, defective parts or tubes in r-f or i-f stages, defective peaking coils in video detector or amplifier stages, and defective focus coil or picture tube.

All such possible causes of trouble should be checked by means of visual inspection, control adjustments, and the various dynamic and static testing methods described in previous lessons. Only when these checks have been made, and all circuit components and voltages found to be satisfactory should alignment be considered necessary to correct the trouble.

The trouble symptoms should be observed carefully in an attempt to determine which section or sections need alignment. For example, either the picture i-f section or the sound i-f section may be mis-aligned if the best reception of both picture and sound cannot be obtained at the same setting of the fine tuning control. An improperly tuned trap circuit may result in interference in either the reproduced picture or sound. The i-f amplifiers must be aligned so they have not only the proper frequency response, but the proper gain as well. The reproduced picture may lack detail, or the balance between the shading in the large areas and the details may be improper if the picture i-f section is mis-aligned with respect to frequency only. However, if the mis-alignment is such that the picture i-f band-pass is wider than necessary, causing lowered gain, then a washed-out picture lacking in contrast and susceptible to noise is obtained.

Inability to reduce the video buzz level sufficiently by adjusting the operating controls of an intercarrier receiver may be due to improper alignment in the picture or sound i-f amplifier. However, a defective tube or circuit can give the same results.

cut, with respect to the frequency of the sound i-f carrier. If the sound i-f circuits are tuned too broadly, the reduced gain may cause reduced volume in the sound output. On the other hand, too sharp tuning of these circuits may result in distortion due to

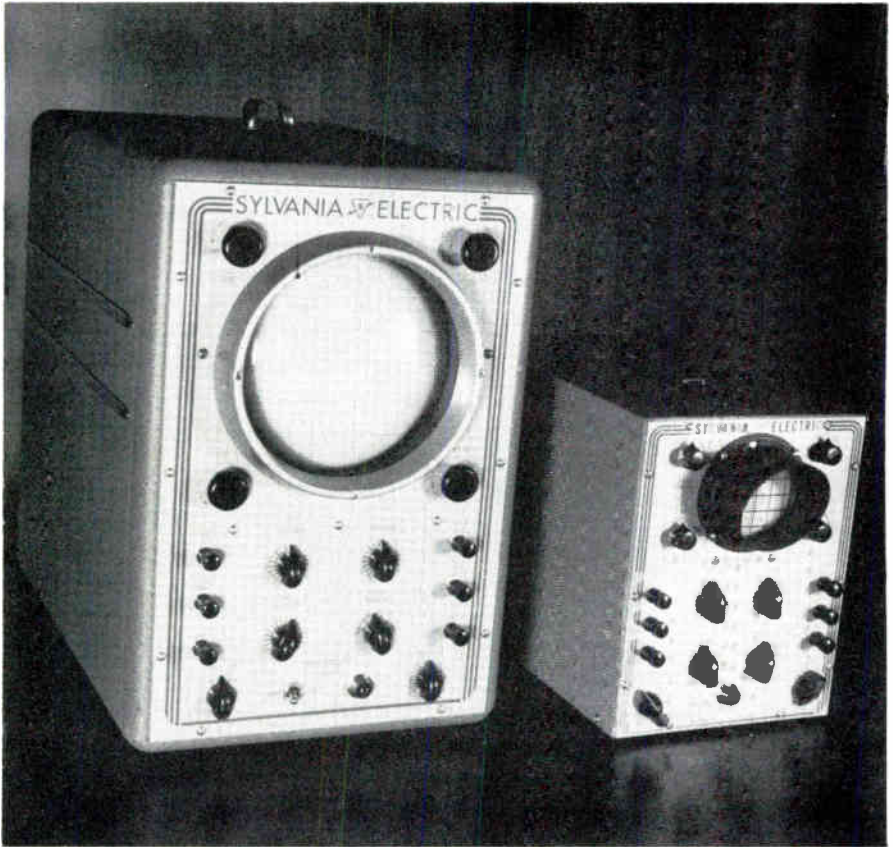

Service type oscilloscopes with either large or small screens are suitable for visual alignment work.

Courtesy Sylvania Electric Products, Inc.

Distorted sound is caused by mis-alignment in the sound i-f section, or the discriminator cir-

clipping on signal deviation peaks, and require frequent retuning to bring the sound in.

The receiver high-frequency oscillator may become mis-aligned to the extent that it is impossible to bring in the sound at all by adjusting the fine tuning control, although picture reception is normal. This situation is more likely to occur in the dual-channel type receiver, but can exist in an inter-carrier receiver as well.

If picture details are poor, or the reproduced sound is weak, or both, the r-f or mixer circuits may be in need of alignment. Note that these symptoms are the same as those which indicate (and are more likely caused by) misalignment in the i-f sections. Thus, while following the general alignment sequence given above, the technician should check the operation of the receiver as the alignment of each section is completed, to determine whether any further alignment is necessary.

A transmitted test pattern affords a convenient means of checking the alignment of the picture i-f circuits. If these circuits are aligned properly, the reproduced pattern should contain vertical wedges which are clear and sharp near the narrow end, and the detail should be in proper contrast balance with the shaded area.

ALIGNMENT EQUIPMENT

The particular instruments needed depend upon the alignment technique used by the serv-

iceman. For those who tune each circuit separately to the resonant frequency listed by the manufacturer, an r-f generator and a voltmeter are needed. Others prefer to adjust the over-all response of the r-f or i-f amplifier by means of a sweep generator and oscilloscope to conform to a desired response curve.

An r-f generator suitable for television receiver alignment should have a tuning range from 4 mc to 50 mc to align the i-f amplifiers, and a range from 50 mc to 220 mc to align the r-f stages of a VHF receiver. A received signal may be employed for making oscillator adjustments in UHF tuners, although complete tuner alignment usually requires a generator which provides signals over the UHF range.

The generator should have a continuously variable attenuator to control the output over a range from one microvolt to about one tenth of a volt. In order to duplicate the alignment recommended by the manufacturer, accuracy becomes important. In fact, calibration error in excess of 2% may cause sufficient circuit misalignment to produce poor quality pictures.

To obtain accurate output indications, the voltmeter used for alignment should not load the circuits under test to any great extent. Any voltmeter having a re-

sistance of at least 20,000 ohms per volt is satisfactory, although an electronic type (vtvm) is preferred.

The controls and front panel appearance of a typical sweep generator are illustrated in Figure 3. This particular model is a dual unit in that it consists of a sweep generator and an r-f signal generator (Marker Oscillator) in the same case. The dial at the upper left of the panel and the large octagonal knob are used to set the sweep generator at the desired center frequency, and the band over which this generator sweeps is determined by the setting of the SWEEP MC control located at the center of the panel.

The center frequency may be chosen in any of the three ranges, 2 to 38 mc, 38 to 88 mc, and 174 to 216 mc for television work, and in the 88 to 108 mc band for FM radio alignment. The sweep width may be varied in steps from 0 to 12 mc. For example, with the SWEEP OSCILLATOR set at 40 mc., and the SWEEP MC switch at 12 mc., the generator sweeps from 34 to 46 mc.

Directly beneath the sweep oscillator dial, the SWEEP switch permits turning the sweep oscillator on and off. The RANGE switch permits selection of one of the operating ranges mentioned, while the LINE SWITCH closes the circuit from the line cord to the power

supply of the unit. At the lower left of the panel are the r-f output jack and binding post, and the course (MULTIPLIER) and fine (RF OUTPUT) output controls, respectively.

To determine whether the receiver tuned circuits are responsive to the desired band of frequencies, etc., it is common practice to inject an r-f signal of a known frequency along with the sweep signal. This constant frequency input results in a small disturbance, or pip, at the point on the observed curve corresponding to the known frequency. These pips are generally called "markers", and one or several may be employed to check various points on the response curve.

Any ordinary r-f signal generator which operates in the proper ranges may be used as a source of marker signals, and, in the unit of Figure 3, the MARKER OSCILLATOR consists of an r-f generator which provides a signal in any of the television i-f and r-f ranges, depending upon the setting of its RANGE switch.

The ranges available are: 4 to 8 mc, 16 to 29 mc, and 27 to 54 mc on fundamentals, and 8 to 16 mc, 54 to 108 mc, and 108 to 216 mc on harmonics. The marker frequencies are given on the dial at the upper right of the panel, and the internal circuits are arranged to superimpose the marker signal

on the sweep signal output. The **MARKER OUTPUT** control varies the amplitude of the marker signal.

At the jack labeled **C.R.O.**, a 60 cycle sine wave voltage is available for use as the time base for the oscilloscope. The sweep generator output is swept over its range, from minimum to maximum and back to minimum, 60 times a second, and the **PHASE** control adjusts the relative sweep and time base phase so that a single trace is obtained on the oscilloscope screen.



This multiple-function instrument provides signal output in the frequency ranges required for television receiver alignment.

Courtesy RCA Victor Div. of Radio Corporation of America

At the lower center of the panel, Figure 3, the **EXT. MARKER** jack permits insertion of a second marker signal from an external signal generator.

The unit contains a circuit which may be operated as an a-f oscillator or as a crystal r-f oscillator as desired. The **MOD.** switch turns the audio oscillator on, and its 400 cycle signal modulates the r-f output of the marker generator. For this use, the sweep generator is turned off, and the modulated r-f output of the marker is available from the r-f output jack. With a crystal plugged into the holder provided, the oscillator provides a signal of accurate frequency which may be used for a test signal. The crystal oscillator output is available at the r-f output jack. Finally, the **MARKER SWITCH** turns the marker generator on or off.

The curves of Figure 4 illustrate the various patterns which are obtained on the screen of an oscilloscope when the outputs of different sweep generators are applied to the picture i-f circuits of a television receiver. If both the sweep generator and the oscilloscope employ a linear or sawtooth sweep, the curve obtained is similar to that of Figure 4A.

However, most sweep generators employ a sine wave sweep, or frequency variation rate, and, if this type of test signal is used, together with a sawtooth time base in the scope, a double trace pattern like that of Figure 4B is obtained. This pattern is due to the fact that the sweep output

varies from a minimum to maximum frequency while the oscilloscope beam moves steadily from left to right on the screen. Then, the beam quickly snaps back to the left side after which it again moves from left to right while the sweep output is changing in frequency from maximum to minimum.

Since the receiver picture i-f circuits are tuned to provide the more gradual drop-off in response near the high frequency end of the pass band, this portion of the curve is produced at the right side of the scope screen for one trace of the beam, and at the left side for the next trace, and so on.

Like the unit of Figure 3, most sweep generators provide a sine wave voltage which can be applied to the oscilloscope horizontal amplifier input, and thus used for the scope time base. With this arrangement, the time base and sweep rate coincide, and a pattern like that of Figure 4A is obtained. If the sweep generator phase control is not set properly, the forward and return traces do not fall at the same position on the screen, and a double trace pattern like Figure 4C is produced. Note that, in this case, the gradual slopes of both curves are at the same side of the screen.

With the sweep signal blanked during the return trace periods, a horizontal line at zero response

level is produced on the scope screen for this trace, and a response curve pattern is produced during the forward trace only, as shown in Figure 4D. Depending upon the sweep generator, oscilloscope, and receiver video detector circuit arrangements, the curves produced may be inverted, turned left-for-right, or both with respect to those illustrated in Figure 4.

Figure 5 illustrates the manner in which the desired response in the various sections of the receiver is specified in the manufacturer's service manuals. The curve of Figure 5A shows the proper over-all response of the picture i-f section. The short vertical lines indicate the points at which the marker pips should be located. If several marker signal sources are available, they all can be applied at the same time. However, a single marker generator can be set to the various test frequencies in succession, and the response of the circuit at each point checked against the given standard pattern.

The actual check frequencies employed vary with different receiver makes and models, and generally are included to indicate the marker points in diagrams like those of Figure 5. Located at the midpoint of the right hand slope of the curve of Figure 5A, the picture carrier intermediate

frequency marker indicates that the over-all response at this frequency should be 50% of maximum.

When the sweep generator method is used to align the sound i-f amplifier circuits, a marker signal at the i-f carrier frequency

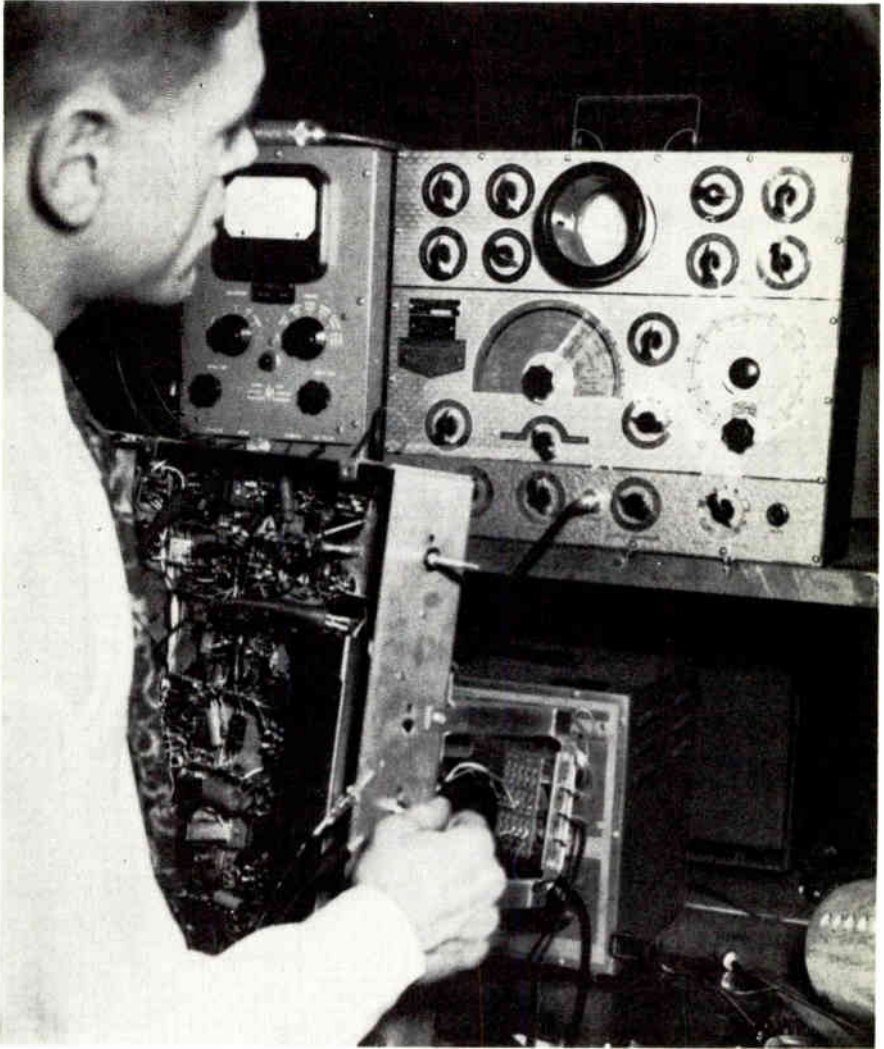

The basic instruments required to service a TV receiver are shown on the top shelf. From left to right, these are a vtvm and combination oscilloscope and signal generator.

Courtesy Philco Corp.

is employed. The response should be symmetrical about this frequency as shown by the curve of Figure 5B. Also, as shown in Figure 5C, the FM detector response increases linearly, but in opposite polarity, as the test signal varies each side of the i-f carrier.

When a sawtooth time base is used in the scope, with sine wave frequency variation in the sweep generator, the FM detector response curve appears as shown by the standard pattern of Figure 5D. In each case, the signal marker utilized corresponds to the sound i-f carrier output of the mixer for dual channel type receivers, and to the 4.5 mc i-f carrier in intercarrier receivers.

Figures 5E and 5F are examples of specified response curves for television receiver r-f section circuits. The standard of comparison for oscillator alignment is shown in Figure 5E, where the picture carrier marker is at 50% response on one slope of the curve and the sound carrier marker is near zero response on the other slope. Typical response required in the r-f amplifier and mixer stages is indicated in Figure 5F. Here, the dashed lines show the maximum allowable variations for different units of a given receiver.

ALIGNMENT PREPARATION

Regardless of the procedure practiced in the alignment proper for any given case, certain pre-

liminary preparations are necessary to permit the actual adjustments to be made with a maximum of convenience, safety, and accuracy.

Since tuning adjustments both above and below the chassis usually are necessary, the receiver chassis must be removed from the cabinet. The chassis should be placed on a bench so that it rests on a side which is free of controls or other protruding parts. To prevent tipping, the chassis should be braced if necessary, by some means such as blocks arranged so they will not slip away.

For alignment and other service work, sometimes it is desirable to remove the picture tube from the chassis for convenience as well as for personal safety. When this is done, the tube should be kept in a regular picture tube carton until it is time to replace it.

In some cases, the picture tube must remain in the socket during alignment, and therefore must be removed from the cabinet, along with the chassis. In the event the tube is not chassis mounted, it may be inserted through the yoke and the focus magnet, and attached to its socket, but to prevent breakage, its weight should be supported by a leather strap or an improvised bracket around

the tube face. THE PICTURE TUBE WEIGHT MUST NOT BE SUPPORTED BY ITS NECK.

In the case of receivers with series connected heaters, removal of the picture tube breaks the continuity of the heater circuit, and a substitute resistive component must be used in place of the picture tube heater. In most cases the heater of a 6SN7GT type tube is suitable for this purpose. All the base pins of the 6SN7GT are clipped off except pins 7 and 8. These heater pins will fit into the picture tube socket openings 1 and 12. The keyway on the 6SN7GT base will not line up with the keyway slot in the picture tube socket, but this does not interfere with the insertion of the tube. Such an arrangement re-establishes continuity in the heater circuit and provides the proper voltage drop across this portion of the circuit. The 6SN7GT used may be an old or defective one, so long as its heater is in good condition.

As a precaution against high-voltage shock, several manufacturers recommend some method of rendering the high-voltage supply circuit inoperative. Usually, this is accomplished by removal of either the horizontal oscillator tube or the horizontal output tube. Again, however, it is emphasized that the specific instructions for each model

should be consulted. For example, in the case of certain Admiral models, the instruction manual states that neither of these tubes should be removed from their sockets during alignment. On the other hand, for the Dumont Models RA-112A and RA-113, removal of the damper tube is directed.

To prevent errors due to drift during warm-up, all test equipment to be used for the alignment should be turned on 20 minutes to half an hour in advance. This procedure applies to any test equipment with which fairly accurate measurements are to be made, whether for alignment or otherwise. Therefore, for certain instruments such as signal generators, it is a good plan to turn them on the first thing in the morning, and leave them on all day when in the service shop. Thus, they are warmed-up and ready for immediate use throughout the day.

PICTURE I-F ALIGNMENT

During alignment of the i-f circuits, erroneous indications may be obtained if signals other than the desired test signals are applied to the input of the section under test. Therefore, some means of preventing the production or passage of signals by the r-f section should be employed. The simplest means consists of

removing the oscillator tube in those sets in which this tube is contained in a separate envelope.

In receivers where the mixer and oscillator are in the same envelope, such as the 6J6 duotriode, this tube is removed and a dummy tube inserted in its place. The dummy is made by clipping the base pin corresponding to the oscillator plate from a spare tube of the same type. This arrangement leaves the mixer in operating condition, it being needed as a means of injecting the i-f test signals. A third method of disabling the oscillator consists of clipping a $.001 \mu\text{fd}$ capacitor from the oscillator grid to ground.

To prevent interference from received signals, the channel selector should be set to a channel in which no station is operating in the area. In some cases, various other control settings are specified by the manufacturer, and should be made accordingly.

The test signal causes variations of the bias in the picture i-f stages due to the action of the receiver agc circuit, and thus results in undesirable changes in stage gain. Usually this fault can be avoided by keeping the signal low. However, to prevent the action, several manufacturers specify the use of a small battery, with its negative terminal connected into the agc circuit

and its positive terminal connected to ground. The values required range between -1.5 and -4.5 volts and may be obtained conveniently from a simple bias source consisting of the components shown in the circuit of Figure 6. Potentiometer P_1 has a resistance of 10,000 ohms, and capacitors C_1 and C_2 each have a capacitance of $.05 \mu\text{fd}$.



Large dial permits accurate setting of the center frequency of the sweep oscillator in this TV alignment generator.

Courtesy Coastwise Electronics Co., Inc.

For alignment of the picture i-f section, the test equipment connections most often employed are illustrated in the simplified diagram of Figure 7. For the first part of the alignment, the r-f signal generator or sweep generator output is applied to the receiver mixer stage, and the vtvm or oscilloscope is connected

across the video detector load resistor as shown. For the over-all response check and final adjustments, the sweep generator is connected to the antenna, and the oscilloscope is left on the detector load.

The signal (or sweep) generator connections to the mixer input are made by clipping the high side of the generator output cable to a tube shield which fits snugly over the mixer tube. For this use, the shield is not permitted to touch the chassis. The ground side of the cable is connected to the chassis close to the mixer tube base. This arrangement provides capacitive coupling between the floating tube shield and the elements of the mixer tube so that the test signal is injected into the i-f circuits. The coupling can be varied by sliding the shield up and down over the tube.

Another method of injecting the test signal consists of removing the mixer tube and wrapping a short length of bare wire around the mixer grid pin in such a way that the end of the wire projects from under the base when the tube is replaced in its socket. Then, in series with a .001 to .005 μ fd capacitor, the high side of the generator cable is connected to this wire. Leads should be kept as short as possible, and an alternative

method consists of eliminating the length of wire, and twisting the blocking capacitor lead around the mixer tube grid pin.

In some receivers, the test generator cable can be connected to the mixer circuit injection point through a hole or a test point provided for the purpose in the tuner chassis. Again a blocking capacitor should be employed, and the ground side of the generator cable is connected to the tuner cover. These connections are illustrated in Figure 8, along with a method of coupling the energy from an external marker generator into the output lead from the sweep generator. The twisted, insulated wires provide sufficient capacitive coupling to superimpose the marker energy onto the sweep signal.

In a few receivers, the video detector load circuit is at a high d-c potential with respect to the receiver chassis. In this case, precaution should be taken to avoid touching or grounding the case of the vtvm or oscilloscope.

In picture i-f section alignment, where the test signal is injected at the mixer stage, it is of paramount importance that the TRAPS ARE ALIGNED FIRST. This is true regardless of whether there are interfering stations in the area, for a misadjusted trap

makes it impossible to obtain the proper i-f response.

If alignment is attempted without first adjusting the traps, only an approximation of the correct response can be attained. Then, when the traps are tuned to their correct respective frequencies, the over-all response still is incorrect, and the whole i-f alignment procedure must be repeated.

beginning, each i-f coil must be tuned to some frequency other than the normal one when an attempt is made to overcome the absorption of energy at frequencies close to that to which the mis-adjusted traps are tuned. Merely correcting the trap adjustments does not of itself correct the mis-adjustments of the other i-f circuits caused by at-

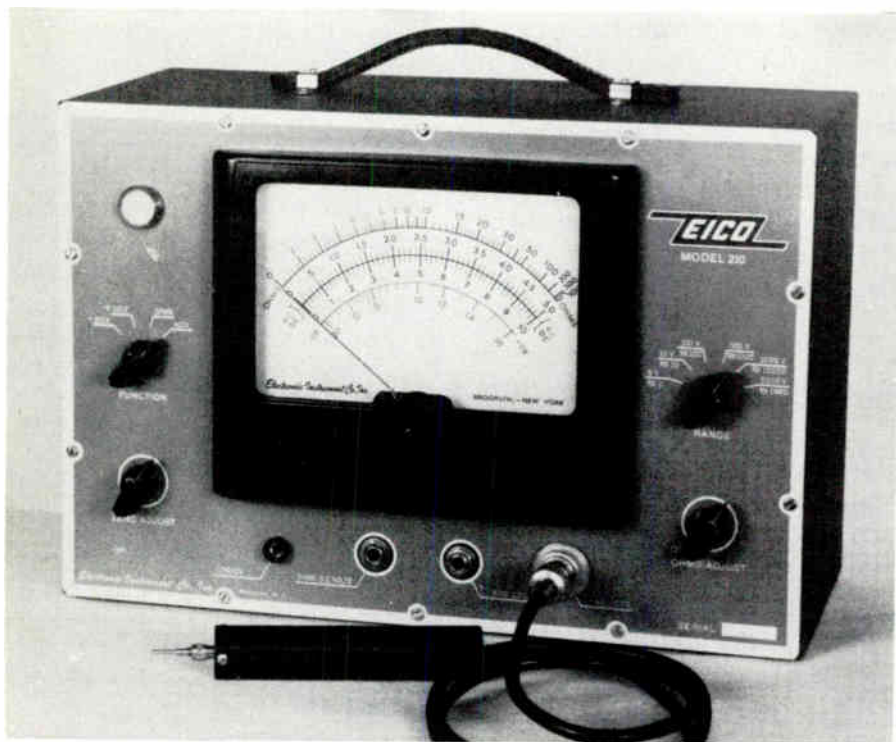

Useful for television alignment, this vacuum tube voltmeter has a large, easily read dial, and an r-f test probe.

Courtesy Electronic Instrument Co., Inc.

This is due to the fact that, with the traps misadjusted at the beginning, each i-f coil must be tuned to some frequency other than the normal one when an attempt is made to overcome the absorption of energy at frequencies close to that to which the mis-adjusted traps are tuned. Merely correcting the trap adjustments does not of itself correct the mis-adjustments of the other i-f circuits caused by at-

For the signal generator and meter technique, with the equipment connected and the receiver power on, the adjustments are made as follows: Set the signal generator for unmodulated r-f output, and its dial to the frequency of the first trap or traps to be tuned. This frequency is given in the alignment instruction chart for each receiver model.

With a non-metallic alignment tool, adjust the movable cores of the specified trap coils to obtain minimum reading on a low direct voltage range of the vtm. The r-f output from the signal generator should be no higher than is necessary to give about a half-scale reading on the 3 volt range of the voltmeter, before the traps are adjusted. However, some increase in generator output may be necessary to make final adjustments of the traps.

After completing adjustments of all traps which are to be tuned to the first trap frequency listed in the instructions, the signal generator dial is set to the second trap frequency given, and the indicated trap coil or coils adjusted for minimum reading on the meter scale as before. This same procedure is followed for each of the listed frequencies until all traps in the i-f section have been tuned.

Next, the signal generator is set to the first i-f test frequency listed, and the specified i-f coil tuned by adjusting its core for maximum deflection of the vtm pointer. As each adjustment is made, the signal generator output should be reduced to maintain a maximum voltmeter reading of not more than 2 volts. This reduction in test signal input is necessary to prevent overloading the later i-f amplifier stages, because such overloading results in false output indications.

The signal generator again is set to each of the other test frequencies in the order in which they are listed, and the corresponding coils tuned for maximum vtm reading. Each time an i-f coil is tuned, the signal generator output is reduced when necessary to prevent the maximum reading from exceeding 2 volts.

To use the sweep generator and oscilloscope system, the sweep generator is attached to the mixer and the oscilloscope is connected across the video detector load resistor as explained for Figure 7. The output from the detector is applied to the vertical input terminals of the scope, and the time base output from the sweep generator is applied to the scope horizontal amplifier input.

The scope sweep selector is set to the horizontal amplifier posi-

tion. The sweep generator is set to the center frequency and to a sweep width of about 10 mc. The scope vertical and horizontal gain controls are adjusted until the pattern almost fills the screen horizontally and about one-half to two-thirds of the screen vertically.

The internal marker generator is turned on, or the external marker generator properly coupled, and set to each of the trap frequencies. With the marker generator adjusted to maximum output, the trap is tuned for minimum marker pip.

After this procedure has been repeated for each trap, the marker output is reduced until the pip is just clearly visible and with the marker set successively to each of the check frequencies, the i-f coil adjustments are made to obtain the desired over-all response curve on the screen of the oscilloscope. Usually, this curve is like that of Figure 5A. The sweep generator output has to be reduced from time to time to avoid inaccurate response indications due to overloaded i-f stages.

A few receiver manufacturers specify a stage-by-stage alignment procedure for the picture i-f section, beginning with the last stage and working toward the first. For example, when double-tuned coupling circuits

are employed in the i-f stages, the alignment is performed with the sweep generator and oscilloscope, in which case a correct response curve is given by the manufacturer for each stage.

To tune the coils of the last stage, the sweep generator output and marker signals are applied to the grid of the last i-f amplifier tube, and the oscilloscope is connected across the video detector load resistor as in Figure 7. Adjustments of the coil cores are made until the required response is obtained as indicated by the markers at the various check frequencies.

After this stage is aligned, the sweep and marker signals are applied to the grid of the preceding i-f amplifier tube, to the plate of which the oscilloscope is connected so that the only indicated response is that of the single stage under test. With appropriate adjustments made in each case, this procedure is followed for each stage in turn. Finally, when the first picture i-f stage is being aligned, the sweep and marker generators are coupled to the mixer circuit in the manner explained for Figure 7.

Except for the last i-f stage, some type of detector probe is required between the i-f tube plates and the vertical input of the scope. Generally, the detector circuit and component values are specified by

the receiver manufacturer, and an example of such a circuit is given in Figure 9. In this case, the values are: C_1 , C_2 , and $C_3 = .001 \mu\text{fd}$, R_1 and $R_3 = 220$ ohms, $R_2 = 10,000$ ohms, and the crystal rectifier is a type 1N34.



To obtain a clear and distinct picture on the screen and faithful reproduction of sound, proper alignment is necessary for all tuned circuits in a television receiver.

Courtesy Hallicrafters Co.

When a stage-by-stage alignment is made, the various traps are tuned before the i-f coils for each particular stage. However, it is not now necessary to tune all the traps in the i-f section before beginning the coupling circuit alignment, as is the case with the alignment system explained in connection with Figure 7.

After a careful alignment procedure has been carried out by either of the above methods, often the serviceman can make improvements by final adjustments with the receiver in operation, while observing a transmitted test pattern. In this way, the limitations in the accuracy of the servicing equipment can be overcome. However, alignment should be nearly completed before this is done. Any attempt to make initial alignment by this method results in a time wasteful process that in no manner assures a good picture.

SOUND I-F ALIGNMENT

For the sound i-f section, the connection points for the alignment equipment are different depending upon whether the receiver is of the intercarrier or dual channel type. The sound i-f and detector circuits of an intercarrier receiver are shown in Figure 10. Here, the 4.5 mc i-f carrier is amplified by the v-f output amplifier, and coupled through C_1 and L_2 to the grid of the first sound i-f amplifier tube V_2 . The FM signal is amplified by the V_2 and V_3 stages, and demodulated by the audio detector V_4 , the a-f signal finally appearing across the volume control potentiometer P_1 .

Generally, data for both alignment methods are given for this section, and either the r-f signal generator or the sweep generator

is connected to the grid of the v-f amplifier tube V_1 , point "A" in Figure 10. A d-c blocking capacitor should be inserted between the generator output lead and the V_1 grid, and it may have a capacitance anywhere from .001 to .01 μ fd.

When a signal generator is used, it is set for an unmodulated output of 4.5 mc, and the d-c probe of a vtvm is connected first to point "C" in the detector circuit, and the cores of L_2 , T_1 , and the primary of T_2 adjusted for maximum reading on the meter. To complete the adjustments, the vtvm probe is connected to point "D", and the secondary core of T_2 adjusted for zero deflection of the meter pointer.

When a sweep generator is used, it is set for a 450 kc sweep with a center frequency of 4.5 mc, and point "C" in the detector load circuit is connected to the vertical input of an oscilloscope. One lead of the stabilizer capacitor C_8 is disconnected, and a curve like that of Figure 5B should be obtained on the scope screen. Core adjustments of L_2 , T_1 , and the T_2 primary are made to produce maximum amplitude and symmetry.

The center frequency point on the curve is indicated by means of an injected marker signal of 4.5 mc. With C_8 reconnected, point "D" is connected to the

scope vertical input, and a curve like that of either Figure 5C or 5D should be obtained. Adjustment of the T_2 secondary winding core is made until the marker pip appears at about the midpoint on the "S" curve of Figure 5C, or at the crossover point of the lines in the pattern of Figure 5D. A slight readjustment of the T_2 primary core may now be made for maximum length and linearity of the diagonal or cross-over lines.

Extreme accuracy is needed for effective intercarrier sound alignment. Therefore, after initial adjustment is made as described, it is necessary to remove the generator, replace the stabilizer capacitor, tune in a station transmitting a test signal, and adjust the coils for the meter indications described for the signal generator meter method.

For sound i-f section alignment in a dual-channel type receiver, the test point connections are indicated in the simplified diagram of Figure 11. For the alignment of the picture i-f section, the various test signals are applied to the mixer stage by means of the floating shield arrangement at point "A". Here, the accuracy of the equipment is not as critical as for intercarrier. However, for good results, the alignment of dual channel sound i-f should be carried out with the same generator used for the picture i-f alignment.

Otherwise, sound and picture for a given channel might come in best at different tuning positions.

When the signal generator system is used, this instrument is set to the sound i-f carrier frequency, and its unmodulated output applied to the receiver mixer, point "A" of Figure 11. First, in series with a 10,000 ohm resistor, the d-c probe of the vtvm is connected to the grid of the limiter tube, point "B", and the cores of the i-f amplifier coupling transformers, including T_2 , adjusted for maximum meter reading. Second, the voltmeter probe is connected to point "C", and the primary of T_3 adjusted for maximum reading. Third, with the voltmeter probe at point "D", the secondary of T_3 is adjusted for minimum reading. In the event the sound i-f circuits are only slightly mis-aligned, the voltmeter connection to point "B" may be omitted, and all the adjustments of the first two steps above made with the meter connected to point "C".

When the sweep generator is used, the i-f amplifier coupling circuits are tuned to produce maximum amplitude and symmetry of the curve of Figure 5B, with the oscilloscope connected through a 10,000 ohm resistor to point "B", Figure 11. Then with the scope connected to point "D", the primary and secondary windings of

T_3 are adjusted for a pattern like that of Figure 5C or 5D, as explained for the intercarrier type receivers.

4.5 MC TRAP ADJUSTMENT

All intercarrier receivers and some dual-channel types contain an LC circuit tuned to 4.5 mc cycles in the output of the video detector or amplifier. This circuit is arranged so that a maximum of energy at this frequency is applied to the sound i-f section in intercarrier receivers, but in both types, the 4.5 mc beat signal is prevented from being applied to the input of the picture tube. Because of this function, the circuit is called a 4.5 mc trap.

Usually, for intercarrier receivers, adjustment of this trap forms part of the sound i-f alignment procedure. However, for some intercarrier receivers and most dual-channel receivers, the 4.5 mc trap is adjusted after the sound i-f section alignment is completed. The r-f signal generator is set to provide a 4.5 mc unmodulated output which is applied to the grid of the first video amplifier stage.

Either of two methods of connecting the vtvm to obtain the output reading may be employed. One consists of connecting the meter d-c probe through a detector circuit like that of Figure 12, to the picture tube grid or cath-

ode, whichever is the signal input element. The ground side of the probe and detector circuit is connected to the receiver chassis. For the circuit of Figure 12, the rectifier may be a type 1N34 crystal, capacitor $C = .05 \mu\text{fd}$, $R_1 = 1$ megohm, and $R_2 = 220,000$ ohms.

The second method consists of removing the 1st sound i-f amplifier tube from its socket, and connecting a $50 \mu\mu\text{fd}$ capacitor from the grid (or cathode) of the picture tube to the grid of the 2nd sound i-f amplifier. The vtvm probe is connected to point "C", Figure 10, with C_s temporarily disconnected, or to point "C", Figure 11. For either method, the trap is tuned for minimum deflection of the meter pointer.

R-F SECTION ALIGNMENT

As explained earlier, for alignment of the picture i-f section, the oscillator is disabled by removing the oscillator tube, etc. This arrangement is retained during the alignment of the sound i-f section, and adjustment of the 4.5 mc trap circuit. For alignment of the r-f section, operation of the oscillator stage must be restored by replacing the original oscillator tube in its socket.

Usually, the signal generator or sweep generator has a co-axial type output cable which has a characteristic impedance on the order of 50 or 75 ohms. This cable

should be terminated in a resistance equal to its characteristic impedance, and also should be matched to the 300 ohm input impedance of the television receiver.

To satisfy these conditions, a resistor network like that of Figure 13A is used. Here, R_1 is made equal to the coaxial cable impedance, and R_2 and R_3 are equal to each other and of such value that the total of R_1 , R_2 , and R_3 is approximately equal to 300 ohms. For example, if $R_1 = 50$ ohms, resistances of 120 ohms each for R_2 and R_3 may be used for a total of 290 ohms. All resistors should be of the carbon or composition type, not wire wound.

Since the r-f or sweep generator output is not very strong, in some cases a matching circuit like that of Figure 13A cannot be used because of the loss it introduces. If the generator has a 73 ohm cable, the cable can be connected directly to the 75 ohm input terminals of the receiver.

If the receiver does not have a 75 ohm input connection, the 73 ohm cable can be matched to the 300 ohm input by means of the arrangement of Figure 13B. Two lengths of 150 ohm twin lead are connected in parallel at one end to match the coaxial cable, and in series at the other end to match a 300 ohm line which, in turn, connects to the receiver input terminals. For channels 7 to 13, the

length L of the matching leads is about $14\frac{1}{2}$ inches, and about 39 inches for channels 2 to 6.

the sweep generator method is employed. The oscilloscope is connected across the video detector

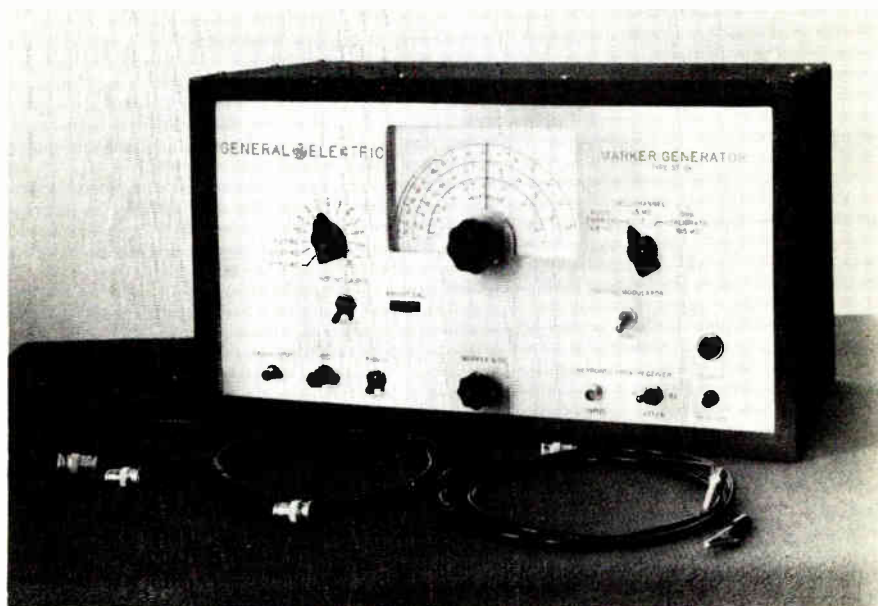

A signal generator specifically designed to produce the various marker signals needed for television receiver alignment.

Courtesy General Electric Co.

The circuit diagram of a typical television receiver r-f section is shown in Figure 14. V_1 is the r-f amplifier, the left hand section of V_2 is the oscillator, and the right hand section is the mixer. As indicated, a turret type channel selector is employed, and fine tuning is accomplished by means of C_{11} . For alignment, the test signals are applied to the antenna terminals at point "A".

Oscillator Alignment

To align the oscillator in inter-carrier type receivers, usually

load resistor, as shown in Figure 7. With the fine tuning control set to the mid-position of its range, the receiver station selector is set to the highest frequency channel to be aligned. For example, in the VHF band, the switch is set to channel 13, and the sweep generator to a center frequency of 213 mc with a 10 mc sweep. Marker signals at the picture and sound r-f carrier frequencies for this channel are employed as check points, and the indicated oscillator coil adjustment made to ob-

tain a response curve like that of Figure 5E.

This procedure is followed for each of the other channels, progressing from the highest to the lowest numbered channel. In each case, the sweep generator is set to a center frequency of the channel, and markers employed corresponding to the picture and sound r-f carriers in that channel.

Generally, for dual-channel type receivers, the signal generator method is specified, in which case the d-c probe of the vtvm is connected to the output of the audio detector, point "D" in Figure 11. The receiver fine tuning control is set to its mid-position, and beginning with the highest channel and working down through the lowest, the signal generator output is set to the sound r-f carrier frequencies and the oscillator coil core adjustments made for minimum meter reading.

Many receivers contain a trimmer across the oscillator tank circuit. This capacitor provides a means of adjusting the oscillator for all channels at once. Alignment of the individual coil cores may not be necessary, and a preliminary attempt should be made to align the oscillator for all channels by adjusting this trimmer. This may be done with either the intercarrier or dual-channel type receivers.

The all-channel trimmer cannot be used to align individual channels, however, and if its adjustment fails to align the oscillator circuits sufficiently, it is necessary to adjust the channel coil cores by one of the methods previously explained.

R-F Amplifier and Mixer Alignment

Generally, the sweep generator method of alignment is specified for the r-f amplifier and mixer stages, for both dual-channel and intercarrier type receivers. The oscilloscope is connected through a 10,000 ohm resistor to the junction between the two series resistors which connect from the mixer tube grid to ground. This test point is indicated as "B" in Figure 14.

The sweep generator center frequency is set to the mid-frequency for each channel, a 10 mc sweep is employed, and markers used which correspond to the respective channel picture and sound r-f carrier frequencies. Usually, adjustments are specified for all channels, beginning with the highest and working down, although adjustments for only certain channels are specified in some cases. All adjustments are made to obtain a response curve similar to that of Figure 5F.

TOUCH-UP ADJUSTMENTS

Often, complete alignment is undertaken unnecessarily. A careful diagnosis of the trouble sometimes will indicate that a mere touching-up of certain adjustments will accomplish the desired results in a much shorter time. In addition, certain of the more critical adjustments often have to be touched-up slightly even after the above steps have been performed carefully.

Generally, some touch-up of the oscillator circuits and the FM detector secondary coil is needed, especially when the accuracy of the dial calibration of the r-f signal generator or marker generator is not known. To make touch-up adjustments, it is necessary to restore the receiver to normal operating conditions by replacing any tubes, etc., which were removed for the regular alignment.

For a dual-channel type receiver, the station selector is set to the highest used channel on which a program or preferably a test pattern is being transmitted. The fine tuning control is set to the mid-position of its range, and the h-f oscillator coil core is adjusted to obtain good resolution (not brightest picture) as observed on the receiver viewing screen. When good resolution and balance are obtained, the picture carrier is at the 50% point on the receiver response curve.

Leaving the oscillator adjusted in this manner, a vtvm is connected to the FM detector output circuit, point "D" Figure 11. The detector transformer secondary core is adjusted for minimum reading on the voltmeter, thus tuning this circuit to a frequency exactly 4.5 mc below the picture i-f carrier.

The receiver channel selector is set to each of the other used channels in turn, and for each channel the corresponding oscillator coil core is adjusted for minimum reading on the vtvm. This completes the touch-up adjustments. However, as previously pointed out, these adjustments cannot be substituted when complete alignment is necessary.

To touch-up the oscillator alignment in an intercarrier type receiver, it is necessary to adjust each oscillator coil core for proper balance between maximum sound and best picture definition, with the fine tuning control in its mid-range position.

All touch-up adjustments should involve only very slight changes in the existing settings. In the event appreciable changes are needed to produce the desired results, then the over-all response curves should be checked using the sweep generator and oscilloscope.

ALIGNMENT DIFFICULTIES

In the visual alignment method with the sweep generator, often various unexpected results are obtained, such that the patterns produced on the oscilloscope screen are considerably different from the curves specified in the manufacturer's service manual. Similar erratic results are obtained with the signal generator and vtmv method.

For the sake of clarity, mention of these difficulties was omitted from the step-by-step procedures given in the preceding paragraphs. However, the causes should be understood by the service technician to assure successful alignment of television receivers.

In addition to being modified due to mis-alignment of the receiver tuned circuits, the observed response curves and vtmv readings may contain irregularities because of the nature of the test equipment, or the inability of the technician to operate the equipment properly.

The service technician should read the instruction manual carefully for every piece of test equipment which he uses. These manuals contain extremely informative data prepared for the express purpose of assisting the technician in properly applying his instruments. Experience alone is never an adequate substitute for reading these manuals.

Stray R-F

Often, stray r-f energy is picked up by the leads connecting the signal or sweep generator to the signal insertion point in the receiver. This energy results in regeneration which causes unstable output indications. To prevent noise pickup in this way, both the center conductor and the ground lead from the generator output cable should be made as short as possible. Neither of these leads should protrude more than two inches from the end of the cable, and may be as short as one inch by omitting the alligator clips.



The selector switch sets the sweep oscillator to the center frequencies of the indicated channels and thus permits rapid channel changing in this TV sweep generator.

Courtesy RCA Victor Div. of
Radio Corporation of America

Moreover, very short wire jumpers should be used as grounds between each piece of test equipment and the receiver chassis at

a point near the circuits being aligned. Whenever connection to the grid of a tube is made, a .001 μ fd mica or ceramic blocking capacitor should be included in series with the high lead. In addition, the output cable should be terminated by a $\frac{1}{4}$ or $\frac{1}{2}$ watt resistor equal to the characteristic impedance of the cable, as illustrated in Figure 15.

Oscilloscope Response

The desired picture i-f response curve has been described in connection with Figure 4, and, providing the sweep generator and receiver circuits are operating properly, the voltage wave-form applied to the vertical input of the oscilloscope is as shown in Figure 16A. This wave-form closely approaches that of a low-frequency square wave. If the scope vertical amplifier has inadequate low-frequency response, the applied voltage is distorted by the amplifier so that the wave-form applied to the deflection plates will be like that of Figure 16B.

As alternate halves of the test voltage cycle are produced on the scope screen during the forward and return trace sweeps of the beam, the resulting pattern produced on the screen will be as shown in Figure 16C. Note that this pattern is due to a fault of the oscilloscope circuit rather

than to mis-alignment of the receiver circuits.

If the technician assumes the distortion of Figure 16C to be due to receiver mis-alignment, and tries to secure the proper response curve by adjusting the cores of the various receiver coils, the result will be mis-alignment of the circuits which may have been properly aligned in the first place. An experienced technician may be able to visualize how the trace of Figure 16C would appear if there were no low-frequency distortion in the oscilloscope amplifier, and make alignment adjustments accordingly.

However, this is difficult to do, and a better plan is to improve the low-frequency response of the oscilloscope by replacing the coupling and bypass capacitors in the scope vertical amplifier circuit with units of higher capacitances. The cathode bypass capacitor should be increased to about 500 μ fd, or can be omitted entirely, although its omission will result in some loss of gain in the amplifier stage.

Figure 16D shows the normal response curve shape for the receiver sound i-f section, while Figure 16E shows the resulting pattern obtained when the normal voltage wave is applied to a scope having poor low-frequency response. In this case, only the lower portion of the curve is pro-

duced with double traces and, knowing the reason for this effect, the technician may ignore these loops and make alignment adjustments to obtain maximum height and symmetry of the upper portion of the curve.

Oscillations

As the receiver and test instruments are all connected to the a-c power line, frequently r-f energy is coupled from the receiver, vtvm, or oscilloscope by radiation or through the power line to the test generator or early stages of the receiver. This feedback causes regeneration and, when a vtvm is connected to the video or audio detector output, the meter reading may remain normal for a few moments, then suddenly build up to a high reading, though no adjustments were made. This may be followed by a fluctuation and a gradual drop in output.

Another symptom of regenerative action is that a very small increase in applied test signal causes a very great increase in the output reading, or a definite change in the response curve when a sweep generator and oscilloscope are used.

When the oscilloscope is connected to the receiver detector output, regeneration causes changes in the existing response curve shape. Sometimes, as a

particular coil core is being adjusted, the proper response will be obtained and then lost when the alignment tool is removed, even when the tool is of the non-metallic type. With either vtvm or scope, these troubles occur especially when the receiver chassis is touched, the instrument test leads or cables are moved around, or when the hand is brought near any of the cables, test instruments, or receiver chassis.

In some cases, the regeneration may be severe enough to cause oscillation in the receiver circuits. When the response is being checked with an oscilloscope, oscillation causes widening of the observed curve in a region corresponding to a band centered about the produced beat frequency, as illustrated in Figure 16F. When a vtvm is used, oscillation results in a reading being obtained at the detector output even though no signal is applied. Then, when a test signal is applied, either the meter reading may be reduced, there may be an erratic change, or no observable change in the reading.

Generally, regeneration and oscillation due to power line feedback can be prevented by providing sufficient conductive grounding contacts between the receiver chassis and all test equipment. Heavy solid wire should be

used for this purpose, or the receiver and test instruments may be placed on a large metal sheet of copper or galvanized iron. However, in some cases, the alignment instructions specify connection of the vtvm common lead to a point of high d-c potential rather than to the receiver chassis. When this connection is made, the meter case should not be touched or allowed to come into contact with the metal sheet, receiver chassis, or any other grounded object.

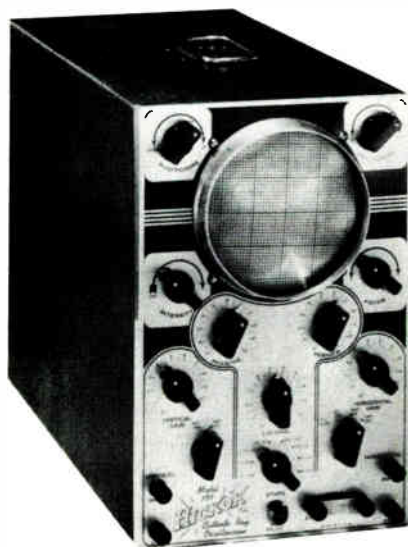

In addition to visual alignment, the cathode ray oscilloscope is useful for observing the various pulse and deflection voltage waveforms during television receiver service work.

Courtesy Hickok Electrical Instrument Co.

Sometimes, when two tuned i-f circuits are resonant to the same

frequency, oscillation occurs in the i-f amplifier when the test signal is applied, so that a high voltmeter reading is obtained at the detector output, independent of the amplitude of the applied signal. If the contrast control circuit is designed to vary the bias on the i-f amplifier grids, this oscillation may be stopped by rotating the contrast control to increase the applied negative bias. Another method consists of removing the test signal from the mixer tube circuit, and applying it through the network of Figure 13A to the receiver input terminals.

Oscillations that occur when the scope or meter is connected to the detector load often can be avoided by connection to the video amplifier grid load resistor. Thus, the high video frequencies that exist across the peaking coils do not reach the oscilloscope or meter. Finally, it may be necessary to ground the grids of the first i-f stages through .001 μ fd capacitors, and apply the test signal to the grid of the last i-f tube only.

After this stage is aligned, the shunting capacitor is removed from and the test signal applied to the grid of the preceding stage for its alignment, etc., until the entire i-f section is aligned. If oscillation still exists, it is probably due to some cause other

than mis-alignment, and a check should be made of i-f amplifier tubes, operating voltages, bypass capacitors, and coil shunting resistors.

R-F Amplitude

It has been mentioned that the signal generator and sweep generator outputs should be kept low, just enough signal amplitude being employed to provide a satisfactory output from the detector circuit. Excessive test signal input may cause overloading in the later i-f stages, and produce erroneous output indications.

For example, suppose the receiver actually is out of alignment such that its picture i-f amplifier has the response shown in Figure 16G. If the test signal input is increased sufficiently, the overloaded stages act as limiters to produce a curve like that of Figure 16H. Here, the flattened top gives the false impression that the i-f section over-all frequency response is correct. Also, the technician experiences the impression that alignment adjustments do not affect the top of the response curve.

If the sweep generator output is not flat over the band of swept frequencies, then this inaccuracy should be accounted for when the instrument is employed to align the circuits of a television receiver. In the case of sweep genera-

tors of the type in which the output of a single oscillator is frequency-modulated to obtain the sweep output, the generator output can be checked by means of an oscilloscope and a detector circuit like that of Figure 12.

In this case, the R and C values used are: $R_1 = 120,000$ ohms, $R_2 = 220,000$ ohms, $C = 270$ μmfd , and the crystal may be a type 1N34. The capacitor lead is connected to the center conductor of the generator cable, and the free lead of R_2 to the vertical input of the scope. The generator center frequency is set to the center of the band to be checked, and the blanking switch turned on.

If the output is constant over the band, two parallel horizontal lines will be produced on the scope screen. However, if the generator output changes with frequency, one of the lines will be slanted or curved in one direction or the other, such as in Figure 16I. If the generator does not contain a blanking switch, only the upper line of Figure 16I is produced.

Most sweep generators obtain their output by means of beating the output of a fixed-frequency oscillator against that of an FM oscillator. In this case, the output contains several spurious frequency outputs in addition to the desired band, and the detector circuit of Figure 12 cannot be employed to check the generator

output in the manner explained above.

About the only practical way that these units can be checked is to apply the test signal to the circuits of a receiver, the response of which is known. Then, any deviation from the known response can be assumed to be due to inaccuracies in the generator output. Of course, all test lead and grounding connections must be made carefully.

For any type sweep generator, if receiver circuit adjustments are made to produce an observed pattern like that of Figure 16J when, for example, the generator provides an output like that of Figure 16I, the coupling circuits then will have been misaligned to compensate for deficiencies in the sweep generator output. That is, the receiver circuits will be pro-

viding less response to frequencies represented by the right side of the curve in the Figure, because the test input is greater in this region. To provide correct alignment in this case, receiver coil adjustments should be made to obtain a curve like that of Figure 16K.

In the various explanations of this lesson, frequent reference has been made to the alignment instructions given in the various manufacturer's service manuals. These instructions are available from a number of sources, in addition to the manufacturers themselves. In the event no such alignment information is available on a particular model, the service technician should be certain of the functions of the various circuits and of the frequencies involved, before making any adjustments.



STUDENT NOTES

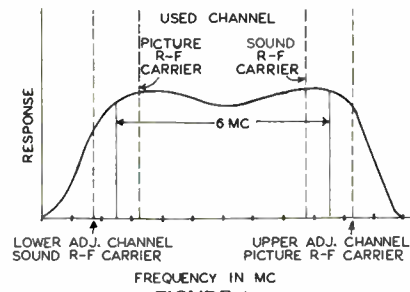

FIGURE 1

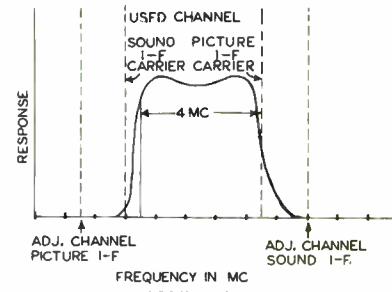

FIGURE 2

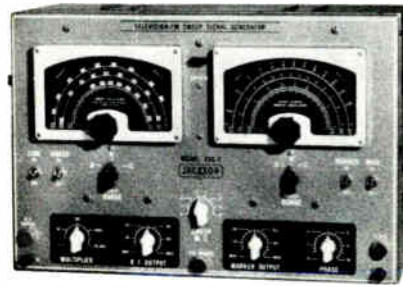

FIGURE 3

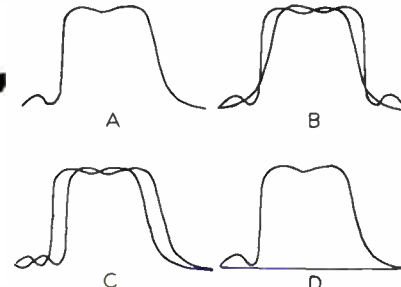

FIGURE 4

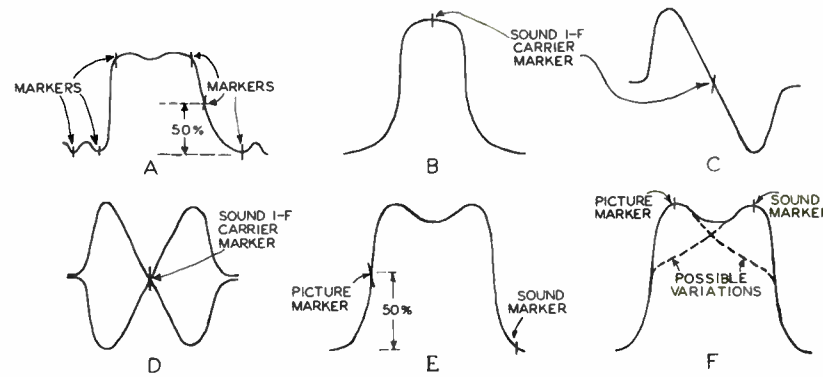

FIGURE 5

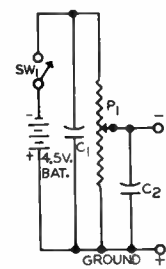

FIGURE 6

TSM-18

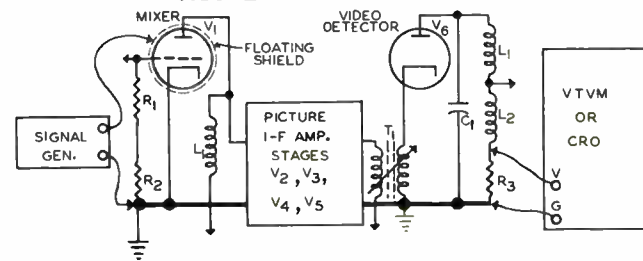

FIGURE 7

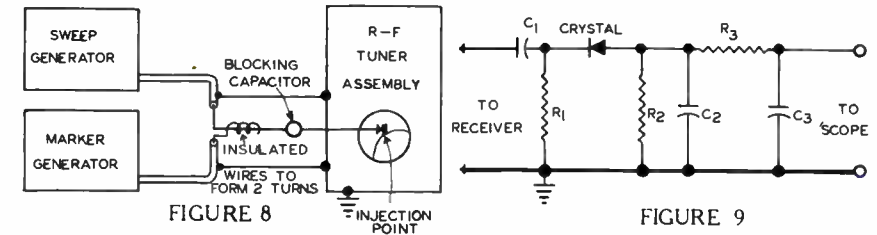

FIGURE 8

FIGURE 9

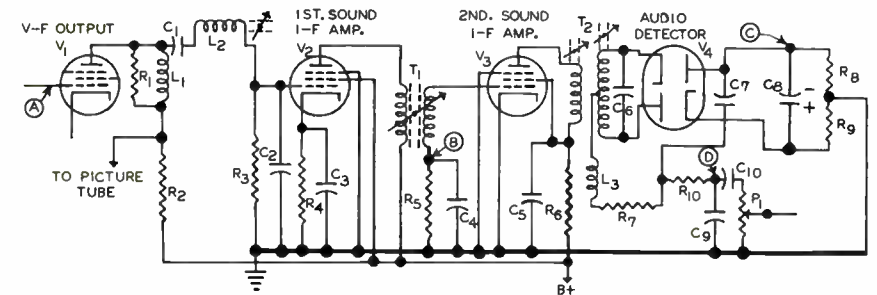

FIGURE 10

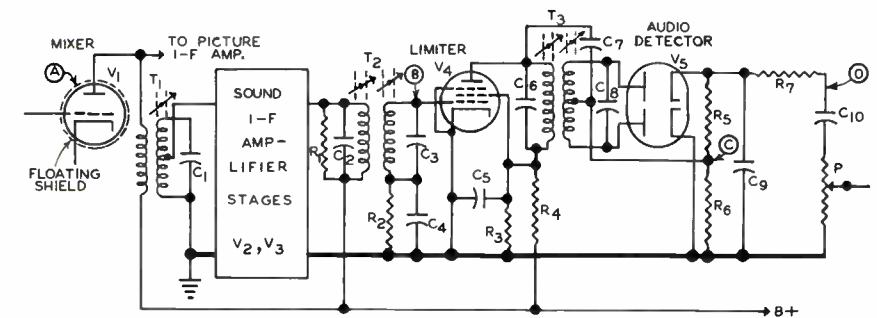

FIGURE 11

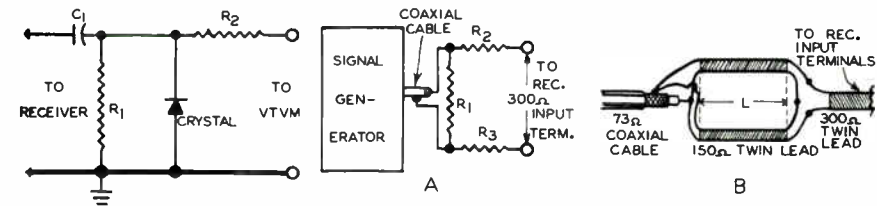

FIGURE 12

TSM-18

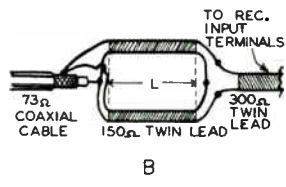

FIGURE 13

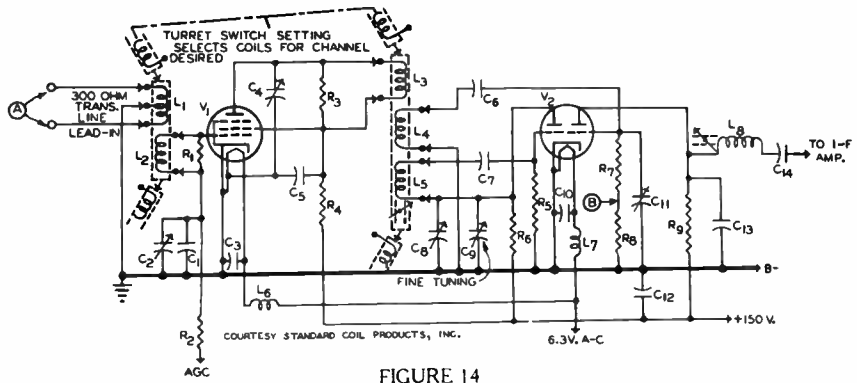

FIGURE 14

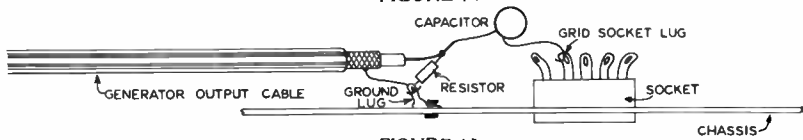

FIGURE 15

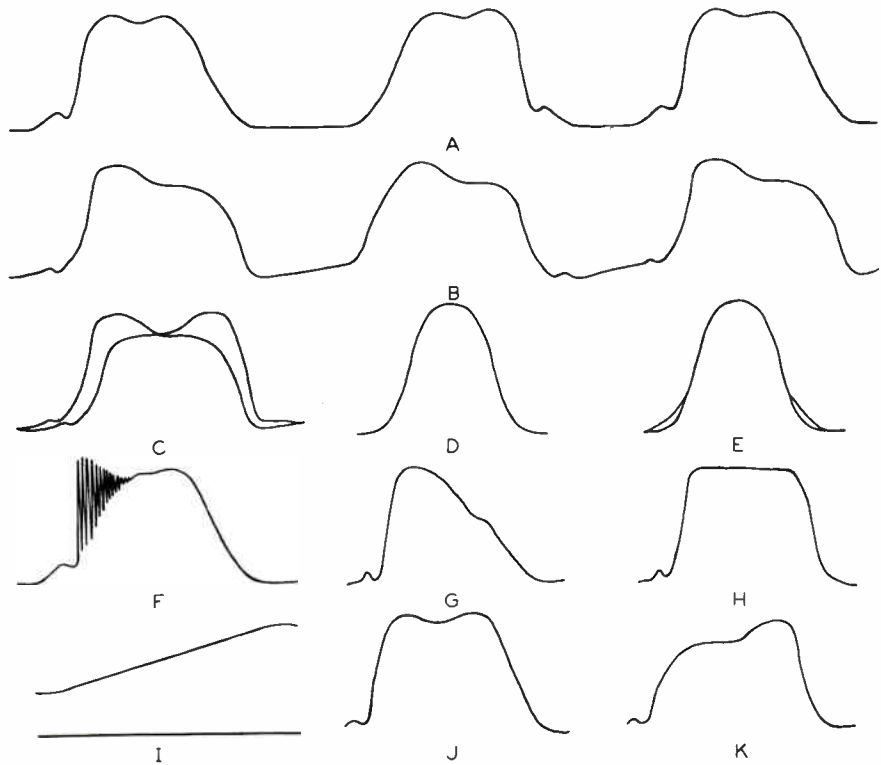

FIGURE 16

TSM-18

FROM OUR *Director's* NOTEBOOK

**"CLOTHE YOUR WORDS
WITH A SMILE"**

"But I only told him the truth!" How often we've heard that defensive statement—and what a world of blundering it tries to cover. Friendships have gone flying out the window, business opportunities down the drain—washed away by thoughtless, impulsive words.

By all means, be truthful . . . always. But temper the blunt truth with a few nice words. Getting along with your fellow man is extremely important when you're in business. Personality and winning ways have a great deal to do with success.

Wear a smile often . . . talk with the "soft pedal" on . . . clothe your very words with your smile. It pays off. Softly spoken, sincere words bring far greater returns to ANYONE than hastily spoken harsh words.

Yours for success,

W. C. Healey

DIRECTOR

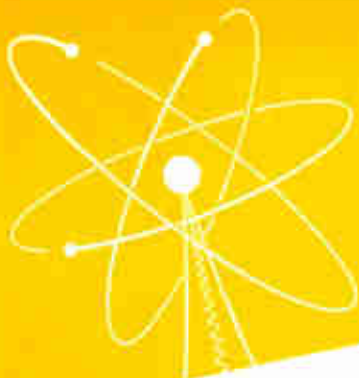

PROJECTION RECEIVERS

Lesson TSM-19A

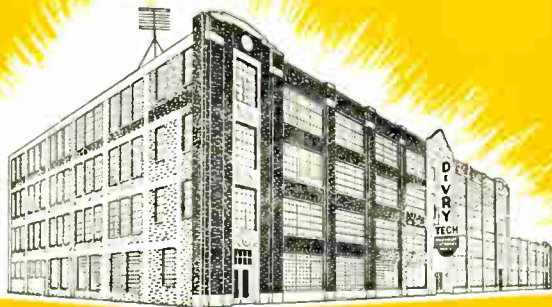

DeVRY Technical Institute
4141 W. Belmont Ave., Chicago 41, Illinois
Formerly DeFOREST'S TRAINING, INC.

PROJECTION RECEIVERS

4141 Belmont Ave.

COPYRIGHT 1955

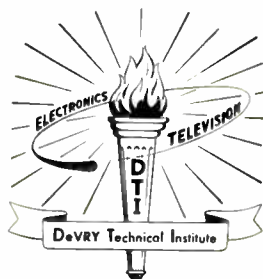

Chicago 41, Illinois

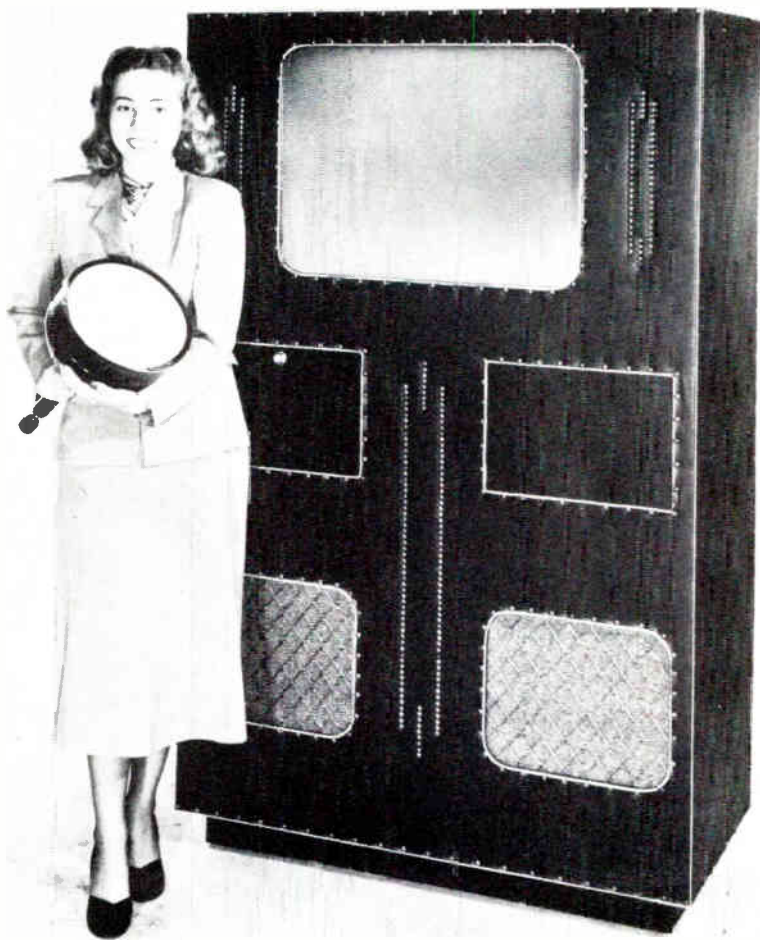

The industrial type projection receivers provide entertainment for large groups.
As shown, the receiver uses a large screen projection tube.

Courtesy U. S. Television Mfg. Corp.

Television Service Methods

PROJECTION RECEIVERS

Contents

	PAGE
High Voltage Supply Circuits	4
Servicing the H.V. Supply	6
Picture Tube Replacement	11
Replacement of Optical Components	12
Viewing Screen	12
Flat Mirror	13
Corrector Lens	13
Spherical Mirror	14
Optical System Alignment	14
Servicing the Protelgram Unit	16
Picture Tube Replacement	16
Centering and Focusing Adjustments	17
Replacement of Focus Coil	19
Deflection Yoke Replacement	20
Optical Service	20
Theater Television Equipment	21
X-ray Radiation	24

Twelve Things to Remember—

1. The value of time.
2. The success of perseverance.
3. The pleasure of working.
4. The dignity of simplicity.
5. The worth of character.
6. The power of kindness.
7. The influence of example.
8. The obligation of duty.
9. The wisdom of economy.
10. The virtue of patience.
11. The improvement of talent.
12. The joy of originating.

—Marshall Field

PROJECTION RECEIVERS

In a previous series of lessons, the various methods were explained which are employed to increase the size of the received image in the projection type television receivers. Although the signal circuits, sync circuits, and deflection circuits are the same in both the projection and direct-view types of receivers, the projection receiver high voltage supply is designed to provide the considerably higher anode potential which is necessary to produce the relatively high screen intensity needed. Here again, the circuits are similar basically in the two types of receivers; just one or more additional stages employed in the voltage-multiplier section of the projection receiver high voltage supply.

Therefore, from an electric standpoint, the troubles which develop and the servicing procedures employed are the same for projection receivers as for direct view units, and having been covered previously, these details will not be repeated now. The essential difference between the two receiver types lies in the fact that the projection unit contains some type of optical system for enlarging the image.

Since mechanical and optical troubles may develop in this system, this lesson is devoted to the adjustment, cleaning, and replace-

ment of the various elements of the optical systems, as well as pointing out important details in the servicing of the high voltage supplies.

HIGH VOLTAGE SUPPLY CIRCUITS

In some projection receivers, the high voltage supply consists of the common flyback circuit arrangement and a voltage-multiplier which contains three or four rectifier tubes and associated capacitors, and the output of which is in the neighborhood of 27 to 30 kv. A second common arrangement consists of a voltage-multiplier driven by a pulse generating circuit which is not associated with the receiver deflection circuits.

A schematic diagram of a pulse type high voltage supply is shown in Figure 1. Here, tube V_1 operates as a blocking oscillator, V_2 as a pulse amplifier, and tubes V_3 , V_4 , and V_5 are the rectifiers in the voltage-multiplier circuit. As indicated by the dashed line, the high voltage transformer T_2 and the voltage-multiplier components are enclosed in an oil filled, sealed can.

The two-section triode V_6 operates as a high voltage cutoff device to prevent a horizontal or vertical line being burned on the

screen of picture tube V_7 in the event of failure in either of the receiver deflection circuits.

Explained in detail in a previous lesson, briefly the action of the circuit of Figure 1 is as follows. The blocking oscillator produces a 1000 cycle pulse which is amplified by V_2 and applied to the primary winding of transformer T_2 . As the entire winding of T_2 serves as the high voltage secondary, the pulse is stepped up in voltage and applied to tube V_3 and capacitor C_9 , which form the first stage of the voltage-multiplier. C_9 is charged to the peak of the voltage pulse across the secondary of T_2 , and so capacitors C_{10} and C_{11} are each charged to twice this peak value.

C_9 and C_{11} are connected in series, as shown, and thus their charges add to provide the total indicated output of 25 kv. Heater windings on T_2 provide current for the rectifier tube heaters, and a fifth winding serves to apply the pulse voltage to the diode to charge C_8 and C_7 . Together with R_8 , these capacitors form a pi type filter to apply a fixed negative bias to the grid of V_2 .

Since the frequency must be approximately correct to obtain the proper heater currents in rectifier tubes V_3 , V_4 , and V_5 , a vernier adjustment of the blocking oscillator frequency is provided by variable capacitor C_6 .

As indicated in Figure 1, the receiver horizontal deflection voltage is applied through capacitor C_{12} to the grid of one section of V_6 , and the vertical deflection voltage through capacitor C_{13} to the grid of the other section. These respective applied voltages cause grid current such that grid leak voltages are developed across grid resistors R_{10} and R_{11} , cutting off the plate currents of tube V_6 .

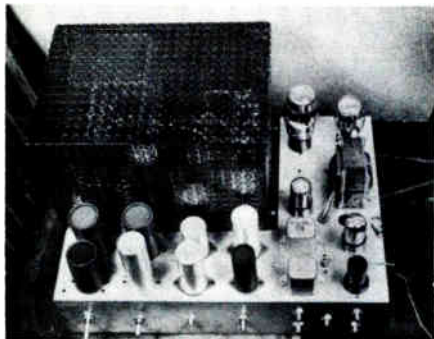

The top view of the high voltage and deflection circuit chassis used in projection type receivers.

Courtesy Television Assembly Co.

Thus, the only voltage drop across resistor R_{12} is due to the beam current of the picture tube. That is, with V_6 cutoff, the greatest part of the picture tube operating bias is the negative voltage applied from the slider on potentiometer P , through resistors R_{14} , R_{15} , R_{16} , R_{17} , and peaking coil L to the grid of V_7 .

Should either deflection circuit fail, the grid leak bias across R_{10} or R_{11} will be reduced or disap-

pear entirely, to permit conduction of the associated triode section of V_6 . The resulting plate current will produce a voltage drop of the indicated polarity across cathode resistor R_{12} , and thus bias the picture tube cathode positive with respect to ground.

In series in the grid-cathode circuit of picture tube V_7 , this bias will add to the operating grid bias to increase the total grid-cathode voltage and thus greatly reduce the intensity of the electron beam. This protection is highly important because if either deflection circuit should fail, the beam at full intensity would burn a hole in the screen material in less than a second.

SERVICING THE H.V. SUPPLY

Symptoms such as no light on the screen, reduced picture brightness, and increased raster width and height indicate trouble in the high voltage supply, or in other receiver circuits upon which proper operation of the high voltage supply depends. First, the usual preliminary check of the power cord plug and fuses should be made. Also, any other connecting plugs and the picture tube socket should be checked to see that they are not disconnected. If no such obvious faults are visible, then a neon bulb may be used to locate the faulty section, and

voltage and resistance tests made to locate the defect in receivers employing the flyback type of high voltage supply.

When a pulse type high voltage supply is employed with a cutoff tube, like the circuit of Figure 1, then trouble in either of the deflection circuits or in the high voltage supply can cause these symptoms. The following check may be employed to determine the faulty section.

With the receiver brightness control set at the extreme counter-clockwise position, tube V_6 is removed from its socket. Next, the screen is watched carefully while the brightness control is advanced slowly until the screen is just illuminated, or until the full clockwise position is reached with no illumination on the screen. This procedure should be followed with great care because IF THE BEAM CURRENT BECOMES EXCESSIVE AT ANY TIME, IT MAY QUICKLY DAMAGE THE PICTURE TUBE SCREEN.

When the above check is made, if a vertical line appears on the screen, trouble is indicated in the horizontal deflection circuits, and further tests should be made in these circuits to locate the defect. In similar manner, trouble is indicated in the vertical deflection circuits if a horizontal line appears on the screen.

In the event the entire screen becomes illuminated, then the

brightness control may be advanced further in an attempt to obtain normal screen brightness. If normal brightness cannot be obtained, the raster has excessive width and height, or if no light can be obtained with the brightness control at maximum setting, then either the high voltage supply is not operating properly, or the picture tube is defective.

or it may be in the oscillator or amplifier stages which together are known as the "driver unit". As in any type of television receiver, TESTS OF THE HIGH VOLTAGE SUPPLY SHOULD BE CONDUCTED WITH THE POWER TURNED OFF for safety. However, if the trouble cannot be located in this manner, it may be necessary to make operating voltage tests.

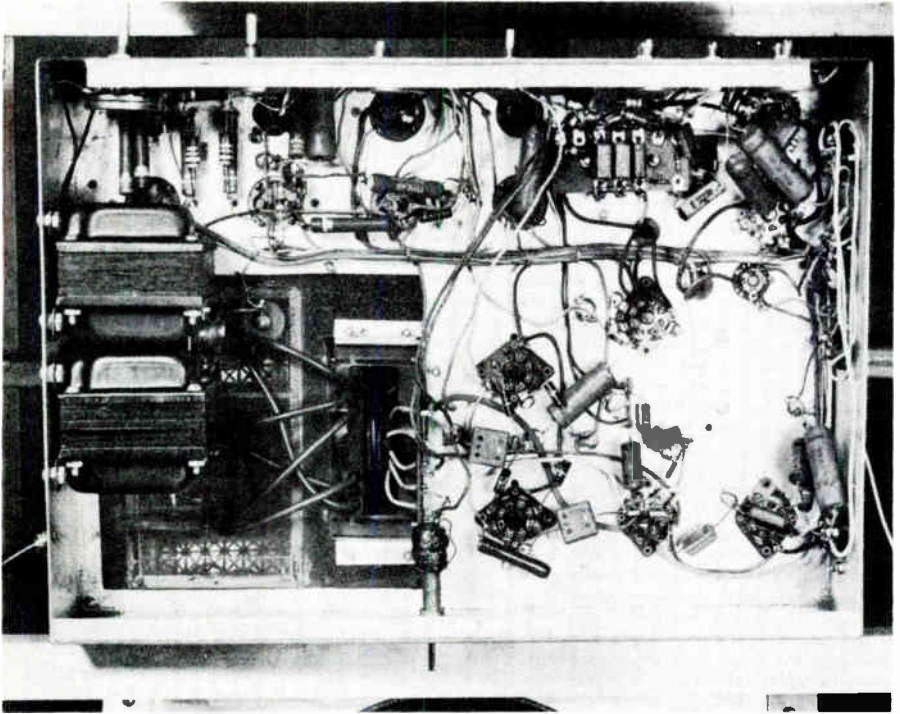

The underchassis view of the high voltage supply shown in the preceding illustration. Note the heavy insulation of leads and ports used in the high voltage section (lower left).

Courtesy Television Assembly Co.

In the high voltage supply circuit of Figure 1, the defect may be located within the sealed can,

When trouble in the high voltage supply is indicated, first the tubes of the driver unit should be

checked by replacing them. The location of these tubes is shown in the drawing of the high voltage supply unit in Figure 2. As shown here, this unit is mounted on a separate chassis and contains only the tubes and circuits of the driver unit and the voltage-multiplier of Figure 1. Not part of the high voltage supply proper, the high voltage cutoff tube circuit is located on the main chassis of the receiver.

Whenever the high voltage driver unit amplifier tube is replaced, care should be taken that the plate lead is dressed away from all other leads or grounded objects by a distance of at least $\frac{1}{4}$ inch. If this is not done, brush discharge may result and produce interference in the received picture.

If the tube check does not correct the trouble, the bottom cover of the chassis may be removed and a voltage check made at the grid pin of the oscillator tube V_1 . As indicated in Figure 1, a bias of approximately -50 volts is present on this grid when the oscillator stage functions normally.

With the power off, resistance tests should now be made in the oscillator circuits if the proper grid bias is not present, or in the amplifier circuits if the V_1 bias is present. In case the resistance tests do not locate the defect, the power should be turned on and

voltage tests made in the driver unit circuits.

As shown in the example of Figure 1, the proper operating voltages are given in the schematic diagram, or in voltage charts, for the different check points in a particular receiver. However, it should be kept in mind that these values represent only the voltages which are present UNDER NORMAL CIRCUMSTANCES; EXTREMELY HIGH VOLTAGES MAY BE PRESENT AT UNEXPECTED POINTS DUE TO ABNORMAL CONDITIONS.

When the driver unit is found to be operating properly, the operation of the sealed can unit may be checked by employing a suitable high voltage probe, insulated test leads, and voltmeter to test the high voltage output. Again, due to the danger involved, EXTREME CAUTION SHOULD BE EXERCISED, and the procedure followed as outlined in the lesson on no raster troubles.

If the high voltage output is low or zero, a defect is indicated either within the can or the high voltage lead. Within the high voltage lead and about 2 to 3 inches from the sealed can, filter resistor R_{19} is concealed. To determine if this resistor is at fault, a needle or a clip with sharp teeth must be used to penetrate the insulation between the resistor and the can.

When a high voltage is measured at this point, R_{19} is indicated to be defective, and should be replaced with a 1 meg resistor, or a series of resistors which total about 1 meg. If a high voltage is not found at this point, the defect is in the sealed can, and therefore, the whole unit will have to be replaced.

To replace the can, all possibility of circuit operation should be removed by first disconnecting the receiver a-c line cord from the wall receptacle. Next, the plate cap P is removed from the amplifier tube, Figure 2, and the 4 leads L unsoldered from the terminals at the top of the sealed can. However, the gland "G" is not unscrewed.

If the bottom cover of the chassis has not been removed previously, it is removed at this time by removing the 4 screws, S, two of which are visible in Figure 2. Finally, loosen the two nuts, N, thus releasing the clamps, C, so that the can may be removed. With the new can in place, clamps C are tightened by means of nuts N, the chassis bottom cover is replaced, and leads L soldered to the terminals on the top of the can. The soldering iron should not be held to these terminals any longer than necessary to make the proper soldered joints.

With care, as explained above, the plate cap is replaced on the

amplifier tube. Finally, when placing the cover over the high voltage unit, it should be oriented so that the 25 kv lead goes directly up through the cover. Should the lead cross over inside the box, severe arcing may result.

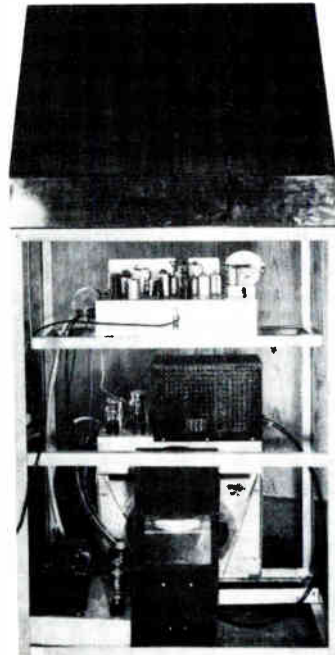

The rear view of a projection receiver. The projection tube, lens, and mirrors (lower center) are enclosed in a shield equipped with a viewing window to permit inspection of the tube while in operation.

Courtesy Television Assembly Co.

To insure maximum life of the rectifier tubes in the voltage-multiplier circuits, the tube heaters should be operated with the proper currents. Among other things, these currents depend upon the operating frequency of the driver unit, and, as mentioned, the oscil-



The 1B3-GT, a half wave rectifier, is designed for use in high voltage circuits.

Courtesy RCA

lator frequency can be varied somewhat by means of capacitor C_6 , Figure 1. However, C_6 should not be adjusted in an attempt to correct for failures in high voltage supply output voltage or cur-

rent regulation, since the operating frequency has negligible effect on the regulation.

To adjust the oscillator to the correct frequency, an oscilloscope, and a source of 1000 cycle voltage may be connected with the high voltage supply unit as shown in Figure 3. The resistor R, of about 10 ohms, is connected in series with the red (+350 V) lead, and serves to produce a sufficient a-c voltage drop to provide a signal for operating the scope vertical deflection circuits.

With the 1000 cycle voltage applied to the horizontal input of the CRO, C_6 is adjusted until the Lissajous figure on the screen indicates a frequency ratio of one-to-one. After the oscillator frequency has been set, resistor R should be removed before the high voltage supply is replaced in the receiver.

In the FADA model 880 projection receiver, a high voltage unit like that of Figure 1 is employed, and, in addition to the regular low voltage power supply, the auxiliary power supply furnishes the 350 volts for the plate and screen circuits and 6.3 volts a-c for the heater circuits of the high voltage supply driver unit. Therefore, in an arrangement of this type, a defect in this auxiliary supply could result in reduced brightness, or no light on the screen, even though the regular low voltage supply is operating properly.

In the event the various checks mentioned above show the power supplies and deflection circuits, including the high voltage cutoff circuit, to be operating properly, then the operating voltages and circuit components in the picture tube circuit should be tested. If this check does not locate the trouble, the picture tube itself should be checked by replacing it with a new one.

PICTURE TUBE REPLACEMENT

The general arrangement of the picture tube and optical system, which has been used in projection receivers made by RCA, GE, Philco, etc., is shown in Figure 4. In these receivers, the picture tube is mounted with its axis vertical as shown, or at an angle to the vertical.

The light rays travel from the tube face to the spherical mirror which then reflects them through the corrector lens to the flat mirror from which they are reflected to the viewing screen. These paths are indicated by the arrows in Figure 4. Since the viewing screen is translucent, the light passes through it so that the image focused thereon is visible to the observers in front of the screen.

Different clamping arrangements are used to hold the picture tube in place in the various receiver makes, and for each mod-

el, the corresponding service manual contains the specific instructions for replacing or installing the picture tube. However, the procedure is nearly the same for all cases, and as an example, here are the procedures for the GE model 901 receiver:

Detach the anode cap and the tube socket. With the tube held securely, use a screwdriver to loosen the screws on the sides of the tube clamp, then spread the clamp open with the blade of the screwdriver, and ease the tube down and out of the clamp and deflection yoke.

Hold the yoke in place and install the new tube from underneath the corrector lens. The deflection yoke textolite sleeve must be kept within the rubber lining on the tube clamp. Pass the tube base through the clamp carefully so the base will not be loosened from the neck.

With the tube rotated so that the anode connection is toward the back of the receiver, tighten the screws to hold the tube firmly in the clamp. Then, attach the anode cap and the tube socket.

The picture tubes employed in these receivers have an insulating coating over the large part of the bulb, as indicated in Figure 4. During humid weather, electric breakdown may occur over this surface due to fingerprints or dust on the coating. Therefore the in-

sulating coating should not be touched when the tube is handled, and the dust cover should be replaced when service work is completed.

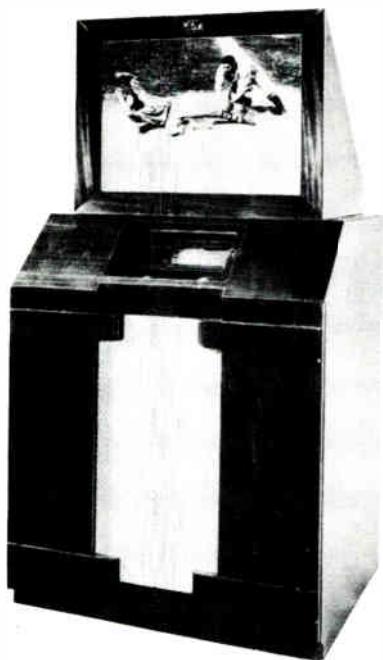

A large screen projection receiver designed for home entertainment.

Courtesy U. S. Television Mfg. Corp.

REPLACEMENT OF OPTICAL COMPONENTS

In addition to the picture tube, occasionally it is necessary to replace a damaged viewing screen or other optical system component in a receiver of the type illustrated in Figure 4. Except for the order in which the various components are removed or in-

stalled, again the procedures are about alike for the various makes and models. The replacement of the optical units for the GE 901 are as follows:

Viewing Screen

With the screen housing in the elevated position, the top rail is removed by removing the screws which hold it in place. Next, the tape strip and three rubber cushions are removed from along the top edge of the screen, and the screen slid up and out by bearing gently upon its surface near the top and center with the palm of the hand.

The new screen is installed by inserting its side edges in the vertical grooves of the housing and sliding it downward using the hand as explained above. The bottom edge of the screen is seated into the grooved recess by tapping GENTLY on the top edge.

The three rubber cushions and tape strip should be replaced, making certain the tape does not cover any of the picture viewing area. Finally, the top rail and holding screws are replaced on the screen housing to complete the assembly.

Whenever the screen is handled, care should be taken that it does not become fingerprinted. In the event it is finger-printed, it should be cleaned with a piece of cotton slightly dampened with Windex

or water. Only a light rubbing action is necessary to clean the screen, and it should not be washed with water or rubbed hard at any time. Dry cotton or a camel's hair brush may be used to remove dust from the screen.

Flat Mirror

To remove the flat mirror in this receiver, it is necessary to remove the viewing screen first, as outlined above. Then, the screws are removed which hold the flat mirror clamps to the screen housing, after which the mirror can be removed from the receiver. Next, measurements should be made along the edge of the mirror to determine the exact locations of the clamps, and then the clamps removed from the mirror.

The replacement mirror has tissue packing on it, and to prevent fingerprinting a front surface mirror, THE TISSUE SHOULD NOT BE REMOVED UNTIL THE INSTALLATION IS COMPLETED.

Usually, a label will be found glued to the back of the mirror. However, in the event there is doubt about which is the front of the mirror, this may be determined by laying it on a flat surface and then carefully approaching the surface of the mirror with an opaque object such as the point of a pencil.

If the image of the object is observed to come into contact with

the object at the surface, then this surface is the front of the mirror. On the back surface, a spacing equal to twice the thickness of the glass will be observed between the object and its image.

Using the measurement data obtained earlier, the clamps are fitted to the edge of the new mirror, at the proper locations and right over the packing tissue. The mirror now is installed in the receiver by aligning the clamps with the original mounting holes in the screen housing and inserting and tightening the screws. Finally, the tissue packing should be removed from the mirror and the viewing screen replaced.

In the event the clamps are loosened on the original mirror, or the mirror is shattered so that the position of the clamps cannot be determined, it is then necessary to employ a cut-and-try method of fitting the clamps to the new mirror and checking their mounting hole alignment to coincide with the mounting holes in the screen housing.

The use of the original holes in the screen housing is necessary because, in each receiver, the original screen was installed with the correct angular alignment at the factory to provide proper reflection angles for the light rays.

Corrector Lens

As shown in Figure 4, the picture tube protrudes through the

hole in the center of the correcting lens, and in this receiver the picture tube mounting bracket (not shown) clamps to the tube base above the lens. Therefore, before the lens can be removed, the picture tube must be removed as outlined above, and also the picture tube mounting bracket by removing the screws which secure it to the corrector lens mounting plate. The lens now may be removed by removing the nuts, lock washers, steel washers and fiber washers which hold it in place on the mounting plate.

The new lens should be mounted with the painted edge and concave surface up, and the mounting hardware replaced in the proper order such that the fiber washers make contact with the top edge surface of the lens and are followed in sequence by the steel washers, lock washers, and nuts, respectively. With the lens installed, the picture tube mounting bracket, deflection yoke, and tube may be replaced.

Spherical Mirror

In the GE projection receiver model mentioned, a large mounting plate supports the spherical mirror, and rubber cushioned clamps hold the mirror on the plate. To replace the mirror, it must be supported while the screws and clamps are removed. Then, the mirror can be lifted out of the cabinet. With the replace-

ment mirror mounted carefully, the clamps are replaced, making certain the rubber cushions are between the mirror edge and clamps so that the cushions bear on the mirror edge.

The viewing screen, flat mirror, corrector lens, and spherical mirror all should be handled in such a way as to prevent fingerprinting. However, if they do contain fingerprints or dust, they should be cleaned as explained above for the viewing screen. In the case of the spherical mirror, dust may be gently brushed to the center of the black area where it may be picked up with scotch tape.

After any of the above components has been replaced, an operating check should be made by viewing a received picture to determine whether the original alignment has been maintained. In some cases, the system may have become misaligned sufficiently to seriously reduce picture quality, and complete re-alignment is needed.

OPTICAL SYSTEM ALIGNMENT

Because of the different methods of mounting the optical system components in the different makes and models of projection television receivers, the details of the alignment procedures differ considerably, and as with the

parts replacements, the specific instructions given in the corresponding service manual should be followed for each individual case. To permit the desired alignment, various adjustment nuts and screws are available. In some cases, equipment such as a test lamp and a sighting jig are needed.

picture tube or the corrector lens. In various receivers, adjustments may be made to obtain the correct angular position of the corrector lens with respect to the flat mirror and screen, the correct centering of the lens with respect to the axis of the optical system, the correct spacing between the lens

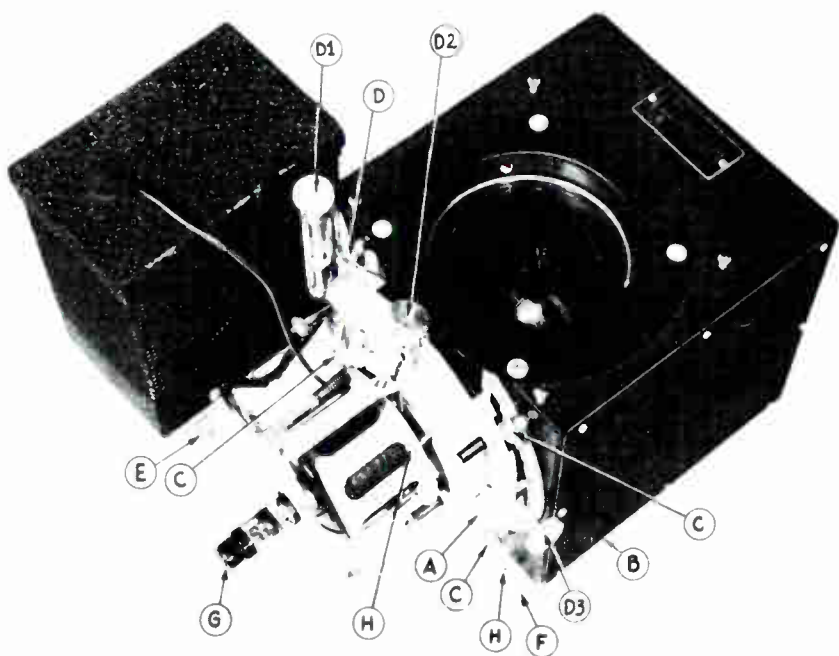

Shown is a complete protelgram unit with the high voltage supply. The unit labels are: A—mounting plate, B—optical box, C—tube assembly mounting screws, D—adjustment lock, D₁—adjustment between tube face and spherical mirror, D₂—tube vertical tilt screw, D₃—tube horizontal tilt screw, E and F—units mounting clamps, G—tube socket, H—mechanical centering and focus screws.

Courtesy Scott Radio Lab.

In most cases, alignment is necessary only when certain components are replaced such as the

and spherical mirror, and the correct lateral position of these two units with respect to each other.

Other adjustments permit the proper positioning of the picture tube and deflection yoke to obtain the best over-all focus, centering, and squaring of the test pattern with respect to the viewing screen. In addition to the above, adjustments may be required to properly position the entire optical unit with respect to receiver cabinet.

SERVICING THE PROTELGRAM UNIT

In general, projection type television receivers fall into two categories: those which employ the basic optical system arrangement shown in Figure 4, and those which use a variation of this arrangement called the Protelgram unit manufactured by North American Philips. A third, smaller group consists of those receivers which contain the refractive type optical system similar to that used in motion picture projectors.

The arrangement of the components of the Protelgram unit is illustrated by the cross-sectional drawing of Figure 5A. Here, the optical components are contained within the optical box on one end of which the focus coil and alignment assembly are mounted and into which the picture tube and deflection yoke are inserted. In addition to the components shown in Figure 5, the complete Protelgram unit includes the high volt-

age supply illustrated in Figures 1 and 2.

Compared to the arrangement of Figure 4, in the unit of Figure 5 the flat mirror contains a hole through which the picture tube bulb protrudes, and the light rays travel from the tube face to the spherical mirror, to the flat mirror, and then through the corrector lens which is shown located above the tube. Leaving the corrector lens, the light rays travel to the viewing screen (not shown), or to another flat mirror, and then reflect to the viewing screen to form the desired enlarged image.

Picture Tube Replacement

In the assembly of Figure 5A, the picture tube is held in place by means of tube clamp C, and is centered by means of the triangular end plate shown in the rear view of the assembly, Figure 5B. To replace the tube, the tube socket is removed, the four nuts M, loosened, and the alignment assembly rotated slightly to the left and then pulled out from the optical box, taking care that the tube does not hit the 45° flat mirror. NEVER hold the assembly by grasping the deflection yoke.

Next, the connector is removed from the anode cup on the picture tube, the two screws A, holding the high voltage cable clamp, are loosened, and the cable removed from the clamp. The tube clamp

screw C, Figure 5A, and the two screws T, Figure 5B, holding the triangular end plate, are loosened to permit the tube to be pulled forward out of the deflection yoke. Finally, the rubber band and light shield are removed from the bulb of the tube.

With the replacement tube held so that the anode cup is down, the light shield is mounted to shield the screen from above and held in place with the rubber band. The tube is pushed into the deflection yoke and alignment assembly as far as it will go. Then tube clamp screw C is tightened to hold the tube in.

The two springs, S, just press against the tube. These springs may clear or extend under the light shield. Then, the tube is kept centered in the hole in the triangular end plate while screws T are tightened.

The high voltage connector is placed in the anode cup and attached securely to the metal anode button. The cable is inserted in the cable clamp, and with the slack taken up, screws A are tightened.

The assembly is inserted into the optical box, taking care that the picture tube clears the opening in the flat mirror, the position of the light shield is not disturbed, and the tube does not shift forward from its seating in the de-

flexion yoke. The alignment assembly is rotated to the right until the bottom of the end plate is parallel with the bottom of the optical box, and the four screws M tightened. Finally, the tube socket is placed over the end of the tube to complete the installation.

Centering and Focusing Adjustments

In the unit of Figure 5, the picture tube faceplate must be located precisely with respect to the spherical mirror, flat mirror, and corrector lens to obtain satisfactory optical definition on the receiver viewing screen. Several adjusting screws are available for so locating the picture tube face when necessary, such as after replacement of the picture tube.

However, before these mechanical adjustments are made, the various electric adjustments should be made to obtain proper size, centering, and focus of the raster on the picture tube face. After checking to see that all connections are complete, the receiver is tuned to a station which is transmitting a test pattern.

If a test pattern is not available, the raster scanning and retrace lines can be used to check linearity and focus. To make the electric adjustments, the dust cover should be moved aside and

the reflected image of the picture tube face observed by looking down through the corrector lens, being careful not to touch the lens.

Never look into the face of a projection tube while the receiver is being operated. At these high voltages, soft X rays are generated which may prove injurious to the technician. By looking at the reflected image through the correction lens, this danger is avoided, since the lens does not pass the X rays.

The receiver size and linearity controls are adjusted to obtain the normal rectangular raster, of proper aspect ratio, which is large enough so that its four corners just touch the edge of the circular tube face. As all four corners cannot be seen from the same position, the position of the eye must be changed so that each corner is viewed separately to make centering adjustments. The focus control is adjusted to obtain the most narrow scanning lines in the raster.

After the electric adjustments are completed, if the image is off-center on the receiver viewing screen so that it does not completely fill the viewing screen frame, then mechanical centering adjustments may be made as follows: Loosen the wing nuts which anchor the optical box to the supporting shelf at the three points, F, Figure 5B. Tilt the assembly

by hand to correct the picture location on the viewing screen, and note which of the tilt screws, F, must be adjusted.

Hold the optical box free of the shelf at the tilt screws to be adjusted, and make the adjustments by turning the allen-head tilt screws clockwise to jack the box into position. Retighten the wing nuts, and make touch-up centering adjustments by means of the receiver centering controls.

In the event the image is tilted on the viewing screen, the four screws, M, may be loosened, and the alignment assembly rotated in the proper direction to correct the condition. When the desired position is obtained, the assembly is secured by tightening screws M.

Indicated in Figure 5B, three thumbscrew adjustments, H, V, and O, are employed to correctly position the picture tube face to obtain proper focusing. Thumbscrews H and V tilt the tube horizontally and vertically, respectively, with the center of the tube face as the center of rotation, while thumbscrew O moves the tube toward or away from the spherical mirror as desired. To make the focusing adjustments, the two locking nuts, L, and three screws N, should first be loosened about one turn each.

Then, in the following order, thumbscrew O is adjusted until

the center of the image is properly focused on the receiver viewing screen, thumbscrew H is adjusted until both sides of the picture are focused equally, and thumbscrew V adjusted until the top and bottom are focused equally. Touch up adjustments of all three thumbscrews should be made, with the setting of O rechecked after each slight adjustment of H or V, until the entire picture is brought into satisfactory focus. Tighten the locking nuts L and screws N.

Finally, looking down through the corrector lens as for the electric adjustments, advance the receiver brightness control and note whether the raster is uniformly bright over its entire area. With no picture signal, the raster illumination should remain uniform as the brightness is decreased.

If one corner is or becomes darker than the remaining area, the focus coil may be out of adjustment. This condition can be corrected by turning the screwdriver adjustment screw R, Figure 5B.

Although this adjustment causes some over-all displacement of the raster, it should not be used for this purpose. Centering of the raster on the picture tube face should be accomplished by means of the receiver electric centering controls.

Replacement of Focus Coil

When it is necessary to replace the focus coil in the Protelgram unit, first the picture tube should be removed as explained above. Then, referring to Figure 6, the three screws, A, are unscrewed and the triangular end plate removed. The cable clamp and the two mechanical centering adjustment screws, B, are loosened, the snap washers, W, and the spring, G, removed, and the focus coil may be removed from the assembly.

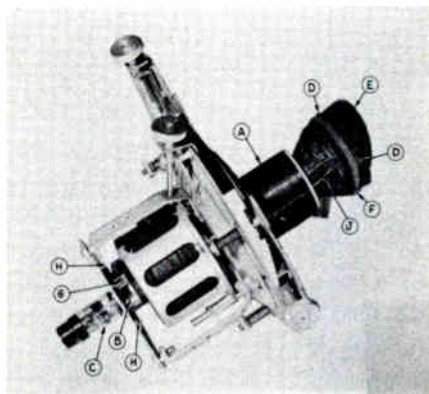

The protelgram unit with the optical box removed. The labels are: A—deflection yoke, B—tube clamp, C—tube neck, D—light shield stops, E—light shield, F—rubber band, and J—aquadag ground spring.

Courtesy Scott Radia Lab.

With the new focus coil in place, the spring G and washers W are replaced, the cable clamp tightened, and the triangular end plate reassembled. The picture tube is installed and the assembly mounted into the optical box as explained previously.

With the Protelgram unit reinstalled in the receiver cabinet, the receiver is switched on and tuned to receive a test pattern. The horizontal and vertical electric centering controls are set to their approximate mid-positions, and the centering adjustment screws B, Figure 6, adjusted until the corners of the test pattern just touch the edge of the picture tube face, as observed by looking down through the corrector lens. When these adjustments are completed, then the electric and mechanical centering and focusing adjustments are made as outlined in the preceding section.

Deflection Yoke Replacement

To replace the deflection yoke in the Protelgram unit, the picture tube and focus coil must be removed first as explained above. After carefully noting the mounting position of the yoke to be removed, the four screws, S, Figure 7, are unscrewed, and from the opposite side of the mounting plate, the ground lug screw is removed. Next, the plastic insulating disc is removed, after which the deflection yoke can be removed from the mounting plate. With the new yoke positioned exactly as the original one was, the entire unit is reassembled. Finally, with a test pattern received, the various centering and focus adjustments are made as explained previously.

Optical Service

With the exception of the picture tube, the components of the optical system within the Protelgram optical box are aligned at the factory, and this box must be returned to the factory for any needed replacement of parts or re-alignment of the mirrors or corrector lens. The optical box is a dust-proof unit, and normally the mirrors inside will not require cleaning.

The top of the corrector lens may be cleaned with a soft cloth. Should it become necessary to clean the mirrors, the side plates of the optical box can be removed and the mirrors dusted with a camel's hair brush and then polished very gently with lens tissue. A spray, such as Windex, may be used if dirt or discoloration is excessive.

In addition to the components in the optical box, receivers employing the Protelgram unit contain a viewing screen, and in some cases, a second 45° flat mirror, both of which are located outside of the box. When damaged, these external optical units may be replaced as described earlier in this lesson for receivers of the type using the optical arrangement of Figure 4.

Also, as mentioned, these units may be cleaned with a piece of absorbent cotton and a liquid solution of the Windex type. AT NO

TIME should the mirrors, lens, or viewing screen in any projection equipment be cleaned with an abrasive cleaning agent such as Bon Ami, Lava Soap, etc.

THEATER TELEVISION EQUIPMENT

Although operating on the same general plan as the home type projection receivers insofar as the optical system is concerned, the television projection equipment employed in theaters must be designed to provide sufficient light output to illuminate satisfactorily a screen large enough to be viewed comfortably by an audience.

In addition, suitable facilities must be available for switching the video circuits to receive signals from either a regular television receiver, microwave relay receiver, or a coaxial cable, and for monitoring the received signals at various points in the system by means of a monitor picture tube and an oscilloscope.

The general layout of the electric equipment employed in the RCA model PT-100 projection system for theaters is shown in Figure 8. As indicated by the dashed lines in the sketch, three different rooms contain the control equipment, projector, and high voltage supply.

In the control room, the signal selector unit permits the selection

of the signals from either of two sources, indicated as lines 1 and 2, the control panel contains the sound and picture monitors, oscilloscope, and controls, and the deflection generator provides the horizontal and vertical deflection currents for the projection tube yoke. The power supply block represents a number of supply and voltage regulator units which provide power for the other units in the control room, power room, and projector.

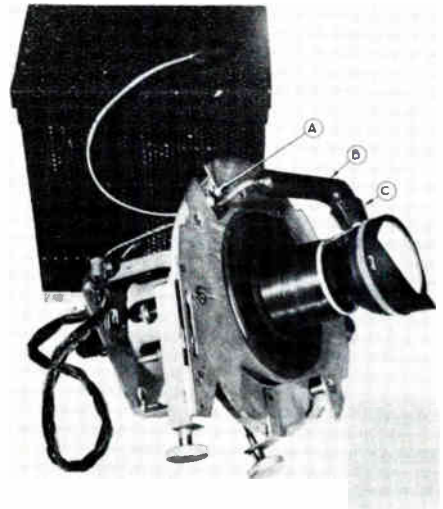

The protelgram showing the high voltage connections. The labels are: A—cable clamp, B—connector insulator, and C—the high voltage cup connector.

Courtesy Scott Radio Lab.

In the projection booth, the projector contains a video amplifier, a projection picture tube of special design to be described, and a reflective optical system

(not shown) which is similar to that of Figure 4, but without the flat mirror. Safely located in a room by itself, the high voltage supply provides outputs of 80 kv for the anode and 18 kv for the focusing electrode of the projection tube.

Figure 9 is a sketch of the switching circuits employed in the signal selector unit in the control room. Here, switch S_1 permits connecting either of the two signal sources, lines 1 and 2, to the input of the projector. Switches S_2 and S_3 permit the picture monitor or the oscilloscope to be connected to either line 1, line 2, or the output of the v-f amplifier in the projector. Thus, the nature of the received signals can be observed in the control room during the program, or, if desired, before projecting the picture on the theater screen.

In addition to the switching circuits shown in Figure 9, the signal selector unit contains various amplifiers and attenuators, as well as circuits which provide for switching alternative audio signal sources to the audio monitor headphones and the regular theater sound system.

The type 7NP4 projection tube employed in the above theater system is shown in the cross-sectional drawing of Figure 10. As indicated, the tube has a face diameter of 7", this size providing

a good balance between light output and the required size of the optical components. The electron gun consists of the indirectly heated cathode, three grids, and the anode which makes conductive contact with a coating on the inside surface of the cone of the tube.

Electrostatic focusing and magnetic deflection are employed, with a deflection angle of 35° . This relatively narrow deflection angle minimizes loss of resolution near the edges of the reproduced image and reduces the deflection power required. This last factor is important because deflection power requirements become greater as the anode operating potential is increased.

The required high light output is obtained by employing a high-efficiency screen and a high-energy electron beam. The screen is made efficient by means of the proper mixture and layer arrangement of phosphors of types capable of converting a high percentage of the electron beam energy into light.

Since the electron beam current is limited by considerations of focusing and energy absorption by the screen, the beam energy is increased by use of 80 kv high anode potential. To maintain the screen at full operating potential and to reflect light forward, an aluminum coating is applied to

the back of the screen, as indicated in the Figure.

Since the deflection yoke is grounded, and the cathode operated at or near ground potential, the full 80 kv is applied over half the length of the tube, from the anode contact to the deflection yoke. To prevent leakage along the outside surface of the tube cone between these two points, the path is made long by locating the anode terminal as far forward on the cone as possible and molding corrugations in the outer surface of the cone, as shown in the figure. In addition, the cone is made longer than usual due to the narrow deflection angle used. Finally, a moisture-repellent, insulating lacquer coating is applied to the outer surface of the cone to prevent the formation of moisture which tends to permit corona and arcing.

To increase the insulation between the deflection yoke and the anode coating on the inner surface of the tube neck, the double-neck arrangement is used as shown. Here, the inner neck carries the anode coating and is inserted into the larger outer neck in such a way that vacuum insulation is provided in the space between the two necks.

To permit bringing the 18 kv lead from the focusing electrode, grid No. 3, out through the tube base, the air is removed from the

base and the base filled with a plastic material having high dielectric strength. Finally, a special type of glass is used in the faceplate of the tube to prevent the faceplate from darkening in a short time due to the electron bombardment.

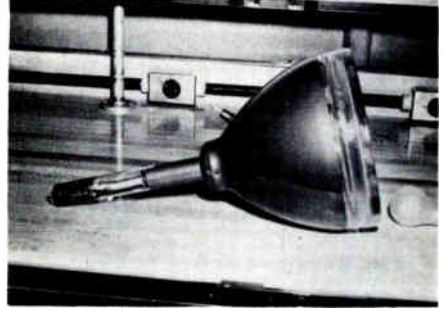

A large screen projection tube. Note: the high voltage connector is off-set and well insulated to prevent arc-over.

Courtesy Philco Corp.

The arrangement of the 7NP4 projection tube and the various optical system components of the RCA theater television unit is shown in Figure 11. As shown here, the 26 inch spherical mirror is located a distance of 30 inches from the correcting lens which, as indicated, has a useful or working diameter of $21\frac{1}{2}$ inches. The entire optical system is designed to focus the image on a standard 15 by 20 foot viewing screen located a distance of 60 feet from the correcting lens.

During normal operation, from 80 to 160 watts must be dissipated on the faceplate of the projection tube, and unless cooling is

provided other than that caused by convection and radiation, the heat generated would reduce the efficiency of the luminescent screen and possibly cause the faceplate to fracture. Therefore, the faceplate temperature is maintained below the recommended maximum value of 100° C by directing upon it a stream of air from a small blower through a hole in the center of the spherical mirror, as shown in Figure 11.

X-RAY RADIATION

Because of the high anode voltages employed in the various projection type picture tubes, the scanning beam electrons bombard the inner surface of the faceplate with sufficient force to produce penetrating X rays.

For example, the X-ray radiation intensity in various directions from the faceplate of the type 7NP4 tube is shown in the polar graph of Figure 12. As indicated, intensity is measured in roentgens per hour per milliamperere, the roentgen being the international standard unit of quantity of X rays.

Although commercial X-ray tubes provide intensities much higher than the values indicated by the curve of Figure 12, the

radiation levels of the television projection tubes are many times higher than is safe for continuous exposure at close range. Therefore the tubes are shielded by enclosing the entire optical system in a metal "barrel". As indicated in Figure 11, the correcting lens is made of a type of glass which absorbs X rays but allows light to pass.

In the Protelgram unit of Figure 5, the X-ray radiation is confined by the optical box and, as recommended by the manufacturer, the picture tube should be operated only when it is inside the box. However, in the event it is necessary to operate the tube outside the box, the observer should be protected by means of a lead glass shield placed in front of the tube face when it is necessary that the observer be within 40 inches of the tube.

This shield should have dimensions such that it will interrupt the X rays between the tube and observer, and should have an equivalent lead thickness of not less than 0.5 mm. In the case of the projection receivers using the optical arrangement of Figure 4, similar precautions should be employed when it is necessary to operate the picture tube outside the protective metal barrel.



STUDENT NOTES

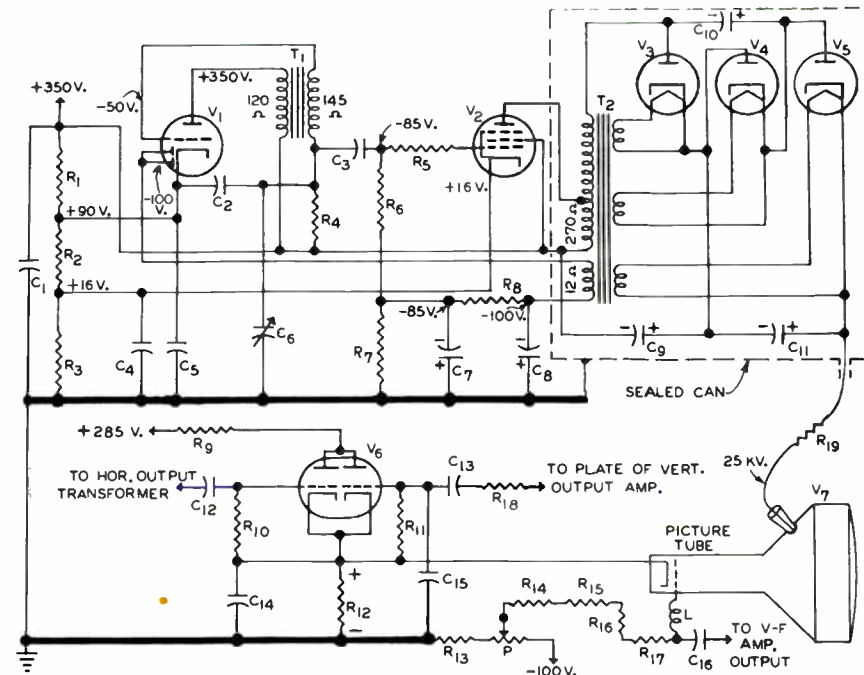
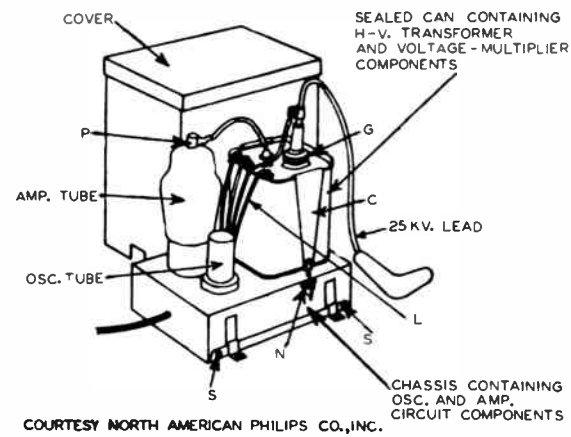

FIGURE 1



TSM-19 FIGURE 2

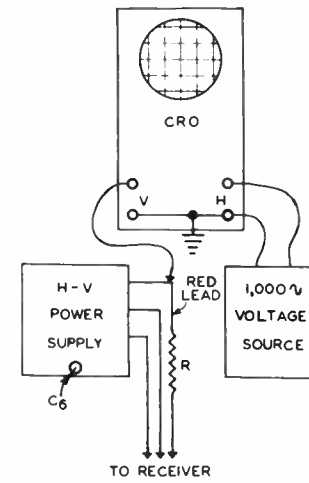

FIGURE 3

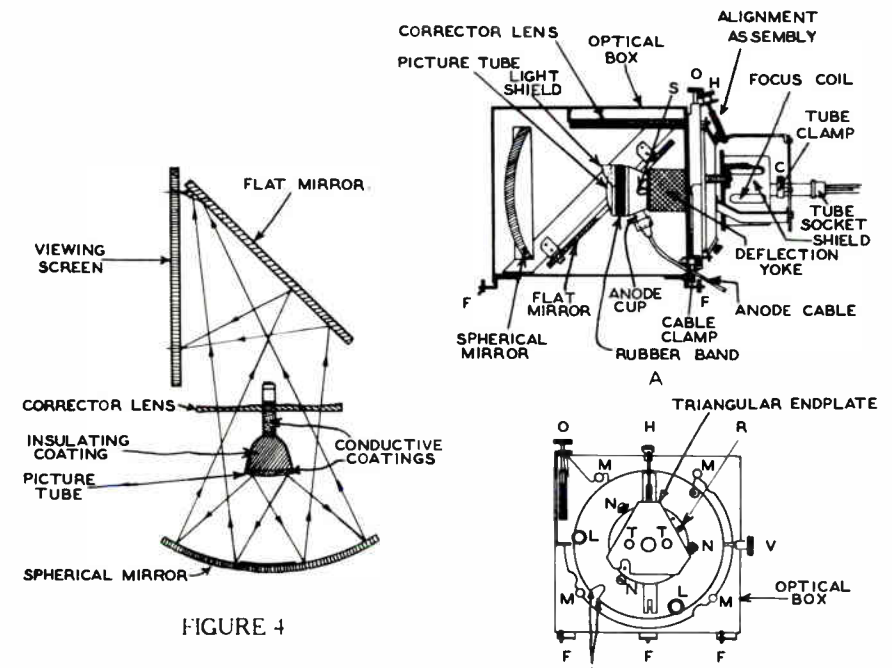
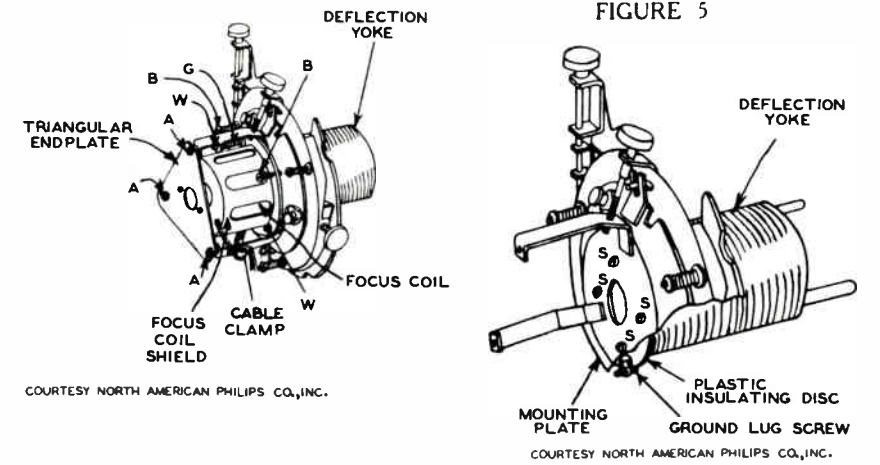

FIGURE 4

B
FIGURE 5



TSM-19 FIGURE 6

FIGURE 7

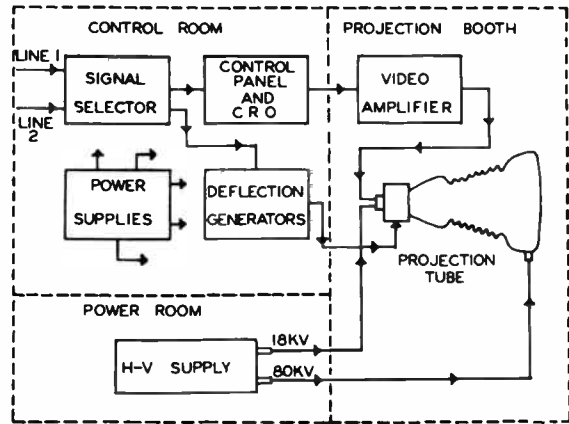

FIGURE 8

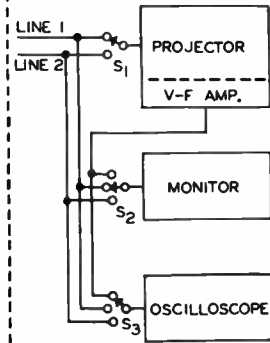
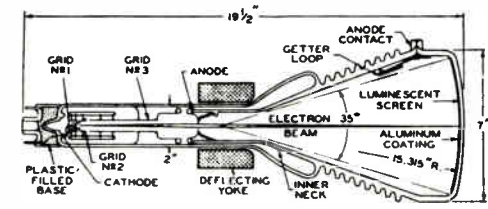
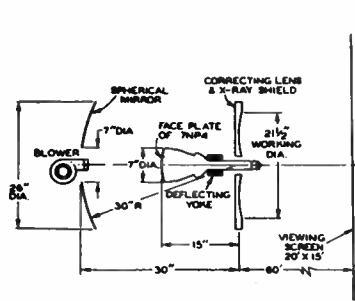

FIGURE 9



COURTESY RCA

FIGURE 10



COURTESY RCA

TSM-19 FIGURE 11

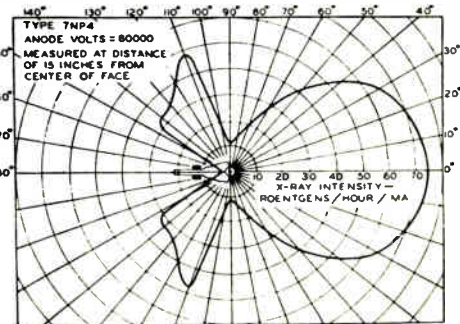

COURTESY RCA

FIGURE 12

FROM OUR *Director's* NOTEBOOK

GET THERE ON TIME

When you take a trip and your train leaves at 5:32, you try your best to be on the platform at that time. The train, unfortunately, won't wait until it is convenient for you to climb aboard.

Neither will your employer wait. As office or shop hours are set for the convenience of the customers, it is important that you be available to serve their needs.

Employers, in particular, frown upon tardiness—not only because you are not there when needed, but you are also setting a bad example for those employees who make the effort to be on time.

Promptness in all your activities is important. It helps to establish you as a reliable person . . . the kind of a fellow who is more deserving of greater responsibilities.

Whether it's for an employment interview, a dinner engagement or for daily work, **BE ON TIME.** Punctuality is worth the small effort it takes.

Yours for success,

W. C. Healey
DIRECTOR

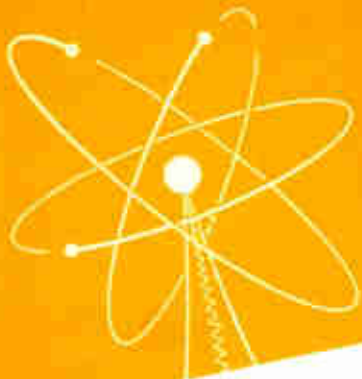

PARTS REPLACEMENT

Lesson TSM-20A

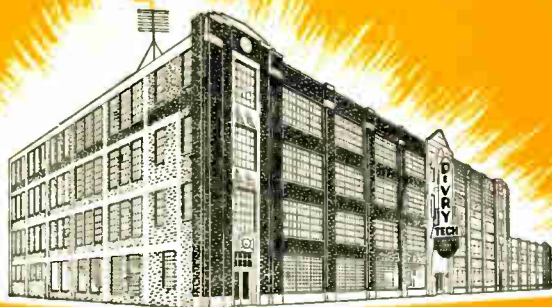

DeVRY Technical Institute

4141 W. Belmont Ave., Chicago 41, Illinois

Formerly DeFOREST'S TRAINING, INC.

PARTS REPLACEMENT

4141 Belmont Ave.

COPYRIGHT 1955

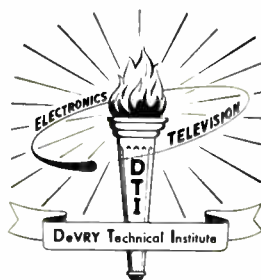

Chicago 41, Illinois

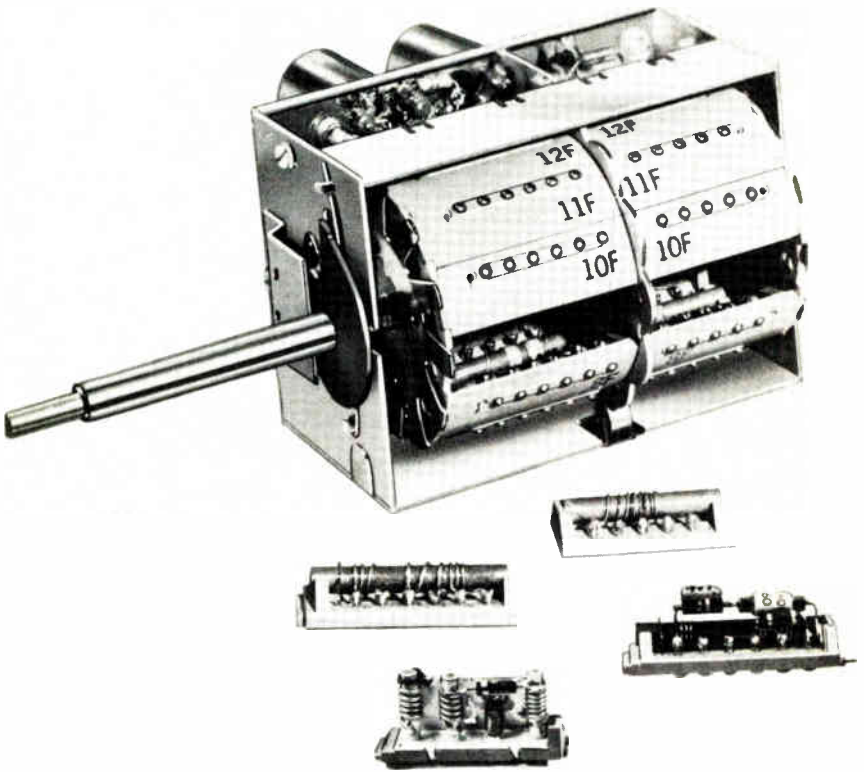

The turret tuner channel tuning strip is held in place by spring clips which permit easy replacement. The channel 9 tuning strip is shown removed to permit replacement with the UHF converter strip in the foreground.

Courtesy Standard Cail Products Co.

Television Service Methods

PARTS REPLACEMENT

Contents

	PAGE
Identification of Components	6
Removal of Faulty Component	8
Installing New Component	10
Operational Test	13
Tuner Repairs	14
Improper Contact	14
Frozen Mechanism	16
Defective Detent	17
Cabinet Repairs	18

Ideals are like stars; you will not succeed in touching them with your hands, but like the seafaring man on the desert of waters, you choose them as your guides, and, following them, you reach your destiny.

—Carl Schurz

PARTS REPLACEMENT

In the earlier lessons of this series, the troubleshooting procedures employed to locate defects in television receivers were covered in detail and, as with any electronic equipment, generally this part of the work forms the most time consuming portion of a given service job.

After the trouble has been found however, there still remains the problem of repairing or replacing the defective part. Although this part of the job is mainly mechanical, care must be taken that the proper electric conditions are restored so the repaired receiver will operate as well as it did before the trouble developed.

Because of the high frequencies and voltages associated with the operation of television receivers, the construction, ratings, and quality of many of the components used are quite critical, as is the physical arrangement of the parts and wiring. Giving careful consideration to these factors, the designer has arranged components to keep leads short and has provided sufficient isolation between stages to prevent undesired interaction.

In certain television receiver circuits, stray inductance and capacitance are so important that the slight disturbance of a single lead may cause improper opera-

tion. Thus, when a television receiver is being repaired, a replacement part should not be "hay-wired" in, but every effort should be made to install it in the same location and relative position occupied by the former defective part and with the same length and location of connecting leads.

Of course, there are a few circuits in which it is permissible to deviate to some extent from specific component values, physical size, and position; but the permissible leeway depends upon the receiver section and stage, and the make and model of receiver. Thus, no specific rules can be given to cover all cases, but in general such deviations will not be detrimental to reception providing they don't: (1) change the frequency response, phase response, or gain of amplifier stages; (2) affect the frequency or stability of oscillators; (3) interfere with the proper action of detectors, limiters, or clippers; or (4) change the amplitude or wave-form of r-f, i-f, video, audio, sync or deflection voltages and currents.

As indicated by these limitations, a knowledge is required of the purpose and action of the stage in which any change is planned. Reference to the previous theory lessons on the subject may be beneficial at such a time.

As an example, in high-frequency stages, the tube input and output capacitances add to the total capacitances which tune the interstage coupling coils to the desired resonant frequencies. When the tube is replaced with one of considerably different interelectrode capacitance, the coupling circuits are detuned. Hence, it may be necessary to try several new tubes before one is found which results in the desired quality of reception. Generally, this method of trying several tubes is less time-consuming than re-aligning the tuned circuits to provide correct response for any given replacement tube.

At high frequencies, it is extremely important that the proper capacitors are used. In paper capacitors, the plates consist of long strips of tinfoil, separated by waxed paper, and rolled into a compact unit. Due to this construction, these plates have appreciable inductance so that a relatively large inductive reactance is presented by the capacitor at high frequencies, and thus impairs the desired action of the unit.

Hence, although used extensively for lower frequencies, paper capacitors are not suitable for the higher television frequencies. Instead, mica, or ceramic capacitors are installed. They are layer constructed and have low dielectric

losses, these features making them ideal for high-frequency circuits.



The proper operation of a television receiver depends upon the construction, rating, and quality of components; and the physical layout of parts and wiring. Shown is a large screen floor model receiver.

Courtesy Westinghouse Electric Corp.

Materials such as hard rubber and ordinary bakelite are subject to leakage at high frequencies, therefore television receiver high-frequency circuits employ materials such as ceramics, lucite, polystyrene, and low-loss bakelite as insulators. When components mounted on these materials are soldered, take care not to damage the insulation or cover it with rosin. Charring a high-grade insulation or leaving flux on it impairs the insulating qualities which are required for good re-

ceiver performance. Although the foregoing precautions apply particularly to the tuner, they also are important with regard to the other sections of the receiver.

IDENTIFICATION OF COMPONENTS

Generally, the function of a component and its electric location in the faulty stage are determined at some time during the regular troubleshooting procedure. Then, when the replacement is made, it is necessary only to check the value and ratings required and the physical position and connections of the component to be replaced.

In many cases, the symptoms or preliminary tests indicate a particular component to be faulty, even though a check has not yet been made on the indicated unit itself. For such cases, as well as during the more detailed troubleshooting procedures, it is desirable to identify various components quickly by their physical appearance, so that further tests can be made. Although many components such as r-f and i-f transformers have about the same general appearance in most electronic equipment, there are a few types of units the appearance of which identifies them as television receiver components or as components used in h-f circuits only, etc.

A few examples of typical components are illustrated in Figures 1 through 6. Used for bypass and coupling purposes in television r-f circuits, the miniature ceramic type of capacitor is shown in Figure 1A. Here, a single pair of electrodes or plates minimizes eddy current losses. The unit is approximately $\frac{5}{8}$ of an inch in diameter and $\frac{5}{32}$ of an inch thick, and shaped to provide a very short current path. Together with short connecting leads, this construction results in the unit having extremely low inductance.

Most materials have a positive temperature coefficient of expansion and, therefore, expand when the temperature rises. When such expansion occurs in inductors and capacitors which are parts of tuned circuits, the resulting changes in reactance detunes the circuits.

To counteract this undesirable effect, capacitors of the type shown in Figure 1B, which have negative temperature coefficients and contract when temperature rises, often are connected across the tuned circuits. Having negligible temperature coefficients, wires made of Invar and Nilvar are used for coils to minimize the increase of inductance with temperature.

Mention of these components is made to emphasize the need for

exact replacements of some television receiver capacitors and coils which, if necessary, may be obtained from the receiver manufacturer by stating the part number of the component needed, and the receiver model and chassis numbers.

Figure 1C shows a molded paper capacitor of the type used in the sweep circuits of the receiver, while a unit used primarily as a high voltage filter capacitor is shown in Figure 1D. The latter type usually has a capacitance of about 500 $\mu\mu\text{fd}$, but, made of Ceramic-X and a high dielectric strength plastic, it has a voltage rating of either 10, 15, 20, or 30 kilovolts.

Figures 2, 3, 4, and 5 show various types of transformers employed in television receivers. A L.V. power supply power transformer is shown in Figure 2. Operating in a full wave rectifier circuit, this unit is designed to provide 295 ma d-c at 405 volts, with an 80 μfd input filter capacitor. It contains two filament windings, 5 volts and 12.6 volts respectively, and has a copper shorting band which serves to reduce raster pulling by minimizing the external field.

Much smaller in size, a vertical blocking oscillator transformer is shown in Figure 3A. Potted in a drawn sheet-metal case with leads

coming out at the bottom, this particular unit measures only $1\frac{3}{4} \times 2\frac{5}{8} \times 1\frac{1}{2}$ inches. Similar in physical dimensions to the common audio transformer, a horizontal blocking oscillator transformer, with channel type frame, is illustrated in Figure 3B.

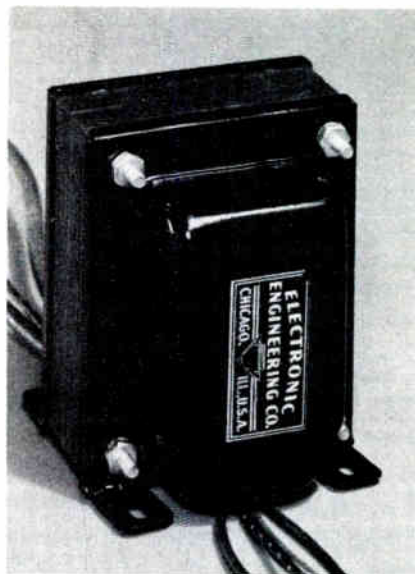

A TV receiver power transformer. The replacement transformer must be designed to meet the circuit requirements.

Courtesy Electronic Engineering Co.

Though only one example of each is shown here, the pot and channel mountings are used for both vertical and horizontal blocking oscillator transformers, and a check of the part numbers or circuit connections should be made for definite identification in any particular case.

A typical vertical deflection output transformer is shown in Figure 4. Although similar to the common power supply filter choke, the vertical output transformer can be distinguished by its somewhat larger size and the greater number of available leads.

The combination type high voltage and horizontal deflection output transformer is shown at the lower right in Figure 5. Here, the locking bar which holds the removable core in place may be seen extending diagonally from an upper to a lower corner of the unit. Of unique design, the transformer employs pressed, powdered iron in the form of a shell about the windings.

Other parts of the high voltage and deflection output circuit shown consist of the high voltage rectifier mounted on the insulated bakelite platform, the high voltage filter capacitor in front of the platform, the tapped damping resistor behind the rectifier, the high voltage anode lead passing through the insulating bracket near the resistor, the width control above the transformer, horizontal sync and deflection circuit tubes, and the sockets for the damper tube and horizontal output tube. At the upper left in Figure 5 are shown the tubular deflection yoke and the shorter focus coil, while single and double magnet ion trap units are il-

lustrated in Figures 6A and 6B, respectively.

REMOVAL OF FAULTY COMPONENT

After tests have indicated a component to be faulty, its exact electric location in the circuit should be determined accurately if this has not been done previously. Even where this seems an unnecessary precaution, often it will save time in the long run, especially if the repair job is interrupted for some length of time.

In cases where there are more than three connecting wires, it may prove helpful to make a pictorial sketch of the connections. Then, regardless of the number or duration of the interruptions, the work can be picked up easily at any point and continued with little likelihood of mistakes.

Where a faulty component has been located by visual inspection only, a mental note of the component in terms of its function should be made, as "the cathode resistor of the video output stage", or "the booster supply filter capacitor", etc., etc.

All components are connected both electrically and mechanically to the receiver. In some cases, the electric connection also serves as the mechanical mounting and, in other cases, the electric and mechanical connections are made

in different ways. Thus, in the first case, disconnecting the part electrically permits it to be removed physically while, in the second case, the component must be disconnected electrically and mechanically in two individual operations. Most resistors and capacitors are examples of the first arrangement, while the second method is employed for heavier units such as the various transformers illustrated in Figures 2 through 5.

For the latter type units usually it is better to remove or disconnect all the wires before attempting to dismount the part. If this plan is not followed, the loosened part may hang by the wires and thus break some of the connections.

Since many of the wires are color coded, some men trust their memory to identify the proper connecting points. A better method is to make a sketch as suggested above, or tie a small marked tag on each wire as it is removed.

Most of the electric connections consist of a wire hooked through a hole in a lug and soldered. A joint of this type may be opened by holding a hot soldering iron on the solder until it melts sufficiently to expose the wire hook, and then opening the hook with a screwdriver or long nose pliers. Then, with the soldering iron kept in contact with the joint to keep

the solder soft, the wire may be pulled out of the lug.

When several wires must be removed from one lug, each can be unsoldered, straightened, and pulled out in the same manner, one at a time. A pointed tool similar to a scribe or an awl is useful for untangling the wires. Excess solder can be removed from the joint with the soldering iron, and should any run to the inner end of the lug, the chassis can be turned so that, when heated, the solder will run out or off.

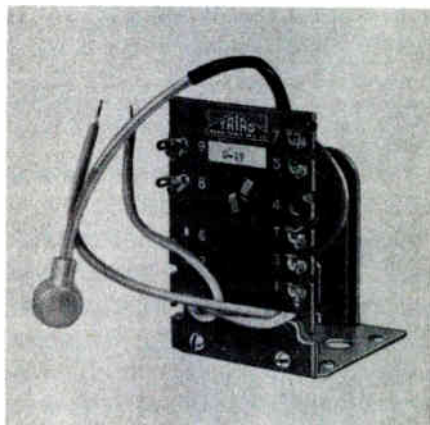

In replacing high voltage transformers, both the electric specifications and the type of mounts determine the unit to use.

Courtesy Triad Transformer Mfg. Co.

It may seem faster to simply cut off the connecting wires of a unit. However, usually the remaining ends interfere with or prevent the replacement of the wires of the new unit and, therefore, must be removed anyway before the desired connections

can be made. After all of the old wires are removed, the excess solder should be removed from the lugs as mentioned, because clean, open holes in the lugs will permit the replacement wires to be installed more quickly.



Copocitors of the type used in high voltage deflection circuits. One of the most important specifications of a replacement copocitor is the d-c W.V. rating.

Courtesy Aerovox Corp.

As Figures 2 through 5 indicate, most of the heavier type units are secured to the receiver chassis by means of mounting bolts and nuts which can be removed with the aid of a screwdriver and socket wrench. In every case, an inspection will reveal what tools are needed, and the proper tools should be used for each type of job.

This is especially important where the work is being done with the customer watching. Probably nothing gives a poorer impression than, for example, the use of a long nose pliers, diagonal cutter, or hammer and chisel to

loosen a nut that should be removed with a wrench.

After the defective component has been removed and before the new unit is installed, a check should be made of all associated circuit components which could affect voltage or current in the replacement component, if this has not been done during the previous trouble-shooting tests. It often happens that some such associated component is the original cause of the trouble, and, if not corrected, it will damage the replacement part when the receiver is operated.

Normally, such additional defective components are found when the regular troubleshooting checks are made. However, in cases where the preliminary inspection reveals a burned resistor or coil, some men may proceed to replace the damaged component immediately, and forget the necessary electric tests. For this reason we emphasize the importance of making tests on all related component parts which could affect the replaced part.

INSTALLING NEW COMPONENT

The receiver manufacturer's service manual or some other available parts list for the chassis being serviced should be consulted to check the required specifications of the replacement part.

Knowing the function and electric location of the defective part, its designation or item number can be found on the schematic diagram and, opposite this number, the parts list gives the needed specifications.

In addition, this list includes the manufacturers part number for the component, and often the corresponding part numbers of one or more component manufacturers. This information facilitates obtaining the correct replacement parts from the jobber, and eliminates guesswork on the part of the serviceman.

For components such as transformers, coils, deflection yokes, etc., the specifications must be obtained from some source of this type, except where, due to experience or for some other reason, the serviceman happens to know exactly what replacement unit is needed in the particular receiver being serviced. When the needed information is not available from the usual sources, often it is better to obtain the proper specifications from the receiver manufacturer than to make a replacement with a unit which may not be designed to meet the circuit requirements.

Generally, resistors are either color coded or marked with printed numbers to show their resistance, but seldom are marked with respect to the wattage rat-

ings or tolerance. However, with a little experience, it is possible to estimate the wattage of most resistors by noting their size, if a parts list is not available.

Typical unit dimensions for various wattage ratings are as follows:

Resistor Type	Wattage	Approximate Dimensions in Inches	
		Length	Diameter
Composition	1/2	3/8	1/8
	1	1/2	1/4
	2	3/4	1/4
Wire-Wound	1/2	3/8	1/8
	1	3/4	1/4
	2	1 1/4	1/4
	5	1 1/2	1/2
	10	1 3/4	3/8
	20	2	1/2

In certain cases, it may be desirable to employ a component with different specifications than the original unit. For example, suppose a 25,000 ohm resistor normally carries 4 ma of current, and the original one-half watt unit is found to be burned out. Substituting the known values in the equation, $P = I^2R$, it is found that the required dissipation is $.004^2 \times 25,000$ or 0.4 watt, which is very close to the maximum rating of the resistor. Should the current increase to 5 ma for an appreciable length of time, the required dissipation is $.005^2 \times 25,000$ or 0.625 watt, and the half-watt resistor will burn out. Therefore, a one-watt replacement unit is desirable in this case.

In general, it is not necessary to calculate the required dissipation when a resistor is to be replaced, but it is a good idea to replace with a higher wattage unit wherever the original unit is found to be burned and no circuit short, etc. exists which could have caused damaging heavy current.

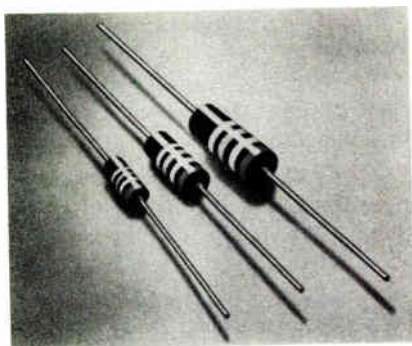

When replacing a defective resistor, often it is a good plan to use a higher wattage unit. Shown are ceramic resistors of $\frac{1}{2}$ watt (small), 1 watt, and 2 watts.

Courtesy Allen-Bradley Co.

Most capacitors are marked in some manner to show their capacitance, and the paper and electrolytic types are marked also with a test or peak voltage, or with a lower value designated "Working Volts". For safety, the working volts employed should be about twice the normal circuit voltage and, because the difference in cost is small, many servicemen replace capacitors with higher voltage ratings than those of the original parts.

For many bypass and filter circuits, the capacitance of the replacement unit can be higher than that of the original capacitor, and often results in improved performance. However, there are many exceptions to this and, in general, the original or specified value should be adhered to except where it is known that a larger capacitance is not detrimental to proper circuit operation.

Often, the parts list includes a description of the components with regard to circuit function, and this description may be employed to locate the desired set of specifications when a circuit diagram with its component designations is not available.

When replacement parts are installed, the mechanical mounting should be made first to provide a solid support for the electric connections. There are a few exceptions where the arrangement will not provide space to make the connections after the part has been mounted mechanically. For components such as resistors and capacitors, the connections are the mechanical supports, but the above rule still holds because all joints should be made secure mechanically before solder is applied.

In cases where the original components were secured mechanically by means of rivets, and were removed by drilling out the rivets,

usually it is more convenient to mount the replacement part with machine screws, held by a nut and lock washer. Often, special tools are required to clinch rivets properly, and even when the proper tools are available, there seldom is room on the chassis to use them, and the required hammering may be detrimental to other components. Even though lead lengths may not be critical in the circuit in question, replacements should always be made so as to retain the original wiring arrangement as closely as possible.

After a replacement part has been properly mounted, the wiring is replaced in the reverse order to which it was removed. Here again it pays to be careful and the wires should be replaced, one by one, only after their electric location has been checked against a diagram or other means of identification. After the electric connection has been completed, it is good insurance to make a continuity test of each wire to make sure the removal and replacement has not caused it to break.

Where wires must be spliced and the joint requires insulation, a short length of insulating tubing or "spaghetti" may be slipped over one of the wire ends before the connection is made and then pulled over the joint after the solder has cooled.

Careful attention to the mechanical details of a wiring job will insure the best electric conditions. All television receivers are subject to vibration which may cause loose wires or components to shift in position. These changes of position may cause noise, introduce feedback to cause oscillation, or degenerative feedback to reduce output. Continued vibration of a connecting wire will cause it to break eventually, a condition which may provide an intermittent trouble. A little extra time spent in doing a good mechanical job of wiring usually is a good investment.

OPERATIONAL TEST

After the repair has been completed, the receiver should be placed in operation for a period of time while the serviceman checks the reception. Many receiver manufacturers guarantee their products against defective material for a period of 90 days on the assumption that any defects will show up in that time. With the same general thought in mind, some television servicemen operate all repaired receivers for an hour or two before making delivery to the customer.

This method is convenient in those cases where the receiver has been taken to the service shop for repair, because the serviceman can work on other jobs while

the operational test is being made, with only an occasional glance at the screen of the repaired receiver. A considerably shorter operational test usually must be made when the repair is completed in the customer's home, since the customer may not appreciate paying for time spent in merely observing the performance of the repaired receiver.



To provide the required deflection, the replacement and the defective yoke specifications must be the same.

Courtesy General Electric Co.

TUNER REPAIRS

In general, television receiver r-f tuner repairs may be classed as either of the electric or mechanical type. Covered previously, the electric repairs include tube and component replacement, alignment and touch-up adjustments. Therefore, the following paragraphs are concerned directly with the mechanical repairs such as cleaning and lubrication, and

replacing or adjusting defective mechanical parts.

Impaired reception may be caused by improper contact of any one of the many switch contacts normally contained in the tuner, by "freezing" or binding at some point in the tuner mechanism, or by improper operation of the detent. The "detent" is the device which snaps the tuning mechanism into place for each channel as the receiver station selector knob is rotated.

Improper Contact

Improper electric contact can be caused by dirt accumulations on or oxidizing of the switch contacts, sprung contact springs, or inadequate spring tension. In general, all electric switch and wiping contact surfaces as well as bearing and shaft surfaces subject to dust, dirt, or grit accumulation should be cleaned with a suitable cleaning fluid and coated with a suitable lubricant. In some cases, defective contact springs can be repaired, but if a spring is damaged beyond repair, usually it is necessary to replace the entire contact panel assembly.

To illustrate the components involved, a Standard Coil Products Co., Inc. tuner is shown in Figure 7. In this typical unit, twelve sets of snap-in coil assemblies are mounted in the turret which, rotated by the station se-

lector knob, serves to connect the proper set of coil contacts to the corresponding contacts of the stationary contact panel assembly.

A second moving part consists of the outer concentric shaft upon which is mounted the rotor of the fine tuning capacitor. As shown, the two contact panels contain a total of eleven contact springs, each of which forms part of the electric circuit between a tuning coil terminal and some point in the fixed circuit of the r-f section.

Cleaning and lubrication are needed when, as the station selector knob is rotated, a raspy sound is heard, the picture tears, and the receiver operation is erratic and intermittent. Contact surfaces may be cleaned with xylol or carbon tetrachloride and a stiff brush small enough to get into or at the actual contact points. After cleaning, the contacts should be lubricated with a very thin film of one of the various types of the conducting lubricants commercially available. The lubricant should be of a type which does not contain zinc or cadmium, and only an extremely small amount should be used.

A method frequently employed consists of mixing equal parts of cleaning fluid and lubricant and applying the mixture by means of an atomizer or a hypodermic syringe to the various contacts to be cleaned and lubricated. The

switch is rotated a few times, and the cleaner evaporates leaving a fine film of the lubricant. Again, only a small quantity of the mixture should be used; too much will have adverse effects on the operation of the tuner.

In addition to the conducting type of lubricant used on the contacts, a fine grade of surface lubricant should be applied to the shafts and bearings, etc. of the tuner. For example, in the case of the tuner of Figure 7, cleaning fluid and contact oil is used on the coil contacts of the turret, and on the stationary panel contacts. For mechanical lubrication, light vaseline or Viscosity Oil Co. #8072 is used at the points where the turret shaft is in contact with the tuner chassis, on the pin or shaft by which the detent spring holds the roller (Figure 8), and between the bracket and rotor of the fine tuning capacitor.

The same general principles apply to other types of tuners, and also to the switches employed to connect the tuner for high or low-band operation. Examples are the end-plate grounding surfaces in variable capacitance tuners, the trolleys, and coil wires in variable inductance units, and the various sliding switch contacts in wafer switch type mechanisms.

When poor contact is due to inadequate tension of a contact spring, small pliers or tweezers

may be employed to bend the spring in the proper direction so that adequate tension will be obtained. This operation should be performed with care so that the spring is not broken or bent sideways, and the movable and fixed contacts should be disengaged while the repair is being made.

In the case of the tuner of Figure 7, several coil assemblies should be removed from the turret to make room to bend the contact spring inward toward the turret. Using a narrow-bladed screwdriver, the spring is bent until its highest point extends about $9/64$ of an inch above the surface of the contact panel.

In the event one of the contact springs is broken or otherwise damaged beyond repair in the unit of Figure 7, it will be necessary to replace the entire contact panel assembly. To accomplish this, the connecting leads to the contact panels should be unsoldered, and their connecting points recorded. The two screws holding the contact panel assembly to the tuner chassis should be removed next, and a heavy soldering iron used to remove the solder bonding the panel assembly to the chassis, but not that holding the end of the turret grounding spring. The assembly can now be removed by spreading the ends of the chassis slightly, and pulling the panel assembly outward. The

new contact panel assembly is installed by following these steps in reverse order.

Frozen Mechanism

Occasionally, tuner mechanisms become frozen or jammed so that the movable parts are very difficult or impossible to turn. In all types of tuners, this condition can be caused by broken or stripped gears, defective mechanical drives and detents, jammed contacts and springs, and control shafts which have become locked due to accumulations of grit, or dirt, etc. In addition, freezing can be caused by broken wafers or warped shafts in wafer-switch mechanisms; bent selector rods, weak springs, or defective locking bars in push-button mechanisms; loose coil assemblies in turret tuners; shorted plates in variable capacitor tuners; and jammed cores in permeability tuned units. Often, to repair or replace defective tuner components of these types, it is necessary to disassemble part or all of the mechanism.

For example, to remove the tuner of Figure 7 from the chassis of the receiver, all connecting wires must be unsoldered, and the connecting point of each recorded. Then, the screws are removed which hold the tuner chassis to the mounting bracket, and the tuner taken out.

To remove the turret, first the bracket is removed which holds the tuning capacitor rotor in toward the tuner chassis. Next the tuning capacitor shaft and rotor, Figure 7, and the associated pressure spring and fiber washer (not shown) are removed. Finally, the two turret securing springs are removed, and the turret lowered out of the tuner chassis. By following the various steps above in reverse order, the turret and tuner may be re-installed after the necessary repairs have been completed.

Defective Detent

All turret and switch type tuners as well as many continuous type tuners employ detents to facilitate the manipulation of the receiver station selector knob. If the detent is defective or out of adjustment in some way, erratic tuning operation, microphonics, or noise may result. Often, intermittent operation is obtained when slight pressure is exerted on the tuning knob, with reception either being obtained or not depending upon whether the switch contacts are made or broken by this action.

In turret type tuners, it is necessary that the detent be adjusted so that the coil contacts on the turret are aligned properly with the stationary panel contacts. This detent alignment is known

as *indexing*. In the Standard Tuner, Figure 7, the detent mechanism consists of a grooved plate, roller, and spring.



A small ceramic capacitor of the type used in high frequency circuits.

Courtesy Erie Resistor Corp.

Figure 8 shows a drawing of the underside of this unit, with the detent components indicated. The grooved plate is mounted around the center of the turret, and contains one groove for each of the twelve channel positions. Held in place by the detent spring, the detent roller runs on the edge of the grooved plate when the turret is rotated, but the force of the spring causes the roller to snap into a groove as each proper position is reached.

Poor indexing may be caused by a worn roller or bearing surface, or a weak detent spring. To adjust the indexing of the unit of Figures 7 and 8, the detent spring holding screw is loosened, and the spring slid up and down until the position is located at which the snap-in coil contacts are making maximum contact with those of the contact panel assembly. When this point is found, the holding screw is tightened. Although indexing adjustments can compensate for slight wear of the vari-

ous parts, a part should be replaced when it has become worn to the extent that proper indexing is difficult.

In the case of wafer-switch type tuners, the detent action may be impaired due to a warped shaft, flattened ball bearings, or weak pressure springs. A detent unit of this type is shown in Figure 9A. Firmly secured to the insulated rotating shaft, the spring plate carries with it a ball bearing which is snapped into the various notches of the locating plate as each channel position is reached. If the detent mechanism is in proper condition, the wipers on the channel selector switch should make the best contact with the spring contacts of the switch when the ball bearing is in the corresponding notch of the locating plate.

In the event improper detent action is obtained because of some fault such as those mentioned above, then the defective part or the entire detent mechanism should be replaced. Replacement units of this type are commercially available, and the defective unit may be torn down as follows:

First, remove the detent shaft from the wafers of the selector switch, taking care that none of the wafers are moved from their original positions. If a wafer is disturbed, the wrong coil connec-

tions will be made when the switch is re-assembled.

Next, with a diagonal cutters, squeeze the retaining ring at the open end to remove it from the groove in the brass shaft, then pry it from the shaft with a screwdriver. Indicated in the exploded view of Figure 9B, this ring is not visible in Figure 9A because it is employed behind the locating plate. The entire detent assembly may now be taken apart as shown in Figure 9B.

To assemble a detent unit of this type, place the ball bearing in a notch of the locating plate, and insert the brass shaft through this plate so that the spring plate fits over the ball as in Figure 9A. Press the two plates together, and slip the new retaining ring onto the brass shaft. Finally, with pliers, clinch the retaining ring tightly around the shaft.

CABINET REPAIRS

Generally, refinishing the television receiver cabinet is not considered part of the regular service job. However, a little time spent on cleaning and restoring the finish often proves to be a worth-while investment in customer confidence. Depending upon competition and other individual circumstances, this type of work may be included as part of the standard service with the time charged to advertising expense; it

may be done in only certain cases with the added cost charged to the individual customer; or it may not be done at all.

Although skill and experience in cabinet refinishing is required to make a professional looking repair when a cabinet has cracked or loose veneer, separated joints, or broken members, there are a few things which the inexperienced repairer can do to improve the appearance of most cabinets. These include cleaning, polishing, and the repair of shallow scratches of the type which penetrate one or two layers of veneer, but do not extend through to the under layers of raw wood.

After a period of time, any cabinet becomes dull unless regularly cleaned and polished, and under certain conditions may eventually acquire a layer of dust, dirt, or even grease. Probably the best method of cleaning the finish consists of using soap and water. However, since moisture and dampness are enemies of finished woodwork, the water should be used sparingly and should not be allowed to remain in contact with the cabinet surface any longer than is absolutely necessary.

A safe procedure is as follows: Dip a piece of cloth in water and then wring it out almost dry. Rub the cloth over a cake of good quality soap and then sponge the cab-

inet no more vigorously than necessary to remove all dirt and finger marks. Finally, use a clean dry cloth to dry the cabinet surface immediately.

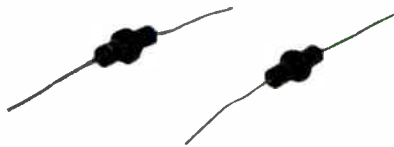

Peaking coil replacements must have the correct inductance and shunt resistance.

DTI Photo

For stubborn cases such as crustations of grease or dirt, the cleaning cloth may be very slightly dampened with a fluid such as benzine. However, great care should be exercised in the use of fluids of this type since most are highly inflammable and may affect the finish if allowed to remain on the surface too long. **AN INFLAMMABLE CLEANING FLUID SHOULD NEVER BE USED INSIDE THE CUSTOMER'S HOME**, and inside the service shop only when there is plenty of ventilation. When it is used, have the cleaning fluid cloth in one hand, a dry cloth in the other hand and wipe the fluid off the cabinet surface immediately. The paste cleaners designed for automobile finishes are not recommended for use on furniture because most contain an abrasive which may cut through the cabinet finish.

After the cabinet is clean, it should be polished to restore its original lustre. Any of the four general types of polishing agents may be used: liquid wax, cream polish, paste wax, or oil. Of these, the first two mentioned are somewhat easier to apply, but the choice depends upon individual preference.



The facus coil specifications, for correct replacement, can be obtained from the receiver manufacturer.

Courtesy Standard Transformer Corp.

A mixture of crude oil and benzine is employed for polishing by many professional cabinet finishers. The proportions used are three parts of crude oil to one of benzine, and this mixture can be prepared at small cost by any local paint dealer.

Dipped in the mixture, a four or five inch square polishing felt, one-half inch thick, is used to apply the polishing agent to the cabinet surface. The felt is kept

saturated so as to apply as much oil as the surface can absorb. Rubbing in the direction of the grain, cover the entire surface and allow it to remain overnight.

With a clean cloth, wipe off the excess the next day, and then rub to bring up the gloss. Again, be careful; both benzine and oil are inflammable.

The most common types of cabinet damages consist of shallow scratches, cracks or checks in the finish. Not to be confused with the more serious cracking or checking of the veneer itself, the checks and cracks referred to here are defects due to expansion and contraction of the finish, resulting from aging, extremes in temperature, and climatic changes.

A paste rubbing compound may be used to restore the finish in the case of small cracks or checks. Rubbing with the grain, a cloth or felt pad is used to apply a liberal quantity of paste to the surface. After each few strokes, pause to wipe away the excess compound with a clean cloth and observe the progress of the work. Too vigorous or too much rubbing may wear away the entire finish.

Prepared oil stain is available for concealing small, superficial scratches, and may be applied with a piece of cloth, or preferably a small artist's brush which

may be obtained at an art supplies store. More than one application may be needed to completely conceal the scratch. Often, the finish will be a lighter color at the edges of the scratch than in the surrounding surface, and the difference cannot be concealed with oil stain. Colored shellac may be prepared for this purpose by diluting white shellac with alcohol until it is very thin—and stirring-in a spirit-soluble powder to obtain the desired color and shade. This powder can be obtained at a paint store, and comes in a variety of colors such as mahogany, walnut, oak, and maple.

The powder is added slowly while the mixture is stirred until the shade corresponds to that of the cabinet finish. When applying, be careful to touch up the scratch only and avoid getting the shellac on the surrounding surface. Again, several applications may be needed to conceal the scratch. If the scratch is still visible after staining, it should be filled in by one of the methods following.

For small, deep scratches, there are available so-called “scratch crayons” which contain both a colored filler and polish. The procedure consists of rubbing the end of the crayon along the scratch until the indentation is completely filled in and cannot be seen.

For larger deep scratches or where a sliver has been gouged out of the cabinet surface, the crevice must be filled with some type of plastic material which matches the surrounding area. The use of wood putties is not recommended because such compounds do not stain very well and are difficult to sand to a smooth surface. Designed for this purpose, kits are available containing shellac sticks, alcohol lamp, a wood finishers “burning-in” knife or spatula, garnet paper, rubbing oil, etc.

Both transparent and opaque stick shellac are available. The transparent type is for use where the scratch is large but has not penetrated the wood beneath the finish. Where a deep scratch has exposed the raw wood, an opaque shellac which matches the cabinet finish should be used. Most cabinet finishes have both light and dark tones and, usually, the results are more satisfactory when a shellac stick is chosen which matches the lighter, background tone, except where a predominantly dark area surrounds the scratch.

The end of the knife is held in the flame of the alcohol lamp until it is hot enough to melt the shellac when pressed against the stick. Then the knife is used to transfer the soft shellac to the scratch, and to press the shellac into place.

Usually, more than one application of shellac will be needed and, after each, the used shellac should be removed from the knife by reheating the blade, wiping it with a cloth, and burnishing it with sandpaper.



A mica capacitor of the type used in high frequency circuits.
Courtesy Sangamo Electric Co.

After the shellac patch is built up slightly above the surface of the cabinet, smooth it by passing the heated blade of a square ended knife over it. Using the rubbing oil as lubricant, carefully sand the shellac surface smooth. This is done by wrapping a piece of 6/0 garnet paper around a wood block, dipping the paper in the oil, and rubbing it in the direction of the grain of the cabinet wood. Keep the block level and do not rub beyond the patched area. After every few strokes, stop, wipe the oil from the surface, and inspect the work. When a smooth level surface is obtained, it should be polished to match the gloss of the surrounding area. If the cabinet has a relatively dull type finish, the patched area can

be dulled after polishing by rubbing it lightly with 3/0 steel wool.

Practice is required to attain the necessary skill needed for satisfactory shellac stick repairing, and this practice should be obtained on furniture other than customers' television receiver cabinets. No matter how well-meaning the serviceman's attempt at repair, unless a professional-looking job is obtained, many customers may consider the cabinet to be in worse condition than it was before the "repair" was made and, justifiably, hold the serviceman responsible.

For example, the knife and melted shellac must be at just the right temperature. If the knife is too hot, the nearby finish may be scorched. To prevent this, some men mask the area by applying cellulose tape along the edges of the area where the repair is to be made. If the shellac is not hot enough, it may be gummy and difficult to work into the scratch. Finally, it will be of doubtful benefit to fill a scratch at all unless the filling material matches the cabinet color and shade perfectly, or almost so.

These precautions are emphasized, not to discourage attempts at cabinet repair, but rather because many servicemen rightly pride themselves on the top-notch quality of the electric and mechanical parts of their work, yet

are perfectly satisfied with a mediocre cabinet appearance. On the other hand, often the customer cares little about the condition of the circuits of his receiver, so long as they operate properly, but the cabinet may be the pride and joy of his living room.



STUDENT NOTES

STUDENT NOTES

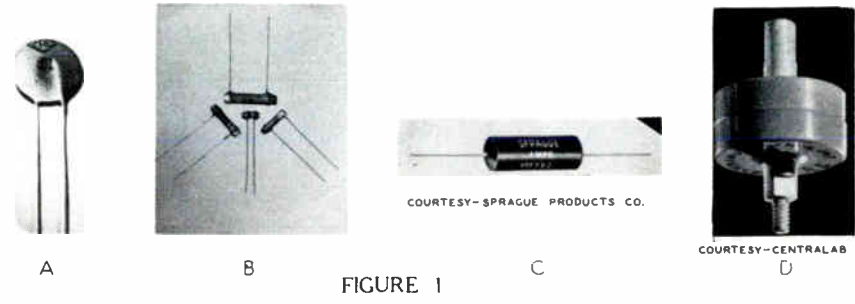
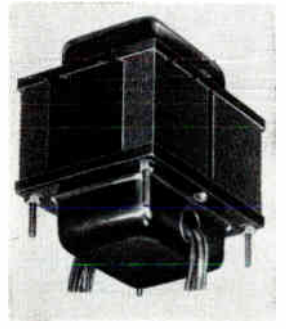

FIGURE 1

COURTESY-SPRAGUE PRODUCTS CO.

COURTESY-CENTRALAB



COURTESY-STANDARD TRANSFORMER CORP.

FIGURE 2



COURTESY-CHICAGO TRANSF. CO.
A



COURTESY-STANDARD TRANSF. CORP.
B

FIGURE 3

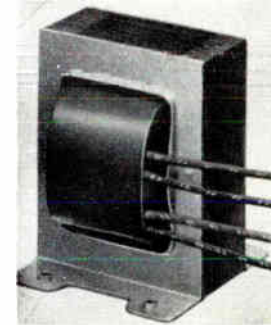

COURTESY-CHICAGO TRANSF. CO.

FIGURE 4

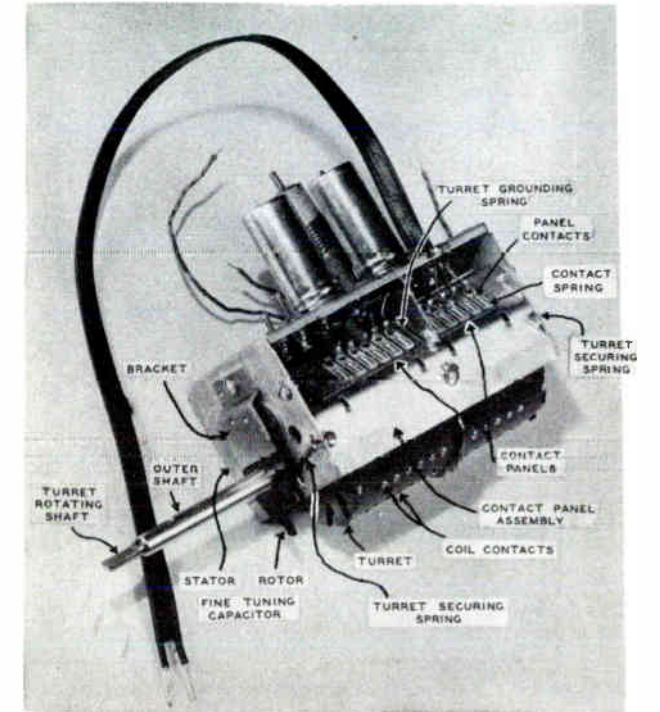

COURTESY OF STANDARD COIL PRODUCTS CO., INC.

FIGURE 7

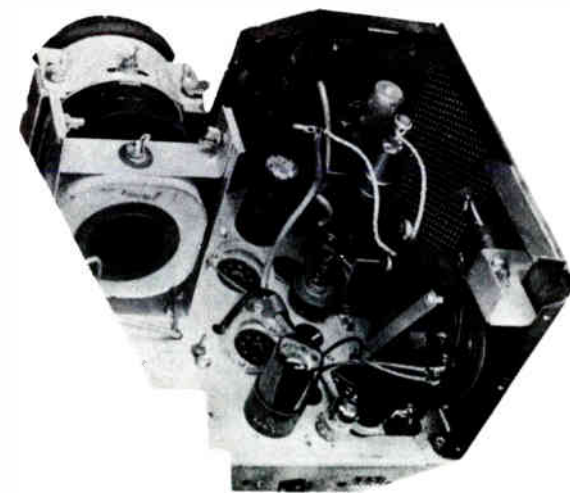

COURTESY-TECH-MASTER PRODUCTS CO.

TSM-20

FIGURE 5

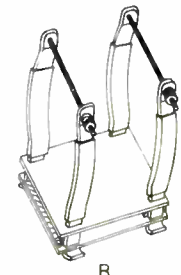
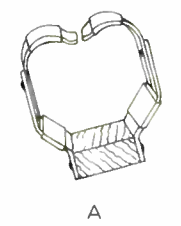
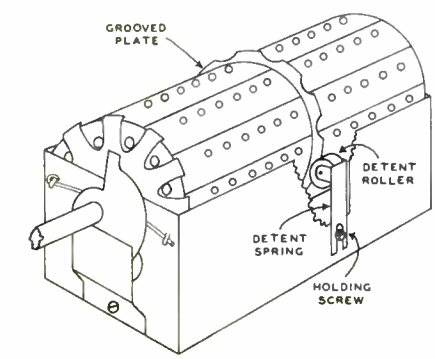

FIGURE 6



TSM-20

FIGURE 8

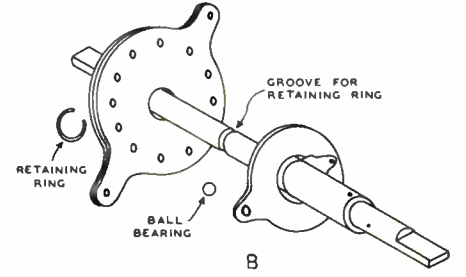
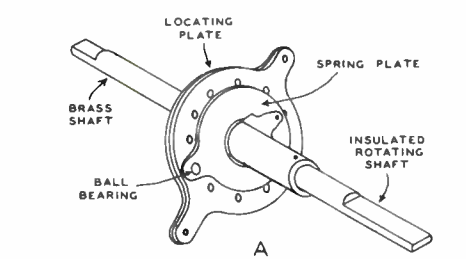

FIGURE 9

FROM OUR *Director's* NOTEBOOK

WHAT IS A CUSTOMER?

Getting and keeping customers is one of the most important things you'll do for your own business. Hence, if you follow the advice below, you'll have a good formula for building a profitable business.

A Customer is the most important person ever to enter your shop—in person, by phone, or by mail.

A Customer is not dependent upon you—**YOU ARE DEPENDENT UPON HIM.**

A Customer is not an interruption of your work—**HE IS THE PURPOSE FOR IT.** You are not doing him a favor by serving him—he is doing you a favor by giving you the opportunity to do so.

A Customer is not an outsider to your business—**HE IS A PART OF IT.**

A Customer is not a cold statistic—he is flesh and blood, a human being with feelings, opinions and needs, **JUST LIKE YOU.**

A Customer is not someone with whom to argue or match wits. Nobody ever won an argument with a customer.

A Customer is a person who brings you his wants. It is your job to handle them profitably for him and yourself.

Yours for success,

W. C. Healey

DIRECTOR